

Popular Mechanics Magazine

318 W. Washington Street, Chicago, U. S. A.

EDITED BY H. H. WINDSOR

ISSUED MONTHLY

SUBSCRIPTION:

SINGLE COPY, 15 CENTS

In United States, and its possessions, Cuba and Mexico, per year, postpaid \$1.50
To Canada 1.75
To all other countries in the Postal Union 2.00

All subscriptions are discontinued at expiration. Please examine the date printed on your wrapper.

Entered as Second Class Matter Sept. 15, 1903, at the Postoffice at Chicago, Illinois, under Act of March 3rd, 1879.

Published monthly by POPULAR MECHANICS CO.

Copyrighted 1913, by H. H. WINDSOR.

The attention of prospective advertisers is called to the policy of this magazine in accordance with which the publisher waives all claim for payment of any advertisement appearing in any issue where the number of copies actually printed and circulated is less than the number printed on the front cover page.

Contents for May, 1913

Aeroplane-Destroying Guns for Submarines.....	617	Electrical Propulsion for Navy Collier.....	651
Tents for Automobilists and Huntsmen.....	618	Using Lime to Thaw the Ground.....	651
German Aerial Motor Wins Big Prize.....	618	Man-Carrying Rocket Failed to Go Up.....	651
Beauty and Utility Combined in a Skyscraper....	619	A Remarkable Railroad Wreck.....	652
Asbestos Pocket for Lighted Cigars.....	620	Piece of Rope Wrecks "Lusitania's" Turbines ..	652
Denmark Buys Electricity from Sweden.....	620	New Underfeed Furnace Discharges Ashes.....	652
Electric Signaling Device for Builders.....	620	First Australian Stamp Has Kangaroo Emblem... 652	
The Automobile Chapel "St. Peter".....	621	Perry's Flagship Raised after Many Years.....	653
The Ore-Handling Machines of the Great Lakes... 622		Miner's Safety Lamp Wins Prize of \$30,000....	654
Automobile Runs Hundred Miles in an Hour....	624	Electric Steering Gear on U. S. Battleship.....	654
Useful Sorting Device for Office Desks.....	625	Radium Found Useful in Silk-Thread Process... 655	
Automatic Electric Steam Cooker.....	625	A Remarkable Railroad Bridge.....	655
Adjustable Cabin Roof for Motorboat.....	625	Is Five Years a Fair Test? A Reply to "What Good is It?".....	656
Cement Mushrooms and Gnomes.....	626	Ship Completely Destroyed by Dynamite Ex- plosion.....	656
Bridges Erected by End Launching.....	626	Motorcycle Drives Newspaper Press.....	658
A Sanitary Street Sweeper.....	628	A New Kind of Packing Material.....	658
Motion-Picture Theaters in Europe.....	628	Figures Reveal Great Telephone Traffic.....	658
Cold-Water Bottles for Hotel Rooms.....	629	Bread More Digestible When Not Kneaded....	658
London Directory Now and Two Hundred Years Ago.....	629	A Powerful Texas Irrigation Well.....	659
Portable Machine Shops for Building Work....	629	Turtle Found in Fire Hose.....	659
A Gas Chandelier of Immense Size.....	631	A Clock That Makes You Remember.....	659
England to Repel German Air Invasion.....	631	Safety Precautions in Electrical Plants.....	660
Conan Doyle Uses Auto-Wheel Bicycle.....	632	Paris Police Use Hand Cannon and Shield....	662
Penlike Safety-Razor Holder.....	632	Water-Tight Telephone Transmitter.....	662
Public Drinking Cups Now Forbidden in Many States.....	632	Fountain Monument to Animals' Friend.....	663
Ireland Has "Straddle" Railway.....	633	Portable Acetylene Lamp-Posts.....	664
Shakespeare's "Trick" Stile.....	633	Electric Bleacher for Soiled Clothes.....	664
Barn as Stage of Outdoor Theater.....	634	Volley Firing of Big Battleship Guns.....	664
Temperature Recorded at High Altitudes.....	634	Bicycle with Reinforced Frame.....	665
Turns Cars Upside Down to Unload Coal.....	634	Movable-Vane Forty-Foot Windmill.....	666
Smaller Horsepower for Automobiles.....	635	Industrial Bridge for Akron, Ohio.....	666
A Ship Railroad of Prussia.....	635	Water-Kite Lead Signals Submarine Obstructions. 667	
A Novel Ink Eraser.....	635	School Garden That Won Prize Cup.....	668
"Carpet Slippers" for Horses.....	636	New York's Honor-System State Prison.....	669
Complete Electric Bakery.....	636	A Changeable Show-Window Display.....	669
Mill Chimney a Copy of Venetian Campanile....	638	Kiel Canal to be Wider and Deeper.....	671
Government to Operate Panama Fuel Stations... 638		Automatic Life Jacket "Rights" Its User.....	671
New Type of Ground for Telephone Wiring....	638	Toylike but Efficient Revolver Range.....	671
Lengthening an Ocean Liner.....	639	Freight-Handling System for Large Warehouse. 672	
Protecting Railroads with Brush Mats.....	640	Government Tests Prove Value of Treating Ties. 672	
Filling Coal Mines with Sand.....	640	New Process for Making Gold Leaf.....	672
Maryland's Automobile Library.....	640	Aeroplane with Pendulum Body Mounting....	673
Combined Impulse and Reaction Turbine....	641	A Lifelike Doll for the Little Folks.....	673
An Artistic Flagpole for a Lawn.....	642	The Stamp and Bank-Note Production.....	674
Low Rates for Electric Cooking Current.....	642	German Method of Using Fish Wastes.....	674
Aqueduct Construction as Deadly as War.....	642	A Motor Vehicle with Extra Rear Wheels.....	675
A Double Microscope with One Eyepiece.....	649	The Smallest Book in the World.....	675
Four Years at West Point.....	643	The Fire Department of Paris.....	678
Photographs by W. H. Stockbridge.....		Hollow Concrete Poles Carry Heavy Load....	678
The Memorial to Airman Chavez.....	648	The Planet Jupiter in the Making.....	679
"Leprosy Now Curable," a Mistake.....	648	Steel Ends to Prevent Loss of Grain in Box Cars. 680	
Invisible Light Used to Detect Forgeries.....	648	Influence of Colored Paper on Light.....	680
A Sanitary Fountain That is Easily Constructed. 649		Fish Made from Gold Coins.....	680
New U. S. Cavalry Sword Has Thrusting Point... 650		The Talking Motion Pictures.....	681

[Continued on Page 6]

Popular Mechanics offers no premiums; does not join in "clubbing offers," and employs no solicitors to secure subscriptions. It is for sale by nearly every newsdealer in the United States and Canada.

Contents—Continued

Mushroom-Poison Tests Unreliable.....	683
Gas Engine Runs on Coal Fuel.....	683
Castings of Human Body by New Process.....	684
Touring Car Converted into Farm Tractor.....	684
A Blacksmith's Novel Advertisement.....	685
Papuan Cradles Resemble Oriole's Nest.....	685
Railroad Track Held Down by Logs.....	686
Minnesota's New Penitentiary.....	686
Mending the Cracks in St. Paul's Cathedral.....	688
The Falling Profit of Farm Produce.....	688
Gas-Electric Car Makes Long Run.....	688
Locating Factories by Means of Models.....	689
Illumination Projectors of the French Army.....	689
Fir Tree as Windmill Tower.....	690
What Electric Delivery Costs Per Ton-Mile.....	690
A Two-Story Suburban Home.....	691
One Hundred Thousand Accidents Classified.....	692
A New Fuel for Automobiles.....	693
Painters' Scaffolding for Ships.....	694
Steel-Block Tire for Motor Cars.....	694
Seeding in Geometrical Designs.....	694
The Chinese "Modern-Clothes" Edict.....	695
Utilizing Waste Wood for Boxes.....	695
Campanile Statue Now upon Ball Bearings.....	696
Rubber-Capped Auto-Horn Bulb.....	696
Safety Egg Holder Made from Paper.....	696
A Dutch Advice-Giving Institution.....	696
The "Lifting Arm" of the Panama Exposition.....	697
Practical and Novel Devices of Many Varieties.....	698
Henry Farman's New Hydro-Aeroplane.....	700
The Velocity of the Gulf Stream.....	700
Sanitary Face Shield for Motorists.....	700
Lamp Reflector That Kills Glare on Road.....	701
Scent Balls Patterned on Cardinal's Orange.....	701
Arrow Hand for Engine Boiler Gauge.....	701
Sanitary Holder for Paintbrushes.....	702
Tricks of Coal Dealers to Give Short Weight.....	702
New Substitute for Turnbuckle.....	702
Screenless Air Cleaners.....	703
Ingenious Homemade Endless Conveyor.....	703
Folding Lavatory for Automobiles.....	703
Ball-Bearing Screwbolts and Nuts.....	704
From the Upper Amazon to the Pacific by Rail.....	704
New Igniter Throws Sparks Outward.....	704
Year Rings in a Lead Pipe.....	704
Streamline Fuel Tanks for Aeroplanes.....	705
Railroad Adopts Standard Brake Club.....	705
Brush Coin Cushion.....	705
Photo-Drying Rack for Engineers.....	706
Three-Part Control of Water Flow.....	706
The Ballad of Billy Bird (verse).....	707
By Ralph Bacon	
Grace Darling's Boat Now in Museum.....	708
House-Heating Plant in Garage.....	708
Moving Locomotives About in the Air.....	709
Machine Mixes Up Ores by Carloads.....	709
Folding Baggage Truck for Hotels.....	710
Six Horses Haul Load of 177 Tons.....	710
Photographs on Both Sides of Paper.....	710
Danube's Largest Bridge Guarded by Police.....	711
Lighter Armor Possible for Warships.....	711
Three-Wheeled Electric Refuse Cart.....	711
Largest Seismograph in America.....	712
Safety of Monoplane as Great as Biplane.....	712
Indian Railway Train Runs Away on Grade.....	713
Water Well Furnishes Gas to Pump Itself.....	713
Some Remarkable Motor-Fuel Tests.....	715
Office Building Built of Oyster Shells.....	715
Letter-Pickup Table for Postoffices.....	715
Chinese Still Pull the Plow.....	716
Expert Designates Finest Street.....	717
A Homemade Tractor Threshing Machine.....	718
Producing Sleep with an Electric Current.....	718
Side Launching of an Ocean Steamer.....	719
Birthday Cake That Cost Two Hundred Dollars.....	719
Light Beam Records Fast Telegraph Messages.....	720
Catching and Canning Sardines in Brittany.....	720
Motor-Car Bodies Made from Clay Models.....	721
Instrument for Timing an Auto Race.....	722
Coast-Defense Hydro-Aeroplane.....	722
The Unusual "High" Way of a London Bridge.....	722
Self-Starter for Motorcycles.....	724
The Evaporation of Ocean Water.....	724
Electric Danger Sign All May Read.....	724
Rock Fold Which Shows How Nature Works.....	725
Direction Signals on Auto Fenders.....	725
Camels Draw Wagons in Australia.....	726
Rotary-Valve Motors for Automobiles.....	726
Cigarettes That Light by Striking.....	727
Waterproofing the Liner "Olympic".....	727
A Self-Loading Motor Garbage Wagon.....	727

The Battle for Safe Water Supplies—II.....	729
By Dr. Allan McLaughlin	
Rubber-Cushion Wheel for Motor Cars.....	734
A Fish That Lives Out of Water.....	734
Sign-Letters for Talks with the Deaf.....	735
Oil Derrick Presents Novel Illusion.....	735
Drill Six Feet Long.....	736
Bridge Loads Overestimated.....	736
Another "What Is It?" Machine.....	736

SHOP NOTES

Drawing Water into a Dry Well.....	737
Magnetic Plumb-Line Holder.....	737
A Lawn Sweeper.....	737
Indicator for a Mail Box.....	738
Protecting Glass While Painting Window Sash.....	738
Siphon for Large Tanks.....	738
A Fire Escape.....	739
Lock for Double-Entrance Doors to a Bathroom.....	739
Sliding Display Board on a Show Case.....	739
Homemade Gauge Tester.....	740
How to Cut Dovetails in Metal.....	740
Care of Rain Pipes.....	740
A Glass Cutter for Circular Work.....	741
Temporary Book Index.....	742
Fish Spear with Removable Points.....	742
Stopping a Leak in Nickelplated Pipe Connection.....	742
Fan Blades on an Ordinary Pulley.....	742
Segment Work in Pattern Making.....	743
Holding a File without a Handle.....	745
Drill Press Used for Light Punching.....	745
Wire Stretcher.....	746
Correcting Typographical Errors in Typewriting.....	746
Vacuum Cleaner for Removing Loose Sand from Molds.....	746
A Hand Scraper for the Woodworker.....	747
A Small Expansion Arbor.....	747
How to Make a Screw-Pitch Gauge.....	747
How to Make a Simple Level.....	748
Calipering Steel Balls.....	748
Inserting Packing Leathers.....	749
Clearing Shellac Varnish.....	749
Overhead Location for an Automobile Mirror.....	749
How to True Up Triangles.....	749
Emergency-Cloth Ends to Attach in a Hacksaw Frame.....	750
A Special Die Holder.....	750
Lubricating the Stern Bearing of a Motorboat.....	750
Combination Side and End Wrench.....	751
Writing Pen for the Draftsman.....	751
Parallel-Rule Center Gauge.....	751
Notch to Locate Slots in an Electric Plug.....	751
Pipe Tee Made of an Old Valve.....	751
Lining Up Automobile Wheels.....	752
Emergency-Cloth Holder for Polishing.....	752
Boring a Deep Hole on a Lathe.....	752
Practical Telephony—Part II.....	753
Planing a Sloping Surface on Metal.....	756
An Inexpensive Electric Blueprinter.....	756

AMATEUR MECHANICS

A Homemade Roller Coaster.....	757
Door-Bell Alarm.....	758
A Jardiniere Pedestal.....	759
A Lawn-Tennis Marker.....	759
A Candle-Shade Holder.....	760
Wire Mesh Used as a Shelf.....	760
Heel Plates.....	760
A Bright Dip for Metal.....	760
An Interesting Vacuum Experiment.....	760
An Electric Anemometer.....	761
Substitute for a Hose Reel.....	763
Addressing a Roll of Papers.....	763
Repairing the Bruised Sides of a Motorboat.....	763
Copying Stand for Photographic Enlarging and Reducing.....	764
Stretching Poultry Fencing.....	765
Alarm to Designate a Filled Storage Battery.....	765
A Centering Gauge.....	765
Starting a Saw Cut.....	766
A Substitute Penholder.....	766
Protecting Binding Posts on Wet Batteries from Corrosion.....	766
A Cork Puller.....	766
Holder for a Garden-Hose Nozzle.....	766
Holder for a Set of Sadirons.....	767
A Garden Roller.....	767
A Substitute for Glaziers' Points.....	767
Patents, Practical or Unique.....	768
Jokes.....	770

Notice to Employers:—Concerns desirous of engaging competent advertisement-writers at a salary of \$35 to \$100 per week are requested to communicate with us. This service is gratis.

LEARN TO WRITE ADVERTISEMENTS

You're
a good
man all right

But Who Knows It!!

That's the vital question with you today.

Who knows beyond the little circle of friends what your true worth is?

Of course, all the "Boys" in the office know it and I dare say the boss knows it too.

But that isn't enough.

You must increase your horizon until it attracts the attention of other business men.

Then your service will bring you The Money.

There is but one way to accomplish this result.

LEARN TO WRITE ADVERTISEMENTS.

Get into a position where your good efforts count for something more than they do in the job you are now holding.

The Advertising Man's good work for his concern is never locked in a vault over night, as is the good work of the firm's Accountant.

The Advertising Man's brains are not fagged out with the deluge of detail as is the case with the good Office Manager.

The Advertising Man's nerves are not on the point of snapping, as is the case with the good Credit Man, the good Estimating Man and the good Superintendent or other Employes of the business grind.

The Advertising Man's home is not merely a stopping place between stations for a few hours of happiness with his family, as is the condition with the good Traveling Man.

The Advertising Man's freedom from the harrowing conditions that surround the average man is due to the fact that his work is fascinating. It arouses

the interest and attracts the attention of competitors and thus keeps his good services continually before them and at a premium.

Such a pleasant situation is indeed inspiring and leads a man to success.

Is there any reason then why you should not be a Page-Davis Man?

The Advertising Man knows his success depends upon himself; that his reputation is being spread broadcast before all business firms, where it will do him the most good every time his handiwork appears in the daily papers.

He does not depend upon the good graces of any one employer for a letter of recommendation when he seeks a change of position, because he has already established a reputation for himself.

That is why Page-Davis Men are successful.

That is why you should get out of the "rut" into the freedom of the most fascinating and profitable profession in the world, where you can double your present salary or income.

The Advertising Man holds the first rank in the estimation of men in business and social life—he is attributed with being above the average. He is always credited with being a money maker.

Such a condition inspires ambition, and it all helps you to success.

If there is the least spark of "go" in you, you will be a Page-Davis Man—a complete success.

The "original school" combines all that was good in earlier advertising with all that is best in modern advertising. It has set the pace for advertisers all over the world. You learn at the fountain-head how to originate clever advertising.

We will send you free, full details regarding the opportunities for you to immediately get into the profession and the latest list of employed graduates earning up to \$100 a week, as a result of this very training we now offer you by correspondence.

Just enter your name on the coupon and address your letter.

Cut out and send this coupon

Page-Davis School—Send me without cost, your beautiful prospectus and all other information.

Name.....

Address.....

City.....

State.....

LEARN JEWELERS ENGRAVING

This high salaried and easily learned trade taught thoroughly by mail. We teach beginners better engraving than can be gained in years of rigid apprenticeship. We also improve the skill of any engraver.

Ask for catalog, Free. Engraving School, 112 Page Bldg., Chicago, Ill.

YOU CAN WRITE A SHORT STORY. Beginners learn thoroughly under our perfect method; many sell their stories before completing the course. We help those who want to sell their stories. Write for particulars. School of Short-Story Writing, Dept. 112, Page Building, Chicago

BE AN ILLUSTRATOR.

by mail how to draw for magazines and newspapers.

Send for Catalog

Learn to draw.

We will teach you

School of Illustration
112 Page Bldg.,
Chicago, Ill.



PAGE-DAVIS SCHOOL

Address } 112 Page Building - CHICAGO
Either Office } 112-150 Nassau St. - NEW YORK

1913 ENLARGED
and REVISED
COURSE — JUST
OUT. Price ad-
vances soon.



WOULD YOU GIVE \$12 to LEARN the AUTO TRADE AS CHAUFFEUR OR MECHANICIAN? Then READ Carefully

Before taking your course I was working in a factory at another trade. I am now repairing autos, as per your Employment Plan, and have more work than I can attend to. I made \$10 for 8 hours' work yesterday. Thanking you for helping me with your course and employment plan, I am, Yours truly, JOHN L. BORK, 973 Liberty St., Toledo, O.

Have just overhauled a car with great success. People told me a person could not learn by mail, and I will admit that it did have me guessing when I first read your ad, but I am now convinced. **The Working Models and the Charts, etc., make it easier to learn by your system than any other way.**—E. A. TUCKER, Charlotte, Mich.

If we PROVE to you that we have started hundreds of others into the repair business and as chauffeurs—who had no previous experience and who knew no more about an auto than you do right now—will you enroll?—of course you would. Now the next thing for you to do is to write me just as quick as possible and LET ME PROVE IT.

H. M. Fewins and S. T. Slayback, both graduates, are now running a Garage and Repair Shop at Woodbine, Iowa.

E. Dwyer, 31 N. Willow St., Montclair, N. J., 19 years old, receives \$25 a week and board.

Harry J. Herbin, Jamestown, Kans., was farming, but has now doubled his income repairing and selling autos.

Milford McClelland, Astoria, Ill., became professional chauffeur and more than doubled his salary. (Now in Denver, Colo.)

A. L. Foust, formerly of Washingtonville, Pa., was in another line of work. He took our course and is now at the head of the leading garage of Milton, Pa.

And we could continue until we had filled this and several more pages.



Our book of testimonials, showing photos of students and their shops—free.

Open a Repair Shop of Your Own BE AN AUTO MECHANICIAN

We can so thoroughly train you that you can open a repair shop or drive a car and make many times more than you are making now. Don't forget, we help you get your start with our *Employment Plan*, if you want it.

DYKE'S NEW IDEA OF TEACHING BY MAIL WITH WORKING MODELS

is something new. We use *real* working models—not just one but *five*. On these models you get actual practice, see the actual operation and learn more than you could from the auto itself—it's easy and quick. You don't have to study hard with this system—we teach through the eye—a new idea. We are the originators of the system of teaching by mail with models. We also use charts—230 of them and a 16 page manikin. Our 40 instructions and Repairman's Instructions are simplicity itself—simple as A B C.

Our Employment Plan for Students

—represents years of work to provide something that no other school had, namely, a way for the graduate to get acquainted with auto and garage owners, to prove his ability and to immediately secure profitable employment.

Mr. Dyke has been identified as a pioneer inventor, supply man, etc., with the auto industry since its beginning. He originated the first auto supply co. and published the first book on autos in America. No other man with such experience is today teaching others. And all the experience and inside information of the auto business he has thus gained, is embodied in this *Employment Plan*.

WRITE TO-DAY for Details of Employment Plan and THIS FREE BOOK

It is instructive and interesting—does not cost you a cent and places you under no obligations whatever—You need it for your own sake, not mine. Don't wait—there's no profit in waiting—WRITE NOW and learn how you can obtain all this training for only \$12, if you act immediately.



DYKE'S CORRESPONDENCE SCHOOL OF MOTORING Box 88, Roe Building, ST. LOUIS, MO.

WARNING: Mr. Dyke is the Originator and Inventor (Patent applied for) of the Working Model System for Teaching by Mail. If others claim to give real models—have them prove it.

Please Mention Popular Mechanics

JUST READY, 4th ED.
Revised and Greatly Enlarged

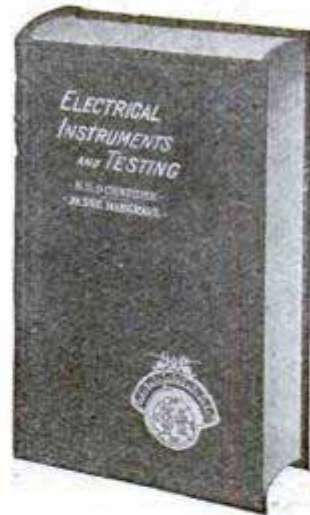

Nearly 300 pages; 150 illustrations

Bound in Cloth, \$1.15 Postpaid

SPON & CHAMBERLAIN 123 P. M. Liberty St. NEW YORK, U. S. A.



MAGIC Tricks, Books and Supplies

Amateurs supplied as well
as the great Professionals

Easy, interesting and entertaining.
Mystify and astonish your friends.
Large, illustrated professional
catalogue of wonders. Price 10c
Read & Covert, 821 E. 43d St., Chicago, Ill.



HERE YOU ARE, BOYS A medallion pin of Foxy Grandpa. Everyone will notice it on the lapel of your coat and try to get a closer look at it. All you have to do is press the bulb.—Foxy Grandpa will finish the job by squirting a fine stream of water over the inquisitive one. Will squirt 20 feet. Greatest joke out. Order one today and fool your friends. Price 15c. Foxy Grandpa and Hooligan both for 25c. 5 for 50c or 1 doz. for \$1.00. A beautiful fountain pen free with every \$1.00 order.
AMERICAN SUPPLY CO., 918 Union St., St. Paul, Minn.

MONTHLY CASH PRIZES

Until further notice in this magazine the Editor of Popular Mechanics will pay two cash prizes each month for the best original contributions to its

SHOP NOTES DEPARTMENT

\$10 for the Best Contribution
\$5 for the Second Best

THIS IS IN ADDITION to our usual rates for such contributed articles.

Quality, not length counts.
Checks will be sent on the last day of each month for the prize articles received during that month. Publication in the magazine will follow in about two months.

PRIZES AWARDED FOR MARCH, 1913

First Prize—R. E. RHINES, Centralia, Wash..... \$10
"To Keep a Large Flag Close to the Pole"

Second Prize—W. H. WHITMER, Portland, Oregon..... \$5
"Destroying Moles"

EXTRA AWARD

On account of there being five contributions this month each of which deserved second prize, we have made an EXTRA AWARD of four additional second prizes, as follows:

LAWRENCE ANNETTE, Port Huron, Mich..... \$5
"A Broken Tap Extractor"

MAULEY K. HASKINS, Syracuse, N. Y..... \$5
"Bathtub under the Floor"

RENICE RADCLIFFE, Laurel, Md..... \$5
"Preserving Out Flowers"

LUTHER TURNER, Beardstown, Ill..... \$5
"Soldering-Iron Cover for Coal-Fire Heating"

All accepted contributions to our departments, "SHOP NOTES" and "AMATEUR MECHANICS," are paid for immediately; checks for prize awards are sent at the end of each month.

Address, EDITOR POPULAR MECHANICS
318 W. Washington St., Chicago



The Tower of Babel is Still Standing

DO you realize that 4000 years after this most wonderful of all towers was built by the ancients (according to the Book of Genesis about 2400 B. C.) its seven stages still rise high above the plains near the site of Babylon? Until a few years ago it had been known as the Mound of Birs Nimrud when Sir Henry Rawlinson discovered in one of the stages the inscribed cylinders which made the identification possible. Other expeditions uncovered many of the thousands of curiously interesting records and documents contained in the great work—

The Library of Original Sources

now for the first time available to the general public. **By taking over the entire unsold edition from the publishers we secured it at an absolutely unheard of bargain.** So now we can offer the few remaining sets to POPULAR MECHANICS readers

**AT LESS THAN IT
COST TO MAKE THEM**

Send us the attached coupon **AT ONCE**, and we will tell you how to get the Library on **EASY MONTHLY PAYMENTS**, and mail you **FREE** a book of rare documents. Remember there are only a limited number of sets, so act quickly. Mail the coupon **NOW**. You assume no obligation. No salesman will call. The book is **FREE**.

THIS MARVELOUS WORK is revolutionizing modern thought. It's turning upside down old notions and ideas. It gives the authoritative, rock-bottom sources of our knowledge on **ALL SUBJECTS OF HUMAN INTEREST** from the earliest civilization down to to-day — the inside facts which the average person has never even heard of.

OVER 100 RESEARCH SPECIALISTS spent 10 years gathering the contents of this great work. Ancient and remote and forgotten civilizations in all parts of the globe were uncovered, and age-buried hieroglyphics on monuments, tablets, sun-baked bricks and palimpsests yielded their secrets; untiring workers ransacked the hidden literature of every age, ancient, mediæval and modern, to find the "original documents" that shaped the civilization and influenced the thought and life of the world. Nothing like it has ever been attempted or thought of before. You'll be amazed at the wealth of information this unique library contains.

DO YOU KNOW that the old Egyptians, 5000 years B. C., had a Bible which they called the "Book of the Dead"? Do you know that the Assyrian sacred literature gives the story of the Creation? Do you know that books and newspapers were printed in Asia thousands of years before printing was invented by Gutenberg? Did YOU ever read Columbus' personal log of his great voyage—filled with strange happenings and ominous forebodings? Do you know that there occurred in Mediæval England a great Socialistic protest—the first of its kind ever known? Do you know by what unique process Harvey demonstrated that the blood does not stand still in the veins, as everyone then thought? Do you know who Machiavelli was, or what world famous treatise he wrote?

YOU'LL FIND THEM ALL—and thousands of others equally as curious and important—in The Library of Original Sources. Every document is in the exact words of the original, translated; every contribution is from the actual eyewitness or person who took part; every idea is in the words of the thinker, investigator, discoverer or inventor.

JACK LONDON SAYS:—"It is a whole library in itself. I certainly never could spare these books from my shelves."

10 sumptuous, massive volumes, bound in rich, deep red Morocco; full-page illustrations, pure silk headbands, printed in large, clear type on hand-made paper, gold tops—a triumph of the bookmaker's art.

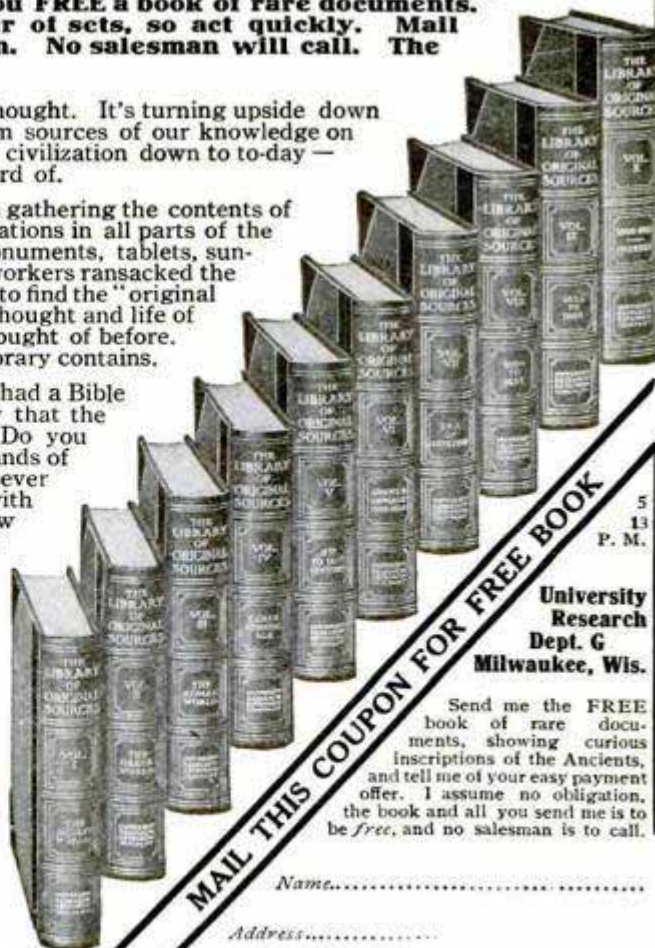

MAIL THIS COUPON FOR FREE BOOK

Name.....

Address.....

5
13
P. M.

University
Research
Dept. G
Milwaukee, Wis.

Send me the **FREE** book of rare documents, showing curious inscriptions of the Ancients, and tell me of your easy payment offer. I assume no obligation, the book and all you send me is to be *free*, and no salesman is to call.

This One





**SHOW CARD WRITERS
EARN FROM
\$21 TO \$50 PER WEEK**

LEARN ABOUT OUR FREE COURSE IN SHOW CARD AND SIGN WRITING

A Great Opportunity! We are offering, for a limited time, a complete course in show card and sign writing to those purchasing our assortment of "Litholia" Ready-to-Use Colors. This is a great opportunity for ambitious persons, either sex, to increase their earning capacity. Good show card writers in demand at \$21 to \$50 weekly, salary or in business for yourself. Our show card course is not a book of alphabets. It's a complete course in lettering compiled by an expert New York show card artist for us. "Litholia" is the only liquid pigment water paint ever manufactured, used the same as cake, distemper or tube colors, but far superior to either. "Litholia" lasts longer, always ready. "Litholia" is the best for the show card writer, the artist, or the interior decorator. A letter of request brings booklet, circulars, and full information.

LITHOLIA PM. COLOR CO., 71 to 81 W. 23rd Street, NEW YORK CITY

SHOP NOTES for 1913

The New Year Book IS NOW READY

All the articles which have been published during the year past in the "Shop Notes Department" of POPULAR MECHANICS MAGAZINE have been reprinted and bound in one handsome volume of

**224 Pages
595 Articles 503 Illustrations
Price 50 Cents**

This is Vol. IX of the series and contains entirely new matter. The seven page index makes it handy of reference and we will mail the book to any address upon receipt of 50 cents, or it can be bought of your book or newsdealer at the same price.

POPULAR MECHANICS, Publishers, 318 W. Washington St., CHICAGO, ILL.

4595 EASY WAYS TO DO HARD THINGS \$4.50

A collection of the most useful experience of years of hundreds of the most successful mechanics, "boiled down" and "Written So You Can Understand It."

Shop Notes Year Books—Vols. I to IX

4595 Articles — 1988 Pages — 4503 Illustrations

50c Per Volume, Postpaid **\$4.50** Per Set of Nine Books in Case, Prepaid

The contents of these books are similar to the articles appearing in this magazine under the heading "Shop Notes."

Order through your dealer or direct from the publishers
POPULAR MECHANICS BOOK DEPT., CHICAGO

The Pictorial Review of Current Events

Cartoons

15 Cents a Copy

Published Monthly

[Published by H. H. WINDSOR, Editor Popular Mechanics Magazine]

A collection of the best and most striking cartoons published in the papers of the world each month.

Here are some of the additional features to be found in the May number:

Chalk Talk Experiences by Karl Kae Knecht, of the Evansville, Ind., Courier; The explanation of the prophetic cartoon, drawn by Ole May of the Cleveland Leader; How a cartoonist builds his picture, by Herbert H. Perry, of the Sioux City Journal; sketches of the lives of Ernest E. Burt, of the Knoxville Journal and Tribune, and William Kemp Starrett, of the Albany Knickerbocker Press; Stories from the Studios, told by the artists; the fifth of Henry C. Williamson's articles on the cartoonists of the past, and the month's review of the work of the cartoonists.

All this in addition to the scores of full page reproductions of the best cartoons that have been printed in the daily papers of the country and publications of the old world.

These reproduced cartoons are selected from a collection of more than ten thousand each month.

Send your order to **CARTOONS**, 318 W. Washington St., Chicago, Ill.

Bound Volumes One and Two NOW READY

These two bound volumes, of six numbers each, contain more than 2,000 reproductions of the very best cartoons that have been printed during the past 12 months. A collection of more than 120,000 cartoons was made in order to secure them. Bound in the two volumes they make an "instant history" of the year 1912 for they are a pictorial record of the events of the world during the past year.

These two books, artistically and durably bound, are now ready for distribution and will be sent all express charges prepaid to any address in the United States or its possessions upon receipt of **One Dollar Each**

Will YOUR Roof stand this test?

If burning embers fell on *your* roof from an adjoining fire, would you be alarmed for the safety of your building?

Statistics show that thousands of buildings are needlessly burned every year—because they are roofed with inflammable materials, easily ignited by sparks and brands. Safeguard your buildings against this dreaded fire hazard by covering them with

J-M Asbestos Roofing

This is the only ready roofing that affords perfect fire protection. It has withstood the flame of a powerful blow-torch for almost an hour without a sign of burning. The wonderful fire-resisting quality of J-M Asbestos Roofing is due to its *all-mineral* construction—layers of Asbestos felt (fire-proof rock), cemented together with Trinidad Lake Asphalt, Nature's time-defying water-proofing.

The absence of perishable animal and vegetable substances also means that J-M Asbestos Roofing contains nothing to rot, melt, dry out, crack or rust. Hence, it *never needs coating or protection of any form. Its first cost is the last cost.* It is the cheapest per year roofing on the market.

Adapted to any type of building—in any climate. Easily applied. J-M Roofing Cleats, packed in each roll, make absolutely watertight seams and give the entire roof a handsome white appearance.

Order from our nearest branch if your hardware or lumber dealer can't supply you.

Write our nearest Branch today for a sample of the curious Asbestos Rock that forms the base of this roofing and Book No. 2871.

H. W. JOHNS-MANVILLE CO.

MANUFACTURERS OF ASBESTOS AND
MAGNESIA PRODUCTS

TRADE
ASBESTOS
MADE

ASBESTOS ROOFINGS, PACKINGS,
ELECTRICAL SUPPLIES, ETC.

Albany
Baltimore
Boston
Buffalo

Chicago
Cincinnati
Cleveland
Dallas

Detroit
Indianapolis
Kansas City
Los Angeles

Louisville
Milwaukee
Minneapolis
New Orleans

New York
Omaha
Philadelphia
Pittsburgh

San Francisco
Seattle
St. Louis
Syracuse

Toronto

THE CANADIAN H. W. JOHNS-MANVILLE CO., LIMITED

Montreal

Winnipeg

Vancouver

1976

POWER GAS
AND THE
GAS PRODUCER



PRICE ONE DOLLAR

ARE YOU INTERESTED IN Cheaper Power?

Under certain conditions the gas producer makes a startling saving in the cost of power, and it is worth every power user's time to know whether or not his present system is the best.

To meet a demand for information which has not been hitherto available except by the employment of an expert, we have been fortunate in securing the services of an eminent gas power engineer, Mr. J. C. Miller, M. E., who has written a book on this subject which we have recently published. It gives **just the information a man wants to have**, comparing the first cost of steam engines and boilers with the gas producer and gas engine, and the comparative cost of maintenance and operation. It tells all about the advantages and troubles of gas producers, and gives full details of how to run them. It is written in an absolutely impartial manner, and not with a view to increase the sale of gas plants, leaving the decision as to the advisability to the individual reader. It will also enable the **Steam Engineer** to understand thoroughly the working of the new system if the change is made, and to handle a plant competently and with confidence.

POWER GAS AND THE GAS PRODUCER

has 200 pages, is printed on the best book paper, profusely illustrated with half-tones from photographs, diagrams, etc., and durably bound in extra cloth.

SENT POSTPAID TO ANY ADDRESS FOR \$1

Popular Mechanics Book Dept., 318 W. Washington Street, Chicago

JUST OUT!**Amateur Mechanics No. 4****Another Big Book for Those Who Like to Make Things**

Similar in style to Amateur Mechanics Nos. 1, 2 and 3 but contains entirely different matter

The scores of ideas of practical things to construct which are all clearly illustrated as well as thoroughly explained will profitably occupy any boy's time and afford many hours of enjoyment.

Among the many interesting things it tells how to make are:

Roller Coaster—Camps—Monoplane Glider—Wireless Telephone Set—Electric Incubator—Arts Crafts Leather Work—Wood Lathe—Canoe—Water Wheel—Enlarging Camera—Motion Picture Camera and Projector—Leaded Glass Panels for Furniture.

All told there are over 200 articles and 200 illustrations. The book contains 128 pages (size 6½ x 9½ in.) nicely printed on good book paper and bound in three color illuminated cover.

PRICE 25 CENTS, POSTPAID

Ask your Book Dealer or send direct to the Publishers

POPULAR MECHANICS BOOK DEPARTMENT
318 W. Washington St., CHICAGO

THE IDEAL BOOKS

For the Wide-Awake American Boy



The handsome set of four books — "Mechanics for Young America" and "Amateur Mechanics" (Nos. 1, 2 and 3) — each book bound separately in Illuminated Covers, and the whole set inclosed in a heavy Bristol Folding Case with extension clasp — will be sent prepaid to any address for

\$1

700 Things a Boy Can Make

1000 Illustrations Showing How Thoroughly Practical and Instructive

Besides telling how to make scores of things useful about the house, full and complete directions are given on constructing the following and hundreds of other things which appeal to the heart of every boy.

Electric Appliances—Steam and Gas Engines—Motors—Wireless and Morse Telegraph—Self-Propelled Vehicles—Toboggans, Bobsleds, Ice-Boats—Boomerangs—Paddle Boats, Canoes, Rowboats—Camping Outfits—Cabins—Tents—Fishing Tackle—Magic Lanterns—Searchlights—Cameras—Telescopes—Glider and Aeroplanes—Kites and Balloons—Aquariums—Electric Furnaces—Electroplating Outfits—Lathes—Foundry Work at Home—Iron, Copper, Brass and Other Metal Work—Bookbinding—China and Pottery Kilns—Parlor Magic Tricks, etc.

Each Book Also Sold Singly at 25 Cents Postpaid
Ask Your Book Dealer or Address the Publishers

Popular Mechanics Book Department
318 W. Washington Street, CHICAGO

A BOOK OF NEW MISSION FURNITURE DESIGNS



Part 3—Mission Furniture HOW TO MAKE IT

A 128 page collection of 36 excellent new designs that have never before been published and that are entirely different from those in the books Parts One and Two previously issued.

Handsome Cloth Binding
Price 50c Postpaid

This new number has just been published and those already in possession of Parts One and Two will find this an even greater value in variety and excellence of the plans.

A feature of the New Book is a Complete Set of Dining-Room Furniture Designed to Harmonize Perfectly

If you are at all handy with tools, you will find that the plainly written directions, dimension drawings and half-tone illustrations will enable you to

Make Your Own Furniture and Save Two-Thirds
The many who use tools for pleasure will find this book a working guide which will furnish many moments of delightful and profitable occupation while several of our readers have been able to devote their entire time to this work by disposing of what they have made at a nice profit. One man made and sold \$400 worth of one piece alone.

Parts One and Two in this series are also 50 cents each postpaid

Ask Your Book Dealer or Address the Publishers
POPULAR MECHANICS BOOK DEPT.
318 W. Washington St. CHICAGO

YOUNG MAN! LEARN DRAFTING

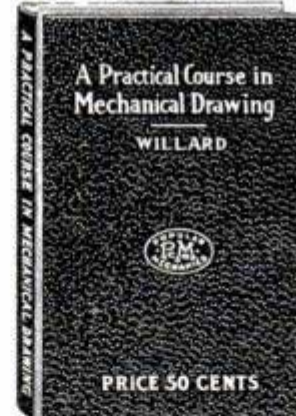

ONE of the most practical subjects of study today; an essential in most lines of engineering; indispensable in many occupations and often the secret of successful advancement; of no less importance to the farmer than the mechanic. There is bound to come a time when you will feel the need of the ability to "lay out" something in accordance with the rules and conventions used in the drafting profession.

Individual Study

may be successfully engaged in with the aid of our new enlarged edition of the book

A Practical Course in Mechanical Drawing

By WM. F. WILLARD

(For several years instructor in Mechanical Drawing at Armour Institute of Technology, Chicago)

160 PAGES — SIZE 5x7 — 157 DRAWINGS — CLOTH COVER

Price 50 Cents, Postpaid

There has been a real need for a book of this kind, as it clinches each problem in the mind of the student by giving the practical application of that problem to every day practice in some phase of the world's work. It meets every modern requirement and is in advance of any other work on the subject. Excellent for use in shop classes, trade or high schools. A complete detailed description of the contents of this book sent free upon request.

Order of your Book Dealer or direct from the publishers

POPULAR MECHANICS BOOK DEPT.
318 W. Washington St., CHICAGO

HOW TO RUN AN AUTO IS SELF-TAUGHT IN AUDELS ANSWERS on AUTOMOBILES

**A New Book from Cover to Cover
LATEST — PRACTICAL — CONCISE — EXPLICIT — BEST**

THE object of this book is to give, in the easiest understood form, the information necessary for the proper **operation, care and maintenance** of an automobile.

To adapt the book to many needs the subject matter is presented in the form of **questions and answers**. Technical terms are explained or made clear by the wording of the answer, which is always brief and direct.

Any one of the definite chapters on **Carburettors, Ignition, Gas Engine Operation, How to Run an Automobile, and Overhauling the Car, Battery Troubles**, are alone worth the price asked for the 28 complete chapters contained in this book of 512 pages, illustrated by **380 illustrations**.

The form and size are such that it is convenient to handle and study.

This book is a self-educator, hence: "he who runs may read" and improve his present knowledge of automobile engineering, and proficiency:

Handsomely bound in durable green cloth and full leather back.

Audels Answers on Automobiles \$1.50

A BOOK WORTH HAVING

"Understand Your Car." Explained in the Following Chapters:

1. Ready Reference Index. 2. The Automobile. 3. The Gas Engine. 4. The Cycle of a Gas Engine. 5. Brief Outline of Gas Engine Principles. 6. Cooling Systems. 7. Fuels. 8. **Carburettors**. 9. **Ignition**. 10. Timing and Balancing. 11. **Gas Engine Operation**. 12. Clutches. 13. Transmissions. 14. The Drive. 15. The Differential. 16. The Running Gear. 17. Tires. 18. Brakes. 19. Ball and Roller Bearings. 20. Lubricants and Lubrication. 21. Motor Cycles. 22. Electrics. 23. Electricity. 24. Dynamos and Motors. 25. Storage Batteries. 26. Methods of Circuit Changing. 27. **How to Run an Automobile**. 28. **Overhauling the Car**.

NONE OTHER JUST AS GOOD

FREE EXAMINATION

We don't want you to take our word, or anyone else's for it. We are willing to send you the book without deposit. Use it seven days in connection with your car. Then send back the book or remit \$1.50. Could anything be fairer?

Cut out and fill in your name and address plainly at the bottom. Place it in an envelope and mail.

This Book Will Speak for Itself

Theo. Audel & Co., 72 Fifth Ave., New York

Kindly mail me copy of **Audels Answers on Automobiles**, and, if found satisfactory, I will immediately remit you \$1.50, or return the book to you.

NAME

OCCUPATION.....

ADDRESS May P. M.



Full of Refreshment

No matter what the temperature—no matter what the strenuous exactions of the day—you will find cooling, restful deliciousness in a glass of

Coca-Cola

A lastingly refreshing beverage. Different and better; absolutely wholesome.

Ask for it by its full name—Coca-Cola—to avoid imitations and substitutes.

Delicious — Refreshing Thirst-Quenching

Whenever you see an Arrow think of Coca-Cola.

Send for Free Booklet.

THE COCA-COLA COMPANY, Atlanta, Ga.

Please Mention Popular Mechanics

Habit or Efficiency?

One of the time-honored customs of many households is the sweeping of carpets and rugs with a primitive corn broom. That this is an absolute waste of energy, a ruthless destroyer of floor coverings and a preventable source of damaging clouds of dust, is vouched for by over twelve million satisfied women who are now using the BISSELL Sweeper.

BISSELL'S "Cyclo" BALL-BEARING Carpet Sweeper

is the most efficient and highly improved carpet sweeper on the market. It brightens and preserves carpets and rugs, and will last for ten years or more, outwearing at least forty corn brooms that would cost from twelve to twenty dollars. Sold by the best dealers everywhere at \$2.75 to \$5.75.

Don't continue to sweep in the old, laborious way when at such a small cost you can make sweeping day a pleasant anticipation instead of a day to be dreaded.

Write for booklet, "Easy, Economical, Sanitary Sweeping."

Bissell Carpet Sweeper Co.
Dept. 153, Grand Rapids, Mich.
(Largest Exclusive Carpet Sweeper Manufacturers in the World.) (27)

Sugar exports from all countries total about 13,000,000,000 lb. a year, while coffee shipments from various lands are averaging 2,750,000,000 lb. The United States buys 1,000,000,000 lb. of the coffee.

The Guarantee of



Reliability



in electrical apparatus is the monogram trade mark of the largest electrical manufacturer in the world—**GENERAL ELECTRIC COMPANY**
General Office: Schenectady, N. Y. Sales Offices in 52 Cities.

"Anyweight" Lawn Roller

Don't spoil your lawn with a roller that's always too heavy or too light for the job. A soft spring lawn needs a very light roller—a dry lawn or a tennis court a heavy one.

Water-Ballast

The "Anyweight" runs easily—is filled or emptied in a jiffy; lasts a lifetime. Write today for booklet—"Care of the Lawn" and catalog, both free.

SAVE MONEY—
Save your lawn.

WILDER-STRONG CO.
Box 70 MONROE, MICH.



Stop Forgetting!



Now, What Was That Fellow's Name?
I Can't Remember Those New Terms.
I Know—But Can't Find Exact Word.
What on Earth Did He Say About It?

A Perfect Memory Is the Key to Success

The mind of the average person is filled with thousands of single unrelated ideas which waver and fluctuate with every emotion, like the billows of the sea.

My method is highly recommended by **ELBERT HUBBARD, PROF. DAVID SWING**, and thousands of others. Ten minutes a day of your spare time will give you this training and not interfere with your work in any way.

The man with a Wandering Mind can never hope to Make Good—he will always be a drug on the market—he has too many competitors.

The great men of all ages are those who acquire the ability to concentrate and to memorize.

You Can Be Trained to Remember Accurately

In the business battle—matching wits each hour of every day—the ability or inability to think on your feet, to remember instantly and accurately means gain or loss. To succeed you must be “forget-proof.” Just as surely as a poorly organized business can be placed upon a basis of perfect systematization and thereby made thoroughly efficient—so can your mind be trained and made a classified indexed and cross indexed filing system of facts so that you can command, on the instant, any thought, fact or argument.

The Dickson Method of Memory Training Will Do

This for You It will enable you to classify impressions, ideas, names, facts and arguments so as to have them ready at a moment's notice at any time. It will train you to think on your feet, to converse in a natural, interesting way, to overcome self-consciousness and bashfulness, to acquire easy, logical thinking. My course is not a theory, but is purely and absolutely scientific—the result of more than 20 years of close, intimate contact with students in schools and colleges and searching their developing minds for means of strengthening their memories.

I Want to Send You My Book, “How to Remember,” Absolutely FREE

Simply clip the coupon and mail it today. It will explain clearly the course that has raised thousands of men from failures to great successes. You can have this same training. My free book is the first step. Don't delay. Age, education, vocation or place of residence makes no difference. Send the coupon today.

How to Get a Free Copy of This Valuable Book

De luxe edition handsomely illustrated, richly bound. Is exactly suited to meet the needs of the man or woman who desires to be a successful public speaker. The price of this 1911 de luxe edition is \$2.00. I will, however, present a copy absolutely free to every student who enrolls for my course of memory training within ten days after reading this offer.

Send the Coupon or Postal Today.



Prof. Henry Dickson

America's foremost authority on Memory Training, Public Speaking, Self-Expression, and Principal of the Dickson Memory School, Auditorium Building, Chicago.

**Prof. Henry Dickson
705 Auditorium Bldg., Chicago, Ill.**

Send me free Booklet “How to Remember,” also full particulars how to obtain a free copy of Dickson's “How to Speak in Public.”

NAME.....

STREET.....

CITY.....STATE.....

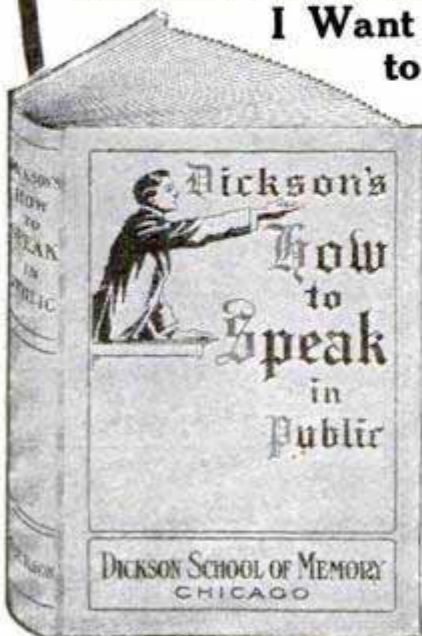

DICKSON SCHOOL OF MEMORY
CHICAGO

Send for Copy of Our New Wireless Manual P1

It contains 96 pages and tells how to erect and maintain wireless telegraph stations. Shows a number of diagrams. Has the Morse and Continental Telegraph Codes. Illustrates the best instruments to use; tells what they are for and how to use them. Do not wait until some other time, but sit down now and send your name and address, and get one. It costs you nothing.



Send for Our Pocket Catalog P26

It contains 212 pages, with over 1,000 illustrations and describes in plain, clear language all about Bells, Push Buttons, Batteries, Telephone and Telegraph Material, Electric Toys, Burglar and Fire Alarm Contrivances, Electric Call Bells, Electric Alarm Clocks, Medical Batteries, Motor Boat Horns, Electrically Heated Apparatus, Battery Connectors, Switches, Battery Gauges, Wireless Telegraph Instruments, Ignition Supplies, etc.

It Means Money Saved to You to have our Manual and our Catalog when you want to buy

MANHATTAN ELECTRICAL SUPPLY CO.

NEW YORK, 17 Park Place

CHICAGO, 114 S. Fifth Ave.

ST. LOUIS, 1106 Pine St.

SAN FRANCISCO, 604 Mission St.

NO-BATTERY ELECTRIC BELLS

FOR DOORS & SIGNALS

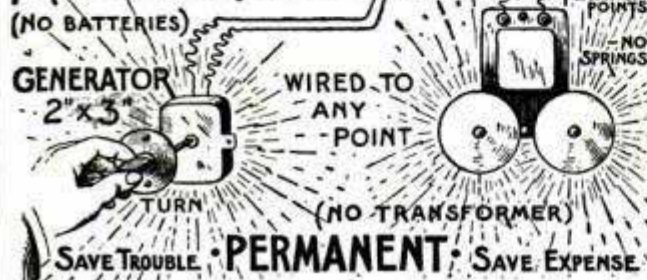

Sent Complete \$3.50. Satisfaction Guaranteed

AGENTS WANTED

SEARLES ELECTRIC CO.

815 Washington Blvd., Dept. 21

CHICAGO

The Voltamp Electric Mfg. Company

is compelled to announce that the unusual demand has completely exhausted the supply of catalogs. A new catalog, larger and more complete, is now in course of preparation.

For anything and everything electrical

WRITE THE

Voltamp Electric Mfg. Co., Voltamp Block, BALTIMORE, MD.

Send for Bulletin "S" on Wireless Telegraphy

It's Free Explains in simple language about the most educational and fascinating of modern sports. Shows you how to get started in this great game for less than one-half usual expenses. Read all the messages in the air, get the correct time daily from the government by wireless. Send messages to your friends without wires. You want our Bulletin "A" and the codes.

SEND A POSTAL TO-DAY. Don't put it off, do it now.

HUNT & McCREE 92-94 Murray St. NEW YORK CITY

"Electro" Lighting Outfit

The handiest thing you ever came across. Will give continuous light for EIGHTY hours before exhausted. Used as bed reading lamp, in dark closets, halls, on stairs, cellars, in dark room, in toilets, etc. Every house needs one or more outfits. The powerful tungsten lamp gives 5 candle power—a beautiful light. The outfit is ready wired and comprises three large Columbia dry cells, brass polished bracket, socket, nickel reflector, nickel snap switch, tungsten lamp, 5 yards best lamp cord, battery connectors, battery box and brass screws. Weight, packed, 10 lbs. Complete outfit as described \$2.00

Send today 5c postage for our No. 11 Electrical Encyclopedia, containing 450 illustrations, 1500 articles and 212 pages of electrical and WIRELESS instruction and important information.

The Electro Importing Co. 233A Fulton St., New York, N. Y. "Everything for the Experimenter"



EXPERIMENTERS IN WIRELESS

Send 2c stamp for Catalogue B, containing everything in Wireless and Electrical Supplies. Prices and quality both right. Do it NOW.

DAWSON & WINGER ELEC. CO., 727 So. Dearborn St., CHICAGO, ILLS.

ELECTRIC HOME, FARM and MOTION PICTURE THEATER LIGHTING PLANTS. Carriage, Bicycle, Fishing and Automobile Lights, Fans, Generators, Railways, Belts. Catalogue 3c. **OHIO ELECTRIC WORKS, CLEVELAND, OHIO**

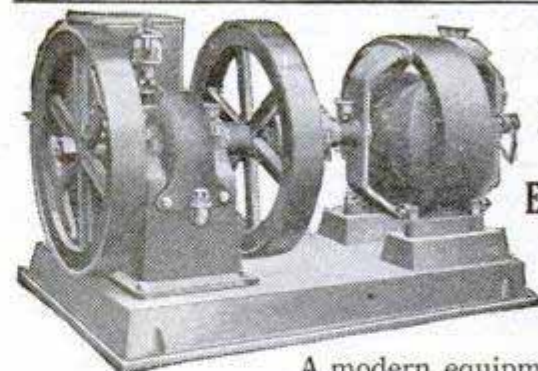

LIGHT YOUR HOUSE WITH ELECTRICITY

Put in a Direct Connected Gasoline Engine and Dynamo.

A modern equipment at small cost for farm and house lighting and small isolated plants. Dynamo has an output of 42 volts and about 15 amperes. Speed 600 R. P. M. For charging 30 Volt Storage Batteries. Operation steady and quiet. Write for circular. **THE CARLISLE & FINCH CO.,** 244 East Clifton Ave., CINCINNATI, OHIO

DUCK'S BIG 325-PAGE ELECTRICAL & WIRELESS CATALOG

Will be mailed to you upon receipt of 6c, stamps or coin, which you may deduct on your first purchase of \$1. Great cost of catalog and low prices prohibit distribution except to those really interested. *Most elaborate catalog in its line.* **SAVE 25% ON STANDARD GOODS.** Catalog contains over 100 pp. Wireless Instruments for commercial and experimental use, with complete diagrams, etc. 15 pp. Telegraph Instruments; 25 pp. Toy and Commercial Motors; 175 pp. flash lights, miniature lamps, lighting plants, storage batteries, ammeters, automobile accessories, launch lighting outfits, advertising displays, tools, pocket knives, Victrolas, microscopes, railways, and electrical and mechanical books.

THE J. J. DUCK COMPANY, 390-392 St. Clair Street, TOLEDO, OHIO

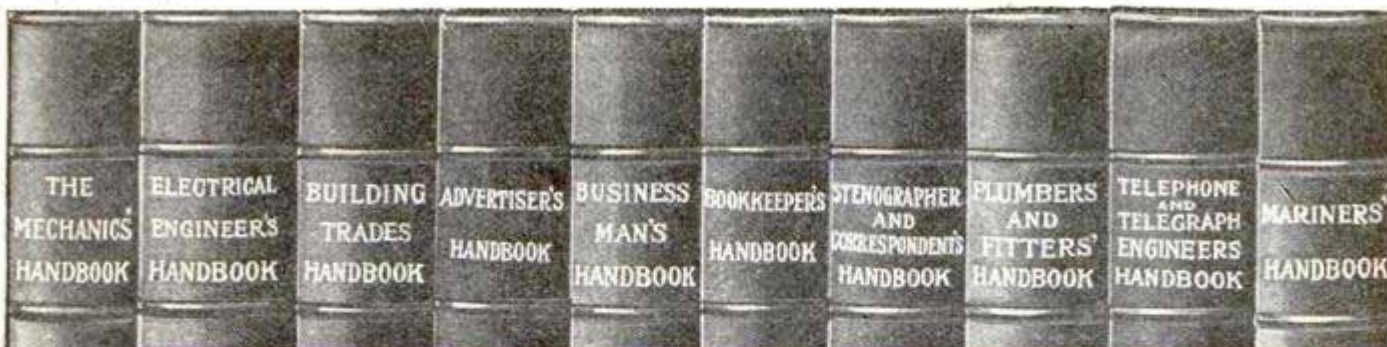

\$1.25 Handbooks for 50c.

No books in existence contain in so small space as much information about the trades and professions of which they treat as do these Handbooks. They are little giant encyclopedias of practical knowledge giving data and information that is hard to find in ordinary books. These Handbooks have been prepared by the well-known textbook writers of the International Correspondence Schools whose textbooks are recognized the world over as the most practical treatises on applied sciences ever published. These Handbooks are consulting experts of the highest rank, and are the most powerful force in the world for the promotion of ambitious men. They are an indispensable help to quicker and better work that will command advancement. They are printed on a high-grade book paper in clear type, and durably and handsomely bound in cloth with gilt titles; contain on an average of 364 pages and 175 illustrations and are regularly sold for \$1.25 each.

SPECIAL OFFER.—We are selling these Handbooks, durably bound in cloth with gilt titles, at a special price for each Handbook of 50 cents.

Mechanics'—Tables; formulas; measurements; belting; mechanical powers; hydro-mechanics; strength of materials; shafting; boiler design; care of boilers; power of boilers; chimneys; exhaust heating; machine design; machine tools; slide valve; pulleys; cylinders and steam chests; pistons; gearing; transit surveying; triangulation; curves; radii and deflections; earth work; track work; electricity; etc.

Advertiser's—How to plan and write an advertisement; type and type measurements; points on printing style; display; preparation of manuscript; proof reading; engraving and printing methods; electrotypes; matrices; advertisement illustrations; magazines; newspapers; retail, department-store, general, trade-paper, and mail-order advertising; trade marks; circulars; advertising agencies; etc.

Stenographer's & Correspondent's—Advice to beginners; shorthand speed; letters of application; punctuation; correct and faulty diction; business correspondence; type-writing; abbreviations; addressing; mailing; rates of postage; duplicating work; etc.

Telephone and Telegraph—Useful tables; mechanics; electricity; magnetism; primary batteries; storage batteries; electrical measurements; telephony; tests with magnetogenerator and bell; telegraphy; Morse telegraph systems; multiplex telegraphy; etc.

Electrical Engineer's—Mechanics; electricity; electrical units; symbols and quantities; physical and electrical properties of metals and alloys; wire gauges; magnetism; dynamos and motors; electric batteries; alternating current apparatus; alternators; transformers; wattmeters; electric transmission; electric lamps; wiring; electric heating and welding; electromagnets; controllers; car wiring; etc.

Business Man's—Arithmetic; tables; business forms; card systems; measures of extension; weight and capacity; time; value of foreign coins; duties on imports; bookkeeping; stenography; correspondence; postal information; financial terms; money and the money market; brokers and brokerage; patents; copyright and trade marks; corporations; business law; publicity; etc.

Plumbers and Fitters'—Arithmetic; involution and evolution; powers, roots, and reciprocals; circles; decimals; geometrical drawing; weights and measures; formulas; mensuration; mechanics; hydro-mechanics; building construction; heating and ventilation; gas-fitting; plumbing; etc.

Mariners'—Logarithms; trigonometry; navigation; terrestrial navigation; celestial navigation; organization of a man of war; naval ordnance; explosives; torpedoes; ship building; speed, tonnage, and fuel consumption; ropes; wind and weather; signals; nautical memoranda; etc.

Building Trades—Loads and structures; strength of materials; properties of sections; strength of rivets and pins; materials of construction; footings and foundations; masonry construction; woods used in building; qualities of timbers; joinery; framing; estimating; elements of architectural design; drainage systems; plumbing fixtures; plumbers' tables; heating and ventilation; gas and gas-fitting; etc.

Bookkeeper's—Arithmetic; formulas; tables; money; percentage; interest; equation of accounts; money and the money market; business law; financial terms; banks and banking; postal information; distances and time between various places; bookkeeping; business forms; card systems; modern office methods; cost accounting; bank bookkeeping; clearing house methods; etc.

International Textbook Co.

Box 872, SCRANTON, PA.

I enclose \$_____ for which please send me the books BEFORE which I have marked X.

- Mechanics' Handbook Advertiser's Handbook
 Elect. Eng. Handbook Business Handbook
 Bldg. Trades Handbook Bookk'per's Handbook
 Plum. & Fit. Handbook Sten. & Corr. Handbook
 Tel. & Tel. Handbook Mariners' Handbook

Name _____

St. and No. _____

City _____ State _____

\$50 Course Free

Learn to Run and Repair Automobiles By the Sweeney System of Practical Experience!

Salesman \$250 Per Month



Repair Man \$1.00 Per Hour



You can earn from \$1,000 to \$5,000 a year in the Automobile business. Thousands of men wanted for chauffeurs, mechanics, demonstrators, salesmen, garage managers, repair men, etc.

THE demand for competent men is more than double the supply. That's why the auto business pays the biggest salaries today. Millions are invested in the manufacture of automobiles. One company alone has orders for 120,000 cars for 1913 delivery. Three hundred thousand is a conservative estimate of the output for the year. Thousands of dollars will go to the men who handle this product and thousands more will go for repairs, storage, chauffeurs, etc. Get into the business and get your share of the money. No hard work in the auto business. You don't have to get up at 4 o'clock in the morning and work till dark; no drudgery, no chores. No hot summers and cold winters to endure. Instead you will have short hours, easy work and regular pay. You get paid for

Demonstrator \$150 Per Month



Chauffeur \$125 Per Month



Live well, dress well, a chance to travel and see the world, stop at the best hotels with all expenses paid. Now to get you to investigate the wonderful opportunity I am offering you I will give for the next thirty days a free scholarship in traction engineering. If you are mechanically inclined, or if you want to get into the most profitable trade in the world, sign the coupon and mail today, and I will send you my big free catalog and free scholarship certificate. Remember, the Sweeney system makes learning easy in six weeks because we teach the right way—letting you work with your own hands on real cars. It's the simplest, quickest, surest and most thorough way of learning this splendid business. **EMORY J. SWEENEY**

We Own Two Traction Engines

Get one of these free \$50 courses in gas traction engineering. Enormous demand in every farming community for engineers. Factories want demonstrators. We teach you by actual work on a traction engine and put you in touch with factory managers who have told us they will take all the trained men we can send them. Here is a wonderful opportunity for any young man mechanically inclined. You can learn by practical work in a few weeks. Remember we give this course free!

Barney Oldfield Indorses Sweeney

Dear Sweeney: I consider yours the most completely equipped Automobile School in America. I have visited many schools in my travels, but yours is far ahead of any I have ever seen, as you teach the mechanical end in a practical way, which, in my estimation, is far ahead of learning it by books and charts. You know me. **BARNEY OLDFIELD.**

Get My Big Catalog This splendid illustrated book is in itself a liberal education. Tells all about the Sweeney System. Gives names of hundreds of successful graduates. In a most fascinating way relates the experience of hundreds of young men who came to this school. Explains how we combine a machinists' course with the automobile course without extra charge. Why we don't teach from books, charts and theory. But how we do teach by giving you practical work and actual handling of cars. (We have on the floor 41 cars, including Fords, Buicks, Jacksons, Overlands, Ramblers, Cadillacs, White Steamers, Packards, etc.) All tools are free. One charge, no extras. This catalog shows how easy it will be for you to get into the best paying business in the world. How we teach you to run a business of your own successfully. How we make you a dealer, or secure you a good position.

FREE Scholarship

Emory J. Sweeney, Pres.
Sweeney Auto School
1460 Woodland Ave., Kansas City, Mo.

Send free scholarship magazine and catalog.

REFERENCES:

Commonwealth Nat'l Bank, Kansas City, Mo.; Dun's or Bradstreet's Mercantile Agencies.

Traction Engineers Earn \$5 to \$10 Per Day

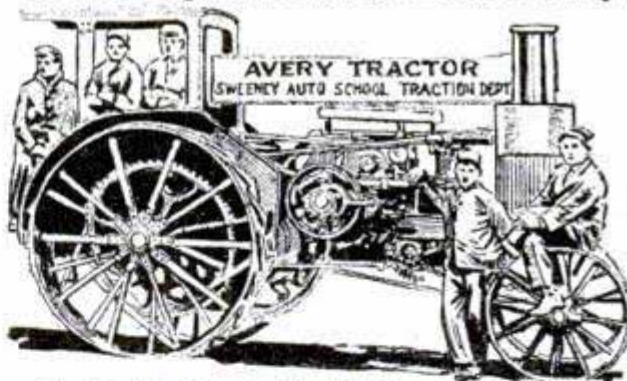

No Books Used—Tools Furnished FREE

Earn More Money The object of this offer is to advertise the Sweeney System and this new branch of work which will naturally be handled by an automobile man. Six weeks after the day you enroll in my great practical school you will be prepared to properly repair any automobile made and drive any car or truck or operate garage and repair shop of your own. You can learn the automobile business thoroughly because the

"Sweeney System" is the most thorough, practical, interesting course of automobile instruction, and embraces every point worth knowing, including vulcanizing, brazing, oxy-acetylene welding, lathe work, machine shop practice, testing and road work, etc. You learn by doing the actual work on real cars with your own hands under the watchful eyes of experienced instructors.

Free Magazine Write today and we will also send you our school magazine absolutely free. I want every man thinking of learning to become an Auto Expert to have my new big illustrated catalog. Write for this great book. Send today—this very minute—now.

Sweeney Auto School

Largest and most completely equipped Auto School in the World
1460 Woodland Ave., Kansas City, Mo.

NAME.....
ADDRESS.....

AUTOMOBILES

AN Automobile for muddy roads is our motor-buggy. It is the only successful mud wagon made; and it is a regular goat for hill climbing. Light weight, large wheels, solid rubber tires, the right kind of an engine for strong pulling at low speeds, and, above all, the Roller Drive, make the most practical motor-driven vehicle on the market. A good motor-buggy has long been needed; it can now be had for \$487.50; a 4-passenger car for \$537.50.

If one be willing to keep his speed down to about twenty miles per hour, these cars will take him over the country more comfortably, more surely, and far more cheaply than anything else made. And they go through the mud. Send for catalogue. C. K. Duryea Motor Co., Saginaw, Mich.

LEARN How to Run An Auto. Audel's Answers on Automobiles will teach all about Carburetors, Ignition, Timing, Engine Troubles, Overhauling and Driving. A complete course of 500 pages with 375 diagrams highly endorsed by men who know. \$1.50 to any address. Money back if not pleased. Theo. Audel Co., 72 Fifth Ave., New York.

SIX Little Yankees kill carbon in automobiles and motor boats. Non-liquid, non-explosive, -harmless, handy, clean. Get more power, smooth running engine, use less gas. \$2 box. All dealers. Six Little Yankees, Philadelphia.

DIAMOND Tires, 28x3 \$8.70; 30x3 \$9.30; 30x3½ \$13.70; 32x3½ \$14.65; 34x4 \$21.50. Other sizes accordingly. Dunlops \$1 extra. 10% with order, balance C. O. D. Auto Tire Brokerage Company, 1406 Michigan Avenue, Chicago.

BARGAIN, five passenger Rambler, elegantly equipped. Perfect condition. \$250. Write at once. Leitner, 832 N. Paulina St., Chicago.

AUTOMOBILE bargains: New and used. Very cheap. Write for list. Box 275, Burlington, Wis.

20 H. P. air-cooled touring, \$150. Hupmobile runabout \$350. C. H. Lewis, Athlens, Tex.

SIMPLEST way on earth to time valves and spark on automobile and gasoline engines. 25c. "Strong," Homer, Mich.

GUARANTEED 5,000 miles without puncture. If your tires are old, don't throw them away, or you'll throw away \$50 to \$200. With Durable Treads we give you a written guarantee for 5,000 miles without puncture. This is binding whether your tires are new or old-tread-worn, rim cut or rut worn. Durable Treads cost only half as much as tires. Write for booklet and special discount at once to Colorado Tire & Leather Co., 1128-M Karpen Bldg., Chicago, Ill.; 524-M W. 34th St., New York City; 435-M Golden Gate Ave., San Francisco, Cal.; 1248-M Acoma St., Denver, Colo.

FOR Sale. Two white Steamers, 5 pass. \$190. 7 pass. \$500. Good condition. C. M. Butler, 3320 N. California Ave., Chicago.

BUICK Model F Touring Car. Bargain. \$200. Saxer, Fleetville, Pa.

"THE How and Why of the Automobile"—A 200-page book of practical information for seekers after the fundamental facts regarding the gasoline engine and its application to the motor car. Interesting and instructive to both the beginner and the expert. Bound in full cloth—250 illustrations. Price, \$1 postpaid. Popular Mechanics Book Dept., Chicago.

THE Last Word in Automobile Literature—New book, "The Modern Gasoline Automobile," 700 (6x9 in.) pages, 500 illustrations, is superior to any treatise heretofore published. Deals with every modern improvement. Price \$2.50 postpaid. Popular Mechanics Book Dept., 318 W. Washington St., Chicago.

AUTOMOBILE model. Every part shown and named. You can to all intents and purposes take off the wheels, raise the hood and remove the body; exposing to view the vital parts. The only practical method of studying the automobile. Price, 50 cents postpaid. Popular Mechanics Book Dept., Chicago.

FORE-DOORS. Bring your open-front car up-to-date. We make fore-doors to fit all standard makes of automobiles. We carry large stock and guarantee prompt shipments. Write for prices and description. Pioneer Fore-Door Mfg. Co., 211-217 W. Georgia St., Indianapolis, Ind.

Classified Advertisements

Advertisements in this section, 15 cents per word, each insertion, minimum 10 words, payable in advance. To insure ads being inserted under proper classified head in the June issue, copy must reach this office not later than May 1st.

Popular Mechanics Magazine, Chicago, Ill.

Bevidere, Ill.

Gentlemen: Wish to state that the results I have had from the motorcycle ad I had inserted in the classified columns of your recent issue of Popular Mechanics Magazine is more than I expected; although I sold my machine to the first party that answered, inquiries are still pouring in. If I have anything to sell in the future you may be sure I will advertise in Popular Mechanics Magazine. Popular Mechanics Magazine is evidently read by people who mean business.

Yours very truly, (Signed) L. DARBY.

BROKEN Cylinders and Crankcases—Send them to be made good as new at fraction of replacement cost. Scored cylinder repaired, \$12. No new piston and rings required because bore is not enlarged. Where cylinders are worn (not scored from loose wrist pin) reboring is only remedy. We do it expertly. Write for complete information and estimates. Waterbury Weld Company, Waterbury, Conn.

HANDSOME Limousine and Automobile. What have you to exchange? L. Hauber, St. Marys, Pa.

KELLY Quick Demountable Wheels, wire or wood, fit any car. Kelly Automobile Co., Congress St. and 46th Ave., Chicago, Ill.

FLAT Tires Abolished—"Tyrefix" stops punctures automatically, permanently. Guaranteed trial package for one tire, one dollar. Agents wanted. Tyrefix Co., Nine Forty-eight East Boulevard, Detroit.

AT your price—two Stanhope Electrics in good condition, best cash offer takes them. Would trade for gasoline roadster. Write now to Parrett Machine Co., Wenona, Ill.

BARGAIN—Mitchell four cylinder roadster. Fully equipped. Good condition. \$400. National Equipment Company, Detroit, Mich.

AUTO Truck, 1 Ton, 60 H. P. Stearns. Good condition, \$575.00. Body built to order extra. Winnetka Garage, Winnetka, Ill.

NEW 35-40 h. p. four cylinder engines, magneto, coil and clutch. F. E. Alford, Goshen, Ind.

DO you want to earn more money? "Tell it to Sweeney." Read page 18.

FREE catalogue. Automobile Instruction Books. Nelson Book Co., Barton, Vt.

FORD owners wanting five electric lights using Ford magneto and storage battery (self-contained system), write American Battery Company, 1129 Fulton St., Chicago.

AUTOMOBILE Instruction. A complete home study course that shows you exactly what you want to know about the automobile. 220 page book giving definite, thorough, authentic and practical detailed information about every part of the automobile as well as thorough instruction in regard to driving, repairing and general care of the complete car. 190 illustrations, \$1.50 postpaid. Popular Mechanics Book Dept., 318 W. Washington St., Chicago.

MUST sell my Reo five passenger touring, elegantly equipped and perfect in every way. \$175. Dr. Spillane, 248 East 119th St., New York City.

AUTOMOBILES. I have all makes on my list, runabouts, \$50 up; Touring Cars, \$75 up; all guaranteed and shipped freight prepaid, send for my list before purchasing. P. King, 213 West 125th St., New York City.

350 **AUTOMOBILE** and Motorcycle Tours. Illustrated; Ideal Trips; best roads in each state; 50 maps; complete road directions. 15c postpaid. Address "Motor Tours," 51 Chambers St., New York City, N. Y.

AUTOMOBILE SUPPLIES

MAKE Your Dollars \$\$ Have Cents. \$150 rear axle, \$45.50; \$50 wind shields, \$10; wheel, \$2.50; transmission and clutch cost \$200, sell \$75; silk mohair tops \$10 each, complete. Send for real bargain list. Puritan Machine Co., 51-57 Tenth St., Detroit, Mich.

VULCAN Guaranteed Casings, 28x3, \$8.35; 30x3, \$8.90; 30x3½, \$13.20; 31x3½, \$13.70; 32x3½, \$14.70; 34x3½, \$15.40; 36x3½, \$16.55; 30x4, \$18.90; 31x4, \$19.60; 32x4, \$20.35; 33x4, \$21.10; 34x4, \$21.85; 35x4, \$22.50; 36x4, \$23.50; 34x4½, \$25; 35x4½, \$26; 36x4½, \$27; 36x5, \$30. These are brand new guaranteed tires and are not factory seconds which are sold at the same identical prices that we sell these guaranteed Vulcan Tires for. Order today. Carlisten-Williams Co., 22nd St. and Michigan Ave., Chicago.

NICKEL plate your Auto trimmings. No battery, just a wet cloth, one box to a car. Guaranteed to last. Order today. \$1 prepaid. Leitner Company, 3211 North Ave., Chicago.

TUBE vulcanizers postpaid \$1.35. Satisfaction guaranteed. Vanderpools, Springfield, Ohio.

CLEAR the road with one of our Electric horns. Operates on dry batteries or storage. \$5. Leitner Company, 3211 North Ave., Chicago.

FOR Sale. Two cylinder 12 H. P. Air cooled Holsman opposed gasoline engine complete and in good condition, \$40. Also 20 H. P. White compound steam engine, \$40. 4½ H. P. Locomobile steam engine, \$10.00. Locomobile steam car parts and repairs. 1423 North Ave., Bridgeport, Conn.

A **FORD** Valve Grinder will grind valves without removing cylinder heads. Automatic rotating motion. Attached in a moment. Fully guaranteed. Write for price. J. H. Wall, Bristol, R. I.

HOW "Fibrovac," the new liquid Automobile tire filler, is made. See "New, Original Valuable Trade Secrets," Miscellaneous column.

CARBURETORS, magnetos, automobile supplies, great bargains. Get bulletin 12. Automobile Appliance Co., 1716 Michigan Ave., Chicago.

OLD Tires look like New with rubberized tirepaint. Formula 50c. Big profits selling it. Chemist, 3125 Washington, Kansas City, Mo.

WELDING of cylinders, axles, crankshafts and all metal parts. Becker & Shoemaker, Elmira, N. Y.

TWO cylinder auto steam engine. Tonkin boiler, copper tanks, A1 condition. C. C. Spence, Weyson, Miss.

YOUNGS' Kerosene Burners fitting Mobile 1903 Steam Cars. \$85.00 reduced to \$20. Fey Specialty Company, Detroit.

AVOID accidents. Dim-a-light, the new device for controlling the glare of electric headlamps. Pellets Magneto Exchange, 1463 Michigan Avenue, Chicago, Illinois.

KEROSENE For Automobiles—Our new Model B. uses successfully half and half mixture lowest grades kerosene and gasoline. Satisfaction guaranteed or money refunded. Greatly increased power, very slow speed on high. Starts easy at Zero. Special Agents' prices. Dep't. P. M. The Air-Friction Carburetor Co., Dayton, Ohio.

BIG money vulcanizing at home. Easy learned. Book 25c. Vanderpool's, Springfield, O.

CYLINDER Rebored including Piston and Rings. \$7 to \$11. Sterling Eng. Co., 321 S. Clinton, Chicago, Ill.

NEW Pressed Steel Frames, 34x163", each \$10. Automobile boilers bought, sold and repaired. New 3 ton chassis and wheels. \$100. Lucas & Son, Bridgeport, Conn.

TIRES. New, Standard Makes. 28x3—\$7.20—Tube, \$2.30; 30x3—\$7.05—\$2.40; 30 x 3 1/2—\$11—\$3.50; 32 x 3 1/2—\$12—\$3.60; 34x4—\$17.25—\$4.75. Other sizes, prices accordingly. Write for complete catalog. 10% with order. Balance C.O.D. Examination allowed. Para Auto Tire Co., 1417 Michigan Ave., Chicago, Ill.

TOOLS and Tool Chests, and Other Tools, for the autoist, shop and home—are listed and described in the Tool Monger, a 390-page catalog mailed on receipt of 6c in stamps. Montgomery & Co., 105 Fulton St., N. Y.

"WAVERLEY shaft drive electric chassis and batteries. Bargain price." Address Box 35, Industrial Bldg., Indianapolis, Ind.

STEAM auto boilers bought, sold and repaired. J. L. Lucas, No. 2 Fox St., Bridgeport, Conn.

MOTORCYCLES AND BICYCLES

GUARANTEED Goodrich Studded Motorcycle tires, 28x2 1/2 casings, \$6.80 and 28x 2 1/2 inner tubes \$2; also 28x2 1/4 casings, \$7.50 and 28x2 1/4 inner tubes \$2.25. These tires are brand new guaranteed stock and the number we have on hand is limited. Order to-day. Carlsen-Williams Co., 22nd St. and Michigan Ave., Chicago, Ill.

THE Ernst Sales Company, 312 West Madison St., Chicago, has a list of all the motorcycle and bicycle manufacturers of the United States. To any one who really intends to make a purchase they will send interesting information.

MOTORCYCLES Cheap. Big clearance sale of new and second hand machines, ask for list "M" just out. American Motor Co., 2724 Michigan Ave., Chicago, Ill.

BARGAINS. Indians, Excelsiors, Harleys, Thors, \$75 and up. Write at once. Stauber, 1013 Montrose Boul., Chicago.

CENTURY Bicycles equipped with Mud Guards, Coaster Brake, etc. \$23.50. Weis Bicycle Co., La Crosse, Wis.

\$45 TAKES Reading Standard, perfect condition guaranteed, compulsory sale. Moore, 826 Boulevard, Akron, O.

MOTORCYCLE attachment for bicycle for sale. Perfect order, 2 1/2 H. P., \$25. F. Cleaver, Palm, Pa.

WANTED—Second hand motorcycles for cash. Send description and lowest price. Harry R. Geer Co., 888 McLaren Ave., St. Louis, Mo.

BARGAINS in Motorcycle Supplies and slightly used motorcycles. I can save you money. Write for particulars. Jewell E. Pierce, Magnolia, Miss.

1912 MERKEL twin, almost like new. Send for description, \$195. Lewis Becker, Atlanta, N. Y.

THOR 1913 chain drive, \$105. Act quick. Burkhart, 3211 North Ave., Chicago.

A-B-C of the Motorcycle—250 page "Show How" book for owners and operators of motorcycles. Fully illustrated, cloth binding. Price \$1, postpaid. Popular Mechanics Book Dept., 318 W. Washington St., Chicago.

5 H. P. MARVEL \$120. New 1912 4 h. p. Yale \$150. New 1912 5 h. p. Yale \$200. New 5 h. p. Pierce \$150. 4 cylinder Pierce \$175. 1910 6 h. p. Merkel \$140. Indian \$45. Thor \$50. Stenger. No. 902 Vine St., Cincinnati, Ohio.

A SNAP—Best offer over \$125 takes late 1912 Yale battery single. Absolutely perfect condition. Run less than 500 miles. M. P. Woodward, Coldwater, Mich.

\$145 BUYS a 1912 Monarch 5 h. p. single. Powerful, speedy. First class condition. Run less than 1000 miles. Glen A. Bechtel, Coldwater, Mich.

FOR sale: Slightly used Yale Single. Best offer takes it. L. J. Myers, Mansfield, O.

TANDEM Attachment \$4. Just what you want. Anderson's Motorcycle Store, Batavia, Ill.

7 H. P. CURTISS \$75. R. Classen, 709 N. 57th Ave. W., Duluth, Minn.

USED Motorcycle Bargains—Harleys, Indians, Thors, Pierce, Yales, Reading, Standard, New Era. Dependable machines at lowest rates for quality. All motors overhauled. Price list upon request. Best selections going now. Seeber & Hofheims, 704-706 Main St., Buffalo, N. Y.

3 H. P. WAGNER Motorcycle Engine \$28. Send stamp for reply. Sisson, Robinson, Ill.

RIDERS Avoid accidents by buying our Mirrorscope Goggle and see everything behind you without turning around. \$1.35 each. \$1.35. Send for list of other specialties. The B-L Sales Co., Dept. A. 53 W. Jackson Boul., Chicago, Ill.

FOR Sale. 1912 Indian Twin \$150. 1911 Excelsior Twin \$135. 1912 Magneto Harley single \$135. Battery Indian \$85. All excellent condition. Arthur Henderson, Crown Point, Ind.

MOTORCYCLE magnetos: New imported U. H. single-cylinder, \$15. Automobile Appliance Co., 1716 Michigan Ave., Chicago.

\$125 BUYS Pierce Single 5 H. P. Slightly used condition. Guaranteed. \$75 Buys Pierce Four Cylinder 7 H. P. 2 speed. Multiple disc clutch. Big bargain. Perfect condition. Satisfaction guaranteed. Seeber & Hofheims, 704-706 Main St., Buffalo, N. Y.

BICYCLE Tires 28x1 1/2 Cactus, puncture proof, self-healing, three in one tire, \$4.85. Delivered free U. S. Sample 5c. McDougald, 1118 N. Clark St., Chicago, Ill.

\$125 BUYS my M. M. motorcycle, magneto model, 4 horsepower, speedometer, prest-o-lite. Otto Finster, Clinton, Wis.

MOTORCYCLE, Pope 1912, used six times. Has tandem and carrying attachment. \$150. McDougald, 1118 N. Clark St., Chicago.

SALE or Exchange for motorcycle, New Job Printing Outfit, cost \$85. Raymond Jones, Westboro, O.

FOR Sale. Indian twin. Cheap. Write Maurice Hull, Marshalltown, Ia.

MITCHELL Motorcycle. Good order, \$35. Box 275. Burlington, Wis.

1911 5 H. P. Indian. Price \$100. Arthur Porter, La Salle, Ill.

BICYCLES \$5, \$7.50, \$10, up. Good tandems, \$10. McDougald, 1118 N. Clark St., Chicago.

BARGAINS in unused machines. E. F. Cavanah, Sibley, Ill.

FOR sale cheap, or trade. Excelsior motorcycle. Mechanically perfect. Geo. Dillingham, Gray, Oklahoma.

MOTORCYCLE Manual—Construction and operation of a motorcycle fully described and illustrated; complete trouble chart; 125 pages; cloth bound, 50 cents postpaid; paper covers, 25 cents. Motorcycle Manual, 51 Chambers Street, New York.

200 MOTORCYCLES, Standard makes guaranteed for season, \$50, \$175. Accessories: heavy carrier, \$3; headlight, \$3.50; Speedometer, \$10; tires, \$5. Chicago Motorcycle Works, 738 Sheridan Rd., Chicago.

MOTORCYCLES and Bicycles 1/2 price: over 100 best makes. Motorcycles \$50 to \$150; bicycles \$5 to \$25. Get list today. Brown Music Co., 9119 Commercial Ave., Chicago.

WE want you to have our 1913 Motorcycle Supply Catalog. Ask for Catalog 14. Give the name of the motorcycle you ride and ask for the Yellow Sheet. Save money by getting acquainted with us. Saufley Supply Company, Kansas City, Mo.

MOTORCYCLES, all makes rebuilt, guaranteed good as new. Indians, Harleys, Excelsiors, Readings, Kultures, Merckels, \$25 to \$100. Tires \$3 to \$6. Buy direct. Save dealers' profits. Deninger Cycle Co., Rochester, N. Y.

BICYCLE Tires. We will send a pair of our guaranteed Aladdin Bicycle Tires by Parcel Post upon receipt of \$4.50. Sample section for 2c stamp. Illustrated circular free. Aladdin Rubber Works, 112 W. Market St., Indianapolis.

BIG bargains in second-hand motorcycles, \$25 up. Indians, Harleys, Thors, Excelsiors and Merckels. Write for descriptions. Howard A. French & Co., Baltimore, Md.

I HAVE all makes on my lists from \$20 up, all guaranteed and shipped freight prepaid, send for my large illustrated list before purchasing. P. King, Automobile Broker, 217 West 125th St., New York City.

BIG bargains in good motorcycles we have taken in exchange on new ones. Send for special bargain list. Shaw Mfg. Co., Galesburg, Kansas.

DON'T buy a Bicycle Motor Attachment until you get our catalog and prices. Shaw Mfg. Co., Dept. 27, Galesburg, Kansas.

AERONAUTICS

NEW Aeroplane Propeller. Delivers the goods. Highly efficient, exceptionally strong, beautiful design. Write for catalog, showing 6 different styles. Do it today. Address nearest office, Double Stamp Propeller Co., 528 So. Ashland Blvd., Chicago, Ill., or Evansville, Ind., "Dept. A."

COMPLETE Plan, drawn to scale, with concise instructions for building a 3 foot Nieuport Monoplane, 25c. Other Plans: Bleriot, 15c; Wright, 25c; Curtiss, 35c; "Cecil Peoli" Champion Racer, 25c. Set of five, \$1. 40 pp. Model Supply Catalog, 5c. Ideal Aeroplane Co., 82 1/2 West Broadway, N. Y.

AERONAUTICAL Supplies—W. & M. specialties, wire strainers, clamps, eye-bolts, etc. Pamphlet Amco, on application. Aeromotion Company, Wright Bldg., St. Louis. Exclusive agents Gnome motors.

LEARN to fly at the most competent Aviation School in the United States. Write immediately for special offer. I. J. Ebert, Box 57, Oak Park, Ill.

BARGAINS—30, 50, 75 horsepower motors, aeroplanes, hydroaeroplanes. Patterson, 986 Trumbull, Detroit.

BAMBOO, cloth, wire and plans for Demoselle Monoplane \$20. R. Goslow, Gaylord, Mich.

30 H. P. for Aero to sell. Arnold Morin, % Canadian Glass Co., Montreal.

BUILDING and Flying an Aeroplane—100-page handbook covering the building of small models, and full sized gliders and machines. In both biplane and monoplane models the well-known Curtiss and Bleriot types are followed. Fully illustrated with detail drawings. Price, \$1 postpaid. Popular Mechanics Book Dept., 318 W. Washington St., Chicago.

HOW To Make a Biplane Glider—Our book "Amateur Mechanics No. 2" contains a complete detailed description of how to make one. Price of book, 25c postpaid. Popular Mechanics Book Dept., 318 W. Washington St., Chicago.

BETH'S patented Biplane-Kite. Excellent Flyer. Closely resembling Standard Flying Machines. Material and minute instructions and drawings \$1, prepaid. Instructions and drawings (without material) 25 cents. Dealers write Otto Beth, Lynbrook, N. Y.

GREY Eagle Motors, new and used. See ad on page 154 for the new Kemp motors. Kemp Machine Works, Muncie, Ind.

REVOLVING Wing monoplane which is absolutely new in knock down form. Send \$5, price \$8, plans, 30c. C. Zickler, Route No. 29 C, Yonkers, N. Y.

BICYCLE Monoplane drawings 30c. Thomas Hofmeister, Overlea, Maryland.

AERIAL AGE magazine sample for ten cents stamps. Address: 132 Auditorium, Chicago.

CHICAGO Aero Works, 143 N. Wabash Ave. Catalog for stamp.

BUY right, at prices right. Get the world's greatest aeronautical catalogue. Sent anywhere for 6 red stamps. Heath Aerial Vehicle Co., Chicago.

BLACKSMITHS

BLACKSMITHS—Learn hand-wrought ornamental ironwork. Our 200-page book "Hand Forging" points out clearly all the guiding principles and methods which underlie all forge work. Written by a practical authority. 122 illustrations, cloth, \$1 postpaid. Popular Mechanics Book Dept., 318 W. Washington St., Chicago.

SHOP Notes—Many valuable kinds for blacksmiths are contained in our series of Shop Notes books, 9 volumes, 50c each postpaid for \$4.50 per set prepaid. Popular Mechanics Book Dept., 318 W. Washington St., Chicago.

BLACKSMITHS—Here is your opportunity to be an expert blacksmith without help as life is short. Try Toy's Modern Methods doing hard jobs easy. Forging and welding all kinds of steel solid, and tempering and hardening all tools to a standard by colored charts. This is real information, not theory. All for one dollar. Send for free samples. W. M. Toy, Sidney, Ohio.

BOOKS AND PERIODICALS

HITTING The Bull's-Eye in reading. Don't buy a book till you know it is what you want. We loan you by mail books you may either buy or return. We plan your short reading courses free. Everybody gets personal attention. Self-help; business; health; recreation; house and home; agriculture; economics and social problems; religion; new thought; books for writers and speakers, etc. Standard books only. Ask for lists and Library Critic and state subjects in which interested. Oriental Esoteric Library, 119, Washington, D. C.

WRINKLES—By Starbuck. 160 pages of practical plumbing information. Tricks in pipefitting—methods of lead working—joint wiping—coils—water backs, etc. \$1 postpaid. Woodard Bros., Des Moines, Iowa.

NEW Book, "Jane," 10c. Catalog of books and den pictures free. Bond Pub. Co., A 5, Columbus, O.

LATE Flash Song Book for a 2c stamp. Antlers, 322 Royal St., New Orleans, La.

"THREE Sisters," 25c. Catalogue for stamp. Duff, 2713 Mozart, Chicago.

BOY'S Book of New Inventions—A story of the adventures of a boy who went to the workshops of inventors, aviators, electricians, and photographers accompanied by a scientist to explain things. Told in a fascinating way and deals with wireless telegraphy, aeroplanes, photography, motion pictures, etc. Price \$1.60 postpaid. Popular Mechanics Book Dept., 318 W. Washington St., Chicago.

2,000 SELECTED Pictures for \$2. A Panorama of World Events, Political—Industrial—Social—Humorous—Tragic—all of intense human interest. An "Instant history of the year 1912." Twelve numbers of Cartoons Magazine for 1912 bound in 2 volumes of six numbers each, representing the best work of over 100 of the best cartoonists, will be sent prepaid for \$2, or either volume for \$1. Cartoons, 318 W. Washington St., Chicago.

GAS for power is taking the place of steam for reasons of economy. Learn all about this great change by reading our new non-technical book on this subject, written by a first-class authority for the practical man. 192 pages, profusely illustrated, cloth binding. Price, \$1 postpaid. Popular Mechanics Book Dept., Chicago.

FOR Sale—Copies of the August, 1912, number of Popular Mechanics Magazine containing the complete articles on the Seven Wonders of the Modern World as selected by an international poll of the greatest Scientists. Price, 15c per copy, postpaid. Popular Mechanics Co., 318 W. Washington St., Chicago.

"METAL Spinning" is the name of the only book published on this interesting art. A concise working manual both for those who desire to spin metal as an art recreation and to follow this work as a trade. 80 pages. 33 illustrations. Price, 50 cents postpaid. Popular Mechanics Book Dept., Chicago.

BACK Numbers of Popular Mechanics Magazine—We can supply the regular monthly issues of this magazine as far back as January, 1911, for 15 cents a copy postpaid. Popular Mechanics Co., 318 W. Washington St., Chicago.

DIETERICH'S 50 Perpetual Motions. Tells all about Perpetual Motion, illustrates 50 different forms. Tells about Patent Office Practice in regard to same. Very interesting. Sent by mail postpaid on receipt of 25c, coin or stamps. F. G. Dieterich, 662 Guray Bldg., Washington, D. C.

MECHANICAL Kinks and Steel Tempering Book (new edition) and Mechanical Digest one year; special offer, 25c. Mechanical Digest, Grand Rapids, Mich.

OVER 100,000 Industrial Facts, receipts, calculations, etc., in every business. A \$6 book prepaid \$2. Elite Book House, Box 3, Station A., Boise, Ida.

FASCINATING books and den pictures. Profusely illustrated catalogue 2c stamp. Curtis Co., L3, Englewood, Chicago.

GAS Engine Troubles and Installation. Cloth, \$1; flexible leather, \$1.50; Automobile Troubles and How to Remedy Them. Cloth, \$1; leather, \$1.50. Eight other practical and reliable mechanical books. Send for circular. Chas. C. Thompson Co., Dept. C, 1126 S. Wabash Ave., Chicago.

MECHANICAL Books, 500 titles. Send for circulars. Proctor Book Co., 559 W. Lake St., Chicago, Ill.

BUILD yourself a boat. A racing cat or speed launch. Send for catalogue. Yacht and Boat Building Books, Rudder Publishing Co., 2½ Hudson St., New York, New York.

ENGINEERS' questions and answers for license, by Hobson, for twenty-five cents, postpaid. Send stamps. Reilly's Book Store, Philadelphia, Pa.

DON'T fail to read Independence and Fortune under Business Opportunities.

READ "The Widow," 10c. Catalogue other books and pictures free. Gem 3 Co., Ypsilanti, Mich.

EDUCATIONAL AND INSTRUCTION

FREE illustrations beautiful art casts, interior, exterior decorations, garden furniture, statuary, with particulars of instructions in mixing and casting Concrete, Plaster, Artificial marble, composition, Paper-mache, Marble dust, etc. (ornamental form). Making elastic and rigid moulds, casting from life, stuccoing frame buildings, modeling, coloring, gilding, burrishing. Mahler, 117 Russell St., Brooklyn, New York.

YOU can earn the best business education, including one year in New York City. Whole or part time. Situations guaranteed. Institute of Business Engineers, 2213 Singer Building, New York City.

"BEAUTY Secrets"—Private instructions. Published to sell for \$1.00. Now 10c. Winslow W. Chase, Dept. 104, Washington, D. C.

BOOKKEEPING or shorthand, easy to learn, low cost, easy terms, catalog free. Brown's Correspondence School, Freeport, Ill.

HEALTH and Success for You if you follow advice given in two 72-page booklets which we will send you upon receipt of six two-cent stamps and the addresses of five young men likely to be interested in them. Interesting circulars free upon request. Address, Success Supply Co., 1416 Market St., Hannibal, Mo.

UNCLE Sam is a liberal employer. Qualify for a Government position. We prepare you by mail for any Civil Service Examination. Write today for free Booklet 32. Capital Civil Service School, Washington, D. C.

\$25 CROSS Real Estate Course, \$1. Guaranteed. 36-page prospectus, testimonials, etc., 4c. Healy, K-1491 Wall, Joplin, Missouri.

"HOW to make Printing Cuts"—Neatest rubber stamps, 25c. Publisher, 49 Clinton St., Albany, N. Y.

THE Seven Wonders of the Modern World—What are they? Do you agree with the selection resulting from the international poll of greatest scientists taken by Popular Mechanics Magazine? The complete result of this vote showing the selection of the wonders together with a historical sketch of each one reprinted in pamphlet form mailed to any address for 10 cents in stamps. Popular Mechanics Co., 318 W. Washington St., Chicago.

YOUNG Man! Learn Drafting—one of the most practical subjects of study to-day—indispensable in many occupations—engage in individual study successfully with the aid of our new book, "A Practical Course in Mechanical Drawing." 160 pages, 157 drawings, cloth, 50 cents, postpaid. Popular Mechanics Book Dept., 318 W. Washington St., Chicago.

MATHEMATICS made easy for all by Ropp's Calculator. Figures out, in the twinkling of an eye, every conceivable problem that occurs in the Office, Store, Shop, Bank, Farm or Factory. Greatest time and labor-saving work on figures in the world. Copyright 1912. Price, \$1. Vest pocket size, 50c. Popular Mechanics Book Dept., 318 W. Washington St., Chicago.

WOOD-Working for Amateur Craftsmen—128-page book, profusely illustrated, giving every essential step in wood-working. Valuable for either self-instruction or for use in manual training courses. Cloth, 50 cents, postpaid. Popular Mechanics Book Dept., Chicago.

OSGOODBY'S Phonetic Shorthand improved correspondence course by world's greatest court stenographer, makes beginners and ordinary stenographers experts. Booklet M free. Osgoodby School Stenography, Rochester, N. Y.

DO you need help? Questions answered on chemistry. Formulas. Guaranteed. Frederick Wirthman, chemist, 3125 Washington, Kansas City, Mo.

HOW to make Rubber Stamps, and 150 Formulas 20c. P. S. Bureau, 4333 N. Sawyer Ave., Chicago.

CROSS Real Estate Course \$3. George Winstel, 1624 Pleasant St., Cincinnati, O.

DO you want to earn more money? "Tell it to Sweeney." Read page 18.

LEARN Auctioneering by mail, make big money for a few minutes selling. Omar System Auctioneering, Box 72 B., Attica, Ind.

IN connection with your clerical work we show you how to earn \$10 to \$15 per week and hold your position besides. No canvassing. We, as manufacturers of patented specialties, have new, easy mail order plans that can be carried on in your own home to keep the factories busy. Large profits. Small capital. If you are one of the want-to-go-ahead kind write today for catalogue (copyrighted), plans and sworn statement. J. M. Pease Mfg. Co., 555 Pease Bldg., Main St., Buffalo, N. Y.

YOU can write 100 words a minute without knowing Shorthand. My new method. Abbreviated Longhand, simpler than the simplest shorthand, tried and approved by thousands. Your money back if not delighted. Sample lesson 20c. Full particulars free. Write today. A. B. Weaver, Court Reporter, Dept. C., Buffalo, N. Y.

DON'T fail to read Independence and Fortune under Business Opportunities.

TRADE SCHOOLS

MAKE \$5 to \$8 a day as skilled Electrician, Plumber, Draftsman, Moving Picture Operator. We teach you in short time at small expense, profitable trades. Free employment bureau places graduates in good jobs. Special limited offer now. Write at once for catalogue and full particulars—no obligations. Dept. 8195, Coyne National Trade School, 51 E. Illinois St., Chicago, Ill.

WOLVERINE Automobile College, 940-2 Jefferson Ave., Detroit, Michigan. Send for catalogue of the best equipped and most successful institution in the country.

DO you want to earn more money? "Tell it to Sweeney." Read page 18.

DRAW Large Salaries. Interior Decorating successfully taught by correspondence. Practical work. Kalamazoo School of Interior Decoration, Dept. A, Academy of Music, Kalamazoo, Mich.

SELF-Setting Planes on trial. Gage Company, Vineland, New Jersey.

\$35 PAYS for a complete, unlimited, practical course in automobile driving and repairing. We have the best equipped school and most up-to-date shop in Chicago. Guarantee satisfaction or will refund your money. Day and evening classes. Call or write Dept. 1, Academy of Automobile Engineering, Calumet 4707, 1452 Michigan Ave., Chicago.

AUTOMOBILE School. You learn with your hands under the superintendence of the best instructors obtainable at the Chicago School of Motoring. Write for particulars. The F. E. Edwards Automobile School & Motor College, Dept. B., 1429 S. Wabash Ave., Chicago, Ill. Phone Calumet 3684.

MAILING LISTS

FREE to business men, copy of our comprehensive "Silent Salesman." Contains over 2000 different classifications of Mailing lists with number and price of each list, and information every business man needs. Accept this free offer. Trade Circular Addressing Co., G 164½ W. Adams, Chicago.

TO MANUFACTURERS

WANT to represent some concern this territory. Box 298, Ft. Worth, Texas.

COLLECTIONS

COLLECTIONS—Bad debts collected everywhere. No collection, no charge. American, Vancouver Mercantile Agency, 336 Hastings St. West, Vancouver, B. C.

CLAIMS; all kinds, collected anywhere. Fidelity Credit Co., Richmond, Va.

PICTURES AND POSTCARDS

CARDS of Notable and Historic places in Ireland, England, Scotland, Catalog and sample card, for 5 cents, stamps, any country. Strain, The Lighthouse, Belfast, Ireland.

POSTCARD collecting is great fun. Have friends everywhere. Receive cards from all countries. Your name inserted free in big exchange list if you send 10c for 4 months subscription to our 24 page magazine. Elite Exchange, R. 12, 3827 N. 44 Ct., Chicago.

TEN Chicago views, big card lists. Sample copies, magazines, papers, etc., 25c. Thrift, 336 So. Sacramento Blvd., Chicago, Ill.

50 POSTCARDS of the San Francisco Fire and Earthquake, 25c. postpaid. Hardy's Bookstore, Oakland, California.

PHOTOS—Nifty ones. 10 for 25c. Duff, 2713 Mozart, Chicago.

2,000 SELECTED Pictures for \$2. A Panorama of World Events. Political—Industrial—Social—Humorous—Tragic—all of intense human interest. An "instant history of the year 1912." Twelve numbers of Cartoons Magazine for 1912 bound in 2 volumes of six numbers each, representing the best work of over 100 of the best cartoonists, will be sent prepaid for \$2, or either volume for \$1. Cartoons, 318 W. Washington St., Chicago.

POST Cards. Photographic Views of Episcopal Churches in New York and Brooklyn, 5 cents each. Send for my list of more than fifty subjects, including exterior and interior views of Cathedral of St. John the Divine. A. Moore, 588 Throop avenue, Brooklyn, N. Y.

BROMIDES, life-color photos, fascinating beauty poses, entrancing mademoiselles, imported, 5—25c; 12—50c. Landsman, 1380 Prospect Ave., New York.

PHOTOGRAPHIC Post Cards, 1000—\$12. 500—\$6. Homer Howry Co., 424 S. Broadway, Los Angeles, Cal.

FRENCH Kook Post Cards—Something funny! Set of 6 "curtain raisers" for 10c. Postpaid. O. K. Pub. Co., Decatur, Ill.

PHOTOS—"Pretty girls." 24 beauty poses 10c. 50 for 20c. Curtis Co., J. Englewood, Chicago.

POSTALS—Just Girls; 10 nifty poses 10c. 30—30c. Bailey, 110 Maple, Napanoch, N. Y.

10 DIFFERENT Exposition Post Cards, 10c Postpaid. Exposition Mail Order Co., Box 2446, San Francisco, Cal.

IMPORTED Photos—Enchanting poses, Classy, appeal to lovers of beauty. Six for 25c. Photo Artist, Box 844, Colorado Springs, Colo.

FLOOD Souvenir, Membership, and Magazine, 10c. Globe Exchange, New Haven, Conn.

ALICE, illustrated, and 4 nifty poses, 12c. S. Wra, Longbeach, Calif.

18 NICE postcards 15c. 35-25c (coin) postpaid. Billie Dutton, 702 W. Markham St., Little Rock, Ark.

CARDS exchanged for results. 10c membership. Pacific Card Exchange, Bryn Mawr, Wash.

5 SPORTING Postcards, 10c. Miss A. A. Banner, Station "R," N. Y. City.

IF you really want to exchange post cards, try our splendid club. Lists circulate in many countries. Membership, 10c. Halcyon Club, Box 133, Erie, Pa.

OUR members in Norway, Switzerland and everywhere would like to exchange cards with you. Membership 10c. International Post Card Exchange, 2917 Washington Blvd., Chicago, Ills.

YOU'LL get cards from everywhere. Membership 10c. Idaho Card Exchange, Dept. K, Box 906, Boise, Idaho.

FOR EXPERIMENTERS

WE build and make finished parts for machines, experimental and electrical apparatus; also tools, gear wheels and brass castings. Prices reasonable. Precision Machine Shop, 1030 North Meridian St., Indianapolis, Ind.

CAMERAS AND PHOTO SUPPLIES

LEARN Transphography—Make money reproducing beautiful colored transparent photographs on watch cases, dials, china-ware, glass, etc. with transpairo. Cost to make 1c. Sell \$2. Knowledge of photography unnecessary. Sample bottle. Formula and instructions 25c. Two new processes included free. Circular 2c. E. Greenhaigh, 816, 58th, Brooklyn, N. Y.

AN Opportunity—Save money buying your developing papers and postals direct from the manufacturer. Nothing equals Instanto quality. Send 25c for three sample dozens, prepaid, prices and directions. The Photo Products Co. (Dept. J) 6100 La Salle St., Chicago.

COLOR photographs true to nature with Tokio transparent colors. It's easy. Outfit and instructions 25c. Sample colored picture 10c. Butterworth Bros. 89 Wallabout Street, Brooklyn, N. Y.

LEARN Photo Tinting—For pleasure and profit. Fascinating occupation for spare time. Any one with artistic leanings can quickly learn to do marketable work. Write for free booklet. Keil-Burr Co., 56-58 Pine Street, New York City.

DEVELOPING and Printing of Quality. Trial order—Any size film developed and printed 25c. Rex Studios, 60th and Girard Ave., Philadelphia.

FILMS Developed, 10 cents roll. All prints 3 cents, first order. Two negatives printed free as sample. V. Paddock, Ashton, Ill.

PEERLESS Folding Dark-Room. Stop sending out films, and wasting money. Peerless eliminates all discomfort of ordinary darkroom and serves all its purposes. Operation visible. Illustrated pamphlet free. Masko Mfg. Co., Box 533-B, Indianapolis, Ind.

FOR Sale—5x7 view camera, tripod, suit case style, carrying case, six double plate holders, Goerz Dagor lens, Multi-Speed Shutter, Reducing back postcard size, with one double plate holder for same. Outfit cost \$125. Best offer over \$80 takes it. Boyce & Irvine, Boonville, Mo.

AMATEURS—Do you want the best grade of developing and finishing? Guaranteed permanent results; quickest returns. Films developed any size 10c. Prints 2 1/4 x 3 1/4, 3c; 2 1/2 x 3 1/4, 3 1/2 x 3 1/2, 3 3/4 x 4 1/4, 4c; 3 1/2 x 5 1/2 or 4 x 5, 5c; on Post Cards, 5c. J. A. Roden, 145 East 61st St., Chicago.

"TRIM SQUARE" Photo Print Marker, indispensable for squaring prints before trimming. Circular free. Flexible Ruler Co., Buffalo, N. Y.

NEW Color Photography. Amateurs, print your landscape views in colors. Send 2 cent stamp for particulars. Address Rud Isenmann, 385 Bergen St., Newark, N. J.

TWELVE Prints any size 25c. 6 exposure films developed and 6 prints 25c. California for results. Homer Howry, 424 S. Broadway, Los Angeles, Cal.

MAKE Magic Disappearing Photos (disappear, then reappear), latest Money-Maker. Also photos on watch cases, china-ware, sofa pillows, leaves, etc. "Beautiful Effects." Particulars free. P. Benson, Stewartville, Minn.

PHOTOGRAPHIC Post Cards from your films. 4c each, 30c dozen; prints same price. Films developed 10c. Careful workmanship. Prompt service. Samples free. Fred S. Marvin, Kane, Penna.

CAMERA users, send three negatives for free prints. Roll or pack developed free if you send 25c for six pictures from same. Vanphoto, Winona, Minn.

SELL Your Photographs to magazine editors. Send dime for detailed requirements and prices paid by 37 publishers. A. S. Dudley, Photographic Expert, Box 7750, Philadelphia.

FREE—Dozen postals from your negative, with every \$1.50 order. Photographic finishing. Erhard Westman, St. James, Minn.

ROLL films developed, 10c. Printing Post Cards, 3 cents each. 15 years' experience. Send for complete price list. F. C. Hoyt, Sac City, Ia.

THE Kamera Shop, 179 Auditorium, Chicago, offers good developing and printing by mail. Prove our quality, send any six exposure roll with three dimes for developing and six velvet prints. Booklet free.

BIG Money Saved on Photographic Lenses and Apparatus—goods exchanged; repairing done. Ralph J. Golsen, 65 East 46th Street, Chicago, Department P.

KODAK Films Developed, 10c per roll, any size. Prompt attention given mail orders. Prints 2 1/4 x 3 1/4 to 3 1/4 x 4 1/4, 3c; 4x5 to 3 1/4 x 5 1/2, 4c. J. M. Manning, Box B, 1062 Third Ave., New York City.

PHOTOGRAPHS wanted by publishers. I'll find a buyer for all prints I deem worthy of publication. Send your name on a postal for leaflet of instruction. A. S. Dudley, Photographic Expert, Box 775 G, Philadelphia, Pa.

PHOTOS copied on Post Cards, Lockets, Stamp Photos. Samples and Illustrated Catalogue 4 cents. Westlake Co., Brooklyn, N. Y.

WE buy, sell and exchange, Bargains in Microscopes, Telescopes, Binoculars, Cameras, etc. Bargain list sent. Kahn & Son, Opticians, No. 54 John St., New York. Established 62 years.

MONEY in Photography. I start amateurs making money at home taking portraits; become professionals. Studio secrets, retouching, etc., fully explained. Wells' Studio, East Liverpool, Ohio.

MOTION PICTURES

WRITE Moving Picture Plays, \$10 to \$100 each. Constant demand. Devote all or spare time. Experience, literary ability or correspondence course unnecessary. Details free. Atlas Publishing Co., 304 Atlas Bank Bldg., Cincinnati, Ohio.

MOTION Picture Work—A large 618-page book covering every phase of the moving picture, its production and its theatre. Indispensable for reference and instruction to the thousands of workers in the motion picture field. Price \$4, postpaid. Popular Mechanics Book Dept., 318 W. Washington St., Chicago.

LEARN to write photoplays and make big money. Producers pay from \$25 to \$100. Easy to learn. Great demand. Ours the only school whose instructor is a successful photoplaywright. Catalog free. Authors' Motion Picture School, Box 130K, Chicago, Ill.

EASY Payments—Moving Picture Machines, standard size. Others, \$5 to \$40, and all moving picture apparatus. Catalogues. Ralph J. Golsen, Department M, 65 East 46th St. Chicago.

WRITE and Sell Motion Picture Plays. Book tells how. Used as text by school. 25c. Play Brokerage, Fostoria, O.

MAKE \$50 to \$100 weekly writing Photoplays. Experience unnecessary. We explain how. Particulars free. Writers' Syndicate, 860A Monadnock Block, Chicago.

MOTION picture plays wanted. You can write them. We teach you by mail. No experience needed. Big demand and good pay. Details free. Ass'd M. P. Schools, 601 Sheridan Rd., Chicago.

FOR ADVERTISERS

5,000 PAPER Drinking Cups, printed, \$1.80 per M. Yarroll, New Britain, Conn.

YOUR 30 word ad in our 24-page postcard magazine 15c. Display 50c inch. Elite Exchange, 3827 N. 44th Court, Chicago.

BARGAIN Advertising Rate—Just to get acquainted. 15 words, one insertion; guaranteed 13,000 copies printed, and one year's subscription, 25c. Digest, Grand Rapids, Mich.

DUPLICATORS AND DEVICES

ROTARY Neostyle, good order \$10.00. Office Appliance Co., Boston, Mass.

THE Modern Duplicator, made without glue or gelatine, is the World's Standard. Fifty to seventy-five exact duplicate copies can be made from each one you write or draw with pen, pencil or typewriter. \$2.40 to \$6.00 according to size. Booklet Free. Durben, Reeves & Co., Mfrs., 339 Fifth Ave., Pittsburg, Pa.

HOW to get a Hektograph that will make 150 copies in 10 minutes; letter size, \$2. Write for circular. Hoyer Duplicator Co., 118 No. La Salle St., Chicago.

CEMENT

IF you want the best information on cement and concrete construction, subscribe for Concrete-Cement Age, leading cement and concrete monthly. Sample copy, 10 cents. Yearly subscription, \$1.50. Concrete-Cement Age, 135 Newberry Bldg., Detroit, Mich.

BUSINESS OPPORTUNITIES

MAKE More Money! Operate a good, substantial Mail Order business—our "Silent Salesman" system can easily be done in spare time yet the possibilities are unlimited! For years "Booster" has actually and accurately led thousands like you over the Successful Road to Wealth. To succeed you've got to read The Booster Magazine for "Booster" is Opportunity and starts you in business for yourself—tells you how to get the dollars—puts you next to the best money making propositions on earth—ones that really get you the money. Send 10c for two months' trial subscription. **Booster Magazine**, Northwestern Building, Chicago.

INSTRUCTION In Mail Order Business of the right kind. Agents opportunities; Work in spare time. Formulas; Manufacturer, Dealer and Agent brought together each month in our magazine. Only 10c per copy, three months 25c. \$1 per year with premium. The "Lever" Mail Trader, 44, Elizabeth, N. J.

WE Start You In Business, furnishing everything; men and women, \$30.00 to \$200.00 weekly operating our "New System Specialty Candy and Popcorn Crispette Factories" home anywhere, no canvassing. Opportunity lifetime; booklet free. **W. Rasdale Co.**, East Orange, N. J.

SELL By Mail—New patented specialties; factory prices; new selling plans; small capital. Spare time; Copyrighted Prospectus free; Mississippi Valley Co., Inc., Box M-629, Pittsburg, Kas.

"THE Art and Process of Dry Cleaning." A fascinating and profitable occupation. 25 cents postpaid. **Auburn Supply Co.**, Dept. DC, 7745 Peoria St., Chicago.

HOME Manufacturing—Pleasant and profitable business quickly established during spare time. Product international necessity. Write for particulars. **Delzell Mfg. Company**, Desk A, 448 South Mathews, Los Angeles, Cal.

BUSINESS Representative, 22 to 30 years old, wanted in every town over 1000. Whole or part time. Opportunity to come to New York. **Institute of Business Engineers**, 2213 Singer Building, New York City.

RESILVER mirrors and make plenty of money. Full instructions, 25 cents. **Auburn Supply Co.**, Dept. RM, 7745 Peoria St., Chicago.

\$3000 IN your back yard starting with few boxes. No ginseng or mushroom dope. Send for Back Lots Scheme Circular. **Metz**, P. O. Box M 87, Times Sq. Station, N. Y.

EARN \$7 to \$12 daily, restoring faded colors in rugs and carpets, whole or spare time. Original Armenian Process. Great demand. No capital. Full particulars free. **Eldred**, Dept. 75, Detroit, Mich.

USE your spare time to build up a mail order business of your own. We help you start for a share in profits. 27 opportunities. Particulars free. **Mutual Opportunities Exchange**, Buffalo, N. Y.

ROADMAN'S and Agents Guide. New edition just out, 100 plans and schemes 25c. Particulars free. **Harry Zimmerman**, 1016 Oakdale, Chicago.

FORM a corporation—Congress Law for D. C. and all states; cheap. Raise money easily. **U. S. Legal Corporation**, Washington, D. C., Representing \$1,225,000,000.

I HAVE Had ten years' experience and have made good in the Mail Order Business; began with \$5. Send for free booklet; tells how. **Heacock**, 5074, Lockport, N. Y.

READ "An Amateur's Experience in Mail Order Business." Exposes pitfalls free. **Arthur Whipple**, West Saginaw, Mich.

AN intelligent person may earn \$100 monthly corresponding for newspapers. No canvassing. Send for particulars. **Press Syndicate**, 700, Lockport, N. Y.

START a Silver Plating Business in your own home—\$25 a week easily made. Complete instructions \$2. **C. E. Clarke**, Box 137, Leavenworth, Kans.

STOP! Investigate at once! New business; No experience; 500% profit making photos with the new One Minute Post Card Camera. Takes and delivers finished post card photos in one minute right on the spot. No plates, films or dark room. Make big money everywhere, traveling or at home. This is your opportunity for immediate and permanent success. Don't delay! Write today for free information. **The One Minute Camera Co.**, Dept. 80, Rand-McNally Bldg., Chicago.

OPERATE Hahn's Premium Machines, the best seller for cigars and candies. **J. Hahn**, 1016 Germantown Ave., Philadelphia, Pa.

WAGE Earners. Every Wage Earner, Foreman, Superintendent, or others, will be given an opportunity to get "A Farm of 10 to 160 Acres, or its equivalent in the world's largest orchards, practically free." Providing you care to accept our advertising proposition, help us to interest your friends and settle up this famous Ozark country. "The land of the Big Red Apple," along the Missouri Southern Railway—54 miles completed—we want the people. Act quickly—limited number only. **Missouri Southern Immigration Co.**, 1412 Great Northern Bldg., Chicago, Ill.

FROM \$2000.00 to \$3000.00 per year is made by many of our customers on operating portable gasoline engine driven vacuum house-cleaning outfits. We make vacuum cleaners of all sizes and types. State how and where machine is to be used, giving full particulars. **Richmond Radiator Company**, 1480 Broadway, New York.

FOR 10c to cover advertising, etc., I'll send scheme (mail-order or local) that brought me \$2 in one hour, with bank reference and testimonials. One man has made \$100 monthly with it—write him. If satisfactory, remit \$1 from profits; if not, return. **Fink**, 3 YMCA, Kane Penn.

YOUR 25-word ad placed in 28 good monthly magazines for \$1.25. One inch display, \$3. Write me before placing any advertising. I'll save you money. **F. L. Miller**, 1000 Bastable Block, Syracuse, N. Y.

PARTY with \$5,000 can become half-owner and make a fortune. **Louis L. Crane's** Box Kite Dirigible Airship, patented, will cross ocean in 100 hours. Absolutely safe. Call or write. **Crane** 259 9th St., Brooklyn, N. Y.

WHY not start a growing business? Make Concrete Fence Posts. Big demand. Big profit. We tell you how. **Myland**, 2125 N. Front, Philadelphia, Penn.

BICYCLE business For Sale, Chicago. Fine trade, large stock, 20 years established. Cheap for cash. **W. M.**, 6th floor, 318 W. Washington St., Chicago.

WE help raise capital at once to start you in retail, manufacturing, patent, real estate, mail-order, or any legitimate business, by means of "our practical method." Particulars free. **The Business Aid Co.**, K 504, Detroit, Michigan.

WOULD you like to own a good-paying mail order business? We have a line that gets repeat orders all the time. You can start in spare time; invest a dollar or two a week and soon own a nice business of your own; write for particulars. **Nadico**, 1664 Belmont Ave., Chicago.

LEARN Metalizing! That fascinating art which transforms flowers, insects, etc., into beautiful jewelry. Pleasant and profitable. Stamp brings sample. **P. Benson**, Stewartville, Minn.

\$1.00 RESILVERING Mirror Formula, and year's subscription to our 24-page postcard magazine 40c. **Elite Exchange**, Dept. C4, 3827 N. 44th Ct., Chicago.

GOOD Money for ladies or gentlemen in every county. Send stamp for samples. **Fairplay Supply Company**, 10 Main, Fort Pierre, South Dakota.

START a formula business—Make \$50.00 weekly, 50 cents silver brings complete instructions and 25 best formulas. **C. Parker**, Box 28, Columbia, Tenn.

ENCYCLOPEDIA of Business Chances. Money making methods exposed; how small ventures lead to wealth; 2000 trade secrets, etc. Descriptive booklet free. **Reimel & Co.**, 96 Broadway, N. Y.

SEND for my booklet "how you can become your own master" without capital, and my big free offer. **E. Daugherty**, 1236 Madison St., Chicago, Ill.

AD Bargains—20 words in 100 monthlies \$1; 100 weeklies \$2; 20 big Sunday papers \$5. **Life Co.**, St. Louis.

THERE'S money in Iowa for you. Address **L. E. Bowers**, 219 S. Dearborn St., Chicago, for special Iowa advertising proposition.

PATENTABLE Ideas wanted—Send for 3 free books. **Richard B. Owen**, 30 Owen Bldg., Washington, D. C.

EGYPTIAN Cleanall. The best grease and oil extractor; large profits; everybody needs it. Complete plans and formula 10c. **The Anjo Company**, Box 497, Galesburg, Ill.

LEARN Electroplating—Practical results may be obtained by following the directions in our book on electroplating. This is a working guide for the beginner written by an old hand at the business. 112 pages, 62 illustrations, cloth, 50 cents postpaid. **Popular Mechanics Book Dept.**, 318 W. Washington St., Chicago.

LET the Parcels Post Help You. Add (\$15 to \$25 weekly) to your present salary or income. Start during spare time and build up a permanent mail-order business of your own. We show you how and help you make good. No canvassing. Experience unnecessary. The Parcels Post makes success doubly sure. Our new ideas and up-to-date plans bring the money. No so-called "Course of Instruction" to sell. We give that free. Write today. Address **Pease Mfg. Co., Inc.**, Dept. A, 70 Broadway, Buffalo, N. Y.

ASK Bode! Advice about "anything" 25c. Particulars free! Write now! **J. Bode**, 561p Main, Hartford, Conn.

\$40 WEEKLY, manufacturing Post Cards. Easy to learn. Stamp gets particulars. **Grandon**, Jackson, Mich.

MAKE and Sell Mission Furniture—From our instructions one man who was an amateur made and sold \$400 worth of just one article alone. We give you 98 designs and easily followed directions for making each piece in 3 books at 50 cents each or \$1.50 per set, postpaid. **Popular Mechanics Book Dept.**, 318 W. Washington St., Chicago.

WE Sell Patents. Established 1900. If you wish to add a new product to your line, write us. **Charles A. Scott Co.**, 1096 Granite Bldg., Rochester, N. Y.

MAIL Order Business. I start you free. **P. Newham**, Waukegan, Ill.

INCORPORATE your business under Arizona laws. Cost small. No franchise tax. Stockholders exempt from corporate debts. Do business anywhere. Laws and forms free. **Southwestern Securities & Investment Company**, Box D488, Phoenix, Arizona.

TRIAL Offer: \$1 places your 25 word ad in 200 different magazines. Send copy now. **King's Magazine**, Box 13P, Little Silver, N. J.

WE start you in a permanent business with us and furnish everything. We have new, easy selling plans and reasonable leaders in the Mail Order line to keep factories busy. No canvassing. Small capital. Large profits. Spare time only required; personal assistance. Write today for (copyrighted) plans, positive proof and sworn statements. **J. M. Pease Mfg. Company**, 541 Pease Bldg., Main Street, Buffalo, N. Y.

BIG Money in the Mail Order Business. Experience unnecessary. Small capital. Instructions free. **Keith**, 719 Central Bldg., Rochester, N. Y.

MAIL Order Dealers! Advertisers! You need our 1913 Advertising Rate Book with the latest Dollar-making feature "Ads That Pay." Hot from the press! Gives you cost of Advertising in 2000 recognized magazines and newspapers, location, circulation, closing dates and other useful knowledge. Includes thirty original Mail Order propositions, winners every one of them. A \$10,000 investment at your service. You can make a legitimate profit of 95c on every dollar order. This very valuable manual sent prepaid to you for 10c. Write now! **Dearborn Advertising Agency**, 521 Dearborn St. Chicago.

INDEPENDENCE and fortune quickly attained in the Manufacturing Mail Order business. I furnish Formulas, Manufacturing Processes and Trade Secrets in all lines. Sold under positive guarantee; 18 years' practical experience. Revision and improvement of Formulas and Processes—reduction of manufacturing cost—utilization of waste materials, etc., a specialty. Booklet, Formula List, and Valuable Information Free. **W. L. Cummings**, Ph. D., 127 Standard St., Syracuse, N. Y.

BIG Profits for You! Manufacture Barley Crisp. New confection. 5c package costs you 1c. Machine, instructions complete \$7.50 prepaid. Send 10c for samples. **Barley Crisp Co.**, 1605 Hyde St., San Francisco.

STOP Here! Let me start you in a home business that will bring you money every day. Experience unnecessary. Spare time. No canvassing. I furnish everything and guarantee success. Send for proofs. **Voorhies**. Desk C. R., Omaha, Neb.

I WILL start you earning \$4 daily at home in spare time, silvering mirrors; no capital; send for free instructive booklet, giving plans of operations. **G. F. Redmond**, Dept. 306, Boston, Mass.

COLLECT money by a sure, simple, system. Income \$1,000 to \$5,000 a year. Quick results. No capital required. Instructive book. "Skillful Collecting," free. **National Collectors Ass'n.**, Long Street, Newark, Ohio.

EXCLUSIVE County Rights for Wonder Cloth now being allotted; everybody buys; big profits; repeat orders come fast; opportunity to start a local, a mail sales and jobbing business; new selling method; small capital; particulars and sample free. Bethlehem Utilities Co., 65 G. Pine St., New York.

LOCAL Manager in Each City not yet Allotted to Sell "Cisco,"—a big money saver,—to automobile owners, supply houses and garages. Large profits. Must be able to handle salesmen and have \$50 to \$250 cash. No proposition like this ever before offered. Address E. C. Rortzahn, 127 Duane St., Suite 92, New York.

AGENTS WANTED

AGENTS Wanted—Here's big money for you—and a stylish nobby suit absolutely free. \$40 a week easy. Many are making more. Nothing to learn. Nothing to buy. Nothing to invest. No capital required. We furnish everything free—even the suit of stylish clothes you wear. Our men are the swell dressers and it don't cost them a cent, and they make big money every week. Get in now. Now is the time for the big money. Your name on a postal brings everything free. The handsomest lot of samples of the latest suitings you ever looked at to choose your suit from. And a book of fashion plates showing the very latest, nifty, nobby styles; also measuring blanks and everything needed—all free. We pay expressage on everything. Send that postal now—don't wait. This is your chance—grasp it. American Woolen Mills Co., Dept. 514, Chicago.

WANTED—Resident agents to introduce the new Short Out to Light. No engines, dynamos or intricate machinery; new inventions revolutionize old methods; costs much less to install and operate than any known method of illumination; gasoline lights that can be switched on and off instantly; artistic fixtures for all purposes, such as the lighting of stores, homes, churches, halls, streets, etc.; nothing to wear out or get out of order; a 10-year guarantee furnished with each system; an opportunity of a lifetime is offered industrious men to get into a permanent money-making business; every system installed sells others; every user an enthusiastic booster. Write at once. Gloria Light Company, 1271 Washington Blvd., Chicago.

YOUNG man, would you accept and wear a fine tailor-made suit just for showing it to your friends Or a Slip-on Raincoat Free? Could you use \$5 a day for a little spare time? Perhaps we can offer you a steady job. If you live in a town smaller than 10,000, write at once and get beautiful samples, styles and this wonderful offer. Banner Tailoring Company, Dept. 274, Chicago.

AGENTS—\$60.00 weekly. We make the finest needle case on the market. 200 to 400 per cent profit. New proposition. Approval plan envelopes makes talking unnecessary. Henderson at Springfield, Mo., made \$83.00 last week. Send 10c for 25c sample containing 115 needles, all particulars free. Buy direct from the importers at wholesale. Write us today. National Importing Co., 226 Granite Bldg., St. Louis, Mo.

AGENTS—\$10 per day sure selling our New 1913 Styles Silk Neckwear. 3 fifty cent ties \$1. Monogram Gold Cuff Link and Stick Pin Set given Free. Cooper made 75 sales in 7½ hours. Profit \$30. Free samples to hustlers. Dayton Neckwear Mfg. Co., Dept. I, Dayton, Ohio.

AGENTS making \$3—\$12 daily. No competition. New rapid sellers. Every home and office your field. No capital required. Write for particulars and strong testimonials. Wm. F. Butler, Dept. J, Milwaukee, Wis.

SALESMEN—Working for us means cash in your pocket every day; Household Device; duplicate orders; profits big, experience unnecessary. Write immediately. Specialties Supply Co., No. 31 Willoughby Street, Brooklyn, N. Y.

SALESMEN Wanted: Our goods are sold around the world. They are required in every home in all civilized countries. We are establishing selling agencies for the large Cities, also for each County throughout the U. S. and want good men for these positions. Business will be permanent and should afford an income of \$3,000 to \$6,000 a year. Small working capital and a good record required. Address Manager, 221 Franklin St., Buffalo, N. Y.

AGENTS, drop dead ones. Awake! Grab this new invention. Low priced water-power home massage machine. Magical, marvelous, mysterious. New field. Big profits. Sold on moneyback guarantee. "Margwarth sold 5 in 10 minutes; 31 in 2 days." "Parker sells 8 first day." Vaughn. "Your machine has merit. Express 6 dozen." Free information. Blackstone Co., 701 Meredith, Toledo, Ohio.

SHOW the "Sweep Cleaner" to any housewife and she will find the money to buy it. Retail for \$7.50. It's two years ahead of any other hand vacuum cleaner and is backed by the makers' reputation of 13 years as manufacturers of carpet sweepers. Write for agents' terms to National Sweeper Co., 20 Laurel St., Torrington, Conn.

DON'T waste time selling something everybody sells! Specialize! Golden Dew Drop Perfumes are fast sellers, quick repeaters. \$5 easily made within few hours. Sample and particulars for dime. Tanner, 181 Lexington Ave., New York.

SIGN Agents, Painters 50% profit with our splendid line guaranteed flexible gold sign letters and trade emblems. Write today for free catalogue and samples. Eastern Specialty Co., Dept. 5, 63 Barclay St., New York.

AGENTS—New invention. Electric Cigar Lighter. Used on cigar cases. Quick seller to Hotels, Drugstores, Restaurants, Pool-halls, Cafes. Big profits. Special offer. Drake Mfg. Co., 142 Reed St., Milwaukee, Wis.

AGENTS—Earn \$25 to \$40 per week selling Nodarn Guaranteed Hosiery. Summer samples now ready. Big commission. Repeat orders. Write today for particulars. Nodarn Hosiery Mills, Desk I, Dayton, Ohio.

WONDERFUL Amazing Invention! Just out. Agents coining money. Lights home or office brilliantly for one cent per night. We loan you sample. Allen-Sparks Gas Light Co., Lansing, Mich.

AGENTS—Our absolutely square \$30 to \$67.50 weekly salary and 30% commission proposition assures steady workers unlimited prosperity. Galloway-Bowman Company, Div. 371, Waterloo, Iowa.

AGENTS—Salary or commission. Greatest seller yet. Every user pen and ink buys on sight. 200 to 500 per cent profit. One agent's sales \$620 in six days; another \$32 in two hours. Monroe Mfg. Co., X 6, LaCrosse, Wis.

AGENTS—You can make \$40 to \$75 a week selling Guaranteed Aluminum Ware to consumers. Complete sales course free. Your territory open. Answer quick. Dept. P. American Aluminum Co., Lemont, Ill.

AGENTS make 500% profit selling our gold window letters, novelty signs and changeable signs. 800 varieties in enormous demand. Catalogue free. Sullivan Co., 1238 Van Buren St., Chicago, Ill.

AGENTS—100% profit—sell to saloons—machine a whirlwind seller. Free sample and salesmanship course. Two sales a day \$15 profit. Write. Simplex Mfg. Co., Dept. 7, Kewanee, Ill.

AGENTS—Men or women, wanted to introduce high grade specialties in every home; quick sales; big profits; write for particulars. J. Weinert & Co., 3405 Pierce Ave., Chicago, Ill.

AGENTS self-filling fountain pen. has 14Kt gold pen guaranteed. Send \$1 for sample and prices. H. D. D. Sutton, West Haven, Conn.

LIVE wire salesmen wanted on salary or commission to introduce a sure winner; big pay; particulars free; answer quickly. M. F. Metz, Decatur, Ill.

MAKE and sell your own goods. Formulas by Expert Chemists. We obtain your Government Serial Number. Catalogue for stamp. B. Mystic Company, Washington, District of Columbia.

AGENTS: Sell the "Majestic" 3 Bellows Vacuum Carpet Cleaner. Sweeper Type. Big Seller. Enormous profits. Exclusive territory. Home Vacuum Cleaner Co., 1922 Wabash Ave., Chicago.

GREAT fortune selling wonderful patented attachable fan for sewing machines, exclusive territory, sample only \$1. Attachable Fan Co., Portland, Oregon.

WHEN you sell Feeny Vacuum Cleaners you deliver the goods. New principle—creates wonderful suction. One general agent's total commissions 1912 was \$18,498. Write today for our attractive proposition. Feeny Mfg. Co., B-28 Muncie, Indiana.

NEW low offer. Three wonderful sellers. Washing, Ironing, Bluing. Housewives use weekly. Samples 10c. Full packages, 25c. Particulars Free. Leibman, 720 A. Lefterts, Richmond Hill, N. Y.

AGENTS wanted quick. Clean legitimate money-making proposition. No space for explanations. Write for full particulars and exclusive territory. Krueger Mfg. Co., Dept. 2A, 167 W. Washington, Chicago.

AGENTS—\$5 daily selling our Handy Tool, 12 articles in one. Lightning seller. Sample free. Thomas Mfg. Company, 462 Third St., Dayton, O.

AGENTS—Something new. Cheapest and best cherry seeder. Easy seller. Big profits. Sample and particulars 10c. C. S. Hendrick, 222 S. Madison, Clinton, Ill.

AGENTS wanted for a new household labor saver. Quick seller. Big profits. Cary-Dane Co., 102 West 101st St., N. Y.

CANVASSERS—Send for sample, quick selling Nickel Safety Razor. Postpaid 22c. Sells 50c. Bohart & Co., Clinton, Iowa.

AGENTS—250% profit. Wonderful little article. Sells like wildfire. Can be carried in pocket. Write at once for free sample. H. Mathews, 1962 Third St., Dayton, O.

YOU can make money everywhere selling our oil properties; situated in Liberty County, near Humble, Texas, in the heart of the Gulf Coast Oil Belt; prices low; terms easy, lots sell rapidly; full descriptive matter furnished free to Agents. Good proposition for quick sales; Agents now making \$50 to \$75 weekly in commissions. Previous experience not necessary. Live Agents wanted in every community. Write today for full particulars. Address, C. A. Bryan & Co., Owners, 260 First National Bank Bldg., Houston, Texas.

SIGN Agents—Painters—Something new and better. Attracto ready-made Gold and Silver letters. 21 kinds, easily applied. Make big money lettering store windows, making signs, and selling our line of flashing, sparkling chipped glass name-plates. No experience needed. Write for sample letter and catalogue and start at once. Address Attracto Sign Co., 2655 North Clark Street, Chicago.

AGENTS—Something new—fastest sellers and quickest repeater on earth. Permanent profitable business. Good for \$50 a week. Safety Razor with soap; Gas and Range Lighter; Life Saving Gas Burner. Sample 25c each. Write for particulars. Manufacturer Berthold, Flushing, L. I.

MAIL Order Dealers should have our proposition. Imprint circulars furnished. Post Supply Company, Waltham, Mass.

SALESMEN wanted for the help-a-phone. Almost every telephone user buys one to three; sells for \$3; \$108 a week clear; instructions in salesmanship free. Regina T. 16 Eiland, North Carolina.

SOAP Agents. Our Vegetable Soap, Toilet Articles and Remedies Excel and Outsell. Sample Free. Buchanan & Co., 54 N. Main St., St. Louis, Mo.

\$60 WEEK Selling New 3½ pound hand power Vacuum cleaner. Retail \$6. Get agency. Manufacturer, 723 Colonial Bldg., Boston.

AGENTS, \$10 daily selling "Perfect" Double Suction Hand Vacuum Cleaners. Territory guaranteed. Perfect Cleaner Co., 384 Hudson St., New York.

AGENTS. Monogram safety razor in beautiful box with any lodge emblem and monogram engraved, sample sixty cents. Hampson, Box 56, Station O., New York.

AGENTS wanted everywhere to sell high grade household specialties; quick sales; write today. United Specialty Agency, Dept. 19, Elko, S. C.

\$6 TO \$12 daily demonstrating Peerless Lawn Edge Trimmer. One free. Trimble & Avery, Dept. 3, Belding, Mich.

WANTED agents calling on Toy Dealers, to take as a side line, an absolutely new Aerial toy. Auto & Marine Specialty Co., Trenton, N. J.

AGENTS. Our 100 per cent profit goods are steady money makers. Three weeks' trial salary guaranteed. Standard Silverware Co., Boston, Mass.

SEND 40c for the Yankee Fire-Kindler, the great fuel saver. Nowell H. Stanton, Dept. M. Poynette, Wis.

BIG money in Essex Fan Motors, run by gas or gasoline. Winfield H. Smith, 10 Lock Street, Buffalo, N. Y.

MEN'S shirts to measure. \$1.25 and up. Outfit free. Peerless Shirt Makers, Dept. 18, Chicago.

AGENTS Wanted—We want a live man in every town to act as a sales manager. We want you in your town. Devote your spare time to our business and you will make bigger money than you ever made before. Give us all your time and we will make you rich. These are facts, not promises. \$50 a week at the start. Besides, a nobby free suit—and all the clothes you want at less than wholesale price. Wear one of our free suits as an advertisement and people will flock to you to buy a suit like it and you will coin money. Get our money making proposition and beautiful book of samples. Just send a postal card. We pay express charges on everything. Join the live wires—send us a postal today. Paragon Tailoring Co., Dept. 514, Chicago.

CURIOUS Books, money-making secrets; send stamp. "Sentenn" E-737 Ursuline, New Orleans, La.

WE want articles to manufacture. Schultz Patent Office, Cincinnati, Ohio.

EDDIE FOY recommends "Colby" Hosiery; Koenig writes, "Orders yesterday, \$43.25;" develop permanent, profitable business; free book tells how. Colby Hosiery Company, 2103-11 Second St., Philadelphia, Pennsylvania.

AGENTS. Our great Luminous picture. Rock of Ages. Wonderful, mysterious; cross shines brilliantly in darkest room. Sample 25c prepaid. Exclusive territory. Big profits. Pioneer Portrait Co., 1249 W. 63rd St., Chicago.

PORTRAIT agents find our plan beats all others. Prompt shipments—rejects credited. 30 days' Credit. Catalogue of Portraits, Frames, Pillow Tops, sheet Pictures and samples free. James C. Bailey & Co., Desk E-6, Chicago.

START a Manufacturing business at home in spare time. Formulas for manufacturing Six Big Sellers and description of 50 other opportunities sent postpaid for 10c. Answer now. C. H. Anderson, Box 111, Chestertown, Md.

AGENTS—Here's an opportunity to earn \$30 weekly and upward. A new line—exclusive territory. Send postal today for full particulars. A. S. Shuh, Sales Mgr., 1700 Sycamore St., Cincinnati, O.

AGENTS—Make 150% Profit! New idea in Door-plates. Sell for 25c. Made in a minute and easily adjusted. Write for proposition. Cellulina Co., Attleboro, Mass.

AGENTS and salesmen will secure free, complete information of numerous money making selling propositions and newest specialties in hands responsible concerns. Address Distributor, 26 Cedar St., N. Y.

AGENTS. A pair of silk hose Free to active Agents. State size. Agents wanted every town for complete and beautiful hosiery line. Large profits. Write today. Triplewear Hosiery Mills, Dept. D, 112 So. 13th St., Philadelphia, Pa.

AGENTS—To sell our new Tire Pump to auto owners. Engine does the pumping, sells for \$5. Exclusive territory. National Novelty Co., Joliet, Ill.

AGENTS make \$10-\$20 daily selling our metallic letters; handsome, durable, universal use; anybody can put on; write for particulars, samples. N. Y. Sign Letter Co., Arbutle Bldg., Brooklyn, N. Y.

AGENTS—Men and women, newest invention. Wing Self Heating Gasoline Flat Iron; guaranteed, sells everywhere. Women delighted. Write for particulars. Wing Mfg. Co., 1608 Fulton St., Chicago.

FRUIT Jar Filler. Household necessity. Insures perfect preserves. Sells on sight. Agents make \$5.00 and upward daily. Absolute guarantee. Sample and instructions 15c. Shearman Mercantile Co., Indianapolis, Ind.

1500% PROFIT selling our Gold Sign Letters. We'll show you how. Sample free. Johnston Co., Quincy, Ill.

AGENTS secure territory for the Ideal Lawn Mower Sharpener. Most practical sharpener made. Write Weyburn Sales, Rockford, Ill.

DEALERS, Agents. Just invented, wonderful dime novelty. Appeals strongly to everyone. Columbia Co., 1557 Wells St., Chicago.

AGENTS—Something New. Quick Seller. Hustler can make \$25 to \$50 weekly. Sample 10c. Consolidated System Co., Wichita, Kans.

WRITE with Your Finger. New Invention. Big Seller. Sample 10c. Dozen 75c. K. Fancy Specialty Co., 303 Ashland Blvd., Chicago.

SOLICITORS Both Sexes \$2.50 a day salary or commission, selling liquid known alcohol flavorings and toilet articles. Manufacturers' Distributing Agency, St. Louis, Mo.

AGENTS wild with excitement. Everybody buys our beautiful two color show cards. Catalogue free. Popular Show Card Co., Dept. MA, 1235 Michigan Ave., Chicago.

READ the Agents Magazine. Make more money. 2 months, 10c. Agents Magazine, Chicago.

DO you want to earn more money? "Tell it to Sweeney." Read page 18.

BY acting as agent for our books, you can use your spare time to good advantage. You do not have to be a "professional" to take this up, as these books are just what everyone wants. Write for particulars. Popular Mechanics Book Dept., 318 W. Washington St., Chicago.

YOU can make more money operating a mail business, but before taking any chances invest 10c for two samples of "Booster"—the one bona fide Mail Order and Agents' publication on earth—a magazine that has for years actually and accurately started others like you in business for themselves by publishing the best money making propositions on earth—ones that really get you the money! Send 10c today—it's worth dollars to you. Booster Magazine, Northwestern Building, Chicago.

AGENTS—A device that Saves Money. Increases Efficiency, adds to Comfort, Convenience; Beautifies the home, office and store—and is Electrical, is the kind of device to sell. Show these features on an article, to the people to-day, and your sale is made. I have that article. If you are alive, wide awake and want to handle a General Agency for the most unique electrical specialty, which will cut lighting bills in half, write for my proposition. Stanley B. Freiberg, 190 Station F, Cincinnati, O.

AGENTS—"Border Wars of Texas," a book of 400 pages of thrilling accounts of Indian raids, battles, etc.; 40 full page illustrations portraying the cruel hardships of the Texas pioneer. It is a quick seller for agents. Sent postpaid for \$1.50 cloth, \$2.00 morocco, or terms, etc., for stamp. Matt Bradley, Tloga, Texas.

WHERE did your money go? Find out. Begin any time with our Daily Expense Record. It will keep you posted and reduce expenses. A very interesting and complete book—50c. Agents wanted. Auburn Supply Co., Dept EX, 7745, Peoria St., Chicago.

HAVE you a few hours to spare? We want man or woman in each town. No capital needed. An hour's work shows dollars earned in spare time. Pocket sample. 400% profit. G. C. Mfg. Co., (Dept. 104), 20 Warren St., N. Y.

SALESMAN in every town over 1000 to represent several manufacturers of hundreds of the best patented articles and other products. Whole or part time. You sell to dealers and appoint agents. The Premo Manufacturing Company, 95 Liberty Street, New York City.

GOVERNMENT Positions Open to Men and Women, \$90.00 month. Annual vacations. Short hours. No "lay offs." Parcels Post means thousands of postal appointments. "Pull" unnecessary. Farmers eligible. Write immediately for free list of positions open. Franklin Institute, Dept N 22, Rochester, N. Y.

"INSPECTOR" is the best seller and most practical article at present. Shows immediately whether milk is pure or watered. Protects every family against fraud. Big profits. Retail 50c. Specialties Co., 672 Eagle Ave., N. Y.

HATPIN point protector and hatpin combined. Meets Hatpin Law. 30,000,000 women need several each. Beautiful designs; tremendous profits. Send 25c to \$1 for samples. Particulars free. Selective Supply Company, Dept. P, Lynn, Mass.

SELL \$10.00 hosiery noon hour, shops, factories; make over \$100.00 per month. Koenig wires, "Sales yesterday \$43.25." Free sample plan. Colby Hosiery Mills, Second and Diamond, Philadelphia, Pa.

\$20-40 WEEKLY, selling guaranteed Hosiery, Underwear, Sweaters, Neckties, Handkerchiefs. Credit. Samples free. Sales Manager, Room 62, 54 Worth St., N. Y.

"GILANOR" Speedy Stitcher Awl. Best automatic awl for leather and heavy goods. Regular \$1.00 Sample, post-paid for 70c and this advertisement. Agents wanted. Gilanor Company, Roswell, N. M.

AGENTS—To sell the newest electric appliance on the market; sold everywhere there is electricity, in the home and office; liberal profits; sales-driving sample, weighs a pound, no experience or knowledge of electricity required; it shows how to use one light instead of two and get the same results; sells for \$3.50 and saves the purchaser an investment of \$25; write for particulars. The Handy Light Co., 16 Handy Light Block, Cincinnati, O.

SELL by Mail. New patented specialties; factory prices; new selling plans; small capital. Spare time; copyrighted prospectus free; Mississippi Valley Co., Inc. Box N-629, Pittsburg, Kan.

I HAVE had ten years' experience and have made good in the Mail Order Business; began with \$5. Send for free booklet. Tells how. Heacock, 147 Charles St., Lockport, N. Y.

AGENTS—Hurry—Something new. Sanitary device for telephones. Millions will be sold. 150% profit. Apply for territory. Hygienic Phosphate Co., 1082 Jefferson, Toledo, O.

BRAND New Line: Solid Aluminum Handle Kitchen Knives. Guaranteed best quality steel. High class proposition. Particulars free. LeRoy Specialty Co., 76 Park Place, N. Y. Room 52.

YOU can make money as our general or local agent. Permanent business. Every woman wants a set; they buy on sight; big profits. Exclusive territory. Write today. Red Cross Supply Co., Dept. 1, St. Louis, Mo.

SELLING Agents Wanted for "Fire Out." Best selling small fire extinguisher. A real money maker for you. Our proposition won't disappoint you. The Inst. Lighter Co., Dept. M, Columbus, O.

AGENTS: or any man, a guaranteed Safety Razor that does the work of the \$3.50 one for 50c, sent anywhere on receipt of price (P. O. Money Order). Arthur C. Morey, Bantam, Conn.

AGENTS that Canvass among Farmers; Make \$300 Monthly. Write, United States Wheel Lubricator Company, Wittenberg, Wis.

AGENTS—\$10 daily can be earned by everybody, undertaking an easy agency as an extra; expert knowledge unnecessary. Write A. Steenken, Amsterdam, Holland. (Postage, 5c.)

SELL Pals Changeable Scarf Pin, Handkerchiefs, Neckwear; send stamp for sample. Pals Manufacturing Co., 25 East 14th Street, N. Y. City.

AGENTS to take orders for Visiting and Business cards; large commission; outfit free. Forman Printery, Waterbury, Conn.

AGENTS. Don't accept any proposition until you read my free booklet. 300% profit; no competition; no canvassing. Electro-Appliance Corroboration, Box 261, Los Angeles, Cal.

\$150 MONTH. No Canvassing or Mail Order Phantom. Absolutely new. Saves merchants \$10. Box 4, Fort Scott, Kan.

BOUGHT on sight in every factory and town. \$4 Raincoats. Write for Agency. Boston Raincoat Company, Box 2815 Boston, Mass.

\$15 DAILY Selling \$20 Soda Fountain. King, 1764 Aberdeen, Philadelphia.

AGENTS, \$25 weekly; credit given. Smith, 1355B, Clinton Avenue, N. Y.

WRITE Me. Enormous profits, Lightning sellers. John Shear, Putnam, N. Y.

CHEWING Gum—Sell to dealers. Clean, profitable business built up quickly with our new brands. Four flavors, novel packages. Send 10c for full pack of each and exclusive territory proposition. Helmet Gum Factory, 39 Opera Place, Cincinnati, O.

AGENTS—A cent sent Swank tells about free offer and how to sell greatest discovery of the age in homes, stores, factories, offices. Easiest seller; out Nov. 29, 1912. Biggest profits. A. H. Swank Mfg. Co., Fremont, O., Dept. 19. Toronto, Canada Branch, 226 Shaw St.

AGENTS make big money selling our new gold letters for office windows, store fronts and glass signs. Any one can put them on. Write today for free sample and full particulars. Metallic Sign Letter Co., 406 N. Clark St., Chicago.

WE are the largest manufacturers of Twisted Wire Brushes in America. Highest grade goods, best service, highest profit. Write for our new catalog. You are sure to win. Fuller Brush Co., 33 Hoadley Place, Hartford, Conn.

\$1,000 EARNED by three people within thirty days selling our Fire Extinguishers. Buyers everywhere, protected territory, 500% profit. Local and State Agents wanted. United Manufacturing Company, 1025 Jefferson, Toledo, Ohio.

AGENTS wanted for "Healo" the toilet preparation for preventing all forms of excessive perspiration. Big money. Start now. Particulars free. Health Medicine Co., Dixon, Ill.

U-KAN-PLATE—The polish that plates; \$18-\$40 week year round; exclusive field; free booklet. C. B. Seabury, L465, Boonton, N. J.

400% PROFIT selling our high grade work. Samples free. Gordon Co., Northwestern Bldg., Chicago.

AGENTS make \$5.00 to \$10.00 a day on the start. Atkinson writes: "The best proposition I have found in my forty years canvassing." Permanent work. Household necessity. Saving 80%. Write to-day for General or Local Agents terms. Free sample. C. H. Stuart & Co., 16 Union St., Newark, New York.

AGENTS—\$200 monthly distributing Newells needle cases. Sell 115 needles in book for 10c and make 200% profit. Approval Plan envelopes make talking unnecessary. Crew Managers write. Send 10c for sample book and particulars. Newell Company, 509 N. Grand, St. Louis, Mo.

AGENTS—\$60 weekly premiums easily made. Write for free particulars and samples today. 100% profit besides premiums. No money required. Lloyd Company, 242 De Ballvere, St. Louis, Mo.

AGENTS—Make \$10 per day selling wonderful lock-stitch-awl-hand-sewing-machine. 100% profit. Sells itself. Send 50c for \$1 sample. W. A. MacKenzie, 268 De Ballvere, St. Louis, Mo.

MONEY making business for high grade agents, selling our S'ek-Call Outfit to Catholic Families. Write for details. Frank Schilling Co., Navate, Ohio.

\$2.50 PER DAY paid one man or woman in each town to distribute free circulars and take orders for concentrated flavoring in tubes. Permanent position. J. S. Ziegler Co., 443-D, Dearborn St., Chicago.

SIGN Agents—Stop paying fancy prices for Gold and Silver Metallic Sign Letters. Note ours: 2-inch letters, 70c; 3-inch, 80c; 4½-inch, 90c per 100. Non-tarnishable, staple goods. 5 assorted samples and instructions, 10c. Particulars free. H. Alexander, manufacturer, 328 East 59th St., New York. Established 1905.

AGENTS \$10 to \$15 per day easily made; 150% profit; exclusive territory; our cleaning, polishing and dustless mop is the big money getter and record breaker. Duncan Bros., 2910 N. Troy St., Chicago.

GOOD Mechanics to use and sell graduated Calipers, Whichway Levels. Paying proposition. Ernest Smith, Columbia, Pa.

500% PROFIT selling our wonderful sign letters for office windows, store fronts and glass signs; resembles finest gold leaf; easily applied; samples free. Metallic Letter Co., 496 N. Clark St., Chicago.

EARN \$15 to \$25 a week or more as our Mail Order Dealer. Right from your own home. Hold your position until entire time is required. We are manufacturers and owners of Patented just-in-season specialties. If you are just starting a Mail Order business or if already established, you can't afford not to handle our Patented Money making getters. We sell exclusively to our Mail Order Dealers. We protect them. We carry stock and furnish everything. No canvassing. Small capital. Experience unnecessary. Write today for latest patented leader and manufacturer's easy selling Mail Order (copyrighted) plan backed up by "Whole Truth," positive proof and sworn statement. J. M. Pease Mfg. Co., 539 Pease Bldg., Main St., Buffalo, N. Y.

SOAP agents make more money selling the celebrated Linro line. Coffee, flavorings, spices, soaps, perfumes, and 135 other items. Big commissions to you. Exclusive territory. Freight allowed. Handsome premiums to your customers. Free sample case. No deposit required. Free catalog. Linro Company, 13 Linro Bldg., St. Louis, Mo.

AGENTS sell rich looking imported 36x68 rugs \$1 each. Carter, Tenn., sold 117 in four days, his profit \$57. You can do as well. Write for sample offer and selling plan. Sample rug by Parcel Post prepaid 98c. A. Condon, Importer, Stonington, Maine.

MEDALLIONS—300% profit. Make up your own goods and be independent. Catalogue free. Resag Co., 1205 Randolph St., Chicago.

AGENTS—Would you take a steady job where you can clear \$20 to \$30 weekly and work up to yearly profits of \$3,000 or more. My line is snappy household goods. Quick sellers. Get busy with postal asking particulars. E. M. Davis, B17 Davis Bldg., Chicago.

WANTED immediately agents to sell our high grade rebuilt typewriters, also ribbons and carbons; over 100% profit. Send for large illustrated catalogue and special agents offer. Harlem Typewriter Exchange, Agency Dept. 215 West 125th St., New York City.

KEY Checks—\$1.45 per 100. Dies for stamping names on checks, fobs, umbrella plates. Wholesale prices—Collar clips, sewing awls, etc. We show you how to make \$5 per day. Pease Die Works, Dept. M., Winchester, N. H.

SELLING our exclusive linen heel and toe guaranteed hoisery direct from mill to wearer. Pays big profits. Customers waiting. Re-orders insure permanent, increasing income. Exclusive territory. Credit. N. Parker Mills, 720 Chestnut St., Phila., Pa.

AGENTS—County and State; men and women everywhere to sell the Pinless Clothes Line; a practical labor saving invention. Lasts life-time, sells on sight, gives perfect satisfaction. Agent Sutton of Georgia, sold over million feet; 100% profit; write quick for exclusive territory; information free; sample prepaid 25c stamps. Pinless Clothes Line Company, 520 Wilcox Bldg., Portland, Oregon.

AGENTS. One cent invested in a postal card will bring you a \$35.00 to \$50.00 a week proposition. Sterling Aluminum Co., Canal Station, Chicago, Ill.

AGENTS make \$30.00 weekly selling our 500 Handy Household Articles; catalogue free. Scheff Company, Desplaines, Ill.

AGENTS—\$50 weekly; we manufacture the best needle case made, a wonderful seller; 200 to 500 per cent profit; talking unnecessary; our copyrighted "Trust Scheme" Envelopes do the work; general agents can make over \$100 weekly; send 10c for a 25c sample containing 115 needles; particulars free; buy direct from the factory at wholesale. Paty Needle Co., 102 Union Sq., Somerville, Mass.

SAMPLE Free—Boyer's Automatic Re-Finisher for Furniture, Store, Bank and office Fixtures—Finest thing in the World. One application lasts a year. Applied with cheese cloth. Boyer Chemical Laboratory Co., State and Michigan Sts., Chicago.

WE manufacture glass paper; plain glass windows made to look like real stained glass; something new; easily applied; big money maker; 2 sample sheets, catalogue in colors, with discount for 10c. Parrish Co., Lakeside Bldg., Chicago.

WE furnish you capital to run profitable business of your own. Become our local representative and sell high grade custom made shirts, also guaranteed sweaters, underwear, hosiery and neckties, direct to homes. Write, Steadfast, Mills, Dept. 10, Cohoes, N. Y.

AGENTS Wanted—Mechanics and shopmen make over \$100 a month in spare time selling transparent handled novelty knives and razors. Big profits. Sales easily made. Write for terms today. Novelty Cutlery Co., 67 Bar St., Canton, O.

YOU can make \$\$\$\$ as our general or local agent. Household necessity; saves 80 per cent; permanent business; exclusive territory; salary or commission; free sample; credit. J. Pitkin, 113 Redd St., Newark, N. Y.

STOP Here! Let me start you in a home business that will bring you money every day. Experience unnecessary. Spare time. No canvassing. I furnish everything and guarantee success. Send for proofs. Voorhes, Desk C. R., Omaha, Neb.

AGENTS—Handkerchiefs, dress goods. Carleton made \$8 one afternoon; Mrs. Bosworth, \$25 in two days. Free samples. Credit. Stamp brings particulars. Freeport Mfg. Company, 59 Main St., Brooklyn, N. Y.

DON'T fail to read Independence and Fortune under Business Opportunities.

AGENTS—Portraits 35c. Frames 15c. Sheet Pictures 1c. Stereoscopes 25c. Views 1c. 30 days' credit. Samples and catalog free. Consolidated Portrait Co., Dept. 1196, 1027 W. Adams St., Chicago.

I WILL start you earning \$4 daily at home in spare time, silvering mirrors; no capital; send for free instructive booklet, giving plans of operation. G. F. Redmond, Dept. 306, Boston, Mass.

PERFECTION Pocket Adding Machine. Lightning seller. Agents wanted. Cincinnati Specialty Mfg. Co., Dept. R, Cincinnati, Ohio.

AGENTS wanted for Oriental novelties, never before seen in America. Quick sellers. Repeaters. Immense profits. Shaw Kanematz, Box 529, Portland, Oregon.

HELP WANTED

SALESMEN Wanted—We want men—salesmen (preferably those with road experience, although this is not absolutely essential). The increased demand for our product has exceeded our expectations and we are in position to use a number of real live salesmen. The field for our product covers almost every line of industry—store, factory, garage, railroad, etc. It is favorably known everywhere, having been widely advertised and successfully sold since 1885.

While we prefer men who have made a success in sales work, we have found that clerks and men of other lines have made remarkable records for themselves. No technical knowledge required.

This is your opportunity to secure a good territory, backed by the heartiest co-operation of a House of Honor, and practically start in business for yourself, fully equipped. The financial results are commensurate with the effort put forth. At any rate, write for our book, giving details, and then decide. Address, S. F. Bowser & Co., Inc., Fort Wayne, Ind.

FREE Illustrated Book tells of about 300,000 protected positions in U. S. service. Thousands of vacancies every year. There is a big chance here for you, sure and generous pay, lifetime employment. Just ask for booklet S-29. No obligation. Earl Hopkins, Washington, D. C.

AGENTS make big money and become sales managers for our goods. Fast office sellers. Fine profits. Particulars and samples free. One Dip Pen Company, Dept. 2, Baltimore, Md.

BIG Profits—Open a dyeing and cleaning establishment, little capital needed. We teach by mail. Write for booklet. Ben-Vonde System, Dept. C, Charlotte, N. C.

SALESMEN, both sexes, for best lands and lots in Houston District. Easy terms; liberal commissions; responsible company. C. W. Hahl Company, Houston, Tex.

SALESMEN everywhere to sell awnings; we teach you the business. Good money. A. W. Jones & Co. No. 602 West 131st St., New York, N. Y.

GET on the stage. Earn from \$40 to \$100 a week in vaudeville. Write to Herb Monahan, Vaudeville Author, Brockton, Mass.

WRITE moving picture plots. Good pay. We will show you how. Ripless Co., Brockton, Mass.

GOOD Letterers in demand. Send stamp for free book, "Successful Lettering." Columbia School of Drafting, McLachlen Bldg., Washington.

SALESMEN—Two for each state; oils, paints. Signet Oil Company, Cleveland, Ohio.

WANTED—Distributors of advertising matter everywhere. American Distributor, Blairsville, Pennsylvania.

CANVASS your home town for me. Enclose stamp for particulars. M. E. French, Clyde, O.

SALESMEN—Sell grocers "The Best Ever." Lady Washington Hulled Beans, Seattle, Wash.

GOVERNMENT Positions Open to Men and Women. \$90.00 month. Annual vacations. Short hours. No "lay offs." Parcels Post means thousands of postal appointments. "Pull" unnecessary. Farmers eligible. Write immediately for free list of positions open. Franklin Institute, Dept N 21, Rochester, N. Y.

DON'T Pay Anything to Learn a Trade. Investigate our system of teaching on actual contract jobs. Plumbing, bricklaying, electricity, automobiles; 200 workmen; six years' experience. Catalog free. United Trade School Contracting Co., Los Angeles.

MEN and Women Wanted for Government positions. \$90.00 month. Parcels Post means thousands of appointments. Write for list of positions open. Franklin Institute, Dep't N 21, Rochester, N. Y.

LOCOMOTIVE Firemen, Brakemen, wages about \$100, experience unnecessary. Send age, stamp. Railway Association, Dep't 89, 227 Monroe St., Brooklyn, N. Y.

PARCELS Post means thousands Government jobs open. Write for free list. Franklin Institute, Dep't N 21, Rochester, N. Y.

WANTED: Hydraulic operators and maintenance men for large power plant in the East. Permanent position with good prospects of advancement for the right men. Plant in small town located directly on the railroad, one hour railroad distance to larger city. Applications with full particulars to be addressed to P. C., 6th floor, 318 W. Washington St., Chicago.

PLEASANT Home Work—Ambitious persons can earn good income in spare time copying letters. Former experience unnecessary. Send today addressed, stamped envelope for particulars. Box 17, Station H. G., New York.

WANTED: Electrical operators and maintenance men for large power plant in the East. Permanent position with good prospects of advancement for the right men. Plant in small town located directly on the railroad, one hour railroad distance to larger city. Applications with full particulars to be sent to P. W., 6th floor, 318 W. Washington St., Chicago.

WANTED—Distributors, men or women, to give away free packages our famous Perfumed Borax Soap Powder; no money or experience needed; good pay. Ward & Co., 209 Institute Place, Chicago.

SALESMEN: Complete Line Lubricating Oils, Auto Oils, Greases, Paints, Varnishes and Specialties. Experience not necessary. Salary or Commission. Central Petroleum Co., Cleveland, O.

Do you want to earn more money? "Tell it to Sweeney." Read page 18.

WRITE Motion Picture Plays. Easy—Big Pay—We'll teach you. Address United Picture Play Ass'n, San Francisco.

WANTED—In every town reliable man to distribute circulars, samples, papers; tack signs, etc. Good pay; no canvassing. Enclose stamp. Charles L. Sims, Rosebank, N. Y.

RAILWAY Mail Clerks wanted. \$90.00 month. May examinations everywhere. Sample questions free. Franklin Institute, Dep't N 21, Rochester, N. Y.

\$\$\$ INFORMATION Reporters Wanted everywhere. Spare time. Big pay. Confidential. Enclose stamp. National Information Sales Company, ANB, Cincinnati.

ANY intelligent person may earn steady income corresponding for newspapers. Experience unnecessary. Address Press Correspondence Bureau, Washington, D. C.

PARCELS POST Jobs open. Write for list. Franklin Institute, Dep't N 21, Rochester, N. Y.

WRITE For Newspapers. My book tells what's news, how to get it, where to sell. Newspaper directory included, 50 cents. No correspondence school. Morris White, Station 50, Detroit.

MEN and Women wanted for Government jobs. Write for free list of positions open. Franklin Institute, Dep't N 21, Rochester, N. Y.

FORMULA and instructions for silvering mirrors. 50 cents. Leroy Jipson, Rockland, Me.

WANTED Salesmen—Earn \$250 per month, sell advertised goods. Best contract on earth. Elato Co., Station L, New York, N. Y.

WANTED—People to go on the road as traveling advertisers. P. Breeden, Box 938, Norfolk, Va.

MEN—Earn \$100 to \$150 monthly investigating; chance to see the world with all expenses paid; write, Lorraine System, Dept. 304, Boston, Mass.

WANTED—Automatic Screw Machine Operators, Hand Screw Machine Operators, and Electrical Instrument Makers. Apply at the Employment Department, Westinghouse Electric & Mfg. Co., East Pittsburgh, Pa.

BE a Detective. Earn \$200 monthly, positions open. A practical course in Detective Work taught by mail. American School of Criminology, Detroit, Michigan, Dept. F.

EARN \$10 to \$15 a week, and hold your position besides. No canvassing. We, as manufacturers of patented just-in-season specialties, have new easy mail order plans to keep factories busy. We furnish everything. Large profits. Small capital. Experience unnecessary. If you are one of the want-to-go-ahead kind, write for our most modern (copyrighted) plans. Sworn Statement. J. M. Pease Mfg. Co., 540 Pease Bldg., Main St., Buffalo, N. Y.

WANTED, Machinists, Agents, double your salary! Saunders' Hand Book Practical Mechanics; lightning reference. Thousands used. \$1.09, \$1.25, \$1.50. Circular sent. E. H. Saunders, 216 Purchase St., Boston, Mass.

MEN and boys to learn automobile repairing, driving on up-to-date cars; electricity, civil engineering, surveying. Methods most practical. Room and board while learning. Positions secured; satisfaction guaranteed; catalog free. National School of Engineering, 2110 W. 7th, Los Angeles.

GOVERNMENT Examinations. Most thorough preparation; \$5; returned if not appointed; particulars free. American Civil Service School, Washington, D. C.

WANTED one thousand chauffeurs and repair men. Our demand for automobile engineers exceeds the supply. Calls for men of intelligence and mechanical bent capable of commanding \$100 to \$150 per month upon graduation. Resident course \$20 to \$60. Home Correspondence course completed by practical road and shop work at this school, highly successful. Look this up. Auto Schools of America, Dept. T, 1609 Michigan Ave., Chicago.

STOP Here! Let me start you in a home business that will bring you money every day. Experience unnecessary. Spare time. No canvassing. I furnish everything and guarantee success. Send for proofs. Voorhies, Desk C. R., Omaha, Neb.

GO on the Stage. Vaudeville career offered you. Experience unnecessary. Managers endorse my method. Instructive vaudeville book free. Write today. Frederic LaDelle, Sta. 10, Jackson, Mich.

I WILL start you earning \$4 daily at home in spare time, silvering mirrors; no capital; send for free instructive booklet, giving plans of operations. G. F. Redmond, Dept. 306, Boston, Mass.

DON'T fail to read Independence and Fortune under Business Opportunities.

MACHINERY, TOOLS AND SUPPLIES

ONE cracker oven for sale with complete machinery for operating same; also 125-HP Steam engine; some rope transmission equipment, shafting, hangers, pulleys, belting and electrical motors. Address, Perfection Biscuit Co., Ft. Wayne, Ind.

I HAVE several different sizes of the following machines for sale: Lathes, shapers, planers, drill presses, punch presses, fox turret lathes, screw machines, gas engines, steam engines and boilers, saw tables, hand saws, swing saws. Pinner, 122 Water St., New York City.

FOR Sale—A1 second-hand steam boiler, 14 ft. long, 60-inch shell, 54 3/4-inch flues, with full front and water column. W. H. Kirby, Quincy, Mich.

MOTOR—5 H. P. General Electric, nearly new A. C. 2-phase, \$50. Woodward Machinery Co., 27 Blymer Bldg., Cincinnati, O.

MACHINISTS, send for free treatise "How to turn up or repair a crankshaft" with Warnock's combination lathe dogs. H. A. Warnock, Chicago, Ill.

WILL exchange \$120 Federal Vacuum Cleaner. Fully equipped. Nearly new—Want Punch Press or Engine Lathe. Koren, 1621 Jackson Blvd., Chicago.

SIXTY Horsepower Gasoline Motor, only used a few days, \$250. C. Baldwin, 2309 University Ave., St. Paul, Minn.

FOR Sale Cheap, one 8 h. p. Vertical Stickney gas-engine, of heavy type, suitable for running small shop. Address R. K. Traa, Minneapolis, Minn.

PULLEYS, Gears, Sprockets, Shafting, Hangers; see page 128. W. A. Jones Foundry & Machine Co., Chicago.

CAMPBELL Tool fits any 1" wide rule. Something every carpenter should have. Postpaid on receipt of 25c. Montgomery & Co., 105 Fulton St., N. Y.

1000 NEW Lathe chucks, \$10 to \$20 each, all sizes. Lucas & Son, Bridgeport, Conn.

ENGINE Lathe, swings 9 1/2", takes 25" between centers. Complete set gears cutting all size threads 3" to 40", \$43.50. Grammes & Sons, Allentown, Pa.

SHAPERS—Hand or Power, will plane 4"x4". Weight 75 pounds. Price with vise \$55. Montgomery & Co., 105 Fulton St., N. Y.

FOR Sale, Lathes, Screw Cutting. S. B. Machine Tool Co., South Bend, Ind.

PULLEYS, Hangers, Gears, Sprockets. Small sizes for models. Montgomery & Co., 105 Fulton St., N. Y.

FOR Sale—Gasoline engines, automobiles, marine and stationary, also castings. Second-hand ones taken in exchange and for sale. Apply with stamps. B. W. Richardson, R. No. 36, Peoria, Ill.

REBUILT Engines—We have on hand a number of rebuilt "Buffalo" engines, guaranteed, at greatly reduced prices. Write for bargain list. Buffalo Gasoline Motor Co., 1293-1303 Niagara Street, Buffalo, N. Y.

CLOSING out entire line of Stickney engines. Brand new and guaranteed by the manufacturers; List price less 25%. F. O. B. Bridgeport. Sizes 1 1/2—5—7 hp. Waldorf Motor & Machine Co., 135 Cannon St., Bridgeport, Ct.

FOR Sale—One 40-inch Sturdevant planing mill steel exhaust fan, single exhaust. Sellers have no use for same and will sell at a bargain. Jno. H. Swisher & Son, Newark, Ohio.

FOR Sale—Smith-Hubbard, Wabash, Indiana. Gas engine, planer, flooring machine, mortiser; cutoff saw; other equipment. Write for particulars: Bargain.

OTTO Gas Engine 10 H. P. with gas bag, muffler, pulley, batteries, etc., for gas or gasoline, cost \$425 sell for \$225. Warren Webster & Co., Point and Pearl Sts., Camden, N. J.

FOR Sale—200 new lathe chucks. Send for list. Lucas & Son, Bridgeport, Conn.

FOR Sale—Dynamo D. C. 1/2 H. P.; 50 Volt; 6 Ampere. In very good condition. Cost \$35. Will sell for \$17.50. D. Nelson, 1128 Oak Grove Ave., Chicago.

WILL sell at a bargain, Storage Battery, 60 Ampere Hour, 6 volts. Excellent condition. Cost \$40. First \$26 takes it. D. Nelson, 1128 Oak Grove Ave., Chicago.

FOR Sale or Trade—Steam boilers of every description. Leavenworth Boiler Works, Leavenworth, Kan.

6 H.P. TWO cycle marine engine \$45. Badger Motor Co., Milwaukee, Wis.

SELF-Setting Planes on trial. Gage Co., Vineland, New Jersey.

PATERN makers! A book devoted to the principles of pattern and core making and molding. Written by G. H. Willard, a practical pattern maker of years' experience. This book, just published, treats the subject in a much more simple, direct and effective manner than most books along this line. 224 pages, 312 illustrations. Price \$1 postpaid. Popular Mechanics Book Dept., Chicago.

SERIES of 8 lithographic models—Steamship, automobile, locomotive, gas engine, steam engine, steam turbine, wireless telegraph and dynamo. Size 8x14 inches. All parts of these machines are shown and numbered to correspond to printed keys of names. Price each, 50 cents, postpaid, or set of 8, \$3.50, postpaid. Popular Mechanics Book Dept., 318 W. Washington St., Chicago.

MECHANICAL ENGINEERS

MACHINE designing, working drawings, experimental machinery. Cary L. Abbott, Mechanical Engineer, 1241 Unity Bldg., Chicago.

EXPERT designing of special machinery, jigs, fixtures and dies, for rapid production at low cost. Eastern Engineering Company, Dorchester Station, Boston, Mass.

MACHINE, Experimental Designing and Working Drawings. Western Engineering Co., 326 W. Madison St., Chicago.

SPECIAL machinery and labor-saving devices designed and built. Ideas developed and inventions perfected. Send drawing or description for estimate. G. Lange, Designing Engineer, 95 Washington St., (Opp. City Hall), Hoboken, N. J.

MANUFACTURING MACHINERY

MECHANICAL, Electrical, experimental and development work. We make Models practical for display, advertising and manufacturing purposes. Novelties, etc., made to order. Send for estimate. Miniature Mechanical Mfg. Co., 10 So. 5th Ave., Chicago.

WE make working models and carry a complete stock of brass gears and model supplies. Send for catalogue. The Pierce Model Works, 3405 Pierce Ave., Chicago, Ill.

WANTED—Pattern and light Machine Work. Send drawing for estimate on your machine complete. Inventions developed. Modern Pattern Shop, Detroit, Mich.

WANTED, medium weight machinery to manufacture on contract. Special machinery built, pattern work. J. T. Schaffer Mfg. Co., Rochester, N. Y.

GENERAL Job Plating and Oxidizing, also Sheet Metal Stamping. Clinton Electro Plating & Stamping Works, Clinton, Ia.

PUNCH Press Tools, Jigs and Fixtures made accurately and promptly. McCall Machine Works, Rochester, N. Y.

WE manufacture anything, can furnish patterns of brass or wood. Castings in brass or cast iron and aluminum. Our shop is equipped with heavy engine lathes, drill presses, new milling machines (universal). Quotation furnished without cost to you. Write. Practical Gas Engine and Machine Works, North Chicago, Ill.

DIES, tools, novelties and hardware specialties made to order. Metal press work. Inventions perfected. A. Amundsen & Co., 542 W. Jackson Blvd., Chicago, Ill.

CLEVELAND Specialty & Manufacturing Co., Cleveland, Ohio, manufacture Water Motors, Fans, Tapping Machines, Magnet-winders, Inventions developed. Special articles to order.

GENERAL Machinist, Designers, Electricians, Pattern Tool Model & Machine Builders, Automatic Devices and Machinery developed and perfected. Scientific and experimental work a specialty. Regal Model & Tool Works, Chicago's Foremost Model Works, 122-128 So. Clark St., Chicago.

PRESS-stamping work reasonable. Dies and models made. We'll manufacture your novelty, or invention, to order. The Monarch, Boone, Iowa.

IRON brass and aluminum castings. Metal specialties. Patterns, models, polishing, plating and japanning. Send for catalogue of pattern shop and model supplies. North Chicago Tool Works, 15 Grove Ave., North Chicago, Ill.

ENGINE CASTINGS AND BLUE PRINTS.

CASTINGS for Wood Turning Lathe Machines ready to assemble, \$2. Murray & Allender, 113 E. Burlington St., Fairfield, Iowa.

CASTINGS and working drawings for 1 1/2 h. p. gasoline motor. Descriptive literature on request. Eastern Engineering Company, Dorchester Station, Boston, Mass.

GASOLINE Engine Castings, with drawings. Cheap. Catalog for stamp. Novelty Manufacturing Co., 833 West 6th St., Cincinnati, Ohio.

BOATS AND LAUNCHES

CHART of a modern submarine boat showing and naming over 200 parts. Size, 14x28 inches. Printed on plate paper. Shows clearly and distinctly all the interior. Mailed in a tube for 25c. Popular Mechanics Book Dept., 318 W. Washington St., Chicago.

MOTORCRAFT Encyclopedia—A 150-page book that tells 1001 things every motor boatman should know. How to overcome engine troubles. Price \$1, postpaid. Popular Mechanics Book Dept., Chicago.

"**RICE** Motor Boats" \$195 to \$475, 20-ft. Special \$275. Ask for Catalogue. Rice Brothers Company, Box 3 East Boothbay, Maine.

FLOUR & FEED MILLING MACHINERY

SPECIAL bargains in second-hand: Attrition mills, burr mills, crushers, corn shellers, bran dusters, dust collectors, purifiers, reels, double, single, 2 and 3-pair high roller mills, sieve bolters, receiving separators, scourers, etc. Write for description and prices. Sprout, Waldron & Co., P. O. Box 429, Muncy, Pa.

FOR SALE

CLEARANCE Sale of just a few fair size Vacuum Cleaners in perfect order. A 1/2 h. p. motor goes with the bargain for \$14.70 together. Cosmos Electric Co., 136 N. Liberty St., New York City.

CASH Register and Toledo Scales, \$25 each. W. Smith, Box 279, New Bedford, Mass.

VACUUM Cleaner parts, pumps, hose, tools, etc., at wholesale. Many dealers and users make stationary plants or cleaning wagons. All sizes. Saves over half. Vacuum Supply Co., Ann Arbor, Mich.

CHEAP—Unused I. C. S. Mechanical Drawing course; 5x7 Lens, auto shutter; 8x10 Telephoto Lens; Panoram Camera; inch Gear Pump; Elbridge Sparking Dynamo. 281, Haines Falls, N. Y.

ENGINEERS transits and levels for sale. All kinds, second-hand, good as new. W. F. Sprengnether, 203 N. 10th St., St. Louis, Mo.

FOR Sale—Two Box Ball Alleys cheap. Practically as good as new. Marengo Amusement Co., Marengo, Iowa.

SALE OR EXCHANGE

SELL Cheap or Exchange—Electric Banjo—Candy Machine—cost \$900. Good Southern Home, twelve acres—also sixteen acres etc.—cost five thousand. What have you? Auto? J. B. Evans, Hotel Albert, Selma, Alabama.

WILL exchange Public Speaking Course for Gas Engine Course, or others. Inch Spark Coils, Camera, cheap. H. Moreau, 154 State St., Boston, Mass.

TRADE four business lots, Obar, New Mexico, centrally located, for automobile in good condition. Investigate. R. J. West, Topeka, Kans.

CLOSING out automobiles; big bargains; part cash, part trade. L. Hauber, St. Marys, Pa.

EXCHANGE Personal Property. We find you equally interested parties, saving much time and expense. Our way eliminates all middle dealers and gets you directly in touch with parties you need. Booklet upon request. National Trading Service, South Bend, Indiana.

SALE or Exchange: Sheet iron rolls. Shear and Punch. Lock Box 305, Flemingsburg, Ky.

WANTED

WANTED—Job work in aluminum and brass casting. Try us. Simmons & Nungesser, Crestline, Ohio.

DIAMONDS, WATCHES & JEWELRY

\$97.50 PER carat for Genuine Perfect Cut Diamonds is the world's lowest price; made possible by the Basch Plan of importing direct to you. Wonderful written money back guarantee with every diamond. Read our big display advertisement on Page 143. Write to-day for De Luxe Basch Diamond Book free, our costly, beautiful 104-page catalogue. L. Basch & Co., Dept. B., 240 S. State St., Chicago.

GENUINE Diamond Rings ladies or gentlemen's \$8.75 and \$9.75—sent free on approval to your bank or express agent—worth \$25.00—guaranteed perfect cut diamonds—mountings 14 Kt. Gold—this remarkably low price due to our large business and direct importations. Order to-day. Crescent Jewelry Co., 538 So. Dearborn St., Chicago.

GENUINE Mexican Opals from Queretaro for rings, scarf pins etc. Prices reasonable. One Dollar up. Postpaid. Box 470, Brownsville, Texas.

TIME and Its Measurement—An unusual book, being a readable and instructive history of time measurement from the sun dial of remote ages down to the clock period and the present day. Of interest to everyone connected with horology and contains much information not available elsewhere. Written by a great authority who has made this study a hobby. Price in cloth binding \$1.50 postpaid. Popular Mechanics Book Dept., Chicago.

GOLD Filled Wedding Ring Free. Warranted 3 years. To introduce our bargain sheets of fine gold filled rings, we will send this ring, any size, upon receipt of 10c in coin to help pay advertising. The Auction Co., Dept. 331, Attleboro, Mass.

\$25 **GENUINE** Diamond Tiffany Engagement Ring, \$1 weekly. Catalog. Metropolitan Jewelry Co., 129 West 125th St., New York.

PATENT ATTORNEYS

INVENTORS. Let us build your model, or come to Washington and use our facilities. Patent Office records and our assistance will help you greatly in perfecting your invention quickly and at minimum expense. Private rooms for inventors. Models built from sketch and description, experimental work, duplicate parts. Practical inventors and idea twisters. Established quarter of a century. Write for information. Doremus Machine Company, 300-302 13th St., Washington, D. C.

"**PATENTS** and Patent Possibilities" is a 72-page treatise which tells all about patents, what to invent and where to sell it. It gives honest advice to inventors, and is full of valuable and interesting information. Write for it today! It is free. H. S. Hill, 905 McLachlen Bldg., Washington, D. C.

FIND our for yourself what to invent and how to procure and sell a patent for the same. My book, "Inventor's Universal Educator," covers the matter from A to Z. 140 pages, elegantly bound. Also contains 600 mechanical movements and 50 perpetual motions. Price \$1.00, postage free. Money returned if not more than satisfactory. F. G. Dieterich, 651 Ouray Bldg., Washington, D. C.

PATENT what you invent. It may be valuable. Write me. No attorney's fee until patent is allowed. Estab. 1882. "Inventor's Guide" Free. Franklin H. Hough, 5212 Loan & Trust Bldg., Washington, District of Columbia.

THE Patentome is interesting and instructive. A liberal education in patents and how to get them. Free on request. Established 1865. Anderson and Son, Patent Solicitors, 707 G St., Washington, District of Columbia.

I POSTPONE \$30 or patent fees till after invention sold. Write postal. E. P. Thompson, M. E. (S. I. T.) Mem. A. I. E. E., etc., Victor Building, Washington, District of Columbia.

PATENTS of value. Prompt and efficient service. No misleading inducements. Expert in Mechanics. Book of Advice and Patent Office Rules free. Clements & Clements, Patent Attorneys, 704 Colorado Bldg., Washington, D. C.

PATENT your invention. First get free "Inventor's Primer" with statistical data. Milo B. Stevens & Co., Estab. 1864, 685 F St., Wash.; 353 Monadnock Bldg., Chicago.

PATENT Solicitor. Laurence J. Gallagher, formerly Assistant Examiner, United States Patent Office, 2 Rector Street, New York.

SEND for free booklet, all about Patents and their cost. Shepherd & Campbell, Patent Attorneys, 500A Victor Bldg., Washington, D. C.

PATENTS secured. Ideas bring wealth. Prompt service. Personal attention. Harry Patton Co., 390 McGill Bldg., Washington, District of Columbia.

PATENTABLE ideas wanted—Send for 3 free books. R. B. Owen, 30 Owen Bldg., Washington, D. C.

YOUR invention may be worth thousands. Its worth to you is governed by the strength of the Patent. For 39 years our firm has been in business. You get the advantage of our extensive knowledge and ripe experience when we procure your patent. Clients in your state. Write today. Louis Bagger & Co., 609 Barrister Building, Washington, D. C.

PATENTS secured or Fee returned. Send sketch for Free Expert Search and Report as to patentability. Books on inventions and patents, and reference book, sent free. John S. Duffie & Co., Dept. 1, Washington, D. C.

WESTERNERS "boost" the West. Patronize Western attorneys. 17 years' experience. Several years in Washington. Stephen Giusta, Cooper Building, Denver, Co.

I HANDLE your Patent work personally. "No clerks prosecute my cases." Write for particulars. Jno. R. Woodworth, Wardur Building, Washington, D. C.

PATENTS explained in my free books, telling what you should know—what to invent—what not to invent—how to sell your patent, etc. Write today. H. L. Woodward, 902 G Street, Washington, D. C.

WILLIAM F. Nickel, Patent Attorney. Formerly examiner United States Patent Office. Correspondence invited. 2 Rector St., New York, N. Y.

REGISTERED Attorneys make our searches. Send sketch for free report. No Attorney fees until patent allowed. Free books. Fuller & Fuller, Washington, D. C.

PATENTS—Herbert Jenner, patent attorney and mechanical expert, 606 F St., Washington, D. C. I report free of charge if a patent can be had and its exact cost. Send for circular.

C. L. PARKER, Ex-member Examining Corps Patent Office, Patent Attorney, 910 G St., Washington, D. C. Inventor's handbook "Protecting, Exploiting and Selling Inventions," sent free upon request.

ON patents, consult Benjamin Roman, Park Row Building, New York.

PATENTS that protect and pay. Advice and books free. Rates reasonable—highest references; best results. Watson E. Coleman, Patent Lawyer, 622 F St., N. W., Washington, D. C.

PATENTS FOR SALE

FOR Sale. Valuable, useful Patent and Patent pending. Fountain Floor Scrubbing Machine, Scrubs, Wipes, Dries and Brightens the floor. Great labor, money and time saver. Boon to everybody. Goldmine to purchaser. Manufacturing cost \$1, selling price \$8 to \$10. Will sell for reasonable offer. S. Selwa, 2336 Elyria Ave., Lorain, Ohio.

EXPANSIBLE Shoeholder for polishing. American and Canadian Patents for Sale. Sonntag's Patent Agency, Balboa Building, San Francisco, California.

PATENTS Sold. Placed on royalty. Commission basis. Green, Fort Dearborn Bldg., Chicago.

FOLDING Shipping Crate, best and handiest in the world. Frank Simon, Box 310, Wheeling W. Va.

PATENT—Will sell Patent on Novel commercial specialty; can be made for 14½¢, retails for \$1 through agents, mail order, or dealers; no experiment; proven success; exceptional chance for man with some capital. Daniels, 234 La Salle St., Rm. 40, Chicago.

GENUINE Telescope Sight; with open Gunsight. Appeals to users of rifles. Fine Model; Information. "Williams," 1325 Arch St., Philadelphia, Pa.

\$1 GREATEST and simplest invention for \$1. Searchlights are turnable without chauffeurs when autos go curve. Sure money-makers. Send for Blueprints and Specifications. Walter H. Zelch, P. O. Box 146, Mt. Washington, Pittsburgh, Pa.

AN Improved Fruit-Picker which removes fruits without injury. Will sell outright or royalty. Information, L. S. Byrne, Cumberland, Maryland.

FOR Sale: Hat Pin-point Protector. J. D. Burke, 236 Wellington Ave., Elgin, Ill.

FOR Sale—Railway Switch Cuspidor Patent. N. Billings, 6223 Washington Ave., Chicago.

VALUABLE Patent. Promises great fortune to party capable of handling agents. Metal device for offices in demand. Costs One Dollar to manufacture, sells for Five Dollars. Manufacturers, investors write Box 376, Clarksburg, W. Va.

PATENT For Sale—That will make you a fortune; used by every farmer. I own and have exclusive control of same; will put out on royalty, or sell our right; have other business; enough on hand to net \$2,000; investigate. Address Box 29, Manlius, Ill.

PATENT for Waste Pipe Tool No. 874512 for sale. For information, address Benjamin & Bassett, 140 S. Dearborn St., Chicago, Ill.

PATENTS

INVENTOR. Seeking what? A patent document of the almighty dollar? Listen! I have taken 27 patents. Patents secured on my "Commercial System" get benefit 25 years experience marketing them. My story, "My First Invention," interesting, instructive. Thomson, P. O. Box 3547, Boston, Mass.

PATENTS sold. I do the business—not merely collecting advance fees. If you own a valuable patent send for a free booklet, "How I can get cash for your invention." No charges made for listing. Patent Advertising & Sales Co., Frankford, Phila.

INVENTORS: My patent made a fortune. Particulars free. Let me sell yours. Eugene Pearl, P23 Union Square, New York.

PATENTABLE ideas wanted—Send for 3 free books. R. B. Owen, 30 Owen Bldg., Wash., D. C.

PATENTS without advance attorney's fees. Send sketch for free report. Books free. Fuller & Fuller, Washington, D. C.

REAL ESTATE AND FARM LANDS

\$5 MONTHLY Buys Suburban Farm. Fruit, truck or poultry farms, near suburban station, only 35 minutes from the city of Houston, near shell boulevard direct to city; beautiful location; rich soil; plenty rainfall; fine climate; two and three crops a year of potatoes, tomatoes, cabbage and other vegetables, which net growers from \$100 to \$300 per acre; fine strawberry country, also in orange and fig belt; cash market in the city for products. Only a few five and ten acre farms at \$50 and \$55 an acre, no interest, no taxes. Five acres, \$5 cash and \$5 monthly; ten acres, \$10 cash and \$10 monthly. Write today for illustrated literature and all particulars. C. W. Hall & Company, Owners, 715 Commercial Bank Bldg., Houston, Texas.

ARIZONA Roosevelt Dam built by U. S. Reclamation Service makes a garden spot of the Salt River Valley. Under irrigation fruits ripen early and bring highest prices. Hungry market right at home. \$100 acre up. Easy terms. Salt River Valley folder about soil, climate, crops and profits free. C. L. Seagrave, Gen. Colonization Agent, A. T. & S. F. Ry., 1849 Ry. Exch., Chicago.

FARMS—Sale or Exchange North East Missouri. All kinds, sizes and prices. Can match any legitimate deal. Farms cheap for cash. Your money in a farm will make five times as much as savings banks will pay. Has advanced here 300% in ten years. Let me show you. E. T. Hockaday, Shelbina, Mo.

MONEY in Massachusetts Farms. Send ten cents for my book of farms. Tells why and how. Big list of farms and summer homes for sale. Owner's price. Z. R. Pinault, 96 William St., New Bedford, Mass.

IF we would give you a 40-acre farm free, along our line of railroad, would you be willing to tell your friends about our land opening? For particulars address Mr. J. B. Clark, Land Commissioner, Live Oak, Perry & Gulf Railroad Company, Box 158, Live Oak, Florida.

FOR Sale. ½ sec. land in Polk Co. Minn., near Co. seat. Population 8,000. N. W. experimental farm two miles, some stock or give passenger auto part payment. Easy terms. C. C. Hutchinson, Box 178, Crookston, Minn.

BUY a farm any place on the continent of North America. We will give you the names of the owners free. American Investment Association, 37 Palace Bldg., Minneapolis, Minn.

\$6,000; IMPROVED 80 acres near Springdale. 30 acres bearing apple, peach, strawberry. 10 acres timber. Excellent peach prospects. Guarantee good interest on price. Fredricks, Springdale, Arkansas.

TWO tracts of 20 and 30 acres each left on Orchard Mesa, near Grand Junction, Colorado. Orchard homes and farms all around them. \$100.00 per acre with terms. E. A. Atwood Estate, Paxton, Ill.

80 ACRES good timber land; nearly all level smooth land; 6 miles from Doniphan, Mo. Price \$800, \$300 cash, balance \$10. per month. C. H. Martin, Doniphan, Mo.

MONTANA—2000 acre stock and grain farm. 200 plowed. 95% plow ground. Ideal for small grain. \$30.00 per acre. F. C. Metzger, owner, Rothiemay, Mont.

IRRIGATED Farms for sale—In "Famous Lower Rio Grande Valley"—Biggest Bargain ever offered. Donna Land & Loan Co., Donna, Tex.

WANTED—Partner to furnish capital to develop Alfalfa farm land owned, profits, investment guaranteed. Wood, Abilene, Texas.

FARM for Cash, Credit or Crop Payments. Particulars. Ernest Moore, Trotters, North Dakota.

REAL Estate Educator—A 256-page book of inside information about the Real Estate Business, specifically: "Don'ts" in Real Estate, "Pointers," Legal Forms for Sale, Exchange, Building and Suretyship Contracts, Bonds, Mortgages, Powers of Attorney, Leases, Landlord's Agreements, Notice to Quit, Deeds, Chattel Mortgages, etc., How to Become a Notary Public or Commissioner of Deeds, Cloth binding, \$1 postpaid. Popular Mechanics Book Dept., 318 W. Washington St., Chicago.

MONEY—Making farms; 13 states; \$10 to \$50 an acre; live stock and tools often included to settle quickly. Big new Catalog No. 36, free. E. A. Strout Farm Agency, Station 3043, 47 W. 34th St., N. Y.

WILL sell eighty acres land easy terms. Owner, Box 128 Greybull, Wyo. 1800B.

AGRICULTURAL Opportunities—A new 300-page book containing 32 soil maps, showing all important soil and agricultural divisions in every state. Prepared by soil and agricultural experts. Gives reliable information concerning soils, crops, agricultural conditions and opportunities throughout the United States and Western Canada. Homeseekers and investors should write for free map, sample pages and descriptive matter. Agricultural Advancement Agency, Box 62, Madison, Wis.

DO you want to "get ahead?" No section in America offers greater opportunities to farmers, investors and manufacturers than the Southern States. If you are desirous of learning about this growing section, write for the free "Southern Field" magazine and land lists. M. V. Richards, Land and Industrial Agt. Southern Railway, Room 64, Washington, D. C.

PECANS yield biggest profits—Ten Dollars monthly buys ten acres finest North Florida Pecan Land—Thirty dollars per acre. Haas, Roanoke Building, Chicago.

CORN, Cotton, Alfalfa and Fruit lands, \$10 to \$50 per acre. List free. Geo. N. Cannon, Foreman, Ark.

ELLWOOD'S Suburban Acre Homesites; best opportunity to own a home in "America's Winter Play Ground;" in the very shadow of Houston, Metropolis of the Southwest; on driveway soon to be shell paved, also on projected Interurban railway; in the pathway of Houston's greatest growth toward the Bay Shore pleasure resorts; surrounded by suburban gardens and fruit farms; in a community of beautiful homes. Mild subtropical climate; ample rainfall; rich black soil, well drained, adapted to strawberry, truck, fig or orange culture; excellent for poultry raising; convenient to good markets at first-class prices. Sold in one, two and five-acre tracts; one-acre \$3 cash and \$3 monthly; two-acres, \$5 cash and \$5 monthly; five-acres, \$10 cash and \$10 monthly. Introductory sale now on; prices soon to advance. Write today for free illustrated folder, maps and plats. Address, H. R. Ellwood, Owner, 101 First National Bank Bldg., Houston, Texas.

GROW apples and grow rich in the glorious fruit district of Southern British Columbia. Our choice lands \$10 cash and \$10 monthly, without interest. Annual profits \$500 to \$1,000 per acre. Orchard, garden, poultry; scenery, hunting, fishing, boating; warm climate; school, postoffice, store; sawmill; daily trains; close to markets; unlimited demand for products. Write quick for maps, photos, free information, West Kootenay Fruit Lands Company, Dept. Z, Box 1087, Nelson, British Columbia.

GOVERNMENT Farms Free. Our 112-page book "Vacant Government Lands" describes every acre in every county in U. S. How secured free. Latest diagrams and tables. All about Free Government Farms. Official 112-page book. Price, 25¢ postpaid. Webb Publishing Co., (Dept. 385) St. Paul, Minn.

FOR Sale—To Close Estate, Administrator offers finest farm in North Dakota, 480 acres; buildings valued at \$12,000; land worth \$60. Good water, near fine growing town, for immediate sale will sell at \$45 per acre, part cash, balance on time. Communicate at once with R. P. Collins, Fargo, N. Dakota.

MUST Sell 320 Acres Best South Dakota Land. Cost \$4800. No waste land—Part improved. Ripe for investment. Will accept \$4000 cash. F. S. Kern, "Owner," Libertyville, Ill.

SNAP—Must sell town lots. \$65. 10% cash. Baxter's Bureau, Napinka, Man., Canada.

CUSTOM Planing Mill, Farm Lands. W. L. Morse, Mancos, Colo. Cyclones unknown.

GET Your Home in the Northwest United States. Locate adjacent to Northern Pacific Railway—the best developed sections of the Northwest—in Minnesota, North Dakota, Montana, Idaho, Washington, Oregon, the land of prize cattle and crops. Stay near home markets; quick transportation; close to good neighbors and good schools; no isolated pioneering. Free United States Government homestead land; state land on easy terms; deeded land at low prices and on crop payment plan. Write quick for free literature about these "prosperity States of America"—say what state most interests you. Ask about low fares. L. J. Bricker, Gen'l Immigration Agent, 256 Northern Pacific Bldg., Saint Paul, Minn.

SUBURBAN Homesites—\$1 Cash, balance easy payments, at Dalworth Park, Texas, suburb on Interurban, midway between Dallas and Ft. Worth, the fastest growing cities in the Great Southwest, only 32 miles apart. Millions going into new skyscrapers, hotels, factories in the two cities and population has trebled in twelve years; fortunes made here in suburban property. Early buyers will make enormous profits. Dalworth Park offers greatest opportunity, being on Interurban, which is to be double tracked, and on T. & P. railroad and Automobile Pike; \$100,000 already spent on water works, natural gas, street improvements, etc.; 43 trains daily; beautiful large homesites, only \$50 and up, in this special sale. \$1 makes first payment. Write today, before prices advance for Free Booklet, showing views, maps and all particulars. The Dalworth Company, 70 Stewart Title Bldg., Dallas, Texas.

200 ACRES \$800. \$100 cash, balance \$10 per month. Other Texas bargains. Land to trade for merchandise. Marvin Reinhardt, Barstow, Texas.

TEXAS school land on market now; you can buy good land at \$2 per acre; pay 5c per acre cash and no more for 40 years, but 3 per cent interest on the balance. Send 6 cents postage for further information. Investor Publishing Co., Dept. 3, San Antonio, Tex.

SELL your property quickly for cash, no matter where located. Don't pay big commissions. Particulars free. Real Estate Salesman Co., Desk B, Lincoln, Nebr.

DOGS, BIRDS, POULTRY, ETC.

RABBITS—Book on raising Belgian Hares, illustrated, 25c postpaid. Book on Pigeons, illustrated, 50c postpaid. Hardy's Bookstore, Oakland, California.

AIREDALE Terriers and Scotch Collies. State wants? Sales list free. Phil Savage, St. Charles, Ill.

HOUNDS, pointers, setters, terriers, poodles. List, stamp, Stodghill, Shelbyville, Ky.

BARRED Rock Eggs: 15—\$1.50. Extra fine quality. Write Milton Diehl, Lawrence, Kansas.

2,000 FERRETS—Prices and book mailed free. N. A. Knapp, Rochester, Ohio.

The Ideal White—a new scientific squab pigeon—twenty ounce squabs in four weeks, phenomenal demand; booklet free. Ausdale Squab Farm, Mansfield, Ohio.

FORMULAS

3,000 FORMULAS, Recipes and Money-Making Secrets, 368 page cloth bound volume, 50c prepaid. Profitable Service Bureau, 4333 N. Sawyer Ave., Chicago.

SILVERING mirrors formula: complete working instructions, 20c. Scientific Bureau, W. Lynn, Mass.

FORMULA for making Invisible or Secret Ink. \$1. Louis Gardner, Natural Steps, Ark.

FORMULAS—3,000 Formulas and Digest, publishing 100 formulas, etc., monthly. One year, 50c; or silvering mirrors formula (has been sold for \$1.00 by others) and Digest one year, 25c; or 200 formulas, money making ideas, etc., and Digest one year, 25c. Digest, Grand Rapids, Mich.

FORMULAS—15 years manufacturing Pharmaceuticals—25,000 formulas, 25c for any formula and advice. Dr. E. J. Wipf, Stanwix, Worcester, Mass.

FORMULAS for silvering and resilvering mirrors. Best yet, 50c. M. J. Romberger, rear 348 Penn St., Reading, Pa.

FREE. Two formulas How to renew dry batteries and resilver mirrors. Send stamp. M. W. Rand, Box 94, Spokane, Wash.

20,000 FORMULAS, Price \$1, prepaid. Complete list 4c stamps. Edm. Bromley, Watervliet, N. Y.

FORMULA for aluminum solder \$1. Box 33, Syracuse, Neb.

10,000 SELECTED scientific, chemical technological, and practical recipes and processes, including hundreds of so-called trade secrets for every business, alphabetically arranged in one large volume of 800 pages. Price \$3 prepaid. Popular Mechanics Book Dept., 318 W. Washington St., Chicago.

BEST candy and ice cream formulas and recipes obtainable. Guaranteed Correct. 280 candy and 50 ice cream recipes. Increase your trade by improving your goods. Complete illustrated book prepared by practical expert. Price \$4 postpaid. Popular Mechanics Book Dept., 318 W. Washington St., Chicago.

FOR MEN

GENTLEMEN—There is no remedy for tobacco, the habit is irresistible. Your health and clean society demand Felwort. Nature's pure product, clean, healthful, inconspicuous to use. Anti Tobacco and magic drug cures often injurious, are generally failures. Ask about Felwort, the Pyrenees Import, Highland Falls, N. Y.

"SHAVEZY" Razor Guard—makes best safety razor. Send 25c and this advertisement and receive sample post-paid. Regular 35c. Agents wanted. Gilman Company, Roswell, N. M.

FOR Sale. Genuine White Burley leaf tobacco. Best in the world. 3 1/2 lbs. \$1 post-paid. Special prices to agents and merchants. John J. Coyle, Owingsville, Ky.

SAFETY razors sharpened; two cents each. Guaranteed. Blade box free. Electro Stropping Co., 134 Shelby St., Detroit, Mich.

\$1 SILK ties three for \$1 postpaid. Unique Novelty Co., Manufacturer, Independence, Iowa.

FOR THE HOME

GOOD Candy! Get busy and learn how to make your own candy. A splendid and complete course, 50c postpaid. Auburn Supply Co., Dept. GC, 7745 Peoria St., Chicago.

VERMONT Maple Syrup \$1.25 gallon. W. S. Bristol, Vergennes, Vt.

PIPELESS Furnace—Simplest and cheapest way to heat your home, easily installed, guarantee bond furnished. Descriptive circular and prices free. Beuret Heating Co., Auburn, Ind.

PURE-Air Ventilators invigorate health, prevent cold. Dustless, draftless. Recommended by physicians. Fit any window. \$1.00 prepaid. Snyder Mfg. Co., Providence, R. I.

SELF-Setting Planes on trial. Gage, Vineland, New Jersey.

NEEDLEWORKERS everywhere require the Little Helper combination Skirt Gauge, Embroidery Hoop Holder and Sewing Clamp, 25c. Snyder Mfg. Co., Providence, R. I.

MAKE your own mission furniture at the minimum of expense. Our 3 books "Mission Furniture, How to Make It." Parts 1, 2 and 3, tell in plain, simple language just how to make 98 different pieces. Full dimensions working drawings and half tones of finished articles. Price, 50 cents each or \$1.50 for the three volumes, postpaid. Popular Mechanics Book Dept., Chicago.

BEAUTIFUL arts-crafts lamps—Anyone can make them out of paper, cardboard and wood. 16 designs. Inexpensive yet artistic. Complete book of instructions. Price, 50c, postpaid. Popular Mechanics Book Dept., Chicago.

METAL Work and Etching—A 96-page handbook for art metal workers telling how to make a great variety of useful and ornamental objects, such as desk sets, arts-crafts jewelry, etc. Price, 50c, postpaid. Popular Mechanics Book Dept., Chicago.

DRY Cleaning Women's Fine Garments. Send goods by parcel post. Write for prices. The Home Dry Cleaning Co., Wilkesbarre, Pennsylvania.

GLIDING Castors for chairs and tables, protects floors and rugs, 15c set. Six set to introduce, 45c prepaid. The Oakra Co., South Bend, Ind.

GOLD Fish, imported snails, aquariums, water plants. Catalogue free. Pioneer Aquarium Co., Gold Fish Hatchery, Racine, Wisconsin.

TELEGRAPHY

TELEGRAPHY taught in the shortest possible time. The Omnigraph Automatic Transmitter combined with standard key and sounder. Sends you telegraph messages at any speed just as an expert operator would. Five styles, \$2 up, circular free. Omnigraph Mfg. Co., 41 G. Cortland St., New York.

PELNAAR School of Telegraphy, Madison, Wisconsin; students placed; unparalleled inducements.

TELEGRAPHY—Morse and wireless—Railway accounting (Station Agency) taught quickly. Railroad Dispatchers' and Western Union Wires and complete Wireless Station in school. Splendid opportunities. Graduates assisted. Living expenses low—may be earned. Largest and oldest school—established 38 years. Investment, \$25,000. Correspondence courses also. Catalog free. Dodge's Telegraph, Railway and Wireless Institute, 15th St., Valparaiso, Ind.

TELEGRAPH receiving learned in a few hours, by the Simplified Method. 25c coin. Sudbury Technical Institute, 80 Vernon Street, Roxbury, Mass.

WIRELESS

WIRELESS Books: "How to make Wireless Instruments;" "Wireless Telephone;" "Construction Induction Coils and Transformers;" "Wireless Hookups;" 96 pages each, profusely illustrated, 25c; all four 75c. Wireless Association, 229 Fulton Street, New York.

A POSTAGE Stamp brings our 2 catalogues free (Wireless and Electric Novelty). Hancock Electric Co., Austin, Texas.

WIRELESS Set, How to Make—96-page book telling how to construct at small cost an outfit suitable for transmitting four or five miles. Price 50 cents, postpaid. Popular Mechanics Book Dept., Chicago.

\$30.00 WIRELESS outfit for sale for \$20.00 or will sell in part. Cheap. B. & F. Novelty Co., Box 237, Rock Island, Ill.

GAMES AND ENTERTAINMENTS

1913 CATALOG of Joke and Trick Novelties. We are the largest manufacturers and importers in the United States. We sell retail and wholesale. If in the mail-order business or if you are a merchant write us before buying elsewhere, as we can save you big money. Send stamp for catalogue. Home Co., 430 Page Street, St. Paul, Minn.

"MODERN Magic" Practical treatise on Art of Conjuring, 563 pages, 318 illustrations, \$1.60 postpaid. Elite Exchange, R20, 3827 N. 44th St., Chicago.

"EVERYBODY'S Scratching" Itch Bugs are causing it. Barrels of laughs. Sample bug 10c. Hosterman, 1314 So. Limestone, Springfield, Ohio.

TRICKS, Tricks, Tricks—Largest assortment of tricks, jokes and novelties in the world. Send 2c stamp for our new illustrated catalogue, just out. C. J. Felsman, Chicago, 164 N. Clark St. (Main Store), 115 State St. (Palmer House Lobby).

CACHOO—A pinch of it blown into the air makes everybody sneeze without knowing why. Package and copy of a big story paper 10c, three for 25c. L. Dolson, Hampton, Iowa.

GET my complete deck of card tricks. A trick for each card, 52 cards, 52 tricks. Send today. Price, 50c. R. Powell, Manhasset, N. Y.

GO on the stage; complete course that all theatrical managers endorse for 50c. Ross, 310 E. East 15th, Kansas City, Mo.

CACHOO Sneeze Powder 10c. Three for 25c. Agents wanted. Illustrated catalog with order. Havsum Fun Co., Box 342, Atlanta, Ga.

MAGIC Pocket Trick 10c. Israel 440A East 146th St., New York.

NEW and Novel Jokes—great fun producers. So simple a child can operate them. 1. The Spilt Jam (Look what you've done to the table cloth! !). 2. Red Hot Cinder (Drop it on the rug or floor in front of fireplace). 3. Damaged Finger (Deceptive blood-soaked bandage. Great sympathy is expressed by your friends). 4. Blot of Ink (The Bookkeeper goes mad. Mother is frantic). Price, 10 cents each, postpaid. Address Popular Mechanics Book Dept., 318 W. Washington St., Chicago.

FREE—Magic catalogue, 208 pages, 350 illustrations, 800 tricks for parlor and stage entertainment. Buy direct from the manufacturer, cheaper and better apparatus. Send 6c stamps for Souvenir Pocket Trick, particulars, etc. Magic Co., Dept. 10, 249 West 38th St., New York.

NEW Spirit Pictures, 10 cents; catalogue. Klein, 1193 Broadway, N. Y.

PLAYS, Vaudeville Sketches, Monologues, Dialogues, Speakers, Minstrel Material, Jokes, Recitations, Tableaux, Drills, Musical Pieces, Entertainments for all occasions. Make Up Goods, Large Catalog free. T. S. Denison & Co., Dept. 11, Chicago.

WIGS and Makeups for theatrical and street use. Percy Ewing, Decatur, Ill.

MAGIC Tricks, Books and Supplies. Largest line in the world. Old reliable firm. Mammoth catalogue, ten cents. See our ad on page 8. Read & Covert, 821 East 43rd Street, Chicago, Ill.

EXTREMELY Funny, scratch itchem powder. Place little on friend's hand—exciting results. Large box 15c. Lone Star puzzle Texas, 15c. Address Solomon's Not. House, Box 271, Ft. Worth, Tex.

MAGIC Trick or Cachoos sneeze powder, 6c postpaid. Catalogue included free. Sthler Co., 304 Washington, Evansville, Ind.

STAMP COLLECTING

ALL Different, 25 unused stamps, 10c.—50 same, 22c.—10 animal stamps, 8c.—20 same, 21c.—15 Russia, 10c. Cheap stamps on approval. C. Arthur Pitkin, Montpelier, Vt.

STAMPS free—8 different Costa Rica, or 3 different Soudan (camel), big stamp lists, etc., for 2c postage. If you collect stamps, write us. Old collections bought. W. C. Phillips & Co., Glastonbury, Conn.

STAMPS Free. 205 different foreign or 100 United States. Remit 25c 6 mos. subscription. McKele's Weekly Stamp News, Boston, Mass.

1000 FOREIGN stamps 13c. 250 foreign and U. S. mixed 10c. 35 U. S. mixed 5c. Marion Stamp Co., Marion, Ohio.

TRY our approvals at 50% off. References required. Brinekerhoff Supply Co., Dept. 4, Carlton, Ore.

APPROVALS 60% discount. Stamps bought. Lang, 1433B-50th, Cicero, Ill.

1000 FOREIGN Stamps, fine mixture, 25c postpaid. Hardy's Bookstore, Oakland, Cal.

APPROVALS, 1 Peru free for application. Roy C. Fairchild, Stratford, Connecticut.

100 DIFFERENT stamps, better than the average, 10c. The Oudyn Company, Greenville, Ill.

50 STAMPS—All different. New Issues S. & C. American in original cover, 25c. A hummer! L. L. Albright Co., Rochester, New York.

20 VAR. Canada 5c. Approvals 50% Ref. Wholesale list free. Providence Stamp Co., Providence, R. I.

25 DIFFERENT British Colonials to applicants for stamps on approval. Chas. Nickles, 122 Florida Ave., Washington, D. C.

STAMPS, 100, all different, free. Postage 2c. Mention paper. Quaker Stamp Co., Toledo, Ohio.

STAMPS—105 China, etc., stamp dictionary and list, 2c. Bullard, Sta. A, Boston.

PACKET of 23 stamps; no two countries alike, 500 hinges. Set of \$1 and \$2 U. S. Rev., all for 5c. Miami Stamp Co., Toledo, Ohio.

STAMPS, 15 varieties, South and Central America, 4c, sent with our net approvals. Palm Stamp Co., 249 No. Carondelet St., Los Angeles, Cal.

24 VARIETIES Cuban stamps 10 cents. List of 6,000 low-priced stamps free. Chambers Stamp Co., 111 P. Nassau St. New York City.

RARE COINS

10 LARGE Cents 50c. 5 Old Bills 15c. 10 Foreign Coins 15c. All different. C. Burgess, 522 Beacon, Toledo, O.

I BUY and sell old coins, stamps, etc. Send stamp for list. Clarence Evans, Somerville, N. J.

\$100 PAID for 1894 Dime S. Mint, \$8 for certain 1853 Quarters, \$100 for certain 1853 Half Dollars, \$2 for 1885 Dime S. Mint, \$6 to \$750 for certain \$5 gold with our Motto, etc. We pay highest cash premiums on thousands of coins to 1909. Keep all old money and send stamp for Large Illustrated Coin Circular. You have nothing to lose. The Numismatic Bank of Texas, Dept. H, Fort Worth, Texas.

\$4.25 EACH Paid For U. S. Flying Eagle Cents dated 1856. We pay Cash premiums on hundreds of Old Coins. Send Ten cents at once for New Illustrated Coin Value Book, 4x7. It may mean your fortune. Clarke & Co., Coin Dealers, Box 15, Le Roy, N. Y.

COINS—20 different foreign 25c. 10 different bills 25c. 200 different stamps 15c. F. L. Toupal Co., Chicago Heights, Ill.

OLD Coins Bought and Sold—60 page Spring Coin Selling Catalog just out. Free to collectors only. Buying Coin Catalog, quoting prices I pay, 10 cents. William Hesslein, Malley Bldg., New Haven, Conn.

OFFICE EQUIPMENT

I WILL buy used No. 4 Multigraph. Write J., 218 W. 9th Ave., Columbus, O.

PUT Atchison's "Shock Absorber Cushion" under your typewriter. Saves your nerves; stops the noise. 25c, postpaid. A. E. Atchison, 4127 W. 21st St., Chicago.

MUSIC

SINGING taught by mail with personal instructions by best teachers. Write for free particulars with testimonials from our graduates. Illinois Conservatory, Studio F, 96 Broadway, N. Y.

ALL the favorite old songs. Words and music complete in book form with attractive cover; size 7½x9½ inches; good value. Price 50 cents, postpaid. Popular Mechanics Book Dept., Chicago.

RAG-TIME piano playing taught by mail. Book free. Christensen, 84 Auditorium Bldg., Chicago.

PIANOS AND MUSICAL INSTRUMENTS

THE new chemical violin bridge, not made of wood, improves violin tone wonderfully. Price 25c. Order one and tell your friends about it. Bauer Music Co., 135 East 34th, New York.

VIOLIN for sale cheap. Excellent toned. Sent on trial, Miss Bertha Marshe, Route 5, Rosedale, Kansas.

TALKING machines and records at cut prices. 100,000—10 inch records never sold less than 60 cents. Our cut price 20c each. Send for catalogue. Deninger, North St., Rochester, N. Y.

TYPEWRITERS AND SUPPLIES

4 GUARANTEED Typewriter Ribbons postpaid for \$1. 100 sheets carbon paper postpaid for \$1. Satisfaction absolutely guaranteed or money cheerfully returned. Mayhen Chemical Company, Cleveland, O.

FOR Sale, L. C. Smith Bros. and Visible Remington Typewriters both good as new. Aver, 430 2nd Ave. S., Minneapolis, Minn.

WOOD Multiple Typewriter (like Writer-press) cost \$75. Sell \$30, with type. D. S. Reynolds, 45 Devonshire St., Boston, Mass.

BANKRUPT Sale—Greatest in history, all standard makes, all good condition. Low as \$10. Get one now and save 25 to 75%. Sent free trial. Write for Catalogue 16. Typewriter Inspection Co., 227 W. 4th St., Cincinnati, O.

TYPEWRITER—Oliver No. 5 guaranteed perfect, shipped on approval, only \$35. H. J. Postlewaite, Hammond, Ind.

OLIVER visible typewriter for sale cheap. Sent on trial, Charley Rickart, Route 5, Rosedale, Kansas.

REORGANIZATION Clearance Sale. Absolutely reliable typewriters (all makes, all models, all prices), shipped anywhere subject to examination. \$5 worth supplies free. Visible, \$10 up. Oldest Typewriter Exchange, Consolidated Typewriter Exchange, Inc., 245 Broadway, New York.

TYPEWRITERS, Bargains, lowest prices and largest list in the world all guaranteed five years, shipped on 15 days' free trial. Remington \$10, Smith Premier \$10, Oliviers \$15, Underwood \$20. Send for our large illustrated catalogue and special agents' offer. Harlem Typewriter Exchange, 213 West 125th St., New York City.

TYPEWRITER Ribbons for all makes guaranteed perfect, four for \$1, carbon paper \$1 per 100. Peerless Ribbon Co., 213 West 125th St., New York City.

SAVE \$25 to \$50 on manufacturers' prices. Buy our Factory Rebuilt Typewriters. Nearest-to-new on the market. Have trademark and guarantee, like new machines. Are thoroughly rebuilt, highly polished, and perfect in appearance. Satisfaction guaranteed. We are the largest rebuilt typewriter concern in the world. Branch stores in leading cities. Write for catalog of standard makes. American Writing Machine Co., Inc., 345 Broadway, N. Y.

NEVER buy a typewriter until you get my complete catalogue and price list of all standard makes. A. E. Atchison, 4127 West 21st St., Chicago.

ELECTRICAL

\$15.00 TAKES ¼ Horsepower Electric Motor with Vacuum Pump or Blower. Motor suitable for other purposes. Koren, 1621 Jackson Boul., Chicago.

RENEW Old Dry Batteries; three best methods with complete instructions, all for 20c. Guaranteed. Profitable service Bureau, 4333 N. Sawyer Ave., Chicago.

ELECTRICITY. Just what you have been looking for. Our Modern Blue Print Chart Method of Electrical Wiring Diagrams. Thoroughly explained so that you can easily understand them. All kinds of Bell Wiring, Annunciators, Telephones, House Wiring, Conduit, Theatre, Isolated Plants, Dynamos, Transformers, Arc Lights, Special Treatise on Motor Wiring. Write now for information. Electrical Wiring Diagram Co., Box A, 173, Altoona, Pa.

PRINTING AND ENGRAVING

PRINTING that pleases. 50 white, blue or golden 8½x11 Bond Letterheads and 50 envelopes to match, 60c; 100 each \$1. 100 Noteheads, Cards, or Return Envelopes, 35c; 250-60 word circulars, 25c. All postpaid. Prompt service. Race Bros., Hudson, N. Y.

100 CARDS, name and address 30c. Business cards, 45c. 100 envelopes, 35c. 100 letterheads, 65c. Elite Exchange, Dept. T, 3827 No. 40th Ct., Chicago.

WE will print circulars 6¼x3 1/3 one thousand \$1.50, five thousand \$5, ten thousand \$8.50. Fairfield Printing Co., Fairfield, Conn.

BIG Lot Power and Hand Printing Presses, Supplies, bottom prices. List for stamp. Popular Bargains, Riceland, Pa.

50 ENVELOPES xxx stock return cards printed, postpaid 25c. W. S. Klein, Ste. Genevieve, Mo.

250 LETTERHEADS, 8½x11, printed and padded, \$1, postpaid. Samples free. John C. Gering, Freeman, S. Dak.

500 BUSINESS Cards, neatly printed, good stock, prepaid \$1.25. Samples for stamp. Grandon-Beaman, Jackson, Mich.

500 BUSINESS Bond Envelopes, \$1.50, postpaid. Art Type Press, Box 318, East Pittsburgh, Pa.

100 CALLING cards 20c. Hawes, Engraver, Wellesley, Mass.

YOUR name on 200 gummed stickers, 10c. Star Co., Clintonville, Conn.

MULTIGRAPHED - Circular Letters, Letter heads, Reasonable. Thomsen's Letter Shop, 88 Missouri Ave., Detroit, Mich.

PRINTED Envelopes. Buy your envelopes from us and save money. Prices including printing, per 1000 envelopes, 3000 \$1.50, 5000 \$1.25, 10,000 \$1.00. Fine white stock. Larger quantities lower prices. Write for samples and prices on any kind, style or quantity. Satisfaction guaranteed. New England Paper Goods Company, Springfield, Mass.

1000 6x9 40 LB. Book Paper circulars, one side, \$1.50 postpaid. Chas. R. Johnston, 139 Third St., Newburgh, N. Y., Expert printer and graduate advertisement writer.

ACTUAL Typewritten Letters. Produced through big typewriter ribbons. Letterhead printing. Billy M. Schwartz, 82 East Congress St., Detroit, Mich.

WE Make Cuts for circulars, catalogues, labels, etc., everything in the engraving line. Burbank Engraving Co., 185 Franklin St., Boston, Mass.

ALL for \$1.10: 100 letterheads, 100 envelopes, and 100 business cards printed to your order on bond paper. Prepaid. Samples free. Carter Co., Rochester, N. Y.

PRINTING—500 either noteheads, envelopes, statements, cards, \$1: 1,000, \$1.50, 1,000 envelope slips, \$1, 1,000 linen finished letterheads or envelopes, \$2.50, 1,000 typewriter letters, \$2. Samples. Model Company, Manchester, Iowa.

1,000 BOND 3¼x6 circulars, \$1 prepaid. Samples. Smith Supply, Waukegan, Ill.

3,000 FINE Letterheads, Envelopes, Cards, all \$7. Get our "Special" for \$1. Samples free. Thomas M. Clark Company, Michigan City, Indiana.

ACME Coin Molders—\$2.60 per 1,000. For 6 coins \$3. Any printing desired. Samples free. Dodd Printing Co., Fort Madison, Iowa.

EXTRA! 100 letterheads, 100 envelopes, 100 return envelopes, \$1 postpaid. Walden Press, Roxbury, Mass.

PRINTING Presses, type, supplies. Catalog free. L. M. Carroll & Co., 320 Madison St., Chicago.

GOOD Printing at low prices. 1,000 good letterheads, envelopes, cards, billheads, labels, circulars, \$2.50. Samples free. Catalogues, booklets, and circulars our specialty. Ernest L. Fantus Co., 523 S. Dearborn St., Chicago.

MULTIGRAPH form letters—\$3 for 1,000. Includes stock, letter, letterhead—sent prepaid in U. S. Specimens free. Perfection Letter Company, Muncie, Indiana.

MISCELLANEOUS

NEW, Original Valuable Trade Secrets: Chemists' collection 4000 formulas, many offered for first time, such trade secrets as "Fibrovac" Liquid Automobile Filler; "Blazon" Brass Polish, "Skat" Soap Paste, Sta-Gloss Furniture Polish, "Tiz" Foot Tablets, Lava Soap, "Magi-Blanco" Hat Bleach, Dustless Dusters, Polishing Cloths and hundreds of other valuable technological formulas. This collection complete in two books and supplementary sheets, with a 32-page Formula monthly for one year. Postpaid \$1.50. Write me about any formula. Liscomb M. Miller, Ph. G., Marietta, Georgia.

EMBOSS Your Own Stationery with your initial, name or monogram by using our nicked steel die hand embosser. Strictly high-class. Send stamp for impression sheets showing 40 styles. Initial 30c. Monogram 60c. Miller Sales Co., Dept. 3, Lexington, Ky.

RUBBER Stamps—Send 45 cents and get name and address on stamp with ink pad. Special prices in large lots. G. C. Krause & Son Co., 814 Cherry St., Chattanooga, Tenn.

INDIAN-Made Bows and Arrows; rawhide bowstrings and hand decorated. 50c. postage 10c. Chi-Na-Na Trading Post, Domingo Indian, Pueblo, New Mex.

GENUINE Indian Moccasins and Blankets made to order. Moccasins \$3. up. Blankets \$10 up. H. Mays, Box 413, Caney, Kans.

ONE man pulls more than five men can if he uses Laurent Cherry Capstan Pulley Blocks, Trenton, N. J.

BLACK Opals, beautiful colors, direct from Australia. Send \$5.00 Money Order for lovely stone. Satisfaction or cash back. Many pleased customers. Catalogue free. Norman Seward, 453 Bourke Street, Melbourne, Australia.

SKELETON Keys—Just what you need. Will open all common door locks, 25c a set. B. & F. Novelty Co., Box 237 Rock Island, Ill.

GENUINE Hand made Black Rose Beads, also Cross Pendant made from California Roses, joined in Turquoise, Ruby, Amber or Crystal. State color wanted. Cross Pendant, 25c, 30 inch strand, \$2. 45 inch strand, \$3, postpaid. Mrs. Lewis Slover, R. No. 3, Sebastopol, Cal.

YOU can make your own zinc cuts by our simple, inexpensive and tested process. No experience necessary. Our course of instructions teaches you thoroughly. Guaranteed. Complete instructions \$1. Book of 150 Formulas free with every order. Profitable Service Bureau, 4333 N. Sawyer Ave., Chicago.

ANALYTICAL and Consulting Chemists. Chemicals supplied to Experimenters. Correspondence Solicited. The S. & S. Chemical Co., 139 No. Main St., Phillipsburg, N. J.

THE Real Thing beats a Moving Picture Show. All for 10c postpaid. Everybody surprised. 16 scenes in all. Fag, Wizard Company, Dept. B, Seagirt, N. J.

INGROWING Toe Nails positively corrected by wearing Johnson's Nail Shield. Send 50c, 401 Little Bldg., Lincoln, Neb.

WANTED—Farmer sons or Mechanics to invent on farm machinery. Write for offer. Thoma Bros., Watertown, R. 9, Wis.

PINEAPPLES—Indian Rivers. Ripened on the plant. Price \$2.25 per crate. Send me your orders. B. K. McCarty, Eldred, Fla.

MARVEL Key Ring. Latest Model. Key Security. 15 cents stamps. "Marvel" Kalamazoo, Mich.

CHECK Protector. 50c will protect your checks as good as a \$25.00 protector—the figures cannot be rubbed or patched. Fits pocket. Fred W. Funk, Waukegan, Ill.

MY book teaches tattooing 25c coin. Machine, Ink and Directions 50c coin. Rebec Mfg. Co., Cedar Rapids, Iowa.

BE Smart. Fashionable European Hotel Labels for your baggage. Agents wanted. Continental Agency, Nottingham, Eng.

EVERYBODY Is Doing It. Doing what? Purchasing an Initial Embossing punch. 30 cents, postpaid. M. S. Zerega, Neponset, Mass.

DRAFTSMAN'S Adjustable Triangle sent free. "3-in-1" Mfg. Co., Hartford, Conn.

WE want articles to manufacture. Schultze Patent Office, Cincinnati, Ohio.

BOOK filled with hundreds of valuable Formulas, 20c. Resilvering Mirror Formula, best ever originated, 20c. Both for 30c. Profitable service Bureau, 4333 N. Sawyer Ave. (Dept. 4), Chicago, Ill.

ARTHUR'S New Building Estimator—A 750-page handbook for Superintendents, Architects, Contractors, Insurance Adjusters, Appraisers and Engineers. Covers all classes of building construction, special wage tables, typical building specifications, prices in detail and approximate, the former based on quantity of material required, time and labor cost based on hourly rate. 1913 edition, \$3, prepaid. Popular Mechanics Book Dept., Chicago.

TOBACCO-Cure. One box cures. Guaranteed or money back. Established 1894. Write for special offer. Allen Distributing Co., 319 Altman Bldg., Kansas City, Mo.

DO you want to go on the stage. Be a Handcuff King. I will teach you how; for particulars address Box 902, Springfield, Mass.

HIGH School Boys—My money raising scheme for Ball Clubs is a "Coin-Puller." Get wise. Free. Osborne, Camden, New York.

GET a pair of Genuine Navajo Indian Dress Moccasins, they make a classy and comfortable house slipper for gentlemen or ladies. \$2, a pair delivered. The Bennett Indian Trading Co., Albuquerque, New Mex.

GENUINE Mexican Cherry opals, round or oblong cut, size about four karats each. \$1 postpaid. The Bennett Indian Trading Co., Albuquerque, New Mexico.

CUTS anybody can make. Simple Etching Process. \$1. Particulars, specimens, for stamp. M. Day, Windfall, Ind.

EARN \$15 to \$25 a week as our mail order dealers. Right from your own home. Hold your position until entire time is required. We are manufacturers and owners of Patented just-in-season, repeat order specialties. If you are just starting a mail order business or if already established, you can't afford not to handle our patented money making getters. We sell and furnish everything. No canvassing. Small capital. Experience unnecessary. Write today for latest patented leader and manufacturers easy selling (copyrighted) mail order plan backed up by "whole truth," positive proof and sworn statement. J. M. Pease Mfg. Co., 552 Pease Bldg., Main St., Buffalo, N. Y.

I WILL start you earning \$4 daily at home in spare time, silvering mirrors; no capital; send for free instructive booklet, giving plans of operation. G. F. Redmond, Dept. 306, Boston, Mass.

BROTHER—Accidentally discovered root will cure tobacco habit. Gladly send particulars. F. Stokes, Mohawk, Florida.

DON'T fail to read Independence and Fortune under Business Opportunities.



NEW IDEA HOSE SUPPORTERS

Try 'Em Before You Buy 'Em

—and obtain quick relief from interrupted circulation, discomfort, irritation, insecurity and all supporter ills. No bands or elastics to bind, creep and give way. A pair of Nickel Plated "New Ideas" (good for years of comfort), sent prepaid for 15c. (Roman Gold Plate, 50c). If you prefer send a two cent stamp for a pair on approval and pay after trial. Address:

Modern Specialty Co., 43rd St., Racine, Wis.

Mathematics Made Easy

FOR ALL, BY

ROPP'S CALCULATOR

Shows the Answer as quickly as a Watch shows the Time, to all practical Examples likely to occur in the Office, Store, Shop, Bank, Farm or Factory. Over 20 sections—each adapted to some special line of business.

Elucidates and simplifies the science of Arithmetic, Mechanics and Mensuration.

Greatest Time and Labor-saving work on Figures ever used in the commercial world.

Desk size, \$1.25; Pocket, leather, \$1.00; Pocket, imitation leather, 50c; Vest-pocket, 50c. New 1912 copyright edition.

POPULAR MECHANICS BOOK DEPT.

318 W. Washington St., CHICAGO

Matchless Pocket Lighter

Durable and Waterproof, with perfect ignition. Satisfaction guaranteed or money refunded. Sent post-paid complete with pocket clip 35c, 4 for \$1. Agents and Dealers wanted.



A perfect lighter. Occupies no more space in the pocket than a pencil. Indispensable to every smoker, hunter, fisherman and automobilist. Nickel plated

SCHILLER MFG. CO., P. A. 1124 Foster Ave., CHICAGO, ILL.

FOR SALE—A Limited Number of Complete Files of

Popular Mechanics Magazine

For 1910-1911 and 1912

These consist of the twelve monthly issues of the magazine for each year and are suitable for binding.

Price \$1.50 Each Postpaid

If copies of the two complete indexes for each year's magazines are desired send 20c additional.

POPULAR MECHANICS CO.

318 W. Washington St.

CHICAGO

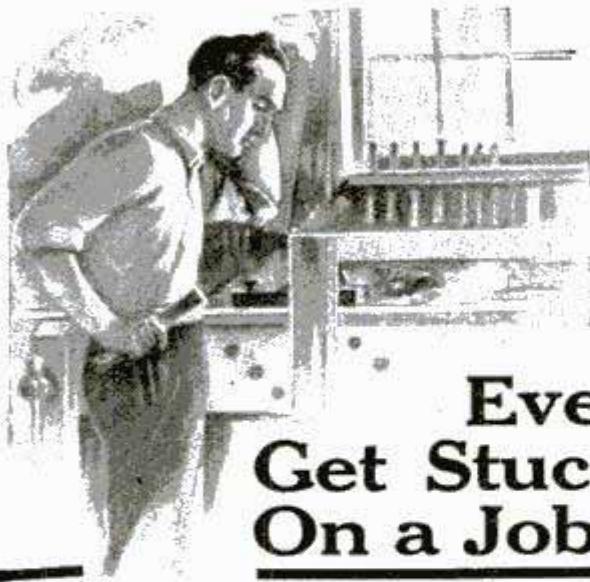

Ever Get Stuck On a Job?

WERE you ever confronted with an emergency job where something unusual had to be done quickly with the few tools at hand or no tools at all? You could have done that unfamiliar job in a jiffy if only some one could have informed you how he did it.

¶ Has it occurred to you that every day, everywhere, men in every department of mechanics, engineers, firemen, carpenters, machinists, plumbers, painters, iron and wood workers, electricians, masons and in fact men in all the trades are meeting and solving these problems in economical, time and labor saving ways?

¶ If a collection of all this useful experience of years, of hundreds of the most successful mechanics could be made, "boiled down" and written so it could be readily understood by anyone who uses tools, would it not be of priceless value to the owner?

¶ This is just what **Popular Mechanics Magazine** has been doing for years, and now our

Series of Shop Notes Year Books

constitutes a veritable encyclopedia of

Easy Ways to Do Hard Things

¶ Naturally these books must be handy of reference to be of value and this feature has not been overlooked as each volume is indexed fully and with great care, so that any subject may be turned to at once.

¶ Why not save yourself the trouble of puzzling out the "kinks" and "short-cuts" when someone has already done it for you? Some one little suggestion may be worth more to you than the price of the entire set of books.

Shop Notes Year Books

VOLS. I TO IX INCLUSIVE

CONTAIN

4595 Articles—1988 Pages—4503 Illustrations

Size 6 x 9 in. Bristol Covers.

PRICE

50c PER VOLUME \$4.50 PER SET of nine Books in Handsome Case Prepaid Postpaid

Order or complete your set to-day

Popular Mechanics Book Dept.

318 W. Washington St.

CHICAGO

You Owe Yourself a Musical Education



There isn't a man or woman on this earth but needs friends. The more friends a man has the more opportunities he has. For whether in business or in social life, it takes *friendship* to secure advancement.

Now the best way to win friendship is through *music*. Music seems to be the key to all hearts. Every door opens to the musician. Money, opportunity and social position are always at his command.

Study Music by Mail For 12½ Cents a Day

Right here is the finest opportunity you will ever have to make yourself a skilled pianist. We have spent '2 years of work, and over \$160,000 in money just to learn how to make piano study easy. We have found the way to cut the cost and to shorten the time mostly spent on a musical education. We teach you to read music from the very first lesson. We can make you a skilled performer by the end of a year.

We offer you something that no other Correspondence Course in music can give—for with our splendid lessons by mail is sent

The Music Master

—It Makes Piano-Study Easy—

the greatest musical invention of the century.

With THE MUSIC MASTER every hour of practice is an hour of progress. No more hours of endless drudgery. No more failures; no more mistakes. But everything taught so simply and demonstrated so plainly right at the keyboard of your piano that even a little child can understand.

Begin to study now. No need to give up other work in which you are engaged. Just use the odd moments of your time and the odd pennies of your money, and in a short time you will be able to play the piano as you never before dreamed that you could play it. Hundreds of others have done this—why not you?

At the successful completion of THE MUSIC MASTER'S Course a Diploma is granted from the German-American Conservatory of Music.

FREE—with THE MUSIC MASTER'S Course—50 pieces of high-grade sheet music.

Mail us this Coupon and we will send you free THE MUSIC MASTER'S OWN BOOK. This is a handsomely illustrated book, full of information about THE MUSIC MASTER and this wonderful Course.

The German-American Conservatory of Music

Now Teaching Piano by Mail

Dept. Q—Steger Building—Chicago, Ill. (22)

AN ORDER FOR

The Music Master's Own Book

This volume to be sent me by return mail free of all expense or obligation on my part.

Name.....

Street and Number.....

Town..... State.....

State whether you desire this course for yourself, son or daughter

Please Mention Popular Mechanics

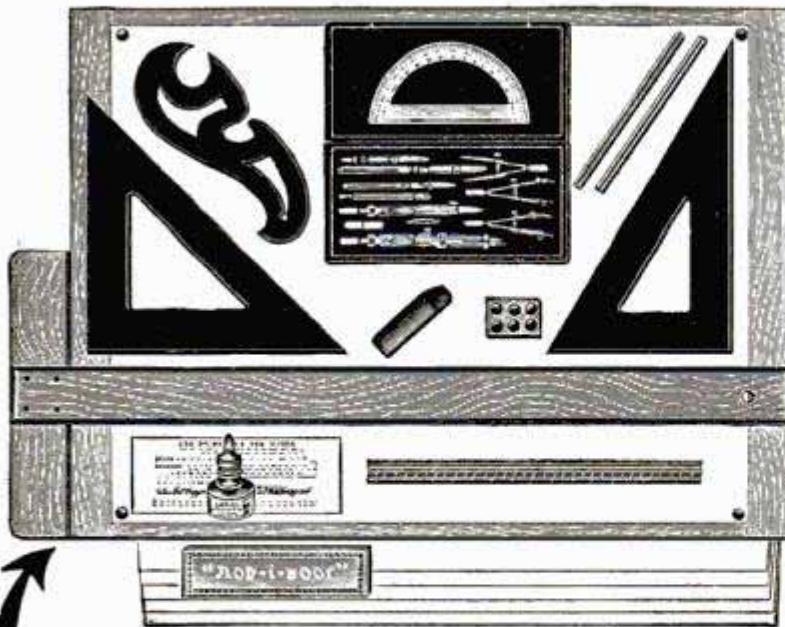

SIZE 20 X 25 INCHES

FREE

This Superb \$15 Draftsman's Working Outfit

Yes, absolutely free. On the great special offer that I am now making, I will give you this superb Draftsman's Working Outfit absolutely free. It is complete and as soon as you get it you will be ready to start work. It's a genuine set—just like the set I use myself. Free to you if you write at once.

Great SPECIAL Offer

A wonderful opportunity now for a few ambitious men. Just think of it. I will give you absolutely free this superb \$15 Draftsman's Working Outfit and this genuine imported German Silver Set of Drawing Instruments. And besides this, I give you an opportunity to **work for me while you are learning**. Start right in and make from \$5.00 to \$10.00 a day as soon as you enroll. But you must write at once—right away. I reserve the right to withdraw this offer in 30 days.

Earn \$125 to \$175 Per Month

I Guarantee

To instruct you UNTIL competent and placed in a permanent paying position at a regular Draftsman's salary of at least \$125 to \$175 per month and guarantee to furnish you free the complete Draftsman's Working Outfit at once from the start.

Would you like to be getting \$175 a month? Easy, pleasant, interesting work among congenial companions, and in a profession with endless opportunities for advancement and influence! Well—you can get it. There are thousands of positions open and always more demand for skilled draftsmen. All big companies issue calls every day in the year for men to fill positions paying from \$125 to \$175 a month **at the start**. Positions paying \$75 to \$100 a week always open. An unlimited opportunity for practically trained draftsmen.

Mail the coupon for valuable book "Successful Draftsmanship," showing you how to become a skilled draftsman in a short time. The book is free if you write at once.

EARN MONEY WHILE LEARNING

On this great special offer that I am now making, I will give you an opportunity to work for me as soon as you enroll, and I am willing to pay you well for this work. You can start making money the day you enroll if you want to. You will find it easy to **make \$5.00, \$10.00 or more in a single day**. A wonderful opportunity to get from a Chief Draftsman personally the training you need in order to hold down a big paying position. Write today for full particulars. Absolutely no obligations of any kind in sending in your name. I will also send you absolutely free and prepaid my new book "Successful Draftsmanship." But you must hurry—because I limit the number of my students in order to train each one personally and individually.



Chief Draftsman DIV. 1195
Engineer's Equipment Co., Inc. CHICAGO, ILL.

FREE

This Imported Genuine German Silver Full Set of Drawing Instruments

Just notice this exquisite set of drawing instruments that I also give you free. They are genuine imported instruments—the kind that the best draftsmen in the country use. I will give them to you free—yes, absolutely free on this great special offer. You get the working outfit and the instruments free. They do not cost you a penny. Write today for full particulars.

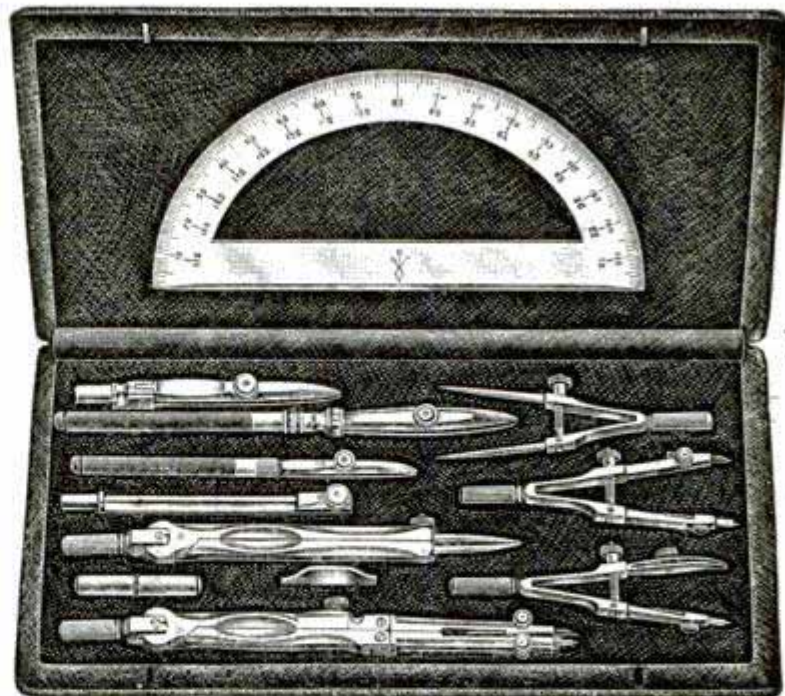

Be a Draftsman!

Draw \$125 to \$175 per month at once

There is always an urgent demand for skilled draftsmen. Companies are issuing calls every day for men to fill positions paying from \$125.00 to \$175.00 per month. Many positions paying \$75 to \$100 per week always open. Work is light, pleasant and profitable.

Chief Draftsman WILL INSTRUCT YOU PERSONALLY AND PROPERLY

I am Chief Draftsman of a large and well known firm. I have been doing the highest paying expert drafting work for a quarter of a century. I know just the kind of training that is demanded from men who get the big salaries. I will give you personal instruction, deal individually with you and give you up-to-date, practical working plans just as your ability and advancement requires. I train you by giving you actual work—practical work, the kind that you must be able to do in order to hold permanent, big paying positions. I give you my individual instruction. If your work is right, I will advance you rapidly. If it is wrong I will show you where, and make you do it right, and do all I can to make you an expert draftsman and designer in a short time.

Pay as You Wish! What I want is the RIGHT KIND of men. Don't bother about expense. The working outfit I will give you free if you get in at once. And I charge just a nominal price for training you to be an experienced draftsman. You can pay the small cost as suits you best. My object is to develop experienced draftsmen—not to establish a money making school.

Send the Coupon for My New Big Book Free

Just put your name and address in the free coupon or a letter or a post card and send it in to me today. I will send you absolutely free and postpaid my new book "Successful Draftsmanship." Absolutely no obligations of any kind. I will also send you absolutely free and prepaid my great special offer that I am now making and show you that you will get the \$15.00 Draftsman's Working Outfit and the genuine Imported German Silver Set of Drawing Instruments absolutely free. You assume no obligations of any kind in sending in the free coupon. Get in line now for a big paying position. Getting the book and full particulars of the special offer is the first step. Write today—now.

Write today NOW



Free Outfit Coupon

Chief Draftsman,
Div. 1195
Engineer's Equipment Co.
Chicago, Ill.

Without any obligation on me whatsoever, please mail your book "Successful Draftsmanship" and full particulars of your liberal "Personal Instruction" offer to a few students. It is understood that I am obligated in no way whatever.

Chief Draftsman Engineer's Equipment Co., Inc.
Div. 1195 CHICAGO, ILL.

NAME.....

ADDRESS.....

Wonderful BOOK FREE!!

Explains Everything You Should
Know About

How To Study

LAW

Any one ambitious to study law and become a successful practicing lawyer at the bar, should not hesitate to send for this GREAT FREE BOOK, which explains exactly what you ought to know before taking up this fascinating and valuable study.

This Book Starts You Right

It shows you how to become a thoroughly competent lawyer—explains the requirements step by step in a plain, simple, direct way that will start you right and save you a lot of time, trouble and expense. There can be no possible failure with this Wonderful Guide to follow. It puts you at once in the path followed by America's Foremost Lawyers—men who have themselves gone through such steps as they now recommend for you. This Free Book shows you

How To Study Law At Home

Under the World's Greatest Masters of Law—how to utilize your spare moments in preparing yourself for a great profession at very small cost—how to prepare for bar examinations in any State—how to increase your mental powers by training that will make you a leader in your community. If you contemplate studying law, you surely want to master the best course in the shortest time at least expense. This Free Book is invaluable to you, no matter what course or school you have in mind, and you might as well send for it—no risk, expense or obligation—and become thoroughly posted.

Save Half Your Tuition

We will not only send you this Wonderful Guide to the Law—absolutely free—but will also point out a way by which you can save half your tuition charges. We are in position to do this for a certain time, so it will be just like keeping a lot of money in your own pocket, if you answer this promptly. Remember, we save you half.

SEND NO MONEY Just your name and address in letter, postal, or on the Free Coupon below, will promptly bring everything Free by return mail. You will find this Guide to the Law an invaluable aid in putting you on the right track. Don't fail to send for it now!

How to Become a Lawyer

LaSalle
Extension
University,

Dept. 59 Chicago, Ill.

Please send me—FREE—Valuable Law
Guide and tell me how to save half on my tuition.

NAME.....

ADDRESS.....

Please Mention Popular Mechanics



I Can Increase Your Earnings

No matter where you live, if you are honest and want an independent business of your own, send your name and address and I will mail you our Big Free 64-Page Book, showing how you may earn

\$3,000 to \$10,000 a Year

in the Real Estate, Brokerage and Insurance Business.

J. H. JOYCE, Pres.

Our system is a positive success. We will teach you by mail and appoint you our

Special Representative

and help you to make money from the start. Write today.
INTERNATIONAL REALTY CORP., 1836 Manhattan Bldg., Chicago, Ill.

A Job with Uncle Sam Is Just Waiting for You

A government position means a job for life with good pay, a liberal vacation, pleasant work, and the assurance that you'll get your pay envelope regularly, in spite of panics or hard times. Wouldn't a job like that look good to you?

Railway Mail, Post Office, Rural Carrier, Custom House, Internal Revenue and Book-keeping "exams" are being held all the time.

Any American citizen, 18 or over, is eligible: a common education sufficient. Decide now that it's what you want, and get your preparation under the personal supervision of a former United States Civil Service Secretary-Examiner. Free Booklet tells all about the details.

WRITE FOR IT TODAY

PATTERSON CIVIL SERVICE SCHOOL

The school with the record for "making good." "Send for Proof."

50 Livingston Arcade

ROCHESTER, N. Y.

SEND
for my
FREE
Books



**DO YOU WANT TO KNOW
HOW TO DEVELOP
VITALITY, ENERGY, ENDURANCE,
NERVE STRENGTH, MUSCULAR STRENGTH
PERFECT PHYSIQUE**

My FREE BOOKS, "The 'Whys' of Exercise" and "The First and Last Law of Physical Culture," tell you, if you are weak or underdeveloped, how to grow strong; if strong, how to grow stronger. They explain how to develop lungs and muscle, the strong heart and vigorous digestion—in short, how to improve health and strength internally as well as externally. Send TO-DAY—NOW—for these FREE BOOKS. Enclose 4c in stamps to cover postage.

PROF. H. W. TITUS, 415 Titus Bldg., New York City
156 E. 23d St.



IF YOU STAMMER

Attend no stammering school till you get my large FREE book and special rate. Largest and best school in the world curing by natural method. Write today. Leo Wells Millard, Pres., North-Western School for Stammerers, Inc., 917 First St., Milwaukee, Wis.

WHEN YOU WANT ANYTHING AND DON'T
KNOW WHERE TO FIND IT
WRITE BUREAU OF INFORMATION,
POPULAR MECHANICS CHICAGO

Chart of a Modern Submarine

Price 25c Postpaid

Showing and naming over 200 parts. Size 14x28 inches. Printed on Plate Paper.

POPULAR MECHANICS BOOK DEPT.
318 W. Washington St. CHICAGO

WHICH?

JOB OR POSITION

Don't wear your life away in the shop. Aim at the HIGHER POSITIONS where brain, not muscle, will be the measure of your ability and compensation.

Learn that which will place you in the PRIVATE OFFICE, where you will be under the personal notice of the executive heads. There you will be thrown in contact with the BIG men—the Captains of Industry—the men who need the services of high-grade help—and who pay salaries running into the thousands for such help.

Shorthand is the one thing that will place you there. You need not spend months in a resident school to learn any of the old-fashioned systems. You are now offered a remarkable improvement in the art. You can learn Paragon

Shorthand in 7 Days

It is being used in the service of the UNITED STATES GOVERNMENT, in law reporting, in the offices of the largest corporations and firms in the land—railroads, banks, etc. You can learn in your own home, during your spare time. Only 26 word-signs, a single alphabet, a few prefix abbreviations and one rule of contraction. Details on request to those seriously interested.

A. LICHTENTAG, President
PARAGON SHORTHAND INSTITUTE

1439-1441 Camp St.
New Orleans, La.



A. LICHTENTAG,
Paragon Shorthand Institute
1439-1441 Camp St., New Orleans, La.

Dear Sir: Please send me your big free book about the Paragon System of Shorthand—I am interested.

Name _____
Address _____
City _____ State _____



PIANO TUNING PAYS

Learn this Independent Profession At Home



MAKING TRIALS OF TRUE TONE BY TUNE-A-PHONE

The TUNE-A-PHONE assures accuracy with or without a knowledge of music. Action Model and tools furnished. Earn \$5 to \$15 per day and regulate your own hours. Diploma granted. Correspondence system. Write for free booklet.

Mr. Daniels writes: "The very first week I started I made \$63.00."

NILES BRYANT SCHOOL,
26 Art Inst., Battle Creek, Mich.

PART SCHOLARSHIP FREE

During the summer months we offer a limited number of part scholarships free to really ambitious young men who are anxious to become expert electricians or Electrical Engineers. Get a

Practical Electrical Education

By our thorough and scientific methods under practical and actual working conditions you must master all branches of Electrical Science and Engineering. We combine the theory with the practice. Write right now about our special offer and interesting school catalog. IT'S FREE. Get it and see what real education is.

SCHOOL OF ENGINEERING OF MILWAUKEE
161-169 Michigan St. MILWAUKEE, WIS.



200 KINDS IRON, WOOD, WIRE & STEEL PUZZLES

Catalog and reader, 10c—3 for 25c
7 for 50c; 15 for \$1—no two alike.
WESTERN PUZZLE WORKS
St. Paul, Minn.



Every Boy His Own Toymaker

Greatest boys' book ever written. Tells how to make a Steam Engine, Telephone, Magic Lantern, Boats, kites, balloons, electrical and mechanical toys, traps, fishing tackle. 200 illustrations; also catalog of 150 puzzles. Keller's Magic Ace Trick Card and "DOUBLE THROAT" warbler and bird call all for only 10c. **WESTERN PUZZLE CO., ST. PAUL, MINN.**

MAKE UP TO \$75 A WEEK

as a Watchmaker and Start Your Own Jewelry Business

Write me today! Let me explain our plan whereby you can become an expert watch repairer in three months—making \$25 to \$75 a week—and own your own jewelry business. I can teach you—I mean YOU—the whole watch repairing business by mail. Write right now!

ROGERS, THURMAN & CO., 1560 Mallers Bldg., CHICAGO



GET THIS COMPLETE HOME COURSE OF LESSONS IN PHYSICAL AND HEALTH CULTURE FREE

The lessons and illustrative charts were prepared by **BERNARR MACFADDEN**, the foremost authority on the subject

The course is the equal of many sold at \$50.00

To every person sending us \$1.00 for **PHYSICAL CULTURE MAGAZINE** we're going to give, absolutely without cost, the Macfadden complete HOME COURSE OF LESSONS IN PHYSICAL AND HEALTH CULTURE. We make this unusual offer as an inducement to get acquainted with the **PHYSICAL CULTURE MAGAZINE**. Just enclose a DOLLAR BILL and say, "Send me your HOME COURSE and make me a subscriber to your magazine." If you are not satisfied we will gladly return your money.

PHYSICAL CULTURE PUBLISHING CO., Room 405 Flatiron Bldg., NEW YORK



Be Boss In the New Profession

Thousands of men are needed. The new profession that is **paying big money** wants you and needs you. Here is your opportunity to get into it **now**. You don't need to leave your present employment. Just a few hours a day in your own home and soon you get your diploma and are a full-fledged Meter Engineer.

Be a Meter Engineer

The profession of Meter Engineering is now in its infancy. It is calling for men. The Central Electric Stations **must** have Meter Engineers, because without them they cannot operate. Thousands of positions now open. Wonderful opportunities. You can get into the profession. It is calling you.

A \$3000 Job for YOU

Meter Engineering is one of the best paying professions in the electrical industry. We can show you hundreds of men who are making better than \$3,000 a year. How would you like to have a \$3,000 job six months from now? Just put your name and address on the free coupon and get full particulars absolutely free. Send it now—today.

Special

For a limited time we are making a special reduced price offer in order to induce men to start the study of Meter Engineering right away. Write for full particulars at once.

Send the Coupon and Get 40-Page

Book FREE

Do not delay an instant. Just put your name and address on the coupon and mail it to us at once. We will send you absolutely free and postpaid, 40-page book on Meter Engineering. It tells you all about the New Profession and about our school. It tells you how you can learn to become a Meter Engineer in your own home during your spare time. Absolutely no obligations of any kind in getting the book. Just your name and address is enough. But write today — now — immediately, while we can still make this great special offer.

**Fort Wayne
Correspondence
School**
Dept. 1195
Fort Wayne
Indiana

FREE Book Coupon

Ft. Wayne Correspondence
School, Dept. 1195
Fort Wayne, Ind.

Gentlemen: Please send absolutely free and prepaid your book on Meter Engineering. Also send me full particulars of the great special offer that is now being made to induce men to study Meter Engineering. I assume no obligations of any sort.

Name.....

Address.....

Please Mention Popular Mechanics



Make Money \$25 to \$50 Per Week in the AUTO BUSINESS

I Will Teach You How To Do It

Right here in Chicago at my Practical School are men from all over the country learning the automobile business—getting ready to earn from \$100.00 to \$300.00 per month—hundreds of other young men have gone into the business and are making money hand over fist.

My 15 Years' Experience in the Auto Business

Makes it possible for me to teach men like you to be chauffeurs, repair men, auto salesmen and demonstrators. Actual work in the "COEY FLYER" factory for every man—shop experience—training to act as a foreman of a big shop.

My Catalogue Is Free

It tells all about this big school of mine right here on Automobile Row—the center of the auto business in America. Correspondence course for men who cannot come to Chicago. Write me personally—do it right this minute.

C. A. COEY, President

C. A. Coey's School of Motoring
Dept. 170, 1424-26 Michigan Ave., Chicago

Now Taught by Mail in 18 Easy Lessons Free Trial Enrollment

SHORTHAND
We positively guarantee to teach the world's greatest system by mail complete in 18 lessons. Costs nothing to make a free trial of our wonderfully simple home-study course. System taught by us now adopted by more than 2,000 schools, including public schools in Boston, Denver, Seattle, Buffalo, and hundreds of other large cities.

Send for particulars today and learn how easily you can now become a shorthand writer.

Learn Right at Home

in spare time. Personal expert instruction. Complete stenographic courses. Typewriters furnished. Low cost, easy terms. Private secretaries and expert stenographers make big money. If you earn less than \$25 a week, write now for Free Trial Enrollment Offer and Free Book telling of big salaries and opportunities. Positions everywhere. Address P. O. Box 1035, Chicago University of Commerce, Chicago, Ill.

LAW TAUGHT BY MAIL

University Methods
Theory and Practice. Faculty, Prominent Attorneys. Courses (UNIVERSITY BANKING, BUSINESS); most Complete, Practical, Easiest, and by mail. University course GUARANTEED. Prepare for bar any state. LAW DEGREES LEGALLY CONFERRED by correspondence. Endorsed by Bench and Bar. Examine Men. Graduates, Students. Write for HANDSOME FREE CATALOG, Special Scholarship Offer and evidence of results.

McKINLEY UNIVERSITY, 1523 E. 55th St., Chicago, Ill.

LEARN WATCHMAKING AND ENGRAVING

Earn while learning. Most practical watch school. Individual instructions. Graduates in great demand. Book free. Chicago School of Watchmaking, 63 E. Van Buren St., Chicago

CACHOO! Make the whole family and all your friends "just sneeze their heads off" without knowing why, with Cachoo, the new long distance harmless snuff. Sent anywhere for 10c. 3 for 25c. 1 doz. and special premium for 90c. AMERICAN SUPPLY CO., St. Paul, Minn.



FREE! OUR BOOK ON HOW TO LEARN ELECTRICITY

Write for Your Copy Today

There is no field which offers such gigantic possibilities to ambitious young men as the Electrical Field. New York is the world's authority on things electrical. Every scientific appliance is used here that has been proven practical. New York's Electrical Power Plants are the finest in the world and our students are taken through them regularly for inspection and instruction.

We teach you electricity by giving you the actual work to do. **YOU LEARN BY DOING!**

Every day new discoveries are being made by men who have studied practical electricity. Our students learn all about the installation of Burglar, Fire Alarm and Electrical Door Opener Systems, Wiring, Shop Practice and Electrical Repairs. The course also includes Estimating and Contracting, Illumination, Sign Wiring, Direct and Alternating Currents, Switchboard Operation and Construction, Dynamos, Motors, etc. In fact, every branch of *Practical Electricity* is taught so thoroughly and so personally that when a student graduates and has his certificate he is several years ahead of the experienced man in the field who has not had special training such as we give.

The course can be completed in six or eight months, although no student is limited as to time. *He stays here and studies until he is actually qualified to hold a good paying position with any of the large electrical companies.* This is NOT a correspondence school but a school where you learn by doing.

Write today for FREE book and full particulars. This is a real opportunity for "live-wire" men who want to get ahead in the world and make something out of themselves.

WRITE NOW!

THE NEW YORK ELECTRICAL SCHOOL
44 West 17th St. NEW YORK

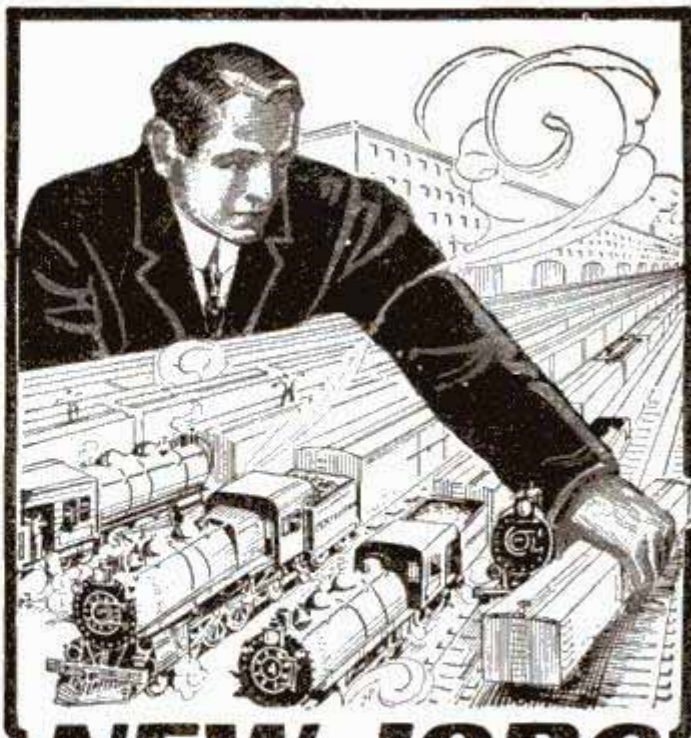

NEW JOBS NOW OPEN

Earn from \$35 to \$100 Weekly as a

TRAFFIC MANAGER

Modern transportation is a jungle of routes and rates calling for specialists who, like the pathfinders of old, have expert knowledge of the trails of traffic. How to route shipments to obtain shortest mileage and quickest deliveries and how to classify goods to obtain lowest rates are two vital factors in business competition. The man who knows how is so valuable to his employer that he commands respect and big remuneration.

Big Salaries Paid to Traffic Managers

Expert traffic managers command from \$2,500 to \$25,000 a year. Why not prepare yourself to fill one of these lucrative positions?

New and Uncrowded Profession

There are half a million LARGE SHIPPERS in the United States. Practically every one of them needs an expert traffic man, and this need is recognized as never before because of the recently enacted railroad rate laws and interstate commerce regulations. The demand for trained and efficient traffic men is many times greater than the supply. *There's room for you.*

Study Traffic and Interstate Commerce

Decide now to become a traffic man. Our Interstate Commerce Course enables you to study AT HOME, without leaving your occupation or sacrificing present income, and to become thoroughly versed and proficient in the strategy of shipping, including routes and classifications, interstate commerce rules and regulations, etc. The instruction is given by some of the biggest traffic managers in the country. The course is easy to grasp and thoroughly practical. Anyone with ordinary intelligence, with reasonable application, can master this new profession.

FREE PORTFOLIO Clip coupon below, sign and mail at once, and we will send you FREE, postpaid, a handsome portfolio containing complete information concerning the opportunities and requirements of this attractive profession. Get posted at once. Clip coupon.

LA SALLE EXTENSION UNIVERSITY, Dept. 60, CHICAGO

FREE PORTFOLIO

COUPON

La Salle Extension University
Dept. 60, Chicago, Ill.

I am interested in the new profession—Traffic Management. Please send me full information and Traffic Book, free of all cost.

Name _____

Occupation _____



Write Address on the Margin Plainly

Please Mention Popular Mechanics



HOW TO TRIM SHOW WINDOWS

Shown in this new book, 150 complete windows for every season of the year illustrated by means of over 200 detail drawings and explained in 256 pages of text matter. Shipped prepaid for \$1.50. This is the 10th year for our

SCHOOL OF WINDOW TRIMMING

CARD WRITING AND ADVERTISING

Best paid and most fascinating professions in the world. A 100 page catalog FREE tells you all about it.



KOESTER SCHOOL, 326 Jackson Boulevard, CHICAGO

DON'T TAKE A COURSE IN Mechanical Drawing

until you have read my proposition. Practical draftsman, working every day in the Drawing Room of the most progressive machine-shop in the west, with long experience also as a Teacher of Mathematics and Drawing, will instruct a few men by mail. **Positively the best means of becoming a practical, well-paid Draftsman.** Instruments furnished. Rates very reasonable. Write for information. A card will do.

DRAFTSMAN, 252 South Corona Street, Denver, Colorado



STAMMER

My book "How to Stop Stammering"—a treatise on "Scientific Talking"—direct to the point.

Write M. L. HATFIELD, 1918 Grove St., OAKLAND, CALIF.



I TEACH BY MAIL

WRITE FOR MY FREE BOOK

"How to Become a Good Penman" and beautiful specimens. Your name elegantly written on a card if you enclose stamp. Write today. Address **F. W. TAMBLYN, 418 Meyer Bldg., Kansas City, Mo.**

JEWELRY ENGRAVING

We teach you, by our new and original method of instruction, this clean, fascinating and profitable business **right at your home**, and furnish you all tools needed absolutely **free**. Write for free book to the

WISCONSIN SCHOOL OF ENGRAVING, Strub Bldg., MILWAUKEE, WIS.

RAILWAY
MAIL
CLERK
EXAMS.

EVERY-
WHERE
MAY
3rd.

YOU—GET A PARCELS POST JOB \$900 to \$1800 A YEAR FOR LIFE

No "layoffs" without pay, because of strikes, financial hurries or the whims of some petty boss. If you want immediate appointment, send TODAY for our schedule showing locations of May 3rd examinations. Any delay means the loss of just so much time in preparing yourself for examination.

We Prepare Candidates Free

Send

PARCELS POST MEANS THOUSANDS OF JOBS OPEN
Coupon Below
FRANKLIN INSTITUTE
(The pathway to plenty)
Dept. O 106, Rochester, N. Y.

The coupon, filled out as directed, entitles the sender to free sample questions; a free copy of our book, "Government Positions and How to Obtain Them," full list of positions open, and to consideration for Free Coaching for the examination here checked.

COUPON

...Bookkeeper	\$900 to \$1800	...Stenographer	(\$800 to \$1500)
...P. O. Clerk	\$600 to \$1200	...Internal Revenue	
...P. O. Carrier	\$600 to \$1200		(\$700 to \$1800)
...Rural Carrier	\$500 to \$1100	...Clerk in the Depts. at	
...Customs Pos.	\$800 to \$1500	Washington	(\$800 to \$1500)
...Railway Mail Clk	\$900 to \$1800	...Canadian Govt. Positions..	

NAME

ADDRESS O 106

Use this before you lose it. Write plainly.

LEARN THE AUTOMOBILE BUSINESS



In four weeks; our guaranteed course \$7.50 leads to steady jobs as chauffeur, mechanic, etc. **FREE.** Simply send name for wonderful new book

"SECRETS OF THE AUTOMOBILE BUSINESS"
Reveals inside workings of auto schools. Also get free "Trouble Chart" which tells immediately how to locate any trouble in the car.

Midland Auto Association 110 Midland Bldg.
KANSAS CITY, MO.

LEARN JEWELERS' ENGRAVING

A high salaried and easily learned trade, taught thoroughly by mail. We will teach the beginner better engraving than he can gain in years of rigid apprenticeship. We will also improve the skill of any engraver. Send for our catalog. The Engraving School, 112 Page Bldg., Michigan Ave., Chicago, Ill.

BE A SALESMAN

Do You Want a Good Position Where You Can Earn From \$1,000 to \$5,000 a Year and Expenses?

There are hundreds of such positions now open. No former experience as a Salesman required to get one of them. If you want to enter the world's best paying profession our Free Employment Bureau will assist you to secure a position where you can earn good wages while you are learning Practical Salesmanship. Write today for full particulars; list of good openings and testimonial letters from hundreds of our students for whom we have recently secured good positions paying from \$100 to \$500 a month and expenses.

Address nearest office. Dept. 122

National Salesmen's Training Association

Chicago, New York, Kansas City,
San Francisco, New Orleans, Toronto.



A Course of Lessons In Drugless Healing

(Mechano-Therapy)

FREE



Not one cent to pay either now or later—no obligation of any kind. Just your simple request

will bring you this valuable course of 62 lessons by return mail *without cost*. This offer is *strictly limited*. We reserve the right to withdraw it at any time without notice. *So don't wait a minute. Send your acceptance right away.*

Why We Are Making This Offer

We want the public to know the *real truth* about Drugless Healing. Besides, these free lessons will demonstrate just how thoroughly, and in what a surprisingly short time you can master this wonderful new profession, at home or in class, without interfering with your regular occupation.

If You Want to Earn \$2500 to \$6000 a Year

if you want an established profession that is remarkably profitable, if you want to become master of your own and others' health and happiness, then send for the free course and see what Drugless Healing has to offer you. Hundreds of successful graduates demonstrate the wonderful efficiency of our methods. How about yourself? Are you satisfied—healthy—happy—making all the money you want? If not, get posted on Drugless Healing *right away*.

Remember—This Offer is Limited

Write NOW for FREE course of lessons. Don't wait to think it over. Get the facts—the real truth—learn what you can earn as a Mechano-Therapist. The FREE 62-lesson course and our free book explain all. Send a postal or letter RIGHT AWAY.

AMERICAN COLLEGE OF MECHANO-THERAPY
Dept. 786, 81 W. Randolph Street Chicago, Ill.

Learn to be An Auto Expert

Six weeks from the day you commence your studies at this great practical school you will be able to repair any make of automobile and drive any car on the market.

Earn \$75. to \$200. a Month

Many of our graduates make even more than this. Big demand for competent repairmen, demonstrators, garage managers and chauffeurs. All practical work. No books used. No tools to buy. Write today for big illustrated free book. Address,

AUTOMOBILE TRAINING SCHOOL, 1185 Locust St., Kansas City, Mo.



LEARN to Repair and Run AUTOMOBILES

Big Money in Auto Business

Travel, get good pay, run garage or auto livery. **FREE** illustrated book tells all. You can learn in a few weeks at home or in our shops. Write for information today.

Kansas City Automobile School

Largest and Best Equipped School in the World
(Conducted by CLIFF HOGAN.)

2181 East 15th Street, KANSAS CITY, MO.



Be a Wireless Operator

Learn at home by mail. Big demand in this new field. Instruction and full equipment for sending and receiving sent on 15 days' free trial. Write for booklet. **MUTUAL TELEGRAPH SCHOOL, 828 Dwight Bldg., Kansas City, Mo.**

LEARN WATCHMAKING AT HOME



You can learn by our modern and original system of instruction every part of the Watchmaker's Trade at home as good or better than at a shop. You can earn money while learning and secure a well paying position or start in business after completing our course of instruction. Good watchmakers are always in demand and earn from \$20 to \$35 per week. For particulars apply to the WISCONSIN SCHOOL OF WATCHMAKING, Stroh Bldg., MILWAUKEE, WIS.

LAW

Great Scholarship Offer!

This Tuition Credit, Valued at \$100.00
WITHOUT CHARGE

Positively the most liberal bona fide offer ever made by an Institution of Learning! A Tuition Credit valued at \$100.00 without a cent of cost to you. This Tuition Credit entitles you to a complete three years' Course in our big Law School—Lectures, Faculty Talks, Examinations and the services of our Consulting Department. The only expense will be for text and postage. We make this liberal offer for advertising purposes. Offer open for a **Limited Time Only**. Take advantage of this opportunity NOW. Clip the coupon and mail it to us for our big Law School Book and full particulars—all FREE—send IMMEDIATELY.

University Instruction at Home

By our superior and successful method of instruction you can master the Law AT HOME just as easily and thoroughly as in the class room of a resident law school. We have had ten years of successful experience in teaching Law by correspondence. Our large and distinguished faculty and staff of special lecturers insure the most efficient service. Our Course covers both theory and practice—prepares for the bar in ANY STATE. We are the only school that actually combines the case and text book method of instruction—same as Harvard, Columbia, Michigan and other big Universities. Our Course is brief and concise—takes only your spare time. Endorsed by Bench and Bar. Write immediately for full particulars of our GREAT SCHOLARSHIP OFFER.



We Furnish this Magnificent Law Library with Every Scholarship. The original cost of this great law library was fully \$50,000. This magnificent set of law books, complete in 12 volumes, covers all the subjects of law. It is written so you can understand every detail of the most complex law problems. Constant revision insures everything being strictly up-to-date. You cannot afford to be without this superb law library. Send coupon IMMEDIATELY.

Business Law Course Know your rights. Protect yourself. Avoid expensive law suits. No knowledge is more important nor practical than knowledge of law. It is the best guarantee of SUCCESS in any business.

Mail This Free Coupon TODAY! Hurry! Hurry! Don't miss out on this great offer.

SEND NO MONEY—just your name and address on the coupon and mail it to us AT ONCE. We will send you our big Law School Book and full particulars of our Great Scholarship Offer—All Free and Prepaid. No obligations on you so send coupon or postal RIGHT AWAY.

American Correspondence School of Law
(The Largest Law School for Home Study in the World)
Dept. 1195
Manhattan Bldg.
CHICAGO, ILL.

FREE Book and Information Coupon

American Correspondence School of Law
Dept. 1195 Manhattan Bldg., Chicago
Gentlemen: I would like to have you send me full particulars of your GREAT SCHOLARSHIP OFFER; also your big Law School Book. Please send everything Free and Prepaid. I obligate myself in no way whatever.



Guarantee
We guarantee to coach free any graduate failing to pass the bar examination in any state. Our Course covers all branches of **American Law** and includes same studies as the leading Law Schools.

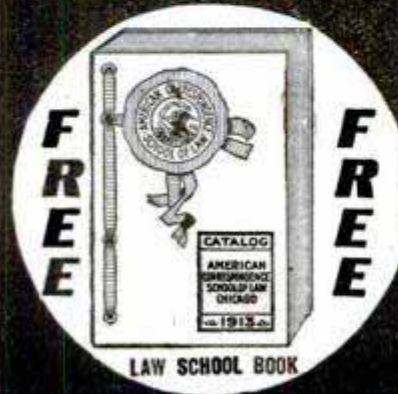

Fold Here, Tear Off, Sign and Mail

Name _____

Address _____

Learn Electricity!



Earn \$150⁰⁰
TO
\$300⁰⁰
a Month

Electricity is today the great motive power of the world. Its use has extended to every phase of life and industry.

Thos. A. Edison says that the field of electricity is in its infancy—that electrical workers of the future will discover uses for this great force now undreamed of.

Right now there are not enough electrical engineers to fill the big paying positions open. Every day our Free Employment Bureau has a call for Electrical Engineers greater than we can fill. Therefore, we are making a very special offer to students at this time.

Write today! Send the free coupon for our catalog and free information.

**We Teach You in a Short Time
—at Small Expense**

In order to supply more electrical engineers we are charging a small tuition fee. Your tools and equipment of all kinds are furnished FREE by the School. You may have easy payments if desired. Our course of instruction is clear, simple and thorough. Our Graduates demand handsome salaries. Don't pass up this opportunity.

FREE TOOLS

We will furnish all the material and tools you use in taking our course — ABSOLUTELY FREE. All we charge is a very small amount for tuition. Many of our students earn their expenses while taking the course.

**Men Wanted
for these Trades**
Electricity Plumbing
Bricklaying
Moving Picture Operating
Mechanical Drawing

We also teach the trades mentioned above. There are unlimited possibilities in any one of these trades. When you have completed our course you will be in a position to demand from \$5.00 to \$8.00 a day right at the start. Or go in business for yourself and make from \$3,000 to \$5,000 a year.

**Send the FREE COUPON for
Catalog and Particulars**

FREE COUPON

L. L. COOKE,
Director

Coyne National
Trade Schools
39-51 E. Illinois St.
Dept. 1195, CHICAGO, ILL.

GENTLEMEN: Without any obligations on me whatsoever, please send me your school catalog and full particulars of this offer to men — ALL FREE.

NAME.....

ADDRESS.....

L. L. COOKE, Director

Coyne National
Trade Schools
39-51 E. Illinois St.
Dept. 1195
Chicago,
Ill.

Please Mention Popular Mechanics

Training Counts

DRAKE'S
HOME STUDY

Mechanical and Electrical Books

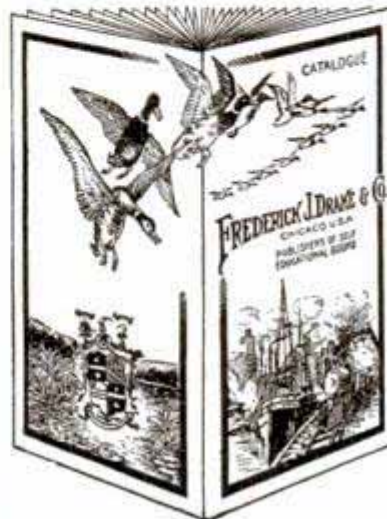

**Will Double
Your Salary**

Practical Instruction Books for mechanics in all lines — Electrical Workers, Engineers, Firemen, Carpenters, Painters, Chauffeurs, Masons, &c.

**WRITE TODAY for
Large 1913 Illustrated
CATALOGUE FREE**

FREDERICK J. DRAKE & CO.
D-8, 1325 Michigan Ave. CHICAGO

LEARN TO RUN AND REPAIR AUTOS

THIS FREE BOOK Explains how you can enter THE AUTOMOBILE BUSINESS

This book explains how we can ACTUALLY START YOU in the Auto business after training you at home by a simple system of lessons, charts and models. Great demand for Auto Experts. You can become a repair man, chauffeur or salesman by our system. We have the highest endorsements of big Auto makers. Our 38 page FREE book explains ALL. Write for it. **PRACTICAL AUTO SCHOOL, 68 Beaver St., NEW YORK, N. Y.**

**Artists, Cartoonists, Illustrators
Earn \$40 a Week Up to \$450**

"Vet" Anderson, internationally known caricaturist, cartoonist and illustrator, teaches caricaturing, cartooning and illustrating by most thorough up-to-date correspondence methods. Comic artists and cartoonists on newspapers earn as high as \$30,000 a year. Learn to draw work that is salable. Inspect other schools, then come to ours and learn right. There are no "ifs" and "ands" about our courses—you can succeed if you will. Send 6c in stamps for our handsomely illustrated catalogue, to cover cost of postage.

"Vet" Anderson School of Illustrating, Inc.
Newark, New Jersey

ADVICE

Information and counsel on any subject under the sun. No matter what you want to know, no matter what your present condition, our big organization can help you.

WRITE TODAY FOR BEAUTIFULLY ILLUSTRATED BOOK FREE
NATIONAL BUREAU OF ADVICE AND EDUCATION, 527 Ashland Block, CHICAGO

MUSIC TAUGHT FREE AT YOUR HOME
Write Today
for our booklet. It tells how to learn to play Piano, Organ, Violin, Mandolin, etc. Beginners or advanced pupils.
AMERICAN SCHOOL OF MUSIC, 50 Lakeside Bldg., Chicago, Ill.

BE AN ILLUSTRATOR
by mail how to draw for magazines and newspapers.
Send for Catalog

Learn to draw. We will teach you
School of Illustration
112 Page Bldg.
Chicago, Ill.

BE A DETECTIVE

Earn from \$150.00 to \$300.00 per month; travel over the world. Write
C. T. LUDWIG, 1600 Scarritt Bldg., Kansas City, Mo.

STUDY LAW

At Home
Become an Attorney

Have a Profession

For over 20 years our graduates have been successfully practicing law in every state in the Union and establishing the reputation of our high grade instruction by correspondence.

YOU Can Be a Lawyer

Three courses: College, Post-graduate and Business Law. Improved method of instruction, combining theory and practice. Actual daily lessons. Approved by Bench and Bar. Classes begin each month. Send for FREE Catalog, giving rules of admission to bar in different states, particulars of our courses, etc. The greatest Law Correspondence School in the world.

CHICAGO CORRESPONDENCE SCHOOL OF LAW
555 Reaper Block Chicago, Ill.



SHORTHAND IN 30 DAYS

We absolutely guarantee to teach shorthand complete in only thirty days. You can learn in spare time in your own home, no matter where you live. No need to spend months as with old systems. Boyd's Syllabic System is easy to learn—easy to write—easy to read. Simple. Practical. Speedy. Sure. No ruled lines—no positions—no shading as in other systems. No long lists of word signs to confuse. Only nine characters to learn and you have the entire English language at your absolute command. The best system for stenographers, private secretaries, newspaper reporters and railroad men. Lawyers, ministers, teachers, physicians, literary folk and business men and women may now learn shorthand for their own use. Does not take continual daily practice as with other systems. Our graduates hold high grade positions everywhere. Send today for booklets, testimonials, etc.

Chicago Correspondence Schools

969 Chicago Opera House Block, CHICAGO, ILL.

I TEACH SIGN PAINTING

SHOW CARD WRITING or LETTERING by mail and guarantee success. Only field not overcrowded. My instruction is unequalled because practical, personal and thorough. Easy terms. Write for large catalogue.

CHAS. J. STRONG, Founder

DETROIT SCHOOL OF LETTERING
Department 102 Detroit, Mich.

"Oldest and Largest School of its Kind"
"Thoroughly Equipped Residence School"



DO YOU LIKE TO DRAW?

That's all we want to know

Now we will not give you any grand prize—or a lot of free stuff if you answer this ad. Nor do we claim to make you rich in a week. But if you are anxious to develop your talent with a successful cartoonist, so you can make money, send a copy of this picture with 6c. in stamps for portfolio of cartoons and sample lesson plate, and let us explain.

The W. L. Evans School of Cartooning
321 Ball Bldg., Cleveland, O.



LEARN WATCHMAKING

refined, profitable labor—Competent men always in demand. We teach it thoroughly in as many months as it formerly took years. Does away with tedious apprenticeship. Money earned while studying. Positions secured. Send for catalog. St. Louis Watchmaking School, St. Louis, Mo.

LEARN TO WRITE EARN \$25 to \$100 ADVERTISEMENTS A WEEK

We can positively show you by mail How to increase your salary. BOOK MAILED FREE.

PAGE-DAVIS CO., 112 Page Building, Chicago, Ill., or 150 Nassau St., New York

LEARNED BY ANY MAN OR BOY AT HOME SMALL COST

VENTRILOQUISM

Send today 2c stamp for particulars and proof.

O. A. SMITH, Room D 78, 823 Bigelow St., PEORIA, ILL.



NAPOLEON A CAPTIVE

NAPOLEON a captive is gazing out across the solemn sea toward France, where he was once Emperor. He realizes that his dream of Universal Empire is at an end, yet is unconscious of his banishment like an outcast a thousand miles from shore to the lonely and barren rocks of St. Helena. This picture illustrates but one event out of all the thousands which are fully described and illustrated in the world-famed publication

Ridpath's History of the World

We are closing out the few remaining sets of the last edition at a great sacrifice in price. They are brand new, down to date and beautifully bound in Half Morocco.

NEVER AGAIN SUCH A BARGAIN

We will name our price only in direct letters to those sending us the Coupon below. Tear off the coupon, write name and address plainly, and mail to us now, before you forget it. Dr. Ridpath's widow derives her income from the sale of his History, and to print our low price broadcast would cause great injury to future sales.

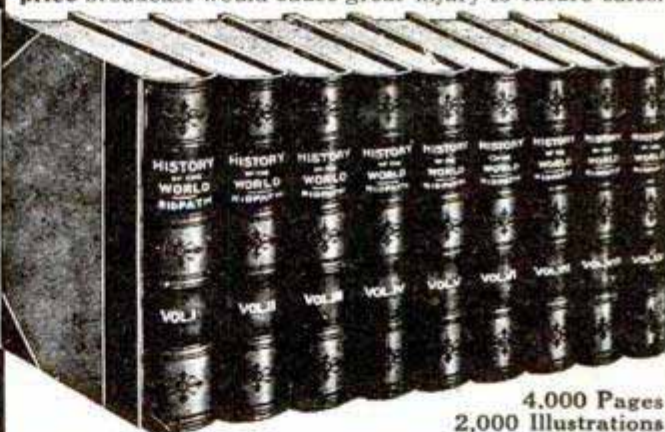

4,000 Pages
2,000 Illustrations

THE REASON for Dr. Ridpath's enviable position as an historian is his wonderfully beautiful style, a style no other historian has ever equaled. Reading this fascinating work widens your mental horizon, arouses your ambition, adds greatly to your fund of knowledge and increases your ability to succeed. Ridpath carries you with him down the long highway of time, through the rise and fall of empires, leaving mankind, today harnessing the powers of earth and air to be his servants, whispering messages across continents and oceans, crowning all with the glorious achievements of the nineteenth century. He covers every race, every nation, every time, and holds you spellbound by his wonderful eloquence. Nothing more interesting and inspiring was ever written. Send following coupon.

Fold here, tear out, sign and mail

Free Coupon

May '13

WESTERN NEWSPAPER ASSOCIATION
140 So. Dearborn St., CHICAGO, ILL.

GENTLEMEN:—Please mail your 46-page free sample booklet of Ridpath's History of the World, containing photogravures of Napoleon, Queen Elizabeth, Socrates, Caesar and Shakespeare, diagram of Panama Canal, etc., and write me full particulars of your special offer to Popular Mechanics readers.

NAME.....

ADDRESS.....

Please Mention Popular Mechanics



We have successful graduates in nearly every State in the Union.

THE OLDEST AND BEST Automobile School

Incorporated for \$10,000.00. The largest, best equipped and MOST RELIABLE automobile school in the country. Unlimited practical instruction on everything pertaining to automobiles. We guarantee to make a chauffeur, repairman, tester, salesman and demonstrator out of you in a short time or we will Refund Your Money. We have arranged with several of Detroit's largest factories to employ our graduates.

COME TO DETROIT, the "Automobile Center," and Learn the Business 67 out of every 100 autos in the country are made in Detroit's 35 auto factories

ADDRESS DEPARTMENT P

MICHIGAN STATE AUTOMOBILE SCHOOL
11-13-15-17 Selden Ave., Near Woodward, DETROIT

SPEAK ANOTHER LANGUAGE

ENGLISH · GERMAN · FRENCH
ITALIAN · SPANISH

CORTINA-PHONE

CYLINDER LANGUAGE RECORD

"The Original Phonographic Method"

DISK LANGUAGE RECORD

Awarded Medals—Chicago, 1893; Buffalo, 1901

Do you want to learn a foreign language by listening to it, without a costly teacher, without loss of time from regular work and at a trifling expense? If so, write at once for a Cortinaphone booklet describing this marvelous method invented by the world famous scientist, Rafael D. Cortina. The outfit consists of the Cortina textbooks, a magnificent phonograph of the two and four minute type, and thirty everlasting non-breakable records, or a Cortinaphone disk machine, thirty disk records (15 double-faced), 3 textbooks and needles.

IDEAL HOME-STUDY METHOD

Thousands have learned a foreign language by our method—just as a child learns its mother tongue—by listening to it. Always ready when you have a few moments to spare. You can learn to speak any language with its help. Write for testimonials from leading University professors and others who have used our method.

We will send the complete outfit, and if you like it you can pay for it in easy instalments.

Write for booklet giving full particulars

CORTINA ACADEMY OF LANGUAGES
Established 1882.

927 Mecca Building
1600 Broadway
NEW YORK

CORTINAPHONE

COPY THIS SKETCH

and let me see what you can do with it. You can earn \$30.00 to \$125.00 or more per week, as illustrator or cartoonist. My practical system of personal individual lessons by mail will develop your talent. Fifteen years successful work for newspapers and magazines qualifies me to teach you. Send me your sketch of President Wilson with 6c in stamps and I will send you a test lesson plate, also collection of drawings showing possibilities for you.

The Landon School of Illustrating and Cartooning
1438 Schofield Building, CLEVELAND, O.



EARN WHILE YOU LEARN BE A WATCHMAKER

Watchmakers and all 'round Jewelers' repairers—in demand now. Six months' course fits you for a position—earn while you learn, too! Write for FREE book—it explains all.

STONE'S SCHOOL OF WATCHMAKING
912 Globe Bldg. ST. PAUL, MINN.



LAW STUDY AT HOME BECOME AN LL.B.

Only recognized resident law school in U. S., Conferring Degree of Bachelor of Laws—LL. B.—by correspondence. Only law school in U. S. conducting standard resident school and giving same instruction, by mail. Over 450 class-room lectures. Faculty of over 30 prominent lawyers. Guarantees to prepare graduates to pass bar examination. Only law school giving Complete Course in Oratory and Public Speaking. School highly endorsed and recommended by Gov. Officials, Business Men, Noted Lawyers and Students. Send today for Large Handsomely Illustrated Prospectus. Special courses for Business Men and Bankers.

HAMILTON COLLEGE OF LAW, 1162 Ellsworth Bldg., Chicago, Ill.

THE UNIVERSITY OF CHICAGO

Correspondence-Study Dept.

HOME STUDY

offers 350 class-room courses to non-resident students. One may thus do part work for a Bachelor's degree. Elementary courses in many subjects, others for Teachers, Writers, Accountants, Bankers, Business Men, Ministers, Social Workers, Etc. Begin any time.

20th Year U. of C. (Div. 20) Chicago, Ill.

LEARN WATCH REPAIRING

Be a watchmaker—you can learn this profitable trade by correspondence in a few weeks in your own home by the DeSelms Chart System. After you complete the course you will know a watch from A to Z. You will know just what the matter is and how to repair one. When you graduate you will be a practical watchmaker and repairer and competent to fill any position. Positions for our graduates.

Ask for our Free Book. It explains our system and terms.

THE DeSELMS WATCH SCHOOL
23 Perry Street ATTICA, INDIANA



CIVIL SERVICE

positions are very desirable. Good salary, short hours, easy work, pleasant surroundings, life positions, steady work, thirty days vacation and thirty days sick leave annually with pay. 46,202 appointments made last year. No political pull needed. Common school education sufficient. Must be 18 years or over. Full information about how to secure these positions and questions used by the Civil Service Commission free.

COLUMBIAN CORRESPONDENCE COLLEGE, WASHINGTON, D. C.

STAMMER NO MORE

I can cure you. Reputation world-wide. Established 16 years. Trial lesson explaining Home Instruction, with 200-page book, FREE. Answer at once.

George Andrew Lewis, 178 Adelaide Street, Detroit, Mich.



Learn Automobile Driving and Repairing

We give you driving lessons and teach you all the technical parts to prepare you for a good paying position. Write for Booklet P. Day and Evening Class.

NORTHWESTERN MOTOR INSTITUTE, 228-230-232 Wisconsin St., MILWAUKEE, WIS.

DRAWING

Caricature, Cartoon, Comic, Commercial, Fashions, Lettering, Newspaper, Magazine and General Illustrating taught by mail. Booklet 6c. Boston School of Drawing, Albion Bldg., Boston, Mass.



Mold Men's Minds by Mail

Maybe the kind of letter you *write* isn't the kind that makes the reader *agree* with you. Maybe the kind you *like* doesn't pay.

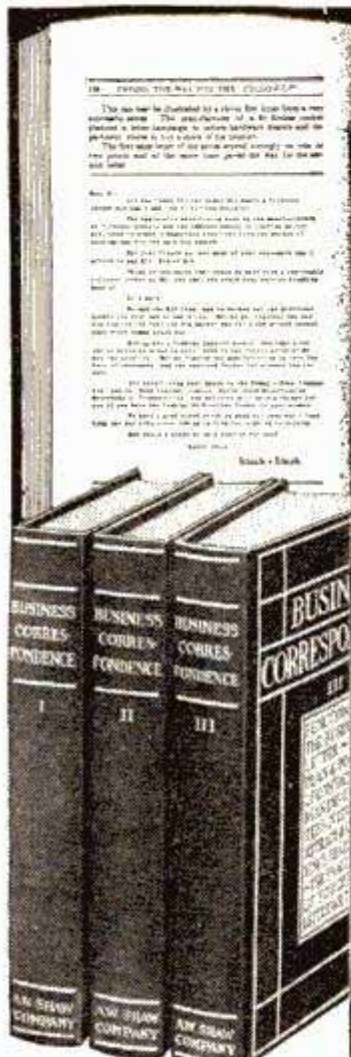

SYSTEM, the Magazine of Business, has for nearly ten years been gathering, sorting, checking up the letters of business men and business firms to find the kinds that actually *do* pay — that get the results wanted. Catchiness, cleverness, smartness—dignity, aristocracy of appearance, and smoothness—have been pierced through and the cold facts of *what the letters did*, ascertained.

Actual examples of how other men have written

- Letters to Follow-up Inquiries see Vol. I, pp. 158, 199; Vol. II, pp. 8, 17, 18, 28, 29, 32, 38; Vol. III, pp. 112, 113
- Unusual Sales Letters—see Vol. I, pp. 132, 133, 134, 147, 161; Vol. II, pp. 35, 36, 37, 177; Vol. III, p. 83.
- "Last Resort" Collection Letters see Vol. III, pp. 134, 135, 136, 137, 138.
- Continuous Follow-up Letters see Vol. II, pp. 8, 17, 18, 31, 32.
- Letters with Clever and Effective Appeal—see Vol. I, pp. 58, 100, 101, 216, 217, 218; Vol. II, pp. 157, 163, 164.
- Opening Paragraphs that get Attention—see Vol. I, pp. 31, 32, 33, 74, 35, 36, 37, 38, 39, 81, 82.
- Interest-Holding Paragraphs see Vol. I, pp. 42, 43, 44, 45, 46, 47, 48, 49, 72, 73, 74, 75, 76, 77.
- Arguments that Clinched the Sale see Vol. I, pp. 52, 53, 54, 55, 56, 57, 58, 59.
- Money-getting Collection Letters see Vol. III, pp. 109, 114, 115, 130, 131, 135, 136, 137, 138.
- Retailers Collection Letters see Vol. III, pp. 121, 122.
- Installment Collection Letters see Vol. III, pp. 128, 129.
- Letters to Bring Cash with Order see Vol. III, pp. 163, 165.
- Letters that get New Customers see Vol. II, pp. 122, 215; Vol. III, pp. 45, 56, 58, 84, 86.
- Paragraphs that Prompt Action see Vol. I, pp. 135, 136, 137, 138, 188, 189, 190, 191, 192, 193, 194, 195, 196; Vol. II, pp. 46, 47.
- Closing Paragraphs that Clinch see Vol. I, pp. 54, 56, 57, 58, 59.
- Letters to Accompany Catalog see Vol. I, pp. 81, 154, 158, 160, 161.
- Letters to Follow-up Real Estate Prospects—see Vol. II, pp. 31, 36, 37, 40, 41, 42; Vol. I, p. 158.
- Salesmen's Letters to Dealers see Vol. III, pp. 96, 97, 98, 101.
- Clever Schemes to Get Replies see Vol. I, pp. 143, 147, 148, 149; Vol. II, pp. 152, 153.
- Letters Offering Premiums see Vol. II, pp. 49, 160.
- Dealers Trade-Getting Letters see Vol. II, pp. 193, 194; Vol. III, pp. 18, 19, 20, 21, 22, 23, 29, 30, 35, 38, 39, 42, 43, 45, 48, 49, 50, 51, 52, 53, 55, 56, 78.
- Letters Emphasizing the "You" Element—see Vol. I, pp. 179, 180.
- Special Inducements to Retailers see Vol. II, pp. 174, 175, 187; Vol. III, p. 8.
- Letters to Get Dealers' Clerks Co-operation—see Vol. III, p. 87.
- Letters that Educate Dealers' Customers—see Vol. II, p. 123; Vol. III, pp. 61, 63, 65, 66.
- Effective Descriptions in Letters see Vol. I, pp. 42, 43.
- Arguments to Advance Prices see Vol. II, pp. 144, 146, 159.
- Clever Answers to Complaints see Vol. III, pp. 172, 179, 180, 181.
- Paragraphs to Increase Effectiveness of Enclosures—see Vol. II, p. 103.
- Letters for Collection Agencies see Vol. III, pp. 132, 133.
- Letters that Appeal to Women see Vol. I, pp. 203, 205, 207, 208, 209, 211, 212, 213.
- Letters that Appeal to Merchants see Vol. III, p. 175.
- Letters that Appeal to Farmers see Vol. II, pp. 118, 119, 120.
- Business-Getting Postals see Vol. I, pp. 175, 182.
- Letters Emphasizing Special Prices—see Vol. II, p. 143; Vol. III, p. 113.
- Letters asking Credit Information see Vol. III, p. 163.
- Letters to Turn Down Poor Credit see Vol. III, pp. 161, 162.

The 553 letters that paid out best in results, with clear, keen analysis of *why* they paid, have now been published. All manner of letters are represented—Sales Letters, Collection Follow-Ups, Letters to Farmers, to Dealers, to Women, to Business Men, Answers to Complaints, "Policy" Letters, Follow-Up Letters, Letters to convey Business or personal Prestige, Letters to get a Job.

Here they are—for any business man to read and study and compare with his own ideas. The *real* letters of real men that really turned the trick—together with the clear, simple *principles* back of every letter, every paragraph, every word, graphically explained.

SYSTEM's trained investigators have for years scanned every letter coming into or going out from SYSTEM's offices. They have been given free access to the correspondence files of many business concerns. They have answered ads, sent coupons, incurred debts and bought on installments, to get the genuine correspondence of actual business. Through newspaper men and Ad Clubs in big cities and small towns, the particularly good letters of local retailers, banks, real estate agents, etc., have been secured. And our experts have run down every striking letter to its source, learned the methods, ideas and policies of each writer—gone over his other letters that *failed* and compared them with those that *won*. And out of them brought back for this great "Business Correspondence Library" not only the *letters* that win, but the very essence of the genius and ability that *made* them win.

What You Can DO With Them

What can you do with *experience*? These letters, and the explanations that go with them, are the *actual experience* of the business firms and men who today can make the most money or gain the most advantage from a business letter. These are the *kind* of letters that will get you what you want whenever you have to or can get it by letter.

\$1 Brings the Complete Library on Approval

Jed Scarboro, 557 Halsey Street, Brooklyn, N. Y., himself a famous writer of sales letters, says: "Only Vol. II has come to hand, but you'd have to shake a cool hundred under my nose to make me give up my copy. I mean it."

W. P. McCubbin, St. Joseph, Mo., writes: "Enclosed are copies of two letters prepared with the assistance of your books. From each we have received \$5,000 in mail orders within three weeks."

M. D. Prevost, New Bedford, Mass., says: "\$350 profit in twenty-four hours from one of the many points in Vol. II of the 'Business Correspondence Library' is the recommendation I give. I took one of the ideas and made an ad of it for yesterday's paper. And, as a result, today I have \$350 more than yesterday with the prospect of a little more."

And Jos. Weiler, Wholesale Produce, Olney, Ill., says: "While I have just got to page 88, Vol. I, I know I'm not going to send them back."

Merle Sidener, Publicity Counsel, Indianapolis, Ind., says: "There was never any chance for the books to go back to you after I had read the first chapter of Vol. I."

You can not only look over Chapter I, which was enough to satisfy Mr. Sidener; you can not only look over to Page 88, which was enough to convince Mr. Weiler; you can not only look over Vol. II, from which M. D. Prevost made \$350 in 24 hours and for which Jed Scarboro says he would not take a hundred dollars—but you can look over all *three* volumes before you agree to pay a penny for them. Send the coupon and merely \$1 deposit for Approval Examination.

I enclose \$1. Send me the 3-volume "Business Correspondence Library" and enter my name for a 2 years' subscription to SYSTEM, the Magazine of Business. I promise to send \$2 a month for the four following months—making \$8 in all. But—if I should not see my money's worth in the first glance through the books and the magazine, I have the privilege of putting them back in the special carton, and returning to you within 5 days of their receipt. And this, it is agreed, shall release me from my promise, cancel my order, and you're then to refund my dollar by return mail.

P. M. 5-13

Name.....

Business.....

Address.....

44-60
East 23rd St.
NEW YORK

SYSTEM
THE MAGAZINE OF BUSINESS

Wabash
and Madison
CHICAGO

Canadian Price \$10—same terms; abroad, \$11—\$5 down, \$2 monthly.



HIGHLAND PARK COLLEGE DES MOINES IOWA

Enter Any Time. 2000 Students Annually

One of the most completely equipped ENGINEERING SCHOOLS in the country. Students may enter any time they are ready to come.

COURSES OFFERED

1. CIVIL, ELECTRICAL AND MECHANICAL ENGINEERING COURSES. Standard courses are offered in Civil, Electrical and Mechanical Engineering. Special opportunity is offered for making up work or for taking a complete course preparatory to the standard Engineering Courses. Shop work from the beginning comes in preparatory courses. See our new Engineering Catalogue.

2. SHORT COURSES
1. One Year Electrical Engineering Course
 2. One Year Telephone Engineering Course
 3. One Year Steam Engineering Course
 4. One Year Machinists' and Automobile Course
 5. One Year Course in Mechanical Drawing

Just a fair common school education is all that is required for entrance to these courses. These courses are very practical and are intended for those who have but limited education and do not see their way clear to take a complete Engineering Course. The Machinists' Course is especially practical. The new machine shops are the most complete to be found in connection with any Engineering School in the United States.

SPECIAL COURSES

1. TRACTION ENGINEERING. This is the most complete course in Traction Engineering offered by any Engineering School in the country. It may be completed in three months. Students are taught how to make all repairs on engines as well as to handle them. Four traction engines used for experimental purposes.

2. GASOLINE AND AUTOMOBILE COURSES. These courses may be completed in three months. They are exceedingly practical. Complete Chauffeur practice. Just a fair common school education is all that is necessary to enter.

3. FARM BLACKSMITHING, FARM CARPENTRY.

Mention course in which you are interested. Address,

O. H. LONGWELL, Pres. DES MOINES, IA.

FRENCH, GERMAN, SPANISH, ITALIAN



Can be learned quickly, easily and pleasantly, at spare moments, in your own home. You hear the living voice of a native professor pronounce each word and phrase. In a surprising short time you can speak a new language by the

LANGUAGE-PHONE METHOD

combined with
ROSENTHAL'S PRACTICAL LINGUISTRY

Send for Booklet and Testimonials

The Language-Phone Method

961 Putnam Building, 2 West 45th Street, N. Y.

WHY NOT BE AN ARTIST?

STUDY drawing at home under Expert Faculty. We have successful students in every part of the world. Turn your Talent into money. Our Students are filling high salaried positions. 14 years successful teaching. Endorsed by high authorities. 18 Courses in Commercial and Illustrative Drawing. Teachers' Normal and Applied Art, Profit or Culture.

Thoroughly Equipped Residence School

Artist's Outfit FREE to Enrolled Students

SCHOOL OF APPLIED ART, 755 Applied Art Bldg., Battle Creek, Mich.

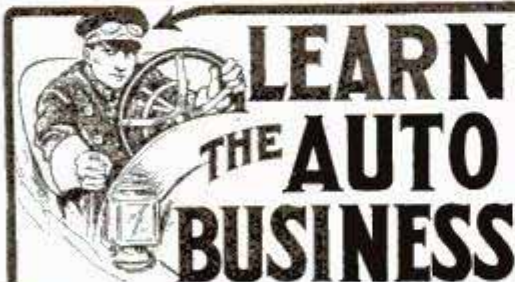

EARN A SPLENDID SALARY

Let us train you in our splendidly equipped shops for a good position as automobile mechanic, salesman or chauffeur. Thousands of graduates are earning big salaries. Complete training in 4 weeks, including extensive practice in repairing and driving high powered cars. Tuition and board reasonable.

Send to-day for catalogue and list of graduates

CLEVELAND AUTOMOBILE SCHOOL, 2341 Euclid Ave., CLEVELAND, O.

Be a Doctor of Chiropractic

The New Drugless Healing Science OF SPINAL ADJUSTMENT

A Dignified, Profitable Profession Easily Learned at Home. Steady Demand for Practitioners Everywhere—Our Students Surprisingly Successful.

Make \$3000 to \$5000 a Year

Your income as a Chiropractor can be this much or more year after year. At the same time you will be serving suffering humanity. Dr. Walter made \$500 the third month after starting; R. M. Johnson has added over \$3,000 a year to his income; Vern Sharpsteen makes \$40.00 a day. In addition, this fascinating profession is building up for these former students of ours a splendid social and professional reputation.

We taught these men in their spare time by correspondence, and in class, to be Doctors of Chiropractic—the

NEW DRUGLESS HEALING SCIENCE of Spinal Adjustment

—and thereby made them independent for life. We will guarantee to teach you with equal success. A common school education is all you need to begin—our simplified training does the rest.



Sample lesson sheets and illustrated book giving full instructions how to get into this well-paid, uncrowded profession at once—mailed

FREE

National School of Chiropractic, Dept. 130, 1553 W. Madison St., Chicago

Drafting will Promote You!

These courses will give you the knowledge that means promotion and big salary: Architectural, Mechanical and Structural Drafting and Design, Estimating and Contracting, Builders' Courses and Plan Reading.

STUDY
D
IT
PAYS

DRAFTING Chicago Technical College

FREE EMPLOYMENT BUREAU. Study at home or in our college classes. State which. WRITE TO-DAY!

603 Athenaeum Building, Chicago, Illinois

BE A TELEGRAPH OPERATOR

Learn at home by mail. Earn \$75 to \$250 per month. Big demand for operators. We send you instrument and instruction on 30 days' FREE trial. Write today for Free Book and Telegraph Code.



MUTUAL TELEGRAPH SCHOOL, 827 DWIGHT BLDG., Kansas City, Mo.



BE A BANKER

Learn a profession that will give you standing and independence. Splendid opportunities. Pleasant work, short hours, all holidays off, yearly vacation with pay, good salary. Diploma in six months. Text books by Edgar G. Alcorn. Catalog free.

AMERICAN SCHOOL OF BANKING, 119 McLane Bldg., COLUMBUS, OHIO

LEARN JEWELRY ENGRAVING

in your own home. Earn \$20.00 to \$50.00 Weekly. Personal instructions. Write for free booklet. Chicago Engraving School, 612 Athenaeum Bldg., Chicago

ARITHMETIC SELF-TAUGHT

A plain, easily-understood volume for all who have not had the opportunity of learning this subject thoroughly, or who have forgotten what they once learned. 257 Pages. Requires no teacher. This great little book sent postpaid for 60 CENTS. Stamps accepted, leather binding \$1.

GEO. A. ZELLER BOOK CO. Est. 1876, 4473 W. Belle Place ST. LOUIS, MO.

SPANGENBERG'S
PRACTICAL
ARITHMETIC
Self-Taught

The First Correspondence School. And the Strongest Teaching LAW BY MAIL



This school was the pioneer. It started with right principles. It steadily gained impetus by giving full-value instruction to its students. For 23 years it has merited the confidence of thousands of young men anxious to learn law, has fitted them for high honor and power, and has fulfilled every pledge. Surely this is the school for you! Our College Law Course and Business Law Course are endorsed by leading jurists, lawyers and law colleges. They are personally taught by attorneys of long experience. They are ably supplemented by authoritative text books, side helps, examinations and encouragement—all included in the one fair price. We have an honest catalog, explaining each detail. Do you mean business? Then write for this catalog.



The Sprague Correspondence School of Law,
290 Amerlean Building,
Detroit, Mich.



Learn a Paying Profession

that assures you a good income and position for life. For seventeen years we have successfully taught

PHOTOGRAPHY

Photo-Engraving and Three-Color Work

Our graduates earn \$20 to \$50 a week. We assist them to secure these positions. Learn how you can become successful. Terms easy—living inexpensive. Write for catalogue—NOW!
ILLINOIS COLLEGE OF PHOTOGRAPHY, 999 Wabash Avenue, Effingham, Ill.

LEARN TO BE A WATCHMAKER

BRADLEY POLYTECHNIC INSTITUTE
Horological Department, Peoria, Illinois



Largest and Best Watch School in America We teach Watch Work, Jewelry Engraving, Clock Work, Optics. Tuition reasonable. Board and rooms near school at moderate rates. Send for catalog of information.
BRADLEY, Dept. S., PEORIA, ILL.



BOYS — MAKE YOUR OWN TOYS

The ToyMaker, greatest boys' book ever written, tells how to make a steam engine, telephone, magic lantern, boats, kites, balloons, electrical and mechanical toys, traps, fishing tackle. 200 illustrations. Send for the book, and novelty catalogue — all for 10c.

AMERICAN SUPPLY COMPANY, 918 Union St., ST. PAUL, MINN.



Hundreds of Millions

of LINENE COLLARS have been worn since they were first invented 40 years ago. More people wear them every year. If you are not one of these people you ought to send for free sample. State size, and whether you want high or low collar.

We publish a beautiful catalogue which we will send FREE. It shows you all the styles and tells you all the prices. You ought not to let another day go by without proving the comfort, convenience and economy of Linene Collars. Send today.

REVERSIBLE COLLAR COMPANY
Department U, BOSTON, MASS.



ELECTRICAL ENGINEERING

men with training are always in demand. Having trained over 2000 young men in the past 20 years in the fundamentals of Applied Electricity, The Bliss Electrical School, with its well-equipped shops and laboratories, is peculiarly well qualified to give a condensed course in Electrical

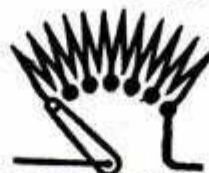

including Mathematics, Steam and Gas Engines, Mechanical Drawing, Shop Work, and Theoretical and Practical Electricity, in all branches. Students construct dynamos, install wiring and test efficiency of electrical machinery. Course, with diploma, complete

IN ONE YEAR

For practical young men with limited time. 21st year opens Sept. 24th. Catalogue on request. 17 Takoma Ave., Washington, D. C.

LEARN TELEGRAPH

Morse or Wireless. Station Agency work also taught. Splendid opportunities. Graduates assisted. We own and exclusively occupy two large modern buildings equipped with R. R. Dispatchers and Western Union Wires and Complete Wireless Station. Oldest and largest school—est. 35 years. Investment \$25,000. Endorsed by Railroad, Wireless and Western Union Officials. Expert, practical teachers. Living expenses may be earned. Tuition low. Easy payments. Correspondence courses also. Catalogs Free.

Dodge's Telegraph, Railway & Wireless Institute
8th Street Valparaiso, Ind.

A SCHOOL WITHIN ITSELF

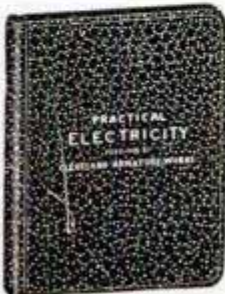

There are XX chapters in all, XIX carrying you from the fundamental principles of electricity on through the various branches to a point where the careful student comprehends the complete designing, care and operation of a dynamo or motor, and one chapter on electric automobiles, outlining their construction, care and operation, and all about storage batteries and how to handle them. Each subject is carefully written and to the point. After a student studies a subject, he is questioned on that subject in such a manner as to bring clearly to his mind the points he needs to know regarding same. The book contains a dictionary defining 1500 Electrical Words, enabling the reader to ascertain the meaning of any electrical word, term or phrase used in this book, as well as hundreds of others in common use. All required tables necessary in the study are in it.

\$2.00 PER COPY—SIXTH EDITION—30,000 COPIES SOLD.

The offer we make of refunding money if book is not satisfactory upon examination is AN UNUSUAL ONE in connection with the sale of a book. But we have no fear of its return. Your decision will be what thousands of others have been. Money would not buy it if it could not be duplicated. We could print testimonials by the hundreds. It is best to order and be your own judge of its merits.

CLEVELAND ARMATURE WORKS, 49 & St. Clair Ave., Cleveland, Ohio

Armatures and Fields Wound — Commutators Filled
AMERICA'S GREATEST REPAIR WORKS

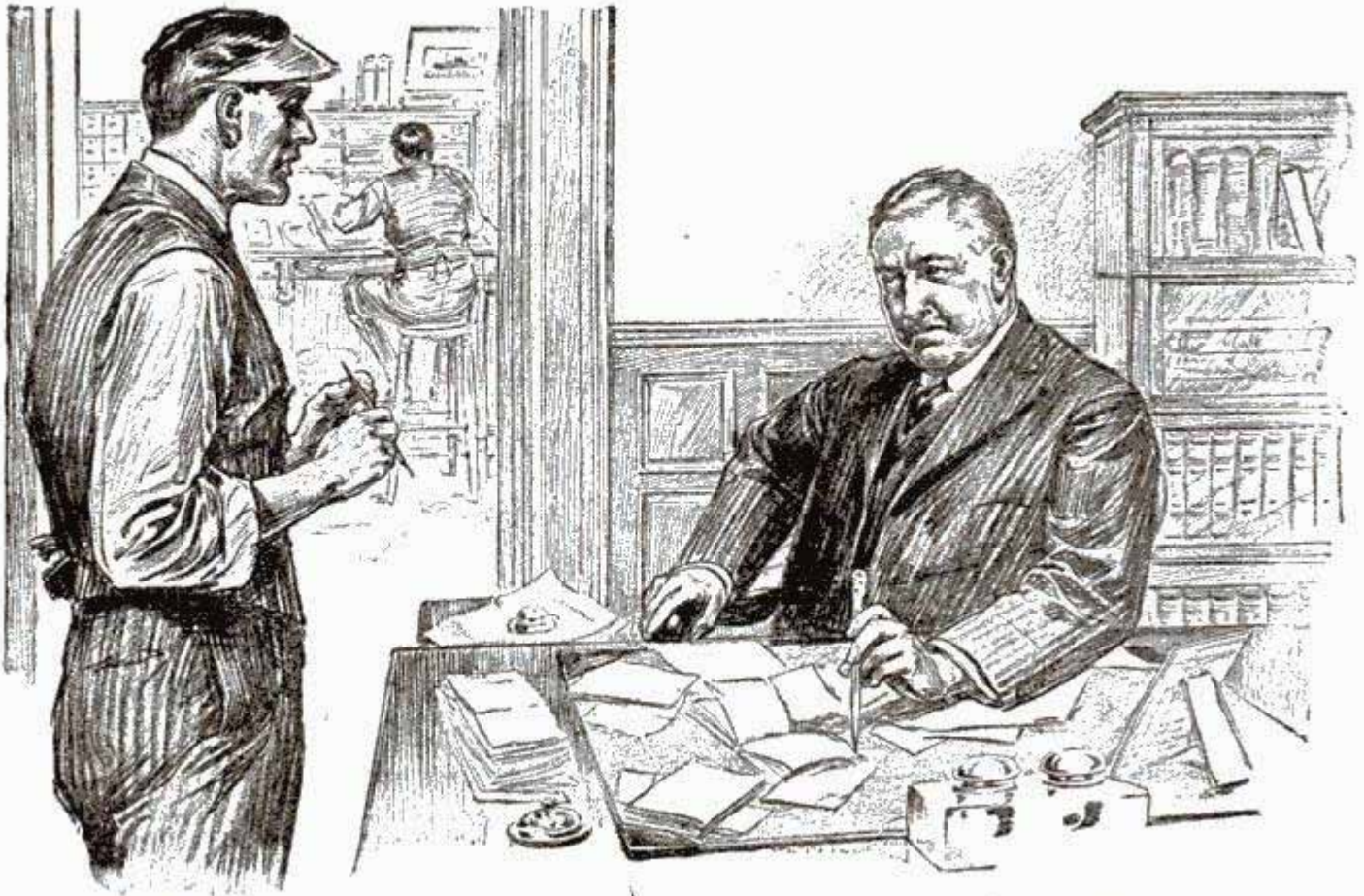

Striking the boss for a raise

Do you have to *ask* your employer for more pay? Do you find it necessary to call his attention to the fact that you are worth more money? Or are you a *trained* man—a man who receives frequent and unasked for increases in salary because the boss knows that your knowledge is valuable to him. There is no limit for the *trained* man—he is the employee who is pushed ahead—he's the chap that the well paying jobs seek. High wages and steady employment are always his, simply because he is too valuable to lose.

But the *untrained* man, plodding along at the same old salary year after year, has nothing in his favor but a record for faithfulness. He feels that his efforts are not appreciated—he doesn't realize that he is only a cog and can be replaced by any one of thousands of similar *untrained* men. He is a good employee, yet he has never made himself necessary to his employer's success. He's the sort of man who always has to *ask* for a raise.

Your Opportunity Coupon

Check the course you want and mail the coupon now

American School of Correspondence, Chicago, U. S. A.

Please send me your Bulletin and advise me how I can qualify for the position marked "X." Pop.Mech.5-13

- | | |
|-------------------------------|---------------------------|
|Electrical Engineering |Lawyer |
|Elec. Light & Power Supt. |Bookkeeper |
|Electrical Wireman |Stenographer |
|Telephone Expert |Private Secretary |
|Architect |Accountant |
|Building Contractor |Cost Accountant |
|Architectural Draftsman |Cert'f'd Public Acc't |
|Structural Engineer |Auditor |
|Concrete Engineer |Business Manager |
|Civil Engineer |Fire Ins. Inspector |
|Surveyor |Fire Ins. Adjuster |
|Mechanical Engineer |Fire Ins. Expert |
|Mechanical Draftsman |Moving Picture Op'r |
|Steam Engineer |Sanitary Engineer |
|Stationary Engineer |Reclamation Eng'r |
|Gas Engine Engineer |Textile Boss |
|Automobile Mechanician |College Preparatory |

NAME

ADDRESS

Become a trained man—get the money without asking

It is easy to get the training you need. You can do it in your spare time and in your home without giving up your work.

For fifteen years the *American School of Correspondence* has been preparing ambitious men everywhere for better jobs at bigger wages. The *American School* will give you the training you need, no matter where you live. It will train you in any branch of *Engineering, Business and Law*, or will prepare you for entrance into any resident college.

Perhaps you've never quite realized how easy it is to secure this training? Mark the coupon and let us explain to you how simple it is to prepare yourself for the position you want. We send no agents to bother you in your home or at your work. All business will be carried on by correspondence and our easy payment plan will allow you to pay as you progress.

Send the coupon today! Learn how to get a raise without asking

American School

of Correspondence, Chicago, U.S.A.

Popular Mechanics Magazine

WRITTEN SO YOU CAN UNDERSTAND IT

Vol. 19

MAY, 1913

No. 5

Aeroplane-Destroying Guns for Submarines

3560

Paul H. Bond

THE development of the aeroplane as an instrument of modern war has for some time been considered as an additional menace to the submarine, for, flying several hundred feet overhead, the airman can locate submarines even when they are moving at a considerable depth and send warning of their presence to a battleship by wireless. Thus it was thought that the aeroplane would have the submarine at its mercy, for the submarine hitherto has had no means of destroying enemies in the air.

Now, however, the Krupp gun works in Germany is making a quick-firing gun designed especially to provide submarines with the means of destroying aeroplanes and dirigibles. This gun,



which can be fired at any angle, is mounted on a disappearing carriage which sinks into a well and is automatically covered with a water-tight slide when the submarine is submerged. The weapon can be raised from its well to the deck and made

ready for firing in 30 seconds. The disappearing carriage is operated by electricity. When an aeroplane or dirigible appears overhead, the submarine so equipped may rise to the surface, the gun be trained upon the enemy, and a rapid bombardment ensue.

TENTS FOR AUTOMOBILISTS AND HUNTSMEN

3493 The larger of the two tents shown in these illustrations is designed especially for the motorist. The other is

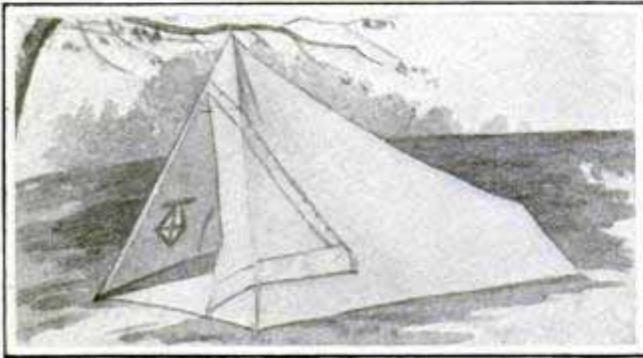

A Huntsman's Tent, Showing Canvas Floor and One of the Ventilators

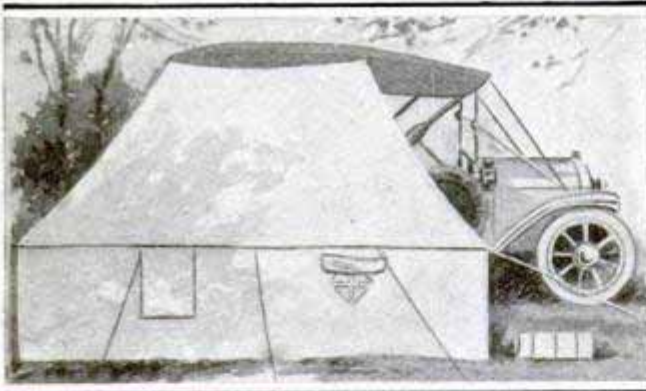

A Handy Canvas-Floored Tent for the Motorist

an excellent outfit for the hunter or fisherman. The most important features of these tents are the canvas floor, which forms one piece with the sides and back, the absence of tent poles, and the arrangement of protected ventilators. The canvas floor prevents bugs or snakes from entering the tent, and, when the floor is stretched over a bunch of leaves and grass, a soft, dry bed is provided. The ventilators, of which there are four to a tent, are all adjustable from the inside, allowing as much or as little fresh air to enter as is desired. The tents

may be erected by throwing the roof lines over the branch of a tree and making fast. The larger of the two tents folds into a package but 7 in. in diameter and 20 in. long.

GERMAN AERIAL MOTOR WINS BIG PRIZE *953*

The prize of \$10,000, which the German emperor offered on his birthday last year for the best German aviation motor constructed before his anniversary this year, was awarded to an inventor who built a 100-hp., 4-cylinder motor along such lines that it is practically proof against breakdowns. The apparatus is, in reality, two motors in one, as duplicates are provided for all the important parts, each of which is capable of taking up its proper functions while the engine is running at full speed. That is, each cylinder has two magnetos and two carburetors that are operated independently of each other, and the other parts are arranged and operated in a similar manner. A total of 45 motors, representing 26 makers,

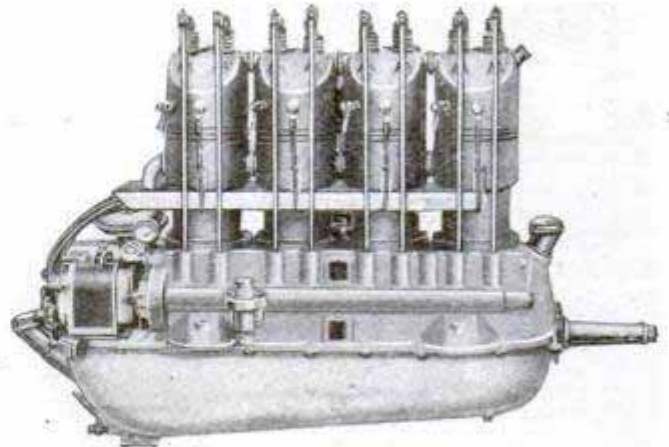

German Aviation Motor That Won a \$10,000 Prize

were entered in the contest, and only three days were allowed for the assembling of each motor.

BEAUTY AND UTILITY COMBINED IN A SKYSCRAPER

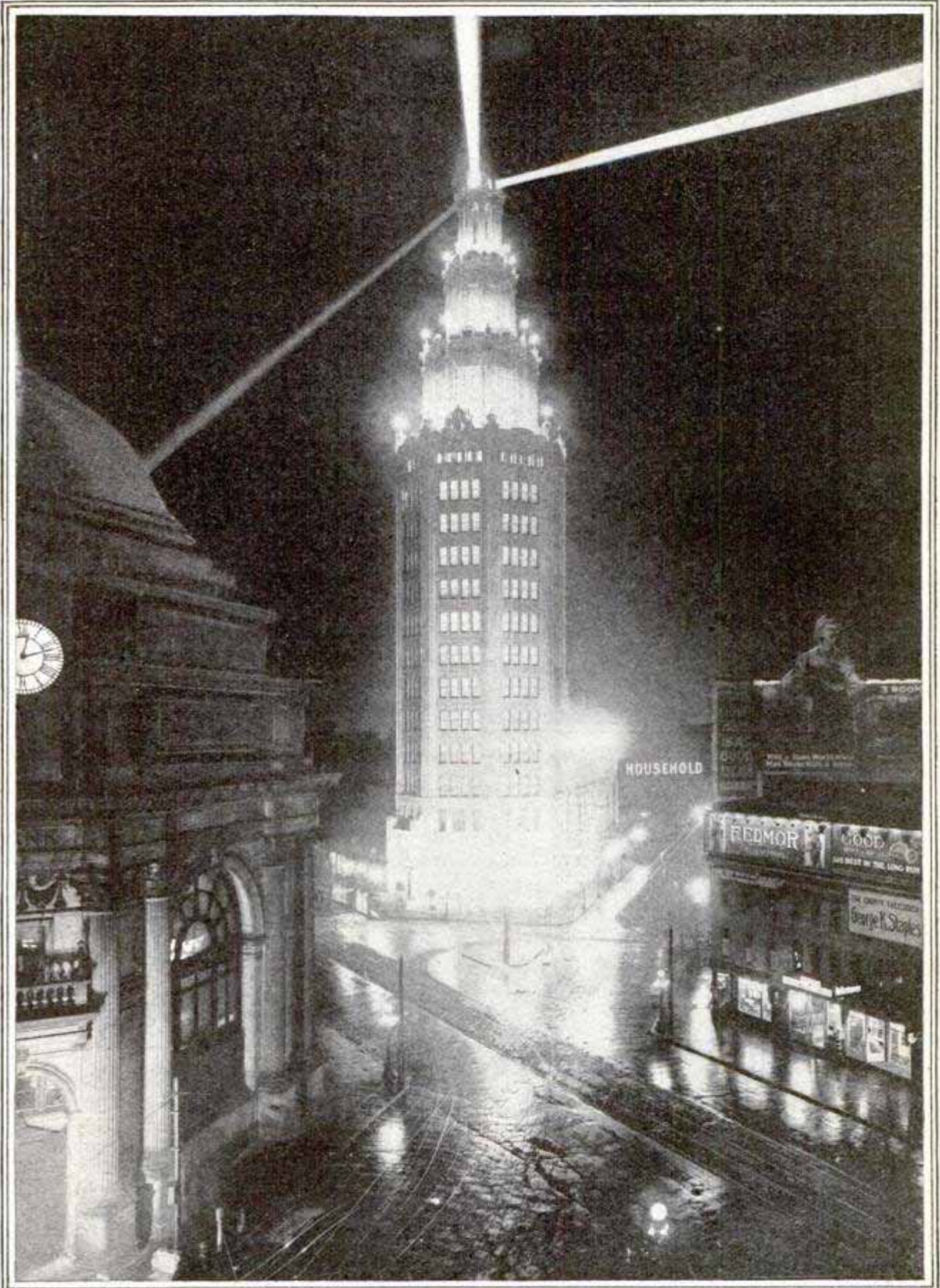

Standing at the junction of three streets and facing an open plaza, this office building in Buffalo, N. Y., occupied by an electric-lighting company, is easily the most striking architectural feature of the city.

3443 ASBESTOS POCKET FOR LIGHTED CIGARS

The new rule in Philadelphia, and some other cities, that anyone carrying a lighted or dying cigar into a street



Asbestos Pockets for Men Who Carry Lighted Cigars onto Philadelphia Street Cars

car must be made to throw it away or be put off, has caused a Philadelphia tailor to equip the suits of the smokers who patronize him with an asbestos pocket. The lighted cigar can be thrust into this pocket without fear of burning the suit, and, when the flap is buttoned down over it, the smoke cannot filter into the car.

3642 DENMARK BUYS ELECTRICITY FROM SWEDEN

One of the most interesting examples of international transmission of electrical energy is that of Sweden to Denmark, where the power cable is carried under water part of the way. Arrangement has been made to transmit 20,000 kw. from the Trollhättan power station in Sweden to Copenhagen, the capital of Denmark, the distance being 200 miles. The method of transmission is to be by direct current at 90,000 volts, which is said to be

more practicable for crossing the Sound than the three-phase alternating current usually preferred for long-distance transmission.

3484 ELECTRIC SIGNALING DEVICE FOR BUILDERS

An electrical signaling apparatus, recently tried out on the new municipal building in New York City, has demonstrated that it is no longer necessary for workmen on high buildings to use ropes as a means of sending signals down to the engineer in charge of the hoisting machinery. In the new method of signaling the signalman on the building wears a belt to which is attached a number of push buttons and one end of a copper wire cable running down to the engineer's station. The lower end of the cable is connected to a series of colored electric lamps and electric horns mounted upon a suitable box placed conveniently near the engineer. The signalman, by simply pressing the proper buttons upon his belt, operates certain lamps and horns below, thus conveying the desired signals to the engineer almost instantaneously. It is said that the apparatus enables the signalman to control the movement of the load as well as if he were actually operating the hoisting engine.

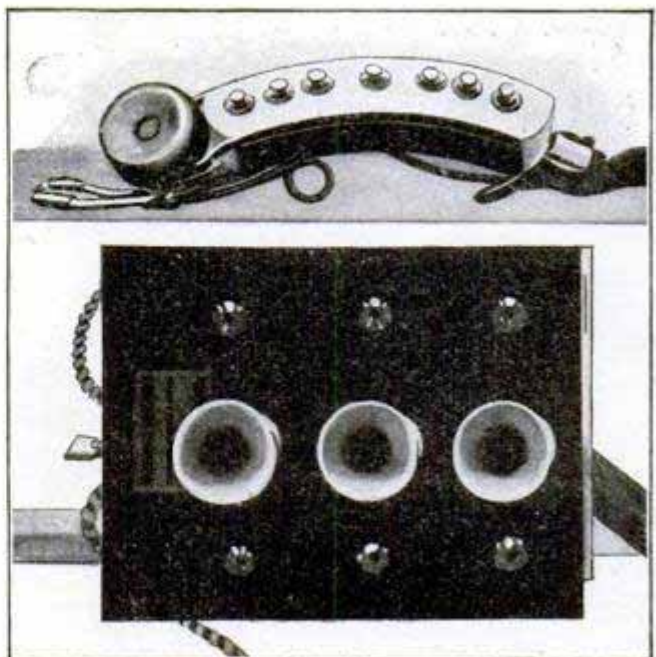

Push-Button Belt Worn by Signalman on Building
Below: Electric Lamps and Horns at Hoisting Engineer's Station

THE AUTOMOBILE CHAPEL "ST. PETER"

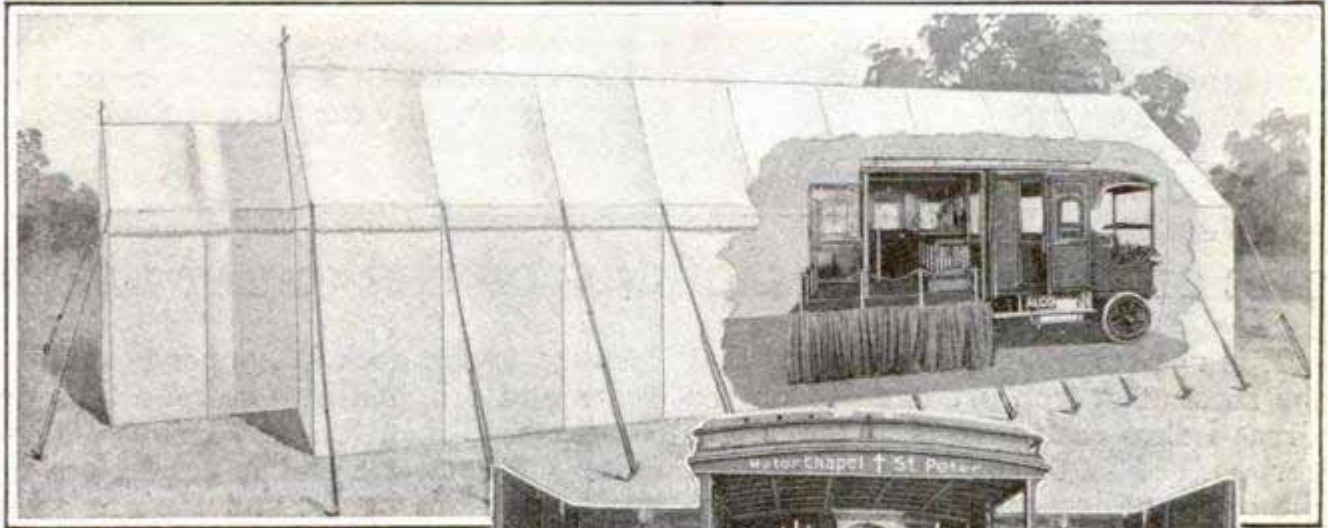

The Tent Arrangement, Used in Rainy or Excessively Hot Weather

The first automobile chapel ever constructed in this country is being used by the Catholic Church Extension Society in the sections of the southwest where the members of the church are too widely scattered to have stationary churches or chapels. It penetrates regions which railroads do not reach. Starting from Brownsville, Tex., the traveling chapel, in charge of two priests, will work its way along the Rio Grande, westward through the state.

The equipment includes all the usual essentials for carrying out the rites of the Catholic church in regular form and with appropriate solemnity. The folding-door construction of the sides of the car and the ingeniously installed drop platform double the floor space when services are being held. In the center of the extension platform is a handsome combination altar and vestment cabinet, with its ornamental brass accessories. Along the outer edge of the platform are fitted demountable brass standards, with heavy silk-cord guards. In the ecclesiastical equipment are included a



Ready for a Service



The Automobile Chapel on the Road

folding confessional, a folding organ, and a folding rack fitted with large tubular bells to call the worshipers to service. When the altar is not in use

it is pushed to the extreme rear and the space in front is used by the priests as living quarters.

The general dimensions of the car are: length over all, 21 ft.; width, 6¾ ft.; height from the ground, 11¾ ft. On top of the machine is carried a 20 by

50-ft. gable-roof khaki tent, which is erected with the automobile chapel inside, at one end, when shelter from rain or from the heat of the sun is required. The sides and back of the car contain eight artistically executed stained-glass windows.

THE ORE-HANDLING MACHINES OF THE GREAT LAKES

It is not surprising, considering that the amount of iron ore handled on the Great Lakes each year is in the neighborhood of 45,000,000 net tons, that the ore-handling apparatus at Duluth-Superior, which is the great receiving port, and at the ports of the lower lakes, where the ore is unloaded, are the most highly specialized in the world, and that the cargoes are handled in less time and at less cost than in any other ports on salt water or fresh.

The Great Northern ore dock at Allouez Bay, Superior, Wis., an immense steel and concrete structure, made the world's record for loading when 10,592 net tons of ore were delivered into the hold of the "W. E. Corey" in 25 minutes. The ore is

hauled to the dock in hopper-bottomed cars and dropped into storage bins or pockets. When the ship comes alongside the dock the chutes are let down, the slides drawn up, and the ore goes rushing into the hold at the rate of hundreds of tons a minute, the big ship sinking swiftly down into the water. The vessel shown alongside this dock is nearly 600 ft. long.

The most modern type of unloader is to be found in operation at Cleveland. Its huge jaws will take a 12-ton bite of ore at once. The operator rides into the hold in a little compartment just above the jaws. Although unloading cannot be as rapid as loading, the speed with which these machines work is remarkable. One of these un-

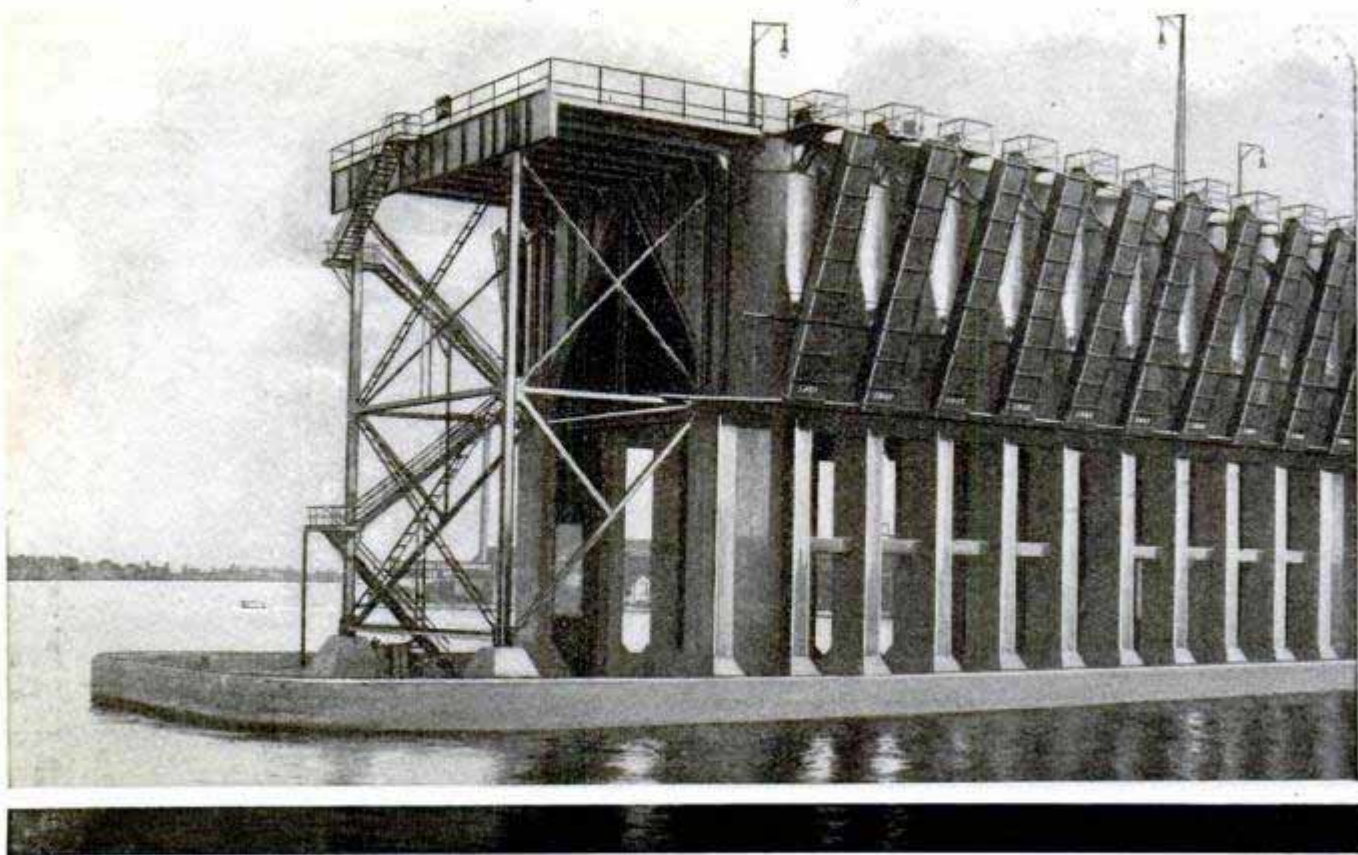

Frank W. P. ... 3492

From National Waterway

already ... lakes

Emptying
a Lake
Freighter
with the
Most
Modern
Type
of Unloader

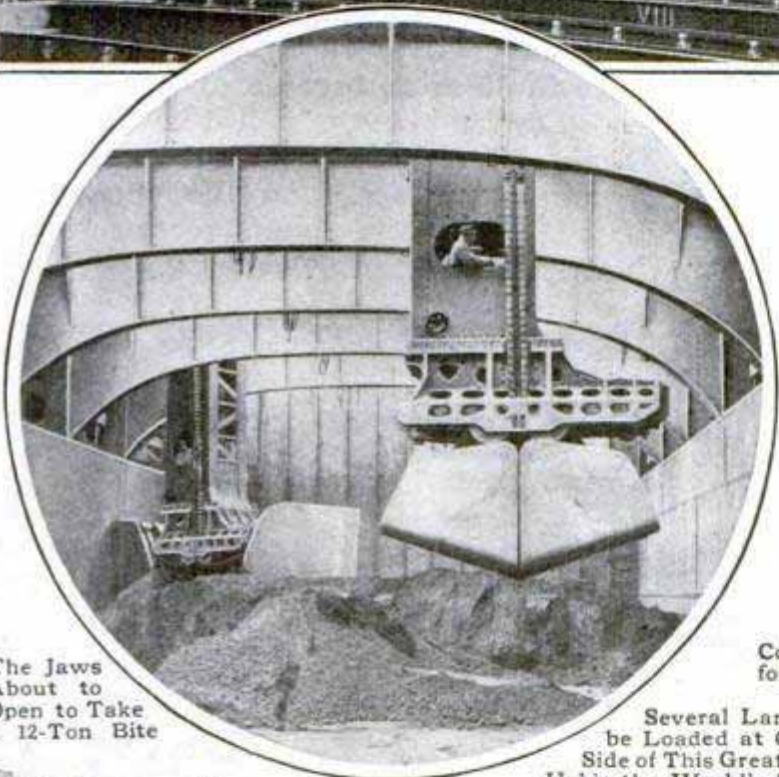
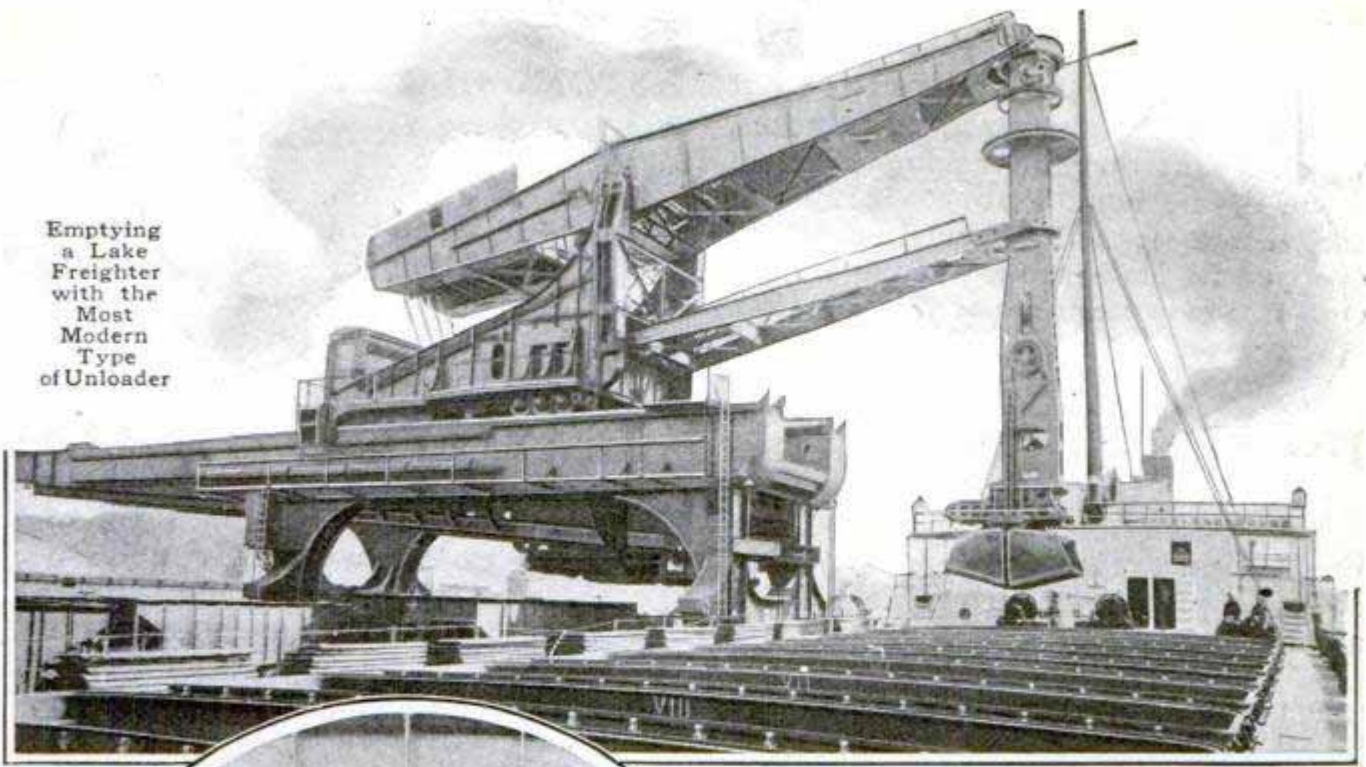

The Jaws
About to
Open to Take
a 12-Ton Bite

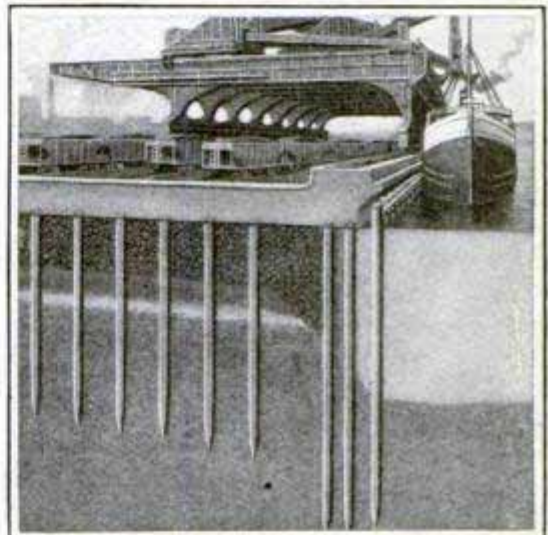

Construction of Foundation
for a Cleveland Ore Dock

Several Large Ore Ships may
be Loaded at Once on Either
Side of This Great Dock, Which
Holds the World's Record

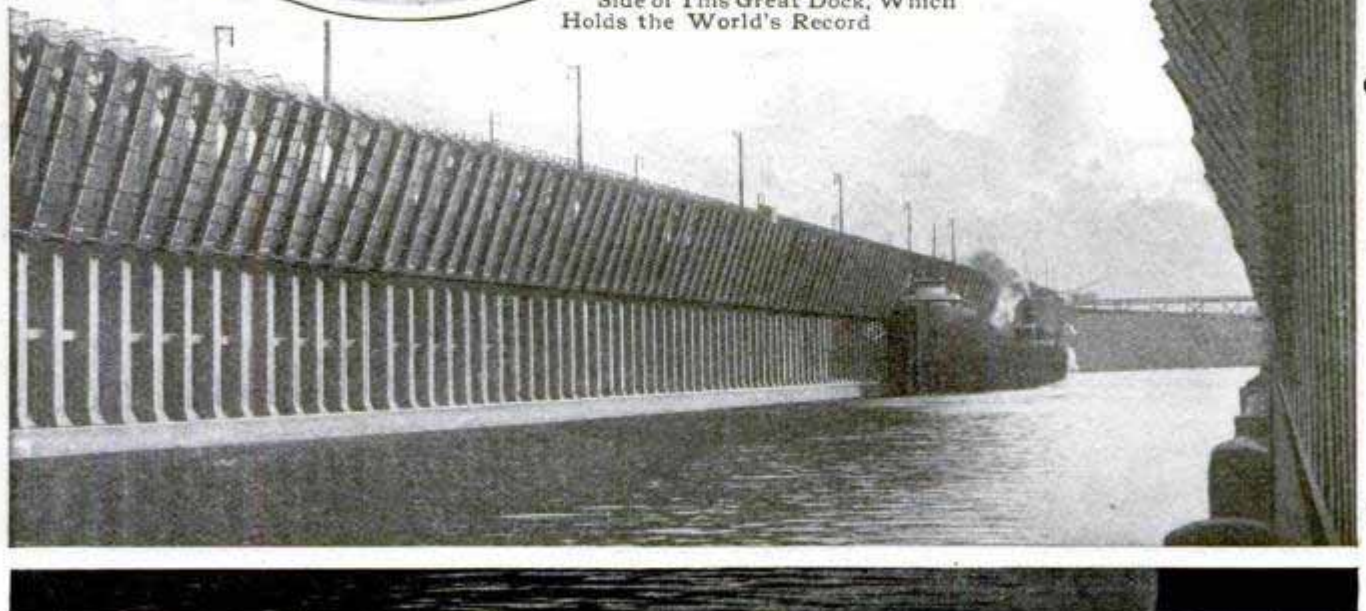

loaders took 2,093 net tons of ore out of a ship in 2 hours and 50 minutes, which means that the machine reached down in the hold, grabbed 12 tons of ore, lifted it out, backed up, and dropped its load into a waiting freight car once every minute without a stop.

Large unloaders of this type require substantial foundations. In the outer harbor at Cleveland the bottom of Lake Erie is of soft clay, so a fill of steellmill and railroad refuse was made to bring the grade to about 5 ft. above the level of the lake. More than 5,000 concrete piles were driven to provide a solid foundation.

AUTOMOBILE RUNS HUNDRED MILES IN AN HOUR ^{36.34}

There is a difference between running 100 miles in one hour and at the rate of 100 miles an hour, for, although the latter has been exceeded by more than 25 miles on at least two or three occasions, the former has just been attained for the first time. This ambition of automobile-racing enthusiasts was realized recently at the famous Brooklands track, in England, and by a little 25-hp. car, which is doubly remarkable, since many attempts have been made to achieve the 100 miles in an hour with cars of up to 200 hp.

The little car, driven by Percy Lambert, traveled, to be exact, just 103 $\frac{3}{4}$ miles in 60 min., breaking the world's record for 50 miles, which it covered in 29 min. 2.5 sec.; for 100 miles, made in 57 min. 49.38 sec., and the one-hour record. The old hour record was slightly more than 97 miles.



Percy Lambert at the "Wheel

Scene During the Record-Breaking Run

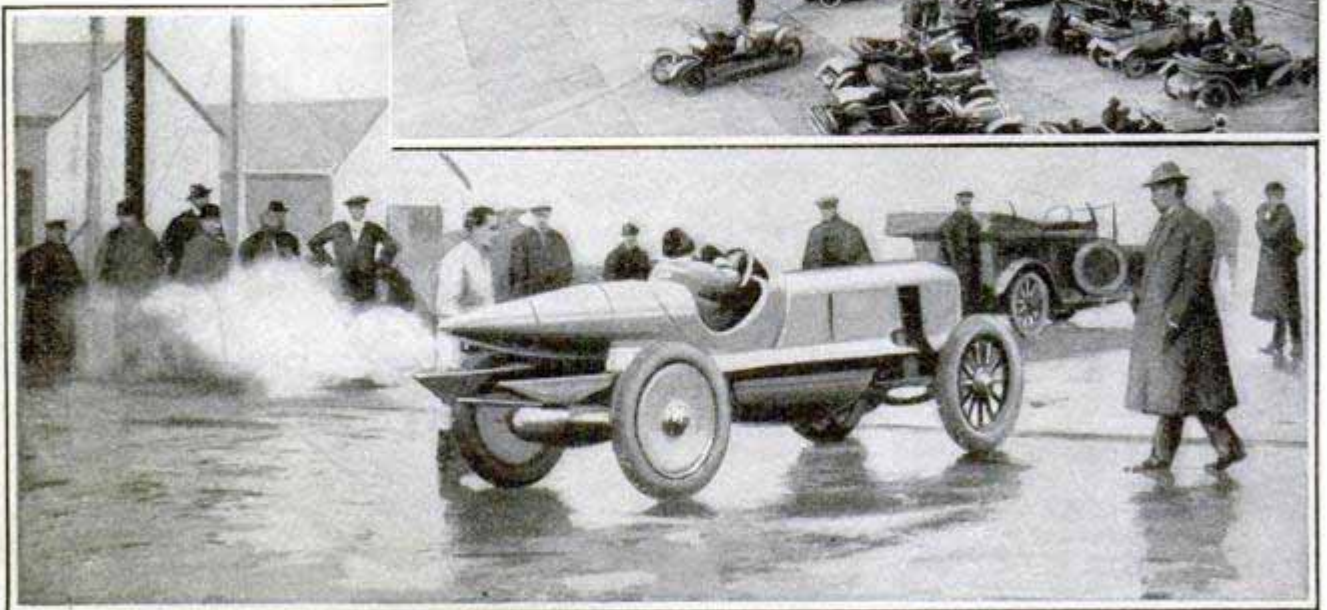

The Start of the Record-Breaking 25-Hp. Car

JAPANESE BUILDING SHIPS TO USE PANAMA CANAL 366

A fleet of large steamers to be used by a Japanese steamship company for a line running from Japan direct to New York by way of Hongkong, Manila, Honolulu and the Panama Canal is being constructed. Six large freight vessels are expected to be ready by the opening of the canal. The trip is expected to take 41 days.

USEFUL SORTING DEVICE FOR OFFICE DESKS

The letter-sorting device or distributor here shown is designed to take the place of desk baskets or trays and is so constructed that its capacity or

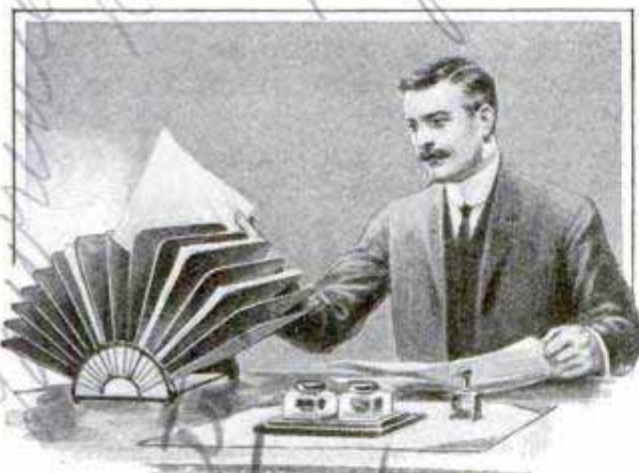

Distributor for Correspondence

compartments may be increased at will by simply inserting more leaves or partitions. The distributor, when fully set up, occupies practically the same space as one of the old-fashioned baskets, but has approximately the capacity of 15 of them.

AUTOMATIC ELECTRIC STEAM COOKER 3445

An automatic electric cooker, which, it is claimed, will cook for four hours at a current-expense of but 6 or 7 cents, uses live steam as the medium for distributing the heat from the electrical unit to the food receptacles. These receptacles are contained within a her-

metically sealed steam chamber, in the bottom of which is placed a small quantity of water. This water is boiled and partially changed to steam by the heat from the heating unit, and, when the steam in the chamber

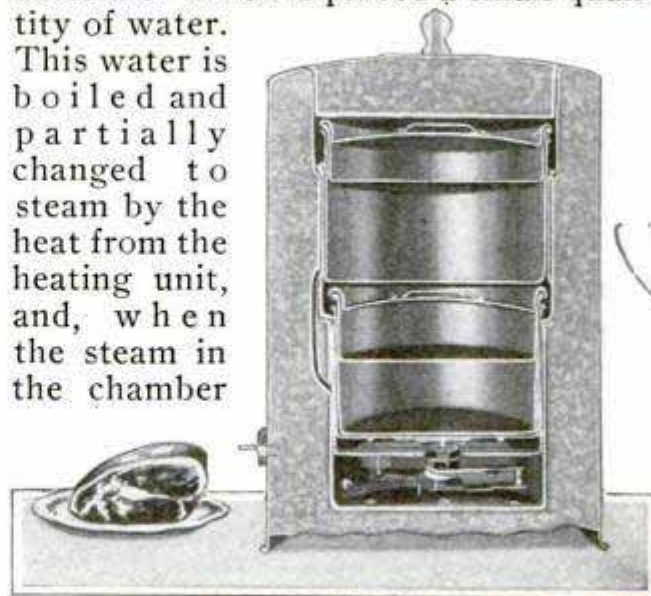

Courtesy Electrical World

Automatic Electric Cooker Using Live Steam as the Means of Distributing the Heat, and of Automatic Regulation

reaches a certain pressure the spring in a diaphragm is overcome, and this, acting upon a pin, opens a switch contact and interrupts the energy supply. A subsequent reduction of the steam pressure in the chamber allows the diaphragm to return to its original position, and the heating commences again.

ADJUSTABLE CABIN ROOF FOR MOTORBOAT 3434

An interesting idea in motorboat-cabin construction has been carried out on the "Altge," a 26-ft. craft used for cruising on Puget Sound. In fine weather the cabin top is raised to the height of the pilot-house roof, but when a high wind is blowing and the sea rough, the top is dropped down, thor-

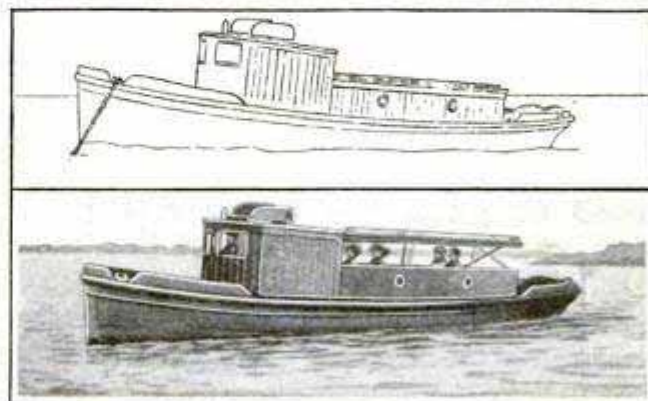

A Puget Sound Motorboat with Roof That can be Raised and Lowered

oughly protecting the passengers from spray, and also lowering the center of gravity and reducing the surface presented to the wind.

CEMENT MUSHROOMS AND GNOMES

Among the most uncommon uses to which concrete has been put in Belgium is the making of mushrooms for

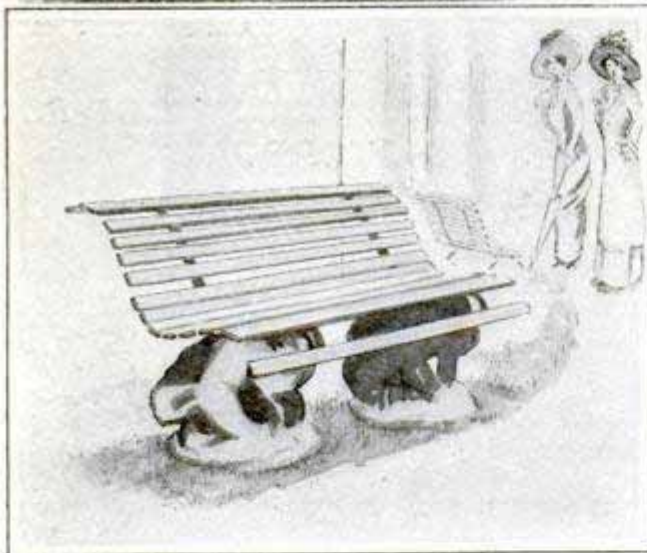

Mushrooms and Gnomes of Cement in Belgian Gardens

decorating gardens, and dwarfish figures of gnomes for supporting the garden seats. If the imagination were sufficiently elastic, it might be presumed that the gnomes had pillaged the mushroom garden at night and, to escape detection, had crawled under the seat, where they became concrete images.

BRIDGES ERECTED BY END LAUNCHING

Two large bridges were recently erected by what is known as the end-launching method, which consists of floating one end of the completed span across the river on a barge, with the inner end mounted on railroad trucks. The largest of these bridges, a 475-ft. span, said to be the longest and heaviest ever erected by end launching, crosses the Monongahela River in Pennsylvania, and was erected under particularly severe conditions. The other example is a bridge over the Jaina River in Santo Domingo, 629 ft.

The Monongahela River bridge was constructed by a railroad completing an extension into the West Virginia coal fields. As the crossing is in the mountains close to the headwaters of the river, where rapid and wide variations in level occur, rises of 5 to 20 ft. in a few hours being comparatively frequent, the end-launching method was decided upon to prevent the work from being delayed by floods. While the span was being erected upon the shore, a steel barge, 200 ft. long and 36 ft. wide, was built for use in floating the outer end of the span across the channel. This barge had to be passed through two locks, one of which is 154 ft. and the other 164 ft. in length. The only way to get it through was to raise its forward end 10 ft. out of water, so that this end would project over the head walls of the locks. This was accomplished by supporting the forward portion of the barge on two auxiliary scows. Permission had also to be obtained from the government to build a temporary cofferdam a sufficient distance above the upper end of each lock to permit the closing of the lower gates behind the barge. The permanent head gates and the tail gates were then opened, the barge floated in with its front end projecting over the head walls, and the tail gates closed. Then the cofferdam was broken and the water allowed to flow in, raising the level to that of the upper channel.

328
Engineering Record

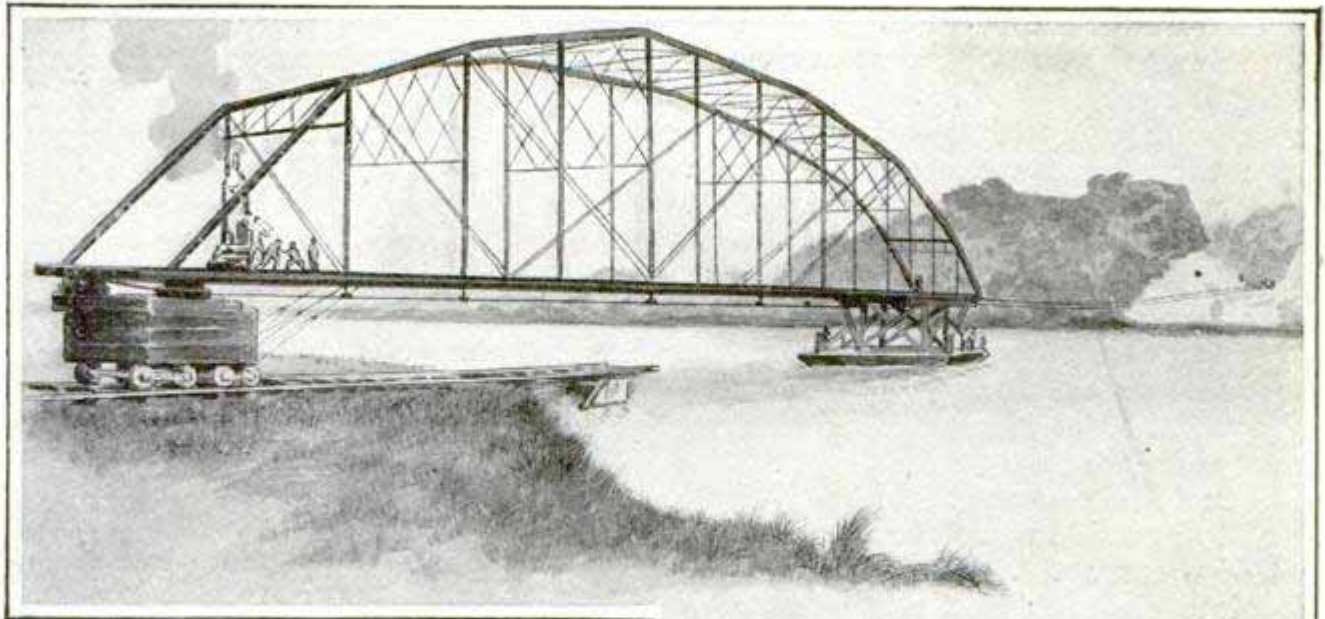

Forward End of Jaina River Bridge Being Projected across the Stream on a Barge, with the Inner End Carried on Trucks

When the barge was at last in position for its task, it was sunk until it floated just above the water, falsework was erected to a sufficient



Manner in Which the Barge for the Monongahela Bridge had to be Floated to Get It through the Locks

height to float the end of the bridge above the pier on which it was to rest, a time was selected when the stage of the river was right for the operations, then the water was

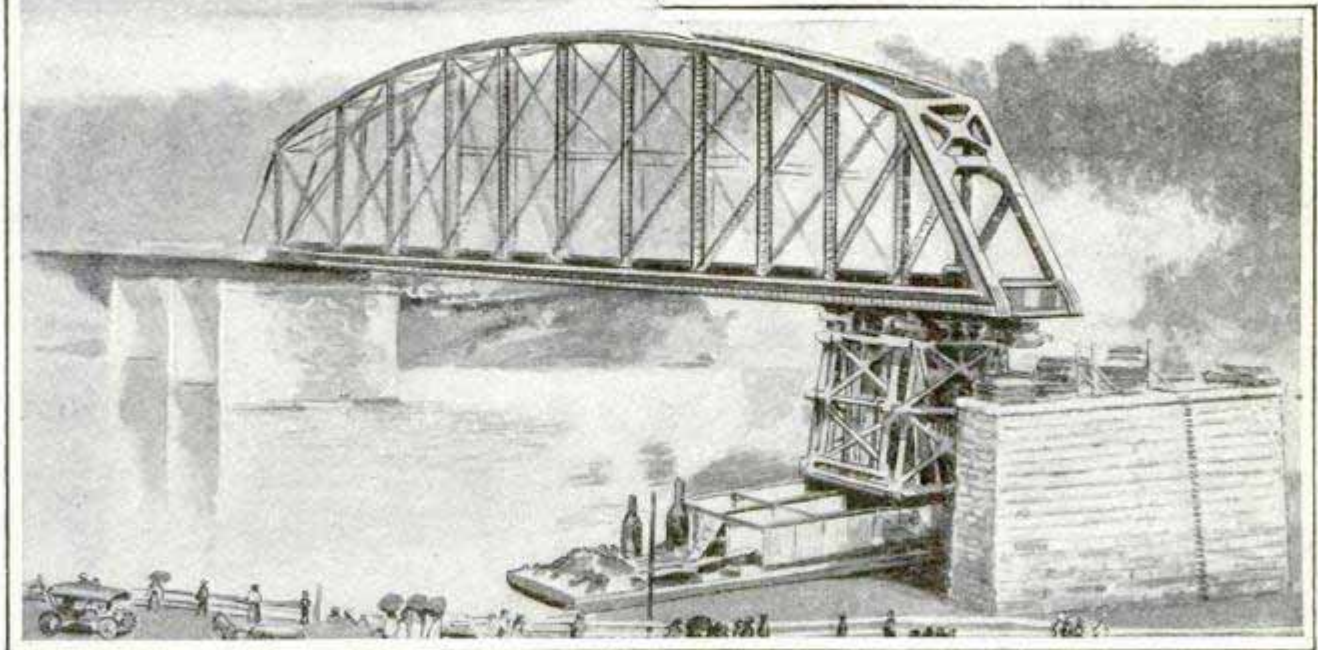
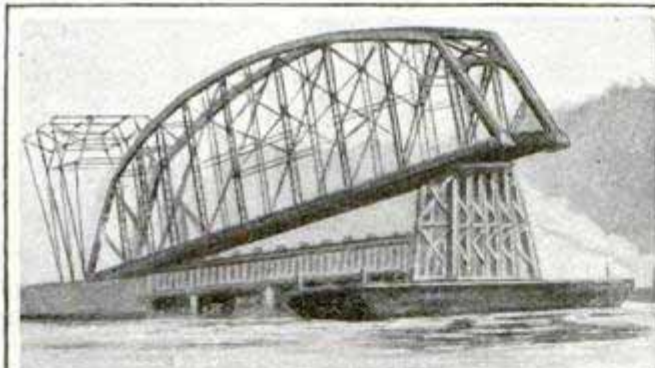

The Position of the Span During the Flood Which Raised the River Level 29 Ft. above Normal

The Monongahela Bridge Approaching Its Final Position

pumped out of the barge until it rose 2 ft., picking the end of the span up and lifting it clear of the blocking. At this point, with everything in readiness to move the span, an exceptionally high flood occurred, the water rising 29 ft. above its normal stage in six hours, with the current moving at a speed of 25 miles an hour. Great cables held the barge in position under the span while the flood lasted, during which it was only saved from filling with water by the quick erection of a water-tight wooden bulkhead around it, as it had tilted to one side when it rose with the end of the span. Although danger of complete disaster faced the engineers during every minute of this flood, the equipment withstood the strain, and the span was finally moved across, the actual time of the crossing being six hours.

The highway bridge erected in a similar manner across the Jaina River is 330 ft. in length. The river is about 50 ft. deep at the point of crossing, and the bottom is so soft that the ordinary method of erecting such bridges could not be used.

361 **A SANITARY STREET SWEEPER** *(Clearer)*

The city of Oakland, Cal., is cleaning its streets with a motor-driven sweeper that is practically noiseless and raises no dust, even when operated on unwatered streets. It operates upon the principle of both the ordinary carpet sweeper and the vacuum carpet cleaner; that is, the rear part of the

machine contains a revolving brush that sweeps the heavier articles from the street to a conveyor, which deposits them into a series of tanks, and two fans, immediately behind and above the brush, suck up the dust and force it through cloth tubes to metal tanks in the forward part of the machine. The machinery is driven by a gas engine which is also used to propel the vehicle.

MOTION-PICTURE THEATERS IN EUROPE *m/v*

England now possesses more than 4,500 motion-picture theaters, with a seating capacity of 2,000,000, representing a capital outlay of \$63,264,500. It is estimated that 28,000,000 people attend these theaters each week. Motion pictures are also particularly popular in Germany, and an extensive censorship is maintained. In Breslau, for instance, this is done by the police department, and before a film can be exhibited it must be tested on a police machine at headquarters. The films examined average about 200 per week, and four regular days have been set for the task.

Federal Horticulture Board
 (The government recently placed a quarantine on lumber and other forest products from sections of New England infested with gypsy and brown-tail moths, in order to prevent the spread of these pests through the country.)

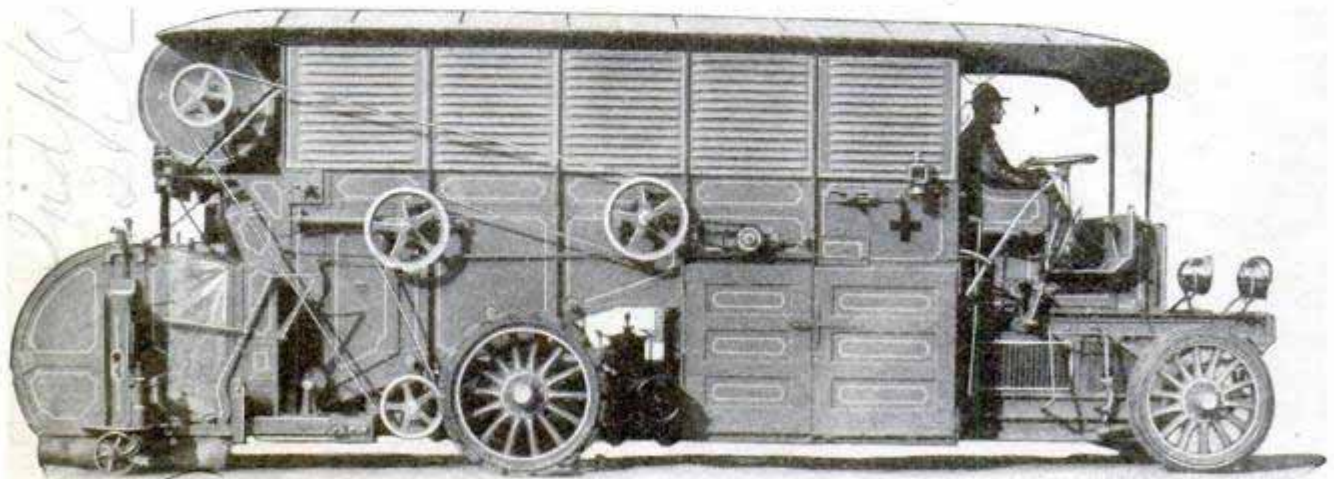

Butler

Sanitary Street-Sweeping Machine Used in Oakland, Cal.

cinematic reports

U. S. WIRELESS STATION AT BALBOA

The United States has bought the wireless apparatus which the Republic of Panama intended to install on the National Palace and it is being erected by the United States Marine Corps at Balboa. One of the smokestacks at the Isthmian Canal Commission's electric plant is used to support the flat-topped antennae. The apparatus will use a 25-cycle, 3-phase current, giving a wave length of 600 meters (1,968 ft.), for communication with ships within a 500-mile radius. The government wireless station at Colon is now transmitting commercial messages to ships at sea at a charge of 8 cents a word.

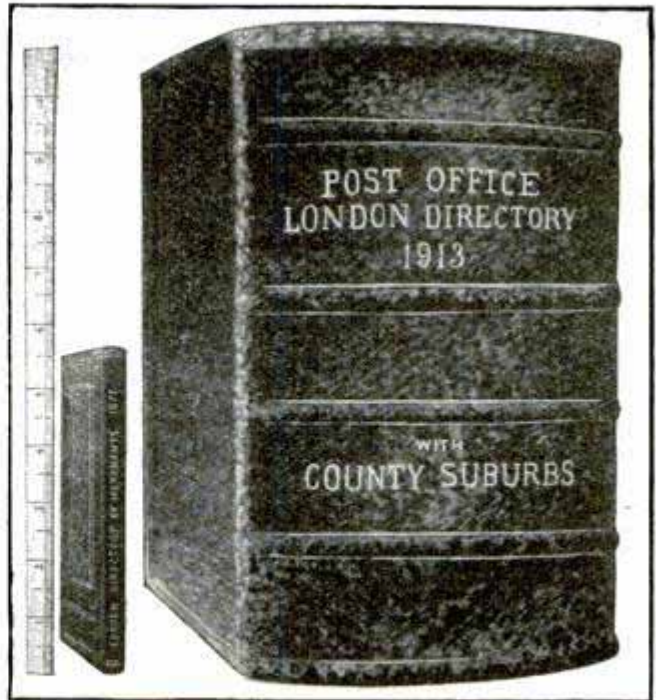

Courtesy The Graphic, London
London's First Directory, Dated 1677, as Compared with the 1913 Directory

3438. COLD-WATER BOTTLES FOR HOTEL ROOMS

The ice-water brigade in hotels will be a thing of the past if the makers of a line of vacuum bottles succeed in generally installing the vacuum carafe especially designed for hotel rooms. The iced or chilled water placed in these bottles will retain its coldness for two days!



recting them at the first sight of their name, to the place of their abode."

3429. PORTABLE MACHINE SHOPS FOR BUILDING WORK

The practicability of installing temporary, electrically driven machine shops in buildings under construction, to do the many small things that are always cropping up in building erection, has been demonstrated in the erection of an electric-railway substation at Brookline, Mass. The portable shop set up in the basement of this building consisted of a 5-hp. motor, the required pulleys, a hacksaw, a grinder, and several other small tools, all mounted on a timber frame.

3444. LONDON DIRECTORY NOW AND TWO HUNDRED YEARS AGO

The first London directory, dated 1677, is here set up beside the 1913 directory, to show how the annual volume has grown. The first directory contains 120 pages, and is 5½ in. high and ¾ in. thick. It is a collection of the names of the merchants living in and about the City of London 236 years ago, and is described as "very Useful and Necessary, Carefully Collected for the Benefit of all Dealers that shall have occasion with any of them; Di-

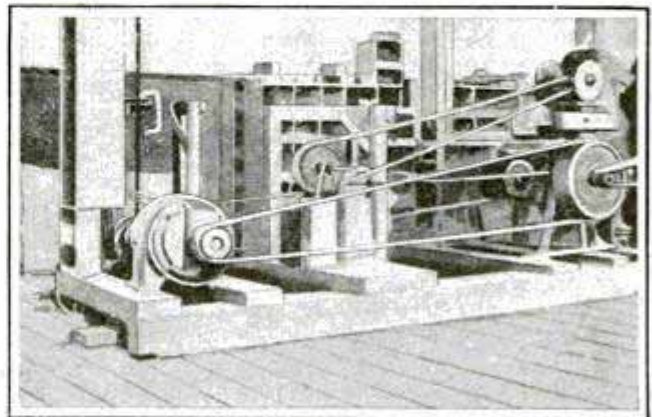

Portable, Motor-Driven Machine Shop in Basement of Building under Construction

The Graphic

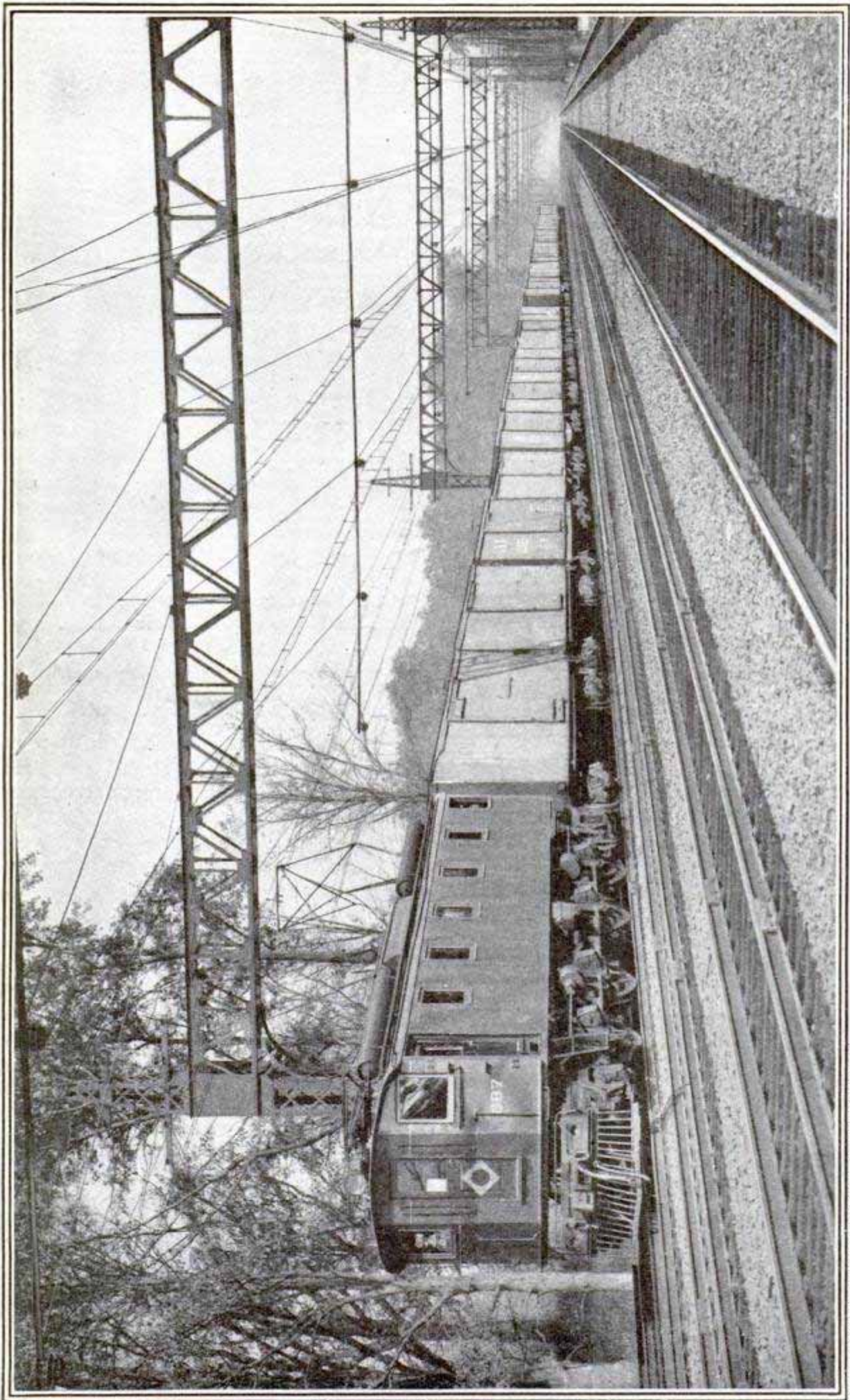

Copyrighted by Brown & Dawson, Stamford, Conn.

The Railroad of the Future—Hauling freight trains with electric locomotives, as is now done on the main line of the New York, New Haven and Hartford Railroad, shown here, will soon cease to be a novelty as electricity gradually supplants steam for motive power

A GAS CHANDELIER OF IMMENSE SIZE ³⁶²⁹

This gas chandelier, which is one of four fixtures of similar size used in illuminating the interior of an immense auditorium in Atlanta, Ga., is claimed to be one of the largest ever made for gas lighting. The fixture is 10 ft. high, has a diameter of 13 ft., weighs 1,000 lb., and uses 15 lamps that produce 10,680 cp. from a gas consumption of 275 cu. ft. per hour.



Gas Chandelier, 13 Ft. in Diameter,
Giving 10,680 Cp. of Light

ENGLAND TO REPEL GERMAN AIR INVASION

The fear of a German invasion, which is widely prevalent in England, has been greatly stimulated in the last few months by reports from many points of mysterious air craft seen by day flying at great heights over various navy yards, arsenals and fortifications, and apparently well-authenticated reports of night visits from airships, of which the moving lights and the noise of the engines gave warning. As it is known that Germany possesses an aerial navy of considerable size, and that several of its war dirigibles have made quite extended trips over the sea, it is believed in the United Kingdom that these strange air

craft are German spies or scout ships sent out to test the possibility of a successful assault from the air.

The British Parliament has officially recognized the danger of an aerial invasion by enacting, at the instance of the War Department, a law prohibiting the passage of air craft over certain areas or, if the government deems it necessary, over the whole coast line and adjacent waters. If any aerial vessel infringes this law, the proper officers are author-

ized, after giving a prescribed warning signal, to fire at and destroy such air craft.

Long-range rifled cannon, mounted so that they can be

aimed at objects in the air, have been bought by the British authorities and mounted at various points along the coast.

SLATE OIL RUNS ENGINES

The production of oil suitable for fuel in engines of the Diesel type from shale and slate has been undertaken in Sweden with excellent results. Shale oil is being produced in England and Scotland, and oil extracted in Sweden by the same method shows excellent results under careful operative tests.

3658
Prof. H. Sjogren
Chair of a. m. at

CONAN DOYLE USES AUTO-WHEEL BICYCLE

The auto wheel is an ingenious auxiliary wheel provided with a tiny



Sir Arthur Conan Doyle and a Companion Using Auto-Wheel Bicycles

motor, designed to run alongside the rear wheel of the ordinary bicycle, being attached to the frame by means of special couplings. Sir Arthur Conan Doyle, of Sherlock Holmes fame, is here shown using one of these machines.

PUBLIC DRINKING CUPS NOW FORBIDDEN IN 22 STATES

The campaign against the common drinking cup has resulted in its abolition by law in California, Colorado, Connecticut, Idaho, Illinois, Iowa, Kansas, Louisiana, Maryland, Massachusetts, Michigan, Mississippi, New Hampshire, New Jersey, Oklahoma, Oregon, South Dakota, Texas, Utah, Vermont, Washington and Wisconsin.

The perils of the public drinking cup were demonstrated by experiments made in the Chicago Board of Health laboratories. Guinea pigs were

treated with material taken from the rims of public-school cups. Five developed abscesses in 72 hours; five died from pus infection and one from diphtheria.

Even "sanitary" cups that can be folded up and re-used have been condemned by some health authorities, only paper cups that are so fragile as to be practically self-destroying being recommended as a substitute for the common cup.

PENLIKE SAFETY-RAZOR HOLDER

To take out of the vest pocket what appears to be a fountain pen, and then proceed to shave with it, is what happens when the users of a new safety razor set about harvesting the facial crop of each day. A dozen blades are carried in the head of the



holder. The blade-holding end of the razor unscrews and is carried in the lower portion of the penlike handle when not in use.

STORAGE-BATTERY CAR MAKES LONG RUN

The first of the new storage-battery cars built for suburban service on the New York Central lines recently made a trip from New York to Boston, a distance of 310 miles, stopping in Poughkeepsie an hour to have its batteries recharged. The trip was the longest and fastest ever made by a car driven by storage batteries, the speed attained during the run being 40 miles an hour. The run was made in less time than the local steam trains require for the trip, but was somewhat slower than the expresses.

Beach Car Co. Batteries. Federal Storage

3261
Mr. Russell at London
11/3/14 mfd by B. G. Small
11/3/14 mfd by B. G. Small

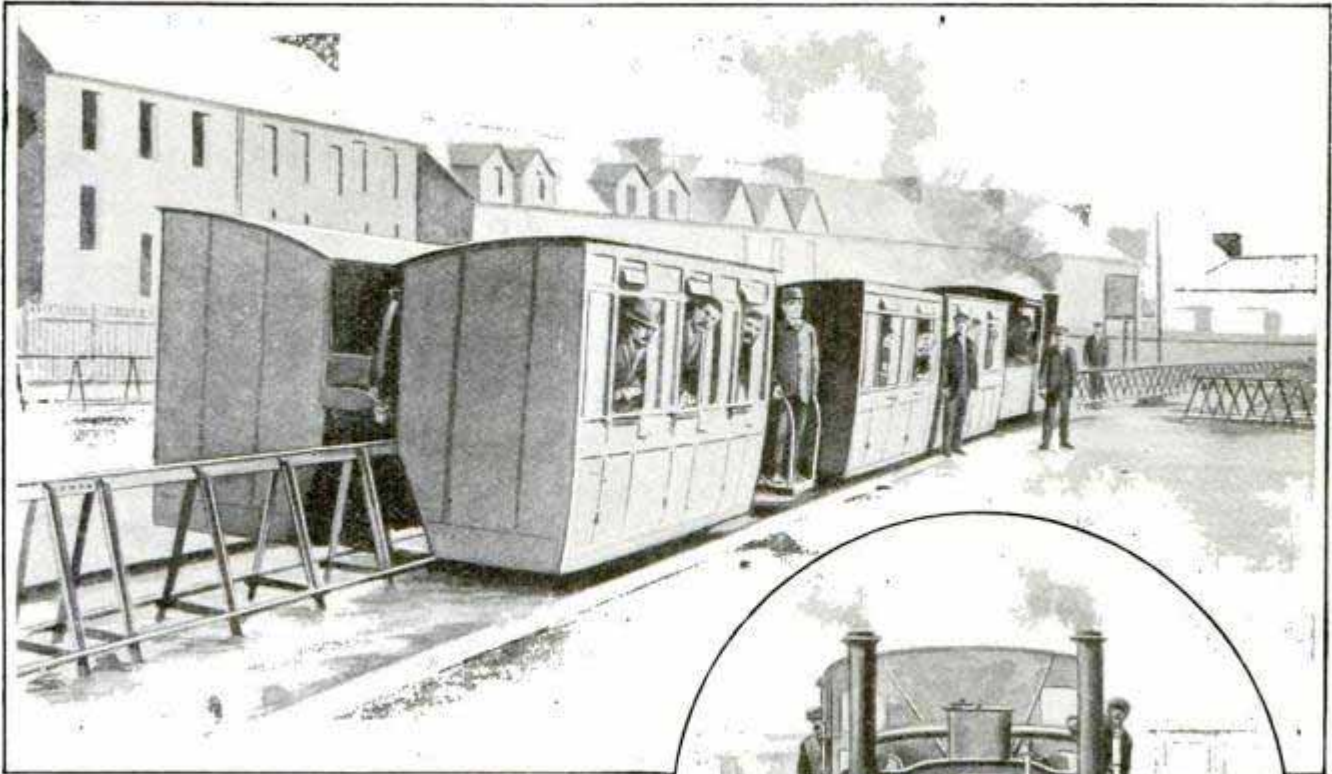

A Train That Straddles the Rail Like a Boy
Straddles a Fence

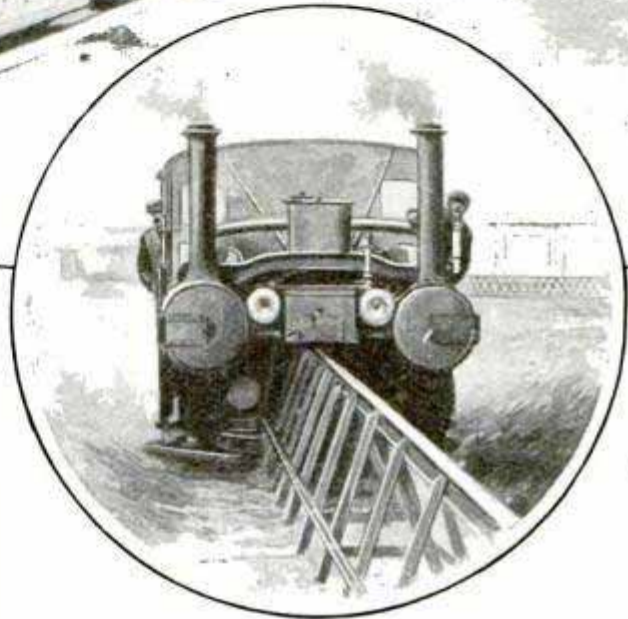

IRELAND HAS "STRADDLE" RAILWAY

Running between Ballybunnion and Listowel, in Ireland, is a unique "peg-leg" railroad, so called because it runs astraddle a single rail, elevated a suitable distance above the ground. The entire weight of the train is carried by this rail, guide rails being arranged nearer the ground to keep the train balanced. Each coach consists of two compartments, one on each side of the elevated rail, and the engine has two boilers, fire boxes and smokestacks. A short railway of similar nature was in operation between Stratford and Gilmour, Pa., about 1878, and another was a feature of Coney Island many years ago.

349 7

SHAKESPEARE'S "TRICK" STILE

This unique "trick" stile, in the fence of Charlcote Park, Stratford-on-Avon, is, like almost everything else in the Shakespeare country, associated with him in story. According to this particular story, Shakespeare had purloined a small deer from one of the herds in the park, and was escaping

with his spoil when seen by the gamekeepers. They set off in pursuit, but he outdistanced them until, reaching the boundary of the park, he attempted to vault over the stile, which collapsed under his weight, pitching him to the ground.

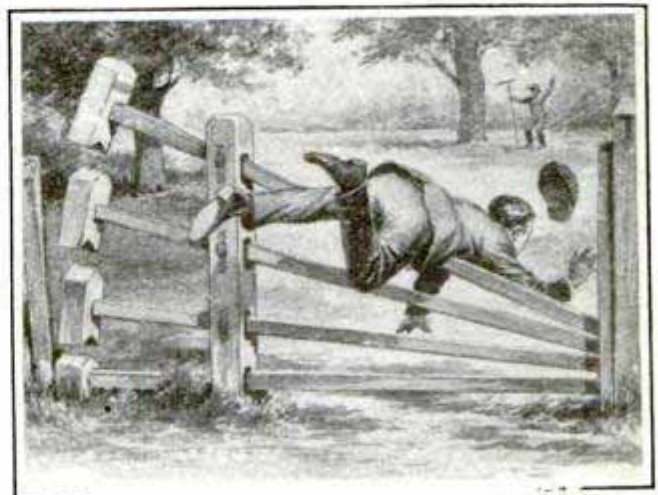

A "Tumbledown" Stile Associated with a Youthful Escapade of Shakespeare

BARN AS STAGE OF OUTDOOR THEATER

Around Sherman Lake, one of the innumerable small bodies of water in New York State, gather many cottagers

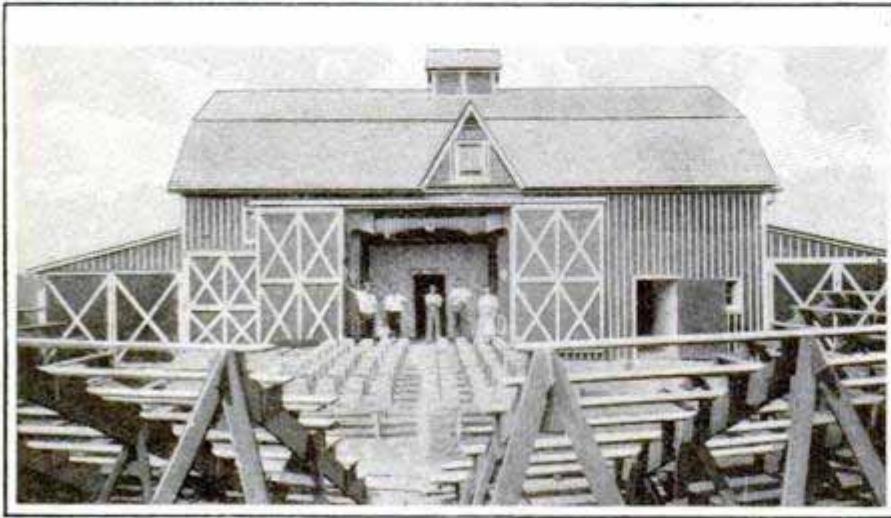

Barn Converted into Stage for Outdoor Theater. The Big Doors Serve as the Curtain

and campers during the summer months. Facilities for amusement, other than those provided by the lake and the surrounding farming country, are scarce, so the owner of a farm near the lake turned his barn into a unique theater. Benches and seats of the circus type, placed in the open air, accommodate the audience, while the central entrance of the barn is the stage.

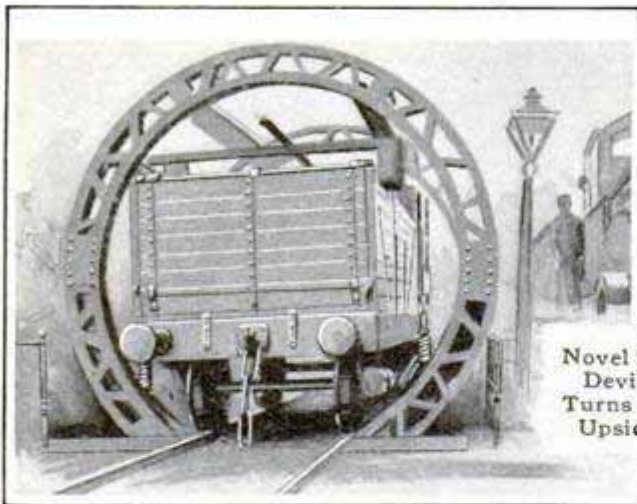

Novel Unloading Device That Turns Coal Cars Upside Down

The big sliding doors, which are opened wide in the haying season to allow the loads to enter, serve as the stage curtain. Five sets of scenery, all made of wall paper, are used. Such a theater, is available wherever there is a barn.

TEMPERATURE RECORDED AT HIGH ALTITUDES

3652'

A small balloon, carrying apparatus for recording conditions of atmosphere, sent up by Professor Gamba, director of the observatory at Pavia, Italy, reached an altitude of a little over 23 miles. At this height the temperature was 67 deg. F. below zero, and the barometer registered a pressure of only .11 in. The lowest temperature found was 70 deg. below zero, at an altitude of 12 miles. The balloon reached the highest altitude in 1 hr. 18 min., and descended in about 46 minutes, having in the meantime traveled about 90 miles from the point where it was sent up.

URNS CARS UPSIDE DOWN TO UNLOAD COAL

A novel device for rapidly unloading gondola coal cars has been adopted by an English railroad at one of its terminals. The car is run onto a section of track extending between two circular steel frames, which form rings large enough to admit the passage of the car. A clamping device holds the car fast to the track when in position, and track, car and all are then rotated until the car is practically upside down,

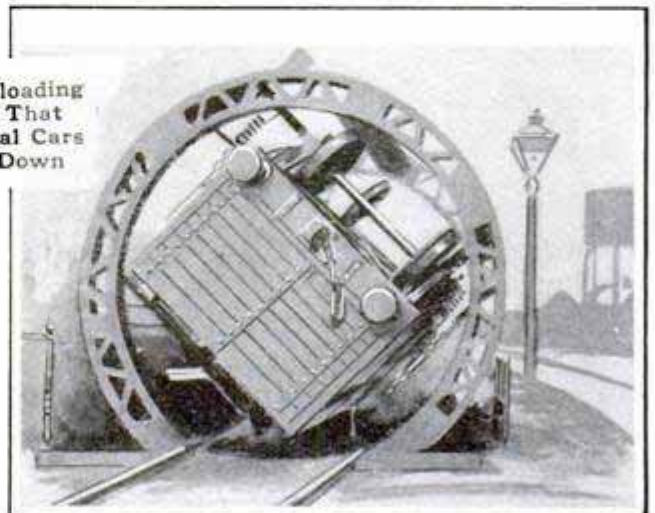

and its contents are discharged into a pit under the track, from which an automatic conveyor carries the coal to the storage pockets.

SMALLER HORSEPOWER FOR AUTOMOBILES 93

Commenting upon the fact that the horsepower of American automobiles is excessive, contrasted with that of the European product, the Automobile says that an accurate survey of the cars listed for 1913 points to a distinct tendency to reduction. The average horsepower of the various four and six-cylinder cars is considerably lower than last year, and, if the price of fuel advances, there may be further reductions in 1914.

Due to the fact that added efficiency is being obtained by changing valve timing, keeping dust out of working parts, the better balancing of crankshafts and reciprocating parts, improved lubrication, and the like, it is said that the maker is able to reduce the piston displacement and yet have as much power as has been available with larger cylinders.

COST AND PROGRESS OF PANAMA CANAL WORK

The total amount of money spent by the United States in construction and engineering work on the Panama Canal to February 1, 1913, was \$167,538,493.65. Of this amount, \$8,282,419.20 had been spent on the Gatun Dam. For this sum of money 118,100,749 cu. yd. of earth had been excavated by dry excavation, and 72,791,530 cu. yd. by dredging. The Culebra Cut accounted for 89,666,817 cu. yd. of this work and there remained to be excavated 27,246,020 cu. yd. to complete the canal.

A SHIP RAILROAD OF PRUSSIA

3383 This ship railroad, which is in operation near Elbing, Prussia, shows the novel means adopted for conveying a barge over dry land when it was found impracticable to make the canal a continuous body of water. The barge is floated over a large platform mounted on wheels, which is then drawn out of the water onto the track and along the

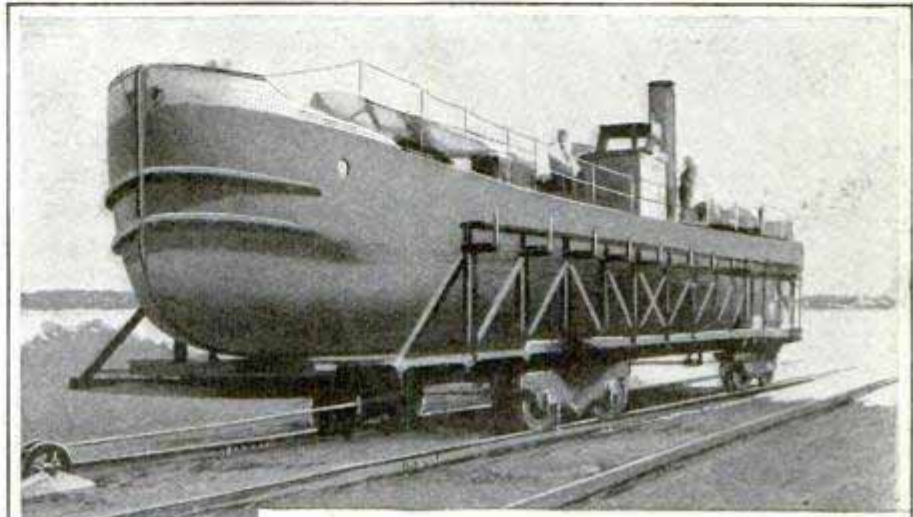

Views of the Ship Railroad near Elbing, Prussia

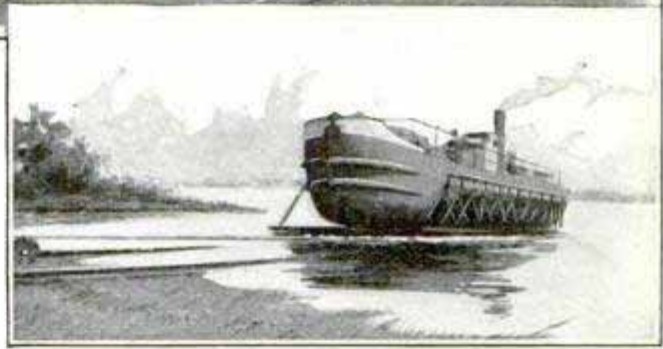

railroad by a cable. Perhaps the most remarkable of similar projects was the Eads ship railroad over the Tehuantepec Isthmus, Mexico, which was never built.

A NOVEL INK ERASER

This eraser is contained in a German-silver holder, so designed that the rubber is fed forward as desired by simply depressing the small lever. By this means the rubber always presents a sharp and clean erasing surface.

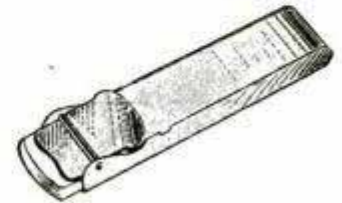

June 1913 50

3494
"CARPET SLIPPERS" FOR HORSES

Cloth shoes or "foot bags," having the bottoms formed of carpet, were made last winter by the Oregon

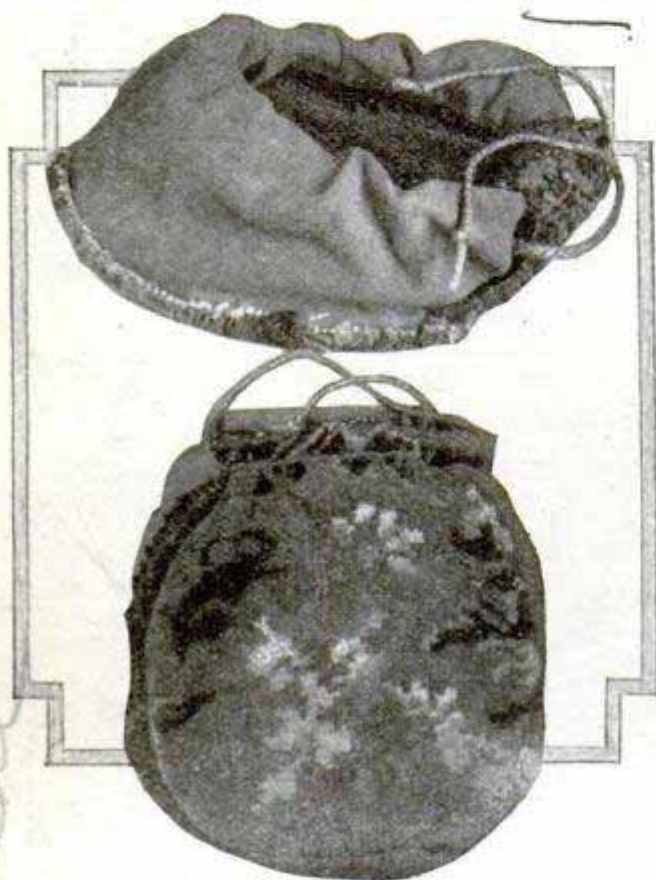

Showing the Sides and Bottom of a "Carpet Slipper" for Horses

Humane Society and put to practical use in Portland to prevent horses from falling on slippery pavements, and to help them regain their feet when they are once down. When not in demand, these "shoes" may be used by the driver as a cushion. The society manufactured several hundred of these shoes last winter, the cost being about 10 cents each. The large teaming concerns in Portland used them extensively.

335
DRESDEN HAS A MUNICIPAL NEWSPAPER

The newspaper known as the Dresdener Anzeiger is owned by the city of Dresden, having been willed to that municipality more than 50 years ago by its publisher, Dr. Justus Guentz, on condition that the profits should be

used for the beautifying of the city and for charitable purposes. The owner of the publishing house which has printed the newspaper since 1848 recently gave the city his plant on the understanding that the profits should be expended in the same manner. The annual profits of the two gifts amount to about \$60,000.

3439
COMPLETE ELECTRIC BAKERY

A fine example of a complete bakery operated by electricity is shown in the accompanying illustrations, the bakery in question being located in Muskogee, Okla. The machines include a flour lifter and conveyor, dough mixer, dough divider, loaf molder, loaf rounder, bread-rising belt, and cake machine. Included with these illustrations is also an interesting electrically driven cracker-stacking machine, and an electrically heated oven.

The process of bread making in a typical electric bakery is as follows: The flour is unsacked into a bin in the cellar and elevated by an electric flour lifter and conveyor into the large hopper above the dough mixer, the hopper being suspended from a lever connected with a scale beam so that it can be weighed at any time. After the dough is mixed it passes into rising tubs, and from the rising tubs into the dividing machine. With each revolution of the wheel of this machine, four loaves of any desired weight are punched out and dropped upon a delivery belt. An ingenious arrangement of small hoppers sift flour into the dough at the proper intervals to avoid any tendency of the dough to stick. A minute after a loaf drops upon the belt it is delivered to the molding machine, which kneads the loaves exactly as the old-fashioned baker did, turning them twice from end to end, then twice from the side, and finally rolling them around the wheel at the bottom. The loaves then roll into a pan and are carried to the oven, all of these operations being performed by electric motive power, and the electric current supplies the baking heat.

Electric Bakery

municipal Dresden

of the

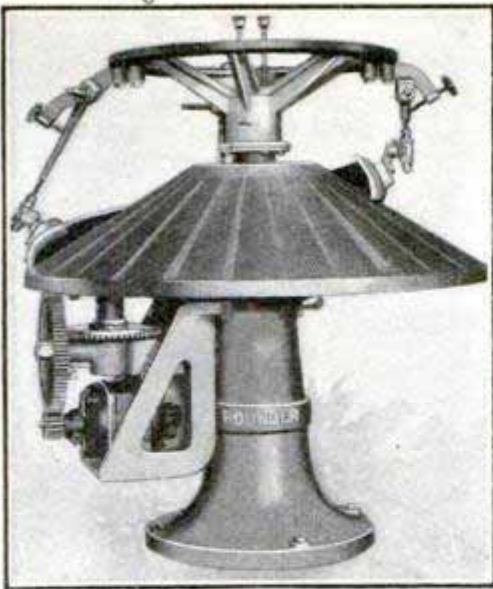

The Loaf Rounder

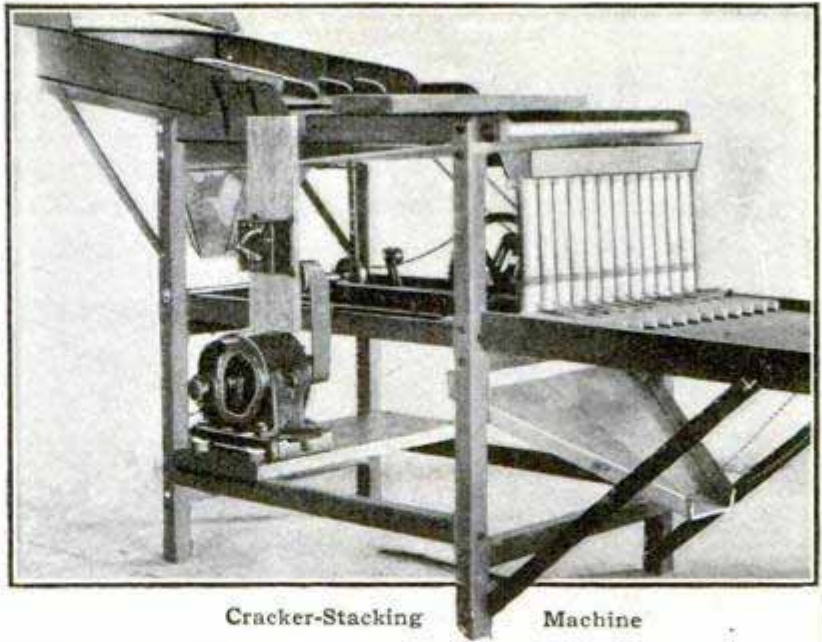

Cracker-Stacking Machine

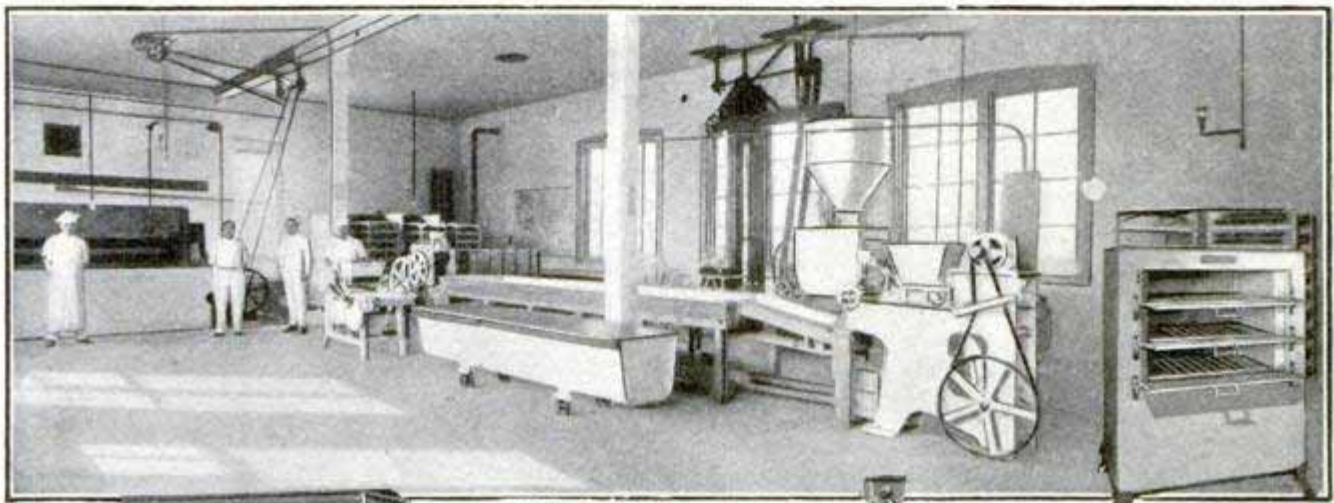

Bakery Completely Operated by Electricity

Electrically Heated Bakers' Oven

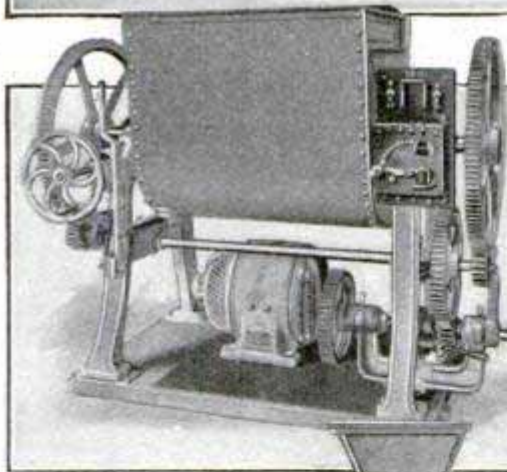

Dough Mixer

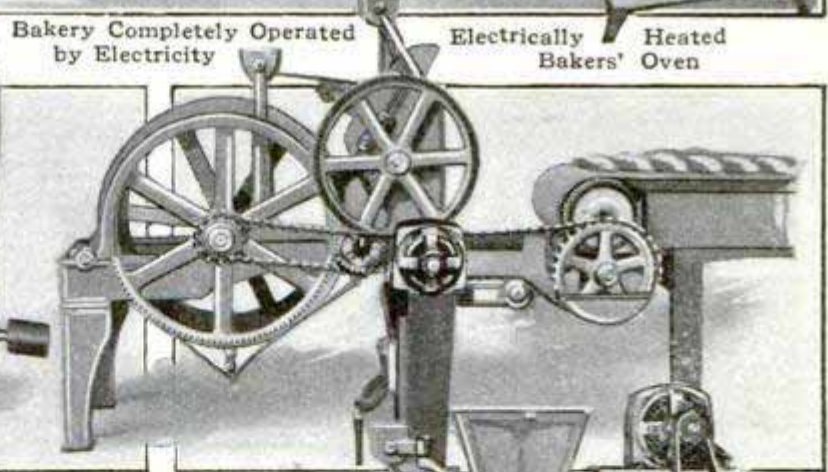

Rising Belt and Loaf Molder

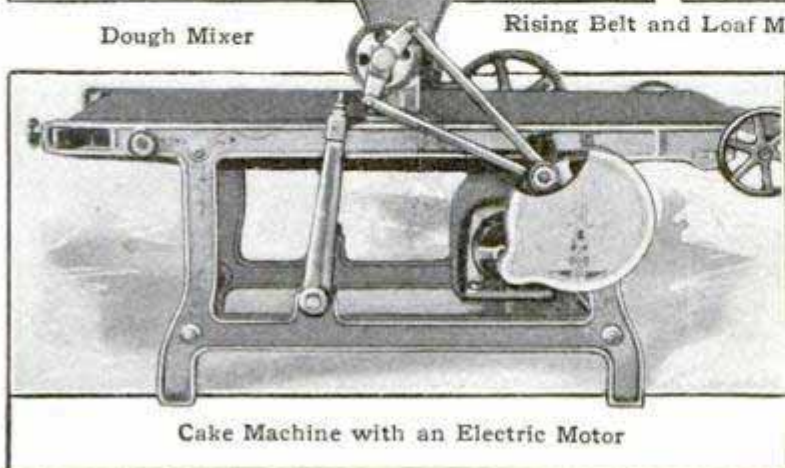

Cake Machine with an Electric Motor

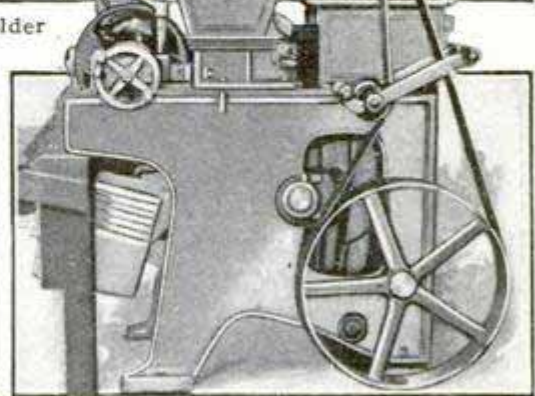

The Dough-Dividing Machine

Mrs. Hutchins Tool Co

MILL CHIMNEY A COPY OF VENETIAN CAMPANILE

A mill chimney at Darwen, England, said to be the most magnificent in the

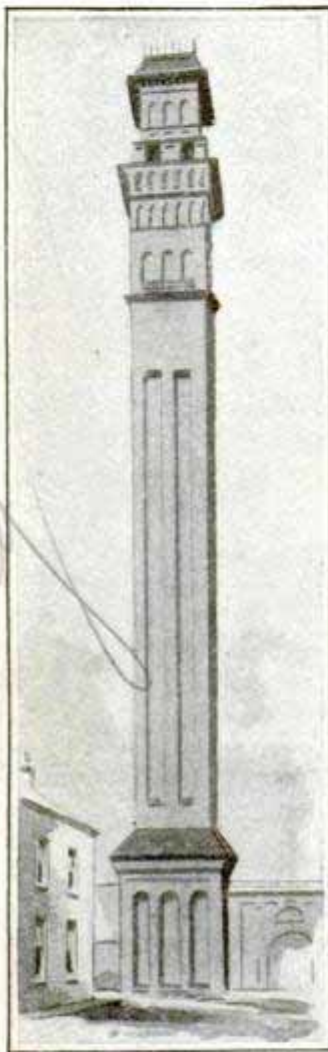

is a stone pedestal 42 ft. in height, bearing a massive stone cornice 35 ft. long on each side. The shaft rising from this pedestal is 24 ft. square, constructed of red, white and black brick, with sandstone trimmings.

GOVERNMENT TO OPERATE PANAMA FUEL STATIONS

Although it will not be the policy of the United States to attempt to monopolize the fuel business on the Panama Canal, and every means will be taken to encourage the establishment of private coal and oil depots, the actual operating plants will be owned and operated by the government. A certain ground area will be set aside for the storage of coal by individuals

or companies, and this area will be served by the government handling machinery. This arrangement will obviate the necessity of any dredging, wharf construction, or purchase of coal-handling machinery by private concerns, and at the same time will enable them to obtain the benefits of the rapid coal-handling machinery to be purchased by the United States. The cost of taking coal in and out of storage, and of the wharfage facilities, will be apportioned at a reasonable price per ton among all individuals and companies on an equitable basis.

A government piping and pumping plant will also be installed for oil fuel. All the oil companies and dealers will have to do will be to construct tanks in the area provided, and run pipe lines to the oil wharves and pumps, which will be used for all vessels alike.

NEW TYPE OF GROUND FOR TELEPHONE WIRING

Moist earth and a considerable area of contact are essentials of good grounding, so this type of grounding

device has been constructed. The three bowls or cups are covered with screens to keep the bowls from being filled with the surrounding earth, and in each bowl is a quantity of charcoal, which aids in attracting and holding the rain water which seeps through the soil. It is claimed that water will remain in the bowls a considerable time after the surrounding soil has lost its moisture. The area of contact with the earth is considerable, as these bowls act as a layer of copper and have their upper and lower surfaces exposed toward the earth.

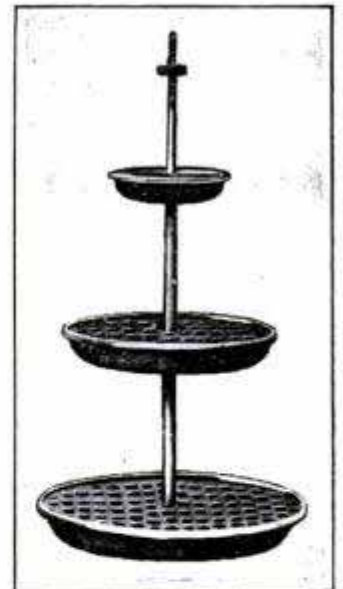

BICYCLES SUPPLANT CAMELS

3342. IN AFRICA

That bicycles are more useful for military purposes in Africa than camels is evidenced by the fact that more than 6,000 of these vehicles were ordered made and sent to Africa for the use of the Italian troops during the closing days of the Italo-Turkish campaign. A considerable number of the bicycles are to be constructed with unusually high frames, the driving gear being about 12 in. above the usual position, so that the pedals will not strike upon rocks and stones when the machines are being propelled across the desert.

that a clear space was left on each side for putting in the additional length.

Upon the completion of the rivet cutting the forward part of the vessel was drawn away by block and tackle. The line of severance was forward of the cross coal bunker at the fore end of the boiler compartment, and the boiler, engines, and machinery generally, were left intact in the stationary part of the hull. The work of filling the 50-ft. gap proceeded rapidly, as the necessary structural parts had been prepared beforehand and brought to the ship's side ready for putting into place. The liner now has an increased cargo-carrying capacity, which was the main object in view, and accommodation for about 30 additional passengers.

LENGTHENING AN OCEAN LINER

3384

An interesting feat of engineering construction was recently completed in England when the ocean liner "Marathon," a steel vessel 454 ft. long and 55 ft. broad, was lengthened to the extent of 50 ft. The operation of cutting out the rivets preparatory to severing the vessel was done entirely by hand and, while this work was proceeding, suitable supports for holding the ship in position, when divided, were laid beneath the hull in such manner

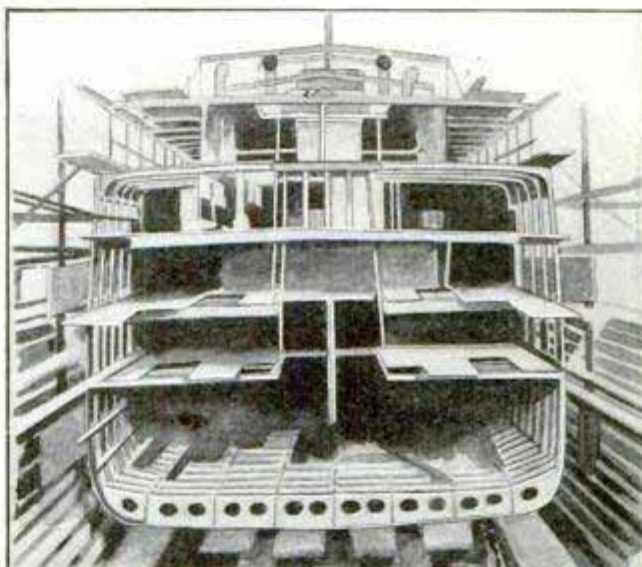

The Engineer Jan. 7, 1913

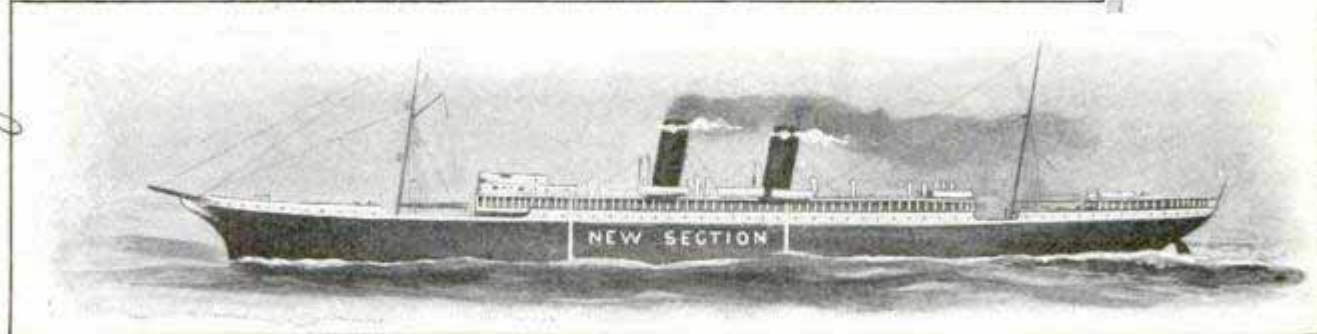

The "Marathon" before Being Cut in Two

The Liner Cut in Two, Looking Forward

The "Marathon" as It Now Appears, with New Section Indicated

Work done by Alexander Stephens & Sons, Ltd
Plymouth

PROTECTING RAILROADS WITH BRUSH MATS

3532

The accompanying illustrations show the method of protecting a \$1,000,000 railroad bridge across the Missouri

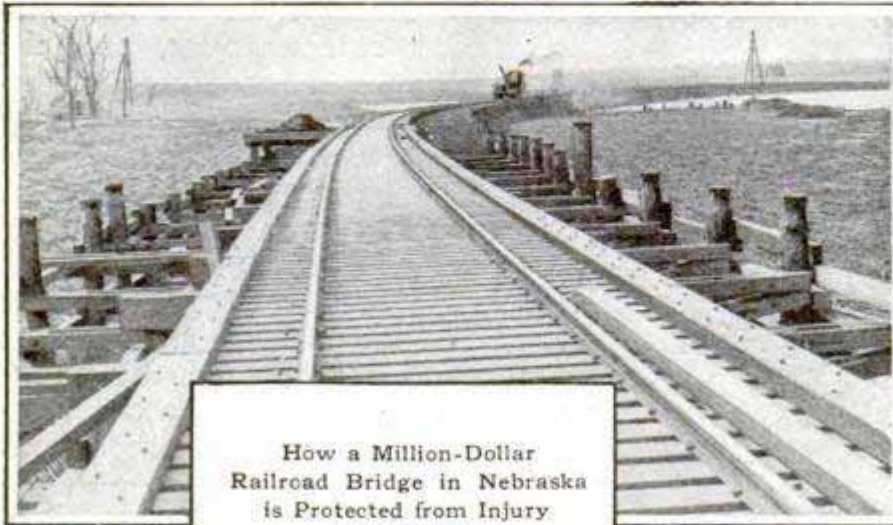

How a Million-Dollar
Railroad Bridge in Nebraska
is Protected from Injury
by River Ice

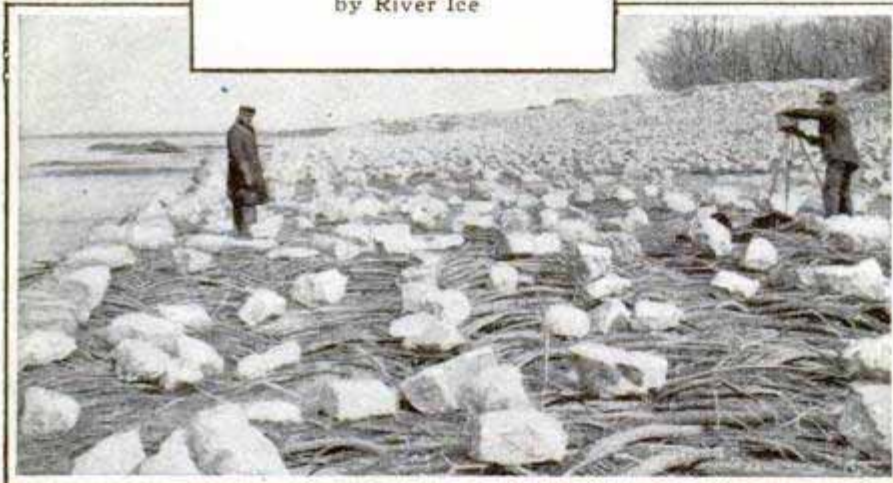

A Section of the Riprap or Brush Work, Containing 10,000 Cords of Brush
Weighted with 600 Carloads of Stone

River near Blair, Neb., from being injured by the ice when it thaws in the spring and piles up against the structure, thus preventing the water from passing. The protection consists of a mat woven of brush and wire cable, one mile long and 166 ft. wide, containing about 10,000 cords of brush weighted down with 600 carloads of stone. The riprap covering is designed to prevent the water from washing away the banks of the river as well as protect the valuable bridge when the ice breaks up.

A \$5,000,000 company has been organized in London to operate lines of cargo vessels propelled by oil engines.

FILLING COAL MINES WITH SAND

3644

The idea of filling the workings of coal mines more or less completely with sand or other waste material was

originated by the anthracite operators in Pennsylvania. In the last few years it has been adopted extensively in various European coal-mining centers. Until this filling system was originated the custom was, and still is to a great extent, to leave a large percentage of the coal in place as pillars to support the roof. At present many of the collieries in the anthracite region are utilizing refuse from the old culm banks, flushing this fine waste underground so that the pillars may be reduced in size or removed. As a result the culm banks are now disappearing and soon will be gone, and sand will be used. The filling up of the worked-out mines will also prevent the crust

caving in, which has been known to happen with serious results.

MARYLAND'S AUTOMOBILE LIBRARY

3528

The most useful automobile in Washington County, Maryland, is the one that serves as a circulating library for the remote cabin dwellers who are too hard-worked to seek literature themselves. The population of the county, outside of Hagerstown, is 30,000, spread over 500 square miles. For several years, Miss Mary L. Titcomb, of Hagerstown, who conceived the idea, carried literature to the out-of-the-way places in a sort of cupboard

Illustration 4
1917

6. 1917

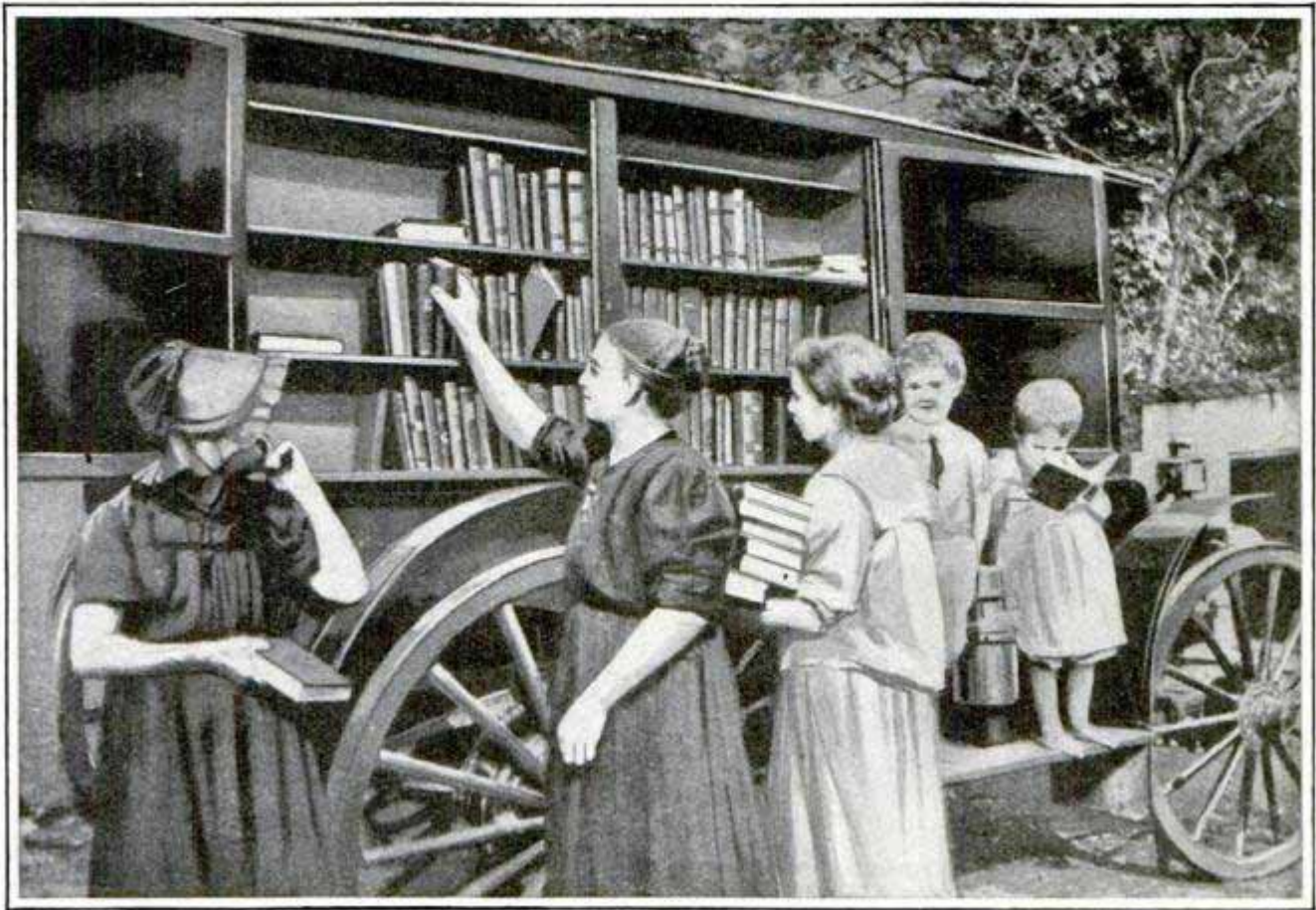

The Automobile Library That has Taught a County to Read

on wheels, drawn by a horse. But this outfit was small, and the horse got tired on the steep roads. So, when a train ran over the wagon and left nothing but splinters, an automobile, provided with a special library body, took its place, and books are now taken to the doors of the readers by 24 routes, covering the whole county. About 2,800 volumes were circulated from door to door during the last six months of 1912.

teeth, making full use of the impact due to velocity, and avoiding all leakage. A film or cushion of steam is at all times maintained between the teeth of the rotors, the result being an elastic contact which produces smoothness of running.

COMBINED IMPULSE AND REACTION TURBINE

A new type of combined impulse and reaction steam turbine is said to give a steam economy from 20 to 50 per cent better than the best of existing standards. The construction of this new turbine is simple, consisting essentially of a case, two heads with bearings, and two rotors. These rotors are herringbone gears, cut by special machinery, without any loose or inserted blades. The steam acts within the pockets formed by these spiral gear

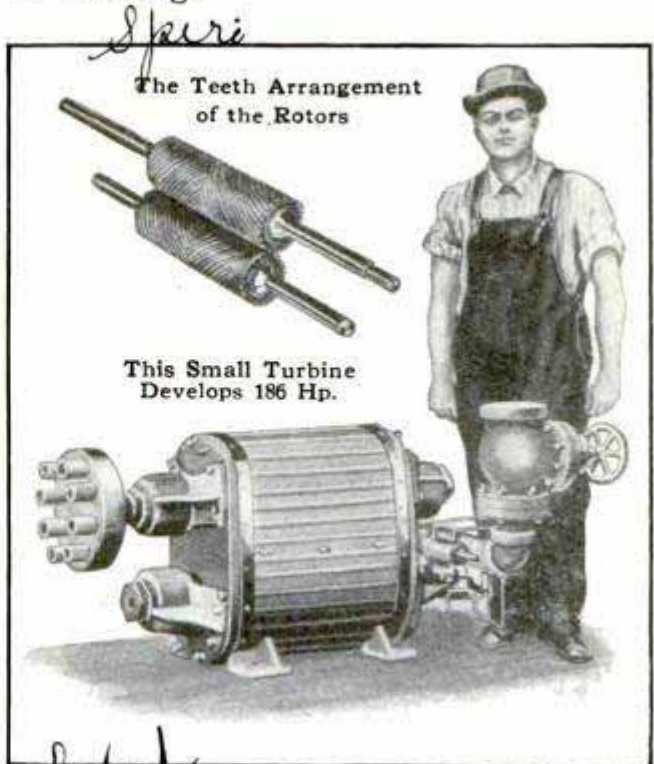

Dr. John Van Diver, Supr
W. H. ... Co

AN ARTISTIC FLAGPOLE

3524 FOR A LAWN

A substantial and particularly graceful flagpole for a lawn is in the yard of



a Chicago residence. The upper half of the pole is round, with the exception of two or three feet at the lower part, which is square. To the sides of this square were bolted four strips of clear material 2 in. wide and 1 in. thick, the strips being spread apart and held by cross-pieces. The pole was erected by bolting the lower ends of these

strips to stakes driven into the ground.

 3649
 LOW RATES FOR ELECTRIC COOKING CURRENT

Although the average charge for electric current used for illumination in the different cities of the United States is about 10 cents per kilowatt-hour, the special rates for electricity used for cooking and heating differ widely. Boston, for instance, charges 10 cents per kilowatt-hour for the first 20 kilowatt-hours, and three cents for all over this. Redding, Cal., charges 3 to 1½ cents per kilowatt-hour, with a minimum charge of \$1 per month; Salt Lake City charges 6.6 cents per kilowatt-hour, with a \$2 minimum and a 10-per-cent discount, and Seattle charges 3 cents per kilowatt-hour, with a minimum of \$2. In Omaha a discount of 5 per cent on all electricity used is made to customers who install equipment enabling them to use electricity exclusively for cooking, and the cooking rate is placed at 6 cents per kilowatt-hour.

AQUEDUCT CONSTRUCTION AS DEADLY AS WAR

Ten out of every 100 men working underground on the new New York aqueduct have been killed or injured every year since the work began. In the two years 1911 and 1912, 134 men were killed and more than 6,000 seriously injured. The New York Commissioner of Labor compares this record with the battle of San Juan, Cuba, in which the American forces lost only 142 killed, or only eight more than in this work of peace. The number of accidents in the aqueduct is nearly six times as great as the number of wounded in this battle and more than three times as many as there were men wounded in the American army during the entire Spanish-American war.

 3382
 A DOUBLE MICROSCOPE WITH ONE EYEPIECE

A microscope that has two objectives for observing two distinct preparations at the same time, but only one eyepiece, has been recently constructed by a German scientist for the purpose of comparing certain objects that may be placed under the instrument. The microscope is so designed that the operator may, at will, also observe the preparation or object under one objective only by turning a small screw which temporarily cuts the other out of service. The instrument is used mainly for the examination of foodstuffs and comparing diseased and healthy tissues, but is equally valuable for industrial purposes, such as the comparison of textile products, paper, steel, and minerals.

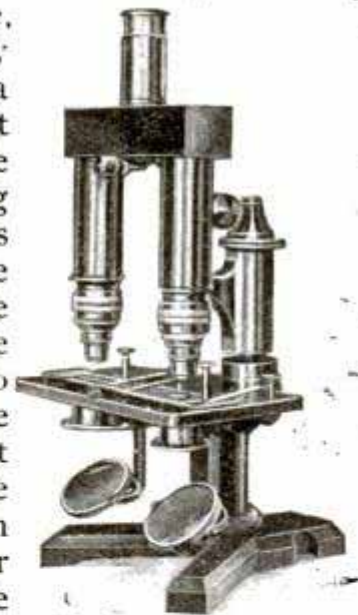

Elect. World
 March, 1913

I have never seen
 (1111)

Four Years at West Point

THE WORK AND PLAY OF THE CADET TOLD
IN PICTURES



1—The Cadet's First Summer

PHOTOGRAPHS BY W. H. STOCKBRIDGE

The story of the life of a West Point cadet, from the day he reports for duty at the U. S. Military Academy until, four years later, he receives his commission as a second lieutenant and is welcomed into the army by the Secretary of War, is told so clearly in this remarkable series of 110 photographs that few words are necessary to explain the whole process of making army officers out of boys from every part of the United States.

Six hundred and fifty cadets are provided for by law. There are but 526 at West Point at present. All cadets are appointed by the President, but the law provides that one shall be chosen from each congressional district, one from each territory and the District of Columbia, one from Porto Rico, two from each state at large and 40 from the United States at large. Senators, representatives and delegates in congress submit to the President the names of the preferred candidates from their respective localities. Usually three names are submitted, a principal and two alternates. The custom is quite general among members of congress of holding competitive examinations open to all the boys in their districts and naming those who pass with the highest rating. All appointments must be made a year in advance of the date of admission, and on the last Tuesday in April the candidates are examined by boards of army officers, meeting at convenient places throughout the country. The examination must show proficiency in algebra, plane geometry, English grammar, composition and literature, geography and history. Candidates must be between 17 and 22 years old, at least 5 ft. 4 in. tall, and physically sound in every way.

Upon passing the examination, each cadet must sign an agreement to serve at least four years in the army after graduation, and subscribe to the oath of allegiance to the Nation. Then, on the morning of June 14, the newly made cadets report at West Point for duty.

For most of them the view shown at the top of this page is the first glimpse of the historic and beautiful spot where they are to live and work—and sometimes play a little—for four years. West Point has been a military post continually since January 20, 1778, and was occupied as headquarters by General Washington during an important period of the War of the Revolution. The first military school was established by the Continental Congress on June 20, 1777, and in 1781, at the request of General Washington, the entire corps of instructors and students was marched from Philadelphia to West Point, where an engineer school, a laboratory, and a library had already been established in separate buildings. General Washington's interest in the Military Academy continued until his death, and during his presidency the rank of "cadet" was created and the school at West Point established on a permanent footing.

The pay of the cadet as an officer of the army, \$600 a year, begins with his admission to the academy. He is also allowed one ration a day or its commutation in money, amounting to 30 cents, which brings his annual income up to \$709.50. His necessary traveling expenses from his home to West Point are paid by the government, but he is required to spend \$160 for his uniform and equipment immediately upon entering, of which at least \$100 must have been deposited with the treasurer of the academy before he is admitted. Money may be spent by cadets only for purposes prescribed by the academy authorities, and they are not allowed to receive money or other supplies from home.

The pictures on the following pages illustrate the first summer of cadet life. As soon as he has acquired a uniform and the rudiments of drill tactics, the "plebe," as the new cadets are called in West Point slang, is sent into camp with the rest of the corps, and lives under canvas or in the open until the end of August.

Next month's pictures will show the cadet's life to the end of his first year.



New Cadets, Just Arrived at West Point, Receiving Instruction from Older Cadets in the Proper Form of Salute

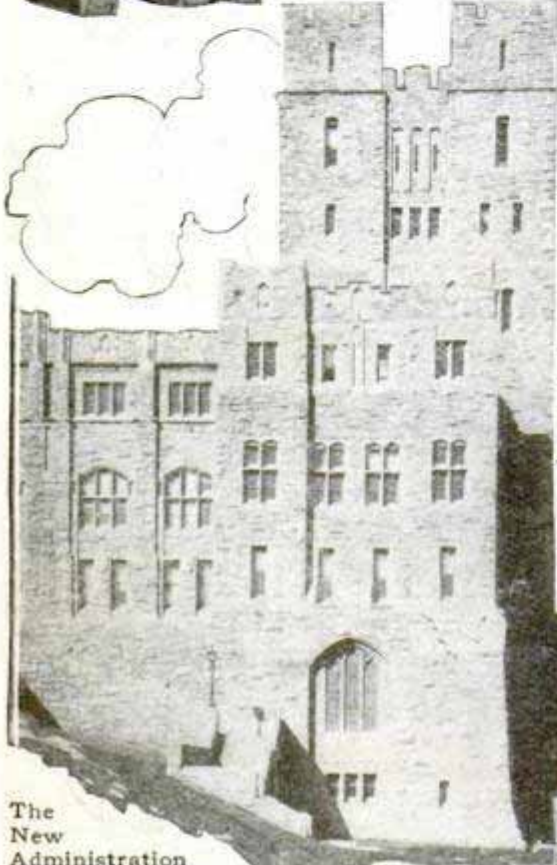

South Cadet Barracks on Right

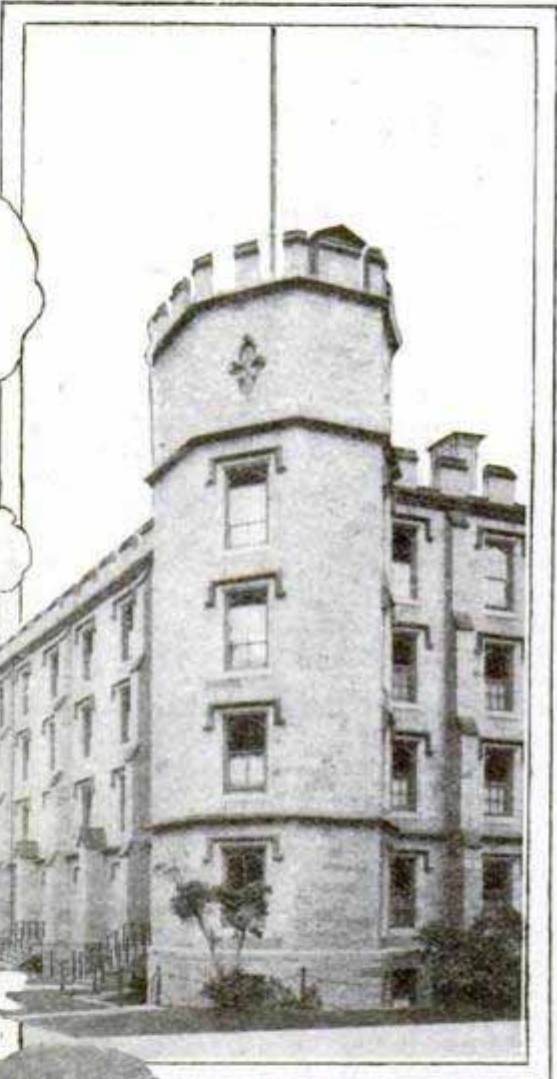

The New Administration Building, the First Place Which the New Cadet Officially Visits

With Uniforms On for the First Time, Learning to March

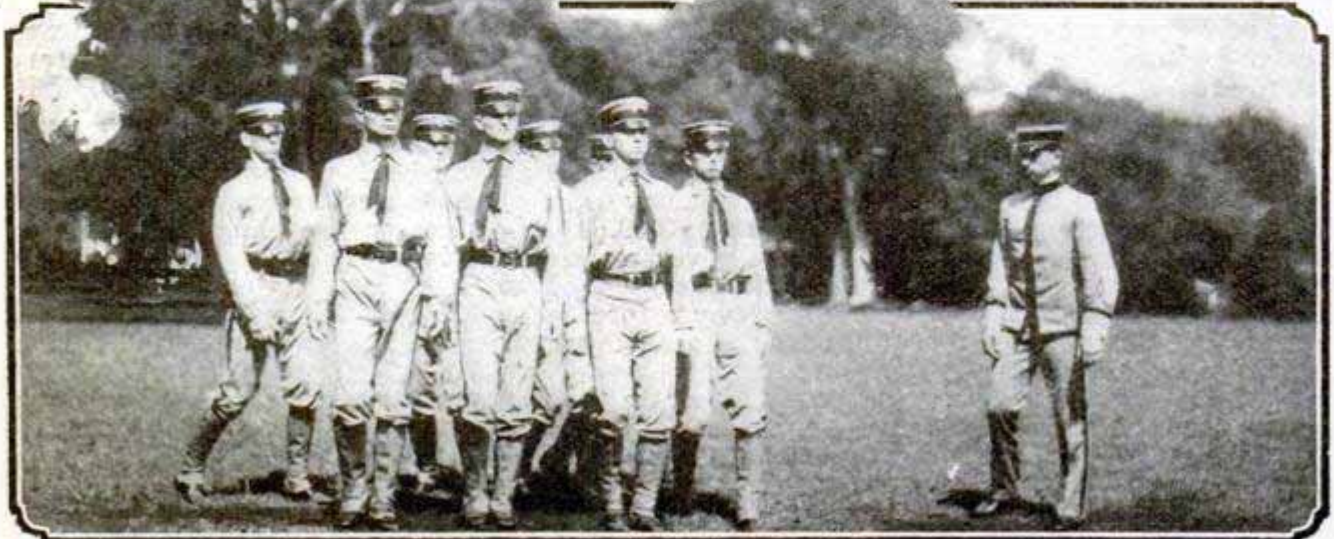



Military Calisthenics or

Setting-Up Exercises



Daily Drills Occupy the First Four Weeks

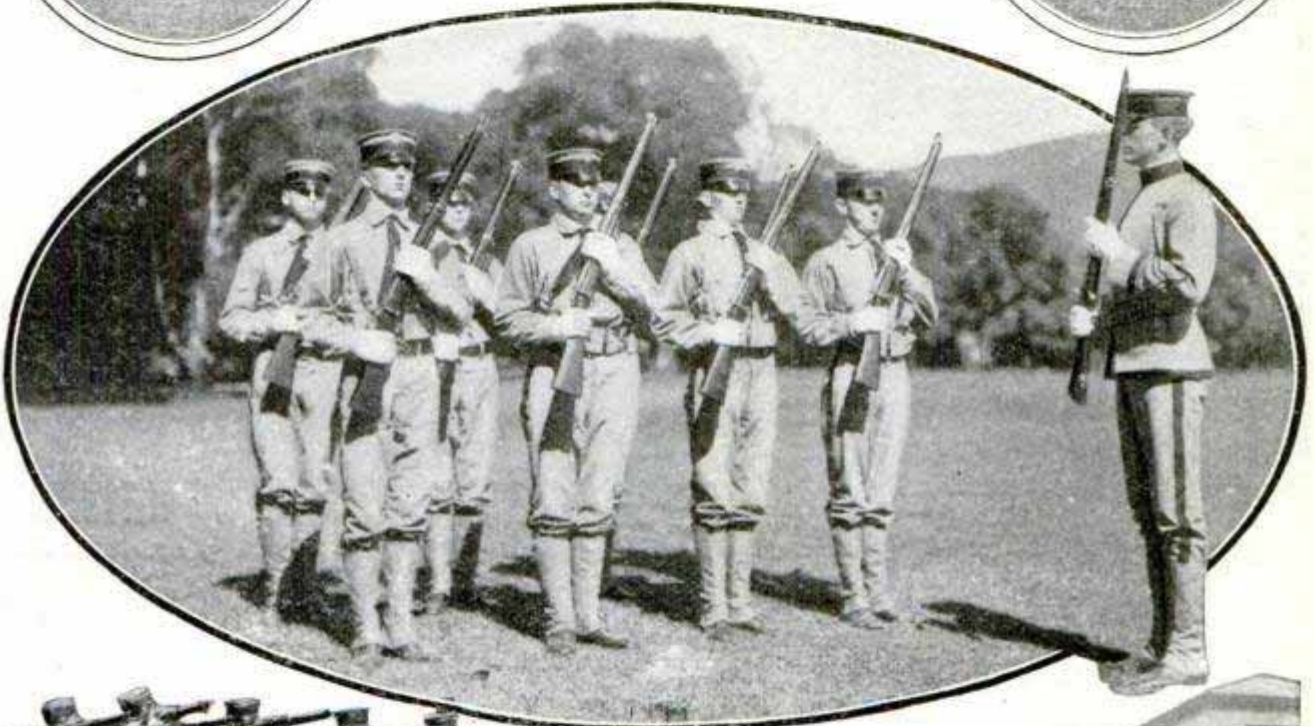

Infantry Drill, under Older Cadets as Instructors, Beginning with the Manual of Arms, Is the First Military Training of the New Cadet

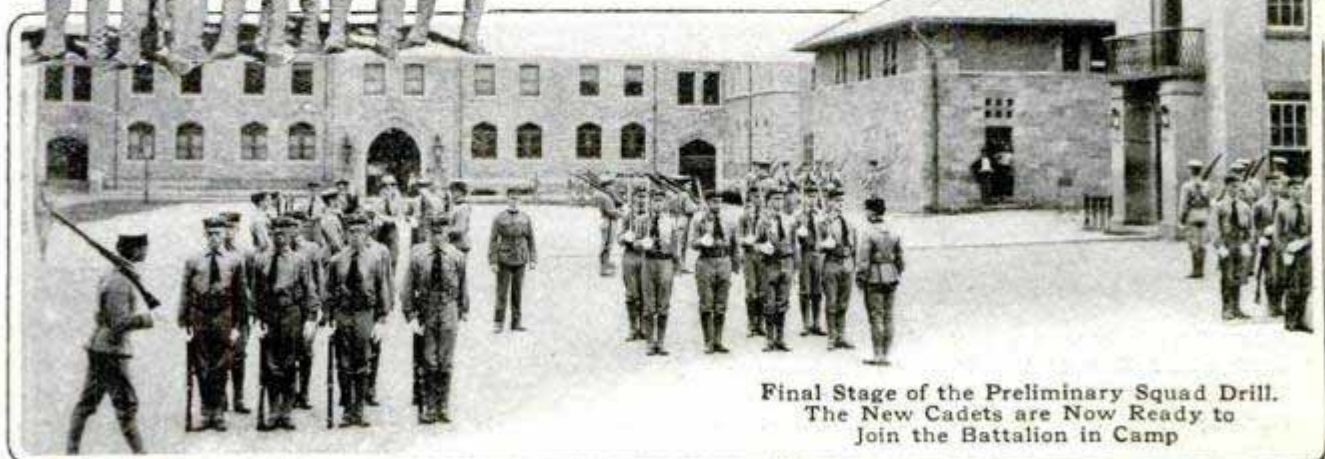

Final Stage of the Preliminary Squad Drill. The New Cadets are Now Ready to Join the Battalion in Camp

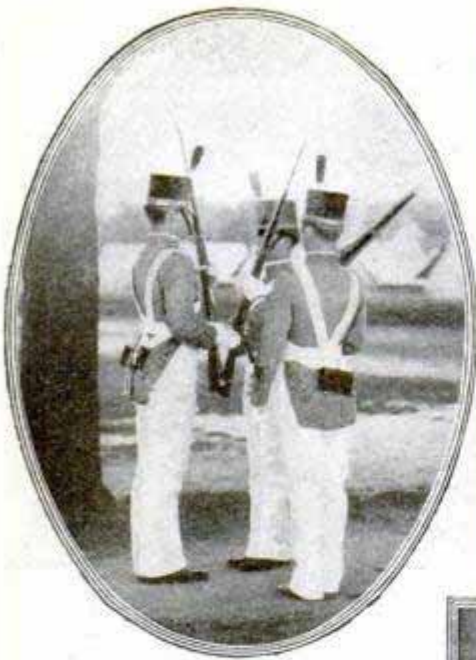

Posting Sentinels in Camp. A Guard is Maintained around Camp at All Times

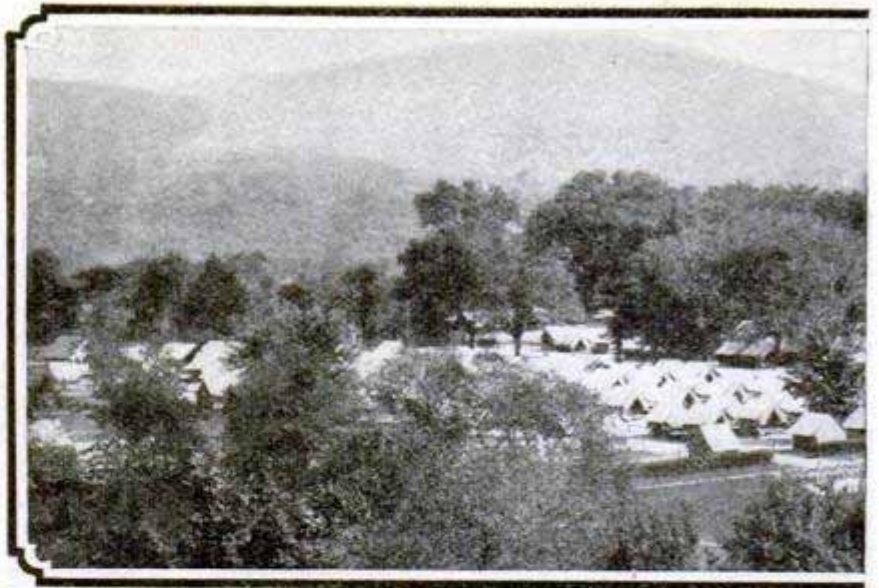

The Start for Camp: Above, About to March to Camp, Carrying Part of Outfit; Below, New Cadets Packing Their Outfits

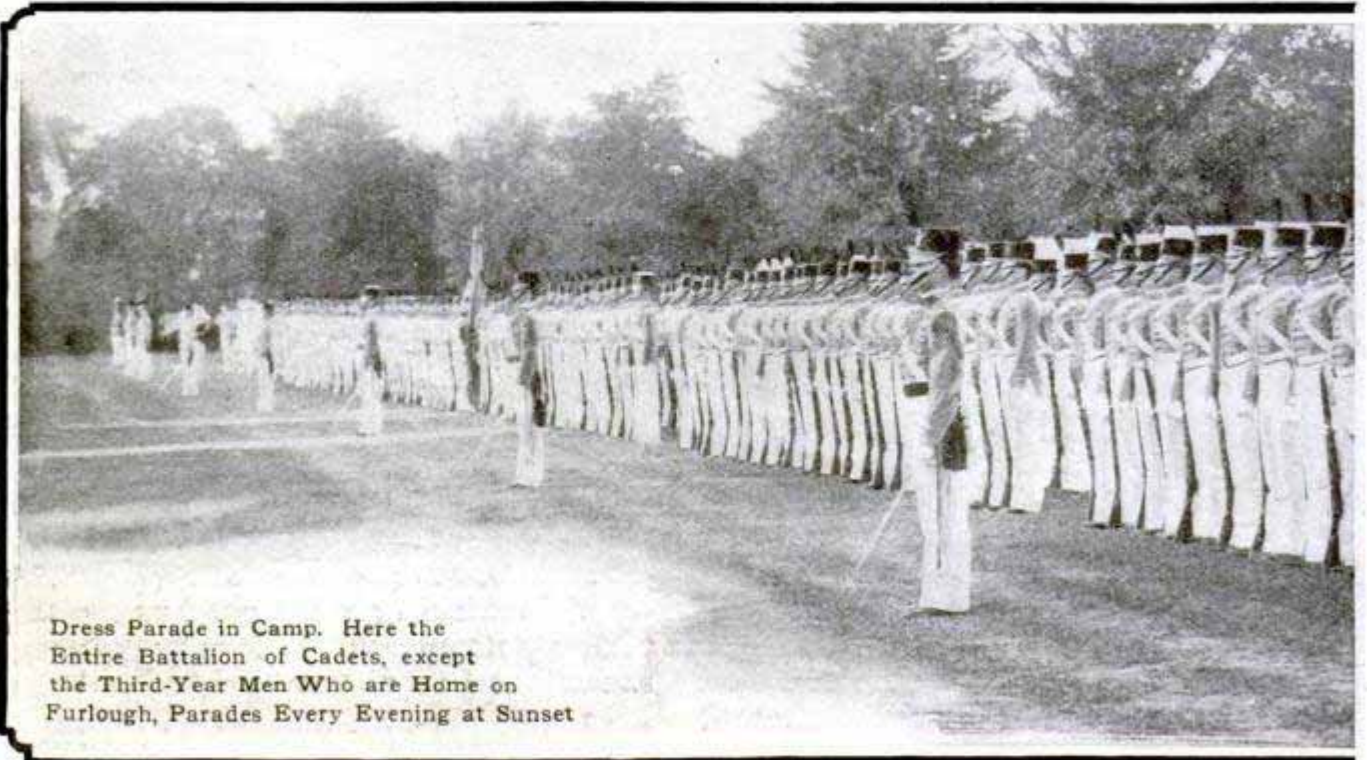
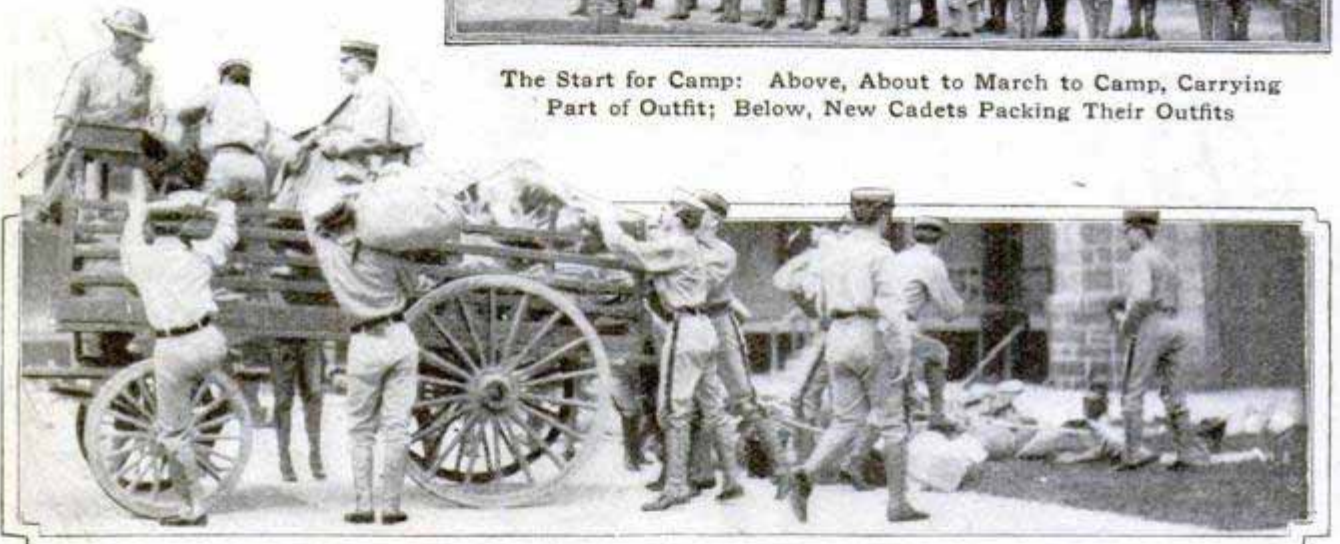

Dress Parade in Camp. Here the Entire Battalion of Cadets, except the Third-Year Men Who are Home on Furlough, Parades Every Evening at Sunset

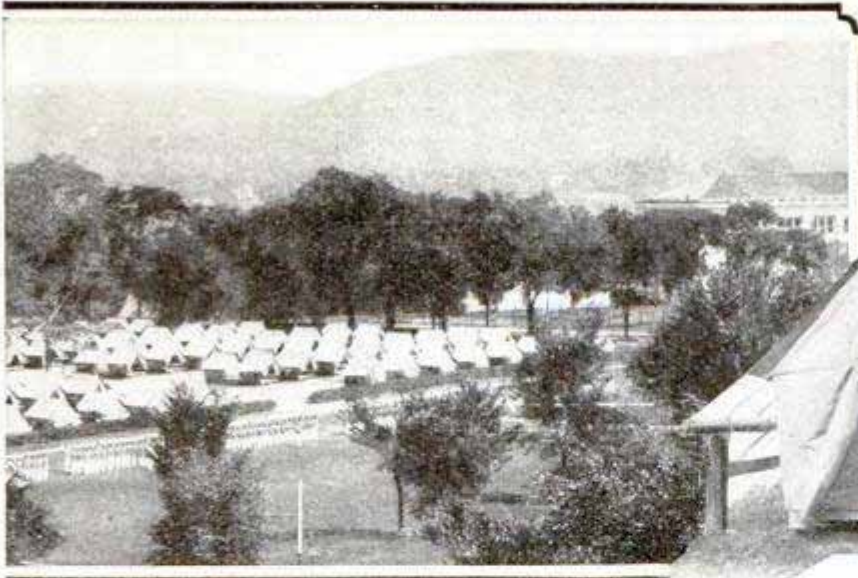

Cadet Camp, on the Military Academy Grounds, Lasts from June 15 to August 28. The Y. M. C. A. Tent, Shown Here, is a Favorite Rendezvous for Cadets off Duty

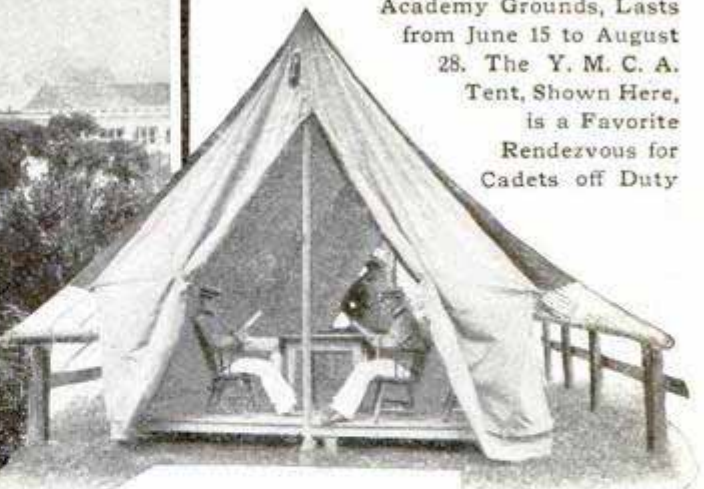

On the Left, the Mess Hall; Below, Cadets Marching from Camp to Dinner, and Scene in the Mess Hall



The New Cadet's First Summer at West Point is Over. He has Had a Taste of Military Life and Is in Fine Trim to Take Up Classroom Work in September

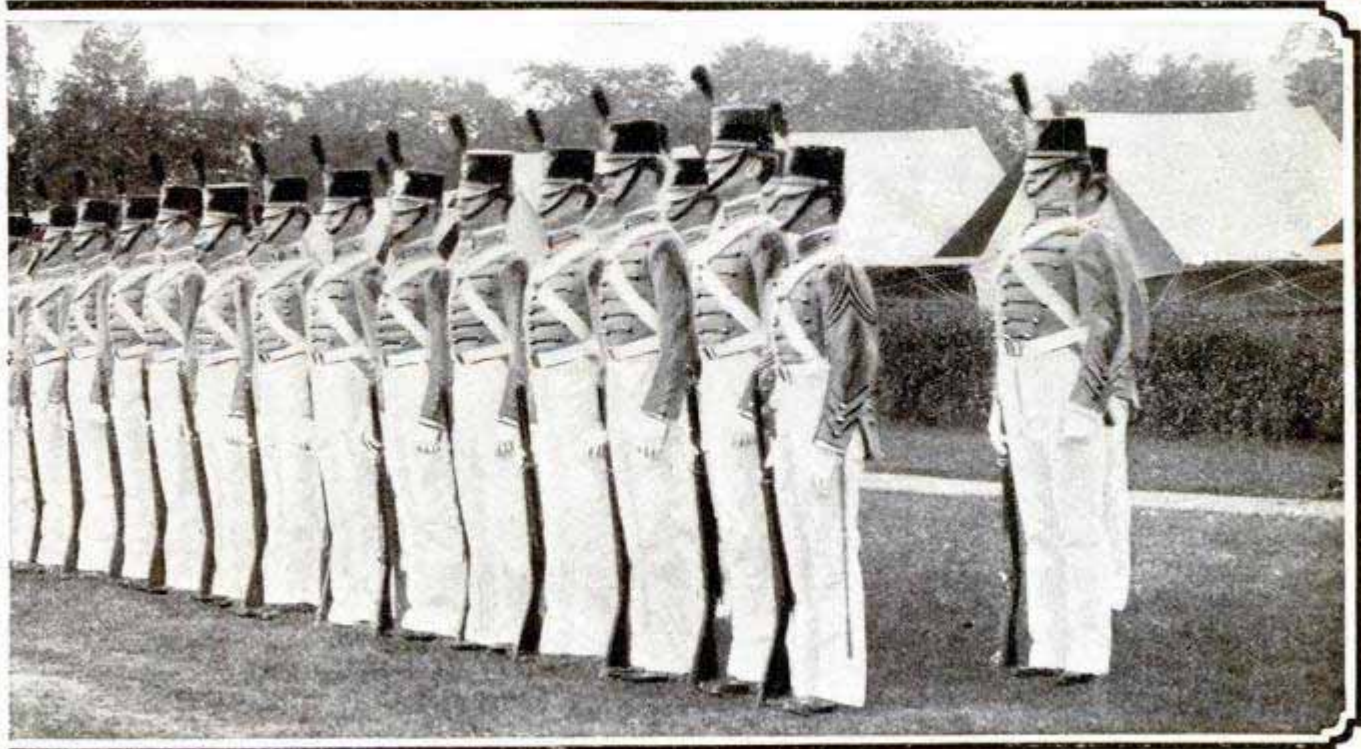

3583
**THE MEMORIAL TO AIRMAN
 CHAVEZ**

On the spot at Domodossola, Italy, where George Chavez, the first airman

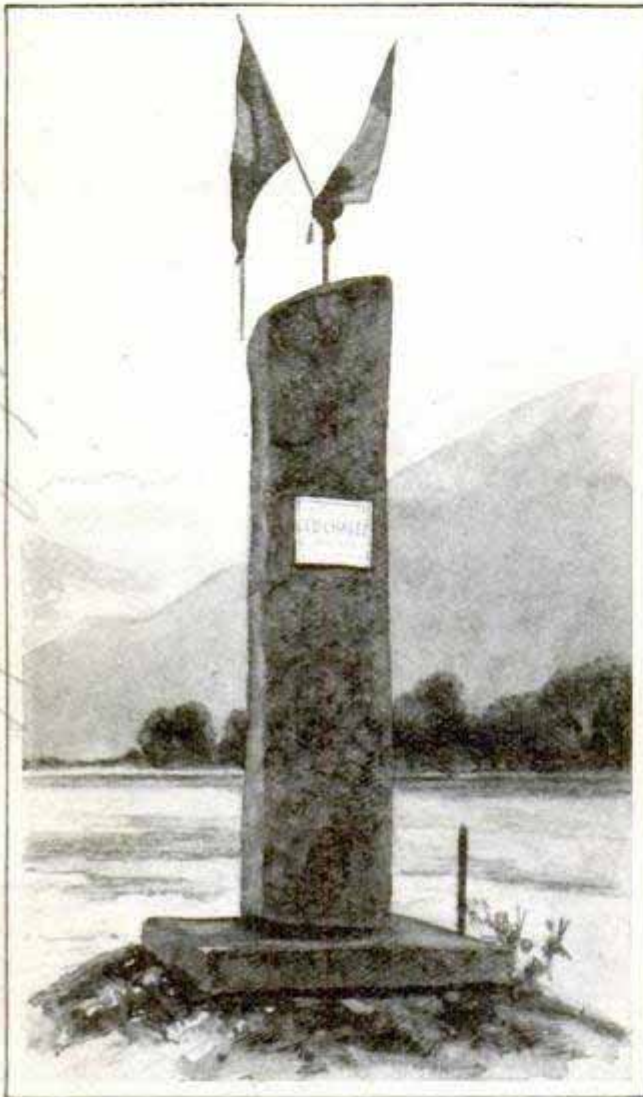

The Chavez Monument at Domodossola, Italy

to fly over the Alps, fell to death in making a landing, has been erected a memorial shaft. It is a simple, rough-surfaced column.

OWING to the requirements of the Post Office department, which distributes magazines by freight, this issue of Popular Mechanics Magazine, in order to reach subscribers and newsdealers by April 20, has to go to press on March 27, nearly a month in advance of publication, and too early to include photographs of such national catastrophes as the Omaha tornado and the floods in Ohio and Indiana.

**"LEPROSY NOW CURABLE," A
 MISTAKE**

In a recent issue of this magazine an article was printed entitled "Leprosy Now Curable." It recounted the alleged use of a carbonic-acid pencil by Dr. J. Williams Lord of Baltimore. The article was prepared by a writer understood to be a graduate physician versed in the special medical subjects which he frequently contributed to newspapers and magazines. Doctor Lord informs us the statement is without foundation, and did not receive his sanction, as he had done no work with the carbonic-acid pencil in the treatment of leprosy.

**INVISIBLE LIGHT USED TO
 DETECT FORGERIES**

By the use of a lens made of quartz covered with a thin film of metallic silver, Prof. R. W. Wood of Johns Hopkins University has developed a practical means of making photographs by the invisible rays of light above the spectrum, known as ultra-violet rays. The quartz lens is necessary because these rays will not pass through ordinary glass, while the silver film acts as a screen to shut out all the visible rays and those below the spectrum, admitting only the ultra-violet light.

Most white objects appear black when photographed by this invisible light. By its use, also, perfectly transparent objects, like glass, may be photographed in black. Photographs of the planets made with this apparatus have been of service in determining the nature of the material and elements of which the stellar bodies are composed. Professor Wood's own photographs of the moon showed conclusively the presence of sulphur in one of the so-called craters on the moon's surface, thus furnishing a further indication that these craters are of volcanic origin.

A practical use of photography by invisible light is its application to the detection of forgeries. Chemical means

Prof. Rev. Wood's Journal of Experiments with Invisible Light

Twenty-four of 100 \$24.⁰⁰

Twenty-four Hundred of 100 \$2400.⁰⁰

Twenty-four Hundred of 100 \$2400.⁰⁰

Check for \$24 Raised to \$2,400 and the Forgery Detected by Invisible-Light Photography. Upper Illustration Shows Original Appearance of Check; Middle Picture, How It Looked When "Raised," and the Lower, a Photograph Made with Ultraviolet Rays, Showing the Word "Hundred" was Written over an Erasure

used by forgers in altering checks and documents have been perfected to the point where it is often impossible to detect the erasures by the use of a microscope. A check originally written for \$24 was raised by a clever forger to \$2,400 and passed the cashier of one of the largest banks in Baltimore without detection. A photograph made by Professor Wood with the ultraviolet rays showed clearly a smudge where a heavy line had been erased and the word "hundred" written in after the "twenty-four," thus proving the check to be a forgery.

While there are chemical methods which are frequently resorted to for testing the authenticity of disputed documents, such as wills, deeds, notes and checks, as well as supposedly ancient manuscripts, the use of chemicals frequently injures or destroys the paper under test. The ultraviolet photography, however, does not affect the document tested in any way.

A SANITARY FOUNTAIN THAT IS EASILY CONSTRUCTED

Any public school with a good well and pump may have a sanitary drinking fountain at small cost, by boring holes about 10 in. apart in a piece of 2-in. pipe, one end of which is plugged so the water will run out only through the holes, the other end being attached to the spout of the pump. A fountain of this sort is in use at a school in Gibsland, La. Any desired length of pipe may be used; the fountain is absolutely sanitary and can be operated by anyone who can work the pump handle.

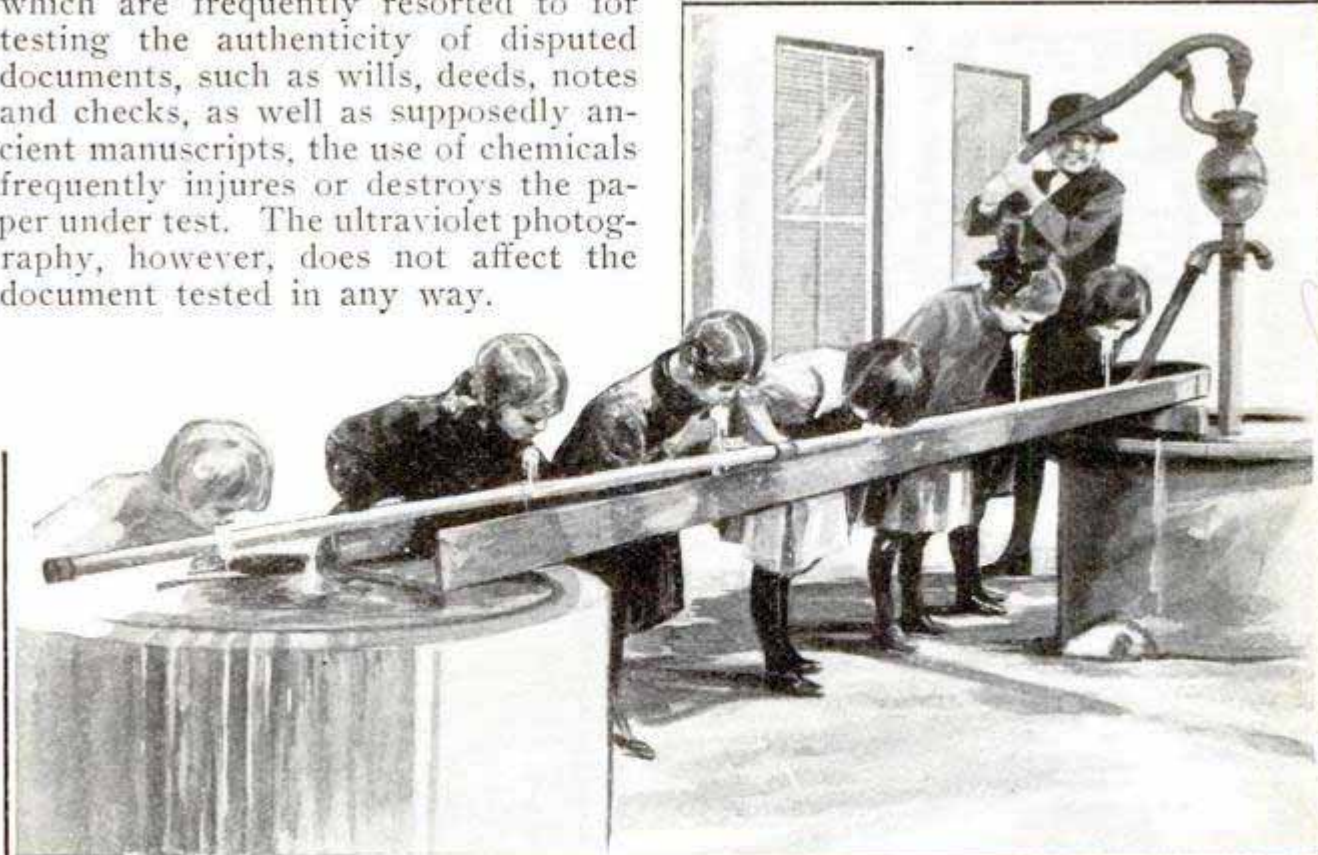

The Hand Pump Turned into a Sanitary Drinking Fountain

W. H. Wood, Jr., La.

NEW U. S. CAVALRY SWORD HAS THRUSTING POINT

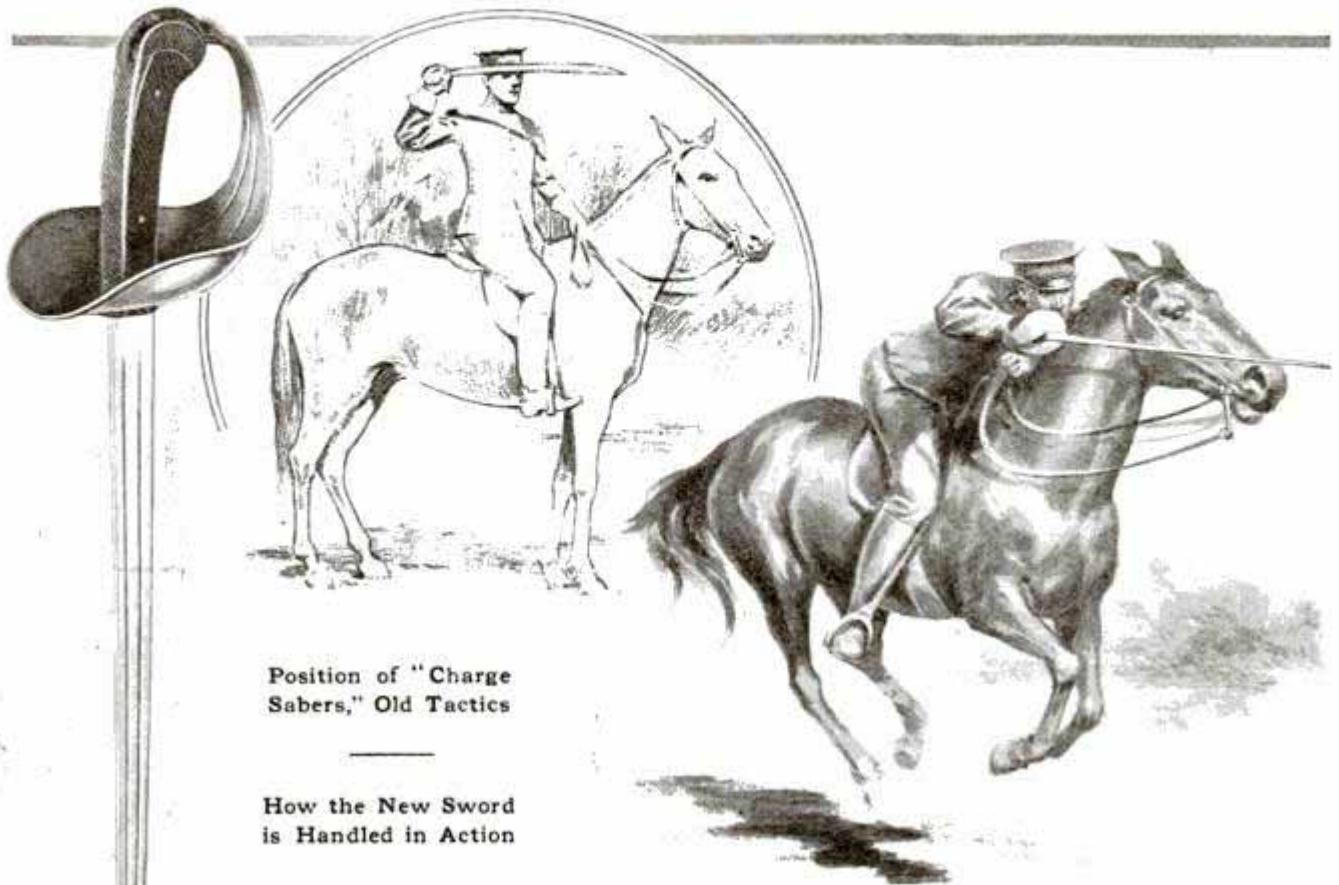

Position of "Charge Sabers," Old Tactics

How the New Sword is Handled in Action

The new sword just adopted by the U. S. Army authorities for cavalry use is strikingly different in almost every detail from the old saber. The blade is $35\frac{7}{8}$ in. long, perfectly straight, sharp on both sides, and tapers to a sharp point. The guard is strongly constructed and affords complete protection to the hand. The sword itself weighs a trifle more than the old saber, but the combined weight of sword and scabbard is about 2 oz. less than the old equipment.

The service scabbard for the new sword is of wood covered with rawhide and canvas. Officers' service scabbards are of dull-finished steel, while they will wear blue-steel scabbards on garrison duty.

The new sword makes it easier to train soldiers to use the point instead of the cutting edge. Cavalry experi-

ence has demonstrated that the sword is much more effective for thrusting than for slashing, although the tendency of the beginner with the saber is to swing it as though it were an ax or a club. A cutting blow, even with a sharp sword, seldom dismounts or disables an opponent, while the forward thrust with the point, even with comparatively little force behind it, usually disables or kills if it reaches its mark.

The new cavalry tactics adopted for the use of the new sword give the cavalryman a much more effective position for the charge. Instead of sitting upright in the saddle and exposing the body to the enemy, the new position projects the sword beyond the horse's nose, while the soldier is protected by the animal's head and neck.

¶The highest flight ever made by an airman was accomplished on March 11, 1913, by M. Perreyon, who reached an altitude of 19,684 ft. in a Bleriot monoplane at Buc, France.

ELECTRICAL PROPULSION FOR NAVY COLLIER

The first electrically driven ship in the U. S. Navy will be the collier "Jupiter," which is being equipped with electric motors for turning its propeller shafts. Experiments with electric propulsion have been made in Europe on small merchant vessels with excellent results. The fuel economy of the turbine engine at high speeds is generally admitted. The interposing of a dynamo and motor between the turbine and the propeller shaft, however, not only makes it possible to maintain the speed of the engine at its most efficient point, at whatever speed the propeller may be driven, but permits of more rapid and certain control of the ship's speed, as well as allowing the use of a steam turbine of less bulk and simpler construction than those in general use on shipboard. The "Jupiter" is to be fitted with a single electric generator and separate motors for its two propeller shafts.

USING LIME TO THAW THE GROUND 3954

Unslaked lime has been used successfully for thawing frozen earth in West Liberty, Iowa. Sewer trenches were being dug during the winter months.

The ground froze to a depth of 4 ft. and resisted all efforts of the trenching machine to break it. Finally quicklime was broken up into small pieces, spread the width of the trench to be opened, and covered with straw, hay or manure. Water was then poured upon it, the covering retained the heat, and this, with the hot water, penetrated the frozen ground sufficiently to enable the trenching machine to make headway.

MAN-CARRYING ROCKET FAILED TO GO UP

In an attempt to emulate the thrilling flight of Jules Verne's hero, who made an imaginary trip from the earth to the moon, a man in New York recently tried to go up in the air on the top of a huge skyrocket loaded with 1,500 lb. of black powder, and descend by means of a parachute, but the rocket failed to leave the ground. The moving-picture men were on hand; an interested crowd was assembled at a safe distance and everything ready for the flight when the rocket exploded with terrific force and threw the would-be hero a distance of about 30 ft., burning and injuring him very severely.

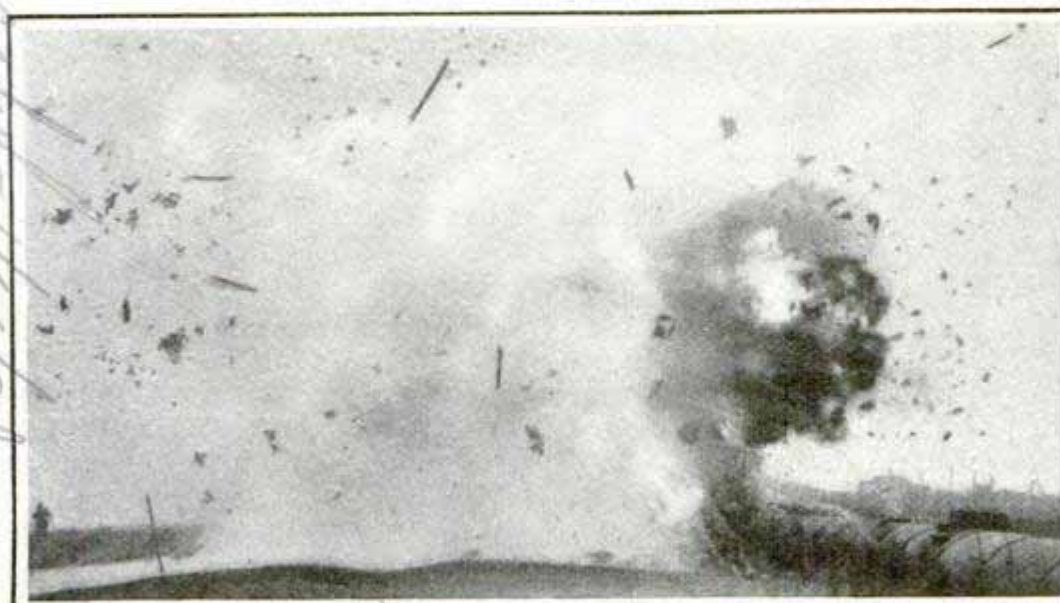

Photos by Underwood & Underwood

What Happened When the Fuse was Lighted

Preparing to Ascend in a Huge Skyrocket

Guinness record
 3/11/31 (1881)

A REMARKABLE RAILROAD WRECK

The amazing feature about this railroad wreck, which recently occurred seven miles west of Columbus, Wis.,

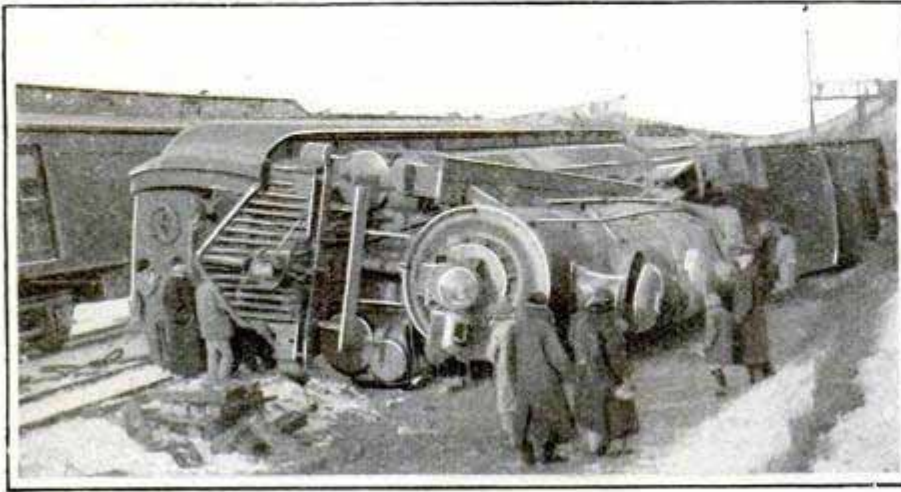

Mile-a-Minute Train Wreck That Injured Only Two Persons

on the C. M. & St. P. railroad, is that the train, while running at the speed of a mile a minute, suddenly left the rails while rounding a curve and failed to injure anyone except the fireman and engineer, although 160 passengers were aboard when the accident occurred. The fireman was bruised and the engineer suffered a broken leg.

PIECE OF ROPE WRECKS "LUSITANIA'S" TURBINES

More than one million blades of the "Lusitania's" turbines were twisted out of pitch and will have to be replaced, at a cost of several hundred thousand dollars, through a trivial accident which recently befell the great vessel. A small piece of rope fell into the hydraulically controlled steering mechanism, causing the steering gear to jam. The order was given to reverse at full speed, but the strain proved too severe for the blades of the turbines.

A new long-distance record for over-sea flying was made recently by a French aviator, who covered a distance of about 160 miles over the Mediterranean Sea from Tunis, Africa, to Sicily.

NEW UNDERFEED FURNACE DISCHARGES ASHES

A new self-dumping underfeed stoker has moving fuel-bearing grates extending across the entire width of the furnace, which carry the fuel down an incline of 20 deg. The coal is distributed evenly through the combined action of a plunger in the retort and the moving grates, allowing a more uniform passage of air than is possible when the coal is in heaps. The discharge of refuse is continuous through the employment of pushers which force the ashes toward an apron. This discharge can be regulated so that the fuel will be entirely burned out. Clinkers are also broken up by the motion.

FIRST AUSTRALIAN STAMP HAS KANGAROO EMBLEM

The kangaroo has been officially accepted as the emblem of the Australian Federation, which has just issued its first postage stamps. These stamps bear a picture of a kangaroo on a white background, the outlines of which take the form of the coast line of the Australian continent. Heretofore each of the states in Australia has issued its own postage stamps. With the establishment of the new federal city of Canberra, the building of which in the wilderness from the plans of an American architect has begun, Australia is becoming nationalized.



Red and yellow kangaroo

3739
3727
Postage stamps
First Australian Kangaroo
3/10/19

PERRY'S FLAGSHIP RAISED AFTER MANY YEARS

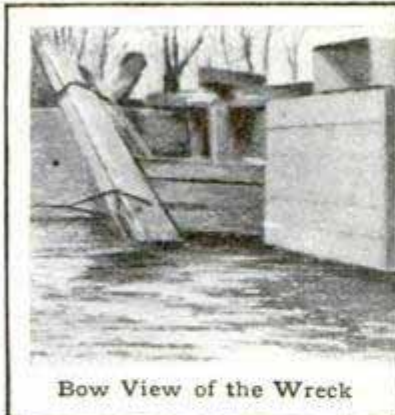

Bow View of the Wreck

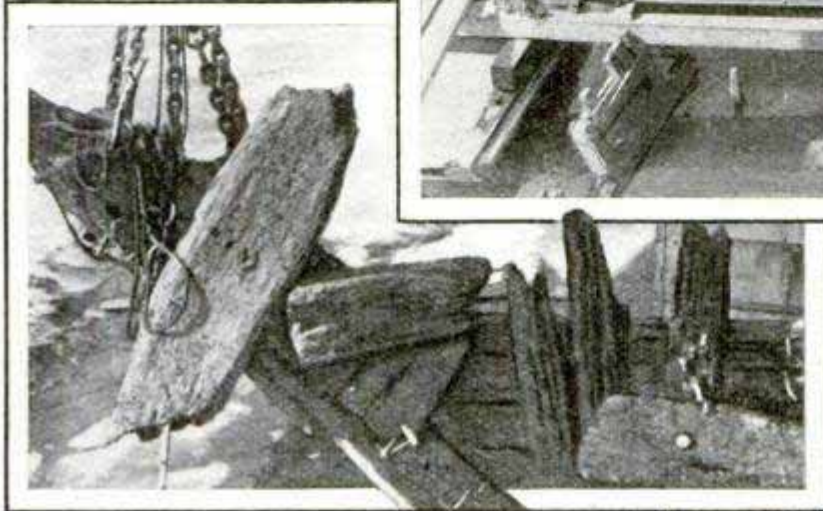
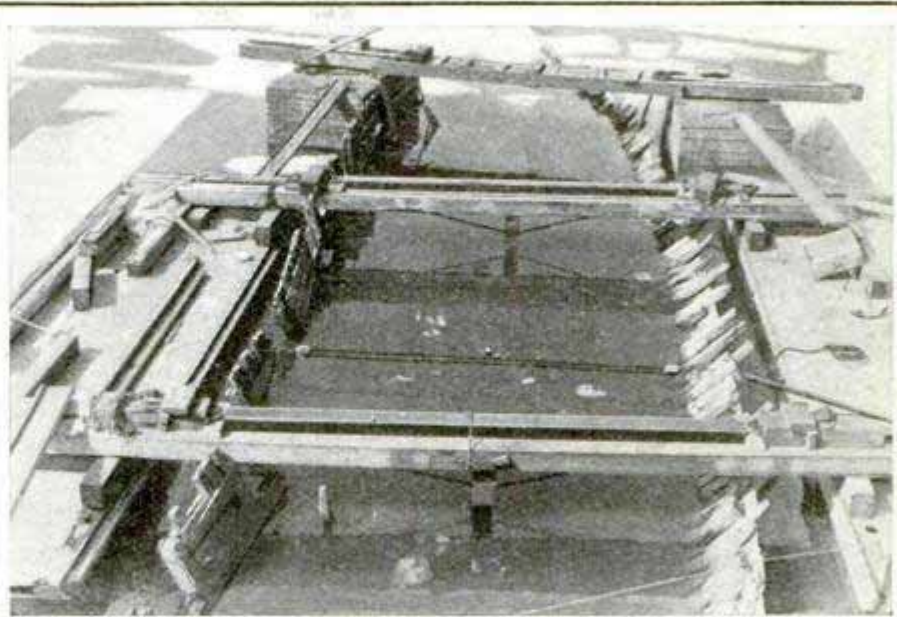

Stern View, Showing Waterlogged Timbers

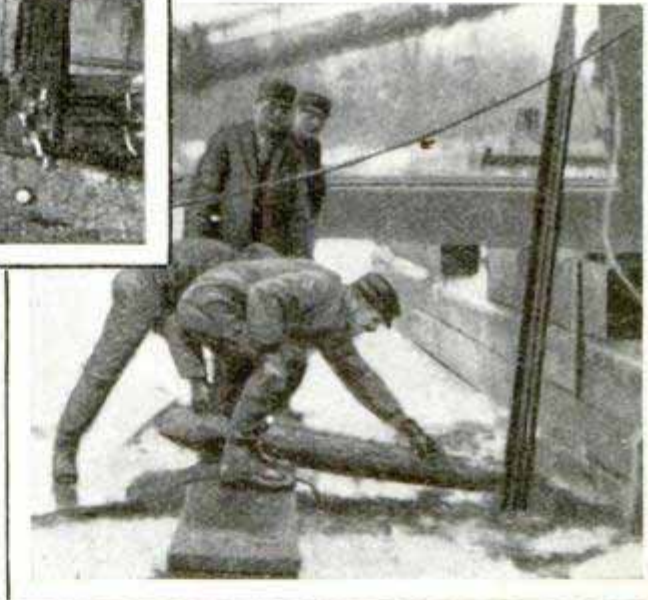

Above: Hull of Commodore Perry's Flagship "Niagara" being Raised from the Bottom of Erie Harbor

Below: Workmen on the Ice Placing Timbers for Raising the Historic "Niagara"

The wreck of the brig "Niagara," Commodore Oliver Hazard Perry's flagship, in the naval battle of Lake Erie, fought off Put-in-Bay on September 10, 1813, was raised on March 6, 1913, from the bottom of Misery Bay, in the harbor of Erie, Pa., and is being restored to its original form for exhibition in connection with the centennial celebration of Perry's victory over the British fleet on the Great Lakes.

The "Niagara" was one of two 20-gun ships, the largest vessels in Commodore Perry's fleet of nine. The "Lawrence," his first flagship, was so shattered in battle that the commander transferred his flag to the "Niagara." This incident is the subject of a famous historical painting which hangs in the Capitol at Washington and represents Commodore Perry being rowed in a small boat from one ship to the other under the fire of the British guns. It was at the close of this decisive battle of the War of 1812 that he sent his fa-

mous message to Gen. William Henry Harrison:

"We have met the enemy and they are ours."

The "Niagara," like the rest of Perry's fleet, was built at what is now Erie, then called Presque Isle. Noah Brown, a shipwright, and fifty carpenters were brought from Philadelphia and hastily constructed a squadron to attack the British fleet on Lake Erie. Shipbuilders who examined the "Niagara" after it was raised, say that the wreck shows evidence of hasty con-

struction with whatever kind of wood or material happened to be at hand.

The historic old vessel was raised by chains attached to pontoons. The chains were passed under the wreck by means of an air hose which was used first to pump away the sand that cov-

ered the wreck and then to form channels under the keel. Several months of preliminary work was necessary before the chains were in place. Then a heavy floating crane was used for hoisting and the "Niagara," lashed between pontoons, was towed to shore.

TAMPING MACHINE FOR REFILLING TRENCHES

^{3.53} This machine tamps the dirt in such an effective manner, as the latter is thrown back into the ditch from which

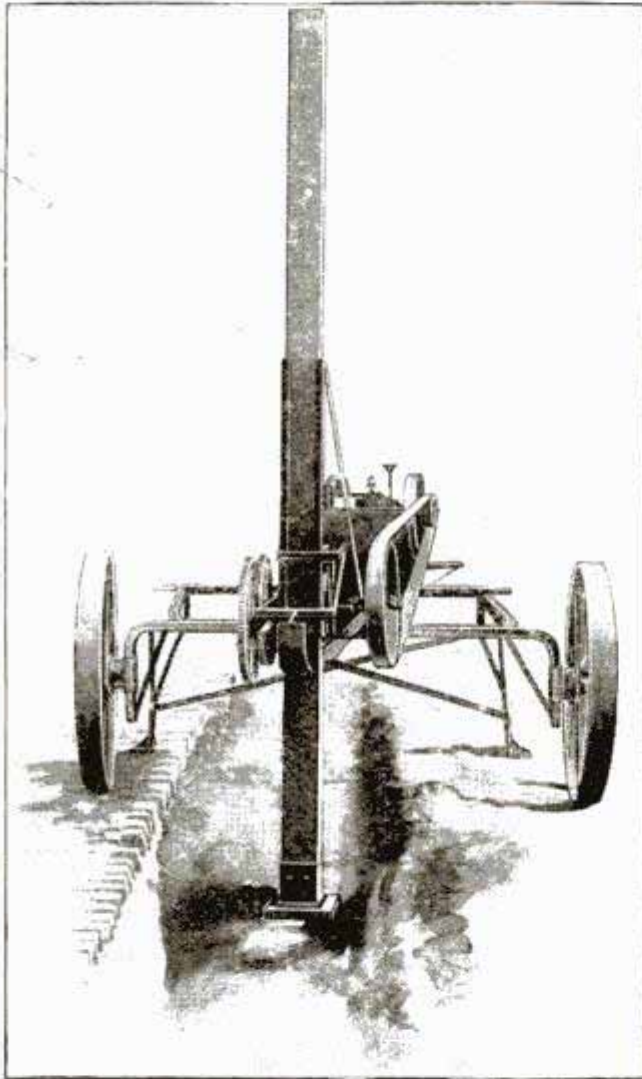

Courtesy Engineering News
Power Tamping Machine for Trench and Surface Work

it was taken, that there will be no settlement whatever of the paving when relaid over the trench. The apparatus is operated by its own gasoline engine; enables all the earth taken out to be put back in a fraction of the time necessary where manual labor is employed, and requires the attendance of only one

man, except on wide ditches and surfaces where the footing is not good. The tamper is adapted for trenches of various widths and depths.

ELECTRIC STEERING GEAR ON 3724 U. S. BATTLESHIP

The U. S. battleship "Mississippi" has been recently equipped with electric steering gear in place of the steam engine which formerly operated the rudder. The motor is geared to a right-and-left screw shaft on which move traveling nuts which, supported by guides and by means of connecting rods, rotate the yoke on the rudder stock. The motor is started and stopped whenever the rudder is moved. It is automatically accelerated in starting by a panel board installed near the motor, which in turn is controlled from any one of four steering stands in different parts of the ship. In stopping, the motor is promptly brought to rest by dynamic braking assisted by a magnetic disk brake which securely locks the motor when at rest. Limit switches are provided for automatically stopping the motor before the rudder reaches a "jammed" position in either direction, and the motor may be reversed from the steering stand when so stopped. The steering stands consist, each, of a single-pole, double-throw master switch which controls the flow of current through the solenoids of the main contactor switches on the control panel.

ⒸThe sum of \$208,878—an average of more than \$6,900 a day—was distributed in benefits to the members of the Employes' Relief Funds of the Pennsylvania Railroad System during a single month.

Laurie mfg Co
 Springfield, Ill.

RADIUM FOUND USEFUL IN SILK-THREAD PROCESS

When silk is combed before being spun into thread it becomes charged with electricity, which causes the ends of the fibers to extend outward, resulting in considerable loss. Several methods have been developed to overcome this, and it has now been found that if a small vessel containing a very weak solution of radium salt be placed near each combing apparatus, the electrical charges emanating from it will neutralize the electrostatic charge of the silk.

A REMARKABLE RAILROAD BRIDGE

The great railroad bridge here shown, which is known as a single-leaf bascule bridge, and is claimed to be the largest structure of its kind in the world, is 235 ft. long, weighs 1,300 tons, and the span is balanced by a counterweight of 200 tons. The bridge, which extends across the Calumet River, at South

Chicago, is raised or lowered in the remarkably short period of 11¼ minutes, the control being effected from the operator's cabin in precisely the same manner as a street car is handled by the motorman.



Single-Leaf Bascule Bridge with a Span of 235 Ft.

IS FIVE YEARS A FAIR TEST? A REPLY TO "WHAT GOOD IS IT?"

The article "What Good Is It?" in the March issue of Popular Mechanics Magazine, has evoked many replies from airmen and others who do not agree with "Licensed Airman," who wrote it. The following, by Mr. O. E. Williams of Scranton, Pa., presents the other side of the argument:

After sixty centuries of travel by land, we have the high-powered automobile and the fast express. And yet the Twentieth Century Limited was wrecked.

After nearly as many centuries of travel by water, we have the "Imperator" and the superdreadnoughts. And yet the "Titanic" sank.

Still the "immortal skeptic" thinks that means of travel by air should be perfected in five years. He acknowledges motors have been improved, but underestimates the value of this. He acknowledges men are doing in aeroplanes today things that were thought impossible four years ago, but undervalues the importance of this. He speaks of one faulty bolt or wire caus-

ing wreckage, but forgets that the same is true of any fast-moving vehicle. Scientists are discovering hitherto unacknowledged aerial laws and applying them to aeroplanes to produce inherent stability, and aviation is on the eve of becoming at least as safe as any other means of swift locomotion.

No amount of knocking on the part of the "immortal skeptic," and others of his ilk, can stem the tide of progress. We have put our hands to the plow and will not look back.

Every one acknowledges that walking is the safest mode of travel, and yet, at that, men die of heart failure. It is not the length of a man's life that counts. It is what he has accomplished.

We live in deeds, not years;
In thoughts, not breaths;
In feelings, not in figures on a dial.
We should count time by heart
throbs;
He most lives who thinks most,
Feels the noblest, acts the best.

SHIP DESTROYED BY DYNAMITE EXPLOSION

A loading hook, jabbed by a careless stevedore into a box of dynamite, was the cause of an explosion that destroyed the British steamship "Alum Chine," which was loading dynamite for the Panama Canal, in the harbor at Baltimore on March 7, this year. About 300 tons of dynamite exploded, killing 30 men, several of whom were on the U. S. collier "Jason," a mile and a half distant; blowing the "Alum Chine" to atoms; riddling the "Jason" with fragments of iron and steel; sinking the seagoing tug "Atlantic," which stood by for rescue; creating a huge wave which tore shipping from moorings, and shattering windows for several miles around. The explosion was felt more than 100 miles away.

Testimony at the official investigation of the disaster revealed that the

first slight explosion started a fire, which in time caused the entire cargo to explode. Several minutes elapsed between the two explosions, which gave most of the men on the ship an opportunity to escape. The one whose carelessness caused the catastrophe was only slightly hurt.

The illustration showing the column of smoke that rose after the explosion was made by a photographer who happened to be on the bay in a launch with his camera ready for work, the shutter being set for an exposure of the 270th part of a second. The picture was taken from a point about two miles distant from the "Alum Chine."

☪The Bureau of Commerce estimates that there are at least 200,000 motorboats in the United States.

The "Alum Chine," Blown to Atoms by the Explosion of 300 Tons of Dynamite

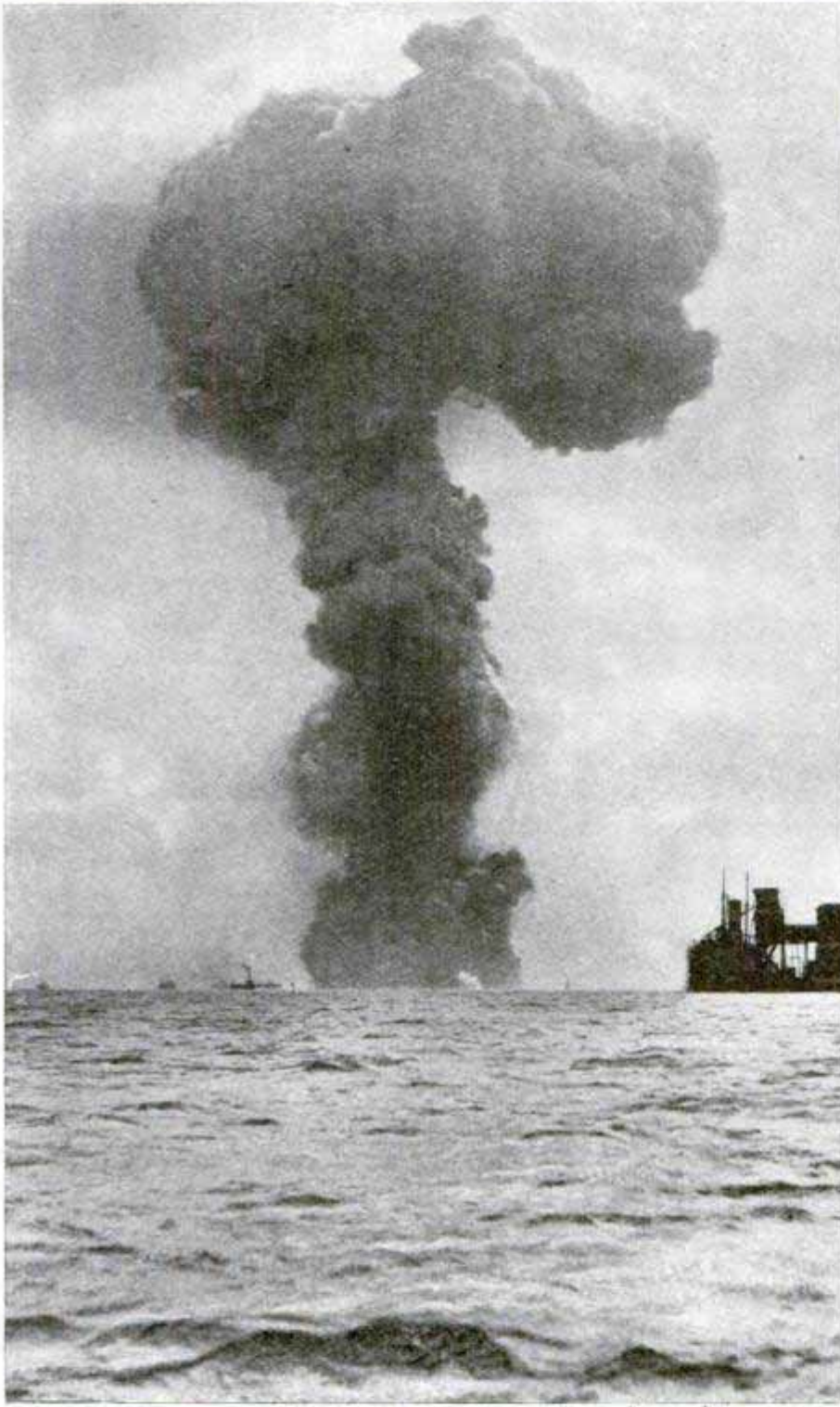
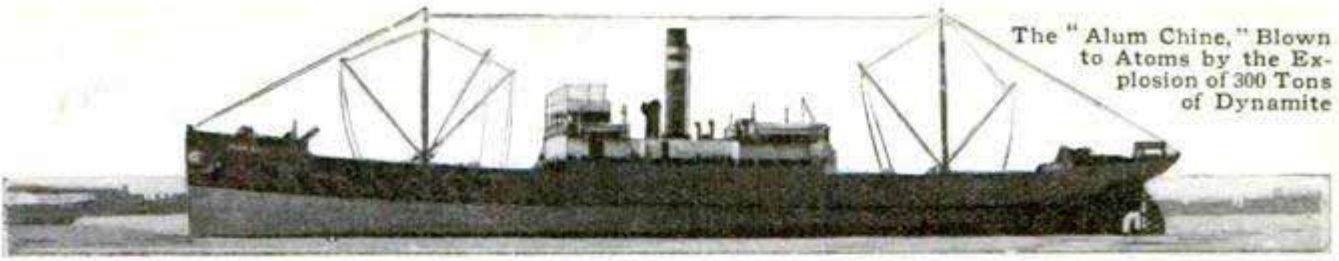

Wreckage on the Starboard Side of the Collier

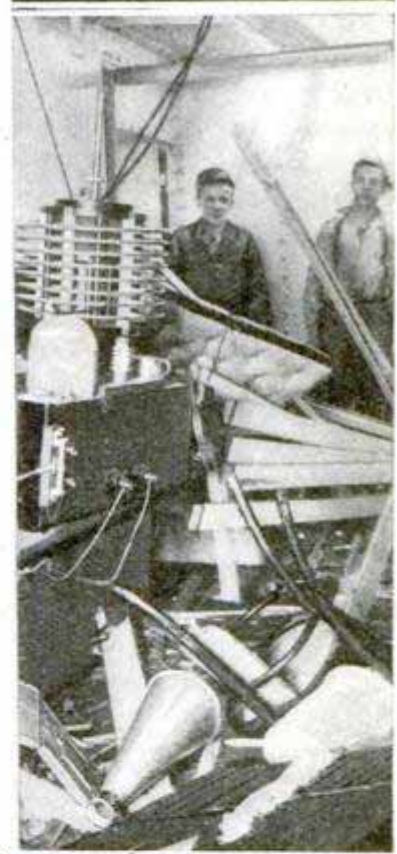

Wreckage of the Wireless Room of the "Jason"

Photograph Made from a Distance of Two Miles at the Moment of the Explosion.



U. S. Collier "Jason," Riddled by Fragments of Iron and Steel from "Alum Chine"

USES MOTORCYCLE TO DRIVE NEW KIND OF WATERPROOF NEWSPAPER PRESS

3595 A motorcycle played an important part in furnishing power for the printing of a newspaper in Elgin, Ill., when

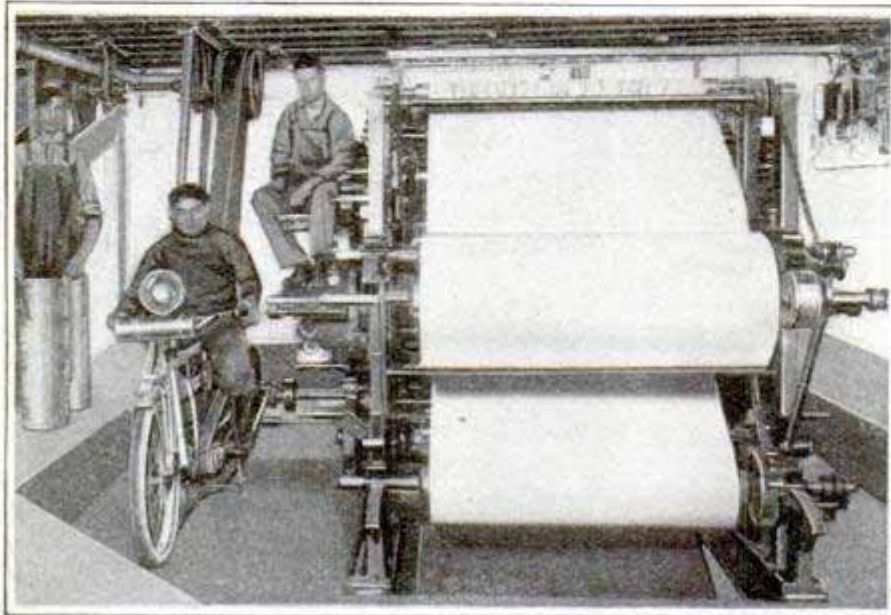

Motorcycle Harnessed to Newspaper Press in Emergency

a sleet storm threw the electric-power service of that city out of commission. The motorcycle was first harnessed up to a trimmer, shaver and router for the finishing of the plates. Then the motorcycle, along with a small portable gas engine, was belted to the shaft of the big press. The combined power grunted and chug-chugged, giving off much smoke, but turned out 100 eight-page papers per minute, which was about half the speed the press usually makes.

374 FIGURES REVEAL GREAT TELEPHONE TRAFFIC

There are 70,000 cities, towns, and villages of the United States within the telephone zone, while one company and its allied branches have established, altogether, 7,456,074 stations throughout the country. The daily average of telephone conversations last year is estimated at 26,310,000. The figures for 1911, the last available comparative tables, show that Europe has only two-fifths of the telephone traffic of the United States.

3712 PACKING MATERIAL

A new kind of packing material, which is made of paper, cloth and pitch or wax, in such a manner that it is more satisfactory than ordinary paper packing, especially for the protection of bottles containing liquids, and other breakable articles during transit, has been placed on the market. The new material is made in various thicknesses for different purposes; is claimed to be impervious to either gas or water, and has strength and pliability sufficient for all the purposes for which it is manufactured. The packing is made up in rolls and has the appearance of ordinary paper coated with a wax or pitch composition and a fabric like mosquito netting, the meshes of which vary according to the purpose for which the paper has been designed.

3717 BREAD MORE DIGESTIBLE WHEN NOT KNEADED

A new way of making bread that can, it is claimed, be digested by the weakest stomach, has been discovered by a Philadelphia woman. The method consists in mixing the flour, water, yeast, etc., quickly, and with the least possible amount of stirring, and then setting it to rise. When raised, the dough is not kneaded, but quickly shaped into loaves, with as little handling as possible and then baked in the usual way. This bread is not quite so white as if prepared in the ordinary way, but, according to scientists, more than 90 per cent of it is easily digested.

ⓄThe hydroelectric plant being installed on the Norefall, Norway, will develop 216,000 hp. and will be one of the largest in the world.

*Mya Lydia Coale
from American - Sharpless
Mel...*

3299-02

J. V.
H. M. Half
M. H. H.
J. V.

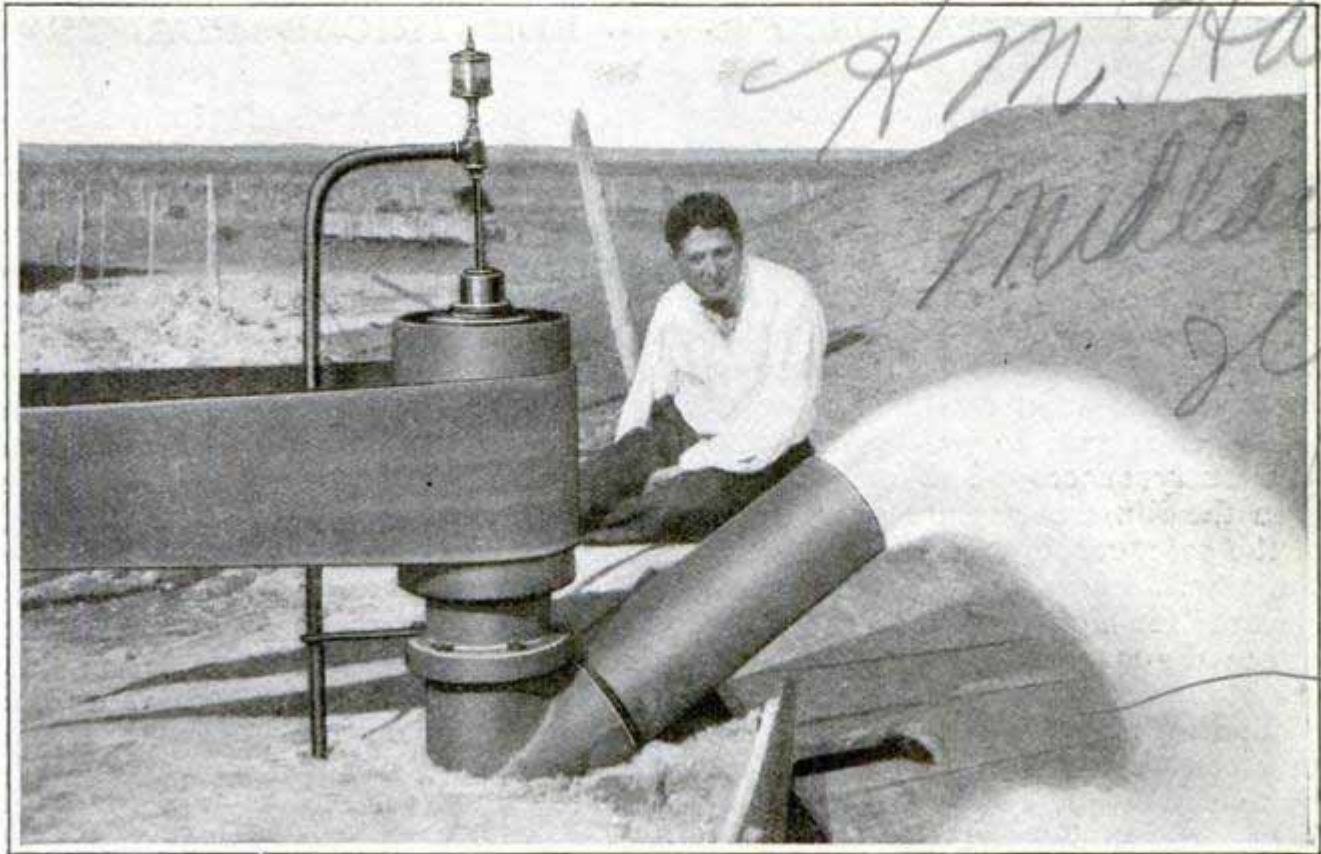

A Texas Irrigation Well Yielding 2,000 Gallons per Minute

A POWERFUL TEXAS IRRIGATION WELL

The plains in the vicinity of Midland, Tex., are being turned into richly productive fields by irrigation, the water being obtained from wells varying in depth from 120 to 250 ft. The pump here shown has a capacity of 2,000 gal. per minute. The well is 120 ft. deep.

TURTLE FOUND IN FIRE HOSE

An unusual incident is recorded in connection with the burning of the Security Building, in St. Louis. The turtle shown in the illustration came through the hose. It is being kept by one of the St. Louis engine companies as a curiosity.



There are 735 coal mines in the United States producing 200,000 tons, or more, each annually.

A CLOCK THAT MAKES YOU REMEMBER

A clock which prevents the forgetting of engagements as well as tells the time of day has been invented by a Californian. Surrounding the clock like the petals of a sunflower are a number of little knobs. If, for instance, the owner of the clock wishes to be reminded at 2:15 o'clock of an engagement or an errand, he places a tag on the proper knob and sets the mechanism. When the time arrives the mechanism automatically projects this knob above its fellows. An alarm may also be rung.

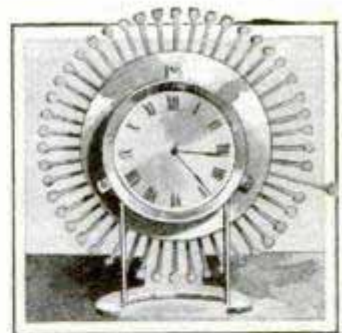

More than 48,000 locomotives were found defective out of 74,000 inspected by the Interstate Commerce Commission's employes in 1912.

H. C. Sawtelle

339 5 SAFETY PRECAUTIONS IN ELECTRICAL PLANTS

The system of accident prevention developed by the New York Edison Company to protect its workers from danger has been recognized by the American Museum of Safety, which recently awarded this company a medal offered by one of the large insurance companies. This electrical company's endeavor to safeguard the lives of its employes is said to be the most conspicuously successful of any in 1912.

In the illustrations are shown some of the safeguarding devices, which include wire cages and "extra danger" placards for high-voltage transformers, screened guard rails for flywheels, rubber gloves and wooden poles used for grounding and discharging work, and an electric pump for furnishing fresh air to workers in manholes. The operators are so hedged about by rules and regulations that even carelessness is practically eliminated. All the high-tension switches which control the generators are installed in separate compartments, and the operator has always before him a number which records the voltage. But before he starts work a considerable amount of formality has

to be gone through. If, for instance, alterations are to be made in the connection or location of any of the high-tension apparatus, or additions connected up, a sketch must be furnished the system operator 24 hours, if possible, before the work is to begin. Then the foreman of the construction department or the employe delegated by him to perform the task has to ascertain from the regulator in charge of the switchboard that the particular cable, bus or switch is not connected with any source of high potential, and that it has been discharged to ground since last it carried high-tension current. Then the system regulator notifies the system operator that the construction department is ready to proceed with the work, the operator orders the regulator to block the switches and connect all conductors to ground and to each other by means of the grounding and short-circuiting devices provided for the purpose. This work is personally inspected by the foreman of the construction department, a "not clear" placard is placed on the apparatus, and the actual work commences.

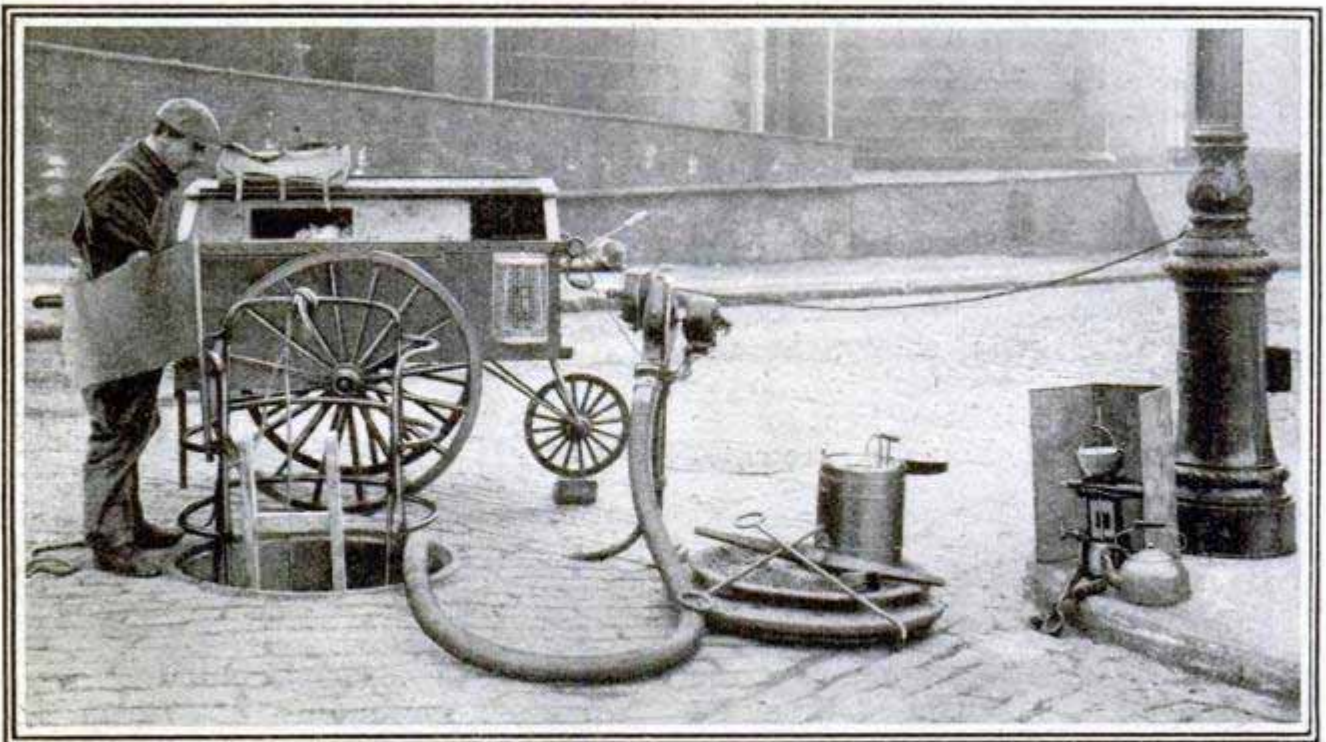

Electrically Operated, Portable Air Pump Furnishes Fresh Air to Workers in the Conduits



Face of the Medal



Medical Cabinet with All the Requirements for First-Aid Work

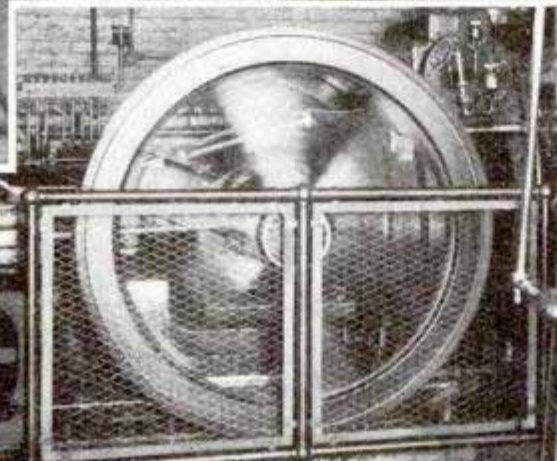

Guard Rail and Screen around Flywheel

All Cables, Switches and the Like must be Discharged to Ground

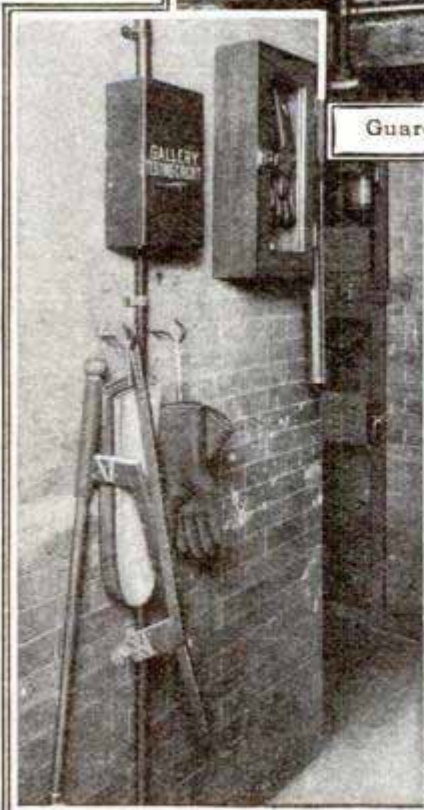

Gloves and Poles for Grounding

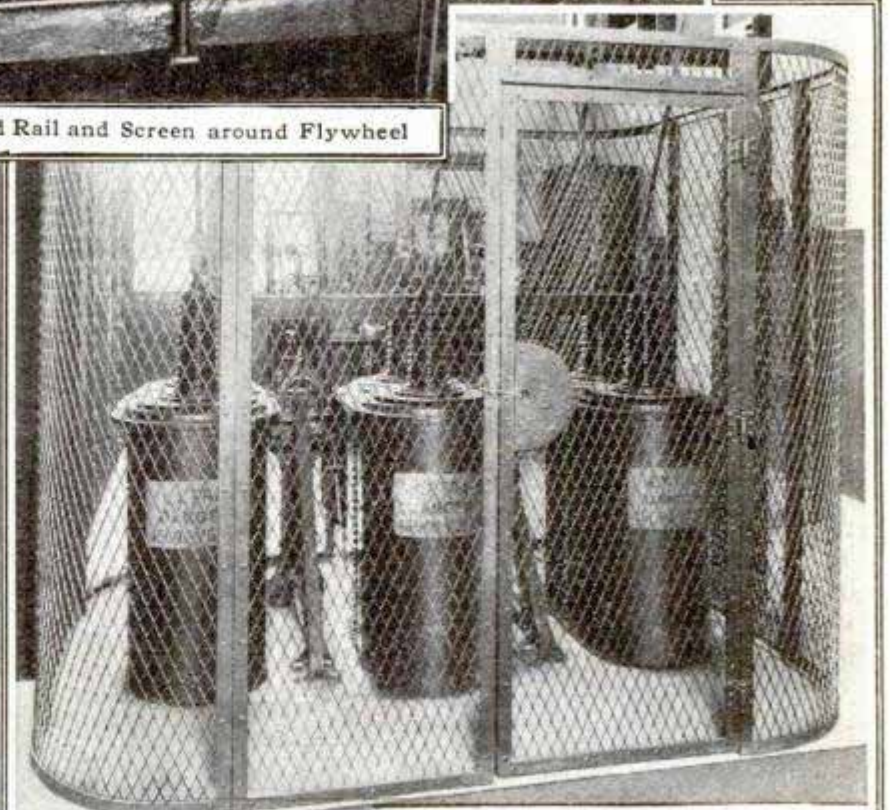

Wire Cages for the Transformers

PARIS POLICE USE HAND CANNON AND SHIELD

The Paris police department is now equipped with what is considered an effective weapon for use in dislodging

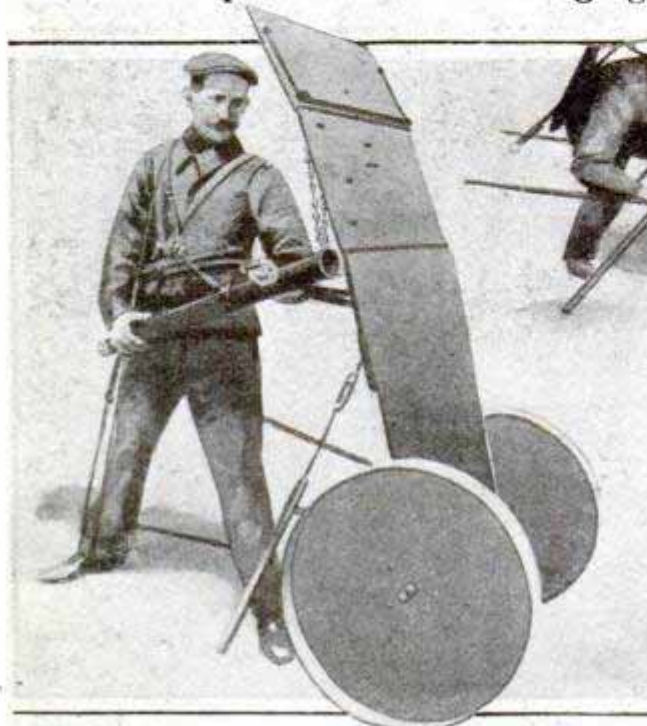

Ready to Discharge a Bomb Containing Suffocating Gases into a Robbers' Den

barrel, a cartridge containing the projecting charge is placed behind it, and the breech block is screwed in. The pulling of a trigger explodes the charge in the cartridge and the bomb is thrown into the building, where it bursts, rendering everyone near it unconscious. As the range of the cannon is not great, a shield is provided for the protection of the operators when it is to be used in fighting barricaded bandits. The shield is made



Advancing, behind the Wheeled Shield, against Barricaded Bandits

of chrome steel, folds in two places, and is provided with wheels. When used as a fire extinguisher the bomb is filled with from 5 1/2 to 6 1/2 lb. of dry fire-extinguishing powder. For life-saving purposes a wooden projectile of sufficient weight is used, the line being attached to one end.

automobile bandits or other criminals who barricade themselves in houses and defy capture, which is a habit the Paris "Apaches" have developed quite extensively in recent years. In two recent affairs of this kind the bandits kept the police off several days.

The weapon is a hand cannon, designed particularly for throwing bombs, which, when they explode, will fill a building or room with suffocating gases sufficiently powerful to overcome the occupants. The cannon looks like a piece of iron pipe, and may be carried in the hands or slung over the shoulder like a rifle. It can also be used as a fire extinguisher, for throwing life lines into the upper windows of burning buildings, forcing doors open by hurling heavy projectiles, and throwing grenades in war time. The diameter of the barrel varies with the purpose for which the cannon is to be used, and the bombs vary in size, according to their composition and purpose, from 11 to 20 lb. In loading, the bomb is inserted in the rear end of the

WATER-TIGHT TELEPHONE TRANSMITTER

A new telephone transmitter having several features of interest is here shown. In the first place, it is a transmitter of unusually high power, and secondly, it is claimed to be absolutely water-tight, which is important where instruments are exposed to the

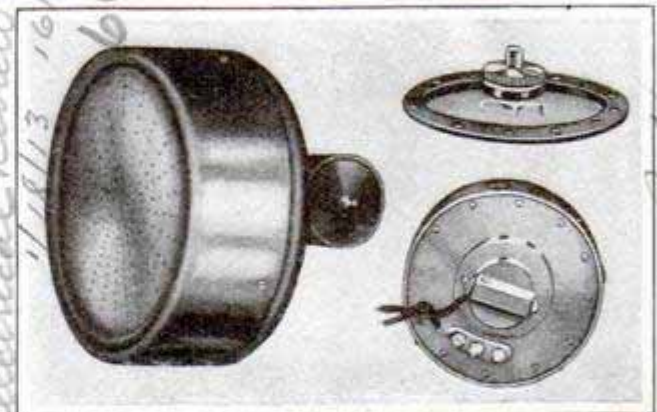

The Complete Transmitter, the Diaphragm Cell and a Rear View, Showing Terminals

weather, as in mines, and like places. The sound-receiving diaphragm is pan-shaped in form, the vibrating surface

Ed. London News 1/14

12

Electrical Review & Western Electric Co. 18813 16

*2288
H. R. Langley & Co. Gunter R.C.*

chui

being similar to that of a drum head. The material used is phosphor bronze, which is noncorrosive. The point of greatest vibration in a diaphragm is midway between the center and the edge, so, in this transmitter, advantage is taken of the fact by connecting the resistance cell to the diaphragm at this point. The result is a sensibility so increased that the usual funnel-shaped mouthpiece, which is necessary in the ordinary transmitter to intensify the sound waves, is eliminated, its place being taken by a flat, perforated, metallic guard.

CAPE COD OYSTERS ACT AS DRAG ON DREDGE

A huge mass of oysters and mussels became attached to the bottom of a large steam dredge in use in excavating for the Cape Cod Canal. When it was attempted to tow the dredge to the Delaware River for use on channel work and a powerful tugboat found it almost impossible to make headway with the dredge in tow, a superficial examination disclosed no reason for the unexpected drag. So the dredge was put into drydock at New York and several barrels of prime Cape Cod oysters were scraped from the hull.

FOUNTAIN MONUMENT TO ANIMALS' FRIEND 3448

A 60-ft. monument having for its base a memorial drinking fountain was recently erected in Postoffice Square, Boston, for the use of horses and smaller animals. The fountain is provided with 16 individual drinking bowls which are used by more than 5,000 horses daily, and upon the top of the monument of granite and cement rests a brilliantly gilded eagle. The monument and fountain cost about \$5,000 and a large portion of this sum was collected by school children to commemorate the life-work of the late George H. Angell of the Massachusetts Humane Society.

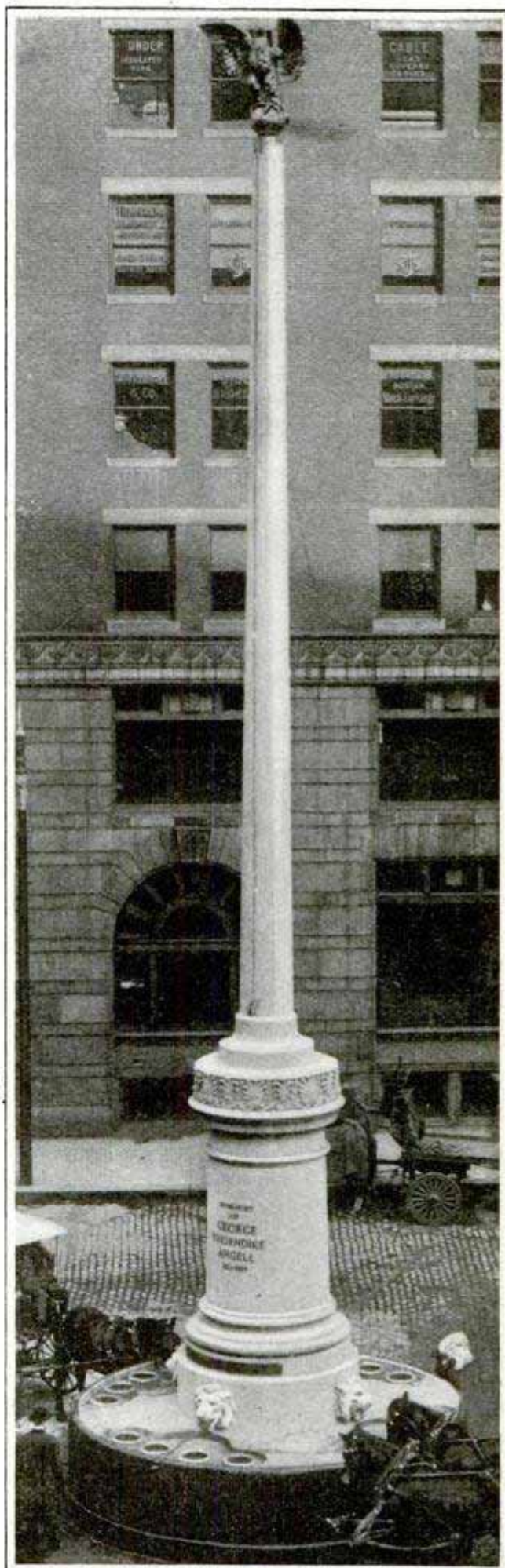

From Our Special Animals

PORTABLE ACETYLENE LAMP-POSTS

By means of a new portable acetylene lamp-post, parks, squares or other open places may be vividly illuminated



Portable Acetylene Lighting Apparatus for Outdoor Gatherings

for special occasions, such as band concerts, and the like, the time taken for the erection or removal of the posts being negligible. All that is necessary is to force the pointed base of the pole into the ground, place a pail of water beside it, drop the acetylene box in the water, and make the required hose connection between the box and the piping in the post. By means of an ingenious mechanism contained in the acetylene box the amount of water entering to generate the gas is automatically regulated. Another type of this device has the pole supported by the water tank, for use in paved places.

⌈Pipe-line transportation of coal mixed with water from the mines to Chicago is proposed.

ELECTRIC BLEACHER FOR SOILED CLOTHES

A machine that combines the principle of electric bleaching with the operation of washing clothes has been put

on the market by an Ohio manufacturer of laundry machinery. A terminal electrode is placed on the inner side of each end of the outer receptacle of an ordinary steam washing machine and to these the service wires are attached. To the heads and partitions of the inner revolving cylinder, a circular electrode is attached, so arranged that some portion of each electrode will at all times be immersed in the washing fluid. Each inner electrode consists of two flat rings bolted together. They have no electrical connection other than through the washing fluid which is also the electrolyte. Therefore, one ring of each electrode acts as a cathode

and the other as an anode. The electric current passing through the washing fluid from one end of the machine to the other sets up a chemical reaction which liberates bleaching gases. The device is said to be thoroughly practical, and inexpensive to operate.

VOLLEY FIRING OF BIG BATTLESHIP GUNS

Naval circles all over the world are following with great interest the remarkable tests in England of Sir Percy Scott's new system of firing the big guns of battleships in volleys. By this system the firing is controlled by a single officer stationed above the conning tower, and the number of guns to be fired, whether five or ten, are discharged simultaneously, the projec-

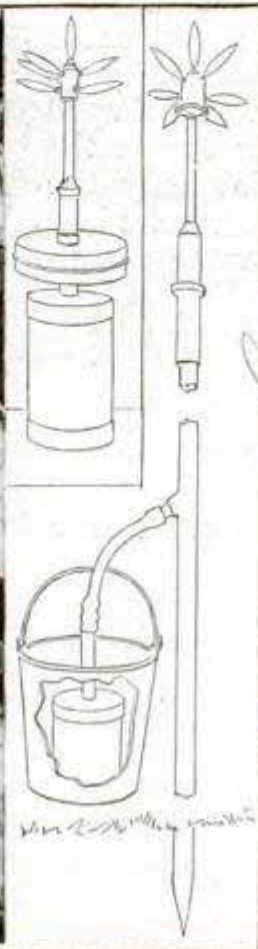

*National Laundry Machinery Co.
Electric Station, Ohio*

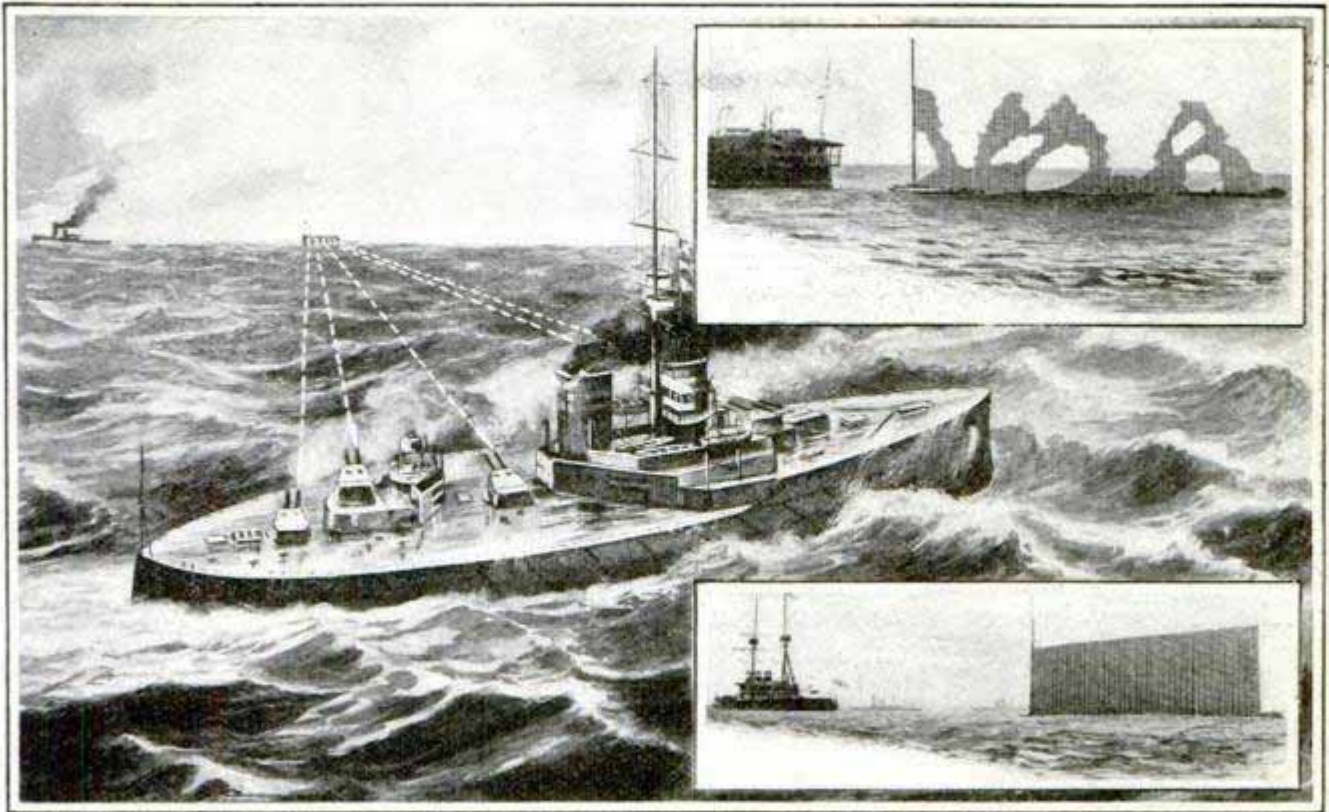

Courtesy The Sphere, London

The "Thunderer" Firing Five Guns Simultaneously in the Volley-Firing System, the Projectiles Flying over the Water Together

Above: The "Thunderer's" Target after Test
Below: Towing a Wooden Lattice Target Out for the Firing Test

tiles leaving the ship's side together, flying over the water together, and striking one crashing, overwhelming blow. By this system there is, of course, the possibility of missing altogether, but in the tests, in which the "Thunderer" was equipped with the Scott control, the target, five miles distant, was torn to pieces by each five-gun volley discharged.

In the gun control at present in use on British battleships the guns are fired in a desultory manner, each individual turret officer determining the aim of his guns. During the tests on the "Thunderer," the "Orion," equipped with the ordinary gun-laying equipment, fired in the ordinary manner at targets to test the relative effectiveness of the two methods. The result leads British naval experts to believe that the Scott volley firing increases the efficiency 6 to 1, not only a greater number of shells reaching the target, but the damage being astounding. The fact that the guns are fired in volleys instead of singly also enables the smoke to clear away for the next volley.

BICYCLE WITH REINFORCED 3303 FRAME

A bicycle of standard construction, the frame of which is reinforced by steel tubing, as shown in the illustration, is on the market. It is claimed by the manufacturers that this type of bracing, which is brazed to the frame

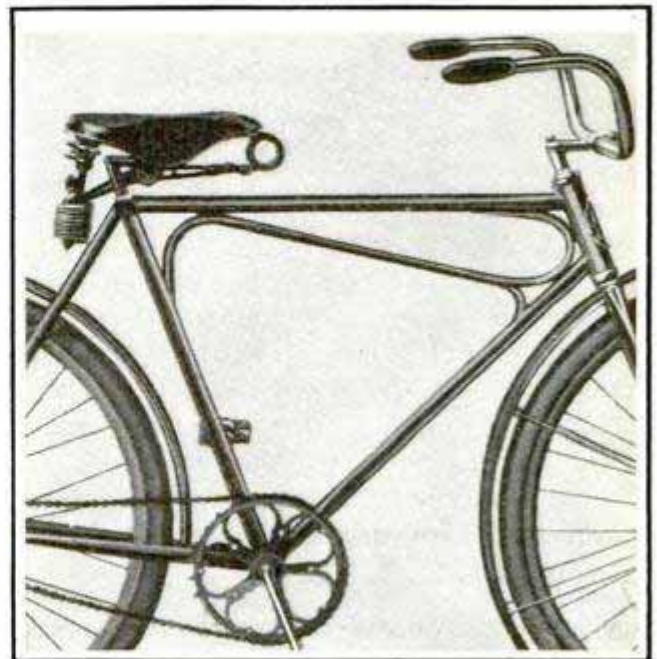

Shock-Absorbing Bicycle Frame

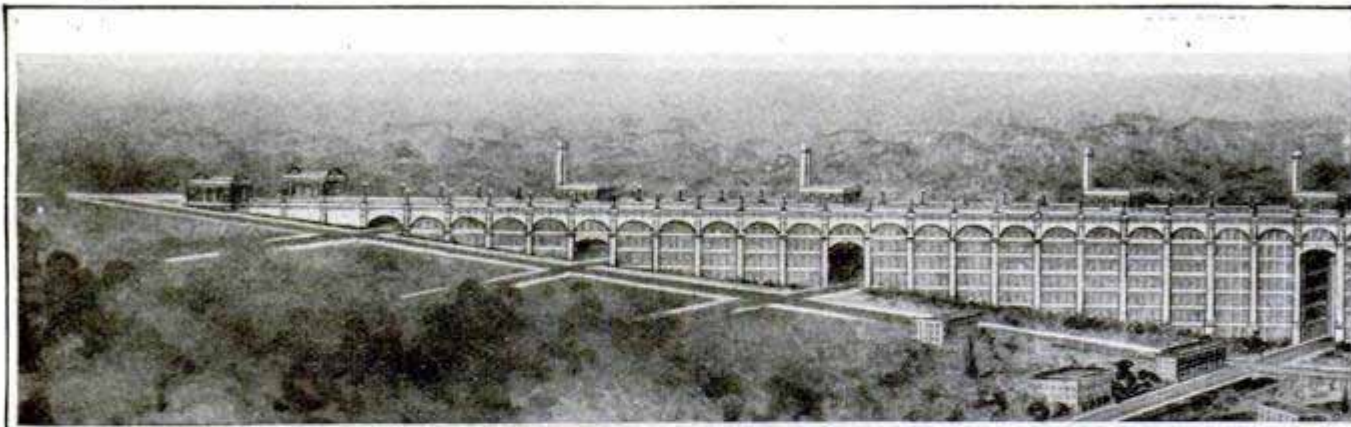

Copyrighted by F. W. Hagloch, Akron, Ohio

The Unique Industrial Bridge Projected for Akron, Ohio. The Space Underneath the Roadway will be

at six different points, enables the frame to withstand more severe shocks without being broken than is possible by using a reinforcing tube fastened in a position parallel with the horizontal or top part of the frame.

MOVABLE-VANE FORTY-FOOT 14 WINDMILL

A windmill of rather unusual size, used by a railroad in India for pumping purposes, is here shown. The wheel, which is 40 ft. in diameter, is designed to move in a light wind of about 10 miles an hour. Due to the large area exposed to heavy winds, the vanes are so mounted that they may be turned partially or completely out of the wind when necessary.

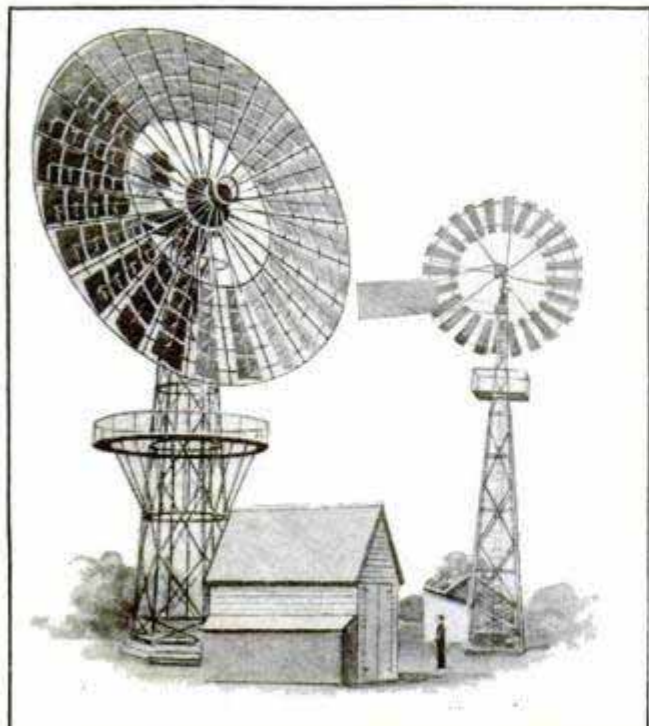

A Large Windmill Used for Pumping Water in India

INDUSTRIAL BRIDGE FOR 3365 AKRON, OHIO

The business men of Akron, Ohio, are planning the construction of a remarkable reinforced-concrete, high-level viaduct. The plan, simply stated, is to erect a line of industrial buildings, 2,583 ft. long by 60 ft. wide, across the valley separating the heart of the city from the section known as North Hill and use the roof as a bridge. The total cost is estimated at \$954,000, and the floor space available for rental would be about 873,000 sq. ft.

According to the plans, as at present drawn, there will be a sidewalk, 8 ft. wide, on one side of the bridge, and on the other side there will be seven freight elevators connecting the overhead roadway with the cross streets and with the factories. On the top story of the building, just under the roadway, will be a railway, enabling the occupants to load and unload goods under their own roof. The building will have its own power and heating plant, which will be sufficiently large to furnish heat and light for the entire downtown district.

It is believed that the considerable amount of convenient and economical floor space could be depended upon to persuade many new industries to locate in Akron.

Smothering fires in coal mines by forcing muck and water into the compartment in which the fire is burning is a plan being tried out by the United States Bureau of Mines.

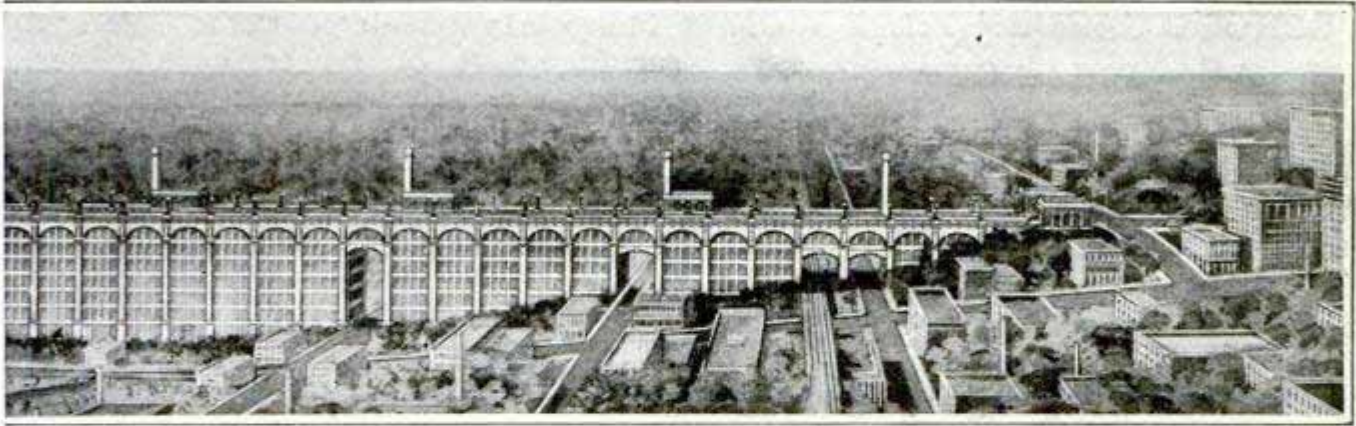

One Long Factory Building, Providing 873,000 Square Feet of Floor Space for Rental to New Manufactories

WATER-KITE LEAD SIGNALS SUBMARINE OBSTRUCTIONS

The Swedish submarine sounding device, known as a water kite, is said to be much more reliable than the ordinary sounding lead. Once sunk to a certain depth, indicated by the dial on its winding box, it keeps steadily at this depth regardless of the rate of speed of the ship, or of her yawings and turnings. It provides an uninterrupted sounding in unknown and dangerous waters, in foggy or misty weather when approaching the coast or shallow water. Suspended under the kite is a steel arrow, at the rear end of which is fitted a smaller kite. When this strikes a shoal or other obstruction the hook attaching the line to the forward end of the main kite is disengaged, the signal bell rings, and

the kite mounts to the surface of the water.

For use as a shoal finder in submarine surveying, two of the kites are usually employed, lowered from two small boats, towed abreast and about 60 ft. apart behind the surveying vessel. Another apparatus, designed on the same principle, has been invented for catching and exploding mines.

Iron of a purity of 99.98 per cent has been produced in the laboratories of the University of Wisconsin.

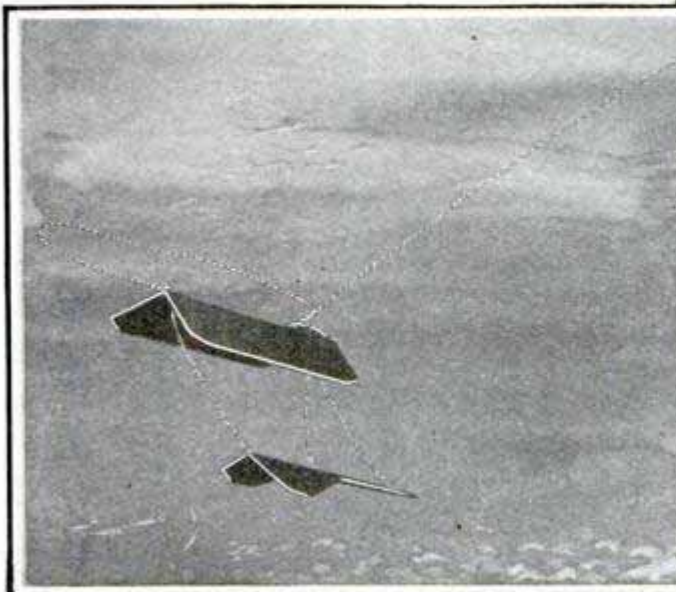
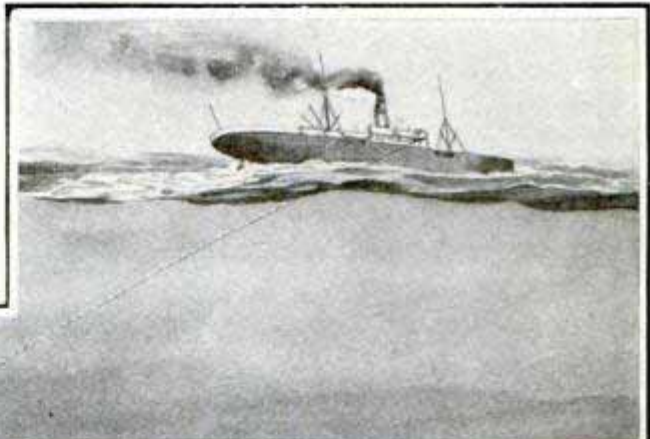

The Manner in Which the Water-Kite Sounding Lead Tows

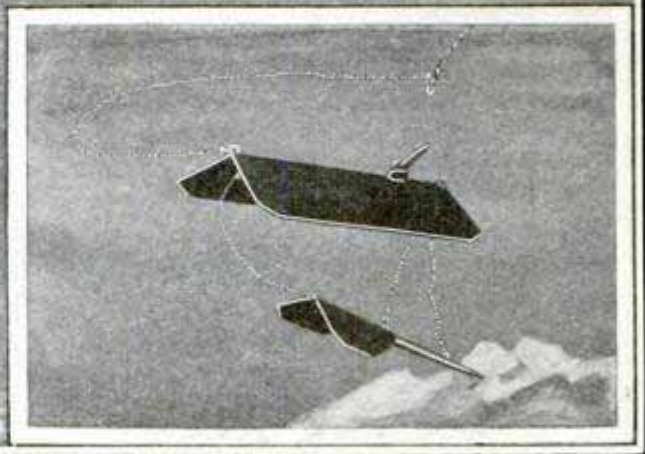

When an Obstruction is Met with a Bell Rings and the Device Rises to the Surface

SCHOOL GARDEN THAT WON

3427 PRIZE CUP

All the Chicago schools entered a competition for a cup to be given to the one which accomplished the most toward the beautifying of its grounds. The Park Side School won the prize.

The points considered were: The best arrangement of flower beds, vines, trees, etc.; the greatest variety of plantings; the best judgment and care in location and arrangement of plants; well-kept grass free from weeds, and the most pleasing general results.

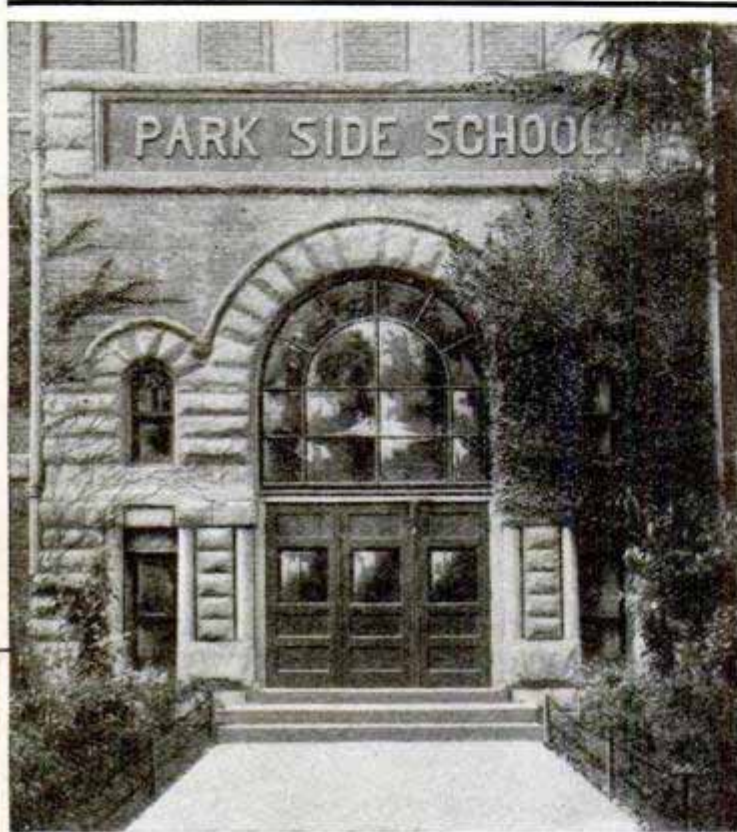

Main Entrance of the Prize School

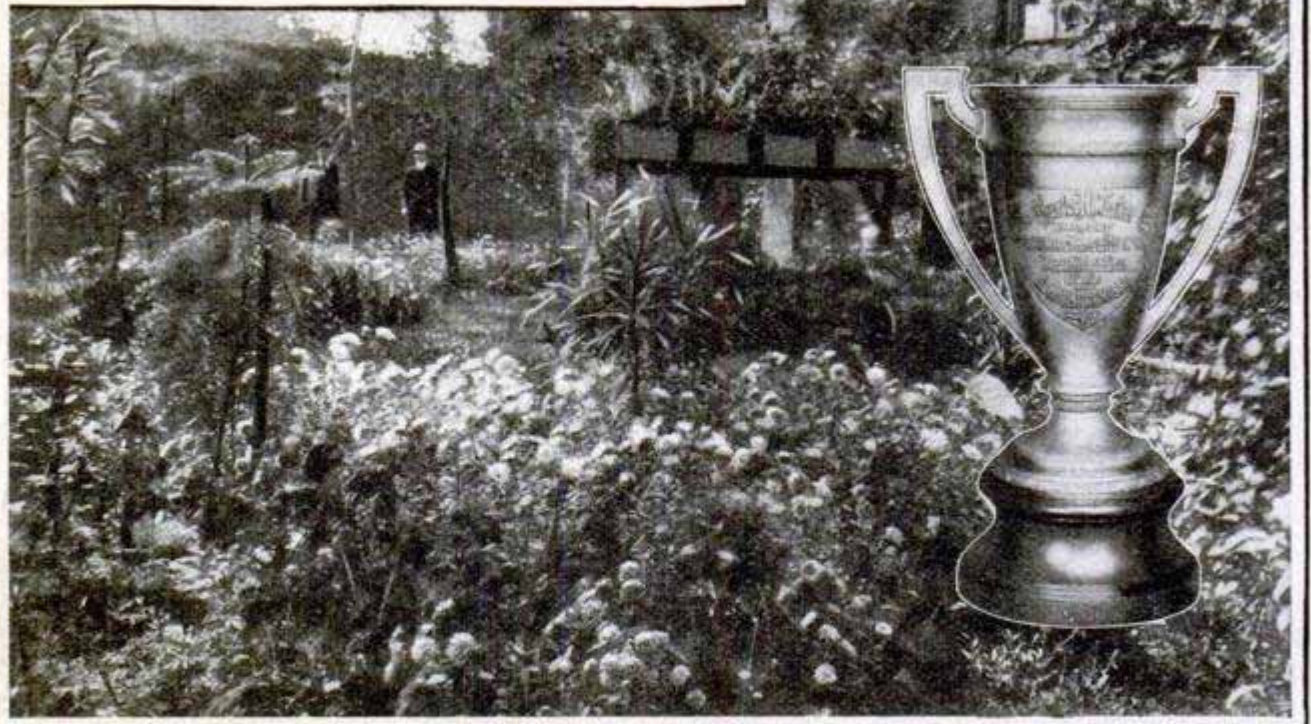

INSPECTION OF PANAMA

355 LOCK GATES

In contracting for the construction of the gates for the Panama Canal locks the most rigid inspection was provided for, and it was specified that 5 per cent of the total price should be withheld until the gates shall have proved themselves satisfactory by actual use. The number of rivets required for the gates is in the neighborhood of 6,000,000, and each of these had to be examined and tested, the imperfect rivets being rejected and new rivets substituted.

Photos by Kaufmann, Weimer & Fabry Co.

The Garden Which Won the Prize for the Best Chicago School Ground The Prize Cup

**NEW YORK'S HONOR-SYSTEM
STATE PRISON 3552**

In the Great Meadows prison, 70 miles north of Albany, the State of New York is successfully working out the honor system that has made Colorado and Arizona famous for prison reform. The prison is simply a 1,000-acre farm, having a huge cell house, and a small stockade connecting it with the smaller buildings in which the mess hall, the offices, and the temporary chapel are located. Half a mile away from the cell house is a baseball diamond where the prisoners may play when working time is over, and on all parts of the 1,000 acres, in the woods, and on the mountain, which serves as a sheep range, prisoners may be seen at work, some of the gangs working without a single guard, and the others with not more than one guard. Two or three of the guards carry rifles, and the other guards have revolvers in their pockets, but these weapons have not been used since the Great Meadows prison came into existence a little more than a year ago.

Unlike the Colorado and Arizona prisons without walls, however, the Great Meadows prison is inhabited by only a picked group of prisoners. They are men transferred from Sing Sing, Auburn and Clinton prisons as being probably those most readily reformed. They have not been previously convicted of felony, so far as the prison records show. They have not passed a period in another prison. They are within a year or two of their release. The temptation to run away is balanced against the desire of making parole and getting a final discharge in a legitimate manner.

3094. ———

A CHANGEABLE SHOW-WINDOW DISPLAY

Quick changes in window display are made possible by an arrangement recently exhibited in New York. The device comprises three compartments, one above the other, and is operated like an elevator in the window space.

To install the device an opening is cut in the floor nearly the size of the display-window platform. There should

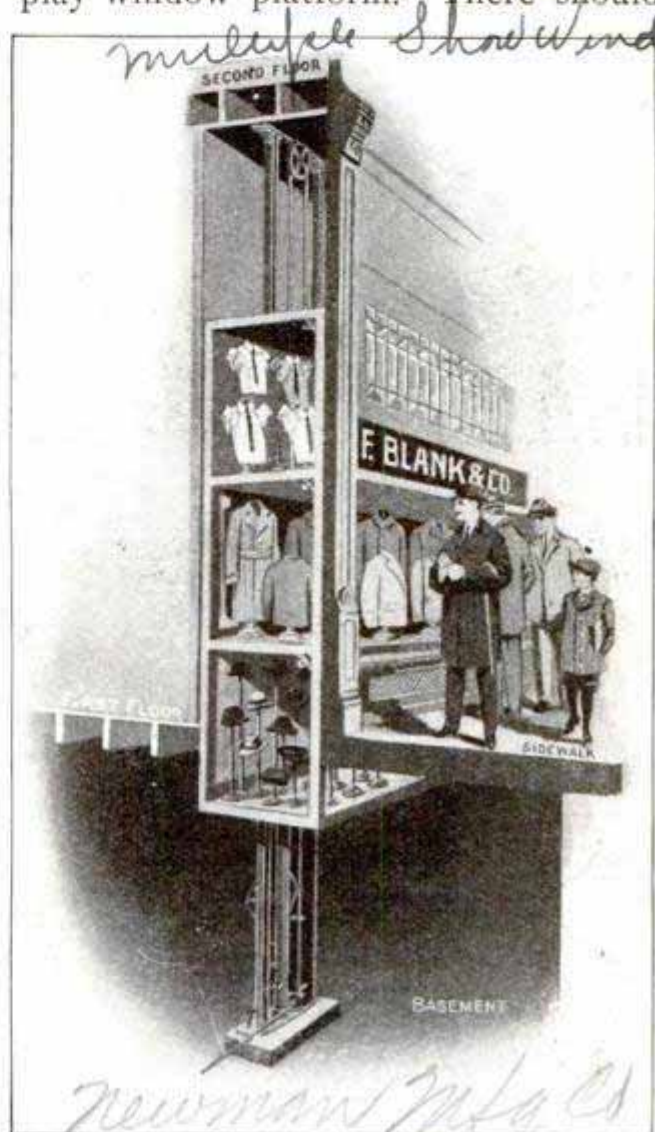

Changeable-Compartment Show-Window Display

be an unobstructed depth of about 8 ft. beneath the flooring, and the ceiling should be about 14 ft. above the floor. The mechanism may be so arranged that only one compartment is on view from the street at a time, the display being changed every hour or two, or the compartments may be slowly moved up and down, city-water pressure furnishing the power. In changing the displays in the compartments, one compartment may be on exhibition while the others are being trimmed.

ⒸThe stone used in the walls of a new Catholic church in Kansas City was originally used for the piers of a Missouri River bridge that was never completed.

*St James
39th + Harrison*

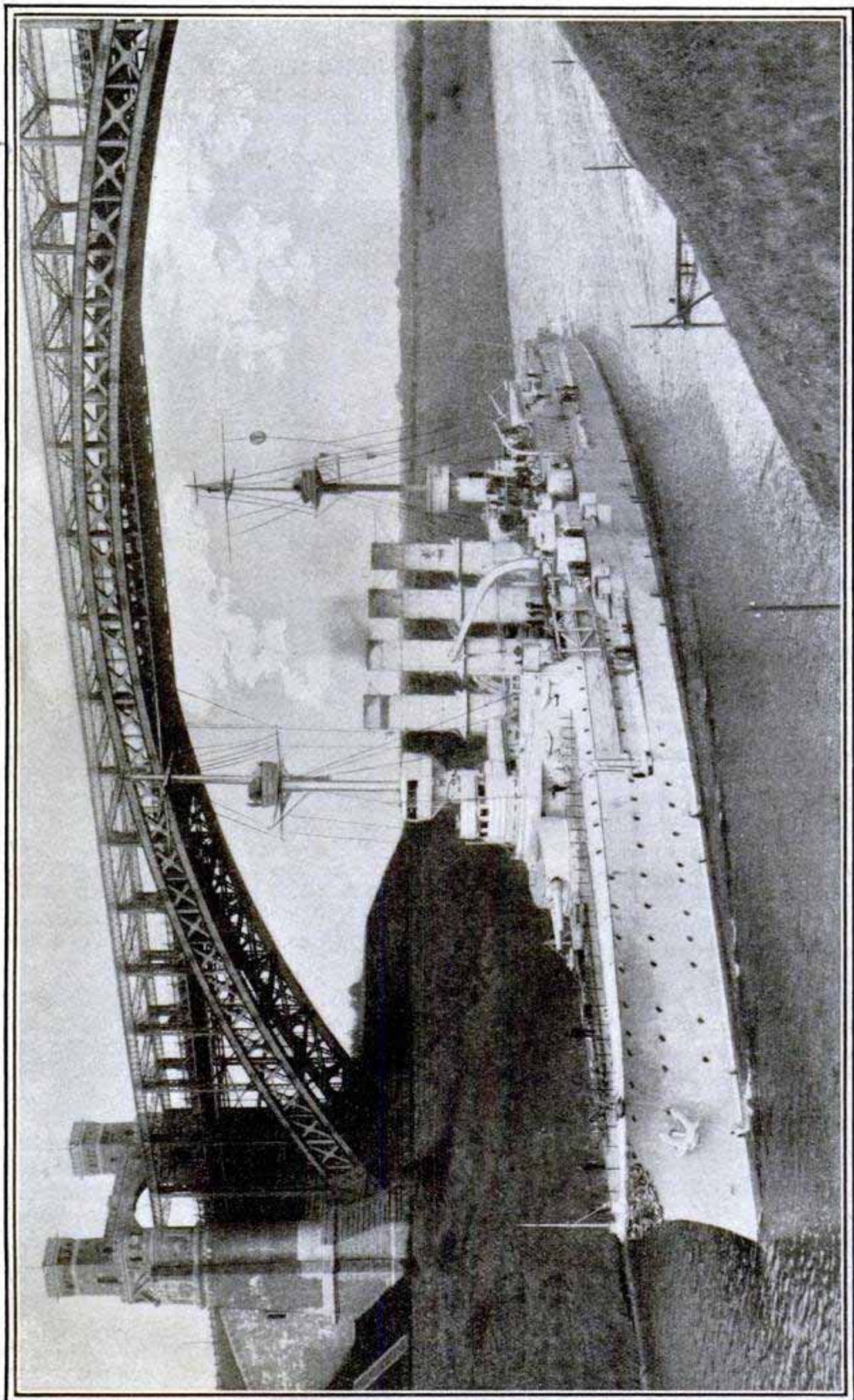

Photo by Trans-Atlantic Co.

The German Battleship "Roon" Passing under One of the Bridges of the Kiel Canal

KIEL CANAL TO BE WIDER AND DEEPER 3474

The widening and deepening of the Kiel Canal, which connects the Baltic with the North Sea, will be completed in the spring of 1915, at an estimated cost of \$56,000,000. The depth will be 45 ft., and the width will be considerably increased. Double locks, 1,082 ft. long and 147 ft. wide, thus larger than the Panama Canal locks, will be constructed at Holtenau and Brunshüttel. All bridges across the canal, except the one at Rendsburg, which will be of the swing type, and one of the largest of its kind in the world, will be elevated sufficiently to give passage to the largest vessels.

AUTOMATIC LIFE JACKET

3393 **"RIGHTS" ITS USER**

The construction of the buoyant compartments of this life jacket, designed especially for motorboat racers, is such as to turn the wearer automatically on his back when helpless, with head well out of water and resting upon the pad at the back. The adaptability of the jacket for persons of all ages is shown in the illustration, both the man and the little girl wearing the same size.



This Life Jacket Automatically Turns the User on His Back, with Head Well Out of Water

TOYLIKE BUT EFFICIENT REVOLVER RANGE

This is not a toy, but a remarkably efficient revolver range that is used in



Revolver Range That may be Used on a Desk or Tent Pole

the office of Maj. Gen. Leonard Wood, chief of staff of the United States army.

A tube is inserted in the barrel of the revolver. In this tube is a rod. When the hammer is snapped the firing pin strikes against the rod, driving the far end of it three or four inches from the muzzle. A spring draws the rod back into position. In using this revolver range, the marksman aims at the upper target and when the hammer is snapped the rod is driven against the lower one. Only an excellent shot can drive the rod against the bull's-eye.

LARGE BELT TRANSMISSION FOR ELECTRIC POWER

Notwithstanding the increasing employment of individual motors for the operation of machinery in factories, there are still many examples of single-belt drive for a main shaft. A belt 207 ft. long and 3½ ft. wide, running at a speed of 90 ft. per second, transmits nearly 3,000 hp. in an Austrian steel mill.

FREIGHT-HANDLING SYSTEM FOR LARGE WAREHOUSE

GOVERNMENT TESTS PROVE VALUE OF TREATING TIES

1134 A large wholesale grocery firm of Los Angeles daily handles about 200 tons of goods of every description by

331 As the result of a series of service tests of railroad ties that are being conducted by the United States Forest Service it

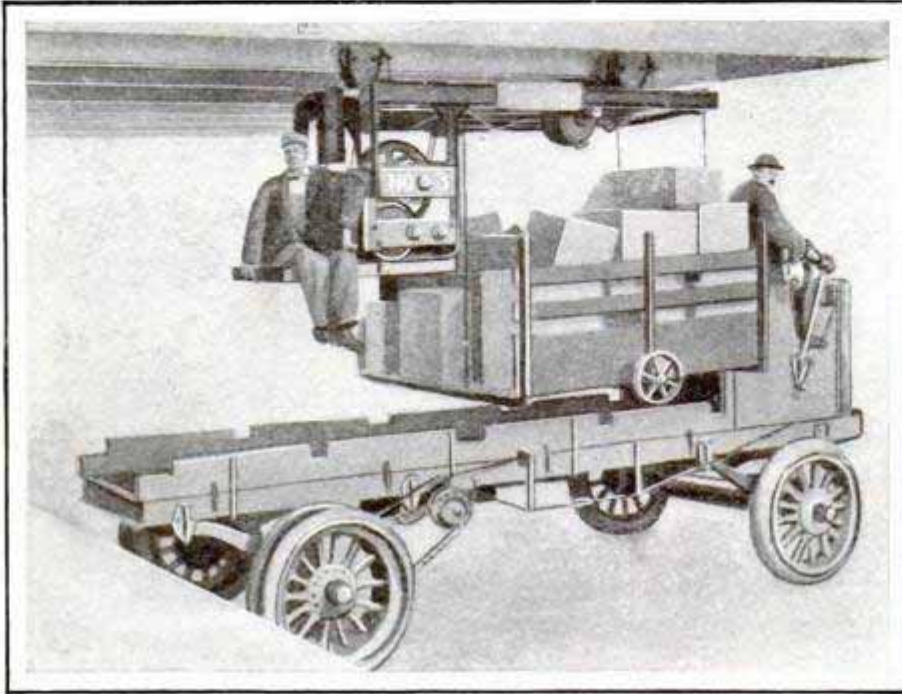

Loading an Automobile Truck by the Telpherage System

the "telpherage" system, which consists of three electric trolleys, with a capacity of two tons each, which travel on the lower flange of an I-beam. The trucks of these trolleys are provided with hoisting drums for lifting the two specially constructed sections of each body from the automobile trucks used in conveying the goods to and from the warehouse. The trolleys carry the loaded sections from the automobile trucks to any part of the warehouse, or from any floor or section of the building to the motor trucks. The operator rides on a platform at the rear of the trolley, which has a maximum traveling speed of 500 ft. a minute.

¶The abandonment of the traditional queue or "pigtail" by the Chinese is throwing quantities of human hair on the markets of the world. Five tons in one shipment was recently offered in England for use in the woolen industry. Large quantities of it are woven into bags for pressing oil seeds.

has been ascertained that the average life of untreated ties laid in the experimental track of the Gulf, Colorado and Santa Fe Railroad Company is as follows: Loblolly pine and hemlock, $1\frac{1}{2}$ years; tamarack, $2\frac{1}{2}$; longleaf pine and red oak, 3; black oak and turkey oak, over $3\frac{1}{2}$, and Spanish oak over 4 years.

In the testing of various species of ties subjected to treatment with preservatives before being laid and after having seen $7\frac{1}{2}$ years of continuous service, it was found that treat-

ment with preservatives will not yield good results unless the ties are sound in the first place, and that the species which, when untreated, decay most rapidly, appear to gain the greatest relative increase of life when treated.

NEW PROCESS FOR MAKING 3327. GOLD LEAF

In a new process for making gold leaf discovered by a London firm a highly polished aluminum ring, about 5 in. in diameter and $5\frac{1}{2}$ in. wide, is covered with a sticky substance, such as a solution of gum, and allowed to dry. The sticky surface is dusted with metallic powder so that it is completely covered with a very thin layer of metal. This layer is then polished and the ring is turned slowly with its lower surface in contact with a solution of a nickel salt, the ring being connected to one pole of a battery, while the other pole is immersed in the nickel solution.

A coating of nickel is thus produced

Chemical report

on the polished layer of base metal. The nickel deposit is washed and the ring is rotated with its surface in contact with a solution of gold, the electrical connections being as before, so that the latter metal is electrodeposited on the nickel. There are thus four layers on the rim of the ring, namely: gum, base metal, nickel, and gold, but each layer of metal is so thin that the combination is said to be even thinner than the best gold leaf. To remove the leaf from the aluminum ring a transverse cut is made in the film and, starting from this cut, the ring is turned slowly with its lower part immersed in a liquid which dissolves the adhesive substance, when the film falls from it and is received upon a band of paper traveling at the same speed as the rim of the wheel. The film and paper are then cut up and made into books.

A LIFELIKE DOLL FOR THE LITTLE FOLKS

A doll that has improved spiral-spring joints and is made of a material which will not chip or break, and claimed to be the most lifelike plaything yet designed for children, has been put on the market. The doll is sanitary because the material from which it is made is not affected by moisture and may, therefore, be washed with soap and water.



AEROPLANE WITH PENDULUM BODY MOUNTING 3233

The body of this French monoplane, containing the pilot's seat and the

back. It is so connected with the tail plane, which is of unusual size, that any forward or backward tilt of the machine, swinging the body in the same direction, causes the tail plane to be depressed or raised, so as to automatically level the machine. The joint which permits the swinging of the body can be instantly locked by a special device whenever it is desirable that the pilot have absolute control of the motions of the machine, as in making an ascent or descent.

The pendulum arrangement is based on the observation that birds in flight always depress their tails when they lower their heads and vice versa. In a recent flight of this machine the pilot

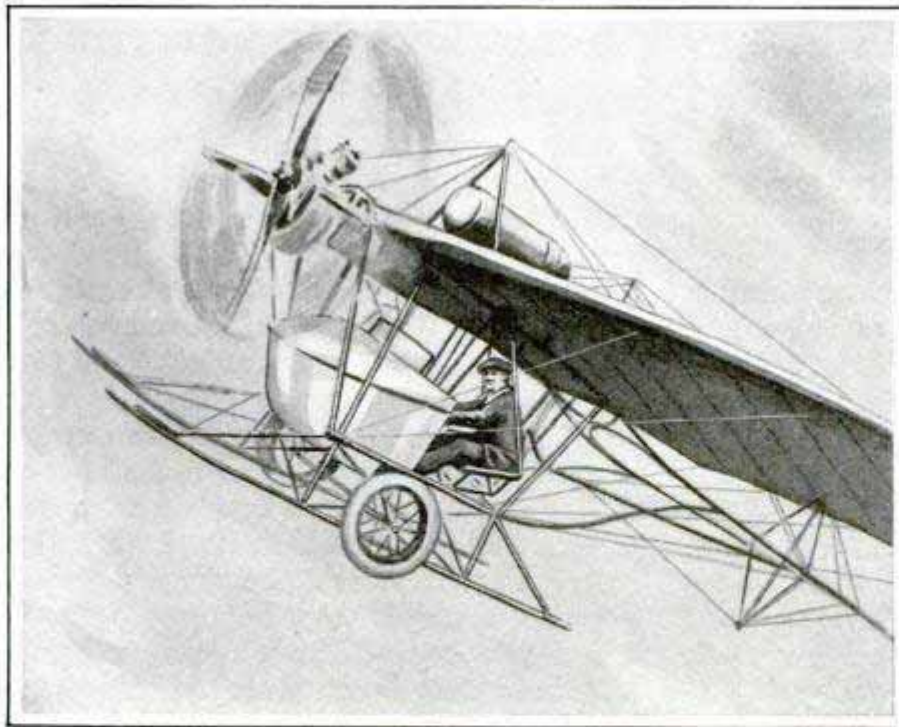

Automatic Longitudinal Stability by Means of a Pendulum Body

steering apparatus, is suspended as a pendulum, free to swing forward and

flew for a period of 35 minutes with folded arms.

Built by M. Morceau

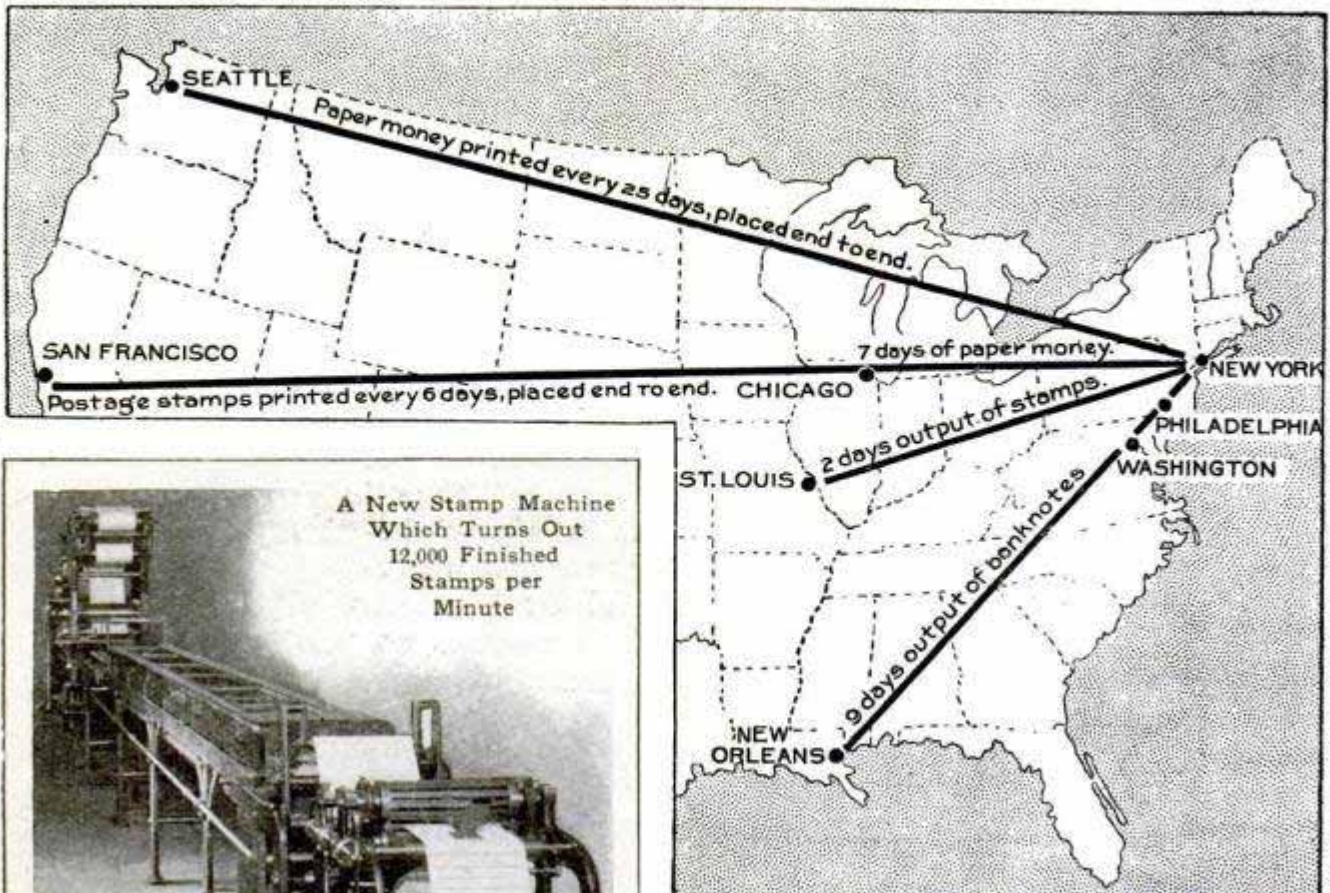

Map Giving an Idea of the Enormous Daily Production of United States Stamps and Bank Notes

prints, gums, perforates, and either cuts into sheets or winds into coils, 12,000 stamps per minute. The bureau now turns out 40,000,000 stamps daily.

GERMAN METHOD OF USING FISH WASTES

The German method of converting fish unsuitable for food and other fish wastes into valuable products, such as grease, glue, fertilizer and meal for fowls, consists in cutting up the bodies and placing the parts in closed vessels or "digestors" and boiling the mass by the use of steam at a temperature of from 248 to 284 deg. F. so as to extract the grease and glue. The mass is then placed in an apparatus containing a cylinder, inside of which is a movable roller that crushes the material into powder after it has been sufficiently dried by steam. The machinery in use at Hamburg is capable of digesting about three tons of raw material at one time, but the load is usually limited to two tons, the boiling process requiring from four to five hours, and the drying process six hours.

95

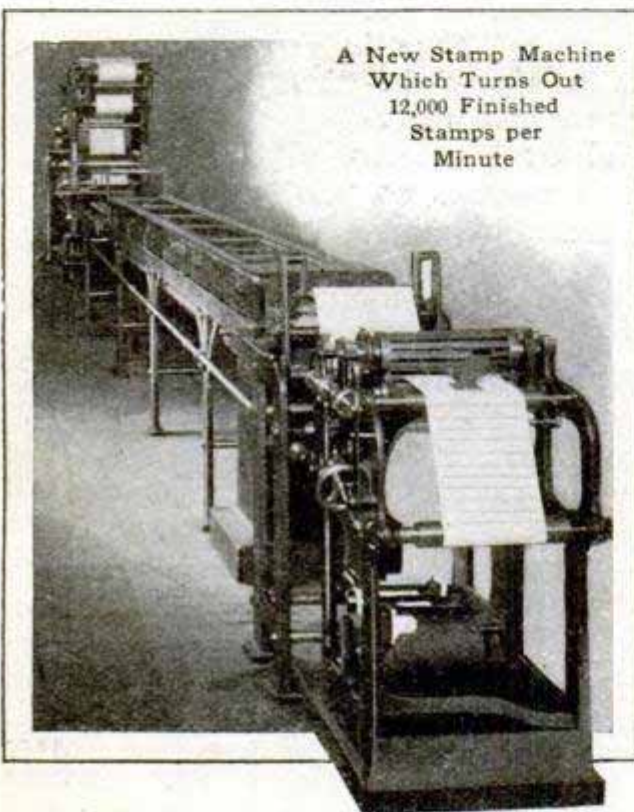

THE STAMP AND BANK-NOTE PRODUCTION

The immensity of the postage-stamp and bank-note production of the U. S. Bureau of Engraving and Printing is excellently illustrated in the drawing. Twenty-five days' output of bank notes, placed end to end, would reach from New York to Seattle; nine days' output, from New York to New Orleans, and seven days' output, from New York to Chicago. Six days' output of stamps would reach from New York to San Francisco, and two days' output, from New York to St. Louis.

The other illustration shows a machine that turns out a mile of postage stamps, in finished form, in every five minutes of operation. This machine

6/19

**A MOTOR VEHICLE WITH
EXTRA REAR WHEELS**

that connect them with extra sprockets on the main rear wheels.

It is claimed that the extra pair of rear wheels secures a more powerful traction and enables the vehicle to turn

A motor truck provided with four rear wheels instead of two, the main rear wheels and the extra rear wheels being mounted upon short axles connected with a movable bar in such a manner that the load is, at all times, equally distributed over all the rear wheels regardless of holes or obstacles, has been designed by a resident of New York City.

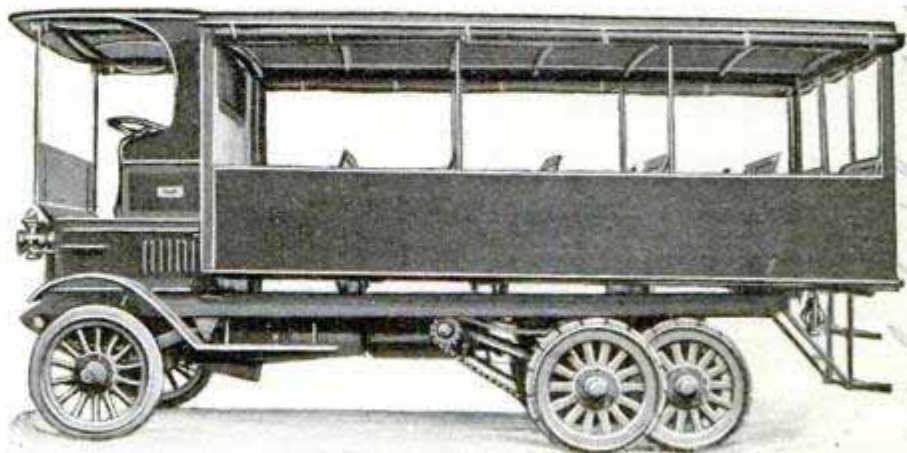

Extra Rear Wheels for Motor Trucks

Power from the engine is supplied by side chains extending from a shaft under the chassis to the forward pair of rear wheels exactly as it is done in the standard truck, and the extra pair of rear wheels are driven at the same time by additional side chains

around sharp corners without slipping, and that the cost of equipping a motor truck with dual wheels of this type is low enough to permit their general adoption.

**THE SMALLEST BOOK IN THE
WORLD**

3529

A reproduction of what the Library of Congress catalogues as the smallest book in the world is here shown in comparison with an ordinary cent. Although the volume, which is paper-bound, measures only two-fifths by two-fifths of an inch and will easily rest upon the thumbnail, it contains 48 pages of Japanese paper upon which are printed an introduction and the

complete Rubaiyat of Omar Khayyam, a famous Persian poet who lived more than a thousand years ago. Of this edition of the Rubaiyat only 57 copies were printed, numbered and signed.

**INCREASE IN RAILROAD
EARNINGS**

The total revenues of the railroads of the United States for 1912 amounted to \$2,923,936,957, of which \$2,033,474,191 was derived from freight traffic. Every mile of railroad, according to the report of the Interstate Commerce Commission, earned a net income above all expenses of \$3,609 for the year, an increase of \$163 over the net revenue per mile of line for 1911.



A Complete Book of 48 Pages

About 102 miles of streets in the Borough of Queens, New York City, were resurfaced during the last four months at an average rate of practically one mile per day. The cost was over \$1,877,000.

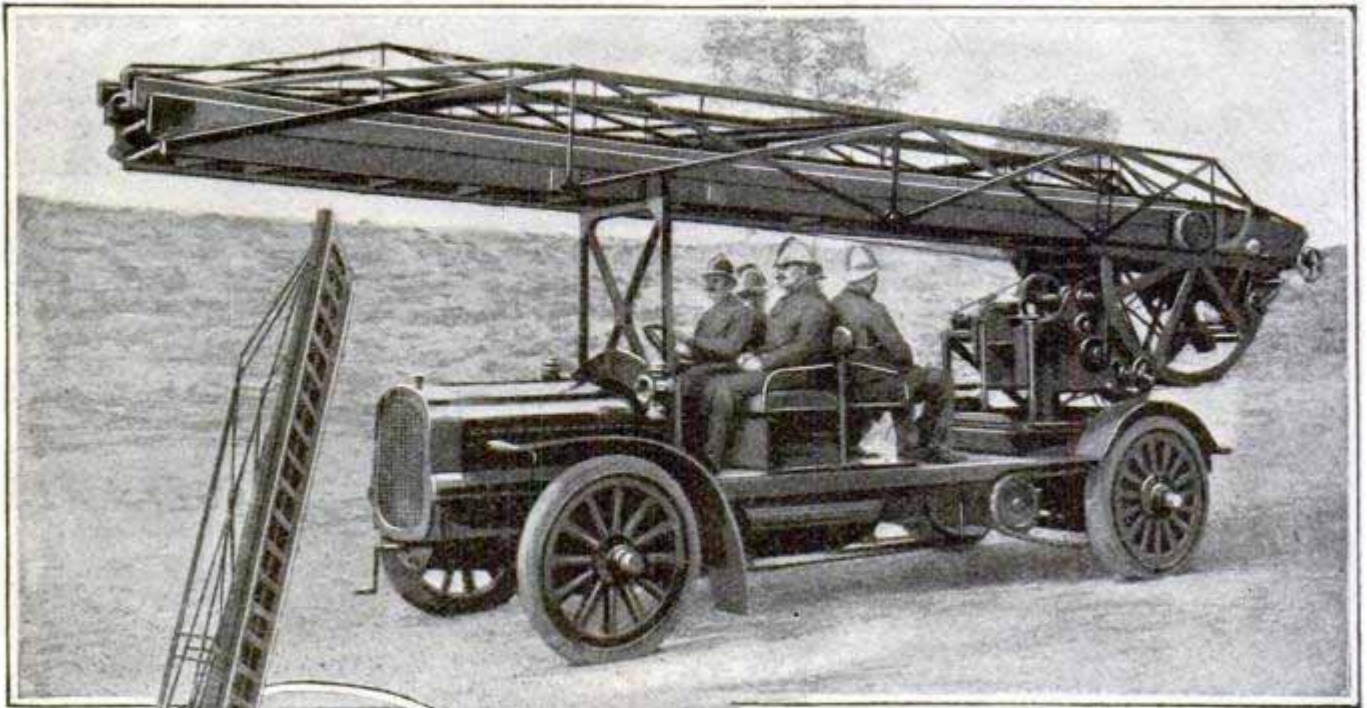

Electrically Raised, 85-Ft. Turntable Ladder of Paris Fire Department



A 65-Ft. Ladder Ready to be Raised

THE FIRE DEPARTMENT OF PARIS

The fire department of Paris is noted for its effective work, much of its efficiency being due to drills in which various appliances are used daily until the firemen become thoroughly proficient. Drill towers, with balconies and projections similar to the six-story apartment buildings of the city, are used with scaling ladders, etc., and these appliances are also employed for drilling with extension ladders and the rescue of human beings by life lines.

The courtyards of some of the fire stations have fireplaces with tall chimneys for practice in putting out chimney fires. Demonstrations are given

with a device by which obstructions or disabled horses can be raised and removed from the streets. The same device is also used on dangerous buildings, or in any place where the firemen are required to lift heavy weights.

The fire department also uses models, illustrating types of buildings common to Paris, in giving the firemen instruction regarding fire prevention and the layout of buildings. When entering burning structures the firemen are clothed in leather jackets, cloth trousers and leather boots. They also wear helmets connected by hose with oxygen tanks strapped to their backs, with compressed-air tanks or with air-pumps operated from without.

The Paris department is under direct control of the minister of war. The men are paid the scale in force in the French army. The officers receive additional pay from the city after 15 years' service, and a pension from the government after having served continuously in the department for 25 years.

¶The world's wealth, as expressed in par value of stock exchange securities, is \$115,800,000,000.

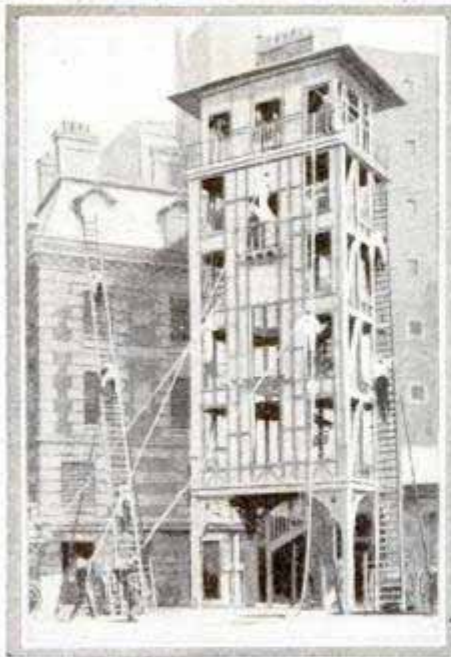

Using the Long Ladder and Life Lines in Rescue Work

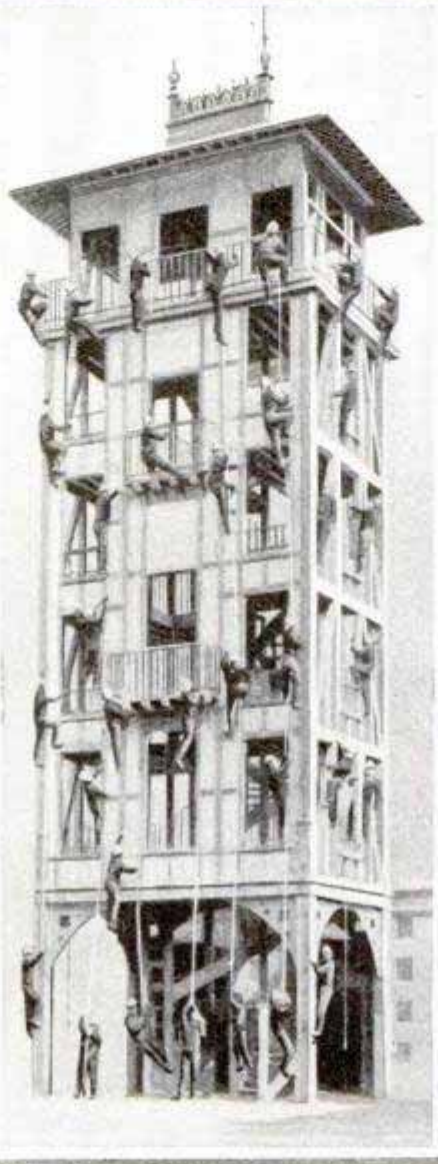

Part of Paris Fire Brigade in a Climbing Drill



Hook and Ladder Balcony and Window-Work Drill



Front and Back View of Air-Pump Smoke Helmet



Back and Front View of Compressed-Air Smoke Helmet

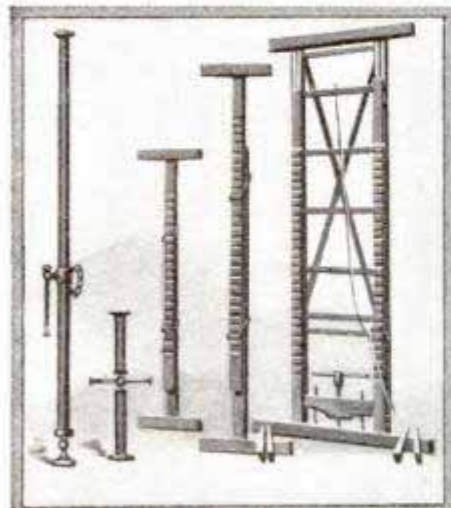

Devices for Supporting Sections of Dangerous Structures



Front and Back View of Oxygen Smoke Helmet

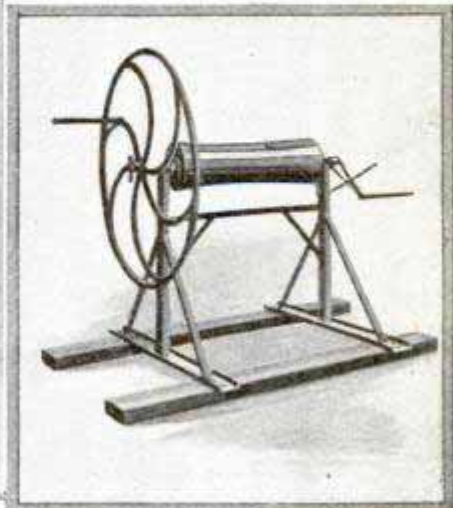

Windlass for Rescue Work on Dangerous Buildings

Reinforced Hollow Concrete Poles
678 3490 POPULAR MECHANICS
Oklahoma City Okla

HOLLOW CONCRETE POLES CARRY HEAVY LOAD

A demonstration of the strength of reinforced, hollow concrete poles is

hollow concrete pole is the ease with which wires from overhead can be connected with underground systems, or with service wires, doing away with unsightly wiring from the tops of poles.

Hollow concrete poles, 35 ft. long, with a diameter of 7 in. at the top and 16 in. at the ground, weigh 1,600 lb., and, when set 6 ft. into the ground, will carry a strain of 1,500 lb. side pull at the top.

ORIGIN OF AUTO- MOBILE BOUQUET 3650 HOLDERS

The bouquet holder for the automobile, which is part of the regular equipment of limousine and other inclosed cars, had its origin, according to one source of information, in the desire of a French automobile concern to pacify an exasperated American customer. It seems that an American woman ordered a car from the French concern some months in advance of an intended European tour, and expected to have the machine placed at her disposal on her arrival in Paris. At that time it was not unusual to order a chassis six months in advance of need, and then be disappointed at delivery time. The body was ready when the American woman arrived in Paris, but the chassis

Reinforced Hollow Concrete Poles
mea Keller Paris

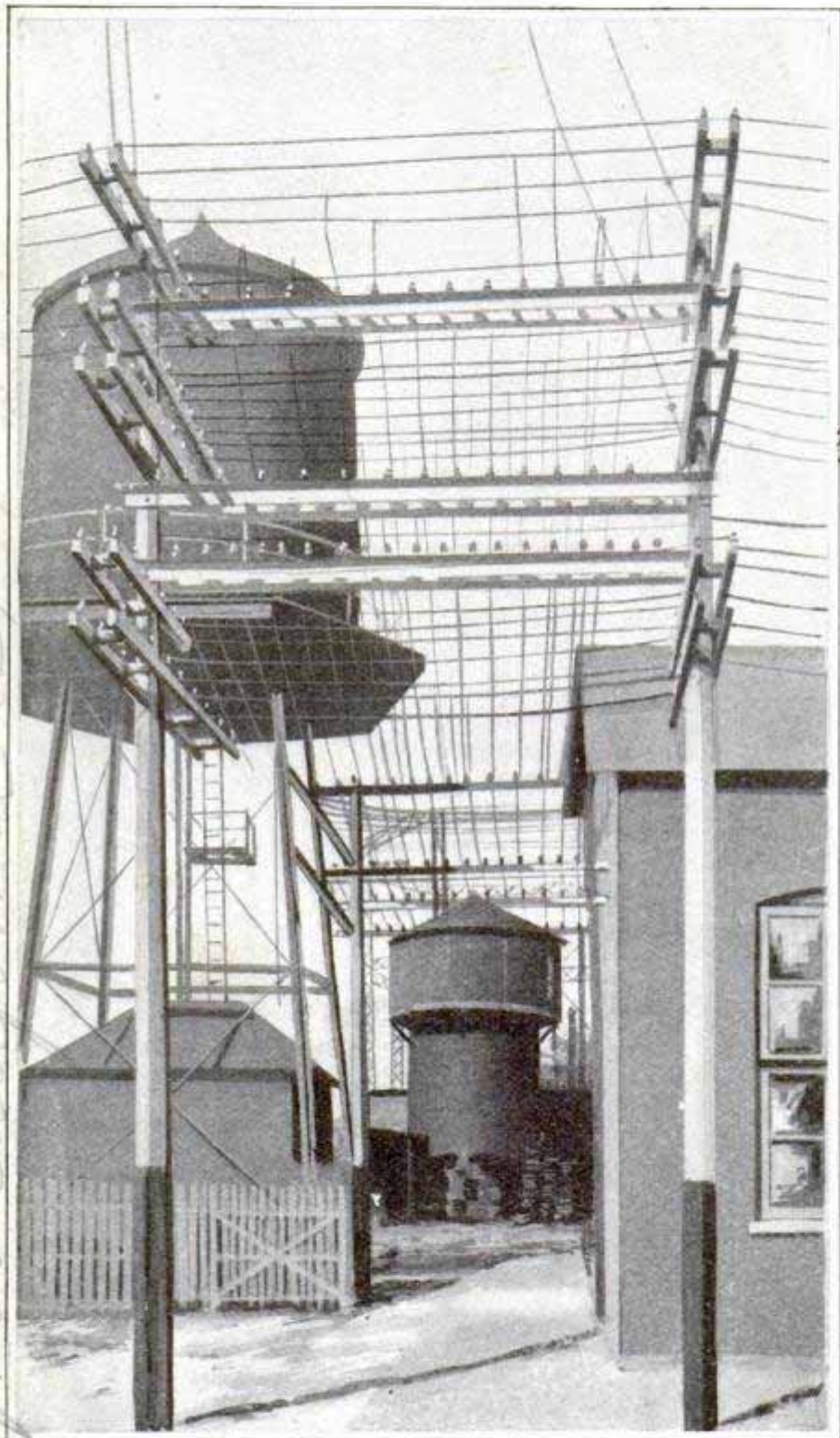

Reinforced, Hollow Concrete Poles, 45 Ft. in Height, Carrying Electric-Power Wires

here shown. These poles, 45 ft. in height, carry the entire main line of the electric-power company in Oklahoma City. One of the features of the

had not made its appearance. Explanation and apology were unavailing, but some days later the chassis arrived, and realizing that the lady's patience

ent

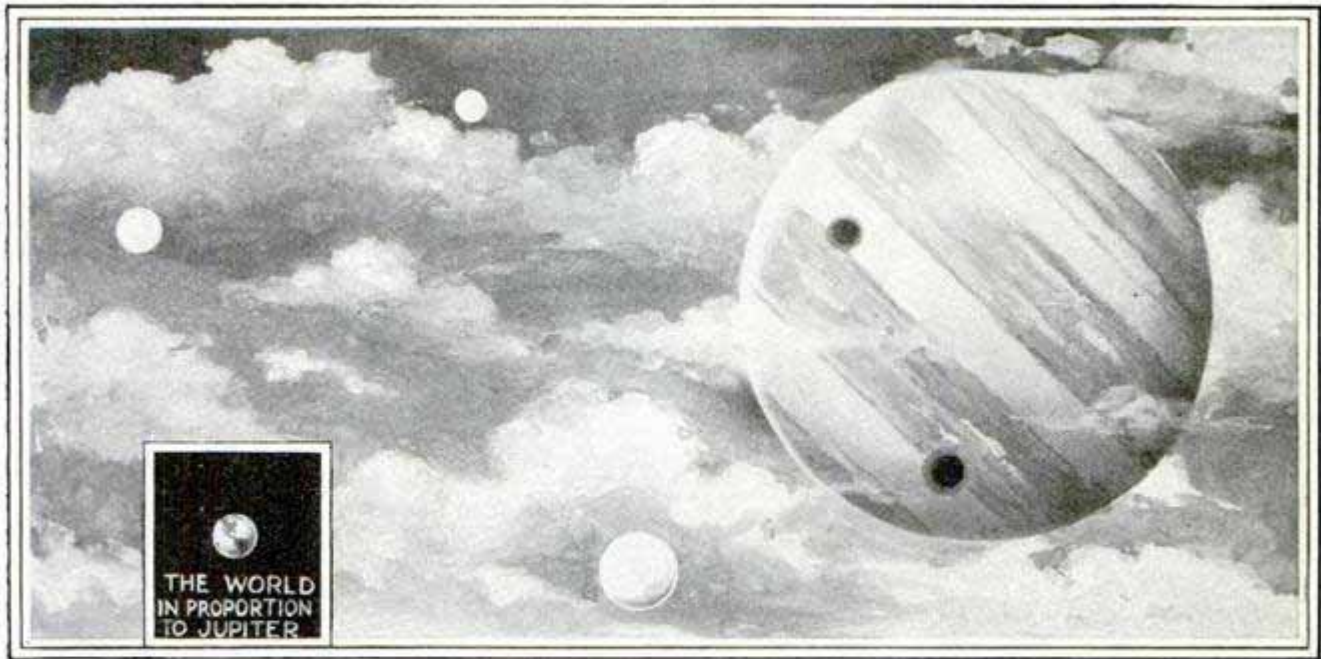

Jupiter and Three of Its Moons — Comparative Size of the Earth Shown at Left

had been sorely tried, the makers sought some means of giving her a pleasing surprise. A quantity of costly flowers was bought, and to arrange them attractively in the car vases were used. The effect was so pleasing that the bouquet holder became part of the standard equipment of high-grade French cars and American builders quickly adopted it.

THE PLANET JUPITER IN THE 3536 MAKING

The planet Jupiter and presumably the still farther distant planets may be said to represent the younger members of the celestial family of worlds of which our earth is in the prime of life, the moon its dead offspring, and Mars an older brother; yet Jupiter, the largest member of this wonderful family, interests us more because, beyond Mars, he is our nearest neighbor. Jupiter also commands our attention more than the others because the few glimpses that astronomers have had of his surface lead them to believe that he now is in a condition immediately preceding the formation of a solid crust, water and land—a state through which our earth once passed.

When viewed through a powerful telescope the surface of Jupiter appears

to be streaked with shades of gray in which brighter and darker spots of many and changing forms are visible. It has been discovered, however, that these shades and spots are not the real surface of the planet, but a deep atmosphere of clouds and vapors, the changing forms and motions of which are not caused by winds, but by the action of heated currents of air or other gases rising from the planet.

As the dark spots of this atmosphere frequently assume the color of light rose or reddish brown, as if reflecting some great fire, the astronomers have decided that the lighter parts of the atmosphere are oceans of water vapor, while the darker spots are holes in the atmosphere through which a glimpse of the real surface of the planet may be had with a sufficiently powerful telescope.

Jupiter revolves around the sun five times as far away as the earth and requires almost 12 years to complete one revolution. Four large and four small moons accompany the great planet, which rotates around its own axis in about 10 hours. The size of Jupiter is such that 1,300 worlds as large as the earth could readily be contained within its interior, yet its specific gravity is so small that the planet would be outweighed by slightly more than 300 earths.

Reclam's Universum.

Jan. 10, 1913

3 4670 STEEL ENDS TO PREVENT LOSS OF GRAIN IN BOX CARS

Corrugated steel plates are now placed on railroad box cars at their

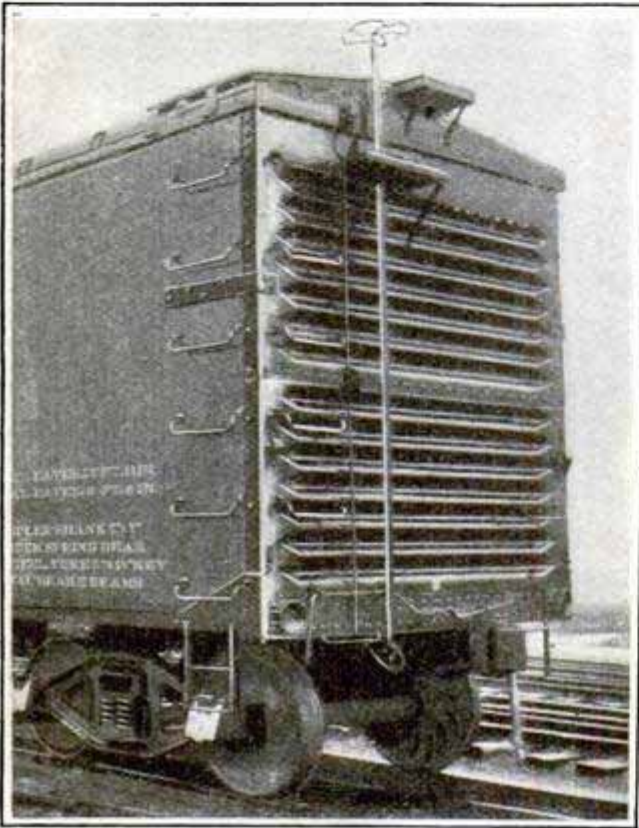

Corrugated Steel End for Grain Cars

ends to prevent loss of grain. Shifting loads of brick, lumber and steel rendered the wooden ends useless for the carriage of grain, it having been found that 70 per cent of the box cars in service were not grain-proof.

3545 INFLUENCE OF COLORED PAPER ON LIGHT

Most attention has hitherto been given to the color value of illuminants, when, after all, according to M. Luckiesh, in a paper read before the Chicago section of the Illuminating Engineering Society, it is the color value of the useful light that is of greatest interest to the user—that is, not the color of the light as it leaves the lamp, but the color it is given by reflection from the walls and ceilings. The light from the metallic filament lamp has been lauded by many because of its nearer approach to daylight than many of the other common illuminants, while a few

have expressed favor for the "softer" yellow glow of the carbon filament lamp. Yet experiments show that only a moderately yellow paper is required to change the color of tungsten light to that of a carbon filament lamp. In indirect lighting the colored walls and ceiling, even though nearly white, appreciably effect color changes in the light.

In direct artificial lighting much less light reaches the working plane by reflection from the walls and ceiling than in semidirect or indirect lighting. In the latter system all the light which is diffusely reflected by colored walls or ceilings is altered in color. When the amount of reflected light is small, especially in direct lighting, the influence of colored paper is small, owing to the small amount of colored light added to the direct light.

110

FISH MADE FROM GOLD COINS

Upon the roof of an old castle in Japan are nets under which may be seen two fish that were made from 2,000 gold coins. Each fish is 9 ft. long and 8 ft. wide and the coins are each 3 in. by 2 in. in size. The fish are kept under nets to prevent the coins from being stolen.



Real Gold Fish are on the Roof

new York Central

110 Bull by a man called nagoya
Kato. / Kusumara in 1660

Proceedings American Institute

THE TALKING MOTION PICTURES

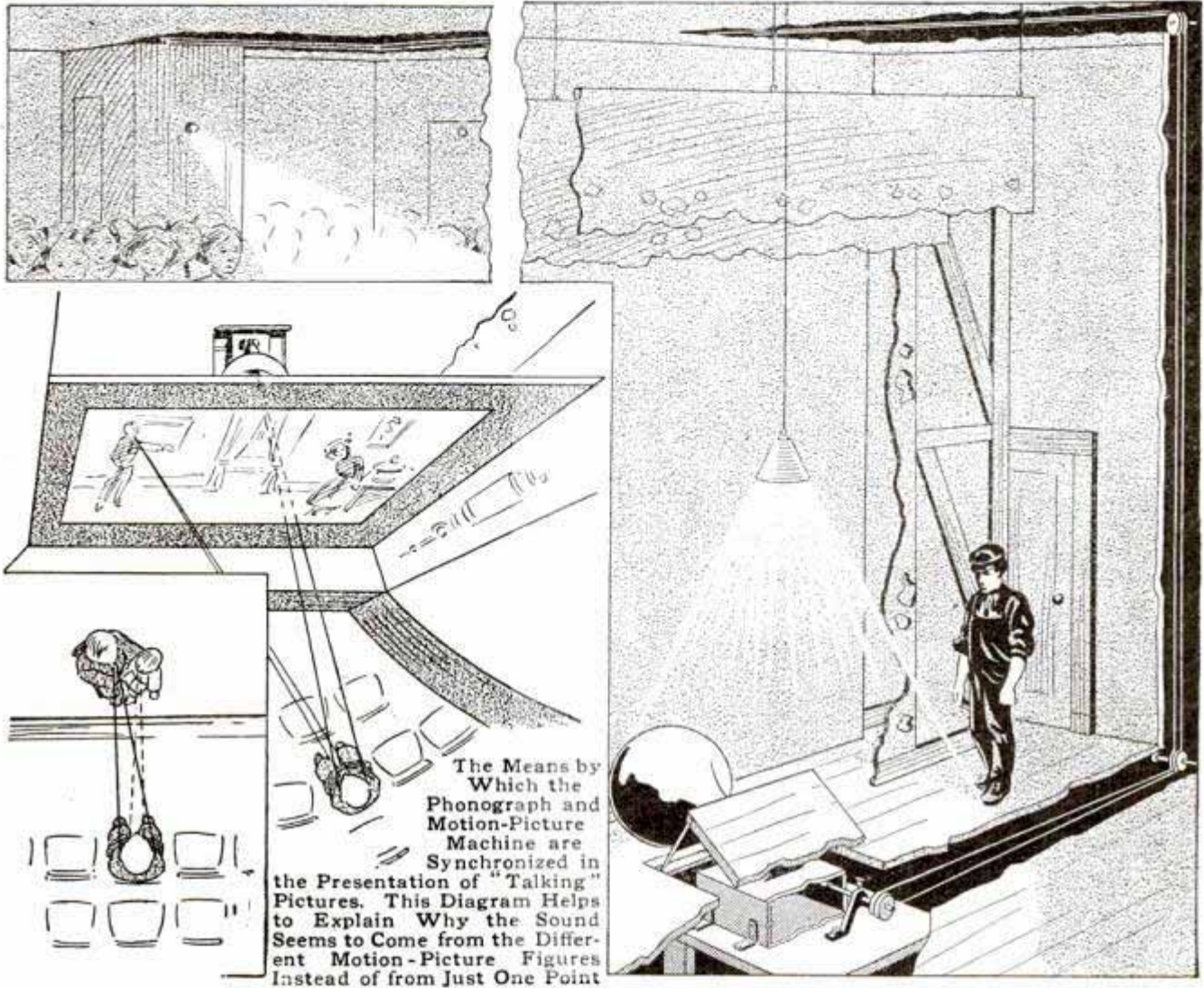

Just how the new talking motion pictures are operated, and why the voices of the people appearing on the screen seem to come direct from the mouths of each, are questions which many people ask whenever the "talkies," as they are now called on New York's East Side, are shown.

One of the illustrations herewith shows the connection by means of which the motion-picture machine, high up in the gallery of the theater, and the phonograph, located in a well in the stage just behind the screen or curtain, are synchronized, or made to operate at the same time and speed, so that the motion of the lips in talking and singing may be simultaneous with the utterance of the sound. Every sound or noise made by the persons producing material for the "talking" pictures is caught by a single phonograph recorder while the

motion-picture camera is taking the pictures. In reproducing the talking pictures all that is necessary is to provide that the phonograph and the motion-picture machine be run in the same relation to each other as when the pictures were made and the sounds recorded. This is done by mechanically connecting the motion-picture projecting machine and the phonograph by means of an endless wire cable running over pulleys. The cable passes under the floor of the stage, up to the top of the proscenium arch, and across the upper regions of the theater by air route to the motion-picture machine. Should the cable slip and so throw the two machines "out of step," so to speak, the operator of the projector can retard or increase the movement of the pictures until they are again synchronized with the phonograph.

Although the sound seems to come direct from the picture of the particular person or instrument represented as producing it, no matter whether at the right, the left or in the center of the screen, it all actually comes from just one point—the horn of the phonograph. That it seems otherwise to the audience is due to the same illusion that makes ventriloquism possible. The stage ventriloquist does not, as popular belief has it, “throw” his voice. He simply talks or sings without moving his jaw and with no perceptible movement of the lips, working the jaw of the manikin at the same time. The eyes and imagination of the audience do the rest, the human ear being seldom able to distinguish a variation of several degrees in the direction of sounds that strike both ears at the same time and with the same force. To make the illusion as perfect as possible the screen,

used for the talking pictures is considerably narrower than the ordinary motion-picture screen or curtain.

The accompanying diagram illustrates the principle. Referring to this diagram, two motion-picture figures, going through the facial movements that accompany utterance, would, one at the extreme right and the other at the extreme left of the screen, be still close enough in line with the real source of sound so that the audience, a little distance back, could not tell from which it was coming if there were no facial movement of either, but, “listening” with the eyes as well as with the ears, the sound seems to come from the one whose lips are moving. Were the screen so wide, however, that some of the talking figures might be shown a considerable distance to the right or left of the source of sound the illusion would be lost.

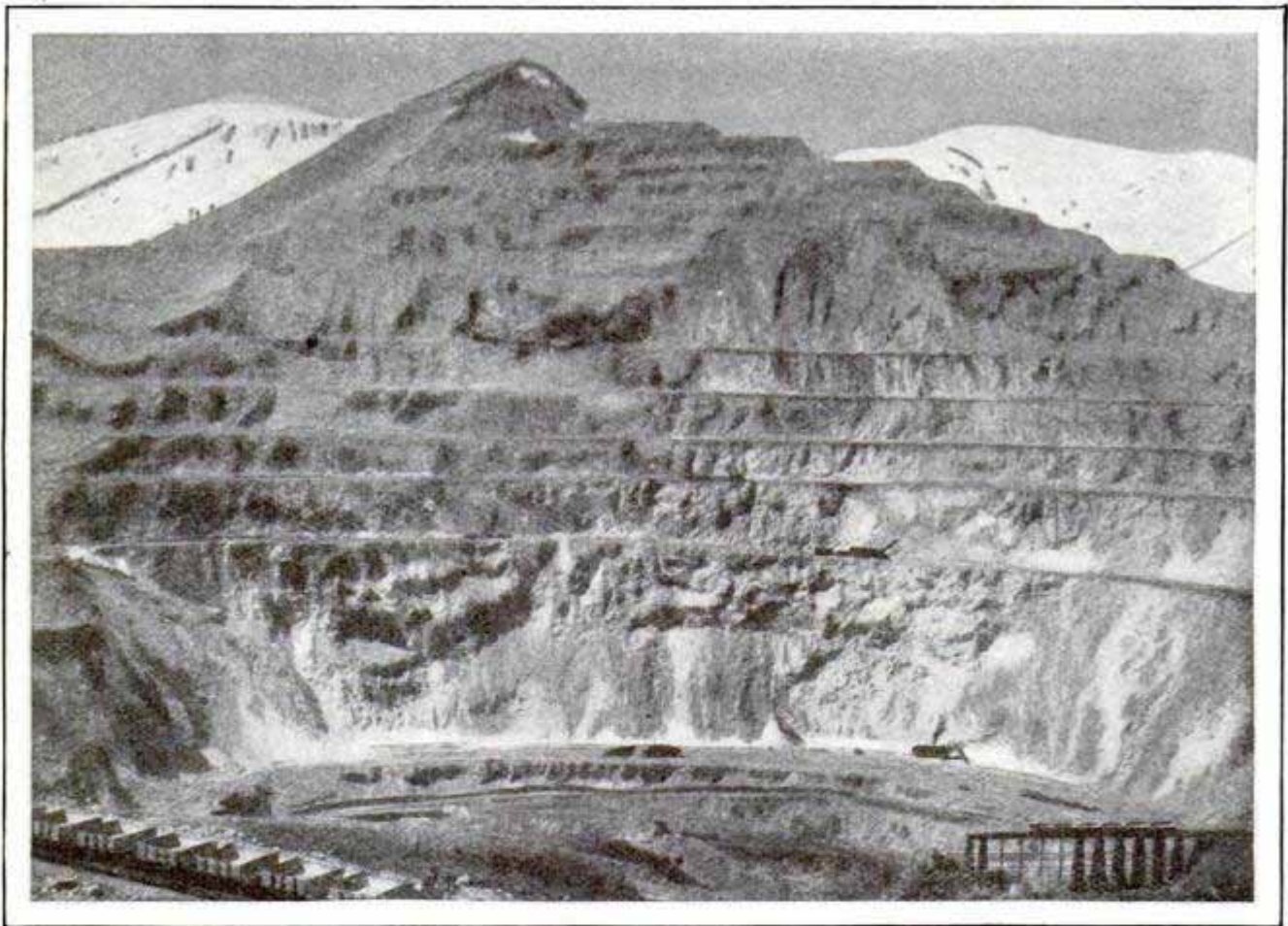

View of the great copper mine at Bingham, Utah. From the pit to the dome the height is nearly 3,500 ft. The ore body, which has less than two per cent copper, was covered by an average of 106 ft. of dirt and rock, and steam shovels remove this capping and get to the ore. More than half a million tons are removed each month, and the amount of ore treated at the mills averages 21,000 tons a day.

MUSHROOM-POISON TESTS

3543 UNRELIABLE

As far as the general public is concerned "toadstool" stands for the poisonous and "mushroom" for the edible varieties of the fleshy, umbrella-shaped fungus, and the popular mind always seeks some test by means of which the toadstool may be distinguished from the mushroom. So far as is known, however, there is not a single test, short of chemical analysis, which will give results of any value whatsoever, according to a circular sent out by the University of California.

The "silver test," which consists of placing a silver spoon or coin with the toadstools while cooking, is the most prevalent. The popular idea is that, if the silver blackens, the toadstool is poisonous. This is absolutely unreliable because there are both poisonous and nonpoisonous species which act alike on silver. Another idea is that if the outer or upper skin of the top of the toadstool peels off readily it is edible, while, in actual fact, some poisonous species will also peel, and certain edible species will not peel.

All toadstools or mushrooms should be avoided in the young or "button" stage, as, at this time, it is impossible to determine, except after long experience, some poisonous from some edible species. It is also wise to avoid all species with gills, white spores, a ring, and a bulblike base, as the most poisonous species are in this group. Those having the cap thin in comparison with the gills, especially if they are bright-colored, and all toadstools which are not strictly fresh, since decay sometimes greatly increases poisonous substances, should likewise be avoided.

325

**GAS ENGINE RUNS ON
COAL FUEL**

In a 1911 issue of this magazine was described an internal-combustion engine, then in its experimental stages, which used coal fuel. In one of the accompanying illustrations may be seen this engine as it appears in operation.

The coal used is fed into a hopper from which it is taken by four worm conveyors through the heater tubes.

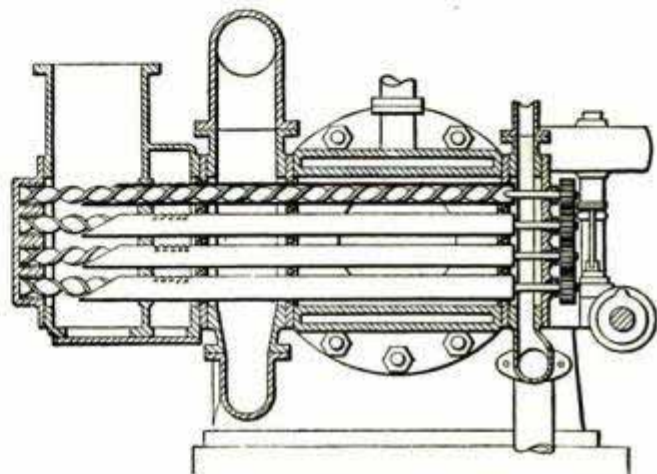
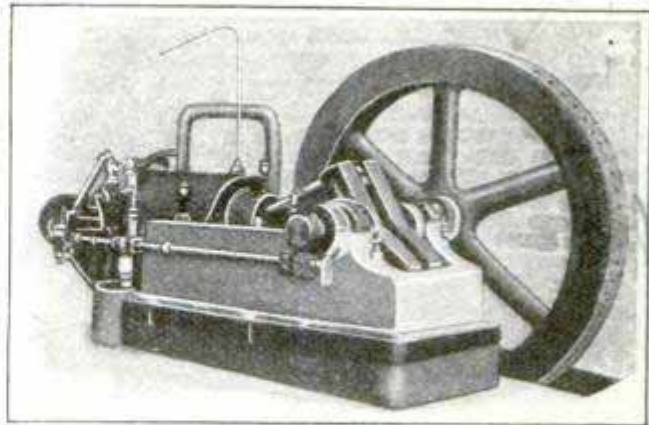

Above: The Coal-Using Internal-Combustion Engine
Below: Diagram of Coal-Feeding and Gas-Forming Section

These tubes pass through the exhaust and combustion chambers of the engine, the heat therein bringing the coal to incandescence. Air, or a mixture of steam and air, is drawn over this incandescent coal by the suction of the engine and mixes with the gases given off from the coal. This mixture passes into the cylinder of the engine. In starting, the coal is brought up to incandescence by running a few minutes on illuminating or other available gas.

A recent contributor to Popular Mechanics Magazine, writing from Canada about the Martello towers at Kingston, Ont., stated that there are none of these relics of early coast defenses in the United States. Several correspondents along the South Atlantic coast have called our attention to the Martello towers of Key West and the famous old tower on Tybee Island, off the Georgia coast.

156-207 St. 711-1000
 156-207 St. 711-1000
 156-207 St. 711-1000

CASTS OF HUMAN BODY BY NEW PROCESS

A new process of making either plaster or metal casts of the face, bust, or the entire human body, known



as "sculptography," has been perfected by an inventor of Boston. By means of compressed air there is sprayed over the part to be reproduced a coating of warm liquid that quickly forms a hard shell or mold which is removed and plaster of Paris

poured into the mold. When the plaster is sufficiently set, the mold is removed and the reproduction is electroplated with a thin coat of copper, thereby giving the appearance of solid

metal. It is claimed that the molding liquid will not stick to the hair, eyebrows or mustache, and the texture of the finest skin is faithfully reproduced. The head and bust shown was reproduced at one sitting of approximately 45 minutes.

IRON ENOUGH IN SIGHT TO LAST 360 YEARS

The supply of iron ore available under present methods of mining in the entire world has been stated by geologists of international reputation at 22,000,000,000 tons, from which it is estimated 10,000,000,000 tons of iron may be produced. At the present rate of consumption, this supply would last the world about 60 years. There are, however, more than 123,000,000,000 tons of ore not now commercially available, which, with improved methods of production, may be made to yield in the future an additional 53,000,000,000 tons of iron, which would run the world along for another 300 years, if no more iron were used annually than at present.

La Technique Moderne

TOURING CAR CONVERTED INTO FARM TRACTOR

A distinctly new type of farm tractor, which can readily be connected to any automobile of standard make and size in a few minutes, is on the market.

traction under the most severe conditions. These wheels, mounted on a rigid axle to which a heavy steel frame is attached by means of a pair of "chairs" bolted over the axle hub, support the rear end of the automobile and raise its rear wheels from the ground. The front wheels remain on the ground and carry one end of the tractor frame suspended from their axle. The power is transmitted from the automobile wheels through a spur gear which is secured in

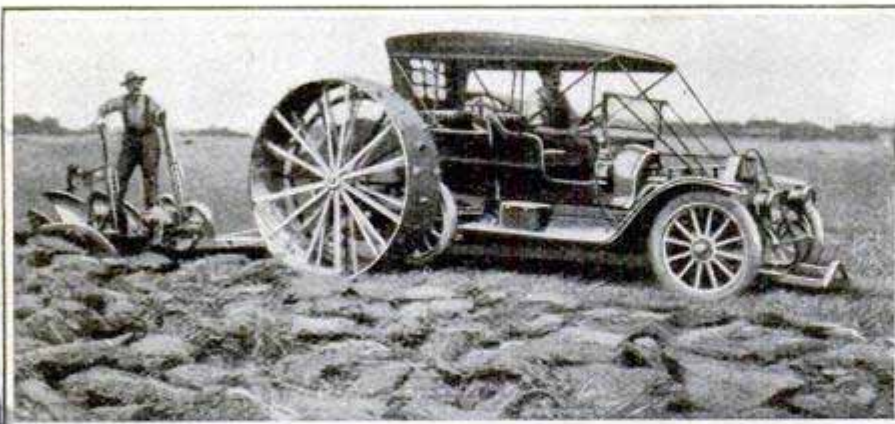

New Type of Automobile Tractor Drawing Three 16-In. Plows in Sod

The tractor, as shown in the illustration, is equipped with a pair of 6-ft. steel wheels with approximately 12-in. tires, heavily spiked to insure ample

place on the hubs of these wheels by a specially designed hub cap. This gear is kept from rotating on the hubs of the automobile by a fingered casting

W. H. Zimmerman

Nov 13 672

Viles, Mich

Congress
at international
in Stockholm

1020

which engages with the rivet heads used in the construction of the automobile hubs. The tractor gearing is so designed that two speeds—one of two miles per hour and one of four miles per hour—are available while the automobile engine is running at its full speed; that is, at a speed which would drive the automobile 25 to 30 miles per hour when on the road.

An auxiliary radiator is mounted on the rear of the tractor and is connected with the cooling system of the automobile by hose connections and pipes. The water circulates through both the auxiliary radiator and the regular radiator of the automobile. A circulating pump and fan and a storage tank holding 24 gal. of water are used in connection with the auxiliary radiator to insure the cool operation of the automobile engine. The tractor, which can be attached to an automobile by one man in about five minutes and disconnected in half that time, is adapted for plowing or any other farming operation in which tractors of the ordinary type are used.

A BLACKSMITH'S NOVEL ADVERTISEMENT

A progressive blacksmith of New Mexico, who makes a specialty of shoeing horses, originated an odd method of advertising by piling

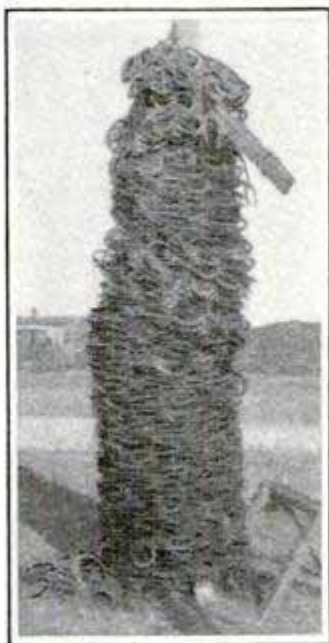

Blacksmith's Horseshoe
Signpost

old horseshoes around a post supporting his signboard.

During 1912 the United States produced 3,124,746,000 bu. of corn, 730,267,000 bu. of wheat, 1,418,337,000 bu. of oats, 223,824,000 bu. of barley, and 35,664,000 bu. of rye.

PAPUAN CRADLES RESEMBLE

3262 - ORIOLE'S NEST

The cradles constructed by the natives of British New Guinea somewhat resemble in shape the nest of a

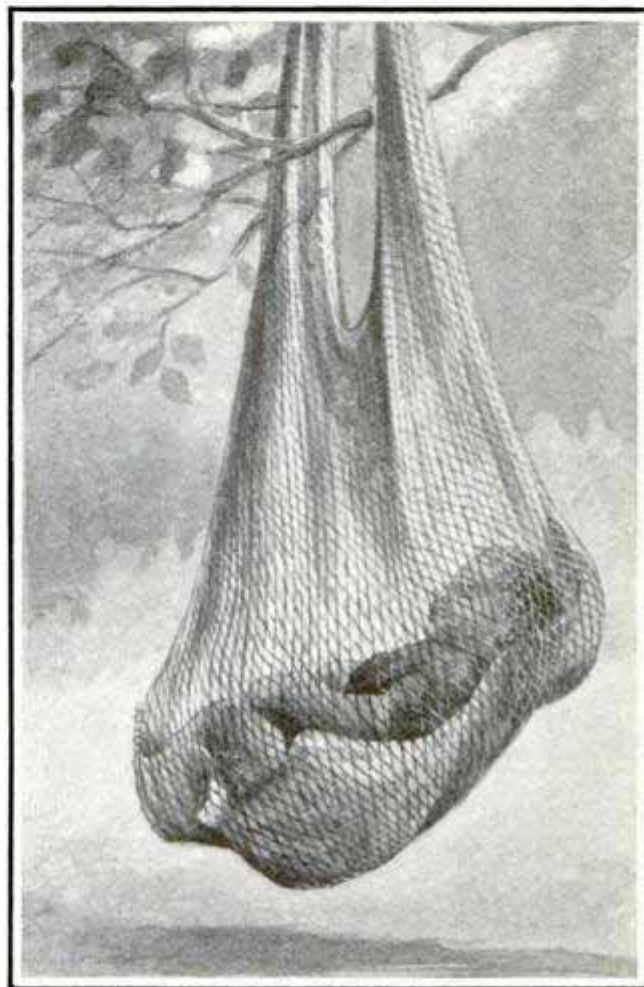

A Nestlike Papuan Cradle

Baltimore oriole. One writer describes them as a cross between a bag and a hammock. They are made of netting and are hung from the branch of a convenient tree or from a crosspiece in the huts.

"There are some Papuan villages in which children absolutely swarm," says the author of Papua, or British New Guinea, "but there are few large families."

J. A. Stubbs.

An oyster grower of Crisfield, Md., raises oysters under almost perfect sanitary conditions by having his oyster beds, utensils and employes examined regularly to detect the presence of disease germs.

RAILROAD TRACK HELD DOWN BY LOGS

When floods threatened to carry away a section of railroad near Memphis recently, a long string of flat cars,



Long Train of Logs Prevents Track from being Carried Away by Floods

loaded with logs, was run onto it to hold the track down.

AVIATION STATIONS IN SAHARA DESERT

3651

The successful long flights made by the French military airmen over the Sahara Desert has led to serious con-

sideration of the practicability of extending the radius of such flights as far south as the Niger River. Military camps will be established at distances of 200 miles apart between Biskra, Algeria, and Timbuktu, in the Sudan, a distance of close to 1,500 miles. At present it takes several months to reach Timbuktu from Biskra, while aeroplanes should be able to make the trip in three or four days. The aerial line is primarily intended for the carrying of mail.

Ⓒ American canneries put out more than 500,000,000 cans of green corn annually.

3436

MINNESOTA'S NEW PENITENTIARY

Minnesota's new prison, which cost \$2,000,000, was constructed on lines which make it one of the best and most modern, architecturally, in the United States, if not in the whole world. Its buildings, which are strictly fireproof, are plain, but substantial and comfortable, following in construction all the laws and rules for obtaining the best hygienic and sanitary conditions.

The new prison is located two or three miles from the old, at Stillwater. The site was selected with particular care as to location and source of pure spring water, the prison farm covering 160 acres, and the prison inclosure proper, 22 acres. From the front is a broad view of the St. Croix Valley, and in the pretty country at the rear is a

spring capable of furnishing 1,500,000 gal. of pure, cold water daily. The buildings are of brick, surrounded by a concrete stockade 26 ft. in height. There are two cell houses, each containing 512 cells. Practically one-third the outside walls of these houses is glass, and there are skylights over the halls, the result being a vast change from the dark, dismal cells of the past. A hospital, thoroughly equipped, adjoins the administration building. The factory buildings and warehouses for the manufacture of farm machinery and binder twine, which are this prison's big industries, are thoroughly modern manufacturing buildings in every respect. The twine factory is 360 ft. long by 86 ft. wide.



The Main Dining Room



Bird's-Eye View of Minnesota's New Prison



One of the Tiers of Well-Lighted Cells

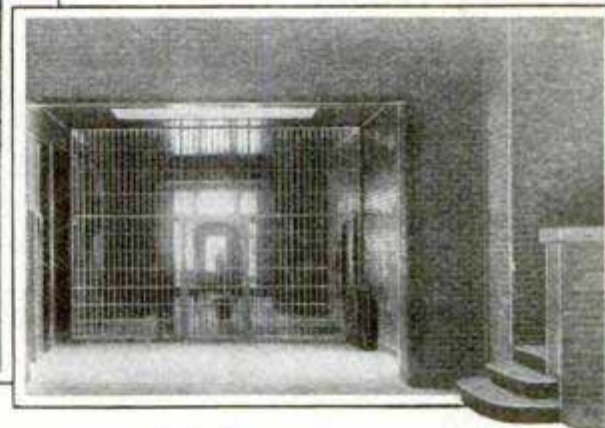

Main Entrance



This is Where the Food is Prepared

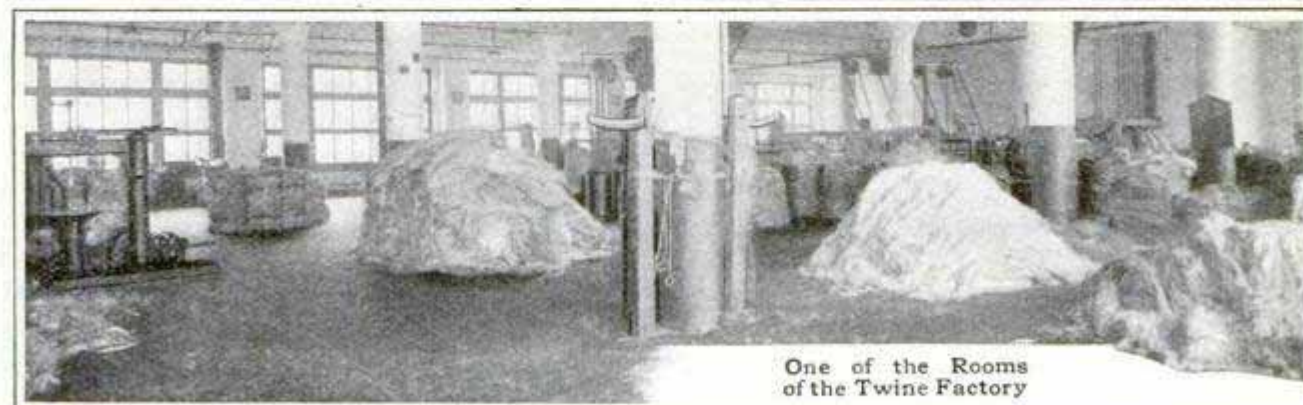

One of the Rooms of the Twine Factory

MENDING THE CRACKS IN ST. PAUL'S CATHEDRAL

12 ⁷ Much anxiety has been felt in England because of the great cracks appearing in the famous St. Paul's



Compressed-Air Machine Forcing Cement into the Cracks in St. Paul's Cathedral Walls

Cathedral, and steps are to be taken to repair its foundation. In the meantime the cracks are being "healed" with cement in the manner shown in the illustration. The compressed air drives the cement into the farthest corners of the crack, causing the stone to bind together again.

THE FALLING PROFIT OF FARM PRODUCE

3 3 5 6
Few people realize, with the exception of those intimately concerned with the producing end, that, regardless of the "high-cost-of-living" cry, the farmer is now receiving less for many staple crops than in 1910. On February 1 of this year the average price received for corn per bushel was 50 cents, as compared with 65 cents on February 1, 1910; the price for oats was 32, as compared with 45 cents; barley, 51, compared with 59, and flaxseed, \$1.06, compared with \$1.92. On February 1, 1910, the farmer received \$12.35 per ton for hay as compared with \$11.64 this year, while in 1913 he was getting 22 cents for eggs as compared with 28 cents in 1910. Apples brought \$1.06 cents per bushel February 1, 1910, and only 74 cents in February of this year. These figures are from the official report of the United States Department of Agriculture.

GAS-ELECTRIC CAR MAKES LONG RUN

3561.
One of the longest single trips ever made by a self-contained electric car was recently accomplished by a gas-electric coach built for one of the big railroad systems. It made the trip from Chicago to Tacoma, 2,201 miles, without any delay, meeting the regular schedule speeds and climbing the grades with ease. It will be used on one of the branch lines running out of Seattle. This type of coach is becoming increasingly popular for use on branch lines having a limited passenger traffic.

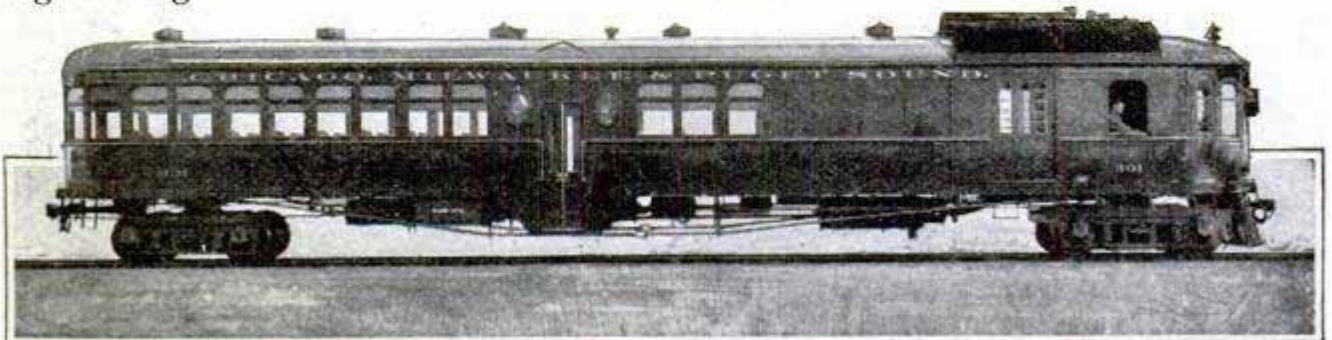

A Gas-Electric Car Which Ran 2,201 Miles on Steam-Train Schedule

Thomas screwing machine

Railroad motor

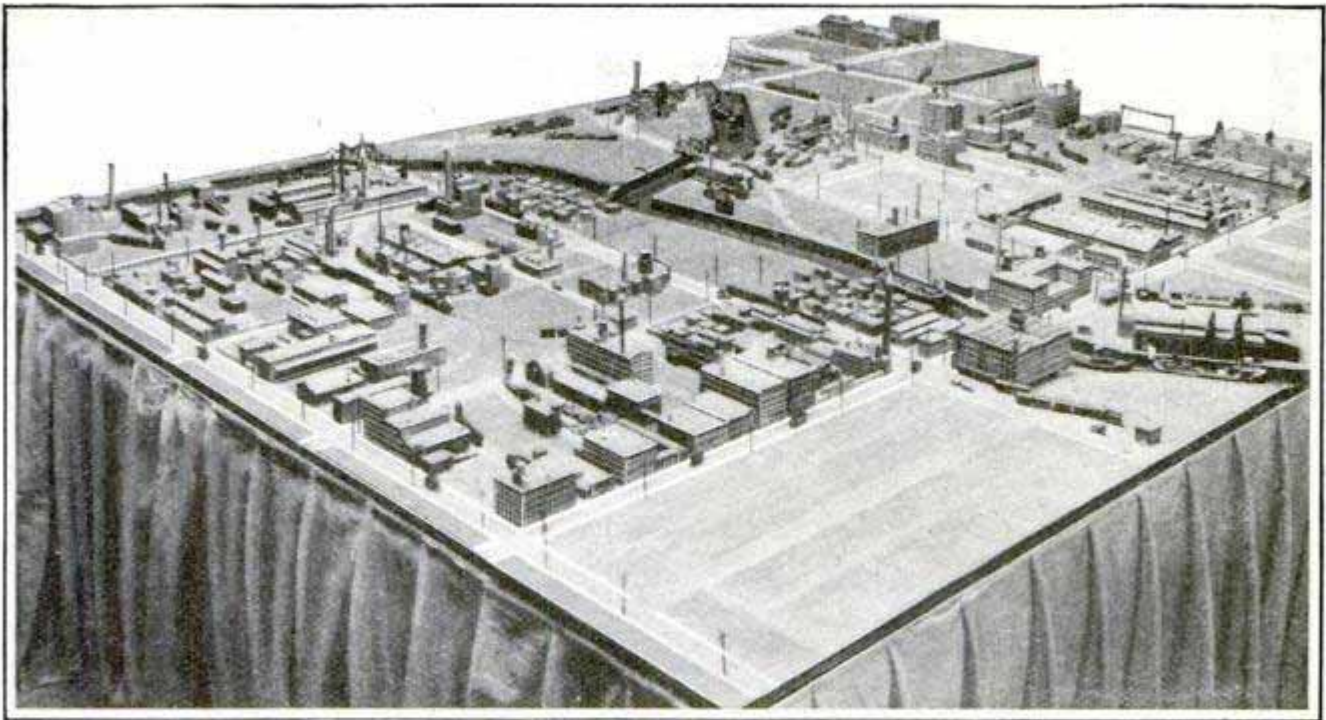

A Chicago Manufacturing District Shown in Miniature

LOCATING FACTORIES BY MEANS OF MODELS *3491*

A model, 15 ft. square, reproducing in miniature a Chicago manufacturing district comprising 300 acres of land, and showing the location of the factories so far erected, the course of the river, location of railroad tracks and arrangement of streets, has proved an excellent means of quickly convincing manufacturing concerns of the advantages and opportunities of the district. Every detail of the plants and railroad trackage and connections are reproduced in plaster, cement, wood and papier-maché. A number of freight trains are shown leaving and entering the district, and freight boats and tugs are shown in the river. The model is being exhibited at real estate and industrial expositions.

glassed-in frame containing this burner are hinged reflectors which may be set at any angle desired. For general camp illumination they are dropped down, but by raising them all to the required angle, a powerful volume of light can be thrown into the sky. This light will not penetrate as high as the

ILLUMINATION PROJECTORS OF THE FRENCH ARMY *944*

Illumination projectors of a simple and particularly effective type have been adopted by the French army. Kerosene oil, carried in the tank that forms part of the base of the light, is vaporized and fed to an incandescent mantle burner which gives as high as 4,000 cp. To the four sides of the

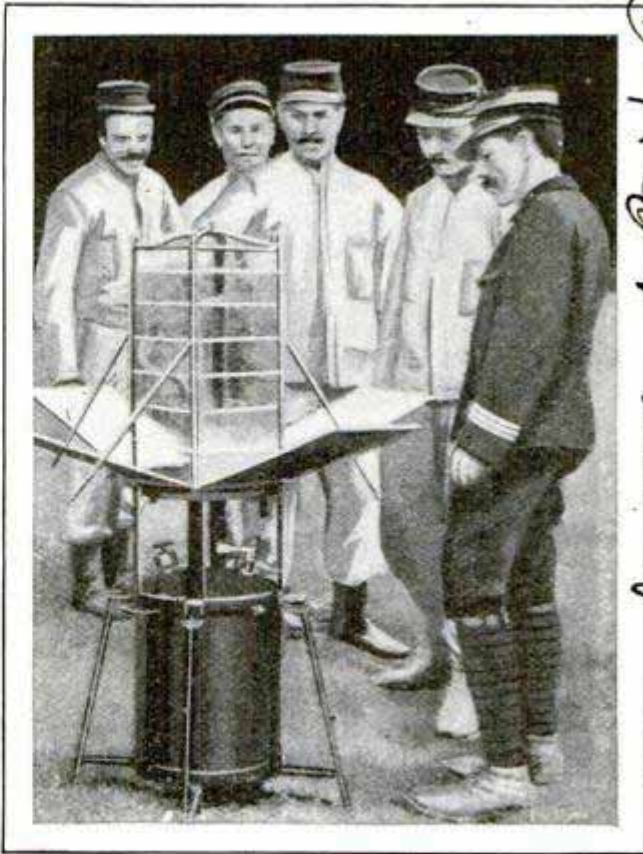

Apparatus for Throwing Light into the Sky

Lumière Kornfeld. Made by Société Française

46. Boulevard de Port Royal Paris, France

beam of a powerful searchlight, but, being much less confined, illuminates a far greater space.

FIR TREE AS WINDMILL TOWER

An illustration of a windmill in a tree was published in a recent issue of this magazine. This is another one,



Windmill Mounted on a Fir Tree

slightly different, located in Scappoose, Ore. The fir tree which serves as the tower was cut off at a height of about 60 ft. from the ground, a well was sunk at the foot of the tree, and a tank house was attached to the side of the trunk about 40 ft. above the ground.

¶ The microphone of a telephone transmitter becomes much more sensitive if the air surrounding it is rarefied, as by heating, and German inventors are working on a practical application of this discovery.

WHAT ELECTRIC DELIVERY COSTS PER TON-MILE ³³⁴⁸

The following table of the comparative cost of delivering merchandise by horses and motor trucks was compiled by an electric-truck manufacturer from observing the 1,500-lb. delivery service of a large department store, a two-ton service of general-merchandise delivery of parcels of medium size, and a five-ton service of large boxes of similar goods delivered over a wide area.

	1500 LB.		TWO TONS		FIVE TONS	
	Horses	Electric	Horses	Electric	Horses	Electric
Miles per day.....	17	30	16	30	12	24
Ton-miles per day	12.75	22.50	32	60	60	120
Cost per day....	\$6.00	\$6.00	\$6.37	\$8.50	\$9.10	\$11.00
Cost per mile... ..	0.35	0.20	0.52	0.28	0.76	0.45
Ton-mile cost.....	0.466	0.207	0.26	0.14	0.15	0.09

The figures given include all expenses, such as electricity at four cents for each kilowatt-hour; \$15 per week for chauffeurs' wages; 12½ per cent each year for depreciation and payment of 6 per cent interest on investment; also taxes, insurance, and the annual renewal of battery plates and tires.

HANDLING ORE IN ALASKA AT "FIFTY BELOW" ³⁶⁵⁹

The handling of ore at a temperature of 50 deg. below zero is a problem that would baffle most railroad and mining companies in the United States. In Alaska the problem has been solved by building ore cars with false bottoms under which pipes are laid through which steam is passed from a large boiler located at the ore bunkers. Throughout last winter ore was hauled daily from White Horse to Skagway in exceedingly low temperatures and, by the application of steam at the Skagway terminal, the ore was thawed so that no difficulty was experienced in dumping the cars.

Railway & Eng Review

A TWO-STORY SUBURBAN HOME

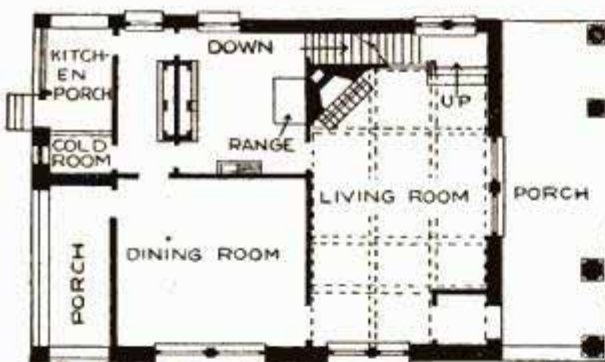
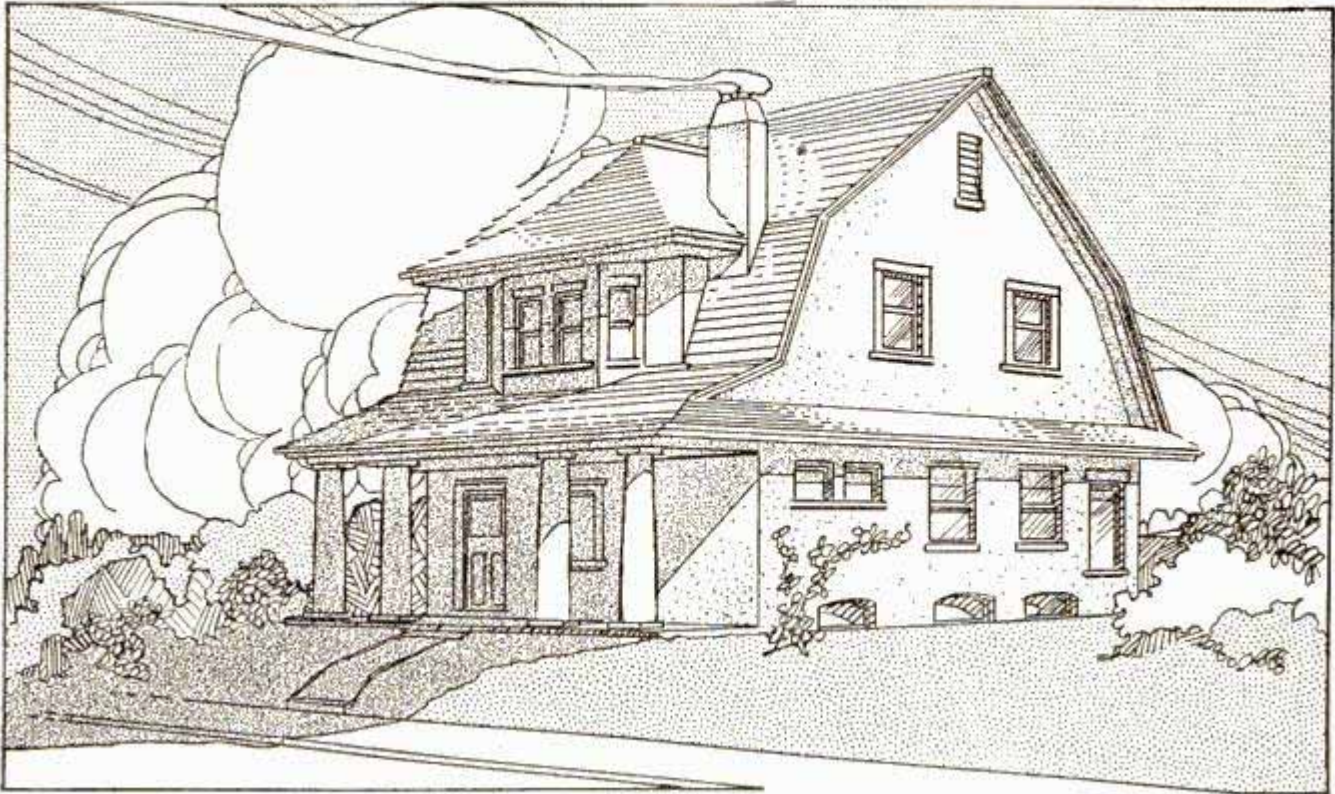

E. F. Lange, Philadelphia, Pa., Architect

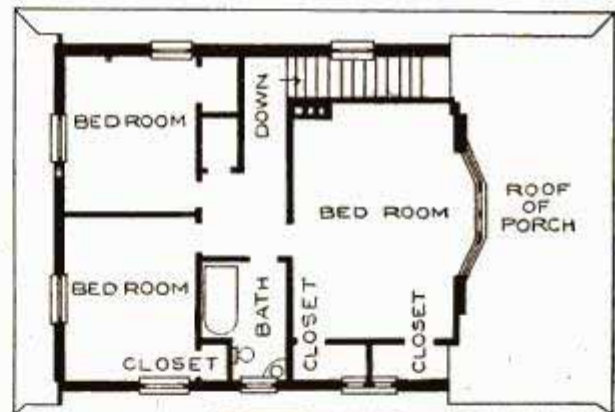

Floor Plans of House Suitable for Suburbs

The arrangement of the first floor of this two-story suburban home provides for a living room, 21 by 13 ft.; dining room, 14 by 13 ft.; kitchen, 11 by 9 ft. 6 in.; pantry cold room, closets, front porch, 8 ft. wide, extending along entire front of house; rear porch, 12 by 5 ft. 6 in., and a kitchen porch. The second floor has two bedrooms, each 12 by 11 ft. 6 in.; owner's front bedroom, 18 by 12 ft., with bay window; bath and five closets.

SPELLING BY ANALOGY

The controller of the central telegraph department of the post office of Great Britain has supplied to his subordinates an official list of words to be used in what has been called "spelling by analogy." It is employed in the room where telegrams sent by telephone are received, the idea being to give clearness when it is necessary to spell out a message, or any part of it,

over the wire. Here is the official list:

A for Apple	N for Nobody
B for Brother	O for Orange
C for Charlie	P for Peter
D for Dover	Q for Queen
E for Easter	R for Robert
F for Father	S for Sugar
G for George	T for Tommie
H for Harry	U for Uncle
I for India	V for Victoria
J for Jack	W for Wednesday
K for King	X for Xmas
L for London	Y for Yellow
M for Mother	Z for Zebra

It is not insisted on that patrons stick to the post-office alphabet.

ONE HUNDRED THOUSAND ACCIDENTS CLASSIFIED

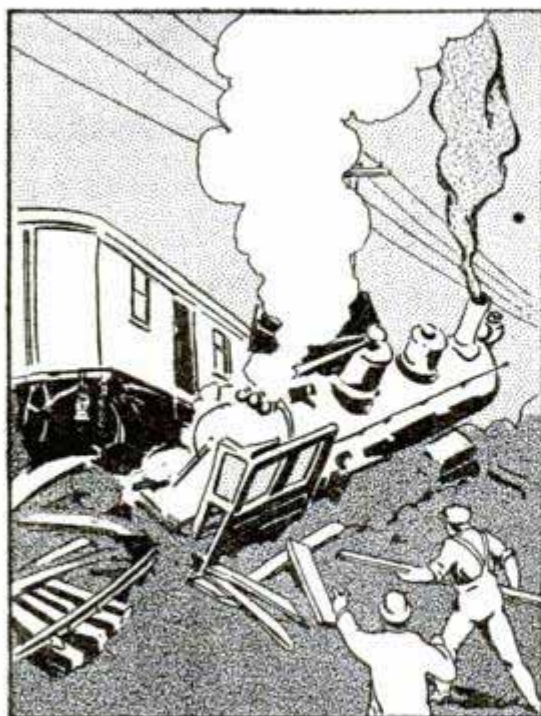

24,936 INJURED IN R.R. ACCIDENTS

Extremely interesting accident statistics have been compiled by the Chamber of Commerce of Rochester, N. Y., with results which may surprise many people. The classification is of 100,000 accidents on which several casualty insurance companies have paid out \$7,455-568. Heading the list, as might be expected, are the travel accidents, with a total of 29,726, of which 24,936 were railroad; 4,356 street-car, and 434, steamboat and steamship accidents. But the type of accident to come second—

that of falls—is surprisingly the total being 18,367, or more than 18 per cent. Of these, 8,222 were falls on the pavement, and 1,946 falls from chairs and ladders. Accidents having to do with carriages, wagons and horses come third, with a total

of 8,135, while the number of automobile accidents among this particular

100,000, was only 1,620, or about 1½ per cent.

It is likewise interesting to note that 209 of the accidents were caused

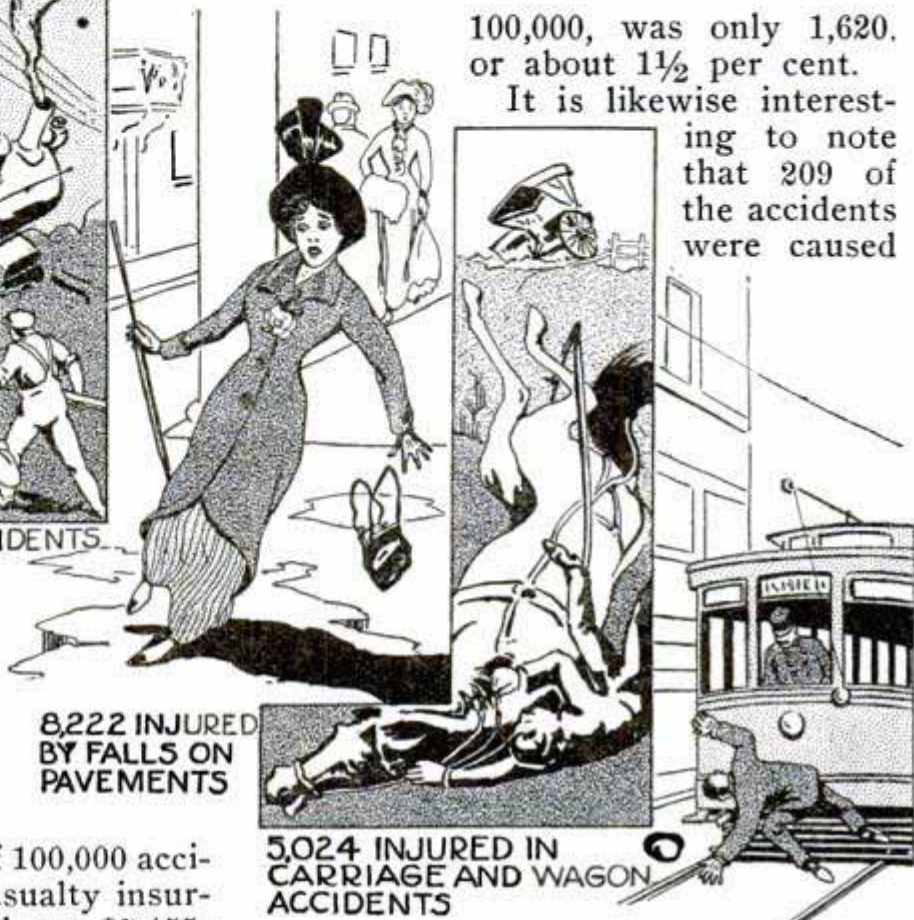

8,222 INJURED BY FALLS ON PAVEMENTS

5,024 INJURED IN CARRIAGE AND WAGON ACCIDENTS

4,356 INJURED IN STREET CAR ACCIDENTS

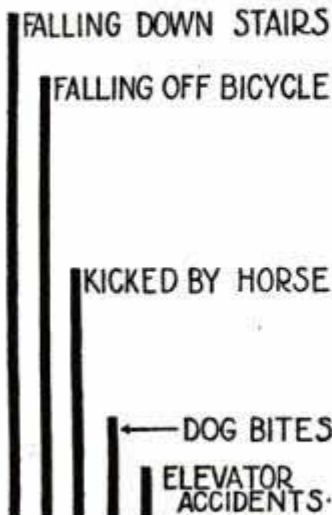

by tripping over door mats and rugs, that there were 4,217 cases of fingers crushed in various ways, 2,969 burns and scalds, 2,877 athletic accidents, 681 bathing or drowning accidents, but only 579 gunshot wounds.

In addition to the above, there were 4,678 persons cut with edged tools or glass; 2,781 injured by the falling of heavy articles; 2,771 bicycle accidents, which shows that bicycling is still extensive in America; 2,417 accidents while lifting heavy articles; 2,083 eye injuries; 1,895 cases of blood poisoning; 1,555 persons cut or bruised by machinery; 1,500 cases of feet being injured by stepping on nails or glass; 1,419 cases of toes crushed in various ways; 1,238 hands lacerated by hooks, nails or wire; 903 slips on rolling stones; 716 bites by dogs or insects; 483 cases of splinters in hands or feet; 385 accidents by contact with furni-

ture in houses; 394 assaults; 291 elevator accidents; 131 cases of fingers caught in electric fans, 96 motorboat and 4,884 miscellaneous accidents.

The same organization has compiled statistics from information furnished by an Eastern railroad, which dispels the popular impression that most of the persons killed while walking on railroad tracks are tramps and vagrants. Out of 964 accidents occurring to trespassers on the railroad right of way, 268 of those injured were laborers, 81 shopmen and mechanics, 44 farm hands 70 school children and students, 32 railroad employes, 8 sailors, 5 soldiers, 8 miners, 3 musicians, 1 teacher, 2 fisher-

men, 2 shoemakers, 4 horse dealers, 4 lumbermen, 3 watchmen, 2 messengers, 3 bakers, 1 contractor, 2 barbers, 3 nurserymen, 18 merchants, 3 cigar makers, 6 hotel men and bartenders, 2 coachmen, 3 linemen, 10 engineers, 4 clerks, 1 chemist, 19 persons of no occupation, 349 whose occupation was unknown, 1 minister, 1 actor and 1 escaped inmate of an insane asylum.



3328

Perogene

A NEW FUEL FOR AUTOMOBILES

A new fuel to be used in place of gasoline for internal-combustion engines is expected to make its appearance in England this summer, the plant for its manufacture now being under construc-

air compressor which sends a current of air through the agitator tank to keep the contents in constant motion. The gasoline, kerosene and benzol are each treated separately with a certain quantity of acid in this agitator, a dark, brown liquid resembling tar being extracted from the benzol, a yellow-white precipitate from the kerosene, and a highly refined gasoline from the gasoline. By the mixing together of the three, in certain proportions, a colorless liquid is obtained which is clean to the touch. The exhaust from it is almost odorless. In tests of this fuel



4,217 HAVE FINGERS CRUSHED IN VARIOUS WAYS



2,969 INJURIES FROM BURNS OR SCALDS

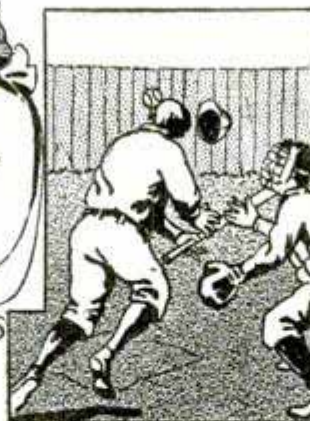

2,877 ACCIDENTS IN ATHLETIC SPORTS



run - 1946 INJURED IN FALLS FROM LADDERS OR CHAIRS. Carburetors do not have to be readjusted for its use.

no trouble was experienced in starting a cold engine or in

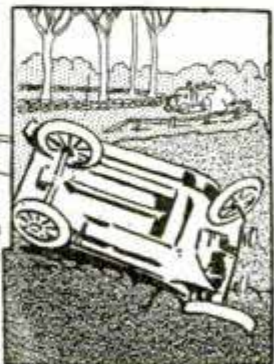

1,620 VICTIMS OF AUTOMOBILE ACCIDENTS

tion. The new fuel is made from gasoline, kerosene and benzol, is said to act in all respects like gasoline, has a good heat value and can be sold for from 25 to 30 per cent less than gasoline.

The experimental plant used in its manufacture comprises what is termed an "agitator," and various settling tanks. An electric motor operates an

PAINTERS' SCAFFOLDING FOR SHIPS

123
A scaffolding particularly designed for use in cleaning, painting, or repair-

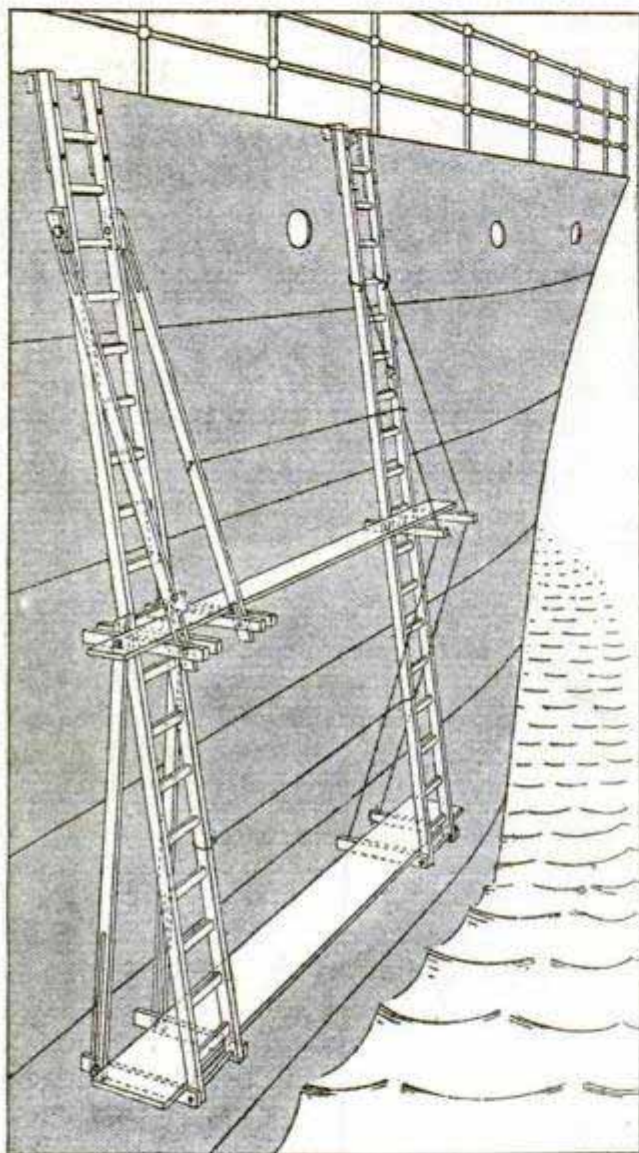

The Scaffolding as Used in Painting a Ship's Hull

ing the hulls of ships is here shown. When not in use it can be folded so as to occupy but little space. The stretchers connecting the struts with the ladder uprights may be rigid and have slotted connection, or may be composed of cable.

⌘The authorities of St. Paul's Cathedral, London, have protested against the proposed construction of a tramway tunnel beneath the churchyard of the cathedral, claiming that such would seriously weaken the eastern foundations of this famous structure.

STEEL-BLOCK TIRE FOR MOTOR CARS

325
A new type of tire for motor-car wheels that is made up of a series of steel blocks, similar to the rubber blocks in the ordinary block-tire construction and with the ends cut off at an angle to eliminate bumps at the intersections, has been placed on the market. The blocks are cast hollow and mounted on a thick rubber pad which covers the outer edge of the wheel, thus causing all shocks to be transmitted through the blocks to the rubber and absorbed. For the purpose of taking up slight shocks a pair of springs is also placed in the hollow of each block and arranged so as to operate against a plate that rests upon the rubber pad. The tire is held in position on the wheel by a pair of flanged rings bolted to the rim of the wheel.

SEEDING IN GEOMETRICAL DESIGNS

A new method of planting seeds has just been invented which is very interesting on account of the perfectly regular geometrical figures in which it will plant single seeds. Such a machine should be of great advantage to gardeners and particularly to florists. The special machine illustrated is designed to plant the seeds either in squares or in triangles, though it could easily be

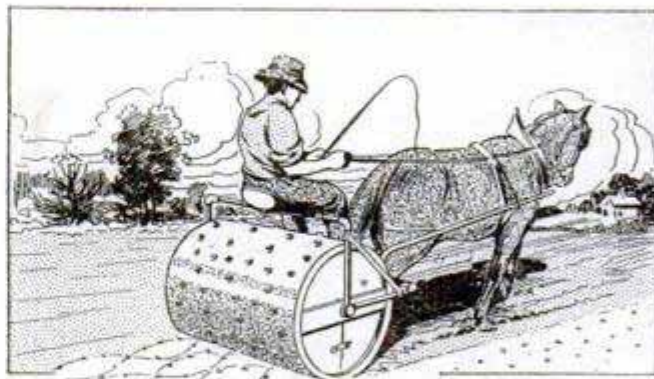

Seeding Machine Plants in Geometrical Figures

modified to plant them in circles, hexagons, rectangles, or any other desired forms.

Agents

The Daily Mail

Patented Steel Block Tire
St. Louis, Mo.

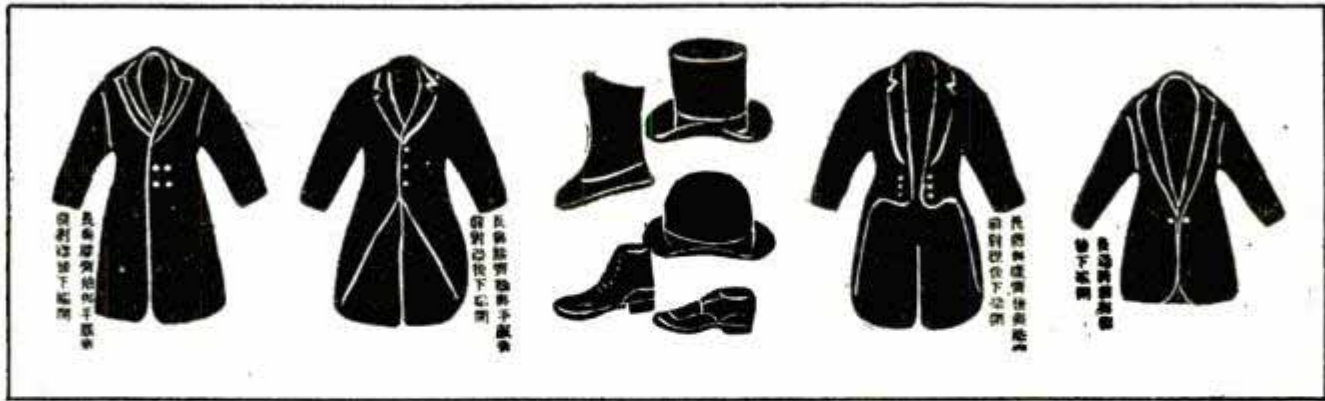

The Modern European Clothes Prescribed by the President of the Chinese Republic

THE CHINESE "MODERN-CLOTHES" EDICT 122

Here, graphically portrayed, is a part of the edict in which the President of the new Chinese Republic prescribed European dress and etiquette for Chinese officialdom. Coats, hats and shoes for morning, afternoon and evening wear are shown, the illustrations representing the Chinese idea of fashionable European costume for men.

STEEL SLEEPING CARS WELL VENTILATED 3463.

Travelers notice the absence of upper windows and decks in the rounded roofs of some modern steel sleeping cars. Recent tests show these contain more and purer air than the wooden type. The average supply of air for 36 steel cars was 53,000 cu. ft. an hour. The cars were entirely closed. The wooden cars with upper windows averaged 40,600 cu. ft. per hour. The carbon dioxide per 10,000 air volumes was only 7.32 volumes for the steel, but 15.90 for the wooden cars.

UTILIZING WASTE WOOD FOR BOXES 115

A machine which takes the cut-off ends and edgings that are usually sold for kindling wood by woodworking plants and shapes it into boards available for boxes, cores for all kinds of veneered and cloth-covered products, and the like, is being marketed by a Canadian concern. The machine does the work of jointing, gluing and unit-

ing automatically, the procedure being as follows:

Two waste boards of random widths are fed into opposite ends of the machine. In one operation the dovetail is cut, the glue spread and the pieces forced together, making a completed joint. Then this piece is passed back through the machine and another board is jointed to it, the operation being repeated until a panel several inches wider than the desired width is obtained. The operator then rips it to size and the edging is returned to the machine to be jointed up to another piece.

The cost of making wide boards out of these narrow strips varies from 50 cents to \$1.25 per thousand board feet, according to the different conditions. The box manufacturer using such a machine can buy waste lumber from mills and convert it into one-piece

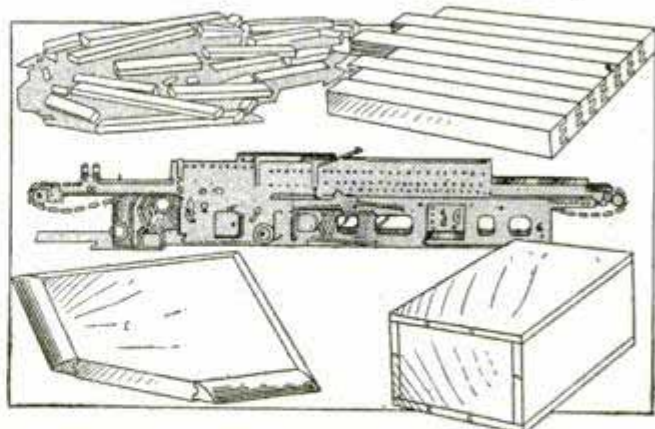

The Machine that Converts Mill Waste into Usable Boards, and Examples of Its Work

ends, sides, tops and bottoms. The cheaper product thus obtained is claimed to be far superior to the ordinary box.

Shanghai Ishee Jinner

Carriage of logs

A Muskegon Dick

CAMPANILE STATUE NOW UPON BALL BEARINGS

1161

The imposing copper statue, which stood upon the top of the famous Campanile of St. Marks in Venice before that structure collapsed in 1902, has been restored to its original position upon the reconstructed church tower by providing the image with an interior vertical shaft. By means of ball-bearing devices at the top of the shaft and between the pedestal and the figure the latter is enabled to turn freely in any direction and better withstand the pressure of high winds, and shocks arising from earthquakes.

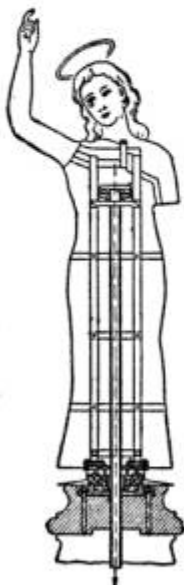

The shaft is also provided with a counterweight of 2,800 lb., the purpose of which is to bring the center of gravity of the whole below the pedestal.

RUBBER-CAPPED AUTO-HORN BULB

615

An automobile-horn bulb, the lower portion of which is in the form of a metal funnel, surmounted by a seamless rubber cap, is being marketed by a London concern. When one cap wears out, another may be substituted in its place by simply unscrewing the band clip.

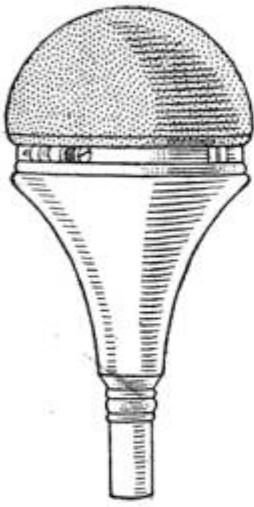

The Woman's National Fire Prevention Association was incorporated in New York recently. The purpose of the organization is to encourage the housewives to avoid fire hazards by awarding prizes to those who keep clean, rubbishless homes.

GASOLINE AND KEROSENE AS MOTOR FUEL

An automobile owner uses gasoline and kerosene for his motor by pouring these liquids in proportions of 5 gal. of the former to 1 gal. of kerosene into the same tank and allowing them to mix. The car which has been using this fuel was run a distance of more than 3,000 miles and its motor was apparently as clean after this test as before the fuel mixture was tried.

SAFETY EGG HOLDER MADE FROM PAPER

7233

This egg holder is made from corrugated strawboard, the egg being inserted by opening an overlapping joint at the side. The container is provided with a small hole at each end so that it may be opened and closed without tearing it. The holder is adapted for sending eggs safely by parcel post, or carrying them with the least possibility of breakage.

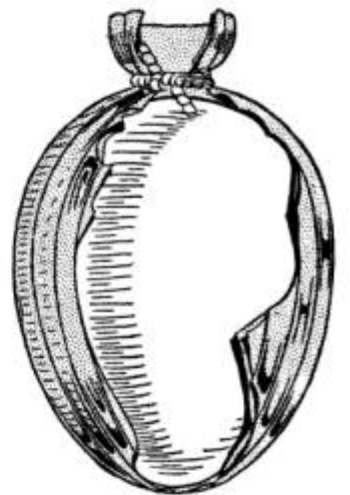

A DUTCH ADVICE-GIVING INSTITUTION

An organization, called the Central Bureau of Social Advice, has been established in Amsterdam, Holland, for the purpose of giving free to regular subscribers, mostly workmen, information regarding various subjects which usually only could be obtained at considerable trouble or expense by the subscribers themselves. The organization, which was suggested by the evident need of workmen for some place where they could go for reliable advice, has three definite objects, as follows: to supply information con-

Central Bureau of Social Advice

cerning institutions and regulations in the interest of workmen; to collect and assort data for that purpose, and to collect material for a library. Information is given not only to subscribers, but to all others who ask for it, and a fee is demanded unless the inquirer is without means to pay. The director of the institution is a doctor of laws; the general management is under the control of a committee of nine persons elected by the subscribers, and the majority of all religious and political parties are represented in the committee, so as to secure impartial action. The sources of information include a special committee that collects all documents relating to the history of workmen's societies in the Netherlands. The bureau's library already contains about 13,000 volumes and over 800 periodicals, many of the latter being from foreign countries. The bureau also selects appropriate clippings from the newspapers and catalogs them for reference by patrons who may be pursuing special subjects. In addition to constant requests from subscribers the bureau has also received requests from other private individuals, industrial concerns, insurance companies, employers' associations, labor bureaus, and foreign governments.

The advice-giving institution began business with about 150 members and this number has since increased to about 700. The permanent members are each required to pay two dollars a year, or a sum not less than \$40 at one time, and special rates are given to workmen's societies, the rates being about 40 cents for each 100 members. The total number of subscriptions at this time amount to about \$2,000, while the state gives \$1,400 annually, and several towns an aggregate sum of about \$800.

THE "LIFTING ARM" OF THE PANAMA EXPOSITION

One of the most prominent or "looming" amusement features of the Panama-Pacific Exposition is to be the "aeroscope" shown in the accompanying illustration. Cradled in a standard 50 ft. high is a long arm, in the end of which is hung a car large enough to accommodate 100 persons. This arm is 240 ft. in length, 40 ft. of which is the counterbalance. During the time the arm is slowly rising, the

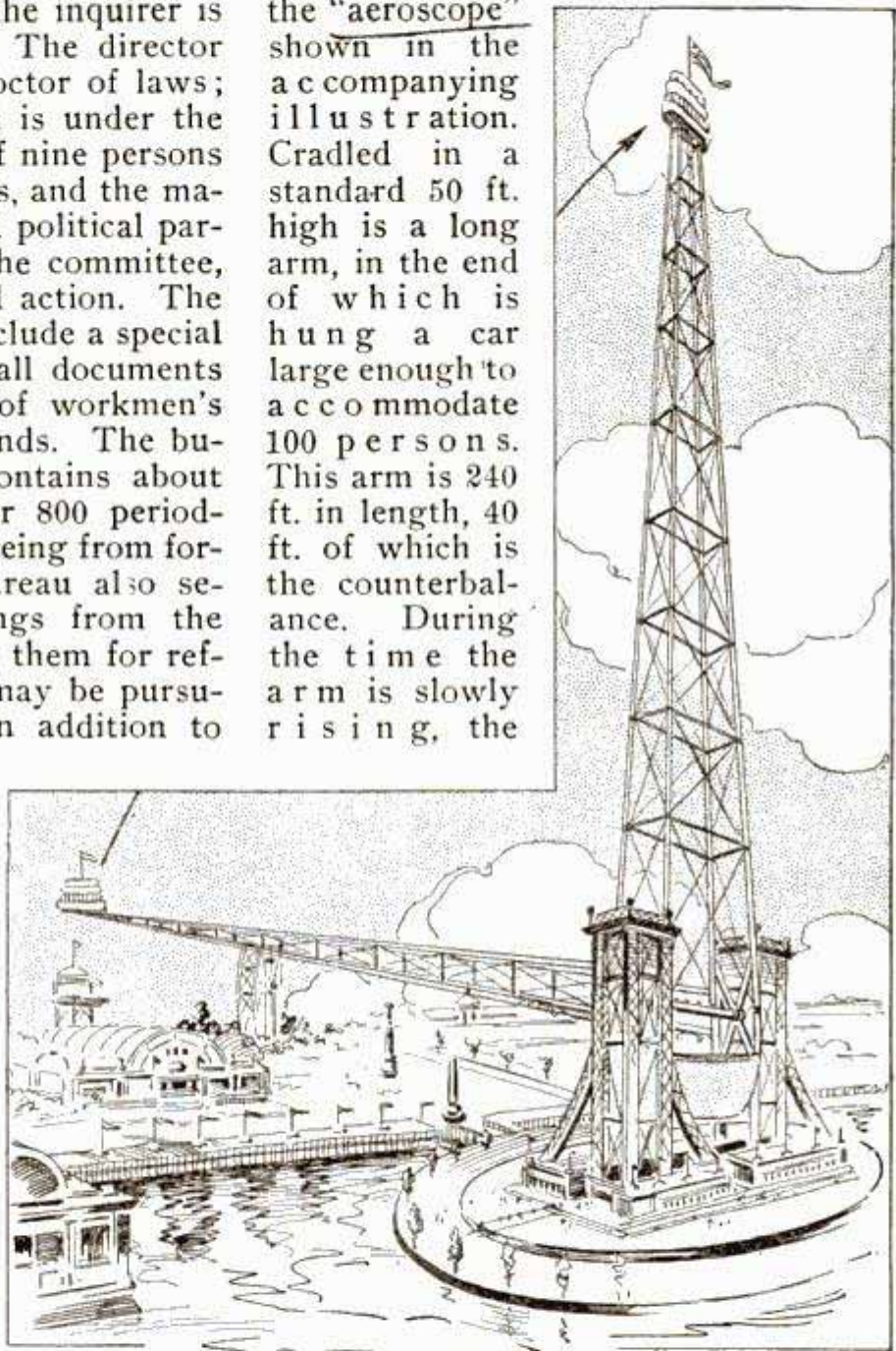

This "Lifting Arm" will be One of the Amusement Features of the Panama-Pacific Exposition

standard, which rests on a circular rack on a concrete foundation, is revolved, affording the passengers a view of the grounds in every direction.

A frozen solution of salt, called "minus ice," is being used in Russia for preserving perishable articles in transit.

3427

PRACTICAL AND NOVEL DEVICES OF MANY VARIETIES

One of the latest novelties for woman's use is an interchangeable toothbrush, to the handle of which a new brush may be attached when the bristles become worn, instead of throwing a way the handle. The brushes are attached by simply pressing



An Interchangeable Toothbrush

them firmly into the space provided for their insertion.

A new type of tumbler has a bulge near the top that prevents the edge of the glass from breaking or chipping when the tumbler is upset, or a number of them are grouped closely



The Bulging Ring Prevents Chipping

together. The bulge also affords a firm grip when removing the glass in one hand from the table, and there-



A Wrist Watch of Odd Design

fore materially lessens the danger of breakage from dropping.

A progressive jeweler of Germany is catering to the craze for wrist watches by originating a number of new designs, an elongated octagon being one of the most popular. The wristband of this distinctive type is made to order

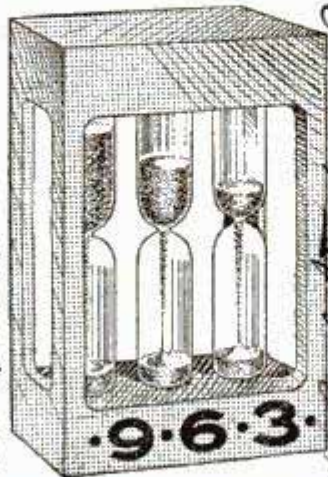

Hourglasses for Measuring Phone Talk

from either metal, leather, fabric, or any other suitable material.

A Dustpan That Saves the Back

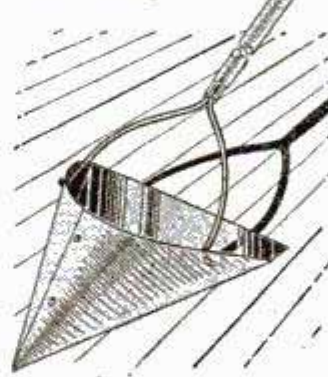

booths, for the purpose of indicating the exact length of a conversation. The sand runs to the bottom of the glasses in three, six and nine minutes, respectively.

A long handle is attached to a new dustpan in such a manner

Although the hourglass is supposed to be no longer used for measuring time, a French telephone company has installed a device consisting of three hourglasses in its public telephone

A Reversible Oil Mop



that the user does not have to stoop over when collecting the sweepings from the floor, and the contents cannot fall out when the pan is raised. The pan is made



Safety Handle for Handbags

of steel and the handle of wood.

An oil mop that absorbs dust without scattering it is so constructed that, by simply removing the handle and reversing the mop, one can turn a clean side out and have practically a fresh mop. The handle



"Next Dose" Medicine Indicator

non-clear
Lennie 73
24 Rue Chausse
Paris

Stocking to
Dresden
Germany

about pick up

No address
see text

Garner MA
15 Louis
Mo.

43 Boul. Strasbourg Paris

THE LATEST APPLICATIONS OF INVENTIVE INGENUITY

of the mop is released by pulling up a small lever.

A "handcuff" safety handle for women's hand-bags hitches the wearer to her valuables, gives her the free use of both hands, prevents the bag from being lost and assists in



Toaster That Can't Burn the Fingers

thwarting purse snatchers. The handle is adjustable to any bag.

A very handy device for the sick-room is an indicator show-



Sewing Clamp and Skirt Gauge

ing when the next dose of medicine should be taken. The dial is mounted upon a wire attaching to the cork of the bottle so that the indicator is always in sight.

An improved bread toaster is operated by the thumb, and the bread is held by spring pressure until released.



Clothes Drier That Hangs from Ceiling

steaming, etc., and leaves both hands free to work with. The device is made of nickel-plated steel and may be carried in the purse or handbag.

A novel wooden clothes drier is attached by a rope to a hook in the ceiling on the porch or in the house. After the clothes are



Easily Repaired Poultry Fountain

hung on the arms the drier is drawn up to the ceiling by the rope and let down the same way. The device folds close like an umbrella when not in use and holds a



Stem Cut-Off for Alarm Clocks

good-sized washing or ironing.

A safety window-cleaning seat for women makes window cleaning safe and easy work, as the seat is quickly and securely attached to any ordinary window sill and cannot be detached until the weight of the body has been removed.

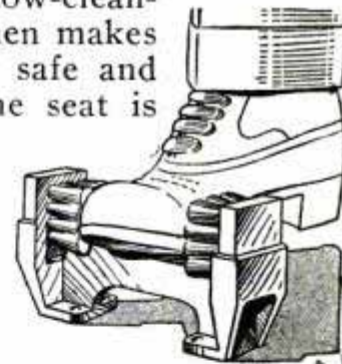

Shoe Scraper That Cleans Thoroughly

A drinking-fountain pan for supplying fresh, clean water to fowls and small animals consists of a steel pan in the center of which is



Safety Seat for Window Cleaning

The device has no sliding rings to burn the fingers, like the old-style toasters, and the handle is made of wood.

A new sewing clamp and skirt gauge holds the material while sewing, mending,



Electric Flatiron That will Not Overheat

fastened the cover of an ordinary Mason fruit jar, to which may be screwed a glass jar filled with water, the whole being then inverted. The advantage of this watering device

is that broken jars may be readily and cheaply replaced.

*Boston Iron Works
20 River St
Mass*

A new type of alarm clock has a knob mounted on a stem, like the knob of a stem-winding watch. When it is desired that the alarm shall ring, the knob is pulled out, and pressing it in again shuts off the sound.

A novel shoe cleaner has not only a scraper bar for the sole of the shoe, but stiff brushes so mounted that they

wipe the mud off the edges and the sides of the uppers at the same time.

Trouble caused by electric flatirons overheating is averted in a new type by an electrothermostat which operates to turn off the current when the desired temperature has been reached. It can be set for different temperatures.

HENRY FARMAN'S NEW HYDRO-AEROPLANE

The boat portion of Henry Farman's latest hydro-aeroplane has probably more the appearance of an ordinary

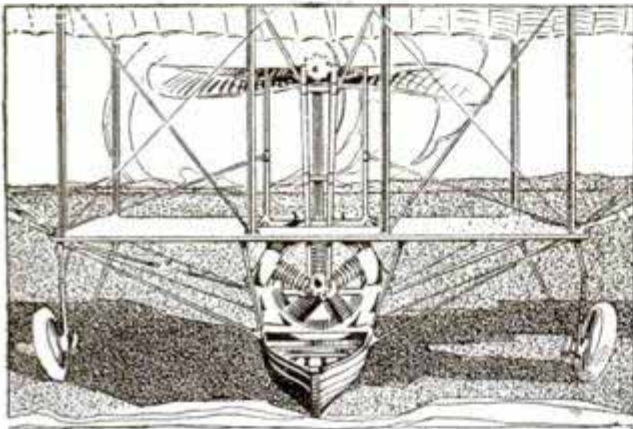

The Pontoon or Float of the New Farman Hydro-Aeroplane is Shaped Exactly Like an Ordinary Boat

water craft of the skiff or rowboat type than do the boat portions of other hydro-aeroplanes. Some of the hulls adopted resemble more or less those of motorboats of the hydroplane order, to be sure, but would create a queer impression if seen floating in the water with the aeroplane upper works removed, while the hull of the Farman machine might easily pass as an ordinary boat.

THE VELOCITY OF THE GULF STREAM

The Gulf Stream, which courses along the northern coast of South America, through the Caribbean Sea, into and around the Gulf of Mexico, emerges into the Atlantic Ocean between Key West and Cuba. When it passes the Peninsula of Yucatan into the Gulf of Mexico, its velocity is one-

fourth of a mile per hour, its width 90 miles, and its depth about 6,000 ft. It passes into the Atlantic at Key West at a speed of from four to five miles an hour, this high velocity being due to its crowding through a narrow and shallow channel. The width of the stream at this point is 50 miles and its depth but 2,100 ft. As it passes through the North Atlantic its velocity decreases rapidly, and off the banks of Newfoundland is less than half what it was when it passed the Straits of Florida.

It is estimated that the Gulf Stream carries daily along the Florida coast the enormous quantity of 436,000,000,000,000 tons of water.

SANITARY FACE SHIELD FOR MOTORISTS

The interesting feature of this guard for the upper part of the motorist's face is the silk gauze, which protects the passages of the nose from inhalation of the particles of dust afloat in the air. The shield, which is light and flexible, folds up and is carried in a leather case when not in use.



The total production of wild and plantation rubber throughout the world in the 12 months ending June 30, 1912, amounted to 93,669 tons, as compared with 79,026 tons in 1909-10.

benome engine.

safe naval machinery.

see see 13

LAMP REFLECTOR THAT KILLS GLARE ON ROAD

A new type of searchlight for automobiles which by an ingenious use of two reflectors can be made either to throw a strong and sharply defined light straight forward only, or to illuminate all the ground in front and to the sides with a soft glareless light, that will not dazzle the driver of an approaching vehicle, has been designed by a foreign inventor. The two reflectors, which are of unequal size, are normally placed one on either side of the lamp, in which case, as shown in the diagram, a strong light of practically parallel rays that illuminates only the road straight ahead is produced. When, on the other hand, it is desired

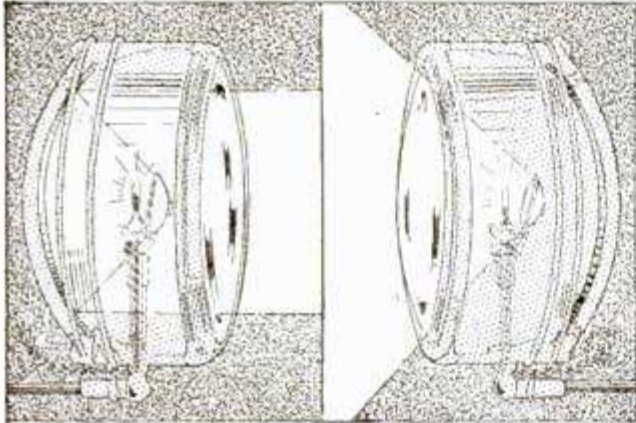

Reflectors Adjusted to Throw Rays over Road Just Ahead of Vehicle

Reflectors Arranged to Diffuse Rays of Light over a Large Area

to light the sides of the road, as at a turn, or to soften the glare of the lamp, the smaller reflector is swung around to a position back of the lamp, by means of a wire connected to the driver's seat, where it cuts off all the light from the large reflector and sends it in diverging rays over a large area in front and to the sides of the vehicle. Different effects may be obtained by having the axes of the reflectors parallel or slightly converging, thus causing the rays to overlap and throw a very strong light into the middle of the road.

Two dredges with dipper handles, 62 ft. long, are cutting the entrance channel to the Panama Canal on the Atlantic side.

SCENT BALLS PATTERNED ON CARDINAL'S ORANGE

The scent ball here shown was designed to perpetuate the charming idea originated by Cardinal Wolsey, who

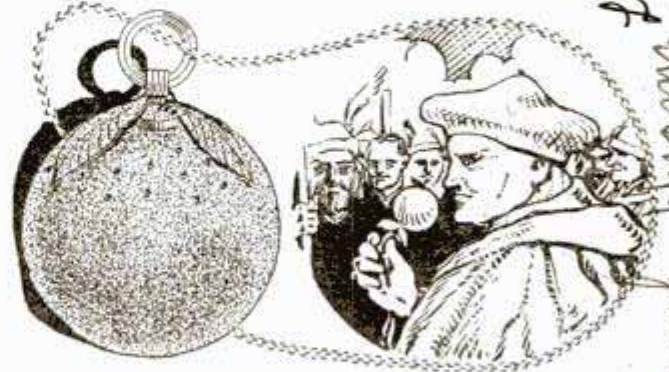

The Cardinal's Orange as a Scent Ball

whenever he was in a crowd or pestered with suitors, "most commonly held to his nose a very fair orange, whereof the meat or substance within was taken out and filled up again with the part of a sponge, wherein was vinegar and other confections against the pestilent air."

In this scent ball the perfume is allowed to escape or remain inclosed by simply turning the upper part.

ARROW HAND FOR ENGINE BOILER GAUGE

In order to make the indications of a sight gauge on the boiler of a stationary engine easily readable at a distance, a German firm has combined with

such a gauge, a lever-operated arrowlike hand which automatically follows the rise and fall of the water in the glass tube. This index is painted black and moves in front of a white-enameled plate attached to the gauge. It is operated by a float which actuates the lever mechanism.

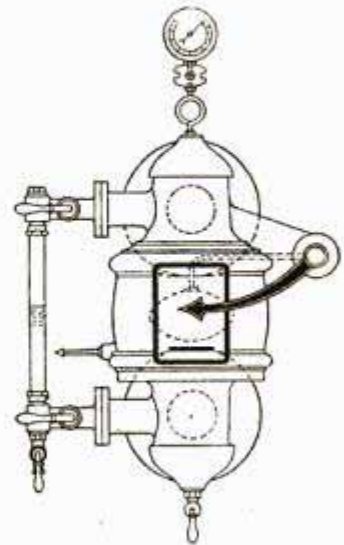

German

1010

89

Frank Hyam, Esq. 128, Red Bank W. Lond.

SANITARY HOLDER FOR PAINTBRUSHES

3242 To keep paintbrushes in good condition during the time they are not in use, particularly when the brushes in

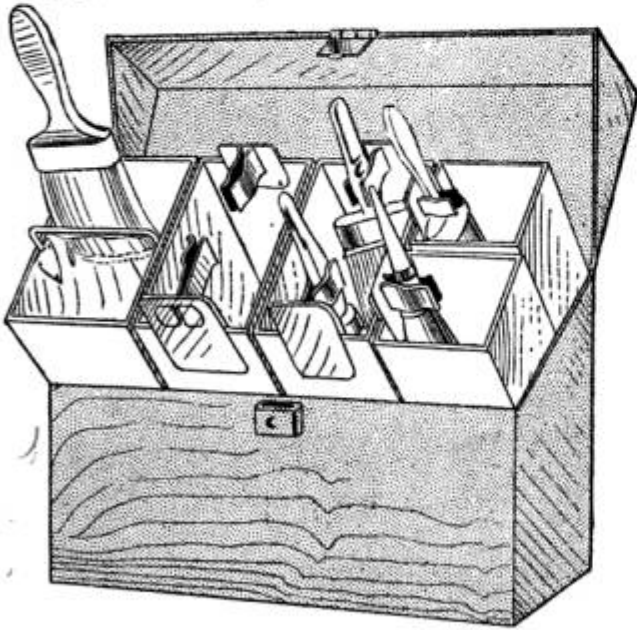

For the Proper Keeping of Fine Paintbrushes

question are to be used in fine interior decoration work, is not a simple task, but one which is aided materially by such a brush keeper as is here shown. The five metal containers in this box make it possible to keep brushes used in different paints and varnishes separate, and the clips keep the brushes from coming in contact with the bottom and sides of the retainers.

A NEW POWER UNIT

3331 SUGGESTED

The adoption of a new power unit, called the "myriawatt" and intended to take the place of the unit "boiler horsepower," has been recommended in a report submitted by a committee of the American Society of Mechanical Engineers and the American Institute of Electrical Engineers. The new unit is suggested as a simple and satisfactory method of rating the energy input of power-generating machinery in terms of the watt, the international power unit. By adopting the myriawatt as an input unit and stating the output in kilowatts, the efficiency of

the power plant is easily calculated. The report also recommends that the terms myriawatt and myriawatt-hour be abbreviated to mw. and mw.-hr. in writing.

TRICKS OF COAL DEALERS TO GIVE SHORT WEIGHT

3407 The New York State superintendent of weights and measures recently unearthed a tricky practice indulged in by some unscrupulous coal dealers to defraud their customers. The practice is to place a number of bags of coal on top of a bulk load and after obtaining the ticket required by law, indicating that the load is full weight, to deliver only the bulk load unless an inspector happens to be in the vicinity, when the extra bags are also delivered. Another fraud discovered in New York is perpetrated by placing a small partition under the seat of the wagon so that a few hundred pounds of coal in the front of the wagon will not be discharged when the body is tilted for dumping.

NEW SUBSTITUTE FOR TURNBUCKLE

A wire stretcher to be used in fastening guy ropes, and the like, and which for certain purposes may advantageously replace the turnbuckle, is shown herewith. It is made in one piece, of forged iron. The wedge, which holds the wire in the slotted slide, has grooved edges so that the wire cannot be cut or damaged, though at the same time it is held without possibility of slipping.



¶ An explosive fire-alarm device, in the form of a sealed can containing an explosive substance which will ignite through a fuse and give an explosive alarm when the fuse is heated to a certain temperature, has just been invented and patented.

Dr. A. Rechin
Retard Coalman
Feb. 1913

SCREENLESS AIR CLEANERS

3281
81-0

An air cleaner which is not a sieve, containing no screens to become clogged, is shown in the accompanying drawing. A sheet of oil is the purifier, catching the dirt particles as the air is passed over it. The dirty air enters a horizontal tube in the cleaner through the pipe shown at the left. In the bottom of this tube is a long, narrow slot through which the air is discharged against the oil which fills the bottom of the cleaner. The oil is not blown aside by the air, but is simply agitated sufficiently to cause the particles of dirt taken from the air to sink to the bottom of the tank, constantly exposing a clean surface of oil

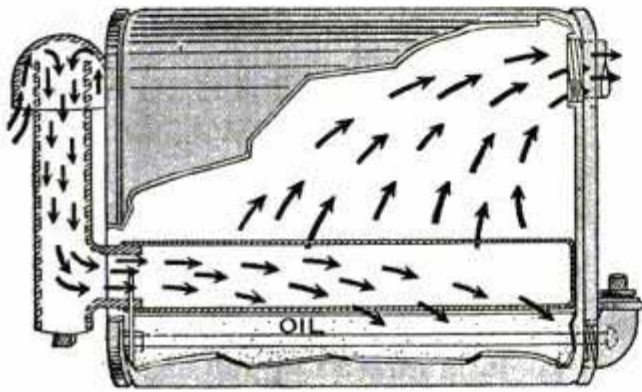

Air Cleaned by Contact with Oil

to the entering air. The air, thus robbed of its dirt particles by contact with the oil, then rises into what is called the expansion chamber of the cleaner and passes through a pipe to the carburetor, air compressor, or other device requiring pure air.

This air cleaner is being used in connection with automobile carburetors, and air-brake compressors on railroad locomotives and electric cars.

**INGENIOUS HOMEMADE
ENDLESS CONVEYOR 921**

The owner of a home in Portland, Ore., having a high, terraced lawn, constructed an ingenious endless carrier for the delivery of wood from the street to the basement of the house. The conveyor is driven by a 3-hp. gasoline engine. Besides saving the lawn

M. A. Brickwell

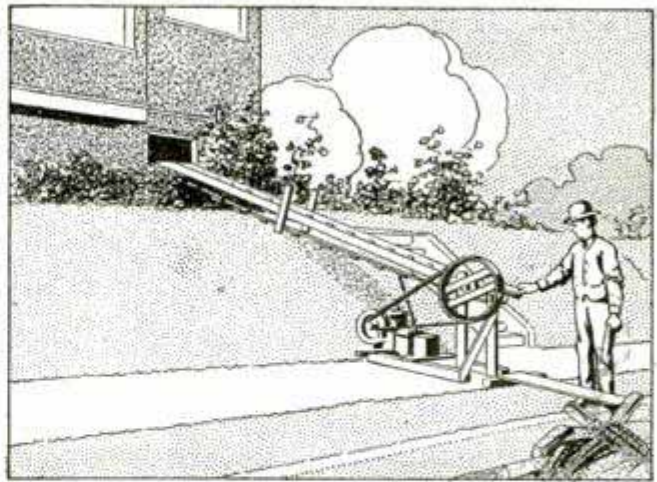

A Gasoline-Driven Conveyor Rigged Up to Handle Wood from the Street to the Basement

and terrace from being trampled and torn up, the conveyor enables him to store away 16 cords of wood in the time it previously took to handle eight cords.

**FOLDING LAVATORY FOR
614. AUTOMOBILES**

A complete lavatory equipment for automobiles of the limousine type, which, when folded out of the way, takes up but little space, has been placed on the market recently. When opened, it provides a washbasin, with running water, and has a compartment for combs, brushes, and the like, and a shelf for towels. The hinged panel of the towel compartment, which is swung upward when the lavatory is in use, has a mirror on its inner side.

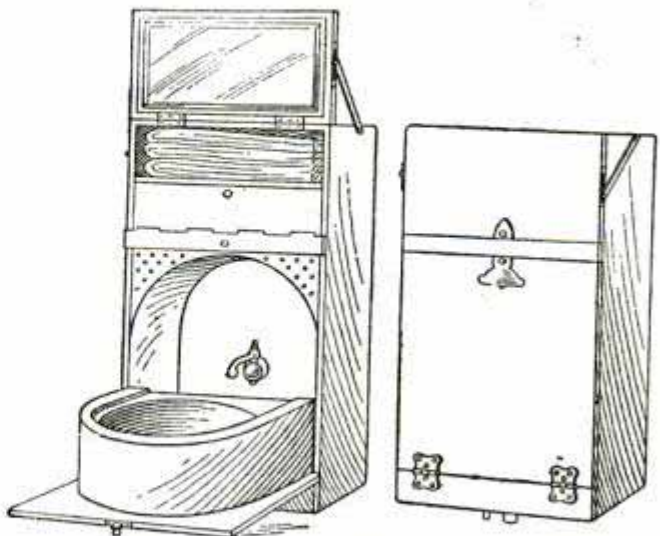

An Ingenious Folding Lavatory for Automobiles

The water for the lavatory is carried in a tank on the top of the car.

M. A. Brickwell

BALL-BEARING SCREWBOLTS AND NUTS

A new application of ball bearings has been brought out recently by a

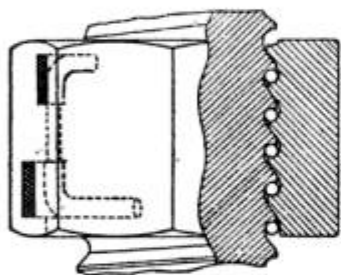

Parisian firm of machinists. As shown in the sketch small steel balls are laid in between those surfaces of the screw and nut which are

not in contact, but if it is desired to work the screw in both directions, both sides of the thread have balls. The nut is provided with a channel, into which the balls fall before they reach the upper side of the nut, being thus conveyed to its lowest thread and insuring that the surfaces of the threads not in contact are constantly provided with balls.

It is, of course, necessary to have means of securely fastening the nut, since the small amount of friction in the threads would otherwise allow it to become loosened easily. For bolts of larger dimensions and subjected to great strains this innovation is expected to prove valuable, while for lighter work and smaller sizes the naturally higher price would preclude their use.

FROM THE UPPER AMAZON TO THE PACIFIC BY RAIL

5329

A tremendous railroad undertaking, the final link to connect the headwaters of the Amazon with the Pacific Ocean, making it possible for shipments of rubber, hard woods and hundreds of tropical products from the Upper Amazon region to reach the United States by way of the port of Callao and the Panama Canal, has been commenced in Peru. The length of this link, which is known as the Amazon-Pacific, is only 250 miles, but, with its eastern end at the river port of Pucallpa, it will climb the eastern slope of the Andes, to connect with the wonderful Oroya railway, which climbs the west-

ern slope and reaches the greatest height known to railroading. The lines of the Oroya railroad reach the summit of the mountains, but then extend north and south, no attempts having been made to descend the eastern slopes.

Steamers of 2,000-ton burden will ply between Pucallpa and Iquitos, a Peruvian city of great commercial importance 2,000 miles from the mouth of the Amazon, to which ocean steamers are already running regularly. To Peru, the new railroad will mean the exchange of eastern and western products within three or four days' time instead of six months. It is expected that the road will be completed by the time the Panama Canal is officially opened.

NEW IGNITER THROWS SPARKS OUTWARD

927

This new form of igniter throws the spark directly outward from the end.

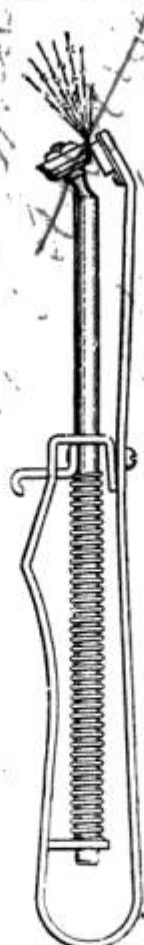

A loose ring of sharpened steel, mounted upon the end of the spring-encircled rod, is driven against the ignition block when the spring is released, projecting the stream of sparks forward. The steel striker, being loosely mounted, is turned slightly with each operation, and therefore the wear is distributed around its entire edge.

YEAR RINGS IN A LEAD PIPE

An underground lead water pipe, which presented a very peculiar form of corrosion was encountered recently during repair work on the water system in a German city. The wall of the pipe was corroded for about four-fifths of its thickness, and the attacked part was found to consist of 48 alternate layers, red and yellow, of two dif-

Yucayali R.R.

Mr. G. S. Andrews
Mechanical

ferent combinations of oxygen and lead. This, together with the fact that the pipe had been underground for 24 years, led scientists to presume that two layers had been formed each year, one during the warm and another during the cold season.

Of practical interest is that the corroded part of the pipe had been imbedded in cement and that the remaining part, without such protection, was found in sound condition. This would naturally suggest that, when pipe is laid in cement, precautions should be taken to prevent moisture from collecting between the pipe and the cement, such, for instance, as some kind of moisture-proof insulation.

STREAMLINE FUEL TANKS FOR AEROPLANES 785

Streamline fuel and lubricating-oil tanks for aeroplanes, made of aluminum or brass, soldered, clinched and welded, were shown at a recent aeroplane exhibit. These tanks are made with lips at each end for attachment to the framework of the aeroplane. They



A Seamless, Streamline Fuel Tank

are likewise provided with special caps which are said to make them proof against danger of explosion.

RAILROAD ADOPTS STANDARD BRAKE CLUB 618

The use of a brake club, which is the name given any stout stick used as a lever in setting the hand brakes on freight cars, was formerly forbidden, because brakemen frequently became too enthusiastic in its use, and would set a brake so tight that the wheels would slide, a procedure which soon ruined the wheels.

With the steadily increasing use of heavy cars, however, the freight brake-

man has found the brake club increasingly necessary, and the Pennsylvania Railroad is now furnishing its brake-

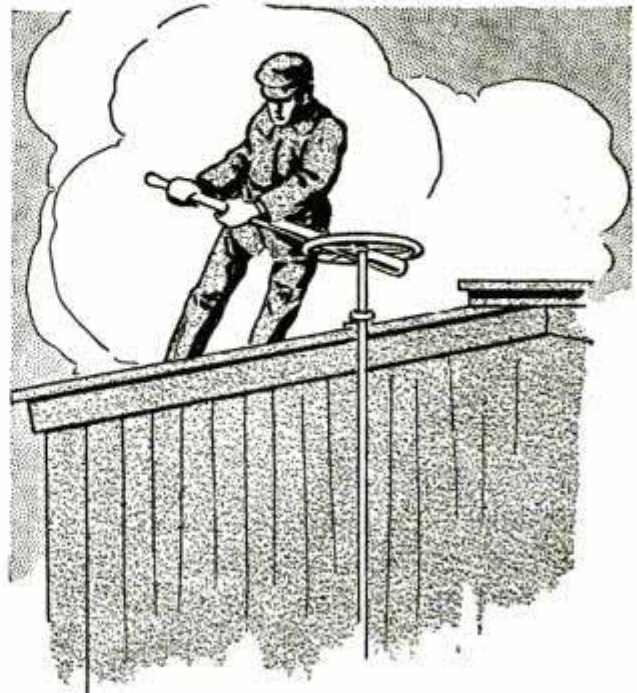

Flawless, Split-Hickory Brake Clubs

men with standard clubs, 28 in. in length, very similar to baseball bats and made of selected, straight-grained, split hickory, entirely free from knots, splits, and like imperfections. The use of stray sticks, picked up at random, is prohibited as risky, as such sticks are liable to break, endangering the life of the user.

3244

BRUSH COIN CUSHION

A brush to take the place of the rubber mat on the cashier's window in stores is a practical novelty recently introduced in Paris. It is easy to pick up coins from such a base, even with gloved fingers, and, should the customer desire, he or she may clean the coins by rubbing them over the bristles.



Price \$1.80

Colorado Day

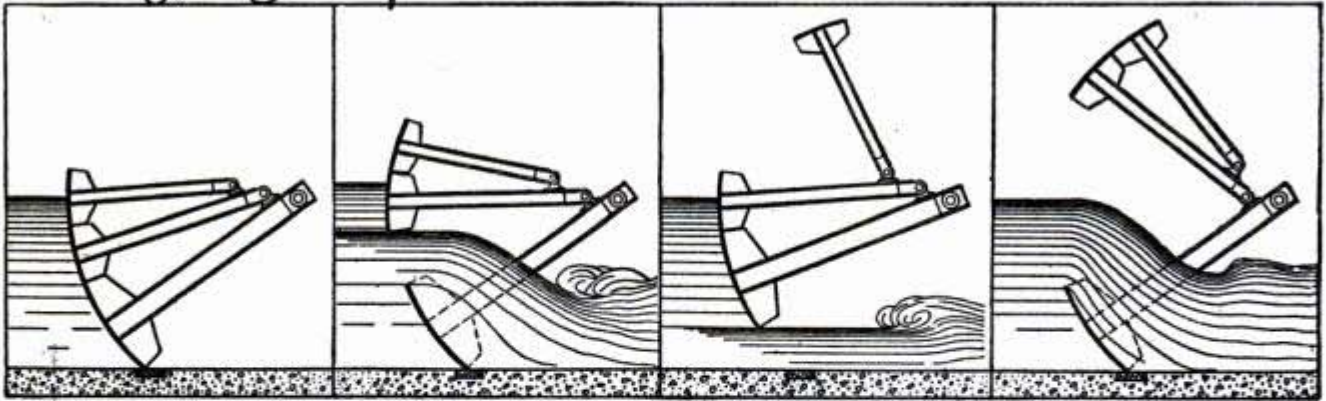

The Three-Part Gate Closed

Position for Intermediate Flow

Position for Waste Underflow

Gate Raised for Overflow

PHOTO-DRYING RACK FOR ENGINEERS

A convenient device for drying engineers' prints by suspending them from the self-retaining jaws of a rack has been put on the market. The construction of the rack is such that the insertion of the print into the clip will hold it securely in position and a touch of the finger will release it. The device occupies but small space and

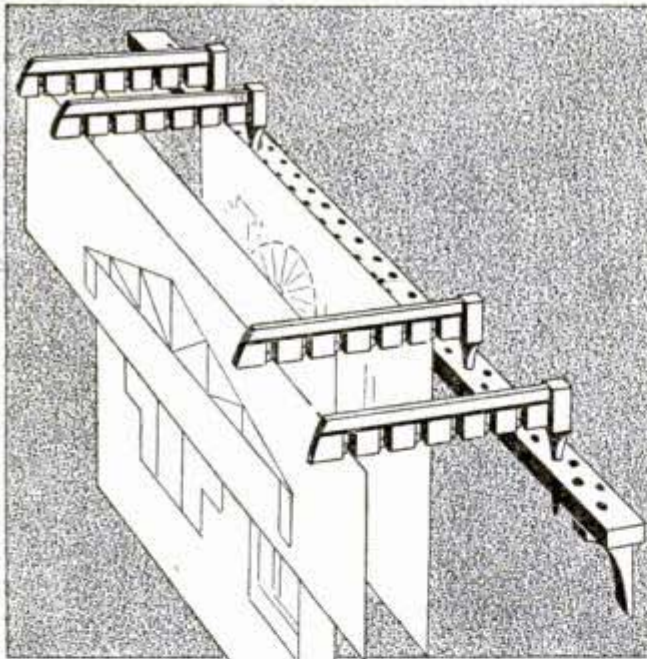

Improved Rack for Drying Engineers' Prints

enables a number of prints to be dried at the same time without creasing or wrinkling.

ⒸThe number of horses in the U. S. increased from 13,500,000, in 1900, to 21,040,000, in 1910, in spite of the rapid development of the automobile.

THREE-PART CONTROL OF WATER FLOW

The operation of this three-part water gate, designed for the control of division dams, main canals and irrigation ditches, and for the control of a reservoir level on the crest of spillways, is clearly indicated in the drawings. They show the gate closed to completely check the flow of water; the two upper sections raised to allow an intermediate flow, the second section keeping surface trash from passing, and the lower section preventing the passing through of heavy gravel on the stream bed; the upper gate section completely lifted, and the two lower sections raised to allow an underflow when it is desired to clear the bottom of waste, and the two upper sections completely raised to allow of a heavy overflow and yet prevent the passing of the heavy gravel on the stream bed.

CARS FOR INVALIDS ON GERMAN RAILWAYS

The German railroad system provides a specially designed car for invalids and cripples who can afford to use it. Every possible convenience for the sick is contained in the car, and a compartment, opening on the level of the station platform with a double door, so that a stretcher can be carried in without difficulty, is set apart for the invalid and attendants. The other section of the car contains a kitchen and a handsomely upholstered compartment for members of the family and accompanying friends.

THE BALLAD of BILLY BIRD

BY RALPH BACON

You never have heard how Billy Bird
Sailed the aerial sea?
Then the tale I'll tell of what befell
As the tale was told to me.

Oh, Billy B. was an airman free
As ever burned gasoline,
And he loved at sight Katherine Kite
Who rode in a Wright machine.

Now Katherine Kite had an eyrie light
Where the airmen loved to go,
For Katherine K. was pretty and gay,
And her father had lots of dough.

Oh, she gave one day a party gay
To airmen bold and free;
And there came ten score or maybe more,
From over the land and sea.

And every one, to the eagle's son,
Claimed the hand of Katherine Kite,
"Bold birds," quoth she, "I'll married be
Before the coming night.

Tank up with care from the hangars there
With papa's gasoline,
And I'll marry the man who proves he can
Follow his bride's machine."

Then her motors banged and her guy wires twanged
And Katherine Kite was gone!
Oh, they spattered the scene with gasoline,
Till the flock flew off the lawn.

But who is the swain in the monoplane
Who follows so close on the Wright?
It's Billy Bird of whom you've heard
With his tanks all full and tight.

Then Katie no doubt let her engines out,
Her engines two and three,
For she looked again for the flying men
And saw only Billy B.

"Oh, Billy B. will you follow me
In the comet's fiery trail?"
"Oh, Katherine Kite, I'll follow your flight
If you tickle the Scorpion's tail."

Oh, lovers will brag but their engines lag
If they haven't got gasoline,
And Billy's are still, while Kate has a gill
To hold up her big machine.

It was none too soon she steered for a moon
Where Saturn's rings run round—
A long hard glide bold Billy must ride
If he lands on Katie's ground.

He slid too soon, for a nearer moon
Was the best that he could do!
By the seven-moon light of a ringed night
The Saturnese watch the two;

And there they must stay till the judgment day
Or the good gods intervene,
Each a broken heart—just a moon apart
For the want of gasoline!

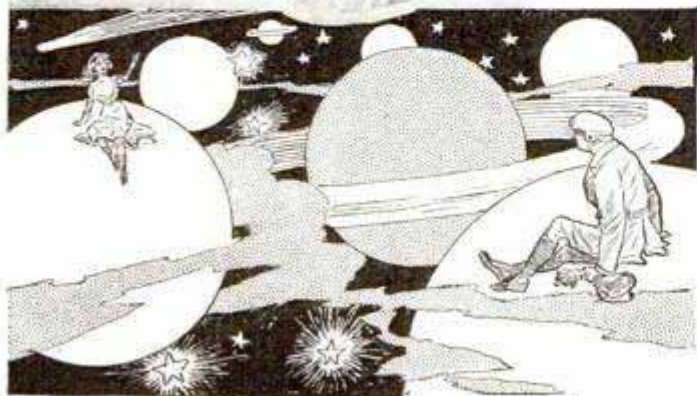
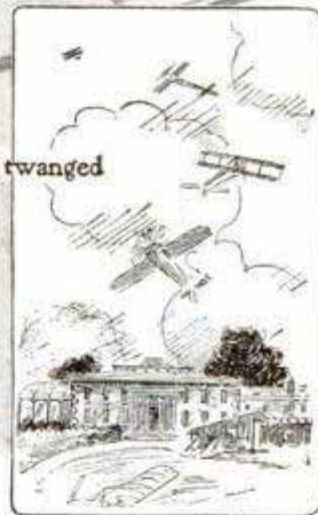
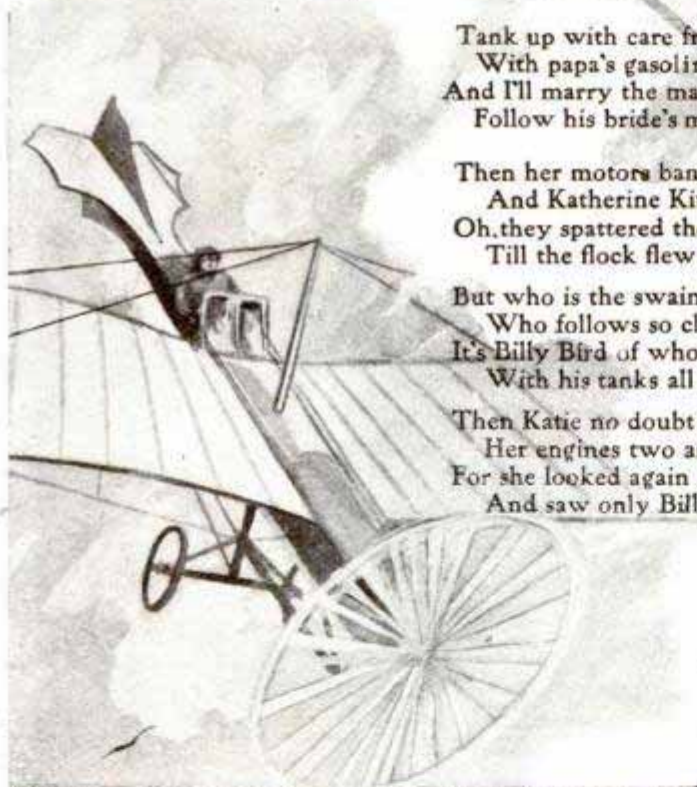
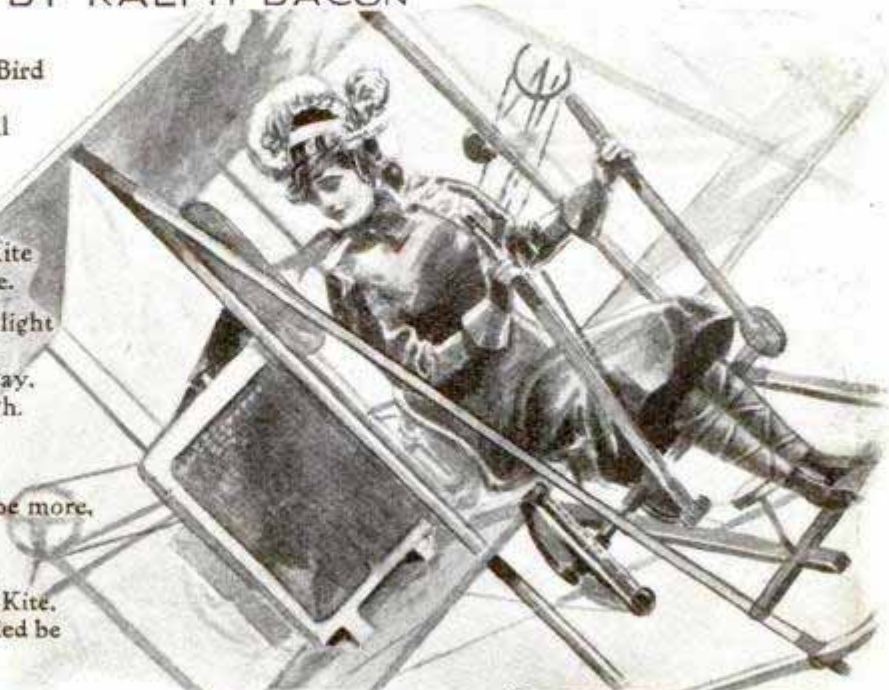

GRACE DARLING'S BOAT NOW IN MUSEUM

The cöble or rowboat, in which Grace Darling and her father, William Darling, rescued nine persons from the wreck of the steamer "Forfarshire" in

a total of 63 people, and bore them safely to Longstone. The thrilling rescue, to which the elder Darling at first offered vigorous objection, made Grace Darling one of the greatest heroines of history, and the boat, together with a pair of her oars, have since been regarded as almost priceless possessions by the people of England.

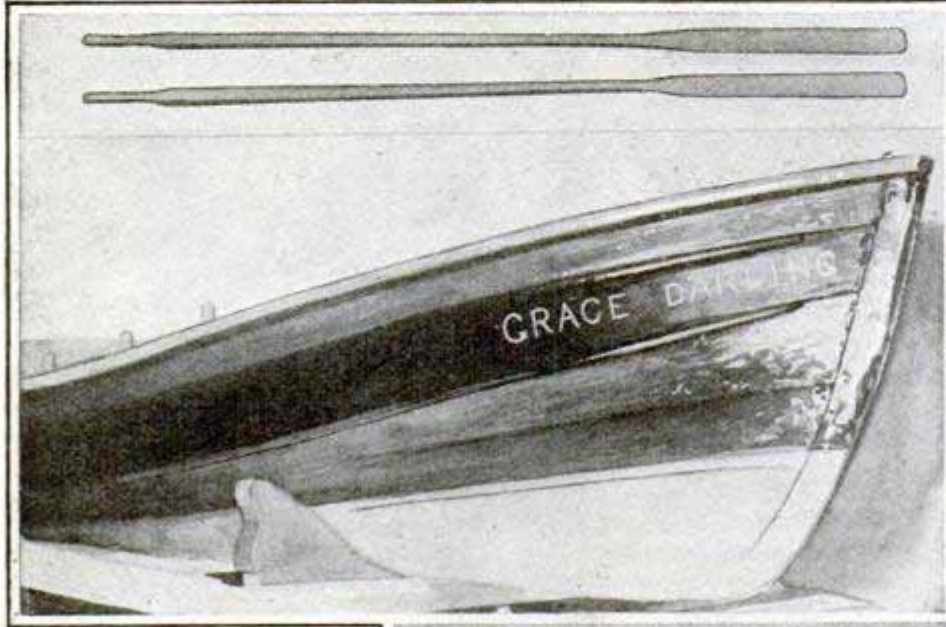

Grace Darling's Boat Which Now Rests in the Dove Marine Museum of England

1838, has been presented by a resident of Newton Hall, Stockfield, England, to the Dove Marine Museum at Cullercoats, England.

The removal of this famous boat to its present location calls to mind the daring exploit of Grace Darling, who, on the morning of September 7, 1838, in company with her father, the light keeper, embarked from the Longstone lighthouse on one of the Farne Islands, near the coast of Northumberland, and rowed more than a mile through boiling seas to the wrecked vessel, which lay broken upon one of the Farne Islands.

By wonderful strength and skill the two Darlings succeeded in reaching the wreck, from which they took the nine persons who still remained alive from

HOUSE-HEATING PLANT IN GARAGE

The heating plant of an Indiana residence is in a garage. Heat is conveyed to the house by an underground steam line surrounded by an almost imper-



Courtesy Illus. London News
Grace Darling and Her Father Rowing to the Wreck

vious tile piping which prevents the loss of heat from radiation. The advantages of such a detached plant are that no coal dust and ashes will be present in the house and there will be no fire hazard from a furnace which is located in the cellar.

Artificial wood made of sawdust and magnesium chloride is used for flooring and interior woodwork generally.

*Hard Residence South Bend, Ind.
Steam line laid in the cellar.*

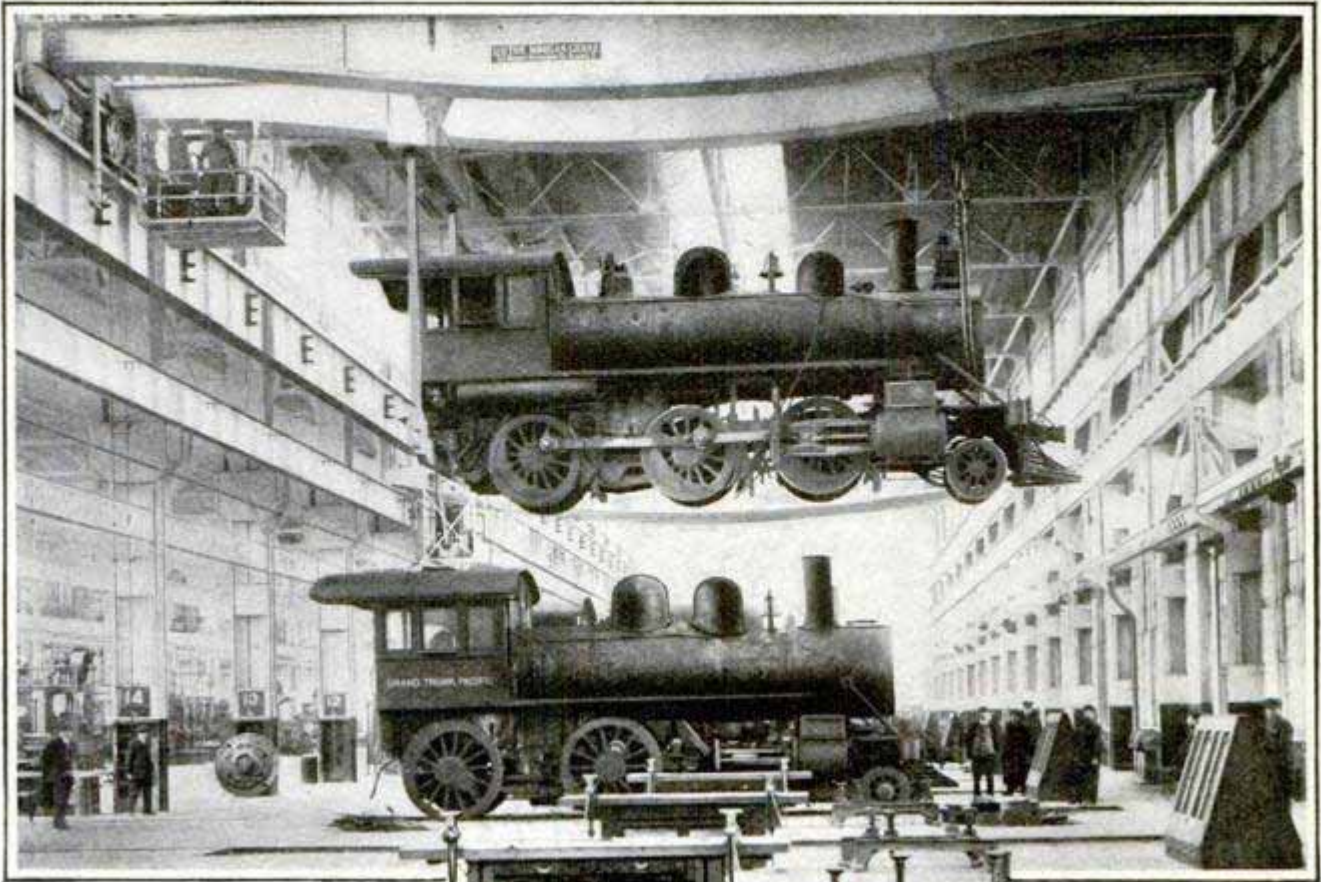

An 80-Ton Locomotive
Lifted into the Air

MOVING LOCOMOTIVES ABOUT IN THE AIR

In the locomotive repair shop of the Grand Trunk Pacific Railway at Transcona, which is just across the Red River from Winnipeg, is a 120-ton overhead crane which is used to lift locomotives into the air from one track, carry them over other locomotives and lower them to another track. The locomotive shown lifted into the air weighs 80 tons.

MACHINE MIXES UP ORES BY CARLOADS

At a large Arizona mine an ingenious device is being operated which saves time, work and money in mixing ores for the smelter. In this mine the various shafts and levels yield ores of different qualities, which when mixed in the right proportion give a good fluxing combination. Usually a machine for this purpose has to be installed, which is very expensive.

In this case the ore is hoisted from the mine in automatic electrically operated dumping skips, depositing the ore on a belt conveyor which leads from the shaft of the mine to a trestle constructed over the railroad tracks. The ore cars are run under this trestle, and a small engine to which the belt



Ore Conveyor Which Automatically Makes Up
Carload Mixture of Various Quality Ores

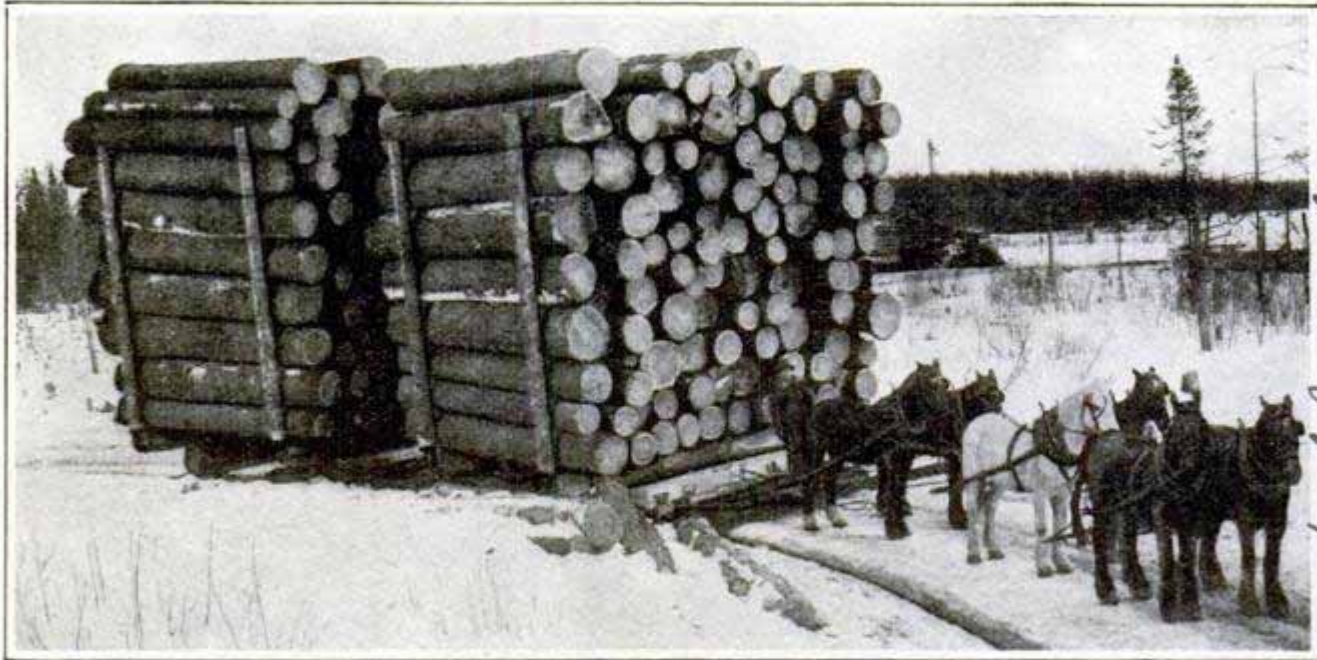

A Load of 200 Logs Weighing 177 Tons, Hauled 15 Miles by Six Horses

conveyor is attached runs up and down the trestle and dumps a layer of ore in each car. When the proper amount of mineral from one level has been deposited in the car, ore from another shaft is in the same manner conveyed to the car, and so on, until the right proportion of each is used. Thus the ore is handled fewer times than in the mixing machine, and it is in the cars, ready for delivery at the smelter.

FOLDING BAGGAGE TRUCK FOR HOTELS

A truck for the handling of trunks and other baggage, especially designed for use on the upper floors of hotels, is so constructed that, when not in use,



The Truck with Handles Folded Back over Body

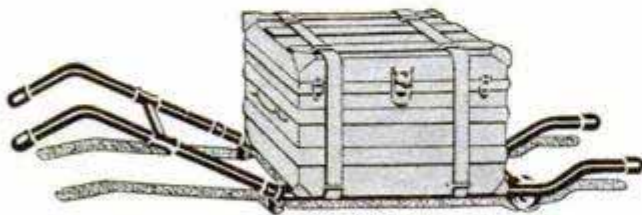

The Truck Opened Out for Use

the handles fold over the body of the truck, which is mounted on small, rubber-tired wheels, to prevent wear on hall carpets.

SIX HORSES HAUL LOAD OF

3442. 177 TONS

One ton to a horse is considered a fair wagon load, but when it is a question of runners instead of wheels, the proportion goes up by leaps and bounds. Even the load that can be carried over snow on runners has a limit, however, and it would seem that 29 tons to the horse would be far beyond it, were not evidence to the contrary at hand. This load of 200 logs, estimated by the U. S. Forest service to weigh 177 tons, was hauled from Pine Island, Minn., to the railroad shipping point, 15 miles distant, by six horses.

PHOTOGRAPHS ON BOTH SIDES OF PAPER

3544

A photographic paper having the sensitive emulsion on both surfaces of the sheet and so treated that photographs can be made on both sides without the one interfering in any way with the other has been invented for use in making photographic copies of documents and public records. The double-surface paper thus reduces the volume of public record books in states that have passed laws permitting the photographic process for recording deeds.

Camp of J. A. D. Irvine

Co.

Roachbury

Wilson

DANUBE'S LARGEST BRIDGE GUARDED BY POLICE ³⁵¹⁴

The great Danube railway bridge between Feteshti and Chernavoda, in Roumania, which structure is nearly 10 miles long, has been placed under a strict military guard in order that no successful attempt may be made to damage the structure by passengers in the trains crossing it. Every carriage of each train carries two Roumanian policemen whose duty is to prevent the windows from being opened and a bomb dropped on the bridge by some Bulgarian, and several torpedo boats are constantly on duty to forestall any attempt to injure the pillars. These extraordinary precautions are being taken because this bridge would play a very important part in case war should be declared between Roumania and Bulgaria.

LIGHTER ARMOR POSSIBLE FOR WARSHIPS ³⁵¹⁰

An English engineer has developed a method of increasing the resistance of armor plate while reducing its weight. The method provides modifications of the whole process of making armor plate, from the ingot to the finished product. The ordinary armor plate has hardened surfaces, front and back, and a soft core. The new armor consists of a number of plates hardened separately and bonded together, the core containing layers of steel as hard as the surface. In heavy plate, the saving in thickness is claimed to be 20 per cent.

An 8-in. plate made in this manner is said to have resisted a 14-in. shell, which would have pierced ordinary armor plate of the same thickness.

THREE-WHEELED ELECTRIC ⁵⁶ REFUSE CART

A rather unusual electrically driven dump cart has been constructed by the Third Avenue Railway in New York

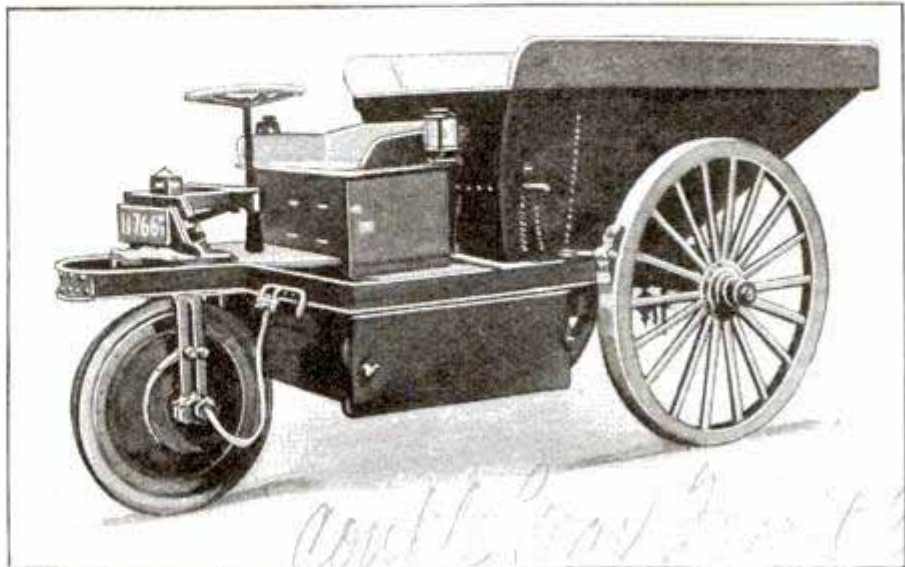

Three-Wheeled, Front-Drive Electric Dump Cart for Handling Refuse.

for the handling of refuse from underground trolley conduits where overhead trolley wires are not permitted. The cart has a two-ton steel body balanced to dump backward. The drive is applied to the front wheel, within which is a 3-hp. direct-current motor, receiving power from storage batteries placed in a box hung from the channel-iron frame just back of the wheel. The wires from the battery reach the motor through a hole in the center of one of the axle stubs.

A MODEL GERMAN FACTORY ³³⁹⁰

A German firm that manufactures optical goods on a large scale has established for its employes a "Volkshaus," or people's house, which contains a well-equipped library, reading rooms, a literary museum, a museum of physics, a school of arts and crafts, an assembly hall capable of seating 1,500 people, a smaller hall for lectures, an art collection, music room, etc. The Volkshaus is available to all the people of the city in which it is located and has proved to be an important educational factor.

William Henry Warrall
Sheffield.

LARGEST SEISMOGRAPH IN AMERICA

The largest seismograph in America was recently presented to the American Museum of Natural History, New York. This device records earthquakes occurring in any part of the world, by utilizing the inertia of heavy weights suspended from a rigid metal frame, which in turn is supported by concrete piers anchored to solid rock. Any

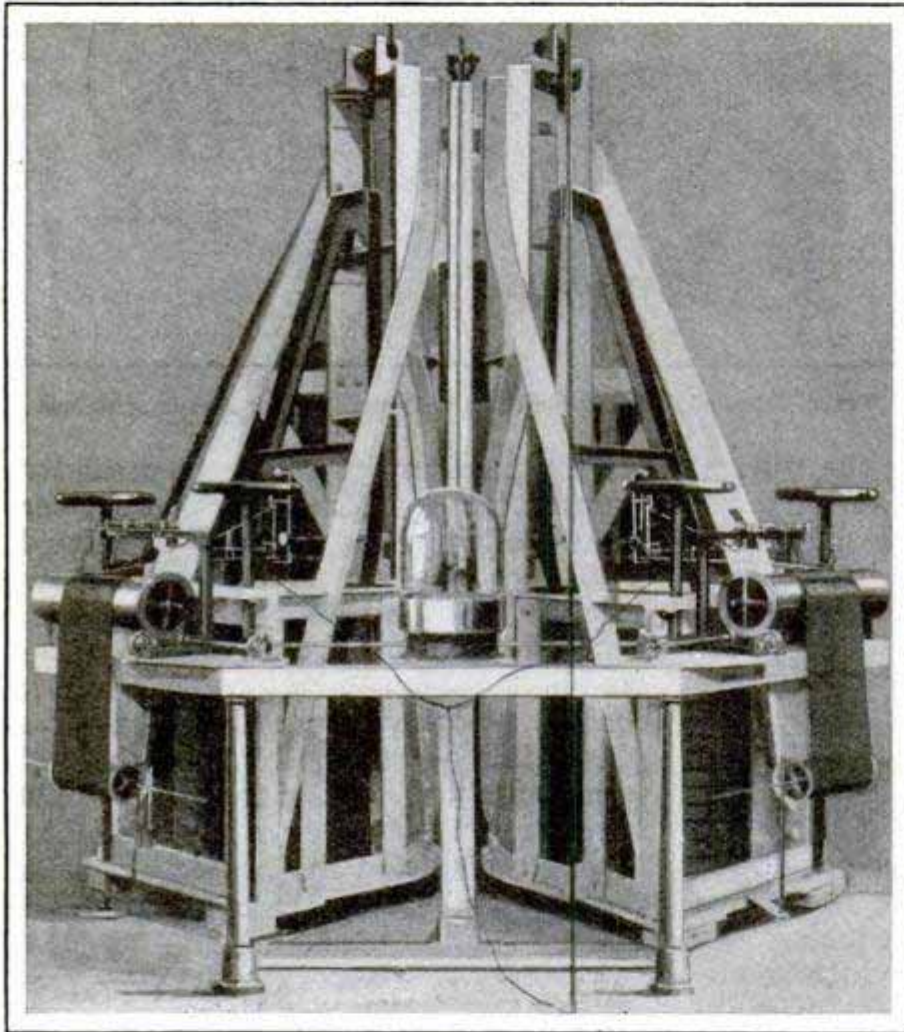

Largest Device for Recording Earthquakes

tremor of the earth causes a slight motion of the frame relative to the suspended masses and this motion is recorded by a delicate point on a moving strip of smoked paper.

☞ Loading coal upon a vessel from cars at the rate of 7,473 tons in $3\frac{3}{4}$ hours, or 1,993 tons per hour, was a feat recently accomplished at Baltimore by employes of the Baltimore and Ohio Railroad Company.

SAFETY OF MONOPLANE AS GREAT AS BIPLANE

3457 Several serious accidents to monoplanes in England recently resulted in an investigation by the War Office to determine the relative structural strength of this type of machine as compared with the biplane. The report of the committee finds the monoplane to be as safe as the biplane. The accidents investigated, according to the report, were not primarily due to causes dependent on the fact that the machines were monoplanes. Dealing with the question of the relative structural strength of monoplanes and biplanes, the opinion is given that it is quite possible to construct a monoplane so that it shall have adequate strength, and that, as concerns stability, there is no reason to conclude that the monoplane, as such, is less stable than the biplane. The final judgment was that there is no reason to condemn the use of monoplanes, provided certain precautions be taken, some of which are applicable to both classes of aeroplane.

"The wings can and should be so designed as to have sufficient strength to resist drift without external bracing," said the committee, "and in view of the grave consequences which may follow fracture of any part of the engine, especially engines of the rotating type, means should be taken to assure that a slight damage to the engine will not wreck the machine. Structural parts, the breakage of which may involve total collapse of the aeroplane, should, as far as possible, be kept clear of the engine."



An Unusually Complete Wreck on an Indian Railway

INDIAN RAILWAY TRAIN RUNS 3477 AWAY ON GRADE

A chaotic wreck occurred recently on the Quetta line of the Indian Railways. A freight, or "goods" train, as they are called in English railroading, was ascending the historic Bolan Pass. Something happened to one of the engines and the train had to be stopped. While the repair was being made the braking system let go and the train started down grade, steadily gaining momentum until, at a speed of some 80 miles an hour, it crashed into a siding. The engines burrowed into the earth, and car was piled upon car.

WATER WELL FURNISHES GAS 3264 TO PUMP ITSELF

The well used by an irrigation company in the famous Whittier district, in California, is unique in that it provides the fuel required for its own pumping. The water is permeated

with natural gas, which, given off when the water commences to flow, is caught in a hood and piped to the gas engine. In starting, the engine is operated for a few minutes on distillate, but the natural gas soon comes in sufficient quantities to do the work.



This Water Well Gives Off Sufficient Natural Gas to Run the Pumping Engine

3298-

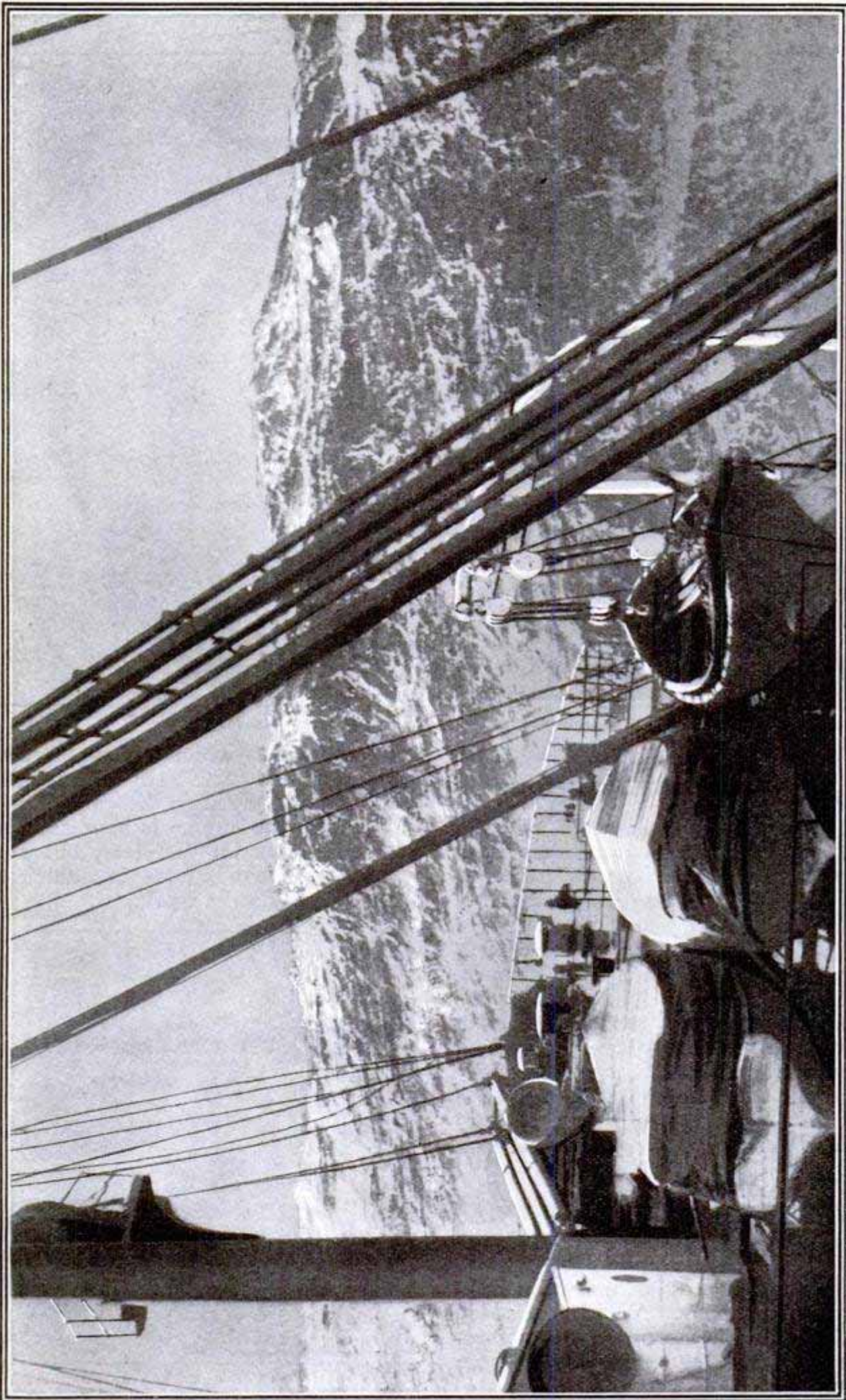

Photo by Underwood & Underwood, N. Y.

When Seafarers Tell of Waves Running "Mountain High" Landsmen are Often Incredulous, but Here is the Proof in This Photograph of a Huge Wave, Taken from the Bridge of an Atlantic Liner

Raverin Augusta
Victoria

SOME REMARKABLE MOTOR-FUEL TESTS

3517

In order to secure a cheaper and more satisfactory fuel for motor-car engines a number of remarkable tests recently conducted in France have demonstrated that naphthaline, which formerly could not be employed to good advantage on account of the difficulty of quickly reducing it to a liquid state, can now be used for operating all motors designed for gasoline, paraffin, or ordinary gas.

The use of naphthaline in motor-car engines is made possible by fitting the tank containing it with a system of pipes through which are conducted the hot exhaust gases from a specially constructed carburetor, thus melting the naphthaline. This carburetor is connected to another carburetor that uses gasoline, as this liquid is employed for starting the engine to enable the naphthaline to be heated by the exhaust gases.

The number of tests indicated that the cost of running a car by using naphthaline, instead of oil and gasoline, was reduced 70 per cent on an average. It is also claimed that, by using crude naphthaline in the manner described, other advantages result: Production of power for small motors is reduced to less than two-fifths of a cent per horsepower-hour; no choking or clogging of engine parts, whether motor is running fast or slow; no danger of an explosion at any time.

CA coal field that has been burning under ground for many years has been found in Germany. Shafts sunk to 18 ft. opened veins of blazing coal.

OFFICE BUILDING BUILT OF OYSTER SHELLS

3293

Galveston has a five-story office building built of oyster shells; that is, it is constructed of concrete consisting



Large Galveston Office Building Constructed of Oyster-Shell Concrete

of 1 part cement, 2 parts sand and 4 parts oyster shell. The oyster shells forming the coarse aggregate were taken from the reefs of Galveston Bay.

One of the oldest houses in the United States, erected in St. Augustine by the Spaniards in the 16th century, was constructed of a sort of plastic mortar composed largely of beach shells.

LETTER-PICKUP TABLE FOR POSTOFFICES

1032

The government is installing in its larger postoffices a labor-saving device in the shape of an automatic letter-pickup table which is expected to increase the efficiency of the postal clerks engaged in this particular work at least 50 per cent. The table is 20 ft. long, 41 1/2 ft. wide and is made entirely of steel. Eight clerks can work at this

Cummins

Cement World
737 So Fifth St.

table and all stand at one side, a few inches from which are various-sized slots leading to a number of endless

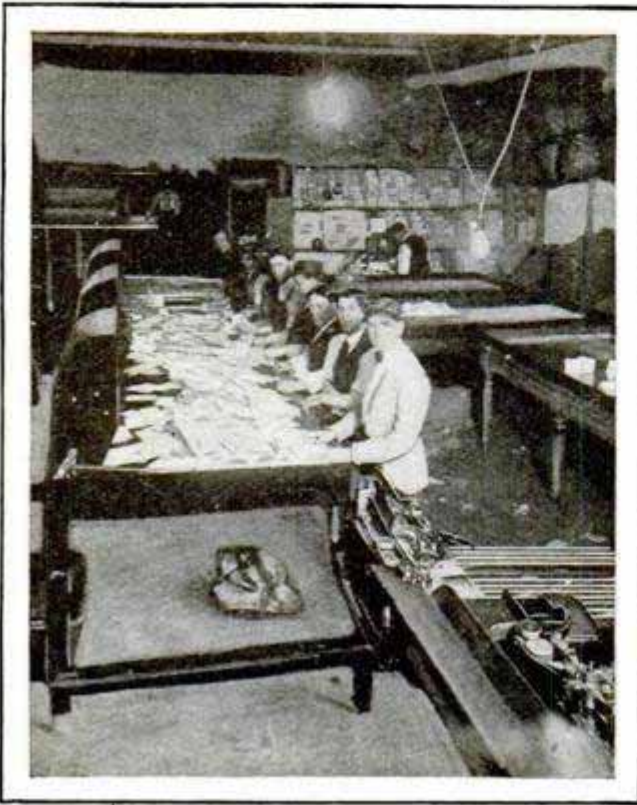

Automatic Letter-Pickup Table Used in Government Postoffices

belts beneath the table. When a sack of mail is emptied upon the table, the clerk takes the letter and, with the stamp facing himself, drops it into the proper slot. The belts carry the letters to one end of the table where they are automatically stacked and then put in the cancellation machine by another clerk. It has been found that the row of smaller slots is used most, as nine-tenths of the letters handled are of the regular-sized envelope.

guyana Switzerland

METAL COATING FOR AUTO BODIES

The finishing of the exterior of automobile bodies with a metallic coating instead of with paint or varnish is receiving considerable attention in German automobile circles. The method of metalizing the surface with a hard, smooth and nonrusting coating is by means of a hot blast. The speed with which the fine particles of metal leave the spraying nozzle is about 5,000 ft. per second. When the spray strikes the surface to be coated the particles are not yet fully solidified, but, remaining plastic for a few moments, are welded into a perfectly homogeneous and adhering film under the high pressure of the stream. In the development of the process it is quite possible that coloring matter can be mixed in to obtain any tint desired.

The Automobile 2/13/13

CHINESE STILL PULL THE PLOW

Today the Chinese are tilling the soil in the same primitive fashion and with the same antiquated implements their forefathers used hundreds of years ago. The hire of men is so cheap that the Chinese farmer cannot afford to use modern horse-drawn plows, and would grudge the animals their provender. The two-man-power plow commonly used turns a furrow 6 in. wide. The men draw the plow about 15 miles in plowing an acre.



Men Still Draw the Plow in China

EXPERT CALLS THIS FINEST AMERICAN STREET

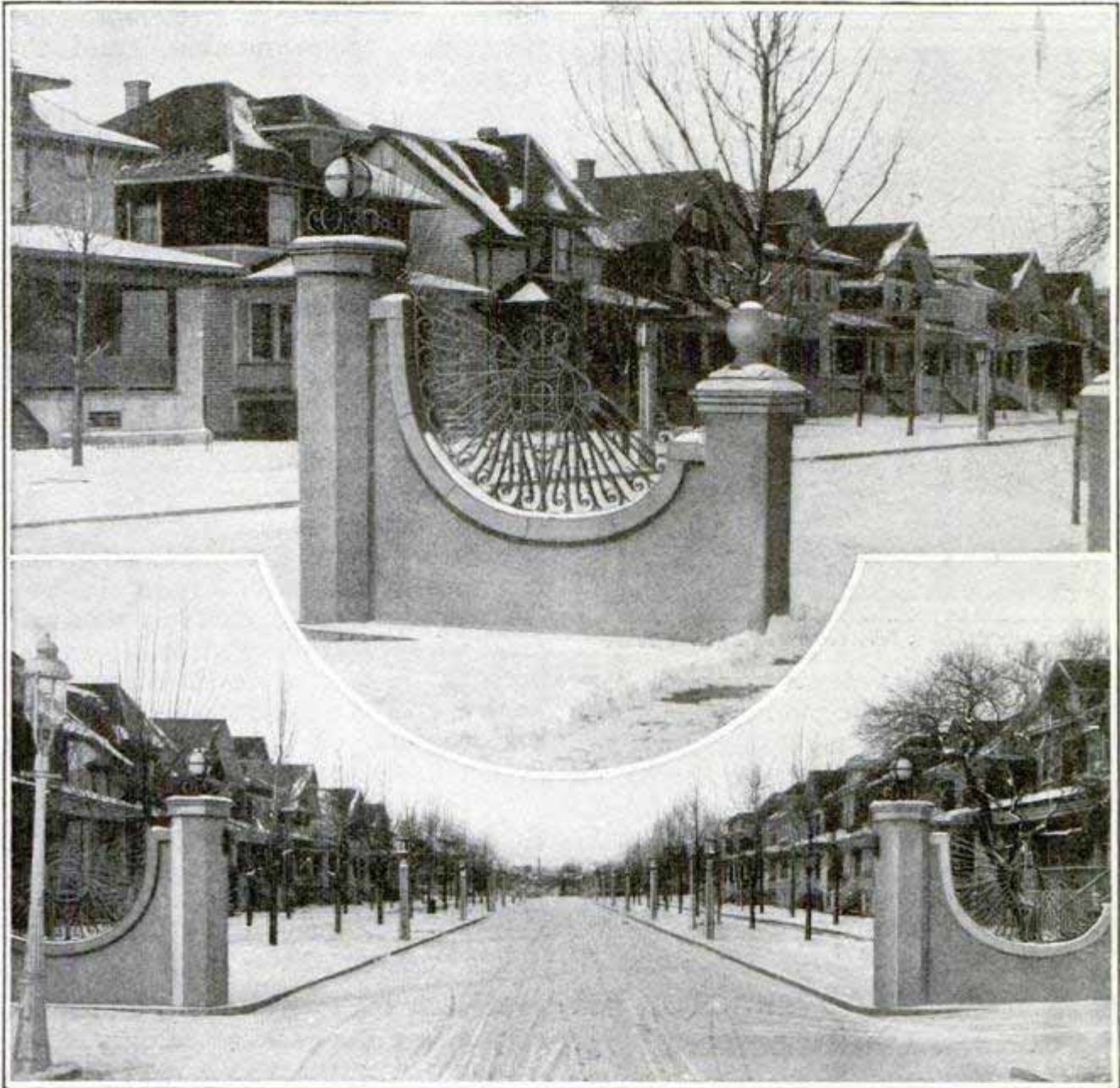

Photo by Chicago Daily News

This Chicago Street is Considered by Swedish Housing Expert to be the Best Model He has Found Anywhere

Residents in the little Chicago street here shown are proud of the fact that Adrian Molin, a Swedish expert on housing and living conditions sent on a world-wide tour of inspection by the government of that country, has declared in his report that this little street, which is three blocks in length, is a model that might well be copied. "Bernard Street," he declares, "is the finest street I have seen in America or in any other country. The points that entitle it to be thus designated are as follows: The location, for one thing, is ideal, the highway perfect, and the

houses architecturally satisfactory and better lighted, better heated and more sanitary than any others I have found."

"QUITRENT" CEREMONY IN ENGLISH LAW COURT

A quaint ceremony takes place annually at the Law Courts in London, the City Solicitor appearing before the "King's Remembrancer" to discharge the quitrent service concerning certain properties in the city of London and the county of Salop. In this ceremony a block of wood, two

bundles of twigs, six horseshoes and a bag of nails are placed on a table.

nails in heaps of 10 each, and then adds another heap of nails. In conclusion the "King's Remembrancer" then says "good number," and the ceremony is over.

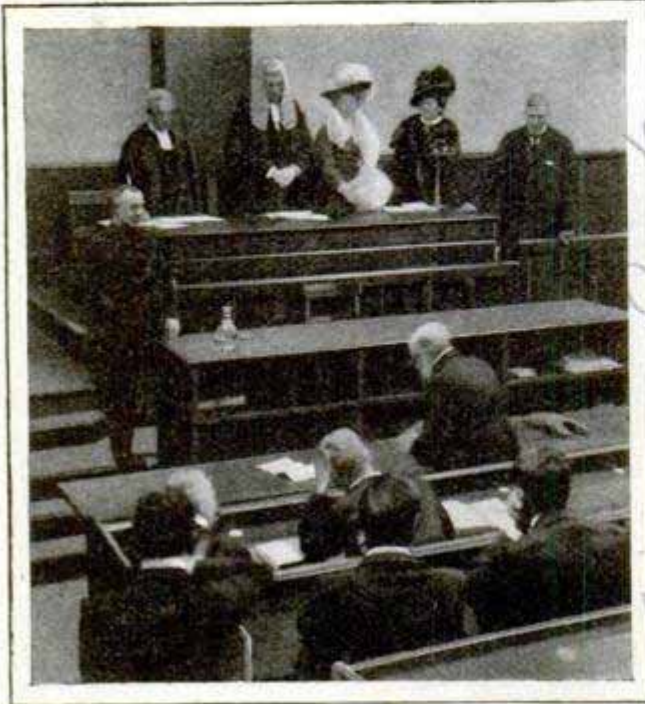

Performing Quitrent Service in British Law Court

Then, when the tenants are called upon to "come forth and do good service," the city solicitor gravely places the first bundle of twigs on the block of wood and cuts it with a hatchet, cuts the second bundle with a billhook (a thick, heavy knife with hooked point, used for pruning purposes), lays out the six horseshoes, counts out 60

PRODUCING SLEEP WITH AN ELECTRIC CURRENT

Causing human beings to go to sleep by means of an electric current is the remarkable achievement claimed by a Berlin physician who already has produced sleep in animals by applying electricity to the base of the brain. By using an improved method of application it is claimed that unconsciousness can be produced quickly and without danger to the individual. An alternating current is used and its effects are said to relieve insomnia, banish neuralgic pains, and provide safe means for controlling violently insane persons. The electric sleep may also be deepened for the purpose of executing criminals or slaughtering animals in a painless manner.

*Dr. J. Hagedorn
Berlin Review 1911*

One way to prevent the hardening of spare automobile-tire tubes is to immerse them in hot water once every month or six weeks.

*Auto Dealer
Repairer*

A HOMEMADE TRACTOR THRESHING MACHINE

The tractor part of this threshing machine was made by a Maine farmer and the thresher is propelled over the

ground at the rate of about four miles an hour by the gasoline engine, which is mounted on the rear part of the specially constructed frame. The same engine is also used to operate the machine, thus dispensing entirely with the need of a separate traction engine.

no name

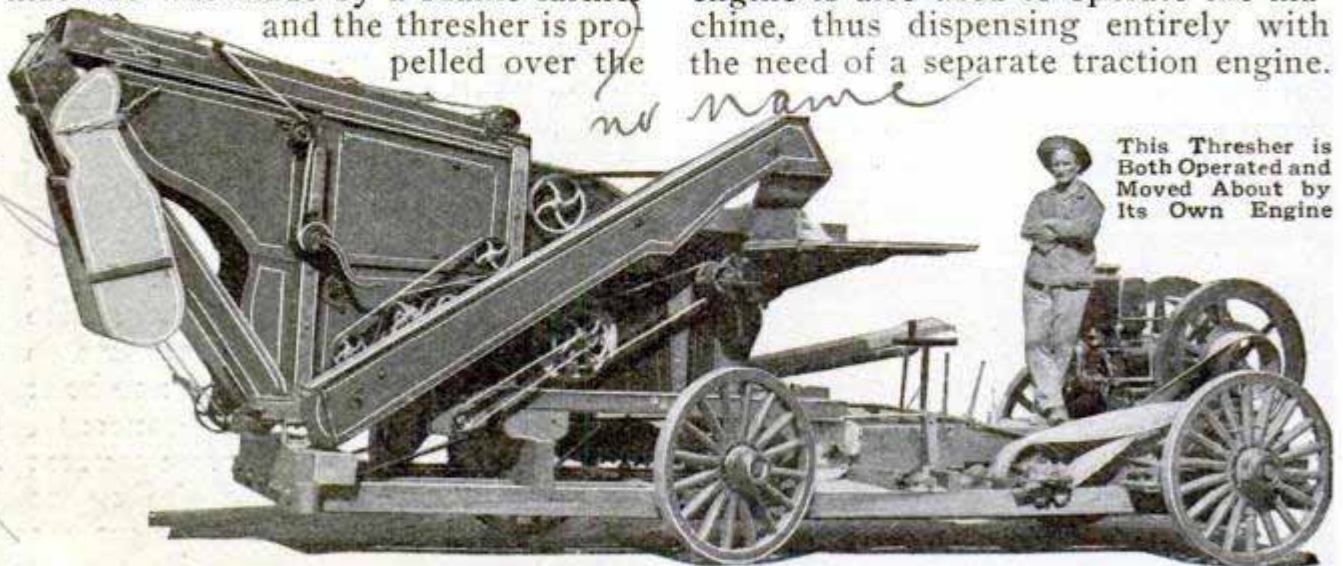

This Thresher is Both Operated and Moved About by Its Own Engine

Howeyan

nt-



Dropping an Ocean Steamship into the Water Broadside

SIDE LAUNCHING OF AN OCEAN STEAMER

The customary method of launching ocean steamships is end first, so this instance of side launching, from a shipyard at Long Beach, Cal., might be considered unusual by persons unfamiliar with shipbuilding methods on the Great Lakes. This vessel, which is 300 ft. in length, was launched broadside because the shipyard in question lacks water space.

Broadside launching is almost universally adopted on the Great Lakes, even for the largest ships, a number of which are considerably over 600 ft. in length. The first vessel of any considerable size to be launched broadside was the famous "Great Eastern." She was so launched because of the narrowness of the water way.

BIRTHDAY CAKE THAT COST TWO HUNDRED DOLLARS

Two hundred dollars were spent by the wealthy parents of a Washington baby for a birthday cake for the infant. The giant cake somewhat resembles the crown of an African potentate. Specially selected bakers worked on

Two Hundred Dollar

the cake for several days, and every pound of sugar, fruit, etc., which went into it was carefully inspected. The upper portion of the cake represents a fountain, with doves in the basin.

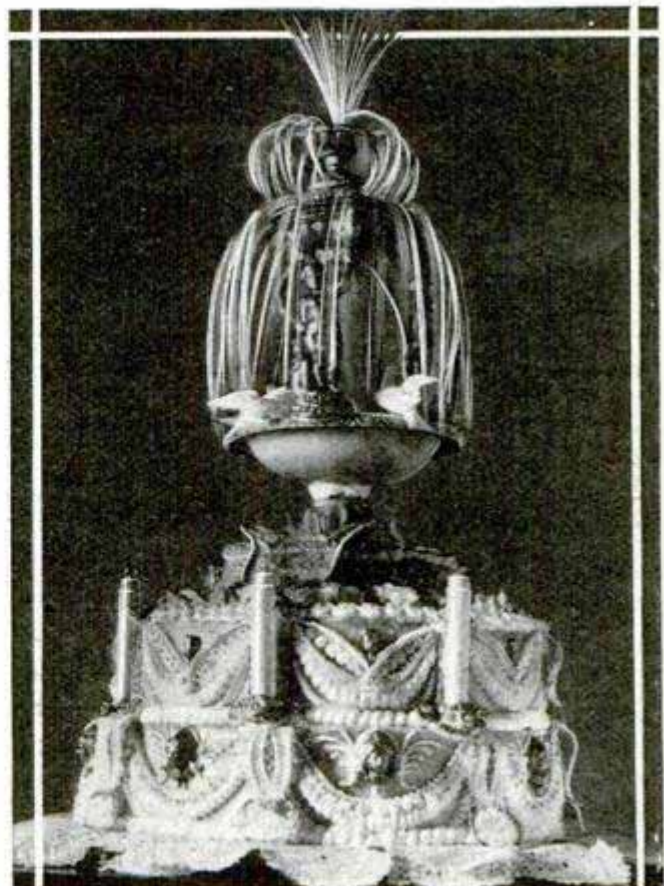

Photo by Clinedinst

Two-Hundred-Dollar Birthday Cake for a Baby

Craig Shipbuilding Co. Long Beach, Cal.

3386 LIGHT BEAM RECORDS FAST TELEGRAPH MESSAGES

An electric device that transmits messages at a rate claimed to be as high as 40,000 words an hour has been

invented by a Hungarian and successfully demonstrated in this country and abroad. The transmitter consists of an

electric motor that drives two drums between which a strip of perforated paper is drawn. The paper is perforated by means of a separate instrument operated by a keyboard similar to a typewriter. The receiving part of the apparatus consists of two telephone receivers, upon the diaphragms of which is mounted a small mirror, and the different strengths of current sent out from the transmitter cause the diaphragms to vibrate in such a manner that perfect letters, like ordinary handwriting, are produced by the movement of the re-

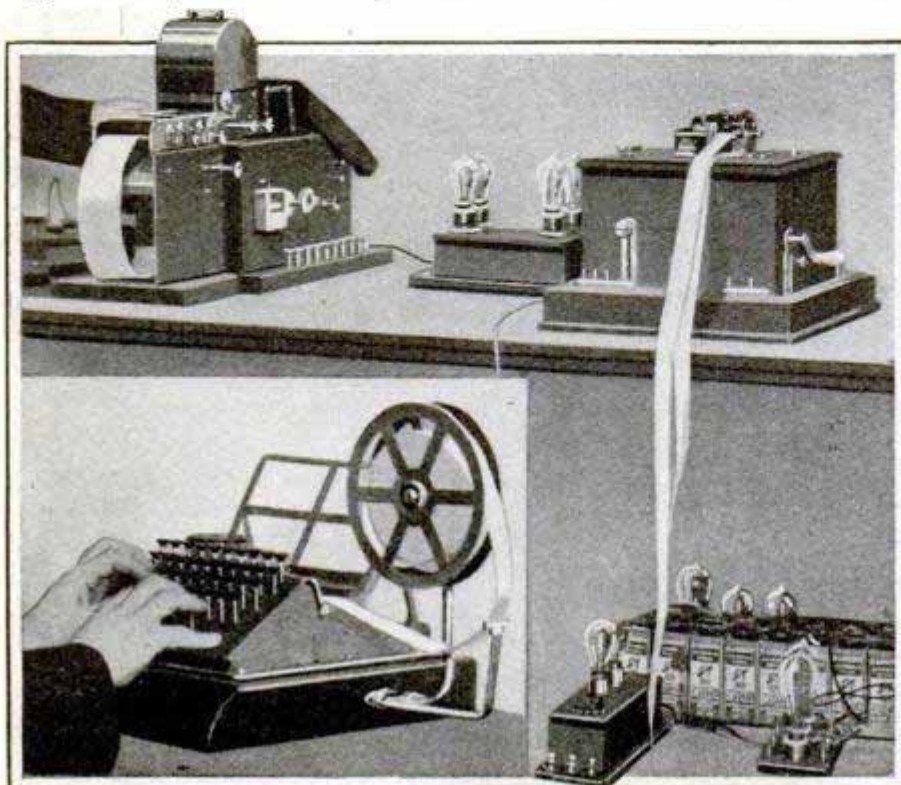

Copyrighted by Underwood & Underwood, N. Y. Telegraphing 40,000 Words an Hour. Upper Picture Shows Transmitter at Right and Receiver at Left. The View in the Lower Left Corner is of the Machine Which Impresses the Message on Tape for Transmission

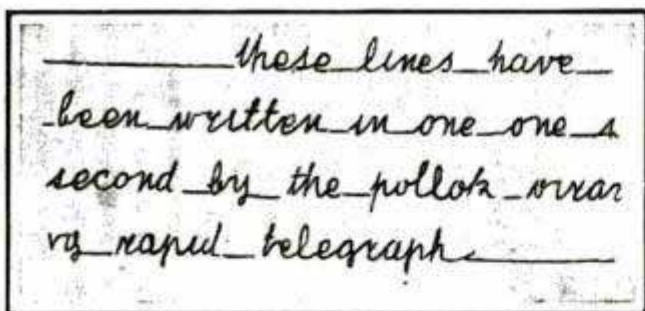

Message Transmitted and Recorded in One Second, at the Rate of over 50,000 Words an Hour

lected light from the mirror upon a strip of photographically sensitized paper. The apparatus is in operation between Paris, Nice and Boulogne, in the service of a French newspaper.

CA ferryboat 433 ft. long and 116 ft. wide for carrying cars across Carquinez Straits, Cal., is being built.

122 3201 CATCHING AND CANNING SARDINES IN BRITTANY

The sardine fishing season begins early in June and the coasts of Norway and Brittany, in France, are the scenes of the largest hauls, the grades of sardines obtained there being superior to the fish caught on the American coasts. As soon as the European fishermen observe shoals of porpoise or flocks of sea gulls off shore the fishing boats are sent to the locality, for the presence of these shoals is an indication that

schools of sardines will be found there. One of the peculiarities of sardine fishing is that distinctive types of nets or seines are used in different localities. The net shown in the illustration is employed on the coast of southwestern Brittany. When it is judged that a sufficient quantity of fish have been caught in this pocketlike type of net, the edges and top are drawn together as a purse is closed with strings. The

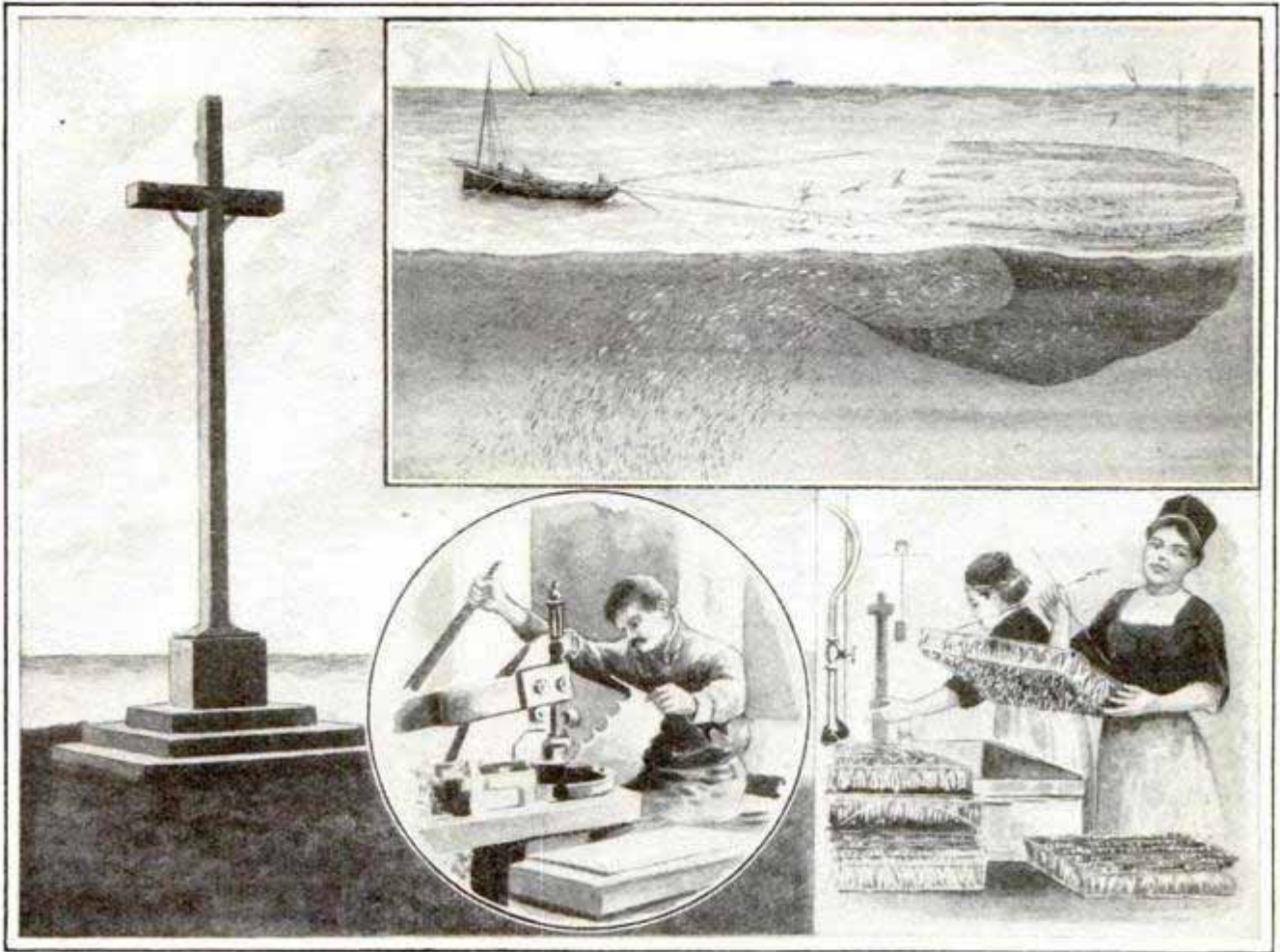

Village Crucifix at Concarneau, Brittany, That Guides Sardine Fishermen to Shore

Catching Sardines Near the Coast of Southwestern Brittany
Making Sardine Cans in Breton Cannery
Cooking Sardines in Breton Cannery

net is then hauled in and the catch taken into the boat by means of dip nets. After the fish are brought ashore they are spread on a table and sprinkled with salt. Then they are cleaned, sorted and dried by being suspended in the open air upon wire screens or nets called "grills." The fish are next laid on wire gratings, two rows deep, and plunged into a boiler containing pure olive oil, which is kept boiling over a furnace until the sardines are sufficiently cooked, when they are taken out and allowed to drip until dry. They are then taken to the oiling room and packed in tin cans with oil and sealed for shipment. For several years past the Breton fisheries have been declining and now produce only a few hundred thousand cans annually.

Ⓒ Egg-shaped briquettes of coal waste compressed with a tar binder are being experimented with as fuel by an English railway.

MOTOR-CAR BODIES MADE FROM CLAY MODELS

A builder of all-steel motor-car bodies is using a new method of design, the first step of which consists in molding the model from soft clay and then shaping it until the desired form is obtained. The proportions of the model are then used in building the steel bodies. The all-steel body is placed in a large oven for the purpose of baking on the enamel and properly drying the paint and varnish, thus causing the finish to adhere more permanently to the metal.

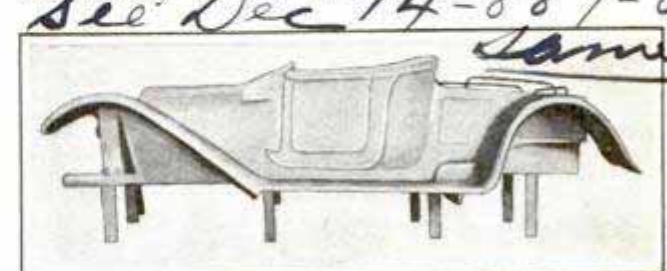

The First Step in Creating a New Design of Motor-Car Body

See Dec 14-887-8150
Same
Edwards
Edwards G. Budd Mfg Co.,
Ontario, 1st St. N.Y.

See 11/13

INSTRUMENT FOR TIMING AN AUTO RACE

1031 This instrument is for timing an automobile race, accurately measuring the length of telephone conversations,

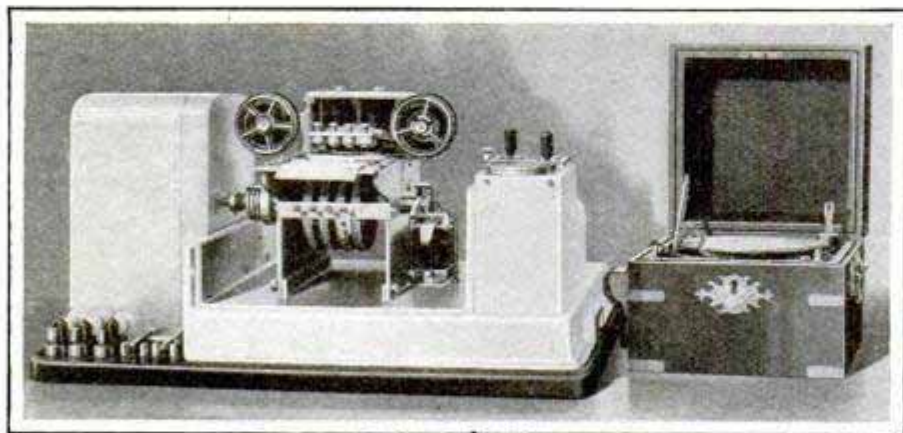

Time-Recording Apparatus for Automobile Races

Chronograph
and registering the elapsed time of certain mechanical operations. The timing of a race is accomplished by three wires connected to the instrument and laid across the race track at certain distances apart to represent one-quarter, one-half and one-mile distances from the timer, from which a fourth and fifth wire also extend directly across the track to indicate the starting and finishing points. When the wheels of the car strike the line the exact time is automatically printed upon a paper ribbon on the timer.

TWENTY-MILE FENCE TO SURROUND PARIS

Paris is to be completely inclosed by an ornamental iron fence 10 ft. in height. This fence will be 20 miles in length, and its purpose is to prevent people from passing into the city without paying the "octroi" or local duties on foodstuffs, gasoline, and intoxicating liquors, which constitute a large portion of the civic revenues. The gates or entrances will be guarded by officials, the fence being the modern substitute for the walls of the past. What remains of the old walls of Paris will be leveled. The cost of the fence will be about \$2,000,000.

COAST-DEFENSE HYDRO-AEROPLANE

3310 The requirements in weight lifting, duration of flight, and climbing, laid down for coast-defense hydro-aeroplanes, were recently exceeded by one of the new Burgess machines. The machine, carrying 600 lb. in addition to the fuel, oil and supplies for the flight, flew for two hours. The climbing requirement of 1,500 ft. in 10 minutes was accomplished in 7 minutes. The war department has asked for 64 aeroplanes to act as aerial eyes for the coast artillery.

The new hydro-aeroplane, embracing the Wright wing-warping principle and control, carries its pilot and passengers out in front of the main planes in the bow of the boat-shaped hull. The motor is behind, and drives the double propellers with a chain.

THE UNUSED "HIGH" WAY OF A LONDON BRIDGE

387 A curious example of a public accommodation which the public, for certain good reasons, would have none of is shown in the accompanying illustration of the Tower Bridge, London. The high-level, inclosed footway was constructed so that the foot passengers could continue their way across the bridge when the drawbridge was raised, the ascent to and descent from the high level being made in elevators in the towers. The public soon discovered that no time was saved by using it, as the people who waited for the drawbridge to close got across just as soon and with less trouble. As a result, this portion of the bridge was closed to the public, but it is not considered altogether a loss, as it adds much to the imposing appearance of the whole.

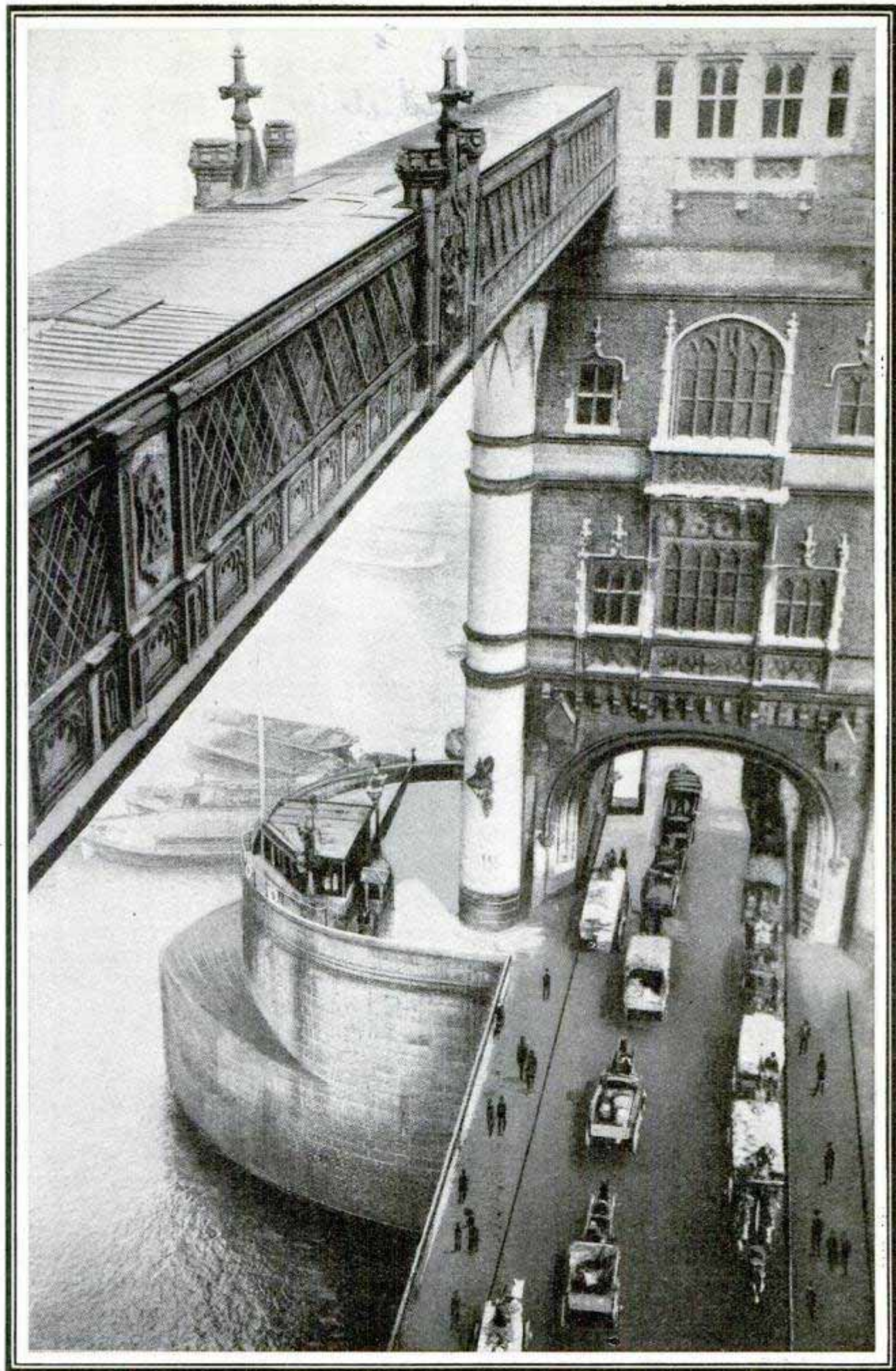

The High-Level Footway of London's Tower Bridge is a "White Elephant"

SELF-STARTER FOR MOTOR-CYCLES THE EVAPORATION OF OCEAN WATER

The new models of a well-known make of motorcycles are equipped with a self-starter which whirls the motor

3259 Middleton Ohio
A German professor has amused himself in spare moments with calculating how long a drop of water stays in the ocean before it is evaporated, and how soon it returns to the ocean again. He figures that the average vacation enjoyed from the time a drop is evaporated, falls as rain and runs back into the ocean again, is only 12 days, this short period being due to the fact that the surface water is all that is acted upon. Calculating the total evaporation from the

The Self-Starter

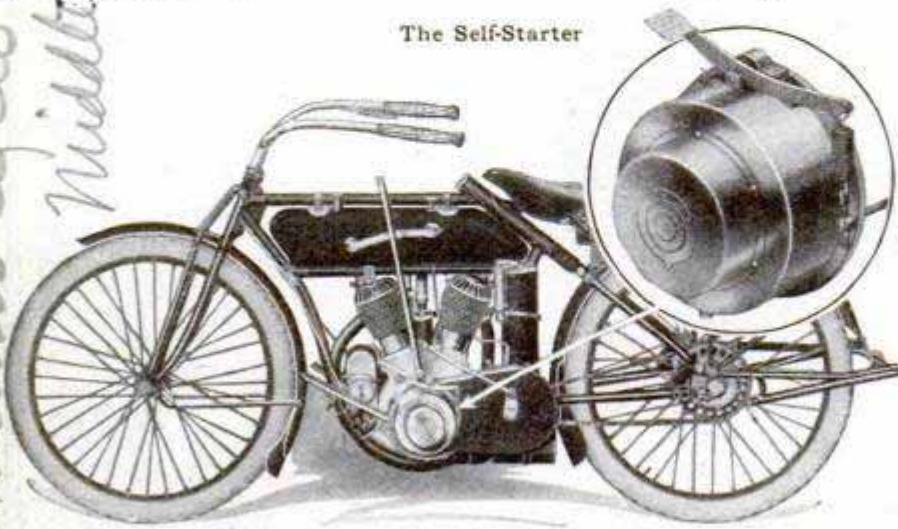

Location of the Self-Starter on the Motorcycle

eight complete revolutions at high speed and is then automatically re-wound by the motor for the next start. The self-starter consists of two powerful springs, which unwind simultaneously, and are contained, with the necessary mechanism, in a steel case that is attached to the crank case. Pressure by the foot on a lever releases the springs and sets the motor revolving.

surface of the oceans and estimating the total volume of water in the oceans, he decides that a drop of water would stay in the ocean 3,460 years, provided it awaited its turn to be evaporated.

RICHEST RAILWAY IN THE WORLD *3257*

Dangerous cataracts make navigation impossible on the Kongo River between Matadi and Leopoldville, so a railway had to be constructed to serve as a connecting link. This road, which is 246 miles in length, and cost \$9,000,000, is said to be one of the richest railway lines in the world, the total receipts since the beginning of its operation in 1898 being \$29,936,769. It costs \$200 to transport one ton of cloth over this road from Matadi to Leopoldville, and the cost of a first-class passage is \$38.60.

More than \$10,000,000 worth of electric dry batteries are manufactured in America annually.

ELECTRIC DANGER SIGN ALL MAY READ

The American Museum of Safety has approved of the sign shown in the accompanying illustration as one that may be understood by all who see, whether they be Italian, Slav, Hungarian, German, or of any other foreign nationality. Any person knowing the English language would understand that "elektrika" has



to do with electricity, and it is doubly familiar to Europeans. And aside from this, the skull and crossbones and the handful of forked lightning should be sufficient warning in themselves. The sign is placed over pits, doors and other places where there is danger of electrical contact.

Annual Report

Miami Cycle Middleton

3314

ROCK FOLD WHICH SHOWS HOW NATURE WORKS

In a remarkable rock fold, which is to be found near Hancock, Md., nature itself gives a plain lesson in the formation of hills and mountains and a clear impression of the mighty forces that were at work in their making.

Originally these layers or strata were flat, the bottom of the primal ocean's bed—for the entire United States was once submerged beneath the waters of the universal ocean—but as the land was uplifted by plutonic and volcanic forces from below, the movement was irregular, the weakest portions of the earth's crust being the first to be pushed upward. The changes which occur in the crust of an apple pie during the process of baking may be compared to that which has happened to the earth's crust on a grand scale. The pie crust, as it appears on the pie when made, is even and flat. As the pie is baked and the confined gases and steam form and expand, they push the crust up, forming irregular miniature hills and valleys. If several layers of crust were used and sufficient force generated within the pie to raise these

crusts, the result would be similar to that shown in the picture where the layers were originally hundreds of feet thick and the internal force and pressure of terrific intensity.

DIRECTION SIGNALS ON 3412 AUTO FENDERS

In one of the latest direction-signaling devices placed on the market the illuminating signals are located on the fenders of the automobile, both at the front and at the back, so that vehicles meeting as well as following may know that a change in direction is intended.

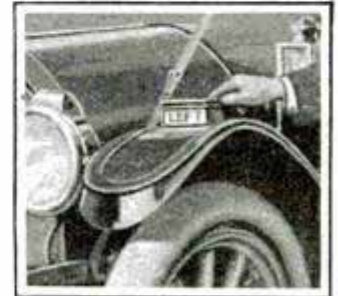

When a turn to the right is to be made the chauffeur presses the proper button, and the front and rear lights on the right fender or fenders shine out the word "right," while a turn in the opposite direction is signaled by the word "left" on the left-side fenders. When not in use the fronts of the signals are covered by shutters, which are raised simultaneously with the throwing on of the lights.

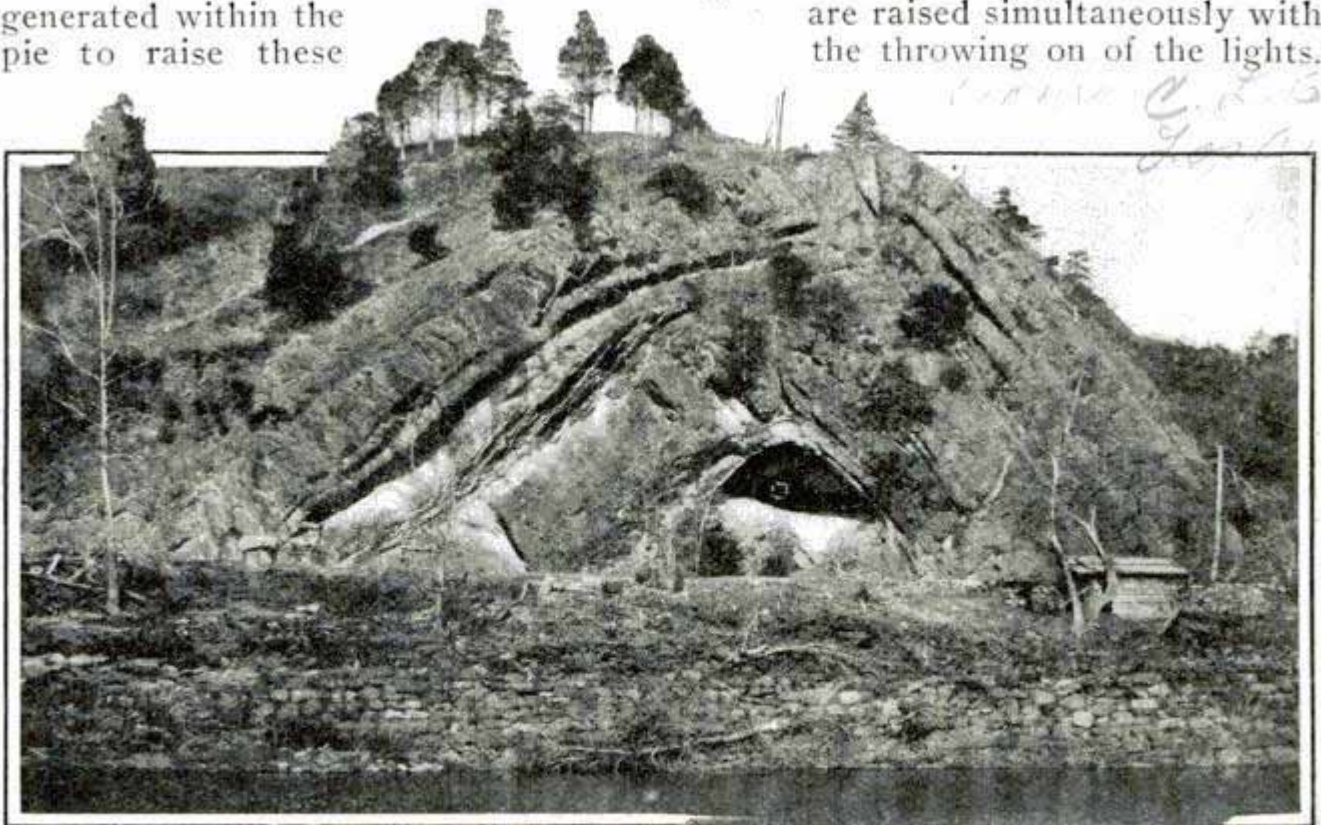

Unusually Characteristic Rock Fold, Near Hancock, Maryland

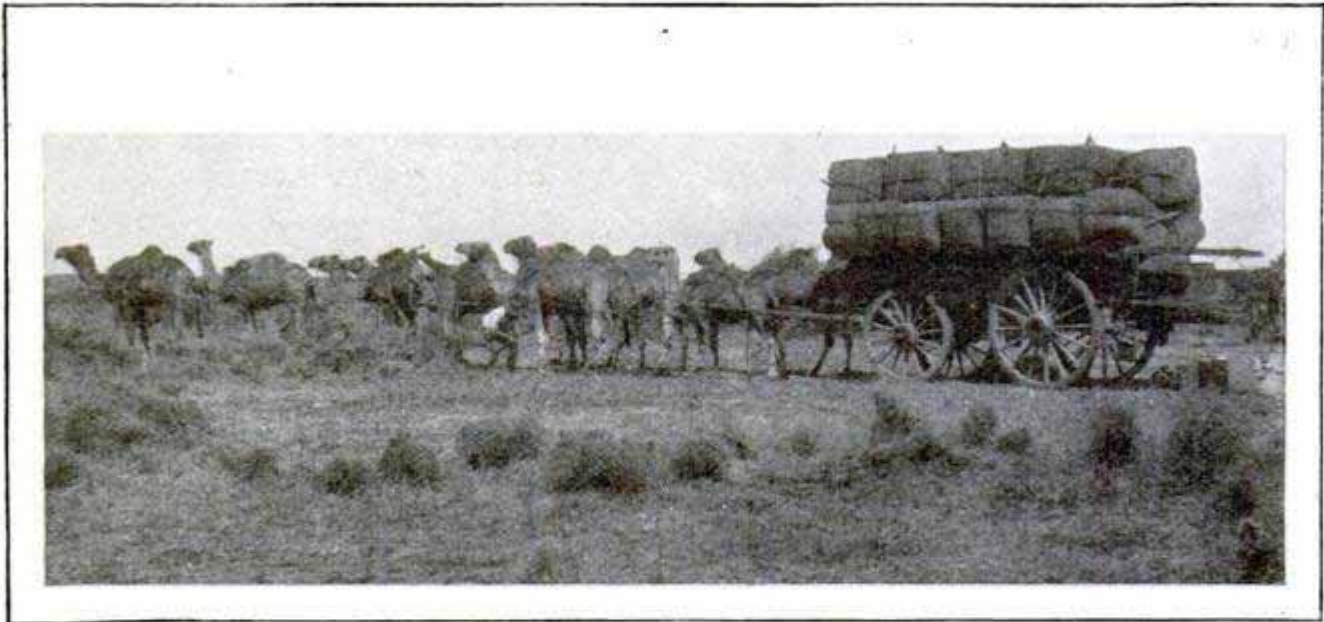

Camels Harnessed to Heavy Wagons in Australia's Interior

CAMELS DRAW WAGONS IN AUSTRALIA

The interiors of the southern and western parts of Australia are almost

entirely without railroads, and as much of this country is practically without water supply, the problem of transportation is a serious one. Camels, imported from Asia, have been tried with fair success under such conditions. Instead of carrying the loads on their backs, however, these camels are trained to draw heavy wagons, as many as 10 and 12 of the animals being harnessed to each.

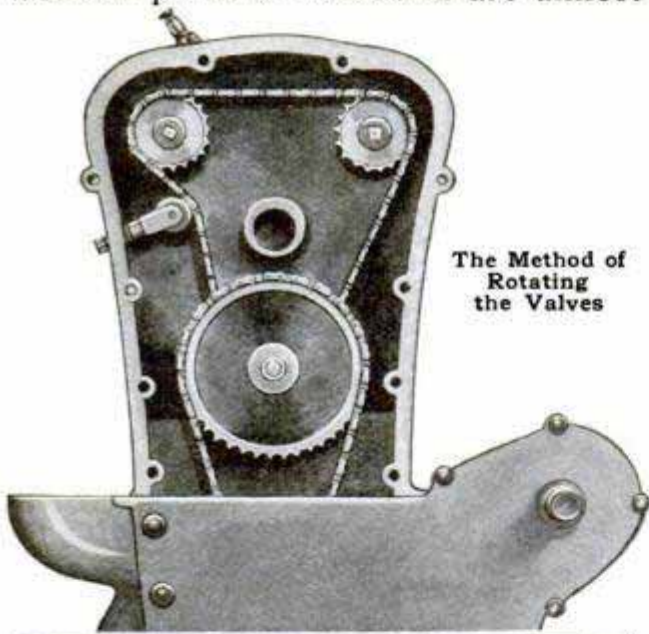

The Method of Rotating the Valves

3364 ROTARY-VALVE MOTORS FOR AUTOMOBILES

The makers of a well-known American automobile are now equipping their machines with either the customary poppet-valve motor or a rotary-valve motor, the latter being an engine which attracted considerable attention at this

Cyrus & Mead

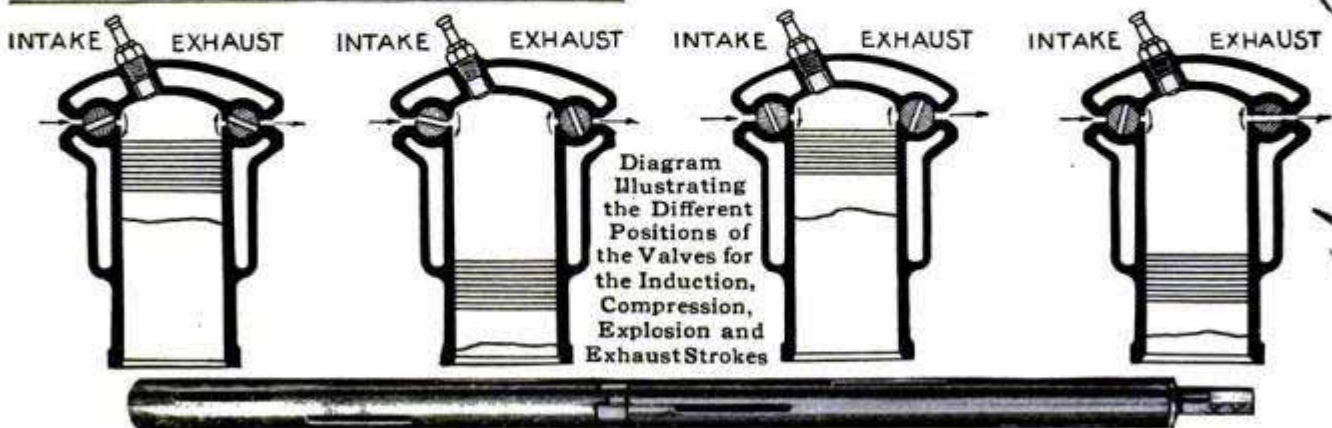
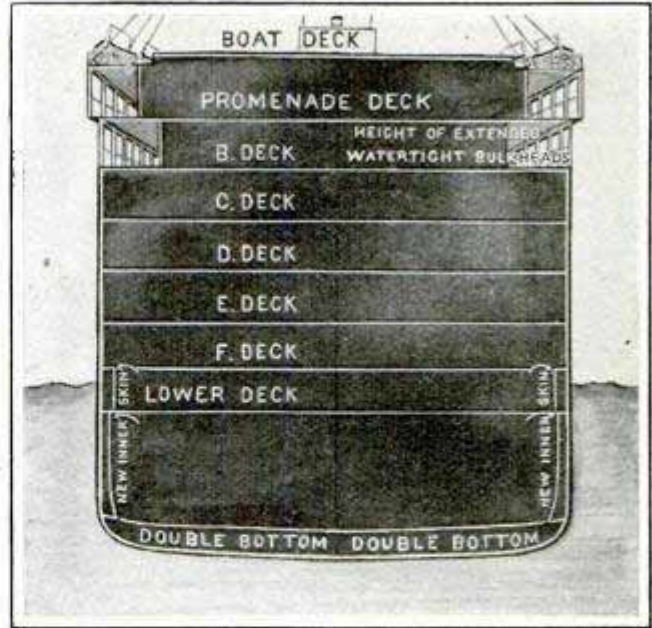

Diagram Illustrating the Different Positions of the Valves for the Induction, Compression, Explosion and Exhaust Strokes

One of the Rotary Valves, Showing the Six Slots or Valve Openings

Arms

year's automobile shows. This motor is provided with two rotary valves, each of which is a cylinder, $1\frac{5}{8}$ in. in diameter, in two parts, connected by a special coupling. The valves each have six slots or openings, $3\frac{7}{8}$ in. long, one for each of the six cylinders of the engine. One of the valve cylinders is for the intake and one for the exhaust. They are rotated by silent chain drive, their position and method of operation being shown in the accompanying illustrations.



Cross-Section View of the Altered "Olympic"

known as the "B" deck, which is situated about 42 ft. above the water line. It is said that the "Titanic" would still be afloat had she been constructed in a similar manner and the steamship officials concerned have, therefore, taken every precaution possible to make the "Olympic" a disaster-proof vessel.

CIGARETTES THAT LIGHT BY STRIKING

✓ 3399

A cigarette that serves as its own match is a novelty in London. These

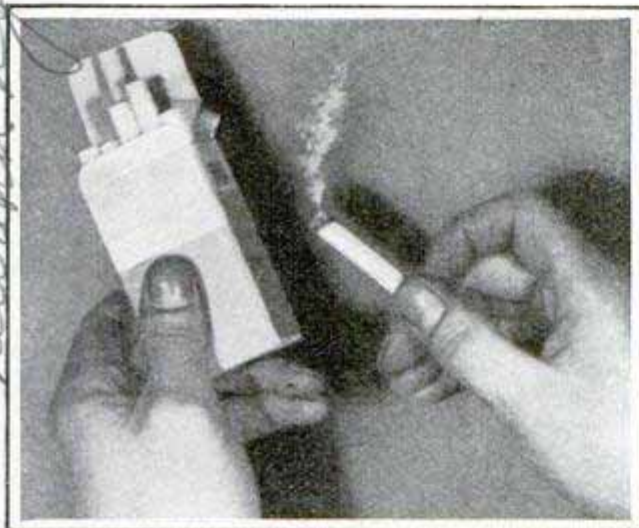

These Cigarettes Ignite by Being Scratched on the Side of the Box

cigarettes are made to strike on the box in the same manner as a safety match. It is claimed that this process of igniting the cigarette in no way impairs its flavor.

WATERPROOFING THE LINER "OLYMPIC" 3385

The accompanying sketch shows the improvements which have been made in the White Star liner "Olympic," the sister vessel of the "Titanic." The most important alterations include the placing of an inner lining, so as to raise the double bottom above the water line, an increased number of water-tight bulkheads, and the raising of some of the latter up to what is

A SELF-LOADING MOTOR GARBAGE WAGON

3 380

The improved type of motor garbage wagon here shown is practically self-loading, the rear part of the vehicle being provided with a conveyor into the lower end of which the refuse is dumped direct from the garbage can of the home. The garbage is carried up to the top of the vehicle by the conveyor and then dumped into the car, and the load is removed through doors on the side of the body.

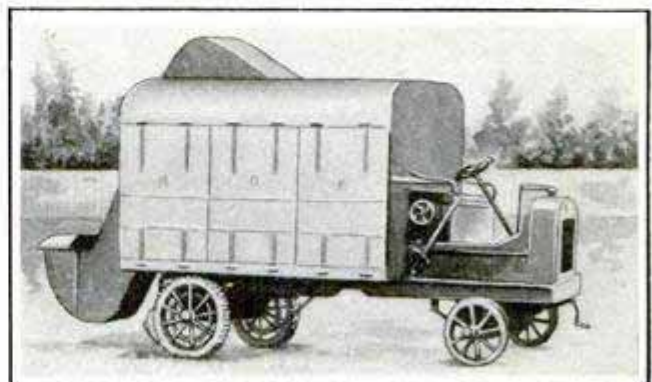

French Motor Garbage Wagon That Loads Itself

*Harland & Wolff, Ltd.
Belfast, Ireland*

La Nature 1/18/13

Autolite Cigarette New York N.Y.

HOW A PURE WATER SUPPLY SAVES HUMAN LIVES

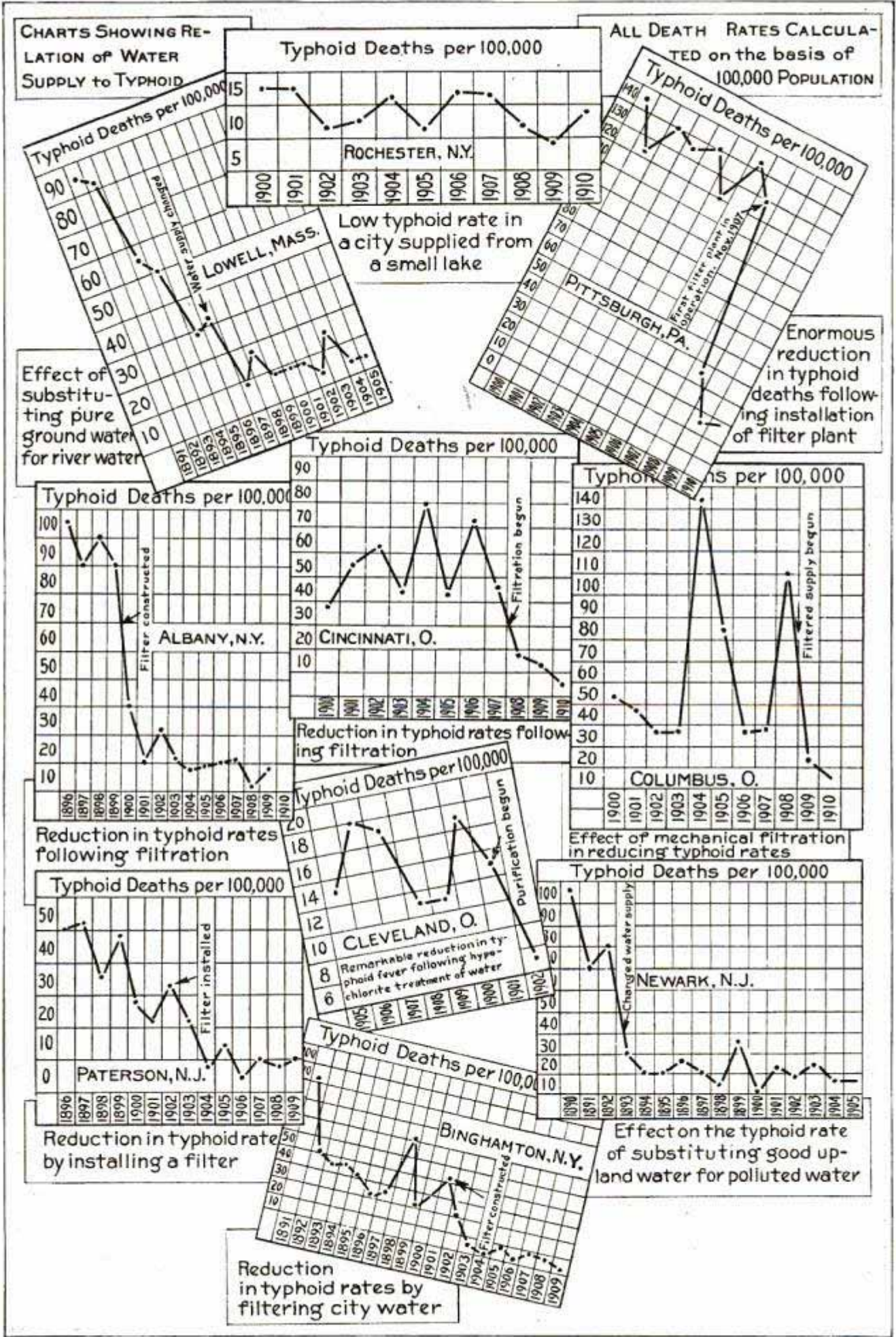



Filtration Plant through Which All Cincinnati Water Must Pass

THE BATTLE FOR SAFE WATER SUPPLIES—II

By DR. ALLAN McLAUGHLIN

U. S. Public Health Service

The Sources of Public Water Supply

[No more convincing proof of the value in terms of human lives of a pure water supply could be found than the charts on the opposite page that indicate the falling off in the typhoid death rate in many cities after purifying methods were applied to the water furnished their citizens. This is the second of a series of articles in this magazine by Dr. McLaughlin, who is one of the foremost authorities on this subject. In the June number he will tell how impure water can be purified, whatever its source.—EDITOR.]

ALL water comes from the atmosphere by condensation or precipitation in the form of rain or snow, fog or dew. This water falling upon the earth becomes the source of our supplies. Ground water is water which has passed through the natural filter of the earth's surface, and is made available for our use by wells or springs. Surface water is the water in ponds, lakes and streams, and while it receives some ground water from springs it also receives the run-off from the watershed, following rains and thaws. Although the rain or melted snow in washing the earth's surface may become contaminated with the germs of disease, the weaker species of these, whose normal habitat is the human intestine, in passing through the upper layers of the soil meet the soil bacteria and in the fierce battle for existence soon succumb to their hardier brethren. Therefore ground water is in reality naturally filtered and purified. For this reason, in general it is a safer source of supply than surface water.

There are certain very important qualifications to this general statement. Ground water from limestone formations or when drawn from shallow wells where soil pollution is intense may be dangerous. On the other hand, surface water, though subject to contamination from sewage and the

washings of the land surfaces following rains and thaws, may be safe on an uninhabited or sparsely inhabited watershed, especially if prolonged storage in natural reservoirs is provided.

Good ground water is the ideal source for water supply from a sanitary standpoint, but there are serious drawbacks which militate against its general use. First, it is difficult in this country to obtain a sufficient flow at reasonable expense for large cities. Second, ground water is often highly mineralized, may be very hard, salty, or impregnated with iron. Ground water is available from several distinct types of sources. The area upon which the rain falls is called the catchment area. The rain water which filters through the catchment area reaches the deeper strata and is stored as ground water. Its sanitary quality will depend upon the character of the catchment area and its underlying strata and the depth from which it is drawn. If the catchment area is sand and the underlying layers sand and gravel, if the catchment area is sparsely peopled and the water is drawn from a good depth, a safe water will result.

If the catchment area is in a limestone region, the water is stored in caverns and crevices in the rock. These are in communication with each other

and with the surface pollution by means of cracks and crevices. In this way water from the surface reaches the subterranean ground water by direct channels, instead of by filtration through sand and gravel.

The danger of pollution is at once apparent. If the surface pollution is small, especially if the source is in an uninhabited or thinly settled region, ground water from limestone may furnish a safe supply. Vienna, Austria, has a limestone ground-water supply from such a catchment area, and it is conceded to be a safe supply. San Antonio, Texas, is supplied by ground water from limestone. Usually, however, large cities find the supply from such sources not only dangerous in quality but inadequate in quantity.

Ground water is much more commonly used for municipal supplies in Europe than in this country. There are two reasons for this: first, we are less fortunate in the geological formation of the country, and, second, we use or waste more water than Europeans; hence, ground-water supplies are often inadequate here which would suffice for a similar population in Northern or Central Europe. We have many areas in this country which furnish large supplies of ground water, especially on Long Island and in southern New Jersey. Brooklyn is supplied in part with ground water.

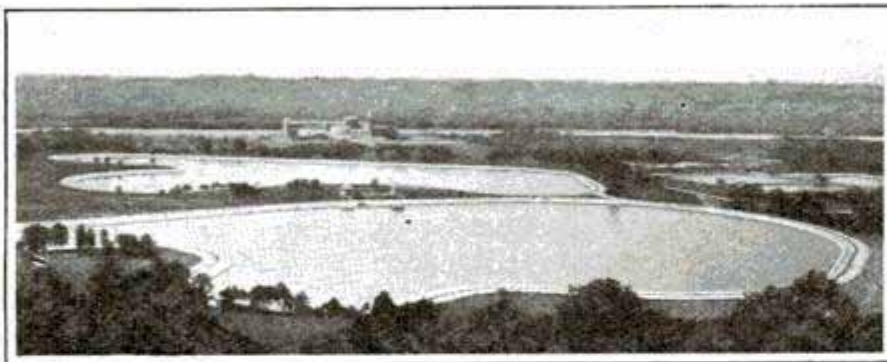

Cincinnati Purification Plant, Showing Settling Reservoirs in Foreground, Filtration Plant in the Middle and Pumping Station for Ohio River Water in Background

The amount of water obtainable by one pumping station is limited, and to collect the ground water on a large scale many separate pumping units are necessary, and this increases the cost greatly. Deep wells in sandstone

are an excellent source of ground water. Areas in Michigan, Illinois, Wisconsin, and Minnesota are underlain with a water-bearing sandstone. This rock furnishes a supply which does not fluctuate as limestone supplies do and is safe from surface pollution. The supply, however, is limited to small cities, although Jackson, Mich., a city of over 25,000 inhabitants, has an adequate supply from this source.

The chief advantage of ground water is freedom from surface pollution. As stated above, when drawn from shallow wells or from limestone rock, ground water may be polluted. Its disadvantages are, small quantity available and high mineral content, giving objectionable tastes or odors or excessive hardness. The sanitary advantage of good ground water is enormous, but the small amounts available at reasonable cost generally exclude it from consideration in large cities. Further, its hardness often makes it an undesirable supply for manufacturing towns and cities.

Surface water as a source of public water supplies may be divided into impounding reservoirs, ponds and small lakes, great lakes, and rivers. In contrast with ground-water supplies, surface-water supplies generally furnish abundance of water, but are usually contaminated. The upper layer of

soil with which surface water is in contact is rich in bacteria, and a part at least of the sewage and wastes from inhabitants of the watershed also finds its way into the streams. The degree of pollution will depend upon the population on the watershed.

The ideal watershed is uninhabited and heavily forested. Such a watershed is rarely available in this country. A certain number of inhabitants on watersheds used for water supplies in America is usually tolerated. There are about 60 persons to

the square mile on the Croton watershed of the New York City supply, and over 700 on the Cochituate (a part of the Boston supply). Pollution from this source is supposed to be nullified by storage. The Boston, New York, Newark, Jersey City, and many other urban supplies in the northeastern states are known as impounding reservoir supplies. That is, upland streams are dammed at convenient points, making great natural reservoirs. The object of this is not only to retain the flood waters for use in the dry months, but also to provide opportunity for storage as an agent of purification. Storage permits sedimentation of suspended matter which carries down many germs, and also holds the water long enough to permit the natural death of the disease germs. Disease germs, of which the typhoid bacillus is a type, do not multiply in water, but decrease in number and gradually disappear, unless reinforced by fresh sewage additions. The time necessary for this disappearance has been variously estimated at from a few days to several weeks. Storage thus becomes a very potent purifying agent if continued long enough and if the pollution is not constant.

Small lakes and ponds as sources of supply resemble impounding reservoirs in their possession of certain natural purifying agencies and the comparative ease with which the watersheds may be policed or controlled. The danger of transient pollution is ever present, however, as in all other surface supplies. The extent of the danger bears a direct relation to the density of population and the amount of storage.

The Great Lakes form the logical source of supply for many millions of people. The supply is inexhaustible

and is of excellent quality if it can be drawn at a sufficient distance from shore. Unfortunately there is a zone of polluted water all along the shore of the Lakes, and the boundaries of this zone are continually changing.

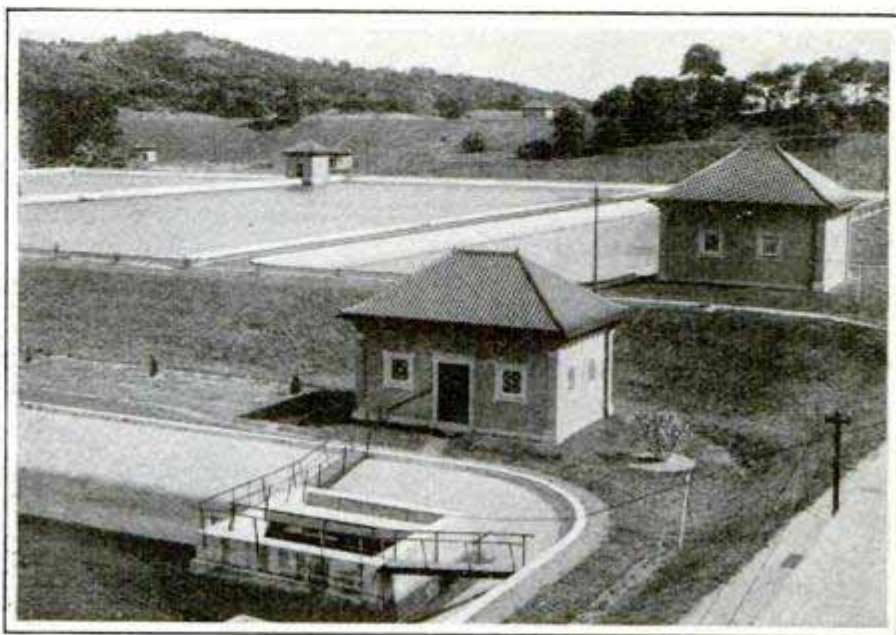

Coagulation Basins, Where Chemical Treatment is Applied to Cincinnati's Water Supply in Addition to Settling and Filtration

Considered as a watershed the Great Lakes present great difficulties in policing and control.

This polluted water is not entirely dependent upon the discharge of sewage by the cities. Even if the sewage of cities on the Lakes were purified so far as economically possible, the zone of polluted water along the shore would be very much in evidence, especially after rains and thaws. The boundaries of this polluted shore water, changing with the winds and currents, make it difficult to place waterworks intakes where they will be safe from pollution at all times. It is impracticable to go farther into the lake than a depth of 75 or 80 ft., and economically inadvisable to construct tunnels longer than 4 miles in order to escape pollution. It is an economic question and it is usually cheaper to use the shorter intake and purify the water in some way, than to extend the intake to a point which would be safe from pollution at all times. The intakes used by our lake cities are now as much as 4 miles from shore, and

two of them are in 75 ft. of water, yet these are occasionally polluted with sewage bacteria. Practically all of these cities are considering some method of purification.

Our great navigable rivers are the natural sources of supply for many millions of people. They are usually polluted throughout their entire length, and in practically every instance river supplies are unfit for use as public water supplies, without purification. These waterways differ greatly from upland streams, ponds, and lakes, inasmuch as they are extremely difficult to control and have a large urban population on their watersheds. Many lives have been sacrificed because of delay in filtering supplies from polluted rivers, but a great deal has been accomplished in the last decade in installing filter plants in river cities.

In considering water supplies which are used without artificial purification, I desire to emphasize the fact that the only types of supply which will furnish unpolluted water at all times are a good ground-water supply and a surface supply from an uninhabited watershed. Some of the impounding reservoir supplies, like those of New York, Boston, Newark, Hartford, etc., although from rather populous watersheds have been considered satisfactory; but they receive pollution, and it is not at all certain that this pollution does not cause disease. The large storage is depended upon to nullify the pollution received. The Jersey City supply is of the impounding reservoir type and the storage was found to give insufficient purification, and since 1908 the water is treated with hypo-

chlorite of lime, with excellent results. Baltimore, depending upon the same kind of supply, obtained by impounding the water of the Gunpowder River, had a very severe typhoid epidemic following a prolonged drouth in 1910. The dry weather decreased the runoff into the reservoir. At the same time the water consumption in the city was at its maximum and the storage factor was almost eliminated. Bacteriologic examination showed the colon bacillus constantly in small samples. With the advent of heavy rains dilution increased, storage was reestablished, the quality of the water improved and the typhoid outbreak ceased. Baltimore has protected itself since by treating the water with hypochlorite of lime. Surface supplies from flowing rivers are in general polluted and should not be used without purification. It is not contended that pure water is not obtainable in the Great Lakes. On the contrary, the storage in these great natural reservoirs is such that pure water may be obtained beyond the zone of shore pollution. Unfortunately, to secure a supply of pure water at all times in most instances is not feasible, either because of engineering difficulties or financial considerations. It is usually cheaper to purify the water in some way, with an intake at a moderate distance off shore, than to attempt to secure pure water with a long intake tunnel.

Purification of all surface-water supplies is inevitable. It is the rule in Europe, and if we carefully examined our supplies daily for the presence of colon bacillus as an index of sewage contamination, and gave proper regard to the result, we would purify in some

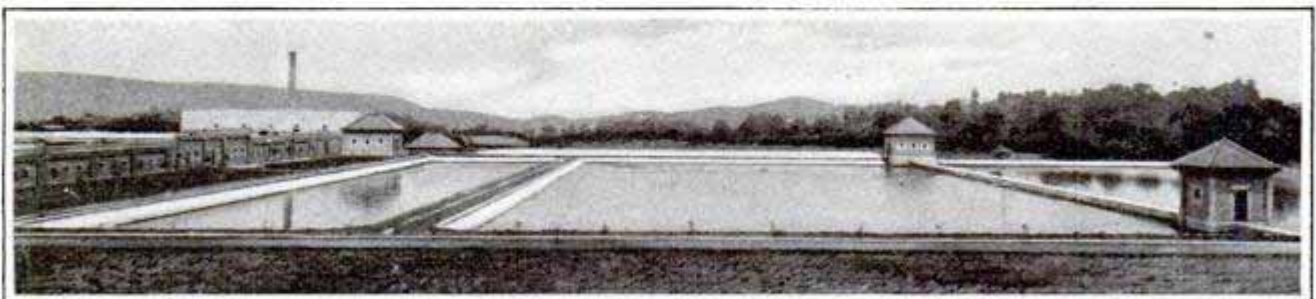

Reservoirs for Filtered Water, Cincinnati Purification Plant. The Highly Polluted Ohio River Water is Here Converted into Safe Water of Very High Quality



The Water Temple at Sunol, Where Surface and Ground Water Mingle for San Francisco's Supply

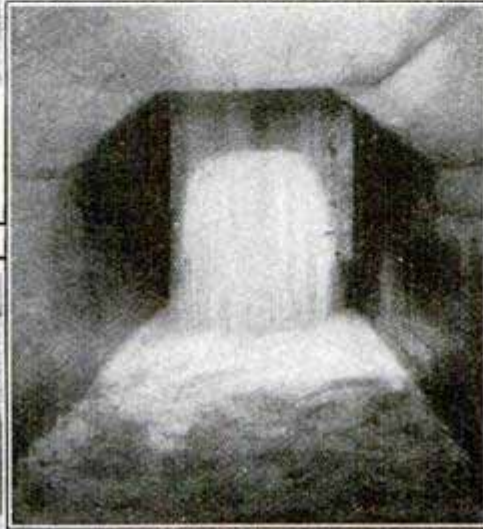

The Meeting of the Waters, Where Artesian and Filtered Surface Water Mingle

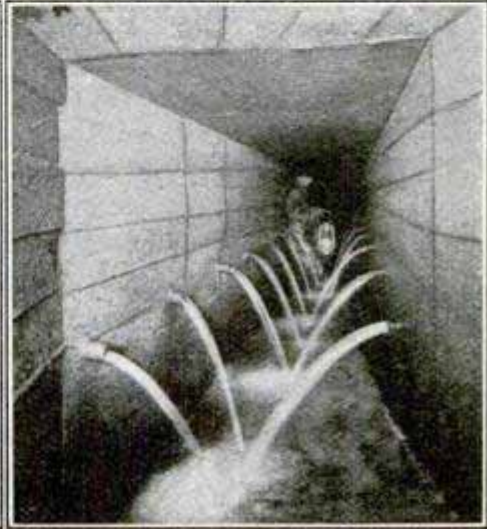

Filter Gallery for San Francisco's Surface Water

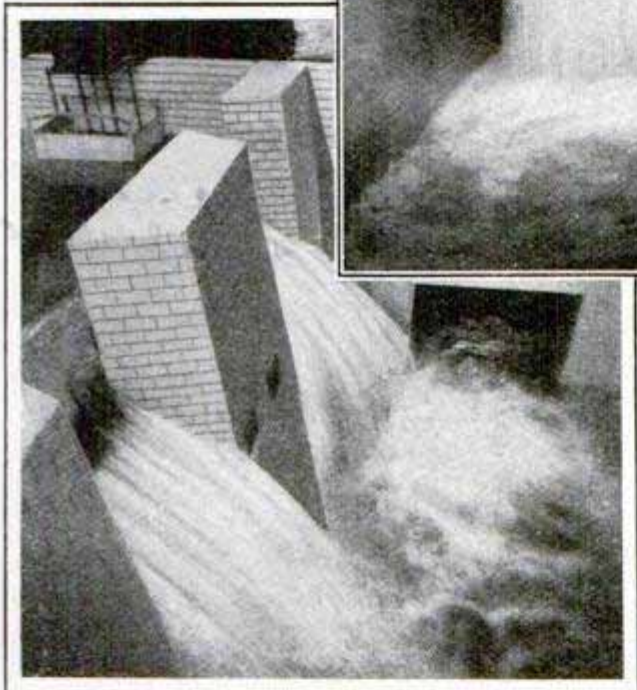

Ground-Water Supply for San Francisco

way practically all our surface-water supplies. With the limitations which

prevent the wide general use of ground-water supplies, it is evident that the great bulk of our urban population must depend upon surface supplies. It is equally obvious that these supplies must be subjected to some method of purification in order to furnish safe water 365 days in the year. The various methods of purification will be discussed in my next article, in order to give some idea of their relative value, cost, and availability.

351² TREATING GASOLINE WITH CAMPHOR FOR MOTORS

English motorists have found that camphor dissolved in the gasoline results in fuel economy, and scientific tests are about to be made to determine to what extent the claims are justified. A motorcyclist tried 1 oz. of camphor to 4 gal. of gasoline, but found that this made the mixture too rich. Using 1 oz. of camphor to 5 gal.

of gasoline, he estimates that the saving in fuel is at least 20 per cent. An automobile user states that he used camphor in his gasoline for six months, the proportion being 1 oz. of camphor to 5 gal. of gasoline. He claims that the camphor has resulted in considerable economy in fuel consumption, that it has made possible the climbing of hills at high speed, and that his engine, which had been very difficult to start, gives no more trouble.

Swivel Cushion Wheel Co.
POPULAR MECHANICS

1114 Michigan Ave Chicago
RUBBER-CUSHION WHEEL FOR MOTOR CARS

An entirely new type of motor-car wheel, constructed with no connection between wood and wood or iron and iron, except

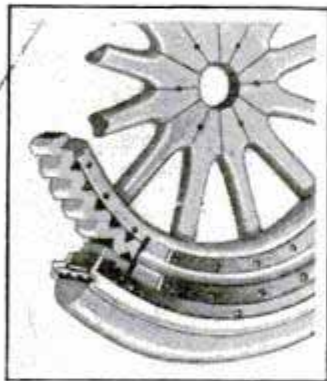

through rubber, is here shown. The invention is practically an automobile wheel fitted with two rims or feloes instead of one. Between these feloes is placed a rubber cushion

consisting of a corrugated strip of rubber for making the wheel springy. The wooden feloes and the space between them are covered on both sides with ring-shaped rubber flanges, mak-

ing the chamber containing the cushion absolutely proof against dust and moisture. These flanges are held in place by means of steel bands, which are bolted through to each side and overlap the cushion chamber so as to prevent a lateral or side motion. The outside feloe is faced with an ordinary steel tire. A long life is claimed for this wheel on account of its rubber cushions being inclosed, thus avoiding any friction or wear between the parts.

By means of a delicate apparatus known as the microdynamometer, roughness or softness of the enamel of the teeth can be detected even when it has progressed to a very slight degree. The value of this device to dentists is said to be considerable, as it enables them to detect the beginning of tooth decay much earlier than has heretofore been possible.

Journal-American Medical Association

3449 **A FISH THAT LIVES OUT OF WATER**



A fish that is provided with a lung for living out of water for months and probably for a year at a time, and which breathes by means of gills when in the water, was recently presented to the American Museum of Natural History by the Public Museum of Liverpool. This peculiar type of fish, which is the second living specimen of a lungfish ever brought to the United States, originally came from the Gambian region of Africa coiled up in the form of a cocoon inclosed in a large lump of earth that had been a part of the bottom of a dried-up stream.

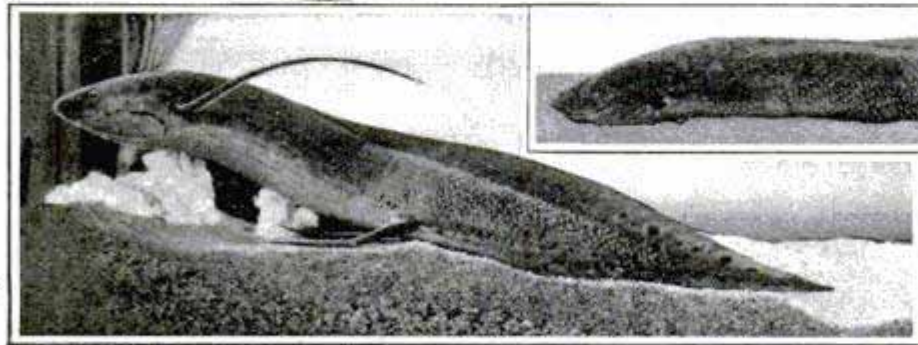

The Lungfish Just Out of Its Prison of Mud

When the clod of earth was received at the museum the only indication that there was life within the

Above: Showing Breathing Hole of Lungfish in Lump of Hardened Mud
 Below: The Lungfish as It Now Appears

Scientific American Supplement 1/25/1913

hardened mass was a small hole through which the fish breathed. The fish was removed from its prison by placing the latter in warm water until the shell became soft enough to remove a part of it, when the fish emerged alive. It is claimed that this species of fish has survived from a very ancient period of time and belongs to the earliest known species of land-living animals that form the connecting link between the true fish family and four-footed animals.

SIGN-LETTERS FOR TALKS WITH THE DEAF

Talking to the deaf without knowing any sign language is accomplished by means of a typewriterlike apparatus devised by a French physician. It consists of an ordinary keyboard, with 42 keys, operating levers to the ends of which lettered tags are attached, so that when the keys are pressed the corresponding letters are brought into view, forming syllables or whole words. The letters are of a size calculated to make them plainly visible to a person of normal sight at a distance of 10 ft. for the smaller machines, and 20 ft. for the larger.

Sign-Writer
for Communi-
cating with
Deaf Persons

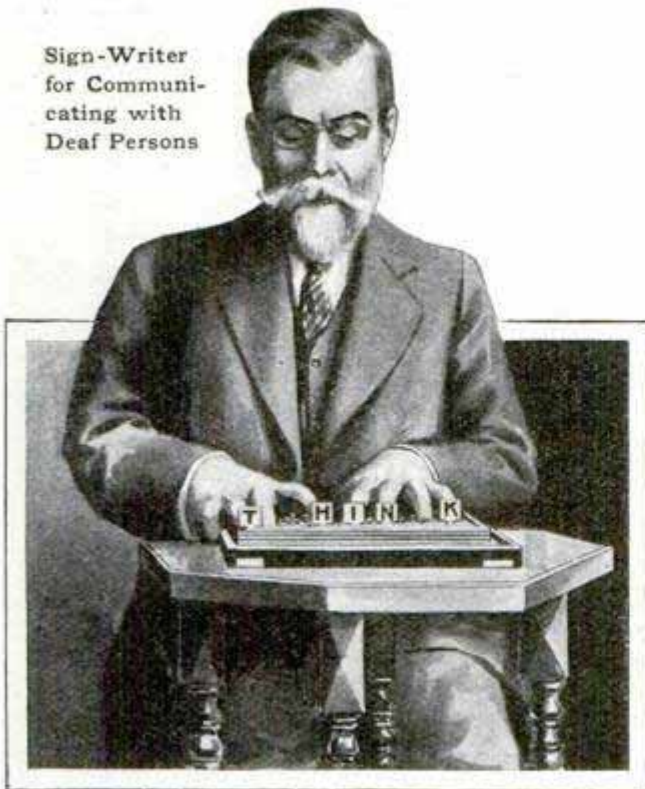

OIL DERRICK PRESENTS NOVEL ILLUSION

This illustration of an oil derrick in southern California presents one of the

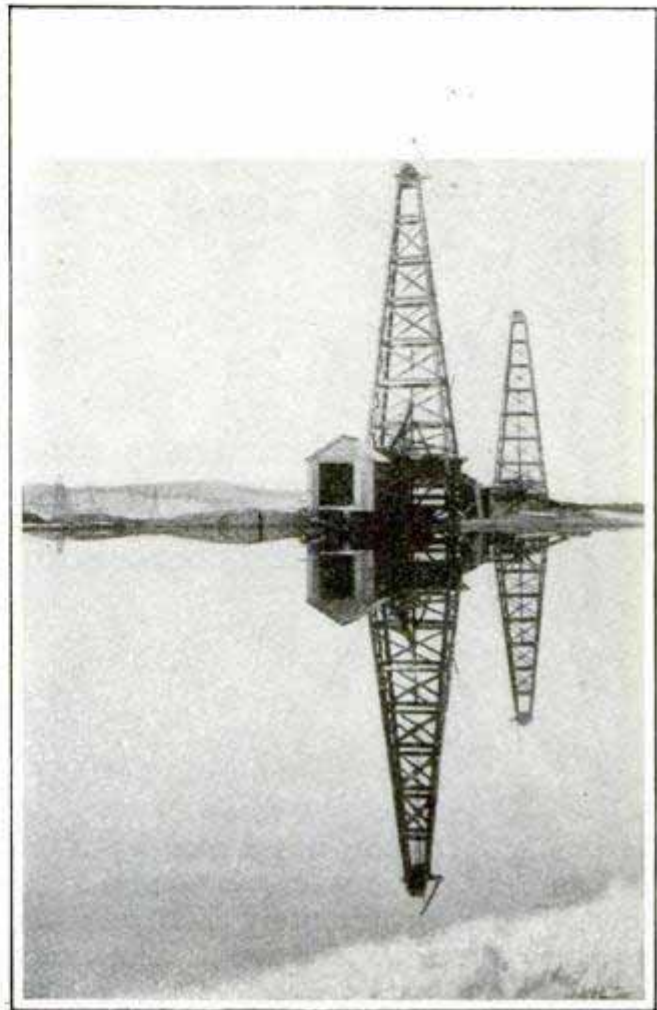

An Optical Illusion in Oil

most remarkable illusions ever caused by reflection. Were it not for the grass and shadow of the lake bank dimly seen in the lower right-hand corner, it would be impossible to tell which is the top and which the bottom of the picture. The reason for this absolute perfection in reflection is that the lake is composed, not of water but of oil, the lake being, in fact, a natural oil reservoir. Where immense gushers are struck which flow continually day and night, the only possible way of saving the oil has been to quickly throw up an earthen dam across some convenient ravine and turn the flow into a great reservoir, whose surface is as smooth and rippleless as glass.

DRILL SIX FEET LONG

One of the largest drills ever made is shown here. It was specially made for a large Pennsylvania-woodworking plant for putting a hole through a stack of boards up to 6 ft. high in one operation.



BRIDGE LOADS OVER-ESTIMATED

The weight of foot passengers used in the calculations of stresses in metal bridges is generally exaggerated and does not correspond to any reality, according to a bridge engineer. Special works on the subject require from 92 to 112

lb. per square foot, but a weight of 92 lb. per square foot corresponds to a density of approximately two persons to every three square feet. The individuals composing a crowd so dense as this would be squeezed together in such a way as to prevent any movement.

In attempting to reach an idea of just how dense a great crowd may be, a number of photographs were made. Assuming the average weight of the persons in these crowds to be 150 lb., the photographs indicated that the maximum load would not be more than 30 lb. per square foot.

On these observations the designer in question bases his opinion that, with the usual factors of safety employed, the estimate of 92 lb. per square foot is very excessive.

More than 1,000,000 gal. of kerosene oil are now consumed by the world every day, and the United States output during 1912 was 220,000,000 gal.

OLYMPIC GAMES OF 1916

Even before the International Olympic Committee had announced its decision to hold the Sixth Olympiad at Berlin in 1916, building and financial plans had been completed for the Berlin stadium. Its erection commenced immediately after the decision was formally announced to the German government, and it will be completed by July of this year, so that there will be a full three years in which to test exhaustively all its arrangements.

The stadium, which will cost in the neighborhood of \$550,000, will be in the Grunewald, the beautiful forest on the western outskirts of Berlin, in the exact middle of the race course of the Berlin Jockey Club. In the center of this inclosure is a little valley, in which the stadium will rest. No part of it will rise above the level of the race course.

ANOTHER "WHAT IS IT?" MACHINE

The machine which was illustrated in the April issue under the head, "An Inhospitable-Appearing Machine," is an automatic side-cut brick table which cuts a stream of clay into whatever size brick is desired.

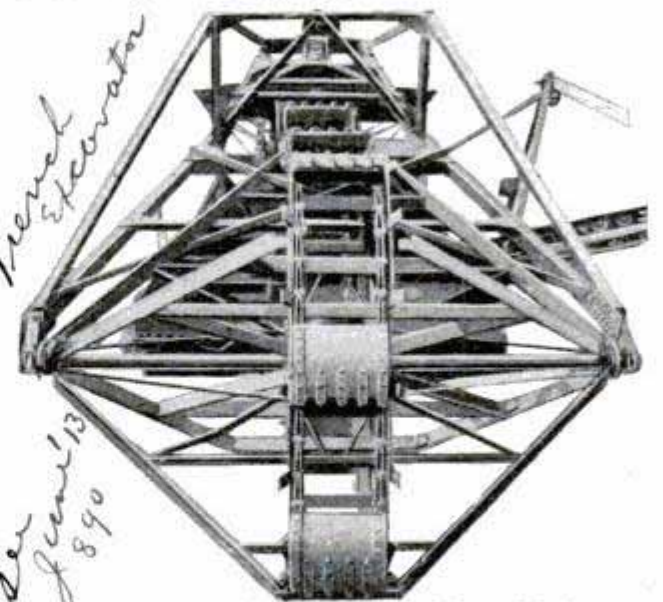

It Looks as if It might be a Queer Kind of Vehicle, but It Isn't

In the accompanying illustration is shown another machine which may baffle the imagination of some readers.

M. Rohrig in Zentralblatt Bauwesen April 6.



Drawing Water into a Dry Well

Having a well that would fail in water supply during a drouth and not caring to dig it deeper, I decided to try out a plan for drawing water into the well. I made an air-tight covering for the top and lowered a box of shavings, soaked in gasoline, to the bottom with a fuse attached that could be ignited through a gimlet hole in the covering material. The burning of the shavings caused a vacuum which drew the water through the earth in the bottom of the well, and when I uncovered it, I had plenty of water and have not been without water since that time.—Contributed by J. W. Bauholster, Gresham, Oregon.

Magnetic Plumb-Line Holder

A handy little device for holding a plumb line is shown in the sketch. It is especially valuable to one working alone around iron structures or in places where a plumb line cannot be tied to iron work. It consists of a rectangular piece of tool steel bent to a U-shape, the ends squared and a hole drilled in the center of the bend for a screw eye. After hardening, the screw eye is riveted in place and the steel magnetized. The size of the magnet will depend upon the weight of the plumb bob used.—Contributed by M. J. McGall, W. Orange, N. J.



A Lawn Sweeper

Not having any use for an old lawn mower I converted it into a lawn sweeper that served the purpose of

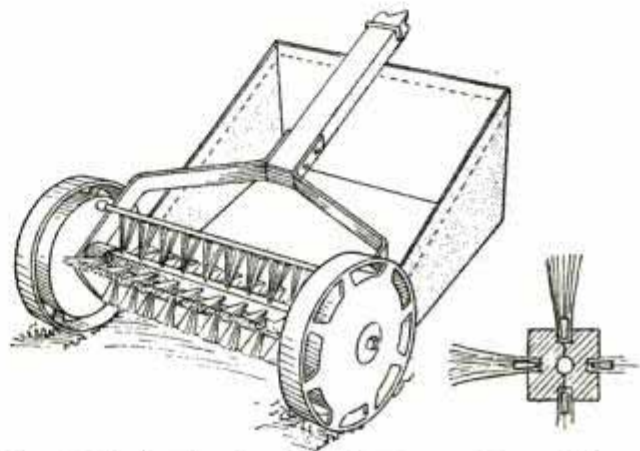

Brush Substituting Revolving Cutters on Lawn Mower for Sweeping and Picking Up Leaves

picking up leaves and pieces of cut grass in a satisfactory manner.

The sweeper was easily and quickly constructed with little expense in the following way: I removed the revolving blades and substituted a brush. The center part for holding the bristles of the brush consisted of two pieces of wood, cut to the length of the old blades and then grooved to fit over the mower axle. They were fastened together on the axle with glue and nails, after which a hole was drilled through the wood and axle and a pin driven in to prevent the finished brush from turning on the metal axle.

The tufts of bristles were taken from a couple of old brushes, $\frac{3}{16}$ -in. holes, $\frac{9}{16}$ in. deep, were bored into the four sides of the wood axle $\frac{3}{4}$ in. apart and the tufts well glued and inserted in them, then further secured with wood pegs or wedges. The ends of the bristles should just clear the knife on the mower when they are revolving.

In running this machine over the lawn the brush will throw the leaves into the apron at the rear.—Contributed by Warren E. Crane, Cleveland, Ohio.

Indicator for a Mail Box

An indicator showing when mail has been deposited in a mail box makes it unnecessary to step outside to see if any letters were left by the postman.

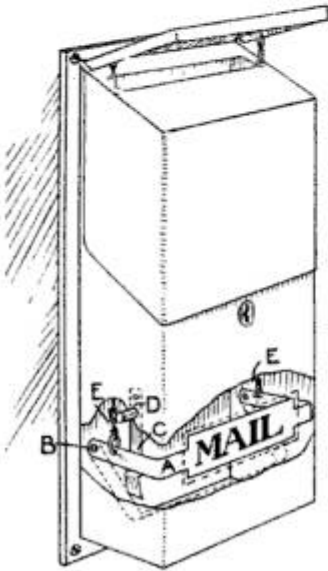

The indicator consists of a piece of heavy tin, A, $\frac{1}{2}$ in. in width and long enough to work up and down freely when placed in the box in the position shown. The center of the tin is cut to a size and shape to

correspond with the opening in the front of the box. The ends of the indicator are hinged on rivets, B, so that it will swing as shown by the dotted lines.

A spring clip, C, is riveted to one side of the box in a position to hold the indicator up, and a push button, D, to release it when the mail is removed from the box is provided. Small chains, EE, connect the indicator with the cover of the letter slot, so that when the latter is raised it sets the indicator, which is held in the position shown until released by the button D.—Contributed by F. L. Matter, Portland, Oregon.

Protecting Glass While Painting Window Sash

The modern bungalow door with its square sash and many panes of glass makes a very tedious job for a painter since at least five coats of stain, filler and varnish are required. The following is a method I am using in the case of plate glass: Common-weight

manila paper is brushed with linseed oil and dried, then cut into sheets the same size as the glass. A piece of the paper is placed in the open sash, then the sheet of glass and another sheet of paper on top of the glass. The glass is fastened in the usual way. The pane of glass is now protected on both sides and remains so until the finish is completed and dry, when the paper is cut out by following the edges of the opening with a blunt-pointed knife held at right angles to the glass. The result is a bright, clean job and a moisture-proof packing between the glass and the wood. The paper is translucent and transmits enough light to work by easily.—Contributed by I. L. Sears, Waverly, Ill.

Siphon for Large Tanks

A swimming pool, or any tank having its drainage overflow at the surface of the water instead of at the bottom, is easily siphoned dry for cleaning purposes by using the device shown in the sketch. The drain pipe passes through the side of the reservoir A, beginning of course near the bottom. The outer end of the tube must be lower than the bottom of the tank A, and is immersed in a small box of water B. At the top of the bend C is a small air hole which can be opened or closed readily.

In operation, if a constant stream of water is flowing, the tank A fills to the level D and the water trickles

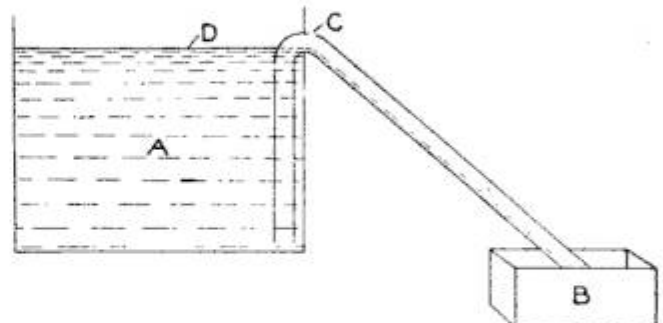

The Siphon is Started by Filling the Tank above the Highest Bend in the Pipe

down the tube. If the small air hole at C is open the water will only flow out to a certain level. If it is desired to empty the tank, no laborious pumping is required to start the big siphon.

Merely plug the air hole C, and the running water drags practically all the air out of the overflow pipe. It then fills with water and acts as a siphon until the tank A is emptied.

If there is no constant flow of water, the siphon can be started by turning on a temporary stream until sufficient air is taken out of the drain tube. It is evident that, unless the outer end of the tube is covered with water, the siphon cannot be started in this way.—Contributed by Harry W. Holmes, Richmond, Ind.

A Fire Escape

A very serviceable fire escape can be made of stake iron and long bolts in the manner shown. The iron forming the side bars, Fig. 1, should be 15 in. long, 1½ in. wide and ¼ in. thick. A ½-in. hole is drilled near each end of the two pieces and bolts, 12 in. long and ½ in. in diameter, are used for the connecting parts or rungs, as shown

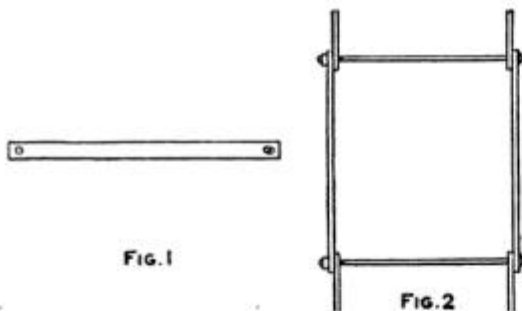

Folding Fire Escape, Made of Metal, That can be Quickly Attached to a Window Sill

in Fig. 2. The upper end pieces are bent and pointed so that they can be hooked on a window sill. A fire escape of this kind, when folded, will not occupy much space, and can be attached to a window sill and lowered almost instantly.—Contributed by Wm. Jenkins, New York City.

Lock for Double-Entrance Doors to a Bathroom

A bathroom having two entrance doors should be provided with a device for locking both doors at the same time from either entrance, and this provision made when the building is in the course of construction. If the doors are

located at right angles, a bell-crank lever must be used at A which is joined with two rods, B B, running to

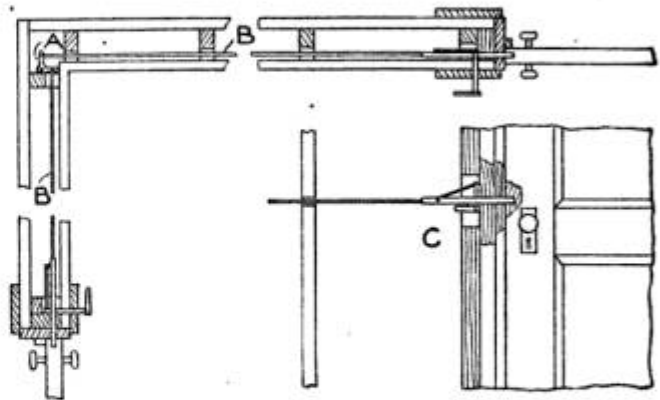

The Locking of One Door Causes the Other to be Locked Simultaneously

the latches at the doors. A lever, which is duplicated on both doors, is made as shown at C. When one door is locked by turning its lever, the other door is locked also.—Contributed by J. E. Carter, St. Petersburg, Fla.

Sliding Display Board on a Show Case

Show cases used for displaying metal goods or any material that is apt to scratch the glass may be fitted with a protector on which articles are placed when they are shown to a customer. A board can be easily made by a carpenter or a handy man, of the same material as the show case and finished in the same manner. The end cross-pieces are rabbeted, as shown at A, and mortised to receive the ends of the centerboard, which can be finished in natural wood, or ribs may be put on the edges to form a depression to re-

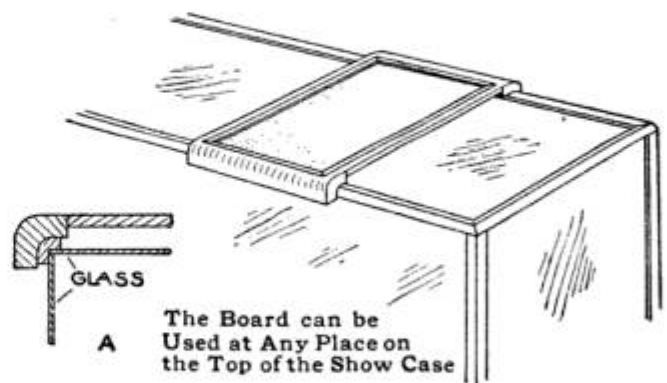

The Board can be Used at Any Place on the Top of the Show Case

ceive a piece of heavy felt. The protector can be slipped along on the show case and used at any place for showing the goods.

Homemade Gauge Tester

The large number of air and water gauges about my plant made it necessary to have a gauge tester, says a correspondent of Power. I constructed a

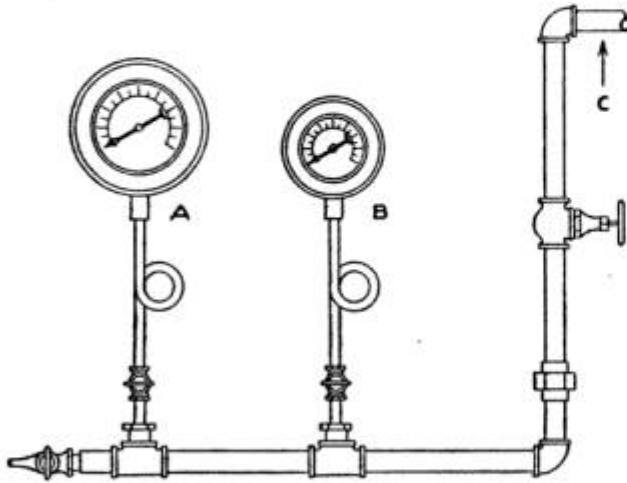

Standard or Test Gauge and Gauge to be Tested on the Pipe Line from a Boiler

tester at home and connected it to the boiler as shown in the sketch. The standard or test gauge is located on the pipe line at A and the gauge to be tested at B. The boiler connection is at C. Gauges may be tested at different pressures by partially closing the valve in the steam line and opening the drain cock at the end until the desired pressure is obtained, as would be shown by the gauge A. All gauges can be kept in perfect working order with very little trouble and expense by using this tester.

How to Cut Dovetails in Metal

Dovetailing in a piece of metal is a very common construction for repairs and for new work, but is usually a slow and exacting job. The task can be

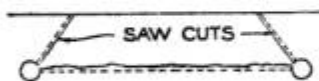

made easier by drilling and sawing out the part for the dovetail insertion. After laying out the dovetail mortise, as shown by the dotted line in the sketch, two holes are drilled at the corners in such a position that a part of them will be left after the dovetail slot is finished. This is seldom objectionable, leaves a much stronger corner, gives clearance for dirt, and

cuts the metal out where it is hardest to work. Two saw cuts are taken just inside of the dotted layout lines. The metal between these lines can be roughed out by any convenient process, drilling, milling, chipping or planing, removing the metal to the lower wave line. In this manner very little stock is left to finish, and the work can be done to the best advantage, as there are no corners to be cut out.

Care of Rain Pipes

The rain pipes of a house should have attention from time to time, and be covered with a coat of good paint inside and out at least once a year. If this is neglected particles of paint will be removed in time, and the unprotected surface of the tin will rust and make a hole rapidly.

If a hole does appear, it should be repaired immediately, in the manner shown at A and B. The surface of the pipe around the hole is thoroughly cleansed of oil, paint and rust, then a

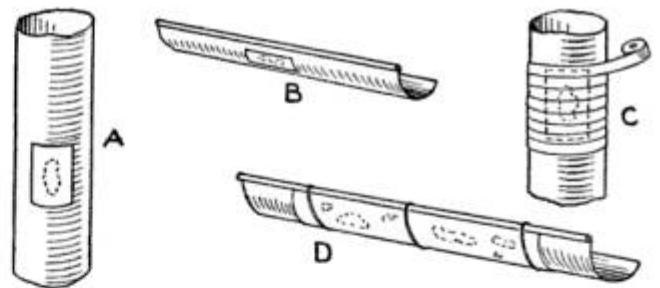

Patches as They are Applied to the Surfaces of Rain Pipes and Gutters over Rusty Parts

piece of tin is cut to cover the opening, allowing a sufficient margin for fastening with solder. After soldering the patch in place the repair is well covered with a coat of paint on both sides.

If no soldering outfit is at hand or one is unable to do soldering work, the repair can be made as shown at C. Coat the piece of tin and pipe around the hole with tar and, while the tar is still in a liquid state, place the tin over the hole and secure it in place by winding some tire tape or electrician's tape around the pipe. The tar will prevent leakage and the tape will hold the tar in place in very warm weather.

When a pipe has been neglected

until it has rusted so that it cannot be cleaned for soldering, it can be repaired as shown at D. A piece of galvanized metal is procured, long enough to cover the part damaged and with sufficient ends to lap on the part not rusted, and bent to the shape of the pipe or gutter, as the case may be, whereupon the inside is coated with

tar and the piece placed over the holes. Secure the piece with wire and apply the tape at both ends to prevent the tar from running out. Coat the inside of the gutter with tar and apply a coat of paint on the metal part. A little attention in time will save the cost of a new system.—Contributed by Edward Sieja, Chicago, Ill.

A Glass Cutter for Circular Work

By F. W. BENTLY, Jr.

*LN. X 1 (15)
2073*

A cutter for making glass disks is almost a necessity for a repair shop of any kind. The varieties of work requiring the use of such a device are quite numerous, but in a great many instances work of this kind is very crudely done by means of an unguided cutter.

A detail sketch of a circular cutter that can be constructed cheaply is shown in Fig. 1. The supports A A are made of 1-in. round iron, flattened at the lower end and bent so as to allow the cutting bed B to be fastened to them. The upper ends are threaded for a standard 1-in. nut, and by means of 8 of these nuts the guide plates C C are securely held. In addition to acting as a bearing for the cutting shaft D, the plates are rigid supports for the upper part of the cutter.

circle, the center of all circles, of course, to be in line with the center of the cutting shaft D.

The guide plates are shown in Fig. 3, and a detail of the main cutting shaft in Fig. 4. A hole is drilled in the lower end of this shaft to receive the cutting arm shown in Fig. 5. At the end of the cutting arm E, Fig. 1, a hole is drilled of sufficient size to hold a common wheel glass cutter. The supports AA, Fig. 1, are shown in detail in Fig. 6.

A light spring, Fig. 1, should be used to automatically raise the shaft D after the cut has been taken. The device can be instantly set to cut a circular piece of glass to any diameter, limited only by the size of the cutting board B. The cutters may be cheaply replaced when they become worn.

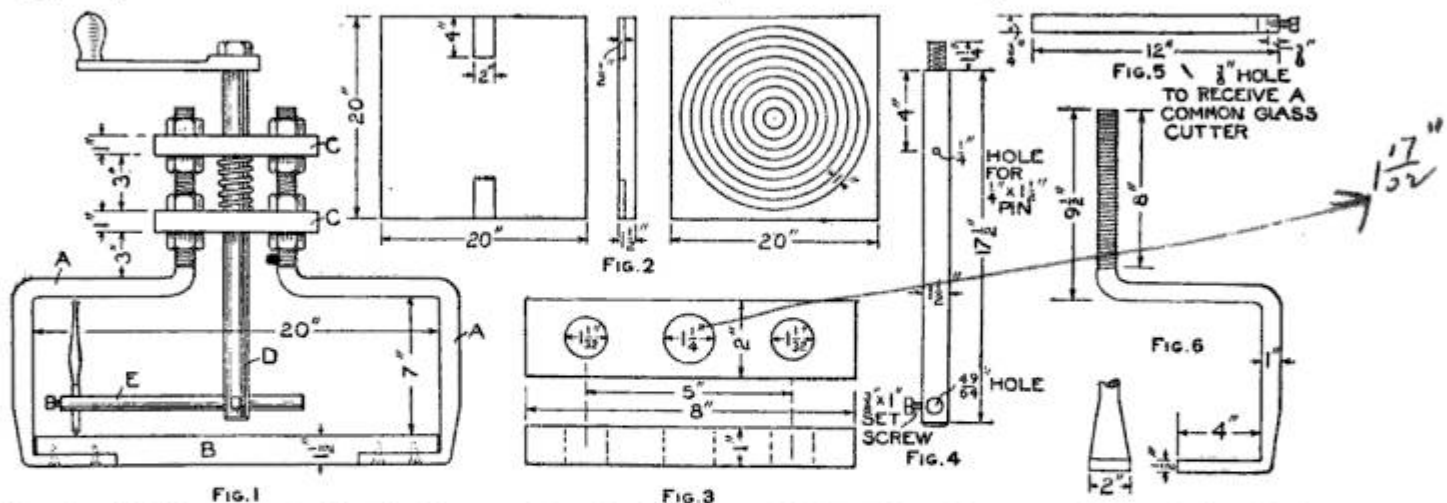

Details of Different Parts for the Construction of a Frame to Hold a Glass Cutter and Drive It in a Circle for Cutting Circular Disks of Glass to Replace Circular Gauge Glasses, and Various Similar Work

The detail of the wooden cutter bed is shown in Fig. 2. The circular guide lines should be scratched with a difference of 1 in. in the diameter of each

ⓄThe reed of an automobile horn may be renewed by flattening it with a hammer, then filing the edges to fit closely into the opening without touching.

Temporary Book Index

In the study or translation of a book in a foreign language it becomes necessary to refer constantly to the notes

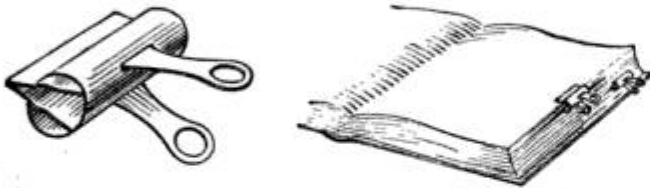

Bill Clips Make an Interchangeable Tab for Indexing, as well as for Holding Divisions of a Book

and vocabulary or index, which many times causes one to lose the place in the text. The use of a few ordinary bill clips, as shown in the illustration, makes it easy to locate instantly any part of the book to which it is desired to refer. The clips separate the unused part of the book from the used and the handles may be labeled as desired. Various sizes can be used, but it is best to select the smallest that will hold the number of pages desired to be clamped together.—Contributed by Harry Schectman, W. Orange, N. J.

Fish Spear with Removable Points

The main part of the spear is made of $\frac{3}{16}$ -in. machine-steel rod, and, in the construction of the three-point spear,

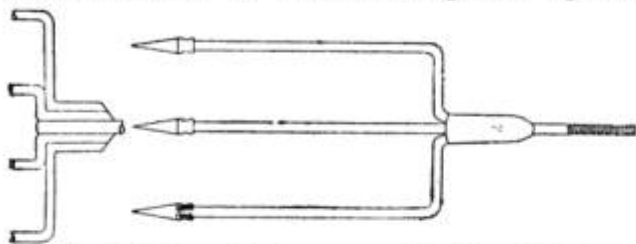

The Points on the Prongs are Hardened Steel and may be Removed and Sharpened

the center rod runs straight and the two outside prongs are bent in the shape shown, then bound to the center rod with fine wire, whereupon the joint is brazed. The four-pronged spear is made in the same manner with all four prongs bent and brazed to the end of the center rod. The points are turned from $\frac{1}{4}$ -in. drill rod, then drilled and tapped. The ends of the prongs are threaded to receive the points. After making the points they are tempered. An extra set of points may be kept on hand and used for re-

placing points that become broken or bruised on rocks.—Contributed by F. S. Cummings, Detroit, Mich.

Stopping a Leak in Nickelplated Pipe Connections

The connection between two nickel-plated pipes in a newly installed lavatory leaked and all attempts to stop it with pipe-thread lubricant failed. The walls of the pipe were so thin and the coupling so short that any substance in the threads would tend to spring the metal out of place. The leak was successfully stopped by inserting a babbitt-metal sleeve, or washer, between the ends of the pipe in the coup-

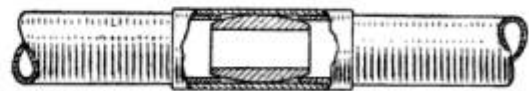

A Babbitt Sleeve in a Coupling between the Ends of Thin Nickelplated Pipes

ling. The babbitt was cast in oval shape and a hole drilled through the center. When the ends of the pipe were turned into the coupling against the babbitt, the sharp edges imbedded themselves in the metal and made a tight joint.—Contributed by J. S. Grant, Winchester, Va.

Fan Blades on an Ordinary Pulley

Having an idle pulley on a rapidly running line shaft, I fitted it up as a fan. Three blades of $\frac{3}{8}$ -in. white pine, cut as shown at A, were fastened on the pulley B at an angle of about 45 deg. Braces were nailed on for added security. No attempt was made to smooth up the blades, but the fan, nevertheless, gave good satisfaction.

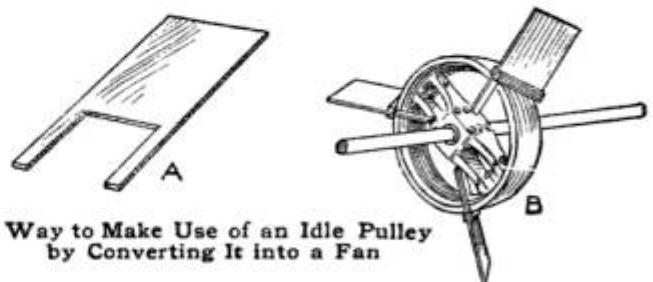

Way to Make Use of an Idle Pulley by Converting It into a Fan

The side strips of the blades A are intended to be nailed to the sides of pulley having no spokes.—Contributed by James M. Kane, Doylestown, Pa.

Segment Work in Pattern Making

By J. H. SHELLY

There are certain kinds of pattern work that require considerable strength, and, for convenience in finishing, it is best to build up the parts in segment courses. This method is to fill in successive layers or courses of wood, their total being equal to the thickness of the piece required and each course divided into a convenient number of pieces called segments. The courses are built up with the segments of one course overlapping the joints of another in a manner similar to laying bricks in a wall. There should always be an equal number of segments in each course. The object of this method is to have the straight grain of the wood to follow, as near as possible, the outline of the pattern, thus eliminating end wood and minimizing the short grain, two factors that usually weaken a pattern.

To turn out this kind of work successfully it is necessary to keep in mind a few general rules, which hold good when applied to all classes of work. It is necessary to use thick, hot glue to obtain the best results, and for the smaller-surfaced segment work the thickest glue should be used. Whenever it is possible to do so, nail the segments together as they are put on, but if for any reason nails cannot be used, it becomes necessary to use toe-

starting another course, but by toenailing one course to another the process may proceed without interruption.

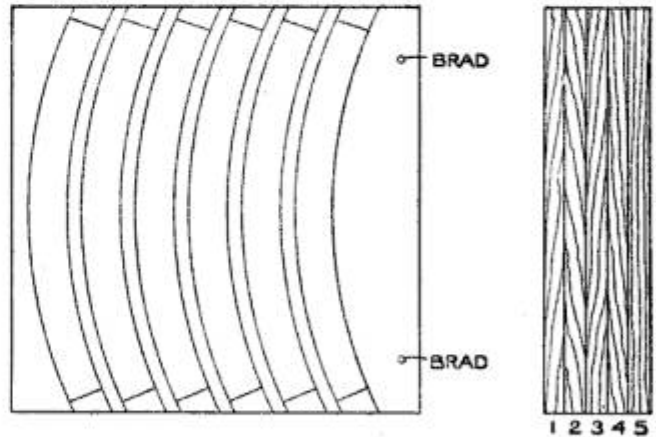

FIG. 1

Cutting Segments with the Grain of the Wood So That There will be No Waste

Use five nails or brads to each segment, three on the outside and two on the inside. The locations for the three outside nails are one at each end and one in the center, the inside ones being placed between the locations of the others. Start the nails before applying the glue and, when nailing, do not drive them in flush, but allow the heads to project about $\frac{3}{16}$ in., so that they may be drawn when the glue is set. Always size the joints between the segments by daubing the ends with glue and rubbing it into the wood with the finger tips. Unless this is done, the

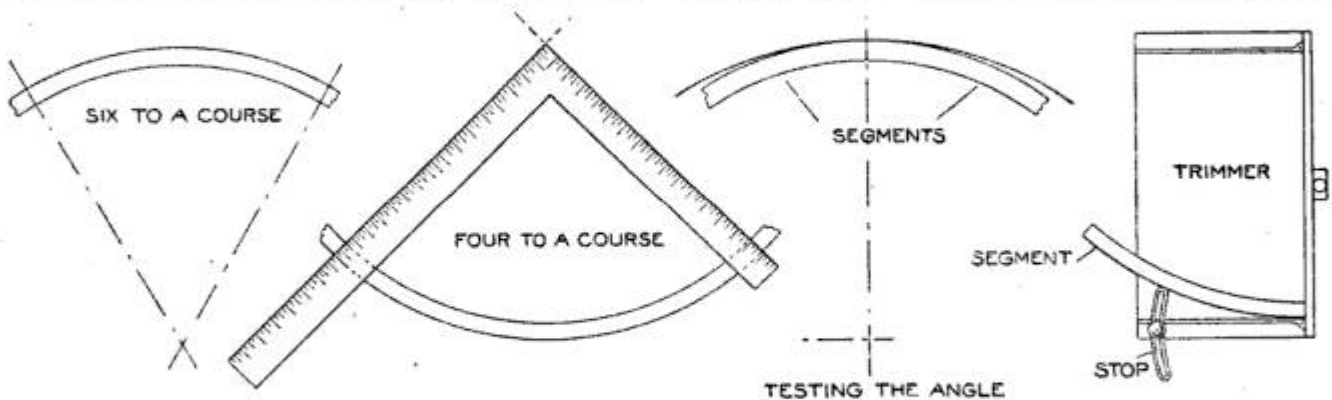

FIG. 2

Manner of Laying Out and Trimming the Segments, Also Fitting Large Segments in Place with the Use of the Trimmer after Setting the Stop to Obtain the Proper Angle

nails or, as a last resort, screw clamps. With the screw clamps it will be necessary to wait for the glue to set before

inside corners at the butted joints are apt to chip off in finishing, especially if they are to be turned on the inside.

For circular work, the most convenient number of segments to a course is six. The radius of the circle being approximately $\frac{1}{6}$ of the circumference,

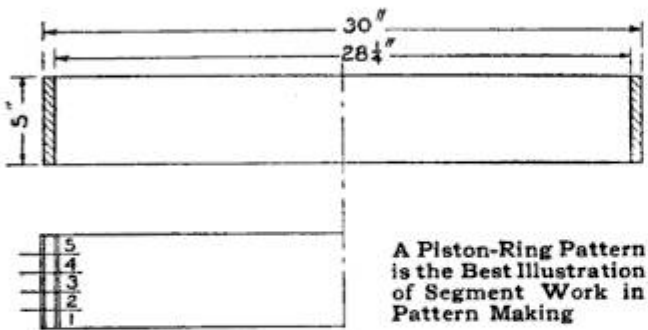

FIG. 3

it is easy to lay out this number of segments, but for very large circles it will be found more economical to divide into eight or even more segments. Small pieces, that are to be turned on the outside only, may be built with four segments to the course, but for inside turning this will not be found satisfactory, as there is too much short grain at the ends of the segments to make a good job.

The number of courses in any particular job will have to be regulated by the thickness of the stock at hand, but three is the smallest number that should ever be used, unless it is something that is to be screwed or otherwise permanently fastened to another piece that will help to strengthen it and keep it from warping.

In marking off segments preparatory to sawing, always use a template made of a piece of thin stock, unless they are very small and can be conveniently laid out with a pair of dividers. If the segments are thin, the stock may be dressed a little full of the required thickness and cut a little longer than the segment length, then after fastening them together with brads much time will be saved in marking them out from the template and in sawing. When cutting the segments in this manner be sure to saw them to length first, allowing $\frac{1}{16}$ in. or more for trimming. This part of the work is fully illustrated in Figs. 1 and 2.

A saving in thickness may be effected by dressing large segments

after they are sawn from the rough plank, and a considerable saving in time by setting the trimmer to the right angle and trimming the ends of all the segments at one setting. This is done by setting the stop on the trimmer as near as possible to the right angle and making the final adjustment by trimming one end of two segments, butting them together and trying them on the circle until the right angle is struck. This makes it necessary to fit but one segment in each course, the last one being trimmed to length.

A piston-ring pattern is a good illustration of this work. The one shown in Fig. 3 is to be finished 30 in. in diameter on the outside, 28 $\frac{1}{4}$ in. inside diameter, and is 5 in. deep. Lay out the full-sized section of one side, or half of the ring, adding $\frac{1}{8}$ in. for machining, inside and out, at the top, and $\frac{3}{32}$ in. at the bottom; and make an extra allowance of $\frac{1}{8}$ in., inside and out, for turning the pattern. The allowance for machining at the bottom is for draft. The segments are cut out as described, a face turned up and the center located. Do not remove the faceplate from the lathe, but set the trammels and strike a circle, the diameter of which is equal to the rough outside diameter of the pattern. In this case it will be about 30 $\frac{1}{2}$ in. Divide this circle into six equal parts and at each division paste a piece of newspaper about 2 in. square. The joints between each segment should fall in the center of these squares and be glued to them at the ends. This will be found sufficient to hold the ring to the faceplate while turning, and the joint is easily broken with a sharp chisel when the job is finished. Put on the first course of segments, toenailing them to the faceplate, and then face off for the second course which will be nailed to the first, but, in facing off, be sure to use a diamond-point tool taking a light cut for roughing.

The courses that follow require no explanation, and by the time the job is built to the proper height, the glue in the paper joint should be dry enough to start turning, but if there is any un-

certainly on this point, it would be better to use a few screws to hold it on the faceplate.

Always build segment jobs on the faceplate in the lathe, unless there is

some very good reason for doing otherwise, as there is nothing that consumes so much time as rolling a large faceplate back and forth between the lathe and the bench.

S. N. X 115

Filler for Cracks in Furniture

Pour boiling water over a quantity of sawdust placed in an earthenware vessel and allow it to set for about one week, thoroughly stirring the mass frequently, then boil it over a fire until it has the consistency of thick paste. Pour this in a coarse cloth and squeeze out the excess moisture. When required for use mix a little of it with a solution of glue water and fill up the cracks or holes with the mixture. When this dries out it has the appearance of wood.—Contributed by Clarke Hill, Weston, Can.

Holding a File without a Handle

Accidents without number have occurred from running the tang of a file into the hand. It is always best to have a handle on the file, but if none is at hand, the file can be safely held as shown in the sketch. It will be noticed that the tang end is not in the hand, and that the hand grasps the file a little farther up, so that if the wrist is turned slightly away, no injury will result even though the file receive a blow on the end. Filing without a handle on work in a lathe is most dangerous of all, but is perfectly safe if done in the manner described. Apropos of filing without a handle, it is interesting to note that filing absolutely per-

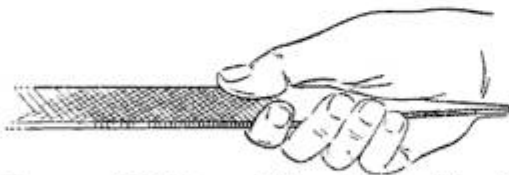

Manner of Holding a File without a Handle to Prevent Injury to the Hand

fect flat surfaces in a vise is best done without a handle. The extra length of a handle means extra leverage, acting opposite to filing flat.

Drill Press Used for Light Punching

Having a number of oblong holes to punch in some thin brass strips, I devised a die that was used in a drill

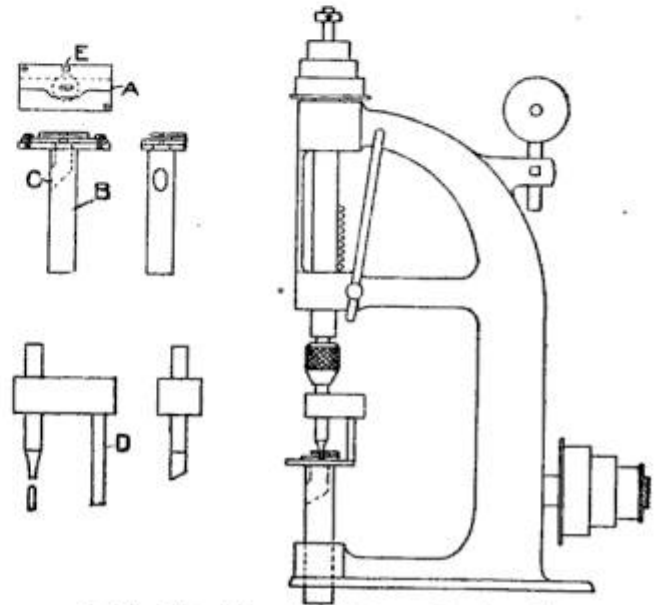

A Die Fitted in a Drill Press for Punching Oblong Holes in the Brass

press in the manner of a hand bench punch. The die and guide plate A was fastened to a stem, B, that was turned to fit the hole in the drill-press standard. The stem was drilled, as shown by the dotted line C, for releasing the punchings. The guide D passes through the slot E in the die A, so that the whole device may be readily set in the drill press and the punch coincide with the die.—Contributed by A. G. Sherk, Irvington, N. J.

Test for Leather Belting

Place a small strip of leather in strong vinegar and if it is of a good quality, it will not change, except to turn a darker color; but if the leather is of a poor quality, the fibers will quickly swell and the leather will soon become a gelatinous mass.—Contributed by Frank J. Taylor, Las Vegas, Nevada.

Wire Stretcher

This stretcher is especially adapted to draw wires taut on an old fence, but can be used for ordinary work in

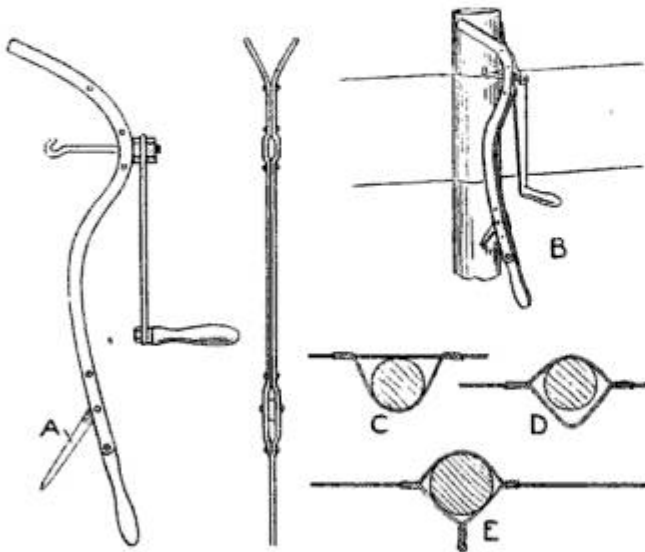

A Stretcher for Tightening Loose Wire on Old Fences, or for Stretching New Wire

putting up a new fence. The handle consists of two pieces of strap iron, about 1 in. in width and 20 in. long, shaped to form a fork at one end and a handhold at the other. A crank, with a shaft and hook, is fitted at the center of the bend, and a projection is pivoted at A. The stretcher, as it is applied to a post, is shown at B. A piece of wire is attached to the main wire around a post, as shown at C, then drawn into the shape shown at D, by the leverage of the handle and the projection A set in the post. This wire is then twisted, as shown at E, until the main wire is stretched tightly.

Correcting Typographical Errors in Typewriting

A time-saving arrangement for correcting typewritten manuscript, where pen or pencil alterations are not allowed, has been used by an ingenious stenographer. A set of typewriter type was procured from the type foundry who keep in stock fonts for different makes of machines. A little holder was made for each type, for greater convenience in handling, but this can be dispensed with, as a little care in handling the type itself will suffice. Then

an ordinary rubber-stamp pad was procured and by using the proper amount of ink a shade similar to the impressions made from the typewriter ribbon was easily obtained. The erroneously printed letter is erased and the correct letter stamped on by using the metal type, having, of course, first pressed the type upon the pad.

Where only one or two letters are to be changed on a page and a large number of pages are to be corrected, a material saving of time can be made, the necessity of putting the sheet in the typewriter and adjusting it in the proper position being obviated. The use of the device is of course restricted to the correction of errors where but few wrong letters have been struck.—Contributed by Geo. H. Thornton, Buffalo, N. Y.

Vacuum Cleaner for Removing Loose Sand from Molds

When setting cores in a sand mold there are always some loose particles that fall into the depressions of the mold which, if not removed, will cause a dirty or ragged part on the finished casting. In some instances these particles fall into places where it is impossible to remove them with a molding tool. I rigged up a device that is giving entire satisfaction and can be used in any part of an irregular mold for drawing out loose particles in the same manner as a vacuum cleaner. The device consists of pipe and fittings, con-

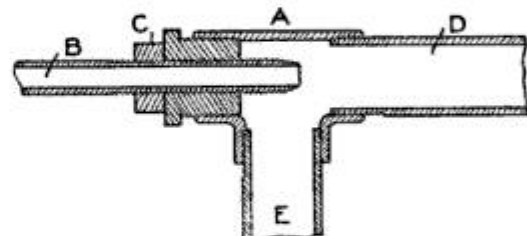

Loose Sand in a Mold is Easier Drawn Out with a Vacuum Than with a Tool

nected as shown and used on an air-pressure line of the shop.

The body of the device is a $\frac{3}{4}$ -in. tee, A, which is fitted with a reducer, C, to admit the end of a $\frac{1}{4}$ -in. pipe, B, having a long thread and a pointed end.

The end of this pipe should extend over the opening in the branch pipe E. The amount of this extension can only be determined by testing it for best results, whereupon the pipe B is fastened permanently with a locknut or a pin. The air rushing through the pipe B causes a vacuum in the pipe E, which is used in the mold. The end of the latter pipe can be fitted with a flexible hose so that it may be more easily handled. The suction set up by this device is sufficient to remove any loose particles from a mold.—Contributed by Eugene J. Desmond, Philadelphia, Pa.

A Hand Scraper for the Woodworker

A very handy scraper, described by a correspondent of the American Carpenter and Builder, is made of a piece

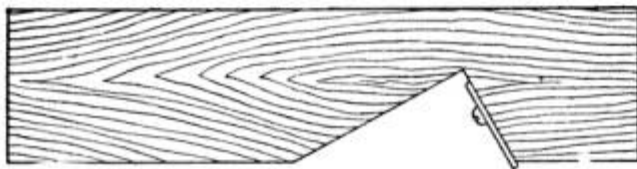

The Scraper is Easily and Quickly Made and Used in a Manner Similar to a Plane

of ordinary ash, 2 in. wide and 6 in. long, with a notch cut in it and a scraper blade fastened with screws in the notch. The blade has slots for the screws instead of holes, so that it may be adjusted for the cut. The notch is located near one end, where the user holds the tool and pushes it along as a plane.

A Small Expansion Arbor

Small gears, as shown in Fig. 1, or similar work, where specifications call for the hole to be ground first and the outside finished last, require a very accurate expanding arbor. Such an arbor, which consists of two parts and a nut for expanding the sleeve, as shown in Fig. 2, can be easily made.

The outer part or sleeve is turned to a neat fit in the hole of the work after both surfaces are ground, then it is

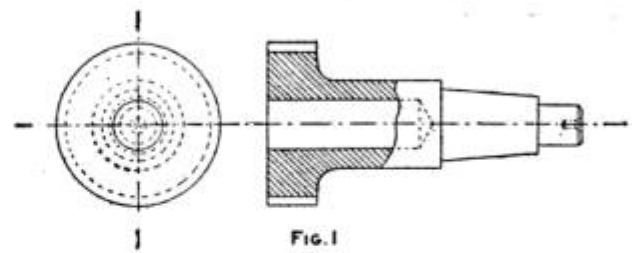

Fig. 1

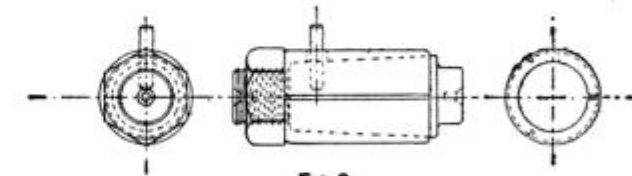

Fig. 2

An Expanding Arbor for Holding Small Work That must be Ground Internally Before Finishing

bored tapering. The center, or expanding part, is turned tapering to fit the bore of the sleeve and threaded on the smaller end. A pin is fitted loosely through the sleeve and driven tightly into the center part. This is to hold the parts together and prevent them from becoming lost.—Contributed by C. E. Bradley, Fall River, Mass.

How to Make a Screw-Pitch Gauge

Cut a clean thread with a new die on a bolt and make a slot through the center of the threaded length. Slip the piece of steel to be used for the gauge in the slot, as shown at A, and clamp it in a vise. It is an easy matter to file the threads into the gauge with a new three-cornered file. The metal is then shaped as shown at B. A set of gauges can be made in this manner and attached to a handle. The number of

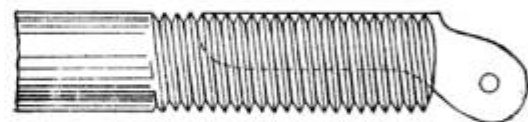

A

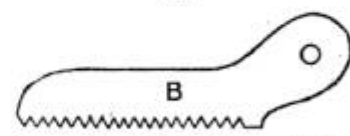

B

The Threads on the Bolt Make a Guide for Filing the Notches on the Gauge

the thread should be stamped or etched on the gauge.—Contributed by Louis A. Novak, Mahanomen, Minn.

How to Make a Simple Level

By ARTHUR MOORE

The level described in the following article was constructed by the writer and has been exceedingly serviceable in view of the fact that it can be used in a number of cases where the ordinary level is quite troublesome to operate.

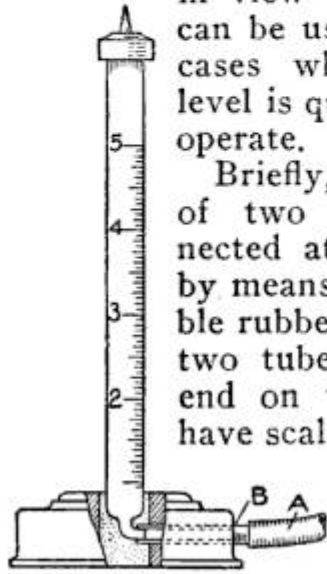

Briefly, the level consists of two glass tubes connected at their lower ends by means of a piece of flexible rubber tubing, A. These two tubes are mounted on end on wooden bases and have scales marked on them,

the points on the scale being measured from the under side of the

base upon which they are mounted. The tubes and connecting hose are filled with water until it rises about halfway in each tube. Two objects can now be adjusted to the same level by placing one of the tubes on each of them and raising or lowering one of the objects until the liquid is at the same height in both tubes.

The level may be constructed as follows: Obtain two pieces of $\frac{1}{2}$ -in. glass tubing about $2\frac{1}{2}$ ft. long. Draw one end of each piece down to at least a $\frac{1}{4}$ -in. diameter, in a gas or alcohol flame, and bend it over at right angles to the main portion of the tube. Cut this small projecting piece off so that the remaining portion projects sideways beyond the side of the main tube about $\frac{1}{8}$ in. Turn, from a piece of hard wood, two pieces, that are to serve as bases, similar to those shown in the sketch. Drill a $\frac{3}{4}$ -in. hole in the top of each of these pieces to a depth about $\frac{1}{8}$ in. less than the thickness of the piece. Obtain two short pieces of brass tube, and drill a hole in the side of each of the wooden bases, so that the tube B will fit in it tightly and enter the large opening near its bottom. Place the end of the

$\frac{1}{2}$ -in. tube with the projection on it in the large opening so that the small projection is in the end of the brass tube, and pour a small quantity of plaster of Paris around it. Hold the glass tube in a vertical position and allow the plaster to harden. A scale may now be marked on the glass tube, or one may be marked on a piece of paper and pasted to the tube. The points on this scale should all be located by measurements from the lower surface of the base. A small cap may be provided for each tube with a sight mounted on it so that the two tubes may be used in running a level line, or leveling a point some distance away. Make sure that the end of the tube is not closed up, as the liquid then could not readily pass from one to the other due to the air pressure. The upper edge of the sights must be the same distance from the lower surface of the base in each case. The glass tubes may be protected by mounting two wooden strips, one on each side, on the wooden base.

Calipering Steel Balls

A method used by a correspondent of American Machinist to caliper hardened steel balls is shown in the accompanying sketch.

A piece of spring steel is bent in the form of a pair of tweezers, with holes of different di-

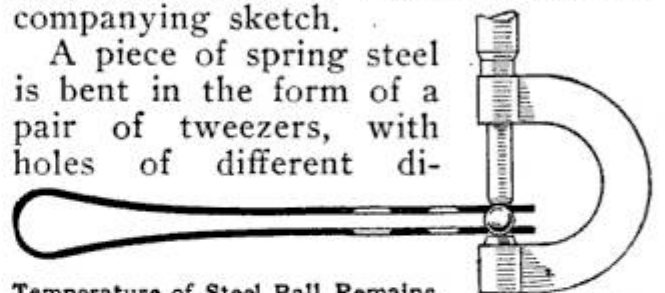

Temperature of Steel Ball Remains Normal; Thus True Measurements are Obtained

ameters drilled in each side and countersunk on the inside. A ball is placed in a hole suitable to its diameter, allowing it to project so that there is no interference with the calipering.

By using the tweezers the heat of the hand does not cause the ball to expand, thus the true diameter may be easily determined.

Washing Pad for Removing Grease from the Hands

Curled hair, such as used in upholstering the finer grades of furniture, is much better than a brush for removing grease and grime from the hands. It penetrates the crevices of the knuckles and nails, and does not abrade the skin at all. To use, simply take a large handful of the hair, apply soap and wet it, then rub over the hands. It will take several days before the wad assumes the form that gives the best results, but once in shape it will last indefinitely. — Contributed by Mabel Hillyer Eastman, Chillicothe, Mo.

Inserting Packing Leathers

It is sometimes very difficult to get a packing leather started into the cylinder. The soft leather will spread and squeeze out at every attempt to push it and the attached piston into the cylinder.

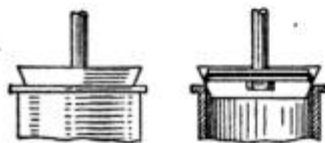

The sketch shows how the leather can be very easily inserted by means of a strip of tin a little larger than the inside circumference of the cylinder. The tin protruding from the opening of the cylinder forms a funnel into which the leather is pressed at all points, thus easily slipping into the cylinder. The tin can be withdrawn with a small pair of pliers. This kink is a time saver when working on all leathers attached to push-up pistons.

Clearing Shellac Varnish

Shellac varnish used in pattern shops has a tendency to hold in suspension impurities that leave dirty streaks on the patterns when the liquid is applied. The liquid can be easily purified by the addition of a few crystals of oxalic acid. The shellac should be stirred, to aid in a thorough mixing, then allowed to settle for several hours. Care should be taken not to use too much acid.

Overhead Location for an Automobile Mirror

The use of a small mirror to reflect a view of the following traffic is fairly common practice, though the location

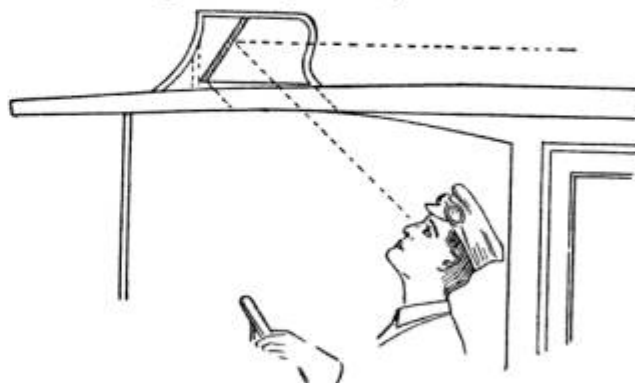

The Mirror Placed on the Roof Makes It Easy to See the Traffic Directly Behind

of such a mirror is not always the best. One difficulty is that traffic close behind a vehicle, equipped with a mirror in the usual position, cannot be seen. In order to obviate this difficulty a driver of a limousine placed the mirror on the roof of the car. The mirror is mounted in a hood which protects it against rain or snow. Through a glass-covered hole in the roof the driver has a good view of the mirror without undue exertion, and the traffic directly behind can be plainly seen.—S. P. McMinn, Brooklyn, N. Y.

How to True Up Triangles

The edges of triangles will become roughened and slightly hollowed out by constant use and must be trued frequently to produce accurate drawings. A very efficient and quick way to true them up is shown in the illustration,

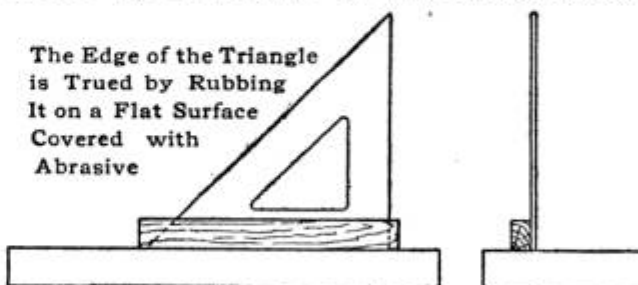

The Edge of the Triangle is Trued by Rubbing It on a Flat Surface Covered with Abrasive

which is easily understood. The abrasive used is a valve-grinding compound that can be procured at any garage.—Contributed by H. M. Briggs, York, Pennsylvania.

Emery-Cloth Ends to Attach in a Hacksaw Frame

A strip of emery cloth, up to 2 in. in width, can be effectively used in a hacksaw frame, if the ends of the cloth



The Strip of Emery Cloth in the Saw Frame is Used in the Same Manner as a File

are held straight to prevent creasing. This may be accomplished by folding the ends over a piece of broken hacksaw blade, then bending a wire clip, to attach it in the saw frame, over the piece of saw blade, as shown in the sketch. In this way a strip of emery cloth may be used like a file.—Contributed by John Steen, Minneapolis, Minnesota.

A Special Die Holder

In some instances it becomes necessary to rethread a stud so placed that it is impossible to get at it with an ordinary die stock. A stud on a cylinder head, for instance, where there are several located, will require a special die holder to turn the die on the stud that needs a new thread. Many times the threads on these studs become bruised or battered in making repairs, and then, too, it may be necessary to reduce the size of the stud to fit some other nut. A special die holder for rethreading these studs is made of a piece of steel or cast iron, bored at one end to receive the die and drilled for a thumb-

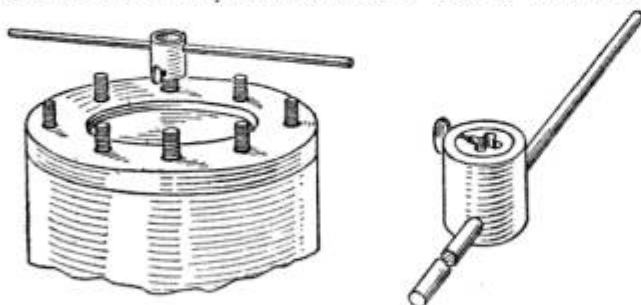

Long Head Diestock for Use in Cutting Threads on a Stud Surrounded by Others

screw. The piece may be of any length and a rod run through a hole drilled in the end opposite the die for a handle.

Lubricating the Stern Bearing of a Motorboat

The usual form of a strut for motorboats provides no means of lubrication for the stern bearing. The sketch shows a method by which grease can be very easily fed to the bearing. A piece of $\frac{1}{4}$ -in. copper tubing is cut long enough to reach from the bearing to a point 6 in. above the waterline and the after edge of the strut filed slightly flat. This will make it easier to solder the tube to it. A hole is bored into the bearing of sufficient diameter to receive the tube and another bored through the strut plate A, Fig. 1, the bottom of the boat and the floor. This hole should be small enough to hold the tubing tightly in place. The tube is now forced through the floor, hull and plate, and into the hole in the bearing for a short distance. By tapping very gently with a hammer it can be straightened

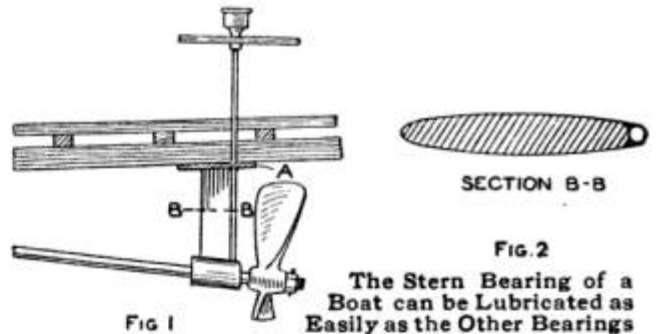

FIG 1

FIG. 2
The Stern Bearing of a Boat can be Lubricated as Easily as the Other Bearings

out and pressed against the edge of the strut. Both the tubing and strut should be cleaned with muriatic acid or some good soldering flux, after which they can be soldered together. The solder should be run in freely between the tube and the whole smoothed over, as shown in Fig. 2. A little solder should be run around the tube where it passes through the plate in order to make the point water-tight. A grease cup of the kind preferred is attached as shown. When the bearing needs lubrication, a turn or two of the screw cap in the cup forces the grease through the tube into the bearing. If the solder is smoothed over carefully, the resistance will be no greater than before the tube was attached.—Contributed by Olaf E. Tronnes, Evanston, Ill.

To Prevent Dirt from Entering beneath the Finger Nails

Sometimes a person is called to help repair a machine in a shop where there is considerable dirt and grease. An office man can keep the dirt from getting under the nails by filling the space between them and the fingers with soap. After the work is finished, the soap is easily washed out and the nails cleaned.—Contributed by Loren Ward, Des Moines, Iowa.

Combination Side and End Wrench

A very handy all-around wrench can be made by shaping the jaws from a piece of steel—a piece of buggy spring



The Construction of the Jaws Makes a Side and End Wrench of One Piece

will do—as shown in the sketch. The size and thickness of the wrench will depend on its use. This makes a side and end wrench.—Contributed by C. C. Hall, Eureka Springs, Ark.

Writing Pen for the Draftsman

An old, discarded ruling pen can be easily changed into a pen for lettering or writing on tracing cloth by grind-



The Shape of a Ruling Pen to be Used in Writing or Making Letters on Tracing Cloth

ing away that portion of the nibs shown by the dotted lines in the sketch. To obtain best results, the pen must be held in the hand so that the opening in the pen is vertical and not at an angle.—Contributed by Wm. Rosenberg, Watertown, Mass.

Parallel-Rule Center Gauge

A very handy little tool for locating the center of any piece of round, square, octagon or oval stock is made in the manner of parallel rules. The material required is two pieces of hard wood, 4 in. long, $\frac{1}{2}$ in. wide and $\frac{3}{8}$ in. thick; two pieces of metal, 3 in.

long, $\frac{3}{8}$ in. wide and $\frac{1}{16}$ in. thick; three wood screws; one bolt with a knurled nut, and a steel point. The parts are

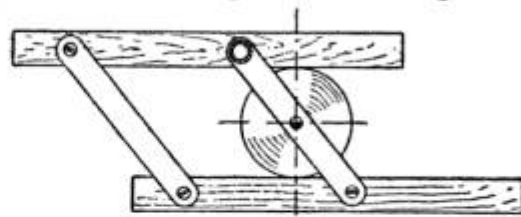

Lines are Scratched across the Ends of the Stock and Their Intersection Marks the Center

put together as shown in the sketch. This will locate centers on stock from $\frac{1}{8}$ in. up to 2 in. in diameter. The method of using the tool is easily understood by the illustration.—Contributed by A. Kerbaugh, Allentown, Pa.

Notch to Locate Slots in an Electric Plug

The electric-light extension cord has grown from a convenience to an actual necessity, and there are many varieties, some with faults, some with virtues, some with both. Of the various kinds of plugs one of the commonest is shown in the sketch.



It is inconvenient to connect one of these plugs in the dark, but, if a groove is cut on an emery wheel in the part shown and the raised lettering removed in the same manner, the brass terminals may be easily inserted in the slots.

Pipe Tee Made of an Old Valve

An old discarded valve body will serve as a tee in an emergency. The upper portion A is usually tapped to make a fine thread, but this opening can be re-threaded with a pipe tap and a tee fitting will be the result. In some instances a reducing tee may be made of the valve part.



ⓄThe approximate wave length of an aerial may be determined by multiplying the height of the aerial by four.

Lining Up Automobile Wheels

The front pair of wheels on all automobiles are "cut under," or have a slight pitch from $\frac{1}{2}$ in. to $1\frac{1}{2}$ in. If

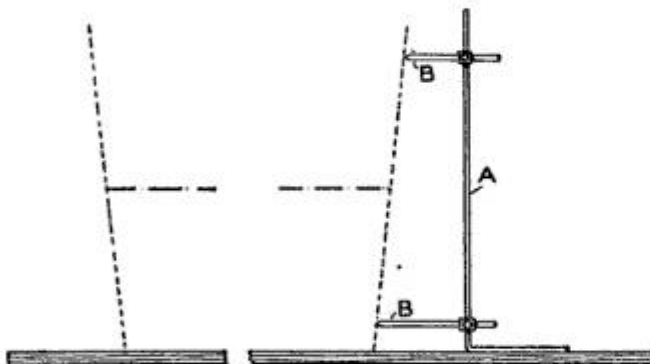

The Pitch of a Wheel is Easily Determined and Its Mate Adjusted to Match It

an axle is bent or twisted in an accident, some means must be employed in the repair shop to get the same "cut-under" to each wheel when straightening the axle. I have used a homemade device which gives the desired results. It consists of a standard, A, to which is attached two sliding pointers, BB. The pointers may be set for any pitch and used in lining up either wheel. The wheels to be lined are placed on a level surface—a straight plank will do—and the device used as shown.—Contributed by T. C. Bevan, Utica, N. Y.

Emery-Cloth Holder for Polishing

The use of a hacksaw frame for holding strips of emery cloth to polish surfaces is a good one, but I find that a decided improvement over this method is to attach the strip of cloth between the ends of a bow. The spring of the wood bow keeps the cloth at a ten-

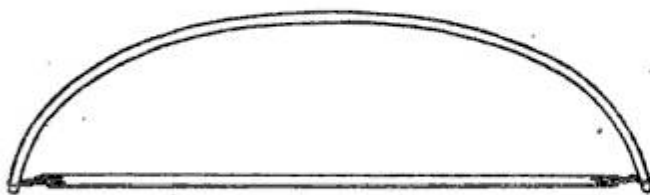

The Strip of Emery Cloth is Kept Taut between the Ends of a Bow

sion and at the same time leaves it sufficient give to allow for inequalities of surfaces and round edges.—Contributed by G. H. Holter, Jasper, Minnesota.

Boring a Deep Hole on a Lathe

When using a boring tool clamped in the tool post of a lathe for boring deep holes, the length of the tool causes it to spring so much that only light cuts can be taken. This makes slow work where there is considerable material to be removed. The following method will hasten the work to some extent.

Instead of setting the tool out far enough to reach the bottom of the hole, set it out far enough to go only half-way. Rough off all the surplus stock with the tool so set, leaving a small amount of material for a finishing cut, then let the tool out and rough the rest of the way, finally taking a finishing cut through the whole length of the hole.

This is well illustrated in the drawing where a casting is to be bored for two bearings A and B. If the tool is set to reach the bottom and used to bore the front bearing, it would not be

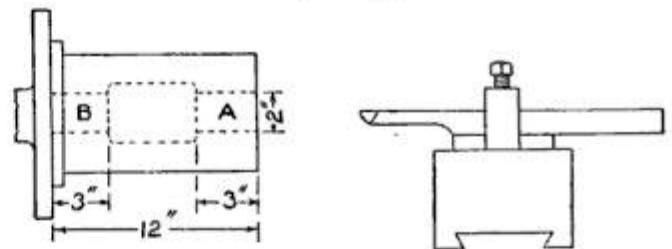

Boring One-Half of the Hole with the Tool Set Close in the Tool Post Hastens the Work

very rigid—it would have a 12-in. overhang, while, if set as shown for the first cut and roughing the bearing A, it will have but 3 in. overhang and the job can be proportionately hastened.

Filling Holes in Castings

Defects in castings may be filled with a paste made of 2 lb. of iron borings, $1\frac{1}{4}$ lb. of dextrine and $\frac{3}{4}$ lb. of litharge, the whole mixture being colored with lampblack to the desired shade. The iron borings should be sifted. After the parts are thoroughly mixed, add enough water to make a paste. This is applied to the defects and blow-holes with a putty knife. When the paste has dried thoroughly, it can be machined just as the metal.

Practical Telephony

By HAROLD HINTON

PART II

Common-Battery System

The central-energy multiple-switch-board system of telephony, usually spoken of as the "common-battery system," is a system whereby all the energy used by the subscribers of each exchange is transmitted from the storage battery in each central office. This storage battery is in turn charged every night by the aid of a motor-generator set in the terminal room of the exchange, or by the aid of a gas or gasoline engine and generator located in the basement of the central office. Modern practice favors a combination of both of these methods of charging, the motor-generator being used whenever possible and the gas-generator set being used in emergency.

The ringing is accomplished through the aid of the ringing machines, of which there are generally two and sometimes three in each office so that one machine does not have to carry all the load and do all the work. These ringing machines are driven by small

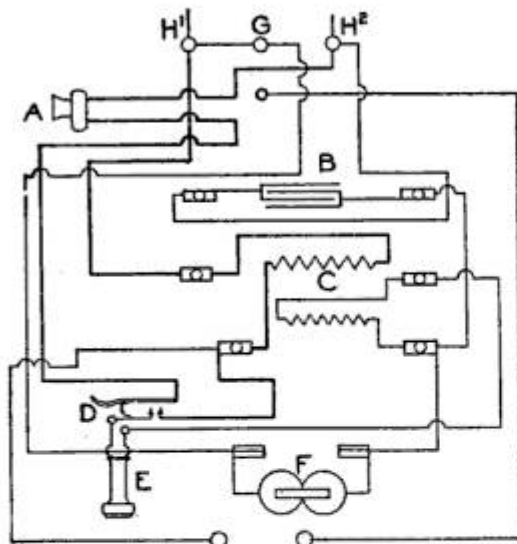

FIG. 9

Connections for a Direct-Line Telephone Where a Common Battery is Used at the Central Office

motors which are connected to them by worm gears. The common-battery system is therefore a vast improvement over the magneto system where

each station must have its own battery and hand generator. The connections for a direct line are shown in Fig. 9, in which A is the transmitter; B, condenser; C, induction coil; D, switch

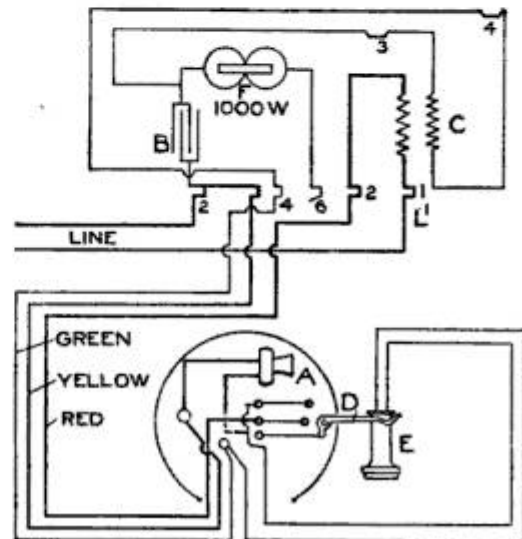

FIG. 10

A Common Wall Set with Connections for a Desk Set on a Common-Battery System

hook; E, receiver; F, ringer; G, ground; and H¹ and H², two line wires. A common wall set, with connections for a desk set, is shown in Fig. 10.

The main difference between the magneto and common-battery systems lies in the switchboard and other central-office equipment. The seemingly complicated workings of two common-battery telephones through an exchange to which they belong is clearly shown in Fig. 11. This sketch shows the American Bell telephone method and the Hayes principle of using repeating coils and battery for all line circuits. One operator cord and two subscriber circuits are shown. Normally the circuit between the line wires is closed only through the subscriber's bell and condenser. The alternating current from the ringing machines at the central office can ring the bells through this circuit, but battery current cannot pass on account of the condenser. Each cord circuit has a repeating coil which has four windings.

In the answering or left-hand side of the cord circuit there is one supervisory relay, A^1 , which controls the answering supervisory lamp, B^1 . This lamp is $\frac{1}{3}$ cp., on 12 volts. There is a simi-

lighting of the lamp B^1 . The current flows through the relay G^1 , thereby breaking the circuit at H^2 through the line relay L , which causes the line lamp L^2 to go out. The operator closes

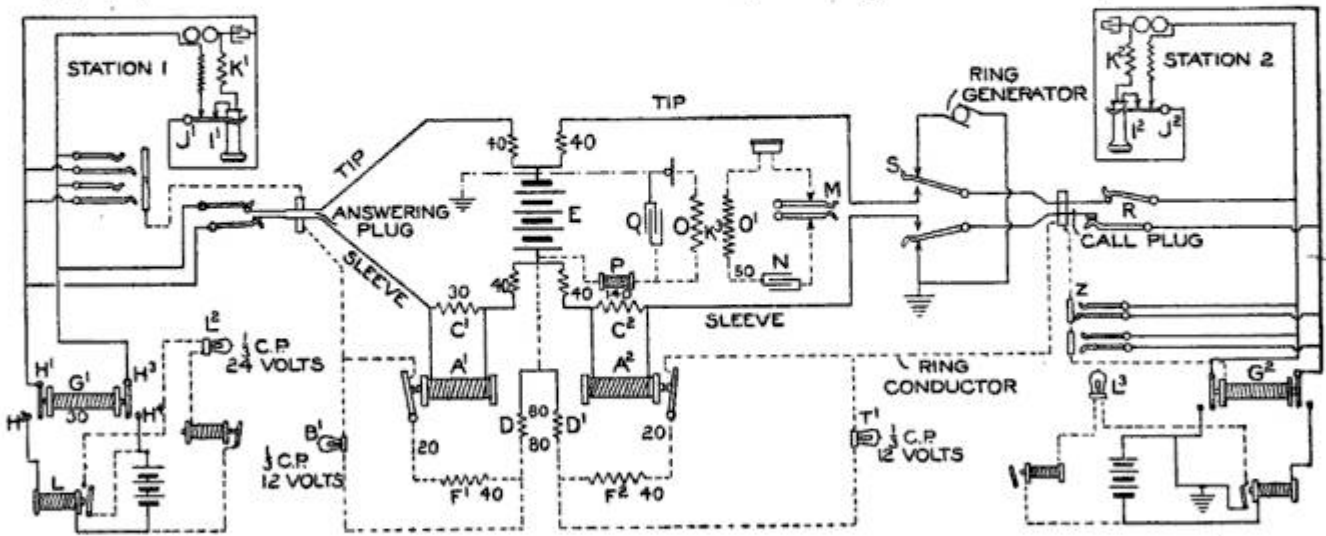

FIG. 11

The Workings of Two Common-Battery Telephones When They are Connected through an Exchange Board in the Central Office, Showing the Course of the Current When the Telephones are Connected by Being Plugged In

lar arrangement in the calling or right-hand side. The relays A^1 and A^2 are shunted so that they will not obstruct the voice currents too much. This is done by noninductive resistances, C^1 and C^2 , which do not interfere with the proper operation of the relays. When the resistance coil D , which is 80 ohms, and the lamp B^1 are in series across the 24-volt battery E , the lamp will light, but it will go out when the 40-ohm resistance F^1 is connected in parallel with the lamp by the operation of the relay A^1 . Normally no current flows through the cut-off relay G^1 , and, therefore, the line circuit is closed between H^1 H^2 and H^3 H^4 .

When the receiver I^1 , at station 1, is removed from the hook, the transmitter J^1 and one winding of the induction coil K^1 form a circuit across the two line wires of a resistance low enough to allow sufficient battery current to flow from E to energize the line relay L , thereby closing its local circuit and lighting the line lamp L^2 , which is $\frac{1}{3}$ cp., on 24 volts, thus notifying the operator for that line.

The operator inserts the plug into the answering jack belonging to that line, and enough current flows through the relay A^1 to close it, which prevents the

the listening key M , and by so doing connects the receiver secondary winding O^1 of the induction coil K^3 and the condenser N across the primary winding O of the coil K^3 . The 140-ohm retarding coil P and the primary coil O are thereby connected to the terminals of the battery E . The retarding coil limits the current through each transmitter and enables the current to be supplied to the operators of all the transmitters from one battery without causing cross talk. The condenser Q improves the transmitting qualities by compensating more or less for the inductance of the retarding coil P .

After making the busy test on the desired line the operator, if the line is not busy, inserts the calling plug into the multiple jack R , opens the listening key and closes the ringing key S . The current from the ringing generator flows through and rings the bell at station 2. The current now takes the course through the battery E , the cut-off relay G^2 , the resistance F^2 , the calling plug Z , the coil D^1 and the supervisory lamp T^1 and closes the relay G^2 , which prevents the lighting of the line lamp L^3 . When the receiver I^2 is removed from the hook, at station 2, the current flows from the battery E ,

through the subscriber's circuit and the relay A^2 , connecting F^2 in parallel with T^1 , which extinguishes the latter.

When the transmitter J^2 is spoken into, its resistance changes sufficiently to produce a variable current through two of the windings, which induces an alternating current in the other two windings of the repeating coil. This alternating current combined with the direct current from the battery produces a current of variable strength in the line circuit at station 2. This variable current in the winding K^2 of the induction coil induces an alternating current in the other winding of the induction coil, thus producing an alternating current in the local circuit containing the receiver, transmitter and condenser. When the conversation is finished, the lamp T^1 will light up as soon as I^2 is hung up, and L^2 will light up as soon as I^1 is hung up. These are disconnect signals and tell the operator to take down the connection, as the conversation is finished.

Party lines are greatly used by the subscribers on account of the lower rate for this style of service; the two-party line having a lower rate than a direct line, and a four-party line having a lower rate than the two-party. While only one bell, that of the station wanted, is rung at a time, there are two things which are sometimes very annoying to the subscriber, viz., the conversation over a party line is not absolutely private, as is the case with the direct style of service, because the other parties on the line may cut in on the line and listen, and when one party is using the line none of the other subscribers can use it, thereby causing considerable inconvenience, not only to the party called but to the calling party as well.

On each position on the switchboard are strips of ringing keys, one for each cord circuit. The first key has a colored, usually red, button and is used for ringing out on a direct line. The other four keys in the strip have black buttons and are used in their order for ringing out on party lines and ringing the individual bells of the various sta-

tions on that line. A four-party phone connection is shown in Fig. 12, which includes the addition of a relay I , and a bias ringer, F . The phones on the four-party line are connected in multiple across the same pair of wires, two of the bells being operated by positive pulsating currents and the other

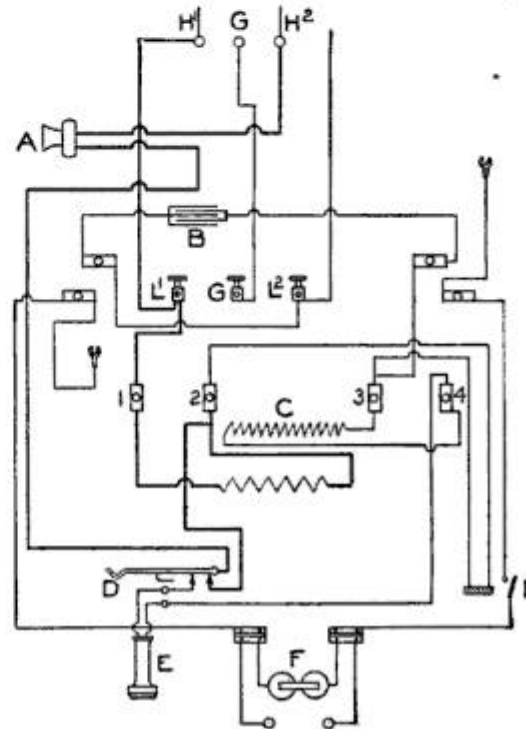

FIG. 12

The Connections for a Telephone in Which Four-Party Phones are on One Line

two, one on either side of the line, by negative pulsating currents, the bells not being in circuit until the relay is actuated. This is accomplished by the operator who, when calling the first station, depresses the first black key in the strip and sends a negative pulsating current down one side of the line through the relay.

When this relay is actuated the bell for that station is brought into the circuit and biased so as to ring with the current. Station 3 on the same side of the line does not receive a ring, as the bell is biased to ring only with a positive pulsating current. The switchboard apparatus for handling these party lines is the same as for direct lines, but the relays must be kept in very close adjustment.

Trunking is a system of connecting two subscribers through two or more

exchanges and is accomplished as follows: Each operator has an "order-wire circuit" with the various exchange names on the buttons. When a call comes in to the operator for a connection outside of her own exchange, which, for example, may be called "Richmond," and the calling station desires line number 571 in another exchange, North, for instance, the Rich-

mond operator presses down the North order button and calls Richmond 571, giving her own exchange name instead of the one originally called for by the subscriber. The incoming trunk operator tests a trunk to see that it is not busy or in trouble, then calls its number to the calling operator who in turn plugs in the subscriber and the connection is made.

(To be continued)

Planing a Sloping Surface on Metal

It is often required to plane a surface of a piece of iron or steel sloping, or at a certain angle, to another side. The usual method is to "cut and try" until

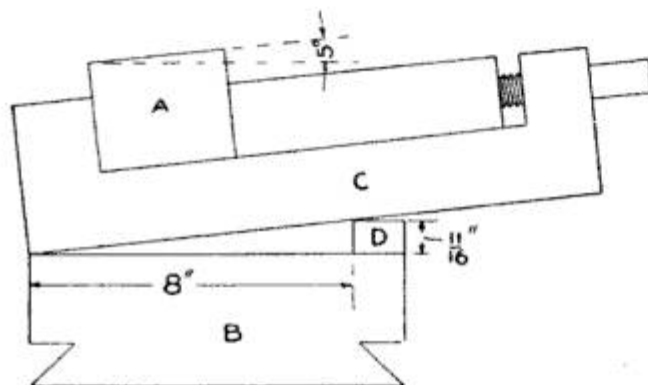

Tilting a Vise Which Holds a Piece Whose Surface is to be Cut Sloping

the correct angle is obtained. A "first-time" method of getting this angle is the following, which also illustrates a simple way of setting up the work.

The block A, as shown in the sketch, is to have one face cut at an angle of 5 deg. with the base. This is a typical case, and it will be assumed that it is done on a milling machine. On the table B of the machine mount the vise C, which has between its jaws the rectangular block, A, with the face to be cut uppermost. Under the vise, and parallel with the side of the machine table, slip a piece of steel $\frac{1}{16}$ in. thick. Several pieces whose combined thickness is $\frac{1}{16}$ in. will also do. Set the inner edge of this piece or pieces 8 in. from the edge of the vise where it rests on the table. A cut taken parallel to the machine table will produce the desired degree of angle.

The thickness of the strip D was determined by the use of the trigonometric formula,

$$\text{tangent} = \frac{\text{side opposite}}{\text{side adjacent}}$$

or, transposed, side opposite = side adjacent \times tangent. Substitute the figures, and the side opposite, which is the thickness of strip D, will be found = $8 \times .08749$, or .699 in. The number .08749 is taken from a table of natural functions. The fraction $\frac{1}{16}$ in. (= .688 in.) is, in this case, near enough to the real value for practical purposes. If greater accuracy is demanded, a few thicknesses of paper could be added.

An Inexpensive Electric Blueprinter

A large glass bottle with a mouth that will admit a 100-watt tungsten electric globe makes a good substitute for the cylindrical blueprinting machine. The drawing, together with the blueprint paper, is wrapped around the outside of the bottle and the electric globe suspended within. The tracing and paper may be held in close contact on the glass with large rubber bands and a sheet of cardboard as a backing. When only a few prints are to be made, the only spare time being at night, this arrangement will prove quite satisfactory.

Ⓞ Vitriol etching fluid will settle and stick to the bottle, but by placing a few very small pebbles in the solution it is easy to loosen up the settlements and cause them to dissolve again.



A Homemade Roller Coaster

By J. H. SANFORD

THE popular roller coaster that furnishes untold amusement for the multitudes that patronize amusement parks during the summer can be easily duplicated in a smaller way on a vacant lot or back yard for the children of the home; or the boys of a neighborhood could contribute to a fund and construct quite an elaborate affair, on the same lines as described, for the combined use of the owners. The one described was built with a track, 90 ft. long, 5 ft. high at one end and 3 ft. at the other, the track between being placed on the ground. In coasting from the high end to the low one, the coaster will run up on the incline, then drift back to within 24 ft. of the starting end. The car was built to seat four children or two adults. The cost of

all the materials for building this roller coaster did not exceed \$10.

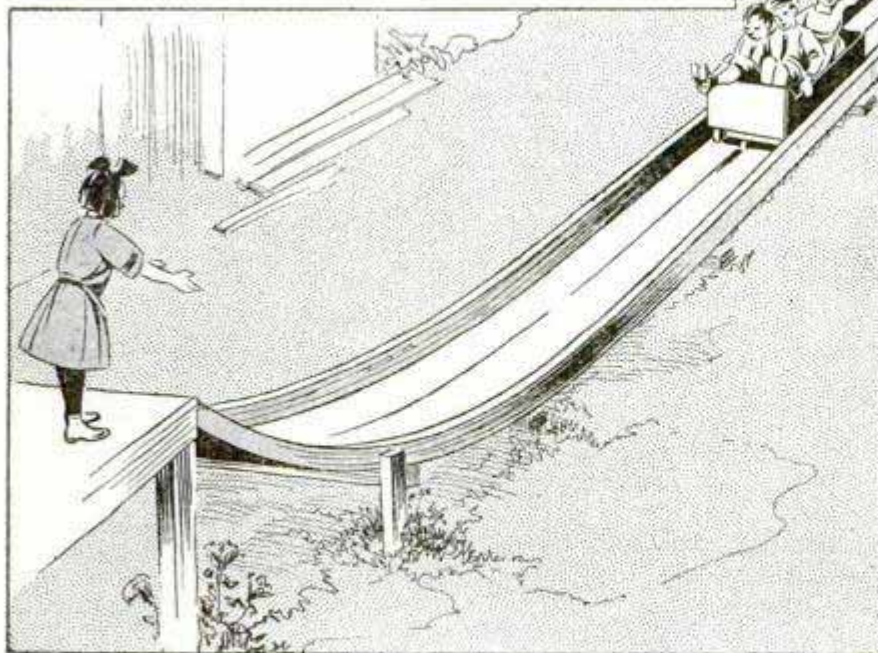
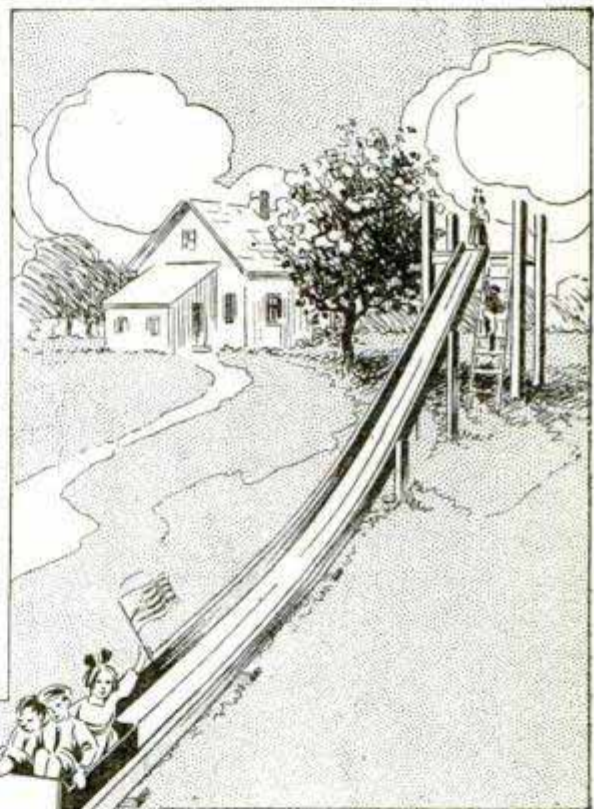

The track is of simple construction and requires but little description. It is necessary to have it straight and nailed firmly to the crossties on the ground and to the trestles where it is elevated. The ties and trestles are placed about 6 ft. apart. The two trestles for the starting platform should be set so that there is a slant to the track of about 6 in. for starting the car with-

Inexpensive Back-Yard Roller Coaster, Suitable for the Enjoyment of the Young as Well as the Older Persons

out pushing it. The car can be carried back for starting by adults, but for children a small rope can be used over the platform to draw it back on the

are properly adjusted, and securely fastened between washers with a nut on the end of the axle. Guide wheels, B, are placed on the sides in the man-

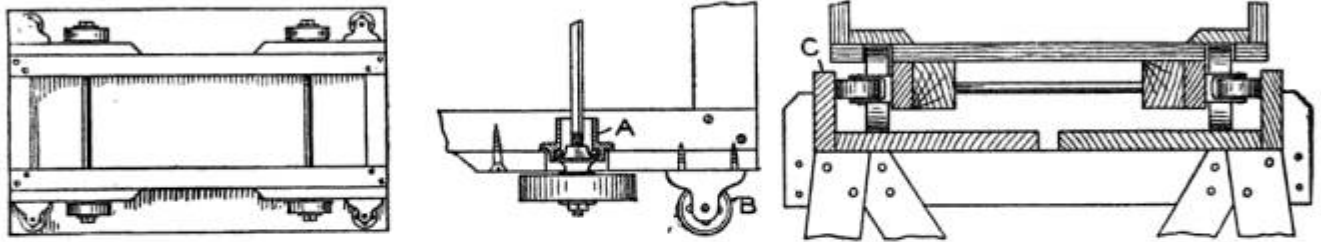

Detail of the Car, Wheels, and the Trestle, Which is Attached to a Tie

track, or a small windlass may be arranged for the purpose.

The main frame of the car is 3 ft. long and about 13 in. wide, firmly fastened at the corners. The axles for the wheels are machine steel, 19 in. long, turned up on the ends and threaded in the manner of a bicycle axle to fit parts of bicycle hubs, attached to the main frame as shown at A. The wheels are solid, 4 in. in diameter and 1 in. thick, and are set on the bicycle cone of the ball cup, after they

ner shown. These wheels are ordinary truck casters, not the revolving kind, 2 in. in diameter.

About $\frac{1}{2}$ -in. clearance should be provided between the guide wheels B and the guard rail C, on the track. When the car is made in this manner it runs close to the track and there is no place where a child can get a foot or hand injured under or at the sides of the car. The one described has been used by all the children, large and small, for a year without accident.

Door-Bell Alarm

A simple door-bell alarm for informing one when the door of a shop or dwelling is opened is shown in the accompanying sketch. It consists of a

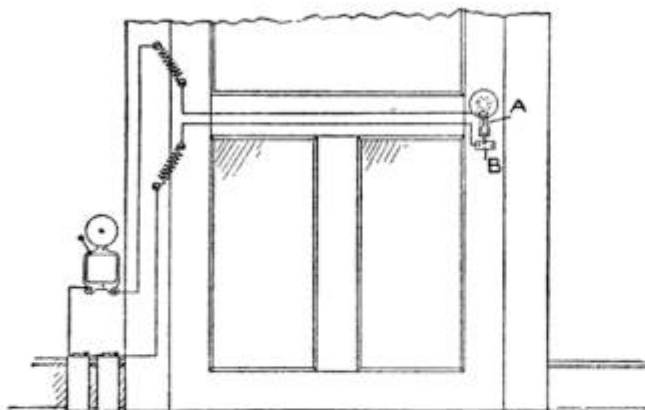

Wiring Diagram and Connections to an Electric Bell That Rings When a Door Knob is Turned

piece of spring brass, A, bent into a circle in the center so that it may be clamped on the doorknob bar by means of a small bolt or screw. The two ends of this piece should be separated as shown and a second piece, B, mounted

on the door so that its outwardly projecting end is between the ends of the piece A. One terminal of an ordinary vibrating bell circuit is then connected under the head of the clamp screw, and the other terminal under one of the screws holding the piece B in place on the door. It is now obvious that the bell circuit will be completed and the alarm sounded when the knob is turned. Make sure that the piece A is bent so that the circuit is completed before the latch has moved a sufficient amount to allow the door to open.

The circuit leading to and from the switch may be completed through the hinges of the door, but it would be better to use small coil springs as shown. There would then be no likelihood of the circuit being open at any time, which might occur if the hinges were used.

☞ Discolored coffee and teapots may be restored to their original brightness by boiling them a few minutes in a solution of borax water.

A Jardinière Pedestal

The pedestal may be made of any close-grained wood, such as basswood or maple, if the stain is to be walnut or mahogany, but it can also be constructed of quarter-sawed oak and finished in a waxed mission or varnished surface. The material required is as follows:

- 1 top, 12 by 12 by $\frac{3}{8}$ in., S-2-S.
- 2 caps, 6 by 6 by $\frac{3}{8}$ in., S-2-S.
- 1 upright, 18 by 4 by 4 in., S-4-S.
- 1 base, 8 by 8 by $\frac{3}{8}$ in., S-2-S.

The top is centered and a circle, $11\frac{1}{2}$ in. in diameter, is drawn upon it, and sawn out. The caps are also centered and circles drawn upon them, $5\frac{1}{2}$ in. and $3\frac{1}{2}$ in. in diameter. Saw them out on the larger circles and center them in a wood lathe and turn out the wood in the smaller circles to a depth of $\frac{1}{2}$ in. The upright is then centered in the lathe and turned to $3\frac{1}{2}$ in. in diameter for its full length.

The base and foot pieces are cut out as shown, fitted together and fastened with screws from the under side. One of the caps is mounted in the center on the base and the other cap in the center on the under side of the top. The upright is then placed in the turned-out parts of the caps and either glued or fastened with screws.

If light wood is used, the finish can be walnut or mahogany. A very

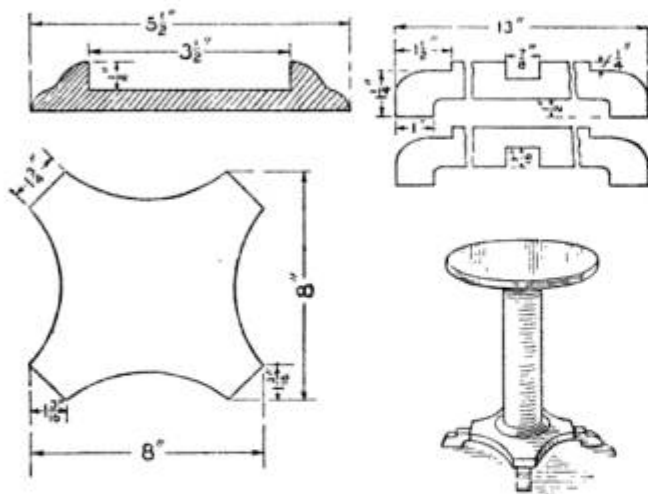

The Pedestal can be Made of a Wood Suitable for Finishing to Match Other Furniture

pretty finish can be worked out in pyrography, if one is familiar with that work.—Contributed by Russell T. Westbrook, Dover, N. J.

A Lawn-Tennis Marker

The liquid receptacle is a metal biscuit box, about 9 in. square and mounted on a wheel with a handle, the

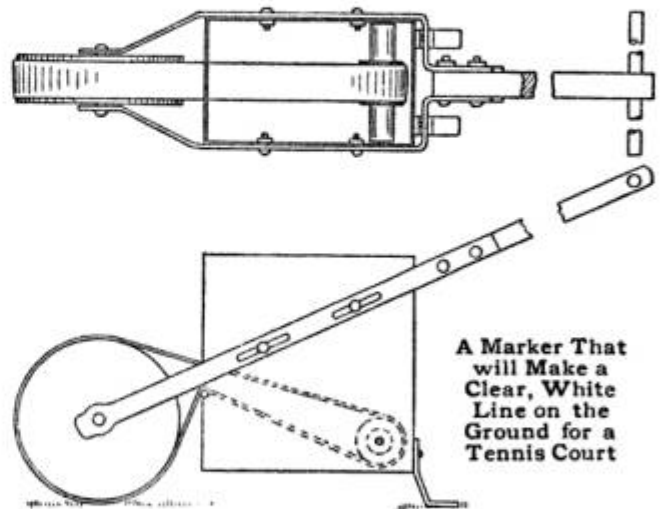

whole being similar to a wheelbarrow. The wheel is 7 in. in diameter and $2\frac{1}{2}$ in. thick. The wheel and box are bolted between two pieces of strap iron in the manner shown, and the handle is attached back of the box. If the box is of very thin metal, boards should be placed within on the sides where it is fastened to the strap iron. A roller is pivoted in the box at the lower back corner and a canvas tape or band run over the roller and wheel in the manner of a belt. The tape should run through a slot cut in the front part of the box, about midway between the top and the bottom. The edges of the tin in the slot must be turned over and hammered down to make a smooth surface for the tape to run over.—Contributed by George N. Bertram, Toronto, Can.

Removing Tannin Stains from Teacups

A small portion of hyposulphite of soda mixed with vinegar will make a good cleaner for teacups having tannin stains. This process does not injure the finest china and is inexpensive. The same solution works quite well on clothes that are accidentally stained with tea. They should be washed out and dried quickly after its application in order to make this method most effective.—Contributed by Loren Ward, Des Moines, Iowa.

A Candle-Shade Holder

A holder for either round or square shades can be easily constructed from a piece of heavy copper wire to fit on a

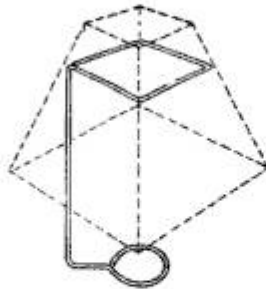
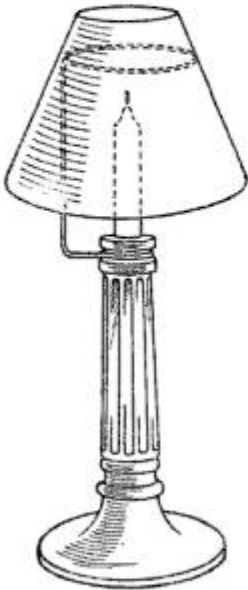

Two Forms of Shade Holder Made of Copper Wire for a Candlestick

candlestick. One end of the wire is looped around the upper end of the candlestick, then bent so that the main part will be vertical. The top end is shaped into a circle 2 in. in diameter or a square having sides 2 in. long, as desired.—Contributed by Harry Slosower, Pittsburgh, Pa.

Wire Mesh Used as a Shelf

In covering a window back of my lathe with wire mesh as a protection I also made a shelf for the tools between the window sill and the lathe bed of the same material. The mesh used was $\frac{1}{4}$ -in. The shelf is always clean, as the shavings and dirt fall through, and the tools may be readily picked up.—Contributed by J. H. Sanford, Pasadena, California.

Heel Plates

A good heel or toe plate can be made by driving ordinary thumb tacks into the leather of the shoe heel or sole. The shape can be varied by using tacks

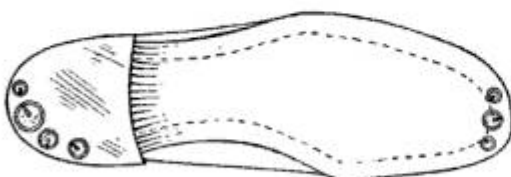

The Heads of the Tacks Form a Wearing Surface Equal to an Ordinary Heel Plate

having different-sized heads.—Contributed by James T. Gaffney, Chicago, Ill.

A Bright Dip for Metal

Articles of brass, copper and bronze may be given a bright luster by dipping them into a solution composed of 50 oz. of nitric acid, 25 oz. of sulphuric acid, liquid measure, and $\frac{1}{2}$ oz. of soot and $\frac{1}{2}$ oz. of salt, by weight. After the articles are dipped into the solution they are removed and thoroughly washed, then dried in sawdust to prevent streaks.

An Interesting Vacuum Experiment

A very interesting experiment may be performed with two drinking glasses, a small candle end and a piece of blotting paper, says the *Pathfinder*. The glasses must be the same size and of the thin-glass kind. The candle end is lighted and set in one glass; the blotting paper is well dampened and placed on top of the glass, and the other glass inverted and its rim placed exactly over the lower one and pressed down tightly. The candle will burn up all the oxygen in the glass and go out.

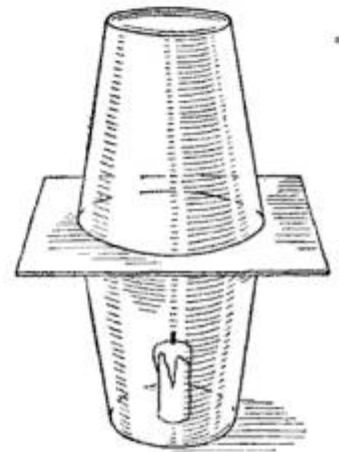

The air in the glass being heated will expand and some of it will be forced out from under the moist paper, and then, as the portion remaining cools, it will contract and draw the upper glass on the paper and make an air-tight joint. The upper glass can then be taken up and the lower one will cling to it.

A Sliver Extractor

If a clipper for the finger nails becomes dull do not throw it away, but keep it in the tool box in a handy place. It is very useful for extracting slivers from the flesh.—Contributed by G. Wokenfuss, McCook, Neb.

An Electric Anemometer

By WM. H. DETTMAN

The construction of this instrument is so simple that any amateur can make one, and if accurate calibrations are desired, these can be marked by comparison with a standard anemometer, while both are placed in the wind.

The Indicator

The case of the indicator is built of thin wood—the material of an old cigar box will do—9 in. long, 6 in. wide and 1½ in. deep. If cigar-box material is used, it must first be soaked in warm water to remove the paper. If a cover is to be used on the box, a slot, on an arc of a circle, must be cut through it to show the scale beneath. The arc is determined by the length of the needle from a center over the axis on which the needle swings. When the box is completed, smooth up the outside surface with fine sandpaper and give it a coat of stain.

The core of the magnet is made by winding several layers of bond paper around a pencil of sufficient size to make an inside diameter of slightly over ¼ in., and a tube 2 in. long. Each layer of the paper is glued to the preceding layer.

Two flanges or disks are attached to the tube to form a spool for the wire. The disks are cut from thin wood, 1¼ in. square, and a hole bored through their centers so that each will fit on the tube tightly. One of them is glued to one end of the tube and the other fastened at a point ½ in. from the opposite end. The space between the disks is filled with seven layers of No. 22 gauge insulated magnet wire, allowing sufficient ends of the wire to project for connections. The finished coil is located in the box, as shown at A, Fig. 1.

The core for the coil is cut from a piece of ¼-in. iron rod, 1¼ in. long, and a slot is cut in each end, ¼ in. deep, into which brass strips are inserted and soldered, or otherwise fastened. The strips of brass are ⅜ in.

wide, one 1½ in. long and the other ¾ in. Two ⅛-in. holes are drilled in the end of the long piece, and one ⅛-in.

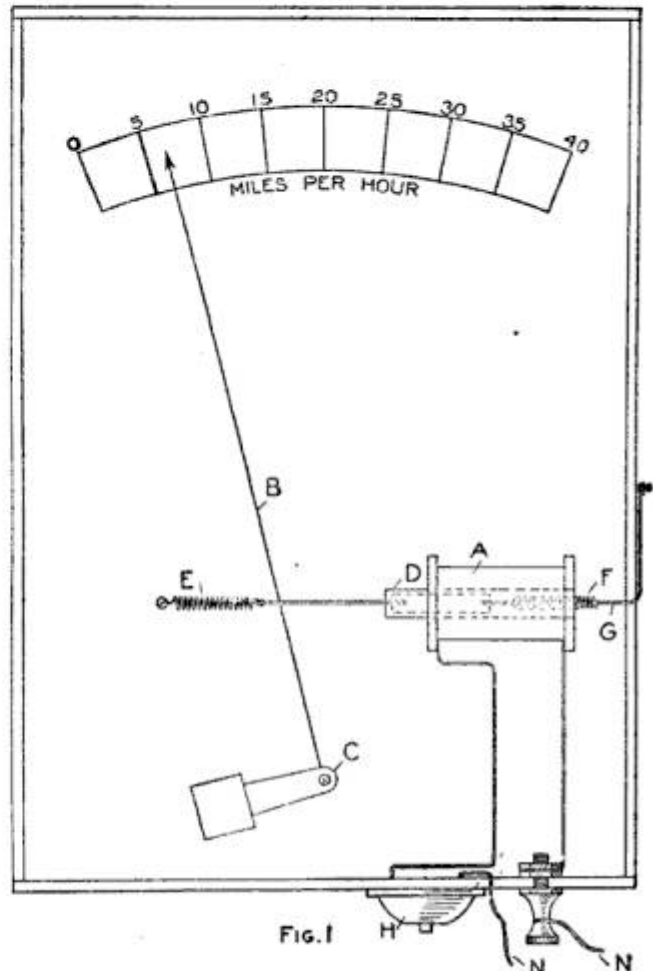

FIG. 1
The Indicator Box with Coil, Needle and Scale, as It is Used in Connection with the Anemometer

hole in the end of the short piece. The complete core with the brass ends is shown in Fig. 2.

The needle B, Fig. 1, is made of a copper or brass wire, about 6 in. long, and is mounted on an axis at C. The detail of the bearing for the axis is shown in Fig. 3. The axis D is a piece of wood fitted in the U-shaped piece of brass and made to turn on brads as bearings, the center being pierced to receive the end of the needle. After locating the bearing for the axis C, Fig. 1, it is fastened in place so that the upper end or pointer of the needle will travel over the scale. The needle is then attached to the bearing after having been passed through the inner

hole of the longer brass strip of the core, and the coil is fitted with the core in the manner shown at D. A light brass coil spring is attached to each end of the core, as shown at E and F, the latter being held with a string, G,

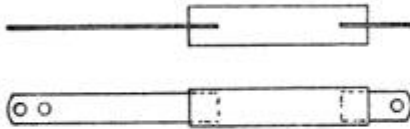

FIG 2

The Metal Core for the Coil and the Bearing Block for the Axis of the Needle



FIG.3

whose end is tied to a brad on the outside of the box, for adjustment. A better device could be substituted by attaching the end of the spring F to a nut and using a knurled-head bolt passed through the box side. One of the wires from the coil is attached to a push button, H, to be used when a reading of the instrument is made. The connections for the instrument consist of one binding post and a push button.

The Anemometer

The anemometer resembles a miniature windmill and is mounted on top of a building or support where it is fully exposed to the air currents. It differs from the windmill in that the revolving wheel is replaced by a cupped disk, A, Fig. 4, fitted with a sliding metal shaft, B, which is supported on crosspieces, CC, between the main frame pieces DD. The latter pieces carry a vane at the opposite end. The frame pieces are $\frac{1}{2}$ in. thick, $2\frac{1}{4}$ in.

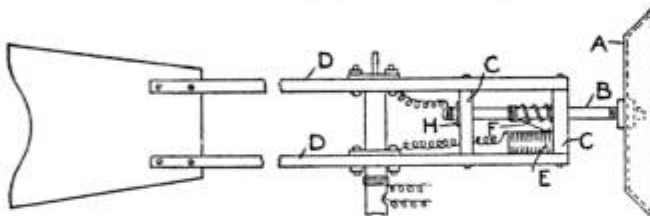

FIG.4

The Anemometer as It is Mounted on a Standard Similar to a Small Windmill Weather Vane

wide and 36 in. long, and the cross-pieces have the same width and thickness and are 4 in. long.

A variable-resistance coil, E, is made as follows and fastened in the main frame. The core of this coil is a

piece of wood, 2 in. square and 4 in. long, and wound with No. 18 gauge single-wound cotton-covered german-silver wire. The winding should begin $\frac{1}{4}$ in. from one end of the core and finish $\frac{1}{4}$ in. from the other, making the length of the coil $3\frac{1}{2}$ in. The ends of the wire are secured by winding them around the heads of brads driven into the core. A small portion of the insulation is removed from the wire on one side of the coil. This may be done with a piece of emery cloth or sandpaper. A sliding spring contact, F, is attached to the sliding shaft B, the end of which is pressed firmly on the bared portion of the wire coil. One end of a coil spring, which is slipped on the shaft between the pieces CC, is attached to the end crosspiece, and the other end is fastened to the sliding shaft so as to keep the shaft and disk out, and the flange H against the second crosspiece, when there is no air current applied to the disk A.

The insulation of the standard upon which the anemometer turns is shown in Fig. 5. The standard J is made of a piece of $\frac{1}{2}$ -in. pipe, suitably and rigidly attached to the building or support, and the upper end, around which the anemometer revolves to keep in the direction of the air currents, is fitted with a plug of wood to insulate the $\frac{1}{4}$ -in. brass rod K. A bearing and electric-wire connection plate, L, is made of brass, $\frac{1}{8}$ in. thick, 2 in. wide and 4 in. long. The bearing and connection plate M are made in a similar manner. The surface of the holes in these plates, bearing against the pipe J and the brass rod K, make the two connections for the wires from the variable-resistance coil E, Fig. 4, located on the main frame, to the wire connections between the two instruments. These wires should be weather-proof, insulated, attached as shown, and running to and connecting

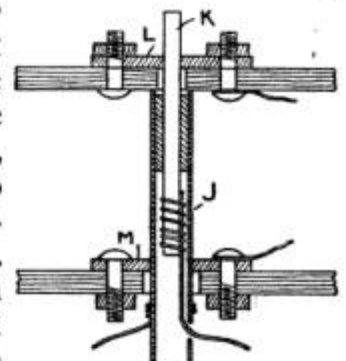

FIG.5

the indicator with the anemometer at NN, Fig. 1.

Two or more dry cells must be connected in the line, and when a reading is desired, the button H, Fig. 1, is pushed, which causes the current to flow through the lines and draw the

magnet core D in the coil, in proportion to the magnetic force induced by the amount of current passing through the resistance in the coils on E, Fig. 4, from the contact into which the spring F is brought by the wind pressure on the disk A.

How to Make Stick Shellac

It is often desired to use shellac in solid or stick form, and to get it into this shape by melting and molding requires considerable time. A much quicker method is to place the shellac in a shallow box, spread it out in a thin layer and play the flame from a Bunsen burner upon it until the mass is melted and run together. Allow it to stand a few seconds, then, with moistened fingers, fold it over and over and shape it with the fingers. It is possible to make a stick 8 or 10 in. long and $\frac{5}{8}$ in. in diameter in about 5 minutes.—Contributed by J. H. Beeber, Rochester, N. Y.

Substitute for a Hose Reel

Not having the room to spare for the ordinary hose reel, I used as a substitute a piece of wire bent into the shape of a letter S and with its aid coiled the hose in a manner to expel the water and leave it in shape for storing.

The hook A is sprung around the hose about 5 ft. from the connection joint and remains there permanently. The end of the hose with the connection C is then brought around in a circle and forced into the hook B. This forms the start for the coil and

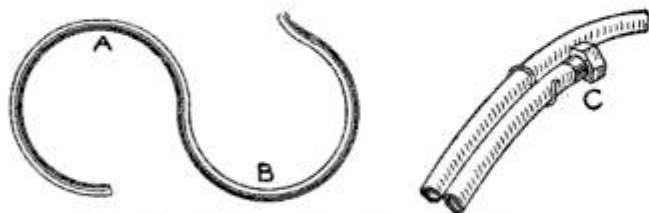

A Hook for Coiling a Hose Instead of Turning It on a Reel

the hose is easily rolled up to the nozzle, the water being expelled during the operation.—Contributed by F. H. Aldrich, Toledo, Ohio.

Addressing a Roll of Papers

When addressing rolled-up papers it is difficult to write on the curved surface. The papers also have a tendency

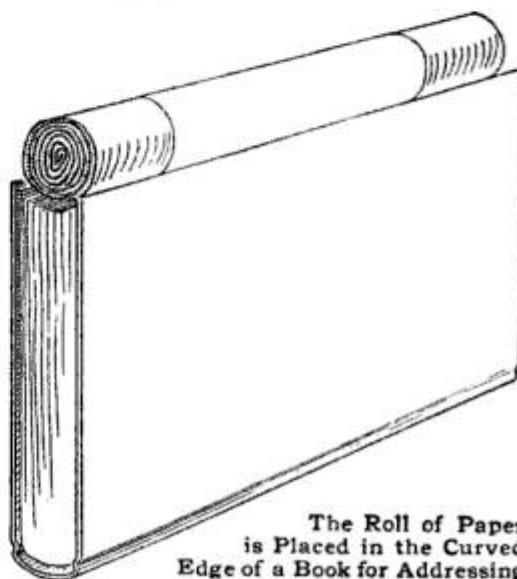

The Roll of Paper is Placed in the Curved Edge of a Book for Addressing

to roll away. By placing the roll in the hollow on the front edge of a large book, as shown in the sketch, it will be found easy to write on the wrapper.—Contributed by W. P. Shaw, Toronto, Canada.

Repairing the Bruised Sides of a Motorboat

When the sides of a boat become scored or bruised scrape the parts clean and fill the depressions with wood cement. The wood cement or stick cement, as it is called, can be procured from a paint store. Heat the cement with a blowtorch and apply it to the bruised parts. Use a heated putty knife to smooth the cement and make the surface level. After sandpapering the fills and applying a coat of paint the boat sides will look as good as new. The cement will not chip or fall out.—Contributed by Henry Beck, Bronx, New York.

Copying Stand for Photographic Enlarging and Reducing

A camera stand or table, which can be put to many uses, is easily made and, when made, will be of particular service, says Work, London, for en-

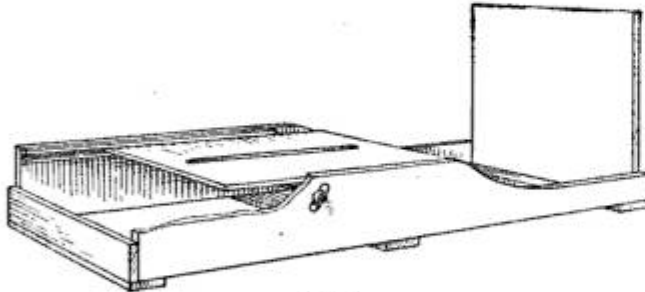

FIG. 1



FIG. 2



FIG. 3

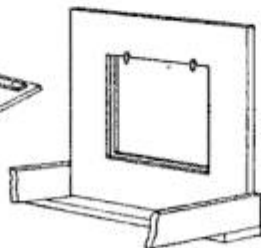

FIG. 4

Camera Stand for Use in Copying and Enlarging,
as Well as for Making Lantern Slides

larging, reducing, copying, and, with a slight modification, for making lantern slides by reduction.

Copying with a camera on a tripod is always a more or less complicated job, because of the ease with which a picture, being focused, may be thrown out of focus, and even out of the field of view, the camera not being attached to the same support as the picture. With the stand shown in the illustration, the picture is attached to the same support as the camera. This makes it possible to place the apparatus on a table, out in the open, or in any other suitable position, where the light may be best for the work. When used for enlarging with artificial light it will also be found convenient, as it may be placed in any position in a darkened room.

The size of the stand will depend on the sizes of pictures to be made, but it is better to have it too large than too small, as a small camera can be used on a large stand while a small stand would be of only limited use. The general appearance of the stand is

shown in Fig. 1. The material list is as follows:

- 2 Sides, $\frac{1}{2}$ in. by $9\frac{1}{2}$ in. by 5 ft., S-2-S.
- 4 Crosspieces, $\frac{1}{2}$ in. by 3 in. by 1 ft. 7 in., S-2-S.
- 4 Guides, $\frac{3}{4}$ in. by $1\frac{1}{4}$ in. by 2 ft. 6 in., S-2-S.
- 2 Bottom Pieces, 1 in. by 9 in. by 2 ft. 6 in., S-2-S.
- 1 Easel, $\frac{3}{4}$ in. by 1 ft. 6 in. by 2 ft., S-2-S.
- 2 Cleats, $\frac{1}{2}$ in. by $1\frac{1}{2}$ in. by 1 ft. 4 in., S-2-S.

Straight-grained soft pine or poplar is the best material to use. The side pieces should be narrowed at one end or to a point about halfway of their length. The extent of this narrowing will depend somewhat on circumstances. The guide pieces are then attached with screws, the two upper pieces so that they have their upper edges flush with the edges of the side boards.

The bottom piece, on which the camera is to be set, is made of the two pieces, cut as shown in Fig. 2, and joined with cleats, as in Fig. 3. The space left after part of one side of each board has been cut away, should be sufficient to make a slot which, when the boards are joined together, will admit the screw to hold the camera in place. A rod is run through holes bored in the sides, just below the two pairs of guides, and fitted with a wing nut for clamping the sliding bottom when a focus and the size of the picture is found.

In copying, the camera is attached to the bottom board and the picture is tacked to the easel. The camera is then focused roughly by means of the rack and pinion, the final, fine focusing being done by moving the sliding bottom board. For enlarging, the lantern is placed on the sliding bottom and the bromide paper tacked to the easel.

For lantern-slide work, which is reducing, it is necessary to cut an aperture in the easel, after the manner shown in Fig. 4. The edges of the opening have a rabbet to receive first a ground glass and then the negative, both being held in place with turn buttons. It is not necessary to have two easels, as this opening can be fitted with a piece to make a level surface when the apparatus is used for copying or enlarging.

Alarm to Designate a Filled Storage Battery

When a storage battery is recharged, the completion of the recharging is marked by the development of gas in the cell. This fact is the basis of a simple electrical device which will ring a bell when the battery is fully charged. A glass tube bent as shown and having a small bulb near its upper end is inserted in the top of the cell, a small quantity of mercury being first introduced in the bend below the bulb. Wires extend down the upper tubing to within a short distance of the mercury. These wires are connected with binding posts so mounted that they can rest on top of the tube, whereupon the bell circuit is completed as shown. Small quantities of gas may develop

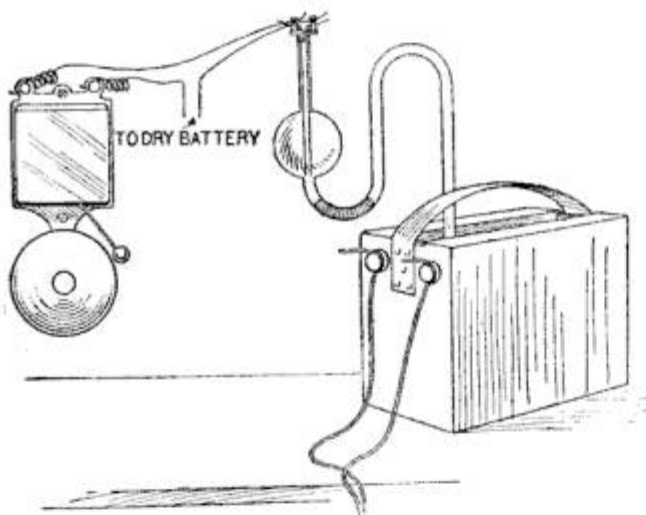

The Gas Generated by a Filled Storage Battery will Make Electric Connections and Sound an Alarm

during the charging of the cell, but if a small hole is pierced in the tube between the mercury and the cell, this gas will not exert pressure enough on the mercury to push it up and connect it with the wires, which will take place first when the development of gas becomes very active at the completion of the recharging.

Stretching Poultry Fencing

The woven-wire poultry fencing is an unusually difficult thing to handle and fasten on posts so that it will be taut and evenly stretched. The best method I have ever seen for drawing this fencing and holding it for nailing

to a post is the use of the device shown in the sketch. It consists of a board, as long as the fencing is wide, with

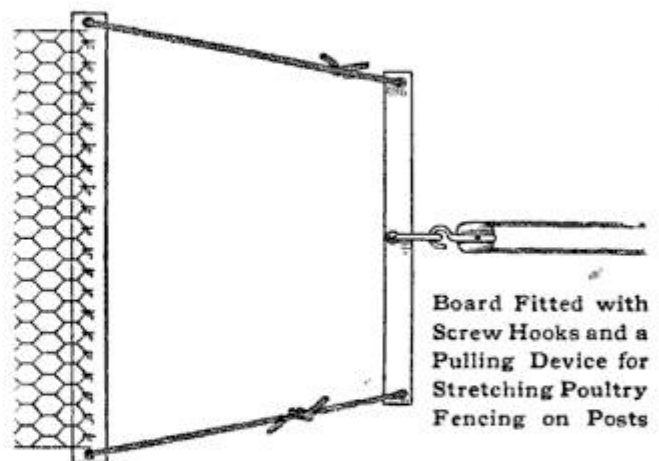

Board Fitted with Screw Hooks and a Pulling Device for Stretching Poultry Fencing on Posts

screw hooks set far enough apart to catch into the meshes of the wire, and a crosspiece attached to the board by pieces of rope at the ends and provided with a pulling loop in the center.—Contributed by Joseph C. Laackman, Meadow Brook, Pa.

A Centering Gauge

The centering gauge consists of a piece of celluloid on which several circles are drawn having different diameters, but all drawn from the same center. A small hole is made at the center to admit the point of a center punch. Two sets of circles may be drawn on one piece as shown, but the lines should be spaced far enough apart to allow the metal to be clearly seen through the celluloid. The sheet is placed on the end of a shaft and adjusted so that a ring will match the circumference of the shaft, then the center punch is set in the center hole

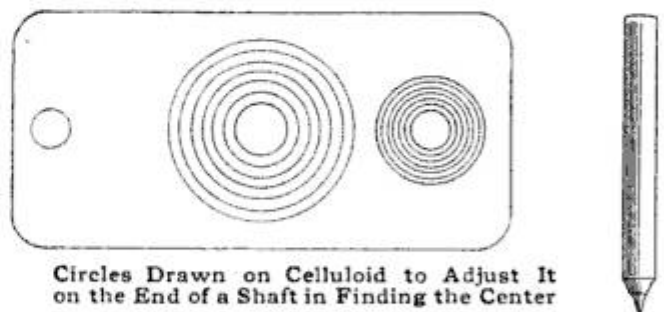

Circles Drawn on Celluloid to Adjust It on the End of a Shaft in Finding the Center

and struck with a hammer. The center punch for marking is shown in the sketch.—Contributed by Harry Holst, San Francisco, Cal.

Starting a Saw Cut

A fine piece of woodwork is often spoiled by the amateur craftsman when starting a cut with a saw. As the

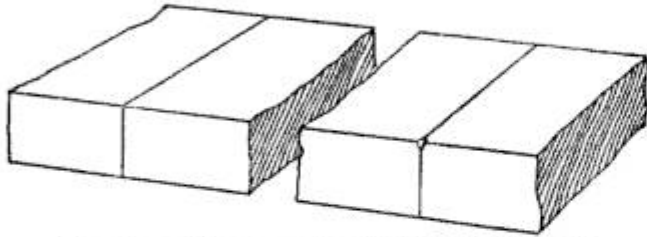

Starting a Saw on a Knife Cut will Prevent Roughing or Splintering the Edge

first stroke of the saw on the edge of the board is made, the teeth often break a splinter from the edge or the saw jumps to one side of the line, thereby making a rough and uneven cut. This can be avoided in a very simple way.

After marking the line, take a sharp knife and make a cut across the edge, as shown, and draw the knife down well over the corners of the board for about $\frac{1}{8}$ in. Place the saw on the cut and start it slowly. The saw blade will follow the cut of the knife blade.

A Substitute Penholder

One evening when my wife was using the only penholder in the house I desired to do some writing and being in a hurry, I hastily made a substitute



The End of the Pencil as It is Prepared to Receive the Pen

holder of a pencil. Two cuts were made in the butt end, as shown; the pen was then slipped in, the outside wound with a rubber band, and my penholder was complete.—Contributed by H. A. Sullwold, St. Paul, Minn.

Protecting Binding Posts on Wet Batteries from Corrosion

When recharging the cells of a wet battery it is best to procure the best grade of sal ammoniac, the kind that is put up in boxes having a sufficient amount for one cell. Then, before putting the solution into the cell, melt

some paraffin used for preserving purposes and dip the upper end of the carbons, zinc, and the glass jar in it. This will apply a coat of insulating wax that will prevent any white deposit from working up on the parts and corroding the binding posts, or terminals.

The cells are then filled in the ordinary manner, after which the carbons and zincs are raised just far enough to admit a layer of common machine oil, about $\frac{3}{8}$ in. thick. The oil not only prevents evaporation but aids greatly to keep the uncovered parts from corrosion.—Contributed by L. R. Kelley, Philadelphia, Pa.

A Cork Puller

A very simple and easy way to remove a stopper from a bottle, when



a cork puller is not at hand, is to press two nails into the cork, as shown in the sketch, and, taking a firm hold on both nails, draw the cork out. Brads may be used on smaller corks. Large and tightly fitted corks may be

drawn by gripping the nails with a pair of pliers.—Contributed by W. A. Jaquythe, Richmond, Cal.

Holder for a Garden-Hose Nozzle

When sprinkling a lawn with an automatic spraying device on a hose nozzle it is necessary to have some kind of an arrangement to tilt the end at the proper angle. I find that a holder made of a heavy piece of galvanized wire bent

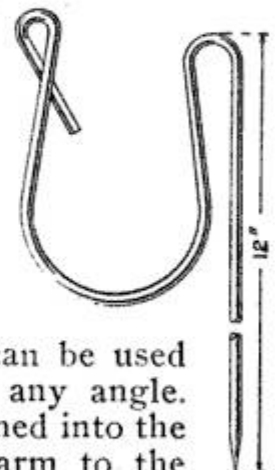

in the shape shown can be used to set the nozzle at any angle. The wire is easily pushed into the earth and does no harm to the lawn.—Contributed by T. J. Ingram, Jr., Lynchburg, Va.

Holder for a Set of Sadirons

A very attractive holder for a set of sadirons and their handle can be made as shown in the illustration, although the design may be changed if desired. The holder consists of a shield-shaped back, which is fastened to the wall in a convenient place and has a shelf with openings for the irons attached to it. The shelf is made in two pieces, the bottom part being covered with a heavy piece of tin while the upper is cut out to receive the irons.

The irons are placed on the upper piece in such positions that they will be attractively displayed and evenly located, and then a lead-pencil mark is drawn around their base. Openings are cut in the wood on these marks and the board fastened on top of the tin-covered shelf. An ordinary brass

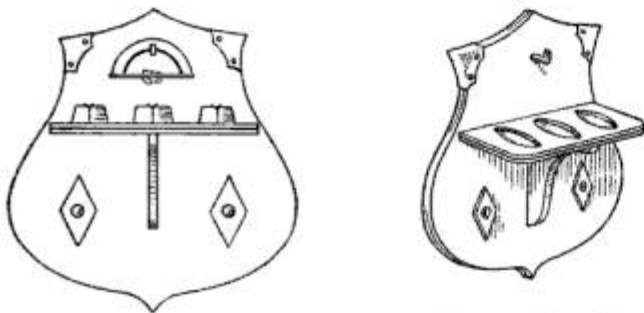

An Ornamented Bracket Shelf for Holding a Complete Set of Sadirons and Their Handle

bracket is used in the center beneath the shelf, to keep it from sagging.

The shield is fastened to the wall with two screws, over which two brushed-brass, diamond-shaped pieces are fastened with large brass tacks, to cover the screw heads. The corners of the shield may be ornamented with brushed-brass designs, and the wood finished as desired. The irons can be set in the holder while hot without fear of burning any part, and they will present a very neat appearance.—Contributed by G. E. Martin, Hastings, Nebraska.

A Garden Roller

A garden roller for digging the earth and crushing clods is easily made of the following material: One round piece of wood, 10 in. in diameter and 18 in. long; two pieces of wood, each 56 in.

long, $2\frac{1}{2}$ in. wide and $1\frac{1}{4}$ in. thick; one piece, 21 in. long, 2 in. wide and 1 in. thick; two $\frac{1}{2}$ -in. lag screws, 6

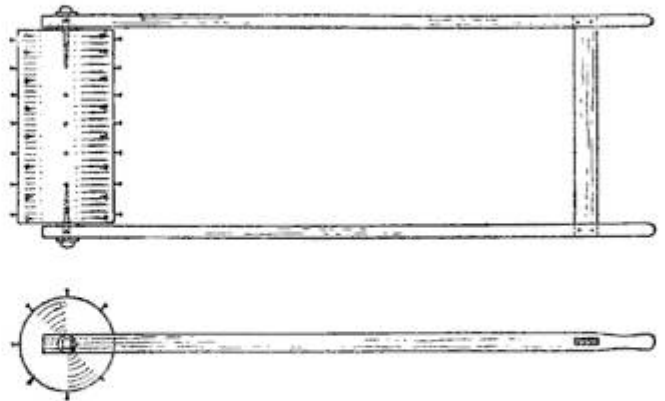

A Roller for Crushing Clods and Digging the Earth in Garden Making

in. long, and a quantity of 8-penny nails.

The short piece of wood is fitted between the two long pieces with tenon-and-mortise joints to serve as a handle at one end and the roller is fastened between the side pieces at the opposite end to revolve on the lag screws. The nails are driven into the roller so that they project about 1 in.

A Substitute for Glaziers' Points

Ordinary small staples make good substitutes for glaziers' tacks. The points of the staples should be drawn apart slightly, as shown at A, to give them a greater holding area and at the same time make them easier to drive. These points seem to hold the glass better than the regular glaziers' points,

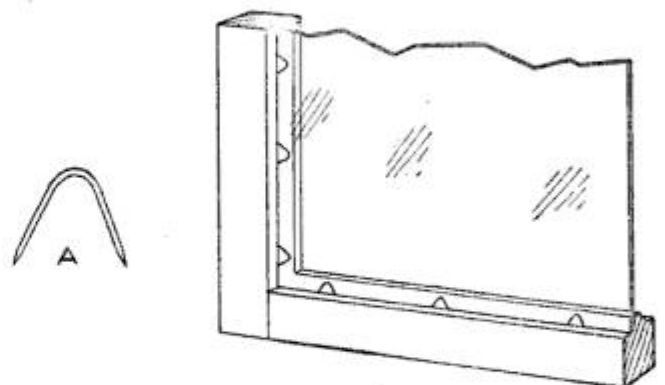

Double-Pointed Tacks, or Staples, with the Points Spread, Used as Substitutes for Glaziers' Points

consequently the putty will not crack and loosen, and renewing is avoided.—Contributed by Edward Sieja, Chicago.

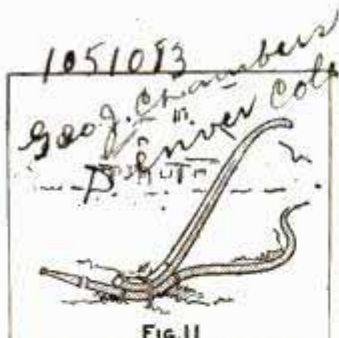

FIG. 11

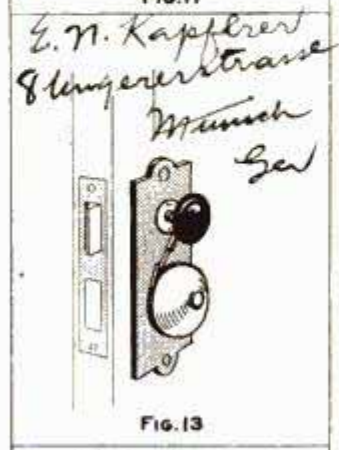

FIG. 13

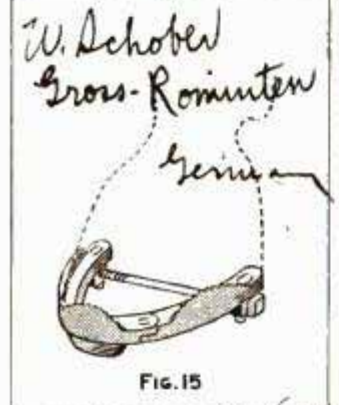

FIG. 15



FIG. 17



FIG. 19

ular stays containing coil springs support the rear, and handlebars and foot rests are provided. The whole weight of the passenger is spring-supported.

HOLDER FOR GARDEN HOSE (Fig. 11)—By using the hose holder here shown, it is a simple matter to change the position of the hose on the lawn or in the garden without having to stoop over or wet and soil the hands.

EXERCISING DEVICE FOR CHILDREN (Fig. 12)—The use of a dining-room table as an exerciser for small children, the child walking around and around, revolving it as a horse revolves a capstan in house moving, is what one inventor contemplates. The table pedestal is swiveled.

BURGLAR-ALARM BELL FOR DOORS (Fig. 13; British patent)—The handle and key of this door are joined by chain links, and the bell rings should anyone on the outside of the door attempt to turn the knob or the key.

CLOTHESLINE PULLEY (Fig. 14)—With the housed-in pulley here shown there is no danger of the line slipping off the wheel and becoming tangled and twisted when not in use. The line is removed from the posts by simply slipping the pulleys off the post hooks.

NAILLESS HORSESHOES (Fig. 15; British patent)—This nailless horseshoe is composed of two parts, hinged together and made fast at the rear by a bolt and nut. This shoe is held to the horse's hoof by means of tooth-edged clips, the teeth of which take hold on the sides of the hoof when the bolt at the rear is screwed tight.

INDIVIDUAL TOWELS (Fig. 16)—In states or cities where the law prohibits the use of a common towel this device may be found useful. The user lifts a clean towel out of one or the other container, uses it, and then lets it drop, the rod to which it is attached depositing it in the soiled towel receptacle underneath. With such a device towels cannot very well be used twice, or be carried away.

FLY POISONER (Fig. 17)—In the hollow head of this trap is a receptacle containing poison. The flies enter through the opening in the top of the head, are poisoned, and then fall into the bottom section. There is but little possibility of a child getting at poison used in this way.

MULTIPLE-TUBE AUTOMOBILE TIRE (Fig. 18)—This tire has a number of inflatable tubes, so formed that they bear on each other, with their contact edges forming right angles. Displacement of the tubes is prevented by ball-and-socket joints located at corresponding points of the abutting faces.

GUARD FOR OVERHEAD TROLLEY WIRES (Fig. 19)—The object of the trolley-wire guard is to prevent the ends from falling to the ground or to hang in such a way as to endanger the life of persons or animals, should the wire break. The guard hangers are easily pushed out of the way by the trolley pole, and then spring back again when the pole has passed.

SECTIONAL AUTOMOBILE TIRE (Fig. 20)—This sectional, nonpneumatic tire differs from one or two other sectional tires now on the market. In the first place it is round, like the pneumatic tire, and, when the sections are placed side by side on the rim, a continuous hole is formed close to the tread. This hole or air space forms an auxiliary cushion, which comes into complete use only when the walls of the main cushion are collapsed by reason of some exceptional jar or impact.



FIG. 12



FIG. 14

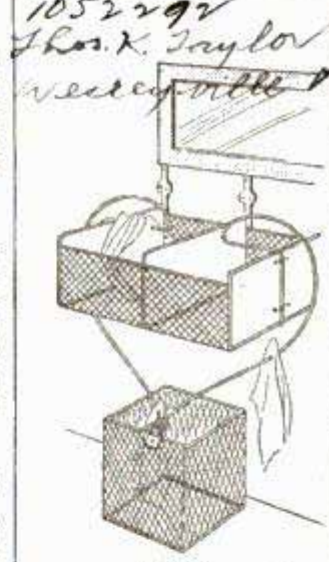

FIG. 16

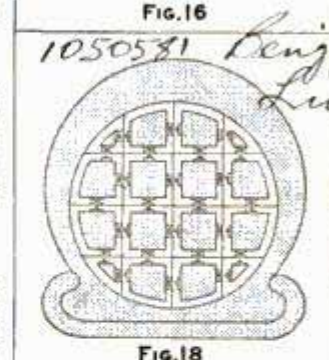

FIG. 18

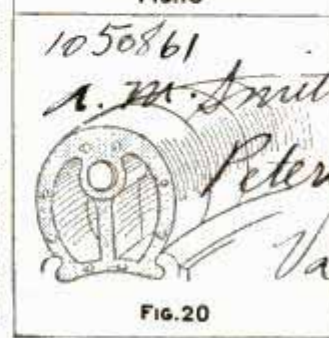

FIG. 20

SADDLEE—A man can hardly wed now unless he can show the girl two licenses.

Denston—Two licenses?

Saddlee—Yes—marriage and automobile.—Boston Post.



A Scotch class was examined in Scripture. "Can any boy or girl here tell me how Noah would be likely to use his time while on the ark?" asked the inspector. One boy timidly showed his hand and replied: "Please, sir, he wad fish." "Well, yes, he might," admitted the inspector. Another little fellow waved his hand, excitedly, and said: "Please, he couldna fish vera lang." "What makes you think so, my little man?" "Because there were only two worms in the ark."—Record-Herald.

"That doctor is a regular human dynamo."

"Yes; when I came in contact with him I myself was highly charged."—Washington Herald.

Some of the best ways of becoming wealthy have been illustrated to us, and here put down. If you will read them carefully and follow instructions explicitly, there is no doubt in our minds but that you will also be able to endow colleges and libraries.

Get a block of business property, a corner preferred. Divide it equally into four parts, and after you have carefully figured the cost on your investment, all you have to do is to find a buyer, sell three-fourths of your lot for \$750,000, and keep the remainder for a warehouse in which to store good ideas.

To figure your profit on this deal tell your wife about the transaction and leave her to explain the same to her friends. About the time it comes back to you you will find that you are worth several millions of dollars.

Invent some handy and useful article to aid suffering humanity. Here are a few suggestions:

- A reinforced-concrete shoe lace.
- A whistling collar button.
- Soap with a handle to it.
- A lead pencil with an unbreakable point.
- A safety razor that will cut whiskers only.—Pacific Naval Monthly.

An old gentleman was trying to cross a main street crossing, and stopped short to allow a big touring car to pass. Just before it reached him a motorcycle dashed around the car, striking the old gentleman and knocking him over. As he arose and brushed off the dust he was heard to remark: "Now, who'd have thought that automobile had a colt!"—Cleveland Motorist.



An admiring parishioner of a young divine in an Ohio town recently had a telephone installed in the clergyman's house. The good man was delighted with the convenience, and used it immediately before going to church.

When the time came for him to announce the first hymn, he read the first lines with his usual impressiveness, and concluded with:

"Let us all unite in hymn seven o three."—Lippincott's.

The Little Girl (a stranger)—My papa's an airynut. Your little boy says his is an airynut, too. Please, is he?

Bobby's Sister (gently)—No, dear; his papa is an angel.

Bobby (triumphantly)—There, didn't I tell you he was a flying-man?—Sketch.

The old mountaineer, who was standing on the corner of the main street in a certain little Kentucky town, had never seen an automobile.

When a good-sized touring car came rushing up the street at about thirty miles an hour and slowed down just enough to take the corner on two wheels, his astonishment was extreme. The old fellow watched the disappearing car with bulging eyes and open mouth. Then, turning to a bystander, he remarked solemnly:

"The horses must sholly ha' been traveling some when they got loose from that gen'leman's carriage."—Youth's Companion.



A group of visitors was going through the county jail and a burly negro trusty was called to open doors for the visitors.

"How do you like it in here?" one of the women asked.

"Like it, ma'am? if evah Ah gets out o' heah Ah'll go so fer from here it'll take nine dollars to set me a postal card."—Ideal Power.

A taxicab in Athens is called a polipolytanticinetharmoxaxe. Most people would rather walk than pronounce it.

"My theory," said the eminent student, "is that the Venus of Milo was holding her drapery up with one of those lost arms."

"I see," replied the man who knows nothing whatever of art; "and signaling for a taxicab with the other."—Washington Star.

Guide—Why did you keep on a-shooting at me arter I hollered an' tole you I wasn't a deer, hey? What made you do that?

Hunter—How did I know but you was lying?—Chicago Daily News.

"His wife is a business woman all right."

"What makes you say that?"

"She's installed a time clock in the hall, and he has to punch it when he goes out nights and when he gets back."

Inventor (at quick lunch counter)—Eureka! The perfect auto tire at last. Give me the recipe for these doughnuts—they're puncture-proof.

A Chicagoan who employs a Swedish maid overheard the following conversation the other day between her cook and the maid next door, also a Swede:

"How are you, Hilda?"

"I well, I like my job. We got cremated cellar, cemetery plumbing, elastic lights—and a hoosit."

"What's a 'hoosit,' Hilda?"

"Oh, a bell rings. You put a thing to your ear and say 'Hello,' and some one says 'Hello,' an' you say 'hoosit.'"—British American.



IF THE PRICE OF GASOLINE GOES UP

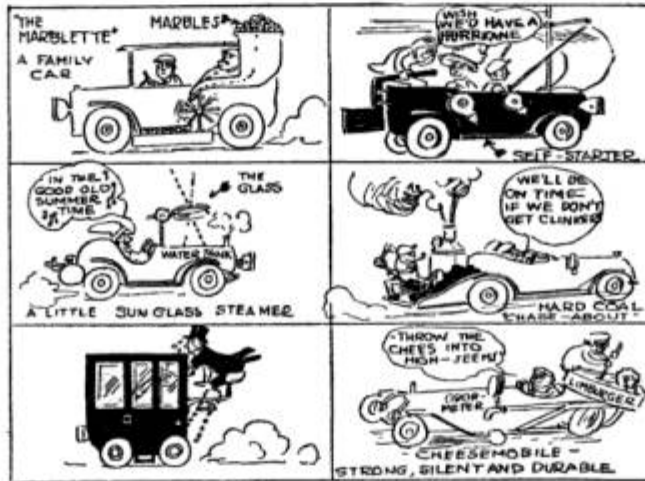

Stanley in the Cleveland Press

Three 10¢ Packages and This 25¢ Book on Beautifying the Home **FREE**

ASK your paint dealer for this book and two 10c packages of Johnson's Wood Dye and a 10-cent package of Johnson's Prepared Wax, free. If your dealer cannot supply you, give us his name, and we will send them free and postpaid.

The book tells how to secure the right artistic wood effects with least expense and trouble.

Johnson's Wood Dye

is a dye, not a stain; it sinks deep down, bringing out the natural beauty without that artificial, grained effect. In half an hour it will be perfectly dry; no dust sticks; no streaks show. It is not only beautiful, but lasting and easy to use. Comes in 17 beautiful shades.

- | | | |
|------------------------|------------------------------|------------------------|
| No. 126. Light Oak | No. 127. Extra Dark Mahogany | No. 131. Moss Green |
| No. 123. Dark Oak | No. 129. Dk. Mahogany | No. 122. Forest Green |
| No. 125. Mission Oak | No. 130. Weathered Oak | No. 172. Flemish Oak |
| No. 140. Early English | No. 131. Br. Weathered | No. 178. Brown Flemish |
| No. 110. Bog Oak | No. 132. Gr. Weathered | No. 120. Fumed Oak |
| No. 128. Lt. Mahogany | | No. 180. Silver Gray |

Johnson's Prepared Wax

A perfect furniture polish and finish for all woodwork, floors and furniture, including pianos. Can be used over all finishes. Is beautifying and protecting.

Present this coupon to your paint dealer for the book and 10c packages. If he hasn't them in stock, fill out the coupon giving us his name and mail to us and we will forward you the book and 10c packages free, postpaid.

S. C. Johnson & Son, Racine, Wis.

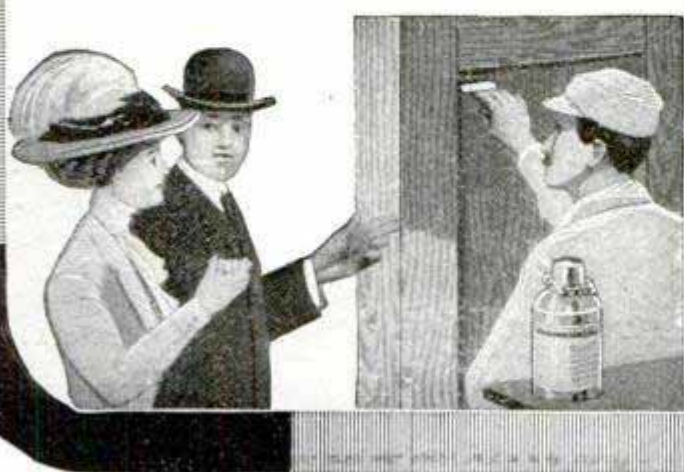

"The Wood Finishing Authorities"

Good at your paint or hardware store for one 25c instruction book, "The Proper Treatment for Floors, Woodwork and Furniture." Two 10-cent bottles Johnson's Wood Dye (Desired Shades.) One 10-cent can of Johnson's Prepared Wax. I asked my dealer (name)

..... but he could not supply me—so please send postpaid.

Name.....

Address.....

City..... State.....

This coupon must first be presented to your paint dealer.

P45

THE
More
Mileage
Strip

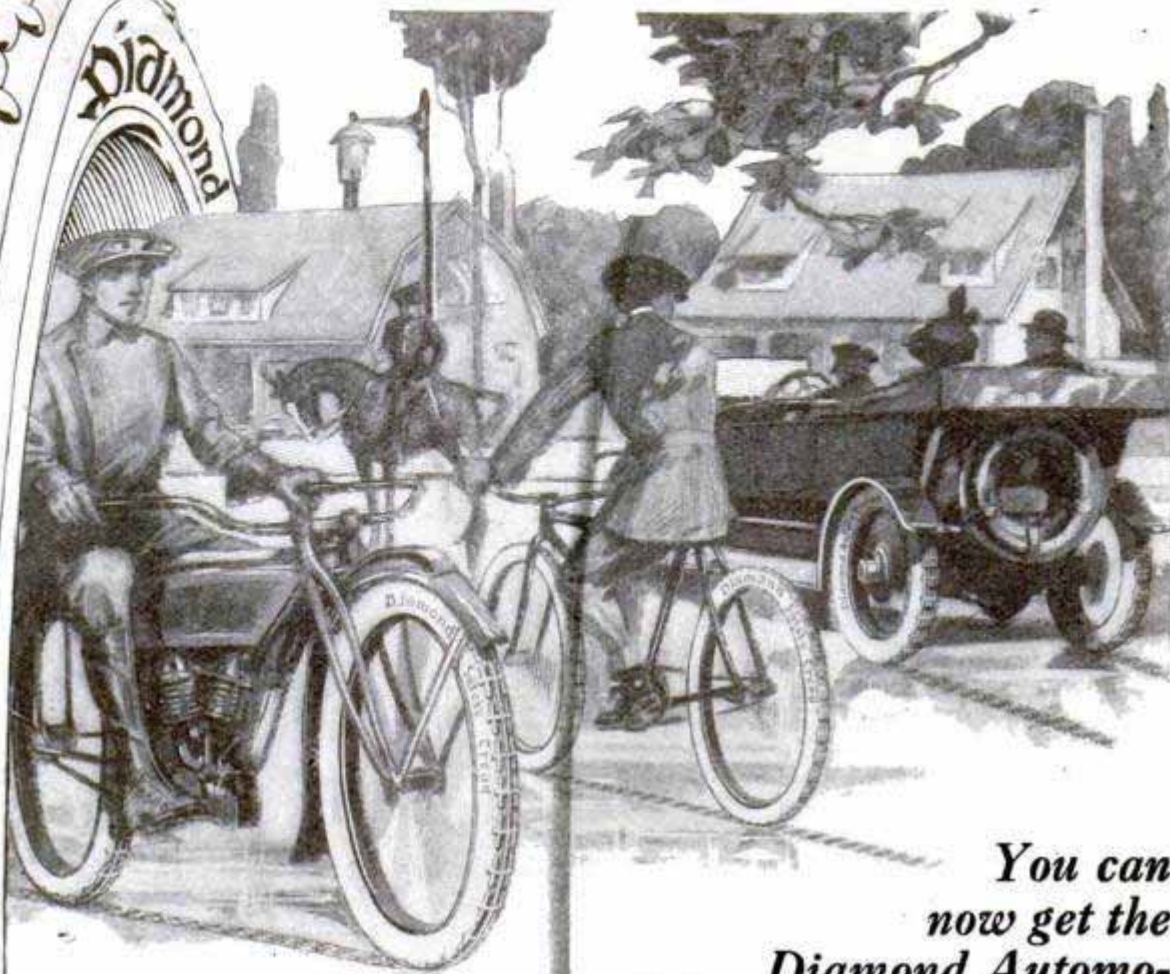

You can
now get the
Diamond Automobile Safety Tread Tire on
your **Motorcycle or Bicycle**

You, as a motorcycle rider, have exactly the same tire problems as the automobilist.

Realizing this, we have built for you a tire, made of the same Vitalized Rubber, the same fabric, the same principle of construction, built in exactly the same manner as our automobile tire.

Diamond Motorcycle Tires

with Safety or Studded Tread and Perfect
3-Point Rim Contact

and in addition the *More Mileage Strip* on the tread—an exclusive Diamond feature. All these distinctive Diamond advantages cost you no more—“More Mileage” Vitalized Rubber—Perfect 3-Point Rim Contact—the Diamond Safety Tread that “won’t slip, won’t slide, won’t skid, it grips.”

So this time buy **Diamond Vitalized Rubber Motorcycle Tires**—
you can get them to fit your rims from

Diamond Dealers Everywhere

Ask your nearest dealer for *Diamond Motorcycle Tire Catalog*

MORGAN DOORS

Applying art to door making gives to Morgan Doors refinements like those obtained in the making of very rich furniture. There are different designs to match architecture and interior decorations.

MORGAN

Every Morgan Door is guaranteed by the maker. Look for the name MORGAN stamped on the top rail.

Write for our book "THE DOOR BEAUTIFUL"

ARCHITECTS: Descriptive details of Morgan Doors may be found in "Sweets Index," pages 1004 and 1005.

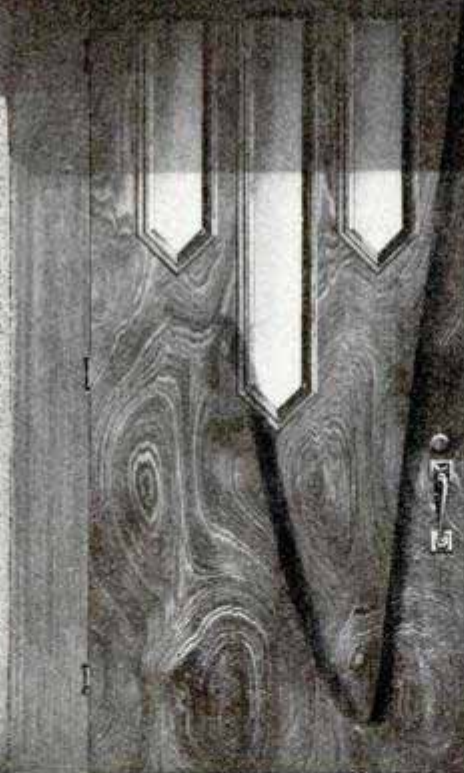

Morgan Sash & Door Company, Dept. C. 24, Chicago, U. S. A.
 Factory
 Morgan Company, Oshkosh, Wis. Distributed by
 Morgan Millwork Co., Baltimore, Md.

Accident Prevention

The PREVENTION OF INDUSTRIAL ACCIDENTS is receiving universal consideration by thoughtful employers.

The Travelers Insurance Company

affords its compensation and liability policyholders not only the most complete coverage based on an unequaled experience and backed by great financial resources, but also

Service

through INSPECTION AND SAFETY ENGINEERING, which is the result of over twenty years' experience and scientific organization along both special and general lines and is the most efficient in the world.

The prevention of accidents has a most important bearing on the cost of compensation and liability insurance.

If you believe with The TRAVELERS

AN INJURY PREVENTED IS A BENEFACTION
AN INJURY COMPENSATED AN APOLOGY

fill out the coupon below and we will indicate how you may avail yourself of TRAVELERS' SERVICE.

TRAVELERS' GOLD MEDAL

AWARDED BY
AMERICAN MUSEUM OF SAFETY

TO THOSE FOREMOST IN
PROTECTING WORKMEN

1910

United States Steel Corp.

1911

Pennsylvania Railroad

1912

New York Edison Company



The TRAVELERS INSURANCE CO., Hartford, Conn.

Please furnish details respecting coverage and service.

Pop. Mech. L.

Name.....

Address.....

Business.....

.....

Please Mention Popular Mechanics

Rubber!

South America's Choicest Product, Developed by North American Ingenuity to the Highest Degree of Efficiency and Utility, in the Manufacture of

Waterman's Ideal Fountain Pen

FROM forest to finish there is a characteristic superiority in Waterman's Ideals. The pure Para rubber used insures durability, tightness and fine finish. The appreciation of the quality of these pens has built our three enormous factories and placed representative assortments in the best stores of every locality for convenient, personal selection. Gold pens to suit every character of handwriting.

Booklet of styles or story of manufacture on request
L. E. Waterman Co., 173 Broadway, New York

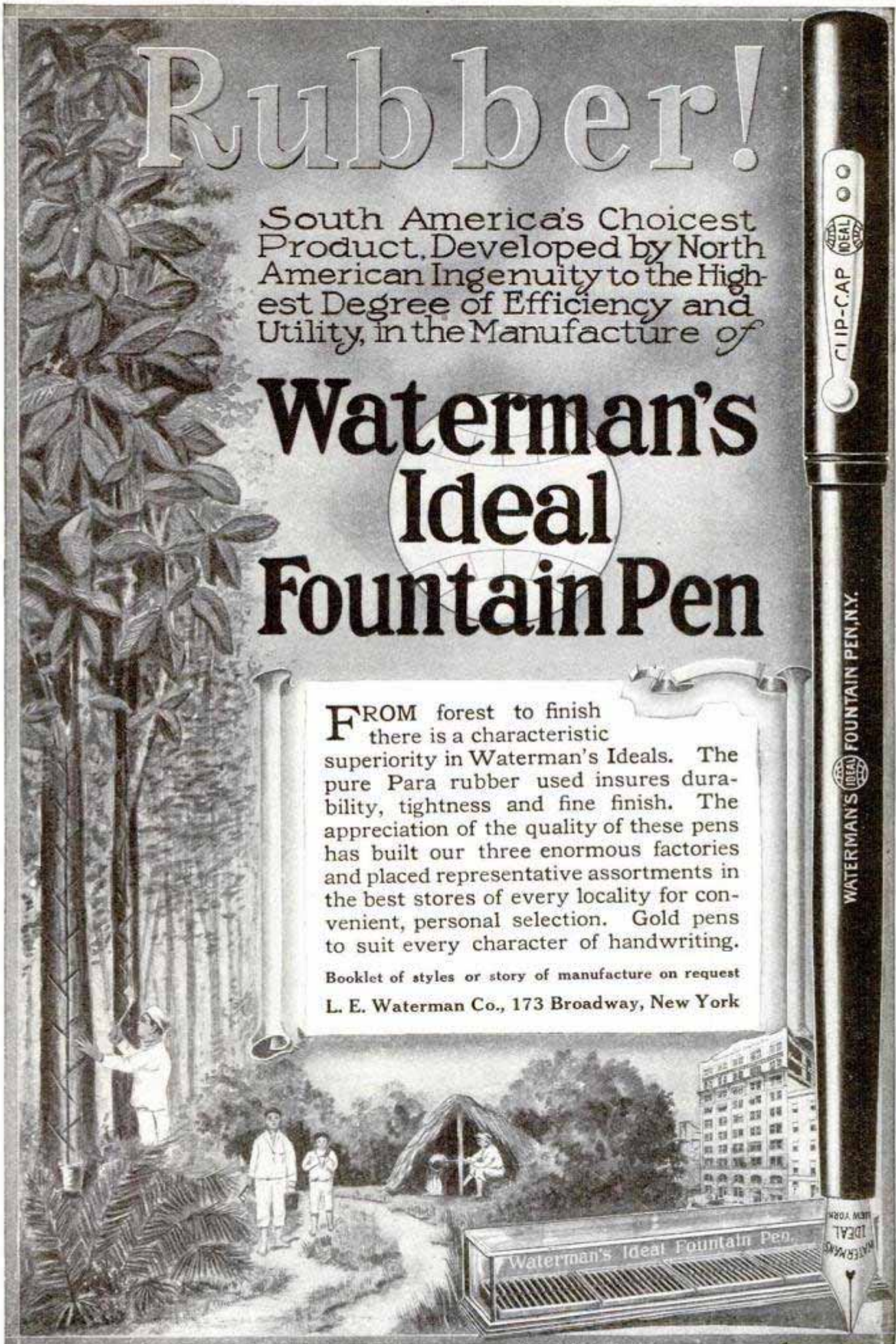

Williams' Shaving Soaps

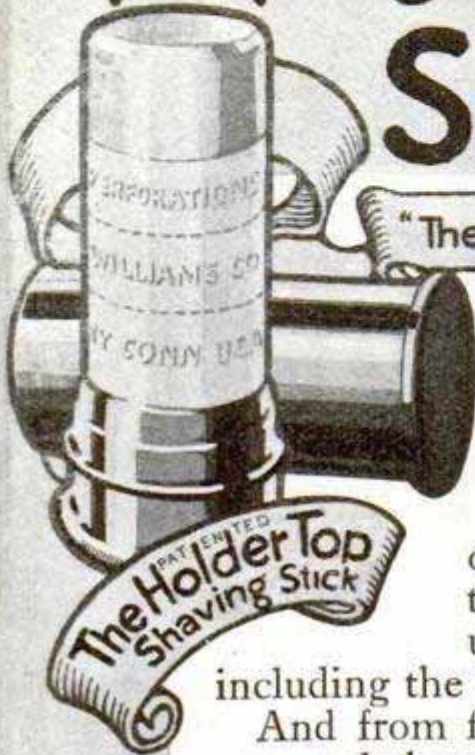

"The kind that won't smart or dry on the face"

When you use Williams' Holder-Top Shaving Stick every shave is a shave of perfect comfort and economy

because the Holder Top not only offers a firm, dry holding surface for the fingers, but also permits you to use the stick down to the last bit,

including the part that you used to throw away.

And from first to last you get a rich, creamy lather that softens the beard, remains moist, and leaves the skin smooth and refreshed.

Other forms of Williams' Shaving Soaps are:

Williams' Shaving Stick Hinged-cover
Nicked Box
Williams' Shaving Powder Hinged-cover
Nicked Box
Williams' Shaving Cream (in tubes)

SPECIAL OFFER
Men's Combination Package

A liberal trial sample of Williams' Holder-Top Shaving Stick, Shaving Powder, Shaving Cream, Jersey Cream Toilet Soap, Violet Talc Powder and Dental Cream. Postpaid for 24 cents in stamps.

A single sample of either of the above articles sent for 4 cents in stamps.

Address

THE J. B. WILLIAMS CO., Dept. A, Glastonbury, Conn.



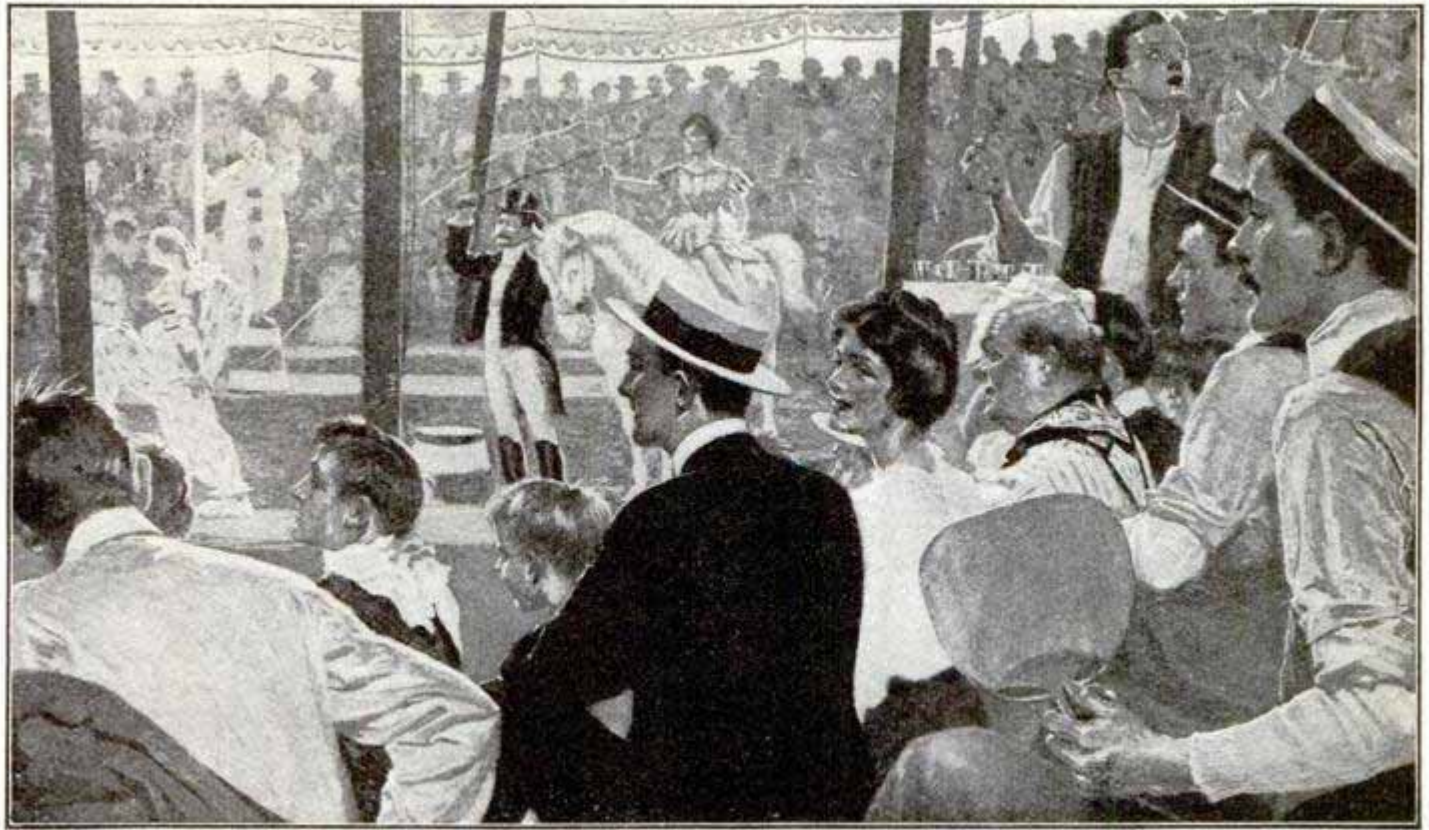

“Gee! I’m Glad I Have On B. V. D.”

THAT’S what the cool, comfortable, *coated* man is thinking, while the cross, comfortless, *coatless* ones are eying him enviously. Don’t *you* be caught without B. V. D. when warm days “put you on the griddle.” B. V. D. weather is *here*—B. V. D. is sold *everywhere*.

To get *genuine* B. V. D. get a good look at the *label*.
On every B. V. D. undergarment is sewed

This Red Woven Label



(Trade Mark Reg. U. S. Pat. Off.
and Foreign Countries.)

B. V. D. Coat Cut Undershirts
and Knee Length Drawers,
50c., 75c., \$1.00 and \$1.50
the garment.

B. V. D. Union Suits (Pat. U. S.
A. 4-30-07.) \$1.00, \$1.50,
\$2.00, \$3.00 and \$5.00 the suit.

The B. V. D. Company,
New York.

London Selling Agency:
66, Aldermanbury, E. C.

Copyrights U.S.A. 1913 by
The B.V.D. Company.



Please Mention Popular Mechanics

The *Indian* Motorcycle

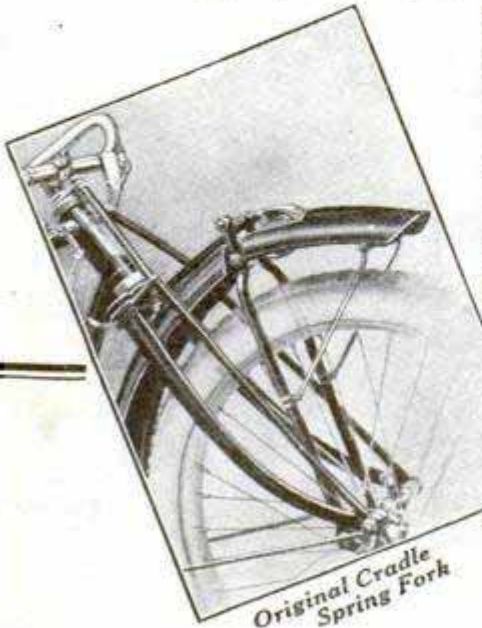

Original Cradle
Spring Fork

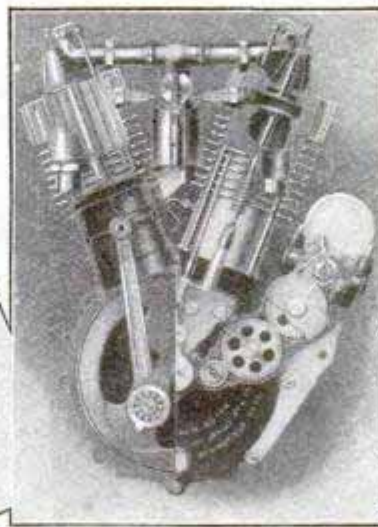

Power Plant of the
"Twin" Indian

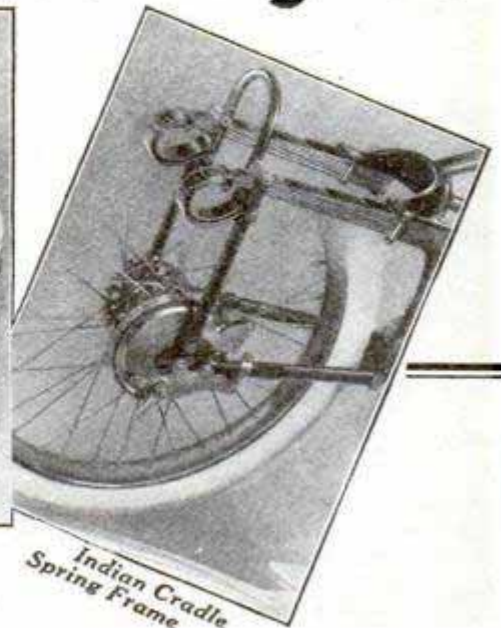

Indian Cradle
Spring Frame

The Four Cardinal Features of Its Wonderful Comfort and Power

Comfort for the Rider has been the chief object of our designers in the 1913 Indian. The prime motorcycle essentials of Power, Speed and Endurance, were so conclusively evident last year that they called for no improvement.

The **Cradle Spring Frame** is an entirely new departure. The rider's comfort is no longer a compromise, no longer a dream. The two sets of leaf springs between which the rear wheel is suspended, absorb road shocks without jarring the rider, either directly or on the rebound. Vibration is prevented and the life of the machine is greatly lengthened. The **Front Fork**, in use on the Indian for the past 4 years, original with us and now widely copied, was the forerunner of the Cradle Spring Frame. The **Hedstrom Motor** is known far and wide as the most powerful and reliable gas engine of its size in the world. To its prowess the Indian Motorcycle owes its greatest achievements on road and track. The **Chain Transmission**, Foot Boards, in addition to pedals and separate foot-control of Brake are other important power and comfort factors.

Prices { 4 H.P. Single Cylinder, \$200 } f.o.b. Factory
 { 7 H.P. Twin Cylinder, \$250 }

Write us for free 1913 catalog describing all models and improvements

THE HENDEE MANUFACTURING COMPANY, 911 State St., Springfield, Mass.

(Largest Motorcycle Manufacturers in the World)

Chicago

Denver

Branch and Service Stations:
 San Francisco Atlanta

Toronto

London

Double chain drive system, showing foot board and brake control

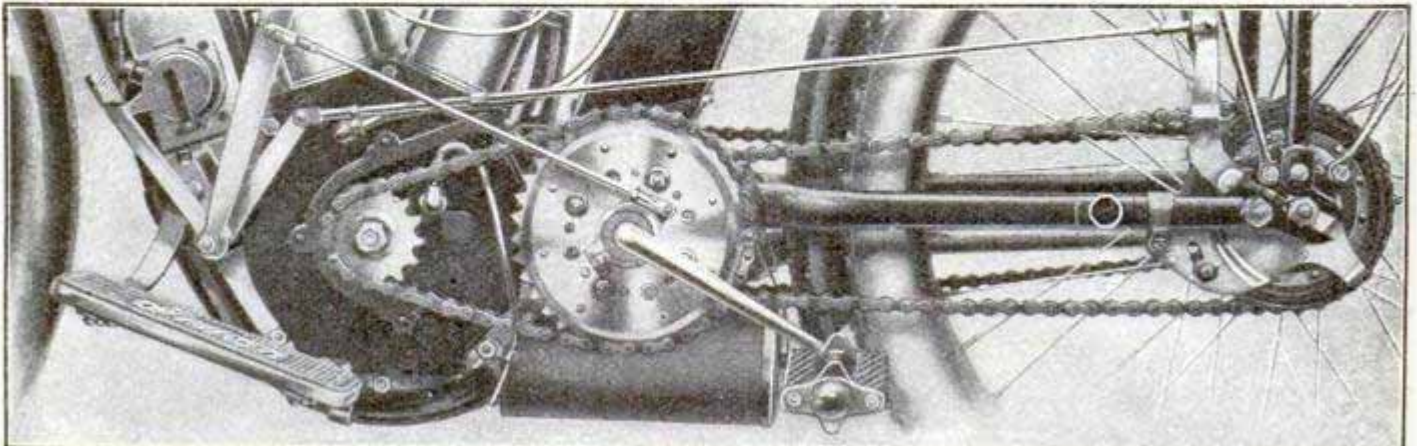

Please Mention Popular Mechanics

"Moving Time" a Fine Time

to Buy a Beautiful Brunswick Billiard-Davenport or

Billiard-Dining Table

Make "Moving Day" a *red letter* day for all the family by providing the new home with a superb Brunswick Home Billiard or Pocket-Billiard Table.

If you have a room—size 11 ft. 6 in. x 14 ft. 6 in. or larger—available *exclusively* for billiards, install the famous Brunswick "Baby Grand." *If space is at a premium, choose either the Brunswick Billiard-Dining-Library Table or the Brunswick Billiard-Davenport Table.*

*Brunswick Billiard Tables
are Used Exclusively by
World's Experts*

"Convertible"

These handsome "Convertible" tables have won widespread popularity because of their *double economy and unexcelled playing qualities.*

They make any room in the house — Dining Room, Living Room, Library or "Den"—available for billiards.

Each style and size of Brunswick Home Billiard Tables have genuine Vermont Slate Bed; celebrated Baby Monarch Cushions; Imported Billiard Cloth. Accurate angles. Scientific construction. Equal in playing qualities to the Brunswick "Baby Grand."



**Combination
Billiard-Dining-Library
Table**

Playing Outfit Free

With each of these magnificent tables you get, *without extra charge*, absolutely everything needed in the way of playing equipment. Outfit includes the celebrated "Baby Monarch" Cushions, Cloth, Cues, Rack (Ball Rack, Ball Basket, Composition Pocket Balls for Pocket Tables); Billiard Balls for Carom Table, Chalk, Tips, Glue, Bridge, Table Cover, Brush, Cue, Clamps, Markers, Set of Rules, etc. Also Book of Instructions on Billiards and How to Play. Complete information accompanies table, showing how anyone with ordinary tools can easily set it up.

Play Billiards at Home!

Billiards is king of home games and pastimes. A Brunswick Home Billiard or Pocket-Billiard Table is a never-failing source of delightful entertainment and mental relaxation for young and old. Attracts the young folks like a "home magnet." Fun for all the family.

Over a Year to Pay!

Our low prices and easy terms bring Brunswick tables within reach of all who love the game. Write for easy terms.

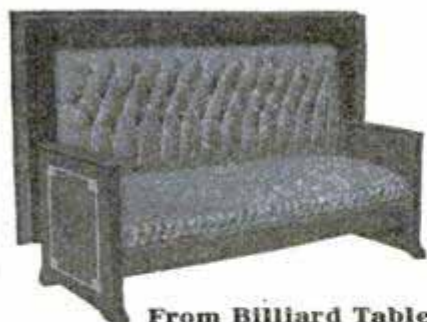

**From Billiard Table
to Davenport Instantly**

Coupon Brings Free Illustrated Literature

Beautiful color-illustrated literature, showing all styles of Carom, Pocket-Billiard and Combination Tables, with detailed description of Tables and complete playing equipment for each, will be sent on request. Also our *Special Introductory Proposition and Easy Terms of Payment.* Send coupon.

COUPON

The Brunswick-Balke-Collender Company
Dept. FM, Wabash Ave. at Harrison St., Chicago

Gentlemen: Please send to the address below, Illustrated Circular of Brunswick Home Billiard and Pocket-Billiard Tables.

Name _____

Address _____

Town _____

State _____

The Brunswick-Balke-Collender Company

Dept. FM, Wabash Ave. at Harrison St., Chicago—9 Factories and 60 Branch Houses



The Power of Silent Service

If the crowd on the stock exchange kept quiet and let one man talk, that man could be heard in every corner of the room. But the shouting members produce a composite of sound, so that no one trader is understood except by a small group around a particular trading post.

If everyone were able to shout twice as loud, the result would be only a greater noise, and less intelligible.

For communication to be universal there must be silent transmission. In a noisy stock exchange where the voice, unaided, cannot be understood across the room, there are hundreds of telephones which carry speech half way across the continent.

The telephone converts the spoken words into silent electrical impulses.

In a single Bell telephone cable, a hundred conversations can be carried side by side without interference, and then distributed to as many different cities and towns throughout the land. Each conversation is led through a system of wire pathways to its proper destination, and whispers its message into a waiting ear.

Silent transmission and the inter-connecting lines of the Bell System are indispensable for universal telephone service.

Without such service, our cities would be slow of speech and the States would be less closely knit together.

AMERICAN TELEPHONE AND TELEGRAPH COMPANY

AND ASSOCIATED COMPANIES

Every Bell Telephone is the Centre of the System

GRAFLEX CAMERAS

On a day
like this

or indoors
like this



Outdoors on bright days you can make pictures like this with exposure as short as 1-1000th of a second, if you wish. And there is no uncertainty. You don't have to guess how far you are from the subject, as there is no focusing scale on the Graflex. Neither is there a "finder." With the Graflex you see the image right side up, the size it will appear in the finished picture, up to the instant of exposure.

Our new Graflex Book tells all about Graflex Cameras, and how they work. May we send you a copy?

THE GRAFLEX

will let you make "snap shots" fast enough to get clean cut outlines, and with exposure enough to make strong, brilliant prints.

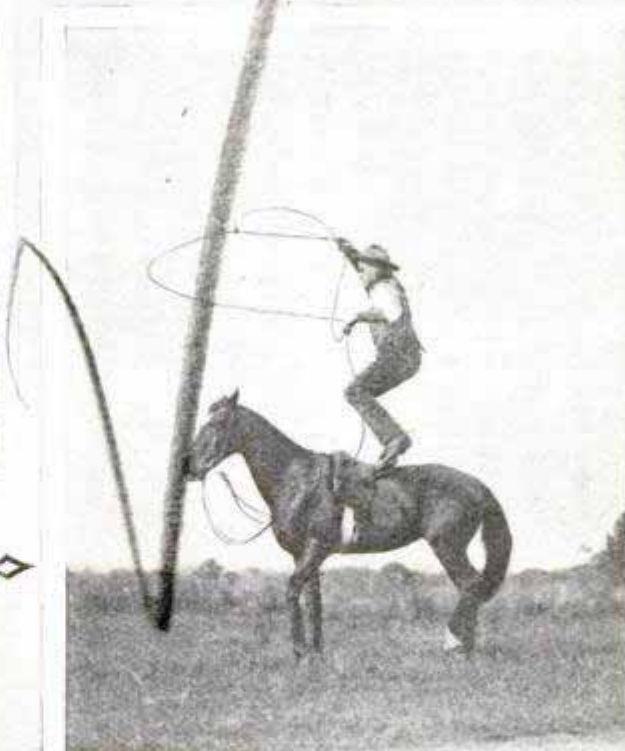

FOLMER & SCHWING DIVISION
EASTMAN KODAK CO.

12 Caledonia Avenue, ROCHESTER, N. Y.

From Childhood to Old Age Kimball Pianos Are Pleasing in Tone

Write Today for Beautifully Illustrated Catalogue.



Mrs. Piano Buyer Before making the purchase of a piano for your home and children we are sure you will want to see our catalogue—you will want to know about our new plan of selling and distributing our pianos direct from our factory and from our various factory distributing points. Write us today for our

Money Saving Plan and Free Catalogues

and learn how easily you can secure the STANDARD Kimball Piano at factory distributing prices and on terms to suit your convenience. Monthly, quarterly or annual payments can be arranged.

Valuable Features of the Kimball

Kimball Pianos possess many important exclusive features, such as our *hermetically sealed* metal covered pin block—the heart of the piano—impervious to dampness, unaffected by heat or cold, strings scientifically treated to prevent rusting, and other valuable features that give the Kimball that *heirloom value* and most splendid musical quality.

Kimball Player-Piano Perfect in Detail

There are very few persons who are not lovers of good music. Unfortunately there have been but a limited number that could produce it, but now with a Kimball Player-Piano in the home, the young, the old and even the feeble "indoor" people can play and reproduce the "Grand Opera" or play any and all of the old time songs or popular pieces.

Our Great Offer

W. W. Kimball Co.
1295 Kimball Hall
Chicago

Please send me free your Piano or Player-Piano Catalogues, prices and terms, and the Musical Herald, containing two pretty songs, words and music.

Name

City

State

R. F. D. or St.

Free Approval Test—We Stand the Freight—Convenient Payments—Catalogues and Herald Free—Old Instruments Taken in Exchange.

Fill out the coupon and send to us today and get FREE our handsome booklets and the Musical Herald, containing two pretty songs, words and music—also valuable piano information, our prices and terms. **Write Today.**

**W. W. Kimball
Company
Chicago**

Delco



Read
About
This
Switch

The Iron with Three Heats

Experience with other types of electric irons in which the heat is not properly controlled has been most unpleasant and costly. The Three Heat Switch on the Delco Iron enables you to control the heat as required, High, Medium or Low. Reduces the amount of current used to a minimum and obviates all danger of scorching. This important feature makes the Delco the only perfect iron on the market. Beautifully nickeled and furnished with stand, cord and plug.

TRY IT TEN DAYS FREE

Use a Delco next ironing day. If not perfectly satisfied send it back at our expense. Write today and you will agree that "It pays to have a Delco." Sent prepaid to any part of the U.S. for \$5.50. Satisfaction guaranteed or money refunded.

DIAMOND ELECTRIC CO.
75 Frederick St., BINGHAMTON, N. Y.

WORLD'S LARGEST CABLE TESTED—The largest hoisting cable in the world was recently tested at South Bethlehem, Pa. A pull of 364 tons was required to break the wire rope, which consisted of 12 strands, each of 19 wires, twisted around a hemp core. The cable was 7,810 ft. in length and weighed 125,360 lb. It is used for drawing cars with a capacity of 100,000 lb. of ore up an inclined plane 5,800 ft. long.

ELECTRIC LIGHT PLANTS Complete gasoline engine, dynamo, switchboard and storage battery \$240. Agents wanted. American Battery Co., 1139 Fulton St., Chicago (Estab. 1889.)



Try to wrench the head off —

MR. MACHINIST — You know the danger of twisting the head off a set screw. Try this on a

MAC-IT SET SCREW

Set the steel block firmly in a vise, take a wrench and try your hardest to twist the head off. Your name, address, business and dealer's name brings test set free.

STRONG, CARLISLE & HAMMOND CO.
327 Frankfort Ave. Cleveland, Ohio

Test
Set
FREE
Pin ad to
letterhead,
give dealer's
name and mail
today.

25 Years Ago, My Son, I began using Star Hack Saw Blades

Whenever a new blade came on the market, I gave it a fair trial, but always came back to a "Star" because I could never find a blade that equalled it in uniformity. That's been my experience—and it's why I always recommend Star Blades. You will find the "Star," 14 teeth per inch, the most reliable all around hack saw blade you can lay your hands on. For 1-16" tubing or less, use Star Blade, 24 teeth to the inch.

Star Hack Saw Frame No. 10

Is quickly adjusted, and will hold blades 6, 7, 8, 9, 10, 11 and 12" long.



MILLERS FALLS COMPANY
28 Warren St. NEW YORK

Write for catalog



Necessity was the Mother of the Remington

WHEN the *need* of the typewriter came to the business world, the Remington came. Others followed.

Remington was the first typewriter — it is still the *first* typewriter.

First in the field, the Remington organization began building experience, step by step, from the actual practice of typewriter users — always a step or two in advance of the users' need. Other makes followed.

Today the Remington typewriter stands unique as the greatest revolutionizer, the greatest energizer the commercial world has ever seen. And by no means *least* of its beneficiaries are *all* other makes of typewriters — for the Remington *created* the typewriter industry and *blazed* the way — for the others to follow.

1,600,000 Remington-written letters mailed in New York City alone every business day in the year.

That tells the story of Remington pre-eminence, of the confidence of captains of commerce in it, of the faith of tens of thousands of efficient employees, of the limitless selection in choice of operators and choice of positions — the machine that has made work for the millions, and millions for the work.



Remington — the first Typewriter

Remington Typewriter Company

(Incorporated)

New York and Everywhere



This 5-Room Summer Cottage \$298

SHIPPED ANYWHERE

BUILD IT YOURSELF— IN A FEW DAYS

DON'T you know a place where you would like to put this cottage, on the shore or in the woods. We will ship it to your station—complete to the last detail, all material being Readi-Cut, so you can build it yourself. It isn't the portable, flimsy kind, but built just like a dwelling house. When it's up, it's up to stay. You get all the lumber, windows, doors, shingles, hardware, paint, nails, glass, everything needed, and full instructions. We have a complete line of summer homes from \$125 up to \$1500 in price—Garages, sleeping porches and sun rooms.

Summer Cottage Catalog No. 99 } Which shall
Dwellings and Bungalow Catalog P } we send you,
or both

North American Construction Co.

383 Aladdin Ave.

BAY CITY, MICH.

Mills in Michigan, Florida, Texas, Missouri and Oregon

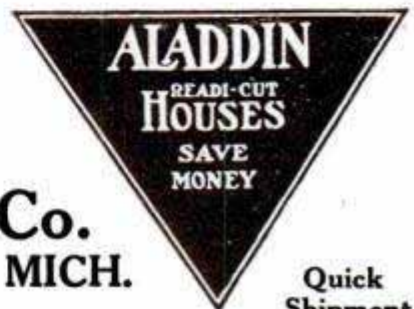

Quick
Shipment

Stamp Collecting



Is a fascinating as well as a profitable pastime, where one makes it a study. If you are interested, write for a free sample copy of the leading publication issued on the subject, edited by C. H. Mekeel, the leading expert in this line in America. If you have a collection of stamps, we will send you selections of foreign stamps on approval upon request.

PRICE LIST FREE If you have any really rare stamps to dispose of, consult us about their sale.

STAMP SECURITY CO. (WELLSTON STATION)
ST. LOUIS, MO.

LIFE-PROTECTING DEVICE WANTED—A costly gold-medal prize has been offered by a German society of electricians for the best apparatus or process evolved in any country for the protection of life or limb, or promoting the health of those engaged in the electrical industry.

The AutoStop Safety Razor

Guarantees 500 Shaves
Ask Your Dealer About It



Amazing Profits In Mushrooms

Anybody can add \$8 to \$40 per week to their income, in spare time, entire year growing mushrooms in cellars, sheds, barns, boxes, etc. I tell you where to sell, at highest prices.

Free Illustrated Instruction Booklet

HIRAM BARTON

Desk 2, 329 W. 48th St., New York

Let Your Engine or Motor Do the Work

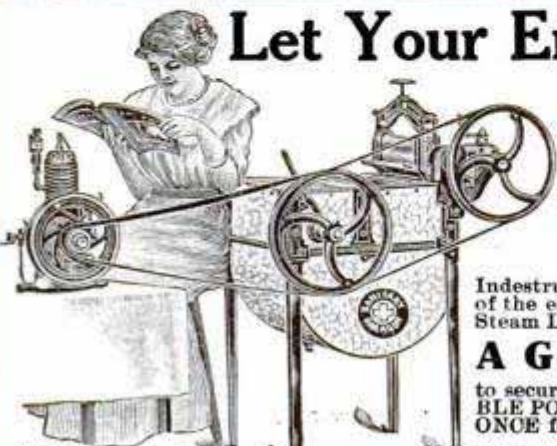

A Blessing For Women

and make an end to washday drudgery in YOUR home. Of course, NONE of the unsanitary, old-fashioned wooden rotary washers will do. ONLY THE MOST UP-TO-DATE machine ought to be good enough for YOUR wife. EXPERTS will tell you that NO MORE DURABLE and PRACTICAL washer can be found than the famous

All Metal Sanitary Paragon Revolving Cylinder Power Laundry Machine

Indestructible. NO WOOD used in any part. The PARAGON is a true reproduction of the expensive and powerful Cylinder Washers exclusively and successfully used in Steam Laundries, Hotels and Hospitals. Over 100,000 Paragon Washers used in the U. S.

A Golden Opportunity for 30 Days Only

to secure one of these wonderful genuine laundry machines, complete with REVERSIBLE POWER WRINGER at a very considerable REDUCTION in price, if you write AT ONCE for Catalog No. 1 and further details of the most generous proposition made.

PARAGON MFG. CO., 2401-03 W. 14th St., CHICAGO

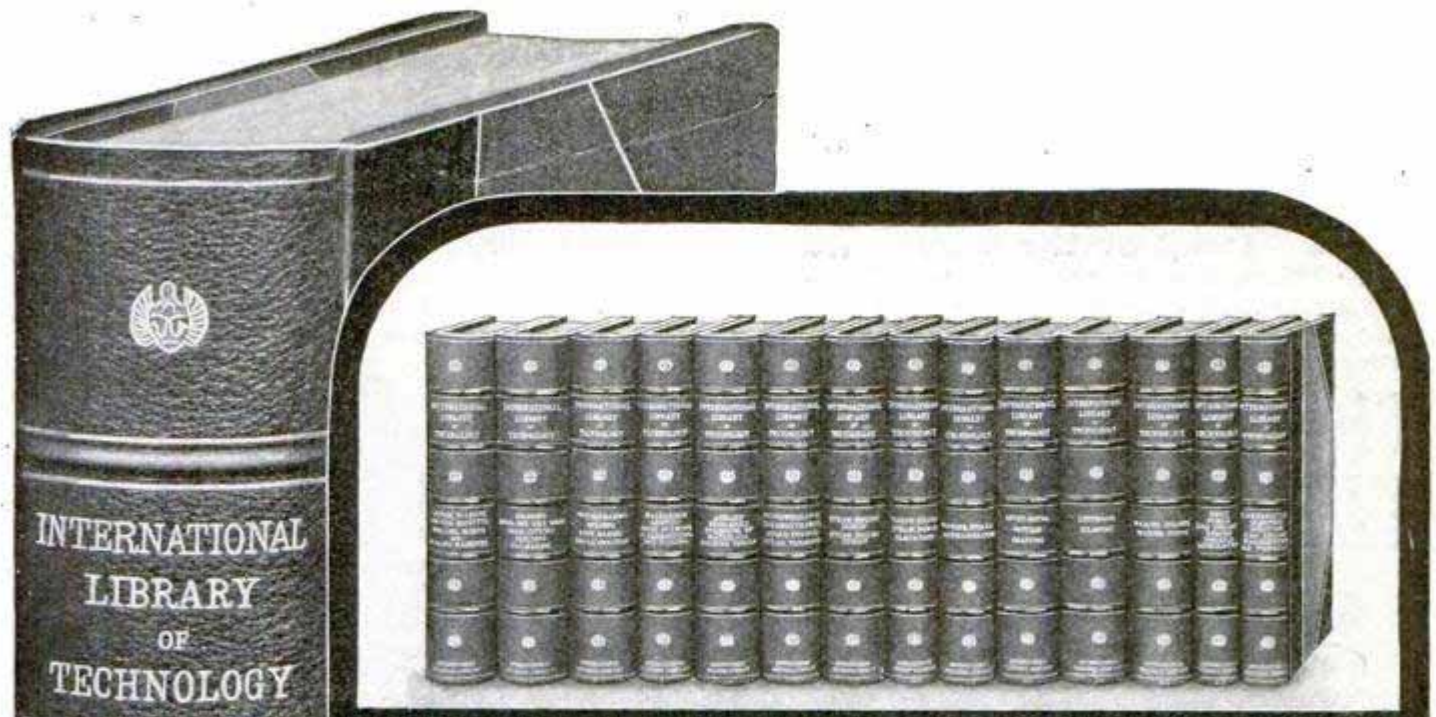

The Greatest Mechanical Library in the World

The Mechanical Engineering Library is part of the International Library of Technology that cost \$1,500,000 in its original preparation. It contains the knowledge given from the life experience of some of the best mechanical engineering experts in the country, edited in a style that nineteen years of experience in publishing home-study textbooks has proved easiest to learn, to remember, and to apply. There is no other reference work in the world that so completely meets the needs of the mechanic as the Mechanical Engineering Library. The volumes are recommended by the highest authorities and are used in nearly all the leading universities and colleges. They treat of practical mechanical methods, starting from the simplest problems and comprehensively covering every branch of the work. Not only can they be used to great advantage by superintendents, foremen, and engineers as an authoritative guide in their work, but since they can be so clearly understood even by persons having no knowledge of higher mathematics, they can be used by all classes of mechanics that are desirous of advancing to higher positions. The Mechanical Library contains 14 volumes durably and handsomely bound in three-fourths red morocco, stamped and numbered in gold.

The books are printed on a high-grade book paper, and the type is large and easy to read. Each volume is 6 by 9 inches in size. If you wish to know more about the greatest and most practical mechanical library in the world, **mark and mail the coupon NOW.**

INTERNATIONAL TEXTBOOK COMPANY
Box 872, Scranton, Pa.

Please send, without further obligation to me, full particulars in regard to the International Library of Technology, with special reference to the Library of Mechanical Engineering.

Name _____

St. & No. _____

City _____ State _____

2c a Week Pays Wash Bill!

Electricity or Water-Power Does the Work

Write for
FREE Book

Just a "Twist of the Wrist" Starts or Stops the Machine!

The 1900 Motor Washers are now at work in thousands of homes. They are doing the work formerly done by women, at a cost of 2c a week for power! Saving thousands upon thousands of dollars in wash bills. Saving worlds of wash-day troubles. Leaving the women free to do other work while the machines are doing the washing.



Doing the wringing with
1900 Electric Motor Washer

The 1900 Motor Washer

Washes a Tubful in Six Minutes!

1900 Water Motor Washer
Can be connected with
any water tap instantly



Handles Heavy Blankets or Dainty Laces

The outfit consists of the famous 1900 Washer with either Electric Motor or Water Motor. You turn on the power as easily as you turn on the light, and back and forth goes the tub, washing the clothes for dear life. Then, turn a lever, and the washer does the wringing. All so simple and easy that it is mere child's play.

A Self-Working Wringer Sent With Every Washer!

The motor runs Washer and Wringer. We guarantee the perfect working of both. No extra charge for Wringer, which is one of the finest made. **Write for FREE BOOK and 30 Days' FREE TRIAL OFFER!** Don't doubt! Don't say it can't be done. The free book proves that it can. But we do not ask you to take our word for it. We offer to send a 1900 Motor Washer on absolute Free Trial for an entire month to any responsible person. Not a cent of security—nor a promise to buy. Just your word that you will give it a test. We even agree to pay the freight, and will take it back if it fails to do all we claim for it. A postal card with your name and address sent to us today will bring you the book free by return mail. All correspondence should be addressed to

1900 WASHER CO., 6061 Court St., BINGHAMTON, N. Y.

OR, IF YOU LIVE IN CANADA, WRITE TO THE CANADIAN WASHER CO., 355 YONGE ST., TORONTO, CANADA.

(23)

HESS FURNACE



We will deliver a complete heating equipment at your station at factory prices and wait for our pay while you test it during 60 days of winter weather.

The entire outfit must satisfy you or you pay nothing. Isn't this worth looking into? Could we offer such liberal terms if we didn't know that the Hess Furnace excels in service, simplicity, efficiency, economy?

We are makers—not dealers—and will save you all middlemen's profits. No room for more details here. Write today for free 48-page booklet which tells all about it.

Your name and address on a post card is sufficient.

HESS, 910 Tacoma Bldg., Chicago

No. 48
"Leader" Hess
Steel Furnace
Price \$49
Delivered East of Omaha and
North of Ohio River
Type and Register Extra

WIRELESS TELEGRAPHY IN HIGH SCHOOLS—
Wireless apparatus has been installed in one of the Chicago high schools for instruction purposes, and a regular course of study mapped out. If the innovation proves to be the success that is expected, many more Chicago high schools are to be so equipped.

SONG POEMS WANTED BIG MONEY IN SUCCESSFUL SONGS. Entirely NEW and UNEQUALLED PLAN. Send us your Poems or Melodies. YOU MAY BE ABLE TO WRITE A HIT. PAST EXPERIENCE UNNECESSARY. Publication GUARANTEED, if acceptable, by the WORLD'S LARGEST, RELIABLE SONG PUBLISHERS. Hundreds of Song writers DELIGHTED with our work. We pay 50 per cent. Washington ONLY city to secure Copyright, and publish for BEST results. HAYWORTH'S MUSIC MAGAZINE and BEAUTIFULLY ILLUSTRATED BOOK, explaining our SQUARE DEAL PLAN, FREE. THIS IS YOUR OPPORTUNITY OF A LIFETIME. Send us your work for FREE inspection and advice. HAYWORTH'S MUSIC PUBLISHING CO., 7560, WASHINGTON, D. C.

\$18.85 for this \$28 Porcelain Enameled Roll Rimmed Sink

Long back and enameled drain board, All in One Piece. 20 in. wide, and 52 in. long. Price includes faucets and legs. WRITE FOR CIRCULARS AND PRICES. Large stock **Plumbing and Heating Supplies** at Wholesale to Consumer at Lowest Prices.

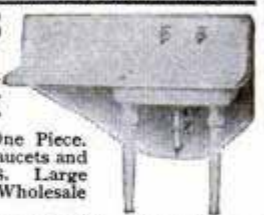

JOHN HARDIN CO., 25 years at same address, 4545 Cottage Grove Ave., Chicago

6034-\$50. Only 20% down and 10% a month 6038-\$75. 6258 \$25.

DIAMONDS ON CREDIT

Buying a high grade Diamond is saving money, not spending it. The "Lyon Method" makes it easy for you to save. Lyon Diamonds are Blue-white and perfect. A written Guarantee Certificate with each Diamond. All goods sent prepaid for inspection. No security required. Write now for Catalog No. 3 10% discount for cash.

J. M. Lyon & Co., 71-73 Nassau Street
NEW YORK

6226 \$35.

6211 \$100.

16026 \$175.

6188 \$175.

6261 \$35.

"Snap Shot" Money in Your Pocket

Big Cash Profits for You \$5 to \$20 a day in your own big-paying business.

This is your opportunity to get out of the "time clock" line and the "pay envelope" brigade. **Without one bit of experience**, you can join our force and become **a one minute photographer**. This is the newest and most profitable branch of the photographic profession. You can work all or spare time—travel or at home. This new, wonderful business will earn enormous profits for you. Everybody buys our new one minute photo post cards. Big money making photos at private houses, picnics, on the streets, in the small towns, in large cities, at fairs, carnivals, conventions, street parades, aviation meets, etc. Profits begin first day and you make **500 per cent on every sale**. Don't delay—don't wait. Write us today for free information, and begin making money at once with

The "Mandel" Post Card Machine

New invention—wonderful machine that takes, finishes and delivers five different styles of photos. Turns out original post card photos (also button pictures) at the rate of three a minute **RIGHT ON THE SPOT WHERE YOU TAKE THEM**. Wonderful, new, photographic process—startling—sensational—

Photos Direct on Post Cards Without Plates, Films, Printing or Dark Room

Machine is everything in one—a complete, portable post card gallery. Excites interest, arrests attention, compels immediate orders from every onlooker. **SMALL CAPITAL STARTS YOU**. Sale of supplies that come to you with outfit practically gives you back entire investment—and you have the business clear and fully established. You begin making money the same day the outfit arrives. Immediate sales—immediate profits. If you are sincere and really want to make \$2,000 this year—**DO NOT DELAY**—show us that you are in earnest—that you mean business. We will show you how to get the money. Write now—at once. Information is **FREE**.

\$600 Profit in 3 Months

That is what A. L. Wood, of Great Falls, Montana, made with a "Mandel" Post Card Machine. We can prove this. Read these late reports: Cable, of Wyo., writes: "Made \$27.00 in 2 hours." Bryant, of Colo., made \$16.00 in 6 hours. Evans, of Miss., says: "Made \$15.75 last Tuesday." Perry, of Ky., "Made \$50.00 in 2 days." Hundreds of actual, bona fide letters like these on file.

WRITE US TO-DAY



Here's one of our lucky "Mandel" operators, busy at the beach, turning out one minute photos of the jolly bathers. This is one of the many ways to make big money as a "Mandel" photographer. ADDRESS EITHER OFFICE

The Chicago Ferrotypes Company

608 Ferrotypes Bldg., Congress & Laffin Sts., Chicago, Ill. OR Dept. 608, 89-91 Delancey St., New York, N. Y.



JAP-A-LAC

Renews
Everything from Cellar to Garret
Sold in Paint, Hardware, Drug & Department Stores

Cleveland The Glidden Varnish Co. Toronto

\$4 a Month For This Genuine

Oliver No. 3 Typewriter \$56

No Money Down — Free Trial

You are not asked to pay any money until this famous typewriter has been delivered to you and you have used it and found it to be satisfactory and wish to keep it.

Then the terms are \$4.00 down and \$4.00 a month until you have paid \$56.00.

Four dollars a month is the exact amount that machines of this quality bring for rental—it amounts to 13c a day—at this rate you can make the typewriter pay for itself.

No cash till you accept it—no interest on payments—no extras of any kind—each machine delivered on this proposition is a genuine perfect No. 3 Oliver typewriter, shipped in the original box as packed at the factory. Each has the full standard equipment and each is guaranteed against defect of material or workmanship for the life of the machine.

Sold without salesmen or agents. You get the saving—No salesmen are necessary to sell a genuine No. 3 Oliver at this price.

12,000 orders have already been filled.

Be sure and send today for our celebrated book, "Your Final Typewriter," which fully describes this famous machine and tells you some very interesting things about the making of typewriters.

Just write your name on a postal card or on the margin of this page and tear it out and mail it now.

Typewriters Distributing Syndicate
166 E76 North Michigan Blvd. Chicago

LET US GIVE YOU THIS TRANSPARENT CELLULOID TRIANGLE

It is 4 inch size, 30°-60° angles. Lowest retail price, 25 cents. Absolutely essential to everyone who draws. We make this offer to introduce our new catalogue showing

SPAULDING'S NEW CARRYING CASES AND COMPLETE OUTFITS

for designers, architects, engineers and students—compact, durable and convenient. Spaulding's Carrying Cases are made light and strong. They provide well arranged compartments, including space for drawing board and T square. Handled like a suit case; unique, practical, inexpensive. Outfits include all necessary equipment. If you draw, send us five 2-cent stamps to-day to pay postage and get the free triangle and the catalogue.

SPAULDING PRINT PAPER CO.
44 Federal St. BOSTON

Avoids Mistakes and Saves Brain Work

For General Office or Personal Desk

Over 60,000 in use
Mostly sold through Recommendation

Buy from your Stationer or order direct

Price includes handsome Morocco case. Every machine guaranteed. Money refunded if not satisfactory after 10 days' trial. Ref. Century Bank, N. Y.—Jefferson Branch—Agents Wanted.

E. Gancher A. A. M. Co. N. Y.
319 Broadway

\$10 Golden Gem Portable Adding Machine



ADDITIVES—SUBTRACTS

GOLDMAN'S Arithstyle

Handiest, Fastest, Cheapest, COMPUTING MACHINE

Adds, Subtracts, Multiplies, Divides. Carries Automatically. Resets Instantly. Easily moved over page, fixed to desk, carried in hand or pocket. 5 in. x 2 1/2 in. x 1 in. Weight, 36 oz. Write for Booklet. Attractive Agents' Proposition.

ARITHSTYLE CO., Suite 105, 118 E. 28th St., N. Y.

ADDING MACHINES

\$1.00 and \$3.50

They add quickly, easily, accurately. Durable; easily reset. Capacity 8 columns. None better for the price. 17,000 sold. Delivery prepaid. Guaranteed as represented. The \$3.50 adder is SELF INDICATING. Order today. Agents Wanted.

J. H. Bassett & Co., Dept. 55A, 5921 Indiana Ave., Chicago

In Russia there are whole villages and districts devoted exclusively to one industry. In Selo Bogorodskoe every peasant's home is a busy factory for wooden toys. The people of Lokotnia spend their days making spools and bobbins. In the Moscow, Nizhni and Vyatka provinces there are furniture-making villages. The Tula district produces harmonium frames; the Semenovskiy district, wooden dishes, and the Verkhoturksky district, pots of beech bark.

TYPEWRITERS ALL MAKES



All the Standard Machines SOLD or RENTED ANYWHERE at 1/2 to 1/3 MFR'S PRICES, allowing RENTAL TO APPLY ON PRICE. Shipped with privilege of examination. Write for cut rate prices, and

TYPEWRITER EMPORIUM, 31-36 W. Lake St., CHICAGO

TYPEWRITERS ALL MAKES



\$100.00 Underwoods, Smiths, Oliviers, Remingtons, etc., from \$10.00 up. Every machine in perfect condition, guaranteed two years, with privilege to exchange at any time. Three hundred typewriters at \$15.00 each, while they last. Write for cut rate prices, and Free Trial Offer

ALL-MAKES TYPEWRITER EXCHANGE, 164 N. Dearborn St., Chicago, Illinois

THERE ARE TWO REASONS



Why we send our Daus' Improved Tip Top Duplicator on ten days' trial. FIRST — It proves OUR confidence in the machine. SECOND—By personal use you can positively tell, before buying, whether it meets your requirements. Each machine contains a roll of "Dausco" Oiled Parchment Back duplicating surface which can be used over and over again. 100 copies from pen-written and 50 copies from typewritten original. Complete Duplicator, cap size, (prints 8 3/4 x 13 in.). Price **\$5.00**

Take advantage of our trial offer. **Felix A. L. Daus Duplicator Co.,** Daus Building, New York, 113 John Street.

Are you satisfied on pay day? When your pay envelope is handed you do you feel there's more than enough there to make both ends meet? In other words, does your salary grow with your needs?

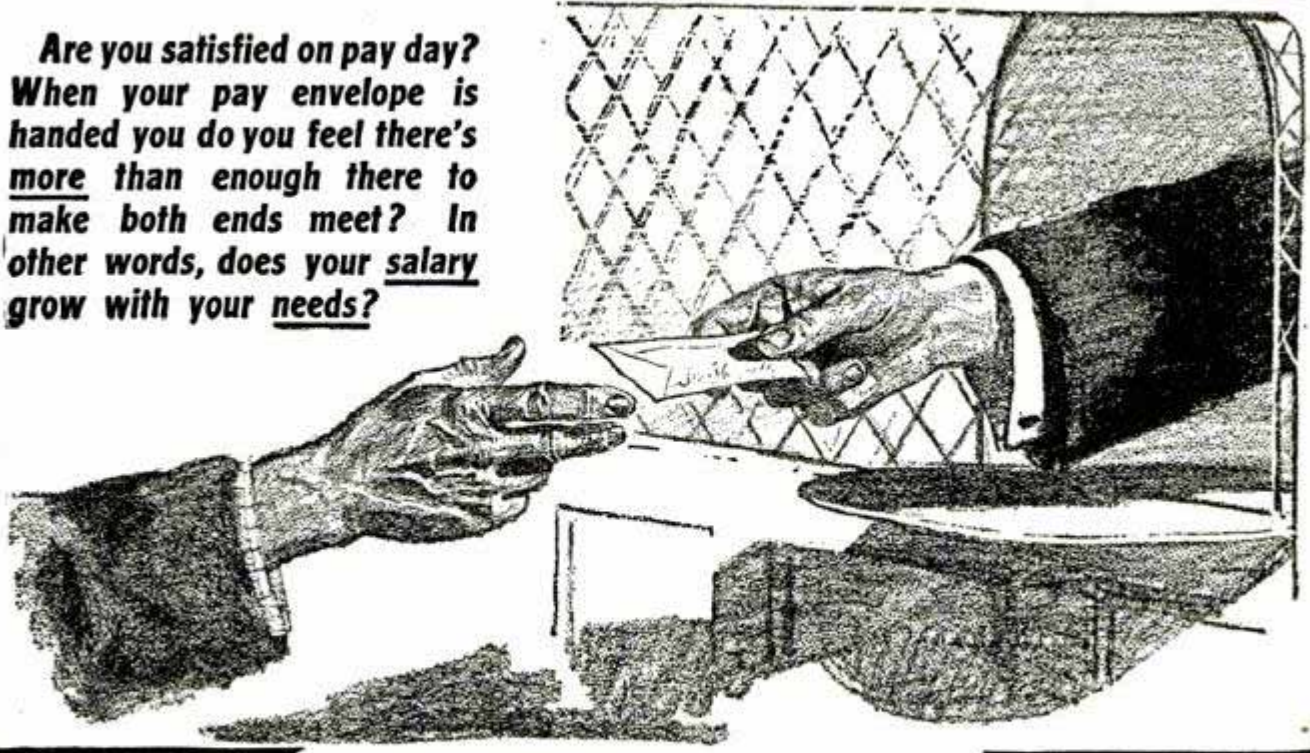

Does Your Salary Grow With Your Needs?

Do you want to earn more? You **CAN**. Do you want to secure a better position? You **CAN**. Do you want to follow some line of work that really appeals to you? You **CAN**. In your own home and spare time do you want to acquire the training that will make all this possible? You **CAN**.

The thing for *you* to do to learn *how* you can, is to mark the attached coupon and mail it today to the International Correspondence Schools. *Without charging you a penny or placing you under any obligation* the I. C. S. will explain just how you can become proficient in some *chosen*, well-paid occupation.

Thousands of other ambitious men have won success through I. C. S. help. Salary increases due to I. C. S. help are *voluntarily* reported at the rate of over 400 a month. The I. C. S. didn't care where these men lived, what they did, what they earned, what little schooling, cash, or spare time they had—so long as they could *read and write*, and were ambitious, the I. C. S. way was open—just as it is open to you.

Twenty-one years of unparalleled success in raising salaries proves the ability of the I. C. S. to make **YOUR** salary outgrow your needs. The first step is **YOURS**—mark and mail the coupon now.

International Correspondence Schools Box 872, Scranton, Pa.

Please explain, without further obligation on my part, how I can qualify for a larger salary and advancement to the position, trade, or profession before which I have marked X.

Electrical Engineering
Electric Lighting
Electric Railways
Electrician
Electric Car Running
Dynamo Foreman
Wireman
Mining Engineer
Telephone Expert
Surveyor
Civil Engineer
Automobile Running
Agriculture

Mechanical Engineer
Mechanical Draftsman
R. R. Construction
Concrete Construction
Architect
Contracting and Build'g
Architectural Draftsman
Plumbing and Heating
Chemist
Bookkeeper
Advertising Man
Civil Service Exams.
Salesmanship

Name _____

St. and No. _____

City _____ State _____

Present Occupation _____

Get Your Canadian Home From the Canadian Pacific



The
Home
Maker



We will make you a long-time loan—you will have 20 years to pay for the land and repay the loan—you can move on the land at once—and your Canadian farm will *make you independent.*

20 Years to Pay

Rich Canadian land for from \$11 to \$30 per acre. You pay only one-twentieth down—balance in 19 equal annual payments. Long before your final payment comes due your farm will have paid for itself over and over. This advertisement is directed only to farmers and to men who will occupy or improve the land.

We Lend You \$2000 for Improvements

The \$2,000 loan will help you in erecting your buildings, and you are given twenty years in which to fully repay this loan. You pay only the banking interest of 6 per cent.

Advance of Live Stock on Loan Basis

The Company, in case of approved land purchaser who is in a position and has the knowledge to take care of his stock, will advance cattle, sheep and hogs up to the value of \$1,000 on a loan basis, so as to enable the settler to get started from the first on the right basis of mixed farming. If you do not want to wait until you can complete your own buildings and cultivate your farm, select one of our Ready-Made farms—developed by C. P. R. Agricultural Experts—with buildings complete, land cultivated and in crop, and pay for it in 20 years. We give the valuable assistance of great demonstration farms—free.

This Great Offer Based on Good Land

Finest land on earth for grain growing, cattle, hog, sheep and horse raising, dairying, poultry, vegetables and general mixed farming, irrigated lands for intensive farming—non-irrigated lands with ample rainfall for mixed and grain farming. These lands are on or near established lines of railway, near established towns.

Ask for our handsome illustrated books on Manitoba, Saskatchewan and Alberta—mention the one you wish. Also maps with full information free. Write today.

G. E. THORNTON, Colonization Agent

Canadian Pacific Railway

Colonization Department

112 W. Adams St., Chicago

FOR SALE—Town lots in all growing towns—
Ask for information concerning Industrial
and Business openings in all towns.



MAKE BIG INCOME

Men and Women can do this all the year at home growing mushrooms in cellars, stables, sheds, boxes, etc. Crop sells for \$1.50 to \$1.00 a lb. \$20.00 a week easily made. Great demand, markets waiting. Start Now. Write for big 32 page Free Illustrated Booklet and learn how to do it. NAT'L SPAWN CO., Dept. 12, BOSTON, MASS.

Please Mention Popular Mechanics



Bathroom Outfit \$35

WITH SHOWER BATH \$43.50

These handsome high-grade plumbing fixtures furnished complete, guaranteed and sold direct, saving you all dealers' profits! Bath Tub and Basin are white porcelain enamel over high-grade cast iron. Toilet is vitreous china with oak seat and copper lined Oak Tank. Any handy person can install outfit; no hot metal required. Send for catalogue.

WATER SUPPLY SYSTEM \$40

Black Steel Tank, 145 gallon capacity, 2 1/4 inch Brass Lined, Double Action, Combination Air and Water Pump, including all Pipe, Fittings, Valves, Gauges, etc., complete.

SHOWER BATH \$8.50

Complete with nickel-plated, rain shower head, ring and curtain attachments, rubber tubing and instantly detachable faucet clutch.

Free Book Our catalogue illustrates and describes everything in the heating and plumbing line at wholesale prices. SEND FOR IT TODAY.

Chelsea Manufacturing & Supply Company
236 West 20th St. Dept. D, New York

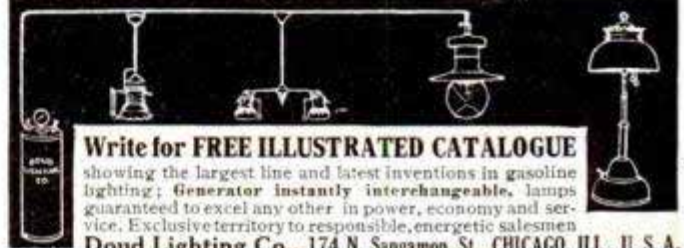

Write for FREE ILLUSTRATED CATALOGUE

showing the largest line and latest inventions in gasoline lighting; Generator instantly interchangeable, lamps guaranteed to excel any other in power, economy and service. Exclusive territory to responsible, energetic salesmen

Doud Lighting Co., 174 N. Sangamon St., CHICAGO, ILL., U. S. A.

To stop following hostile vessels, or even for purposes of attack when the conditions are right, a German naval officer has invented a Greek fire that will burn while floating on water.



Poultry Paper 44-124 page periodical, up to date; tells all you want to know about care and management of poultry for pleasure or profit; four months for 10 cents.

Poultry Advocate, Dept. 98, Syracuse, N.Y.

BUY GOOD PAINT DIRECT

AND SAVE 50c A GALLON



30 years' experience, a modern factory, pure materials and selling direct is why it will pay you to buy

Brown Seal Prepared Paints

Shipped on approval. Write for colorcard and prices.

THE YUMA PAINT CO.
456 E. First St. Dayton, Ohio

Don't Handicap Yourself

in the race for business by failure or neglect to provide yourself with the best business card the world thus far affords

Peerless Patent Book Form Cards

In use the cards are detached one by one as occasion demands. The edges are absolutely smooth, incomprehensible as that may seem, and every card is clean, flat, perfect and unmarred.

They attract attention and they get attention. Send for sample book and detach them for yourself—You will never be satisfied with anything else.

Send today

THE JOHN B. WIGGINS COMPANY Engravers, Plate Printers, Die Embossers
62-64 East Adams Street, CHICAGO





POWER for YOU!

Power from within! Strength that is **more** than mere muscular strength—the strength of perfect health, abundant nerve force—the strength of the **perfect man** now within your reach through **Vibration!** Nine people out of every ten are only **half alive**. They exist—they do not really live. How about yourself. Listen—

All the Benefits of Life—Strength—Youth

may be returned to you through **Vibration**. For **Vibration** is **Life** itself. It will chase away the years like magic. Every nerve, every fibre in your whole body will fairly tingle with the force of your own **awakened power!** Stagnation simply cannot exist. You are made over—new—from head to foot. Your blood is sent humming along through every vein, artery and tiny capillary. Poisonous matters in your system are **washed away**. Your self-confidence—**your self-respect**—are increased a hundred fold. Yes, **Vibration** will do all this and more, **much more**. And it is within your reach. You can enjoy its wonder-working powers right at home, right in the privacy of your own room. You can give yourself the same identical treatments that you would receive in the offices of the world's most famous specialists—all without extra charge.

You may give yourself Swedish Movement, Vibrating Chair Treatments, Electric Baths, Faradic or Galvanic Electric Treatments—just such treatments as you would have to pay from \$2.00 to \$3.00 for—yours without charge through the White Cross Electric Vibrator.



The White Cross Electric Vibrator

is the result of years of work and experiment. It is absolutely perfect. If you have your house wired for electricity, you can connect it up as easily as an electric lamp; if not, it will run perfectly on its own batteries.

Special Offer for a Limited Time

For a short time only we are making a remarkable Special Introductory Offer on the White Cross Electric Vibrator, in order to place at least one of these splendid instruments in every city, town and village in the country—an amazing offer to those who write at once—amazing discounts—actual rock bottom prices direct **if you act at once**.

FREE BOOK Sign coupon and mail it today. Get our splendid big **FREE** book telling you all about the marvels of **Vibration**. Read what great scientists say. Post yourself on what it will do for you. Learn all about the **White Cross Electric Vibrator** and our limited offer. No obligations at all—send coupon, post card or letter **today**.

Lindstrom, Smith Co.

Desk 1195, 218 So. Wabash Ave., Chicago, Ill.

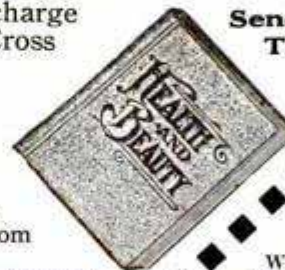

Send for
This Book

**FREE
BOOK COUPON**

**LINDSTROM,
SMITH CO.**

Desk 1195

218 So. Wabash Ave.
Chicago, Ill.

Without any obligation at all, please send me, free and prepaid, your free book on **Vibration**, full particulars of the White Cross Vibrator and your Special 60 Day Offer.

NAME

ADDRESS

.....
Cut this out and mail it today

all use
The **PEN-DAR** Locker
PLISHED STEEL

A Business Opportunity

THE near future will see not merely fire-proof buildings, but fire-proof *furniture* and *fixtures* to go into these buildings.

☐ To construct a building that *won't burn*, and then to fill it up with things that *will burn*—that's just like building a great big furnace and kindling a great big fire. A spark—then off she goes!

☐ PEN-DAR Lockers take the place of these dry old wooden closets and lockers—the tinder and fire-wood that require only a spark to make a roaring furnace of the building.

☐ The transition of furniture and fixtures for large industrial plants from wood to metal, is gaining headway. Soon it will become universal. The *best* locker will gain the lion's share of locker sales.

☐ We can help you establish a business of your own—or add a profitable branch to your present business. *Write for particulars.*

Edw. Darby & Sons Co., Inc., 243 Arch Street, Philadelphia, Pa.
Makers of Steel Cabinets, Bins and Shelving

MAGIC FISH LURE!

Best bait for attracting all kinds of fish ever discovered. It sure does get 'em! Seems as though they just can't keep away from it. Will keep you busy hauling in the finny beauties. Makes fishing a REAL pleasure. Use Magic Fish Lure and you'll catch a big string every time while the other fellows go home empty-handed marveling at your "luck." Good any season. Won't spoil. Not unlawful to use. Sent 25c for box containing enough for 500 baits. Money back if not satisfied. Valuable catalog sent FREE. Write for it today.

Lotz Bros, 155 N. Main St., St. Louis, Mo.

French horse butchers are obliged to display a sign-board showing the kind of meat they sell and are not allowed to trade in any other sort of meat except that of mules and donkeys.

A BOOK OF PLANS FREE FOR YOU

Your easy chance to get a beautiful and instructive book of house plans entirely FREE. Just send us the names and addresses of all the carpenters and builders in your town. That's all you have to do. Really no work to it. Simply mail in your list and get your plan book easy and FREE. Remember—a 125 page plan book for your list of carpenters' and builders' names.

RADFORD ARCHITECTURAL CO., Medinah Bldg., Chicago, Ill.



Mobiloil

A grade for each type of motor.

THIS BUNGALOW \$900 CAN BE BUILT FOR

This and many others in my new book, Building Plans for Modern Homes, will save you hundreds of dollars. One of the most complete and comprehensive books of plans ever published by any architect. Fifth edition just off the press. One hundred and fifty floor plans and photographs of bungalows, etc., costing from \$250 up; gives sizes and cost to build. Sent postpaid for \$1.



FREDERICK H. GOWING
ARCHITECT
18 Tremont St. BOSTON



3 CUSTOM SHIRTS FOR \$5.00

I make shirts that fit you, because I make your shirts from your measurements and guarantee to take them back if they do not satisfy you.

I send you 100 samples to select from

I send you measurement blank with rules. I send you the finished shirts express prepaid. No ready-made shirts in my shop, but facilities for quick delivery of the highest grade of custom work. Write for my samples. Spring samples now ready. (Higher priced fabrics, too.) No agents.

CLARENCE E. HEAD (Master of Shirtecraft), 110 Cayuga St., ITHACA, N.Y.



KEITH'S \$1 Offer



Keith's Design No. 1400
To introduce Keith's, the recognized authoritative magazine on planning, building and decorating we now offer for \$1.00 to enter a six months' subscription and mail you postpaid
Two Books of Plans
Homes Costing \$1,000 to \$2,500
Send today for this great value offer and get a splendid \$2 a year 80-page magazine for six months and two of Keith's Archt. Studies containing **200 plans.**
M. L. KEITH, 429 McKnight Bldg., Minneapolis, Minn.

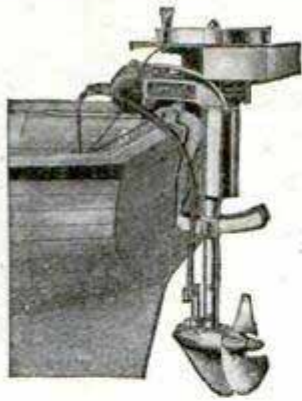

How I Love to "Evinrude"

I LOVE to skim up the river in my motor driven row-boat. I glide along in and out of the little nooks and baylets with their over-hanging trees and feel that the best hours of the whole golden Summer are spent with my



It drives my rowboat eight miles an hour and it's so simple I operate it myself.

No Cranking—It Starts With A Swing

of the fly-wheel. Its propeller is weedless and when the day's fun is over, Brother John detaches it (in less than one minute) and brings it into the house. It carries like a satchel and when the summer is over we take the motor home with us. It goes wherever we go.

Beautifully illustrated Catalog on request.

EVINRUDE MOTOR COMPANY

228 M Street

MILWAUKEE, WIS.

New York City Show Rooms: Hudson Terminal Bldg., 30 Church St., N. Y.

California Show Rooms: 423 Market St., San Francisco

Seattle Representatives: Woodhouse Gasoline Engine Co., 62-64 Marion St.



Incandescent lamps in which the filaments are in the form of an inverted cone have been found to give one-fifth more light than those of the same size in which filaments form cylinders.

Yours, Free

The sport with a thousand thrills! All you want to know about it—practical hints, the true how and why—and all the little tips and inside facts about this trickiest of game fishing are put up to you right in



That Free Heddon Book about Bass Casting

It shows you in sumptuous colors the outfit you want—Heddon's Genuine Dowagiac Split Bamboo Rods and Dowagiac Artificial Baits—the most scientific, certain and humane of lures.

JAMES HEDDON'S SONS, Dowagiac, Mich.

Box 100 (Pronounce it "Do-wah-jee-ack")

CASTING MADE EASY WITH THIS REEL

HERETOFORE those who were able to cast and who after many years of practice had acquired the art were the only ones who got the large fish. A recent invention, the SOUTH BEND ANTI-BACK-LASH REEL enables any man, woman or child to cast without any previous experience whatsoever. All one has to do is to cast out the bait and the reel automatically thumps the line and keeps it from tangling and snarling. The reel is finely made of solid german silver, jewelled bearing caps, cool steel pinions.

Expert casters use it for moonlight casting. Large, beautifully illustrated catalog on fishing tackle and information about this wonderful reel, free upon request.

SOUTH BEND BAIT CO.
3519 Colfax Av.
South Bend, Ind.



Learn to Shoot at the Gun Club

FREQUENCY of practice, convenience of club grounds and the enthusiastic help of skilful and competitive shooters makes proficiency with the shotgun easy to attain, and provides delightful recreation.

Read the Story of TRAPSHOOTING and "Hints to Beginners"

by an experienced shooter Start in the game now by sending for "Sport Alluring" Booklet No. 248

DU PONT POWDER CO., WILMINGTON, DEL.

Pioneer Powder Makers of America

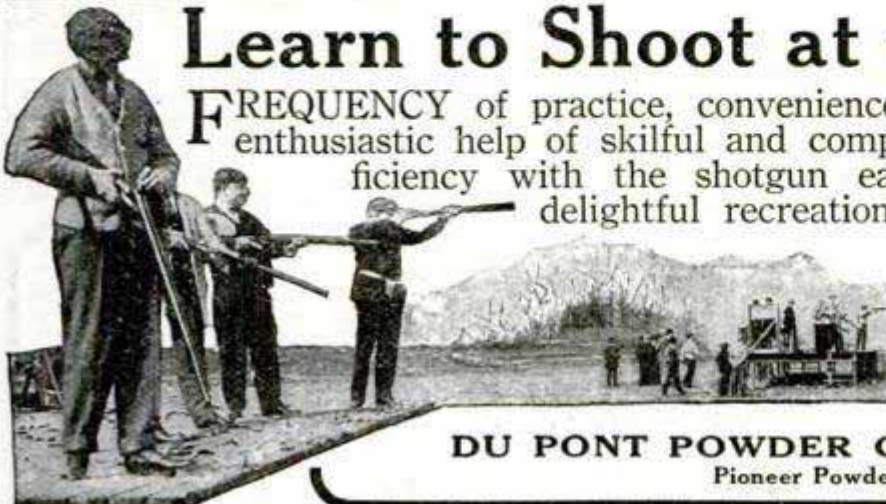

PATENT YOUR IDEAS

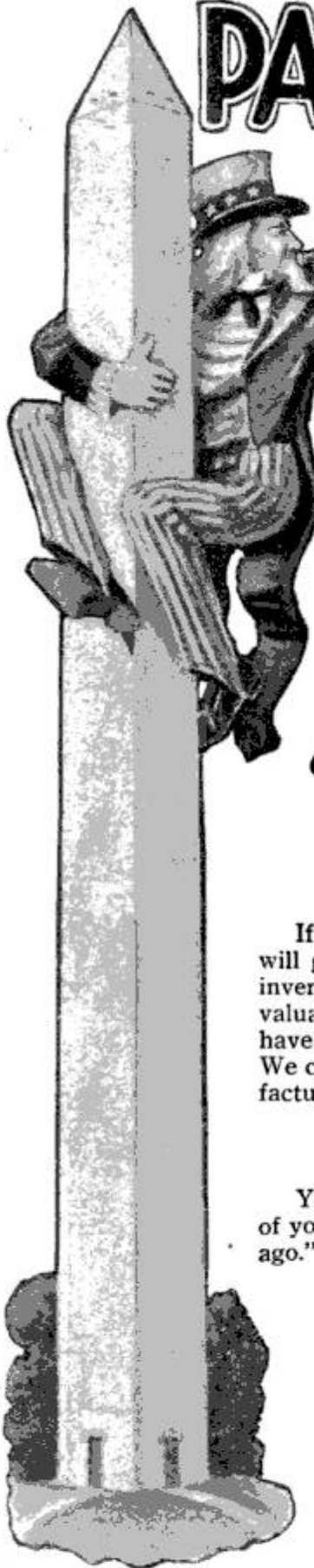

—*There is a Constant Demand
for Good Inventions*

Thousands of the biggest money-making inventions have been the "little" things that have made people wonder why they were never thought of before.

"WHAT TO INVENT"

and

"HOW TO OBTAIN A PATENT"

These Books Sent Free

If you have an invention send us a sketch, photograph or model of it. We will give you a report as to its patentability absolutely free. If you have no invention send for our book, "What to Invent." It contains hundreds of valuable suggestions. We are recognized authorities on patent matters and have helped hundreds to find a ready and profitable market for their ideas. We can prove it. If you wish to sell your patent we will advertise it in manufacturers' journals at our expense.

Don't Wait—Find Out NOW!

Your idea will never do you any good if some one else patents it ahead of you. Act quick! Let the other fellow say "he thought of it a long time ago." You reap the profit. Let the others wish they had.

Advice Free—All Matters Confidential

We have secured patents for thousands of inventors and have many letters proving the value of our services. Write us. Send rough drawing or model of your invention for our opinion. We will guard it carefully and report quickly. You are under no obligations to proceed further. Our plan is simply a square deal to all. Our books, "What to Invent" and "How to Obtain a Patent" are the best publications written for the man who has an idea to patent, or who is of an inventive turn of mind. They show just how to proceed with your idea and tell of hundreds of things to invent. We gladly send these books free. The sooner you write for them the sooner you will know all about patents and the many different lines in which new inventions or improvements may be made.

If you have an invention send us a sketch of it for report and ask for the books at the same time.

CHANDLEE & CHANDLEE, 970 F Street, Washington, D. C.

REGISTERED ATTORNEYS

(Combined with H. Ellis Chandlee & Co.)

Patents

**Trade Marks and
Copyrights Secured
or Fee Returned**

Special Offer—Free Search of Patent Office Records

Send us a model or sketch and description of your invention, and we will make a *Free Search* of the *Patent Office Records* to ascertain if it is patentable. If we report the invention patentable, we will guarantee to obtain a patent or return our fee, and furnish a certificate of patentability backed by a bonded contract to that effect.

This Certificate of Patentability will protect the inventor and serve as proof of the invention until the case can be filed in the U. S. Patent Office.

Obtaining Assistance for Inventors

Our certificate is of great assistance to inventors who require financial aid to obtain patents.

Our Four Books Mailed Free

to any address. Send for these books—the finest publications ever issued for free distribution.

How to Obtain a Patent

Our illustrated eighty-page Guide Book is a book of reference for inventors, and contains 100 mechanical movements illustrated and described.

Fortunes in Patents

Tells how to invent for profit, and gives history of successful inventions.

What to Invent

Contains a valuable **LIST OF INVENTIONS WANTED** and suggestions concerning profitable fields of invention; also information regarding prizes offered for inventions, among which is

Prize of One Million Dollars

offered for one invention, and \$10,000 for others.

Patents That Pay

Contains letters from our clients who have built up profitable enterprises founded upon patents procured by us; also endorsements from prominent inventors, manufacturers, Senators, Congressmen, Governors, etc.

We Advertise Our Clients' Inventions Free

In a list of Sunday newspapers with two million circulation, in manufacturers' journals and in the *World's Progress*. Sample Copy Free. We save you time and money in securing patents. After the patent is granted we assist you **TO SELL YOUR PATENT.**

Foreign Patents

WE HAVE DIRECT AGENCIES IN ALL THE PRINCIPAL FOREIGN COUNTRIES and secure FOREIGN PATENTS in the shortest possible TIME and at the LOWEST COST. Write for our Illustrated Guide Book on Foreign Patents, sent free to any address.

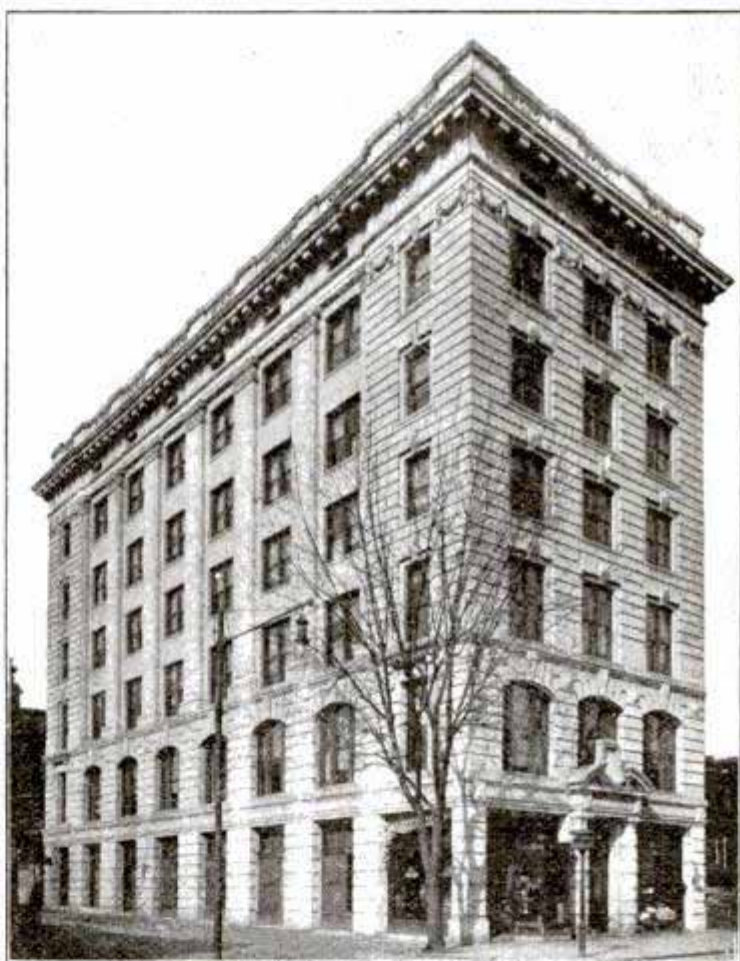

VICTOR BUILDING

Our new \$150,000 building opposite U. S. Patent Office
SPECIALLY ERECTED by us for OUR own use

WANTED NEW IDEAS

Send for **LIST OF PATENT BUYERS** who consult us when purchasing patents. Contains requests from **MANUFACTURERS, MAIL ORDER HOUSES and PROMOTERS** for patents secured by us, and suggestions as to New Ideas they wish to purchase. We invite manufacturers and promoters to address our Sales Department regarding the purchase or leasing of a number of meritorious patents secured by us.

REFERENCES

Second National Bank, Washington, D. C.

Union Savings Bank, Washington, D. C.

Chamber of Commerce, Washington, D. C.

Pitner Gasoline Lighting Co., Chicago, Ill.

National Savings and Trust Co., Washington, D. C.

R. G. Dun & Co., Washington, D. C.

Smethport Glass Co., Smethport, Pa.

The Melvin Gauge and Signal Co., Scranton, Pa.

M. Winter Lumber Co., Sheboygan, Wis.

VICTOR J. EVANS & CO., Patent Attorneys

NEW YORK OFFICES: 132 Nassau St.

PHILADELPHIA OFFICES: 1429 Chestnut St.

Main Offices: 724-726 9th St., N. W., WASHINGTON, D. C.

WANTED-IDEAS

Manufacturers are constantly writing me for patents procured through me. The demand for good ideas

Protected by Owen Patents

is greater than ever before. Send for my free books and read the letters from the greatest manufacturers in this country. Read their requests for Owen Patents and see for yourself what ideas they want. You can help supply the unceasing demand for good inventions.

My clients are provided with free manufacturing facilities, and I aid them in many ways, without charge, to sell their patents. Applications filed through me advertised free.

You will get a strong patent or I will get no compensation. Your interests are my interests.

FREE!

A simple request will bring you the following three finest patent books published absolutely free—you will incur no obligation by writing me.

"SUCCESSFUL PATENTS"—a new 72 page guide book; tells how to proceed to be successful; describes my advantageous business methods.

"STEPPING STONES"—gives lists of over 200 inventions wanted; gives forecasts by Edison and many other authorities; tells the plain truth about prizes of millions of dollars for inventions.

"PATENT PROMOTION"—tells you how to promote your invention; why some inventors fail; the value of your rights, etc.



Write for these books today—NOW! Advice costs nothing

VERY HIGHEST REFERENCES

Columbia National Bank,
Washington, D. C.

American Loktile Co.,
Alexandria, Va.

National Metal Tile Co.,
Washington, D. C.

National Supply Co.,
Berlin, N. H.

Louden Machinery Co.,
Fairfield, Iowa.

Antholene Mfg. Co.,
Hutchinson, Kans.

Whitehead Hosiery Mills,
Burlington, N. C.

Dickinson Mfg. Co.,
Des Moines, Iowa.

SPECIAL!

Send me a sketch or model of your invention and I will make a search of the U. S. Patent Office Records **FREE OF CHARGE** and report to you concerning patentability, practicability, etc.

And an immense number of others whose letters are printed in my booklets.

Your work will receive my **PERSONAL** attention—but my fees are no higher than others.

RICHARD B. OWEN

9-303 OWEN BLDG.
WASHINGTON, D. C.

Inventors submitting their inventions to me are protected in a tangible manner until their applications are filed.

PATENTS THAT PAY

\$561,530.00 Made by Clients

"MY TRADE-MARK"

\$561,530.00 Made by Clients

Proof back of it—write for my FREE literature—it will pay!



BOOK "What and How to Invent—Proof of Fortunes in Patents"—FREE

Containing: Views of Prominent Men and Publications on Inventions; "Patents Wanted"; "How to Advertise Your Patent"; "How to Secure Money to Procure a Patent"; Suggestions as to what to Invent; What my clients have done; Women Inventors, etc.



\$20,000.00 in Two Prizes

INSTRUCTIVE CIRCULARS GIVING FULL INFORMATION—FREE

EXPERT—PROMPT SERVICES
112-page Guide Book for Inventors, FREE

E. E. VROOMAN,
Registered Patent Attorney

871 F Street, N. W.
Wash., D. C.

Wash., D. C.

Old-established branches throughout the world

Active Powers of Inventive Genius



INVENTORS

Our Brain Belongs to You. Our Ideas Are Free of Charge.

All we want in return is to build your model, special machinery, dies, tools and jigs to manufacture sheet metal goods, etc. We are expert mechanics, over thirty years experience and have one of the best equipped shops in the country. Ask for Booklet No. 17. Consultation free. Experimental work strictly confidential.

A. NACKE & SON
236-242 S. 9th St., Philadelphia, Pa.

AMERICAN MODEL AND TOOL WORKS

617-631 W. Jackson Blvd., CHICAGO

WE MAKE MODELS, TOOLS, DIES, MOLDS, PATTERNS AND MODEL PARTS. EXPERT GEAR CUTTING. Inventions developed and simplified, also manufacturing.

Mechanical & Electrical EXPERIMENTAL AND DEVELOPMENT WORK

WE MAKE MODELS PRACTICAL

for advertising and manufacturing purposes. We make your tools, dies, machinery, metal specialties, novelties, etc., to order. Send for an estimate. Address **MINIATURE MECHANICAL MFG. CO.**, 10 S. 5th Ave., CHICAGO

The chemistry of flower colors has been under close observation by a special committee of the British Association for the Advancement of Science for several years.

PATENTS

EXPERIENCED INVENTORS employ my method. So will you eventually. Why wait. FREE book and application blank. W. T. Jones, 803 G St. Washington, D. C.



MECHANICAL SUPPLIES AND MATERIAL of all kinds. EXPERIMENTAL AND LIGHT MACHINE WORK to order. 132 MILK STREET. BOSTON

WANTED To manufacture METAL SPECIALTIES, 20 years experience in making Dies, Tools and Special Machinery. Expert work. Complete equipment. NATIONAL STAMPING & ELECTRIC WORKS 412 S. Clinton Street, Dept. 3 Chicago, Ill.

PATENTS WORTH MONEY

For books that tell WHAT patents bring MOST MONEY, and WHY—send 10 cents postage to R. S. & A. B. LACEY, E45 Washington, D. C. Established 1869

PATENTS PROCURED AND SOLD;

Easy terms; careful, conscientious work; advice

FREE; new BOOK FREE; correspondence solicited; highest references; send sketch to-day.

H. J. SANDERS SUITE A CRILLY BLOCK Chicago, Ill.

PATENTS BUILD FORTUNES FOR YOU

Our free booklets tell how, what to invent, How To CHOOSE AN ATTORNEY, and save you money.

Prosperous clients in all states. Best bank and other references. WRITE TODAY

D. SWIFT & CO., 317 SEVENTH ST., WASHINGTON D. C.

PATENTS C. L. PARKER

Formerly Member Examining Corps, U. S. Patent Office
PATENT LAWYER
210 MCGILL BLDG.
WASHINGTON, D. C.

Patents, Trade Marks, Copyrights, Patent Litigation

Handbook for Inventors, "Protecting, Exploiting and Selling Inventions" sent free upon request.

PATENTS THAT PROTECT and PAY

Advice free. Terms reasonable. Highest references. Best results.

Send sketch or model for FREE examination and opinion.

Recommended Patent Lawyer in the Bankers' Register and special list of selected lawyers.

Also in Martindale's Law Directory, Sharp and Alleman's Directory of Lawyers, The Gast-Paul Directory of Lawyers, and Kime's International Law Directory.

ALL BUSINESS GIVEN PROMPT AND PROPER ATTENTION

A large list of strong recommendations furnished free

WATSON E. COLEMAN, Patent Lawyer, 622 F St., N.W., Washington, D.C.

MOTOR AND DYNAMO BARGAINS

Send For Bulletin 24

If you do not read our Monthly Bargain Bulletin, you are overlooking many good things. Ask for it today. It's free.

We Buy and Sell Electrical Machinery of All Kinds paying cash for anything you may have outgrown, or giving you a liberal allowance on either new or rebuilt apparatus carrying our ironclad guaranty. Prompt repairs — nation-wide service — pleased patrons everywhere.



WE DO NOT HANDLE NOVELTIES OR TOYS

THE F. BISSELL CO., 226 Huron St., Toledo, Ohio

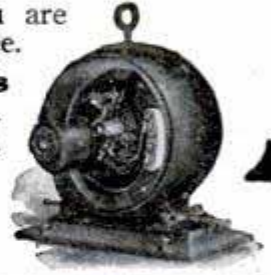

A PRIVATE WATER SYSTEM

at low first cost and no operating expense is supplied by a

RIFE RAM

This ram will pump and deliver where you want it, either into a pneumatic or open tank, any quantity of water.

It operates automatically with the overflow from a stream, artesian well or spring amounting to 3 or more gallons per minute and a head or slanting fall of 3 or more feet.

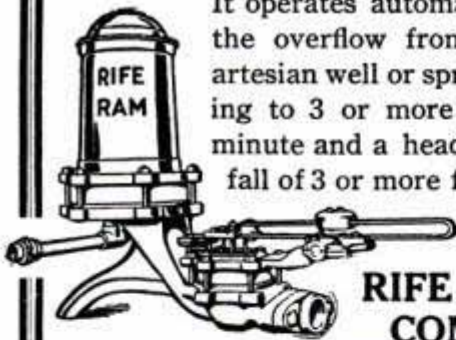

Free booklet on request

RIFE ENGINE COMPANY

2131 Trinity Bldg., NEW YORK CITY

This Lathe Costs You \$12

Complete with lathe tools and scroll saw attachment as shown in cut. An ideal outfit for home work or small shops. Well built and highly finished, polished parts nickel plated. Swing of lathe, 5 in. Length of bed, 24 in. Distance between centers, 13½ in. Write for full information. If you are interested in scroll saw work, send 10c for Bowman & Russell catalogue 64 of patterns. We also sell scroll saw wood—all kinds.

ORR & LOCKETT HARDWARE CO.
Lathe Dept., 14-16 W. Randolph St., CHICAGO

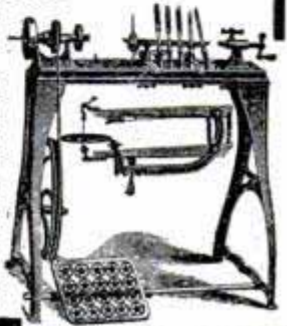

LATHES

\$75 Screw Cutting Foot or Power
9 to 13 inch

CATALOG FREE

SOUTH BEND MACHINE TOOL CO., 423 Madison St., South Bend, Ind.

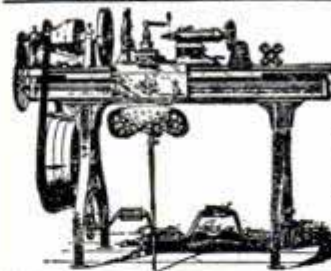

LATHES

9 to 13-inch Swing

List price \$75 and up according to size. When ready to buy send for Lathe Catalog and prices.

W. F. & John Barnes Co.
100 Ruby Street, ROCKFORD, ILL.

Running Water When & Where You Want It

City convenience at one-half—and less—the cost. Running water in the house and barn or garage—all you want of it at the turn of a faucet. No hand pumping—all the fuss and bother left out. A

"JARVIS" POWER PUMP

and a good well or cistern is all you need. Install Pump yourself—easily, quickly. We furnish everything—piping, fittings, fixtures, etc. Runs by gasoline engine or electricity at little cost. Catalog No. 16 tells the whole story—write today for free copy. Good Proposition for Dealers—Write!

JARVIS ENGINE & MACHINE WORKS, LANSING, MICH.

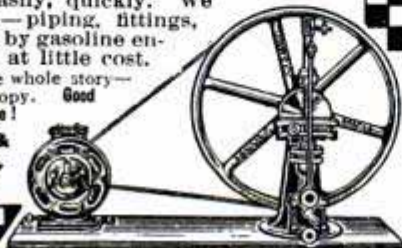

VACUUM PUMPS

For Powerful Portable and Stationary Vacuum Cleaning Plants. They take up their own wear. Powerful; Noiseless; can't get out of order.

GET CATALOG No. 23



LEIMAN BROS., 62P John St., NEW YORK

Prepare for More Business

The CRESCENT Universal wood worker will cut your cost of production, increase your profits. A complete outfit for the small shop in one machine. Find out all about it. Our catalog gives description and tells about our line of hand saws, planers, planers and matchers, swing saws, disk grinders, saw tables, shapers, borers. Variety wood workers.

THE CRESCENT MACHINE CO.
93 Columbia St., LEETONIA, OHIO

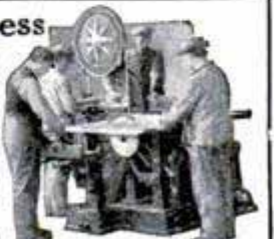



Our Guarantee:
Your money back if you are not
entirely satisfied.

Prices Range From \$60.00 Up.

The Lathe to Buy

You cannot make a mistake in buying a lathe from us. We are offering the best lathe values on earth. Expert mechanics have chosen our lathes to do the work for their shops. **Hundreds are now in use.** Every lathe we sell adds one more satisfied customer to our list. That ought to be sufficient recommendation for anyone wanting to buy a lathe.

Don't turn away work that you should have.

Buy one of our lathes and be ready for the man with the profitable lathe job.

QUALITY AND WORKMANSHIP UNEXCELLED. We save you \$25.00 to \$150.00, according to size of lathe.

Write for Machinery Catalog 80P62. Mailed Free on Request.

We make no shipments outside of the United States.

Address **Sears, Roebuck and Co., Chicago, Ill.**

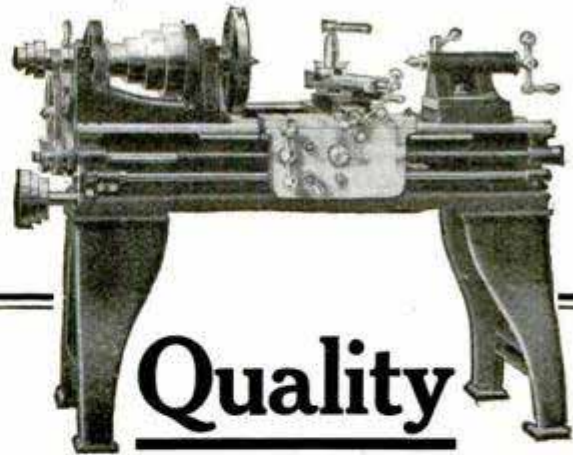

Quality

is of course the most essential requisite of a lathe for **Garage work**, as well as for **Automobile and general repair work.** We have it in our lathes, but we have kept the **price very low.**

We would be glad of an opportunity of convincing you that we offer both **high quality and low price** in the **Sebastian Lathe.** Our catalog free.

The Sebastian Lathe Co.
107 Culvert Street CINCINNATI, OHIO

LET THE RED DEVIL WATER MOTOR DO YOUR WORK

6-inch Motor

Improved construction, absolutely perfect, runs your washing machine and a hundred other things. Power for small tools. $\frac{1}{4}$ horse power on $\frac{1}{2}$ -inch pipe, 80 pounds pressure; 1 horse power on 2-inch pipe, 60 pounds pressure. New net price, \$5.00 cash with order.

No. 1492 4-inch Motors for grinding, polishing and buffing. Runs sewing machines, fans, bottle washers, etc. Price with emery, buffing wheel, silver polish and pulley, \$3.00. No. 1493 Motor and pulley only, \$2.50. $\frac{1}{8}$ horse power on 80 pounds pressure. Improved construction. Speeds, 3,000 to 5,000 revolutions per minute. Only scientifically and mechanically perfect small water motor manufactured. Patented construction makes it possible. Tremendous output warrants the price. Money back for any reason.

CATALOGUE AND LARGE SHEET FREE

DIVINE WATER MOTOR CO.

Dept. T UTICA, NEW YORK, U. S. A.

For the name of your local hardware or tool dealer, we will send you free booklet on "Theory and Design of Water Motors."



6-Inch
Bucket
Wheel

Make Money Out of Keys

Write for particulars
and Catalogue 104

There's a big, live, opportunity making Duplicate Keys

The Cylinder Key Duplicating Machine

is worth its weight in gold to Tinsmiths, Hardware men, Plumbers, Electricians, etc. It offers hustlers a chance to get into a steady business or a profitable sideline wherever there are doors to lock. It is simple, accurate and inexpensive.

ORR & LOCKETT

14 W. Randolph St. CHICAGO

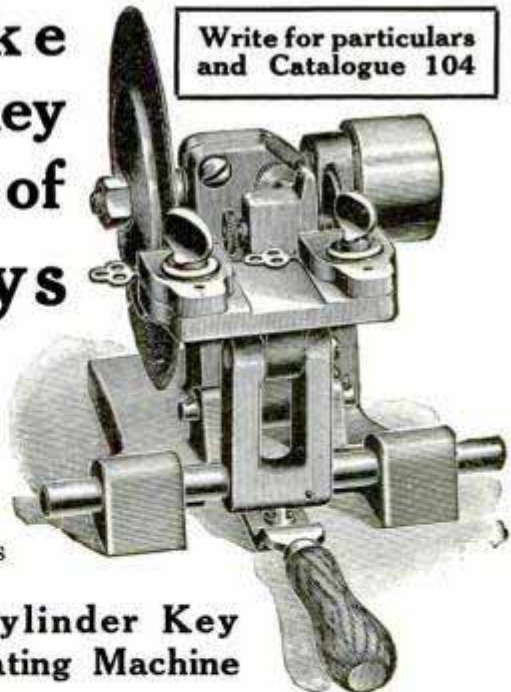

Stanley Tools

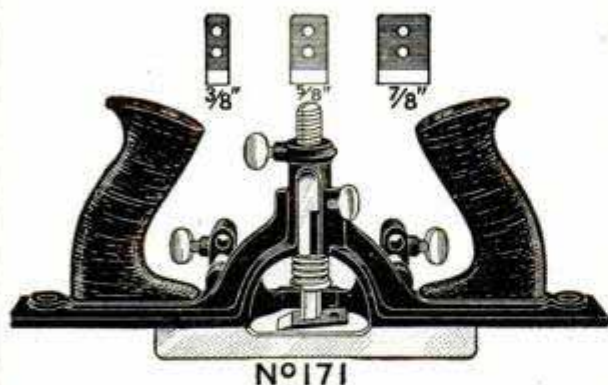

Stanley Door Trim Plane

THIS Plane will make mortises for Butts, Face Plates, Strike Plates, Escutcheons, etc., without the use of a butt gauge or chisel. In fact, it might very properly be termed a mechanical chisel.

☞ It is also a very superior Router Plane for surfacing the bottom of grooves or other depressions parallel with the general surface of the work.

☞ The Plane is japanned, has nickel-plated trimmings, rosewood handles, and three forged steel cutters.

No. 171 Length, 11 Inches
Weight, 3 Pounds **List, \$2.75**

SEND FOR SPECIAL CIRCULAR

Stanley Rule & Level Co.
NEW BRITAIN, CONN. U.S.A.

Pete Says

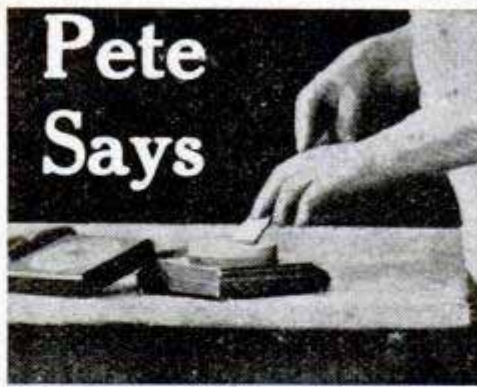

Just put that tool on a *Carborundum* Sharpening Stone

Give it a couple of rubs across that clean-cutting surface.

Feel it take hold?

Carborundum cuts—it doesn't rub the edge on the tool—cuts clean and quick.

The stones won't glaze—they last a life-time.

Thousands of carpenters and mechanics besides myself use them.—There should be one in your tool kit.

Carborundum Round Combination Stone No. 107, . . . \$1.00

Carborundum Pocket Stone, 0.15
At your hardware dealer

*Have you read the Romance
of Carborundum?*



The
**Carborundum
Company**

Niagara Falls, N. Y.



Please Mention Popular Mechanics

Detachable Swivel

"Off agin, on agin!"

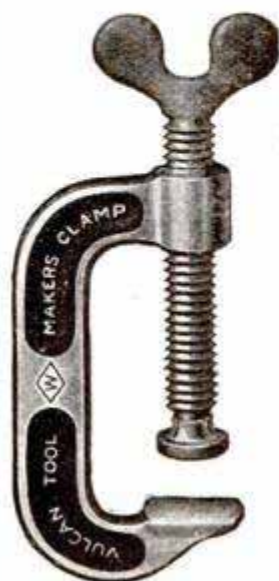

Like a glove button or clasp describes the application of the feature just incorporated in the dependable drop-forged and heat-treated

"Vulcan" Tool-Makers' Clamps

Positive application
Dependable strength
Unlimited usefulness
Profitable companion

Made in three sizes, with total capacity of 1 to 3 inches; use with or without swivel.

Get (free) catalogue of dependable drop-forged tools

J. H. WILLIAMS & CO.
Superior Drop-forgings
47 Richards St. Brooklyn, N. Y.

LAKE SAILORS FOR U. S. NAVAL RESERVE

The government plans a naval reserve composed of sailors on lake and coast vessels. These trading and passenger ships use 100,000 officers and sailors, masters, deck officers, engineers, oilers, water tenders and quar-

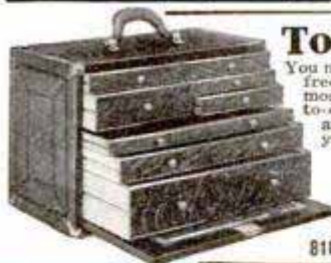

Tool Cases for Machinists & Toolmakers

You need one of the many styles shown in our free catalogue. They are the best built and most practical on the market and it's the up-to-date way to keep tools in good condition and orderly arranged. We ship direct to you and guarantee complete satisfaction.

H. Gerstner & Sons

Mfrs. of Mechanics' High Grade Tool Cases
818 Germantown Street, DAYTON, OHIO

12 Handy Tools in 1

Automatic Combination Tool

Lifts or pulls 3 tons, is a wire stretcher and splicer, post and stump puller, vise, clamp, wrench, cider press, etc. Patented automatic features make it work easier and quicker. Saves cost of eleven tools. 30 days FREE trial. State and County Agents Wanted. Write today for booklet and exclusive territory. AUTOMATIC JACK CO., Box 224, Bloomfield, Ind.

Shoe & Harness Repair Kit \$1

SENT PREPAID

Outfit consists of Automatic Stitching Awl Handle (which alone costs \$1 if bought elsewhere), One Automatic Collar Awl, 3 eye-pointed Awls, Stitching Horse, 2 Spools Thread (3 and 5 cord), Wax, Bobbins and Wrench, all neatly packed in heavy case. Do your own repairing of harness, shoes, saddles, belts, tents, paulins, etc., and save repair bills. Quickly pays for itself in money saved. Send \$1 today. Money back if not satisfied.

LOTZ BROS.

Dept. 1 ST. LOUIS, MO.

Speed
Changed
at a
Finger-
touch

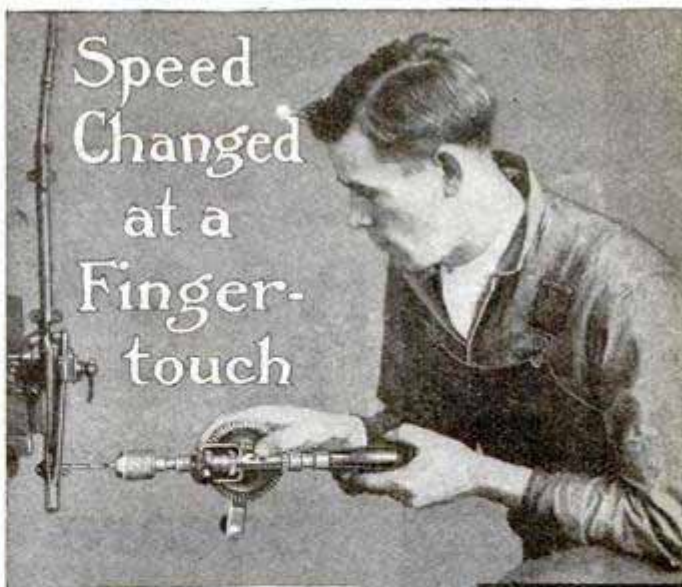

Quickly and easily change the speed to fast or slow, just by shoving the shifter pin backward or forward with your finger. No complicated adjustments—no need to take the drill from the work.

With scarcely a stop in working, you can control immediately the cutting speed of the drill point. For quick, light work

"YANKEE" Plain Hand Drill No. 1445

This drill is 15 in. long, weight 3 3/4 pounds. Double speed. Three-jaw chuck holds round shank drills up to 3/8" diameter. Made also with two-jaw chuck. Spindle gears, extra strong cut teeth. Handle holds magazine for drill points and attaches to frame by milled nut—cannot work loose or split. Three positions of shifter—fast, slow or locked—for changing drills. Every part strongly made and carefully finished with "YANKEE" exactness and precision.

"YANKEE" Plain Hand Drill
Price \$3.00

Your Dealer Can Supply You

Write for "Yankee" Tool Book"—free—showing styles of Yankee Ratchet, Breast, Hand Drills and other "Yankee" Tools.

NORTH BROS. MFG. CO., Philadelphia

"YANKEE" TOOLS
Make Better Mechanics

Please Mention Popular Mechanics

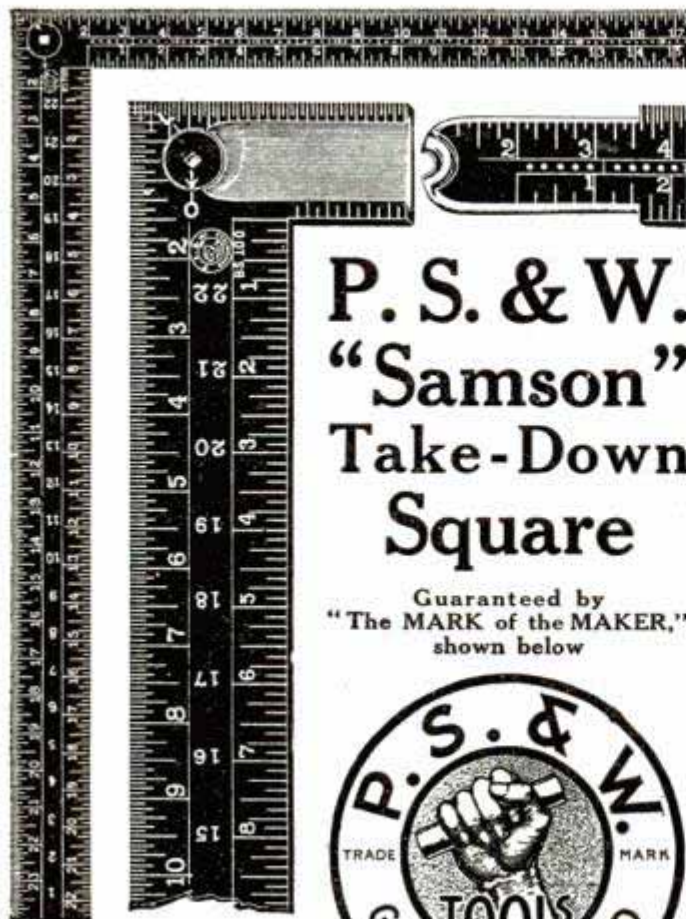

P. S. & W. "Samson" Take-Down Square

Guaranteed by
"The MARK of the MAKER,"
shown below



IT IS strong and accurate, easy to take apart, and when locked you'd never know it wasn't one solid piece.

That long shoulder carrying the groove gives extra strength, and the locking device is the simplest one made, and can be operated by a nail or the shank of any tool that will fit into the slot.

The P. S. & W. Take-Down is made either with rafters or ordinary markings.

It is only one of many top-notchers in the very large and complete line of P. S. & W. guaranteed steel squares.

P. S. & W. CARPENTERS' TOOLS

These include the finest and most complete lines of braces and bits, chisels and gouges, draw-knives, pliers, and other tools for carpenters.

You'll find them all listed in our "Mechanics' Handy List," which shows over 200 tools for Carpenters, Machinists, Electricians and Tinsmiths. The book is handy pocket size and has over 30 pages of valuable shop tables and useful information.

Sent free at your request

THE PECK, STOW & WILCOX CO.

MFRS. of the Largest Line of Mechanics' Hand Tools Offered by Any Maker

Southington, Conn. New York, N. Y. Cleveland, Ohio
Address 20 Murray St., New York City



The P. S. & W. Samson Take-Down Square is packed in a neat, water-proof canvas case, as shown above.

Please Mention Popular Mechanics

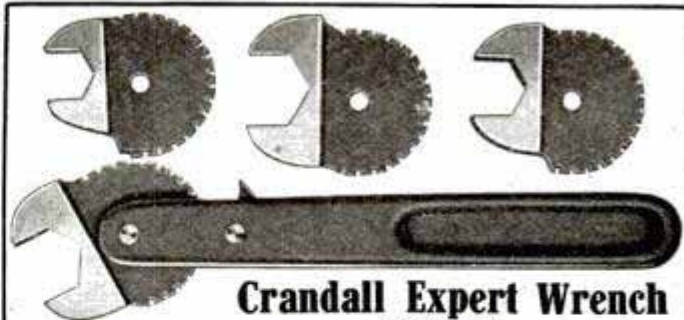

Crandall Expert Wrench (PATENTED)

No further need for cold chisel and hammer in those close places. The "Expert" will operate in 1" space for handle swing. Jaw sizes instantly interchangeable without extra tools. Drop forged and case hardened. 14 possible angles with each jaw. 4 sizes and handle as shown in neat duck kit, only \$2.50 the set, at your dealer's or sent prepaid by Parcels Post anywhere in U. S. on receipt of price. Circulars on request.

Dealers and salesmen get our proposition.

EXPERT UTILITY CO., 356-8 E. 3rd St., Cincinnati, O.

Make Things of Leather



No. 1 Double Ended Leather Working Tool, 50c

You can make hand bags, pocket books, card cases, a hundred useful and attractive things in leather. It's fun and it's easy to learn. An investment of 50 cents in tools will start you. Send for our Arts and Crafts Catalog 24.

ORR & LOCKETT HARDWARE CO.
14 W. Randolph Street, CHICAGO

termasters, all first-class material which can be enrolled now, given instruction and retained for a small amount ready for serious war. They could then be immediately assigned to auxiliary ships and strengthen our navy where it is now weakest. This will secure the country a maximum of advantage at a minimum of cost.

FOR SEWING LEATHER

The Speedy Stitcher is the latest and best of anything ever offered for \$1.00.



Agents make over 200% profits.

Send at once for catalog and terms.

AUTOMATIC AWL CO., 26 Gardner Terrace, WORCESTER, MASS.

To Make Soldering Easy USE THE ALLEN SODERING PASTE

Made in Chicago, U. S. A.
An absolutely reliable soft flux.
One of the easiest forms to apply, just squeeze it on, then apply your solder. Good for all kinds of electrical and mechanical work, as you can reach difficult out-of-the-way places with it. Makes a strong, secure joint. For sale by all leading electrical, hardware and auto supply houses. If Yours Won't Supply You Send 20c and his name for trial tube.



L. B. ALLEN CO., Inc., Sole Manufacturers, 4530 No. Lincoln St., CHICAGO, ILL.

Christiansen's Steel Screw Vise

Is the handiest ever out. It can be attached to a plank or a heavy table top in 5 minutes. Any Hardware Dealer can get this Vise for you.



Price is only \$2.00

C. CHRISTIANSEN, 2219 Grand Ave., CHICAGO, ILL.

SIX TOOLS IN ONE

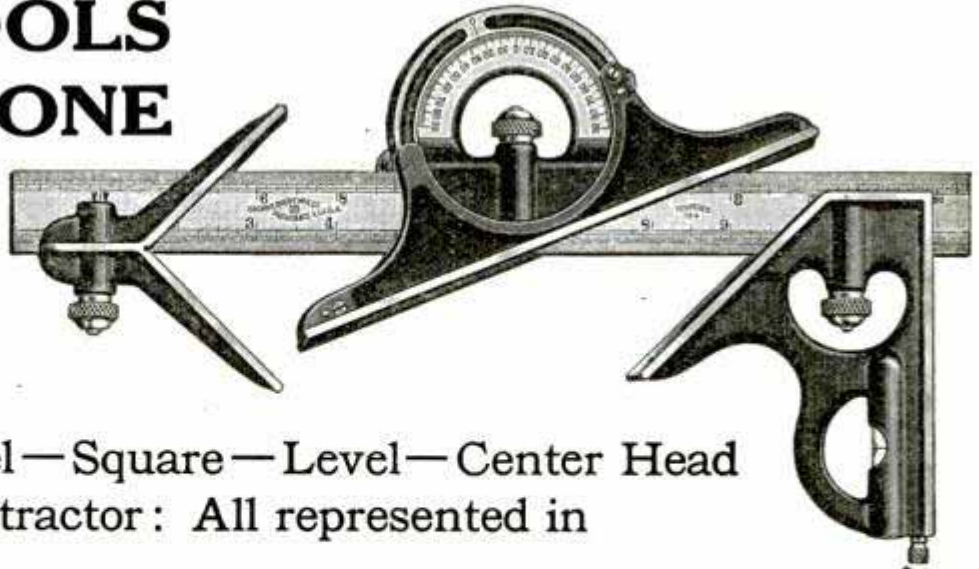

Made in
Several Sizes

A Rule — Bevel — Square — Level — Center Head
and Protractor: All represented in

B. & S. Combination Sets

The mechanic will find this set a valuable addition
to his kit, and will appreciate its many uses.

If your hardware dealer does not have them in stock, write us.

BROWN & SHARPE MFG. CO.

SEND FOR CATALOGUE

PROVIDENCE, R. I., U. S. A.

SLIDE TO IT CIVIL SERVICE Examinations Made EASY by Use of RICHARDSON'S SLIDE RULE.

State, County, and City Civil Service Commissions are adopting plan of
U. S. Government by requiring the use of Slide Rules in examinations.

There seems to be a misunderstanding about what the Slide Rule will accomplish, many think it an instrument, the use of which is applicable only to Engineers and Technical men. So frequently have I heard this remark that I have completely re-written and enlarged my instruction book, *The Slide Rule Simplified*, which shows the actual setting of the rule by 90 full size engravings, 52 pages 7x10, each illustration and example is explained and "written so you can understand it." In fact any person who has never seen a Slide Rule, and not a technical person, could not help but learn its use. The examples selected and shown by illustrations are those which frequently come up for solution by the Banker, Broker, Auditor, Inventory Man, Cost Estimator, Printer, Paper Mfr., Contractor, Salesman, Time-Keeper, Bookkeeper, Lumber, Land, and other merchants too numerous to mention.

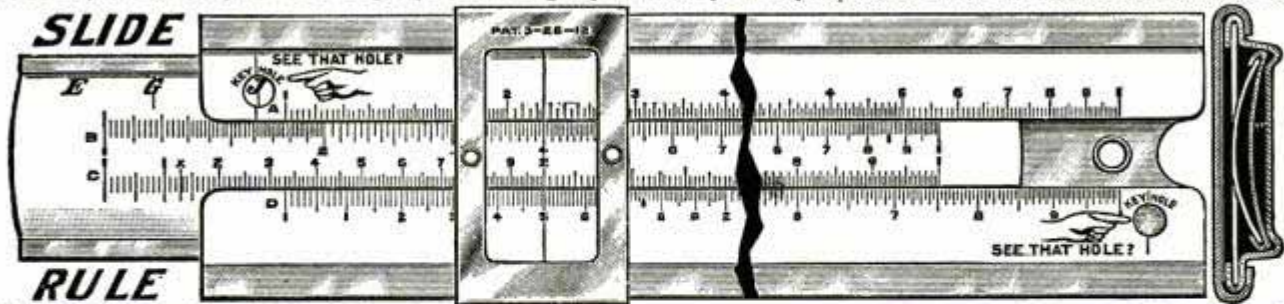

This Slide Rule will multiply, divide, solve proportion, extract the square and cube roots, find the decimal equivalent of vulgar fractions or "vice versa," calculate interest, percentage. Also the mensuration of superficies, and the rule of three. For Engineers, Electricians, Draftsmen, Superintendents, Master Mechanics, etc., the rule is indispensable in their work. It is one of the most valuable instruments ever offered to mankind. For Electricians it is a complete wire table in itself. The Richardson Direct Reading Slide Rule is specially designed for those who wish to learn its use. Its operation being very simple. You simply place the key to the problem wanted in the keyhole (the key is printed in red on slide, see cut) and answer is given direct: such as the Horse Power of Engines, Pumps, Boilers, Belts, Water Falls; size of duct for ventilating; radiation and size grate, and steam main; change gear and pulley problems; areas, circumference and diameter of circles. This Rule is my 1913 type now on the market for the first time. Made in two sizes, coat and vest pocket 11x1 1/2x 1/4 and 5 1/2x1 1/2x 1/4. 11" has Sine, Log, and Tangent scales. No wood in their construction, scales white celluloid, printed from engine divided plates in two colors, and washable, secured by an improved locking device in an absolutely non-corrodible Aluminum and Monel Metal framing.

Another Handy Tool

Folding Pocket Rule is made of German Silver; it can be used as a Hook-rule, Caliper-gauge, Protractor, Triangle or Tri-square. The Protractor is divided to five degrees and the Vernier reads to one-half degree. This handy and indispensable Rule can be set to any desired Angle.

6 inch two fold	\$1.25
12 inch two fold	2.00
Chamois lined case	15c extra

Price of 11" rule, ordinary case, \$2.50. Full leather case, 50c extra. 5" rule and full leather case, \$2.50. 11" rule, bristol board scales for demonstrating uses, \$1.00. If ordered now the book, *The Slide Rule Simplified*, goes FREE with each rule.

GEO. W. RICHARDSON CONSULTING ENGINEER
Ex-Chief Electrician, U. S. Navy
4218 24th Place, CHICAGO, U. S. A.



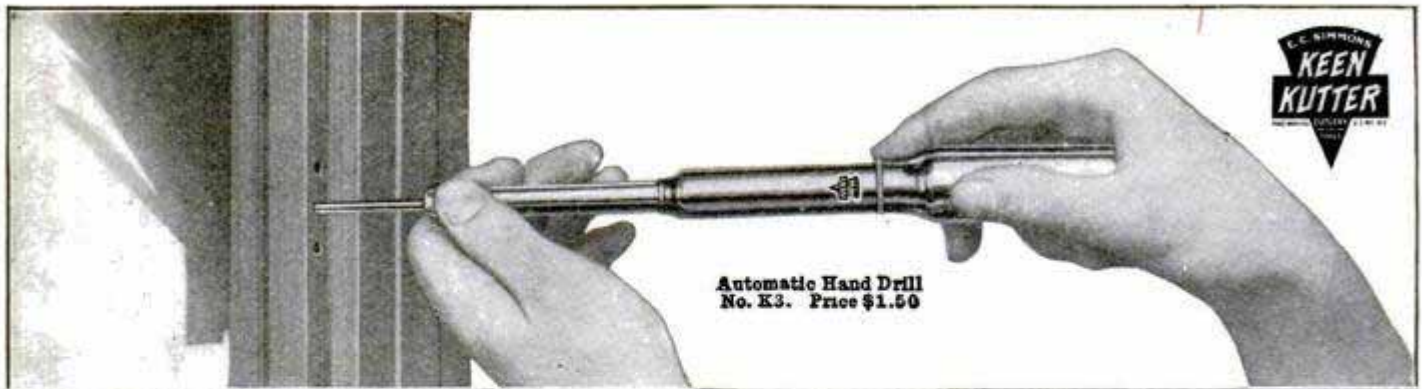

Automatic Hand Drill
No. K3. Price \$1.50



Quality Tools for Quality Work

It's a genuine pleasure working with Keen Kutter tools—they are so easy to handle and stand up to their work so well. Keen Kutter tools will satisfy the most expert mechanic. The quality of steel, cutting edges, points, handles and temper—all of these essentials—must be absolutely right before any tool can bear the famous Keen Kutter trade mark. To do quality work you must have quality tools; therefore, insist on



Plane
No. K10
Price \$2.75



Pliers
No. K958
Price \$1.75

KEEN KUTTER

"The Recollection of Quality Remains Long After the Price is Forgotten."
Trade Mark Registered.

If not at your dealer's, write us.

SIMMONS HARDWARE CO., Inc.

St. Louis, New York,
Philadelphia, Toledo, Minneapolis,
Sioux City, Wichita.

Keyhole Saw, No. KP—Price \$0.20

Screw
Driver
No. K50/8
Price \$0.50



Saw, No. K88/26
Price \$2.00

Brace
No. KR13
Price \$2.35



Chisel
No. KSB1
Price \$0.75

GASOLINE SOLDERING IRON BLOW TORCH

Cuts time and Fuel Bill
50%. Address Dept. I.



EMMELMANN BROS. MFG. CO., INDIANAPOLIS, IND., U.S.A.

STOP THAT LEAK

Solderene

and a Candle are all you need to make a permanent repair.

Full directions with each stick. It requires no skill. Anybody can use it. Price, Ten Cents.

SOLDERENE MFG. COMPANY, 90 Portland St., BOSTON, MASS.

That animals have been distributed over the earth by the oscillation of its axis, which has changed the climate of various lands, is the theory advanced by a German scientist.

\$1.00

Postpaid

Myers' Wonderful Sewing Awl

sews leather, canvas, shoes—anything, heavy or light. Complete repair shop in itself. Saves many trips to town. Mends harness, saddles, wagon covers, blankets, buggy tops, belts, etc. Can't get out of order. Original and only awl with diamond point full grooved needle to protect the thread. **BIG MONEY FOR AGENTS.**

C. A. MYERS CO., 6339 Lexington Ave., Chicago, Ill.



SIDE VIEW

TOP VIEW

NEW IMPROVEMENTS NOW MAKE The American Combined Level and Grade Finder Most Practical, Durable and Convenient Instrument Made

At one glance you can get the true slant on any line or grade either in degrees, inches or percentage, or all at the same time, and will at once give the exact distance needed to plumb up to a true level. The additional spirit level glass now placed in middle of instrument with points on dial will give 3 grades for leveling. The longitudinal recess shown in cut is well worth the low price of the instrument. Write AT ONCE for circular and Testimonials. Special Introductory Price given to First Applicants with privilege of taking Agency. Address **EDWARD HELB, Mfr., Box 75, RAILROAD, PENNA.**

Grobet Swiss Files

and other high-class Tools are shown in "THE TOOL-MONGER"—its 375 pages, and will be mailed on receipt of 5 cents in stamps.

MONTGOMERY & CO., 107 Fulton Street, NEW YORK CITY

Portable Cases

FOR TOOL MAKERS AND MACHINISTS

Twelve styles, felt lined drawers, solid brass trimmings, best of material, beautiful finish, low prices, satisfaction guaranteed. Ask for booklet of cases built for service.

The Pilliod Lumber Co. SWANTON, OHIO

"AMERICAN" Key Cutter

ADD TO YOUR INCOME

With little effort you can make **\$5 to \$10** a day

The "AMERICAN" is the only machine on the market (barring none) that sharpens, hones, and stropps razors, sharpens all kinds safety razor blades, scissors, clippers, pocket knives, surgical instruments, etc. No previous experience required. REMEMBER THE "AMERICAN" Key-Cutter is a little wonder. Cuts Square, Angular or Round slots.

AMERICAN SHARPENING MACHINE CO. (Inc.)
Dept. 5 184 W. Washington St. CHICAGO

"AMERICAN" Sharpener

Could You Improve Your Work?

Maybe you could if you are not a thoroughly experienced mechanic, but we know you could do more work and keep the quality up to your requirements if you had a complete equipment of

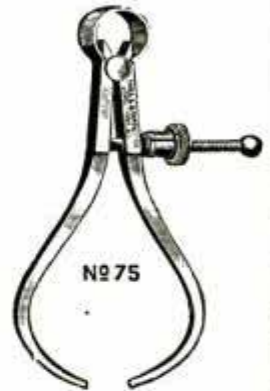

Starrett Tools

There is a Starrett for nearly every purpose. There are micrometers, rules, and gages for fine measurements, protractors, squares, levels for laying out work and expansion pliers, cut nippers, screw drivers, and ratchet wrenches for your various other needs.

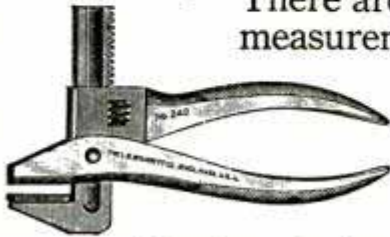

No ad can do these tools justice nor give you any conception of the variety of tools we make. Send us your name and we will mail you our 274-page free catalogue No. 19AP because it shows the full line with the prices. Write now.

ALL GOOD HARDWARE STORES CARRY STARRETT TOOLS

The L. S. Starrett Co., Athol, Mass. 42-180

SMALL TIME LOST BY NEW YORK LOCOMOTIVES—The total amount of time lost during 1912 by the 33 electric locomotives operating on the Pennsylvania Railroad terminal lines in New York aggregated only 33 minutes, the total distance covered by these locomotives being about 900,000 miles.

A pleasant upward circulation of air is claimed for a new electric fan with horizontal blades and a deflecting plate above them.

Pipe-Threading Tools

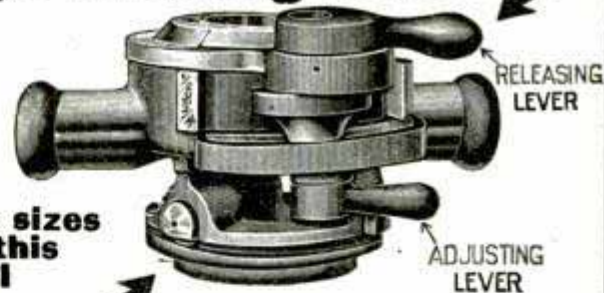

Six sizes in this tool

The die-stock illustrated is built to meet your need for a tool that is easier to adjust and operate than ordinary stocks and yet will thread a wider range of sizes.

OSTER Bulldog No. 102 DIE STOCK

threads six sizes— $\frac{1}{8}$ ", $\frac{3}{16}$ ", $\frac{1}{4}$ ", $\frac{5}{16}$ ", $\frac{3}{8}$ " and $\frac{1}{2}$ ". Five Big Mechanical Features—(1) Lever-Locking Dies, (2) Self-Locking Guides, (3) No Re-setting, (4) No loose bushings, (5) No breakable small parts. Combines wide-range, easy operation and low cost of upkeep. One of the famous Oster Bulldog Line of pipe-threading tools—twenty years' experience in building right tools at right prices for all uses. Catalog and booklet free—use coupon.

This Booklet FREE



The Oster Trademark



THE OSTER MFG. CO.
2100 E. 61st St., CLEVELAND, OHIO

Please send "Bulldog Tale" and catalog.

Name.....

Address.....

City..... State..... (2100)

BAR BENDERS

For Concrete Reinforcements

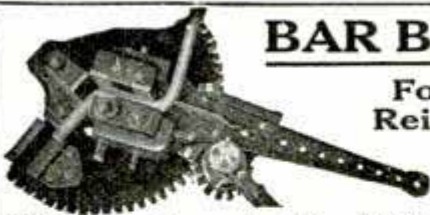

WRITE FOR OUR BENDING TOOL CATALOGUE.

Wallace Supply Co. 124 No. Jefferson St., Chicago 26 Cortlandt St., New York City

Yes, It's a Fact!

Drilling a stone wall is a "snap" with a "RED DEVIL" Chain Drill.

No. 2017 is a hand feed, ball bearing, portable drill press, fitted with our Giant chuck, taking round or square shank drills $\frac{3}{16}$ to $\frac{1}{2}$ ".

It's one of nine styles we make, and all hardware dealers sell. Ask your local dealer, but be sure it's a RED DEVIL you get. If not on sale locally, send us \$2.40 and we will send you one only prepaid.

SMITH & HEMENWAY CO.
510 Chambers Street, New York, U. S. A.

(With a "Red Devil" plier, you can cut any wire)





WHEN he sees the Irwin stamp of sure quality, he is satisfied. That's the bit he wants.

He wants the Irwin because he has to have a bit which will cut sure and true into the hardest wood, or knots; which will not clog; which will not tear the softest wood.

He is a mechanic and knows that the hand-filed sharp edges of the Irwin will never fail. He knows that the

IRWIN BIT

—being of uniform strength, made of one piece of flawless extra high-grade crucible auger-bit steel, and tempered by the secret Irwin process, will never bend or break where twist and shank unite.

He cannot afford to experiment. Neither can you. If your dealer hasn't Irwin Auger Bits, write us direct. The Irwin is bound to satisfy you. It is the only solid-center-stem bit made in

6,500 Styles and Sizes

—for every purpose—so you are sure to find just exactly what you need in the Irwin line. If not satisfactory, money is refunded.

Irwin Auger Bit Company

Largest in the World

Station E12

Wilmington, Ohio

Made From the Finest Sheffield Cast Steel

SWISS FILES

CARRIED IN STOCK BY

EDGAR T. WARD'S SONS

The Genuine "Dick" Files

Are manufactured at Esslingen on the Swiss frontier and are celebrated for their superior quality and uniformity of cut. All styles, shapes and cuts on hand.

SEND FOR CATALOGUE AND QUOTATION

EDGAR T. WARD'S SONS

25 Purchase St. BOSTON, MASS.

PRICES OF FARM PRODUCTS—On January 1, 1913, the prices of agricultural products were about 17.2 per cent lower than on the first day of 1912, 6.5 per cent lower than in 1911, 17.3 per cent lower than in 1910, 5.9 per cent lower than in 1909, and 7.7 per cent lower than the prices received on January 1, 1908.

FOR MENDING HARNESS

shoes, tents, awnings, pulley belts, carpets, saddles, suit cases, buggy tops, dash boards, or any heavy material. **Stewart's Automatic Awl** is the only perfect Sewing Awl.

It takes a wax thread, feeds from spool and does the work of any harness maker machine. It is indispensable for farmers. Agents wanted. Sent prepaid for \$1.25. Send at once for catalog.



STEWART-SKINNER CO.
26 Hermon Street
Worcester, Mass.

Building Contractor Agents

Wanted to use and help sell the

Rapid Floor SCRAPER

One man scrapes more floor than three by hand
Get our Free Catalog



FREE TRIAL

MONARCH MFG. CO.
505 Shepard Bldg.
Grand Rapids, Michigan

A BIG MONEY MAKER FOR AGENTS



The Instantaneous Home Solder with a thousand practical uses

Simply heat the article to be mended over a candle, lamp or gas flame—apply Tinol, and you can make immediate repairs of anything of metal. In every home and office Tinol is a tremendous money-saver to those who know its uses. It sells on sight. Easy to demonstrate; easier to repeat orders. Send 10c at once for sample, and agent's proposition.

Men and women everywhere are making big money—so can you.
HESS & SON, 1039 Chestnut St., PHILADELPHIA
Hamilton coupon in every package.

American Patent Sales Company

"We buy, sell and exploit domestic and foreign patents of recent issue. We have representatives in different parts of the world. We make no charges to inventors unless patents are sold by us. If you have any valuable patents to sell communicate with us." **WE EXPLOIT**

The Master Slide Rule,



the only **Rule in the World** whereby inside measurements of doors and windows, etc., can be taken rapidly and accurately. It is also far superior to any other rule for outside measurements of walls and ceilings, etc., as it can be extended and closed instantly. **Mechanics, Builders, and Architects, try one today! Don't wait!**

On receipt of 15 cents per lineal foot, a 4, 5, or 6 foot rule will be sent to you prepaid. Large profits to agents. Write for circulars and particulars.

AMERICAN PATENT SALES COMPANY
417-A Fifth Ave. NEW YORK CITY



EAGLE CLAW WRENCH

Every man of the house familiar or not familiar with tools has at times a difficult piece of work no tool can handle. The emergency tool, the **Eagle Claw Wrench**, takes the place of all wrenches and many other tools and does the work no other tool can do. Acts as pliers and does work pliers cannot do; holding round, square, oblong, hexagon or other shapes firmly. Drop forged and fully warranted.

Capacity of wrench: 7 inch wrench—7 inch 45 degree; up to 1/2 inch pipe or any object up to 1 inch square, wt. 3/4 lb., \$1.00. 10 inch wrench—10 inch 45 degree; up to 1 inch pipe or any object up to 1 1/2 inch square, wt. 1 5/16 lb., \$1.25. 13 inch wrench: up to 1 1/4 inch pipe or any object up to 2 inches square, wt. 2 1/2 lb., \$1.50.

Your dealer has it on sale; if not send us his name, with remittance, and tool will be sent you prepaid.

AMBLER, HOLMAN & CO.
Dept. A, 571 W. Washington St., Chicago, Ill.

LUFKIN

A trade-mark and a guarantee

Measuring Tapes and Rules



Send for sample piece of instantaneous reading tape and our complete catalogue.

THE LUFKIN RULE CO.
SAGINAW, MICH.

DEADLY AFRICAN POISONS—The Central African negro is an expert poisoner and is always in fear of it, for poison is the subtlest means at command for getting rid of an enemy or satisfying a grudge. The most fatal poison available is prepared from the ujunju tree, which grows in German East Africa. Very few natives will even venture to cut the tree down, for a mere prick from a splinter will cause terrible and sometimes fatal inflammation. The natives say that neither moths nor snakes will go near this tree and that birds

WINSLOW STRENGTH COMPUTING SLIDE-RULE

For instantly computing the strength of steel or wooden beams or ANY beam of ANY material, ANY fiber stress, ANY factor of safety, ANY size, span, spacing, loading, load per sq. ft., per lin. ft. or total load, ANY bending moment, section modulus or number of beams. Any beam figured in six seconds—just push one slide and read the answer. Makes minutes do the work of hours. Nothing like it on the market at any price. Money back if you want it. Price \$10.00. Descriptive booklet free.

HENRY W. TOMLINSON, Steinway Hall, Chicago, Ill.

9 Months' Rent Buys a Transit or Level For Engineers or Surveyors



Highest Quality—These Civil Engineering Instruments are of the highest quality, newest patterns and 1913 models. Full set of accessories included. Full guarantee backed by our fifty-year record as makers of the world's standard engineering instruments.

No Interest—No interest, strings or red tape of any kind. Just pay the rent for nine months and you own the instrument outright.

Send For Particulars—If you are an engineer or surveyor write today for full particulars of this wonderful offer and complete descriptions. Ten days' trial.

A. S. ALOE CO., 515 Olive St., St. Louis, Mo.



The Magic Wand

As the magician of old performed miracles with the aid of his magic wand, so does the magician of today—the electrician—achieve most wonderful results with a power as mysterious and invisible as that which came from the wand of the sorcerer. The field of Electricity is limitless—new uses for this great force are discovered daily and large salaries are paid to those who know how to handle it. Prepare yourself, then, to become a big man in this field; learn from these books all that is necessary for you to know. If a beginner, you can soon fit yourself to make your start in this fascinating work at a good salary. If a worker, engineer or expert, you can add to your knowledge and put yourself in line for a better job at bigger pay.

The American School's Cyclopaedia of Applied Electricity
is the greatest Electrical Reference Library in the World

Contains 3,200 pages, 7x10 inches; 2,600 illustrations, full page plates, diagrams, etc.; hundreds of valuable tables and formulas; carefully cross-indexed for quick, easy reference. The books are substantially bound in half red morocco, gold stamped, and are printed in large, clear type on special quality paper.

Important Subjects Covered

Theory, Calculation, Design and Construction of Generators and Motors—Electrical Measurements—Electric Wiring—Electric Welding—Types of Generators and Motors—Management of Generators and Motors—Storage Batteries—Electric Lighting—Alternating-Current Machinery—Station Appliances—Power Stations—Power Transmission—Central Station Engineering—Electric Railways, Including Single-Phase—The Electric Telegraph—Telephone Equipment, Systems and Operation—Wireless Telegraph and Telephone—Telautograph, Telephonograph, etc.

NOW SENT FREE The complete seven volumes, not a sample volume, will be sent, express prepaid, for seven days' free examination; returnable at our expense if the books do not contain the information you want. If you keep them, pay \$2.00 seven days after receipt and then \$2.00 a month until you have paid the special introductory price of \$19.80. The regular price of this great Cyclopaedia is \$35.00. Just fill in and mail the coupon. It won't cost you a cent to examine the books. We know they'll be worth many times their cost to you. Mail the coupon now and you'll receive your books promptly.

\$12.00 Consulting Membership Free

With every set is included a year's Consulting Membership, regular value \$12.00, entitling you to the free advice of a staff of Electrical Engineers. This will give you practical help in handling working problems which are too specific to be taken up in detail in the Cyclopaedia. There will be no limit to this service. A single problem solved for you might be worth more than the first cost of the books.

American School of Correspondence
Chicago, U. S. A.

7 DAY EXAMINATION COUPON

AMERICAN SCHOOL OF CORRESPONDENCE, Chicago, U. S. A.

Please send me Cyclopaedia of Applied Electricity for seven days' free examination. I will send \$2.00 within seven days and \$2.00 a month until I have paid \$19.80; otherwise I will notify you and hold the books subject to your order. Title not to pass until fully paid. Pop. Mech. 5-13

NAME

ADDRESS

EMPLOYER

Please Mention Popular Mechanics

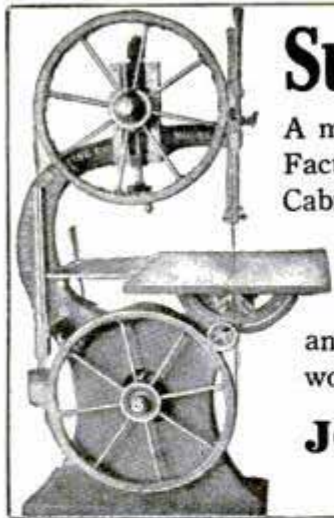

Superior Woodworking Machinery

A modern line of woodworking machinery for Furniture Factories—Piano Factories—Box Factories—Cabinet Shops—Pattern Shops—Carpenter Shops—Wagon Shops—Repair Shops—Contractors—Manual Training Schools, etc. If interested write for our catalogue and *net prices*. Largest manufacturers of woodworking machinery in Chicago.

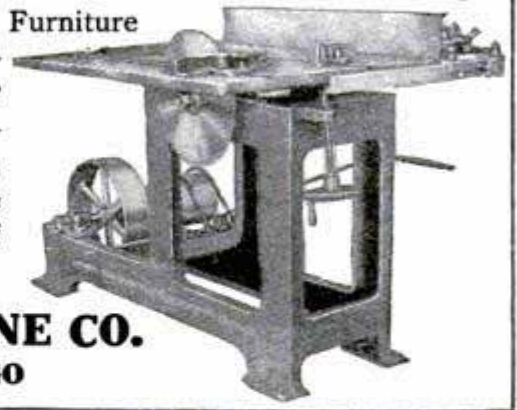

JONES SUPERIOR MACHINE CO.
1726 Dickson Street, CHICAGO



JONES
MACHINE MOULDED
Pulleys and Gears
Clutches, Sprockets
Shafting and Hangers

The Largest
Line of
Power
Transmitting
Appliances
in the country

SEND FOR GENERAL CATALOGUE A18

W. A. JONES FOUNDRY & MACHINE CO., 1400 North Ave., CHICAGO

15 Days' FREE Use

Moth Proof Red Cedar Chest 15 Days' Free Trial



Piedmont Red Cedar Chest makes ideal birthday or wedding gift. **Protect furs and woolens from moths, mice, dust and damp.** Every home needs one. Charmingly useful and decorative. Write for illustrated 56-page **Prepaid** catalog showing all beautiful designs in **Piedmont Chests** and amazing low prices. Also book "Story of Red Cedar". Postpaid. **FREE.** Write today. **Piedmont Red Cedar Chest Co. Dept. 169, Statesville, N.C.**

never rest in its branches.

The gall of the crocodile, when dried in the sun and pulverized, is also deadly.

The telephone has invaded Jerusalem, a system having been installed that connects official points, business houses, and some residences.

I WILL START YOU
earning \$4 daily at home in spare time, silvering mirrors; no capital; send for free instructive booklet, giving plans of operation. G. F. REDMOND, Dept. 306-A, BOSTON, MASS.

(ESTABLISHED 1873)

Charles Buck Tools

Highest Award World's Columbian Exposition
Highest Award World's Centennial Exposition

Send name of dealer and four cents in stamps for new art catalog.

Charles Buck Edge Tool Co., Millbury, Mass., U. S. A.

Grow Mushrooms

Big and Quick Profits

Costs Little to Start a Safe Business

Increase your income \$5 to \$70 a week by learning mushroom culture from biggest mushroom man in the world. Fourteen years' experience enables me to give any man or woman practical instructions worth many dollars. Only spare time required. Can be grown in sheds, old barns, or basements. I have started thousands and will show you how Free. This is your opportunity; send for Free Book giving particulars, how to start, etc. Address



A. V. Jackson, Falmouth Mushroom Cellars, Inc.
24 Gifford Street Falmouth, Massachusetts
Formerly Jackson Mushroom Farm, Chicago, Illinois

Please Mention Popular Mechanics

BAND INSTRUMENTS WURLITZER

Catalog contains 282 pages, 788 illustrations, 67 color-plates. 2561 articles described—all musical instruments and supplies. Superb quality and lowest direct prices. Free trial and easy payments. We supply the United States Government. Mention what instrument you are most interested in. Write for the big **FREE CATALOG**

2 Points of Supply. Address the nearer one.
THE RUDOLPH WURLITZER CO.
101 E. 4th St., Cincinnati 308 S. Wabash Av., Chicago



Your Dealer's Price for This Dining Room Table is \$45⁰⁰

—AND IT IS WORTH IT



Brooks Extension Dining Table No. 311

Constructed of the choicest quarter-sawed Oak, 54-inch top closed, 90-inch extension. Massive, substantial — no furniture you can buy is better made and

Our Factory Price to You is - - - \$22.50

Saving You Over Half Average Retail Price

We absolutely guarantee that you will be satisfied with this piece and everything you purchase of us — or your money will be paid back at once. Write for our beautiful illustrated Furniture Book now and see many more equally attractive pieces at equally low prices for living room, den, dining room, library or bedroom. Everything shipped in complete sections. A few minutes with the screw driver and it is all ready for use.

From Factory to you — that's how we do it. Write for book. It will tell you all about the famous Brooks Furniture and 100 bargains.

BROOKS MANUFACTURING COMPANY
2705 Sidney Street SAGINAW, MICH.

FISH THAT TOW SHIPS.—Towing a ship by becoming entangled in the anchor cable is claimed for the great ray by the fishermen of Florida waters, in which this marine monster abounds. The body of the animal, which sometimes weighs 1,000 lb., has immense black fins and from the head protrude hornlike formations that give the animal a very repulsive appearance.

Grab's Handy Cord Cutter

Big Money for Agents

Here's the quickest seller and biggest money maker that's out this year. It's another one of the famous Grab line of specialties.

Grab's Handy Cord Cutter sells for 25c and every store, jobbing house, mail order house and manufacturer needs from one dozen to a gross. Desirable territory still open, which we will let out to live, responsible people. Grab's Handy Cord Cutter is handsome in appearance, highly nicked finish, has a razor edge blade. One quick pull across it cuts the toughest cord or twine. Is attached to wrapping counter, desk, or ledge. Write today for descriptive matter of this and other Grab specialties. Sample cord cutter sent for 25c.

VICTOR M. GRAB & COMPANY
115 Ashland Block Chicago, Ill.

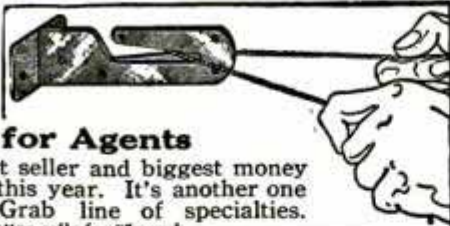

WHAT ONE AGENT DID

One agent went into an Iowa town of 20,000 last week, went right down the main retail street and sold every store from one dozen to a gross of these cord cutters. \$10.25 was his profit in one day.

Learn to Play the Violin or Cornet



Flute, Clarinet, or some other instrument. You'll get enjoyment from it all your life and can make good money playing in Bands or Orchestras if you wish. We include with every instrument an **Instruction Book and Lessons** (by correspondence) **free**. Thousands have learned by this method. Our prices are very low on all musical instruments. We import our Violins direct from best European makers. **Our Special Complete Violin Outfits at \$10 are great value.** Others from \$2.50 to \$25 and up. Cornet Outfits, complete, \$9.25 up. **Band Instruments** of all kinds sent on **Six Days' Trial.** We sell for cash or monthly payments. **Satisfaction guaranteed.** Write for free catalog and mention what instrument you are interested in.

W. J. DYER & BRO. (Estab. 1870) Dept. 101, St. Paul, Minn.

SPECIAL

\$5.90

Size 7 x 7 ft.
Genuine Full Weight
8 oz. Duck



Boys' Special Offer Genuine Wall Tent Complete

Just think of it. This 7x7 foot genuine eight-ounce duck wall tent for only \$5.90. Everything complete. Poles, ropes and pins. Big enough for four boys. Strong enough to stand blizzards or storms. You can have lots of fun this winter. Don't stay in the house. Take your boy friends out in the tent. You cannot possibly get wet. It's nice and warm too. Great to sleep in. Start to save today. Sign your name to the coupon and tear it off and send it to us. We will mail you at once a beautiful book telling you many things you ought to know about outdoor life. This book is absolutely free and prepaid.

Army Shelter Tents

Commonly Called "Dog Tents" — Made up in 2 Sections, Complete with Poles and Pins

Special White Cloth

Special Khaki Cloth

\$2.25

\$3



Just like the regular soldiers use. Boy Scouts all over the country are using them. Can be set up and taken down in a minute. When not in use can be easily carried on your back. Absolutely waterproof. This tent is 5 ft. 3 in. long by 3 ft. 6 in. wide by 3 ft. 9 in. high. The poles are spliced. Every boy ought to have one of these tents. Send your order in today. They are going like hot cakes.

Send FREE Coupon for New Camp Guide

Just put your name and address on free coupon and mail it at once. We will send you our new 1913 Camp Guide. Gives a hundred pointers on camping boys should know. Tells how, when and where to camp out. We also send a list of supplies you need and where you can get them cheapest. Book is sent free and prepaid. No obligations of any kind. Mail coupon now. Do it now as the supply of these books is limited.

FREE
Camp Guide
Coupon

H. Channon Company

Dept. 1195
Randolph and
Market Sts., Chicago

Gentlemen: Please send me, absolutely free and prepaid your new 1913 Camp Guide. Also full particulars of bargains you are offering on tents and other supplies.

**H. CHANNON
COMPANY.**

Dept. 1195
Randolph and
Market Sts.
Chicago
Illinois

Name

Address

Please Mention Popular Mechanics



For Solid Enjoyment

there is nothing like a really good rifle, whether used for indoor or outdoor shooting. You can invest in no better weapon than the

B. S. A. AIR RIFLE

No rifle can excel it for target practice or shooting small game. Absolutely the most economical because ammunition costs almost nothing. Shoots specially constructed "Adder" Pellet. *Special model for ladies and boys. Write for illustrated price list.*

The Birmingham Small Arms Co., Ltd.
Birmingham, ENGLAND

Representative: HENRY SMAIL, Dept. P. M.
106 Worth Street, New York

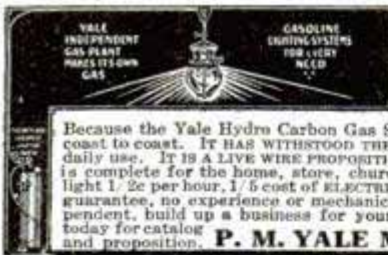

Agents Wanted Everywhere

WHY YOU SHOULD SELL THE YALE LINE

Because the Yale Hydro Carbon Gas System of lighting is known from coast to coast. It has withstood the test of time. Thousands are in daily use. It is a live wire proposition, one of permanency. Our line is complete for the home, store, church, hall, etc. 1000 candle power light 1.2c per hour, 1/5 cost of electricity or gas, sold on a money back guarantee, no experience or mechanical knowledge required. Be independent, build up a business for yourself. We will help you. Write today for catalogue and proposition. **P. M. YALE MFG. CO., CHICAGO, ILL.**

Will you take this:

We want 55 or 40 men right away who can use the following tools: auger, screw-driver, hammer and wrench. We want you to install or put in our Hydro-Carbon Lighting System, and fill orders. We furnish full instructions and complete charts so you can do the work with the common tools named above.



Our lighting system is for farm, village or town homes where for a slight cost we fully equip a house with a perfect, safe, simple, lighting system. The combination of hydro carbon flame and gas mantles produces a bright, steady light, remarkable for its brilliancy compared with regular gas or kerosene lamps. Lights as easily as ordinary gas. No lamps to fill. No grease, grime or dirt. No expensive piping to do, simply a hollow copper conduit wire no larger than a slate pencil. No tearing of floors, breaking plaster, no muss or litter. The wire is easily and quickly passed through partitions attached to mouldings, walls or ceilings.

If you will accept our catalogue and the description of our system, if you are interested in starting a profitable, pleasant business, where you can be kept busy and make big money quick. Let us hear from you. **Write us today**—just on a postal or in a letter addressed to us, write as follows. "Mail full particulars." We will offer you a very attractive opportunity that may mean very much more to you than you think. Address

NAGEL-CHASE MFG. CO.
156 East Erie St. Chicago

Make Your Own Gas

The Detroit Combination Gas Machine provides the home with a Satisfactory Gas Supply. Gas to Light with. Gas to Cook with. Gas to Heat Water for the bath, laundry and other uses common to city coal gas, at no greater cost. On the market over forty years. More than 20,000 in daily use. Our catalog will interest you. Write to-day for copy, and names of users in your vicinity.

Detroit Heating & Lighting Co.
490 Wight Street Detroit, Mich.

Carburetor under ground
Machine in basement

The "BEST" LIGHT

Used in every civilized country on earth. Best and cheapest light for homes, stores, factories and public buildings. Makes you independent of lighting companies. Over 200 styles. Every lamp warranted. Makes and burns its own gas. 100 to 2,000 candle-power. Agents wanted. Write to-day for catalogue and prices.

THE BEST LIGHT CO.
324 East 5th Street, Canton, O.

No Dirt
No Grease
No Odor

2¢ a week

Nulite Portable Parlor Lamp

The cheapest, best and most beautiful light obtainable for town or country. Makes and burns its own gas; 300 C. P. 5 hours for 1 cent. Can be used anywhere with amazing results. Low in price. Thoroughly reliable. Many new and exclusive features. Best proposition of the year for agents. **WRITE TODAY FOR FULL DETAILS**

National Stamping & Electric Works
422 S. Clinton Str., Chicago

Air to Burn

There is plenty of it, and it costs nothing. Most beautiful and powerful light since dawn was invented. Over 500 styles of fixtures for home or business. Write for catalogue.

AMERICAN GAS MACHINE CO.
190 Clark Street Albert Lea, Minn.

Triumph Light

EVERYBODY WANTS BETTER LIGHT. HERE IT IS

This new 100 to 700 candle power light turns up and down like gas. One-third cost of electricity, gas or kerosene. For home, church or store. Anyone can operate. Perfection guaranteed or money back. Write for catalogue (P. O. P.), Dept. 1, Agents Wanted. **BRILLIANT GAS LAMP COMPANY** No. 182 North State Street, Chicago, Illinois

JUBILEE SELF-HEATING FLAT IRON

Best in the world — one replaces the stove and 3 or 4 of the old flat irons. Heat regulated at will — easy to learn. Does beautiful work — thousands in use. Fuel costs 3c for 10 hours. Good seller — Price reasonable. Agents wanted, men and women. Booklet free.

JUBILEE MANUFACTURING CO., 14th and Howard Sts., Omaha, Neb.

Easiest Way to IRON

**30
Days'
Free
Trial**

All ironing drudgery abolished. Every housewife who does her own ironing or employs help to do it, also the Professional Laundress, needs a

Simplex Ironer

"The Practical Household Machine"

to save the time, labor and expense of ironing the old hand way. It produces a most beautiful finish, superior to that of an expert hand laundress, besides insuring longer life to your Linens, Towels, Curtains, Underwear, Flat Pieces, in fact, 80 per cent of your entire ironing.

Costs 1c an hour to heat by gas or gasoline. Also heated by electricity. Easily operated. Reasonable in price.

Mail your request for FREE "Ironing Hints" Booklet and 30 day FREE Trial Offer to us today.

American Ironing Machine Co.
506--168 N. Michigan Blvd., CHICAGO, ILL.

ROYALTY CHERISHES TALISMANS—The superstitious belief in talismans and their influence on the fates of individuals is common to all ranks of society. King George of England has on his automobile a small

BUY PLUMBING SUPPLIES AT WHOLESALE Will Save You 30%



Don't pay retail prices. Full stock on hand for prompt shipment. Send for free catalog.

B. P. KAROL, 768 to 772 West Harrison St., Chicago

Ironing A Pleasure

Self Heating Iron Makes and burns its own gas at one-third cent per hour. Safe and Simple. Saves Labor, Time, and Money.

AGENTS 100,000 in use. Every home wants one. Send for Free Sample Proposition.

NATIONAL STAMPING & ELECTRIC WORKS
421 So. Clinton St. CHICAGO, ILL.

IRON WITHOUT A FIRE

Cut out the drudgery. Save time—labor—fuel. No walking back and forth to change irons—always the right heat for the best work if it's an

IMPROVED MONITOR SAD IRON
Self Heating. Satisfaction Guaranteed

Over half a million Monitors in use. Strong, simple, easy to operate. Heat regulated instantly, no dirt, no odor.

\$10 to \$20 a Day

**Agents, Salesmen
Managers Wanted**

No experience required. Every household a prospect. Sells almost on sight, NOT SOLD IN STORES. Martin, Tenn., made \$5000 in 1 year. Trimmer, Ill., writes, "Sold 12 in 10 hours." Mrs. Nixon, Vt., made \$14 in half a day. You can do it too. Send for big colored circular, shows iron full size explains everything. Exclusive selling rights—no charge for territory.

The Monitor Sad Iron Co., 203 Wayne St., Big Prairie, O.



"Listen! Grandpa"

says little Yim Chong, and Wu Ting Fang listens with delight to his grandson. For the eminent Chinese diplomat and statesman, formerly deaf, hears again. He is one of the 17,000 sufferers from deafness whose hearing has been restored by the remarkable

NEW 4-TONE Mears Ear Phone

is absolutely new and scientifically correct in principle. It has **FOUR TONES**. It is not only four times as helpful, four times as efficient, four times as convenient, and four times as satisfactory as the best device of earlier invention, but its use positively benefits and improves the natural hearing.

This perfected model Mears is instantly adaptable to every condition and requirement. Your finger moves a tiny switch on the back of the receiver and chooses any one of its four different tone adjustments. Every sound made clear and distinct.

Free Trial

Will you try a Mears Ear Phone for ten days in your own home at our expense? Will you believe the evidence of your own ears? The trial cost you nothing. Write us today.



The Offer

In order to give our patrons the *personal* service that is possible only when we deal with them *direct*, we have discontinued all our American Agencies. Our New 4-Tone model ear phone can be had only direct from our New York office. To advertise our new direct selling plan and to introduce the perfected Mears 4-Tone, we are making a **Special Limited Offer** for a short time only.

If you live in New York, call at our offices for free demonstration.

Booklet on Request

Fill out coupon and mail it to us. We will send you promptly the Mears Ear Phone Book. This book explains the causes of deafness, tells how to check the progress of the malady and how to treat it. Mail the coupon today for this book and Special Introductory Offer. Do it now.

Mears Ear Phone Co.

Suite 1195
45 W. 34th St.,
NEW YORK
N. Y.

Name

Address

COUPON

**Mears Ear
Phone Co.**
Suite 1195

45 W. 34th Street
New York, N. Y.

Gentlemen: Please mail me, free and post-paid, your Mears Ear Phone Booklet and particulars of your Special Introductory Offer on your new model Four-Tone Mears Ear Phone and Free Trial Offer.

Pay As You Are Able Your Credit Is Good

FREE
1913
LATEST
SPRING STYLES
ENCYCLOPAEDIA
AND SAMPLES



No Agents—No Canvassing—No Lag

Send your name first—send no money. Get our latest **Big Encyclopedia** of hundreds of latest **Fashions** and **Free Samples** of men's 1913 Spring Suits and Overcoats mailed at our expense.

Dress Like The Best
Guaranteed Perfect Fit
Absolute Satisfaction Guaranteed, or no charge. You'll save big money too. Prices lower than cash tailors and *your credit is good* with us for all you want.

MADE-TO-ORDER Your Own Measure
No extra charges. No interest. No security asked. Save big money and compare our goods and styles with all others. You'll be perfectly astonished at our splendid values.

Take Six Months To Pay Us
You take no risk. Your own eyes judge our values. Select your cloth from our sample book and then let us make your suit to your measure. We guarantee safe delivery and perfect fit, and all is

Sent On Approval
Don't Delay. You can now dress just as you like—have all the latest, swellest clothes—surprise your friends with something in new styles—have bigger selection than any city and town tailors could show you. The magnificent style book is sent free. **Write a Postal Now**, while you think of it, and get our style book.

Stanley-Rogers Co.,
526-536 S. Clark Street,
CHICAGO, ILL.
The World's Foremost Credit Tailors for Men

WRITE US TO-DAY

Caution: NO AGENTS, NO CANVASSING, NO COLLECTORS

HEAVEN AND HELL Swedenborg's 400 page work, 15 cents, postpaid.
PASTOR LANDENBERGER, Windsor Place, St. Louis, Mo.

Save \$1.25



\$2.75 For This \$4.00 All Leather Shoe

Why pay dealers and jobbers extra profits—buy direct and save your shoe money. This splendid "LOTZ SPECIAL" (black) shoe is a wonder for either dress or work. Gun Metal side. Guaranteed All Pure Leather, half double sole, reinforced shank, Rocker last. Handsome, durable, stylish; easily worth \$4.00—our **DIRECT** bargain price only \$2.75—any size—delivered prepaid. Money back if not the best shoe value you ever saw. Saves you \$1.25.

\$2.75 Prepaid Illustration above shows one of many styles for men—all bargains! Send for Free Circular showing some money-saving shoe offers. Name and address brings it.

LOTZ BROS., 111 NO. MAIN ST., ST. LOUIS, MO.

ILLINOIS

Best WATCH on Earth NOW SOLD ON CREDIT

For the first time in history the great, genuine **ILLINOIS** Watch is now sold exclusively by us by mail on credit. This is the greatest public triumph of the age—it will revolutionize the Watch business. For over 40 years the **ILLINOIS** Watch has been acknowledged the standard Watch worn by America's great men and women. No man or woman should now be without a famous **ILLINOIS**.

Take Your Own Time To Pay

Iron-Clad Guarantee
Part for part—in accuracy, wear, finish, beauty, material and workmanship, the **ILLINOIS** is superior to any other Watch at any price. Both the makers and we stand back of this Watch with a guarantee that absolutely protects you. We are one of the largest Watch Distributors in the world. For over 35 years we have sold all kinds of Watches, and honestly tell you that the **ILLINOIS** is the best at any price.

NO MONEY DOWN
The famous **ILLINOIS** costs you less than inferior makes. Nowhere else can you buy a genuine **ILLINOIS** on our terms. No dealer can undersell us even for cash. Sent on approval—you take no risk—pay as you please.

HANDSOME BOOK FREE
Our **FREE**, beautiful, profit-sharing book, describing the **ILLINOIS** Watch, easy credit terms, and reproducing many handsome styles, awaits you. Send name and address today.

FREDDRO WATCH CO., Dept. 300, St. Louis, Mo.

SENT FREE—NO PAYMENT DOWN

brass figure of Britannia, holding a crown in outstretched hands and at whose feet a lion crouches. He never undertakes a trip without it. The Czar possesses a protecting ring which contains a piece of wood said to have come from Christ's cross. He always wears this, and further insists that a gold watch belonging to him must never, under any circumstances, stop running. A

We Dress You Better

For less money or no charge. Suits made to order \$15. Pants \$3.50. Express prepaid. No agents. Send for samples stating colors preferred.

Peerless Tailors, Pine St., Chambersburg, Pa.

THIS THIN MODEL 20 YEAR WATCH \$2.95

Elegant hunting case beautifully engraved, gold finished throughout, stem wind and stem set, fitted with finely finished ruby jewel movement, guaranteed a correct timekeeper, with long gold finished chain for Ladies or vest chain for Gents. Let us send it C. O. D. for examination at your nearest express office. If you think it a bargain and equal in appearance to any \$15.00 gold finished watch pay the express agent our special sale price \$2.95 and express charges, and it is yours. If you send \$2.95 with order we will send by insured parcel post. Mention if you want Ladies' 6 size, Boys' 16 size or Gents' 18 size. Address Mutual Sales Co., P29, 306 W. Madison St., Chicago, Ill.



HUNTING CASE

BE YOUR OWN BOSS



Agents
Earn Big Money Selling Golden Rule genuine hand forged English razor Steel Knives, that will cut and hold the edge. We will put any photo or lodge emblem on one side of the transparent handle and name and address on the other. We have a complete, fully guaranteed line of knives, razors, strops and cutlery specialties. Quick sales. Big Profits. Exclusive territory. Experience unnecessary. We teach you how. Write today for Catalog and Terms. **Golden Rule Cutlery Co., 552 W. Lake St., Dept. 202, Chicago**

GENUINE Perfect Cut DIAMONDS BASCH \$97.50 PER CARAT
 Guaranteed

No. 19A13
\$48.75
1/4 Carat Solitaire

No. 19A14
\$12.00
1/4 Carat Solitaire

No. 19A15
\$11.25
1/4 Carat Solitaire

No. 19A16
\$38.00
Two 1/4 Carat Dia.

\$97.50 PER CARAT

saves You \$50 Per Carat—35%

Here are our IMPORTER'S PRICES, the lowest in the world: 1/8 carat \$8.25; 1/4 carat \$17.50; 1/2 carat \$45.00; 3/4 carat \$67.50; 1 carat and larger, **\$97.50 per carat!** Enormous sales, reaching every community—importing direct from the diamond cutters TO YOU—*cash methods*, low expenses, no losses,—all these *combine* to save you **\$50 per carat, 35%** below the retailer's prices.

We Legally Guarantee to Refund the Full Price in Cash, Less 10%, Any Time Within 2 Years; and to allow you to return any Basch diamond in exchange at the full price, at any time! We legally certify the **carat weight, quality and value, in writing!** Our wonderful guarantee insures your **absolute satisfaction**, protects you against loss, makes you certain about the **value** you secure for your money! **We ship any diamond you select**, allowing examination, to your own express office or bank, absolutely without cost or risk, or obligating you to buy. **You see before you pay!**

104 Page De Luxe Basch Diamond Book, Free to You!
 Tells you how we have succeeded in making a price of **\$97.50 per carat**, the world's lowest price for **genuine perfect cut diamonds**; explains the **BASCH PLAN and GUARANTEES**; illustrates thousands of articles in Diamond, Platinum, Gold and Silver Jewelry; Watches, Silverware, Cut Glass, etc. Enables you to judge diamond values; to buy diamonds intelligently! Write Now! for your free copy! Address

No. 19A17
\$33.50
1/4 Carat Solitaire

No. 19A18
\$61.25
1/4 Carat Solitaire

No. 19A19
\$50.50
1/4 Carat Solitaire

No. 19A20
\$74.50
1/4 Carat Solitaire

No. 19A21
\$103.50
1 Carat Solitaire

L. BASCH & CO., Dept. B 247, S. State St. Chicago, Ill.

Prices are for Diamond and Mounting complete. Any article shipped on approval

misfortune-bringing opal ring connected with many royal deaths in Spain was finally fastened by Queen Christina to the statue of the Virgin of Almadena in Madrid. Though it is easy of access and very valuable, the worst Spanish thief would not dare steal it. Napoleon had a talisman that insured, he believed, certain

Rapid Fireless Cooker Get My 1913 **SPECIAL Price Offer**



Saves 1/3 food bill, 1/3 fuel, half your work, and food tastes better.
30 DAYS FREE TRIAL
 Complete outfit aluminum utensils free. Covers and cooking compartments lined with pure aluminum. Dust-proof, odorless.
Write for Free Book and direct-from-factory prices.
WM. CAMPBELL CO., Dept. 64, Detroit, Mich.

Man-Smoke This



It's puff after puff of indescribable smoking delight when you light a pipeful of French's Mixture. Words cannot do justice to the fragrance, richness and smoothness of this charming blend of North Carolina Red and Golden Leaf. Examine it under a microscope and you will find it to be the cleanest and purest. Smoke a pipeful and you will tell your friends that French's Mixture is the most satisfying and economical tobacco you ever touched a match to.

Scotch Calabash Pipe Free

Don't pay your good money for stale tobacco from the dealer's shelves. Get that pleasing, mellow French's Mixture that comes fresh and sweet to you direct from the factory. If you want to get more pleasure out of smoking than you ever before got, just send 40c for 1-4 pound of French's Mixture (granulated) or 45c for 1-4 lb. of French's Long Cut. Send now and we will include—FREE—a Scotch Clay Calabash Pipe.

Sample Pouch Send 10c (silver or stamps) for a large sample pouch of this delicious age-ripened tobacco.
FRENCH TOBACCO CO., Dept. 5249, Statesville, N.C.

AGENTS SALESMAN MANAGERS YOUNG OR OLD NEW BUSINESS



NEW BUSINESS JUST OUT
 DROP THE DEAD ONES. AWAKE! START WITH THIS NEW INVENTION, THE 20th CENTURY WONDER
 Get started in an honest, clean, reliable, permanent, money-making business. Sold on a money-back guarantee

The Blackstone Water Power Vacuum Massage Machine For the Home. No Cost to Operate. Lasts Life-Time

LISTEN No Competition, New Field, New Business. Price within reach of all. That's why it's easy to sell. Endorsed by Doctors and Masseurs. Removes Wrinkles, rounds out any part of the face or body, brings back Nature's beauty. Almost instant relief can be given all kinds of pains. A demonstration convinces the most skeptical person. Sales easily made.

Read On! What Others Do, So Can You.
 Parker writes, sold eight machines first day. Margwarth, says, I am making \$19.00 per day. Schermerhorn, eight dozen machines first month. Shaffer writes, am selling four out of five demonstrations. Vaughn, orders one dozen, four days later wires "ship six dozen by first Express." Lewis, sells four first hour. Men, women, everybody makes money. No experience necessary. Protected territory to active workers. We own all patents. Big book entitled, "The Power and Love of Beauty and Health" Free. Investigate now, today. A postal will do. A big surprise awaits you. Address,
BLACKSTONE MFG. CO., 702 Meredith Bldg., TOLEDO, O.

AGENTS GENERAL AGENTS ROAD MEN MAKE MONEY HERE Start Now—Today



Are You a Live Wire?



Are you one of the want-to-go-ahead class? Let **Parcels-Post** help you make money. We, as manufacturers, need you—you need us for mutual profits.

DEAL DIRECT With the Manufacturer

We are ready and going to appoint **co-workers** under our simple co-operative "tried out" and successful selling methods for local or mail-order business. A **profitable business** can be conducted from your own home. Small capital and spare time required to start. **Big Profits. Experience Not Essential.**

Warehouse privileges free

Manufacturer's co-operative working plan and **Detailed Information** of our latest patented ideal repeat order **Mail order "money-getters."** Positive proofs and sworn statements now ready and waiting to be mailed **FREE** to you. It's up to you to write. **J. M. PEASE MFG. CO., 807 Pease Bldg., Main St., Buffalo, N. Y.**



Large modern Factory and ground it stands on. Owned and occupied by us alone

Price \$7.50 Up

Made \$30 First Day

B. Basha, of Bell Island, Newfoundland, did this with our

CHAMPION MINUTE PHOTO MACHINE

That beginners make such profit at the start, shows that **no experience is needed** in this wonderful money-making business. Robt. Bock, Willow Hill, Pa., took in \$35 in one day. Vernard Baker, Holbrook, Neb., \$29.90. Jas. F. Wende, Ashton, Idaho, \$26. C. V. Lovett, Ft. Meade, Fla., made \$50 in one day. These testimonials are just a few of many hundreds we have on file.

Pictures in Post Cards and on Buttons all the rage at Fairs, Carnivals, Picnics, Resorts, Schools, Depots, Factories, on Streets—anywhere—everywhere. Our Champion Camera takes pictures size $2\frac{1}{2} \times 3\frac{1}{2}$, $1\frac{1}{2} \times 2\frac{1}{2}$ and buttons. Finishes complete photo in 30 seconds; 200 an hour. **No dark room.** Easiest, quickest, biggest money-maker known. Small investment. About 85c profit on each dollar you take in. *Be your own boss.* Write at once for Free Book, Testimonials and Liberal Offer.

AMERICAN MINUTE PHOTO CO.

2214 Ogden Ave., Dept. E 318 CHICAGO, ILLINOIS

\$29.50 In Two Days

is what Mr. Ewald of Illinois made with our **DIAMOND POST CARD GUN**

You can do as well. It takes 3 sizes Photo Post Cards on Paper **DIRECT**

WITHOUT PLATES OR FILMS

Also Button Photos finished on the **SPOT** in $\frac{1}{2}$ minute. No canvassing. Experience unnecessary. 8c profit on every dime. **\$7.50 up.** Circulars of this new invention mailed **FREE.** **THE INTERNATIONAL METAL & FERROTYPE CO., Dept. 501, Chicago, Ill.**

Only \$36.00 The Wonderful ILLUSTRATOR LANTERN

With our improved famous **ALCO RADIANT LIGHT.**

This new 1912 Model has many improvements and double brilliancy. Write for illustrated circular of this and Lanterns of all styles and lights at bottom prices. **IF YOU OWN A LANTERN** we should have your name to mail to you our regular announcements of new slides and lecture sets. 75,000 Lantern Slides to rent. **POST CARD MAGIC LANTERN** reflects image of postcard or any other picture or object. Prices, \$2.75, \$12.50, \$25.00, \$80.00, express paid.

WILLIAMS, BROWN & EARLE, Inc., 918 Chestnut St., Philadelphia, Pa., Lantern Dept. 20
Engineering, Microscope, Optical, Scientific, Photo Lantern Slide Supplies

Rémoh Gems Look and Wear Like Diamonds

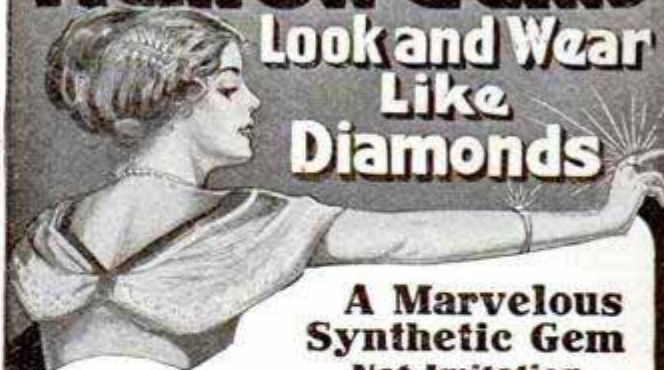

A Marvelous Synthetic Gem Not Imitation

—the greatest triumph of the electric furnace. **Will cut glass**—stands filing, fire and acid tests like a diamond—guaranteed to contain no glass. Remoh Gems have no paste, foil or backing—their brilliancy is guaranteed forever. One-thirtieth the cost of a diamond. These remarkable gems are set only in 14 Karat Solid Gold Mountings.

Sent On Approval Anywhere In U. S.

—your money cheerfully refunded if not perfectly satisfactory. Write for our 4-color De Luxe Jewel Book—yours for the asking. Address

Remoh Jewelry Co.,
622 Washington Ave., St. Louis



protection from untimely death, which he handed down to his heirs. The late King Edward of England would never separate from a bracelet which he wore on his left arm.

WATER POURS OUT **AGENTS \$35 TO \$75 A WEEK INCOME** New invention. Scrubs, takes up water. No wringing, no cloths, less work. Big sales—big profits. Exclusive territory. Write today. Special terms. **PIRRUNG MFG. CO., Dept. 270, Chicago, Ill.**



\$15.00 to \$35.00 Per Day Easily Made

Taking photographs with our **ONE MINUTE TINTYPE and POSTCARD CAMERAS.** Pictures made direct without use of negatives. Toned, fixed and developed in one solution. No experience or dark room necessary. **Cameras from \$10.00 up to \$35.00 each.** Complete photos cost 1c to 2c each, sell for 10c, 15c and 25c each. *Send for Free Catalogue and Price List today.*

NEW YORK FERROTYPE CO., 168 Delancey St., New York City, Dept. III
Branch 113 S. Halsted Street, Chicago, Ill.

GO INTO THE

Moving Picture Business

From \$50 to \$75 starts you and you will earn as much in 1 or 2 nights

\$25 And more per night can be made exhibiting

with our machine in halls, schools, churches, theaters, etc., in your own and surrounding towns. We furnish everything—rent films, too. Only a small payment required to get this new and unexcelled machine. Balance may be paid in easy installments. Write for particulars

P. & W. Sales Company
443 So. Dearborn St., Chicago, Ill.



OVER 65 YEARS' EXPERIENCE

PATENTS

TRADE MARKS
DESIGNS
COPYRIGHTS, &c.

Anyone sending a sketch and description may quickly ascertain our opinion free whether an invention is probably patentable. Communications strictly confidential. **HANDBOOK** on Patents sent free. Oldest agency for securing patents. Patents taken through Munn & Co. receive *special notice*, without charge, in the

Scientific American.

A handsomely illustrated weekly. Largest circulation of any scientific journal. Terms, \$3 a year; four months, \$1. Sold by all newsdealers.

MUNN & CO. 359 Broadway NEW YORK

Branch Office, 625 F St., Washington, D. C.

\$513 Clear Profit First 51 Days from an Investment of \$175



is the result of operating one American Box Ball Alley. Four others took in \$8,540 first 16 months. Many pay for themselves first month. Go into this business yourself. You can start with \$75. No gambling device, but most practical and popular bowling game in existence. Splendid for high-class amusement and physical exercise. Liberal patronage by good people everywhere. Many sales to churches, schools, homes. Quickly installed—easily portable. No helpers required—really automatic—small expense—receipts nearly all profit. We sell only one person in each locality. Get this monopoly now. Easy payments. Catalog free.

AMERICAN BOX BALL COMPANY, 1301 Van Buren St., Indianapolis, Ind.

DIAMONDS SELL FOR \$100,000,000 A YEAR— The present expenditure of \$100,000,000 yearly for diamonds indicates the world's prosperity and also increased supplies due to the African mines. The production of rough diamonds has reached 8,000,000 carats a year, valued at \$50,000,000. After syndicate, commer-

GO INTO THE MOVING PICTURE BUSINESS



On Our **Easy Payment Plan**
Make \$20 to \$50 per night

With our Moving Picture Outfit. We sell everything—Films, too. Write for our Catalog.
MOVING PICTURE SALES CO.
Dept. A, 219 S. Dearborn St., Chicago, Ill.

PARISIAN GEMS

A Real Gem Full of Fire and Brilliancy

The most remarkable scientific discovery of the age; a dazzling, scintillating gem. Parisian Gems have the fiery beauty of genuine diamonds; will cut glass and retain their brilliancy; guaranteed for 20 years. Set only in genuine solid gold 14k mountings.
Sent on Approval: See Them Before Paying
Write for Illustrated Price List

PARISIAN GEM CO.
Dept. 0, 621 Broadway, New York



1 CARAT GEM 14 K. SOLID GOLD LADIES RING \$5.00



1 CARAT GEM 14 K. SOLID GOLD MEN'S RING \$7.50

* SEE * THEM * SPARKLE *

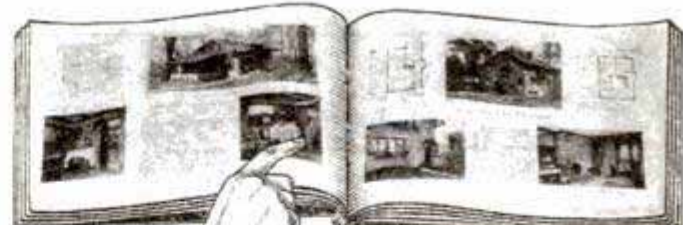

Sent Free

HERE is your chance to secure absolutely **FREE OF CHARGE** the most complete and up-to-date plan book ever published. No carpenter or contractor who wishes to be familiar with the latest in building construction—no man who is contemplating erecting a home—can afford to be without it. This great new plan book, "**Modern American Homes**," contains plans and specifications for 168 different structures, including excellent exterior and interior views, detailed estimates, etc. Designed by the leading architects of this country. Includes city, country and suburban homes, bungalows, farm houses, summer cottages, tent houses, camps, garages, apartment houses, and various public buildings. Contains 224 pages, 9½ x 12¾ inches, and 426 illustrations. Printed on heavy enameled paper and substantially bound.

THE CYCLOPEDIA OF Architecture, Carpentry and Building



consists of ten massive volumes; 4,760 pages, 7x10 in.; 4,000 illustrations, full page plates, building plans, diagrams, etc.; hundreds of valuable tables and formulas; carefully cross-indexed for quick, easy reference.

This work covers everything in the building professions, from the first rough sketch of the architect to the acceptance of the finished structure. It includes wood, stone, steel, and reinforced concrete construction; estimating and contracting; a study of the Greek and Roman Orders; interior finishing and decorating; and modern house lighting and sanitation.

Partial Table of Contents—
Mechanical, Freehand, Perspective and Architectural Drawing, Lettering, Pen and Ink Rendering, The Orders, Superintendence, Strength of Materials, Masonry, Reinforced Concrete, Carpentry, Steel Square, Stair-Building, Hardware, Steel Construction, Roof Trusses, Practical Problems, Estimating, Contracts, Specifications, Building Law, Sanitation, Sheet Metal Work, Electric Wiring and Lighting.

We'll Send the Plan Book FREE

With every order for a Cyclopaedia we will include the Plan Book, absolutely free of charge and send you the Cyclopaedia and the Plan Book, express prepaid, for seven days' free examination. You keep the books a full week—examine them thoroughly at your leisure—and if they don't meet with your expectations they may be returned at our expense. Remember—the complete set, Cyclopaedia and Plan Book, are sent free upon receipt of the coupon below and we pay express charges both ways if they are not satisfactory.

Another Free Offer With each set is included a year's Consulting Membership, regular value \$12.00, entitling you to the free advice of a corps of Expert Architects. This will give practical help in handling building problems which are too specific to be taken up in detail in the Cyclopaedia. This service alone is worth more than the first cost of the books.

American School of Correspondence, Chicago, U. S. A.

FREE PLAN BOOK COUPON

American School of Correspondence, Chicago, U.S.A.

Please send Free Plan Book, also Cyclopaedia of Architecture, Carpentry and Building for seven days' examination. I will send \$2.00 within seven days and \$2.00 a month until I have paid \$24.80 for Cyclopaedia (Plan Book included free), or notify you and hold books subject to your order. Title not to pass until fully paid. Pop. Mech. 5-13

NAME

ADDRESS

OCCUPATION

EMPLOYER

Please Mention Popular Mechanics

Bristling With Good Points

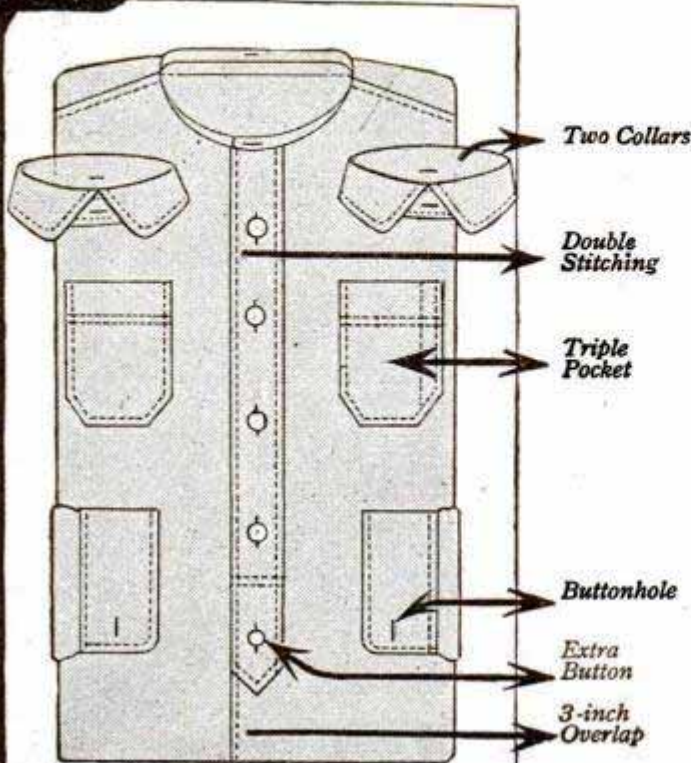

These shirts you ought to know because they have more comfort features than any other shirts at any price and their wear is guaranteed.

SIGNAL \$1 Coat Shirts

Union Made Two detachable collars are the only shirts combining all these improvements. Extra button at bottom of breast plait for smooth fit. Rip-proof, gap-proof, sleeve slit, specially cut skirts overlapping three inches in front. Two detached or one attached collar. Buttonholes for white cuffs. Double-needle machine stitching. Two pockets—one a triple pocket.

The easy-on, easy-off coat style makes short work of dressing and undressing. Made from fast color, shrinkless percales in a big variety of neat patterns. Only expert union labor employed. You can't get a good shirt for less. You can't get a better work shirt for more.

Sent at Our Risk. Ask your dealer. If he hasn't them, tell us his name and your size and we will express a couple C.O.D. If not delighted with them on examination, return at our expense! Write for folder showing big variety of other styles, and sample swatches.

Hilker-Wiechers Mfg. Co.
Manufacturers of SIGNAL Work Clothes
1256 Mound Ave., Racine, Wisconsin

Remington Arms—Union Metallic Cartridge Co. Arms and Ammunition 299 Broadway, New York

Rust Squeaks

positively prevented by 3-in-One on anything metal indoors or out; keeps everything bright; oils everything right; free from acid; free sample.

stopped; 3-in-One oils everything right, locks, clocks, hinges, sewing machines, typewriters; generous free sample sent by **THREE-IN-ONE OIL CO.**, 42CNB, Broadway, New York.

cial and dealers' profits are added to duties and royalties, the consumer pays \$100,000,000. A royalty of 60 per cent is paid on certain African diamonds. A movement has just been consummated that threatens to enhance even these enormous expenses to the consumer, by lowering the standard of weight. Americans greatly

21-JEWEL \$25.00 WATCH

Do you want a Gold Watch? If so, without a cent deposit—we will send this 25-year, fully guaranteed American made watch, beautifully engraved, open face or hunting case, ladies' or gents' size. If it pleases you and you think it equals any \$25 gold watch you have ever seen, you can pay us \$3.95. We let you see, test and examine it, if you send name and address.

RANDOLPH WATCH CO., Dept. 41, CHICAGO



Mount Birds

We teach you **by mail** to stuff and mount all kinds of **Birds, Animals, Game Heads**. Also to tan skins and make rugs. Be your own taxidermist. Decorate your home with your beautiful trophies or increase your income selling specimens and mounting for others. Easily, quickly learned in spare time by men and women. Highest endorsements by thousands of students. Write today for our great free book "**How to Mount Birds and Animals**" free—write today. **N. W. School of Taxidermy, 1195 Elwood Bldg., Omaha, Neb.**



Parquet

A NEW WALL AND FLOOR COVERING Surface Oak Fiber Veneer

A facsimile of the oak itself, is used the same as wall paper, full directions in each roll. Sufficient quantity in one roll to lay a border around a floor 16'x16', made in two shades, light oak and dark oak, in two patterns Parquet and Quartered, as cut above. Rolls are 36" wide, 11½ yds. long, printed in all oil colors, on a heavy Manila Fiber stock. When finished looks like a parquetry or oak floor. Roll delivered anywhere in the U. S. for **\$1.50**



Quartered Oak

HUGH SILVER & SON OGDENSBURG, N. Y. and Prescott, Ontario, Canada

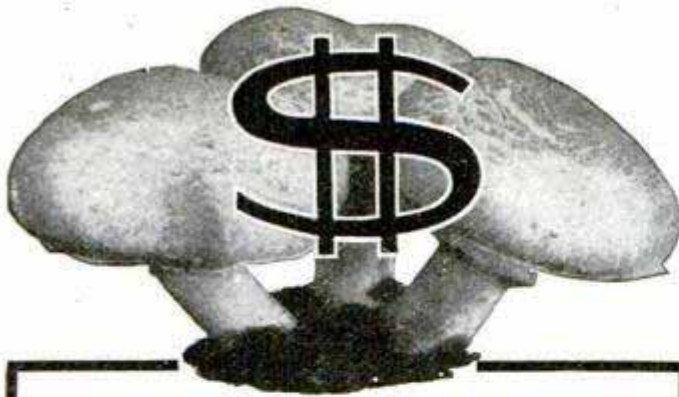

The Truth About Mushrooms

Big, Quick Profits. Small Capital. Now Is Best Time.

Biggest, quickest, surest and easiest money-maker is growing mushrooms. Bigger money is being made in mushrooms now than ever before, by those who are today putting in practice the great revolutionary improvement in mushroom culture explained in our new book, "The Truth About Mushrooms." Open your eyes to an opportunity you never realized. No matter what your occupation or location, you can now

Add \$10 to \$70 a Week to Your Income

without interference with present work. Small capital to start. Men and women can easily do it. Now is time to start. This great book explains everything from A to Z, and things which even many mushroom growers never knew before. Get first-hand information from the greatest practical authority. Start in the world's best-paying business now. Grow in cellars, sheds, boxes, etc., or increase your profits many fold if you are already a grower. Send for the free book today sure.

Bureau of Mushroom Industry, Dept. 10, 1342 N. Clark St., Chicago, Ill.

lead in buying, for nearly one-half of the world's total product is bought by them. British South Africa is far to the front in production with 5,586,625 carats. German Southwest Africa, Brazil, British Guiana and British India together yield only 1,104,000 carats, while the rest of the world combined produces 1,309,375 carats.

Do Your Printing!
 Cards, circulars, books, newspaper. Press \$5, Larger \$18, Rotary \$60. Save money. Big profit printing for others. All easy, rules sent. Write factory for press catalog, TYPE, cards, paper, outfits, etc.
THE PRESS CO., Meriden, Conn.

BUYS THIS PRINTING PRESS
 The "Ideal" is an absolutely practical printing press, suitable for store, office or home. It's a wonder—always ready for work. Save dealers' profits. Write for a copy of our free catalog of printing presses and supplies.
IDEAL PRESS CO., CHICAGO, ILL.

Folding BATH TUB
 Costs little, no plumbing, requires little water. Weight 15 pounds, and folds into small roll. Full length baths, far better than tin tubs. Lasts for years. Write for special agents offer and full description.
ROBINSON MFG. CO., 130 Vance Street, TOLEDO, OHIO. Manufacturers Turkish Bath Cabinets.

GET ON THE VAUDEVILLE STAGE
 I tell you how! Fascinating profession for either sex. Big salaries. Experience unnecessary. Splendid engagements always waiting. Opportunity for travel. Theatrical agents and authorities endorse my methods. Thirty years' experience as manager and performer. Illustrated book "All About Vaudeville" absolutely FREE. Send me your name and address TODAY.
FREDERIC LA DELLE, Sta. P., JACKSON, MICH.

BLUE WHITE GENUINE DIAMONDS
 MODERATE PRICES EASY TERMS

Buy direct from Importers and Save Dealer's Profits. Startling low prices—and pay in little amounts from time to time.

Certified Guarantee with every Diamond—guaranteeing its weight and quality. A safe way to buy and save money—no inconvenience—and have the Diamond now. Perfectly cut, blue white Diamonds, gleaming, sparkling, scintillating—genuine high quality. Not a cent to pay until you have examined the Diamond. We send you free magnifying glass. Any diamond in our

Beautifully Illustrated Diamond and Watch Free Catalog will be sent for examination without obligation. This offer is open to every honest person—OPEN TO YOU. Note the wonderful values shown here—No. 40-1-2 kt.; No. 42-5-8 kt.; No. 43-1-4, 1-16 kt.; No. 46-3-8 kt.; No. 47-5-8 kt.; No. 48-3-8, 1-16 kt.; No. 49-5-8, 1-16 kt. Compare these prices with others. We import the rough Diamonds, cut them here, save 35 percent duty. Give the saving to you. Write today for our BIG CATALOG and SPECIAL WORLD-BEATING OFFER of One Carat Diamonds for only \$100.

All Diamonds, also watches, on easy terms—no money first. Send for Catalog today.

The Walker Edmund Co., DIAMOND IMPORTERS
 Dept. C
 State and Madison Sts., Chicago, Ill.

40 \$65. 46 \$35. 42 \$55.
 45 \$40. 47 \$90. 48 \$60. 49 \$100.

I will send as long as they last my 25 Cent Book

STRONG ARMS
 For 10c in stamps or coin

Illustrated with 20 full page halftone cuts, showing exercises that will quickly develop, beautify, and gain great strength in your shoulders, arms, and hands, without any apparatus.

PROF. ANTHONY BARKER
 644 Barker Bldg., 116 W. 42d Street, New York

To Entertain 311 Jokes and Riddles, 73 Toasts, 91 Parlor Amusements, 21 Puzzles, 15 Tricks with Cards, 7 Comic Recitations, 3 Monologues, 12 Funny Readings, 8 Fortune Secrets, 52 Money Making Secrets. All 10c postpaid.

J. C. DORN, 709 S. Dearborn St., Dept. 17, CHICAGO, ILL.

Boys' Own Toy Maker
 Tells how to make a Talking Machine, Camera, Electrical Motor, Bicycle Boat, Canoe, Boomerang, Bobsled, Wind Mill, Microscope, Water Wheel and Motor, Stilts, Toboggan, Snow Coaster and Sail Boat, Telephone, Electric Bell, Railroad, Wind Mobile, Paddle Raft, Traps, Kites, etc. All 10c, postpaid.

J. C. DORN, 707 So. Dearborn St., Dept. 38, CHICAGO, ILL.

EARN \$3 TO \$9 A DAY
 Mechanics, Millmen, and Shopmen make extra money during spare time selling Photo Knives and Razors with Scientifically Tempered Blades. Sales easily made. Special agents instructions. Write today for Special Outfit offer.
CANTON CUTLERY CO., Dept. 259, CANTON, O.

RED OR BLACK LONG OR SHORT "VULCAN" INK PENCILS
 The ONLY perfect, non-leakable ink pencils at a moderate price.

A smooth, perfect pen unequalled for writing, ruling and manifolding.

TWO SIZES
 4 1/2 & 5 1/2 INCHES

LASTS A LIFETIME. (Extra size, 8 inches (black only) \$1.25.)

J. C. ULLRICH & CO., 27 Thames St., New York **Established 1884** **AGENTS WANTED**

By mail, postpaid upon receipt of PRICE.

4 Pictures a Minute

Taken Direct on Full Size Post Cards
Read This

On the trip I just came off of I made \$55 in one day and could not turn out work fast enough," says Ethan Allen, Washington.
And This—"Typhoid got me and took \$10 a day away from me," McDowall of New York.

These and many other letters prove you can do as well or better with this absolutely

I made \$55 in one day

NEW - PLATELESS DAYDARK

(Trade-Mark)
DIRECT ON POST CARD

A new, high class business with tremendous money-making possibilities requiring no experience—no canvassing. **No plates, films or printing—finish what you take where you take it.**

Big Money—Small Investment

working picnics, fairs, from house to house or at home—out of doors or indoors—anywhere, making four finished pictures a minute of any subject.

4 THINK OF IT **4**
Times as many pictures
Four Times as fast
Four Times the profit

FREE Investigate—write to-day.
for our Daydark catalog—just issued.
Write that postal NOW
Daydark Specialty Co. 502 Daydark Bldg., St. Louis, Mo.



\$5.50 buys this GUARANTEED TENT

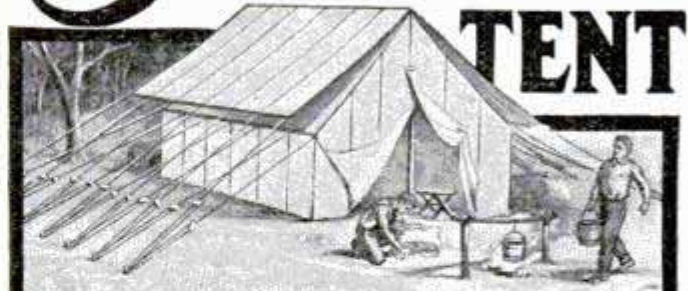

Unheard of Introductory Price

Wall Tents Full weight, 8 oz. Duck, double lap seams, complete with tent poles, ropes, pins, etc. All ready to set up—Wonderful bargains.

7 x 7.....	\$5.50	12 x 14.....	\$12.25
7 x 9.....	6.55	14 x 16.....	16.00
9 1/2 x 12.....	9.10	14 x 18.....	17.25

These Exceptional Bargains

are offered for a short time only. Save money by buying direct from the largest, most reliable manufacturers of Tents, Awnings and Campers' supplies in the country. Supplying the U. S. War Department.

Let us tell you about our new Watershed and Mildew Proof Process. Write at once for free descriptive booklet and price list on everything made of canvas.

Get your letter to us quick before these big bargains are snapped up.

THE HETRICK BROS. COMPANY
1217 Fernwood Avenue Toledo, Ohio



AGENTS STEADY INCOME

Wide Awake Men and Women. You can secure protected Territory to sell International Portable Lamps and Lighting Systems. Our Self-Heating Sad-Iron is positively the simplest and most practical Iron on the market. We challenge competition. **Your Chance.** Territory is being rapidly taken. If you want a good steady income write to us Today.

International Light, Novelty & Specialty Co.,
311 River Street, Dept. 36, Chicago, Ill.



Would You

Show this wholly visible Typewriter to your friends and let them see wherein it excels any \$100 Typewriter made, if we would send one to you **Free of One Cent of Cost** for you to keep forever as your own? Then on a postal card, or in a letter to us, simply say: Mail particulars.

EMERSON TYPEWRITER CO., Box M2716, Woodstock, Illinois

BUY YOUR FURNACE \$10 DOWN \$10 A MONTH



Our monthly payment plan of selling direct saves you the dealer's profits and charges for installation. The

JAHANT FURNACE

with the patented "Down Draft System" is best for residences, schools, hotels, churches, etc., because it delivers plenty of heat wherever and whenever desired at a saving of 1/3 to 1/2 in fuel bills. Install the Jahant yourself. We send complete outfit, freight prepaid, with special plans, detailed instructions and all necessary tools for installation. Satisfaction guaranteed or money refunded.

Write for free illustrated book.

THE JAHANT HEATING CO.
168 Mill Street AKRON, OHIO

Save 1/3 to 1/2 on Fuel Bills

WRITE FOR BOOKLET OF INVENTOR'S SUPPLIES

UNION MODEL WORKS (Established 1882) 119 S. Clark St., CHICAGO
The oldest, most reliable, most efficient model making and experimental house in the west



WHITE VALLEY GEMS IMPORTED from FRANCE!

SEE THEM BEFORE PAYING! These gems are chemical white sapphires — LOOK like Diamonds. Stand acid and fire diamond tests. So hard they easily scratch a file and will cut glass. Brilliance guaranteed 25 years. All mounted in 14K solid gold diamond mountings. Will send you any style ring, pin or stud for examination—all charges prepaid—no money in advance. Write today for free illustrated booklet, special prices and ring measure. **WHITE VALLEY GEM CO., Dept. E-901 Saks Bldg., Indianapolis, Ind.**

NO MORE BALD HEADS



When our VACUUM CAP is used a few minutes daily. We accept no pay until you have tried the Cap 60 days and are satisfied. The Vacuum Cap is an appliance that draws the blood to the Hair Roots and starts a new healthy crop of hair. It stops Dandruff, stops the hair from falling out. Bought by Doctors and men who

know that it is the only reasonable HAIR GROWER known to science. No Drugs Used. Write for application blank, testimonials, and booklet on "HAIR," sent sealed in plain envelope, FREE.

THE MODERN VACUUM CAP CO.

T. 559 BARCLAY, DENVER, COLO.



Send \$
One
Dollar
for this Watch

**Genuine Illinois
Guaranteed 20 Years**

You can own a watch now that is a real worth-while watch—a dependable, warranted, perfect timepiece. Our price and our easy credit terms of payment are the sensation of the watch business. Send only \$1.00 for this genuine Illinois 17-jewel, 20-year gold-filled guaranteed watch. Price only **\$13⁷⁵**

Many others in our big free Jewelry Catalog.

A Year to Pay the Rest

Mail us \$1.00 and we will send the watch for a month's free trial, examination and use. You may send it back if not the biggest watch bargain you ever saw. Send for Big Free Watch and Jewelry Book, showing hundreds of just such big values—all sold on easy credit.

Spiegel, Mau, Stern Co.
3521 Wall Street, Chicago (413)

"Little Wireless Phones"

For the ears that will cause you to

HEAR

What eye glasses are to failing sight, my invisible ear drums are to lost or failing hearing. Just as simple and common sense and on the same principle, for they magnify sound as glasses magnify sight. They are really tiny telephones of soft, sensitized material, safe and comfortable, which fit into the orifice of the ears and are invisible. They can be removed or inserted in a moment and worn for weeks at a time, for they are skillfully arranged for perfect ventilation and anti-friction. These little wireless phones make it easy to hear every sound distinctly, just as correct eye glasses make it easy to read fine print. Among the nearly 400,000 people whom they have enabled to hear perfectly, there has been every condition of deafness or defective hearing. No matter what the cause or how long standing the case, the testimonials sent me show marvelous results.



Common-Sense Ear Drums

have restored to me my own hearing—that's how I happened to discover the secret of their success in my own desperate endeavors to be relieved of my deafness after physicians had repeatedly failed.

It is certainly worth your while to investigate. Before you send any money just drop me a line. I want to send you free of charge my book on deafness and plenty of evidence to prove to you that I am entirely worthy of your confidence. Why not write me today?

GEORGE H. WILSON, President
WILSON EAR DRUM CO., Incorporated
1188 Inter-Southern Bldg. LOUISVILLE, KY.

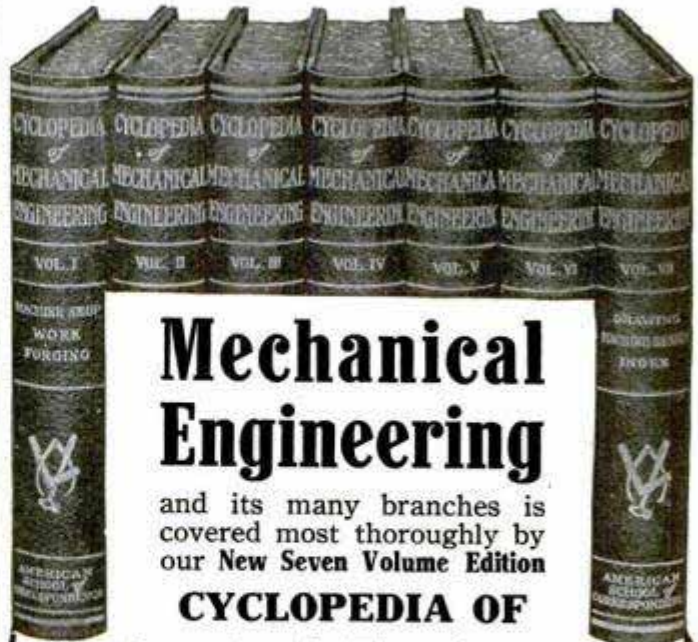

**Mechanical
Engineering**

and its many branches is covered most thoroughly by our New Seven Volume Edition

CYCLOPEDIA OF

**Mechanical Engineering
Gas Engine Operation and
Modern Shop Practice**

In this wonderful work will be found instruction in Gas Engine Operation and Manufacture; Machine Shop Work; Assembling of Machinery; Tool Making and Shop Management in such simple and comprehensive form that the student cannot fail to benefit by it. Every detail of mechanical engineering is thoroughly analyzed and treated, rendering the books of unusual value to the experienced mechanic and shop manager, as you will note by reading "Subjects Thoroughly Covered."

The Cyclopeda contains 3,092 pages and is supplemented with a series of practical test questions, including over 2,327 full-page plates, illustrations, tables, formulas and "shop kinks."

Subjects Thoroughly Covered

- Machine Shop Work — Vertical Milling Machine — Motor-Driven Shops — Shop Lighting — Forging — Electric Welding — Tool Making — Metallurgy — Manufacture of Iron and Steel — High-Speed Steel — Flaws in Castings — Electric Lifting Magnets — Magnetic Clutches — Making a Machinist — The Ideal Foreman — Pattern Making — Foundry Work — Automatic Coal and Ore Handling Appliances — Machine Parts — Construction of Boilers — Types of Boilers — Boiler Accessories — Steam Pumps — Air Compressors — The Steam Engine — The Steam Turbine — Indicators — Valve Gears — Refrigeration — Gas Producers — Gas Engines — Automobiles — Elevators — Sheet Metal Work — Practical Problems in Mensuration — Mechanical Drawing — Drafting Room Organization — Machine Design.

WE'LL PROVE THEIR VALUE TO YOU

by sending you the complete Cyclopeda absolutely free for examination—just mail the coupon. Keep the books seven days—test every formula. You will agree that they are all we state, and more. Send \$2.00 after examination and \$2.00 a month until you have paid the special price of \$19.80. The regular list price is \$36.00. If the books do not meet with your requirements, advise us and we will remove them at our expense.

ANOTHER GREAT OFFER With each set is included a year's Consulting Membership, regular value \$12.00, entitling you to the free advice of a staff of Mechanical Engineers. This will give you practical help in handling working problems which are too specific to be taken up in detail in the Cyclopeda. A single problem solved for you might be worth more than the first cost of the books.

FREE EXAMINATION COUPON

American School of Correspondence, Chicago, U. S. A.

Please send set Cyclopeda of Mechanical Engineering for 7 days' free examination. I will send \$2.00 within 7 days and \$2.00 a month until I have paid \$19.80, or notify you and hold the books subject to your order. Title not to pass until fully paid. Pop. Mech. 5-13

NAME

ADDRESS

OCCUPATION

EMPLOYER

GOOD LUCK in Every WATERLOO BOY MACHINE

FOUR LEAF CLOVER LUCK
ECONOMICAL
DEPENDABLE
DURABLE

LOW COST

OUR BINDING 5-YEAR GUARANTEE COVERS EVERY PART OF EVERY MACHINE WE MAKE

Good Luck is the product of good judgment. If you choose farm machines for the good material and good construction in them you'll get good service—and that will be "lucky" for you.

WATERLOO BOY MACHINES Embody 20 years of honesty—20 years of Experience in building the best—20 years of leadership all over the world, proving their quality. And you can buy them for less money in first cost, less in operating cost, and less in the long run, than any other dependable machines on the market.

INVESTIGATE AND CONVINCE YOURSELF.

The Waterloo Boy GASOLINE ENGINE In its 20 years on the market, has gone into every civilized country; is recognized the world over as the **lowest priced high-grade engine built.**

The Waterloo Boy CREAM SEPARATOR Is chosen by tens of thousands of shrewd buyers who will not buy a cheap, short-lived machine which will waste half the butter fat. Nor will they buy the higher priced machine which is no better and often not so good.

The Waterloo Boy Low-Down, 1-MAN FARM TRACTOR Is light weight, light draft, strongly and all steel **MANURE SPREADER** simply built, low standing and easy to load, smooth spreading. Sells at the lowest price ever made on a machine of this class.

The Waterloo Boy Is designed for all farm work from plowing to harvesting. Has pulling power of 12 good horses. Many important new features make it far superior to any others. **Sells at low price.**

We have a message of importance for you. Write for **FREE Catalog** and full information.
WATERLOO GASOLINE ENGINE CO., 1021 W. 3rd Ave., WATERLOO, IOWA.

POWER For all Purposes

The High Powered, Light Weight Cushman Engine measures out just enough gasoline to do the work required. Advanced 4 cycle type. Weight under 200 lbs. 4 h. p. rating but actually develops over 5 h. p.

AUTOMATIC THROTTLE GOVERNOR WITH HIGH GRADE SCHEBLER CARBURETOR

Easy speed changes, special friction clutch pulley. Also new 6-8 and 20 h. p. high efficiency engines for heavy work. Now ready. Free book describes all. Write for it.

CUSHMAN MOTOR WORKS, 2068 N. St., Lincoln, Neb.

USE OF CIRCASSIAN WALNUT IS EXTENSIVE
—The United States is probably the largest consumer of the famous Circassian walnut, the most expensive of cabinet woods. Single trees of this wood have sold for over \$3,000. This high cost is due to a scarcity of that beautifully figured variety of these trees which is demanded for furniture and interior finish. The common trees of this species are plentiful and of small value. The eastern slopes of the Caucasus, the Himalaya mountains, northern India, Upper Burma and the Black

The Money Making Muncie

Perfect power producer. Operates on crude-fuel, solar and gas oils. Also kerosene and distillate.

Low consumption.
Close regulation.

MUNCIE GAS ENGINE & SUPPLY CO., 1227 Main St., Muncie, Ind.

3 to 12 H. P.

34c

Runs this 6 H. P. Engine for a 10 hour day on KEROSENE

By means of the patent throttle you can run it as a 4 H. P. engine for 23 cents a day, or as a 2 H. P. for 12 cents a day. Many other strong points; force-feed lubrication; uniform speed; sight-feed fuel supply; automobile muffler; no cranking; runs either way; uses any fuel oil satisfactorily. And it's **Guaranteed for 10 Years.** Write for catalogue and 30 days' free trial.

WE PAY THE FREIGHT

ELLIS ENGINE CO., 65 Mullett St., Detroit, Mich.

BUY A TESTED ENGINE

For whatever purpose you may need an engine, whether for running an experiment shop or for handling the machines necessary to take care of a small business, buy a thoroughly tested engine. It is always cheaper in the long run, even though it costs a little more at first. The important part is that you have power when you need it.

I H C Oil and Gas Engines

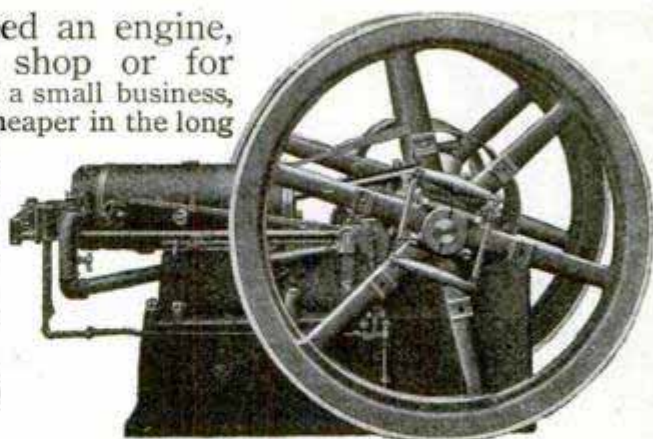

are thoroughly tested before they leave the factory, and

are again tested when they are installed in the purchaser's place of business. Besides testing the engine thoroughly, we guarantee its satisfactory performance and that guarantee is worth having.

Among satisfied users of I H C engines are model makers, carpenters, tin and metal workers, bakers, launderers, printers, and men in practically every line of business where a steady dependable power is required. You cannot buy a better engine. Sizes: 1 to 50-horse power, tractors: 12 to 60-horse power. Styles: one to suit your needs. Fuels: gas, gasoline, kerosene, naphtha, or alcohol. Write for catalogue, which gives complete information of the whole line.

INTERNATIONAL HARVESTER COMPANY OF AMERICA

(INCORPORATED)

16 Harvester Building

CHICAGO

Sea grow the more aristocratic variety. In Europe and the United States Circassian walnut is called English walnut, but has no great value. The demand for the Circassian walnut, which always exceeds the supply, has led to substitution. Our American red gum and butternut, as well as some of the African and South American woods which resemble Circassian walnut are often sold as such. But none of them possesses the delicate tones, fine bird's-eye figures, burls and velvety texture of the real wood. The government has just issued literature which tells the distinctive marks of the genuine article.

SMALL ENGINES

1-8 H. P.
UP

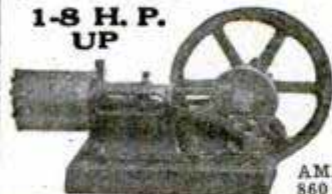

Steam, Gas and Gasoline. For Amateurs and Mechanics. Circulars for Stamp. Big Catalogue Engines, Small Power Machinery and Electric Light Plants, 2 Lights up. Sent for 10c (coin preferred). Refunded first order.

AMATEUR MECHANICS SUPPLY CO.
860 G Monadnock Bldg. CHICAGO

"INGECO" ENGINES

1 1/2 to 350 H. P.

Gas, Gasoline,
Oil and
Producer Gas

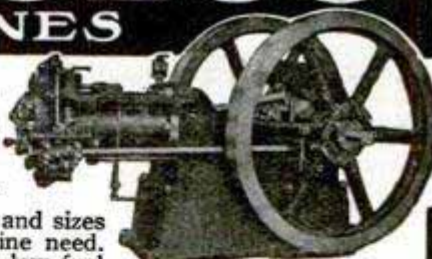

Includes all types and sizes to meet every engine need. Simple to operate—low fuel cost—substantial construction. Perfectly balanced, smooth, steady, reliable. Sales branches and stocks everywhere. If you expect to buy an engine our expert will tell you what is best and cheapest for you.



INTERNATIONAL GAS ENGINE CO.,
116 Halhoff Pl., CUDAHY, WIS. (Suburb of Milwaukee)

This Extraordinary Engine

Single and Double Cylinders—Burns Gasoline, Kerosene, Gas or Distillate—Simplest, Most Powerful, Reliable and Economical Engine Made. All Sizes, 1 1/2 to 50 H. P. We Will Trust You.



Saves
1/2
Fuel
2/3
Weight
Gives
Most
Power

The Only Engine that Has Solved the Problem of Violent Vibration

This is the famous TEMPLE which stands on its feet—the up-to-date Economical Engine that has won every prize contest against well known makes. Practically no vibration! Explosions take place low down close to the ground which absorbs and does away with the shock and strain on the engine. In every other engine explosions occur high up, causing violent vibrations that reduce life of engine. Crank Shaft over Cylinder secures perfect lubrication by gravity. No other engine has this! "TEMPLE" alone, has downward lubrication—hence less friction and greater power from every pint of fuel!

30 Days' Free Trial—Easy Terms

strongest engine built. Prove these claims by 30 days' free trial test.

Don't buy an Engine until you have investigated the "TEMPLE." Most powerful, economical, reliable, easiest starting.

Write today for Big Special Offer and Full Particulars

THE TEMPLE PUMP CO. (60 Years in Business)

102 Meagher St., Chicago, Ill.

YOU CAN TEST IT 30 DAYS FREE

"HELP WANTED"

-Uncle Sam.



Railway Mail Clerks

PARCELS POST means hundreds of appointments
Examinations everywhere May 3rd.

\$900⁰⁰ to \$1800⁰⁰ a Year for LIFE

No "layoffs" without pay, because of strikes, financial surries or the whims of some petty boss. Excellent opportunities for quick advancement to Higher Government Positions. If you want immediate appointment, send **TODAY** for our schedule showing locations of the May 3rd examinations. Any delay means the loss of just so much time in preparing yourself for examination.

SEND COUPON BELOW

FRANKLIN INSTITUTE
Dept. 0182, ROCHESTER, N. Y.

The coupon, filled out as directed, entitles the sender to free sample questions; a free copy of our book, "Government Positions and How to Obtain Them," Full List of Positions Open; and to consideration for Free Coaching for the examination here checked.

We Prepare Candidates Free

COUPON

... Railway Mail Clerk	(\$800 to \$1800)	... Customs Positions	(\$800 to \$1500)
... Postoffice Clerk	(\$600 to \$1200)	... Internal Revenue	(\$700 to \$1800)
... Postoffice Carrier	(\$800 to \$1200)	... Stenographer	(\$800 to \$1500)
... Rural Mail Carrier	(\$600 to \$1100)	... Clerk in the Departments at Washington	(\$800 to \$1500)
... Bookkeeper	(\$900 to \$1800)	... Canadian Government Positions	

Name.....
Address.....

O 182

Use this before you lose it. Write plainly.

2 1/4 HORSE POWER

HERE is the most reliable 2 1/4 H. P. Engine in America. It gives such perfect satisfaction that we ship it anywhere in the world on terms of only one-half the purchase price or **only \$24⁷⁵** with your order and six months' time on the balance. If you want an engine any size, 1 1/2 to 12 H. P., write me today for Big 4-color Engine Catalog and Price List, lowest you ever heard of. Save you \$20.00 to \$100.00 sure. Do it now—today.

OTTAWA MFG. CO., 846 King St., Ottawa, Kans.



Our Washer Woman Own Her for \$23

This Gasoline Engine turns the washer and wringer, churn, grindstone, or any light machinery. Fully equipped with batteries, switch, coil, spark plug, tank, etc., ready to run. Seven speeds. Easy to operate. Money refunded if not satisfactory. Get information now.

Dealers—Handle Our Washer Woman and Washer
MADISON GASOLINE ENGINE CO., MADISON, WIS.



\$50 to \$300 SAVED

We are manufacturers, not merchants. Save dealers', jobbers' and catalog house profit. 10 or more men in every township can save \$50 to \$300 on my High Grade Standard Gasoline Engines from 1 1/2 to 15 H. P., price direct to you lower than dealers or jobbers pay for similar engines in car-load lots for spot cash.

GALLOWAY

Price and quality speak for themselves and you are to be the sole judge. Sell your poorest horse and buy on **30 Days Free Trial**

Direct From My Factory Satisfaction or Money Back

Write for special proposition to 10 or more men. Send for my big **BOOK FREE.**

WM. GALLOWAY, Pres.
WM. GALLOWAY CO.
1965 Galloway Station
WATERLOO, IOWA



You Can Make From \$5 to \$10 a Day

Jack of All Trades Kerosene Engines

More Power
Half the Cost

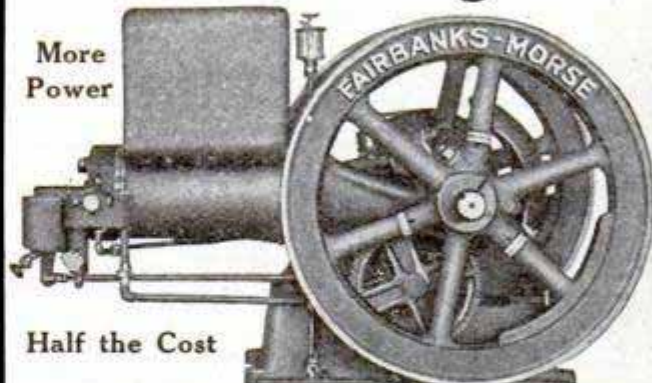

Develop more than rated power on either Kerosene or Gasoline. Adapted to all power work on the farm. Our immense factory facilities enable us to sell these

High Grade Engines At Remarkably Low Prices

Jack of All Trades are strongly built of best materials. Large bearings. Ample Lubrication. All parts accessible—you can get at every nut with a simple S wrench. 2, 4 and 6 h. p. Horizontal. Also 2, 4 and 6 h. p. Vertical. Other types up to 500 h. p.

Write for Catalog No. DU49. State size and type preferred.

Fairbanks, Morse & Co. 900 S. Wabash Ave. Chicago, Ill.

Fairbanks Scales, Oil and Gasoline Engines, Oil Tractors, Pumps, Water Systems, Electric Light Plants, Windmills, Feed Mills

Experiments in Germany seem to have showed that dried potato vines have the same value for feeding stock as good meadow hay.

Anti-Nicotine Pipe

"Get The Pleasure Without The Poison" Trade Mark Reg.

The Pipe They Let You Smoke At Home

Looks and colors like meerschaum. Absorbs the nicotine and keeps on tasting sweet. You never had such an enjoyable smoke. Order 3 or More Today.

H. MENGES
The Smoker's Friend
326 N. 7th St., St. Louis, Mo.

40¢
Three For **\$1.00**
Sent Prepaid Anywhere Money Back If Not Satisfactory



ERICKSON LEG

Arms, Wheel Chairs, Crutches, Stockings.

SOLD ON EASY TERMS

E.H. ERICKSON ARTIFICIAL LIMB CO.,
17 Wash. Av. N., MINNEAPOLIS, MINN.

Does not chafe, overheat or draw end of stump. **SEND FOR CATALOG**

Largest Limb Factory in World.



BRIGHTEN YOUR WITS

with our brain tickling puzzles. Sample for 10 cents or three good ones for 25 cents. Catalog included.

WONDER NOVELTY CO., Dept. I, Box 123, St. Paul, Minn.

CACHOO!

Make the whole family and all your friends "just sneeze their heads off" without knowing why, with CACHOO, the new long distance harmless snuff. Sent anywhere for 10c. 3 for 25c. 90c a dozen. Catalog included FREE.

PEERLESS TRICK & NOVELTY CO., Dept. B, CHICAGO



BARODA DIAMONDS

Flash Like Genuine

ANY STYLE

at 1/40 the cost—IN SOLID GOLD RINGS

Stand acid test and expert examination. We guarantee them. See them first—then pay. **Special Offer**—14k Tiffany ring 1 ct. \$5.98. Gents ring 1 ct. \$6.98. 14k Stud 1 ct. \$4.88. Sent C. O. D. for inspection. **Catalog FREE**, shows full line. Patent ring gauge included, 10c. The Baroda Co., Dept. 98, Leland & Dover Sts., Chicago



Caille Perfection Waterproof Engines



6 H. P. Single Cyl. Engine With Waterproof Igniter.

HERE'S an engine with an absolutely waterproof ignition system. Splash, rain, snow or sleet can't stop it. Give it air and it will run submerged. Turn a fire hose on it and it will continue running just the same. It's the most simple, most compact, most reliable engine ever designed for marine use. Runs equally well in fresh or salt water. All parts are completely enclosed. No oil can splash out to soil clothing. Any member of your family can safely run it. Needs no protection whatever. Runs on gasoline or kerosene.

Needs No Batteries, Magnetos, Coils or Timers

The Perfection Igniter produces such an extremely hot spark, of such high voltage, that no matter how poor the mixture may be when starting, a simple rock of the flywheel sets the engine going at once. The igniter is completely enclosed in a waterproof case, and all parts so arranged that it is impossible for it to get out of order. No batteries, no complicated wiring, no auxiliary apparatus is required; not even a switch. Speed of engine does not affect the spark. The igniter runs in either direction, enabling you to run your boat forward or backward, without reversing device. Not affected by heat or cold.

Send for Beautiful Engine Book

Describes our complete line of engines for all purposes, from 2 to 30 H. P. Shows our popular 8 H. P. Double Cylinder Unit Power Plant in colors. Write today. A postal brings all.

CAILLE PERFECTION MOTOR CO.,
1207 Caille Street, DETROIT, MICHIGAN



Build Your Hydroplane

14x4 Toppan Bullet Hull complete \$125, K. D. Frame \$30. Also 21 ft. V-Bottom Runabout Hull \$225, K. D. Frame \$40.

Send for circular. Special prices on Engines.

TOPPAN CO., 3 Haverhill St., BOSTON, MASS.

GET THIS CATALOG

FULL OF VALUABLE INFORMATION TO EVERY BOAT OWNER ON

RACING PROPELLER WHEELS, REVERSE GEARS AND MARINE ACCESSORIES

LARGE CATALOG FREE. SEND TODAY

MICHIGAN WHEEL CO.

1139 MONROE AVE., GRAND RAPIDS, MICH.



ENGINES - ON APPROVAL -



30 days free trial

Strictly high grade engines with Planhard or Schebler carburetor, water and spark proof commutator, flange coupling, electric circuit breaker, patented gas tight bearings, and complete equipment.

2 H. P. \$50; 4 H. P. \$75; 7 H. P. \$100; 10 H. P. \$150; 18 H. P. \$250. Magnificent 1913 Marine Engine Catalog.

Truck and Hand-Car Engines



For R'y Hand-Cars, Factory trucks, lumber carts, Mining cars, etc. Sliding base belt tightener starts slowly, not with sudden jerk. Reversible, runs either way. Splendid also for electric light outfits, moving picture machines, spray pumps, etc. Get prices and catalog of this line also.

NORTHWESTERN MOTOR CO.

757 Spring St.

EAU CLAIRE, WIS.



Send For This Camera ON 10 DAYS FREE TRIAL

To Popular Mechanics readers who mail coupon below at once, we will send this beautiful Folding Camera for 10 days' free trial without one cent in advance. Do not send us any money. Just fill out and mail coupon below and this beautiful Camera will be sent to you on trial with all charges prepaid. We want you to use the Camera and see what splendid pictures it takes. The picture is post-card size—3¼ by 5½ inches, yet the Camera when closed measures only 9¼ by 4¾ by 2 inches, and weighs less than two lbs. It has the famous new dust-proof crystal Lens, Automatic Shutter, Brilliant Reversible Finder with Spirit Level, which works either horizontally or vertically. The Camera is made of Aluminum, covered with genuine Seal Grain Leather. Fittings are of Polished Nickel.

Here is Our Great Camera Offer

We are fighting the great Camera Trust! We are determined to push our independent line and so we make you this liberal offer. Tear off and mail coupon below and we will ship you this beautiful Folding Senco Camera for ten days free trial. After you have used this Camera ten days, if you find that it is just the Camera you want, send us only \$2 cash and \$2 a month for 9 months, until our special price—\$20 is paid. If the Camera is not satisfactory and you do not wish to keep it, then you may return it at our expense, so you see, you take absolutely no risk.

BARGAIN FILM OFFER

In order to try our Camera you will need a roll or two of films, so we make you this special offer: Send us 50 cents when you send the coupon and we will send you with the Camera a roll of films that will take six pictures. After you have taken the pictures, mail us the roll of films and we will then develop and print them for you and return them ABSOLUTELY FREE OF CHARGE. This free trial offer is good for a short time only, therefore, do not wait, but fill out and mail coupon below at once.

American Optical Supply Co.
1609 N. 14th St.
St. Louis, Mo.

Send me, for 10 days free trial, Folding Senco Camera No. 3-A, express prepaid. If the Camera is satisfactory, I will send you \$2 as first payment and \$2 per month thereafter until your special price of \$20 is paid. If the Camera is not satisfactory, and I do not wish to keep it, I will notify you in 10 days and the Camera is then to be returned at your expense as offered Popular Mechanics readers.

American Optical Supply Co.

1609 N. 14th St.
St. Louis, Mo.

NAME.....

ADDRESS.....



MULLINS STEEL BOATS CAN'T SINK

Built like Government Torpedo Boats of tough, puncture-proof, galvanized steel plates, pressed to rigid form and so securely joined together that a leak is impossible. The Mullins Steel Boats are GUARANTEED against puncture, leaking, waterlogging, warping, drying-out, opening seams, and NEVER REQUIRE CALKING. Air-tight compartments like a lifeboat.

MOTORS—The Loew-Victor 4-cycle and Ferro 2-cycle—light—powerful—simple—can be operated by the amateur—the beginner—start like automobile motors—one man control—never stall at any speed—exhaust silently under water.

Our beautiful book, illustrated in colors, is free.

THE W. H. MULLINS COMPANY

The World's Largest Boat Builders

151 Franklin St., Salem, Ohio, U. S. A.



Safest Family Boat Built.

STEEL ROW BOATS AND CEDAR CANOES

Build Your Own Boat



The Frame We Ship You

SEND FOR OUR CATALOG

which tells you all about it. You can build a 20 ft. launch for \$30 from patterns, that you could not buy at any factory for less than \$150, or you can buy the complete frame and build this 50 ft. cruiser shown in the picture for less money than you would have to pay for the cheapest 25 ft. finished cruiser you could buy.



The Boat You Build

DEFOE BOAT & MOTOR WKS., 1113 State Str., BAY CITY, MICH.

from our patterns or knock down frames. You save $\frac{1}{2}$ the cost and enjoy the work. Patterns and frames for boats of all types and sizes, from the canoe pattern at \$1.75 to the 65 ft. yacht frame at \$350

**12 Horse Power
4 Cylinder
4 Cycle**

Weight 370 lbs.

**Speed
600 to 1000 R. P. M.**

Made in one size only. A specialized article.

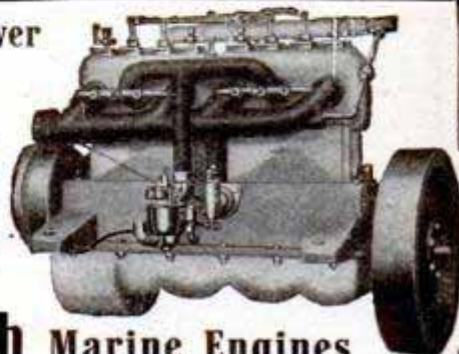

Kermath Marine Engines

the world's standard in 12 H. P. size, are made of the finest materials the market affords and workmanship of pronounced excellence. **Prices \$150 to \$200**

Kermath Mfg. Co., DETROIT, MICH. Dept. P

Jeffery's SPECIAL MARINE CANOE GLUE

BEST FILLER FOR CANVAS



Any puncture or leak in boat or canoe can be repaired in 5 minutes. It is as valuable to a canoeist as a repair kit to a bicyclist or automobilist. It is a Johnnie-on-the-spot article that no boatman should be without. It does not dry up nor deteriorate in the can, but will be found equally ready for use in ten years as today. Friction top emergency cans, 25 cts. each; weight, ready to mail, 6 oz.

Send for circulars. At all Sporting Goods Houses

L. W. Ferdinand & Co., 203 South St., Boston, Mass., U. S. A.

KEMP AIR COOLED AEROPLANE MOTORS

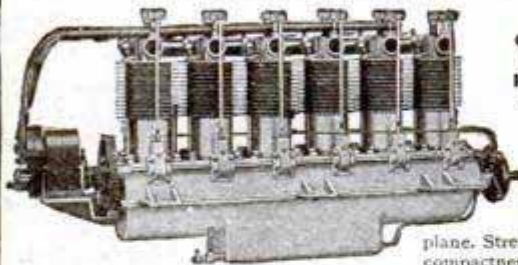

MODELS

- G-2 16 H. P.
- I-4 35 H. P.
- H-6 55 H. P.
- J-8 75 H. P.

Designed and built to the requirements of the Aeroplane and Hydroplane. Strength, reliability, compactness, lightness,

simplicity, efficiency, fuel economy, ease of adjustments, ease of starting, and minimum head resistance, the ten most important points, and our motors contain these features. Built by skilled mechanics and only the best of material and equipment used. It will be better and cheaper to equip your plane with a reliable and efficient power plant in the start.

KEMP MACHINE WORKS, Muncie, Indiana, U. S. A.



\$85

COMPLETE WITH 4 H. P. MOTOR

\$85 buys this 18 ft. Dumphy Semi Speed Model—for the complete finished K. D. frame, together with a H. P. motor and marine equipment. We carry in stock for immediate shipment a complete line of finished launches, rowboats and canoes. Also K. D. frames for any kind of boat.

Get our catalog.

DUNPHY BOAT MFG. CO., Eau Claire, Wis.

Motor Boating Without Danger

The man with a Baldridge Reverse Gear in his boat can laugh at the dangers that threaten the man who controls his boat in a "hit or miss" way. The "Baldridge booster" controls his boat like an automobile—stops, reverses, goes ahead, simply by moving a lever—engine doesn't stop. Superior features of "Baldridge" construction make it almost wear-proof. Fully enclosed.

Get Free Book

If not at your dealer's, send now for free book on safe motor boating.

THE BALDRIDGE GEAR CO. 682 W. Gr. Blvd. Detroit, Mich.

VIM MOTORS

**5 to 55 h. p. THREE KINDS—
SPEED—REGULAR—HEAVY DUTY**

Strong, neat, simple—absolutely dependable. Win your enthusiastic confidence. Accessible. Built to last a life time. Heavy brass fittings. Non-back-firing. Double ignition. Easy starting fly wheel.

VIM MOTOR COMPANY

**1, 2, 3 and 4 CYLINDER
USE GASOLINE OR KEROSENE**

Your boat will provide exhilarating and healthful recreation—equipped with a VIM. It's the old boatman's choice. Thousands now in use, 8 or 9 years old. Read 27 reasons why in "Boating Facts"—our new free book.

105 Water Street, Sandusky, Ohio

DIAMONDS ON CREDIT
SAVE
One-Third to One-Half

Special selection Diamond-Set Jewelry.
 LaVallieres, Rings, Ear Screws, Stick Pins,
 Cuff Links and Stud. Mountings are 14 solid gold—except
 N-51, N-60, N-61 and N-62, which are platinum. Fine, brilliant white diamonds. These hand-
 some pieces on our usual liberal **CREDIT TERMS**: One-fifth down, balance divided
 into 8 equal amounts, payable monthly. **Send for Free Jewelry Catalog**, ex-
 plaining our Easy Credit Plan. Any article sent for your examination,
 charges prepaid. We want you to see for yourself that you can
 save money by sending to us when in need of a Diamond, Watch, etc.

LOFTIS BROS. & CO., Diamond Cutters
 Dept. N 894, 108 N. State St.
CHICAGO, ILL.
 Branches: Pittsburgh,
 Pa., and St. Louis,
 Mo.

N-55 \$100 N-57 \$50 N-56 \$25 \$50 N-52 \$50 N-53 \$65 N-55 \$40 N-54 \$15 N-50
 \$45 N-51 \$75 N-62 \$25 N-61 \$25 N-60 \$5 N-59

**Turn Your Row Boat Into
 A Launch With This
 2 H.P. AMERICAN Engine**

Especially designed for row boats, canoes and launches up to 20 feet long. Just the thing for a fishing boat. If desired can be run slow enough to troll. No reverse gear needed. Engine can be reversed without stopping. Starts without cranking. Guaranteed for life. Sold on 30 days' trial.

\$125 Buys This "American Special" 16 Foot Launch
 Seats 7 to 9 people. Elegantly finished. Embodies engine described above. Just the thing for summer homes. We also build Stationary Engines. Send for engine catalog describing complete line. Also boat circular. Write today.

American Engine Co., 474 Boston St., Detroit, Mich.

note the great amount of shrinkage in the fleece due to scouring. Wyoming's fleeces shrunk 67 per cent. The total flock in the United States decreased by 1,280,000. The greater part of this decrease was in the western states, due to the severe winter last year.

BAY STATE MOTORS
 "Perfect Simplicity" and "Simple Perfection" are the results, embodied in these Motors, of 15 years devoted to the developing of these essential characteristics, which enable us to put on the market a reliable and economical motor at a reasonable price. Write for catalog, stating size and type (2 or 4 cycle) of motor wanted. We also furnish castings for these motors.

BAY STATE MOTOR WORKS
 Successor to
A. J. HOULE MOTOR WORKS
 580 South East Street, HOLYOKE, MASS.

WATKINS' SPECIAL MOTORS

3 H. P. Single Cylinder . . .	30 lbs.
6 H. P. Double Cylinder . . .	60 lbs.
12 H. P. Four Cylinder . . .	100 lbs.

A strictly HIGH GRADE Motor that will give CONSTANT and EFFICIENT service. Especially adapted for CANOES and LIGHT BOATS. Aluminum base, copper water jacket, steel shaft, bronze bearings.

THE WATKINS MOTOR CO.
 837-839 West Sixth Street CINCINNATI, OHIO

THE SCRIPPS
 COMPLETE
MARINE POWER PLANT

1913 Catalogue Just Off The Press

If you are interested in marine motors, send for it. It is, by far, the most beautiful and interesting engine book ever published. Fully describes all of the famous Scripps motors—One, Two, Four and Six Cylinders—regular and extra heavy duty types, 4 to 96 horsepower. Ask about our Air-Self Starter, Kerosene motors and the Scripps Midget—our new 7 horsepower, 4-cylinder Tender Motor.

Scripps Motors are carried in stock by

NEW YORK—Bowler, Holmes & Hecker Co., 141 Liberty Street. **BOSTON**—Walter H. Moreton, 218 State Street. **PHILADELPHIA**—W. E. Gochenaur, 631 Arch Street. **JACKSONVILLE, FLA.**—Gibbs Gas Engine Co., Foot of Main Street. **SEATTLE, WASH.**—S. V. B. Miller, 72 Marion Street. **SAN FRANCISCO, CAL.**—California Gas Engine & Motor Boat Co., 76 Clementina Street. **LOS ANGELES, CAL.**—Marine Engine & Supply Co., 121 E. 6th Street. **DULUTH, MINN.**—Kelley Hardware Co., 118 1/2 W. Superior Street. **TORONTO, ONT.**—Schield-Holden Machine Co., 2 Carlow Ave. **NEW ORLEANS, LA.**—Arthur Davie, 130 Chartres Street.

SCRIPPS MOTOR COMPANY
 637 Lincoln Avenue
DETROIT MICHIGAN

BUILD YOUR OWN STEEL BOAT

From patterns and printed instructions. **Save 75 Cost.** Work easy. Material furnished. Also finished boats. Send for catalogue and prices.

F. H. DARROW STEEL BOAT CO., 517 Perry St., ALBION, MICH.

The Powerful "Porto"—55 lbs.—2 H. P.

The most power for the price—the most power for the weight—that's what you get in the ORIGINAL portable marine engine. Note this—2 3/4 bore, 3 in. stroke—that's what counts. That's why the PORTO drives an 18 ft. row-boat 7 miles an hour, for 4 hours on a gallon of gasoline.

On or Off in 5 Minutes—Sold on Trial

The new model is copper jacketed, has under water exhaust, steers with tiller ropes. Get our catalog for complete details of this and other Waterman Motors for every purpose.

WATERMAN MARINE MOTOR CO., 230 Mt. Elliott Ave., DETROIT, MICH.

Write Now



Roberts Motors in Both Outfits

ROBERTS MOTORS FOR BOATS AND FLYING BOATS

This shows Hugh Robinson in a Roberts Equipped Flying Boat saluting the pilot of a Roberts all water craft. Roberts Motors are built in twenty-one models, 3 to 125 H.P., 1 to 6 cylinders. Standard, Aerolite, and Featherweight Types.

Operation on *KEROSENE* or *GASOLINE*
Marine or Aero Catalog *FREE*

THE ROBERTS MOTOR CO.

1419 Columbus Ave., Sandusky, Ohio, U.S.A.

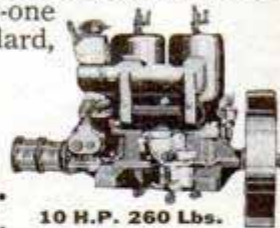

10 H.P. 260 Lbs.

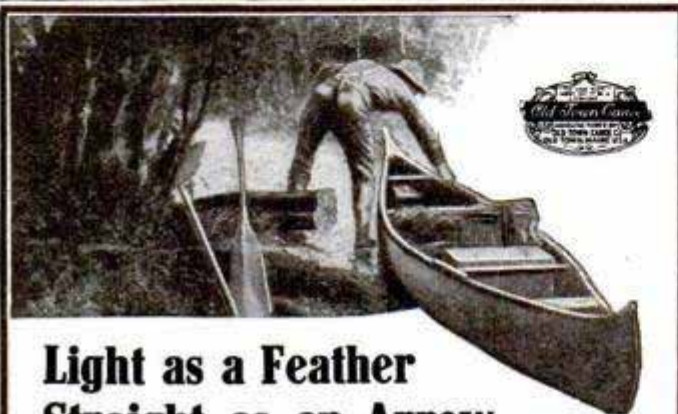

Light as a Feather Straight as an Arrow

Unless your canoe is that kind you don't know what a real joy a thoroughbred canoe is. There are hundreds of ill-balanced canoes that are as cranky as a balky horse. The genuine

"Old Town Canoe"

built by the master workmen of this trade, sets the pace for canoe designers and builders the world over. The "Old Town" is the choice of experienced hunters, campers, and voyageurs. You will appreciate the great difference between the genuine "Old Town" and its emulators, whether you summer in the wilds or keep your own canoe in the park lake.

Write for our catalog of canoe facts. Agents everywhere. 3000 canoes in stock assure prompt delivery.

OLD TOWN CANOE CO., 1265 Middle St., Old Town, Maine, U.S.A.

MULLINS CEDAR CANOES CAN'T SINK

The famous Yale and Harvard models—highest grade material—finest finished—the strongest, staunchest, handsomest canoes built. When equipped with Mullins Patented Buoyancy Pads these canoes have sufficient buoyancy to float when capsized or filled with water and keep two people afloat. Open gunwale construction—Keel—Heavy Pressed Bronze Bang Plates protecting stems.

Handsome Colored Catalog Free

THE W. H. MULLINS CO.

362 Franklin Street

Salem, Ohio



THE TRIMMING OF ELECTRIC LAMPS IN BOURNEMOUTH, ENG.—The old method of trimming the arc lamps on the exceptionally tall poles which are a distinguishing feature of Bournemouth, Eng., was to push a large cage on a truck to the foot of each post, to attach the cage to a lifting cable, and to hoist this, with a man inside, to the top. Now, this has all been supplanted by the safe and cheaper method of lowering the lamps to the ground for trimming and cleaning.

Send Stamp for Catalog—
Ask about the

**"FAULTLESS KID"
Family Launches,
Runabouts, Cruisers,
Hydroplanes**

VALLEY BOAT & ENGINE CO.
1205 Hess St., Saginaw, Mich.



Building a Boat is Great Sport

**And the Brooks' System
Saves Two-Thirds of
the Ordinary Cost**

The pleasure of owning a boat—going where you will on river or lake—is keen. But the pride of being the master-builder of your own boat—to know what you have under you—is a far greater satisfaction. And the building itself is recreation. The Brooks' Knock-Down System of building—from canoe to cabin cruiser—not only saves $\frac{2}{3}$ of the cost but provides the best materials procurable and guarantees every part accurate—the whole absolutely right and seaworthy. Every Brooks' K. D. boat is sold on a Money-back guarantee.

Spare time Winter Evenings—a little money and you can easily triple the pleasure of your vacation days and leisure hours.

BROOKS MANUFACTURING CO., 8205 Sidney St., SAGINAW, MICH.



Only \$28

For the Knock-down Frame of this 23-foot motor boat, including

full-sized patterns and illustrated instructions to finish—speed $9\frac{1}{2}$ to 14 miles an hour—12 passengers. *Free Boat Book* shows this and other models.

Brooks' Boat Book Free
—Write for It Today

18 Ft. Launch \$142.50
Complete
WITH 3 H. P. GRAY MOTOR

No sport in the world will give you more real enjoyment for the dollar invested than motor boating—a clean—safe—invigorating sport that anyone can enjoy because of the low first cost and low cost of maintenance. Write for full details of this 18-foot launch—it is a wonderful value—get details of our new boat buyers' service and full information about various types and sizes of boats and prices complete with Gray Motor installed. Many people do not realize that motor boats are so simple and easy to operate and care for—that the up-keep cost is very low and that boats of practically any type can be purchased complete with Gray Motor installed—all ready to put in the water. Our boat buyers' service and boat builders' catalog will be of special interest to such parties.

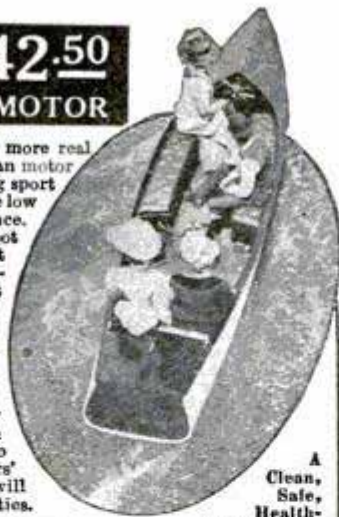

A Clean, Safe, Health-Giving Sport



A strictly high grade outfit complete in every detail. 6 H. P. Gray Motor for power—automobile control—reverse gear—mahogany trimmed—a seaworthy and handsome little craft that will make a speed of 12 to 14 miles per hour.

Here is Another Special 18 ft. Boat **\$285**

Model U

3 H. P. GRAY Motor—guaranteed to develop 4 H. P.—with Complete Outfit ready to install in boat **\$55**

Gray Motors are standard the world over and are made in sizes from 3 to 36 H. P. 1, 2 and 3 cylinders for boats of all types and sizes. Prices advertised always include complete equipment—no extras to buy. Over 1000 dealers sell Gray Motors and give Gray Service. Write today and get a free copy of our valuable engine book "M" and boat catalogue "B."



GRAY MOTOR COMPANY

56 Gray Motor Bldg. DETROIT, MICH.

HORSE SHOW REPRODUCED AS TABLE DECORATION—During the last horse show in New York a novel table decoration was arranged for a small dinner party at one of the hotels. It comprised a reproduction of the tanbark ring at Madison Square Garden, with little horses, coaches, drivers and riders, all propelled around the circle by electricity. Judges, stable boys and other attendants were also shown in miniature.

The municipal authorities of Berlin have forbidden men to smoke while driving automobiles, ruling that many accidents have been due to the practice.



Motor Boaters

We have perfected a method of installing engine in boats, that gives more speed and makes installing simple.

Send for "Practical Information" and catalog of motor boat hardware and specialties.

MECHANICAL DEVICES CO., Watervliet, N. Y.

Little Giant
GASOLINE MOTORS

Are masterpieces of marine engine construction. They are light, powerful and extremely durable. They meet the requirements of every power boat owner because they are designed by experts and built by experts. Of the two cycle, three port type of construction, they are built in six sizes ranging in power from 11-2 H.P. up to 16 H.P. in single and multiple cylinders. The prices starting at \$38.50 for the complete 11-2 H.P. motor. A catalog describing these "Dwarfs in Size but Giants in Strength" is a very interesting book and a copy will be sent to you free of all cost on your simple request. Write for it to-day—now.

Strelinger Marine Engine Co.
171 W. Woodbridge, Detroit

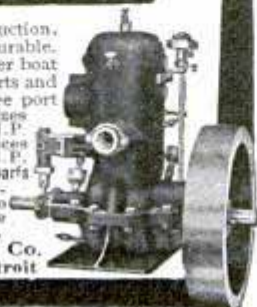

Typewriter Sensation

2 Dollars a Month

Buy a genuine Standard No. 2

SMITH-PREMIER

Typewriter and at

\$72.20 less than the manufacturer's price.



Never before has anything like this been attempted. Dealers get \$3.00 a month rent for this make of machine not nearly as perfect as the one we will send you, and you pay only **TWO DOLLARS A MONTH AND OWN IT.**

Send the Coupon and We Will Ship You This Smith-Premier Typewriter

When the typewriter arrives, deposit with the express agent \$7.80 and take the typewriter three days and try it. If you find it to be the best typewriter you ever saw, satisfactory in every respect, keep it and send us \$2.00 each month, until our special price of \$27.80 is paid. If you don't want to keep it, return it to the express agent, and he will give you back your \$7.80, and return the typewriter to us. We will pay the return express charges.

You won't want to send this machine back after you have seen it and tried it. You can't imagine the perfection of these machines till you see one, and the price is **\$72.20 less than the catalogue price**, and it is guaranteed just as if you paid \$100.00.

Perfect machines only, complete outfit, nothing extra to buy, no strings of any kind to this offer. Just think of buying such a typewriter for \$7.80 down and \$2.00 a month. Thousands of people have paid \$100.00 cash for Smith-Premiers. It's standard, by many considered the best typewriter ever built. A key for each character, so each character is always the same; a type brush for cleaning the type built into the machine; the tilting carriage; comes to you with tools, rubber cover, everything ready. It runs beautifully. It's wonderfully simple and strong. It will last a lifetime. I sold a similar supply of these beautiful machines about a year ago to everybody's satisfaction.

Only 200 orders will be filled on this offer. Act today to be sure

The coupon states the terms. Fill it out, send it now, today. You can't lose, and it's the greatest economical typewriter opportunity you will ever have.

COUPON

HARRY A. SMITH, Dept. P,
No. 180 North Dearborn Street, Chicago, Ill.

Ship me a No. 2 Smith-Premier f.o.b. Chicago, as described in this advertisement. I will pay you the \$20.00 balance of the special \$27.80 purchase price, at the rate of \$2.00 per month. The title to remain in you until fully paid for. It is understood that I have three days in which to examine and try the typewriter. If I choose not to keep it I will carefully repack it and return it to the express agent. It is understood that you give the standard guarantee for one year.

Name.....

Address.....

Shipping Point.....



Try This Infallible Plug in Your Motorboat

J-D Reliance Spark Plugs cannot be short-circuited by any motor, no matter how much carbon or soot forms on them. They even spark in water. A patented electrical action keeps the tip of the porcelain around the embedded platinum wire scoured clean as a hound's tooth. Price \$1.00



Spark Plugs. A complete line for motor boats, automobiles, stationary engines, motorcycles. Write today for free illustrated list card.

The Reliance is but one of the many J-D types. Another leader is the J-D Visible Gap with a window in the porcelain. It locates ignition trouble at a single glance. No more testing and fussing. Costs \$1.00. The J-D Conical and Petticoat, at 75c, and with points of solid platinum-iridium at \$1.25, in open and closed ends, are splendid values. You will never get the best out of your motor until you use J-D plugs. Write us today.

JEFFERY-DEWITT COMPANY, 21 Butler Avenue, Detroit, Mich.

Save a Season's Gasoline Cost Good Times Guaranteed

L-A Motors Direct from Factory to You

Sold on their Merits



Act as your own agent and save the retailer's profit—buy direct from the factory a dependable Lockwood-Ash Motor guaranteed for a year. Six models, all sent on 30 days' trial.

This 1½ H. P. Motor and Complete Outfit,

\$36²⁵
Freight Paid

We pay the freight and give you a month to test out the engine. You get a reliable motor with complete outfit, including propeller, ignition system and shaft, as shown. You save at least \$13.75—a season's gasoline cost. Give yourself and your friends good times at small expense. Motor boating is a healthful, fascinating and economical sport. Write for our new 1913 catalog today. Post yourself on Motor Boating. Learn about the famous L-A Motors. The catalog's free—write today.

LOCKWOOD ASH MOTOR CO., 208 Horton Ave., JACKSON, MICH.



4 HP. to GASOLENE AMERICAS QUALITY **SMALLEY** MARINE MOTORS 1513 TRUMBULL ST.

250 HP. KEROSENE **OLDEST.** ENDURES GENERAL CO. BAY CITY MICH.

PALMER MOTORS AND LAUNCHES

Ask for free Engine or Boat Catalog. Address Dept. K Engines, 2 to 40 H.P., 2 & 4 cycle, always in stock

PALMER BROS., Cos Cob, Conn.

HYDRO-SPEEDO BOAT ATTACHMENT

Equip your BOAT or CANOE with our HAND POWER DEVICE. It is so simple a child can operate it. Move lever handle forward and backwards. It's easier than oaring, and for the same amount of energy will give twice the speed of the primitive method of rowing. Light in weight, cheap in price. No expense to operate. One or more persons can enjoy the sport without interrupting the operation of the others. A big boon to those who like boating and fishing. No noise. No danger of accidents. A perfect hand power unit anyone can install. Send for illustrated Circular and prices. Orders filled in rotation.

DUPLIX POWER DEVICES CO. (Not Inc.), 1119 Karpen Bldg., CHICAGO

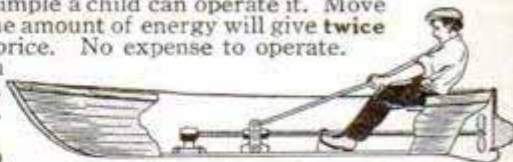

\$38⁰⁰
UP

Reliable—Dependable—Durable—Satisfactory
That's the GILE

When you put a GILE engine in your boat, you've got a motor on which you may rely to GO at all times. You can thoroughly understand it—it is so simple in design that it practically eliminates all repair expense, and so easily operated that your wife, mother, sister or sweetheart can readily run it, and it couldn't be of better material, design or construction if you paid three times the price we are asking. GILE engines are made only of the very best material, are of superior design, and expert construction. They are manufactured in one of the most up-to-date and progressive plants in the country, are carefully tested out, are RIGHT in every way, and FULLY guaranteed. They fill every requirement of satisfactory service, are durable, long lived, and in fact just the engine you've been always looking for—a motor which will "MOTE" wherever and whenever you want it or need it. Our prices will astonish you. Write for free catalog and further information—we know we can interest you.

(This is the 16-foot Ideal)



GILE BOAT & ENGINE CO.
10 Filer Street LUDINGTON, MICH.

16', 18', \$87⁰⁰
20', 24',
26' UP



**DIAMONDS
ON CREDIT**

**Would you
Accept this special offer?**

Positively Without an Equal!

Beautiful genuine Diamond Ring, perfectly white, extra quality, Ladies or Gents hand made 14k Solid Gold mounting, worth regularly about \$50.00 each.

Special this Month only \$37⁵⁰

If you have in mind buying a \$50 or even a \$60 Diamond, see this Special Ring before you buy. Our extensive handling of Elgin Watches throughout the world, enabled us to buy a big lot of these specials at about 30 per cent. below their actual value, and now offer them for only

\$5⁰⁰ Down and \$5⁰⁰ a Month

You assume no risk whatever because we send the Diamond for your approval before you pay one cent.

FREE DIAMOND BOOK! Write TODAY for our free Diamond and Elgin Watch Book, it's printed on our own presses and said to be the most attractive Catalog published.

HARRIS-GOAR CO.
Dept. 859, Kansas City, Mo.

MINNEAPOLIS A "MOVING-PICTURE" CITY—
In Minneapolis statistics have been completed which show that three-fifths of the city's entire family population attend moving pictures. These figures are of more than local interest, for such conditions exist in other places. The popularity of the "movies" is summed up by the mother who said: "After a hard day's work moving pictures are the best relaxation."

Important Announcement

NACO, The National Camera, will be on the market May 1st, and will be sold direct to the consumer on the plan that has met with such great favor throughout the country. We will send it on free trial, and if you desire to keep it, you can have ten months' time to pay. Naco, The National Camera, is the best \$20.00 value on the market and this easy payment plan makes our offer doubly attractive. Deliveries will be made in the order that they are received. Write today for full particulars—we will regard your request as a reservation.

NATIONAL CAMERA CO., 901 Lucas Ave., Saint Louis, Mo.

INVISIBLE SUSPENDER BELT

Fits instantly inside waist band, entirely out of sight. Does away with unsightly suspenders and uncomfortable belts. Keeps trousers up neatly, securely. Keeps shirt down, preventing "bagging." Wonderful for fat men or thin men. A Necessity for all men—mechanics, farmers, office men, professional men.

Ask your dealer. If he can't supply you, we will.

TRAVELING MEN—The Ko-Ko-Mo Suspender Belt is a real side line. Write "quick" for terms and territory. Send **50c** and your waist measurement for sample belt—or \$1 for silk belt—and full details. Money returned if you are not entirely satisfied.



KO-KO-MO BELT CO. KOKOMO, INDIANA



**Fifty Cents a Week
Employs These Eight
Engineering Experts**

50c a week—\$2.00 a month for but one year—will bring to your door a work which contains the condensed knowledge and experience of over a score of Civil Engineers—a work which will give you, without loss of time and at no expense, advice and assistance equal to that of the best experts and consulting engineers. With these books in your office—eight faithful, efficient and tireless assistants—you are prepared to cope with any difficulty, however great, that may arise.

**The American School's Cyclopaedia of
CIVIL ENGINEERING**

is compiled from the instruction papers used in the regular correspondence work of the school; contains 3,900 pages; 3000 illustrations, folding maps, diagrams, etc., with a special cross index for quick reference. The eight large volumes are bound in half morocco and are printed in large, clear type on special quality paper. This great work—a most complete review of Civil Engineering—will solve every problem likely to confront you in your daily work and will place the solution before you so clearly and concisely that you cannot fail to understand and profit by it.

Sent Absolutely Free—Express Prepaid

The complete eight volumes, not a sample volume, will be sent, express prepaid, for seven days' free examination; returnable at our expense if the books do not contain the information you want. If you keep them, pay \$2.00 seven days after receipt and then \$2.00 a month until you have paid the special introductory price of \$24.80. The regular price of this great Cyclopaedia is \$40.00.

Just fill in and mail the coupon. It won't cost you a cent to examine the books. We know they'll be worth many times their cost to you. Mail the coupon now and you'll receive your books promptly.

Some Important Subjects Covered

Drawing, Plane Surveying, Plotting and Topography, Strength of Materials, Masonry, Reinforced Concrete, Hydraulics, Waterways, Water Supply, Irrigation, Water Power, Sanitation, Highway Construction, Steel Construction, Roof Trusses, Practical Problems, Bridge Engineering, Railroad Engineering, Cost Analysis, Harbor and River Improvement.

\$12.00 Consulting Membership Free

With every set is included a year's Consulting Membership, regular value \$12.00, entitling you to the free advice of a staff of Civil Engineering Experts. This will give you practical help in handling working problems which are too specific to be taken up in detail in the Cyclopaedia. There will be no limit to this service. A single problem solved for you might be worth more than the first cost of the books.

American School of Correspondence, Chicago, U. S. A.

FREE OFFER COUPON

American School of Correspondence, Chicago, U. S. A.

Please send Cyclopaedia of Civil Engineering for 7 days' free examination. I will send \$2 within 7 days and \$2 a month until I have paid \$24.80; otherwise I will notify you and hold the books subject to your order. Title not to pass until fully paid. Pop. Mech. 5-13

NAME

ADDRESS

OCCUPATION

EMPLOYER

MAKE \$250⁰⁰ A MONTH REPAIRING AUTO-MOBILE TIRES

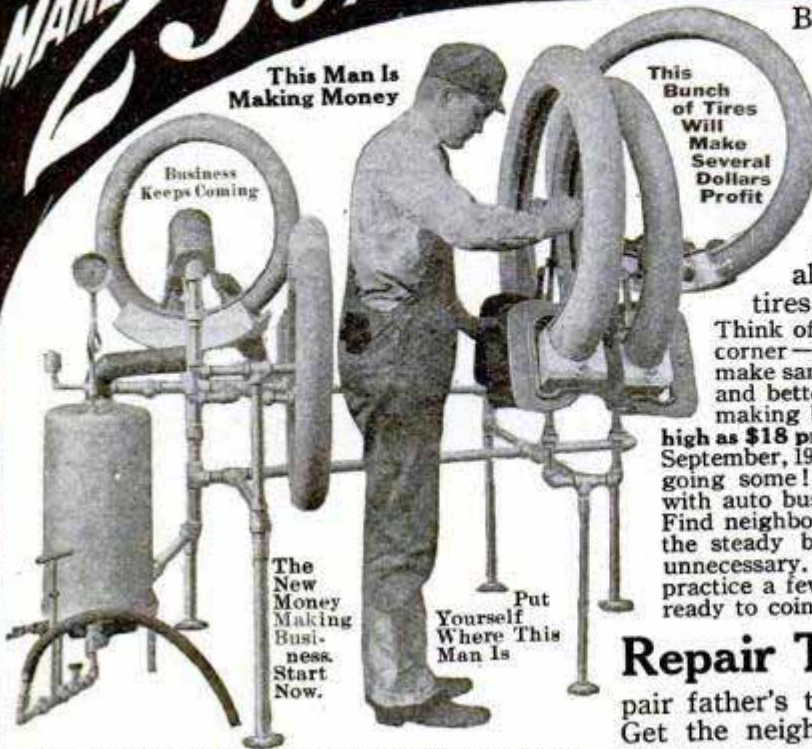

This Man Is Making Money

Business Keeps Coming

This Bunch of Tires Will Make Several Dollars Profit

The New Money Making Business Start Now.

Put Yourself Where This Man Is

Be first to enter this new big paying business in your town. Open your pockets. Let the dollars pour in. Act quick. Every auto sold means more tires to mend. Automobile business is growing fast—enormous field for tire repairing. Punctures and blowouts are common. Tires need retreading and vulcanizing. Something going wrong all the time. Thousands forced to buy new tires because they can't get old ones fixed. Think of the old bicycle days—repair shops on every corner—all making money—busy day and night. Autos make same proposition over again—only ten times bigger and better. Users of Haywood Tire Repair Plants are making big money. Johnson, Tex., writes: "I made as high as \$18 profit in a day." Another man who bought a plant September, 1911, writes he has cleared over \$3000.00. That's going some! Operate a plant as side line in connection with auto business—garage or as an independent business. Find neighborhood where there's a bunch of autos—get all the steady business besides transient work. Experience unnecessary. You learn quick. Simply follow directions—practice a few days on a couple of old tires and you'll be ready to coin money. Business comes fast and easy.

Repair Tires at Home. Young men! and boys repair father's tires—get money he pays garage man. Get the neighbor's work. Make money to attend

college or to start a garage and repair business. Auto owners—repair your own tires—save money—pay for your outfit in short time. We have outfits for home use. Anyhow investigate. Send today for catalogue. See the wonderful possibilities in this marvelous field. Learn of the enormous money-making opportunities in this fascinating new business.

HAYWOOD TIRE & EQUIPMENT CO., 624 N. Capitol Ave., Indianapolis, Ind.

\$9250—Our Price for Next 30 Days

We now offer the Edwards "Steelcote" Garage (1913 Model), direct-from-factory, for \$92.50. But to protect ourselves from advancing prices of steel, we set a time limit upon the offer. We guarantee this record price for 30 days only. Just now we can save you \$35 or more.

Edwards Fireproof Steel Garage Quickly Set Up Any Place

An artistic, fireproof steel structure for private use. Gives absolute protection from sneak thieves, joy riders, fire, lightning, accidents, carelessness, etc. Saves \$20 to \$30 monthly in garage rent. Saves time, work, worry and trouble. Comes ready to set up. All parts cut and fitted. Simple, complete directions furnished. Absolutely rust-proof. Joints and seams permanently tight. Practically indestructible. Locks securely. Ample room for largest car and all equipment. Made by one of the largest makers of portable fireproof buildings. Prompt, safe delivery and satisfaction guaranteed.

(101)



Postal sent today brings new 56-page illustrated Garage Book by return mail. Address

The Edwards Mfg. Co.

620-670 Eggleston Avenue, Cincinnati, Ohio

Please Mention Popular Mechanics

ONE-THOUSAND-MILE BEACH SPEEDWAY FOR THE GULF—A beach speedway, over 1,000 miles long, is proposed for the Gulf-coast country of Texas and Louisiana. All the way from Atchafalaya Bay on the Louisiana coast to the Rio Grande's mouth the



RANGER BICYCLES

Have imported roller chains, sprockets and pedals; New Departure Coaster-Brakes and Hubs; Puncture Proof Tires; highest grade equipment and many advanced features possessed by no other wheels. Guaranteed 5 yrs.

FACTORY PRICES direct to you are less than others ask for cheap wheels. Other reliable models from \$12 up. A few good second-hand machines \$3 to \$8.

10 DAYS' FREE TRIAL We ship on approval, freight prepaid, anywhere in U.S., without a cent in advance. DO NOT BUY a bicycle or a pair of tires from anyone at any price until you get our big new catalog and special prices and a marvelous new offer. A postal brings everything. Write it now. **TIRES, Coaster-Brake Rear Wheels, lamps, parts, sundries, half usual prices.**

Rider Agents everywhere are coining money selling our bicycles, tires and sundries. Write today. **MEAD CYCLE CO., Dept. L 108, CHICAGO**

MOTORCYCLE SUPPLY CATALOGUE

LOWEST PRICES—LARGEST EVER ISSUED

In it we list 1242 guaranteed articles for the motorcycle owner at prices lower than others. We pay transportation charges. A \$20,000 stock for immediate shipment. Motor repair parts at half price. You can't be up-to-date without our 1913 catalog.

For 4c, catalog will be mailed to you.

Write today.



MOTORCYCLE EQUIPMENT CO. MECO 8106 HAMMONDSPORT, N.Y.

NEVERLEAK

Heals Punctures and Leaks

Prevents Flat Tires



A 4 oz. tube of Neverleak Tire Fluid injected into each of your tires will save you those aggravating tire troubles that are always catching you just when you want your wheel the most. It will save you expensive repair bills. Neverleak is a preservative of both the fabric and rubber of which bicycle tires are made. It prevents all trouble on account of tires being porous, will stop threadleaks or those caused by defective repairs, will instantly heal all punctures within the bounds of reason. Make the test and satisfy yourself. Do it today, don't wait for trouble.

Used and sold by bicycle repairmen and dealers in bicycle supplies everywhere

Buffalo Specialty Company
400 Ellicott St. BUFFALO, N. Y.

GOOD YEAR

AKRON, OHIO.

THE GOODYEAR TIRE & RUBBER COMPANY, Main Office and Factory, Akron, Ohio
Branches and Agencies in 103 Principal Cities. More Service Stations than Any Other Tire

NO-RIM-CUT TIRES

10% Oversize — save half on tire bills — Write for latest Tire Book.

beach will be logged as a direct result of the increase in winter tourists to those parts. The hard-packed sand of this section is constantly kept in perfect condition by moisture from the ocean for long stretches, some of which cover over 100 miles. Such a course would be



\$40 Motorcycle

We have the largest line of new and used Motorcycles in the country at the lowest prices. We also have a thoroughly equipped repair department and are in position to furnish repairs for any machine. Send us your machine to be overhauled. We pay cash for second hand motorcycles. Send for Catalog.

HARRY R. GEER CO., 888 McLaran Ave., ST. LOUIS, MO.



Bicycles

50% Off

Factory Price until we close a retail dealer in your community. When retail dealer in your community takes hold of "America" line this offer positively ceases. Order at once and save HALF.

Famous "America" Wheels

Not "cheap" mail-order wheels. Not sold in a "cheap" mail-order way. Only wheel with Truss Frame, giving double strength, and Hygienic Spring Fork, taking up every shock. Comes complete. **GUARANTEED TEN YEARS** (twice the guaranty of any other wheel). Protection from thieves — protection from accidents. Satisfaction or money back.

Write for FREE Illustrated Catalog
AMERICA CYCLE MFG. CO., Dept. 1067
1108 South Michigan Boulevard CHICAGO, ILL.

GET A

"SEARCH-LIGHT" BICYCLE LAMP



BURNS GAS

Makes its own gas and won't jar out

An inexpensive lamp of highest QUALITY. Gives very bright light. Handsome, strong, serviceable and beautifully finished. Can be attached to head or fork. Has adjustable bracket. Be sure to buy a "Search-Light." Ask your dealer. If he's sold out, write us. Send for illustrated catalog.

BICYCLE PUMPS

Get a Bridgeport Pump at your supply store or write and we will see that you are supplied. Send for catalog of pumps.

Bridgeport Brass Company

P. O. Station K
Bridgeport, Conn.

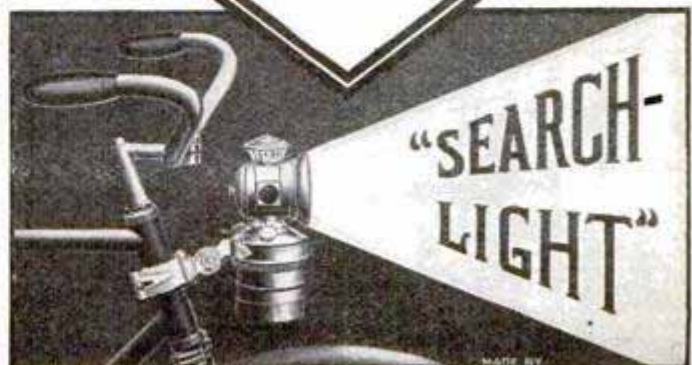
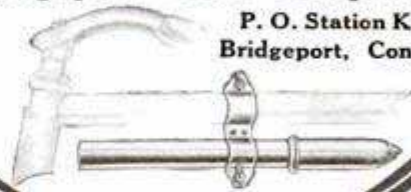

Please Mention Popular Mechanics

EVERY CAR OWNER NEEDS THIS BOOK

IT makes you intimately familiar with every electrical device on your car or motor boat. Tells you how to avoid electrical trouble, how to locate it and how to correct it. Written by experts in such simple terms that any one can understand it.

The only book ever written that covers every phase of electric installation on automobiles and motor boats. Write today for a copy before the edition is exhausted.

Sent postpaid for 25c.

THE PACKARD ELECTRIC CO.

Dept. X

Warren, Ohio

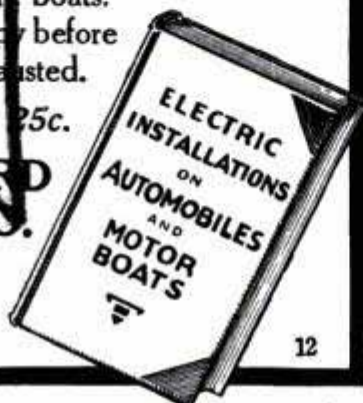

12

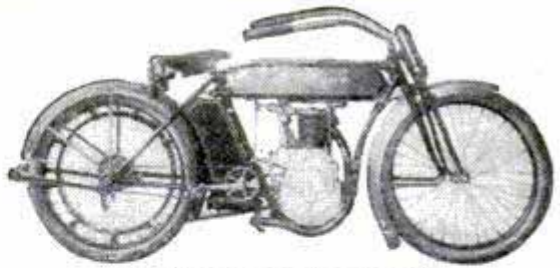

THE FEILBACH LIMITED

Here's a Lighter, Stronger, Faster Motorcycle

Speed, comfort, quality and all that the term "Limited" signifies in connection with railway travel is embodied in this newer, stronger, faster, easier riding motorcycle—the

Feilbach Limited

a new departure in motorcycle construction. Its many special features, including Long Wheel Base, Spring Fork, Special Seat Support with Longitudinal Springs and its neat, trim, graceful appearance appeal instantly to the motorcycle enthusiast. **Price \$250**

You will never realize what maximum motorcycle comfort and quality are until you see and ride the Feilbach Limited. Whatever you do, don't buy a motorcycle before you get details of the Feilbach Limited. Write us today for Folder A. **Agents Wanted.**

FEILBACH MOTOR CO.
1248 Holton St. MILWAUKEE, WIS.



Convert Your Bicycle into a Motor-Cycle

using our Attachable Outfit. Fits any wheel. Also Marine and Stationary Motors and Finished Castings. Stamp for circulars. **STEFFEY MFG. CO.,** Girard Ave. and 30th St., PHILADELPHIA, PA.

5 H. P. 1913 Peerless Motorcycle

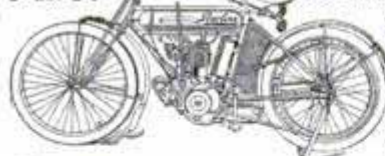

With Free Engine Idler and Bosch Magneto, together with the best there is in motorcycle construction—Power, Silence, Endurance, and those Wearing Qualities so essential for low cost of maintenance. **5 MILES FOR ONE CENT.** Agents Wanted—Liberal Discounts

PEERLESS MOTORCYCLE CO., 179 Huntington Ave., BOSTON, MASS.



Carfare Pays For This Bicycle

What you save riding to work and for pleasure will pay for your "Rick-Made" bicycle—in one year—after that it will actually put money in the bank for you. The "Buffalo" is the best looking, easiest running and most durable bicycle made. Coaster brake, tool kit, long mud guards and bell given without extra cost. Has standard 45-position handle-bars, 3-spiral spring suspension seat, "Beats All Punctureproof" tires, "Brampton" roller chain; mirror nickel and piano enamel finish, special hanger and other features making it the best bicycle buy—needs no repairs.

Guaranteed for L-I-F-E

Other New Bicycles \$14.55 to \$50

30 Days' Free Tryout

We express this bicycle, charges prepaid, so you can examine and approve it at your Express Co.'s office before you spend a cent. If then you are satisfied and certain it is as good or better than any \$50 bicycle you ever saw, pay the Express Agent only \$27.55—ride the bicycle for 30 days—then if you think you don't want it, we will promptly give you back your money and pay the return charges. Don't delay—or you'll forget—write now.

RICK CYCLE WORKS
Dept. C Buffalo, N. Y.

Send for POCKET CATALOG FREE Lowest Prices

REO THE FIFTH Final and crowning achievement of R. E. Olds, pioneer designer of Autos. A standard size 30 to 35 horsepower four cylinder car of modern refinements priced at only \$1,095.

R. M. OWEN & CO., General Sales Agents
REO MOTOR CAR CO. LANSING, MICH.

ideal for motor cars. One natural barrier is in the way, the San Luis Pass, between Galveston and the Brazos River, where a gasoline ferry for motor cars will be installed.

A black plaster is the "first thought" in Chinese first aid. If the trouble heals under the plaster, well and good, otherwise another plaster is added.

HAVOLINE OIL Our new "HAVOLINE Tour Books" will be ready for distribution May 1st. Send us your name and Registration Number and 10c to cover cost of mailing and you will be registered to receive your copy upon publication. Which State do you want "routed"? **INDIAN REFINING CO., 17 Battery Place, New York**

Build YOUR OWN SIDE CAR Motorcycle

Side Cars two parts. Four models to choose from. Send **\$65.00** for Catalogue and terms. **UP**

AGENTS WANTED
Baxter Side Car Co., 119 Broadway, Cambridge, Mass.



RIDER AGENTS WANTED

in each town to ride and exhibit sample 1913 model. Write for Special Offer. **Finest 1913 Models \$10 to \$27** with Coaster-Brakes and Puncture-Proof Tires. **1911 and 1912 MODELS \$7 to \$12** ALL OF BEST MAKES..... **100 Second-Hand Wheels** All makes and models, good as new **Great Factory Clearing Sale. \$3 to \$8** We Ship on Approval without a cent deposit, pay the **10 Days' Free Trial** freight & allow **TIRES** coaster-brake wheels, lamps, and sundries, half usual prices. **DO NOT BUY** till you get our catalogue and offer. Write now. **MEAD CYCLE CO. Dept. L108 CHICAGO**

HENDERSON

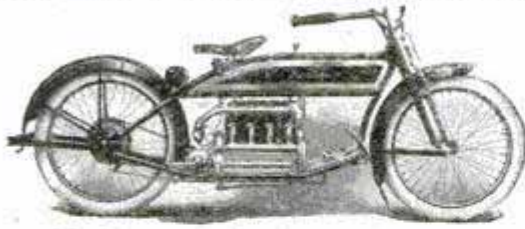

8 H. P., 4 cylinders, free engine, chain drive **\$325**

Why Four Cylinders?

Because the motorcyclist wants three things—power, flexibility of power and easy riding.

The Henderson's four cylinders develop 8 horsepower—enough and to spare to go over any road or climb any hill you will encounter, and far more speed than you will dare use.

This power is flexible. You can throttle to walking speed and still it pulls. You can jump to high speed without nursing the motor.

Four cylinders produce less vibration than one. They are placed low, so the center of gravity is low. The machine rides easier and holds the road better; the wheelbase is longer.

These things have given the Henderson national popularity. Write for the literature.

Henderson Motorcycle Co.
1158 Cass Ave. DETROIT, MICH.

CHINESE COOKING APPARATUS—As Chinese cooking is either stewing or boiling, the apparatus is very primitive. The little open-air eating houses found everywhere along the streets of the native portion of Tientsin and along the wharves have the simplest kind of a furnace supporting a kettle. This kettle answers all possible purposes. In the Chinese houses a very thin cast-iron kettle is placed over the fire and everything which the family eats is cooked therein.



WE SELL YOU AT WHOLESALE

Agents' Price One
AMERICAN
Motorcycle or Bicycle

Honest hand-made machines at factory cost. Write now for catalog. Say whether interested in Motorcycle or Bicycle.
\$139.85 **\$18.85**
AMERICAN MOTOR CYCLE CO., 1005 American Bldg., CHICAGO



HARLEY-DAVIDSON "5-35" THE SILENT GRAY FELLOW

Climbs hills, pulls through sand and over roads impassable to the average automobile. The "5-35" motor will pick up from a standing start to 40 miles an hour in 300 feet. Ful-Floeing Seat and Free Wheel Control are exclusive Harley-Davidson features.

Description of these and other features on request.

Harley-Davidson Motor Co., 294 B St., MILWAUKEE, WIS.



THE GREAT AMERICAN
Eagle

9-12 H. P. Chain Drive Twin
Send for catalog and prices.
EAGLE MOTOR CO.
(P. M.) Brockton, Mass.



The Simple Story of a Business and Mechanical Success

THIRTEEN years ago the first Flying Merkel Motorcycle was created in a little shop in Milwaukee. Mechanically correct, even in those days, it achieved instant popularity. With the progression of the industry the popularity of the Flying Merkel has more than proportionately increased. This year there will be more than 15,000 new Flying Merkel motorcycles on the highways and byways of the earth.

There is a simple little moral in the foregoing statement: Were the Flying Merkel Motorcycle not more wonderful than its makers claim it would not today enjoy the tremendous prestige that is accorded it.

There are many reasons for this condition. To begin with, nothing but the finest materials obtainable in the markets of the world enter into the construction of the Flying Merkel. None but the most skilled mechanics are employed by this company. Every part is minutely inspected before it reaches the assembly room—a rigid system of inspection that costs a great deal more than any system of inspection in any other motorcycle factory in the world. After being assembled each and every Flying Merkel Motorcycle undergoes the most thorough road test before it reaches the shipping room. Without fear of contradiction we emphatically state, "the Flying Merkel is the best motorcycle made."

As to the features of the machine itself: The Flying Merkel is the *only* motorcycle in the world with a Self-Starter, a labor-saving device hitherto obtainable only on the highest priced automobiles. It also has the only reliable Two-Speed Hub on the market, the gears being always in mesh and therefore impossible to strip. It has the only adjustable Spring Frame in the world, more than 300 inches of spring steel absorbing all the unevenness of road travel, and making the roughest road seem as a boulevard. The full Hess-Bright Ball-Bearing Motor makes it not only the most powerful but also the fastest motorcycle engine in the world. The Flying Merkel 7 H. P. twin will climb hills that big 10 H. P. machines cannot begin to surmount and for 13 years it has been able to lead any stock machine on the road.

The real test for any motorcycle is a long distance endurance run. During 1912 Flying Merkel Motorcycles won a larger percentage of endurance contests than any other motorcycle in the world.

We do not ask you to take our word for it. Examine every motorcycle on the market and compare them point by point with the Flying Merkel, and you will find every so-called improvement is but an adaptation of features that have been distinctively Flying Merkel for years. More than that, you will find incorporated in the Flying Merkel many features not possessed by any other motorcycle.

If you would learn more about the *Best Motorcycle in the World*, write today for our latest illustrated art catalog which describes the wonderful Self-Starting, Two-Speed, Spring Frame, Ball-Bearing Flying Merkel Motorcycle in detail. This handsome booklet is FREE for the asking. Just address

The Miami Cycle & Mfg. Co.
350-370 Hanover Street, MIDDLETOWN, OHIO, U. S. A.



Equip Your Motorcycle with the
ORBIN-BROWN SPEEDOMETER
 "The Speedometer of Absolute Accuracy"

It will prevent you from unknowingly exceeding the speed limit. It will measure distances for you. It will tell you just how many miles you get out of your tires and each gallon of gasoline.

Extremely simple centrifugal mechanism. No small, delicate parts to jar loose or become broken. At the low price of \$15.00. Sold by leading motorcycle dealers everywhere. Write for catalog.

The American Hardware Corporation
THE CORBIN-SCREW DIVISION
 302 High Street New Britain, Conn.
 Branches: New York Chicago Philadelphia
 Makers of the celebrated Corbin Coaster Brake for Bicycles and Motorcycles

Prest-O-Lite



The Only Practical Light for Motorcycles

Prest-O-Lite is the only lighting system that makes night riding possible, pleasant and SAFE.

The ready-to-use gas costs no more—usually costs less—than the carbide a generator consumes.

The first cost is low [\$10]. Prest-O-Lite never gets to be second-hand, and is always a **READY CASH ASSET**.

You can easily afford it. You cannot afford to be without it if you ride at night. One accident might cost you more than years of Prest-O-Lite service.

Easily attached to any motorcycle. We will arrange for immediate exchange service for anyone, anywhere.

See any motorcycle (or automobile) dealer, or write us.

DON'T ACCEPT AN IMITATION!

The genuine Prest-O-Lite, when empty, can be immediately exchanged for a full one, ANYWHERE AND ALWAYS. Imitations cannot.

The Prest-O-Lite Co., Indianapolis, Ind.
 Branch offices and Service Stations in all principal cities. Charging plants in all parts of the country.
 Exchange Agencies Everywhere

Ten Days' Free Trial

allowed on every bicycle we sell. We **Ship on Approval and trial** to anyone in the U. S. and *prepay the freight*. If you are not satisfied with the bicycle after using it ten days, ship it back and *don't pay a cent*.

FACTORY PRICES Do not buy a bicycle or a pair of tires from anyone at any price until you receive our latest **Art Catalogs** of high grade bicycles and sundries and learn our *unheard of prices and marvelous new special offers*.

IT ONLY COSTS a cent to write a postal and **FREE** by return mail. You will get much valuable information. **Do Not Wait; write it Now!**

TIRES, Coaster-Brake rear wheels, lamps, parts, repairs and sundries of all kinds at half usual prices.

MEAD CYCLE CO. Dept. L 108 CHICAGO



Schickel
 VALVELESS TWO-STROKE
Motorcycle
 SIMPLE-NEAT SERVICEABLE

Send postal for catalog

THE SCHICKEL MOTOR CO., 69 Garden St., STAMFORD, CONN.

MAKE YOUR BIKE A MOTORCYCLE



at a small cost, by using our attachable outfit. Fits any Bicycle. Easily attached. No special tools required.

Always Ready to Run

Mr. O. H. Bouter, of Winnipeg, Man., writes that, "I have tested your attachment out in Manitoba and Florida sands, and would not be without one. I never have five minutes of trouble. It is always ready to run."

Mr. R. E. Lightfoot, of Mo., writes that, "I have one of your Motorcycle Attachments and am glad to say it gives good satisfaction. It will go over the steepest of hills and rough roads."

FREE BOOK Write today for bargain list and free booklet, fully describing the **SHAW Bicycle Motor Attachment**. Motorcycles all makes, new and second-hand, \$35.00 up.

SHAW MANUFACTURING CO.
 Dept. 6 GALESBURG, KANSAS

MOTORCYCLE SUPPLIES

Motorcycle Supplies
 We Make the Price

To get our latest book **FREE**, give name of your motorcycle. This is the most complete exclusive motorcycle accessory catalog ever published. You can't afford to be without it. Address us today.

KANSAS CITY MOTORCYCLE SUPPLY CO.
 1501 Grand Ave. Kansas City, Mo.

SEND FOR MOTOR CYCLE CATALOGUE

Three great Pope features

Overhead-valve Motor—more power and speed. Rear Spring Suspension, helical *expansion* type, insures comfort. Spring Fork absorbs vibration.

Model H	"Lightweight"	\$165
Model K	"The Big 4"	\$200
Model M	"5 h. p."	\$215
Model L	"Twin"	\$250

Get the details. Write today.
THE POPE MANUFACTURING COMPANY
 479 Capitol Ave., Hartford, Conn.

Also makers of Pope-Hartford Automobiles, Columbia, Rambler and Pope Bicycles

POPE
 MOTOR CYCLES

Pope quality has never been questioned



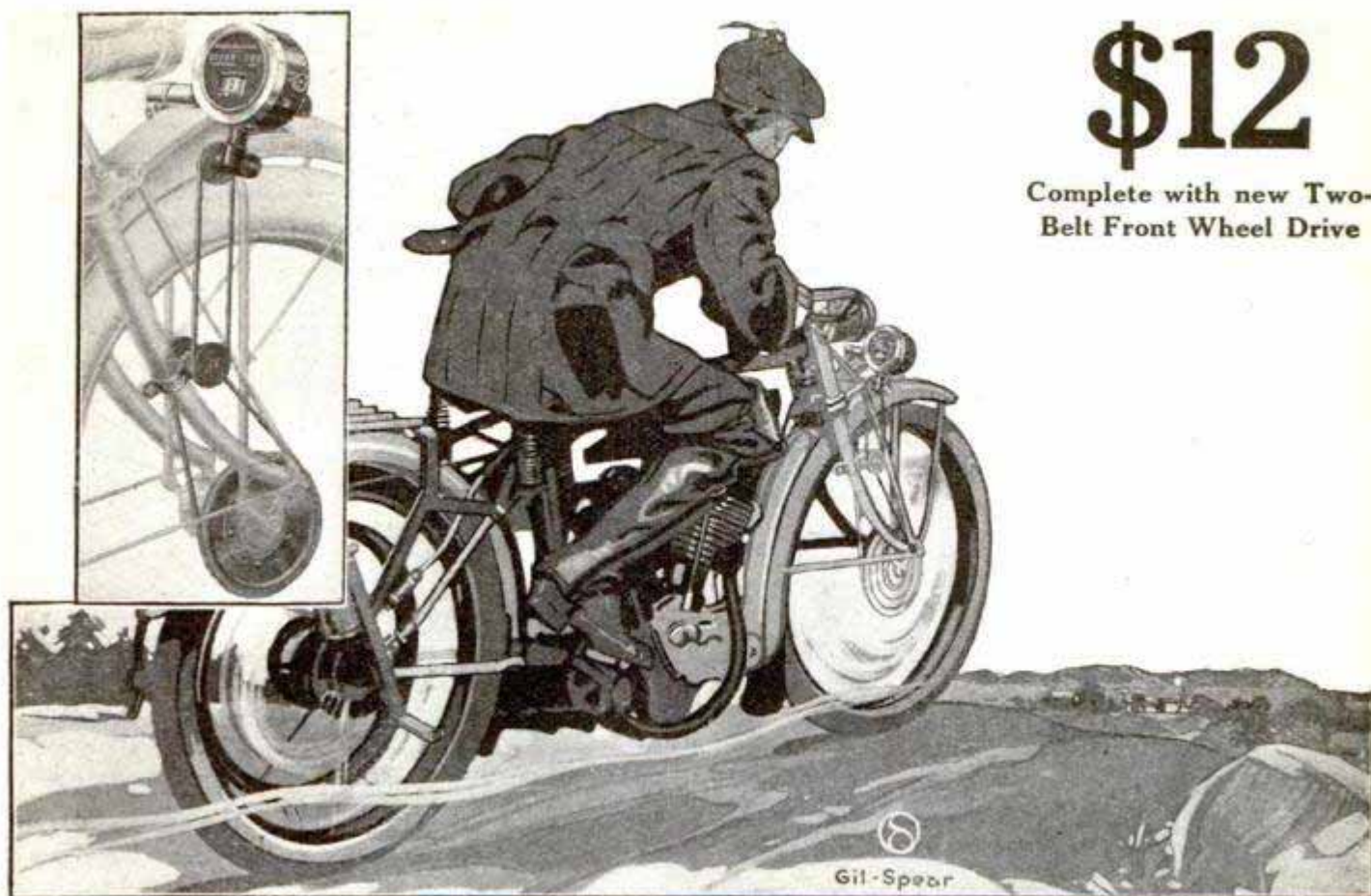

This Shows the new Two-Belt Front Wheel Drive

\$12

Complete with new Two-Belt Front Wheel Drive

Motorists Are Enthusiastic About the New Stewart Motorcycle Speedometer

With the New Two-Belt Front Wheel Drive

The New 1913 Stewart Motorcycle Speedometer is installed in an entirely new manner and is driven by an entirely new method. We formerly installed the Speedometer upon the frame or handlebars and drove it with a flexible shaft. We now install it upon the mudguard or extension spring and drive it with a two-belt drive from the front wheel.

By installing the Speedometer upon the mudguards or extension spring *we utilize the direct rays of the headlight to illuminate it at night*—thus the purchaser is saved the cost of equipping with a lighting system.

Our front wheel two-belt drive is an ideal method of driving a motorcycle. For it we have abandoned all other methods of driving. During a period of twelve months it has fully demonstrated its superiority under the most crucial road tests and is being rapidly adopted by expert motorcycle tourists, motorcycle divisions of police departments, and thousands who require a speedometer or driving

equipment that can be depended upon to indicate accurately at every speed *and to unfailingly register every turn of the front wheel.*

The Stewart Motorcycle Speedometer is built of the same costly materials as the highest priced automobile speedometers. It is a beautiful piece of work—handsome, strong, and serviceable.

The New 1913 Stewart Motorcycle Speedometer is fully guaranteed.

Examine one of these instruments at your dealer's. They are for sale by reliable dealers all over the world. The price is \$12 for the entire instrument with all of its connections complete.

Write us for an interesting booklet describing and illustrating the most practical motorcycle speedometer made.

We maintain the largest chain of service stations in the world. A Stewart on your motorcycle entitles you to this international service.

The Stewart Speedometer Factory

1906 Diversey Blvd., Chicago, U. S. A.

A Great Achievement!!

Hammers Drop Forged from the New Vanadium Steel

Two years ago an authority said "The first toolsmith to successfully drop forge hammers from vanadium steel will revolutionize the tool business. Hammers so forged will outlast any other 3 to 1".

The "Vandor" Vanadium Hammers are here and in the few months they have been on the market they have already made the ordinary steel hammer a back number.

Don't be satisfied with just an ordinary hammer—ask your dealer for and insist upon

—**"VANDOR"**—

Vanadium Steel Hammers

Absolutely Warranted

In 2 styles, finishing and standard. Style 21½ is here illustrated—Note the exclusive features, the new hexagon reinforced pattern—the wonderful bite. Perfect balance and grip. Finest second growth hickory handle. All efficiency, with minimum effort—it works with you. It will outlast any ordinary hammer triple fold. It's the big favorite for general use. Numbered guarantee tag with every tool.

Ask your Dealer for the
—**"VANDOR"**— Vanadium
Hammer.
If he can't supply you send
Us \$1 and his name—we'll
see you get the hammer.

Van Doren Mfg. Co.
Dept. 105 Chicago Heights, Ill.

Enclosed find \$1 for which send "Vandor"
Vanadium Hammer, Postpaid.

My dealer's name is _____

My name is _____

Address _____



TO DEALERS:
Every Vandor
Vanadium Hammer
is packed in
individual carton
with a numbered
guarantee. Vandor's
Vanadium displays
we'll the hammers
for you.
Write us today.

Standard
 Finishing



One of 38 Styles

Greatest Piano Offer

Indeed the greatest, most stupendous, most amazing piano offer ever made—a simply sweeping, paralyzing offer. And on a piano of the highest standard, the Superb Wing. Shipped for Free Trial; Freight Prepaid Think of it. Shipped to you, direct from our factory—A FOUR WEEKS' ABSOLUTELY FREE TRIAL in your own home—and we pay all the freight! Write for our art catalog and particulars of our Rock Bottom offer. SEND NOW.

WING & SON (Est. 1868), Dept. 1195, 9th Ave. & 13th St., New York, N. Y.

AGENTS WANTED

I want good agents in every county to sell a new, guaranteed Automatic Razor Strop. Sample furnished free. Exclusive territory. No deposit required. Complete information free. Write today. Make \$40 to \$80 a week.

L. C. WORST, Pres.

114 State Street

FREMONT, OHIO

NO SMOKE
NO SMELL

HAVE BETTER LIGHT

WITH THE "PERFECT" BURNER

Wonderful new invention—turns dim red flame into big brilliant, white, steady light. As good as gas or electricity. Works on any lamp. No smoke, no smell. Makes one lamp do work of three. Prevents eye strain. Saves oil. Fine for all night use. Guaranteed. Price 20c, for No. 1 or No. 2 lamp, or No. 2 Cold Blast lantern, by mail prepaid. Agents Wanted. Write quick. PERFECT BURNER CO., 474 Spitzer Bldg., Toledo, O.

YOUR OWN NAME ON A SELF-FILLING



JOHN BROWN

\$1.50

Non-Leakable High-Class MORTON PEN

J. MORTON, 45 Maiden Lane, New York

The most "individual pen" you ever owned. Unique—because no other pen offers such a distinctive novelty. Practical—for easy identification in case of loss. Great seller for agents.
AGENTS WANTED

Let Kingery

WE'LL TREAT YOU RIGHT

Start You
in the
Popcorn
and
Peanut Business

See his page ad on page 186—April Popular Mechanics
KINGERY MFG. CO., 390 Pearl Street, CINCINNATI, O.

\$15.00 TO \$20.00 PER DAY PROFIT FOR YOU!

Here is your chance to go in business and make **BIG MONEY** this summer. No knowledge or experience in photography required. **Photos made direct on POST CARDS or TIN TYPES** without the use of plates, negatives or dark room. Developed, toned and fixed in one solution, and delivered on the spot in **ONE MINUTE**. Don't miss this opportunity to become independent. Write today for our new catalogue and price list.

JAMESTOWN FERROTYPE COMPANY
Dept. 146, 1113 S. Halsted Street, Chicago, Ill.



Fits any Motor, 2 or 4 cycle. **EFFICIENCY WITH SILENCE** Simply installed in any boat.

Designed to new principles, scientifically applied, the **HYDREX** cools—CALMS all motor Exhausts. Comfort for you and those ashore. Kills primary and secondary rish. Won't wear out. Approved by Government Inspector. No BACK PRESSURE when above or under water. Send for "PRACTICAL DETAILS" and illustrated Sheets, free to all.

HYDREX SILENT EXHAUST WORKS, 28 Church St., New York



Solar Motorcycle Lamps

are the neatest looking, strongest and most efficient lamps made. The product of light specialists, makers of 90% of the automobile lamps used on the high grade cars of America. Catalog shows many styles—gas, oil and electric. Write for it today.

BADGER BRASS MFG. CO.

Kenosha, Wis. New York City, N. Y.

The Best Book for Beginners

A Practical Course in Mechanical Drawing

Price 50c
Postpaid

By
Wm. F. Willard

POPULAR MECHANICS BOOK DEPT.
318 W. Washington St., Chicago

BOYS! HERE ARE 700 THINGS YOU CAN MAKE

and 1000 pictures that show you how

Set of 4 books telling how to make wireless outfits, boats, camp equipment, aerial gliders, kites, self-propelled vehicles, engines, motors, electrical apparatus, cameras and 690 other things that delight the heart of the average boy.

These books sent postpaid to any address for **\$1**

The contents of the four volumes are like the articles appearing in this magazine under the heading "Amateur Mechanics."

For sale by news and book dealers, or address the publishers
POPULAR MECHANICS BOOK DEPT., CHICAGO

Startling Watch Offer

The Great Burlington Special
Direct to You at the Rock-Bottom Price

The world's masterpiece of watch manufacture now sold direct. The superb Burlington Special, adjusted to temperature, isochronism and positions, 19 jewels, fitted at the factory into the superb gold strata case—now sold direct to you at the rock-bottom price—the same price that even the wholesale jeweler must pay.

A Watch Offer Without Parallel

We have decided to make such a tremendous offer direct to the public on a first-class time-piece that old watch selling methods will be swept aside. The famous Burlington direct and at the same price even the wholesale jewelers must pay. And, in order to make the proposition doubly easy for the public, we will even allow the rock-bottom price, if desired, on terms of \$2.50 a month.

Get the Burlington Watch Company's FREE Watch Book

A book that will tell you the inside facts about the watch industry. It will tell you what you ought to know before you even examine a watch. It will tell you the inside facts about watch prices and explain the many superior points of the Burlington over the double-priced products. Just send your name and address TODAY. Sign and mail this coupon.

BURLINGTON WATCH CO.
Dept. 1195, 19th St. and Marshall Blvd., Chicago, Ill.



FREE Book Coupon
Burlington Watch Co.
19th St. & Marshall Blvd., Chicago
Dept. 1195

Please send me, without obligation and prepaid, your free book on watches and a copy of your \$1000 challenge, with full explanations of your cash or \$2.50 a month offer on the Burlington Watch.

Name

Address

DEVELOPING MOTION-PICTURE FILMS—The developing of motion-picture films is so considerable and delicate a task in itself that a plant has been established at Lyons, France, to do just this work alone. It is capable of finishing over 130,000 ft. of film per day.

LOW FACTORY PRICES
on Invalid Chairs and Tricycles. Send 10c in stamps for big illustrated catalog.
GORDON MFG. CO. 412 MADISON AVE., TOLEDO, O.

SENT ON 30 DAYS' TRIAL TO RESPONSIBLE PERSON
The Handiest Tool Holder Made
Constructed of hardened steel, well and truly made. Holds any shape of stock down to No. 60 Drill. Write for Catalog E.
B. MORGAN, Manufacturer of SPECIALTIES
Bellevue St., NEWPORT, R. I.

VELVET THE SMOOTHEST TOBACCO 10c
8½ Pound Electric Suction Cleaner
At last a suction cleaner a woman can handle as easily as a carpet sweeper. Weighs no more. Takes up only two-thirds as much room. Can be packed away in small box. Rolls on rubber-tired wheels—moved without effort. More powerful than big unwieldy machines.
The MORROW 10 Days Free Trial
We take all the risk. Write today for our Free Book. Just send a postal with your name and address.
THE MORROW COMPANY, Dept. 1195, Waukegan, Ill.
Good Territories Still Open—Agents and Dealers Write

"Come-Packt" Furniture in 30,000 Homes!

Try It in YOUR Home—at OUR Risk—and Save 50%!

Come-Packt Furniture speaks for itself. It's made of Quarter-Sawn White Oak, in hundreds of exclusive designs and very handsomely finished. Order all you want, use it a year—get your money back any time you say.

We could not make this furniture better if we asked double our prices.



Dining Table
45-Inch Top . . **\$19⁷⁵**
(Dealer's Price \$38.00)



Price \$17.95
(Dealer's Price \$38.00)

Just Try It at Our Risk—Save Dealer's Profits!
Our large FREE illustrated catalog is a Furniture Exposition in itself. By all means get it and compare our prices and furniture with others. All shipments direct from our factory. Write today.
Morris Chair \$10²⁵
(Dealer's Price \$21)



COME-PACKT FURNITURE COMPANY, 501 Fernwood Ave., Toledo, Ohio





Install Your Own Plumbing and Heating Systems

Save all cost of skilled labor. Save on all material. New practical Gibbons method. My big, new book tells you how to install your own modern water system, heating plant and bathroom outfit. Under the practical Gibbons method you can do it yourself. Plans furnished free. Before you build, before you make improvements, send for my valuable book. It is post-paid, free to you.

Gibbons Method My method is a revelation even to the most experienced contractors and builders. Get this free book and learn the money-making secrets of modern plumbing and heating. See my amazing bed-rock prices.

Book Free

My new book gives you greater buying power than your local dealer. Thousands of things illustrated and simplified. Electric lighting plants for homes, gasoline engines, hydraulic rams, pumps, pipes, valves, acetylene lighting plants, all accessories, everything guaranteed.

Write Today Home-owners, contractors and builders need my wonderful new book. The low prices of my high quality material will astound you. A post-card brings the book to you postpaid, free.

M. J. GIBBONS, Dept 5249, Dayton, Ohio

MONEY FOR YOU IN A NEW BUSINESS

Write us at once -today. Learn how you can make \$50.00 a week in the one minute picture business.

No Experience Necessary

Everybody buys these new one minute post card photos. Be a one minute photographer—make money the first day you start work with the

One Minute Camera

Press this bulb of profit



A Complete Portable Photo Studio

Takes and Delivers Photo Post Cards in a Minute

Snap the Bulb; Deliver the Picture; Collect your money—All in a Minute!

Small Investment—Make 80c Profit on Every Dollar—Making photos direct by our new process—

Photos Made Direct on Post Cards No Plates, Films or Dark Room

If you are ambitious and want to get in a big-paying business of your own, start at once. Our ONE MINUTE CAMERA is a big money maker at fairs, carnivals, in small towns, large cities—everywhere. The 20th century photographic sensation. **WRITE AT ONCE FOR FULL PARTICULARS.**

THE ONE MINUTE CAMERA CO., Dept. 155, 536-538 S. Clark St., Chicago

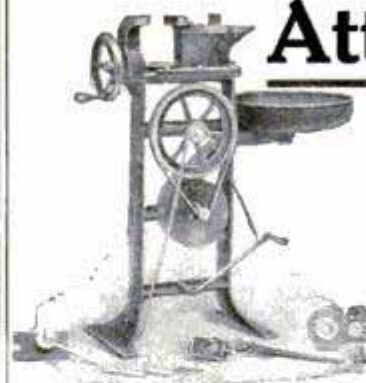

Attention!

Machinists
Electricians
Garage Men
Engineers
Farmers
Factories
ETC., ETC.

The Ideal Combination Tool

SIX TOOLS IN ONE

A Forge, Anvil, Drill Press, Vise, Emery Wheel, Pipe Vise

Six Practical Tools Combined in One

Save Time, Labor and Money That's All

MANUFACTURED BY

Tessmer Machine & Tool Co.
DETROIT, MICH.

GOVERNMENT DESTROYS 25,000,000 STAMPS— About 25,000,000 new postage stamps made in honor of the Panama Canal will be destroyed, due to the fault of the engraver who labeled a picture of the Pedro Miguel locks, "Gatun Locks." The government's loss of \$2,000 might have been made up by a sale to stamp collectors, who offer big prices for stamps that have errors on them and are withdrawn.

Used Piano Bargains

A good standard make used piano is a better investment than a cheap new piano. We carry a large stock of used standard make pianos, taken in exchange as part payment on new Starck Pianos and Player Pianos. Prices \$75.00 to \$195.00. 30 days' free trial; easiest payments; 50 FREE MUSIC LESSONS.



WRITE TODAY FOR BARGAIN LIST.
P. A. STARCK PIANO CO 385 Starck Building, Chicago, Ill.

Use Steel Shingles

and Save Big Money

Send for amazing low factory-price on genuine Edwards Steel Shingles. They beat wood shingles and prepared roofing a MILE, yet cost much less. And we pay freight!

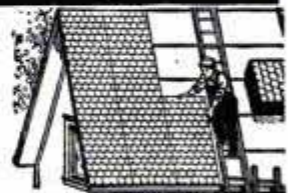

Edwards STEEL Shingles

are guaranteed rust-proof, fire-proof, lightning-proof and weather-proof—due to our famous Tightcote Process. No painting, no patching, no hiring mechanics—any man can quickly lay them. Made in big sheets ready to put on over old roof or sheathing. Every Edwards roof is guaranteed against lightning by a \$10,000 Guaranty Bond. Over 100,000 Edwards roofs in U. S. Made by biggest sheet-metal maker in the world. Postal sent now brings Catalog 550 and Special Factory-Prices by return mail. Give size of roof if you can. (88)

THE EDWARDS MFG. CO., 500-550 Culvert St., Cincinnati, O.



**THIS
17
JEWEL
ELGIN
IN 25 YEAR
GOLD CASE ONLY
\$12.75**

30 DAYS FREE TRIAL

Now—during this Special Sale—is a splendid time to buy a fine Watch. We would like to send you this 17-Jewel Elgin in hand engraved 25-year gold case for your inspection. It sells regularly at \$20.00. We save you nearly one half. If you answer this advertisement you can buy it for \$12.75.

NO MONEY DOWN

We don't want you to send us one cent. Not a penny. Merely give us your name and address that we may send you this handsome Watch on approval. If after you receive it and want to keep it, then you pay us only

\$2.00 A MONTH

If you don't want to keep it, send it back at our expense. You assume no risk whatever in dealing with us. You do not buy or pay a cent until we have placed the watch in your hands for your decision. We ask **NO SECURITY, NO INTEREST.** No red tape—just common honesty among men. If this offer appeals to you **WRITE TODAY** for

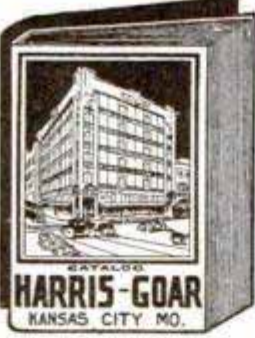

Our Big Free WATCH and DIAMOND BOOK!

HARRIS-GOAR CO.

Dept. 850 KANSAS CITY, MO.
THE HOUSE THAT SELLS MORE ELGIN WATCHES THAN ANY OTHER FIRM IN THE WORLD.



\$3.00 A MONTH

Buy This Beautiful L. C. SMITH TYPEWRITER Has Back Spacer, Tabulator, Two Color Ribbon, in fact every modern feature for the maximum convenience and operating efficiency.

Send today for the greatest typewriter opportunity ever offered.

HARRY A. SMITH, Dept. M, 180 North Dearborn St., Chicago



We Ship on Approval

without a cent deposit, prepay the freight and allow **10 DAYS FREE TRIAL** on every bicycle. **IT ONLY COSTS** one cent to learn our unheard of prices and marvelous offers on highest grade 1913 models.

FACTORY PRICES Do not buy a bicycle or a pair of tires from anyone at any price until you write for our new large Art Catalog and learn our wonderful proposition on the first sample bicycle going to your town.

RIDER AGENTS everywhere are making big money exhibiting and selling our bicycles. We sell cheaper than any other factory.

TIRES, Coaster-Brake rear wheels, lamps, repairs and sundries at half usual prices. Do Not Wait! write today for our latest special offer on "Ranger" bicycle.

MEAD CYCLE CO. Dept L 108 CHICAGO



Box of Havana Cigars only 50c

This box of Spanish cedar contains five of the most superb Tampa made cigars ever offered to the American public. The Juan del Rey private box brand. We have prepared this special lot of boxes of five Juan del Reys to send out by parcel post to men who want the finest smoke the supreme tobacco fields of Cuba can afford. Send the coupon below and get five of the finest cigars you ever smoked or offered to a friend.



Finest Cuba Grown

The Juan del Rey is made of the finest grown Cuban leaves, all Havana. It is made exclusively for fine box trade. It is not handled by jobbers. We own and control the brand and sell them exclusively to gentlemen who appreciate the most delicately rich quality at the price of an ordinary 10c cigar. The saving when measured by quality is very great. Send the coupon today and get a sample box of five magnificent Havana cigars.

To Introduce Supremely Fine Cigars

We will send this box of cigars by parcel post direct to your office or your home. The price on these five cigars is the same as if you had bought a full box of fifty. We pay the additional cost and expenses to introduce this cigar to you. If you have been paying more than 10c for your cigars you owe it to yourself to prove to your own taste that we have the finest cigar at a moderate price ever offered.

Special Offer

For a limited time we will send this specially packed box of five Club House cigars to enable you to sample the quality of the Juan del Rey private box brand. We have built up our great private box trade over the United States by the elegance of quality, the saving in price and the highly satisfactory advantages of dealing direct with us. We feel sure we will have you for a regular customer if you will try this sample box.

Send Coupon 50c

Send this coupon and enclose with it only 50c. Send money order, stamps or silver or check. We will send you also full illustrated description of the Juan del Rey line of cigars, also description and sample of French's Mixture, the "aristocrat of smoking tobacco." If you enjoy a fine pipe smoke send anyway for free sample of French's Mixture. Send while this special cigar offer is open. Send today.

French Tobacco Co., Dept 15 Statesville, N. C.

French Tobacco Co., Dept. 15, Statesville, N. C.

Gentlemen:—Enclosed herewith is 50c for which please send me by parcel post all prepaid Spanish Cedar box containing five Club House Juan del Rey cigars guaranteed to be the finest Cuban grown Tampa made cigars, suited to men accustomed to fine Havana cigars.

NAME.....

ADDRESS.....

Light Medium Dark Sample Smoking Tobacco

AGENTS! \$1200.00

in Cold Cash Made, Paid, Banked in 30 Days, by Stoneman—\$15000 to Date.

LISTEN

This opportunity is open to you—this money—the cold cash—can be yours. We want 5,000 good men immediately. The opportunity is open for acceptance today. You, and you alone, by waiting too long, can lose it. No experience necessary. Business supplies capital. Get complete facts at once. Ask to be shown. Get in line. Make 1913 the biggest you have ever lived or dreamed of. You don't have to wait a month—not even a week—payments can start the first day; and you can work into a position which enabled R. V. Zimmerman, a farmer of Indiana, to order

\$13,245.00 IN 110 DAYS

We have been quietly securing men from all walks of life—ministers, clerks, farmers, doctors, lawyers, teachers, etc.—enabling them with our co-operation and \$50,000 APPROPRIATION, to get what we here offer and can do for you. Some of these men you may know—possibly have envied their prosperity without understanding the reason of their success. 1913 will break all records—agents actually getting rich. Think of these figures: Langley (liveryman), \$115 FIRST DAY; Rasp (agent), \$1,685 in 73 days; Beem (solicitor), \$164.25 WEEKLY FOR 12 WEEKS; Korstad (farmer), \$2,212 in a few weeks; Juell (clerk), \$6,800; Hart (farmer), \$5,000; Wilson (cashier), \$3,000 IN 30 DAYS. Let us refer you to these men—to the U. S. GOVERNMENT, to banks, business houses, noted people at home and abroad—let us tell you about our startling plan of universal distribution through special representatives which absolutely insures

\$1000.00 Per Man, Per County

You, by acting NOW—TODAY—can get this proposition for your section. This is not a fairy tale, fake, or humbug; for, LISTEN—IT IS GOING ON DAILY.

If you can use \$1,000.00—real money—SAY SO. Don't hesitate—don't delay a minute, but get the thousand-dollar hustle—get your first thousand dollars—first start—first taste of REAL INDEPENDENCE—POWER, INFLUENCE, LUXURIES. Join hands with us and enjoy abundant prosperity. So get mighty busy—write today. It costs nothing but a cent to find out all about it and to receive absolute proof.

Investigate and Be Amazed

Find out how Oviatt (Iowa minister) ordered over 800 outfits in 11 days; Cook (solicitor) \$4,000 to date; Rogers (surveyor) \$2,800. He writes: "Selling baths has got me one piece of property, expect to get another." Learn how O. P. Schleicher, Ohio (minister), received \$195 TWELVE HOURS AFTER APPOINTMENT. Hundreds share a similar prosperity—banking money—buying homes, automobiles. Hoard (doctor) \$2,200. SAME APPOINTMENT SHOULD MEAN SAME MONEY TO YOU. Rise to big earnings, wage freedom, ownership and private monopoly. KNOWING THE REASON DISPELS ALL DOUBT.

Risk One Cent to Make Thousands

And say with Lodewick, Maine (solicitor):—"Lucky I answered your ad. It's great—money coming fast—17 orders to date—sells on sight." Why should not Cashman say: "The man who could not sell your goods could not sell bread in a famine." Get a postal card—put your name and address on it this minute—drop it in the mail box, addressed to us today. Heed this caution from Chas. Starr, of Michigan, who writes: "Sorry this field is closed—SHOULD HAVE ACTED SOONER, but was skeptical. Your local man's GREAT SUCCESS has set everybody talking and proves I WAS A CHUMP. WONDERFUL WHAT A MAN CAN DO WITH A REAL OPPORTUNITY."

SEND NO MONEY Business supplies capital. Credit given to active distributors. Investigate first. Asking to be shown doesn't obligate you one bit. Just spend one cent today—ACT NOW—BE FIRST. Don't let somebody else get the territory you want. We want 5,000 good men to act as our special representatives immediately—send your application by the FIRST MAIL. Just a postal card will do. Send it now.

THE ALLEN MFG. CO., 3682 Allen Bldg., TOLEDO, OHIO



Strange Invention

Gives every home a bath-room for only \$6.50; excels others costing \$150 to \$200. Abolishes tubs, bowls, buckets, wash-rags, sponges. Turns any room into a bath-room. WITH HOT OR COLD RUNNING WATER. Cleanses almost automatically. No plumbing—no water works—self-heating. Gives cleansing, frictional, massage and shower baths. So simple a child can operate. Truly marvelous. A modern home-bathing, without drudgery, inconvenience, muss or lugging water, filling up, emptying, cleaning, putting away. Could anything be more popular? Think of the millions who want bath-rooms! At sight, people exclaim, "There, there, that is what I have been looking for!" OVER 200,000 DELIGHTED CUSTOMERS—Used by U. S. GOVERNMENT. Think what you could do with this in your territory. No competition—fascinating—high-grade business.

"BUFFALO" MARINE ENGINES

If marine engine efficiency has any interest for you do not fail to get the 1913 "Buffalo Book."

It describes fully the "Buffalo" line of four-cycle gasolene and kerosene engines—3 to 150 h. p.—for work boats, speed boats, launches and cruisers.

BUFFALO GASOLENE MOTOR CO.
1293-1305 Niagara Street, BUFFALO, N. Y.

"Odd Jobs"

bob up at house-cleaning time which really require a Bench and tools. With a Grand Rapids HOME BENCH

many things can be "fixed" with convenience and pleasure that now require the expense of a mechanic.

Thousands of well regulated homes have a home bench—why not you?

Send today for free catalog of all styles and prices.

GRAND RAPIDS HAND SCREW CO.
1620 Front Ave., Grand Rapids, Mich.

If you want one of our Stone Blotters send 15c when writing for catalog.



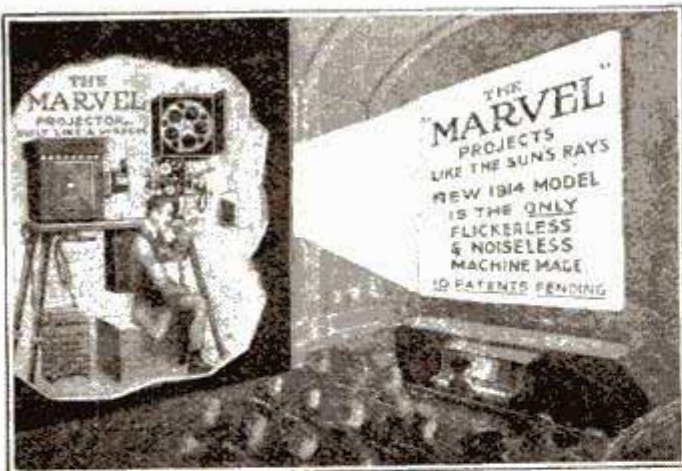

GO INTO THE MOVING PICTURE BUSINESS \$20.00 AND MORE PER NIGHT CAN BE MADE ANYWHERE WITH OUR MACHINE

It is a startling fact that in hundreds of cities and small towns, are young men who have gotten rich from running Moving Picture Shows, having started with but little money.

There is a fortune in your own, and surrounding towns waiting for the first man to show our **FLICKERLESS** moving pictures. Don't let someone else take this big income. Rent a store, a hall, a church, a school-room or a discontinued garage, put in a "MARVEL" and watch the people flock in to see the new **FLICKERLESS** Moving Pictures.

We furnish you with a complete outfit. "MARVEL" machine, Films, Supplies, Circulars, Tickets and HOW TO GO ABOUT IT. Don't delay, write at once for full information, **FREE**.

WITH A "MARVEL" YOU'RE BOUND TO SUCCEED

MARVEL MOTION PICTURE MACHINE CO.
Corner Farmer & John R. Sts. DETROIT, MICHIGAN

MUD SPLASHING PUNISHABLE IN SAXONY
—Mud splashing is held to be a punishable offense in Saxony, and the motorist has but two alternatives when the roads are muddy. He must either confine his speed to a walking pace or wait until the mud dries up or freezes, otherwise he is liable to run afoul of the laws. In the last case before the Dresden Court of Appeals the driver was adjudged to have committed an offense against the traffic regulations in that he did not slow down when passing through mud, but he was dismissed with just a reprimand for the simple reason that no one had been near enough to get splattered.

WHITE ZIRCON

The only substitute for diamond showing a magnificent play of color. Cuts glass and resists fire and acid tests. A natural gem mined only in Ceylon. Far superior to white sapphire or topaz. Guaranteed satisfactory at one-twentieth the price of diamond. Mounted in solid gold and platinum. Sent free for examination. Catalogue and "Facts About Gems" by Prof. G. M. Butler of the Colorado School of Mines, mailed free.

THE ZIRCON GEM CO., 425 Boston Bldg., DENVER, COLO.

GRAY MOTORS FOR BOATS

Largest Builders of 2-cycle Motors in the World. Over 1000 responsible dealers.

3 H.P. with Complete Outfit ready to install \$55
ALSO 4.2 TO 36 H.P.

Guaranteed by a big responsible concern. Write for big catalog—tells and shows you all about these high grade motors and how they are made.

GRAY MOTOR CO., 598 Gray Motor Bldg., Detroit, Mich.

ANTI-CRANK LACKA-MOTORS

2 to 45 H. P. **THE WORLDS SIMPLEST** Installed Operated by anyone.

Complete Outfits ready for Rowboat or Schooner. **GUARANTEED TWELVE YEARS** building, perfecting, success with **THE ONE TYPE**. Write to Originators of **VALVELESS** for new "MARINE BOOK," a liberal Educator to all, free. Address Department M. **LACKAWANNA MFG. CO., Office and Factory, Ballston Spa, N. Y.**

*Thin Model
17-Jewel
Movement*

*25-Year
Guaranteed
Gold-Strata Case*

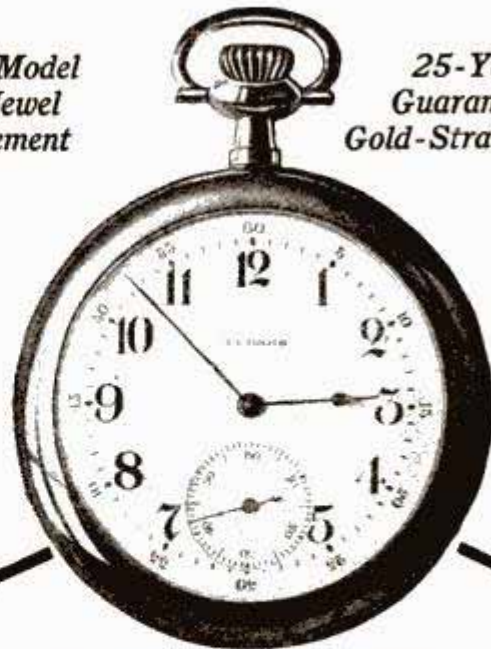

**Send for This Watch
On 7 Days' Free Trial**

To Popular Mechanics Readers who mail coupon below at once we will send this beautiful "Thin Model" 25-year guaranteed gold-strata watch, on 7 days approval without one cent in advance — but YOU MUST BE QUICK.

This superb Watch is indeed a triumph in the art of watch-making. The photograph above shows the actual size of the Watch. The movement is the famous 17-jewel Illinois Movement which has no superior throughout the entire world. This Watch is not only a perfect time-keeper, but the graceful thin model gold strata case lends it a beauty and distinction which will make it a constant joy to you every time you look at it.

Payments—Only \$2 a Month

This is the greatest "watch value" in America, but we do not ask you to take our word for it. Our plan is to send you the Watch on approval so that you can see the Watch itself, examine it carefully and wear it for a week before paying us any money or obligating yourself in any way. We do not want you to send us one cent now. Just fill out and mail coupon below and we will then send you the Watch carefully packed, express prepaid. After you have worn this beautiful Watch a week, if you decide to keep it, you may send us only \$2 cash and then \$2 a month for 10 months thereafter. But if the Watch is not satisfactory and you do not wish to keep it, then you may return it to us "express collect." So, you see, you take absolutely no risk.

Free Monogram Offer To those who mail coupon

below promptly, we offer to engrave by hand, their initials on the back of this watch in exquisite ribbon monogram letters. So then, if you answer promptly, you may have your own initials handsomely engraved by hand on the back of this superb watch, free of charge. Jeweler's regular charge is from \$1.50 to \$2.00, but if you are prompt, we will do it for you **FREE**. This is a great opportunity — one that you must not miss. Tear off and mail coupon at once.

LACLEDE WATCH CO.
1127-29 Pine St.
St. Louis, Mo.

Send me for examination, your 17-jewel 25-year guaranteed gold-strata Watch, express prepaid. If the Watch is satisfactory I will send you \$2 as first payment and \$2 a month thereafter until your special price of \$22 is paid. If the Watch is not satisfactory and I do not wish to keep it, I will notify you within 7 days and the Watch is then to be returned at your expense, as offered Popular Mechanics Readers. (NOTE: Print initials you wish engraved in monogram, on edge of coupon. If you prefer back of the watch wrought in special floral design instead of monogram, write us to that effect.)

LACLEDE WATCH CO.

1127-29 Pine St.
St. Louis,
Mo.

NAME.....

ADDRESS.....

Please Mention Popular Mechanics



The Home of Achievement

ADLER-ROCHESTER CLOTHES

You can have the best style, tailoring, and woollens by demanding Adler-Rochester Clothes

L. ADLER BROS. & CO.
Rochester, N. Y.

Write for our Style Book giving the correct Spring and Summer, 1913 Styles and Dress Suggestions.

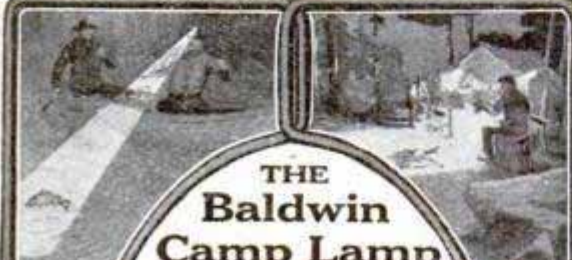

THE Baldwin Camp Lamp

Gives a white penetrating light. 8 1/2 inch high. Weight ready for use, 5 oz.



Burns acetylene gas. Will not blow out. Absolutely safe.

Can be fastened on cap or belt, carried in hand, or stood on table. No oil or grease. The Baldwin Camp Lamp makes nights in camp just as pleasant as during the day because it gives the best artificial light next to sunlight. Rowing or canoeing at night is made safe. On "hikes" through the woods it is unequalled because it projects its light 150 feet and prevents stumbling and bad falls over obscure obstacles. It makes automobile repairing an easier, pleasanter task. For sale by leading Hardware and Sporting Goods Dealers—sent prepaid on receipt of price. Brass, \$1.00; highly polished nickel with hinged handles, \$1.50. Send for free illustrated catalog and instructive booklet "Knots and How To Tie Them." Give name and address of your dealer.

JOHN SIMMONS CO.
34 Franklin St., New York City
52 St. Nicholas St., Montreal, Can.
242 Mansford Block
San Francisco, Cal.

Learn the new profession Tree Surgery



Not overcrowded and offers splendid and unusual opportunities to honorable young men. Ages 20 to 28. Students must have attended high school, and be physically sound and of good character. After completing two years' course, good men make \$1,000 to \$5,000 a year. Positions guaranteed to good men after graduation. Every city, park, orchard and private estate needs an Expert Tree Surgeon. Positions open also with established companies or State and National Governments. Special attention to Fruit Growing. Tuition moderate, including first year's board. We pay salary second year. Write promptly for full particulars. Address the Secretary.

DAVEY INSTITUTE OF TREE SURGERY
Box 201, KENT, OHIO

Brand New Typewriter

Bennett \$18 Portable Typewriter, marvel of simplicity, speed, efficiency, does work of \$100 machines. All important improvements, visible writing, standard 84 character keyboard, etc. Slips in grip or pocket. Durable low-priced because only 250 parts. Others 1700 to 3700. Write at home, office, on train, everywhere. No special desk needed. Made by experts in same factory where \$175 to \$1000 Elliott-Fisher Billing Machines are made. Can send parcel post. Sold on money-back-unless-are-made. Careless guarantee. Send for catalog. Special offer to live agents.



\$18

Q. C. BENNETT TYPEWRITER COMPANY
366 Broadway, New York

The Handy-Andy Electric Lantern

Gives a Bright White Light on the Darkest Night



HANDY-ANDY ONE DRY CELL ELECTRIC LANTERN

USES ANY COMMON NO. 6 DRY BATTERY

Adapted for the Farmer, the City Man or Woman, the Motorist, the Yachtsman, the Woodsman, the Miner, the Camper, the Country Doctor, the Hunter, the Warehousemen, EVERYBODY; — to Use ANYWHERE, at ANY TIME

A Wonderful Invention made possible by the high development of the metallic filament Electric Lamp. A marvelous Electric Bulb enables one to use any cheap "No. 6" Dry Battery (the same that is used on door bells) and obtain a Bright, Strong, White Light to see by.

The "Handy-Andy Electric Lantern" replaces the stinking, smoky kerosene lantern, which is always troublesome, dirty and dangerous.

Just think of it. You can buy a cheap "No. 6" Dry Battery of any make. Set it in the "HANDY-ANDY ELECTRIC LANTERN." Turn on the switch and have a LIGHT that illuminates hundreds of feet ahead. You can burn it for hours continuously because this wonderful metallic filament Electric Bulb uses so very little current that an ordinary Dry Cell will last from six months to a year, depending on the service that you give the Lantern.

We Want AGENTS and SALESMEN that are live wires. You will have to show us that you are wide-awake before we will even consider giving you any agency, and you must act quick before some real live money maker beats you to the selling of this ELECTRIC LANTERN.

A 15 Cent Dry Battery is Good Enough, though the 25 Cent kind will be better. Even a Discarded Dry Cell that a Motorist has thrown away will give good service in this lantern, providing the Battery is not "dead."

The marvelous Bulb is protected by mechanical means and no jar or ordinary use to which the "HANDY-ANDY" is subjected will break it. If a Bulb should be broken through carelessness, we will mail you one postpaid for 40 cents.

At the price that the "HANDY-ANDY ELECTRIC LANTERN" is sold, you couldn't afford to buy a cheap tin contraption or glass chimneys for a dirty, smoky oil lantern.

Be convinced. Buy it of your Jobber. If he does not sell it order direct from us. We will send it to you via PARCELS POST for \$2.50 less the Battery, which you can buy from any dealer.

days, you will quickly see that this is the best selling proposition out. You

P. MEAD MFG. CO., 3906 Sheridan Road, Chicago, Ill.

Do your own Grinding

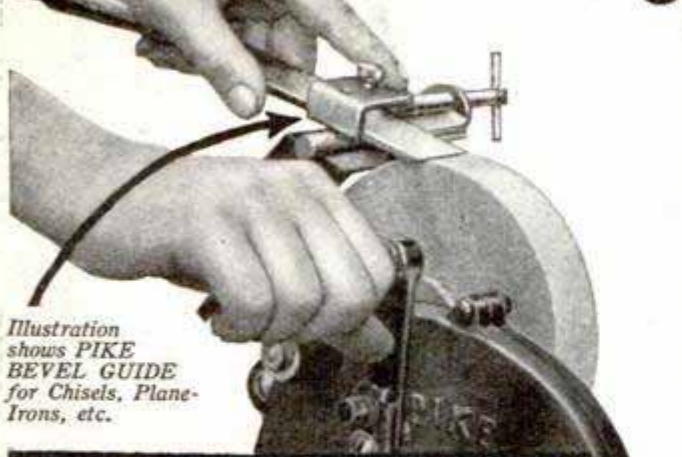

Illustration shows PIKE BEVEL GUIDE for Chisels, Plane-Irons, etc.

It's cheaper. Besides sharp tools save money by doing quicker, better work. No "know how" needed. With the PIKE BEVEL GUIDE, even a novice can grind as true as an expert. Patented and found only on the

PIKE PEERLESS TOOL GRINDER

They cut steel so easily that in a few moments you can make a hatchet, a chisel, a scythe, a hoe or an axe as keen and quick as when new. **Pike Peerless Junior \$5. Pike Peerless Senior, \$7.** Guaranteed forever against all mechanical defects. Other Pike Grinders from \$3 up. Send for booklet "A Sharp Edge in a Hurry."

FREE A PIKE STONE. Send your dealer's name and 4c for packing and mailing and we will send a Pike India Vest Pocket Stone, also our famous book "How to Sharpen." You will be pleased. Write today.

PIKE MANUFACTURING CO., 100 Main St., Pike, N.H.



An electric alarm that gives warning when a mine roof begins to move has been invented by an Australian.

Build Model Aeroplanes



A fascinating pastime. Get "IDEAL" Plans and Drawings which are accurate, with clear, concise building instructions. **PRICES**—Wright 3 ft. Biplane, 25c; Bleriot 3 ft. Monoplane, 15c; "Cecil Peoli" Champion Racer, 25c; Curtiss Convertible Hydroaeroplane (new), 35c; Nieuport Monoplane (new), 25c. **COMPLETE SET OF FIVE \$1, postpaid.** 40 pp. Ideal Model Aeroplane Supply Catalogue 5c. **IDEAL AEROPLANE & SUPPLY CO., 82-88 West Broadway, New York**

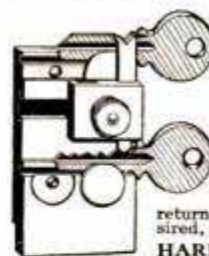

Duplicate Keys Made in One Minute By the Harrison Key Filing Machine

Invaluable for Machinists, Building Superintendents, Repair shops, Locksmiths, Carpenters, Master Mechanics, Janitors, Garages, etc. Anyone can make a perfect duplicate key without injury to original or master key, to fit any pin tumbler lock—Yale, Sargent, Norwalk, Reading, Russell & Erwin, Corbin, Vassar, Etc., Etc. A customer writes:—"We made 65 keys in 1 hour and 16 minutes. Can you beat it?" Price \$3.00 for machine complete with two filing guides and our new model clamp attachment. Remit by Post Office Money Order or New York Checks. Shipment by mail postpaid. Diamond files furnished at cost if desired, price 30c. Send for circular telling all about this machine.

HARRISON & COMPANY, 81½ New Street, NEW YORK

UNDERFEED FURNACE OR BOILER Cuts Your Coal Bill

1/2 to 2/3

DIVIDE your heating cost last winter by two or even three—that's what it will cost next winter if you put in an Underfeed.

THE PECK **Williamson** Underfeed FURNACES BOILERS

Produce in coldest weather **more heat, cleaner heat** and more **even heat** than any other heater. Require least attention in feeding, regulating and cleaning. Let us prove it. Mail coupon for **FREE Book.**

THE PECK-WILLIAMSON COMPANY, 398 West Fifth St., Cincinnati, O.

Send me **UNDERFEED** Furnace Book.....
FREE Boiler Book.....
 [Indicate by X Book you desire]

Name.....
 Address.....
 Name of my dealer.....

In Thrilling Moments Like This

Your camera—your lenses—*must* not fail you. If you wish to *unfailingly* record incidents in real life not as the eye sees them—*actually* but as they happen—use

GOERZ LENSES CAMERAS

A Goerz Lens takes pictures that are worth money, because they show in clearest, sharpest detail, incidents which the eye itself is not quick enough to grasp. A Goerz Lens may be fitted to the camera you now have.

Our Book on "Lenses and Cameras" will be sent for the asking.

C. P. Goerz American Optical Co., 323 C, East 34th St., New York



\$350 SAVED



WALTHAM WATCHES ON CREDIT Your Monogram Engraved FREE

Sent On 30 Days Trial—No Money Down

\$3.50 Monogram, Name or Initial FREE. Engraved and sent on approval, express paid, before you pay one cent.

Gold cases guaranteed for 25 years, fitted with high grade Waltham movements or standard makes. 30 days Free Trial, all at my expense. The test that tells. You risk nothing. Rock Bottom Payments. Terms smashed. No red tape, no publicity. Write now for Beautiful FREE catalog. FREE engraving offer. No Money Down, FREE Trial Plan.

SQUARE DEAL MILLER, Pres., Miller-Hoefler Co., 156 Miller Bldg., Detroit, Mich.

CANADIAN OFFICE, WINDSOR, ONTARIO, CANADA

STYLE NO. 105



Shall I Send You This Book?

It tells how to make money in a new, easy, fascinating business. The same business made me independent. If you are ambitious to make a big success in life—if you are striving to get out of a rut and make money, I'll gladly send you a copy of my book free. This isn't a book for curious folks who "just want to see what it's like"—it's a book packed full of valuable information and ideas and helps on how to make money. If you're in earnest—if you want to "get there" write me today for this book. A two cent stamp brings it.

Make Money Manufacturing Crispettes Nearly 4c Profit in Each Package

Crispettes are a new, delicious popcorn confection. Nothing like them in shape, taste or quality. Instant hit everywhere at parks, resorts, pavilions, circuses, fairs, carnivals, on trains, at depots, theatres, moving picture shows, confectionery shops, etc. My book tells how to make them—how to sell them. I've started others. Let me start you. Just read these extracts from letters—all recent.

Wm. Budd Leitch writes: "Started business New Year's day. Since then I have done a good business. Am well pleased with results."

G. W. Sperbeck says: "I am having fine success with the machine and getting more trade every week. Got the work down fine now."

D. B. Barrett writes: "I sold my interest in the Crispette Machine we bought, to my partner and have regretted it ever since. Send me new book."

**My Offer Is
For YOU
Send for
the Book**



E. M. Cox says: "Have been running almost three weeks and supply the demand only by running steadily through the day. Selling everything I can make and getting it out good too."

No special seasons. All year 'round proposition. Book tells how to work it. Join the money makers. Be one of them—not an onlooker. Anyhow, investigate. Drop me a line today, and I'll send you the book, all charges paid.

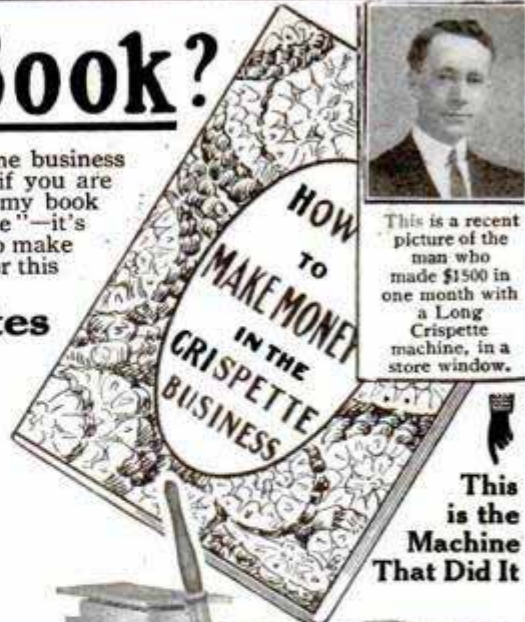

This is a recent picture of the man who made \$1500 in one month with a Long Crispette machine, in a store window.

This is the Machine That Did It



SEND FOR THE FREE BOOK

W. Z. LONG, 754 High Street, Springfield, Ohio



KEYLESS PADLOCK

No knobs to turn—no clicks to count. Press the buttons and it flies open—10,000 combinations possible. Operated as easily in dark as in light. Solid brass. **AGENTS making 100% profit.** Sells on sight—no competition. Sample free to workers. Write today. Address American Keyless Lock Co., 653 Jackson Blvd., Chicago

We Cannot Cure Your Back-ache!

BUT, we can help you to prevent it by inducing you to purchase one of our small household engines to do the back-ache producing work.

We make them in three sizes, 1/4 H. P., 1/2 H. P., and 1 H. P. Every family needs at least one of them. They are perfectly safe in the hands of women and children. They operate on gasoline, kerosene or alcohol— are reliable, durable, silent, and economical. So many different kinds of work can be done with them that we want you to send a stamp for our catalog, so we can tell you all about them, and how ridiculously low priced they are.



Send stamp for catalog

ELGIN WHEEL & ENGINE CO., ELGIN, ILL.

When properly cared for, brass dies for printing on wood have been known to run between two and three million impressions before wearing out. Such dies should be cleaned after every 2,500 or 3,000 impressions.



NO MORE MOTORBOAT EXPLOSIONS

TWO DOLLARS MAKES YOUR GASOLINE TANK AS SAFE AS WATER

The McNutt Safety Bung can be installed in tanks of all dimensions, making the same non-explosive. Safety Screw Cap prevents vapor from leaving the tank but permits air to enter as required to break vacuum. The prevention of the vapor alone will save cost of installation. Navy Department is equipping Dreadnaughts, Battleships and smaller vessels with this device. Write for further information or order today specifying size of opening, thread and depth of tank. Average size supplied for \$2.00 expressed prepaid. McNUTT NON-EXPLOSIVE CAN CO., 352 Pearl Street, NEW YORK

A Sure—Big Money Maker

Pound of sugar makes 30 five cent packages delicious candy—sells like wildfire—eighth season—thousands used—original investment returned many times over first season—

Empire Candy Floss Machine

making sure big profits everywhere. POP-CORN—PEANUT ROASTER—ICE CREAM CONE MACHINE—sure winners. Agents Proposition Extraordinary.



STEVENS MANUFACTURING AND SUPPLY CO.
Dept. P. M.—Fisher Building, CHICAGO, ILL.



TOLEDO MARINE MOTORS

The kind that make boating a pleasure. When you start you know there'll be no engine troubles to mar the trip. A marvel of smooth working simplicity that the non-mechanical can easily understand and operate. Complete, gear-anted, 2 cycle, 2 port. 1-2x1-2, 1-2x1-2. Write today for catalog. **THE UNIVERSAL MACHINE CO., Pike Ave., BOWLING GREEN, O.**

3 H. P. 1 cyl.,	\$ 65.00
6 H. P. 1 cyl.,	84.00
6 H. P. 2 cyl.,	125.00
12 H. P. 2 cyl.,	160.00
18 H. P. 3 cyl.,	250.00

Wanted

AGENTS & SALESMEN



THE SWEDISH VIBRATOR

An amazing scientific invention. Endorsed by physicians, athletes, actresses, judges, and thousands of men and women who have used it. Agents and Salesmen are wiring orders. Enthusiasm is unbounded. Every man and woman making money fast and easy. 100,000 already sold, 1,000,000 to be sold this year. Secure territory at once. Mail your application today, stating county you desire. This is the one important thing today—do it now.

This is an opportunity for you to make \$5000 this year as a high grade salesman. **No experience necessary. No delay. No charge for Territory. No competition. Exclusive field. Success assured. Remarkable offer.** Read every word carefully. Get an appointment and get started without delay.

We are appointing men every day to manage our business in local territories. **We need good, honest men who are willing to work—and we will give you today this opportunity to**

Make \$5000 This Year

It is the chance of a lifetime. You will be in business for yourself. **You will be your own boss— independent, abundant money, pleasant position—and your time will be your own. At home or traveling—all or spare time—get an appointment immediately and commence earning money next week.**

The Swedish Vibrator

Most amazing seller ever invented. **A new proposition for salesmen.** Endorsed by the highest authorities of the world. A machine for home massage and vibratory treatment. Can be operated by simply attaching to electric lamp socket, or by ordinary dry batteries—in cities, towns, country—anywhere, everywhere. **Needed by every man, woman and family. Anyone can use it.** Get complete literature free and learn the wonders of this brilliant invention—a machine that gives 30,000 thrilling, invigorating, penetrating, revitalizing vibrations per minute. One-minute demonstration gets the order. **Irresistible desire to own it once you feel the living, pulsing touch of its rhythmic vibratory motion.** Sold upon five-year, cash certificate guarantee and 30 Days' trial.

150% Profit Throw away the little novelties upon which you have to make ten or twenty sales a day to pay expenses. Become a real salesman and make real and quick and big money. **One sale a day means \$90 net profit a week.** Many averaging four, five and even ten a day. **This is actually the most brilliant, easy and high class proposition that has ever been offered to wide awake agents, general agents, and managers.**

Don't Delay Get free literature and complete information at once. Send just your name and address on a postal card and all will be mailed free immediately. **Agents' sample furnished at wholesale price. Investigate.** It costs you nothing to find out. Territory being rapidly assigned. **But one man allowed in a field.** Give the name of your county. Send your name and address today. This is a brilliant opportunity. Do not neglect. Do not put it off. **Act immediately.** Address

THIS OPPORTUNITY

is open to anyone who wants to make money and who is willing to work. We furnish complete instructions that enable you to start immediately. Nothing difficult. No experience required. We want applications from men and women in unoccupied territory everywhere—clerks, teachers, mechanics, farmers, etc., etc.—all can make money on this grand, new, easy selling plan. Act today. Put your name and address on a postal card and mail it at once. Find out all about this tremendous opportunity.

THE SWEDISH VIBRATOR CO., Dept. 87, 215-230 Schiller St. CHICAGO, ILL.



FRANK CHANCE, Manager New York American League: "After seeing how it removes stiffness and soreness from my arms, legs and fingers, each player absolutely insisted on having one; and had it cost twice as much they would have had it."



ELSIE JANIS, the dainty and popular actress, says: "The nice things I could and do say about your vibrator, I cannot write, as I would not have space enough."



JULIA SANDERSON says: "I don't see how I got along without it. It certainly is far better than anything I ever tried for the throat and vocal cords."



WM. H. CRANE, the famous American actor, says: "I have been using your vibrator for several weeks for nervous trouble, circulation, etc., and found it exceedingly beneficial. It is all that you claim for it."



Champion Wrestler of the World uses the Swedish Rhythmic Vibrator and says:

"For limbering up, keeping in condition and strengthening the muscles, there is nothing that equals or exceeds the use of the Swedish Electric Vibrator. I always use one in my training and I certainly find it a wonderful help. It reaches the seat of all stimulation and gives me a perfect circulation. Its use gives all the muscles elasticity, makes one powerful, quick and active."

"Being a firm believer in vibratory massage, I tried various makes of Vibrators, but did not find one of enough efficiency to withstand the severe use I put them to until I purchased yours. You have, in my opinion, the only perfect Vibrator on the market, and I can consistently recommend its use to all athletes and those who desire health and strength."

\$5,000 a Year from Ten Acres With Six Months Vacation

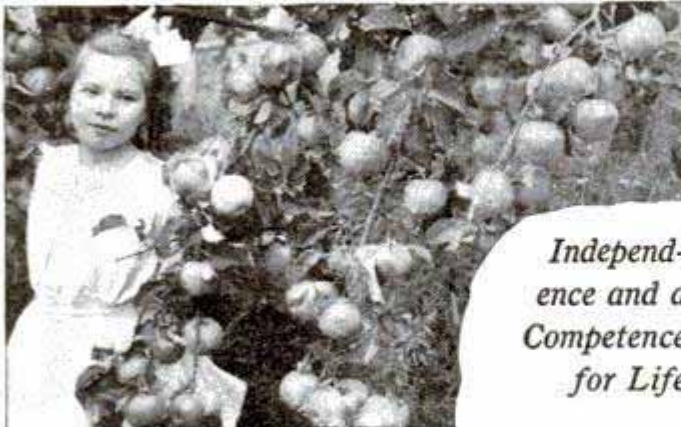

Independence and a Competence for Life

Five Thousand Dollars a Year

net income from ten acres of matured apple and cherry orchard in the *frostless and wormless* Bitter Root Valley with a *home and six months vacation* annually in one of the most magnificently endowed natural environments on the Creator's footstool, with *golf links, hunting, fishing and mountain climbing* and with neighbors of culture, education and refinement—is the opportunity we offer you.

We believe you will *investigate* this opportunity because this appeal for investigation is directed to broad-minded and sensible readers, living in an age of scientific progress which has made the impossible of yesterday the reality of today. This is *not* an offer of something for nothing. It is an opportunity for you to make an immensely profitable compact based on mankind's partnership with Nature. *We are now growing more than three thousand acres of fruit trees, one to three years old, for satisfied customers who would not consider selling their orchards at a large advance over their cost.*

\$5,000 Yearly For Life From Ten Acres

A Bitter Root Valley apple orchard bears commercially in its fifth year. Ten acres, fully developed, should be capable of returning you during early maturity, strictly net, a profit of \$2,000 to \$5,000 yearly. Beginning with the 10th year from planting, judged by experience of others, 10 acres should net you an income of \$5,000 yearly and employ only half your time.

If you have a fair-sized income now and are willing to improve your condition, *you do not need much capital* to possess one of these big-paying orchards.

Our Proposition and Plan

briefly stated is this: We will sell you a CHOICE 10-ACRE ORCHARD HOME TRACT (spring of 1913 planting) best standard varieties apples and cherries—with the Company's definite written contract to care for and develop your orchard under expert horticultural supervision for five full growing seasons from date of planting, including all land taxes and irrigation charges. You may, if desired, assume personal charge of your orchard at any time and secure a refund.

The land should easily become worth, conservatively stated, in fair comparison with other improved land, \$1,000 an acre. There is a clean profit to you of 100 per cent on a 5-year investment to count on at the outset. Only a \$300 cash payment required now to secure your orchard tract—balance in easy payments divided over a ten-year period. Your payments for the first few years are practically ALL the cash outlay you will have, as *your orchard tract should meet all payments falling due while in commercial bearing period and yield you a handsome profit besides.* Our reservation plan provides for inspection of the land by you, and **your money back** if dissatisfied.

—INVESTIGATE by using this coupon TODAY—

BITTER ROOT VALLEY IRRIGATION CO.
849-855 First National Bank Building, Chicago, U. S. A.

Robert S. Lemon, General Sales Manager.

Please send me full information concerning your Riverview Orchard Tracts in Bitter Root Valley.

Name _____

Street No. or Rural Route _____

Town _____

State _____



Laying Paying Poultry

Anybody who has a little spot of ground can raise poultry with *pleasure*. Anybody who knows how can raise poultry with *profit*.

The book that tells how is the "Poultry Guide-Post." Philip R. Park, one of the best known and most successful poultry raisers in America, wrote it and it tells all he knows about raising poultry for profit. It is a handsome, cloth-bound book with 132 big pages. Its regular price is \$1.

You need the successful man's poultry trade paper too. It is called "Profitable Poultry." A splendid monthly magazine—full of practical experience written by men who know. Regular price \$1.00 a year.

\$2 for \$1 and send no money

Write us that you want to see the book. When you have looked it over, send us \$1.00 (if you want to keep it) and we will then send you, without further charge, the magazine "Profitable Poultry" for a year. Bought singly they would cost you \$2.00— for the next 30 days \$1.00 buys both—and you don't have to pay that until you have seen the book.

The Park & Pollard Company
70 Canal Street BOSTON, MASS.

HILDEBRANDT BAITS HOOK AND LAND 'EM

Experienced anglers choose them. Small outfit, interchangeable, catches any fresh water game fish. "Stand-ard," "Slim Eli" and "Idaho." Gold, copper, brass, and nickel finish for bright or dull days. They spin so easy! Ball bearing—reversible. Don't catch in weeds. **Free New 1913 Catalog** Lists everything you need. Actual size illustrations. New flies, baits, spinners, rods, etc. Tells how to equip economically. Two cent stamp brings it.

The J. J. Hildebrandt Company, 1305 4th St., Logansport, Ind.

EARN \$40 TO \$80 A WEEK

Selling Ann Arbor Lamps and Lighting Systems. Everybody wants this famous light. Show it, it sells itself. No experience necessary. Besides regular earnings we mail cash bonus checks every month to successful agents. Don't delay; write me at once. H. H. Seeley, Pres., Superior Mfg. Co., 294 Second St., Ann Arbor, Mich.



OVER
\$400
Made
in One
Day

Operating
the



CIRCLING WAVE, the catchy amusement device that combines the pleasure of the merry-go-round with the joy of boating on the gently rolling lake or bay. At Eagerton, Ind., Booher Bros. made \$350.90 in six hours, and one day at Crawfordsville, \$402, and another made \$380 in six hours. **You can do this also** and employ only one assistant.

Write today for description of the **CIRCLING WAVE** and its wonderful money-making power.

ARMITAGE & GUINN, 159 Mill St., Springville, Erie Co., N. Y.

FREE!

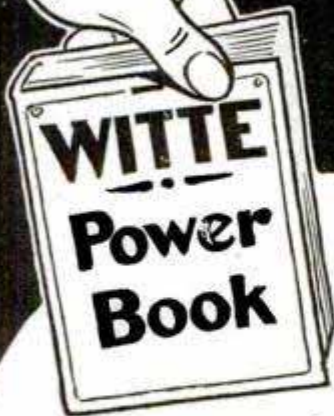

Absolutely FREE and Prepaid!

I Want to Send You This Marvelous Book Full of Money-Making Facts—New Ideas—and Valuable Information You Should Know

Every page of reading matter is filled with valuable hints and short cuts to **SUCCESS**. This great book explains in detail the tremendous, positively tremendous opportunity I now offer to readers of this magazine. It tells how to turn minutes into dollars—how you can do the work of five men with little effort—how to increase your present profits—how to add **new** and bigger profits to your income.

Big Money for YOU If You Own the Famous WITTE Engine

Yes, more real dollars and cents than you would believe. Money saved and money made in the Shop, Factory, Home, or on the Farm. The **FAMOUS WITTE ENGINE** possesses 30 distinct advantages over other Engines. It is made in 54 Styles and Sizes; from 1½ to 40 Horse Power produces power for every purpose; tested 10% to 20% overload; is run by Gasolene, Kerosene or Gas; Tank cooled, hopper cooled or pump circulation; built so that any part can be substituted by new improvements 100 years from now; cuts fuel bills in **HALF**; **COSTS BUT 1c PER HOUR PER H. P. TO RUN.**

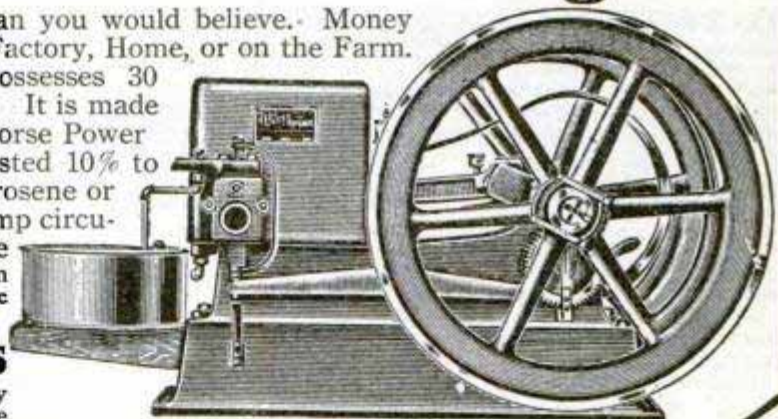

At Factory Prices

By selling direct from my factory to users, my prices are way down below even the wholesale price. I give my customers the benefit of the saving of all middlemen's profits.

Guaranteed for Five Years

factory which has stood foremost in the Engine Field for **MORE THAN 43 YEARS**. **WITTE ENGINES** have stood the test of time. **WITTE ENGINES** bought 25 years ago are still making money for their owners—they pay for themselves over and over again. On this great offer my **PRICES ARE SO LOW AND TERMS SO REASONABLE** that I prefer to quote them only in **Direct Letters**.

I give an **IRON CLAD GUARANTEE** with every one of my **WITTE ENGINES**.

Back of this **GUARANTEE** is my big **MORE THAN 43 YEARS**. **WITTE ENGINES** bought 25 years ago are still making money for their owners—they pay for themselves over and over again. On this great offer my **PRICES ARE SO LOW AND TERMS SO REASONABLE** that I prefer to quote them only in **Direct Letters**.

60 Day FREE Trial Offer

Yes, I will ship any one of my Famous Witte Engines to you to use and test for 60 Days at **MY EXPENSE**. Prove for yourself that all I say is true. With my valuable book I will send full particulars of this Great Special Offer.

To Readers of Popular Mechanics!

Offer Limited—Mail Coupon Immediately

Send No Money. Everything sent to you free and prepaid. This offer may not appear again so send for free book and full particulars this very day—send **Immediately**.

WITTE IRON WORKS CO.

Dept. 1749
Kansas City, Mo.

FREE BOOK COUPON

Witte Iron Works Co.
Dept. 1749
Kansas City, Mo.

Gentlemen: Without any obligation on me please send me, **FREE AND PREPAID**, your Big Money-making Book and details of your Special Offer on your Famous Witte Engine.

TEAR HERE, SIGN AND MAIL

NAME.....

ADDRESS.....

Mail
The
FREE
Coupon

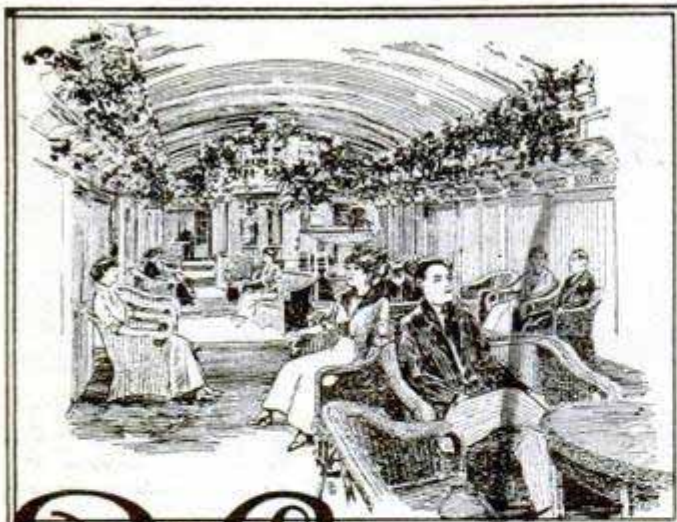

D&C LAKE LINES

A Lake Trip for Rest and Recreation

Arrange your vacation or business trip to include one of our palatial lake steamers. Every detail that counts for your convenience and comfort has been provided. The above view shows the "Palm Court with fountain of running water, on the latest steamer, City of Detroit III," operating between Detroit and Buffalo.

The Water Way

Daily Service between
Buffalo, Detroit, Cleveland & Mackinac

"The Floating Home Away From Home"

This wonderful liner is not surpassed by any fresh water steamer in the world, and contains unique features seen only in the finest metropolitan hotels; 600 staterooms, with phone and running water in every room. Perfect rest at night, and privacy by day.

Excellent dining service, cozy, inviting. Smoking rooms, writing rooms, drawing rooms, imported Orchestrons, perfect attendance with maids for the ladies. All Modern Safety Devices Complete and Approved by U. S. Government.

Your Railroad Tickets are Good on D. & C. steamers between Detroit and Buffalo, Detroit and Cleveland, either direction. Information regarding rates and time tables upon request. Prompt connections with railroads for all principal cities. For illustrated booklet and map of Great Lakes, write, including 2-cent stamp, to

Detroit & Cleveland Navigation Co.

PHILIP H. McMILLAN, Pres.
A. A. SCHANTZ,
Vice-Pres. and Gen. Mgr.
L. G. LEWIS, Gen. Pass. Agt.

72 Wayne St.,
DETROIT, MICH.

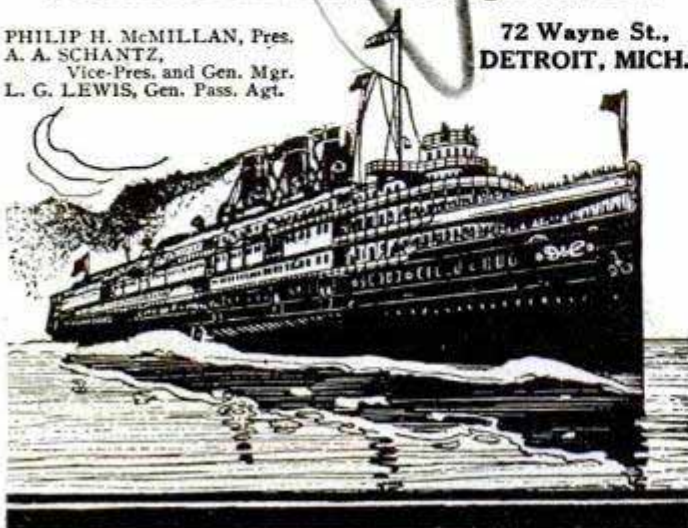

\$1.00 Down

GETS THIS **Guaranteed**
Weatherproof
Waterproof
OVERCOAT

For Motorists, Teamsters, Chauffeurs, Farmers, Railroad Men and general use. Made of toughest grade specially-prepared, highest-quality canvas—tan color—full $\frac{3}{4}$ length—absolutely waterproof—light—pliable—neatly finished—well tailored—stylish—carefully sewed. Seams, double lapped—heavy binding—large roomy pockets—horn buttons—worked button holes—better value than coats usually selling for \$18 and up.

Wonderful Value

Price Complete \$6.50—charges prepaid. Send us \$1.00 as a guarantee of good faith and we will send you one of these coats—prepaid—subject to examination. If you find it as represented, pay the balance of \$5.50 and the coat is yours. If not satisfactory, return it to us and we will refund your money.

When sending your order, give height, chest and waist measure and length of sleeve. Order at once as our output is limited.

HETRICK BROS. CO.

1250 Fernwood Ave.

Toledo, Ohio

NOTE—Special waterproof inner lining—detachable—for extra rough weather—\$1 extra.



LEARN VENTRILOQUISM

and earn \$30 to \$200 a week. A "WONDERFUL ART" easy to learn. Red stamp for particulars. Write today. PROF. CHAS. K. MALOTTE, Indianapolis, Ind.

I Can Use 150 Men At \$30 a Week To



sell my unequalled line of household necessities at half ordinary retailers' prices. No experience required. This is your opportunity to get into a permanent, profitable business at an increasing yearly income. I have done exactly what I want you to do. My 17 years' experience and large six story factory building are back of you assuring you success. They also prove my proposition is right. If you want to make big money quick write me personally today, sure, for full particular

E. M. DAVIS, President

E. M. DAVIS CO., E14 Davis Block, CHICAGO



You Can Be An Auto Expert

We teach you the entire subject by mail in 10 weeks' spare time, and assist you to secure good position. Demand for trained men can't be filled. Simple, practical and personal instruction. Free auto model to each student.

FIRST LESSON FREE—WRITE FOR IT NOW

Owners—we supply competent men

Empire Auto Institute, 232 Empire Bldg., Rochester, N. Y.

The Original Automobile School

The Perfect Food Tonic

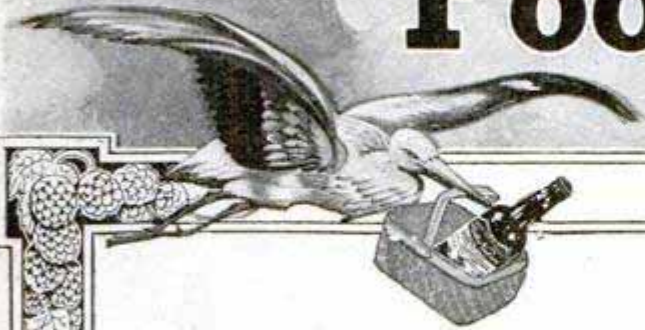

All the nutritive elements of the best American Barley and the aromatic, nerve-quieting tonic properties of the choicest Saazar Hops are scientifically combined in

ANHEUSER-BUSCH'S

Malt-Nutrine
TRADE MARK

A predigested liquid food, acceptable to the weakest stomach; strengthening convalescents, weak or anaemic, building up the overworked and nerve-tired; invigorating old age.

Of greatest value to nursing mothers.

Malt-Nutrine contains 14½% of Malt Solids and 1⁹⁰/100% of Alcohol. Declared by U. S. Internal Revenue Department a Pure Malt Product and NOT an Alcoholic Beverage.

Sold by druggists and grocers.

A postal brings a beautifully illustrated *Malt-Nutrine* Booklet FREE—well worth reading.

ANHEUSER-BUSCH, ST. LOUIS, MO.



Flex-A-Tile Asphalt Shingles

Combine beauty with permanency and low price

They are made of solid Asphalt surfaced with chipped slate or granite in natural colors of deep red and green.

They make a wonderfully artistic roof—are easily and quickly put on and last as long as the house stands. They are the ideal modern roof.

THE HEPPE'S COMPANY
1021 Forty-Fifth Street, CHICAGO, ILL.

We have a sample that we want to send you free. Write for it.



30 Days Trial

"IDEAL" Fireless Cookstove



Works while you sleep or go about other duties. Special 1913 features put the "Ideal" in a class by itself. Cooks faster, better; keeps food hot longer. **Roasts, Bakes, Steams, Stews, Boils** perfectly. Lining and utensils **pure aluminum**—will not rust, corrode, crack or chip. Seamless cooking compartments. **Steam Valve**, only cooker with automatic condenser.

SAVES TIME, LABOR, FUEL, MONEY

Cooker Book FREE

Beautiful illustrated book describing the making of Fireless Cookstoves and their many varied uses, together with full details of our **30 day trial offer** and **easy payment plan** sent free on request. A postal will do.

THE TOLEDO COOKER CO., 1343 W. Bancroft St., Toledo, O.

WALKING STICKS PREVENT ROUND SHOULDERS—The assertion is made that if more men carried walking sticks there would be fewer round shoulders. The reason given is that the man who carries a stick swings his arms, which pulls the shoulders backward and pushes out the chest. The walking stick should be long enough to reach well up the hip, and should be carried alternately in either hand.

Monuments



You can now buy the most beautiful monuments, tombstones or markers at lowest quarry prices, direct by mail, under the strongest guarantee ever made by a monument firm. Choose from 200 exclusive designs and take—

A Year to Pay

No collectors to annoy you. We sell direct from the quarry, save you all unnecessary profits and allow the lowest terms of payment. We do all lettering and satisfy you in every way.

FREE! Our latest Art Portfolio, done magnificently in purple and gold. Sent everywhere, FREE, just for the asking. Address:

Westminster Monument Co., 209 Westminster Bldg., Chicago



No. 501.

"OHIO" CHISELS

are made from high grade and specially selected tool steel, and the care, skill and experience of our 89 years in the Edge Tool business is put into every tool bearing our "Ohio" Trade Mark shown here. The result is a high grade and very satisfying tool, with a keen, tough and lasting cutting edge.

"OHIO" PLANES

are fitted with our special extra Heavy Cutter, which prevents Chattering or Trembling when used in hard or knotty timber. High grade cutters, accurate adjustments and true faces are only a few of the points in which our planes excel and make it well worth your while to insist on having them from your dealer.

Write for our free Catalogue of High Grade Tools and Benches

OHIO TOOL CO. (Dept. 3)
COLUMBUS, OHIO



The Phonograph Offer you have been waiting for—Don't miss this opportunity Music lovers delighted with SUPERB "Royal" Tone

Unsolicited Testimonials

Big list from all parts of the country sent to all who answer this ad.

ROYAL BEATS REST TO A STANDSTILL

It is a fine talking machine and many people who hear it play, say it beats all the rest to a standstill.

ROBERT CAMPBELL,
Portland, Me.

ROYAL GRANDEST AND FINEST MACHINE

I think my Royal Talking Machine is the grandest and finest talking machine I have ever heard.

J. H. GRIFFIN,
No. 123 Williams St.,
Bradford, Pa.

ROYAL IS GRAND

Your machine is grand. Everyone speaks about what a fine machine it is, —so distinct. I cannot praise it enough.

J. M. SPELLACY,
No. 3 Metallic Ave.
Jamestown, N. Y.

COULD NOT DO WITHOUT ROYAL

I think my machine is the best in Oil City and many say it is the loudest and most clear toned they have ever heard. I could not do without it.

MRS. T. E. SWISHER,
13 W. 5th St.,
Oil City, Penn.

WOULDN'T TRADE ROYAL FOR ANY OTHER

I like the Royal Talking Machine fine and think this is the best and the plainest machine I have ever heard.

JOHN WITTENBURG,
R.F.D. No. 1, Box No. 25,
Alexander, Ark.

EDISON OWNERS PREFER ROYAL

Those who have heard the Royal say it is the best that is made, even those that have the Edison. If they did not have Edisons they would get Royals.

THOS. J. HYERSON,
Eadenville, N. Y.

HAS OWNED ALL MAKES BUT LIKES ROYAL BEST

Received Royal all O. K. Best one I ever heard or saw. I have owned all makes but the Royal beats them all.

JOHN KNIGHTON,
Blue Springs, Miss.

ROYAL BEST MACHINE IN JASPER COUNTY

I have the best machine in Jasper County. I can play with the Edison or any of them and it beats them all. My machine is the talk of the town. Many thanks for it.

GEORGE W. GUESS,
West Liberty, Ill.

ROYAL DRAWS BIG CROWDS

I can say I am well pleased with my machine. My father is the postmaster and merchant here and the machine draws big crowds and everybody enjoys the music.

PENN STALIONS,
Delwood, Ill.

Total Cost **\$7⁵⁰**
Only . . .

By Our Great

7

Months' Time

Purchase Plan

You actually save \$17.50 by taking advantage of this Unparalleled Offer:



THE ROYAL

brings the living, breathing voices of the world's greatest singers into the home.

Your Choice of These Two Instruments at Above Terms

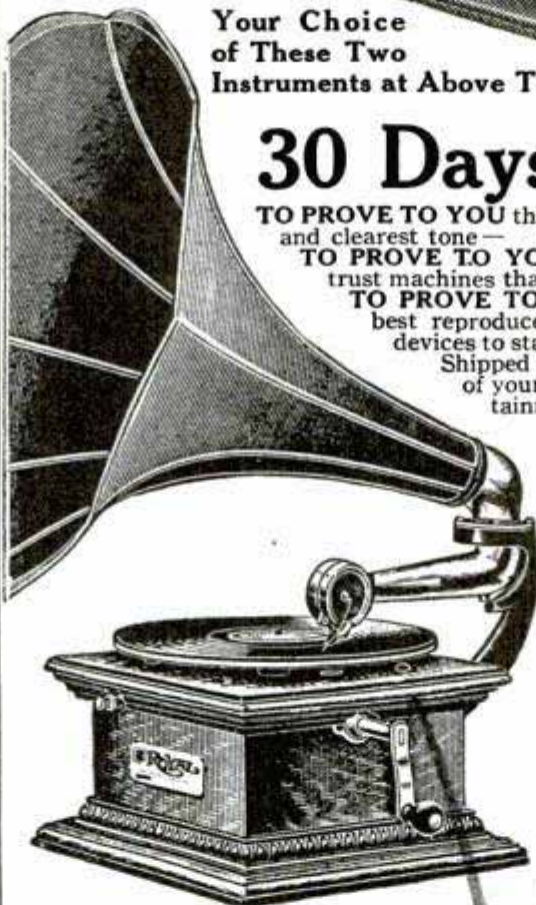

30 Days' FREE Trial

TO PROVE TO YOU that the Royal has the sweetest, purest, loudest, and clearest tone—

TO PROVE TO YOU that it is as large and handsome as the trust machines that sell at \$25.00—

TO PROVE TO YOU that it has the strongest motor, the best reproducer and tone arm and the most ingenious devices to start, stop and control the music.

Shipped with a supply of 10-inch double-disc records of your selection so you can enjoy the finest entertainment for one whole month. Return the outfit

At Our Expense

if for any reason you do not wish to keep it after the Free Trial. Enjoy the finest entertainment for one whole month even if you are not thinking of buying a machine. Make home a pleasant place for yourself, family, and friends at least for one month. No embarrassing explanations to make if you decide to return the outfit after Free Trial. Whether you keep it or not we will be glad of the opportunity to prove to you and your friends what a wonderful entertainer the Royal is—how far superior to anything else you have ever heard—how good, wholesome music, as played on the Royal makes home and life more pleasant—how it strengthens home ties and the bonds of friendship.

Mail Coupon Today

or drop a postal for our large, handsome, illustrated circular, record book, big list of unsolicited testimonials and other literature—**ALL FREE**—no obligations whatever. Get posted on talking machine values whether you intend to take advantage of this offer or not. Our literature is worth having. The coupon or just your name and address on a postal brings it to you **FREE**. Better write **NOW**, before you forget.

Central Distributing House
Dept. A41, 61st and May Sts., Chicago

S. DAVIS, Mgr., Central Distributing House, Dept. A41, 6101-11 May St., Chicago
Send me your beautiful, large circular, big list of testimonials, record book and other literature—**ALL FREE**. This places me under no obligation to order.

Name.....
P. O.....
State.....

All readers, who are or expect to be in the market for a high grade phonograph, should write for full particulars about this extra-liberal offer.

**Ready
for
Anything**
—at any time.



Fast roads
Rough roads
Loose Macadam
Oiled roads
Heavy mud
Oily floors
Slippery pavements

For each and every condition there's a particular feature of safety and service in

PENNSYLVANIA Oilproof VACUUM CUP TIRES

The suction hold of the vacuum cups, guaranteed to prevent skidding on wet or greasy pavements—

The absolutely oilproof quality, immune against deterioration from oily roads and garage floors—

The thick walled cups that drive deep and give unequalled traction in mud or sand—and thrust aside sharp stones and puncturing objects—

The extreme toughness and phenomenal heat radiating powers of the tread, offering the utmost resistance to the abrasion and friction of fast travel over fine roads—

And finally the definite printed guarantee of 4,000 miles attached to each casing—a distance far exceeded by the actual average service mileage.

In Stock Everywhere.

PENNSYLVANIA RUBBER COMPANY, Jeannette, Pa.

Pittsburgh - 505 Liberty Ave.
Cleveland - 1837 Euclid Ave.
Detroit - 254 Jefferson Ave.

BRANCHES

Chicago, 1004 Michigan Ave.
Minneapolis, 34 S. 8th Street

Kansas City - 514 E. 15th St.
Omaha - 215 S. 20th Street
Seattle - Armour Building

Pennsylvania Rubber Company of New York
New York, 1700 Broadway Boston, 149 Berkeley St. Dallas, 411 S. Ervay St.

Pennsylvania Rubber Company of California
San Francisco, 512-14 Mission Street Los Angeles, 930 S. Main Street

An Independent Company with an independent selling policy.



ÆTNA-IZED?



A Wrecked Home

After a gas explosion in the middle of the night in which five persons were injured, this is the way one home looked. There are accidents of travel, accidents on the street and in the office—but ten per cent. of all accidents happen in or about the home. Not all of them are so serious as this one, but all of them cause bodily injuries and everybody needs the protection afforded by accident insurance in the **ÆTNA LIFE**.

The accident policies of the **ÆTNA LIFE INSURANCE COMPANY** of Hartford, Conn.,

cover liberally all kinds of accidents.

In 22 years it has paid out over ten millions in accident claims, and in 14 years, over one million in health claims. Its 110 millions of assets and its great reputation for prompt and liberal settlements gives the **ÆTNA** the leading place in the accident insurance business, and it is the largest Company in the world writing Life, Accident, Health and Liability Insurance.

Send for information about its policies.

SEND IN THE COUPON TO-DAY

ÆTNA LIFE INSURANCE CO., (Drawer 1341) Hartford, Conn.

Pop. Mech. Tear off

I am under 60 years of age and in good health. Send me information about Accident and Health Insurance. My Name, business address and occupation are written below.

Jackson

NO HILL TOO STEEP
NO SAND TOO DEEP

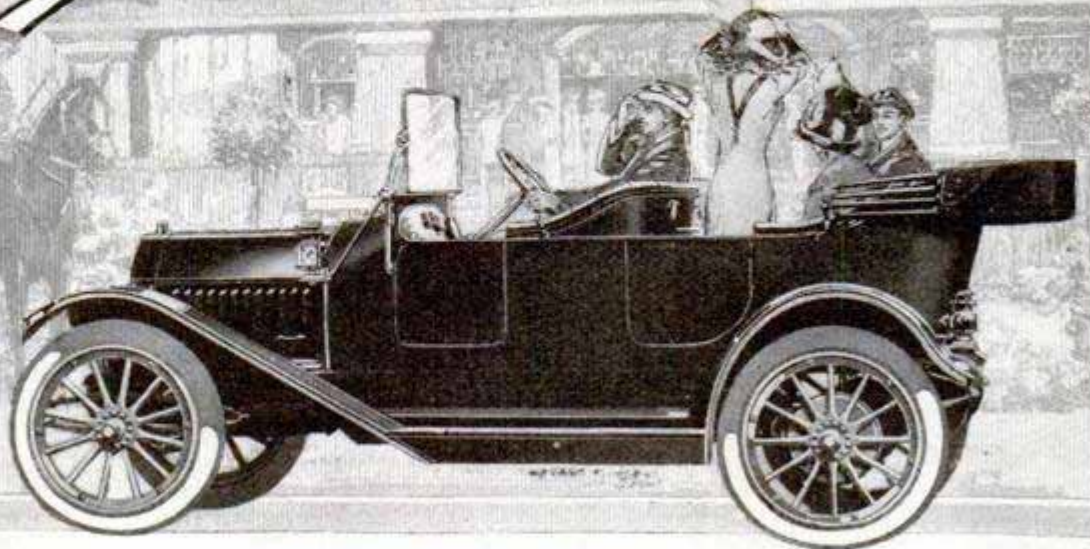

Jackson "Olympic"—\$1500

Four cylinders, 35 horsepower; unit power plant; long stroke motor $4\frac{1}{2} \times 4\frac{1}{4}$ inches; 115-inch wheel-base; 34x4 inch tires. Complete equipment, including Disco starter. Black and nickel trimmings. Electric starter and lights, optional, \$225 extra.

"Majestic"—4 cylinders, \$1975. "Sultanic"—6 cylinders—five passenger, \$2500—seven passenger, \$2650

Buyers are judging car comfort by what they find in the Jackson

So much has been said and printed recently about Jackson comfort that thousands of automobile buyers are making it the basis of their comparisons.

This is the position in which you will find yourself when you inspect the Jackson and the various other cars.

You will not be able to ignore the Jackson nor to put it out of your mind as you examine other cars; nor to avoid comparing these others with it.

It is true that you will see many comfortable cars, because this year manufacturers are exerting unusual energy in this direction.

But you will find also that the Jackson dominates the entire field.

If you seek the reason for this you will discover that other manufacturers are beginning to do only now what we have been doing for years—providing for the passengers' ease.

Experience is always valuable; and the experience of eleven years has taught our engineers how to harmonize the details of motor car construction and produce maximum comfort.

Long ago experiment demonstrated that the full elliptic spring has 33 to 100 per cent more action and resiliency than any other type; so all Jacksons are fitted with four full elliptic springs.

Jackson wheelbases are long; and they contribute to the riding ease because their ratio to wheel sizes, springs, car weight and load to be carried, is carefully worked.

With 10-inch seat cushions, slanted a bit toward the rear; we build the backs to shoulder height and upholster them richly, too.

We have provided a motor of the long stroke, enclosed-valve type that is silent, sure and powerful.

And back of it a train of transmission and driving mechanism, fitted with ball and roller bearings throughout, developed to the high point reached in the motor.

All the Jacksons are equipped with self-starting devices—two of them electric and an electric starter optional on the third—which add the last touch to the convenience of their operation.

See the Jackson; have a demonstration of its remarkable comfort; and we are willing to leave the decision to your judgment.

Jackson Automobile Company, 1301 E. Main St., Jackson, Mich.



You Want to Pass the Crowd?

think straight. You must travel with ease as well as with speed, if you expect to get there. That's why O'Sullivan's Heels of New Live Rubber are an invaluable aid to efficiency. They protect the body from the impact of walking; they conserve nervous energy; they make the step light and easy; and they lessen fatigue.

Nature gave us heels to walk on—and Nature's heels are simply soft cushions of flesh to take up the shock of the body's weight when the foot is thrown forward.

Civilized man has defeated Nature's purpose with his hard shoe-heels of iron nails and armor-plate leather. Every step you take on hard leather heels is like the blow of a hammer.

O'Sullivan's HEELS of New Live Rubber

In wearing O'Sullivan's Heels you are merely going back to Nature. These soft cushions of springy rubber, placed under your heels, take up the jar and shock of walking. They make every pavement feel like a well-kept lawn.

Successful people wear O'Sullivan's Heels, for they have learned that these wonderful aids to walking lessen fatigue, and make more efficient the men and women who wear them.

O'Sullivan's Heels are invisible when attached, as they have the shape and color of leather heels.

Their cost is fifty cents, which includes the labor of putting them on. Any shoemaker has them, and it takes about fifteen minutes to change from hard leather to elastic rubber.

Suppose you give them a trial, and

O'Sullivanize Your Walk



AutoStrop Safety Razor Co.

345 Fifth Avenue

TORONTO

New York

LONDON

NOTICE!

In the fall of 1912 we announced the policy of Guaranteeing 500 Shaves from each package of 12 Blades.

This guarantee is entirely reasonable, because the self-contained stropping feature in the AutoStrop Safety Razor makes stropping so simple and efficient that a shaver cannot resist the temptation to use it. The stropping assures long life to the blade in addition to smooth, cool shaving.

Past experience has shown that the 500 shave Guarantee is conservative.

We take this opportunity of again calling the nature of this Guarantee to the attention of the public:-- "Should anyone fail to get at least 500 Shaves from each package of 12 Blades he will, upon mailing them to us, receive in return enough new blades to make good his shortage.

AUTOSTROP SAFETY RAZOR CO.

H. J. Gaisman

PRESIDENT.

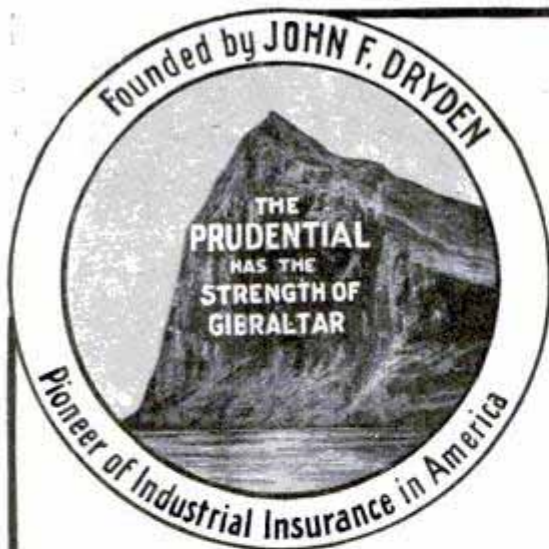

Wonderful Increase in 1912

*In Strength, Stability, Safety
and Public Usefulness*

Assets, over	- - - - -	291 Million Dollars
Liabilities	{ Including Policy Reserve, 228 Million Dollars; and amount set aside for Holders of Deferred Dividend Policies, 31½ Million Dollars; of which there is payable in 1913, over 4 Million Dollars }	nearly 267 Million Dollars
Capital and Surplus, over	- - - - -	24 Million Dollars
Paid Policyholders in 1912, over	- - - - -	31 Million Dollars

**Total Paid Policyholders Since Organization,
Plus amount held at interest to their credit, over
FIVE HUNDRED AND TWENTY-FIVE MILLION DOLLARS**

Life Insurance Issued and Paid for in 1912, over	- - - - -	480 Million Dollars
Increase in Insurance in Force, over	- - - - -	192 Million Dollars

**More than 11 Million Policies in Force Insuring over
2 BILLION, 211 MILLION DOLLARS**

Over \$73,000,000 invested in Real Estate Bonds and Mortgages.

**Amount of Voluntary Concessions paid to Policy-
holders to date, nearly 17½ Million Dollars.**

Premiums were Reduced in 1912 on New Ordinary Policies, and on new \$500. and \$750. Intermediate Policies.

126,000 Death Claims and Endowments paid in 1912.

Lowest Expense Rate in the Company's History.

The Prudential

Insurance Company of America

INCORPORATED AS A STOCK COMPANY BY THE STATE OF NEW JERSEY

FORREST F. DRYDEN, President

Home Office: NEWARK, N. J.

Suggested: (Whether you are insured or not) write for particulars of Prudential Monthly Income Policy, which guarantees an income for 20 years or life. Write today. Dept.

DRAW BIG MONEY!

Yes: \$125 to \$175 Per Month to Start

I know you would like to draw such a salary and more, and you positively will earn this amount easy when you are a thorough

Practical Trained Draftsman and Designer

The constant demand for my trained men always exceeds the supply. Many positions paying \$75 to \$100 per week remain open on account of the shortage of the proper men to fill them. Some weeks over 250 positions paying the highest salary in all parts of the country are open and I would like to prove this to you by sending you one of my regular weekly lists of open positions.



Chief Draftsman Will Train You Personally and Instruct You Properly

On practical Drafting room work UNTIL you are absolutely competent in every respect as a first class Draftsman and UNTIL you are placed in a permanent paying position at a salary paying at least \$125 per month. This is a most exceptional opportunity for just a limited few selected ambitious men, between the ages of 16 and 40, whom I will train personally and give individual Instruction as required in order to fill the constant demand for properly trained men in this line.

Absolutely FREE! this Complete \$15 Draftsman's Working Outfit
IF You Write to Me AT ONCE

By sending the FREE COUPON on bottom of this page for my most liberal FREE OFFER for the \$15.00 Draftsman's Working Outfit, and also for my special offer to

Earn Big Money at Once
While Learning at Home

Yes, my friend, you can make big money at once right at home from the very start—as much as **\$5 to \$10 per day**. I will pay you while learning.



I give EACH of my students my own PERSONAL ATTENTION—therefore, I limit the number of my students and if you desire such an opportunity then get busy NOW and WRITE TO ME AT ONCE. Don't wait until tomorrow, but do it TO-DAY. You can earn much more than I charge for my spare time and personal training. This is not a money making correspondence school. We NEED good men to fill good paying positions and my practical working training is the result of the most urgent need for Draftsmen.

With my twenty-two years' experience as Chief Draftsman in handling men, I know exactly how urgent good men are needed all the time, and I will give you the benefit of my twenty-two years' experience at this work and will make you as high grade a man as you desire to be. You can draw \$125 to \$175 per month and steadily keep on going higher, as many good men draw \$5,000 per year in this line. You can do the same if you will grasp this opportunity.

FREE BOOK and EARNING while LEARNING Offer Coupon

**Chief Draftsman,
Division 1195,
Engineer's Equipment Co.,
Chicago, Ill.**

Without any obligation on me whatsoever, please mail your book "Successful Draftsmanship" and full particulars of your liberal "Personal Instruction" offer to a few students. It is understood that I am obligated in no way whatever.

Remember: You can be earning good money while you are learning at home to do the practical Drafting room work.

Mail FREE COUPON at once for my book "Successful Draftsmanship," also list of open positions and for the free offer to be earning good money at once while you are learning at

home. This offer is positively limited and in order to benefit thereby you must act **AT ONCE**—not tomorrow but **TO-DAY**.

**Address: Chief Draftsman
Engineer's Equipment Co. (Inc.)
Division 1195 CHICAGO, ILL.**



I Guarantee

To instruct you UNTIL competent and placed in a permanent paying position at a regular Draftsman's salary of at least \$125 to \$175 per month and guarantee to furnish you free the complete Draftsman's working Outfit at once from the start.

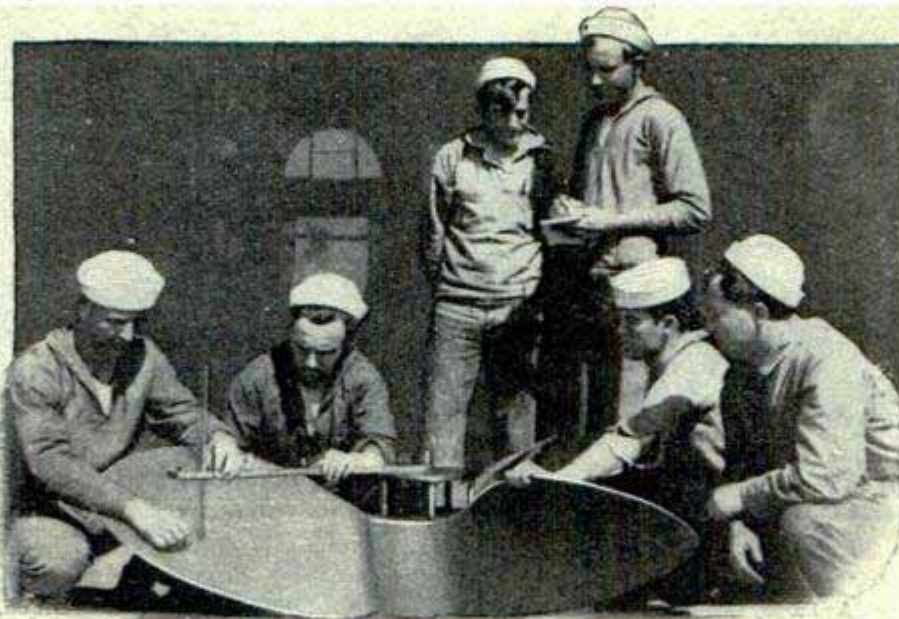

Measuring the pitch of a propeller; scene at Navy Trade School.

Good Pay and *Clear* Pay

**Do You Know These Facts
About the Men Who Work
At *Trades* in the Navy:**

DO you know that skilled men of more than *50 different trades* are required in the U.S. Navy to run the great ships and care for their machinery?

Do you know that every one of these *thousands* of men is *paid well* and gets certain advantages which no position in civil life could give him?

Do you know that these men have practically all their living expenses paid—even free medical attendance if necessary? That they are promoted regularly and are never “laid off”?

Do you know that they live a healthy, open air life, such as no fac-

"CYPRESS lumber defies decay. You save repair bills."

CYPRESS

"THE WOOD ETERNAL"

IS A \$1000. 3-ROOM CYPRESS COTTAGE ABOUT RIGHT? WELL, HERE IT IS!

And a joy and a blessing it will be to anyone with a little plot of earth to put it on.

FULL PLANS & SPECIFICATIONS FREE TO ALL PEOPLE WHO LOVE LITTLE HOMES

Ample for any competent carpenter to build from. Above estimate of cost is a fair average figure the country over.

WRITE RIGHT NOW for VOL. 32, of the CYPRESS POCKET LIBRARY

Think now—
Learn now—
and you'll
do better
Buying
when
ready.

Also ask for Vol. 1 with U. S. Gov't report on Cypress, and full list of these 35 invaluable text books.

