

POPULAR MECHANICS

WRITTEN SO YOU CAN UNDERSTAND IT

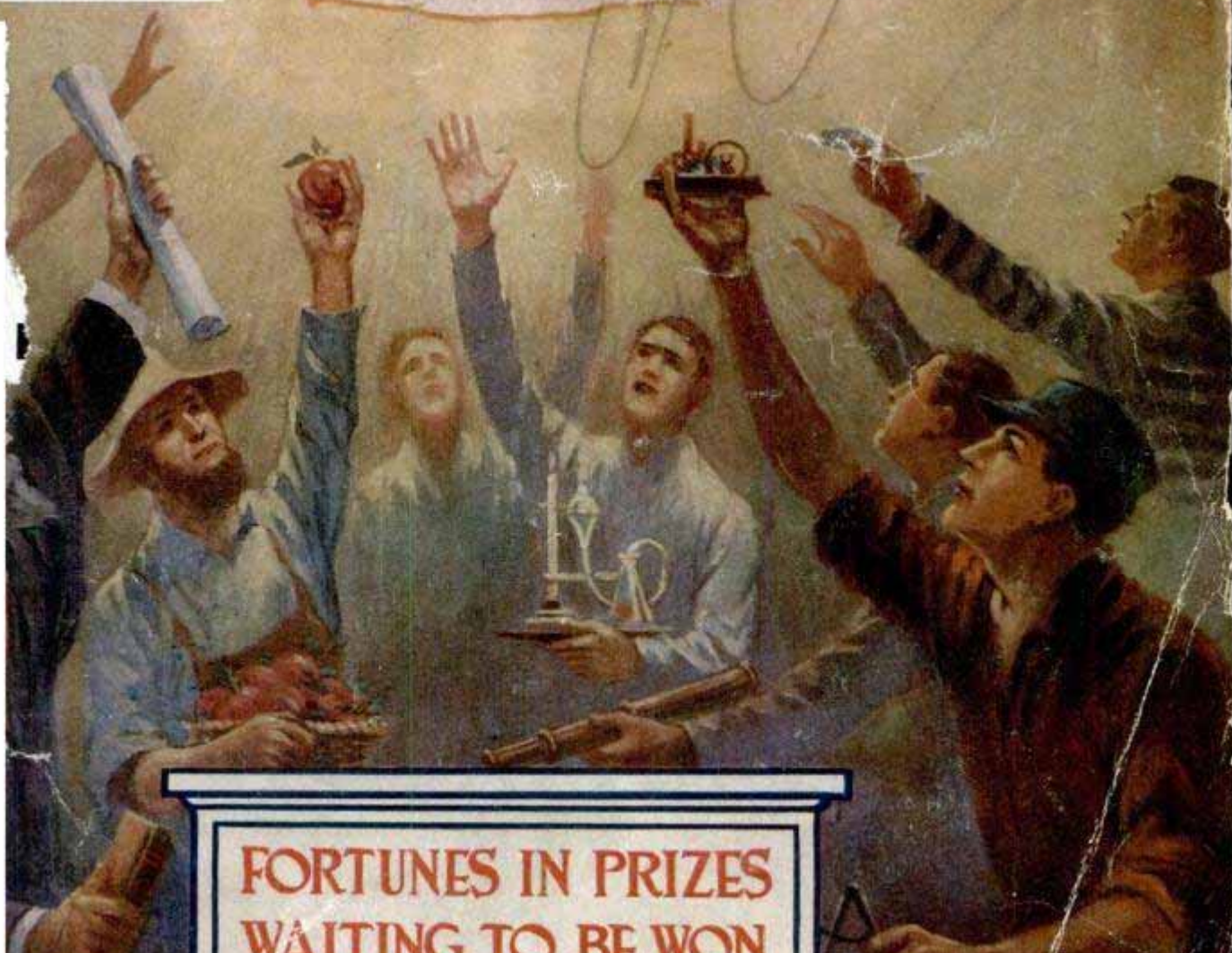

FORTUNES IN PRIZES
WAITING TO BE WON

\$867 Buys the Material To Build This Home

NO MONEY IN ADVANCE

We Save Home Builders 30% to 50%



Design No. 117

\$708 Six Rooms and Bath. A Modern Bungalow, Excellent Interior. Size, 39 feet, 6 inches by 27 feet.



Design No. 55

\$743 Six Rooms and Bath, all rooms convenient and roomy. Size 22 ft. by 31 ft.



Design No. 50

\$998 Eight Rooms and Bath, very attractive Exterior; Five Closets, Airy Balcony. Size 28 ft. by 28 ft.



Design No. 53

\$1078 Seven Rooms, Bath, Large Living and Main Bedroom, Modern in every respect. Size 27 x 36 ft.

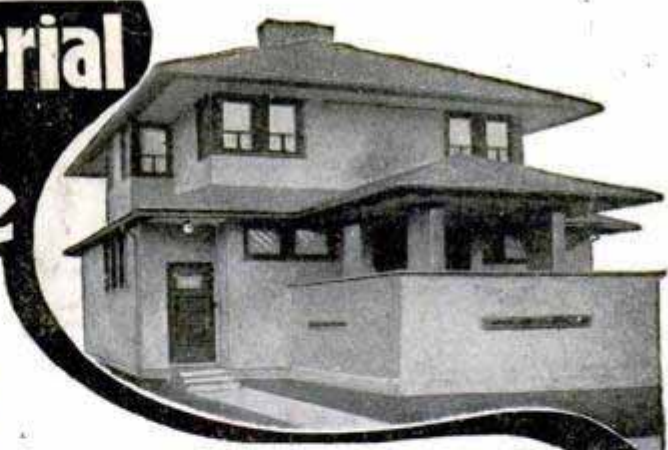

Design No. 152-D
Seven rooms and bath, modern, up-to-date interior, a beautiful home, 28 x 28.

The Chicago House Wrecking Co. would not dare ship you a carload of building material, valued anywhere from \$500 to \$1000 without one cent down, if we misrepresented one single item. You are perfectly safe, we take all the risk.

No one else in all the world can make such low prices on new Building Material. Our reputation as cash buyers places at our command, first—every bargain worth having. We are satisfied with one small profit—let the in-between profits remain in your pocket—means an immense saving—that means all previous

New Building Material Prices S-M-A-S-H

Then, when our expert knowledge of what to buy and how to buy at the right price is combined with the expert knowledge of our most complete Architectural Department, the result is practical, modern, beautiful buildings, constructed absolutely without compromise—to satisfy all tastes and all pocketbooks.

We not only save you from 25% to 50% on your completed building, but we give you all the assistance you need for its proper and economical construction, free of charge—Blue Print Plans, prepared by expert architects, Specifications and Material Lists, together with any other information you may need.

Compare our offers and you will be satisfied that none can compete with our price—and none can equal our service.

\$10,000 BOOK OF PLANS Mail the Coupon Today **FREE**

A truly wonderful book given away Free. One hundred pages of modern, up-to-date designs. Free to all parts of the United States. Other points upon receipt of 25c.

\$2 Brings Complete \$50 Set Blue Prints and Specifications for Any of These Beautiful Homes

The object of this advertisement is not to sell plans, but if you are interested in any of the designs shown on this page, we will to save time, send a complete set of Plans, Specifications and full descriptive Material List, showing sizes, style, quality and catalog number of the material that we furnish. The best part of it is, that the entire \$2 will be credited on your order, or if plans do not suit, you may return them and all but 50c will be refunded. In addition, we will also name, upon request, delivered prices for complete Plumbing Outfit and Heating Plant of any kind and furnish complete specifications free of charge.

FREE Price Wrecking Catalogs

Send for our Special Building Material Catalog No. 101, Plumbing Catalog No. 133 and Heating Catalog No. 120 showing a complete line of construction of house, barn, or any other building. The newest and latest features in each line at low prices.

Read Our Guarantee—It Is Your Protection

Our guaranteed proposition to you is to furnish the material as specified in the Material List in all brand new stock, of the grade, sizes, style, quality and catalog number mentioned, and in quantities sufficient to complete the design strictly according to the plans. We also guarantee prompt shipment of order. All material loaded in one car from our plant here.

Our Paid-Up Capital Stock, \$2,000,000



Heating Plants

Write for our prices on our complete bathroom outfit. We guarantee a saving of 30 to 50 per cent.

Plumbing Material

Steam, Hot Water and Warm Air. Let us estimate on your requirements. Big saving.

Chicago House Wrecking Company, Dept. F7 CHICAGO

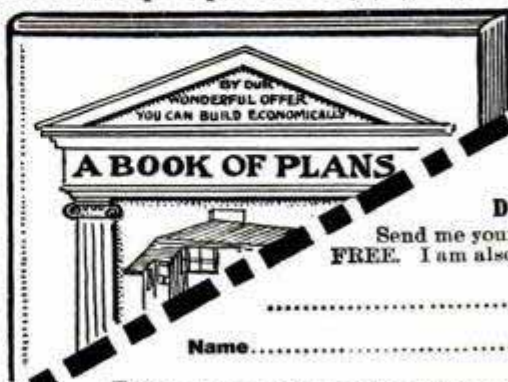

Chicago House Wrecking Company, Dept. F7, Chicago, Ill.

Send me your \$10,000 Plan Book FREE. I am also interested in

.....
 Name.....
 Town.....
 County..... State.....

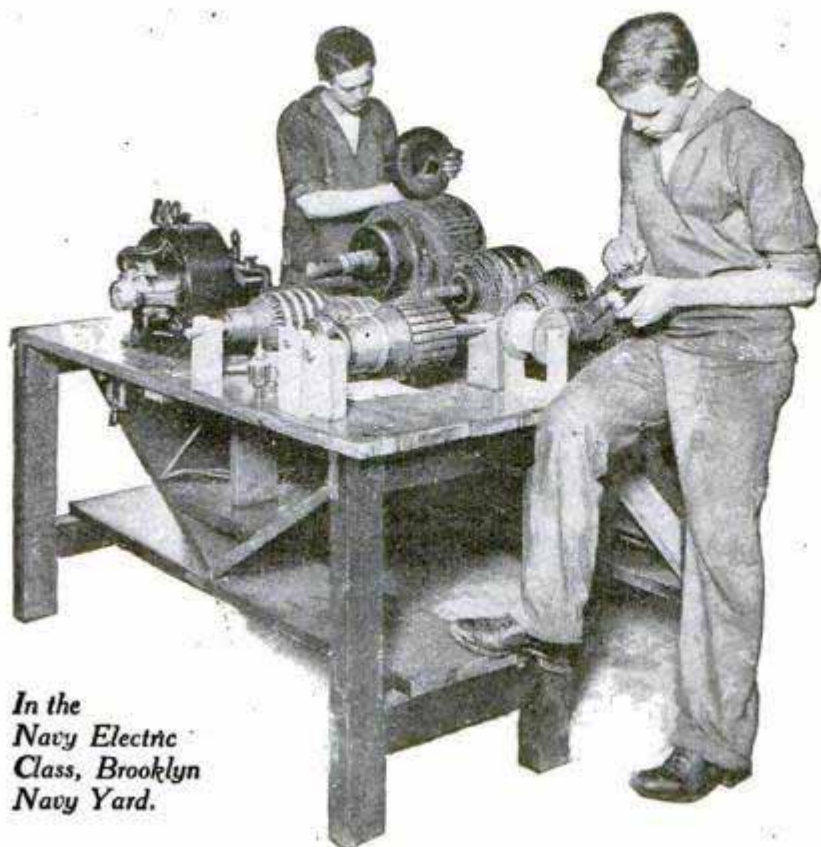

*In the
Navy Electric
Class, Brooklyn
Navy Yard.*

Navy Trades Pay Good Men Well

IF you are between 18 and 25, ambitious and of a mechanical turn of mind, read this:

The United States Navy employs men of *50 different trades* to operate and care for the intricate machinery which makes up the modern warship.

These men are skilled workmen of the highest order. Some of them learned their trades before entering the Navy, but most of them have been especially trained for their work in the Navy's trade schools, and by practical experience on board ship.

These men receive excellent pay—nearly all clear money—because board, lodging and many other advantages are free.

The hours are good and the work is steady—no layoffs. Promotions with increased wages are easily earned. Chance to save money excellent. The life is far healthier than any factory or shop job can be. And there are frequent changes of scene and plenty of good companionship.

Call at the Navy Recruiting Station near you (look for address in the want columns of your local Sunday newspaper) and get full particulars about different kinds of work, pay, hours, etc. Or write for interesting free books describing Navy trades and the daily life on a United States man-o'-war.

If you put this off you're likely to forget. So mail a postcard today—*now*.

Bureau of Navigation, Box 69, Navy Department, Washington, D. C.

UNITED STATES NAVY



"Build of CYPRESS Lumber at FIRST, and NEVER HAVE TO REBUILD"



CYPRESS



VOL. 6 of THE CYPRESS POCKET LIBRARY, with COMPLETE WORKING PLANS of T

\$1,650 FIVE ROOM **BUNGALOW**

built (as all good Bungalows should be) from

CYPRESS, OF COURSE

("AND NO SUBSTITUTES")

WILL BE SENT FREE with our compliments TO ALL GOOD

BUNGALOW

FOLKS

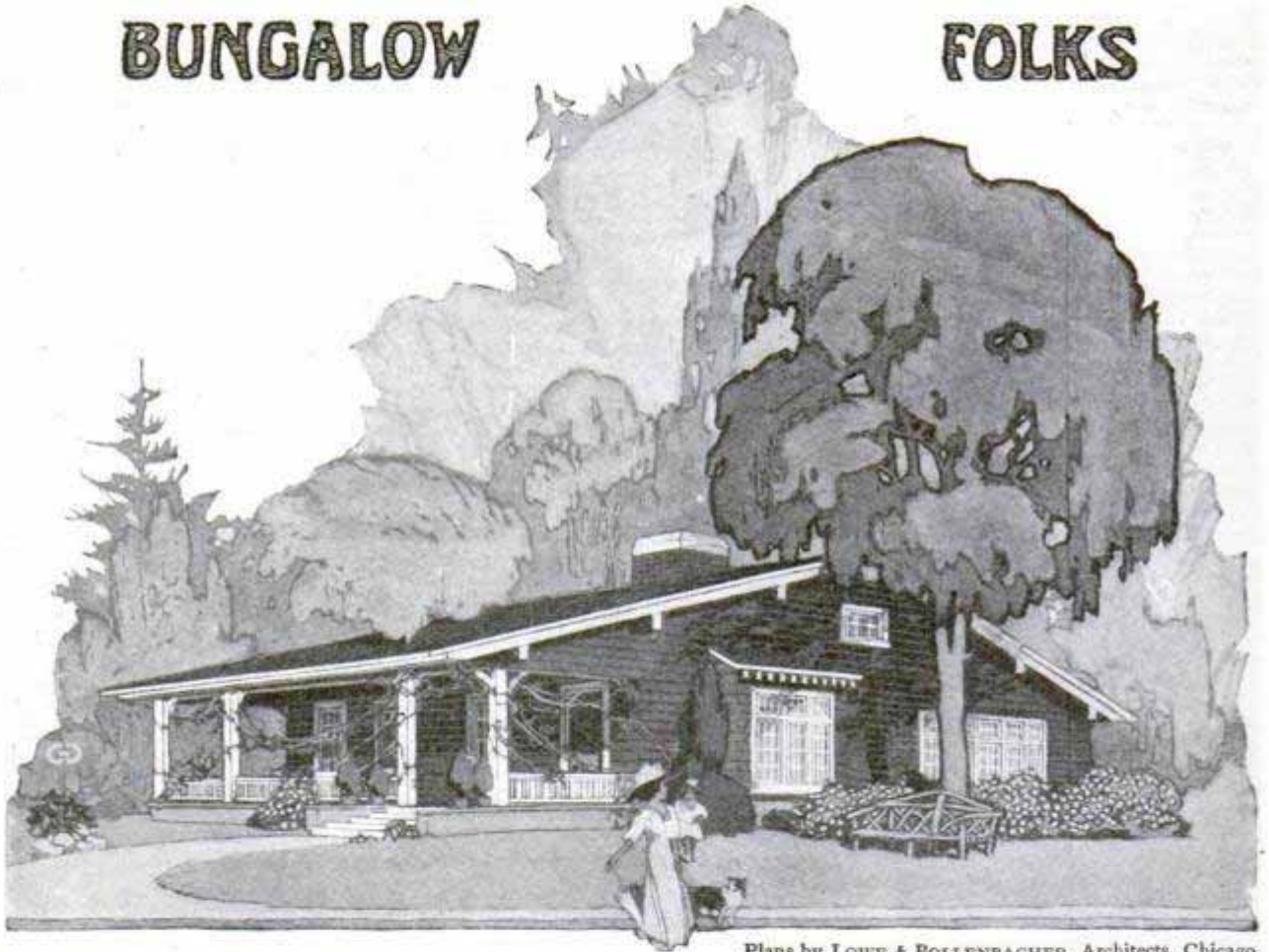

Plans by LOWE & BOLLENBACHER, Architects, Chicago.

SPECIFICATIONS GO WITH WORKING PLANS and are SUFFICIENT for any competent carpenter TO BUILD FROM.

The less you have to spend in building, the more important it is that you secure the longest possible life for your investment. The more you spend, the more important it is that your money shall represent a definite and permanent investment, and not have to be spent over again in exasperating repairs. CYPRESS is "the one best buy" in the entire wood market for those who care what they get for their lumber money. "CYPRESS lasts forever." CYPRESS DEFIES THE ROT-INFLUENCES which destroy other woods. CYPRESS does not warp or shrink or swell like most woods—and it takes paint or stain perfectly. Whether for MANSION, PASTURE-FENCE OR "LITTLE JOB OF BACK-STEPS" — remember — "IF YOU BUILD WITH CYPRESS YOU BUILD BUT ONCE."

ASK our "ALL-ROUND HELPS DEPT." any question about Wood. Our reply will be frank. We recommend CYPRESS only where CYPRESS can prove itself "the one best wood" for your use.

SOUTHERN CYPRESS MANUFACTURERS' ASSOCIATION

1219 HIBERNIA BANK BUILDING, NEW ORLEANS, LA.

We produce CYPRESS but do not retail it. INSIST ON IT NEAR HOME. Wide awake Local Dealers sell CYPRESS; if yours does not, WRITE US, and we will tell you where you CAN get it.

Popular Mechanics Magazine

318 W. Washington Street, Chicago, U. S. A.

EDITED BY H. H. WINDSOR

ISSUED MONTHLY

SUBSCRIPTION:

SINGLE COPY, 15 CENTS

In United States, and its possessions, Cuba and Mexico, per year, postpaid \$1.50
To Canada 1.75
To all other countries in the Postal Union 2.00

All subscriptions are discontinued at expiration. Please examine the date printed on your wrapper.

Entered as Second Class Matter Sept. 15, 1903, at the Postoffice at Chicago, Illinois, under Act of March 3rd, 1879.

Published monthly by POPULAR MECHANICS CO.

Copyrighted 1913, by H. H. WINDSOR.

The attention of prospective advertisers is called to the policy of this magazine in accordance with which the publisher waives all claim for payment of any advertisement appearing in any issue where the number of copies actually printed and circulated is less than the number printed on the front cover page.

Contents for April, 1913

Baseball-Catching and Returning Device	463	Quartz-Crystal Spheres	503
Portable Searchlight for Linemen	464	Langley Medals Awarded to Curtiss and Eitel	504
Surface-Propellered Motorboat	464	Putting the Aeroplane to Commercial Use	504
Cleveland's Great Concrete Bridge	465	Front-Drive Motor Truck of Unique Design	505
Compact Willow Table and Chairs	465	Lighthouse Keepers Get News by Phone	505
Motion-Picture School for Railroad Firemen	466	Seal Catching on the Newfoundland Ice Floes	506
The Burglar with a "Cloven Hoof"	468	By M. F. Power	
Ownership of the Suez Canal	468	Pistol with Lamp for Lighting Target	508
A Dirigible Balloon in the Making	468	The Senators' Monorail in Operation	509
Gas Producer and Engine for Farmers	470	An Unusually Small Electric Heater	509
Cactus-Rope Bridge Two Hundred Feet Long	470	Adjustable-Length Jacob's Ladder	510
The Battle for Safe Water Supplies—I	471	A Pressure System of Filtration	510
By Dr. Allan McLaughlin		Prisons That Are Model Structures	510
Wireless Stations of the World	476	A Fireplace Open on All Four Sides	512
Organ with Pipes Thirty-Seven Feet Long	478	The Pneumatic Tire of the Future	512
Motor Trucks Undergo Severe Tests	478	Navigating Apparatus on a Roof	512
Ship Destroyed by Its Cargo of Sodium	478	Government Counts Paper Money by Machine	513
Developing New Coal Field by Electric Power	479	Locomotive Boiler with an "Accordion" Joint	514
London Omnibuses Tested by Tilting Them	479	Chinese Take to Electric Advertising Displays	514
Beard Formed of Live Honeybees	479	Hydroplane That is Built of Steel	515
Fighting the Moth with Automobile Sprayer	480	Bugs Roasted and Eaten like Chestnuts	515
"Powder Monkey" Shoots up Snowslides	480	Motor Sugar-Cane Harvester	515
Great Wave Overwhelms English Liner	481	Great Boulder Moved with Difficulty	516
Gazelle Takes Revenge on Its Destroyer	481	Aluminum Face Hides Battle Scars	516
The New Grand Central Terminal New York	482	A Steam-Engined Motorcycle	516
Parachutes for Aeroplane as Well as Airman	484	Barge Built of Concrete at Baltimore	517
Double-Deck Lift Bridge of Immense Size	484	Norway's Crown Prince Has Tiny Automobile	517
Death Rate of Mine Rescuers	485	Japanese Firemen Cling to Ancient Customs	518
Dog's Dining Room in England	485	Church Tower Uncovered after Long Burial	520
Primitive but Powerful Zulu Orchestra	486	The Big Ships of the Future	520
Portable Schools for Temporary Use	486	Insulating Shoes for Electrical Workers	520
Dynamite Carrier Made on "Thermos" Principle	487	The Cleaning of Passenger Cars	521
Throwing Big Boulders with Steel Bucket	487	Gasometer Built of Reinforced Concrete	522
New Trowel for Stucco Work	487	"Submarine Fiddling" for United States Navy	522
The Sea-Shell Windows of the Philippines	488	World's Consumption of Artificial Gas	523
Camel's-Hair Belting Used Many Years	488	Homes of Two Famous Foreign Hermits	523
Scott Expedition Proved Value of Motor Sleds	489	Unusual Picture of Marine Surgery	524
Natural-Gas Explosion Wrecks Dwelling	490	Burial of Garbage from Small Cities	524
Creation of Substances from Electric Energy	490	Cement Mountains and Porcelain Towns	524
Projects Motion Pictures That Do Not Flicker	491	Firemen Weave Shawls in Leisure Time	525
Convenient Arrangement of School Cloakroom	491	View of the Assouan Dam	526
Electric Ice Fountain on Chicago Boulevard	492	River Water Used Eight Times in California	527
Transcontinental Road to Run by Electricity	492	Sight-Seeing Canal Train	527
Talks by Wireless Phone across Mediterranean	494	Motor Car for Both Peace and War	527
Canals of Mars Indicate Life on Planet	494	The Nightingale Statue in the Making	528
A "Tape Measure" Fire Escape	496	Value of Motorboats to Tusket Lobstermen	528
Invisible Aeroplane may be Developed	496	New French Farm Tractors	529
Portraits of the Human Eye Reveal Character	497	Motorcycle with Several New Features	530
Caboose Up-Ended without Breaking Coupling	497	Photographing the Time in Auto Speed Tests	530
Convict Establishes Curio Trade	498	Bridge Piers Built by Spouting Concrete	531
Launches Life Boats from Either Side of Ship	498	Steamboat Provided with "Artificial Rain"	531
Comment and Review	499	The New Potatolike Vegetable	532
By Frank Parker Stockbridge		Steel Cable Ties Itself into Odd Knot	532
Captain Amundsen's Chicago Medal	502	New Colored Moving Pictures	533
New Money to be Smaller and Simpler in Design	502	An Aerially Propelled Water Glider	533
Natural Gas Providing Automobile Fuel	503	First Underground Railroad	533

[Continued on Page 6]

Popular Mechanics offers no premiums; does not join in "clubbing offers," and employs no solicitors to secure subscriptions. It is for sale by nearly every newsdealer in the United States and Canada.

This Roofing Never Costs a Cent for Maintenance

It's false economy to put your money in a "cheap" roofing that has to be painted, regravelled or repaired every year or two. The *real* cost of a roofing is the *purchase price plus the cost of maintenance.*

J-M Asbestos Roofing is the only ready roofing that never requires a single cent's worth of coating, regravelling or other protection. Therefore it *costs less per year of service* than any other roofing.

This roofing never needs any protection because it is made of layers of stone (Asbestos) felt securely cemented together with Trinidad Lake Asphalt. It is *mineral through and through*—literally a sheet of *pliable stone*. There isn't a particle of perishable material in

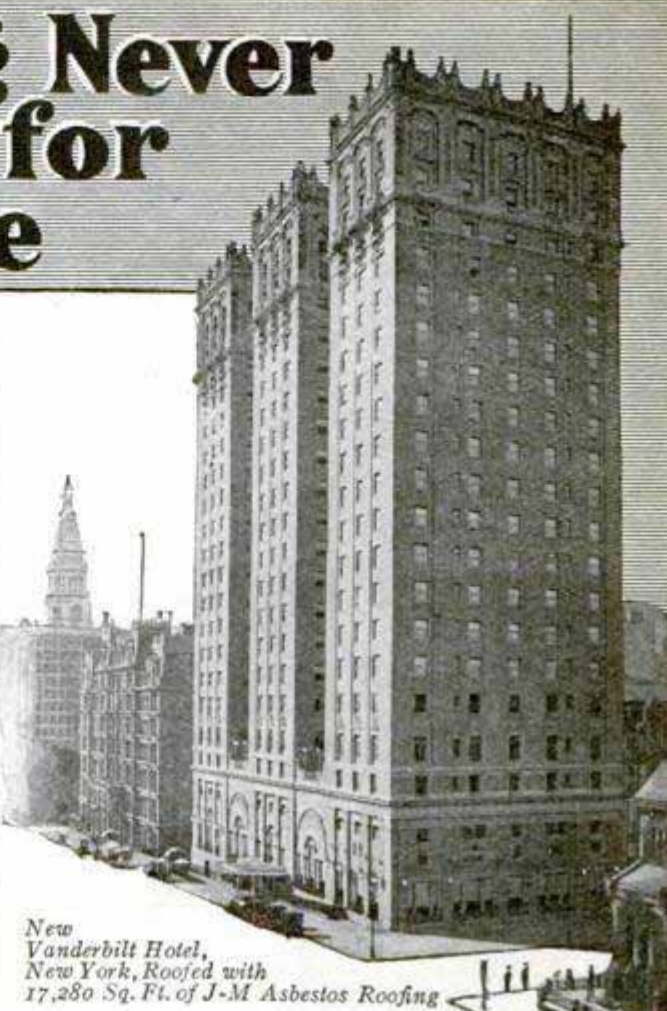

*New Vanderbilt Hotel,
New York, Roofed with
17,280 Sq. Ft. of J-M Asbestos Roofing*

J-M ASBESTOS ROOFING

Is it any wonder that this stone roofing is not affected by rain, heat, cold, salt air, chemical fumes, etc., and that it affords absolute protection against fire? And is it any wonder that this roofing is still in good condition on hundreds of roofs after more than 25 years of service?

J-M Asbestos Roofing comes in rolls ready to lay; also furnished in built-up form. Suitable for any type of building. Easy to lay. J-M Roofing Cleats, packed in each roll, make absolutely water-tight laps and give the entire roof a handsome white appearance.

Your dealer sells J-M Asbestos Roofing—if not, order from our nearest branch.

Write for sample of the curious Asbestos Rock from which this Roofing is made and our Book No. 2771.

H. W. JOHNS-MANVILLE CO.

MANUFACTURERS OF ASBESTOS AND
MAGNESIA PRODUCTS

TRADE
ASBESTOS
MARK

ASBESTOS ROOFINGS, PACKINGS,
ELECTRICAL SUPPLIES, ETC.

Albany
Baltimore
Boston
Buffalo

Chicago
Cincinnati
Cleveland
Dallas

Detroit
Indianapolis
Kansas City
Los Angeles

Louisville
Milwaukee
Minneapolis
New Orleans

New York
Omaha
Philadelphia
Pittsburgh

San Francisco
Seattle
St. Louis
Syracuse

For Canada—
Toronto

THE CANADIAN H. W. JOHNS-MANVILLE CO., LIMITED

Montreal

Winnipeg

Vancouver

1967

1913 ENLARGED and REVISED COURSE — JUST OUT. Price advances soon



WOULD YOU GIVE \$12 to LEARN the AUTO TRADE AS CHAUFFEUR OR MECHANICIAN? Then READ Carefully

Before taking your course I was working in a factory at another trade. I am now repairing autos, as per your Employment Plan, and have more work than I can attend to. I made \$10 for 8 hours' work yesterday. Thanking you for helping me with your course and employment plan. I am, Yours truly, JOHN L. BORK, 973 Liberty St., Toledo, O.

Have just overhauled a car with great success. People told me a person could not learn by mail and I will admit that it did have me guessing when I first read your ad, but I am now convinced. **The Working Models and the Charts, etc., make it easier to learn by your system than any other way.**— E. A. TUCKER, Charlotte, Mich.

If we PROVE to you that we have started hundreds of others into the repair business and as chauffeurs—who had no previous experience and who knew no more about an auto than you do right now—will you enroll?—of course you would. Now the next thing for you to do is to write me just as quick as possible and LET ME PROVE IT.

H. M. Fewins and S. T. Slayback, both graduates, are now running a Garage and Repair Shop at Woodbine, Iowa.

E. Dwyer, 31 N. Willow St., Montclair, N. J., 19 years old, receives \$25 a week and board.

Harry J. Herbin, Jamestown, Kans., was farming, but has now doubled his income repairing and selling autos.

Milford McClelland, Astoria, Ill., became professional chauffeur and more than doubled his salary. (Now in Denver, Colo.)

A. I. Foust, formerly of Washingtonville, Pa., was in another line of work. He took our course and is now at the head of the leading garage of Milton, Pa.

And we could continue until we had filled this and several more pages.

Open a Repair Shop of Your Own BE AN AUTO MECHANICIAN

We can so thoroughly train you that you can open a repair shop or drive a car and make many times more than you are making now. Don't forget, we help you get your start with our *Employment Plan*, if you want it.

DYKE'S NEW IDEA OF TEACHING BY MAIL WITH WORKING MODELS

is something new. We use *real* working models—not just one but five. On these models you get actual practice, see the actual operation and learn more than you could from the auto itself—it's easy and quick. You don't have to study hard with this system—we teach through the eye—a new idea. We are the originators of the system of teaching by mail with models. We also use charts—230 of them and a 16 page manikin. Our 40 instructions and Repairman's Instructions are simplicity itself—simple as A B C.

Our Employment Plan for Students

—represents years of work to provide something that no other school had, namely, a way for the graduate to get acquainted with auto and garage owners, to prove his ability and to immediately secure profitable employment.

Mr. Dyke has been identified as a pioneer inventor, supply man, etc., with the auto industry since its beginning. He originated the first auto supply co. and published the first book on autos in America. No other man with such experience is today teaching others. And all the experience and inside information of the auto business he has thus gained, is embodied in this *Employment Plan*.

WRITE TO-DAY for Details of Employment Plan and THIS FREE BOOK

It is instructive and interesting—does not cost you a cent and places you under no obligations whatever—You need it for your own sake, not mine. Don't wait—there's no profit in waiting—WRITE NOW and learn how you can obtain all this training for only \$12, if you act immediately.

DYKE'S CORRESPONDENCE SCHOOL OF MOTORING

Box 88, Roe Building, ST. LOUIS, MO.

WARNING: Mr. Dyke is the Originator and Inventor (Patent applied for) of the Working Model System for Teaching by Mail. If others claim to give real models—have them prove it.

Our book of testimonials, showing photos of students and their shops—free.



Wonderful BOOK FREE!!

Explains Everything You Should Know About **How To Study**

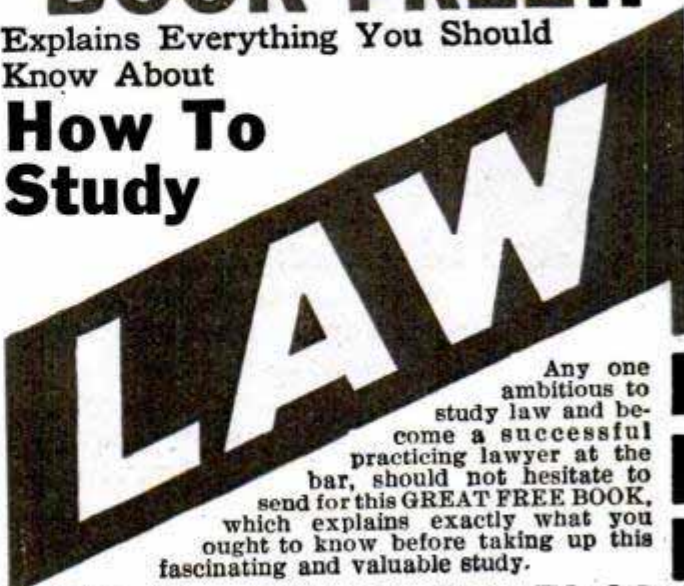

Any one ambitious to study law and become a successful practicing lawyer at the bar, should not hesitate to send for this GREAT FREE BOOK, which explains exactly what you ought to know before taking up this fascinating and valuable study.

This Book Starts You Right

It shows you how to become a thoroughly competent lawyer—explains the requirements step by step in a plain, simple, direct way that will start you right and save you a lot of time, trouble and expense. There can be no possible failure with this Wonderful Guide to follow. It puts you at once in the path followed by America's Foremost Lawyers—men who have themselves gone through such steps as they now recommend for you. This Free Book shows you

How To Study Law At Home

Under the World's Greatest Masters of Law—how to utilize your spare moments in preparing yourself for a great profession at very small cost—how to prepare for bar examinations in any State—how to increase your mental powers by training that will make you a leader in your community. If you contemplate studying law, you surely want to master the best course in the shortest time at least expense. This Free Book is invaluable to you, no matter what course or school you have in mind, and you might as well send for it—no risk, expense or obligation—and become thoroughly posted.

Save Half Your Tuition

We will not only send you this Wonderful Guide to the Law—absolutely free—but will also point out a way by which you can save half your tuition charges. We are in position to do this for a certain time, so it will be just like keeping a lot of money in your own pocket, if you answer this promptly. Remember, we save you half.

SEND NO MONEY Just your name and address in letter, postal, or on the Free Coupon below, will promptly bring everything Free by return mail. You will find this Guide to the Law an invaluable aid in putting you on the right track. Don't fail to send for it now!

How to Become a Lawyer

(Tear Off and Mail This Free Coupon Now)

LaSalle Extension University, Dept. 43, Chicago, Ill.

Please send me—FREE—Valuable Law Guide and tell me how to save half on my tuition.

NAME.....

ADDRESS.....

Please Mention Popular Mechanics

"The Chaldean Story of the Flood"

Dug Up From the Ruins of Ancient Chaldea

DO YOU KNOW that there has been dug up from the ruins of old Chaldea a complete story of the Flood—the same in every detail as Moses' account in Genesis—and that it was written thousands of years before his version appeared? Hardly one in a million has ever had an opportunity of seeing this startling story—*HAVE YOU?* But it is one of the many thousand curiously interesting accounts in

The Library of Original Sources

now for the first time available to the general public. Up to the present this remarkable Library has only been sold by subscription, but by taking over the *entire unsold edition* from the publishers we secured it at an *absolutely unheard of bargain*. Therefore we are able to offer the few remaining sets to POPULAR MECHANICS readers

AT LESS THAN IT COST TO MAKE THEM

Send us the attached coupon **AT ONCE**, and we will tell you how to get the Library on **EASY MONTHLY PAYMENTS**, and mail you **FREE** a book of rare documents showing curious inscriptions of the Ancients. Remember there are only a **limited number of sets**, so act quickly. Mail the coupon **NOW**. You assume **no obligation**. No salesman will call. The book is **FREE**.

THIS MARVELOUS WORK is revolutionizing modern thought. It's turning upside down old notions and ideas. It gives the authoritative, rock-bottom sources of our knowledge on **ALL SUBJECTS OF HUMAN INTEREST** from the earliest civilization down to to-day—the inside facts which the average person has never even heard of.

OVER 100 RESEARCH SPECIALISTS spent 10 years gathering the contents of this great work. Ancient and remote and forgotten civilizations in all parts of the globe were uncovered, and age-buried hieroglyphics on monuments, tablets, sun-baked bricks and palimpsests yielded their secrets; untiring workers ransacked the hidden literature of every age, ancient, mediaeval and modern, to find the "original documents" that shaped the civilization and influenced the thought and life of the world. Nothing like it has ever been attempted or thought of before. You'll be amazed at the wealth of information this unique library contains.

DO YOU KNOW that the old Egyptians, 5000 years B. C., had a Bible which they called the "Book of the Dead"?—Do you know that the Assyrian sacred literature gives the story of the Creation?—Do you know that books and newspapers were printed in Asia thousands of years before printing was invented by Gutenberg?—Do you know that Columbus wrote a journal of his voyages to the new world and that it has been found, translated and published?—**DID YOU EVER READ** the "Ball and Tyler Rebellion"? Luther's "Ninety-five Theses"—which he nailed to the church door—or Machiavelli's "Prince"?

YOU'LL FIND THEM ALL—and thousands of others equally as curious and important—in the Library of Original Sources. Every document is in the exact words of the original, translated; every contribution is from the actual eyewitness or person who took part; every idea is in the words of the thinker, investigator, discoverer or inventor.

JACK LONDON SAYS:—"It is a whole library in itself. I certainly never could spare these books from my shelves."

10 sumptuous, massive volumes, bound in rich, deep red Morocco; full-page illustrations. Pure silk headbands, printed in large, clear type on hand-made paper, gold tops—a triumph of the bookmaker's art.

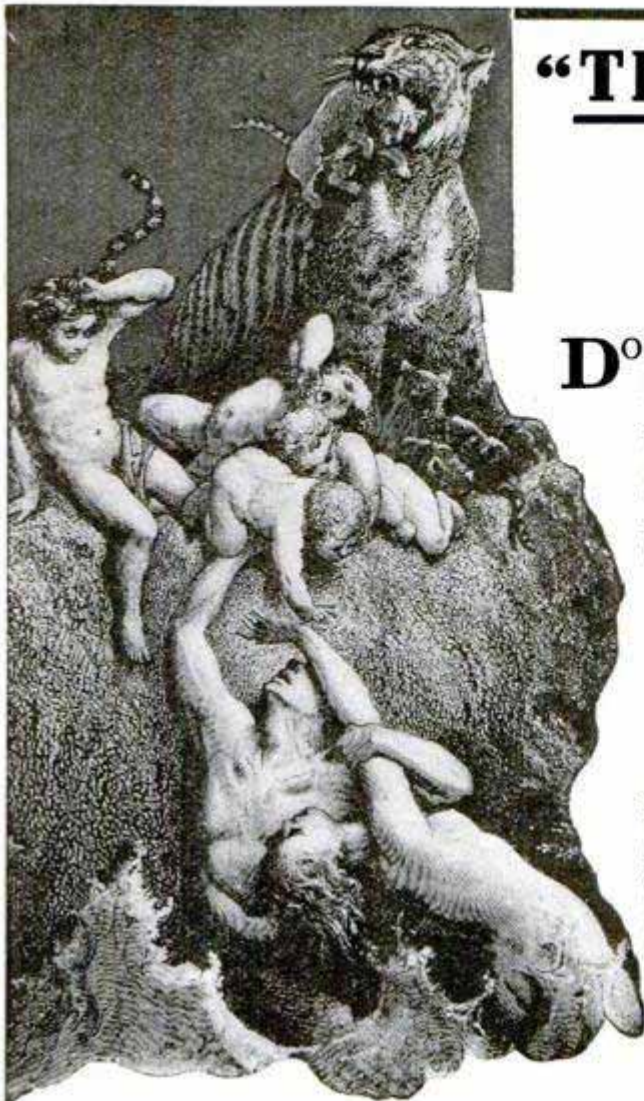
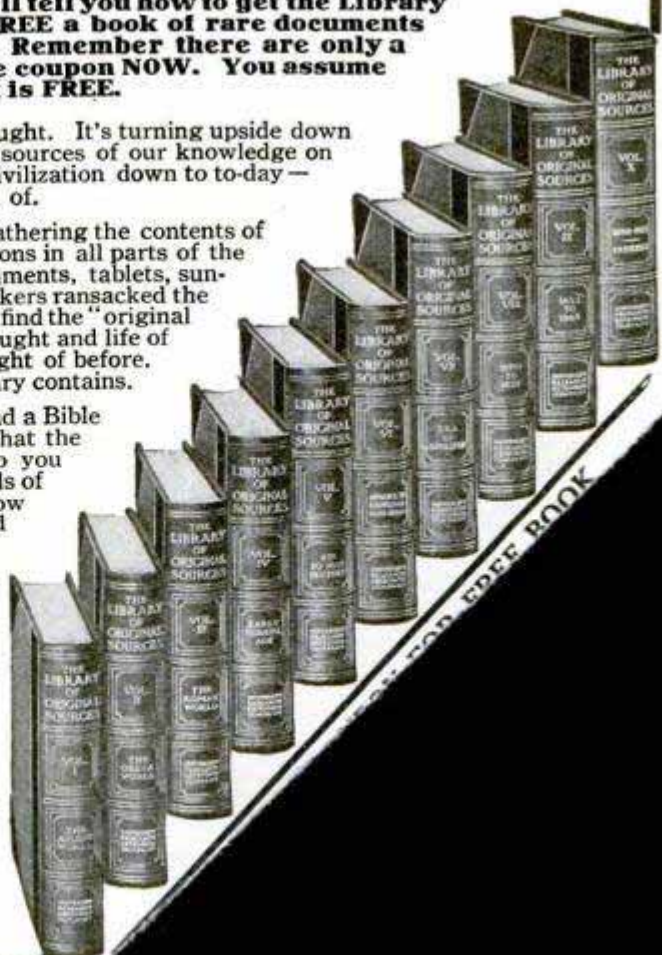

"EVERYMAN"



Lisle
25
Cents

Silk
50
Cents

PAD
Boston Garter

Velvet Grip

HOLDS YOUR SOCK
SMOOTH AS YOUR SKIN

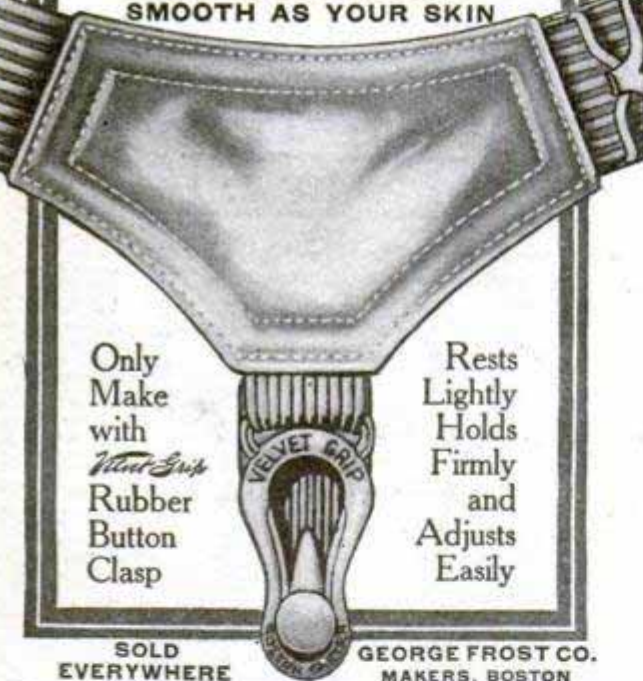

Only
Make
with
Velvet Grip
Rubber
Button
Clasp

Rests
Lightly
Holds
Firmly
and
Adjusts
Easily

SOLD
EVERYWHERE

GEORGE FROST CO.
MAKERS, BOSTON

BOYS — MAKE YOUR OWN TOYS

The Toymaker, greatest boys' book ever written, tells how to make a steam engine, telephone, magic lantern, boats, kites, balloons, electrical and mechanical toys, traps, fishing tackle. 200 illustrations. Send for the book, and novelty catalogue — all for 10c.

AMERICAN SUPPLY COMPANY, 918 Union St., ST. PAUL, MINN.

JUST READY, 4th ED.
Revised and Greatly Enlarged

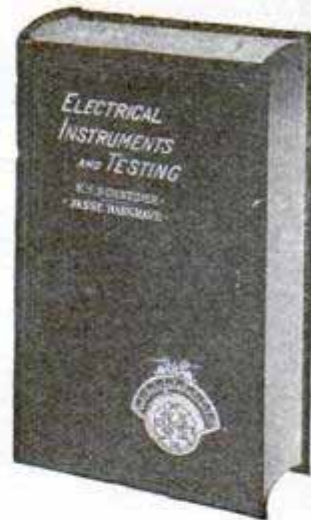

Nearly 300 pages; 176 illustrations

Bound in Cloth, \$1.15 Postpaid

SPON & CHAMBERLAIN 123 P. M. Liberty St. NEW YORK, U. S. A.



200 KINDS IRON, WOOD, WIRE & STEEL PUZZLES

Sample with Catalog, 10 cents or 3 leaders for 25 cents

WESTERN PUZZLE WORKS
St. Paul, Minn.

MONTHLY CASH PRIZES

Until further notice in this magazine the Editor of Popular Mechanics will pay two cash prizes each month for the best original contributions to its

SHOP NOTES DEPARTMENT

\$10 for the Best Contribution
\$5 for the Second Best

THIS IS IN ADDITION to our usual rates for such contributed articles.

Quality, not length counts.

Checks will be sent on the last day of each month for the prize articles received during that month. Publication in the magazine will follow in about two months.

PRIZES AWARDED FOR FEBRUARY, 1913

- First Prize—J. W. MADISON, Oshkosh, Wis.,..... \$10
"Closing Water-Gauge Valves at a Distance"
- Second Prize—GERTRUDE M. BENDER, Utica, N. Y.,..... \$5
"Removing Broken Machine Screws"

EXTRA AWARD

On account of there being five contributions this month each of which deserved second prize, we have made an EXTRA AWARD of four additional second prizes, as follows:

- JOHN P. KOLAY, Ithaca, N. Y.,..... \$5
"Dogs to Hold Threaded Shafts in a Lathe"
- WM. C. TERRY, Boston, Mass.,..... \$5
"Chain Oilier for a Bearing"
- WM. A. ROBINSON, Waynesboro, Pa.,..... \$5
"Tool for Laying Out Mortises and Tenons"
- CHAS. POST, Home, Kan.,..... \$5
"Parallel Vise Jaws"

All accepted contributions to our departments, "SHOP NOTES" and "AMATEUR MECHANICS," are paid for immediately; checks for prize awards are sent at the end of each month.

Address, EDITOR POPULAR MECHANICS
318 W. Washington St., Chicago

A SCHOOL WITHIN ITSELF

There are XX chapters in all, XIX carrying you from the fundamental principles of electricity on through the various branches to a point where the careful student comprehends the complete designing, care and operation of dynamo or motor, and one chapter on electric automobiles, outlining their construction, care and operation. All about storage batteries and how to handle them. Each subject is carefully written and to the student studies a subject, he is questioned on that subject in such a manner as to bring clearly to his mind the facts to know regarding same. The book contains a dictionary defining 1500 Electrical Words, enabling the reader to know the meaning of any electrical word, term or phrase used in this book, as well as hundreds of others in common use. The necessary in the study are in it.

COPY — SIXTH EDITION — 30,000 COPIES SOLD.

The offer we make of refunding money if book is not satisfactory is AN UNUSUAL ONE in connection with the sale of a book. But we have no fear of its being what thousands of others have been. Money would not buy it if it could not be duplicated. It is best to order and be your own judge of its merits.

Clair Ave., Cleveland, Ohio

Armatures and Fields Wound — Commutators Filed
AMERICA'S GREATEST REPAIR WORKS



CHARGE OF SCOTS GRAYS AT WATERLOO

WELLINGTON held this regiment of cavalry in reserve at the battle of Waterloo, awaiting the supreme moment when an overwhelming charge might turn the tide of battle. The instant the French lines wavered the order was given to charge and the Scots Greys Cavalry hurled themselves against the French like a thunderbolt. This charge ended forever the career of Napoleon and his dream of universal empire vanished away with the smoke of his artillery. The celebrated picture shown herewith from Ridpath's History, the original of which was purchased by Queen Victoria, illustrates but one event of all the thousands which makes up the history of every nation, empire, principality or power in the world famed publication

Ridpath's History ^{OF} THE World

WE will name our special low price and easy terms of payment only in direct letters. A coupon for your convenience is printed on the lower corner of this advertisement. Tear off the coupon, write your name and address plainly and mail. We do not publish our special low price for the reason Dr. Ridpath's widow derives her support from the royalty on this History, and to print our low price broadcast would cause injury to the sale of future editions.

Six Thousand Years of History

RIDPATH takes you back to the dawn of history long before the Pyramids of Egypt were built; down through the romantic troubled times of Chaldea's grandeur and Assyria's magnificence; of Babylonia's wealth and luxury; of Greek and Roman splendor; of Mohammedan culture and refinement; of French elegance and British power, to the dawn of yesterday. He covers every race, every nation, every time and holds you spellbound by its wonderful eloquence.

46 Page Booklet FREE

WE will mail our beautiful forty-six page free booklet without any obligation on your part to buy. It will show Ridpath's wonderfully beautiful style. He pictures the great historical events as though they were happening before your eyes; he carries you with him to see the battles of old; to meet kings and queens and warriors; to sit in the Roman Senate; to march against Saladin and his dark-skinned followers; to sail the southern seas with Drake; to circumnavigate the globe with Magellan. He combines absorbing interest with supreme reliability, and makes the heroes of history real living men and women, and about them he weaves the rise and fall of empires in such a fascinating style that history becomes as absorbingly interesting as the greatest of fiction.

**WESTERN NEWSPAPER ASSOCIATION
CHICAGO**

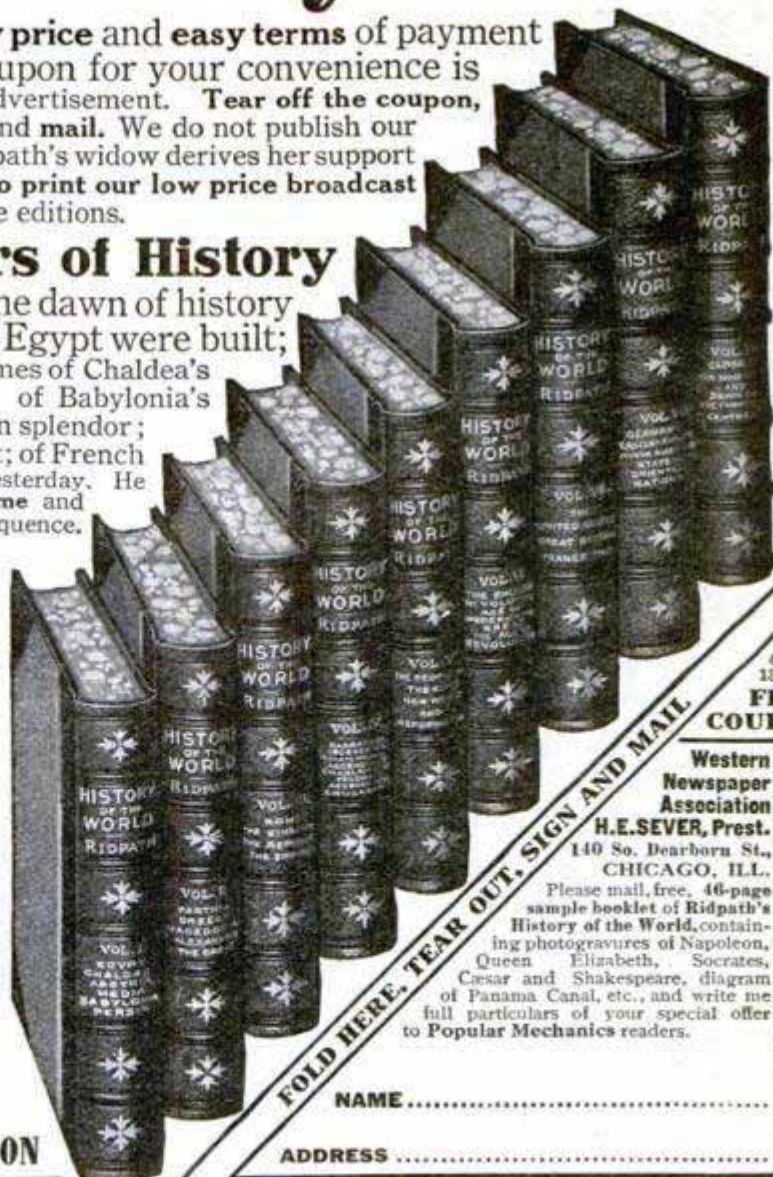

FOLD HERE. TEAR OUT. SIGN AND MAIL.

NAME

ADDRESS

NO AGENT WILL CALL

**FREE
COUPON**

**Western
Newspaper
Association
H.E. SEVER, Prest.
140 So. Dearborn St.,
CHICAGO, ILL.**

Please mail, free, 46-page sample booklet of Ridpath's History of the World, containing photographs of Napoleon, Queen Elizabeth, Socrates, Caesar and Shakespeare, diagram of Panama Canal, etc., and write me full particulars of your special offer to Popular Mechanics readers.

WANTED-IDEAS

Manufacturers are constantly writing me for patents procured through me. The demand for good ideas

Protected by Owen Patents

is greater than ever before. Send for my free books and read the letters from the greatest manufacturers in this country. Read their requests for Owen Patents and see for yourself what ideas they want. You can help supply the unceasing demand for good inventions.

My clients are provided with free manufacturing facilities, and I aid them in **many ways, without charge**, to sell their patents. **Applications** filed through me advertised free.

You will get a strong patent or I will get no compensation. Your interests are my interests.

FREE!

A simple request will bring you the following three finest patent books published **absolutely** free—you will incur no obligation by writing me.

"SUCCESSFUL PATENTS"—a new 72 page guide book; tells how to proceed to be successful; describes my advantageous business methods.

"STEPPING STONES"—gives lists of over 200 inventions wanted; gives forecasts by Edison and many other authorities; tells the plain truth about prizes of millions of dollars for inventions.

"PATENT PROMOTION"—tells you how to promote your invention; why some inventors fail; the value of your rights, etc.



Write for these books today—NOW! Advice costs nothing

VERY HIGHEST REFERENCES

Columbia National Bank,
Washington, D. C.
American Loktile Co.,
Alexandria, Va.
National Metal Tile Co.,
Washington, D. C.
National Supply Co.,
Berlin, N. H.

Louden Machinery Co.,
Fairfield, Iowa.
Antholene Mfg. Co.,
Hutchinson, Kans.
Whitehead Hosiery Mills,
Burlington, N. C.
Dickinson Mfg. Co.,
Des Moines, Iowa.

SPECIAL!

Send me a sketch or model of your invention and I will make a search of the U. S. Patent Office Records **FREE OF CHARGE** and report to you concerning patentability, practicability, etc.

And an immense number of others whose letters are printed in my booklets.

Your work will receive my **PERSONAL** attention—but my fees are no higher than others.

RICHARD B. OWEN

9-303 OWEN BLDG.
WASHINGTON, D. C.

Inventors submitting their inventions to me are protected in a tangible manner until their applications are filed.

This Book Will Help You

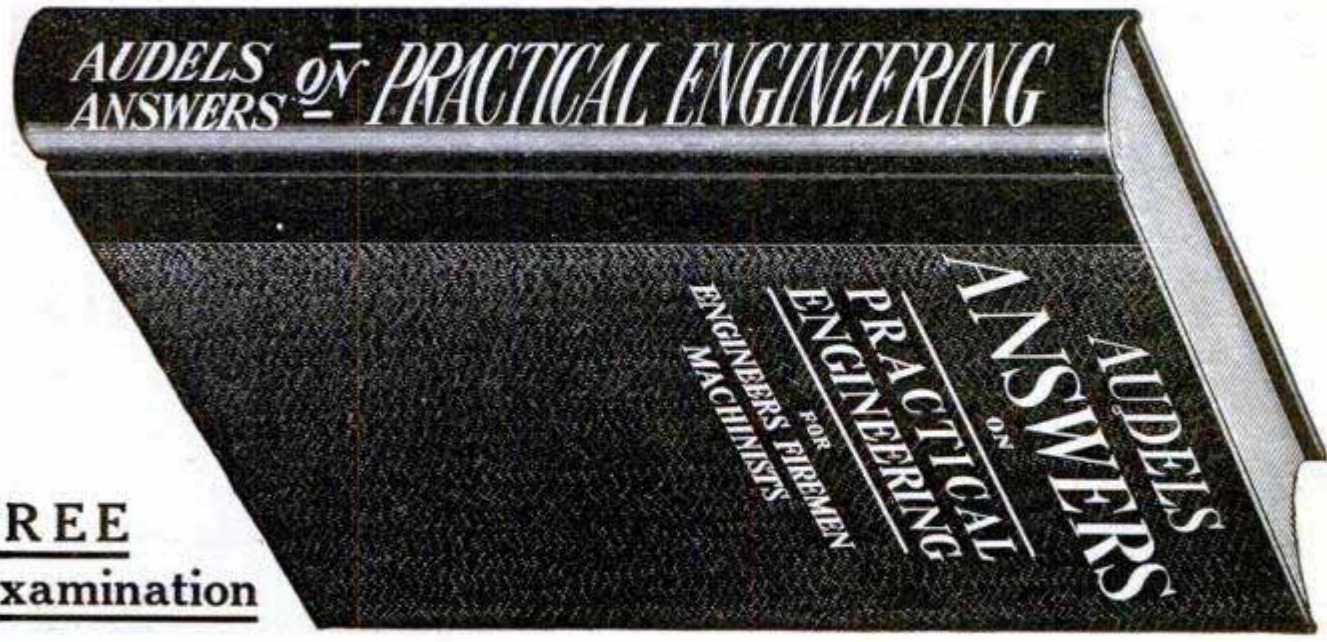

FREE
Examination

The Man Best Informed Wins Out

EVERY ENGINEER should make it a point to know the theory of what he is doing. It is not enough to do what you are told. A man can do what he is told for ten years without making any satisfactory progress in his occupation.

When you are told to do a thing, it means that some one else has done the thinking, weighed the evidence, and decided on the course to pursue. Of course, if that be your work, the only thing is to do it when you are told. But don't deceive yourself into thinking that ten years of experience of this kind will give you as much ability as if you did at least some of the thinking and planning for yourself. The way to advance is to think and know what ought to be done, and why it ought to be done a certain way.

Try to get a broad view, not only of your own part of the work, but of everything that in any way comes in contact with it. Understand the framework of which your work is but a cross bar. Know something of the cause of which your work is but an effect. Know something of the effect of which your work is the cause. And, above all, know why it is done one way, and not another.

Learn the Theory Underlying the Work

Good books that teach, no matter what they cost, will earn you more money than anything else you could buy

If You Are Interested

and it will bring to your plant a book of sterling merit, for free examination. You can have one week in which to dig out the mine of valuable information contained in its 200 or more pages.

sign, and mail the coupon,

Please send me for examination one copy

Audels Answers on Practical Engineering \$1

If I keep the book, I promise to send you within 7 days after receiving it ONE DOLLAR, in full payment; if I do not keep it, I will mail it back to you within 7 days.

PLAIN FACTS

that you should know, plainly explained in Audels Answers on Practical Engineering

- 1, Answers on Air. 2, Water. 3, Steam. 4, Fuel and Heat. 5, Steam Boilers. 6, Boiler Construction. 7, Water Tube Boilers. 8, The Steam Gauge. 9, The Safety Valve. 10, Properties of Steam. 11, Installation of Boilers. 12, Management of Boilers. 13, Engineers' Law. 14, Firemen's Law. 15, Steam Engines. 16, The Valve and Valve Gear. 17, The Corliss Engine. 18, Engine Arithmetic. 19, Lubricators. 20, Installation and Operation of Engines. 21, Steam Pumps. 22, Injectors. 23, Feed Water Heaters. 24, Steam Heating. 25, Steam Traps. 26, Belts, Gears, and Pulleys. 27, Steam Turbines. 28, Refrigeration. 29, Practical Electricity. 30, Elevators.

When you spend your good hard earned money for books, always make sure that you are going to receive something that will assist you in bettering your position.

Garry It in Your Pocket for One Week

and at the end of the time, if you do not think the book is worth one dollar, mail it back to us. If it is, you can mail us \$1.00 in payment for your copy. If you fail to consider this liberal offer you are not dealing fairly with yourself. We take all risk that "Audels Answers on Practical Engineering" is a book you should own. Act now before you forget it.

THEO. AUDEL & CO., 72 5th Ave., NEW YORK

Signature.....

Occupation.....

Address.....

Patents

**Trade Marks and
Copyrights Secured
or Fee Returned**

Special Offer—Free Search of Patent Office Records

Send us a model or sketch and description of your invention, and we will make a *Free Search* of the *Patent Office Records* to ascertain if it is patentable. If we report the invention patentable, we will guarantee to obtain a patent or return our fee, and furnish a certificate of patentability backed by a bonded contract to that effect.

This Certificate of Patentability will protect the inventor and serve as proof of the invention until the case can be filed in the U. S. Patent Office.

Obtaining Assistance for Inventors

Our certificate is of great assistance to inventors who require financial aid to obtain patents.

Our Four Books Mailed Free

to any address. Send for these books—the finest publications ever issued for free distribution.

How to Obtain a Patent

Our illustrated eighty-page Guide Book is a book of reference for inventors, and contains 100 mechanical movements illustrated and described.

Fortunes in Patents

Tells how to invent for profit, and gives history of successful inventions.

What to Invent

Contains a valuable **LIST OF INVENTIONS WANTED** and suggestions concerning profitable fields of invention; also information regarding prizes offered for inventions, among which is

Prize of One Million Dollars

offered for one invention, and \$10,000 for others.

Patents That Pay

Contains letters from our clients who have built up profitable enterprises founded upon patents procured by us; also endorsements from prominent inventors, manufacturers, Senators, Congressmen, Governors, etc.

We Advertise Our Clients' Inventions Free

In a list of Sunday newspapers with two million circulation, in manufacturers' journals and in the *World's Progress*. Sample Copy Free. We save you time and money in securing patents. After the patent is granted we assist you **TO SELL YOUR PATENT.**

Foreign Patents

WE HAVE DIRECT AGENCIES IN ALL THE PRINCIPAL FOREIGN COUNTRIES and secure **FOREIGN PATENTS** in the shortest possible **TIME** and at the **LOWEST COST.** Write for our Illustrated Guide Book on Foreign Patents, sent free to any address.

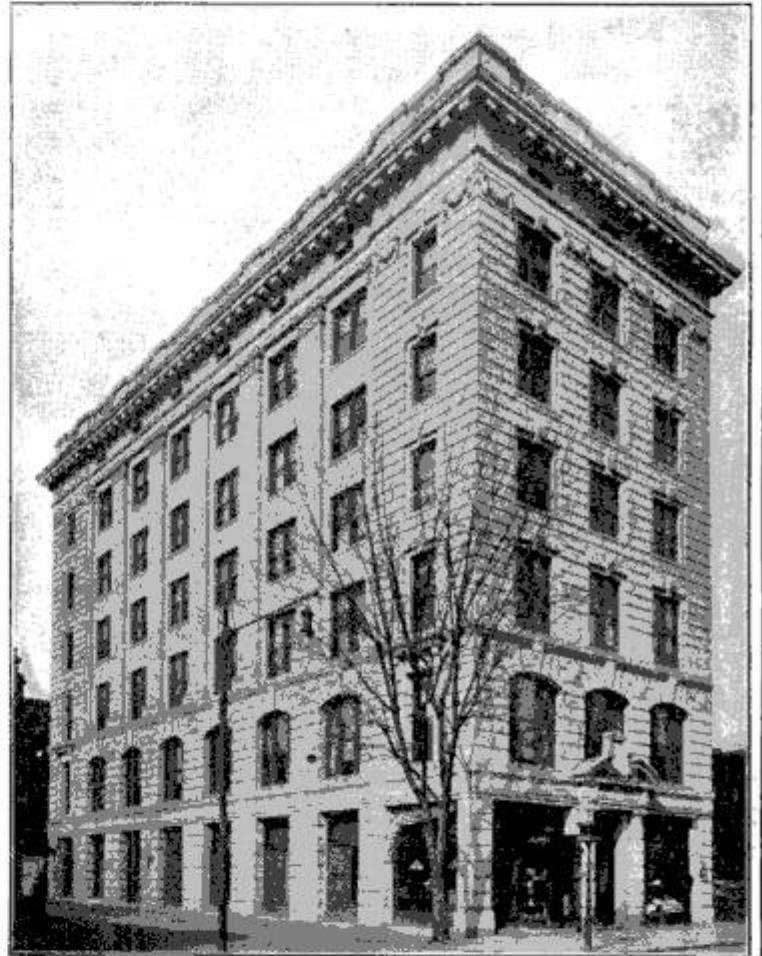

VICTOR BUILDING

Our new \$150,000 building opposite U. S. Patent Office
SPECIALLY ERECTED by us for OUR own use

WANTED NEW IDEAS

Send for **LIST OF PATENT BUYERS** who consult us when purchasing patents. Contains requests from **MANUFACTURERS, MAIL ORDER HOUSES and PROMOTERS** for patents secured by us, and suggestions as to New Ideas they wish to purchase. We invite manufacturers and promoters to address our Sales Department regarding the purchase or leasing of a number of meritorious patents secured by us.

REFERENCES

Second National Bank, Washington, D. C.
Union Savings Bank, Washington, D. C.
Chamber of Commerce, Washington, D. C.
Pitner Gasoline Lighting Co., Chicago, Ill.
National Savings and Trust Co., Washington, D. C.
R. G. Dun & Co., Washington, D. C.
Smethport Glass Co., Smethport, Pa.
The Melvin Gauge and Signal Co., Scranton, Pa.
M. Winter Lumber Co., Sheboygan, Wis.

VICTOR J. EVANS & CO., Patent Attorneys

NEW YORK OFFICES: 132 Nassau St.

PHILADELPHIA OFFICES: 1429 Chestnut St.

Main Offices: 724-726 9th St., N. W., WASHINGTON, D. C.

→ **PROTECT YOUR IDEA!** ←

PATENTS THAT PAY

\$561,530.00 Made by Clients

"MY TRADE-MARK"

\$561,530.00 Made by Clients

Proof back of it—write for my FREE literature—it will pay!



BOOK "What and How to Invent— Proof of Fortunes in Patents"—FREE

Containing: Views of Prominent Men and Publications on Inventions; "Patents Wanted"; "How to Advertise Your Patent"; "How to Secure Money to Procure a Patent"; Suggestions as to what to Invent; What my clients have done; Women Inventors, etc.



\$20,000.00 in Two Prizes

INSTRUCTIVE CIRCULARS GIVING FULL INFORMATION — FREE

EXPERT—PROMPT SERVICES

E. E. VROOMAN,

Registered Patent Attorney
871 F Street, N. W.

Wash., D. C.

112-page Guide Book for Inventors, FREE

Old-established branches throughout the world

LEARN HOW A PATENT MAY BE MADE VALUABLE

Send for this **FREE BOOK** which tells you **What You Should Know What To Invent What NOT To Invent How To Sell Your Patent**

Copies of nearest Patents and report in every case without charge
H. L. WOODWARD, 9th & G Sts., Washington, D. C.

PATENTS WORTH MONEY

For books that tell **WHAT** patents bring **MOST MONEY**, and **WHY**—send 10 cents postage to
R. S. & A. B. LACEY, E45 Washington, D. C. Established 1869

Portuguese East Africa still contains the following big game in abundance: Buffalo, crocodile, eland, elephant, giraffe, brindled and white-tailed gnu or wildebeest, hartebeest, hippopotamus, hyena, koodoo, rhinoceros, roan antelope, sable antelope, waterbuck and zebra. There is a great variety of smaller game.

Japan makes use of marine vegetation more than any other nation, much of its seaweed being manufactured into edible gelatin.

PATENTS

to pay must fully protect. **FREE** booklet.
Mason, Fenwick & Lawrence, Est. 52 years.
616 F St., Washington, D. C., and New York

Send for New Helpful Plan for Inventors

PATENTS

EXPERIENCED INVENTORS employ my method. So will you eventually. Why wait. **FREE** book and application blank.
W. T. Jones, 803 G St. Washington, D. C.

PATENTS

ELECTRICAL AND MECHANICAL
EXPERT

WILLIAM. C. LINTON
910 G Street, WASHINGTON, D. C.

Send today for **FREE** booklet, how to obtain them

PATENTS BUILD FORTUNES FOR YOU

Our free booklets tell how, what to invent, How To CHOOSE AN ATTORNEY, and save you money.

Prosperous clients in all states. Best bank and other references. **WRITE TODAY**

D. SWIFT & CO., 317 SEVENTH ST., WASHINGTON D. C.

PATENTS PROCURED AND SOLD;

Easy terms; careful, conscientious work; advice

FREE; new **BOOK FREE**; correspondence solicited; highest references; send sketch **to-day**.

H. J. SANDERS SUITE A CRILLY BLOCK Chicago, Ill.

PATENTS

C. L. PARKER
Formerly Member Examining
Corps, U. S. Patent Office
PATENT LAWYER
210 MCGILL BLDG.
WASHINGTON, D. C.

Patents, Trade Marks, Copyrights, Patent Litigation

Handbook for Inventors, "Protecting, Exploiting and Selling Inventions" sent free upon request.

PATENTS THAT PROTECT and PAY

Advice free. Terms reasonable. Highest references. Best results.

Send sketch or model for **FREE** examination and opinion.

Recommended Patent Lawyer in the Bankers' Register and special list of selected lawyers. Also in Martindale's Law Directory, Sharp and Alleman's Directory of Lawyers, The Gast-Paul Directory of Lawyers, and Kime's International Law Directory.

ALL BUSINESS GIVEN PROMPT AND PROPER ATTENTION

A large list of strong recommendations furnished free

WATSON E. COLEMAN, Patent Lawyer, 622 F St., N. W., Washington, D. C.

PATENT YOUR IDEAS

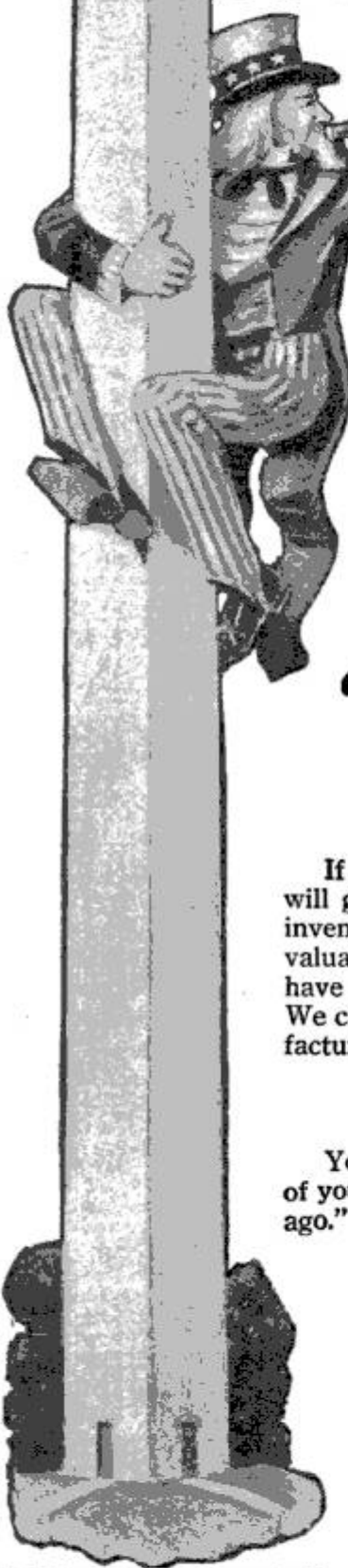

*—There is a Constant Demand
for Good Inventions*

Thousands of the biggest money-making inventions have been the "little" things that have made people wonder why they were never thought of before.

"WHAT TO INVENT"

and

"HOW TO OBTAIN A PATENT"

These Books Sent Free

If you have an invention send us a sketch, photograph or model of it. We will give you a report as to its patentability absolutely free. If you have no invention send for our book, "What to Invent." It contains hundreds of valuable suggestions. We are recognized authorities on patent matters and have helped hundreds to find a ready and profitable market for their ideas. We can prove it. If you wish to sell your patent we will advertise it in manufacturers' journals at our expense.

Don't Wait—Find Out NOW!

Your idea will never do you any good if some one else patents it ahead of you. Act quick! Let the other fellow say "he thought of it a long time ago." You reap the profit. Let the others wish they had.

Advice Free—All Matters Confidential

We have secured patents for thousands of inventors and have many letters proving the value of our services. Write us. Send rough drawing or model of your invention for our opinion. We will guard it carefully and report quickly. You are under no obligations to proceed further. Our plan is simply a square deal to all. Our books, "What to Invent" and "How to Obtain a Patent" are the best publications written for the man who has an idea to patent, or who is of an inventive turn of mind. They show just how to proceed with your idea and tell of hundreds of things to invent. We gladly send these books free. The sooner you write for them the sooner you will know all about patents and the many different lines in which new inventions or improvements may be made.

If you have an invention send us a sketch of it for report and ask for the books at the same time.

CHANDLEE & CHANDLEE, 970 F Street, Washington, D. C.

REGISTERED ATTORNEYS

(Combined with H. Ellis Chandlee & Co.)

Stop Forgetting!



Now, What Was That Fellow's Name?
I Can't Remember Those New Terms.
I Know—But Can't Find Exact Word.
What on Earth Did He Say About It?

A Perfect Memory Is the Key to Success

The mind of the average person is filled with thousands of single unrelated ideas which waver and fluctuate with every emotion, like the billows of the sea.

The man with a Wandering Mind can never hope to Make Good — he will always be a drug on the market — he has too many competitors.

The great men of all ages are those who acquire the ability to concentrate and to memorize.

You Can Be Trained to Remember Accurately

In the business battle — matching wits each hour of every day — the ability or inability to think on your feet, to remember instantly and accurately means gain or loss. To succeed you must be "forget-proof." Just as surely as a poorly organized business can be placed upon a basis of perfect systematization and thereby made thoroughly efficient — so can your mind be trained and made a classified indexed and cross indexed filing system of facts so that you can command, on the instant, any thought, fact or argument.

The Dickson Method of Memory Training Will Do

This for You It will enable you to classify impressions, ideas, names, facts and arguments so as to have them ready at a moment's notice at any time. It will train you to think on your feet, to converse in a natural, interesting way, to overcome self-consciousness and bashfulness, to acquire easy, logical thinking. My course is not a theory, but is purely and absolutely scientific — the result of more than 20 years of close, intimate contact with students in schools and colleges and searching their developing minds for means of strengthening their memories.

I Want to Send You My Book, "How to Remember," Absolutely FREE

Simply clip the coupon and mail it today. It will explain clearly the course that has raised thousands of men from failures to great successes. You can have this same training. My free book is the first step. Don't delay. Age, education, vocation or place of residence makes no difference. Send the coupon today.

How to Get a Free Copy of This Valuable Book

De luxe edition handsomely illustrated, richly bound. Is exactly suited to meet the needs of the man or woman who desires to be a successful public speaker. The price of this 1911 de luxe edition is \$2.00. I will, however, present a copy absolutely free to every student who enrolls for my course of memory training within ten days after reading this offer.

Send the Coupon or Postal Today.

My method is highly recommended by **ELBERT HUBBARD, PROF. DAVID SWING**, and thousands of others. Ten minutes a day of your spare time will give you this training and not interfere with your work in any way.



Prof. Henry Dickson

America's foremost authority on Memory Training, Public Speaking, Self-Expression, and Principal of the Dickson Memory School, Auditorium Building, Chicago.

Prof. Henry Dickson
705 Auditorium Bldg., Chicago, Ill.

Send me free Booklet "How to Remember," also full particulars how to obtain a free copy of Dickson's "How to Speak in Public."

NAME.....

STREET.....

CITY.....STATE.....

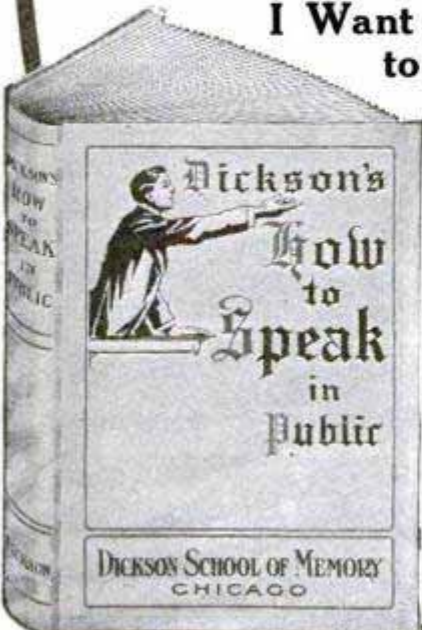

Dickson's
How to Speak in Public

DICKSON SCHOOL OF MEMORY
CHICAGO



FREE

This \$15 Drawing Outfit

But you must write at once. Offer expires in 30 days. I make this most exceptional great offer only to a limited number of

selected students.—Just think of it! A complete, regular Draftsman's \$15 Working Outfit with high grade Imported German Silver Set of

INSTRUMENTS—ALL FREE

Be a Draftsman!

Draw \$125 to \$175 per month at once

There is an urgent demand always for skilled draftsmen. Our companies are issuing calls every day for men to fill positions paying from \$125.00 to \$175.00 per month. Many positions paying \$75 to \$100 per week always open. Work is light, pleasant and profitable. Unlimited opportunities for expert draftsmen and designers. Mail coupon for valuable book, "Successful Drafting." It explains how you can become a skilled draftsman in a short time. It's free—Just think:



Chief Draftsman Will instruct you personally

A most wonderful opportunity for a limited and selected number of ambitious men! For over twenty years I have been doing the highest paying expert drafting work. I am Chief Draftsman of a large and well known company. Long ago I saw the urgent demand for practical, trained draftsmen and I organized my practical method for ambitious men whom I trained personally. Each month the demand for practical, trained draftsmen is growing—higher salaries are being paid right along. Never before have we felt the need as we do today for men who really know practical drafting—the way I am training my students. At this time I can accommodate a few more men (from the ages of 16 to 40) in my spare time. If you write me at once I will send you my book, "Successful Drafting," with full particulars—all free. But you must write to me—or send coupon now

I Guarantee

To instruct you until competent and placed in a position at a regular salary paying from \$125.00 to \$175.00 per month and furnish you free \$15 Working Outfit at once.

FREE
Outfit Coupon

Earn Big Money at once
while Learning at home

Yes, my friend, you can make big money at once right at home from the very start,—as much as \$5 to \$10 per day I will pay you, while learning.

Chief Draftsman:
ENGINEER'S EQUIPMENT CO.
Div. 1194 CHICAGO, ILL.

Without any obligation on me, please mail your book "Successful Draftsmanship" and full particulars of your liberal "Personal Instruction" offer to a few students. It is understood that I am obligated in no way whatever.

Mail Free Coupon Now

Mail this Free Coupon at once and I will send you my book "Successful Draftsmanship" and full particulars—all FREE.

I will send my book if you write at once, absolutely free—also particulars about my offer to a few ambitious men who want to make from \$2,500 to \$5,000 a year. No obligations whatever on you in sending the coupon.

NAME

ADDRESS

Address **Chief Draftsman**

Division 1194, Engineer's Equipment Co. (Inc.)
CHICAGO, ILL.



AUTOMOBILES

BROKEN Cylinders and Crankcases—Send them to be made good as new at fraction of replacement cost. Scored cylinder repaired, \$12. No new piston and rings required because bore is not enlarged. Where cylinders are worn (not scored from loose wrist pin) reboring is only remedy. We do it expertly. Write for complete information and estimates. Waterbury Weld Company, Waterbury, Conn.

OXY-ACETYLENE Welding, Cutting and Brazing. We have a large Oxy-Acetylene Department, employ only experienced men and are prepared to do the simplest or the most difficult work. Proposals solicited. The Alexander Milburn Company, Baltimore, Md.

4 CYL. 4 x 5 motor, new, \$50; Chalmers 30, 4 cyl. with taxicab and touring bodies, \$450; Marion 30, 4 cyl., 5 pass., \$425; Stearns 30-60, 4 cyl., 7 pass., \$450; Rambler, 4 cyl., 5 pass., \$450; Flanders 20, 4 cyl., 5 pass., foredoor, \$600. Winnetka Garage, Winnetka, Ill.

DIAMOND Tires, 28x3 \$8.70; 30x3 \$9.30; 30x3½ \$13.70; 32x3½ \$14.65; 34x4 \$21.50. Other sizes accordingly. Dunlops \$1 extra. 10% with order, balance C. O. D. Auto Tire Brokerage Company, 1406 Michigan Avenue, Chicago.

If it's a matter of price, consider rebuilt and repainted automobiles. Write for Bargain sheet; we will surprise you. Eureka Auto Co., Beavertown, Pa.

FOR Sale—E. M. F. Automobile 1911 Model just repainted. Cheap if sold before April 20th. Send stamp for particulars. Claude Lusk, Wapakoneta, Ohio.

BIG Bargains—5 Passenger Steamer \$275. Steam Truck \$425. Fully equipped, perfect mechanically, kerosene burners. Will demonstrate. L. G. Snyder, 5035 State St., Chicago.

FORD owners wanting five electric lights using Ford magneto and storage battery (self-contained system), write American Battery Company, 1129 Fulton St., Chicago.

FOR Sale or Trade—One truck, one taxicab, three pleasure cars. Photo. upon application. Hauber Auto, Works, St. Marys, Pa.

AUTOMOBILE Instruction. A complete home study course that shows you exactly what you want to know about the automobile. 220 page book giving definite, thorough, authentic and practical detailed information about every part of the automobile as well as thorough instruction in regard to driving, repairing and general care of the complete car. 190 illustrations, \$1.50 postpaid. Popular Mechanics Book Dept., 318 W. Washington St., Chicago.

FOR Stanley Steamers; Newport Condenser Outfits, Kerosene-Distillate, Naphtha-Gasoline Burners, High Pressure Water Gauge. 526 Fourteenth, Denver, Colorado.

OXY-ACETYLENE Welding—Directions construction use plant from materials handy. Scale drawings, fluxes, formulas. Practical complete. 50c. American, Aberdeen, S. D.

SIX Little Yankees kill carbon in automobiles and motor boats. Non-liquid, non-explosive, harmless, handy, clean. Get more power, smooth running engine, use less gas. \$2 box. All dealers. Six Little Yankees, Philadelphia.

AUTOMOBILE Instruction—\$55.25. Four weeks' course. Best equipped school in the country. Men enrolled from all parts of the U. S. Booklet P. M. on request. West Side Y. M. C. A., 318 West 57th Street, New York.

MOTOR delivery truck, \$275. Two grinding or polishing lathes cheap. George Willis, Canal Dover, Ohio.

INCREASE your income. Get our complete transfer outfit for Monogramming autos and motorcycles. Motorists Accessories Co., Ashland, O.

BATTERY Tester size of watch, 85c postpaid. All kinds electric auto supplies. Catalog. Boyd Sales Co., Philadelphia, Pa.

FOUR cylinder Ford, \$150. White steam automobile, \$70. Excellent conditions. W. Robb, Canal Dover, Ohio.

STEAM Car Correspondence School. Particulars. 526 Fourteenth St., Denver, Colo.

AUTOMOBILE Driving Self-Taught. An exhaustive treatise on the management, care and operation of Motor Cars. 250 pages. liberally illustrated, \$1. Profitable Service Bureau, 4333 N. Sawyer Ave., Chicago.

\$375 BUYS two passenger Maxwell. Full equipment, including Gas Lamps, Wind Shield and Top; also extra tire and case. Robert C. Fay, 1303 Heyworth Bldg., Chicago.

Classified Advertisements

Advertisements in this section, 15 cents per word, each insertion, minimum 10 words, payable in advance. To insure ads being inserted under proper classified head in the May issue, copy must reach this office not later than April 1st.

Philadelphia, Pa., December 27, 1912

Popular Mechanics Magazine, Chicago, Ill.

Gentlemen: You are entitled to know that the small 33 word advertisement which we had in your magazine brought replies from every conceivable corner of the globe. Not only was practically every state in the Union represented, but Porto Rico and Hawaii as well.

We consider this nothing short of marvelous results from so small an ad and are preparing plans to further use your columns to the limit of their possibility, and you will hear from us at a later date. We thank you for your interest in our behalf and are,

Very truly yours,

(Signed) AMERICAN CUCKOO CLOCK CO., Inc.

WAVERLY Electric Runabout; has no battery; otherwise condition good. Cheap for \$110 to quick buyer. Breslin Garage, Albany, N. Y.

HOW to Repair Automobiles. Large book \$1 postpaid. Satisfaction guaranteed. Nelson Book Co., Barton, Vt.

LEARN How to Run An Auto. Audel's Answers on Automobiles will teach all about Carburetors, Ignition, Timing, Engine Troubles, Overhauling and Driving. A complete course of 500 pages with 375 diagrams highly endorsed by men who know, \$1.50 to any address. Money back if not pleased. Theo. Audel Co., 72 Fifth Ave., New York.

HOW to time automobile, air ship and motorcycle motors, correct, simple, postpaid 25c. J. C. Gehring, Ft. Wayne, Ind.

CHAUFFEURS—Before taking examination send ninety cents for questions and answers, with instructions for securing license. L. I. Lutes, Ex-State Examiner of Chauffeurs, Utica, N. Y.

MUST sell my Reo five passenger touring, elegantly equipped and perfect in every way. \$175. Dr. Spillane, 248 East 119th St., New York City.

GUARANTEED 5,000 miles without puncture. If your tires are old, don't throw them away, or you'll throw away \$50 to \$200. With Durable Treads we give you a written guarantee for 5,000 miles without puncture. This is binding whether your tires are new or old-tread-worn, rim cut or rut worn. Durable Treads cost only half as much as tires. Write for booklet and special discount at once to Colorado Tire & Leather Co., 1210 Majestic Bldg., Chicago, Ill., 528-M W. 34th St., New York City; 435-M Golden Gate Ave., San Francisco, Cal., 1348-M Acoma St., Denver, Colo.

AUTOMOBILES. I have all makes on my list, runabouts, \$50 up; Touring Cars, \$75 up; all guaranteed and shipped freight prepaid, send for my list before purchasing. P. King, 213 West 125th St., New York City.

350 AUTOMOBILE and Motorcycle Tours. Illustrated; Ideal Trips; best roads in each state; 50 maps; complete road directions. 15c postpaid. Address "Motor Tours," 51 Chambers St., New York City, N. Y.

WHITE Steam Automobiles, second-hand and new; all second-hand parts, Whites, Stanleys, Locomobiles, or other Steam Automobiles. Prices reasonable. State your wants. Lake View Garage, Lake View, New Jersey.

SIMPLEST way on earth to time valves and spark on automobile and gasoline engines, 25c. "Strong," Homer, Mich.

AUTOMOBILE SUPPLIES

SILVER plate your auto trimmings and get ready for spring. Ar-gen-tor will plate them in less time than it takes to polish brass, we guarantee it. No battery, just a wet cloth and Ar-gen-tor. One box plates any car. Does not contain mercury, cyanide or acids to harm any metals. Order today, \$1 prepaid. Forest City Sales Co., Dept. 3, Fremont, Nebr.

AVOID accidents. Dim-a-light, the new device for controlling the glare of electric headlamps. Pellets Magneto Exchange, 1463 Michigan Avenue, Chicago, Illinois.

HYDROCARBON Converters suit any automobile or marine engine, successfully uses any liquid fuel, reduces expenses 85%, increases power, simple, safe, absolutely reliable. First turn starts engine in any temperature. Guaranteed for life. Hydrocarbon Process Co., 801 Continental Bldg., Denver, Colorado.

TWO 20th Century tire protectors, size 34x4, never used, \$12 each. Frank Whitten, Blackfoot, Idaho.

THIS month only—One dollar for Fire Extinguisher, no danger of losing your auto by fire. M. Dutton, Lawrence Ave., Norfolk, Virginia.

KEROSENE For Automobiles—Our new Model B, uses successfully half and half mixture lowest grades kerosene and gasoline. Satisfaction guaranteed or money refunded. Greatly increased power, very slow speed on high. Starts easy at Zero. Special Agents' prices. Dep't. P. M. The Air-Friction Carburetor Co., Dayton, Ohio.

GREAT gasoline saving device, admitting air above carburetor. Controlled from seat. Make it yourself. Old tires made into inner-shoes. Positively successful. Full information worth \$100. Send 30c stamps. R. Mitchell, 619 Broadway, Los Angeles, Cal.

PEERLESS car sliding gear transmission, rear drive axle, wheels, frame, steering gear, etc., cheap. Badger Motor Co., Milwaukee, Wis.

BIG money vulcanizing at home. Easy learned. Book 25c. Vanderpool's, Springfield, O.

THIRTY hp. engine and transmission \$250. Wheels, tires, rims, axles, radiator, lamps, searchlight and generator, magneto, Schebler carburetor, Unit sparker, springs, steering. One portable garage. Prices low. Write quick. Chesney L. Jones, Haskell, N. J.

GASOLENE Ruler, measures in gallons any Auto tank, 15 in. long, 20 adjustable, numbered, brass markers. 50 cents post paid. Circular. Goodnow Mfg. Co., 755 Old South Building, Boston, Mass.

CYLINDER Rebored including Piston and Rings, \$7 to \$11. Sterling Eng. Co., 331 S. Clinton, Chicago, Ill.

TIRES. New, Standard Makes, 28x3—\$7.20—Tube, \$2.30; 30x3—\$7.65—\$2.40; 30 x 3½—\$11—\$3.50; 32 x 3½—\$12—\$3.60; 34x4—\$17.25—\$4.75. Other sizes, prices accordingly. Write for complete catalog. 10% with order, Balance C.O.D. Examination allowed. Para Auto Tire Co., 1417 Michigan Ave., Chicago, Ill.

NEW Pressed Steel Frames, 34x163", each \$10. Automobile boilers bought, sold and repaired. New 3 ton chassis and wheels \$100. Lucas & Son, Bridgeport, Conn.

TOOLS and Tool Chests, and Other Tools, for the autoist, shop and home—are listed and described in the Tool Monger, a 390-page catalog mailed on receipt of 6c in stamps. Montgomery & Co., 105 Fulton St., N. Y.

"**WAVERLEY** shaft drive electric chassis and batteries. Bargain price." Address Box 35, Industrial Bldg., Indianapolis, Ind.

WELDING of cylinders, axles, crankshafts and all metal parts. Becker & Shoemaker, Elmira, N. Y.

STEAM auto boilers bought, sold and repaired. J. L. Lucas, No. 2 Fox St., Bridgeport, Conn.

MOTORCYCLES AND BICYCLES

OUR stock used motorcycles now complete. Early buyers save 30%. Have best selection, Indians, Harleys, Yales, Pierce, etc. List on request. Seeber & Hofheims, Buffalo, N. Y.

ADVISE us make and model motorcycle wanted and we will quote lowest prices. Terms to suit. Rogers Bros., 21 Irving St., Waltham, Mass.

200 MOTORCYCLES, Standard makes guaranteed for season, \$50, \$175. Accessories: heavy carrier, \$3; headlight, \$3.50; Speedometer, \$10; tires, \$5. Chicago Motorcycle Works, 738 Sheridan Rd., Chicago.

LATEST Wagner; overhauled; new piston and rings; "V" belt; combination seat and luggage carrier; excellent condition, \$90. Ralph Glerum, Devils Lake, N. D.

100 BICYCLES slightly used and second-hand \$7 up. Covington Cycle Wks., Covington, Ky.

EXCELSIOR Motorcycle, fine condition, \$75. G. G. Moore, Claremont, Ill.

1911 5 H.P. INDIAN. Price, \$105. John Small, La Salle, Ill.

RIDERS Avoid accidents by buying our Mirrorscope Goggle and see everything behind you without turning around, \$1.75 each. \$1.75. Send for list of other specialties. The B-L Sales Co., Dept. A, 53 W. Jackson Blvd., Chicago, Ill.

FOR Sale—Motorcycle. Perfect order. Write 205 Cottonwood St., Grand Forks, N. Dak.

TWIN cylinder, five horse, Indian motorcycle, 1910 model. Just overhauled at factory, new tires, free engine, good as new, \$145. B. A. Workman, Woodward, Okla.

MOTORCYCLES, 1912 Flanders, magneto, clutch, \$65. Excelsior, \$60. Harley, \$65. March, \$35. Others, all guaranteed. Frank Gravatt, Atlantic City, N. J.

BICYCLES for sale—All sizes, \$5 up. Tandems, triplets. William McDougald, 1118 N. Clark St., Chicago.

BARGAINS in Indian motorcycles; 1912 machines never been used, cheap. E. Cavanaugh, Sibley, Ill.

TWIN Indian five, \$60. Photo on request; would trade. B. Erwin, Britt, Ia.

FOR sale cheap, or trade. Excelsior motorcycle. Mechanically perfect. Geo. Dillingham, Gray, Oklahoma.

MINNEAPOLIS 4 HP. Thor motor, 1911 model, never run a minute with clutch, \$150. Geo. Smith, 4351 Evans Ave., St. Louis, Mo.

FOUR cylinder Pierce, \$100. Good condition. Send stamp for reply. A. F. Stearns, Paxton, Ill.

MERKEL twins 1912 chain or belt drive, \$150. Merkel 1911 twins, \$100. Olive Cycle Co., 1035 No. Grand Ave., St. Louis, Mo.

MOTORCYCLE Manual—Construction and operation of a motorcycle fully described and illustrated; complete trouble chart; 125 pages; cloth bound, 50 cents postpaid; paper covers, 25 cents. Motorcycle Manual, 51 Chambers Street, New York.

TIRES, \$3 each—28x2 1/4, 26x2 1/4, studded or corrugated. 28x2 1/2 tubes, \$1.75. Now is the time to equip your machine while the opportunity lasts. Write for bargain list and catalogue. Motorcycle Sales & Supply Co., 1407 Michigan Ave., Chicago.

MOTORCYCLES and Bicycles 1/2 price; over 100 best makes. Motorcycles \$50 to \$150; bicycles \$5 to \$25. Get list today. Brown Music Co., 9119 Commercial Ave., Chicago.

FOR Sale—Flying Merkel Motorcycle with Eclipse Clutch. Used for demonstrating, ridden less than thousand miles, factory overhaul, shipped direct from factory. Be quick. Carolina Merkel Co., Sumter, S. C.

MERKEL motorcycle, single cylinder, 3 1/2 horsepower, minor repairs needed, \$35. C. A. Uptearaff, Jr., 2310 N. Sag. St., Flint, Mich.

LOOK—\$4 buys the best Tandem Attachment made. Fits any machine. Anderson's Motorcycle Store, Batavia, Ill.

\$35 COASTER Brake Bicycles at \$22.50. Supplies at low prices. Send for Catalogs. J. D. Newlon, New Lexington, Ohio.

3/4 PEUGEOT Motorcycle engine, Mauser rifle, cheap, stamp. Kaiser, 4461 Boulevard, Weehawken, N. J.

WE want you to have our 1913 Motorcycle Supply Catalog. Ask for Catalog 14. Give the name of the motorcycle you ride and ask for the Yellow Sheet. Save money by getting acquainted with us. Saufley Supply Company, Kansas City, Mo.

WANTED Motorcycle, second-hand, H. Peras, 92 Adelaide, Winnipeg, Canada.

MOTORCYCLES Cheap. Big clearance sale of new and second hand machines, ask for list "M" just out. American Motor Co., 2724 Michigan Ave., Chicago, Ill.

MOTORCYCLES, all makes rebuilt, guaranteed good as new, Indians, Harleys, Excelsiors, Readings, Kultures, Mercks, \$25 to \$100. Tires \$3 to \$6. Buy direct. Save dealers' profits. Deninger Cycle Co., Rochester, N. Y.

BICYCLE Tires. We will send a pair of our guaranteed Aladdin Bicycle Tires by Parcel Post upon receipt of \$4.50. Sample section for 2c stamp. Illustrated circular free. Aladdin Rubber Works, 112 W. Market St., Indianapolis.

BIG bargains in second-hand motorcycles, \$25 up. Indians, Harleys, Thors, Excelsiors and Mercks. Write for descriptions. Howard A. French & Co., Baltimore, Md.

I HAVE all makes on my lists from \$20 up, all guaranteed and shipped freight prepaid, send for my large illustrated list before purchasing. P. King, Automobile Broker, 217 West 125th St., New York City.

BIG bargains in good motorcycles we have taken in exchange on new ones. Send for special bargain list. Shaw Mfg. Co., Galesburg, Kansas.

DON'T buy a Bicycle Motor Attachment until you get our catalog and prices. Shaw Mfg. Co., Dept. 27, Galesburg, Kansas.

AERONAUTICS

COMPLETE Plan, drawn to scale, with concise instructions for building a 3 foot Nieuport Monoplane, 25c. Other Plans; Bleriot, 15c; Wright, 25c; Curtiss, 35c; "Ceil Peell" Champion Racer, 25c. Set of five, \$1. 40 pp. Model Supply Catalog, 5c. Ideal Aeroplane Co., 82 1/2 West Broadway, N. Y.

BICYCLE Monoplane Prints, side elevation, plan, front elevation, and complete details 30c. Framework also low. Thomas Hofmeister, Overlea, Maryland.

TRAVEL over land, water, or through the air with the same machine. The quickest, safest and most pleasant way. Patent pending. Build your own machine at cost of material. For particulars write Geo. C. St. Louis, 220 Clark St., Fresno, Cal.

GREY Eagle Motors, new and used. See ad on page 153 for the new Kemp motors. Kemp Machine Works, Muncie, Ind.

BLUEPRINTS for bicycle aeroplane, 50c. Hull Monoplane Co., Marshalltown, Ia.

BUILD a glider. Blueprints showing every detail accompanied by complete instructions, \$2.50. Guaranteed flyer. Very inexpensive. Lock Box 119, Onida, S. D.

HYDRO-Aeroplanes ready for power. Wilson, Port Jefferson, N. Y.

CHICAGO Aero Works, 143 N. Wabash Ave. Catalog for stamp.

BUY right, at prices right. Get the world's greatest aeronautical catalogue. Sent anywhere for 6 red stamps. Heath Aerial Vehicle Co., Chicago.

BATES Aeroplane Motors, cheapest motors flying. Catalog free. Carl Bates, 104 West Oak St., Chicago.

BOOKS AND PERIODICALS

HITTING the Bull's-Eye in reading. Don't buy a book till you know it is what you want. We loan you by mail books you may either buy or return. We plan you short reading courses free. Everybody gets personal attention. Self-help; business; health; recreation; house and home; agriculture; economics and social problems; religion; new thought; books for writers and speakers, etc. Standard books only. Ask for lists and Library Critic and state subjects in which interested. Oriental Esoteric Library, 119, Washington, D. C.

GAS Engine Troubles and Installation. Cloth, \$1; flexible leather, \$1.50; Automobile Troubles and How to Remedy Them. Cloth, \$1; leather, \$1.50. Eight other practical and reliable mechanical books. Send for circular. Chas. C. Thompson Co., Dept. C, 1126 S. Wabash Ave., Chicago.

NEW Book, "Jane," 10c. Catalog of books and den pictures free. Bond Pub. Co., A 5, Columbus, O.

MECHANICAL Kinks and Steel Tempering Book (new edition) and Mechanical Digest one year; special offer, 25c. Mechanical Digest, Grand Rapids, Mich.

DIETERICH'S 50 Perpetual Motions. Tells all about Perpetual Motion, illustrates 50 different forms. Tells about Patent Office Practice in regard to same. Very interesting. Sent by mail postpaid on receipt of 25c, coin or stamps. F. G. Dieterich, 662 Ouray Bldg., Washington, D. C.

MECHANICAL Books, 500 titles. Send for circulars. Proctor Book Co., 559 W. Lake St., Chicago, Ill.

"MAIDEN Widow," 25c. Catalogue for stamp. Paul Duff, 2713 Mozart, Chicago.

BUILD yourself a boat. A racing cat or speed launch. Send for catalogue. Yacht and Boat Building Books, Rudder Publishing Co., 2 1/2 Hudson St., New York, New York.

ENGINEERS' questions and answers for license, by Hobson, for twenty-five cents, postpaid. Send stamps. Reilly's Book Store, Philadelphia, Pa.

DON'T fail to read Independence and Fortune under Business Opportunities.

READ "The Widow," 10c. Catalogue other books and pictures free. Gem 3 Co., Ypsilanti, Mich.

3,000 RECIPES, Formulas 40c. Roadman's Guide—100 Money-making schemes, 25c. Machinery Books, 92 Titles, 25c each. List Free. Scientific Book Shop, Syracuse, N. Y.

EDUCATIONAL AND INSTRUCTION

SHORTHAND. Unigraph Hits the Spot. The business world demands accuracy in stenography and 90% of the shorthand writers today cannot produce it. Why? Their school or system was deficient. Learn the truth about shorthand—our free booklet will put you in touch with a real live proposition—and give you details that will open the door to thousands of positions for Expert Stenographers. Send for it today—Now. The Unigraph Co., Dept. 3, Omaha, Nebr.

FREE! Catalogue of beautiful Art Castings, in Concrete, Plaster, Artificial Marble, Paper mache, Composition, Marble dust, Interior and exterior decorations, Garden-furniture, Statuary, etc. Describing instructions of their manufacture, including Flexible mould making. Renovating frame buildings with artificial stone. Modeling, Coloring. Gold leaf gilding-burnishing. Paper selecting, hanging. Casting from life. Big profits, low expense, little labor. Mahler, 117 Russell St., Brooklyn, New York.

AMBITIOUS young men and women. Prepare now for entrance to schools of Law—Medicine—Nursing—Pharmacy and Engineering. Residential or home-study courses. University affiliation. Write immediately to Brooks Classical School, Dept. PM, Schiller Bldg., Chicago, U. S. A.

UNCLE Sam is a liberal employer. Qualify for a Government position. We prepare you by mail for any Civil Service Examination. Write today for free Booklet "2. Capital Civil Service School, Washington, D. C.

LEARN a profession in 180 hours that will make you independent for life. Booklet, "How to Succeed," sent postpaid. Address Dept. P. M., Weltmer Institute, Nevada, Mo.

LEARN Auctioneering by mail, make big money for a few minutes selling. Omar System Auctioneering, Box 72 B., Attica, Ind.

VENTRILOQUISM easy. \$10 professional course \$1. Bruner, 186 Radde St., L. I. City, N. Y.

YOU can draw cartoons and comic pictures. I teach beginners thoroughly, practically, rapidly. Learn high-salaried, uncrowded profession. Low cost. Details, 6c. Hamilton School, 209 E. Ontario St., Chicago, Ill.

FOR Sale—I. C. S. course, complete Electrical Engineering. Bargain, Box 3, Elyria, Ohio.

DRAFTSMEN send stamp for free book, "Successful Lettering." Columbia School of Drafting, McLachlen Bldg., Washington.

LEARN Auctioneering by correspondence. P. O. Box 72 B, Attica, Ind.

IN connection with your clerical work we show you how to earn \$10 to \$15 per week and hold your position besides. No canvassing. We, as manufacturers of patented specialties, have new, easy mail order plans that can be carried on in your own home to keep the factories busy. Large profits. Small capital. If you are one of the want-to-go-ahead kind write today for catalogue (copyrighted), plans and sworn statement. J. M. Pease Mfg. Co., 555 Pease Bldg., Main St., Buffalo, N. Y.

I TEACH rapid business writing by mail. Your card and journal free. Francis B. Courtney, Box A, 492, Detroit, Mich.

"HOW to make printing cuts"—200 formulas, 20c. Publisher, 49 Clinton St., Albany, N. Y.

THE Mastery of Words. How to command the right word. Invaluable. Write E. D. Snow, Main St., Hornell, N. Y.

CANDY making—\$15 course 50c. Circular free. Eagle Co., "L." Quincy, Mass.

YOU can write 100 words a minute without knowing shorthand. My new method, Abbreviated Longhand, simpler than the simplest shorthand, tried and approved by thousands. Your money back if not delighted. Sample lesson 20c. Full particulars free. Write today. A. B. Weaver, Court Reporter, Dept. C., Buffalo, N. Y.

DON'T fail to read Independence and Fortune under Business Opportunities.

TRADE SCHOOLS

MAKE \$5 to \$8 a day as skilled Electrician, Plumber, Draftsman, Moving Picture Operator. We teach you in short time at small expense, profitable trades. Free employment bureau places graduates in good jobs. Special limited offer now. Write at once for catalogue and full particulars—no obligations. Dept. 8194, Coyne National Trade School, 51 E. Illinois St., Chicago, Ill.

LEARN to be an Automobile expert. Our experts will train you on real automobiles to become successful chauffeur, repairman, tester, demonstrator or salesman. Practical experience guaranteed. Our graduates succeed. Send today for terms and catalogue D., Peoria School of Motoring, H. F. Edwards, Educational Director, 824-826 Main St., Peoria, Ill.

YOUNG Man—Learn a trade. The plumbing, heating and ventilating trade offers excellent opportunities. Better pay, better work. Easy to learn by the Litchfield Trade School methods. Instruction from practical work. The best equipped school in the country. Reasonable rates. You make the start—we'll do the rest. Send for booklet today. Litchfield Trade School, Libertyville, Ill.

DRAW Cartoons. See Hamilton School ad under "Education and Instruction."

\$35 PAYS for a complete, unlimited, practical course in automobile driving and repairing. We have the best equipped school and most up-to-date shop in Chicago. Guarantee satisfaction or will refund your money. Day and evening classes. Call or write Dept. 1, Academy of Automobile Engineering, Calumet 4707, 1452 Michigan Ave., Chicago.

AUTOMOBILE School. You learn with your hands under the superintendence of the best instructors obtainable at the Chicago School of Motoring. Write for particulars. The F. E. Edwards Automobile School & Motor College, Dept. B., 1429 S. Wabash Ave., Chicago, Ill. Phone Calumet 3684.

MAILING LISTS

WE can furnish the names of 100,000 mail order buyers at the rate of \$2 a 1,000. Lessig, 3859 Coral St., Phila., Pa.

NAMES and addresses of over 1,000 Iowa farmers. Just obtained. \$1 postpaid. "Durant," Nora Springs, Iowa.

1000 NAMES of Arkansas farmers, typewritten. Guaranteed 99% correct. Price \$1.50. W. H. Fowler, Rogers, Ark., Box 23.

FREE to business men, copy of our comprehensive "Silent Salesman." Contains over 2000 different classifications of mailing lists with number and price of each list, and information every business man needs. Accept this free offer. Trade Circular Addressing Co., G 164½ W. Adams, Chicago.

PICTURES AND POST CARDS

PANAMA Canal, native, tropical photographs, 15 postpaid \$1 bill. Isthmian Photo Co., Box 101, Empire, Canal Zone.

COLLECT Post cards! Great fun! Receive cards from everywhere! Your name inserted free in exchange list if you send 10c for four months' subscription to our 20-page magazine. Elite Exchange, R 11, 3327 N. 44th Court, Chicago.

JOIN the Texas Post Card Exchange, membership one dollar a year. Young lady agent wanted in each town. Texas Post Card Exchange, Daingerfield, Texas.

JOIN the only Mexican Exchange and collect cards, coins or stamps from the whole world. Membership only 10c coin. Tomas Gongora, San Luis Potosi, Mexico.

PICTURES of the capital of our country, 10-25c or 30-50c. Walter P. Shaw, 1407 Monroe Street, Washington, D. C.

18 NICE postcards 15c. 35-25c (coin) postpaid. Billie Dutton, 702 W. Markham St., Little Rock, Ark.

YOU'LL get postcards from everywhere, membership 5c. Adv. ½c. per word. Butz 86, North Tonawanda, N. Y.

WESTERN Postals, Cowboys, Bucking Horses, Wild Animals and others western, from life. 50, all different, postpaid, \$1. Cody View & Postcard Co., Cody, Wyo.

VIEWS of Younger Brothers capture in exchange for views of general interest in Minnesota; or two for five cents. The Little Store Around the Corner, Madella, Minn.

HAWAIIAN Girls. Finest thing in Art Photography. Suitable, fine framing. Three for a Dollar. Hawaiian Service Bureau, Honolulu.

HAVE Friends everywhere. Receive postcards from all countries. Membership 10c. Hoosier Card Exchange, Terre Haute, Ind.

10 DIFFERENT Exposition Post Cards, 10c. postpaid. Exposition Mail Order Co., Box 2446, San Francisco, Cal.

PHOTOS—"Pretty Girls," 24 artistic beauty poses, 10c. Lists, 2c. Curtis Co., J—Englewood, Chicago.

FUN! Corresponded privately, years, on common Post Cards! (Unsealed.) Common Ink. New way! Directions, 10c. Verne Michener, Salem, Iowa.

PICTURES and Postcards. Hawaiian Post Cards beautifully colored, 12 for 25c. Hawaiian Service Bureau, Honolulu.

20 BEAUTIFUL Postcards; Greeting, Birthday, Best Wishes, Congratulations, Flowers, Views, etc. Gold, embossed, etc. 10c. 100 40c. Bailey, 110 Maple, Napanoch, N. Y.

GREAT Pastime. Exchange postals. "True-Blue" has perfect plan. Leading club; many members; big monthly magazine. Write to Ed Ericson, Elroy, Wis.

CARDS exchanged for results. 10c membership. Pacific Card Exchange, Bryn Mawr, Wash.

GET acquainted all over the world. Exchange post cards. Membership 10c. Universal Exchange, 3859 Coral St., Philadelphia, Pa.

25 BIRTHDAY, colored views, 10c. Hundred, 35c. Catalogue, duty free. Awdrey McCreery & Co., Wallaceburg, Ont.

NIGHT Scene Post Cards. Flashlights from life. Eight for 12c. S. Wra, Longbeach, Calif.

POSTALS—Just Girls; 10 nifty poses 10c. 30-25c. Bailey, 110 Maple, Napanoch, N. Y.

PHOTOS, pretty girls, 10 nifty poses, 10c. Lessig, 3859 Coral St., Phila., Pa.

5 SPORTING Postcards, 10c. Miss A. A. Banner, Station "R," N. Y. City.

ARTISTIC hand-colored Photos. Beautiful landscapes. Oil Painting and Water Colors. Write today. August Duna, 138 Zeigler St., Boston, Mass.

IF you really want to exchange post cards, try our splendid club. Lists circulate in many countries. Membership, 10c. Halcyon Club, Box 133, Erie, Pa.

OUR members in Norway, Switzerland and everywhere would like to exchange cards with you. Membership 10c. International Post Card Exchange, 2917 Washington Blvd., Chicago, Ills.

YOU'LL get cards from everywhere. Membership 10c. Idaho Card Exchange, Dept. K, Box 906, Boise, Idaho.

CAMERAS AND PHOTO SUPPLIES

LEARN Transphography—Make beautiful colored transparent photographs, on watch dials, chinaware, silverware, glass, celluloid, etc., with Transparo. Cost 1c each, sell, \$2. Learn in one hour. No tools required. Knowledge of photography unnecessary. Mr. St. John, Bridgeport, Conn., says, "Transparo is O. K." Sample bottle, formula, and instructions 25c. E. Greenhalgh, 816 58th, Brooklyn, N. Y. "If it isn't from Greenhalgh—it isn't Transphography."

LET experts finish your valuable photographs. Developing free. Prints, postcard size, five cents, others proportionately. We do anything, photographically speaking. The Landell Studios, 3712 Ivy St., Indiana Harbor, Indiana.

ROLL films developed, 10c. Printing Post Cards, 3 cents each. 15 years' experience. Send for complete price list. F. C. Hoyt, Sac City, Ia.

AMATEUR Photographers, send stamp and film for sample of the best postcard you ever saw. W. R. Clement, Box 1046, St. Louis, Mo.

KODAK Films developed and printed and enlarged. We develop any film 10c, we make any print up to 5x7 3c. We make an 8x10 enlargement of any negative for 25c. Brownie film developed and six prints and one 8x10 enlargement 50c. Price and Quintard, Poughkeepsie, N. Y.

TO introduce our superior finishing, during March and April one roll film developed and printed and 8x10 black or sepia Mounted enlargement for 35c. "We finish your Kodak pictures better." Colonial Art Company, Box 566, St. Louis, Mo.

PEERLESS Folding Dark-Room. Stop sending out films, and wasting money. Peerless eliminates all discomfort or ordinary darkroom and serves all its purposes. Operation visible. Illustrated pamphlet free. Masko Mfg. Co., Box 533-B, Indianapolis, Ind.

THE Kamera Shop, 179 Auditorium, Chicago, offers good developing and printing by mail. Prove our quality, send any six exposure roll with three dimes for developing and six velvet prints. Booklet free.

MAIL us your Kodak work. Films developed, 10c per roll all sizes. Prints 2c up. Post cards 4c. Good work and prompt returns. Tutbill Studio, Middletown, N. Y.

BIG Money Saved on Photographic Lenses and Apparatus—goods exchanged; repairing done. Ralph J. Golsen, 65 East 46th Street, Chicago, Department P.

FREE. Enlargement from your negative, with every \$1.50 order. Photographic finishing. Erhard Westman, St. James, Minn.

FILMS Developed. Send me your films for best work. Send negative for free sample print, and prices. Henry Schall, 256 North Main, Decatur, Ill.

BOYS: Make your camera pay. My plan tells how. Send 25c. W. H. Fowler, Rogers, Ark., Box 23.

5x7 CAMERA, complete outfit. Want small gasoline engine. H. R. Dague, Washington, Pa.

THE Latest Invention. Combination Moving Picture Camera. Projecting Machine, printer, stereopticon and photo enlarging machine combined in one. Simple, compact, anyone can operate it. Standard size film. Compact Camera Works, 213-215 S. Leavitt St., Chicago, Ill.

FILMS Developed Free. Prints 3c up. Send two negatives, any size, for sample cards. Monroe Co., Jamestown, N. Y. Professional Experts.

FILMS developed, ten cents per roll. Best results guaranteed. Jackson, 74 Woodward Ave., Detroit, Mich.

KODAK Films Developed, 10c per roll, any size. Prompt attention given mail orders. Prints 2¼x3¼ to 3¼x4¼, 3c; 4x5 to 3¼x5¼, 4c. J. M. Manning, Box B, 1062 Third Ave., New York City.

PHOTOGRAPHS wanted by publishers. I'll find a buyer for all prints I deem worthy of publication. Send your name on a postal for leaflet of instruction. A. S. Dudley, Photographic Expert, Box 775 G, Philadelphia, Pa.

PHOTOS copied on Post Cards, Lockets, Stamp Photos. Samples and Illustrated Catalogue 4 cents. Westlake Co., Brooklyn, N. Y.

WE buy, sell and exchange. Bargains in Microscopes, Telescopes, Binoculars, Cameras, etc. Bargain list sent. Kahn & Son, Opticians, No. 54 John St., New York. Established 62 years.

BROMIDE Enlargements 11x14, 50c; 8x10, 25c. Kodak Developing and Printing—the better kind. All work guaranteed satisfactory. The Rex Studios, 60th and Girard Ave., Philadelphia.

POCKET Photo Outfit, very cute; full outfit prepaid 10 cents. Warfel, Photographer, Cadiz, Ohio.

MONEY in Photography. I start amateurs making money at home taking portraits; become professionals. Studio secrets, retouching, etc., fully explained. Wells' Studio, East Liverpool, Ohio.

MOTION PICTURES

EASY Payments—Moving Picture Machines, standard size. Others, \$5 to \$40, and all moving picture apparatus. Catalogues. Ralph J. Golsen, 65 East 46th St., Chicago.

EDISON exhibition moving picture machine; bargain for \$75. L. Hoberdier, Market St., Canton, Ohio.

\$25 TO \$100 paid for Motion Picture Plots. Your ideas are valuable. Learn how to develop them under successful playwright. Big demand. Catalogue and interesting particulars free. Authors' Motion Picture School, 1533K, First National Bank Bldg., Chicago.

EDISON Moving Picture Machine, 2 pin, 200 feet of film, \$100. Will trade for motorcycle. J. J. Conway, 129 E. 10th St., Covington, Ky.

WRITE Moving Picture Plays; \$10 to \$100 each; all or spare time; experience or correspondence course unnecessary. Details free. Atlas Publishing Co., 304, Cincinnati, Ohio.

YOU can earn big money writing moving picture plays. Great demand. We teach only sure method. Send for free booklet of valuable information and special prize offer. Chicago Photoplaywright College, Box 278B.S., Chicago.

MOTION picture plays wanted. You can write them. We teach you by mail. No experience needed. Big demand and good pay. Details free. Ass'd M. P. Schools, 601 Sheridan Rd., Chicago.

FOR ADVERTISERS

YOUR 30 word ad in our 20-page postcard magazine 15c. Display 50c inch. Elite Exchange, 3827 N. 44th Court, Chicago.

TWENTY-FIVE word advertisement inserted 100 periodicals \$1. Particulars 4c. Max Janes, Joplin, Missouri.

BARGAIN Advertising Rate—Just to get acquainted, 15 words, one insertion; guaranteed 13,000 copies, printed, and one year's subscription, 25c. Digest, Grand Rapids, Michigan.

SEVEN Line Ad in Star Magazine, year's subscription, 70c. 50,000 circulation. Levert Dolson, Hampton, Iowa.

YOUR ad placed in nearly fifty magazines, 3 months, 5 cts. per word. A. S. Mankin & Co., Alexandria, Va.

SANITARY Paper Drinking Cups—Samples upon request. Yarroll, New Britain, Conn.

I ORIGINATE and write Pulling Advertising Matter. Geo. R. Hoagland, 517 Main, Kansas City, Mo.

TO MANUFACTURERS

A MANUFACTURING concern with a large, completely equipped, up-to-date plant, is in a position to manufacture sheet metal specialties. These can be stamped, spun, welded or otherwise. Address The A. M. Co., 1420-26 W. Baltimore St., Baltimore, Md.

WE sell, transfer, demonstrate, collect. Have Auto. office, showroom. Box 25, Grand Forks, N. D.

BLACKSMITHS

BLACKSMITHS—Here is your opportunity to be an expert blacksmith without help as life is short. Try Toy's Modern Methods doing hard jobs easy. Forging and welding all kinds of steel solid, and tempering and hardening all tools to a standard by colored charts. This is real information, not theory. All for one dollar. Send for free samples. W. M. Toy, Sidney, Ohio.

BUSINESS OPPORTUNITIES

MAKE More Money! Operate a good, substantial Mail Order business—our "Silent Salesman" system—can easily be done in spare time yet the possibilities are unlimited! For years "Booster" has actually and accurately led thousands like you over the Successful Road to Wealth. To succeed you've got to read The Booster Magazine for "Booster" is Opportunity and starts you in business for yourself—tells you how to get the dollars—puts you next to the best money making propositions on earth—ones that really get you the money! Send 10c for two months' trial subscription. Booster Magazine, Northwestern Building, Chicago.

WE Start You In Business, furnishing everything; men and women, \$30 to \$200 weekly operating our "New System Specialty Candy Factories," home or small room anywhere; no canvassing. Opportunity lifetime; booklet free. W. Ragsdale Co., East Orange, N. J.

AMBITIOUS men, you want to make more money. Have plan by which you can double your earnings. No canvassing. Write for free booklet "Within Your Reach." M. Robinson, Box 2063, Montreal, Canada.

USE your spare time to build up a mail order business of your own. We help you start for a share in profits. 27 opportunities. Particulars free. Mutual Opportunities Exchange, Buffalo, N. Y.

DRAW life sentence manufacturing our list five products! 600 per cent profit! Few dollars starts. Costs, selling prices, selling points, how marketed, all told in detail. Fifty cents. Act quick. McArthur Mfg. Co., Dept. C., Church & Adelaide, Toronto.

SELL by mail—New patented specialties; factory prices; new selling plans; small capital. Spare time. Copyrighted prospectus and samples free. Mississippi Valley Co., Inc., Box M629, Pittsburg, Kans.

LESSONS in mail order business. (Circular mailing, agents, schemes, plans and up to date information each month in our magazine, 10c copy. Three months, 25c. The "Lever" Mail Trader, 44, Elizabeth, New Jersey.

CONDUCT Employment Agency; business entirely new; enormous steady profits. Special offer. Particulars for stamp. Hilton, 49 Western Ave., Waterville, Maine.

FACTORY formula, one we use for resilvering mirrors, big money maker. Work can be done at home at spare time; full instructions, \$1. Smith Furniture Co., St. Marys, Ohio.

AD Bargains—25 words in 100 monthlies. \$1; 100 weeklies, \$2. Life Co., St. Louis.

LEARN a light manufacturing business that pays \$25 weekly in any locality. Particulars free. B. H. Elkins, Farmington, New Hampshire.

LEARN painting portraits on glass. Complete printed instructions, 25 cents. Schleier Co., 1524 Lula, Box 482, Wellston, Mo.

LET the Parcels Post Help You. Add (\$15 to \$25 weekly) to your present salary or income. Start during spare time and build up a permanent mail-order business of your own. We show you how and help you make good. No canvassing. Experience unnecessary. The Parcels Post makes success doubly sure. Our new ideas and up-to-date plans bring the money. No so-called "Course of Instruction" to sell. We give that free. Write today. Address Pease Mfg. Co., Inc., Dept. A, 70 Broadway, Buffalo, N. Y.

YES, It's a new one, never advertised before. A beer coil cleaner that works like shot in a bottle. Build routes cleaning coils at 25c each. We lease you machine with exclusive territory. Weighs 15 lbs. Sand Blast Beer Pipe Cleaner Co., 312 Madison St., Chicago, Ill.

SELL your formulas, ideas, plans and knowledge by mail. Some make \$1,000 monthly. Instructive booklet for stamp. Information System, 292 Marietta, Ohio.

YOU can make \$10 to \$20 a day in ice cream cone business. Outfit and formulas \$8.50. Particulars free. U. S. Specialty Co., Dept. 39, New Philadelphia, Ohio.

BE Prosperous. Go into the Real Estate Business. Great opportunities now. Make Big Money without capital. We'll train you. Free Book—How To Win. Represent us. American Realty League, San Francisco.

START a Wall Paper Cleaning Business, or manage a shop for me. Material furnished; profits half; write today. Milliken Co., Davenport, Ia.

WE Sell Patents, Established 1900. If you wish to add a new product to your line, write us. Charles A. Scott Co., 1096 Granite Bldg., Rochester, N. Y.

WILL Furnish Model, and assign reasonable, the county rights to manufacture an efficient outdoor Fly-catching Device. Agents wanted. D. J. Spangler, Elkhart, Ind.

FORM a corporation—Congress Law for D. C. and all States, cheap. Raise money easily. U. S. Legal Corporation, Washington, D. C., representing \$1,225,000,000.

I MAKE \$5 a day in the "Handy Man" business. Particulars. Houlgate. The Handy Man, 1010 Cypress Ave., Pasadena, Cal.

\$40 WEEKLY, manufacturing postcards. Easy to learn. No fake. Send stamp. Grandon, Jackson, Mich.

INCREASE your income without capital. No fake, mail order or canvassing scheme. Descriptive circular free. Box 1301, Vermillion, S. Dak.

START your own business; Big Money. New plan. Particulars free. Write now. Box 193, Norwich, N. Y.

MAIL Order Business, I start you free. P. Newnham, Waukegan, Ill.

DON'T start in Mail Order Business until you get our plan. Box 2792 Boston, Mass.

LET me start you in the mail order business anywhere. I started with an idea and \$100.00 and made six hundred and fifty thousand dollars in 18 months. I tell you what to do and how to do it. Don't be a wage slave; get out of the rut; get grit; get backbone; wake up and start now. Write and learn of my money-making mail order plans. My great free book, "How to Achieve Mail Order Success," tells all about my own achievements and how I equip, teach and get you started. This book tells how to quickly start in your home, while otherwise employed. It is a B line to a large income. Send for my new free book and start making money now. Address President, Mail Order School, Suite 1167 Brecht Bldg., Denver, Colo.

STOP; Investigate at once: New business; No experience; 500% profit making photos with the new One Minute Post Card Camera. Takes and delivers finished post card photos in one minute right on the spot. No plates, films or dark room. Make big money everywhere, traveling or at home. This is your opportunity for immediate and permanent success. Don't delay! Write today for free information. The One Minute Camera Co., Dept. 72, Rand McNally Bldg., Chicago.

SMALL Investors Opportunity—\$2 to \$10 invested monthly will mean much to you in future. Limited number of shares insured by bank to pay well. Profits great with probably unprecedented surety. We own 15,000 acres. Ask for information. Swastika Sheep and Land Co., 611 S. Bdw., Albuquerque, N. M.

START a Candy Kitchen. Big money. Best course of instruction ever originated, complete 50c. Profitable Service Bureau, 4335 N. Sawyer Ave., Chicago.

ENCYCLOPEDIA of Business Chances. Money making methods exposed; how small ventures lead to wealth; 2000 trade secrets, etc. Descriptive booklet free. Reimel & Co., 96 Broadway, N. Y.

\$1.00 RESILVERING Mirror Formula, and year's subscription to our 20 page postcard magazine 40c. Elite Exchange, C3, 3827 N. 44th Ct., Chicago.

INCORPORATE your business under Arizona laws. Cost small. No franchise tax. Stockholders exempt from corporate debts. Do business anywhere. Laws and forms free. Southwestern Securities & Investment Company, Box D488, Phoenix, Arizona.

500% PROFIT, making the new "Blackboard" advertising slides for moving picture theatres. Complete instructions and material, 25 cents. William A. Temple, Fort Dodge, Iowa.

WE help raise capital at once to start you in retail—manufacturing—patent—real estate—mail order or any legitimate business by means of "Our Practical Method." Particulars free. The Business Aid Co., K504, Detroit, Mich.

MAMMOTH mail order magazine 10c. C. White, Publisher, Hazlehurst, Miss.

EARN \$5.00 during spare time. Experience or capital unnecessary. Samples and full particulars for stamp. Miller Sales Co., Dept. B., Lexington, Ky.

PATENTABLE ideas wanted—Send for 3 free books. Richard B. Owen, 30 Owen Bldg., Washington, D. C.

I MADE \$50,000 in five years with a small mail order business; began with \$5. Send for free booklet. Tells how. Heacock, 5074 Lockport, N. Y.

AN intelligent person may earn \$100 monthly corresponding for newspapers. No canvassing. Send for particulars. Press Syndicate, 700 Lockport, N. Y.

TRIAL Offer: \$1 places your 25 word ad in 200 different magazines. Send copy now. King's Magazine, Box 13P. Little Silver, N. J.

RESILVER mirrors and make plenty of money. Full instructions, 25 cents. Auburn Supply Co., Dept. CC, 7746 Peoria St., Chicago.

"THE Art and Process of Dry Cleaning." A fascinating and profitable occupation. 25 cents postpaid. Auburn Supply Co., Dept. EE, 7746 Peoria St., Chicago.

AGENTS—A big new moneymaking proposition. Write today. Williams-Crosby Co., 2728 Washburn Ave., Chicago.

WE start you in a permanent business with us and furnish everything. We have new, easy selling plans and seasonal leaders in the Mail Order line to keep factories busy. No canvassing. Small capital. Large profits. Spare time only required; personal assistance. Write today for (copyrighted) plans, positive proof and sworn statements. J. M. Pease Mfg. Company, 541 Pease Bldg., Main Street, Buffalo, N. Y.

BIG Money in the Mail Order Business. Experience unnecessary. Small capital. Instructions free. Keith, 719 Central Bldg., Rochester, N. Y.

MAIL Order Dealers! Advertisers! You need our 1913 Advertising Rate Book with the latest Dollar-making feature "Ads That Pay." Hot from the press! Gives you cost of Advertising in 2000 recognized magazines and newspapers, location, circulation, closing dates and other useful knowledge. Includes thirty original Mail Order propositions, winners every one of them. A \$10,000 investment at your service. You can make a legitimate profit of 85c on every dollar order. This very valuable manual sent prepaid to you for 10c. Write now! Dearborn Advertising Agency, 521 Dearborn St., Chicago.

A Bit Shy on Salary? I pick up \$1,500 yearly additional from newspaper correspondence. My book tells what's news, how to get it, where to sell. Newspaper directory included. No correspondence school expense; only 50 cents. Morris White, Station, 50, Detroit, Mich.

INDEPENDENCE and fortune quickly attained in the Manufacturing Mail Order business. I furnish Formulas, Manufacturing Processes and Trade Secrets in all lines. Sold under positive guarantee; 18 years' practical experience. Revision and improvement of Formulas and Processes—reduction of manufacturing cost—utilization of waste materials, etc., a specialty. Booklet, Formula List, and Valuable Information Free. W. L. Cummings, Ph. D., 127 Standard St., Syracuse, N. Y.

BIG Profits for You! Manufacture Barley Crisp. New confection. 5c package costs you 1c. Machine, instructions complete \$7.50 prepaid. Send 10c for samples. Barley Crisp Co., 1605 Hyde St., San Francisco.

STOP Here! Let me start you in a home business that will bring you money every day. Experience unnecessary. Spare time. No canvassing. I furnish everything and guarantee success. Send for proofs. Voorhies, Desk C. R., Omaha, Neb.

I WILL start you earning \$4 daily at home in spare time, silvering mirrors; no capital; send for free instructive booklet, giving plans of operations. G. F. Redmond, Dept. 306, Boston, Mass.

MANUFACTURE Gold Letters for signs—\$100 per month easy. I start you. Experience unnecessary. Take like wildfire. Prospectus free. J. F. McPherson, 673 Brown Avenue, Butler, Pa.

COLLECT money by a sure, simple, system. Income \$1,000 to \$5,000 a year. Quick results. No capital required. Instructive book. "Skillful Collecting," free. National Collectors Ass'n., Long Street, Newark, Ohio.

AGENTS WANTED

BE an Ind-Electric Representative. You can make anywhere from \$50 to \$150 a week selling the Ind-Electric Health and Beauty Battery—one of the most remarkable inventions of the decade—a device for which there is a market in every home in America. Our representatives are making this much right now—a few make more. You can do the same if you are the right man or the right woman. No special experience necessary. We coach you—tell you of the methods others have used to succeed. With perseverance and enthusiasm you may do as well as our "top-notchers," who are making dandy incomes. We give exclusive territory and let you organize your own subagents. Territory being closed rapidly. Write at once to the Ind-Electric Mfg. Co., Desk 19, 432 Peoples Gas Building, Chicago. Capitalization, \$100,000.

GENERAL Agents—Capable of calling on the big trade themselves and handling canvassers for the house to house and office to office business, to sell the newest electric specialty on the market; sold everywhere there is electricity in the home, office, factory, store, hotel, liberal profits; sales-driving sample, weighs a pound; no experience or knowledge of electricity required; shows how to use one light instead of two and get the same results; sells for \$2.50, \$3.50, \$5 and saves the purchaser an investment of \$25. Write for particulars. The Handy Light Co., 153 Handy Light Block, Cincinnati, Ohio.

MAKE \$8 to \$10 a day with the Bissell Electric Suction Cleaner. Men who can quickly clean a whole house, rugs, carpets, bedding, upholstering, get big pay. If you are making only \$2 or even \$3 per day, you can make three times that with a Bissell cleaner. Let it pay for itself out of a part of the profits; you keep the rest. Works fast, earns \$1 per hour. Easy terms to you. Build your own business on our money, and you can also make a commission on sales. Ask us. The Bissell Motor Co., Toledo, Ohio.

MAN Wanted as Exclusive Agent. We manufacture six styles Self-wringing Mops, for all purposes, including an absolutely new combination Scrubbing Brush Mop that is Self-wringing. Every woman wants this proven success. New inexperienced men make \$9.00 per day. One man made \$120 the second week. No investment. Send for catalogue and exclusive territory proposition that will make you independent. Hilker Mop Co., 1219 Grand Ave., Chicago, Ill.

AGENTS. Look into this Money Proposition. It's a good live repeat seller for every house. Unlimited field. You don't have to talk your head off. Free sample. J. F. Jordan Mfg. Co., 417 Niagara St., Niagara Falls, N. Y.

PORTRAIT agents find our plan beats all others. Prompt shipments—rejects credited. 30 days' Credit. Catalogue of Portraits, Frames, Pillow Tops, Sheet Pictures and samples free. James C. Bailey & Co., Desk D, Chicago.

AGENTS Wanted—We want a live man in every town to act as a sales manager. We want you in your town. Devote your spare time to our business and you will make bigger money than you ever made before. Give us all your time and we will make you rich. These are facts, not promises. \$50 a week at the start. Besides, a nobby free suit—and all the clothes you want at less than wholesale price. Wear one of our free suits as an advertisement and people will flock to you to buy a suit like it and you will coin money. Get our money making proposition and beautiful book of samples. Just send a postal card. We pay express charges on everything. Join the live wires—send us a postal today. Paragon Tailoring Co., Dept. 414, Chicago.

\$50 A MONTH earned at your own home! No canvassing or collecting required. All our work may be done in any room of the house in spare time without interfering with your regular duties and without your nearest neighbor knowing you work for us. New system of business and the greatest offer ever made. Write now before it is too late! Blye & Co., Dept. 31, Terre Haute, Indiana.

YOUNG man, would you accept and wear a fine tailor-made suit just for showing it to your friends? Or a Slip-on Raincoat Free? Could you use \$5 a day for a little spare time? Perhaps we can offer you a steady job. If you live in a town smaller than 10,000, write at once and get beautiful samples, styles and this wonderful offer. Banner Tailoring Company, Dept. 202, Chicago.

AGENTS Wanted—Here's big money for you—and a stylish nobby suit absolutely free. \$40 a week easy. Many are making more. Nothing to learn. Nothing to buy. Nothing to invest. No capital required. We furnish everything free—even the suit of stylish clothes you wear. Our men are the swell dressers and it don't cost them a cent, and they make big money every week. Get in now. Now is the time for the big money. Your name on a postal brings everything free. The hand-somest lot of samples of the latest suitings you ever looked at to choose your suit from. And a book of fashion plates showing the very latest, nifty, nobby styles; also measuring blanks and everything needed—all free. We pay expressage on everything. Send that postal now—don't wait. This is your chance—grasp it. American Woolen Mills Co., Dept. 414 Chicago.

WANT three swell made-to-measure shirts? Show our samples to friends, take a few orders easy and make enough profit to get yours free. New fancy patterns, made just as you want them. One good agent wanted in each town, spare time or all time. Write for beautiful samples; wholesale and retail prices and our liberal offer. Peerless Shirt Makers, Dept. 15, Chicago.

MANUFACTURERS' agents take notice. If the family tooth powder (the greatest tooth cleaning preparation in the world) is not represented in your county, here is a valuable agency or side line. A big seller and a repeater. Write for proposition. J. M. Forrest, MD, DDS., 3287 Mission St., San Francisco, Cal.

AGENTS—"Border Wars of Texas," a book of 400 pages of thrilling accounts of Indian raids, battles, etc.; 40 full page illustrations portraying the cruel hardships of the Texas pioneer. It is a quick seller for agents. Sent postpaid for \$1.50 cloth, \$2.00 morocco, or terms, etc., for stamp. Matt Bradley, Tioga, Texas.

SALESMEN—Our Press Button Automatic Opener Pocket Knife, the very newest out. Our sales cards sell them quickly for the dealer at a good profit. Fine side line, 80c brings sample knife and card. Knife Guaranteed is worth \$1.50, money back if not satisfied. Act quick. Unique Novelty Co., Independence, Iowa.

BE quick—get the agency—never such a seller—make \$100.00 a week. Model Vacuum Cleaner—carpet sweeper type—wonderful suction—your profit over 100 per cent—no competition—patented—we start you—the cleaner sells itself—free sample to workers. Braham Co., D40, Cincinnati, O.

CHEWING Gum—Sell to dealers. Clean, profitable business built up quickly with our new brands. Four flavors, novel packages. Send 10c for full pack of each and exclusive territory proposition. Helmet Gum Factory, 39 Opera Place, Cincinnati, O.

WANTED—Ambitious, hustling, town or country man. In each locality. Who desires to get ahead and earn more. Part or whole time. Fine chance—Experience not needed. Write quick for Cash-Bonus offer. Box 9C, 292, Covington, Ky.

BIG opportunity for the right man in your town. Exclusive control—something new—legitimate—no canvassing—small capital required—give references. Drawer 165, New Haven, Conn.

AGENTS on salary or commission. The greatest agents' seller ever produced; every user of pen and ink buys it on sight; 200 to 500 per cent profit; one agent's sales amounted to \$620 in six days; another \$32 in two hours. Monroe Mfg. Co. X., 60 La Crosse, Wis.

AGENTS—A cent sent Swank tells about free offer and how to sell greatest discovery of the age in homes, stores, factories, offices. Easiest seller; out Nov. 29, 1912. Biggest profits. A. H. Swank Mfg. Co., Fremont, O., Dept. 19, Toronto, Canada Branch, 226 Shaw St.

AGENTS make big money selling our new gold letters for office windows, store fronts and glass signs. Any one can put them on. Write today for free sample and full particulars. Metallic Sign Letter Co., 406 N. Clark St., Chicago.

WE are the largest manufacturers of Twisted Wire Brushes in America. Highest grade goods, best service, highest profit. Write for our new catalog. You are sure to win. Fuller Brush Co., 33 Hoadley Place, Hartford, Conn.

HAVE you a few hours to spare? We want man or woman in each town. No capital needed. An hour's work shows dollars earned in spare time. Pocket sample. 400% profit. G. C. Mfg. Co., (Dept. 104), 20 Warren St., N. Y.

\$1,000 EARNED by three people within thirty days selling our Fire Extinguishers. Buyers everywhere, protected territory, 500% profit. Local and State Agents wanted. United Manufacturing Company, 1025 Jefferson, Toledo, Ohio.

MILK Tester "Inspector" shows immediately if milk is pure or how much water is added. Utmost practical article. Retail 50c; big profits. Specialties Co., 672 Eagle Ave., New York, N. Y.

AGENTS—Get particulars of one of the best paying propositions ever put on the market. Something no one else sells. Make \$4,000 yearly. Send postal today for particulars. E. M. Feltman, Sales Mgr., 6178 Sycamore St., Cincinnati, O.

WHEN you sell Feeny Vacuum Cleaners you deliver the goods. New principle—creates wonderful suction. One general agent's total commissions 1912 was \$18,498.00. Write today for our attractive proposition. Feeny Mfg. Co., A28, Muncie, Ind.

AGENTS: Do you need a license? The Agent's Protector proves it. 100 pages. Every live agent should have a copy. Price 25c. Kay Company, 401 E. 5th St., South Boston, Mass.

AGENTS—100% profit—sell to saloons—machine a whirlwind seller. Free sample and salesmanship course. Two sales a day \$15 profit. Write. Simplex Mfg. Co., Dept. 7, Keweenaw, Ill.

AGENTS—Our Electric Rug and Carpet Cleaner positively makes old rugs and carpets look like new, cleans everything, sells in every home. Sample prepaid 25c. write today. Electric Sales Co., Indianapolis, Ind.

AGENTS—New invention, Aluminum Cigar Lighter. Used on cigar cases. Quick seller to Hotels, Drugstores, Restaurants, Poolhalls, Cafes. Big profits. Special offer. Drake Mfg. Co., 142 Reed St., Milwaukee, Wis.

AGENTS make 500% profit selling our gold window letters, novelty signs and changeable signs. 800 varieties in enormous demand. Catalogue free. Sullivan Co., 1238 Van Buren St., Chicago, Ill.

SELLING Agents Wanted for "Fire Out." Best selling small fire extinguisher. A real money maker for you. Our proposition won't disappoint you. The Inst. Lighter Co., Dept. M., Columbus, O.

AGENTS—New article, record breaking sales everywhere. Write for free sample and new catalogue. Kay Company, 401 E. 5th St., South Boston, Mass.

MAKE and sell your own goods. Formulas by expert chemists. We obtain your government serial number. Catalogue for stamp. B. Mystic Company, Washington, D. C.

AGENTS wanted for "Healo" the toilet preparation for preventing all forms of excessive perspiration. Big money. Start now. Particulars free. Health Medicine Co., Dixon, Ill.

I MADE \$50,000 in five years with a Small Mail Order Business; began with \$5. Send for free booklet. Tells how. Heacock, 146 Charles St., Lockport, N. Y.

U-KAN-PLATE—The polish that plates; \$18-\$40 week year round; exclusive field; free booklet. C. B. Seabury, 1465, Boonton, N. J.

AGENTS—We have a proposition worth \$40 to \$60 a week to you with no competition. Galloway-Bowman, Div. No. 309, Waterloo, Iowa.

400% PROFIT selling our high grade work. Samples free. Gordon Co., Northwestern Bldg., Chicago.

AGENTS—Latest and best novelty wanted in every home, send 25 cents for sample. A. Wood Novelty Co., Box 956, Portland, Oregon.

MEN—Women. All towns. Sell greatest moneymaker. Big pay. Credit allowed. Sample free. Horner Manufacturing, 524 Pittsburgh, Pennsylvania.

SIGN Agents—Painters—Something new and better. Attracto ready-made Gold and Silver letters. 21 kinds, easily applied. Make big money lettering store windows, making signs, and selling our line of flashing, sparkling chipped glass name-plates. No experience needed. Write for sample letter and catalogue and start at once. Address Attracto Sign Co., 2655 North Clark Street, Chicago, or 519 Pacific Bldg., San Francisco.

SALESMEN Wanted, best seller on market, 200% profit. Liversidge, Newburyport, Mass.

YOU can make more money operating a mail business, but before taking any chances invest 10c for two samples of "Booster"—the one bonafide Mail Order and Agents' publication on earth—a magazine that has for years actually and accurately started others like you in business for themselves by publishing the best money making propositions on earth—ones that really get you the money! Send 10c today—it's worth dollars to you. Booster Magazine, Northwestern Building, Chicago.

\$61.50 WEEKLY introducing and selling a new Gas Light Burner for Kerosene Lamps. Beautiful light. No chimney. No mantle. Perfectly safe. Simple in construction. Nothing to get broken or out of order. Will not burn out. Durable. Will last for years. Low price. Easy to sell. 200 per cent profit. Experience not necessary. Sample free. Why not try one on your lamp? Beware of imitations. No branch offices. Luther Manufacturing Co., Dept. 223, Cincinnati, Ohio.

AGENTS make \$5.00 to \$10.00 a day on the spot. Atkinson writes: "The best proposition I have found in my forty years canvassing." Permanent work. Household necessity. Saving 80%. Write to-day for General or Local Agents terms. Free sample. C. H. Stuart & Co., 16 Union St., Newark, New York.

AGENTS—\$200 monthly distributing Newells needle cases. Sell 115 needles in book for 10c and make 200% profit. Approval Plan envelopes make talking unnecessary. Crew Managers write. Send 10c for sample book and particulars. Newell Company, 509 N. Grand, St. Louis, Mo.

SECURE territory now for Gravity Spiral Hinge. Sample 50c postpaid, deducted from first order. Agents making \$10 daily. Hoosier Hinge Co., Goshen, Ind.

AGENTS—\$60 weekly premiums easily made. Write for free particulars and samples today. 100% profit besides premiums. No money required. Lloyd Company, 242 De Balvere, St. Louis, Mo.

SELL by mail—New patented specialties; factory prices; new selling plans; small capital. Spare time; copyrighted prospectus and samples free. Mississippi Valley Co., Inc., Box N629, Pittsburg, Kans.

AGENTS—Made five days' test spare time, cleared thirty dollars; you can do same. Send for particulars today. Stewart Specialty Company, Columbus, Ohio.

SOMETHING new. Sanitary Parawax Folding Drinking Cups; postpaid, 10c, 3 for 25c. Niagara Falls Novelty Co., Box 765, Niagara Falls, N. Y.

MAKE \$20 daily operating our Minute Picture Machines. Experience unnecessary. Small investment; large profit. Free book, testimonials, etc. Write American Minute Photo Co., Dept. E335, Chicago, Ill.

AGENTS—Make \$10 per day selling wonderful lock-stitch-awl-hand-sewing-machine. 100% profit. Sells itself. Send 50c for \$1 sample. W. A. MacKenzie, 268 De Balvere, St. Louis, Mo.

AGENTS and salesmen will secure free, complete information of numerous money making selling propositions and newest specialties in hands of responsible concerns by addressing Distributor, R-13-26 Cedar St., New York.

AGENTS—\$15.00 per day, selling new portable desk lamp and other electric fixtures. Write for special offer. Runkel Manufacturing Company, Milwaukee, Wis.

HOSIERY; knit ties; sample free, Sutton sold twelve dozen in one week besides hosiery. 100% profit; appoint sub-agents, develop permanent profitable business. Colby Hosiery Co., Second and Diamond, Philadelphia, Pennsylvania.

AGENTS wanted quick. Clean legitimate money-making proposition. No space for explanations. Write for full particulars and exclusive territory. Krueger Mfg. Co., Dept. 2A, 167 W. Washington, Chicago.

MAIL Order Opportunities: 25 new propositions. No competition! Make 95c profit on dollar order. Complete outfit, 10c. Mail Dealers Wholesale House, 447 Franklin Bldg., Chicago.

AGENTS—"Art Match Scratchers." Sell everywhere. New, novel, attractive. Proposition and sample, 10c coin. C. Leberman, Box 521, Tiffin, Ohio.

NAME on Rubber Stamp, 15c; with address, 25c. National Stamp Works, 42 N. Fifth Ave., Chicago. Catalogue.

"**TLL** Take a Box." Agents, sell a staple necessity and hear this every few minutes. Big money. Particulars free. Write a postal now, and mail to C. S. Mason, Westboro, Mass.

AGENTS—Save time and money. Your name in our syndicate magazine directory will bring you big mail and the best offers from dealers and manufacturers. Special service. Three issues, 25c. Results guaranteed. Copy of our magazine, 10c. The "Lever" Mail Trader, 44, Elizabeth, N. J.

AGENTS—Make big money this spring cleaning wall paper; also cleaning carpets on the floor without taking them up. Formulas and complete instructions for doing both for dime. Box 134-A, Newport, Ky.

FOR sewing leather, the speedy stitcher. 50c postpaid. Agents wanted. Boyd Sales Co., Kingessing Sta., Philadelphia, Pa.

TUNGSTEN Flash Light, nickel plated, vest pocket size 75c postpaid. Catalog. Boyd Sales Co., Philadelphia, Pa.

MONEY making business for high grade agents, selling our Sick-Call Outfit to Catholic Families. Write for details. Frank Schilling Co., Navarre, Ohio.

SALESMEN wanted for the Help-a-Phone. Every telephone user needs one. Sells for \$3. Salesmen's profit, \$100 a week and up. Send for complete set instructions in salesmanship free. Wolverson Specialty Co., Massillon, Ohio.

AGENTS—Get busy with new device every automobile owner needs. Liberal commission. Sells on sight. Particulars free. R. Dunlap, Route 4, Hilliards, Ohio.

HAT Mirror with your name on. Latest craze; sample 10c. T. Sullivan, 100 Abbott Ave., Fitchburg, Mass.

READ the Agents Magazine. Make more money. 2 months, 10c. Agents Magazine, Chicago.

SELL three things for Washing, Ironing, Bluing. Interests every housewife. Samples 10c. Three full packages, 25c. Particulars free. Leibman, 720 Lefferts, Richmond Hill, New York.

POPULAR Show Card Co., Dept. APR, 1235 Michigan Ave., Chicago. Please hurry forward free two-color catalog. Yours for business.

\$2.50 PER day paid one man or woman in each town to distribute free circulars and take orders for concentrated flavoring in tubes. Permanent position. J. S. Ziegler Co., 443-D, Dearborn St., Chicago.

SUCCESSFUL Brains. The Open Door of Opportunity. Brand new book. Full of money-making trade secrets and valuable information. Alvin Hamel, 3635 Armitage Ave., Chicago.

AGENTS Wanted. Send 35c for Tube of Water Proof Shoe Polish in Case with Dauber and Polisher complete, and one of each of our Catalogues and Agent's terms. A. S. Mankin & Co., Alexandria, Va.

CASH for names, addresses, information, etc. Steady income at home. Instructive booklet for stamp. Information System, 293 Marietta, Ohio.

AGENTS. If you don't make \$4 profit the first day selling Tate's Guaranteed Dust Absorbing cloths, brushes, mops, etc., return sample outfit. Many agents make \$25. Write quick for particulars. Dept. A-4, Consumers Direct Supply Co., Boston, Mass.

AGENTS who are looking for a permanent agency. We make no foolish boasts. By taking our line of men's tailored to order suits at wholesale prices you will have a permanent business, that will grow year after year. This is no one suit proposition. We do not urge you to buy a suit for yourself. We want you to sell them. No experience needed to make a success. Our \$16.50 Suits as good as others at \$25. Send your name and address to Highland Tailoring Co., Cincinnati, Ohio.

SIGN Agents—Stop paying fancy prices for Gold and Silver Metallic Sign Letters. Note ours: 2-inch letters, 70c; 3-inch, 80c; 4½-inch, 90c per 100. Non-tarnishable, staple goods. 5 assorted samples and instructions, 10c. Particulars free. H. Alexander, manufacturer, 328 East 59th St., New York. Established 1905.

AGENTS \$10 to \$15 per day easily made; 150% profit; exclusive territory; our cleaning, polishing and dustless mop is the big money getter and record breaker. Duncan Bros., 2910 N. Troy St., Chicago.

"**CREASE-EM**" keeps trousers pressed two months. No trouble to apply. Will not injure the cloth. Liberal size package, 10c. "Crease-Em" Co., Chicago. Agents wanted.

SIGN Agents, Painters, 500% profit with our splendid line guaranteed non-tarnishable gold sign letters, trade emblems make-up-yourself aluminum door plates. Catalogue, samples free. Eastern Specialty Co., Dept. 5, 63 Barclay St., N. Y.

AGENTS, something new, big success. LatherKream, no cup, no brush, no soap, no lather, just apply and shave. Exclusive territory, write quick, send twenty-five cents for sample. Mory & Thorn, Dept. "C," 260 West Broadway, New York.

WANTED Hustling Agents, not afraid to make Big Money. Absolute necessity in every home, shop and factory. Sells 75c, your profit, 45c. Another sells \$1.50, your profit 85c. 250,000 sold in Chicago, alone. Exclusive territory. Frederick, 2255 State St., Chicago.

AGENTS Wanted—Parcels Post Maps, and booklets. Good profits. Sample, fifty cents. E. R. Bogart, Station C, Buffalo, N. Y.

BURGLAR Proof Door Fasteners, attached instantly to any door without tools. Cannot be picked. Sample and particulars. 25c silver. Burglar Proof Lock Company, 435 River St., Dayton, Ohio.

VACUUM Cleaner agents wanted everywhere. Most powerful Double-Suction Cleaner made, guaranteed 5 years. Best yet. Rev. Waterman, of Iowa, without experience, made \$234 in 5 days. Postal card brings proposition. Warner Vacuum Cleaner Co., Box Z, Muncie, Ind.

SALESMEN—Send your name and address to Raymond E. Wood, 117 Dreyer Bldg., Cincinnati, Ohio. I am the manufacturer's Sales Manager for the best household and office electric specialty ever invented. Sells for \$3.50 and \$2.50. Guarantee for credit or deposit required. Capable men only need apply. I want only a few men. The work is permanent, profitable and high-grade. You will be given territory and expected to produce business.

"EVER Ready" trousers pressers work while you sleep; no heat, no expense, simple, practical and convenient; crease and press perfectly. New invention. Price, \$2. Liberal commission to agents. H. O. Stamp & Co., 622 Third St., Milwaukee, Wis.

AGENTS to sell soaps, perfumes and toilet articles, good profits. Hopfinger & Roth, 219 N. 2d St., St. Louis, Mo.

EXCELLENT opportunity for salesmen to sell our Magic Weeders and Hoes, the king of garden tools, to stores or house to house. Excellent exclusive or side line. Exclusive territory. Sample 35c prepaid. Reichard Mfg. Co., Bangor, Penna.

LIVE agents everywhere; big proposition; big profits; absolutely needed wherever water or steam pipes used; no capital required. Fullest protection; Postal brings particulars. Patterson-Allen Engineering Co., Dept. A, New York.

SALESMEN paid \$108 weekly salary. Sell Help-a-Phone. Instruction in salesmanship free. Also distributors wanted at \$4 daily. Write quick. Harper Specialty Co., St. Marys, W. Va.

LIVE agents, Male and Female, looking for first-class proposition send for particulars, Letroy Specialty Co., 76 Park Place, N. Y., Room 52.

AGENTS to take orders for visiting and business cards of distinction. Folder P free. Forman Printery, Waterbury, Conn.

MAIL Dealers, Agents. Twenty new, practical, exclusive specialties. Money-making plans and circulars free. Columbia Mfg. Co., 1557 Wells St., Chicago.

SELL and install our No-Battery Electric Bells at big profit, \$5 to \$10 a day. Expert knowledge not necessary. We can help you start a big profitable business. Write for terms. Searles Electric Co., 1154C Monadnock Block, Chicago.

IF you want the best agency proposition ever offered wide awake canvassers write us at once; exclusive territory. The Wabash Pottery, Roseville, Ohio.

AGENTS. Our great Luminous picture, Rock of Ages. Wonderful, mysterious; cross shines brilliantly in darkest room. Sample 25c prepaid. Exclusive territory. Big profits. Pioneer Portrait Co., 1242 W. 63rd St., Chicago.

WRITES with Water. Helios Pocket Pen with compressed ink. Regular price 25c. Sample to agents 10c. Wm. Muller, U. S. Sole Agent, Security Bldg., San Francisco.

HOME Manufacturing—Pleasant and profitable business quickly established during spare time. Product international necessity. Write for particulars. Delzell Mfg. Company, Desk A, 448 South Mathews, Los Angeles, Cal.

\$20-\$40 WEEKLY selling Hosiery, Underwear, Sweaters, Neckties. Liberal commissions; samples free. Sales Manager, Room 62, 54 Worth St., New York.

WANTED—People to travel and put out advertising. Write today. P. Breeden, Box 938, Norfolk, Va.

AGENTS to sell the newest electric appliance on the market; sold everywhere there is electricity in the home and office; liberal profits; sales-driving sample, weighs a pound, no experience or knowledge of electricity required; it shows how to use one light instead of two and get the same results; sells for \$3.50 and saves the purchaser an investment of \$25; write for particulars. The Handy Light Co., 15 Handy Light Block, Cincinnati, Ohio.

EARN \$20 to \$50 weekly mailing circulars. Anyone, anywhere, spare time. Full instructions, two dimes. F. J. Smith, Box 472D, Waterloo, Iowa.

GOOD Mechanics to use and sell graduated Calipers, Whichway Levels. Paying proposition. Ernest Smith, Columbia, Pa.

AGENTS in every city and town can double their income selling low-priced, tailored-to-order raincoats of the finest kind. Write for samples, free raincoat offer and exclusive territory. English Raincoat Tailors Ltd., 500 Fifth Ave., N. Y.

500% PROFIT selling our wonderful sign letters for office windows, store fronts and glass signs; resembles finest gold leaf; easily applied; samples free. Metallic Letter Co., 496 N. Clark St., Chicago.

REMNANT Store, 1331 E. Linn, Cincinnati. Greatest Dry Goods Bargains on Earth. Proposition to agents and storekeepers.

AGENTS—\$10 per day sure selling our New 1913 Styles Silk Neckwear, 3 fifty-cent ties \$1. Monogram Gold Cuff Link and Stick Pin Set given Free. Cooper made 75 sales in 7 1/2 hrs. Profit \$30. Free Samples to hustlers. Dayton Neckwear Mfg. Co., Dept. I, Dayton, O.

SIDE Line salesmen and specialty men wanted. Japanese Novelty Co., Clinton, Ia.

AGENTS make \$30.00 weekly selling our 500 Handy Household Articles; catalogue free. Scheff Company, Desplaines, Ill.

MEDALLIONS—300% profit. Make up your own goods and be independent. Catalogue free. Resag Co., 1205 Randolph St., Chicago.

EARN \$15 to \$25 a week or more as our Mail Order Dealer. Right from your own home. Hold your position until entire time is required. We are manufacturers and owners of Patented just-in-season specialties. If you are just starting a Mail Order business or if already established, you can't afford not to handle our Patented Money making getters. We sell exclusively to our Mail Order Dealers. We protect them. We carry stock and furnish everything. No canvassing. Small capital. Experience unnecessary. Write today for latest patented leader and manufacturer's easy selling Mail Order (copyrighted) plan backed up by "Whole Truth," positive proof and sworn statement. J. M. Pease Mfg. Co., 539 Pease Bldg., Main St., Buffalo, N. Y.

SOAP agents make more money selling the celebrated Lirno line. Coffee, flavorings, spices, soaps, perfumes, and 135 other items. Big commissions to you. Exclusive territory. Freight allowed. Handsome premiums to your customers. Free sample case. No deposit required. Free catalog. Lirno Company, 13 Lirno Bldg., St. Louis, Mo.

AGENTS sell rich looking imported 36x68 rugs \$1 each. Carter, Tenn., sold 115 in four days, his profit \$57. You can do as well. Write for sample offer and selling plan. Sample rug by Parcel Post prepaid 98c. A. Condon, Importer, Stonington, Maine.

AGENTS—Would you take a steady job where you can clear \$20 to \$30 weekly and work up to yearly profits of \$3,000 or more. My line is snappy household goods. Quick sellers. Get busy with postal asking particulars. E. M. Davis, B17 Davis Bk., Chicago.

BIG Seller, Side line or agents. Johnston, Newport, R. I.

WANTED immediately agents to sell our high grade rebuilt typewriters, also ribbons and carbons; over 100% profit. Send for large illustrated catalogue and special agents offer. Harlem Typewriter Exchange, Agency Dept. 215 West 125th St., New York City.

KEY Checks—\$1.45 per 100. Dies for stamping names on checks, fobs, umbrella plates. Wholesale prices—Collar clips, sewing awls, etc. We show you how to make \$5 per day. Pease Die Works, Dept. M., Winchester, N. H.

MAKE \$21 next Saturday. Sell startling new invention—just out. Combination Burner and Filler for all Coal Oil Lamps. Unbreakable steel mantle. Big white powerful light. No smoke or smell. Fills Lamps quick. No dirty hands—no slopping oil. Low in price—selling like wildfire. Agents coining money. Johnson, Fla., cleared \$40 first week. Hess, Iowa, made \$7 one day. Exclusive territory and protection free. Not sold in stores. Send no money but write quick for details. Fairchild Co., 512 Nasby Bldg., Toledo, Ohio.

AGENTS—My Twelve "Money-makers" bring repeat orders. Easy selling plans. Big profits. A. Rolfe, 923 N. Alder, Philadelphia, Pa.

SELLING our exclusive linen heel and toe guaranteed hosiery direct from mill to wearer. Pays big profits. Customers waiting. Re-orders insure permanent, increasing income. Exclusive territory. Credit. N. Parker Mills, 720 Chestnut St., Phila., Pa.

AGENTS—County and State; men and women everywhere to sell the Pinless Clothes Line; a practical labor saving invention. Lasts life-time, sells on sight, gives perfect satisfaction. Agent Sutton of Georgia, sold over million feet; 100% profit; write quick for exclusive territory; information free; sample prepaid 25c stamps. Pinless Clothes Line Company, 520 Wilcox Bldg., Portland, Oregon.

AGENTS. One cent invested in a postal card will bring you a \$35.00 to \$60.00 a week proposition. Sterling Aluminum Co., Canal Station, Chicago, Ill.

AGENTS—\$50 weekly; we manufacture the best needle case made, a wonderful seller; 200 to 500 per cent profit; talking unnecessary; our copyrighted "Trust Scheme" Envelopes do the work; general agents can make over \$100 weekly; send 10c for a 25c sample containing 115 needles; particulars free; buy direct from the factory at wholesale. Patsy Needle Co., 102 Union Sq., Somerville, Mass.

BOKARA Diamonds—Agents, everyone, to wear and sell our famous Bokara Diamonds. Write for sample offer and catalogue free. Northwestern Jewelry Co., 52 Northwestern Bldg., Chicago.

WHERE did your money go? Find out. Begin any time with our Daily Expense Record. It will keep you posted and reduce expenses. A very interesting and complete book—50c. Agents wanted. Auburn Supply Co., Dept. HH, 7746 Peoria St., Chicago.

AGENTS: Earn \$5 and \$10 daily. Sell an entirely new line of Air Brush Design Show Cards, Price Tickets and other novelties. 350 varieties, Every Merchant buys. Catalogue free. L. D. Thompson Co., 3159 La Salle St., Chicago.

AGENTS—250% profit. Wonderful little article. Sells like wildfire. Can be carried in pocket. Write at once for free sample. H. Mathews, 1962 Third St., Dayton, Ohio.

AGENTS—\$5 daily selling our Handy Tool, 12 articles in one. Lightning seller. Sample free. Thomas Mfg. Company, 462 Third St., Dayton, Ohio.

SAMPLE Free—Boyer's Automatic Re-Finisher for Furniture, Store, Bank and office Fixtures—Finest thing in the World. One application lasts a year. Applied with cheese cloth. Boyer Chemical Laboratory Co., State and Michigan Sts., Chicago.

WE manufacture glass paper; plain glass windows made to look like real stained glass; something new; easily applied; big money maker; 2 sample sheets, catalogue in colors, with discount for 10c. Parrish Co., Lakeside Bldg., Chicago.

CHANDELIER Clothes Dryer—Pulls up to ceiling on porch or in house. Clothes out of way. Holds good size washing or ironing; weighs three pounds; sent prepaid, \$1.50. Every home will buy one. Agents wanted. Auburn Supply Co., Dept. DD, 7746 Peoria St., Chicago.

SALESPeOPLE everywhere will wish to find out why agents of the "Ever Ready" Specialties are doing better than others. A postal will bring all particulars. A. Lowell Mfg. Co., 108 Fulton St., New York City.

WE furnish you capital to run profitable business of your own. Become our local representative and sell high grade custom made shirts, also guaranteed sweaters, underwear, hosiery and neckties, direct to homes. Write, Steadfast Mills, Dept. 10, Cohoes, N. Y.

AGENTS—Earn \$25 to \$40 per week selling Nodarn Guaranteed Hosiery. Sales are simply doubled with our New Plan. 2 pr. guaranteed 2 mo., 3 pr. 3 mo., 4 pr. 4 mo., 6 pr. 6 mo. Spring Samples Free. Nodarn Hosiery Mills, Desk I, Dayton, O.

AGENTS Wanted—Mechanics and shopmen make over \$100 a month in spare time selling transparent handled novelty knives and razors. Big profits. Sales easily made. Write for terms today. Novelty Cutlery Co., 67 Bar St., Canton, O.

YOU can make \$\$\$\$ as our general or local agent. Household necessity; saves 80 per cent; permanent business; exclusive territory; salary or commission; free sample; credit. J. Pitkin, 113 Redd St., Newark, N. Y.

STOP Here! Let me start you in a home business that will bring you money every day. Experience unnecessary. Spare time. No canvassing. I furnish everything and guarantee success. Send for proofs. Voorhies, Desk C. R., Omaha, Neb.

AGENTS—Handkerchiefs, dress goods. Carleton made \$8 one afternoon; Mrs. Bosworth, \$25 in two days. Free samples. Credit. Stamp brings particulars. Freeport Mfg. Company, 59 Main St., Brooklyn, N. Y.

AGENTS—Portraits 35c. Frames 15c. Sheet Pictures 1c. Stereoscopes 25c. Views 1c. 30 days' credit. Samples and catalog free. Consolidated Portrait Co., Dept. 1196, 1027 W. Adams St., Chicago.

AGENTS—Our Columbia Folding Hand Bag is the best proposition on the market. Not sold in stores. Big profit. Write for terms and other big sellers. S. V. Diamond, 35 West 21st St., N. Y. C.

I WILL start you earning \$4 daily at home in spare time, silvering mirrors; no capital; send for free instructive booklet, giving plans of operation. G. F. Redmond, Dept. 306, Boston, Mass.

AGENTS—Ask us about our snappy household specialty line which will clear you \$50 to \$80 weekly. American Aluminum Co., Div. 7, Lemont, Ill.

DON'T fail to read Independence and Fortune under Business Opportunities.

AGENTS—Ladies or gentlemen, to sell the highest grade toilet goods, flavoring, etc., direct to families. High class house; fair dealing; repeat orders sure; large cash commissions. Address Kingham Bros., Indianapolis, Ind.

PERFECTION Pocket Adding Machine. Lightning seller. Agents wanted. Cincinnati Specialty Mfg. Co., Dept. R, Cincinnati, Ohio.

AGENTS wanted for Oriental novelties, never before seen in America. Quick sellers. Repeaters. Immense profits. Shaw Kanematz, Box 529, Portland, Oregon.

1500% PROFIT selling our Gold Sign Letters. We'll show you how. Sample free. Johnston Co., Quincy, Ill.

DUPLICATORS AND DEVICES

THE Modern Duplicator, made without glue or gelatine, is the World's Standard. Fifty to seventy-five exact duplicate copies can be made from each one you write or draw with pen, pencil or typewriter. \$2.40 to \$6.00 according to size. Booklet Free. Dufbeen, Reeves & Co., Mfgs., 339 Fifth Ave., Pittsburg, Pa.

HOW to get a Hektograph that will make 150 copies in 10 minutes; letter size, \$2. Write for circular. Heyer Duplicator Co., 118 No. La Salle St., Chicago.

COLLECTIONS

COLLECTIONS—Bad debts collected everywhere. No collection, no charge. American, Vancouver Mercantile Agency, 336 Hastings St. West, Vancouver, B. C.

ACCOUNTS collected anywhere; strictly commission basis; weekly reports. Benson, Menomonie, Wis.

CLAIMS; all kinds, collected anywhere. Fidelity Credit Co., Richmond, Va.

HELP WANTED

A MONEY Proposition. Do you want to own a mail order business—be independent—your own boss? Would you manage an Agency for me in your vicinity or elsewhere? All printed matter furnished for one-half the profits. Write for particulars. Hazen A. Horton, Desk 617, Tekonsha, Mich.

MEN and Women Wanted for Government Parcel Post and other Government positions. \$90 month. Annual vacations Short hours. Thousands of appointments coming. "Pull" unnecessary. Farmers eligible. Write immediately for free list of positions open. Franklin Institute, Dept. M-21, Rochester, N. Y.

WANTED Salesmen—Earn \$250 per month, sell advertised goods. Best contract on earth. Elato Co., Station L, New York, N. Y.

U. S. GOVERNMENT needs Railway Mail Clerks immediately to handle Parcel Post, \$90 month. Examinations everywhere May 3rd. Common education sufficient. Write for list of positions open. Franklin Institute, Dept. M-21, Rochester, N. Y.

CASH for information, names, formulas, and ideas. Steady, profitable home business. Instructive booklet for stamp. Information System, 294, Marietta, Ohio.

PARCEL Post means thousands Government Positions open to men and women \$75 month. Railway Mail Clerk examinations everywhere May 3rd. Write for list positions open. Franklin Institute, Dept. M-21, Rochester, N. Y.

MAKE money writing short stories. Big pay. Free booklet tells how. United Press Syndicate, San Francisco.

MEN and Women Wanted for Government Parcel Post positions. \$90 month. Write for vacancy list. Franklin Institute, Dept. M-21, Rochester, N. Y.

WANTED—People to go on the road as traveling advertisers. P. Breeden, Box 938, Norfolk, Va.

WANTED—Railway Mail Clerks, \$90 month. Examinations everywhere May 3rd. Write for vacancy list. Franklin Institute, Dept. M-21, Rochester, N. Y.

BE A detective—Earn \$150 to \$300 per month; travel over world. Stamp for particulars. National Detective Agency, Dept. S-1, Chicago.

3,500 GOVERNMENT Jobs Open. Write for list. Franklin Institute, Dept. M-21, Rochester, N. Y.

RAILWAY Mail Clerks wanted. Examinations everywhere May 3rd. Sample questions free. Franklin Institute, Dept. M-21, Rochester, N. Y.

BIG money writing songs.—We pay hundreds of dollars a year to successful writers. Experience unnecessary. Song poems wanted with or without music—will pay one-half of profits if successful. Send us your work today. Acceptance guaranteed if available. Largest concern in the country. Free particulars. Dugdale Co., Dept. 265, Washington, D. C.

FREE illustrated book tells of about 300,000 protected positions in U. S. service. Thousands of vacancies every year. There is a big chance here for you, sure and generous pay, lifetime employment. Just ask for booklet S-29. No obligation. Earl Hopkins, Washington, D. C.

WANTED—Hustling man, every town, and country community. Who wants to get ahead, learn, and earn more. Fine chance. Write quick for full particulars. Box A6-293, Covington, Ky.

SALESMEN calling on Railroad and other Machine Shops, Boiler Works, Garages, etc. are invited to communicate with The A. M. Co., 1429, 26 W. Baltimore St., Baltimore, Md.

BIG profits—Open a dyeing and cleaning establishment, little capital needed. We teach by mail. Write for booklet. Ben-Vonde System, Dept. C., Charlotte, N. C.

AGENTS make big money and become sales managers for our goods. Fast office sellers. Fine profits. Particulars and samples free. One Dip Pen Company, Dept. 2, Baltimore, Md.

WRITE Moving Picture Plays; \$10 to \$100 each; all or spare time. Experience or correspondence course unnecessary. Details free. Atlas Publishing Co., 3045, Cincinnati, O.

BE A Detective; Big pay. Easy, pleasant work. Traveling everywhere. Write National Detective Agency, Department 2, Houseman Block, Grand Rapids, Mich.

LOCOMOTIVE Firemen and Brakemen for all Railroads. Wages, \$80 to over \$100 monthly. Promotion, engineer, conductor. Age 18-35, experience unnecessary. No strike. Rushing business—many hundred men employed monthly. State age; send stamp. Railway Association, Dept. 89, 227 Montoe Street, Brooklyn, N. Y.

INTELLIGENT persons can earn good income at home in spare time copying letters. Fine opportunity, experience unnecessary. Stamp brings particulars. Box 17, Station H. G., New York.

SONG poems wanted—Send us your song poems or melodies. They may become big hits and bring thousands of dollars. Past experience unnecessary. Available work accepted for publication. Instructive booklet and information free. Marks-Goldsmith Co., Dept. 18, Washington, D. C.

REPORT local information, names, etc., to us. Big pay. Enclose stamp. National Information Sales Co., AQB, Cincinnati, O.

DRAW Cartoons. See Hamilton School ad under "Education and Instruction."

ANY intelligent person may earn steady income corresponding for newspapers. Experience unnecessary. Address Press Correspondence Bureau, Washington, D. C.

DETECTIVES, men and women, earn from \$250.00 to \$500.00 per month. Write for particulars. Interstate Detective School, Peoria, Ill., Suite 11.

WANT a better job? Our book shows how to find best openings any line, 25c; circular free. Southern Jobbing Co., Gunter Building, San Antonio, Texas.

MEN—Earn \$100 to \$150 monthly investigating; chance to see the world with all expenses paid; write, Loraine System, Dept. 304, Boston, Mass.

WANTED—Distributors of advertising matter everywhere. American Distributor, Blairsville, Pennsylvania.

SALESMEN—Two for each state; oils, paints. Signet Oil Company, Cleveland, Ohio.

SONG poems wanted. New plan. Big money. Past experience unnecessary. Send poems or melodies. Free book and advice. Hayworth Music Co., 660 G, Washington, D. C.

WANTED: First Class Electrical Instrument Makers for our Experimental Department. Address, Employment Department, Westinghouse Electric & Mfg. Company, East Pittsburgh, Pa.

WANTED—Automatic Screw Machine Operators, Hand Screw Machine Operators, and Electrical Instrument Makers. Apply at the Employment Department, Westinghouse Electric & Mfg. Co., East Pittsburgh, Pa.

WANTED—Distributors, men or women, to give away free packages our famous Perfumed Borax Soap Powder; no money or experience needed; good pay. Ward & Co., 1775 Berceau Ave., Chicago.

WANTED, Machinists, Agents, double your salary! Saunders' Hand Book Practical Mechanics; lightning reference. Thousands used. \$1.00, \$1.25, \$1.50. Circular sent. E. H. Saunders, 216 Purchase St., Boston, Mass.

BE A Detective. Earn \$200 monthly, positions open. A practical course in Detective Work taught by mail. American School of Criminology, Detroit, Michigan. Dept. F.

EARN \$10 to \$15 a week, and hold your position besides. No canvassing. We, as manufacturers of patented just-in-season specialties, have new easy mail order plans to keep factories busy. We furnish everything. Large profits. Small capital. Experience unnecessary. If you are one of the want-to-go-ahead kind, write for our most modern (copyrighted) plans. Sworn Statement. J. M. Pease Mfg. Co., 540 Pease Bldg., Main St., Buffalo, N. Y.

GOVERNMENT Examinations. Most thorough preparation; \$5; returned if not appointed; particulars free. American Civil Service School, Washington, D. C.

WANTED one thousand chauffeurs and repair men. Our demand for automobile engineers exceeds the supply. Calls for men of intelligence and mechanical bent capable of commanding \$100 to \$150 per month upon graduation. Resident course \$20 to \$60. Home Correspondence course completed by practical road and shop work at this school, highly successful. Look this up. Auto Schools of America. Dept. T, 1600 Michigan Ave., Chicago.

STOP Here! Let me start you in a home business that will bring you money every day. Experience unnecessary. Spare time. No canvassing. I furnish everything and guarantee success. Send for proofs. Voorhies, Desk C. R., Omaha, Neb.

GO on the Stage. Vaudeville career offered you. Experience unnecessary. Managers endorse my method. Instructive vaudeville book free. Write today. Frederic LaDelle, Sta. 10, Jackson, Mich.

I WILL start you earning \$4 daily at home in spare time, silvering mirrors; no capital; send for free instructive booklet, giving plans of operations. G. F. Redmond, Dept. 306, Boston, Mass.

DON'T fail to read Independence and Fortune under Business Opportunities.

MEN and boys to learn automobile repairing, driving on up-to-date cars; electricity, civil engineering, surveying. Methods most practical. Room and board while learning. Positions secured; satisfaction guaranteed; catalog free. National School of Engineering, 2110 W. 7th, Los Angeles.

SITUATIONS WANTED

MAN of 32 wants work in boiler room to learn firing. Write E. C. W., Box 65, Roundup, Mont.

MACHINERY, TOOLS AND SUPPLIES

DYNAMO—10 kw. Belted to Gasoline Engine. 400-25 Watt Tungsten Lamps. Makes complete Picture Show outfit. Dynamos, motors, engines, boilers of all kinds. Harold R. Wilson Machinery Co., St. Louis, Missouri.

2 CYL. 7 hp. and 12 hp. marine engines, completely equipped, \$125. Stationary, \$150. Brand new, genuine bargains. F. E. Alford, Goshen, Ind.

VACUUM cleaner parts for stationary plants or wagons. Vacuum Supply Co., Ann Arbor, Mich.

FOR Sale cheap—Lazier gasoline engine 25 h. p. First class condition. J. F. McGurk, Shortsville, N. Y.

1000 NEW Lathe chucks, \$10 to \$20 each, all sizes. Lucas & Son, Bridgeport, Conn.

PULLEYS, Gears, Sprockets, Shafting, Hangers; see page 150. W. A. Jones Foundry & Machine Co., Chicago.

CAMPBELL Tool fits any 1" wide rule. Something every carpenter should have. Postpaid on receipt of 25c. Montgomery & Co., 105 Fulton St., N. Y.

ENGINE Lathe, swings 9 1/2", takes 25" between centers. Complete set gears cutting all size threads 3" to 40", \$43.50. Grammes & Sons, Allentown, Pa.

SHAPERS—Hand or Power, will plane 4"x4"x4". Weight 75 pounds. Price with vise \$55. Montgomery & Co., 105 Fulton St., N. Y.

FOR Sale, Lathes, Screw Cutting, S. B. Machine Tool Co., South Bend, Ind.

PULLEYS, Hangers, Gears, Sprockets, Small sizes for models. Montgomery & Co., 105 Fulton St., N. Y.

SEND 50c for booklet "How to Run and Install Gasoline Engines," and year's subscription to Gas Energy. 28 Murray St., New York.

FOR Sale—Gasoline engines, automobiles, marine and stationary, also castings. Second-hand ones taken in exchange and for sale. Apply with stamps. B. W. Richardson, R. No. 36, Peoria, Ill.

REBUILT Engines—We have on hand a number of rebuilt "Buffalo" engines, guaranteed, at greatly reduced prices. Write for bargain list. Buffalo Gasoline Motor Co., 1293-1305 Niagara Street, Buffalo, N. Y.

THE latest improvement in Test Indicator, every machinist and toolmaker should send for booklet. C. E. Robinson Co., 96 West River St., Orange, Mass.

FLOUR AND FEED MILLING MACHINERY

SPECIAL bargains in second-hand: Attrition mills, burr mills, crushers, corn shellers, bran dusters, dust collectors, purifiers, reels, double, single, 2 and 3-pair high roller mills, sieve bolters, receiving separators, scourers, etc. Write for description and prices. Sprout, Waldron & Co., P. O. Box 429, Muncy, Pa.

MANUFACTURING MACHINERY

GENERAL Machinist, Designers, Electricians, Pattern Tool Model & Machine Builders, Automatic Devices and Machinery developed and perfected. Scientific and experimental work a specialty. Regal Model & Tool Works, Chicago's Foremost Model Works, 122-128 So. Clark St., Chicago.

MODELS made for inventors. Low prices. W. H. Gall, 635 Thomas St., Grand Rapids, Mich.

WE manufacture anything, can furnish patterns, of brass or wood. Castings in brass or cast iron and aluminum. Our shop is equipped with heavy engine lathes, drill presses, new milling machines, (universal). Quotation furnished without cost to you. Write. Practical Gas Engine and Machine Works, North Chicago, Ill.

WE make all kinds of pattern work, mail your blue prints for bids. We are prompt and reasonable. Covington Cycle Works, Covington, Ky.

WANTED, medium weight machinery to manufacture on contract. Special machinery built, pattern work. J. T. Schaffer Mfg. Co., Rochester, N. Y.

PRESS—stamping work reasonable. Dies and models made. We'll manufacture your novelty, or invention, to order. The Monarch, Boone, Iowa.

PUNCH Press Tools, Jigs and Fixtures made accurately and promptly. McCall Machine Works, Rochester, N. Y.

IRON brass and aluminum castings. Metal specialties. Patterns, models, polishing, plating and japanning. Send for catalogue of pattern shop and model supplies. North Chicago Tool Works, 13 Grove Ave., North Chicago, Ill.

INVENTORS. We manufacture Metal Specialties of all kinds to order; largest equipment; lowest prices. Send perfect sample for low estimate and best expert advice free. The Eagle Mfg. Co., Dept. B, Cincinnati, O.

ENGINE CASTINGS AND BLUE PRINTS

BLUE—prints and Specifications to build tractor from blinder parts, using stationary gasoline engine. Value guaranteed. The Empire Garage, Lewistown, Mont.

"1" CARBURETOR Castings with float and four blue prints, \$1.95. Blue prints only 25c. F. J. L., 300 Ocean Ave., New London, Conn.

CASTINGS and working drawings for 1 1/2 horse, gasoline motor. Descriptive literature on request. Soleum Company, 195 Blake Street, Westville, Conn.

BLUE prints for making screw cutting lathe easily and cheaply made. Fifty cents prepaid. Al Waychoff, Lyons, Colo.

GASOLINE Engine Castings, with drawings. Cheap. Catalog for stamp. Novelty Manufacturing Co., 853 West 6th St., Cincinnati, Ohio.

MECHANICAL ENGINEERS

SPECIAL machinery and labor-saving devices designed and built. Ideas developed and inventions perfected. Send drawing or description for estimate. G. Lange, Designing Engineer, 95 Washington St., (Opp. City Hall), Hoboken, N. J.

MACHINE design and building our specialty, Edison A. Lynn, Mechanical Engineer, Holyoke, Mass.

MACHINE designing, working drawings, experimental machinery. Cary L. Abbott, Mechanical Department, 1241 Unity Bldg., Chicago.

CEMENT

CEMENT colors for cement blocks, etc. Send for samples and prices. Haverstick & Co., Trenton, N. J.

CONCRETE Molds, catalogue free. 5 Market St., St. Louis, Mo.

IF you want the best information on cement and concrete construction, subscribe for Concrete-Cement Age, leading cement and concrete monthly. Sample copy, 10 cents. Yearly subscription, \$1.50. Concrete-Cement Age, 135 Newberry Bldg., Detroit, Mich.

BOATS AND LAUNCHES

"PATTERNS for Metal Boats." We sell patterns for metal boats, less than half the labor to build than a wood boat. Also our "Shoal Eater" Propeller Boat, which runs in 5 in. of water. Ask for Catalogue "K." Harbour Metal Boat Co., East St. Louis, Ill.

FOR SALE

CANNED Goods Wholesale. World renowned New Jersey fruits and vegetables. Tomatoes—Lima Beans—Spinach—Pumpkin—Corn—Pears—Strawberries—Blackberries, etc. Write for price per case—24 tins per case. Eastern Trading Co., Trenton, N. J.

SPORTSMEN! Hunters! Union Repeater, like new \$12. We sell or trade new and used guns. Liberal allowances made for old ones. List of gun bargains free. Toledo Gun Exchange, Dep't "C," Toledo, O.

6" COIL (Queen Co.) worth \$75. Sell best offer. A. Dunten, Beaver Dam, Wis.

ELGIN Watches—\$2 a month. Why not buy your Elgin watch now while you can get it at a special price and on such easy monthly payments that you'll never miss the money? This month we will sell you a \$20 17 jewel Elgin in 25 year gold case for \$16.50 or a fine \$30 17 jewel Elgin in 25 year gold case for only \$19.75, no money down, sent subject to your approval. Write for free catalog. We are the largest watch house in America and trust honest people everywhere. Harris-Goar Co., Dept. 781, Kansas City, Mo.

FOR Sale—Several hundred new Fireless Cookers, redwood case, galvanized iron covered, aluminum cooking vessels, sanitary metal pads, two and three compartment sizes. Have discontinued manufacturing cookers and will close out at great sacrifice, prefer to sell entire lot to party in shape market, get prices and particulars, M. M. Johnson Co., Clay Center, Neb.

VACUUM cleaner parts, hose and pumps for stationary plants or wagons. Vacuum Supply Co., Ann Arbor, Mich.

POPULAR priced stationary vacuum cleaners at wholesale. Koch Vacuum Machine Co., Troy, Ohio.

FOR Sale—Moose, Elk, Deer Heads, Fine specimens. R. Saylor, 497 So. Broadway, Dayton, Ohio.

ICELESS Soda Fountain and outfit used one season. Dysingers, Albion, Mich.

FOR Sale or Exchange—New Victor power vacuum cleaner. Box 25, Grand Forks, N. D.

FOR Sale—Good paying general repair shop. Lock Box 44, Morrison, Illinois.

EMPIRE Candy Floss Machine; also International Correspondence School Complete Commercial Course. Henry Liebo, Peru, Ind.

WANTED

WANTED—An original novelty for stage exhibition. Address A. O. Duncan, 49 West 28th St., New York City.

SALE OR EXCHANGE

SALESMANSHIP Course of famous Sheldon School; Dickson Memory School course for anything can use. Herbert Shaw, Pleasureville, Kentucky.

DIAMONDS, WATCHES, JEWELRY

GENUINE Perfect Cut Diamonds can now be bought direct from 34-year-established Importer at these world's lowest prices: 1/4 carat, \$8.25; 1/2 carat, \$17.50; 3/4 carat, \$45.00; 1 carat, \$67.50; 1 carat and larger, \$97.50 per carat. We guarantee the carat weight, quality and value of every diamond, legally in writing. We contract to refund your money; to accept any diamond we sell at the full purchase price in exchange at any time. We ship C. O. D. on approval by express or to your bank, at our expense, without obligating you to buy. No deposit required. Write for 104 page illustrated Basch Diamond Book, Free! It tells you how to buy diamonds intelligently, and at 40% below prevailing prices. See our display ad on page 143. Address, L. Basch & Co., Dept. A. 240, S. State St., Chicago, Ill.

\$25.00 **DIAMOND** Tiffany engagement ring \$1 weekly. Wedding rings, 14K and 18K, \$5 up. Catalog. Metropolitan Jewelry Co., 129 West 125th St., New York City.

PATENT ATTORNEYS

FIND out for yourself what to invent and how to procure and sell a patent for the same. My book, "Inventor's Universal Educator," covers the matter from A to Z. 140 pages, elegantly bound. Also contains 600 mechanical movements and 50 perpetual motions. Price \$1.00, postage free. Money returned if not more than satisfactory. F. G. Dieterich, 651 Ouray Bldg., Washington, D. C.

"PATENTS and Patent Possibilities" is a 72-page treatise which tells all about patents, what to invent and where to sell it. It gives honest advice to inventors, and is full of valuable and interesting information. Write for it today! It is free. H. S. Hill, 905 McLachlen Bldg., Washington, D. C.

PATENTS of value. Prompt and efficient service. No misleading inducements. Expert in Mechanics. Book of Advice and Patent Office Rules free. Clements & Clements, Patent Attorneys, 704 Colorado Bldg., Washington, D. C.

PATENT what you invent. It may be valuable. Write me. No attorney's fee until patent is allowed. Estab. 1882. "Inventor's Guide" free. Franklin H. Hough, 522 Loan & Trust Bldg., Washington, D. C.

PATENTS Explained in my free books telling what you should know—what to invent—what not to invent—how to sell your patent, etc. Write today. H. L. Woodward, 902 G Street, Washington, D. C.

THE Patentome is interesting and instructive. A liberal education in patents and how to get them. Free on request. Established 1865. Anderson and Son, Patent Solicitors, 707 G St., Washington, D. C.

PATENT your invention. First get free "Inventor's Primer" with statistical data. Milo B. Stevens & Co., Estab. 1864, 685 F St., Wash.; 353 Monadnock Bldg., Chicago.

SEND for free booklet. All about patents and their cost. Shepherd & Campbell, Patent Attorneys, 500A Victor Bldg., Washington, D. C.

PATENTS—Herbert Jenner, patent attorney and mechanical expert, 606 F St., Washington, D. C. I report free of charge if a patent can be had and its exact cost. Send for circular.

WESTERNERS "boost" the West. Patronize Western attorneys, 17 years' experience. Several years in Washington. Stephen Glusta, Cooper Building, Denver, Colorado.

PATENT your ideas and make money. Free book. Williamson and Williamson, 1325P Arch Street, Philadelphia, Pa.

PATENTABLE ideas wanted—Send for 3 free books. R. B. Owen, 30 Owen Bldg., Wash., D. C.

INVENTORS' Guide Free. Tells all. Send sketch for free opinion. Long experience. Patent sales furthered. Inventors assisted. Write today. Wm. N. Moore & Co., 504 L & T Bldg., Washington, D. C.

PATENTS and Trade-Marks. My booklet "How to Save Money" sent free on request. Absolute protection guaranteed and confidential service rendered. Lester L. Sargent, Patent Lawyer, Dept. 20, 718 12th Street, Washington, D. C.

PATENT Your Good Ideas. A decade of experience ready to serve you. Trade-marks registered. Write today for particulars. George A. Hutchinson, 730 Loan and Trust Building, Washington, D. C.

PATENT secured or Fee returned. Send sketch for Free Expert Search and Report as to patentability. Books on inventions and patents, and reference book, sent free. John S. Duffie & Co., Dept. 1, Washington, District of Columbia.

PATENT Books Mailed Free—showing 100 mechanical movements invaluable to inventors and mechanics—and telling what is patentable, how to obtain patent or partner, how to sell, etc. Free on request. Chas. E. Brock, 701 Eighth St., Washington, District of Columbia.

C. L. PARKER, Ex-member Examining Corps Patent Office, Patent Attorney, 910 G St., Washington, D. C. Inventor's handbook "Protecting, Exploiting and Selling Inventions," sent free upon request.

PATENTS and trade-marks secured. Write for terms. Harry Patton, 390 McGill Bldg., Washington, D. C.

ON patents, consult Benjamin Roman, Park Row Building, New York.

PATENTS that protect and pay. Advice and books free. Rates reasonable—highest references; best results. Watson E. Coleman, Patent Lawyer, 622 F St., N. W., Washington, D. C.

PATENTS, electrical and mechanical a specialty. Book Free. Joshua R. H. Potts, Patent Lawyer, 8 Dearborn St., Chicago; 805 G St., Washington; 929 Chestnut St., Philadelphia.

PATENTS

PATENTS Sold. We do the business—not merely collecting advance fees. If you own a valuable patent send for a free booklet. "How we can get cash for Your Invention." No charges made for listing. Patent Advertising & Sales Co., Frankford, Phila.

PATENT Folly. Few inventions make money. Why? Get interesting story. "My First Invention." Henry C. Thomson, "Invention Adviser," 25 years' practical experience as inventor and manufacturer patented devices. Not a patent lawyer. May advise against patenting. P. O. Box 3547, Boston, Mass.

PATENTABLE ideas wanted—Send for 3 free books. Richard B. Owen, 30 Owen Bldg., Washington, D. C.

INVENTORS: My patents made a fortune. Particulars free. Let me sell yours. Eugene Pearl, 123 Union Square, New York.

YOUR invention may be worth thousands. Its worth to you is governed by the strength of the Patent. For 39 years our firm has been in business. You get the advantage of our extensive knowledge and ripe experience when we procure your patent. Clients in your state. Write today. Louis Bagger & Co., 609 Barrister Building, Washington, D. C.

PATENTS obtained by competent and reliable attorney. Personal services. Fees reasonable. Consultation Free. Alan Franklin, Room 2008—165 Broadway, N. Y.

PATENTS without advance attorney's fees. Send sketch for free report. Books free. Fuller & Fuller, Washington, D. C.

PATENTS FOR SALE

SODA Fountain Mixer. German, French, Belgium, etc., rights, \$2,500 each. Other inventions. Write for specifications. J. Frank Diggins, Box 11, Petersburg, Tenn.

PATENT Devices for holding and dispensing beverages. Being barrel, tank or other receptacle or container. Write Joseph Vergano, Santa Rosa, Cal.

A PATENTED Adjustable Pipe Union for sale. The Otis Machine Works, 191 Mill St., Rochester, N. Y.

NEW metal novelty, enormous demand. E. Work, 8343 Garesche, St. Louis.

PATENT 1,053,533. Butter Merger machine, merges equal quantity milk and butter. New process. Lucien Pratte, Waterbury, Conn.

NECKTIE Slide. Effective device. Preserves temper. Sekots Co., Lincoln, Illinois.

PATENT 888,348. Rotating Cultivator Fenders. Great improvement. Manufacturing begun. Patent and business \$1,500. Address A. B. Nichols, Hastings, Minn.

EXPANSIBLE Shoeholder, American and Canadian Patents for Sale. Sonntag's Patent Agency, Balboa Building, San Francisco, California.

BUY my safety and automatic elevator brake. Avoid law suits and save thousand lives annually. No. 1,040,734. Write owner for literature. E. J. Mounts, Box 559, Krum, Texas.

COMBINATION Trunk. Greatest ever invented, handy for travelers, can be used for writing desk, mirror, etc. Will sell or royalty. Information, Victor Paler, Harvey, Ill.

TELEGRAPHY

TELEGRAPHY—Morse and wireless—Railway accounting (Station Agency) taught quickly. Railroad Dispatchers' and Western Union Wires and complete Wireless Station in school. Splendid opportunities. Graduates assisted. Living expenses low—may be earned. Largest and oldest school—established 38 years. Investment, \$25,000. Correspondence courses also. Catalog free. Dodge's Telegraph, Railway and Wireless Institute, 15th St., Valparaiso, Ind.

TELEGRAPHY taught in the shortest possible time. The Omnigraph Automatic Transmitter combined with standard key and sounder. Sends you telegraph messages at any speed just as an expert operator would. Five styles, \$2 up, circular free. Omnigraph Mfg. Co., 41 G. Cortland St., New York.

REAL ESTATE AND FARM LANDS

GET Your Home in the Northwest United States. Locate adjacent to Northern Pacific Railway—the best developed sections of the Northwest—in Minnesota, North Dakota, Montana, Idaho, Washington, Oregon, the land of prize cattle and crops. Stay near home markets; quick transportation; close to good neighbors and good schools; no isolated pioneering. Free United States Government homestead land; state land on easy terms; deeded land at low prices and on crop payment plan. Write quick for free literature about these "prosperity States of America"—say what state most interests you. Ask about low fares. L. J. Bricker, Gen'l Immigration Agent, 256 Northern Pacific Bldg., Saint Paul, Minn.

WISCONSIN, the home of the dairy cow and red clover, rich soil, pure water, healthy, contented, sociable people. Send for descriptive booklet. Stoddard-Toftoy Company, Farm Department, Madison, Wis.

CO-OPERATIVE Colony locating here. Co-operators invited. Edward Miller, Crystal Springs, Fla.

TEXAS Land on 15 Years' Time. Farms in 40, 80 and 160-acre tracts, north of Houston, in the Famous Southeast Texas Coast Country, at \$30 to \$35 an acre, selling on terms of \$1.50 an acre cash and balance in payments, running fifteen years. Possession at once. Railroad through land; store, post-office and station. Fertile soil—produces money-making staple crops of corn, cotton, potatoes, peanuts, cane, as well as truck and fruit crops that net \$100 to \$300 an acre. Mild climate; two crops a year; splendid hog and cattle country; pure water, ample rainfall, no irrigation needed; good markets. Greatest opportunity ever offered the renter, young men, those who want more land, and investors, to get a real farm—not a truck patch. Sale just opened. Write today for free maps, plats and illustrated literature. C. L. Peirce, owner, 226 First Nat'l Bank Bldg., Houston, Texas.

BUY Land in Florida. Buy Health at Charlotte Harbor, and be happy. L. L. Barnhill, Charlotte Harbor, Fla.

SUBURBAN Homesites—\$1 Cash, balance easy payments, at Dalworth Park, Texas, suburb on Interurban, midway between Dallas and Ft. Worth, the fastest growing cities in the Great Southwest, only 32 miles apart. Millions going into new skyscrapers, hotels, factories in the two cities and population has trebled in twelve years; fortunes made here in suburban property. Early buyers will make enormous profits. Dalworth Park offers greatest opportunity, being on Interurban, which is to be double tracked, and on T. & P. railroad and Automobile Pike; \$100,000 already spent on water works, natural gas, street improvements, etc.; 43 trains daily; beautiful large homesites, only \$50 and up, in this special sale. \$1 makes first payment. Write today, before prices advance for Free Booklet, showing views, maps and all particulars. The Dalworth Company, 70 Stewart Title Bldg., Dallas, Texas.

OPENING Sale of Lots at League City Heights-On-The-Interurban, midway between Houston and Galveston. Interurban station on property. Large, beautiful suburban homesites—50x125 feet. League City has 1,000 population, 50 trains daily. Three steam railroads and Interurban. First lots only \$40 each. You can get choice location now. Payments \$2 cash and \$2 monthly. Buy now while price is low and values along Interurban line just beginning to make rapid increase. Suburban property near Houston is best investment in South. \$17,000,000 spent on new buildings in this city in two years. These lots will sell quickly. \$1 with inquiry, as part payment, reserves choice lot. Write at once for free maps, plats and illustrated literature. Address, Galveston-Houston Interurban Land Co., 940 Union Nat'l Bank Bldg., Houston, Texas.

\$5 MONTHLY Buys Suburban Farm. Fruit, truck or poultry farms near Suburban station, only 35 minutes from the city of Houston, near shell boulevard direct to city. Beautiful location; rich soil; plenty rainfall; fine climate; two and three crops a year of potatoes, tomatoes, cabbage and other vegetables, which net growers from \$100 to \$300 per acre; fine strawberry country, also in orange and fig belt. Cash market in the city for products. Only a few fine and ten acre farms at \$50 and \$55 an acre. No interest, no taxes. Five acres, \$5 cash and \$5 monthly; ten acres, \$10 cash and \$10 monthly. Write today for illustrated literature and all particulars. C. W. Hahl & Co., Owners, 801 Commercial Bank Bldg., Houston, Texas.

GO South and Prosper—The greatest opportunities in America are offered by Southeastern States. Fortunes are made from truck, fruit, poultry, cattle, dairying and general farming. Land values lowest in America. Climatic and living conditions ideal. Farm lists, the "Southern Field" magazine and all facts free. M. V. Richards, Land and Industrial Agent, Southern Railway, Room 64, Washington, D. C.

TEXAS—Gulf Coast Market Gardens Pay Big Profits. Wonderful fertility, ample rainfall, delightful climate, cheap lands (\$20 to \$50 acre), low taxes, good roads, schools. Cotton, corn, potatoes, yield high. Dairying and poultry raising make big returns. Gulf Coast folder free. R. Z. Kennedy, Colonization Agent, G. C. & S. F. Ry., Galveston, Tex.

IF we would give you a 40 acre farm free, along our line of railroad, would you be willing to tell your friends about our land opening? For particulars address Mr. J. B. Clark, Land Commissioner, Live Oak, Perry & Gulf Railroad Company, Box 158, Live Oak, Florida.

GOVERNMENT Farms Free. Our 112-page book "Vacant Government Lands" describes every acre in every county in U. S. How secured free. Latest diagrams and tables. All about Free Government Farms. Official 112-page book. Price, 25c postpaid. Webb Publishing Co. (Dept. 385) St. Paul, Minn.

FOR Sale—Farms improved or partly improved in Michigan's fruit and potato belt. Come, inspect; judge yourself. Harry Starr, Greenville, Mich.

FOR Sale in Oregon. Water Power Electric Plant. Forty foot fall. Five acres land in town of 1000 population. Good position for electrician. Some business property. Write for information. Box 2078, Portland, Oregon.

MONEY-making Farms—13 States, \$10 to \$50 an acre; live stock and tools often included to settle quickly. Big illustrated catalogue No. 36 free. E. A. Strout Farm Agency, Station 3043, 47 West 34th Street, New York.

FINE 2 flat building in Chicago; choice residence location; paying handsomely on investment; modern; rented; small first payment takes it, balance like rent. Sanders, 504 Crilly Building, Chicago.

200 ACRES \$800. \$100 cash, balance \$10 per month. Other Texas bargains. Land to trade for merchandise. Marvin Reinhardt, Barstow, Texas.

MYERS & Van Tassel Gulf Coast Earth Merchants Land, large or small tracts, garage best location. Write us. Alvin, Tex.

SOUTH Georgia farm, timber lands in Pecan, Sugarcane Belt. Floyd Frederick, Valdosta, Ga.

LANDOLOGY, a magazine giving the facts in regard to the land situation. Three months trial subscription, free. If for a home, or as an investment, you are thinking of buying good farm lands, simply write me a letter making it personal and say, "Mail me Landology and all particulars free." Address Lloyd M. Skinner, Gen'l Mgr., Skidmore Land Co., Box 303, Marinette, Wis.

CUSTOM Planting Mill, Farm Lands, W. L. Morse, Mancos, Colo.

U. S. FREE Homestead Lands. New Atlas (Copyrighted) Just issued in 4 colors, size 10x16, of the Rocky Mountain and National Forests, contains 6 colored maps—Colorado, Wyoming, Utah, New Mexico, Idaho, Montana. Tells about new U. S. 3-year Homestead Law, Carey Act, Desert Land Act, Mining Laws. Other valuable information, up-to-date. Worth \$1.00, for 50c postpaid. Atlas Dept., Denver Weekly Post, Denver, Colo.

BUY a farm any place on the continent of North America. We will give you the names of the owners free. American Investment Association, 37 Palace Bldg., Minneapolis, Minn.

GROW apples and grow rich in the glorious fruit district of Southern British Columbia. Our choice lands \$10 cash and \$10 monthly, without interest. Annual profits \$500 to \$1,000 per acre. Orchard, garden, poultry; scenery, hunting, fishing, boating; warm climate; school, postoffice, store; sawmill; daily trains; close to markets; unlimited demand for products. Write quick for maps, photos, free information. West Kootenay Fruit Lands Company, Dept. Z, Box 1087, Nelson, British Columbia.

TEXAS school land on market now; you can buy good land at \$2 per acre; pay 5c per acre cash and no more for 40 years, but 3 per cent interest on the balance. Send 6 cents postage for further information. Investor Publishing Co., Dept. 3, San Antonio, Tex.

SELL your property quickly for cash, no matter where located. Don't pay big commissions. Particulars free. Real Estate Salesman Co., Desk B, Lincoln, Neb.

DOGS, BIRDS, POULTRY, ETC.

SETTERS and Pointers, trained on Quail, Grouse and Chicken; Fox hounds, trained on Fox, Cat, Wolf, Deer and Rabbit; Coon hounds, trained on Coon, Bear, Skunk, O'possum and Squirrel. Shipped on trial. Also puppies, bitches in whelp and stud dogs. Fifty page illustrated catalogue five cents stamps. Blue Grass Farm Kennels, Berry, Kentucky.

WHITE Runner Ducks from prize birds \$10 pair, \$25-\$35. Trio eggs 75 cents and \$1, each guaranteed. Mrs. J. M. Underwood, Box 120, La Fayette, Georgia.

IRISH terriers. Best pal on earth. Dead game. Faithful to death. Coast Native Kennels, Tacoma, Wash.

BULLFROG Culture—Easy, tremendously profitable and something not overdone. We started 1909. Aqualife Corp., Seymour, Conn.

BARRED Rocks. Best in the South. You can win with my strain. Eggs \$5 per 15. H. H. Murray, Barred Rock Specialist, Newnan, Ga.

EGGS, Columbian Wyandottes, get our list. Collies from champions, cheap. S. D. Eckler, Ashtabula, O.

2,000 FERRETS—Prices and book mailed free. N. A. Knapp, Rochester, Ohio.

PIGEONS! Pigeons! Thousands, all breeds. Large free illustrated matter. Prov. Squab Co., Providence, R. I.

WHITE Wyandottes—Useful and beautiful—exemplify the highest achievement in the breeding of this variety. 15 eggs, \$5, 30, \$9. Trapped. Established 1892. Booklet. F. H. Wood, Cortland, N. Y.

12c PAYS for years subscription to Star Magazine—America's Premier Quarterly Farm, Poultry and Pet Stock Magazine. Levert Dolson, Hampton, Iowa.

SCOTCH Collie for sale. Trained. Charles Kesler, Dongola, Ill.

THE Ideal White—a new scientific squab pigeon—twenty ounce squabs in four weeks. phenomenal demand; booklet free. Ausdale Squab Farm, Mansfield, Ohio.

WHITE Orpington Eggs, \$3 per 15. Wm. Buslap, 3731 Columbia St., Chicago.

AIREDALES—All ages, best breeding, watch dogs, hunters, collies, puppies, grown dogs. State wants. Phil Savage, St. Charles, Ill.

FORMULAS

3,000 FORMULAS, Recipes and Money-Making Secrets, 368 page cloth bound volume, 50c prepaid. Profitable Service Bureau, 4333 N. Sawyer Ave., Chicago.

FORMULAS and Recipes. The latest and most practical. Have just what you want for the household, toilet, medicinal and workshop. 20 cents each, or three for 50 cents. Satisfaction guaranteed. H. A. Dessar, Nyack, New York.

BOOK filled with hundreds of valuable Formulas, 20c. Resilvering Mirror Formula, best ever originated, 20c. Both for 30c. Profitable service Bureau, 4333 N. Sawyer Ave. (Dept. 4), Chicago, Ill.

NEW Formulas and New Plan for making Big Money. Simple to put up, easy to operate with small capital. All mailed for only ten cents. Commercial Chemists, 731 Williamson Building, Cleveland, O.

FORMULA for making heavy nickel on brass. Price 25 cts. Lowell Grieces, Lacon, Ill.

FORMULA for carpet cleaning soap. Send 4 cts. for sample. J. P. Clifton, 393 Fargo Ave., Buffalo, N. Y.

GREATEST yet—1,000 formulas, 20c. Johnson & Co., Phoenix, Ariz.

ELECTRICIANS, engineers, mechanics. Here is your chance. 4 standard articles you can make in your spare time will increase your incomes. Self-fluxing solder, Black Diamond commutator compound, soldering stick, soldering paste, 4 formulas. \$1. Guaranteed. Box 237, La Salle, New York.

FORMULA. How to make tough and resilient composition, for making printing rollers, for summer and winter use. 50 cts. Geo. L. Silver, 11 Isabella St., Ogdensburg, N. Y.

FORMULAS for anything. Write for particulars. E. J. Wilver, 101 N. Main St., Phillipstung, N. J.

FORMULAS and instructions for manufacturing six big sellers sent complete for 10c. Ross, 310 1/2 East 15th St., Kansas City, Mo.

BARGAIN—Book containing 3,000 tried formulas and recipes for only \$2. A gold mine. E. F. Kuhn, Dunlap, Ill.

I HAVE a valuable formula for manufacturing fire proof paint. No machinery required. 20c gallon any quantity. Hard, durable finish; satisfaction guaranteed, money refunded. 25c. Box 237, La Salle, New York.

FORMULAS—3,000 Formulas and Digest, publishing 100 formulas, etc., monthly. One year, 50c; or silvering mirrors formula (has been sold for \$1.00 by others) and Digest one year, 25c; or 200 formulas, money making ideas, etc., and Digest one year, 25c. Digest, Grand Rapids, Mich.

A LONG felt want. How to make powdered solder, no machinery, process 25c. Box 237, La Salle, N. Y.

FOR MEN

SAFETY Razor Blades (any make) sharpened better than new (latest improved No. 14 Odell electric power machines). Each blade hair tested. New edge or no charge. Single edge, 25c dozen; double edge, 35c dozen. Send postal for mailing envelope and circular, or mail blades today, enclosing money or stamps. Blades returned promptly postpaid. Vest pocket blade holder free. Copeland & Co., 76 Dorrance St., Providence, R. I.

GENTLEMEN who love clean society: Adopt Felvoort for your Croun. Forsake the untidy tobacco habit. Use Felvoort a herbacious root from the Pyrenean Alps. Clean, aromatic, inconspicuous to use. An invaluable tonic. Particulars free. The Pyrenees Import, Highland Falls, N. Y.

COLLARS, Eighteen for \$1 postpaid. Standard styles. Same goods at your dealer cost \$2.25. The 2 for 25c kind. Send for illustrated catalog. Economy Sales Co., 422-28 Broadway, Albany, N. Y.

LOOK prosperous. Be well dressed. Silk 4-in-hand ties, guaranteed three months—three for \$1. Eight solid colors. Money back if dissatisfied. American Sales Agency, 1528 Masonic Temple, Chicago.

\$1 SILK ties three for \$1 postpaid. Unique Novelty Co., Manufacturer, Independence, Iowa.

WANTED Ten Thousand Gentlemen of good taste to try our "Figola" Havana cigar. 25 box \$1 prepaid. Beaver Cigar Co., Canton, Ill.

SAFETY razor blades sterilized and sharpened better than new; 2 cents each. Five years' success. Send for blade box and circular. Electro Stropping Co., 134 Shelby St., Detroit, Mich.

FOR THE HOME

BEAUTIFUL Genuine Hand Painted Plates, 6 inches in diameter. Any Flower or Fruit; assorted if desired. Set of 6 for \$2.50 or 12 for \$4.75. Single Plates 50c each. We guarantee absolute satisfaction or refund money. Thonanders Studio, 1102 Barry Ave., Chicago.

GOOD Candy! Get busy and learn how to make your own candy. A splendid and complete course. 50c postpaid. Auburn Supply Co., Dept., GG, 7746 Peoria St., Chicago.

PAINT—Save two-thirds on your cost and half on your freight for paint. No oil needed. Only cold water. Hardens like stone after use and is waterproof. Send for samples and prices. Fenimore & Co., Trenton, N. J.

FULL plans and particulars for building an inexpensive "Iceless Cooler," keeping even temperature 12 months in the year, sent for 50c coin or stamps. Money returned if not satisfactory. Iceless Cooling Co., Duluth, Minn.

BUILD your own fireless cooker. Save ninety per cent in fuel bills. Guaranteed instructions 25 cents. Rehsom Co., Elmira, N. Y.

MAKE your own ice with our expansion forms. Model with directions mailed for twenty-five cts. Ausdale Co., Mansfield, Ohio.

GAMES AND ENTERTAINMENTS

KER-CHU powder. Pinch blown into the air makes them just sneeze their heads off without knowing why. Extremely funny, but absolutely harmless. Big package and Catalogue 10c. 3 for 25c, 7 for 50c, 16 for \$1. 35 for \$2, prepaid same day order is received. Agents and dealers supplied. Joseph Methieu, 203 Court St., Brockton, Mass.

MAGIC Tricks, Books and Supplies. Largest line in the world. Old reliable firm. Mammoth catalogue, ten cents. See our ad on page 34. Read & Covert, 821 East 43d Street, Chicago, Ill.

BOY Electrician with 75 illustrations for making Batteries, Dynamos, Telegraph and Wireless, including 2 catalogs postpaid, 12c. Supreme, 52 W. 34th St., Chicago.

NEW Magic Tricks, 84 Card Tricks, 6c. New Catalogues free. Magic Parlors, Minneapolis, Minn.

CACHOO! Long distance sneeze powder, fool whole family. Price, 10c. 3 for 25c, 6 for 45c, 1 doz., 75c, including 2 catalogs. Supreme Nov. Co., 52 W. 34th St., Chicago.

LOADS of Fun with Cachon. Blow a pinch in the air. Watch everybody "just sneeze their heads off" without knowing why. Great Fun. Harmless. Sample 10c. 3 for 25c. 75c a dozen. Catalogs included. American, 48 Judge St., Brooklyn, New York.

10 CARD Tricks and Cards, 10c. McGuinness, 612 E. 4th St., Brooklyn, N. Y.

TRICKS, Tricks, Tricks—Largest assortment of tricks, jokes and novelties in the world. Send 2c stamp for our new illustrated catalogue, just out. C. J. Felsman, Chicago, 164 N. Clark St. (Main Store), 115 State St. (Palmer House Lobby).

MAKE More Money. Be a Ventriloquist. Anyone can learn by my method. About 2,500 words, twelve lessons, \$2. "Skeels" the Magician, Box 443, Storm Lake, Iowa.

CACHOO—Funny Sneeze Powder, 10c and copy big story paper. Twelve for 75c. Levert Dolson, Hampton, Iowa.

ITCH Bug funniest joke yet, everybody's wild. Sample and catalogue, 10 cts. Hulse Co., 93 So. Norwalk, Conn.

13 FUNNY Love Letters (read two ways). All new, 10 cents. J. Hardway Co., 207 S. Lee St., Bloomington, Ill.

NEW Magic—Hermann's Multiplying Balls for 75 cents! Just to introduce catalogue. Western Sales Company, 950 Cromwell Ave., St. Paul, Minn.

SHOW Business. Fascinating profession. Big salaries. Experience unnecessary. Write for free stage instruction booklet. Stage Studio, Dept. 10, 249 West 38th St., New York.

WE pay 80c per hundred to distribute free samples of our tricks. Easy work. Particulars for 2c stamp. Hersh Company, W. F. Road, New York.

"NEW card tricks." Clever, original; for amateur or professional. 40 pages, 50c. Donald Holmes, 3709 Olive St., Kansas City, Mo.

153 TRICKS, and catalogs. All 10c. Amco, 8 Judge St., Brooklyn, N. Y.

FREE—Magic catalogue, 208 pages, 350 illustrations, 800 tricks for parlor and stage entertainment. Buy direct from the manufacturer, cheaper and better apparatus. Send 6c stamps for Souvenir Pocket Trick, particulars, etc. Magic Co., Dept. 10, 249 West 38th St., New York.

NEW Spirit Pictures, 10 cents; catalog. Klein, 1193 Broadway, N. Y.

250 MAGIC Tricks and catalogue, 10c. Curtis, P—Englewood, Chicago.

VENTRILQUISM. Complete instructions for One Dollar. M. Lindeman, P. O. Box 244, Brooklyn, N. Y.

PLAYS, Vaudeville Sketches, Monologues, Dialogues, Speakers, Minstrel Material, Jokes, Recitations, Tableaux, Drills, Musical Pieces, Entertainments for all occasions. Make Up Goods, Large Catalog free. T. S. Denison & Co., Dept. 11, Chicago.

WIGS and Makeups for theatrical and street use. Percy Ewing, Decatur, Ill.

STAMP COLLECTING

STAMPS Free! 100 different or if preferred, a set of 14 Austria Jubilee. Mention Gift D72, send 4c postage. "A.B.C." Illustrated priced Catalogue of the World's Stamps, 850 pps, 7,000 illustrations including U. S., 70c post free. Bright & Son, 164 Strand, London, England.

50 DIFFERENT Unused Stamps, Album and Hinges. Only 25c. Essex Co., 4730 Chickering Ave., Cincinnati, Ohio.

SPECIAL—Send 13c for 6 different Honduras. Acme Stamp Co., St. Louis, Mich.

FREE 150 Egypt, etc. 1c approvals. Providence Stamp Co., Providence, R. I.

60 DIFF. Austria-Hungary revenue stamps, 25c. Oscar Hartmann, 1534 26th Ave., Denver, Colo.

APPROVALS—Up - to - date, medium priced. 5 Bolivia for reference. Fine line 1c each. Mrs. Louise Kellogg, West Hartford, Conn.

FINE Packet Stamps, 25c. Wistow, 452 Queen, East, Toronto, Canada.

PRICE List of postage stamps free. Parker, Bethlehem, Pa.

25 DIFFERENT British Colonials to applicants for approval selections who send 2c postage. C. E. Nickles, 122 Florida Ave., Washington, D. C.

STAMPS, 100, all different, free. Postage 2c. Mention paper. Quaker Stamp Co., Toledo, Ohio.

STAMPS—105 China, etc., stamp dictionary and list, 2c. Bullard, Sta. A, Boston.

200 STAMPS, 2c. Fine approvals 60% discount. Orange Stamp Co., 492 Mountain View Ave., Los Angeles, Calif.

PACKET of 23 stamps; no two countries alike, 500 hinges. Set of \$1 and \$2 U. S. Rev., all for 5c. Miami Stamp Co., Toledo, Ohio.

STAMPS, 15 varieties, South and Central America, 4c, sent with our net approvals. Palm Stamp Co., 249 No. Carondelet St., Los Angeles, Cal.

24 VARIETIES Cuban stamps 10 cents. List of 6,000 low-priced stamps free. Chambers Stamp Co., 111 P. Nassau St. New York City.

STAMPS—Old Stamps Purchased. Highest prices paid. Poole, Altadena, California.

RARE COINS

\$100 PAID for 1894 Dime 8. Mint, 88 for certain 1853 Quarters, \$100 for certain 1853 Half Dollars, \$2 for 1885 Dime 8. Mint, \$6 to \$750 for certain \$5 gold without Motto, etc. We pay highest cash premiums on thousands of coins to 1909. Keep all old money and send stamp for Large Illustrated Coin Circular. You have nothing to lose. The Numismatic Bank of Texas, Dept. H, Fort Worth, Texas.

GREENBACKS—Pack of \$1.200 Stage Bills and present, 10c; 3 packs 25c. Send for a pack and show the boys what a wad you carry. Arthur Nichols, Chill, New York.

U. S. COIN and Stamp Exchange Premium Coin Catalogue, published since 1873, 10c. 1099 Fratney St., Milwaukee.

\$4.25 EACH Paid For U. S. Flying Eagle Cents dated 1856. We pay Cash premiums on hundreds of Old Coins. Send Ten cents at once for New Illustrated Coin Value Book, 4x7. It may mean your fortune. Clarke & Co., Coin Dealers, Box 15, Le Roy, N. Y.

COINS—20 different foreign 25c, 10 different bills 25c, 200 different stamps 15c. F. L. Toupal Co., Chicago Heights, Ill.

OLD Coins Bought and Sold—60 page Spring Coin Selling Catalog just out. Free to collectors only. Buying Coin Catalog, quoting prices I pay, 10 cents. William Hesslein, Malley Bldg., New Haven, Conn.

PIANOS & MUSICAL INSTRUMENTS

FOR Sale—Genuine Johann Glass, Leipzig, Germany, concert violin. Professional outfit. Highly valued. Need cash, sacrifice at half value. Description, Lock Box 403, Dresden, Ohio.

VIOLIN for sale cheap. Excellent toned. Sent on trial. Miss Bertha Mardes, Route 5, Rosedale, Kansas.

TALKING machines and records at cut prices. 100,000—10 inch records never sold less than 60 cents. Our cut price 20c each. Send for catalogue. Deninger, North St., Rochester, N. Y.

THE new chemical violinbridge, not made of wood, improves violin tone wonderfully. Price 25c. Tell your friends about it. Bauer, 135 East 34th, New York.

MUSIC

SINGING taught by mail with personal instructions by best teachers. Write for free particulars with testimonials from our graduates. Illinois Conservatory, Studio F, 96 Broadway, N. Y.

"CARNATION Day"—Sweet effective solo sung with great feeling expressly for Mother's Day. Price 7c. Robert Baxter, 3227 Sansom St., Philadelphia.

PLAY piano or organ—songs, waltzes, marches, instantly without teacher. Astonishing invention—national sensation. Address Musician Selfmaker, Chicago.

SHEET Music. Three copies popular selections 10 cents. Cooperative Music Exchange, 133 Meserole, Brooklyn, N. Y.

POEMS wanted. Cash for good talent. Send ms. to Inland Music House, Chicago.

LEARN ragtime, motion picture, vaudeville piano playing with copyrighted self-instructor for beginners or advanced. Postpaid, \$2. List of contents free. Feltman, Fitzgerald Building, New York.

SONG Poems Examined Free. Send yours, make money. We get results. Music Clearing House, 147 West 45th, N. Y.

SONG Poems Wanted. Cash for good ones. Needham Music House, 61 Pierce Street, St. Louis, Mo.

RAG-TIME piano playing taught by mail. Book free. Christensen, 84 Auditorium Bldg., Chicago.

PIANO playing and music easily and correctly learned. My copyrighted self instructor shows how. Music quickly mastered. Book complete, 50c. J. Strohm, 326 Audubon Ave., New York.

SONG Poems Wanted—Send us your song poems or melodies. They may become big hits and bring thousands of dollars. Past experience unnecessary. Available work accepted for publication. Instructive booklet and information free. Marks-Goldsmith Co., Dept. 20, Washington, D. C.

ELECTRICAL

RENEW Old Dry Batteries; three best methods with complete instructions, all for 20c. Guaranteed. Profitable Service Bureau, 4333 N. Sawyer Ave., Chicago.

ELECTRICITY. Just what you have been looking for. Our Modern Blue Print Chart Method of Electrical Wiring Diagrams. Thoroughly explained so that you can easily understand them. All kinds of Bell Wiring, Annunciators, Telephones, House Wiring, Conduit, Theatre, Isolated Plants, Dynamos, Transformers, Arc Lights, Special Treatise on Motor Wiring. Write now for information. Electrical Wiring Diagram Co., Box A, 173, Altoona, Pa.

\$15 takes nearly new ¼ hp. electric motor and rotary vacuum cleaner pump. C. Koren, 1021 Jackson Blvd., Chicago.

WIRELESS

THE best 25c wireless books published. "How to Make Wireless Instruments," by 20 wireless experts, 96 pages, 75 illustrations. "Wireless Telephone," by H. Gernsback, 80 pages, 57 illustrations. "Construction of Induction Coils and Transformers," by H. W. Secor, 100 pages, 72 illustrations. "Wireless Hook-ups," 100 pages, 161 illustrations. Price, 25c each or the four for 75c, prepaid. Wireless Association, 229 Fulton St., New York.

OFFICE EQUIPMENT

GENUINE Facsimile rubber stamps are time savers, \$1.50 postpaid. An office necessity. C. H. Thomas, 902 Swede St., Norristown, Pa.

PUT Atchison's "Shock Absorber Cushion" under your typewriter. Saves your nerves; stops the noise. 25c, postpaid. A. E. Atchison, 4127 W. 21st St., Chicago.

PRINTING AND ENGRAVING

ACTUAL Typewritten Letters. Produced through big typewriter ribbons. Letterhead printing. Billy M. Schwartz, 82 East Congress St., Detroit, Mich.

100 CARDS, name and address 30c. Business cards, 45c. 100 envelopes, 35c. 100 letterheads, 60c. Elite Exchange, Dept. T6, 3827 No. 44th Ct., Chicago.

WE Make Cuts for circulars, catalogues, labels, etc., everything in the engraving line. Burbank Engraving Co., 185 Franklin St., Boston, Mass.

ALL for \$1.10; 100 letterheads, 100 envelopes, and 100 business cards printed to your order on bond paper. Prepaid. Samples free. Carter Co., Rochester, N. Y.

HALFTONE cuts from photos 10 cents square inch, minimum \$1, delivered free. Photoengraving Co., Clay Center, Kansas.

PRINTING—500 either noteheads, envelopes, statements, cards, \$1; 1,000, \$1.50. 1,000 envelope slips, \$1. 1,000 linen finish letterheads or envelopes, \$2.50. 1,000 typewriter letters, \$2. Samples. Model Company, Manchester, Iowa.

500 EITHER good bond letterheads, note heads, statements, cards or 6x9 circulars, printed to please, prepaid \$1. Recorder Printery, Roulette, Pa.

1,000 CARDS printed in 2 colors, \$2. 50 letterheads and 50 envelopes printed, mailed, 25c. The Two Color Press, 1134 Center St., Chicago, Ill.

1,000 BOND 3½x6 circulars, \$1 prepaid. Samples. Smith Supply, Waukegan, Ill.

YOUR name on 200 gummed stickers, 10c. Star Co., Clintonville, Conn.

3,000 GUMMED labels, \$1. 1x2 inches, any printing, postpaid. Cash with order. Geo. A. Rogaliner, Monessen, Pa.

This School is Supreme in Teaching Law by Mail

THE ORIGINAL SCHOOL

It established correspondence instruction 23 years ago. It was founded on sane methods, sound courses and authoritative teaching. It has never deviated therefrom. It has had phenomenal success and enjoys unlimited respect. Right now

The Sprague Correspondence School of Law

is best equipped—best qualified to teach you law—for legal practice or for business. It is really a SCHOOL. The catalog proves this. And it explains each advantage in detail, lists the thousands of successful graduates, and gives the fair prices for the College Law Course and Business Law Course.

If you want the best—WRITE NOW FOR THIS CATALOG.

The Sprague Correspondence School of Law

289 American Building
Detroit, Mich.



NEW JOBS NOW OPEN

Earn from \$35 to \$100 Weekly as a

TRAFFIC MANAGER

Modern transportation is a jungle of routes and rates calling for specialists who, like the pathfinders of old, have expert knowledge of the trails of traffic. How to route shipments to obtain shortest mileage and quickest deliveries and how to classify goods to obtain lowest rates are two vital factors in business competition. The man who knows how is so valuable to his employer that he commands respect and big remuneration.

Big Salaries Paid to Traffic Managers

Expert traffic managers command from \$2,500 to \$25,000 a year. Why not prepare yourself to fill one of these lucrative positions?

New and Uncrowded Profession

There are half a million LARGE SHIPPERS in the United States. Practically every one of them needs an expert traffic man, and this need is recognized as never before because of the recently enacted railroad rate laws and interstate commerce regulations. The demand for trained and efficient traffic men is many times greater than the supply. There's room for you.

Study Traffic and Interstate Commerce

Decide now to become a traffic man. Our Interstate Commerce Course enables you to study AT HOME, without leaving your occupation or sacrificing present income, and to become thoroughly versed and proficient in the strategy of shipping, including routes and classifications, interstate commerce rules and regulations, etc. The instruction is given by some of the biggest traffic managers in the country. The course is easy to grasp and thoroughly practical. Anyone with ordinary intelligence, with reasonable application, can master this new profession.

FREE PORTFOLIO Clip coupon below, sign and mail at once, and we will send you FREE, postpaid, a handsome portfolio containing complete information concerning the opportunities and requirements of this attractive profession. Get posted at once. Clip coupon. **LA SALLE EXTENSION UNIVERSITY, Dept. 38, CHICAGO**

FREE PORTFOLIO

COUPON

La Salle Extension University
Dept. 38, Chicago, Ill.

I am interested in the new profession—Traffic Management. Please send me full information and Traffic Book, free of all cost.

Name

Occupation



Write Address on the Margin Plainly

Please Mention Popular Mechanics

LEARN to Repair and Run AUTOMOBILES



Big Money in Auto Business

Travel, get good pay, run garage or auto livery. FREE illustrated book tells all. You can learn in a few weeks at home or in our shops. Write for information today.

Kansas City Automobile School

Largest and Best Equipped School in the World
(Conducted by CLIFF HOGAN.)

2180 East 15th Street, KANSAS CITY, MO.

Salesmen Wanted

DO YOU WANT A GOOD POSITION WHERE YOU CAN EARN FROM \$1,000.00 TO \$5,000.00 A YEAR AND EXPENSES?

There are hundreds of such positions now open. No former experience as a salesman required to get one of them. If you want to enter the world's best paying profession our Free Employment Bureau will assist you to secure a position where you can earn good wages while you are learning Practical Salesmanship. Write today for full particulars; list of good openings and testimonial letters from hundreds of our students for whom we have recently secured good positions paying from \$100.00 to \$500.00 a month and expenses. Address nearest office, Dept. 122

National Salesmen's Training Association

Chicago New York Kansas City San Francisco New Orleans Toronto



Learn to Write

I can make a good penman of you at home during spare time. Write for my free book "How to Become a Good Penman." It contains specimens and tells how others mastered penmanship by my method. Your name will be elegantly written on a card if you enclose stamp.

F. W. TAMBLIN, 418 Meyer Bldg., KANSAS CITY, MO.

BE A TELEGRAPH OPERATOR

Learn at home by mail. Earn \$75 to \$250 per month. Big demand for operators. We send you instrument and instruction on 30 days' FREE trial. Write today for Free Book and Telegraph Code.



MUTUAL TELEGRAPH SCHOOL, 827 DWIGHT BLDG., Kansas City, Mo.

AN ART SCHOLARSHIP FREE

WRITE AT ONCE for full particulars of this Special Limited Offer. No charge, no obligations. Your name and address brings you handsome, illustrated Prospectus, and explanation of this unusual offer, by return mail, free. Remember this offer is strictly limited. DON'T TAKE CHANCES. WRITE NOW.

FINE ARTS INSTITUTE, Studio 9114, OMAHA, NEB.



Continued from Page 30

200 BOND letterheads and 125 bond envelopes for \$1.10 postpaid. Echo Printery, Gladstone, Mich.

3,000 FINE Letterheads, Envelopes, Cards, all \$7. Get our "Special" for \$1. Samples free. Thomas M. Clark Company, Michigan City, Indiana.

ACME Coin Mailers—\$2.60 per 1,000. For 6 coins \$3. Any printing desired. Samples free. Dodd Printing Co., Fort Madison, Iowa.

150 BOND Letterheads, 150 envelopes, neatly printed \$1. postpaid. 1000 circulars, 125 words, printed and milled \$1. Strodl, West Hoboken, N. J.

5,000—4-PAGE folders \$10. 10,000—\$15. Good work. Grandon-Beaman Co., Jackson, Mich.

150 LETTER heads and 150 envelopes neatly printed to order \$1. prepaid. (Guaranteed). Union Pub. Co., Uniondale, Ind. Dept. M.

250 BOND Letterheads and 250 Envelopes to match \$2. Ross A. Weyandt, Wooster, Ohio.

EXTRA! 100 letterheads, 100 envelopes, 100 return envelopes, \$1 postpaid. Walden Press, Roxbury, Mass.

PRINTING presses all sizes, type and supplies. List for stamp. Popular Bargains, Richland, Pa.

100 WHITE envelopes printed, 30c. 500, \$1.25. Prepaid. F. Johnson, 625 E. 40th St., Chicago.

PRINTING Presses, type, supplies. Catalog free. L. M. Carroll & Co., 320 Madison St., Chicago.

GOOD Printing at low prices. 1,000 good letterheads, envelopes, cards, billheads, labels, circulars, \$2.50. Samples free. Catalogues, booklets, and circulars our specialty. Ernest L. Fantus Co., 523 S. Dearborn St., Chicago.

MULTIGRAPH form letters—\$3 for 1,000. Includes stock, letter, letterhead—sent prepaid in U. S. Specimens free. Perfection Letter Company, Muncie, Indiana.

TYPEWRITERS AND SUPPLIES

REORGANIZATION Clearance Sale. Absolutely reliable typewriters (all makes, all models, all prices), shipped anywhere subject to examination. \$5 worth supplies free. Visible, \$10 up. Oldest Typewriter Exchange. Consolidated Typewriter Exchange, Inc., 245 Broadway, New York.

TYPEWRITER "Bankrupt Stock" secured. Saves 55%. Good as new. While they last \$10 to \$40. Remington; Underwood; Oliver; Smith Premier; L. C. Smith. Act today. Pay after 3 days' trial if satisfied. Guaranteed for one year. We also have our "Regular Stock" of all makes.—Factory re-builds, etc. Typewriters General Sales Co., 720 Traction Bldg., Cincinnati, Ohio.

TYPEWRITERS, latest No. 2 L. C. Smith, like new \$12.50. Underwood No. 5 with back spacer \$50. Guaranteed. Typewriter Sales Co., Lincoln Inn, Cincinnati, Ohio.

TYPEWRITERS, all makes. Agents wanted in every town. Sample machine at cost. Special bargains this month. Typewriter Repair Co., 519 Main St., Cincinnati, O.

OLIVER visible typewriter for sale cheap. Sent on trial. Charley Rickart, Route 5, Rosedale, Kansas.

TYPEWRITERS. Bargains, lowest prices and largest list in the world all guaranteed five years, shipped on 15 days' free trial. Remington \$10, Smith Premier \$10, Oliver \$15, Underwood \$20. Send for our large illustrated catalogue and special agents' offer. Harlem Typewriter Exchange, 213 West 125th St., New York City.

REMINGTON No. 8 model, good condition. \$8 cash. Wagner, 350 Eam, Arlington, N. J.

TYPEWRITER Ribbons for all makes guaranteed perfect, four for \$1, carbon paper \$1 per 100. Peerless Ribbon Co., 213 West 125th St., New York City.

SAVE \$25 to \$50 on manufacturers' prices. Buy our Factory Rebuilt Typewriters. Nearest-to-new on the market. Have trademark and guarantee, like new machines. Are thoroughly rebuilt, highly polished, and perfect in appearance. Satisfaction guaranteed. We are the largest rebuilt typewriter concern in the world. Branch stores in leading cities. Write for catalog of standard makes. American Writing Machine Co., Inc., 345 Broadway, N. Y.

NEVER buy a typewriter until you get my complete catalogue and price list of all standard makes. A. E. Atchison, 4127 West 21st St., Chicago.

MISCELLANEOUS

FORMULAS bought from reliable source produce reliable goods. I furnish Formulas, Processes and Trade Secrets in all lines. 22 years supplying largest manufacturers with the best in Formulas. Don't waste time and money on trash and antiquated "junk" but send today for my "Red Seal" list—every one guaranteed reliable. Liscomb Miller, Technological Chemist, Marietta, Georgia.

GET a pair of Genuine Navajo Indian Dress Moccasins, they make a classy and comfortable house slipper for gentlemen or ladies. \$2. a pair delivered. The Bennett Indian Trading Co., Albuquerque, New Mex.

RAINCOATS at Manufacturer's Prices. Men's and women's. Stylish and serviceable, in tan or gray. By parcel post \$2.85. Money back if unsatisfactory. Give breast measure. Illustrated folder and samples free. B. & J. Rubber Co., 161 Summer St., Boston, Mass.

RAILWAY Mail Clerks—Wanted. \$75.00 month to commence. Parcel Post means hundreds appointments. Every second week off at full pay. Steady work. Examinations everywhere May 3rd. Common education sufficient. "Pull" unnecessary. Farmers eligible. Write immediately for free specimen questions and full list of Government Positions open. Franklin Institute, Dept. M-22, Rochester, N. Y.

SELF-Filling, Non-Leakable Fountain Pen, finest grade rubber, beautifully chased cap and barrel, highly polished, No. 4, 14kt. solid gold pen, \$2. W. Garrett, Moulton, Iowa.

CARD cases, billfolds, pocket lighters, cigarette, cigar cases, names stamped, gold. Catalog Free. Safford Manufacturing Company, 5943 Summer, Philadelphia, Pa.

TATTOOING supplies, machines \$2.50. To advertise, 0 colored designs 15c. price list free. J. F. Barber, 1019 Vine St., Cincinnati, Ohio.

BE Smart. Fashionable European Hotel Labels for your baggage. Agents wanted. Continental Agency, Nottingham, Eng.

FOR plumbing supplies or information, write. John Heald, Jamestown, N. Y.

CAMDEN Woolens—Ladies' and gents' suitings direct from factory; write for samples. F. A. Packard, Mgr. Retail Dept., Box M. Camden, Me.

GENUINE Mexican Cherry opals, round or oblong cut, size about four karats each. \$1 postpaid. The Bennett Indian Trading Co., Albuquerque, New Mexico.

BEST Extension Ladder at factory prices. Write to John J. Potter, 14 Mill St., Binghamton, N. Y.

GRANDFATHER'S Clock Works, \$5. Slightly shop-worn, quantity limited, others with chimes, all prices; also several nice grandfather's clock cases, exceptional bargains. Clock Company, 1673 Ruffner St., Philadelphia, Pa.

GET ready for trout season. Try my special Scotch flies, 10c or 3 for 25c. D. Thompson, Haines Falls, N. Y.

TOBACCO Cure. One box cures. Guaranteed or money back. Established 1894. Write for special offer. Allen Distributing Co., 319 Altman Bldg., Kansas City, Mo.

CUTS anybody can make. Simple Etching Process, \$1. Particulars, specimens, for stamp. M. Day, Windfall, Ind.

DON'T throw your fountain pen away. Send it to us for estimate to repair. Virginia Co., 6106 Walnut St., Philadelphia, Penna.

GREAT novelties, sample seven cents. Rose, 631 Hanover, Baltimore, Md.

"HEAVEN and Hell." Swedenborg's great work. 400 pages, 15 cents, postpaid. Pastor Landenberger, Windsor Place, St. Louis, Mo.

FOR Sale—Indian Relics—old ones. E. F. Kuhn, Dunlap, Illinois.

THE art of tattooing. Complete book. 25c. coin. Prof. Rebec, Cedar Rapids, Iowa.

LINOLEUM—We cut linoleum to diagram and give you wholesale prices, sending free with each order cement for laying correctly. Color plates and estimates given on receipt of measurements. Haverstick & Co., Trenton, N. J.

TEMPERING, new process, any one can temper, perfectly, all tools and springs. Write for particulars. H. I. Davis, Beaver Creek, Minn.

BATTLESHIP drawings. Easy to color with paints or crayons. Ten cents. W. Leiferst, 2042 South Second Street, Philadelphia, Penn.

SAVE postage. Weigh all mail. Scale 10c. "Juron," R1409 Noble, Chicago.

GENUINE Navajo Indian lucky rings, coin silver. Guaranteed Navajo hand work. 60c postpaid. The Bennett Indian Trading Co., Albuquerque, New Mex.

EARN \$15 to \$25 a week as our mail order dealers. Right from your own home. Hold your position until entire time is required. We are manufacturers and owners of Patented just-in-season, repeat order specialties. If you are just starting a mail order business or if already established, you can't afford not to handle our patented money making getters. We sell and furnish everything. No canvassing. Small capital. Experience unnecessary. Write today for latest patented leader and manufacturers easy selling (copyrighted) mail order plan backed up by "whole truth," positive proof and sworn statement. J. M. Pease Mfg. Co., 552 Pease Bldg., Main St., Buffalo, N. Y.

INFORMATION on any subject. Any question within reason answered, 10c each. Geo. Gifford, Jr., 28 West 33d St., Bayonne, N. J.

I WILL start you earning \$4 daily at home in spare time, silvering mirrors; no capital; send for free instructive booklet, giving plans of operation. G. F. Redmond, Dept. 306, Boston, Mass.

BROTHER—Accidentally discovered root will cure tobacco habit. Gladly send particulars. F. Stokes, Mohawk, Florida.

DON'T fail to read Independence and Fortune under Business Opportunities.

BE a Handcuff King. Earn big money on the stage. Vaudeville Circuits pay \$100 week up. I teach everything in this line. For particulars, address Box 902, Springfield, Mass.

Matchless Pocket Lighter

Durable and Waterproof, with perfect ignition. Satisfaction guaranteed or money refunded. Sent post-paid complete with pocket clip 35c, 4 for \$1. Agents and Dealers wanted.

A perfect lighter. Occupies no more space in the pocket than a pencil. Indispensable to every smoker, hunter, fisherman and automobilist.



SCHILLER MFG. CO., P. A. 1124 Foster Ave., CHICAGO, ILL.

AGENTS: You Can't Make a Cent

With the BEST line of new articles to be had unless you know about the "Nu-Pantz" Creaser, "Nu-Life" Vacuum Massage Machine, New Idea Hose Supporter and other "Modern Specialties of Proven Merit." No time lost in experimenting; something new always in hand—something that sells and keeps you making money all the time. File your name and address at once and get started in a permanent, profitable business with a satisfactory cash income always insured. Address

MODERN SPECIALTY CO., 43d St., Racine, Wis.

\$50 Course Free

Learn to Run and Repair Automobiles By the Sweeney System of Practical Experience!

Salesman \$250 Per Month



Repair Man \$1.00 Per Hour

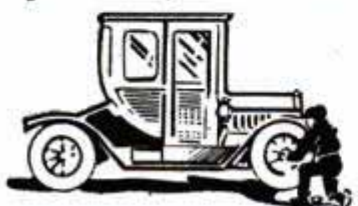

You can earn from \$1,000 to \$5,000 a year in the Automobile business. Thousands of men wanted for chauffeurs, mechanics, demonstrators, salesmen, garage managers, repair men, etc.

THE demand for competent men is more than double the supply. That's why the auto business pays the biggest salaries today. Millions are invested in the manufacture of automobiles. One company alone has orders for 120,000 cars for 1913 delivery. Three hundred thousand is a conservative estimate of the output for the year. Thousands of dollars will go to the men who handle this product and thousands more will go for repairs, storage, chauffeurs, etc. Get into the business and get your share of the money. No hard work in the auto business. You don't have to get up at 4 o'clock in the morning and work till dark; no drudgery, no chores. No hot summers and cold winters to endure. Instead you will have short hours, easy work and regular pay. You get paid for

Demonstrator \$150 Per Month



Chauffeur \$125 Per Month



what you know, not for the work you do. Live well, dress well, a chance to travel and see the world, stop at the best hotels with all expenses paid. Now to get you to investigate the wonderful opportunity I am offering you I will give for the next thirty days a free scholarship in traction engineering. If you are mechanically inclined, or if you want to get into the most profitable trade in the world, sign the coupon and mail today, and I will send you my big free catalog and free scholarship certificate. Remember, the Sweeney system makes learning easy in six weeks because we teach the right way — letting you work with your own hands on real cars. It's the simplest, quickest, surest and most thorough way of learning this splendid business.

E. J. SWEENEY

Traction Engineers Earn \$5 to \$10 Per Day

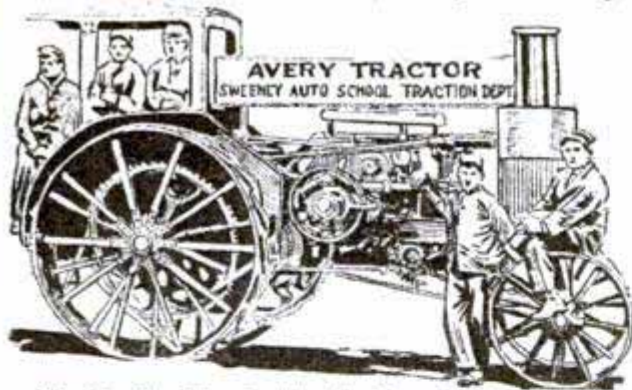

No Books Used — Tools Furnished FREE

Earn More Money The object of this offer is to advertise the Sweeney System and this new branch of work which will naturally be handled by an automobile man. Six weeks after the day you enroll in my great practical school you will be prepared to properly repair any automobile made and drive any car or truck or operate garage and repair shop of your own. You can learn the automobile business thoroughly because the

"Sweeney System" is the most thorough, practical, interesting course of automobile instruction, and embraces every point worth knowing, including vulcanizing, brazing, oxy-acetylene welding, lathe work, machine shop practice, testing and road work, etc. You learn by doing the actual work on real cars with your own hands under the watchful eyes of experienced instructors.

Monthly Magazine Write today and we will also send you our monthly school magazine absolutely free. I want every man thinking of learning to become an Auto Expert to have my new big illustrated catalog. Write for this great book. Send today—this very minute—now.

We Own Two Traction Engines

Get one of these free \$50 courses in gas traction engineering. Enormous demand in every farming community for engineers. Factories want demonstrators. We teach you by actual work on a traction engine and put you in touch with factory managers who have told us they will take all the trained men we can send them. Here is a wonderful opportunity for any young man mechanically inclined. You can learn by practical work in a few weeks. Remember we give this course free!

Barney Oldfield Indorses Sweeney

Dear Sweeney: I consider yours the most completely equipped Automobile School in America. I have visited many schools in my travels, but yours is far ahead of any I have ever seen, as you teach the mechanical end in a practical way, which, in my estimation, is far ahead of learning it by books and charts. You know me.

BARNEY OLDFIELD.

Get My Big Catalog This splendid illustrated book is in itself a liberal education. Tells all about the Sweeney System. Gives names of hundreds of successful graduates. In a most fascinating way relates the experience of hundreds of young men who came to this school. Explains how we combine a machinists' course with the automobile course without extra charge. Why we don't teach from books, charts and theory. But how we do teach by giving you practical work and actual handling of cars. (We have on the floor 41 cars, including Fords, Buicks, Jacksons, Overlands, Ramblers, Cadillacs, White Steamers, Packards, etc.) All tools are free. One charge, no extras. This catalog shows how easy it will be for you to get into the best paying business in the world. How we teach you to run a business of your own successfully. How we make you a dealer, or secure you a good position.

FREE Scholarship

REFERENCES:

Commonwealth Nat'l Bank, Kansas City, Mo.; Dun's or Bradstreet's Mercantile Agencies.

E. J. SWEENEY, Pres.
Sweeney Auto School
1469 Woodland Ave., Kansas City, Mo.

Send free scholarship and catalog.

Sweeney Auto School

Largest and most completely equipped Auto School in the World

1469 Woodland Ave., Kansas City, Mo.

NAME.....

ADDRESS.....

Be a Draftsman

Draw \$125 to \$175 a Month



Big demand now for skilled Draftsmen at \$125 to \$175 per month to start. Thousands of men making \$3,000 to \$5,000 a year. The work is light, pleasant and profitable. Unlimited opportunities for expert draftsmen and designers. Mail coupon for valuable book, "Successful Draftsmanship." It explains how you can become a skilled draftsman in your own home, during your spare time. The book is free now—write at once.

Personal Instruction by Chief Draftsman

I am Chief Draftsman of a large and well known firm. Long ago I saw the urgent demand for practical trained draftsmen. Each month the demand for practical trained draftsmen is growing—higher salaries are being paid right along. I give my students just the kind of training they need. **Special offer for those who write at once.**

FREE \$15.00 Drawing Outfit IF YOU WRITE AT ONCE



On account of the urgent demand for more and better men in the drafting field, I will give **absolutely free** this \$15.00 drawing outfit if you enroll at once. It is a practical outfit. The same kind of an outfit that I use myself. I have been doing practical drafting work for twenty years and I know the kind

of instruments you should have. They are not toys, but are **genuine working instruments** selected from the line of one of the largest manufacturers in the country. This is the outfit that I give you **absolutely free** if you enroll now.

I Guarantee To instruct you until you are competent and placed in a position paying \$125 to \$175 a month.

Earn While Learning

Yes, my friend you can make big money at once right at home—as much as **\$5 to \$10 per day**. I will pay you while learning.

Mail FREE Coupon for My New Book

FREE Book Coupon
Chief Draftsman,
Engineer's Equipment Co.
Division 1194

Absolutely no obligations of any kind. The book is absolutely free and prepaid. It tells you dozens of things you should know about drafting work and it tells you just exactly the kind of personal instruction that I give you. I will also send you a list of the positions that I know are open.

Without any obligations on me whatsoever, please mail me your book, "Successful Draftsmanship" and full particulars of your liberal "Personal Instruction" offer to students. It is understood that I am obligated in no way whatever.

Do not delay. Your name and address on the coupon is the first step towards success. Mail the coupon at once—now—while I am making this great special offer.

Name

Address

Chief Draftsman,
Engineer's Equipment Co.
Division 1194
CHICAGO, ILL.

Please Mention Popular Mechanics

REVERSIBLE "Linene"

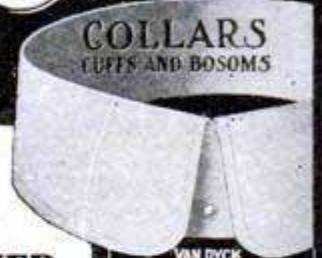

WEAR ONE SIDE THEN THE OTHER

That's what you can do with Linene collars. Both sides are alike. 10 collars for 25 cents at the stores, or by mail 30 cents in U. S. stamps. Parcel post stamps preferred. Single sample free.

State Size and Style

Send for beautiful catalogue

REVERSIBLE COLLAR CO.
Department U BOSTON, MASS.

COLLARS
CUFFS AND BOSOMS

VAN DYCK
Sizes 12 to 18 Inches
Front 14 Inches-Back 11 Inches

ANGELO
Sizes 12 1/2 to 20 Inches
Front 21 Inches
Back 1 Inch

RAPHAEL
Sizes 12 to 20 Inches
Front 21 Inches
Back 1 Inch

RUBENS
Sizes 12 to 20 Inches
Front 2 Inches-Back 1 Inch



MAGIC Tricks, Books and Supplies

Amateurs supplied as well as the great Professionals

Easy, interesting and entertaining. Mystify and astonish your friends. Large, illustrated professional catalogue of wonders. Price **10c**
Read & Covert, 821 E. 43d St., Chicago, Ill.



HERE YOU ARE, BOYS

A medallion pin of Foxy Grandpa. Everyone will notice it on the lapel of your coat and try to get a closer look at it. All you have to do is press the bulb.—Foxy Grandpa will finish the job by squirting a fine stream of water over the inquisitive one. Will squirt 20 feet. Greatest joke out. Order one today and fool your friends. Price 15c. Foxy Grandpa and Hooligan both for 25c. 5 for 50c or 1 doz. for \$1.00. A beautiful fountain pen free with every \$1.00 order.

AMERICAN SUPPLY CO., 918 Union St., St. Paul, Minn.



Every Boy His Own Toymaker

Greatest boys' book ever written. Tells how to make a Steam Engine, Telephone, Magic Lantern, Boats, kites, balloons, electrical and mechanical toys, traps, fishing tackle. 200 illustrations; also catalog of 150 puzzles, Keller's Magic Ace Trick Card and "DOUBLE THROAT" warbler and bird call all for only 10c. WESTERN PUZZLE CO., ST. PAUL, MINN.



WINDOW TRIMMING

Advertising and Card Writing are the best paid professions in the world. Interesting prospectus **FREE** tells you all about it. KOESTER SCHOOL, 306 Jackson Boulevard, CHICAGO

JEWELRY ENGRAVING

We teach you, by our new and original method of instruction, this clean, fascinating and profitable business **right at your home**, and furnish you all tools needed absolutely **free**. Write for free book to the **WISCONSIN SCHOOL OF ENGRAVING**, Strah Bldg., MILWAUKEE, WIS.

Be a Wireless Operator

Learn at home by mail. Big demand in this new field. Instruction and full equipment for sending and receiving sent on 15 days' free trial. Write for booklet. **MUTUAL TELEGRAPH SCHOOL, 828 Dwight Bldg., Kansas City, Mo.**

THIS IS THE CAR



**F
R
E
E**

**F
R
E
E**

I GIVE YOU FREE

This Big 50 Horse Power Coey Flyer is given to students who qualify without one cent in cash. My course in Motoring teaches you how to run and repair any car and I help you to

Make Big Money in the Automobile Business

There is a man's job waiting for every young man who will apply my lessons in his daily work. My course of instruction has taken men off the farm, out of stores and offices. It has given them a salary instead of wages. It means steady work at good pay the year 'round in place of a job now and then and dead broke in between times.

Learn Motoring from a Man Who Buys, Sells and Manufactures Cars

I built the first garage and ran the first taxicab in Chicago. I won the most races and taught more successful men the automobile business than any man teaching Motoring—one success after another has made me a fortune. I sell on an average of a car a day and manufacture the Coey Flyer. My lessons are based on 15 years of money-making experience.

First Lesson FREE to Everyone Answering this Advertisement.

C. A. COEY
President

C. A. Coey's School of Motoring,

1424-26 Michigan Ave.
Dept. 139

Chicago

4000 Men Owe Their Start in Life to My Course in Motoring

It is so simple, so complete and so easily learned that no matter where you are, no matter if you never even rode in a car, you will be able to go right into the business and make good—your knowledge will give you confidence, your work will give you satisfaction. You will receive big money for what you know.

A Few Cents a Day Pays for This Profitable Education

You will learn in a few weeks at a small cost what has made me rich and successful the past 15 years. I wrote these lessons myself and I spend my time every day doing the very things that I teach you to do. It is making me money and it will do the same for you.

Send for My Catalogue and First Lesson, Both Free

It tells how you can make more money and have a better time than you ever dreamed was possible. You can pay cash or in installments—I don't care which.

I Help Rich and Poor to Get a Start

Now, don't put off getting started. Spring is nearly here and you will just have time to take the course and get a fine job this summer.

MY BIG FREE BOOK TELLS HOW

You can get this 50 H. P. Car Free and make money in the Auto Business. Read this letter:

"I am making it so well running automobiles and no expense. Just having a swell time and good pay at \$25.00 a week. I read the contract. Have decided to go into the business. I know that I will do well with you to help me. Your course made a capable man of me."

CLIFTON BURRELL, Virginia

ting my book—Write today.

just have time to take the course and get a fine job this summer.



The Auto-Pneumatic Swimming Belt
Self-inflating. Readily adjusted. Weighs 1½ lbs. Folds to 5x6 in. Waterproof, non-corrosive, indestructible. The only practical safeguard to sealers and bathers—a boon to aquatic sport, a life saver. Don't risk cheap, flimsy devices. **Price \$5**
AUTO-PNEUMATIC SWIMMING BELT, Inc., 309 Broadway, New York

CACHOO! Make the whole family and all your friends "just sneeze their heads off" without knowing why, with Cachoo, the new long distance harmless snuff. Sent anywhere for 10c. Cat'g included FREE
AMERICAN SUPPLY CO., 918 Union St., ST. PAUL, MINN.



LEARN ABOUT OUR FREE COURSE IN SHOW CARD AND SIGN WRITING

A Great Opportunity! We are offering, for a limited time, a complete course in show card and sign writing to those purchasing our assortment of "Litholia" Ready-to-Use Colors. This is a great opportunity for ambitious persons, either sex, to increase their earning capacity. Good show card writers in demand at \$21 to \$50 weekly, salary or in business for yourself. Our show card course is not a book of alphabets. It's a complete course in lettering compiled by an expert New York show card artist for us. "Litholia" is the only liquid pigment water paint ever manufactured, used the same as cake, distemper or tube colors, but far superior to either. "Litholia" lasts longer, always ready. "Litholia" is the best for the show card writer, the artist, or the interior decorator. A letter of request brings booklet, circulars, and full information.

LITHOLIA PM. COLOR CO., 71 to 81 W. 23rd Street, NEW YORK CITY



SHOW CARD WRITERS EARN FROM \$21 TO \$50 PER WEEK

HOW TO SPEAK

**At Political Meetings—
Lodge and Board Meetings—
Public Dinners—**

Anywhere
GRENVILLE KLEISER,
(Former Yale Instructor)

through his famous Mail Course in Public Speaking and the Development of Power and Personality can also help you to sell more goods—converse entertainingly—build up a strong personality that will give you widened power and opportunity

"Your Course has done for me just what you claimed, it has made a public speaker of me. It has built up my personality and self-confidence to such an extent that I do not mind how large the audience may be."—*A. Taylor, St. John, N.B.* Hundreds of similar letters on file.

Write on a Post-card today: "Send me full free particulars of the Kleiser Public Speaking Course."
Price of Course will be advanced soon.

FUNK & WAGNALLS COMPANY
Dept. 706
NEW YORK

"GIVE ME 15 MINUTES A DAY!"

BOOKKEEPING TAUGHT IN 20 LESSONS

New and valuable plan by Expert Accountant—"Bookkeeping in a Nutshell"—practical, simplified system giving every essential in 20 snappy lessons at a very small cost. Unique Course—different, original—winnows the wheat from chaff—quick, easy way to master—no drudgery, no waste of time—saves money to business man—only real system for beginner, revelation to the experienced. Everybody needs this. Booklet fully describing everything Free for name and address. Send for it today.
THE WILLARD AUDIT ASSOCIATION, 1736 Manhattan Bldg., CHICAGO



CHAUFFEURS

Send for **Free** sample copy **American Chauffeur**. Contains valuable information about engines, ignition, carburetion, manifolds, motor balance, cooling and lighting systems, etc. All news of motor world. Every amateur or professional chauffeur should read it. Write now.
The American Chauffeur Publ. Co., 251 Butler Bldg., Cincinnati, O.



Would You

Show this wholly visible Typewriter to your friends and let them see wherein it excels any \$100 Typewriter made, if we would send one to you **Free of One Cent of Cost** for you to keep forever as your own? Then on a postal card, or in a letter to us, simply say: Mail particulars.

EMERSON TYPEWRITER CO., Box M161, Woodstock, Illinois

SUCCESSFUL EGG FARMING



200 Eggs a Year Per Hen

HOW TO GET THEM

THE seventh edition of the book, "200 Eggs a Year Per Hen," is now ready. Revised, enlarged, and in part rewritten, 96 pages. Contains among other things the method of feeding by which Mr. S. D. Fox, of Wolfboro, N. H., won the prize of \$100 in gold offered by the manufacturers of a well-known poultry food for the best egg record during the winter months. Simple as a, b, c,—and yet it will start hens to laying earlier and to induce them to lay more eggs than any other method under the sun. The book also contains a recipe for egg making food used by Mr. Fox, which brought him in one winter day 68 eggs from 72 hens; and for five days in succession from the same flock 64 eggs a day. Mr. E. F. Chamberlain, of Wolfboro, N. H., says: "By following the methods outlined in your book I obtained 1,496 eggs from 91 R. I. Reds in the month of January, 1902." From 14 pullets picked at random out of a farmer's flock the author got 2,999 eggs in one year—an average of over 214 eggs apiece. It has been my ambition in writing "200 Eggs a Year Per Hen" to make it the standard book on egg production and profits in poultry. Tells all there is to know, and tells it in a plain, common-sense way.

You can get this book with a year's subscription to the **AMERICAN POULTRY ADVOCATE**, both for 75 cents; two-years' subscription and book for \$1.00, or given free as a premium for two yearly subscriptions at 50 cents each. Book alone for 50 cents.

Our paper is handsomely illustrated, 44 to 124 pages. 50 cents per year. 3 months' trial, 10 cents. **Sample Free.** CATALOGUE of poultry books free.

AMERICAN POULTRY ADVOCATE
312 Hodgkins Block SYRACUSE, N. Y.

WOOD-BLOCK PAVEMENTS IN PARIS—The use of wooden blocks for paving has increased to such an extent in Paris that most of the main avenues on both sides of the Seine are now paved with that material.



GREIDER'S FINE CATALOGUE

and calendar of pure-bred poultry for 1913, large, many pages of poultry facts, different breeds in natural colors. 70 varieties illustrated and described. Incubators and brooders, low price of stock and eggs for hatching. A perfect guide to all poultry raisers. Send 10c for this noted book.

B. H. GREIDER, Box 2, RHEEMS, PA.

A GOOD INCOME and INDEPENDENCE IN Poultry Raising

pleasant, congenial, outdoor work, awaits you. Learn, by mail, at home, from Poultry Experts, how to operate a money-making poultry business.

WE TEACH YOU SET YOU UP IN BUSINESS

at once, for this season, with equipment and select flock prize fowls from our big \$25,000 poultry plant. Details, and splendid illustrated Brochures, **FREE.** This offer limited—write today.

Park Ridge School of Poultry Culture, Suite 9, Kalm's Bldg., Chicago



MAKE BIG INCOME

Men and Women can do this all the year at home growing mushrooms in cellars, stables, sheds, boxes, etc. Crop sells for \$1.50 to \$1.00 a lb. \$20.00 a week easily made. Great demand, markets waiting. **Start Now.** Write for big 52 page **Free Illustrated Booklet** and learn how to do it.

NAT'L SPAWN CO., Dept. 12, BOSTON, MASS.

GET THIS COMPLETE HOME COURSE OF LESSONS IN PHYSICAL AND HEALTH CULTURE FREE

The lessons and illustrative charts were prepared by **BERNARR MACFADDEN**, the foremost authority on the subject

The course is the equal of many sold at \$50.00

To every person sending us \$1.00 for **PHYSICAL CULTURE MAGAZINE** we're going to give, absolutely without an eight months' trial subscription to the **MACFADDEN COMPLETE HOME COURSE OF LESSONS IN PHYSICAL AND HEALTH CULTURE.** We make this unusual offer as an inducement to get acquainted with the **PHYSICAL CULTURE MAGAZINE.** Just enclose a **DOLLAR BILL** and say, "Send me your **HOME COURSE** and make me a subscriber to your magazine." If you are not satisfied we will gladly return your money.

PHYSICAL CULTURE PUBLISHING CO., Room 404 Flatiron Bldg., NEW YORK



Men Wanted!

To Learn The Watch Repairing Business F-R-E-E!

Yes, free—absolutely free! Positively the most remarkable offer ever made in the history of the business. The Great Jewelry House of Rogers Thurman & Co. through its Watch-making College, offers to teach you at home by mail to become an Expert Watch Repairer. Write at once for details of this great offer. No obligations on you—so write immediately.

Be Our Representative —\$225.00 a Month!

We want a responsible representative in every district to learn this fascinating, pleasant and profitable business.

SPECIAL!

Don't confuse this with the ordinary offer. Something new, — different — attractive. You simply cannot afford to miss it. Write immediately.

Wonderful opportunity to make big money. We will start you in a jewelry business of your own—back you in every way possible. Knowledge of watch repairing required—hence our liberal Free Offer. C. F. Elmore, the expert, will instruct you personally.

Valuable Book FREE!

This book contains valuable hints, secrets and facts that you should know. It explains all about our liberal offer. Tells you how to succeed.

Write Immediately! Just send post-card with name and address. SEND NO MONEY. We will mail you valuable book and full particulars—ALL FREE AND PREPAID. Be the fortunate man in your town to receive this offer—WRITE IMMEDIATELY.

ROGERS THURMAN & CO. 3 South Wabash Ave. CHICAGO, ILLINOIS



THIS JOB PAYS \$25-\$50 Weekly

You Can Be An Auto Expert

We teach you the entire subject by mail in 10 weeks' spare time, and assist you to secure good position. Demand for trained men can't be filled. Simple, practical and personal instruction. Free auto model to each student.

FIRST LESSON FREE—WRITE FOR IT NOW

Owners—we supply competent men

Empire Auto Institute, 232 Empire Bldg., Rochester, N. Y.
The Original Automobile School



LEARN THE AUTO BUSINESS BIG MONEY

Write TO-DAY for our FREE BOOK on how to learn the auto business. Our method is up-to-date, thorough and within the grasp of all. Here is your chance to make BIG MONEY—DON'T MISS IT. Send us a post card at once and let us explain. WE ASSIST YOU TO SECURE A POSITION IN ANY PART OF THE COUNTRY.

"Perfectly simple. You can do it, if I can."

N. Y. SIMPLEX AUTO SCHOOL, Singer Bldg., N. Y. City



IF YOU STAMMER

Attend no stammering school till you get my large FREE book and special rate. Largest and best school in the world curing by natural method. Write today. Lee Wells Millard, Pres., North-Western School for Stammerers, Inc., 917 First St., Milwaukee, Wis.

MUSIC TAUGHT FREE AT YOUR HOME Write Today

for our booklet. It tells how to learn to play Piano, Organ, Violin, Mandolin, etc. Beginners or advanced pupils. AMERICAN SCHOOL OF MUSIC, 50 Lakeside Bldg., Chicago, Ill.



Be Boss In the New Profession

Thousands of men are needed. The new profession that is paying big money wants you and needs you. Here is your opportunity to get into it now. You don't need to leave your present employment. Just a few hours a day in your own home and soon you get your diploma and are a full-fledged Meter Engineer.

Be a Meter Engineer

The profession of Meter Engineering is now in its infancy. It is calling for men. The Central Electric Stations must have Meter Engineers, because without them they cannot operate. Thousands of positions now open. Wonderful opportunities. You can get into the profession. It is calling you.

A \$3000 Job for YOU

Meter Engineering is one of the best paying professions in the electrical industry. We can show you hundreds of men who are making better than \$3,000 a year. How would you like to have a \$3,000 job six months from now? Just put your name and address on the free coupon and get full particulars absolutely free. Send it now—today.

Special

For a limited time we are making a special reduced price offer in order to induce men to start the study of Meter Engineering right away. Write for full particulars at once.

Send the Coupon and Get 40-Page

Book FREE

Do not delay an instant. Just put your name and address on the coupon and mail it to us at once. We will send you absolutely free and post-paid, 40-page book on Meter Engineering. It tells you all about the New Profession and about our school. It tells you how you can learn to become a Meter Engineer in your own home during your spare time. Absolutely no obligations of any kind in getting the book. Just your name and address is enough. But write today—now—immediately while we can still make this great special offer.

FREE

Book Coupon
Ft. Wayne Correspondence School Dept. 1194
Fort Wayne, Ind.

Gentlemen: Please send absolutely free and prepaid your book on Meter Engineering. Also send me full particulars of the great special offer that is now being made to induce men to study Meter Engineering. I assume no obligations of any sort.

Fort Wayne Correspondence School
Dept. 1194
Fort Wayne, Indiana

Name.....

Address.....



We have successful graduates in nearly every State in the Union.

THE OLDEST AND BEST

Automobile School

Incorporated for \$10,000.00. The largest, best equipped and MOST RELIABLE automobile school in the country. Unlimited practical instruction on everything pertaining to automobiles. We guarantee to make a chauffeur, repairman, tester, salesman and demonstrator out of you in a short time or we will Refund Your Money. We have arranged with several of Detroit's largest factories to employ our graduates.

COME TO DETROIT, the "Automobile Center," and Learn the Business 67 out of every 100 autos in the country are made in Detroit's 35 auto factories

ADDRESS DEPARTMENT P

MICHIGAN STATE AUTOMOBILE SCHOOL
11-13-15-17 Selden Ave., Near Woodward, DETROIT

The Pathway  to Plenty

HELP WANTED
AVERAGE \$90.00 MONTH
by U.S. "GOVERNMENT"

Railway Mail Clerks

Examinations Everywhere May 3
Thousands of Parcel Post Vacancies

No "Layoffs" without pay, because of strikes, financial flurries or the whims of some petty boss. Excellent opportunities for quick advancement to Higher Government Positions. If you want immediate appointment, send Today for our schedule showing locations of the May 3rd Examinations. Any delay means the loss of just so much time in preparing yourself for examination.

We Prepare Candidates Free

Send Today **FRANKLIN INSTITUTE**
Dept. N 106, Rochester, N. Y.

The coupon, filled out as directed, entitles the sender to a free copy of our book, "Government Positions and How to Obtain Them," sample questions, and to consideration for Free Coaching for the examination here checked.

.... Railway Mail Clerk (\$900 to \$1800) Customs Positions (\$600 to \$1500)
.... Postoffice Clerk (\$800 to \$1200) Internal Revenue (\$700 to \$1800)
.... Postoffice Carrier (\$800 to \$1200) Stenographer (\$800 to \$1500)
.... Rural Mail Carrier (\$500 to \$ 900) Clerk in the Departments at Washington (\$800 to \$1500)
.... Bookkeeper (\$900 to \$1800)	

NAME.....
ADDRESS..... N106

Use this before you lose it. Write plainly.

Learn to be An Auto Expert



Six weeks from the day you commence your studies at this great practical school you will be able to repair any make of automobile and drive any car on the market.

Earn \$75. to \$200. a Month

Many of our graduates make even more than this. Big demand for competent repairmen, demonstrators, garage managers and chauffeurs. All practical work. No books used. No tools to buy. Write today for big illustrated free book. Address,
AUTOMOBILE TRAINING SCHOOL, 1185 Locust St., Kansas City, Mo.

THE UNIVERSITY OF CHICAGO

Correspondence-Study Dept.

HOME STUDY

offers 350 class-room courses to non-resident students. One may thus do part work for a Bachelor's degree. Elementary courses in many subjects, others for Teachers, Writers, Accountants, Bankers, Business Men, Ministers, Social Workers, Etc. Begin any time.

20th Year **U. of C. (Div 20) Chicago, Ill.**

CIVIL SERVICE

positions are very desirable. Good salary, short hours, easy work, pleasant surroundings, life positions, steady work, thirty days vacation and thirty days sick leave annually with pay. 46,202 appointments made last year. No political pull needed. Common school education sufficient. Must be 18 years or over. Full information about how to secure these positions and questions used by the Civil Service Commission free.

COLUMBIAN CORRESPONDENCE COLLEGE, WASHINGTON, D. C.

MEN WANTED



Prepare as **Firemen, Brakemen, Electric Motormen, and colored Train Porters.** Hundreds put to work—\$65 to \$150 a month. No experience necessary. **500 more wanted.** Enclose stamp for Application Blank. Name position you want.

I. RAILWAY C. I. Dept. 35 Indianapolis, Ind.

DON'T TAKE A COURSE IN Mechanical Drawing

until you have read my proposition. Practical draftsman, working every day in the Drawing Room of the most progressive machine-shop in the west, with long experience also as a Teacher of Mathematics and Drawing, will instruct a few men by mail. **Positively the best means of becoming a practical, well-paid Draftsman.** Instruments furnished. Rates very reasonable. Write for information. A card will do.

DRAFTSMAN, 252 South Corona Street, Denver, Colorado

FRENCH, GERMAN, SPANISH, ITALIAN

Can be learned quickly, easily and pleasantly, at spare moments, in your own home. You hear the living voice of a native professor pronounce each word and phrase. In a surprisingly short time you can speak a new language by the

LANGUAGE-PHONE METHOD

combined with **ROSENTHAL'S PRACTICAL LINGUISTRY**

Send for Booklet and Testimonials
The Language-Phone Method
961 Putnam Building, 2 West 45th Street, N. Y.



WHY NOT BE AN ARTIST?



STUDY drawing at home under Expert Faculty. We have successful students in every part of the world. **Turn your Talent into money.** Our Students are filling high salaried positions. 14 years successful teaching. Endorsed by high authorities. 18 Courses in Commercial and Illustrative Drawing. Teachers' Normal and Applied Art, Profit or Culture.

Thoroughly Equipped Residence School
Artist's Outfit FREE to Enrolled Students
SCHOOL OF APPLIED ART, 755 Applied Art Bldg., Battle Creek, Mich.

OUR HANDSOME ART YEARBOOK IS FREE TO YOU

Learn Automobile Driving and Repairing

We give you driving lessons and teach you all the technical parts to prepare you for a good paying position. Write for Booklet P. Day and Evening Class.

NORTHWESTERN MOTOR INSTITUTE, 228-230-232 Wisconsin St., MILWAUKEE, WIS.

LEARN WATCHMAKING EARN BIG SALARIES

College famous for teaching highest art of watch work, jewelry, engraving, optics. 18 years' success. Graduates command big salaries. Moderate rates. Boarding homes nearby. Special book ready. Write **PHILA. COLLEGE OF HOROLOGY, 1338-48 Somerset St., PHILA., PA.**

Signal Engineers Will Require Thousands More Employees



**\$125 to \$300
A MONTH**

Write today! A most wonderful opportunity for the ambitious man. Railroads need hundreds of Signal Engineers. Will pay **big money** for **practical, trained experts**. You need no experience to take up this work. Send a post card immediately.

Chief Signal Engineer will instruct you personally. Department of Signaling organized to train men to fill these big positions open. Chief Signal Engineer will instruct you **right in your own home** by mail. We teach you to be a **practical expert signal engineer** capable of earning from \$125 to \$300 a month at the very start.

FREE \$13.50 Outfit to Those Who Enroll at Once

Don't delay. More trained men wanted right now. Demand growing. Future unlimited. Outfit consists of miniature locomotive, tracks, standards, block signals, etc.

Offer Limited—So Hurry Just send post card for our catalog and full information. A big chance for you. Send immediately. No obligations.

Dept. of Signaling, Desk 1194
491 Cass Street, Chicago



I TEACH SIGN PAINTING

SHOW CARD WRITING or LETTERING by mail and guarantee success. Only field not overcrowded. My instruction is unequalled because practical, personal and thorough. Easy terms. Write for large catalogue.

CHAS. J. STRONG, Founder

DETROIT SCHOOL OF LETTERING
Department 102 Detroit, Mich.

"Oldest and Largest School of its Kind"
"Thoroughly Equipped Residence School"

STUDY LAW AT HOME

The oldest and most successful school in the world, teaching law by the correspondence plan, will send **Free** its beautiful catalog and testimonials showing how thousands of ambitious men, through its **Regular College Course**, became successful practitioners, and how other thousands climbed to commanding business positions by taking **The Business Law Course**. Easy Payment Plan.

THE SPRAGUE CORRESPONDENCE SCHOOL OF LAW
257 American Building DETROIT, MICH.

DRAWING

Caricature, Cartoon, Comic, Commercial, Fashions, Lettering, Newspaper, Magazine and General Illustrating taught by mail. Booklet 6c.
Boston School of Drawing, Albion Bldg., Boston, Mass.



LEARN WATCHMAKING AND ENGRAVING

Earn while learning. Most practical watch school. Individual instructions. Graduates in great demand. Book free.
Chicago School of Watchmaking, 63 E. Van Buren St., Chicago

LEARN TELEGRAPH

Morse or Wireless. Station Agency work also taught. Splendid opportunities. Graduates assisted. We own and exclusively occupy two large modern buildings equipped with R. R. Dispatchers and Western Union Wires and Complete Wireless Station. Oldest and largest school—est. 33 years. Investment \$28,000. Endorsed by Railroad, Wireless and Western Union Officials. Expert, practical teachers. Living expenses may be earned. Tuition low. Easy payments. Correspondence courses also. Catalogs Free.

Dodge's Telegraph, Railway & Wireless Institute
8th Street Valparaiso, Ind.

New Parcel Post Will Require Thousands More Employees

The United States Civil Service will require the appointment of approximately 35,000 employes during the coming year.

The opportunities for positions in the Civil Service were never better.

Civil Service positions are desirable because the hours for work are not too long, salaries are good and certain, and promotions are frequent.

The greater number of appointments will be made in the Post-Office Service, paying from \$600 to \$1,700 and more per year; the R. F. D. Service, paying \$1,100 per year to standard routes; and the Railway Mail Service, paying from \$900 to \$1,800 per year.

If you are an American over 18 years old and can read and write you can make sure of appointment to one of these positions by study of an I. C. S. Civil Service Course.

Just mark and mail the coupon below and we will send you booklet giving names of I. C. S. students who are now holding Civil Service positions at good pay. We will also tell you how you, too, can enter this most pleasant and profitable employment.

Pleasant work—good salaries—life positions.

Mark and Mail This Coupon

INTERNATIONAL CORRESPONDENCE SCHOOLS
Box 872-C, Scranton, Pa.

Please explain, without further obligation on my part, how I can qualify for the Civil Service position before which I have marked X.

P. O. Clerk
Mail Carrier
R. F. D. Carrier
Stenographer
Bookkeeper
Typewriter
Ry. Mail Clerk
Ry. Mail Weigher
Messenger
Elevator Conductor
Apprentice
Skilled Laborer

P. O. Inspector
Immigrant Inspector
Guard
Janitor
Gauger
Storekeeper
Assistant Weigher
Sampler
Deputy Officer
Pressman
Bookbinder
Watchman

Name _____

St. & No. _____

City _____ State _____

Present Occupation _____

Please Mention Popular Mechanics

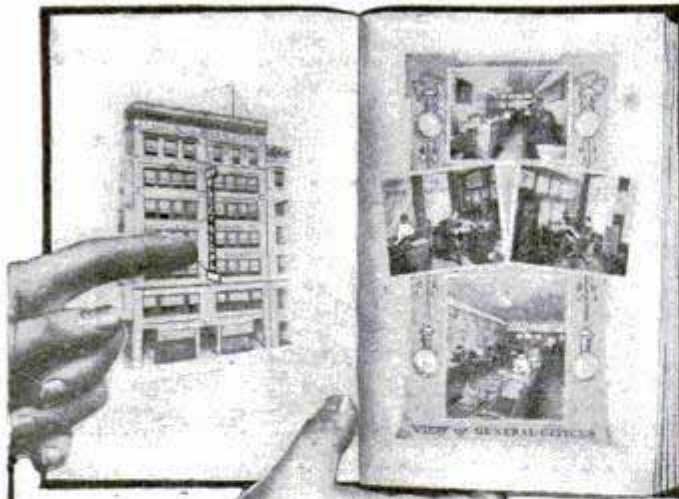

Write
for
this
FREE BOOK

It may mean
the opening
wedge to the
opportunity
of your life

THE New York Electrical School teaches men practical electricity and shows them the way to earn big money by becoming expert electricians. No profession has a more splendid future than electricity.

We teach our students how to become master electricians by painstakingly drilling them in the actual work they will be called upon to do when they accept a situation at big pay. Each scholar is personally taught from the day he enters, and individual instruction is given in all practical branches of the work. Students are first taught the simpler electrical work and as they gradually progress they are taken from department to department until finally they can completely equip a building from the blue prints the students themselves have drawn. When they receive their certificate they are ready to go out in the world with a profession that will never forsake them. Not a correspondence school—you "Learn by Doing."

Good Electricians Are Always in Demand

and the money they earn is often twice as much as other men earn from ordinary trades.

**Write for Our Free Catalog
and Get Full Particulars**

It is more than likely that this is your opportunity. There is no work that a man can do from which he will get more pleasure and profit than from electrical work. Write to-day.

The New York Electrical School
44 West 17th Street, New York

Training Counts

**DRAKE'S
HOME STUDY**

Mechanical and Electrical Books

WILL

Double Your Salary

Practical Instruction Books for mechanics in all lines—Electrical Workers, Engineers, Firemen, Carpenters, Painters, Masons, Chauffeurs, etc.

|| **WRITE TODAY** ||
for large 1913 Illustrated
Catalogue **FREE.** ||

FREDERICK J. DRAKE & CO.
D-8, 1325 Michigan Ave. CHICAGO

DR. Le BOY

Director American College of Mechano-Therapy—
the International Home of Drugless Healing

Gives YOU These Books

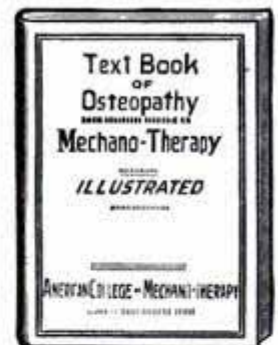
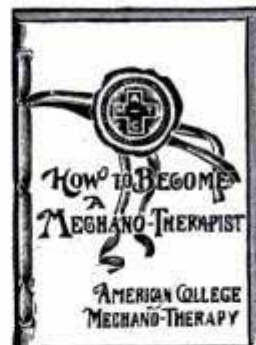

Would you be interested in knowing about Mechano-Therapy, the great profession of drugless healing? Would you like to earn wealth by the noble dignified practice which spreads health and happiness to those who come to you for benefit?

These Free Books Tell

you in plain, simple language the facts and truths about Mechano-Therapy. They point out the great opportunity for men and women of ordinary education to learn a grand, dignified, respected, noble profession of which they may make from \$3,000 to \$6,000 each year. The larger book we send contains 62 complete lessons on the treatment of familiar and common ailments.

If you want to know what a great opportunity this announcement places before you, if you are ambitious to do something useful in the world, if you desire to make a good income, if you are carefully considering your future welfare, then here and now is YOUR opportunity. This means much to you.

Opportunity knocks at your door, but YOU must open the door. Therefore today, in a letter or on a postal, simply write me "Please send the two free books and particulars." Address

DR. WM. L. LE BOY
24 Manierre Bldg. CHICAGO, ILL.

SPEAK ANOTHER LANGUAGE

ENGLISH · GERMAN · FRENCH
ITALIAN · SPANISH

CORTINA-PHONE

"The Original Phonographic Method"

Awarded Medals—Chicago, 1893; Buffalo, 1901

Do you want to learn a foreign language by listening to it, without a costly teacher, without loss of time from regular work and at a trifling expense? If so, write at once for a **Cortinaphone** booklet describing this marvelous method invented by the world famous scientist, Raphael D. Cortina. The outfit consists of the **Cortina** textbooks, a magnificent phonograph of the two and four minute type, and thirty everlasting non-breakable records.

IDEAL HOME-STUDY METHOD

Thousands have learned a foreign language by our method—just as a child learns its mother tongue—by listening to it. Always ready when you have a few moments to spare. You can learn to speak any language with its help. Write for testimonials from leading University professors and others who have used our method.

RECORDS FURNISHED IN ANY LANGUAGE

We will send the complete outfit, and if you like it you can pay for it in easy installments.

Write for booklet giving full particulars

CORTINA ACADEMY OF LANGUAGES

Established 1882.

926 Mecca Building
1600 Broadway, near 48th St.
NEW YORK



CORTINAPHONE

DO YOU LIKE TO DRAW?

That's all we want to know

Now we will not give you any grand prize—or a lot of free stuff if you answer this ad. Nor do we claim to make you rich in a week. But if you are anxious to develop your talent with a successful cartoonist, so you can make money, send a copy of this picture with 6c. in stamps for portfolio of cartoons and sample lesson plate, and let us explain.

The W. L. Evans School of Cartooning
321 Ball Bldg., Cleveland, O.



EARN WHILE YOU LEARN BE A WATCHMAKER

Watchmakers and all 'round Jewelers' repairers—in demand now. Six months' course fits you for a position—earn while you learn, too! Write for **FREE** book—it explains all.

STONE'S SCHOOL OF WATCHMAKING
912 Globe Bldg. ST. PAUL, MINN.

LEARN TO WRITE ADVERTISEMENTS EARN \$25 to \$100 A WEEK

We can positively show you by mail How to increase your salary. **BOOK MAILED FREE.**
PAGE-DAVIS CO., 112 Page Building, Chicago, Ill., or 150 Nassau St., New York

BE A BANKER

Learn a profession that will give you standing and independence. Splendid opportunities. Pleasant work, short hours, all holidays off, yearly vacation with pay, good salary. Diploma in six months. Text books by Edgar G. Alcorn. Catalog free.
AMERICAN SCHOOL OF BANKING, 119 McLene Bldg., COLUMBUS, OHIO

LEARN WATCHMAKING AT HOME



You can learn by our modern and original system of instruction every part of the **Watchmaker's Trade** at home as good or better than at a shop. You can earn money while learning and secure a well paying position or start in business after completing our course of instruction. Good watchmakers are always in demand and earn from \$20 to \$35 per week. For particulars apply to the **WISCONSIN SCHOOL OF WATCHMAKING, Stroh Bldg., MILWAUKEE, WIS.**

Learn Electricity!



Earn \$150⁰⁰
TO
\$300⁰⁰
a Month

Electricity is today the great motive power of the world. Its use has extended to every phase of life and industry.

Thos. A. Edison says that the field of electricity is in its infancy—that electrical workers of the future will discover uses for this great force now undreamed of.

Right now there are not enough electrical engineers to fill the big paying positions open. Every day our **Free Employment Bureau** has a call for Electrical Engineers greater than we can fill. Therefore, we are making a **very special offer** to students at this time.

Write today! Send the free coupon for our catalog and free information.

We Teach You in a Short Time —at Small Expense

In order to supply more electrical engineers we are charging a small tuition fee. Your tools and equipment of all kinds are furnished **FREE** by the School. You may have **easy payments** if desired. Our course of instruction is clear, simple and thorough. Our Graduates demand handsome salaries. Don't pass up this opportunity.

FREE TOOLS

We will furnish all the material and tools you use in taking our course—**ABSOLUTELY FREE.** All we charge is a very small amount for tuition. Many of our students earn their expenses while taking the course.

Men Wanted for these Trades

Electricity Plumbing
Moving Picture Operating
Mechanical Drawing

We also teach the trades mentioned above. There are unlimited possibilities in any one of these trades. When you have completed our course you will be in a position to demand from \$5.00 to \$8.00 a day right at the start. Or go in business for yourself and make from \$3,000 to \$5,000 a year.

Send the FREE COUPON for Catalog and Particulars

No obligations on you at all. Just fill out the coupon and mail it today. Take this step towards **success.** Let us tell you how you can master electricity or any other profitable trade in a short time—make a bigger success than you ever dreamed of making. Fill out the coupon and mail it at once.

L. L. COOKE, Director
Coyne National Trade Schools
39-51 E. Illinois St.
Dept. 1194
Chicago, Ill.

FREE COUPON

L. L. COOKE, Director

Coyne National Trade Schools

39-51 E. Illinois St.
Dept. 1194 CHICAGO, ILL.

GENTLEMEN: Without any obligations on me whatsoever, please send me your school catalog and full particulars of this offer to men—**ALL FREE.**

NAME.....

ADDRESS.....

Learn to Play the Piano

and Your Position in Life Is Assured



Music has advanced many a man and woman from a narrow life and hard work, and put them where they had at command money, friends, congenial surroundings, and all the good things of this world.

Everywhere skilled pianists are in great demand. The great cities are fairly calling for men and women who can play. There are *fourteen thousand* motion picture theatres in the country. Every year sees these theatres demand higher class pianists and offer higher pay. There are dances and social entertainments of various sorts in every town or city in the land. For all these the young man or woman who can play and *play well* is in constant demand at a good, high fee.

As a *creator of opportunity*, music has no equal. The man who can give pleasure through his playing will find all doors open to him and a royal welcome wherever he goes. Music will bring him friends. It will take him into the homes of influential people. It will win him the confidence of those who can

help him. *It will push him along in business as no other accomplishment can do.*

Study Music by Mail for 12½ Cents a Day

That is all it will cost you to take the most wonderful Correspondence Course for the piano that has ever been created. Hundreds of its successful students are today earning big money and winning high honors. Scores of prominent music teachers recommend it. Thousands of students are now enrolled. Bear in mind that this is a Correspondence Course *marvelously perfected*. For the first time in history you can study by mail, in your own home, the teachings of the great music masters of Europe and America — *and have these teachings illustrated at the keyboard of your piano by a Demonstrator* —

The Music Master

— It Makes Piano Study Easy —

the greatest musical invention of the century.

THE MUSIC MASTER is a teacher that is with you not only while you *take the lesson* but while you *practise* as well. It is thorough. It is scientific. It keeps you from making mistakes in practise, thus saving months in time and hundreds of dollars in money. It makes you enthusiastic over practise. It makes piano study so easy that you learn almost without effort.

With THE MUSIC MASTER you can *play music from the very beginning*. And you can become a *skilled performer by the end of a year*.

AN ORDER FOR

The Music Master's Own Book

This volume to be sent me by return mail free of all expense or obligation on my part

Name _____

Street _____

Town _____

State _____

State whether you desire this course for yourself, son or daughter

A Great Conservatory Course Now Taught by Correspondence

The German-American Conservatory of Music spent upon the creation of this Correspondence Course twelve years of work, and thousands of dollars in money. And the result of its effort is simply this:—*Piano study made easy*. No more hours of endless drudgery. No more failures. No more mistakes. But everything taught *so simply* and demonstrated *so plainly*, right at the keyboard of your piano, that *even a little child* can understand.

A Diploma is granted from the German-American Conservatory of Music upon the successful completion of THE MUSIC MASTER'S Course.

Make up your mind *now* that you will get out of the rut of narrow opportunities. Determine to fit yourself for something better than you have today. *Don't wait for time*. Use the time that you have, even if it be only a few minutes a day. Keep right on with the work you are doing. Give music your spare moments. *It will pay*.

Mail Us This Coupon

and we will send you *free* THE MUSIC MASTER'S OWN BOOK. This is a handsomely illustrated volume full of information about our wonderful invention and our splendid system of instruction.

FREE—with THE MUSIC MASTER'S Course—fifty pieces of high grade piano music, selected and edited by The German-American Conservatory.

The German-American Conservatory of Music
Now Teaching Piano by Mail
Dept. M Steger Building Chicago, Ill.

YOU CAN NOW LEARN

SHORTHAND

By Mail—In 18 Easy Lessons!

Anyone can now learn the world's greatest system—at home complete in 18 lessons. It will not cost you one cent to make the trial. Write today for particulars of this great offer. The shorthand taught by us is now used in more than 2000 resident schools and colleges, including 600 public schools—in Boston, Denver, Buffalo, Kansas City, St. Paul, and hundreds of other large cities. Has rapidly become the most popular system in use today. Any child with a common school education can learn it. Wonderfully simple. Pronounced by experts to be the easiest to learn, read and write. No shading, no positions, no arbitrary outlines to memorize, no tedious study and practice as with other systems. Words never heard before can be written scientifically and read like print. The monthly shorthand magazine supplied our students is now read by nearly 50,000 men, women and children. Articles on literature, science, business, etc., all written in shorthand; readable as print. Thousands have been fascinated and benefited by this novel means of mental training and development.

FREE TRIAL ENROLLMENT



Private Secretaries Make Big Money



The Ideal Vocation for Women

Mail the coupon at once and learn how you can make an absolutely FREE trial of this easily-learned shorthand system right in your own home. You need not risk a single penny. Make up your mind today, now—that you will learn to write shorthand.

It is more than a wonderful money-making profession—it is a remarkable accomplishment, a business asset, a time-saver and daily aid to ministers, lawyers, students, newspaper reporters, authors, and men and women required to do writing in any form. **Woodrow Wilson** wrote his entire "History of the American People" in shorthand before it was typewritten. **Mrs. William Jennings Bryan** learned stenography in order to be of greater personal service to Mr. Bryan. Shorthand is a tremendous advantage in taking minutes of conversations, public speeches, meetings, lectures, telephone messages, memoranda, private data, etc.

The Stepping-Stone to Success

Shorthand has been a big factor in the success of many men and women foremost in business, political, and professional life. Among the conspicuous examples of men who have risen to prominence, power and wealth by aid of shorthand are: **Geo. W. Perkins**, partner of J. Pierpont Morgan and organizer of the Harvester Trust; **Wm. H. Newman**, Pres. N. Y. Central Lines; **Hon. Frank S. Black**, Ex-Governor of N. Y.; **Darius Miller**, 1st Vice Pres. Burlington Railroad; **Geo. B. Cortelyou**, Priv. Secretary to Presidents McKinley and Roosevelt, Member of Roosevelt's Cabinet, and now President of the Consolidated Gas Co., New York; **Edward Bok**, Editor of the Ladies Home Journal.

To the young man or woman seeking profitable employment and rapid advancement we say—**Learn Shorthand!** It is the short cut to success. To any man or woman, ambitious for *self-improvement* and greater *business power*, we say—**Learn Shorthand!**

Stay Right at Home—SEND THE COUPON

No need to give up your present work. Earn while you learn. Give us your spare time only. Personal instruction by experts. Surprisingly low cost. **Easy Payments.** We offer complete stenographic courses by mail—Shorthand, Typewriting, Office Practice, Dictation, Business English, Secretarial Work, Court and General Reporting. Typewriters furnished. Stenography has advanced thousands from poverty and hard work to fine salaries and easy hours. Positions everywhere. If you earn less than \$25 a week write today for

Free Book on Shorthand telling of the wonderful opportunities offered those having a knowledge of shorthand and typewriting. Mail the coupon at once and we will send this handsome, illustrated booklet free. Get into a fascinating profession that pays big money and leads to the high places. Don't stick to a poorly paid job until too late to change. Any person 15 years of age with a common school education can take up our courses. A 19 year old writer of the system we teach established a world's record for speed and accuracy in public contest with the speediest shorthand experts of the world. Send today for list of official court reporters and particulars of remarkable feats young people have accomplished with the shorthand taught by us.

Mail the free coupon or send postal card now.

CHICAGO UNIVERSITY OF COMMERCE

P. O. Box 1034, CHICAGO, ILL.

FREE Trial Coupon

**C. U. of C.,
P. O. Box 1034, Chicago, Ill.**

GENTLEMEN: Without obligation to me please send full particulars regarding your **FREE TRIAL ENROLLMENT OFFER** and Booklet describing your Home-study Shorthand and Stenographic courses.

NAME

OCCUPATION.....

ADDRESS

CITY.....STATE.....

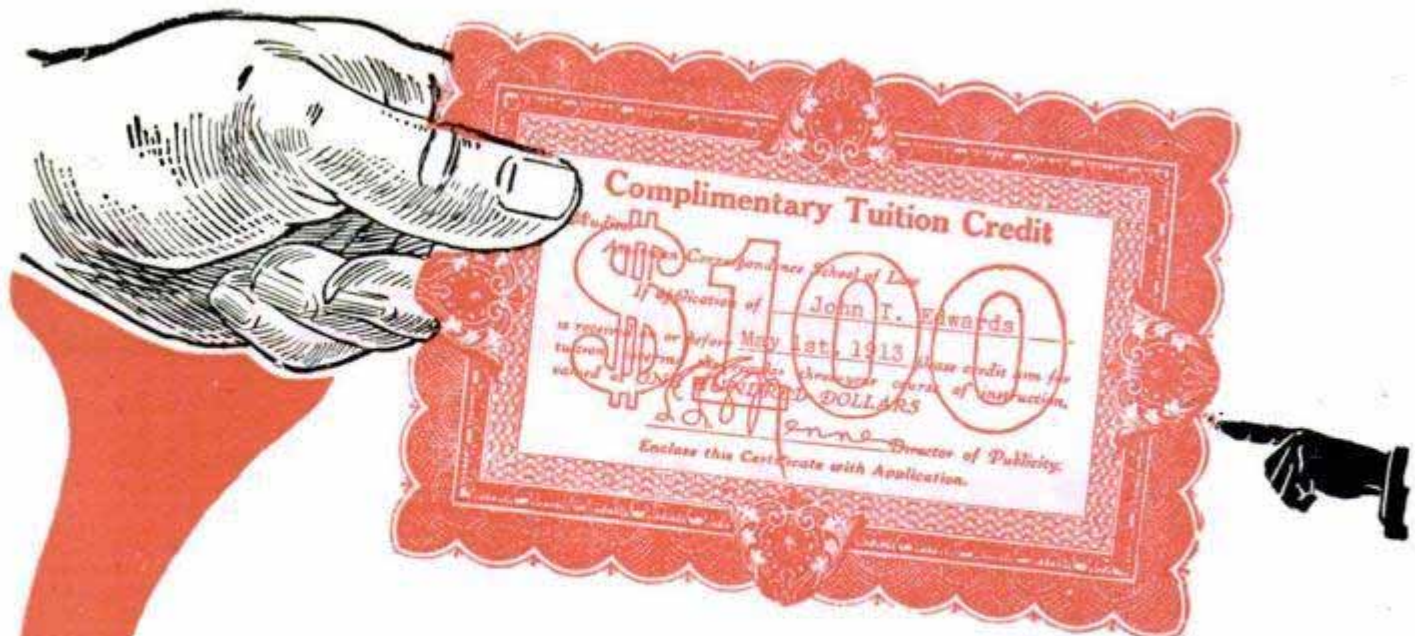

Are You Ambitious to Become a Lawyer, to Attain the Highest
Our Great Scholarship Offer

At this particular time we are offering you a **Tuition Credit Valued at \$100.00 Absolutely Without Charge**. This Tuition Credit entitles you to a complete three years' Course in our big law school, Lectures, Faculty Talks, Examinations and the services of our Consulting Department. The only expense will be for text and postage. We make this liberal offer for advertising purposes. The offer is open for a **limited time only**. Take advantage of this remarkable opportunity **Now**. Hurry, hurry, or you may be too late. Clip the coupon and send it to us for full particulars—**NOW**—today.

Many brilliant lawyers studied law at home. Resolve **NOW** to take advantage of this remarkable opportunity. This offer is strictly limited—so hurry if you want to be one of the fortunate ones to receive a scholarship. Clip the coupon at the bottom of the page and send it to us **at once**. It will bring you our big 132-page Law School Book and full particulars **Free**.

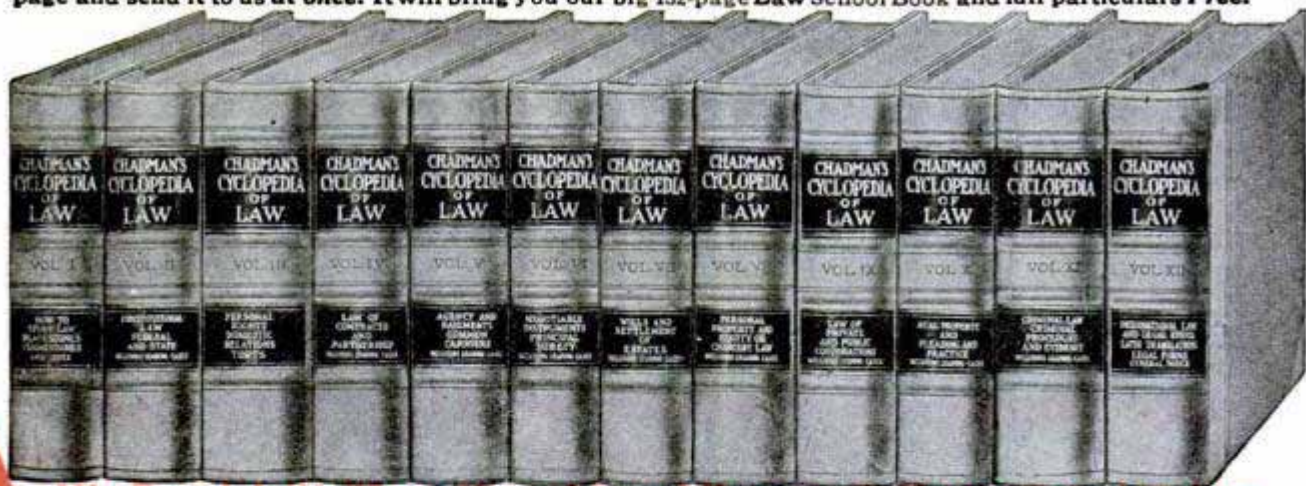

We Furnish this Magnificent Law Library with Every Scholarship

The original cost of this great Law Library was fully \$50,000. This magnificent set of law books complete in 12 volumes, covers all the subjects of law. It is written so you can understand every detail of the most complex law problems. Constant revision insures everything being strictly up-to-date. With the aid of these splendid volumes you will grasp the study of law in a surprisingly short time. You cannot afford to be without this superb law library. Send coupon **immediately**.

Guarantee

We Guarantee to coach FREE any graduate failing to pass the bar examination in **ANY STATE**. Our course covers all branches of American Law and includes same studies as leading Law Schools.

AMERICAN CORRESPONDENCE
 Dept. 1194 **Manhattan Building**

LAW University Instruction At Home!

Accept This Tuition Credit Valued at \$100.00

Without Charge

OFFER LIMITED, So Write Immediately If You Want a Scholarship Success in Business? Then Read This Great Scholarship Offer

Superior Advantages of Our School

We have had ten years of successful experience in teaching law by correspondence. Our large and distinguished faculty and staff of special lecturers insure the most efficient service. Our Course covers both theory and practice—prepares for the bar in ANY STATE. We are the only school that actually combines the case and text book method of instruction—same as *Harvard, Columbia, Michigan and Other Big Universities*. Our course is adapted for men who want to prepare for the practice of law or for men who want a legal knowledge for business purposes. We have the simple, easy and direct method of law instruction. Our course is brief and concise—takes only your spare time. LEARN while you EARN.

Don't let old age find you in the untrained class, looking back on lost opportunities. This is one of those rare chances to train yourself for higher accomplishments—to insure your future—to succeed. Decide now to be come legally trained. Send coupon at once. Remember this offer is *limited*—so hurry!

Business Law Course *Protect Yourself! Know Your Rights!* *Avoid Expensive Law Suits!* Ignorance of the law excuses no one. We have a Course for those who do not intend to practice law, but who want a knowledge of law for business purposes. No knowledge is more important or practical. It sharpens the reason, broadens the mind and perfects the memory. Knowing law is the best guarantee of success in any business.

Big 132-Page Law School Book FREE!

Write today for our big 132-page Law School Book. It tells the importance and advantages of a law education—contains valuable information every man should know. Everything sent FREE and prepaid. No obligation.

Mail This Free Coupon Today

Hurry—Hurry! Don't miss out on this great offer! Send no money—just put your name and address on the coupon and send it to us at once. Remember at this time we offer you a Tuition Credit valued at \$100.00, covering our Complete Course in Law *Absolutely Without Charge*. This offer is limited—so mail the coupon immediately.

SCHOOL OF LAW
Chicago, Ill.

Endorsed by Bench and Bar

W. P. Bell, Attorney General, State of Washington—"I cannot refrain from giving your excellent system of instruction my hearty approval."

Edward Brundage, Ex-Corporation Council, City of Chicago: "Your Cyclopedic of Law is of inestimable service to men in all walks of life."

James Livingston, County Judge, Johnson Co., Nebraska: "I highly recommend your Course to anyone seeking a legal education." (A former student of our school)

P. C. Crenshaw, Gen. Mgr. Standard Oil Co. Sales Dept.—"Too much cannot be said in favor of your Course."

John Hamilton, Ex-President American Bankers' Ass'n: "Your Encyclopedia is a valuable acquisition to any business man's library."



Don't Delay!
Send the
Coupon
Now

Fold Here, Tear Off, Sign and Mail

FREE
Information
COUPON

American Correspondence
School of Law

Dept. 1194 Manhattan Bldg. CHICAGO, ILL.

Gentlemen: Without any obligation on me whatsoever, please send me your free 132-page Law School Book and full particulars of your free \$100.00 Tuition Credit Offer.

Name

Address

The T. D. S. Method Places This Typewriter Easily Within Your Reach

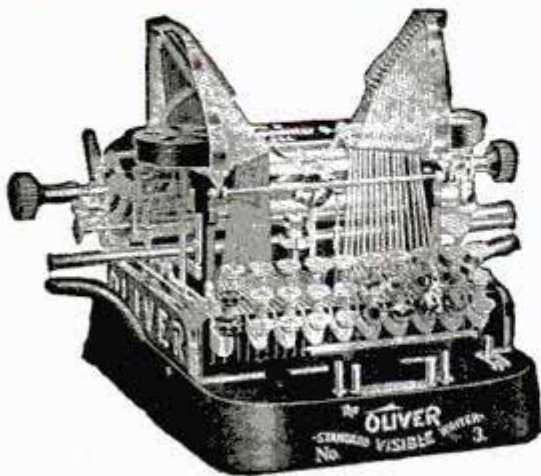

No. 3 OLIVER At \$56.00 **On the Rental Purchase Plan**

Read this offer carefully. It is intended to give you just what you want—a dependable, standard, visible typewriter at a price consistent with your requirements and on terms convenient. Our method marks an epoch in the typewriter industry. Heretofore the only machines available at this price or near this price, were inferior grades, which few wanted, or else a second-hand machine in questionable condition.

The typewriter that we offer is the famous, genuine No. 3 Oliver, complete with every perfection, every device that ever went out with this model at the maker's standard price. Our method makes the price possible. We sell direct to merchants, without salesmen at less than agency prices.

Free Trial—No Deposit

We do not ask or expect any money from you until after you have used the typewriter and it has proven to be just what you want—the best typewriter for your purpose.

The machine that we will ship you on approval, without deposit, is a perfect No. 3 Oliver, guaranteed to be equal in quality of any typewriter, regardless of price. The machine is shipped to you in the original box in which it leaves the factory of the maker. Each machine is guaranteed against defect of material or workmanship, just as if you paid the full price. The Oliver No. 3 is dependable. It seldom requires adjustment and never wears out.

It is so simple that after a few minutes' reading of the instruction book that accompanies the machine, you can typewrite on it. After a few hours' practice you can write as fast as with pen or pencil, and in a few weeks three times as fast.

Visible Writing The Oliver No. 3 is a visible writer—every letter is in plain sight as soon as printed, a necessity to those who compose as they write.

Universal Keyboard All \$100 standard typewriters have adopted the universal keyboard. It is a waste of time to learn any other.

Capacity You will never be held back in your work if you own an Oliver. It has unlimited speed. The ingenious arrangement of its working parts cannot be described on paper. You will best appreciate when you use. The beautiful work turned out on this typewriter will give your letters distinction.

It is a great manifolder — as many as twenty carbon copies can be made at one writing.

Will Write on Ruled Lines or you can rule lines with it. It will do any practical thing that any typewriter will do, and has many features not found in other makes. It cuts a perfect stencil for mimeograph work.

Will Last a Lifetime Because the Oliver has only one-third as many working parts as the other \$100 machines — because it is built on the correct mechanical principle — because it is made of better than necessary material; it out-lasts all others — does not get out of order — so simple anyone can easily master its construction and operation with a few minutes' attention. There is no task too great for this sturdy machine, and above all, it is dependable.

Easy to Run The downward stroke of the type-bar and the perfect lever adjustment and smooth, wide bearing gives the Oliver the lightest action. It is a pleasure to strike the keys. Compact — portable — efficient — a typewriter anyone may be proud to own.

The Proven Typewriter You cannot make a mistake in getting a typewriter of the make that the two largest mail order houses have selected and use exclusively—183 railroads have purchased them—thousands of merchants and professional men all over the world have endorsed the Oliver.

Easy to Own On our plan you pay just the amount that machines of this quality earn as rental. \$4 a month is only 13 cents a day. You practically rent the machine for 13 months and then it is yours and you save practically one-half and you use the machine while paying for it. It will surely earn its own way — bring you in more money than you pay out.

Give This Typewriter a Chance to Sell Itself You can have it on trial without obligation—no salesman or agent will call on you — you will be the sole judge. It has got to sell itself, or there is no sale and no obligation. Do not hesitate to accept this liberal trial offer — it is our method of doing business, and we urge you to let us send the machine for trial and examination.

If you do not find it to be a satisfactory typewriter — if you do not find that it meets your every requirement, that it is perfect in every detail and the best typewriter you ever saw, you are not obliged to keep it, and we pay the transportation charges back.

With each machine is a complete outfit, metal cover, ribbon, tools and a big instruction book, practice paper, carbon paper—everything you need.

Isn't that fair? You do not have to send any money, just fill in the attached coupon blank, and mail today.

FREE TRIAL COUPON

Typewriters Distributing Syndicate
166 D-96 North Michigan Boulevard, Chicago

GENTLEMEN—You may send me a No. 3 Oliver Typewriter for five days' trial.

If I decide to keep the typewriter, I agree to pay \$56 as follows: \$4 within five days from the date the machine is delivered for trial and \$4 each month thereafter until the \$56 price has been paid. Title remaining in you until then. Otherwise, I will return it to you at your expense.

10 per cent discount for all cash after five days' trial; or 10 per cent discount for cash on the unpaid balance of contract any time excepting only for the final monthly payment.

Name

Address

TYPEWRITERS DISTRIBUTING SYNDICATE 166 D-96 North Michigan Boulevard
CHICAGO

Extra! Free!

To Men Ambitious to Become DRAFTSMEN



ROBERT HARDIE
Chief Engineer

The most remarkable, the most liberal offer ever made in the history of Drafting. I want 50 men (ages 16 to 55) immediately to take up this drafting work. No experience necessary. I will teach you to become an expert draftsman **right in your own home—by mail.** There will be a position waiting for you the minute you finish my course. You can take up this work and still keep your present position. Just devote your spare time to my "personal" instructions. When you have finished you should demand at least

\$150⁰⁰ to \$200⁰⁰ Per Month

That's what many of my graduates are making today—some \$3,000 to \$5,000 a year. There is an enormous demand for trained draftsmen **right**

now. The demand is growing. The work is light, profitable and interesting. Advancement rapid. You are paid for what you **know**, not the quantity of hard work you do. By my practical method of instructions you can become **Expert Draftsman and Designer** in an amazingly short time.

Now Here Is My Astounding Offer!

This \$25.00 FREE Tuition Credit

Yes, if you write **at once** I will give you this **Tuition Credit** valued at \$25.00—**absolutely FREE.** I am making this great offer in order to supply expert draftsmen to meet the big demand of large engineering construction and railroad companies. On this special offer you will receive my "personal" instruction—just as though you paid the full tuition. My long and successful experience in this work enables me to give you just the kind of training that will enable you to rise to the highest salaried position without difficulty. Send the coupon for my book "The Road to Success" and full particulars of this great offer **at once.** Hurry! Write today while this special offer is open.



Guarantee

I guarantee to instruct you until placed in a position paying from \$75 to \$200 per month. Our Employment Bureau places students in positions without additional charge.

Free! \$17.50 Set of Drawing Instruments If You Write at Once

As an extra inducement to get in touch with the right kind of men I will give a magnificent set of drawing instruments valued at \$17.50—**positively free.** Handy size, leather bound pocket case. This set will be of use to you for years to come—when you are succeeding as Expert Draftsman and Designer. I cannot promise to hold this offer open indefinitely. You must write immediately if you want to take advantage of this marvelous opportunity. Just send the coupon.

Mail This FREE COUPON Right Away

Don't delay an instant. Take advantage of this splendid offer now—right now. The coupon will bring you absolutely free my book "The Road to Success." It contains valuable information every man should know. I will also send you full particulars of this special offer to give you a \$25.00 Tuition Credit in drafting—remember, \$25.00—**without one cent of cost to you.** Don't put this matter off or you may be too late. This is an opportunity that does not come along every day—a chance to increase your earning power—to insure your future—to **succeed.** Just put your name and address on the coupon and mail it at once, or send post-card—but act **immediately.**

CHIEF ENGINEER

Room 522, Engineering Building, Chicago, Ill.

FOLD HERE, TEAR OFF, SIGN AND MAIL

FREE
COUPON

CHIEF ENGINEER
Room 522
Engineering Bldg.
Chicago, Ill.

Dear Sir: Without any obligations on me, please send me your book "The Road to Success" and full information about your great \$25.00 Free Tuition Credit Offer. Send everything **FREE AND PREPAID.**

NAME

ADDRESS.....

SHORTHAND IN 30 DAYS

We absolutely guarantee to teach shorthand complete in thirty days. You can learn in spare time in your own home, no matter where you live. No need to spend months as with old systems. Boyd's Syllabic System is different in principle from all other systems. The first radical improvement in shorthand since 1839. It is easy to learn—easy to write—easy to read. Simple. Practical. Speedy. Sure. No ruled lines—no positions—no shading, as in other systems. No long list of word signs to confuse. Only nine characters to learn and you have the entire English language at your absolute command. The best system for stenographers, private secretaries, newspaper reporters. Lawyers, ministers, teachers, physicians, literary folk and business men may now learn shorthand for their own use. Thousands of business and professional men and women find their shorthand a great advantage. The Boyd System is the only system suited to home study. Our graduates hold lucrative, high-grade positions everywhere. Send today for free booklets, testimonials, guarantee offer, and full description of this new Syllabic shorthand system. Address—

CHICAGO CORRESPONDENCE SCHOOLS, 969 Chicago Opera House Block, CHICAGO, ILL.

Get there—Yourself!

Don't stop to envy the successful man. Study and ambition have placed him where he is to-day—and YOU have the same chance! Study at Home!



Drafting

Pays Big Salaries

Machine Drafting, Machine Design, Structural and Architectural Drafting and Design, Builders' Courses, Plan Reading, Estimating, Contractors' Courses, Etc. Regular and short courses. Students study blue prints of buildings and machinery in actual construction. Low tuition, easy payment. Free employment bureau. Free outfit to all Home Study students. Study at home in leisure hours; work is same as in our college day and evening classes. Both resident and correspondence courses. State which you want.

CHICAGO TECHNICAL COLLEGE
603 Athenaeum Building, Chicago, Ill.



Free Automobile

TO STUDENTS who qualify. Ride around taking orders in "COEY FLYER" 6 cylinder—5 passenger car. We teach you to make big money in automobile business. Easy lessons—free model—no experience necessary.

First Lesson FREE to everyone answering this ad.

C. A. COEY'S SCHOOL OF MOTORING

1424-1426 Michigan Avenue
Dept. 127 CHICAGO, ILL.



COPY THIS SKETCH

and let me see what you can do with it. You can earn \$20.00 to \$125.00 or more per week, as illustrator or cartoonist. My practical system of personal individual lessons by mail will develop your talent. Fifteen years successful work for newspapers and magazines qualifies me to teach you. Send me your sketch of President Wilson with 6c in stamps and I will send you a test lesson plate, also collection of drawings showing possibilities for you.

The Landon School of Illustrating and Cartooning
1438 Schofield Building, CLEVELAND, O.



LEARN THE AUTO BUSINESS

EARN A SPLENDID SALARY

Let us train you in our splendidly equipped shops for a good position as automobile mechanic, salesman or chauffeur. Thousands of graduates are earning big salaries. Complete training in 4 weeks, including extensive practice in repairing and driving high powered cars. Tuition and board reasonable.

Send to-day for catalogue and list of graduates

CLEVELAND AUTOMOBILE SCHOOL, 2341 Euclid Ave., CLEVELAND, O.



PIANO TUNING PAYS

Learn the most independent of all professions. You can learn quickly and easily by devoting your spare time for a few weeks, to our correspondence system. Our wonderful invention the TUNE-A-PHONE eliminates all guess work and assures success with or without a knowledge of music. We furnish full size action model and necessary tools. You can earn \$5 to \$15 per day, travel in any civilized country, see the world and regulate your own hours for business. School chartered by State. Diploma granted. Guaranteed as represented or tuition refunded. Write today for free illustrated book and valuable information.

NILES BRYANT SCHOOL, 158 Art Inst., BATTLE CREEK, MICH.

7 DAYS—All You Need To Learn PARAGON SHORTHAND

Sounds incredible, but absolutely true. Remarkable invention of expert. Simplest system ever devised. Speed capacity beyond reach of the hand. Easy to read. Is being used in service of U. S. Government, in offices of Railroads, Banks and other big corporations, Law Reporting, etc. POSITIVE PROOF or NO MONEY.

Write For Free Particulars Today! Now!

PARAGON INSTITUTE, 1401 Coliseum Pl., New Orleans, La.

BE A DETECTIVE

Earn from \$150.00 to \$300.00 per month; travel over the world. Write C. T. LUDWIG, 1600 Scarritt Bldg., Kansas City, Mo.

ADVICE Information and counsel on any subject under the sun. No matter what you want to know, no matter what your present condition, our big organization can help you.

WRITE TODAY FOR BEAUTIFULLY ILLUSTRATED BOOK FREE NATIONAL BUREAU OF ADVICE AND EDUCATION, 527 Ashland Block, CHICAGO

LEARN JEWELERS' ENGRAVING

A high salaried and easily learned trade, taught thoroughly by mail. We will teach the beginner better engraving than he can gain in years of rigid apprenticeship. We will also improve the skill of any engraver. Send for our catalog. The Engraving School, 112 Page Bldg., Michigan Ave., Chicago, Ill.

ARITHMETIC SELF-TAUGHT

A plain, easily-understood volume for all who have not had the opportunity of learning this subject thoroughly, or who have forgotten what they once learned. 257 Pages. Requires no teacher. This great little book sent postpaid for 60 CENTS. Stamps accepted, leather binding \$1.

GEO. A. ZELLER BOOK CO.
Est. 1870, 4473 W. Belle Place ST. LOUIS, MO.

SPANGENBERG'S
PRACTICAL
ARITHMETIC
Self-Taught



HIGHLAND PARK COLLEGE DES MOINES IOWA

Enter Any Time. 2000 Students Annually

One of the most completely equipped ENGINEERING SCHOOLS in the country. Students may enter any time they are ready to come.

COURSES OFFERED

1. CIVIL, ELECTRICAL AND MECHANICAL ENGINEERING COURSES. Standard courses are offered in Civil, Electrical and Mechanical Engineering. Special opportunity is offered for making up work or for taking a complete course preparatory to the standard Engineering Courses. Shop work from the beginning comes in preparatory courses. See our new Engineering Catalogue.

2. SHORT COURSES
- 1. One Year Electrical Engineering Course
 - 2. One Year Telephone Engineering Course
 - 3. One Year Steam Engineering Course
 - 4. One Year Machinists' and Automobile Course
 - 5. One Year Course in Mechanical Drawing

Just a fair common school education is all that is required for entrance to these courses. These courses are very practical and are intended for those who have but limited education and do not see their way clear to take a complete Engineering Course. The Machinists' Course is especially practical. The new machine shops are the most complete to be found in connection with any Engineering School in the United States.

SPECIAL COURSES

1. TRACTION ENGINEERING. This is the most complete course in Traction Engineering offered by any Engineering School in the country. It may be completed in three months. Students are taught how to make all repairs on engines as well as to handle them. Four traction engines used for experimental purposes.

2. GASOLINE AND AUTOMOBILE COURSES. These courses may be completed in three months. They are exceedingly practical. Complete Chauffeur practice. Just a fair common school education is all that is necessary to enter.

3. FARM BLACKSMITHING, FARM CARPENTRY. Mention course in which you are interested. Address, O. H. LONGWELL, Pres. DES MOINES, IA.

LEARN TO RUN AND REPAIR AUTOS



TWO COMPLETE COURSES FOR PRICE OF ONE. Standard Course and New 1913 Advanced Course. TWO MODELS. MOVING PICTURES of Auto Engine—over 994 Pages, and 1713 Charts and Diagrams included. Other schools ask MORE for ONE out-of-date course. We teach you at HOME to earn BIG MONEY. Diplomas issued and graduates assisted to positions. Great demand for Auto Experts. Our 38 page book with Employment Plan, sample lessons, many charts and diagrams FREE. Write for it—NOW.

PRACTICAL AUTO SCHOOL, 68 Beaver Street, New York City

LEARN TO BE A WATCHMAKER

BRADLEY POLYTECHNIC INSTITUTE
Horological Department, Peoria, Illinois



Largest and Best Watch School in America We teach Watch Work, Jewelry Engraving, Clock Work, Optics. Tuition reasonable. Board and rooms near school at moderate rates. Send for catalog of information. BRADLEY, Dept. S., PEORIA, ILL.

Artists, Cartoonists, Illustrators Earn \$40 a Week Up to \$450



"Vet" Anderson, internationally known caricaturist, cartoonist and illustrator, teaches caricaturing, cartooning and illustrating by most thorough up-to-date correspondence methods. Comic artists and cartoonists on newspapers earn as high as \$30,000 a year. Learn to draw work that is salable. Inspect other schools, then come to ours and learn right. There are no "ifs" and "ands" about our courses—you can succeed if you will. Send 6c in stamps for our handsomely illustrated catalogue, to cover cost of postage.

"Vet" Anderson School of Illustrating, Inc. Newark, New Jersey



LEARNED BY ANY MAN OR BOY AT HOME SMALL COST

VENTRILOQUISM

Send today 2c stamp for particulars and proof. O. A. SMITH, Room D 77, 823 Bigelow St., PEORIA, ILL.

Free Study Course Good Pay Besides Learn Salesmanship AT HOME FREE



If you are a man between 17 and 50 years of age—and write to me at once—I will teach you to be an expert salesman without one penny of cost. And if you prove yourself sincere in your studies—I will see that you get good pay while you are learning. I will give you expert advice and simple instructions—that will quickly qualify you for one of the many first-class jobs waiting for salesmen to fill. There is no reason why you cannot make \$4,000 to \$5,000 a year—you are bound to be successful.

The ever-growing demand for good salesmen causes me to make this offer. It is good only for the first 500 men who write me. I say the first 500 men, because quick action is the first requisite to good salesmanship.

My method of selling instruction is the only practical one. It is the only one that always succeeds—and turns out first-class, big money-making salesmen every time.

I Give You Actual Experience

Besides giving you the Instruction Books, I also supply you with a first-class outfit of actual samples. You read over my simple instructions only once—then you take your samples and try your hand at selling. You need do this only in spare time—until your success and the big money you make convince you that selling is what you are really cut out for.

You Get THIS ACTUAL SELLING EXPERIENCE. You make good money on every order, and all this instruction and Experience doesn't cost you a cent. After you have been at this in spare time for only a month or two—you will be splendidly qualified for a Big Money Job.

The article I supply you to sell is Nationally known as the BEST of its kind. Every man needs it and buys it.

The Opportunity of Your Lifetime

This is your chance to get absolutely FREE a practical study course that may be worth thousands of dollars to you. It has made hundreds of men successful beyond even their fondest dreams. This is YOUR chance. Don't—for pity's sake—don't miss it. And DON'T WAIT! Remember, only the first five hundred men get these fine, VALUABLE STUDY COURSES FREE. Just write and say "PLEASE TEACH ME HOW TO BE AN EXPERT SALESMAN." Address

H. L. Kahn, Sales Mgr., 410 S. Market St., Chicago



Learn a Paying Profession

that assures you a good income and position for life. For seventeen years we have successfully taught

PHOTOGRAPHY

Photo-Engraving and Three-Color Work

Our graduates earn \$20 to \$50 a week. We assist them to secure these positions. Learn how you can become successful. Terms easy—living inexpensive. Write for catalogue—NOW!

ILLINOIS COLLEGE OF PHOTOGRAPHY, 999 Wabash Avenue, Effingham, Ill.



STAMMER

My book "How to Stop Stammering"—a treatise on "Scientific Talking"—direct to the point.

Write M. L. HATFIELD, 1918 Grove St., OAKLAND, CALIF.

ELECTRICITY

Complete in One Year

SCIENTIFIC ELECTRICITY IN ALL ITS BRANCHES

Bliss Electrical School

Studies restricted to theoretical and practical electricity, mechanical drawing and necessary engineering work. Teaches simplicity, concentration, hard work. For young men of energy and character. 20 years of greatest success. Graduates hold first-class positions. 21st year begins Sept. 24, 1913. Write for catalog.

15 Takoma Ave., WASHINGTON, D. C.

STUDY LAW

AT HOME

Become an LL.B.

*The Only Law School
of its Kind in America*

Special and Exclusive Features

ONLY recognized resident law school in the United States conferring Degree of Bachelor of Laws—LL.B.—by correspondence. **ONLY** law school in U. S. conducting standard resident school and giving same instruction, by mail. **ONLY** law school giving over 450 class-room lectures to its extension students. **ONLY** law school giving a full 3-year, University Law Course, by mail, having an actual faculty of over 30 prominent lawyers, (3 of whom are Asst. United States' Attorneys) in active practice. **ONLY** law school in existence giving Complete Course in Oratory and Public Speaking, in conjunction with its law course. (This course is free to all students and is second only in importance to the law course itself.)

Other Good Features

In addition to the above, the Hamilton College of Law (note this is a College of Law—not an institute, correspondence school, etc.) has many valuable features not possessed or offered by other law schools. We guarantee to prepare our students to pass bar examinations. This course is intensely interesting and fascinating—not dull and dry like the ordinary correspondence course. Our system of conducting examinations is the most thorough, complete and expensive (to us) of any examinations ever given. A student can, if he chooses, take part of our course by mail and finish in our resident school, where he will receive full credit for all work done by mail. Our resident school is recognized by all standard law schools in the United States.



Our Degree Bachelor of Law, LL.B.
NOT a Diploma or Certificate



From Lecture Room to Student
No Other Law School Can Use
This Illustration

leges) who are now earning their Degree LL.B. A Probate Judge (one of our students) says: "I am delighted with the course prescribed and your method of teaching law. It is far in advance of what I expected to receive."

Law Library FREE This library consists of 12 volumes of standard text books, used in conjunction with our class-room lectures. These law books, if purchased at retail, would cost almost one-half the cost of our entire 3 year course.

Price and Terms

The price of this comprehensive, ideal and incomparable law course, including the Law Library, over 450 Class-Room Lectures, Course in Oratory and Public Speaking, and everything complete, is considerably less than the tuition alone of any resident law school, and is no more than that charged by the many make-shift law courses (issuing diplomas, certificates, etc.) now offered the public. The terms of payment are so easy that the course is within reach of all.

Illustrated Prospectus Free Also a great deal of "Evidence" substantiating all our claims. Send today and get the complete story—all the facts—then judge for yourself. A postal will do. The answering of this ad may mean the turning point in your career.

HAMILTON COLLEGE OF LAW

1106 Ellsworth Bldg. - - - Chicago, Ill.

NOTE: We have prepared and offer to business men five special and distinct business courses as follows: Business Men's, Bankers', Commercial, Real Estate, and Credit Men's Law Courses. These are fully described in our regular prospectus.



These 12 Volumes are Free to Students

School Highly Endorsed

and recommended by Government Officials, Business Men, Noted Lawyers and Students. We have as students a number of practicing lawyers (not graduates of recognized law colleges)

Be a Doctor of Chiropractic

The New Drugless Healing Science OF SPINAL ADJUSTMENT

A Dignified, Profitable Profession Easily Learned at Home. Steady Demand for Practitioners Everywhere—Our Students Surprisingly Successful.

Make \$3000 to \$5000 a Year

Your income as a Chiropractor can be this much or more year after year. At the same time you will be serving suffering humanity. Dr. Walter made \$500 the third month after starting; R. M. Johnson has added over \$3,000 a year to his income; Vern Sharpsteen makes \$40.00 a day. In addition, this fascinating profession is building up for these former students of ours a splendid social and professional reputation.



We taught these men in their spare time by correspondence, and in class, to be Doctors of Chiropractic—the

NEW DRUGLESS HEALING SCIENCE of Spinal Adjustment

—and thereby made them independent for life. We will guarantee to teach you with equal success. A common school education is all you need to begin—our simplified training does the rest.

Sample lesson sheets and illustrated book giving full instructions how to get into this well-paid, uncrowded profession at once—mailed

FREE

National School of Chiropractic, Dept. 130, 1553 W. Madison St., Chicago

LEARN WATCH REPAIRING

Be a watchmaker—you can learn this profitable trade by correspondence in a few weeks in your own home by the DeSelms Chart System. After you complete the course you will know a watch from A to Z. You will know just what the matter is and how to repair one. When you graduate you will be a practical watchmaker and repairer and competent to fill any position. Positions for our graduates.

Ask for our Free Book. It explains our system and terms.

THE DeSELMS WATCH SCHOOL
23 Perry Street ATTICA, INDIANA



DRAFTING and DESIGNING

No Previous Knowledge Necessary

EARN \$125—\$150 MONTHLY

We are practical and expert draftsmen. We instruct you on Practical Drafting Room work. Actual working blue prints used. Drawing outfit furnished free. Are you ambitious to earn more money? If so, write for descriptive catalog.

COLUMBIA COR. SCHOOL, Dept. P. PHILADELPHIA



LEARN WATCHMAKING

refined, profitable labor—Competent men always in demand. We teach it thoroughly in as many months as it formerly took years. Does away with tedious apprenticeship. Money earned while studying. Positions secured. Send for catalog. St. Louis Watchmaking School, St. Louis, Mo.

LEARN JEWELRY ENGRAVING

in your own home. Earn \$20.00 to \$50.00 Weekly. Personal instructions. Write for free booklet. Chicago Engraving School, 612 Athenaeum Bldg., Chicago

BE AN ILLUSTRATOR

by mail how to draw for magazines and newspapers.

Send for Catalog

Learn to draw.

We will teach you School of Illustration 112 Page Bldg. Chicago, Ill.



STAMMER NO MORE

I can cure you. Reputation world-wide. Established 16 years. Trial lesson explaining Home Instruction, with 200-page book, FREE. Answer at once.

George Andrew Lewis, 178 Adelaide Street, Detroit, Mich.



HOW WE CAN DO IT—These Ten Famous Business Books, Formerly \$27, Now—60 CENTS EACH

How to Sell Goods

—How to ginger up a sales force
—How to drum business in dull seasons—How to route, handle and check salesmen—How to train, develop and coach a sales force—How to win the dealer's cooperation and support—How to meet objections and how to be a good "closer"—How to handle wholesalers and retailers to the best advantage—How to judge a good salesman—How to work the "big stick" plan of selling goods to retailers—How to analyze your proposition and pick out its selling points—How to make the consumer influence dealers to buy your goods—How to get out of the ranks of the "clerks" and become a real salesman.

And hundreds of other vital pointers and plans for clerks, salesmen, retailers, wholesalers, manufacturers, mail order houses, etc.

How to Buy at Rock Bottom

—How to know to a nicety what stock is on hand—How to keep track of promises, agreements, deliveries, etc.—How to play one salesman against another and take advantage of every opportunity to get a lower price—How to thoroughly master the ins and outs of the buyer's position so that you can meet the crack salesman in every line on equal terms—How to devise a simple system which will bring to your notice automatically, all data, prices, etc., about a given article—How to formulate a complete purchasing and record system for a mail order house, a factory, or a retail, or wholesale store.

And other priceless pointers on purchasing that business men should know about.

How to Collect Money

—How to judge credit—How to collect by mail—How to handle "touchy" customers—How to be a good collector and how to hire one—How to organize a credit and collections department—How to weed out dishonest buyers from the safe risks—How to get quick, accurate, inside information about a customer's ability to pay—How to write smooth, diplomatic letters that bring in the money without giving offense—How to devise a simple and effective system of insuring prompt and periodical collections of all your accounts.

How to Advertise a Business

—How to plan and lay out an advertising campaign—How to judge and select the right mediums to reach any given class—How to write, refine, illustrate, display, place, and check advertisements—How to develop a crisp, hard-hitting, goods-selling style of expression—How to prepare bold, creative, head-line copy to conduct a magazine campaign—How to "drive home" its effect on dealers, wholesalers and consumers simultaneously—How to make a small appropriation count—How to advertise for inquiries and turn them into sales.

And an infinite variety of other practical points on every phase of advertising.

How to Meet and Handle Men

—How to develop strong individual personality—How to approach and impress men—How to attract, interest, persuade, conciliate and convince men—How to break down the walls of reserve and prejudice in an interview and turn enmity into cordiality and respect—How to pick men—How to prospect, judge, analyze ability in a prospect's employ—How to train and coach new employees—How to inspire men with desperate determination and untiring loyalty to work, to think, to act, even to fight in your behalf—How to keep in personal working touch with an entire working force, making each man feel your special interest in him.

And section after section meeting and managing, directing and controlling, inspiring and enthusing all sorts and dispositions of human nature.

We searched the world for a new kind of paper and found it in Germany. We fine-combed America for new processes of printing and binding and we secured them. The result is that we can make our "Supreme Offer" to the business world of these 10 greatest books of business at a price that surpasses all our experience—77% below the original cost—60c each instead of \$27.

1497 Vital Business Secrets Yours to Use Tomorrow Morning

But the man who realizes that this is not just a bargain offer but an opportunity to get actual business experience for a pittance will be the man to profit from reading these facts. We would have to show you these books to make you understand that only after ten years of striving have we been able to make this sweeping offer, to present this downright book value at a cost price, leaving the hundreds of business plans, methods and secrets free to you.

In the first edition of these books, the cost of getting the facts from 112 of the world's greatest business men and putting them on paper, this editorial cost, was absorbed in the \$27 price paid by thousands. Actually \$9,463

five business men alone have purchased sets of these books. So that we have to charge you hardly a penny for the contents of the books—only the rock bottom cost of paper, printing, binding, transportation and the mere telling about these books to you.

\$1 Brings You All 10 Books

Ask any printer if he can produce these books for 60 cents and he will answer NO. We searched the world for a light strong paper to reduce binding and shipping expense. We found it in Germany. Then we used many of our former plates—cutting expense to zero there. Then we got unbelievably low estimates on printing and binding 30,000 sets. The RESULT is a complete business experience which you could not ordinarily obtain after years of uphill work, in your hands for 6 cents a day spread out over four months only. \$1 sent today, brings the books to you tomorrow.

112 Great Business Men Tell "How" to Make Business Pay

Think of the two ways before you, one of struggling along for years and years to get experience, the other of having 112 of the world's greatest business men tell you where and how to improve your work and better your money-making in a few evenings of reading leisure. These 112 business men tell you how they meet problems, how they turned defeat into victory, how they rose from small jobs to the

ure and master at ease. The 112 great men who made these books are not mere writers but men whose names stand for success—they are the authors of the Business Man's Library, Alexander H. Revell, Founder and President of the great firm bearing his name; Sears

Roebuck & Company's Comptroller; John V. Farwell & Company's Credit man; Kellogg Switchboard & Supply Co's Buyer; Sherwin-Williams Company's President and 107 others. Let these men plan your work for you tomorrow morning! Their help costs you nothing.

Don't plod and blunder along in a small job expecting to get ahead somehow, someday. Don't worry over problems other men have solved. Why spoil opportunities and waste chances, which with the proper knowledge you might turn into money in a week, a month, a year, instead of spending a lifetime to get experience?

Then add the help which you will get from SYSTEM, which stands preeminent, the Magazine of Business, 250 to 356 pages in every issue, and 750,000 regular readers. Whether you own your own business or are employed, SYSTEM will show you new ways of saving time and cutting out drudgery. It has helped thousands to better salaries, bigger profits, that would have been impossible, undreamed of without SYSTEM.

C. S. Conner "One new idea gained is alone worth its price, which, by the way, should be its actual weight in silver, for there are many money-making, time-saving, labor-reducing, profit-securing ideas spread over its pages."

James W. Van Cleave "The big point of merit in your publications is that they give us the actual experience of thousands of other business men. No matter how successful the man, he can profit from help like this."

Alfred Dolge "I wish the Work could be brought before every man who wants to build a real business career. Millions of dollars might be turned from loss to profit."

The May Company "The best of us have a good deal to learn from the rest of us. That is the reason why, no matter how successful or prosperous may be the employer or employee, he can learn from SYSTEM's works." S. M. Gross, Supt.

Alfred Dolge "I wish the Work could be brought before every man who wants to build a real business career. Millions of dollars might be turned from loss to profit."

seats of the mighty. Here are not generalities, but facts, plans, methods, diagrams, charts which have made money, increased salaries, enlarged businesses, yours to know today and use in your own business tomorrow. The man in charge can increase his producing, managing ability and results; the employee can better position, increase salary, command eventual success.

Roebuck & Company's Comptroller; John V. Farwell & Company's Credit man; Kellogg Switchboard & Supply Co's Buyer; Sherwin-Williams Company's President and 107 others. Let these men plan your work for you tomorrow morning! Their help costs you nothing.

Don't plod and blunder along in a small job expecting to get ahead somehow, someday. Don't worry over problems other men have solved. Why spoil opportunities and waste chances, which with the proper knowledge you might turn into money in a week, a month, a year, instead of spending a lifetime to get experience?

Then add the help which you will get from SYSTEM, which stands preeminent, the Magazine of Business, 250 to 356 pages in every issue, and 750,000 regular readers. Whether you own your own business or are employed, SYSTEM will show you new ways of saving time and cutting out drudgery. It has helped thousands to better salaries, bigger profits, that would have been impossible, undreamed of without SYSTEM.

C. S. Conner "One new idea gained is alone worth its price, which, by the way, should be its actual weight in silver, for there are many money-making, time-saving, labor-reducing, profit-securing ideas spread over its pages."

James W. Van Cleave "The big point of merit in your publications is that they give us the actual experience of thousands of other business men. No matter how successful the man, he can profit from help like this."

Alfred Dolge "I wish the Work could be brought before every man who wants to build a real business career. Millions of dollars might be turned from loss to profit."

The May Company "The best of us have a good deal to learn from the rest of us. That is the reason why, no matter how successful or prosperous may be the employer or employee, he can learn from SYSTEM's works." S. M. Gross, Supt.

Alfred Dolge "I wish the Work could be brought before every man who wants to build a real business career. Millions of dollars might be turned from loss to profit."

How to Manage a Business

—How to keep track of stock—How to figure and charge estimates—How to check deliveries and mistakes—How to get the most out of those under and around you—How to size up the money-making possibilities of new ventures—How to detect and eliminate needless items of expense and waste—How to get up blanks, forms, records and simple systems for all kinds of businesses—How to devise a perpetual inventory system that will tell you every day the value of all material on hand—How to turn a losing business into a profitable one—How to make a profitable business more profitable.

And countless other things that every man in an executive position needs in his daily work.

How to Get Money by Mail

—How to write ads—How to begin a letter—How to turn inquiries into orders—How to formulate a convincing argument—How to get your reader to ACT at once—How to cover territory salesmen can't reach—How to keep tab on results of all mail work—How to key ads, circulars and all mail sales—How to prepare an enclosure for a business-getting letter—How to supplement the efforts of salesmen with live, business-getting letters—How to answer file and follow up inquiries from advertisements and those which come in the regular course of business.

And page after page of practical working detail—not only for mail order firms but particularly helpful to those not making a specialty of mail order business.

How to Stop Cost Leaks

—How to detect waste—How to make an inventory—How to figure "overhead" expenses—How to systematize an entire factory or store—How to cut out red tape in a simple cost system—How to keep close watch on material and supplies—How to apportion the right number of employees to a specific job—How to decide between piece-work, day wages and bonus systems—How to keep tab on productive value of each machine and employ—How to figure depreciation, burden, indirect expense, upkeep, profit, loss and cost.

And chapter after chapter of priceless plans for practically every kind of business in which an accurate cost system is essential to money-making success.

How to Get and Hold a Position

—How to apply for a position and get it—How to answer a want ad., in person or by letter—How to compose a strong, original letter of application—How to secure the highest market price in selling your services—How to prepare and apply for advancement—How to quickly gain and hold your employer's confidence—How to master the entire routine, the science, the duties of your position—How to become a department head, a general manager—How to study the work of the man above you, without offending or antagonizing him.

Not good advice merely, but practical, down-to-the-earth instruction in the branches of business that will enable the ambitious employee to actually earn more—have more—be more.

Office and Accounting Methods

—How to keep office accounts—How to devise and install a complete record and accounting system—How to take loose leaf trial balances—How to devise a system that will give you your monthly statement on time—How to install a simple system that will give you a daily report of your business condition—How to use the loose leaf in handling collections—How to manage and systematize an office—How to speed up an office force to top-notch efficiency—How to keep exact office costs—How to handle a stock-keeping and shipping department, with complete inventory receiving and shipping blanks and forms for each.

How, in fact, to enjoy peace of mind, comfort and satisfaction, in the certainty that there are no faulty methods throughout your entire office organization.

SYSTEM, Wabash Ave. and Madison St., CHICAGO



Striking the boss for a raise

Do you have to *ask* your employer for more pay? Do you find it necessary to call his attention to the fact that you are worth more money? Or are you a *trained* man—a man who receives frequent and unasked for increases in salary because the boss knows that your knowledge is valuable to him. There is no limit for the *trained* man—he is the employee who is pushed ahead—he's the chap that the well paying jobs seek. High wages and steady employment are always his, simply because he is too valuable to lose.

But the *untrained* man, plodding along at the same old salary year after year, has nothing in his favor but a record for faithfulness. He feels that his efforts are not appreciated—he doesn't realize that he is *only* a cog and can be replaced by any one of thousands of similar *untrained* men. He is a good employee, yet he has never made himself necessary to his employer's success. He's the sort of man who always has to *ask* for a raise.

Your Opportunity Coupon

Check the course you want and mail the coupon now

American School of Correspondence, Chicago, U. S. A.

Please send me your Bulletin and advise me how I can qualify for the position marked "X." Pop. Mech. 4-13

- | | |
|--------------------------------|--------------------------|
| Electrical Engineering | Lawyer |
| Elec. Light & Power Supt. | Bookkeeper |
| Electrical Wireman | Stenographer |
| Telephone Expert | Private Secretary |
| Architect | Accountant |
| Building Contractor | Cost Accountant |
| Architectural Draftsman | Cert'd Public Acc't |
| Structural Engineer | Auditor |
| Concrete Engineer | Business Manager |
| Civil Engineer | Fire Ins. Inspector |
| Surveyor | Fire Ins. Adjuster |
| Mechanical Engineer | Fire Ins. Expert |
| Mechanical Draftsman | Moving Picture Op'r |
| Steam Engineer | Sanitary Engineer |
| Stationery Engineer | Reclamation Eng'r |
| Gas Engine Engineer | Textile Boss |
| Automobile Mechanician | College Preparatory |

NAME

ADDRESS

Become a trained man—get the money without asking

It is easy to get the training you need. You can do it in your spare time and in your home without giving up your work.

For fifteen years the *American School of Correspondence* has been preparing ambitious men everywhere for better jobs at bigger wages. The *American School* will give you the training you need, no matter where you live. It will train you in any branch of *Engineering, Business and Law*, or will prepare you for entrance into any resident college.

Perhaps you've never quite realized how easy it is to secure this training? Mark the coupon and let us explain to you how simple it is to prepare yourself for the position you want. We send no agents to bother you in your home or at your work. All business will be carried on by correspondence and our easy payment plan will allow you to pay as you progress.

Send the coupon today! Learn how to get a raise without asking

AMERICAN SCHOOL OF CORRESPONDENCE
CHICAGO, U. S. A.

Popular Mechanics Magazine

WRITTEN SO YOU CAN UNDERSTAND IT

Vol. 19

APRIL, 1913

No. 4

3265-B

Baseball-Catching and Returning Device

Pat. # 1,030,558. June 25, 1912

BASEBALL pitchers crop up like wild flowers in every part of the country when spring begins to make itself felt, and there is hardly a village, even a four corners, that does not hold an aspirant for big-league honors who believes that all he requires is systematic practice. Just how to get the practice, however, is often a difficult problem, for a catcher is required for every pitcher, and John may be busy or disinclined at the time Jim wants to pitch. So a baseball enthusiast of Jamestown, N. D., has invented and patented a ball-catching and returning device.

The device consists of a curved tubular casing mounted on a suitable standard. The balls entering the flared mouth of the device, which is the bottom opening, would all be within such a radius

as to be termed a strike. Entering this opening, they strike against the curved back of the casing, run up the curved neck and are discharged from the upper opening with sufficient force, so the inventor claims, to return to the pitcher, or at least to enable him to catch them with a very short run.

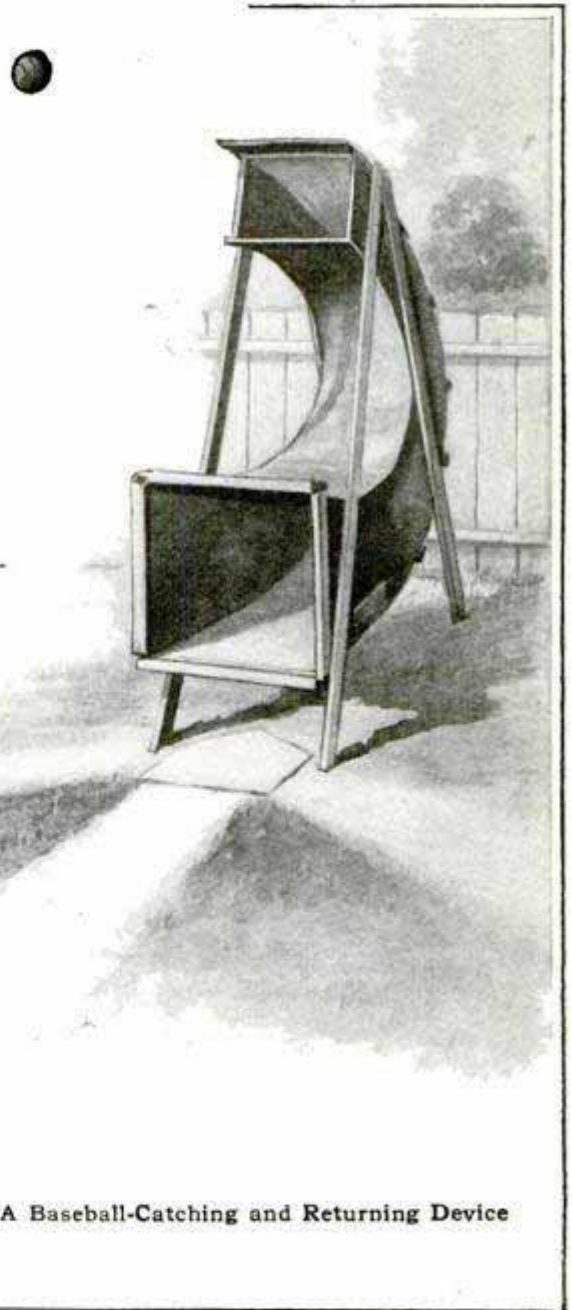
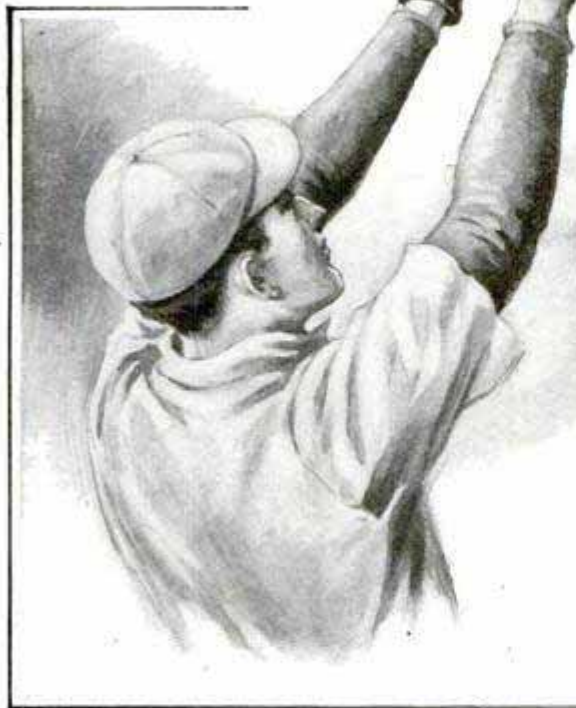

A Baseball-Catching and Returning Device

311 Pennsylvania av. S. Fred H. Wood

311 Pennsylvania av. S. Fred H. Wood

114 W 14th St
Marion, Ind.

A hinged flap, or wing, designed to form a continuation of the side of the casing, projects over the top of the discharge mouth. This wing may be moved downward for swift balls, and

upward for slow balls, thus regulating the velocity of the return of the ball. Modifications of this device may be used for indoor games, in which a ball as large as a basketball can be used.

PORTABLE SEARCHLIGHT FOR
3295 LINEMEN

The difficulty of detecting a crossed or broken overhead wire at night with an ordinary hand lantern has resulted in the invention of an acetylene searchlight connected by a strong flexible rubber tube to a tank carried in a leather case on the back of the lineman using it. The lamp has a powerful reflector that throws a concentrated beam of light which will make objects distinguishable at a distance of 75 to 100 ft.



or broken overhead wire at night with an ordinary hand lantern has resulted in the invention of an acetylene searchlight connected by a strong flexible rubber tube to a tank carried in a leather case on the back of the lineman using it. The lamp has a powerful reflector that throws a concentrated beam of light which will make objects distinguishable at a distance of 75 to 100 ft.

SURFACE-PROPELLERED
MOTORBOAT

The twin "surface" or semisubmerged propellers and the folding side rudders are the features of this high-speed motorboat, which, although designed particularly for use on weed-filled waterways, is also being developed as a type of craft particularly adapted for use in waters where sudden storms make the possibility of "beaching" an important factor.

It is the weedless feature, however, combined with the high speed, that is the most interesting. Weighing considerably over a ton, the little 22½-ft. hull, driven by a 25-hp. engine, makes a speed of as high as 20 miles an hour in water having a depth of but from 1 to 2 ft., heavily grown with eel grass. In several tests at low tide, over river flats, where the grass lay on the top of the water and the tips of the propeller blades actually dug into the mud at times, the boat maintained its high speed, although chopped eel grass was actually driven in under the brass fittings on the transom and into every

Chas. A. W. Baldwin

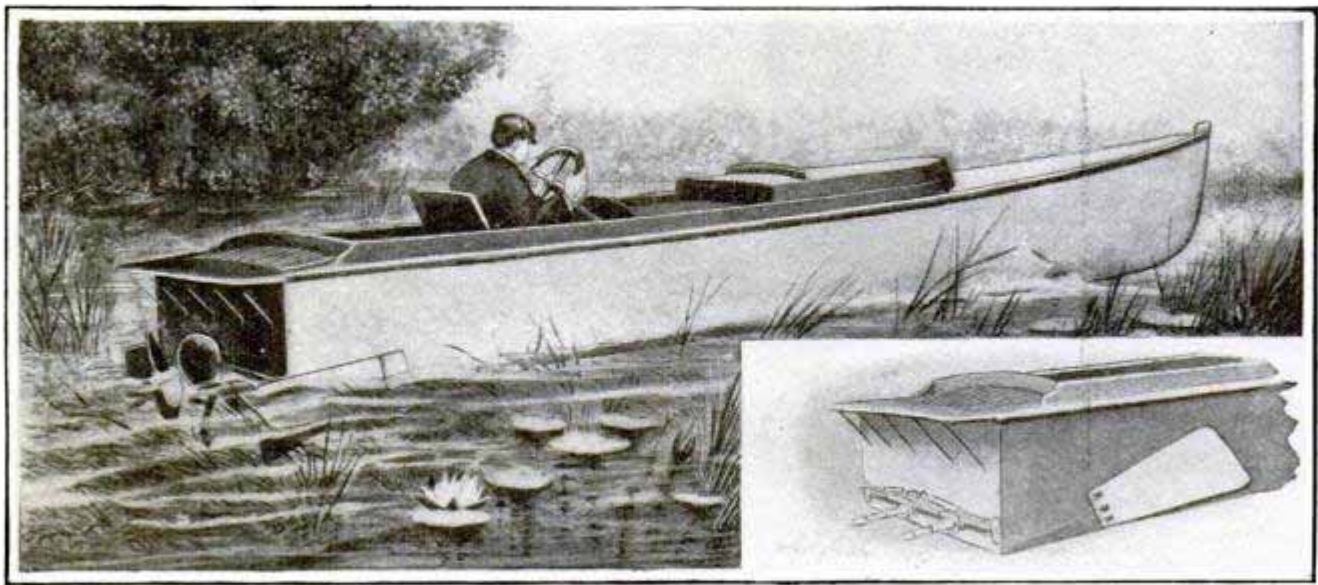

The Arrangement of "Surface" Propellers and Side Rudders

The Rudders Folded Forward Out of the Way for Beaching

Emf

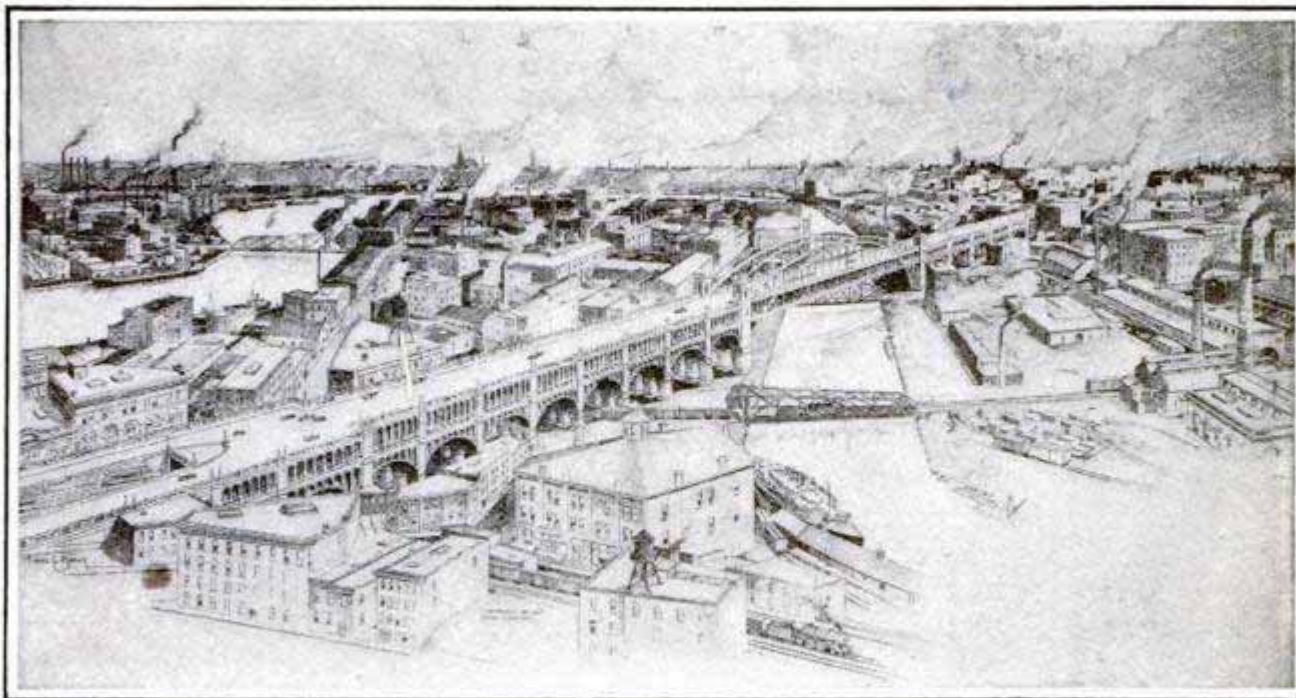

Copyrighted by Frank E. Brown

Cleveland's 2,880-Ft. Double-Decked Viaduct, Construction of Which has Commenced

corner above water where it could hang.

The side rudders, which may be detached from the operating mechanism and folded out of the way, should it be desirable to run the boat upon a beach, are also weed-proof.

A novel feature of the power plant is the arrangement by means of which the two propellers are driven by the one engine. One propeller and shaft is coupled direct to the engine shaft, and upon the first mentioned shaft is mounted a gear wheel engaging with a similar wheel on the shaft of the second propeller, which it thus drives. Of course, with this arrangement, one propeller revolves to the right and the other to the left.

CLEVELAND'S GREAT CON- 3267-crete BRIDGE

One of the largest and most artistic concrete viaducts in the country is being erected over the Cuyahoga River in Cleveland. It has a length of 2,880 ft., and is a double-decker, the upper deck carrying a driveway 42 ft. wide, for automobiles and other vehicles, with 12 ft. of sidewalk on each side. The lower deck will carry four street-railway tracks. The clearance over the channel will be 93 ft. About 1,500 pre-

molded concrete piles are being driven to carry the nine piers nearest the water.

COMPACT WILLOW TABLE AND CHAIRS

A willow table with four specially constructed chairs, which are so designed that they may be slipped under the table in an upright position, thus enlarging the floor space and improving the general appearance of the room, is being manufactured for use in restaurants, summer gardens, lawns or porches. The seats of the chairs are brought to a point in front instead of being square-bottomed, and the backs are made low enough to be pushed beneath the top of the table.



Willow Table with Disappearing Chairs

*White Willow Table
Waterproof Willow Chairs*

Union Pacific
Central

MOTION-PICTURE SCHOOL FOR RAILROAD FIREMEN

A MOTION-PICTURE theater on wheels has recently been inaugurated by the educational bureaus of several railroads for the purpose of demonstrating fuel economy to firemen and engineers. The demonstration coach is equipped with a moving-picture machine which throws pictures of the proper and improper firing of locomotives on a screen at one end of the car, and the classes for instruction occupy the regular car seats facing the screen.

Some of the pictures show the difference between stiff-back firing, where the coal scoop is held tight with both hands and a jerking strain comes on the back each time a shovelful of coal is fired, and easy firing, where the scoop is handled properly and the coal is fired with a swing. The pictures also show the ease with which coal is placed where it is wanted when the scoop is held properly; the proper method of lining up the sides and corners of the fire box; the way in which to turn the scoop to put a fire directly under the door; the proper amount of coal to pick up in the scoop, and the bad results of picking up too much.

In addition to the proper handling of the scoop shovel, the right method of preparing the fire before starting upon the trip is also shown by pictures indicating how the fire should be built up gradually, starting long enough before leaving

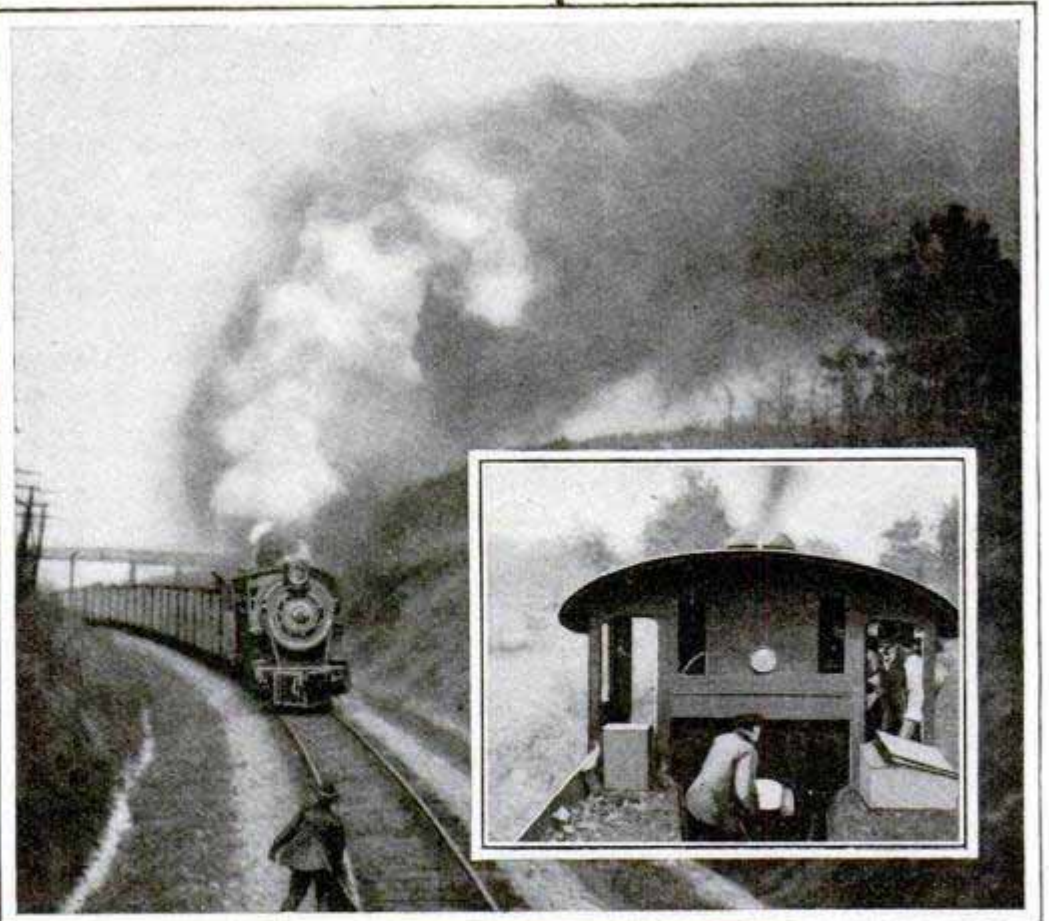

Dummy Firebox, Showing Wrong Firing. Double-Header, Flagged: First Engine, Properly Fired; Second Engine, Improperly. Small View: Improper Firing

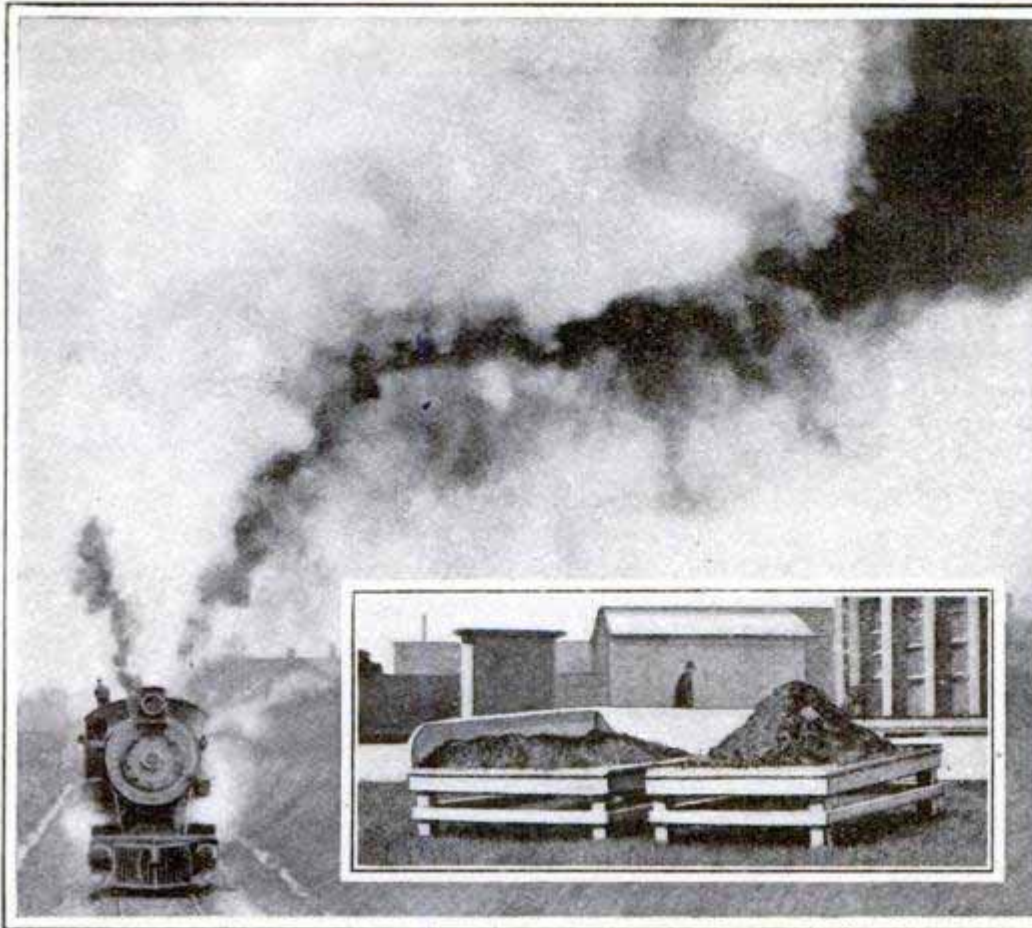

Double-Header on Hill: First Engine Fired Correctly, But Second Engine is Not. Insert Shows Amount of Coal Wasted by Allowing Engine to "Pop Off" for 3½ Minutes. Views on Right: Double-Header Leaving Yard; Front Engine Stack Clear; Rear Engine Producing Pillar of Smoke

time to get a good, bright bed of fire on the grates. One of the accompanying illustrations of a double-header going up a hill amply demonstrates this fact, as the fireman on the first engine fired his engine properly, thus making practically no smoke and plenty of steam, while the fireman on the second engine made volumes of smoke, but failed to keep his fire in a proper condition for raising the maximum amount of steam.

As the average fireman has no realization of the discomfort caused passengers by smoke traveling back over the train, a moving picture, taken from the observation platform of a passenger train, is also thrown on the screen to vividly impress this objectionable feature upon the minds of the observers. Another film, portraying the useless waste of fuel due to the improper coaling of engines, illustrates the engine moving up to the coal chute; the tank properly filled, but not overflowing; and then additional coal being put on the tank until it overflows and the excess falls upon the ground to become a total loss.

That the teaching of fuel economy to firemen and engineers with the aid of moving pictures is a valuable method of instruction is evidenced from a test run made by the engine and crew of a Lehigh Valley passenger train from Buffalo to Jersey City. This trip was made with an average of about 7 lb. of coal to the car mile instead of about 24 lb., the average



Teaching with "Movies"
— A Strip of Film

for the year. Only 15 tons of fuel were actually used during the entire run, as against 25 or 30 tons, the usual amount consumed during the trip. Additional tests showed that, with two

crews on the same engine on the same run on alternate days, one fireman used almost twice as much coal as the man who had received practical instruction in firing an engine.

THE BURGLAR WITH A "CLOVEN HOOF"

3238-03
Curious wooden imitations of the hoofs of a horse and cow, found hidden beside a roadway, are being ex-

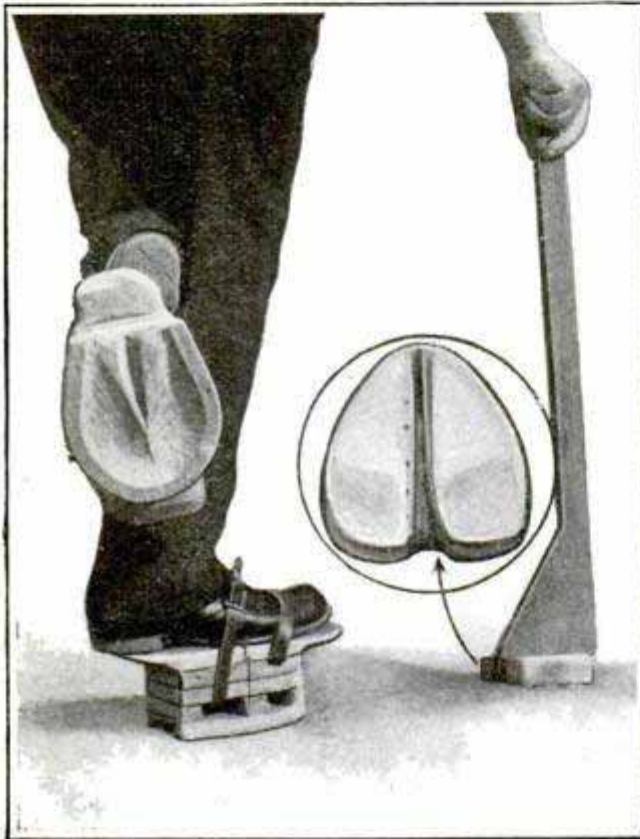

The Burglar's Wooden Hoofs, Designed to Throw Pursuers Off the Trail

hibited by the chief of police of Long Beach, Cal., as the ingenious means used by a burglar to throw pursuers off his trail. Other articles found along with the hoofs were a bottle of nitroglycerin, and other tools of the yeggman's trade. The "hoof" idea is believed to be something entirely new in police history.

It is estimated that the total mileage made by automobiles registered in Massachusetts during one year is about 185,806,000, while the mileage on the New York state roads approximates 400,000,000 per year.

Engineering &
Contracting

OWNERSHIP OF THE SUEZ

3329-B CANAL

The question of ownership of the Suez Canal has come to the front to a considerable extent in the newspaper publicity given the Panama Canal tolls controversy, and the general assumption seems to be that Great Britain owns it, either through the occupation of Egypt, or by direct ownership of a majority of the shares.

"The British government does not own it, but is merely a private stockholder, and does not own even a majority of the shares," says the Wall Street Journal. "It has, in fact, an equity which might, in conceivable circumstances, be extinguished altogether. The affairs of the canal are governed from Paris. On the board of directors are 21 French members, 10 English and one Egyptian. The manager and secretary, together with the president, and even the manager of the London office, are French. The majority of the stock is owned by private interests in France."

A DIRIGIBLE BALLOON IN THE 1225. MAKING

The accompanying illustrations show a new dirigible in course of construction in France. This battleship of the air is of the Spiess rigid type and has a length of 288 ft., a maximum diameter of 39 ft., and a volume of approximately 293,000 cu. ft. The balloon is designed to have a total lifting capacity of nearly nine tons and will contain 11 separate gas bags. The motive power will be furnished by two 120-hp. motors coupled to four propellers which are to be arranged and driven as in the Zeppelin airships of Germany. It is estimated that the new dirigible will have a speed of about 35 miles per hour.



Lightness and Strength
are Both Essential

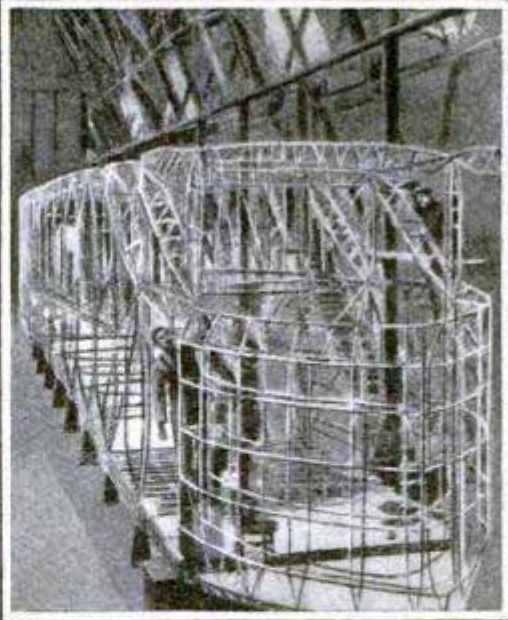

Frame of the Under
Body or Cabin

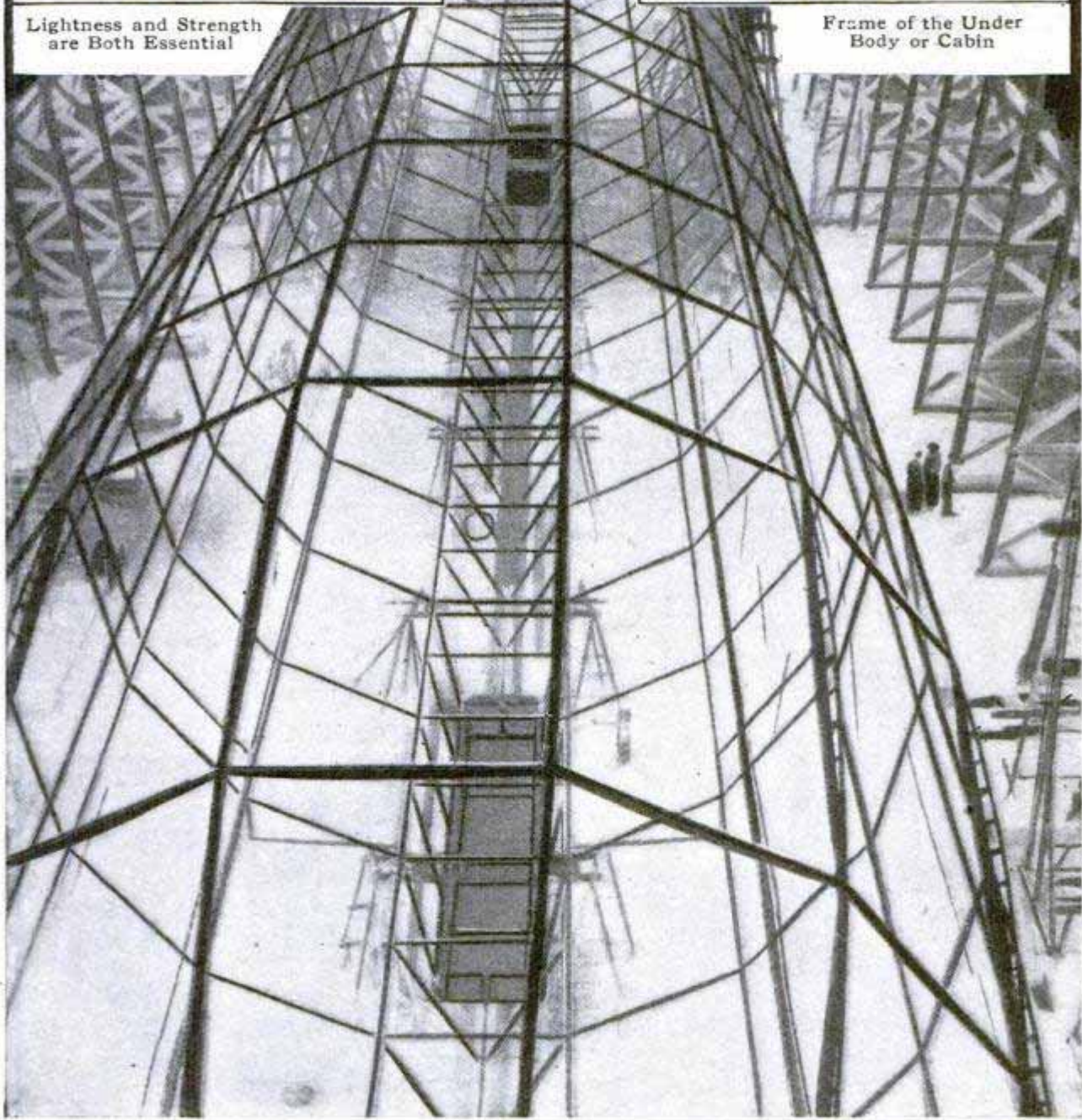

Courtesy Illus. London News

A Battleship of the Air in Course of Construction in France

GAS PRODUCER AND ENGINE FOR FARMERS

A farm engine driven by a gas motor and equipped with a producing plant for making its own gas has been in-

ELECTRICAL CLUB HOUSE FOR EMPLOYEES

Electrical baths is one of the new features of the new club house recently opened in New York City for the employes of a large corporation. All of the members may now avail themselves of the benefits of electric bathing, along with the other privileges which the new club house offers. The members may also take a four-year course of instruction in electrical engineering under competent teachers without any cost to themselves, as a thoroughly equipped laboratory is maintained for this purpose. Owing to its complete and unusual electrical equipment

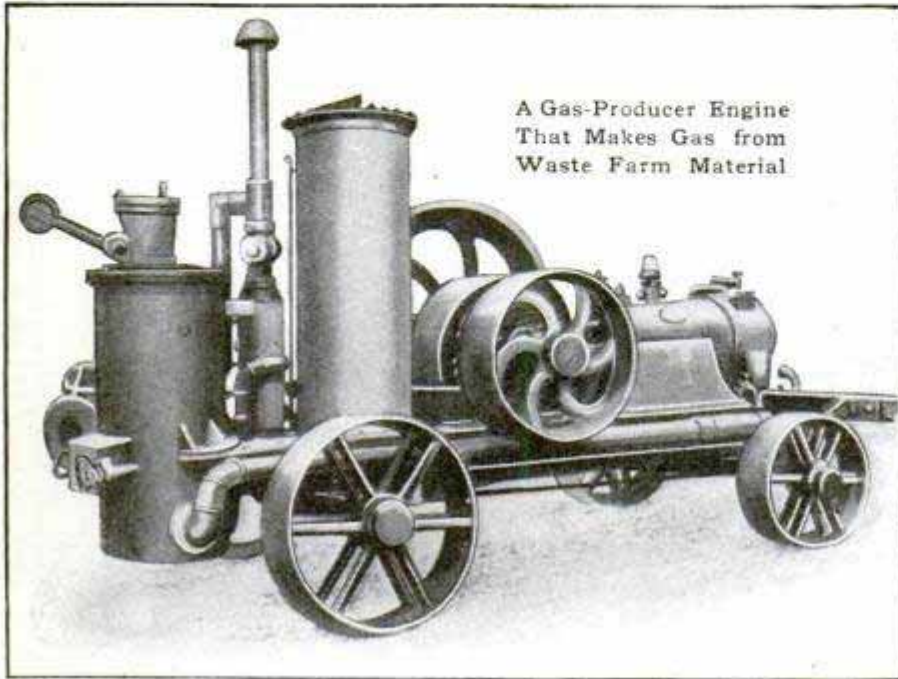

A Gas-Producer Engine That Makes Gas from Waste Farm Material

vented in Europe. The apparatus is so constructed that gas can be made from anthracite coal, coke and charcoal, or even waste farm material such as moldy hay, bark, sawdust and dry leaves. By the use of waste products, such as those mentioned, it is possible to produce power at a cost of about one cent per horsepower hour. The machine is made in various sizes; sells for one-half the price of a steam locomobile; weighs one-third less, and the cost of operation is but one-tenth as much as that of the latter.

this new club house might almost be called the electrical club house.

CACTUS-ROPE BRIDGE TWO HUNDRED FEET LONG

Over the Apurimac River in Peru is a graceful rope bridge more than 200 ft. in length. It is constructed of 32 ropes made of maguey, a species of cactus, and terminates on each side in a thatched hut.



Rope Bridge Made by the Natives of Peru

A novel method of preserving eggs, for which a United States patent has recently been granted, is the invention of a resident of London, England. The eggs are first dipped into a solution of gelatin, then into a solution of amyl acetate, which is a celluloid composition that maintains around the shell of each egg the atmosphere of camphor vapor. It is claimed that eggs preserved in this manner may be kept for a year at any ordinary temperature and will then taste like fresh-laid eggs.

*168 Salton Lane
Cable & Co
1223
340
London Eng
Patent # 1,043,600
Hans Jerne
Dinsbury*

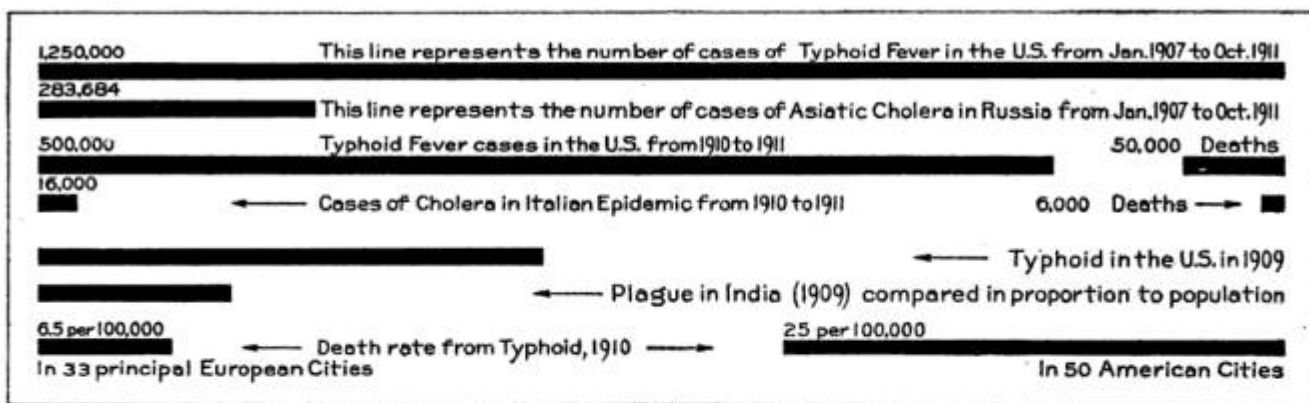

THE BATTLE FOR SAFE WATER SUPPLIES—I

By DR. ALLAN McLAUGHLIN

United States Public Health Service

[Two and one-half times as much typhoid fever in the United States in proportion to population as there is plague in India! More deaths by eight times from typhoid in the United States in two years than there were from cholera in Italy in the same years of the great cholera epidemic! Nearly four times as many deaths from typhoid among a given number of American citizens as among the peoples of overcrowded Europe! These startling facts ought to convince America that the prevalence of typhoid is our greatest national disgrace—for the stamping out of typhoid is easy. A pure water supply will cut its ravages down instantly.

New York is spending \$125,000,000 on a reservoir that will impound the streams of half the Catskills and a tunnel one hundred miles through solid rock to bring the pure mountain water to its people. Los Angeles has gone 250 miles up into the snow-capped Sierras and tapped the Owen River for water for a hundred years to come. San Francisco wants to dam the Hetch-Hetchy valley in the Yosemite National Park as a reservoir from which to obtain an unending supply of pure water. Even little villages are putting in water works and purification plants to get water free from typhoid germs.

Just what dangers lie in impure water is told in this first article of a series written especially for Popular Mechanics Magazine by Dr. Allan McLaughlin of the United States Public Health Service. Doctor McLaughlin is recognized as perhaps the foremost American authority on this subject. His work in the Public Health Service has been notable and resulted in his recent appointment as sanitary adviser to the International Joint Commission which is investigating the pollution of the boundary waters between the United States and Canada. Later articles will discuss the best methods of water purification and their cost.—Editor.]

THE question of sewage-polluted water supplies is indissolubly connected with the excessive prevalence of typhoid fever in the United States. Polluted water supplies are responsible for excessive rates of dysentery, for an increased general death rate, and are also a significant factor in our infant mortality; but typhoid fever is the greatest single item of loss to be charged to contaminated water.

This excessive prevalence of typhoid fever in the United States has been characterized, and not without reason, as a national disgrace. Certainly that portion of our typhoid prevalence which is due to polluted water supplies is preventable, and our failure to prevent does not redound to our credit. The rather common use of sewage-polluted water supplies without purification has been responsible for disaster in the shape of typhoid-fever epidemics in our cities, with a frequency not pleasant to contemplate.

The average American citizen dis-

plays toward sanitary problems a very dangerous apathy. It is difficult to arouse his interest in anything so well-known as typhoid fever. Cholera or plague, or any scourge which to him suggests a quick and mysterious death, will awaken his instinct of self-preservation and arouse him to activity; not so typhoid fever. It has been all about him always, excites no terror, and is viewed indifferently as an inevitable visitation which comes every year and takes its toll from the community. He never asks himself, "Is this visitation inevitable?" or, "May not typhoid fever be prevented or reduced?" Twenty deaths per 100,000 probably represent 200 cases of typhoid fever. Suppose 200 cases of Asiatic cholera or of bubonic plague occurred in any American city of 100,000 population. Would not strenuous activity be displayed, and very properly so, for the eradication of the scourge? The complacency of officials in the face of typhoid-fever rates above 20 deaths

annually per 100,000 population is difficult to explain. If the rate is below 20, many municipal officials are inclined to be satisfied with this rate, because it is lower than that of less fortunate cities.

What may be considered a low rate for typhoid fever? Let us compare typhoid-fever rates in American cities with those of the northern European cities.

In Chicago, in 1906, 18 persons out of every 100,000 died of typhoid fever. In Stockholm, Sweden, in the same year, only two persons died of typhoid out of every 100,000 population. The typhoid death rate of Louisville, Kentucky, in 1910, was 31 per 100,000 population; and in 1907 almost reached the appalling figure of 70 deaths from this one disease for each 100,000 citizens. But in Hamburg, Germany, in 1910, the rate was only a trifle over four per 100,000, and, in 1907, was only three. Indianapolis, New Orleans, Detroit, Saint Paul, Minneapolis, Kansas City, Omaha, Buffalo, Columbus, Toledo, Pittsburgh, Memphis, Nashville and Milwaukee, in 1909, lost 18 or more out of every 100,000 of their inhabitants from typhoid, while neither Christiana, Norway; Munich, Berlin and Dresden, Germany; Edinburgh and Glasgow, Scotland; Vienna, Austria; Copenhagen, Denmark, nor London, England, in the same year lost as many as five citizens out of each 100,000 from this disease. The 33 principal European cities, with a total population of 31,500,000, show a death rate from typhoid, in 1910, of 6.5 per 100,000 population, or a total of less than 2,050 deaths from this disease in all the cities in that year. In the same year 50 American cities having a total population of 20,250,000 lost 5,062 of their

inhabitants from the same cause. The excess of 18 deaths per 100,000 in America over Europe shows that the cases of typhoid fever which were preventable by methods within our grasp would probably reach 175,000, and the deaths so avoided would reach a total of 16,200. In 1909, there were more cases of typhoid fever in the United States than there were cases of plague in India, in spite of the fact that India's population is two and one-half times that of the United States.

From January, 1907, to October, 1911, there occurred in Russia 283,684 cases of Asiatic cholera. This included the appalling epidemic of 1910. According to a conservative

estimate there occurred in the United States during the same period 1,250,000 cases of typhoid fever, or more than four cases of typhoid fever in the United States for every case of cholera in Russia. We heard a great deal of the terrible ravages of cholera in Italy in 1910-11; yet in

these two years there occurred in Italy about 16,000 cases of cholera, with about 6,000 deaths, and in the United States in the same period we had more than a half million cases of typhoid fever and 50,000 deaths.

We are accustomed to speak of certain countries as pest-ridden, and a residence in them or even a brief visit is considered with apprehension. But do we consider the prevalence of typhoid fever in our country with sufficient seriousness?

No single measure in reducing typhoid fever on a large scale approaches the effect of substituting a safe for a polluted water supply. As an instance of this wholesale saving of human life the reduction of typhoid fever in Pittsburgh may be cited. Since the instal-

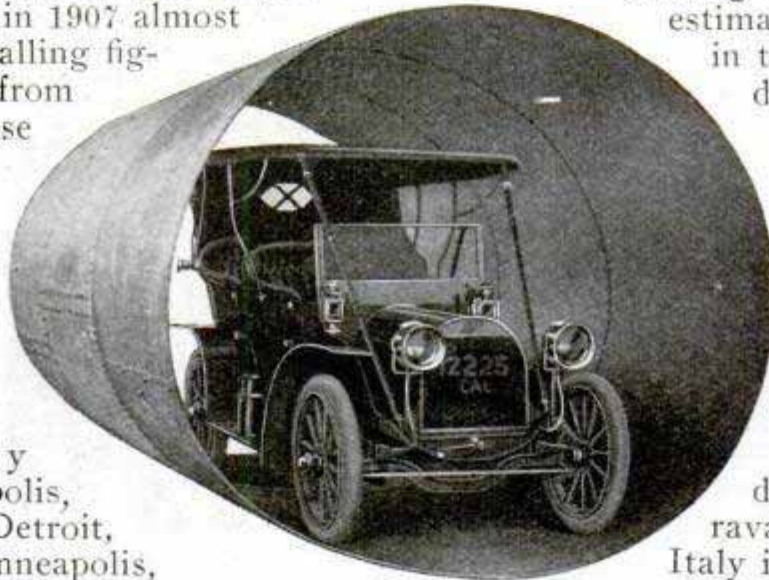

Section of the Ten-Foot Pipe of the Los Angeles Aqueduct

lation of the Pittsburgh filter plants there has been an annual saving in that city of 400 lives from typhoid fever alone. Statistics prove the effect of the various methods of water purification in reducing the typhoid-fever rate.

The battle for safe water supplies has been beset with many difficulties. It is extremely difficult to shake the average citizen out of his apathetic attitude toward preventable disease. It is necessary to educate him so that he will understand the danger in polluted water, and the necessity for a safe water supply. He must be shown what constitutes safe water. He must be taught that safe water is essential for his health and happiness and that it is his inalienable right to demand and receive safe water from the municipality. There is also the difficulty of arousing municipal officials to a sense of their responsibility in the matter of water supply. They must be convinced that it is their plain duty to furnish safe water to the citizens 365 days in the year. Failure to do this results in wholesale homicide, and where the facts of pollution are known it amounts to passive murder.

What is a safe water supply? From a sanitary standpoint, a safe water supply is one

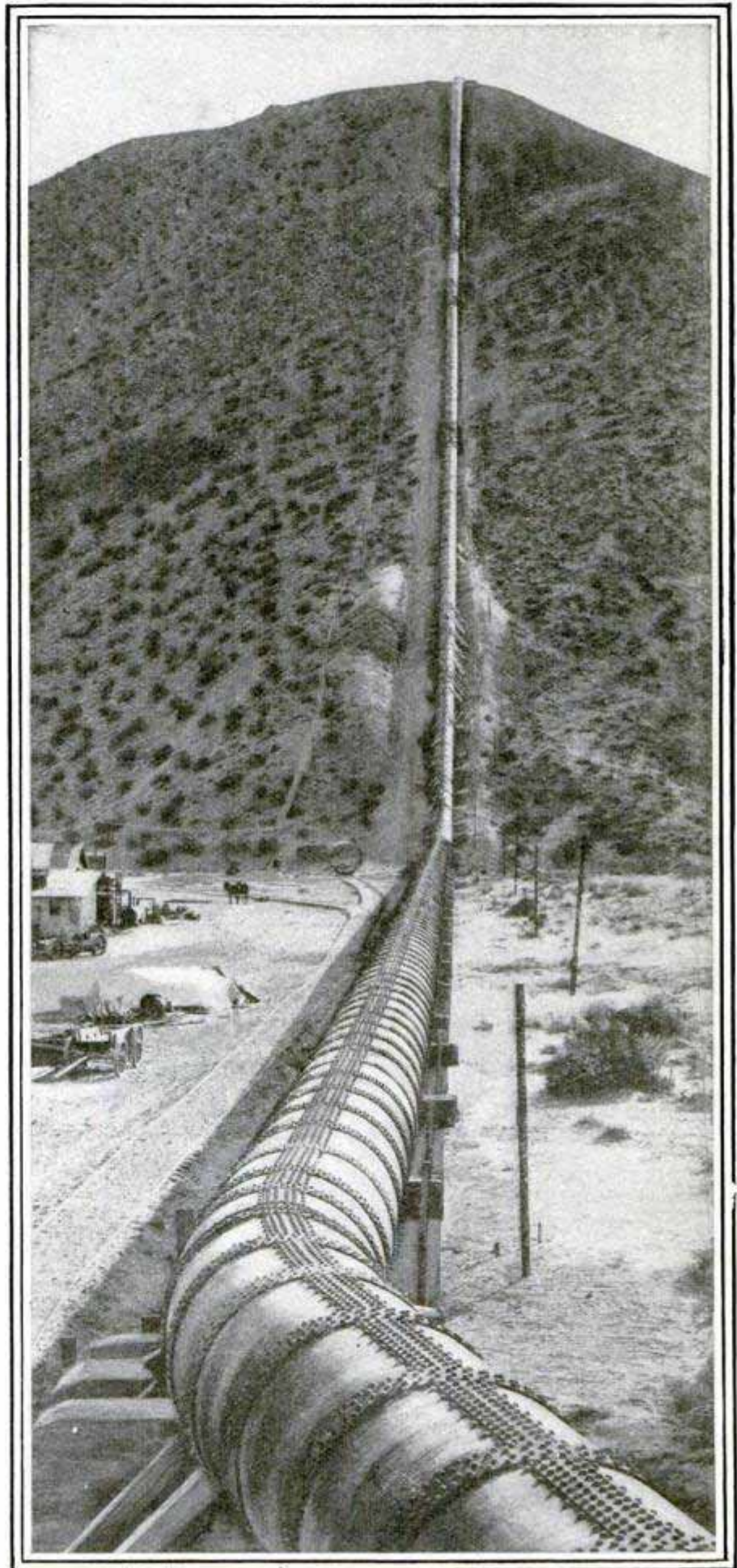

Through This Ten-Foot Siphon the Water Lifts Itself over a Hill 850 Feet High

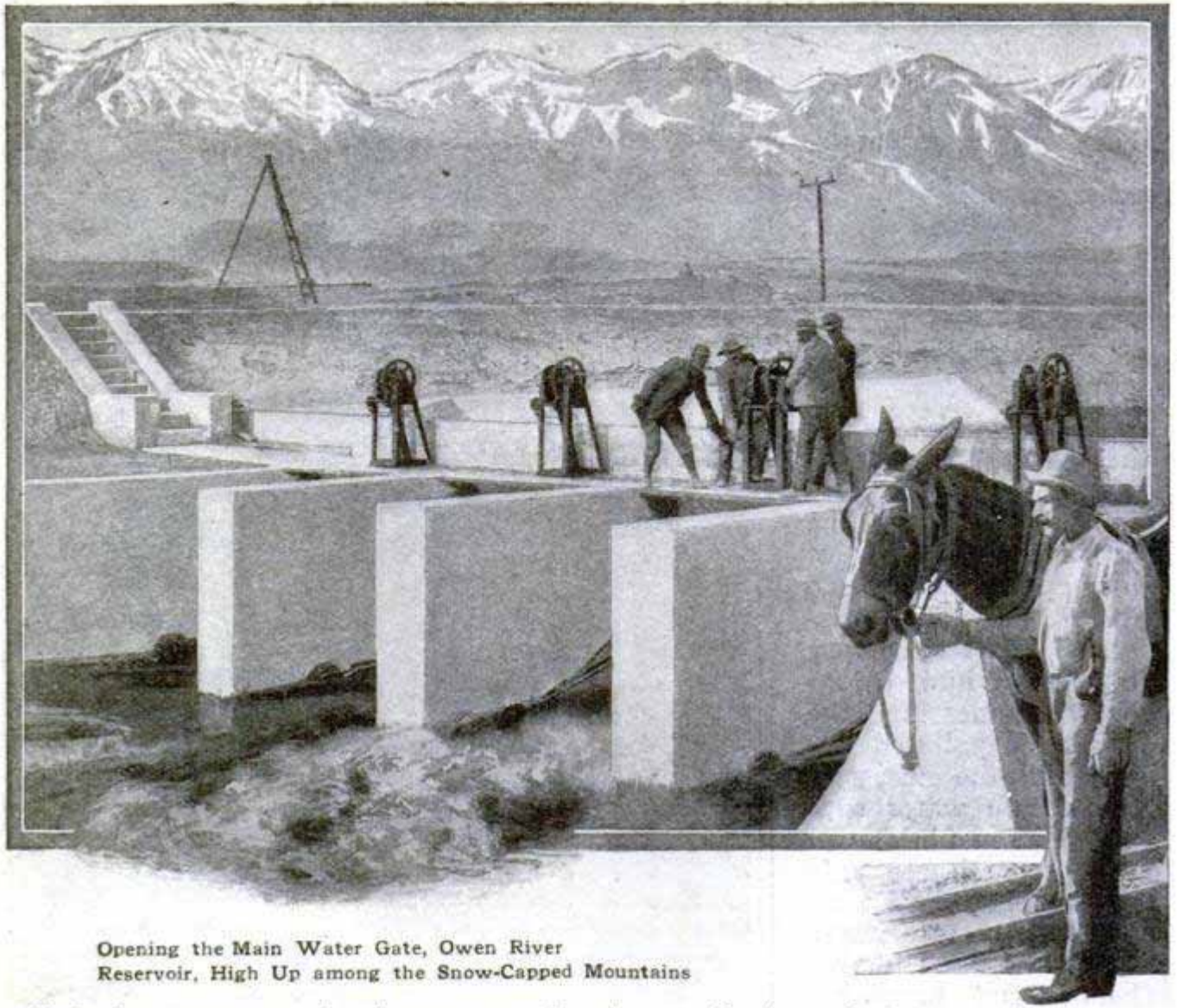

Opening the Main Water Gate, Owen River Reservoir, High Up among the Snow-Capped Mountains

which does not contain the germs of typhoid fever, cholera, dysentery, or other diseases. How do we know when the supply is safe? There is only one way in which we can assure ourselves that the water supply is safe, and that is by daily bacteriological examination. In plain words, samples must be taken to determine the number of germs in each cubic centimeter (1 c.c. = about 15 drops) and the presence or absence of germs which are of faecal or intestinal origin.

A good, safe water supply should contain not more than 100 germs to the cubic centimeter, and should show absence of the colon bacillus or other organisms of sewage origin. The predominant germs in intestinal discharges are the colon bacillus and its relatives. These germs greatly outnumber the typhoid or other disease-producing germs to be found in sewage. It is a "needle in the haystack" proposition to find the typhoid bacillus in water because of

the small size of the samples taken. It is the custom, therefore, to test for the colon bacillus, because the probability of finding it is very much greater in samples of 10 cubic centimeters (about one dessert-spoonful). The presence of the colon bacillus indicates faecal contamination, and faecal contamination means the possibility of typhoid or other intestinal germs being in the water.

The knowledge and acceptance of these simple facts as to what constitutes safe water would solve the problem. Although these standards for safe water are accepted by the leading sanitarians all over the world, we find American municipal authorities satisfied with water which is known to be polluted, and in many instances assuming their supplies to be safe without proper daily bacteriological examination. We find further that the average American citizen does not know what constitutes safe water and patiently and

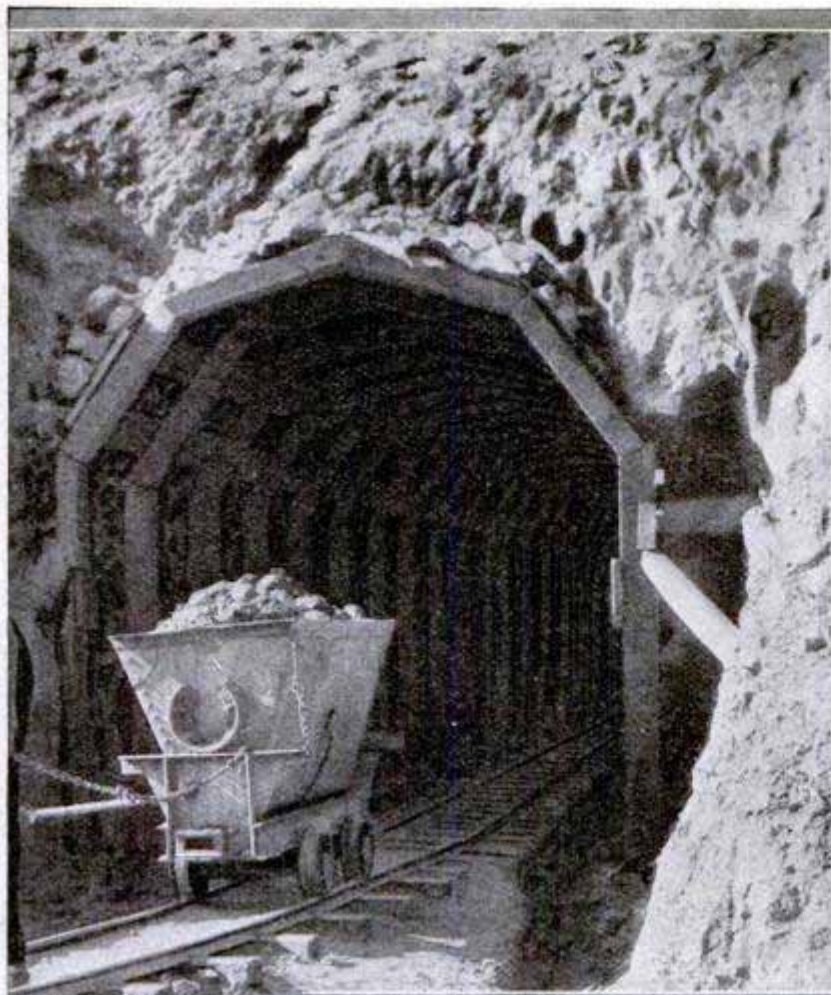

South Portal of the Tunnel on the
"Seven Power" Division

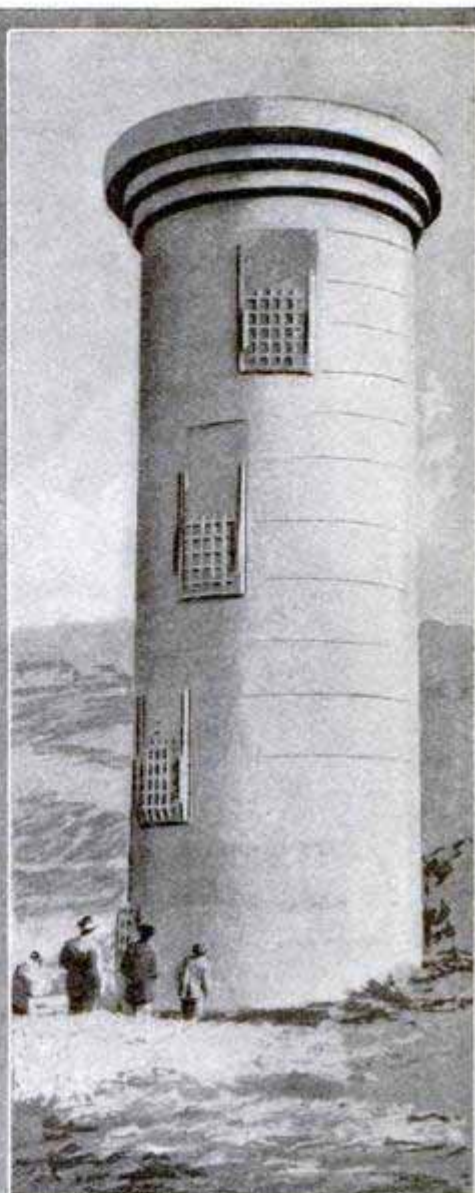

Haiwee Aeration Tower, Where Flow
of Water is Regulated

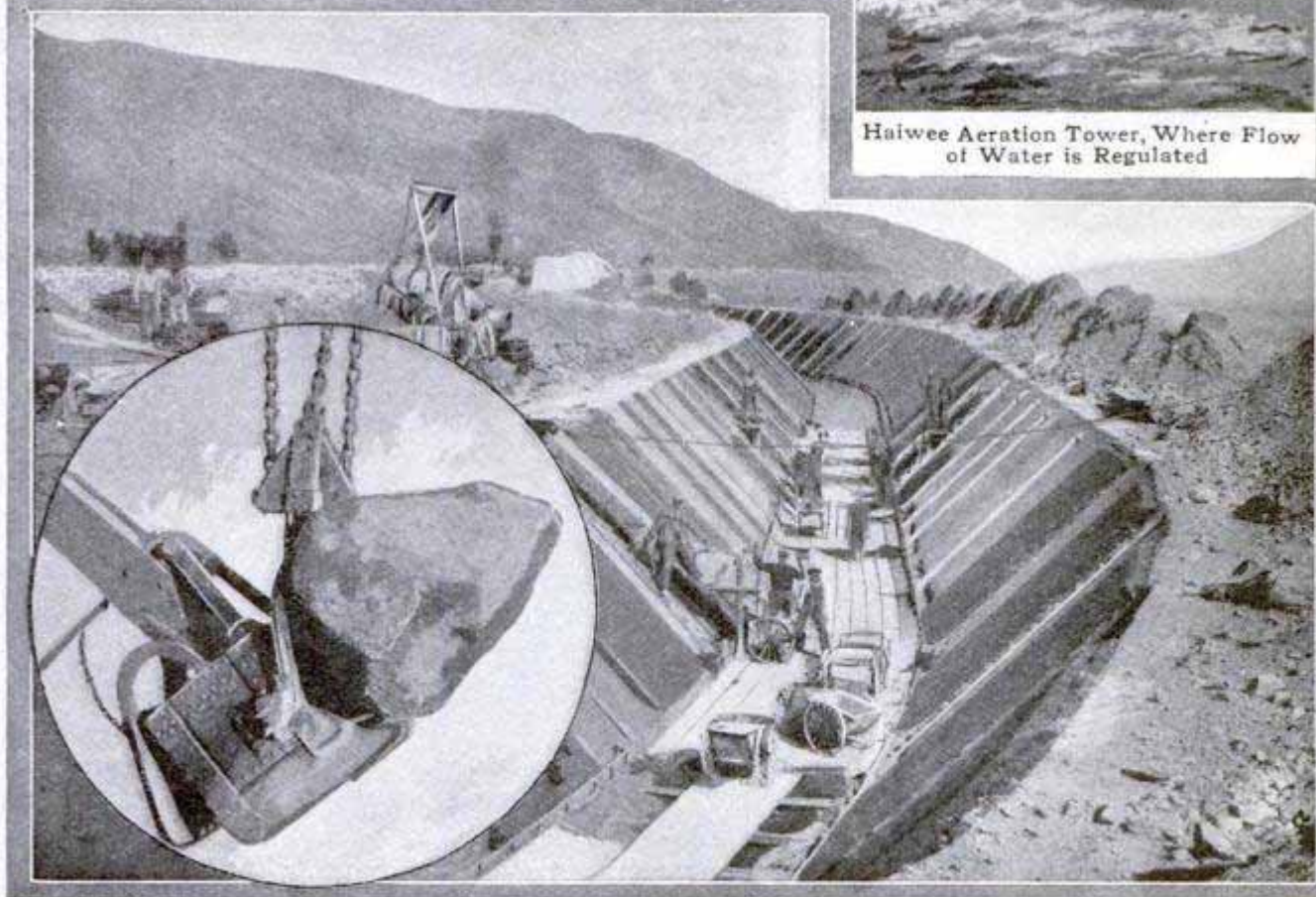

Open-Ditch Construction of the Los Angeles Aqueduct, 250 Miles Long, with a Total Fall of Three-Quarters of a Mile; Cost \$24,500,000. There are 22 Miles of Unlined Ditch and 38 Miles of Open Concrete Conduit

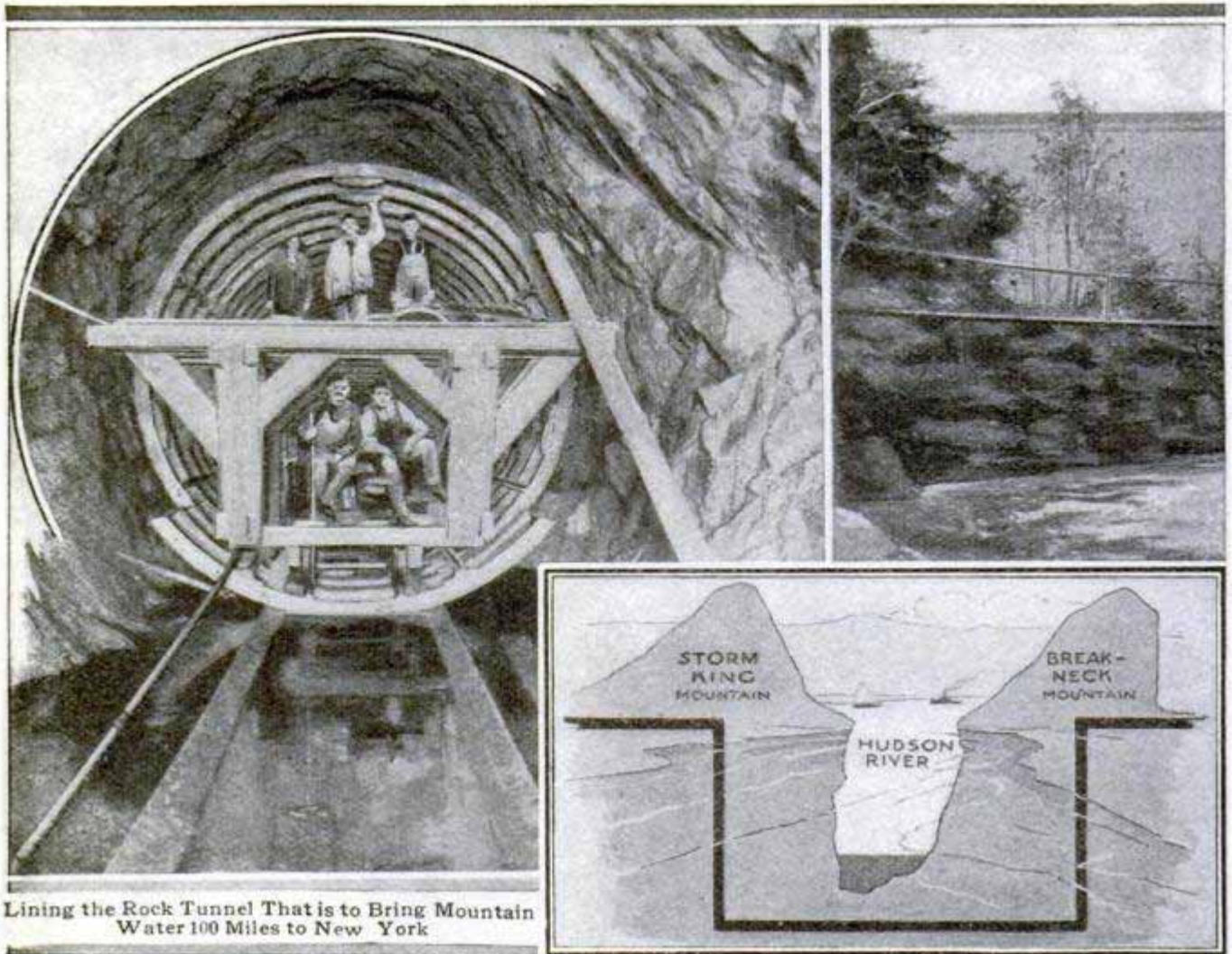

Lining the Rock Tunnel That is to Bring Mountain Water 100 Miles to New York

Photo by Paul Thompson

Diagram Showing How Tunnel is Carried under Hudson River

trustfully accepts the polluted water furnished him by the municipality.

American water rates are usually about \$2.50 per capita. Safe water supplies are within the reach of every one; the additional cost of purification when necessary would be small. In fact, in Toledo, Ohio, the installation of an efficient mechanical filter plant resulted in lower rates because of more general use and increased consumption of the new supply. The most expensive methods of purification cost less per capita than what the average citizen pays for ice or telephone.

Purified water supplies, safe at all times, would result in a typhoid fever reduction to less than 10 deaths per 100,000. This would mean an annual saving of at least 15,000 lives from typhoid fever alone, and the prevention of at least 150,000 cases of typhoid fever. Is this saving of life worth the cost? It is the writer's opinion that safe water is worth all we ever pay for it, and that this cost is so reasonable

that there is no excuse for any city's failure to supply safe water 365 days in the year.

3336. WIRELESS STATIONS OF THE WORLD

There are 375 public wireless coast stations in the world at the present time, according to a report from the International Bureau of Wireless Telegraphy. Of this number the United States has 142; Canada, 33; Great Britain, 43; Germany and its colonies, 22; Italy, 19; Russia, 19; France, 17; Spain, 10, and Denmark, 9. The British and French colonies also have a number of stations.

Of the wireless stations on board war vessels the United States has 247; Great Britain, 213; France, 141; Germany, 112; Italy, 77; Japan, 70, and Russia, 70. The merchant marine of Great Britain has 455 stations; the United States, 253; Germany, 206; France, 68, and Italy, 47.

L. d. Messerham

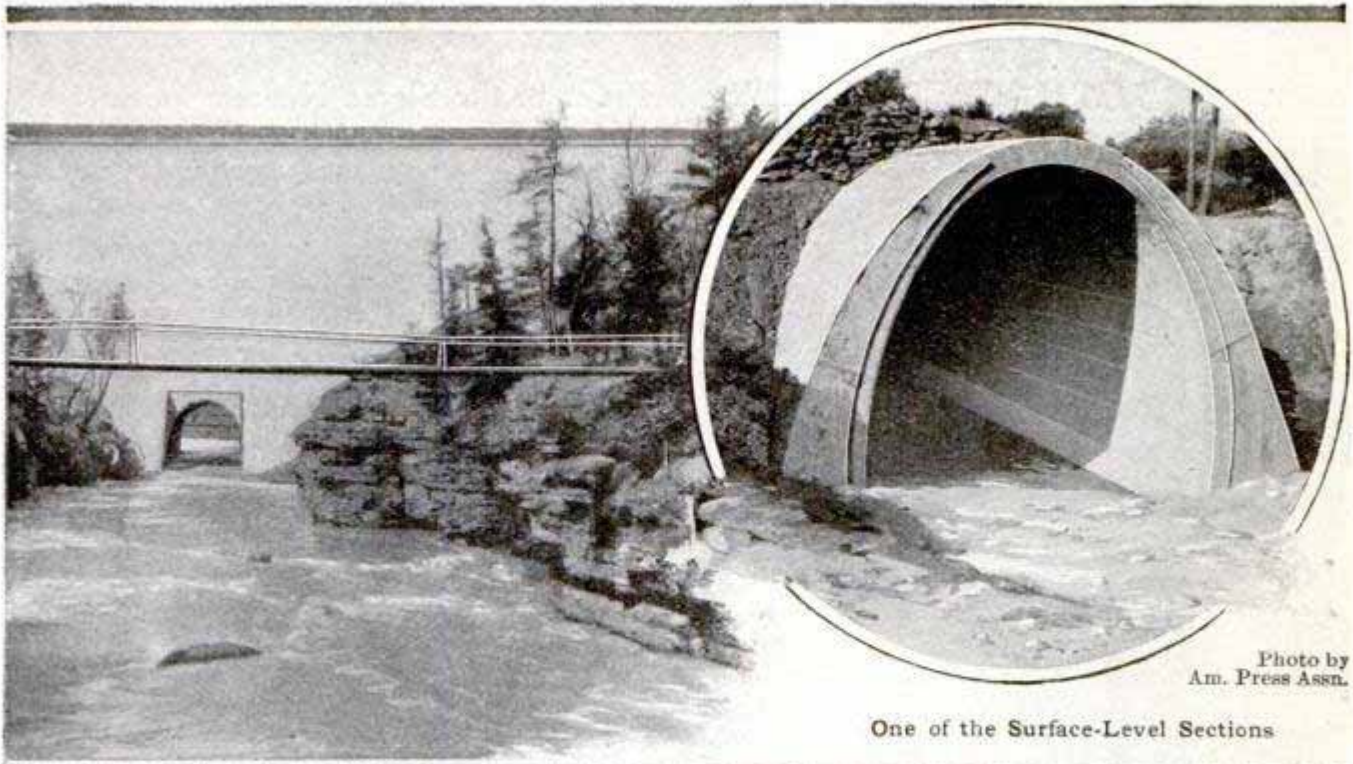

Photo by Am. Press Assn.

One of the Surface-Level Sections

Photo by Paul Thompson
Olive Creek Dam That Impounds Water for Ashokan Reservoir

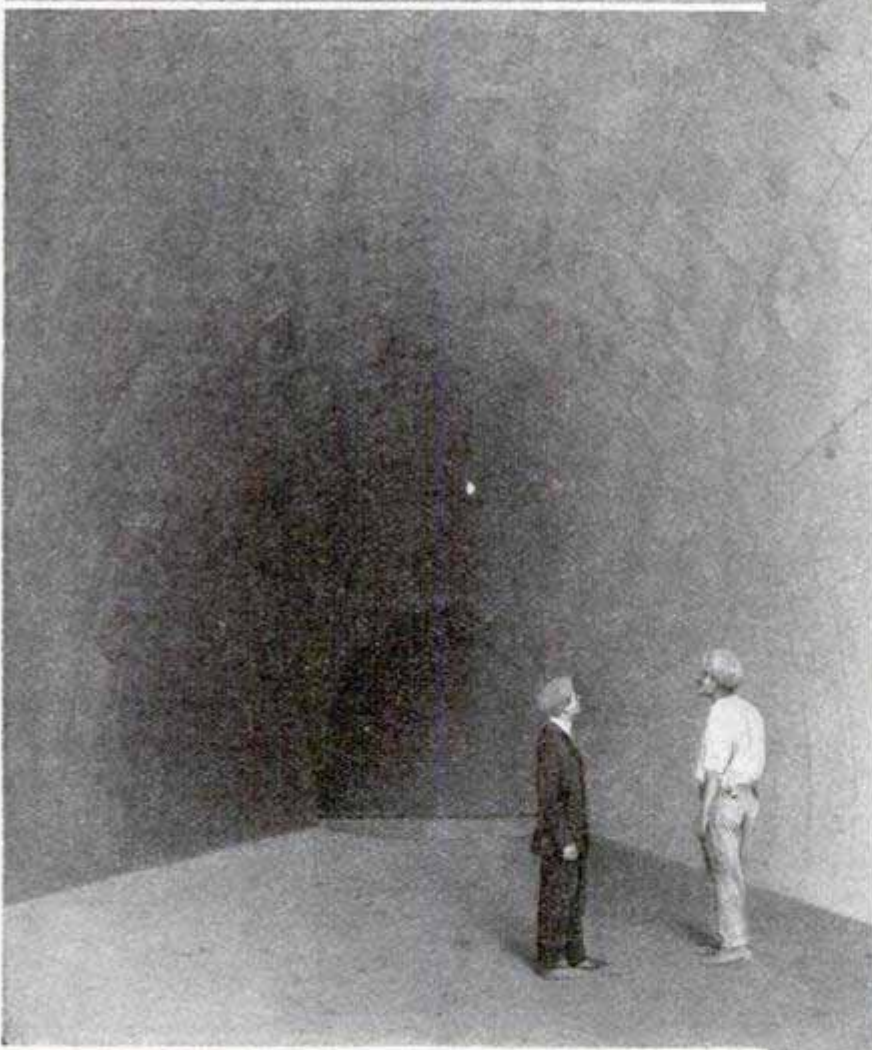
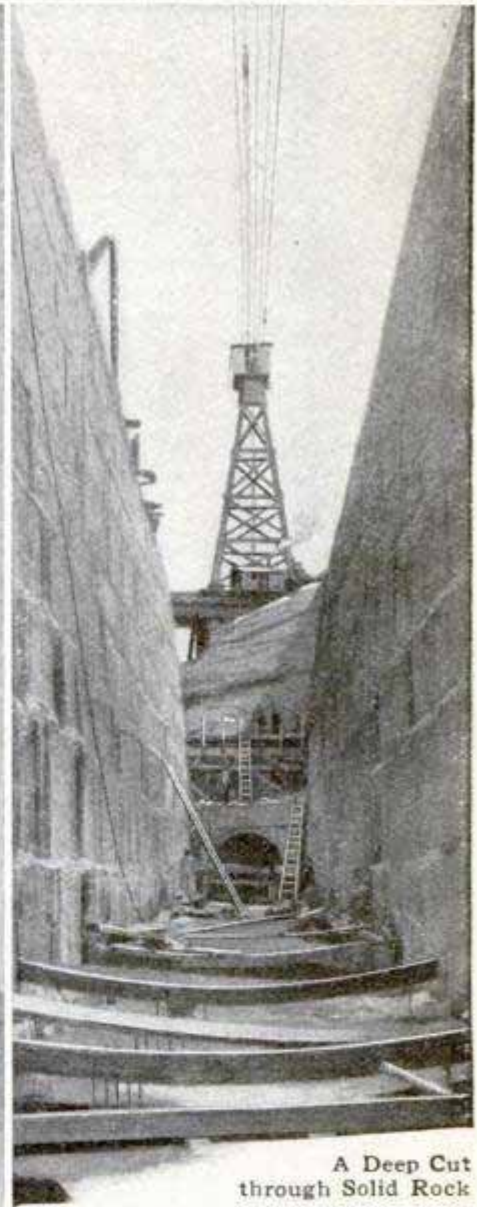

Photo by Am. Press Assn.

A Completed Section of the Tunnel, Which is Lined with Concrete Throughout Its Length



A Deep Cut through Solid Rock

Photo by Paul Thompson

New York's Aqueduct That Cost \$125,000,000 and is Hewn through Solid Rock under Mountains and City Streets

San Francisco Calif

ORGAN WITH PIPES THIRTY-SEVEN FEET LONG

The new electrically operated organ of St. Michael's Church, in Hamburg, Germany, is one of the largest in the world. It has 12,173 pipes, a total of 163 voices or main registers, 125 auxiliary registers for combining further shades of timbre; five keyboards, each of 61 keys, and a pedal keyboard of 32 keys. The height of the organ is 57 ft., the longest pipes, one of which is shown in the accompanying illustration, are 37 ft. long, and the shortest are about 1 in. in length. The organ took nearly three years to construct.

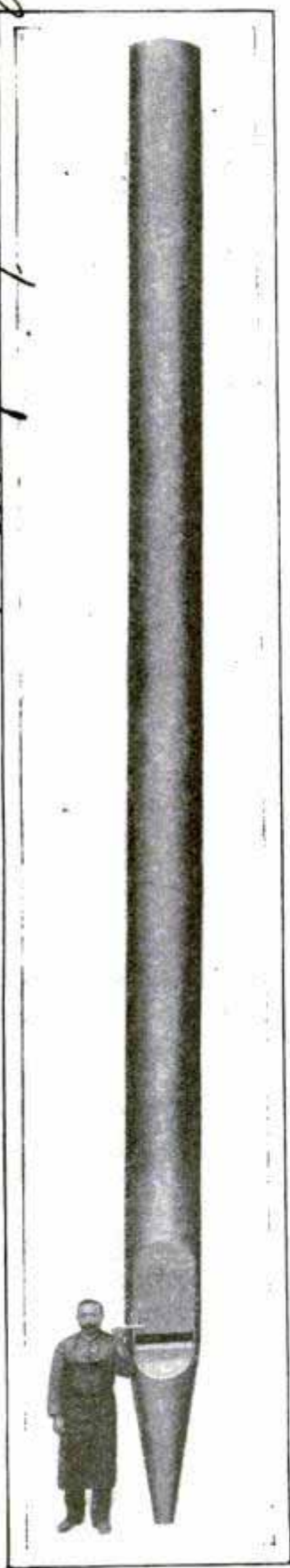

Germany, is one of the largest in the world. It has 12,173 pipes, a total of 163 voices or main registers, 125 auxiliary registers for combining further shades of timbre; five keyboards, each of 61 keys, and a pedal keyboard of 32 keys. The height of the organ is 57 ft., the longest pipes, one of which is shown in the accompanying illustration, are 37 ft. long, and the shortest are about 1 in. in length. The organ took nearly three years to construct.

MOTOR TRUCKS UNDERGO SEVERE TESTS

Two big tasks of an unusually severe nature were successfully accomplished recently in California by motor trucks. One of these was in connection with the construction of the

River in the Sierra Nevada mountains. Late last summer the contractors decided that heroic measures were necessary to put the work in a safe condition to withstand the winter weather. Several villages lay in the valley, and the breakage of the dam would have meant great loss of property and probably of life. Cement and other material had to be hauled from Keddy, 25 miles distant, and, as the materials had to be rushed, the only apparent way to accomplish the task successfully was by motor trucks. Five cars were used, and these, carrying 5-ton loads, were run 24 hours a day for 40 days. The roads were so bad that new tires had to be put on every 1,000 miles, but the cars themselves stood the strain successfully.

The other test was in the transportation of all the material for an 8-in. oil-pipe line which passes over a long stretch of the Mohave Desert, and crosses the coast range at an elevation of 3,900 ft. The length of this line is 158 miles, yet all the work of hauling the steel pipe, having lengths of 15 and 22 ft., was done by a fleet of 15 motor trucks.

SHIP DESTROYED BY ITS CARGO OF SODIUM

The disaster which befell the steamship "Hardy" through the "vindictive" behavior of its "demon cargo" is one that will go down in ship annals as remarkable. The cargo consisted of metallic sodium in cases and mineral waters. Some of this water reached the sodium and set a quantity of it on fire, and the captain, not understanding the nature of sodium, ordered the hose played upon it. As a result, two tons of it was set on fire and several explosions followed. Nonplussed, the captain then ordered all of the cases thrown into the sea. Some of the first of these cases exploded, others were thrown back onto the deck in a fiery condition by the explosion, the vessel caught fire, and a terrific explosion of the cases still in the hold caused the vessel to break amidships and sink.

Big Meadows dam, on the Feather

Built by Messrs. J. J. Walcker & Co. Ludwigsburg Germany

3354

The *Ornithologist* 8 0
21.12.1913

**DEVELOPING NEW COAL FIELD
BY ELECTRIC POWER**

340

A new soft-coal field, which is said to be even larger than the great bituminous fields of Western Pennsylvania, has been recently opened to development by the construction of a railroad from West Virginia through the Carolinas to the Atlantic seaboard. This new coal field underlies parts of Tennessee, Virginia, West Virginia and Kentucky, south and west of the West Virginia fields which are already under development. A \$500,000 electric plant, operated by coal produced from a mine at its door, is being constructed to furnish power for the operation of the first mines in this territory.

**BEARD FORMED OF LIVE
HONEYBEES**

1265

This man is wearing a temporary beard formed of live bees that were caught in the act of swarming and in-

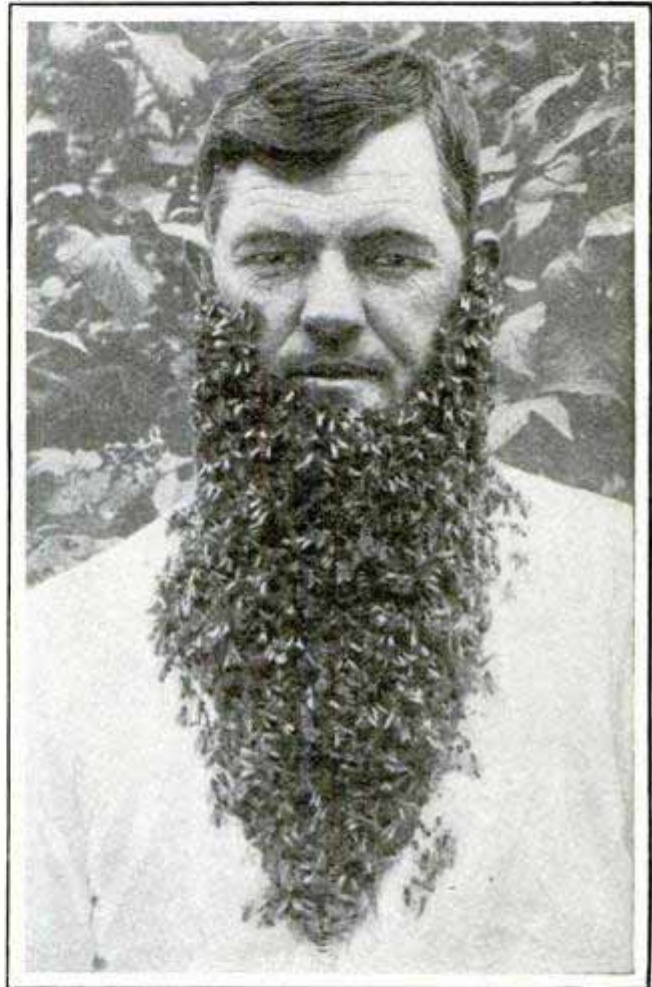

Copyrighted by Underwood & Underwood, N. Y.
This Beard is Formed of Live Honeybees

**LONDON OMNIBUSES TESTED
BY TILTING THEM**

1190

The stability of the motor omnibuses of London is ascertained before the vehicles are put into commission by subjecting them to a series of tilting tests, one of which is here shown. These tests indicate that the busses, when empty, will capsize when the rear axle is at an angle of 41 deg. When the top only of the vehicle is loaded an angle of but 28 deg. is required, and if loaded inside and outside, the carriage will fall over when the axle is raised to an angle of 35 deg.

Blamler

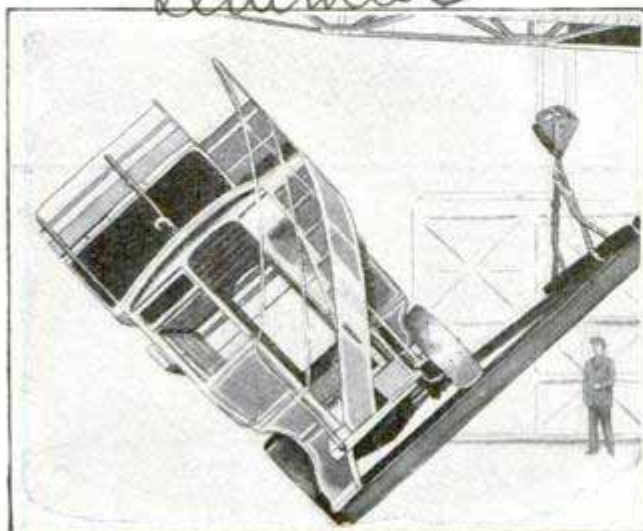

London Omnibus Undergoing a Tilting Test

duced to form the beard by putting the queen bee into a small cage and suspending it from the man's chin. The cluster of honey gatherers was then dropped in front of a hive by a shake of the head and the swarm went into their new quarters accompanied by their queen, thus forming a new colony.

3 3 3 3

CA prize hen that is said to hold the world's record for egg production, having laid a total of 281 eggs within 12 months, was recently sold for \$800. The fowl, which is of the White Plymouth Rock variety, was purchased by the publishers of a poultry paper from a resident of Illinois.

7-2-11

FIGHTING THE MOTH WITH AUTOMOBILE SPRAYER

In Massachusetts, where hundreds of thousands of dollars have been spent

in the fight to exterminate the gypsy moth, every scientific and mechanical means available have been used in the campaign. Among the spraying devices developed by the state authorities, one of the most successful has been this automobile sprayer. It will throw two streams of moth-destroying liquid into the topmost branches of the highest trees. The nozzle men stand on the flat, railed-in top of the tank, the truck stopping or moving slowly along as tree after tree is sprayed.

The solution sprayed upon the foliage during the period in which the moth caterpillars feed upon the trees is composed of about 10 lb. of arsenate of lead to 100 gal. of water.

"POWDER MONKEY" SHOOTS UP SNOWSLIDES

A Swedish "powder monkey," an expert in handling explosives, blasted a heavy snowslide along a western railway line by welding together three steel bars, each $1\frac{1}{2}$ in. in diameter, and forcing them through the snow almost down to the track, or to a depth of

about 35 ft. The hole made by the steel bars was loaded with 62 kegs of blasting powder and five dynamite cartridges of about 40-per-cent strength which were exploded by electricity, with the result that a large hole was made to within a foot of the track. Three or four other holes were made, loaded and fired in a similar manner, enabling the rotary snowplows to clear the slide in a few hours' time.

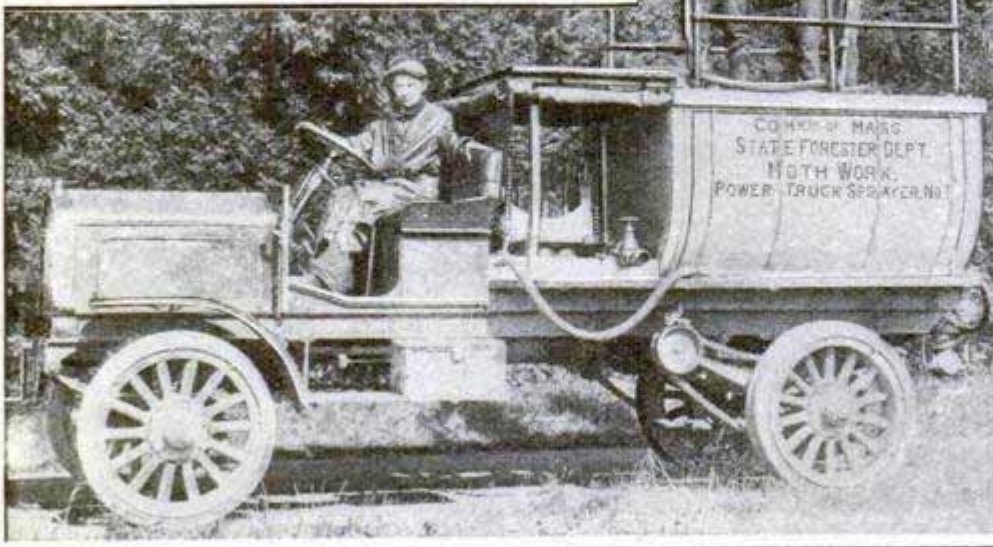

An Automobile Sprayer Used in Massachusetts in Destroying the Gypsy Moth

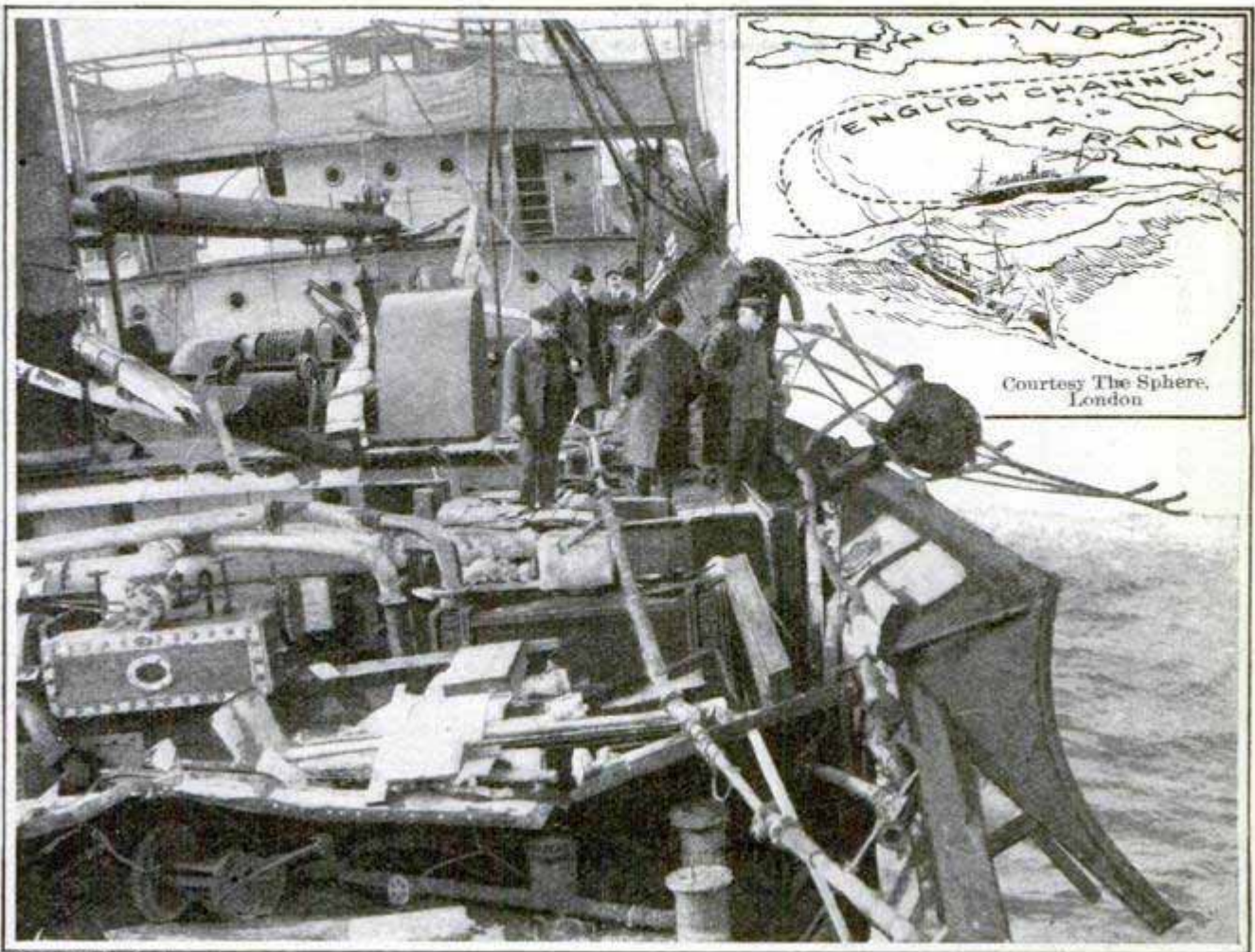

Photo by Topical

English Liner "Narrung" after Conflict with Mighty Waves, and a Diagram Showing How She was Forced Back to Port

GREAT WAVE OVERWHELMS ENGLISH LINER

Compelled to return to port a battered and waterlogged ship with her deck showing terrible havoc, nevertheless afloat and without the loss of a single life, was the experience of the English liner "Narrung" as the result of having encountered a terrific gale near Ushant Island off the northwest coast of France. Slightly south of this danger spot the vessel met with some very high seas, one of which is described as being 70 ft. high, burst-

ing full upon her deck and causing the wreckage shown in the illustration. Rather than continue the 90 minutes' battle against such fearful odds, the liner was turned and headed back to port.

GAZELLE TAKES REVENGE ON ITS DESTROYER

125 This python was found dead on a farm near Buluwayo, in South Rhode-



Python Killed by the Horns of a Gazelle It had Swallowed. The Protruding Horns are Clearly Shown

sia, after having swallowed a gazelle, the horns of which had cut through the snake's skin. A day or so before the snake was found, it had been seen struggling with a gazelle along the bank of a near-by river.

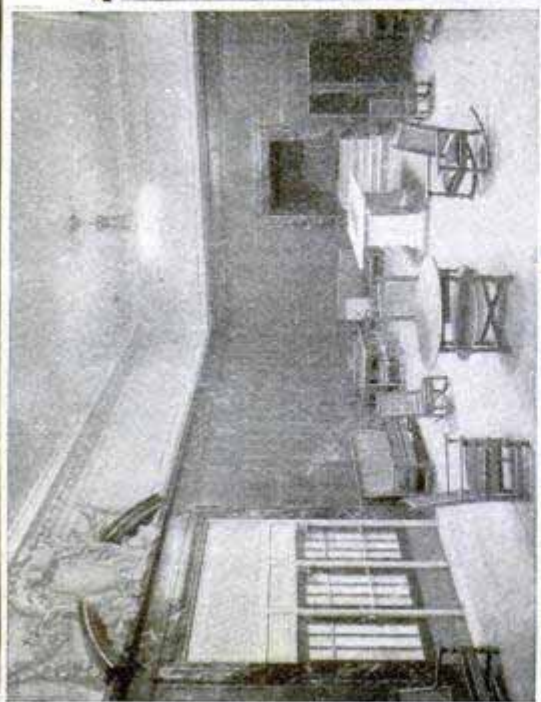

A Corner of the Ladies' Waiting Room

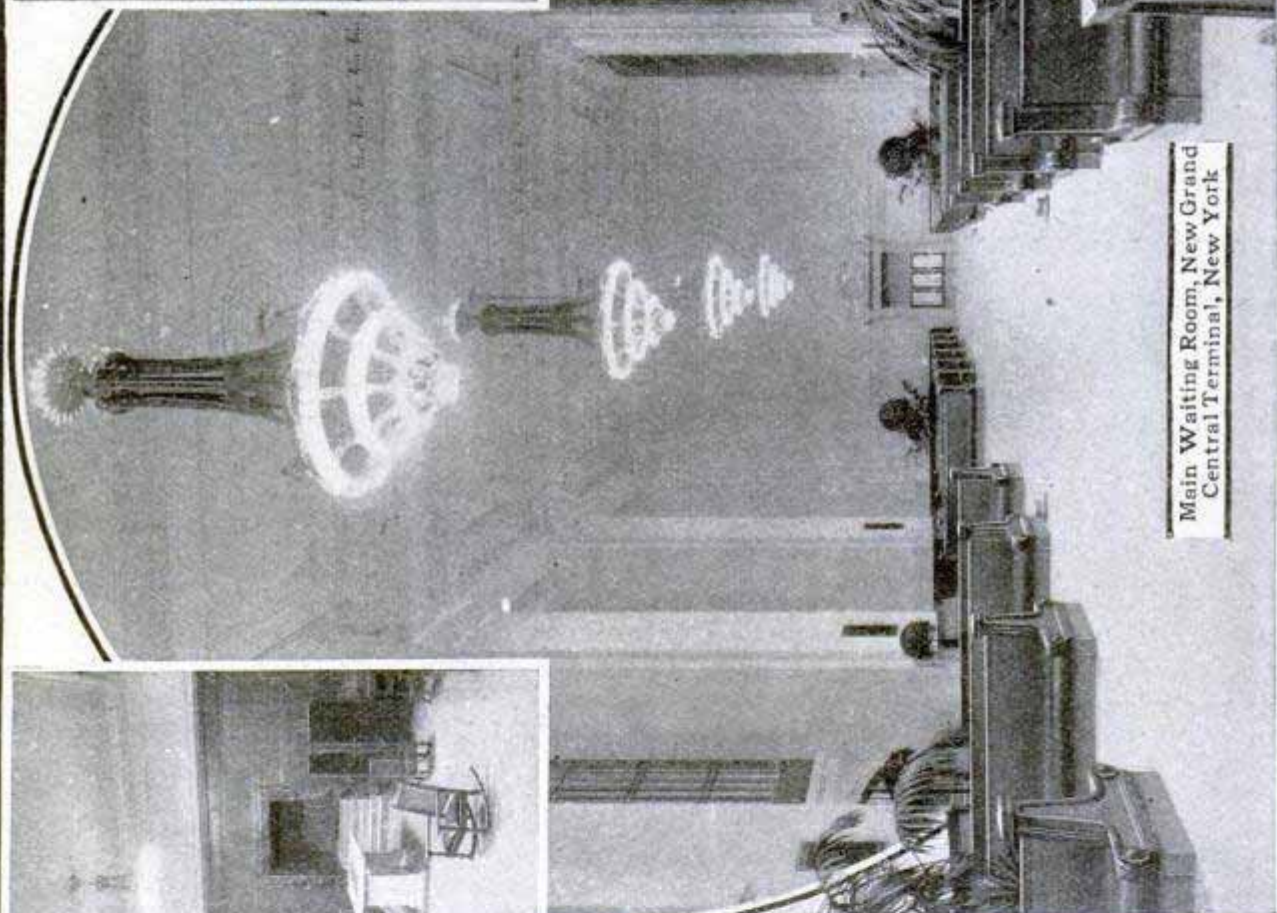

Main Waiting Room, New Grand Central Terminal, New York

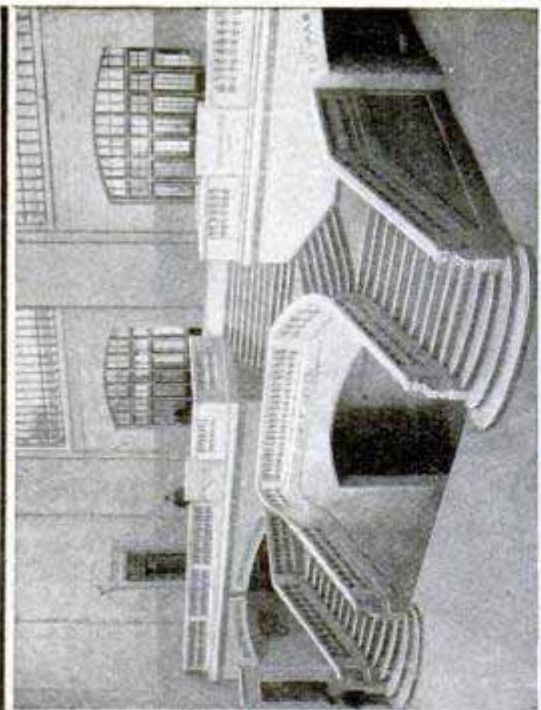
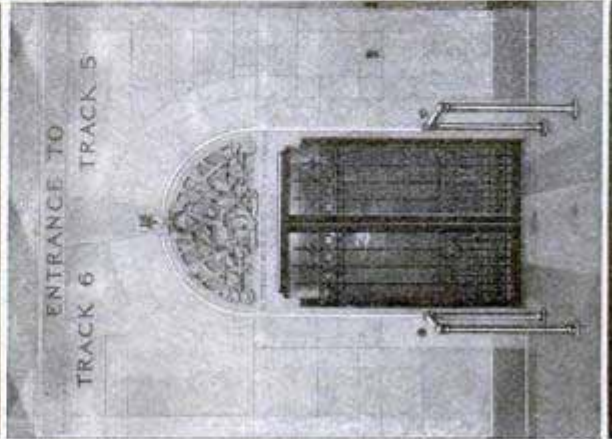
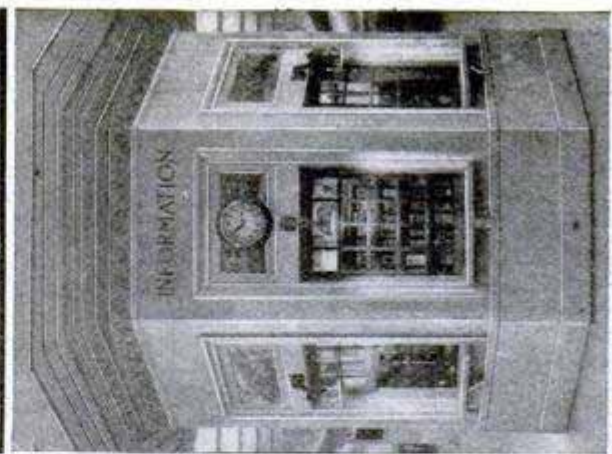

Photo by Paul Thompson
Grand Stairway to Concourse



Train Entrance on Suburban Level



Information Booth on Suburban Floor

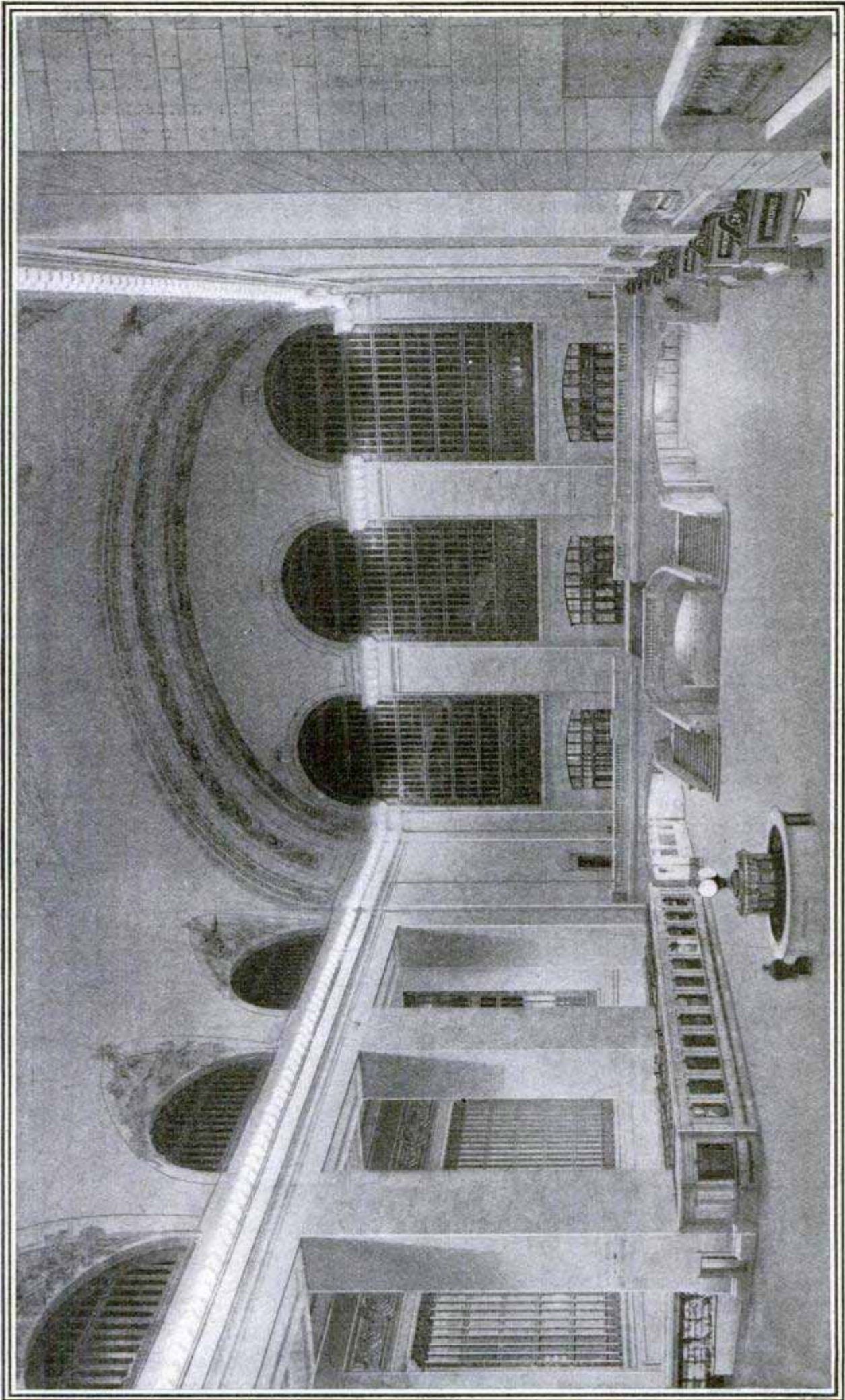

The New Grand Central Terminal, New York, the World's Largest Railroad Station, Contains 67 Tracks, Totalling 33 Miles. The Picture Shows the Main Concourse

PARACHUTES FOR AEROPLANE AS WELL AS AIRMAN

The energies of practically all the inventors of parachutes for airmen have been directed toward the development of a device for the airman alone, the aeroplane itself being allowed to drop to earth unhindered. Parachutes for the whole aeroplane have just

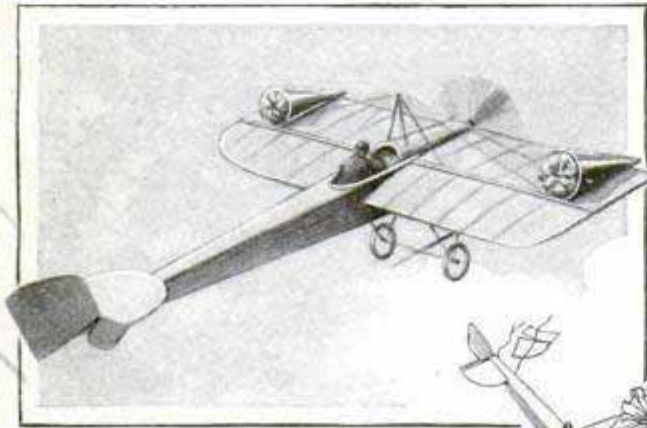

The Parachutes in the Containers on the Wings of the Aeroplane

been designed by a French inventor. Two folded parachutes, contained in cone-shaped receptacles, are attached to the wings as near the ends as possible. By means of a simple mechanism, operated by the movement of a small hand lever, these parachutes are pushed out of the containers, after which they are claimed to open freely, no matter in what manner the aeroplane may be falling. All the airman has to do is to hang on to the aeroplane.

AUTOMOBILE THAT "BUCKS" LIKE A BRONCHO

A bucking automobile has recently been patented by a Chicago inventor. It is intended to be used for amusement purposes only. The wheels are not centered on the axles, but set eccentrically and the front wheels may be revolved independently of the rear wheels, so that a wide variety of vertical motions may be given to the body of the car. By alternating the eccentricities between front and rear, the result is a series of plunges or "bucks"

not unlike the action of a bucking horse. The device is particularly designed for use in amusement parks. The patentee makes no claim of high speed with this invention.

DOUBLE-DECK LIFT BRIDGE 325' OF IMMENSE SIZE

What is probably the largest double-deck lift bridge in the world and the only one having a movable lower deck, which may be raised enough to clear the top of all vessels requiring not over 70 ft. clearance without interfering with the traffic on the upper deck of the bridge, has been built by the Oregon-Washington Railway and Navigation Company across the Willamette River, at Portland, Ore.

The bridge has two decks, the lower being used for a double railroad track,



An Actual Demonstration of the Operation of the Parachutes

and the upper contains double tracks for street cars; also two sidewalks and wagon roads. The total length of the structure, from approach to approach, is 2,500 ft.; each of the approach spans weighs 6,500 tons and more than 9,000 tons of steel were used in the bridge proper. The concrete piers, which support the spans, were sunk in bed-rock 60 ft. below the surface of the water, measure 50 by 90 ft. and are 120 ft. high. The height of the central towers is 243 ft. to the top of the sheaves, and 363 ft. from the base of the foundation, or approximately as

Edward W. Desenfans
3721 Ferdinand St.

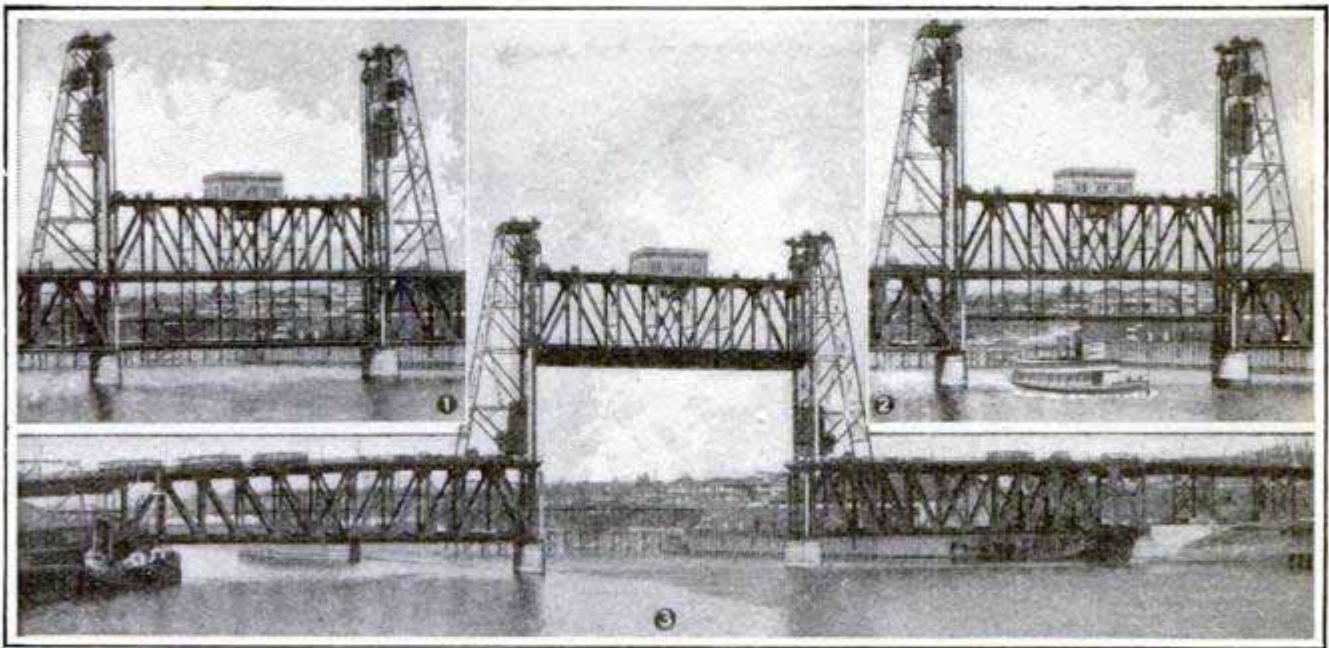

Double-Deck Lift Bridge: 1, Both Levels Down; 2, Lower Level Partly Raised; 3, Both Levels Raised

high as an office building of 30 stories. The lift span, which is 250 ft. in length and weighs, with its machinery, about 2,500 tons, is raised to a height of 140 ft. above the high-water line by means of $2\frac{1}{4}$ -in. steel cables having a breaking strain of many thousand tons. The double-deck lift span is raised and lowered by electric motors, and special devices are provided for automatically controlling the lift at any height in case an accident should occur while it is in motion.

DEATH RATE OF MINE RESCUERS

Two of the 24 experienced mine rescuers of the United States Bureau of Mines lost their lives while attempting to save imprisoned miners during the past year, and seven others were overcome by poisonous mine vapors and were rescued only after the most heroic efforts, according to a report issued by the government. In the period of one year 40 entombed miners have been rescued directly through the efforts of the bureau's men and perhaps as many more by individual miners who were trained in rescue work by the Bureau of Mines. Although the death rate is 80 out of 1,000 men employed by the bureau, the high mortality does not deter miners from entering the dangerous business.

DOG'S DINING ROOM IN ENGLAND

The illustration shows a section of the dining room that a restaurant proprietor of Chelsea, England, has provided for the dogs of those who fre-



Dog's Dining Room Operated by a Cafe Manager at Chelsea, England

quent his place of business. Three pence (or six cents) is charged for each dog's meal.

Denver is said to use more electric lighting in proportion to its population than any other city in the country, the amount being 3 cp. per head.

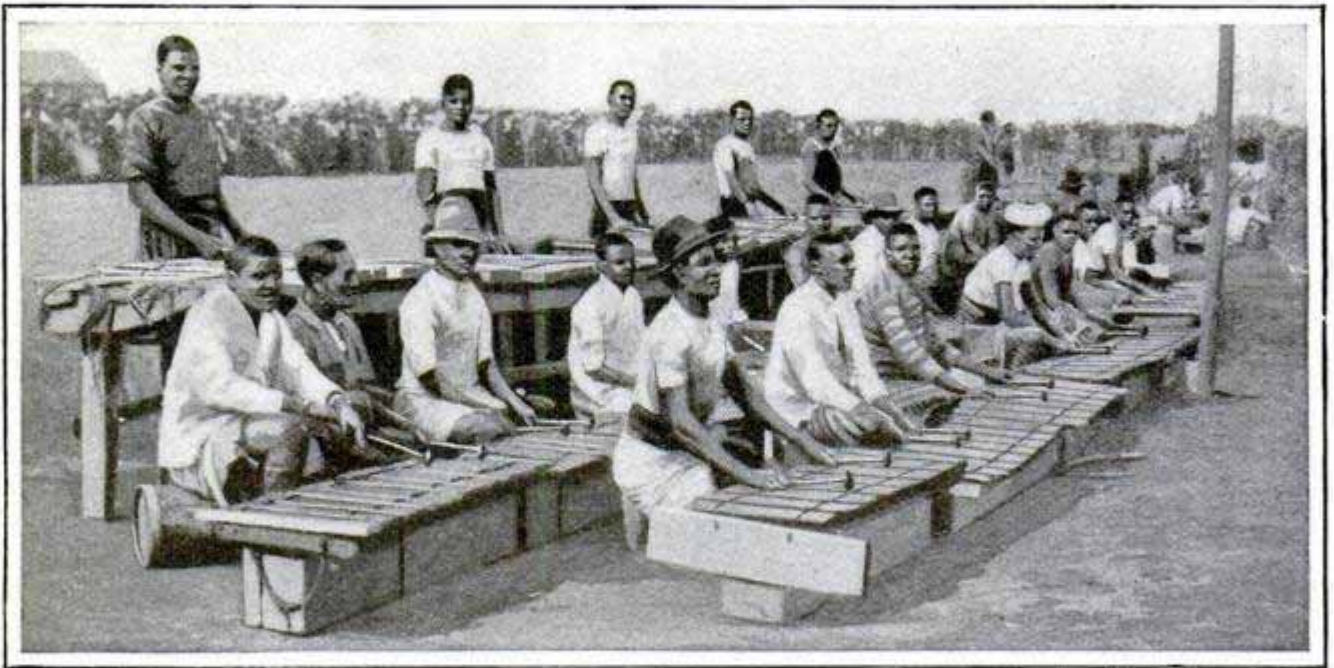

Courtesy The Sphere, London

Zulu Orchestra About to Make Dance Music

**PRIMITIVE BUT POWERFUL
ZULU ORCHESTRA**

The primitive but powerful Zulu orchestra here shown is about ready to provide dance music for the natives of Northern Nigeria, who, when work in the mines is suspended, are accustomed to holding dances on Sundays. Hundreds of the Zulus, usually clothed in war attire, participate in these festivities which frequently continue for

12 hours and, by the end of this time, many of the natives taking part collapse from utter exhaustion.

**PORTABLE SCHOOLS FOR
TEMPORARY USE**

Los Angeles is making use of a system of portable school buildings which is very practical, especially for rapidly growing cities. When overcrowding threatens some particular school building, it is a simple matter to add two or three class rooms by erecting the portable buildings on the school grounds or upon some conveniently located vacant lot. One of the Los Angeles schools is now making use of eight

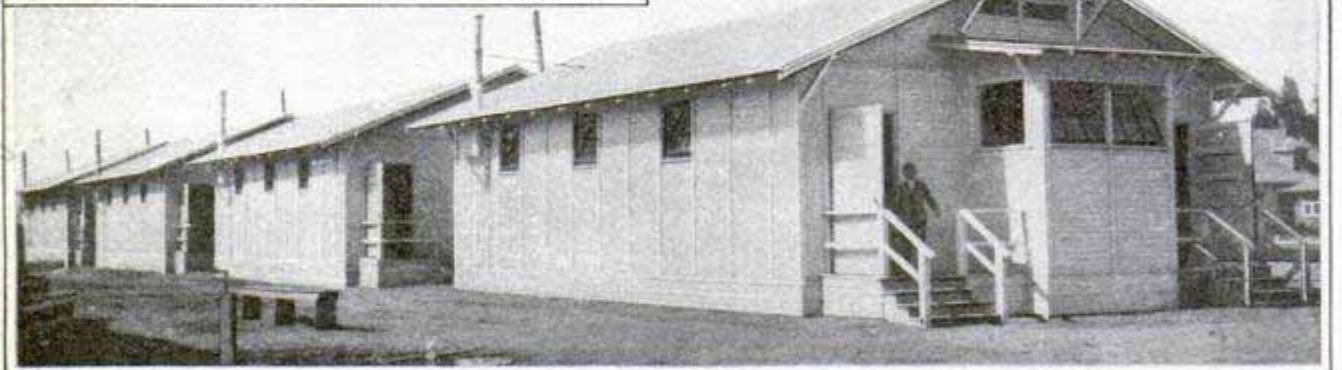

A Portable School Used in an Arizona Town

Four Portable School Buildings in Los Angeles

such buildings, which stand upon a lot directly across the street from the permanent structure.

The portable school buildings are about the size of the ordinary class room, and, although of light construction, are comfortable and well heated. They are collapsible, the largest sections being so small as to be easily handled by two men. The sections are bolted together, and it is possible to assemble or take down one of the buildings in a few hours.

A somewhat similar type of portable school, provided with flaps which can be lifted for ventilation, is being used in an Arizona town.

DYNAMITE CARRIER MADE ON "THERMOS" PRINCIPLE

The expediency of keeping dynamite from freezing in cold weather, particularly during the time it is being taken from the magazine to the place of use, has resulted in the invention of a nonfreezing carrier constructed on the principle of the thermos

bottle. When dynamite is placed in the bottles or tubes, of which there are three, and the corks are firmly inserted in the ends, it will remain unfrozen for at least 12 hours, even when the carrier is exposed to a temperature considerably below zero. Before placing dynamite in the tubes the carrier is placed in a room having a temperature of 65 deg. F. or higher, and the corks are withdrawn for at least five minutes.

THROWING BIG BOULDERS WITH STEEL BUCKET

Throwing immense boulders with an "orange-peel" steel bucket, as a baseball is thrown with the hand, is frequently done with modern devices for excavating and rehandling rock, gravel and dirt. The construction of the bucket, which is operated by steam or

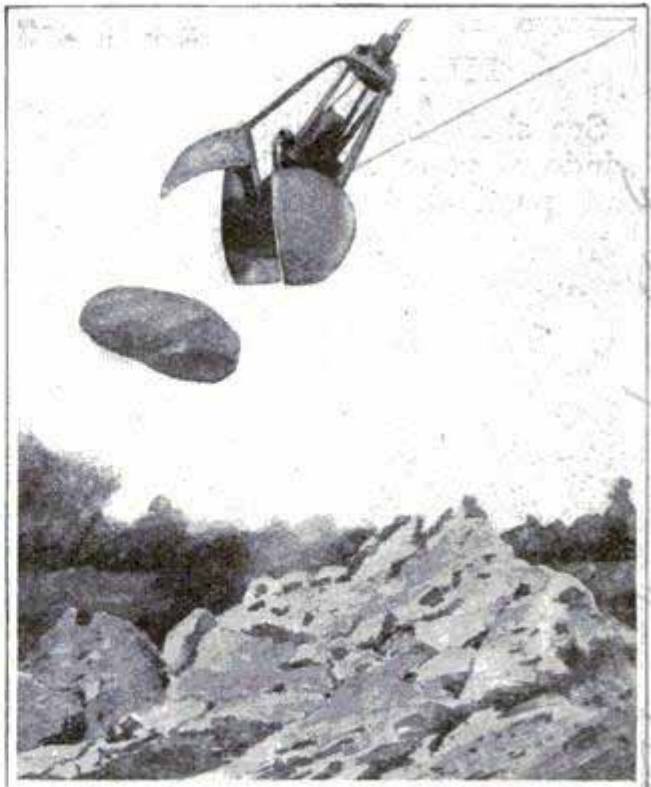

Throwing a Boulder with an "Orange-Peel" Bucket

electric power, is such that large boulders are quickly picked up and cast to one side of the excavation with ease, the contents of the bucket being released while in midair, thus materially increasing the amount of work that may be accomplished by the apparatus.

NEW TROWEL FOR STUCCO WORK

A new trowel for the application of rough-cast stucco has been patented by a Minnesota contractor. The open-work construction of this trowel causes it to pick up and throw the stucco on the walls in small dabs.



More than \$40,000,000 worth of agricultural implements were shipped from the United States to foreign countries in 1912.

Drum age

3259

W. Newhall Co

3282 B

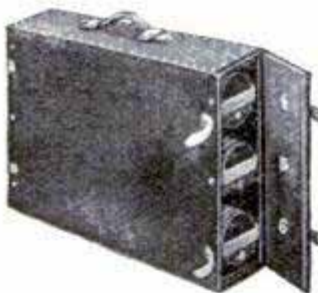

THE SEA-SHELL WINDOWS OF THE PHILIPPINES

Sea shells are used as generally for window panes in the Philippines, and particularly in

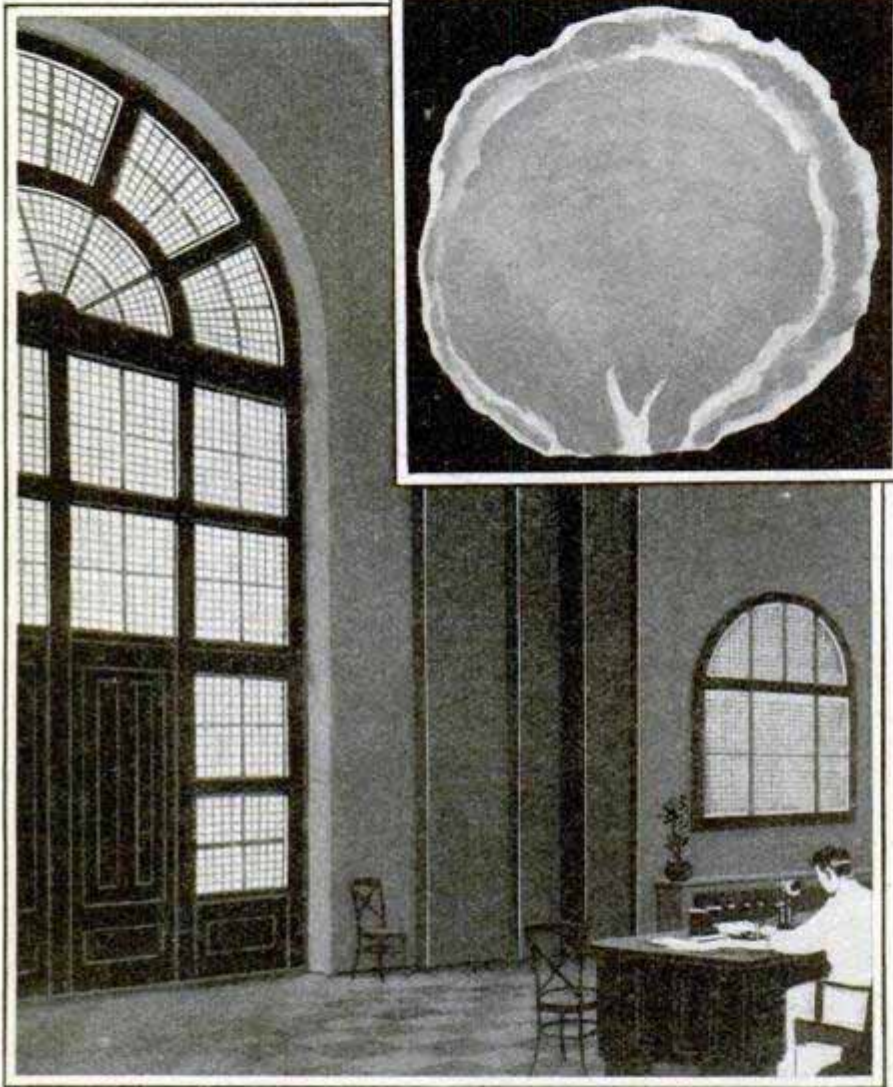

Kapas-Shell Windows in the Main Entrance of the Philippine General Hospital, Showing the Soft Sunlight Effect

Manila, as is glass in this country, and the effect of tropical sunlight filtering through the silvery grayness of the shells, softened and gentle, is magnificent. The windows in the main entrance of the Philippine General Hospital, Manila, are probably as fine a modern example of the use of the sea shells as can be obtained. The sea-shell windows may also be seen at their best in the old churches.

Manila alone uses in the neighborhood of 5,000,000 Kapas shells each year for windows. The largest-sized shells will square about 3 in. These sell for from \$4 to \$5 per thousand, ac-

ording to quality. Shells that will form panes of about 2 sq. in. sell for anywhere from \$1.50 to \$3 per thousand, and are used for ordinary purposes, in dwellings, stores, and the like. Tests prove the shell panes to be much stronger than glass.

CAMEL'S-HAIR BELTING USED MANY YEARS

A new mill at Milton, N. H., is to be equipped throughout with camel's-hair belting because the shafting and machinery of the old mill, which was recently destroyed by fire, were run 24 hours daily for 10 years with such belting, and it was still in excellent condition when the mill burned. This type of belting is used to a considerable extent in tanneries and in mills where steam and acid fumes abound. It appears to be as impervious to moisture and acids as is a camel to the scorching rays of the sun on the great Sahara Desert.

Milton Leather Board Co.

SIXTEEN-INCH GUN BUILT FOR GERMAN NAVY

Although there seems to be no probability that any of the German ships now building will be equipped with 16-in. guns, it is stated that such a gun, firing a projectile weighing close to a ton, has been constructed and is undergoing tests. Such a gun would be several sizes larger than the most powerful type at present used in any navy. The latest of the German battleships to be launched is designed for nothing heavier than the standard 12-in. gun.

SCOTT EXPEDITION PROVED VALUE OF MOTOR SLEDGS

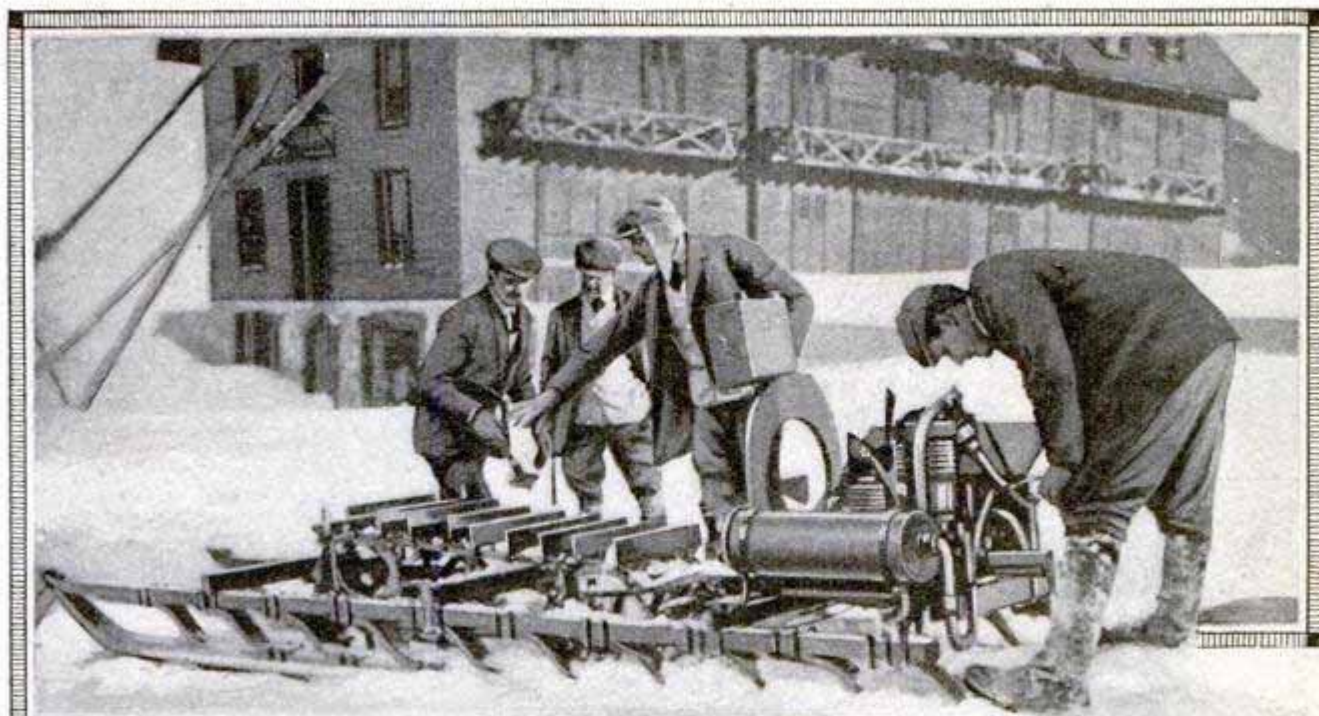

One of the Motor Sledges of the Scott Expedition, Photographed in the Antarctic

The value of motor sledges in arctic explorations was demonstrated by the success of Capt. Robert F. Scott's expedition to the South Pole, on which motor vehicles and Siberian ponies were depended upon for transportation

in addition to the customary dog trains. Captain Scott's diary, found with his body where he perished in a blizzard on March 29, 1912, on his way back from the Pole, which he had reached on January 18, refers in several places to the service rendered by the motor sledges. The motors found unexpected difficulty in traveling over sea ice that was partly covered with snow, but nearer the Pole, where the snow was thickly packed, succeeded in hauling trains of supplies and, according to Captain Scott, placed the possibilities of motor traction beyond question. The trail left by the motors was followed by the commander of the expedition to a point less than 10 deg. from the Pole, where the motors had to be abandoned because of the overheating of the air-cooled engines.



Captain Scott at His Winter Quarters



Photos by Paul Thompson
The "Terra Nova," Captain Scott's Combination Sail and Steamship, Caught in the Ice

NATURAL-GAS EXPLOSION WRECKS DWELLING

The destructive force of natural gas was demonstrated in the wrecking of a house in Cincinnati from a gas explosion in the cellar, following a small fire. The family escaped early, but when the firemen went to the cellar with their lanterns, a terrific explosion lifted the building from its foundation and blew out the sides and front. The



Natural-Gas Explosion Wrecked This Cincinnati House

upper story settled back on the foundation walls in a half-collapsed condition. Four firemen were buried in the ruins and were dug out unconscious.

—

CA barrel of oil started west from Chicago, February 12, in a race around the world to settle a \$1,000 wager that it would reach Cleveland, Ohio, by the last of May.

CREATION OF SUBSTANCES FROM ELECTRIC ENERGY

3438
That matter may be created out of energy is seriously admitted as a possibility in the light of recent discoveries and experiments by such eminent scientists as Sir William Ramsay and Prof. Norman Collie.

In investigating the contents of used X-ray bulbs, Sir William Ramsay recently found traces of helium, the existence of which could not be explained. Professor Collie independently came to the conclusion that if cathode rays are passed through pure hydrogen gas in a certain manner there is present in the hydrogen tube considerable quantities of neon, which is one of the rarer elements of the atmosphere, and by some change of conditions the element helium is substituted for neon.

"Inasmuch as there is certainly no helium or neon in the bulbs," says Sir William Ramsay in an interview in the London Daily Mail, "and as the possibility of their entrance from the outside air, which contains them, was excluded by carefully devised experiments, the only conclusion which can

be drawn is that these elements are the product of some action going on in the bulb; either the transmutation of the metal of the cathode, or of one of the numerous elements present in the glass, into neon and helium; or that hydrogen is thus converted into both of these gases; or that the electricity itself, in the form of electrons, gives rise to the birth of these elements. In short, either the

transmutation of one element into another, or the creation of an element from electricity. This points to a way for a change of one form of matter, supposed to be incapable of it, into another.

"The importance of the discovery is that we have deciphered another line in the book of nature and have opened the door to further discoveries. There may be commercial consequences; there probably will be. We are on the threshold of an entirely new departure in scientific investigation."

3500

PROJECTS MOTION PICTURES THAT DO NOT FLICKER

An improved type of moving-picture machine which projects perfectly colored pictures without even the faintest suggestion of the flicker which causes eye strain and consequent disorders of the nervous system, is so constructed that the film moves continuously without interruption, there being no stopping or jerking, and no dark periods between pictures.

The flicker is done away with by directing the light through the film against revolving mirrors, which rock up and down in such manner that a continuous picture, instead of a series of snapshots, is projected through the

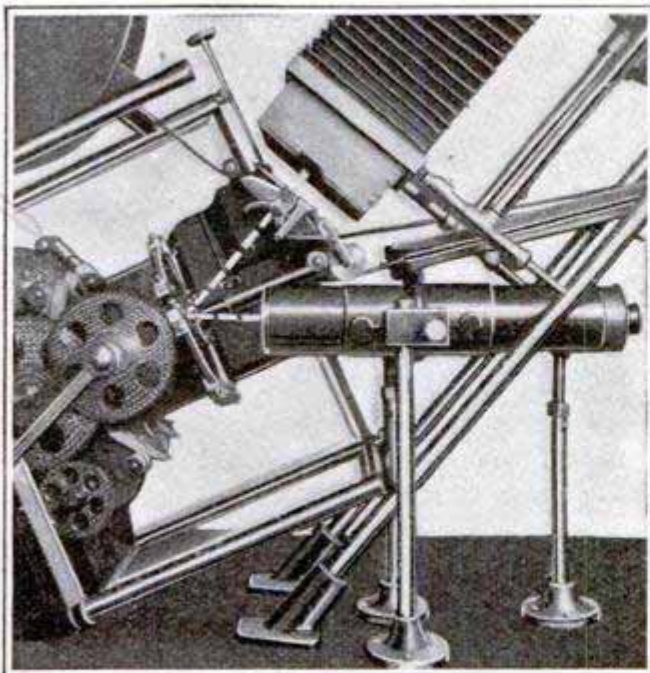

Motion-Picture Projector That Eliminates the "Flicker"

lens onto the screen. The construction of the machine is such that the arc light cannot set fire to the film when the latter is not in motion.

CONVENIENT ARRANGEMENT OF SCHOOL CLOAKROOM

An ingenious method of providing a place for school children to hang up

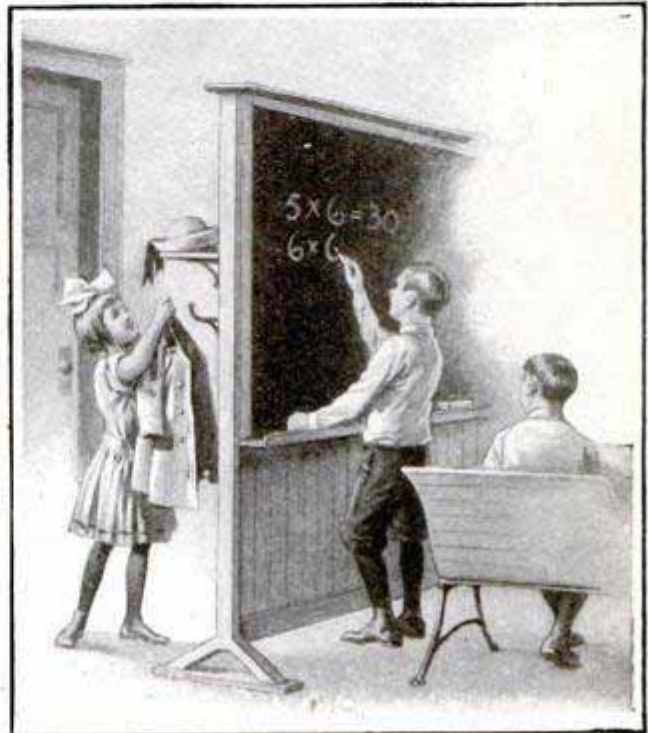

Partition Forms Cloakroom and Provides Blackboard Space

their hats and wraps out of sight of the pupils when in their seats, and at the same time always under the teacher's eye, so that petty thieving and other disorder in the cloakroom can be detected and checked, was originated in a school at Akron, Ohio, and has been adopted in schools elsewhere. The cloakroom is separated from the schoolroom proper by a partition 6 ft. high, set out a few feet from the blank wall of the room. The hooks for clothing are placed on the back of this partition, while on the other side is a blackboard visible from every part of the schoolroom. The partition extends from the back of the room only part of the way to the teacher's desk, so that the teacher, facing the pupils, can see what is going on in the cloakroom and the schoolroom at the same time.

ELECTRIC ICE FOUNTAIN ON CHICAGO BOULEVARD

At the north end of Grand Boulevard, Chicago, is a fountain which was

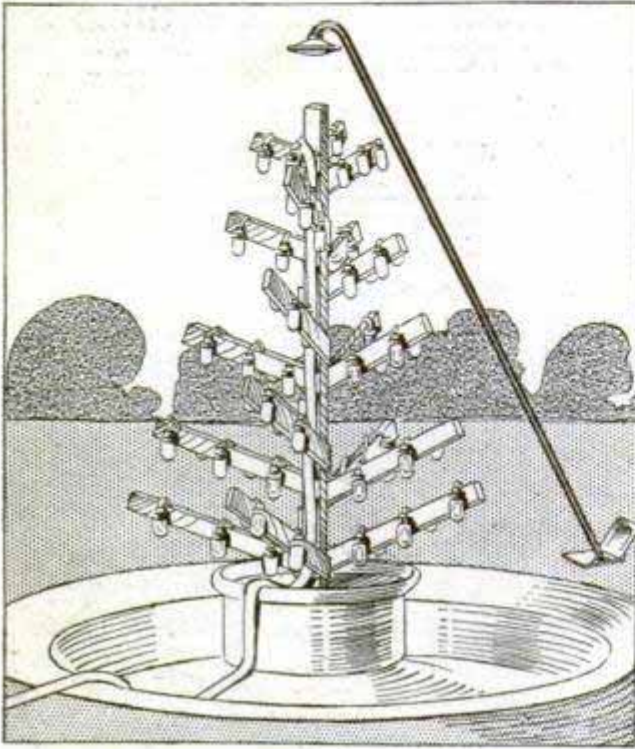

The Framework, Showing Method of Hanging the Lamps and Obtaining the Water

useless during the winter months until the South Park Commissioners decided to convert it into an "electric iceberg." The remarkable beauty of the result is shown on the opposite page. The method of its construction is so simple that it can be duplicated easily and inexpensively wherever the weather remains at the freezing point for any considerable time.

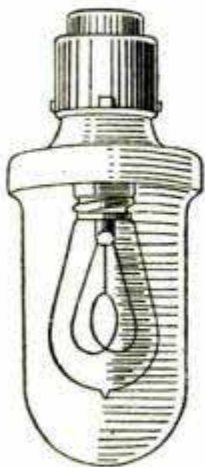

Globe-Encased Lamp

branch. The lamps were incased in "vapor-proof" protective globes, which

are also waterproof and not only protect the lamps, but prevent the heat from melting the ice which soon solidly surrounds them. The water was piped through an ordinary garden hose to a length of iron pipe, propped at an angle so as to reach 2 or 3 ft. above the top of the upright. This pipe was bent at the top to discharge downward, and provided with a head of the type used on sprinkling cans.

Only 30 electric lamps were strung on the framework of this fountain, and all where they would chiefly illuminate the southern side, which faces the boulevard. In zero weather the ice formed in sufficient proportions to incase the upright and projecting arms completely in less than a week. A fine spray of water was kept constantly flowing from the sprinkler nozzle as long as freezing weather lasted.

TRANSCONTINENTAL ROAD TO RUN BY ELECTRICITY

³⁴⁰⁹ The first important electrification of a steam railroad in America, with the exception of such local applications as the suburban trains out of New York and a few tunnel equipments, is to be undertaken at once by the Chicago, Milwaukee and Puget Sound Railroad, which is preparing to equip 450 miles of its transcontinental line for electric traction. Electric locomotives taking power from overhead wires will probably be used in the sections where the new power is to be adopted, in Montana and Idaho. The power is to be furnished by the Great Falls Power Company of Montana, which has obtained permission from the United States government to use some of the water now going to waste in the government reservations in that section. The annual coal bill of the railroad amounts to \$6,000,000, without counting the cost of transportation over its own lines. It is expected that the electrification will reduce this expense very materially.

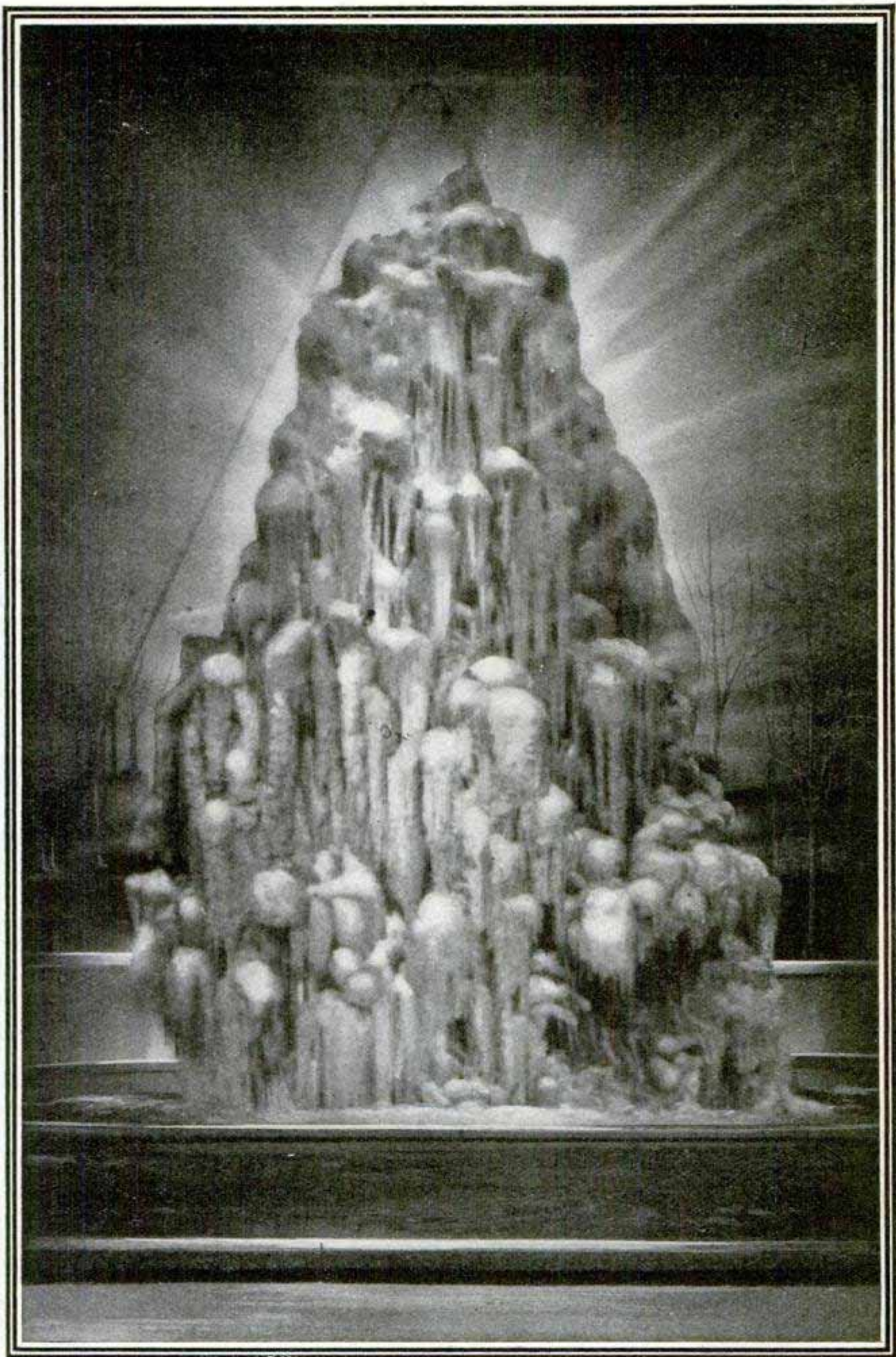

The Electric Iceberg; a Novel and Striking Winter Park Decoration

TALKS BY WIRELESS PHONE ACROSS MEDITERRANEAN

A wireless telephone system that is attracting much attention among European scientists is the invention of an

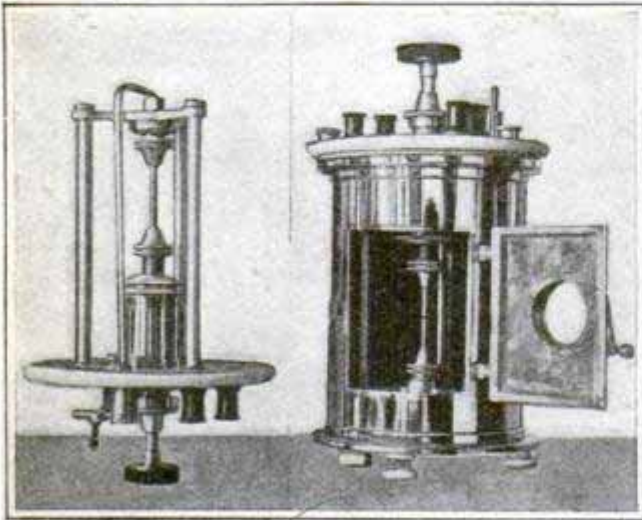

Wireless Telephone Invented by Italian Engineer

Italian engineer. Details of the mechanism have not been received in America, but it is said to operate sub-

stantially on the principle of the wireless telegraph, and it is claimed that conversation has been carried on by means of it between Rome, Italy, and Tripolis, Africa, a distance of about 650 miles across the Mediterranean.

BIG PRIZE FOR AUTOMATIC TRAIN-STOPPING DEVICE

A prize of \$10,000 has been offered for the invention of the best automatic device that will safely stop trains disregarding fixed signals. The reward will be paid by the New York, New Haven and Hartford Railroad on the order of the Interstate Commerce Commission, the Railroad Commissioners of Massachusetts and the Public Utilities Commissioners of Connecticut.

CA recently cast propeller, 18½ ft. in diameter and weighing 24,531 lb., is said to be the largest ever made in this country. It is four-bladed and made of manganese bronze.

made by Hyde Wadsworth & Co.

CANALS OF MARS INDICATE LIFE ON THE PLANET

3294 Investigations recently conducted upon an elaborate scale at the great observatory of Flagstaff, Ariz., prove to the satisfaction of many astronomers that the network of canals on the planet Mars is evidence of mighty efforts on the part of the Martians to preserve the fast-diminishing supply of water. The telescope has revealed that Mars is evidently a world of unusual beauty, but bearing signs of great age; a planet inhabited by intelligent beings, but a world which has reached the period when its seas have practically dried up. The heretofore startling claims of Prof. Percival Lowell, who was one of the first scientists to insist that Mars is the abode of a race of highly civilized people, are now being ably supported by Prof. James H. Worthington, another noted scientist, who says that there can no longer remain any doubt of the existence of canal builders on Mars.

The same authority also declares that the construction of these canals is made comparatively easy because the Martians have no mountains to contend with. In another section of his report on this interesting subject, Professor Worthington says: "Assuming that the Martian atmosphere exerts a pressure of 2½ in. of mercury upon the surface—and it can scarcely be greater than this—Lowell has shown that water would boil at a temperature of 111 deg. F. As the solar energy falling on Mars is certainly not less than that which heats the rocks of the Sahara to at least 130 deg. F., it is clear that evaporation is much more rapid there than here; and, consequently, water traveling in an open channel would evaporate long before it reached the tropics of the planet, a journey which we know occupies several weeks. It is, therefore, probable that the water is carried in something

Current Opinion

for steamship Chufearns owned by W.H. L...

akin to pipes, and this is rendered the more plausible by the fact that the water does not flow naturally but is driven, a conclusion to which the shape of the planet has led us." The professor further declares that, "on account of the weakness of gravity on Mars it is probable that, though water may be

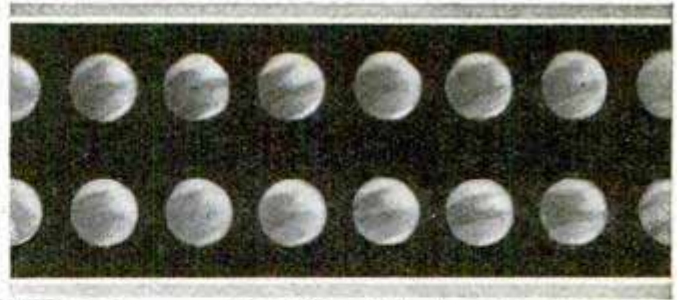

Exact Size of Photographs of Mars Taken through Telescope

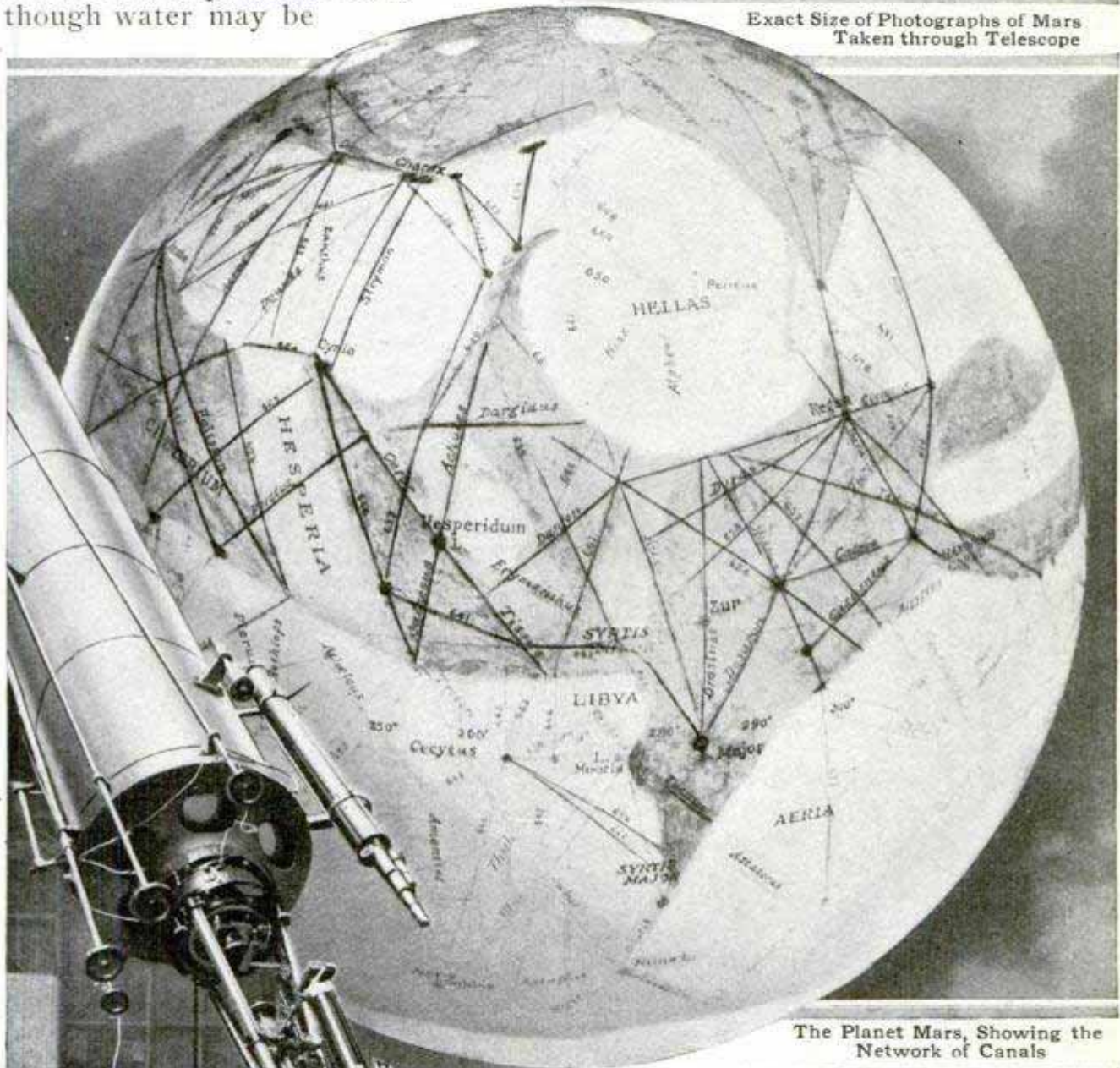

The Planet Mars, Showing the Network of Canals

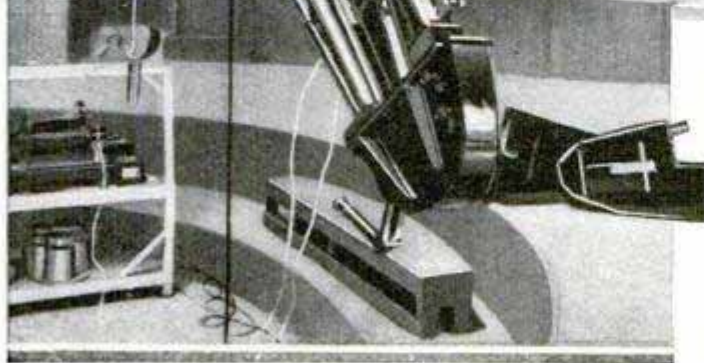

Photographic Telescope by Which Pictures of Mars were Made

scarce, yet the commoner parts of the earth's atmosphere may be present there. Among these gases are those which make life possible here, namely: water vapor, oxygen, nitrogen and carbon dioxide. It appears, therefore, that we are justified in concluding that the atmosphere of Mars may be like our own, though less dense, and that it is disappearing gradually."

Improved Tower 7 N. My. Co.
 309 Victoria av. Pueblo, Colo.
 POPULAR MECHANICS
 E. F. Gobatti, Treas.

A "TAPE-MEASURE" FIRE ESCAPE
 3340

When a spider wishes to drop from its web in a tree or other elevation it spins a thread to support its descent, and this, figuratively speaking, is just what the user of the "tape-measure" fire escape does in descending from a fire-swept building.

This remarkable fire escape consists of a narrow band of steel tightly rolled upon a spool contained in a casing. In using the device, the end of the tape is made fast at the point from which the escape is to be made, a leather belt, attached to the spool casing, is fastened around the waist, and the user drops to the ground, regulating the speed at which the tape unwinds by means of a clutch device.

The efficiency of the device was tested recently from the fourth floor of the firemen's drill tower in Los Angeles, the drop being 200 ft. A tape of sufficient length and width is being constructed for a demonstration from the tower of the 55-story Woolworth building in New York.

INVISIBLE AEROPLANE MAY BE DEVELOPED

3460 The United States War Department is experimenting with a transparent material for covering aeroplanes which is said to render the machine almost invisible in the air at a comparatively low altitude. The new substance, which has also been tested by Austrian army fliers, is in the form of a semi-liquid enamel, which dries into thin sheets that are almost colorless, flexible, and tough, and while resembling celluloid in appearance, is noninflammable. It is claimed that this substance is lighter and stronger than canvas. Besides aiding the airman to conceal his whereabouts, an advantage claimed for machines covered with this new material is that the occupant can see both surfaces of his planes, and keep an eye on every wire and bolt, and, in the case of monoplanes, that it is much easier for him to observe the land over which he is traveling.

Edmond F. Gobatti and Peter Vescovi }
 Los Angeles Calif }
 Inventors }



Escaping from a Building in the Same Way a Spider Drops by Its Thread

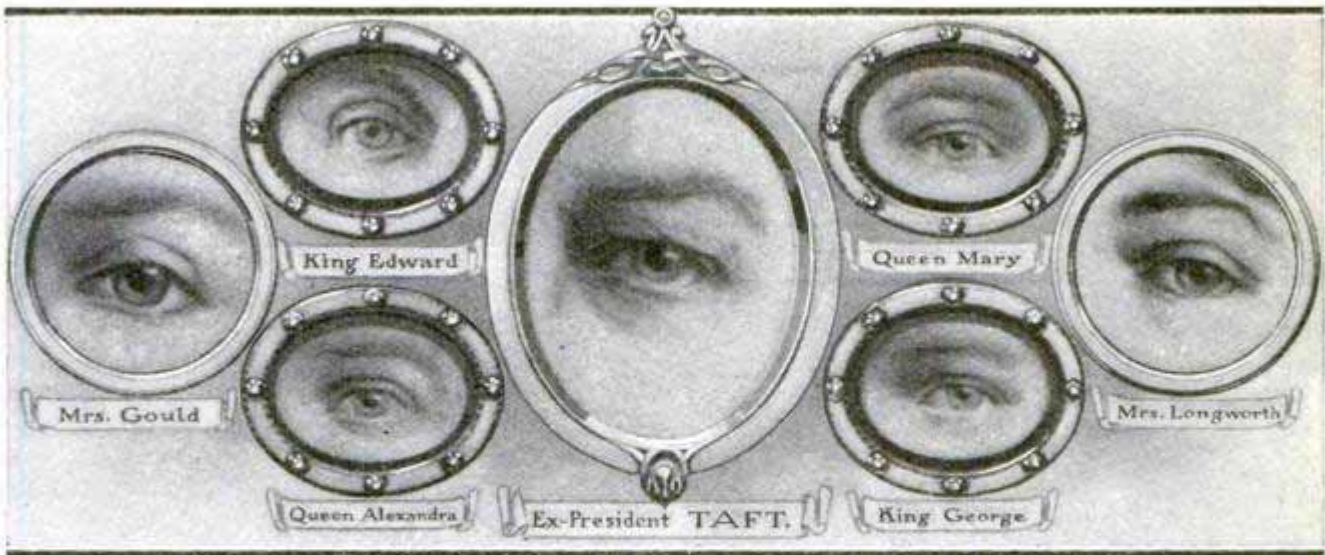

Portraits of the Eyes of Well-Known Persons Painted on Ivory by an English Artist

PORTRAITS OF THE HUMAN EYE REVEAL CHARACTER

Painting portraits of the human eye is an interesting revival of a very ancient custom by Mr. Alyn Williams, President of the British Royal Society of Miniature Painters. Mr. Williams recently visited America and painted from life pictures of the left eyes of ex-President Taft, Mrs. Alice Roosevelt Longworth, Mrs. George Gould, and other prominent Americans. Queen Mary of England had painted for her husband, King George, a set of sleeve links, on the four faces of which were painted the pictures of her own eye, that of the king, the eye of the late King Edward VII, and the eye of Queen Alexandra. These cuff links, like the other eye portraits referred to, are painted on ivory, and are

placed behind a crystal lens and mounted in gold and jewels. It is claimed by the artist that the human eye gives a complete character index of the individual and that a recognizable portrait can be made in this manner. The ancient Egyptians and some of the forgotten races of Southern Asia carried amulets bearing portraits of the human eye as a charm against evil, but it is not claimed that these modern miniatures have any such magic effect.

CABOOSE UP-ENDED WITHOUT BREAKING COUPLING

In an end-to-end collision between two freight trains in the yards of the Southern Pacific Railroad at Benson, Ariz., the caboose at the end of one train was up-ended in the manner shown without even breaking the coupling that connected it with the flat car to which it was attached. The flat car remained solidly on the track, due to its heavy load of cement pipe. The steel gondola of the other train shaved off the bottom of the caboose slick and clean.

A steel gasoline motorboat for pilot service at Port Said is being built in France. It will be 68 ft. 9 in. long and develop a speed of 13.8 miles.

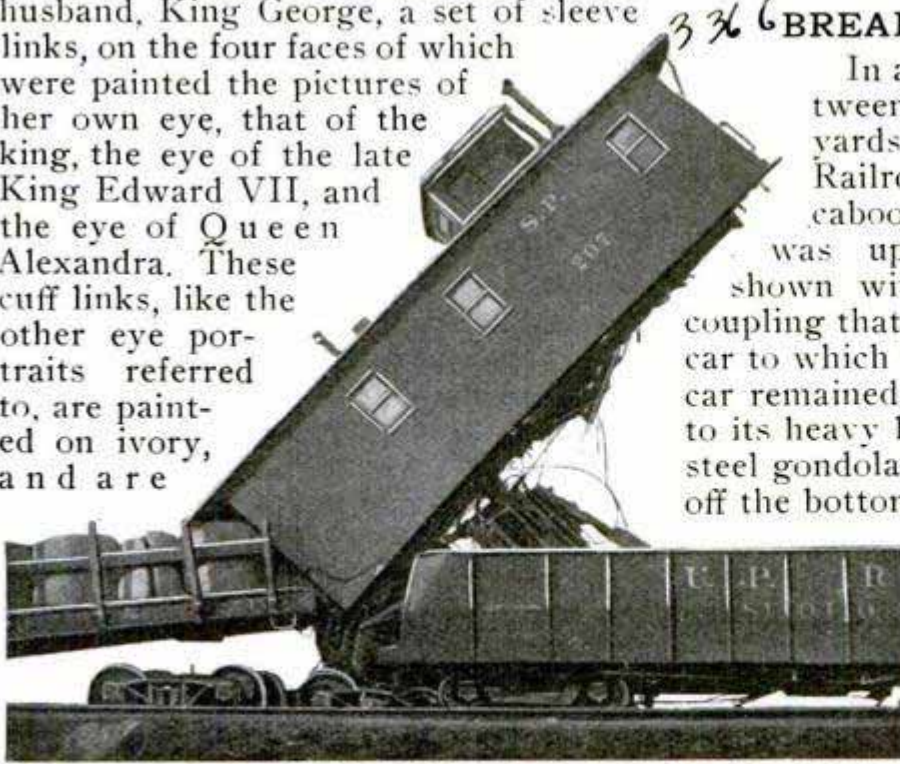

The Coupling Attaching This Caboose to the Flat Car was Not Even Broken

*Los Angeles
Calif*



Three Designs of Horsehair Hat Bands

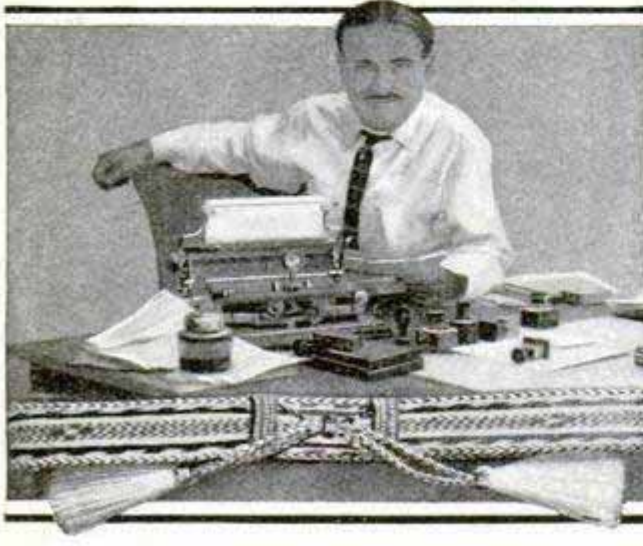

Weaving Hat Bands

Louis Eytinge, a Convict Who Made a "Business" of the Horsehair Weaving of Arizona's Prisoners

CONVICT ESTABLISHES CURIO TRADE

Before Louis V. Eytinge, now serving a life sentence in the Arizona state prison, entered that institution the prisoners, or at least the Mexicans, Indians and cowboys among them, sold to the visitors for a few cents the hat bands, watch fobs, and other trinkets, they wove out of horsehair. At present, through the business ability of Eytinge, who was struck by the commercial possibilities of this craft, a regular business has been organized which brings in an annual profit of \$5,000. Eytinge's share of the profits as business manager goes by his own wish to the State of Arizona, and he has in this manner repaid the costs of his trial and is now paying off the reward given by the state for his capture.

It became possible for Eytinge to put his ideas into practice when the prisoners were removed from Yuma to the modern prison at Florence and a humane prison administration was inaugurated under Governor Hunt. He first set about standardizing the output of the voluntary workers and then placed samples with wholesale dealers

in curios. A few orders followed and by degrees a substantial business was developed. There is nothing haphazard about the business methods employed. Even the stationery used by Eytinge shows attention to detail, and a postoffice box is given as the address, so that the casual correspondent will have no reason to suppose that he is dealing with a prison inmate.

LAUNCHES LIFEBOATS FROM EITHER SIDE OF SHIP

A method of launching lifeboats, by which all the boats can be lowered from either side of the vessel, has been put into operation on the Channel steamers plying between Flushing, Holland, and Folkestone, England. The boats, instead of hanging from davits, rest on supports which are provided with wheels that travel on rails laid athwartship. Thus, if the vessel is careening to either side, all of the boats can be quickly rolled to the low side and launched in the usual manner. Or, in case of a severe storm, all the passengers can be taken off on the lee side with less danger of the boats being smashed.

COMMENT AND REVIEW

THE singular fact," said President Woodrow Wilson in a recent speech, "is that nothing is done in this country today as it was done twenty years ago." He was referring especially to political activity, but his statement, broad as it is—for "nothing" is a big word—applies literally to every branch of business, industry, science and art. *Nothing* is done as it was done when men still young were boys. And even most of the commonplace things of every day, that we accept as matters of course because we have always seen them about us, are so new that people now living remember when they were not.

*Nothing is
Done as It
Used to Be*

Only two or three years ago Edward Entwistle died in Iowa, and he, as a boy of sixteen, had fired the boiler for Stephenson's "Rocket," the first successful steam locomotive—so new is the railroad. As a boy I talked with people who had seen Fulton's "Clermont," the first steam-propelled vessel. Not long ago I met Charles Haswell, who was the first chief engineer of the United States Navy, and he told me of the tremendous opposition of Navy officers to the introduction of steam power for ships of war.

Such everyday things as the bicycle, the telephone, the phonograph, the typewriter, motion pictures, aniline dyes, automobiles, electric lights, gas engines, aeroplanes, submarines, roller skates, fountain pens, alarm clocks, safety razors, steel ships, barbed-wire fences, traction engines, gang plows and modern machinery generally—all these and a list a hundred times as long have come into existence in the lifetime of men who are still young. Only the other day I dined with the man who built the first electric railroad, and he is several years under sixty. Not long ago the magazines were full of wonderful stories about the new way of putting up office buildings that was being attempted in Chicago—by building a steel frame and filling in the walls afterward. And not long before that, the invention that made the "skyscraper" possible was brought out—the hydraulic elevator.



POPULAR MECHANICS MAGAZINE is in itself an example of how new everything is. Thirty, or even twenty years ago it could not have existed, for into its production go a dozen inventions and materials that were unheard of when we who are still young were children. Wood-pulp paper, that makes the modern popular-priced magazine possible, is a very modern invention. So are the high-speed presses, that take the paper from the roll and print both sides at once from electrotypes plates, 96 pages at a time. So is the type-setting machine, that makes

*Magazine
Making Is
a New Art*

new type for every issue at half the cost of hand composition. So are many other machines that play important parts in the printing and binding and distributing of the magazine. But even if all these modern inventions had been available in the time of my grandfather, or yours, it still would have been impossible to produce Popular

Mechanics Magazine for the lack of three other elements that are the essential things that make the magazine of today what it is.

First among these is dry-plate photography. Every kind of photography is new enough, for that matter. The very first person whose portrait was ever painted by the sun's rays was still living a year or two ago. But down to about thirty years ago the taking of photographs involved a dark-room close at hand, quantities of chemicals, bulky apparatus for the preparation and development of the old-fashioned "wet plates," and such long exposures that only "posed" pictures could be made—the "snapshot" was unheard of. Even with these handicaps, a few courageous and enterprising men succeeded in making remarkable pictures, but these successful photographers were few and far between. Now the dry plate and the film negative have put photography at the command of everyone, while fast lenses and high-speed shutters make possible photographs of aircraft in flight, machinery operating at top speed, every moving object as it looks in motion—pictures full of life and action that tell at a glance more vividly than pages of description, more accurately than the best artists could draw them, what the new world-wonders look like, how they are made, what they can do.



I SOMETIMES think that the greatest educational force in the world today is the film camera. The picture speaks a universal language that tells more at a single glance than the swiftest stenographer could put on paper in hours. The "picture writing" of primitive tribes is the oldest known means of recording facts. It survives in the Chinese alphabet, every character in which represents a distinct idea, a conventionalized picture—the character meaning "danger," for example, representing a girl standing on the edge of a cliff. But while few

*The One
Universal
Language*

foreigners can master the intricate symbols of Chinese writing, any Chinaman intelligent enough to "press the button" can write with his camera a story that everyone in the world can read. And the untold millions of photographs, made literally from pole to pole, have done more, I believe, to educate the people of the present generation and broaden their mental horizons than any other one modern device. Few people can write a description of a ship, a machine, a natural phenomenon or a strange custom so graphically, completely and yet concisely that everyone who reads will see the thing described as the author saw it. Still fewer can draw a picture that will come anywhere near conveying a correct impression. But the hundreds of paid and volunteer correspondents of Popular Mechanics Magazine, in every part of the world, send us descriptions that need no translations, drawings that are as accurate as the processes of nature—news written with the camera in the only universal language.

The dry-plate photograph alone, however, even added to the mechanical devices for the production of magazines cheaply and in large quantities, would not have made the modern magazine possible. The photographs taken in the Civil War were practically

valueless to the periodicals of that day, because there was no way of reproducing them in print except by first redrawing them on wood and then cutting away the surplus wood and printing from the engraved block. First the artist lost some of the essentials of the picture, then the engraver hewed away part of the artist's work, as a rule, and the result was far from accuracy. The invention of process engraving eliminated the wood engraver and with him one source of inaccuracy. Then, about 25 years ago, came the half-tone process, that transfers the actual photograph to the printed page, with all its lights and shadows, details and outlines, tone gradations, distances and perspectives reproduced as the camera caught them.



BUT—this is the point I have been aiming at all along—all of these wonderful inventions could never have made a magazine like this possible if it were not literally and exactly true, as

*This
Wonderful
New Age
We are
Living In*

President Wilson put it, that "nothing is done today as it was done twenty years ago." *That* is the essential fact—that this age we are living in today is a *new* age, an age in which everybody, all over the world, is doing new things, interesting, important, wonderful. New devices, new methods, new machines to make new products, new proofs of the power of the

human mind to conceive and the human hand to construct instruments with which to conquer the forces of nature and bring them to the service of humanity—these are the characteristics of the age we live in. Never have the creative forces of mankind moved so fast as in the lifetime of us who are now on earth. Never before have there been so many people in the world eager to know what the world is doing, and how it is doing it.

When I was a very little boy a dear old aunt told me how, in her childhood, she walked three miles through the woods to a neighbor's to bring home fire in an iron kettle, because their own fire had gone out and the tinder was wet. Puzzled, I asked:

"Why, didn't you have any matches?"

"Nobody had any matches then," she replied. "Matches hadn't been invented."

It was a real shock to me. So far as I knew, matches had always existed. I could not conceive of a universe without matches, any more than the youngster of today can imagine a world without telephones, electric lights or automobiles. Youth seldom realizes that the commonplaces of today were the wonders of yesterday.

Think of that, you young people of sixteen or sixty, the next time you ride in an electric car, send a wireless to a friend at sea or take the elevator in a modern office building. Once you realize how truly wonderful are the everyday things you pass without a glance, you will find new vistas opening all around you—vistas down which you will gain new perceptions of the destiny of mankind, new inspiration to great thoughts, and a new conception of this big world of ours.

FRANK PARKER STOCKBRIDGE



Back of the New U. S. Paper Money, Which will be Smaller Than Present Currency

3369-03

CAPTAIN AMUNDSEN'S CHICAGO MEDAL

The Chicago Geographic Society recently presented Roald Amundsen, who was first to reach the South Pole, with a gold medal, the obverse side of which shows the emblematic figure of Chicago, with the skyline of the city in the background. The reverse side of the



Obverse and Reverse Sides of Medal Presented to Amundsen by Chicago Geographic Society

medal has the seal of the society in the center, with laurel and oak on one side and corn and wheat on the other.

3450

NEW MONEY TO BE SMALLER AND SIMPLE IN DESIGN

The new paper money to be issued by the U. S. Treasury will be 6 in. long and $2\frac{1}{2}$ in. wide, instead of 7 in. by 3 in. as at present. On the backs there

will not be a sign of a dollar mark or any figure of value, and no lettering except the "U. S. A." under the central figure. There is no background, and in the expanse of clear white paper the new money will display, it will resemble the paper money of European nations.

The pictures on the new money represent America enthroned between Peace and Prosperity, with Labor bringing his products to Prosperity and Peace dispatching Commerce to distribute America's commodities to the world. These figures were drawn from life by the artist, Kenyon Cox, a professional model serving for America and the artist's fifteen-year-old son for Commerce.

The same design is to be used for the backs of all denominations. For the face of the new money, only the one-dollar denomination has as yet been accepted. It will bear the portrait of George Washington in a medallion in the center and no other engraving except a simple scroll-work border and the value in each corner. Portraits of other presidents will be used on the other notes. Treasury officials expect that practically all the notes now in circulation will be replaced by the new ones within two years.

☞Forty-two per cent of the population of America lives in cities.

**NATURAL GAS PROVIDING
AUTOMOBILE FUEL**

550
Natural gas as an automobile fuel is being experimented with in West Virginia, where the largest gas wells in America are located. The gas is compressed in seamless tanks, holding from 300 to 2,000 cu. ft. at a cost to the user of about 13 cents per 1,000 cu. ft. A well-known car using natural gas, on the Indianapolis speedway, made a mileage of 100 on 25 cents worth of fuel. The same car consumed 30 cents worth of gasoline in running 20 miles on the same track. A one-ton truck was driven 75 miles on the contents of two 300-ft. tanks without exhausting them. A comparison recently made by one of the largest automobile manufacturers between gasoline at 13 1/2 cents a gallon and natural gas at 30 cents per 1,000 cu. ft., which were tested in the same 40 hp., four-cylinder motor, showed a cost of 20 1/4 cents an hour on gasoline and 3.6 cents on natural gas.

Natural gas is produced in 23 states, all the way from the Atlantic to the Pacific and from Mexico to Canada, and the compressed gas can easily be shipped in cylinders at a low cost. For three or four years natural-gas producers have been obtaining an excellent quality of gasoline from the natural gas itself and this fluid is now being marketed by producers in West Virginia, Ohio, Pennsylvania, Oklahoma, California, Colorado, Illinois, and New York. The method followed in the eastern gas fields generally is that of condensing the gas at a pressure of from 100 to 300 lb. to the square inch, which extracts the gasoline, and the gas is then led into pipes and used for heating and lighting purposes almost as readily as in its original state.

From 2 3/4 to 3 1/2 gal. of gasoline can be obtained from 1,000 cu. ft. of natural gas by this process.

A process recently adopted in California produces gasoline from natural gas by refrigeration. A chilling plant

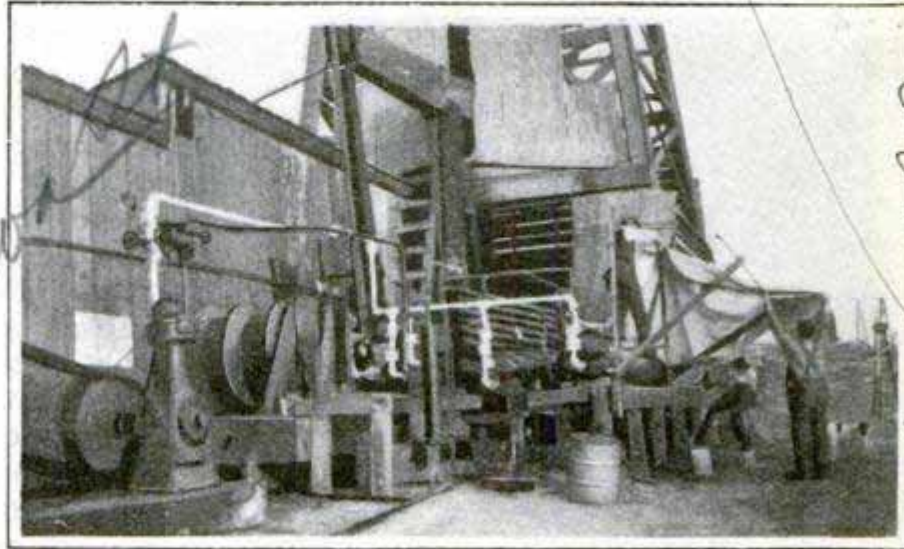

A California Plant for Making Gasoline from Natural Gas

similar to that used in making ice subjects the gas to intense cold as it passes through a series of containers. By the successive lowering of the temperature rhigolene and other of the more valuable petroleum products are also given off as by-products, the rhigolene, which is extremely volatile, being utilized to obtain still lower temperatures.

3455-03

QUARTZ-CRYSTAL SPHERES

The quartz-crystal sphere recently given to the American Museum by J. Pierpont Morgan is said to be the finest specimen in America. It is a little more than 4 in. in diameter, of perfect proportions, and "water pure." The largest known crystal sphere, which measures 7 in. in diameter, is in the Green Vault in Dresden.

The crystal ball, which is an enviable feature in all beautiful mineral collections, is of great value when the size is large, as there is a rarity of quartz masses of desirable quality for their creation. The grinding of a mass of quartz into a ball by hand, as formerly done in the Orient, consumed much time, but skill, patience and hereditary

Dr. W. C. Cutler, Cal.

pride made up for any lack of labor-saving tools. The mass of quartz, at first rudely rounded into globular



Photo by American Museum, New York
Beautiful Crystal Sphere Presented to the American
Museum of Natural History by J. Pierpont Morgan

form by chipping with small steel hammers, was rounded down to an even surface with powdered garnet or emery, held in cylindrical iron troughs. The final polish, transforming the dull surface into a lustrous mirror, is imparted by rubbing with bamboo, and with the hand dipped in rouge. When finished, the ball was usually mounted upon bronze waves, which bore it like a congealed drop of the water's spray. Modern mechanical devices have now shortened the laborious process of the Eastern workmen, and pieces of quartz are placed in semicircular grooves in huge grindstones, where they are held until the contour coincides with the rounded sides of the revolving mold.

Crystal gazing, as a supposed means of foretelling the future, has a very ancient history. It was widespread in the Orient, and the Assyrians, Hebrews, Greeks and Romans practiced it.

☞ Seventy lives are lost annually through forest fires, according to the U. S. Forest Service.

LANGLEY MEDALS AWARDED TO CURTISS AND EIFFEL

The regents of the Smithsonian Institution at Washington recently awarded the Langley Memorial Medals for especially meritorious investigations in connection with the science of aerodromics, or flight with wings, and its application to aviation, to Gustave Eiffel, the French engineer who built the great tower in Paris that bears his name, and Glenn H. Curtiss, the American inventor and aeroplane manufacturer. This is the first award of the medals since 1908. Mr. Curtiss was chosen because of his development of the hydro-aeroplane and M. Eiffel for important laboratory researches in air resistance which he recently conducted. The medals will be presented at Washington, D. C., on May 6, 1913, the seventeenth anniversary of the first successful flight of a heavier-than-air machine, the invention of the late Prof. S. P. Langley, Secretary of the Smithsonian Institution.

PUTTING THE AEROPLANE TO COMMERCIAL USE

An effort to establish the practical value of the aeroplane as a commercial vehicle is being undertaken in England. Many airmen have carried small packages of merchandise from one city to another, but in most cases the transportation has been merely for some special advertising purpose and the trips have seldom been repeated. A tobacco company of Newcastle, however, has arranged with a local airman to make regular deliveries of tobacco and cigars to several towns in Northumberland and Durham. The airman uses a machine with a 60-hp. engine and has contracted to carry any amount of goods up to 200 lb. weight on his trips. The first delivery was made on February 10, 1913, and the plan was to have regular deliveries by aeroplane every other day. The particular firm making this contract suffered a great deal of inconvenience and delay in its deliveries during the recent railroad strike.

The Shipping World

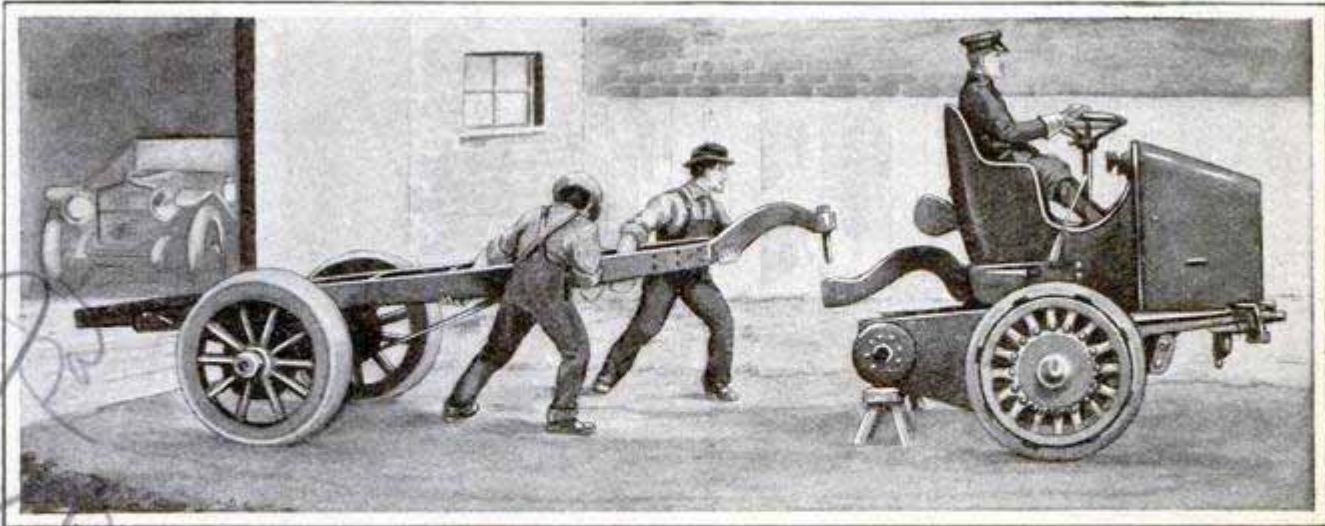

Connecting Up the Tractor Automobile with Its Trailer Section

FRONT-DRIVE MOTOR TRUCK OF UNIQUE DESIGN

A front-drive gasoline motor truck, the whole front portion of which, including the complete power plant, the driver's seat, etc., turns in steering, the rear portion being practically a trailer, has made its appearance on the automobile market. If desired, only the front portion of the motor truck need be purchased, along with a few feet of the forward end of the frame, so arranged that it can be attached to any kind of a vehicle after the front wheels of the same have been removed. This feature is particularly interesting in connection with converting horse-drawn fire apparatus into motor driven.

THE BARREL CONSUMPTION OF AMERICA

More than 150,000,000 barrels, kegs and circular packages are turned out by the cooperage industry of the United States each year, the heaviest consumer being the cement industry, with the flour business ranking next, closely followed by sugar. The barrel demand for molasses, oil, lard and pork is also enormous.

A permanent building, 80 ft. long, 45 ft. wide and 18 ft. high, with concrete walls only 2 in. thick, is being constructed in England and will be used for moving-picture shows.

LIGHTHOUSE KEEPERS GET NEWS BY PHONE

During recent storms along the English and French coasts the keepers of the lighthouse on the Needles, which is the name given a cluster of chalk-rock islands in the English Channel off the west shore of the Isle of Wight, were shut off from land for several days. The telephone, however, was in good working condition and the newspapers were read to them every day.

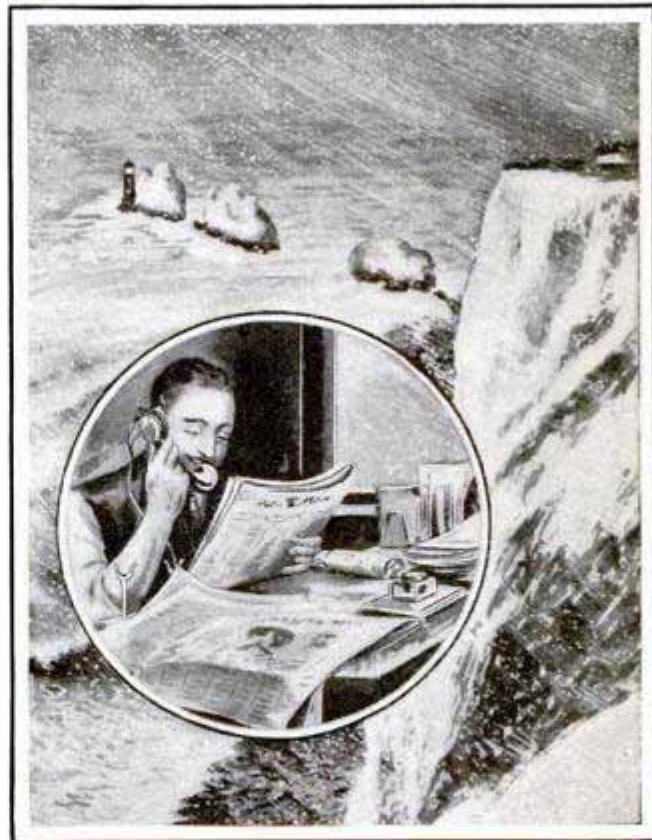

The Lighthouse Keepers on the Needles had Newspapers Read to Them over Telephone During Long Storm

SEAL CATCHING ON THE NEWFOUNDLAND ICE FLOES

By M. F. POWER

WHEN Peary picked Capt. Bob Bartlett and a crew of Newfoundlanders to man the good ship "Roosevelt" on the dash to the North Pole, he came to the right place to find men accustomed to fighting fierce battles with the icy seas. The fisherman of Newfoundland is a hardy composition. A traditional descendant of the bold English, Scotch, and Irish "deep-sea men" of Queen Elizabeth's day, he has lost none of the characteristics of those intrepid sailors who laid the foundations of Britain's colonial empire. To us of Newfoundland the call of the North has no unpleasant sound, and when the arctic floes sweep down the coast our fishermen are glad. For on those floes sport myriad seals, whose fat and fur are the source of great colonial prosperity.

The seal fishery begins about March 12. More than twenty ships, powerfully constructed and specially modeled to pierce the ice pack, now engage in the industry. In the olden times sailing ships were employed, and their traditions are still preserved in the ballads and folklore of the islanders. Many a tale, laudatory of the ancient vikings, is told for the emulation of the modern sealer. The old seal killers were a brave race, who overcame in an almost miraculous manner the difficulties of rafting ice, and returned majestically with bumper cargoes to receive the acclamation of their friends in their sea-girt villages. No returning Roman conqueror ever obtained the ovation of triumph with more enthusiasm than did the old-time colonial captain who came back from the gory icefield laden with the pelts of the seal.

Nowadays this fishery has lost much of its poetry, as modern equipment eliminates many of the sources of former dangers. Nevertheless there are occasions when the present-day sealers confront romantic situations and fascinatingly thrilling experiences.

Disasters causing loss of life have



Discharging the Cargo of Seals and Skins at the Home Pier



Peeling the Fat from a "Harp" Seal Pelt



Seal Fishermen Leaving the Ship to Seek Their Unresisting Prey



Killing the "Harp" Seals on the Ice Floes

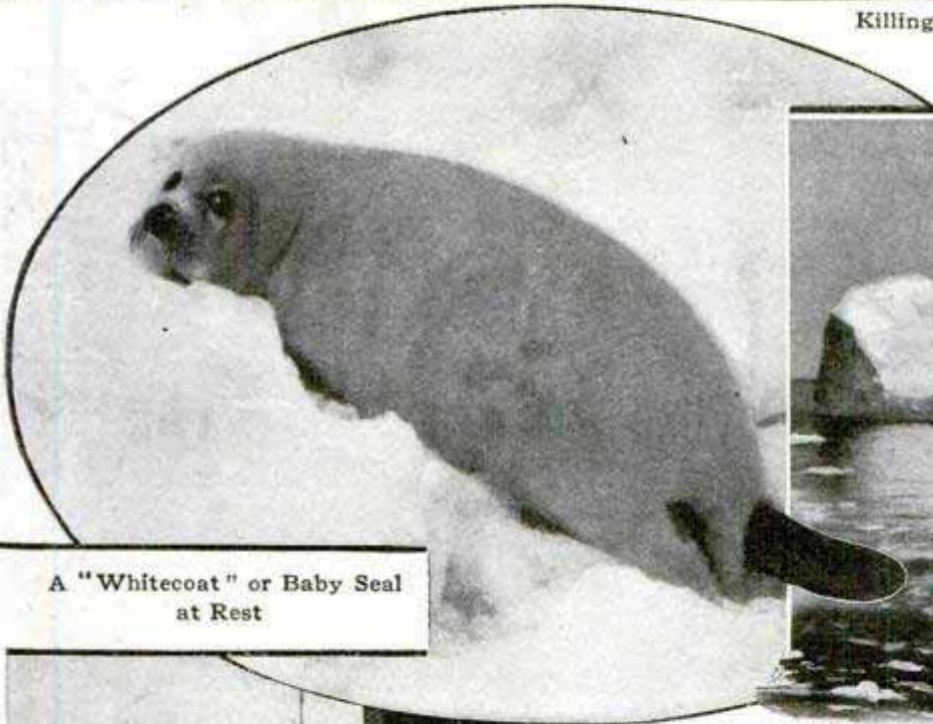

A "Whitecoat" or Baby Seal
at Rest



The Peril of the Berg
is Always Present



A Newfoundland Steam Sealer in the Ice

not been rare. One of the worst chronicled is the "Greenland" disaster. The "Greenland" had sent her men some distance from her on a fine morning. Toward evening a sudden snowstorm arose and the sealers in vain sought their ship. During the awful night that followed many perished from exposure. The bodies were recovered and brought to St. Johns.

Each sealing steamer carries a crew of two or three hundred men, according to her tonnage. The voyage lasts about a month for the successful ships and a couple of weeks longer for those which, having missed the main body of seals at the outset, must scour the ocean after the ice has broken up. When the ships reach the whelping ice, as the field is called where the young seals are born and grow, they often wait a few days before slaughtering in order to get the pelts well matured. It is simply marvelous to watch the rapidity of their growth. Within a few days the baby seal, called the "whitecoat," a few pounds in weight, develops into the prime young "harp," whose average weight is about 45 pounds.

Into the great patch of the young harp seal the captain sends his crew. Divided into watches, they take orders from the master watch. The seals are

slaughtered with ease by a well-directed stroke of a staff and then collected on the larger ice pans to facilitate the loading on board. When the ship has her load panned the whole crew is called to the loading; then her prow is homeward set and she enters port with all flags flying. There is great rivalry among the men to be the first ship in, and on the land there is always great excitement when the first ship is signaled.

After the landing of the seals they are skinned and the fat is rendered into oil. The skins are mostly tanned in England, while the oil finds a ready market for lubricating purposes on both continents. The seal fishery is, after the cod fishery, the most valuable asset of our commerce and has been for many years a source of vast wealth to Newfoundland. Many think that the advent of the modern ice-crushing steamer with immense carrying capacity, will shortly cause an extinction of the seal.

Trained under such trying conditions the Newfoundland fisherman develops a constitution of iron. He cheerfully suffers hardships, and with bravery amounting to the reckless faces light-heartedly the colossal dangers of the storm and ice-bound seas.

PISTOL WITH LAMP FOR LIGHTING TARGET

The pistol here shown has a small electric lamp fastened lengthwise under the barrel and controlled by the trigger.

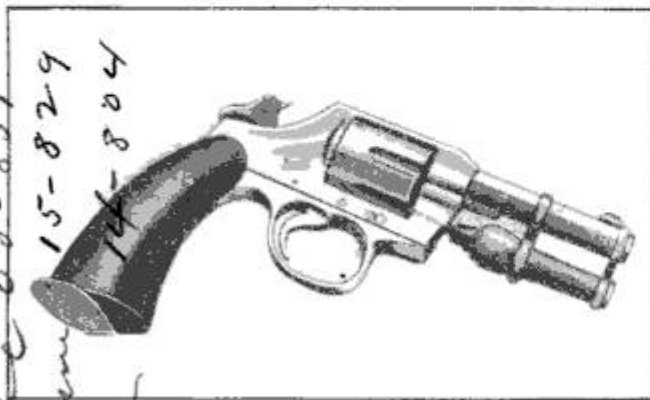

This Pistol Illuminates Its Target

The battery is contained within the handle of the weapon and the bullet strikes inside the circle of light cast by the lamp, thus making this type of fire-arm an especially desirable one to have around when burglars are in the house.

Although great quantities of crude rubber are now required in this country, due to the automobile, the amount imported last year, valued at \$100,000,000, was no greater in value than two classes of imported luxuries combined. The importation of diamonds and other precious stones for the year is valued at between \$40,000,000 and \$50,000,000, while that of laces and embroideries reached about the same figure.

Andria Aubler. Warla

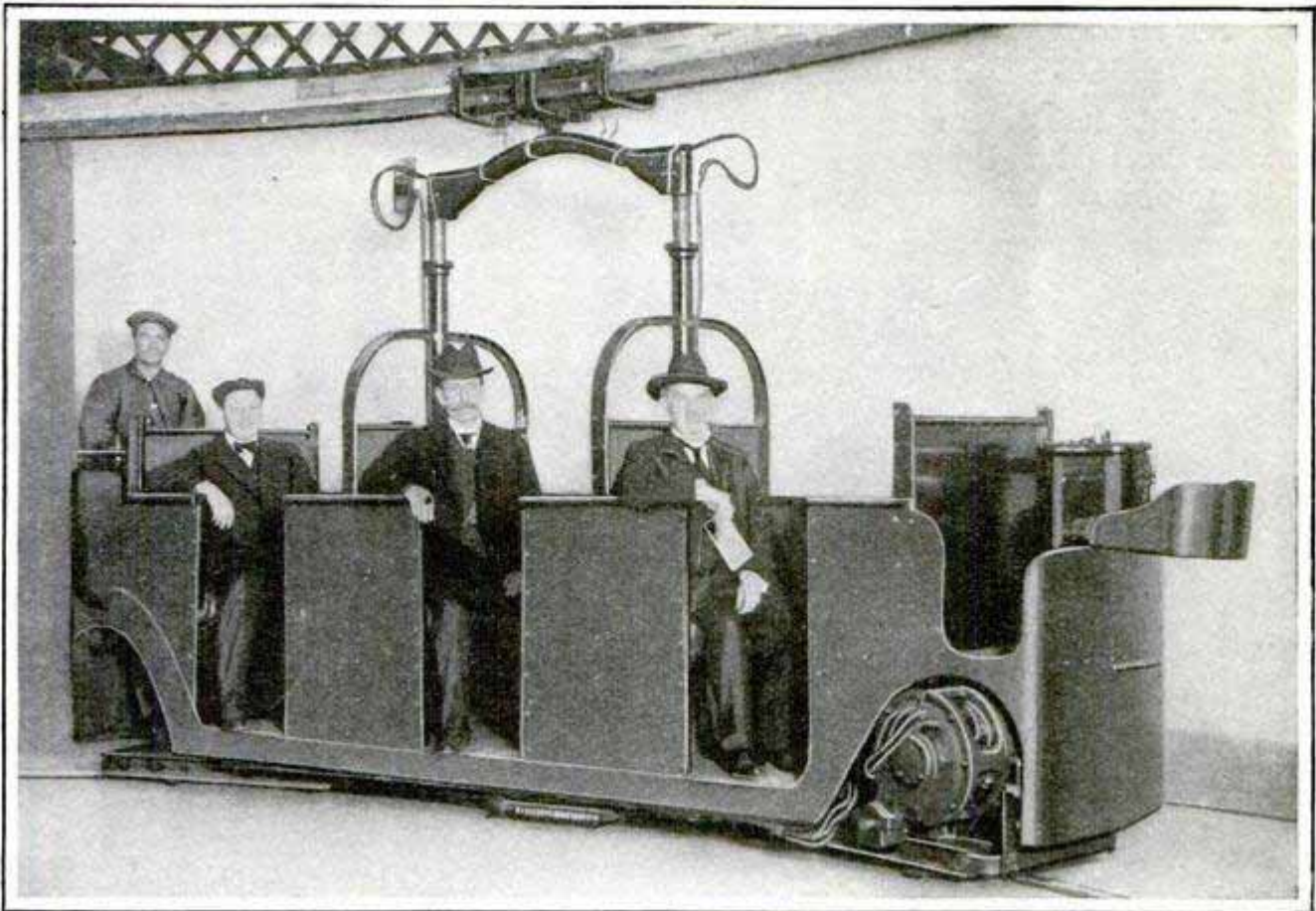

Photo by Harris & Ewing
 Senators Williams of Mississippi and Swanson of Virginia Enjoying Their First Ride on the Monorail

THE SENATORS' MONORAIL IN OPERATION

The little monorail system in the subway connecting the Capitol at Washington with the building in which the Senators have their private offices is now in operation. The underground passage, which is shaped like an elongated "S," is 750 ft. in length. Until the installation of the electric monorail system the journey through the subway was made by automobile. The little car, which runs on a single rail and is kept upright by an overhead rail, seats 12 persons.

PRISONER DEVISES STOLEN AUTOMOBILE ALARM

An alarm which sounds when a person attempting to steal an automobile tries to start the engine was devised recently by an automobile mechanic serving a term in the Denver jail. The device emits sirenlike calls for help the moment the thieving "joy-rider" attempts to crank the car. The inventor

believes the racket will fill the thief with terror, as well as attract attention. The owner of the car sets the alarm in operative position when he leaves the car.

AN UNUSUALLY SMALL ELECTRIC HEATER

An exceptionally small electric heater of the type that illuminates as well as heats is shown in the accompanying illustration. Although weighing less than half a pound, it is not a toy, but a practical heater for bathrooms, small bedrooms, and for the cold corners of a large room. It is claimed to operate at a cost of but one cent an hour.

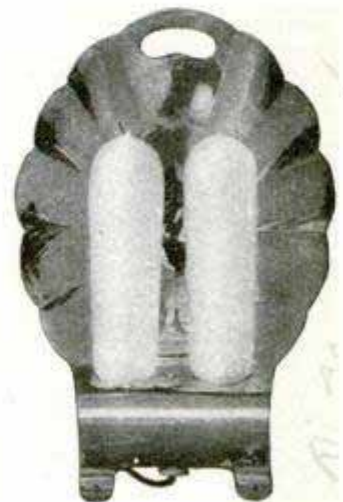

Handwritten note: ...

Handwritten notes: ...
 ...
 ...
 ...

ADJUSTABLE-LENGTH JACOB'S LADDER

A Jacob's ladder that is easily adjustable as to length, the lower part folding up, has been constructed espe-

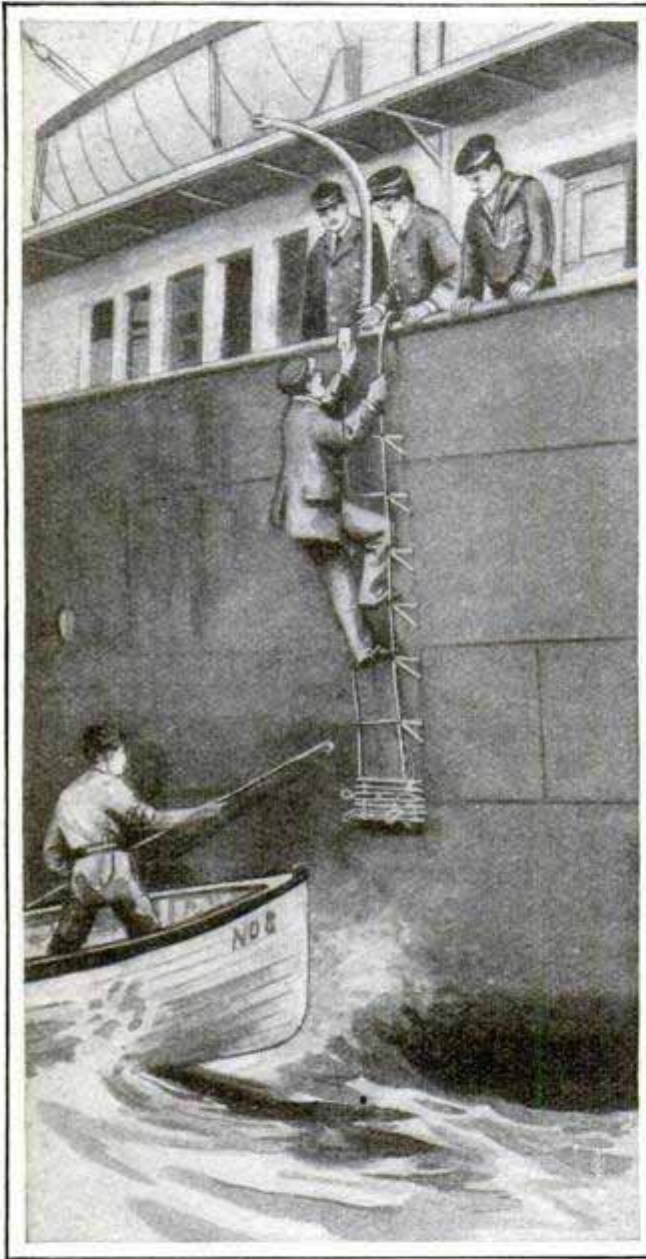

Jacob's Ladder That can be Used for Outside Access from Boiler Room to Deck

cially for Great Lakes shipping. It can be used, for instance, as an outside means of access from the engine-room port to the deck. The steps of this ladder are made of aluminum, and the hooks are bronze.

CA gigantic scheme for utilizing the water power of Finland to supply electrical energy to St. Petersburg and its environs has been undertaken by the principal bankers of Russia.

A PRESSURE SYSTEM OF FILTRATION

27 A new type of sewage-disposal plant, especially designed for glue factories, slaughter houses, tanneries, and the like, is provided with pressure filters. The sewage is pumped from a basin through these filters until the solid matter accumulates to a considerable thickness on top of the filter beds. Then the water is drawn back into the supply basin and compressed air is introduced to force out the remaining water and dry out the solid matter, which, thereupon, becomes a flexible cake on top of the filter bed. This cake is then rolled up and removed to a press to have any remaining moisture squeezed out. It may then be ground up and sold for fertilizer, chicken or hog feed, according to its composition.

PRISONS THAT ARE MODEL STRUCTURES

1160 The new federal prison at Leavenworth, Kan., in which are housed prisoners of the United States, is a massive structure of steel and masonry containing 1,200 cells, each of which will hold two prisoners. The building of this great prison was begun 15 years ago and cost the government \$4,000,000. More than 6,000,000 brick and several hundred tons of steel were used, and the masonry for the entire structure was made within the walls by the prisoners. Physical punishment is not administered in this prison, the corrective measures being limited to the wearing of certain uniforms and confinement in isolation cells where the inmates are given rock to be broken.

The proposed new \$3,500,000 penitentiary at Joliet, Ill., will be located on the west bank of the Des Plaines River about one mile from the site of the present institution. Eight circular cell houses with glass roofs, instead of the regular "inside cell" type, are to be constructed in addition to the other necessary buildings. These houses will be 120 ft. in diameter with four tiers of 60 cells, thus providing room for 240

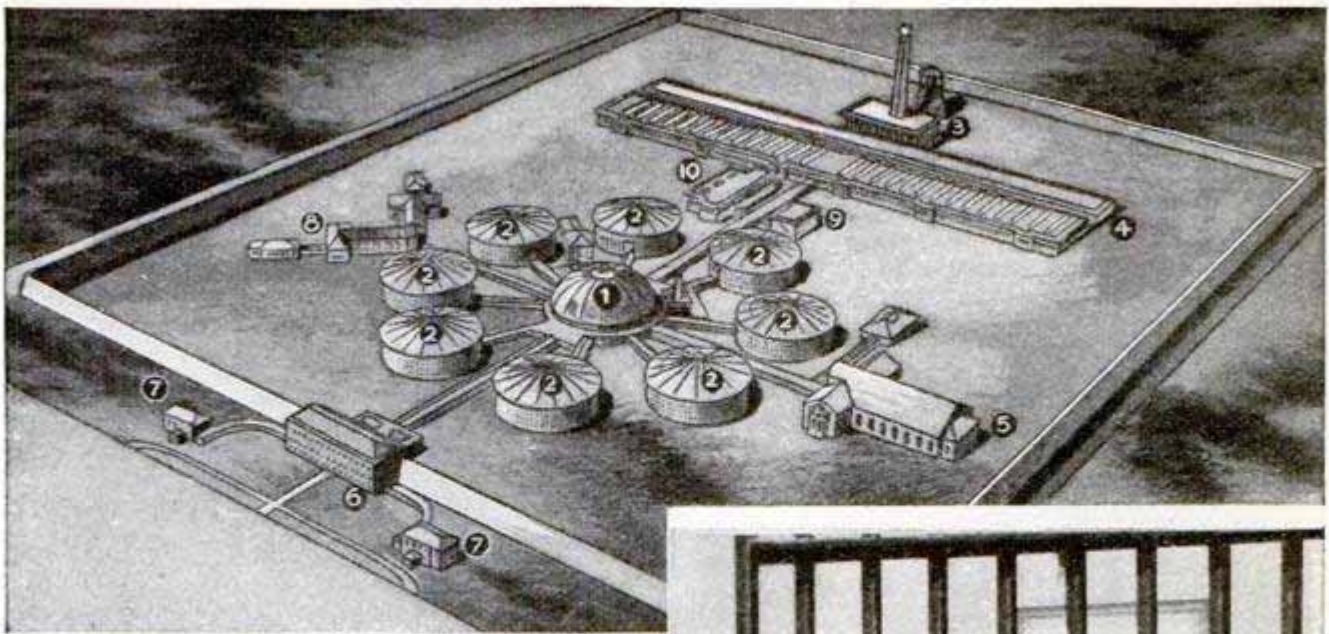

Plan of New State Penitentiary at Joliet, Ill. The Circular Cell Houses Mark a Distinct Departure from Present Methods of Prison Construction: 1—Dining Room; 2—Cell Houses; 3—Power House; 4—Shops; 5—Chapel; 6—Administration Building; 7—Wardens' Houses; 8—Hospital; 9—School; 10—Bath House

prisoners in each house, or a total capacity for about 2,000 inmates. Each cell house will be built around a conning tower so that a full view of the cells can be had from a central point, and all of the houses will be grouped around a large dining hall which will be located in the center of the 60 acres selected for the penitentiary proper. It is proposed to use prison labor only in building the new prison, which will probably be completed by 1915.



Prisoners are Given Rock to Break, as Punishment, in the New Federal Prison at Leavenworth

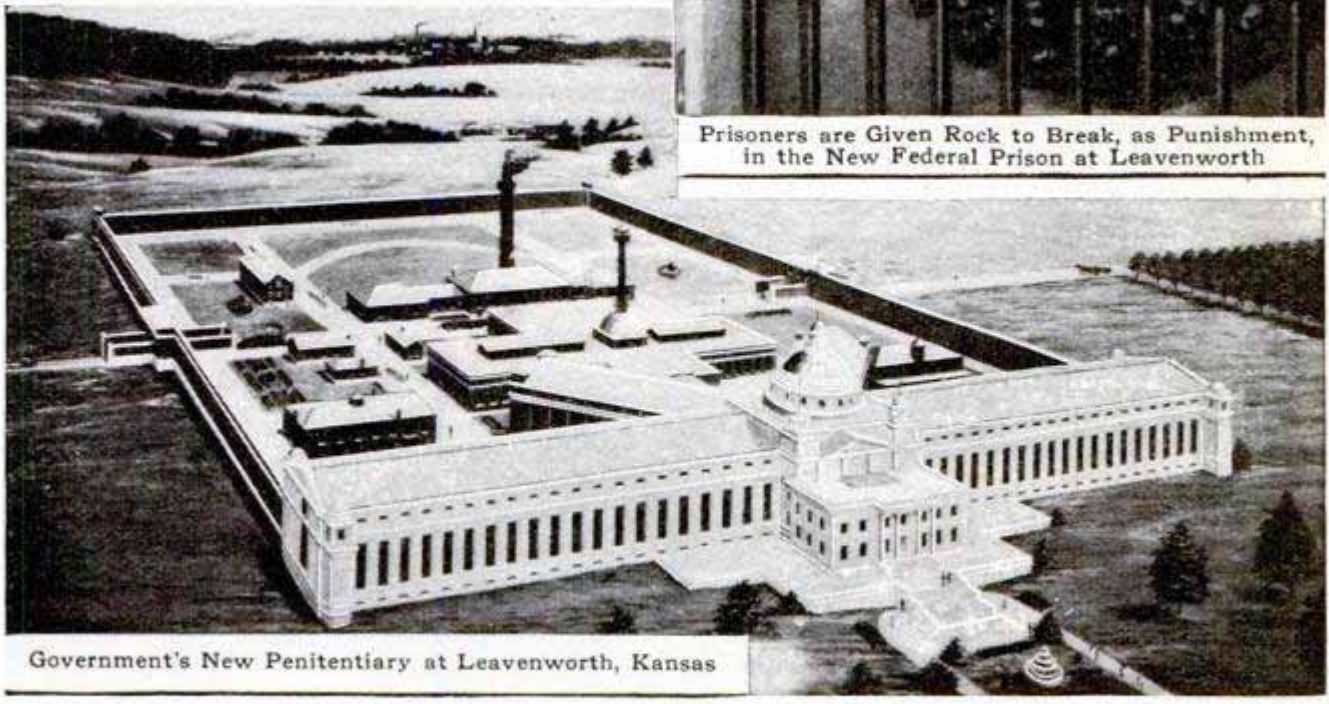

Government's New Penitentiary at Leavenworth, Kansas

A FIREPLACE OPEN ON ALL FOUR SIDES

On top of the rise overlooking the ocean and San Pedro, Cal., is a unique bungalow having a fireplace that is

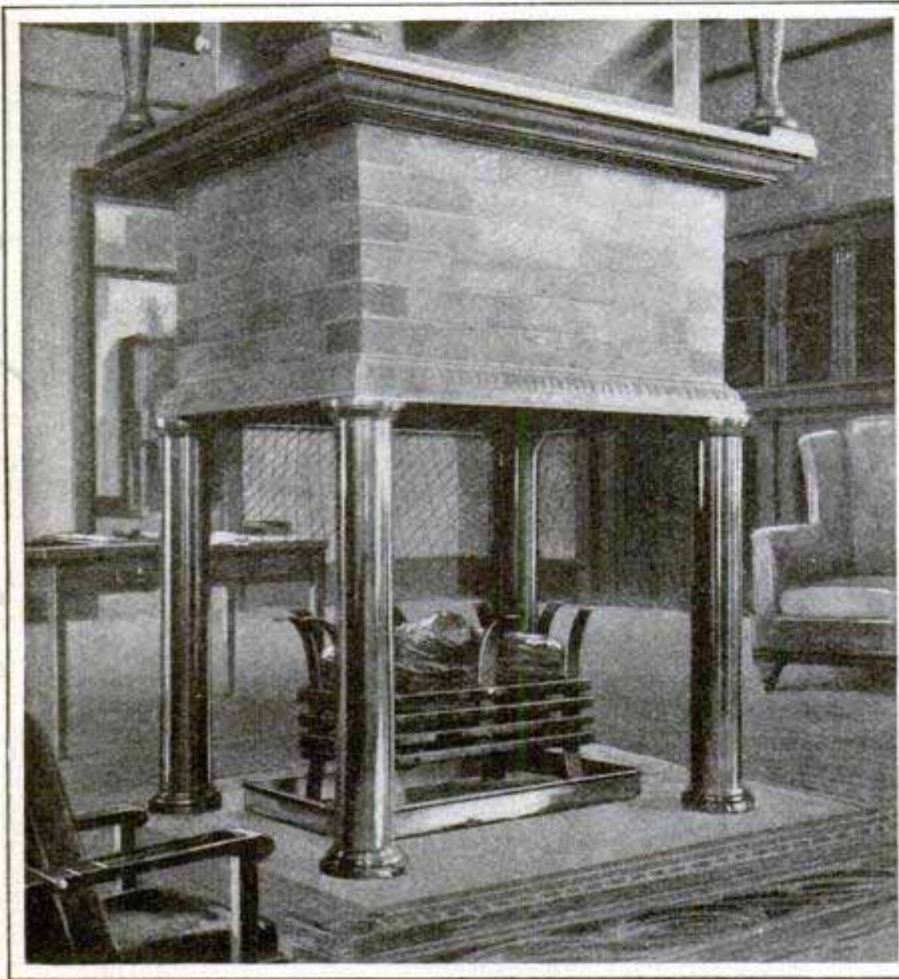

A Fireplace Whose Fire Sends Out Heat and Ruddy Glow on all Four Sides

open on all sides. This fireplace is so unusual that the city of Los Angeles refused a building permit because of it, yet the inventor insists that it is perfectly safe. The chimney, which comes down at the focal point of the arches of the den and the living and dining rooms, is supported by four nicked-steel columns. Under the center of the chimney is placed a steel grate. Screens are in place on two sides of the fireplace. Chairs for the family and guests may be placed on all four sides when desired.

☐The French Aero Club has pronounced itself in favor of a special test and license for hydro-aeroplane pilots.

THE PNEUMATIC TIRE OF THE FUTURE

3273
Small pneumatic tires of twin construction will be the automobile tire of the future, according to one who has given the subject close attention and experimented with tires of various kinds. At present the twin type is used only for large vehicles because tires of twin construction have a much longer life than the other type. Although it has been said that wide twin tires retard speed, it has been found practicable to use them on motor vehicles of every description having a propelling power as low as 12 hp. This change from single to twin tires will necessitate the use of two sizes for one car, one size for the front wheels, and another for the rear wheels. It is claimed, however, that the slight inconvenience caused by using unequal sizes on the same vehicle

will be more than outweighed by the money saving involved and the additional security of tread obtained when the wheels are provided with pneumatic tires of twin construction.

NAVIGATING APPARATUS ON A ROOF

867
The Royal Technical College in Glasgow has a splendidly equipped school of navigation where future officers of the merchant marine may learn their profession. On the roof of the school is a revolving platform on which is mounted a ship's steering wheel, a compass, and other implements designed for experimental work in adjusting a ship's compass so as to make

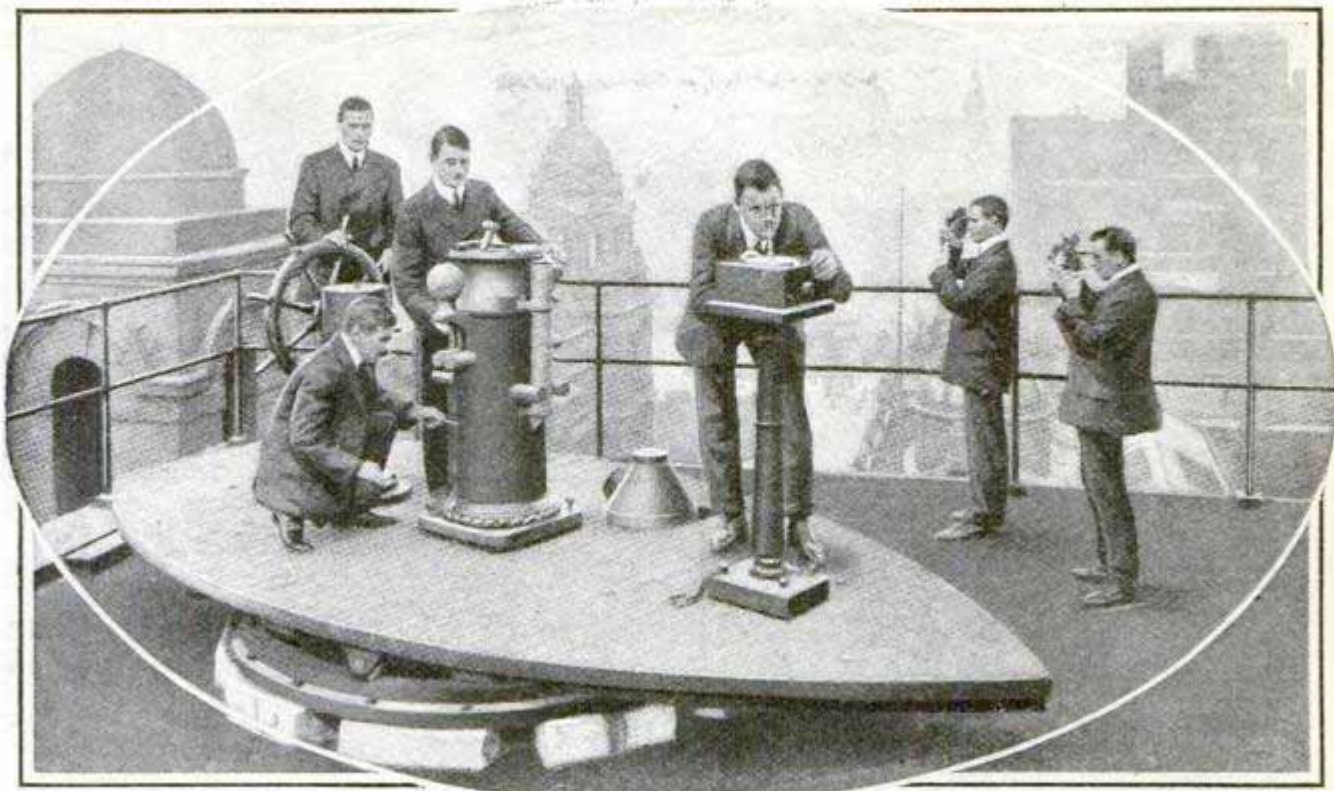

Students of Navigation Adjusting a Ship's Compass on the Roof of a School of Navigation in Glasgow

it independent of the various magnetic forces set up in the steel hull of a ship by the earth's magnetism. The students of navigation stand on the platform and are carried around with it as it revolves, thus making the imitation of "swinging ship" as nearly perfect as is possible on shore.

GOVERNMENT COUNTS PAPER MONEY BY MACHINE

For more than a century United States paper money has been counted by hand in the Treasury Department. A counting machine now in operation has proved so satisfactory that 12 more are being built.

Bills are "fed" between revolving rolls and disks, breaking an electric circuit, which releases two flap-doors opening into a rack into which the bills drop. The counting device is attached to the doors. No count can be made if a bill is not in the machine.

When 99 bills have fallen into the rack, the doors fly up again to receive the hundredth bill, but a mechanical trip prevents their dropping. This is a signal to the operator to put a marker on top of the hundredth bill. The pile

of bills is then "banded" and is ready for circulation.

Bills of three denominations may be counted at one time, the machine having a speed of 35,000 bills a day, as against 15,000 a day, considered the limit of capacity of the most expert hand counters.

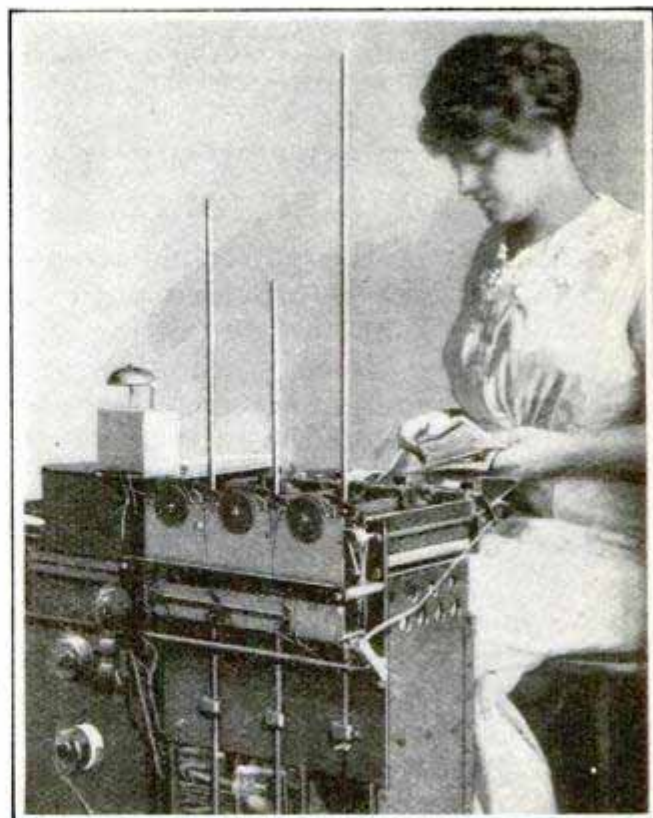

This Machine Counts Paper Money for the Government

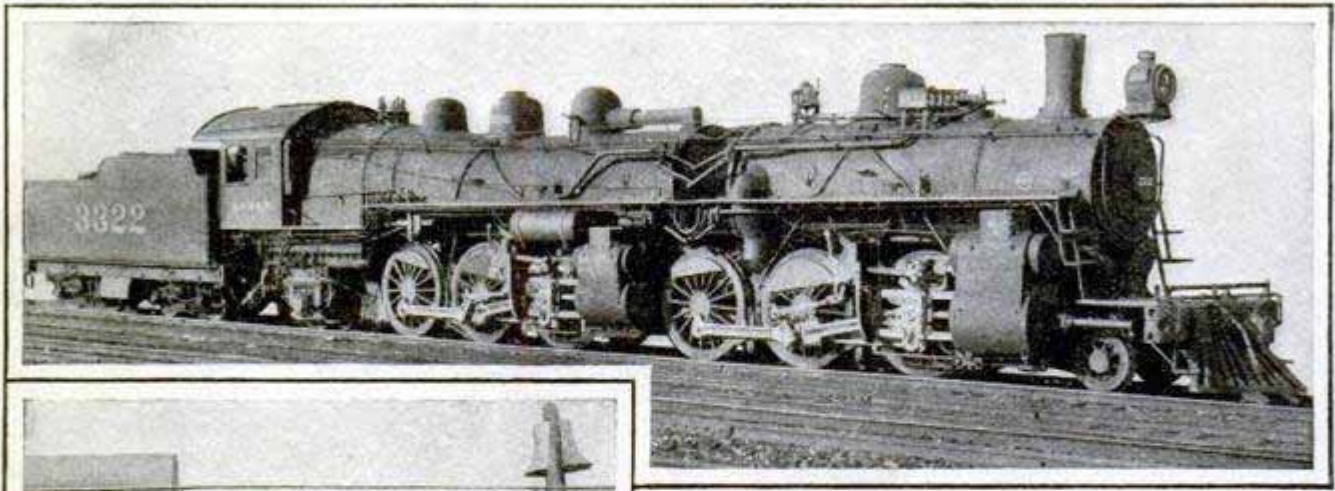

Latest Type of Mallet Articulated Locomotive Showing "Accordion" Joint in Boiler to Permit Rounding of Curves

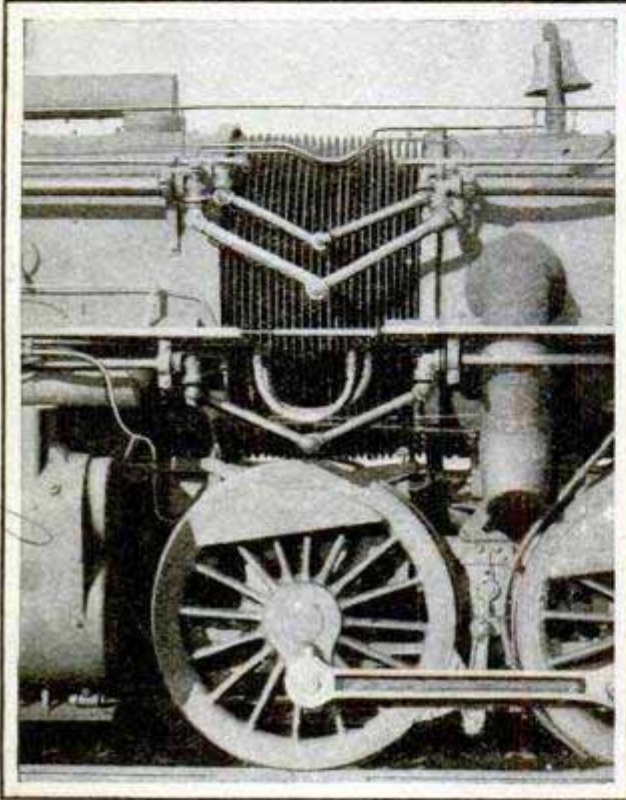

Near View of the "Accordion" Joint on the Newest Mallet Articulated Locomotive

LOCOMOTIVE BOILER WITH AN "ACCORDION" JOINT

The boiler of the powerful locomotive here shown is provided with an "accordion" joint for permitting the boiler to bend when passing curves, otherwise the front or rear wheels would be forced off the rails or would cause them to spread, making an accident inevitable. In this type of locomotive there are four cylinders, each pair of which operates a set of driving wheels in individual frames. The two frames are connected together by a hinge, and the two ends of the boiler by the flexible or "accordion" joint. This arrangement enables an engine with as many as 10 pairs of driving wheels to pass curves with no greater

degree of friction or resistance than attends the use of the regular type of locomotive.

CHINESE TAKE TO ELECTRIC ADVERTISING DISPLAYS

Chinese merchants in Shanghai have taken up electric advertising to a surprising extent, and particularly is this so in Nanking Road, Shanghai's principal native business street. How electrical display advertising was started in this section is a rather interesting story. The municipal authorities are forcing property owners to move back when rebuilding, so as to allow more sidewalk space. The proprietors of the first store thus compelled to move back feared that the competitors who had not rebuilt and were therefore not compelled to move back would have an advantage, so erected a steel staging completely covering the front of the store and arranged an extensive electrical display. This was no sooner in operation than another moved-back store erected a similar display, and competition in electric signs has been growing ever since.

The U. S. Consul General in Shanghai also reports that the Chinese cotton mills are beginning to use electricity for power.

Electric saws are being used by at least one packing company to cut up meat for retailers.

1229
Popular American
Ornamental repair
 (10) 3ala

HYDROPLANE THAT IS BUILT OF STEEL 1182

A hydroplane built entirely of steel, instead of wood, has been completed by a resident of Boom, Belgium, and is said to have attained a speed of about 45 miles an hour. The boat is only about 16 ft. in length and weighs 360 lb. The motor is of the four-cylinder type, weighs 400 lb., and is rated at 24 hp. It is claimed that the rudder, which is placed a fraction over 3 ft. from the bow, instead of in the usual location, enables the boat to turn at high speed in a narrow channel, making a complete circle 40 times an hour in a river 60 ft. wide, and 70 times an hour when the width is 300 ft. The inventor also claims that his boat amply demonstrates that hydroplane hulls built of steel may be made to satisfy the most rigid requirements.

MOTOR SUGAR-CANE HARVESTER 84

This motor-driven machine for harvesting sugar cane is one of several constructed in an endeavor to win a



Harvesting Sugar Cane with a Motor-Driven Machine

\$2,000 prize once offered by the Louisiana Sugar Planters' Association. The machine is propelled and operated by a 60-hp. engine. It has an arrangement of rollers and knives which grasp, cut and top the sugar cane, delivering it stripped and ready for the sugar mill. Only one man is required to operate it.

BUGS ROASTED AND EATEN LIKE CHESTNUTS 121

An insect much resembling the June bug, and found in great quantities in the high plains about Quito, the capital of Ecuador, is toasted and eaten as a delicacy by the natives of that country. They are sold in the streets in the same manner as are chestnuts in the cities of this country. The roasted bugs taste very much

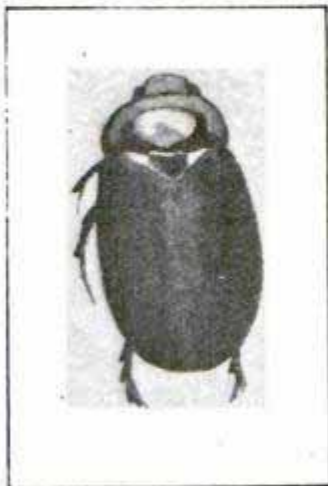

like toasted bread, with no pronounced flavor.

AUTOMOBILE LAUNDRY FOR 3216 DETROIT

An automobile-laundry company has been organized in Detroit for the purpose of washing and polishing automobiles, and the cleaning of their engines by compressed air. The arrangement of the laundry provides for the entrance at one door of a soiled car, which, after having made a complete circuit of the cleaning establishment, will make its exit through another door in a thoroughly renovated condition. The entire process requires from 15 to 20 minutes and different crews of men are employed for day and night service.

Automobile laundry 3216

GREAT BOULDER MOVED WITH 1196 DIFFICULTY

This immense boulder, which marks the site of Fort St. Joseph, at Niles, Mich., was recently moved to its pres-

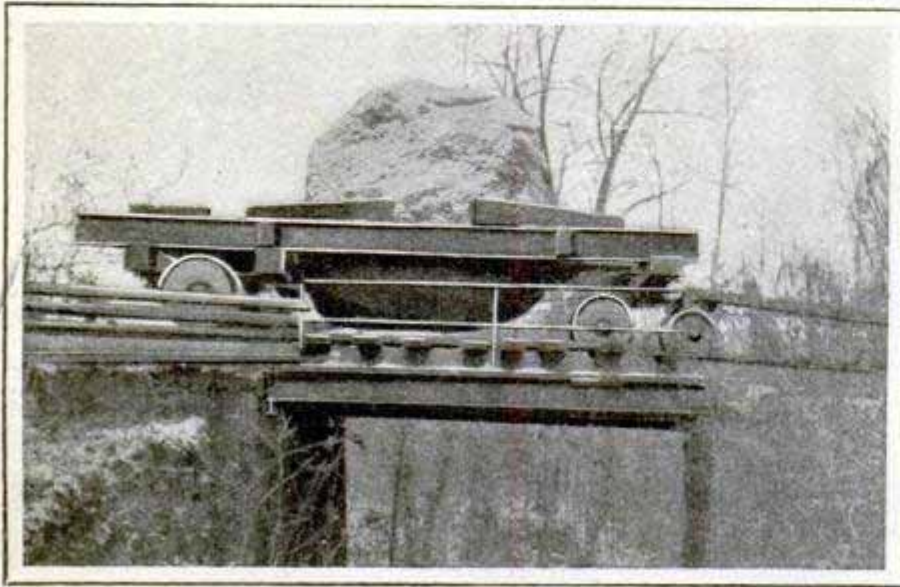

Heavy Boulder Pushed over 3¼-Mile Mud Road by Hand

ent location from the woods, a distance of three and one-half miles, over roads too soft to use a traction engine, by laying more than 1,000 ft. of corduroy road and using a capstan the entire distance. The stone is about 11 ft. long, 10 ft. wide, 12 ft. high, and weighs approximately 50 tons.

ALUMINUM FACE HIDES BATTLE SCARS

A French soldier who took active part in the Franco-Prussian war in 1871 has been furnished with an ingenious mask which effectively conceals the scar left when part of his face was blown away by a shell during battle. In place of the man's nose and cheek bones were unsightly hollows, and a sculptor made for him an aluminum mask, which is held in position by an invisible piece of mechanism. The mask, which extends from just above the eyebrows to the lower part of the cheeks, was painted by a special process to give it a natural appearance and molded so as to show wrinkles as in real life.

A STEAM-ENGINE 108 MOTORCYCLE

A steam-driven motorcycle has been evolved, after two years of experimenting, by an English manufacturer of steam automobiles. The unique machine has successfully passed through its trials, and a number of them are to be placed on the market. The engine is mounted back of the rear fork, underneath and slightly in front of the saddle, and the reservoir fills the space within the diamond frame. The water is flashed into steam the moment it reaches the generator, the steam passing to the cylinder through a pipe and being

ejected through two tubes on either side of the generator casing. A handlebar grip controls the water supply, and another handlebar lever controls the steam release.

The starting of the motorcycle seems to be the only drawback. An auxiliary alcohol lamp has to be brought into use before the main burner can be ignited, about 10 minutes being required before a start can be made. The machine is capable of 40 miles an hour, and is said to be exceptionally economical in fuel consumption.

PERUVIAN AIRMAN FLIES OVER THE ALPS

The first successful flight over the Swiss Alps was made the latter part of January by Jean Bielovucic, a Peruvian airman, in less than half an hour. The ascent was made from Brigue, Switzerland, on the stroke of noon and the airman landed at Domodossola, Italy, at exactly 12:25. The first man to fly across the Alps was the Peruvian Chavez, who fell just before landing and died a short time later.

3218
Mr. Jean Monod and
M. Henri Valette

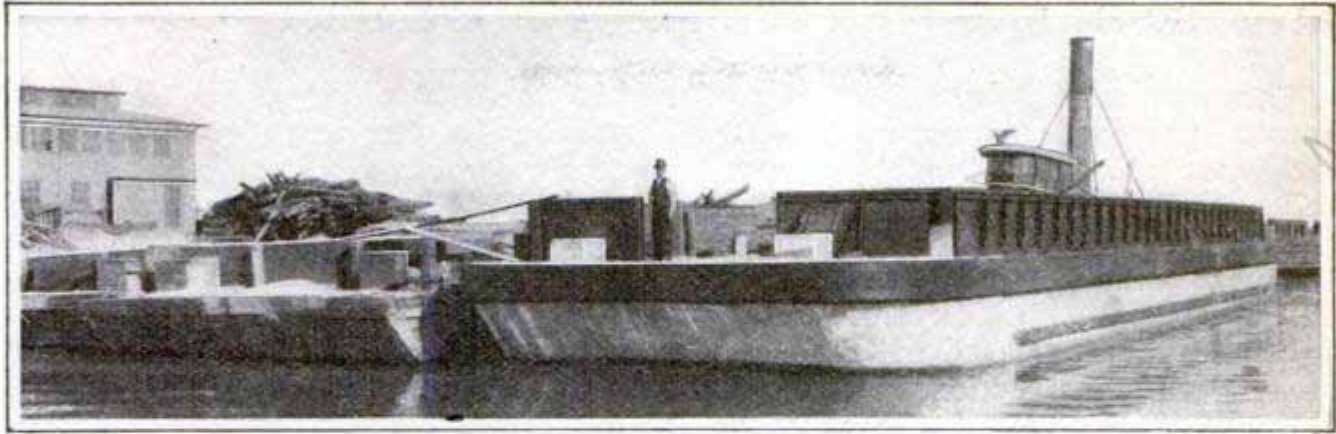

New Reinforced-Concrete Barge Built at Baltimore

BARGE BUILT OF CONCRETE AT BALTIMORE

A reinforced-concrete barge, which has just been completed at Baltimore, is 112 ft. long, 29 ft. wide, and 10 ft. deep. The side walls are 4 in. thick; the ends and bottom are 6 in., and the floor or deck is 3 in. thick. The deck

is supported not only by the several 6-in. walls that form the bulkheads for the 20 compartments, but also by 20 pillars, each 6 in. square. One of these pillars is placed in the center of each compartment.

The barge has a carrying capacity of 500 tons and will be used for transporting sand and gravel.

Always built in Baltimore

NORWAY'S CROWN PRINCE HAS TINY AUTOMOBILE

Prince Olaf, the little heir to the throne of Norway, has been given a "baby" automobile by his grandmother, Queen Alexandra. The miniature car, which is here shown in comparison with a man of average height, is an exact reproduction of a well-known American make, save that it is driven by electricity instead of by a gasoline engine. The weight of the car complete is 300 lb.,

and the highest speed that can be attained is 7 miles an hour.

Prince Olaf learned to run the car the morning after it was given to him, and has become an enthusiastic motorist.



The Miniature Automobile Operated by Prince Olaf of Norway

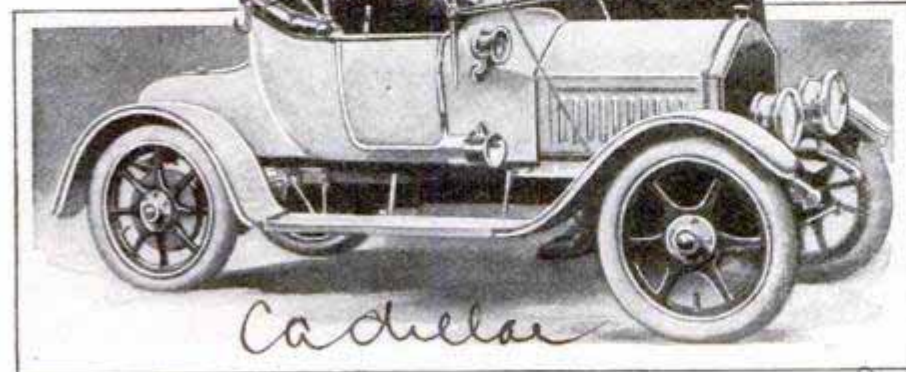

STEEL KITCHEN CABINETS

3309-05

A kitchen cabinet made entirely of cold-rolled steel, with electrically welded joints, finished in and out with snow-white porcelain enamel, is one of the innovations of the year in kitchen furniture. It can be washed with soap and water without detriment. The cabinet contains a sliding table top, metal-sifter flour bin, removable sliding shelves made of wire, tea, coffee and spice jars, swing glass sugar bin, racks for pans, towel racks, and the like.

Sanisteel Metal

JAPANESE FIREMEN CLING TO ANCIENT CUSTOMS

The empire of Japan, as is well known, has made wonderful progress in almost every department of human endeavor during recent years, and this rapid development also applies to the Japanese fire departments in the larger cities, especially in Tokyo. The fire-fighting apparatus used in this city is of modern construction, and several features, indicative of the most advanced methods, stand out among others characteristic of remoter periods.

The fire-fighting apparatus of the Japanese, in former times, was as primitive as the prowess of the firemen was unequalled. The most useful machine then employed was a crude hand pump, which threw a stream so small that it could scarcely dampen a heated wall. Long poles with hooks to pull, and others with pikes for shoving, were also used to raze the flimsy little wooden houses, so as to form a firebreak and thus check the spread of the flames. The firemen were divided into brigades, one for each section of the city, and the members wore tight-fitting cotton trousers and coats of the same material. They also had gloves and socks of thick canvas. Each brigade was composed of the pikemen, the hookmen, and the standard bearer, who carried the "matoï" or standard of the brigade in the front of the battle with the flames. This device was supposed to frighten the "fire demon."

With the introduction of modern methods of fire fighting, the majority of the old customs have been abandoned. The pikes, hooks and the "matoï" are still used, however, and in the eyes of a foreigner the latter continues to play one of the most prominent parts in Japanese fire fighting, as every fireman is prepared to follow it to death, if need be.

Formerly the men worked without receiving any compensation for their services, which were rendered chiefly for the glory accorded to members of the fire-fighting brigades. Wages are now paid the firemen, but only from

\$1.25 to \$2.50 a month, so the chief attraction of the brigade members is still the honor.

When the Tokyo firemen are not on brigade duty they willingly undertake any work offered to them, such as assisting carpenters to build houses, doing odd jobs about the houses, or carrying messages for the citizens. The firemen are also employed to decorate the streets during religious festivals and to carry the banners and bouquets at funerals. On bargain days in some of the department stores extra assistance is frequently required to care for the shoes and umbrellas of the visitors, and the fire laddies are always afforded an opportunity to do this extra service. Many members of the fire brigade also find additional employment as night watchmen, who patrol the streets clapping two pieces of wood sharply together to inform the sleeping citizens that no robbers are in sight.

Once every year a great review of the fire brigades is held near the central police station. During this gala occasion the firemen entertain the multitude with acrobatic performances and other physical feats necessary to an efficient fire fighter. At the end of the performance each brigade is presented with \$2.50, one hundred cuttlefish and a keg of wine, for a banquet during the evening.

The city of Tokyo has a total of six fire-brigade stations, 40 branch offices, and altogether there are 1,703 professional firemen in the metropolitan district.

Steady, although not particularly rapid, improvement of country roads is shown by the following figures: In 1909 about 8½ per cent of the roads in the United States were improved, while at the close of 1912 the percentage of improved roads reached close to 10. In the five years preceding March, 1912, the Federal Government built 215 object-lesson roads, amounting, in all, to about 300 miles.

U. S. Dept. of Agriculture

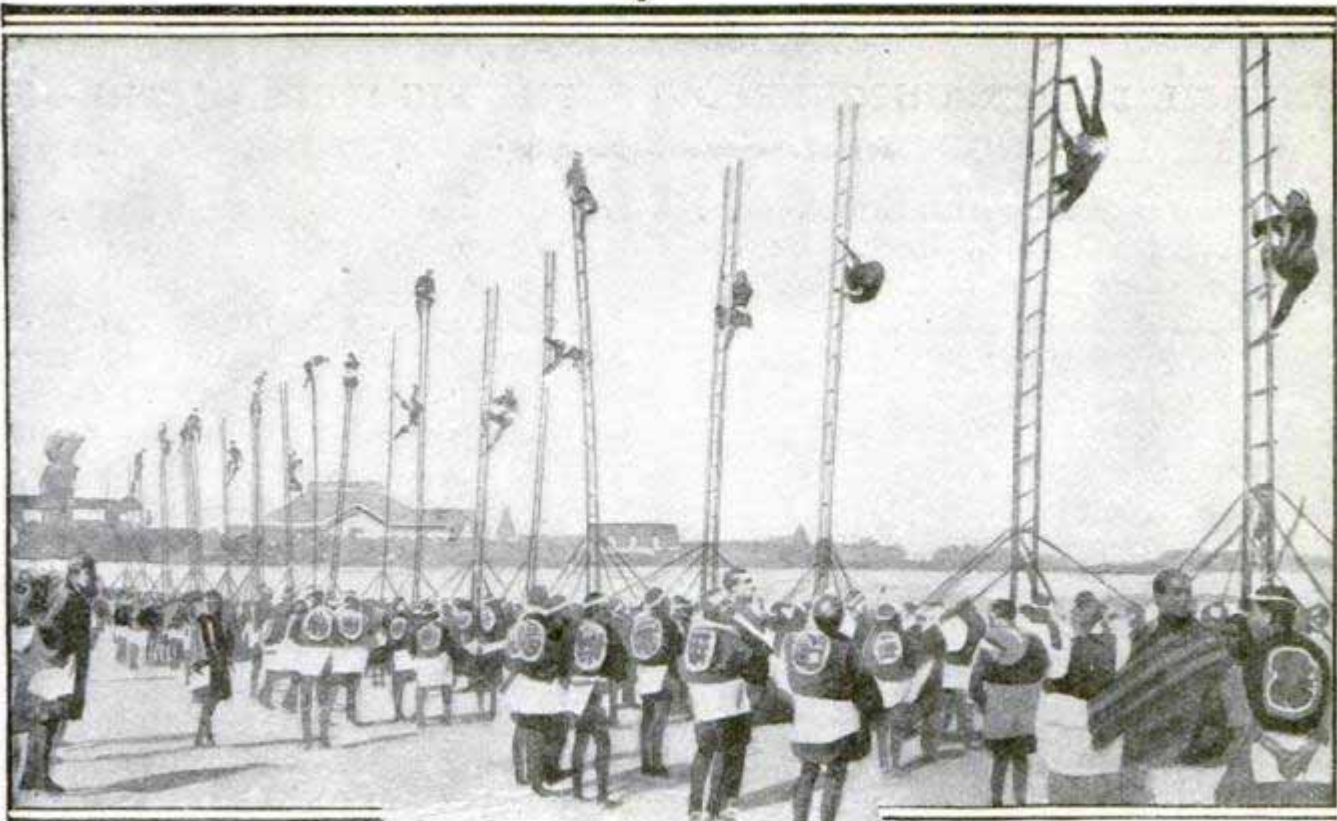

The Ladder Drill is Used by the Japanese Firemen

Fire Engine Used by the

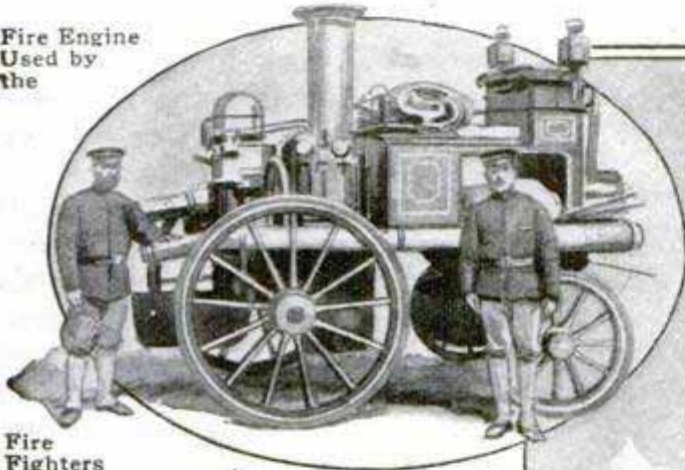

Fire Fighters of Japan

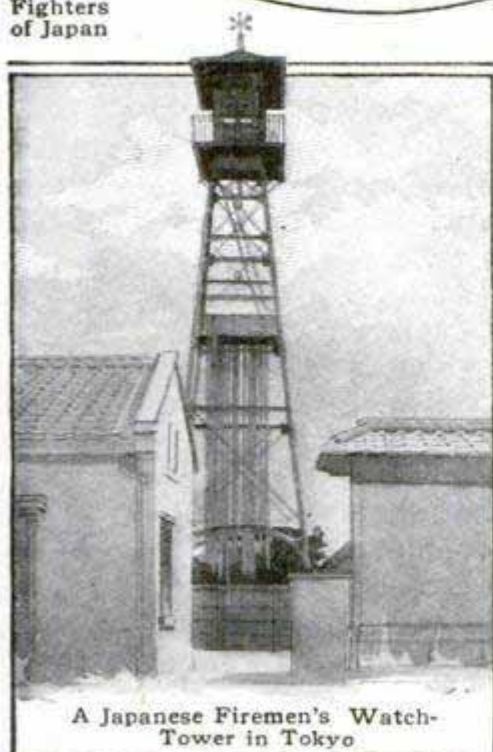

A Japanese Firemen's Watch-Tower in Tokyo



The Matoi, or Zeal-Inspiring Standard of the Japanese Fire Brigades

**CHURCH TOWER UNCOVERED
AFTER LONG BURIAL**

1219 The tower of the parish church in the long-buried village of Eccles, on the Norfolk coast, England, which has

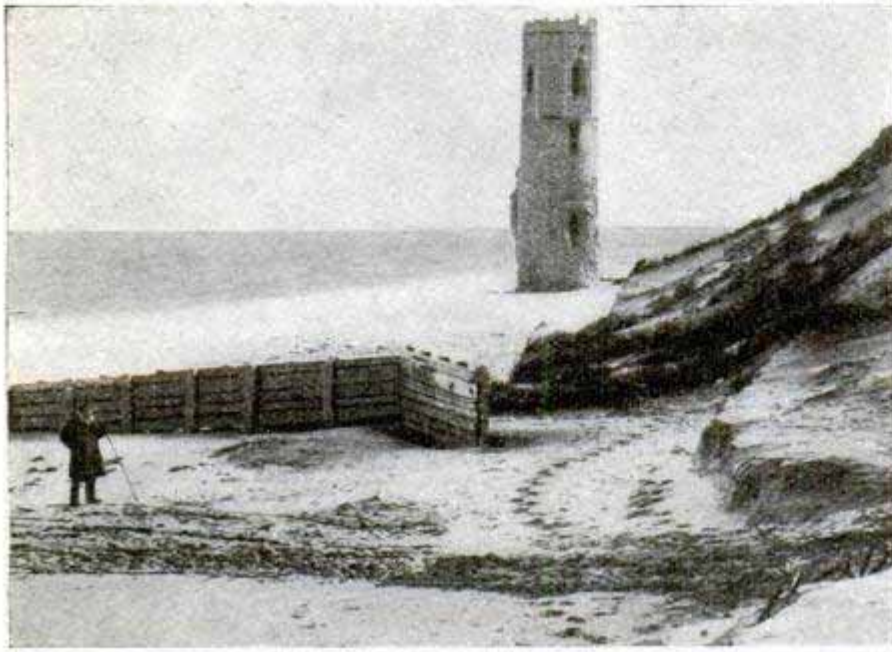

An Ancient Church Tower in England Recently Uncovered

been practically submerged with sand for the past 32 years, was uncovered by a violent gale that recently swept this section of the English coast. The tower marks the site of the village that, in 1605, was destroyed by a mighty sea.

**MOTOR-CAR LINE TO THE
KLONDIKE**

1192 It is probable that an automobile line from White Horse to Dawson, in the Yukon Territory, will be established soon, as the road has been greatly improved by the government during the last summer. The passageway was made wider and the grades reduced to such an extent that automobiles can climb them with heavy loads. As it has been thoroughly demonstrated that motor cars can be operated in a temperature as low as 70 deg. below zero, it is expected that this type of vehicle will be of material assistance in rapidly developing the northern country.

**THE BIG SHIPS OF THE
FUTURE**

3271. At the first International Congress of Maritime Navigation, held in Philadelphia, it was predicted that in 1950 the 20 largest boats on the Atlantic will have an average length of 1,100 ft., with a beam of more than 100 ft., and a draft of nearly 40 ft. A forecast, however, made some years ago for 1923, materialized last year, and it may well be that this forecast for 1950 will find itself an actuality 15 or 20 years sooner than the time prophesied.

Work being done to better docking facilities all over the world gives a slight indication of what may be expected.

The plans for the new locks of Tilbury Dock, London, provide for ships of a length of 1,250 ft., a width of 130 ft., and a draft of 39 ft. The Suez Canal is to be deepened to 39 ft. by 1915.

**INSULATING SHOES FOR
ELECTRICAL WORKERS**

98 With the ordinary flat-soled rubber shoe worn by electrical workers it is difficult to tell how far safety has been affected by wear, especially as the wear takes place inside the shoe as well as outside. Consequently, one concern is turning out a rubber shoe of the ordinary type with crossed rubber ribs vulcanized upon the sole, the heel and the instep. An adjustable ankle strap enables the shoe to be worn on various sizes of foot over the ordinary walking shoe.



St. Helens Cable
D. Helms Co. Ltd

Continental Report

THE CLEANING OF PASSENGER CARS

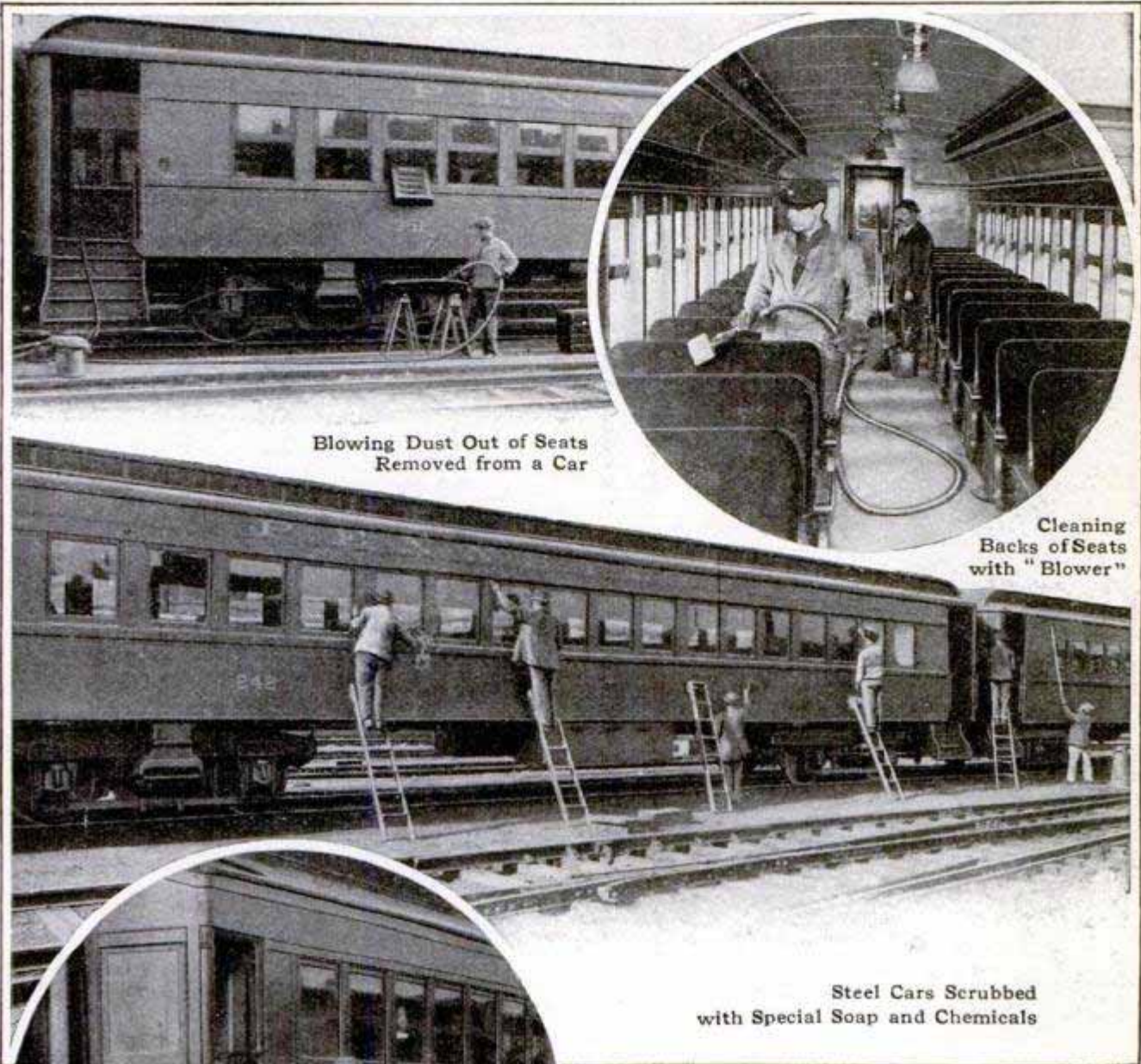

Blowing Dust Out of Seats Removed from a Car

Cleaning Backs of Seats with "Blower"

Steel Cars Scrubbed with Special Soap and Chemicals

The Ordinary Cleaning of Steel Cars

Spring cleaning comes only once a year, but house cleaning on a railroad, which is akin to the annual spring cleaning, in thoroughness at least, is

a continuous performance. It is done in a manner that would delight the tidiest housewife, and on a scale so enormous that it would make her throw up her hands in amazement. In the Pennsylvania's yard at Sunnyside, Long Island, for instance, over 11,000 vestibuled cars are cleaned every month or more than 350 a day; and the same thing is being done in all the great railway yards of the country. The traveler, boarding a train which is shining and spotless inside and out, does not stop to think that a few hours before the same cars were returning dusty and travel-stained from a run, with seats and carpets bearing traces left by other travelers.

M. Berger.

GASOMETER BUILT OF REINFORCED CONCRETE

Although gas tanks made of concrete are not an entirely new method of construction, the use of this material for

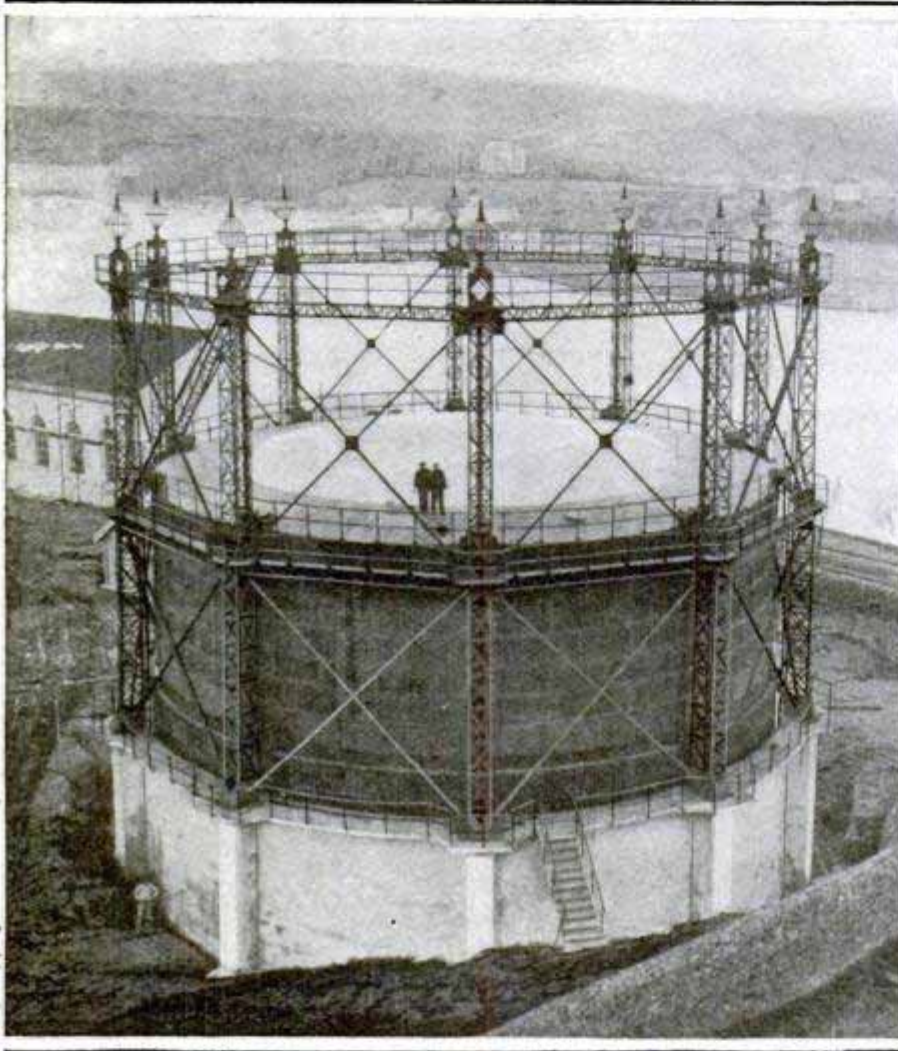

Gasometer at San Sebastian, Spain

the moving parts of a gasometer is rare. One of the features of the pressure tank here shown is the lights mounted upon the tops of the upright girders as a means of illumination, and also for the purpose of lending decoration to an otherwise ordinary example of reinforced concrete construction. This gasholder or gasometer was built at San Sebastian, Spain.

☞ The descendants of Paul Revere have donated funds for repairing the spire of the Old North Church in Boston, upon which the two signal lanterns were hung that caused him to take his famous "midnight ride" in 1775.

"SUBMARINE FIDDLING" FOR UNITED STATES NAVY

3.3.21
"Submarine fiddling" is the latest device adopted by the United States navy to make more effective its means of communication during time of war. The phrase tersely describes the plan employed for signaling from submarine torpedo boats when operating either on or under the surface.

On one side of the vessel are two steel projections, to each end of which is fastened a tightly stretched wire that rests against the roughened rim of a wheel. When the wheel revolves the wire is set in vibration as a violin string is agitated when a bow is drawn across it. The wheel, which plays the part of a bow, is connected by a shaft with an electric motor and the motor is controlled by a Morse telegraph key. When the key is pressed the wheel instantly begins to revolve and the wire is caused to vibrate.

Any operator may use the key precisely as he would an ordinary telegraph key, and vibrations are set up in the wire corresponding to the dots and dashes of the Morse system. The receiver may be placed under water off shore and connected by ordinary telephone wires with a fort or station on land.

The invention was carefully tested on a submarine torpedo boat at Hampton Roads and it was found that the vibration of the wire could be detected at a distance of five miles, an ordinary telephone receiver being employed to catch the message which was transmitted from a station on shore.

3358-B WORLD'S CONSUMPTION OF ARTIFICIAL GAS

It is estimated that the gas produced for illumination, cooking and heating in the cities and towns of the world reached a total in 1912 of approximately 620,000,000,000 cu. ft., in the manufacture of which about 60,000,000 tons of coal were consumed. From this coal was also produced about 30,000,000 tons of coke and 3,000,000 tons of tar. London still leads in gas consumption, per capita, with Amsterdam, Berlin, New York and Paris following.

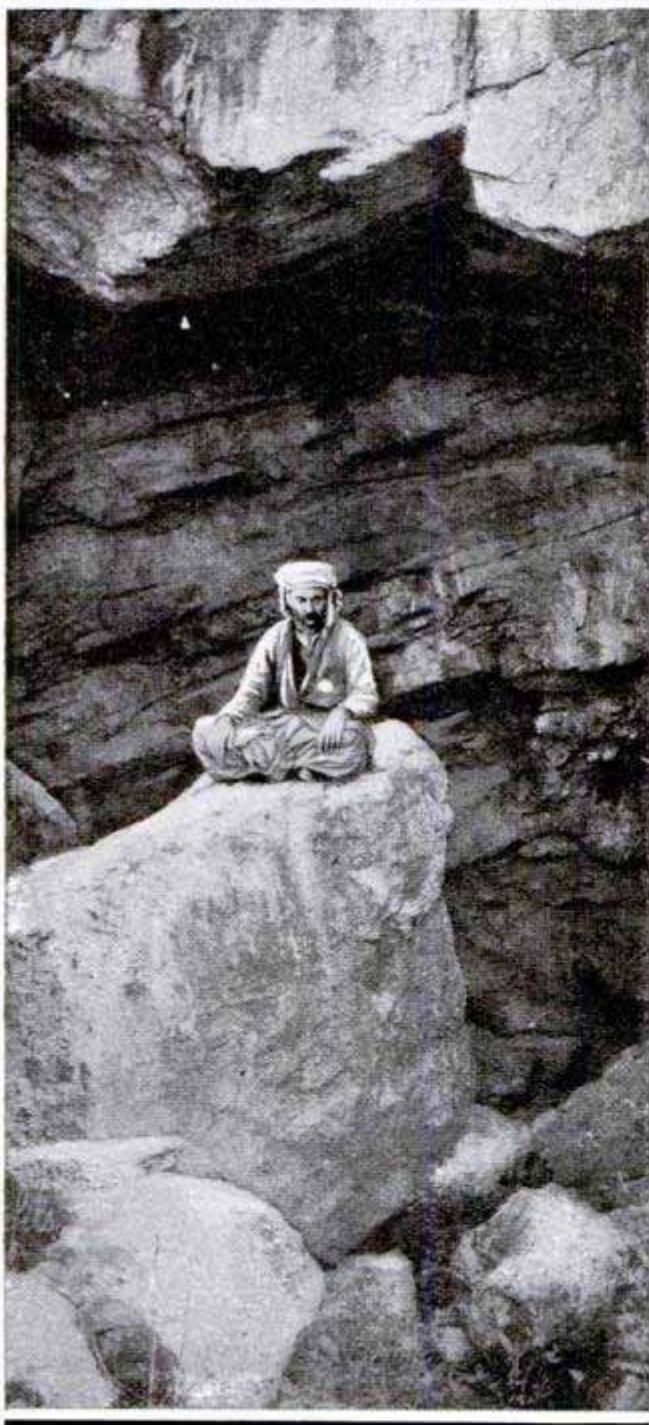

Senor Juaõ Valente

HOMES OF TWO FAMOUS FOREIGN HERMITS

Nearly every locality, even in this country, has its hermit or a tradition of one, but very few hermits have homes as unusual as the ones here shown. The hermit of Baniyas, a small village near Damascus, lives in a grotto, and is most often seen squatting on a large rock within it. Campanario, Madeira Island, has a hermit who lives in the hollow base of a giant chestnut tree.

UNUSUAL PICTURE OF MARINE SURGERY

3260 Marine surgery, even to the extent of cutting off half of a big ship and replacing it with new construction, is not uncommon, but it is unusual, to say the least, to see the two halves of a ship moored side by side and facing in

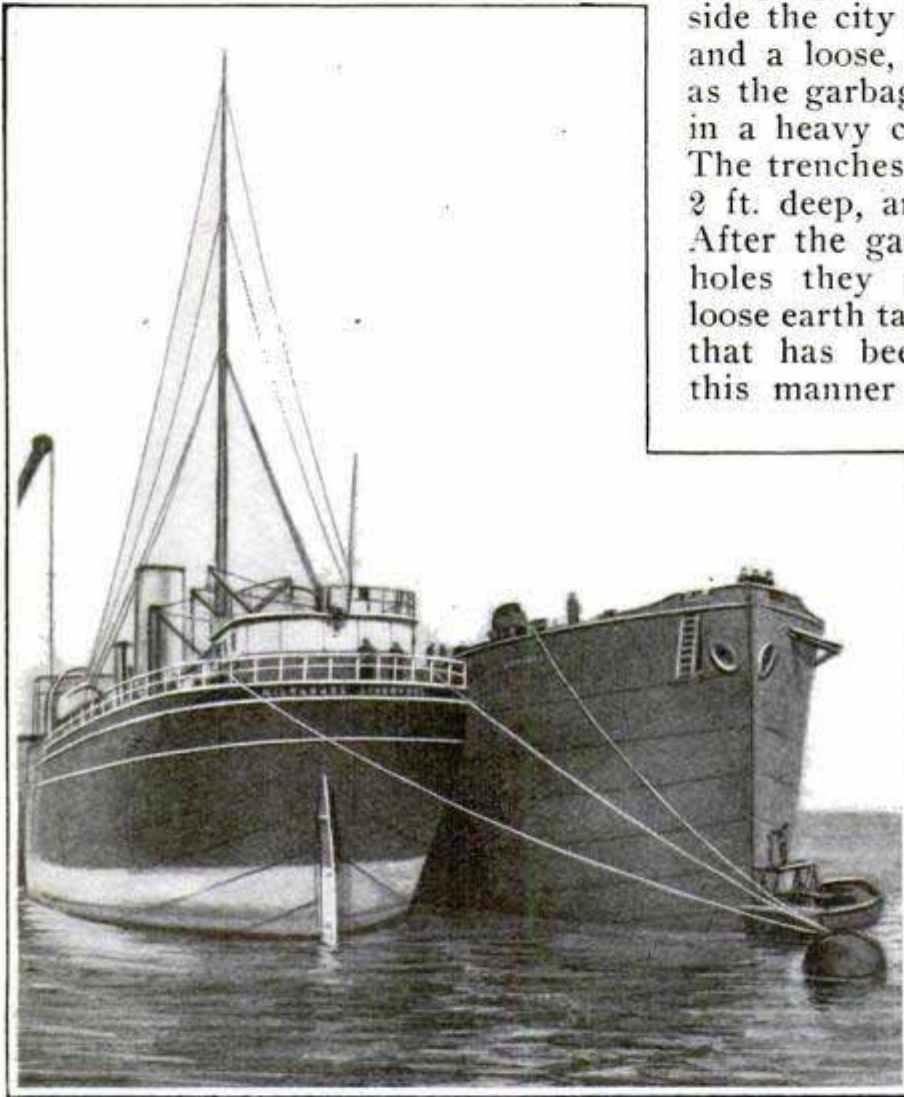

Stern and Bow of the Same Vessel Photographed Side by Side

the same direction. The vessel is the "Milwaukee," of Liverpool, whose forward portion met with a disaster which necessitated the surgical operation. The photograph was taken just after the new forward half was launched. The two sections were then floated into drydock for the "wedding ceremony."

ⒸThe United States has 20,567,000 horses valued at \$2,278,222,000, and approximately 4,386,000 mules.

BURIAL OF GARBAGE FROM SMALL CITIES

3341 The disposal of garbage in small cities and villages by burying it in the ground is considered the most sanitary method possible where economy must be considered, according to an engineer of the Ohio State Board of Health. For this purpose a section of level land outside the city limits should be secured, and a loose, loamy soil is preferable, as the garbage does not readily decay in a heavy clay or coarse sandy soil. The trenches should be dug from 1 to 2 ft. deep, and about 6 or 7 ft. long. After the garbage is thrown into the holes they should be covered with loose earth taken from a near-by trench that has been newly excavated. In this manner the entire field may be used and, after a certain time, according to the character of the soil, has elapsed, the land can be used again for the same purpose.

Experiments conducted by another sanitary engineer indicated that, if the garbage is spread over the ground to a depth of about 1 ft. and covered with a 12-in. layer of earth, the greater part of the refuse will have disappeared in from six to nine months without giving forth any objectionable odor, and solid parts of the waste will

have decomposed entirely within three or four years.

CEMENT MOUNTAINS AND PORCELAIN TOWNS

The mountains of this giant relief map of Salzburg, Austria, and its district, were made of cement and various natural stones, while porcelain was used to make the towns and cities. The natural representation of meadows, forests, lakes and rivers was



Courtesy The Sketch, London

Great Relief Map of Salzburg, Austria, and Its District, Made from Cement, Stones and Porcelain

obtained by the use of paint. The work was begun by Herr Pornbacher, a sculptor, in 1905, and has just been completed at a cost of more than \$10,000.

IMPROVED METHOD OF TREAT- 3349 ING FLAX FIBER

A new method of preparing flax fiber of much finer grade than can be produced in the ordinary manner has been discovered by a Russian engineer. The process consists in treating the flax with alcohol, and then mineral oil and steam, with the result that linen and cotton can be made for less than one-fourth the cost of producing a similar grade of cloth by the old method. The new process also has the advantage of reducing the amount of waste and permits the use of both long and short fibers.

Cheveline

19 FIREMEN WEAVE SHAWLS IN LEISURE TIME

Members of the Syracuse fire department have found a unique way of converting leisure time into profit. They make fine Shetland shawls, weaving them on a large wooden frame. The first shawl completed was as soft as

silk, and perfectly made. Three more are now under way. The idea has, of course, the approval of the fire-department heads.

There is much monotony in a fireman's existence, and hours of time are spent in playing cards and such games as checkers. The possibility of breaking this monotony by doing work that is profitable is one that should appeal to firemen all over the country. There are many kinds of things firemen might make during spare time.

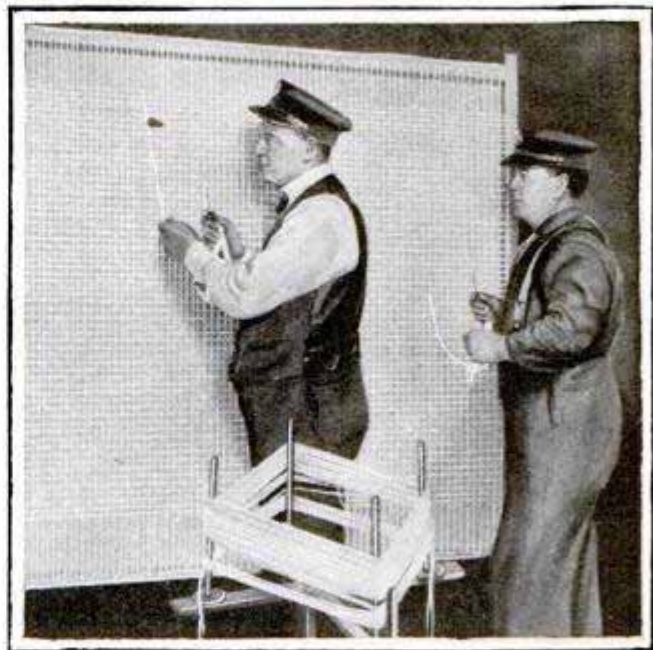

Syracuse Firemen Making Shetland Shawl during Leisure Moments

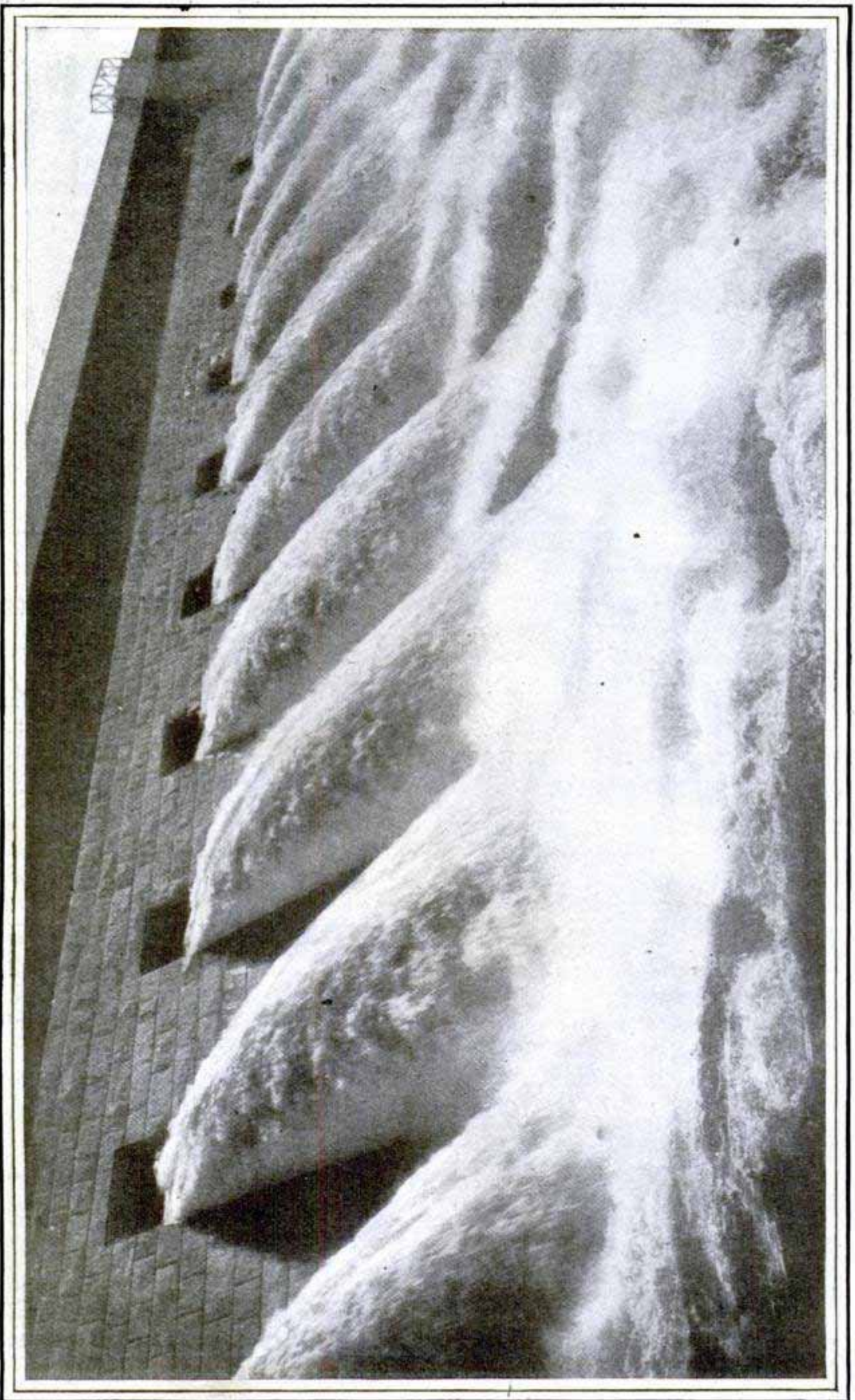

Courtesy The Sphere, London

A Striking View of the Assouan Dam on the River Nile Showing Open Sluices of One of the Greatest Feats of Modern Engineering

RIVER WATER USED EIGHT TIMES IN CALIFORNIA 115

A part of the water of the Santa Ana River in southern California is used eight times, as follows: From a reservoir in the San Bernardino Mountains it is diverted through two electric power plants and then used for irrigation purposes about Redlands and Highlands. The water not absorbed by the ground is recovered through springs and used for irrigating the land about San Bernardino. Some of it reappears in the river above Riverside Narrows and is utilized for power purposes. It is then returned to the river above Corona and distributed by canals to the orange groves around Santa Ana. Some of the water is once more recovered by the pumping plants west of this city and used for the eighth time.

SIGHT-SEEING CANAL TRAIN

115 It is now possible for visitors to see the entire Panama Canal by means of a special sight-seeing train put into commission for this purpose. The daily schedule of the train provides for a trip over the Pacific division during the morning and through the great Culebra cut in the afternoon of Monday, Wednesday and Friday. The trip to Gatun dam is made on Tuesday, Thursday and Saturday. Two consecutive week days are required for seeing the entire work, which is further explained by lectures delivered at the tourist station in Ancon and illustrated by the use of models.

Canal Record

MOTOR CAR FOR BOTH PEACE AND WAR 115

One of the most adaptable motor cars that has ever been constructed is here shown. The vehicle, which is

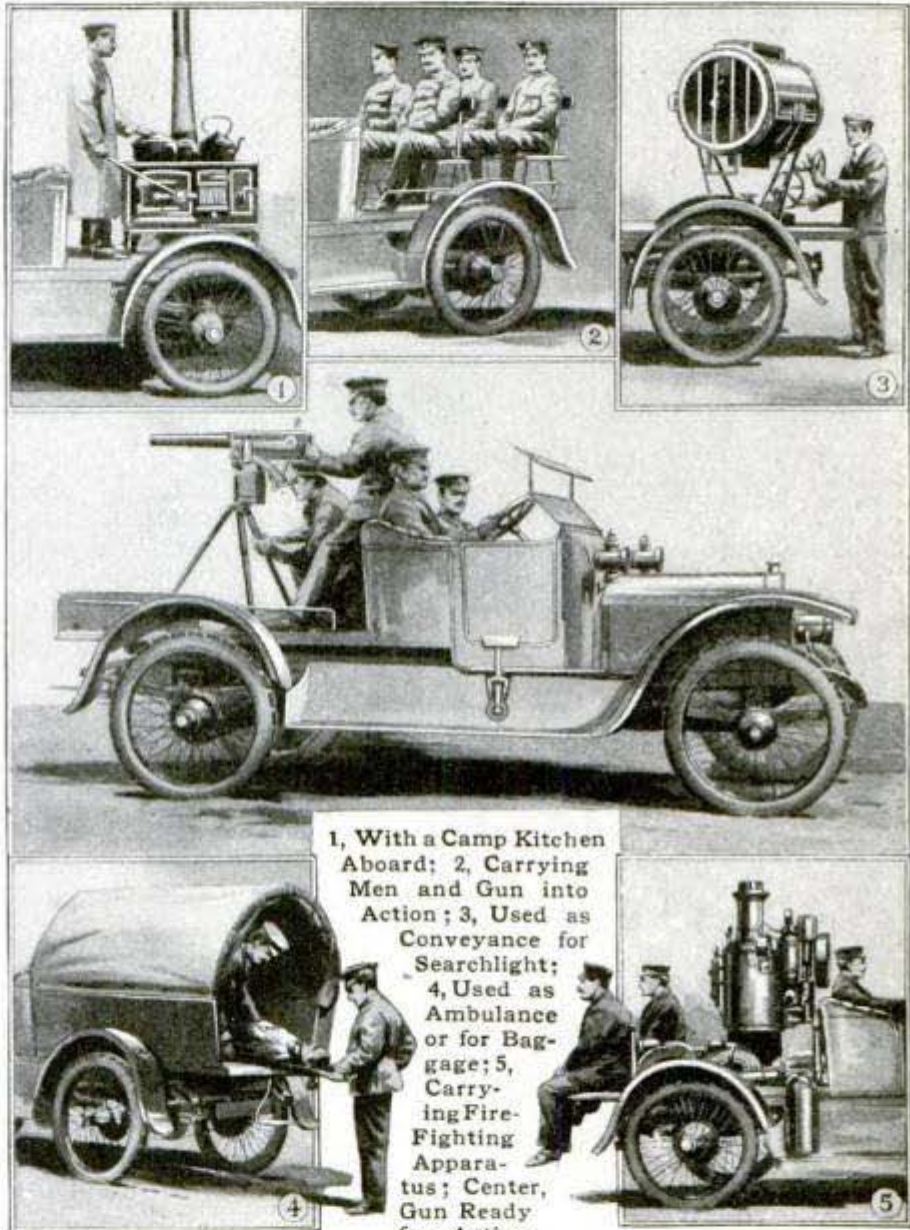

1, With a Camp Kitchen Aboard; 2, Carrying Men and Gun into Action; 3, Used as Conveyance for Searchlight; 4, Used as Ambulance or for Baggage; 5, Carrying Fire-Fighting Apparatus; Center, Gun Ready for Action

fitted with a 15-hp. engine and an extra-strong chassis, has a two-seated touring body so arranged that the rear portion may be quickly detached. This part may then be replaced by one of various other bodies which are mounted on folding legs and casters, so that the interchanging process can be effected without difficulty by one individual. Thus, the vehicle can be quickly converted into a practical fire-fighting apparatus; an ambulance; a baggage wagon; a camp kitchen; a

conveyance for carrying a field gun and soldiers into action; a gun carriage for supporting the gun when it is discharged; or the car may be used for transporting a searchlight during military operations.

THE NIGHTINGALE STATUE IN THE MAKING

The sculptor who is making the Florence Nightingale statue uses methods that differ a little from those

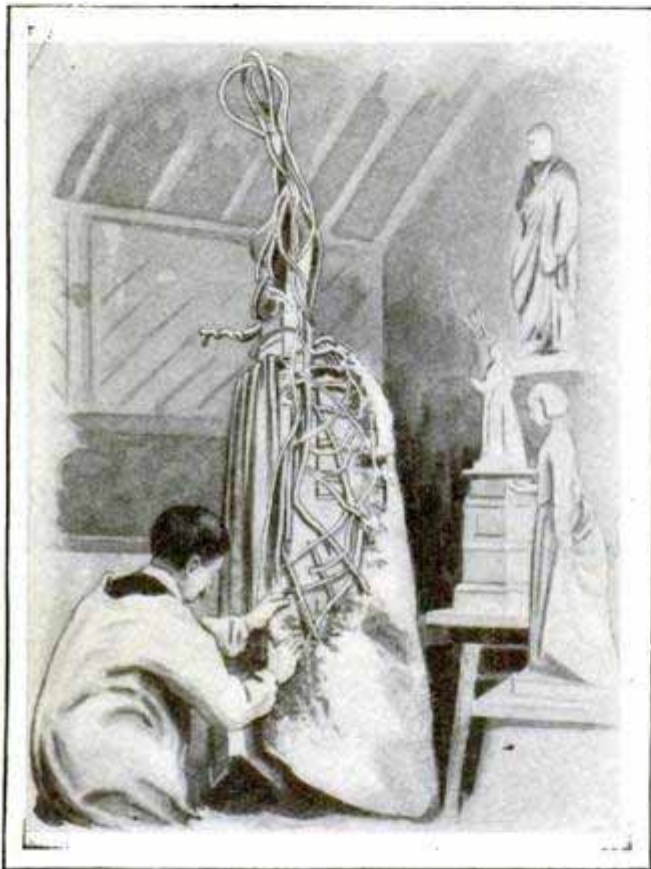

A Sculptor Using a Framework of Wood and Gas Pipe

of his contemporaries, according to the London Graphic. In the first place, he is almost entirely his own workman. After his small plaster statuette is finished, he constructs a framework of wood and gas pipe that reminds one of a dressmaker's frame, slightly exaggerated, and on this foundation applies the plaster superstructure himself.

Over eight billion pounds of sugar were consumed in the United States during 1912, and one-fourth of this amount came from our own cane in Hawaii and Porto Rico.

VALUE OF MOTORBOATS TO TUSKET LOBSTERMEN

There is probably no settlement of fishermen along the Atlantic Coast more benefited by the motorboat than the lobstermen of the Tusket Islands, in the mouth of the Tusket River, Nova Scotia. During the open season for lobsters the trappers must be near the base of supplies, so hundreds of lobstermen and their families seek these little, rocky islands and live upon them in communities that are isolated from the world at large.

Until the advent of the motorboat the lobsters were obtained only by means of the sail or rowboat, which always meant a waste of time in setting traps in locations favorable for a catch. It was customary for a crew to take all day in placing the traps, some of which had to be located miles apart. Then it took another day to sail or row over the same route to haul up the 30 or 40 traps and withdraw the lobsters. Now the motorboat, usually a small but seaworthy craft, powered by a 3 or 5-hp. engine, is almost universally used, enabling the lobstermen to go over the routes twice each day.

BLOWTORCH CLEANS ICE FROM SWITCHES

A blowtorch consisting of a brass tubing, 2 in. in diameter and about 5 ft. long, with a burner at one end and a gasoline valve and pressure pump at the other, has been devised especially for thawing ice, snow or sleet from switch points, derails, frogs and other movable track connections. The tube has a capacity of 3 qt. of gasoline, which is sufficient for about three hours' operation. The flame is about 2 in. in diameter and 12 in. long.

The torch was tested recently in the Chicago yards of the Chicago Great Western Railroad. One man using the torch cleaned 160 switches in three hours, an amount of work that would have required five or six men to accomplish in the same time, using picks and brooms.

A. S. Walker

3325-03

3227

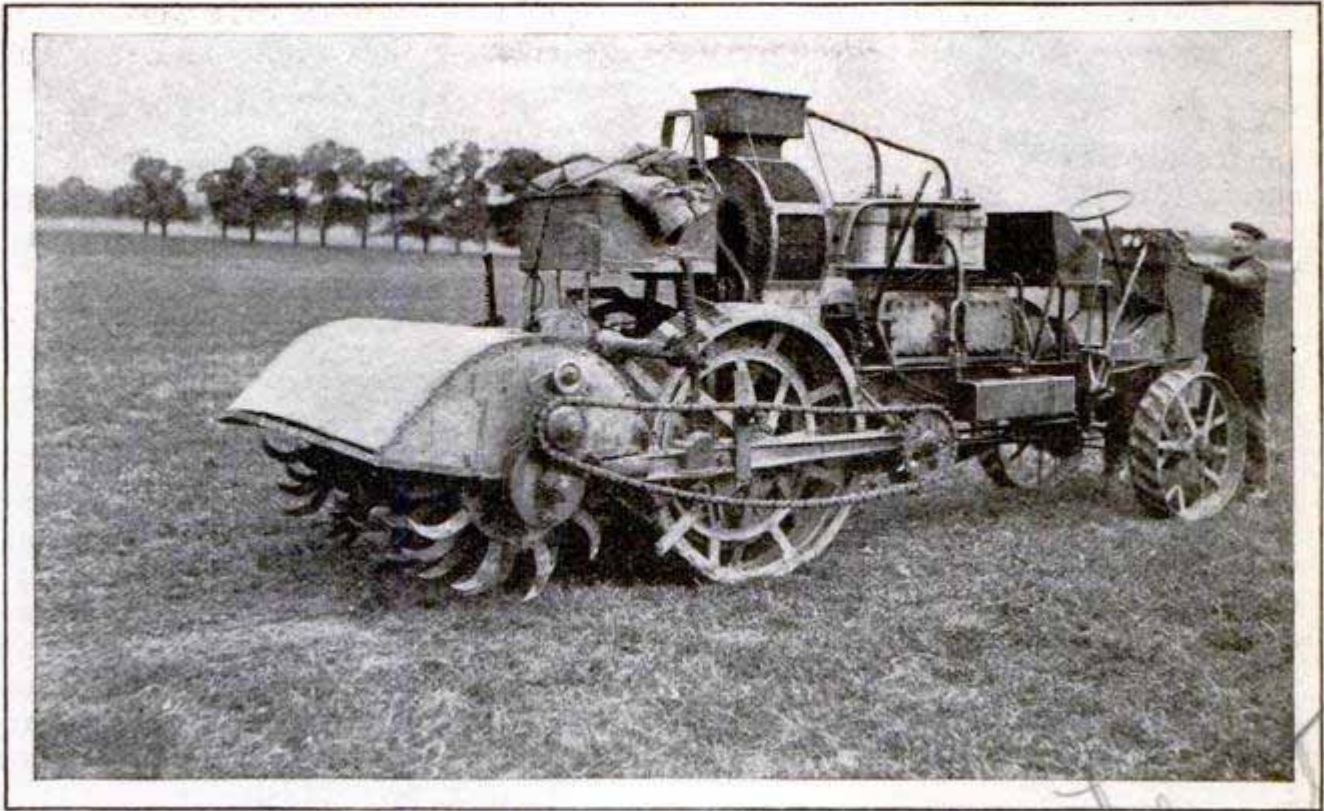

French Self-Contained Soil-Breaking Machine

NEW FRENCH FARM TRACTORS

Machines have "nationalities" as well as peoples. That is, machines evolved in different countries for similar purposes have many characteristics that differ. The two farm tractors here shown, for instance, would instinctively impress the American farmer as "for-

eign," even though seen on an American field.

¶The amount of capital invested in the electrical business in the United States is in the neighborhood of \$6,000,000,000.

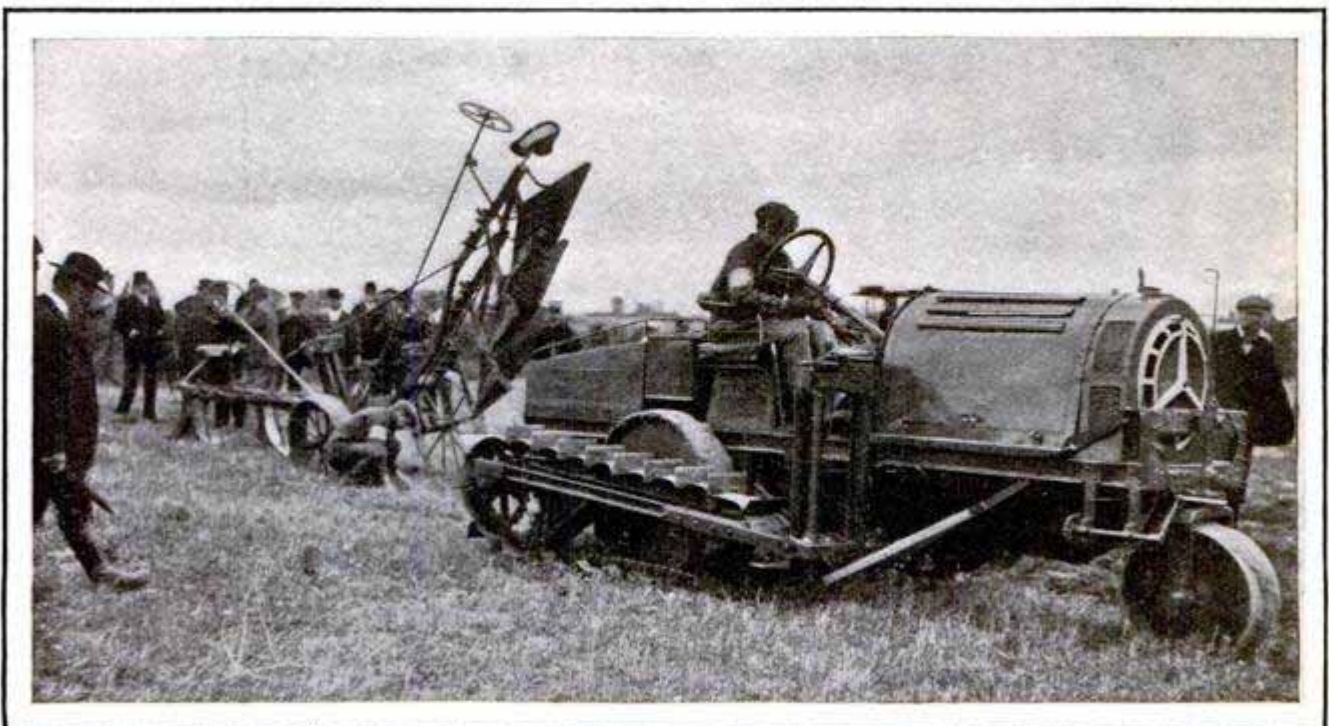

A French Tractor Hitched to a Double-Ended Plow

**MOTORCYCLE WITH SEVERAL
NEW FEATURES 3304**

One of the most important and valuable features of motorcycles of recent manufacture is the rear spring suspen-

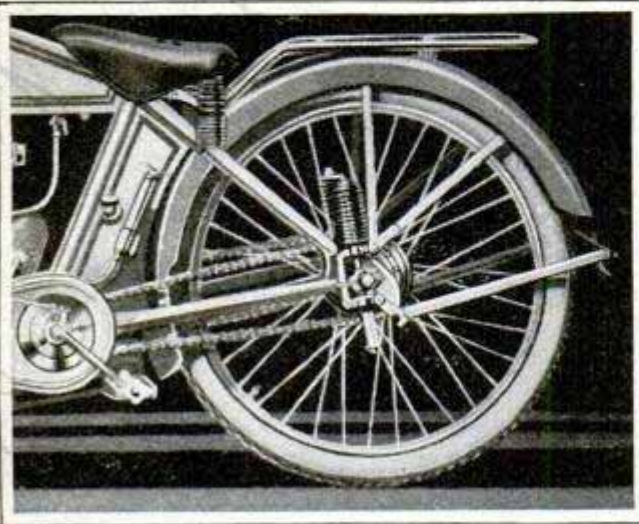

One of the Latest Types of Motorcycles

sion, a device which absorbs shock, insures greater safety and comfort, and results in a longer wheel and tire life than other forms of rear-spring suspension thus far employed on motorcycles. By its use, in combination with the spring fork shown in the illustration, the frame, motor and rider are completely suspended, and the only

idea of motion present in the mind of the rider is that of a quiet, forward glide, instead of shocks and jars incident to passing over uneven surfaces. The improved model also has a motor built with overhead valves, a feature which represents another distinct advance in motorcycle construction.

**PHOTOGRAPHING THE TIME IN
20 AUTO SPEED TESTS**

An example of a photographic method of determining the speed of an automobile is shown in the accompanying illustration. The photograph shows what appears to be two watches and two racing automobiles. It is, however, the same watch and the same car, photographed twice, and the method of the taking, and of determining the speed, are as follows: A stop watch is suspended on a bracket in front of a stereo-camera having two lenses and shutters arranged for independent operation. When the racing car rushes down the speedway toward the camera, the double picture is taken by snapping first one shutter and then the other, a distinct time interval being allowed. The stop watch indicates the time that

Photographic Method of Determining Speed. What Appears to be Two Watches and Two Racing Automobiles, is Really Two Exposures, the Movement of the Stop-Watch Hand Showing the Lapse of Time

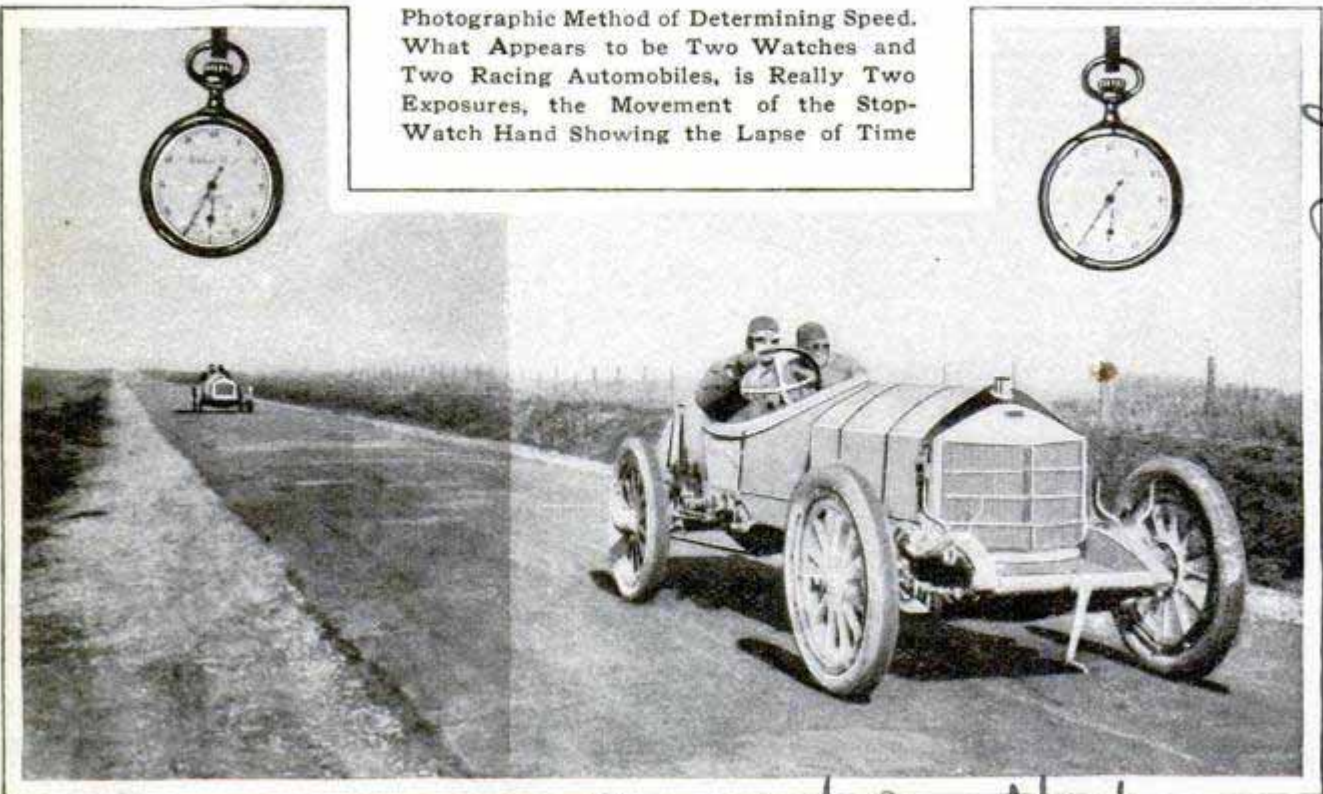

Motor Parkway, L.A.

Accepted by

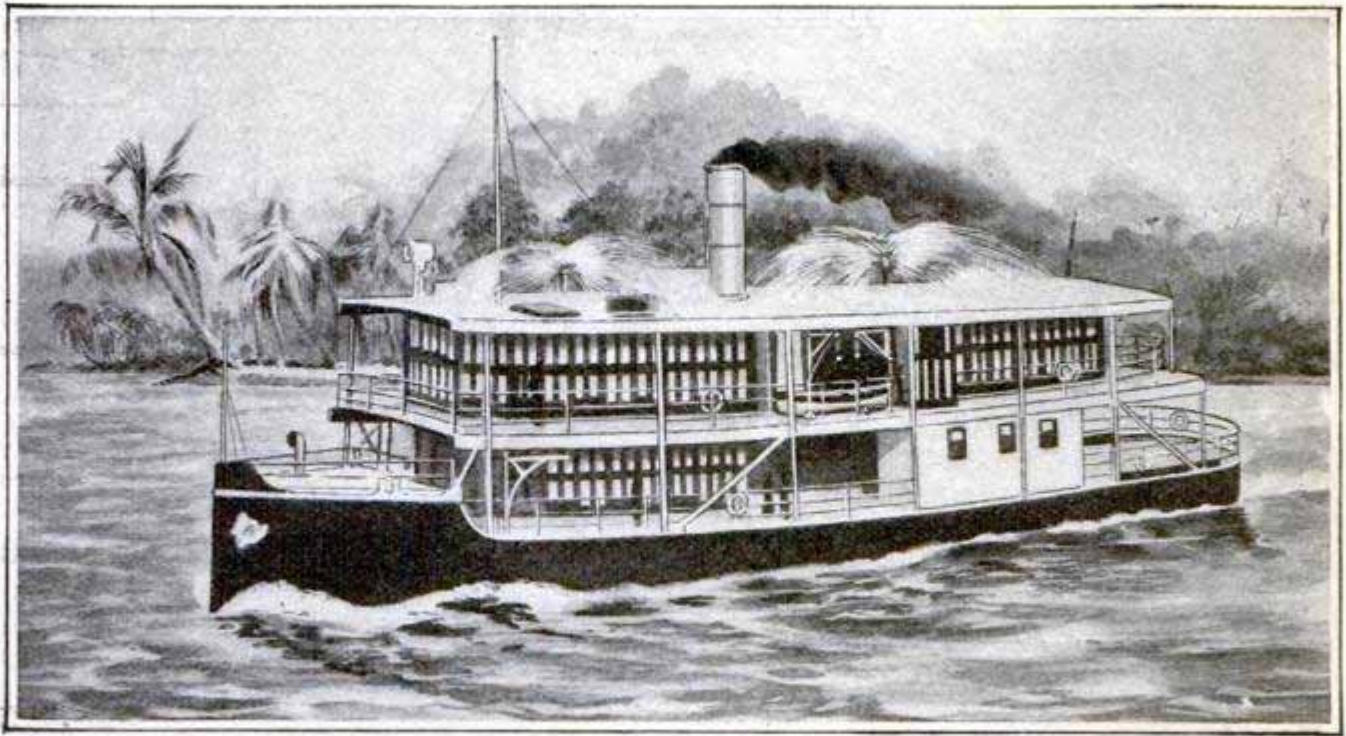

The Cabins of This River Steamer are Kept Cool by Fountains That Play on the Roof Awning

elapses between the exposures, and the distance traveled by the automobile is ascertained by considering the focal length of the camera, an exact measurement being made on each negative, compared with a previously prepared scale.

The illustration shows Ralph Mulford driving a racer on the Long Island motor parkway. The distance covered between exposures was 151 ft., and the hand of the stop watch is shown to have advanced just one second, which gives a speed of 102.95 miles per hour.

STEAMBOAT PROVIDED WITH 325 ARTIFICIAL RAIN "

The shallow-draft passenger steamers built by an English shipbuilding concern for river service in the tropics are equipped with "artificial rain." Up through the awning forming the roof of the upper cabin project two water pipes, each of which is fitted with a spray head. These fountains throw sprays of water over the awning, and the rapid evaporation under the hot rays of the sun keeps the cabins cool.

119 BRIDGE PIERS BUILT BY 7 SPOUTING CONCRETE

Building the piers of a new bridge by dropping the concrete down through a long pipe from the deck of the old bridge was an original method of engineering recently employed in constructing a large railroad bridge over the Ohio River, at Louisville. By using short tapered sections of pipe coupled together the many batches of concrete were successfully dropped the entire distance of 115 ft. to the pier foundations without injuring the quality of the building material.

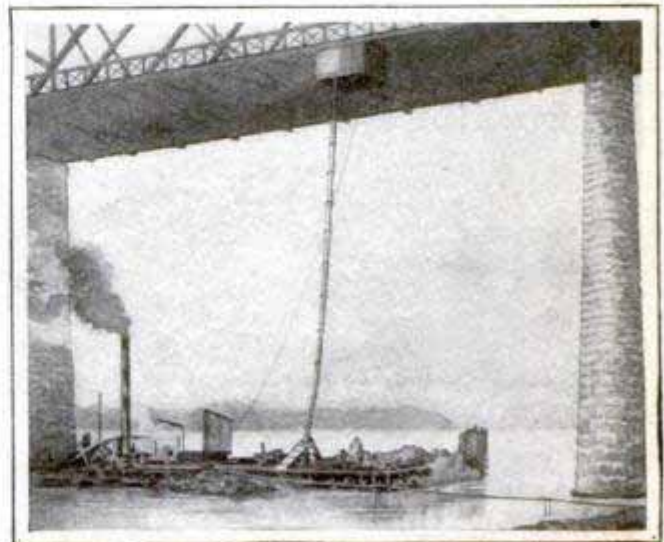

Courtesy Railway Age Gazette

Building Bridge Piers by Dropping Concrete through Pipe

32 35

THE NEW POTATOLIKE VEGETABLE

This queer-looking vegetable is the "dasheen," a food plant the seed of



which is now being distributed in all parts of the country by the Agricultural Department. It is a semitropical vegetable which may be prepared and eaten like potatoes, and, with its hairy skin peeled off, resembles a potato in appear-



Semitropical Potatolike Vegetable being introduced by Agricultural Department

ance. The taste of this vegetable is very "meaty" and rich.

STEEL CABLE TIES ITSELF INTO ODD KNOT

This peculiarly shaped knot of cast-steel wire rope was tied by itself when

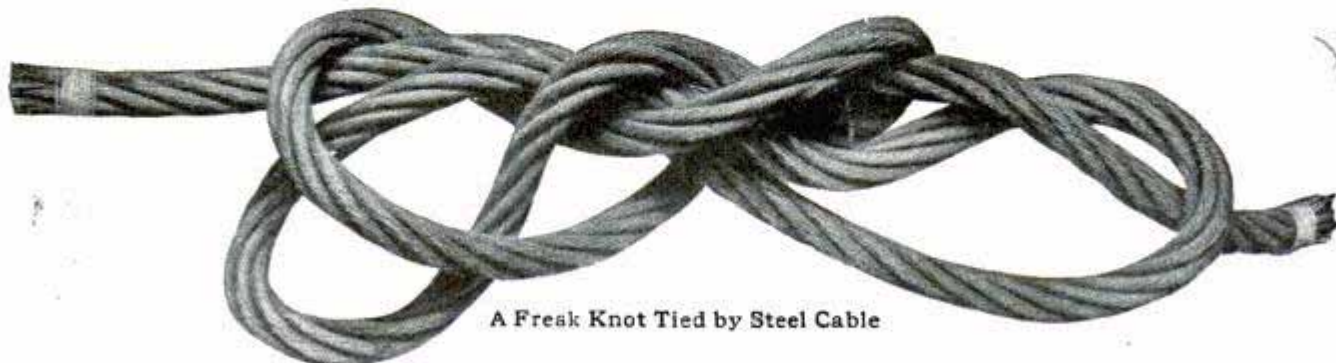

A Freak Knot Tied by Steel Cable

the shaft engine of a coal mine met with an accident whereby the drum

was set free and the rope and cage began to fall. The rope, which was finally torn from the drum and drawn into the shaft, at some point along the course looped itself into the knot seen here without breaking a single strand of wire. The cable was 1,280 ft. long, $\frac{7}{8}$ in. in diameter, and was made of six strands of No. 19 gauge wire wound around a Manila-rope center.

Isas Review Feb. 1913

COST HALF A CENT A MILE TO RUN MOTORCYCLE

3406
 Figures carefully kept for a period of nine months of the cost of the operation of a motorcycle by a resident of Ohio showed a total cost of only \$25.48 for traveling 4,172 miles. This expense covered gasoline, oil, repairs and all other actual expenses, but not depreciation of tires or the working parts of the motor. Forty-four gallons of gasoline were used at a cost of \$9.47 and 10 gal. of oil, which cost \$10.26. Repairs cost \$5.75. The total expense, in proportion to distance traveled, figured out about one-half cent a mile.

MANUFACTURING LIGHTING GAS FROM SEWAGE

167
 Lighting gas is being manufactured from sewage at a plant especially constructed for the purpose in Brünn, Austria. A cubic meter (about 35 cu. ft.) of sewage contains on the average $\frac{1}{10}$ lb. of sludge, and it is from this sludge, resembling peat when dried, that the gas is obtained. About 37 tons of dry sludge are being treated daily by

the plant, yielding 290,863 cu. ft. of gas and 610 lb. of ammonia.

NEW COLORED MOVING PICTURES

A well-known firm has just succeeded in applying the three-color process of color photography, invented some years ago, to moving-picture films, and the results are far superior to any seen up to the present time. The method employed in making the picture is to take three photographs at the same time through different-colored screens, and then superimpose the three films. When a strong light is cast through the combined films the various tints are seen with extreme exactitude. The pictures are a quarter the size of the usual film, so that they are quite small, and the rolls consequently shorter. At present the endeavors of the firm seem to have been concentrated on landscape and flower photography, and such a high state of perfection in reproducing colors has not been obtained in other fields. The flowers in vases, revolved before the camera, come out on the white screen with perfect stereoscopic effect.

AN AERIALY PROPELLED WATER GLIDER

The Bleriot concern in France is experimenting with an interesting type of craft called a water glider. It has

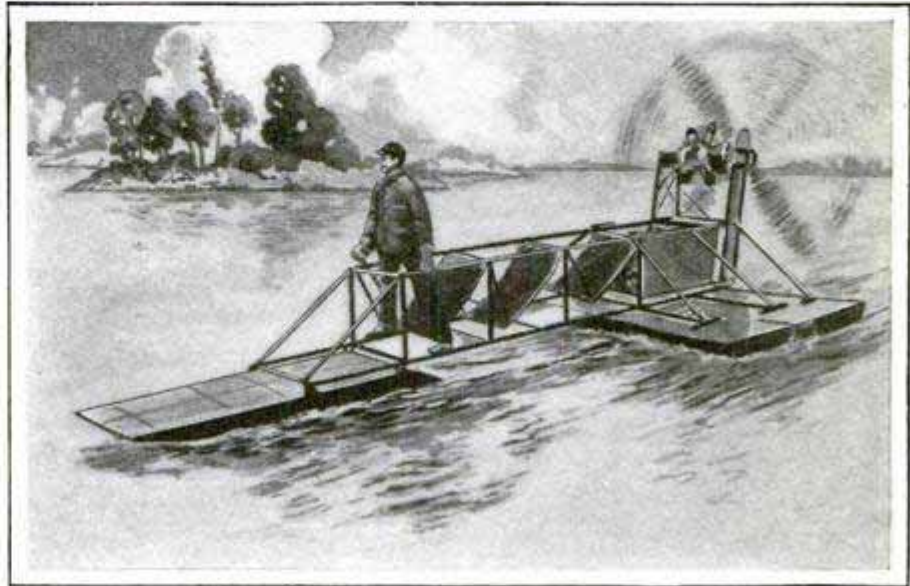

A Water-Glider Type of Motorboat Designed by Bleriot

three floats, one in front, and two in the rear, connected by a sort of bridge, on which there are three canvas seats of the reclining-chair type. This machine, driven by an aerial propeller, is said to attain an exceptionally high speed.

Ⓒ Natural butterfly wings mounted between sheets of rock crystal are a new jewelry fad.

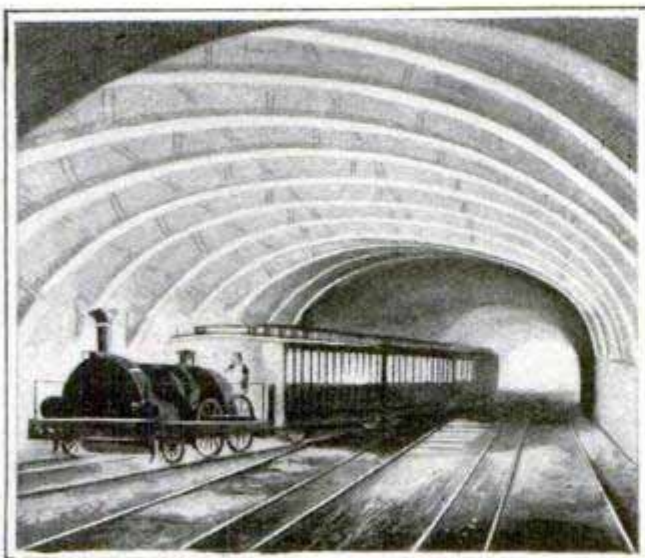

Courtesy The Sphere, London
The Train That Opened the Service in the London Subway 50 Years Ago

FIRST UNDERGROUND RAIL-

3245 ROAD *metropolitana*

London recently celebrated the 50th anniversary of the first underground railway built to facilitate passenger transportation in a city. The first section of the London "underground" was opened to the public in 1863, and the accompanying illustration shows the first train. The locomotive is a six-wheeled tank engine designed to bottle up its steam and smoke, so as to keep the air in the tunnel clear.

Steam locomotion did not give way to electricity in the London subways until 1906.

COMBINED WIND AND TREAD MILL OPERATES MINE

3268-03
A curious windmill is used to hoist coal out of the mine shaft and to pump water from a mine at Cherryvale, Kan.

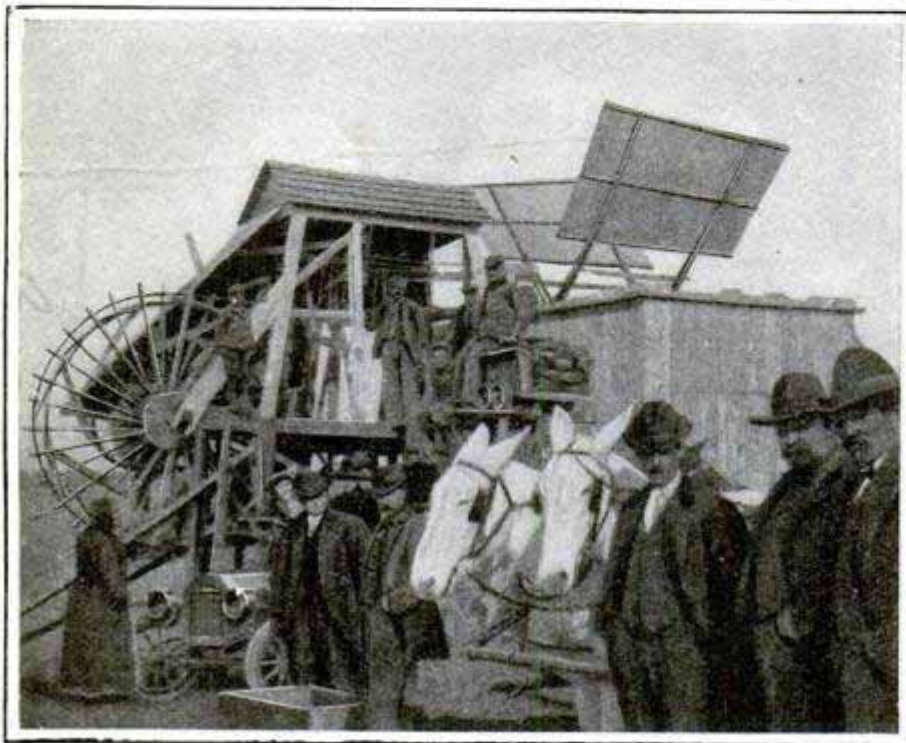

Unique Wind and Tread Mill Used to Hoist Coal and Pump Water from a Mine

There are four vanes, each being 7 ft. long by 4 ft. wide, mounted on a horizontal shaft extending east and west, the prevailing wind being from the south. When the wind blows from the north, a system of shifting belts reverses the driving apparatus. A wind blowing from the east or west is useless.

One of the curious features of this unique outfit is the tread wheel. When the wind is too light the load is hoisted by walking upon this wheel. The owner of the mine claims that the windmill will hoist a half ton of coal with a 10-mile wind. With a 20-mile wind, 100 loads can be hoisted in eight hours.

9717
With a new ignition device for gasoline engines, called a "synchronizer," and designed to take the place of a magneto, it is possible to obtain either a vibrating or a nonvibrating spark, the first being used for starting and the second for steady running.

GERMANY'S NEW LAW ON FIREARM MARKS

3332
3240
The German government has passed a law prohibiting the passage through its custom house of any firearm that does not bear a mark showing that it has been thoroughly tested and fired by the makers. At the custom house a chart is kept on file showing the various gun-manufacturing firms whose proof marks are registered in Germany. Other firms in London, Manchester, Paris, Liege and St. Etienne are included, but no American manufacturer is represented. For this reason the manufacturers of all American guns exported to Germany should apply to the Bundesrath, Berlin, for the registration of their

proof marks. The application should give a picture of the marks and indicate where they are situated on the guns, together with the caliber and other important details of the firearms. The new law is intended to protect the public from using firearms that are unsafe.

THE OLD IRON SIDE-WHEELER "LADY OF THE LAKE"

There are several reasons why this old side-wheel passenger boat is of interest. In the first place this illustration is reproduced from a photograph taken 46 years ago, just before the vessel was launched into Lake Memphremagog, located just over the Vermont border in Canada. Secondly, her hull is of solid iron, and iron hulls were not particularly numerous in 1867. Then again, she was built in sections in Scotland, shipped across the ocean in one of the Canadian transatlantic liners, and put together at the point shown in the

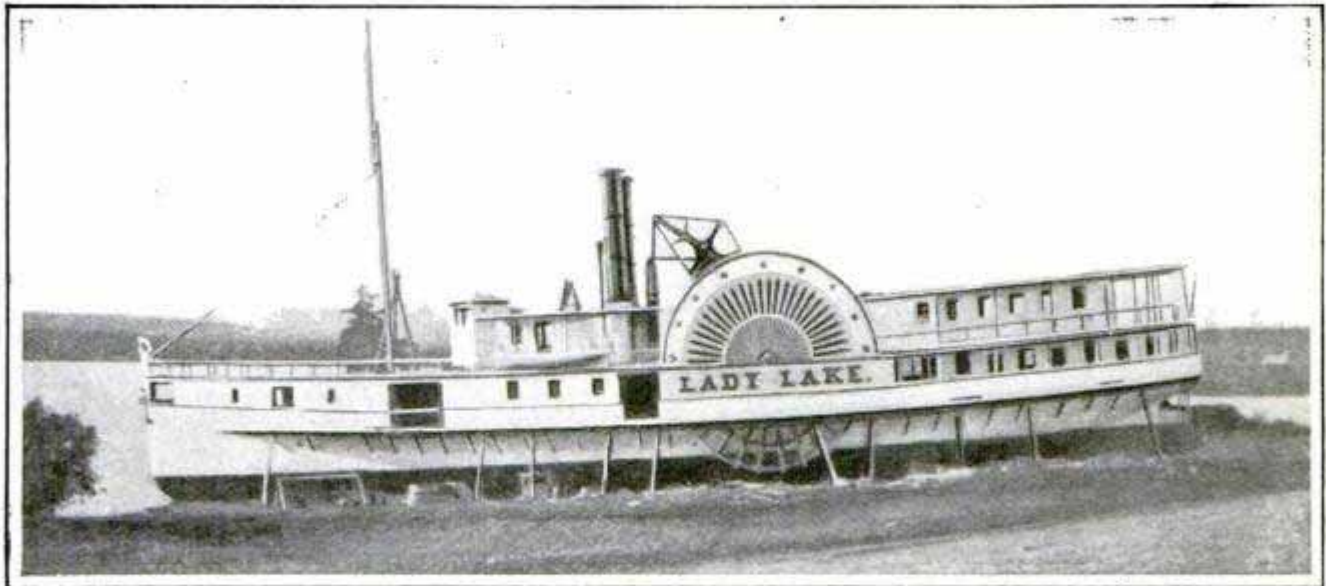

Iron Side-Wheeler Built Nearly a Half Century Ago in Scotland, and Shipped to Canada in Sections

illustration. Finally, she is still being used on Lake Memphremagog, and

there is every reason to believe that she will run many years more.

CATHOLIC CHURCHES TO BE CONNECTED BY WIRELESS

330 If the different governments interested do not make too serious a protest, the principal Catholic churches of Italy, France, Austria, and perhaps several other European countries, will be connected with the Vatican and with each other by wireless. Cardinal Maffi, archbishop of Pisa, who is prominent as a scientist, has been carrying on the experiments and has already communicated successfully with the Jesuit church in Gratz, Austria, following which the Austrian military authorities ordered the immediate demolition of the station, fearing that it was intercepting army messages. Cardinal Maffi is unofficially striving to convince the authorities that his wireless system is specially attuned and that the intercepting of messages from other sources is impossible.

NEW YORK'S NEW AUTOMOBILE STREET CLEANER

The street-cleaning department of New York City, in an effort to find a more efficient method of cleaning the

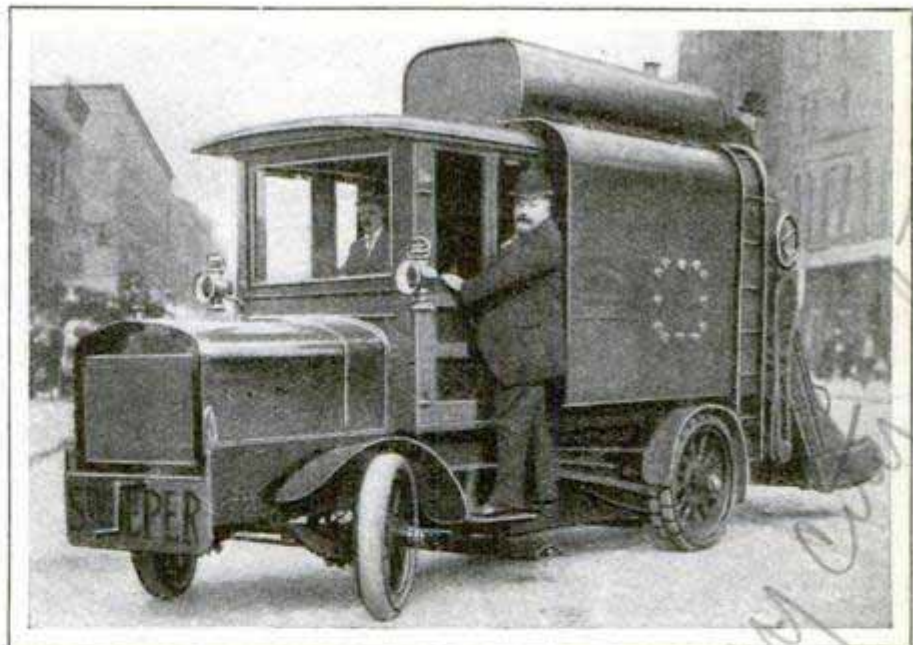

Photo by Paul Thompson

How New York is Cleaning Her Streets

streets of this great metropolis, is testing a street cleaner mounted upon a motor truck. It will be observed that the vehicle has a steel-toothed scraper, for loosening hard snow, ice and refuse, attached beneath the body.

WATER TANK MADE FROM A BUOY

The rather odd water tank here shown was originally a buoy that was rejected on account of some defect and

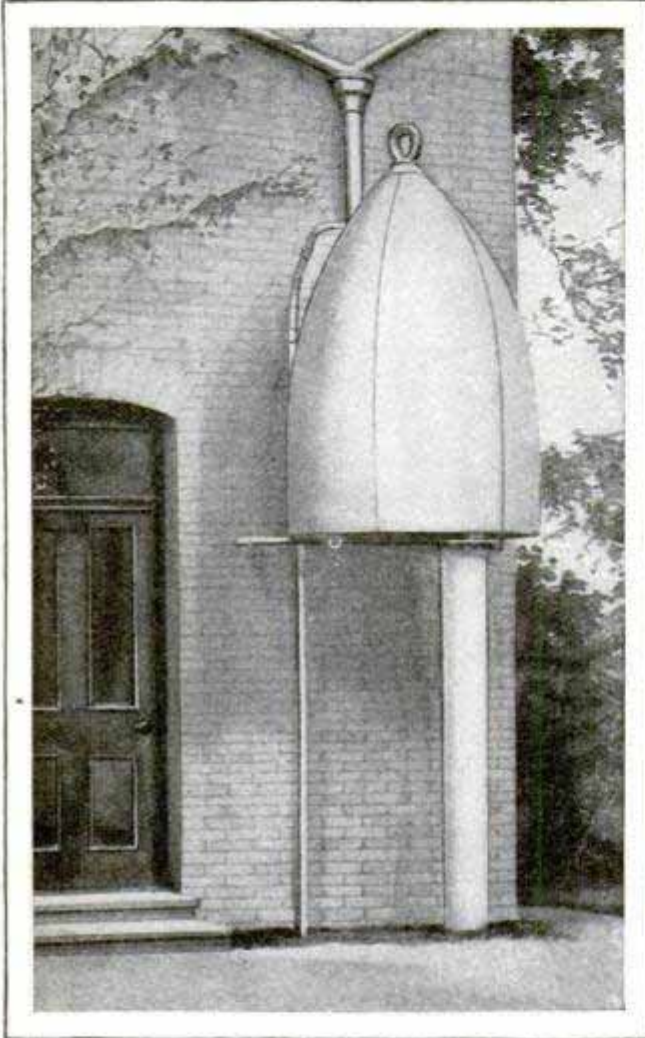

Water Tank That Originally was a Buoy

returned to the manufacturer. A householder saw the discarded piece of ironwork some time afterward and, after having bought it, had the conical-shaped vessel erected as a water tank in front of his home.

SHIPLOAD OF OATS CHANGES BALANCE OF TRADE

One shipload of oats arriving at the port of Tripoli, Africa, last December changed the balance of trade between that country and the United States in favor of America. The cargo was shipped from Newport News November 22, on the steamship "Corozal," which arrived at Tripoli December 12

and attracted much attention, as it was the first American freight steamer ever seen in that port. The cargo of oats, valued at \$128,608, was consigned to the Italian government, which is making preparations to provide adequate terminal facilities in its new possessions in Africa to encourage foreign trade.

HOW SAVAGES MAKE MILK OF COCOANUTS PALATABLE

Improving the quality of the milk from coconuts by cutting off the tops and placing the nuts over a bed of hot ashes until the warmth causes the "butter" in the surrounding meat of the nut to be absorbed by the milk is a method used by natives along the Orange River in South Africa. According to the Illustrated London News this treatment changes the quality of the raw milk of the nut and gives it a more palatable taste. In order to prepare the milk from several nuts at one time the Hottentots convert old iron hoops into crude holders like the ones here shown.

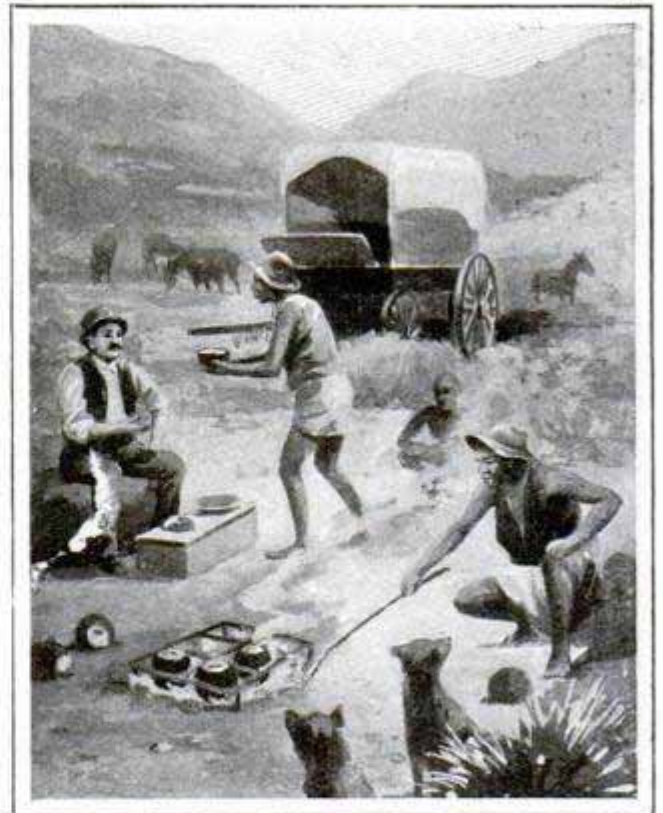

Enriching Milk from Coconuts by Heating Them over Hot Ashes

AN ARTISTIC BUNGALOW THAT COST ONLY \$4,500

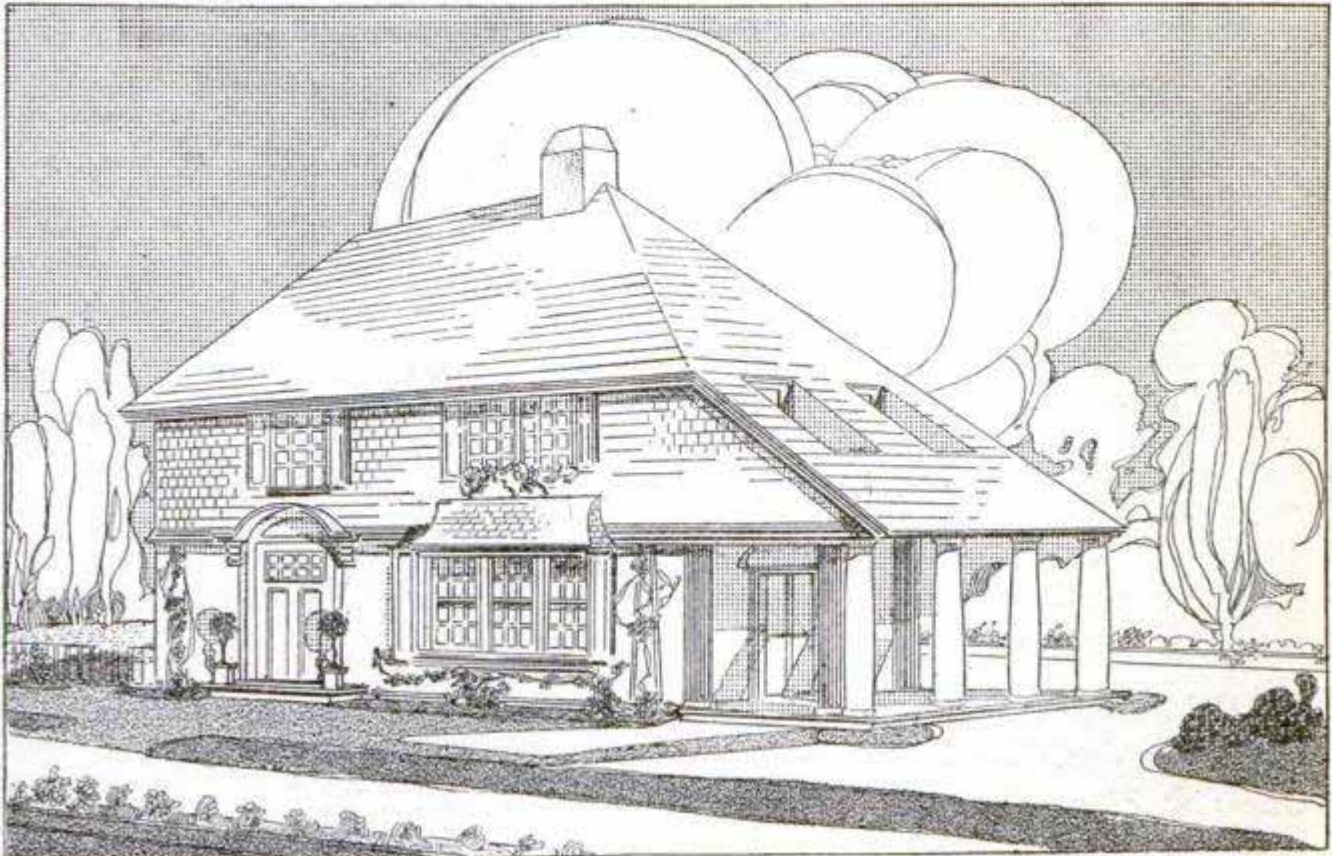

Wm. F. Leppin, Architect, Brooklyn, N. Y.

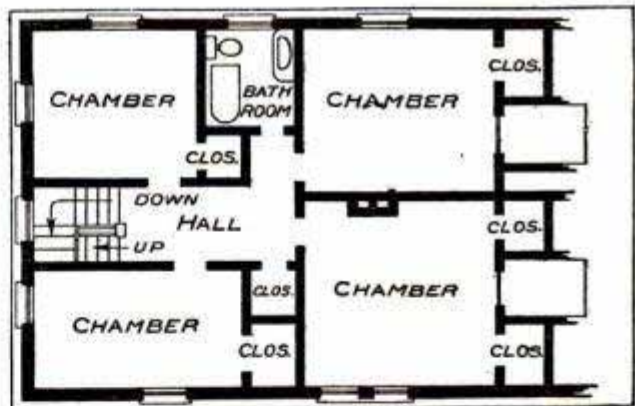
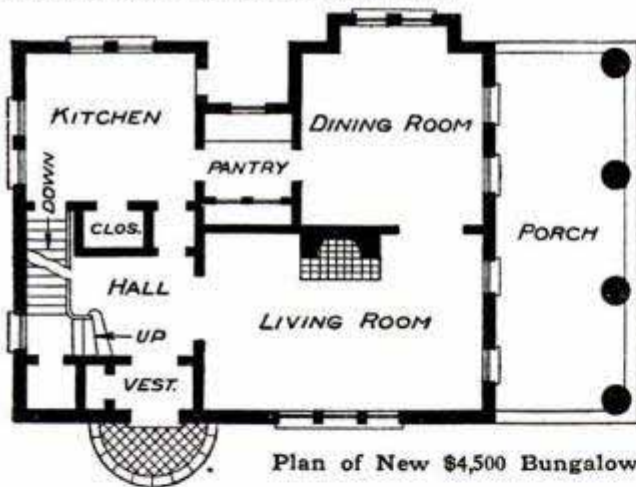

Plan of New \$4,500 Bungalow Being Built Near New York City

This design for a \$4,500 bungalow being built near New York City provides for the following arrangement on the first floor: living room, 13 by 20 ft.; dining room, 13 by 13 ft.; kitchen, 11 by 12 ft.; pantry, 7 by 8 ft.; a hall, closets and a porch, 12 by 30 ft. The second floor contains four bedrooms averaging about 11 by 14 ft., a bathroom, hall, and the necessary closets.

CHINA USING TYPEWRITERS IN LARGER NUMBERS

There has been a steady increase in the use of typewriters among Chinese business houses, due to the recent changes in Chinese political and commercial organizations. Exporters of typewriting machines report that for-

eign firms in the open ports are also increasing the use of this labor-saving device, since a number of Hongkong schools are producing a large and increasing force of capable Chinese stenographers. About 500 typewriting machines are already in use among the more conservative commercial houses in Hongkong.

PARCEL-POST SCALES SHOW AMOUNT OF POSTAGE ⁹⁸⁷

These scales, designed especially for the parcel post, indicate automatically, according to zones, the amount of postage required for the package weighed by it. When the package is placed upon the scale, the hand on the dial not only shows its weight, but also the amount of postage required for all the postal zones.

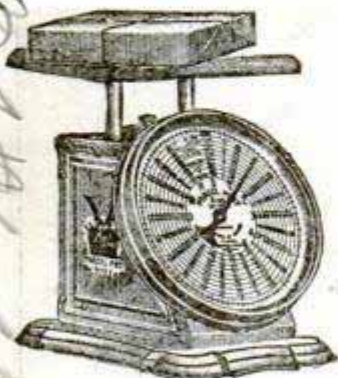

HOW RAPIDLY GASOLINE EVAPORATES

One pint of gasoline left in an uncovered basin in a room at a normal or average temperature will entirely evaporate within 24 hours. As gasoline vapor is denser than the surrounding air, unless disturbed by active air currents its presence in the room may be detected for many hours. One pint of gasoline will make 200 cu. ft. of explosive mixture and this mixture is seven times more powerful than gunpowder.

ELECTRIC BLANKET FOR AUTO RADIATORS ⁹²⁶

A simple and effective device for preventing the freezing of the radiator, and other parts of the cooling system

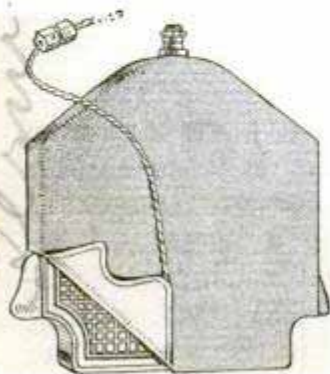

of an automobile, while the machine is standing in a cold garage, has been put on the market in the form of an electric radiator blanket. It comprises two thicknesses of cloth between which are

placed a number of fine, flexible resistance wires, connection being made by means of a flexible wire to a screw plug. When the machine is driven into the garage, all that is necessary to do is to place the blanket over the radiator, screw the plug into the nearest fixture and turn on the current.

DETECTS CARBONIC OXIDE GAS IN THE AIR ⁹⁷⁷

A simple and reliable device for automatically registering the presence of carbonic oxide in the air is shown in this diagram. It consists of a closed U-shaped tube containing a small quantity of colored fluid, terminating in bulbs, one of the bulbs being covered with a substance which absorbs the carbonic oxide gas and thereby becomes more or less heated, according to the quantity of gas present. When this happens, the air in the side of the tube topped by this bulb also becomes heated and expands, forcing the fluid to rise in the other tube.

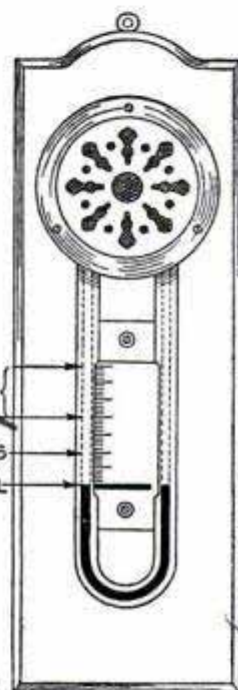

Carbonic oxide is a gas which occurs when coal is burned without a sufficient supply of air, and is often present in rooms heated by coal stoves.

AIRSHIPS OF LARGER SIZE BEING BUILT ⁴³⁶

The new airships being constructed by the German government will have a larger carrying capacity than those built heretofore. Each of them will accommodate a crew of 15 persons, several tons of explosives, two machine guns, and all of the new vessels have been designed to remain in the air for at least 60 hours without landing.

Zeppelein

OLD CARRIAGE BODY USED FOR AUTOMOBILE

109 One of the "classiest" automobiles seen on the boulevards of Chicago has a body that was once part of a horse-drawn brougham of rare design and workmanship. The automobile in question is the property of Harold F. McCormick, John D. Rockefeller's son-in-law. The brougham, built by a famous carriage builder, was a favorite with Mr. McCormick, so he had the body mounted on an automobile chassis. Two men in livery, the driver and a footman, ride on the front seat, as in the days when the brougham was horse-drawn.

THREE HUNDRED THOUSAND DOL- LAR ALBUM

1193 A wealthy citizen of Budapest, Hungary, has an autograph album which contains the finest collection of modern autographs in the world. The leaves of the volume, which is about 10 in. thick, are covered with signatures and sentiments written in 44 different languages. The collector has spent more than eight years' time and over \$70,000 traveling about the world to secure the contents of his remarkable book, for which he has refused the sum of \$300,000.

¶The new street cars for Ottawa, the capital of Canada, have floors of double thickness, with tarred paper between. This makes the cars much warmer than does the old-style single floor, and also muffles the noise of the motors and running gear underneath.

Electrical News

PLAGUE GARMENTS OF THE PAST AND PRESENT

Hundreds of years before germs were discovered physicians knew from experience that certain diseases could



The Plague-Proof Garments of 1656 and 1911

be contracted by contact with the sufferers, or by breathing the same air. Accordingly, in times of plague, contamination was guarded against by the wearing of plague-proof garments. The garment worn about the time of the plague in Rome, 1656, was not dissimilar to that worn by the cholera workers in Manchuria in 1911, but the birdlike face-covering is unique.

¶An "emergency squadron" of motorcyclists has been established by a motorcycle manufacturer for the purpose of repairing the vehicles of any motorists who may be stranded upon the roads adjacent to New York City.

NOVELTIES AND ODDITIES, USEFUL AND ORNAMENTAL,

A lamp, designed for lighting the interior of an automobile equipped with a canopy top, has a shutter, which, when closed, protects the bulb from being broken when the top is raised or lowered. The shutter is shaped like a cylinder and the inside is silverplated, thus

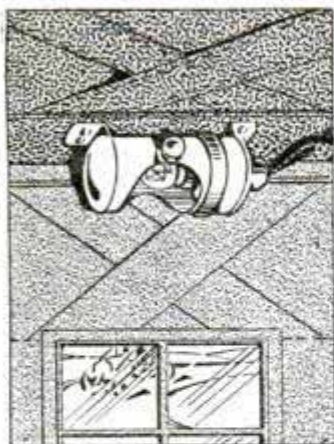

Canopy-Top Lamp for Motor Cars

making an excellent reflector.

An ingenious automobile headlight "glare remover" consists of a round pane of amber-colored glass so mounted



Motor-Car Headlight-Glare Remover

upon the windshield that, by looking through the amber glass, the glare of approaching headlights is effectually removed without ob-



Microscope Lamp of New Design

structing the view of the road and the motor car that may be approaching.

A new lamp, especially adapted for microscopic examinations in hospitals and laboratories, is one that has a knuckle joint at the top by which the lamp can be adjusted to any



Address Book for Retail-Store Customers

desired angle. The long, conical reflector has been found most useful in concentrating the light upon the object to be examined.

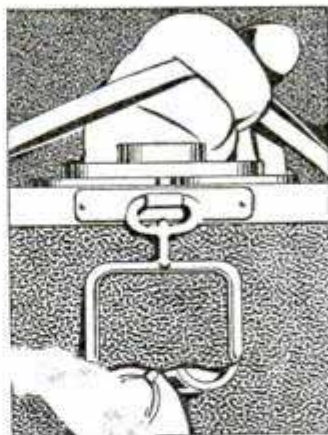

Pay Enter Purse men

with the customer's name and address printed on each label, which is covered with wax-paper protectors. The customer, when making a pur-

One of the latest and most useful novelties on the market is a customer's address book containing 100 gummed labels



Makes Water Hot in Sixty Seconds

chase that is to be charged, simply detaches a label and hands it to the salesperson for attaching to the sales sheet, thus making wrong

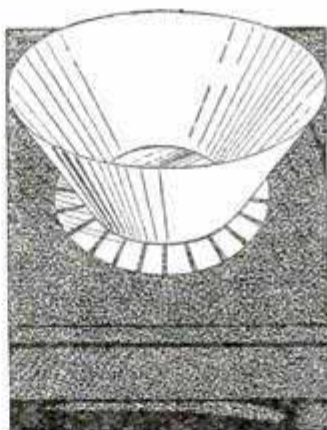

Sanitary Paper Dish for Ice Cream

delivery impossible.

A purse for holding four nickels in such a way as to be easily and quickly withdrawn when boarding cars, even though the hands are gloved, has been placed on the market. The

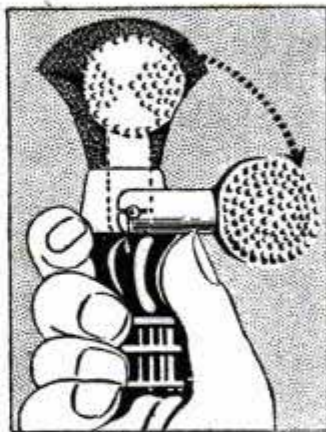

Shaving Brush and Beard Softener

novelty is snapped

*Overland Co. Battery 116 Market St. St. Louis
 Lewis St. Boston Mass.
 Prof. W. H. W. Cardiff Wales
 Kansas City Mo.
 Howard Mfg. Co. 427 Hudson St. N.Y.C.*

*Gule Purse Co. Kansas City Mo.
 American Water Sup. Co. 127 Broadway St. Boston, U.S.A.
 Howard Mfg. Co. 427 Hudson St. N.Y.C.*

troublesome cardboard cap, can also be employed as a stopper for the bottle and is, for sanitary reasons, made entirely of metal.

At the last automobile show in New York City there was on exhibition for the first time a motor car having one headlight built into the front frame, just above the radiator, instead of two lamps in the usual position. The new type of lamp, which may be equipped to use either acetylene or electricity, is shown in one of the illustrations.

By the use of an ingenious egg cooker, which is constructed upon the order of a chafing dish, eggs may be boiled, poached, or steamed at one and the same time. The eggs to be poached are dropped into little cups and the heat is obtained from a small alcohol lamp beneath the cooker.

An indoor clothes reel is 3 in. in diameter and is equipped with 15 ft. of stout braided cord wound up inside a dust-proof metal cabinet. The line is put up by drawing out the ring at the end of the cord and attaching the cord to hooks on the wall. The line is taken down by removing the cord from the hooks and rewinding it into the cabinet by turning the reel.

The blade of a new spade for cement construction, such as walls, piers, abutments and all other exposed sur-

faces, is designed to force back the stone from the form, thus leaving a space which is quickly filled by the freer cement, sand and water, producing the smooth surface so much to be desired in concrete construction. The projections on the blade are sufficiently high to give a suitable thickness to the smooth surface for all requirements.

A handy oilcan for engineers is provided with a funnel and automatic shut-off. The combination receptacle prevents overflowing the oil tank and spilling the liquid over the engine and other parts of the machinery.

A pendant for preventing the breaking of gas mantles by vibration has been invented. The device is so arranged that the lamp is partly suspended by means of a spring which absorbs the jars and vibrations, thus extending the life of the mantle without interfering with its incandescent properties.

A signaling device recently invented for motorists consists of a small red lamp attached to the back of an automobile glove with a small battery in the lower side of the gauntlet. The lamp is lighted by bringing the thumb and forefinger together, the driver at the same time extending his hand out from the car's side to warn drivers behind of a turn or stop.

ELECTRIC SIGN THAT TALKS

A distinctly new type of electric talking sign which continually builds up words, letter by letter, at the right end of the sign, from a perforated tape, and



Electric Talking Sign That Automatically Reproduces New Words from a Perforated Tape

then moves them to the left end where they disappear, letter by letter, has been invented by a resident of Michigan. The device consists of a bulletin

board, behind the entire display surface of which is fastened vertical and horizontal rows of lights, and a controller for producing the flashes. There is a contact on the controller corresponding to each light, and over these contacts there is permitted to pass an endless tape perforated with holes to correspond to the desired letters and words; the principle of the operation being the same as that used in player pianos, except that the action is electrical and not pneumatic. The tape or ribbon can be perforated to reproduce any style of type, or any language, symbol or design, and the copy may be changed as often as desired. The operation of the sign is entirely automatic and requires no attention other than

J. W. Everett H. Buckley

setting the starting and stopping mechanism, and changing the reel of tape when the display of new copy is desired.

SIMPLE METHOD OF ROUGHLY MEASURING GRADIENTS

A motorist often has cause to desire a fairly accurate idea of the steepness of a gradient, and a simple method of making a rough measurement is shown in the drawing. The person desiring to estimate the gradient takes a stick or some other straight instrument, holds it out horizontally, sights along it, and notes the point where an imaginary line extending from his eye would hit the ground. Assuming the height of the person, to the height of his eyes, to be 5 ft., and the distance from his position to the spot where the imag-

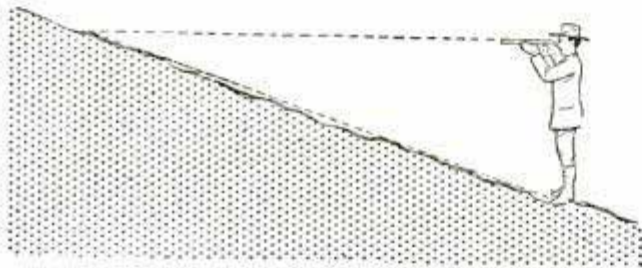

A Simple Method of Obtaining a Fairly Accurate Measurement of a Gradient

inary line from his eye hits the ground to be 17 ft., the average gradient would be 1 in $3\frac{2}{5}$.

The sighting stick must, of course, be held absolutely horizontal, and it is, therefore, advisable to have a companion who will say when the sighting is correct.

AEROPLANE STARTING CRANK AND MUFFLER

An engine provided with a starting crank similar to that of the automobile engine, and also with an adequate muffler, is being used on Burgess aeroplanes. Without leaving his seat, the airman gives the motor a half turn, thus starting it. The magneto used is so constructed as to give as hot a spark when retarded as when fully advanced, thus making it possible to start the motor with the magneto.

Startervant motor

The muffler, which is located just beneath the lower plane, is said to be

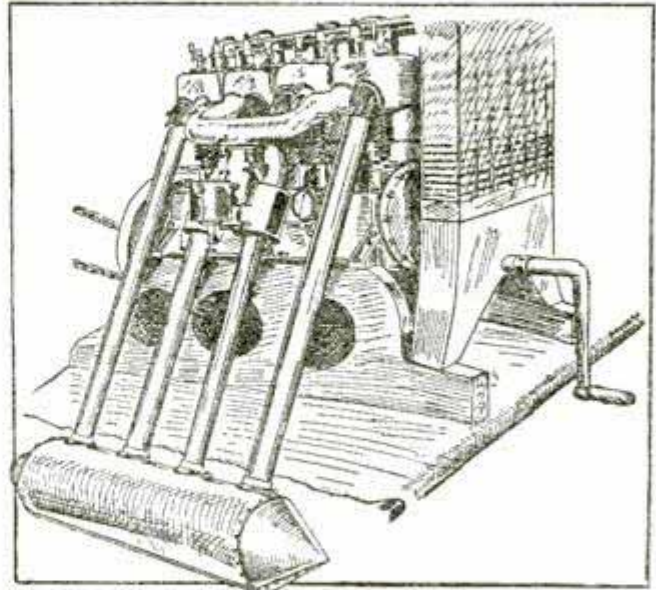

Courtesy Aeronautics

An Aeroplane Engine Provided with Simple Starting Crank and Muffler

so effective that the only noticeable noise is that made by the chains driving the propellers. The portion of the plane through which the exhaust pipes pass to the muffler is formed of aluminum plates. It is claimed that the muffler does not reduce the power of the motor more than four or five per cent.

EGG CRATE FOR THE COAT POCKET

This pasteboard carton for holding a dozen eggs should appeal especially to the commuter who desires to take eggs home in his pocket rather than carry the package by hand, although the carrier is equally useful otherwise. The carton opens and closes like a

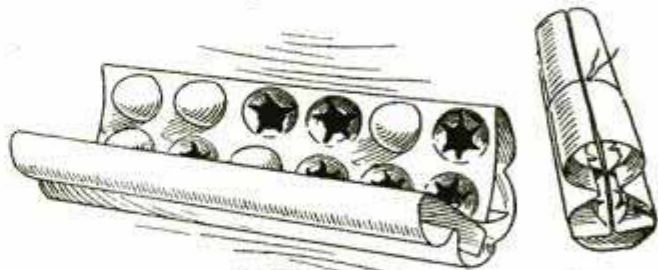

Carton for Carrying Eggs

book; contains but two rows of holes, and is, therefore, sufficiently narrow to slip into the ordinary coat pocket with ease.

Cart. Co. Inc.

AN ILLUSION OF BOWLEGS AND KNOCK-KNEES

Were it not possible to immediately prove the assertion, it would seem almost foolhardy to insist that the bow-

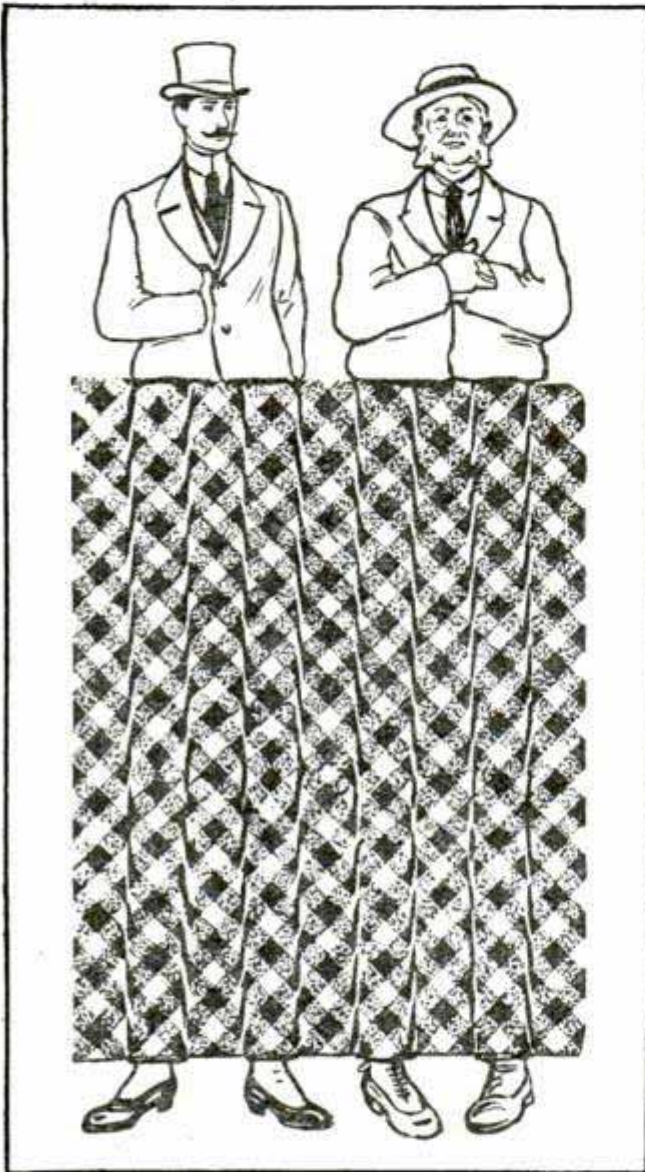

Appearance to the Contrary, These Legs are Perfectly Straight

legs and the knock-knees of the figures here shown are really only an optical illusion. By holding the page horizontally, near the level of the eyes, and sighting along the outlines, the legs will be found perfectly straight.

A. P. Lawrence

¶The professor of chemistry at the Royal Academy, London, has found that the surest way of determining the age of a painting is to analyze the pigments. The ingredients used by the painters, as well as the proportions, have been found to vary in the different ages of painting.

COLUMBIA-RIVER DAM TO PRODUCE 300,000 HP.

To harness the Columbia River, at Five Mile Rapids, about 190 miles from its mouth, thereby establishing the largest water-power plant in the world, is the plan of Oregon's state engineer. The cost of this undertaking is estimated at \$23,000,000. It is proposed that Oregon and Washington, having equal shares in the water of the Columbia, shall each pay half of this amount.

The plan calls for the construction of a dam at the head of the Columbia River gorge, the diversion of the stream through a canal about a mile and a half long, and a power house containing 21 turbines of the largest type now manufactured. The output of this plant will be 300,000 hp., which is one-tenth of the total horsepower developed in the world, according to the report of United States Commissioner of Corporations. Power can be furnished near-by consumers through electric transmission, at \$9 per horsepower year, it is stated.

With the canal cut through solid rock a fall of 74 ft. can be secured at low water. The river at this point has a mean annual flow of 235,000 second feet, as compared with about 73,000 near Keokuk, on the Mississippi River, 220,000 at Niagara, 664,000 at the mouth of the Mississippi and 115,800 on the Nile.

The dam at the end of the canal will be 150 ft. high and similar to the proposed emergency dam in the Panama Canal. It will consist of a number of wickets or steel beams, dropped from an overhead support to a nearly vertical position, fitting into a concrete shoulder at the bottom of the channel. Down the face of these beams will be rolled a heavy steel curtain. During flood times this curtain can be raised and the wickets removed, leaving no obstruction in the water.

Detailed plans for this plant have been drawn and numerous industries in the east and in Europe are ready to build plants on the Pacific Coast if the project is carried out.

screwed into the under side of the stair railing, attached one end to the pull-chain of the lamp socket, and at-

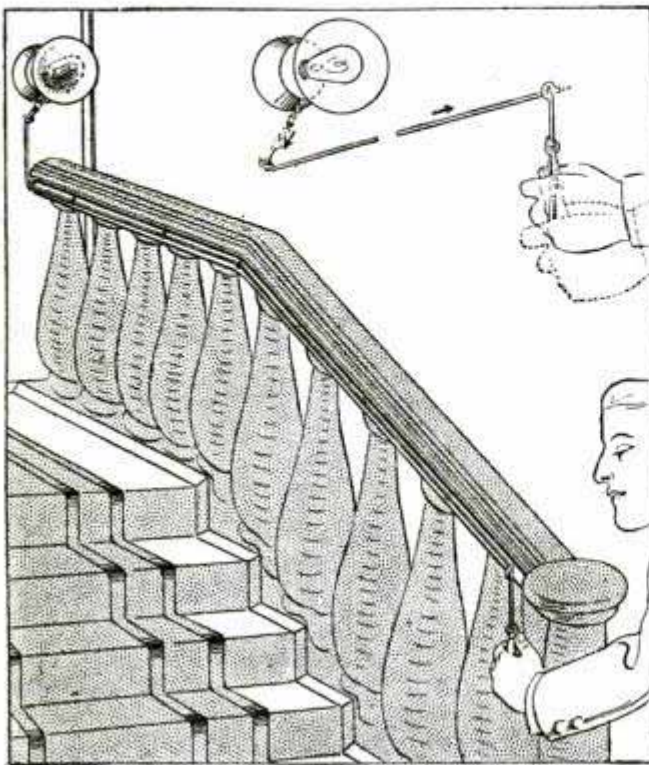

Fishline Control for Stairway Lamp

tached the other end to a handle, which was hung under the railing at the foot of the stairs. A slight pull turns the lamp on or off.

SHOCK-ABSORBING PLATFORM FOR RAILWAY CARS

An improved system of construction for protecting the ends of a railroad-car body in collisions and wrecks has been designed by a resident of Ohio. The construction is such that, in case of a severe shock, the platform and vestibule will collapse, forming a cushion space of almost 8 ft. between two cars, before the car bodies come together. In a train containing eight coaches this space would be more than 50 ft. of cushion construction, or, it is claimed, sufficient to absorb the shock and consequent damage before the cars containing the passengers could be seriously disturbed. This result is accomplished by fastening extension platforms to the center sills of the car body with rivets in such manner that these will shear when the car receives a shock of unusual severity. The steps,

vestibule doors and hood will also collapse when the rivets shear, thus tending to further absorb the force of the collision. The entire end of the car body is covered with a heavy steel plate which extends from the upper portion of the roof to the bottom of the end sill; this plate being provided for further strengthening the end of the car body, to hold the end posts in position and prevent parts of the vestibule from piercing the end of the car. The entire platform, vestibule, hood and sill extensions are made in one piece and may be attached to the car at any time after it is built.

PROJECTING SUBMARINE TORPEDOES FROM AEROPLANES

Admitting that the scheme is beyond the capacity of the ordinary aeroplane at present, but firmly believing that aeroplanes can be built that would be adequate, Rear Admiral Bradley A. Fiske, in command of the First Division of the Atlantic fleet, has invented a method of, and apparatus for, directing and delivering a self-propelled submarine torpedo from an aeroplane.

The torpedo, which may be of the Whitehead or fish type, is held in a rigid, horizontal position in a belt under the lower frame of the aeroplane. In making the attack, the airman flies at a comparatively high elevation to a point about two or three thousand feet from the enemy's battleship, then

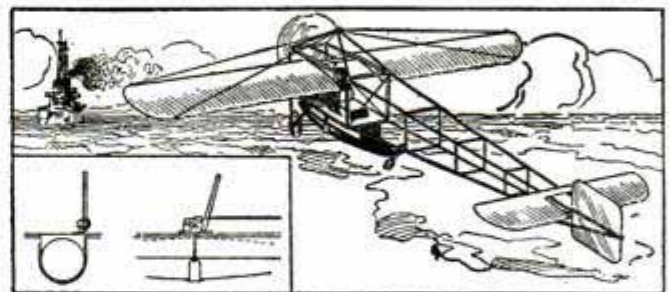

The Submarine Torpedo in Position. Insert Shows Method of Attachment

swoops downward as rapidly and as nearly vertically as possible until within 10 or 15 ft. of the water, meanwhile directing his flight so that, on reaching the desired low elevation, the

Barney & Smith Car Co
Dayton Ohio 3211

July 16, 1912
1.0 32. 39 &

nose of the torpedo bears upon the battleship. The throwing of a lever sends the torpedo on its mission, first starting its propelling mechanism and then dropping it into the water. From then on the torpedo performs its work in the usual way.

"The advantage of approaching the enemy's battleship at a relatively high elevation," says Rear Admiral Fiske, "and then swooping down to a low one for the release of the torpedo, is that it is practically impossible with present guns to hit an object swiftly falling from a height, owing to the resulting rapid change in range and consequent elevation of the guns.

"At the present time," he continues, "the torpedo boat has practically no chance to inflict disaster upon a battleship in the daytime. To such an extent is this true, that one never thinks of a destroyer attacking a battleship in the daytime, except under very peculiar circumstances. In the night, on the other hand, the battleship has very little chance against the destroyer, if the latter gets within torpedo range. It is the aim of my invention to attack the battleship in the daytime with the same kind of a torpedo that a destroyer carries, the approach being accomplished in such a manner that the guns of the battleship would have very little chance of hitting the aeroplane."

MACHINE FOR LAYING DUST IN MINES

To effectually lay the dust in mines, cement mills and other industrial plants where dust-laden air is objectionable or dangerous to the health of workmen, a new type of air moistener has been designed by an engineer of the United States Bureau of Mines. As shown in the illustration, the device consists of a hollow wheel mounted upon the shaft of an electric motor, which serves to rotate a steel fan set within the larger end of the machine. When the fan is set in motion and water is permitted to enter the hub of the wheel or drum, the water is drawn

forward by suction and forced, under a pressure of more than 200 lb. per square inch, out through the nozzles in

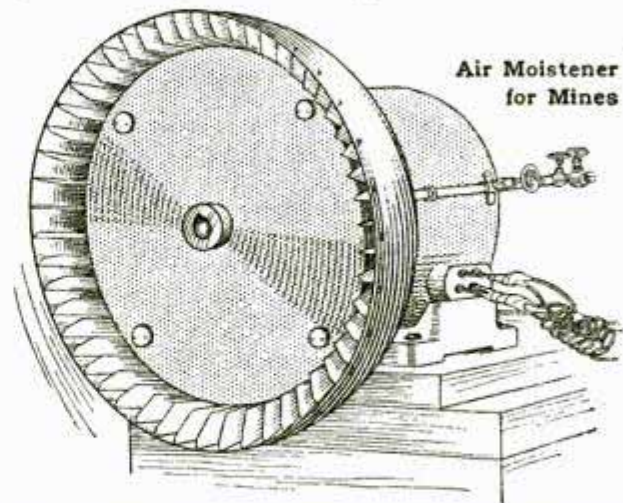

the form of a fine spray. The spray is still further broken up and diffused in the form of vapor by means of a secondary current of air, generated by another set of fan blades on the back of the wheel, and driven out between the rim of the fan and its surrounding box.

LUGGAGE FRAME FOR SIDE CARS

An exceptionally practical and neat luggage-carrying arrangement for the side-car type of motorcycle is here shown. The frame into which the luggage is set, supported by straps, is divided into a large and a small section,

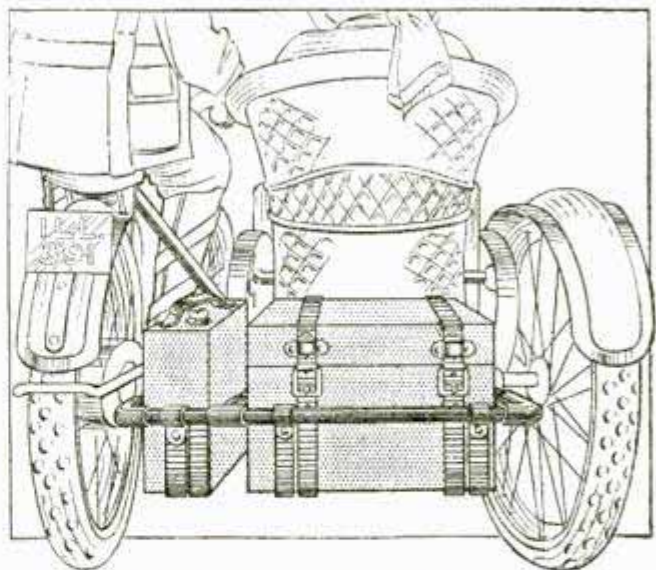

A Neat and Practical Luggage Arrangement for Side Cars

the larger section accommodating a trunk or box, and the smaller being for an extra can of oil, or similar article.

The maker

Osologna

PACKAGE RECEIVER UNDER MAIL BOX

In hotels, apartment houses and office buildings equipped with mail chutes the mailing of articles too large to go into the box usually involves leaving such packages on the floor or on top of the box, with much danger of loss by accident before the postman arrives. A Chicago hotel has solved the problem by attaching a large ornamental metal tray below the mail box.



mental metal tray below the mail box.

ONE OF MANY SPRING WHEELS FOR AUTOS

The particular merit claimed for the spring wheel shown in this illustration



is that the springs are so designed and located that, no matter how the load is applied, it is uniformly distributed over the entire number of springs at the same time. Any load or shock which has a tendency to distort the wheel or tire produces a movement of the outer and inner rims with reference to each other, that causes a slight elongation of all the springs.

HEAT RECEIVED BY EARTH FROM THE SUN

One square yard of the earth's surface receives each day averaging six hours of sunshine an amount of heat equal to that contained in 1.8 lb. of coal, according to an Italian chemist. At this rate one square mile would receive each day heat equivalent to the combustion of more than 2,600 tons of coal; or during the year an area of about 1,200 miles receives an amount of energy from the sun equivalent to the 1,100,000,000 tons of coal and lignite mined annually in the United States, and Europe.

INDIRECT LIGHTING WITH ARC LAMPS

An arc lamp equipped for indirect lighting has made its appearance in London. An enameled-iron reflector is attached to the lower part and an inner glass globe is provided to keep the reflecting surface free from dust. As there is no wandering of the arc, which is kept perfectly steady by the inclosed gases, an unusually effective distribution of light is obtained.

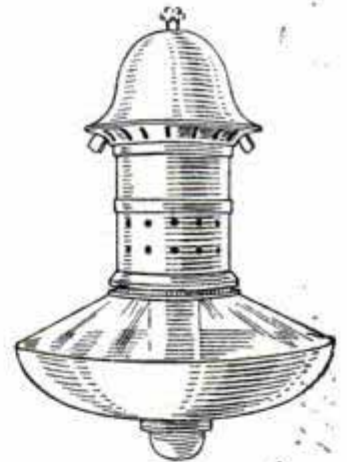

MOTORCYCLE FREIGHT RATES TO BE REDUCED

The present freight rates charged for carrying motorcycles by all railroads west of the Mississippi River will be reduced in accordance with a recent decision of the Interstate Commerce Commission, which rules that this class of vehicle shall be shipped at the same rate as bicycles in the future. The railroads affected have also been ordered to refund all freight charges collected for the past two

Wheel Co. Nashville, Tenn. 211 Gunn St. Deaton

years in excess of the rates charged for transporting bicycles. The motorcycle manufacturers and dealers, in order to obtain their refund, however, must file with the Commission the dates of the shipments, the amount of the freight bills and the excess charges.

PARISIANS WORE CREPE AT HORSE-OMNIBUS FUNERAL

The passengers, driver and conductor wore crepe bands on their arms and hats when the funeral or last journey of the horse-omnibus in Paris took place recently. The old vehicle was decorated with wreaths by the great crowd that had assembled to witness the suppression of the city's last bus line, and the motormen of a line of new automobile omnibuses sat with caps in hand and played a funeral dirge upon horns as the horse-omnibus started upon its final trip.

"DUSTLESS" TABLE FOR HARDWARE DISPLAY

The proprietor of a hardware store in St. Louis has devised what he calls a "dustless table" for the display of the many small articles that make up much of the stock of such establishments. The table proper has a wire-screen top, over which is placed a wooden frame divided into sections, or compartments, of different sizes. Each morning when

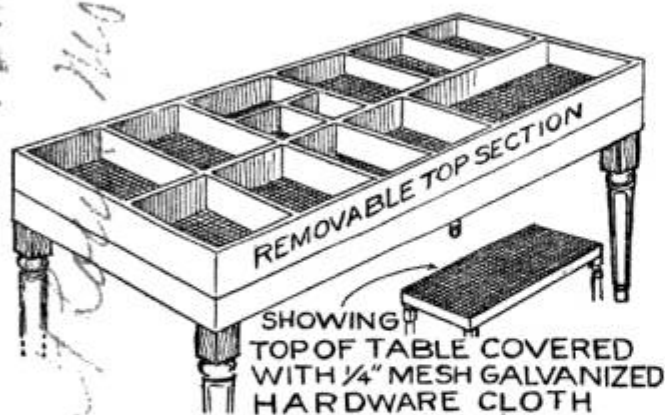

A Table through Which the Dust, Brushed from Articles on Display, may Drop

the articles in these compartments are dusted, the dust falls through onto the floor, from which it can easily be brushed up.

GRAPPLE ADJUSTS ITSELF TO OBJECTS OF ANY SHAPE

A grappling hook that automatically adapts itself to the shape of any object

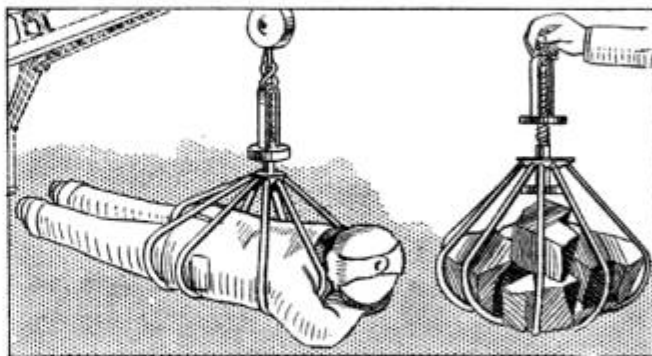

A Grapple Which Automatically Adjusts Itself to the Shape of the Object Lifted

or objects it is used to lift, whether they be round, square, oblong or irregular in outline, is here shown. It consists essentially of two round plates, one of which is fixed and mounted upon a tube on which the other slides. The fixed plate carries 10 hooks, each independent of the others. A pawl-and-ratchet arrangement permits the hooks, which are held in notches cut in the edge of the sliding plate when the grapple is thrown out, to adjust themselves to the form of the object to be lifted and instantly locks them in this position, through the operation of the sliding plate, when the grapple is lifted.

ENORMOUS HORSEPOWER IN ONE CYLINDER

Although at present the maximum horsepower derived from any single cylinder of an internal-combustion engine is, as far as present available knowledge goes, not more than 500 hp., a German firm announces that it is now prepared to turn out an oil-burning engine of the marine type that will develop 4,000 hp. in one cylinder. The new engine is said to be of the two-cycle, double-acting type.

A new type of disappearing bed that can readily be attached to an ordinary closet door and moved into the closet when not in use, has been put on the market. It measures 3 ft. in width and is 6 ft. 10 in. high.

Callahan

JOURNAL JACK HAS WHEEL-HOLDING DEVICE 79

The feature of particular interest in this ball-bearing jack, designed for use in the inspection, removal, or replacement of the

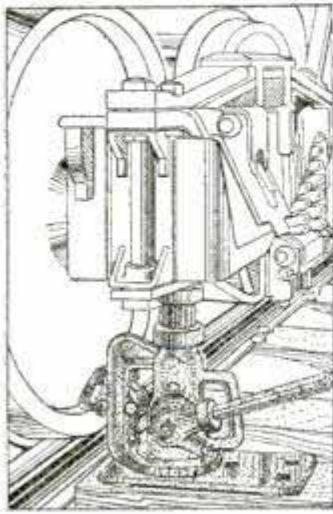

of the journal brasses of passenger and freight cars, is the device which holds the wheel firmly on the track while the journal box is being raised. This does away with the necessity of wedging down the wheel on the track.

GERMAN PAPER CLOTH 53

A new German paper cloth, said to be practicable for a variety of uses, is made by depositing a thin sheet of pulp on a felt, placing a sheet of cotton or linen cloth upon the pulp, and then depositing another sheet of pulp upon this cloth, the whole being run through a special machine. The pulp and cloth mix so intimately that the whole forms a solid and compact sheet.

MEASURING THE WATER IN BUTTER 47

This little apparatus for measuring the percentage of water in a consignment of butter operates in the following manner:



Hung from the lower end of the balance beam is an aluminum cup and a small weight. The pointer is brought to the zero mark on the scale by turning the thumbscrew in one of the

legs, which tilts the support. Then

the little weight, hung on the balance beam with the cup, is removed and the device again balanced by placing sufficient butter in the cup to equal the removed weight. The cup is then taken from the balance beam and the butter heated until all the water is evaporated, which is accomplished when the butter begins to turn brown. When the cup is replaced on the balance arm the pointer directly indicates on the scale the per cent of water in the butter.

CHOKING THE WIND FROM A VENTILATOR

A device that, it is claimed, solves one of the most difficult problems in ventilating engineering—that of interference of wind with the steady intake of air on the intake roof pipe—has recently been perfected. The device is simple and has no moving parts to get out of order, consisting only of a ventilating head of special design placed at the upper end of an intake pipe, and in this head a candle can be burned without being blown out by prevailing winds. Within the ventilating head is a reservoir of still air, from which, regardless of the direction or intensity of the wind, a uniform supply of air is drawn for ventilating purposes. A



conical wire-mesh screen, partially covered by a metal weather shield, and inclosing a baffle ring and collar, comprise the ventilating head.

In spite of its simple construction this device was an exceedingly difficult thing to work out, as its success in operation depends on an exact relation between the area of space under the weather shield, the size of wire and area of openings in the wire mesh, and the size and location of the baffle ring. The air pipe is carried to a point below the basement level, from which, in steam-heated buildings, individual pipes are led to openings behind the

no maker

radiators. With furnace heat, direct connection is made with the return pipe at the point where it enters the furnace, and a uniform volume of fresh air is supplied through the registers. An additional means of insuring uniformity of air current is a double wall to the intake pipe, warm air from the building passing up between the two walls of the pipe, and the cold air coming down the center.

NEARLY THREE THOUSAND PATENTS EACH MONTH

The number of applications for patents received by the U. S. Patent Office during the fiscal year ending June 30, 1912, was 69,236, and the number of patents granted was 34,200. During the past five years the number of patents granted annually has not varied to any considerable degree. On July 1 of last year, there were 21,059 patent applications awaiting decision.

MOTOR-CAR LOSSES EXPLAINED

The amount of power lost by an automobile motor which develops a certain horsepower when turning at the number of revolutions required to propel the vehicle at a given speed is best explained by using a gallon of gasoline as the basis of computation. Of this quantity only .081 gal. actually serves to propel the car, while the balance is

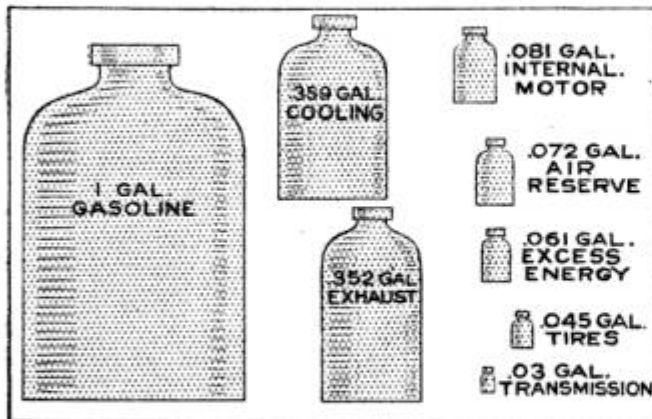

Sources of Automobile-Motor Power Losses

used up for other purposes in the manner described in the accompanying illustration from Motor Car.

DRILLING SEA BOTTOMS IN ROUGH WATERS

Ship channels often must be deepened by drilling rock bottoms and blasting, an operation always more or less

This Submarine Drilling Outfit is Not Disturbed by Rough Water

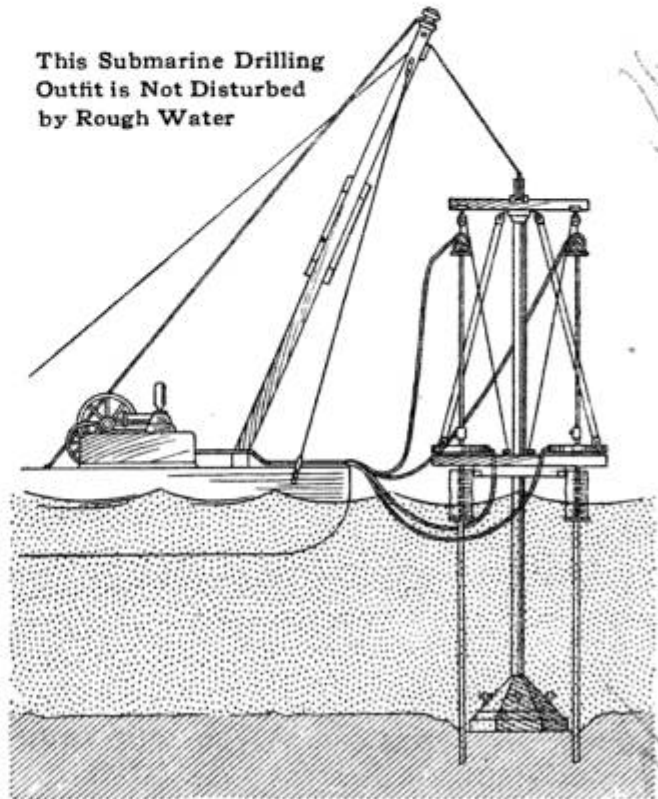

difficult, particularly where the water is liable to be rough, and a Hawaiian engineer has therefore attempted to meet this problem by means of the apparatus shown in the diagram. It comprises a drill standard, or mast, having a heavily weighted base, designed to be lowered overboard to rest on the sea bottom. Adjustably mounted on this mast is a platform, from which drills are operated by means of power transmitted from the drilling vessel through flexible connections. The result of this arrangement is that rising and falling of the drilling vessel in rough water does not in any way affect the working of the drill.

Aviation is rapidly becoming popular in Morocco and the French military pilots there are daily making cross-country flights, covering in one hour distances which it took the French troops three weeks to traverse last spring.

DEVICE FOR BANDAGING AUTO TIRES

The wrapping of a tire casing with tape, a frequent and not altogether easy operation if properly done, is aided by the use of the device here shown. The machine was especially designed for the application of a bandage to a casing undergoing repairs, and consists of a frame, 30 in. long and weighing about 16 lb. The bandage tape is carried on a spool at one end of the frame, and is conducted

over two rollers, to keep it straight as it is wrapped and tightened around the casing. A brake keeps the tape taut on the spool, preventing all slack.

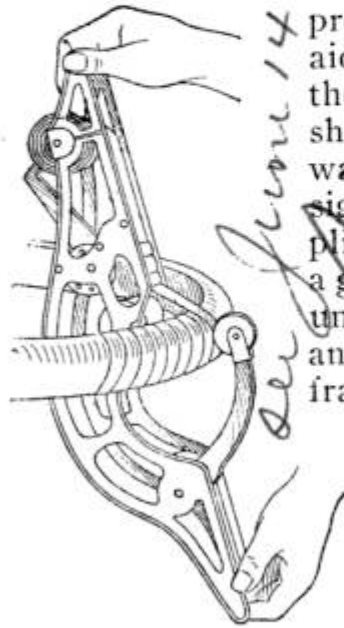

See June 14 - 811-6

REVIVING VICTIMS OF ELECTRIC SHOCK

In reviving persons that have been shocked by an electric current the rescuer should first break the circuit by a single quick movement if that has not already been done. This can be accomplished without receiving a shock by using a dry coat, a dry rope, a dry board or stick, or any other dry non-conductor. Metal or any moist material should not be employed for the purpose and the rescuer should use but one hand, if the aid can be practically so rendered. The best protection possible to use while handling a victim of shock is rubber gloves or rubber cloths, but if these cannot be obtained quickly, dry cloth will answer. After the victim has been released from the current he should be laid upon his stomach, with arms outstretched above his head. The rescuer then kneels, straddles the subject's thighs, and faces his head. The palms of the rescuer's hands are

Electrical Inducers

placed on the small of the victim's back, with thumbs nearly touching each other, and with fingers spread over the lower ribs. With arms held straight the rescuer should swing forward slowly, so that the weight of his body is gradually brought to bear upon the subject. This movement should require from two to three seconds, and it should not be violent, as some of the internal organs might be injured. The lower part of the chest and also the stomach are thus compressed, and the air is forced out of the lungs, causing the victim's breathing to be restored.

CALIPERS TO INDICATE CENTER

An interesting and handy tool is found in a new type of calipers which instantly indicate the center of any round or square object on which they are placed. The center is automatically found to be at the point touched by the centering rod when the legs of the calipers are closed on the sides of the shafting or other object; it will also indicate on oval objects. A spring in the center pin permits action without any adjustment.



W.M.H. 7/2/12

BUTTONHOLE WATCH FOR COAT LAPELS

The market is flooded with watch novelties for women. Here is one for men. It is a little buttonhole watch claimed to keep excellent time, designed especially to be worn on the lapel of the coat.

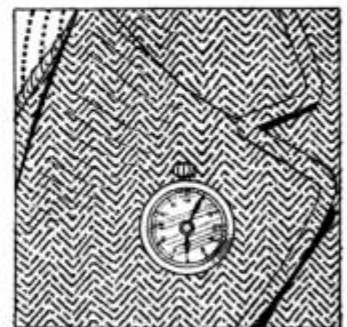

The electric-railway trackage throughout the United States at the end of 1911 was 41,028 miles, and 91,457 cars were in operation.

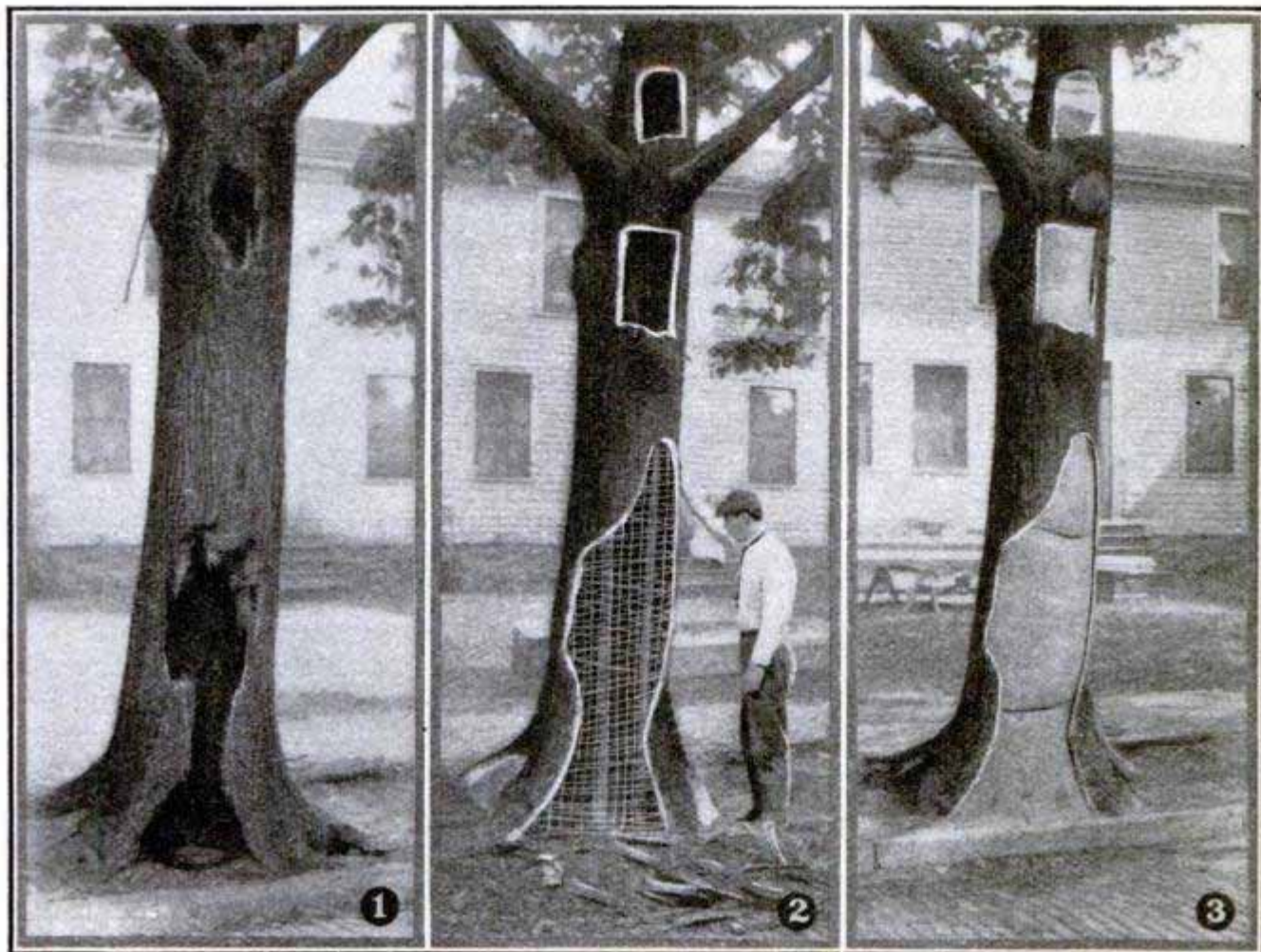

The Tree in Need of Surgery

The Decayed Portions Removed and the Lower Cavity Reinforced

The Completed Operation

THREE STAGES IN TREE SURGERY

An unusually fine example of tree surgery, showing the decayed tree, the stages of preparation, and the completed operation, is here illustrated. The tree in question was decayed and eaten into by boring insects.

How and why such an operation as this will save a tree is often asked and quite easily answered, when it is understood that the live part of a tree trunk is directly underneath the bark, while the center of the trunk is often dead wood, the only purpose of which is that of support. The growth of the tree takes place immediately under the bark, a new ring or layer being produced each year. Therefore, if the center of the tree becomes decayed, all that is necessary is to remove the decayed portion with a chisel, spray the inside of the cavity with an anti-fungous preparation to check any remaining rot, apply a heavy waterproof

paint, put in place the reinforcing wire, and fill the cavity with cement. The bark will completely heal over in time, under ordinary conditions.

TRANSPORTING A REGIMENT BY MOTOR TRUCKS

Plans for transporting a regiment of soldiers from Fort Benjamin Harrison, near Indianapolis, to the Pacific Coast and back again on motor trucks next year have been perfected and will be submitted to Congress for approval. The journey, if made, will be the largest experiment of the kind ever undertaken by the War Department and will cost approximately \$450,000.

Asphalt was known to the ancients and this material is said to have been employed as a binder in masonry by the Babylonians.

*City Forester Carl J. Seely
Holl Wayne, Ind.*

CUPS FOR WOUNDED BALKAN SOLDIERS

The five cups here shown are samples of 2,000 receptacles made in England and sent to the seat of the Balkan

war for use by the sick and wounded soldiers. It will be observed that each of the cups for the united Balkan states bears an imprint of the Red Cross, while the specimen of those intended for Turkey bears the Red Crescent, the emblem of the relief society of that country.

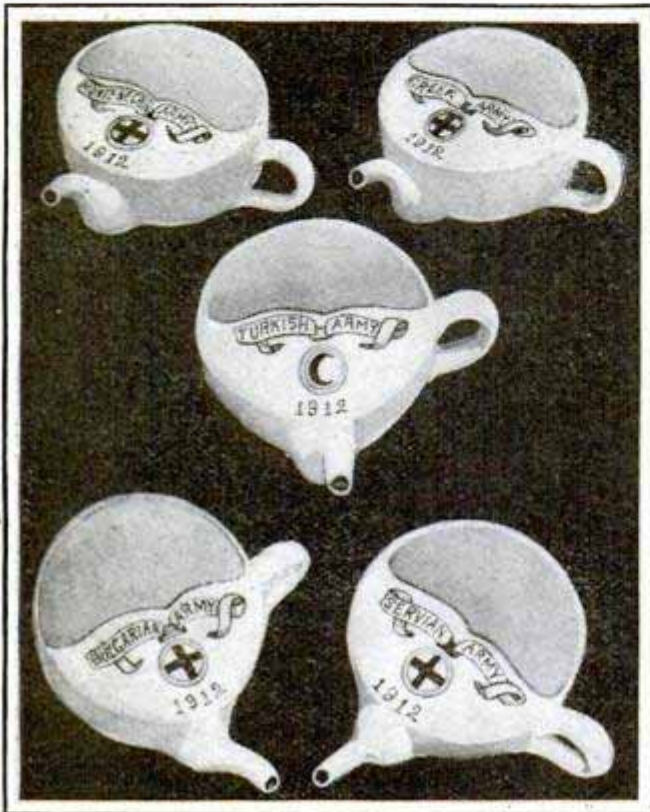

Courtesy The Sketch
Samples of 2,000 Cups Recently Sent to Sick and Wounded Soldiers of the Balkan War

AUTO SERVICE ACROSS THE ALPS

An electric automobile service has been established across the Alps at a cost of approximately \$500,000. The line, which is about 25 miles in length, extends from Airolo, Switzerland, through the Bedretto Valley and the Nufenen Pass, and ends at Ulrichen in the Valais region, on the Italian side of the Alps. The automobiles have a capacity for 22 passengers and make the trip in one and three-quarter hours on express service, running at the rate of 12 to 22 miles an hour. The company has 10 stations along the route and three trips are made daily in each direction when there is no snow on the road to interfere with the passage of the vehicles.

THE "STANDARD SCHOOLS" OF RURAL ILLINOIS

Inspecting the country schools as regards grounds, building, furnishings, heating, ventilation, library, water supply, and sanitation, as well as to the qualifications of the teachers, and the granting of a "Standard School" diploma to the schools found to be fit in all these respects, is the method adopted by the Illinois State School authorities as an incentive to improvement.

With the presenting of the diploma goes a placard or name plate. This is of steel, covered with a black preparation, and bearing the legend "Standard School" in gold lettering. Placed on the door of the school, it may be read several hundred feet away. Some 657 of the 10,532 one-room country schoolhouses in the state have already earned the right to display these plates.

Among the specifications of a "standard school" are: an ample playground, good approaches, convenient fuel houses, a sound, well-painted building in good repair, a jacketed stove in the corner of the room instead of an unprotected stove in the center, the floor and interior clean and tidy, suitable desks for children of all ages, properly placed; a good collection of maps, dictionaries and juvenile books, and a sanitary water supply. In addition, the school must be well organized, with regular attendance and at least seven months' schooling each year, and the teacher must have not less than a high-school education, receive a salary of at least \$360 per year, and be ranked by the county superintendent as a good or superior teacher.

Francis L. Blair Super. Dept. of Public Instruction of State of Illinois

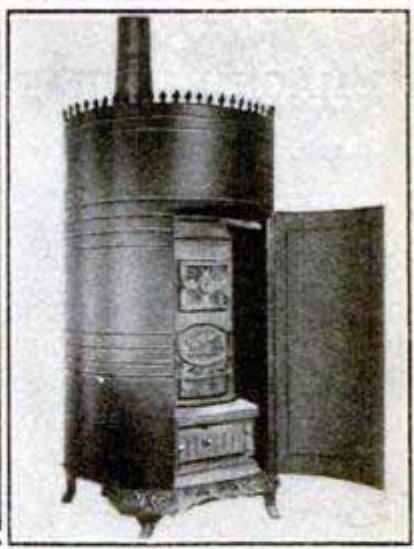

An Example of Faulty Heating. The Stove should be Jacketed, as Shown at the Right, and should be Placed in a Corner Instead of in the Center of the Room

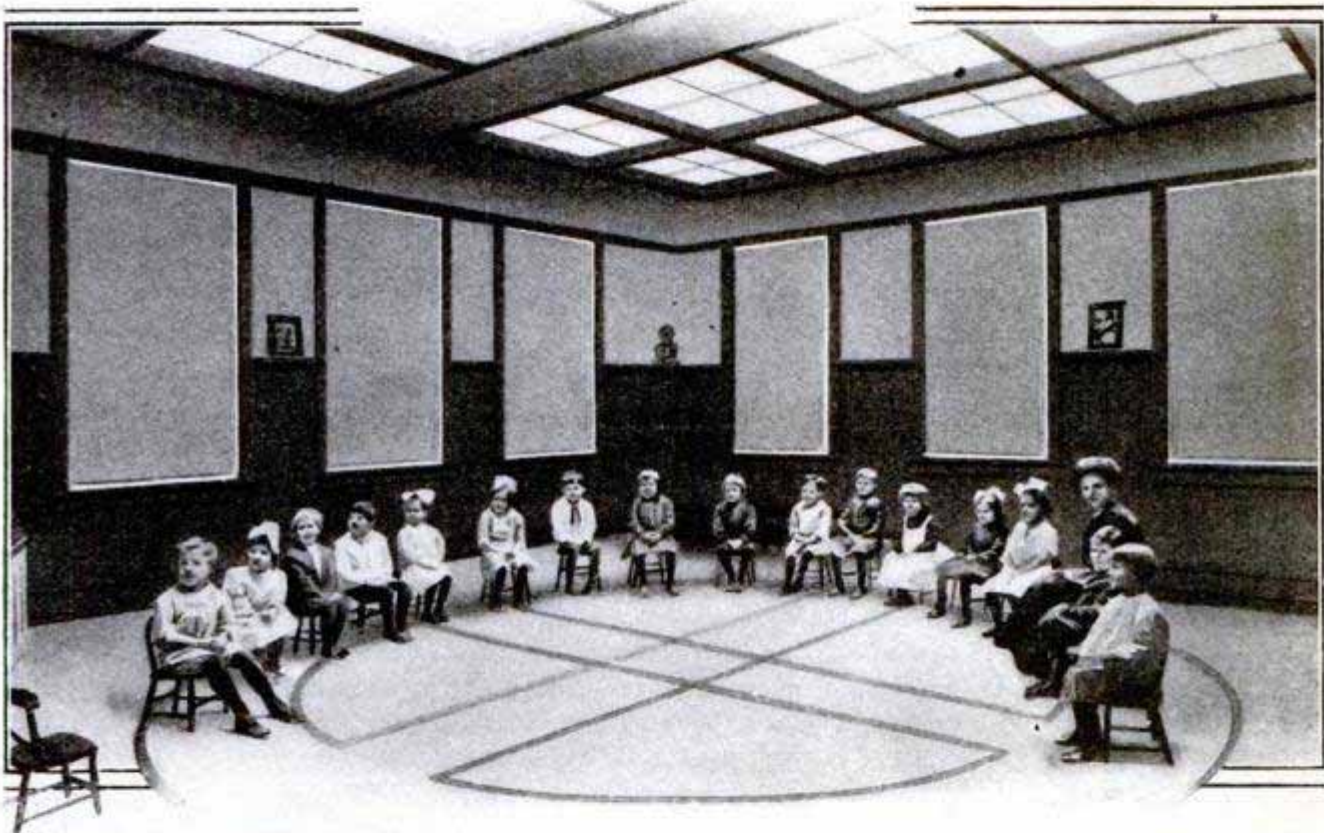

An Interesting Example of Overhead Lighting in a Single-Story Flat-Roofed School



The "Standard School" Placard is Coveted in Illinois

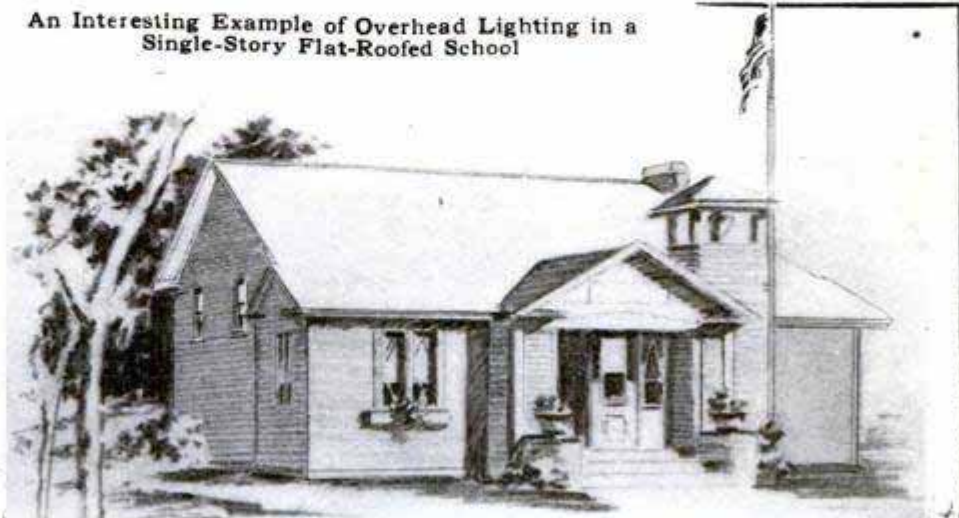

Country-School Architecture of this Kind Suits the Illinois School Authorities

MACHINE THAT HEATS

106 ASPHALT MIXTURE

A road-making machine that heats the asphalt while it is being mixed has been placed on the market. The hot mixer is so constructed that the flame from the fire box of the boiler is forced into the



Road-Making Machine That Heats and Mixes at Same Time

2 mixing drum through an asbestos-lined heating pipe by means of a powerful blast. A slide valve at the boiler permits accurate control of the heat and, by means of a damper in the hood of the boiler, the draft can be diverted through the stack when the heat is shut off from the mixer. The heating attachment is swiveled on a cast-steel elbow, so as to swing to one side when the drum is tilted. The heat produced in the drum averages above 600 deg.

F., and the materials are "sprayed" by the blades in the drum, thus permitting the heat to reach every particle in the mass. It is claimed that a batch of material can be heated and mixed by this machine in about two and one-half minutes.

WESTERN RAILROAD TO OPERATE WIRELESS

26 The Union Pacific Railroad is to operate a wireless telegraph system along its lines. The first installation will be a technical experiment station, said to be the second of the kind in this country, and other stations will be erected later. Application has been made to the Department of Commerce and Labor for a license to maintain the wireless system.

V-SHAPED AEROPLANE

958 FLIES WELL

One of the V-shaped aeroplanes recently developed in Europe has been flying exceptionally well in England, particularly in a strong wind. It has no tail, the engine and propeller are both located at the rear, and there are two rudders, placed at the ends of the "V." It is claimed that this machine has sufficient automatic stability to right itself without the use of the ailerons.



A V-Shaped, Tail-Less Aeroplane That is Making Successful Flights in England

Blumner Aeroplane

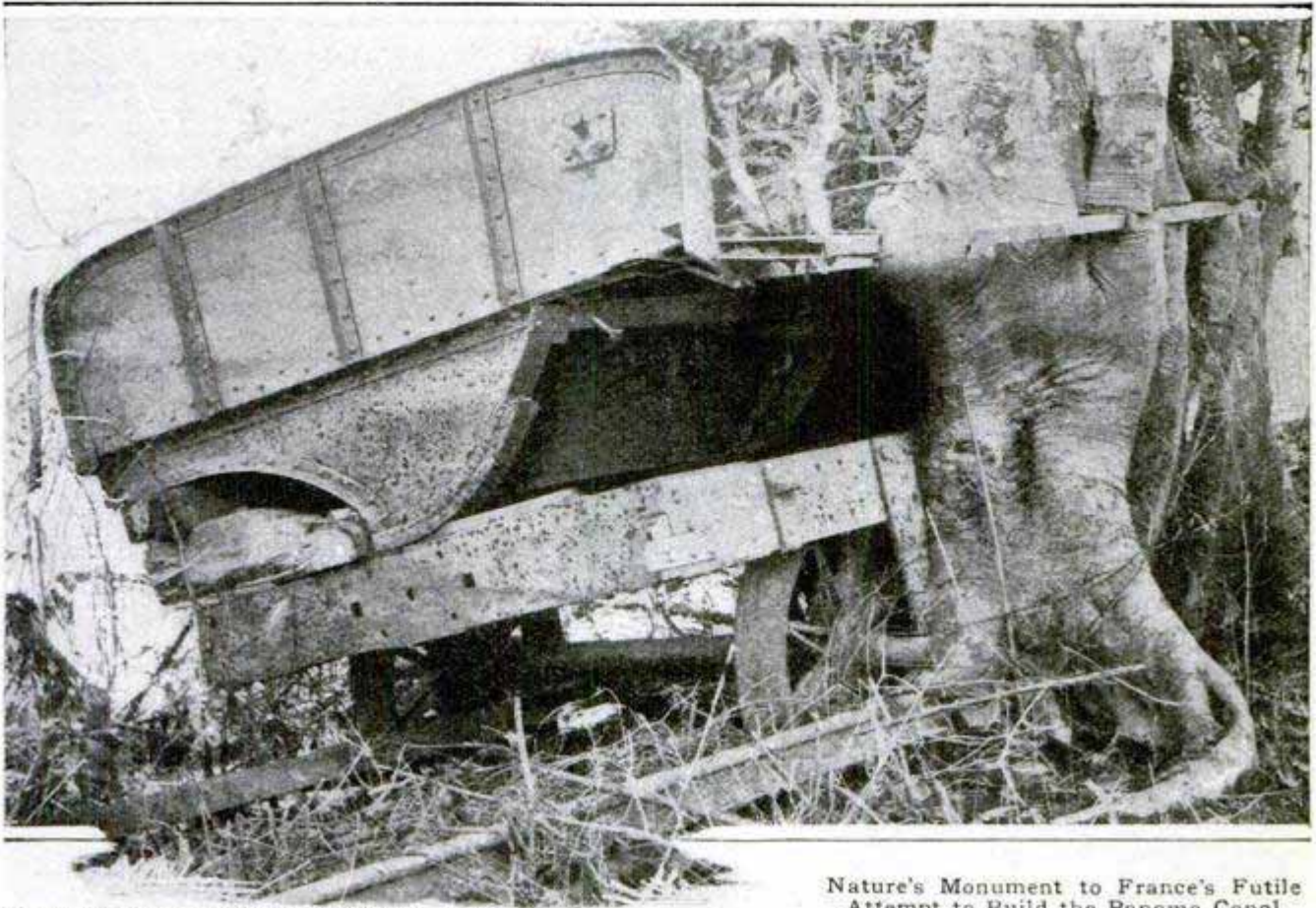

Nature's Monument to France's Futile Attempt to Build the Panama Canal

Copyright by Underwood & Underwood, N. Y.

NATURE'S MONUMENT TO FRANCE'S FAILURE

One of the most unusual photographs of nature's freaks, that describes better than words the futile attempt of the French to build the Panama Canal, is here reproduced. In 1888, when the French discontinued further attempts to build the canal, after having spent approximately \$280,000,000, they were so utterly discouraged that the costly machinery was left along the route of labor to rust and turn into junk. As time passed by, a tree, which had taken root near the tilting dump car here pictured, grew until it had entwined itself about an iron rail of the vehicle. The tree continued to increase in size until the rail finally became a part of the tree. When the gates are finally closed this tree and car will lie at the bottom of Gatun Lake.

⌈The production of copper in the United States during 1912 was 1,249,000,000 lb., worth \$200,000,000, an increase of 151,000,000 lb. over 1911.

ARMORED MOTOR CRUISER IN 506 ACTUAL WAR

The Turko-Italian war, whatever else it accomplished, provided a few actual tests for modern implements. Much publicity has already been given to the actual use of dirigible balloons and aeroplanes, and in the accompanying illustration is shown one of the armored motor cruisers which was extensively used in the campaign. This machine carries a rapid-fire gun, and is manned by the driver, a gunner, and two officers.

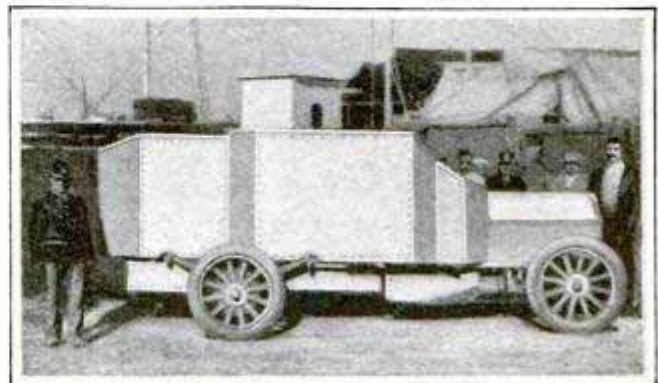

An Armored "Cruiser" Automobile Used in the War in Tripoli

GIANT THERMOMETER MARKS CINCINNATI'S CHARITY

Interest in the collection of a fund for charity was recently incited in Cincinnati by indicating the collections

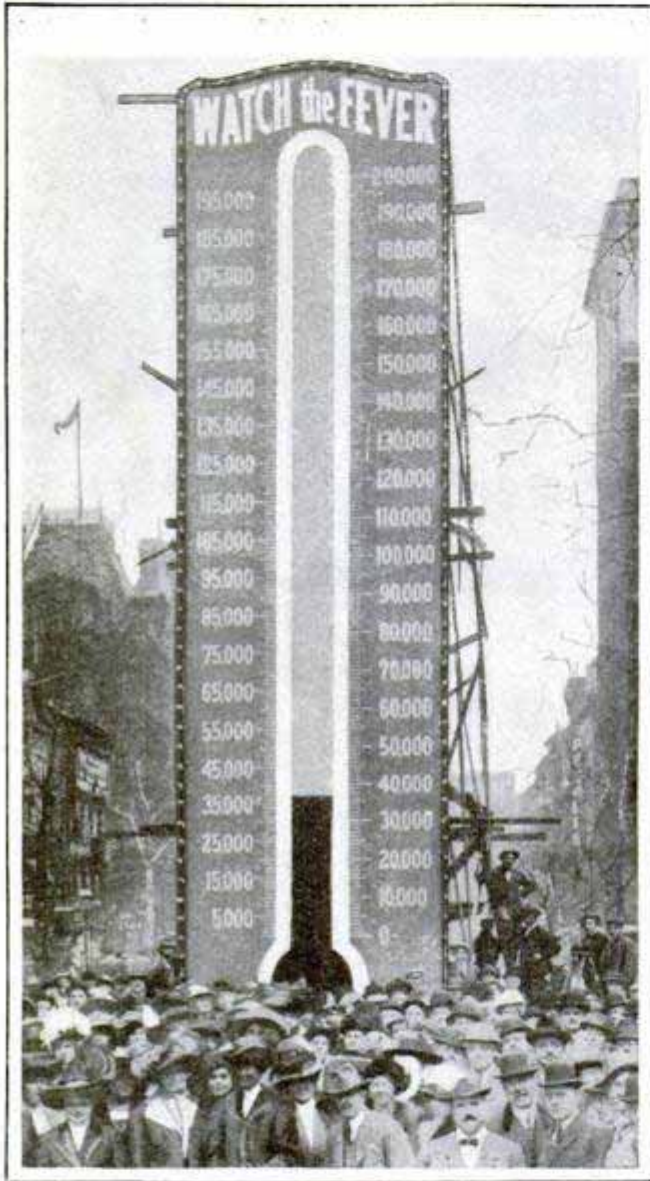

Courtesy Bain News Service, N. Y.
Cincinnati's Charity Record

from hour to hour upon a huge thermometer which was erected in one of the public squares. The force of collectors was divided into two teams—one being composed of men and the other of women. As fast as a subscription was received the amount was telephoned to subscription headquarters and the "mercury" immediately went up.

It is believed that the demand for steel rails during this year will reach the enormous total of 3,000,000 tons.

MAKING PLANTS ABSORB MORE IRON

Officials of the agricultural experiment station in Vienna, Austria, are conducting experiments with a view to increase, if possible, the amount of iron absorbed by certain plants, for the purpose of ascertaining the effect on the human body when these plants are used as food.

As artificially prepared foods containing iron do not always produce the desired effect, because the iron is not completely used by the digestive organs, it is hoped that this difficulty may be overcome by forcing plants to take up a larger quantity of iron during their growth.

The experimenters have already succeeded in growing spinach containing approximately seven times more iron than is found in the ordinary spinach, by adding hydrate of iron to the soil, and it is believed that the process may be successfully used with other plants of the same class.

INGENIOUS FOOT WIPER FOR 3205 AUTOMOBILES

An ingenious foot wiper for attaching to the footboard of an automobile is so constructed that, by lifting the brush part up and outward with the foot, the brush is caused to slide automatically under the footboard. The wiper is brought into the proper position for use by drawing it forth from its place beneath the footboard by means of a handle attached to the outer edge of the plate upon which the brush is secured.

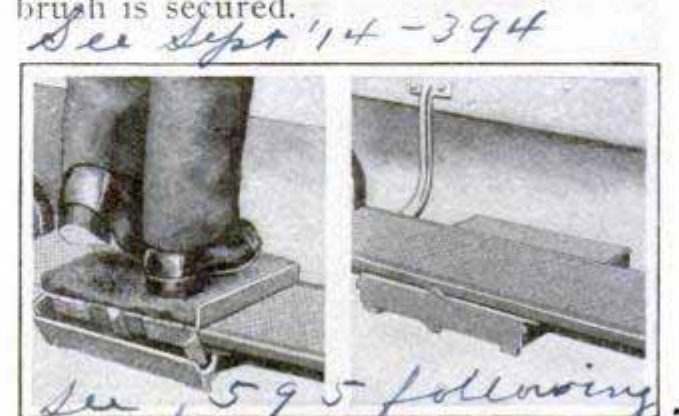

Automobile Foot Wiper in Use and under Footboard

Good Samaritan Hospital

1227

3315

FORTUNES IN PRIZES WAITING TO BE WON

[Every little while a report gains currency that a million-dollar prize has been offered for the performance of some impossible mathematical feat or the invention of some contrivance of problematical value. Many innocent persons have been deluded into spending their time and money in the pursuit of these phantom prizes. Feeling certain, however, that there must be many genuine prizes waiting to be won, Popular Mechanics Magazine communicated with the fifty-five foremost scientific organizations of America, the one hundred largest industrial and trade associations and the ninety principal learned societies of foreign countries. If there are any prize offers of value not disclosed in the information thus collected, the editor would be glad to learn of them.—EDITOR.]

A DOZEN fortunes, even as fortunes are reckoned today, are lying, in cash, in the treasuries of as many organizations, to be awarded as prizes to inventors, discoverers and scientists. Scores of lesser prizes, any one of which represents a splendid reward for a year or two of labor, lie unclaimed, waiting for the man who is able to fulfill the conditions of the gifts. Much of this prize money is the interest on inexhaustible funds, and is given annually or at other stated intervals. But much more of it is in single large amounts—\$1,000, \$10,000, \$20,000, \$25,000—even one great lump of \$100,000 is waiting for the first person who can prove his claim to it.

There is \$23,800 in Germany for the first person who presents a perfect proof of a well-known mathematical theorem. There is \$20,000 in France ready to be given to anyone who finds a cure for one of the commonest diseases. And, to get nearer home, there are sums ranging all the way down from \$10,000 offered in America for mechanical devices that are sure to be invented sooner or later.

Largest of the prizes awaiting inventors is the \$100,000 offered by the International Association of Recognized Automobile Clubs, for the best substitute for gasoline. This prize, which was announced last December, is to be given only for some product that can be used in existing internal-combustion motors, is available in large quantities and is of such a nature that it cannot be monopolized by a trust. Other conditions are yet to be announced. Here is a prize worth winning. Experiments with benzol, with methyl alcohol and with a mixture of the two, have encouraged inventors to work along those lines, but it is possible that some American will come to the front with a new volatile hydrocarbon, or with a satisfactory method of carbureting kerosene, that will capture the big prize. And the winner does not have to yield ownership in his invention to get the \$100,000, but like most of the other prizes for industrial research, this prize is a bonus, not purchase money.

Should the new fuel, when found, be capable of manufacture from some substance produced in Great Britain, there is another prize ready for the fortunate inventor, the 2,000 guineas (\$10,500) offered by the British Society of Motor Manufacturers and Traders for a fuel that meets this condition. The Royal Automobile Society of England will conduct tests of all fuels offered for this prize.

Along the same line of automobile improvement is an opportunity to win \$2,500 by a simple mechanical invention. This sum will be paid by the Royal Automobile Society of England for the best carburetor, the fund having been placed in the society's hands by Mr. G. K. Chamberlain, an American. This contest is open, like the others mentioned, to inventors of all the world.

The largest standing prize in America for an invention is one of \$10,000 for a machine for pulling and topping sugar beets, offered by the Great Western Sugar Company of Denver. The successful device must require comparatively little power and if operated by



horses not more than four horses per beet row. It must pull and top all the beets, separate the beets and tops and leave all convenient to load. It must be adjustable and salable at retail for not more than \$300, if horse-drawn, or \$500, if self-propelled. If not won by March 1, 1915, the prize may be withdrawn, but the first device offered before that date that fulfills all the requirements will get the prize—and the inventor will retain the ownership of his invention.

Fifteen years ago the Louisiana Sugar Planters Association offered a prize of \$2,000 for a sugar-cane harvester. Thus far none has been produced that meets all the requirements, and the prize offer has lapsed, but many inventors are at work on this line, and, as the secretary of the association writes, "whoever makes a successful cane harvester will become a millionaire very quickly, and will not need the \$2,000."

The effort to convert coal waste and low-grade coal into briquettes and so utilize it economically has occupied the attention of many inventors for years. The government of New Zealand recently announced the offer of a prize of £250 (\$1,250) for a more economical process of making briquettes from slack coal.

One of the largest sums available for the reward of inventive genius and application is the Pollock Prize Fund of \$50,000, held by the Conservatory of Arts and Trades of Paris, to be distributed in prizes for inventions for saving life at sea. This fund was founded by the daughters of Mr. and Mrs. Anthony Pollock, of Washington, D. C., who were drowned when the French ship "La Bourgoyne" sank off the Grand Banks on July 5, 1898. Several awards, mostly of small amounts, have been made from the fund for life-saving devices, which are on exhibition in a special room at the conservatory, but there is still nearly \$30,000 available for the reward of inventors of meritorious apparatus. The largest single award that has been made from this fund, \$20,000, was given by the jury in 1900 to L. Colineau for the plan of constructing the "bridge" of a steamship in the form of a detachable steel barge with water-tight compartments, 40 ft. wide and extending in length the entire width of the ship.

One of the largest prizes for the protection and preservation of human life is the sum of 25,000 marks (\$5,950) for the invention of an electric miners lamp combined with a dependable device to indicate the condition of the air and give warning of the presence of a dangerous amount of explosive gases. This prize is offered by the mining interests of the Dortmund district in Germany.

Comparatively small in amount, but important because of the scientific recognition which any award by the Royal Society of Arts of Great Britain carries with it, is the prize of £20 (\$100) it offers to the inventor of the best portable apparatus for enabling men to undertake rescue work in mines. The winner of this prize will be allowed to choose between the money and a gold medal. The fund from which it is provided was established in 1813 by Anthony Fothergill.

The American Red Cross has at its bestowal one prize of 6,000 roubles (\$3,100); two prizes of 3,000 roubles (\$1,550) each, and six of 1,000 roubles (\$515) each, to be awarded, from a special fund created by the Empress Maria Feodorovna of Russia, for devices and apparatus for the amelioration of the sufferings of the sick and wounded in time of war. The American Red Cross also awards annually the William Howard Taft prizes of \$50, \$25, \$15 and \$10,



by J. C. Bennett, New Orleans, La.

W. H. Fothergill

One of the largest prizes for the protection and preservation of human life is the sum of 25,000 marks (\$5,950) for the invention of an electric miners lamp combined with a dependable device to indicate the condition of the air and give warning of the presence of a dangerous amount of explosive gases. This prize is offered by the mining interests of the Dortmund district in Germany.

given to railroad men for services and devices for the prevention of accidents.

A certain machine in general use for splitting leather is productive of many serious accidents. A prize of \$100 is offered by the National Association of Tanners for a safety device for this machine.

A prize for scientific achievement that is well worth winning is the Pierre Curie prize of 100,000 francs (\$20,000) offered by the French Academy of Sciences to the first person who succeeds in establishing communication with some planet other than Mars. Apparently the French scientists believe we are to be "wirelessing" to Mars in the not far distant future!

Some what easier to win, at first glance, though the problem for the solution of which it is offered has baffled men of science for more than two hundred years, is the Wolfskehl prize of 100,000 marks (\$23,800) offered by the Academy of Sciences of Goettingen, Germany. All one needs to do to get it is to prove to the satisfaction of mathematicians generally that Pierre Fermat was right when he wrote, in a letter of October 18, 1640, that no integral values of x , y and z can be found to satisfy the equation " $x^n + y^n = z^n$ " if " n " is an integer greater than 2. That's all—just prove he knew what he was talking about and collect that \$23,800! Fermat was a tax collector who pursued pure mathematics as a hobby, and his letters, published after his death in 1665, contain original contributions to the theory of numbers which prove him to have been one of the greatest mathematical geniuses that ever lived. A hundred years after Fermat's death a German savant demonstrated the correctness of all but two of the Frenchman's mathematical deductions. One of the remaining two is known in the world of science as "Fermat's Last Theorem," and a fortune awaits the first to prove Fermat right. Dr. P. Wolfskehl of Darmstadt died in 1907 and left 100,000 marks for this purpose. The mathematicians of the entire world are concentrating upon the effort to win it. Not long ago a convict, released on parole from the Missouri State Penitentiary, announced that in his seven years of imprisonment he had demonstrated Fermat's Last Theorem and was going to get the prize. A University professor of mathematics is said to have resigned his position to devote his time to the effort to win the Wolfskehl prize, and thousands of other mathematicians are at work on the problem. If no one wins the prize by September 1, 2007, the conditions of the award may be changed. Part of the accumulated interest of the fund was awarded a year ago for a partial demonstration.

Here is another brain-teaser: "What is the expression of the C. Neumann theorem in the theory of the Newtonian potential, applied to the oval-shaped solid derived from the ellipsoid by the method of reciprocal radii?" Answer that correctly and the Prince Jablonowski Society of Leipzig, Germany, will give you a prize of 1,500 marks (\$357) if the solution is the best one received before October 31, 1913.

Mathematical problems are favorites among prize-giving societies of Europe. The Paris Academy of Sciences offers a long list of awards, headed by the Jean Reynaud prize of 10,000 francs (\$2,000), given every five years for the most notable work in mathematics. In 1913 this society will award also the Petit d'Ormay prize of 10,000 francs for the best contribution in pure and applied mathematics, seven other prizes, aggregating 16,240 francs, for original work in higher mathematics, and the Wilde prize of 2,000 francs





for the most important contribution to science in the preceding two years. In 1914 the Paris Academy will give a prize of 3,000 francs for the best solution of a certain problem in trigonometry, and in the same year will award the Fourneyron prize of 1,000 francs for the best theoretical and experimental study of turbines.

The Royal Academy of Science of Belgium offers, for 1913 and later, two prizes of \$200 each, and one of \$240, for work in higher mathematics; a prize of \$280 for the best paper relating to public works offered before June 30, 1913; a biennial prize of \$200 for discoveries in physiology, a triennial prize of \$360 for original work in general biology, a prize of \$480 every six years for contributions to political economy and social science, and one of \$300 every five years for the best treatise on spiritualistic philosophy based on pure reason.

A prize of \$1,000 is waiting in Philadelphia for the first resident of North America who shall determine by experiment whether the invisible rays of light below the spectrum, known to science as "infra-red" rays, are or are not transmitted with the same speed as other light rays. This Boyden Premium was established by Uriah H. Boyden of Boston in 1859, and placed in the custody of the Franklin Institute of Philadelphia, to be given to anyone who would determine the relative speed of all the invisible light rays, but in 1907 part of the fund was awarded for the discovery of the relative speed of the visible rays and those above the spectrum—the "ultraviolet" rays of the scientists.

Every three years there is a chance for students of electrical science to win \$4,500. This is the interest, at 3 per cent, on a fund of \$50,000 deposited with the Montefiore Association of Liège, Belgium, by George Montefiore Levi, given for the best original work on scientific advancement and the progress made in technical applications of electricity.

A cash prize of no fixed amount is given every five years by the Royal Society of Sciences and Arts of Gothenburg, Sweden, for an important scientific discovery. The Royal Society of Edinburgh offers the Keith prize of a gold medal and \$200 to \$250 for the best communication on a scientific subject received before the end of its 1913 session. It also offers biennially the Makdougall-Brisbane prize of a gold medal and a sum of money for an essay or paper having references to any branch of scientific inquiry, whether material or mental.

Leaving out of consideration hundreds of prizes open only to members of particular organizations or inhabitants of certain countries, the list of important or curious prizes offered in Europe is still a long one. One that is not to be awarded until 1931 consists of £116/10 (\$356.71) in British "consols" or government bonds, deposited by Sir Frederick Bramwell with the British Association for the Advancement of Science and to be given by them 18 years hence for a paper dealing with the whole question of the prime movers, of 1931 and especially with the then relation between steam engines and internal-combustion engines.

Largest of the standing rewards offered for medical research is the Bréant prize of 100,000 francs (\$20,000) offered by the medical section of the French Academy of Sciences for the discovery of a means to cure Asiatic cholera. The entire sum will be given to the discoverer of a genuine cure, but the interest may be awarded from

*French Academy of Sciences
Medical Section*

time to time in smaller prizes for work advancing the scientific knowledge of this disease.

The largest American award for medical research is the cash prize of \$1,000 offered every three years by the College of Physicians of Philadelphia for an important contribution to medical science. The same institution awards annually the Alvarenza prize of \$180 for medical research. The Harvard Medical School gives two Boylston prizes, of \$75 each, annually, for original research in medical science.

Every two years some young architect or architectural draftsman gets the Le Brun Traveling Scholarship of \$1,000 with which to spend six months in European study, offered by the New York Chapter of the American Institute of Architects. Every year the National Association of Sheet Metal Contractors of the United States gives \$300 in cash, tools and books to journeymen and apprentices for ability in sheet-metal work.

The British Royal Society gives \$500 every five years for works on jurisprudence, from a fund established in 1844. An annual distribution of \$2,000 is made by a Chicago manufacturing company for essays on economic subjects. The American Historical Association gives every two years the Justin Winsor prize of \$200 for independent research in American history and the Herbert Baxter Adams prize of \$200 for original work in European history. The Boston Society of Natural History gives two prizes of \$50 each every year, the Walker prizes, for essays on subjects selected by the society. And an annual prize of \$20 for inventors is derived from a legacy left many years ago by John Scott, of Edinburgh, in the hands of the Philadelphia Board of City Trusts.

Greatest of all of the periodical money prizes, but not subject to competition in the ordinary sense, are the five Nobel prizes of about \$40,000 each, awarded annually from a fund left by Alfred Nobel, inventor of dynamite, to the persons who have rendered the greatest service in physics, chemistry, literature, medicine and peace. The Swedish Academy of Sciences awards the first two; the Swedish Academy, the third; the Caroline Institute of Sweden the fourth, and the Norwegian Storting, the last-named. Two Nobel prizes have come to America—a peace prize to Theodore Roosevelt for his services in ending the Russian-Japanese War, and a prize in medicine to Dr. Alexis Carrel of the Rockefeller Institute of Medical Research.

Pages could be filled with the list of American and European offers of medals for invention, research and discovery. Oldest of these American trophies is the "Magellanic Gold Medal," an oval plate of solid gold of the value of ten guineas (\$50) given annually by the American Philosophical Society of Philadelphia, from a fund founded in 1786 by John Hyacinth de Magellan, of London, for the best discovery or most useful invention relating to navigation, astronomy, or natural philosophy.

To gain the Albert medal of the British Royal Society is probably the highest honor that can come to an inventor or scientist, while the John Fritz medal is the most notable American reward for research and invention. Two Americans, Edison and Bell, have each received both medals.

Such are the prizes the world offers for creative work. Fortune as well as fame is more than ever before the reward of research and industry.



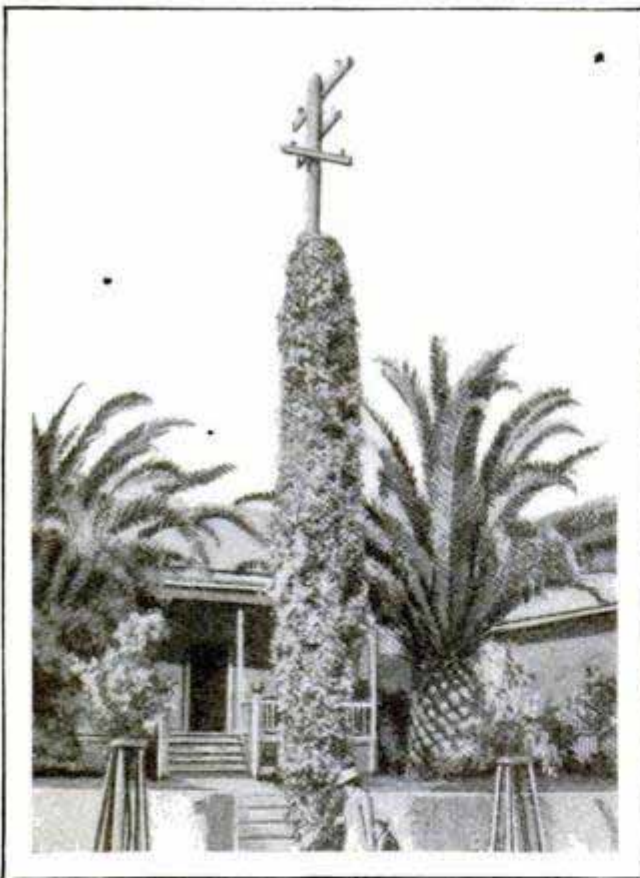

Photo by Paul Thompson

Weird Funeral Procession of the Late Prince Luitpold of Bavaria

TELEPHONE POLE USED AS ORNAMENT

1132 The illustration shows how a resident of California converted an unsightly telephone pole in front of his bungalow into an ornament by permitting vines to grow upon it, accord-



Ornamental Telephone Pole in California

ing to the Telephony magazine. The vines, it will be observed, are not allowed to reach the wires.

QUAINT FUNERAL OF LATE BAVARIAN REGENT

The section of a long line of "gugelmänner" or cowled men here shown is a part of the remarkable funeral procession which accompanied the body of Prince Luitpold, regent of Bavaria, during a two-hours' march through the streets of Munich. The cowled men are members of an ancient order of churchmen, whose shields are decorated with the Bavarian arms, and for centuries members of this order have marched in funeral processions of royal personages. Each of the shields bears the inscription that Prince Luitpold, the King's Regent, was born in 1821 and died in December, 1912.

USING POWER TO "PULL" IS BETTER THAN TO "PUSH"

229 Makers of the front-drive and tractor type of motor truck are laying considerable stress on the fact that it is easier to pull than to push a load. The same claim is being made for the four-wheel-drive type of motor truck, but with this kind of machine it is a matter of both pull and push. Among the additional claims are: less danger of skidding, a more equal tire-load distribution, and a better ability to run through deep sand, over mud and muck with a load which a rear-wheel-drive machine could not carry under the same conditions.

12/14/1912

102 IN DEFENSE OF THE AUTOMOBILE

1188 STEEL COAL CAR SHATTERED BY WOODEN GONDOLA

According to Sir John Macdonald, a member of the British Road Board, the wear and tear, dust and mud, of macadam roads is not altogether due to the automobile. He claims that macadam roads would be all right if the road-making rules laid down by the late Mr. MacAdam were strictly followed, instead of being more or less disregarded. He also insists that the wear of such roads is not caused by the suction of automobile tires, but almost entirely by the crushing effect of horseshoes and iron-tired wheels.

In a railroad accident which recently occurred near Apple River, Ill., two

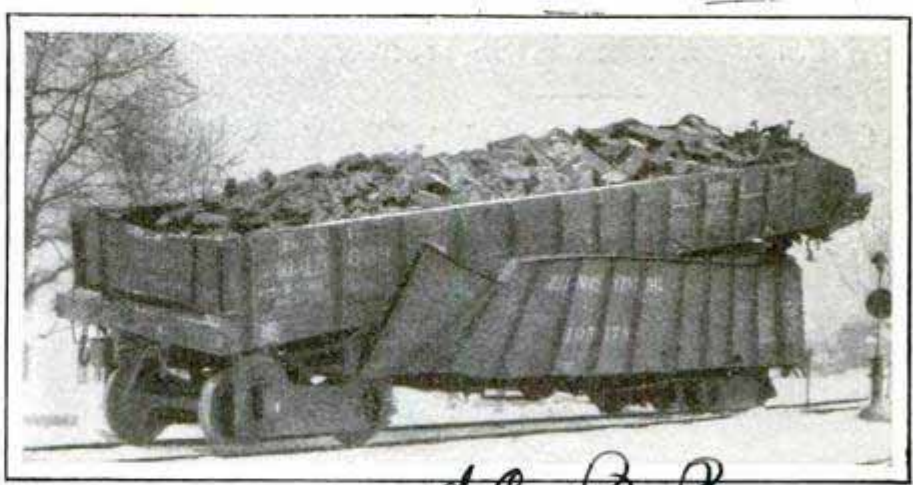

d. C. B. R.
The Steel Car Sustained the Most Damage

loaded coal cars collided and the result is here pictured. It will be noticed that the wooden car was but slightly shattered, while the steel gondola sustained severe damages, a rather remarkable result under the circumstances.

Coal tar is being used as fuel in one of the steel plants at Sharon, Pa.

3202 The Iron Magazine

ARTIST-BLACKSMITH MAKES FLOWERS OF IRON

These illustrations give a fair idea of the remarkable character of work wrought by a New Jersey blacksmith who fashions beautiful flowers, wreaths and festoons of blossoms in wrought iron with hammer, tongs, and anvil. The reproductions are so true to nature

that art critics who have viewed his masterpieces declare his work to be that of an artist in every particular. The artist-blacksmith discovered several years ago that he had the ability to fashion designs in metal and since then has devoted all his spare time to

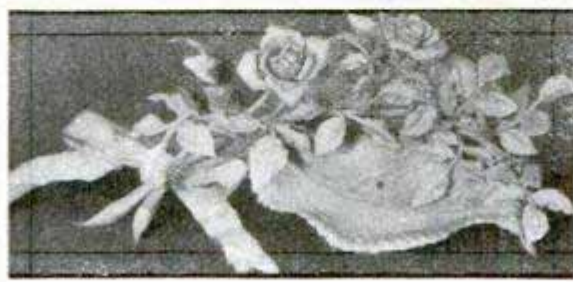

Specimens of Beautiful Flowers Made of Wrought Iron by a Blacksmith with Hammer, Tongs and Anvil

James Egan, Plainfield, N. J.

work of this kind. One of his more elaborate designs is a pair of doors recently completed for a public building. These doors contain historical groups, typical scenes of the Continental period, and are as intricate and delicate in detail as though cast in bronze.

COAL MINES WITH STRAY ELECTRIC CURRENTS

Stray electric currents were found to exist in certain coal mines of Kentucky during an investigation as to the cause of premature mine explosions by the chief mine inspector of that state. It was found, says the Fuel Magazine,

that such explosions occurred when one end of a large copper needle used in mine-blasting operations was inserted into the loading hole and placed in contact with the powder while the other end of the needle was allowed to touch a layer of coal adjacent to the hole, or permitted near enough to it so the current could jump from the coal to the end of the needle.

A lamp on the tower of the courthouse in Marion, Ind., flashes a red signal whenever patrolmen are wanted to call police headquarters by telephone. Every policeman is required to respond when the red light glows.

NEW AUTOMOBILE DESIGNS

Among many other new and interesting automobile-body designs exhibited at the automobile show in Paris were the two here shown. The most radical feature of the closed car is the glazed roof. The other car has a well-like tonneau.

Others invariably use their mouths as a holder for nails, so a nail company is now marketing lath nails in sanitary paper-lined kegs.

Youngstown Sheet & Tube Co.

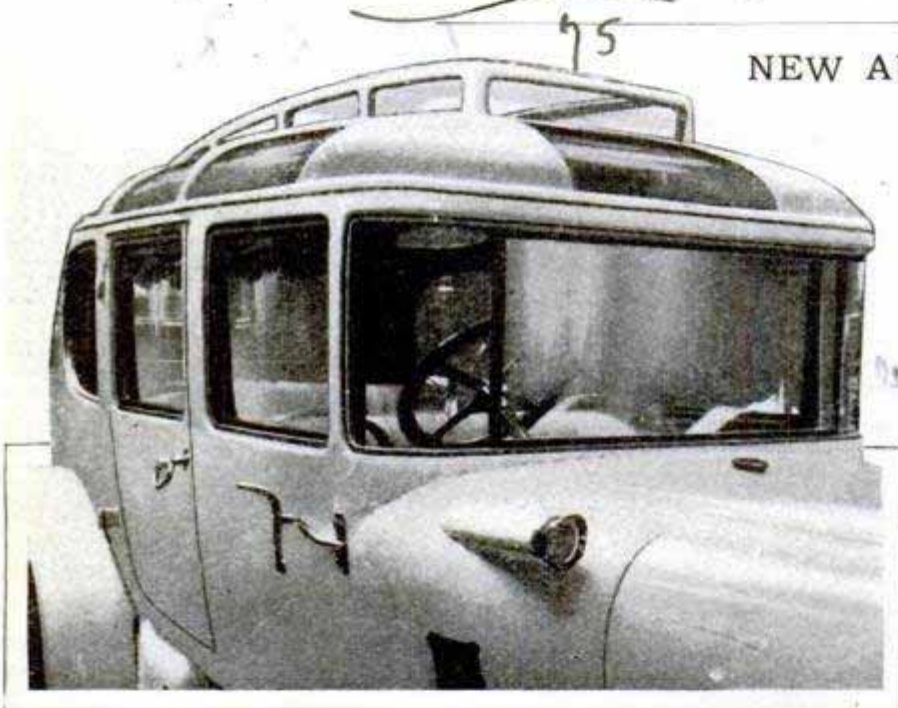

A Glass-Roofed Automobile

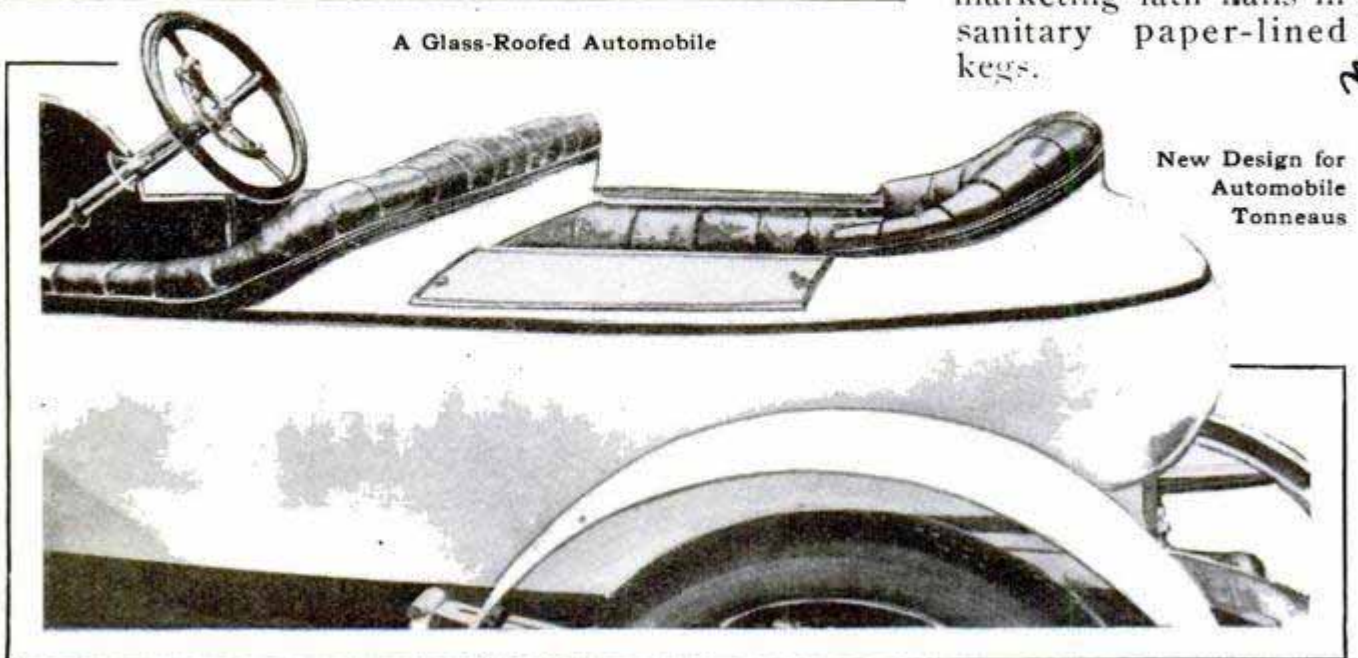

New Design for Automobile Tonneaus

no data

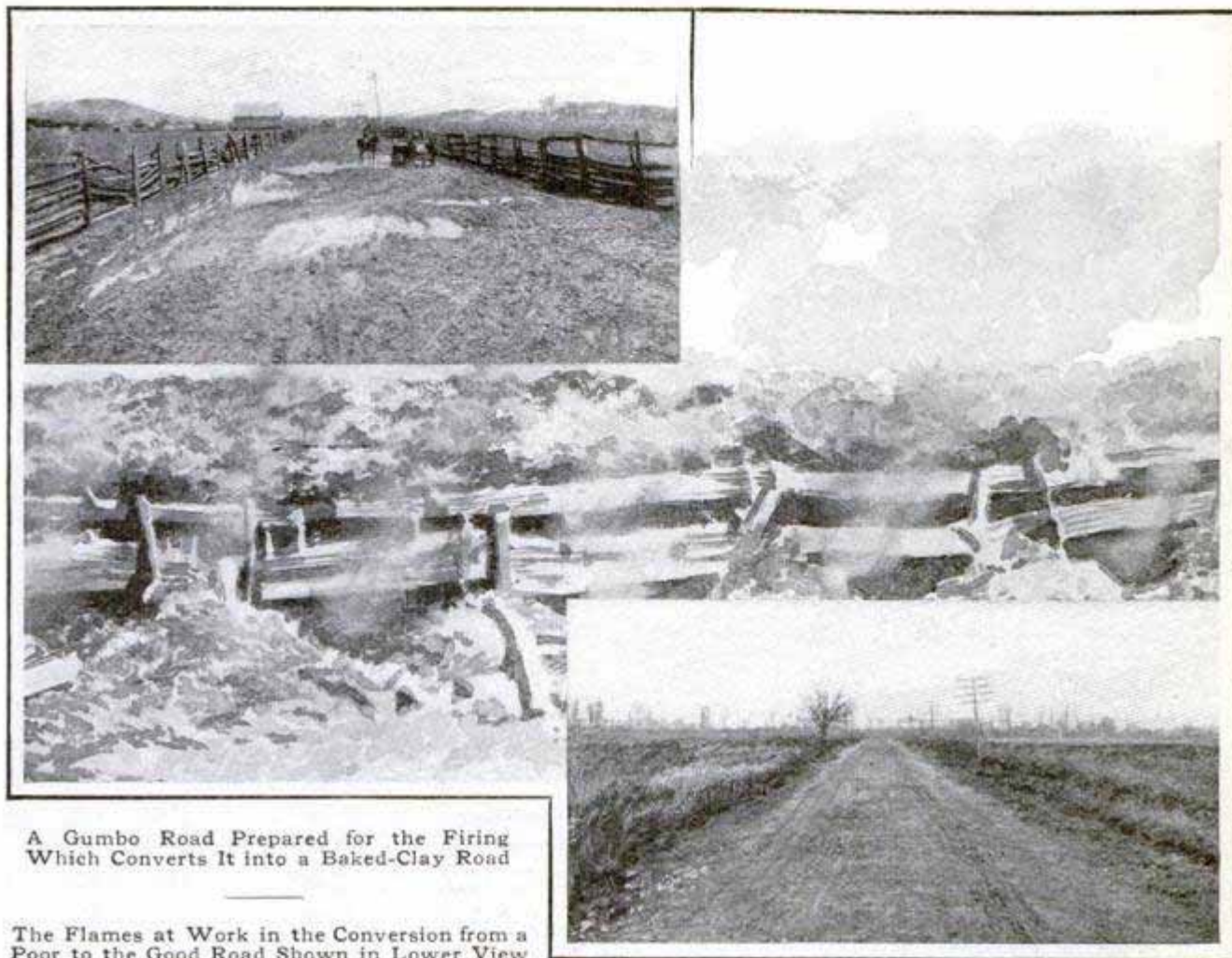

A Gumbo Road Prepared for the Firing Which Converts It into a Baked-Clay Road

The Flames at Work in the Conversion from a Poor to the Good Road Shown in Lower View

MAKING GOOD ROADS BY FIRING POOR ONES

Blazing a trail of good roads through the south is not a figure of speech but an actuality, for many miles of good roads are being made by setting fire to poor ones, the result being what is known as a baked-clay road.

There are no poorer roads in all the United States than the "gumbo" roads of the south—gumbo being the name given a certain kind of mud or clay that is particularly sticky, clings tenaciously, seems to have no bottom, and will not support any weight. Gumbo, however, contains a large percentage of organic matter, which will burn when dry, and, as a result, a road of this material, properly prepared and set on fire, emerges from the fiery ordeal as a "perfectly good" road, and one, moreover, that stays so for a considerable period of time.

The process of converting a gumbo road to baked clay begins by plowing the roadway and making ditches

on the sides. Cordwood is laid in a sort of flooring across the furrows, which run crosswise of the road; great lumps of sticky gumbo are spread over this floor, along with more wood, loosely strewn about, then a second floor of wood is laid, and the whole covered with gumbo, tamped and rounded off. Fire is now set to the road, and the flames, rushing through the furrows, which serve as flues, ignite the wood. After the heat has driven the water out of the gumbo, this, too, ignites, and the actual cooking process is in full swing.

"It is more than merely drying out the gumbo," says C. H. Claudy, in *Motor*. "It is a peculiarity of this gumbo that, at low temperature, it clinkers. And these clinkers, when broken up, are quite different from the original lumps of gumbo. The clinker is not only fairly hard, but, if properly burned, will not make mud when mixed with water. In this is the triumph of

the burned-clay road. When the fire has burned itself out, the road maker has not only a thorough mixture of dry clay and wood ashes, but a good depth of gumbo clinker, which he promptly proceeds to break into small pieces, to spread evenly, and finally to roll and compact into a real road."

To all intents and purposes, the road so made is a fine dry stretch of crumbled brick.

ENGLAND'S "GIGANTIC" LOCOMOTIVE

England's most powerful locomotive is shown in the accompanying illustrations. It is spoken of in England as

"an elephant of the railroads," as "an enormous, unique engine," and as "the latest gigantic locomotive." "This elephant of the railroads is remarkable in many ways," says one writer. "The usual outside cylinders have given place to inside cylinders, which are no less than 21½ in. in diameter and of the exceptional length of 17 ft. 3 in. The engine and tender, in working order, weigh 122 tons."

Railroading conditions in America, of course, are different, but it is interesting nevertheless to make some comparisons. The "big" locomotive of the Virginian Railroad weighs, with tender, 316 tons, and will draw 155 loaded 50-ton freight cars at 10 miles an hour. The "big" locomotive of the Atchison, Topeka and Santa Fe Railroad weighs, with tender fully loaded with oil, fuel and water, 425 tons, the engine alone weighing 308 tons. The total length over engine and tender is 121 ft. 7 in.

DUPLICATE CASTS OBTAINED BY USE OF GLUE MOLDS

The American Museum of Natural History, New York, which has accomplished important work in making casts of Indian and Eskimo heads from life, has evolved a particularly effective method of making duplicate casts, the feature of which is a glue mold. In the process of obtaining the mold the cast to be duplicated is first covered with a half-inch thickness of clay and then a two-piece plaster mold is made over the clay. When the plaster has hardened the mold is taken off, the half-inch thickness of clay is removed from the head, and then the model is put back in position in the plaster mold, which is like a jacket or hood,

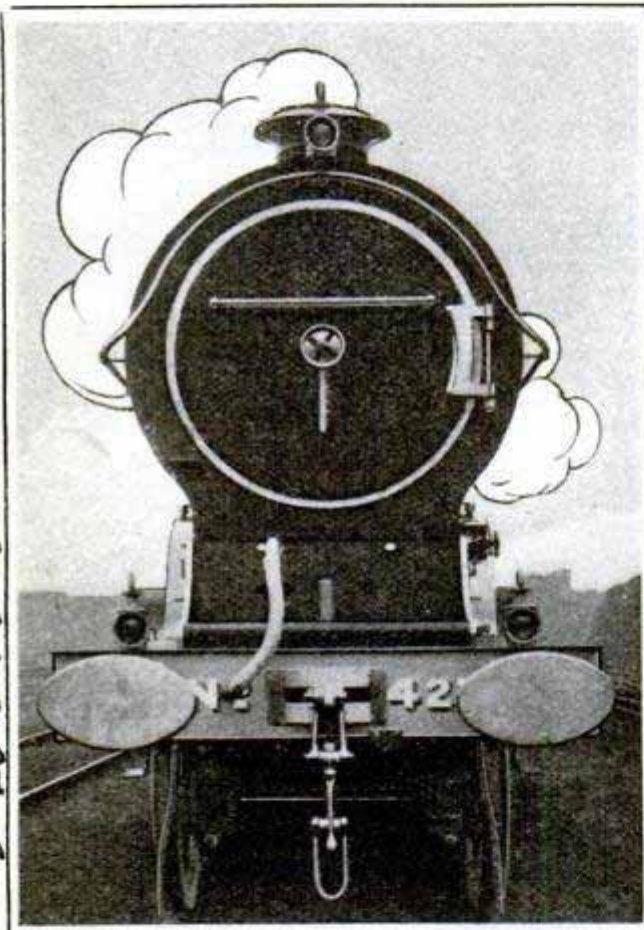

Front View of England's "Enormous" Locomotive

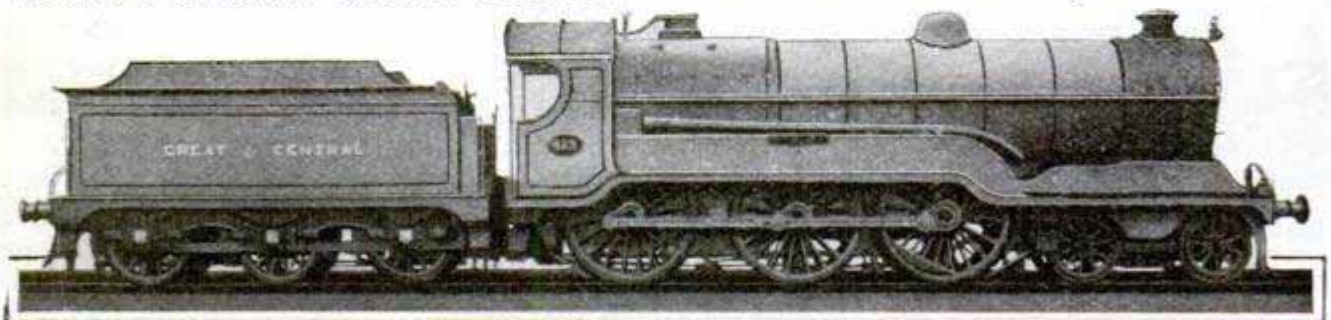

Side View of the Most Powerful Locomotive in England

Photo by Paul Thompson

323

Great Central R.R. Eng.
Porter Works



1, Method of Making the Jacket, the Model Being Covered with a Half-Inch Thickness of Clay, of Which a Part has been Removed to Show the Face Underneath; 2, Model with One Half of Jacket in Place, Showing the Space to be Filled with Glue; 3, Pouring the Glue into the Jacket; 4, The Glue Mold as It Appears When Looking into It; 5, A Number of Casts

Courtesy Am. Mus. of Nat. Hist.

separated from the model by a half-inch space. This space is then filled with glue, poured in as shown in one of the illustrations. As the glue rises in the space about the model, holes previously cut in the jacket to allow the escape of air are plugged with clay, the funnels at the top and side of the jacket are also capped with clay, and the glue is allowed to stand for 12 hours. The glue mold thus obtained is firm enough to produce an accurate cast, yet yielding enough to allow its removal intact, no matter how many undercuts the features of this cast may present. A large number of duplicate casts can be made from such a mold.

3274 A CITY WHERE AUTOMOBILES ARE PROHIBITED

The little city of Odder, Denmark, is remarkable for the fact that its four thousand people have never relaxed from their early declaration never to permit the driving of a motor car through the streets. In consequence of this united opposition there may be witnessed any day in that city the odd sight of a man, clothed in a business suit and wearing a soft hat, sitting

astride a black horse, drawing the automobile of some visitor through the town. The spectacle affords amusement for the children who climb into the vehicle and accompany its occupants. A severe fine has been provided for any attempt to violate the rather unusual ordinance.

STAIR-CLIMBING MADE EASY FOR THE WEAK-HEARTED

The curious device attached to the lower foot in the illustration, although suggestive of the old patten or wooden shoe is, in reality, a steel slipper designed for assisting weak-hearted people to climb stairs by providing the foot with means for additional springiness. Only one slipper is used and it is held in position by a strap passed over the foot.



"Slipper" for Assisting Weak-Hearted People to Climb Stairs

HUGE COLUMNS OF GRANITE TO LAST 10,000 YEARS

By GUY E. MITCHELL

Granite is the most enduring of building stone. All rocks are subject to the destructive action of the elements—rain, sun and frost—but it is estimated that the best quality of granite, under ordinary building strain, will, in the average humid climate in a temperate zone, outlast 100 to 1 a common quality of sandstone. As a specific example, the great pillars of the United States Treasury building at Washington, on three sides of the structure, were cut from Maine granite quarries. There are 56 of these huge columns, each 39 ft. in height, but on the east side of the building, which was intended to be the back, sandstone pillars were used, quarried from a sandstone formation along the Potomac River. At the end of a century of wear, these sandstone pillars had so crumbled, flaked, and some of them actually cracked, as to threaten the destruction of that side of the building covering the great money vaults of the government. They were consequently replaced with an equal number of granite columns. The point is that the original granite pillars appear as perfect today as when they were first erected; they cannot be told by any but an expert from the new granite pillars which have replaced the sandstone pillars, and it is believed by architects that under prevailing conditions all the pillars of the treasury building will be as solid and effective 10,000 years hence as they are today, should the treasury building and the Republic endure for such a period.

Of course, there is no hewn granite in existence known to be 10,000 years old, but there are granite edifices made by man more than 3,000 years ago which are today in an apparently perfect state of preservation.

The interesting feature has developed in modern stone-construction work, that old-fashioned hand hewing is sometimes better than machine work. This is shown in the huge granite columns which adorn the Cathedral of St.

John the Divine, in New York City. It was proposed that these should be the greatest of granite monoliths—one-piece pillars—eight of them, each 54 ft. in height and 6 ft. in diameter. They were accordingly quarried in the rough from the Fox Island quarries, Maine, and prepared for finishing in a gigantic lathe. The first pillar was adjusted in the lathe and successfully turned down to the desired dimensions.

"What a grand thing a lathe is," said the foreman as he surveyed the massive pillar, ground down to a nicety. "We would have worked a dozen men for days with hand tools on this."

But when the workmen returned in the morning, they found the dressed pillar split transversely and ruined. A second pillar was turned and likewise carefully removed from the lathe. During the night the watchman heard a loud cracking and bursting noise, and upon examination found that the second pillar had split.

"H'm!" remarked the foreman, in the morning, "lathes are not so much after all."

It was concluded that the enormous size and weight of the columns, held in the lathe at only two pivotal points, constituted too great a strain upon the stone molecules, resulting in the practical destruction of the columns, even after the job of turning had been completed and the strain relaxed. It was therefore deemed necessary to cut the monoliths in two pieces before placing them in the lathe. Had the columns been dressed down by hand, as would have been done 100 years ago, there would have been no question of their cracking; on the other hand, the cost of the work would have been greatly increased.

CA 917-ft. wireless tower with an estimated radius of 6,000 miles is being erected at Nauen, Germany, to replace the one which was blown down there about a year ago.



Replacing the Sandstone Columns of the U. S. Treasury with Granite That will Last 10,000 Years

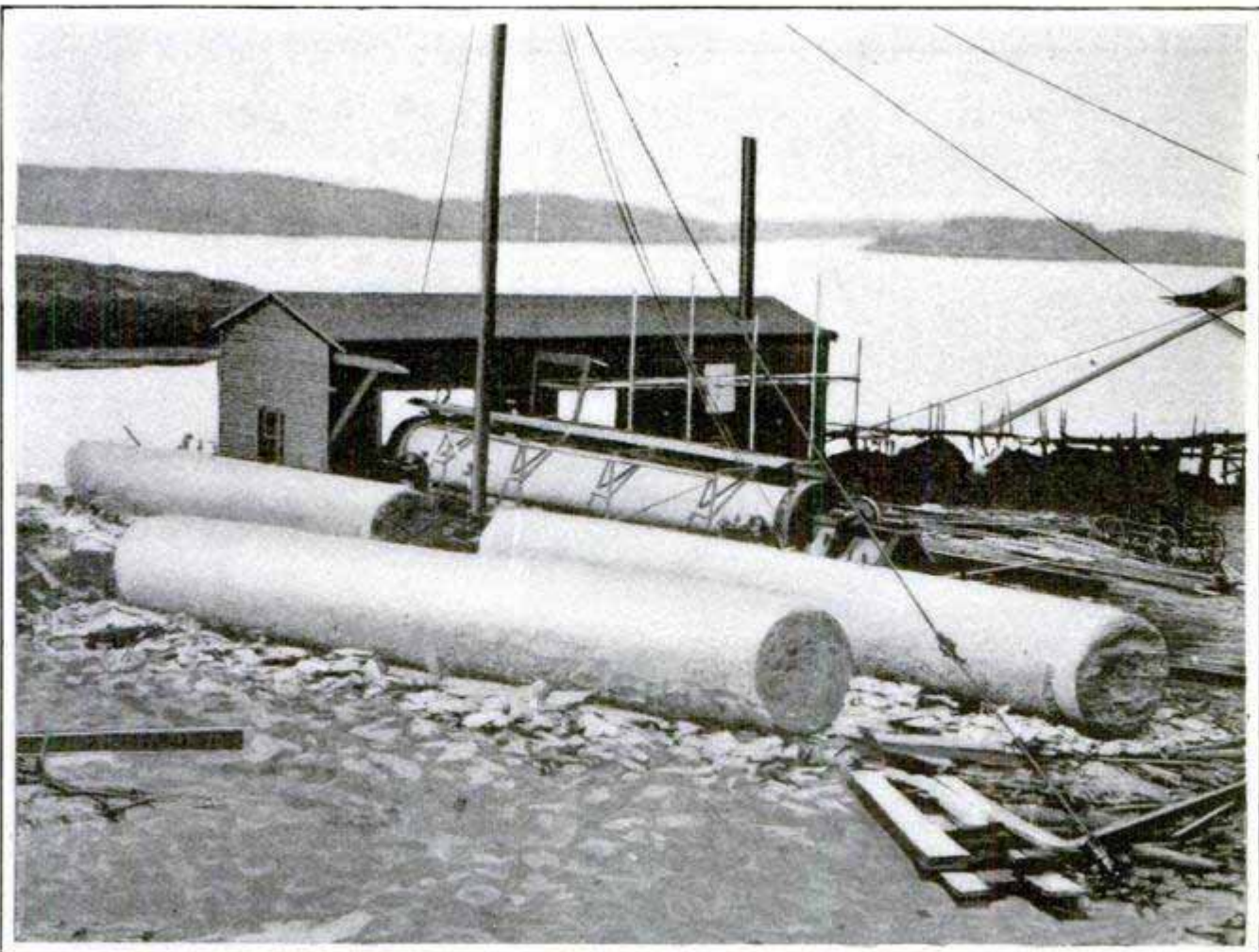

Giant Granite Monoliths, 54 Ft. Long and 6 Ft. Thick, That Cracked When Turned in a Lathe

Army Engineering Engineer
Hallas. Texas

CAB WITH THREE WHEELS USED THIRTY YEARS

This three-wheeled cab was designed about 30 years ago by a veteran cabman of London and has been in



Three-Wheeled Cab Used in London for Thirty Years

continuous use by him since that time. The inventor claims that the vehicle cannot be and never has been overturned.

A "SHAKING DOWN" METHOD OF CONCRETE PAVING

185 A new method of constructing concrete pavement, in which the concrete mixture is "shaken down" by means of a vibrator, has been adopted with success in several Texas cities. The purpose of the "shaking down" is to force surfacing material into the body of the concrete, thus producing a dense mass.

The subgrade is prepared as for any other pavement, and then the concrete is mixed and spread, as much water being used as the mass will retain without draining. After the spreading has advanced a few feet, a coating of crushed granite is applied and the surface is ready for the vibration treatment. Platforms, 20 in. wide and as long as desired, made up of $\frac{7}{8}$ by 4-in. strips, are then laid to support the vibrator, which is mounted on rollers. The vibration causes the crushed granite to sink in.

Vibrating

SPEED-INDICATING LAMPS FOR AUTOMOBILES

995 Mention was recently made in this magazine that the chief of police of Los Angeles was attempting to have an ordinance passed to compel the installation of speed-indicating lamps on all automobiles. The device which the chief is advocating is here shown. In a brass case, designed to be placed on the radiator, are mounted two sets of bull's-eyes, each set comprising a red, a white, and a green light. The mechanism which automatically switches the different lights off and on, according to the speed of the car, is

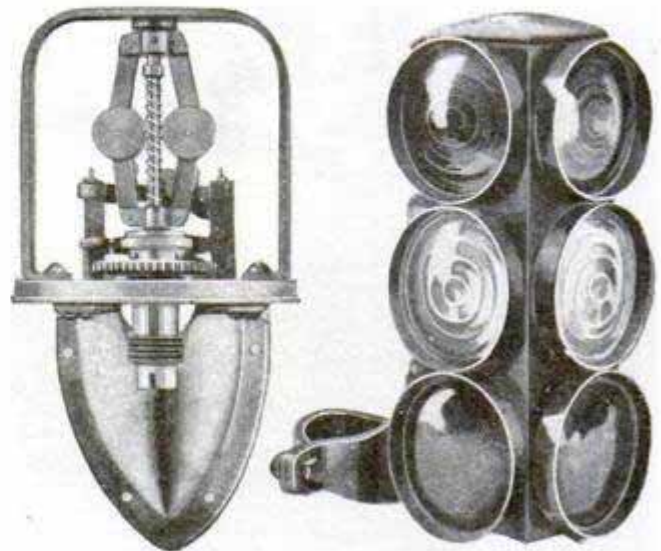

The Speed-Indicating Lamps and the Mechanism Which Operates Them Automatically

no make

connected with a speedometer shaft. The white light shows when the car is making a speed of 10 miles or less; the green light, at speeds of over 10 and under 20 miles, and the red light is displayed when the car makes more than 20 miles.

ADMISSION OF MOTOR CARS TO NATIONAL PARKS *1222*

Automobiles are admitted, under appropriate regulations, to the following national parks: Mt. Rainier, Wash.; Glacier, Mont.; Crater Lake, Ore.; General Grant, Cal.; Wind Cave, S. D., and the Platt National Park, Okla. They are not admitted in the Yellowstone, the Yosemite, or the Sequoia National Parks. The question of admitting motor cars into the Yosemite Park is now under consideration by the Federal authorities.

HYDRO-AEROPLANE CARRIES SIX PERSONS *915*

The new hydro-aeroplane constructed for Baron. Deutsch de La Meurthe, the ~~well-known~~ French sportsman who was one of the first patrons of aerial navigation, is spoken of as a hydro-aerobus, because it easily and comfortably carries six persons in the cockpit of the boat portion.

Mfr. Vasini

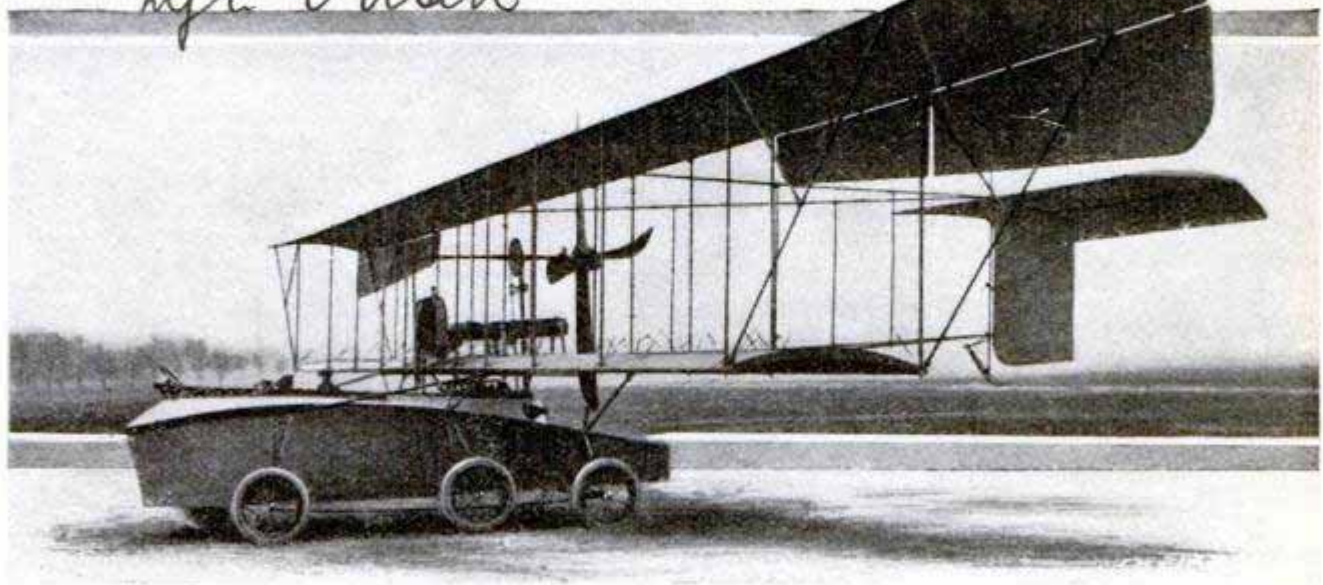

The Six-Passenger Flying Boat Owned by Baron Deutsch de La Meurthe

REEL THAT TAKES UP AND PAYS OUT WIRE

The combined take-up and pay-out wire reel here shown is made from sheet steel and has an adjustable wire

Combined Take-Up and Pay-Out Wire Reel

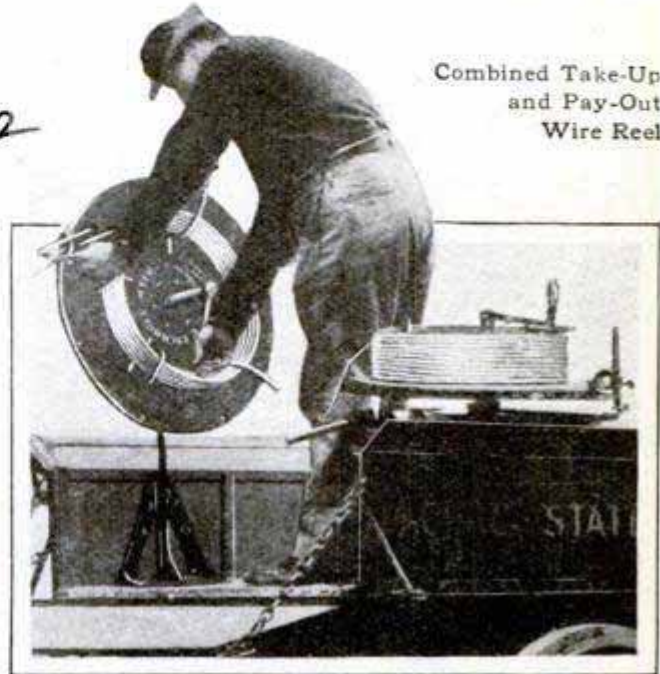

guide and arms that can be adapted for different-sized coils of wire. The reel has no rims or spokes to cut through the insulation of the wire, and it is provided with a brake for holding the wire at any desired tension without slipping. This type of reel eliminates the necessity of using one reel for paying out and another for taking up wire.

12
A PRIMITIVE SKYSCRAPER THAT RIVALS IN BEAUTY

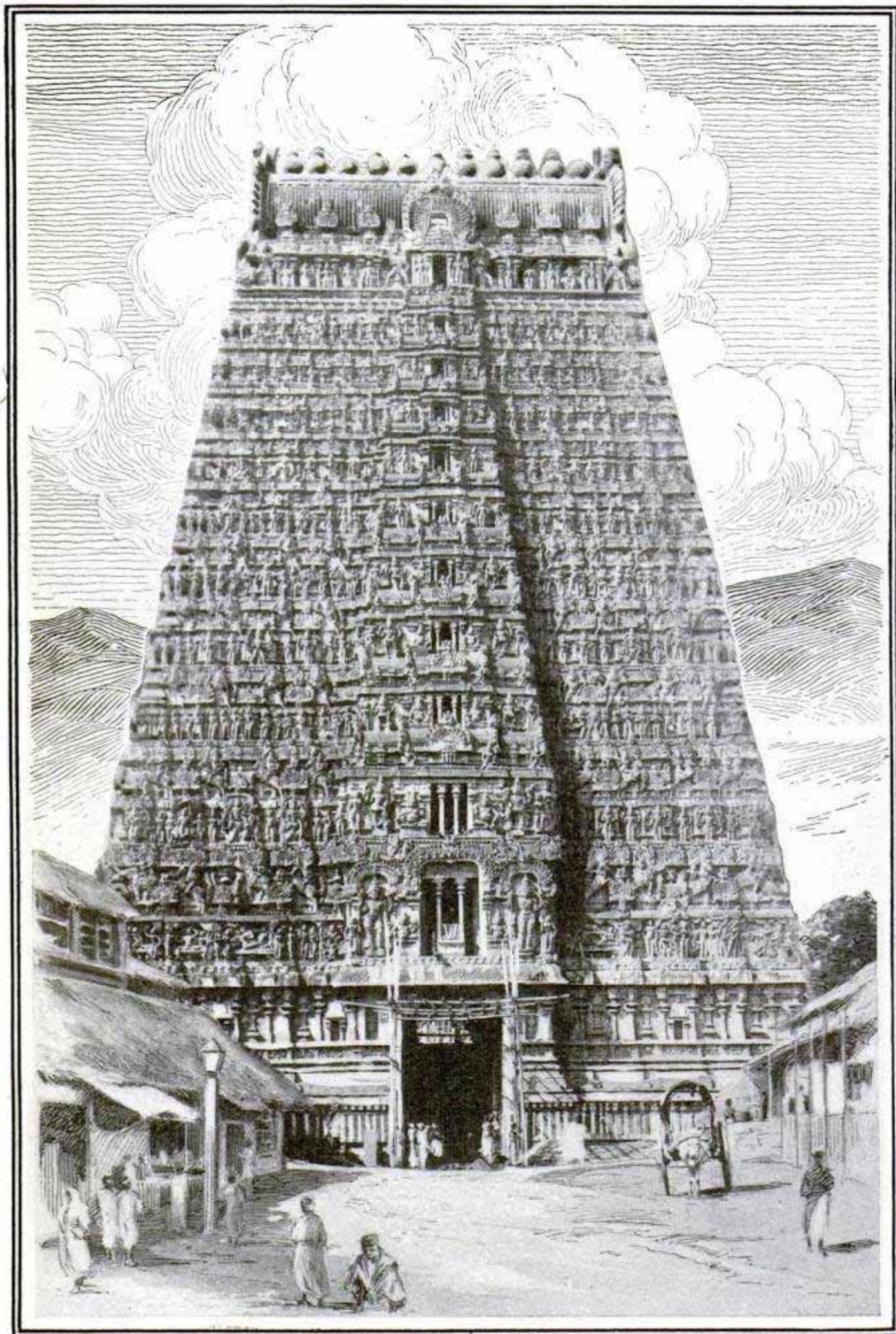

This Twelve-Story Hindu Temple at Kumbhakonam, India, was Built Many Centuries Ago by a Bayak King

Copyright, Underwood & Underwood

THE LATEST SPLENDID TRIUMPH OF ARCHITECTURE

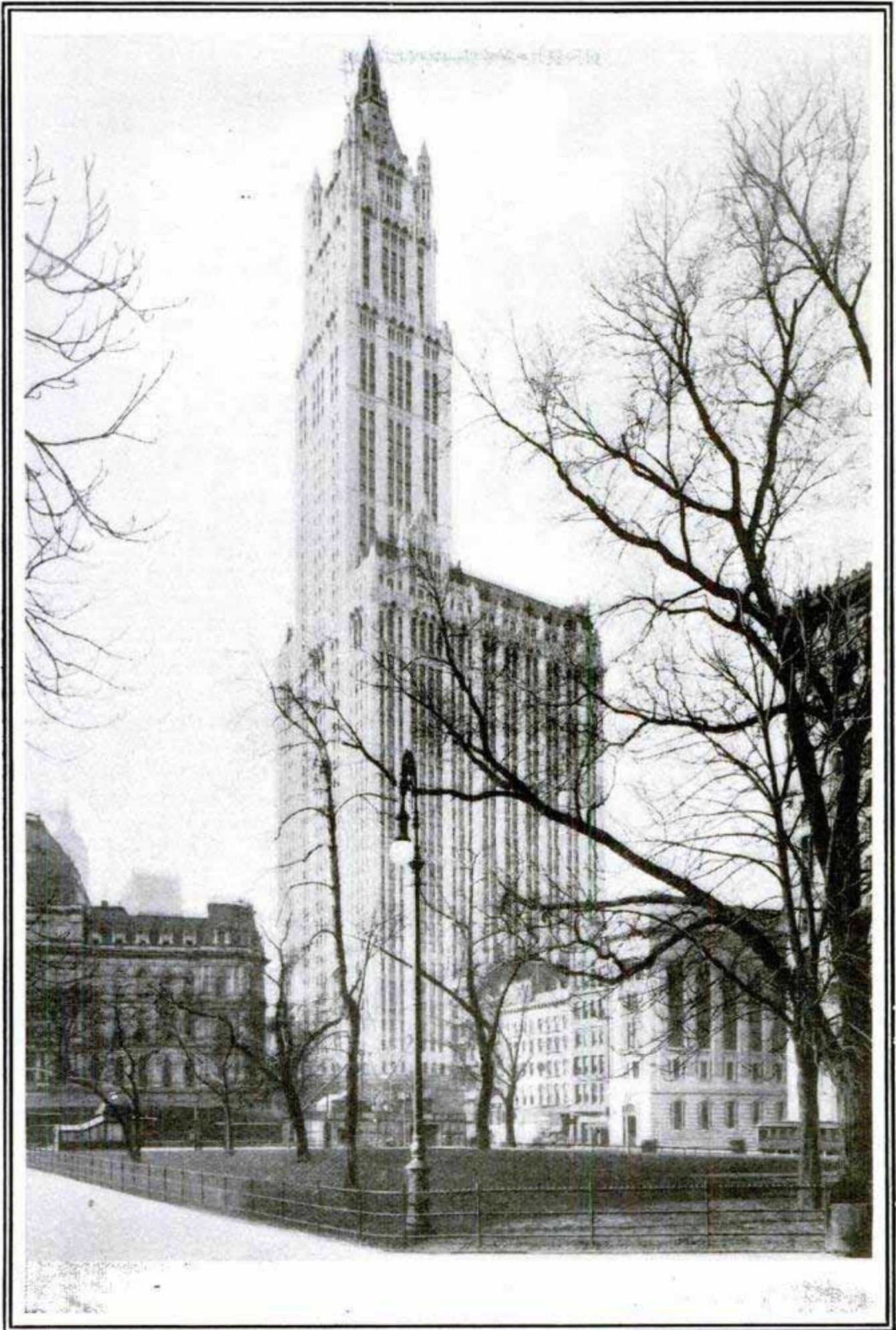

Copyright, Underwood & Underwood

The Fifty-Five-Story Woolworth Building Soars in Cathedral-Like Beauty beside New York's City Hall Park

NEGLECTED MONUMENT TO GREAT EXPLORER

Overgrown with small palms and other tropical vegetation is the monument to Magellan, on the Island of



Monument to Magellan, in the Philippines. Which has become Overgrown with Vegetation

Mata in the Philippines, where he was killed in 1521 by the hostile natives. The monument was erected many years ago on the spot where he was slain, but the island is not much visited, and the monument, especially in the years since American occupation of the islands, has become much in need of repair.

Can an arrangement has been devised by means of which mail bags and other packages may be picked up from the ground by an aeroplane in full flight.

W. A. A. A.

ATLANTIC TO PACIFIC BY TELEPHONE

¹²¹⁴ Before the end of 1913 it will be possible to telephone between the Atlantic and Pacific Coasts and another line connecting these two points will be completed before the Panama-Pacific exposition of San Francisco opens in 1915, according to officials of the American Telegraph and Telephone Co. One route will be via Omaha, Denver and Salt Lake City to Los Angeles, and the other via Omaha, Julesburg and Cheyenne to San Francisco.

At present the longest telephone line in the world is between New York, or Boston, and Denver. The distance from New York to the Pacific Coast by telephone will be approximately 3,300 miles and the cost of conversation is expected to be about \$18 per minute.

¹¹⁶⁷ PARACHUTE-TESTING DEVICE

This method for testing a parachute without a human being accompanying it, consists in folding up the parachute and fastening it to a dummy which is then placed on a framework suspended by block and tackle from some high structure. When a rope attached to this framework is pulled, the framework is tipped and the dummy is thrown into the air with the parachute.

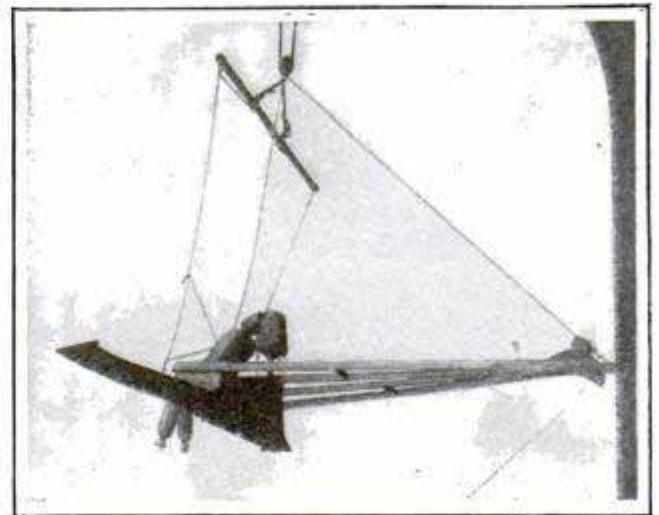

Testing Parachutes with a Dummy Instead of a Human Being

Luftfahrt

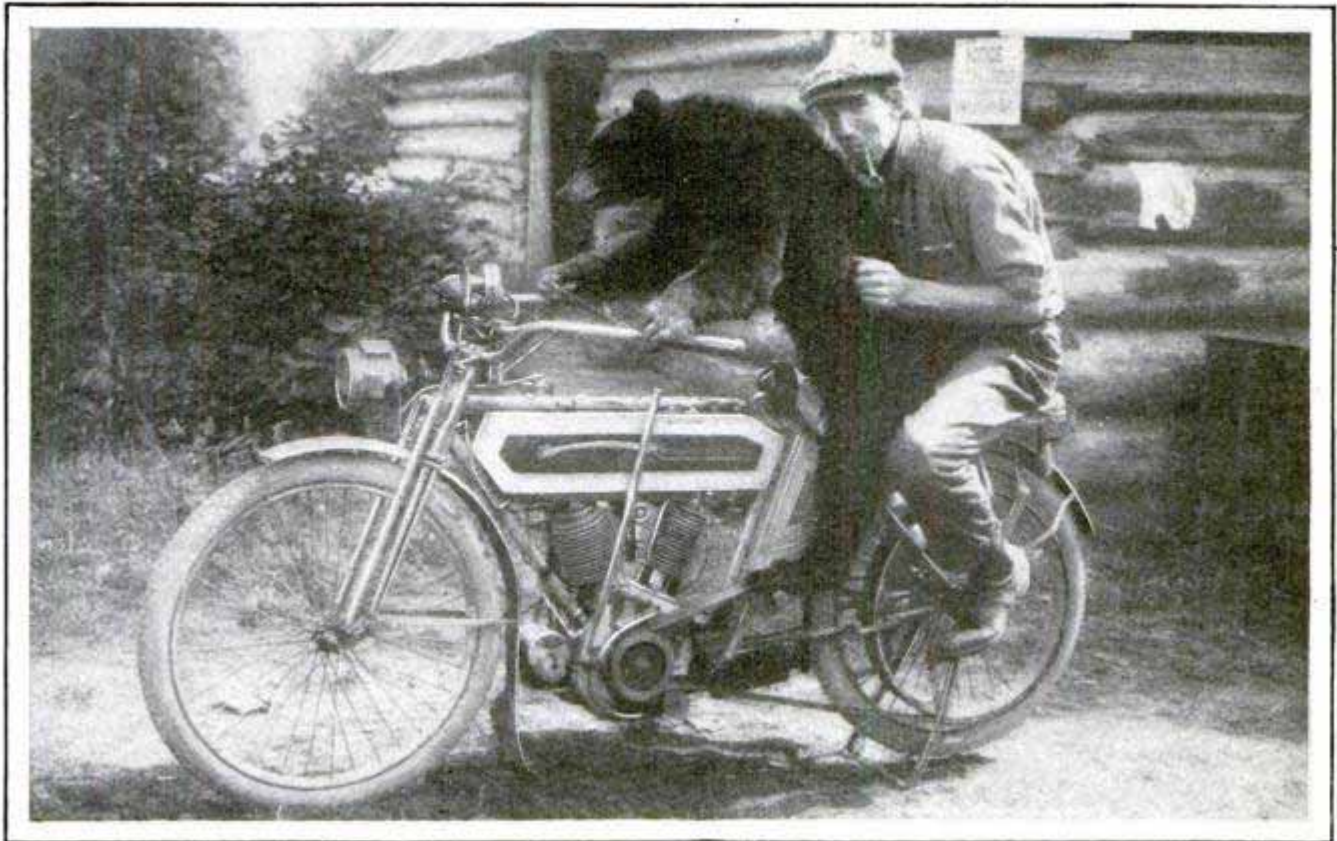

A Bear That is More or Less Familiar with Motorcycle "Joy Riding"

60
BEAR AS MOTORCYCLE COMPANION

It would be dangerous to allow this bear to usurp the operator's seat, were the motorcycle in actual operation, but the animal appears very much at home with its fore paws on the handlebars and its hind paws on the pedals. This is due to the fact that this pet bear has had many motorcycle rides as a passenger.

CARS FOR DISINFECTING THE CLOTHING 32 71

Railroad cars containing apparatus for disinfecting the clothing and baggage of passengers who have been exposed to contagious diseases, have been put into service on a railway line in Italy. Each car is fully equipped with two sets of disinfecting apparatus; one being a steam-stove system, and the other designed to disinfect the clothing by means of formalin. Two cars are already in operation and several others are in course of construction for use in the southern part of the country.

2
GREENHEART WOOD USED FOR PANAMA CANAL LOCKS

The sills and fenders of the Panama Canal locks are made of British Guiana greenheart, a wood which, according to the Department of Agriculture, outlasts iron and steel when placed in water. It is used in ship and dock building, trestles, bridges, shipping platforms, flooring, and for all purposes involving great wear and tear. The woods of two species of West African trees have been introduced into British markets as substitutes for greenheart under the name of African greenheart, but both are inferior to the South American tree.

All the gates, piers, and jetties of the Liverpool docks and practically all the lock gates of the Bridgewater Canal in England are of greenheart. It furnished the material also for the 50 pairs of lock gates in the Manchester Ship Canal. When the greenheart dock gates in the Mersey Harbor at Liverpool were removed in order that the channel might be deepened and widened, the same wood was again employed in building the enlarged

gates, and wood placed in the gates of the Canada dock, in 1856, was used again in its reconstruction, in 1894. Nansen's ship, the "Fram," and the antarctic ship "Discovery" were built of greenheart. In addition to its use as timber, great quantities of the wood are made into charcoal.

Though it grows in parts of British, French, and Dutch Guiana, Venezuela, Brazil, Colombia, Peru, Trinidad, Jamaica, and Santo Domingo, it is being cut only in British Guiana, where it is found along the seacoast and watercourses, seldom extending more than 50 miles inland. Greenheart once brought \$1 per cubic foot at the point of shipment, but the present

price is considerably less. Constant drain for more than 100 years upon the most accessible stands of greenheart in British Guiana has stripped the forest of its best material, and the wood now obtained is of inferior quality. Tracts are now being cut over in some places for the third time. Only the heartwood of the tree possesses the peculiar durability desired, and the best wood is found in old trees.

The wood of three other species of the same botanical family is occasionally cut and sold with the genuine greenheart. These are the white cirouballi or sirauballi, the yellow cirouballi, sometimes called "black cedar," and the keritee or kretti.

"MAINE'S" TURRET AND GUNS ARE MONUMENT'S BASE

The government of Cuba intends to perpetuate the memory of the battleship "Maine" by the erection of a monument in Havana. The chief feature of the monument will be the port after turret and guns of the "Maine," recovered from the wreck last year when it was raised from the bottom of Havana Harbor. The design for the monument submitted by Señor Emilio Heredia has been approved by the government of Cuba, and is shown in the accompanying photograph.

The monument will be placed in a park just west of the Santa Clara battery, at the entrance to Vedado,

a suburb of Havana. The sculptor has sought to represent the birth of the Republic of Cuba amid the smoke and flame accompanying the destruction of the famous battleship. The figure of a woman is seen rising out of the smoke above the turret and guns which form the base of the monument. The figure will be in marble, while the turret itself will rest on a stone base. The monument will be 27

ft. in height and will be surrounded by a fence made of anchor chains taken from the wreck of the "Maine."

A bronze tablet will be attached to the face of the turret, under its guns. This tablet will bear the text of the joint resolution passed by the United States Congress which declared Cuba's inde-



Cuba's Memorial to the "Maine" Shows Sculptured Smoke Arising from the Battleship's Turret

pendence and which was tantamount to a declaration of war with Spain. Five other tablets will be placed on the sides of the turrets. These will represent, in bas-relief, the arrival of the "Maine" in Havana Harbor, its destruction, the wreck as it appeared in the harbor, the work done to raise the "Maine," and finally, the burial of the hulk on March 16, 1912.

TROLLEY CAR AND AUTO ACCIDENTS *1201*

One human being is injured every 12,053 miles traveled by a trolley car and one for every 178,666 miles covered by a motor car, but before a fatal accident occurs the trolley travels 800,000 miles and the automobile 2,400,000 miles. These figures apply to employes and occupants only, it being necessary for the automobile to travel three times as far as the trolley before killing an outsider, and about seven times as far before injuring one.

Engineering Record
ELASTIC SADDLE FOR MOTOR-
3207 **CYCLES**



An improved saddle for bicycles and motorcycles, in addition to having the ordinary form of spiral spring support beneath the seat, is also provided with two adjustable spring coils so mounted within the two upright rods that their tension may be increased or lessened at will by simply turning the thumbscrews attached to the lower ends of the rods. The

saddle can also be raised or lowered by loosening the clamps above the thumbscrews, and the two supporting rods give perfect rigidity to the seat at all times.

KITE TRAIN USED BY FRENCH ARMY

1003
A new form of kite or kite train which lifts a man in a balloon basket to a considerable height for the purpose of observation, when the wind is too strong to employ a captive balloon, is being used by the French army. The arrangement consists of two separate trains.

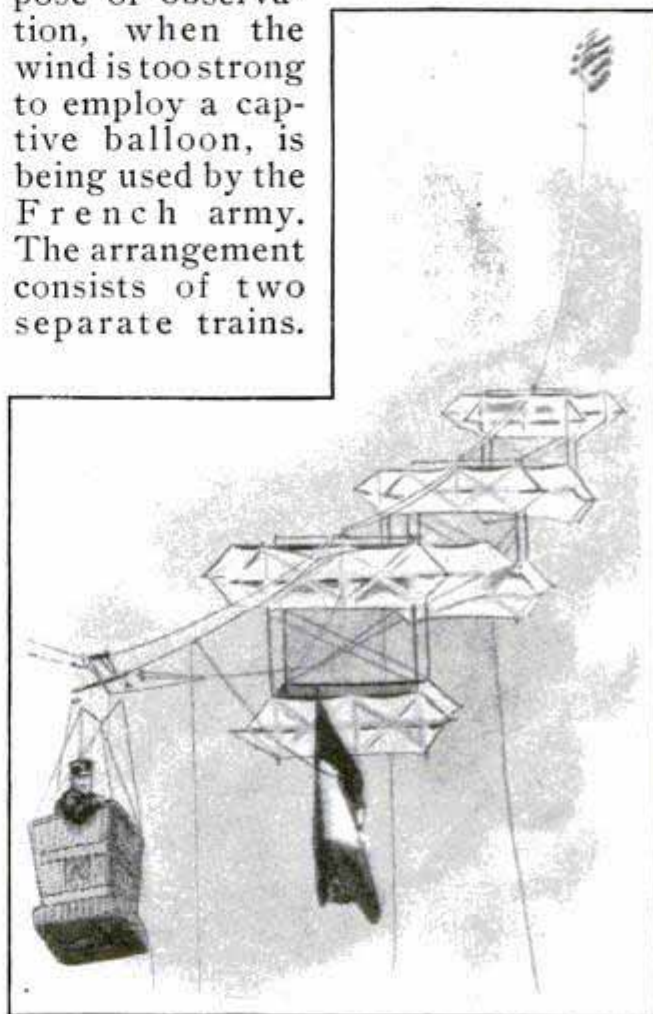

Observing the Enemy from a Kite Train

The first carries and stretches the cable on which the other—the towing train—pulls up the basket. The entire system uses as many as eight different kites, each of these being made of several surfaces, on the box-kite principle, the total surface of the kites being about 1,000 sq. ft. An automobile is used to convey the cable drum and draw a second vehicle which contains the kite apparatus.

More than 3 hp. of electricity is being used by the contractors to every man at work in constructing the Lexington Avenue and Broadway tunnels in New York City. The current is used to operate all apparatus requiring more than manual power.

"Subs" T. M. Inventions Catalogue

ARMORED AEROPLANES FOR U. S. ARMY FLIERS

Armored aeroplanes, providing for the protection of the airman, pilot and engine, are demanded in the latest specifications for flying machines issued by the War Department. A special design for the armored cover has not been drawn by the department, the design being left to the ingenuity of the manufacturers. It is specified, however, that the finest chrome steel shall be used and that the armor shall be about .075 in. thick. Tests made by the Ordnance Bureau show that chrome steel .06 in. thick will withstand the steel-pointed bullet used in the regular army rifle at a distance of 2,000 ft. The missile, striking the armor squarely, will produce a deep dent but will not penetrate. To make an armored cover sufficient to protect the airman, pilot and engine will require 15 sq. ft., or more, of this thin, but strong steel. The armor will weigh between 35 and 50 lb. and will thus add no material burden to that imposed on the aeroplane.

Armored aeroplanes have been the subject of experiment abroad, but have not been used heretofore in this country. In some types of machine the guides running to the tail or rudder have been covered by fabric which, at a distance, gives the same appearance as armor. However, the armored car will not only carry side armor, but, of more importance, bottom armor and two upper hoods to protect the engine.

Three aeroplanes will be bought shortly under the new specification, which aside from the question of armor, includes many new requirements. The length of flight carrying a live load of 450 lb. has been doubled; heretofore the test flight was only two hours and could be made largely over an aviation field; the new test requires four hours' continuous flight, which must cover a minimum distance of 180 miles and be made over a course designated by the examining board. Only the end of the flight may be conducted over an aviation field. The purpose of this requirement is to as-

certain the power of the machine under actual service conditions. Flight over a smooth and protected field does not always demonstrate what a machine will do when flying over trees, hills, towns or water. The eagerness of the Signal Corps to obtain a machine which will still be useful, even when one of its drivers is disabled, when rough ground is encountered, or when the engine is put out of commission, is quite apparent.

Without saying so, in so many words, the War Department is driving at a standard form of control and in the new specifications has gone so far as to say, "The system of control must be of a pattern approved by the board of officers conducting the tests." A standard and, as near as possible, uniform control is desirable for the same reason that standard forms of weapons are desirable—the enlisted man and officer will not be confronted by a strange device in time of need.

Besides wireless apparatus each machine shall carry the following equipment: a tachometer, a compass, one aneroid barometer, a barograph, a map holder, pad and pencil holder, a clock and an indicator for measuring angles of incidence.

The wireless apparatus will be provided by the Signal Corps itself, but manufacturers bidding on aeroplanes will be furnished with necessary plans so that they may provide a place for the installation of this apparatus.

The generator will be attached to the aeroplane engine. The antenna, instead of being sent up into the air as from a ground station, will drop from the base of the aeroplane, swinging in the air. It will be kept on a reel and may be released or wound up again by the airman while in flight by pressing a foot mechanism. The wireless apparatus will add about 75 lb. to the weight of the machine.

CA \$3,000,000 rubber company has been organized and is erecting a large automobile-tire factory in Brazil.

QUEER HOUSE BUILT IN ONE DAY

The accompanying picture represents probably one of the oddest-shaped dwellings in Illinois. More than that, its construction was accomplished in a very unusual way. It was hauled 16 miles in a buggy and was put up between the hours of two o'clock Sunday morning and midnight following. The building is formed of odds and ends found in a carpenter shop, which were hauled to their present location and there put together. The queer-looking building stands on a concrete foundation.



Built of Odds and Ends

Over 600,000 lb. of fish were caught during one trip by fishermen near Beaufort, N. C.

859

OVEN BAKES MORE THAN TWO THOUSAND PIES AN HOUR

An oven 75 ft. long and turning out 2,225 apple pies an hour, which were served free to the public, was the sensation of the National Apple Show and Jubilee Carnival recently held in Spokane. The apples were first made into



sauce in a gigantic sheet-steel kettle, 18 ft. high and 10 ft. in diameter, 500 bu. being cooked at a time. From the kettle the sauce was passed between the crusts and onto an endless chain which took the pies through the oven, the cooking journey lasting 1½ minutes. The pies, which were about 3 in. in diameter, were served to the public steaming hot as they emerged from the oven. An oven of like type will make bread "by the mile" at the Panama-Pacific Exposition.

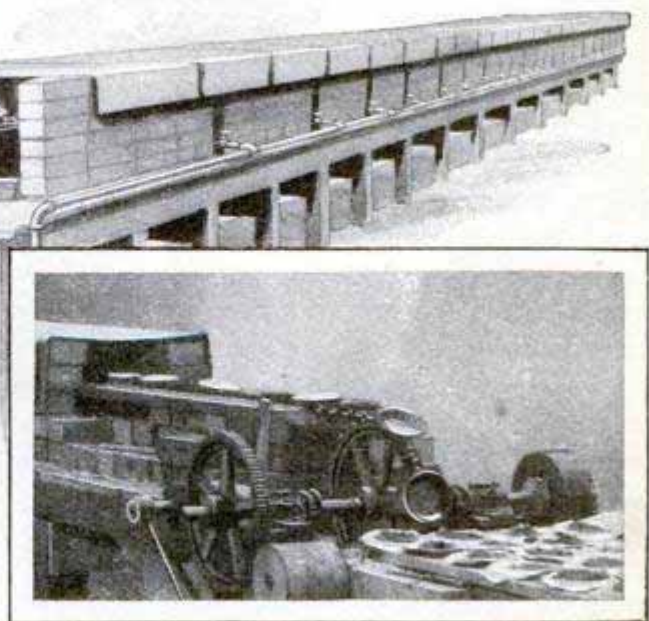

A Monster Oven Which Baked 2,225 Apple Pies an Hour for Free Distribution to the Public Attending Spokane's Apple Show

Made by

FLOATING STORE OF MOTOR-BOAT SUPPLIES

1093 A new departure in motorboats is here shown. This boat is practically a floating store or salesroom of gas-



Motorboat Store with Engine Supplies

engine supplies, as it carries almost everything that may be needed by other boats in cases of emergency, or when the regular source of supply on land cannot be reached without difficulty. The supply boat travels constantly over Puget Sound from Olympia to the Cape and is regarded as one of the most useful boats plying on that water.

CONCRETE FIFTY YEARS IN 3270 THE OCEAN

That concrete remains entirely intact, after having been more than half a century in sea water, is a fact that has been established by recovering several blocks from the ocean where they have lain since 1858, when three seaport docks in Denmark were constructed of Portland cement.

One of the blocks was tested under the direction of the Danish Minister of War and the result indicated that the sea-water apparently had no effect whatever upon the specimen analyzed. The block, to which is attached the report of the test, is on exhibition at the German Museum of Nature in Munich.

PARACHUTE TRIALS FROM 968 THE EIFFEL TOWER

Since the fatal drop, some time ago, of an inventor who attempted to demonstrate the practicability of his parachute for airmen by jumping with it from the Eiffel tower, the French government has prohibited further experiments of like nature. Tests of such devices, however, can still be made from the tower, providing a weight be substituted for the human body, and a recent test, so conducted, proved successful. The parachute

in question, opening out to a diameter of 40 ft., is spread by a system of springs operating automatically the moment the fall begins. In the trial the apparatus opened fully before it had fallen 60 ft.

AN INHOSPITABLE-APPEARING 52 MACHINE

There are a number of machines so extraordinary or "queer" in shape that the average beholder might rack his brain for days in trying to guess their purpose.

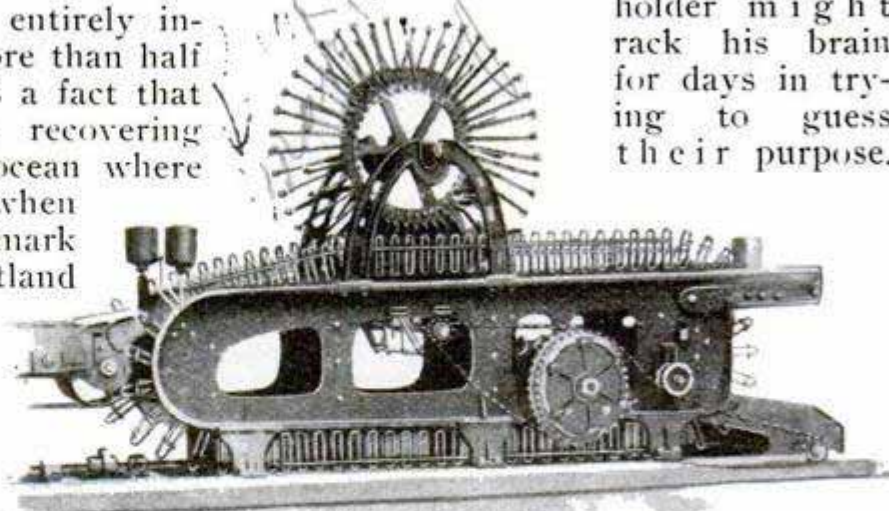

What is It?

Here is a machine which might, were we living in the middle ages, be easily mistaken for an instrument of human torture, but its reason for being is a production we see every day.

Concrete, Cement Age.



Shop Horse with Roller Attachments

The shop horse is a necessary appliance and its use can be greatly increased if it is supplied with a set of combination rollers. It is best to build these horses complete, as all parts will then be proportioned correctly to receive the roller supports.

The posts A, A, are shaped from wrought iron, 47 in. long, $2\frac{1}{2}$ in. wide and $\frac{5}{8}$ in. thick, the part on which the top plate B rests being 7 in. long, so that each post is 20 in. in length. The top plate is 20 in. long, 6 in. wide and $\frac{5}{8}$ in. thick. The bracket C is formed as shown from a piece of metal $22\frac{1}{2}$ in. long, 4 in. wide and $\frac{1}{4}$ in. thick,

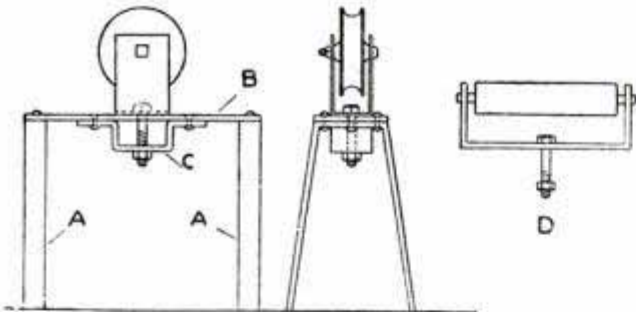

Shop Horse with Interchangeable Attachments for Handling All Kinds of Round and Plate Stock

making the two vertical parts 9 in. long.

A grooved metal pulley, 8 in. in diameter, is fitted in a yoke which is attached to the horse with a bolt as shown. A roller, D, 2 in. in diameter and 15 in. long, also fitted in a yoke, may be attached to the horse in the same manner as the pulley.

The grooved pulley is used for round iron, rods and shafting, while the roller is adapted for holding plates, channels and angle iron. The attachments can be quickly changed or removed entirely and the horse used in the ordinary manner.

A Rack for Bicycles

One retail firm uses a very practical device for storing bicycles. It consists of a frame built up of 1-in. gas

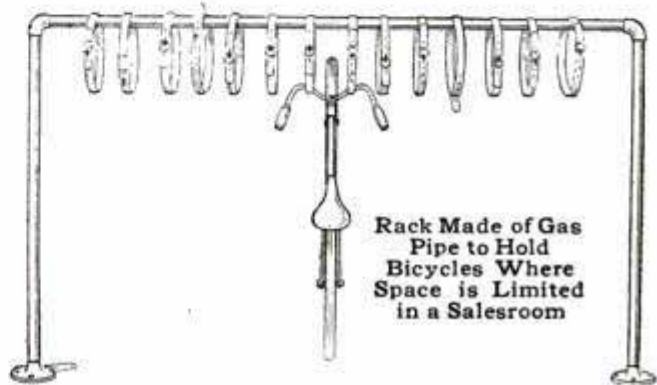

Rack Made of Gas Pipe to Hold Bicycles Where Space is Limited in a Salesroom

pipe, two floor plates and two els. The height of the frame is 42 in. and the width 6 ft. Skate straps are used for attaching the handlebar to the rack.

Utilizing Waste Heat in a Gas Water Heater

The changing of an outlet pipe from A to B, as shown in the sketch, from a large gas-heated boiler resulted in quite a saving of fuel. The burned gases and heat passing out through the heat pipe

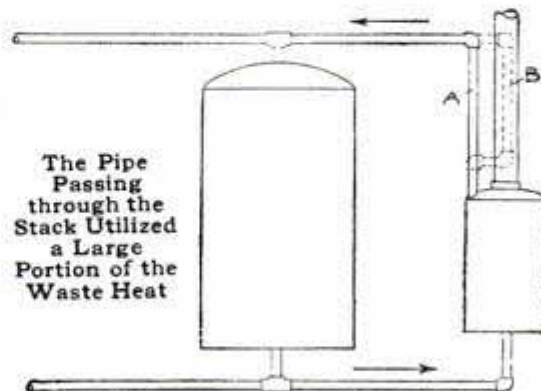

The Pipe Passing through the Stack Utilized a Large Portion of the Waste Heat

or stack aided considerably in heating the water.—Contributed by John F. Hurst, Louisville, Ky.

Drawers in Stair Steps

Where space is limited in the modern bungalow or cottage having second-floor rooms, drawers may be

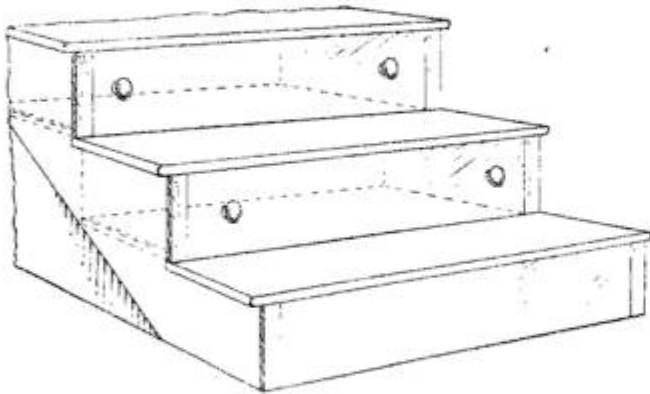

Each Step on a Stairway may Contain a Drawer in Which Many Articles can be Stored

constructed to enter the riser on each step and used to store many articles not in everyday use. The drawers should be snugly fitted in the openings to keep out the dust. After using the drawers, care should be taken to close them again.—Contributed by Fred L. King, Islip, N. Y.

A Portable Chain Conveyor

The conveyor shown in the illustration was used to remove ashes from the slab pit of a sawmill, and saved its cost many times. Its length is 64 ft., with a height of 30 in. at the receiving end, and 14 ft. at the delivery end.

Old boiler tubes were cut the right length and used for rolls under the conveyor to insure easy and smooth motion. A 3-hp. engine was used at the high end for propelling the chain. The parts consist of 2 by 4, 2 by 6 and 2 by 8-in. material.

The lower end of the conveyor was

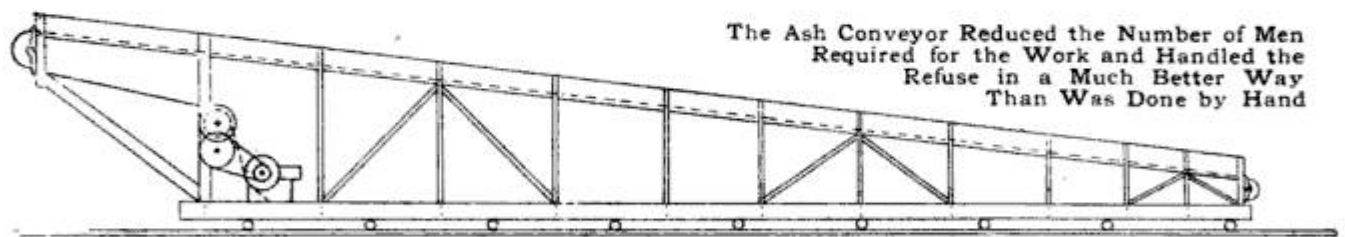

The Ash Conveyor Reduced the Number of Men Required for the Work and Handled the Refuse in a Much Better Way Than Was Done by Hand

kept close to the ash pile to make the shoveling easy. The other end delivered the ashes to the dump wagons.—Contributed by J. W. Shannon.

To Make Grape Vinegar

A simple apparatus by which moldy grapes or spoiled wine can be converted into vinegar has been designed by experts of the Department of Agriculture. By the use of this apparatus waste grapes, which otherwise would be thrown away, can be made into an excellent vinegar. For preparing grape vinegar on a small scale the first thing necessary is a comparatively clean room where an average temperature of 70 deg. F. can be obtained. The parts needed for the apparatus are a cask of about 50 gal. capacity, a wooden spigot, a thermometer, a long-stem glass funnel, and a glass tube. If smaller quantities of vinegar are to be prepared, barrels of 10 gal. capacity can be utilized.

The cask selected should be arranged

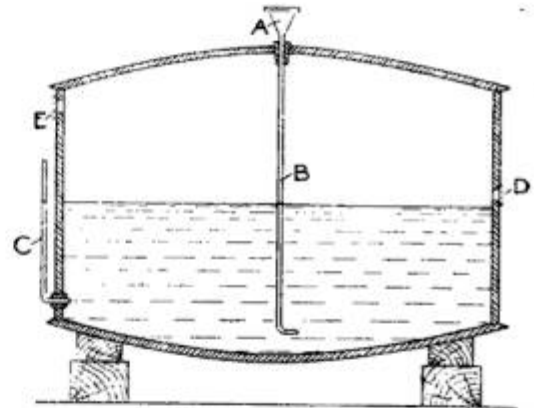

Section of the Cask and Its Attachments Which are Used for Converting Grape Wine into Vinegar

and fitted up with the appliances shown in the sketch. The glass funnel A is placed in the cask with the long stem B almost touching the bottom, the tube being bent at its lower end as shown. In the left head of the cask a hole is bored for the purpose of

inserting a cork holding a glass tube, C, which is also bent at right angles at its lower end and serves as a gauge to determine the level of the vinegar or

fluid in the cask. The tube and cork may be removed at the end of the vinegar-making process and replaced by a wooden spigot for drawing off the finished product. Holes for ventilation, which may be stoppered, are bored in the ends of the cask, one at D, just above the center of the right end, and another at E, near the top of the head which contains the tube C. These holes are covered with pieces of varnished metal netting to prevent the entrance of vinegar flies.

The manufacture of vinegar from grapes has two stages: First, the alcoholic fermentation, by which the sugar is changed into alcohol and carbonic-acid gas; second, the acetic fermentation, in which the alcohol is changed into acetic acid.

After arranging the cask on blocks, as shown in the illustration, from 2 to 3 gal. of good vinegar is placed in the cask through the funnel A. This amount represents 10 per cent of the wine to be fermented. All the grape juice must first be converted into wine and then heated to 85 or 90 deg. F. It is poured into the cask in quantities of one-fourth or one-third of the total amount to be fermented at intervals of one week; that is, if 30 gal. are to be fermented and the additions are to be made by thirds, 10 gal. are poured in first, 10 gal. the second week, and the final 10 gal. the third week. The last addition of wine must fill the cask almost to the level of the ventilator E. Thereupon the wine-vinegar mixture must remain at perfect rest, otherwise the acetic-acid bacteria which produce the vinegar will sink to the bottom and become inert, as far as vinegar production is concerned. When the wine has been converted into vinegar, it is drawn off through a spigot placed in the opening previously holding the gauge glass C. The process takes anywhere from one to three months, depending entirely on the temperature, which at no time should be over 93 deg. F.; the supply of air admitted through the ventilators D and E, and the quantity of alcohol in the wine.—Contributed by Wm. P. Kennedy.

Wrapping-Paper Stand

The shipping department of a large department store had to be increased to take care of the rapidly growing

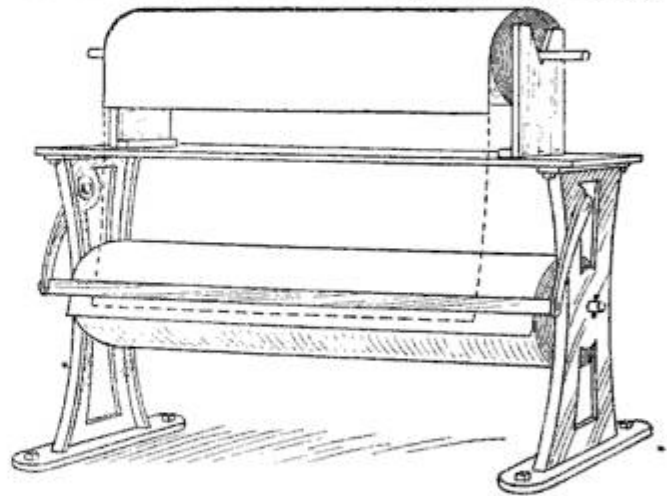

A Narrow Paper-Roll Stand Built Temporarily on Top of the Regular Stand

trade, and instead of waiting for small-sized wrapping-paper reels these were constructed on top of the ordinary reel in the manner shown in the illustration. Two pieces, or standards, with V-shaped notches on their upper ends were toe-nailed to the top crosspiece on the reel frame and a piece of old broom handle used for an axle. The end of the narrower paper was passed under the cutter on top of the wider paper.—Contributed by Geo. P. Kuch, Sidney, Ohio.

Vise Anvil for Riveting Tubes

For riveting on the inside of a piece of pipe or tubing the fixture illustrated is excellent. It consists of a short bar of round steel with a short right-angle bend at one end. Two holes are drilled and pins are driven in crossways. This piece is put in a vise with one pin on top of the jaws and one beneath. It is

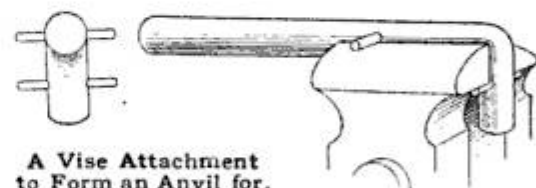

A Vise Attachment to Form an Anvil for Riveting Tubes or Piping

obvious that if a tube or pipe is slipped over the free end a solid anvil is secured on which to do riveting.

Homemade Friction-Clutch Pulley

A friction-clutch pulley can be constructed from material usually found about most shops. The one shown

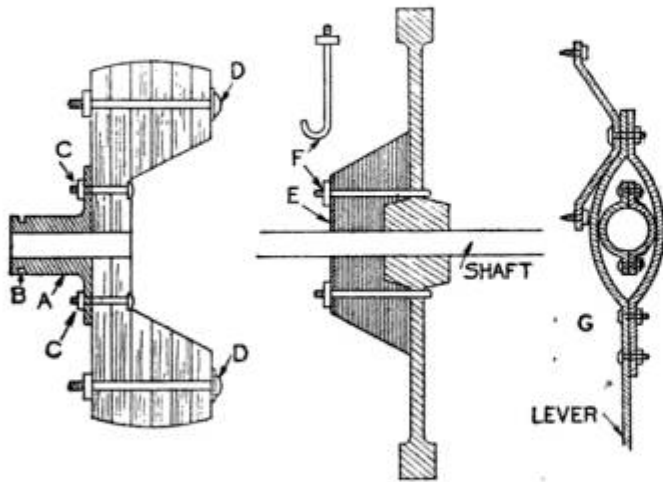

Homemade Friction-Clutch Pulley Used on a Gasoline Engine to Start and Stop the Line Shaft

was made of parts described as follows: The piece A is a part of an old lawn-mower wheel, which had the rim cut off and a groove, B, $\frac{1}{2}$ in. wide and $\frac{3}{8}$ in. deep, turned in the hub. The flange was drilled for four $\frac{3}{8}$ -in. carriage bolts, C, which hold the two first circular pieces of hardwood to the piece A. These pieces should be placed so that the grain of the wood will be crossed. The pulley is further built up of circular pieces or segments of wood to the desired thickness, always crossing the grains in laying each layer. The subsequent layers are fastened with bolts D. The built-up part is then turned in a lathe in the form shown.

The cone part is built up of fiber and, when completed, should be of such size and shape as to fit the turned part in the pulley, the sloping surface being a trifle larger so that the cone will grip the surface before it reaches the bottom of the hole. The fiber is clamped to the flywheel, or other wheel, with a metal disk, E, and bolts, F. A split collar and yoke, which fits into the groove B, was made as shown at G, and with it the pulley can be set into or thrown out of motion.—Contributed by C. W. Bahrke, Lebanon, Ore.

☉ Coin bags used by banks make excellent bags for carrying automobile-tire inner tubes.

Alarm Ground Detector

In the operation of an electrical generating station, considerable trouble is often experienced due to the system becoming grounded. One ground will, as a rule, produce no serious trouble, but it is always advisable to keep the systems as clear of grounds as possible in order to prevent the damage that is likely to result if the system becomes grounded on both sides of the generator. As an example: If the generator A, Fig. 1, is operating a number of lamps, B, no difficulty will be experienced or trouble result so long as there is only one ground, C. A second ground, D, shown by the dotted lines, will produce either a partial or dead short on the line, depending upon the resistance of the two ground connections, C and D, and it is obvious that the trouble resulting from two such grounds would be of a rather serious nature if the ground connections be of low resistance.

A great many generating stations are equipped with what is termed a ground detector, and it is necessary for the station attendant to operate a contact key or switch, that controls this instru-

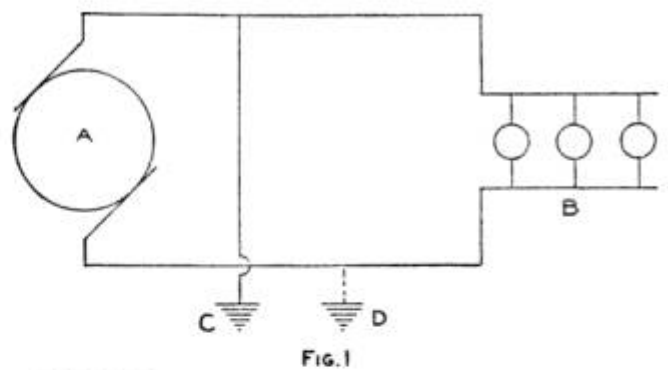

FIG. 1

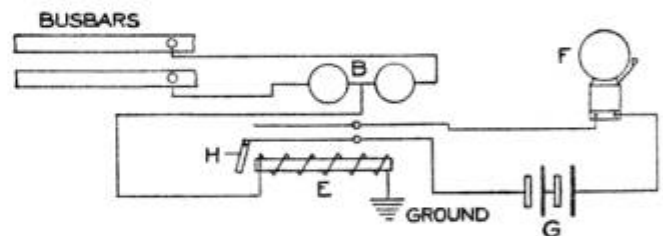

FIG. 2

A System with Two Grounds on It, and the Circuit of an Audible Ground Detector

ment, in order to test the system for grounds. The following simple device has the decided advantage of giving an audible signal the instant the ground comes on the system.

This ground detector may be constructed at a very small expense as follows: A diagram of the connections is shown in Fig. 2. An even number of incandescent lamps, of equal voltage and candlepower, are connected in series between the busbars of the switchboard. Only two lamps are shown in Fig. 2 and that is all there would be needed on a 110-volt circuit. If the voltage between the busbars is higher than 110 volts, more lamps should be used. A high-resistance relay, E, is connected from the center of the group of lamps to ground. This relay controls a circuit composed of an ordinary vibrating bell, F, and a battery of several cells, G.

If the busbars are free from grounds, there will be no current in the relay winding, and since the springs, which its armature, H, controls, are normally out of contact, the bell circuit will be open. When, however, one of the busbars becomes grounded, there will be a current established in the winding of the relay; its armature will draw up and cause the two springs to come into contact with each other, and, as a result, the bell will be operated, thus immediately notifying the attendant that there is a ground on the system.

The higher the resistance of the relay, the more sensitive the signal will be, just as in measuring insulation resistance with a series voltmeter. A relay that will serve the purpose very well may be procured from almost any telephone company for less, perhaps, than it would cost to make one.

Rollers for Handling Large Cylindrical Work

These adjustable rollers were designed for use in connection with drill presses, and serve the same purpose on large work as the V-block on small work, the advantage being that the work rests on two rollers which rotate with the pulley or whatever is being drilled.

The device consists of a plate with T-slots into which the bolts holding the roller bearing may be moved or

adjusted to fit the work in hand. When the work on the rolls is set centrally with the drill it is only necessary

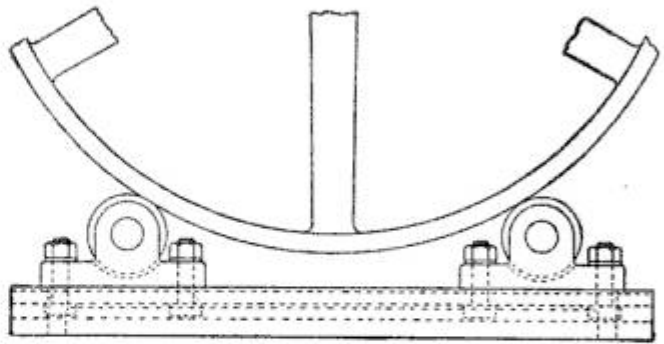

Rolls on Which to Revolve the Work for Drilling Holes Centrally or on a Radial Line

to revolve the wheel or cylinder to the locations for the drill holes.—Contributed by F. H. Mayoh, Pawtucket, R. I.

To Prevent Machine Parts from Being Tarnished by Sulphur

A way to prevent brass machine parts from tarnishing when sulphur is used in the building is to paint them with naphtha or heavy oil. This can be removed with hot water and the brass polished with a dry cloth. This treatment is also good for the lighting fixtures in a home, while being fumigated, as it insures against damage by the acid fumes.—Contributed by Loren Ward, Des Moines, Iowa.

Nonsplashing Bucket Attachment

A partly filled shop bucket will splash over when any liquid is added, especially if heavier liquids are poured in quickly. This may be prevented by attaching two or more strips of sheet metal in the top of the bucket in a sloping position similar to a window shutter. These strips may be attached with clips at the ends, as shown at



The Strips Allow the Liquid to Enter the Pail, but It cannot Splash over the Edge

A in the sketch. Any liquid poured on the strips will easily enter the bucket without splashing over the rim.

A Hatpin Protector

The protruding pointed end of a hatpin causes no little trouble for the wearer in crowded places as well as

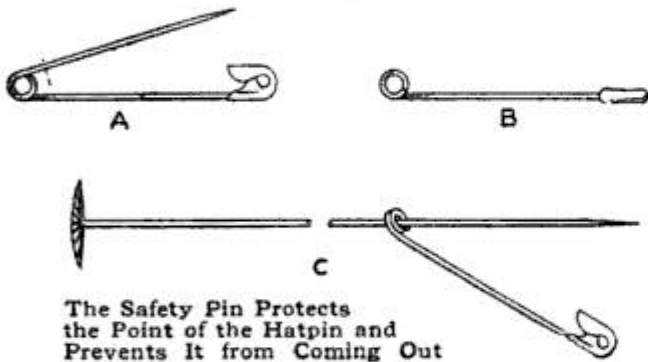

The Safety Pin Protects the Point of the Hatpin and Prevents It from Coming Out

a scratched face for anyone that may be near. The way in which one person avoided this difficulty is shown in the sketch. A safety pin was procured and the pointed end cut off on the dotted line as shown at A, whereupon the remaining part was bent as shown at B. The coiled end is slipped onto the hatpin, as shown at C, and the other end over the pin point in the manner of a regular safety pin.—Contributed by Alex. Mikulan, Seattle, Wash.

Inserting and Removing Gaskets

When inserting a gasket between flanges that cannot be separated to any great distance, it is always troublesome to get the gasket into position, says Power. To overcome this, fold a piece of stiff paper as shown in the sketch. The paper and gasket can be easily slipped in be-

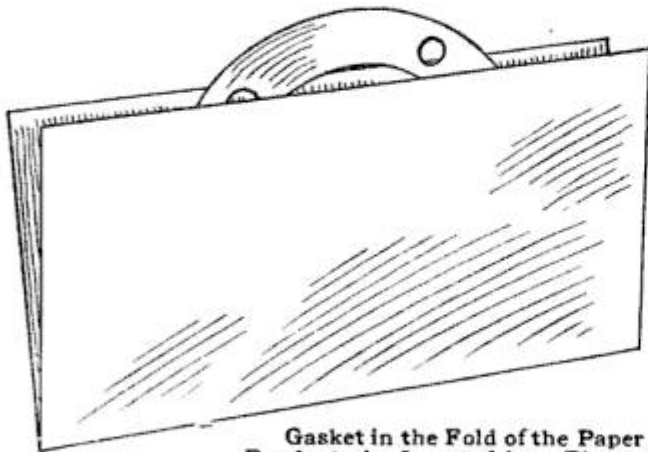

Gasket in the Fold of the Paper Ready to be Inserted in a Flange

tween the flanges and after one or two bolts are put in place the paper can be taken out.

To remove an old gasket when the flanges can be separated but very little is usually difficult unless a length of pipe is taken out. A simple way is to drive a cold chisel in the lower side of the joint sufficiently to loosen the flanges, and then run an old saw through the joint, sawing out the gasket. After sawing partly through, drive the chisel in the top of the joint to keep the flanges from pinching the saw and saw out the remainder of the gasket.

A Tool Holder

A very handy drill and nail-set holder can be made as shown in the illustration. The cone part is turned from a piece of hard wood and holes are bored to receive the tool shanks. The base may be constructed as desired.

The cone is made to revolve on an upright spindle, which may be the protruding part of a nail driven up through the bench top, or set in a base to make it portable.—Contributed by Lorenz Schneider, Jonesboro, Ark.

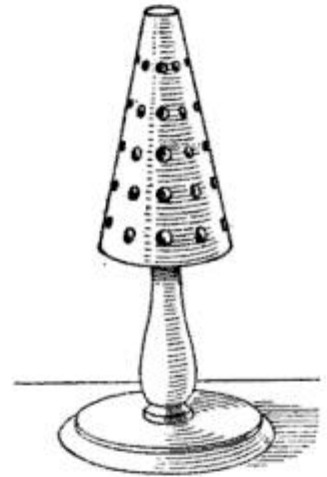

Gauntlets on Gloves

When the fingers or palms of gloves with gauntlets wear out, do not throw away the gloves, but cut off the gauntlets and procure a pair of gloves with short wrists to which the old gauntlets can be sewn after the wrist bands have been removed from the new gloves. The sewing may be done either by hand or on a machine, gathering in any fullness in the bellows of the cuff on the under side. A pair of gauntlets will outwear three or four pairs of gloves.—Contributed by Joseph H. Sanford, Pasadena, Cal.

Practical Telephony

By HAROLD HINTON

PART I

It is doubtless true that few people stop to realize what great strides have been made in perfecting the telephone. Nearly all of the present generation can remember when the old "magneto" phones were in use in every city and town where there were telephones; then came the time when the magneto phones were removed from the cities and relegated to the country villages and rural lines and their place was taken by the "common battery" phones. These phones have, in some localities, been replaced by the "automatic," and now we are entering the age of wireless telephony. Each system will be treated briefly in its turn beginning with the

Magneto Telephone

The magneto telephone set consists of a receiver, transmitter, hand generator or magneto, battery, induction coil, cut-out and switch. These pieces of apparatus are arranged and connected, as shown in Fig. 1, so that by leaving the receiver on the hook and turning the crank of the magneto a drop is released in the exchange to attract the attention of the operator who cuts in, inquires what, or who, is wanted, plugs in the line and rings the party which was called. The circuit showing both phones connected through the switchboard will be seen in Fig. 2.

The line construction is about the same as is used for other telephone work, but the drop wires (the wires connecting the phone with the line wires) are connected up a little differently than in other and more advanced telephone work. The drop wires are connected up, as shown in Fig. 3, so that whenever any party on the entire line calls the exchange all of the bells ring; and when any party on the line is called by the central office all the other phones on that line ring. It is not uncommon for these magneto lines to have from 12 to 15 stations, and that is one of its greatest drawbacks,

because the bells cannot be rung separately as they can on the common battery.

The magneto phone was an excellent

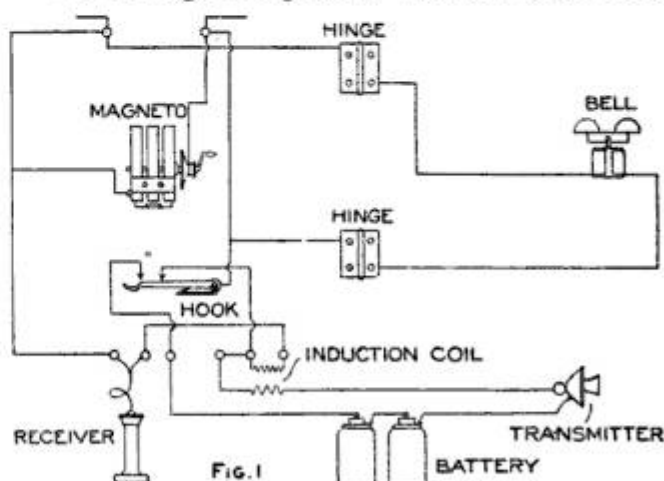

Fig. 1
Wiring Layout and Connections for the Old-Style Magneto Type of Telephone

piece of work until it was replaced by the common-battery system, and, it is still admired by those who must use that style of service or do without it entirely.

The phone itself is a very simple affair, the line work is comparatively simple, and the maintenance cost is low; in fact, the whole outfit is simplicity itself to those who have gone through the common-battery and automatic stages. The principal and most vital piece of apparatus in either the local or common-battery systems is the switchboard.

The switchboard is a device by means of which two lines may be connected together so that conversation

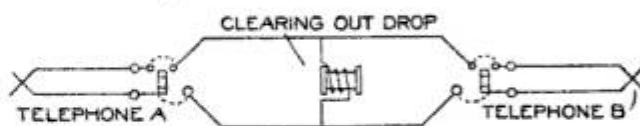

Fig. 2
Circuit Connecting Two Magneto Telephones through a Switchboard Where A is Calling B, or Vice Versa

may be held from one line to the other. A simple form of magneto switchboard is shown in Fig. 4. This style switchboard is still in use and is built in the shape of a cabinet, the face of which has a number of annunciator drops and

"jacks." The "jacks" are the openings into which the cord plugs are put, to

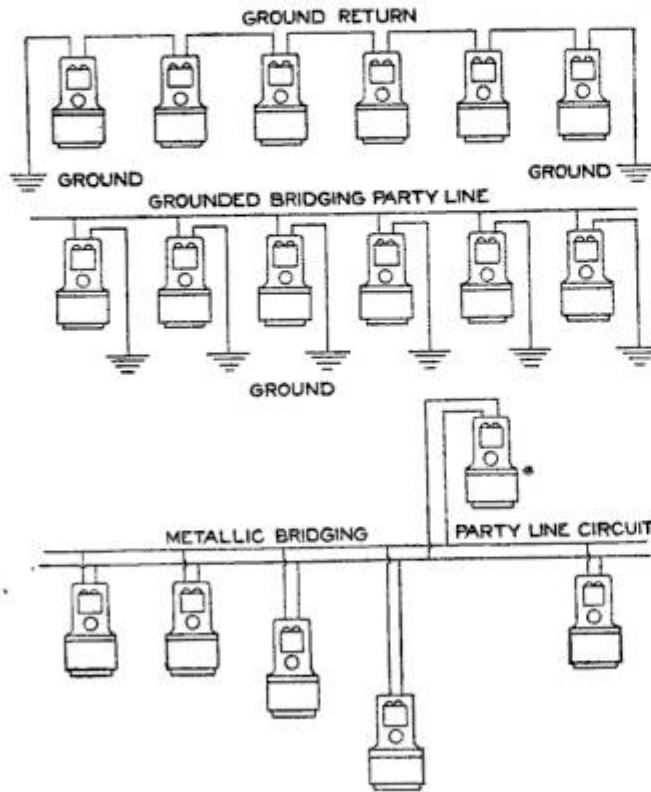

FIG. 3

Three Methods of Returns, Two Are Common Returns and the Other a Metallic for Magneto Telephones

make the answering connection when the call is made.

There are two principal kinds of line circuits; first, where one wire is run directly into the exchange and the other enters through a "ground" or a

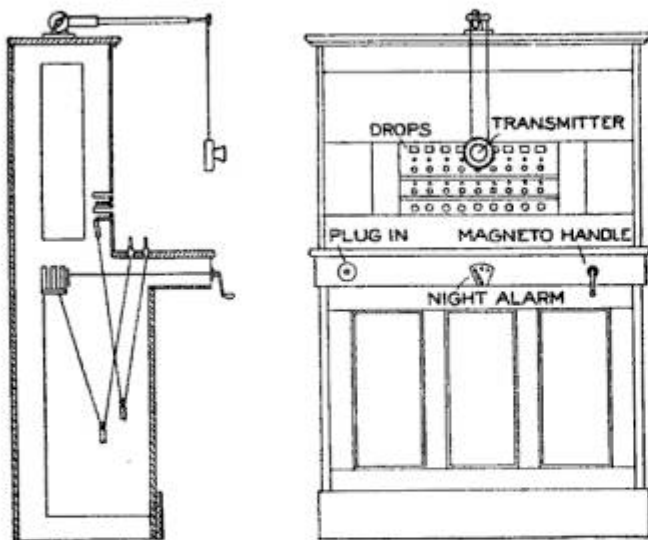

FIG. 4

A Magneto Switchboard, Carrying Drops for Connecting Any Two Lines of Magneto Telephones Together

"common return," as shown in Fig. 5; and second, where the two wires are

run into the exchange, Fig. 6. This latter is what is termed a "metallic circuit" and, when properly constructed, is the only one which will assure the most efficient results.

Each magneto switchboard has six circuits as follows:

First—A line circuit must be provided for each line entering the exchange. The only apparatus in this circuit proper is a combined drop and jack, to the terminals of which the subscriber's line is led. The ringing current comes in through a jack and the winding of the drop. When the operator plugs in to answer a call, a contact is broken in the jack and the drop winding is cut out of the talking circuit.

Second—A night-alarm circuit is provided, there being only one such circuit on the entire switchboard. This is used whenever the operator is not directly in front of the board, as is

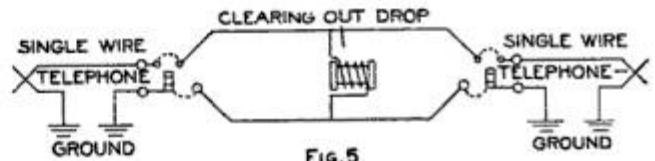

FIG. 5

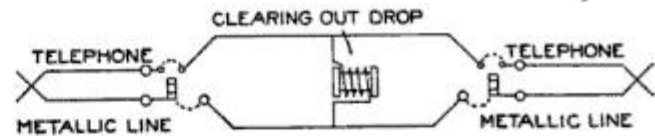

FIG. 6

The Two Principal Line Circuits, One a Ground Return and the Other Metallic

usually the case at night, and a call comes in which might not be noticed without it. The night-alarm contacts close when the shutter A, Fig. 7, falls and the alarm bell rings until the operator answers the call and restores the drop.

Third—A pilot circuit, of which there is usually one on each operator's position.

Fourth—The cord circuits, the number of these depending on the number of line circuits and the greatest number of connections likely to be up at one time.

Fifth—The operator's circuit, one of which is provided for each operator. These two circuits are shown in Fig.

8 and operate as follows: In the cord circuit is placed a ringing key, A; a listening key, B, and a ring-back key, C. A clearing-out drop (which is really a disconnect signal) is bridged across the two sides of the circuit. This drop does not shunt the voice currents to any great extent, but is readily thrown by the generator in ringing off. The keys A and C have platinum contacts and are the only apparatus through which the voice currents pass. The ringing keys A and C allow the operator to ring out on either cord at will. Each ringing key, when operated automatically, opens the cord circuit, so that no generator current passes back to ring in the operator's ear.

The operator's set consists of a head phone, D; a cut-in jack, E; an induction coil, F; a transmitter, G, and a battery, H.

Sixth—The generator circuit, one of which is provided for each operator.

When the magneto phone is to be used for farm or rural lines without any switchboard, that is, as shown in Fig. 3, it is best to use three or more cells of battery, according to the length and condition of the line. This material may be purchased very cheaply at present, and if the phones are connected up as in Fig. 1 and the line wires are

carefully run, being sure that there are no grounds on the line, any group of

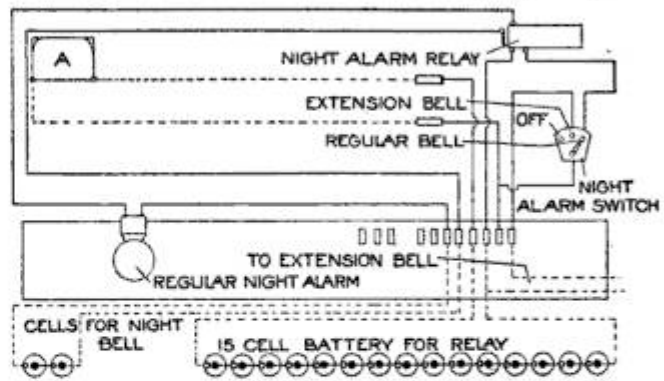

FIG. 7

Wiring Layout for a Night-Alarm Bell, to Ring When a Contact is Made as the Drop Falls

people may have a little telephone system of their own by having signals for calling each other. No. 12 galvanized

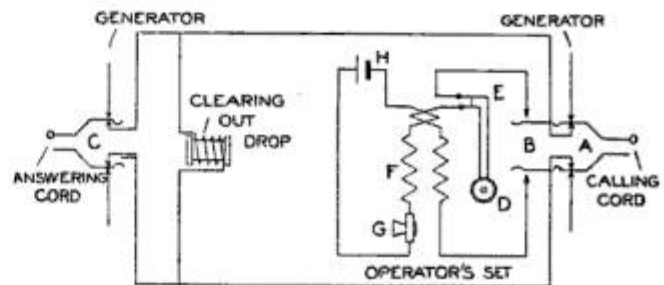

FIG. 8

Wiring Diagram of a Circuit Used at the Office Switchboard by the Operator

iron wire is generally used, but copper is a better conductor—if money is no object.

(To be continued)

Facing a Worm Gear on a Lathe

A worm gear having a large lead, say, 3 or 4 in., may be easily faced on a lathe with the attachment shown in the illustration. Fasten two studs in a plate so that they will enter the screw snugly, and attach the plate to the crosshead of the lathe directly beneath

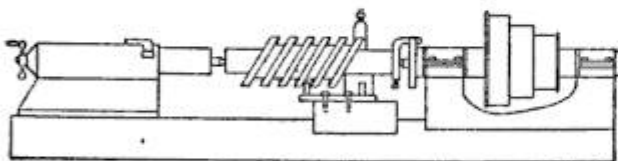

The Worm as it Turns in the Lathe Centers Causes the Proper Feed of the Carriage

the center of the screw, when the latter is set in the centers of the lathe. The proper tool is then placed in the tool post, and the lathe started. The pins

will cause the carriage to travel with a speed equal to the travel of the screw, and the tool can be fed as in ordinary lathe work.—Contributed by D. J. Jones, Massena, N. Y.

ⒸA piece of candle is often quite useful for the motorcyclist. It can be

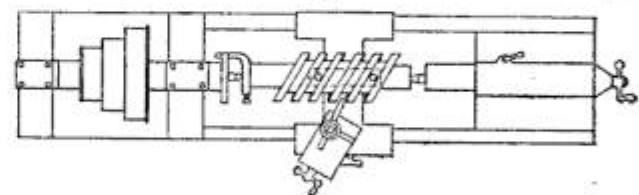

placed in the headlight, or put on the belt for oil, and used to prevent "shorts" by applying to the spark plug in damp weather.

A Stencil-Cutting Machine

A machine for cutting stencils may be very easily made by slightly altering a discarded sewing machine, and

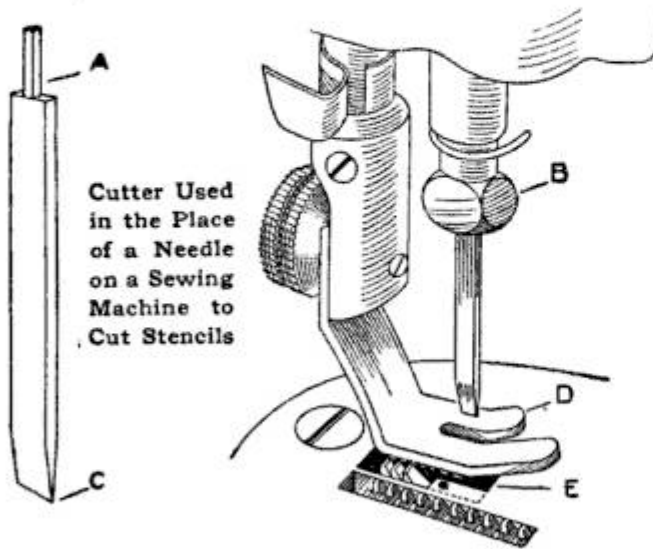

supplying a cutter in the place of the needle. The cutter is made from a piece of spring as long as the needle used in the machine. It is cut and filed as shown, the end A being filed round on two edges and the hole in the needle holder B filed to concave on one side with a small round file. If this is carefully done, the end A of the blade will fit snugly in the holder. The end C is filed to a cutting edge and sharpened on an oilstone. The slot in the foot D, Fig. 2, should be filed on both sides so that the blade will just pass through. The opening in the foot plate E is filed on the right side as shown by the dotted lines, so that the blade will not strike it. The machine will take work 18 in. wide, if half of it is done from one end and the remaining part from the other.—Contributed by C. L. Herbert, Chicago, Ill.

Cutting Trees with Wire

A wire heated with an electric current has often been used to saw through large trees or rather to burn its way through. A later and neater method of felling a tree is to move a fine wire back and forth with great rapidity by an electric motor so that the wire, heated by friction, burns a narrow cut through the tree. The cut

is cleaner than a saw cut, and the method permits the cutting to be done below the surface of the earth so that no stump is left. A central power plant could be located in a forest to supply current for portable motors.—Contributed by Harry N. Holmes, Richmond, Ind.

To Clean the Surface of a Whetstone

The uncovered whetstone soon takes on a gloss from dust particles that collect on it. This smooth, glossy surface can be easily removed by applying powdered pumice to the stone just before using it. This treatment removes the grit, and the knife blade will be polished. At the same time it is quickly ground to a good edge. The powder can be kept ready for use in a face-powder can with a shaker top.—Contributed by J. Harry Priestley, Lawrence, Mass.

Separating Steel Balls of Different Sizes

A manufacturer of automobiles discovered that a large stock of steel balls, from which balls were taken for a thrust bearing, were not all true to size. The first attempt was to measure each ball with the micrometer, but the number was so great that the job became tedious. After measuring about 500 balls in this manner the workman devised a plan which readily separated the balls quickly and accurately.

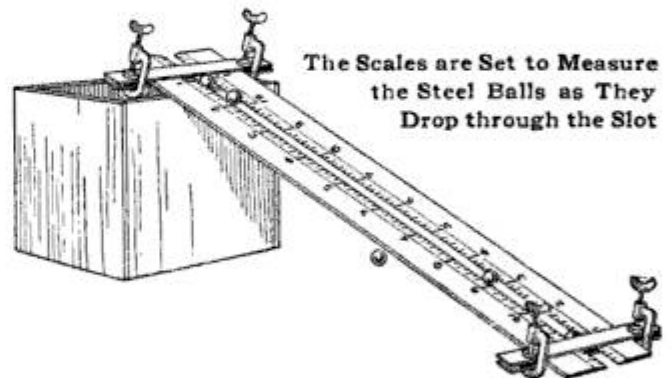

Two ordinary 12-in. steel scales were procured and their ends placed between two strips of metal that were used to clamp them solidly when the space be-

tween the scales was found. Two balls were selected from the lot, one of them .0005 in. under size and one .0005 over. The smaller ball was placed between the scales at the top and the larger at the bottom. The space taken up at each end by the ball and strips was just 1 in., thus making the opening between the scales only 10 in. long so that each division represented .0001 in. The scales were placed at an angle of 45 deg. and the balls were allowed to roll down in the slot between them. When a ball reached a space large enough to drop through its size would be designated by the reading of the scales at that point, and receptacles were placed beneath to catch the different-sized balls. Those passing through at the center of the scales were the ones kept for use in thrust bearings.—Contributed by Henry J. Marion, Pontiac, Michigan.

A Hacksaw Reflector

Occasionally the repairman is called upon to use a hacksaw where the light is poor, and in such cases it is difficult to cut to the line. A correspondent of

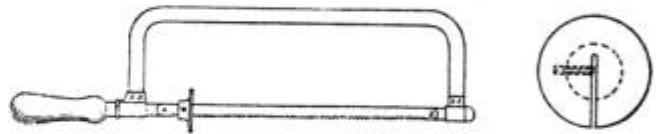

The Light is Reflected on the Line of the Work to be Cut

Motor Car uses an easily made device, which is fitted over the saw blade, to reflect the light on the work. It consists of a round disk of sheet brass or other light metal, which is turned to have a collar at the back and enameled white on the face. A slot is cut through the center so that it may be slipped over the blade of the saw. The reflector is held in place with a set-screw.

Homemade Ditch-Digging Machine

A contracting firm, unable to procure day laborers in sufficient number for excavation work on a large storage-house site, solved the difficulty by building an automatic ditch-digging machine of odds and ends of material such as can be found around any large industrial plant. The frame is built of 12-in. square pieces to support a large central timber which hangs

loose on a heavy rod at the top. The swinging timber, which is kept against the earth by a wire cable fastened to the front end of the frame, supports a chain of buckets running over sprocket

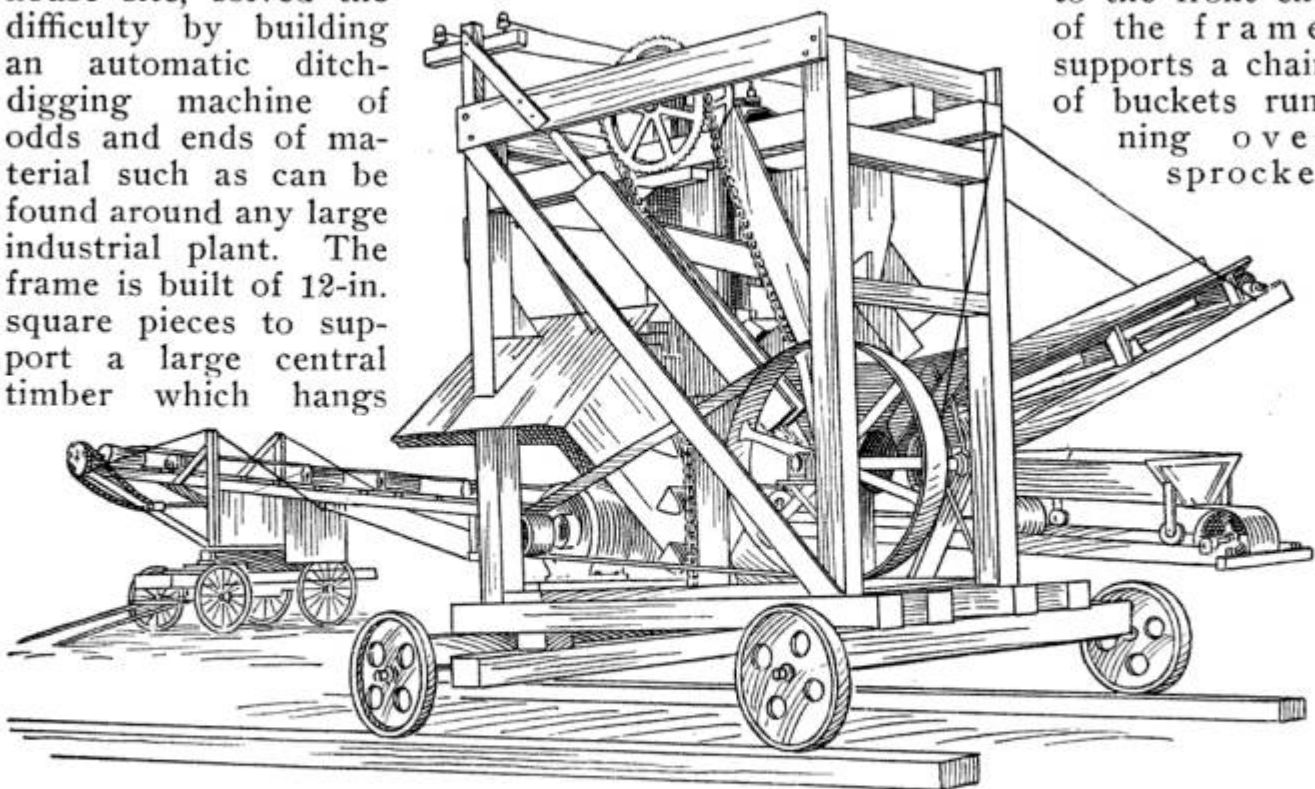

A Machine Constructed for Excavating Ditches for Concrete Walls of a Large Cement Storage House

wheels at its upper and lower ends. Two men loosen the earth in front of the buckets, which carry the dirt up and dump it on a short elevator that, in turn, drops it into a hopper set over a moving belt. The belt runs over rollers whose bearings are attached to a long framework supported on cables and resting on a truck at the outer end. The hopper can be moved along on the long framework as the

machine moves forward over the ditch. The belt carries the loose earth to the point where it is dumped or loaded into wagons. The machine is driven by two electric motors, one 10 and the other 6-hp., and can handle 250 cu. yd. of earth in 10 hours. The framework, being mounted on wheels, can be moved to any location where excavating is to be done.—Contributed by R. J. Wheeler, Allentown, Pa.

Compression Spring for an Oilcan Bottom

An old oilcan, or a new one for that matter, not having sufficient spring in the bottom may be supplied with a

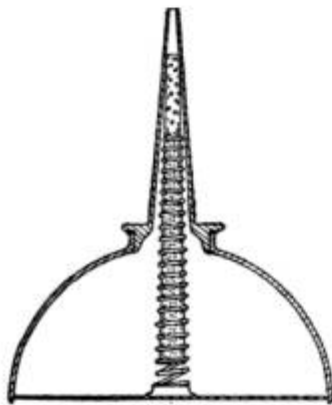

supplementary spring in the following manner: An open coil spring is fitted around a brass tube whose upper end is made tapering to fit the inside of the spout on the oilcan and the lower end cut so that the space between it and the bottom will be about $\frac{1}{2}$ in. A piece of thick leather is cut to fit the end coil on the spring at the bottom to prevent any wear on the metal.—Contributed by Edwin Menger, San Antonio, Tex.

Lock for a Miter Joint

Picture-frame joints, or mitered joints for any piece of work, may be made better and more solid by locking them with a key. The parts will then stand

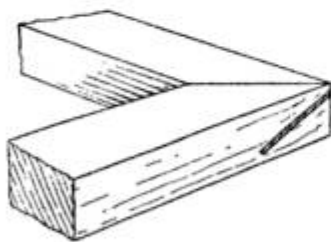

considerable strain of pull or pressure in opposite directions without damage to the joint. The manner of making the key lock is clearly shown in the sketch. After the parts are mitered

and fit closely together, a wide saw cut is made across both parts and in a downward direction. This cut is filled with a well-glued wedge.—Contributed by F. H. Tillotson, Sycamore, Ill.

and fit closely together, a wide saw cut is made across both parts and in a downward direction. This cut is filled with a well-glued wedge.—Contributed by F. H. Tillotson, Sycamore, Ill.

A Steam Trap

An automatically operating device for exhausting condensation water has recently been brought out by a German firm of machinists. It differs from other devices of this kind by its simplicity, the easy accessibility of all its parts and the absence of movable and therefore easily worn parts, so that it is safe and reliable.

It consists of an elliptic steel tube, A, which is braced across its longer axis by another tube, B, that has no connection with the tube, A, how-

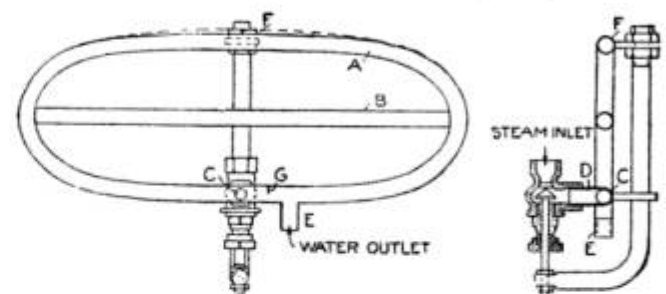

An Efficient Steam Trap for Placing at the Lowest Point in a Steam Line

ever, but prevents the device from expanding through the heat of steam or water in any other direction than the vertical. At the point C there is a connecting piece of pipe, D, through which the water is admitted, and at E, one for letting it out. Screwed onto D is a valve which is connected to the steam system. The valve stem is rigidly connected to the tube A at the point F, so that all relative motion of

the points C and F are duplicated by the cone of the valve stem. When the distance between C and F is increased, the valve is closed; when decreased, it is opened.

Should the elliptic tube become thoroughly heated by the steam entering, it tends to expand, but can only do so in a vertical direction so that the valve immediately closes, and steam cannot enter. When the tube cools off, the valve opens admitting the water.

In use, this process is self-regulating, so that the valve is open only just long enough to allow the water to flow out. In order to further prevent escape of steam, a small baffle plate, G, is inserted between C and E, which closes off the upper half of the tube. Air that may come with the steam is heavier than the latter, and therefore flows away before the steam, so that the device thus also serves to free the steam system from air.

Shoe Cleaner for an Automobile Running Board

Although devices permitting the automobilist to scrape the mud from his shoes before entering the car are fairly common and several manufacturers have incorporated them in their designs for the coming season, none is quite so ingenious or so well designed as the one shown in the sketch. This is adopted by a foreign manufacturer. As may be seen, the scraper is attached beneath the running board and consists

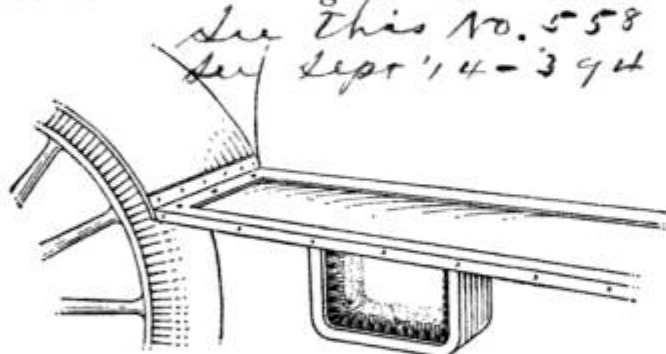

A Shoe Scraper Attached to the Under Side of the Running Board on an Automobile

of a brush which not only removes the mud from the soles of the shoes but takes it from the sides as well.

Gate Made of Piping

A short-line railroad utilized a quantity of old discarded pipe for making gates on their right of way. The pipes

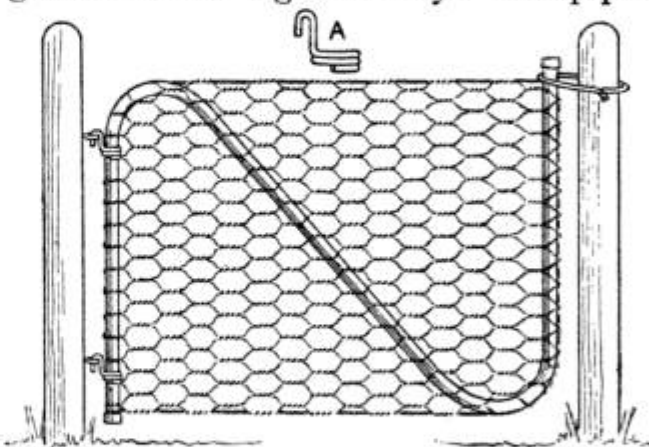

Gate Frame Made of One Piece of Pipe Bent to Hold the Fencing Material

were bent into the shape of the letter S, the vertical end pieces being left straight and the fencing material attached to them. The hinge device consisted of a piece of heavy wire bent as shown at A. The hook part fits into the opening of a large screw eye or eyebolt fastened in the post. A latch can be made of a wire loop and used in the manner shown.—Contributed by Maurice Baudier, New Orleans, La.

Measuring Hay in a Stack

There can be no set rule for obtaining the amount of hay in a stack, but approximate tonnage may be determined in the following manner. Measure the base of the stack each way, then measure from the base on one side, over the top and to the base on the other. Multiply the length by the width and the result by $\frac{1}{3}$ of the length over the top. This will give the number of cubic feet in the stack.

The number of cubic feet of hay in a ton must be reduced in proportion to the time it has been stacked. Of newly stacked hay, before any settling takes place, about 500 cu. ft. are required to make a ton. Three months of settling will reduce the number of cubic feet to 400.

If a stack is not put up on straight lines, several over-top measurements must be made and the average taken.

To Make Holes in Metal with Hemispherical Bottoms

On a certain piece of work holes with perfect hemispherical bottoms had to be made and for cutting out this part

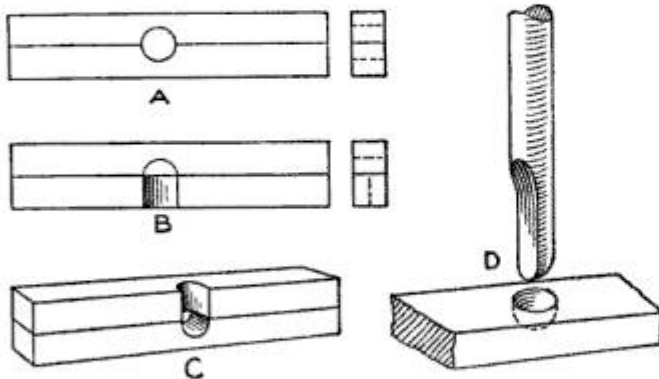

Shaping a Tool for Cutting Perfect Hemispherical Bottoms of Holes Drilled in Steel

of the drill hole a special tool was required. As accuracy was necessary the tool edge had to be a perfect half circle on the proper radius. The edge was shaped as follows:

Two short lengths of $\frac{1}{4}$ -in. square tool steel, A, were clamped together in a hand vise and a hole of the desired diameter was drilled through the joint crosswise, so that when the pieces were separated, exactly one-half of the hole came within each piece. The pieces were then hardened and again returned to the hand vise, but not in the same position as when drilled. The two half-circular cuts were placed at right angles to each other, as at B, and then clamped so that the edge on the face surface resembled a U, as shown at C.

The twist drill used for drilling the hole was reversed in the chuck and the shank slowly rotated against the two pieces in the hand vise at the union of the two half holes. The effect of this was to scrape off the end of the shank until it assumed the form of a perfect hemisphere.

The next step was to cut a flat place on the shank, as shown at D, to form a cutting edge and also make room for the cuttings. This was accomplished by removing one of the hardened pieces from the hand vise and placing the drill shank in the groove, then filing until it was cut down to the hardened

steel or just half the diameter of the drill, as shown at D. The hardened steel makes the gauge and jig at the same time. After hardening the tool, it did perfect work.—Contributed by Wm. G. Toplis, Philadelphia, Pa.

Substitute for a Flexible Shaft

The advantages of a flexible-shaft grinder for polishing and general grinding purposes have long been conceded, but a flexible shaft is rather too expensive for those who have not much of this work to do. A very fair substitute can be had by making a shaft as follows:

The shaft A is made of a piece of $\frac{1}{4}$ -in. cold-rolled steel, 10 ft. long, and the pieces B and C are shrunk on so as not to weaken the shaft. The head B is threaded to fit the spindle of a grinder running at about the proper rate of speed. The head C has a shoulder at one end and a stem which is threaded for a nut and collar, to hold the buffing wheel D. Two wood handles or grips, E and F, are a loose fit and are held in place by a set of collars not shown in the sketch.

In operation, the workman takes a grip in each hand, after attaching the grinder tightly on the shaft, and applies it to the work. The $\frac{1}{4}$ -in. shaft is sufficient to transmit all the power supplied to a machine for doing a similar kind of work. The shaft gives a range of about 3 ft. without serious or tiresome cramping. A hook or snap should be provided to hold the free end of the shaft while the operator is

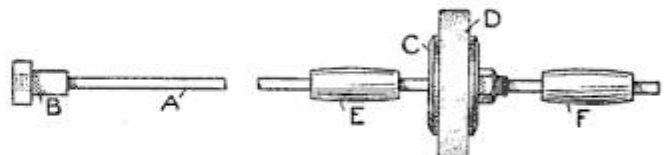

The Flexibility of the Cold-Rolled Shafting is Sufficient to Give a Range for Ordinary Work

not polishing, but wishes to leave the wheel in motion.—Contributed by D. A. Hampson, Middletown, N. Y.

ⒸGround glass should never be lettered on the ground side, as the paint stain cannot be removed.

To Keep Bright Metal Free from Rust

If the neat workman cares to keep his machine clean and free from rust, he should use a mixture of melted lard and camphor in the proportion of 1 lb. of lard to 1 oz. of camphor, to which is added sufficient black lead to give it color. Rub this mixture on the machine parts, after they are well cleaned, and allow it to stand for a day, then rub it off with a clean cloth. This will keep rust from bright parts and the machine in a good appearance.

Preventing Handsaw from Slipping When Standing on End

As I was much annoyed by having the handsaws that were leaned against a sawhorse or other support when not



in use slip and fall to the floor, I filed two points on the end of each saw blade to hold the saw where it was set.

The saw blade should be filed off square at the end and at right angles to a line on the center of gravity. Two teeth are then

formed by filing away sufficient metal on the blade. The teeth should be located near the sides. A saw fixed in this way will stand in almost any place or position.—Contributed by Howard Weddle, Dinuba, Cal.

An Intermittent Siphon for Flush Tanks

The intermittent siphon for flush tanks, shown in the sketch, consists of a piece of $\frac{7}{8}$ -in. pipe bent as at A and placed in the tank in an upright position. The inlet B should have a valve attached. The siphon will not act until the water reaches the level shown by the dotted line, when the air will be driven out of the curved pipe. By turning the valve in the inlet pipe the rate of incoming water can be regu-

lated and the box emptied at any interval desired. The amount of water coming in must of course be less than

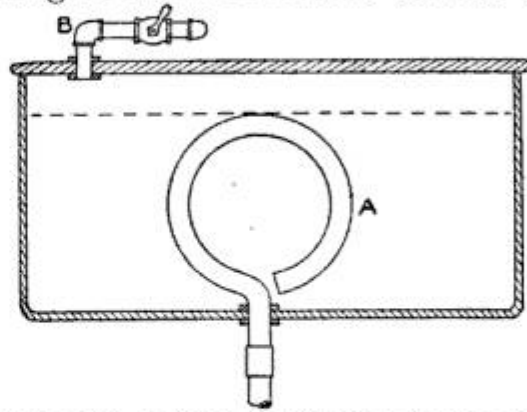

The Length of Time for Flushing is Regulated by Valve on the Inlet Pipe

the amount which can pass out of the outlet.—Contributed by Olaf E. Tronnes, Evanston, Ill.

Grinding In Piston Rings

While overhauling an automobile the owner decided to put in new piston rings, and as the cylinders were slightly worn, it was considered best to grind the new rings in to fit the cylinder bore before replacing the cylinders, thus immediately obtaining a better fit rather than waiting until the rings had in actual service worn themselves to the shape of the cylinder. In order to make the job less laborious, the rig illustrated was constructed. The cylinders were placed on a block on the bench, to which they were secured with a carpenter's parallel-saw clamp. A crude shaft was made of a piece of pipe and on it a wood crank and a wood handle were fastened. With this outfit the

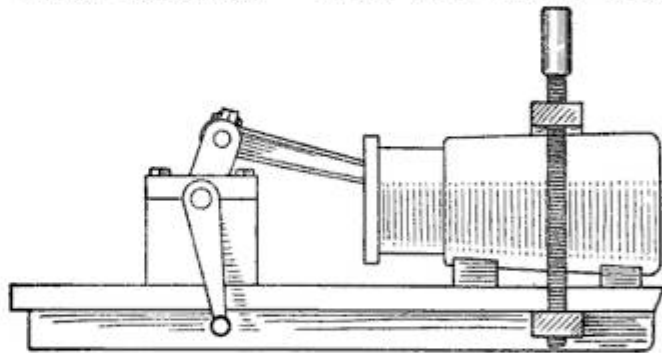

Temporary Arrangement for Grinding in New Piston Rings to Fit the Bore of a Worn Cylinder

work was made easy, and the cylinders could be perfectly cleaned of the abrasive used with no danger of its getting into the bearings.

Keyseating in a Lathe

Having to cut a keyway in a sleeve that was too long for our keyseating machine, the job was accomplished on

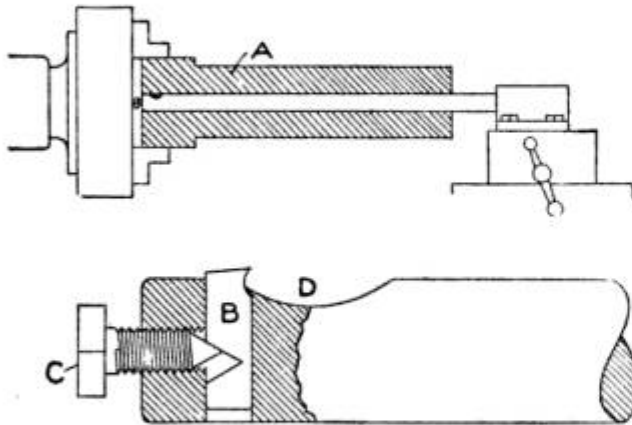

The Sleeve as It is Set in a Lathe Chuck and the Cutter-Bar End

a lathe in the following manner: The sleeve A was set true in a lathe chuck and a piece of cold-rolled steel that was a sliding fit in the bore of the sleeve was used as a cutter bar, one end being drilled to hold the cutter B and tapped for a feed screw, C. A place was cut out of the bar, at D, to carry the chips away.

The bar was held in the boring-bar holder, and, with the lathe not running, the bar was run into the bore of the sleeve until the cutter cleared the end at the chuck. The screw C was then turned, which set the tool to take a cut, and then the carriage run back by hand, the tool cutting as it was pulled through the bore. The operation was repeated until the keyway was cut to the proper depth.—Contributed by F. L. Pyle, Chicago, Ill.

Locking a Setscrew

A setscrew can be easily locked by the use of notches filed in the end as shown in the sketch. When the screw is turned in tightly the raised portions will sink deeply into the metal and prevent the screw from coming loose.—Contributed by G. H. Holter, Jasper, Minn.

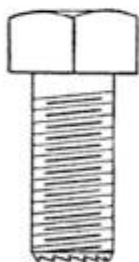

☐ A sanitary paper towel makes a good substitute for filter paper.

Draining an Automobile in a Garage

It is prudent, of course, to drain all the water from the radiator of an automobile every night during cold weather. It is annoying to place the car outside the garage while the water drains slowly out, and it is equally aggravating to have the garage floor covered with water. If the floor is of wood, this trouble may be easily overcome.

Bore a 1-in. hole in the floor directly under the drain petcock and place in it a wide-mouthed funnel. Put a mark on the floor as a guide for the front wheels and it will be easy to stop the car so that the petcock will be right over the funnel. When the water is all drained out, allow the engine to run for half a minute to evaporate any water left in the radiator, pump, or water jackets. It is always well to drain all water from the water jackets of the carburetor also.—Contributed by J. R. Quirk, Wheatland, Wyo.

Stopping Leaks in a Tin Roof

The usual method of fastening roofing of any kind is to drive a small nail through a tin disk and the roofing into

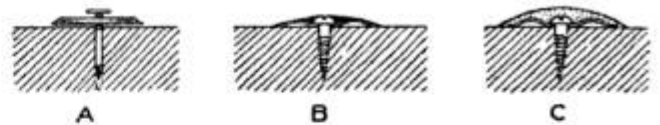

Disks Fastened with Screws and Soldered to a Tin Roof Make Permanent Repairs

the sheathing beneath. When a tin roof fastened in this manner bulges, it will draw out the nail, and the expansion and contraction of the metal will leave the nail and disk in the position shown at A. If a screw, brass or iron, is used, this difficulty can be prevented. After the disk is screwed down, solder the head of the screw to the disk, and the edge of the disk to the tin roofing, as shown at B. If soldering is impossible, cover the disk with putty as at C. A leak can be stopped by fastening one of these disks over it in the manner described. In either case, the disk should be given a coat of paint after it is fastened down.

A Steam Trap for Heating-Coil Drainage

By F. W. BENTLEY, Jr.

The perfect drainage of large heating coils which are necessarily located a considerable distance from the boiler is often a difficult proposition. The difficulty in securing an efficient means for draining such coils arises more in connection with coils which are placed in different and separate buildings of a plant, all of which are supplied with steam from the same boiler. This condition, of course, prevents a return of condensation to the boiler, and necessitates the use of some other provision for the drainage of the heating coils.

A great many styles of traps and water drains are on the market, it is true, but most of them are designed with a view toward assisting the manufacturer in the sale of other machinery in connection with them; this condition often making it impossible to secure such a device for certain drainage purposes without paying an exorbitant price for its special manufacture.

The principal requisites of a steam trap for the drainage of heating coils are reliability and simplicity. The general appearance and location of a drain or trap that can be constructed with but very little expense is shown in Fig. 1. All operating parts are of metal, and the trap itself can be cheaply and readily constructed in any local machine shop possessing even a very limited equipment.

The construction of the trap and the principle of its operation are very simple. Saturated steam from the lowest point in the coils enters the trap at A, Fig. 2, accumulating at the bottom of the trap, below and around the basin B and floating it. To the inside bottom of the basin B is soldered the hollow perforated sleeve C, the inner bottom part of which forms a seat for the hollow stem D. The buoyant force of the water around the basin B consequently keeps this joint perfectly tight. However, as the water rises in the trap from the accumulation of condensation, it finally flows into the basin B over its

top. Water will run into the basin only until the weight of water accumulating in it overcomes the buoyancy of the water around and below it, when the basin and consequently the sleeve C drop away from the hollow stem D. This action allows the water in the basin to be forced up through the hollow stem D to the atmosphere, through the connecting drip pipe taking away

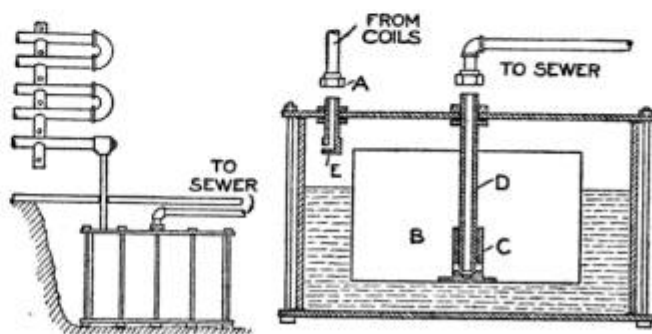

Fig. 1

Fig. 2

Location of the Steam Trap on the Radiator and the Detail of Its Construction

the condensation. This action of the trap continues until water enough escapes from the basin to allow the buoyancy of the water below it to force the basin upward, bringing the sleeve C in contact with the stem D and closing the trap.

The sleeve C should be bored so as to allow only a free and easy slide of the sleeve over the stem D, after which the joint or seat at the bottom should be carefully ground in with the stem, to prevent an escape of steam when the basin is emptied of water and forced upward by the buoyancy of the water around and below it.

A detail sketch of the stem D is shown in Fig. 3, to illustrate the manner in which it is attached to the top head in order to allow the copper gasket to form a tight joint when the holding nut on top of the head is tightened. The inlet E is shown in Fig. 4 and is constructed and fastened to the top head much in the same manner. Its lower opening should be at one side of the basin B and below the top of the same when in either closed

or discharging position. The opening is turned so that the slight pressure of the steam entering the trap is exerted against the walls of the cylinder in-

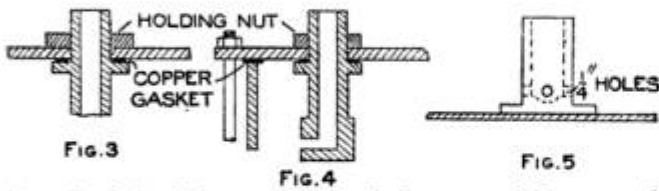

Detail of the Inlet and Turned Parts, and Manner of Connecting Them to the Trap

stead of against the basin B, which might tend to cause the sleeve C to bind on the stem D and prevent the trap from working with any degree of sensitiveness. The basin B should be constructed of copper in order to prevent its corrosion by the water and steam. When soldering the sleeve to the bottom of the basin care should be taken to locate it centrally, otherwise the buoyant force of the water acting on the basin might be exerted unevenly and cause the sleeve to bind on the stem D. The detail of the part C is shown in Fig. 5.

In order to show the cheapness of such a trap, the details of one which

the writer constructed for draining the coils heating an office building are given. The coils in question were composed of 20 pieces of 1-in. pipe, 15 ft. long and connected by return els.

In the construction of the trap, a piece of 8-in. pipe, 10 in. long, was used as a cylinder. Two round plates of sheet iron, $\frac{3}{8}$ in. thick, were used for the heads. The heads, cut to a diameter of $10\frac{1}{2}$ in., were bolted to each end of the cylinder by eight $\frac{1}{2}$ -in. bolts, 11 in. long. The parts C, D, and E were turned on a small lathe in less than two hours. The upper end of E was turned to take a $\frac{1}{4}$ -in. union attached to the $\frac{1}{4}$ -in. nipple which drains the coil.

The superiority of this homemade trap lies in the fact that there are no rubber diaphragms to rot or decay, or thin metallic ones to burst, in case the trap should freeze up. As the trap will continually dispose of condensation as long as there is the least amount of pressure in the coils, there is no danger of either the trap or coils freezing up in the coldest of weather.

A Priming-Cup Tank

Priming cups of various designs are furnished on most autos, but they all have one fault: when the gasoline is needed for priming purposes, it is generally in some inaccessible place. The oilcan which is carried for this purpose is usually empty, and the motorist is compelled to crawl under the car and get a sufficient amount from the carburetor or gasoline tank.

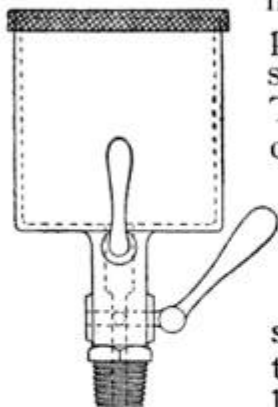

The sketch shows an original idea which will overcome this fault. A small tank, which is fitted with two shut-off valves, is attached to the priming cup. When the upper valve is closed and the lower opened, the gasoline in the space between the two

valves is injected into the cylinder and a rich mixture is formed for easy starting. Then, by closing the lower valve and opening the upper, the device is ready to be used again.—Contributed by Edwin M. Wise, Toledo, Ohio.

Fastening Cotters

A common method, used by almost every machinist, is to drill a hole for a cotter the same size as the diameter of the pin and after inserting the cotter to spread its ends with a chisel or screwdriver so as to give them a short hook or bend as shown in the sketch A. A cotter, fastened in this manner, is hard to remove. A better way is to drill the hole about .005 or .01 in. larger than the diameter of the cotter. Open the pin B with a

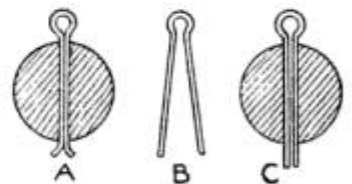

screwdriver, which gives it a spring tension; then, when the cotter is inserted, the tension will hold it in place and it cannot be jarred out, while at the same time it is easily removed and will retain its shape.—Contributed by Walter Butz, Pearl River, N. Y.

Removing Dents from Thin Metal Articles

Dents in any kind of sheet metal, especially the brass fixtures of an automobile, are exceedingly difficult to straighten out and make a neat-appearing piece of work. One of the best methods of doing this is to make a clip of metal, steel or brass, as shown at A in the sketch, and solder the small part turned at right angles to the metal in the dent. The sunken metal can

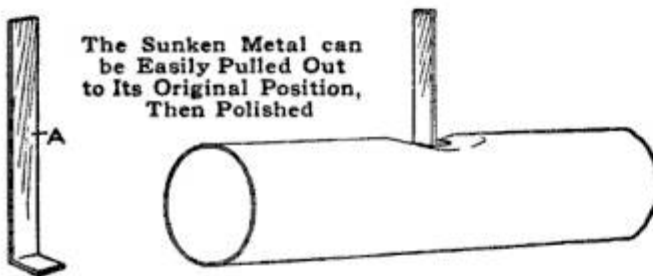

The Sunken Metal can be Easily Pulled Out to Its Original Position, Then Polished

then be pulled up, the clip unsoldered and the surface polished. It is not necessary to drill a hole in the fixture and the surface can be smoothed up like new.—Contributed by Chas. Kaufman, Santa Ana, Cal.

Smoke Hood for Forges

The ordinary hoods over a blacksmith's forge, which are supposed to carry the smoke and gases directly into the open air or into the factory chimney, have all the disadvantage that the draft is usually only strong enough to carry away the hottest smoke and gases, while the cooler ones as a rule roll out under the edge of the hood into the rooms which is the main reason why blacksmiths always have grimy faces and inflamed, red eyes. With an auxiliary hood fitted over the ordinary hood, its lower edge extending a little below the latter, leaving only a narrow space between the two

hoods, and provided with an exhaust pipe of its own, which may lead to a window or perforation in the wall

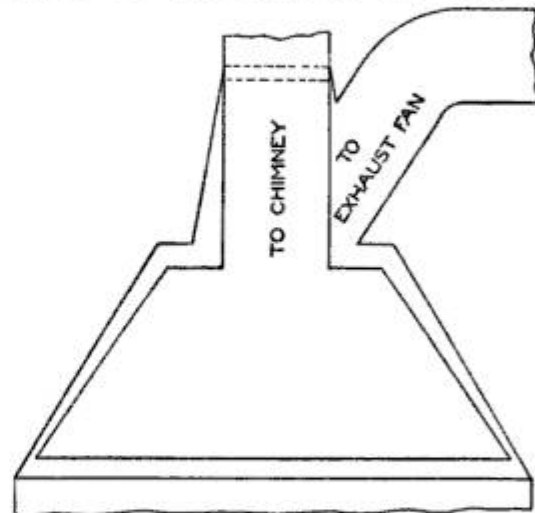

An Auxiliary Hood and an Exhaust Pipe to Expel All Smoke from a Forge

where a fan is placed, all the smoke will be expelled and the air in the room is kept fresh and clean.

Soldered Joints on Telephone Wires

A large percentage of telephone troubles is usually found in poor connections caused by neglect and carelessness of the construction and repair men, says a correspondent of Telephony. Upon repairing a new copper wire with an old one, in which the joints had been bridged and soldered, a very noisy circuit was found. When investigated, it was discovered that all joints had been bridged, but, in soldering the bridging wires, many loose connections were overlooked. The bridges were made as shown at A. That is, the bridging wire was wound around the line wire in a closed coil and the solder applied to the outside of the coil. This resulted in all the solder

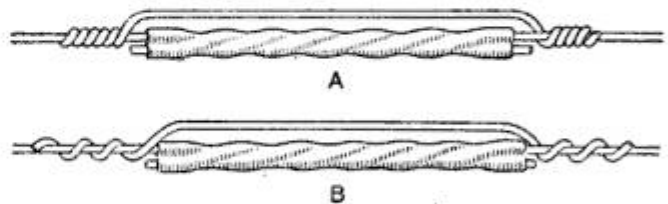

The Closed Coils will Not Make as Good a Joint as the Open Coils

on the bridging wire being held on the outside, so that none reached the line wire. This made loose connections between the bridging and the line

wires. The proper method of connecting the bridging wire is shown at B. By leaving plenty of surface of the line wire between the turns of the bridging wire, solder will take hold of both wires equally well, and a good joint will be made.

In soldering drop wires to the line wires, the same care should be taken and the joint made practically the same as shown at one end of the sleeve in sketch B.

A Fence-Wire Grip

The grip consists of a block of wood grooved to receive the wire and fitted with a wedge for the holder. The

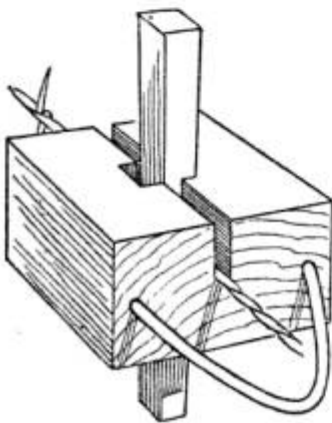

groove should be cut about one-half the depth of the block, and a hole bored in its center and squared to receive the wedge. The hole should be in such a position that the wire will be slightly kinked

when the wedge is driven in tightly. The block is also fitted with a wire loop at one end to attach to the wire stretcher. Holes are bored through the block and the ends of the wire loop inserted, and twisted together or otherwise fastened.

Working Self-Hardening Steel

Self-hardening steel, used so much for tool holders in repair work where high-speed steel is too expensive, is too hard to be worked into special shapes. It can be forged at a low red heat, but must be used carefully as it is very brittle. While red hot, it can be filed. It is well to know this, and, while using a file on hot metal is not good practice, circumstances sometimes compel one to do it.

Bought in the bar, self-hardening steel is expensive, as it is wasteful to cut it up into tool lengths. Cutting it

up by a friction saw is not wasteful, but few steel users have this tool. When broken off in a vise with the aid of a big wrench, its irregular fracture causes waste of stock and much loss of time in grinding it to shape. The same is true when it is nicked all around on the corner by grinding it on an emery wheel and then breaking. The long, rounded projection must be ground off before using. Cutting on the anvil with a chisel, when hot, is fairly economical, but a better way is to nick it deeply on the bottom by placing it on the corner of a revolving emery wheel and nicking the sides slightly, or otherwise as desired, leaving the top flat, then breaking off the piece. The amount of grinding and the way it is ground by this three-side method enable one to control the line of fracture and produce a tool whose general shape is already formed so that it requires a minimum of finishing and no loss of stock is caused.

Heat-Retaining Pail for Pitch

In laying a paper roof on a cold day I experienced some difficulty to keep the pitch warm enough to work well.

To overcome this trouble I constructed a heat-retaining pail, as shown, which keeps the pitch in a working condition for a much longer time on a cold day. An old wooden bucket was secured and lined with newspapers.

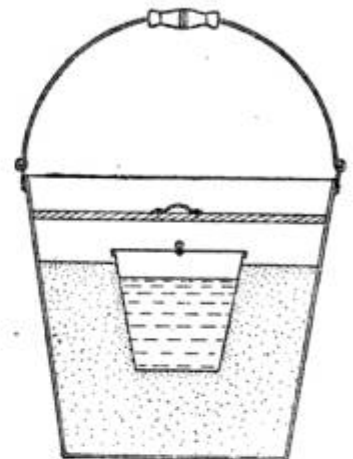

Then the bottom was covered with hot sand to a depth of 3 in., the smaller pail with the pitch set on this and the sides filled in with hot sand in the manner of packing an ice-cream freezer. Covers were made for each pail, as shown. This device has kept pitch at a working heat for six hours on a very cold day.—Contributed by Alfred H. Rose, Ipswich, Mass.



am M. 4-437

Freezing a Basin to a Chair

Fill a basin or pot half full of snow, and secretly put a handful of table salt in it and place the vessel on a chair or table, wetting the space where it is to be set. After holding the basin in place for about two minutes, continually stirring the contents, it will freeze to the chair so solidly that when the basin is lifted the chair will come along with it.

This experiment is quite interesting to an audience and can be performed at any assemblage with success. If the instructions are carried out closely, the trick will always succeed and the audience will consider it magic. Even if performed in a warm room, the combination of snow and salt will reduce the temperature below the freezing point where the bottom of the vessel comes in contact with the chair seat.—Contributed by Harry Slosower, Pittsburgh, Pa.

An Envelope and Stamp Moistener

A moistener for postage stamps or envelopes can be easily made from a screw-top jar. A strip of felt cut as wide as the jar is deep and made into a roll large enough to fit the neck of the jar serves as a wick. The metal top is perforated, and, after filling the jar with water, it is screwed into place. This makes a very inexpensive moistener for the library desk.

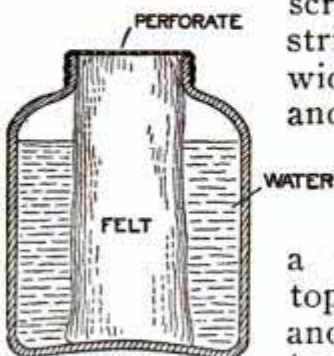

A Homemade Drill Press

An ordinary breast drill is used in the construction of this drill press, it being rigidly secured to a piece of oak, A, 2 in. square and 18 in. long, which

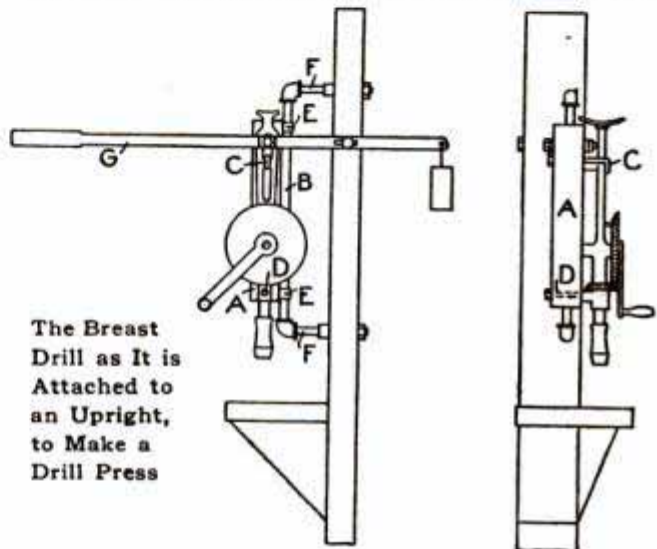

is a sliding member on the pipe B. In attaching the breast drill to the wood, a bolt, having a hook on the head end, was used at the top, at C, and a stud at the bottom D. Pipe clips, EE, were attached on one side of the block to fit loosely over the pipe B. The vertical part of the pipe is supported by two horizontal pieces, FF, which are fastened to a post. A feed lever, G, is pivoted at the top of the vertical piece of oak A and fulcrumed on the post with a bolt through a slot, the extending end carrying a weight as a counterbalance. The illustration clearly shows the construction of this very useful drill press.—Contributed by W. A. Ready, Boston, Mass.

CA pair of bicycle trousers guards makes excellent sleeve bands when the cuffs are turned back and rolled above the elbows.

Battery Jars Made of Bottles or Fruit Jars

Many amateur experimenters, especially those interested in electricity, frequently require a medium-sized battery jar, or container, for the different

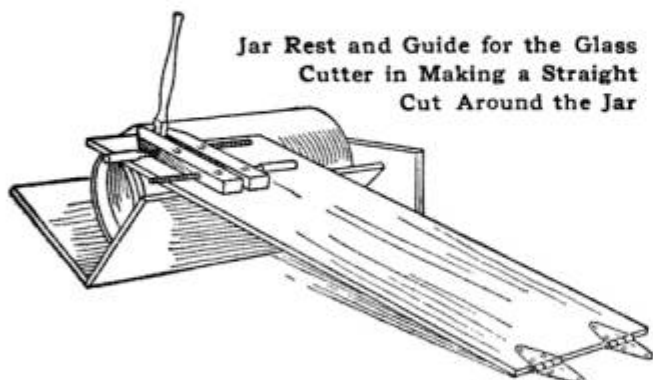

batteries, condensers, rectifiers, etc., which, as a rule, are not procurable in the rural districts and small towns, and when ordered from a distance are slow in coming. Battery jars that are very inexpensive and convenient can be easily made in the following manner:

Purchase a number of 1-gal. bottles, or large fruit jars and arrange to cut off their tops. Nail two boards together so as to form a right angle, which is to serve as a rest for the jar, and an aid in making a perfectly straight cut around it with a glass cutter. No doubt, all experimenters have a vise of some kind, or an ordinary wooden clamp, that they can use in holding the glass cutter rigidly in a fixed position. Nail a board across one end of the jar rest, place the jar in the rest with the bottom of the jar against the closed end, and then fasten the clamp or vise holding the glass cutter in position, making sure the cutter is at the proper cutting angle and the correct distance from the bottom of the jar. Now rotate the jar until a complete circle is made and then the top can be easily removed by tapping on the inside with a file or other instrument directly beneath the cut.

A simple arrangement of jar support and cutter is shown in the accompanying sketch. The support for the cutter is hinged at one end so that the cutter may move up and down to cor-

respond to the irregularities in the surface of the jar. A slight pressure should be applied to the cutter as the jar is rotated.

Protector for Photographic Prints

Photographs to be mounted on calendars, match trays, glove boxes, pyrographic novelties, and many similar articles, can be protected with a piece of negative film. The film is cleaned of its coating by using hot water and soda. When the film is dry, it is squeegeed to the wet photographic print, if the print has a glossy surface; but if the print has a mat surface, a thin coating of starch paste must be used. In the latter case, the film should be squeegeed quite forcibly to press out the surplus paste. The print and its covering can be trimmed to any desired shape and used in many ways.

The prints can be fastened to brass or aluminum work with shellac. They also can be used in ornamenting leather goods, such as card cases, pocket books, and hand bags. If one knows how to color the prints, the effect of porcelain paintings may be obtained.—Contributed by Albert Gibson, Chicago, Ill.

An Alcohol Lamp

Procure an empty brass cartridge case, A, 3 or 4 in. long, and cut or file off the narrow or thin part that holds the bullet, or,

preferably, procure a shell which is of a uniform diameter for its whole length. After doing this, drill eight small holes, B, around its circumference at the base end as near the rim as possible. The



shell is then fitted with a round wick almost up to the level with the holes. The outside is fitted with a circular

piece of wick, C, of sufficient length to dip into the alcohol in the bottle and protrude about $\frac{1}{8}$ in. above the bottle neck. An ordinary alcohol-lamp retainer will do, but its neck should be of sufficient diameter to allow the outside wick to slip in easily.

The outside wick C is lighted and the heat vaporizes the alcohol within the shell A, which will rush out through the holes B and burn, making a large and hot flame. Owing to the intense heat of this lamp it is very handy for soldering and for laboratory use.—Contributed by H. Vincent, Yokohama, Japan.

Transplanting Plants

Many plants for the garden are grown in hot beds or greenhouses and are transplanted when the warmer days of spring come. If the roots are

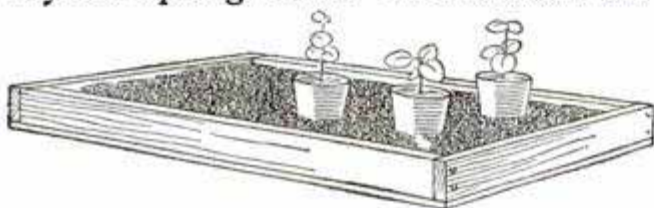

Each Plant is Grown in an Individual Cylinder Which can be Transplanted Bodily

disturbed or not sufficient soil left on them, the plant will have a setback and it will require considerable attention to make it grow. One gardener devised a plan whereby the plant roots are not disturbed in the transplanting. His method is to prepare a box with loose-fitting sides to carry a number of paper cylinders in which each plant is grown until it is large enough for transplanting.

The cylinders are made of oil or wax paper, slightly tapering and without top or bottom. The bottom of the box is first covered with a layer of soil, then the cylinders are set in and filled, whereupon the box is filled in with soil around the cylinders to aid in holding the moisture. When transplanting time comes the cylinders containing the plant are removed to the garden and set in the earth. The paper may be left in place, as the roots can grow through it.—Contributed by Warren E. Crane, Cleveland, O.

Brooder for Small Chicks

A very simple brooder can be constructed by cutting a sugar barrel in half and using one part in the manner



Brooder for Young Chicks Kept Warm with a Jug of Boiling Water

described. Line the inside of the half barrel with paper and then cover this with old flannel cloth. Make a cover for the top and line it in the same manner. At the bottom cut a hole in the edge, about 4 in. deep and 4 in. wide, and provide a cover or door. The inside is kept warm by filling a jug with boiling water and setting it within, changing the water both morning and night. When the temperature outside is 10 deg. the interior can be kept at 90 or 100 deg., but the jug must be refilled with boiling water at least twice a day.

Faucet Used as an Emergency Plug

A brass faucet split as shown at A during a cold spell, and as no suitable plug to screw into the elbow after removing the faucet was at hand, I drove a small cork, B, into the end of the faucet and screwed it back in place. The cork converted the faucet into an

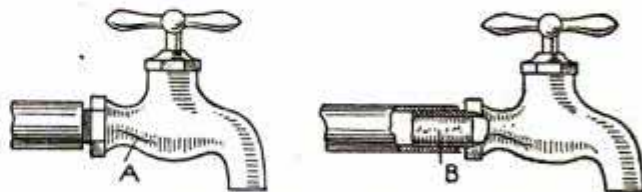

A Tight-Fitting Cork Driven into a Cracked Faucet Converted It into an Emergency Plug

emergency plug which prevented leakage until the proper fitting to take its place could be secured.—Contributed by James M. Kane, Doylestown, Pa.

Disk-Throwing Pistol

A pistol for throwing small disks of paper or metal balls, can be easily made at almost no expense as shown in the sketch. Two pieces of board,

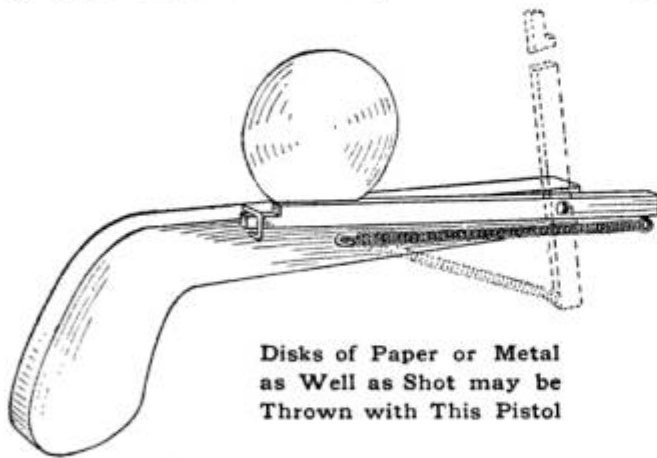

one of which is shaped to the form of a pistol, are hinged together and a fairly strong spiral spring is fastened at the front end of the movable piece and the middle of the other. A slot is sawed in the movable piece to hold the disk, or a small round depression may be formed in it to receive a bean, pea, or shot. The movable arm is folded back and held in position by means of a stirrup of wire fastened on the other part. When the movable part is disengaged by pulling the stirrup away with the finger, the disk will be thrown with considerable force, depending on the strength of the spring.

Displaying Dye Colors

A certain druggist utilized old electric bulbs for displaying dye colors. Water was colored with a dye and the end of a bulb dipped into the liquid. Then the tip end was broken off, and

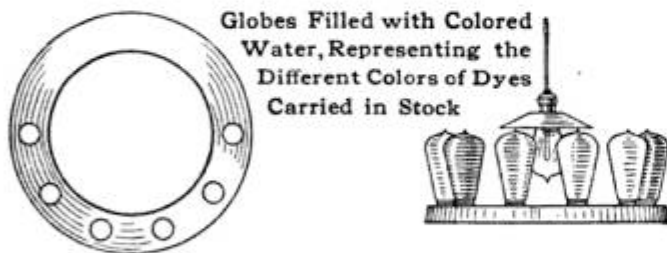

the bulb being a vacuum, the colored water was drawn into it, and filled the globe. The point was then sealed with paraffin.

A ring-shaped piece, 15 in. in diameter and $2\frac{1}{2}$ in. wide, was cut from a piece of board, and 1-in. holes bored, $2\frac{1}{2}$ in. apart, in one-half of the ring. The globes holding the colored water were set in these holes and a light with a round shade placed in the center. It proved to be an attractive display and a good method of showing the colors.—Contributed by Maurice Baudier, New Orleans, La.

A Homemade Bench Vise

A serviceable and inexpensive bench vise can be made in the following manner: Procure a piece of hard wood, 1 in. thick, and shape it into an eccentric with an extending handle, as shown at A. The jaws B are made of material 2 in. thick, and the drawbar C is a 2

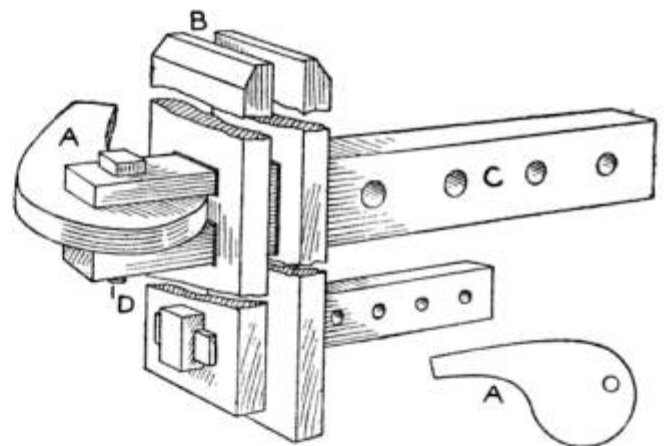

A Vise That can be Quickly Constructed Where No Bench Vise is at Hand

by 3-in. piece of hickory. The outer end of the bar is slotted to receive the eccentric handle, through which a bolt, D, passes to form a bearing. Holes are bored into the opposite end of the bar, 2 in. apart, into which a peg is inserted to come against the back side of the rear jaw. This provides an adjustment for a range of various thicknesses of material. Another bar is located at the bottom of the jaws to provide a means of keeping the jaws parallel. This bar is made in a similar manner to the bar C. The rear jaw can be fastened to the side of a bench, post, or any support that may be handy.—Contributed by Wm. S. Thompson, Columbia, Tenn.

How to Make a Small Electric Motor

By W. A. ROBERTSON

The field frame of the motor, Fig. 1, is composed of wrought sheet iron, which may be of any thickness so that, when several pieces are placed together, they will make a frame $\frac{3}{4}$ in. thick. It is necessary to lay out a template of the frame as shown, making it $\frac{1}{8}$ in. larger than the dimensions given, to allow for filing to shape after the parts are fastened together. After the template is marked out, drill the four rivet holes, clamp the template, or pattern, to the sheet iron and mark carefully with a scribe. The bore can be marked with a pair of dividers, set at $\frac{1}{8}$ in. This will mark a line for the center of the holes to be drilled with a $\frac{1}{4}$ -in. drill for removing the unnecessary metal. The points formed by drilling the holes can be filed to the pattern size. Be sure to mark and cut out a sufficient number of plates to make a frame $\frac{3}{4}$ in. thick, or even $\frac{1}{8}$ in. thicker, to allow for finishing.

After the plates are cut out and the rivet holes drilled, assemble and rivet them solidly, then bore it out to a diameter of $2\frac{3}{4}$ in. on a lathe. If the thickness is sufficient, a slight finishing cut can be taken on the face. Before removing the field from the lathe, mark off a space, $3\frac{3}{8}$ in. in diameter, for the field core with a sharp-pointed tool, and for the outside of the frame, $4\frac{1}{2}$ in. in diameter, by turning the lathe with the hand. Then the field can be finished to these marks, which will make it uniform in size. When the frame is finished so far, two holes, $3\frac{5}{8}$ in. between centers, are drilled and tapped with a $\frac{3}{8}$ -in. tap. These holes are for the bearing studs. Two holes are also drilled and tapped for $\frac{1}{4}$ -in. screws, which fasten the holding-down lugs or feet to the frame. These lugs are made of a piece of $\frac{1}{8}$ -in. brass or iron, bent at right angles as shown.

The bearing studs are now made, as shown in Fig. 2, and turned into the threaded holes in the frame. The bearing supports are made of two pieces of

$\frac{1}{8}$ -in. brass, as shown in the left-hand sketch, Fig. 3, which are fitted on the studs in the frame. A $\frac{5}{8}$ -in. hole is

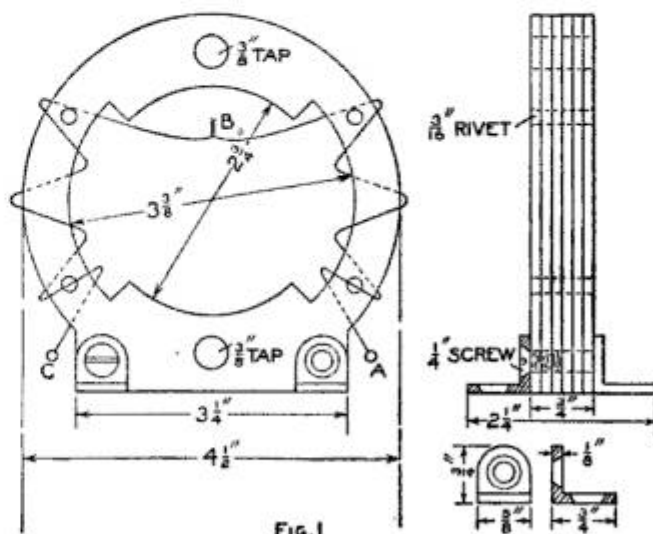

FIG. 1

The Field-Coil Core is Built Up of Laminated Wrought Iron Riveted Together

drilled in the center of each of these supports, into which a piece of $\frac{5}{8}$ -in. brass rod is inserted, soldered into place, and drilled to receive the armature shaft. These bearings should be fitted and soldered in place after the armature is constructed. The manner of doing this is to wrap a piece of paper on the outside of the finished armature ring and place it through the opening in the field, then slip the bearings on the ends of the shaft. If the holes in the bearing support should be out of line, file them out to make the proper adjustment. When the bearings are located, solder them to the supports, and build up the solder well. Remove

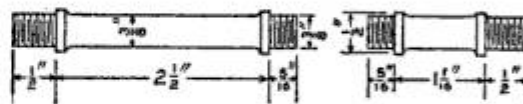

FIG. 2

The Bearing Studs are Turned from Machine Steel Two of Each Length being Required

the paper from the armature ring and see that the armature revolves freely in the bearings without touching the inside of the field at any point. The supports are then removed and the solder turned up in a lathe, or otherwise finished. The shaft of the arma-

ture, Fig. 4, is turned up from machine steel, leaving the finish of the bearings until the armature is completed and fastened to the shaft.

The armature core is made up as fol-

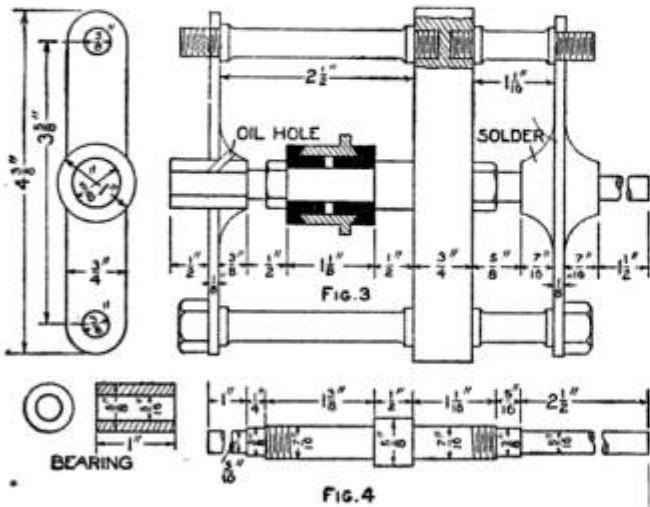

FIG. 4

The Assembled Bearing Frame on the Field Core and the Armature Shaft Made of Machine Steel

lows: Two pieces of wrought sheet iron, $\frac{1}{8}$ in. thick, are cut out a little larger than called for by the dimensions given in Fig. 5, to allow for finishing to size. These are used for the outside plates and enough pieces of No. 24 gauge sheet iron to fill up the part between until the whole is over $\frac{3}{4}$ in. thick are cut like the pattern. After the pieces are cut out, clamp them together and drill six $\frac{1}{8}$ -in. holes through them for rivets. Rivet them together, and anneal the whole piece by placing it in a fire and heating the metal to a cherry red, then allowing it to cool in the ashes. When annealed, bore out the inside to $1\frac{1}{16}$ in. in diameter and fit in a brass spider, which is made as follows: Procure a piece of brass, $\frac{3}{4}$ in. thick, and turn it up to the size shown and file out the metal between the arms. Slip the spider on the armature shaft and secure it solidly with the setscrew so that the shaft will not turn in the spider when truing up the armature core. File grooves or slots in the armature ring so that it will fit on the arms of the spider. Be sure to have the inside of the armature core run true. When this is accomplished, solder the arms of the spider to the metal of the armature core. The shaft with the core is then put in a

lathe and the outside turned off to the proper size. The sides are also faced off and finished. Make the core $\frac{3}{4}$ in. thick. Remove the core from the lathe and file out slots $\frac{1}{4}$ in. deep and $\frac{7}{16}$ in. wide.

The commutator is turned from a piece of brass pipe, $\frac{3}{4}$ in. inside diameter, as shown in Fig. 6. The piece is placed on a mandrel and turned to $\frac{3}{4}$ in. in length and both ends chamfered to an angle of 60 deg. Divide the surface into 12 equal parts, or segments. Find the centers of each segment at one end, then drill a $\frac{1}{8}$ -in. hole and tap it for a pin. The pins are made of brass, threaded, turned into place and the ends turned in a lathe to an outside diameter of $1\frac{1}{4}$ in. Make a slit with a small saw blade in the end of each pin for the ends of the wires coming from the commutator coils. Saw the ring into the 12 parts on the lines between the pins.

The two insulating ends for holding these segments are made of fiber turned to fit the bore of the brass tubing, as shown in Fig. 7. Procure 12 strips of mica, the same thickness as the width of the saw cut made between the segments, and use them as a filler and insulation between the commuta-

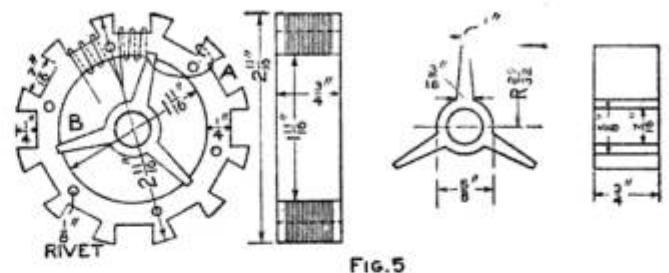

FIG. 5

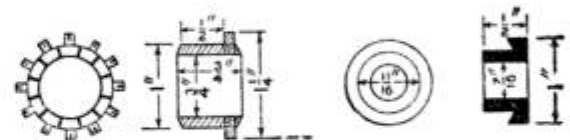

FIG. 6

FIG. 7

Armature-Ring Core, Its Hub and the Construction of the Commutator and Its Insulation

tor bars. Place them on the fiber hub and slip the hub on the shaft, then clamp the whole in place with the nut, as shown in Fig. 3. True up the commutator in a lathe to the size given in Fig. 6.

The brush holder is shaped from a

piece of fiber, as shown in Fig. 8. The studs for holding the brushes are cut from $\frac{5}{16}$ -in. brass rod, as shown in Fig. 9. The brushes consist of brass or copper wire gauze, rolled up and flattened out to $\frac{1}{8}$ in. thick and $\frac{1}{4}$ in. wide, one end being soldered to keep the wires in place. The holder is slipped on the projecting outside end of the bearing, as shown in Fig. 3, and held with a set-screw.

The field core is insulated before winding with 1/64-in. sheet fiber, washers, $1\frac{1}{8}$ in. by $1\frac{1}{2}$ in., being formed for the ends, with a hole cut in them to fit over the insulation placed on the cores. A slit is cut through from the hole to the outside, and then they are soaked in warm water, until they become flexible enough to be put in place. After they have dried, they are glued to the core insulation.

The field is wound with No. 18 gauge double-cotton-covered magnet wire, about 100 ft. being required. Drill a small hole through each of the lower-end insulating washers. In starting to wind, insert the end of the wire through the hole from the inside, at A, Fig. 1, and wind on four layers, which will take 50 ft. of the wire, and bring the end of the wire out at B. After one coil, or side, is wound start at C in the same manner as at A, using the same number of turns and the same length of wire. The two ends are joined at B.

The armature ring is insulated by covering the inside and brass spider with $\frac{1}{16}$ -in. sheet fiber. Two rings of $\frac{1}{16}$ -in. sheet fiber are cut and glued to the sides of the ring. When the glue is set, cut out the part within the slot ends and make 12 channel pieces from 1/64-in. sheet fiber, which are glued in the slots and to the fiber washers. Be sure to have the ring and spider covered so the wire will not touch the iron or brass.

Each slot of the armature is wound with about 12 ft. of No. 21 gauge double-cotton-covered magnet wire. The winding is started at A, Fig. 5, by bending the end around one of the projections, then wind the coil in one of

the slots as shown, making 40 turns, or four layers of 10 turns each, shellacking each layer as it is wound. After the coil is completed in one slot, allow about 2 in. of the end to protrude, to

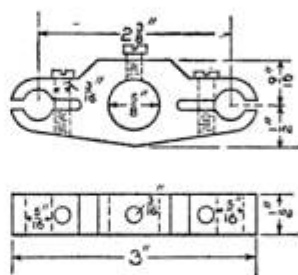

FIG. 8

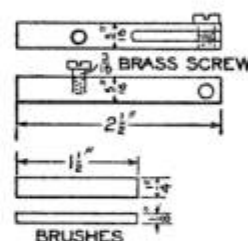

FIG. 9

The Insulated Brush Holder and Its Studs for Holding the Brushes on the Commutator

fasten to the commutator segment. Wind the next slot with the same number of turns in the same manner, and so on, until the 12 slots are filled. The protruding ends of the coils are connected to the pins in the commutator segments after the starting end of one coil is joined to the finishing end of the next adjacent. All connections should be securely soldered.

The whole motor is fastened with screws to a wood base, 8 in. long, 6 in. wide and 1 in. thick. Two terminals are fastened at one side on the base, and a switch at the other side.

To connect the wires, after the motor is on the stand, the two ends of the wire, shown at B, Fig. 1, are soldered together. Run one end of the field wire, shown at A, through a small hole in the base and make a groove on the under side so that the wire end can be connected to one of the terminals. The other end of the field wire C is connected to the brass screw in the brass brush stud. Connect a wire from the other brush stud, run it through a small hole in the base and cut a groove for it on the under side so that it can be connected through the switch and the other terminal. This winding is for a series motor. The source of current is connected to the terminals. The motor can be run on a 110-volt direct current, but a resistance must be placed in series with it.

☞ New tinware rubbed over with fresh lard and heated will never rust.

A Shot Scoop

In the ammunition department of our hardware store the shot was kept in regular square bins and dished out

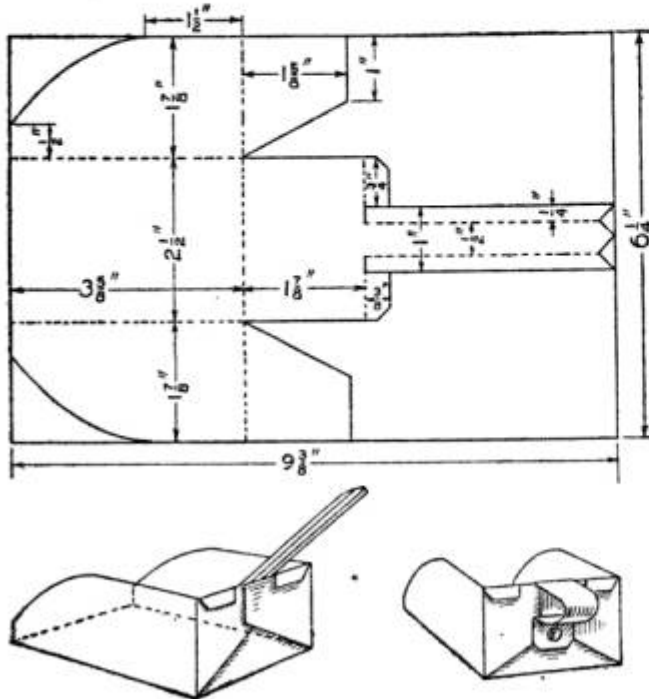

A Small Square Scoop Made of Tin for Dipping Up Shot Stored in a Square Bin

with a round-bottom scoop. This was very difficult, especially when the bottom of the bin was nearly reached, as the round scoop would roll over them and only pick up a few at a time. To overcome this difficulty I constructed a square-shaped scoop that gave entire satisfaction. The scoop can be used for other purposes as well.

A thick piece of tin, $6\frac{1}{4}$ by $9\frac{3}{4}$ in., was marked out as shown, the pattern being cut on the full lines and bent on the dotted ones. The strip for the handle was riveted to the end of the scoop.—Contributed by Geo. B. Wright, Middletown, Conn.

Removing Grease Stains from the Leaves of a Book

Happening to get a grease spot on a page of a valuable book, I found a way to remove it without injury to the paper, which has been tried out several times with success.

Heat an iron and hold it as near as possible to the stain without discoloring the paper, and the grease will dis-

appear. If any traces of the grease are left, apply powdered calcined magnesia. Bone, well calcined and powdered, and plaster of Paris are also excellent absorbents of grease.

A beautifully bound book, and quite new, had oil from a lamp spilled over it. There was no quicklime to be had, so some bones were quickly calcined, pulverized and applied. The next morning there was no trace of oil, but only an odor which soon vanished.—Contributed by Paul Keller, Indianapolis, Ind.

Tightening Cane in Furniture

Split cane, used as part of furniture, such as chair seats, often becomes loose and the threads of cane pull out. This can be prevented by sponging with hot water, or by applying steaming cloths to the cane. This process also tightens the shreds of cane and does not injure ordinary furniture. If the article is highly polished, care should be taken to prevent the hot water from coming in contact with anything but the cane.

Cleaner for a Stovepipe

A long horizontal pipe for a stove soon fills with soot and must be cleaned. The usual method is to beat the pipe after taking it down to be cleaned, but a much better device for the purpose is shown in the sketch.

A scrub brush is procured and cut in two, the parts being hinged to a cross-piece fastened to a long broom handle. The brushes are pressed outward



A Cleaning Brush to Remove the Accumulated Soot in a Long Horizontal Stovepipe

against the inside surfaces of the pipe with a wire and spring, as shown.—Contributed by C. L. Herbert, Chicago, Illinois.

Waterproofing a Wall

The best way to make a tinted wall waterproof is to first use a material composed of cement properly tinted and with no glue in it—one that will not require a glue size on the wall. After this coating of cement is applied directly to the plaster, cover it completely with water enamel and, when dry, give the surface a thorough coating of varnish. This will make a perfectly impervious covering, which steam, water or heat will not affect.—Contributed by Julia A. White, New York City.

Polishing Flat Surfaces

The work of finishing a number of brass castings with flat sides was accomplished on an ordinary polishing wheel, from which the first few layers of cloth were removed and replaced with emery cloth. The emery surface of the cloth was placed outward and trimmed to the same diameter as the wheel. This made a sanding and polishing wheel in one.—Contributed by Chester L. Cobb, Portland, Maine.

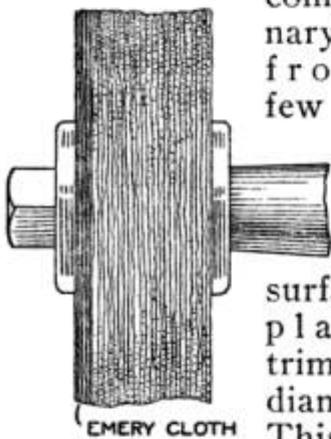

Rubber Tip for Chair Legs

An inexpensive method of preventing a chair from scratching the floor is to bore a hole of the proper size in the bottom end of each chair leg and then procure four rubber stoppers of uniform size and press them into place.

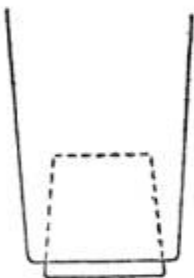

This cushion of rubber eliminates vibrations, and they will not slip nor mar the finest surface upon which they rest.—Contributed by W. A. Jaquythe, Richmond, Cal.

Adjusting a Plumb-Bob Line

When plumbing a piece of work, if there is no help at hand to hold the overhead line, it is common practice to fasten the plumb line to a nail or other suitable projection. On coming down to the lower floor it is often found that the bob has been secured either too high or too low. When fastening the line give it plenty of slack and when the lower floor is reached make a double loop in the line, as shown in the sketch. Tightening up on the parts A A will bind the loop bight B, and an adjustable friction-held loop, C, will be had for adjusting the bob accurately either up or down.—Contributed by Chas. Herrman, New York City.

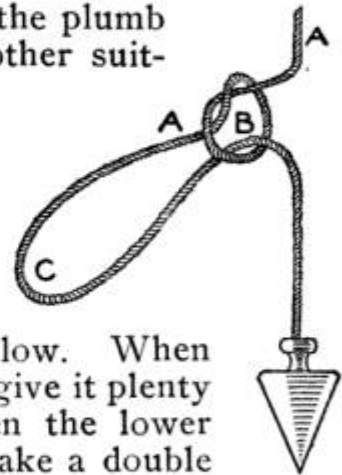

Drier for Footwear

A drier for footwear can be readily made by a tinner, or anyone that can shape tin and solder. The drier consists of a pipe of sufficient length to enter the longest boot leg. Its top is bent at right angles and the other end is riveted to a base, an inverted stew-pan, for instance, in whose bottom a few perforations have been made to let air in. The boot or stocking to be dried is placed over the pipe and the whole set on a heated surface. The heat will cause a rapid circulation of air which will dry the article quickly.—Contributed by Wm. Roberts, Cambridge, Mass.

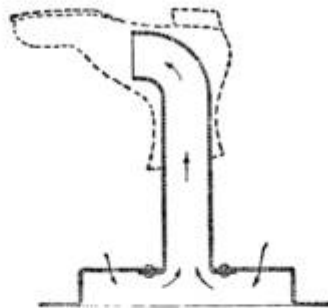

A very satisfactory repair can be made by using a good photographic paste to fasten a torn window shade to its roller.

Automatic Electric Heat Regulator

It is composed of a closed glass tube, A, Fig. 1, connected by means of a very small lead pipe, B, to another

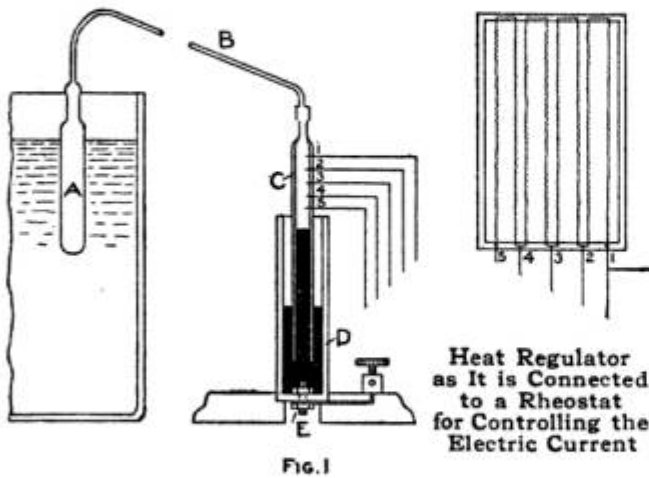

glass tube, C, open at the bottom and having five pieces of platinum wire (1, 2, 3, 4 and 5), which project inside and outside of the tube, fused into one side. This tube is plunged into an ebonite vessel of somewhat larger diameter, which is fastened to the base by a copper screw, E. The tube C is filled to a certain height with mercury and then petroleum. The outer ends of the five platinum wires are soldered to ordinary copper wires and connections made to various points on a rheostat as shown. The diagram, Fig. 2, shows how the connections to the supply current are made.

The apparatus operates as follows: The tube is immersed in the matter to be heated, a liquid, for instance. As

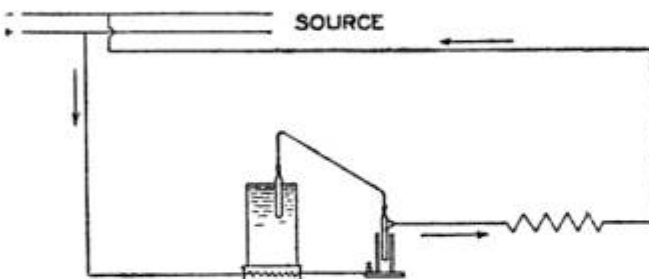

FIG. 2

Wiring Diagram Showing How the Connections to a Source of Current Supply are Made

the temperature of this rises, the air expands and exerts pressure on the petroleum in the tube C so that the level of the mercury is lowered. The current is thus compelled, as the plati-

num wires with the fall of the mercury are brought out of circuit, to pass through an increasing resistance, until, if necessary, the flow is entirely stopped when the mercury falls below the wire 5.

With this very simple apparatus the temperature can be kept constant within a 10-deg. limit, and it can be made much more sensitive by increasing the number of platinum wires and placing them closer together, and by filling the tube A with some very volatile substance, such as ether, for instance. The petroleum above the mercury prevents sparking between the platinum wire and the mercury when the latter falls below any one of them.

Repairing a Washer on a Flush Valve

When the rubber washer on the copper flush valve of a soil-basin tank becomes loose it can be set by pouring a small quantity of paraffin between the rubber and the copper while the valve is inverted, care being taken to have the rubber ring centered. This makes a repair that will not allow a drop of water to leak out of the tank.—Contributed by Frank Jermin, Alpena, Michigan.

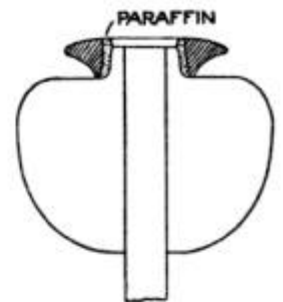

Cleaning Discolored Silver

A very quick way to clean silver when it is not tarnished, but merely discolored, is to wash the articles in a weak solution of ammonia water. This removes the black stains caused by sulphur in the air. After cleaning them with the solution, they should be washed and polished in magnesia powder or with a cloth. This method works well on silver spoons tarnished by eggs and can be used every day while other methods require much time and, therefore, cannot be used so often.

Sharpening Scissors

When sharpening scissors on a grindstone it is very difficult to procure a straight edge. For those not having the facilities of a grinding arrangement a very handy device that will produce a straight and sharp edge can be easily constructed as follows:

Procure a block of wood, $1\frac{1}{2}$ in. long, 1 in. wide and $\frac{1}{2}$ in. thick, and saw a kerf square with the face of the block, as shown at A. Attach a piece

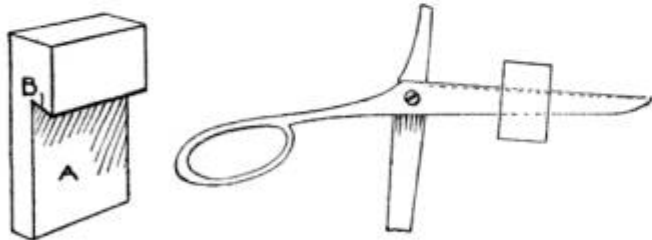

A Block of Wood Fitted with a Piece of Emery Cloth for Sharpening Scissors Correctly

of fine emery cloth in the kerf, at B, with glue, taking care to have it flat on the sloping surface only and allowing no part of the cloth to turn the sharp corner and lie on the back side. Apply the block to the scissor blade as shown and draw it back and forth from one end to the other, being careful to keep the back side of the blade flat against the block. Without being familiar with scissors grinding, anyone can sharpen them correctly with this block.—Contributed by Harriet Kerbaugh, Allentown, Pa.

Counter Brush for a Shop

A very serviceable brush for use around a shop can be made from a discarded or worn-out push broom as shown at A. Pull out the bristles from one-half of the brush and shape the wood of that end with a knife or



A Discarded Push Broom Shaped to Form a Brush for the Bench or Counter

spokeshave to the form of a handle, and the brush will be formed as shown at B.—Contributed by James T. Gaffney, Chicago.

A Curtain Roller

Procure a window-shade roller, an umbrella rib and two strips of oilcloth, each 1 in. wide and 4 in. long. Cut the

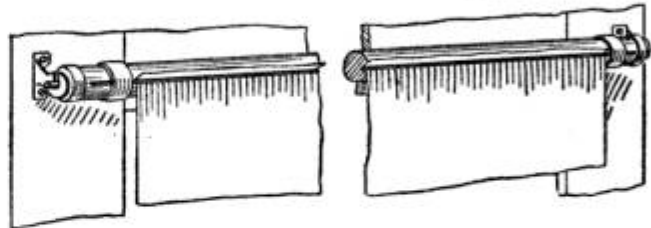

The Curtain is Easily Attached to and Detached from the Roller for Cleaning

roller off so that it will be 6 in. longer than the distance across the window, then cut a groove in it to insert the rib. Sew the pieces of oilcloth so that they will just fit over the ends of the roller. When this is done lay the curtain across the groove, then press the rib and curtain into the groove and push the oilcloth bands over the ends of the rib to keep it in place.—Contributed by E. L. McFarlane, Nashwaakes, N. B.

Shade-Holder Bracket for a Gas Jet

An old umbrella rib makes a very effective shade-holder bracket for a gas jet. The ends of the rib are bent to fit around the pendant upright and the support end is shaped into a hook. It can be quickly applied or removed. The outer end is bent into a hook to

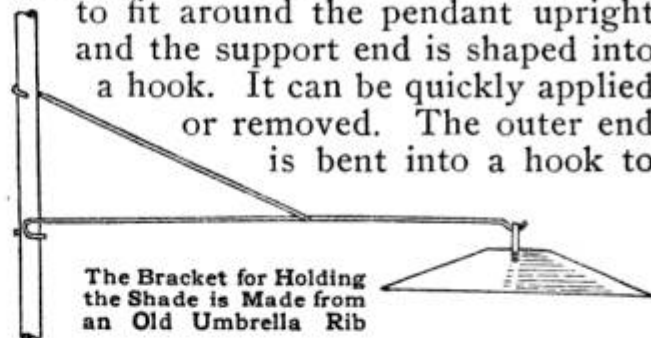

The Bracket for Holding the Shade is Made from an Old Umbrella Rib

hold the shade. The rib can be cut to fit a pendant arm of any length.—Contributed by Edward Keegstra, Paterson, N. J.

To Longer Preserve Cut Flowers

A good way to keep cut flowers fresh is to place a small amount of pure salt of sodium in the water. It is best to procure this salt at a drug store because commercial salt will cause the flowers to wither, due to the impurities in the soda. Call for pure sodium chloride.



Fig. 11

forming a strip of bristles not unlike a curtain fringe in appearance. The unrolled bristles may be washed by hand or machinery, then dried and ironed like an ordinary pocket handkerchief, after which it is again rolled up to form a lathering brush.

PNEUMATIC SADDLE REST (Fig. 12; British patent)—A method of using pneumatic balls as well as springs for the mounting of a motorcycle saddle is here shown. The initial compression of the springs and pneumatic balls may be regulated by turning the thumbscrews. The balls are held in place by means of cups.

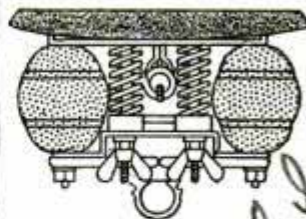

Fig. 12

WOOD-KNOB LATCH (Fig. 13)—The necessity of metal fittings on doors often spoils the artistic value of fine interior woodwork. Here is a new wood-knob door latch of which nothing shows on the outside but the knob.

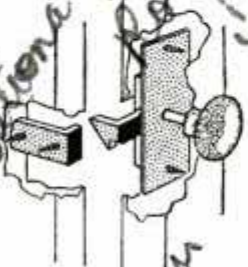

Fig. 13

SHEET-MUSIC TURNER (Fig. 14)—This pneumatic device for turning sheet music is so designed that the person undertaking this service for the pianist may stand out of the way. Pressure on the bulb operates a piston and swings metal rods attached to the sheets of music by means of clips. Release of pressure on the bulb serves to return the piston for the next turning operation.



Fig. 14

ANTISKIDDING CHAIN OF NEW DESIGN (Fig. 15)—In this antiskidding device the chain is used, only as a supporting means for the skid-preventing balls, which, in ordinary running, are merely carried by the tire and are under no pressure. Side friction, however, exerts a side pull on the chains, drawing the balls on one side or the other toward the road contact of the tire, thus jamming them into the tire and preventing further skidding.



Fig. 15

A SUPPORT FOR THE FISHING ROD (Fig. 16; British patent)—The shoulder strap terminates in a cup adapted to receive the handle end of the fishing pole, and a loose-end strap is provided with a hook to engage the pole and hold it in position. The device leaves the fisherman's hands free to remove his catch from the hook and put on new bait.



Fig. 16

SAFETY FUSE PULLER (Fig. 17)—This non-shock fuse puller comprises an insulating handle with an adjustable tong grip. It is claimed that with this tool a fuse can be pulled or put in "hot" while the operator is standing in a damp or conductive place with as much safety as if he were standing on a glass-insulated platform. The movable crosspiece permits a firm grasp to be taken on the fuse cylinder.



Fig. 17

FLOOR-SCRUBBING MACHINE (Fig. 18)—The brush arrangement of this machine is said to be such that the floor may be almost as conveniently scrubbed in corners as in the middle of the room. The water is fed to the brushes through a row of sprinkler perforations running lengthwise of the tank.

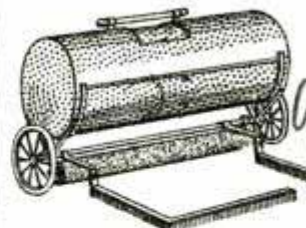

Fig. 18

A "SHOCKING" BURGLAR ALARM (Fig. 19)—This burglar alarm, which is of a complicated and "fearsome" design, will probably shock the person whose house it is designed to protect more than it will the burglar. Over the head of the bed is a sprinkler, which discharges a shower of cold water over the face and head of the sleeper when the window is raised or the door opened.



Fig. 19

AUTOMATIC TIRE PUMP (Fig. 20)—This tire-inflating air pump, designed to be driven by the flywheel of the motor, or, if the flywheel is enclosed, by a gear and slip gear on some exposed shaft, such as the pump shaft or magneto shaft, automatically stops pumping when the pressure in the tire reaches the proper limit. When used in connection with the flywheel it takes its power through a leather-faced conical disk or wheel, which is brought into contact with the flywheel by pulling a lever.



Fig. 20

Michael Remond
National Rock Co
1047 77th Ave
Bridgeton, N.J.
Electric Device Mfg Co
120th St
Bridgeport Conn
06406
5333
Woodnick & Son
2000 0

J. S. Seldon
35 Berry St
Providence R.I.
Genl. Distributer
Alfred E. Co
Standard Work
Electric
Resistor
ing.
Abbie Stewart
Provo Utah
Woodnick & Son
2000 0

A PSYCHOLOGIST came upon a hard-working Irishman toiling, bareheaded, in the street. "Don't you know," said the psychologist, "that to work in the hot sun without a hat is bad for your brains?" "D'ye think," asked the Irishman, "that Oi'd be on this job if Oi had any brains?"

It was a beautiful evening and Ole, who had screwed up courage to take Mary for a ride, was carried away by the magic of the night:

"Mary," he asked, "will you marry me?"

"Yes, Ole," she answered softly.

He lapsed into silence that at last became painful to his fiancée.

"Ole," she said, desperately, "why don't you say something?"

"Ay tank," Ole replied, "they bane too much said already!"—San Francisco Standard.

Father—That looks like an Italian ship.

Son—Papa, don't you think it's awful kind of us to let the other nations use our ocean?—Collier's Weekly.

Jack McGee comes up from Florida with an account of what happened when the circus train went bump in the woods down there and the Old Man offered the surrounding niggers a dollar each for bringing the animal specimens back. The price was not good enough for one gigantic and gorilla-made speculator, who wanted it doubled for a giraffe he said he had hived back-a-ways. The Old Man hadn't missed any giraffe, but he was willing to find out about it. He asked the gorilla if he was sure he knew what he was talking about. He was.

"Yassuh. Ah is, 'n it's a mighty savage giraffe, too. Done bite me twice in de laig. Ah ain' fetchin' no giraffe in fo' no dollah. Swuff two."

The Old Man gave him a dollar down and promised another on delivery of the goods. He took it and went away.

Next morning he came in, looking as though some one had been cleaning fish on him—lacerated, bloody and lame. In one hand he carried a club the size of your leg. In the other, over his shoulder, was one end of a rope. At the other end of the rope, battered, half hairless, limp and utterly dejected, dragged a ten-foot royal Bengal man-eating tiger.—Will Eaton in Press Club Scoop.

Years ago a former United States Senator from one of our Western States was foreman of a gang of lumberjacks, mostly Swedes. One day he had three or four with him on a raft.

"You better gat some one to tak Ole's plaise," one of the men addressed him.

"What's the matter with Ole?"

"Hae yost went under the raft and I tank hae's not coming back."

Ernest Thompson-Seton said, "I asked a little boy in one of my camps to tell me something wonderful about birds.

"Why," said the little boy, 'how they come out of the eggs, that's wonderful.'

"Now," I went on, 'tell me something about them more wonderful still.'

"Why," he answered, 'it's more wonderful how they ever got inside the eggs.'—Cincinnati Enquirer.

Pat and Mike were crossing the Delaware River on a ferryboat. They were watching intently a big dredging barge that was sending its mammoth scoops under the water and bringing up tons of mud.

"Pat," says Mike, "wouldn't yez loike to be a-workin' over there on that mud-digger?"

"Yis," says Pat, "but begorra, Oi'd hate to be one of the fellows under the water that's fillin' up thim shovels."—San Francisco Examiner.

Farmer (seeing a street sprinkler for the first time)—These city folks certainly are smart. Look what that fellow has fixed at the back of his wagon to keep the boys from stealing a ride!

The Hotel Clerk (suspiciously, to prospective guest, whose bag has come apart, thereby disclosing a strange contrivance)—May I ask what that queer thing is?

The Prospective Guest—This is a new patent fire-escape. If your hotel caught fire, I could let myself down from the window so easily—see?

The Hotel Clerk—Exactly; our terms for guests with fire escapes are invariably cash in advance.—The Sketch.

A lawyer was cross-examining an old German about the position of the doors, windows, and so forth, in a house in which a certain transaction occurred.

"And now, my good man," said the lawyer, "will you be good enough to tell the court how the stairs run in the house?"

The German looked dazed and unsettled for a moment. "How do the stairs run?" he queried.

"Yes, how do the stairs run?"

"Vell," continued the witness, after a moment's thought, "ven I am oopstairs dey run down, and ven I am downstairs dey run oop."—Everybody's

Tommy came out of a room where his father was tacking down a carpet. He was crying lustily.

"Why, Tommy, what's the matter?" asked the mother.

"P-p-p-papa hit his finger with the hammer," sobbed Tommy.

"Well, you needn't cry about a thing like that," comforted his mother. "Why didn't you laugh?"

"I did," sobbed Tommy.

A country school teacher was cashing her monthly check at the bank. The teller apologized for the filthy condition of the bills, saying, "I hope you are not afraid of microbes."

"Not a bit of it," the schoolmarm replied. "I'm sure no microbe could live on my salary."—Lippincott's.

For a whole solid hour the captain had been lecturing his men on "The Duties of a Soldier," and he thought that now the time had come for him to test the results of his discourse.

Casting his eyes around the room, he fixed on Private Murphy as his first victim.

"Private Murphy," he asked, "why should a soldier be ready to die for his country?"

The Irishman scratched his head for a while; then an ingratiating and enlightened smile flitted across his face.

"Sure, captain," he said pleasantly, "you're quite right. Why should he?"—Philadelphia Inquirer.



Courtesy London Motor

A MODERN HORATIUS AT THE BRIDGE

"But those behind cried 'forward!' and those before cried 'back!'"

—Lays of Ancient Rome



All These FREE!

Present this coupon to your paint or hardware dealer for our 25-cent Instruction Book. He will also give you free two 10-cent bottles of Johnson's Wood Dye, which comes in 17 shades, such as Mission Oak, Early English, Mahogany, etc., and one 10-cent can of Johnson's Prepared Wax. Our book tells how to secure the right artistic wood effects with least expense and trouble.

Johnson's Wood Dye

is a *dye*, not a stain. It sinks deep down bringing out the natural beauty of the wood. In half an hour it will be perfectly dry. No dust sticks, no streaks show. Not only beautiful but lasting and easy to use. May be applied over old worn varnish or shellac.

Value
55c—FREE

Good at your paint or hardware store for one 25c book, two 10c bottles of Johnson's Wood Dye and one 10c can of Johnson's Prepared Wax.

Johnson's Prepared Wax

a perfect furniture polish and finish for all woodwork, floors, and furniture, including pianos. Can be used over all finishes. Is beautifying and protecting. Our book tells how to apply it over any wood—new or old. Get the book and 10c packages free from your dealer.

I asked my dealer (name)

.....
but he could not supply me—so please send postpaid.

S. C. Johnson & Son, Racine, Wis.

"The Wood Finishing Authorities"

Name.....

Address.....

City..... State.....

P. A. 4 This coupon must first be presented to your dealer



The Winged Message

Noah's messenger was a dove. In Solomon's time, pigeons were trained to carry messages. Brutus used them at the siege of Modena. They served the Turks in their fights against the Crusaders. In mediæval wars they were more useful than ever before.

France had a carrier-pigeon mail service, with messages reduced by photography and read through a microscope.

Even today carrier pigeons are utilized as news-bearers in isolated parts of Europe.

In America, the land of the telephone, the carrier pigeon is bred only for racing. The winged word has taken the place of the winged messenger.

Pigeons may fly more than a mile a minute, but the telephone is as quick as speech itself.

The dove is the emblem of peace. The telephone is the instrument of peace. The telephone lines of the Bell System unite a hundred million people in one national family.

**AMERICAN TELEPHONE AND TELEGRAPH COMPANY
AND ASSOCIATED COMPANIES**

One Policy

One System

Universal Service

EXTRA! EXTRA!

68,570 "Baby Grand" Inquiry Letters Burned!

If Your Letter Was Among Them—WRITE AGAIN, AT ONCE

The fire, which on February 13, destroyed the General Offices of the Brunswick-Balke-Collender Company in Chicago, swept away all the accumulated correspondence and card records resulting from our advertising of BRUNSWICK HOME BILLIARD AND POCKET-BILLIARD TABLES in this and other publications. While the fire destroyed all correspondence relating to the "BABY GRAND" and other styles of Home Billiard Tables, *our factory facilities were untouched.* We have nine factories and 60 branch houses, with complete stocks of all sizes and styles of Brunswick Tables.

In order to avoid confusion and delay, we ask all who have already corresponded with us to WRITE AGAIN, AT ONCE. We are now established in new General Offices and are equipped to transact business with our customary promptness.

THE BRUNSWICK-BALKE-COLLENDER CO.

Play HOME BILLIARDS On the "BABY GRAND"

Billiards holds the scepter of supremacy over all indoor games for the home. It affords the delightful combination of physical exercise, mental relaxation, excitement and *fun* for young and old. *Real billiards* can only be played on a *real* billiard table. You can now secure, *in home sizes*, the famous Brunswick tables, used exclusively by the billiard experts of the world.

The Brunswick "BABY GRAND" is the world's finest Home Billiard Table. Genuine mahogany, inlaid design, highly finished. Celebrated Baby Monarch cushions. Vermont slate bed. Concealed drawer holds complete playing equipment.

The "Baby Grand" is furnished either as a Carom or Pocket-Billiard Table or as a combination Carom and Pocket-Billiard Table, as desired.

Our Brunswick "Convertible" Billiard or Pocket-Billiard Tables serve also as Dining and Library Tables or Davenport. Excellent playing qualities.

Send Coupon for Illustrated Circular

Circular accurately describes and illustrates *in full colors* the many styles and sizes of Billiard and Pocket-Billiard Tables designed for the home. Gives special prices and full details of Easy-Payment Proposition.

THE BRUNSWICK-BALKE-COLLENDER CO.

Nine Factories and 60 Branch Houses

Dept. E.W., Harrison St. and Wabash Ave., Chicago



The World's Famous
"BABY GRAND"

Over a Year to Pay! Full Playing Outfit Free

Play while you pay! Our low prices and easy terms bring Brunswick Tables within reach of all who love the game. Complete Playing Equipment and all accessories furnished free with each table. Outfit includes cues, balls, bridge, rack, markers, rules and book, "How to Play."

The Brunswick-Balke-Collender Co.

Dept. E.W., Harrison St. and Wabash Ave., Chicago

Gentlemen: Please send to the address below, Illustrated Circular of Brunswick Home Billiard Tables.

Name _____

Address _____

Town _____

State _____

(If you have already corresponded with us,
please write, giving full details)

(84)

No-Rim-Cut Tires

Our Average Profit \$2.90 Per Tire

Goodyear tires, according to size, sell all the way from \$15.55 to \$104.95.

The popular size—34x4—costs you from \$32.95 to \$37.90, according to type and tread.

And our average profit last year, all sizes considered, was exactly \$2.90 per tire. In getting at this we figure no interest on millions of capital invested.

Why We Tell It

This is something unusual—this telling of profit. But we know of no better way to show you exactly the value you get in these tires.

That's half of the tire question—the actual money which goes into work and materials.

Tires could be made at half our cost which would look as good as Goodyears. The material cost depends entirely on the maker's standard. So does your cost per mile.

We Never Skimp

Goodyears are built without regard to expense, to give you the utmost mileage.

We learn what is best by countless comparisons made on tire testing machines.

Thus we have tested some 240 formulas and fabrics. We wore the tires out and metered the mileage.

Then we adopted that formula and fabric which cost the least per mile—no matter what it cost per tire.

That's what you get in every Goodyear tire. And we get for our service and capital just \$2.90 over cost, averaging all the sizes.

Lowest Making Cost

We build more tires, by long odds, than any other plant in the world. And our factory is equipped with the latest machinery, much of our own invention.

Thus production cost is brought to the minimum, type and worth considered.

Nearly all that we get for a tire, therefore, goes into things that count.

That's how you get, at the Goodyear price, tires that can't be rim-cut—tires 10 per cent oversize.

What we cut from our profit goes into these things. What we save by efficiency goes there. And those two features, on legions of cars, have cut tire bills right in two.

In view of these facts, can you think any tire offers more real value than you get in a Goodyear tire? Can anyone serve you more efficiently? Will anyone take less profit?

10% Oversize

Fortunes Are Spent to Improve Them

Here's another side to tire making which consists of dead expense.

We maintain a laboratory for chemical research. Also a large experimental department.

Half a hundred men—mostly technical graduates—are here seeking ways to better Goodyear tires.

Here tires are destroyed on tire testing machines to prove out formulas and methods. Here materials are analyzed. And scores of trained minds here are constantly thinking how to add to Goodyear mileage.

\$100,000 Per Year

These departments cost us about \$100,000 per year. Yet that will mean, on this year's probable output, only five cents per tire.

Five cents per tire to guard all the materials, and to constantly lessen your tire bills.

For a good many years we've been doing this for you. And you find the result in Goodyear tires of today.

Outsell All Others

Now note the result, after two million Goodyears have told men what they do.

These tires by far outsell all other tires. And the demand for Goodyears has grown like an avalanche as the facts about them spread.

Last year's sale by far exceeded our previous 12 years put together. And the demand from users this year is running twice as large as last.

Consider this fact, then consider how men are now keeping track of tire mileage. These are days of odometers—days when men know the service that tires are rendering.

It was under these conditions, mark you, that Goodyear tires came to outsell others.

And you, like the rest, want tires that can't rim-cut, tires 10 per cent over-size.

You want tires built by the mileage test, as Goodyear tires are built. You want tires sold at a minimum profit, as Goodyear tires are sold.

Then ask for Goodyear No-Rim-Cut tires. Make your tests as others have made them. You will then adopt these tires, as hundreds of thousands have done. And your tire upkeep will drop to minimum.

Write for the **Goodyear Tire Book—14th-year edition**. It tells all known ways to economize on tires.

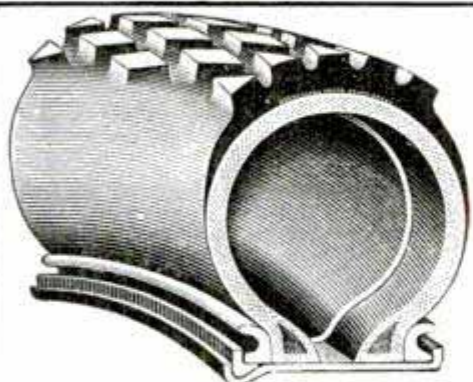

GOOD YEAR

AKRON, OHIO

No-Rim-Cut Tires

With or Without Non-Skid Treads

THE GOODYEAR TIRE & RUBBER COMPANY, AKRON, OHIO

Branches and Agencies in 103 Principal Cities

More Service Stations Than Any Other Tire

We Make All Kinds of Rubber Tires, Tire Accessories and Repair Outfits

Main Canadian Office, Toronto, Ont.—Canadian Factory, Bowmanville, Ont.

(1013)

In 1918—What?

By R. E. Olds, Designer

Many a car will run well for a summer. But how will it run in five years from now? And what will it cost in the meantime?

Those are the main questions in motor car buying. It is the second summer that shows up a poor car. But it may take five seasons to really prove out a good one.

For 26 years men have used cars of my building. And thousands of these men know how my cars perform after five years or more of use.

Reo the Fifth is my latest car. But all its prestige is based on ancient experience. My cars today are judged mainly by records, covering many years.

And because of those records, this factory of ours rarely catches up with its orders.

What I Know

I know that steel, unless proved by analysis, often falls short of

requirements. So we analyze each lot twice.

I know that gears can't be properly proved with a hammer. So we use a 50-ton crushing machine.

I know that all driving parts should have big over-capacity. So we add 50 per cent margin of safety.

I know that steel castings often have flaws. So in Reo the Fifth we use 190 drop forgings. They cost twice what castings cost.

I know that ball bearings often fall down. So we use in this car 15 roller bearings. Common ball bearings would cost one-fifth as much.

I know that oversize tires mean enormous economy. So we use tires 34x4.

A carburetor should be doubly heated. So we use hot air and hot water both.

We use a \$75 magneto.

A costly centrifugal pump.

Radical Tests

I know that we can't be too cautious. So every car gets countless tests and inspections. We discard any part for the slightest shortcoming.

Each engine is given five radical tests, lasting for 48 hours.

Important parts are hand-fitted. They are ground over and over until we get utter exactness. We limit our output to 50 cars daily, so our men are never hurried.

As a result, every Reo the Fifth goes out a perfect car.

Rough-Road Cars

Our One-Rod Control

All these extremes add about \$200 to the necessary cost of each car. They probably save, on the average, \$500 during the life of the car.

They save in tire upkeep, in repairs and replacements. And they keep a car running as well as new after years and years of use.

There is no other way to make a car fit for use on American roads. One must have big brakes, big springs, big tires. One needs immense over-capacity. Drop forgings, roller bearings, tested materials — all these things are needed.

I would never buy a car built otherwise, so I shall never build one.

In Reo the Fifth, all the gear shifting is done by one center rod, placed out of one's way. It is done by moving this rod only three inches in each of four directions.

There are no levers, side or center. Both brakes are operated by foot pedals. So both front doors are clear. And this car, like all leading cars, has the left side drive.

This simple control is immensely desirable. See how much it means.

This car has a 17-coated body, luxurious

upholstering of genuine leather, electric lights, nickel trimmings.

The extra cost of our hidden parts is made up by factory efficiency. We build all our own parts. We build only one model. That fact alone saves us 20 per cent.

That's why a car built as we build it can be sold at the Reo price. It offers unmatched value.

Sold by a thousand dealers. Write for our 1913 catalog and we'll direct you to the nearest show-room.

R. M. Owen & Co. General Sales Agents for **Reo Motor Car Co., Lansing, Mich.**
Canadian Factory, St. Catharines, Ont.

Reo the Fifth

The 1913 Series

\$1,095

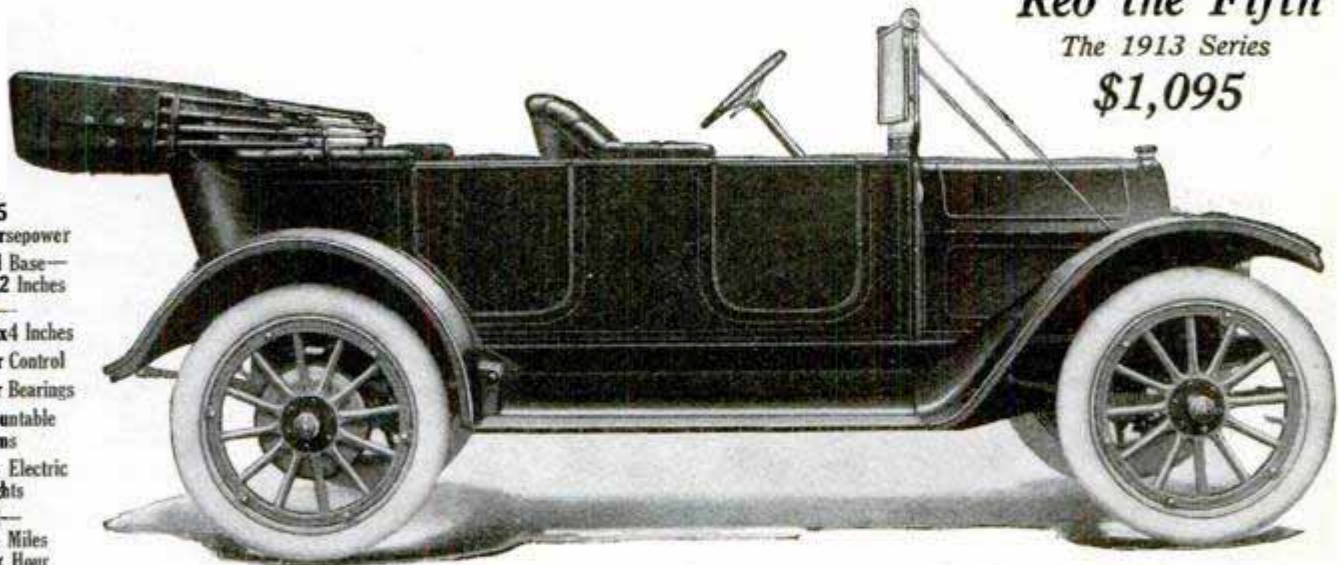

30-35
Horsepower
Wheel Base—
112 Inches
Tires—
34x4 Inches
Center Control
Roller Bearings
Demountable
Rims
Three Electric
Lights
Speed—
45 Miles
per Hour
Made with
5 and 2
Passenger
Bodies

Top and windshield not included in price. We equip this car with mohair top, side curtains and slip cover, windshield, gas tank for headlights, speedometer, self-starter, extra rim and brackets — all for \$100 extra (list price \$170).

Gray & Davis Electric Lighting and Starting System at an extra price, if wanted.

(168)

Are You A Live Wire

In every establishment there are a few men in the "thick" of things, who do the planning. In the *thin* of things and trailing off into nowhere are the many who fill the ordinary jobs and who cut but very little figure in the place. **You** are in either the *thick* or *thin* of things. If in the thin, **switch**—you **CAN**.

Mark and mail the attached coupon and learn how the International Correspondence Schools can help you become an expert in your *chosen occupation*. Doesn't matter who or what you are, where you live, what you earn, or what little schooling you have had, the I. C. S. **can** help you.

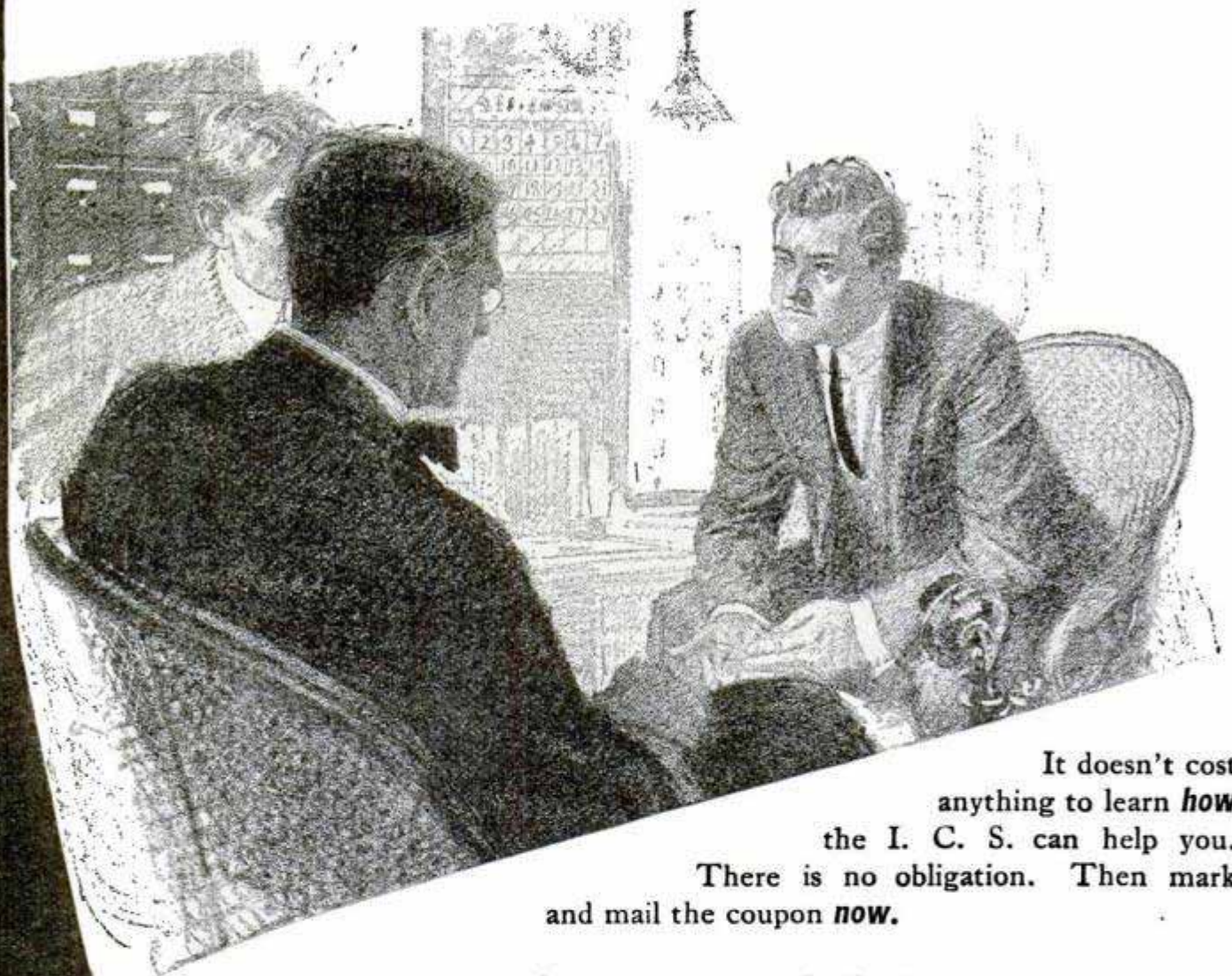

It doesn't cost anything to learn **how** the I. C. S. can help you. There is no obligation. Then mark and mail the coupon **now**.

The advice and information the I. C. S. will send you free, if you will but mark the coupon, will really open your eyes to far greater success than you ever can achieve without the efficiency the I. C. S. can impart to you **in your spare time**. It will surprise you to learn how easy the

in the Business?

I. C. S. can make the way for you, how the I. C. S. arranges terms to suit you, how the I. C. S. is ready night and day—whenever **you're** ready, how thousands of other ambitious men owe their **success in life** to I. C. S. encouragement and help.

Every month there are **voluntarily** reported by I. C. S. students over four hundred salaries raised. This only **begins** to indicate how the I. C. S. can help **you**. Twenty-one years of raising salaries the world over proves the ability of the I. C. S.

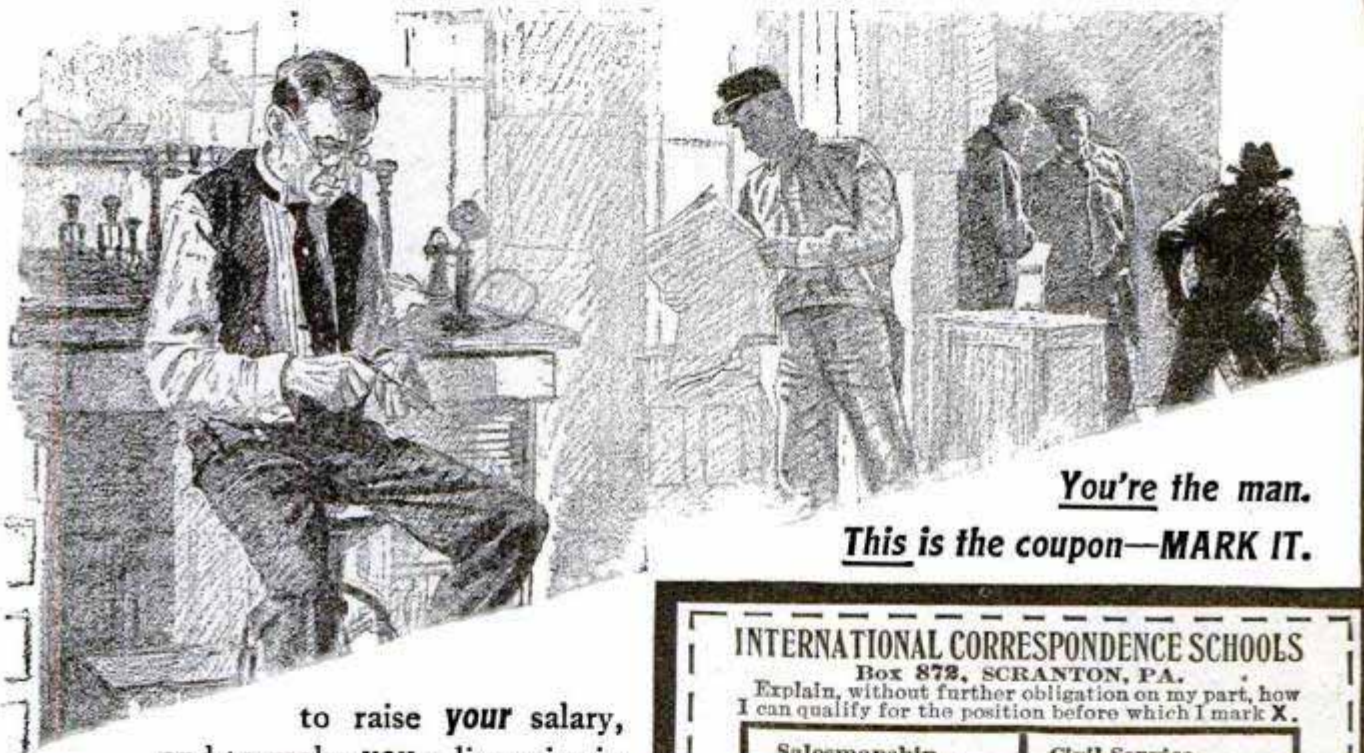

You're the man.

This is the coupon—MARK IT.

to raise **your** salary, and to make **you** a live wire in the business. In other words, the I. C. S. gives you more than mere instruction: it gives you real **help** and **advice**, based on the actual experience gained in helping thousands of other poorly-paid but ambitious men win success. Are you willing to be shown? Then **prove** it by marking and mailing the coupon today. From the moment of marking the coupon you will begin to move from the **thin** to the **thick** of things.

Mark and mail the coupon **NOW**.

INTERNATIONAL CORRESPONDENCE SCHOOLS

Box 872, SCRANTON, PA.

Explain, without further obligation on my part, how I can qualify for the position before which I mark X.

Salesmanship
Electrical Engineer
Elec. Lighting Supt.
Electric Car Running
Electric Wireman
Telephone Expert
Architect
Building Contractor
Architectural Draftsman
Structural Engineer
Concrete Construction
Mechan. Engineer
Mechanical Draftsman
Refrigeration Engineer
Civil Engineer
Surveyor
Mine Superintendent
Metal Mining
Locomotive Fireman & Eng.
Stationary Engineer
Textile Manufacturing
Gas Engines

Civil Service
Railway Mail Clerk
Bookkeeping
Stenography & Typewriting
Window Trimming
Show Card Writing
Lettering & Sign Painting
Advertising
Commercial Illustrating
Industrial Designing
Commercial Law
Automobile Running
Teacher
English Branches
Good English for Everyone
Agriculture
Poultry Farming
Plumbing & Steam Fitting
Sheet Metal Worker
Navigation
Languages
Chemist

Spanish
French
German

Name _____

Present Occupation _____

Street and No. _____

City _____ State _____

*Maintains the correct lubricating
body at any motor speed or heat*

212°

Polarine

FRICION REDUCING MOTOR OIL

IT doesn't thin out on the hottest day—nor under the severest operating conditions. The water may boil but *Polarine lubricates* and avoids any friction damage.

It works as well in one car as another. The type or make doesn't matter at all. Polarine is the year-round, all-weather oil for any motor car or motor boat.

Produced by the World's lubrication specialists who have made a life study of friction problems.

Polarine keeps the surfaces unimpaired so cars can be re-sold without any replacements and thus bring an excellent re-sale price. It saves its cost many times over in eliminating repairs. Protects you from carbon and smoky plugs and makes motoring the pleasure it should be. Use it in your car, beginning today.

STANDARD OIL COMPANY

(AN INDIANA CORPORATION)

*Makers of special lubricating oils for leading engineering
and industrial works of the world*

ZERO

Flows Freely at Zero

A Million Dollars Worth Of Harley-Davidsons In The Government Service

THE World's Largest Motorcycle user, the United States Government, uses more Harley-Davidsons than all other makes combined. These machines are today used by nine different government departments.

In the Government Mail Service alone there are over 3800 Harley-Davidsons in daily use, collecting and delivering mail,—a fitting tribute to their reliability.

“Hundreds of individuals and corporations have proven the Harley-Davidson to be the ideal motorcycle for commercial use.” The

HARLEY-DAVIDSON

today holds the World's Economy Record, as well as World's Records for Endurance and Reliability. It is the only motorcycle made with the Ful-Floteing Seat and Free-Wheel Control (both patented features), two of the greatest comfort devices known to motorcycling.

The Ful-Floteing Seat places 14 inches of concealed springs between the rider and the bumps. These springs assimilate all jar and vibration, thus doing away with the great discomfort of the ordinary motorcycle.

The Free-Wheel Control permits the stopping and starting of the Harley-Davidson without the customary running alongside or hard pedaling. Instead this machine can be stopped and started by the mere shifting of a lever. This, and many other exclusive features will be willingly demonstrated by any Harley-Davidson dealer.

Call on him for demonstration or write to us for illustrated catalog.

HARLEY-DAVIDSON MOTOR COMPANY

Producers of High Grade Motorcycles for eleven years.

294 B STREET

MILWAUKEE, WIS.

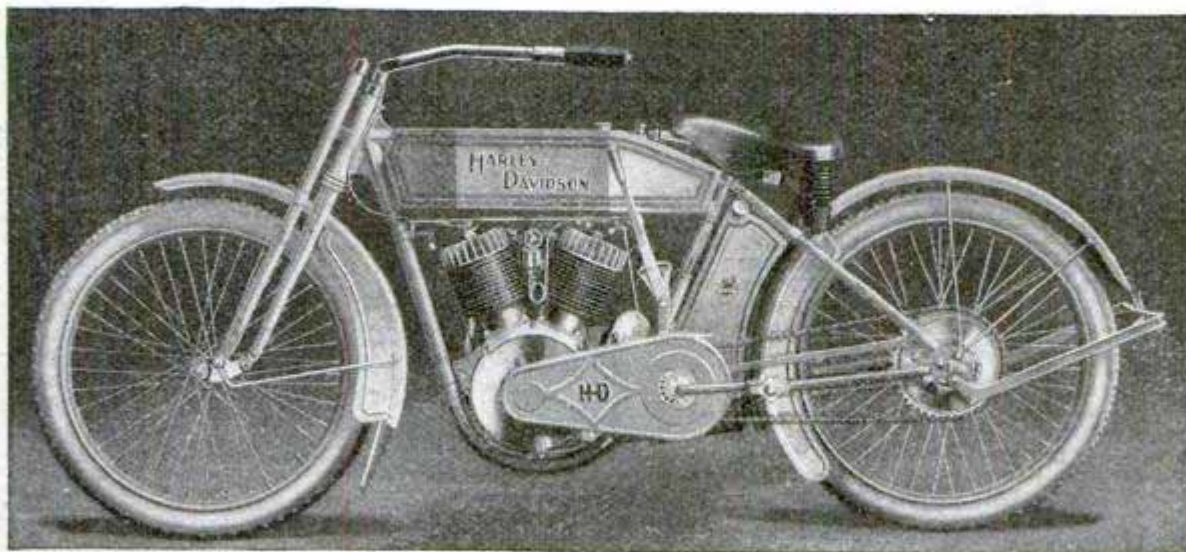

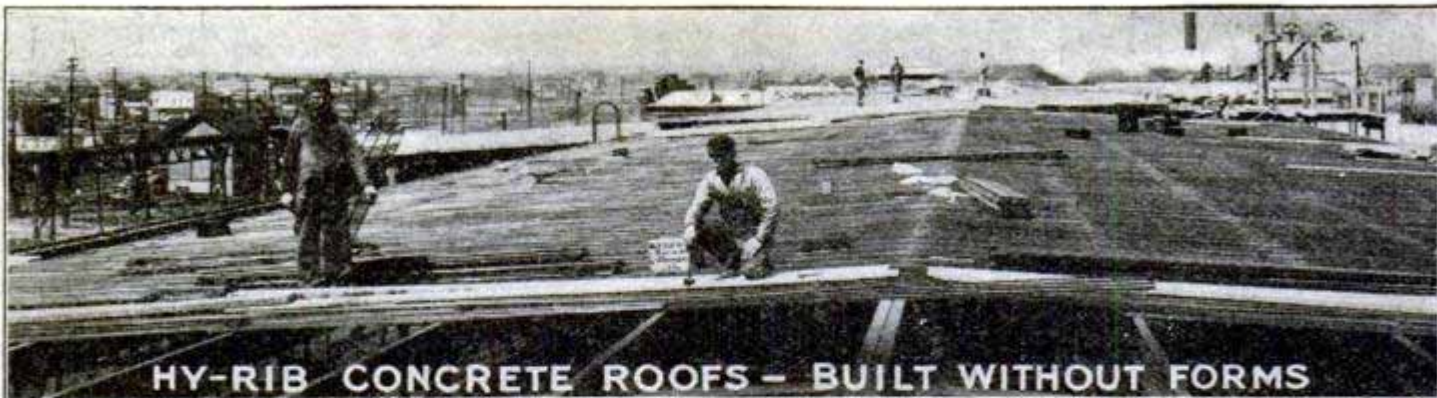

HY-RIB CONCRETE ROOFS - BUILT WITHOUT FORMS



HY-RIB SIDINGS



HY-RIB CEILINGS

Inexpensive Fireproof Construction With Hy-Rib

All the requirements of successful, modern construction—permanence, durability, fireproofness and economy are ensured by the use of Hy-rib. A steel sheathing, stiffened by rigid deep ribs, Hy-rib does away with forms and perfectly reinforces concrete. Hy-rib construction is monolithic, permanent—never burns or rots.

Roofs Hy-rib roofs are light, fireproof and low in first cost. Their after-cost is practically nothing.

Walls Since Hy-rib combines reinforcement, forms, lath and studs, Hy-rib walls are built more quickly, with less labor and at lower cost.

Partitions, etc. Partitions, floors, ceilings, etc., built with Hy-rib are easily and cheaply constructed, permanent, fireproof and sanitary.

Whenever or whatever you intend to build, it will pay you to learn about the economy and other advantages of Hy-rib. Write us about your plans and receive interesting literature and useful suggestions free.

TRUSSED CONCRETE STEEL CO.
662 Trussed Concrete Bldg. DETROIT, MICH.



INVEST YOUR MONEY IN THE CANADIAN WEST

Real Estate in Western Canada is today the most highly profitable and at the same time one of the safest forms of investment, if wisely selected. The country is developing with extraordinary rapidity. **Land values**, both farm and city, are continually and swiftly advancing. Careful selection and thorough investigation will enable you to invest and make **very large profits**. The continuous expansion of Western Canada for many years to come is an absolute guarantee of the security of your investment.

Saskatchewan

The Investors' El Dorado

the largest, most important and most rapidly growing of the provinces of the Canadian West, offers **opportunities for money-making investment**, such as can be found in no other place in the world. Thousands of large fortunes have already been made by shrewd investors in its **City Properties** and **rich Farm Lands**. The secret of success lies in entrusting your investments to firms thoroughly established, firms who take no chances with your money, and whose ripe experience enables them to place it to the best advantage. We have been handling investments in Saskatchewan for many years and have made large profits for our clients. We can do the same for you. **Write today for our handsome free booklet**, telling of the wonderful growth of Saskatchewan and the unlimited opportunities that abound in its rich farm lands and rapidly growing cities and towns. It places you under no obligation, and the opportunities offered are too great to be missed for lack of investigation.

ANDERSON, LUNNEY & CO.
REGINA, SASKATCHEWAN

Please Mention Popular Mechanics

A fortunate landslide in China recently uncovered a rich deposit of coal many miles from where any coal had been known to exist.

Build Model Aeroplanes



A fascinating pastime. Get "IDEAL" Plans and Drawings which are accurate, with clear, concise building instructions. **PRICES**—Wright 3 ft. Biplane, 25c; Bleriot 3 ft. Monoplane, 15c; "Cecil Peoli" Champion Racer, 25c; Curtiss Convertible Hydroaeroplans (new), 35c; Niouport Monoplane (new), 25c. **COMPLETE SET OF FIVE \$1**, postpaid. Send 5c for 40 pp. Catalog of "Ideal" Model Aeroplane Supplies. **IDEAL AEROPLANE & SUPPLY CO., 82-88 West Broadway, New York**



Mobiloil

A grade for each type of motor.



WANTED

Bright Young Men to distribute samples and literature and call on local manufacturers for orders. No salesmanship required. Protected territory. Permanent position. Hustlers only need apply. Any worker can make good. **THE M. W. DUNTON CO., Providence, R.I.** Send for "Kink" No. 2, containing 25 soldering suggestions. **It's FREE**

SOLDERERS!

Used Piano Bargains

A good standard make used piano is a better investment than a cheap new piano. We carry a large stock of used standard make pianos, taken in exchange as part payment on new Starck Pianos and Player Pianos. Prices \$75.00 to \$195.00. 30 days' free trial; easiest payments; **50 FREE MUSIC LESSONS.** WRITE TODAY FOR BARGAIN LIST.

P. A. STARCK PIANO CO., 384 Starck Building, Chicago, Ill.





I'M GOING "EVINRUDING"

THE lake is mine. The river too and every little inlet of the bay, because I "Evinrude" to where I want to go. I go alone if I wish or I fill the boat with friends. Eight miles an hour I glide through the waters and the propeller never *did* know a weed. My



with its merry little purr of two full horse power, will fit *any* row boat; mine or a rented one and it's so simple that I operate it myself.



IT WEIGHS BUT FIFTY POUNDS and **IT CARRIES LIKE A SACHEL.** Brother John takes it whenever he goes on fishing trips to the lakes, and he says that's why he gets fish. This motor doesn't crank you know; we simply give the fly wheel a swing and presto! We're "Evinruding" through the water.

Illustrated catalog sent upon request.

EVINRUDE MOTOR CO.,
227 M Street MILWAUKEE, WIS.

Members of National Association of Engine & Boat Manufacturers
New York City Show Room Hudson Terminal Bldg 30 Church St.
Western Agents: Woodhouse Gasoline Engine Co., 62 Marion St.,
Seattle, Wash.; A. Hebgren, 51 Market St., San Francisco
Cal.; F. G. Epton, Box 829, Portland, Oregon.

WOMAN READS ELECTRIC METERS—An electric-light company of northern Illinois has in its employ a woman of 19 years, who reads 150 meters every month and is qualifying for an advanced position in the operating department.

LOW FACTORY PRICES
on Invalid Chairs and Tricycles. Send 10c in stamps for big illustrated catalog.
GORDON MFG. CO. 412 MADISON AVE., TOLEDO, O.

3 Genuine French Briar Anti-Nicotine Pipes \$1
Electrically seared and need no breaking in. Vegetable Compound nicotine Cartridge. Patent mouthpiece; vent on top. Heavy nickel mounting. Guaranteed not to burn out in 5 years.
50 CENTS EACH OR THREE FOR \$1
Choice of bent or straight stem—state which in ordering. Satisfaction guaranteed or money refunded. 10 cartridges free with 3 pipes.
H. MENGES, 315 Menges Building, ST. LOUIS

Moth-Proof Cedar Chest

15 Days' Free Trial



A Piedmont Southern Red Cedar Chest protects furs and woollens from moths, mice, dust and damp. Pays for itself in what it saves. Shipped direct from factory at factory prices Use one for 15 days' at our expense. We prepay all freight charges.
Book Free Write for 64-page, finely illustrated catalog, and book, "Story of Red Cedar." Also particulars of spring offer. All post-paid, free to you. Write today--NOW!
Piedmont Red Cedar Chest Co., Dept. 133, Statesville, N. C.

Water-Ballast "Anyweight" Roller

Don't spoil your lawn with a cumbersome fixed-weight roller that pulls like a load of lead and is always too heavy or too light for the conditions. A soft spring lawn demands a very light roller—a dry lawn or a tennis court a heavier one. Remember—less money buys a really perfect machine—an

"Anyweight"—up to ½ ton

BY OUNCES IF YOU WISH

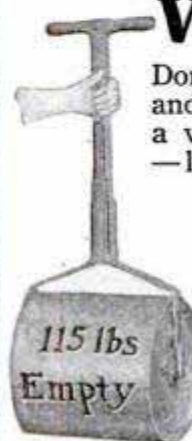

Runs easily under heaviest ballast—a hollow, hardened steel, rust-proof drum—filled or emptied in a jiffy—will last a lifetime. Made in one or two sections—drums boiler-riveted or acetylene-welded—various sizes. **VALUABLE BOOKLET "Care of the Lawn"** mailed free. Write for it today and save money—save your lawn.

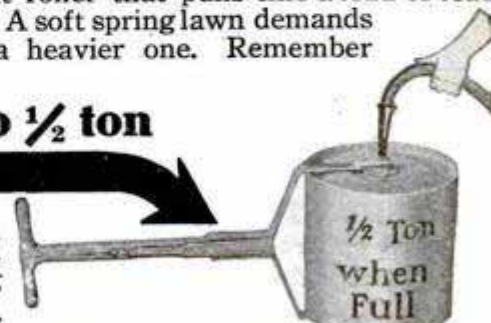

Wilder-Strong Implement Co., Box 70, Monroe, Mich.

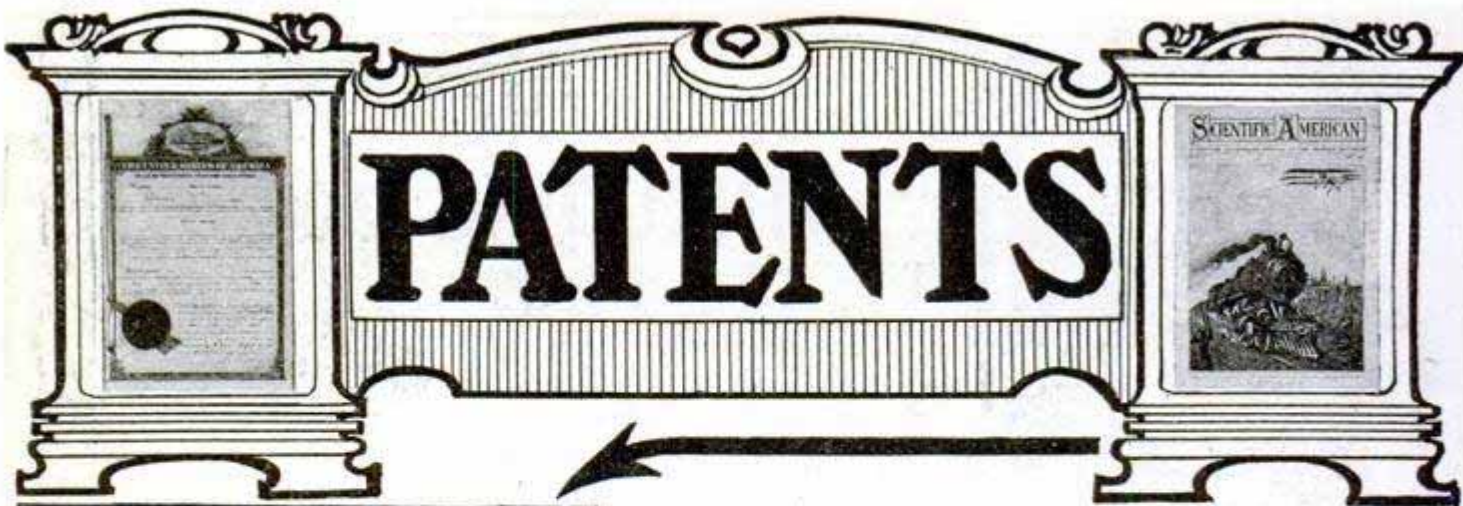

NEW YORK OFFICE, 359 BROADWAY

FOR SIXTY-SEVEN YEARS the firm of MUNN & CO. has conducted the largest patent practice in the country. We file thousands of applications for patents every year. Our system is so perfected that every case receives the best of attention and is prepared by experts who have had special training in handling every class of invention.

☐ SEND SKETCH. If you will send us a sketch, no matter how crude, we will give you a fair and candid opinion as to whether it is probable a patent can be obtained. All matters of this kind are strictly confidential and the description and sketches will be dated and placed in our secret archives for future reference. This service and our Hand Book on Patents are free if you will write us at once.

☐ QUALITY. The quality of our work has given us an unrivalled reputation among Patent attorneys and we are the recognized American attorneys for many leading Foreign Patent Solicitors. Our staff consists largely of Examiners from the United States Patent Office, who are therefore familiar with the latest procedure and the best practice. Our draftsmen are all expert mechanical constructors who are able to show the invention in operative form.

☐ FREE NOTICE. All patents secured through our house receive a free notice in the SCIENTIFIC AMERICAN. No better or more economical method of introducing your invention to the attention of the public could be devised.

☐ OUR OFFICES. Our Washington office is located in our own building, near the Patent Office. This permits of our attorneys making special oral arguments with the Patent Office Examiners—an advantage not enjoyed by local attorneys.

☐ "TRADE MARKS AND TRADE NAMES"—a 48 page book written by an expert and printed in two colors. Profusely illustrated and bound in stiff covers. Mailed postpaid for 25 cents.

☐ We do not offer prizes or other specious inducements, but rely upon our recognized reputation of over half a century. Our fees are as low as is consistent with good work.

WASHINGTON OFFICE
625 F Street, N. W.
Washington, D. C.

MUNN & CO., Patent Attorneys
359 Broadway, New York, N. Y.



WASHINGTON OFFICE



HARTMAN'S - CHICAGO

FREE

396-Page
BOOK
Send a
Postal

Save **15% to 50%**
**On Home
Furnishings**

Get our big color illustrated
1913 catalog of 7000 Home Furnishing Bargains by sending your name and
address to us on a postal. Everything sent direct to your home, anywhere you live on

Easiest Credit Terms on Record

No interest, no notes, no mortgage, no collections. We treat you right, just as we have
treated over 1,000,000 families, our regular customers, this way during our 58 years of easiest home-furnishing history.

Take 30 days Free Examination and use anything you wish to order under our guarantee of money-back,
with freight paid by us both ways if not absolutely satisfied.

We are the original easy-credit-payment Home Furnishing Concern. Our
many million dollar capital gives us greatest buying power and trusting power on
easiest terms at lowest prices—guaranteed lower for equal quality than other
concerns can offer. Lower than your local dealer has to pay for his small selection
before he adds his profit for you to pay extra. So why not investigate? It costs
you only a penny for a postal. Save your money by deciding to find out right way.

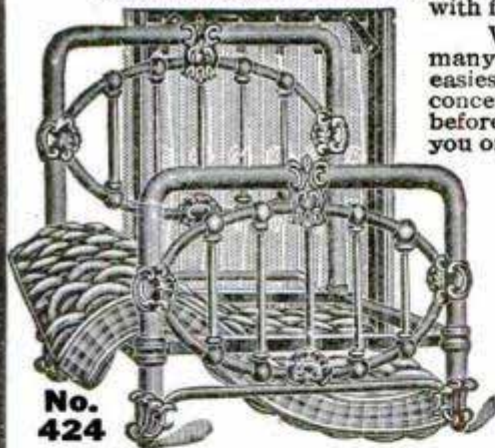

No.
424

Startling Bed Outfit Offer

Just to give you an example of what immense bargains
our big catalog contains, we ask you to order this wonder-
ful Complete Bed Outfit consisting of massive iron
bed in 4 ft 6 inch width, soft top mattress with durable
tickling and all Steel Angle Springs with spiral spring
supports. Its equal was never before offered. The bed
will be furnished in choice of White or Pea Green
Enamel or in Gold (Vernis Martin) finish. **\$8.75**
Order it on 30 days free trial. Price

Terms \$1.00 Cash, 75c monthly

—offered you on credit—including everything in Home Furnish-
ings, Carpets, Rugs, Chairs, Tables, Parlor Sets, Bed Room Sets,
Curtains, Ranges, Stoves, Lamps, Baby Carriages, Bedding,
Blankets, Bicycles, Clocks, Kitchen Cabinets, Cameras, Dishes and
Glassware, Guns, Refrigerators, Sewing Machines, Phonograph
Records, Silverware, etc., etc.—in fact everything to make home
happier, more comfortable and a better place to live in and enjoy.

Spend a cent or two for postage now and maybe save a month's
pay—and more. Such wonderful bargain prices that you'll be astonished.

All you need to do is to send us your name and address. Use
a postal, or letter. We do the rest—FREE.

Write Us Today
**ONE YEAR
TO PAY**

You can take a
year or so to pay us in
such small amounts
that you won't miss
the money—yet you'll
have what you want
and need all the time
and get it right away.

Our catalog shows
you over 7000 highest
quality, latest style,
brand new, articles

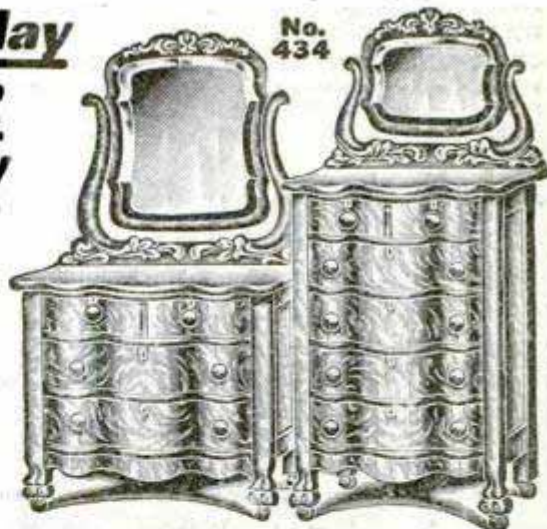

No.
434

Big Dresser and Chiffonier Bargain

For the first time in history has such quality of dresser with
chiffonier to match been offered so low in price. Both pieces
are made of solid oak with genuine quartered oak, serpentine
shaped fronts, having beautifully carved tops and claw feet,
wood handles, locks, key and casters. Dresser top measures
38x20 ins. French Bevel Plate Mirror measures 24x20 ins.
Chiffonier 32x20 inch top. French Bevel Mirror **\$11.95**
12x18 ins. Price each

Terms \$1.00 cash, \$1.00 monthly.
Price for both pieces, \$23.00. Terms \$2 cash and \$2 monthly.

HARTMAN

FURNITURE & CARPET CO.
3945 Wentworth Ave., Chicago

Largest, oldest and best
known home furnishing
concern in the world.

Established 1855—58 Years of Success—22 Great Stores—1,000,000 Customers

Do You Want Money?



LISTEN! Have you an ambition to make \$5 to \$20 a day, and get out of the "time clock" line? Would you like to start out for yourself in a big, quick-paying business today?

THEN put your name and address on a postal card and mail it to us at once. You can make just as much as our other men are making. You can do it right away. Here are some recent reports: Cable, of Wyo., writes: "Made \$27.00 in 2 hrs." Bryant, of Colo., made \$16.00 in 6 hrs. Evans, of Miss., says: "Made \$15.75 last Tuesday." Perry, of Ky.: "Made \$50.00 in 2 days." Williams, of N. C.: "Made \$5.00 in 2 hours." Gue, of Ind.: "Big success first day." Pruitt, of Okla.: "Can't supply the demand." Hundreds of actual bona fide letters like these on file.

Join our force and become a **One Minute Photographer**. Stop marking time in the "pay envelope brigade." Here is a new business—tremendous opportunities—the world for your field—travel or work at home—all or spare time—big, quick, clean profits at private houses, parties, picnics, on the street, in the small towns, in great cities, at fairs, carnivals, conventions, reunions, street parades, aviation meets, etc., etc.—**NO EXPERIENCE NEEDED**—Profits begin at once—first day—first minute—and you **Make 500% on Every Sale**. Don't delay—don't wait—act—write at once for complete free information about the

MANDEL POST CARD MACHINE

A new invention—wonderful machine, that takes, finishes and delivers five different styles of photos. Turns out original post card photos (also button pictures) at the rate of three a minute **RIGHT ON THE SPOT WHERE YOU TAKE THEM**. Wonderful, new photographic process—startling—sensational—

PHOTOS DIRECT ON POST CARDS Without Plates, Films, Printing or Dark Room

Machine is everything in one—a complete portable post card gallery. Excites interest, arrests attention, compels immediate orders from every onlooker. Sale of supplies that come to you with outfit practically gives you back entire investment—and you have the business clear and fully established. You begin making money the same day the outfit arrives. Immediate sales—immediate profits. If you are sincere and really want to make \$2,000 this year—**DO NOT DELAY**—show us that you are in earnest—that you mean business. We will show you how to get the money. **Write NOW—AT ONCE. INFORMATION IS FREE.**

ADDRESS EITHER OFFICE

THE CHICAGO FERROTYPE CO.

485 Ferrotpe Bldg.,
CHICAGO, ILL.

OR

Dept. 485 Public Bank Bldg.
NEW YORK, N. Y.





Startling Watch Offer

A Watch Offer Without Parallel

Write for our free book on watches; a book that posts you on watches and watch values—explains reasons for our most remarkable rock-bottom price offer **DIRECT TO YOU** on the highest grade Burlington.

IF YOU WANT a highest grade watch (ladies' or gentlemen's) or if you ever expect to own such a watch, write NOW for the Free Burlington book. See coupon below.

We won't "knuckle down" to selling systems among dealers, so we have decided to make such a tremendous and wonderful offer direct to the public on a first-class time piece, that no "system", no dealers under contract will or can stop us. You, too, will seize this opportunity to get the "Burlington Special" direct on this wonderful offer.

You should not buy a worthless watch just because it is cheap. Nor need you pay "system" prices now for a top-notch watch. The Burlington watch book explains.

Your Own Monogram

In Any Style

The New Inlaid Enamel; the Ribbon Monogram; the Emblem of your Lodge and scores of handsome designs.

Write for Free Book.

\$2.50 A Month at the Rock Bottom Price

No Money Down

\$2.50 a month for the world's most superb time piece! The easiest payments at the rock-bottom price—the *Rock-Bottom* price direct to you. To assure us that everybody will quickly accept this introductory direct offer, we allow cash or easy payments just as you prefer.

Get The **Free Burlington Book**

We ship the watch on approval, prepaid (your choice of ladies' or gentlemen's open face or hunting case). You risk absolutely nothing—you pay nothing—not one cent unless you want the great offer after seeing and thoroughly inspecting the watch.

Now Write for watch book.

It will tell you what you ought to know before you even examine a watch. It will tell you the inside facts about watch prices, and will explain the superior points of the Burlington over the double-priced products. Just send your name and address today.

THIS BOOKLET will quickly convince you, too, that you DO want this superior watch—made in the independent factory that is fighting contracts as best it can by giving better quality and superior workmanship throughout; we will quickly convince you that the Burlington watch, on which there is only one rock-bottom price (the same rock-bottom price everywhere), is THE watch for the discriminating buyer. You will be posted on inside facts and prices when you get the Burlington Company's remarkable book on watches. Send the coupon.

No Letter Necessary
COUPON Will Do

Free Book Coupon
BURLINGTON WATCH CO.

Dept. 1194, 19th and Marshall Blvd.
CHICAGO, ILLINOIS

Please send me (without obligations prepaid) your free book on watches and copy of your \$1,000 challenge, with full explanation of your cash, or \$2.50 a month, offer on the Burlington Watch.

BURLINGTON WATCH CO.

Dept. 1194, 19th & Marshall Blvd., Chicago, Ill.

Name

Address

Name

Address

ARROW MOTOR CO., 2825 W. 19th St.,
Dept. 1194 Chicago, Ill.

Gentlemen: Without any obligation on me please send me your new catalog with complete information about your wonderful Aviation Type Motor used on the Arrow. Also tell about your Rock-Bottom, Easy Payment Price Offer.

**FREE
Coupon**

The New 1913 ← ARROW →

With The Wonderful
**AVIATION
TYPE
MOTOR**



\$1250 And the Celebrated Arrow
Per Month Motorcycle Is **YOURS**

Yes, that is all we ask you to pay for the wonderful new style Arrow. \$12.50 a month. Never before was such an offer made on **any motorcycle**. We make this offer because we know that the **Arrow** is superior to all other motorcycles in design and mechanical construction. We sell **direct**. No extra middlemen's profits for you to pay. The engine used on the **Arrow** has been selected after thousands of miles of trying road work and its superiority has been proven in every point. The marvelous **aviation type motor** gives 20 per cent better speed and efficiency than any other motorcycle made—and with no greater gasoline consumption.

There is style and dash in every curve of the **Arrow**. Every piece and part is backed up with our five year ironclad guarantee. Just imagine speeding over the roads with a great **Arrow**—driven by the **Aviation Type Motor**. You whirl at the rate of the express—then by a touch you reduce the speed to a crawl. It responds instantly to your will.

Here at last is the Perfect Motorcycle.

The Arrow's Famous Aviation Type Motor

A motor just like the bird men use! That's why it's called the aviation type motor. You know how perfect the motor on an aeroplane must be—how it must be subject to change at the slightest touch. That's the kind of a motor we have put into the **ARROW**.

The **AVIATION TYPE MOTOR** is the most powerful motor put into any motorcycle, yet it is the most easily controlled. You can hardly hear it running across the street.

Every feature of the **ARROW** is the latest and most up-to-date that could be secured. Nothing has been spared to make this the "greatest of them all."

Ride It While You Are Paying For It

There is no need for you to wait until you have all the money before you buy a motorcycle. We will ship the wonderful **ARROW** to you and let you pay for it a little at a time. We give you an **IRON-CLAD GUARANTEE** that we will replace free of charge any part of the **ARROW** that breaks within five years because of defective workmanship. You run no risk in buying an **ARROW**.

Dealer's Credit To You If You Write Quick

This offer is to quickly place **ARROWS** in every locality. We give you the same terms we allow to dealers, just requiring a part payment with plenty of time to pay the rest. Send for free catalog today—don't wait.

Send The Free Coupon Now Just put your name and address on the coupon and mail it at once. Even though you are not thinking of buying a motorcycle right now send and get our catalog and full particulars. Mail the coupon right away, while our rock-bottom, easy payment price offer is still open. Write quick.

THE ARROW MOTOR CO., Dept. 1194 2825 W. 19th St., Chicago, Ill.

WITTE Engine Prices lower than lowest bottom ever known before

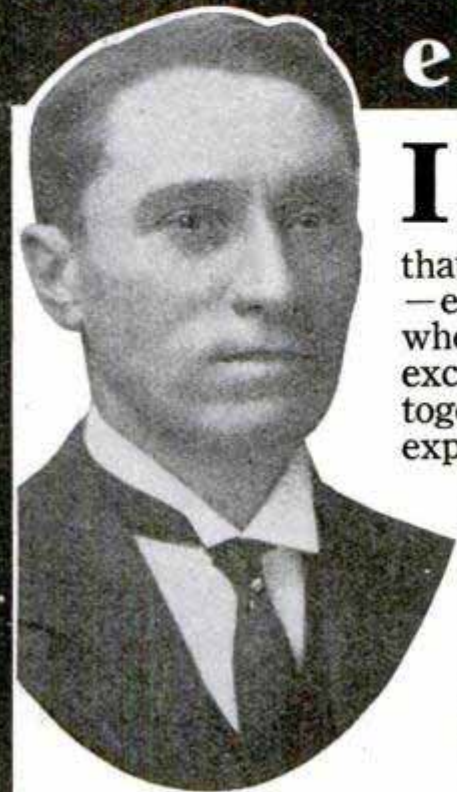

ED. H. WITTE

Pres. Witte Iron Works Co.
for 25 years has done nothing but
make gas engines. He personally
guarantees every engine he makes.

I am selling more engines than
ever and over 75% of my trade
comes from old customers.
The 54 styles and sizes of
Witte engines use any kind of fuel from gasoline to kerosene
or gas. You can buy any Witte Engine under the most
binding and liberal 5-year guarantee and you can have
60 days free trial before you decide whether you want
the sale closed and the purchase price released to us.

I can afford to be liberal. Nature gives us \$50,000
a year in free heat, light and power. Our 43 years'
experience costs us nothing now, but is
worth another \$50,000 a year to our busi-
ness. I offer to share my good fortune with
every engine buyer in America. Come and
see us, or if you can't come send for our

FREE CATALOGUE

Use the coupon at the right, or if more
handy write us a post card or letter. I
want you to know all about our unequalled
low prices, and unmatched high quality engines.
You want the very utmost value for your money;
and I believe our offer will prove that we have it
for you. At any rate I want the chance to show you
as soon as you can write—to-day or to-night. Address:

WITTE IRON WORKS CO.,
1749 Oakland Ave., Kansas City, Mo.

I HAVE knocked the bottom out of engine prices. Gone
down to the prices of those who advertise to save you
\$50.00 to \$300.00, and then gone down still lower than
that. And I have raised the Standard of Engine Quality
—engine usefulness and durability clear UP past the point
where others had stopped. My quarter-million-dollar
exclusive gas engine factory and great natural gas well,
together with the 43 years of painstaking and fruitful
experience of my company at the same business, have
made my low prices possible. I not only manufacture
for less cost, but I sell direct to you for wholesale
prices—yes, for less than I used to charge agents
and dealers. The middle man's expenses and big
profits put nothing of value into any engine. So I
quit helping dealers collect heavy extra charges from
engine users. Let me send you my present liberal
selling plans and money saving prices before you
buy any kind of an engine.

The Famous WITTE GAS AND GASOLINE ENGINES

**Direct to You—at Less Than
My Former Wholesale Prices**

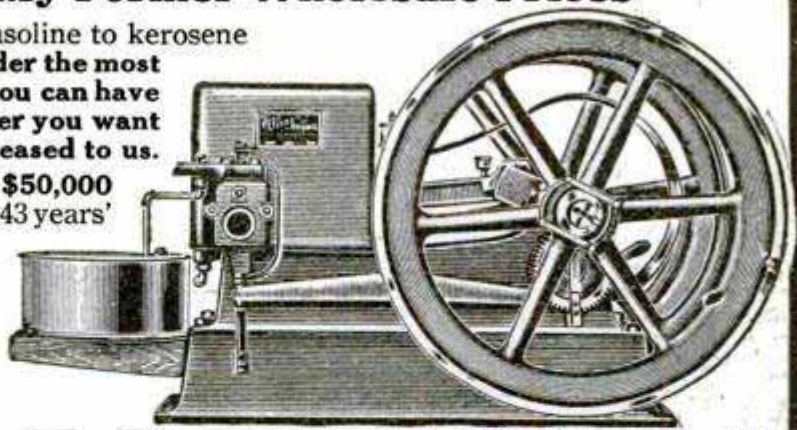

WITTE IRON WORKS CO.,

1749 Oakland Avenue, KANSAS CITY, MO.

GENTLEMEN:—Without any obligations to purchase or pay for
anything, please send me your Free Catalog. Also send full par-
ticulars of your FREE TRIAL OFFER. I need a.....H. P. Engine.

Name.....

Address.....

Velvet

**THE
SMOOTHEST
TOBACCO**

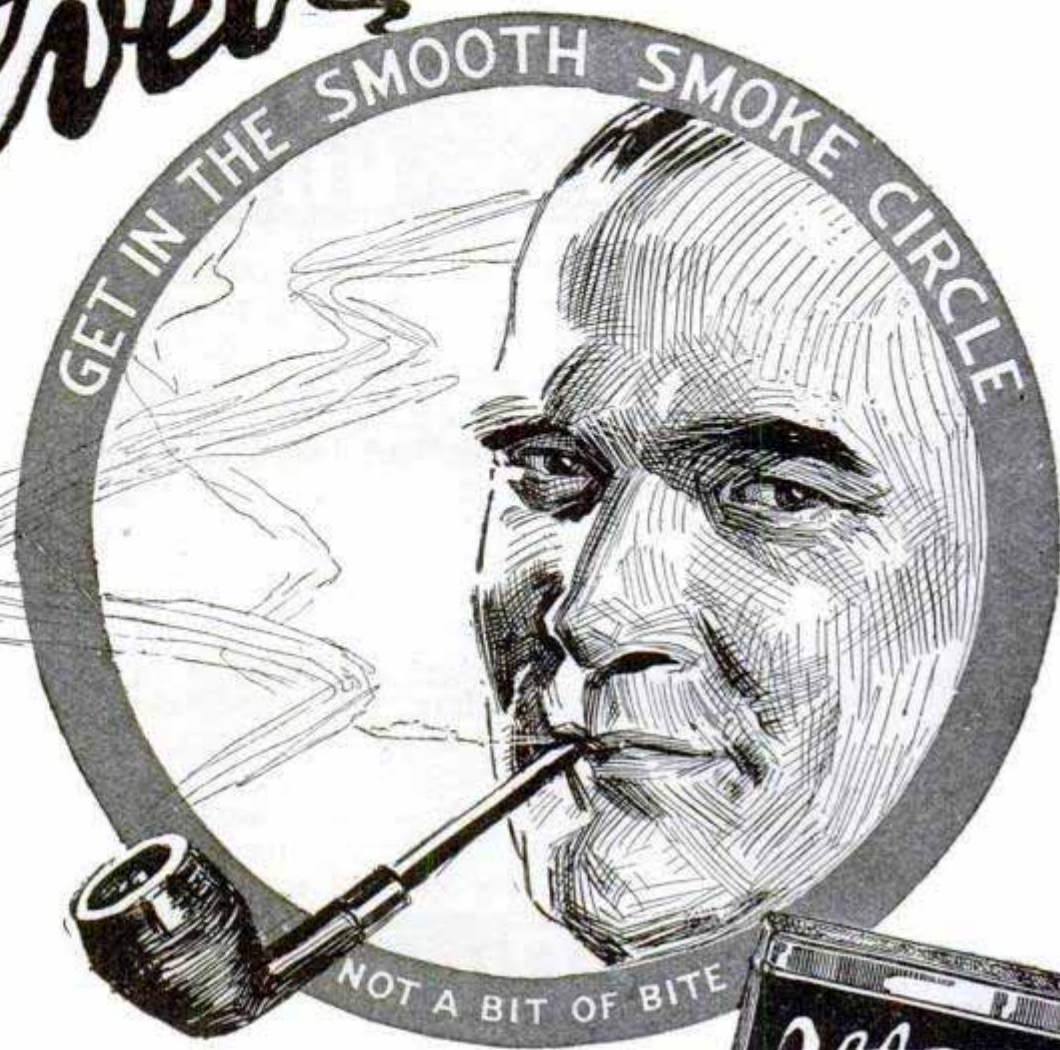

In this uncertain world
all things are smooth to
"the man on the inside."

Liggatt & Myers Tobacco Co.

10¢ TINS
Handy 5¢ bags
One pound glass
humidor jars



Do Your Printing!

Cards, circulars, books, newspaper. Press \$5, Larger \$18, Rotary \$60. Save money. Big profit printing for others. All easy, rules sent. Write factory for press catalog. TYPE, cards, paper, outfits, etc. **THE PRESS CO., Meriden, Conn.**



RIDER AGENTS WANTED

in each town to ride and exhibit sample 1913 model. Write for Special Offer. Finest **\$10 to \$27** Guaranteed 1913 Models with Coaster-Brakes and Puncture-Proof Tires. 1911 and 1912 MODELS **\$7 to \$12** ALL OF BEST MAKES..... **100 Second-Hand Wheels** All makes and models, good as new Great Factory Clearing Sale. **\$3 to \$8** We Ship on Approval without a cent deposit, pay the **10 Days' Free Trial**

TIRES coaster-brake wheels, lamps, and sundries, half usual prices. **DO NOT BUY** till you get our catalogue and offer. Write now. **MEAD CYCLE CO. Dept. L108 CHICAGO**

Please Mention Popular Mechanics

Remington Arms—Union Metallic Cartridge Co. Arms and Ammunition

299 Broadway, New York

MECHANICAL PERFECTION

in writing equipment is guaranteed in the World's Standard **WATERMAN'S IDEAL FOUNTAIN PEN.** SOLD BY LEADING DEALERS EVERYWHERE.

WEAR

Trade Mark

Registered

B.V.D. U. S. Patent Office and Foreign Countries

UNDERWEAR



For 36 years we have been paying our customers the highest returns consistent with conservative methods. First mortgage loans of \$200 and up which we can recommend after the most thorough personal investigation. Please ask for Loan List No. 721 \$25 Certificates of Deposit also for saving investors. **PERKINS & CO. Lawrence, Kans.**

Retail Price
Reduced to
\$10.00

White Cross Electric Vibrator



No. 23 The marvelous instrument that has been such a boon to the medical and scientific world. Endorsed by prominent physicians everywhere. Used by physicians in their practice and can be used by an individual himself.

Agents Wanted

Where We Have No Dealers Handling Our Goods Now

We are making a wonderful offer to agents where we have no dealers now. **From \$5,000 to \$10,000 a year** can be made if you will write for the big offer which we are making. We want representatives everywhere. In every town and county.

The White Cross Electric Vibrator is easy to demonstrate. Easy to sell. Good profits for the man or woman anxious to make a big, quick success. An article that you can be proud to sell. An article in which both the well and the sick are interested.

You can show everybody just how the White Cross Electric Vibrator works. Just set it to humming and buzzing and they will see what it will do for them.

Write for the big proposition which we are making to agents and local representatives right away. Remember, we want a local representative every place where we have no dealer now.

Power for You



Vibration relieves
Indigestion

Power from within! Strength that is **more** than mere muscular strength—the strength of perfect health, abundant nerve force—the strength of the **perfect man** now within your reach through **Vibration!**

Nine people out of every ten are only **half alive**. They exist — they do not really live. How about yourself? **All the joys of life, strength and youth** may be returned to you through **Vibration**. For **Vibration is life itself**. It will chase away the years like magic. Every nerve, every fibre in your whole body will fairly tingle with the force of your own **awakened power!** Stagnation simply cannot exist. You are made over—new—from head to foot.

Send the **FREE** Coupon for Book "Health and Beauty"

Do not delay an instant. Send the free coupon for our wonderful new book, "Health and Beauty." We will send it to you absolutely free and prepaid — no obligations whatever. Learn all about the wonderful **White Cross Electric Vibrator**. Write now and take advantage of our 1913 publicity offer. Do not delay. We will send the book absolutely free and prepaid.



FREE

Book Coupon

Lindstrom, Smith Co.

Desk 1194

218 S. Wabash Ave.
Chicago, Ill.

GENTLEMEN: Without obligation on me, please send me free and postpaid, your book, "Health and Beauty." Also send me full particulars of the new offer you are making on the genuine White Cross Electric Vibrator.



The White Cross
Electric Vibrator

LINDSTROM, SMITH COMPANY
Desk 1194, 218 S. Wabash Ave., CHICAGO, ILL.

Name

Address

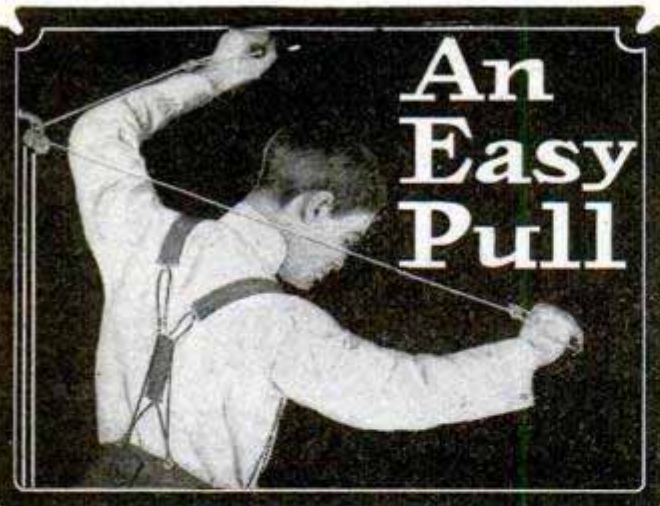

An Easy Pull

To save time and temper, to have perfect fitting clothes, to enjoy real luxury, put a pair of

Shirley President Suspenders

on every suit, business, pleasure, evening or dress. This lets you keep each pair properly adjusted, keeps each suit ready to put on, saves time when you are dressing—just when you always need it most. Shirley Presidents are suspender perfection, as almost everybody knows. They provide perfect support without pressure or strain on clothes or body. *Light, Medium and Extra Heavy. Extra lengths for tall men. Signed guarantee on each pair.*

Price 50c

Any dealer or from the factory

THE C. A. EDGARTON MFG. CO.
303 Main St. SHIRLEY, MASS.



How to Install Running Water In Your Own Home

Save cost of skilled labor. Save on all material. Post yourself on the new method. The Practical Gibbons method. My book explains how you can install running water, a modern heating plant, also electric or acetylene lighting plant, at an amazingly small cost. Send for this valuable book.

Book Free

My new book gives you greater buying power than your local dealer. It is the most valuable catalog for you ever issued. Thousands of things illustrated and priced. Hot water and steam heating plants, gasoline engines, hydraulic rams, pipes, pumps, valves, electric lighting plants, acetylene lighting plants, all accessories. Everything guaranteed, high quality at direct, rock bottom prices to you. You certainly ought to have this valuable book.

Write Today My valuable book tells you all about my new money-saving, time-saving and labor-saving method. See the low prices of my high quality material. My book is post-paid, free to you. Just send your name. Write today.



M. J. GIBBONS, Dept. 5248, DAYTON, OHIO

The United States supplies Russia with three-fourths of its typewriters, 20 kinds of machines being sold there.



AGENTS

MEN AND WOMEN. 100 PER CENT PROFIT

Something new. Big Seller. Good repeater. No competition. Not sold in stores. Concentrated Non-Alcoholic Food Flavors. Over 50 kinds. Put up in collapsible tubes. Four drops go as far as a teaspoonful of bottle extract. Also Perfumes and Toilet Preparations. Every home a possible customer. Hustlers should make \$8 to \$10 a day. Experience unnecessary. We teach you how. Fine sample case furnished to workers. Be first in your territory. Write today—a postal will do—for full particulars

FREE

AMERICAN PRODUCTS CO., 5302 Sycamore St., Cincinnati, O.

Get the Money!

Make \$5 to \$10 a Day!



Taking orders for our famous "Progress" made-to-measure Suits, Pants, Vests and Overcoats. Our tailoring is known everywhere as the swellest, best-fitting and most serviceable. Our agents are the most successful—do biggest business.

EVERY "PROGRESS" AGENT A WALKING ADVERTISEMENT

Our men dress in the height of fashion. They attract attention everywhere, get in the social swim, make money fast and easy.

WE BACK YOU TO THE LIMIT NO MONEY OR EXPERIENCE NEEDED

We stand back of our agents, treat them square and help them succeed. Exclusive territory granted.

Money-Maker's Outfit FREE!

Send a postal or letter at once for Complete and Practical Tailoring Outfit, including full line of elegant cloth samples, superb fashion plates, tape measure, full instructions, selling helps, etc.

The PROGRESS TAILORING CO., Dept. 204, Chicago

\$8,000 to \$10,000 YEARLY



Make Money Out of Others' Fun

Pleasing the Public Pays Big Profits and owners of our famous attractions frequently make from \$8,000 to \$10,000 every year. We make everything in the Riding Gallery line, from a hand-power Merry-Go-Round to the highest grade Carousels. Bring in hundreds of dollars daily. It is a delightful, attractive, big paying, healthful business. Just the thing for the man who can't stand indoor work, or is not fit for heavy work.

Just the business for the man who has some money and wants to invest it to the best advantage. Our goods are the finest appearing, easiest running, and most attractive line manufactured. They are simple in construction and require no special knowledge to operate. If you want to get into a money-making business, write to-day for catalogue and particulars.

HERSCHELL-SPILLMAN CO.

Park Amusement Outfitters

333 Sweeney St., N. TONAWANDA, N. Y., U.S.A.

THE MECHANICS HANDBOOK ELECTRICAL ENGINEERS HANDBOOK BUILDING TRADES HANDBOOK ADVERTISER'S HANDBOOK BUSINESS MAN'S HANDBOOK BOOKKEEPERS HANDBOOK STENOGRAPHER AND CORRESPONDENTS HANDBOOK PLUMBERS AND FITTERS' HANDBOOK TELEPHONE AND TELEGRAPH ENGINEERS HANDBOOK MARINERS' HANDBOOK

\$1.25 Handbooks for 50c.

No books in existence contain in so small space as much information about the trades and professions of which they treat as do these Handbooks. They are little giant encyclopedias of practical knowledge giving data and information that is hard to find in ordinary books. These Handbooks have been prepared by the well-known textbook writers of the International Correspondence Schools whose textbooks are recognized the world over as the most practical treatises on applied sciences ever published. These Handbooks are consulting experts of the highest rank, and are the most powerful force in the world for the promotion of ambitious men. They are an indispensable help to quicker and better work that will command advancement. They are printed on a high-grade book paper in clear type, and durably and handsomely bound in cloth with gilt titles; contain on an average of 364 pages and 175 illustrations and are regularly sold for \$1.25 each.

SPECIAL OFFER.—We are selling these Handbooks, durably bound in cloth with gilt titles, at a special price for each Handbook of 50 cents.

Mechanics'—Tables; formulas; measurements; belting; mechanical powers; hydro-mechanics; strength of materials; shafting; boiler design; care of boilers; power of boilers; chimneys; exhaust heating; machine design; machine tools; slide valve; pulleys; cylinders and steam chests; pistons; gearing; transit surveying; triangulation; curves; radii and deflections; earth work; track work; electricity; etc.

Advertiser's—How to plan and write an advertisement; type and type measurements; points on printing style; display; preparation of manuscript; proof reading; engraving and printing methods; electrotypes; matrices; advertisement illustrations; magazines; newspapers; retail, department-store, general, trade-paper, and mail-order advertising; trade marks; circulars; advertising agencies; etc.

Stenographer's & Correspondent's—Advice to beginners; shorthand speed; letters of application; punctuation; correct and faulty diction; business correspondence; type-writing; abbreviations; addressing; mailing; rates of postage; duplicating work; etc.

Telephone and Telegraph—Useful tables; mechanics; electricity; magnetism; primary batteries; storage batteries; electrical measurements; telephony; tests with magnetogenerator and bell; telegraphy; Morse telegraph systems; multiplex telegraphy; etc.

Electrical Engineer's—Mechanics; electricity; electrical units; symbols and quantities; physical and electrical properties of metals and alloys; wire gauges; magnetism; dynamos and motors; electric batteries; alternating current apparatus; alternators; transformers; wattmeters; electric transmission; electric lamps; wiring, electric heating and welding; electromagnets; controllers; car wiring; etc.

Business Man's—Arithmetic; business forms; card systems; measures of extension; weight and capacity; time; value of foreign coins; duties on imports; bookkeeping; stenography; correspondence; postal information; financial terms; money and the money market; brokers and brokerage; patents; copyright and trade marks; corporations; business law; publicity; etc.

Plumbers and Fitters'—Arithmetic; involution and evolution; powers, roots, and reciprocals; circles; decimals; geometrical drawing; weights and measures; formulas; mensuration; mechanics; hydro-mechanics; building construction; heating and ventilation; gas-fitting; plumbing; etc.

Mariners'—Logarithms; trigonometry; navigation; terrestrial navigation; celestial navigation; organization of a man of war; naval ordnance; explosives; torpedoes; ship building; speed, tonnage, and fuel consumption; ropes; wind and weather; signals; nautical memoranda; etc.

Building Trades—Loads and structures; strength of materials; properties of sections; strength of rivets and pins; materials of construction; footings and foundations; masonry construction; woods used in building; qualities of timbers; joinery; framing; estimating; elements of architectural design; drainage systems; plumbing fixtures; plumbers' tables; heating and ventilation; gas and gas-fitting; etc.

Bookkeeper's—Arithmetic; tables; money; percentage; interest; equation of accounts; money and the money market; business law; financial terms; banks and banking; postal information; distances and time between various places; bookkeeping; business forms; card systems; modern office methods; cost accounting; bank bookkeeping; clearing house methods; etc.

International Textbook Co.

Box 872, SCRANTON, PA.

I enclose \$_____ for which please send me the books BEFORE which I have marked X.

—Mechanics' Handbook —Advertiser's Handbook
—Elect. Eng. Handbook —Business Handbook
—Bldg. Trades Handbook —Bookkeeper's Handbook
—Plum. & Fit. Handbook —Sten. & Corr. Handbook
—Tel. & Tel. Handbook —Mariners' Handbook

Name _____

St. and No. _____

City _____ State _____

The Current 'O Scope

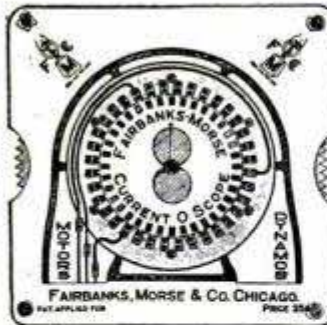

shows graphically the principle of the 3 phase alternating current and how an Induction Motor works.

One follows the current changes step by step through a complete cycle, noting at all times the direction and relative strength of the currents in the three phases and the shifting of the magnetic fields.

Unique Instructive

It makes the theory clear and understandable

Note what some prominent educators say about it:

"Very ingenious—will prove of value to any student of induction motors." ERNST BERG, *Professor of Electrical Engineering, University of Illinois.*

"It certainly is a unique affair and clearly shows the current and magnetic relations in an induction motor." W. E. FREEMAN, *Professor of Electrical Engineering, State University of Kentucky.*

"The Current 'O Scope is certainly a very neat model for illustrating the action of the 3-phase alternating current induction motor." L. V. LUDY, *Professor Experimental Engineering, Purdue University.*

If you are a student or in any way interested in induction motors you should have a Current 'O Scope.

Mailed promptly on receipt of price, 25 cents in stamps

Fairbanks, Morse & Co.
900 S. Wabash Ave., Chicago, Ill.

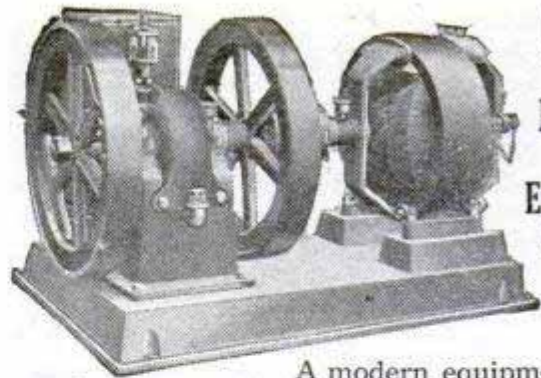

LIGHT YOUR HOUSE WITH ELECTRICITY

Put in a Direct Connected Gasoline Engine and Dynamo.

A modern equipment at small cost for farm and house lighting and small isolated plants. Dynamo has an output of 42 volts and about 15 amperes. Speed 600 R. P. M. For charging 30 Volt Storage Batteries. Operation steady and quiet. Write for circular.

THE CARLISLE & FINCH CO., 244 East Clifton Ave., CINCINNATI, OHIO



Send for Bulletin "S" on Wireless Telegraphy

It's Free

Explains in simple language about the most educational and fascinating of modern sports. Shows you how to get started in this great game for less than one-half usual expenses. Read all the messages in the air, get the correct time daily from the government by wireless. Send messages to your friends without wires. You want our Bulletin "A" and the codes.

SEND A POSTAL TO-DAY. Don't put it off, do it now.

HUNT & McCREE 92-94 Murray St. NEW YORK CITY

DUCK'S BIG 325-PAGE ELECTRICAL & WIRELESS CATALOG

Will be mailed to you upon receipt of 6c, stamps or coin, which you may deduct on your first purchase of \$1. Great cost of catalog and low prices prohibit distribution except to those really interested. *Most elaborate catalog in its line.* **SAVE 25% ON STANDARD GOODS.** Catalog contains over 100 pp. Wireless Instruments for commercial and experimental use, with complete diagrams, etc. 15 pp. Telegraph Instruments; 25 pp. Toy and Commercial Motors; 175 pp. flash lights, miniature lamps, lighting plants, storage batteries, ammeters, automobile accessories, launch lighting outfits, advertising displays, tools, pocket knives, Victrolas, mirrors, microscopes, railways, and electrical and mechanical books.

THE J. J. DUCK COMPANY, 390-392 St. Clair Street, TOLEDO, OHIO



This book is brimful of information on **ELECTRICITY** Motors, Dynamos, Wireless, Induction Coils, Rheostats, Miniature Electric Railways and parts, etc.

It's a valuable, up-to-date catalog of one of the largest and most reliable electrical manufacturers in the country. **Send for it**,—6c in stamps or coin,—which will be refunded on your first order of 50c or over. No postals answered.

Voltamp Electric Mfg. Co., Voltamp Block, Baltimore, Md.

Experimenters in Wireless

Our brand new CATALOGUE "B" is just off the press; is replete with things of interest to the amateur experimenter. Prices and quality are both right and a 2c stamp brings you same by return mail. **Send for it NOW.**

DAWSON & WINGER ELECTRIC CO.
729 So. Dearborn St., CHICAGO, ILL.

Send for Copy of Our New Wireless Manual P1

It contains 96 pages and tells how to erect and maintain wireless telegraph stations. Shows a number of diagrams. Has the Morse and Continental Telegraph Codes. Illustrates the best instruments to use; tells what they are for and how to use them. Do not wait until some other time, but sit down now and send your name and address, and get one. It costs you nothing.

Send for Our Pocket Catalog P26

It contains 212 pages, with over 1,000 illustrations and describes in plain, clear language all about Bells, Push Buttons, Batteries, Telephone and Telegraph Material, Electric Toys, Burglar and Fire Alarm Contrivances, Electric Call Bells, Electric Alarm Clocks, Medical Batteries, Motor Boat Horns, Electrically Heated Apparatus, Battery Connectors, Switches, Battery Gauges, Wireless Telegraph Instruments, Ignition Supplies, etc.

It Means Money Saved to You to have our Manual and our Catalog when you want to buy

MANHATTAN ELECTRICAL SUPPLY CO.

NEW YORK, 17 Park Place CHICAGO, 114 S. Fifth Ave. ST. LOUIS, 1106 Pine St. SAN FRANCISCO, 604 Mission St.



B.S.A. AIR RIFLE

FOR SMALL GAME



For Solid Enjoyment **Accurate - Kills - at 50 Yards**

there is nothing like a really good rifle, whether used for indoor or outdoor shooting. You can invest in no better weapon than the

B. S. A. Air Rifle

A serious practice arm. Will last a lifetime. Kills clean at 50 yards. "Adder" Pellets, made especially for B. S. A. weapons, cost almost nothing. Little noise — no smoke — no fire — no cleaning troubles.

Special Models for Ladies and Boys

Send now for circular price list — mailed free on application.

THE BIRMINGHAM SMALL ARMS CO., Ltd.
Birmingham, ENGLAND

Representative: HENRY SMAIL, Dept. P. M., 106 Worth St., New York

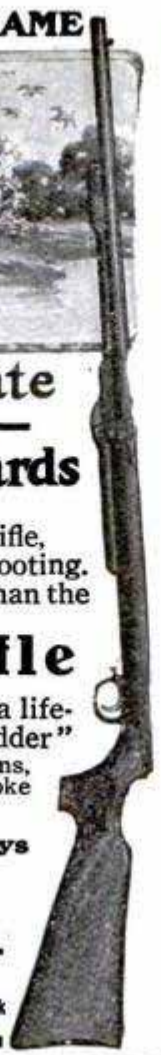

Grab's Handy Cord Cutter

Big Money for Agents



Here's the quickest seller and biggest money maker that's out this year. It's another one of the famous Grab line of specialties.

Grab's Handy Cord Cutter sells for 25c and every store, jobbing house, mail order house and manufacturer needs from one dozen to a gross. Desirable territory still open, which we will let out to live, responsible people. Grab's Handy Cord Cutter is handsome in appearance, highly nicked finish, has a razor edge blade. One quick pull across it cuts the toughest cord or twine. Is attached to wrapping counter, desk, or ledge. Write today for descriptive matter of this and other Grab specialties. Sample cord cutter sent for 25c.

VICTOR M. GRAB & COMPANY
114 Ashland Block Chicago, Ill.

WHAT ONE AGENT DID
One agent went into an Iowa town of 20,000 last week, went right down the main retail street and sold every store from one dozen to a gross of these cord cutters. \$10.25 was his profit in one day.

How to Stop Snoring



Use Dr. Page's remarkable Snore-Mute and you can't snore. You won't humiliate yourself. You won't annoy others. Simplest device ever perfected on scientific principles. Stops snoring and restores normal breathing while sleeping. Light as a feather, small, simple and antiseptic. Get a Snore-Mute and sleep without snoring.

Dr. Page's Snore-Mute

Adjusted instantly. Very comfortable and pleasing to wear. Gives you greater benefits from your sleep. Carry it in your card-case when traveling or visiting. Send only 25c today for your Snore-Mute. Money back if you are not delighted.

Booklet Free Write today for booklet on snoring, post-paid, free. Send only 25c today for Snore-Mute and booklet. Send for free booklet anyway. Post card brings it free. Send to-day.

DR. C. S. PAGE CO., Dept. 5248, Ironwood, Mich.

SUPPOSE YOU HAD A BILLIARD TABLE

NO DULL EVENINGS

The family with a Billiard and Pool Table of its own is never at a loss for a lively, fascinating way to spend an evening. These splendid games provide a constantly new, varying interest. Every member of your family will enjoy them.

No other form of entertainment will appeal so strongly to your guests. Your home will become a most attractive place to which your friends will delight to come.

YOUR HOME POPULAR



\$1⁰⁰ DOWN

Terms, \$1 or more down (depending upon size and style), and a small amount each month. Prices \$15 up. Balls, cues, etc., free. (This cut shows Table No. 73—\$50. Stand \$2.50 extra. \$5 down, \$5 per month.)

BURROWES Billiard and Pool Table

needs no special room. It can be mounted upon dining or library table or on its own legs or folding stand. Set up or taken down in a moment.

BECOME AN EXPERT AT HOME

Burrowes Tables are adapted for the most skillful play. Some of the leading experts use them for home practice. The most delicate shots can be executed with the utmost precision.

For a few cents a day—far less than it would cost you to play in a public poolroom—you can have a handsome Burrowes Table of your own. Under our selling plan, you can play on your own Table while paying for it.

VERY SMALL COST

FREE TRIAL—NO RED TAPE

On receipt of first installment we will ship Table. Play on it one week. If unsatisfactory return it, and on its receipt we will refund your deposit. This insures you a free trial. Write today for illustrated catalog giving prices, terms, etc.

E. T. BURROWES CO., 167 Spring St., Portland, Me.

Our Bulletin 24

tells of special bargains in fully guaranteed rebuilt electrical machinery. Send for your copy today.

We will buy or sell your way. We are such large handlers of rebuilt and electrical machinery that you can't



afford to sell or buy without first studying our free *Monthly Bulletin No. 24*. Remember that whether you buy new or used machinery, our liberal guaranty holds you absolutely safe.

We do prompt repair work for patrons all over the United States
The F. Bissell Co., 226 Huron St., Toledo, Ohio

MOTOR AND DYNAMO BARGAINS

We Will Buy

any electrical machinery that you may have outgrown, or accept it in trade on other apparatus.

We do not handle novelties or toys



LET THE RED DEVIL WATER MOTOR DO YOUR WORK

6-inch Motor

Improved construction, absolutely perfect, runs your washing machine and a hundred other things. Power for small tools. $\frac{1}{4}$ horse power on $\frac{1}{2}$ -inch pipe, 80 pounds pressure; 1 horse power on 2-inch pipe, 60 pounds pressure. New net price, \$5.00 cash with order.

No. 1492 4-inch Motors for grinding, polishing and buffing. Runs sewing machines, fans, bottle washers, etc. Price with emery, buffing wheel, silver polish and pulley \$3.00. No. 1493 Motor and pulley only, \$2.50. $\frac{1}{2}$ horse power on 80 pounds pressure. Improved construction. Speeds, 3,000 to 5,000 revolutions per minute. Only scientifically and mechanically perfect small water motor manufactured. Patented construction makes it possible. Tremendous output warrants the price. Money back for any reason.

CATALOGUE AND LARGE SHEET FREE

DIVINE WATER MOTOR CO.

Dept. T UTICA, NEW YORK, U.S.A.

For the name of your local hardware or tool dealer, we will send you free booklet on "Theory and Design of Water Motors."



6-Inch Bucket Wheel



WE will turn your idea into a reality and make you a model for patenting. Dies, Tools and Metal Specialties are manufactured by us in the best equipped factory for this work in the world. Send us your models for estimate.
KOHLER DIE & SPECIALTY CO.
 823 W. Washington Blvd., Chicago



VACUUM PUMPS

For Powerful Portable and Stationary Vacuum Cleaning Plants. They take up their own wear. Powerful; Noiseless; can't get out of order.

GET CATALOG No. 23

LEIMAN BROS., 62P John St., NEW YORK

THE FLOATING WATER-POWER PLANTS OF ITALY—One of the interesting sights on the River Po, in Italy, are the old floating water-power plants. The mills, comprising a water wheel mounted between two small barges, called "sandoni," are completely covered over and look like hump-backed Noah's Arks, being painted as brilliantly as German toys. The mills are not only painted in the gayest colors, but adorned with religious paintings and designs.



MECHANICAL SUPPLIES AND MATERIAL of all kinds. **EXPERIMENTAL AND LIGHT MACHINE WORK** to order.
 132 MILK STREET, BOSTON

AMERICAN MODEL AND TOOL WORKS

617-631 W. Jackson Blvd., CHICAGO
 WE MAKE MODELS, TOOLS, DIES, MOLDS, PATTERNS AND MODEL PARTS. EXPERT GEAR CUTTING.
 Inventions developed and simplified, also manufacturing.

WRITE FOR BOOKLET OF INVENTOR'S SUPPLIES

UNION MODEL WORKS (Established 1882) 119 S. Clark St., CHICAGO
 The oldest, most reliable, most efficient model making and experimental house in the west

WANTED To manufacture METAL SPECIALTIES, 20 years experience in making Dies, Tools and Special Machinery. Expert work. Complete equipment.
NATIONAL STAMPING & ELECTRIC WORKS
 412 S. Clinton Street, Dept. 3 Chicago, Ill.

This Lathe Costs You

Complete with lathe tools and scroll saw attachment as shown in cut. An ideal outfit for home work or small shops. Well built and highly finished, polished parts nickel plated. Swing of lathe, 5 in. Length of bed, 24 in. Distance between centers, 13 $\frac{1}{2}$ in. Write for full information. If you are interested in scroll saw work, send 10c for Bowman & Russell catalogue 64 of patterns. We also sell scroll saw wood—all kinds.

\$12

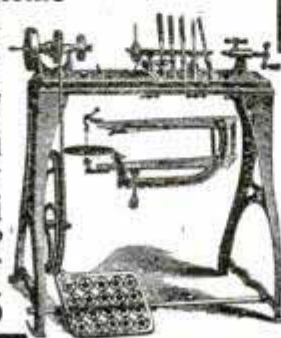

ORR & LOCKETT HARDWARE CO.
 Lathe Dept., 14-16 W. Randolph St., CHICAGO

Please Mention Popular Mechanics

Active Powers of Inventive Genius



INVENTORS Our Brain Belongs to You. Our Ideas Are Free of Charge.

All we want in return is to build your model, special machinery, dies, tools and jigs to manufacture sheet metal goods, etc. We are expert mechanics, over thirty years experience and have one of the best equipped shops in the country. Ask for Booklet No. 17. Consultation free. Experimental work strictly confidential.

A. NACKE & SON
 236-242 S. 9th St., Philadelphia, Pa.

"IDEAL" Lawn Mower Grinder

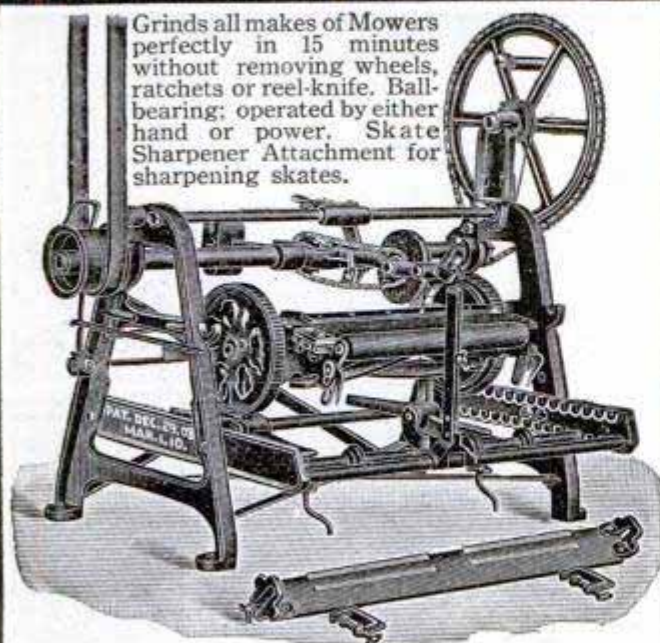

Grinds all makes of Mowers perfectly in 15 minutes without removing wheels, ratchets or reel-knife. Ball-bearing; operated by either hand or power. Skate Sharpener Attachment for sharpening skates.

"You Grind It As You Find It."

WRITE TODAY for full information of this great labor-saver and money-maker. Will do the work so much better, quicker and easier you cannot afford to do without it. The only practical machine for sharpening Lawn Mowers on the market. Over 5000 in use. Fully warranted. Sold on easy-payment terms. Write today. Don't delay.

HEATH FDY. & MFG. CO., Plymouth, Ohio

NAVY'S FIRST STEEL VESSEL WELL PRESERVED—Repairs to the outside plating of the "Dolphin," the first steel vessel constructed for the United States navy, were found to be unnecessary when the ship was recently examined at the Brooklyn navy yard, although the craft was built in 1883.

With room for more than 200 cars, Denver claims to have the largest exclusively electric garage in the world.

Prepare for More Business

The **CRESCENT** Universal wood worker will cut your cost of production, increase your profits. A complete outfit for the small shop in one machine. Find out all about it. Our catalog gives description and tells about our line of band saws, planers, planers and matchers, swing saws, disk grinders, saw tables, shapers, borers, Variety wood workers.

THE CRESCENT MACHINE CO.
93 Columbia St., LEETONIA, OHIO



LATHES

\$75 Screw Cutting
Foot or Power
9 to 13 inch

CATALOG FREE

SOUTH BEND MACHINE TOOL CO., 423 Madison St., South Bend, Ind.

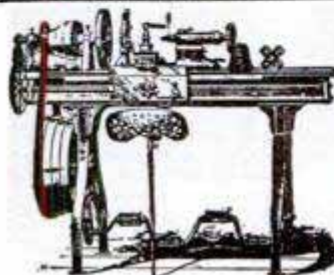

LATHES

9 to 13-inch Swing

List price \$75 and up according to size. When ready to buy send for Lathe Catalog and prices.

W. F. & John Barnes Co.
100 Ruby Street, ROCKFORD, ILL.

Get This Business By Installing a Lathe In Your Shop.



Many a good paying job has to be turned down because a shop is not equipped with a lathe to do the work. Are you in this class? If so, **buy one of our lathes and be ready for the man with the lathe job.**

Our lathes are made to satisfy expert mechanics. They are guaranteed accurate, strong and unexcelled in workmanship. We sell the right lathe for your shop and save you \$25.00 to \$150.00 on every lathe according to size. Write for our Machinery Catalog 80P45, free on request. It tells you where to buy the best machinery at the lowest possible prices. We make no shipments outside the limits of the United States.



Sizes, 9 to 18-Inch Lathes;
Also Gap Beds.

Prices Range From \$60.00 Up

Address Sears, Roebuck and Co., Chicago

Can You Shave?

Rub a little "3 in One" on your razor stop till leather becomes soft and pliable; draw razor blade between thumb and finger moistened with "3 in One;" then strop. The razor cuts 5 times as easy and clean; holds the edge longer. "A Razor Saver for Every Shaver" which gives the scientific reasons, and a generous trial bottle sent free. Write to-day.

3 in 1 OIL CO.
42 CNR Broadway
New York

Running Water When & Where You Want It

City convenience at one-half—and less—the cost. Running water in the house and barn or garage—all you want of it at the turn of a faucet. No hand pumping—all the fuss and bother left out. A

"JARVIS" POWER PUMP

and a good well or cistern is all you need. Install Pump yourself—easily, quickly. We furnish everything—piping, fittings, fixtures, etc. Runs by gasoline engine or electricity at little cost. Catalog No. 16 tells the whole story—write today for free copy. Good Proposition for Dealers—Write!

JARVIS ENGINE & MACHINE WORKS,
LANSING, MICH.



A Chance to Build a Business of Your Own

We can show every manufacturer the advantages of Pen-Dar Lockers, and we want one good, live man in every territory uncovered at this time to reap the harvest.

PEN-DAR PLANISHED STEEL LOCKERS



are essential to every well equipped factory, school, or building in which employees work. They protect employees from dishonest associates—they prevent one great cause of big fires.

Every manufacturer can be induced to provide his employees with PEN-DAR Lockers—a convenience that will increase their value to him.

Have you the ability and ambition to go into business for yourself? If so, write us today.

Edw. Darby & Sons Company, Inc.
243 Arch Street Philadelphia, U. S. A.
Makers of Steel Cabinets, Bins, and Shelving



You won't need rubbers.

Never Mind the Weather

Step right out into the rain or snow.

LEAKANOT KEEPS THE FEET DRY

A liquid waterproofing dressing for shoes or anything leather. Made with a base of pure rubber, the only real waterproofer. Colorless, odorless, invisible—Leakanot will not discolor tan shoes—it is equally effective on black or tan leather. Soaks into the pores, seams and stitches and makes the leather soft and pliable—rubberizes it and lengthens its life.

One application will last a long time—the best protection against wet feet—doesn't prevent a brilliant shine.

Buy of your druggist, shoe store, grocer, general store, or send us 25c for a 3 oz. can.

National Rubber Co., 105 Narco Bldg., St. Louis, Mo.



THE "DOCUMENT ROOM" OF THE U. S. CAPITOL—The document room of the United States Capitol is provided with tiers of pigeon holes, running from floor to ceiling, in which are stored the thousands of

Yours, Free

The sport with a thousand thrills! All you want to know about it—practical hints, the true how and why—and all the little tips and inside facts about this trickiest of game fishing are put up to you right in **That Free Heddon Book**

It shows you in sumptuous colors the outfit you want—Heddon's Genuine Dowagiac Split Bamboo Rods and Dowagiac Artificial Baits—the most scientific, certain and humane of lures.

JAMES HEDDON'S SONS, Dowagiac, Mich.
Box 100 (Pronounce it "Do-wah-jl-ack")



Learn Trapshooting

The Most Fascinating Outdoor Recreation
Quickly Develops Amateurs into Experts

TRAPSHOOTING supplies the coveted chance to learn to shoot safely and satisfactorily. It regards no game laws, "closed" seasons nor game preserves. The "clay birds" fly every day and afford opportunities for the attainment of expertness and achievement of notable victories at the traps, and later, in marsh or field.

Send for FREE BOOKLET containing an enthralling description of Trapshooting, pictures of famous shooters, prominent events, gun clubs, special trophies donated to winners, and "Hints to Beginners."

Ask for "Sport Alluring" Booklet No. 248

THE SPORT ALLURING



DU PONT POWDER CO., Wilmington, Del.

**PIONEER POWDER
MAKERS OF AMERICA**

When Quality Is At Stake



you welcome anything that will insure perfection.
That's why thousands of mechanics are today using

Starrett Tools

for the work on which rests the reputation of the plant. They know these tools are always reliable. If a Starrett says so, it's right.



If you have exact work to do, send for a Starrett Catalog No. 19AP and see what tool you want for your particular job.

The L. S. STARRETT CO., Athol, Mass.

42-92

good, bad and indifferent bills that go over from session to session without action by Congress. "This room is the graveyard of a thousand hopes," says the R. F. D. News. "In it are measures that mean poverty or prosperity to individuals; stagnation or activity to cities; honor or dishonor to the half-forgotten names of men who fought in years gone by. In this narrow room, which is barely half the size of a dairy-lunch room, are bills which, if passed in their entirety, would cause the few remaining hairs on the heads of several justices of the Supreme Court to rise in mortal horror and agony."

WE SHIP ON APPROVAL

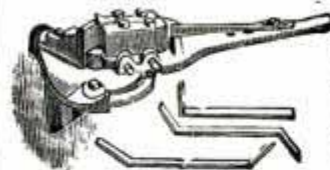

Our Hand Power Angle Benders are so indispensable for bending rods, squares and flat pieces into all sorts of angles that we do not hesitate to ship tools for 10 days free trial. Made in 3 sizes to cover a wide range of work. We also make hand power tools for bending eyes, hooks, "U" shapes, hinges, rings, etc. Write for complete descriptive catalogue.

WALLACE SUPPLY CO., 124 No. Jefferson St., Chicago; 26 Cortlandt St., New York City



Portable Cases

**FOR TOOL MAKERS
AND MACHINISTS**

Twelve styles, felt lined drawers, solid brass trimmings, best of material, beautiful finish, low prices, satisfaction guaranteed. Ask for booklet of cases built for service.

The Pilliod Lumber Co.
SWANTON, OHIO

\$1.00

Postpaid
Myers' Wonderful Sewing Awl
sews leather, canvas, shoes—anything, heavy or light. Complete repair shop in itself. Saves many trips to town. Mends harness, saddles, wagon covers, blankets, buggy tops, belts, etc. Can't get out of order. Original and only awl with diamond point full grooved needle to protect the thread. **BIG MONEY FOR AGENTS**
C. A. MYERS CO., 6339 Lexington Ave., Chicago, Ill.

A "Red Devil" You have been waiting for — "A scientifically shaped tool"



**Red
Devil
No. 942**

Yes, scientifically shaped to fit your hand — shaped so accurately and perfectly that it fits like a glove — smooth — no "Kinks," no pinch — It's 5 in. long — drop forged steel — Gun metal finished — "Dentyne milled" handles — Your hardware dealer has it on sale — Ask for "Red Devil" No. 942 — 5 in. If he can't supply send us 80c and one only sample pair will be sent you prepaid.

Try your **DEALER FIRST** — But insist on "Red Devil"
Smith & Hemenway Co., 510 Chambers St., New York, U S A

THE EXCELSIOR BRAD SET. PRICE 25 CENTS

Takes No. 18
and No. 20
Brads from ¼
to ¾ in. long



**THIS END IS
MAGNETIZED**

The tool illustrated above will be indispensable to the Pattern Maker, Cabinet Maker, or Picture Framer who purchases it. It will set brads in places that would be inaccessible without it, and dispenses with the brad awl and nail set. If, after a fair trial, you are not satisfied that you have received your quarter's worth, your money will be promptly returned to you on receipt of tool.

**Standard Tool Supply Co., 140-142-144 W. 22d St.
NEW YORK CITY**

REG. U. S. PAT. OFF.



You can put all your strength back of this P. S. & W. Solid-Handle Wrench



The complete wrench



Forged in one piece of solid steel

Just Three Pieces

HHEAD, bar, shoulder and handle frame are forged in one piece and case-hardened.

The only other parts, except the wood facings of the handle, are the extra-heavy knurled thumb-screw, and the extra-strong sliding-jaw.

This is the strongest general-purpose wrench manufactured, and is guaranteed by the trade-mark shown above, "The MARK of the MAKER."

Write for free copy of the "Mechanic's Handy List," a 170-page book, convenient pocket size, listing over 200 tools for Carpenters, Machinists, Electricians, Tinsmiths and other tool-users. The book also contains many pages of useful information, valuable shop tables, etc.

The Peck, Stow & Wilcox Co.

MFRS. of the Largest Line of Mechanic's Hand Tools Offered by Any Maker

Southington, Conn. Cleveland, Ohio New York, N.Y.
Address correspondence 20 Murray St., New York City

Sharpen It on a Cleveland

With a Cleveland grindstone and a little knowhow, you can always put the right cutting edge on the tools you work with—bench, farm machinery or any other kind. Do not be tricked by the misleading term "Berea Grit" into thinking you are getting the genuine

CLEVELAND GRINDSTONES



"Berea Grit" is not "Berea Stone" but a mere geological name which does not refer to grindstone quality for tools for bench or farm use. It is absolutely unfit for such purposes. **Look for the Trademark. It's Your Protection.**

The little Giant, shown here, is a convenient size for the man who keeps his own tools in order whether in city or on farm. Mounted for power or hand use on ball bearing light running frame. Has tool rest and drip pan. Mounted accurately and runs true.



The Empire has a higher frame, a design made especially for farm use. Extra strong frame insures steady running. If you don't know a Cleveland dealer, or if you need a special purpose stone, write us.

The Cleveland Stone Co.

650 Hickox Bldg. CLEVELAND, OHIO

NAVIGATION ON THE OSAGE—One of the very crookedest streams anywhere is the Osage River in Missouri. In that region they tell of a farmer living on the banks of that river who had a small flatboat, which one day he loaded with produce and floated down to



Grobet Swiss Files

and other high-class Tools are shown in "THE TOOL-MONGER"—its 375 pages, and will be mailed on receipt of 5 cents in stamps.

MONTGOMERY & CO., 107 Fulton Street
NEW YORK CITY



Tool Cases for Machinists & Toolmakers

You need one of the many styles shown in our free catalogue. They are the best built and most practical on the market and it's the up-to-date way to keep tools in good condition and orderly arranged. We ship direct to you and guarantee complete satisfaction.

A. Gerstner & Sons.

Mfrs. of Mechanics' High Grade Tool Cases
818 Germantown Street, DAYTON, OHIO

Christiansen's Steel Screw Vise

Is the handiest ever out. It can be attached to a plank or a heavy table top in 5 minutes. Any Hardware Dealer can get this Vise for you.



Price is only **\$2.00**

C. CHRISTIANSEN, 2219 Grand Ave., CHICAGO, ILL.

American Patent Sales Company

We buy, sell and exploit in the U. S. A., Canada, and abroad, good foreign and domestic mechanical patents. We have live representatives in all parts of the world. We make no charges to inventors unless patents are sold by us. If you have any valuable patents to sell communicate with us.

WE EXPLOIT

The Master Slide Rule,



the only Rule in the World whereby inside measurements of doors and windows, etc. can be taken rapidly and accurately. It is also far superior to any other rule for outside measurements of walls and ceilings, etc., as it can be extended and closed instantly. **Mechanics, Builders, and Architects, try one today! Don't wait!**

On receipt of 15 cents per lineal foot, a 4, 5 or 6 foot rule will be sent to you prepaid. Large profits to agents. Write for circulars and particulars.

AMERICAN PATENT SALES COMPANY
417-A Fifth Ave. NEW YORK CITY

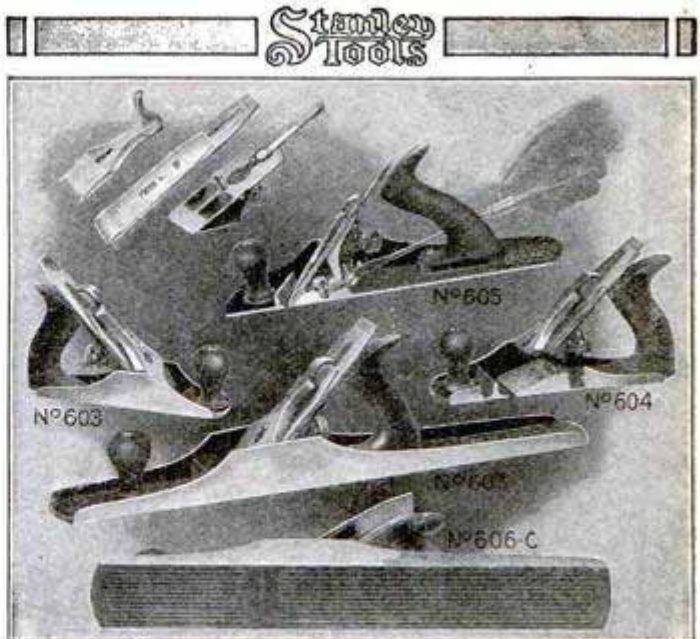

STANLEY

"Bed Rock" Planes

For fine work on hard and knotty wood, this Plane surpasses all others.

The Cutter, Frog and Bottom are so machined and fitted that they are practically one solid piece of metal, thus preventing any chance of vibration.

The Frog travels in a groove, ensuring it being square with the mouth of the Plane, and preventing shifting or "wobbling."

The width of the mouth can be regulated by use of a Screw Driver without removing the cutter or lever.

The shape of the sides is a distinctive feature, and adds greatly to the strength of the Plane.

The Cutters are made of the best English steel and are adjustable, both endwise and sidewise.

The Handles and Knobs are of rose-wood and finely finished.

These Planes are used by those who pride themselves upon having the best tools obtainable.

A postal will bring you an attractive circular containing complete description

ADDRESS

Stanley Rule & Level Co.
NEW BRITAIN, CONN. U.S.A.

LUFKIN

A trade-mark and a guarantee

Measuring Tapes and Rules

Send for sample piece of instantaneous reading tape and our complete catalogue.

THE LUFKIN RULE CO.

SAGINAW, MICH.



market, six miles away. He exchanged the produce for goods at one of the stores and loaded his goods in the flatboat.

"How are you going to get your stuff home, Bill?" asked a friend. "Got a steamboat to tow you back?"

"I am going to float it back," was the response.

"How are you going to do that? I don't understand."

"I guess you don't know much about this river. It doubles on itself just below here and runs back to

STOP THAT LEAK

TRADE MARK
Solderene
PATENTED THE U. S. A.

and a Candle are all you need to make a permanent repair.

Full directions with each stick. It requires no skill. Anybody can use it. Price, Ten Cents.
SOLDERENE MFG. COMPANY, 90 Portland St., BOSTON, MASS.

"Odd Jobs"

bob up at house-cleaning time which really require a Bench and tools. With a Grand Rapids

HOME BENCH

many things can be "fixed" with convenience and pleasure that now require the expense of a mechanic.

Thousands of well regulated homes have a home bench — why not you?

Send today for free catalog of all styles and prices.

GRAND RAPIDS HAND SCREW CO.
1620 Front Ave., Grand Rapids, Mich.

If you want one of our Stone Blotters send 15c when writing for catalog.



THERE'S A PLACE IN YOUR TOOL-KIT FOR A

Carborundum Niagara Grinder



COMPACT, serviceable little machines for tool grinding—just the right machine for the carpenter, craftsman, mechanic, or for household use.

EVERY MACHINE IS EQUIPPED WITH A CARBORUNDUM WHEEL

the fastest, coolest cutting wheel for all-around work.—The machines are mechanically right—every part accurately made and fitted—carefully assembled—they run quietly—easily—nicely finished—small parts nicked—made in four sizes—fitted with tool rest.

- | | |
|---|--------|
| No. 1 Carborundum Wheel 4-inch diameter, | \$2.50 |
| No. 2 Carborundum Wheel 5-inch diameter, | 3.50 |
| No. 3 Carborundum Wheel 6-inch diameter, | 5.00 |
| No. 4 Carborundum Wheel 7½-inch diameter, | 8.00 |

At your hardware dealer—who also sells Carborundum Sharpening Stones.

The
**Carborundum
Company**
Niagara Falls, N. Y.



Detachable Swivel

"Off agin, on agin!"



Like a glove button or clasp describes the application of the feature just incorporated in the dependable drop-forged and heat-treated

"Vulcan" Tool-Makers' Clamps

**Positive application
Dependable strength
Unlimited usefulness
Profitable companion**

Made in three sizes, with total capacity of 1 to 3 inches; use with or without swivel.

Get (free) catalogue of dependable drop-forged tools

J. H. WILLIAMS & CO.

Superior Drop-forgings

47 Richards St. Brooklyn, N. Y.

within less than a quarter of a mile of my place. I've got a landing on both banks and a team of horses that can drag the boat over from one landing to the other."—Kansas City Journal.

CEMENT THAT RESISTS GREAT HEAT—A new high-temperature cement, which it is said can be practically used instead of fire clay wherever working temperatures range between 1,500 and 3,100 deg. F., has been put on the market.

FOR MENDING HARNESS

shoes, tents, awnings, pulley belts, carpets, saddles, suit cases, buggy tops, dash boards, or any heavy material. Stewart's Automatic Awl is the only perfect Sewing Awl.

It takes a wax thread, feeds from spool and does the work of any harness maker machine. It is indispensable for farmers. Agents wanted. Sent prepaid for \$1.25. Send at once for catalog.



STEWART-SKINNER CO.
26 Hermon Street
Worcester, Mass.

Make Things of Leather



No. 1 Double Ended Leather Working Tool, 50c

You can make hand bags, pocket books, card cases, a hundred useful and attractive things in leather. It's fun and it's easy to learn. An investment of 50 cents in tools will start you. Send for our Arts and Crafts Catalog 24.

ORR & LOCKETT HARDWARE CO.

14 W. Randolph Street, CHICAGO



**Brown & Sharpe
Mfg. Co.**

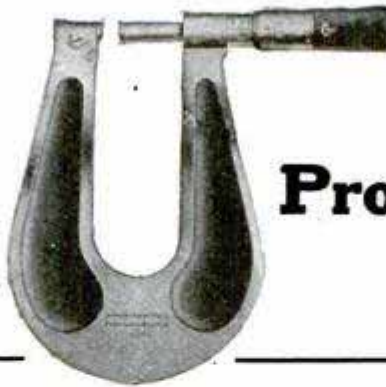

**Providence, R. I.
U. S. A.**



Six handy tools recently added to our line. They are of the same high quality that has established *B. & S. Tools* as *Standard* throughout the world. Ask any hardware dealer to show you this line.

**Have you a copy of our 640 page
1913 General Catalogue?
MAILED FREE**

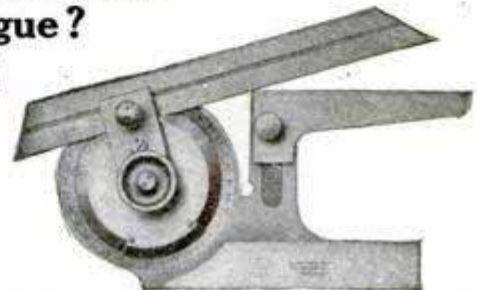
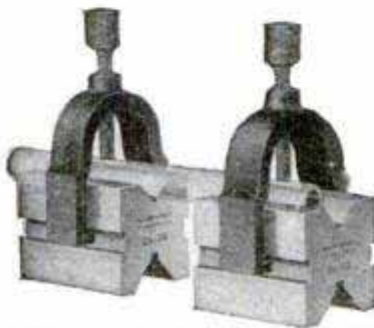

More fuel is consumed in the city of Pittsburgh and its immediate vicinity than in any other city in the world.

**WHEN YOU WANT ANYTHING AND DON'T KNOW
WHERE TO FIND IT—WRITE BUREAU OF
INFORMATION, POPULAR MECHANICS, CHICAGO**

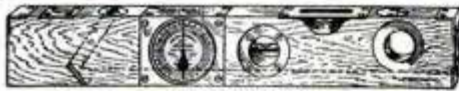

SIDE VIEW



TOP VIEW

NEW IMPROVEMENTS NOW MAKE

**The American Combined Level and Grade Finder
Most Practical, Durable and Convenient Instrument Made**

At one glance you can get the true slant on any line or grade either in degrees, inches or percentage, or all at the same time, and will at once give the exact distance needed to plumb up to a true level. The additional spirit level glass now placed in middle of instrument with points on dial will give 3 grades for leveling. The longitudinal recess shown in cut is well worth the low price of the instrument. Write **AT ONCE** for circular and Testimonials. Special Introductory Price given to First Applicants with privilege of taking Agency. Address **EDWARD HELB, Mfr., Box 75, RAILROAD, PENNA.**

CLAMPS

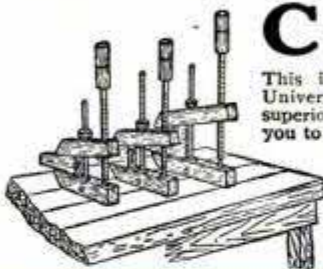

This illustration shows The Ducharme Patent Universal Clamp, and a glance at it will show its superiority over the old-style clamps, as it allows you to set your work upright and clamp upright, and at the same time to stack them side by side on the bench or shelf while the glue has a chance to set. Write for Circular C and Price List.

MANUFACTURED BY
THE DUCHARME MACHINE CO.
389 Riverside Ave., Medford, Mass.

(ESTABLISHED 1873)

Charles Buck Tools

Highest Award World's Columbian Exposition
Highest Award World's Centennial Exposition

Send name of dealer and four cents in stamps for new art catalog.

Charles Buck Edge Tool Co., Millbury, Mass., U. S. A.

**A Handy Drill
for Every Use**

A quality tool that will perform good service always—

HAND DRILL No. 3

is 11 inches long and has a chuck that holds from 0 to 3-16 inch drills. Entire weight 21 ounces. Has hollow handle to hold drill points with a unique, quick and convenient method of removing and attaching handle to get at drills. **PRICE \$1.00**

MILLERS FALLS CO.
28 Warren St., New York City

**"AMERICAN"
Key Cutter**

ADD TO YOUR INCOME With little effort you can make **\$5 to \$10** a day

The "AMERICAN" is the only machine on the market (barring none) that sharpens, hones, and stropps razors, sharpens all kinds safety razor blades, scissors, clippers, pocket knives, surgical instruments, etc. No previous experience required. **REMEMBER THE "AMERICAN" Key-Cutter is a little wonder. Cuts Square, Angular or Round slots.**

AMERICAN SHARPENING MACHINE CO. (Inc.)
Dept. 4 184 W. Washington St. CHICAGO

**"AMERICAN"
Sharpener**

"YANKEE" TOOLS

Make Better Mechanics



"Yankee" No. 1430

THE little hustler, the baby hand drill of the big "YANKEE" Tool family. Small, compact, light — yet strong and durable, and made with exactly the same care, precision and expert finishing as the largest of its brothers. Gives big speed on light drilling — just the tool for small, accurate jobs.

"Yankee" Plain Hand Drill No. 1430

Length - - 10 3/4 inches
Weight - - 1 1/4 pounds

Malleable iron frame, steel spindle with cut teeth. Three-jaw chuck. Holds round shank drills to 3/16 in. diameter. Detachable handle contains magazine for drills. Adjustable hardened steel bearing in lower end of frame.

"Yankee" Plain Hand Drill No. 1430

Price \$1.75

Your dealer can supply you

NORTH BROS. MFG. CO.
PHILADELPHIA

Write for "Yankee" Tool Book" — free — showing styles of Yankee Ratchet, Breast, Hand Drills and other "Yankee" Tools.

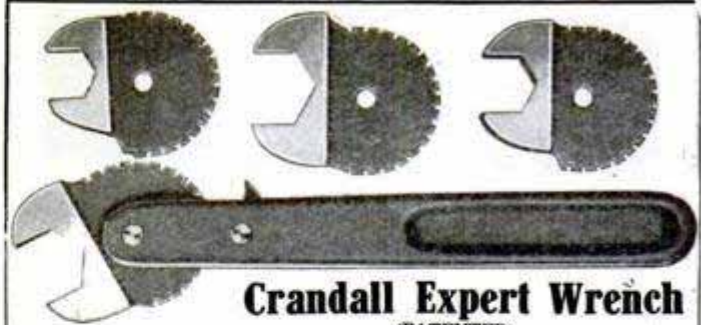

Crandall Expert Wrench (PATENTED)

No further need for cold chisel and hammer in those close places. The "Expert" will operate in 1" space for handle swing. Jaw sizes instantly interchangeable without extra tools. Drop forged and case hardened. 14 possible angles with each jaw. 4 sizes and handle as shown in neat duck kit, only \$2.50 the set, at your dealer's or sent prepaid by Parcels Post anywhere in U. S. on receipt of price. Circulars on request.

Dealers and salesmen get our proposition.

EXPERT UTILITY CO., 356-8 E. 3rd St., Cincinnati, O.

9 Months' Rent Buys a Transit or Level For Engineers or Surveyors

Highest Quality — These Civil Engineering Instruments are of the highest quality, newest patterns and 1913 models. Full set of accessories included. Full guarantee backed by our fifty-year record as makers of the world's standard engineering instruments.

No Interest — No interest, strings or red tape of any kind. Just pay the rent for nine months and you own the instrument outright.

Send For Particulars — If you are an engineer or surveyor write today for full particulars of this wonderful offer and complete descriptions. Ten days' trial.

A. S. ALOE CO., 515 Olive St., St. Louis, Mo.



Dr. W. E. Geil, who in 1908 journeyed from end to end of the Chinese Wall, says that with its extensions its total length is really 2,550 miles, and that originally 40,000 stone towers guarded it.

SENT ON 30 DAYS' TRIAL TO RESPONSIBLE PERSON



The Handiest Tool Holder Made

Constructed of hardened steel, well and truly made. Holds any shape of stock down to No. 60 Drill. Write for Catalog E.

B. MORGAN, Manufacturer of SPECIALTIES
Bellevue St., NEWPORT, R. I.

Building Contractor Agents

Wanted to use and help sell the

Rapid Floor SCRAPER

One man scrapes more floor than three by hand
Get our Free Catalog



FREE TRIAL
MONARCH MFG. CO.
504 Shepard Bldg.
Grand Rapids, Michigan

A BIG MONEY MAKER FOR AGENTS



Tinol

The
**Instantaneous Home
Solder with a thousand practical uses**

Simply heat the article to be mended over a candle, lamp or gas flame—apply Tinol, and you can make immediate repairs of anything of metal. In every home and office Tinol is a tremendous money-saver to those who know its uses. It sells on sight. Easy to demonstrate; easier to repeat orders. Send 10c at once for sample, and agent's proposition.

Men and women everywhere are making big money — so can you.
HESS & SON, 1039 Chestnut St., PHILADELPHIA
Hamilton coupon in every package.

To the Man Without A College Education

The Winslow strength computing Slide-Rule gives engineering skill and accuracy. Adds to his earning power and prestige.

WINSLOW STRENGTH COMPUTING SLIDE-RULE

Makes minutes do the work of hours and will pay for itself in one day's use. Solves any beam problem in six seconds or less. Invaluable to Draftsmen, Estimators, Builders, Engineers, Architects, Superintendents. New — Nothing else like it at any price, the shortest, surest, simplest method of instantly solving all questions concerning strength of beams of any material, any size, span, spacing or load. Direct reading and easy to operate. Used and endorsed by eminent engineers and architects. Made of German Silver. Size 3 1/2 in. x 10 1/2 in. — in cloth covered case, with valuable book of instructions.

Special introductory price \$10.00
Leather pocket case 50c.

ANOTHER W-S-R, (for reinforced concrete slabs) will be ready April 1st. As complete in its field as the above. Size 6"x11"—cardboard. Price \$1.50.

Money back guarantee. Agents wanted.
HENRY W. TOMLINSON
Steinway Hall, Chicago, Ill.



Descriptive Booklet Free

FOR SEWING LEATHER

The Speedy Stitcher is the latest and best of anything ever offered for \$1.00.



Agents make over 200% profits.

Send at once for catalog and terms.

AUTOMATIC AWL CO., 26 Gardner Terrace, WORCESTER, MASS.

SNAILS CAN LIVE WITHOUT AIR—It remains for the common snail to dispute the high authority who said: "To all organized creatures the removal of oxygen, water, nourishment, and heat causes death to ensue." The snail is an organized creature with lungs, heart and a general circulation, being in every respect an air-breathing creature, yet it can live without the least air. In frosty weather it retreats into its shell and secretes that silky texture which makes its shell absolutely impervious to air and water.

GASOLINE SOLDERING IRON BLOW TORCH

Cuts time and Fuel Bill 50%. Address Dept. I.



EMMELMANN BROS. MFG. CO., INDIANAPOLIS, IND., U.S.A.



Lockstitch Awl sews shoes, harness, rugs, canvas, etc.

with lockstitch like sewing machine. 60c each, 2 for \$1.00; Waxed Thread free. Stamps taken. Snap for Agents.

W. A. MacKENZIE, 251 LLOYD BUILDING, ST. LOUIS, MO.

TOBACCO HABIT BANISHED

In 48 to 72 Hours

Yes, positively permanently banished almost before you know it. Pleasant, easy to take. Results quick, sure, lasting. No craving for tobacco in any form after first dose. Not a substitute. Harmless, no poisonous habit forming drugs. Satisfactory results guaranteed in every case or money refunded. *Tobacco Redeemer* is the only absolutely scientific and thoroughly dependable tobacco remedy ever discovered. Write for free booklet and positive proof.

NEWELL PHARMACAL CO., Dept. 25, ST. LOUIS, MO.

THIS THIN MODEL 20 YEAR WATCH \$2.95

Elegant hunting case beautifully engraved, gold finished throughout, stem wind and stem set, fitted with finely finished ruby jewel movement, guaranteed a correct timekeeper, with long gold finished chain for Ladies or vest chain for Gents. Let us send it C.O.D. for examination at your nearest express office. If you think it a bargain and equal in appearance to any \$15.00 gold finished watch pay the express agent our special sale price \$2.95 and express charges, and it is yours. If you send \$2.95 with order we will send by insured parcel post. Mention if you want Ladies' 6 size, Boys' 16 size or Gents' 18 size. Address **Mutual Sales Co., F29, 306 W. Madison St., Chicago, Ill.**



HUNTING CASE pay the express agent our special sale price \$2.95 and express charges, and it is yours. If you send \$2.95 with order we will send by insured parcel post. Mention if you want Ladies' 6 size, Boys' 16 size or Gents' 18 size. Address **Mutual Sales Co., F29, 306 W. Madison St., Chicago, Ill.**

Easy cutting?



Yes— Easy cutting is perhaps the most important characteristic of the die-stock shown here but it's only one of many distinctive features to interest you in the

OSTER MATCHLESS 3B DIE STOCK

For instance, the dies are receding and neither the dies nor guides require changing. Wide adjustment enables you to thread all sizes of pipe from 1 to 2 inch with one set of dies. No bothersome bushings to adjust nor other loose parts to trouble you. This is absolutely the only stock fitted with a *Patented Chip Shield* which prevents chips from clogging the leader-screw and wearing away the thread.

The Oster Matchless 3B is one of the famous Oster Bulldog Line of hand, belt and motor operated pipe-threading tools which includes an easily-operated, thoroughly tested tool for every use. Twenty years' experience means accurate construction at reasonable prices. Let us know your need and we will suggest a suitable tool.

BOOKLET FREE

Just off the Press —free booklet containing eight actual letters between the Oster Mfg. Company and a Matchless 3B user,—an unusually interesting pipe-threading story. Sent free with complete catalog by return mail. Use the coupon now.

THE OSTER MFG. CO.
2100 East 61st St.
CLEVELAND, OHIO
U. S. A.



USE THE COUPON NOW
Please send me free your booklet "Through the Mail," and catalog.
NAME.....
CITY.....
STATE.....
(2100)

SLIDE TO IT CIVIL SERVICE Examinations Made EASY by Use of RICHARDSON'S SLIDE RULE.

State, County, and City Civil Service Commissions are adopting plan of U. S. Government by requiring the use of Slide Rules in examinations.

There seems to be a misunderstanding about what the Slide Rule will accomplish, many think it an instrument, the use of which is applicable only to Engineers and Technical men. So frequently have I heard this remark that I have completely re-written and enlarged my instruction book, **The Slide Rule Simplified**, which shows the actual setting of the rule by 90 full size engravings, 52 pages 7x10, each illustration and example is explained and "written so you can understand it." In fact any person who has never seen a Slide Rule, and not a technical person, could not help but learn its use. The examples selected and shown by illustrations are those which frequently come up for solution by the **Banker, Broker, Auditor, Inventory Man, Cost Estimator, Printer, Paper Mfr., Contractor, Salesman, Time-Keeper, Bookkeeper, Lumber, Land,** and other merchants too numerous to mention.

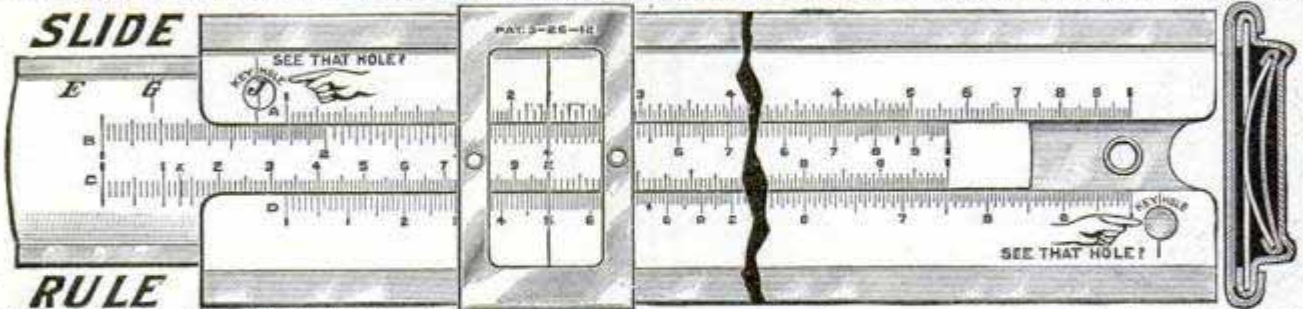

This Slide Rule will multiply, divide, solve proportion, extract the square and cube roots, find the decimal equivalent of vulgar fractions or "vice versa," calculate interest, percentage. Also the mensuration of superficies, and the rule of three. For Engineers, Electricians, Draftsmen, Superintendents, Master Mechanics, etc., the rule is indispensable in their work. It is one of the most valuable instruments ever offered to mankind. For Electricians it is a complete wire table in itself. The Richardson Direct Reading Slide Rule is specially designed for those who wish to learn its use. Its operation being very simple. You simply place the key to the problem wanted in the keyhole (the key is printed in red on slide, see cut) and answer is given direct: such as the Horse Power of Engines, Pumps, Boilers, Belts, Water Falls; size of duct for ventilating; radiation and size grate, and steam main; change gear and pulley problems; areas, circumference and diameter of circles. This Rule is my 1912 type now on the market for the first time. Made in two sizes, coat and vest pocket 11x1 1/2x3/4 and 5 1/2x1 1/2x3/4. 11" has Sine, Log, and Tangent scales. No wood in their construction, scales white celluloid, printed from engine divided plates in two colors, and washable, secured by an improved locking device in an absolutely non-corrodible Aluminum and Monel Metal framing.

Another Handy Tool

Folding Pocket Rule is made of German Silver; it can be used as a Hook-rule, Caliper-gauge, Protractor, Triangle or Tri-square. The Protractor is divided to five degrees and the Vernier reads to one-half degree. This handy and indispensable Rule can be set to any desired Angle.

- 6 inch two fold \$1.25
- 12 inch two fold 2.00
- Chamois lined case 15c extra

Price of 11" Rule, ordinary case, \$2.50. Full leather case, 50c extra. 5" rule and full leather case, \$2.50. 11" rule, bristol board scales for demonstrating uses, \$1.00. If ordered now the book, **The Slide Rule Simplified**, goes FREE with each rule.

GEO. W. RICHARDSON CONSULTING ENGINEER
Ex-Chief Electrician, U. S. Navy
4218 24th Place, CHICAGO, U. S. A.

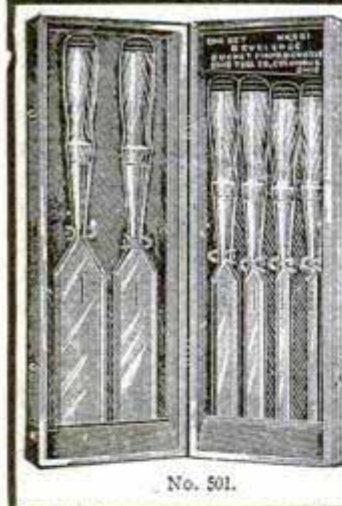

No. 501.

"OHIO" CHISELS

are made from high grade and specially selected tool steel, and the care, skill and experience of our 89 years in the Edge Tool business is put into every tool bearing our "Ohio" Trade Mark shown here. The result is a high grade and very satisfying tool, with a keen, tough and lasting cutting edge.

"OHIO" PLANES

are fitted with our special extra Heavy Cutter, which prevents Chattering or Trembling when used in hard or knotty timber. High grade cutters, accurate adjustments and true faces are only a few of the points in which our planes excel and make it well worth your while to insist on having them from your dealer.

Write for our free Catalogue of High Grade Tools and Benches

OHIO TOOL CO. (Dept. 3)
COLUMBUS, OHIO

are made from high grade and specially selected tool steel, and the care, skill and experience of our 89 years in the Edge Tool business is put into every tool bearing our "Ohio" Trade Mark shown here. The result is a high grade and very satisfying tool, with a keen, tough and lasting cutting edge.



Made From the Finest Sheffield Cast Steel

CARRIED IN STOCK BY

EDGAR T. WARD & SONS

Swiss Files

The Genuine "Dick" Files

Are manufactured at Esslingen on the Swiss frontier and are celebrated for their superior quality and uniformity of cut. All styles, shapes and cuts on hand.

SEND FOR CATALOGUE AND QUOTATION

EDGAR T. WARD & SONS

25 Purchase St., BOSTON, MASS.

FREE \$1,000,000 Worth of Elegant Silverware and Big Book of 5,000 Bargains in Home Furnishings--Send the Coupon



This magnificent silverware is of warranted quality and made by the celebrated house of Wm. Rogers & Co. You can get anything you want in silver, absolutely without cost. Write quick for illustrated circular from which to make your selection.

From Forest to Factory Direct to You

Our business has reached the enormous size where we own and operate our own forests, lumber mills, railways, factories, warehouses. Our manufacturing cost is the lowest on record! You get the direct and entire benefit. Not one middleman gets a profit. You buy of us at

Prices Lower Than Dealers or Mail Order Houses Can Buy For

Just look at the prices of the 3 articles illustrated and remember these are goods of good dependable quality.

FREE TO YOU

IF YOU ANSWER THIS ADVERTISEMENT

Mail the coupon right now for our Bargain Book and circular from which to choose your free silverware. Don't give yourself a chance to forget!

30 Days' FREE Trial—

C.O.D. if Desired—Everything you order of this great house must absolutely satisfy. We guarantee satisfaction. Send cash with order, or one-fourth with order, balance C.O.D. Keep the goods 30 days. Use them, enjoy them, test them. If you aren't fully pleased, return and we'll refund all you've paid and transportation charges both ways. Already we have 1,000,000 satisfied customers. You'll like the Lincoln, Leonard prices, merchandise and silver. Send us your name on the coupon today. Fill it out right now.

LINCOLN, LEONARD & CO. 1279 37th St. CHICAGO

Largest exclusive distributors of home furnishings in the world [26]

Name.....
R.F.D or Street.....
Town.....
State.....

Send me, postage prepaid, your Big Book of 5,000 Bargains in Home Furnishings and full information regarding your gifts of Free Silverware to your customers.

LINCOLN, LEONARD & CO.

1279 37th St.
CHICAGO,
ILL.

\$6.75



\$7.65



\$2.69



GREAT TURTLES IN NEW YORK AQUARIUM
—From time to time great sea turtles are seen in the North Atlantic Ocean, and occasionally some are captured and brought into the port of New York. In the New York Aquarium there are now 12 green turtles of various sizes, the smallest weighing not more than 10 lb. and the largest about 400. A loggerhead turtle received in the late summer of 1900 is still on exhibi-

Resident Agents Wanted An opportunity of a life-time is offered to get into a permanent money-making business selling Gloria Gasoline Lighting Systems. Every system installed sells others. Every user an enthusiastic booster. **WRITE AT ONCE. GLORIA LIGHT CO., 1272 Washington Blvd., CHICAGO, ILL.**



Nulite Portable Parlor Lamp

The cheapest, best and most beautiful light obtainable for town or country. Makes and burns its own gas; 300 C. P. 5 hours for 1 cent. Can be used anywhere with amazing results. Low in price. Thoroughly reliable. Many new and exclusive features. Best proposition of the year for agents.

WRITE TODAY FOR FULL DETAILS

National Stamping & Electric Works
422 S. Clinton Str., Chicago

Triumph Light

EVERYBODY WANTS BETTER LIGHT. HERE IT IS

This new 100 to 700 candle power light turns up and down like gas. One-third cost of electricity, gas or kerosene. For home, church or store. Anyone can operate. Perfection guaranteed or money back. Write for catalog (P. O. P.), Dept. 1, Agents Wanted, **BRILLIANT GAS LAMP COMPANY** No. 182 North State Street, Chicago, Illinois



Make Your Own Gas

The Detroit Combination Gas Machine provides the home with a Satisfactory Gas Supply.
Gas to Light with. Gas to Cook with. Gas to Heat Water for the bath, laundry and other uses common to city coal gas, at no greater cost. On the market over forty years. More than 20,000 in daily use. Our catalog will interest you. Write to-day for copy, and names of users in your vicinity.

Detroit Heating & Lighting Co.
490 Wight Street Detroit, Mich.

Carburetor under ground
Machine in basement

Will you take this:

We want 35 or 40 men right away who can use the following tools: auger, screw-driver, hammer and wrench. We want you to install or put in our Hydro-Carbon Lighting System, and fill orders. We furnish full instructions and complete charts so you can do the work with the common tools named above.



Our lighting system is for farm, village or town homes where for a slight cost we fully equip a house with a perfect, safe, simple, lighting system. The combination of hydro carbon flame and gas mantles produces a bright, steady light, remarkable for its brilliancy compared with regular gas or kerosene lamps. Lights as easily as ordinary gas. No lamps to fill. No grease, grime or dirt. No expensive piping to do, simply a hollow copper conduit wire no larger than a slate pencil. No tearing of floors, breaking plaster, no muss or litter. The wire is easily and quickly passed through partitions attached to mouldings, walls or ceilings.

If you will accept our catalogue and the description of our system, if you are interested in starting a profitable, pleasant business, where you can be kept busy and make big money quick. Let us hear from you.

Write us today—just on a postal or in a letter addressed to us, write as follows. "Mail full particulars." We will offer you a very attractive opportunity that may mean very much more to you than you think. Address

NAGEL-CHASE MFG. CO.
14 St. Clair Block, Chicago

2c a Week Pays Wash Bill!

Electricity or Water-Power Does the Work

Write for
FREE Book

Just a "Twist of the Wrist" Starts or Stops the Machine!

The 1900 Motor Washers are now at work in thousands of homes. They are doing the work formerly done by women, at a cost of 2c a week for power! Saving thousands upon thousands of dollars in wash bills. Saving worlds of wash-day troubles. Leaving the women free to do other work while the machines are doing the washing.

The 1900 Motor Washer

1900 Water Motor Washer
Can be connected with
any water tap instantly



Washes a Tubful in Six Minutes!

Handles Heavy Blankets or Dainty Laces

The outfit consists of the famous 1900 Washer with either Electric Motor or Water Motor. You turn on the power as easily as you turn on the light, and back and forth goes the tub, washing the clothes for dear life. Then, turn a lever, and the washer does the wringing. All so simple and easy that it is mere child's play.

A Self-Working Wringer Sent With Every Washer!

The motor runs Washer and Wringer. We guarantee the perfect working of both. No extra charge for Wringer, which is one of the finest made. **Write for FREE BOOK and 30 Days' FREE TRIAL OFFER!** Don't doubt! Don't say it can't be done. The free book proves that it can. But we do not ask you to take our word for it. We offer to send a 1900 Motor Washer on absolute Free Trial for an entire month to any responsible person. Not a cent of security—nor a promise to buy. Just your word that you will give it a test. We even agree to pay the freight, and will take it back if it fails to do all we claim for it. A postal card with your name and address sent to us today will bring you the book free by return mail. All correspondence should be addressed to



Doing the wringing with
1900 Electric Motor Washer

1900 WASHER CO., 6043 Court St., BINGHAMTON, N. Y.

OR, IF YOU LIVE IN CANADA, WRITE TO THE CANADIAN WASHER CO., 355 YONGE ST., TORONTO, CANADA.

(23)



IRON WITHOUT A FIRE

Cut out the drudgery. Save time—labor—fuel. No walking back and forth to change irons—always the right heat for the best work if it's an

IMPROVED MONITOR SAD IRON
Self Heating. Satisfaction Guaranteed

Over half a million Monitors in use. Strong, simple, easy to operate. Heat regulated instantly, no dirt, no odor.

Agents, Salesmen Managers Wanted **\$10 to \$20 a Day**

No experience required. Every household a prospect. Sells almost on sight. **NOT SOLD IN STORES.** Martin, Tenn., made \$5000 in 1 year. Trimmer, Ill., writes, "Sold 12 in 10 hours." Mrs. Nixon, Vt., made \$14 in half a day. You can do it too. Send for big colored circular, shows iron full size explains everything. Exclusive selling rights—no charge for territory.

The Monitor Sad Iron Co., 203 Wayne St., Big Prairie, O.



tion and weighs about 450 lb. The leatherback turtles which are frequently seen in summer and sometimes captured, do not appear to endure captivity. They swim continually, take no food and soon die.—Fishing Gazette.

Rapid Fireless Get My 1913 SPECIAL COOKER Price Offer



Saves $\frac{1}{3}$ food bill, $\frac{1}{3}$ fuel, half your work, and food tastes better.

30 DAYS FREE TRIAL

Complete outfit aluminum utensils free. Covers and cooking compartments lined with pure aluminum. Dust-proof, odorless.

Write for Free Book and direct-from-factory prices.

WM. CAMPBELL CO., Dept. 64, Detroit, Mich.

HESS MEDICINE SANITARY LOCKER

The Only Modern, Sanitary STEEL Medicine Cabinet

or locker finished in snow-white, baked everlasting enamel, inside and out. Beautiful beveled mirror door. Nickel plate brass trimmings. Steel or glass shelves.

Costs Less Than Wood

Never warps, shrinks, nor swells. Dust and vermin proof, easily cleaned.

Should Be In Every Bath Room

Four styles—four sizes. To recess in wall or to hang outside. Send for illustrated circular.

HESS, 910 L Tacoma Bldg., Chicago
Makers of Steel Furnaces. Free Booklet.



The Recessed Steel Medicine Cabinet

The "BEST LIGHT"

Makes and burns its own gas. A safe, brilliant light which casts no shadow. Clean and odorless. Over 200 styles of lamps from 100 to 2,000 candlepower. Unequaled for homes, offices, stores, factories, churches, etc.

Write for Catalog.

Agents Wanted

The Best Light Co.
324 E. 5th St., Canton, O.



300 CANDLE POWER

An Ironing— Convenience

Every Housewife Needs



Whether you do your own ironing or have help to do it the **Simplex Ironer** will

save your time, clothes, labor and money. The professional laundress can double her earnings. No more ironing drudgery, no tired arms and feet, no lame back, no unbearable heat. Longer wear to your linens.

Every woman who has ironing to do does herself an injustice in getting along without a

SIMPLEX IRONER

"The Practical Household Machine"

Your table and bed linen, flat pieces, underwear, plain clothes—80% of your ironing—all beautifully done without effort on the Simplex. No chance of scorching. Takes up little room. Requires no expensive connections.

Costs 1 cent per hour to heat by gas or gasoline. Also furnished to heat by electricity. Reasonable in price. Write at once for FREE "Ironing Hints" Booklet, Catalog and 30-Day Free Trial Offer.

AMERICAN IRONING MACHINE CO.
506, 168 N. Michigan Blvd. Chicago, Ill.

CALIFORNIA PRODUCES THE WORLD'S BEANS—Although Boston has the reputation of being the most extensive bean-preparing city in the world, California is the largest bean producer. About 87 per cent

BUY PLUMBING SUPPLIES AT WHOLESALE



Don't pay retail prices. Full stock on hand for prompt shipment. Send for free catalog.
B. F. KAROL, 768 to 772 West Harrison St., Chicago

Will Save You 30%

CLASS-PINS

FACTORY TO YOU

For College, School, Society or Lodge

Descriptive catalog with attractive prices mailed free upon request. Either style of pins here illustrated with any three letters and figures, one or two colors of enamel. **STERLING SILVER, 25c each; \$2.50 dozen. SILVER PLATE, 10c each; \$1.00 dozen.**

BASTIAN BROS. CO., 23 Bastian Bldg., Rochester, N. Y.

AND BADGES



This Up-to-date Sanitary Bath Room

Anybody can install this outfit

Outfit, complete Standard Make, ONLY



\$35

30 gallon copper Boilers complete, \$11
Two-part set Tubs, warranted, \$6, etc.

All joints are threaded or slip.

Estimates free on any kind of new Plumbing Material. Crated and shipped to all parts on receipt of money order.

THE BARRY PLUMBING SUPPLY
326 Dorchester Ave. So. Boston, Mass.



I am the Man

Drafting.



Work for YOU as soon as you become my student

Yes, that's exactly what I mean. As soon as you become my student you can begin earning a handsome income while learning at home. Draftsmen are in demand everywhere. Salaries from \$150 to \$300 a month. I can train you how to become a first class draftsman at home during your spare time by mail.

EARN WHILE A STUDENT

Send the free coupon to me today and I will tell you just exactly how you can begin earning an income while you are learning drafting. I mean just what I say. This is a great extra special offer I am making. You should write at once. Absolutely no obligations of any kind in sending the coupon. But you must write at once. I cannot make this offer broadcast to everyone. So I will take the names in the order that they are received. Get yours in early.



FREE This \$15.00 Drawing Outfit

If you register at once. This is just the kind of an outfit I use myself. They are not toys, but actual working instruments. If you will register at once, I will give this outfit to you absolutely free. I have selected this outfit from the line of one of the largest manufacturers in the

country. Send the free coupon today for full particulars.

A Few Men Wanted

What I want is the right kind of men. Don't bother about the expense. I give each one of my students personal instruction. If your work is right, I tell you so. If it is wrong, I tell you just exactly where it is wrong. There is an urgent demand today for skilled Draftsmen. The big companies are issuing calls every day in the year for men to fill positions paying from \$125 to \$175 a month to start. Many positions paying \$75 to \$100 a week always open. Here is your opportunity.

I Guarantee

To instruct you until you are competent and placed in a position paying \$125 to \$175 a mo.

Send the Coupon for Big Free Book

Do not delay. Just put your name and address in the free coupon and mail it in at once. I will send you absolutely free and prepaid my new book "Successful Draftsmanship." The book is absolutely free and prepaid if you write at once. No obligations on you whatever in sending in the free coupon. But be sure to write today as the supply of books is limited. I will also tell you about my special offer so that you can earn a handsome income as soon as you become a student. Send the coupon.

FREE Earning Offer Coupon

**Chief Draftsman
Engineer's Equipment Co.
Division 1194
CHICAGO, ILL.**

Without any obligation on me whatsoever, please mail your book "Successful Draftsmanship" and full particulars of your liberal "Personal Instruction" offer to a few students. It is understood that I am obligated in no way whatever.

Address
**Chief Draftsman
Engineer's Equipment Co.
(Inc.)
Division 1194
CHICAGO
ILL.**

Name.....

Address.....



JAPA-LAG

RENEWS

EVERYTHING FROM CELLAR TO GARRET
For Sale in Paint, Hardware, Drug & Department Stores



QUALITY
IN EVERY DROP



CLEVELAND, TORONTO,
NEW YORK, CHICAGO, LONDON

Makers of Glidden's Green Label Varnishes, White Enamels, Endurance (Mission) Wood Stains, Waterproof Flat Wall Finishes & Cement Coatings

LET US GIVE YOU THIS TRANSPARENT CELLULOID TRIANGLE

It is 4 inch size, 30°+60° angles. Lowest retail price, 25 cents. Absolutely essential to everyone who draws. We make this offer to introduce our new catalogue showing

SPAULDING'S NEW CARRYING CASES AND COMPLETE OUTFITS

for designers, architects, engineers and students—compact, durable and convenient. Spaulding's Carrying Cases are made light and strong. They provide well arranged compartments, including space for drawing board and T square. Handled like a suit case; unique, practical, inexpensive. Outfits include all necessary equipment. If you draw, send us five 2-cent stamps to-day to pay postage and get the free triangle and the catalogue.

SPAULDING PRINT PAPER CO.
44 Federal St. BOSTON

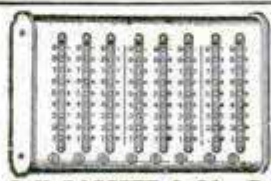

Add Quickly — Accurately Machines \$1.00 and \$3.50

They add quickly, easily, accurately. Durably made. Easily reset. Capacity 8 columns. NONE BETTER FOR THE PRICE. 17,000 sold. Delivery prepaid. Guaranteed as represented. Send \$1.00 for the \$1.00 Adder or if you want a BETTER MACHINE, send \$3.50 for our SELF INDICATING Adder. ORDER TODAY. AGENTS WANTED.

J. H. BASSETT & CO., Dept. I-B, 5921 Indiana Av., CHICAGO, ILL.



TYPEWRITERS ALL MAKES

\$100.00 Underwoods, Smiths, Oliviers, Remingtons, etc., from \$10.00 up. Every machine in perfect condition, guaranteed two years, with privilege to exchange at any time. Three hundred typewriters at \$15.00 each, while they last. Write for our rate prices, and Free Trial Offer

ALL-MAKES TYPEWRITER EXCHANGE, 164 N. Dearborn St., Chicago, Illinois



TYPEWRITERS ALL MAKES

All the Standard Machines SOLD or RENTED ANYWHERE at 1/4 to 1/2 MFR'S PRICES, allowing RENTAL TO APPLY ON PRICE. Shipped with privilege of examination. Write for Illustrated Catalog L.

TYPEWRITER EMPORIUM, 31-36 W. Lake St., CHICAGO

of the world's supply of beans, according to the Country Gentleman Magazine, are grown in this state. The five counties of San Diego, Orange, Los Angeles, Santa Barbara and Ventura raise the Lima bean. Southern California grows \$11,000,000 worth of beans annually on a strip of land that follows the ocean and does not extend farther inland than 16 miles.



Washburne's Pat. "O.K." Paper Fasteners, used exclusively by those who desire the best in Office, Bank, School, and Home. Made of Brass and nickel-plated Steel, three sizes; put up in Bright Metal boxes of 50 & 100 each. Your Stationer, 10, 15, 20 & 25¢. Send 10¢ for box of 50 assorted. Booklet free. YEARLY SALE NOW 100 MILLION.
THE O. K. MFG. CO., Syracuse, N. Y.



GOLDMAN'S Arithstyle
Handiest, Fastest, Cheapest, COMPUTING MACHINE
Adds, Subtracts, Multiplies, Divides.
Carries Automatically. Resets Instantly.
Easily moved over page, fixed to desk, carried in hand or pocket. 5 in. x 2 1/2 in. x 1 in. Weight, 36 oz.
Write for Booklet. Attractive Agents' Proposition.
ARITHSTYLE CO., Suite 104, 118 E. 28th St., N.Y.

3000 Typewriters \$10 and UP
All Standard Makes



Slightly used and Factory Rebuilt — good as new. Fully guaranteed, shipped to you for FREE TRIAL. Write today.
E. C. UNDERWOOD & CO.
P. M. 170 Randolph St. CHICAGO

TRY IT YOUR SELF FOR 10 DAYS WITHOUT DEPOSIT



If not satisfactory, return it and no questions asked. DAUS IMPROVED TIP TOP DUPLICATOR with "Dausco" Oiled Parchment Back negative roll is the result of 25 years' experience and is used and endorsed by thousands of business houses and individuals. 100 copies from pen-written and 50 copies from typewritten original — Clear, Clean, Perfect. Complete Duplicator, Cap size (prints 8 3/4x13 in.), price — \$5.00

FELIX A. L. DAUS DUPLICATOR CO., Daus Building, 111 John St., New York

BE YOUR OWN BOSS



Agents
Earn Big Money Selling Golden Rule genuine hand forged English razor Steel Knives, that will cut and hold the edge. We will put any photo or lodge emblem on one side of the transparent handle and name and address on the other. We have a complete, fully guaranteed line of knives, razors, strops and cutlery specialties. Quick sales. Big Profits. Exclusive territory. Experience unnecessary. We teach you how. Write today for Catalog and Terms.
Golden Rule Cutlery Co., 552 W. Lake St., Dept. 201, Chicago

The "E-Z" Self-Filler Pen - \$1.50

The Pen you need. Made right to write right. Lasts a life-time.



Patent Clip 14-Karat Gold Pen

(Remove Cap. Insert Pen in Ink-Well, press ball of clip in hole—Pen fills instantly)

A perfect Self-Filling Pen at moderate price—\$1.50 complete by Parcel Post

Agents Wanted. Small investment. Big profits. Write now. J. C. ULLRICH & CO., 27 Thames St., N. Y.

**Your Dealer
Asks \$14⁰⁰**

**Our Factory
Price
\$7⁵⁰**

Quarter-sawed oak
MASTER-BUILT Chair,
Marokene Leather
Cushion, height 37½ in.,
width 31 in., depth 21 in.



Brooks Chair
No. 11

**Write for Book of
MASTER-BUILT Furniture**

Mail a postal for beautifully illustrated 64-page Free book of MASTER-BUILT furniture showing chairs, rockers, settees, tables, desks, couches, dressers—all of quarter-sawed oak. Wide variety of designs, combining comfort with sturdy construction—a lifetime of service. Finished in color you choose. Shipped in complete sections—easily assembled in a few minutes.

—And the Factory Prices

save you over half the retail price. For the same investment you get just twice as much furniture. Money Back Guarantee on every piece. Mail post card for free book—NOW.

BROOKS MFG. CO.

2704 Sidney Street, SAGINAW, MICH.

OREGON DITCHES RUINED BY BEAVERS— Beavers, which are protected by law in Oregon, are becoming such an unbearable pest in destroying some of the irrigation ditches in the state that a law will be introduced at the next session of the legislature to

\$6⁵⁰ SUIT

MADE TO ORDER

**Linings and Trimmings
Guaranteed for Two Years**
Amazing low price for a suit made to your individual measure from your choice of cloth in latest fashionable style, guaranteed to fit you perfectly. We send big selection of cloth samples **Free and save you half.** Don't buy a suit or overcoat anywhere at any price until you see our samples and wonderful offer. Everything guaranteed.



The Capitol Tailors, Dept. 390, Chicago

EARN \$3 TO \$9 A DAY

**Mechanics, Millmen,
and Shopmen make
extra money during
spare time selling Photo Knives and Razors with Scientifically Tempered Blades. Sales easily made. Special agents instructions. Write today for Special Outfit offer.**
CANTON CUTLERY CO., Dept. 259, CANTON, O.



WHITE VALLEY GEMS IMPORTED from FRANCE
SEE THEM BEFORE PAYING!
These gems are chemical white sapphires—**LOOK like Diamonds.** Stand acid and fire diamond tests. So hard they easily scratch a file and **will cut glass.** Brilliance guaranteed 25 years. All mounted in **14K solid gold diamond mountings.** Will send you any style ring, pin or stud for examination—all charges prepaid—**no money in advance.** Write today for free illustrated booklet, special prices and ring measure.
WHITE VALLEY GEM CO., Dept. D-901 Saks Bldg., Indianapolis, Ind.

Camp Guide

**Sent
FREE!**



**Just your name
and address on
the Coupon below brings**

you the new 1913 edition of our famous Camp Guide, absolutely free. The most practical book on camp life ever written. Gives you practical information written by experienced men who have spent years in camps in every part of the country. **This camp guide tells you everything you need to know about camping—** it tells you how to camp successfully and enjoyably—gives you the information that you could not possibly secure otherwise except by actual and often disagreeable experience.

**Get Ready NOW for Your
VACATION!**

The time for planning is growing short. **Go camping.** You cannot find a more healthful or enjoyable way of using the time at your disposal.

But when you do go—go right! Send for our new Camp Guide and Catalog the first thing you do. You will find listed and described the largest line of Tents, Camper's Supplies, Sails and Canvas Specialties carried by any manufacturer in the United States. **We sell direct from our huge factories to you.** You are sure of getting the **very highest qualities** it is possible to obtain at **less** than you would have to pay at retail for decidedly inferior goods.

Look at these Wonderful

Values This 7x7 ft. Wall Tent, made of the



very best quality 8-oz. Single Filling Duck, cut and made with the most extreme care.

A simply astounding bargain at only \$5.90



Family Compartment Tent, 9x16½ ft. Made of the best selected quality of 10-oz. Double Filling Duck. May be divided into rooms for eating and sleeping to suit convenience. Insures

absolute privacy. The ideal tent for family or small party. **Specially priced at only \$26.25**

**Now Write for our FREE
Camp Guide and
Catalog—don't bother with a letter—just**

your name and address on the attached coupon will bring you this great book by return mail. Whether you intend going camping this year or not, you should be sure to get this free book at once. You should certainly get our lowest prices, our bed-rock factory prices, on the very finest line of canvas specialties and camper's goods that it is possible to produce.

**H.Channon Company,
Department 1194
Market and Ran
dolph Sts.,
Chicago,
Ill.**

**H.Channon Company,
Market and Randolph Sts.
Dept. 1194 Chicago**

Gentlemen.—Kindly forward me free, postpaid, your new 1913 Catalogue and Camp Guide

**Don't Bother
with a Letter**
Send the coupon
for this FREE
book today

Name
Address

No letter necessary; just send the coupon

Please Mention Popular Mechanics

ELGIN WATCHES ON CREDIT



Thin Model 12-Size 17-Jewel

This Month, we want to send you this fine **\$30.00 Elgin Watch**, a very thin model, 12-Size, 17-Jewel—the Classiest Gent's Watch made today and yet one that has long been the **Standard Watch of the World**, complete with Double Strata Gold Filled Case, **fully Guaranteed for Twenty-Five Years**, on



FREE TRIAL \$19.75 || \$2.50 A MONTH

P. S. HARRIS, Pres. Harris-Goar Co.

This is the watch that will appeal to you instantly—and if you yourself don't say it is the biggest Elgin Watch bargain you ever saw, send it back at our expense. If you wish to keep it the way is easy. Pay us only \$2.50 and the rest in similar amounts each month. **No interest—no security**—just common honesty among men. We want you to see for yourself that this fine 17-Jewel Elgin is better than other watches costing twice or three times as much. **Send for Our Big Free Catalog**

WRITE TODAY for particulars and we will send you our new **FREE WATCH AND DIAMOND BOOK**, also our book called "Facts vs Bunc" or all about the watch business both at home and abroad. Write today, **HARRIS-GOAR CO., Dept. 796, Kansas City, Mo.**



The House That Sells More Elgin Watches Than Any Other Firm in the World.

Learn to Play the Violin or Cornet



Flute, Clarinet, or some other instrument. You'll get enjoyment from it all your life and can make good money playing in Bands or Orchestras if you wish. We include with every instrument an **Instruction Book and Lessons** (by correspondence) free. Thousands have learned by this method. Our prices are very low on all musical instruments. We import our Violins direct from best European makers. **Our Special Complete Violin Outfits at \$10 are great value.** Others from \$2.50 to \$25 and up. Cornet Outfits, complete, \$9.25 up. **Band Instruments** of all kinds sent on **Six Days' Trial.** We sell for cash or monthly payments. **Satisfaction guaranteed.** Write for free catalog and mention what instrument you are interested in.

W. J. DYER & BRO. (Estab. 1870) Dept. 101, St. Paul, Minn.

allow them to be killed. Tygh Valley, one of the first districts in Oregon to be put under modern irrigation, is so infested with the animals that irrigation ditches have been diverted from their course in a night, others made absolutely useless, young and tender trees sawed off or peeled and eventually killed, and other crops ruthlessly ravaged.—Journal of Electricity, Power and Gas.



We Ship on Approval

without a cent deposit, prepay the freight and allow **10 DAYS FREE TRIAL** on every bicycle. **IT ONLY COSTS** one cent to learn our unheard of prices and marvelous offers on highest grade 1913 models.

FACTORY PRICES Do not buy a bicycle or a pair of tires from anyone at any price until you write for our new large Art Catalog and learn our wonderful proposition on the first sample bicycle going to your town.

RIDER AGENTS everywhere are making big money exhibiting and selling our bicycles. We sell cheaper than any other factory.

TIRES, Coaster-Brake rear wheels, lamps, repairs and sundries at half usual prices. Do Not Wait; write today for our latest special offer on "Ranger" bicycle.
MEAD CYCLE CO. Dept L 108 CHICAGO

ERICKSON LEG

Arms, Wheel Chairs, Crutches, Stockings. **SOLD ON EASY TERMS**
E. H. ERICKSON ARTIFICIAL LIMB CO., 17 Wash. Av. N., MINNEAPOLIS, MINN.



Does not chafe, overheat or draw end of stump. **SEND FOR CATALOG**
Largest Limb Factory in World.

AGENTS
SALESMAN
MANAGERS
YOUNG OR OLD
NEW BUSINESS



NEW BUSINESS JUST OUT

DROP THE DEAD ONES. AWAKE! START WITH THIS NEW INVENTION, THE 20th CENTURY WONDER
Get started in an honest, clean, reliable, permanent, money-making business. Sold on a money-back guarantee

The Blackstone Water Power Vacuum Massage Machine For the Home. No Cost to Operate. Lasts Life-Time
LISTEN No Competition, New Field, New Business. Price within reach of all. That's why it's easy to sell. Endorsed by Doctors and Masseurs. Removes Wrinkles, rounds out any part of the face or body, brings back Nature's beauty. Almost instant relief can be given all kinds of pains. A demonstration convinces the most skeptical person. Sales easily made.

Read On! What Others Do, So Can You.
Parker writes, sold eight machines first day. Margwarth, says, I am making \$19.00 per day. Schermerhorn, eight dozen machines first month. Shaffer writes, am selling four out of five demonstrations. Vaughn, orders one dozen, four days later wires "ship six dozen by first Express." Lewis, sells four first hour. Men, women, everybody makes money. No experience necessary. Protected territory to active workers. We own all patents. Big book entitled, "The Power and Love of Beauty and Health", Free. Investigate now, today. A postal will do. A big surprise awaits you. Address, **BLACKSTONE MFG. CO., 669 Meredith Bldg., TOLEDO, O.**

AGENTS
GENERAL AGENTS
ROAD MEN
MAKE MONEY HERE
Start Now—Today



If You are in the Market for a RARE Old VIOLIN

This Book Will be Sent You Without Cost

If you appreciate the time, money, travel, experience and work necessary to produce such a book; if you realize that we have bought and sold more precious violins than any other house in America, then we know this book will be treasured by you.

Within white and gold covers, in the highest form of the printer's and graver's art are faithful color-type plates of rare old violins we own. Many of them are world renowned masterpieces.

From Stradivarius and Guarnerius violins at \$10,000, down to genuine old violins at \$50 and \$100, we show and describe rare old instruments which have responded to the bows of masters of greater or lesser fame.

In this book you feel and breathe the atmosphere of the violin world and if you wish to buy a good old violin this book is for you.

It goes without saying when you buy a valuable violin it is most necessary that you deal with a responsible house whose word and guarantee will protect you.

To those who are soon to be in the market for a fine violin we extend this invitation to write us for a complimentary copy

LYON & HEALY, 23-36 E. Adams St., Chicago

The world's largest music house. Owners of the famous Hawley collection.

RARE OLD VIOLINS



LYON & HEALY - CHICAGO

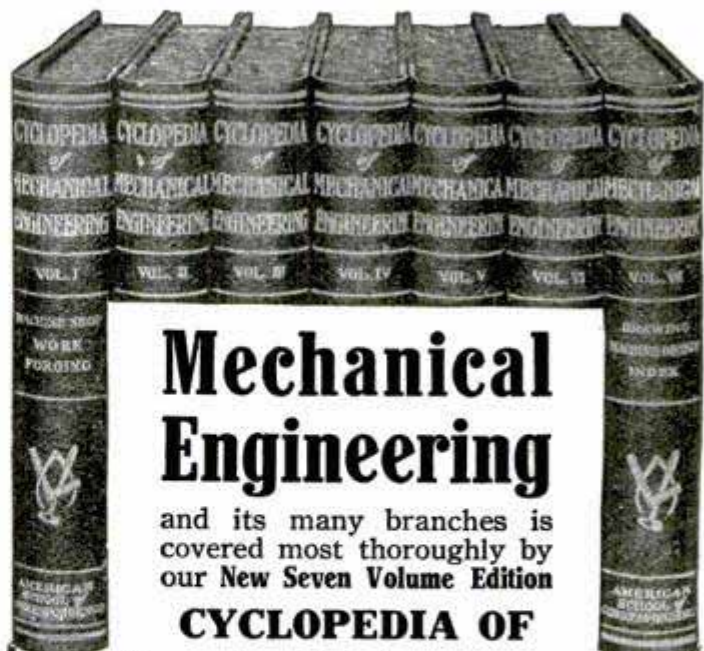

Mechanical Engineering

and its many branches is covered most thoroughly by our New Seven Volume Edition

CYCLOPEDIA OF

Mechanical Engineering Gas Engine Operation and Modern Shop Practice

In this wonderful work will be found instruction in Gas Engine Operation and Manufacture; Machine Shop Work; Assembling of Machinery; Tool Making and Shop Management in such simple and comprehensive form that the student cannot fail to benefit by it. Every detail of mechanical engineering is thoroughly analyzed and treated, rendering the books of unusual value to the experienced mechanic and shop manager, as you will note by reading "Subjects Thoroughly Covered."

The Cyclopaedia contains 3,092 pages and is supplemented with a series of practical test questions, including over 2,327 full-page plates, illustrations, tables, formulas and "shop kinks."

Subjects Thoroughly Covered

- Machine Shop Work — Vertical Milling Machine — Motor-Driven Shops — Shop Lighting — Forging — Electric Welding — Tool Making — Metallurgy — Manufacture of Iron and Steel — High-Speed Steel — Flaws in Castings — Electric Lifting Magnets — Magnetic Clutches — Making a Machinist — The Ideal Foreman — Pattern Making — Foundry Work — Automatic Coal and Ore Handling Appliances — Machine Parts — Construction of Boilers — Types of Boilers — Boiler Accessories — Steam Pumps — Air Compressors — The Steam Engine — The Steam Turbine — Indicators — Valve Gears — Refrigeration — Gas Producers — Gas Engines — Automobiles — Elevators — Sheet Metal Work — Practical Problems in Mensuration — Mechanical Drawing — Drafting Room Organization — Machine Design.

WE'LL PROVE THEIR VALUE TO YOU

by sending you the complete Cyclopaedia absolutely free for examination — just mail the coupon. Keep the books seven days — test every formula. You will agree that they are all we state, and more. Send \$2.00 after examination and \$2.00 a month until you have paid the special price of \$19.80. The regular list price is \$36.00. If the books do not meet with your requirements, advise us and we will remove them at our expense.

ANOTHER GREAT OFFER With each set is included a year's Consulting Membership, regular value \$12.00, entitling you to the free advice of a staff of Mechanical Engineers. This will give you practical help in handling working problems which are too specific to be taken up in detail in the Cyclopaedia. A single problem solved for you might be worth more than the first cost of the books.

FREE EXAMINATION COUPON

American School of Correspondence, Chicago, U. S. A.

Please send set Cyclopaedia of Mechanical Engineering for 7 days' free examination. I will send \$2.00 within 7 days and \$2.00 a month until I have paid \$19.80, or notify you and hold the books subject to your order. Title not to pass until fully paid. Pop. Mech. 4-13

NAME

ADDRESS

OCCUPATION

EMPLOYER

I WILL START YOU

earning \$4 daily at home in spare time, silvering mirrors; no capital; send for free instructive booklet, giving plans of operation.
G. F. REDMOND, Dept. 306-A, BOSTON, MASS.

GREAT HORSEPOWER OF GREEN RIVER—United States engineers claim that the Green River, a tributary of the Colorado, is capable of developing nearly a million horsepower if its waters were properly utilized.

\$18.85 for this \$28 Porcelain Enameled Roll Rimmed Sink

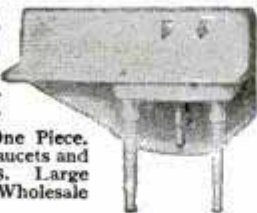

Long back and enameled drain board, All in One Piece. 20 in. wide, and 32 in. long. Price includes faucets and legs. WRITE FOR CIRCULARS AND PRICES. Large stock Plumbing and Heating Supplies at Wholesale to Consumer at Lowest Prices.

25 years at same address

JOHN HARDIN CO., 4545 Cottage Grove Ave., Chicago

This Morris Chair \$1 25

65c monthly — total price \$5.45. Latest design. Kiln dried heavy stock. Genuine Fabricord Leather. We have 3000 such bargains for you. And all **SOLD ON CREDIT**. You use and enjoy the goods now — pay as you can. 30 DAYS' GUARANTEED FREE TRIAL. Send at once for our big illustrated catalogue. It's FREE to you.
Spiegel, May, Stern Co.
1678 35th St., Chicago, Ill.

I will send as long as they last my 25 Cent Book STRONG ARMS

For 10c in stamps or coin

Illustrated with 20 full page halftone cuts, showing exercises that will quickly develop, beautify, and gain great strength in your shoulders, arms, and hands, without any apparatus.

PROF. ANTHONY BARKER
643 Barker Bldg., 110 W. 42d Street, New York



"Made \$28 in 1 Day

I Don't Know of Anything to Compete With the Minute Picture Business"

Price
\$7.50
Up



So says J. A. McMillian, of Nettie, W. Va., who has one of our Champion Cameras. If you want to make more money than you've ever made before—quicker and easier—this is the business for you. No matter where you live or what your occupation, you can coin money right from the start.

EXPERIENCE NOT NECESSARY

J. H. Arnold, Rock Lake, N.D., writes: "Received outfit O.K. Took it to a little town, set it up for 2 hours and took in \$12.35."

"Made \$25 yesterday," writes Arthur Neely, Alvarado, Tex. "First day did \$30 in business," says B. Basha, Bell Island, Newfoundland. "Made \$50 Christmas" — C. V. Lovett, Fort Meade, Fla. "Had an excellent business of \$29.90." — Vernard Baker, Holbrook, Neb.

Photo Post Cards All the Rage at Fairs, Picnics, Carnivals, Resorts, Schools, Factories, Depots, on Streets — anywhere, everywhere. Camera takes pictures size 2 1/4 x 3 1/4, 1 1/4 x 2 1/4 and one-inch buttons. Photograph persons singly or in groups, houses, animals, autos, beautiful scenes, etc. Make them on the spot, in broad daylight. No gallery, no rent, no profits to divide with others. The

Champion Minute Picture Machine takes, develops and finishes perfect pictures in 30 seconds: 200 an hour. **No Dark Room.** Nearly 85c profit on each \$1.00 you take in. Get into this lucrative business at once. Travel if you like—see the world and enjoy life. Quit working for others; be your own boss. An opportunity like this does not occur every day. Take advantage of it and write for Free Book, Testimonials, Liberal Offer, etc.

AMERICAN MINUTE PHOTO COMPANY

2214 Ogden Ave., Dept. E 317, CHICAGO, ILL.

Think Man— This Business for YOU

ANSWER this little ad—send no money—investigate this quick profit, easy, independent business. You can start at once. Own it permanently. Be your own boss.

\$50 Per Week
Making Photos on Post Cards

—Everybody's getting them. Most popular. Control your locality.



No Experience Necessary— Write at Once

Work only part or all your time. Many making more than \$50 a week. Why not you? Investigate this wonderful new business.

One Minute Camera

Press the Bulb



Makes big money Everywhere, No plates, films, printing or dark room.

Remember it costs you nothing to investigate. Address:

This camera delivers Photo Post Cards right on the spot. You make **500% Profit** every time you press the bulb.

Write a postal for complete proposition.

The One Minute Camera Co.
Dept. 44, Rand-McNally Bldg. Chicago

INVISIBLE SUSPENDER BELT

Fits instantly inside waist band, entirely out of sight. Does away with unsightly suspenders and uncomfortable belts. Keeps trousers up neatly, securely. Keeps shirt down, preventing "bagging." Wonderful for fat men or thin men. A Necessity for all men—mechanics, farmers, office men, professional men.

Ask your dealer. If he can't supply you, we will. **TRAVELING MEN**—The Ko-Ko-Mo Suspender Belt is a real side line.

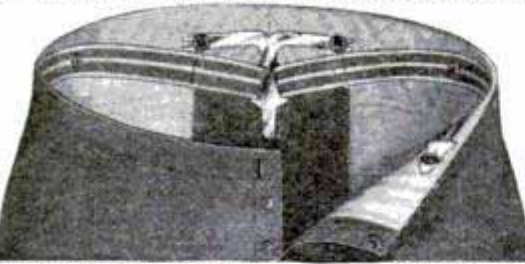

Write "quick" for terms and territory. Send

50c

and your waist measurement for sample belt—or \$1 for silk belt—and full details. Money returned if you are not entirely satisfied.

KO-KO-MO BELT CO. KOKOMO, INDIANA

\$29.50 In Two Days



is what Mr. Ewald of Illinois made with our **DIAMOND POST CARD GUN** You can do as well. It takes 3 sizes Photo Post Cards on Paper DIRECT

WITHOUT PLATES OR FILMS

Also Button Photos finished on the SPOT in 1/2 minute. No canvassing. Experience unnecessary. 8c profit on every dime. **\$7.50 up.** Circulars of this new invention mailed FREE.

THE INTERNATIONAL METAL & FERROTYPE CO., Dept. 401, Chicago, Ill.

SIGHT-IMPROVING DEVICE FOR LOCOMOTIVE CABS—An apparatus for keeping the front window of a locomotive cab clear in order that the engineer may obtain an uninterrupted view of track and signals ahead under every possible condition of weather, regardless of the speed of the train, has been invented. It is called the motorscope and is made of thin sheet metal in the form of deflecting plates that force the air outward, thus keeping the glass clear at all times.

Daylight Pictures at Home

Do you show Moving Pictures, Post Card, or Lantern Slides? A Mirroirde curtain will give you a picture 200% brighter and clearer. Mirroirde is used in over 3000 Theaters, Churches, and Institutions, the world over. Endorsed the peer of all. It's canvas coated with a pure mercury-foil glass amalgam silver white. It won't crack, peel, or tarnish. Handsomely mounted in a self contained metallic case. Samples for a five cent stamp. Mirroirde patents pending.

THE J. H. GENTER COMPANY, NEWBURGH, N. Y.

GO INTO THE Moving Picture Business

From \$50 to \$75 starts you and you will earn as much in 1 or 2 nights



\$25 And more per night can be made exhibiting with our machine in halls, schools, churches, theaters, etc., in your own and surrounding towns. We furnish everything—rent films, too. Only a small payment required to get this new and unexcelled machine. Balance may be paid in easy installments. Write for particulars

P. & W. Sales Company
443 So. Dearborn St., Chicago, Ill.

Only \$36.00 The Wonderful ILLUSTRATOR LANTERN

With our improved famous ALCO RADIANT LIGHT.

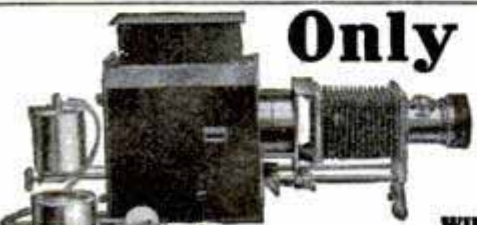

This new 1912 Model has many improvements and double brilliancy. Write for illustrated circular of this and Lanterns of all styles and lights at bottom prices. **IF YOU OWN A LANTERN** we should have your name to mail to you our regular announcements of new slides and lecture sets. 75,000 Lantern Slides to rent. **POST CARD MAGIC LANTERN** reflects image of postcard or any other picture or object. Prices, \$2.75, \$12.50, \$25.00, \$60.00, express paid.

WILLIAMS, BROWN & EARLE, Inc., 918 Chestnut St., Philadelphia, Pa., Lantern Dept. 20
Engineering, Microscope, Optical, Scientific, Photo Lantern Slide Supplies

GENUINE Perfect Cut DIAMONDS BASCH \$97.50 PER CARAT
 Guaranteed

No. 19A13
\$48.75
1/2 Carat Solitaire

No. 19A14
\$12.00
1/4 Carat Solitaire

No. 19A15
\$11.25
1/4 Carat Solitaire

No. 19A16
\$38.00
Two 1/4 Carat Dia.

No. 19A17
\$33.50
1/4 Carat Solitaire

No. 19A18
\$61.25
3/4 Carat Solitaire

No. 19A19
\$50.50
1/2 Carat Solitaire

No. 19A20
\$71.50
1/2 Carat Solitaire

No. 19A21
\$103.50
1 Carat Solitaire

No. 19A13
\$48.75
1/2 Carat Solitaire

No. 19A14
\$12.00
1/4 Carat Solitaire

No. 19A15
\$11.25
1/4 Carat Solitaire

How We Can Make This World's Lowest Price

We reach every community in this vast nation while the retail jewelers are dividing the business of a single neighborhood. We have the *money-power* plus the *Sales-volume* to buy in \$100,000.00 lots for cash right from the Amsterdam Diamond Cutters; whereas the retailer must buy on credit in small lots from a MIDDLEMAN. We have NO LOSSES because of our CASH METHODS. Our mail-expenses are just 1/5 the cost to run a store. Combine these advantages—and you will quickly see why we can save you \$50.00 per carat (35%) below the prevailing retail prices; why jewelers buy from us when able to pay cash to save 10% under their wholesale cost.

It Is Easy for You to See Our Diamonds

We send any diamond and mounting for your inspection direct to your nearest express office or bank. Send no money, whatever. No obligation to purchase. Every diamond guaranteed genuine, perfect cut and proportioned, pure and brilliant.

The Basch Money Back Guarantee Protects You

against disappointment or loss! It is a written contract to buy back any diamond and pay you the full purchase price less 10%, in cash any time within two years, making it possible for you to cash-in your investment at a moment's notice. Full purchase price always allowed in exchange. Carat weight, quality and value of ever diamond legally guaranteed.

The De Luxe 104 Page BASCH DIAMOND BOOK, FREE to YOU

6 color art cover, thousands of illustrations of latest styles in Diamond, Platinum, Gold and Silver Jewelry, Watches, Silverware, etc. This authoritative Diamond Guide tells you how to buy a diamond safely, intelligently and at the world's lowest price. **WRITE TODAY.**

Address,
L. BASCH & CO. Dept. A247 S. State St. Chicago, Ill.

All mountings 14K Solid Gold Illustrations exact size.



Prices are for Diamond and Mounting complete. Any article shipped on approval

LONG LIFE OF MOTOR CARS—A London department store has in operation 22 motor vehicles which have traversed a total of 1,110,000 miles. This is at the rate of 50,000 miles for each vehicle, and one of them has averaged almost 12,000 miles per year during the past eight years and is apparently in as good condition as when it was first purchased.

\$50 Per Week and Up



AGENTS CAN YOU BEAT THIS?
 "Worked 2 Days—Sold 70 Stoppers—My Profit \$70."
Statement of R. F. Whitfield, Miss.

There are all kinds of stoppers, but only one **Angle-Strop**. Automatically stoppers and hones old-style or safety blades. Gives "Heel-and-toe" stroke as barbers do by hand. A red-hot seller—see Whitfield's statement. Dandy territory open. Special proposition for hustlers. **Don't Wait—Write Quick—Now!**

100% Profit.

THE VICTOR SPECIALTY CO., 239 Cook St., Canton, Ohio

Man-Smoke This



It's puff after puff of indescribable smoking delight when you light a pipeful of French's Mixture. Words cannot do justice to the fragrance, richness and smoothness of this charming blend of North Carolina Red and Golden Leaf. Examine it under a microscope and you will find it to be the cleanest and purest. Smoke a pipeful and you will tell your friends that French's Mixture is the most satisfying and economical tobacco you ever touched a match to.

Scotch Calabash Pipe Free

Don't pay your good money for stale tobacco from the dealer's shelves. Get that pleasing, mellow French's Mixture that comes fresh and sweet to you direct from the factory. If you want to get more pleasure out of smoking than you ever before got, just send 40c for 1-4 pound of French's Mixture (granulated) or 45c for 1-4 lb. of French's Long Cut. Send now and we will include—FREE—a Scotch Clay Calabash Pipe.

Sample Pouch Send 10c (silver or stamps) for a large sample pouch of this delicious age-ripened tobacco.

FRENCH TOBACCO CO., Dept. 5248, Statesville, N.C.

NO MORE BALD HEADS



When our VACUUM CAP is used a few minutes daily. We accept no pay until you have tried the Cap 60 days and are satisfied. The Vacuum Cap is an appliance that draws the blood to the Hair Roots and starts a new healthy crop of hair. It stops Dandruff, stops the hair from falling out. Bought by Doctors and men who know that it is the only reasonable HAIR GROWER known to science. No Drugs Used. Write for application blank, testimonials, and booklet on "HAIR," sent sealed in plain envelope, FREE.

THE MODERN VACUUM CAP CO.
 S. 559 BARCLAY, DENVER, COLO.

\$513 Clear Profit First 51 Days from an Investment of \$175



is the result of operating one American Box Ball Alley. Four others took in \$8,540 first 16 months. Many pay for themselves first month. Go into this business yourself. You can start with \$75. No gambling device, but most practical and popular bowling game in existence. Splendid for high-class amusement and physical exercise. Liberal patronage by good people everywhere. Many sales to churches, schools, homes. Quickly installed—easily portable. No helpers required—really automatic—small expense—receipts nearly all profit. We sell only one person in each locality. Get this monopoly now. Easy payments. Catalog free.

AMERICAN BOX BALL COMPANY, 1301 Van Buren St., Indianapolis, Ind.

Pay As You Are Able

Your Credit Is Good

FREE
1913
LATEST
SPRING STYLES
ENCYCLOPAEDIA
AND SAMPLES



No
Agents
—No
Can-
vass-
ing

**WRITE US
TO-DAY**

Caution: NO AGENTS, NO CANVASSING, NO COLLECTORS

Send your name first—send no money. Get our latest **Big Encyclopedia** of hundreds of latest **Fashions** and **Free Samples** of men's 1913 Spring Suits and Overcoats mailed at our expense.

Dress Like The Best
Guaranteed Perfect Fit
Absolute Satisfaction Guaranteed, or no charge. You'll save big money too. Prices lower than cash tailors and *your credit is good* with us for all you want.

MADE-TO-ORDER Your Own Measure
No extra charges. No interest. No security asked. Save big money and compare our goods and styles with all others. You'll be perfectly astonished at our splendid values.

Take Six Months To Pay Us

You take no risk. Your own eyes judge our values. Select your cloth from our sample book and then let us make your suit to your measure. We guarantee safe delivery and perfect fit, and all is

Sent On Approval
Don't Delay. You can now dress just as you like—have all the latest, swellest clothes—surprise your friends with something in new styles—have bigger selection than any city and town tailors could show you. The magnificent style book is sent free. Write a **Postal Now**, while you think of it, and get our style book.

Stanley - Rogers Co.,
526-536 S. Clark Street,
CHICAGO, ILL.

The World's Foremost Credit Tailors
for Men

TOBACCO-BAN GUARANTEED EASY TO TAKE.
Relieves all craving for tobacco in 70 to 120 hours. Write today.
BANNER REMEDY CO., Dept. G, 33 W. 9th St., Kansas City, Mo.

To Entertain 311 Jokes and Riddles, 73 Toasts, 91 Parlor Amusements, 21 Puzzles, 15 Tricks with Cards, 7 Comic Recitations, 3 Monologues, 12 Funny Readings, 8 Fortune Secrets, 52 Money Making Secrets. All 10c postpaid.
J. C. DORN, 709 S. Dearborn St., Dept. 17, CHICAGO, ILL.

Boys' Own Toy Maker
Tells how to make a Talking Machine, Camera, Electrical Motor, Bicycle Boat, Canoe, Boomerang, Bobsled, Wind Mill, Microscope, Water Wheel and Motor, Stilt, Toboggan, Snow Coaster and Sail Boat, Telephone, Electric Bell, Railroad, Wind Mobile, Paddle Raft, Traps, Kites, etc. All 10c, postpaid.
J. C. DORN, 707 So. Dearborn St., Dept. 38, CHICAGO, ILL.

Write for FREE ILLUSTRATED CATALOGUE
showing the largest line and latest inventions in gasoline lighting: Generator instantly interchangeable, lamps guaranteed to excel any other in power, economy and service. Exclusive territory to responsible, energetic salesmen
Doud Lighting Co., 174 N. Sangamon St., CHICAGO, ILL., U. S. A.

Rémoh Gems

Look and Wear Like Diamonds



A Marvelous Synthetic Gem Not Imitation

—the greatest triumph of the electric furnace. Will cut glass—stands filing, fire and acid tests like a diamond—guaranteed to contain no glass. Rémoh Gems have no paste, foil or backing—their brilliancy is guaranteed forever. One-thirtieth the cost of a diamond. These remarkable gems are set only in 14 Karat Solid Gold Mountings.

Sent On Approval Anywhere In U. S.
—your money cheerfully refunded if not perfectly satisfactory. Write for our 4-color De Luxe Jewel Book—yours for the asking. Address

Rémoh Jewelry Co.,
622 Washington Ave., St. Louis



PERSONALLY-OWNED STREET CARS—Each resident of Mombasa, a seaport town of East Africa, owns his own street car, just as elsewhere a man owns his own carriage. The small tracks of the unique street-car system cover the entire town and the cars are pushed from behind by the natives with poles.

GET ON THE VAUDEVILLE STAGE
I tell you how! Fascinating profession for either sex. Big salaries. Experience unnecessary. Splendid engagements always waiting. Opportunity for travel. Theatrical agents and authorities endorse my methods. Thirty years' experience as manager and performer. Illustrated book "All About Vaudeville" absolutely FREE. Send me your name and address TODAY.
FREDERIC LA DELLE, Sta. P., JACKSON, MICH.

WURLITZER FREE CATALOG
SUPPLIES THE U.S. GOV'T.
BAND INSTRUMENTS
282 Pages. 788 Illustrations. 67 Color Plates. 2561 Articles Described. Every Musical Instrument. Free Trial. Superb Quality. Lowest Prices. Easy Payments. Mention instrument you are interested in.
THE RUDOLPH WURLITZER CO.
308 S. Wabash Ave., Chicago. 101 E. 4th Ave., Cincinnati.

Let Us Send You The New Edison Phonograph On FREE TRIAL

We will send the New Edison right to your home for a free trial. Your choice of outfits. \$2.00 a month now pays for a genuine Edison Phonograph at lowest Rock-Bottom prices and without even interest on monthly payments. Send today for our beautiful Free Edison catalog. Just write on a postal, "Please send me your Free Edison Catalog." Then sign your name and address. Do this today.
Babson Bros., Edison Phonograph Distr.
1194 Edison Block Chicago, Ill.



Save
\$25 to \$75

on First Cost—
Then

MORE HEAT
WITH LESS FUEL

Are you willing to pay \$25 to \$75 more for a furnace not nearly as good as the Kalamazoo? Certainly not, especially when the Kalamazoo gives greater heat and cuts down fuel bills. Furnace and complete fittings shipped direct at factory price.

30 Days' Free Trial—Cash or Credit

You don't keep the Kalamazoo unless it *proves* in service that it can heat your house perfectly at minimum expense. Convenient payments. We pay freight charges.

Furnace Book Free

Gives you facts that will save you money in buying, installing and operating your furnace. We're glad to mail it free—write a request on a postal,—ask for catalog No. 936.

KALAMAZOO STOVE CO.

Mfrs., Kalamazoo, Mich.

We have two other catalogs, one describing Heating and Cooking Stoves, the other describing Gas Ranges. Which one do you wish? Trade Mark Registered.

A Kalamazoo And Gas Stoves Too
Direct to You



Ready-Made Bungalows

We can sell you a beautiful one, two, three, four, five or six room bungalow or cottage, **already built**. Shipped to you in sections, finished and complete. You can put it up yourself in a few hours time. **Only a wrench and screwdriver needed**. No sawing, no nailing, no carpenter work whatsoever. Can be taken down, moved and put up again in a day's time. Every part made to fit to perfection. **Absolutely windproof, waterproof and stormproof.**

\$195⁰⁰ and Up

For permanent and portable summer and winter homes, artistic cottages, garages, school houses, churches, stores and hunters' cabins.

Warm in winter, cool in summer. Made of best lumber. Everything finished and complete. All doors and windows hung. All necessary hardware furnished and already set.

Free Design Book Write today for our beautiful Ready Made Building Book, showing artistic designs in ready made bungalows, cottages and garages, illustrating each one finished and erected and giving the full details of all our great bargains. Write for this Free Book NOW. Address

ST. JOHNS BUILDING CO.

1266 Peoples Gas Bldg., Dept. 1194 Chicago, Ill.

PANAMA CANAL'S INFLUENCE WORLD-WIDE
—The impulse of the Panama Canal in the world's commercial progress is already felt on a large scale, for the world's great ports are to spend \$1,000,000,000 in the next five years for harbor improvements to handle the increase in deep-sea commerce due to the canal. This movement is world-wide, extending even to far Yokohama on the other side of the globe, which port will expand its harbor limits. Montreal, Toronto, Halifax,

SEDGWICK'S BEST HOUSE PLANS
BEAUTIFUL HOMES

200 costing \$1500 to \$8000, Price \$1.00
SEDGWICK'S BUNGALOWS AND COTTAGES
50 New Designs, \$1000 to \$4000, Price 50c.
For \$1.25 I will send you BOTH Books.

For BEST RESULTS, consult a man of experience and reputation for GOOD WORK.

CHAS. S. SEDGWICK, Architect
1135 M Lumber Exchange, Minneapolis, Minn.
Send 25 cts. for Church Portfolio



KEITH'S 20 WONDER HOUSES



A New Book of 20 Plans showing photo views as actually built and large floor plans for 20 selected types of Keith's best ideas in Bungalows, Cottages and Houses, costing \$2,000 up. They are Wonder Houses for practical, inexpensive homes. Send silver or stamps.

10c

M. L. KEITH, 428 McKnight Bldg., Minneapolis, Minn.

YALE INDEPENDENT GAS PLANT
GASOLINE BURNING SYSTEMS FOR EVERY NEED

Because the Yale Hydro Carbon Gas System of lighting is known from coast to coast. It has withstood the test of time. Thousands are in daily use. It is a LIVE WIRE proposition, one of permanency. Our line is complete for the home, store, church, hall, etc., 1000 candle power light 1/2c per hour, 1/5 cost of ELECTRICITY OR GAS, sold on a money back guarantee, no experience or mechanical knowledge required. Be independent, build up a business for yourself. We will help you. Write today for catalog and proposition.

P. M. YALE MFG. CO., CHICAGO, ILL.

Agents Wanted Everywhere
WHY YOU SHOULD SELL THE YALE LINE

THIS BUNGALOW \$900 CAN BE BUILT FOR

This and many others in my new book, Building Plans for Modern Homes, will save you hundreds of dollars. One of the most complete and comprehensive books of plans ever published by any architect. Fifth edition just off the press. One hundred and fifty floor plans and photographs of bungalows, etc., costing from \$250 up; gives sizes and cost to build. Sent postpaid for \$1.



FREDERICK H. GOWING ARCHITECT
18 Tremont St. BOSTON

A BOOK OF PLANS FOR YOU FREE

Your easy chance to get a beautiful and instructive book of house plans entirely FREE. Just send us the names and addresses of all the carpenters and builders in your town. That's all you have to do. Really no work to it. Simply mail in your list and get your plan book easy and FREE. Remember—a 125 page plan book for your list of carpenters' and builders' names.

RADFORD ARCHITECTURAL CO., Medinah Bldg., Chicago, Ill.



Gold Medal Camp Bed No. 1
Our new catalog is now ready

We manufacture the genuine Gold Medal camp furniture and outfits. There are cheap imitations on the market. Our catalog is free to all. We sell through jobbers and dealers.

GOLD MEDAL CAMP FURNITURE MFG. CO.
Racine, Wis., U. S. A.

UNCLE SAM WANTS YOU



Parcel Post

Positions Open

Thousands of Railway Mail Clerks to be Appointed

Examinations Everywhere May 3rd

Rapid advancement to higher Government Positions. No "Layoffs" because of STRIKES, FINANCIAL FLURRIES or THE WHIMS OF SOME PETTY BOSS. THE POSITION IS YOURS FOR LIFE. Country residents and city residents stand the same chance for immediate appointment. Common sense education sufficient. Political influence NOT REQUIRED.

We are Preparing Candidates Absolutely Free of Charge

Write immediately for schedule showing the places of the May 3rd examinations. Don't delay. Every day you lose means the loss of just so much coaching before the rapidly approaching examinations.

FREE COACHING COUPON

FRANKLIN INSTITUTE, Dept. N 182, Rochester, N. Y.

The coupon, properly filled out, entitles the sender to free sample questions; a free copy of our valuable book, "GOVERNMENT POSITIONS AND HOW TO OBTAIN THEM," and to consideration for FREE COACHING for the Civil Service Examination here checked.

... Railway Mail Clerk	(\$800 to \$1800)	... Customs Positions	(\$600 to \$1500)
... Postoffice Clerk	(\$600 to \$1200)	... Internal Revenue	(\$700 to \$1800)
... Postoffice Carrier	(\$500 to \$1200)	... Stenographer	(\$800 to \$1500)
... Rural Mail Carrier	(\$600 to \$1100)	... Clerk in the Departments at Washington	(\$800 to \$1500)

Name

Address

Use this before you lose it.



The Truth About Mushrooms

Big, Quick Profits. Small Capital. Now Is Best Time.

Biggest, quickest, surest and easiest money-maker is growing mushrooms. Bigger money is being made in mushrooms now than ever before, by those who are today putting in practice the great revolutionary improvement in mushroom culture explained in our new book, "The Truth About Mushrooms." Open your eyes to an opportunity you never realized. No matter what your occupation or location, you can now

Add \$10 to \$70 a Week to Your Income

without interference with present work. Small capital to start. Men and women can easily do it. Now is time to start. This great book explains everything from A to Z, and things which even many mushroom growers never knew before. Get first-hand information from the greatest practical authority. Start in the world's best-paying business now. Grow in cellars, sheds, boxes, etc., or increase your profits many fold if you are already a grower. Send for the free book today sure.

Bureau of Mushroom Industry, Dept. 10, 1342 N. Clark St., Chicago, Ill.

ILLINOIS

Best WATCH on Earth NOW SOLD ON CREDIT

For the first time in history the great, genuine ILLINOIS Watch is now sold exclusively by us by mail on credit. This is the greatest public triumph of the age—it will revolutionize the Watch business. For over 40 years the ILLINOIS Watch has been acknowledged the standard Watch worn by America's great men and women. No man or woman should now be without a famous ILLINOIS.

Take Your Own Time To Pay

Iron-Clad Guarantee
Part for part—in accuracy, wear, finish, beauty, material and workmanship, the ILLINOIS is superior to any other Watch at any price. Both the makers and we stand back of this Watch with a guarantee that absolutely protects you. We are one of the largest Watch Distributors in the world. For over 35 years we have sold all kinds of Watches, and honestly tell you that the ILLINOIS is the best at any price.

NO MONEY DOWN
The famous ILLINOIS costs you less than inferior makes. Nowhere else can you buy exclusively a genuine ILLINOIS on credit. No dealer can undersell us even for cash. Sent on approval—you take no risk—pay as you please.

HANDSOME BOOK FREE
Our FREE, beautiful, profit-sharing book, describing the ILLINOIS Watch, easy credit terms, and reproducing many handsome styles, awaits you. Send name and address today.

FREDDRO WATCH CO., Dept. 300, St. Louis, Mo.

SENT FREE—NO PAYMENT DOWN

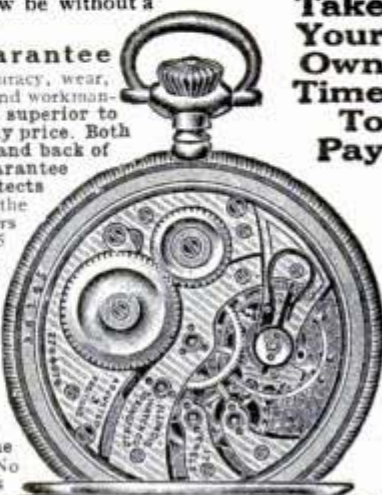

Valparaiso, Buenos Aires, London, Hamburg, Havre, Boulogne, Calais, Yokohama, Seattle, New York, Boston, Los Angeles, Charleston, New Orleans, San Francisco, Port Arthur and Mobile are some of the progressive world ports.

In this concerted movement New York leads with a project providing \$85,000,000. London, the world's greatest port, proposes to spend on the Thames \$70,000,000. Brazil will give to five ports, \$125,000,000. Halifax will use \$30,000,000; Buenos Aires, \$27,000,000; Havre, \$20,000,000; Seattle, \$20,000,000; Toronto, \$18,000,000.

Leaky Rubber Goods

Can be mended in a few minutes by you. No experience necessary. We guarantee to mend any leaks in all goods made of rubber, or refund your money. Send 15 cents for sample containing 2 rubber patches worth 50 cents and instructions how to mend your rubber goods. Try a sample and if they don't prove satisfactory we will gladly refund your money.

SOLD ONLY BY
CROWN RUBBER PATCH CO.
Room 108, Patterson Bldg. DAYTON, OHIO

You Can Afford These Fashionable Jewels

\$6.90 Buys Men's Solid Gold Tooth Ring, ¾ ct. Lapid Gem.

\$5.90 Buys Ladies' Solid Gold Ring, ¾ ct. Lapid Gem.

\$4.90 Buys Solid Gold Stud, ½ ct. Lapid.

\$3.90 Buys 3-Jewel Tie Pin.

All Lapid Jewels Insured by Jewel Policy Against Loss of Stone, Brilliance or Damage. Free Inspection by Express C. O. D.

LAPIDS

REAL Jewels

Red White Blue
Ruby—Diamond—Sapphire

Greatest Production of the Gem Chemists' Art

Lapid Jewels are true reproductions of natural stones—so perfect they cannot be distinguished by color, weight or brilliancy. The richness and sparkling beauty denote great care in creation and precision in cut and polish. All are set in Fine Solid Gold Mountings. Articles illustrated are a Special Value and will be sent C. O. D. for free examination, or Parcel Post prepaid on receipt of price. Special terms to agents, I reset jewelry and heirlooms with Lapid. Jewel Insurance Policy with each purchase. Write for catalog showing many new styles. Albert W. Engel (Gem Expert Since 1879) AB 4700 Dover St., Chicago



Pm, with red, white & blue Lapid, \$3.90

Set Six Screws— Save Furniture Dollars!

It takes six minutes to drive these six screws, and the saving is \$13.25. Now if your time is worth more than \$2.21 a minute, don't read any further.

This advertisement is for those who want high-grade furniture at rock-bottom prices and approve a selling plan that actually saves big money.

**Over 30,000
American Homes**

buy Come-Pack Furniture for these substantial reasons. Here is an example of Come-Pack economy.

This handsome table is Quarter-Sawn White Oak, with rich, deep, natural markings; honestly made; beautifully finished to your order. Height, 30 inches; top, 44x28 inches; legs, 2½ inches square. Two drawers; choice of Old Brass or Wood Knobs. It comes to you in four sections, packed in a compact crate, shipped at knock-down rates.

Our price, \$11.75. With a screw-driver and six minutes you have a table that would ordinarily sell for \$25!

Free Catalog Shows 400 Pieces

for living, dining or bedroom. Color plates show the exquisite finish and upholstery. Factory prices. Write for it today and we will send it to you by return mail. (11)

Come-Pack Furniture Co., 401 Fernwood Ave., Toledo, O.

000,000, and Montreal, \$17,000,000.

These improvements, which consist in extension of harbors and building large docks, imply that bigger and better ships will be had.

The whole of Dewey's fleet at Manila did not cost as much as one of those modern \$15,000,000 battleships which Congress has authorized at this session. The total cost of the vessels under his command amounted to not over \$13,000,000. Naval warfare does not grow less expensive.

Parcel-Post Does It SAVE \$1.50 ON PANTS

Send \$3.50 with waist and inside leg measure, stating color and width of stripe preferred. Guaranteed \$5.00 value. Money back if wanted. PEERLESS TAILORS, Pine Street, Chambersburg, Pa.

You Want This Card

Because it will represent you better, or do more for you than any other card, in getting some desired interview. The famous

Peerless Patent Book Form Card

is the exclusive choice of the man of distinction everywhere. It is one of the evidences of his distinction. You cannot appreciate or understand the uniqueness of this card without a visual examination of it. The fact that you are not now using it, if you are not, is accounted for solely by the further fact that you have not examined it. Examine it forthwith. Send for a sample tab today and detach the cards one by one and note their perfectly smooth edges—their absolute perfection. It is the card you want.

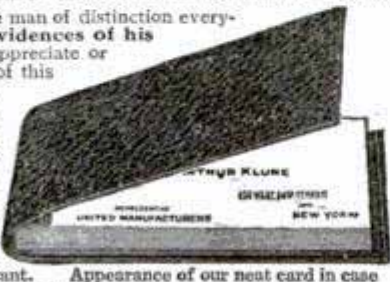

Appearance of our neat card in case
THE JOHN B. WIGGINS COMPANY Engravers, Plate Printers, Die Embossers
62-64 East Adams Street, CHICAGO

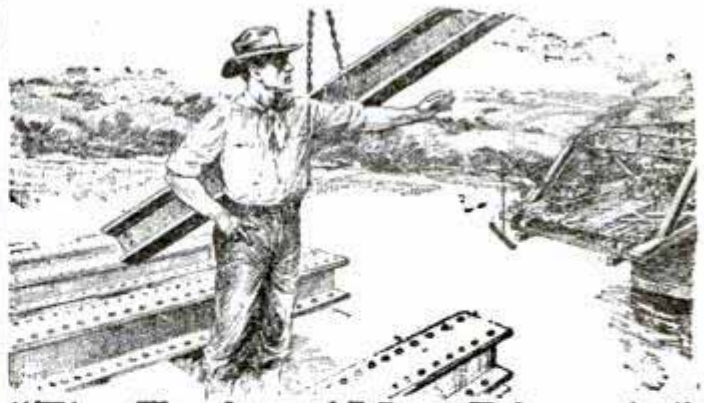

"The Trained Man Directs"

In every line of work there are two classes of men—the "LEADERS" and the "FOLLOWERS." The man who "leads," who "directs" the work is no better fundamentally than his fellow-workmen who call him "boss"—but his "SPECIAL TRAINING" gives him this leadership. Decide NOW to become "specially trained"—to be the man who "directs." You can have at your command the expert advice of a corps of Civil Engineers—the absolute answer to every question which confronts you in your work, if you own

The Complete Encyclopedia of Civil Engineering

This great cyclopedia is NOT a collection of theories, but the actual, tried and tested experience of the greatest engineers the world has known. It contains more up-to-date, accurate, money-saving information on all branches of Civil Engineering than you can find in any other set of books. It is written in a clear, concise and comprehensive manner—printed on good book paper—new type. Easily read and understood. These volumes are handsomely bound in half-Morocco—3900 pages—over 3000 illustrations, folding maps, diagrams, etc.

Besides the strictly technical knowledge, you will receive valuable information on the handling of men and general training in "leadership."

- Some of the Important Subjects Covered**
- Plane Surveying—Mechanical Drawing—Plotting and Topography—Railroad Engineering—Statics—Strength of Materials—Roof Trusses—Mill Building Construction—Cost Analysis in Relation to Engineering—Masonry and Reinforced Concrete—Steel Construction—Practical Problems in Construction—Bridge Engineering—Highway Construction—Hydraulics—Water Supply—Irrigation Engineering—Water Power Development—Sewers and Drains—House Drainage and Sanitation—River and Harbor Improvement.

Examine These Books Free of Charge— Just Mail the Coupon

We want you to see this magnificent set of books—we want you to examine them at your leisure. If you sign and mail the coupon today, the complete eight volumes, not a sample volume, will be sent, express prepaid, for seven days' free examination; returnable at our expense if they do not contain the information you want. If you do decide to keep them, pay \$2.00 seven days after receipt and then \$2.00 a month until you have paid the special introductory price of \$24.80.

\$12.00 Consulting Membership Free

With every set is included a year's Consulting Membership, regular value \$12.00 entitling you to the free advice of a staff of Civil Engineering Experts. This will give you practical help in handling working problems which are too specific to be taken up in detail, in the Cyclopedia. There will be no limit to this service. A single problem solved for you might be worth more than the first cost of the books.

American School of Correspondence Chicago, U. S. A.

FREE OFFER COUPON

American School of Correspondence, Chicago, U. S. A.

Please send Cyclopedia of Civil Engineering for 7 days' FREE examination. I will send \$2 within 7 days and \$2 a month until I have paid \$24.80, otherwise I will notify you and hold the books subject to your order. Title not to pass until fully paid.

Pop. Mech. 4-13

NAME.....
ADDRESS.....
EMPLOYER.....
OCCUPATION.....

GOOD LUCK in Every WATERLOO BOY MACHINE

**FOUR
LEAF
CLOVER
LUCK**



ECONOMICAL



DEPENDABLE



DURABLE



LOW COST



**OUR BINDING
5-YEAR GUARANTEE
COVERS EVERY PART
OF EVERY MACHINE
WE MAKE**

Good Luck is the product of good judgment. If you choose farm machines for the good material and good construction in them you'll get good service—and that will be "lucky" for you.

WATERLOO BOY MACHINES Embody 20 years of honesty—20 years of Experience in building the best—20 years of leadership all over the world, proving their quality. And you can buy them for less money in first cost, less in operating cost, and less in the long run, than any other dependable machines on the market.

INVESTIGATE AND CONVINCE YOURSELF.

The Waterloo Boy GASOLINE ENGINE In its 20 years on the market, has gone into every civilized country; is recognized the world over as the lowest priced high-grade engine built.

The Waterloo Boy CREAM SEPARATOR Is chosen by tens of thousands of shrewd buyers who will not buy a cheap, short-lived machine which will waste half the butter fat. Nor will they buy the higher priced machine which is no better and often not so good.

The Waterloo Boy Low-Down, all steel MANURE SPREADER Is light weight, light draft, strongly and simply built, low standing and easy to load, smooth spreading. Sells at the lowest price ever made on a machine of this class.

The Waterloo Boy 1-MAN FARM TRACTOR Is designed for all farm work from plowing to harvesting. Has pulling power of 12 good horses. Many important new features make it far superior to any others. Sells at low price. We have a message of importance for you. Write for FREE Catalog and full information.

WATERLOO GASOLINE ENGINE CO., 1021 W. 3rd Ave., WATERLOO, IOWA.

\$50 to \$300 SAVED

We are manufacturers, not merchants. Save dealers', jobbers' and catalog house profit. 10 or more men in every township can save \$50 to \$300 on my High Grade Standard Gasoline Engines, from 1½ to 15 H.P., price direct to you lower than dealers or jobbers pay for similar engines in car-load lots for spot cash.

GALLOWAY

Price and quality speak for themselves and you are to be the sole judge. Sell your poorest horse and buy on 30 Days Free Trial



You Can Make From \$5 to \$10 a Day

**Direct
From My
Factory
Satisfaction
or Money Back**

Write for special proposition to 10 or more men. Send for my big BOOK FREE.

WM. GALLOWAY, Pres.
WM. GALLOWAY CO.
1965 Galloway Station
WATERLOO, IOWA

Judging from its present advanced condition the Panama-Pacific Exposition, unlike most world's fairs, will be completed on its opening day, February 20, 1915. The entire 625 acres of grounds are now prepared and exposition headquarters are complete. The last two great expositions were not so far advanced a year before their opening. The main exhibit palaces will be completed by contract even eight months before the opening.

The Money Making Muncie

Perfect power producer. Operates on crude-fuel, solar and gas oils. Also kerosene and distillate. Low consumption. Close regulation.

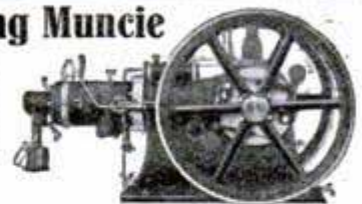

MUNCIE GAS ENGINE & SUPPLY CO., 1227 Main St., Muncie, Ind.

**We
Will
Arrange
Easy Terms
To Suit
You**

Saves 50% in Fuel

**Built on The ONLY Correct Principle
World's Best Farm Engine**

Remember, the "UNITED STATES" is the only Engine which stands on its feet—not a Horizontal or Standard Vertical. Explosions occur low down and shock is transmitted directly into the earth—not into the engine! Result is: (1) Violent vibrations entirely overcome; (2) Bulk and weight greatly reduced; (3) Saving of 50% in fuel; (4) The only practical portable engine made; (5) all parts in sight, easily understood; (6) Lubrication by gravity, the only sure way—(7) Absolutely frost proof. In order to prove all these claims—and many more points of special merit—we earnestly invite you to

Test It Now At Our Risk 30 Days Free Your credit is good with us. Test this Engine thoroughly for 30 days, and, if satisfied, pay us part cash, balance on terms to suit. All sizes—2 to 50 H.P.—single and double cylinders. Burns Gasoline, Kerosene, Gas, Distillate. Thousands of users say that U. S. Engines are world beaters. Why should you think of buying any other engine?

Write for Free Catalog and Our New Easy Payment Plan
UNITED STATES ENGINE WORKS, 502 Fifteenth Place, Chicago, Ill.

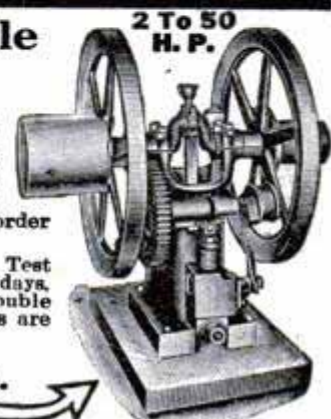

Buy Power and Service with Your Engine

The purchase of an engine deserves more than ordinary consideration. A good engine lasts a long time so that it's worth while to be careful and avoid mistakes. You must have steady power to do your work and service in case of accident. The sure way to obtain these two essentials with your engine is to purchase an

I H C Oil and Gas Engine

Built of tested material — backed by a responsible company — I H C engines are furnishing steady power to many thousands of manufacturers, business men and experimenters. They are being used every day by model-makers, machinists, pattern makers, molders, carpenters, bakers, printers — in practically every business where dependable, economical power is required.

You cannot buy a better engine than the I H C. Made in every size from 1 to 50-horse power; in all styles, vertical, horizontal, portable, stationary, air or water cooled; they operate on gas, gasoline, kerosene, naphtha, or alcohol. I H C oil tractors, 12 to 60-horse power. Our catalogue, giving full information, will be sent on request. Write for it.

International Harvester Company of America

(Incorporated)

16 Harvester Building

Chicago U S A

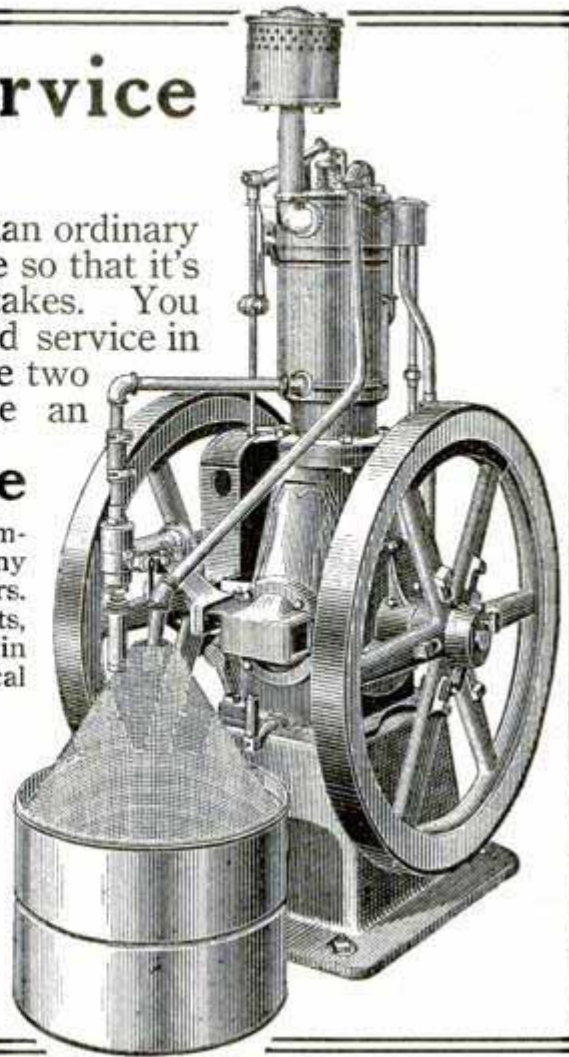

SMALL ENGINES

1-8 H. P.
UP

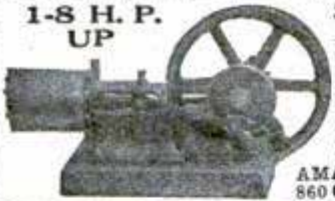

Steam, Gas and Gasoline. For Amateurs and Mechanics. Circulars for Stamp. Big Catalogue Engines, Small Power Machinery and Electric Light Plants, 2 Lights up. Sent for 10c (coin preferred). Refunded first order.

AMATEUR MECHANICS SUPPLY CO.
860 G Monadnock Bldg. CHICAGO

I Am Yours for \$19.50
Try me for 10 days

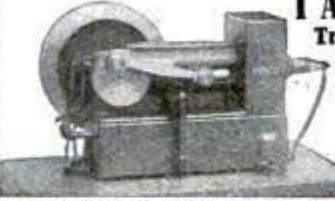

This is our 1-2 horse power Gasoline Engine fully equipped. Switch, Coil, Spark Plug, Gasoline Tank, Mixing Valve all ready to run. Fully Guaranteed. Return if not satisfactory and money refunded. Will run Washing Machines, Cream Separators, Butter Churns, or any light machinery where small power is required. **Inclose 2c stamp for reply.**

SEVERKROPP ENGINE CO., 1224 18th St., Racine, Wis., U.S.A.

"INGECO" ENGINES

1 1/2 to 350 H. P.

Gas, Gasoline,
Oil and
Producer Gas

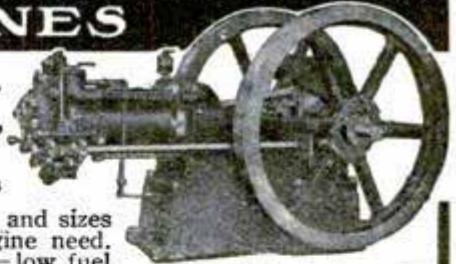

Includes all types and sizes to meet every engine need. Simple to operate — low fuel cost — substantial construction. Perfectly balanced, smooth, steady, reliable. Sales branches and stocks everywhere. If you expect to buy an engine our expert will tell you what is best and cheapest for you.



INTERNATIONAL GAS ENGINE CO.,
116 Holthoff Pl., CUDAHY, WIS. (Suburb of Milwaukee)

3 to 12
H. P.

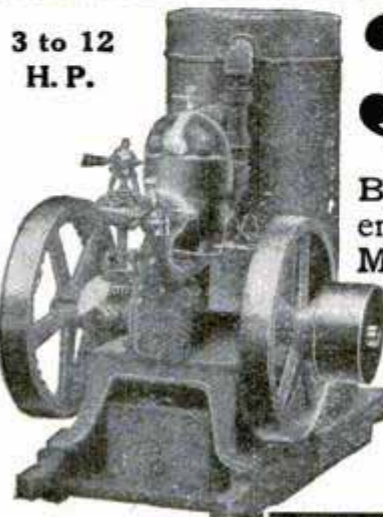

34c

**Runs this 6 H. P. Engine for a
10 hour day on KEROSENE**

By means of the patent throttle you can run it as a 4 H. P. engine for 23 cents a day, or as a 2 H. P. for 12 cents a day. Many other strong points; force-feed lubrication; uniform speed; sight-feed fuel supply; automobile muffler; no cranking; runs either way; uses any fuel oil satisfactorily. And it's **Guaranteed for 10 Years.** Write for catalogue and 30 days' free trial.

WE PAY THE FREIGHT

ELLIS ENGINE CO., 65 Mullett St., Detroit, Mich.

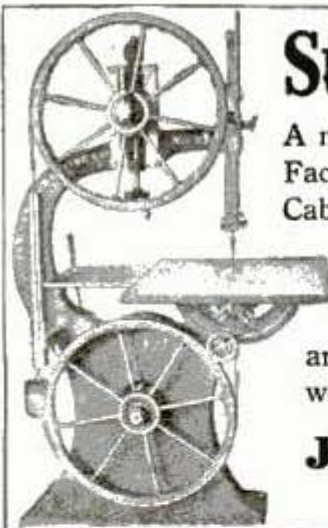

Superior Woodworking Machinery

A modern line of woodworking machinery for Furniture Factories—Piano Factories—Box Factories—Cabinet Shops—Pattern Shops—Carpenter Shops—Wagon Shops—Repair Shops—Contractors—Manual Training Schools, etc. If interested write for our catalogue and *net prices*. Largest manufacturers of woodworking machinery in Chicago.

JONES SUPERIOR MACHINE CO.
1726 Dickson Street, CHICAGO



**JONES
MACHINE MOULDED
Pulleys and Gears
Clutches, Sprockets
Shafting and Hangers**

The Largest
Line of
Power
Transmitting
Appliances
in the country

SEND FOR GENERAL CATALOGUE A18

W. A. JONES FOUNDRY & MACHINE CO., 1400 North Ave., CHICAGO

"BUFFALO" MARINE ENGINES

If marine engine efficiency has any interest for you do not fail to get the 1913 "Buffalo Book."

It describes fully the "Buffalo" line of four-cycle gasoline and kerosene engines—3 to 150 h. p.—for work boats, speed boats, launches and cruisers.

BUFFALO GASOLENE MOTOR CO.
1293-1305 Niagara Street, BUFFALO, N. Y.

GRAY MOTORS FOR BOATS



Largest Builders of
2-cycle Motors in the
World. Over 1000
responsible dealers.

3 H.P. with Complete Outfit ready to install \$55
ALSO 4 & TO 36 H.P.

Guaranteed by a big responsible concern. Write for big catalog—tells and shows you all about these high grade motors and how they are made.

GRAY MOTOR CO., 498 Gray Motor Bldg., Detroit, Mich.

2 1/4 HORSE POWER

HERE is the most reliable 2 1/4 H.P. Engine in America.

It gives such perfect satisfaction that we ship it anywhere in the world on terms of only one-half the purchase price or with your order and six months' time on the balance. If you want an engine any size, 1 1/2 to 12 H.P., write me today for Big 4-color Engine Catalog and Price List, lowest you ever heard of. Save you \$20.00 to \$100.00 sure. Do it now—today.

OTTAWA MFG. CO., 846 King St., Ottawa, Kans.

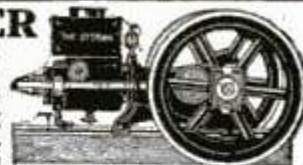

**\$38⁰⁰
UP**

**Reliable—Dependable—Durable—Satisfactory
That's the GILE**

When you put a GILE engine in your boat, you've got a motor on which you may rely to GO at all times. You can thoroughly understand it—it is so simple in design that it practically eliminates all repair expense, and so easily operated that your wife, mother, sister or sweetheart can readily run it, and it couldn't be of better material, design or construction if you paid three times the price we are asking. GILE engines are made only of the very best material, are of superior design, and expert construction. They are manufactured in one of the most up-to-date and progressive plants in the country, are carefully tested out, are RIGHT in every way, and FULLY guaranteed. They fill every requirement of satisfactory service, are durable, long lived, and in fact just the engine you've been always looking for—a motor which will "MOTE" wherever and whenever you want it or need it. Our prices will astonish you. Write for free catalog and further information—we know we can interest you.

(This is the 16-foot Ideal)

GILE BOAT & ENGINE CO.
10 Filer Street
LUDINGTON, MICH.

16', 18', 20', 24', 26' UP
\$87⁰⁰



New Fields Open To You

Aviation—Automobile—Motorboat

Become an automobile operator, aviator, or motor boat engineer in a few weeks. You can learn all that is necessary for you to know from this four volume.

New Edition—Cyclopedia of AUTOMOBILE ENGINEERING

1,700 pages, 7x10 inches; 1,500 illustrations, full page plates, folding maps, diagrams, etc. This up-to-date work covers the construction and maintenance of all types of pleasure cars and commercial trucks, also motor-cycles, motor boats, aeroplanes, and monoplanes.

Now Sent Free. We will send the complete set, express prepaid, for seven days free examination; returnable at our expense. If you keep the books, send us \$2.00 within seven days—then \$2.00 a month until you have paid the special low price of \$12.80. The regular price of these books is \$20.00. Write us today, giving your occupation and name of employer or reference, and the books will be sent you immediately. Further information regarding this great offer will be sent upon receipt of a postal.

Another Free Offer. With every set is included a year's Consulting Membership, regular value \$12.00, entitling you to the free advice of a staff of experts. They will give you practical help in solving your difficult problems.

American School of Correspondence
5781 Drexel Avenue Chicago, U. S. A.



The AutoStrop Safety Razor Guarantees 500 Shaves Ask Your Dealer About It

HILDEBRANDT BAITS HOOK AND LAND 'EM

Experienced anglers choose them. Small outfit, interchangeable, catches any fresh water game fish. "Standard," "Slim Eli" and "Idaho." Gold, copper, brass, and nickel finish for bright or dull days. "They spin so easy!" Ball bearing—reversible. Don't catch in weeds. **Free—New 1913 Catalog** Lists everything you need. Actual size illustrations. New flies, baits, spinners, rods, etc. Tells how to equip economically. Two cent stamp brings it. The J. J. Hildebrandt Company, 1304 4th St., Logansport, Ind.

Amazing Profits In Mushrooms

Anybody can add \$8 to \$40 per week to their income, in spare time, entire year growing mushrooms in cellars, sheds, barns, boxes, etc. I tell you where to sell, at highest prices. Free Illustrated Instruction Booklet

HIRAM BARTON
Desk 2, 329 W. 48th St., New York

(SCOUT'S-COMPASS-WATCH) Trade Mark

The Dependable Companion for man or boy. The story of this original and unique combination is told in these three words.

(SCOUT'S-COMPASS-WATCH) Trade Mark

Price \$1.25

HOW TO GET ONE. Go first to your jeweler, hardware or sporting goods dealer. If not on sale send his name and \$1.25 and we will send you one at once, postpaid.

SCOUT'S COMPASS WATCH CO.
409 Lumber Exchange Bldg., Minneapolis, Minn.



The Demands of Business

are a constant tax upon mental, physical and nervous forces. The effects of concentration, worry and overwork soon become evident. Unless proper nourishment for brain and nerves be provided, complete breakdown is the inevitable result.

Pabst Extract The "Best" Tonic

quickly dispels the effects of overwork, nerve exhaustion and brain-fag. It feeds the nerve centres, strengthens the muscles and quickly restores both mind and body to a normal, healthy state.

Order a Dozen from
Your Druggist

Insist Upon It Being "Pabst"

FREE BOOKLET, "Health Darts," tells all uses and benefits of Pabst Extract. Write for it.

Pabst Extract Co., Milwaukee, Wis.



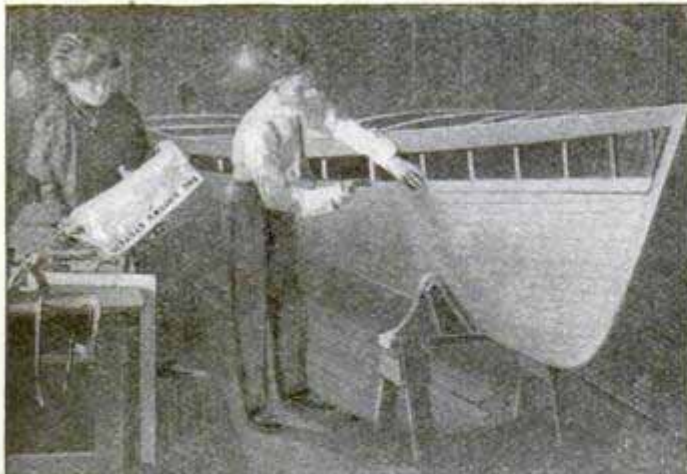

Why Don't YOU Build a Boat?

Hundreds of men and boys are now working evenings building their Brooks boats. Why don't You start a boat? We send you all parts shaped and fitted, ready to put together, and the nails, screws and hardware to complete the boat. If you can handle hammer, saw and screw-driver, you can easily nail these parts into a staunch, beautiful power boat, sail boat, row boat, or canoe. Lots of men make a Brooks boat every year and sell it at a profit after using it all summer.

The Brooks System Makes It Easy and Saves 2/3 Boat Builder's Price

Our instructions are so simple, every step is made so clear, that you'll find the work not only easy but enjoyable. We guarantee satisfaction or we return your money.

If you prefer, get the full-sized patterns only, with full instructions at from \$2 to \$12.

FREE—Brooks Boat Book, full of illustrations. Dozens of models and sizes from the smallest duck boat to big cruisers. Write today for this book. Address

BROOKS MANUFACTURING CO.
8204 Sidney St., Saginaw, Michigan

Only \$28 for the Knockdown Frame of 23 ft. motor boat, including full-sized patterns and illustrated instructions to finish—speed 9 1/2 to 14 miles an hour—12 passengers. Write for *free boat book*. Shows this and other models.



THE SCRIPPS

COMPLETE
MARINE POWER PLANT

1913 Catalogue Just Off The Press

If you are interested in marine motors, send for it. It is, by far, the most beautiful and interesting engine book ever published. Fully describes all of the famous Scripps motors—One, Two, Four and Six Cylinders—regular and extra heavy duty types, 4 to 96 horsepower. Ask about our Air-Self Starter, Kerosene motors and the Scripps Midget—our new 7 horsepower 4-cylinder Tender Motor.

Scripps Motors are carried in stock by

NEW YORK—Bowler, Holmes & Hecker Co., 141 Liberty Street. BOSTON—Walter H. Moreton, 218 State Street. PHILADELPHIA—W. E. Cochran, 631 Arch Street. JACKSONVILLE, FLA.—Gibbs Gas Engine Co., Foot of Main Street. SEATTLE, WASH.—S. V. B. Miller, 72 Marion Street. SAN FRANCISCO, CAL.—California Gas Engine & Motor Boat Co., 76 Clementina Street. LOS ANGELES, CAL.—Marine Engine & Supply Co., 121 E. 6th Street. DULUTH, MINN.—Kelley Hardware Co., 118-120 W. Superior Street. TORONTO, ONT.—Schofield-Holden Machine Co., 2 Carlow Ave. NEW ORLEANS, LA.—Arthur Duvie, 130 Chartres Street.

SCRIPPS MOTOR COMPANY

637 Lincoln Avenue
DETROIT MICHIGAN



PALMER MOTORS AND LAUNCHES

Ask for free Engine or Boat Catalog. Address Dept. K
Engines, 2 to 40 H.P., 2 & 4 cycle, always in stock

PALMER BROS., Cos. Cob, Conn.

Motor Boaters

We have perfected a method of installing engine in boats, that gives more speed and makes installing simple.

Send for "Practical Information" and catalog of motor boat hardware and specialties.

MECHANICAL DEVICES CO., Watervliet, N. Y.



MULLINS STEEL BOATS CAN'T SINK

Built like Government Torpedo Boats of tough, puncture-proof, galvanized steel plates, pressed to rigid form and so securely joined together that a leak is impossible. The Mullins Steel Boats are GUARANTEED against puncture, leaking, waterlogging, warping, drying-out, opening seams, and NEVER REQUIRE CALKING. Air-tight compartments like a lifeboat.

MOTORS—The Loew-Victor 4-cycle and Ferro 2-cycle—light—powerful—simple—can be operated by the amateur—the beginner—start like automobile motors—one man control—never stall at any speed—exhaust silently under water.

Our beautiful book, illustrated in colors, is free.

THE W. H. MULLINS COMPANY

The World's Largest Boat Builders

151 Franklin St., Salem, Ohio, U.S.A. Famous Yale and Harvard Model Canoes

STEEL ROW BOATS AND CEDAR CANOES



Here's The Engine For The Man Who Runs His Own Launch

PRICE
COMPLETE
READY TO RUN
\$150

EVERY effort has been made to simplify its design. There's nothing complicated about it. We even build an absolutely water-proof ignition system to use in connection with this engine, thus avoiding ignition troubles. Engine is designed to run on gasoline or kerosene.

Caille Perfection Unit Power Plants

are the height of simplicity. Any member of the family can run them. All parts are completely enclosed except the fly wheel. No oil can splash out—no water can splash in. One large sight-feed lubricator oils cylinder walls, piston, piston-pin and crank-pin. The engine shown is designed for a 16 or 30-foot launch. Has two cylinders—cast en bloc like an automobile engine. Requires less space than most engines of the single cylinder type.

This is but one of the Caille engine family. We also build other types and other sizes for larger or smaller boats. Our beautiful free catalog explains all. Send for it today.

Caille Perfection Motor Co.,
1207 Caille St.,
Detroit, Mich.

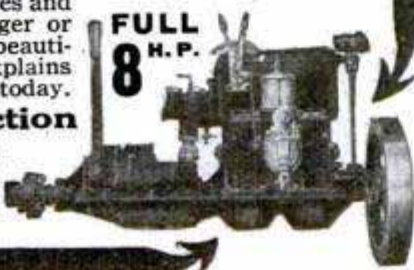

FULL
8 H.P.

KEMP AIR COOLED AEROPLANE MOTORS

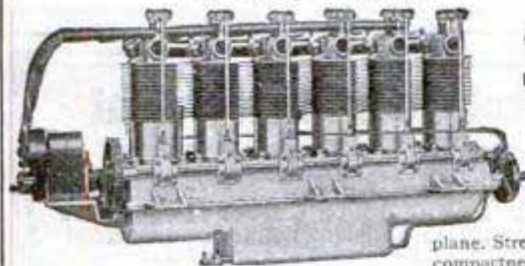

MODELS
G-2 16 H. P.
I-4 35 H. P.
H-6 55 H. P.
J-8 75-H. P.

Designed and built to the requirements of the Aeroplane and Hydroplane. Strength, reliability, compactness, lightness,

simplicity, efficiency, fuel economy, ease of adjustments, ease of starting, and minimum head resistance, the ten most important points, and our motors contain these features. Built by skilled mechanics and only the best of material and equipment used. It will be better and cheaper to equip your plane with a reliable and efficient power plant in the start.

KEMP MACHINE WORKS, Muncie, Indiana, U. S. A.

MARINE ENGINES

Strictly high grade engines, with Planhard or Schebler carburetor, water and spark proof commutator, flange coupling, electric circuit breaker, patented gastight bearings, bronze propellers, Pfanzstiel coil and equipment complete.

2 H. P.—\$ 50 10 H. P.—\$150 Magnificent 1913
4 H. P.— 75 18 H. P.— 250 Marine Engine Catalog
7 H. P.— 100

Truck and Hand-car Engines

Our "Casey Jones" Engine makes a motor truck out of your push cart, or a motor car out of your old hand car. For railroads, factories, lumber yards, farmers, etc. Get prices and catalog of this line also.

NORTHWESTERN MOTOR CO.
757 Spring St. EAU CLAIRE, WIS.

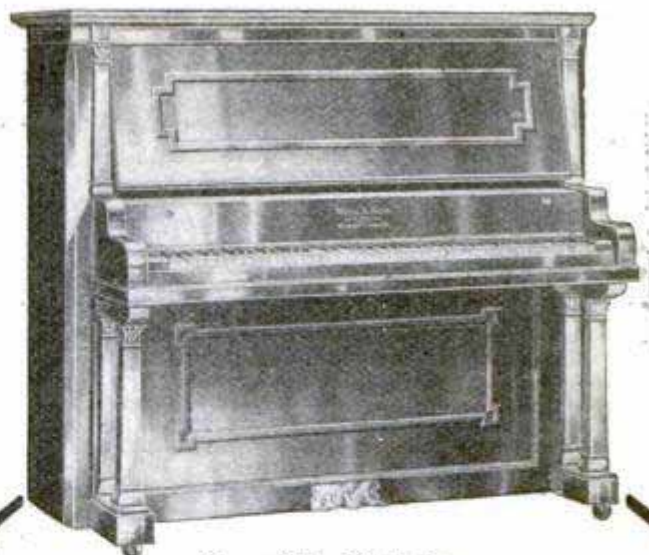

One of the 38 Styles

The Superb Wing Shipped to You on an Absolute Free Trial

We, the manufacturers of Wing Pianos for 45 years, will send you a genuine Wing Piano or Player Piano tested and guaranteed by us without one penny from you. We will ship the piano free with all freight paid in advance by us. You are not out one cent in money or trouble.

This offer is backed by a 40 year guarantee by the manufacturer and places you in the very same position as if you were a dealer. You buy at exactly the same price that any dealer must pay. You do business direct with a factory that has sent out more than 45,000 pianos. Remember, we pay all freight. No interest charged. No payment down. No deposit. Not a cent until end of four weeks absolutely free trial in your own home and then nothing unless you are absolutely satisfied—and you are the judge.

Greatest Piano Offer Here is indeed the greatest, the most tremendous, the most amazing offer ever made in the history of the Piano. A simply paralyzing offer—yes, the most gigantic of ultra-liberal offers. Just think of it!—your choice of 38 styles of the superb Wing for four full weeks in your own home without paying us a penny. Don't fail to investigate this amazing free shipment offer. If you send coupon at once you may have the Wing equipped with our wonderful Instrumental Accompaniment without extra charge—giving the effect of the guitar, harp, zither banjo and mandolin.

Send Coupon (or Postal) NOW for "The Book of Complete Information About Pianos"

The N. Y. World says: "This is a book of educational interest every one should own." Would you like to know all about pianos, how to judge the fine points of quality and price in buying a piano? Then send the coupon for the piano book which we are sending out FREE for the present. You will be astonished at the amount of information about piano quality and piano prices, and how to avoid the deceptions of the piano salesmen. **The Coupon brings this 156-page book FREE.** This is a magnificent book, a complete encyclopedia on the piano; posts you on the making of a piano from start to finish and how to judge the fine points of a piano. Free and prepaid, provided you write at once. With this piano book we will send free our beautiful catalog showing new art styles and full explanation of our Rock-Bottom Prices on the Wing Piano. Just drop a postal or a letter, or mail the coupon without any letter. Write Now.

FREE COUPON

Wing & Son
(Est. 1868)
Wing Bldg., 9th Ave.
and 13th St.
Dept. 1194 New York, N.Y.

Wing & Son
(Established 1868)

Wing Building
9th Avenue and
13th Street

Dept. 1194

New York
N. Y.

Gentlemen:—Without any obligations to purchase or pay for anything, please send me free and prepaid "The Book of Complete Information About Pianos." Also send full particulars of your Free Shipment offer on the Wing Piano and catalog of latest art styles.

Name.....
Address.....

Please Mention Popular Mechanics

VIM MOTORS

The Boat Builders' "Stand-By"—The Boat Owners' Pride

5 to 55 h. p. 3 KINDS—Speed-Regular-Heavy Duty

Strong, neat, simple—absolutely dependable. Give honest, enduring service—constant satisfaction. Win your enthusiastic confidence. Easily accessible—crank case conveniently opened from either side. Non-back-firing. Double ignition. Easy starting fly wheel. Connections for rear-starter. Equipment includes Paragon reverse gears, Mea Magnets, Noxon distributor, heavy brass fittings and many other exclusive features.

VIM MOTOR COMPANY

1, 2, 3 and 4 CYLINDER
USE GASOLINE OR KEROSENE

Your boat, equipped with a VIM, will make your day or evening on the water,—with the pure air, refreshing breeze—the lure of the great outdoors—one of exhilarating enjoyment and healthful recreation. Thousands in use, many of them eight or nine years old. The old boatman picks the VIM. Read twenty-seven reasons why in our new book, "Boating Facts".

Send For Your Copy Today.
104 Water Street, Sandusky, Ohio

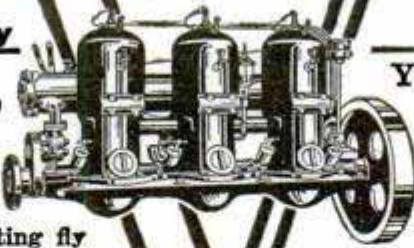

Bumble Bee



Roberts Motors are used exclusively in the Bumble Bees. The one shown above is making 24 m. p. h. with a 3 cyl. 15 H. P. Aerolite. The one below is running 14 m. p. h. A 6 H. P. is used in this.

21 Models, 3 to 125 H. P., 1 to 6 Cyl.

All models operate successfully on
KEROSENE OR GASOLINE

Aviation Motors

for Aeroplanes and Flying Boats

4 cyl. 50 H. P. 6 cyl. 75 H. P. 6 cyl. 125 H. P.

MARINE OR AERO CATALOG FREE

THE ROBERTS MOTOR CO.

1419 Columbus Ave. Sandusky, Ohio U. S. A.

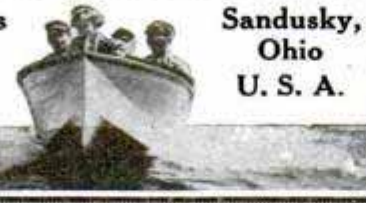

BUILD YOUR OWN STEEL BOAT

From patterns and printed instructions. Save 2/3 Cost. Work easy. Material furnished. Also finished boats. Send for catalogue and prices.

F. H. DARROW STEEL BOAT CO., 517 Perry St., ALBION, MICH

Turn Your Row Boat Into A Launch With This 2 H.P. AMERICAN Engine



Especially designed for row boats, canoes and launches up to 20 feet long. Just the thing for a fishing boat. If desired can be run slow enough to troll. No reverse gear needed. Engine can be reversed without stopping. Starts without cranking. Guaranteed for life. Sold on 30 days' trial.

\$125 Buys This "American Special" 16 Foot Launch
Seats 7 to 9 people. Elegantly finished. Embodies engine described above. Just the thing for summer homes. Send for engine catalog describing complete line. Also boat circular. Write today.

American Engine Co., 474 Boston St., Detroit, Mich.



There was brought into New York the other day what is regarded as the largest turtle ever received from the tropics. It was 10 ft. long and weighed over 500 pounds.

Control Your Motor Boat this way—it's the safe way

Moving a single lever stops, reverses, or sends your boat ahead. Engine doesn't stop. That is the "Baldrige way." Contrast it with the old, dangerous way of stopping the engine and letting "her" float up. Stop gambling with collisions and "smash-ups."

Get a Baldrige Reverse Gear

—the gear with the unbroken main shaft that positively prevents the usual exasperating gear troubles. Fully enclosed; thousands in use.

Send for free book telling the good points of "Baldrige" construction.

If you are in the boat business, write for dealer's proposition. Some good territory still open.

THE BALDRIDGE GEAR CO.
682 W. Grand Blvd., Detroit, Mich.

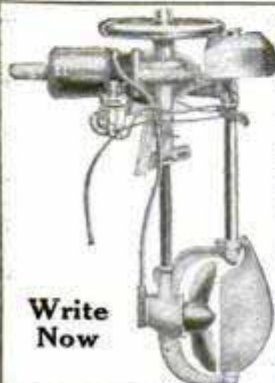
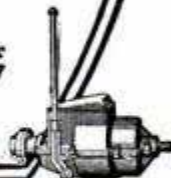

The Powerful "Porto"—55 lbs.—2 H. P.

The most power for the price—the most power for the weight—that's what you get in the ORIGINAL portable marine engine. Note this—2 3/4 bore, 3 in. stroke—that's what counts. That's why the PORTO drives an 18 ft. row-boat 7 miles an hour, for 4 hours on a gallon of gasoline.

On or Off in 5 Minutes—Sold on Trial

The new model is copper jacketed, has under water exhaust, steers with tiller ropes. Get our catalog for complete details of this and other Waterman Motors for every purpose.

WATERMAN MARINE MOTOR CO., 120 Mt. Elliott Ave., DETROIT, MICH.

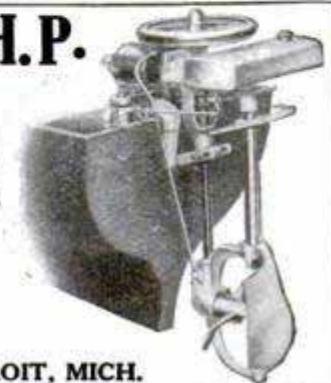

Write Now

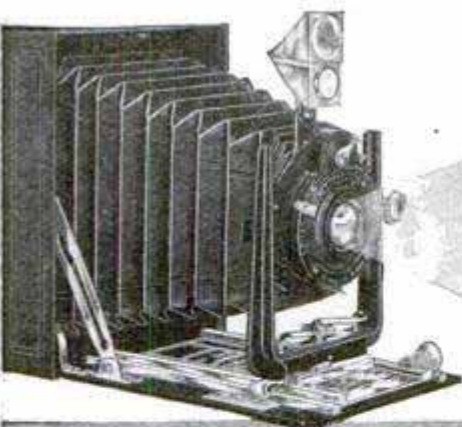

No Action is Too Speedy for a Goerz

Human events and incidents transpire quickly—but not too quickly for a Goerz Camera fitted with a Goerz Lens.

When perfect first exposures are imperative—when you must depend on your camera, not on the sun or weather—when you must be sure of strength and detail—use a Goerz. For a compact folding hand camera the

GOERZ TENAX CAMERA

is conceded the best for all-around photography. A Goerz Lens in an ordinary camera will make twice as good results.

Send for Special Catalog on High Grade "Lenses and Cameras"

C. P. GOERZ AMERICAN OPTICAL CO.
3230 East 34th Street, New York



Send for Handsome Colored Catalogue

The famous Yale and Harvard models—highest grade material—finest finished—the strongest, staunchest—handsomest canoes built.

MULLINS CEDAR CANOES CAN'T SINK

When equipped with Mullins Patented Buoyancy Pads these canoes have sufficient buoyancy to float when capsized or filled with water and keep two people afloat. Open gunwale construction—Keel—Heavy Pressed Bronze Bang Plates protecting stems. *Handsome Colored Catalogue Free.*

THE W. H. MULLINS CO.
362 Franklin Street Salem, Ohio

Build Your Own Boat



The Frame We Ship You

SEND FOR OUR CATALOG

which tells you all about it. You can build a 20 ft. launch for \$30 from patterns, that you could not buy at any factory for less than \$150, or you can buy the complete frame and build this 50 ft. cruiser shown in the picture for less money than you would have to pay for the cheapest 25 ft. finished cruiser you could buy.



The Boat You Build

DEFOE BOAT & MOTOR WKS., 1113 State Str., BAY CITY, MICH.

from our patterns or knock down frames. You save $\frac{1}{2}$ the cost and enjoy the work.

Patterns and frames for boats of all types and sizes, from the canoe pattern at \$1.75 to the 65 ft. yacht frame at \$350

BAY STATE MOTORS

"Perfect Simplicity" and "Simple Perfection" are the results, embodied in these Motors, of 15 years devoted to the developing of these essential characteristics, which enable us to put on the market a reliable and economical motor at a reasonable price. Write for catalog, stating size and type (2 or 4 cycle) of motor wanted. We also furnish castings for these motors.

BAY STATE MOTOR WORKS

Successor to
A. J. HOULE MOTOR WORKS
580 South East Street, HOLYOKE, MASS.

WATKINS' SPECIAL MOTORS

- 3 H. P. Single Cylinder . . . 30 lbs.
- 6 H. P. Double Cylinder . . . 60 lbs.
- 12 H. P. Four Cylinder . . . 100 lbs.

A strictly HIGH GRADE Motor that will give CONSTANT and EFFICIENT service. Especially adapted for CANOES and LIGHT BOATS. Aluminum base, copper water jacket, steel shaft, bronze bearings.

THE WATKINS MOTOR CO.
837-839 West Sixth Street CINCINNATI, OHIO

12 Horse Power 4 Cylinder 4 Cycle

Weight 370 lbs.

Speed
600 to 1000 R. P. M.

Made in one size only. A specialized article.

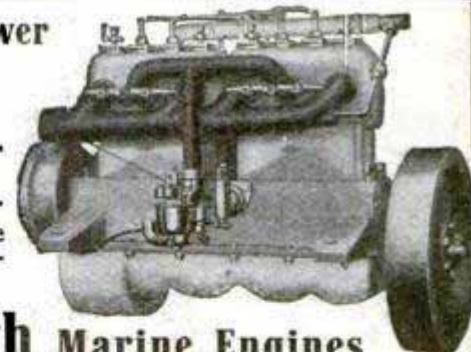

Kermath Marine Engines

the world's standard in 12 H. P. size, are made of the finest materials the market affords and workmanship of pronounced excellence. Prices \$150 to \$200

Kermath Mfg. Co., DETROIT, MICH. Dept. P

Save a Season's Gasoline Cost Good Times Guaranteed

Act as your own agent and save the retailer's profit—buy direct from the factory a dependable Lockwood-Ash Motor guaranteed for a year. Six models, all sent on 30 days' trial.

This 1½ H. P. Motor and Complete Outfit,

We pay the freight and give you a month to test out the engine. You get a reliable motor with complete outfit, including propeller, ignition system and shaft, as shown. You save at least \$13.75—a season's gasoline cost. Give yourself and your friends good times at small expense. Motor boating is a healthful, fascinating and economical sport. Write for our new 1913 catalog today. Post yourself on Motor Boating. Learn about the famous L-A Motors. The catalog's free—write today.

LOCKWOOD ASH MOTOR CO., 208 Horton Ave., JACKSON, MICH.

L-A Motors Direct from Factory to You

Sold on their Merits

\$36²⁵
Freight Paid

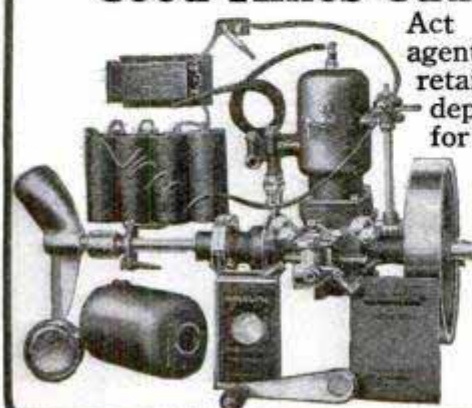

Write to-day for the
STRELINGER
 1913 CATALOG

THIS book will make you a better engine buyer. If you are an experienced Motor Boat operator, or inexperienced, you will gain something by reading it. No matter what size or type of engine you are going to buy this year, whether you have decided on the make or not, it is unwise to close the sale until you have at least read the 1913 Strelinger Catalog. Strelinger engines have been running smoothly, powerfully and economically for fifteen years. They are in use in all parts of the world. Over eight thousand satisfied owners can tell you of their merits. Our line is most complete, affording just the right size and type of motor for every boat. This line includes the Strelinger four cycle, heavy duty motors ranging from 4 to 40 H. P., and the Little Giant line of two cycle, three port, general utility engines powered from 1½ to 16 H. P. in single and multiple cylinders. If you have a runabout, a work boat or a cruiser, you will find the motor you want listed in our 1913 catalog.

Let us send you a copy. Write for it to-day. It's FREE



Little Giant No. 4
8 to 10 H. P.

STRELINGER MARINE ENGINE CO.
 171 W. Woodbridge St., DETROIT MICH.

**AGENTS \$45 TO \$80
 A WEEK**



Thousands of dollars paid to agents already in the field; Will Gunckle, of Ohio, got \$240 worth of orders first week. A. Bernier, of Kansas, made \$30 in four hours. Made 8 calls, took 6 orders. Well, of Mo., made \$10 in one hour. Hamilton, of Wyoming, made \$60 first two days. We

want good agents in every county in the United States, Canada and Mexico.

NEW INVENTION Just out. Nothing like it. **FOLDING BATH TUB.** Gives to every home a complete bath room in any part of the house—without expense. Biggest, quickest, surest money maker of the century for agents. Territory being rapidly assigned. Send your application today. **100% PROFIT** We back you with our capital and experience. We give you complete instructions, assistance and co-operation. No charge for territory. Don't delay. Send your name at once. Write plainly and give name of your county. Complete particulars FREE. Write today.

ROBINSON MFG. CO., 130 Vance St., TOLEDO, O.

Save \$1.25



**\$2.75 For This \$4.00
 All Leather Shoe**

Why pay dealers and jobbers extra profits—buy direct and save your shoe money. This splendid "LOTZ SPECIAL" (black) shoe is a wonder for either dress or work; Gun Metal side. Guaranteed All Pure Leather, half double sole, reinforced shank, Rocker last. Handsome, durable, stylish; easily worth \$4.00—our DIRECT

\$2.75 Prepaid bargain price only \$2.75—any size—delivered prepaid. Money back if not the best shoe value you ever saw. Saves you \$1.25. Illustration above shows one of many styles for men—all bargains! Send for Free Circular showing some money-saving shoe offers. Name and address brings it.

LOTZ BROS., 111 NO. MAIN ST., ST. LOUIS, MO.

This
 Canoe
 is a
 Master-
 piece



The test of a canoe is not its looks. Will it paddle true? Is it light or does it drag your arms out? Will it last? The

"Old Town Canoe"

answers every canoe query 100% perfect. Beautifully proportioned, beautifully balanced. Light as a feather. True as an arrow. Known the world over for fine construction and reliability. It is built by experts. All planks are long lengths, fastened at each rib with 4 copper tacks, clinched. Agents everywhere show "Old Town Canoes." 3000 in stock here insure prompt deliveries. Write for illustrated, descriptive catalog. Sent free.



OLD TOWN CANOE CO.,

1264 Middle St., Old Town, Maine, U. S. A.



Build Your Hydroplane

14x4 Toppan Bullet Hull complete \$125, K. D. Frame \$30. Also 21 ft. V-Bottom Runabout Hull \$225, K. D. Frame \$40.

Send for circular. Special prices on Engines. **TOPPAN CO., 3 Haverhill St., BOSTON, MASS.**

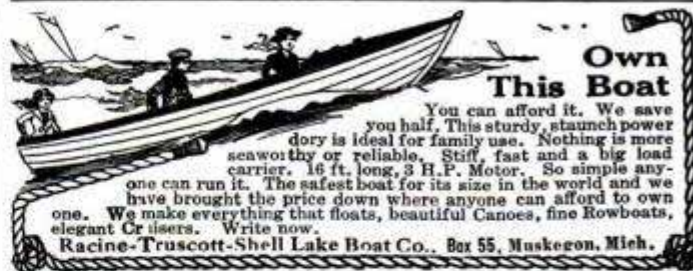

**Own
 This Boat**

You can afford it. We save you half. This sturdy, staunch power dory is ideal for family use. Nothing is more seaworthy or reliable. Stiff, fast and a big load carrier. 16 ft. long, 3 H.P. Motor. So simple anyone can run it. The safest boat for its size in the world and we have brought the price down where anyone can afford to own one. We make everything that floats, beautiful Canoes, fine Rowboats, elegant Cr users. Write now.

Racine-Truscott-Shell Lake Boat Co., Box 55, Muskegon, Mich.

GET THIS CATALOG

FULL OF VALUABLE INFORMATION TO EVERY BOAT OWNER ON

**RACING PROPELLER WHEELS,
 REVERSE GEARS AND
 MARINE ACCESSORIES**

LARGE CATALOG FREE. SEND TODAY

MICHIGAN WHEEL CO.
 1139 MONROE AVE. GRAND RAPIDS, MICH.



4 HP. to
**GASOLINE
 AMERICA'S
 QUALITY
 SMALLEY**



250 HP.
**KEROSENE
 OLDEST
 ENDURES
 GENERAL CO**
 BAY CITY MICH

1513 TRUMBULL ST.

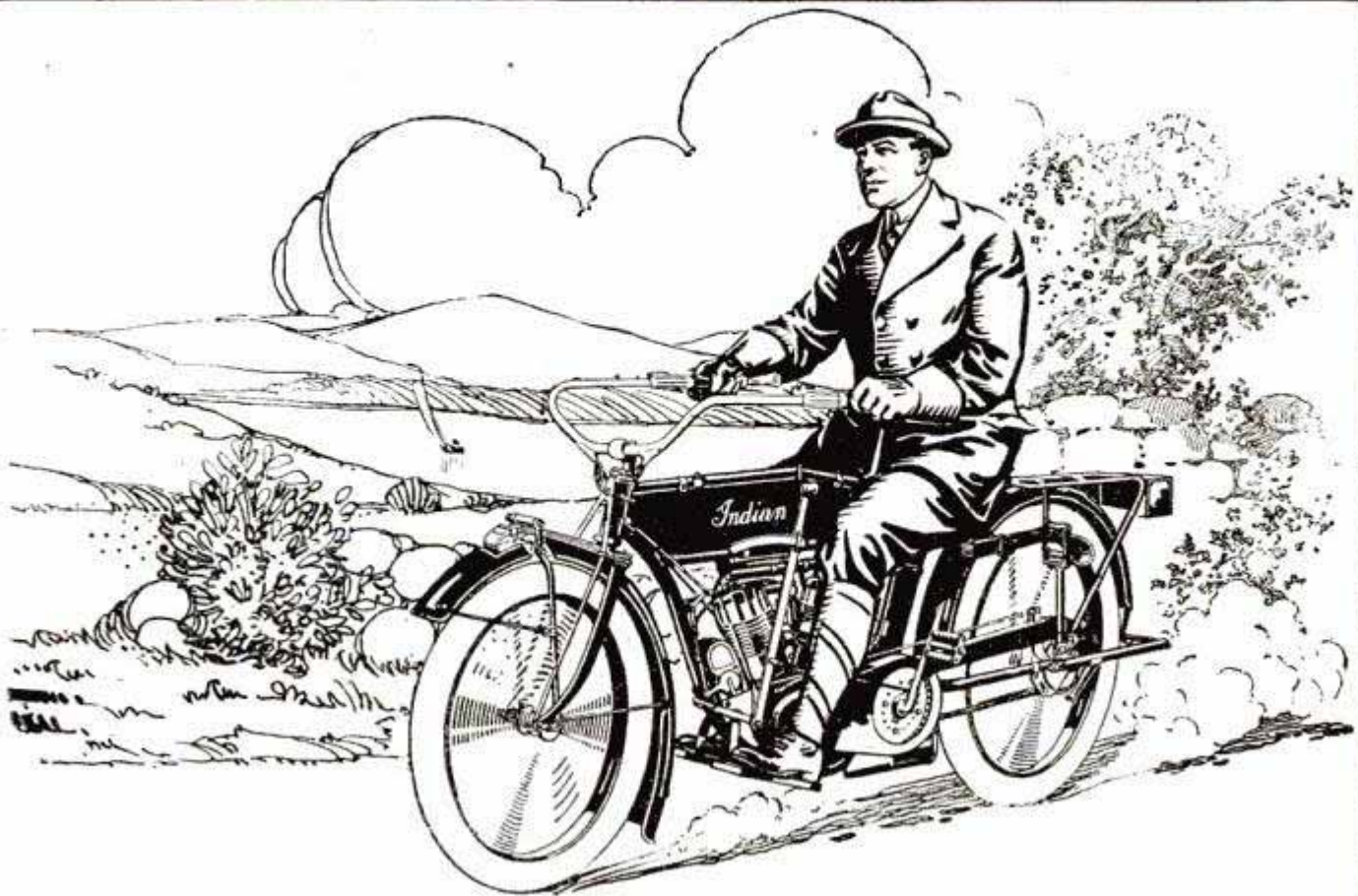

You know motorcycling at its very best when you're astride

The *Indian* Motorcycle

The 1913 models of the Indian Motorcycle are as complete and as satisfying as the most exacting rider could demand. The prime essentials of Power, Speed, Flexibility, Comfort, Reliability and Ease of Control are positively superb in each instance. No less than eleven improvements this year. Twenty-nine minor "refinements" in addition. Most important new features are those providing absolute riding comfort. No jolting—no vibration.

The Cradle Spring Frame

is the greatest of all improvements. Riding on the Indian is like riding on air, so smooth is its running. There's no strain on the nervous system and no unnecessary jarring of the machine and fittings. The "life" of the motorcycle is greatly increased.

Equipment of footboards in addition to pedals, on 4 H. P. and 7 H. P. "regular" models, is another new feature. You have the choice of two comfortable riding positions with the double brake control in each. You may use the pedals merely for starting the motor if you wish. Improved luggage carrier will commend itself to tourists and traveling men especially.

Any speed from 4 to 50 miles an hour. Free Engine Clutch gives the Indian a thousand speeds. Motor has reserve power that takes you up any hill. Wonderfully economical motorcycle to maintain. No "extras" on the 1913 models. No increase in prices.

First get a free demonstration from the nearest of our 2000 dealers throughout the country. No matter where you live, there's an Indian dealer handy. Ask us for his name and address.

Prices { 4 H.P. Single Cylinder, \$200 } f.o.b. Factory
 { 7 H.P. Twin Cylinder, \$250 }

Write us for free 1913 catalog describing all models and improvements

THE HENDEE MANUFACTURING COMPANY, 911 State St., Springfield, Mass.

(Largest Motorcycle Manufacturers in the World)

Chicago

Denver

Branch and Service Stations:
 San Francisco Atlanta

Toronto

London

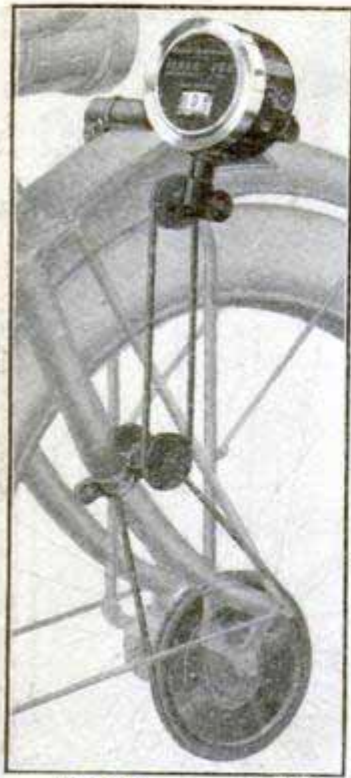

\$12

Complete with new Two-Belt Front Wheel Drive

This Shows the new Two-Belt Front Wheel Drive.

Stewart Speedometer

MAGNETIC PRINCIPLE

The First Practical Motorcycle Speedometer

A speedometer is just as necessary and important on your motorcycle as it is on an automobile. Every automobile is equipped with a speedometer. Eighty per cent of them are equipped with Stewarts.

This new speedometer will pay for itself in a year, in tire adjustments, alone, as practically every tire company bases all adjustments on odometer readings. If you have no odometer it is impossible to correctly figure out your tire mileage.

This new speedometer enables you to keep accurate track of your gasoline and oil consumption. It tells you instantly if your engine is not giving full power and helps you follow road maps when touring.

This is the first really practical motorcycle speedometer ever made. No amount of road jars, rut jolts or sudden jerks can affect the driving arrangement of this speedometer.

It will never get out of line. Our new patented and exclusive Two-Belt Front Wheel Drive makes this impossible.

No amount of vibration can throw the mechanism of this speedometer out of adjustment. It always works with absolute precision under the most severe conditions.

No weather condition can affect it. Works as perfectly in wet weather as in dry weather.

This speedometer can be attached either to your front extension spring or mudguard, so that your headlight will show directly on its face. You can read it at night as easily as in daylight. This is another exclusive feature.

It has a 75-mile speedometer; 100,000-mile season odometer; 100-mile trip register, which can be readily reset to any tenth of a mile without disturbing total mileage of season register.

Examine one of these advanced instruments at once. For sale by dealers all over the world. The price is \$12, complete. We guarantee satisfaction.

Write us for a handsome catalogue which fully describes this new and improved instrument

The Stewart Speedometer Factory

1906 Diversey Blvd., Chicago, U. S. A.

POPE MOTOR CYCLES

Three great new features insure your comfort—

Rear Spring Suspension on helical springs that expand, gives you comfort and spring assistance in place of spring resistance. In connection with

The Spring Fork, the frame, motor and rider are ideally suspended. The combination gives a forward gliding motion that will delight you.

Overhead Valves give the most power, the smoothest running, the greatest speed, least surface exposed to heat, best cooling—most complete exhaust of spent gases,—least weight, lowest gasoline and oil consumption and minimum cost to run and maintain. The entire explosion is directly over the piston. All energy developed is applied with no loss in time nor force, straight downward, with maximum power.

Pope Quality Has Never Been Questioned

Pope Motor Cycles are made in four models

These machines are alike in quality and perfection of detail. Each is suited for a different purpose. **Model H—Lightweight**—4 h.p., belt drive, imported magneto. Weight 160 pounds. A wonderful value, **\$165.** **Model K—The Big Four**—Big 4 h.p., belt drive, imported magneto, overhead valves, spring seat post, **\$200.** **Model M—5 h.p.**—Chain drive, Bosch Magneto. Rear spring suspension, overhead valves, **\$215.** **Model L—Twin**—Twin Cylinder, 7-8 h.p., chain drive, Bosch magneto, rear spring suspension, overhead valves, **\$250.**

Send for the handsome 1913 Catalogue:

The finest ever issued. It contains pages of specifications and details, every one of which will interest you. Write today.

The Pope Manufacturing Co.

479 Capitol Ave., Hartford, Conn., U. S. A.

Also makers of Pope Bicycles
—Catalogues Free.

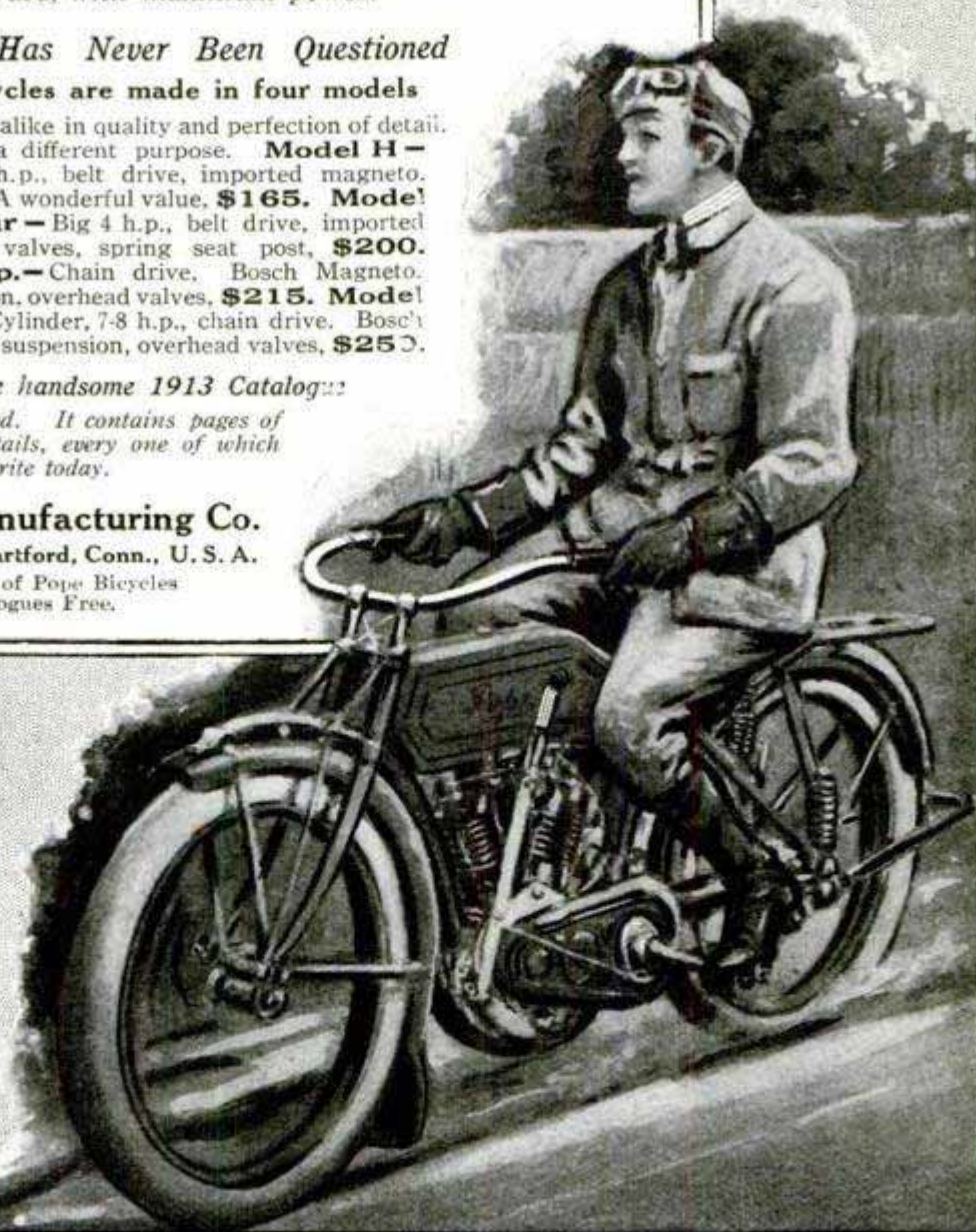

MAKE \$250⁰⁰ A MONTH REPAIRING AUTO-MOBILE TIRES



This Man Is Making Money

Business Keeps Coming

This Bunch of Tires Will Make Several Dollars Profit

The New Money Making Business. Start Now.

Put Yourself Where This Man Is

Be first to enter this new big paying business in your town. Open your pockets. Let the dollars pour in. Act quick. Every auto sold means more tires to mend. Automobile business is growing fast—enormous field for tire repairing. Punctures and blowouts are common. Tires need retreading and vulcanizing. Something going wrong all the time. Thousands forced to buy new tires because they can't get old ones fixed. Think of the old bicycle days—repair shops on every corner—all making money—busy day and night. Autos make same proposition over again—only ten times bigger and better. Users of Haywood Tire Repair Plants are making big money. Johnson, Tex., writes: "I made as high as \$18 profit in a day." Another man who bought a plant September, 1911, writes he has cleared over \$3000.00. That's going some! Operate a plant as side line in connection with auto business—garage or as an independent business. Find neighborhood where there's a bunch of autos—get all the steady business besides transient work. Experience unnecessary. You learn quick. Simply follow directions—practice a few days on a couple of old tires and you'll be ready to coin money. Business comes fast and easy.

Repair Tires at Home. Young men! and boys repair father's tires—get money he pays garage man. Get the neighbor's work. Make money to attend

college or to start a garage and repair business. **Auto owners**—repair your own tires—save money—pay for your outfit in short time. We have outfits for home use. Anyhow investigate. Send today for catalogue. See the wonderful possibilities in this marvelous field. Learn of the enormous money-making opportunities in this fascinating new business.

HAYWOOD TIRE & EQUIPMENT CO., 609 N. Capitol Ave., Indianapolis, Ind.

\$9250—Our Price for Next 30 Days

We now offer the Edwards "Steelcote" Garage (1913 Model), direct-from-factory, for \$92.50. But to protect ourselves from advancing prices of steel, we set a time limit upon the offer. We guarantee this record price for 30 days only. Just now we can save you \$35 or more.

Edwards Fireproof Steel Garage Quickly Set Up Any Place

An artistic, fireproof steel structure for private use. Gives absolute protection from sneak thieves, joy riders, fire, lightning, accidents, carelessness, etc. Saves \$20 to \$30 monthly in garage rent. Saves time, work, worry and trouble. Comes ready to set up. All parts cut and fitted. Simple, complete directions furnished. Absolutely rust-proof. Joints and seams permanently tight. Practically indestructible. Locks securely. Ample room for largest car and all equipment. Made by one of the largest makers of portable fireproof buildings. Prompt, safe delivery and satisfaction guaranteed.

(101)



Postal sent today brings new 56-page illustrated Garage Book by return mail. Address

The Edwards Mfg. Co.

620-670 Eggleston Avenue, Cincinnati, Ohio



WE SELL YOU AT WHOLESALE

Agents' Price One **AMERICAN**

Motorcycle or Bicycle

\$139⁶⁵

Honest hand-made machines at factory cost. Write now for catalog. Say whether interested in Motorcycle or Bicycle.

AMERICAN MOTOR CYCLE CO., 1004 American Bldg., CHICAGO



\$18⁸⁵



Ten Days' Free Trial

allowed on every bicycle we sell. We **Ship on Approval and trial** to anyone in the U.S. and *prepay the freight*. If you are not satisfied with the bicycle after using it ten days, ship it back and *don't pay a cent*.

FACTORY PRICES Do not buy a bicycle or a pair of tires from anyone at any price until you receive our latest Art Catalogs of high grade bicycles and sundries and learn our unheard of prices and marvelous new special offers.

IT ONLY COSTS a cent to write a postal and **FREE** by return mail. Everything will be sent you **FREE** by return mail. You will get much valuable information. **Do Not Wait; write it Now!**

TIRES, Coaster-Brake rear wheels, lamps, parts, repairs and sundries of all kinds at half usual prices.
MEAD CYCLE CO. Dept. L108 CHICAGO

NEW AUTO TIRES

28x3...	\$ 7.50	32x3 1/2...	\$ 13.00	34x4...	\$18.75
30x3...	8.00	33x3 1/2...	14.00	36x4...	20.00
32x3...	8.50	34x3 1/2...	14.00	35x4 1/2...	24.00
29x3 1/2...	11.00	30x4 ..	16.00	36x4 1/2...	27.50
30x3 1/2...	12.00	31x4 ..	17.00	37x4 1/2...	31.00
31x3 1/2...	13.00	32x4 ..	17.50	37x5 ..	35.00

The above are Diamond Tires, but as we are selling them at 40 per cent less than regular prices, maker's name is buffed off.

SPECIAL OFFER Send us the money for the amount of order (or if satisfied factory will ship C. O. D. when expressage accompanies order), use the tires ten days, and if you are not satisfied we agree to refund amount paid on return of tires to us at Chicago.

CARLSTEN-WILLIAMS CO., Dept. P.
S. E. Cor. 22nd Street and Michigan Avenue, CHICAGO

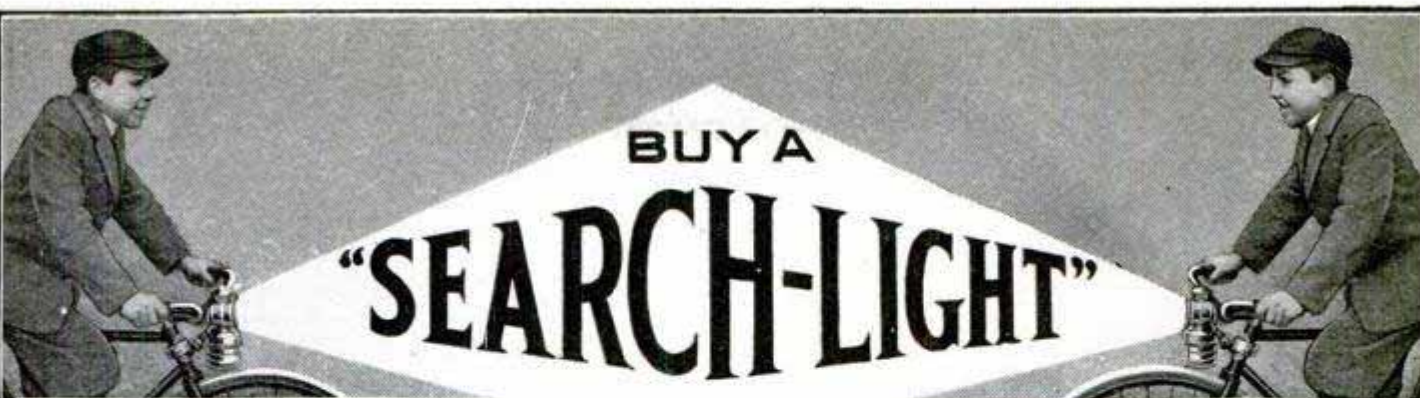

BUY A
"SEARCH-LIGHT"

BICYCLE LAMP

BURNS GAS—MAKES ITS OWN GAS

If you ride a wheel, get a "SEARCH-LIGHT" gas lamp. It gives a better light than any other lamp. It enables you to see far ahead, see all the ruts and holes and ride just as easily and fast as you would in the daytime. The "SEARCH-LIGHT" makes its own gas. It won't jar out. The "SEARCH-LIGHT" is nickel-plated, has red and green jewels, universal bracket, can be adjusted to any angle and attached to either head or fork. Ask your dealer. If he's sold out, write for handsome illustrated catalog—it's free.

You Need a New Pump At this season of the year, it's time to buy a new pump. We make more bicycle pumps than any other manufacturer. BRIDGEPORT Pumps are reliable and always work. Tell your dealer you want a "BRIDGEPORT Pump."

Write today for our handsome, illustrated pump catalog

BRIDGEPORT BRASS CO., P. O. Station K, Bridgeport, Conn.

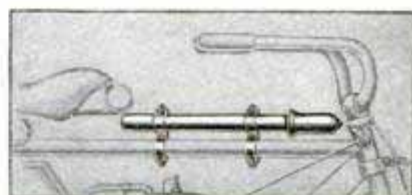

MOTORCYCLE
SUPPLIES



Motorcycle Supplies

We Make the Price

To get our latest book FREE, give name of your motorcycle. This is the most complete exclusive motorcycle accessory catalog ever published. You can't afford to be without it. Address us today.

KANSAS CITY MOTORCYCLE SUPPLY CO.
1501 Grand Ave. Kansas City, Mo.

Jackson
No hill
too steep. No
sand too deep.

OLYMPIC \$1500
4 cylinders
MAJESTIC \$1975
4 cylinders
SULTANIC \$2650
6 cylinders

JACKSON AUTOMOBILE CO.

1301 East Main St. JACKSON, MICH.

MOTORCYCLE SUPPLY CATALOGUE

LOWEST PRICES—LARGEST EVER ISSUED

In it we list 1242 guaranteed articles for the motorcycle owner at prices lower than others. We pay transportation charges. A \$20,000 stock for immediate shipment. Motor repair parts at half price. You can't be up-to-date without our 1913 catalog.

For 4c, catalog will be mailed to you.

Write today.



MOTORCYCLE EQUIPMENT CO.
MECO
ALCO
HAMMONDSPOUT, N.Y.

Write for
Booklet

Agents
Wanted



The FEILBACH LIMITED

is a Motorcycle of SPEED and STYLE

It is built at a slightly higher price to meet the demand for a **higher grade** machine. It is the first machine of such riding quality, ease of control and dependability so as to recommend itself for ladies' use. A mechanical examination and a trial of the marvelous horizontal spring seat support would convince you. 5 H. P., long stroke, offset crank, clean, silent, smokeless, bumpless. **PRICE \$250**

FEILBACH MOTOR CO., 1146-52 Holton St., MILWAUKEE, WIS.

The brake that saves!

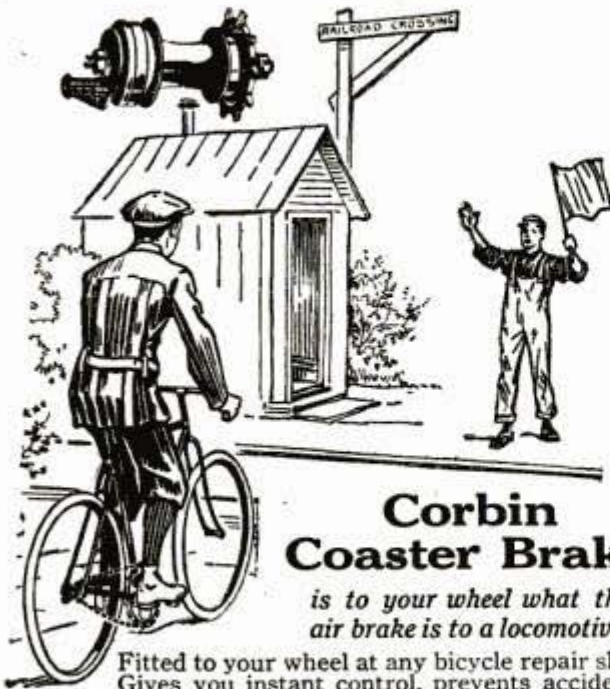

Corbin Coaster Brake

*is to your wheel what the
air brake is to a locomotive.*

Fitted to your wheel at any bicycle repair shop. Gives you instant control, prevents accidents. The two-speed model is an immense assistance when riding on up-grades and against strong head winds. Invaluable to elderly riders especially. Corbin Brakes are operated solely by the pedal. Simple, strong and reliable.

Send for 1913 free catalog showing
all Corbin Brakes, Hubs and Axles

CORBIN SCREW CORPORATION DIVISION
(American Hardware Corporation)
302 High Street New Britain, Conn.
Licensed Coaster Brake Manufacturers

Treat Your Tires With NEVERLEAK

Tire Fluid

It means freedom from tire troubles for the rest of the season; freedom from worry and unnecessary expense.

With Neverleak in your tires you can always depend upon reaching your destination without aggravating stops for repairs. You can enjoy the convenience and pleasure of wheeling more than ever before.

It makes your tires leak proof and heals punctures on the run without your even knowing they have occurred. It makes your tires wear longer.

A 25c tube treats a tire and it will last as long as your tire lasts. Treat your tires with Neverleak now—today. Don't wait. You can get Neverleak of any bicycle repairman or dealer in bicycle supplies. They all use and sell it.

BUFFALO SPECIALTY COMPANY
400 Ellicott St., Buffalo, N. Y.



Without an Equal

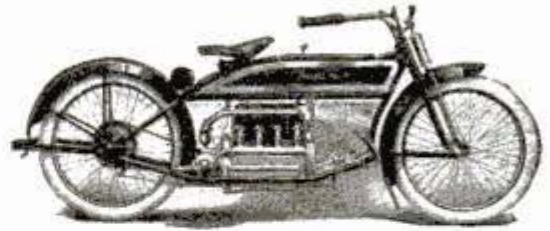

THE HENDERSON \$325
4 cylinders; 8 H. P.

☐ The Henderson is literally without an equal.

☐ And it is the only motorcycle that has the flexibility, the continuity of power development and the vibrationless comfort that result from multiple cylinders.

☐ Give these facts due consideration before you buy; and write for the Henderson catalogue.

Henderson Motorcycle Co.
1158 Cass Ave. DETROIT, MICH.



\$40 Motorcycle

We have the largest line of new and used Motorcycles in the country at the lowest prices. We also have a thoroughly equipped repair department and are in position to furnish repairs for any machine. Send us your machine to be overhauled. We pay cash for second hand motorcycles. *Send for Catalog.*
HARRY R. GEER CO., 888 McLaren Ave., ST. LOUIS, MO.

The Baldwin Lamp



Projects a 14-candle power light 150 feet. Burns Acetylene gas. Weight, 6 oz.; height, 3½ in. No oil, soot or glass. Absolutely safe and simple. Fifty hours' light costs 25c. Ideal for Night Fishing, Trapping, Hunting or for work about the farm or machinery. Useful as well to replace automobile tires in the dark. If your dealer cannot supply you write us direct and ask for catalogue and free instructive booklet, "Knots and How to Tie Them."

JOHN SIMMONS CO.
Price, \$1.00 162 Leonard St. New York City

RANGER BICYCLES

Have imported roller chains, sprockets and pedals; New Departure Coaster-Brakes and Hubs; Puncture Proof Tires; highest grade equipment and many advanced features possessed by no other wheels. Guaranteed 5 yrs. **FACTORY PRICES** direct to you are less than others ask for cheap wheels. Other reliable models from \$12 up. A few good second-hand machines \$3 to \$8.

10 DAYS' FREE TRIAL We ship on approval, freight prepaid, anywhere in U.S., without a cent in advance. **DO NOT BUY** a bicycle or a pair of tires from anyone at any price until you get our big new catalog and special prices and a marvelous new offer. A postal brings everything. Write it now. **TIRES, Coaster-Brake Rear Wheels, lamps, parts, sundries, half usual prices.** Rider Agents everywhere are coinng money selling our bicycles, tires and sundries. Write today.
MEAD CYCLE CO., Dept. L 108, CHICAGO





Bicycles 50% Off

Factory Price until we close a retail dealer in your community. When retail dealer in your community takes hold of "America" line this offer positively ceases. Order at once and save **HALF**.

Famous "America" Wheels

Not "cheap" mail-order wheels. Not sold in a "cheap" mail-order way. Only wheel with Truss Frame, giving double strength, and Hygienic Spring Fork, taking up every shock. Comes complete. **GUARANTEED TEN YEARS** (twice the guaranty of any other wheel). Protection from thieves—protection from accidents. Satisfaction or money back.

Write for **FREE Illustrated Catalog**
AMERICA CYCLE MFG. CO., Dept. 1067
 1108 South Michigan Boulevard CHICAGO, ILL.

Our New 1913 Catalogue Ready

Automobile, Motorcycle and Bicycle accessories, tires and specialties mailed on request. Discount to Dealers.

COVINGTON CYCLE CO., Covington, Ky.
 WHOLESALE DISTRIBUTORS

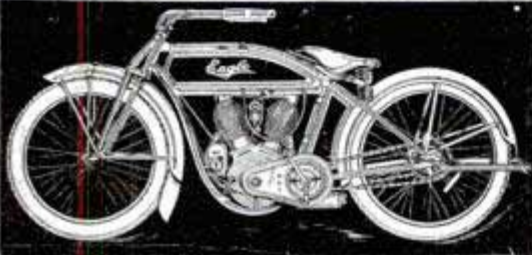

THE GREAT AMERICAN Eagle

9-12 H. P. Chain
DRIVE TWIN
Send for catalog
and prices.

EAGLE MOTOR CO.
 (P.M.) Brockton,
 Mass.

Build YOUR OWN Motorcycle SIDE CAR

Side Cars two parts. Four models to choose from. Send for Catalogue and terms.

**\$65⁰⁰
UP**

AGENTS WANTED

Baxter Side Car Co., 119 Broadway, Cambridge, Mass.

5 H. P. 1913 Peerless Motorcycle

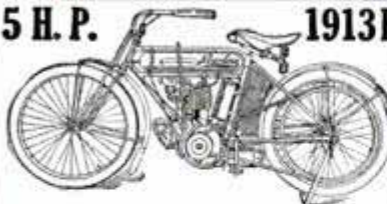

With Free Engine Idler and Bosch Magneto, together with the best there is in motorcycle construction—Power, Silence, Endurance, and those Wearing Qualities so essential for low cost of maintenance.
5 MILES FOR ONE CENT
 Agents Wanted—Liberal Discounts

PEERLESS MOTORCYCLE CO., 179 Huntington Ave., BOSTON, MASS.

THE FLYING MERKEL

The Only Self-Starting
Two-Speed Motorcycle
in the World.

SEND FOR CATALOG JUST OUT

THE MIAMI CYCLE & MFG. CO.
 350-370 Hanover St. MIDDLETOWN, O.

The Roof is More Than Simply Protection Against the Weather

It is the most prominent feature of your home. The feature that is first to be seen and that makes or mars the rest.

Flex-a-Tile Asphalt Shingles

are as durable as slate—as light and as economical as wood and as beautiful as tile.

Made of solid asphalt, surfaced with chipped slate or granite in rich natural colors of green or red—colors that can't come off or fade because they *are* natural.

Don't fail to write for the Flex-a-Tile Book and a free sample

A great proposition for wide-awake dealers—write for details

THE HEPPE'S COMPANY
 1021 Forty-fifth Avenue
 Chicago, Ill.



Please Mention Popular Mechanics



Speedler

On Your Motorcycle

Attach to handle bar. The marvelous speed spray for motorcycles. Lydon Speedler fits every motorcycle. For speed. For power. For cooling. For economy. Attach in a few minutes. Increases engine power 20 per cent or more. Gives your motorcycle a marvelous increase in speed. Removes carbon. Keeps engine cooler. Positively guaranteed on 30 days' free trial. Your money back if it does not pay for itself in a month.

More Speed

A Lydon Speedler gives your motorcycle more speed when you want it. Control at your finger-tip always. A finger-tip touch and you have a marvelous increase of power, of speed and saving of gas. It's the spray that does it. The powerful cross-current air spray of the Lydon Speedler renews the mixture to the highest degree of combustion. Speedler will give more life and value and higher speed in your motorcycle than any device ever perfected.

Increases Engine Power

Get more power and speed. Add 20 per cent to your present engine power by attaching a Lydon Speedler. Make your engine run smoother. Speedler is a perfect decarbonizer and handy primer. Pays for itself every month. It has our absolute money-back guarantee.

30 Days' Free Use

The Lydon Speedler is sold on 30 days' free trial. Use it for 30 days and get your money back if you are not entirely satisfied. Dealers everywhere are authorized to give 30 days' free trial. If your dealer is not supplied write to us for full descriptions and all particulars. Use it 30 days free and get your money back if you are not delighted with it. Write today for full description of this marvelous money saving, power making, speed device, postpaid free. **LYDON MFG. CO., Dept. 5248, Chicago, Ill.**

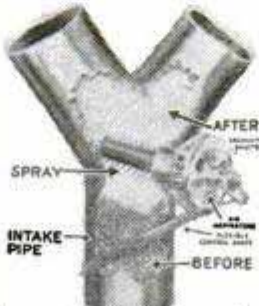

Prest-O-Lite

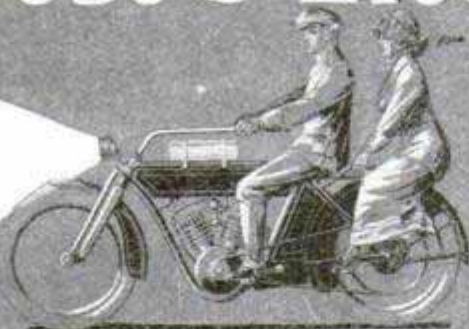

The Only Practical Light for Motorcycles

Prest-O-Lite is the only lighting system that makes night riding possible, pleasant and SAFE.

The ready-to-use gas costs no more—usually costs less—than the carbide a generator consumes.

The first cost is low (\$10). Prest-O-Lite never gets to be second-hand, and is always a READY CASH ASSET.

You can easily afford it. You cannot afford to be without it if you ride at night. One accident might cost you more than years of Prest-O-Lite service.

Easily attached to any motorcycle. We will arrange for immediate exchange service for anyone, anywhere.

See any motorcycle (or automobile) dealer, or write us.

DON'T ACCEPT AN IMITATION!

The genuine Prest-O-Lite, when empty, can be immediately exchanged for a full one, ANYWHERE AND ALWAYS. Imitations cannot.

The Prest-O-Lite Co., Indianapolis, Ind.

Branch offices and Service Stations in all principal cities. Charging plants in all parts of the country.

Exchange Agencies Everywhere

Locate Your Ignition Troubles with One Glance

The J. D. Visible Gap Spark Plug lays bare all ignition trouble. If the spark is seen jumping the gap, but ignition is faulty, look for your trouble between the gap and the sparking point. If there is no spark in the gap, your trouble is behind. This new great plug also facilitates timing, intensifies spark, uses only minimum current and cleans itself when you widen the gap by turning knurled adjusting nut. Gap can also be entirely closed.



Every part is made in our own factory—even the heat-defying porcelain being produced in our potteries from secret formulas. This unequivocal guarantee goes with every plug.

"YOUR MONEY BACK OR A NEW PLUG IF YOU ARE NOT SATISFIED."

If your dealer hasn't the J. D. Visible yet, send your money direct to us, specifying size wanted or make of car, and we will ship prepaid. Remember, the price is only \$1.00 for this plug.

FREE LITERATURE ON REQUEST

Jeffery-DeWitt Co.
521 Butler Ave., DETROIT, MICH.



\$1.00



Schickel
VALVELESS TWO-STROKE
Motorcycle
SIMPLE—NEAT
SERVICEABLE

Send postal for catalog

THE SCHICKEL MOTOR CO., 69 Garden St., STAMFORD, CONN.

MAKE YOUR BIKE A MOTORCYCLE

at a small cost, by using our attachable outfit. Fits any Bicycle. Easily attached. No special tools required.

"It Runs Fine!"

Mr. Blacketer, of Indiana, writes: "I received my attachment in first-class condition. The motor was easily attached, and runs fine. It does not take an experienced person to run a Shaw. I recommend it to anyone desiring, at a small cost, a motorcycle for power, speed and reliability."

FREE BOOK Write today for bargain list and free booklet, fully describing the SHAW Bicycle Motor Attachment. Motorcycles all makes, new and second-hand, \$35.00 up.

SHAW MANUFACTURING CO.
Dept. 6
GALESBURG, KANSAS





FOR the new Standard of tire service demanded in present day motoring, motorcycling and bicycling, you must come to

PENNSYLVANIA Oilproof VACUUM CUP TIRES

The Double-distance Tires that positively Defy Skidding and are Immune from "Oil Disease."

Motorcycle Size, Automobile Tires —that's what Vacuum Cup Motorcycle Tires are—made exactly the same as the phenomenally long wearing Vacuum Cup Automobile Tires—same construction, same stock, same Sea Island cotton fabric with a tensile strength of 420 lbs. per square inch, as against 125 in other motorcycle tires.

Guaranteed for **5,000 MILES** and average far more

RED TREAD VACUUM CUP OILPROOF BICYCLE TIRES

Single Tube and Clincher Type

Have precisely the same characteristics and carry our exceptional guarantee of an entire season's satisfactory service under the liberal conditions printed on tag attached to each tire. Everywhere the tire demand is swinging over to Vacuum Cup Oilproofs like a tide—from motorists, motorcyclists and bicyclists alike.

Pennsylvania Rubber Co., Jeannette, Pa.

Pittsburgh, 505 Liberty Ave. }
Cleveland, 1837 Euclid Ave. } Branches }
Detroit, 254 Jefferson Ave. }
Chicago, 1004 Michigan Ave. } Minneapolis, 34 S. 8th Street
Kansas City, Mo., 514 E. 15th St.
Omaha, 215 S. 20th Street
Seattle, Armour Building

Pennsylvania Rubber Company of New York
New York City, 1700 Broadway
Boston, 149 Berkeley Street
Dallas, 411 S. Ervay Street

Pennsylvania Rubber Company of California
San Francisco, 512-514 Mission Street
Los Angeles, 930 S. Main Street



An Independent Company with an independent selling policy



SOLVED! The SHIRT PROBLEM

A few seconds is all it takes to slip on or take off the Signal Coat Shirt. The coat style prevents yoke-splitting, temper-trying, overhead-tugging. And this is only *one* of a combination of comfort features you get in no other shirt no matter how much you pay.

SIGNAL \$1 COAT SHIRT

Union Made Two Detachable Collars

the only work shirt worth having: Extra Button at Bottom of Breast Plait, Rip-proof, gap-proof sleeve slit; specially cut skirts overlapping 3 inches in front; 2 detached or one attached collar as desired; buttonholes for white cuffs; double-needle machine stitching; 2 pockets, one a triple combination for pencil, watch and handkerchief.

In comfort and in economy the Signal has solved the shirt problem for every railroad man who ever wore it. It will end your difficulties.

Is This Worth Proving? Ask your dealer. If he hasn't Signals, tell us his name and your size and we will express you a couple C. O. D. If not delighted with them on examination, *return at our expense.*

Write for folder showing big variety of other styles and sample swatches. Address



Hilker-Wiechers Mfg. Co.

Mfrs. of SIGNAL Work Clothes
1256 Mound Ave. Racine, Wisconsin

Learn This



Weekly Salary Guaranteed

How's That Strike You?

Some liberal offer, Hey? It's just exactly what we do for you. We put you on a regular salary basis besides enabling you to make the *biggest cash profits on regular sales* in the tailoring business. All we ask is that you wear and show our high grade, hand-tailored, made-to-measure suits, overcoats, genuine English slip-ons, etc., and be

The Best Dressed Man in Your Town—And We Pay You a Salary

The Knickerbocker Tailoring Company is the one house that *really* boosts the game for you—we're the Big Tailoring House that does things on a big, generous scale. We give you *more* at the start than others can figure out in 20 years. *We prepay everything—and if our garments are not satisfactory you don't accept them. Quit fooling around with the old plan—cast your lot with the BIG house that pays you like a prince and treats you like a gentleman.*

We're the ONLY House Paying Salaries

Don't forget that; *we want you to know this is true yourself.* Not only do you get a big weekly salary, but we furnish you with a complete Sample Outfit—the swellest ever put out—everything necessary—FREE and Express Prepaid. No money needed with us. In addition to all this, just to show you what kind of people we are, we'll give you a

FREE SUIT and RAINCOAT

for good measure. YOU CAN'T BEAT IT. We've simply knocked the props from under 'em all. Now get this:

We'll Put You on Our Pay Roll AT ONCE!

So send us your name and address today—be the first in your town to get this wonderful, liberal salary. Do it NOW.

Knickerbocker Tailoring Co., Dept. 401, Chicago



FREE SUIT

"Little Wireless Phones"

For the ears that will cause you to

HEAR

What eye glasses are to failing sight, my invisible ear drums are to lost or failing hearing. Just as simple and common sense and on the same principle, for they magnify sound as glasses magnify sight. They are really tiny telephones of soft, sensitized material, safe and comfortable, which fit into the orifice of the ears and are invisible. They can be removed or inserted in a moment and worn for weeks at a time, for they are skillfully arranged for perfect ventilation and anti-friction. These little wireless 'phones make it easy to hear every sound distinctly, just as correct eye glasses make it easy to read fine print. Among the nearly 400,000 people whom they have enabled to hear perfectly, there has been every condition of deafness or defective hearing. No matter what the cause or how long standing the case, the testimonials sent me show marvelous results.

Common-Sense Ear Drums

have restored to me my own hearing—that's how I happened to discover the secret of their success in my own desperate endeavors to be relieved of my deafness after physicians had repeatedly failed.

It is certainly worth your while to investigate. Before you send any money just drop me a line. I want to send you *free of charge* my book on deafness and plenty of evidence to prove to you that I am entirely worthy of your confidence. Why not write me today?

GEORGE H. WILSON, President

WILSON EAR DRUM CO., Incorporated

1024 Inter-Southern Bldg.

LOUISVILLE, KY





Bathroom Outfit \$35

These handsome high-grade plumbing fixtures furnished complete, guaranteed and sold direct, saving you all dealers' profits! Bath Tub and Basin are white porcelain enamel over high-grade cast iron. Toilet is vitreous china with oak seat and copper lined Oak Tank. Any handy person can install outfit; no hot metal required.

Water Supply System \$40

Black Steel Tank, 145 gallon capacity, 2½ inch Brass Lined, Double Action, Combination Air and Water Pump, including all Pipe, Fittings, Valves, Gauges, etc., complete.

Heating Plants \$95 Up

We will save you 30 to 60 per cent on a modern steam or hot water heating system, complete in every detail.

Free Book Our catalogue illustrates and describes everything in the heating and plumbing line at wholesale prices. SEND FOR IT TODAY.

Chelsea Manufacturing & Supply Company
135 West 24th St. Dept. D, New York

Learn the new profession Tree Surgery

Not overcrowded and offers splendid and unusual opportunities to honorable young men. Ages 20 to 28. Students must have attended high school, and be at least 5 foot 7 in height, physically sound and of good character. After completing two years' course, good men make \$1,000 to \$5,000 a year. Positions guaranteed to good men after graduation. Every city, park, orchard and private estate needs an Expert Tree Surgeon. Positions open also with established companies or State and National Governments. Special attention to Fruit Growing. Tuition moderate, including first year's board. We pay salary second year. Write promptly for full particulars. Address the Secretary.

DAVEY INSTITUTE OF TREE SURGERY

Box 201, KENT, OHIO

Health? Take Turkish Bath at Home—Only 2 Cents



Physicians are abandoning drugs for this new treatment. If your mind or body is tired, open your pores and feel the rapid change in your condition, at cost of 2c a bath. **The Robinson Bath Cabinet** is the only scientifically constructed bath cabinet ever made for the home. **Great \$2 Book Sent Free**—"The Philosophy of Health and Beauty". Write today. Agents Wanted **ROBINSON MFG. CO.**, 319 Robinson Bldg., Toledo, O.

A MONEY-MAKING PROPOSITION For a Live, Hustling Man

We offer exclusive protected territory to wide awake men to sell International Ideal Portable Gasolene Lamps and Lighting Systems and to attend to our business.

Your Chance!

Territory is being taken rapidly. If you want to make a business man's income, write to us now. Our plan insures quick sales and our exclusive models and patents distance all competition. "Our Help Sales Plan" means dollars to you. Splendid side lines. Our newly patented self-heating sad iron beats any and all.

For full particulars write
International Light, Novelty & Specialty Co.

311 River St., Dept. 20, CHICAGO

Deaf People Now

HEAR

Distinctly!
Clearly!
Perfectly!



*In The
Hollow of
Your Hand*

every kind of sound with the aid of the latest marvelous invention, the remarkable

New 4-Tone Mears Ear Phone

The great, new electrical marvel for the deaf. Perfect hearing at last! This remarkable invention has four different sound strengths, four different adjustments, instantly changed by a touch of the finger. You regulate the instrument by a tiny switch to meet any condition of your ear or to hear any sound—low pitched conversation near you or sounds from any distance. The whole range of hearing of the healthy, natural ear is covered by this new 4-Tone Special Model Mears Ear Phone.

Special Limited Offer

Write at once for our Big Special Introductory Offer on this new wonder. To advertise and quickly introduce this greatest of all inventions for the deaf, we are going to sell the first lot of these new **four-tone** phones **DIRECT** from our laboratory to users at the jobber's lowest net price. This offer applies only to the first lot finished—a limited number. Write today—send the coupon—and you can save more than one-half the retail price. A few dollars, payable on easy terms, if desired, secures you complete relief from your affliction. But the **jobber's price** is confidential. You must write for it. Do it now and save both wholesaler's and retailer's profits.

Try it 10 Days in Your Own Home **FREE**

Every Mears Ear Phone is sold only on Free Trial. Ask about our great free trial offer. Test this amazing instrument on your own ears, under any conditions of service for ten days. Nothing to pay for the trial. The Mears Ear Phone is the only scientific and perfect hearing device for the deaf. Already 14,000 Single Tone Mears Ear Phones have been sold.

Send Coupon Now For Free Book

If you live in New York call at our office for free demonstration.

The Mears Ear Phone book explains all the causes of deafness; tells how to stop the progress of the malady and how to treat it. Send the coupon at once for Free Book and our Special Limited Introductory Offer. Send at once.

**Mears Ear Phone
Co., Suite 1194
45 W. 34th Street
New York, N. Y.**

COUPON

**Mears Ear
Phone Co.
Suite 1194**

**45 W. 34th Street
New York, N. Y.**

Gentlemen: Please mail me, free and post-paid, your Mears Ear Phone Booklet and particulars of your Special Introductory Offer on your new model Four-Tone Mears Ear Phone and Free Trial Offer.

Name

Address

COMPLETE 5-ROOM HOUSE \$298



ALADDIN



A LADDIN Read-i-Cut Houses are not portable. They are built exactly the same as any well constructed dwelling house. They cannot be taken apart when once erected. They are strong, warm, convenient and permanent. Our patent plaster board is warmer than lath and plaster. Aladdin houses are the original knocked-down houses. They have been used for years in every part of the country. Aladdin houses are sold under a positive and definite guarantee backed by a gold bond. This guarantee covers safe arrival of material, quality and quantity. The Aladdin catalog contains 100 designs to choose from.

READI-CUT HOUSES

SAVE MONEY



and complete instructions. Houses from 2 to 12 rooms. Save four profits by buying direct from mill. Quick delivery. *Send stamps today for Catalog P.*

THE Aladdin method enables you to buy all the material for a complete house direct from the original producer. It saves four profits on the lumber, millwork, hardware and labor. You keep the mid-

dlemen's profits in your own pocket. Aladdin Read-i-Cut Houses are shipped everywhere. Every piece of material comes to you cut and fitted and ready to nail in place. No skilled labor required. Permanent, attractive, warm and lasting. Price includes all lumber cut to fit, shingles, doors, windows, glass, patent plaster board, interior trim and finish, paint, nails, locks, hardware

NORTH AMERICAN CONSTRUCTION CO.

Mills in Michigan; Texas; Oregon;
Florida; Missouri and California

382 Aladdin Ave., BAY CITY, MICH.

OVER
\$400
Made
in One
Day

Operating
the



CIRCLING WAVE, the catchy amusement device that combines the pleasure of the merry-go-round with the joy of boating on the gently rolling lake or bay. At Eagerton, Ind., Booher Bros. made \$150.90 in six hours, and one day at Crawfordsville, \$402, and another made \$380 in six hours. You can do this also and employ only one assistant.

Write today for description of the CIRCLING WAVE and its wonderful money-making power.

ARMITAGE & GUINN, 159 Mill St., Springville, Erie Co., N. Y.

DO not ill-treat your face or handicap your razor by using an inferior lather. Whichever method you prefer—Stick, Powder or Cream—you cannot be sure you are using the best until you have tried Colgate's. Buy your favorite method at your dealer's—or send 4c in stamps for a trial size of any one.

COLGATE & CO.

Dept. 81. 199 Fulton St., NEW YORK

Steady Work for YOU

Would you take a steady job selling my quick moving, snappy line of soaps, perfumes and toilet preparations? No experience needed. I pay cash; no premiums. If you are looking for an unusual opportunity for making big money quick write me a postal saying, "Mail full particulars." Address **E. M. DAVIS, President**
E. M. DAVIS CO., A 172 Davis Block, Chicago

You Are Sure of

Cabot's Shingle Stains

They have been the standard for more than thirty years, and are specified by nine-tenths of the architects, who know them from experience. Their colors are soft, rich and beautiful, and guaranteed fast. Their vehicle is Creosote, which thoroughly preserves the wood, and they contain no kerosene or other cheapener. Why experiment with unknown stains, when you are sure of Cabot's? If a substitute is used on your house, you are the loser.

You can get Cabot's Stains all over the country. Send for samples and the name of nearest agent.

SAMUEL CABOT, INC., MANFG. CHEMISTS
6 Oliver St., Boston, Mass.



Stained with Cabot's Shingle Stains. Aymer Embury II, Architect, N. Y.



Quality

is of course the most essential requisite of a lathe for **Garage work**, as well as for **Automobile and general repair work**. We have it in our lathes, but we have kept the **price very low**.

We would be glad of an opportunity of convincing you that we offer both **high quality and low price** in the **Sebastian Lathe**. Our catalog free.

The Sebastian Lathe Co.
107 Culvert Street CINCINNATI, OHIO

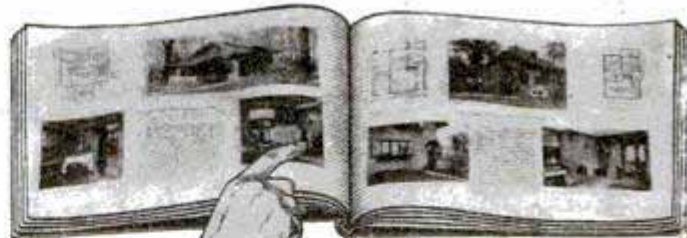

Sent Free

HERE is your chance to secure absolutely **FREE OF CHARGE** the most complete and up-to-date plan book ever published. No carpenter or contractor who wishes to be familiar with the latest in building construction — no man who is contemplating erecting a home — can afford to be without it. This great new plan book, "**Modern American Homes**," contains plans and specifications for 168 different structures, including excellent exterior and interior views, detailed estimates, etc. Designed by the leading architects of this country. Includes city, country and suburban homes, bungalows, farm houses, summer cottages, tent houses, camps, garages, apartment houses, and various public buildings. Contains 224 pages, 9 1/2 x 12 3/4 inches, and 426 illustrations. Printed on heavy enameled paper and substantially bound.

THE CYCLOPEDIA OF Architecture, Carpentry and Building

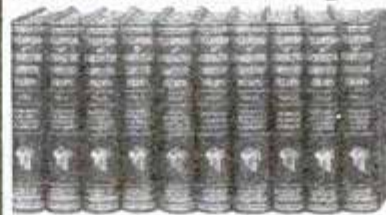

consists of ten massive volumes; 4,760 pages, 7x10 in.; 4,000 illustrations, full page plates, building plans, diagrams, etc.; hundreds of valuable tables and formulas; carefully cross-indexed for quick, easy reference.

This work covers everything in the building professions, from the first rough sketch* of the architect to the acceptance of the finished structure. It includes wood, stone, steel, and reinforced concrete construction; estimating and contracting; a study of the Greek and Roman Orders; interior finishing and decorating; and modern house lighting and sanitation.

Partial Table of Contents

Mechanical, Free-hand, Perspective and Architectural Drawing, Lettering, Pen and Ink Rendering, The Orders, Superintendence, Strength of Materials, Masonry, Reinforced Concrete, Carpentry, Steel Square, Stair-Building, Hardware, Steel Construction, Roof Trusses, Practical Problems, Estimating, Contracts, Specifications, Building Law, Sanitation, Sheet Metal Work, Electric Wiring and Lighting.

We'll Send the Plan Book FREE

With every order for a Cyclopedia we will include the Plan Book, absolutely free of charge and send you the Cyclopedia and the Plan Book, express prepaid, for seven days' free examination. You keep the books a full week — examine them thoroughly at your leisure — and if they don't meet with your expectations they may be returned at our expense. Remember — the complete set, Cyclopedia and Plan Book, are sent free upon receipt of the coupon below and we pay express charges both ways if they are not satisfactory.

Another Free Offer With each set is included a year's Consulting Membership, regular value \$12.00, entitling you to the free advice of a corps of Expert Architects. This will give practical help in handling building problems which are too specific to be taken up in detail in the Cyclopedia. This service alone is worth more than the first cost of the books.

American School of Correspondence, Chicago, U. S. A.

FREE PLAN BOOK COUPON

American School of Correspondence, Chicago, U.S.A.

Please send **Free Plan Book**, also Cyclopedia of Architecture, Carpentry and Building for seven days' examination. I will send \$2.00 within seven days and \$2.00 a month until I have paid \$24.80 for Cyclopedia (**Plan Book included free**), or notify you and hold books subject to your order. Title not to pass until fully paid. *Pop. Mech.* 4-13

NAME

ADDRESS

OCCUPATION

EMPLOYER

ELECTRIC LIGHT PLANTS Complete gasoline engine, dynamo, switchboard and storage battery \$240. Agents wanted. American Battery Co., 1139 Fulton St., Chicago (Estab. 1889.)

BRIGHTEN YOUR WITS

with our brain tickling puzzles. Sample for 10 cents or three good ones for 25 cents. Catalog included.

WONDER NOVELTY CO., Dept. I, Box 123, St. Paul, Minn.



DUPLICATE KEYS

made in little over a minute by the

HARRISON M. I. P. KEY FILING MACHINE

Yales, Corbins, Russell & Erwins, Norwalks, Readings, etc. The greatest invention of the age, price within the reach of the masses. Master Mechanics, Hardware Stores, Superintendents of Buildings, Locksmiths, etc., cannot afford to be without this tool. Price \$3 complete by mail free. Send for circular.

HARRISON & CO., 81 1/2 New Street, New York

Important Announcement

See next month's issue of Popular Mechanics for the greatest camera offer that has ever been made in America. We advise you to defer your purchase until you see and read this remarkable offer. We are sure you will want to take advantage of it.

NATIONAL CAMERA CO., St. Louis, Mo.

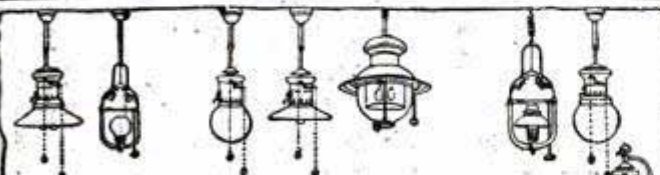

Air to Burn

There is plenty of it, and it costs nothing. Most beautiful and powerful light since dawn was invented. Over 500 styles of fixtures for home or business. Write for catalogue.

AMERICAN GAS MACHINE CO.

190 Clark Street

Albert Lea, Minn.

17 Jewel WALTHAM

20-Year Gold Case



Here's the greatest watch value in America. It's the latest model—just the right size—handsome 20-year gold case and a 17-Jewel Waltham movement. I'll guarantee that it will give you better service than you can get anywhere else at double the price.

15 Days' Free Trial

I know this 17 Jewel Waltham is so much better than anything your local dealer can offer you that I will send it to you absolutely free for 15 days' trial. Take it—use it—carry it for 15 days, only

\$2⁵⁰

and the balance in six easy payments of \$2.50 each. If you don't think it's the best watch you ever saw for the money send it back. I will pay the charges both ways and you won't be out one cent. No notes, no interest, no security. All dealings strictly confidential.

Gold Chain FREE! To the first 100 readers of this paper who order this watch we will give an elegant \$5.00 GUARANTEED GOLD CHAIN FREE. We sell watches, diamonds and jewelry BY MAIL to ONE-HALF MILLION people in all parts of the world. If you want a watch, diamond or jewelry of any kind, you can't afford to invest a single dollar until you get our catalog and prices—the lowest you ever heard of for the BEST GOODS, and our terms—the most liberal offered by any retail jeweler in the world.

Write today for our Catalog. It will save you \$10.00 to \$50.00 sure.

RYER JEWELRY CO. 606 Ryer Building
Kansas City, Mo.

ELECTRIC House, Farm and Motion Picture Lighting and Power Plants. Carriage, Bicycle, Hunting, Fishing and Automobile Lights. Generators, Railways. Catalog 3c.
OHIO ELECTRIC WORKS, CLEVELAND, OHIO



\$15.00 to \$35.00 Per Day Easily Made

Taking photographs with our **ONE MINUTE TINTYPE** and **POSTCARD CAMERAS**. Pictures made direct without use of negatives. Toned, fixed and developed in one solution. No experience or dark room necessary. Cameras from \$10.00 up to \$35.00 each. Complete photos cost 1c to 2c each, sell for 10c, 15c and 25c each.

Send for Free Catalogue and Price List today.

NEW YORK FERROTYPE CO., 168 Delancey St., New York City, Dept. III
Branch 1113 S. Halsted Street, Chicago, Ill.

Make Money Out of Keys

Write for particulars and Catalogue 104

There's a big, live, opportunity making Duplicate Keys

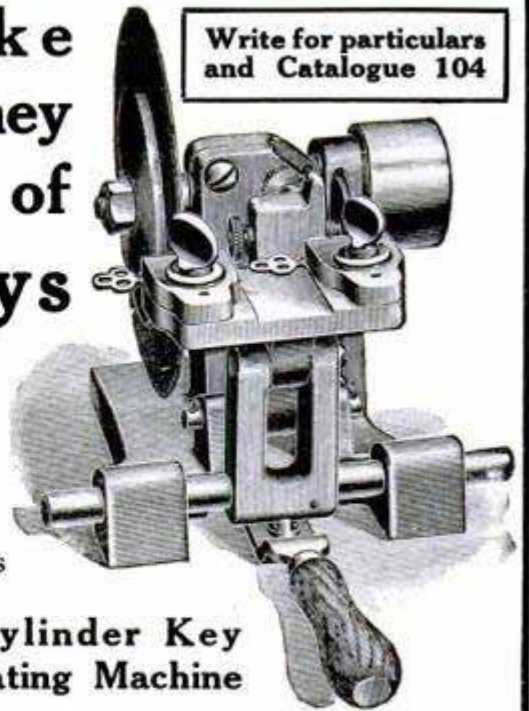

The Cylinder Key Duplicating Machine

is worth its weight in gold to Tinsmiths, Hardware men, Plumbers, Electricians, etc. It offers hustlers a chance to get into a steady business or a profitable sideline wherever there are doors to lock. It is simple, accurate and inexpensive.

ORR & LOCKETT

14 W. Randolph St. CHICAGO



WHITE ZIRCON

The only substitute for diamond showing a magnificent play of color. Cuts glass and resists fire and acid tests. A natural gem mined only in Ceylon. Far superior to white sapphire or topaz. Guaranteed satisfactory at one-twentieth the price of diamond. Mounted in solid gold and platinum. Sent free for examination. Catalogue and "Facts About Gems" by Prof. G. M. Butler of the Colorado School of Mines, mailed free.

THE ZIRCON GEM CO., 419 Boston Bldg., DENVER, COLO.

Avoids Mistakes and **Saves Brain Work**
For General Office or Personal Desk
Over 60,000 in use
Mostly sold through Recommendation

Buy from your Stationer or order direct
Price includes handsome Morocco case. Every machine guaranteed. Money refunded if not satisfactory after 10 days trial.

Sales Agents Wanted

E. Gancher A. A. M. Co. N. Y.
319 Broadway



\$10 Golden Gem
Portable
Adding Machine

Let Your Engine or Motor Do the Work

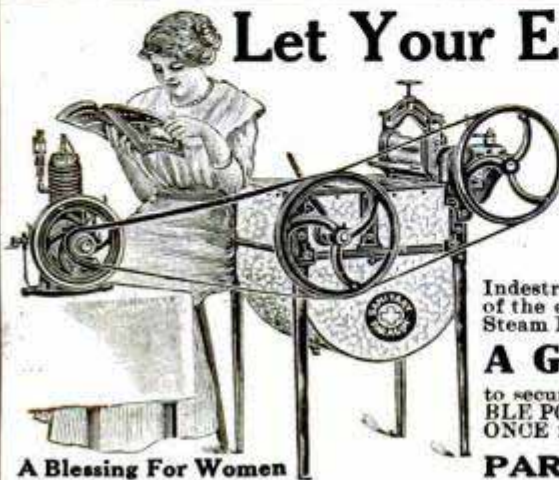

A Blessing For Women

and make an end to washday drudgery in YOUR home. Of course, NONE of the unsanitary, old-fashioned wooden rotary washers will do. ONLY THE MOST UP-TO-DATE machine ought to be good enough for YOUR wife. EXPERTS will tell you that NO MORE DURABLE and PRACTICAL washer can be found than the famous

All Metal Sanitary Paragon Revolving Cylinder Power Laundry Machine

Indestructible. NO WOOD used in any part. The PARAGON is a true reproduction of the expensive and powerful Cylinder Washers exclusively and successfully used in Steam Laundries, Hotels and Hospitals. Over 100,000 Paragon Washers used in the U. S.

A Golden Opportunity for 30 Days Only

to secure one of these wonderful genuine laundry machines, complete with REVERSIBLE POWER WRINGER at a very considerable REDUCTION in price, if you write AT ONCE for Catalog No. 1 and further details of the most generous proposition made.

PARAGON MFG. CO., 2401-03 W. 14th St., CHICAGO

TRY IT
TEN DAYS
FREE

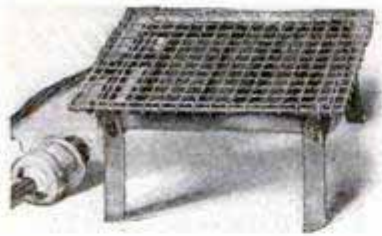

Delco ELECTRIC TOASTER

uses only about half the current required by an upright toaster, still giving as perfect service as any toaster on the market. Can be used for heating water, chafing dish, popping corn, and many other things. Handsomely nicked and furnished complete with cord and plug. Can be attached to any electric light socket. We will send you a Delco Electric Toaster by Parcel Post

ON TEN DAYS' FREE TRIAL

If it does not meet your approval send it back at our expense. Satisfaction guaranteed or money refunded.

PRICE ONLY \$3.00

On sale at your dealer's or Electric Light Co. Manufactured by the makers of the celebrated Delco Electric Three Heat Iron.

DIAMOND ELECTRIC CO.

75 Frederick Street, Binghamton, N. Y.

Indorsed by Good Housekeeping Institute.

GINSENG The best paying crop. One acre worth from \$30,000 to \$40,000. Easy to grow. Easy to dispose of. Large profits from small space in back yard. My book entitled, **HOW TO RAISE GINSENG**, tells how, from choosing plot to marketing. Illustrated, and contains dimension drawings for laying out beds, shading, etc. Sent postpaid for 50 cents. **F. IVES, Box 488, MINNEAPOLIS, MINN.**

The Guarantee of
Reliability
in electrical apparatus is the monogram trade mark of the largest electrical manufacturer in the world—**GENERAL ELECTRIC COMPANY**
General Office: Schenectady, N. Y. Sales Offices in 52 Cities.

An Electric Bell Without a Battery

30 DAYS' FREE TRIAL

Our No-Battery Electric Bell is positively the greatest invention of the age. This new inexhaustible and indestructible bell carries its own generator. When you

turn the button, it generates its own electricity and rings loud and as long as the button is turned.

Anybody Can Install It

No expert electrician needed to install this bell. Any man who knows how to use a screw-driver and hammer can place it without any additional cost.

30 Days' Trial Send \$3.50 and we will send you the complete outfit. You risk absolutely nothing. If after a thirty-days' trial you do not find the bell as represented, return it to us and we will refund your money.

Searles Electric Co., 11548 Monadnock Block, CHICAGO

An Invisible Policeman Guards Your Fingers From Ink Smears

HIS name is *Capillary Attraction*. And his "fixed post" is at the lower end of the feed tube in every Parker Lucky Curve Fountain Pen.

He stands there and arrests any ink drops that would like to get out around the writing end of the pen to smear your fingers when you remove the pen cap to write.

For when ink drops stay up in the narrow feed tube of a fountain pen in your pocket, there's trouble. The heat of your body—98 degrees—heats the air in the pen (see X-Ray diagram). This hot air expands and pushes up the feed tube to escape, pushing those ink drops up and out around the writing end of the pen.

Now the Parker feed tube is curved and touches the barrel wall. See X-Ray. This touch creates Capillary Attraction (that curious natural force that makes sponges absorb, etc.) and the instant you turn your Parker point up, Capillary Attraction just yanks back any ink drops that try to stay in the feed tube, and drops them down below with the other ink.

Result—an empty feed tube when the air expands. This curved feed tube is the famous Parker Lucky Curve.

PARKER LUCKY CURVE FOUNTAIN PEN

Parkers write smooth as polished marble, because their 14K gold nibs have tips of hardest Iridium. Parker Spear Head Ink Controller insures even, regular flow. Parker Disappearing Clip clings close, but recedes when you remove pen cap. Price 25c extra.

Standard style Parker Pens \$2, \$2.50, \$3, \$4, \$5, \$10 and up, according to size and decoration.

Parker Jack Knife Safety Pen

is built so ink-tight that you can carry it anywhere without its leaking. Handy, Small. Prices \$2.50, \$3, \$4, \$5 and up.

Get a Parker on trial. If you're not pleased, dealer will refund within 10 days of purchase. If your dealer doesn't sell Parkers, send us his name and we'll mail you handsome, complete catalog.

Start getting a Parker pen to-day.

PARKER PEN COMPANY
100 Mill St., JANESVILLE, WIS.



No. 20 1/2
Beautiful
Chasing
on Barrel
and Cap.
Price \$2.50



Please Mention Popular Mechanics

THE MARVEL PROJECTOR
MULTI-LINE & WATCH

THE MARVEL PROJECTS
LIKE THE SUN'S RAYS
NEW 1914 MODEL
IS THE ONLY
FLICKERLESS
& NOISELESS
MACHINE MADE
10 PATENTS PENDING

GO INTO THE MOVING PICTURE BUSINESS

\$20.00 AND MORE PER NIGHT CAN BE MADE EXHIBITING WITH OUR MACHINE

It is a startling fact that in hundreds of cities and small towns are young men who have got rich in a few years from running moving picture shows, having started with but a little money.

There is a fortune in your own, and surrounding towns, waiting for the first man to get a moving picture machine. Don't let someone else take this big income. Only a small payment required to get this new machine, balance can be paid in easy installments while you are using machine.

The wonderful thing about this machine is that it is low priced, yet is one of the best on the market. Gives marvelous bright, clear pictures. Get a machine that will last—get the **MARVEL**.

Don't waste time. Write for full information.

MOTOGRAPHIC SUPPLY CO. DEPT. A, HOME BANK BLDG., DETROIT, MICH.

A Constant Water Supply

for all purposes is easily secured by installing a

RIFE RAM

which operates by running water. Its cost is low; easily installed. Can be used either with OPEN or Pneumatic Tank.

SIMPLE—DURABLE—ECONOMICAL—EFFICIENT



The **RIFE RAM** operates with any fall from 3 ft. to 50 ft. and will pump water to a height 3 to 25 times the fall. If you have a flow of 3 or more gallons per minute from a spring, artesian well, brook or river, write for our free Catalog and information.

RIFE ENGINE COMPANY
2131 Trinity Bldg., New York City



Standard Typewriters \$10 and up. All makes—Smiths, Remingtons, Oliviers, Underwoods, etc., at $\frac{1}{2}$ to $\frac{3}{4}$ manufacturers' prices, 500 typewriters at \$10 to \$15.

FULLY GUARANTEED 2 YEARS

Send To-day for Catalogue and Liberal Offer.

Consolidated Typewriter Exchange, Dept. 164, 333 So. Dearborn St., Chicago

Shoe & Harness Repair Kit \$1

SENT PREPAID

Outfit consists of Automatic Stitching Awl Handle (which alone costs \$1 if bought elsewhere), One Automatic Collar Awl, 3 eye-pointed Awls, Stitching Horse, 2 Spools Thread (3 and 5 cord), Wax, Bobbins and Wrench, all neatly packed in heavy case. Do your own repairing of harness, shoes, saddles, belts, tents, paulins, etc., and save repair bills. Quickly pays for itself in money saved. Send \$1 today. Money back if not satisfied.

LOTZ BROS.

Dept. 1

ST. LOUIS, MO.

Wear **BEFORE** You Buy "PROCESSED HOSIERY" The **NEW** Stocking

DURABILITY—Doubled } *It's all in the amazing*
COMFORT—Absolute } *"DUAL" Process*
TEXTURE—Beautiful }

Six pair in a Sanita-seal Packet sent without charge to convince you. Order ANY STYLE from our free catalog, "Book of Stockings."

Soldiers' uniforms have been processed to stop bullets. Now comes "Processed Hosiery." You cannot wear holes in it. No "drop-stitch" troubles.

For Men, Women, Children, Cotton, wool, lisle, cashmere, silk. All colors, plain and embroidered. 25c to \$25.00 a pair.

LADY WANTED—MAKE GOOD INCOME SELLING PROCESSED HOSIERY TO FRIENDS

PROCESSED HOSIERY CO., 11-E, West 34th St., NEW YORK



A Square Deal

Watches On Credit

High Grade **WALTHAM** and **ELGIN** MOVEMENTS

We sell the finest watches made. No matter where you live,

YOUR CREDIT IS GOOD

Better goods at lower prices. Write for Big Free Catalog of Watches, Diamonds, Jewelry, Silverware and our Easy Terms of Payment.

MILLER-HOEFER COMPANY
154 Miller Bldg., Detroit, Michigan

DIAMONDS
WATCHES JEWELRY
ON CREDIT
BRILLIANT JEWELRY
COMPANY
704 MARKET ST. SAN FRANCISCO, CAL.

SEND FOR FREE CATALOG

FREE TOBACCO REMEDY

If you want to banish the nicotine habit and remove all craving, simply send name to White Cross Society (chartered by State of Missouri) for free sample treatment.
H. C. BURGET, Secretary, 811 Kemper Bldg., Kansas City, Mo.

Mechanics for Young America

The Most Interesting Book For Boys Published

Tells how to make boats, tents, fishing tackle, camps, motors, windmills, kites, balloons and many mechanical and electrical devices. 128 pages.

Every page illustrated. 25 cents postpaid
POPULAR MECHANICS BOOK DEPT.,
318 W. Washington St., CHICAGO



Carfare Pays For This Bicycle

What you save riding to work and for pleasure will pay for your "Rick-Made" bicycle—in one year—after that it will actually put money in the bank for you. The "Buffalo" is the best looking, easiest running and most durable bicycle made. Coaster brake, tool kit, long mud guards and bell given without extra cost. Has standard 45-position handle-bars, 3 spiral spring suspension seat, "Beats All Punctureproof" tires, "Brampton" roller chain; mirror nickel and piano enamel finish, special hanger and other features making it the best bicycle buy—needs no repairs.

Guaranteed for **L-I-F-E**

Other New Bicycles \$14.55 to \$50

30 Days' Free Tryout

We express this bicycle, charges prepaid, so you can examine and approve it at your Express Co.'s office before you spend a cent. If then you are satisfied and certain it is as good or better than any \$50 bicycle you ever saw, pay the Express Agent only \$27.55—ride the bicycle for 30 days—then if you think you don't want it, we will promptly give you back your money and pay the return charges. Don't delay—or you'll forget—write now.

RICK CYCLE WORKS
Dept. C

Buffalo, N. Y.

Send for **POCKET CATALOG** FREE Lowest Prices

4 Pictures a Minute

Taken Direct on Full Size Post Cards
 Read This
 "On the trip I just came off of I made \$55 in one day and could not turn out work fast enough," says Ethan Allen, Washington.
 And This—"Typhoid got me and took \$10 a day away from me," McDowall of New York.
 These and many other letters prove you can do as well or better with this absolutely



NEW—PLATELESS DAYDARK

(Trade-Mark)
 DIRECT ON POST CARD
 A new, high class business with tremendous money-making possibilities requiring no experience—no canvassing. No plates, films or printing—finish what you take where you take it.
Big Money—Small Investment working picnics, fairs, from house to house or at home—out of doors or indoors—anywhere, making four finished pictures a minute of any subject.

500% Profit

4 Times as many pictures
4 Four Times as fast
4 Four Times the profit
FREE Investigate—write to-day. for our Daydark catalog—just issued. Write that postal NOW.
 Daydark Specialty Co., 402 Daydark Bldg., St. Louis, Mo.

\$3.00 A MONTH
 Buys This Beautiful L. C. SMITH TYPEWRITER
 Has Back Spacer, Tabulator, Two Color Ribbon, in fact every modern feature for the maximum convenience and operating efficiency.
 Send today for the greatest typewriter opportunity ever offered.
HARRY A. SMITH, 180 P. North Dearborn St., Chicago

EARN \$40 TO \$80 A WEEK

selling Ann Arbor Lamps and Lighting Systems. Everybody wants this famous light. Show it, it sells itself. No experience necessary. Besides regular earnings we mail cash bonus checks every month to successful agents. Don't delay; write me at once. H. H. Seeley, Pres., Superior Mfg. Co., 294 Second St., Ann Arbor, Mich.

Double Claw Hammer
 \$1.10 by Parcels Post. Money cheerfully refunded if not satisfactory. Pulls nails without bending and holds them for driving, a great convenience in overhead work. No more pounding fingers.
KEYLESS PADLOCK
 "All you gotta do is pinch it, but — you gotta pinch it right." Requires no keys. 40,000 combinations possible. Set your own combination. Press buttons and it flies open—that's all. \$1.10 by Parcels Post. Special terms to agents on both articles.
GOOD TIMES CO., Dept. H.K., Minneapolis, Minn.

DIAMONDS ON CREDIT

Write for Our Free Catalog. Over 2,000 illustrations of Diamonds, Watches, Jewelry, etc. Select any article desired, have it sent to you, all charges prepaid. If satisfactory, send us one-fifth of the purchase price and keep it; balance in eight equal monthly amounts.
 278 Genuine Diamond Ring, Loftis "Perfection" mounting, 14k solid gold. TERMS, \$4 a month.
LOFTIS DIAMOND MERCHANTS
 Dept. M894 108 N. State St. CHICAGO, ILL.
 BROS & CO. 1123

No. 278
\$40

Save \$15.20

by buying these books now. Take advantage of our liberal offer and get the greatest engineering library ever published at almost half the regular price. The work of thirty-two experts, it has been compiled especially for the Engineer, Fireman, Superintendent, Shop Owner, Mechanic, Student, Inventor, or any user of power. Covers every subject you are likely to meet in practical engineering, and is valuable both for study and reference. Read the synopsis below and gain an idea of the scope of this great work.

The American School's Cyclopaedia of Steam Engineering

contains 3,300 pages; 2,500 illustrations, full-page plates, diagrams, etc.; hundreds of valuable tables and formulas; carefully cross-indexed for quick, easy reference. The seven large volumes are bound in half morocco and are printed in large, clear type on special quality paper.

READ THIS SYNOPSIS

Construction of Boilers—Boiler Accessories—Fuel Economizers—Mechanical Stokers—Steam Pumps—Steam Engines—Indicators—Valve Gears—Steam Turbines—Gas and Oil Engines—Fuels—Automobiles—Carbureters—Locomotive Boilers and Engines—The Air-Brake—Single-Phase Electric Railway—Elevators—Marine Boilers—Marine Engines—Heating and Ventilating—Compressed Air—Transmission—Absorption and Compression Refrigeration—Ammonia Machines—Direct Current Dynamos and Motors—Management of Dynamos and Motors—Electric Wiring—Electric Lighting, etc.

Now Sent Free

The regular price of this great Cyclopaedia is \$35.00, but we are just now offering it at the special introductory price of \$19.80, payable in small monthly installments. Not only this, but the complete seven volumes, not a sample volume, will be sent, express prepaid, for seven days' free examination; returnable at our expense if the books do not contain the information you want. If you keep them, pay \$2.00 within seven days and then \$2.00 a month until you have paid the special price of \$19.80.

Send no money—just fill out and mail the coupon. It won't cost you a cent to examine the books; we know they'll be worth many times their cost to you. Fill out the coupon today and save \$15.20.

\$12.00 Consulting Membership Free
 With every set is included a year's Consulting Membership, regular value \$12.00, entitling you to the free advice of a staff of Engineering Experts. This will give you practical help in solving your difficult problems—a service alone worth more than the first cost of the books.

American School of Correspondence, Chicago, U. S. A.

FREE OFFER COUPON
 American School of Correspondence, Chicago, U. S. A.
 Please send Cyclopaedia of Engineering for 7 days' FREE examination. I will send \$2 within 7 days and \$2 a month until I have paid \$19.80, otherwise I will notify you and hold the books subject to your order. Title not to pass until fully paid. Pop. Mech. 4-13

NAME.....
 ADDRESS.....
 EMPLOYER.....

Please Mention Popular Mechanics

Shall I Send You This Book?

It tells how to make money in a new, easy, fascinating business. The same business made me independent. If you are ambitious to make a big success in life—if you are striving to get out of a rut and make money, I'll gladly send you a copy of my book free. This isn't a book for curious folks who "just want to see what it's like"—it's a book packed full of valuable information and ideas and helps on how to make money. If you're in earnest—if you want to "get there" write me today for this book. A two cent stamp brings it.

Make Money Manufacturing Crispettes Nearly 4c Profit in Each Package

Crispettes are a new, delicious popcorn confection. Nothing like them in shape, taste or quality. Instant hit everywhere at parks, resorts, pavilions, circuses, fairs, carnivals, on trains, at depots, theatres, moving picture shows, confectionery shops, etc. My book tells how to make them—how to sell them. I've started others. Let me start you. Just read these extracts from letters—all recent.

Wm. Budd Leitch writes: "Started business New Year's day. Since then I have done a good business. Am well pleased with results."

G. W. Sperbeck says: "I am having fine success with the machine and getting more trade every week. Got the work down fine now."

D. B. Barrett writes: "I sold my interest in the Crispette Machine we bought, to my partner and have regretted it ever since. Send me new book."

My Offer Is For YOU
Send for the Book



This is a recent picture of the man who made \$1500 in one month with a Long Crispette machine, in a store window.



This is the Machine That Did It



E. M. Cox says: "Have been running almost three weeks and supply the demand only by running steadily through the day. Selling everything I can make and getting it out good too."

No special seasons. All year 'round proposition. Book tells how to work it. Join the money makers. Be one of them—not an onlooker. Anyhow, investigate. Drop me a line today, and I'll send you the book, all charges paid.

SEND FOR THE FREE BOOK

W. Z. LONG, 740 High Street, Springfield, Ohio

Name..... Try to wrench the head off
Address.....
City..... State.....
Mr. MACHINIST—did you ever twist the head off a set-screw? Then try this on the

MAC-IT SET SCREW

Set the steel block firmly in a vise, take a wrench and try your hardest to twist the head off. Your name and address on the coupon brings you a trial set.

THE STRONG, CARLISLE & HAMMOND CO.
327 Frankfort Ave. Cleveland, Ohio

\$85

COMPLETE WITH 4 H. P. MOTOR

\$85 buys this 18 ft. Dunphy Semi Speed Model—for the complete finished K. D. frame, together with a H. P. motor and marine equipment. We carry in stock for immediate shipment a complete line of finished launches, rowboats and canoes. Also K. D. frames for any kind of boat. **Get our catalog.**

DUNPHY BOAT MFG. CO., Eau Claire, Wis.

BUY YOUR FURNACE \$10 DOWN \$10 A MONTH

Our monthly payment plan of selling direct saves you the dealer's profits and charges for installation. The

JAHANT FURNACE

with the patented "Down Draft System" is best for residences, schools, hotels, churches, etc., because it delivers plenty of heat wherever and whenever desired at a saving of 1 3/4 to 1 1/2 in fuel bills. Install the Jahant yourself. We send complete outfit, freight prepaid, with special plans, detailed instructions and all necessary tools for installation. **Satisfaction guaranteed or money refunded.**

Write for free illustrated book.

THE JAHANT HEATING CO.
25 Mill Street AKRON, OHIO

Save 1/3 to 1/2 on Fuel Bills

Get a Raincoat! FREE!

Just for showing it to your friends any man or woman can get a stylish English Slip-on Raincoat absolutely FREE; and **Make \$5 a day easy during spare time** No money or experience needed. It's easy. Send a post card tonight for this great Free offer, terms, samples, etc. We assume all risk.

THE STEVENSON CO., Dept. 43, 22 Quiney St., CHICAGO

WIN NEXT \$1,200

We tell you how; \$40,000 already won by ten inexperienced people. Stoneman received \$1,200 one month; \$15,000 to date; Korstad \$2,200 in two weeks; Schleicher \$195 first 12 hours. Strange invention, startles the world. Gives every home a bathroom with hot and cold running water for \$6.50; abolishes plumbing, water works; self-heating; little wonder Hart sold 16 in 3 hours, \$5,000 to date; Lodewick 17 first day. Credit given; investigate today. Beat others to exclusive sale; means fortune.

ALLEN MFG. CO., 3649 Allen Bldg., Toledo, Ohio

WHY PAY TWO PRICES FOR FENCES

We manufacture hundreds of designs of ornamental fences, both Wire and Iron Picket, Arches and Entrance Gates. "cheaper than wood," for lawns, churches, cemeteries, parks and factories, etc. **Write for free catalog and special prices.**

ENTERPRISE FOUNDRY AND FENCE CO.
2422 Yandes Street Indianapolis, Indiana

FREE If interested in Tool Grinders, send for our new booklet "A Sharp Edge in a Hurry." If you enclose 4 cents for packing and mailing, we'll include **FREE** a Pike India Vest Pocket Stone, also our famous book "How to Sharpen"

J. PIKE MANUFACTURING CO., 100 Main St., PIKE, N. H.

Convert Your Bicycle into a Motor-Cycle using our Attachable Outfit. Fits any wheel. Also Marine and Stationary Motors and Finished Castings. Stamp for catalog. **STEFFEY MFG. CO.,** Girard Ave. and 30th St., PHILADELPHIA, PA.

STEEL Shingles Will Save You a Pile of Money



When you think how cheap Edwards Steel Shingles are, how much longer they last, how much easier they are to put on than commonplace roofing, it's hard to tell just how much we do save each buyer. It's a big pile of money.

They Beat Wood Shingles

The best wood shingles to be had nowadays seldom last 10 years, and it's a long, slow, tedious job putting them on. Besides, any building with wood shingles is a regular "fire trap"—apt to burn up any moment. Edwards Steel Shingles last over twice as long as wood, and as they come in big clusters of 100 or more, anybody can put them on in almost no time. Furthermore, they are absolutely fire-proof and are guaranteed so by a \$10,000 Cash Bond.

No Chance of Rust

Unlike ordinary iron roofing, Edwards Steel Shingles never rust. With the Edwards Steel Shingle, the nails are completely covered by our patented interlocking device, and the edges are made absolutely rust-proof by the famous Edwards Tightcote Process. No chance for rust. Remember, too, that Edwards Steel Shingles are much easier to put on than any other roofing.

Write for Factory Prices, Freight Paid

Edwards Steel Shingles are not only the longest lasting and easiest laid roof in the world, but their cost is amazingly low. That's because we sell direct from factory to user. And with 100,000 good customers, we only want a small 9% profit per sale. And we pay the freight. Just send a postal for our latest Roofing Book 450 and Special Factory Prices. Then see for yourself what astonishing prices you can now get on the World's Finest Roofing Material. Give size of your roof, if possible. Write today and our proposition will come by return mail. (99)

THE EDWARDS MANUFACTURING CO.
400-450 Lock Street, CINCINNATI, OHIO

The Latest Wonder

makes shaving a joy. A new idea—a new principle in razor sharpening. The "Midget" Hone, a newly invented device, that hones any ordinary razor with a couple of strokes only. Quickly adjusted to fit any size and so small it may be carried in the vest pocket. Price \$1.00 post paid

Address "Midget" Razor Hone Mfrs.
Dept. 4, 184 W. Washington St., Chicago



This Portable Typewriter

sent on approval—saves time, work and money—\$18 in United States.

Here is an efficient, portable typewriter that writes and as clearly as \$100 machines saves \$82. Standard keyboard—visible writing, makes 2 carbons —takes full size letter sheet; low cost because simple. Has only 250 parts. Others 1700 to 3700. Our guarantee says "Money back if not satisfactory." Try the Bennett at our risk. Can be mailed parcel post; send for catalog.

AGENTS WANTED
**Q. B. BENNETT
TYPEWRITER CO.**
366 Broadway, New York

\$18

NEW HAND BOOKS FOR HOME STUDY

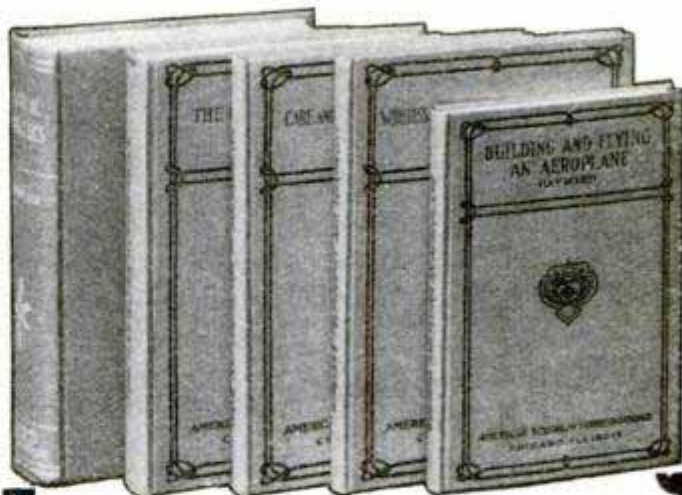

JUST OFF THE PRESS

Nine new books just added to our practical handbook series.

Care and Operation of Autos . . .	\$1.00
The Gasoline Automobile . . .	2.00
Building and Flying an Aeroplane	1.00
Practical Aeronautics	3.50
Descriptive Astronomy	1.50
Wireless Telegraphy & Telephony	1.00
Modern American Homes	2.50
Alternating Current Machinery .	3.00
(New Edition)	
Motion Pictures	4.00

Owing to a constant and increasing demand for single volumes treating on the above subjects and on special phases of Engineering and Business, we are selling through the leading book stores in the United States and Canada a series of 70 handy handbooks written by experts and selling at \$1.00 to \$4.00 each. They are the best, most authentic and up-to-date books on Automobile, Aeronautical, Electrical, Civil, Steam and Mechanical Engineering, Building and Business, that have ever been written. They are suitable for the use of the student or practical man or can be used as a quick and ready reference by the skilled worker.

Send for our new catalog listing these single volumes. If your dealer does not have the particular book of this series that you want, ask him to order it for you or order it direct from us yourself. Any book ordered direct will be sent postpaid upon receipt of price and may be returned after a five-day examination if not suited to your needs in every way. Upon its receipt we will refund your money promptly.

Sold by the leading bookseller of your city. Ask to see them —satisfy yourself of their value.

American School of Correspondence
CHICAGO, U. S. A.

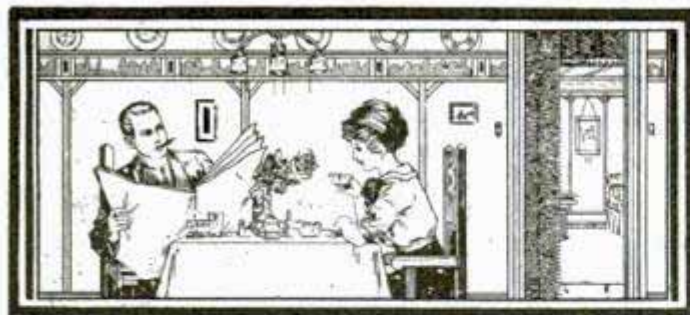

UTILITY WALL BOARD

is more than simply an artistic covering for walls and ceilings — it is a protection against dampness, cracking, heat and cold that ordinary plaster walls are heir to —

Read this letter from a prominent Chicago business man —

"Heppes Company:

GENTLEMEN — My little bungalow in Kissimee Park, Florida, is covered inside, walls and ceilings, with Utility Wall Board. We came north and left the house locked from the last of June to September. When our caretaker opened the house in the fall he was surprised to find everything as dry as a bone, and no sign of vermin anywhere. The books and shoes were not mouldy and the range was free from rust. The house was closed during the entire rainy season. It was the only dwelling in the park that was not damp and mouldy and in which there were no insects or vermin.

Our house is the warmest in cold weather, and the coolest in hot weather on the beach.

Very truly yours,
ISAAC S. DEMENT."

Utility Wall Board takes the place of both lath and plaster — it is more attractive — more durable — easier to put on — cheaper.

Don't fail to write for free sample

Wide awake responsible dealers wanted — write for details

THE HEPPE'S COMPANY
4516 FILLMORE ST. CHICAGO, ILL.

THERE'S FUN IN IT!



AND MONEY IN IT!

Aviation of To-day offers Great Opportunities for Ambitious, Intelligent young men, of responsibility.

Exhibitions — Demonstrations — Sales

You can learn to sell, care for, handle, flying boat, hydroaeroplane, and aeroplane, only at the Curtiss Camps.



Write to-day for booklet on the
"Curtiss Training Schools"

Curtiss Aeroplane Company
31 Lake Street Hammondsport, N. Y.

WORK FOR US — \$50 to \$75 EVERY WEEK

START NOW



Experience not necessary. Honest and willingness to work is all we ask, selling **The Easy Wringer Mop** make \$5000 a year.

LISTEN: One man's orders \$2600 one month — profit \$1650. Mere boy in Pa., made \$9.00 in 2½ hours. **It sells itself.** No investment required. Sample free with first order. Valuable booklet **Free. Write Today.**



THE U. S. MOP CO., 105 Main Street, Toledo O.

HAVOLINE OIL

Our new "HAVOLINE Tour Books" will be ready for distribution May 1st.

Send us your name and Registration Number and 10c to cover cost of mailing and you will be registered to receive your copy upon publication. Which State do you want "routed"?

INDIAN REFINING CO., 17 Battery Place, New York

CACHOO! Make the whole family and all your friends "just sneeze their heads off" without knowing why, with CACHOO, the new long distance harmless snuff. Sent anywhere for 10c. 3 for 25c. 90c a dozen. Catalog included FREE.



PEERLESS TRICK & NOVELTY CO., Dept. R, CHICAGO

EARN \$3000.00 THIS YEAR

IN THE Vacuum Cleaning Business

The new, easy, profitable business. Big demand for professional Vacuum Cleaners. Everybody now wants vacuum cleaning. Makes housecleaning unnecessary. Clean whole house in four hours — disturb nothing. Women delighted. A. O. Rainbow, Texas, writes "Your machine knocks out from \$20 to \$35 in 6 hrs. easy."

Let Your Profits Pay For Your Machine

Our B. B. Vacuum Cleaner is a wonder. Powerful — reliable — guaranteed. Send today for big colored circular, full particulars and our 30 day trial proposition.

McCreery Mfg. Co., 990 Dorr St., Toledo, Ohio

LEARN TO PAINT SIGNS and SHOW CARDS



THERE'S MONEY IN IT

I'll teach you personally—by mail—you'll succeed. Wonderful field—for both men and women. Easy terms. Thousands of merchants need help. Price cards, Sale cards, Window Cards, banners, signs, etc. are used in enormous quantities. Crawford, B. C., writes, "Earned nearly \$200.00 since taking course." Parrott, Okla., says, "Earned several times cost of course since enrolling." Gold lettering on Glass and wood, valuable feature of course. You learn everything from the ground up. When your course is completed you should be an expert. Knowledge of sign and show card writing helps you wherever you are. Thousands employ sign writers. Pay is good—work easy and fascinating—hours short.

EARN \$18 TO \$35 A WEEK

Many of our students now make more than this operating a business of their own. My instruction is unequalled because practical, personal and thorough. 20 years experience as a sign writer back of the course. Natural talent unnecessary. Earn while you learn. Do practice work at reduced prices. — help pay for course. Fritzer, Minn., writes, "Did job recently and got \$10.00, profit \$7.05. Just think—did this after only one lesson." We assist graduates to get positions. Write for large, complete catalog A4, pictures and testimonials of graduates, samples of work, terms, etc. Address me personally.

CHAS. J. STRONG, Founder
 Detroit School of Lettering
 Department 204 Detroit, Michigan
 "Oldest and Largest School of its kind."

Monuments



You can now buy the most beautiful monuments, tombstones or markers at lowest quarry prices, direct by mail, under the strongest guarantee ever made by a monument firm. Choose from 200 exclusive designs and take—

A Year to Pay No collectors to annoy you. We sell direct from the quarry, save you all unnecessary profits and allow the lowest terms of payment. We do all lettering and satisfy you in every way.

FREE! Our latest Art Portfolio, done magnificently in purple and gold. Sent everywhere, FREE, just for the asking. Address:

Westminster Monument Co., 204 Westminster Bldg., Chicago.

\$200 A MONTH BE YOUR OWN BOSS



If you are making less than \$50 a week you should write us to-day. We can help you to wealth and independence by our plan. You can work when you please, where you please, always have money and the means of making barrels more off.

HOW WOULD YOU LIKE to start out from home on a combined business and pleasure trip, stay at the best hotels, and live like a lord and clean up \$10 every day? Work at amusement places, crowded street corners, manufacturing institutions, anywhere and everywhere, ten minutes' walk from home or on the other side of the globe. Just set a machine up any place you happen to select, and clean up \$10 above operating expenses each and every day.

PAPER POST CARDS DIRECT

My proposition is the WONDERFUL NEW COMBINATION CAMERA, with which you can take and instantaneously develop eleven entirely different styles of pictures including Buttons, four styles and sizes of Paper Post Cards and six styles of Tintype Pictures. Every plate is developed without the use of films or negatives, and is ready to deliver to your customer in less than a minute after making the exposure. This REMARKABLE INVENTION takes 100 pictures an hour. Everybody wants pictures and each sale you make advertises your business and makes more sales for you.

NO EXPERIENCE NEEDED

Simple instructions accompany each outfit and you can begin to make money in fifteen minutes after the outfit reaches you. A trifling investment will get this WONDERFUL OUTFIT for you and put you in a position to make \$2,500 a year. If you want to be independent, and absolutely your own boss, write me to-day and I will send you by return mail, full free information regarding this WONDERFUL PROPOSITION, including letters offering positive proofs from every part of the world. DON'T DELAY. ANSWER THIS ANNOUNCEMENT TO-DAY.
L. LASCELLE, Mgr., 855 W. 43rd St., Dept. 783, New York, U. S. A.

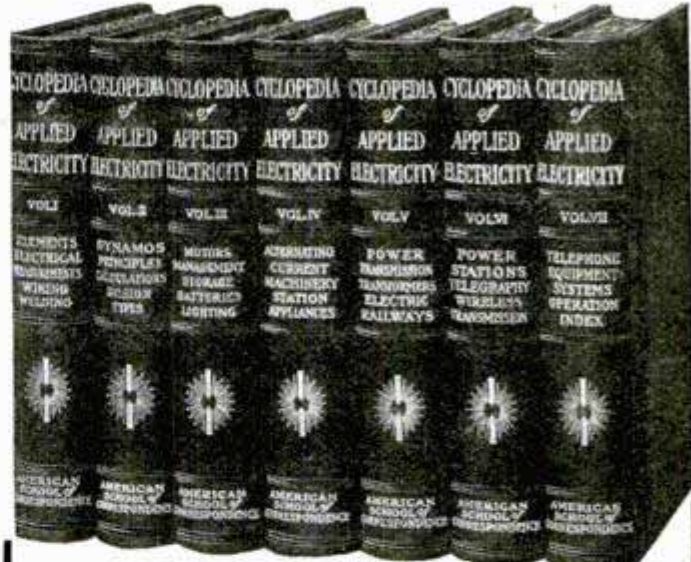

NOW SENT FREE

We will send this great electrical reference library to you, EXPRESS PREPAID, for seven days' free examination; returnable at our expense. If you decide to keep the books, you can buy them at almost half the regular price, payable in small monthly installments. Whether student, worker or expert, you can gain from these seven volumes an intimate knowledge of your work—knowledge which will eventually mean success and higher pay. The work of thirty-two experts, this library is recognized as a standard reference work by technical schools, libraries and practical men throughout the country.

The American School's Cyclopedia of Applied Electricity

contains 3,200 pages, 7x10 inches; 2,600 illustrations, full page plates, diagrams, etc.; hundreds of valuable tables and formulas; carefully cross-indexed for quick, easy reference. The books are substantially bound in half red morocco, gold stamped, and are printed in large clear type on special quality paper.

Important Subjects Covered

- Theory, Calculation, Design and Construction of Generators and Motors — Electrical Measurements — Electric Wiring — Electric Welding — Types of Generators and Motors — Management of Generators and Motors — Storage Batteries — Electric Lighting — Alternating-Current Machinery — Station Appliances — Power Stations — Power Transmission — Central Station Engineering — Electric Railways, including Single-Phase — The Electric Telegraph — Telephone Equipment, Systems and Operation — Wireless Telegraph and Telephone — Telautograph, Telephonograph, etc.

Sent Absolutely Free—Express Prepaid

The complete seven volumes, not a sample volume, will be sent, express prepaid, for seven days' free examination; returnable at our expense if they do not contain the information you want. If you keep the books, pay \$2.00 seven days after receipt and then \$2.00 a month until you have paid the special introductory price of \$19.80. The regular price of this great Cyclopedia is \$95.00.

Just fill in and mail the coupon. It won't cost you a cent to examine these books. We know they'll be worth many times their cost to you. Mail the coupon now and you will receive your books promptly.

Another Great Free Offer

With every set is included a year's Consulting Membership, regular value \$12.00, entitling you to the free advice of a staff of expert Electrical Engineers. This will give you practical help in handling working problems which are too specific to be taken up in detail in the cyclopedia. There will be no limit to this service. A single problem solved for you might be worth more than the first cost of the books.

American School of Correspondence, Chicago, U.S.A.

FREE EXAMINATION COUPON

American School of Correspondence, Chicago, U.S.A.

Please send set Cyclopedia of Applied Electricity for 7 days' free examination. I will send \$2.00 within 7 days and \$2.00 a month until I have paid \$19.80, or notify you and hold the books subject to your order. Title not to pass until fully paid. Pop. Mech. 4-13

NAME

ADDRESS

OCCUPATION

EMPLOYER



**E.C. SIMMONS
KEEN
KUTTER**
THE MAKERS OF CUTLERY AND TOOL
TOOLS



Plane No. K5
Price \$2.25



Draw Knife No. K8
Price \$1.00

The Key to Clever Work

Get pleasure and satisfaction from your work—no matter how small the job—by using good tools. There is no economy in ordinary tools. Realize what Keen Kutter tools mean to every man who uses them. They are sturdily built of the finest steel and guaranteed faultless. They last a lifetime under most exacting service.



Hatchet No. KC2
Price \$1.00

KEEN KUTTER

Quality Tools



Bit Brace No. KR8
Price \$2.00

always hold their edges. They are tested to the limit and must be absolutely as represented or the dealer is authorized to return your money or give you a new tool.

"The Recollection of Quality Remains Long After the Price is Forgotten."
Trade Mark Registered. —E. C. SIMMONS.

If not at your dealer's, write us.

SIMMONS HARDWARE CO., Inc.
St. Louis New York Philadelphia
Toledo Minneapolis Sioux City Wichita

Hand Saw No. K88 | 26-26 in.
Price \$2.00



The Allen Soldering Stick



It is put up regularly in round sticks, six inches long and one inch in diameter, in individual wooden boxes. It is applied by simply rubbing the stick on the joint, when heated, causing the solder to adhere firmly, making a perfect joint without in any way corroding the wire, or affecting the insulation. There is no waste as the stick can be used down to the last particle. It can be carried about in the grip or pocket without danger of breakage, and is always ready for use.

L. B. Allen Co., Inc., Sole Manufacturers, 4530 No. Lincoln St., CHICAGO, ILL.

AGENTS WANTED

I want good agents in every county to sell a new, guaranteed Automatic Razor Stropper. Sample furnished free. Exclusive territory. No deposit required. Complete information free. Write today. Make \$40 to \$80 a week.

L. C. WORST, Pres.

114 State Street

FREMONT, OHIO



WRITE TODAY For Our New Catalogue
27 MODELS. 48 PAGES

"Faultless" Designs, Workmanship and Materials, Thorough Tryouts in water, mean *Satisfied Customers.*

VALLEY BOAT & ENGINE COMPANY
1204 Hess St., Saginaw, Mich.

Awake the "Edison"



in your boy by giving him the gift that is as instructive and useful as it is entertaining. Our small engines or power plants are unusually interesting for the mechanically or electrically inclined boy. And they may be profitable, too, in the hands of any

bright boy. One young man is helping pay his college expenses by charging ignition storage batteries with our baby motor. Our engines will furnish power to grind skates, a house lighting dynamo; drive a motor ice boat, canoe, boy's auto, or help mother run the washing machine, cream separator, sewing machine or pump. Start the boy right by getting one of our engines. Ask for catalogue A to-day.

ELGIN WHEEL & ENGINE CO.
ELGIN, ILL.



TOLEDO MARINE MOTORS

The kind that make boating a pleasure. When you start you know there'll be no engine troubles to mar the trip. A marvel of smooth working simplicity that the non-mechanical can easily understand and operate. Complete guaranteed, 2 cycle, 2 port 1-2x3 1-2, 4 1-2x4 1-2. Write today for catalog C

THE UNIVERSAL MACHINE CO., Pike Ave., BOWLING GREEN, O.

Finding Financial Freedom

By FRANKLIN O. KING

Did You ever stay Awake all Night trying to Figure out a Plan which would Free you from the Financial Fetters that seem to have You Tied—Hand and Foot? Half the World doesn't Worry so much How the Other Half Lives, but EVERY-MAN should Try to Find How *He and His Family* can Live Half-way like *Human Beings*.

Thirteen Per Cent. of the People of the United States own Eighty-seven Per Cent. of the Wealth, while the Remaining Thirteen Per Cent. of Wealth is Doled out between the Eighty-seven Per Cent. of the People that are *Left*. Most of Us are nearly always "*Left*." Now I haven't any Grouch against Society, but I should like to Mix a Few Loaves and Fishes with the Crumbs and Husks that fall from DIVES' Table. The Fault, however, is Not Entirely with the Rich Man—It is largely YOURS and MINE. The Unequal Distribution of Wealth is due almost entirely to the Unequal Distribution of Population. These are Fundamental Facts minus Frills and Fallacies.

There are too many Good People Trying to Live in the Cities on a slender margin of Resources, who Ought to Be Elsewhere in this Broad Land where Fertile Acres stretch Unoccupied under Gentle Breezes, and where All of the Best of Earth's Products are to Be Found in Overflowing Abundance. A Pied Piper is Perpetually Pulling Them from the Country to some Magical Metropolis, and There They Live and Swelter in City Tenements and Flats—Dreaming of the Days when "Three Square Meals" was a Habit and not a Hallucination. The City's Lure has Led Them from the Country Fields that Fed Them. I didn't Intend to Break into Poetry, but *I Do Want You to Break Away from Poverty*.

My Advice to You, therefore, is—GET A HOME IN GULF COAST TEXAS. I would Further say—GET A HOME IN OUR DANBURY COLONY—IN THE RAIN BELT, where you can Grow Three Big Money-Making Crops a Year, and Where IRRIGATION and FERTILIZATION do not eat up the Profits Your HANDS CREATE.

We are Extending to our Colonists the kind of CO-OPERATION that CO-OPERATES—building Bridges, making Roads, and Ditches, etc., and have Expended nearly Fifty Thousand Dollars the past Summer in such Improvements. More than Ten Thousand Acres have been Sold during the past ten Months to Satisfied Purchasers,

because we have a proposition that can Stand Unashamed beneath the Spot Light of Publicity, and Where Your Days of Prosperity Shall Be Long Upon The LAND. We are selling Real Land and not Sand—GET THAT—a Rich, Loamy, Black Soil, that YOU COULDN'T WEAR OUT IN A HUNDRED YEARS.

I believe you could save Twenty-five Cents a Day if You tried. I know you would Try if you Realized that our Growers of Figs, Strawberries and Early Vegetables clear a net profit of \$300 to \$500 an Acre. Men have Realized more than \$1,000 an Acre growing Oranges in our Country. Remember that our Early Vegetables get to Northern Markets in Mid-Winter and Early Spring, when they command Top Prices.

One German Truck Grower on adjoining lands this spring realized nearly \$500 from three-fourths of an acre of Strawberries. You could do as well if you only Tried, and on a Ten-Acre Tract FIND FINANCIAL FREEDOM.

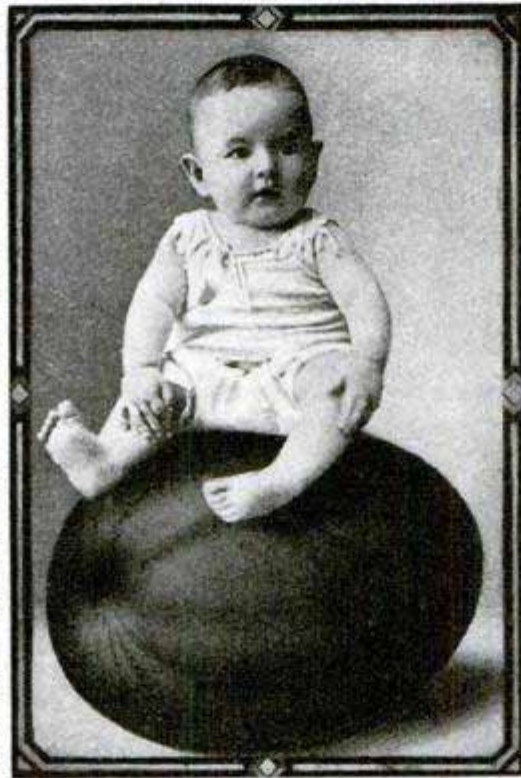

Two Texas Gulf Coast Products

The Biggest Price paid for a car of watermelons on the Houston Market this year was \$140. The car was shipped by the Danbury Fruit and Truck Growers' Association.

We are situated within convenient shipping distance of Three Good Railroads, and in addition to this have the inestimable Advantages of Water Transportation through the Splendid Harbors of Galveston and Velasco, so that our Freight Rates are Cut Practically in Half. The Climate is Extremely Healthful and Superior to that of California or Florida—Winter or Summer—owing to the Constant Gulf Breeze.

Our Contract Embodies Life and Accident Insurance, and should You Die, or become totally disabled, Your Family, or anyone else You name, will get the Farm without the Payment of Another Penny. If You should be Dissatisfied, we

will Absolutely Refund your Money, as per the Terms of our Guarantee.

Write for our Free Book, which contains nearly 100 Photographs of Growing Crops, etc. Fill Out the Blank Space below with your Name and Address, plainly written, and mail it to the Texas-Gulf Realty Company, 1510 Peoples Gas Building, Chicago, Illinois. Read it Carefully, then use your own Good Judgment.

* * *

Please send me your book, "Independence With Ten Acres."

15 Wagon Beds and Racks in One



One Wagon Bed, for Everything

No lifting, tugging, straining. No changing of boxes or racks. Once on the gears, always there, ready for anything you want to haul. A great, new, modern invention — absolutely reliable and practical. Guaranteed for Five Years. It will last five times that long. Our guarantee means money back if not satisfied.

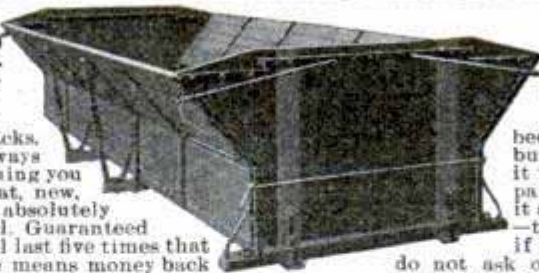

30 Days' Free Trial on Your Farm

We do not ask you to buy this bed and then try it; but we want to send it to you, freight prepaid, and let you try it and use it 30 days — then you can buy it if it makes good. We do not ask one penny down — we ship on 30 Days' Free Trial.



The MELROSE Convertible Wagon Box

The only real new wagon idea of the century. Practical in every detail.

Can be changed from a grain-tight box to hay rack, stock rack, corn bed, or for any of the hundred farm purposes; and any boy old enough to drive a team can make any change in less than a minute anywhere, without assistance or tools of any kind. There are no ratchets, springs, cogs or complications. It is simplicity itself — absolute, practical perfection.

The Melrose costs you but little more than a standard make of old-fashioned, single-purpose wagon box. It weighs less than an ordinary, cumbersome, single-purpose hay rack, regardless of the fact that it is steel bound, steel silled, braced and bolted throughout — **absolutely indestructible**. It is already in use on thousands of farms, and is **endorsed by Government Agricultural Experiment Stations**. Learn about it today. Learn how you can save money, time and labor.

Remember — we will ship the "Melrose" to you without one penny down. We prepay the freight. You may use it on your own wagon 30 days, and if you do not find it to be just what you want, you send it back at our expense. We take all the risk. This is certainly worth your investigation. **Agents Wanted**

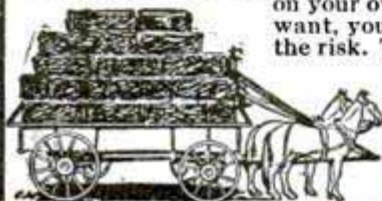

Write for **free catalogue** and this great 30 days' free trial offer at once. Put your name and address on a postal and mail it to us today.

The American Wagon Co.
100 Lincoln Ave. DIXON, ILL.

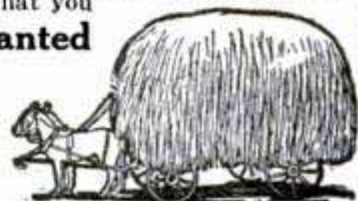

The Pictorial Review of Current Events

Cartoons

15 Cents a Copy

Published Monthly

[Published by H. H. WINDSOR, Editor Popular Mechanics Magazine]

A collection of the best and most striking cartoons published in the papers of the world each month.

Here are some of the additional features to be found in the April number:

The story of Miss Emma M. Gordon and her views on the part a woman cartoonist can take in the cause of Socialism; The Influence of the Cartoon, by J. E. Whiting, the cartoonist of the Louisville Post; The Story of Yesterdays in which Frank Wing, of the Minneapolis Journal, describes his series of human interest cartoons; sketches of the lives of Karl K. Knecht, of the Evansville Courier, and Will De Beck, of the Pittsburgh Gazette Times; Stories from the Studios, told by the different cartoonists; the fourth of Henry C. Williamson's articles on the cartoonists of the past, and the month's review of the work of the cartoonists.

All this in addition to the scores of full page reproductions of the best cartoons that have been printed in the daily papers of the country and publications of the old world.

These reproduced cartoons are selected from a collection of more than ten thousand each month.

Send your order to **CARTOONS**, 318 W. Washington St., Chicago, Ill.

Bound Volumes One and Two NOW READY

These two bound volumes, of six numbers each, contain more than 2,000 reproductions of the very best cartoons that have been printed during the past 12 months. A collection of more than 120,000 cartoons was made in order to secure them. Bound in the two volumes they make an "instant history" of the year 1912 for they are a pictorial record of the events of the world during the past year.

These two books, artistically and durably bound, are now ready for distribution and will be sent all express charges prepaid to any address in the United States or its possessions upon receipt of **One Dollar Each**

Wanted

AGENTS & SALESMEN



THE SWEDISH VIBRATOR

An amazing scientific invention. Endorsed by physicians, athletes, actresses, judges, and thousands of men and women who have used it. Agents and Salesmen are wiring orders. Enthusiasm is unbounded. Every man and woman making money fast and easy. 100,000 already sold, 1,000,000 to be sold this year. Secure territory at once. Mail your application today, stating county you desire. This is the one important thing today—do it now.

This is an opportunity for you to make \$5000 this year as a high grade salesman. **No experience necessary. No delay. No charge for Territory. No competition. Exclusive field. Success assured. Remarkable offer.** Read every word carefully. Get an appointment and get started without delay.

We are appointing men every day to manage our business in local territories. **We need good, honest men who are willing to work—and we will give you today this opportunity to**

Make \$5000 This Year

It is the chance of a lifetime. You will be in business for yourself. **You will be your own boss—independent, abundant money, pleasant position—and your time will be your own. At home or traveling—all or spare time—get an appointment immediately and commence earning money next week.**

The Swedish Vibrator

Most amazing seller ever invented. **A new proposition for salesmen.** Endorsed by the highest authorities of the world. A machine for home massage and vibratory treatment. Can be operated by simply attaching to electric lamp socket, or by ordinary dry batteries—in cities, towns, country—anywhere, everywhere. **Needed by every man, woman and family. Anyone can use it.** Get complete literature free and learn the wonders of this brilliant invention—a machine that gives 30,000 thrilling, invigorating, penetrating, revitalizing vibrations per minute. One-minute demonstration gets the order. **Irresistible desire to own it once you feel the living, pulsing touch of its rhythmic vibratory motion.** Sold upon five-year, cash certificate guarantee and 30 Days' trial.

150% Profit Throw away the little novelties upon which you have to make ten or twenty sales a day to pay expenses. Become a real salesman and make real and quick and big money. **One sale a day means \$90 net profit a week.** Many averaging four, five and even ten a day. **This is actually the most brilliant, easy and high class proposition that has ever been offered to wide awake agents, general agents, and managers.**

Don't Delay Get free literature and complete information at once. Send just your name and address on a postal card and all will be mailed free immediately. **Agents' sample furnished at wholesale price. Investigate. It costs you nothing to find out. Territory being rapidly assigned. But one man allowed in a field.** Give the name of your county. Send your name and address today. This is a brilliant opportunity. Do not neglect. Do not put it off. **Act immediately.** Address



FRANK CHANCE, Manager New York American League: "After seeing how it removes stiffness and soreness from my arms, legs and fingers, each player absolutely insisted on having one; and had it cost twice as much they would have had it."



ELSIE JANIS, the dainty and popular actress, says: "The nice things I could and do say about your vibrator. I cannot write, as I would not have space enough."



JULIA SANDERSON says: "I don't see how I got along without it. It certainly is far better than anything I ever tried for the throat and vocal cords."



WM. H. CRANE, the famous American actor, says: "I have been using your vibrator for several weeks for nervous trouble, circulation, etc., and found it exceedingly beneficial. It is all that you claim for it."



Frank Gotch

Champion Wrestler of the World uses the Swedish Rhythmic Vibrator and says:

"For limbering up, keeping in condition and strengthening the muscles, there is nothing that equals or excels the use of the Swedish Electric Vibrator. I always use one in my training and I certainly find it a wonderful help. It reaches the seat of all stimulation and gives me a perfect circulation. Its use gives all the muscles elasticity, makes one powerful, quick and active."

"Being a firm believer in vibratory massage, I tried various makes of Vibrators, but did not find one of enough efficiency to withstand the severe use I put them to until I purchased yours. You have, in my opinion, the only perfect Vibrator on the market, and I can consistently recommend its use to all athletes and those who desire health and strength."

THIS OPPORTUNITY

is open to anyone who wants to make money and who is willing to work. We furnish complete instructions that enable you to start immediately. Nothing difficult. No experience required. We want applications from men and women in unoccupied territory everywhere—clerks, teachers, mechanics, farmers, etc., etc.—all can make money on this grand, new, easy selling plan. Act today. Put your name and address on a postal card and mail it at once. Find out all about this tremendous opportunity.

THE SWEDISH VIBRATOR CO., Dept. 80, 215-230 Schiller St. CHICAGO, ILL.

\$27.00 TO \$40.00 PER WEEK

NEW SELF-HEATING IRON

MAKES ITS OWN HEAT



The "New Standard"

WRITE FOR FREE SAMPLE PROPOSITION

It takes women by storm. Quick, easy sales. Grandest aid to women ever invented. Entirely new. Sells almost on sight. Show 10 people—sell 8. Even 2 or 3 sales a day net you

\$27.00 TO \$40.00 A WEEK

No experience required. No need to stop your regular work. Sell evenings. Go right into home and demonstrate. Everybody is interested. Women make as much money as men. Saves its cost every month. Women simply can't resist. Selling is almost as easy as giving them away. All year business. Field hardly touched. Every home a prospect. Not sold in stores. Sells on its merit. Right size—right weight—right price. Looks good. Is good. Carry it anywhere. Iron anywhere. No stove needed. Cheapest fuel—two cents does ordinary family ironing. Each iron tested before shipping. Ready for use when received. Six sales a day should be easy. Double that isn't hard work. Think of the profit.

Write quick for **FREE SAMPLE PROPOSITION** and agents selling plan.
C. BROWN MFG. CO.
1177 Brown Bldg.
Cincinnati, Ohio

I BUY THIS PRINTING PRESS

The "Ideal" is an absolutely practical printing press, suitable for store, office or home. It's a wonder—always ready for work. Save dealers' profits. Write for a copy of our free catalog of printing presses and supplies.
IDEAL PRESS CO., CHICAGO, ILL.



ANTI-CRANK

LACKA-MOTORS



THE WORLDS SIMPLEST Installed Operated for all boats. Complete outfits ready for Rowboat or Schooner. **GUARANTEED TWELVE YEARS** building, perfecting, success with **THE ONE TYPE.** Write to Originators of **VALVELESS** for new "MARINE BOOK," a liberal Educator to all, free. Address Department M. **LACKAWANNA MFG. CO.,** Office and Factory, Ballston Spa, N. Y.

Special to PLUMBERS

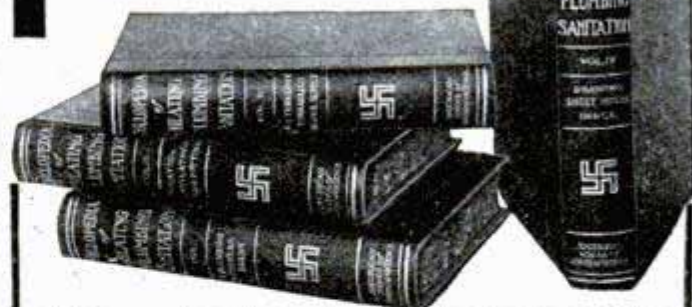

This is your last chance to obtain the greatest work on Domestic Engineering ever published at almost half the regular price. No plumber who would succeed can afford to be without these valuable books.

Cyclopaedia of Heating, Plumbing and Sanitation

Consists of four big volumes; 1600 pages; 1600 illustrations, diagrams, etc. Bound in half morocco and printed on enameled paper in large, clear type; titles stamped in gold. This great work is a complete review of plumbing, heating, ventilation and sanitation, and contains everything a plumber should know about his business.

Now Sent Free. We will send the books for seven days free examination, returnable at our expense if they do not contain the information you want. The regular price of this set is \$20.00, but we are just now offering it at the special price of \$12.80, payable in monthly installments of \$2.00 each. Write today, giving your occupation and name of employer or reference, and the books will be sent you immediately. Or, if you desire further information, drop a postal asking for details regarding this special last chance half-price offer.

Another Free Offer. With each set is included a year's Consulting Membership, regular value \$12.00, entitling you to the free advice of a corps of expert Domestic Engineers. This will give you practical help in solving your difficult problems.

American School of Correspondence
5791 Drexel Avenue Chicago, U. S. A.

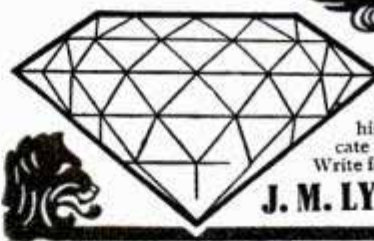

Diamonds on Credit

20% Down; 10% a Month

Every customer is protected by our written guarantee to refund his money if his dealer can duplicate our diamond at our price. Write for Illustrated Catalog No. 3.

J. M. LYON & CO., 71-73 Nassau St. New York City

"Listen to the WIRELESS"

The Interstate Wireless Outfit

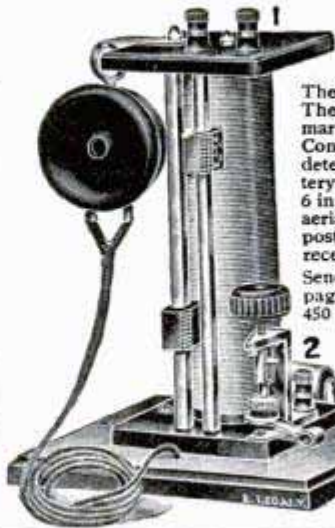

The latest word in Wireless Receiving outfits. The most compact little outfit ever put on the market. Receives messages over 400 miles. Comprises double slide tuning coil, standard detector, 75 ohm Telephone Receiver, battery, all mounted on heavy oak base. Size 6 in. x 6 in. x 9 in. Weight 3 1/2 lbs. Attach aerial wire to post 1, ground to post 2 and outfit is ready to receive. Price complete as described **\$3.75**

Send today 4c postage for our famous 220 page electrical cyclopaedia No. 11 containing 450 illustrations and over 1500 electrical articles, information on wireless and electrical subjects.

Ask for our Free Treatise on Wireless Telegraphy.

THE ELECTRO IMPORTING CO.

233 A Fulton St., New York

"Everything for the Experimenter"

JUBILEE SELF-HEATING FLAT IRON

Best in the world — one replaces the stove and 3 or 4 of the old flat irons. Heat regulated at will — easy to learn. Does beautiful work — thousands in use. Fuel costs 3c for 10 hours. Good seller — Price reasonable. Agents wanted, men and women. Booklet free.

JUBILEE MANUFACTURING CO., 14th and Howard Sts., Omaha, Neb.



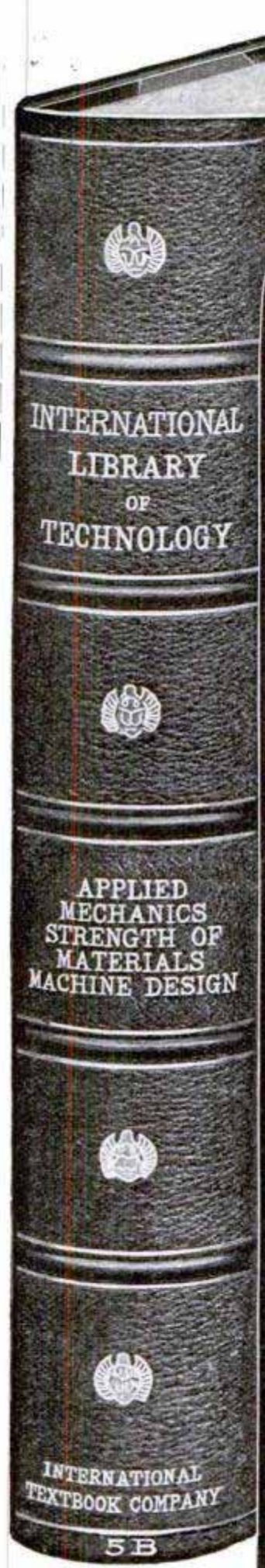

The Greatest Mechanical Library in the World

The Mechanical Engineering Library is part of the International Library of Technology that cost \$1,500,000 in its original preparation. It contains the knowledge given from the life experience of some of the best mechanical engineering experts in the country, edited in a style that nineteen years of experience in publishing home-study textbooks has proved easiest to learn, to remember, and to apply. There is no other reference work in the world that so completely meets the needs of the mechanic as the Mechanical Engineering Library. The volumes are recommended by the highest authorities and are used in nearly all the leading universities and colleges. They treat of practical mechanical methods, starting from the simplest problems and comprehensively covering every branch of the work. Not only can they be used to great advantage by superintendents, foremen, and engineers as an authoritative guide in their work, but since they can be so clearly understood even by persons having no knowledge of higher mathematics, they can be used by all classes of mechanics that are desirous of advancing to higher positions. The Mechanical Library contains 14 volumes durably and handsomely bound in three-fourths red morocco, stamped and numbered in gold. The books are printed on a high-grade book paper, and the type is large and easy to read. Each volume is 6 by 9 inches in size. If you wish to know more about the greatest and most practical mechanical library in the world, **mark and mail the coupon NOW.**

INTERNATIONAL TEXTBOOK COMPANY
 Box 872, Scranton, Pa.

Please send, without further obligation to me, full particulars in regard to the International Library of Technology, with special reference to the Library of Mechanical Engineering.

Name _____

St. & No. _____

City _____ State _____

Please Mention Popular Mechanics

**THIS \$2.50 A
SUIT MONTH**

\$16.50

**Classy
Clothes**

**For Classy
Men and Women**

Would You Accept This Offer?

Nothing Free, except our Catalog and sample fabrics. The Import is not primarily a Mail-Order House, but a high-class Shop, catering direct to Metropolitan Men and Women and by mail to those in the smaller towns who appreciate clothing of a little better quality.

For Cash or \$2.50 a Month

We offer a Pure Woolen Worsted, Silk Stripe, latest conservative model, London shrunk, bluffed lapels, hand worked button holes, extra quality trimmings, strictly hand tailored throughout, regular \$25.00 value,

**Our Special Price, \$16.50
Only....**

"The Import" has long been known as "The Classy House for Classy People."

The Fit, Quality and Fashion Guaranteed have made it so.

FREE CATALOG! A postal card will bring you our color catalog for Men and Women, Sample Fabrics and CREDIT if you wish.

THE IMPORT CLOTHING CO., Department 3, KANSAS CITY, MO.



Are You a Live Wire?



Are you one of the want-to-go-ahead class? Let Parcels-Post help you make money. We, as manufacturers, need you—you need us for mutual profits.

DEAL DIRECT With the Manufacturer

We are ready and going to appoint co-workers under our simple co-operative "tried out" and successful selling methods for local or mail-order business. A profitable business can be conducted from your own home. Small capital and spare time required to start. **Big Profits. Experience Not Essential.**

Warehouse privileges free

Manufacturer's co-operative working plan and Detailed Information of our latest patented ideal repeat order Mail order "money-getters." Positive proofs and sworn statements now ready and waiting to be mailed **FREE** to you. It's up to you to write. **J. M. PEASE MFG. CO., 807 Pease Bldg., Main St., Buffalo, N. Y.**



Large modern
Factory and ground
it stands on. Owned
and occupied by us alone

Please Mention Popular Mechanics

Jeffery's SPECIAL MARINE CANOE GLUE

BEST FILLER FOR CANVAS



Any puncture or leak in boat or canoe can be repaired in 5 minutes. It is as valuable to a canoeist as a repair kit to a bicyclist or automobilist. It is a Johnnie-on-the-spot article that no boatman should be without. It does not dry up nor deteriorate in the can, but will be found equally ready for use in ten years as today. Friction top emergency cans, 25 cts. each; weight, ready to mail, 6 oz.

Send for circulars. At all Sporting Goods Houses
L. W. Ferdinand & Co., 203 South St., Boston, Mass., U. S. A.

Build a Guaranteed Home With KELLASTONE

The Stucco That Will Not Crack

Write today for the Kellastone Book and full information regarding Kellastone—the only guaranteed stucco in the world. If you are thinking of building or if you are now a home owner, we have information of vital immediate interest for you. Write for it today.

U. S. KELLASTONE CO.

Dept. 1292, McCormick Bldg., Chicago, Illinois



A Sure — Big Money Maker

Pound of sugar makes 30 five cent packages delicious candy—sells like wildfire—eighth season—thousands used—original investment returned many times over first season—

Empire Candy Floss Machine

making sure big profits everywhere. **POP-CORN — PEANUT ROASTER — ICE CREAM CONE MACHINE**—sure winners. Catalog 100 tells about it. Agents Proposition Extraordinary.

STEVENS MANUFACTURING AND SUPPLY CO.

Makers and Distributors Stevens' Pocket Lighter, Non-Leaking Tire Valve—Stevens' Line Auto Accessories.

Dept. P. M.—Fisher Building, CHICAGO, ILL.



Here's the first lesson in efficiency

The new science of efficiency is a science of economy. Its first principle is to save energy; to avoid frittering away time and labor on useless effort; to avoid the waste of nervous and physical strain.

The world is growing efficient; to keep step with its progress, you must keep yourself at the tip-top mark of optimism and energy.

When you walk with hard leather heels you waste energy at every step. Every step on hard heels and hard pavement sends a jar along your spine, the center of the body's nervous mechanism.

No wonder you feel nervous and out of sorts after a day's work; no wonder you have blue streaks and pessimistic spells; no wonder your back aches and your feet hurt. Save your energy by fitting your shoes with

O'Sullivan's

Heels of New Live Rubber

O'Sullivan's Heels make walking easy. They are cushions of live rubber, and that means rubber with the spring in it.

They put wings on your feet, and give you the erect bearing and confident step that goes with health and optimism.

They mean a return to Nature,

for they make every footfall like a step on soft, springy grass.

O'Sullivan's Heels cost fifty cents a pair (attached); their use is an economy, for they last longer than leather heels, and they help to keep shoes in shape.

Made for everybody — men, women and children.

At Every Shoemaker's

50c a Pair, Attached

LET Kingery

HE'LL TREAT YOU RIGHT

START YOU IN THE POPCORN AND PEANUT BUSINESS



The business that's almost sure to make you well-off. Large profits—modest investment. No dull seasons. You can make money, spring, summer, fall and winter. Everybody buys popcorn and peanuts the year 'round.

It's An Easy Business To Start

No expensive rent to pay. No clerk hire. No friends needed to help. No advertising. No long, dreary wait to work up a trade. The demand for popcorn and peanuts is world-wide. Their appetizing odor whets the appetite—makes sales. Just place your machine where the people gather and pass and you should take in lots of money. Scarcely anything to learn. Popping corn and roasting peanuts are automatic. Just get a good stand, start up, and people will walk up and leave their nickels. Nickel after nickel, all day long, and in the evening. **And nickels count up fast.** Nickel businesses build up fortunes. It's easy to get a nickel—hard to get a dollar. Lots and lots of popcorn and peanut men own homes, store building, and even automobiles. It's a great business. It doesn't seem so ordinarily, because it comes a nickel at a time and doesn't need a large investment.

Think of the Field! The Big Opportunities!

Popcorn and peanuts are in demand on the street, in parks, dancing pavilions, at circuses, summer resorts; on trains, at depots, theatres, moving picture shows, in front of stores, around in the residence portions—everywhere. Use the best popcorn and peanuts. Put them in a nice, neat package—"The Kingery way"—hand out with a smile or cheery word and you should do a big business. With certain machines, men add gum, cigars, candies, etc., and make money in this line. Kingery tells you how in his free book—gives you the benefits of his 31 years in the business—he helps you in every way he can.

Big Profits for Store Keepers

Confectionery shops, fruit stores, news stands, groceries, etc., can make a lot of money on the side with a Kingery machine. It's a valuable addition to any retail business. Kingery makes all kinds of machines to suit every need, from a small roaster to big wagons. A style to fit every need at right prices and easy terms.

Better Your Financial Condition Become well-off. Have a nice bank account; own a home; buy a farm; send your children to college; do a lot of things you'd like, with the profits from this wonderful business. It comes in nickels, but the nickels come fast and the biggest part of the nickel is your profit. Better write Kingery today. Ask for his free book, "Possibilities" and his handsome catalog No. 41-B. Tell him how you're fixed—what you're doing now—about your town, etc. Needn't write a long letter unless you want to. Write with a pencil, on a postal, if it suits you better. Just say—"Kingery, tell me how I can make money in the peanut and popcorn business." Address simply.

KINGERY, — KINGERY MFG. CO.
390 Pearl St. CINCINNATI, O.

Kingery has started Thousands—Let him start you Now! He'll treat you right

Jos. Lyman, New York state, says—"More than satisfied with machine and the way you did business with me. Took in \$7.80 in 3 hours." Many prosperous men owe their good fortune to a Kingery machine. Just read these extracts from letters written to Kingery. B. A. Knight, Mo. (town of only 1000) writes, "Taken in \$109.60 first 30 days. Am well pleased." W. H. Green, Ala., old man of 70, one arm, writes, "Average sales \$40 a month in town of only 1,200." W. L. Johnson, Okla., writes, "Took in \$4.00 first afternoon." F. L. Lainson, Ia., says, "Sold 200 sacks of corn in 3 hours, last Saturday." C. W. Buckley, Ohio, after 2 days' use, writes, "Have sold 50 lbs. peanuts. Am well pleased." Letter after letter like these, come to Kingery constantly.

Kingery will help you start in the popcorn and peanut business

He will sell you a machine — 25 per cent cash — balance in easy monthly payments

Get Your Canadian Home from the Canadian Pacific

The Home-maker



It will make you a long-time loan—you will have 20 years to pay for the land and repay the loan—you can move on the land at once—and your Canadian farm will **make you independent.**

This offer is directed only to men who will actually occupy or improve the land.

Why not go where you can own 10 acres for every acre you now own or farm; where **every** acre will produce **double** what a worn-out acre produces anywhere?

Not on the face of Mother Earth can you find better land than this rich virgin Canadian soil. The enormous crop yield per acre **proves** this every season.

We Give You 20 Years to Pay

We will sell you rich Canadian land for from \$11 to \$30 per acre. You need pay only **one-twentieth down.** Think of it—only **one-twentieth** down, and then the balance in 19 equal annual payments. Long before your final payment comes due your farm will have paid for itself over and over again. Many good farmers in Western Canada have paid for their farms with one crop.

We Lend You \$2,000 for Farm Improvements

An offer of a \$2,000 loan for farm development, with no other security than the land itself, **guarantees our confidence** in the fertility of the soil and in your ability to make it produce prosperity for you and traffic for our lines.

The \$2,000 loan will help you in erecting your buildings and making things easier at the start, and you are given 20 years in which to fully repay this loan. While enjoying the use of this money you pay only the banking interest of 6 per cent.

Advance of Live Stock on Loan Basis

The Company, in case of approved land purchaser who is in a position and has the knowledge to take care of his stock, will advance cattle, sheep and hogs up to the value of \$1,000 on a loan basis, so as to enable the settler to get started from the first on the right basis of mixed farming.

Farms Made Ready by Experts if Desired If you want a place already established select one which our department of agricultural experts has developed. On our Ready-Made-Farm, house and other buildings are up, well is dug, farm fenced, fields cultivated and in crop, all waiting for those who want an immediate start and quick results—all planned and done by men who know—our own agricultural specialists. Take 20 years to pay if you want to.

We give **free** service—expert advice—the valuable assistance of great demonstration farms, in charge of agricultural specialists employed by the Canadian Pacific for its own farms. This service is **yours—free.**

This Great Offer Is Based on Good Land

The Canadian Pacific offers you the finest land on earth for grain growing, cattle, hog, sheep and horse raising, dairying, poultry, vegetables and general mixed farming—irrigated lands for intensive farming—non-irrigated lands with ample rainfall for mixed and grain farming. Remember, these lands are located on or near established lines of railway, near established towns.

Your new home and your fortune are ready for you in the famous; fertile Canadian West, with its magnificent soil, good climate, churches, public schools, good markets, good hotels, unexcelled transportation—and **20 years in which to pay for your farm and repay the improvement loan.** Here is the Last Best West—where your opportunity lies. Don't delay. Mail the coupon below at once. The best land will be taken first—so time is precious for you. **Write today.**

G. E. THORNTON, Colonization Commissioner
Canadian Pacific Railway Colonization Department
112 West Adams St., Chicago, Ill.

FOR SALE—Town lots in all growing towns—Ask for information concerning Industrial and Business openings in all towns.



Book on Manitoba Book on Saskatchewan Book on Alberta
 (Make a cross in the square opposite the book wanted)
 G. E. THORNTON, Colonization Commissioner,
 Canadian Pacific Railway Colonization Department,
 112 West Adams St., Chicago, Ill.
 Please send me the books indicated above.
 Name.....
 Address.....
 Town..... State.....

DRAW BIG MONEY!

Yes: \$125 to \$175 Per Month to Start

I know you would like to draw such a salary and more, and you positively will earn this amount easy when you are a thorough

Practical Trained Draftsman and Designer

The constant demand for my trained men always exceeds the supply. Many positions paying \$75 to \$100 per week remain open on account of the shortage of the proper men to fill them. Some weeks over 250 positions paying the highest salary in all parts of the country are open and I would like to prove this to you by sending you one of my regular weekly lists of open positions.



Chief Draftsman Will Train You Personally and Instruct You Properly

On practical Drafting room work UNTIL you are absolutely competent in every respect as a first class Draftsman and UNTIL you are placed in a permanent paying position at a salary paying at least \$125 per month. This is a most exceptional opportunity for just a limited few selected ambitious men, between the ages of 16 and 40, whom I will train personally and give individual Instruction as required in order to fill the constant demand for properly trained men in this line.



Absolutely FREE! this Complete \$15 Draftsman's Working Outfit
IF You Write to Me AT ONCE

By sending the FREE COUPON on bottom of this page for my most liberal FREE OFFER for the \$15.00 Draftsman's Working Outfit, and also for my special offer to

Earn Big Money at Once While Learning at Home

Yes, my friend, you can make big money at once right at home from the very start—as much as \$5 to \$10 per day. I will pay you while learnin -



I give EACH of my students my own PERSONAL ATTENTION — therefor limit the number of my students and if you desire such an opportunity then get busy NOW and WRITE TO ME AT ONCE. Don't wait until tomorrow, but do it TO-DAY. You can earn much more than I charge for my spare time and personal training. This is not a money making correspondence school. We NEED good men to fill good paying positions and my practical working training is the result of the most urgent need for Draftsmen.

With my twenty-two years' experience as Chief Draftsman in handling men, I know urgent good men are needed all the time, and I will give you the benefit of my two experience at this work and will make you as high grade a man as you desire to be. You can draw \$125 to \$175 per month and steadily keep on going higher, as many good men draw \$5,000 per year in this line. You can do the same if you will grasp this opportunity.

I Guarantee

To instruct you UNTIL competent and placed in a permanent paying position at a regular Draftsman's salary of at least \$125 to \$175 per month and guarantee to furnish free the complete Draftsman's working Outfit at once from the start.

FREE BOOK and EARNING while LEARNING Offer Coupon

Chief Draftsman, Division 1194, Engineer's Equipment Co., Chicago, Ill.

Without any obligation on me whatsoever, please mail your book "Successful Draftsmanship" and full particulars of your liberal "Personal Instruction" offer to a few students. It is understood that I am obligated in no way whatever.

Remember: You can be earning good money while you are learning at home to do the practical Drafting room work.

Mail FREE COUPON at once for my book "Successful Draftsmanship," also list of open positions and for the free offer to be earning good money at once while you are learning at home.

This offer is positively limited and in order to benefit thereby you must act AT ONCE—not tomorrow TO-DAY.

Address: Chief Draftsman Engineer's Equipment Co. (Inc.) Division 1194 CHICAGO, ILL.

NAME.....

ADDRESS.....

Save money, time and shop equipment **30 Days Free Trial**

HERE is a tool grinder with artificial diamond wheels that makes tool sharpening amazingly easy—and the low cost extra attachments transform it into 17 other machines—jig saw, rip saw, forge, lathe, drill, etc. Try it free for 30 days. Then, after 30 days' free trial, send it back at my expense if you feel you can afford to do without it.

LUTHER SHOP TOOL GRINDER

DIMO-GRIT, the new artificial diamond sharpening substance, cuts steel as emery cuts soft copper. No danger of drawing temper, no water cooling needed. Just a light touch of the wheels peels the steel away in tiny shavings. 25 times faster than grindstone, 10 times more efficient than emery. DIMO-GRIT Wheels will not wear lopsided or glaze. They outwear any number of grindstones, which is one money-saving—they make tools last longer and save time, another money-saving. They make tool sharpening so easy that your tools are always in perfect edge, making all your general work easier, quicker, and increasing production, which means money-making.

The Luther Shop Tool Grinder, foot and hand power—is built of steel and iron—nothing to wear out—enclosed shaft drive like an automobile, dust-proof bearings—runs easy as a sewing machine—DIMO-GRIT Wheels turn 2500 revolutions per minute—every part built like a high grade lathe. Tool rests and sharpening attachments enable anyone to do difficult grinding such as sharpening twist drills, chisels, plane bits, gumming saws, etc.

This outfit saves work, time and money more ways than any other machine in your shop. Write for free book and pick out the outfit you want. 30 days' free trial.

**LUTHER GRINDER
MFG. CO.**

809 Michigan St., MILWAUKEE, WIS.



14 Tools in One

The Luther shop outfit includes 14 attachments and accessories.
1—Fine Dimo-Grit wheel. 2—Coarse Dimo-Grit wheel. 3—Universal tool rest. 4—Chisel and plane bit guide. 5—Dimo-Grit razor hone. 6—Dimo-Grit scythe stone. 7—Dimo-Grit saw gummer. 8—Felt polishing wheel. 9—Medium Dimo-Grit wheel. 10—Cloth buffing wheel. 11—Dimo-Grit oil stone. 12—Dimo-Grit pocket hone. 13M—Plane bit honing attachment. 14M—Twist drill sharpening attachment.
The 17 extra attachments, jig saw, drill, forge, lathe, etc., enable you to get a full shop equipment at amazingly low cost.



30 Days Free Trial

No money needed, no promises to make—return this coupon and get Free 40 page book, and pick out the outfit you would like to try. I will send it to you free—use it like your own for 30 days—sharpen all your tools—then if you do not wish to keep it, return it at my expense. No hard feelings if you do.

The wonderful scientific story of artificial abrasives is told in this free book—a marvelous story of science.

LUTHER GRINDER MFG. CO.
1809 Michigan St., Milwaukee, Wis.

Please send me 40-page free book from which I can select a Luther Grinder outfit for 30 days' free trial, should I decide to do so. This puts me under no obligations of any kind.

Name.....

Address.....

Williams'

PATENTED
Holder Top Shaving Stick



Until the last
bit is used

You used to throw away this much of your Shaving Stick

You can use Williams' Holder Top Stick down to the very end. Grip the metal cap that holds the stick. Your fingers need never touch the soap, not even when there is only the thinnest wafer of it left. No matter how much or how little remains, you have absolute ease of manipulation always. Add to this feature the rich, creamy, luxurious lather that has made Williams' Shaving Soaps famous and you have the perfect shaving stick.

Four forms of the same good quality:

- Williams' Shaving Stick (in the Hinged-cover Nickeled Box)
- Williams' Holder Top Shaving Stick
- Williams' Shaving Powder (in the Hinged cover Nickeled Box)
- Williams' Shaving Cream (in Tubes)

SPECIAL OFFER — Men's Combination Package
consisting of a liberal trial sample of Williams' Holder Top Shaving Stick, Shaving Powder, Shaving Cream, Jersey Cream Toilet Soap, Violet Talc Powder and Dental Cream. Postpaid for 24 cents in stamps.

A single sample of either of the above articles sent for 4 cents in stamps.

Address The J. B. Williams Co., Dept. A, Glastonbury, Conn.

