

POPULAR MECHANICS

WRITTEN SO YOU CAN UNDERSTAND IT

BS by The Book Shop Bindery - 5809 W. Division St. - Chicago 57, Ill.



\$785 Buys the Material To Build This Home

NO MONEY IN ADVANCE

We Save Home Builders 30% to 50%

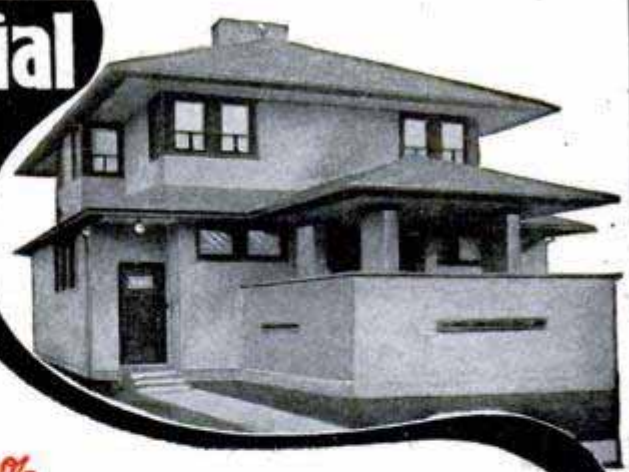

Design No. 152-D
Seven rooms and bath, modern, up-to-date interior, a beautiful home, 28x28.



Design No. 117
\$635 Six Rooms and Bath. A Modern Bungalow, Excellent Interior. Size, 39 feet, 6 inches by 27 feet.



Design No. 55
\$655 Six Rooms and bath, all rooms convenient and roomy. Size 22 ft. by 31 ft.



Design No. 50
\$872 Eight Rooms and Bath, very attractive Exterior; Five Closets, Airy Balcony. Size 28 ft. by 28 ft.



Design No. 53
\$960 Seven Rooms, Bath, Large Living and Main Bedroom, Modern in every respect. Size 27 x 36 ft.

The Chicago House Wrecking Co. would not dare ship you a carload of building material, valued anywhere from \$500 to \$1,000 *without one cent* down, if we misrepresented one single item. You are perfectly safe, we take all the risk. No one else in all the world can make such low prices on new Building Material. Our reputation as cash buyers places at our command, first—every bargain worth having. We are satisfied with one small profit—let the in-between profits remain in your pocket—means an immense saving—that means all previous

New Building Material Prices S-M-A-S-H-E-D

Then, when our expert knowledge of what to buy and how to buy at the right prices is combined with the expert knowledge of our most complete Architectural Department, the result is practical, modern, beautiful buildings, constructed absolutely without waste—to satisfy all tastes and all pocketbooks.

We not only save you from 25% to 50% on your completed building, but we give you all the assistance you need for its proper and economical construction, free of charge—Blue Print Plans, prepared by expert architects, Specifications and Material Lists, together with *any other information* you may need.

Compare our offers and you will be satisfied that none can compete with our price—and none can equal our service.

\$10,000 BOOK OF PLANS Mail the Coupon Today FREE

A truly wonderful book given away Free. One hundred pages of modern, up-to-date designs. Free to all parts of the United States. Other points upon receipt of 25c.

\$2 Brings Complete \$50 Set Blue Prints and Specifications for Any of These Beautiful Homes

The object of this advertisement is not to sell plans, but if you are interested in any of the designs shown on this page, we will, to save time, send a complete set of Plans, Specifications and full descriptive Material List, showing sizes, style, quality and catalog number of the material that we furnish. The best part of it is, that the entire \$2 will be credited on your order, or if plans do not suit, you may return them and all but 50c will be refunded. In addition, we will also name, upon request, delivered prices for complete Plumbing Outfit and Heating Plant of any kind and furnish complete specifications free of charge.

FREE Price Wrecking Catalogs

Send for our Special Building Material Catalog No. 100, Plumbing Catalog No. 133 and Heating Catalog No. 120 showing a complete line of construction of house, barn, or any other building. The newest and latest features in each line at low prices.

Read Our Guarantee—It Is Your Protection

Our guaranteed proposition to you is to furnish the material as specified in the Material List in *all brand new stock*, of the grade, sizes, style, quality and catalog number mentioned, and in quantities sufficient to complete the design strictly according to the plans. We also guarantee prompt shipment of order. All material loaded in one car from our plant here. Our Paid-Up Capital Stock, \$2,000,000

Heating Plants

Write for our prices on our complete bathroom outfit. We guarantee a saving of 30% to 50%.

Plumbing Material

Steam, Hot Water and Warm Air. Let us estimate on your requirements. Big saving.

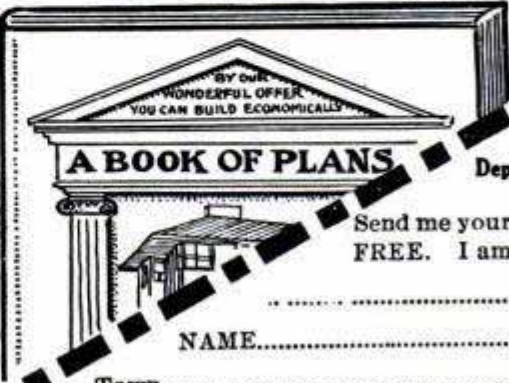

Chicago House Wrecking Company, Dept. F-7, Chicago, Ill.

Send me your \$10,000 Plan Book FREE. I am also interested in

NAME.....

Town.....

County..... State.....

Chicago House Wrecking Company, Dept. F-7 CHICAGO

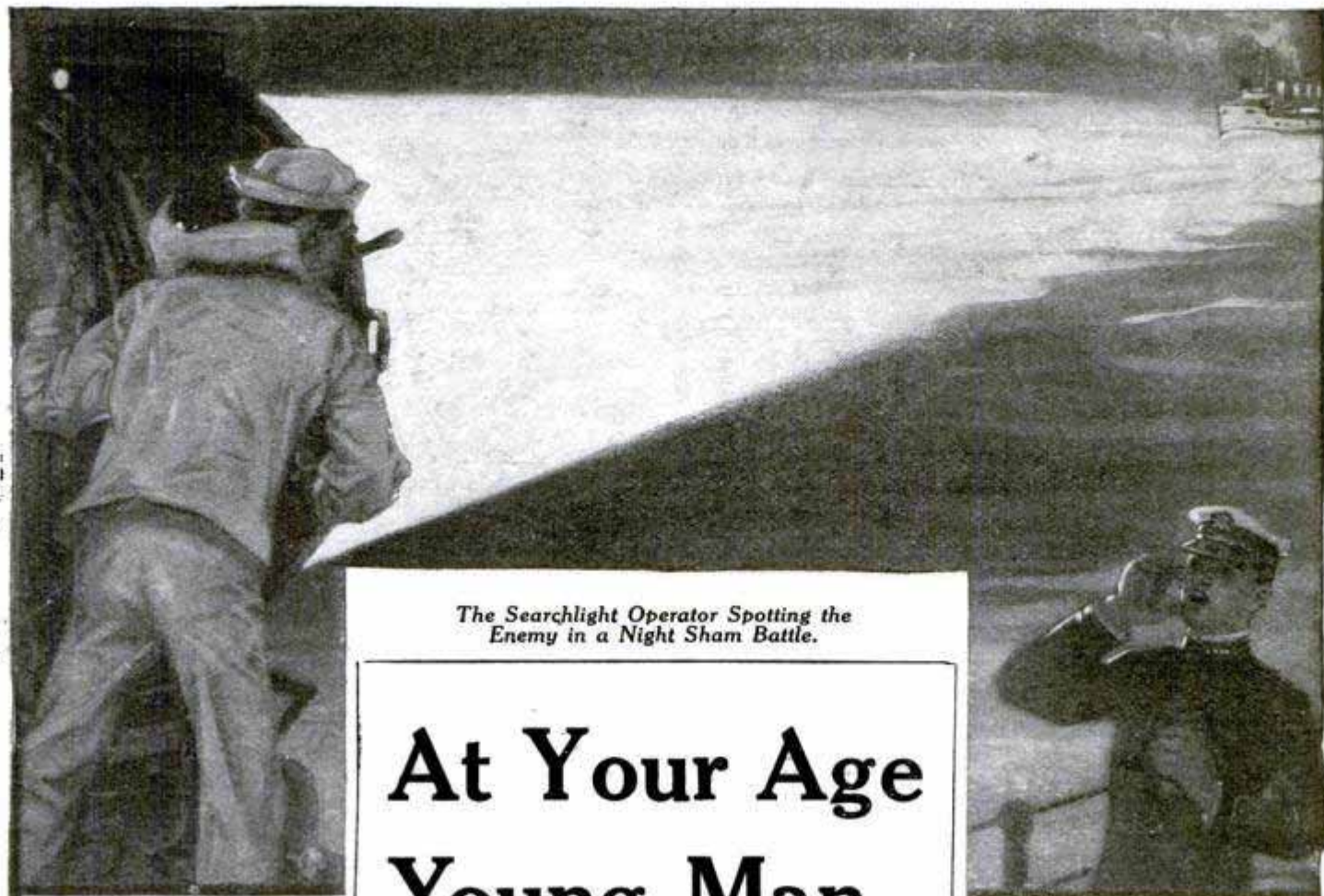

The Searchlight Operator Spotting the Enemy in a Night Sham Battle.

At Your Age Young Man—

IF you are between 17 and 25, you are at the most important age of your life—the age of making your decision. Are you going to postpone deciding on a permanent, beneficial life work, or will you drift on from pillar to post, sticking to nothing and getting no permanent good out of anything?

Unless you have made a firm decision on something you intend to make your life work, investigate the United States Navy.

Find out what it will do for you—as a life work, or as a course of training.

Four years in the Navy will build you up a fine physique and will train you in self reliance and discipline. This training will stand by you to the end of your life.

If you show special aptitude the Navy may teach you some valuable trade that will make you a fine living, even if you don't stay in the Navy.

Call at the nearest Navy Recruiting Station (we'll send you the address) and find out the whole truth about Navy pay, hours, promotion, training, fine companionship, the 50 different trades, chances to see the world, and opportunity to lay by money. Write for the interesting free book, "The Making of a Man-o'-Warsman," which describes in simple language and clear pictures the daily life of the enlisted men.

Have your parents read it, too.

If you put off sending you'll forget, so write for this book before you lay this magazine aside. Write to

BUREAU OF NAVIGATION, BOX 69, NAVY DEPT., WASHINGTON, D. C.

UNITED STATES NAVY

This One



HE WHO USES CYPRESS BUILDS BUT ONCE

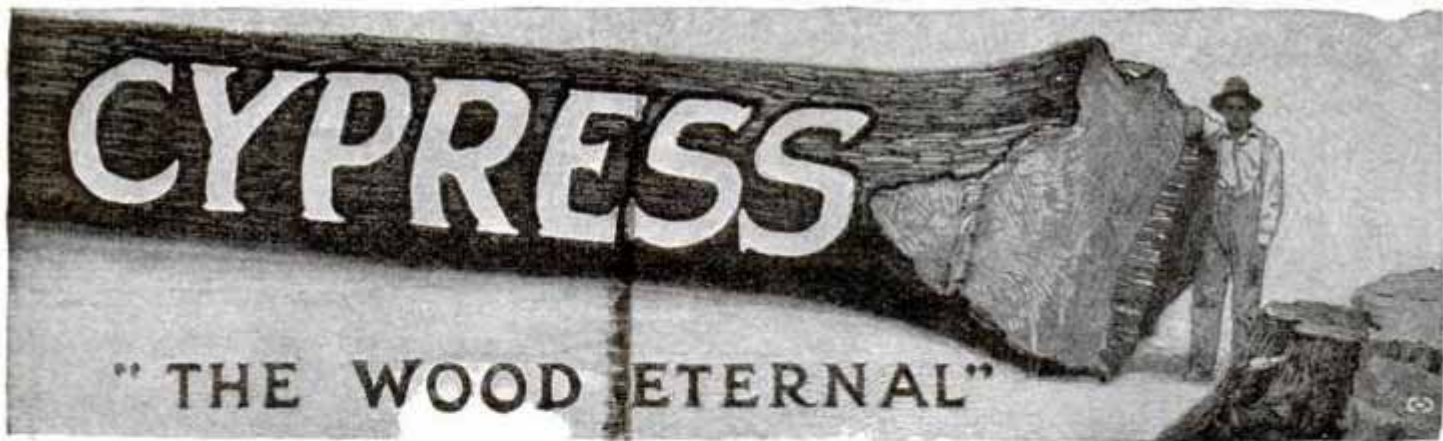

You know the ancient fame of
C Y P R E S S
 but do you know its uses *today*,
 and their significance to *you*?



CYPRESS is *the* wood of Scriptural history, and of romance; CYPRESS was the mystic wood of mythology—and it was the reliance of the sturdy builders of early America; CYPRESS always has been a magnet for those who have wrought sentiment and beauty into useful things—and CYPRESS is *today* the *staple wood* of the hard-headed calculating buyer who seeks the most *lasting* values for his lumber-money. This concerns *YOU*—if you like to avoid repair bills on anything made of wood.

It was of CYPRESS, according to Pliny, that the famous statue of Jupiter was carved; it existed more than six centuries without a sign of decay.

The historic Gates of Constantinople were of CYPRESS; they were on duty for eleven centuries without a furlough.

The CYPRESS doors of ancient St. Peter's, in Rome, were in a state of perfect preservation when removed by Eugenius IV; they had been swinging on the faithful for twelve centuries.

The only Egyptian mummies that survive intact and unblemished are those whose executors filed them in CYPRESS receptacles.

To bring the record nearer home—there was Thomas Lyon, who in 1640 built him a house in Greenwich, Connecticut. He put CYPRESS shingles on its roof and sides. With no exterior repairs of consequence, this house is today occupied as a residence. **THIS WAS AMERICAN CYPRESS**—the kind we own and cut and are selling you.

CYPRESS is in truth "the wood eternal." He who uses Cypress builds but once. If you are putting up a palace or a pasture-fence, and want to build it "for keeps"—**USE CYPRESS.**

There is a liberal education (and a wonderful *investment* value for you) in the CYPRESS advertising—and in the detailed information and reliable counsel to be had promptly, *WITHOUT COST*, if you will **WRITE US YOUR OWN NEEDS** (big or little), and **ASK YOUR OWN QUESTIONS** of the "All-round Helps Department" of the

Southern Cypress Manufacturers' Association

1219 HIBERNIA BANK BUILDING, NEW ORLEANS, LA.



BUY ON CYPRESS AT YOUR LOCAL DEALER'S. IF HE HASN'T IT, LET US KNOW AT ONCE

Popular Mechanics Magazine

318 W. Washington Street, Chicago, U. S. A.

EDITED BY H. H. WINDSOR

ISSUED MONTHLY

SUBSCRIPTION:

SINGLE COPY, 15 CENTS

In United States, and its possessions, Cuba and Mexico, per year, postpaid - - - - \$1.50
 To Canada - - - - - 1.75
 To all other countries in the Postal Union - - - - - 2.00

All subscriptions are discontinued at expiration. Please examine the date printed on your wrapper.

Entered as Second Class Matter Sept. 15, 1903, at the Postoffice at Chicago, Illinois, under Act of March 3rd, 1879.

Published monthly by POPULAR MECHANICS CO.

Copyrighted 1912, by H. H. WINDSOR.

The attention of prospective advertisers is called to the policy of this magazine in accordance with which the publisher waives all claim for payment of any advertisement appearing in any issue where the number of copies actually printed and circulated is less than the number printed on the front cover page.

Contents for January, 1913

Scots Still Test Skill with Ancient Caber.....	1	Gates Form Runaway Stopping Chute.....	46
White-Light Installation for Photographers.....	2	Flying Corps Asked to Try Parachutes.....	46
Trolley Car Bends in the Middle.....	2	Great German Protecting and Power Dam.....	47
"Magnet Bill" an Important Unit of an Auto Concern.....	3	Telephoning Fifty Miles by Wireless.....	48
Windmill Mounted on a Live Tree.....	4	Temporary Burial Place for Panama Chinese.....	48
Hiding an Army from Aerial Scouts.....	4	Glass Tubes Finer than Hair.....	49
Deer Impales Itself on Picket Fence.....	6	A "Boomerang" Blow-Pipe Glider.....	49
Lids for Funnels of Battleships.....	6	Automobile Headlight as Trouble Signal.....	50
Auto Delivery Wagon Looks Like Locomotive..	7	Portable Retort for Surgeons.....	50
Tungsten Lamp Burns in Spite of Collision.....	7	Memorial to "Titanic's" Wireless Operator.....	51
Cutting the Portholes in a Great Liner.....	7	A "Raincoat" for the Straw Hat.....	51
Enormous Loss of Water at Gatun Lake.....	8	Aeroplane Landing of Philadelphia Hotel.....	51
Use Telescopic Mast to Trim Trees.....	9	Pontoon Bridge at Bagdad.....	52
Explosives as Medicine.....	9	Pneumatic Woodcarving Tool.....	52
Police Zebras of German Africa.....	10	Electric Towboat Used on French Canals.....	53
Device Makes Engine Spark Visible.....	10	Raincoat Converted into Motorcycle Suit.....	53
Flying Motorboats the 1913 Sport.....	11	A New Type of Propeller.....	54
Motion-Picture Show in Passenger Station.....	12	England Loses another Submarine and Crew.....	54
Duck Shooting from Flying Motorboats.....	13	New Silencer for Motorcycle Engines.....	55
Gas Smokehouse for the Curing of Hams.....	14	Combined Mercury-Vapor and Tungsten Lamp...	55
The Advance of Shipping in the Last Year.....	14	Fragment of Armor Plate as Memorial.....	55
An Aerially Propelled "Water Bug".....	14	Four-Compartment Side-Dumping Motor Truck..	56
Apartment House Only One Story High.....	15	A Mechanical Anvil Hammer.....	56
Dressing the Faithful Light Buoys for their Stormy Winter Sea Service.....	16	Marble Mosaic for Windows.....	57
London to Have Subway for Postal Service.....	18	Primitive Well Boring in China.....	57
What the Popular Furs Really Are.....	18	Disinfector Motor Cars for Use in Germany.....	58
Stealing with the Heel of a Shoe.....	19	Uphill Safety Tracks Stop Runaway Trains.....	59
A "Perambulating" Machine Shop.....	20	Fireproof Clothes for the Future.....	60
Air Gun Stores Power for Sixty Shots.....	20	"Neptune" in a Hatteras Northwester.....	60
Elephants Haul Boiler Through Jungle.....	21	Oil-Barrel Origin of Automobile Shape.....	62
Motor Mail Collecting Made Easy.....	21	Corrugated Hulls for Battleships.....	62
Freight Transportation in Alaska.....	22	Collision of Auto Fire Engines Wrecks House...	63
New Last-Resort Method of Resuscitation.....	22	Concrete Slabs as Fine as Porcelain.....	63
Aeroplane Reports War Moves by Wireless.....	23	Dwarf Suspension Bridge in Long Service.....	63
London Has the Prize Freak Automobile.....	23	Testing the Gondola of the Brucker Airship.....	64
Huge Flagpole for Exposition.....	24	Best Wood Pulp Made by Dull Grindstones.....	65
Settling Cement Dust by Electricity.....	24	A Formidable Musical Instrument.....	65
Colossal Statues Carved from Single Blocks.....	25	Old Tank Rejuvenated by Use of Concrete.....	66
Trophy of Merit for Park Employes.....	26	Passenger Stations Have White "Dead Line".....	66
The New Safety Rules for Transatlantic Liners..	26	Submarine Wrecked in the Surf.....	66
Aviation Now as Safe as Football.....	27	Jack-and-the-Beanstalk Chain Trick.....	67
Far-Flung Messages of Government Wireless.....	30	Coals Identified by Coking Test.....	68
Comment and Review.....	31	Scouting the Border on a Motorcycle.....	69
By H. H. Windsor		Phosphorescent Fish of the Deep Sea.....	69
Eighteen Tons of Iron Lost Daily by Rust....	35	Two Motion-Picture Shows in One Theater.....	70
Voting Tents Used in Los Angeles.....	35	A Mono-Gyroplane Built for Ocean Trip.....	70
Scenes Attending the War in the Balkans.....	35	Binnacle with Double Lighting System.....	71
Progress Markers in the Aviation Show.....	38	Correct Stair Climbing Taught Children.....	71
By Victor Loughheed		Sustaining Life with Cold.....	72
A Ten-Story Office Building Collapses.....	41	By Al. H. Martin	
The Government as an Express Company.....	41	Alaskan Steamer High Aground.....	73
Hydro-Aeroplane Launching Ways for Battle- ships.....	42	The New Military Double-Seated Monoplanes...	73
Portable Control for Electric Cranes.....	43	Turbine Yacht Resembles Torpedo Destroyer...	74
Krupps Subject Guns to Severe Tests.....	44	Draft Producer for Chimneys.....	75
		Electric Power Plant for the Kitchen.....	75
		Glass-Bottomed Boat for Sea-Formation Study..	76
		New Specifications for Scouting Aeroplanes....	76

[Continued on Page 6]

Popular Mechanics offers no premiums; does not join in "clubbing offers," and employs no solicitors to secure subscriptions. It is for sale by nearly every newsdealer in the United States and Canada.

Contents—Continued

Pumping Tires from Propeller Shaft.....	77	A Countersink.....	122
New Lighting Unit Gives Wide Distribution....	77	A Brush Bridle.....	123
An Ingenious German Electric Bell.....	78	A Gasoline-Engine Valve Lifter of Large Capacity.....	123
Target Practice of the Atlantic Fleet.....	78	To Make Cement Tests.....	123
Electric "Daylight" Egg Tester.....	78	Packing Flour in Sacks.....	124
Leather Holder for Spare Wheels.....	79	A Sandpaper Stick.....	124
Bicycle Hanger on French Police Automobile....	79	Bands for Pipe Covering.....	125
Special Telephone Set for Paralytic.....	79	Spraying Insulation Liquids into Armature Windings.....	125
Street Ferries for Use at Crowded Crossings....	80	Cooling a Hot Bearing.....	125
Electricity Pumps Water to Irrigate Rice.....	80	Oil-Can Holder for an Automobile.....	126
Spotting the Antics of Distant Cyclones.....	81	A Tube-Cutting Tool.....	126
Electric Current from Bicycle Wheel.....	82	A Knife for Extracting Slivers.....	126
New Form of Insert for Concrete Walls.....	82	A Private Ice House.....	127
A "Fore-and-Aft" Direction Indicator.....	83	Antidotes for Poisons.....	130
Exchangeable Hard-Steel Treads for Rails.....	83	A Line Spreader.....	131
Gyroscopes Tested on U. S. Destroyer.....	83	Homemade Registering Gauge for Liquids.....	131
Thermometer Represents Costly Research.....	84	To Hold the Ends of Boards on a Small Strip....	131
Growing Tropical Fruits in Washington.....	85	Straightening a Motorcycle Fork.....	132
Pitless Turntable for Automobiles.....	85	Laying Out Sections for a Hollow Metal Ball....	132
Boats for Paris Streets in Case of Floods.....	85	An Unusual Conduit Crossing.....	132
Traffic Semaphores for Busy Crossings.....	86	Painting Concrete.....	133
Distribution of the "Titanic" Fund.....	86	Rotary Cutting Tool for a Wood-Turning Lathe....	133
Combination Twenty-Four and Twelve-Hour Watch.....	86	Radiating Bend in a Stovepipe.....	134
Combined Electric Comb and Curling Iron.....	87	Center Rest for Long Milling-Machine Work....	134
Pen-Pulling Device.....	87	Temporary Repair on a Valve.....	134
Automobile Jack that Fits Small Space.....	87	Repairing a Leak in a Water Jacket.....	134
An Automatic Door Handle.....	88	Starting a Tap True with the Work.....	135
Ordinary Camera Made Stereoscopic.....	88	Wagon-Tire Fasteners.....	135
Automobile Provided with Rudder.....	88	Protecting Windows While Painting.....	135
Aeroplane-Wing Covers Made of Steel.....	89	Valve for a Gasoline-Tank Vent.....	135
Prize-Winning Design for Safety Lamp.....	89	Drawing Board for Long Drawings.....	136
Valve-Closing Electric-Connection Box.....	89	Square Attachment to Determine Die-Clearance Surfaces.....	136
How to Predict Changes in the Seasons.....	90	Wire Joints Soldered with Heat from a Motorcycle Engine.....	136
Simple and Effective Insulator.....	90	Cutting Circles without a Compass Saw.....	136
"Hounds and Hares" Game on Motorcycles.....	91	Eye Shield for Gun Sighting.....	136
Growing Flowers that Will Keep Fresh.....	91	How to Make a Fluting Machine for Small Columns.....	137
Manicuring an Ocean Liner at Her Dock.....	92	Air-Cooled Commutator Brushes.....	139
Using Eggs as Germ Destroyers.....	92	An Emergency Four-Jawed Chuck Made of a Faceplate.....	139
Incandescent Mantles for Automobile Headlights..	93	Storage-Bin Marker Plate for Twist Drills.....	139
German Wingless Aeroplane.....	93	Connecting Ends for Coil Springs.....	139
Oldest Railroad Ticket Office Still Stands.....	93	A Vegetable Slicer.....	140
How the Spider Uses Structural Principles Like a Skilled Engineer.....	94	An Anvil Calking Tool.....	140
By J. E. Murphy		A Paint-Pot Stand.....	140
Giraffe Marked Like a Picture Puzzle.....	98	AMATEUR MECHANICS	
Shipping Gold Across the Atlantic.....	98	A Flash-Light Telegraph on a Kite Line.....	141
Removable Linings for Hospital Ambulances....	99	Hangers for Barn Tools.....	141
Our Canal Builders to English Eyes.....	99	Guide Ropes on a Bobsled.....	141
Two-Span Aerial Railway in Rio de Janeiro.....	100	Brush Hanger for a Dark Room.....	142
Artificial Cow's Milk Made from Beans.....	101	Lighting a Basement Light.....	142
Fir-Tree Odor Disgusts Boll Weevils.....	102	Projecting Protractor Readings.....	143
Spiral Stairs Converted into Freight Chutes....	102	A Door Stop.....	143
Machine to Make a Rug a Minute.....	102	Time Indicator for Medicine Bottles.....	144
Farman Biplane Has Detchable Cabin.....	103	A Washtub Stand.....	144
New "Safety" Crank for Automobiles.....	103	Pipe Used as Leather Punch.....	144
Aerially Propelled Bicycle Sledge.....	104	To Prevent Oilcloth from Cracking.....	144
Diesel Type of Engine for Farm Tractors.....	104	Combination Lock for a Drawer.....	145
Detroit's Dog-Catching Automobile.....	104	How to Start Small Machine Screws.....	145
Queer Monoplane Has Japanese Engine.....	105	An Umbrella Holder for Display Purposes.....	146
Paper Insulation Lasts Twenty-three Years....	105	Holder for a Milk Card.....	146
Hundred-Foot Log Bridge Spans River.....	106	Frame for Printing Post Cards from Negatives....	146
Leaded Silk as Safeguard for X-Ray Operators....	106	Finger Protection on Laboratory Vessels.....	146
Opening the Way for Glass Houses.....	107	A Novel Show-Window Attraction.....	147
Anti-Hatpin Crusade in Bavaria.....	108	How to Make a Mop Wringer.....	147
"Explosion" Locomotives for Desert Railways....	108	A Vise Used as a Caliper Gauge.....	148
Orchard Tractor Driven by Boy.....	108	Homemade Tack Puller.....	148
Studying the Colors in Brick.....	109	How to Make a Radium Photograph.....	148
Impressions of Aeronaut Turned Airman.....	110	Pulling Wire Through Curved Electric Fixtures....	149
New Superdreadnought Launched in England....	110	An Automatically Closing Drawer.....	149
Measure Wind Velocity with Electricity.....	111	A Cork Puller.....	149
Under-Water Signal System for Navy.....	111	Uses for a Bamboo Pole.....	149
Motor-Car Lock Grips Clutch Lever.....	111	Making Common Lock Less Pickable.....	150
Repairing Arteries with Glass Tube.....	112	To Prevent Corks Sticking in Bottle Necks....	150
Motor Cars Two to One on Massachusetts Road....	113	Eraser Holder.....	151
British Military Biplane of Advanced Type.....	113	A Soap Shake.....	151
Great Rock Resembles Human Head.....	114	Ear Repair on a Bucket.....	151
Bullock Power on Roof of Turkish Bath.....	114	Cleaning Dirt from Tufts in Upholstering.....	151
Is Your Intended Home Well Built?.....	115	Substitute for a Rubber Stamp.....	152
By M. W. Douglas		A Hanging Vase.....	152
German "Air-Yacht" Club Pennants.....	120	Locking Screws in Door Hinges.....	152
Operating Hotel with Telautograph.....	120	Patents Practical or Unique.....	
SHOP NOTES		153	
A Wagon Brake.....	121	Jokes.....	
To Keep a Reserve Supply of Gasoline in a Tank..	121	154	
To Fasten Covers on Shipping Boxes.....	121		
New Form of Dry Battery for Long Life.....	122		
Applying Gravel to Roads with a Manure Spreader.....	122		

CLEANS
WITH DETERMINATION
SCOURS
WITH DISCRETION
POLISHES
WITH DESPATCH



WORKS WITHOUT WASTE

Let Us SHOW
YOU Hundreds
of Other Testi-
monials



WOULD YOU GIVE \$12 TO LEARN THE AUTO TRADE? Then READ Carefully

\$50 would not buy my course. After I got through Book 4 of instructions 13 and 14, 15 and 16, I had a job grinding valves. I did the job in four hours. Next day I put on four piston rings, which took six hours. These two jobs paid for my course. I am now overhauling an engine for a party. I am not afraid to tackle any job now. If I get stuck I am sure I can find the remedy in the instructions. I knew nothing at all about an auto before, and I want to thank you for helping me.—Henry G. Ehredt, 523 E. 8th Av., Homestead, Pa.

If we *prove* to you that we have started hundreds of others into the repair business and as chauffeurs—who had no previous experience and who knew no more about an auto than you do right now—will you enroll?—of course you would. Now the next thing for you to do is to write me just as quick as possible and *let me prove it.*

H. M. Fewins and S. T. Slayback, both graduates, are now running a Garage and Repair Shop at Woodbine, Iowa.
E. Dwyer, 31 N. Willow St., Montclair, N. J., 19 years old, receives \$25 a week and board.
Harry J. Herbin, Jamestown, Kans., was a farmer, but has doubled his income repairing and selling autos.
W. R. McClelland, Astoria, Ill., was an auto driver. Became professional chauffeur and more than doubled his salary.
Donald Stewart, Oakland City Ind., became a chauffeur at \$25 a week.

And we could continue until we had filled this and several more pages.

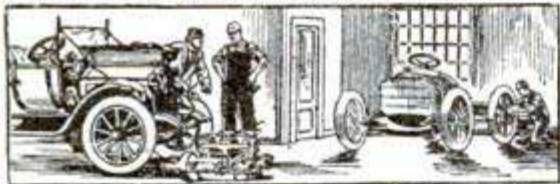

Our book of testimonials, showing photos of students and their shops—free.

All the Result of the Dyke System

We can so thoroughly train you that you can open a repair shop or drive a car and make many times more than you are making now. Don't forget, we help you get your start with our *Employment Plan*, if you want it.

DYKE'S NEW IDEA OF TEACHING BY MAIL WITH WORKING MODELS

is something new. We use *real* working models—not just one but *five*. On these models you get actual practice, see the actual operation and learn more than you could from the auto itself—it's easy and quick. You don't have to study hard with this system—we teach through the eye—a new idea. We are the originators of the system of teaching by mail with models. We also use charts—175 of them and a 16 page manikin. Our 40 instructions and Repairman's Instructions are simplicity itself—simple as A B C.

Our Employment Plan for Students

This represents years of work to provide something that no other school had, namely, a way for the graduate to get acquainted with auto and garage owners, to prove his ability and to immediately secure profitable employment.

Mr. Dyke has been identified as a pioneer inventor, supply man, etc., with the auto industry since its beginning. He originated the first auto supply co., and published the first book on autos in America. No other man with such experience is today teaching others. And all the experience and inside information of the auto business he has thus gained, is embodied in this *Employment Plan*.

WRITE TO-DAY for Details of Employment Plan and THIS FREE BOOK

It is instructive and interesting—does not cost you a cent and places you under no obligations whatever—You need it for your own sake, not mine. Don't wait—there's no profit in waiting—WRITE NOW and learn how you can obtain all this training for only \$12, if you act immediately



DYKE'S CORRESPONDENCE SCHOOL OF MOTORING Box 88, Roe Building, ST. LOUIS, MO.

NOTE.—This is a chance you may never have again to get into the fastest growing, best paying industry the world has ever known, a field that is growing faster than men can qualify for the work.

Be a Doctor of Chiropractic

The New Drugless Healing Science OF SPINAL ADJUSTMENT

A Dignified, Profitable Profession Easily Learned at Home. Steady Demand for Practitioners Everywhere—Our Students Surprisingly Successful.

Make \$3000 to \$5000 a Year

Your income as a Chiropractor can be this much or more year after year. At the same time you will be serving suffering humanity. Dr. Walter made \$500 the third month after starting; R. M. Johnson has added over \$3,000 a year to his income; Vern Sharpsteen makes \$40.00 a day. In addition, this fascinating profession is building up for these former students of ours a splendid social and professional reputation.



We taught these men in their spare time by correspondence, and in class, to be Doctors of Chiropractic—the

NEW DRUGLESS HEALING SCIENCE of Spinal Adjustment

—and thereby made them independent for life. We will guarantee to teach you with equal success. A common school education is all you need to begin—our simplified training does the rest.

Sample lesson sheets and illustrated book giving full instructions how to get into this well-paid, uncrowded profession at once—mailed

FREE

National School of Chiropractic, Dept. 130, 1553 W. Madison St., Chicago



AN ART SCHOLARSHIP FREE

WRITE AT ONCE for full particulars of this Special Limited Offer. No charge, no obligations. Your name and address brings you handsome, illustrated Prospectus, and explanation of this unusual offer, by return mail, free. Remember this offer is strictly limited.

DON'T TAKE CHANCES. WRITE NOW.
FINE ARTS INSTITUTE, Studio 9111, OMAHA, NEB.



MAGIC Tricks, Books and Supplies

Amateurs supplied as well as the great Professionals

Easy, interesting and entertaining. Mystify and astonish your friends.

Large, illustrated professional catalogue of wonders. Price 10c

Read & Covert, 821 E. 43d St., Chicago, Ill.

ELECTRICITY IN A NUTSHELL



Laird & Lee's Vest Pocket Practical Compend of Electricity, by Jas. A. Beaton, A. M. Magnetism and Electricity, Batteries, Accumulators, Wiring, Dynamos and Motors, Lighting, Plating, X-Rays, Wireless Telegraphy, Electricity Applied to Medicine and Surgery, Current-Carrying Capacity, etc., of Different Wires—Electric Railways, Naval and Military Uses of Electricity, Submarine Telegraphic Cables, Vocabulary of Technical Terms, etc. Cloth, 25c; Leather, 50c. Postpaid by

LAIRD & LEE, Publishers,
1732 Michigan Ave. Chicago, Illinois.



200 KINDS IRON, WOOD, PUZZLES WIRE & STEEL

Sample with Catalog, 10 cents or 3 leaders for 25 cents.

WESTERN PUZZLE WORKS
St. Paul, Minn.



Every Boy His Own Toymaker

Greatest boys' book ever written. Tells how to make a Steam Engine, Telephone, Magic Lantern, Boats, kites, balloons, electrical and mechanical toys, traps, fishing tackle. 200 illustrations; also catalog of 150 puzzles. Keller's Magic Ace Trick Card and "DOUBLE THROAT" warbler and bird call all for only 10c. WESTERN PUZZLE CO., ST. PAUL, MINN.

LAW

This \$100.00 Tuition Credit

FREE

\$100 Complimentary \$100 Tuition Credit

Auditor

American Correspondence School of Law

If application of Mr. WM. L. Page,
of Kenilworth, Ill., is received on or
before 30 days please credit him with One Hundred
Dollars for tuition, covering the regular three-year course
of instruction. Charge to advertising account.

J. B. Lyttleton, Director of Publicity.

To secure \$100 Credit for Complimentary Tuition this Certificate must be enclosed with application

This is a reduced size picture of the Complimentary Tuition Credit Certificate we give you free

Offer Expires in 30 Days, So Write if You Want a FREE Scholarship

A positively tremendous offer for the ambitious man. Here is your opportunity to get your tuition in a great law school—the largest in the world—**positively without a cent of cost to you.** Graduate correspondence students most successful in passing bar examinations. But these complimentary tuition credits are limited in number. We are doing this for advertising purposes and offer will be withdrawn in thirty days. So hurry. Mail coupon for this startling offer.

Study Law at Home on This Great Offer Lincoln, Garfield, Clay—
a host of great men received their training at home. Look what these men have accomplished. Our graduates are filling responsible positions in every state of the union. Our course covers the same ground as Harvard, Columbia and other big law schools.

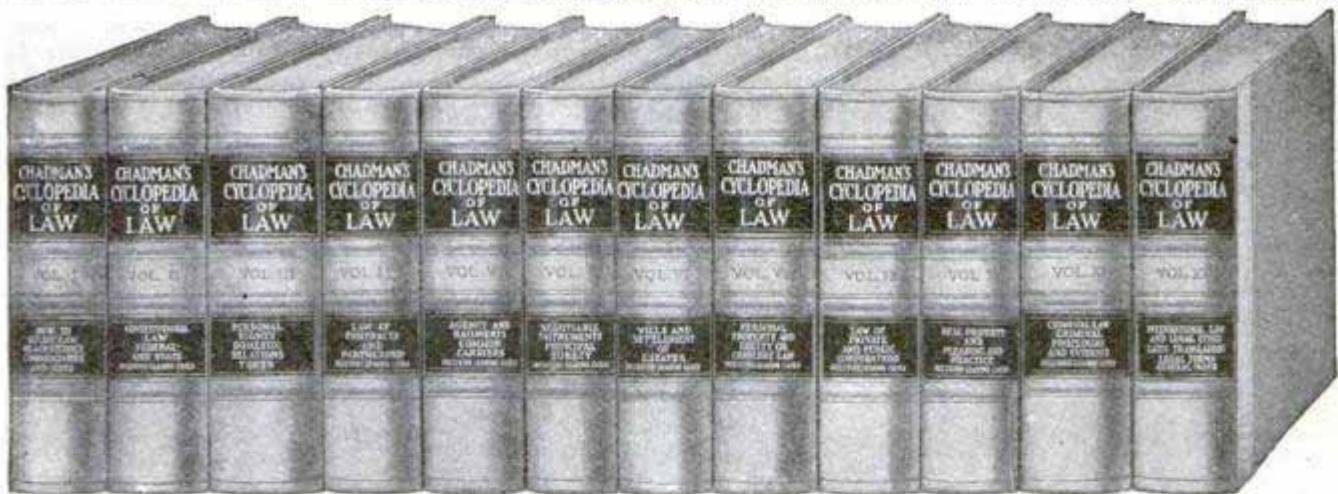

We furnish this Magnificent Law Library with every Free Scholarship

WE GUARANTEE to coach free any student failing to pass a bar examination. Our course covers both theory and practice and prepares for the bar in any state.

Twelve of the most magnificent law books ever published. Written so that you can understand every detail of the most complex law problems. With the aid of these splendid volumes in connection with our masterful lessons and lectures, you will grasp the subject of law in a surprisingly short time. Then we give you a **Special Business Course.** Thus you get a thorough knowledge of commercial law—invaluable to every business man. Don't fail to send the coupon this very day. You'll regret it if you don't.

FREE Coupon

American Correspondence School of Law Dept. 1191 Manhattan Bldg., Chicago

Gentlemen: Without any obligations on me whatsoever, please send me your catalog and particulars of your free scholarship offer.

Send This Coupon SEND IT TODAY

Think of it! A complimentary tuition credit of \$100, covering the regular three-year course of instruction. You only pay for text books and postage. That's all. Get full details of the greatest law offer ever made. Don't fail to get our big, new school catalog. A book you should have. It's FREE. Remember this offer is limited. This is the opportunity of your life. Mail the coupon AT ONCE.

AMERICAN CORRESPONDENCE SCHOOL OF LAW
Dept. 1191, Manhattan Bldg., Chicago, Ill.

Name

Address.....

Our Supreme Offer, Starting Now, of Our Latest, Greatest Business Books, Untold Value, at 60 Cents Each

How to Sell Goods

—How to ginger up a sales force—How to drum business in dull seasons—How to route, handle and check salesmen—How to train, develop and coach a sales force—How to win the dealer's cooperation and support—How to meet objections and how to be a good "closer"—How to handle wholesalers and retailers to the best advantage—How to judge a good salesman—How to work the "big stick" plan of selling goods to retailers—How to analyze your proposition and pick out its selling points—How to make the consumer influence dealers to buy your goods—How to get out of the ranks of the "clerks" and become a real salesman. And hundreds of other vital pointers and plans for clerks, salesmen, retailers, wholesalers, manufacturers, mail order houses, etc.

How to Buy at Rock Bottom

—How to know to a nicety what stock is on hand—How to keep track of promises, agreements, deliveries, etc.—How to play one salesman against another and take advantage of every opportunity to get a lower price—How to thoroughly master the ins and outs of the buyer's position so that you can meet the crack salesman in every line on equal terms—How to devise a simple system which will bring to your notice automatically, all data, prices, etc., about a given article—How to formulate a complete purchasing and record system for a mail order house, a factory, or a retail, or wholesale store.

And other priceless pointers on purchasing that business men should know about.

How to Collect Money

—How to judge credits—How to collect by mail—How to handle "touchy" customers—How to be a good collector and how to hire one—How to organize a credit and collections department—How to weed out dishonest buyers from the safe risks—How to get quick, accurate, inside information about a customer's ability to pay—How to write smooth, diplomatic letters that bring in the money without giving offense—How to devise a simple and effective system of insuring prompt and periodic collection of all your accounts. And valuable information obtainable in no other way, for credit men, collectors, accountants and every business man interested in this vital department.

How to Advertise a Business

—How to plan and lay out an advertising campaign—How to judge and select the right mediums to reach any given class—How to write, refine, illustrate, display, place, and check advertisements—How to develop a crisp, hard-hitting, goods-selling style of expression—How to prepare bold, original headlines—How to conduct a magazine campaign—How to "drive home" its effect on dealers, wholesalers and consumers simultaneously—How to make a small appropriation count—How to advertise for inquiries and turn them into sales. And an infinite variety of other practical points on every phase of advertising.

How to Meet and Handle Men

—How to develop strong individual personality—How to approach and impress men—How to attract, interest, persuade, conciliate and convince men—How to break down the walls of reserve and prejudice in an interview and turn enmity into cordiality and respect—How to pick men—How to weigh, judge, analyze ability in a prospective employe—How to train and coach new employes—How to inspire men with desperate determination and uttering loyalty to work, to think, to act, even to fight in your behalf—How to keep in personal working touch with an entire working force, making each man feel your special interest in him. And section after section meeting and managing, directing and controlling, inspiring and enthusing all sorts and dispositions of human nature.

Yours, the Mighty Total Experience of Generations in Thousands of Businesses in Ten Powerful Volumes, almost FREE

1497 Vital Business Secrets

Here are the plans, the rules, the answers of business which put men right in their struggle for success

If you only knew! If you could only realize that this offer places within your reach the knowledge which will straighten out snarls in your business life, make the way plain. Here are 1,497 real money methods, proved by thousands of businesses for every business man, big or small, steel man or grocer, manager or bookkeeper. Since the first edition, this remarkable Business Man's Library has been purchased by 39,463 concerns and by many of the greatest business men living.

One little sentence in one of these books may break down a barrier between you and success

60-Cent Price the Result of 10 Years of Striving

A short time ago many thousands paid us \$27 for a set of books similar to these, but we were impatient that more thousands, who could not afford them at that price, might obtain them. We find that the first edition sales absorbed practically all of the editorial cost, so that we need make the price of this edition only on the raw product—paper, printing, binding and shipping—and the mere cost of telling you about them. We searched the world for a light, strong paper to take good printing, to reduce binding and shipping expenses—and we found it in Germany. Then we reduced the margin on plates, binding and packing. Offering 30,000 sets of these Business Man's Libraries at 60 cents a volume, now means practically giving away complete business experience which 999 out of 1000 persons could not ordinarily obtain after long years of up-hill work.

The things which have cost men dearly in fortunes and careers are made plain to you in the brilliant pages of business secrets. Out of the success-struggles of modern business, the failures as well as the monumental achievements, comes this message to millions, as the answer to daily questions, doubts, ignorance—at a price which does not approach the value of many a single paragraph! This is the greatest offer we can possibly foresee for this decade.

These books present 2,079 pages jammed full of new ways of making money told by the Master Minds of Business. This set is a guide to the man in the private office, and to the worker it gives the short cuts to better days, larger salaries and eventual success. Why waste years plodding and blundering along, spoiling opportunities and wasting chances when you can get inside knowledge of business, of the executive board, the departments, the factory, of financing and selling and advertising? What power can hold you back from accepting this offer at only 6 cents a day spread over only four months?

Is a small self-limited job keeping you from seeing and knowing? Find out from 112 great, big men—not mere writers, but national business men, whose names inspire admiration and confidence—Alexander H. Revell, Founder and President of the great firm bearing his name; Sears, Roebuck & Company's Comptroller; Montgomery Ward & Company's Buyer; John V. Farwell & Company's Credit Man; Sherwin-Williams Company's President; and 107 others. Let them place at your disposal the crystallized experience of the whole world of business.

Then add the help which you will get from SYSTEM, which stands pre-eminent, the Magazine of Business, with 260 to 350 Pages in every issue [and 750,000 regular readers. Whether you own your own business or are employed—SYSTEM will show you new ways of saving time and cutting out drudgery. It has helped hundreds to better salaries, bigger profits that would have been impossible, undreamed of, without SYSTEM. Read our offer now and accept priceless help at trifling cost—less than you pay for carfare or cigars, distributed over four months only.

Our Supreme Offer: We offer you for 6 cents a day, term only four months, these 10 substantial volumes, published in an attractive 30,000-set edition, printed in large bold type on fine light-weight paper, full cloth bound with covers in four colors—suitable for any library or desk. And this 6-cent offer includes an 18 months' subscription to SYSTEM (price \$3.00). That's \$9.00 only in all, spread out thin over four months. Your check or money order, or a dollar bill, today will start the books to you tomorrow, transportation charges fully prepaid, and give you SYSTEM for eighteen months. One dollar now and \$2.00 a month until \$9 is paid. (West of the Rockies, \$10; Canada, \$11). Long before the first month is out, these books will have a chance to put into your pocket many times their cost. Send without delay as this Edition is going to disappear the fastest of any we ever put out.

Simply tear this ad out now, say "I accept your offer in Popular Mechanics, January, 1913", write your name and address on a piece of paper, pin all together with your dollar and send to **SYSTEM, Wabash and Madison Sts., Chicago**

How to Manage a Business

—How to keep track of stock—How to figure and charge estimates—How to check deliveries and mistakes—How to get the most out of those under and around you—How to size up the money-making possibilities of new ventures—How to detect and eliminate needless items of expense and waste—How to get up blanks, forms, records and simple systems for all kinds of businesses—How to devise a perpetual inventory system that will tell you every day, the value of all material on hand—How to turn a losing business into a profitable one—How to make a profitable business more profitable. And countless other things that every man in an executive position needs in his daily work.

How to Get Money by Mail

—How to write ads—How to begin a letter—How to turn inquiries into orders—How to formulate a convincing argument—How to get your reader to ACT at once—How to cover territory salesmen can't reach—How to keep tab on results of all mail work—How to key ads, circulars and all mail sales—How to prepare an enclosure for a business-getting letter—How to supplement the efforts of salesmen with live, business-getting letters—How to answer, file and follow up inquiries from advertisements and those which come in the regular course of business. And page after page of practical working detail—not only for mail order firms but particularly helpful to those not making a specialty of mail order business.

And page after page of practical working detail—not only for mail order firms but particularly helpful to those not making a specialty of mail order business.

How to Stop Cost Leaks

—How to detect waste—How to make an inventory—How to figure "overhead" expenses—How to systematize an entire factory or store—How to cut out red tape in a simple cost system—How to keep close watch on material and supplies—How to apportion the right number of employees to a specific job—How to decide between piece-work, day wages and bonus systems—How to keep tab on productive value of each machine and employe—How to figure depreciation, burden, indirect expense, upkeep, profit, loss and cost. And chapter after chapter of priceless plans for practically every kind of business in which an accurate cost system is essential to money-making success.

How to Get and Hold a Position

—How to apply for a position and get it—How to answer a want ad. in person or by letter. How to compose a strong, original letter of application—How to secure the highest market price in selling your services—How to prepare and apply for advancement—How to quickly gain and hold your employer's confidence—How to master the entire routine, the science, the duties, the problems of an executive, a department head, general manager—How to study the work of the man above you, without offending or antagonizing him. Not good advice merely, but practical, down-to-the-earth instruction in the branches of business that will enable the ambitious employe to actually earn more—have more—be more.

Office and Accounting Methods

—How to keep office accounts—How to devise and install a complete record and accounting system—How to take loose leaf trial balances—How to devise a system that will give you your monthly statement on time—How to install a simple system that will give you a daily report of your business condition—How to use the loose leaf in handling collections—How to manage and systematize an office—How to speed up an office force to top-notch efficiency—How to keep exact office costs—How to handle a stock-keeping and shipping department, with complete inventory, receiving and shipping blanks and forms for each. How, in fact, to enjoy peace of mind, comfort and satisfaction, in the certainty that there are no faulty methods throughout your entire office organization.

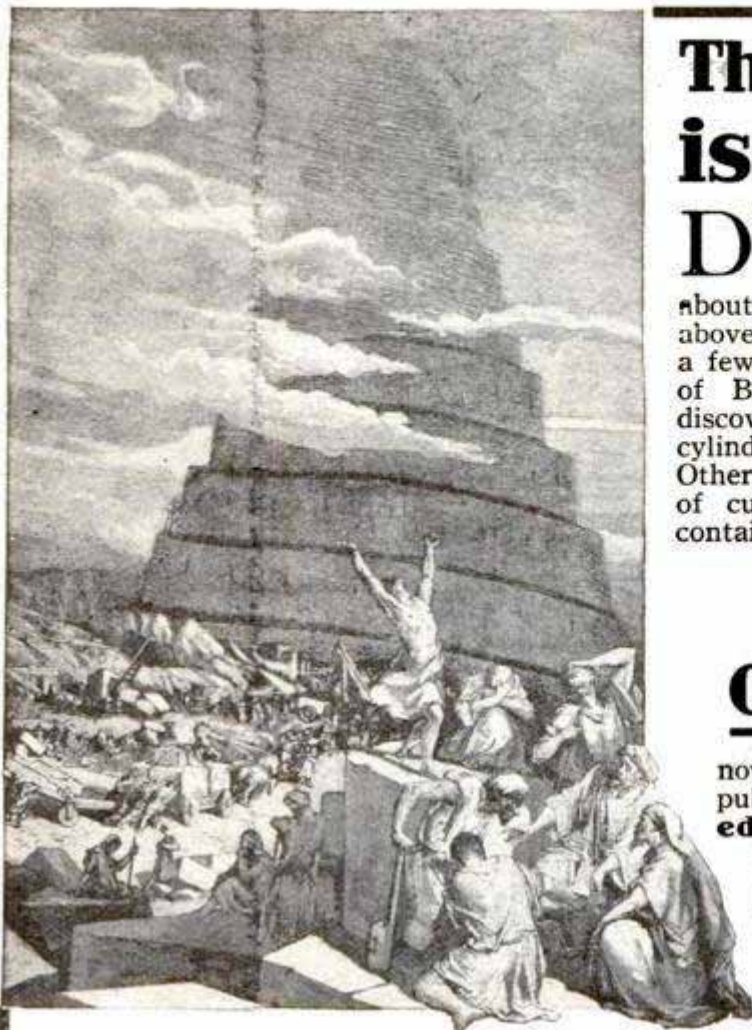

The Tower of Babel is Still Standing

DO you realize that 4000 years after this most wonderful of all towers was built by the ancients (according to the Book of Genesis about 2400 B. C.) its seven stages still rise high above the plains near the site of Babylon? Until a few years ago it had been known as the Mound of Birs Nimrud when Sir Henry Rawlinson discovered in one of the stages the inscribed cylinders which made the identification possible. Other expeditions uncovered many of the thousands of curiously interesting records and documents contained in the great work—

The Library of Original Sources

now for the first time available to the general public. **By taking over the entire unsold edition from the publishers we secured it at an absolutely unheard of bargain.** So now we can offer the few remaining sets to POPULAR MECHANICS readers

**AT LESS THAN IT
COST TO MAKE THEM**

Send us the attached coupon **AT ONCE**, and we will tell you how to get the Library on **EASY MONTHLY PAYMENTS**, and mail you **FREE** a book of rare documents. Remember there are only a limited number of sets, so **act quickly. Mail the coupon NOW. You assume no obligation. No salesman will call. The book is FREE.**

THIS MARVELOUS WORK is revolutionizing modern thought. It's turning upside down old notions and ideas. It gives the authoritative, rock-bottom sources of our knowledge on **ALL SUBJECTS OF HUMAN INTEREST** from the earliest civilization down to to-day—the inside facts which the average person has never even heard of.

OVER 100 RESEARCH SPECIALISTS spent 10 years gathering the contents of this great work. Ancient and remote and forgotten civilizations in all parts of the globe were uncovered, and age-buried hieroglyphics on monuments, tablets, sun-baked bricks and palimpsests yielded their secrets; untiring workers ransacked the hidden literature of every age, ancient, mediaeval and modern, to find the "original documents" that shaped the civilization and influenced the thought and life of the world. Nothing like it has ever been attempted or thought of before. You'll be amazed at the wealth of information this unique library contains.

DO YOU KNOW that the old Egyptians, 5000 years B. C., had a Bible which they called the "Book of the Dead"?—Do you know that the Assyrian sacred literature gives the story of the Creation?—Do you know that books and newspapers were printed in Asia thousands of years before printing was invented by Gutenberg?—Do you know that Columbus wrote a journal of his voyages to the new world and that it has been found, translated and published?—**DID YOU EVER READ** the "Ball and Tyler Rebellion"? Luther's "Ninety-five Theses"—which he nailed to the church door— or Machiavelli's "Prince"?

YOU'LL FIND THEM ALL—and thousands of others equally as curious and important—in the Library of Original Sources. Every document is in the exact words of the original, translated; every contribution is from the actual eyewitness or person who took part; every idea is in the words of the thinker, investigator, discoverer or inventor.

JACK LONDON SAYS:—"It is a whole library in itself. I certainly never could spare these books from my shelves."

10 sumptuous, massive volumes, bound in rich, deep red Morocco; full-page illustrations on India Vellum, pure silk headbands, printed in large, clear type on hand-made paper, gold tops—a triumph of the bookmaker's art.

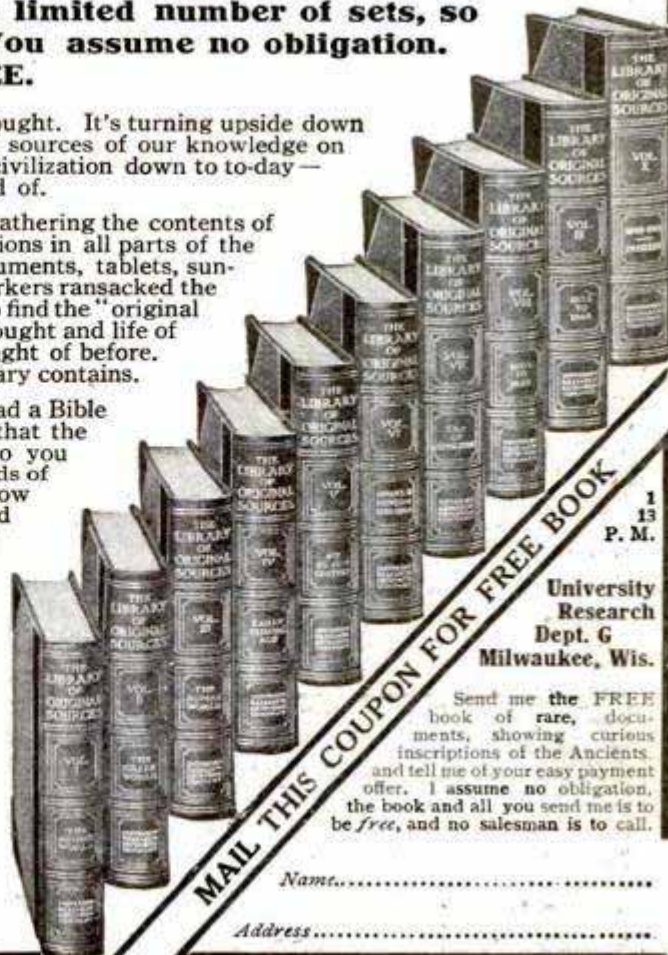

MAIL THIS COUPON FOR FREE BOOK

1
13
P. M.

University
Research
Dept. G
Milwaukee, Wis.

Send me the **FREE** book of rare, documents, showing curious inscriptions of the Ancients, and tell me of your easy payment offer. I assume no obligation, the book and all you send me is to be free, and no salesman is to call.

Name.....

Address.....

Memory is Power

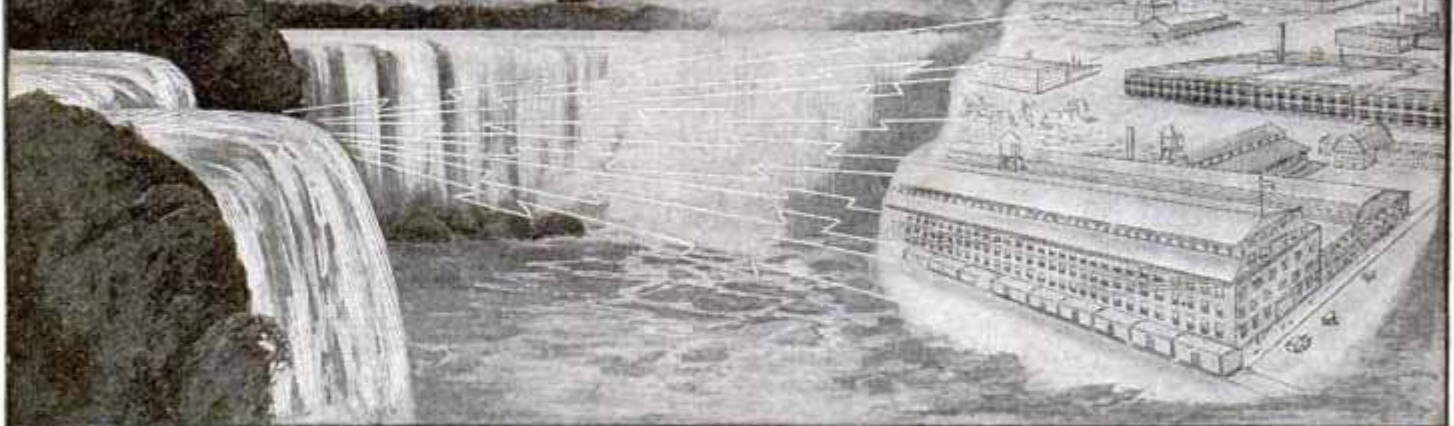

For countless ages the tremendous power generated by Niagara Falls was wasted. Today science has harnessed this mighty natural force in the service of man, and factories in distant cities are now lighted and operated by power generated at Niagara. Yet, greater than this former waste of material power is the colossal waste of mental power through lack of proper memory training.

Are You Wasting Your Power?

MEMORY IS POWER! A perfectly trained memory is absolutely indispensable to the man or woman who expects to achieve REAL headway in life. For no matter how brilliant your mind may be—no matter how great your natural mental aptitude—your power will be wasted like the unharnessed Niagara unless you possess the trained ability to REMEMBER what you know precisely at the right time

A Perfect Memory Is the Key To Success

The mind of the average person is filled with thousands of single unrelated ideas which waver and fluctuate like the waves of the sea with every passing emotion. The man with a "wandering mind" is like a rudderless boat at the mercy of treacherous currents and eddies, drifting helplessly and hopelessly to certain failure.

Successful men are those who "harness" their powers through ability to memorize and concentrate. In the modern business battle—matching wits each hour of every day—the ability or inability to think on your feet, to remember instantly and accurately, means gain or loss. To succeed you *must* be "forget-proof." Therefore resolve this very day to "STOP FORGETTING!"

What the Dickson System of Memory Training Will Do For You

My System of Memory Training is successful because it is thoroughly scientific yet intensely practical in its adaptability to the needs of all. It is the natural easy way to mental mastery—the short straight path to proficiency. It will teach you among many other things: How to remember names, faces, facts, figures, engagements, etc.—How to acquire the habit of logical thinking with the power to concentrate at will on any desired subject; ability to memorize studies, pass examinations, etc.—How to focus your thoughts effectively on the vital details of a business proposition.—How to think on your feet and make an effective extemporaneous speech.—How to overcome self-consciousness and bashfulness, etc., etc.

I Want to Send You My Book, "How to Remember," Absolutely FREE

Simply clip the coupon and mail it today. It will explain clearly the course that has raised thousands of men from failures to great successes. You can have this same training. My free book is the first step. Don't delay. Age, education, vocation or place of residence makes no difference. Send the coupon or postal today.

How to Get a Free Copy of This Valuable Volume

De luxe edition handsomely illustrated, richly bound. Is exactly suited to meet the needs of the man or woman who desires to be a successful public speaker.

The price of this 1912 de luxe edition is \$2.00. I will, however, present a copy absolutely free to every student who enrolls for my course of memory training within ten days after reading this offer.

Send the Coupon or Postal Today

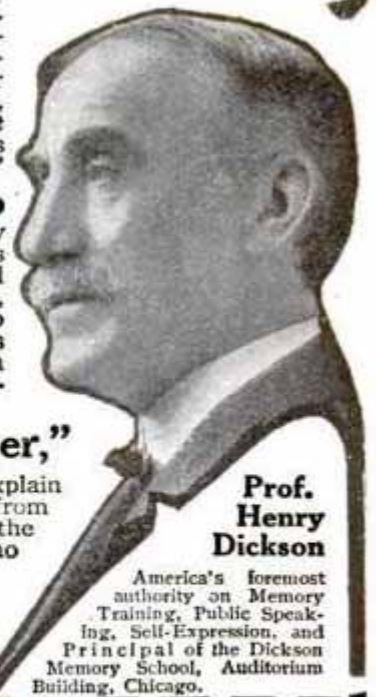

Prof. Henry Dickson

America's foremost authority on Memory Training, Public Speaking, Self-Expression, and Principal of the Dickson Memory School, Auditorium Building, Chicago.

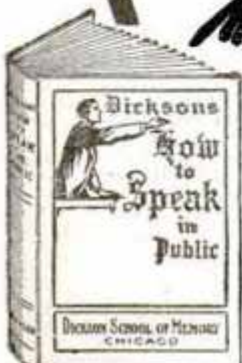

Prof. Henry Dickson
705 Auditorium Bldg., Chicago, Ill.

Send me free Booklet "How to Remember," also full particulars how to obtain a free copy of Dickson's "How to Speak in Public."

NAME.....

STREET.....

CITY..... STATE.....

HOW TO RUN AN AUTO IS SELF-TAUGHT IN AUDELS ANSWERS ON AUTOMOBILES

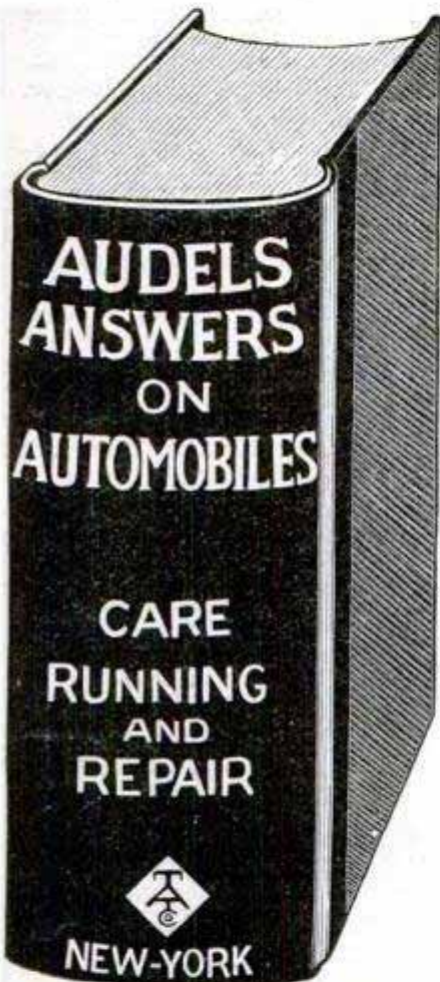

**A New Book from Cover to Cover
LATEST — PRACTICAL — CONCISE — EXPLICIT — BEST**

THE object of this book is to give, in the easiest understood form, the information necessary for the proper operation, care and maintenance of an automobile.

To adapt the book to many needs the subject matter is presented in the form of **questions and answers**. Technical terms are explained or made clear by the wording of the answer, which is always brief and direct.

Any one of the definite chapters on **Carburettors, Ignition, Gas Engine Operation, How to Run an Automobile, and Overhauling the Car, Battery Troubles**, are alone worth the price asked for the 28 complete chapters contained in this book of 512 pages, illustrated by **380 illustrations**.

The form and size are such that it is convenient to handle and study.

This book is a self-educator, hence: "he who runs may read" and improve his present knowledge of automobile engineering, and proficiency.

Handsomely bound in durable green cloth and full leather back.

Audels Answers on Automobiles \$1.50

A BOOK WORTH HAVING

"Understand Your Car." Explained in the Following Chapters:

1. Ready Reference Index. 2. The Automobile. 3. The Gas Engine. 4. The Cycle of a Gas Engine. 5. Brief Outline of Gas Engine Principles. 6. Cooling Systems. 7. Fuels. 8. Carburettors. 9. Ignition. 10. Timing and Balancing. 11. Gas Engine Operation. 12. Clutches. 13. Transmissions. 14. The Drive. 15. The Differential. 16. The Running Gear. 17. Tires. 18. Brakes. 19. Ball and Roller Bearings. 20. Lubricants and Lubrication. 21. Motor Cycles. 22. Electrics. 23. Electricity. 24. Dynamos and Motors. 25. Storage Batteries. 26. Methods of Circuit Changing. 27. How to Run an Automobile. 28. Overhauling the Car.

NONE OTHER JUST AS GOOD

FREE EXAMINATION

We don't want you to take our word, or anyone else's for it. We are willing to send you the book without deposit. Use it seven days in connection with your car. Then send back the book or remit \$1.50. Could anything be fairer?

Cut out and fill in your name and address plainly at the bottom. Place it in an envelope and mail.

This Book Will Speak for Itself

Theo. Audel & Co., 72 Fifth Ave., New York

Kindly mail me copy of **Audels Answers on Automobiles**, and, if found satisfactory, I will immediately remit you \$1.50, or return the book to you.

NAME

OCCUPATION

ADDRESS Jan. P. M.



NEW JOBS NOW OPEN

Earn from \$35 to \$100 Weekly as a

TRAFFIC MANAGER

Modern transportation is a jungle of routes and rates calling for specialists who, like the pathfinders of old, have expert knowledge of the trails of traffic. How to route shipments to obtain shortest mileage and quickest deliveries and how to classify goods to obtain lowest rates are two vital factors in business competition. The man who knows how is so valuable to his employer that he commands respect and big remuneration.

Big Salaries Paid to Traffic Managers

Expert traffic managers command from \$2,500 to \$25,000 a year. Why not prepare yourself to fill one of these lucrative positions?

New and Uncrowded Profession

There are half a million LARGE SHIPPERS in the United States. Practically every one of them needs an expert traffic man, and this need is recognized as never before because of the recently enacted railroad rate laws and interstate commerce regulations. The demand for trained and efficient traffic men is many times greater than the supply. There's room for you.

Study Traffic and Interstate Commerce

Decide now to become a traffic man. Our Interstate Commerce Course enables you to study AT HOME, without leaving your occupation or sacrificing present income, and to become thoroughly versed and proficient in the strategy of shipping, including routes and classifications, interstate commerce rules and regulations, etc. The instruction is given by some of the biggest traffic managers in the country. The course is easy to grasp and thoroughly practical. Anyone with ordinary intelligence, with reasonable application, can master this new profession.

FREE PORTFOLIO Clip coupon below, sign and mail at once, and we will send you FREE, postpaid, a handsome portfolio containing complete information concerning the opportunities and requirements of this attractive profession. Get posted at once. Clip coupon. LA SALLE EXTENSION UNIVERSITY, Dept. 414, CHICAGO

**FREE
PORTFOLIO**

COUPON

La Salle Extension University
Dept. 414, Chicago, Ill.

I am interested in the new profession—
Traffic Management. Please send me full information and Traffic Book, free of all cost.

Name

Occupation



Write Address on the Margin Plainly

Please Mention Popular Mechanics

Honk! Honk!

25c
Postpaid



Send to-day for **BOOK**
**How to Drive
a Motorcycle**

and learn how to get the best results from your engine and the greatest pleasure when you ride.

IT TELLS How to make an easy start—Styles of Mounting—Driving on the level—Hill climbing—How to take corners—How to stop on the level, on hills—Cooling the engine—Driving with a side car—Lubrication—Roadside adjustments and repairs—Tires and tire troubles—Care of the Motorcycle when not in use, etc.

88 pages. Over 30 photographic plates and diagrams.

SPON & CHAMBERLAIN
123 P. M. Liberty St., NEW YORK, U. S. A.

LEARN TO BE A WATCHMAKER

BRADLEY POLYTECHNIC INSTITUTE
Horological Department, Peoria, Illinois



Largest and Best Watch School in America
We teach Watch Work, Jewelry, Engraving, Clock Work, Optics. Tuition reasonable. Board and rooms near school at moderate rates. Send for catalog of information.
BRADLEY, Dept. S., PEORIA, ILL.

SHORTHAND Now Taught By Mail

In 18 Easy Lessons! Positively guaranteed. System taught by us adopted by public schools in Boston, Denver, Buffalo, Omaha, Seattle and more than 2000 other cities. America's most popular shorthand because easy to learn, read and write. Complete stenographic courses by mail. Typewriters furnished. Low cost, easy terms. Write now for free book on big salaries and opportunities. Positions everywhere.
CHICAGO UNIVERSITY OF COMMERCE, Box 1031, Chicago, Ill.

Here's Your Chance!

Earn \$20.00 to \$35.00 a week Besides Present Salary

We must develop more expert moving picture operators for our customers at once. Positions paying big money open! You can learn to become expert operator **right in your own home**. Experts teach you "personally." This is no correspondence school. A chance to go into business for yourself. Special offer now—write at once—immediately for full particulars.

MOVING PICTURE SUPPLY HOUSE (Operator Department)
1191 Hoyne Bldg., CHICAGO, ILL.

MAKE UP TO \$75 A WEEK

as a Watchmaker and Start Your Own Jewelry Business

Write me today! Let me explain our plan whereby you can become an expert watch repairer in three months—making \$25 to \$75 a week—and own your own jewelry business. I can teach you—I mean YOU—the whole watch repairing business by mail. Write right now!

ROGERS, THURMAN & CO., 1560 Mallers Bldg., CHICAGO



IF YOU STAMMER

Attend no stammering school till you get my large **FREE** book and special rate. Largest and best school in the world curing by natural method. Write today. **Lee Wells Millard, Pres., North-Western School for Stammerers, Inc., 917 First St., Milwaukee, Wis.**

BE AN ENGRAVER

LEARN AT HOME—EARN \$25 to \$50 WEEKLY. We give personal instructions and furnish necessary tools **FREE**. Terms reasonable. Complete particulars by mail.

Chicago Engraving School, Dept. 20, Athenaeum Bldg., Chicago

**This \$40,000
Law Library
Shipped FREE**

**The Towering Genius
of Finance Says:**

*"The greatest risk in business
is legal risk."*

—J. Pierpont Morgan.

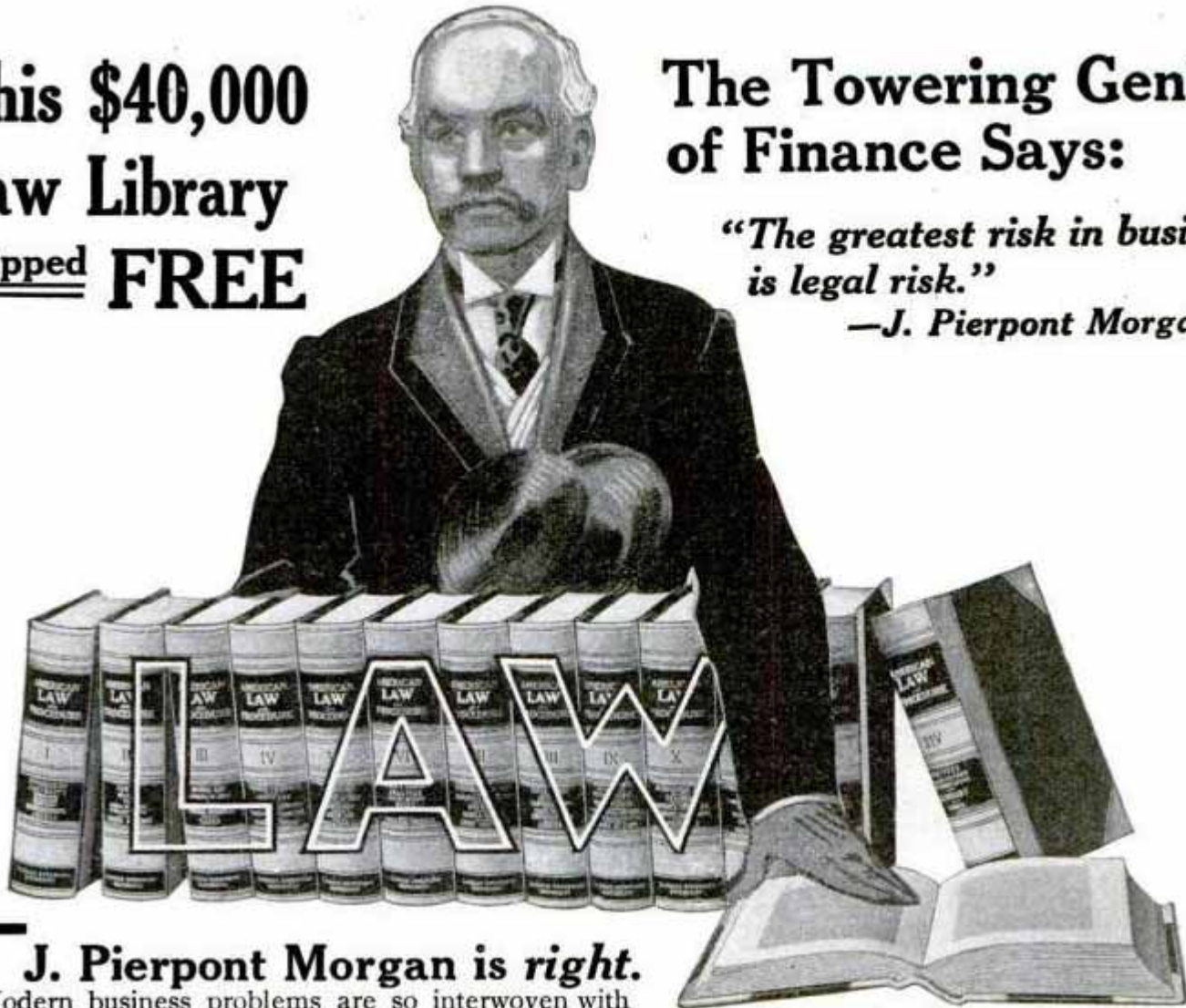

J. Pierpont Morgan is right.

Modern business problems are so interwoven with legal problems that a business man incurs constant risk unless he has instant access to exact and reliable legal information and guidance. Big business men, who employ the best legal talent, never depend *entirely* on their lawyers' advice. They always acquire enough legal knowledge to be able to discuss any legal problem intelligently and reason with their lawyers concerning it. Their own knowledge of the law is the basis upon which they judge the soundness of their attorneys' advice.

"American Law and Procedure" Every Man's Law Library; Complete in 14 vols. 3/4 sheep

The need of a comprehensive treatment of American law and procedure which would serve the business man and all laymen as a *reference work*, and be of practical value in all of the many legal problems which commonly arise in business, domestic and civic life, has been forcefully realized for the past decade. This great public need has at last been supplied in this great NON-TECHNICAL LAW LIBRARY, which in effect is the equivalent of having a staff of brilliant lawyers constantly at your elbow. It is the most notable achievement of the century in law text publishing. No library is complete without it.

The executive head of a large department store (name on request) writes as follows: "If it were not for my thorough grounding in the fundamentals of law, obtained through 'American Law and Procedure', I would now have to locate my attorney right at my elbow, so often is it necessary for

me to have legal guidance in the conduct of my business. I now act with a confidence born of a firm conviction that I will not make any legal mistakes."

Non-Technical, Down to Date, Authoritative, Standard

Easy to understand. Stripped of all useless technicalities and obsolete subject matter. Written in clean-cut business English and is easily understandable.

\$40,000 Expended in Authorship. It is absolutely authoritative, because written by more than a score of the leading specialists in the law departments of the great universities (Harvard, Chicago, Michigan, Illinois, Wisconsin, Iowa, Leland Stanford) and produced under the editorship of James Parker Hall, A. B., L.L.B., Dean of the Law School, University of Chicago, and James DeWitt Andrews, L.L.D., formerly of the Law Faculty of Northwestern University, now of New York Bar, legal writer and famed as "The Blackstone of America."

15,000 Illustrative Cases. It includes 15,000 cases, which appear as concurrent parts of the text, each clearly illustrating a rule or principle of law.

Easy to Consult. The contents are especially classified and indexed for quick and easy reference, so that you can get answers to your legal problems as easily as consulting a dictionary or an encyclopedia.

Strictly Down to Date. It is in every particular modern, standard and authoritative. The subject matter and cases are strictly down to date, covering the most recent developments of American law.

Covers Entire Field of American Law. "American Law and Procedure" is the only non-technical work ever published which covers the entire field of American jurisprudence. Every subject of American law is given thorough and comprehensive treatment. Fourteen volumes of full standard size, 6 1-2 by 9 1-2; 3-4 sheep.

The Complete 14 Volumes Shipped Free, Express Prepaid

for your 7-day examination. Our great introductory offer (see coupon) enables you to make a large saving, representing the middleman's profit, if you act quickly. We want you to *know* how easily you can inform yourself on any question of law with this great work at your elbow. It costs you nothing to get the complete set in your home or office. Mail the coupon today and receive the complete 14 volumes by return express, charges paid. Read them. Examine them. Then decide if "American Law and Procedure" is a work you want. If not, send them back and we will pay the return express charges without a word. Don't wait until the offer is withdrawn and it is too late. **SEND THE COUPON NOW.**

**FREE EXAMINATION
COUPON**

La Salle Extension University
Dept. 514 Chicago

Gentlemen: Please send me at once your \$75 set of "American Law and Procedure", complete in 14 volumes, bound in 3-4 sheep, for FREE 7 days examination. If I am satisfied, you are to accept this coupon as credit for \$26, and I will send you \$4 within seven days and \$8 each month until I have paid a total of \$49. If I decide not to keep the law library, I will notify you at once and hold the books subject to your order, return express to be paid by you. Title not to pass to me until the books are fully paid for.

Name.....

Occupation.....

Address.....

LA SALLE EXTENSION UNIVERSITY Dept. 514

CHICAGO

BOOKS-THAT-TELL-HOW-TO-DO-THINGS

A uniform series printed on the best book paper and durably bound in extra cloth. Size 5 x 7 inches.



Mission Furniture, How to Make It IN THREE VOLUMES

PART ONE—Plain directions with working drawings and illustrations for making 21 different designs. 96 pages. **PART TWO**—32 additional designs treated in the same manner. 128 pages. **PART THREE**—36 excellent new plans entirely different from those in the other 2 books. 128 pages. Price of each volume, 50 cents.

Artistic. Inexpensive. Easily made in the home

Arts-Crafts Lamps, How to Make Them

By J. D. ADAMS

Explicit instructions for making 16 different beautiful lamps out of paper, cardboard and wood. A working drawing and illustration accompany each design. 96 pages.

18 beautiful designs which the amateur can easily make

Lamps and Shades in Metal and Art Glass

By JOHN D. ADAMS

Four different kinds of construction, built up—soldered—etched and sawn shades are treated. The designs range from ordinary reading lamps to pretentious chandeliers. 128 pages.

Covers every essential step in wood-working

Wood-Working for Amateur Craftsmen

By IRA S. GRIFFITH, A. B.

Special chapters bring out every cut, joint and process, proper use and care of tools, working up of material, etc. 125 illustrations. 128 pages.

A complete handbook for art metal workers

Metal Work and Etching

By J. D. ADAMS

Gives every detail for making a great variety of useful and ornamental objects such as book ends, desk sets, jewelry, hinges, drawer pulls, paper knives, letter openers, match boxes, tie and pipe racks, pad corners, etc. 50 illustrations. 96 pages.

The only book published on this interesting art

Metal Spinning

By PROF. F. D. CRAWSHAW

A practical working manual for those who desire to spin metal as an art recreation or to follow this work as a trade. 33 illustrations. 80 pages.

Authorities proclaim it one of the best books on the subject

Electroplating

By HENRY C. REETZ

A treatise which will not only enable the humblest beginner to make a start, but which gives pointers of value to even the most experienced electroplater. 62 illustrations. 112 pages.

Any boy can construct this at a trifling cost

How to Make a Wireless Set

By ARTHUR MOORE

Explains in an understandable manner the construction of an outfit suitable for transmitting 4 or 5 miles. Fully illustrated. 96 pages.

A wonderful story

HEAT

By PROF. J. G. OGDEN

An immensely interesting and instructive book pertaining to heat and its relation to modern mechanics. 50 illustrations. 128 pages.

One of the most remarkable non-technical books written

The Kingdom of Dust

By PROF. J. G. OGDEN

The author deals with this vast kingdom as: A Boundless Domain, The Friend of the Housewife, The Foe of the Workman, The Skeleton in the Closet, The Right Hand of Death, Earth's Winding Sheet, Beginning and Ending of All Things Earthly. 40 illustrations. 128 pages.

PRICE PER VOLUME, 50 CENTS POSTPAID

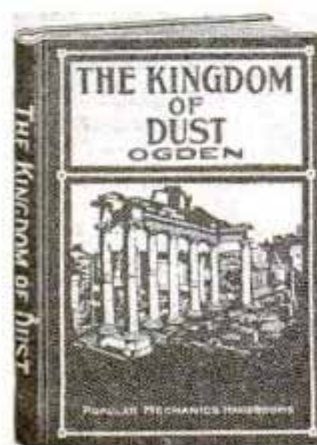
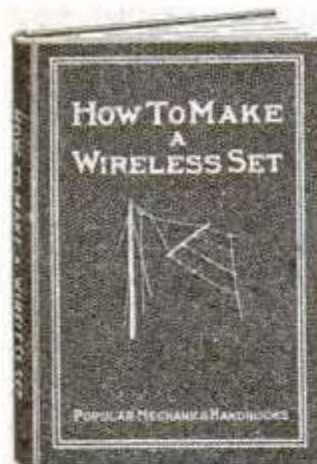
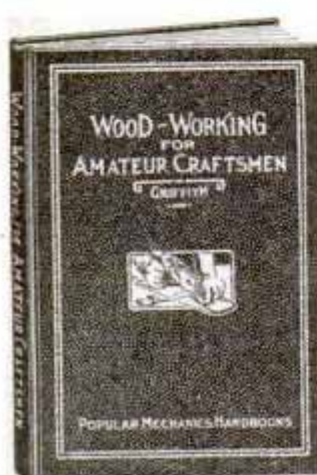
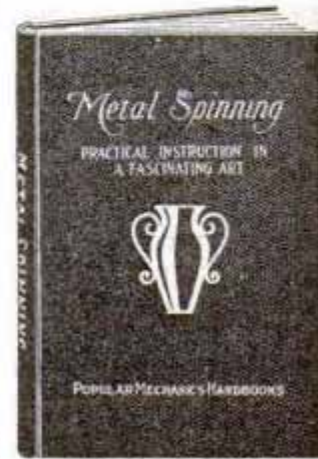
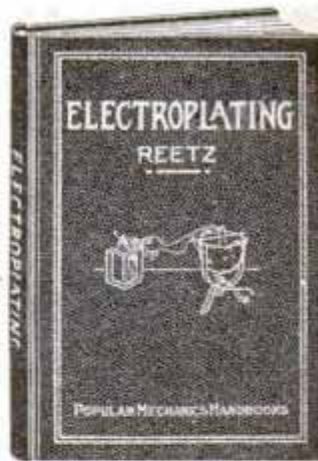
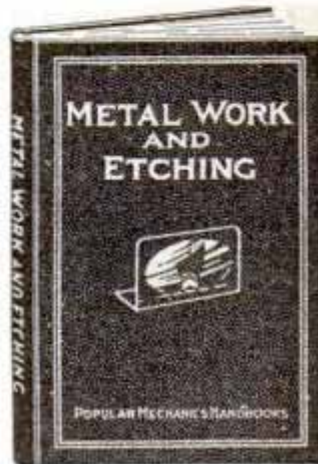
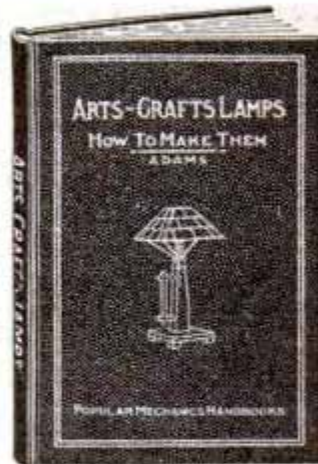

Popular Mechanics Book Department, 318 W. Washington St., Chicago



QUEEN OF SHEBA'S VISIT TO KING SOLOMON

THE Queen of Sheba's Visit to King Solomon is one of the most famous incidents in the history of the ancient world. The beautiful picture shown herewith from Ridpath's History illustrates but one event of all the thousands in the complete work. Truly it may be said of the merits of this History as was said of the splendor of King Solomon's Court: "The half has never been told." All nations, ancient and modern, are embraced in the world-famed publication

Ridpath's History OF THE World

Popular Mechanics readers are offered **one more opportunity** to place this splendid History in their homes. We will mail our beautiful 46-page free booklet of **sample pages** to all interested in our offer, and without any obligation to buy. A coupon for your convenience is printed in the corner of this advertisement. We offer the remaining sets, brand new, down to date, beautifully bound in half morocco,

At a VERY LOW PRICE and on EASY TERMS

We will name our price only in **direct letters** to those sending us the **Coupon** below. **Tear off the Coupon, write name and address plainly, and mail to us now before you forget it.** Dr. Ridpath is dead, his work is done, but his widow derives her support from his history, and **to print our price broadcast**, for the sake of more quickly selling these few sets, would cause **great injury to future sales.**

President McKinley

said: "I am familiar with Ridpath's History, and cordially recommend it to the people."

William J. Bryan

says: "Dr. Ridpath's History is a lasting monument to his intelligence and industry."

Bishop Vincent

says: "Ridpath's History is a permanent college chair of general history in one's own house."

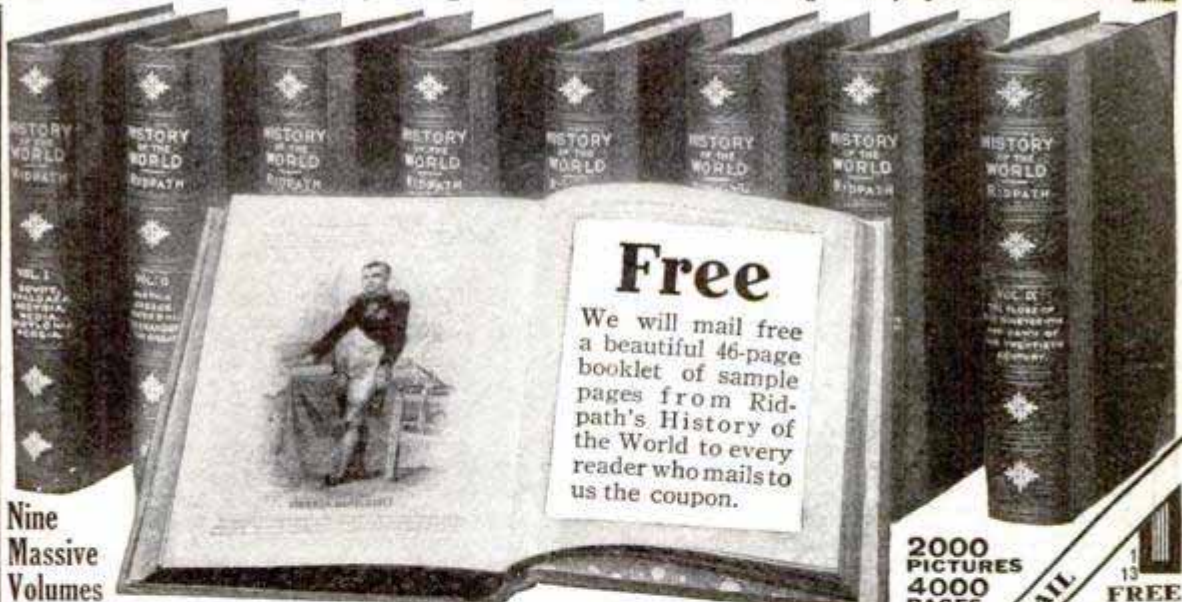

Nine Massive Volumes

2000 PICTURES
4000 PAGES

13
FREE COUPON

RIDPATH throws the mantle of personality over the old heroes of history. Alexander is there,—patriot, warrior, statesman, diplomat—crowning the glory of Grecian history. Xerxes from his mountain platform sees Themistocles, with three hundred and fifty Greek ships smash his Persian fleet of over a thousand sail and help to mold the language in which this paragraph is written. Rome perches Nero upon the greatest throne on earth, and so sets up a poor madman's name to stand for countless centuries as the synonym of savage cruelty. Napoleon fights Waterloo again under your very eyes, and reels before the iron fact that at last the end of his gilded dream has come. Bismarck is there—gruff, overbearing, a giant pugilist in the diplomatic ring—laughing with grim disdain at France which says: "You shall not." Washington is there, "foursquare to all winds," grave, thoughtful, proof against the wiles of British strategy and the poisoned darts of false friends; clear-seeing over the heads of his fellow-countrymen, and on into another century, the most colossal world-figure of his time. Ridpath covers every race, every nation, every time, and holds you spell-bound by its wonderful eloquence. Nothing more interesting, instructive and inspiring has ever been written.

**WESTERN NEWSPAPER ASSOCIATION
CHICAGO**

FOLD HERE, TEAR OUT, SIGN AND MAIL

Name

Address

Western Newspaper Association
H. E. SEVER
President
140 So. Dearborn St.
CHICAGO, ILL.

Please mail, free, 46 page sample booklet of Ridpath's History of the World, containing photogravures of Napoleon, Queen Elizabeth, Socrates, Caesar and Shakespeare, diagram of Panama Canal, etc., and write me full particulars of your special offer to Popular Mechanics readers.

Be a Draftsman!

Earn \$125⁰⁰ to \$175⁰⁰ per month to start

There is an urgent demand today for skilled draftsmen. The big companies are issuing calls every day in the year for men to fill positions paying from \$125.00 to \$175.00 per month at the start. Many positions paying \$75.00 to \$100.00 a week always open. The work is light, pleasant and profitable. Unlimited opportunities for expert draftsmen and designers. Mail the coupon for valuable book "Successful Drafting." It explains how YOU can become a skilled draftsman in a short time. This book is free at present—so write at once.

Chief Draftsman Will Instruct You Personally



A most wonderful opportunity for a limited and selected number of ambitious men! For over twenty years I have been doing the highest paying expert drafting work. I am CHIEF DRAFTSMAN of a large and well known company. Long ago I saw the urgent demand for practical, trained draftsmen and I organized my practical method for ambitious men whom I trained personally. Each month the demand for practical trained draftsmen is growing—

higher salaries are being paid right along. Never before have we felt the need as we do today for men who REALLY KNOW practical drafting—the way I am training my students. At this time I can accommodate a few more men (from the ages of 16 to 40) in my spare time. If you will write me *at once*, I will send you my book "Successful Drafting" with full particulars—ALL FREE. But you must write to me—or send the coupon immediately.



This \$13.85
Drawing
Outfit

FREE!

If You Write to Me AT ONCE

Because of the urgent demand for more and better men in the drafting field, I will give ABSOLUTELY FREE this \$13.85 drawing outfit to students who enroll right away. No expense to you for instruments. As Chief Draftsman of a big engineering firm I know exactly the quality and quantity of PRACTICAL training, knowledge and actual up-to-date experience (not school knowledge) you must have in order to obtain a good position and advance to highest salary. This is NOT a regular correspondence school course. I deal individually with each student and give you individual practical working plans (just as your ability and advancement requires) which fit your particular needs. Men who expect to be Superintendents, Mechanics, Engineers—must know practical Drafting as I teach it.

Pay as You Wish!

ing outfit I will give you free if you get in at once. And I charge just a nominal price for teaching you to be an experienced draftsman. You can pay the small cost as suits you best. My object is to develop experienced draftsmen—not establish a money making school.

What I want is the RIGHT KIND of men. Don't bother about expense. The work-

I Guarantee

To instruct you *until competent and placed in a position at a regular salary*. I will help you to secure a position paying from \$125.00 to \$175.00 a month.

Mail this Free Coupon at once and I will send to you my book "Successful Draftsmanship" and full particulars—All Free.

Mail Free Coupon NOW

I will send my book to those who write at once absolutely free—also full particulars about my offer to a few ambitious men who want to make from \$2500 to \$5000 a year. No obligations on you whatever in sending the coupon.

Address

Chief Draftsman

Division 1191

Engineer's Equipment Co. (Inc.)

CHICAGO, ILL.

FREE Information Coupon

Chief Draftsman,
Division 1191,
Engineer's Equipment Co.,
Chicago, Ill.

Without any obligation on me whatsoever, please mail your book "Successful Draftsmanship" and full particulars of your liberal "Personal Instruction" offer to a few students. It is understood that I am obligated in no way whatever.



NAME

ADDRESS

AUTOMOBILES

GUARANTEED 5,000 miles without puncture. If your tires are old, don't throw them away, or you'll throw away \$50 to \$200. With Durable Treads we give you a written guarantee for 5,000 miles without puncture. This is blinding whether your tires are new or old—read-worn, rim cut or rut worn. Durable Treads cost only half as much as tires. Write for booklet and special discount at once to Colorado Tire & Leather Co., 1010 Broadway, Denver, Colo.

MOTOR Wagons—Read the "Power Wagon" for reliable information concerning machines employed for business purposes. Issued monthly; single copies, 25 cents; \$2 a year. The most valuable journal of its kind published. The Power Wagon, McCormick Bldg., Chicago.

WILL give my personal mortgage on improved real estate for a 1911 or 1912 Auto in good shape and worth prices asked; must be a reliable make. A., Box 263, Milford, Conn.

STUCK Deep in Mud or Sand? My new appliance will help you out. E. I. Spencer, 3201 E. Douglas Ave., Wichita, Kansas.

FOR Sale—Automobiles. Ford, \$100; Buick, \$250; Premier, \$75; Chase, \$200; Olds delivery, \$100. Gasoline and steam engines \$25 up; 18x24 lathes, \$150. Wanted, universal miller. F. J. Rettig, Wabash, Indiana.

ACETYLENE welding and brazing of automobile parts done by men with experience. Charges reasonable. Becker & Shoemaker, Elmira, N. Y.

BARGAIN high speed, four cylinder auto engine, five inch bore, eight inch stroke; complete outfit suitable for racer or boat. Box 362, Hammonton, N. J.

AUTOMOBILES. Sacrifice sale on new and used cars. Box 275, Burlington, Wis.

CYLINDERS Reground. Pistons, Rings. Merritt, 311 West 59 Street, New York City.

40 HORSE Automobile, \$450. 621 Commerce Bldg., Kansas City, Mo.

FOR Sale—Stanley Auto in excellent condition; cheap. W. J. Morgan, Box 284, Seaton, Ill.

"The How and Why of the Automobile"—A 200-page book of practical information for seekers after the fundamental facts regarding the gasoline engine and its application to the motor car. Interesting and instructive to both the beginner and the expert. Bound in full cloth—250 illustrations. Price, \$1 postpaid. Popular Mechanics Book Dept., Chicago.

AUTOMOBILE model. Every part shown and named. You can to all intents and purposes take off the wheels, raise the hood and remove the body; exposing to view the vital parts. The only practical method of studying the automobile. Price, 50 cents postpaid. Popular Mechanics Book Dept., Chicago.

1912 MIDLAND racing roadster, 40 hp. 4 cylinder for sale, complete equipment including demountable rims, 2 extra tires and rims, speedometer, clock, etc. Perfect condition. New June 1st. Cost complete \$2,250. Will accept \$1,150 cash. S. Breakstone, 1712 Michigan Ave., Chicago, Ill.

AUTOMOBILE instructions, four weeks' course covering shop and road work—provision for out-of-town men. Send for booklet. P. M. West Side Y. M. C. A. Automobile School, 318 West 57th St., New York, N. Y.

FORD owners wanting five electric lights available anytime, using Ford magneto for charging a storage battery (self contained system). Write American Battery Company, 1129 Fulton St., Chicago.

FOR Sale—Four light auto trucks in good running condition. Will sell cheap. The Heer Engine Company, Portsmouth, Ohio.

SIX Brand New \$650 solid tire runabouts, 14 hp., 2 cylinder, gearless transmission, engines in front. Price, \$275 each. Eureka Auto Co., Beavertown, Pa.

FOR Sale—One Thomas 40, 5 passenger auto, full equipment. One rear axle, one four speed transmission, and engine parts. H. W. Baum, Evans Mills, N. Y.

SIMPLEST way on earth to time valves and spark on automobile and gasoline engines. 25c. "Strong," Homer, Mich.

SOME good values in 1910 and 1911 Ford touring cars and runabouts. Badger Motor Co., Milwaukee, Wis.

Classified Advertisements

Advertisements in this section, 10 cents per word, each insertion, minimum 10 words, payable in advance. To insure ads being inserted under proper classified head in the February issue, copy must reach this office not later than January 1st.

Chicago, Illinois, September 7, 1912.

Popular Mechanics Magazine, Chicago, Ill.

Gentlemen:—We have been using the classified columns of all the large newspapers and magazines throughout the United States regularly for the past twelve years, but Popular Mechanics Magazine is at the head of our list for results.

Replies from our advertisement in Popular Mechanics Magazine cost us less than one-half the replies we received from the best mediums we have ever used and our only regret is that there are not more magazines published that would produce inquiries such as we receive from Popular Mechanics.

Yours truly,

(Signed) G. A. SULLIVAN & CO.

MUST leave city at once. Will sacrifice my 7 pass. Packard, with two bodies, cab sides and fore doors on Limousine, fore-doors and new top on open body. Fully equipped, newly painted, complete \$1,600. Best bargain in the city. Address E. A. Roser, 4551 Kenmore Ave., Phone Edg. 6260.

WELDING by oxy-acetylene process—How construct and use plant from materials handy. Scale drawings, fluxes, chemicals, formulas. 50c prepaid. American Publishers, Aberdeen, S. D.

AUTOCAR runabout; 2 cylinder; 12 H.P. in good condition. Cheap. Tessmer Machine & Tool Co., Detroit, Mich.

CLASSY Maxwell roadster, cheap; fine condition. 1913 improvements. W. Relna, Springfield, O.

AUTOMOBILE dealers, reach country readers through ads in Boyce's Weeklies. Circulation 1,200,000 weekly. Send for free Result Checking Book. Use letter-head. Classified Dept., 500 Dearborn Ave., Chicago, Ill.

STEAM Car Correspondence School, Particulars, 520 Fourteenth St., Denver, Colo.

WINTON motor truck, bargain. George Wills, Canal Dover, Ohio.

AUTOMOBILE SUPPLIES

REPAINT your car yourself—with our materials and full instructions, you can repaint your car as well as a regular painter and save from \$25 to \$50, depending on its size. Previous experience unnecessary. Latest colors. Write today for full information and color cards. We also make Liquid Gun Metal, the National Brass Enamel, \$1 a can, express prepaid. The only article of proven merit for lamps, radiators, etc. No polishing. Arscot Varnish Co., Dept. P, Rock Island, Illinois.

TIRE Specials. Guaranteed Tires. 1912 fresh stock; just bought an entire surplus stock. Order today while they last; 28x3—\$8.90. Tubes, \$2.40; 30x3—\$9.60—\$2.53; 30x3½—\$12.75—\$3.35; 32x3½—\$14.20—\$3.55; 34x4—\$21.25—\$4.80. Other sizes, prices in proportion. Write for complete list. We ship C. O. D. subject to examination upon receipt of express charges. Para Auto Tire Co., 1425 Michigan Ave., Chicago, Ill.

AUTO Clutch Slipping Cured. Bull dog automobile clutch dressing greatly increases life of clutch and brake linings, and very appreciably increases their holding power and efficiency; 6 ounce can by mail, 60c postpaid. Bull dog Clutch and Belt Dressing Co., Waynesboro, Pa. Garage Owners: We have an attractive proposition to offer you.

FORD, Buick, Overland, E. M. F., Maxwell, Air-Friction Carbureters, drive your cars three miles per hour on high. Much more speed; much less gas. Starts easy in cold weather. Satisfaction or refund money. Air-Friction Carbureter Co., Dayton, Ohio.

EVERYBODY'S got the habit, plate your auto trimmings with Ar-gen-tor in one minute, outfit one dollar. A beautiful lasting silver plate contains no mercury. Forest City Sales Co., Fremont, Nebr.

FOR Sale. 50 small steam auto engines, \$5 to \$10 each. Lucas & Son, Bridgeport, Conn.

We make a better unguaranteed Automobile Tire than most guaranteed tires. You get exactly what you pay for. Gums, Fabrics and Mechanical goods. National Company, 1400 Clybourn Place, Chicago, Illinois.

STEAM auto boilers bought, sold and repaired. J. L. Lucas, No. 2 Fox St., Bridgeport, Conn.

TIRES—New 1912 Para—Imperial firsts; full names and serial numbers; fully guaranteed 3,500 miles; 28x3, \$9.15; 30x3, \$10.22; 30x3½, \$14.85; 32x3½, \$15.82; 34x4, \$22.76. Other sizes at same saving. Shipments C. O. D. on approval. No deposit required. Atlas Tire Co., 1771 Broadway, New York; and Kansas City.

IGNITION and lighting apparatus repaired successfully where others fail. Parts in stock for all makes. Send your next work to us and be convinced. Catalogue sent free. Pellet's Magneto Exchange, 1463 Michigan Avenue, Chicago, Ill.

FOR Sale—Two four cylinder 30 hp. motors, \$130 each. Two cyl. 20 hp., \$78. Two cyl. 14 hp., \$65. Two cyl. 14 hp. air cooled and transmission, \$35. Four cyl. 12 hp. air cooled, \$45. Badger Motor Co., Milwaukee, Wis.

CHARGE the battery yourself. "American" rectifiers—all sizes. Storage batteries—all sizes. American Battery Company, 1127 Fulton St., Chicago.

CYLINDER rebored, including new piston and rings; \$8 to \$12 a cylinder. Sterling Engine Co., 331 S. Clinton St., Chicago, Illinois.

12 H. P. HOLSMAN auto engine transmission, spark coil, carburetor muffler. First check for \$35 takes it. Wilson McClintock, Mill City, Oregon.

REBUILT air cooled auto engine, 10 hp., \$35. Also axles, steering gears, colls, axle oilers, etc. Becker & Shoemaker, Elmira, N. Y.

START Vulcanizing Business. Pays big profits; easy to learn with our book; price, 25 cents. Vanderpools, Springfield, Ohio.

AUTO tires mended in one minute. Write for particulars. M. R. Silvermail, Altamont, N. Y.

LEADER "Water Jacket" Vulcanizer does tire patching right anywhere. Circular explains. E. Taylor Co., Cleveland, Ohio.

COLEMAN'S Waterproof Filler makes leaky tops waterproof, faded tops brighter, easily applied, not satisfactory money returned. \$2 per gallon. Order or have your dealer order. Virginia Waterproofing Corporation, 324 Arcade Bldg., Norfolk, Va.

AUTOMOBILE and Motorboat owners: Here is a real self-starter that will start your engine without cranking. Uses gasoline the natural fuel. Adapted to Fords. Only \$16. Guaranteed. Write today for free circular. Northern Laboratories, Chicago.

TIRES—New fresh stock, while they last; 28x3, \$7.75; 30x3, \$8.60; 30x3½, \$11.50; 32x3½, \$12.40; 34x4, \$18; other sizes, prices accordingly; write for complete catalog. 10% with order, balance C. O. D.; examination allowed. Para Auto Tire Co., 1417 Michigan Ave., Chicago, Ill.

IDEAL Tube Vulcanizer. A perfect repair in 15 minutes for 2c. Complete outfit \$2.50. Circular. Billinger Co., Saranac, Mich.

FOR Sale. Bevel gear drive timkin rear axle. Also drop front axle complete with wheels and tires, suitable for 2,500 lb. car—cheap. C. B. Kirkham, Savona, N. Y.

THE patch that holds—beats vulcanizing for tubes. Make it yourself. Formula 25c. W. E. Pettit, 13576 Euclid Ave., Cleveland, Ohio.

FORD Oil gauge. No Ford owner should be without one. \$1 prepaid. Billinger Co., Saranac, Mich.

HIGH tension. 4 cylinder, U&H magneto, \$40. R. S. Box 251, Mason City, Iowa.

KEEP your automobile bright as new, our polishing cloth does it. By mail 25c. Edwin Wallace Co., Box 1011, Dallas, Texas.

14 PIECE auto repair kit, \$3.25. Box 251, Mason City, Iowa.

MOTORCYCLES AND BICYCLES

SUPPLIES—One thousand guaranteed articles shown in our big free catalog P. at rock bottom prices. Kellers 25c booklet, construction, management and care, now 15c. Motorcyclist, dollar magazine, 25c for trial half year. Indian Mica Spark Plugs, two for \$1. Complete line motor repair parts for 10 leading makes sent prepaid at manufacturers prices. Motorcycle Equipment Co., Hammondsport, N. Y.

BIG bargains in good motorcycles we have taken in exchange on new ones. Send for special bargain list. Shaw Mfg. Co., Galesburg, Kansas.

PREPAID Motorcycle Supplies. Send for catalog listing every motorcycle accessory. All goods shipped prepaid. You will save money. Immediate shipment. Write a postal now. Sauffley Supply Company, Kansas City, Mo.

50 USED motorcycles, guaranteed running order; \$25 up. Shipped on approval. Parts for F.-N's, Curtiss, Royals, Pioneers, M.-M's, Indians, Thors. New York Motorcycle Co., New York City.

MOTORCYCLE bargains; Indian, Harley, Excelsior, Pierce, Thor, Reading, New Era at right prices. Seeber's, 704 Main St., Buffalo, New York.

DON'T buy a Bicycle Motor Attachment until you get our catalog and prices. Shaw Mfg. Co., Dept. 27, Galesburg, Kansas.

MOTORCYCLE and Bicycle Repairing— a 300-page book of up-to-date practical information. Profusely illustrated. Price, \$1 postpaid. Popular Mechanics Book Dept., Chicago.

MOTORCYCLE Manual—Construction and operation of a motorcycle fully described and illustrated; complete trouble chart; 125 pages; cloth bound, 50 cents postpaid; paper covers, 25 cents. Motorcycle Manual, 51 Chambers Street, New York City.

HARLEY-Davidson, 1912 single, tires never punctured, complete lamp and generator \$150, also Twin, \$165 and 1912 Iver-Johnson, good as new \$130. C. B. Vaughan, Paterson, N. J.

FOUR cylinder Pierce motorcycle, \$225, fine order, with brand new tandem attachment, horn, generator, magneto, tools, leather leggings. Sibley, 112 East 128th St., New York.

1912 INDIAN twins, \$215; singles, \$175, never been uncrated. Cash must accompany all orders. Guaranteed new machines. Hurry your order. E. F. Cavanah, Sibley, Ill.

PIERCE, four cylinder, two speed, fine condition; run 1,200 miles; will sell for \$200 complete. Williams Drug Company, Buxton, Iowa.

HIGHEST cash offer takes five-horse Indian. Ralph Leffler, Tiffin, Ohio.

1912-7 MERKEL equipped like new; bargain. A. Ehresman, Gridley, Ill.

1912-MERKEL Twin, \$150. E. H. Swartz, Ellwood City, Pa.

1912 7 H.P. Indian, in absolute perfect order \$175. 1912 7 H.P. Merkel \$160. 4 H.P. Excelsior \$100. Other bargains. Callwell's Motorcycle Agency, 5 South Water St., Newburgh, N. Y.

MOTORCYCLES Cheap. Big clearance sale of new and second hand machines, ask for list "M" just out. American Motor Co., 2724 Michigan Ave., Chicago, Illinois.

SAVE \$25 to \$50 by buying your motorcycle now. Our list comprises late models Harley, Excelsior, Indian, Triumph, Marsh, Armac, Scrivens, Ashtabula, Ohio.

ELECTRIC Light for Motorcycles. Storage battery built right. \$5. American Battery Co., 1131 Fulton St., Chicago.

MOTORCYCLE Riders, send 25c one year's subscription. Has Motorcycle and Gas Engine Department, etc. Digest, Grand Rapids, Mich.

1912 HARLEYS, Excelsiors, Triumph; 1911 Harley, Excelsior, Indian. All guaranteed perfect. Our prices lowest. Scrivens, Ashtabula, Ohio.

BELT drive 4 H.P. motorcycle; bargain. Van Zandt, 614 Pearl, Dallas, Texas.

EVERYBODY rides our motorcycle. 10 days free trial. Send no money. Second-hand and rebuilt motorcycles \$25 to \$100. Indians, Excelsiors, Kultures, Thors, Yales, Harleys, Armacs. Every machine guaranteed for one year. Buy direct; save dealers' profit. Send for catalogue. Denninger Cycle Co., Rochester, N. Y.

THE Simplex Sight Gauge for Harley-Davidson, Excelsior, Flanders and other motorcycles. Shows oil level in engine at all times; keeps clean; Agents wanted; postal brings catalog. Buck Sales Company, 211 N. 12th St., St. Louis.

1912 MODEL Pierce single, five with magneto, clutch and new tires, \$175. Jesse Edsall, Michigan City, Ind.

FOR Sale 1912 Marsh Metz. Wm. Phillips, Jr., Bellaire, Ohio.

WAGNER 1912 4 hp. Fine condition, \$105. Frank Scarborough, Bonham, Tex.

FOR Sale. New side car for motorcycles. \$35 complete. Herman Kaskel, Spencerville, O.

AERONAUTICS

FOR Sale or Trade for Automobile— Elbridge Aeromotor, 40 hp., propeller, radiator, etc. Warren Bauman, Lock Haven, Pa.

BATES Aeroplane Motors, cheapest motors flying. Catalog free. Carl Bates, 194 West Oak St., Chicago.

PATENTS secured on Aeronautical Inventions. C. L. Parker, 910 G St., Washington, D. C.

"VEHICLES of the Air," the newest and only up-to-date contribution to the literature of aeronautics, contains large working plans of all successful modern flying machines. This book of 500 pages, 140 half-tone photographs and 130 drawings is the only book published containing every known fact of this interesting subject. Size, 9x 5 1/2 inches. Price \$2.50 net, postage 25 cents extra. Popular Mechanics Book Dept., Chicago.

MODEL Aeroplanes. How to Make and Fly Them. By W. Twining. Consisting of 5 sheets of scaled drawings, showing three different models, with descriptive booklet. By mail, 55c. Popular Mechanics Book Dept., Chicago.

COMPLETE plans drawn to scale, accompanied by clear building instructions—Wright 3 ft. biplane, 25c; Bleriot 3 ft. monoplane, 15c; "Cecil Peoli" champion racer (official record 1,691 ft.), 25c. Send 5c for our new 40 pp. illustrated catalog, most complete, including Rules for Model Contests. Ideal Aeroplane & Supply Co., 82 1/2 West Broadway, New York.

AVIATORS—Notice Maxim Rotary Motors—The Six-Shooter introduction offer for a short time only. Maxim Rotary Little Six, 36, \$1,500 for \$750. Maxim Rotary Medium Six, 50, \$1,750 for \$875. Maxim Rotary Big Six, 75, \$2,000 for \$1,000. Guaranteed and demonstrated by Maxim Rotary Motor Company, 379 Golden Gate Ave., San Francisco, Cal.

TANDEM Monoplane Glider. Double surfaced wings. Spread 20 ft. Guaranteed man carrying, \$25. Knockdown, \$19. Plans, \$1. Wright Glider Plans, \$1. "Aviation." Lawrence, Kansas.

FOR Sale—New eight cylinder Hall-Scott sixty hp. motor, with propeller. Guaranteed perfect, make offer. D. Alexander, 52 Tompkins St., New York, N. Y.

CURTIS Convertible Hydroaeroplane. Scale drawing and concise building instructions. 35c. Ideal Aeroplane Supply Co., New York.

COMPLETE Plans. Nieuport monoplane \$2. Deperdussin monoplane, \$3. Wright biplane, \$3. Aeroplane Rib Patterns, \$1. "Aviation." Lawrence, Kansas.

WANTED financial assistance to Build— sell outright—furnish drawings or supervise the construction of aeroplane to fly around the world in 10 days, carrying 200 passengers. John N. Bosch, Jr., Cementon, Pa.

COMPLETE catalog. Aeroplanes and hydroplanes for stamp. Models included. Chicago Aero Works, 164 North Wabash.

"LIFE Hood"—the latest safety device. Patent for sale. Send for complete description. Lee Miller, 4339 Calumet Ave., Chicago.

FOX forty \$275. Albatross fifty \$390. Detroit Aero 1913, \$190. Equipped, guaranteed. Garage, 118 Bagg, Detroit.

NEW \$65. Curtiss Alighting gear \$15. Made by Rubel Co., New Bleriot monoplane \$200. Catalogues four cents. Aero, Louisville, Ky.

LEARN to fly. Pilots license guaranteed. Tuition fee only \$300. Bleriot monoplanes used. Illustrated catalog free. American Aeroplane Supply House, Hempstead, N. Y.

YOU can make all the woodwork for your aeroplane at cost with an "Amerco" rip mold. Price \$2. We furnish the metalwork cloth, blue prints, etc., cheap. American Aviation Co., Inc., 3200 Logan Blvd., Chicago.

SEE! The world's largest and most complete aeronautical catalogue in the world. Now off the press. Sent anywhere for 6 stamps. Heath Aerial Vehicle Co., Chicago.

AVIATION explained every week in Aero and Hydro, \$3 yearly; three months, \$1. Sample 10c. Aero and Hydro, 539 S. Dearborn, Chicago, Ill.

BOOKS AND PERIODICALS

BUILD yourself a boat. A racing cat or speed launch. Send for catalogue. Yacht and Boat Building Books, Rudder Publishing Co., 2 1/2 Hudson St., New York, New York.

ENGINEERS' questions and answers for license, by Hobson, for twenty-five cents, postpaid. Send stamps. Reilly's Book Store, Philadelphia, Pa.

DON'T fail to read Independence and Fortune under Business Opportunities.

1,200 CARTOONS for \$1. A Panorama of World events, Political, Industrial, Social, Humorous, Tragic—all of intense human interest. Six numbers of Cartoons Magazine (January to June, 1912, inclusive) representing the best work of over 100 of the best cartoonists and handsomely and durably bound in book form; will be sent prepaid to any address for \$1. Cartoons, 318 W. Washington St., Chicago.

FOR Sale—Copies of the August, 1912, number of Popular Mechanics Magazine containing the complete articles on the Seven Wonders of the Modern World as selected by an international poll of the greatest Scientists. Price, 15c per copy, postpaid. Popular Mechanics Co., 318 W. Washington St., Chicago.

GAS for power is taking the place of steam for reasons of economy. Learn all about this great change by reading our new non-technical book on this subject, written by a first-class authority for the practical man. 192 pages, profusely illustrated, cloth binding. Price, \$1 postpaid. Popular Mechanics Book Dept., Chicago.

"METAL Spinning" is the name of the only book published on this interesting art. A concise working manual both for those who desire to spin metal as an art recreation and to follow this work as a trade. 80 pages. 33 illustrations. Price, 50 cents postpaid. Popular Mechanics Book Dept., Chicago.

BACK Numbers of Popular Mechanics Magazine—We can supply the regular monthly issues of this magazine as far back as January, 1911, for 15 cents a copy postpaid. Popular Mechanics Co., 318 W. Washington St., Chicago.

Standard Business Books Loaned by Mail, for return or purchase at option. Advice on short reading courses free. Personal Training; salesmanship; advertising; book-keeping; banking; investments; choosing a career; system and efficiency; agriculture; popular law; business letter writing; speakers' and writers' books, etc. Also, health; house and home; public questions; science; religion. Ask for lists and Library Critic, and state subjects in which interested. Oriental Esoteric Library, 119 Washington, D. C.

GAS Engine Troubles and Installation. Cloth, \$1; flexible leather, \$1.50; Automobile Troubles and How to Remedy Them. Cloth, \$1; leather, \$1.50. Eight other practical and reliable mechanical books. Send for circular. Chas. C. Thompson Co., Dept. C, 1126 S. Wabash Ave., Chicago.

THE Practical Gas Engineer. Smooths the "kinks" and rough places for the owner and operator of a gasoline engine or motor. Price, \$1 postpaid. Longnecker Publishing Co., Anderson, Ind.

BOOKS. Any kind published. Catalogue free. Reese Publishing House, Mount Pleasant, Pennsylvania.

READ "The Widow," 10c. Catalogue other books and pictures free. Gem 3 Co., Ypsilanti, Mich.

STEEL Tempering Book for mechanics and Mechanical Digest one year, special offer, 25c. Mechanical Digest, Grand Rapids, Mich.

MECHANICAL Books. Latest. Send stamp for catalogue. Crescent Book Store, 329 South Halsted, Chicago.

MECHANICAL Books. 100 titles. Best prices. Send for circulars. The Proctor Book Co., 559 C-W. Lake St., Chicago, Ill.

3,000 RECIPES, Formulas 40c. Roadman's Guide—100 Money-making Schemes 25c. Scientific Book Shop, Syracuse, N. Y.

FASCINATING Books: "Cleopatra," 25c. Stamp brings catalogue. Paul Duff, 2713 Mozart, Chicago.

EDUCATIONAL AND INSTRUCTION

IN connection with your clerical work we show you how to earn \$10 to \$15 per week and hold your position besides. No canvassing. We, as manufacturers of patented specialties, have new, easy, mail order plans that can be carried on in your own home to keep the factories busy. Large profits. Small capital. If you are one-of-the-want-to-go-ahead kind, write today for catalogue (copyrighted) plans and sworn statement. J. M. Pease Mfg. Co., 555 Pease Bldg., Main St., Buffalo, New York.

YOU can earn \$90 to \$175 a month immediately on leaving our School. We teach you at small expense to become expert Electrician, Plumber, Bricklayer, Painter, Decorator, Draftsman or Moving Picture Operator. Write immediately for catalog and full particulars. Coyne National Trade School, Dept. 9191, 51 E. Illinois Street, Chicago, Ill.

YOU can write 100 words a minute without knowing Shorthand. My new method, Abbreviated Longhand, simpler than the simplest shorthand, tried and approved by thousands. Your money back if not delighted. Sample lesson 20c. Full particulars free. Write today. A. B. Weaver, Court Reporter, Dept. C., Buffalo, N. Y.

COURSES By Mail: Civil Service, Normal, Academic, Business, Law, Real Estate, and Engineering. 60-page Bulletin free. Write for it today. For "Special Tuition Scholarship," apply Carnegie College, Rogers, Ohio.

"LEARN Lettering." Our book will tell you how. Method used by Schools of Design. Sent postpaid for \$1. Standard Supply Co., Providence, R. I. Lock Box 549.

SHORTHAND writer benefits all Pitmanic writers by fluency drill, commercial, legal, medical and reporting departments. Three months for 25c. The Shorthand Writer, Schiller Building, Chicago.

SIZING-UP people accurately. You need it. Easily learned. Only three dollars, reduced price. Money back. Established ten years. Circulars. W. H. Young, Thomson, Georgia.

SIMPLIS Shorthand by Mail. Easiest learned. The fastest writers use "Simplis." Write today. C. Churchill Business Institute, Grand Rapids, Mich.

PLASTER and concrete casting, instructions, \$1 (ornamental), 12,000 words, 200 illustrations, clear, simple, concise; treatise on manufacturing artificial marble, paper mache, casting marble dust, modeling, coloring, gold leaf gilding and burnishing, elastic moulds, casting from life, casting without skill garden furniture, fountains, benches, etc.; interior decorations, rich ceiling beams, wall panels, columns, figures, etc.; renovating old buildings with stucco, concrete and plaster to mansions. 2,000 word illustrated description free. Mahler, 117 Russell St., Brooklyn, New York.

LEARN Show Card Writing, and be your own Boss. Show card writers, earn \$75 to \$125 monthly. Our course teaches this profession thoroughly and complete. Original price, \$30. We sell the same complete course for \$4. Circular and particulars free. Thompson & Company, Dept. 3rd "A," 3159 La Salle St., Chicago.

PARAGON Shorthand. Learned in one week. Valuable invention by expert stenographer—Not by mere theorist. Writers in Government employ. Speed capacity beyond reach of the hand. Paragon Shorthand Institute, 1432 Camp St., New Orleans, La.

LEARN Pattern Drafting. Metal workers, tanners, plumbers, anyone working sheet metal can cut their own patterns when taking our home study instruction. Address Osborne School, H-640, Liberty Street, Springfield, Mass.

TO the Trade. How to open any lock pin-tumbler cylinder without keys, picks or tools. Wonderful secret. Copyrighted instructions, \$1. Chas. E. Williams, Box 1661, Atlanta, Ga.

UNCLE Sam is a Liberal Employer. Qualify for a Government position. We prepare you by mail for any Civil Service Examination. Write today for free Booklet 32. Capital Civil Service School, Washington, D. C.

AMERICA'S finest penman teaches by mail successfully. Your name on a card and Journal free. Write before bedtime, tonight. Francis B. Courtney, Box A. 492, Detroit, Michigan.

IMPROVE Your Manners—Be popular—Win friends. Happiness and wealth. Write Wagner, 1243 Lexington Avenue, New York.

"HOW to Make Printing Cuts" and "200 formulas," 15c. Publisher, 49 Clinton St., Albany, N. Y.

BE Quick at Figures. New shortcut, 25c. Book Department, Addison, N. Y.

RESIDENTIAL course in Chiropractic at half tuition. Write for particulars. Antigo School of Chiropractic, Antigo, Wis.

DON'T fail to read Independence and Fortune under Business Opportunities.

THE Seven Wonders of the Modern World—What are they? Do you agree with the selection resulting from the international poll of greatest scientists taken by Popular Mechanics Magazine? The complete result of this vote showing the selection of the wonders together with a historical sketch of each one reprinted in pamphlet form mailed to any address for 10 cents in stamps. Popular Mechanics Co., 318 W. Washington St., Chicago.

1,200 CARTOONS for \$1. A Panorama of World Events, Political, Industrial, Social, Humorous, Tragic—all of intense human interest. Six numbers of Cartoons Magazine (January to June, 1912, inclusive) representing the best work of over 100 of the best cartoonists and handsomely and durably bound in book form will be sent prepaid to any address for \$1. Cartoons, 318 W. Washington St., Chicago.

MATHEMATICS made easy for all by Repp's Calculator. Figures out, in the twinkling of an eye, every conceivable problem that occurs in the Office, Store, Shop, Bank, Farm or Factory. Greatest time and labor-saving work on figures in the world. Copyright 1912. Price, \$1. Vest pocket size, 50c. Popular Mechanics Book Dept., 318 W. Washington St., Chicago.

STOP working for wages. Learn a profession in 180 hours which will make you independent for life. Booklet, "How to Succeed," sent postpaid. Address Dept. P. M. Weltner Institute, Nevada, Mo.

ARE you interested in Land Surveying, or Mathematics. Write for attractive proposition. National Correspondence School, 116 S. Michigan Boul., Chicago, 17th Floor.

BOOKKEEPING. Rapid Calculations, Expert Auditing, Banking, etc. Send 25c in stamps. Garfield Commercial School, 1016 Germantown Ave., Philadelphia, Pa.

"TELEPHONE Troubles and How to Find Them," (56 pages). 25c. Hyde Co., 183 5th St., Milwaukee, Wis.

AMBITIOUS people wanted to learn the optical business. Free booklet. Lincoln College of Optometry, Lincoln, Nebraska.

CROSS Real Estate Course, \$3. George Winstel, 1624 Pleasant Street, Cincinnati, Ohio.

BRIEFHAND enables you to write 100 words a minute, using longhand characters. In order to introduce this latest substitute for shorthand we are distributing 5,000 copies of the complete self-teaching Briefhand Manual, containing 2,900 illustrations, for 25 cents each. Order one today before all are taken. Premier Briefhand School, Box 97, Washington, D. C.

COMPLETE Motion Picture Playwriting Course in book form, with addresses of twenty-five buyers. Sell your ideas, easy money. Book postpaid, 25 cents (silver). United Play Brokerage, Desk A, Fostoria, Ohio.

SHORTHAND. Improved correspondence course by world's oldest Supreme Court Stenographer. Makes beginners and ordinary stenographers expert. Strictly reliable. Booklet A free. Osgoodby School of Stenography, Rochester, N. Y.

LEARN about the mail order business. Our Directory sent free. Big Mail Directory, 1124-P Foster Ave., Chicago.

WE teach practical show card lettering by mail; money maker; samples free. Address, Thompson School, Dept. A, Pontiac, Michigan.

THE Mastery of Words. How to command the right word. Invaluable. Write E. D. Snow, Main St., Hornell, N. Y.

FOR Sale, I. C. S. course in architectural drafting. Will sell cheap or exchange for good motorcycle. Lewis W. Pike, General Delivery, Brattleboro, Vt.

1,200,000 COUNTRY and small town homes reached weekly by a classified ad in Boyce's Weeklies. Ask for free result book. Use letterhead. Classified Dept., 500 Dearborn Ave., Chicago, Ill.

"FEET Troubles—Cause and Prevention." Send stamp. Dr. Tracy, South Boston, Mass.

TRADE SCHOOLS

MAKE \$5 to \$8 a day as skilled Electrician, Plumber, Draftsman, Painter, Decorator, Moving Picture Operator. We teach you in short time at small expense, profitable trade. Free employment bureau places graduates in good jobs. Special limited offer now. Write at once for catalogue and full particulars—no obligations. Dept. 5191, Coyne National Trade School, 51 E. Illinois St., Chicago, Ill.

CHAUFFEUR, Repair Man, Tester, Salesman and Demonstrator. We guarantee to qualify you for all of above positions in a short time or we will refund your money. Come to Detroit "the Automobile Center" and learn the business. Michigan State Auto School, The Old Reliable School, 11 to 17 Selden Ave., near Woodward, Dept. P., Detroit, Mich.

AUTOMOBILE School. You learn with your hands under the superintendence of the best instructors obtainable at the Chicago School of Motoring. Write for particulars. The F. E. Edwards Automobile School & Motor College, Dept. B., 1429 S. Wabash Ave., Chicago, Ill. Phone Calumet 3684.

MEN Wanted—For auto salesmen, Demonstrators, and drivers. Our graduates in big demand. We supply men to six Auto Makers and over 35 Auto Companies. Write for free book, Practical Auto School, 117 Pearl Street, New York.

PAINTING. Decorating, Paper Hanging taught by actual practice. Free catalogue. Chicago School of Painting, 414 Dearborn Ave., Chicago.

TRADE Schools are very successful advertisers in Boyce's Weeklies. Circulation 1,200,000 per issue. Write for free Result Checking Book. Use letterhead. Classified Dept., 500 Dearborn Ave., Chicago, Ill.

PICTURES AND POST CARDS

POST CARDS—Hundreds of notable and historic scenes in Ireland, England and Scotland—Add some of these beautifully colored views to your collection; interesting and instructive. Catalog and one sample card sent for 5 cents in American stamps. Strain, P. M., The Lighthouse, Belfast, Ireland.

WHY don't you collect post cards? It's great fun. Receive cards from everywhere. Your name inserted free in our exchange list if you send 10c for a 4 months subscription to our 20-page magazine. Send that time now. Elite Exchange, Dept. R8, 3827 N. 44th Ct., Chicago.

If you really want to exchange post cards, try our splendid club. Lists circulate in many countries. Membership, 10c. Halcyon Club, Box 133, Erie, Pa.

25 BEAUTIFUL High Grade Souvenir Post Cards. Also our new illustrated catalog for only 10c. The Rehm Co., Weehawken, N. J.

SEND 15c for our set of views showing every State Capitol, put up in neat folder in geographical order. Hand colored post-cards of beautiful women; 6 for 25c. Chicago postcards, 6 for 5c. Circular of others free. Elite Exchange, Dept. R8, 3827 N. 44th Ct., Chicago.

DANDY Hand-Made Comic postals (colored) for 10c. Wish you'd see them. Post-Card Artists, 2226 Barry Ave., Chicago.

20 POSTCARDS, 10c. Volk, Dept. 3, 681 Washington Street, New York.

READ Pictures Instead of Words—The current history of the world in cartoons. 1,200 cartoons for \$1. Jan. to June, 1912. Inclusive issues of Cartoons Magazine, handsomely and durably bound in book form will be sent to any address prepaid for \$1. Cartoons, 318 W. Washington St., Chicago.

OIL paintings are the best mediums to decorate your home. For particulars, address Au. Duna, 138 Zeigler St., Roxbury, Massachusetts.

YOU'LL be delighted; thousands of eager exchangers; fine 52-page magazine, trial 10c. Round World Postal Club, B23, Dayton, Ohio.

FORGET the Rest—Join the best! Largest correspondents' magazine published. Membership, 10c. Globe Exchange, 433 Lexington, New Haven, Conn.

JOIN the 20th Century Post Card Club—Membership and 10 fine postcards, 10c. Randless Publishing Co., Hutchinson, Kans.

EXCHANGE Postcards with Foreign Collectors. Membership 10c. Everybody's Post-card Club, 5128 Wabash ave., Chicago.

25 ASSORTED High Grade Souvenir Post Cards postpaid 10c. Address The S. & D. Co., Dept. 75, Brunswick, Maine.

CARDS exchanged for results. 10c membership in Pacific Card Exchange, Bryn Mawr, Wash.

10 BEAUTIFUL Postcards and name in Eureka Post Card Exchange, 10c. 451 P Oakwood Blvd., Chicago.

POST Cards, Wreck of "Steamer Titanic," 6 only 10c. G. Downs, Athens, Maine.

IF you collect postals or anything else, you should have your name in "Collectors' Directory." Dime will do it. State your specialty. Lee Specialty Co., Bellevue, Washington.

12 POST Cards; name in exchange catalogs; coupon; premium list; magazine 10c. Mrs. M. Dolsen's Home Journal, Brooklyn, N. Y.

20 BEAUTIFULLY colored Oregon view post cards 25c. Milton, 229 Larrabee St., Portland, Oregon.

5 PHILADELPHIA Views and worldwide membership 10c. International Exchange, 130 Wishart St., Phila., Pa.

PHOTOS. "Beautiful women;" 36 beauty poses, 10c. Curtis Co., J. I. Englewood, Chicago.

12 ASSORTED high grade art Post Cards 10c. M. Tepper, 146 Marcy Ave., Brooklyn, New York.

POSTALS. "Pretty Girls;" 4 bewitching posts, 10c. 12 for 25c. Curtis Co., L2, Englewood, Chicago.

26 POST cards, birthday, etc. 10c. Ward Specialty Co., Dept. CP., 1235 Michigan Ave., Chicago.

10 FASCINATING photos, mademoiselle "beauty poses," 25c. 9 miniatures free. Landsmin, 204 West 23rd, New York.

JOIN "Michigan" Exchange membership and club paper. 10c. Fred Ueck, Stevensville, Michigan.

OUR members in Norway, Switzerland and everywhere would like to exchange cards with you. Membership 10c. International Post Card Exchange, 2917 Washington Blvd., Chicago, Ills.

SPECIAL! Forty colored postcards, views of New York City, 25c. Ten Colorado postcards, 10c. Fifteen general American views, 10c. All different and postpaid. Allen Leathers, Fort Collins, Colorado.

YOU'LL get cards from everywhere. Membership 10c. Idaho Card Exchange, Dept. K, Box 906, Boise, Idaho.

20 BEAUTIFUL Post Cards assorted ten cents—satisfaction guaranteed. Landin Sales Co., 4106 W. Cornelia Ave., Chicago.

GET 10 views of Camden or Philada for 10 cts. Porter, Everett & Norris Sts., Camden, N. J.

CAMERAS AND PHOTO SUPPLIES

KODAK Films Developed, 10c per roll, any size. Prompt attention given mail orders. Prints 2 1/4 x 3 1/4 to 3 1/4 x 4 1/4. 3c; 4x5 to 3 1/4 x 5 1/4, 4c. J. M. Manning, Box B, 1062 Third Ave., New York City.

TWO enlargements from small films, 25c (silver). Burt Co., Wollaston, Mass.

AMATEUR Photographers. Send postal for free sample copy of The Camera—the magazine for photographers, \$1.50 yearly. Covers every department. Tells how to earn money. Eliminates waste; save 65% on something every amateur wants. The Camera, Dept. 28, Philadelphia.

SPECIAL Holiday Offer. Send 60c and your favorite negative for beautiful Sepia print mounted on 1913 Calendar and also a 10x12 Enlargement. This offer expires January 31st. Colonial Art Company, Box 566, St. Louis, Mo.

FOR Sale—Photograph tent 14x28 with sky-light, 10 oz., double filled, used two months; 5x7 studio camera with multiplying attachment and stand. Claude Lusk, Wapakoneta, Ohio.

MONEY in Photography. I start amateurs making money at home taking portraits; become professionals. Studio secrets; retouching, etc., fully explained. Wells' Studio, East Liverpool, Ohio.

PHOTOGRAPHIC Post Cards made from your films or plates, by one of long experience; 4c each; 30c dozen; \$1.50 hundred. Films developed, 10c per roll. Satisfaction guaranteed or money refunded. All work postpaid. Fred S. Marvin, Kane, Pennsylvania.

WE buy, sell and exchange. Bargains in Microscopes, Telescopes, Binoculars, Cameras, etc. Bargain list sent. Kahn & Son, Opticians, No. 54 John St., New York. Established 62 years.

COLOR Photography. Amateurs, print your Landscape views in colors, no special apparatus. Send 2 cts stamp for circular. Rud. Isenmann, 385 Bergen St., Newark, New Jersey.

SEND 10c for three feet real motion picture film. 48 pictures. L. E. Adams, Portland, Me.

TRANSPHOGRAPHY, the new art of producing beautiful colored transparent photos on watch cases, chinaware, novelties, etc., with Transparo. Pleasant, inexpensive, profitable. Formula, sample bottle, and instructions, 25c. Greenhalgh, 816 58th Street, Brooklyn, N. Y.

BIG Money Saved on Photographic Lenses and Apparatus—goods exchanged; repairing done. Ralph J. Golsen, 65 East 46th Street, Chicago, Department P.

LEARN to transfer Photos to Watch cases, chinaware, sofa pillows, etc. Five excellent formulas and complete instructions 25c. P. Benson, Stewartville, Minn.

6 POSTCARDS and one 8x10 enlargement from any photo or amateur negative for 50c. Commercial Photo Co., 74 Woodward Ave., Detroit, Mich.

TWO cameras one 4x5 one 3 1/4 x 3 1/4. Jonathan Laubach, Benton, Pa.

FILMS Developed Free! All prints to 5x7, 4c each; 40c doz. Post-cards same price. Free enlargements from your favorite negatives. Buyers found for all salable prints. Interesting circular mailed on request. V. Paddock, Ashton, Ill.

KODAK Films Developed. Send 20 cents in stamps and film, any size, 6 or 12 exposure, and we will furnish one print from each good negative as trial order. Roanoke Cycle Company, Roanoke, Va.

NEW York's largest photographic store will take your old Camera or anything photographic in exchange toward any new Kodak or new Camera of any make or size, or high grade Anastigmat lenses; send today for the largest photographic bargain list. Koehler's Camera Exchange, 7 East 14th Street, New York City.

BEAUTIFUL Calendar Free from your negative. Developing, printing and enlarging. Work guaranteed. Write Westman & Erhard, St. James, Minn.

CAMERA users—our "Exposure Meter" tells you how to make Snap Shots successfully. Sent Free for Stamp. G. M. Monroe Co., Jamestown, N. Y.

MAKE money in photography. "Cash and the Camera" given complete system, detailed plans, 247 vital pointers. Send \$1 and I'll include requirements and prices paid by 39 leading publishers (all postpaid). Circular free. Dudley, Photo Expert, Box 775 G, Philadelphia, Pa.

ANY roll film developed 5c; all prints 3c. Photo postals 3c each; 100, \$1.50. 8x10. Enlargements 20c. Caulkins Photon Works, Oneonta, N. Y.

MOTION PICTURES

WRITE Plots for Motion Picture Shows! Good pay, easy work. Quick's complete course tells how, and where to sell. Price reduced from \$12.00 to \$1 postpaid. Central Sales Co., 1416 Market St., Hannibal, Mo.

WRITE Motion Picture plots and make \$25 to \$30 a week. Easy if you know how. Particulars free. Motion Picture Bureau, Box 1328, Los Angeles, Calif.

MOVING Picture Theatre List for sale, 11,305, price \$20, covering United States. Guarantee 98% correct under two-cents stamp. Particulars, Trade Circular Addressing Company, Desk H, 164 1/2 W. Adams St., Chicago.

MOTION picture plays wanted. You can write them. We teach you by mail. No experience needed. Big demand and good pay. Details free. Ass'd M. P. Schools, 601 Sheridan Rd., Chicago.

WRITE Moving Picture Plays; \$10 to \$100 each; all or spare time; experience or correspondence course unnecessary. Details free. Atlas Publishing Co., 304, Cincinnati, Ohio.

FOR Sale—Moving Picture Film 1c per foot. H. Davis, Watertown, Wisconsin.

\$5 TO \$40—Moving Picture Machines—Send for catalogue. Ralph J. Golsen, 65 East 46th Street, Chicago, Department P.

WANTED—Moving Picture Outfit. Outfits sold. Fred L. Smith, Amsterdam, N. Y.

WRITE Moving Picture Plots. Good Pay. We will show you how. Ripless Co., Brockton, Mass.

DUPLICATORS AND DEVICES

RAPID copying process, for circulars, sheet music, letters; simple, cheap. All sizes. Process, 20 cents. Information for stamp. W. Bruckman, Marion, Oregon.

HOW to get a Hektograph that will make 150 copies in 10 minutes; letter size, \$2. Write for circular. Heyer Duplicator Co., 118 No. La Salle St., Chicago.

TO MANUFACTURERS

MANUFACTURERS—Inventors—We want several specialties to sell. Our force of agents can sell goods of merit. Give full details in first letter. Simplex Mfg. Co., Kewanee, Ill.

RELIABLE concern in San Francisco, California, wants to represent reliable concern for state or coast. E. R. Levy Company, 24 California St., San Francisco, Cal.

WANTED—Exclusive agency high grade proposition for Northwest or Pacific Coast. Box 633, Seattle, Wash.

BLACKSMITHS

BLACKSMITHS—Here is your opportunity to be an expert blacksmith without help as life is short. Try Toy's Modern Methods doing hard jobs easy. Forging and welding all kinds of steel solid, and tempering and hardening all tools to a standard by colored charts. This is real information, not theory. All for one dollar. Send for free samples. W. M. Toy, Sidney, Ohio.

BUSINESS OPPORTUNITIES

INDEPENDENCE and fortune quickly attained in the Manufacturing Mail Order business. I furnish Formulas, Manufacturing Processes and Trade Secrets in all lines. Sold under positive guarantee; 18 years' practical experience. Revision and improvement of Formulas and Processes—reduction of manufacturing cost—utilization of waste materials, etc., a specialty. Booklet, Formula List, and Valuable Information Free. W. L. Cummings, Ph. D., 127 Standard St., Syracuse, N. Y.

WE start you in a permanent business with us and furnish everything. We have easy selling plans and seasonable leaders in the Mail Order line to keep the factories busy. No canvassing. Small capital. Large profits. Spare time only required. Personal assistance. Write today for (copyrighted) plans, positive proof and firm statements. J. M. Pease Mfg. Co., Pease Bldg., Main St., Buffalo, New York.

A MAIL Order Opportunity for You. Here is your chance to secure selling rights in a protected new specialty selling at popular price, registered at Washington; high profit for the dealer; enormous demand, easy sales; we furnish highest grade advertising matter, instructions, etc., and carry the stock if you wish; lowest wholesale terms. Full details sent free. Box 131A, Newport, Ky.

BIG Profits for You! Manufacture Barley Crisp. New confection. 5c package sells you 1c. Machine, instructions complete \$7.50 prepaid. Send 10c for samples. Arley Crisp Co., 1605 Hyde St., San Francisco.

MAIL order ads that pay. 20 different propositions fully explained. All bona fide, no fire money-getters. Each one the foundation of a successful Mail Order business. Send 10c for full particulars and regular bulletin of new propositions. Mail Dealers Wholesale House, 450 Franklin Bldg., Chicago, Ill.

FACTORY site for sale at a great bargain. Saw Mill complete; 80 horse power boiler and 65 horse power engine, on deep water; good railroad facilities. Worth \$500. Will sell for \$1,500. One-half cash, balance \$25 per month. Address, Deamont Mfg. Co., Laine, Mississippi.

HAVE you anything to advertise? Our Rate Book tells you all about advertising mediums, rates, circulation, closing dates, etc. Sent for 10c. Worth dollars. Folder free. Correspondence invited. Dearborn Advertising Agency, 455 Franklin Bldg., Chicago.

STOP Here! Let me start you in a home business that will bring you money every day. Experience unnecessary. Spare time, no canvassing. I furnish everything and guarantee success. Send for proofs. Voorces, Desk C. R., Omaha, Neb.

BE a Mirror Expert. \$3-\$10 day; spare time home at first; no capital; we train, start you making and silvering mirrors; French method. Free prospectus. W. P. Herr, Pres., 87 Saratoga Ave., Brooklyn, New York.

BE Independent. Start Money Making Mail Order Business at Home. New Plans, everything furnished. Only small capital required. Free booklet and particulars will show. W. P. Miller Co., Box 254, Muskegon, Mich.

I WILL start you earning \$1 daily at home in spare time, silvering mirrors; no capital; send for free instructive booklet, showing plans of operations. G. F. Redmond, Dept. 306, Boston, Mass.

MANUFACTURE Gold Letters for signs—60 per month easy. I start you. Experience unnecessary. Take like wildfire. Prospectus free. J. F. McPherson, 673 Owen Avenue, Butler, Pa.

MAKE \$100 to \$500 a month and get it in the 7 o'clock crowd. Opportunity for a life-time. Free particulars. Address: Estate Correspondence Schools, 1528-Masonic Temple, Chicago.

BE Your Own Boss. Start mail order business. We teach you. 20 years established. Everything furnished. "Starter" free. Krueger Co., Dept. 2B, 167 W. Washington, Chicago.

MECHANICS—Tinsmiths. Make money this winter making lamp heaters at a cost of 10 cents each. Directions and blue print, one dollar. Crawford, Bedford ad, Schenectady, N. Y.

PATENTABLE ideas wanted—Send for free books. Richard B. Owen, 30 Owen Bldg., Washington, D. C.

MAKE More Money! Operate a good substantial Mail Order Business—our "Silent Salesman" system—can easily be done in spare time yet the possibilities are unlimited! For years "Booster" has actually and accurately led thousands like you over the Successful Road to Wealth. To succeed you've got to read The Booster Magazine for "Booster" is Opportunity and starts you in business for yourself—tells you how to get the dollars—puts you next to the best money making propositions on earth—ones that really get you the money! Send 10c for two months trial subscription. Booster Magazine, Northwestern Building, Chicago.

I WANT you to handle "Successful Brains" and my other Mail Order books—they are the best on earth—millions of copies should be sold on merits alone—fortunes should be made by those who heed their teaching! Write me and I will make it to your advantage to sell these, my newest and best books by furnishing you circulars and books at the right figure. May I send you confidential Mail Dealers' prices? Weissgerber, Northwestern Building, Chicago.

EXTREMELY small capital starts a sensible, legitimate and profitable mail order business. If you are, or you intend to become a mail dealer, answer this ad; you receive proof, facts and details how you may start a clean and independent business with \$10. Address Expert, 420 Home Bank, Baltimore, Md.

AGENTS wanted: Men or Women now employed to work one hour a day to sell "Clearall." Indispensable for storekeepers, railroads, street car Cos., automobilists, etc. Quick seller, 100% profit. Send 25 cents (coin) for large sample and full details. Northern Laboratories, Chicago.

MAIL Order Firms. Commission circulars insuring matters \$20 on every thousand mailed. Books on Success, Self-Culture, etc., 25c, sample 12c. Successful plan free. Popular Institute, Englewood, Chicago.

PATENTS Secured—C. L. Parker, 910 G St., Washington, D. C.

MAKE \$10 daily restoring colors to faded rugs and carpets. Spare time. Tremendous opportunity everywhere. Simple; easy. Mirror silvering course free. Free particulars. Cox, Dept. MC., Omaha, Neb.

YOUR opportunity to become manufacturer. Product international necessity. Profitable business quickly established, at home, during spare time. Sample and particulars. Delzell Mfg. Company, Desk A, 448 South Mathews, Los Angeles, California.

LEARN to Metalize. Make exquisite and beautiful jewelry of roses, butterflies, etc. Pleasant, profitable employment. Stamp brings sample and particulars. P. Benson, Stewartville, Minn.

GOOD Results. Greatest Mail Order Magazine published. Two \$50.00 Courses now being published. Three issues, 10c. Publishers, 2311PM North 43 Av., Chicago.

\$10 TO \$20 a day without canvassing. Most stupendous merchandising plan ever conceived. Write quick. Ziebart, 3232 Rhodes Ave., Chicago, Ill.

USE your spare time to build up a mail order business of your own. We help you start for a share in profits. 27 opportunities. Particulars free. Mutual Opportunities Exchange, Buffalo, N. Y.

OPERATE Hahn's Premium Machines. Let them gather pennies for you. The best seller for cigars and candies. J. L. Hahn, 1016 Germantown Ave., Philadelphia, Pa.

FORM a corporation—Congress Law for D. C. and all States; cheap. Raise money easily. U. S. Legal Corporation, Washington, D. C. Representing \$1,225,000,000.

MANUFACTURE and control exclusively best Mechanics Hand Soap Made. Fortune in it for you if you hustle. Complete course \$1, with ten 10c boxes soap free. J. C. Brown, 50 Chestnut Ave., Auburn, R. I.

TRIAL Offer: \$1.00 places your 25 word ad in 200 magazines; regular price 6c per word. Kings Magazine, Box 13 P., Little Silver, N. J.

BUSINESS opportunities for you—with money making methods in Digest you can make \$\$\$! One year subscription only 25c. Digest, Grand Rapids, Mich.

BEST Cream Metal Polish ever made. Complete instructions, formula and one gallon Polish for \$1. J. C. Brown, 27 Washington St., Providence, R. I.

MAIL Order Business, I start you free. No investment but postage and stationery. P. Newham, Waukegan, Ill.

TURN your spare time into money. Join us in a profitable mail order business, one that you can operate at home. Large profits; quick returns; small investment. Our 10 years' successful manufacturing experience, personal assistance and new ideas assure your success. Write for positive proof and free booklet. Pease Mfg. Co., incorporated, 144-148 Broadway, Desk A, Buffalo, N. Y.

NICKELPLATING done at home. Big profits. Mail 25c for sample bottle and particulars. Eynon Mfg. Co., 2773 West 15th Street, Cleveland, Ohio.

GET into the Oxy-Acetylene Welding Business. Needed everywhere, an unlimited field and enormous profits. We furnish full instructions and blue print plan for building your own plant at low cost. Write at once before your territory is taken. Price, \$1.25 postpaid. J. M. Crowner, 113 So. Schuyler St., Ottumwa, Iowa.

BE Independent. Make \$50 weekly with a New Invention, just patented. 8c profit on every dime. Small investment. Experience unnecessary. Circulars mailed free. International Metal & Ferrotyping Company, Dept. B16, Chicago, Ill.

INCORPORATE your business under Arizona laws. Cost small. No franchise tax. Stockholders exempt from corporate debts. Do business anywhere. Laws and forms free. Southwestern Securities & Investment Company, Box D488, Phoenix, Arizona.

COLLECT money by a sure, simple, system. Income \$1,000 to \$5,000 a year. Quick results. No capital required. Instructive book. "Skillful Collecting," free. National Collectors Ass'n., Long Street, Newark, Ohio.

YOUR Opportunity—Work for yourself; 200 money making formulas for 25c, including the famous resilvering mirror formula. The Hoover Co., Dept. 7, 529 E. Beck St., Columbus, O.

ENCYCLOPEDIA of Business Chances. Money making methods exposed; how small ventures lead to wealth; 2,000 trade secrets, etc. Descriptive booklet free. Reimel & Co., 96 Broadway, N. Y.

MAIL Order Business in its true light and particulars showing how you can obtain a loan of advertised mail order instructions and "schemes," sent free on request. Library Division 29, The Mail Order News, Fishkill, N. Y.

"THE Art and Process of Dry Cleaning." A fascinating and profitable occupation. 25 cents postpaid. Auburn Supply Co., Dept. EE, 7716 Peoria St., Chicago.

FORMULAS furnished by expert chemists, for manufacturing Toilet, Household, and Technical products. Government serial numbers obtained. Catalogue for stamp. B. Mystic Company, Washington, D. C.

MONEY for You. Learn the "Dry Cleanings" business. Formulas and complete instructions, 13-2c stamps. Profitable Service Bureau, 4333 N. Sawyer Ave., Chicago.

SPARE Time Money Maker. Unlimited possibilities. Little capital required. Complete instructions and sample 25c. Particulars free. P. Akorn, Rosebank, New York.

WE Help Raise Capital at once to start you in retail—manufacturing—patent—real estate—mail order or any legitimate business by means of "Our Practical Method." Particulars free. The Business Aid Co., K501, Detroit, Mich.

EARN from \$10 to \$15 a day refinishing and waterproofing automobile tops with "No-Crack" waterproofer. \$2 per can express prepaid. Write Brinkley Bros., 726 E. 15th St., Kansas City, Mo.

AN intelligent person may earn \$100 monthly corresponding for newspapers. No canvassing. Send for particulars. Press Syndicate, 700, Lockport, N. Y.

GET money in every mail. \$1 starts profitable mail order book business. Particulars free. H. J. Teeple, Decatur, Ind.

WE Start You in Business, furnishing everything; men and women, \$30 to \$200 weekly operating our Original "New System Specialty Candy Factories," home or small room anywhere. Opportunity lifetime; booklet free. W. Ragsdale Co., East Orange, N. J.

SHEET bluing, mending tissue, gold eyed needles, for trust plan and mail order dealers. Three samples, 10c. Frank Shilling Co., Navarre, Ohio.

I Made \$50,000 in five years with a small mail order business; began with \$5. Send for free booklet. Tells how. Heacock, 5074, Lockport, N. Y.

SELL your formulas, ideas, plans and knowledge by mail. Some make \$1,000 monthly. Instructive booklet for stamp. Information System, 283, Marietta, Ohio.

YOUR Brain can make \$200 while your muscles make fifty cents. Write for proposition. Dunning, Aulander, N. C.

BEFORE Starting Mail Business or accepting agency, ask me about my "Money-makers." A Rolfe, 923 N. Alder, Philadelphia, Pa.

144 PENCILS with your four line ad, only \$1.90 prepaid. Crescent Pencil Co., Tibodaux, La.

WORTH \$ \$ \$—How to succeed in the Mail Order Business, free. M. Hathaway, Rolling Prairie, Ind.

MAKE \$1 earn \$50. Razor Blade Sharpening pays large profits. Easily handled in spare time at practically no expense. Three million owners use four million blades weekly. Big demand for sharpening. Booklet "How to Operate a Sharpening Business" free. What others have done you can do in your town and by mail. Nice money making opportunity for those who apply now. G. A. Haynes, Boston, Massachusetts.

MAKE \$50.00 to \$100.00 monthly. In your spare time—Experience unnecessary. Want active man each locality. Insurance Benefit Protection for sickness, injury, death. Write for Cash-Bonus offer. Box No. 293, Covington, Ky.

START a credit reporting office, every merchant needs and will pay for this service. You can make money. Field new and white for the harvest. No capital required. Ask for booklet. Free. National Protective Service, Uhrichsville, Ohio.

FREE information and instructions on the mail order business. Our publication tells how to successfully operate mail order plans; gives "truthful" advice and opens a way for you to win. Sample copy free. Big Mail Directory, 1124-P Foster Ave., Chicago.

GUARANTEE anyone \$50 weekly from start, without capital. Salary if desired. No canvassing. Something new. Better investigate quick. Make your spare time profitable. L. M. Todd & Co., Dept. 6, Holladay, Va.

EARN \$7 to \$12 daily, restoring faded colors in rugs and carpets, whole or spare time. No capital. Free Booklet, tells how. Wm. A. Eldred, Dept. 75, Detroit, Mich.

YOUR classified ad can be placed in 1,200,000 small town homes at low cost every week. Ask for free Result Checking Book. Use letterhead. Classified Dept., Boyce's Weeklies, 500 Dearborn Ave., Chicago, Ill.

I HAVE practical ideas for non-winding spring motor without weights which will operate large or small machinery. Want partner with money to promote and manufacture same. D. E. Robinson, 103 North 7th Ave., North Yakima, Wash.

BIG Profits: Open a dyeing and cleaning establishment, little capital needed. We teach by mail. Write for booklet. Ben-Vonde System, Dept. C, Charlotte, N. C.

INVEST two dimes for "My Experience in the Mail Order Business." It will save you dollars by preventing mistakes. Don't take chances. Profit by my experience. Eugene Lee, Bellevue, Washington.

PAYS itself monthly; salesmen earn \$48; state managers earn \$36; we get \$36; \$750 capital required. Damon Co., Bowling Green, Ky.

LET me start you in a brand new profitable home business. Utilizing new discoveries. Experience unnecessary; spare time; both sexes. Baur 212a West 114th, New York.

GUARANTEED Remington typewriter free with \$1 monthly. Typewriting Course, Merit Service, Oshkosh, Wis.

PATENTS wanted to sell. Mine made a Fortune, particulars free, send description of yours. Eugene Pearl, M23, Union Sq., New York.

\$1 STARTS paying mail order business at home. Particulars free. Box 115, Brooklyn, N. Y.

FIVE Hundred Things Worth Knowing. Stamp for particulars. Paul Zurflich, Modesto, Calif.

EARN Money at home. Particulars for stamp. Palmer, 2448 Cortland St., Chicago.

BE our representative. Big money making opportunity. Particulars free. Schiller Mfg. Co., 1124A Foster Ave., Chicago.

AGENTS WANTED

EARN \$15 to \$25 a week or more as our Mail Order Dealer Right from your own home. Hold your position until entire time is required. We are manufacturers and owners of patented just-in-season specialties. If you are just starting a Mail Order Business or if already established, you can't afford not to handle our Patented Money-Making Getters. We sell exclusively to our Mail Order Dealers. We protect them. We carry stock and furnish everything. No canvassing. Small capital. Experience unnecessary. Write today for Latest Patented Leader and Manufacturer's Easy Selling Mail Order (copyrighted) plan backed up by "Whole Truth." Positive Proof and Sworn Statement. J. M. Pease Mfg. Co., 539 Pease Bldg., Main St., Buffalo, N. Y.

SPECIAL Sales Manager wanted in your town right away. Plenty of money for you to spend. Hottest tailoring offer ever made. Orders turned over to you. Make \$50 a week at the start. Only part of your time. Your hobby free suit will attract so much attention that orders will simply roll in. Every order means dollars to you. Other good features. Paragon suits sell like wildfire. We prepay all express charges, too. Now is the time to get in. Be the first in your town to get this great offer. An opportunity to make the biggest success ever. Send post card with your name and address for our book of beautiful samples and full particulars. All free, so write at once. Paragon Tailoring Co., Dept. 1191, Chicago, Ill.

ANYONE can make big money easy selling the Aladdin Kerosene Mantle Lamp. No experience necessary. A demonstration sells a lamp in nine out of ten homes. One agent sold over 1,000 on money-back guarantee, not one returned. Another made over \$300 in 15 days. Hundreds doing as well. Evenings may be made profitable. Special introductory offer to the first man in each neighborhood who writes for agency proposition. Mantle Lamp Co., 351 Aladdin Bldg., Chicago, Ill.

YOUNG man, would you accept and wear a fine tailor made suit just for showing it to your friends? Or a Slip-on Raincoat Free? Could you use \$5 a day for a little spare time? Perhaps we can offer you a steady job. Write at once and get beautiful samples, styles and this wonderful offer. Banner Tailoring Company, Dept. 962, Chicago.

AGENTS—\$50 weekly; we manufacture the best needle case made, a wonderful seller; 200 to 500 per cent profit; talking unnecessary; our copyrighted "Trust Scheme" Envelopes do the work; general agents can make over \$100 weekly; send 19c for a 25c sample containing 115 needles; particulars free; buy direct from the factory at wholesale. Paty Needle Co., 102 Union Sq., Somerville, Mass.

AGENTS—County and State; men and women everywhere to sell the Pinless Clothes Line; a practical labor saving invention, lasts life-time, sells on sight, gives perfect satisfaction. Agent Sutton of Georgia, sold over million feet; 100% profit; write quick for exclusive territory; information free; sample prepaid 25c stamps. Pinless Clothes Line Company, 520 Wilcox Bldg., Portland, Oregon.

WE have recently patented three fast selling inventions and want agents everywhere. Will simply say that these goods are of real worth and sell at popular prices. It will pay you to investigate this immediately. Winfield H. Moody Mfg. Co., 3075 Easton Ave., St. Louis, Mo.

WITH a large force of hustling agents always at work, we are in the market for all kinds of Agents and Mail Order supplies. Send samples, and state best terms. Woodard & Osborne, Camden, New York.

\$10 A DAY for Agents, Selling the New 1912 Fall Style Silk Neckties and giving free with each purchase a beautiful Monogram Roman Gold Finish Cuff Link and Stick Pin Set. Samples free. Dayton Neckwear Co., Room 25, Dayton, Ohio.

MILK Tester "Inspector" shows at once if milk is pure or watered. Utmost practical household article at present. Just run. Sells at sight. Retail 50c. 100% profit. Specialties Co., 672 Eagle Ave., New York, N. Y.

BE Independent! Start a mail order business in your own home. We tell you how, and furnish everything needed wholesale. An honorable and profitable business for man or woman. Particulars free. Many make \$3,000 a year. Murphy Mfg. Co., South Norwalk, Conn.

FREE, swell suits to wear—plenty of money to spend as our special manager in your town. Make \$40 a week easy. Suits sell like hot cakes. Your own free suit will get seeds of orders from your friends. Only part of your time. No money nor experience necessary. All orders we take in your section turned over to you. This is a most stupendous opportunity for one man in each town. Get in Quick! We pay express on everything. Send a post card with your name and address for beautiful samples and full particulars, all free. Entirely new plan. Chance of a lifetime. Don't miss it. No obligations. Hurry. Write today. American Woolen Mills Co. Dept. 1191, Chicago, Ill.

MANAGER wanted every city and county handle best paying business known, legitimate, new, exclusive control, no insurance or book canvassing. Address Chas. F. Halstead, 43 West 34th St., New York.

MEDALLIONS sell at sight, 300 per cent to 500 per cent profit. Make up your own goods and be independent. "It's easy." Catalog free. Fred Resag Co., 1205 W. Randolph St., Chicago.

AGENTS wanted to sell sales books of good commissions in every city in the country. Write for samples and commissions. Chicago Sales Book Company, 158 N. Desplaines St., Chicago, Ill.

AGENTS—700 Things a Boy Can Make—Can you beat it? Set of 4 books that sell for only \$1. Everyone is interested. Enough to keep a boy busy until he grows up. Parents want them for their lads. Good liberal commission. Exclusive territory. Write to Popular Mechanics, Book Dept. 318 W. Washington St., Chicago.

PLEASANT home work; no canvassing or collecting to do! Earn \$50 month in your spare time. All our work may be done in any room of the house without even your nearest neighbor knowing you work for us, if you so desire. Write today! Wilbert F. Biye & Co. Dept. 31, Terre Haute, Ind.

AGENTS—Easily earn \$25 to \$40 per week selling Kno-Darn Guaranteed Hosiery direct-from-the-mill proposition; 20% better; costs less; M. Garwood sold \$400 worth in six weeks; send for free sample; no money required. Kno-Darn Hosiery Mills, Desk 15, Dayton, Ohio.

WE are the largest manufacturers of Twisted Wire Brushes in America. Highest grade goods, best service, highest profit. Write for our new catalog. You are sure to win. Fuller Brush Co., 33 Hoadle Place, Hartford, Conn. Western branch Wichita, Kansas.

AGENTS make big money selling our new gold letters for office windows, store fronts and glass signs. Any one can put them on. Write today for free sample and full particulars. Metallic Sign Letter Co., 406 N. Clark St., Chicago.

AGENTS—Something new—fastest seller and quickest repeater on earth. Permanent profitable business. Good for \$50 to \$75 a week. Write for particulars. American Products Co., 6125 Sycamore St., Cincinnati, Ohio.

AGENTS—We manufacture glass paper Plain glass windows made to look like stained glass; something new; easily applied big money maker; two sample sheets of paper, with catalogue in colors and discount sheet, for 10c. S. H. Parrish & Co., 202 S. Clark St., Chicago.

EVERYBODY'S Using it Now! The Imperial Self-Heating Sad Iron; sells in every home; \$50 per week to hustler. Write I. B. Farmer, 415 W. Magnolia, Fort Worth, Texas.

AGENTS Wanted—Mechanics and shoemakers make over \$100 a month in spare time selling transparent handled novelty knives and razors. Big profits. Sales easily made. Write for terms today. Novelty Cutlery Co., 67 Bar St., Canton, O.

YOU can make \$888 as our general local agent. Household necessity; saves 10 per cent; permanent business; exclusive territory; salary or commission; free sample; credit. J. Pitkin, 113 Redd St., New York, N. Y.

500% PROFIT selling our wonderful silver letters for office windows, store fronts and glass signs; resembles finest gold leaf easily applied; samples free. Metallic Letter Co., 406 N. Clark St., Chicago.

AGENTS—New "Colonial" 10 piece Aluminum Set. An unparalleled opportunity. The aluminum trust prices smashed. Fortune for you in next six months with this special. Housekeepers wild over it, don't delay a minute. Dundee Mfg. Co., 46C Chauncy St., Boston, Mass.

STOP Here! Let me start you in a home business that will bring you money every day. Experience unnecessary. Spare time canvassing. I furnish everything and guarantee success. Send for proofs. Voorss, Desh C. R., Omaha, Neb.

AGENTS—What size Silk Hose do you wear? Send no money. Write today. Offer expires 30 days. Agents wanted in every town. Large profits. Beautiful line. Triple-Wear Mills, Dept. D., 112 So. 13th St., Phila., Pa.

A WONDERFULLY profitable business quickly established in your own community during year wear sight selling dress shoes to men and women from our factory to buyers. No risk. Kusion Komfort Shoe Co., Lynn, Mass.

AGENTS—\$2.50 Cutlery Set free with each set. Forest Rose Rogers Silverware. Every woman buys. 80c profit each sale. Sales a day easy. \$7 outfit sent on approval. Wilson Mfg. Co., B202, Lancaster, Ohio.

KEY Checks—\$1.45 per 100—35 styles. (e) dies for stamping names and addresses, key rings, watch fobs, umbrella keys. Get into the business. We show you how to make \$5 per day. Pease, Die Maker, Dept. M, Winchester, N. H.

AGENTS—\$10 daily with specialty no housewife or office employe can resist; stylish bonanza; particulars free. Harrison Specialty Company, 2524 S. 41st St., Chicago, Ill.

AGENTS—Handkerchiefs, dress goods.leton made \$8 one afternoon; Mrs. Bosworth, \$25 in two days. Free samples. Credit. Stamp brings particulars. Free-Press Mfg. Company, 59 Main St., Brookline, N. Y.

AGENTS—Portraits 35c. Frames 15c. Post Pictures 1c. Stereoscopes 25c. Views 30 days' credit. Samples and catalog free. Consolidated Portrait Co., Dept. 106, 1027 W. Adams St., Chicago.

PORTRAIT Agents—Send for free catalog. Portraits, Frames, Medallions, Pillows, Sheet Pictures, etc. Prices, quality considered, lowest of any. Pioneer Portrait Co., 1265 W. 63d St., Chicago.

AGENTS—Our Columbia Folding Handkerchief is the best proposition on the market. Sold in stores. Big profit. Write for forms and other big sellers. S. V. Diamond, 35 West 21st St., N. Y. C.

I WILL start you earning \$4 daily at home in spare time, silvering mirrors; no initial; send for free instructive booklet, showing plans of operation. G. F. Redmond, Dept. 306, Boston, Mass.

\$100 MONTHLY and expenses to trustworthy men and women to travel and distribute samples; big manufacturer. Steady Work, S. Scheffer, Treas., G. W., Chicago.

AGENTS—250% profit. Wonderful literature. Sells like wildfire. Can be carried in pocket. Write at once for free sample. H. Mathews, 1962 Third St., Dayton, Ohio.

AGENTS—Everybody wears Hose. Sell direct consumer; the line that repeats. Credit plan helps you. Exclusive Agency Hustlers. Address D 2 Lehr Mfg. Co., Denver, Colo.

AGENTS to sell to dealers and make 50 per cent on sales; article of merit, attractively displayed. Retails at 10c; send 5c sample. Rawlings, Box 1053, Central Station, St. Louis, Mo.

PORTRAIT Agents—If you want better portraits for less money, try me. I guarantee satisfaction. Twenty years experience. L. T. Kunde, Artist, 53 Cawker Building, Milwaukee, Wis.

AGENTS—Write it! Enclose stamp. Brief and Fishing trips. MSS returned or check. The Avalon Book-Exchange, Avalon, Ill.

AGENTS—Something live—something fresh—something new. Something that's a seller, and bringing our boys \$35 a week and up. National Manufacturing Co., Mont, Ill.

EXCEPTIONAL opportunity for agents with limited capital to sell private trade stores, celebrated C. R. L. cigars. Sell, 144 Grand St., New York.

AGENTS—Ask us about our snappy household specialty line which will clear \$50 to \$80 weekly. American Aluminum Co., Div. 7, Lemont, Ill.

AGENTS—\$5 daily selling our Handy Tool. 12 articles in one. Lightning seller. Sample free. Thomas Mfg. Company, 462 Third St., Dayton, Ohio.

I WANT salesmen to sell an advertising novelty of merit. Side line or exclusive. Sample free. Desk 1, Andrew Paysen, Clinton, Iowa.

AGENTS make \$30 week by selling our 500 handy household articles; catalogue free. Scheff Co., Desplaines, Illinois.

EVERY woman will buy Powdered Roach Poison. Sample 10c, formula 25c. Manufacture 25c size, cost 4c. Selvidge Supply Co., Ritta, Fla.

AGENTS—Do you want to make big money? Then write today for our plan and be independent. Benjamin Ray & Co., Box 479, Lumpkin, Ga.

REMNANT Store, 1331 E. Linn, Cincinnati. Greatest Dry Goods Bargains on Earth. Proposition to agents and storekeepers.

AGENTS wanted to sell household specialties—\$6 to \$10 daily. Send for catalog and sample. Harrison Specialty Co., P. O. Box 1603, Pittsburgh, Pa.

DON'T fail to read Independence and Fortune under Business Opportunities.

WANT three swell made-to-measure shirts? Show our samples to friends, take a few orders easy and make enough profit to get yours free. New fancy patterns, made just as you want them. One good agent wanted in each town, spare time or all time. Write for beautiful samples, wholesale and retail prices and our liberal offer. Peerless Shirt Makers, Dept. 1, Chicago.

CHANDLER Clothes Dryer—Pulls up to ceiling on porch or in house. Clothes out of way. Holds good size washing or ironing; weighs three pounds; sent prepaid, \$1.50. Every home will buy one. Agents wanted—Auburn Supply Co., Dept. DD, 7746 Peoria St., Chicago.

AGENTS—Start independent business. My combined pressure cooker and double boiler is so simple that it can be combined out of the utensils in any kitchen. You can either manufacture it yourself, and make a large profit, or you can sell the plans direct to your customers. Full description, with selling plans, \$5. Claude Melnotte, Box 166, College View, Nebr.

SALESMEN: Our Press Button Automatic Opener Pocket Knife, the very newest out. Our sales card sells them quickly for the dealer at a good profit. Fine side line; 80c brings sample knife and card. Knife guaranteed, is worth \$1.50; money back if not satisfied; act quick. Unique Novelty Co., Independence, Iowa.

MAKE \$30 to \$60 weekly selling our new 300 Candle Power Gasoline Table and Hanging Lamp. For homes, stores, halls, churches. No wick, no chimney; 1c per night. Big profits. Exclusive territory. We prepay freight. Sunshine Safety Lamp Co., 938 Factory Bldg., Kansas City, Mo.

AGENTS on salary or commission. The greatest agent's seller ever produced; every user of pen and ink buys it on sight; 200 to 500 per cent profit; one agent's sales amounted to \$620 in six days; another \$32 in two hours. Monroe Mfg. Co., N. C. La Crosse, Wis.

THE money is yours if you grab this winner. It sells to everybody. No talking necessary. Just show it and the sale is made. 100% profit. The wise agent will send for free particulars. Norton Supply Co., R. D. No. 35, Box 10, Dept. 2, Barberton, Ohio.

WHERE did your money go? Find out. Begin the New Year with our Daily Expense Record. It will keep you posted and reduce expenses. A very interesting and complete book—50c. Agents wanted. Auburn Supply Co., Dept. HH, 7746 Peoria St., Chicago.

AGENTS \$5 to \$10 a day easily made selling Bixby's Best Silver Cleaner for cleaning all metals without rubbing. It will sell on sight. If you are a hustler and mean business, send for a sample and terms to agents. Curiosity seekers stay out. Edw. G. McLacklan, 134 Pollock St., New Bern, N. C.

WANTED—Agent to act as Manager in each county. \$150 month easily made. No canvassing. No experience. Success guaranteed. Big expensive samples, instructions, plans and starter, all 10c postage. Dept. 44, Myers & Co., Cambridge, O.

BE Independent. Make \$50 weekly with a New Invention, just patented. 8c profit on every dime. Small investment. Experience unnecessary. Circulars mailed free. International Metal & Ferrotype Company, Dept. B17, Chicago, Ill.

AGENTS—Ladies or gentlemen, to sell the highest grade toilet goods, flavoring, etc., direct to families. High class house; fair dealing; repeat orders sure; large cash commissions. Address Kingham Bros., Indianapolis, Ind.

DID you ever hear of anyone selling Popular 25c Sheet Music at 5c? You can do it, and make 300 per cent. Four sample copies and proposition, 10c. Chicago Book & Music Co., 535 S. Wabash Ave., Chicago.

DO you want to make big money? Resilver mirrors and you'll have plenty. Full instructions for 15-2c stamps. Profitable Service Bureau, 4333 N. Sawyer Ave., Chicago.

AGENTS—\$200 monthly distributing Newells needle cases. Sell 115 needles in book for 10c and make 200% profit. Approval Plan envelopes make talking unnecessary. Crew Managers write. Send 10c for sample book and particulars. Newell Company, 5600 Delmar, St. Louis, Mo.

AGENTS make \$15 per day easy. 150% profit. Our cleaning, polishing, and dustless mop has everything beat. With our goods you can sell every home. Duncan Bros., 2931 N. Troy St., Chicago.

HOT Seller. Over 100% profit. House door guard. Every housewife wants one or more on sight. \$1 a dozen. \$10 gross. Sample postpaid, 20c. Allen Door Guard, 215 Loomis Street, Chicago.

GULFORD Kerosene Mantle Lamps are replacing ordinary lamps like lamps replaced candles. Our live agents will average \$50 weekly all winter. Guilford Co., Seville, Ohio.

SUBSTITUTE for Eggs—Big money supplying Bakeries, Restaurants, Groceries, etc. Formula (guaranteed) with instructions sent prepaid for \$1. W. C. Delzell, 448 South Mathews, Los Angeles, California.

FORTABLE Shower Bath Apparatus. Gives fifteen minutes bath, bathe in any room. Price, \$6 with heater. \$3 allowed off this price for distributing twelve catalogues. Electric Bath Co., Findlay, Ohio.

400% PROFIT selling Gordon Photo Pillow Top. High grade work. Samples and catalogue free. Luther Gordon Co., Northwestern Bldg., Chicago.

EXCLUSIVE representatives to handle "Dahl-Mo-Stat Heat Regulator." Write for circular and discount. Dahl Manufacturing & Sales Company, 324 Fifth Ave. S., Minneapolis, Minn.

HUSTLING Agents Wanted for our fast selling Sanitary Household Brushes. Steady work. Big profits. Postal brings particulars. Dept. C, Hale & Kavanek, New Britain, Conn.

AGENTS—Sell our high grade line of perfumes, toilet articles, soaps and combination sets; 150% profit. We are manufacturers. Hopfinger and Roth, St. Louis, Missouri.

SIGN Letter Agents—Defy competition handling our flexible letters. 5 different styles. All quality. Guaranteed non-tarnishable. 4" letters, 90c per 100. H. Alexander, Manufacturer, 328 East 59th St., New York. Established 1905.

AGENTS—\$20-\$40 weekly, selling Hosiery, Underwear, Sweaters. Samples free to hustlers. Large line. Liberal commission. References required. Sales Manager, Room 42, 54-62 Worth St., New York.

REPRESENTATIVE wanted in every city and town—whole or part time—to handle best paying business known. Legitimate—new—exclusive control—no canvassing. Address Drawer 165D, New Haven, Conn.

AGENTS Mail Dealers. Most practical winning quarter specialty invented. Necessity everywhere. Twenty other money-makers. Cover new field. Columbia Mfg. Co., 1557 Wells St., Chicago.

RESILVER mirrors and make plenty of money. Full instructions, 25 cents. Auburn Supply Co., Dept. CC, 7746 Peoria St., Chicago.

(CELLULOSIA) Door Plates, new, lettering pure gold. Send for sample case. Nothing invested, 100% profit, sell to every house. Public demand them. La Fontaine, Inventor and Mfr., Sherburne, N. Y.

AGENTS, best selling, very rare and newest Japanese novelties that we have ever seen. Catalog free, sample 25c. Otuka Co., 1120 Georgia St., Los Angeles, California.

PERFECTION Pocket Adding Machine. Lightning seller. Agents wanted. Cincinnati Specialty Mfg. Co., Dept. R. Cincinnati, Ohio.

CASH for names, addresses, information, etc. Steady income at home. Instructive booklet for stamp. Information System, 284 Marietta, Ohio.

AGENTS Wanted—Lucrative and suitable proposition for men or women. Two big ideas in one small package. For particulars—Address, Y. Q. Caldwell, Paris, Tennessee.

SMALLEST Alarm Clock, bible and telescope, 10c each prepaid. W. H. Garner, A-119 South Lafayette St., Evansville, Ind.

AGENTS—For Pocket Fraction Computer. Every office desk needs one; sample, 50c. Erickson Specialty Co., Blackduck, Minnesota.

SALESMEN wanted, no experience required; new, snappy proposition. Good for office and home. Good commission. Write us, R. H. Randolph Co., Dept. 54, Berlin, Pa.

SALESMAN wanted for live wire proposition; 100% profit, \$15 to \$25 per day, sells at sight; particulars free. M. L. Flack, Rankin, Okla.

OUR agents are making big money selling automobile necessity. Write for particulars. Midland Trading Company, Bloomfield, N. J.

I MAKE \$3.50 a day at home, spare time, working my new, easy plans, so can you; particulars for stamp. John Menihan, 218 S. Fourth St., St. Louis, Mo.

HUSTLING agents, either Sex, sell Uo-line Polishing Cloths; every demonstration sells; big profits. Glenside Galenical Co., Glenside, Pa. Box 40.

WINNER—Well I guess. Let me tell you all about it. You can make big money selling this article. Send now for free particulars. John Beer, Dept. A, Sunman, Indiana.

AGENTS—Mail Order Men. Your 25 word ad in 100 Magazines, \$1. Box 22, Station B, Worcester, Mass. The Williams Specialty Co.

AGENTS get the new, unequaled dollar seller. The Universal Shoe Cleaner Mfg. Co., Enterprise, Kansas.

BIG money selling indestructible pens. Outwear all others. Package, 10c. P. M. Miles Co., Lynn, Mass.

AGENTS 400% profit. Send 25c for 5. Sell for \$1.25. Particulars free. Direco, Box 51, East Bangor, Pa.

NEW proposition; quick sale; no limit to orders you get. Sample sent. Mention Popular Mechanics. A. L. Gibson, Nevada, Ohio.

AGENTS—Kimo—Great seller, free sample. Write H. Van Dine, Department M, 152 William Street, N. Y.

AGENTS—Make money selling Ives Razor Paste. Box 25c. Write Lem Ives, Anderson, Mo.

GIRLS—Earn Money. Write today for our steady income offer. The Purezo Co., Urbana, Ill.

AGENTS wanted, big money. Francis J. Mathlez, 393 Herkimer St., Brooklyn, New York.

HAVE you a few hours to spare? We want man or woman in each town. No capital needed. An hour's work shows dollars earned in spare time. Pocket sample, 400% profit. G. C. Mfg. Co. (Dept. L.) 20 Warren St., N. Y.

SALESMEN—Send your name and address to Raymond E. Wood, 114 Dreyer Bldg., Cincinnati, Ohio. I am the manufacturer's Sales Manager for the best household and office electric specialty ever invented. Sells for \$3.50 and \$2.50. Guarantee for credit or deposit required. Capable men only need apply. I want only a few men. The work is permanent, profitable and high-grade. You will be given territory and expected to produce business.

AGENTS! 1000% profit selling our beautiful religious Masterpiece "Christ at Golgotha." Size 14x28 inches, beautiful colors. Sells like wildfire for 25c. Your cost \$2.50 per hundred. Sample 10c. Merchants Specialty House, 521 Dearborn St., Chicago.

MAKE \$10 daily restoring colors to faded rugs and carpets. Spare time, tremendous opportunity everywhere. Simple; easy. Mirror silvering course free. Free particulars, Cox, Dept. MC, Omaha, Neb.

AGENTS. Wild with excitement! Do you blame them? Of course you don't. Everybody eager to buy our beautiful artistic air brush show cards, printed in colors, 11x14, 350 varieties. No talking—simply show the show cards to merchants—the cards speak for themselves. Big profits, something new under the sun. Tide just setting in. The show cards are great—you'll say so—you can't help it. Wake right up, no time to argue. Do it now—send this very minute a letter or postal for free two color catalog. Popular Show Card Co., Dept. JA 1235 Michigan Ave., Chicago, Ill.

AGENTS—Would you like a steady position at \$30 a week to start and a chance to be promoted to district manager at \$3,000 yearly? No experience required. My agents have steady work all the year. I need more agents quick. This fine position is open to you if you will write me personally at once. E. M. Davis, President, Davis Co., 264 Davis Bldg., Chicago.

AGENTS—To sell the newest electric appliance on the market; sold everywhere there is electricity, in the home and office; liberal profits; sales-driving sample, weighs a pound, no experience or knowledge of electricity required; it shows how to use one light instead of two and get the same results; sells for \$3.50 and saves the purchaser an investment of \$25. Write for particulars. The Handy Light Co., 12 Handy Light Block, Cincinnati, Ohio.

\$1,000 EARNED by three people within thirty days selling our Fire Extinguishers. Buyers everywhere; protected territory; 500% profit. Local and State Agents wanted. United Manufacturing Company, 1242 Jefferson, Toledo, Ohio.

AGENTS—100% profit—sell to saloons—machine a whirlwind seller. Free sample and salesmanship course. Two sales a day \$15 profit. Write. Simplex Mfg. Co., Dept. 7, Kewanee, Ill.

STOP canvassing! \$10 to \$20 a day without canvassing. Most stupendous merchandising plan ever conceived. Write quick. Ziebart, 3232 Rhodes Ave., Chicago, Ill.

AGENTS—Live hustling men to canvass the homes and offices, selling my new electric device. Cuts electric bills in half. A demonstration sells it. Repeat order getter. You can make big money without previous experience. Complete outfit and selling instructions \$5.45 and I guarantee money back if not satisfactory. Exclusive territory is going fast. Write me today for my proposition. Stanley B. Freiberg, 126 Station F, Cincinnati, Ohio.

REPRESENTATIVES everywhere to sell the Fastest, Simplest and Most Wonderful Calculator on earth. Calculations in whole numbers or fractions are instantaneous. Entirely new idea. Easily understood. Will revolutionize all present methods. Sells for \$5.00. Write today Instantaneous Calculator Company, Detroit.

AGENTS—No experience required, earn \$20 to \$40 weekly, selling household specialties, write for particulars. Charles J. Haines Co., 1505 Linden Ave., Baltimore, Md.

SPHINK Ink—safety ink, shows tampering. Nongumming, noncorrosive; sells from pocket, 200% profit, best side line. Proposition free. Bayless Sons Company, Muncie, Indiana.

AGENTS—Salesmen. Seasonable seller, latest \$3.50 electric invention fills demand never before supplied; home, office, store, everywhere eagerly sought. Repeat orders outnumber first sales, you control territory, no competition, unlimited possibilities. Write Frank W. Allen, Agency Manager, 138 Station F, Cincinnati, Ohio.

FORMULAS—3,000 Formulas and Digest Publishing 100 formulas, etc., monthly. One year 50c or Silvering Formulas and Digest, one year 25c—or 200 Formulas and Digest one year, 25c. Digest, Grand Rapids, Mich.

AGENTS—No less than \$888 per day; new article; whirlwind seller. Free sample. Write today for particulars. Lindsay Mfg. Co., Box 1573, Lindsay, Cal.

GENERAL Agents—Capable of calling on the big trade themselves and handling canvassers for the house to house and office to office business to sell the newest electric specialty on the market; sold everywhere there is electricity in the home, office, factory, store, hotel, liberal profits; sales-driving sample, weighs a pound; no experience or knowledge of electricity required; shows how to use one light instead of two and get the same results; sells for \$2.50, \$3.50, \$5.00 and saves the purchaser an investment of \$25.00. Write for particulars. The Handy Light Co., 150 Handy Light Block, Cincinnati, Ohio.

EARN \$100 a week at home; One man made \$185 in 15 days with \$5 capital. Write for free circular describing all. F. Smith Sales Co., Box B472, Waterloo, Iowa.

AGENTS in every town, best selling household articles. Start at once. Large demand for goods. \$25.00 to \$50.00 a week. Success assured. Investigate today. Mail Specialty Co., Dept. H, Williamsport, Pa.

THINK of the number of flue holes in America. Every one needs the new patented Pipe and Collar Support. Agent wanted. J. H. Allen, 1290 Magoffin Ave., El Paso, Tex.

WANTED—Agents. An automobile necessity. Sells easily and quickly. Big profit on each sale. For particulars, write Oakland Merchandising Co., H., 109 Oakland Ave., Pontiac, Mich.

AGENTS wanted to handle quickest selling household specialty on market; 100% profit. Sells itself. Every sale brings repeat orders. Write today. Agents Supply Co., Box 1071, Pasadena, Cal.

AGENTS wanted for Oriental novelties never before seen in America. Quick seller. Repeaters. Immense profits. Sha Kanematz, Box 529, Portland, Oregon.

1500% PROFIT selling our Gold Sig Letters. We'll show you how. Sample free. Johnston Co., Quincy, Ill.

PHENOMENAL Success awaits salesman with our sales-driving specialties. Emporium Co., Minneapolis, Minn.

READ the Agents Magazine. 2 month 10c. Yearly 50c. Agents Magazine, Chicago.

FOR money making propositions write P. Newnham, Waukegan, Ill.

YOU can make more money operating Mail Order business but before taking chances invest 10c for two samples "Booster"—the one bona fide Mail Order and Agents' publication on earth—a magazine that has made money for others and will show you how! Send 10c today—1 worth dollars to you. Booster Magazine Northwestern Building, Chicago.

SIGN Agents—Painters—Something new and better. Attracto ready-made Gold and Silver letters. 21 kinds, easily applied. Make big money lettering store window making signs, and selling our line of flashing, sparkling chipped glass name-plate. No experience needed. Write for sample letter and catalogue and start at once. Address Attracto Sign Co., 2655 North Cla Street, Chicago, or 519 Pacific Bldg., San Francisco.

AGENTS—\$60 weekly; we make the best "Self-Sharpening Shears" on the market something new and different, cannot dull or work loose due to our patent tension spring. No selling experience needed. Our original selling plan gets the order every woman buys on sight. Particulars free. 7c sample "Self-sharpening Shears" free. Satisfaction guaranteed or 25c refunded. J. R. Hoag, Mount Airy, Pa.

\$61.50 WEEKLY. Introducing and Selling a New Gas Light Burner for Kerosene Lamps. Beautiful light. No chimney. No mantle. Perfectly safe. Simple in construction. Nothing to get broken or out of order. Will not burn out. Durable. We last for years. Low price. Easy to sell. 200 per cent profit. Experience not necessary. Samples free. Why not try one your lamp? Beware of imitations. Branch offices. Luther Manufacturing Co. Dept. 163, Cincinnati, Ohio.

ARE You Receiving Double profit your Winter's Work? Control of low Thermozone sales will bring this to you. Small cash capital needed. Exclusive right for this universal product if you qualify. Write Victory Company, 208 Pearl St. Buffalo, N. Y.

MANUFACTURER of popular brand linens and too guaranteed hosiery was agents to sell direct to consumers. Ped man earned \$136.20 in five days. Exclusive territory. Credit. Send for particulars. N. Parker Mills, 720 Chestnut St., Phila., Pa.

BEAUTIFUL Embossed Gold Wind Letters make 1000% profit without expense. New easy proposition. Signs always needed. Ours last for years. Rock bottom prices. Essentials to work with mail free. Embossed Letter Co., 235 W. 110th St., Chicago.

AGENTS. One cent invested in a postcard will bring you a \$35.00 to \$60.00 week proposition. Sterling Aluminum Co. Canal Station, Chicago, Ill.

AGENTS To sell our Vacuum Cleaner, carpet sweeper type, three year guarantee, write Manufacturer, 1419 Main St., Kansas City, Mo.

"AGENTS Wanted" advertisers are most successful and enthusiastic users of advertising space in Boyce's Weeklies. The 2,000,000 circulation pays big. Write for free Result Checking Book. Use letterhead. 60 Dearborn Ave., Chicago, Ill.

CANVAASERS, either sex. Send for factory price. Kitchen necessity, patented. Mary E. French, Clyde, Ohio.

AGENTS—Either sex, handle three articles housewives use weekly. Free trial samples, get the business. All year re-peaters. Permanent income. Attractive proposition and samples for 6c postage. Leibman Mfg. Co., Richmond Hill, New York City.

AGENTS Wanted everywhere to handle our specialty, big demand, easy seller, no canvassing; write for particulars. C. G. Randall Co., New London, Conn.

PECANS as an investment pay better than Life Insurance. Stock for sale. Agents wanted. 5% guaranteed while grove is being developed. Capital \$200,000. Georgia State Pecan Co., Box 513, Valdosta, Ga.

AGENTS. Cost 2c, sell 25c. Sign letters put on with roller. Samples free. Embossed Letter Co., 230 West Illinois St., Chicago.

SHAVEZY Guard makes Safety Razor of our own favorite blade. Excellent line for shopmen everywhere. Sample 25c. Particulars, red stamp. Keon Mfg. Co., Waltham, Mass.

BOKARA Diamonds—Agents, everyone, to wear and sell our famous Bokara Diamonds. Write for sample offer and catalogue free. Northwestern Jewelry Co., 52 Northwestern Bldg., Chicago.

GERMAN Silver Key Tags, Stamped with our name and address. A 25c sample postpaid, 15c. Agents wanted. 100%. Randall Novelty Co., Nashua, N. H.

WE Pay \$80 A Month Salary and furnish rig and all expenses to introduce our guaranteed poultry and stock powders. Address Bigler Company, X368, Springfield, Illinois.

AGENTS—men and women, newest invention. Wing Self Heating Gasoline Flat Iron; guaranteed, sells everywhere. Women delighted. Write for particulars. Wing Mfg. Co., 1608 Fulton St., Chicago.

ONE Million Agents Wanted. Fast sellers costing 2c, selling 25c, in quantities to 50. Every firm needs. Postal brings samples. Embossed Co., 240 West Illinois St., Chicago.

IN every locality—\$50.00 to \$100.00 monthly. For sparetime—Experience unnecessary. Cash benefits when sick, injured, and at death. Write for Cash-bonus offer. Box NT-293, Covington, Ky.

AGENTS—Make \$5 daily handling our up-to-date Door Plates, Name Plates, House Numbers, Signs, etc. Samples free. Brett Bros., Boston, Mass.

AGENTS—Make \$2 each selling our wonderful luminous crucifixes; nothing to sell in a day; absolutely new; shine all night in darkest room. Pioneer Portrait Co., 259 W. 63rd St., Chicago.

PORTRAIT agents find our plan beats all others. Prompt shipments—refunds credited. 30 days' Credit. Catalogue of Portraits, Frames, Pillow Tops, Sheet Pictures and samples free. James C. Bailey & Co., Desk T-1, Chicago.

AGENTS Sell Rich Looking Imported 6x68 rugs \$1 each. Carter, Tenn., sold 15 in four days, his profit \$57. You can do as well. Write for sample offer and selling plan. Condon, Importer, Stonington, Maine.

AGENTS—Callender shoe-scraper pays large profits; Adams sold 5 dozen first 2 days; every housekeeper will buy; guaranteed proposition. Smith Mfg. Co., Mansfield, Ohio.

EVERYBODY needs Rubber Stamps. Make them yourself. Simple instructions. 15 vulcanizer. Circulars free. Stamp Works, Newcastle, Ind.

AGENTS. Be quick—get the agency—never such a seller—make \$100.00 a week—Model Vacuum Cleaner—carpet sweeper type—wonderful suction—Sells for \$8.50—your profit over 100 per cent—no competition—patented—we start you—the Cleaner sells itself—free sample to workers. Model Vacuum Co., D25, Cincinnati, O.

MANUFACTURE fast selling article. Sell yourself or through others. Capital to start \$2. Sample and particulars 10c. Box 449, Cincinnati.

WE want boys to represent us. Splendid premiums given. Magazine and particulars 5c. American Youth, 1124-A Foster Ave., Chicago.

AGENTS. Our Publication tells where to get best propositions. Sample free. Big Mail Directory, 1124-P Foster Ave., Chicago.

BIG money in Essex Fan Motors, run by gas or gasoline. Winfield H. Smith, 10 Lock Street, Buffalo, N. Y.

5,000 LIVE Agents wanted, big profits. Will N. Hoyt, Brockton, Mass.

AGENTS wanted. No trash. Crown Mfg. Co., Cedar Falls, Iowa.

AGENTS make \$30 weekly, fast selling novelty. Fine sample outfit. Particulars Free. Pals Manufacturing Co., 25 East 14th Street, N. Y. City.

SIGN Painting Agents. 1000% profit. Best and cheapest window letters made. Mounted sample free. Success positively guaranteed. Embossed Letter Co., 245 West Illinois St., Chicago.

BE our representative. Big money making opportunity. Particulars free. Schiller Mfg. Co., 1124A Foster Ave., Chicago.

HELP WANTED

"GET Out of the Rut." Make \$15 to \$50 a week during a few hours of spare time at home. Get the big profits in the Mail Order Business. Represent the manufacturer. No canvassing. I want ambitious fellows to handle my "latest" and the increased output of my new factories. I show you my methods are successful, before you start business. Personal coaching, and warehouse privileges free to co-workers. Write now for copyrighted plans, "whole truth," positive proof and sworn statements. J. M. Pease, Gen'l Manager, J. M. Pease Mfg. Company, 576 Pease Bldg., Main St., Buffalo, N. Y.

WANTED one thousand chauffeurs and repair men. Our demand for automobile engineers exceeds the supply. Calls for men of intelligence and mechanical bent capable of commanding \$100 to \$150 per month upon graduation. Resident course \$20 to \$60. Home Correspondence course completed by practical road and shop work at this school, highly successful. Look this up. Auto Schools of America, Dept. T, 1660 Michigan Ave., Chicago.

WANTED—Agents, Machinists. Attention! Increase salary, new revised Saunders' Hand-Book of Practical Mechanics. Best ever ready reference. Thousands in use. Postpaid \$1 cloth; \$1.25, \$1.50 leather flap. Big profits. E. H. Saunders, 216 Purchase St., Boston, Mass.

WANTED—A man or woman, all or spare time, to secure information for us. Work at home or travel. Experience not necessary. Nothing to sell. Good pay. Send stamp for particulars. Address M. S. I. A., 522 I. Building, Indianapolis, Indiana.

INTELLIGENT persons can earn good income at home in spare time copying letters. Fine opportunity, experience unnecessary. Send today addressed, stamped envelope for particulars. Box 17, Station H. G., New York.

THE demand for cartoonists is increasing. Many young men have talent, but not the opportunity of developing it. We can suggest an inexpensive method that will add anyone anxious to take up the study of drawing. Send your name and address to box 223, Glencoe, Ill.

STOP Here! Let me start you in a home business that will bring you money every day. Experience unnecessary. Spare time. No canvassing. I furnish everything and guarantee success. Send for proofs. Voorbles, Desk C. R., Omaha, Neb.

GO on the Stage. Vaudeville career offered you. Experience unnecessary. Managers endorse my method. Instructive vaudeville book free. Write today. Frederic Labelle, Sta. 10, Jackson, Mich.

I WILL start you earning \$4 daily at home in spare time, silvering mirrors; no capital; send for free instructive booklet, giving plans of operations. G. F. Redmond, Dept. 306, Boston, Mass.

WANTED—High class reliable state sales managers for a store fixture without competition. Commissions \$300 to \$500 per month. Address the Buckley Specialty Co., Lima, Ohio.

SALESLADY wanted for Highgrade Corset, not sold in stores. Best corset, best proposition to salesladies. References. Wade Corset Co., Station L, New York.

ANY intelligent person may earn good income corresponding for newspapers. Experience unnecessary. Address Press Correspondence Bureau, Washington, D. C.

DETECTIVES earn from \$100 to \$500 per mo. and expenses. How much are you earning? Write for particulars. Interstate Detective School, McDougal Bldg., Peoria, Illinois.

WE have few openings in each state for Sales Manager to distribute American Flags. P. O. Box 466, Bridgeport, Conn.

DON'T fail to read Independence and Fortune under Business Opportunities.

500 MEN 20 to 40 years old wanted at once in every state for Electric Railway Motormen and Conductors; \$60 to \$100 a month; no experience necessary; fine opportunity; no strike; write immediately for application blank; address Manager, W-10, Dwight Bldg., Kansas City, Mo.

MEN and boys to learn automobile repairing, driving on up-to-date cars; electrically, civil engineering, surveying. Methods most practical. Room and board while learning. Positions secured; satisfaction guaranteed; catalog free. National School of Engineering, 2110 W. 7th, Los Angeles.

BIG Money Writing Songs. Hundreds of dollars have been made by successful writers. We pay 50 per cent of profits if successful. Send us your original Poems, Songs or Melodies today, or write for free particulars. Dugdale Co., Dept. 285, Washington, D. C.

WANTED—First Class Gridley and Brown & Sharpe Automatic Screw Machine Operators, also Hand Screw Machine Operators and Tool Setters. Apply by letter to the Employment Department, Westinghouse Electric & Mfg. Company, East Pittsburgh, Pa.

WANTED—Distributors, men or women to give away free packages our famous Perfumed Borax Soap Powder; no money or experience needed; good pay. Ward & Co., 1775 Berceau Ave., Chicago.

WANTED—First Class Electrical Instrument Makers and Gridley and Brown & Sharpe Automatic Screw Machine Hands. Address Employment Department, Westinghouse Electric & Mfg. Company, East Pittsburgh, Pa.

LOCOMOTIVE. Firemen and Brakemen for all railroads; \$80 to \$100 monthly. Age 18 to 35. Experience unnecessary; no strike. Promotion, Engineer, Conductor. Railroad Employing Headquarters—over 400 men sent to positions monthly. State age; send stamp for application. Railway Association, Dept. 89, 227 Monroe Street, Brooklyn, N. Y.

LINOTYPE instruction; twelve weeks. \$80; unlimited course. \$150; largest school in existence; \$20,000 equipment. Empire School, 419 First Ave., New York.

SALESMEN visiting garages East of Mississippi to fill in part time for us. References exchanged. Waterbury Welding Co., Waterbury, Ct.

WANTED—Instrument Makers, Brown & Sharpe and Gridley Automatic Screw Machine Operators. Address Employment Department, Westinghouse Electric & Mfg. Company, East Pittsburgh, Pa.

CASH for information, names, formulas, and ideas. Steady, profitable home business. Instructive booklet for stamp. Information System, 285, Marietta, Ohio.

WANTED—Distributors of advertising matter everywhere. Your advertisement in Barkley's Magazine, 1c word. American Distributor, Blairsville, Pennsylvania.

GOVERNMENT positions open to men and women. \$90.00 month. Annual vacations. Short hours. No "layoffs." Purely Post means thousands of postal appointments. "Pull" unnecessary. Farmers eligible. Write immediately for free list of positions open. Franklin Institute, Dept. J 21, Rochester, N. Y.

GET away from wage slavery—make more money! Operate a mail order business—our "Silent Salesman" system—can be done in spare time and the possibilities are unlimited. For years "Booster" has actually and accurately led thousands like you over the Successful Road to Wealth—it tells you how to get the dollars—puts you next to the best money making propositions on earth. Send 10c for two months trial subscription. Booster Magazine, Northwestern Building, Chicago.

\$75.00 MONTH paid Railway Mail Clerks. Examinations coming. Preparation free. Franklin Institute, Dept. J 21, Rochester, N. Y.

ANYBODY without work spare time or evenings, I will pay \$12 a week and commission, latest thing out, no fake, send 10c for sample outfit, and start right in selling them. Box 101, Springfield, Mass.

PARCELS Post means thousands Railway Mail Clerks needed. \$75.00 month commence. Examinations announced Jan. 15th. Farmers eligible. Common sense education. Write for free list positions open. Franklin Institute, Dept. J 21, Rochester, N. Y.

WE teach you a trade in few months' time; pay wages after second month. Electricity, automobiles, plumbing, bricklaying, 100 satisfied workmen today; 40 jobs going. Catalog free. United Trade School Contracting Co., Los Angeles.

PARCELS Post means thousands Railway Mail Clerks needed. \$75.00 month commence. Examinations announced Jan. 15th. Write for free list positions open. Franklin Institute, Dept. J 21, Rochester, N. Y.

ANY competent person desiring to better his position can learn something of advantage about different ways of getting positions. Send for particulars. Hilliard Munson, Niagara Falls, N. Y.

RAILWAY Mail Clerks Wanted. \$75.00 month. Thousands Parcels Post appointments. Write immediately. Franklin Institute, Dept. J 21, Rochester, N. Y.

DO You Want to Start a Silver Plating business at home; be independent, your own boss. My descriptive pamphlet shows you how. Write today. Milliken Co., Davenport, Iowa.

PARCELS Post means thousands Railway Mail Clerks needed. \$75.00 month commence. Write for list positions open. Franklin Institute, Dept. J 21, Rochester, N. Y.

MAKE \$10 daily restoring colors to faded rugs and carpets. Spare time. Tremendous opportunity everywhere. Simple; easy. Mirror silvering course free. Free particulars. Coxe, Dept. MC, Omaha, Neb.

9,500 GOVERNMENT Jobs Open. Write for list. Franklin Institute, Dept. J 21, Rochester, N. Y.

MAKE Money At Home reproducing photographs of persons and scenes upon watch-cases, dials, plates, spoons, vases, etc. Knowledge of photography unnecessary. Write today for attractive proposition. Kalos Mfg. Co., 7 Hamilton Place, Boston, Mass.

DON'T let this get by you. I want a live man in your town to make \$1,000.00 to \$3,000.00 per year Extra Money. Write today and you will get a wonderful offer. Earl Pauley, Erie Bank Building, Buffalo, New York.

GOVERNMENT Customs—Internal Revenue. Railway Mail Clerk examinations everywhere soon. Get prepared by former Government Examiner. "Real Courses." Write Now for free booklet. C. Patterson Civil Service School, Rochester, N. Y.

ENTER The Merchant Tailoring Business for yourself. Learn to cut men's clothes by our easy system. Big profits—no investment. Full particulars free. Write today. Success School of Cutting, Dept. 11, Jackson, Mich.

ACTIVE men wanted in each locality. \$50.00 to \$100.00 monthly for sparetime—Experience unnecessary. Sick, injury, death Insurance Protection. Write for Cash-Bonus offer. Box NU-293, Covington, Ky.

WANTED Salesmen—Earn \$250 per month. Sell dealers highly advertised article. Samples not necessary. Elato Co., Station L, New York, N. Y.

IF you want help, tell your wants in 1,200,000 rural homes simultaneously. Use Boyce's Weeklies. Write for free result Checking Book. Use letterhead. Classified Dept., 500 Dearborn Ave., Chicago, Illinois.

GET Your Preparation for United States Civil Service School Examinations from former United States Civil Service Secretary Examiner. "One who knows." Free booklet. Arthur R. Patterson, Rochester, New York.

SALESMEN: To handle our high grade Lubricating Oils, Auto Oils, Greases, Paints, Varnishes and Specialties. Salary or Commission. Central Petroleum Co., Cleveland, Ohio.

YOU can make big money writing letters for us during spare time. We furnish everything. International Mercantile Alliance, 125 Bloomfield Street, Hoboken, N. J.

BE a Detective—Earn \$150-\$300 monthly. Greatest opportunities. Write Frederick Wagner, 1243 Lexington Avenue, N. Y.

WANTED—Young Men who believe they can sell genuine diamonds, exceptional opportunity. Write William H. Mullally, Newark, N. J.

\$\$\$\$\$ for information, names, etc. We sell same for you on commission to our clients. Experience unnecessary. Enclose stamp. National Information Sales Co., ADX, Cincinnati, O.

MACHINERY, TOOLS, SUPPLIES

WE supply set patterns, Cast Iron flasks, Drawings, Machined parts for 7-2 cycle engines 3 1/4 inch bore, 2 hp. for \$1.50 complete. Also sets for 1, 3, 4, 6, 8, 12, 15, 20, 35 hp. 4 cycle, also for small ice machines. Cheap. Engineer, 3015 Walnut St., Milwaukee, Wis.

HOW to quickly start your gasoline engine in zero weather. Make device yourself. Costs but few cents. Guaranteed right. Drawings and instructions, one dollar. Money back if won't work. Send bill in envelope today. Addison Johnston, Box D, Stettler, Alberta.

FOR Sale—Gasoline engines, automobiles, marine and stationary, also castings. Second-hand ones taken in exchange and for sale. Apply with stamps. B. W. Richardson, R. No. 36, Peoria, Ill.

REBUILT Engines—We have on hand a number of rebuilt "Buffalo" engines, guaranteed, at greatly reduced prices. Write for bargain list, Buffalo Gasoline Motor Co., 1293-1305 Niagara Street, Buffalo, N. Y.

FOR Sale—Engine lathe, swings 9 1/2 in. takes 25 in. between centers. Complete with full set change gears to cut all size threads, 3 to 49 in.; price only, \$43.50. Address L. F. Grammes & Sons, Allentown, Pa.

LATHE for sale—For bargains in small lathes write South Bend Machine Tool Co., Dept. L, South Bend, Ind.

SCREW Machine, Hartford, 1 1/2 in. capacity, \$125; 14 inch speed Lathe, \$22. 3145 Penn Avenue, Pittsburgh, Pa.

24 INCH 10 ft. Engine Lathe. Lloyd Bros., Doylestown, Ohio.

PATTERN makers! A book devoted to the principles of pattern and core making and molding. Written by G. H. Willard, a practical pattern maker of years experience. This book, just published, treats the subject in a much more simple, direct and effective manner than most books along this line. 224 pages, 312 illustrations. Price \$1 postpaid. Popular Mechanics Book Dept., Chicago.

SERIES of 7 lithographic models—Steamship, automobile, gas engine, steam engine, steam turbine, wireless telegraph and dynamo. Size 8x14 inches. All parts of these machines are shown and numbered to correspond to printed keys of names. Price each, 50 cents postpaid, or set of 7, \$3 postpaid. Popular Mechanics Book Dept., 318 W. Washington St., Chicago.

FOR Sale—20 hp. Gas Engine in good running condition. Cheap for cash. Write immediately. The Heer Engine Company, Portsmouth, Ohio.

CASTINGS for sale 5-10-20 hp. Will also sell finished marine gasoline engines on partial payment plan. Richards Engine Works, Manitowoc, Wis.

FOR Sale—A 14-inch swing 5-foot bed heavy screw cutting lathe and a small wood turning lathe. F. E. L., 5510 Woodlawn Ave., Chicago, Ill.

ACETYLENE Gas Machine for sale, 15 light Colt. Hollenback, 41 W. Broad St., Columbus, O.

BARGAINS in used Lathes. State size required, stamp. 2643 E. Union, St. Louis, Mo.

MACHINISTS, send for free treatise "How to turn up or repair a crankshaft" with Warnock's combination lathe dogs. H. A. Warnock, Chicago, Ill.

THE latest improvement in Test Indicator, every machinist and toolmaker should send for booklet. C. E. Robinson Co., 96 West River St., Orange, Mass.

GREAT bargains. Small screw-machine, (turret-lathe) typewriter, motors, desk, pulleys, hangers, belting, watchman's clock. Wm. H. Forse, Anderson, Indiana.

HOW to make Dynamo—and Digest Publishing 100 Mechanical Kinks, etc., monthly. One year, 25c. Digest, Grand Rapids, Mich.

FOR Sale—100 H. P. Engine, First Class condition, now running. 2609 Wilcox-av., Chicago.

FOR Sale—1 lathe, drill press, two AC motors at bargain. Get descriptions and prices. Jess E. Neal, Seymour, Ind.

FOR Sale—High grade 10"x25" foot lathe, \$66.50. Tim O'Brien, 305 Greenwood, Marion, Ohio.

FREE—"How to Run and Install Gasoline Engines." Greatest little book ever published on this subject, sent free with year's subscription to Gas Energy. Learn how to solve all knotty Gas Engine problems in few moments. O. L. Stevens, Ind., writes, Gas Energy is best magazine published. Send 50c for year's subscription. Book free. Gas Energy, 28 Murray St., New York.

AUTO—Marine Engines. One cylinder \$25-\$35; Two cylinder \$45-\$75; Four cylinder \$75-\$100; \$150-\$250. W. D. Peck, 18 Sawyer Ave., East Orange, N. J.

POWER Press—Ferracute No. P3, 750 pound fly wheel, \$235. Pinner, 122 Water Street, New York City.

PULLEYS, Gears, Sprockets, Shafting, Hangers; see page 123. W. A. Jones Foundry & Machine Co., Chicago.

UNIQUE engines are small, powerful and compact. See our ad on page 144. Amateur Mechanics Supply Co.

GAS Engine, 22 Horse Power, Fairbanks-Morse make \$350.00. Pinner, 122 Water Street, New York City.

FLOUR AND FEED MILLING MACHINERY

SPECIAL bargains in second-hand: Attrition mills, burr mills, crushers, corn shellers, bran dusters, dust collectors, purifiers, reels, double, single, 2 and 3-pair high roller mills, sieve bolters, receiving separators, scourers, etc. Write for description and prices. Sprout, Waldron & Co., P. O. Box 429, Muncy, Pa.

ENGINE CASTINGS AND BLUE PRINTS

ENGINE castings, 1 1/2 horse vertical gasoline, air-cooled, \$7. Three-horse marine water-cooled, \$9 cash; drawings included; catalogue for stamp. Novelty Manufacturing Co., 853 West Sixth St., Cincinnati, Ohio.

COMPLETE set of detail drawings for a 15 hp. compound reversing marine engine (steam), \$2.50. D. W. Lyon, Engineer, 1226 Broadway, Alameda, California.

DETAIL drawings complete for successful 2 1/2 hp. two cycle Gasoline engine. George A. Teeling Company, 25 Berwick Park, Boston, Mass.

CASTINGS 2 1/2 x 1 Horizontal Steam Engine \$10. 50% with order. Fred J. Van Dermark, Ludow, Ky.

MANUFACTURING MACHINERY

DIES, tools and working models made. Stamping and press-punch work reasonable. Will manufacture your novelty or invention under contract. The Monarch, Onawa, Iowa.

IRON brass and aluminum castings. Metal specialties. Patterns, models, polishing, plating and japanning. Send for catalogue of pattern shop and model supplies. North Chicago Tool Works, 15 Grove Ave., North Chicago, Ill.

LIGHT or heavy metalwork, tools, machines and specialties manufactured, or manufactured and sold. Enterprise Machinery Co., 566 Washington Boul., Chicago.

INVENTORS. We manufacture Metal Specialties of all kinds to order; largest equipment; lowest prices. Send perfect sample for low estimate and best expert advice free. The Eagle Mfg. Co., Dept. B, Cincinnati, O.

PERSONAL attention to your mechanical problems—Inventions developed—Wood and Gated Metal Patterns—Light manufacturing—Write now. H. Haussman, 49 W. Kinzie St., Chicago, Ill.

INVENTORS—You can sell your patent if you have a high class model to show. Inventions developed and light manufacturing. Ragan Machine Shop, 414 East 15th St., Kansas City, Mo.

WE manufacture anything, can furnish
terns, of brass or wood. Castings in
s or cast iron and aluminum. Our
p is equipped with heavy engine lathes,
l presses, new milling machines, (uni-
al). Quotation furnished without cost
rou. Write. Practical Gas Engine and
hine Works, North Chicago, Ill.

ANTED, medium weight machinery to
ufacture on contract. Special machin-
uilt, pattern work. J. T. Schaffer
Co., Rochester, N. Y.

UNCH Press Tools, Jigs and Fixtures
e accurately and promptly. McCall
hine Works, Rochester, N. Y.

BOATS AND LAUNCHES

HART of a modern submarine boat
ving and naming over 200 parts. Size,
28 inches. Printed on plate paper,
s clearly and distinctly all the in-
or. Mailed in a tube for 25c. Popular
hanics Book Dept., 318 W. Washing-
St., Chicago.

OTORCRAFT Encyclopedia—A 150-
e book that tells 1001 things every mo-
boatman should know. How to over-
e engine troubles. Price \$1, postpaid.
ular Mechanics Book Dept., Chicago.

MECHANICAL ENGINEERS

AS engine trouble no more, learn all
t it. All kinds engineering. 10 yrs.
erience. Information free. Baldwin
ly Agency, 802 S. Mole St., Phila.,
sylvania.

ACHINE Designing, Inventors' Ideas
loped. Working drawings, models and
rimental machinery. Cary L. Abbott,
hanical Engineer, 1241 Unity Bldg.,
ago.

ERICAN Commercial-Efficiency Eng-
ers, Chicago. Consulting, Organizing,
iciency Register. Representatives wanted.
e for particulars.

CEMENT

you want the best information on
nt and concrete construction, subscribe
Concrete-Cement Age, leading cement
concrete monthly. Sample copy, 10
s. Yearly subscription, \$1.50. Con-
-Cement Age, 135 Newberry Bldg., De-
-Mich.

JUSTABLE Burial Vault Moulds, new
simple. Make the best vault known
offers big profits for right man. Write
booklet, A. S. V. Co., Peru, Ind.

ACHINE making Building Stones, fifty
s. William Barten, Gordon, Nebraska.

MAILING LISTS

WE will mail free to any business man
y of our comprehensive "Silent Sales-
" containing over 2,000 different classifi-
ons of Mailing Lists with the num-
in and price of each list. This price
contains information which should be
the hands of every business man and
generous offer should be accepted.
e Circular Addressing Company, Desk
64½ W. Adams Street, Chicago.

FOR ADVERTISERS

BARGAIN Advertising Rate—Just to get
anted—15 words, one insertion, guar-
anteed 10,000 copies, printed, and one year's
cription 25c. Digest, Grand Rapids,

B. Bargains: 30 words in 100 weeklies
; in 100 monthlies, \$1. Life Pub. Co.,
ouis.

OUR 30 word ad in our 20 Page Post-
Magazine, 15c. Display, 50c inch.
Exchange, 3827 No. 44th Ct., Chicago.

OUR Ad in Ad-Age will reach nearly
Agent and Mail Dealer in the U. S.
s one cent a word. Sample 5c. Ad-
Big Flats, N. Y.

OW to write pulling ads. 20c. Box 91,
na, Ill.

L about advertising; collecting agency
magazine writing free. The Advance,
ng Prairie, Ind.

WORDS. 100 magazines and mid-
Big Ten, special number, \$1.50. Sam-
opy to all remitting today. Mid-West
er, Dixon, Illinois.

COLLECTIONS

AIMS: all kinds, collected anywhere.
ity Credit Co., Richmond, Va.

FOR SALE

FOR Sale. Small lathe, microscope,
phonograph, gasoline engine, typewriter,
battery jars, paper cutter, printing press
with type. Send Stamp. Slingerland
Bros., Cobleskill, N. Y.

FOR Sale. "Pony" pencil press and out-
fit (for printing names, etc. on pens and
pencils) and one Smith-Premier typewriter.
Will sell cheap for cash. C. K. Wyatt,
Box 2088, Conway, So. Car.

HAVE several Boxball bowling alleys, and
tepin pool-tables at bargain prices, just
the thing for your club, home, or billiard
room. Sobel & Loehr Co., 707 Engineers
Bldg., Cleveland, O.

RUBBER Stamp Making Outfit. Stamp
Works, Newcastle, Ind.

\$25.00 6x9 SELF inking printing press;
\$60.00 worth of Body, Display and Fancy
type. 70% is new; \$25.00 Typewriter; \$15.00
Desk and revolving chair; \$50.00 worth of
gold plated jewelry and stationery, new
goods; \$15.00 worth cuts, cases, cards,
inks, etc. All in first class condition.
If taken immediately purchaser can secure
benefit \$41.00 worth mail order advertis-
ing. Price for all \$150. Ross, 378 Front
St., New York.

ELECTRIC Arc Lamps, job lot 250
only, never used, 110 volts, 4-5 amperes,
1,000 candlepower, sold regularly at \$16.
Bargain price each without casing and
globe, guaranteed in working order, with
one set carbons, \$3.50. Cosmos Electric
Co., 136 N. Liberty St., New York.

FOR Sale—Light manufacturing business
patents, stock and tools of a novelty in
daily use; can be sold by mail or agents;
a good business for a small investment.
H. E. Grebner, Beverly, Mass.

VACUUM pumps for vacuum cleaning
outfits; also used for blowing; the only
pumps that take up their own wear; can't
get out of order; belt it to your engine or
motor; make a wagon outfit and do your
neighbor's cleaning; big profits. Leiman
Brothers, 62 P. C. John St., New York
City.

FOR Sale—Ten Power Bush Terlux field
glass, government model, perfect condition,
cost \$75, sell \$45. Ralph Rosenstiel,
Freeport, Ill.

FOR Sale—Unused, 30 x 40 multicolor
Kidder press; takes paper from web, cuts
or slits; 1,500 impressions per hour. In-
man Manufacturing Company, Inc., Am-
sterdam, N. Y.

BINOCULARS Da-Nite. High or low
power in one. A bargain. Stamp brings
full particulars. Earle Gage, Ashville, New
York.

FOR Sale—20 point Moose Head, R.
Saylor, 499 So. Broadway, Dayton, Ohio.

BLACK Diamond oven, No. 5; used one
year. Excellent condition. Chas. Wine-
land, College View, Neb.

IMPLEMENT Business—For sale. Must
sell on account of poor health. Good loca-
tion and business. A. E. Eckland, Brock,
Sask.

FOR Sale—Mounted Bull Elk head, large
antlers, cheap. R. Saylor, 499 So. Broad-
way, Dayton, Ohio.

ENGINEERS transits and levels; slightly
used. W. F. Sprengnether, 203 N. 10th
St., St. Louis, Mo.

TEETH AND GUMS

OXLITE—Is absolutely harmless. Tight-
ens loose teeth. Positively makes your gums
firm and healthy. Send only \$1. Satisfac-
tion guaranteed or money back. Instructive
illustrated booklet free. Write for it now.
The Oxlite Co., Waco, Texas.

SALE OR EXCHANGE

FOR sale or exchange for underslung
automobile-launch, thirty foot, ten miles.
Fully equipped, three seasons old. Arnold
Francois, Wilmington, Del.

ROYAL Plating outfit. Patent on floor
surfacing machine. E. Fiske, 101 Sheffield
Ave., Buffalo, N. Y.

PATENT on automobile berth. Will
trade for new automobile. Six-cylinder,
seven-passenger preferred. Write. Willis
Lazarus, Cairo, Ill.

EXCHANGE High grade L. C. Smith
gun for motorcycle; good order. R. Voel-
tinger, 1338 Pine St., Vicksburg, Miss.

WILL exchange new \$127 printing outfit
for good motorcycle. E. W. Baxter, 27 Ox-
ford St., Oshkosh, Wis.

FOR Sale or Trade—Edison Universal
Kinetoscope and complete outfit slides and
films for two lectures. Will take stereopti-
con or small printing outfit in part trade.
Box 54, Ramona, Calif.

WANTED

HUSTLING man in each locality. To
introduce us to friends. Make \$50.00 to
\$100.00 monthly in sparetime—Experience
unnecessary. Sick, injury, death insurance
Protection. Write for Cash-Bonus offer.
Box NR-293, Covington, Ky.

WANTED. To buy second hand printing
press and outfit; will buy whole or part of
outfit for cash. C. K. Wyatt, Box 2088,
Conway, So. Car.

WANTED—Catalogues, Wood, Iron,
Wire Working Machinery and Tools. Home
Specialty Co., 2137 Hanna St., Fort Wayne,
Indiana.

WANTED—Popular Mechanics, before
1906. Reasonable Price. Raymond Brown,
Ridge Ave., East Aurora, N. Y.

DIAMONDS, WATCHES, JEWELRY

BUY genuine perfect cut diamonds di-
rect from the importer at the lowest prices
in the world; ¼ carat, \$8.25; ½ carat,
\$17.50; ¾ carat, \$45; 1 carat and over,
\$97.50 per carat. Written contract to buy
back every diamond for 90% in cash and
allow full price paid on all exchanges.
Send no money. We ship C. O. D. privi-
lege of examination without deposit and
without obligating you to purchase. Send
for big Basch Diamond Book. Free! Es-
tablished 33 years. See our display ad on
page 143. Address L. Basch & Co., Dept.
L 340, S. State St., Chicago, U. S. A.

BARGAIN Bulletin. Jewelry novelties
sent free. Popular Jewelry Co., Dept. J.,
1235 Michigan Ave., Chicago.

PATENTS

BEFORE patenting your invention, get
line on its commercial possibilities. I've
had many years experience selling patents.
For \$1.00 I'll give you benefit of it.
Charles A. Scott, Granite Bldg., Roches-
ter, N. Y.

PATENTS without advance attorney's
fees. Send sketch for free report. Books
free. Fuller & Fuller, Washington, D. C.

INVENTORS, my patent made a fortune,
let me exploit yours, particulars sent free.
Eugene Pearl, P-23 Union Sq., New York.

WE sell patents. Established 1900. Ex-
perience. Highest references. To buy or
sell, write Charles A. Scott Co 1096 Gran-
ite Bldg., Rochester, N. Y.

PATENT application prepared and prose-
cuted for \$25.00. Send for booklet. Harry
Patton, 390 McGill Bldg., Washington,
D. C.

FIND out for yourself what to invent
and how to procure and sell a patent for
the same. My book, "Inventor's Universal
Educator," covers the matter from A to Z.
140 pages, elegantly bound. Also con-
tains 600 mechanical movements and 50
perpetual motions. Price \$1.00, postage
free. Money returned if not more than
satisfactory. F. G. Dieterich, 651 Ouray
Bldg., Washington, D. C.

PATENTS Secured. Send sketch and if
possible model for free Experts Search and
Report as to patentability. Books on in-
ventions and patents, and reference book,
sent free. John S. Duffie & Co., Dept. 1,
Washington, D. C.

SEND For Free Booklet. All About Pat-
ents and Their Cost. Shepherd & Camp-
bell, Patent Attorneys, 500A Victor Bldg.,
Washington, D. C.

PATENTS secured—Reports on patent-
ability, validity and infringement. Patent
suits conducted. C. L. Parker, 910 G St.,
Washington, D. C.

WANTED—Manufacturer to make and
market automatic pressure pump on royalty.
Have patterns. Hamilton, Bangor, Mich.

PATENTABLE ideas wanted—Send for
3 free books. Richard B. Owen, 30 Owen
Bldg., Wash., D. C.

INVENTIONS patented free—marketed on
commission. Address Inventors' Agency,
Chicago. Also valuable inventions con-
stantly for sale. Promoters investigate.

PATENTED Safety Elevator—Safety Ele-
vator manufacturers and manufacturers in
general investigate. Accidents entirely
eliminated. Roussel, 1101 Diamond Bank
Bld., Pittsburgh, Pa.

PATENTS ATTORNEYS

"PATENTS and Patent Possibilities," is a 72-page treatise which tells all about patents, what to invent and where to sell it. It gives honest advice to inventors, and is full of valuable and interesting information. Write for it today. It is free. H. S. Hill, 905 McLachlen Bldg., Washington, D. C.

PATENTS—Herbert Jenner, patent attorney and mechanical expert, 608 F St., Washington, D. C., established 1883. I make a free examination and report if a patent can be had and exactly what it will cost. Send for circular.

PATENT what you invent—It may be valuable. Write me. No attorney's fee until patent is allowed. Estab. 1882. "Inventor's Guide" free. Franklin H. Hough, 522 Loan & Trust Bldg., Washington, District of Columbia.

THE patentome is interesting and instructive. A liberal education in patents and how to get them. Free on request. Established 1865. Anderson & Son, Patent Solicitors, 707 G St., Washington, D. C.

PATENTS, Trade-Marks, Opinions, Legal Causes, George A. Hutchinson, Attorney at Law, Loan and Trust Building, Washington, D. C. Ten years experience. Honest work guaranteed.

PATENT your invention. First get free "Inventor's Primer" with statistical data. Milk B. Stevens & Co., Estab. 1864, 685 F St., Wash.; 353 Monadnock Bldg., Chicago.

PATENTS that protect and pay. Advice and books free. Rates reasonable—highest references; best results. Watson E. Coleman, Patent Lawyer, 622 F St., N. W., Washington, D. C.

C. L. PARKER, Patent Attorney, 910 G St., Washington, D. C. Inventor's handbook "Protecting, Exploiting and Selling Inventions," sent free upon request.

SEND for free booklet. All about Patents and Their Cost. Shepherd & Campbell, Patent Attorneys, 500A Victor Bldg., Washington, D. C.

PATENTABLE ideas wanted—Send for 3 free books. Richard B. Owen, 30 Owen Bldg., Washington, D. C.

YOUR invention may be worth thousands of dollars, but its value to you is governed solely by the scope of the patent. Our 38 years continuous practice insures expert service in getting a Dependable Patent. Write today. Louis Bagger & Co., 602 Barrister Bldg., Wash., D. C.

PATENTS and trade marks. My booklet "how to save money on your patent" sent free on request. Absolute protection guaranteed and confidential service rendered. Lester L. Sargent, Patent Lawyer, Dept. 20, 12th Street, Washington, D. C.

PATENT Books Mailed Free—showing 100 mechanical movements invaluable to inventors and mechanics—and telling what is patentable, how to obtain patent or partner, etc. Free on request. Chas. E. Brock, 701 Eighth St., Washington, D. C.

PATENTS Bring Fortunes. Our free book tells how. Send sketch for free opinion as to patentability. Best references from inventors of many years experience. Wm. N. Moore & Co., 504 Loan & Trust Bldg., Washington, D. C.

PATENTS explained in my free books telling what you should know—what to invent—what not to invent—how to sell your patent, etc. Write today. H. L. Woodward, 902 G Street, Washington, D. C.

PATENTS of value. Prompt and efficient service. No misleading inducements. Expert in mechanics. Book of advice and patent office rules free. Clements & Clements, Patent Attorneys, 704 Colorado Bldg., Washington, D. C.

PATENTS, trade-marks, copyrights, patent litigation. Book and advice free. William C. Linton, Mechanical and Electrical Expert, 301 McGill Bldg., Washington, D. C.

PATENTS procured and positively sold if the idea has merit; all countries; satisfied clients my best references; send sketch today; book free. Sanders, 7 Crilly Building, Chicago, Ill.

INVENTORS On American and foreign patents, and trademarks, consult Benjamin Roman, Park Row Building, New York.

REACH the country inventor at low cost by using Boyce's Weeklies. Circulation 1,200,000. Ask for free result Checking Book. Use letterhead. Classified Dept., 500 Dearborn Ave., Chicago, Ill.

GOOD patents obtained. Reliable new plan. Surest, cheapest, best. Write now. W. N. Stevens, 76 Adams St., Washington, D. C.

SEND sketch or model for free advice on patentability. Book telling truth about "No patent, no pay." Sent free. John J. Thompson, patent attorney, Box P, 1110 F St., Washington, D. C.

NO attorney's fees until patent allowed. Free search and books. Fuller & Fuller, Washington, D. C.

PATENTS FOR SALE

INVENTORS! Our great facilities for manufacturing and marketing any article in Glass, Wood, Steel or Brass through our Branch Display Rooms and Expert Specialty Salesmen in every large city, also Canada, should command your instant attention. U. S. Bottlers' Machinery Co., 1033-41 W. Lake St., Chicago.

FOR Sale—A patented, useful article for sale. Can be made for a cent. Will furnish dies. Robt. H. Paubel, 61 Church St., Meriden, Conn.

FIVE new patents; folding armchair, folding desk; value \$10,000; will sell for \$20,000; folding rocker; also new kind of window sill and window; folding, changeable and operating table. J. S., mechanic, 3616 N. Broadway, St. Louis, Mo.

FOR SALE or royalty, useful, two new Patent Spring Check Hinge and Spring Hinge, single and double side, both ball bearing. Write Joseph M. Zuk, New Britain, Conn.

FOR sale. U. S. Patent 1,041,519 motor wheel. Can be attached to any bicycle in a minimum of time. Meaning business; send for blueprint. A. C. Seibak, 2630 Potomac Ave., Chicago, Ill.

FOR sale. Canadian Patent Right, Metal Weatherstrip. Thousands of houses equipped. W. W. Hoaglund, 29 Columbia St., E., Detroit, Mich.

PATENT for sale on device that shows the names of streets when riding in streets or elevated cars. Robert Ekron, 4740 No. Sacramento Ave., Chicago.

FOR sale, snap; U. S. Pat. 1,027,237. Frameless Gate. Rolls up, solves the gate problem. Allan Campbell, Brandon, Manitoba, Canada.

IMPROVED Animal Trap, manufactured cheaper; economical, superiority. Krieger, Wooster Ohio.

FOR Sale—Patent for operating dirigible balloon in a perpendicular direction by springs up or down; also horizontally; balloon necessary only for sustentation. New invention, worth investigating. For particulars address A. M. Waxler, 843 Jackson St., Philadelphia, Pa.

WHO will buy? U. S. patent No. 1014889, issued Jan. 16th, 1912, or Canadian Patent No. 142,994 issued Sept. 24th, 1912. Will sell for best offer. G. L. McDonald, Paragould, Ark.

FOR Sale—Half interest in U. S. Patent (793,929) Power Transmission Clutch. Veegin Patent. Thoroughly tried out. Communicate with F. J. Feineman, 804½ Pine St., St. Louis, Mo.

PATENTED can and opener. Best yet. Manufacturers should investigate. Address K, Box 203, Kankakee, Ill.

U. S. PATENT on portable fire escape. Light, strong, safe; can be carried in suit case; a life saver. Emery Snyder, Springfield, Ohio.

FOR Sale—Mouse trap invention. For particulars write Leo Nebel, Lake Preston, So. Dak.

PATENT for sale in whole or part, covering preparation of one of the chief products used in the manufactories of the world. A big monopoly. Investigate. W. R. Miller, 1053 The Leamington, Minneapolis, Minn.

FOR Sale—United States Patent No. 1003631, also Canadian No. 135752 for Disc Sharpener. Most successful Disc machine patented. If interested, write Dr. J. A. Roth, Rock Rapids, Iowa.

PATENT No. 952154 Lace Curtain Pole \$475, if taken soon. Better look this up. W. L. Thurber, Shellrock, Iowa.

FOR Sale—Best offer takes patent lawn mower. Address L. H. Mac Lella Sag Harbor, N. Y.

FOR Sale. Patent No. 1,045,247 Automatic Music leaf turner just issued. Exceptional opportunity. Sol Bachrach, Piquette, Ohio, Box 12.

PATENT for sale, best little household article ever invented. Thoreau, 1062 V Chicago Ave., Chicago, Ill.

PATENTED—Penholders containing household eraser. Best offer takes it. Box 157 Pittsburgh, Pa.

REAL ESTATE FARM LANDS

"FOLLOW the Lead of Wise Buyers Go to Los Indos, Isle of Pines—the beautiful, fertile, American inhabited tropical island only 180 miles from Key West, Fla. June climate year round—no frosts. Abundance of rain—no irrigation. Big profits oranges, lemons, grape-fruit, pineapples, etc. American stores, schools, churches, bank newspapers, etc. Our lands surround Los Indos, the only deep-sea harbor on the island. Unusual opportunity for home investment. 10 acres will make you independent. Easy terms. Prices now low land rapidly increasing in value. Title guaranteed. Write for complete information. Cañada Land & Fruit Co., 1 Wisconsin St., Milwaukee, Wis.

GROW apples and grow rich in the glorious fruit district of Southern British Columbia. Our choice lands \$10 cash an acre \$10 monthly, without interest. Annual profits \$500 to \$1,000 per acre. Orchard garden, poultry; scenery, hunting, fishing, boating; warm climate; school, postoffice store; sawmill; daily trains; close to markets; unlimited demand for products. Write quick for maps, photos, free information. West Kootenay Fruit Lands Company, Dept. Z, Box 1037, Nelson, British Columbia.

MECHANICS, Tradesmen, Salesmen, Clerks and Railwaymen. Apple orchard developed under expert management. Make money while you sleep. \$6 down, \$1.50 per month. You may develop your own land. Strawberries and all other crops bring large returns while trees are growing. Strong benefit features. Agents wanted. Literature. Ozark Fruit and Land Co., Panburn, Arkansas.

WOULD you consider sometime making Florida your home if you could now secure? Free of one dollar's cost one of the best 40-to-160-acre farms in the Suwannee river land belt? Simply write us, saying, "Map particulars." Address Room 57, Live Oak Ferry & Gulf Railroad Company, Live Oak Florida.

CASH For Your Business and Real Estate. I bring buyers and sellers together. If you want to buy, sell or trade any kind of business or property write me today. Established 1881. Frank P. Cleveland Real Estate Expert, 1308 Adams Express Building, Chicago.

MONEY Making Farms: 17 States; 0 to 1,000 acres, \$10 to \$50 an acre; live stock, tools and crops often included. Settle quickly. Mammoth Illustrated Catalogue No. 35, free. E. A. Strout Fat Agency, Station 3043, 47 West 34th St. New York.

TEXAS school land on market now; you can buy good land at \$2 per acre; pay 5c per acre cash and no more for 40 years but 3 per cent interest on the balance. Send 6 cents postage for further information. Investor Publishing Co., Dept. San Antonio, Tex.

CHEAP patented state school land South Texas, \$1 an acre cash, balance 2 years. For all particulars write F. C. Counable, Trustee, 491 Commercial Bldg., Houston, Texas.

DELAWARE Farms, \$15 an acre live-stock, implements and crops often included. We offer best bargains, and pay buyer's railroad fare. Catalog free. De & Reils, Inc., Dept. 43, Wilmington, Del.

KAUFMAN & Henderson County Texas. 800 acres of Black Hog Wall Valley Land—200 acres in cultivation. Guaranteed to carry \$15 per acre—low. Our price \$27.50. Whaley Realty Co., Marbank, Tex.

FREE information about good cheap lands of Liberty county. Shell roads, crops, water transportation and interurbans coming. Small or large tracts well located near Houston and Beaumont. Address P. Daniel, Liberty, Texas.

BARGAIN—Lot 2, block 62, Los Angeles lights, addition to city San Antonio, Texas—price \$250; \$50 cash, \$10 per month. H. Worth Jones, Mobank, Tex.

ALL kinds of real estate for sale and investments in the Sarasota district. Write Harry L. Higel, Sarasota, Florida.

FOR Sale—80 acres irrigated land in the famous Uncompahere Valley, Delta County, Colorado. F. T. Mayer, Owner, Denton, Tex.

SEND for list. Irrigated and unirrigated lands. Morrill County, new country. Bolt, Bridgeport, Nebr.

MEN wanted—Hundreds of skilled workmen needed in South Milwaukee, Wis., at once. Big wages, living cost low. Small living city—every city convenience. Near Milwaukee and Chicago. A real home city. \$1 down, \$1 a week. Write at once for information to Chas. R. Davis, Dept. A, Milwaukee, Wis.

SELL your property quickly for cash, no matter where located. Don't pay big commissions. Particulars free. Real Estate Businessman Co., Desk B, Lincoln, Nebr.

SUBURBAN home sites on electric line Manitowoc Beach on Lake Michigan, five miles from growing cities of Manitowoc and Two Rivers at \$100 each, \$5 down, \$5 monthly. No interest, no taxes. Charles R. Davis, 214 Mitchell Bldg., Milwaukee.

OHIO Fruit, Poultry farms, good buildings. 2a-\$1,250, 4a-\$2,000, 10a-\$2,500, 15a-\$500, 23a-\$1,800, 50a-\$3,000, part cash. Irish, Bratenahl, Cleveland.

REDUCE your high cost of living. Buy one acre fertile truck farm within walking distance of Big Allis Chalmers Plant, 2 minutes to Milwaukee. Charles R. Davis, 2 Mitchell Bldg., Milwaukee.

DESIRABLE farm 198 acres, \$60 acre. x 105, Fairfield, Ill.

5 MONTHLY buys suburban farm, fruit, truck or poultry farms near suburban station, only 35 minutes from the city of Houston, near Shell boulevard direct to city. Beautiful location; rich soil; plenty rainfall; fine climate; two and three crops of potatoes, tomatoes, cabbage and other vegetables which net growers from 90 to \$300 per acre. Fine strawberry country, also in orange and fig belt. Cash market in the city for products. Only a five and ten acre farms at \$50 and \$55 acre. No interest, no taxes. Five acres, cash and \$5 monthly; ten acres, \$10 cash and \$10 monthly. Write today for illustrated literature and all particulars. C. W. Hill & Co., Owners, 734 Commercial Bank Bldg., Houston, Texas.

OWN a Farm Home in the Southeast and escape the cold winters. \$10 an acre—easy terms—buys fine lands producing up to three crops annually. Fortunes in apples, truck, livestock, dairying, poultry general farming. Land lists, subscription to "Southern Field" all services free. V. Richards, Land and Industrial Agent, Southern Railway, Room 64, Washington, D. C.

REAL Estate Wanted—Will pay cash for home property or farm. Must be a bargain. Give description and lowest price. Address Farm Buyer, Box 1308, Cherry Valley, Illinois.

OPENING Sale of Lots. At League City lights-on-the-Interurban, midway between Houston and Galveston. Interurban Station property, large, beautiful suburban homes—50x125 feet. League City has 1,000 population, 50 trains daily. Three steam roads and interurban. First 100 lots only \$40 each. Payments \$2 cash and \$2 monthly. Buy now while price is low and goes along interurban line just beginning to make rapid increase. Suburban property near Houston is best investment in the south. \$17,000,000.00 spent on new buildings in this city in two years. These lots will sell quickly. Send \$2 now as first payment and get choice location, or write at once for full particulars. Address, Galveston-Houston Interurban Land Co., 940 National Bank Bldg., Houston, Texas.

A PROFITABLE investment—40 acres Texas wheat land, increasing in value every day, new and growing country. Price \$400. Terms \$10 down and \$10 a month. C. Dougherty, Cripple Creek, Colorado.

EAST Texas Farm. \$10 Cash, \$1.00 per week. No interest. J. R. Nichols, Timpson, Tex.

ORGANIZER'S Bonanza. Everybody wants land on the Co-operative Homestead Plan. A. Hawk, Crystal Springs, Fla.

BIG Colony locating near Tampa. Co-operative Homestead Plan. Land in Sunny South at Fraction Usual Cost. Edward Miller, Crystal Springs, Florida.

SASKATCHEWAN, Canada, good farms \$15 to \$35 per acre on easy crop payments if desired. B. Nedam, Pipestone, Minnesota.

FOR Sale—Fine 168-acre stock and dairy farm. Particulars and photo on request. Isaac Kouw, Holland, Michigan.

DOGS, BIRDS, POULTRY, ETC.

POULTRY Paper, 44—124 page periodical, up to date, tells all you want to know about care and management of poultry, for pleasure or profit, 4 months for 10c. Poultry Advocate, Dept. 3, Syracuse, N. Y.

EGGLAND. Single comb white Leghorn cockerels from heavy laying stock, fifty and seventy-five cents. Egglard Farm, Mt. Vernon, Iowa.

DIXIE Coon Hound Kennels, Water Valley, Miss., is headquarters for wide awake coon hounds. No loafers here. Fifteen days' trial. Order today.

BUFF Orpingtons from first prize birds, Dane Huffington, Latham, Kansas.

POULTRY. Small fruit and garden paper, 6 months 10c. Kiger's Poultry Journal, Brighton, Iowa.

FINE Rose Comb Red Pullets and Cockerels. Dr. Bradshaw, Ogden, Iowa.

SCOTCH Collie, Airedale Terriers. Send for list. W. R. Watson, Oakland, Iowa.

WHITE and Brown Ferrets for sale. Price list free. Bert Ewell, Wellington, Ohio.

PEDIGREED English Bloodhound pups from expert mantrailing stock. H. Whitworth, Carlyon Rd., Cleveland, Ohio.

FOR Sale—Pedigreed Airedales. W. F. Goodin, Columbus, Mont.

GREAT Dane Dogs. Send for list. E. H. Hillyard, Dubuque, Iowa. Slumberland Place.

AIREDALES—Collies. Pups, grown stock. Prices reasonable. Phil Savage, St. Charles, Ill.

BLOOD Hounds for sale. Two trained dogs. G. King, Cuba, Ill.

FORMULAS

PAINTERS Friend is a book of Formulas and up-to-date instructions in Painting, Tinting, etc., for painters and others. Price \$1. J. Duval, Grand Junction, Colo.

FORMULA for making Flexible Mirrors and Duplicator, 15c both. Hanblett, 10 Ellingsburg St., Lowell, Mass.

COLOGNE and Haircurlingwash—Formulas, Parisian way, 25c each; stamps; Szal-peter, 136 East 127 Street, New York.

210 MONEY making formulas and Ad-Age four months for 15c. Ad-Age, Big Flats, N. Y.

SEND 20 cents in stamp or coin for formula and directions for putting a glossy finish on table tops, that will not scratch. No varnish used. P. O. Box 462, Trenton, N. J.

FIREPROOF Paint. Five formulas for making Fireproof Paint. Postpaid, 50 cents. Houston Formula Co., 1708 Washington Ave., Houston, Texas.

BOOK filled with hundreds of valuable formulas. Yours for 10 2c stamps. Profitable Service Bureau, 4333 N. Sawyer Ave., Chicago.

RESILVERING Mirrors—The best formula ever originated with special instructions for 25 2c stamps. C. F. Smisor, 4091 Drexel Boulevard, Chicago.

SPECIAL formula for making a rich black on brass. Price 13 2c stamps. C. F. Smisor, 4091 Drexel Boulevard, Chicago.

THREE best methods of recharging dry batteries, all for 25 2c stamps. C. F. Smisor, 4091 Drexel Boulevard, Chicago.

ENCYCLOPEDIA of Business—contains 3,000 formulas and 200 ways to start in business, also valuable information sent postpaid on receipt of \$1. James H. Monson, 548 Main St., Kansas City, Mo.

10,000 FORMULAS, new book, 800 pages, price \$3. Circular free. B. Newham, Waukegan, Ill.

FOR MEN

SAFETY razor blades sterilized and sharpened better than new; 2 cents each. Five years' success. Send for blade box and circular. Electro Stropping Co., 134 Shelby St., Detroit, Mich.

FOR \$1.25 we will send you, charges paid, sample box of 25 of best 10c quality Havana cigars you have ever smoked. Direct from factory to smoker. Ask for The San Marco. Keller Cigar Co. 1039 Greenwich street, Reading, Pa.

FOR Sale—40,000 pounds best leaf tobacco, mail stamps for samples. Anton Warrin, Franklin, Ky.

THE "active" Stroppler insures fifty to one hundred smooth shaves with each wafer blade. It's worth investigating. Free booklet. King Stroppler Co., Cleveland, O.

A MILD and pleasant smoke, "Figola" clear Havana cigar twenty-five box \$1 prepaid. Money back if not satisfied. Beaver Cigar Co., Canton, Ill.

CAPITALIZE your sparetime. Make \$50.00 to \$100.00 monthly. Experience unnecessary. Want active man each locality. Introduce us to friends. Sick, injury, death Insurance Protection. Write for Cash-Bonus offer. Box NP-293, Covington, Ky.

DISCARD your suspenders and get satisfaction, comfort and pleasure the year round by wearing the original, invisible, non-slipping L. & N. belt, \$1 postpaid. Send for circulars. L. & N. Belt Co., 1257 N. Clark, Chicago, Ill.

DIRECT from "Factory to Feet" Men's fine union made shoes at a saving of \$1.00 to \$2.00 per pair. Satisfaction guaranteed. Prompt shipment. Write tonight for "All styles" booklet. Pathfinder Shoe Company, Dudley, Mass.

ALL makes of safety razor blades sharpened better than new. All work guaranteed. Write for circular. Stanley H. Calkins, Cohoes, New York.

SAFETY Razor Blades Sharpened Better Than New, with our Latest Improved Automatic, Power Stropping Machine, for 2c each. Keen Edge Guaranteed. Detroit Sharp Edge Co., 1436 Wabash Av., Detroit, Mich.

FOR THE HOME

GOLD Fish—the most beautiful, least troublesome and longest lived pets. Aquarium globes, water plants. Free catalogue. Pioneer Aquarium Co., Racine, Wisconsin.

MAKE your own mission furniture at the minimum of expense. Our 3 books "Mission Furniture. How to Make It." Parts 1, 2 and 3, tell in plain, simple language just how to make 86 different pieces. Full dimension working drawings and half tones of finished articles. Price, 50 cents each or \$1.50 for the three volumes, postpaid. Popular Mechanics Book Dept., Chicago.

METAL Work and Etching—A 96-page handbook for art metal workers telling how to make a great variety of useful and ornamental objects such as desk sets, arts-crafts jewelry, etc. Price 50c, postpaid. Popular Mechanics Book Dept., Chicago.

BEAUTIFUL arts-crafts lamps—Anyone can make them out of paper, cardboard and wood. 16 designs. Inexpensive yet artistic. Complete book of instructions. Price, 50c, postpaid. Popular Mechanics Book Dept., Chicago.

FOR Christmas—give a Daily Expense Record for a gift to begin with the New Year. It will be appreciated and will help reduce expenses. Very complete and instructive, 50c postpaid. Auburn Supply Co., Dept. JJ, 7746 Peoria St., Chicago.

CHAIR tips, thick, durable, woven wool felt. No more scratched polished floors, or noise. Easily attached, are better than rubber. Dozen prepaid, eight 2c stamps. Give diameter wanted, you will be pleased. Chas. Haeusser, 1267 Broadway, Albany, N. Y.

CHRISTMAS Candy. Get ready and learn how to make your own candy. A splendid and complete course, 50c postpaid. Auburn Supply Co., Dept. GG, 7746 Peoria St., Chicago.

MARTIN'S Prepared Bladder Bags for Ice and Hot Water used in the sick room and hospitals. Superior to rubber, being soft, featherweight and flexible. Will not leak. At your druggist, or sent on receipt of 25c coin or stamps. Henry Martin & Co., 5323 Greenwood Ave., Chicago.

GET my money saving price on that prescription you are having filled frequently. William B. Davis, Ph. D., 517 Main St., Sta. K, Wilkes-Barre, Pa.

PRESENT family—Our Daily Expense Record; helps to reduce cost of living; post-paid, 50c; 25 household hints free. Agents write also. Parkinson, 5837 5th Ave., Chicago, Ill.

HOW to make Ice Yacht, Pantograph, Rubber Stamps, Incubator, 25c each. Large list of others. C. M. Shigley, Columbus, Ohio.

GAMES AND ENTERTAINMENTS

AMATEUR Minstrel Shows. Complete play written for you after you acquaint us with your needs. Guarantee you use every joke. Three hour performance for four End-Men, "Two Dollars." Entertainment, Box 414, Ardmore, Pa.

PLAYS, Vaudeville Sketches, Monologues, Dialogues, Speakers, Minstrel Material, Jokes, Recitations, Tableaux, Drills, Musical Pieces, Entertainments for all occasions. Make Up Goods. Large Catalog free. T. S. Denison & Co., Dept. 11, Chicago.

YOU can be a magician, travel, give shows, earn money. I tell how. Send stamp. Prof. Rapp, Box 1115 F, Madison, Wis.

NEW and Novel Jokes—great fun producers. So simple a child can operate them. 1. The Spilt Jam (Look what you've done to the table cloth! !). 2. Red Hot Cinder (Drop it on the rug or floor in front of fireplace). 3. Damaged Flinger (Deceptive blood-soaked bandage. Great sympathy is expressed by your friends). 4. Blot of Ink (The Bookkeeper goes mad. Mother is frantic). Price 10 cents each postpaid. Address Popular Mechanics Book Dept., 318 W. Washington St., Chicago.

FREE—1913 magic catalogue, 208 pages, 350 illustrations, 800 tricks, puzzles, illusions for parlor or stage entertainment. Positively the largest assortment in the world. Buy direct from the manufacturer, cheaper and better apparatus. 30 years in the magical business. Send 6c (stamps) for souvenir Pocket Trick Bargain list and particulars. Magic Co., Dept. 10, 249 West 38th St., New York.

THE "Magic" Fortune Teller. Will answer any question. It will also advise. You and your friends will be entertained for hours. Each one is handsomely nickelled, of best workmanship, and will not get out of order. Price 20c, 3 for 50c, by mail. Parkhurst Novelty Co., Dept. 2, East Orange, N. J.

DIMINISHING Card, Twister-scope, ring and finger, immovable card, quarter trick, jumping string. Apparatus for all, 10 cts. Merlin, 3218 Snyder Ave., Brooklyn, N. Y.

MAGIC Trick Cards. With these cards you can perform the most wonderful illusion. Change from Jacks to aces, blank cards, etc. The transformations are mystifying. Price 10 cents with big illustrated catalog. Walwen Magic, 148 Nassau St., New York.

FORTUNE Telling Chart—New, scientific. Combines Palmistry, Astrology and Phrenology. (size 17 x 21 inches). Mailed for 25c, silver. Daniels, 2533 Church Ave., Brooklyn, N. Y.

A CART load of fun for ten cents. Catalog free. McGuinness Co., 612 East Fourth Street, Brooklyn, N. Y.

SPIRIT pictures, 35 subjects—easy to do—10c. Klein, 1193 Broadway, N. Y.

WIGS and Makeups for theatrical and street use. Percy Ewing, Decatur, Ill.

KER-CHU powder. A pinch blown into the air makes everyone just sneeze their heads off without knowing why. Great fun. Absolutely harmless. Sample vial, 10 cents, three for 25 cents. Catalogue included. Joseph Methieu, 203 Court St., Brockton, Mass.

NEW Magic Tricks! Just Out. Souvenir Trick and three Illustrated Bargain Catalogues of Magic Tricks, Books, Jokes, Puzzles, etc., free. Eagle Magic Co., Minneapolis, Minn.

TRICKS—Tricks—Tricks. Largest assortment of tricks, jokes and novelties in the world. Send 2c stamp for illustrated catalogue. C. J. Felsman, Chicago, 164 N. Clark St., (Main Store), 115 State St., (Palmer House Lobby).

MAGIC Tricks, Books & Supplies. Largest line in the world. Old reliable firm. Mammoth catalogue, ten cents. See our ad on page 8. Read & Covert, 821 East 43d Street, Chicago, Illinois.

SEND 10c for Two Standard Puzzles and receive free. Two Card, Two Coin Tricks. Two Joke Novelties, with apparatus and catalogues. Puzzle Works, 323 N. Eugene St., Chicago.

GREAT Fun with Sneezing Powder, and Itching Powder—10c each postpaid, with catalogues. Novelty Woras, 323V Eugene St., Chicago.

STAMP COLLECTING

WE publish the most important periodical upon the subject of stamp collecting in America. Free sample copy. Tell us if you are interested in this fascinating pursuit, or if you seek information about the value of rare stamps and where to find them. Or perhaps both? We submit desirable stamps on approval to collectors, and furnish information to sellers. Stamp Security Co., Wellston Station, St. Louis, Mo.

STAMPS free—8 different Costa Rica, or 3 different Soudan (camel), big stamp lists, etc., for 2c postage. If you collect stamps, write us. Old collections bought. W. C. Phillips & Co., Glastonbury, Conn.

500 FOREIGN Stamps and hinges, album, 10c. Essex Co., 4730 Chickering Ave., Cincinnati, Ohio.

FREE 200 foreign stamps including Gwalior, Canton, Morocco, Tunis and King George issues—4c (stamps) postage. American stamps bought. Buying list 10c. Light-brown Stamp Co., Palmerston, R. 4., Southsea, England.

STAMPS 100 varieties 2c. Approvals half and one cent net. Palm Stamp Co., 249 N. Carondelet St., Los Angeles, Calif.

SPECIAL, 250 different stamps (no envelopes), 15c. Atlas Stamp Co., W. Somerville, Mass.

PACKET of 23 stamps; no two countries alike, 500 hinges. Set of \$1 and \$2 U. S. Rev., all for 5c. Miami Stamp Co., Toledo, Ohio.

100 FOREIGN Stamps, all different, some very rare in each set, 25c. Auburn Supply Co., Dept. FF, 7746 Peoria St., Chicago.

COLLECTING stamps an interesting profitable hobby. 100 different foreign, 2c. Low priced stamps on approval. C. Arthur Pitkin, Montpelier, Vt.

205 DIFFERENT foreign stamps free. Remit 25c six months subscription McKee's Stamp Weekly, Boston, Mass. If preferred stamp album holding 1,200 stamps.

FREE—8 varieties unused for name, address three collectors, 3c postage. Utica Stamp Co., Utica, N. Y.

STAMPS, 100, all different, free. Postage 2c. Mention paper. Quaker Stamp Co., Toledo, Ohio.

STAMPS—105 China, etc., stamp dictionary and list, 2c. Bullard, Sta. A, Boston.

FOREIGN Stamps—1,000 mixed, 20 cts. Stanton, (F) Norwich, N. Y.

50 DIFFERENT, 10 cents. McCann, 321 No. Newton, Minneapolis, Minn.

24 VARIETIES Cuban stamps 10 cents. List of 6,000 low-priced stamps free. Chambers Stamp Co., 111 P. Nassau St., New York City.

FINE unsorted mission stamps, many countries; eleven pounds, \$4.00 free, anywhere. Cash with order. Ern Willems, Pacification, Ghent, Belgium, Europe.

100 ATTRACTIVE foreign revenue stamps 20c. Bulletin free. Oscar Hartmann, 1534 26th Ave., Denver, Colo.

STAMPS—Old Stamps Purchased. Highest prices paid. Poole, Altadena, California.

RARE COINS

FOREIGN Coins, 10 different, 15c. Old Bills, 10 different, 35c. C. L. Burgess, 522 Beacon, Toledo, Ohio.

COINS. I pay from \$1 to \$600 for thousands of rare coins, stamps and paper money to 1894. Send stamp for illustrated circular, get posted and make money quickly. Vonbergen, the Coin Dealer, Dept. P, Boston, Mass.

OLD Coins Bought and Sold—My new 50 page Fall Coin Selling Catalogue just out—Free to Collectors Only—Buying Coin Catalogue sent on receipt of 10c—William Hessein, Malley Bldg., New Haven, Conn.

GREENBACKS—Pack of \$1,200 Stage Bills and present, 10c; 3 packs 25c. Send for a pack and show the boys what a wad you carry. Arthur Nichols, Chill, N. Y.

WE want to buy rare old money of all kinds. We pay \$100 for certain 1853 half dollars; \$8.00 for certain 1853 quarters; \$100 for 1894 Dime S. Mint, etc. We pay highest cash premiums on thousands of coins and bills dated to 1907. Send today 4c for our large illustrated coin circular. It's full of valuable information. The Numismatic Bank, Dept. H, Fort Worth, Texas.

\$7.75 PAID for Rare Date 1853 Quarters \$20.00 for a Half-Dollar. We pay a cash premium on hundreds of coins. Keep all money coined before 1900, and send 10 cents at once for our New Illustrated Coin Value Book; size 4x7. It may mean your fortune. C. F. Clarke Co., Coin Dealers, Box 15, Le Roy, N. Y.

COINS—20 different foreign 25c, 10 different bills 25c, 200 different stamps 15c. F. L. Toupal Co., Chicago Heights, Ill.

COINS—California Gold, 25c size, 40c, 50c size, 75c.—Coin 1,500 years old, 15c. Ray Chapin, New Berlin, N. Y.

MUSIC

LEARN piano playing and music easily and correctly. My copyrighted self instructor positively shows how without teacher from beginning to advanced Scales, Chords, Modulations, Progressions, "Carmen, Trovatore, Lohengrin, Lucia," etc., quickly mastered. Text complete, 75c. J. E. Strohm, 326 Audubon ave., New York.

WE made a fortune on "Billy," "Cheer Up Mary," "Keep on Smiling," and a dozen other hits. We are making big money for new writers. Send us your Poems, Songs or Melodies. Kendis & Paley, 1307 Broadway, New York.

SHEET Music. Popular selections at wholesale. To introduce our proposition we will send two big hits, postpaid for 10c. Humboldt Music House, 1856 N. Humboldt St., Chicago.

SONG Poems wanted. Cash or royalty paid for popular hits. Particulars free, with bulletin of latest gems. Agents make \$10 daily selling our music. Needham Music House, 61 Pierce, St. Louis, Mo.

RAG-TIME piano playing taught by mail. Book free. Christensen, 84 Auditorium Bldg., Chicago.

SEND stamp for list of 250 orchestras of dance music. Chas. Eads, Valentine, Neb.

ALL the favorite old songs. Words and music complete in book form with attractive cover; size 7½x9½ inches; good value. Price 50 cents, postpaid. Popular Mechanics Book Dept., Chicago.

TO introduce our catalogue we will include one copy of the latest sheet music, with same for 10c. The Music Shop, 3227 Beach ave., Chicago.

"MY Airship Girl," just out. "Moonshine," Indian lyric. Introduction prices, 20c; the two, 35c. Author, William Gilles Bow, Wash.

SONG poems wanted. Send us your song poems or melodies. They may become big hits and bring thousands of dollars. Past experience unnecessary. Available work accepted for publication. Copyrights secured. Instructive booklet and information free. Marks-Goldsmith Co., Dept. 20, 506 14th street, Washington, D. C.

LEARN Violin or Mandolin by note; our charts with 20 illustrations fully explained show how, 25c; superior Violin strings 50c set; Mandolin, 18c set. Mayberry, 175 6th Ave., New York.

WANTED—Song Poems and Melodies of all kinds for immediate publication. Mozart Music Library, 1431 Broadway, New York.

SONG Poems examined free. Send yours make money. Music Clearing House, 147 West 45th, N. Y.

ONG Writers—Get our proposition be-
ing paying to have your work published.
Salter Music Publishing Co., Perth
boy, N. J.

POEMS wanted. Cash for good talent
and Music House, Chicago.

PIANOS AND MUSICAL INSTRUMENTS

ANJOS, Mandolins, Guitars and real
size Violins at Factory prices. Joseph
gers, Jr., Mfr., Farmingdale, N. J.

FOR Sale—Good 'cello. N. Johnson, 529
Vine, Newton, Iowa.

TELEGRAPHY

TELEGRAPHY—Morse and wireless—
lway accounting (Station Agency)
ght quickly. Railroad Dispatchers' and
stern Union Wires and complete Wire-
Station in school. Splendid oppor-
tunities. Graduates assisted. Living ex-
enses low—may be earned. Largest and
est school—established 38 years. Invest-
nt, \$25,000. Correspondence courses
o. Catalog free. Dodge's Telegraph,
lway and Wireless Institute, 15th St.,
paraiso, Ind.

TELEGRAPHY taught in the shortest
sible time. The Omnigraph Automatic
nmitter combined with standard key
l sounder. Sends you telegraph mes-
es at any speed just as an expert op-
er would. Five styles, \$2 up, circular
e. Omnigraph Mfg. Co., 41 G. Cort-
d St., New York.

WIRELESS

THE best 25c wireless books published.
ow to Make Wireless Instruments," by
wireless experts, 96 pages, 75 illustra-
ns. "Wireless Telephone," by H. Gerns-
ck, 80 pages, 57 illustrations. "Construc-
n of Induction Coils and Transformers,"
H. W. Secor, 100 pages, 72 illustrations.
ireless Hook-ups," 100 pages, 161 il-
trations. Price, 25c each or the four
75c, prepaid. Wireless Association, 229
lton St., New York.

WIRELESS Set, How to Make—96-page
ok telling how to construct at small
t an outfit suitable for transmitting
r five miles. Price 50 cents, postpaid.
ular Mechanics Book Dept., Chicago.

POTENTIOMETER Rods 1,000 Ohms 15c.
Miller, 382 Brooklyn, Detroit, Mich.

ELECTRICAL

ELECTRICITY. Are you interested? If
m can teach you all kinds of wiring,
m the simplest to the most complicated,
our Blue-print-chart-method. It is so
ple any one can understand it. We
ow you how to wire for all kinds of
ls, annunciators, telephones, house wir-
ng, conduit, theatre, isolated plants, dyna-
ms, transformers, arc lights, special treat-
e on all kinds of motor wiring. Write
w for information. Electrical Wiring
gram Co., Box A 173, Altoona, Pa.

RENEW Old Dry Batteries: formula and
mplete instructions twelve 2c stamps.
aranteed. Profitable Service Bureau, 4333
Sawyer Ave., Chicago.

DRY batteries worn out, made better
n new at low cost. Instructions, 20c.
llamaek, Grampian, Penn.

BATTERY Testers, 50c each, or \$5 per
zen. This is a bargain. Standard Sup-
y Co., Box 960, Providence, R. I.

PRINTING AND ENGRAVING

1,000 CIRCULARS, 3x4 in., 65c; 5,000,
50, prepaid. Will print them as circu-
s, labels or shipping labels. Harry P.
mmuel, 3025 Germantown Ave., Philadel-
ia, Pa.

5,000 PRINTED gummed labels \$1 de-
ered. Parcels Post address labels 5 cents
ackage. Gilmartin, 54 East 129th, New
rk.

PRINTING Presses, type, supplies. Cat-
og free. L. M. Carroll & Co., 326
dison St., Chicago.

ALL for \$1.10: 100 letter heads, 100 en-
opes, and 100 business cards printed to
r order on bond paper. Samples free.
rter Co., Rochester, N. Y.

50 CALLING cards 25c. Grandon,
nter, Jackson, Mich.

DISTINCTIVE business-getting printing.
Samples 2c. Kigerpress, Brighton, Iowa.

5,000 FOUR page folders \$10. 10,000
\$15. Grandon, Printer, Jackson, Mich.

1,000 GUMMED labels, 2x1. 50c post-
paid anywhere; we print anything; cata-
logue free. Walter's Printery, 35 Myrtle
Ave., Brooklyn, N. Y.

PRINTING—500 either envelopes, note-
heads, statements, cards \$1.00; 1,000, \$1.50.
1,000 envelope slips \$1.00. 500 linen finish
letterheads or envelopes \$1.50; 1,000, \$2.50.
Imitation typewriter letters \$2.00 per 1,000.
Model Company, Manchester, Iowa.

100 CARDS, name and address 30c.
Business cards, 45c. 100 envelopes, 35c.
100 letterheads, 60c. Elite Exchange, Dept.
T3, 3827 No. 44th Ct., Chicago.

GOOD Printing at low prices. 1,000
good letterheads, envelopes, cards, billheads,
labels, circulars, \$2.50. Samples free.
Catalogues, booklets, and circulars our spe-
cialty. Ernest L. Fantus Co., 523 S. Dear-
born St., Chicago.

GUMMED Labels—1,000, 48c. 3,000, 85c,
size 1x2 inches printed and postpaid. Other
styles and sizes. Send for catalogue. Robert
Finnesey, Bulletin Bldg., Philadelphia,
Pa.

100 ENGRAVED style calling cards, 25c.
100 business cards or envelopes, 40c. Ret-
ter Bros., Box 142-P, Tippecanoe City, O.

100 CAMBRIC Bond letterheads and 100
envelopes, prepaid for \$1. People's Press,
Preston, Minn.

PRINTING Presses; various sizes; type
and supplies. Bargain list for stamp.
Popular Bargains, Richland, Pa.

FREE—Book-form card case, with 50
name cards at 30c postpaid. Jno. J. Fried-
man, 532, West 3rd, Erie, Penna.

ACTUAL Typewritten Letters. Cheap.
Produced through big, typewriter ribbons.
Letterhead printing. Samples, 4c postage.
Billy M. Schwartz, 82 Congress St., East,
Detroit, Mich.

FOR \$2.90 will print to your order 500
envelopes and 500 letter heads. Material
and work first class. Samples free. Pearl
Printing House, Palestine, Ill.

MULTIGRAPH form letters—\$3 for 1,000.
Includes stock, letter, letterhead—sent
prepaid in U. S. Specimens free. Perfec-
tion Letter Company, Muncie, Indiana.

ACME Coin Makers—\$2.60 per 1,000.
For 6 coins \$3. Any printing desired.
Samples free. Dodd Printing Co., Fort
Madison, Iowa.

HEADQUARTERS for type, brass rule,
printing presses and material. Lowest
prices. Philada. Printers Supply Co., 14 S.
Fifth street, Philadelphia.

1,000 BOND 3 1/2 x 6 circulars, prepaid, \$1.
Smith Supply, Waukegan, Ill.

200 TASTY letterheads, billheads or en-
velopes plate printed \$1, postpaid. Plate
Printery, Richland, Pa.

GUMMED Stickers, 3,000, \$1. Adver-
tising Specialties. Catalogue free. Mac-
Taggart, 1235 Arch, Philadelphia, Penn-
sylvania.

LOOK here—100 letterheads, 100 en-
velopes, 100 return envelopes or business
cards, printed for \$1 postpaid. Walden
Press, Roxbury, Mass.

YOUR name and address on 1,000 white
gummed labels for return envelopes, mail
packages, books, etc. The handiest thing
you ever saw. Price, 50 cents. Harold R.
Parnelle, 108 Calhoun St., Springfield,
Mass.

1,000 IMITATION Typewritten letters,
heading black, body purple, \$3. (1,000 3 1/2 x
5 1/2 colored bond ad slips, 150 words \$1
postpaid.) Samples free. Good's Printery,
Harrisonburg, Va.

BUSINESS Producing stationery is our
specialty. Send for samples and prices.
The Letterhead Shop, 4105 Colorado Ave.,
Chicago.

PRINTING and Lithographing samples,
4c. Otter Press, 563 Lexington Ave.,
Brooklyn, N. Y.

CRANSTON paper cutter, good as new,
\$35. George Wills, Canal Dover, Ohio.

OFFICE EQUIPMENT

PUT Atchison's "Shock Absorber Cush-
ion" under your typewriter. Saves your
nerves; stops the noise. 25c, postpaid.
A. E. Atchison, 4127 W. 21st St., Chicago.

TYPEWRITERS AND SUPPLIES

SAVE \$25 to \$50 on manufacturers'
prices. Buy our Factory Rebuilt Type-
writers. Nearest-to-new on the market.
Have trademark and guarantee, like new
machines. Are thoroughly rebuilt, highly
polished, and perfect in appearance. Satis-
faction guaranteed. We are the largest
rebuilt typewriter concern in the world.
Branch stores in leading cities. Write for
catalog of standard makes. American
Writing Machine Co., Inc., 345 Broadway,
N. Y.

WOULD you show our wholly visible
Typewriter to your friends and let them see
wherein it excels any \$100 Typewriter
made, if we would send one to you Free of
one cent of cost for you to keep forever as
your own? Then on a postal card, or in
a letter to us, simply say, Mail particulars.
Emerson Typewriter Co., Box 183, Wood-
stock, Illinois.

TYPEWRITERS—Agents wanted in every
town and city to represent us. Sample
machine at cost. Write for proposition.
Large profits and your own machine at
cost. Special this month, 100 sheets car-
bon and 3 typewriter ribbons for \$2. Gla-
zier's Typewriter Exchange, Leonard Bridge,
Conn.

SAVE \$25 Prudent Buyers: Rebuilt Un-
derwoods, Olivars, Royals, Fox Visibles,
\$28.50; Smiths, Remingtons, \$18.50; Sent
on approval. Write for "Specials." Old
Reliable, Consolidated Typewriter Exchange,
245 Broadway, N. Y.

TYPEWRITERS—Every kind on the
market. Write today for best bargain you
ever secured. Shipped anywhere on ap-
proval. \$10 up. Fletcher Typewriter Co.,
207 N. 7th St., St. Louis, Mo.

NEVER buy a typewriter until you get
my complete catalogue and price list of all
standard makes. A. E. Atchison, 4127
West 21st St., Chicago.

TYPEWRITER Bargains. Royal Stand-
ard Visibles, like new, \$25. Get catalogue
and bargain list. Minnesota Typewriter
Company, Minneapolis, Minn.

TYPEWRITERS: Oliver No. 5, only \$35.
Guaranteed absolutely perfect. Shipped on
approval. H. J. Postlewaite, Hammond,
Ind.

GENUINE typewriter bargains, no mat-
ter what make, will quote you lowest prices
and easiest terms. Write for big bargain
list and catalogue 17. L. J. Peabody, 278
Devonshire St., Boston.

TYPEWRITERS—Bankrupt sale; great-
est sale in history, good condition, guar-
anteed one year. Low as \$10. Sent for
trial at our expense. Write for catalogue
16. Typewriter Inspection Co., 237 W. 4th
St., Cincinnati, Ohio.

OLIVER latest model No. 5, and L. C.
Smith, good condition. Cost \$100; sell for
\$30. Box 33, Oakley, Ohio.

FOR Sale—Royal typewriter, cost \$65,
used for three months, sell for \$40. August
E. Theurer, Jr., 3022 Seymour Ave., Cleve-
land, Ohio.

MISCELLANEOUS

VALUABLE collection of reliable formu-
las, rare trade secrets of every description.
Result of chemists 20 years collecting and
research. "Sunblaze" Brass Polish, "Gold
Dollar" polishing cloths, "Solveo" Paint
and Varnish Remover, Bakers Egg Sub-
stitute, "Dandelion" Butter Color, "Scat"
Chemical Soap, Solderine, Massage Cream,
Hancock's Liquid Sulphur, True Maple
Flavor, Italian Egg Preserver, Artificial
Rubber, Tire Cements and Fillers, Lumin-
ous Paints, Magic Dry Cleaner, Dustless
Dust Cloths, and hundreds of other in-
dustrial and technological formulas, many
printed for the first time. Complete in 2
books with late added supplementary sheets,
also a 32 page formula monthly for a year,
\$1.25 postpaid. Write me for information
regarding any formula or preparation. Lis-
comb J. Miller, Care Evak Chemical Co.,
Marietta, Georgia.

YOUR ad goes into 1,200,000 rural homes
every week if you use Boyce's Weeklies.
Low rate and big returns. Write for free
Result Checking Book. Use Letterhead.
Classified Dept., 500 Dearborn Ave., Chi-
cago, Ill.

OWN a business. Make big money. Be independent. Start during spare time at home and grow fast. Mail order or local. We, as manufacturers, have a new "tested out" selling plan that will make big money for our co-workers. Newly patented everyday necessities of positive merit. Repeat orders. We train you. Are now ready to add representatives in all localities. Get out of the "rut" and write me for full outline of (copyrighted) plans, sworn statements and positive proof. Grasp this opportunity by writing me today. J. M. Pease, president, J. M. Pease Mfg. Co., 609 Pease Bldg., Main St., Buffalo, N. Y.

"BLACK" Opals—Australia's most beautiful gem. Exquisite colors—deep red, blue, green, gold, violet. Order direct from Australia, at Australian prices. Write for illustrated catalogue. Norman Seward, 455 Bourke street, Melbourne, Australia.

I WILL start you earning \$4 daily at home in spare time, silvering mirrors; no capital; send for free instructive booklet, giving plans of operation. G. F. Redmond, Dept. 306, Boston, Mass.

BLACKSMITHS, wood workers, contractors, etc., get circulars and prices on our all Steel Jointer Heads, makes wood working easy. John Whisler, Gibson, Iowa.

TOBACCO Cure. One box cures. Guaranteed or money back. Established 1894. Write for special offer. Allen Distributing Co., 319 Altman Bldg., Kansas City, Mo.

RARE Books. Swedenborg's "Heaven and Hell," 400 pages, 15 cents postpaid. Pastor Landenberger, Windsor Place, St. Louis, Mo.

BROTHER—Accidentally discovered root will cure tobacco habit. Gladly send particulars. F. Stokes, Mohawk, Florida.

DON'T fail to read Independence and Fortune under Business Opportunities.

FIVE Sporting Postcards, 10c. Miss A. A. Banner, Station R, N. Y. City.

BEN Franklin printing office complete, \$1.50. Juron & Co., 1400 Noble, Chicago.

MATHEMATICS made easy for all by Ropps' Calculator. Figures out, in the twinkling of an eye, every conceivable problem that occurs in the Office, Store, Shop, Bank, Farm or Factory. Greatest time and labor-saving work on figures in the world. Copyright, 1912. Price, \$1 Vest pocket size, 50c. Popular Mechanics Book Dept., 318 W. Washington St., Chicago.

1,200 CARTOONS for \$1. A Panorama of World Events. Political—Industrial—Social—Humorous—Tragic—all of intense human interest. Six numbers of Cartoons Magazine (January to June, 1912, inclusive) representing the best work of over 100 of the best cartoonists, and handsomely and durably bound in book form will be sent prepaid to any address for \$1. Cartoons, 318 W. Washington St., Chicago.

\$50.00 TO \$100.00 monthly. For your spare time. Experience unnecessary. Want active man each locality. Introduce us to friends, Sickness, injury, death benefits. Write for Cash Bonus offer. Box NS-293, Covington, Ky.

DO your teeth drop? Dentaffix, a new scientific discovery. Guaranteed to hold artificial plates firmly in place whether you eat, talk or cough. A creamy, vegetable powder; pleasant and harmless. Not a cement, does not harden. Dentaffix means comfort, health and happiness to millions. Postpaid, in plain wrapper, 50c; stamps taken. The Hoffmann Laboratories, 59 National Bank Bldg., Easton, Penn. Your money refunded at once if Dentaffix fails.

PULLS or lifts two tons. A one man tackle block. Best and handiest puller ever invented for moving or rigging; pulling wires or cables. Saves its cost in one day. Small size for automobilists and others. Illustrated circular can be had by addressing Laurent Cherry Pulley Block Co., Trenton, N. J.

NEW Boy's Magazine; altogether different; stirring stories; Boy Scouts. Mechanical, Electrical and other departments. Special features each issue. Three months subscription 10c. American Youth, 1124-P Foster Ave., Chicago.

PATENTS secured—C. L. Parker, 910 G St., Washington, D. C.

FELT pennants. All colleges, 40c each. Larger sizes, 50c. Elite Exchange, Dept. P2, 3827 No. 44th Ct., Chicago.

I WILL write the story of your life in a song poem, 4 verses 50c; 8 verses \$1. Send your story to Hugo Hedlin, 450 No. Clark Street, Chicago, Ill.

BECOME an Escape King. Packing Case, Cloth Bag, and Milk Can Escape. These three secrets only 25c. Magic Works, 323 W. Eugenie St., Chicago.

TELEPHONE Managers. Tell us your telephone troubles. We will help you. Charges reasonable. Circuits and apparatus designed for special requirements. Telephone Dep. Box 350, Aberdeen, S. D.

YOUR name and address stamped on German Silver Key Check, 25c silver. Key chain free. L. D. Thompson Co., 3159 LaSalle St., Chicago.

THE Macrophone. Wonderful new instrument. Delivers all sounds with original intensity, talks as if speaker were present; transfers piano, etc., to any distant point. The Macrophone, 170 Purchase St., Boston.

WHY work in the rut. I make \$200 a week; let me show you, any man can do the same. J. Underwood, 4749 No. Sacramento Ave., Chicago.

SMOKELESS Powder, guaranteed cheapest and best ever discovered. Write C. Lortie, 165 Miller Ave., Brooklyn, N. Y.

MAKE More Money! Operate a Mail Order business—our "Sident Salesman" system—can be done in spare time yet the possibilities are unlimited. But don't invest any money in the Mail Order business until you have read "Booster," for The Booster Magazine starts you in business for yourself—puts you next to the best money making propositions on earth—ones that really get you the money! Send 10c for two months' trial subscription. Booster Magazine, Northwestern Building, Chicago.

CANDY making—\$15 course 50c. Circular free. Eagle Co., "L" Quincy, Mass.

RAILWAY Mail Clerks—Wanted. \$75.00 month to commence. Parcels Post means thousand appointments. Every second week off duty at fully pay. Short hours. Steady work. Examinations announced everywhere Jan. 15th. Common education sufficient. "Pull" unnecessary. Farmers eligible. Write immediately for free specimen questions and schedule of examination places Franklin Institute, Dept. J 22, Rochester New York.

NIAG-Rine. A Wonderful Ink. New discovery. For expert drawings or writing use. Does not corrode or blot. Chemical proof, water proof, non-poisonous and will not stain fingers. Give it a trial. Large bottle or tube postpaid, only 20c. More facts and pens free. Address Chas. Haecusser, 1267 Broadway, Albany, N. Y.

CIRCULARS mailed with our 20 page magazine, 15c per 100. Elite Exchange 3827 No. 44th Ct., Chicago.

DEVELOP your muscles perfectly by the only sure and easy method yet discovered. Price \$1.00 or free for five addresses of young men and 12c. Address Geo. P. Wyatt, Manitou, Oklahoma.

EIGHT Games For Ten Cents—Chess, Checkers, Fox and Geese, Nine Men Morris, Authors, Introduction Game, Spanish Prison, Dominoes; a whole year's amusement and the whole thing for only 10 cents. Send 10c today and all eight games will be mailed you. Chester Ruble Centralia, Washington.

NICKEL Plate Your Auto Trimmings, Typewriters, etc., with Electro-Knickel Plate. Is applied with a cloth and plates a coat of metal (without a battery) on brass, nickel, steel or iron. Price \$1.00 prepaid. Auto Dept. Gun Metal Finish Co. Decatur, Ill.

ANYBODY can make good cuts with my simple zinc etching process; price, \$1 specimens and particulars for stamp. T. M. Day, Box M, Windfall, Ind.

ONE Dozen, Patent, Fountain Feed Pens, will fit any pen case for 25c prepaid. Callwell's Motorcycle Agency, 5 South Water St., Newburgh, N. Y.

BE a Handuff King. Earn big money on the stage. Vaudeville Circuits pay \$100 week up. I teach everything in this line. For particulars, address Box 902, Springfield, Mass.

REFINISH Your Piano or other furniture in a beautiful Art Finish, always popular. Method of a leading New York manufacturer, with explicit instructions, \$1. Guaranteed Formula Co., Topeka, Kan.

SACHET Powder in bulk; Envelopes for premium purposes; free particulars; sample 5c. A. Cadby Co., 77H Woodward Road, Providence, R. I.

FREE—Over one hundred varieties, Gunned Hotel Baggage Labels—sample with instructions, 10c. A. O. Alexander, Atlantic City, N. J.

I HAVE some dandy articles for home manufacture. Big profit payers. Particulars free. P. Benson, Stewartville Minnesota.

TOBACCO Cure, full details, etc., and one year subscription to Digest, 25c. Digest, Grand Rapids, Mich.

When you want anything and don't know where to find it—write Bureau of Information, Popular Mechanics, Chicago



If We Send You This \$10 RAINCOAT

for only \$5.00, will you promise to show it to your friends and take their orders if we pay you a good profit on each order? Simply cut this ad out, state breast measure, send no money and we will send you this \$10.00 Slipon Raincoat, express prepaid, C. O. D., subject to examination and try on. Guaranteed positively waterproof and storm proof, 50 inches long, the most useful garment ever made. If you find it a real \$10 coat, pay the express agent \$5.00 and take it; otherwise, pay nothing and coat goes back. This is a great chance to get a fine Slipon Raincoat at half-price, so order at once.

BANNER TAILORING COMPANY
Raincoat Dept. 963 CHICAGO, ILLINOIS

IF IT ISN'T AN EASTMAN IT ISN'T A KODAK

AGENTS—SURE MONEY

Showing the "NU-PANTZ" Creaser

Find out now about this new, exclusive article. Aluminum self-heating outfit, creases trousers, sleeves, etc., almost automatically. Sells at \$3.50, saves customer \$15.00 to \$30.00 a year. Five sales a day nets \$162.50 a month. Hustlers sell five in half a day. "Nu-Pantz Salesmanship" given in first letter, insures sales from the start, and means money to the live man who acts to-day—while it is new. Address



Racine Creaser Co., 43rd St., Racine, Wis.

LEARN WATCHMAKING EARN BIG SALARIES
 College famous for teaching highest art of watch work, jewelry, engraving, optics. 18 years' success. Graduates command big salaries. Moderate rates. Boarding homes nearby. Special book ready. Write PHILA. COLLEGE OF HOROLOGY, 1338-48 Somerset St., PHILA., PA.

WHINE LIKE A PUPPY Sing like a canary, imitate birds and beast with **DOUBLE THROAT. LOTS OF FUN.** Thousands sold. Price 10c; 4 for 25c; 12 for 50c.
FUN MAKERS, Dept. 4, KEWANEE, ILL. 

Three Excellent Books for Those Who Like to Make Things
Amateur Mechanics Nos. 1, 2 & 3
 PRICE 25 CENTS EACH POSTPAID
 Popular Mechanics Book Department 318 W. Washington St. CHICAGO

WHEN YOU WANT ANYTHING AND DON'T KNOW WHERE TO FIND IT
 WRITE BUREAU OF INFORMATION,
 POPULAR MECHANICS CHICAGO

A Gift Suggestion
 POSSIBLY a subscription to Popular Mechanics Magazine would make an acceptable holiday present to some friend. The giver will certainly be gratefully remembered every month for a whole year.
\$1.50 Per Year
 ORDER THROUGH YOUR NEWSDEALER OR ADDRESS
Popular Mechanics Co.
 318 West Washington Street, Chicago

MONTHLY CASH PRIZES
 Until further notice in this magazine the Editor of Popular Mechanics will pay two cash prizes each month for the best original contributions to its

SHOP NOTES DEPARTMENT
\$10 for the Best Contribution
\$5 for the Second Best
 THIS IS IN ADDITION to our usual rates for such contributed articles. Quality, not length counts. Checks will be sent on the last day of each month for the prize articles received during that month. Publication in the magazine will follow in about two months.

PRIZES AWARDED FOR NOVEMBER, 1912
 First Prize—A. O. CORWIN, Charleston, S. C. \$10
 "To Repair the Bottom of a Ship"
 Second Prize—HENRY J. MARION, Pontiac, Mich. \$5
 "Clip for Holding Tool Checks"
EXTRA AWARD
 On account of there being five contributions this month each of which deserved second prize, we have made an EXTRA AWARD of four additional second prizes, as follows:
 J. G. DAVIS, Paterson, N. J. \$5
 "Handle on the End of a Suit Case"
 H. C. RINGLE, Cambridge, Ill. \$5
 "Dual Ignition for a Gasoline Engine"
 K. W. BROWNING, Salt Lake City, Utah. \$5
 "Coal-Bucket Chute to Prevent Spilling the Coal"
 H. C. DIXON, Johnstown, Pa. \$5
 "Template for Draftsmen"
 All accepted contributions to our departments, "SHOP NOTES" and "AMATEUR MECHANICS," are paid for immediately; checks for prize awards are sent at the end of each month.
Address, EDITOR POPULAR MECHANICS
 318 W. Washington St., Chicago

\$50 GAS TRACTION COURSE FREE

Get one of these free \$50 courses in gas traction engineering. Enormous demand in every farming community for engineers. Factories want demonstrators. We teach you by actual work on a traction engine and put you in touch with factory managers who have told us they will take all the trained men we can send them. Here is a wonderful opportunity for any young man mechanically inclined. You can learn by practical work in a few weeks. Remember we give this course free! Our new traction engine has just been bought at suggestion of manufacturers in order to train young men for the work. The regular price of this course is \$50 but we want to start out a few graduates immediately, so sign coupon to-day and get the free scholarship entitling you to the full gas traction engineering course free. No previous experience is required.

EARN MORE MONEY

The object of this offer is to advertise the Sweeney System and this new branch of work which will naturally be handled by an automobile man. If you come here to take our free course you will see the work we are doing in training men for the automobile business. A trade where you are in demand 12 months in the year. Work pleasant—big demand for trained men. 90% of the automobiles in daily use are not in proper adjustment on account of shortage of experienced automobile mechanics. I want you to see for yourself, how thoroughly and practically I teach all about the automobile. Six weeks after the day you enroll in my great practical School you will be prepared to properly repair any automobile made and drive any car or truck or open a garage and repair shop of your own. You can learn the automobile business thoroughly because I have been years in working out for quick, thorough instruction, the

"SWEENEY SYSTEM" PRACTICAL AUTOMOBILE CONSTRUCTION

the most thorough, practical, interesting course of automobile instruction, and embraces every point worth knowing, including vulcanizing, brazing, oxy-acetylene welding, lathe work, machine shop practice, testing and road work, etc. You learn by doing the actual work on real cars with your own hands under the watchful eyes and ready suggestions of experienced instructors.

No Books Used—Tools Furnished FREE
 The tuition is low and, after you have paid that, you do not have another cent of expense in the school. You do not learn from books, but by practical work on real automobiles in everyday use.

Mail Coupon To-day and get back our scholarship offer on gas traction engineering, also catalog of automobile school, free magazine and other interesting, money-making information.
Sweeney Auto School
 1466 Woodland Ave.
 Kansas City, Mo.
E. J. Sweeney, Pres.
SWEENEY AUTO SCHOOL
 1466 Woodland Ave.
 Kansas City, Mo.
 Send free scholarship and catalog.

FREE COUPON
 NAME.....
 ADDRESS.....

"HELP WANTED"

-Uncle Sam.



**Railway Mail Clerks
Clerks in the Internal Revenue
and Custom Services**

Thousands of appointments coming
Spring Examinations Everywhere

**\$800⁰⁰ to \$1800⁰⁰ a Year
for LIFE**

No "layoffs" without pay, because of strikes, financial flurries or the whims of some petty boss. Excellent opportunities for quick advancement to Higher Government Positions. If you want immediate appointment, send **TODAY** for our schedule showing locations and dates of the Spring examinations. Any delay means the loss of just so much time in preparing yourself for examination.

We Prepare Candidates Free

SEND COUPON BELOW
FRANKLIN INSTITUTE
(The Pathway to Plenty)
Dept. K 106, ROCHESTER, N. Y.

The coupon, filled out as directed, entitles the sender to free sample questions; a free copy of our book, "Government Positions and How to Obtain Them," and to consideration for Free Coaching for the examination here checked.

COUPON

.... Railway Mail Clerk (\$900 to \$1800) Customs Positions (\$800 to \$1500)
.... Postoffice Clerk (\$800 to \$1200) Internal Revenue (\$700 to \$1800)
.... Postoffice Carrier (\$800 to \$1200) Stenographer (\$800 to \$1500)
.... Rural Mail Carrier (\$800 to \$1200) Clerk in the Departments at Washington (\$800 to \$1500)
.... Bookkeeper (\$800 to \$1800) Canadian Government Positions

Name.....
Address..... K 106
Use this before you lose it. Write plainly.

STUDY LAW

At Home

Become an Attorney



Have a Profession

For over 20 years our graduates have been successfully practicing law in every state in the Union and establishing the reputation of our *high grade instruction by correspondence.*

YOU Can Be a Lawyer

Three courses: College, Post-graduate and Business Law. Improved method of instruction, combining theory and practice. Actual daily lessons. *Approved by Bench and Bar.* Classes begin each month. Send for **FREE** Catalog, giving rules of admission to bar in different states, particulars of our courses, etc. *The greatest Law Correspondence School in the world.*

CHICAGO CORRESPONDENCE SCHOOL OF LAW
655 Reaper Block Chicago, Ill.

LEARN THE AUTO BUSINESS

EARN A SPLENDID SALARY

Let us train you in our splendidly equipped shops for a good position as automobile mechanic, salesman or chauffeur. Thousands of graduates are earning big salaries. Complete training in 4 weeks, including extensive practice in repairing and driving high powered cars. Tuition and board reasonable.

Send to-day for catalogue and list of graduates

CLEVELAND AUTOMOBILE SCHOOL, 2341 Euclid Ave., CLEVELAND, O.

Learn to Write



BEGIN TODAY
WRITE FOR MY **FREE BOOK**

I can make a good penman of you at home during spare time. Write for my free book, "How to Become a Good Penman." It contains specimens and tells how others mastered penmanship by the Tamblin System. Your name will be elegantly written on a card if you enclose stamp to pay postage.

FREE BOOK Write for it Today

F. W. Tamblin, 418 Meyer Bldg. Kansas City, Mo.

COPY THIS SKETCH

and let me see what you can do with it. You can earn \$20.00 to \$125.00 or more per week, as illustrator or cartoonist. My practical system of personal individual lessons by mail will develop your talent. Fifteen years successful work for newspapers and magazines qualifies me to teach you. Send me your sketch of Governor Wilson with 6c in stamps and I will send you a test lesson plate, also collection of drawings showing possibilities for YOU.



The Landon School of Illustrating and Cartooning
1438 Schofield Building. CLEVELAND, O.

THIS MAN



is one of thousands who have secured good positions as Traveling Salesmen through our Free Employment Bureau and earn from \$1,000 to \$5,000 a year. There are hundreds of such positions now open. No experience needed to get one of them. We will teach you to be an expert Salesman by mail in eight weeks, and secure you a good position where you can earn good wages while you are learning Practical Salesmanship. Write today for full particulars, list of good openings and testimonials from more than a thousand men we have recently placed in good positions. Address (nearest office.) Dept. 122.

National Salesmen's Training Association
Chicago, New York, Kansas City, San Francisco, New Orleans, Toronto



LEARN DRAFTING AT HOME

Your spare time this winter will secure you an excellent position. Instruments free. Small tuition. Write for catalogue.

MAXTON INSTITUTE
158 Lawrence St., BROOKLYN, N. Y.

MUSIC TAUGHT FREE

AT YOUR OWN HOME

By the *Oldest and Most Reliable School of Music in America - Established 1895*

Piano, Organ, Violin, Mandolin, Guitar, Banjo, etc. Beginners or advanced players. One lesson weekly. Illustrations make everything plain. Only expense 2c per day to cover cost of postage and music used. Write for **FREE** booklet which explains everything in full.

AMERICAN SCHOOL OF MUSIC 33 Lakeside Bldg., CHICAGO



How To Do It Safely?

Give up struggle for mere existence in city? Plan now safe way out. No cost to investigate. **Free Book** explains plan for man or woman. (No land to sell. No agents.) **We teach Farming by Mail.** All subjects. Which interests you!

American Farmers School 285 Laird Bldg. Minneapolis, Minn.

Be Independent!

Learn a Trade!



Plumbing is one of the best paying of all trades. Easy to learn. Plumbers receive from \$6 to \$10 a day. And that's right at the start too. How would you like to have \$50.00 in your pay envelope the first week after you graduate?



Electricians are always in demand. Big pay and short hours. Exceptional opportunities to rise higher.



Here is the Coyne National Trade Schools, where you will be taught thoroughly and perfectly by actual work and practical instruction all the details of the trade you select. Our graduates are always in demand. Employers realize their ability and are anxious to give them work.

Don't go around from door to door looking for a job. Be independent. Look the world straight in the eye and make others come to you. Be independent. The demand for skilled workmen far exceeds the supply. We teach you in a short time the highest paying trades.

\$5⁰⁰ to \$8⁰⁰ a Day

Never before were such high salaries paid. YOU ARE WANTED. Jobs—good jobs—are open now. \$5.00 to \$8.00 a day right from the start. No experience necessary. Unlimited future. Success certain. We teach you **Electricity; Plumbing; Bricklaying; Drafting and Moving Picture Operating.** We teach you in a short time at **small expense.** We give you the **actual work** to do right in our school, besides teaching the theory and fundamental principles of these trades. More requests for trained men come to our **Free Employment Bureau** than we can fill—hence we are making a **Very Special Offer** at this time. Send the free coupon for full information **at once.**

Start Your Own Business

\$3,000 to \$5,000 a Year

Many of our graduates go into business for themselves upon leaving school. Make \$3,000 to \$5,000 a year. You can do the same. We'll give you every assistance possible. Our School is the

Oldest, Largest and Best Equipped Trade School in America

You can enter any time. Open all the year round. Day and night sessions. Tuition **VERY LOW** at this time. Easy payments if desired. We will help you pay your way through school.

Free Tools We will furnish **FREE** all the tools and equipment you use while taking course. No expense to you.

Send the Coupon For Big Free Book

Start on the right road to success **NOW.** If you want to rise above the untrained class; if you want to assure your future—if you want your knowledge and services to be in demand **MAIL THIS COUPON AT ONCE.** Come to busy Chicago. These trades pay \$6.00 a day—8 hours' work. Get our Catalog and full particulars. No obligation on you at all—so mail the coupon immediately.

L. L. COOKE, Director
Coyne National Trade Schools

Dept. 1191, 39-51 E. Illinois St.
 CHICAGO

Free Coupon

L. L. Cooke, Director
Coyne National Trade Schools
 Dept. 1191, CHICAGO, ILL.

Please send me **FREE AND PREPAID** your School Catalog and full particulars about learning a trade. I assume no obligations.

NAME

ADDRESS

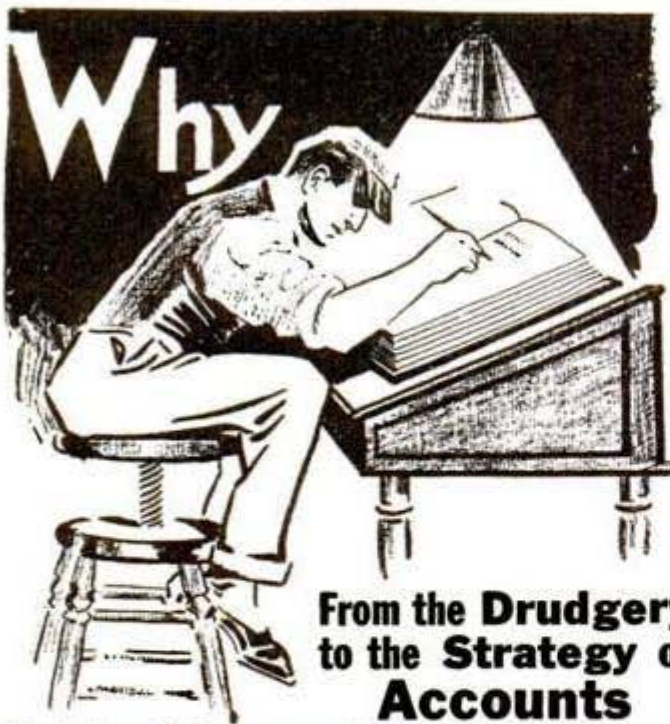

From the Drudgery to the Strategy of Accounts

The Business World pays a mere living to the routine workers; it gives its big salaries to brain-workers. Why not graduate from the drudgery of bookkeeping to the strategy of accounting?

Study Higher Accountancy

Take advantage of your present occupation; make a profit on the time, money and energy you have already invested by becoming a bookkeeper; use your knowledge and experience as the foundation on which to build your success in the profession of higher accountancy.

Salaries \$3,000 to \$20,000 per Annum

Auditors, Chief Accountants and Certified Public Accountants are all earning big salaries, and public accountants are often paid large fees equal to those received by famous lawyers. Any intelligent, energetic bookkeeper or office man can, by study and application, make himself at least a \$3,000 to \$5,000 man.

An Uncrowded Profession

As a bookkeeper, a hundred now are waiting for your job; as an expert accountant, a hundred big paying positions are waiting for you. There are only 900 certified public accountants in the United States and half a million concerns needing annual or semi-annual audits. The field is unlimited, uncrowded, and financial success sure to award ability. Whether you know bookkeeping or not, we can prepare you.

La Salle Home Study Course in Higher Accountancy

You need not sacrifice your position or income. Use your spare time only and make rapid, sure progress with the La Salle Extension University Home-Study Course, which enables you to study with one of the great educational institutions of the age, and to receive the instruction of the recognized masters of the profession. Our instruction is given by Eminent Accountants, such as, for instance: William Arthur Chase, C. P. A., LL. B., formerly President of the American Association of C. P. A.'s and Lecturer on Accountancy in the University of Illinois. Ours is the only home-study course of University grade. Don't waste precious time or risk your future with any but the very best instruction; get full information at once concerning La Salle Course. See coupon below. We prepare you for practical work.

Get Out of the Rut

You can do it. Others have—you can; but there's no time to lose. Stir your ambition, fire up your energy, decide to make a small investment of time and money now, to make yourself capable of earning many times your present salary with a great deal less drudgery.

See Coupon Below.

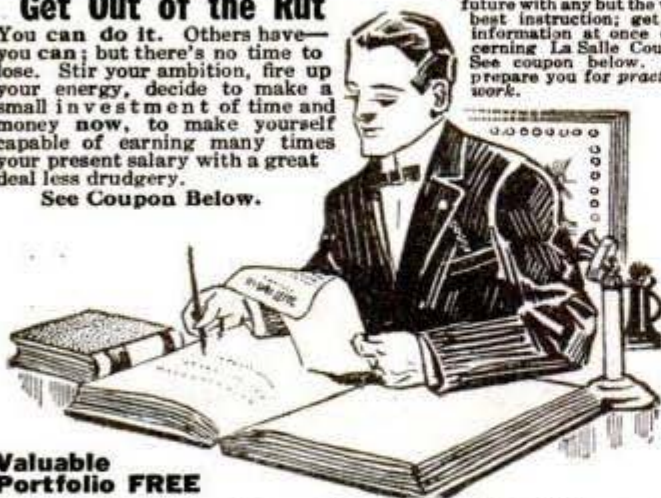

Valuable Portfolio FREE

La Salle Extension University, Dept. 415, Chicago, Ill.

FREE COUPON

La Salle Extension University, Dept. 415, Chicago, Ill.

Please send, without cost or obligation to me, catalog and full particulars regarding your course in Higher Accountancy, and advise at once if I am eligible for one of your Special Scholarships.

Name

City

State

Please Mention Popular Mechanics

A Rising Profession



Send for This Book

It's free and it shows you the way to a new profession which offers remarkable opportunities and which is not overcrowded. Thousands of business houses are looking for trained traffic managers. They will pay big salaries because such men can save them large sums of money every year.

We Are Traffic Men Teaching Practical Traffic Work

Our course of instruction by correspondence will increase your efficiency and raise your salary. Write for the book today. Tell us how you are situated and what you are doing. We want to help you but we can't do it unless you tell us something about yourself. Don't delay—write today.

COUPON

National Traffic College
12 S. La Salle St.
Chicago

Send me your free book.

NAME

National Traffic College
12 S. La Salle St.
CHICAGO

ST. & NO.

CITY & STATE

OCCUPATION

We Can Increase Your Income



No matter where you live, if you are honest and want an independent business of your own, send your name and address and we will mail you our Big Free 64-Page Book, showing you how you may earn

\$3,000 to \$10,000 a Year
in the Real Estate, Brokerage and Insurance Business.

Our President

Our system is a positive success. We will teach you by mail and appoint you our

Special Representative

and help you make money from the start. Write today.
International Realty Corp. 1436 Manhattan Bldg., Chicago



LEARN TO RUN AND REPAIR AUTOS.

Be an auto expert. We teach you at home. No need to leave your work while learning. Our course is so simple and thorough that you become an expert in 12 lessons. Free auto model furnished to each pupil. Diplomas issued and graduates assisted to positions. There is a big demand and big pay for Chauffeurs, Mechanicians, Demonstrators, and Salesmen. Our 38-page book containing employment plan, sample lessons, with many sets of charts and diagrams, is free. Write for it—today—now.

PRACTICAL AUTO SCHOOL, 68 Beaver Street, New York

WORK FOR UNCLE SAM

Government positions offer pleasant employment with good pay. Custom House, Internal Revenue, Bookkeeper, Railway Mail and Post Office Examinations everywhere soon. Any American citizen, 18 or over, eligible. Common education sufficient. Our free booklet shows how you can prepare under personal supervision of former Secretary of Civil Service Examiners. Write for Booklet to-day. PATTERSON CIVIL SERVICE SCHOOL, 100 Irving Place Rochester, N. Y.



Be the Boss

Get in the New Profession

Thousands of men are needed. The new profession that is paying big money wants you and needs you. Here is your opportunity to get into it now. You don't need to leave your present employment. Just a few hours a day in your own home and soon you get your diploma and you are a full-fledged Meter Engineer.

Be a Meter Engineer

The profession of Electrical Meter Engineering is now in its infancy. It is calling for men. The Central Electric Stations *must* have Meter Engineers, because without them they cannot operate. Thousands of positions now open. Over 400,000 new meters are going to be installed next year. Just think of the vast army of men that will be needed. And besides, Meter Engineers now are so scarce that the Central Stations are willing to pay huge sums for competent men. *YOU* can get into the profession. It is calling you.

A \$3,000 Job for YOU

Electrical Meter Engineering is one of the best paying professions in the electrical industry. We can show you hundreds of men who are making better than \$3,000 each year. **How would you like to have a \$3,000 a year job six months from now?** Just put your name and address on the free coupon and get full particulars absolutely free. Send coupon now — *today*.

Special

For a limited time we are making a special reduced price offer in order to induce men to start the study of Meter Engineering right away. Write for full particulars at once.

Send the Coupon for FREE Book

Do not delay an instant. Just put your name and address on the coupon and mail it to us at once. We will send you absolutely FREE and postpaid, our new book on Meter Engineering. It tells you all about the New Profession and about our school. It tells you how you can learn to become a Meter Engineer in your own home during your spare time. Absolutely no obligations of any kind. Just your name and address is enough. But write today — now — immediately while we can still make this great special offer.

Fort Wayne Correspondence School
Dept. 1191

Fort Wayne, Indiana

FREE Book Coupon

Fort Wayne Correspondence School
Dept. 1191, Ft. Wayne, Ind.

Gentlemen: Please send me absolutely free and prepaid your book on Meter Engineering. Also send me full particulars of the great special offer that is now being made to induce men to study Meter Engineering. I assume no obligations of any sort.

Name

Address

THE OLDEST AND BEST

AUTOMOBILE SCHOOL

Incorporated for \$10,000.00. The largest, best equipped and MOST RELIABLE automobile school in the country. Unlimited practical instruction on everything pertaining to automobiles. We guarantee to make a chauffeur, repairman, tester, salesman and demonstrator out of you in a short time or we will Refund Your Money. We have arranged with several of Detroit's largest factories to employ our graduates.

We have successful graduates in nearly every State in the Union

COME TO DETROIT, THE "AUTOMOBILE CENTER," AND LEARN THE BUSINESS
67 out of every 100 autos in the country are made in Detroit's 35 auto factories

ADDRESS DEPT. P **MICHIGAN STATE AUTOMOBILE SCHOOL** 11-13-15-17 Selden Ave.,
Near Woodward, Detroit

Be a Draftsman Draw \$125 to \$175 a Month



Wonderful opportunities now at hand! Write today. Work is light—pleasant and profitable.

Personal Instruction by Chief Draftsman

Yes, I instruct each one of my students personally. I give you practical training. If your work is right I tell you so—if it is wrong, I show you where it is wrong. For twenty years I have been doing the highest paying expert drafting work. My object is to supply the big demand for trained, practical draftsmen. At this time I can accommodate a few more men (ages from 18 to 40) in my spare time. Will give you individual and personal instruction.

FREE \$15.00 Drawing Outfit

If you enroll at once. An extra special inducement at this time to get draftsmen. I will train you right in your own home at a small expense. Pay as you wish.

Write at Once For my valuable book, "Successful Draftsmanship." Also full information about my special offer. No obligations. Write today—**now**—immediately while I am making this special offer. Earning while you learn.

Chief Draftsman, Division 1191
Engineer's Equipment Co. (Inc.) Chicago, Ill.

I Guarantee
To instruct you until you are competent and placed in a position paying \$125 to \$175 a month.



LEARN PIANO TUNING AT HOME

You can learn quickly and easily by devoting your spare time to the study of our Correspondence system. Our wonderful invention, the Tune-a-Phone, gives the exact number of beats that should occur in the test intervals. With it the student knows what the result should be. It eliminates guess work. Our graduates earn \$5 to \$10 a day the year round. We furnish full-sized action model and necessary tools. Write for valuable book FREE.

Niles Bryant School of Piano Tuning, 47 Fine Arts Bldg., Battle Creek, Mich., U.S.A.

WE CAN MAKE YOU WEARN \$125 TO \$150 A MONTH

Light, pleasant work. Study in your spare time. Be a Draftsman. Demand greater than the supply. Positions always open. Catalog sent Free, telling you how.
COLUMBIA COR. SCHOOL, Dept. P, Drexel Bldg., PHILADELPHIA

MEN WANTED!

SOUND MEN—21 to 40 years old wanted at once for Electric Railway Motormen and Conductors in every state. Wages \$60 to \$100 a Month. Experience unnecessary. Permanent employment, no strike. Write immediately for Application Blank. No colored men hired. Address Manager Employment Department, Room 935 Dwight Bldg., Kansas City, Mo.



STAMMER

My book "How to Stop Stammering"—a treatise on "Scientific Talking"—direct to the point.

Write M. L. HATFIELD, 1918 Grove St., OAKLAND, CALIF.

LEARN JEWELERS' ENGRAVING

A high salaried and easily learned trade, taught thoroughly by mail. We will teach the beginner better engraving than he can gain in years of rigid apprenticeship. We will also improve the skill of any engraver. Send for our catalog. The Engraving School, 112 Page Bldg., Michigan Ave., Chicago, Ill.



**SHOW CARD WRITERS
EARN FROM
\$21 TO \$50 PER WEEK**

LEARN ABOUT OUR FREE COURSE IN SHOW CARD AND SIGN WRITING

A Great Opportunity! We are offering, for a limited time, a complete course in show card and sign writing to those purchasing our assortment of

"Litholia" Ready-to-Use Colors This is a great opportunity for ambitious persons, either sex, to increase their earning capacity. Good show card writers in demand at \$21 to \$50 weekly, salary or in business for yourself. Our show card course is not a book of alphabets. It's a complete course in lettering compiled by an expert New York show card artist for us. "Litholia" is the only liquid pigment water paint ever manufactured, used the same as cake, distemper or tube colors, but far superior to either. "Litholia" lasts longer, always ready. "Litholia" is the best for the show card writer, the artist, or the interior decorator. A letter of request brings booklet, circulars and full information.

LITHOLIA PM. COLOR CO., 71 to 81 West 23d Street, NEW YORK CITY

FREE INSTRUCTION

IN THE OPERATION OF THE

Curtiss Flying Boat

will be given to those taking a regular course of training at the

Curtiss School of Aviation, San Diego, Cal.



First Hydroaeroplane Races at Hammondsport, N. Y.

David McCulloh in his "Flying Boat" leads; he is accompanied by Mr. Curtiss; Lincoln Beachey is second, accompanied by Lansing Callan, while Francis Wildman, instructor at Hammondsport School, is third with the standard hydroaeroplane.

AMONG the men who have learned aviation at Curtiss Schools are: Lieut. T. G. Ellyson, now in charge of the aeroplanes of the U. S. Navy; Lieut. J. H. Towers, who just established a new world's Hydroaeroplane record of 6 hrs. 10 min. 38 sec.; H. Robinson, who recently introduced the Hydroaeroplane in Europe and is now instructor in a Curtiss School; C. C. Witmer, now in St. Petersburg demonstrating Hydroaeroplanes to the Russian Navy and Army; Lieut. J. W. McClaskey, instructor in a Curtiss School; Lincoln Beachey, "The World's Greatest Aviator"; S. C. Lewis, now instructor in the Morane School in France; J. Lansing Callan, now an instructor in a Curtiss School; Francis Wildman, now instructor in a Curtiss School; Beckwith Havens, now a demonstrator; W. B. Atwater, now demonstrating to the Japanese Government, besides, a score of men who own their own machines and fly in contests and exhibitions and a dozen others have taken positions with either manufacturers or exhibition concerns.

OUR San Diego, Cal., Aviation Training Grounds, situated on North Island, in San Diego Harbor, are the finest in America, if not in the world. North Island is leased by us exclusively for Aviation purposes, and comprises one thousand acres of flat, level sand, unobstructed by rock, tree, or building, thus offering every advantage as a flying course. The Island is entirely private, yet within a few minutes of San Diego, one of the most progressive and attractive cities on the Pacific Coast.

The First Class Began Instruction December 1st.
Another Class Will Start January 1st, 1913.

A \$100.00 deposit will reserve a place for you in this class. Mail or wire it to-day. Our Booklet "TRAINING" mailed upon request.

The Curtiss Aeroplane Co., Hammondsport, N.Y.



I TEACH SIGN PAINTING

SHOW CARD WRITING or LETTERING by mail and guarantee success. Only field not overcrowded. My instruction is unequalled because practical, personal and thorough. Easy terms. Write for large catalogue.

CHAS. J. STRONG, Founder

DETROIT SCHOOL OF LETTERING
Department 102 Detroit, Mich.

"Oldest and Largest School of its Kind"
"Thoroughly Equipped Residence School"



BE A BANKER

Learn a profession in four months that will give you standing and independence. Splendid opportunities. Pleasant work, short hours, frequent holidays, yearly vacation with pay, good salary. Study at home. Highly endorsed. Catalog free.

E. G. Alcorn, Pres. AMERICAN SCHOOL OF BANKING
119 McLene Building Columbus, Ohio



MEN WANTED

Prepare as Firemen, Brakemen, Electric Motormen, and colored Train Porters. Hundreds put to work—\$65 to \$150 a month. No experience necessary. 500 more wanted. Enclose stamp for Application Blank. Name position you want.

I. RAILWAY C. I. Dept. 35 Indianapolis, Ind.

LEARN WATCHMAKING

Refined, profitable labor—Competent men always in demand. We teach it thoroughly in as many months as it formerly took years. Does away with tedious apprenticeship. Money earned while studying. Positions secured. Send for catalog. St. Louis Watchmaking School, St. Louis, Mo.



LEARNED BY ANY MAN OR BOY AT HOME SMALL COST

Send today 2c stamp for particulars and proof.

A. SMITH, Room D 74, 823 Bigelow St., PEORIA, ILL.

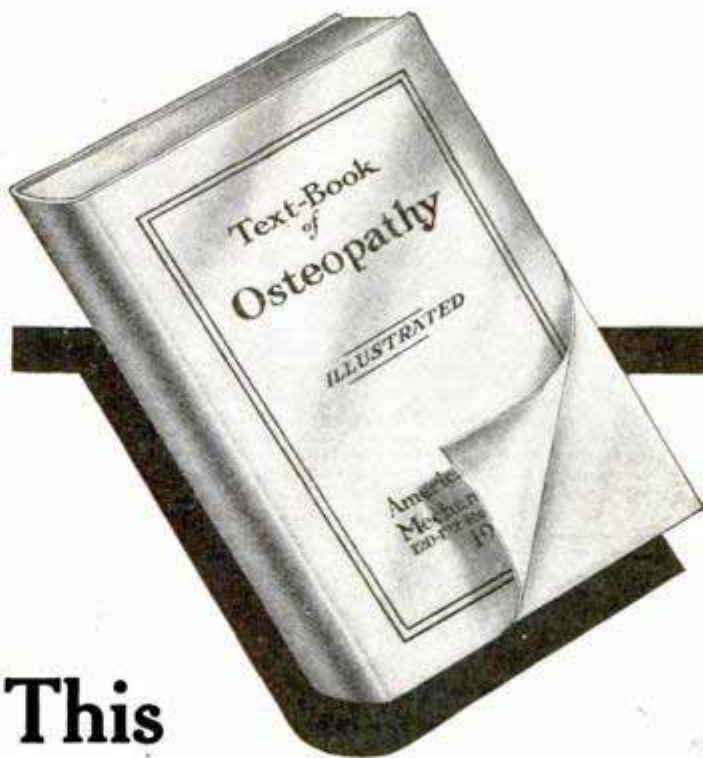

This Authoritative Book on the Science of OSTEOPATHY ABSOLUTELY FREE

More than 90 pages (profusely illustrated) containing complete and authoritative information concerning the theory and practice of Osteopathy, together with a full explanation of the profit and honor that comes to Practitioners of the Science of Mechano-Therapy (Drugless Healing); a Science far simpler and more comprehensive than Osteopathy—sent Absolutely Free to readers of "Popular Mechanics."

The possession of this remarkable book has opened the door of Opportunity to an army of ambitious men and women who desired to become Practitioners in the Science of Drugless Healing.

Thousands of successful Practitioners all over the civilized world attest to the ability of the American College of Mechano-Therapy, to educate men and women in class or by correspondence in this highly profitable and honorable profession. Eighteen millions of people in the United States today call in a Drugless Healer when they are sick.

Many of our graduates are averaging from \$10 to \$30 per day—and become proficient through studying only in their spare time in their own home.

The expert Practitioner in this Art and Science occupies an enviable position in the social and professional world—he is an expert in his knowledge of the Natural Laws of Drugless Healing.

The object of the College, in presenting you with this free text book on Osteopathy, is to enable us to more clearly define—to give you a more thorough understanding—of the Science of Mechano-Therapy (Drugless Healing). We gladly take the loss entailed by this presentation.

Send us two 2-cent stamps to cover postage. Fill in the coupon below carefully, and we will send you this book immediately, with our compliments. Address

AMERICAN COLLEGE OF MECHANO-THERAPY

Dept. 695 81 W. Randolph Street Chicago, Ill.

CLIP THE COUPON NOW

American College of Mechano-Therapy,
Dept. 695, Chicago, Ill.

To the Dean:—Please send me, with your compliments, your large text book on Osteopathy, together with complete information regarding your course in the Science of Mechano-Therapy.

My Name is

My address is

City.....State.....

The filling out of this COUPON entails no obligation whatsoever

Please Mention Popular Mechanics



Watchmaking Learn at Home

My Name.....
Address.....

Write today for free book. Tells how you can master the fine trade of watch making and earn big money. Marvelous opportunity to become independent. Learn at home. Learn this trade while holding your present position. Start in business yourself. Or take a fine paying position. We make you a better watch-maker than the men who learn the trade at the shop. Our graduates get more money. Write today for book of opportunity, it is post-paid, free to you. Send free coupon.

Wisconsin School of Watchmaking
Dept. 5245
Stroh Bldg., Milwaukee, Wis.

GENTLEMEN: Send me your free book explaining your practical course in watch-making and all particulars of your easy payment offer.

Book Sent to You Free Just send your name and address. Do that now and we will send you our great book which tells you how you can stay right at home and become the finest watch-maker by this new method. The course of instruction is very simple, very plain, very short. No fancy education is necessary. Get our free book and see for yourself what a great opportunity this is for you. Don't neglect this. Write for the book today and get it free.

FREE BOOK COUPON

Easy Payments Don't wait until you have all the money. The cost of the course is very small as we make a special, low, best-rock price offer and give you a long time to pay. Earn money while you are learning. Send free book coupon or copy it on a piece of paper or a post-card. See what a great opportunity this is for you. Get all particulars and see for yourself. Don't wait a minute or put this off. Send the coupon. Write today.

WISCONSIN SCHOOL OF WATCHMAKING Dept. 5245 Stroh Bldg. MILWAUKEE, WIS.



MEN WANTED

For the Postoffice Service

Railway Mail Clerks, Rural Carriers, City Clerks and Carriers.

For the Departmental Service

Stenographers, Book-keepers, Clerks, Examiners, Auditors, Expert Accountants, Draftsmen, Surveyors. Actual office and field practice given in our training quarters. Students of limited means earn expenses while learning.

For the Forest Service

Supervisors, Assistants, Rangers, Guards and Office Clerks.

Salary—\$1100 to \$5000 a Year

Mention position preferred. Write for free manual.

NATIONAL CIVIL SERVICE TRAINING ASSOCIATION

820 Wyandotte Street
KANSAS CITY, MO.

KEEWATIN ACADEMY FOR BOYS

An outdoor tutoring school. Winter Home in Florida. Address Principal, Mezer, Wis., or 1416 Masonic Temple, Chicago, Central 3029.

LEARN THE

AUTOMOBILE BUSINESS



In four weeks; our guaranteed course \$7.50 leads to steady jobs as chauffeur, mechanic, etc. **FREE.** Simply send name for wonderful new book

"SECRETS OF THE AUTOMOBILE BUSINESS"

Reveals inside workings of auto schools. Also get free "Trouble Chart" which tells immediately how to locate any trouble in the car.

Midland Auto Association 110 Midland Bldg. KANSAS CITY, MO.

"The Original Phonographic Method"



LANGUAGES

GERMAN—FRENCH—ENGLISH ITALIAN—SPANISH

or any other language learned quickly and easily by the Cortina-Phone Method at home. Write for free booklet today; easy payment plan.

CORTINA-PHONE

Cortina Academy of Languages
923 Mecca Bldg., 1600 Broadway, Cor. 48th St., New York

DRAWING

Caricature, Cartoon, Comic, Commercial, Fashions, Lettering, Newspaper, Magazine and General Illustrating taught by mail. Booklet 6c. Boston School of Drawing, Albion Bldg., Boston, Mass.



LEARN WATCHMAKING

Engraving and Jewelry repairing. Earn while learning. Our school endorsed by leading jewelers. Positions secured for graduates. Send for Free catalogue

CHICAGO SCHOOL OF WATCHMAKING
Dept. 20, 59 E. Van Buren St. CHICAGO

BE A DETECTIVE

Earn from \$150.00 to \$300.00 per month; travel over the world. Write **C. T. LUDWIG, 1600 Searritt Bldg., Kansas City, Mo.**

BE AN ILLUSTRATOR by mail how to draw for magazines and newspapers. Send for Catalog

Learn to draw. We will teach you **School of Illustration** 112 Page Bldg. Chicago, Ill.



WINDOW TRIMMING

Advertising and Card Writing are the best paid professions in the world. Interesting prospectus **FREE** tells you all about it. **KOESTER SCHOOL, 306 Jackson Boulevard, CHICAGO**

STAMMER NO MORE

I can cure you. Reputation world-wide. Established 16 years. Trial lesson explaining Home Instruction, with 200-page book, **FREE.** Answer at once. **George Andrew Lewis, 178 Adelaide Street, Detroit, Mich.**



LEARN TO REPAIR AND RUN AUTOMOBILES



EARN BIG MONEY IN AUTOMOBILE BUSINESS

as a chauffeur, repairman, salesman. Work pleasant. Big demand for trained men. Fine chances for starting automobile livery, agencies, taxicab and repair companies. Learn the automobile—every part, and its mechanical operation thoroughly and practically in a few weeks. Write today for our interesting free book and learn about the tremendous opportunities everywhere in

this new business and our excellent course of training.
KANSAS CITY AUTOMOBILE SCHOOL
(Conducted by CLIFF HOGAN)
(Largest and Best Equipped Automobile School in America)
2107 E. 15th Street, Kansas City, Mo.

Here's YOUR Chance!

Study

DRAFTING

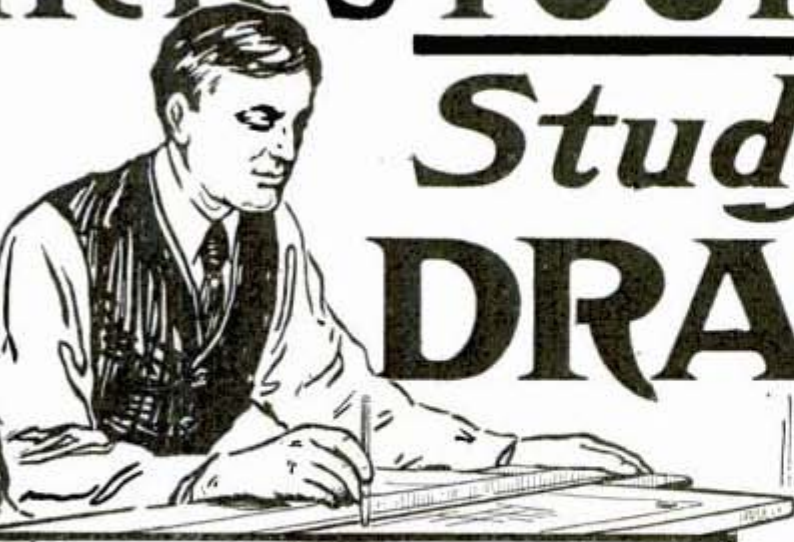

YOU can go right to the TOP and earn a big salary with pleasant work by studying drafting. Without leaving home—without a good schooling—if you can only read and write, we can train you to lift yourself out of the low-paid, ordinary class, and make you an *extraordinary, high-salaried* man! Drafting gives you a well-paying profession, and, besides, opens up the way to bigger jobs—manager, superintendent, chief engineer, government positions, contractor, business owner, etc.

NOW is **YOUR** Opportunity!

This is *your* chance to promote yourself! This is *your* chance to become leader in your trade! Don't put it off! Don't be satisfied to stay where you are, when it is so easy to advance! Drafting will give you the training that you *must have* to succeed! Mark and mail the coupon *now!*

Chicago Technical College

HOME STUDY COURSES

Machine Drafting, Machine Design, Architectural and Structural Drafting and Design, Builders' Courses, Plan Reading, Estimating, House Planning, etc. Regular and short courses. Students study blue prints of buildings and machinery in actual construction.

Free outfit to Home Study students. Free Employment Bureau. Remember, the home study work is the same as in our college day and evening classes. We give both resident and correspondence courses. State which you want.

CHICAGO TECHNICAL COLLEGE

603 Athenaeum Building, Chicago, Illinois, U. S. A.

You are looking for an opportunity to advance. Here it is! Just mark and mail the coupon today. Do it NOW while you think of it! This is YOUR OPPORTUNITY!

Good Positions Big Salaries

Chicago Technical College

603 Athenaeum Building, Chicago, Illinois.

Gentlemen: I have marked with a cross (X) the branch or branches I am interested in. Please tell me how I can qualify for a good, well-paying position.

- | | |
|---|--|
| <input type="checkbox"/> Mechanical Drawing | <input type="checkbox"/> Structural Design |
| <input type="checkbox"/> Machine Drafting | <input type="checkbox"/> Plan Reading |
| <input type="checkbox"/> Machine Design | <input type="checkbox"/> Estimating |
| <input type="checkbox"/> Architectural Drafting | <input type="checkbox"/> House Planning |
| <input type="checkbox"/> Structural Drafting | <input type="checkbox"/> General Contracting |

Name.....

Address.....

Town.....

State.....

Resident or Home Study Course

How You Can Get An Automobile FREE

We want honest, sober young men in every county to learn at home to repair, run, and to teach others, and then sell the COEY "FLYER," a 6 cylinder, 50 H. P., 5 passenger Automobile—"The World's Best Value." Write for full particulars how you can get one free—address:

**C. A. Coey's
School of
Motoring**
Dept. 209
1424-26 MICHIGAN AVE.
CHICAGO, ILL.

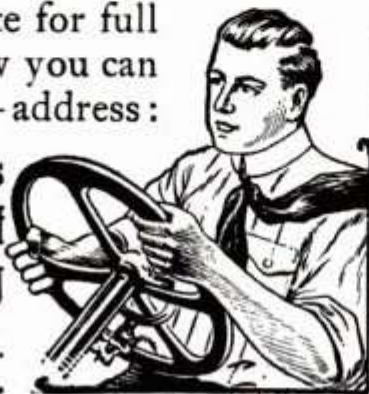

HIGHLAND PARK COLLEGE DES MOINES IOWA

Enter Any Time. 2000 Students Annually

One of the most completely equipped ENGINEERING SCHOOLS in the country. Students may enter any time they are ready to come.

COURSES OFFERED

1. CIVIL, ELECTRICAL AND MECHANICAL ENGINEERING COURSES. Standard courses are offered in Civil, Electrical and Mechanical Engineering. Special opportunity is offered for making up work or for taking a complete course preparatory to the standard Engineering Courses. Shop work from the beginning comes in preparatory courses. See our new Engineering Catalogue.

2. SHORT COURSES
1. One Year Electrical Engineering Course
 2. One Year Telephone Engineering Course
 3. One Year Steam Engineering Course
 4. One Year Machinists' and Automobile Course
 5. One Year Course in Mechanical Drawing

Just a fair common school education is all that is required for entrance to these courses. These courses are very practical and are intended for those who have but limited education and do not see their way clear to take a complete Engineering Course. The Machinists' Course is especially practical. The new machine shops are the most complete to be found in connection with any Engineering School in the United States.

SPECIAL COURSES

1. TRACTION ENGINEERING. This is the most complete course in Traction Engineering offered by any Engineering School in the country. It may be completed in three months. Students are taught how to make all repairs on engines as well as to handle them. Four traction engines used for experimental purposes.

2. GASOLINE AND AUTOMOBILE COURSES. These courses may be completed in three months. They are exceedingly practical. Complete Chauffeur practice. Just a fair common school education is all that is necessary to enter.

3. FARM BLACKSMITHING, FARM CARPENTRY.

Mention course in which you are interested. Address,

O. H. LONGWELL, Pres. DES MOINES, IA.

WHY NOT BE AN ARTIST?

STUDY drawing at home under Expert Faculty. We have successful students in every part of the world. Turn your Talent into money. Our Students are filling high-salaried positions. 14 years successful teaching. Endorsed by high authorities. 18 Courses in Commercial and Illustrative Drawing. Teachers' Normal and Applied Art, Profit or Culture. Thoroughly Equipped Residence School. Artist's Outfit FREE to Enrolled Students. SCHOOL OF APPLIED ART, 755 Applied Art Bldg., Battle Creek, Mich.

EARN WHILE YOU LEARN BE A WATCHMAKER

Watchmakers and all 'round Jewelers' repairers—in demand now. Six months' course fits you for a position—earn while you learn, too! Write for FREE book—it explains all. **STONE'S SCHOOL OF WATCHMAKING** 912 Globe Bldg. ST. PAUL, MINN.



Learn a Paying Profession that assures you a good income and position for life. For seventeen years we have successfully taught **PHOTOGRAPHY** Photo-Engraving and Three-Color Work. Our graduates earn \$20 to \$50 a week. We assist them to secure these positions. Learn how you can become successful. Terms easy—living inexpensive. Write for catalogue—NOW! ILLINOIS COLLEGE OF PHOTOGRAPHY, 999 Wabash Avenue, Effingham, Ill.

ELECTRICITY

Complete in One Year
SCIENTIFIC ELECTRICITY
IN ALL ITS BRANCHES

Bliss Electrical School
Studies restricted to theoretical and practical electricity, mechanical drawing and necessary engineering work. Teaches simplicity, concentration, hard work. For young men of energy and character. 20 years of greatest success. Graduates hold first-class positions. Opened Sept. 25. Write for catalog.

15 Takoma Ave., WASHINGTON, D. C.

LEARN TELEGRAPH

Morse or Wireless. Station Agency work also taught. Splendid opportunities. Graduates assisted. We own and exclusively occupy two large modern buildings equipped with R. R. Dispatchers and Western Union Wires and Complete Wireless Station. Oldest and largest school—est. 38 years. Investment \$25,000. Endorsed by Railroad, Wireless and Western Union Officials. Expert, practical teachers. Living expenses may be earned. Tuition low. Easy payments. Correspondence courses also. Catalogs Free.

Dodge's Telegraph, Railway & Wireless Institute
8th Street Valparaiso, Ind.

"How to Make Good Locomotive Engineer"

Full instructions, 61 pages. Full cloth binding. 50c postpaid. Special introductory half price offer. F. J. Prior, 1711 The Republic, Chicago, Ill.

THE UNIVERSITY OF CHICAGO
Correspondence-Study Dept.
HOME STUDY
offers 350 class-room courses to non-resident students. One may thus do part work for a Bachelor's degree. Elementary courses in many subjects, others for Teachers, Writers, Accountants, Bankers, Business Men, Ministers, Social Workers, Etc. Begin any time.
20th Year U. of C. (Div 20) Chicago, Ill.

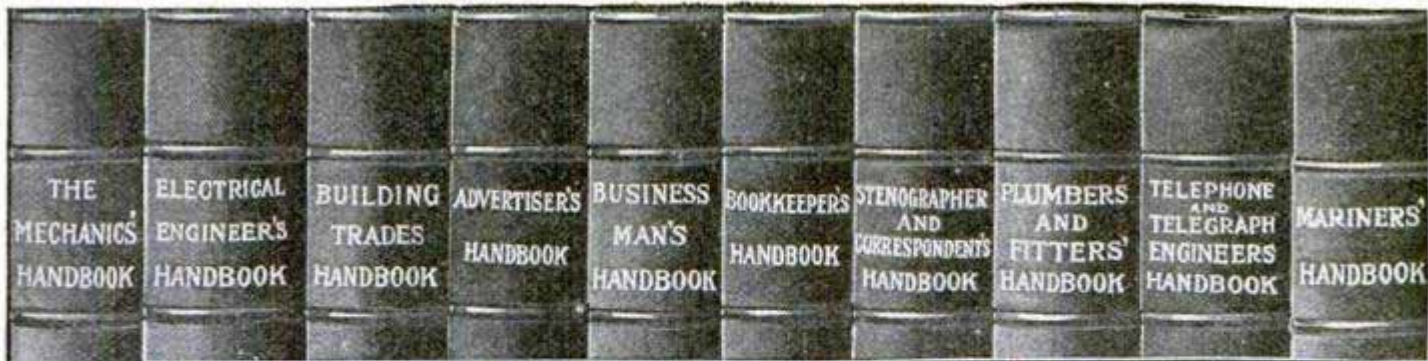

\$1.25 Handbooks for 50c.

No books in existence contain in so small space as much information about the trades and professions of which they treat as do these Handbooks. They are little giant encyclopedias of practical knowledge giving data and information that is hard to find in ordinary books. These Handbooks have been prepared by the well-known textbook writers of the International Correspondence Schools whose textbooks are recognized the world over as the most practical treatises on applied sciences ever published. These Handbooks are consulting experts of the highest rank, and are the most powerful force in the world for the promotion of ambitious men. They are an indispensable help to quicker and better work that will command advancement. They are printed on a high-grade book paper in clear type, and durably and handsomely bound in cloth with gilt titles; contain on an average of 364 pages and 175 illustrations and are regularly sold for \$1.25 each.

SPECIAL OFFER.—We are selling these Handbooks, durably bound in cloth with gilt titles, at a special price for each Handbook of 50 cents.

Mechanics'—Tables; formulas; measurements; belting; mechanical powers; hydro-mechanics; strength of materials; shafting; boiler design; care of boilers; power of boilers; chimneys; exhaust heating; machine design; machine tools; slide valve; pulleys; cylinders and steam chests; pistons; gearing; transit surveying; triangulation; curves; radii and deflections; earth work; track work; electricity; etc.

Advertiser's—How to plan and write an advertisement; type and type measurements; points on printing style; display; preparation of manuscript; proof reading; engraving and printing methods; electrotypes; matrices; advertisement illustrations; magazines; newspapers; retail, department-store, general, trade-paper, and mail-order advertising; trade marks; circulars; advertising agencies; etc.

Stenographer's & Correspondent's—Advice to beginners; shorthand speed; letters of application; punctuation; correct and faulty diction; business correspondence; type-writing; abbreviations; addressing; mailing; rates of postage; duplicating work; etc.

Telephone and Telegraph—Useful tables; mechanics; electricity; magnetism; primary batteries; storage batteries; electrical measurements; telephony; tests with magnetogenerator and bell; telegraphy; Morse telegraph systems; multiplex telegraphy; etc.

Electrical Engineer's—Mechanics; electricity; electrical units; symbols and quantities; physical and electrical properties of metals and alloys; wire gauges; magnetism; dynamos and motors; electric batteries; alternating current apparatus; alternators; transformers; wattmeters; electric transmission; electric lamps; wiring; electric heating and welding; electromagnets; controllers; car wiring; etc.

Business Man's—Arithmetic; tables; business forms; card systems; measures of extension; weight and capacity; time; value of foreign coins; duties on imports; bookkeeping; stenography; correspondence; postal information; financial terms; money and the money market; brokers and brokerage; patents; copyright and trade marks; corporations; business law; publicity; etc.

Plumbers and Fitters'—Arithmetic; involution and evolution; powers, roots, and reciprocals; circles; decimals; geometrical drawing; weights and measures; formulas; mensuration; mechanics; hydro-mechanics; building construction; heating and ventilation; gas-fitting; plumbing; etc.

Mariners'—Logarithms; trigonometry; navigation; terrestrial navigation; celestial navigation; organization of a man of war; naval ordnance; explosives; torpedoes; ship building; speed, tonnage, and fuel consumption; ropes; wind and weather; signals; nautical memoranda; etc.

Building Trades—Loads and structures; strength of materials; properties of sections; strength of rivets and pins; materials of construction; footings and foundations; masonry construction; woods used in building; qualities of timbers; joinery; framing; estimating; elements of architectural design; drainage systems; plumbing fixtures; plumbers' tables; heating and ventilation; gas and gas-fitting; etc.

Bookkeeper's—Arithmetic; formulas; tables; money; percentage; interest; equation of accounts; money and the money market; business law; financial terms; banks and banking; postal information; distances and time between various places; bookkeeping; business forms; card systems; modern office methods; cost accounting; bank bookkeeping; clearing house methods; etc.

International Textbook Co.

Box 872, SCRANTON, PA.

I enclose \$_____ for which please send me the books BEFORE which I have marked X.

- —Mechanics' Handbook —Advertiser's Handbook
- —Elect. Eng. Handbook —Business Handbook
- —Bldg. Trades Handbook —Bookkeeper's Handbook
- —Plum. & Fit. Handbook —Sten. & Corr. Handbook
- —Tel. & Tel. Handbook —Mariners' Handbook

Name _____

St. and No. _____

City _____ State _____

STUDY LAW

AT HOME Become an LL.B.

*The Only Law School
of its Kind in America*

Special and Exclusive Features

ONLY recognized resident law school in the United States conferring Degree of Bachelor of Laws—LL.B.—by correspondence. **ONLY** law school in U. S. conducting standard resident school and giving same instruction, by mail. **ONLY** law school giving over 450 class-room lectures to its extension students. **ONLY** law school giving a full 3-year, University Law Course, by mail, having an actual faculty of over 30 prominent lawyers, (3 of whom are Asst. United States' Attorneys) in active practice. **ONLY** law school in existence giving Complete Course in Oratory and Public Speaking, in conjunction with its law course. (This course is free to all students and is second only in importance to the law course itself.)

Other Good Features

In addition to the above, the Hamilton College of Law (note this is a College of Law—not an institute, correspondence school, etc.) has many valuable features not possessed or offered by other law schools. We guarantee to prepare our students to pass bar examinations. This course is intensely interesting and fascinating—not dull and dry like the ordinary correspondence course. Our system of conducting examinations is the most thorough, complete and expensive (to us) of any examinations ever given. A student can, if he chooses, take part of our course by mail and finish in our resident school, where he will receive full credit for all work done by mail. Our resident school is recognized by all standard law schools in the United States.



Our Degree Bachelor of Law, LL.B. NOT A Diploma or Certificate



From Lecture Room to Student No Other Law School Can Use This Illustration

leges) who are now earning their Degree LL.B. A Probate Judge (one of our students) says: "I am delighted with the course prescribed and your method of teaching law. It is far in advance of what I expected to receive."

Law Library FREE This library consists of 12 volumes of standard text books, used in conjunction with our class-room lectures. These law books, if purchased at retail, would cost almost one-half the cost of our entire 3 year course.

Price and Terms

The price of this comprehensive, ideal and incomparable law course, including the Law Library, over 450 Class-Room Lectures, Course in Oratory and Public Speaking, and everything complete, is considerably less than the tuition alone of any resident law school, and is no more than that charged by the many make-shift law courses (issuing diplomas, certificates, etc.) now offered the public. The terms of payment are so easy that the course is within reach of all.



These 12 Volumes are Free to Students

Illustrated Prospectus Free Also a great deal of "Evidence" substantiating all our claims. Send today and get the complete story—all the facts—then judge for yourself. A postal will do. The answering of this ad may mean the turning point in your career.

HAMILTON COLLEGE OF LAW
1106 Ellsworth Bldg. - - Chicago, Ill.

NOTE: We have prepared and offer to business men five special and distinct business courses as follows: Business Men's, Bankers', Commercial, Real Estate, and Credit Men's Law Courses. These are fully described in our regular prospectus.

Please Mention Popular Mechanics

SHORTHAND IN 30 DAYS

We absolutely guarantee to teach shorthand complete in only thirty days. You can learn in spare time in your own home, no matter where you live. No need to spend months as with old systems. Boyd's Syllabic System is easy to learn—easy to write—easy to read. Simple. Practical. Speedy. Sure. No ruled lines—no positions—no shading as in other systems. No long lists of word signs to confuse. Only nine characters to learn and you have the entire English language at your absolute command. The best system for stenographers, private secretaries, newspaper reporters and railroad men. Lawyers, ministers, teachers, physicians, literary folk and business men and women may now learn shorthand for their own use. Does not take continual daily practice as with other systems. Our graduates hold high grade positions everywhere. Send today for booklets, testimonials, etc.

Chicago Correspondence Schools
969 Chicago Opera House Block, CHICAGO, ILL.

CIVIL SERVICE

positions are very desirable. Good salary, short hours, easy work, pleasant surroundings, life positions, steady work, thirty days vacation and thirty days sick leave annually with pay, 46,302 appointments made last year. No political pull needed. Common school education sufficient. Must be 18 years or over. Full information about how to secure these positions and questions used by the Civil Service Commission free.

COLUMBIAN CORRESPONDENCE COLLEGE, WASHINGTON, D. C.

LEARN WATCH REPAIRING

Be a watchmaker—you can learn this profitable trade by correspondence in a few weeks in your own home by the DeSelms Chart System. After you complete the course you will know a watch from A to Z. You will know just what the matter is and how to repair one. When you graduate you will be a practical watchmaker and repairer and competent to fill any position. Positions for our graduates.



Ask for our Free Book. It explains our system and terms.
THE DeSELMS WATCH SCHOOL
23 Perry Street ATTICA, INDIANA

SUCCESS SHORTHAND

The best system for beginners; a post-graduate course for stenographers. Highest world's records for speed and accuracy and a greater number of court reporters than any other system in the last seven years. Instruction by mail, satisfaction guaranteed. Write for FREE Catalog

SUCCESS SHORTHAND SCHOOL

W. L. JAMES, Chief Instructor
Dept. 101, Schiller Bldg., Chicago, Illinois

Learn Electric Signalling



At Home—By Mail

A splendid profession. Great opportunity. Big demand by railroads for signal engineers. More men needed all the time to fill vacant positions. You can keep present position while learning.

\$1,800 TO \$4,500 PER YEAR

Rapid advancement from the first. Easy to learn. Takes but short time. Write today for free booklets. Do not put this off. Special offers to new students

DEPARTMENT OF SIGNALLING, Desk 1191, 491 Cass St., CHICAGO

STUDY LAW AT HOME

22 YEARS OF SUCCESS. Instruction by mail adapted to everyone. FOR AMBITIOUS MEN who want to prepare for practice or who want to take our business law course so as to better their business prospects. Take spare time only. Can refer to successful graduates located in every section of the country. Handsome catalogue and Easy Payment Plan free

The Sprague Correspondence School of Law
257 American Bldg., DETROIT, MICH.

ARITHMETIC

SELF-TAUGHT

A plain, easily-understood volume for all who have not had the opportunity of learning this subject thoroughly, or who have forgotten what they once learned. 257 Pages. Requires no teacher. This great little book sent postpaid for 60 CENTS. Stamps accepted, leather binding \$1.

GEO. A. ZELLER BOOK CO.
Est. 1870, 4473 W. Belle Place ST. LOUIS, MO.

SPANGENBERG'S
PRACTICAL
ARITHMETIC
Self-Taught

Be a Show Card Writer

Mastery of Show-card writing opens the way for rapid and lucrative advancement.

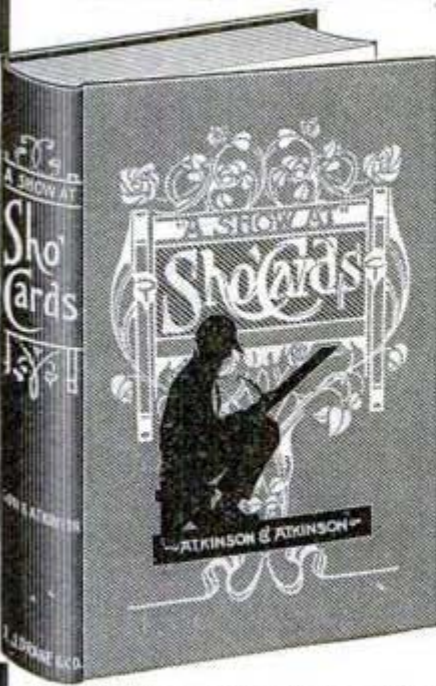

Progressive business firms want Show-card Writers to write cards that will sell goods. Show-card Writing opens two avenues:—Work on a good salary or business for yourself.

You can master Show-card Writing quickly and easily through the simplified instructions in our new book:

“A Show at Sho’ Cards”

It tells all there is to know about this lucrative profession

“A Show at Sho’ Cards” is a handsome book of 320 pages, beautifully bound, has upward of 150 specially designed engravings and card writing alphabets. Tells you what tools to use and

what materials are needed, where to get them and how to use them to produce attractive effects. This book will be sent, charges paid, upon receipt of price, \$3.00, with privilege of returning and money refunded if not perfectly satisfactory.

DESCRIPTIVE BOOKLET FREE
FREDERICK J. DRAKE & CO.
 Dept. 11 1325 Michigan Ave., Chicago, Ill.

REVERSIBLE “Linene”

TRADE MARK

Send for Beautiful Catalogue FREE

Our Beautiful Catalogue shows 12 styles of collars, 2 styles of cuffs and 3 styles of bosoms. Write for it at once, and at the same time send for sample collars. We will send you one sample of any style shown in this ad for 6 cents in U. S. stamps, or 10 collars by mail for 30 cents—they cost only 25 cents at the stores. State size and style.

In the manufacture of these goods only the finest grade of cloth is used. They are finished both sides alike in pure starch with a dull luster that wears longer than linen without smooching. Solid comfort is assured, for they never fray and chafe the neck, are exactly molded to it and do not “wilt” in hot weather. They may be reversed, so that each wearing costs only 1 1/4 cents.

WAN DYCK
 Sizes 12 to 18 Inches
 Front 14 Inches Back 13 Inches

ANGELO
 Sizes 12 to 20 Inches
 Front 21 Inches Back 1 Inch

RAPHAEL
 Sizes 12 to 20 Inches
 Front 21 Inches Back 1 Inch

RUBENS
 Sizes 12 to 20 Inches
 Front 2 Inches Back 1 Inch

REVERSIBLE COLLAR CO.
 Department U BOSTON, MASS.

Pres. Roosevelt's Secretary
 Wm. Loeb, now gets \$12,000 annually. Geo. Cortelyou, Pres. McKinley's secretary, is now Pres. Consolidated Gas Co.; salary, more than \$30,000. Both owe their success to

STENOGRAPHY

The big places in business today are filled by MEN and WOMEN trained in stenography. Put yourself in the Big Income Class. Nothing will do it quicker than a knowledge of stenography.

TYPEWRITER IN YOUR HOME FREE

Let us show you how you can advance your position in life. Write now for FREE PROSPECTUS—just say “send the proofs.”

Practical Correspondence Schools, 113 N. Pearl St., New York, N. Y.

DO YOU LIKE TO DRAW?

That's all we want to know

Now we will not give you any grand prize—or a lot of free stuff if you answer this ad. Nor do we claim to make you rich in a week. But if you are anxious to develop your talent with a successful cartoonist, so you can make money, send a copy of this picture with 6c. in stamps for portfolio of cartoons and sample lesson plate, and let us explain.

The W. L. Evans School of Cartooning
 321 Ball Bldg., Cleveland, O.

Learn Automobile Driving and Repairing

We give you driving lessons and teach you all the technical parts to prepare you for a good paying position. Write for Booklet P. Day and Evening Class.

NORTHWESTERN MOTOR INSTITUTE, 228-230-232 Wisconsin St., MILWAUKEE, WIS.

ADVICE

Information and counsel on any subject under the sun. No matter what you want to know, no matter what your present condition, our big organization can help you.

WRITE TODAY FOR BEAUTIFULLY ILLUSTRATED BOOK FREE

NATIONAL BUREAU OF ADVICE AND EDUCATION, 527 Ashland Block, CHICAGO

LEARN TO WRITE ADVERTISEMENTS EARN \$25 to \$100 A WEEK

We can positively show you by mail how to increase your salary. BOOK MAILED FREE.

PAGE-DAVIS CO., 112 Page Building, Chicago, Ill., or 150 Nassau St., New York

HERE YOU ARE BOYS

A medallion pin of Foxy Grandpa. Everyone will notice it on the lapel of your coat and try to get a closer look at it. All you have to do is press the bulb.—Foxy Grandpa will finish the job by squirting a fine stream of water over the inquisitive one. Will squirt 20 feet. Greatest joke out. Order one today and fool your friends. Price 15c. Foxy Grandpa and Hooligan both for 25c. 5 for 50c or 1 doz. for \$1.00. A beautiful fountain pen free with every \$1.00 order.

AMERICAN SUPPLY CO., 918 Union St., St. Paul, Minn.

BOYS—MAKE YOUR OWN TOYS

The Toy-maker, greatest boys' book ever written, tells how to make a steam engine, telephone, magic lantern, boats, kites, balloons, electrical and mechanical toys, traps, fishing tackle. 200 illustrations. Send for the book, and novelty catalogue—all for 10c.

AMERICAN SUPPLY COMPANY, 918 Union St., ST. PAUL, MINN.

A SCHOOL WITHIN ITSELF

There are XX chapters in all, XIX carrying you from the fundamental principles of electricity on through the various branches to a point where the careful student comprehends the complete designing, care and operation of a dynamo or motor, and one chapter on electric automobiles, outlining their construction, care and operation, and all about storage batteries and how to handle them. Each subject is carefully written and to the point. After a student studies a subject, he is questioned on that subject in such a manner as to bring clearly to his mind the points he needs to know regarding same. The book contains a dictionary defining 1500 Electrical Words, enabling the reader to ascertain the meaning of any electrical word, term or phrase used in this book, as well as hundreds of others in common use. All required tables necessary in the study are in it.

\$2.00 PER COPY—SIXTH EDITION—30,000 COPIES SOLD.

The offer we make of refunding money if book is not satisfactory upon examination is AN UNUSUAL ONE in connection with the sale of a book. But we have no fear of its return. Your decision will be what thousands of others have been. Money would not buy it if it could not be duplicated. We could print testimonials by the hundreds. It is best to order and be your own judge of its merits.

CLEVELAND ARMATURE WORKS, 49 & St. Clair Ave., Cleveland, Ohio

Armatures and Fields Wound—Commutators Filled
 AMERICA'S GREATEST REPAIR WORKS

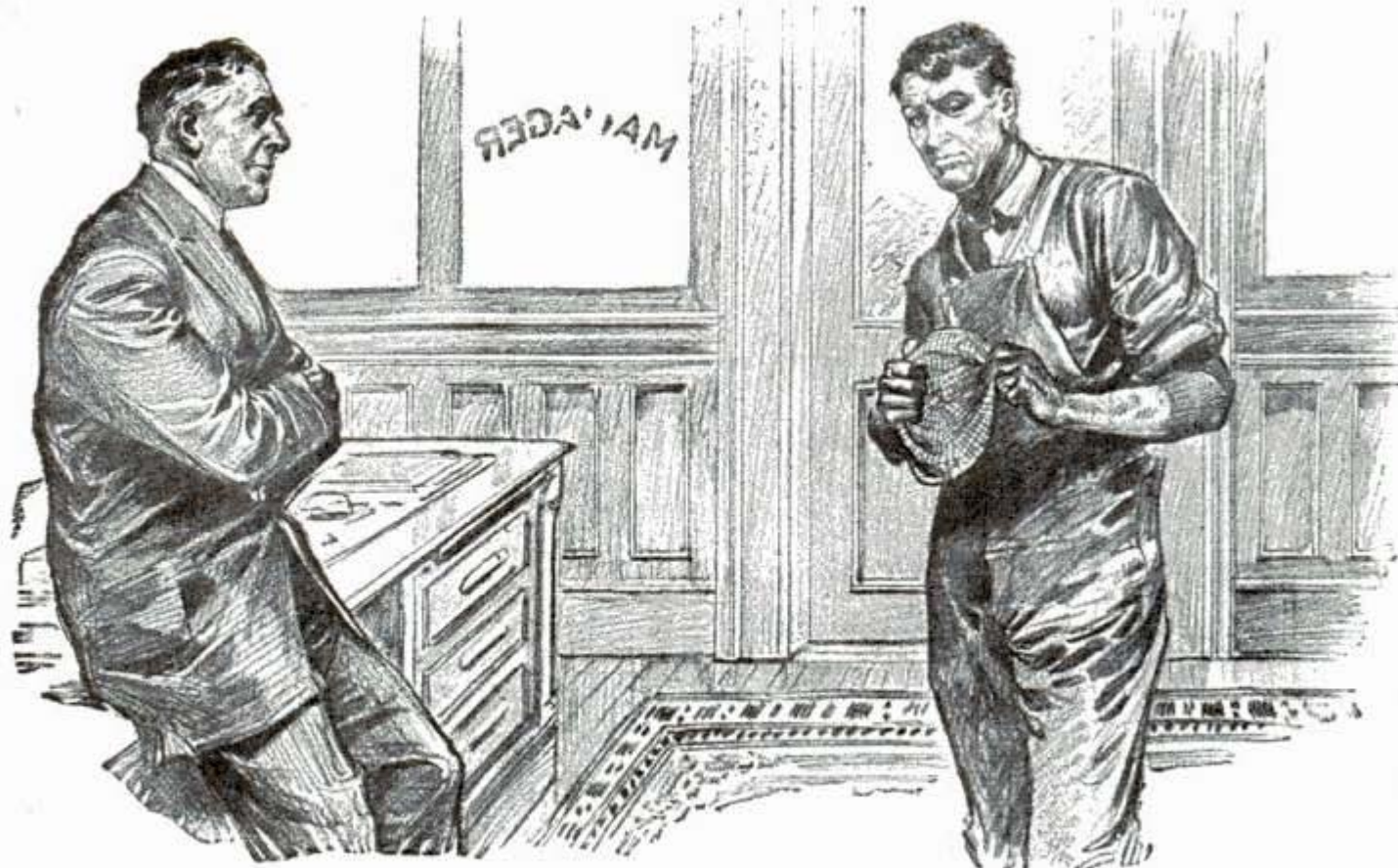

When Training Counts

“Yes sir, I’ve been with you going on five years and I think I deserve a raise.”

You are right “up against it” when you ask for a raise if the only recommendation you have is “years of service.” This will never get you anywhere. You must have special training; you must demonstrate to the boss that you are more valuable to him on account of this special training; on account of preparing yourself to fill the shoes of the man just ahead of you. Then if you can’t get what you think you’re worth, there are always hundreds of other jobs open to the trained man.

Length of service will decrease your efficiency rather than increase it. Five years ago you were a younger man; you had more ambition; you could do more work—you had something to look forward to. To-day, if you have not been improving your mind, if you haven’t been training yourself for a better job, you are in a rut—you have been grinding away at the same old job. Your employer may value your services, but you are probably worth only what he pays—no more.

Your Opportunity Coupon

Check the course you want and mail the coupon now

American School of Correspondence, Chicago, U. S. A.
Please send me your Bulletin and advise me how I can qualify for the position marked “X.” Pop.Mech. 1-13

- | | |
|-------------------------------|--------------------------|
|Electrical Engineering |Lawyer |
|Elec. Light & Power Supt. |Bookkeeper |
|Electrical Wireman |Stenographer |
|Telephone Expert |Private Secretary |
|Architect |Accountant |
|Building Contractor |Cost Accountant |
|Architectural Draftsman |Cert’fd Public Acc’t |
|Structural Engineer |Auditor |
|Concrete Engineer |Business Manager |
|Civil Engineer |Fire Ins. Inspector |
|Surveyor |Fire Ins. Adjuster |
|Mechanical Engineer |Fire Ins. Expert |
|Mechanical Draftsman |Moving Picture Op’r |
|Steam Engineer |Sanitary Engineer |
|Stationary Engineer |Reclamation Eng’r |
|Gas Engine Engineer |Textile Boss |
|Automobile Mechanician |College Preparatory |

NAME

ADDRESS

HOW THE AMERICAN SCHOOL WILL GIVE YOU THE TRAINING YOU NEED.

The American School of Correspondence was established fifteen years ago for the benefit of ambitious men and women everywhere. This school makes it possible for you to obtain the education and training you need without leaving home or giving up your work. It will bring a practical college course to you right in your own home. No matter where you live the American School will train you in any branch of **Engineering, Business and Law**, or prepare you for entrance into any resident college.

Write the American School now, while the subject of making more money is on your mind. State how far you went in the public schools, what you are doing now, and what you would like to be. Your case will receive special attention. The American School will tell you the best and quickest way to better your condition and get more money. Check the coupon and mail it now. Don’t let this matter drag another day. Another year might slip by and find you at the same old job and prospects for a raise very slim.

NOTICE—The American School has been established 15 years and is not connected with any other school using the name “American.” We do not employ agents.

American School of Correspondence
CHICAGO, U. S. A.

Popular Mechanics Magazine

WRITTEN SO YOU CAN UNDERSTAND IT

Vol. 19

JANUARY, 1913

No. 1

Scots Still Test Skill with Ancient Caber

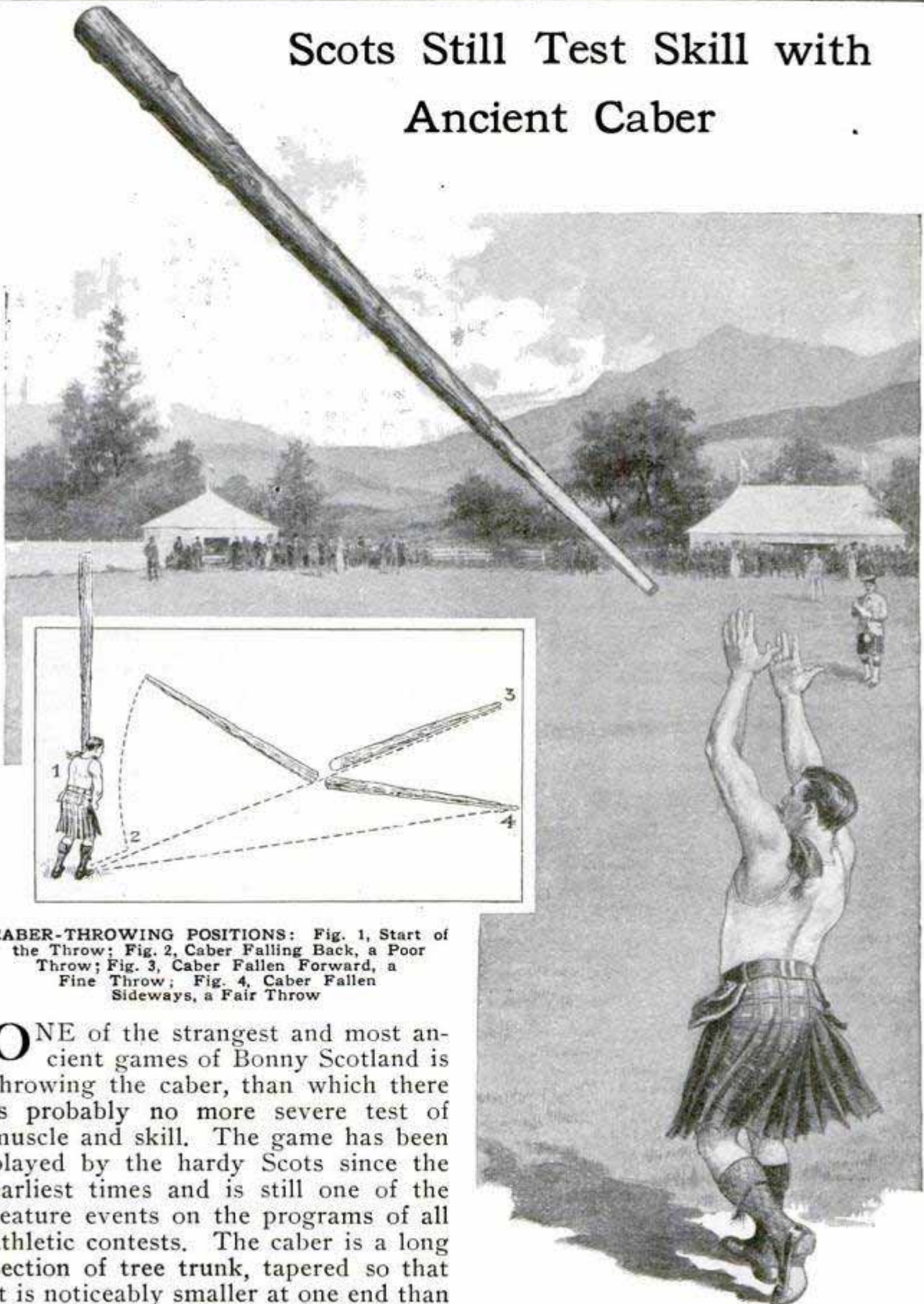

CABER-THROWING POSITIONS: Fig. 1, Start of the Throw; Fig. 2, Caber Falling Back, a Poor Throw; Fig. 3, Caber Fallen Forward, a Fine Throw; Fig. 4, Caber Fallen Sideways, a Fair Throw

ONE of the strangest and most ancient games of Bonny Scotland is throwing the caber, than which there is probably no more severe test of muscle and skill. The game has been played by the hardy Scots since the earliest times and is still one of the feature events on the programs of all athletic contests. The caber is a long section of tree trunk, tapered so that it is noticeably smaller at one end than

at the other. The man who essays to test his strength by tossing it raises the pole to a vertical position in his hands, smaller end down, and then throws it into the air and away from him. He must make the large end of the pole hit the ground and the pole fall in such a way that the small end will describe a half circle. The prize goes to the man whose caber, having been thrown in the manner described, lands on the ground with its smaller

end farthest away from the throwing point. Considerable skill is required to make the throw, as well as considerable strength. The caber is likely to fall over sideways instead of straight forward when the large end hits the ground, or it is likely to fall at an angle or even fall back the way it has come. Therefore, everything else being equal, the longest throw is always that which causes the caber to fall straight away from the player.

WHITE-LIGHT INSTALLATION FOR PHOTOGRAPHERS

An installation of the Moore tube to provide artificial daylight in a photographic studio is shown in the accompanying illustration. The tube is coiled into a comparatively small area for a lamp of this kind. When nitrogen gas is used in the tube a yellow light is obtained, but with carbon diox-

ide the light is said to be almost exactly like daylight, not only in color, but also in that it is diffused, the light coming from such a large area as to be almost shadowless. The carbon dioxide is admitted to the tubing from the container by means of an automatic valve, which assures that the gas inside the tube and the electrical conditions will remain constant. The valve is regulated by an electromagnetic solenoid, which responds to any slight variation in the current passing, and feeds, as a rule, about every 10 or 20 seconds.

TROLLEY CAR BENDS IN THE MIDDLE

An experimental street car known as the articulated car has just been put into service on one line in Boston. This car embodies a number of new features making for safety, comfort and convenience of passengers. As the name articulated indicates, the car is jointed, which enables a car of large capacity to be used on tracks having sharp curves without dangerous overhang of cars, and is, therefore, particularly well adapted to meet the conditions in Boston which is famous for its narrow and crooked streets.

The car has a total length of 63 ft. and can be operated on all lines where short cars are now used without exceeding the overhang clearance of the short cars. Another feature of great importance, as applying to Boston conditions, is the distribution of the weight of the car on the tracks, which enables



Imitation-Daylight Illumination Tubing Installed in Photographic Studio

Ans. McFarlane Moore

Moore Tube 2/15 temporarily withdrawn from market pending a change
 by N.Y. Co. of General Ele.

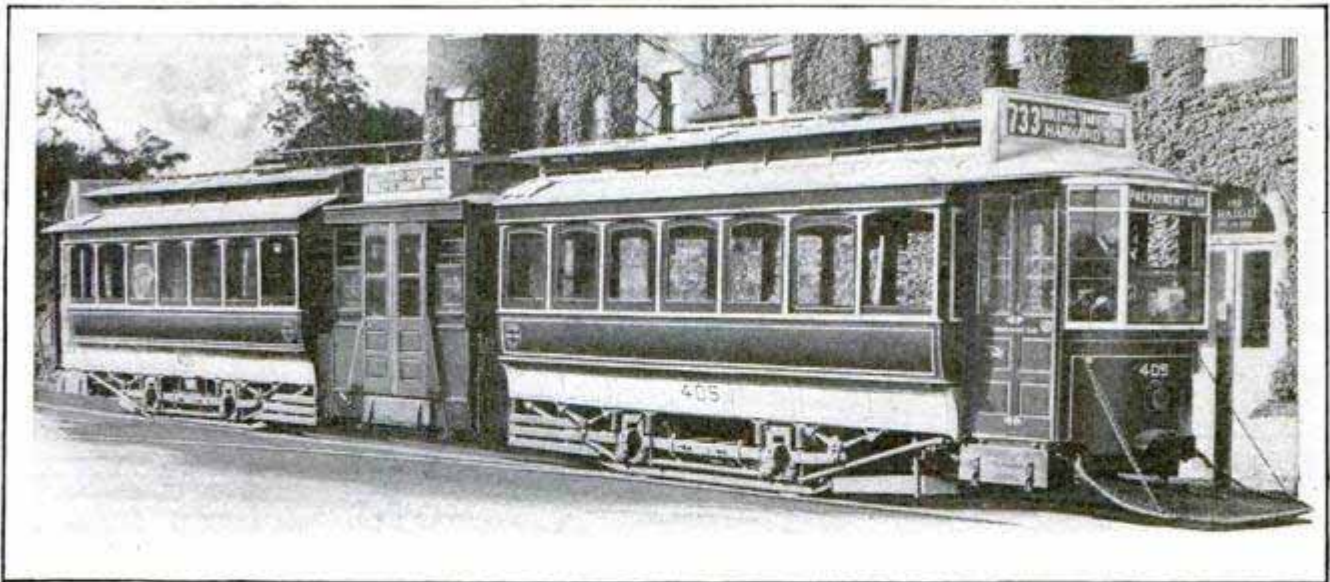

Articulated Car, for Service on Boston's Winding Streets

it to be safely operated over bridges designed for light cars. It has three compartments, one at each end with the usual vestibule, and a center compartment pivotally connected to the end compartments in such a manner as to provide at all times a safe and easy passage between the compartments.

The trucks are placed under the end compartments, and thus the center compartment can be carried closer to the street which permits a low entrance step. The car, at present, has folding steps at the center-compartment doors, but it is the intention, in future designs, to lower this compartment still more, so that there will be but one step from the street into it. The conductor, being stationed near the central door, is enabled to give passengers entering or leaving a car careful attention at all times, and also has a better opportunity of seeing passengers who desire to leave.



"Magnet Bill" is the Official Preventor of Tire Punctures and Cuts in the Plant of a Toledo Automobile Concern

As the entrance and the exits are closed by doors, passengers cannot enter or leave while the car is in motion, thus eliminating boarding and alighting accidents. The doors and steps of the center compartment are operated by an improved type of pneumatic appliance with just sufficient force to open and close doors properly and smoothly.

Another interesting feature is the arrangement of the roof, which permits the conductor to see the trolley at all times and enables him to replace the trolley on the wire without leaving his position.

708 ———
**"MAGNET BILL," AN
 IMPORTANT UNIT
 OF AN AUTO
 CONCERN**

"Magnet Bill" doesn't look like a very important part of the big automobile plant in which he is employed in Toledo, Ohio, but he may be seen, summer or winter, rain or shine, walking slowly about the plant with eyes

Willys-Overland

cast down, and is a very important unit, indeed, for he saves the company several thousand dollars each year in avoided tire cuts and punctures.

The tool in "Magnet Bill's" right hand is a big steel magnet strapped

to the end of a shovel handle, and in the other hand is a pail. His eyes are constantly cast down because his job is to remove from the roadways every nail and bit of iron or steel that might cause a puncture.

WINDMILL MOUNTED ON A LIVE TREE

54 On Vashon Island, in the Sound between Seattle and Tacoma, may be seen a windmill rising out of the foliage of a fir tree. The tree trunk is the tower that supports the windmill, and against one side of it is erected a ladder, the power-transmission shafting, etc. The well is at the foot of the tree.

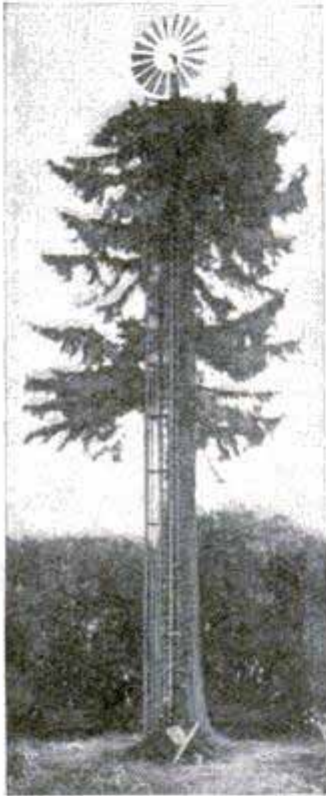

WASHABLE WALL PAPER

To combine the hygienic properties of a good oil paint with the pleasing effect and artistic color combinations of ordinary wall hangings in a paper fabric, would seem a rather difficult accomplishment, but a German concern has recently brought out a product which is said to be a successful solution of the problem and little more costly than ordinary wall paper.

The resistance of the new fabric against processes of disinfection and against ordinary cleaning has been officially tested. Daily washing and brushing with water for 8 to 10 consecutive days had no injurious effect, nor did a 1-per-cent solution of corrosive sublimate do any harm, while some colors did not withstand soap and soda solutions.

This wall paper is made in several kinds and patterns from the plainest to the most ornamental and artistic.

WET-CORK FILLING FOR MOTOR TIRES

An inventor has recently planned and constructed automobile tires in which the air chamber is replaced with wet compressed cork. Tests show that this tire compares favorably with the pneumatic as regards elasticity, and is far superior to the solid rubber tire. Taking the elasticity of iron as a unit, that of solid rubber tires would be represented by 5, of the cork tire, 10 to 12, and of the pneumatic tire, inflated with air of six atmospheres' pressure, 15; all being subjected to the same load. The elasticity of cork depends on the great number of air holes it contains, making it, in fact, a natural pneumatic. The cork filling or core is first inserted in an inner casing of rubberized linen or chrome-tanned leather, and then into the outer rubber tire. This new tire, the inventor claims, will remain equally elastic in hot and cold weather, will not suffer from punctures, retaining, even if the outer rubber tube is cut through, its resiliency; it is also much cheaper.

HIDING AN ARMY FROM AERIAL SCOUTS

604 Although the scouting aeroplanes of the Red army, in the recent British army maneuvers, kept the commander informed of the movements of the greater part of the Blue army, they failed to discover the whereabouts of the 4th Blue division. It transpired, however, that the commander of this division had moved his forces warily by night, and had taken every precau-

At Fir Tree Farm, on Vashon Island between Seattle and Tacoma

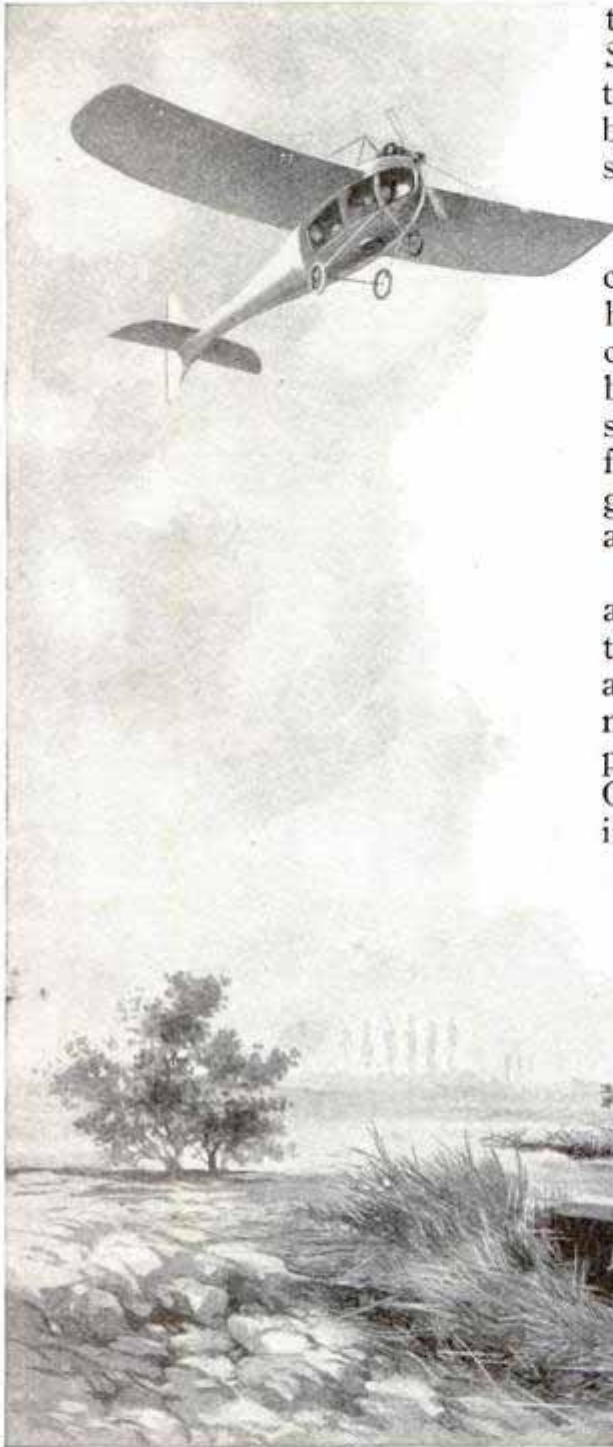

tion in the early dawn when nearing Saffron Walden to hide the marching troops. The night had been dark, there being no moon, and the morning was somewhat misty. Whenever the noise overhead announced the approach of a Red biplane, the troops halted and crouched down under the cover of hedgerows. Every small wood and copse was also taken advantage of, both the infantry and cavalry being successfully hidden in this manner from the searching scrutiny which began immediately the light rendered aerial observation possible.

Field batteries of the contending armies, wheeled into the desired position, were masked from the gaze of the airmen in many ingenious ways. The masking of batteries also played an important part in the maneuvers of the German army, one of the accompanying illustrations showing a German battery hidden from the aerial corps.

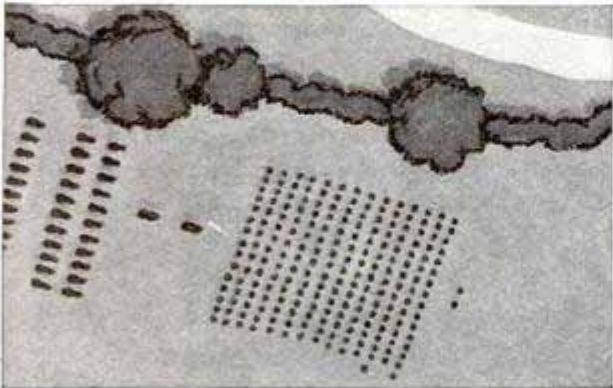

Gun of a German Battery Hidden from the Eyes of Aerial Scouts by a Roof Consisting of Canvas Laid over a Framework and Covered with Earth

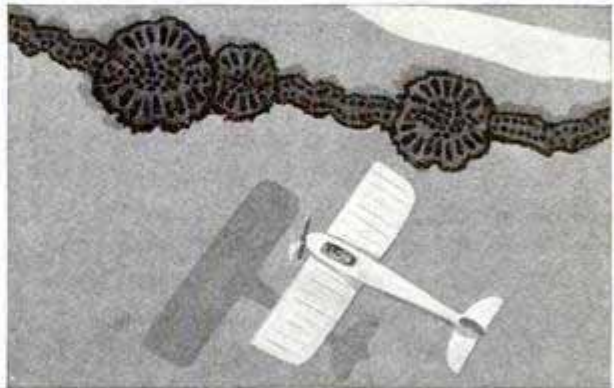

How Army, Moving in the Open, Looks to Aerial Scouts

Marching Army Hiding from Aeroplane by Crouching under Trees and Hedgerows

DEER IMPALES ITSELF ON PICKET FENCE

This Deer Attempted to Jump
the 7-Ft. Iron Picket Fence
with the Result Shown

Copyrighted by
Brown & Dawson,
Stamford,
Conn.

590

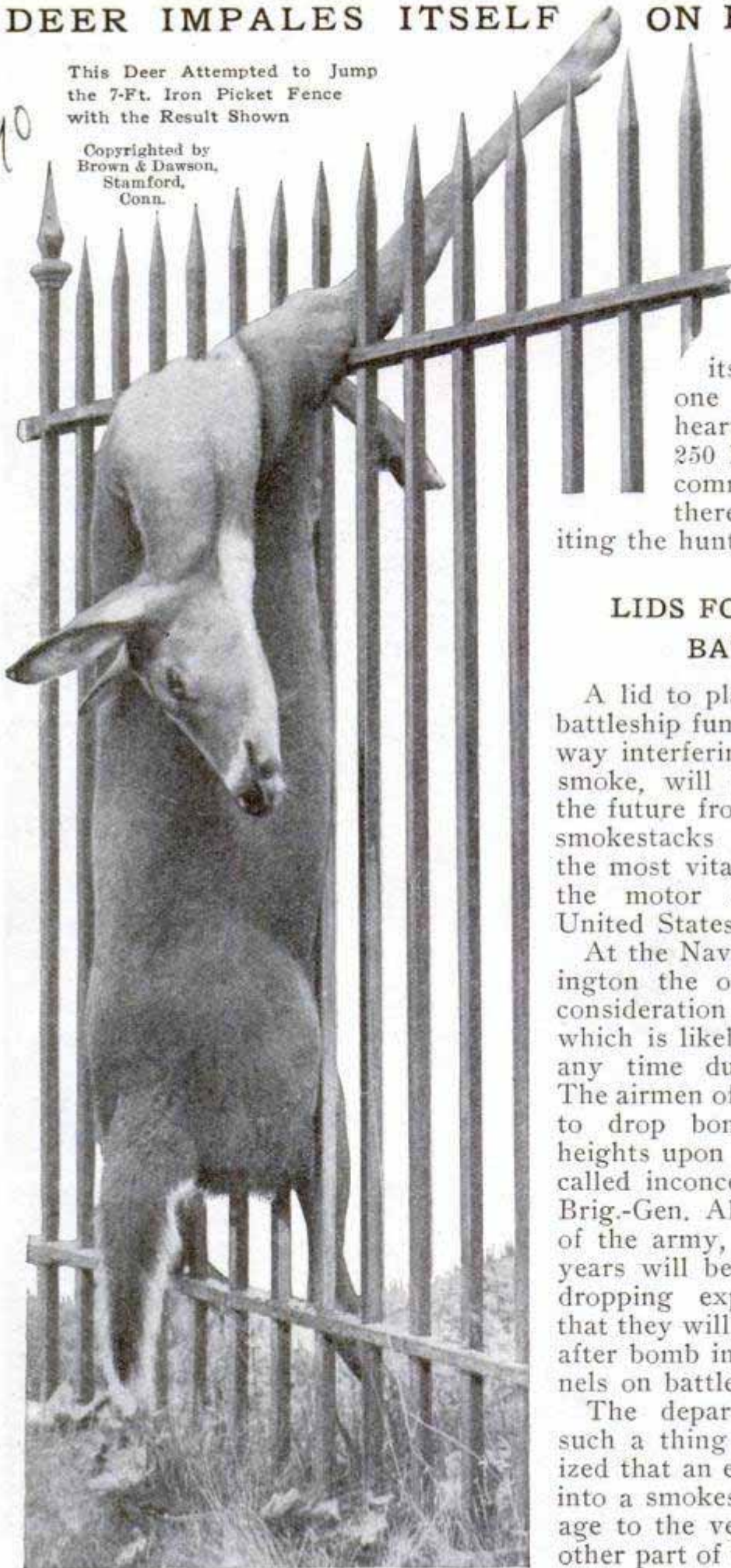

A full-grown deer recently ran through the village of Noroton, three miles north of Stamford, Conn., and tried to jump a 7-ft. iron picket fence surrounding an estate. It missed the jump by a few inches and impaled itself on the sharp pickets, one of which entered its heart. The animal weighed 250 lb. Deer are now very common in Connecticut, as there is a game law prohibiting the hunting of them.

LIDS FOR FUNNELS OF
BATTLESHIPS

A lid to place over the mouths of battleship funnels, which, while in no way interfering with the emission of smoke, will prevent the airman of the future from dropping bombs into smokestacks and thus destroying the most vital parts of the vessels—the motor sections—is what the United States navy wants.

At the Navy Department in Washington the officers have had under consideration this serious proposition which is likely to face any nation at any time during this airship age. The airmen of today are being trained to drop bombs from fairly great heights upon targets of what may be called inconceivably small sizes, and Brig.-Gen. Allen, chief signal officer of the army, says his men in a few years will be so adept in the art of dropping explosives from airships that they will be able to deposit bomb after bomb in the mouths of the funnels on battleships.

The department wants to make such a thing impossible. It is realized that an exploding bomb dropped into a smokestack can do more damage to the vessel than if it hits any other part of the ship. Hence the de-

sire for a lid. The engineers and mechanics in the department are now working on designs for such a protection.

AUTO DELIVERY WAGON LOOKS LIKE LOCOMOTIVE

The introduction of the motor-propelled vehicle in modern business has enabled those who so desire to greatly alter the general appearance of their delivery vans and thus obtain much publicity and advertisement by adopting peculiar shapes, sizes or colors for their vehicles. There are numerous examples of this tendency throughout the country, but one of the most curious is to be found in Pittsburgh, where a clothing firm has built its auto delivery wagon in the shape of a locomotive. It has a tall stack at the front, before which is placed a headlight. The under portion of the body is equipped with a cowcatcher and the chauffeur sits in a cablike superstructure. The goods to be delivered are



Auto Delivery Van of a Pittsburgh Merchant Built to Resemble a Locomotive

carried in a structure to the rear of the chauffeur's cab which resembles a locomotive tender.

TUNGSTEN LAMP BURNS IN SPITE OF COLLISION

Taking advantage of the collision between a large motor truck and a lamp-post, which resulted in the latter being bent entirely over, so that the glass-enclosed tungsten lamp was inverted and almost touched the pavement, while half of the post remained upright, the manufacturers of this lamp had the doubled-up post photographed and are using it as an adver-

tisement. The lamp continued to burn despite the accident and the advertisement reads as follows:

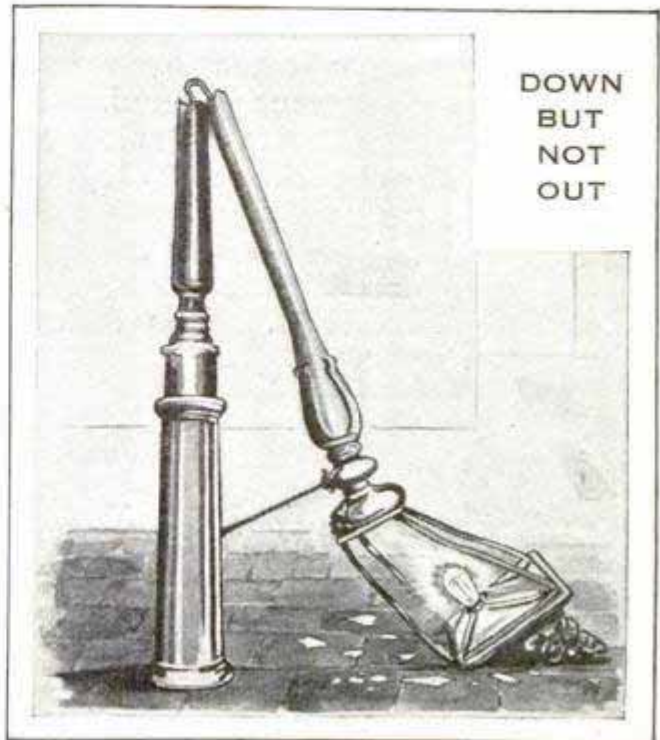

Tungsten Lamp That Kept Burning after Wreck of Lamp-Post

CUTTING THE PORTHOLES IN A GREAT LINER

The making of the portholes of a great liner is a part of the construction accomplished after the thick steel plates of the vessel's sides have been riveted in place. The accompanying illustration shows how it was done on the great German liner "Imperator," the operator seen at the right being in the act of cutting out a porthole.

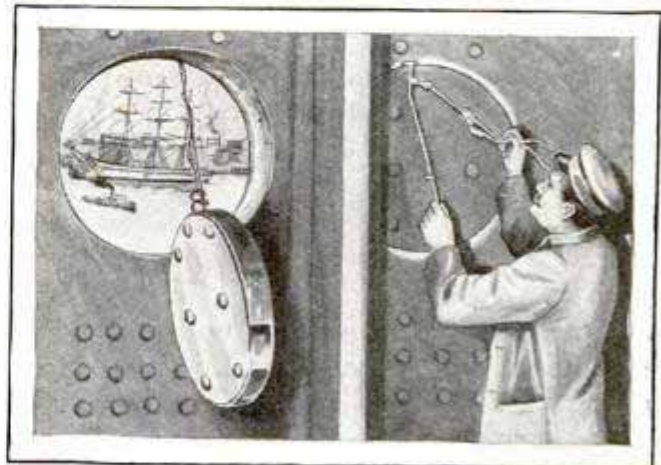

Boring Out the Portholes of the German Liner "Imperator"

ENORMOUS LOSS OF WATER AT GATUN LAKE

The magnitude of the great lake at Gatun, on the Panama canal, which is now beginning to fill up behind the Gatun dam, is indicated by figures which have been recently compiled by the engineers on the unavoidable daily loss of water in the lake due to leakage at gates and locks, seepage through the lake bottom, evaporation, and the operation of the hydroelectric plant to obtain power and light. This daily

The amount of daily wastage shown by these figures would fill a water tank 521 ft. in each dimension. New York, Chicago and Philadelphia each use between 500,000,000 and 550,000,000 gal. of water per day for all purposes, or about half the daily wastage from the Gatun lake.

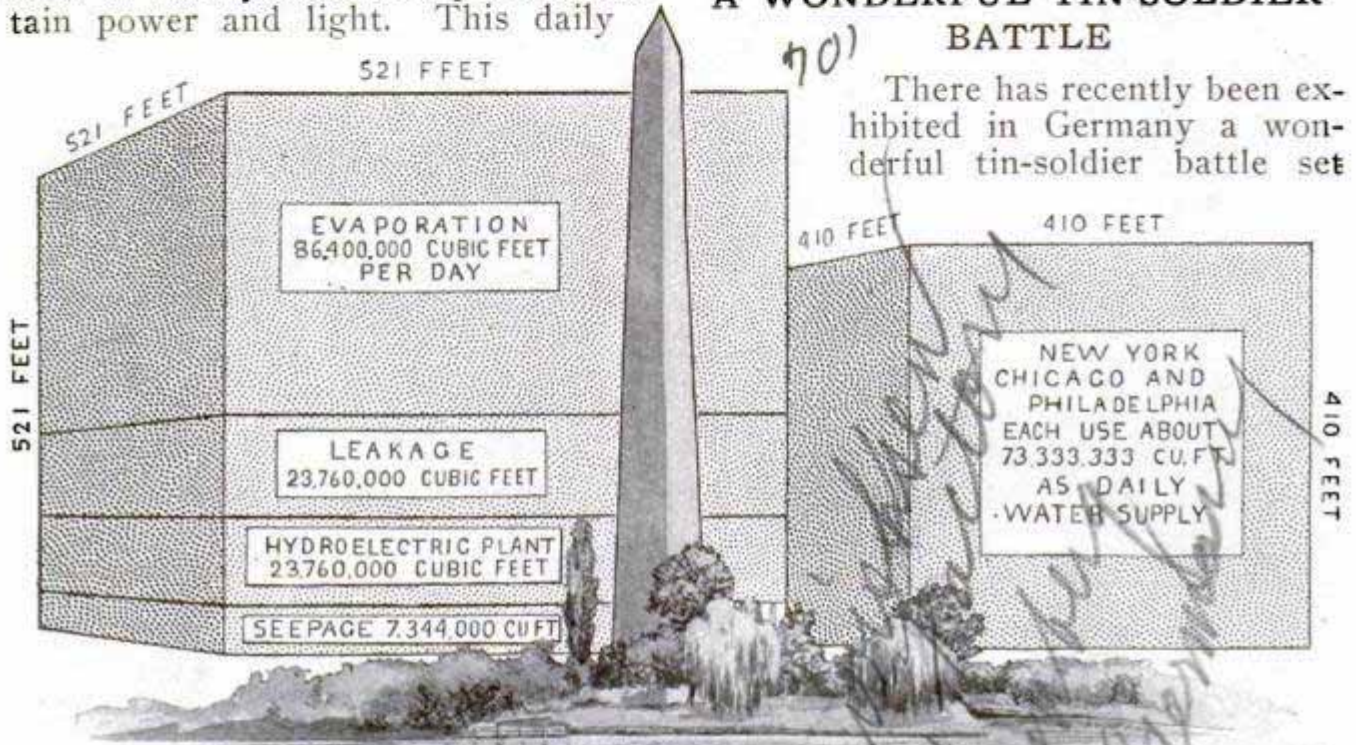

A WONDERFUL TIN-SOLDIER BATTLE

There has recently been exhibited in Germany a wonderful tin-soldier battle set

loss will amount to 1,059,420,000 gal., or about 141,000,000 cu. ft. of water. The evaporation from the lake is placed at 1,000 cu. ft. a second; the leakage at 275 cu. ft.; the seepage at 85 cu. ft., and the amount used by the hydroelectric plant at 275 cu. ft.

Eight wet months and four dry months are shown by the tables of 22 years' observations on the Isthmus, and these observations indicate that from January to April of each year the aggregate losses of water from the lake will be greater than the inflow. Making an allowance for the water used in 48 lockages a day, which is the most that can be handled in the canal, the engineers find that the lake will always have enough water, even in the dry season, to allow 30 ft. in the canal.

The Daily Water Loss of Gatun Lake Indicated by Comparison with Washington Monument

having no less than 14,000 tin soldiers from a well known Nuremberg toy factory. Upon a battlefield about 16 ft. square is being reproduced the bloody battle near St. Privat between the German and French armies, in 1870. In the right corner back of the village of St. Privat, whose church has already been set on fire by the shots, the French troops are shown in the forest of Gaumont, where they are receiving in a storm-attack the advancing German troops. The village of Roucourt is already taken by the Germans and the set piece shows the strongest phase of the battle, and is otherwise rich in historically interesting scenes.

made by Heinwisher



**USE TELESCOPIC
MAST TO TRIM
TREES**

A novel use for the type of portable observation tower designed in Germany particularly for military purposes, and consisting of a telescopic mast with platform at the top, has been found in Berlin's parks. The illustration shows the mast being used as an accessory in tree-trimming. The mast proper comprises a number of steel tubes, which telescope, one in another, the mast being extended or collapsed by one or two operators, turning the crank handles as shown.

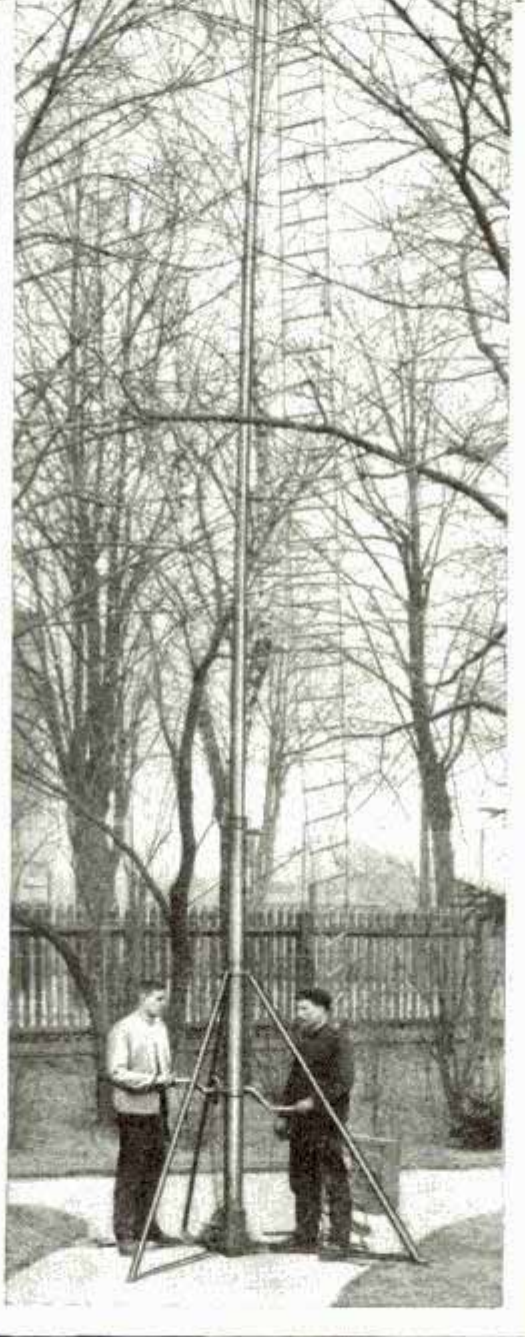

German Military Observation Mast Used for Tree-Trimming

**EXPLOSIVES AS
MEDICINE 438**

The statement that violent explosives, such as cordite, for instance, are a good cure for seasickness or insomnia, has been hailed with considerable levity, yet

diers are claimed to have discovered the strong sedative effect of cordite, and it is claimed that an English

the recommendation of nitroglycerine as a cure for the former is beginning to obtain support. It is well known that nitroglycerine dilates the blood vessels, and its use as a cure for seasickness is based on the assumption that this complaint is caused by cramps of the blood vessels and consequent anemia of the central nerve system. The dose is one spoonful of a mixture of 20 drops of a 1-per-cent solution of nitroglycerine in about one-seventh of a quart of distilled water. Its use, however, is not recommended without the advice of a physician.

Cordite, the fibrous, cottonlike explosive, largely used in modern warfare and in blasting, is likewise stated to be a fine remedy for insomnia. British sol-

Dr. W. Burwinkel, German

Annua. Sept 21, 1912

Tommy tore off a piece, when suffering from sleeplessness, chewed and swallowed the fiber, and was sleeping a few moments later. This is another experiment which should not be tried without the consent of a doctor.



German Policemen in Africa Mounted on Zebras

POLICE ZEBRAS OF GERMAN AFRICA

The enormous death rate among horses brought to Africa by the Germans early led to attempts to break the native zebras to the saddle and to crossbreed them with horses in order to procure mounts for troops and civil officials. Not very promising, at first, these attempts have lately been crowned with success, as witnessed by the accompanying illustration which shows two police troopers mounted on trained zebras.

☐ Wireless messages are exchanged without difficulty between Lima and Iquitos, in Peru, over 600 miles apart, in spite of the facts that the Andes rise to a height of over 18,000 ft. between the two points and that the Lima station lies close to the foot of the mountains.

DEVICE MAKES ENGINE

749 SPARK VISIBLE

An adaptation of the Crookes tube is being used to tell from the outside whether the sparks wanted on the inside of a motor cylinder are properly and regularly produced. The instrument, which has the appearance of a very thick lead pencil, sharpened, is a copper tube containing a small Crookes bulb. The pencil point is an electrode set in hard rubber, and a nonconductive plug with a hole through the center is inserted in the butt end. In operation, the pencil-like point is placed against any exposed portion of the ignition circuit of the motor, such, for instance, as the top of the spark plug; the observer's hand clasps the copper tube firmly,

to ground whatever amount of current may be able to pass through, then puts his eye to the hole in the butt end, and when the ignition circuit is closed to produce the spark, a light becomes visible in the tube. If this light is strong and steady, the spark is of the same character; if no light appears, the plug is short-circuited, and if the light is irregular, the spark is poor.

FIRE ENGINES PROVIDED WITH ELECTRIC LAMPS

752 Storage batteries have been installed on the engines of the Memphis fire department, and tiny electric bulbs now illuminate the steam and water gauges and other parts of the machinery requiring light and close attention. Until this idea was adopted, the engineer had to run about the engine with a lantern, the light of which was unsatisfactory, particularly on rainy nights.

FLYING MOTORBOATS, THE 1913 SPORT

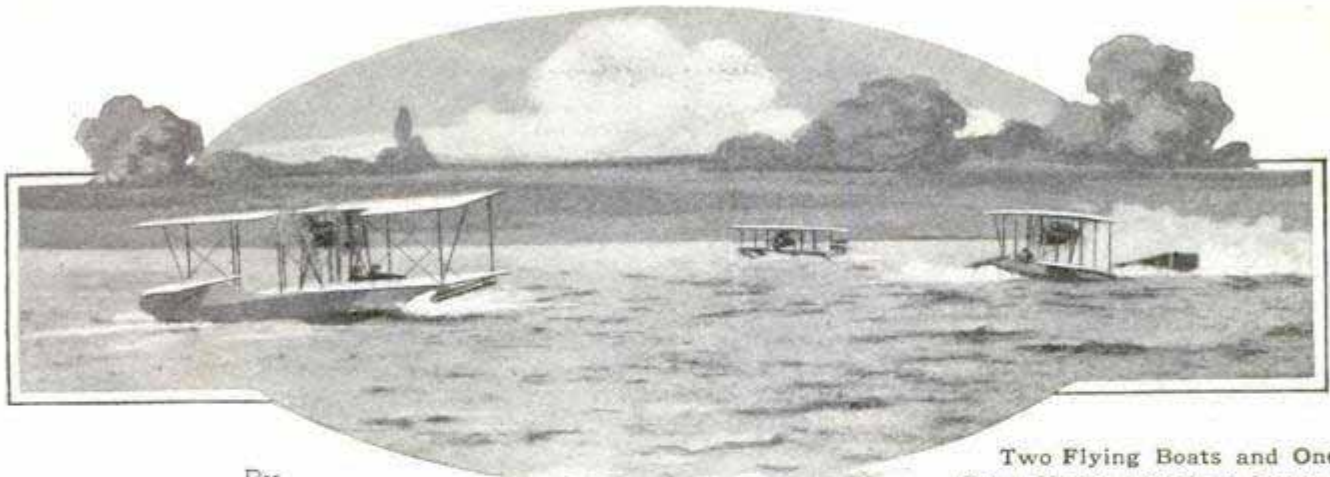

By
GLENN H. CURTISS

Two Flying Boats and One
Older Hydro-Aeroplane Jockey-
ing for Position at Start of a Race

THE flying boat has now placed aviation among the "safe and sane" sports. Flying has rightly been referred to as the acme of ease, comfort and exhilaration. The landings have not always been so delightful, but with the flying boat it is as easy to alight from a flight as it is to steer an automobile alongside a curb and stop.

In the first recorded race of these craft, recently held on Long Island, the sight of three machines jockeying for position was inspiring, while the close finish of the return trip from the outer buoy would stir the blood of any sportsman. On both the Atlantic and Pacific seaboards this fall duck shooting from hydro-aeroplanes and flying boats has been attempted with remarkable success.

Water flying is safe mainly be-

cause there is always a good place to alight. It is not necessary to guide the machine along a narrow course for starting or to pick one's ground in landing. The surface beneath is smooth and level and one may head in any direction with safety. There are no fences, trees, telegraph wires or buildings to dodge, or which will cause eddies in the air and upset one as he tries to land. Winds over the water are invariably much steadier than over land, and if, through carelessness or inexperience, the operator does make a bad landing, or plunges the boat at too steep an angle into the water, or strikes a wing too hard, the accident cannot be grave. The machine is not seriously damaged and the operator is none the worse, except for his "ducking."

The first development in water fly-

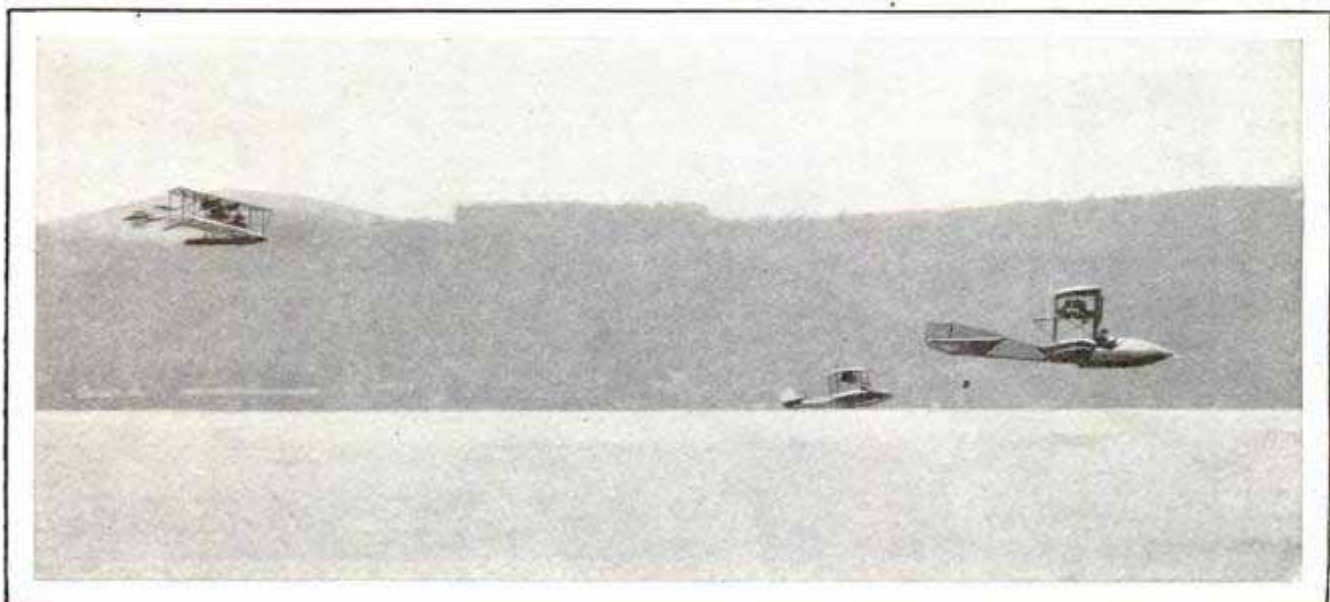

Finish of Race of Flying Motorboats, David McCulloch, with Glenn H. Curtiss as a Passenger, in the Lead

ing, the hydro-aeroplane, has these advantages, but the later flying boat with its large surplus of buoyancy has all the advantages of a motorboat and a flying machine combined. It is as seaworthy as any motorboat of its size, and flies as well as any aeroplane of equal proportions.

Now that we have a safe system of flying, the development of aviation is sure and unlimited. For racing, nothing can compare with the flying boat. There is the same chance to jockey for position as in yacht racing, and every opportunity for the airman to exhibit his skill in rounding the buoys and making his starts and landings. I can picture no prettier nor more impressive sight than a fleet of flying boats rising from the water at the start of a race, or coming down the course "neck and neck" at the finish.

There is now no reason why a man who can afford to own a flying boat should not enjoy the sport. The flying boat may be kept in a boathouse, anchored to a buoy or housed in a hangar on land. With an equipment of folding wheels, the machine may be started on land and run out into the water under its own power.

On the water, the flying boat is handled like an ordinary motorboat, although the controls resemble those of an automobile. The rudder is operated by a steering wheel, which also operates the device for elevating. The engine is controlled by a foot throttle. With the engine throttled, the machine will turn about within a radius of 100 ft. When the throttle is opened, the machine gradually climbs on top of the water, and after the first hundred feet is planing on the water much the same as a hydroplane. In this manner it runs on the water until a speed of 45 or 50 miles an hour is attained, when a slight movement of the elevating device will bring it into the air.

The standard machine flies at about 60 miles an hour. To alight, the operator simply sails along close over the surface of the water and throttles his engine. The boat descends until it touches the water, and if the engine is

kept throttled, the boat glides over the water until it has lost its speed, when it settles down and once more becomes an ordinary motorboat.

The flying boat used has a hull 25 ft. long by 2½ ft. beam, it has 250 sq. ft. of wing surface and has a carrying capacity of 600 lb. It will carry fuel supply for a flight of 400 miles. It is fitted with dual control, so that either the operator or passenger, who sit side by side, may assume full control of the machine.

The military advantages of the flying boat have already been recognized. Both the Army and Navy departments of the United States have ordered this new machine, and others are being built for the German and Russian navies, while a French company is building them for France, Italy and England.

The army has established its winter station at North Island, San Diego Harbor, where a number of officers are being sent to be trained in the operation of the flying boat and in aviation generally. The coming of all this activity creates a demand for operators, and with the certainty that the flying boat will be taken up largely as a sport, as well as for military and naval purposes, young men interested in aviation will be encouraged to continue their studies and become familiar with the construction, care and operation of the latest type of flying machine, the flying motorboat.

MOTION-PICTURE SHOW IN 448 PASSENGER STATION

Fully understanding how slowly the time passes when waiting for a train, particularly for a train that is late, the railroad officials having to do with the equipment of the new union passenger station in Kansas City have favorably considered the idea of providing a motion-picture show in the waiting room. Such an idea for the entertainment of passengers while waiting for trains is new, and should prove popular.

DUCK SHOOTING FROM FLYING MOTORBOATS

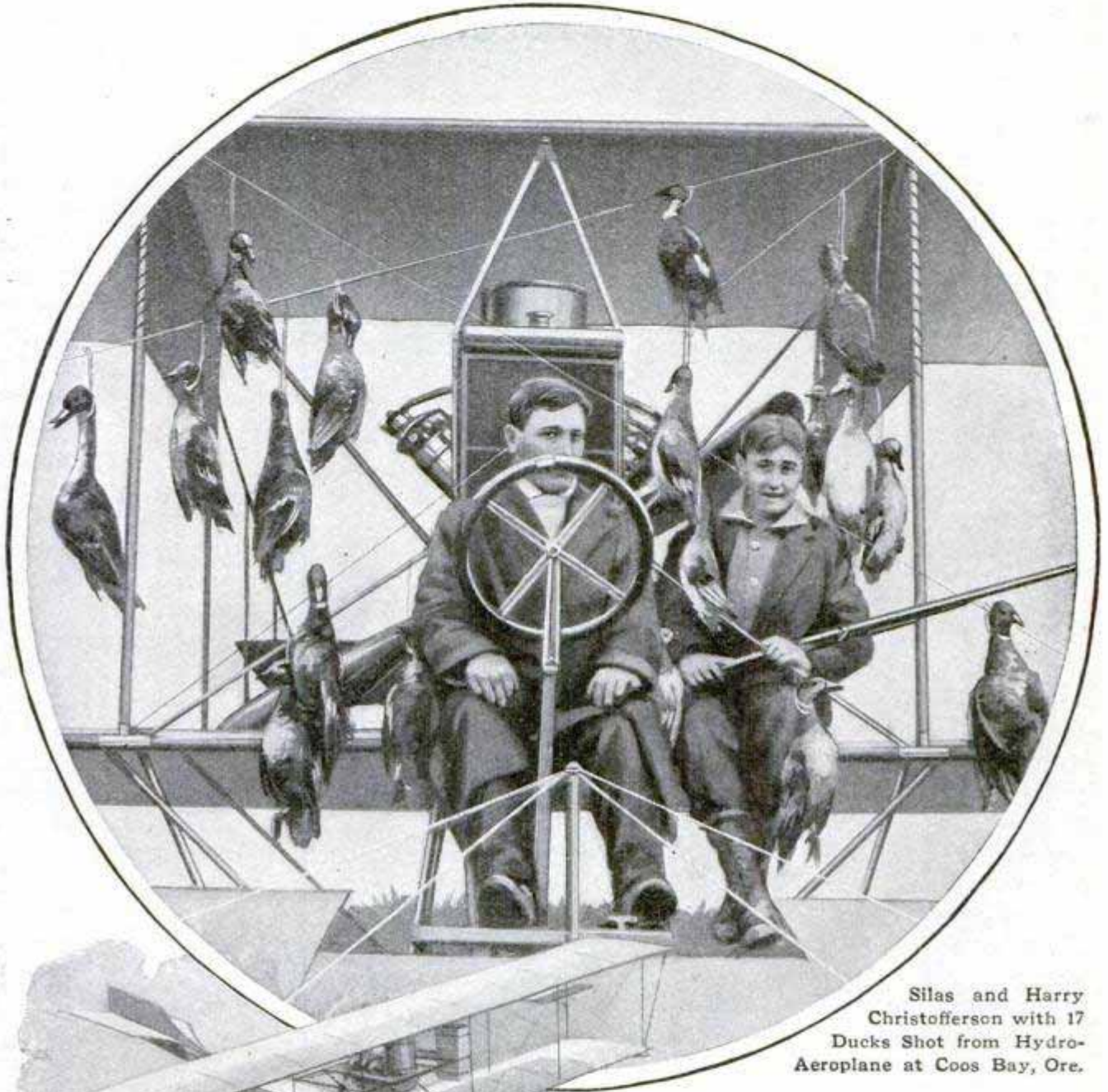

Silas and Harry Christofferson with 17 Ducks Shot from Hydro-Aeroplane at Coos Bay, Ore.

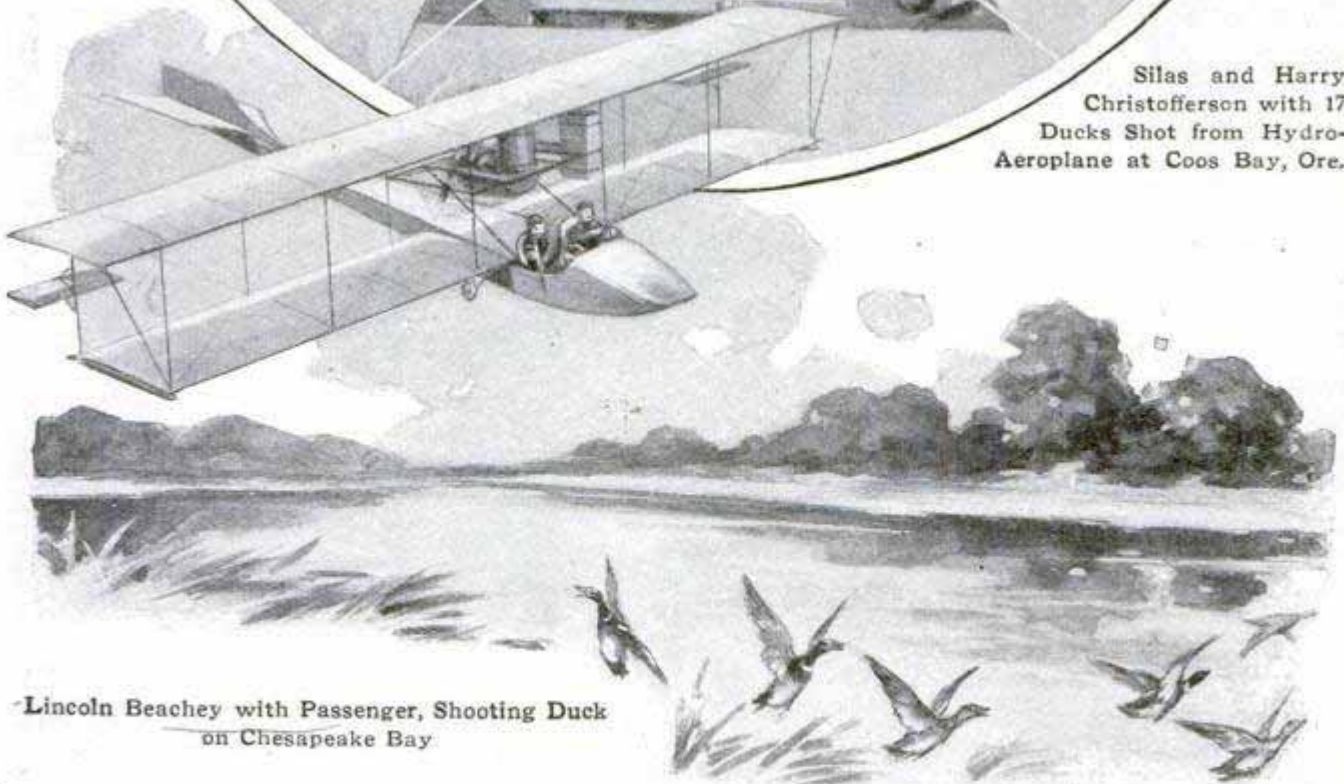

Lincoln Beachey with Passenger, Shooting Duck on Chesapeake Bay

for J. W. Lamp 606 S. Broadway
Dalhousie, Md
GAS SMOKEHOUSE FOR THE CURING OF HAMS

The smoking of hams, frankfurters, and the like, is accomplished by one meat concern in Baltimore, Md., in a

the temperature desired, generally 140 degrees.

The gas smokehouse has a capacity of 30 medium-sized hams, or 175 lb. of frankfurters.

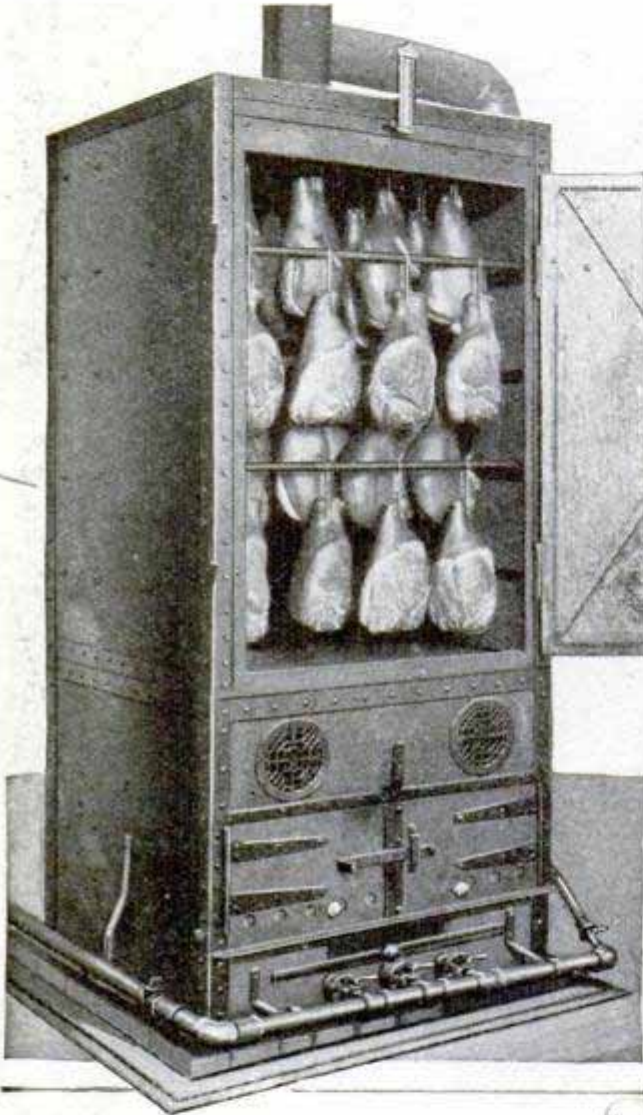

Curing Hams in a Gas Smokehouse

smokehouse heated by gas, which is said to be a new departure in the curing of meats.

It is claimed that the gas smokehouse has the distinct advantage over the wood smokehouse of being entirely independent of weather conditions, and that the saving of time is considerable. The practice is to hang the meats in the smokehouse cold, and then to apply the heat from the gas burners only. When a temperature of 120 deg. is obtained, the sawdust, which may be cedar, oak or hickory, is ignited and the smoke applied to the meat. Then the gas heat is regulated according to

THE ADVANCE OF SHIPPING IN THE LAST YEAR

758
The amount of shipping registered at Lloyd's at the end of the fiscal year ending June 30, 1912, numbered 10,445 vessels, approximating 21,500,000 tons. The vessels built during the year numbered 684, of which 623 were steamships and 61 sailing vessels. A feature of interest is the growing number of merchant ships equipped with improved refrigerating machinery, and used for oversea carriage of frozen and chilled meats, fruits, dairy produce, and the like. At present there are 161 refrigerated ships, and 22 are under construction.

The number of vessels equipped with wireless telegraph is 1,392, as compared with 1,013 a year ago. Six hundred and twenty-five are equipped with submarine signaling apparatus.

AN AERIALY PROPELLED "WATER BUG"

The aerially propelled water craft shown in the accompanying illustration is called the "Water Bug" by its owner. He says it is constructed on the principle of the flat stone skipping over the water. The little vessel is 18 ft. long and 9 ft. wide. It draws but 2 1/2 in. of water.



The "Water Bug," a Small Craft Driven by an Air Propeller

Henry Seidel

606 So Broadway
Balt. Md.

The Engineer Nov. 1, 1912

725

APARTMENT HOUSE ONLY ONE STORY HIGH

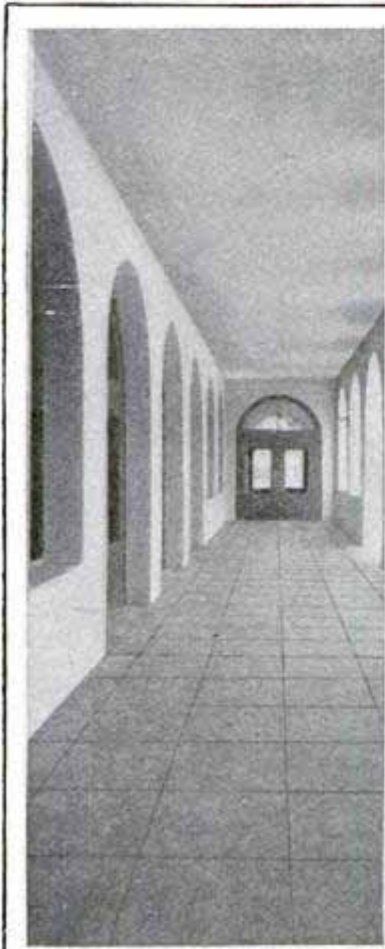

Main Loggia of Apartment House



Upper View—Main Entrance, One Pillar of Pergola Being Visible to the Right.

Lower View—Wing of Cottages with Terraced Garden Main Loggia in Background

Apartment houses only one story high have been evolved by an architect of Sierra Madre, Cal., after the Spanish mission style. The cottages or apartments are built on the north and west sides of a town block, leaving the south and east sides open for the sun to reach each cottage and allow the residents an outlook on a green terraced lawn. Designed for small families, each apartment consists of only three rooms with an entrance loggia, which can be used for a sleeping porch or sitting room. While they all join in one long rambling structure, the individual apartments are so cleverly constructed that they give no less privacy than a cottage in a well built-up neighborhood. Each family has its own well defined bit of garden and walk, which merge harmoniously into the larger lawn.

The entrance to the grounds and cottages is a very beautiful arched doorway which leads directly to the pergola in the center of the grounds. This pergola is for the joint use of the residents. Green foliage will eventually cover this structure, but until it is sufficiently matured, palm fronds have been utilized for shelter from the sun.

As many as 72 war aeroplanes lined up in a recent review of the French air fleet. Every machine was ready to take to the air, the commanders, pilots and observers standing at attention in front of the machines during the inspection. After a brief and businesslike review by the war minister, machine after machine rose and flew away, 20 of them leaving for posts on the eastern frontier.

DRESSING THE FAITHFUL LIGHT BUOYS FOR

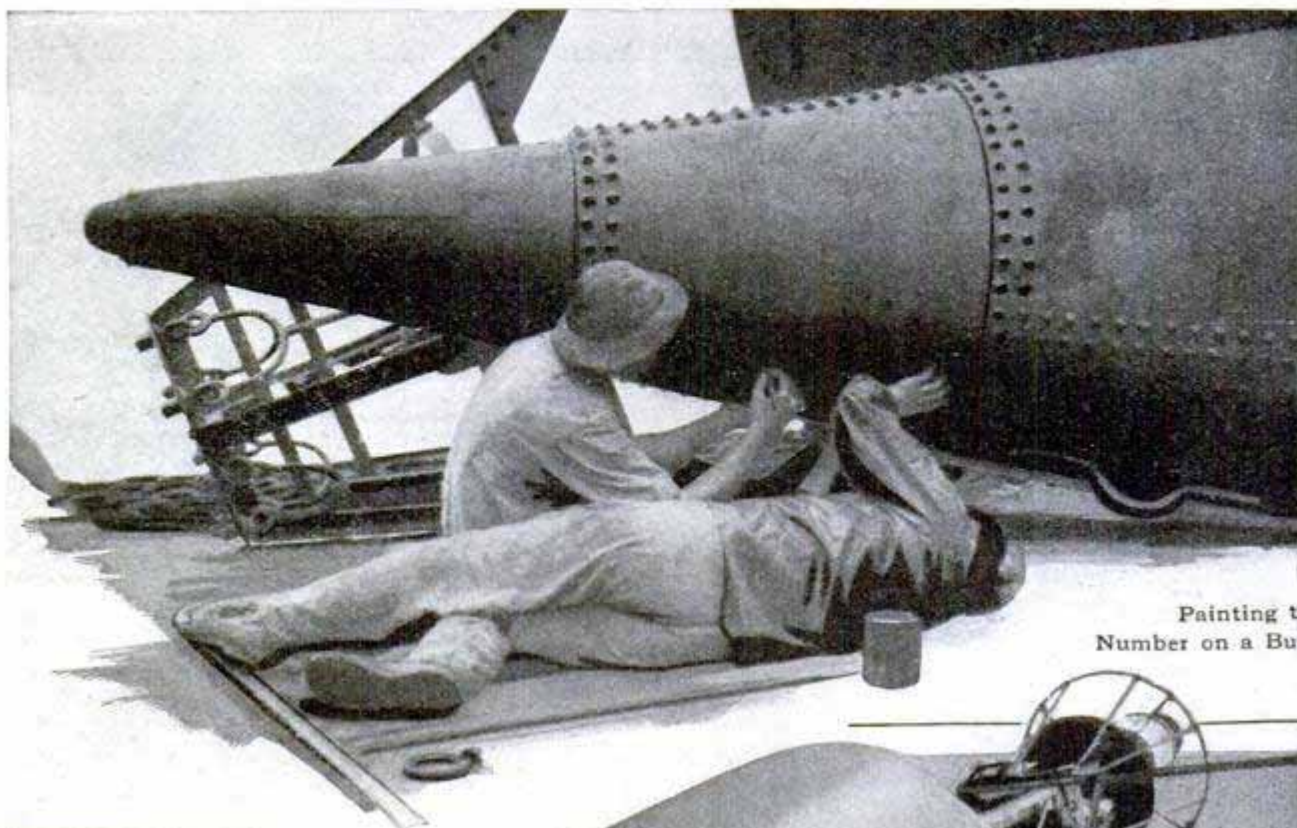

Painting the
Number on a Buoy

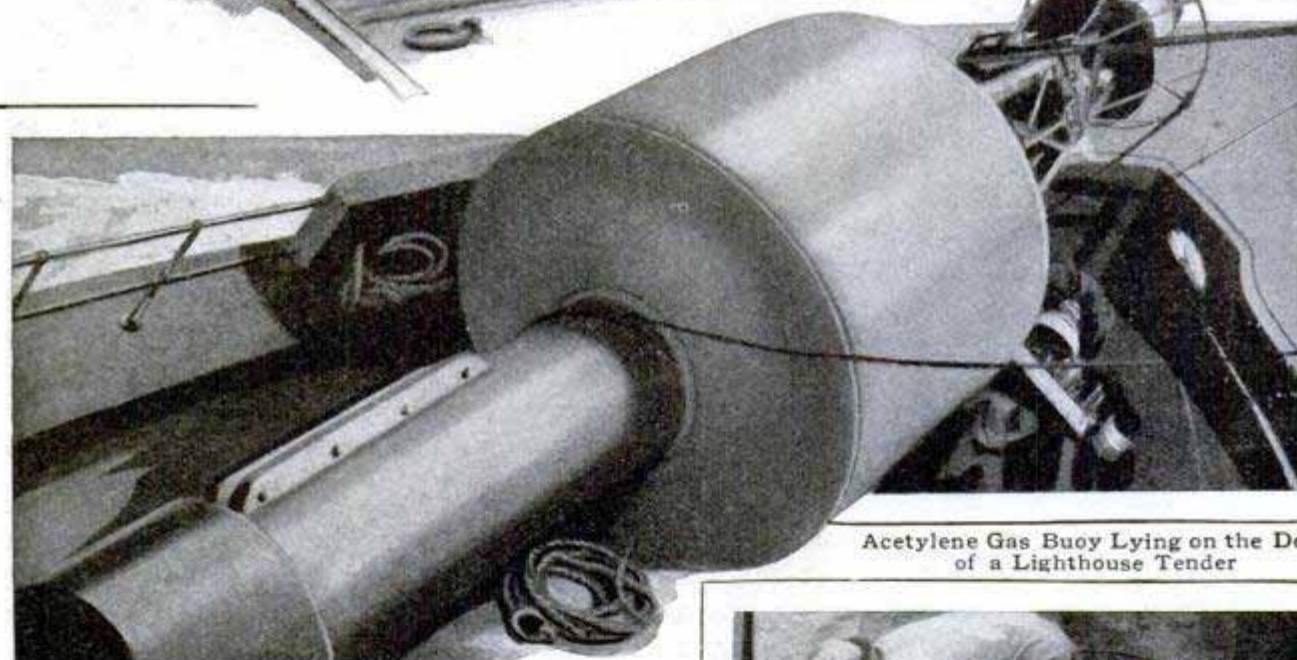

Acetylene Gas Buoy Lying on the Deck
of a Lighthouse Tender

Lowering a Bell Buoy
into the Water

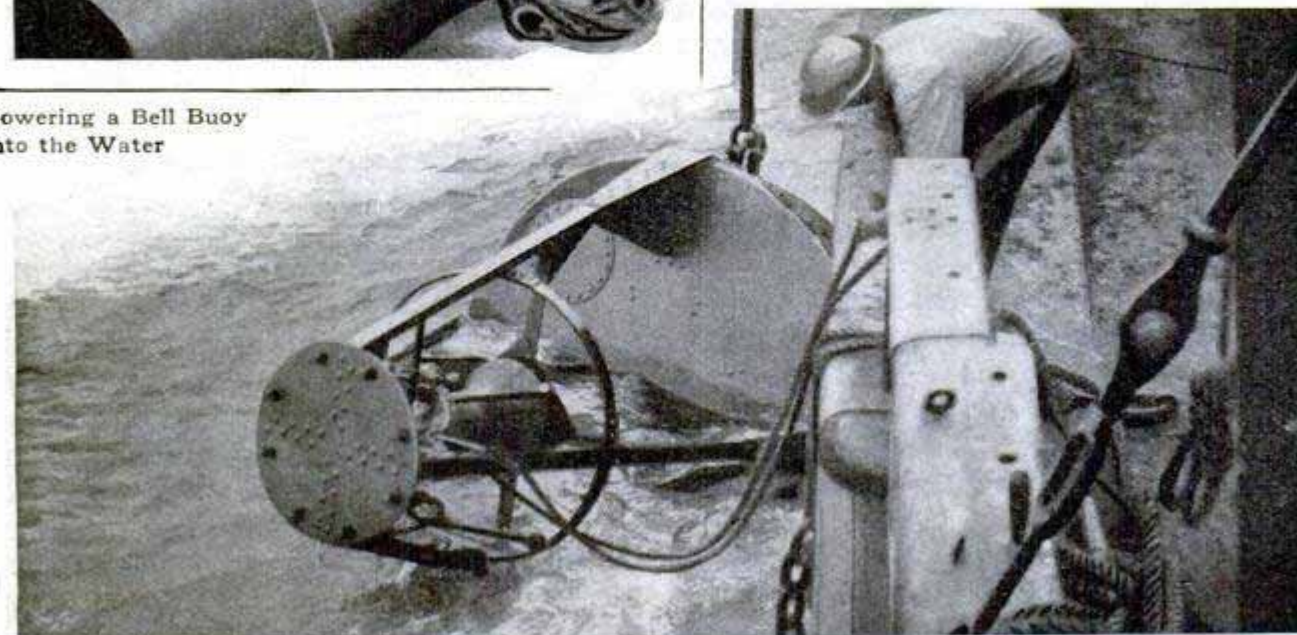

THEIR STORMY WINTER SEA SERVICE

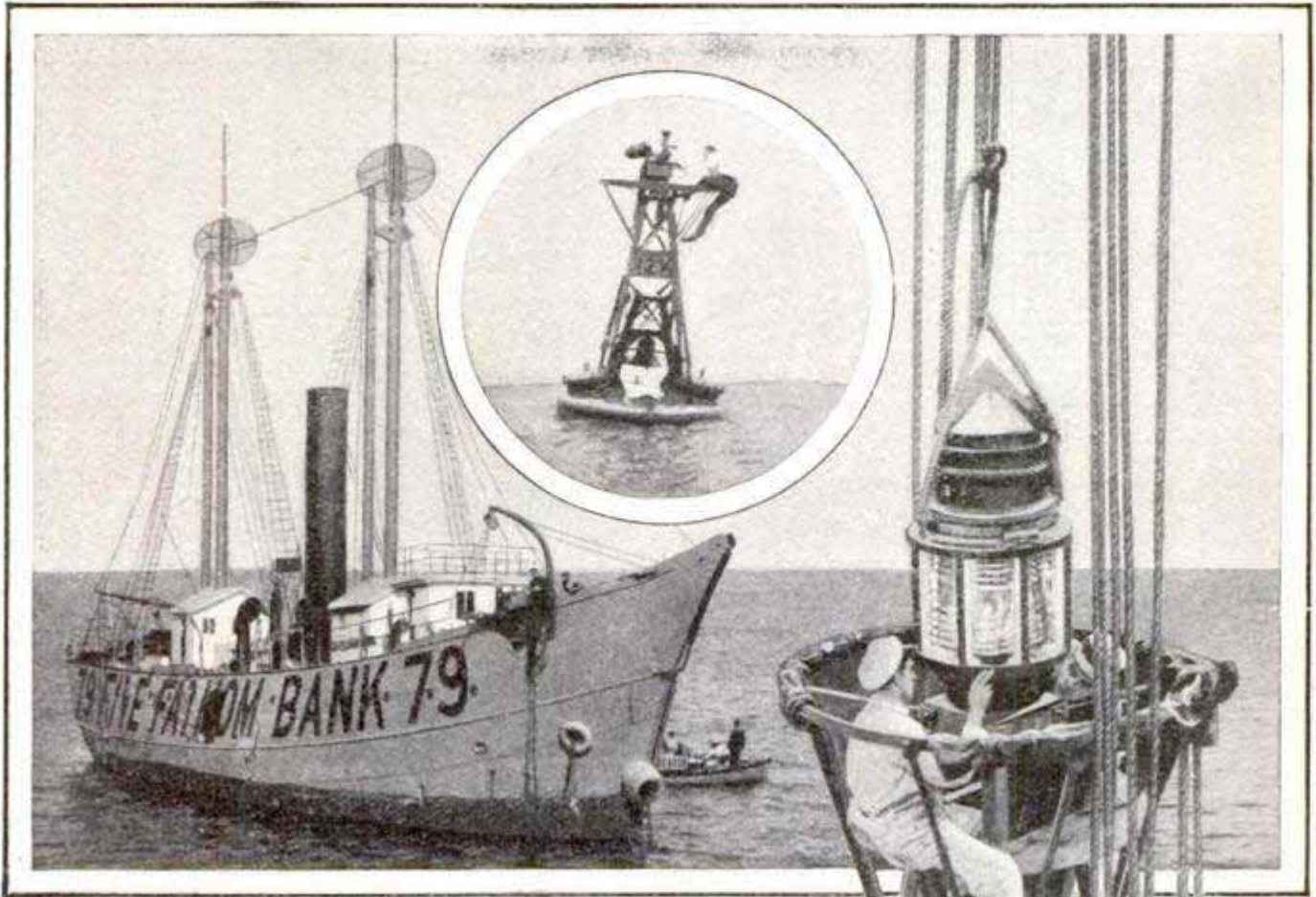

A Lightship on a Five-Fathom (30-Ft.) Bank.
Round Picture — Fixing the Lamp
of an Acetylene Buoy

Although the navy and the revenue service have been made familiar to the general public of the country through the press, the operations of still another maritime department of the United States government, that which has to do with the safeguarding of navigation, are but little known.

In the accompanying illustrations are shown a lightship, and five scenes having to do with the preparing and placing of the many buoys, of which there are several types, that mark channels, indicate dangerous shoals, and the like.

¶ In order to make inn and hotel accommodations for automobile tourists in England more satisfactory, the Automobile Association has placed in a large number of hotels cabinets, each equipped with a comb, brush, and clean towels, and has furnished its members with keys. Each hotel keeper is required to keep the cabinet supplied with clean towels.

Placing
Lamp
on a
Buoy

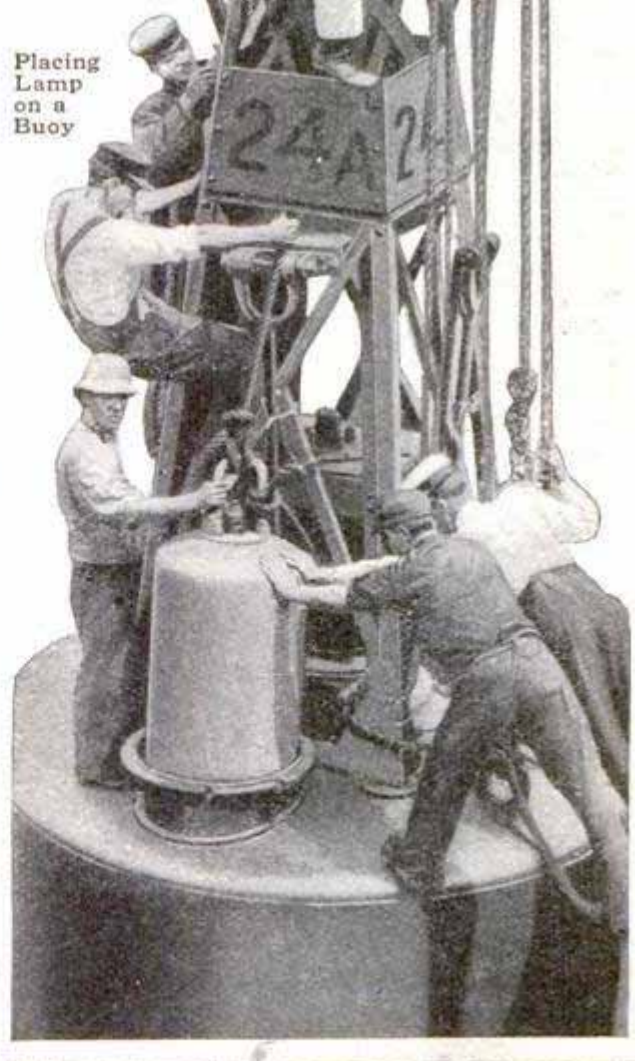

LONDON TO HAVE SUBWAY FOR POSTAL SERVICE

A subway for the carriage of mails, and incidentally to act as a duct for underground telegraph and telephone wires, is being seriously considered by the British government to relieve, at least a little, the present traffic congestion in the streets of London. It is proposed to construct a tunnel under the streets that will be about 9 ft. in diameter and have two tracks large

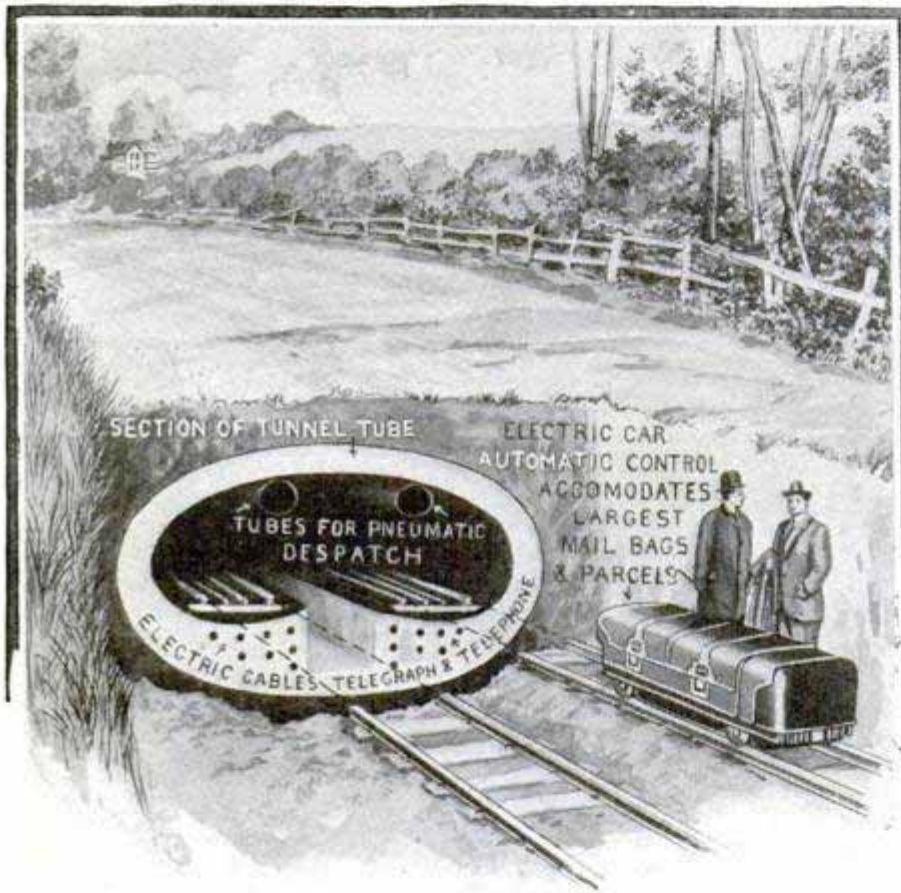

London's Proposed Subway for the Transportation of Mails

enough to accommodate a car 3 ft. wide by 6 ft. long. The tracks will be constructed on concrete foundations on either side of the tunnel and there will be a runway between them to be used as a footpath by persons whose business requires them to patrol the tunnel. Beneath the concrete platforms on which the tracks rest will be ducts for electric wires. The electrically operated mail cars, large enough to accommodate the largest mail bags, will, it is proposed, have a trunklike shape and be equipped with automatic controls. It is believed that this

system will be a great improvement over the pneumatic-tube system that is in use in this country and the underground system employed in Paris for the same purpose.

WHAT THE POPULAR FURS REALLY ARE

Although a great number of popular-priced furs masquerade under names that no actual animal claims as its own,

there is no particular secrecy about it. One of the fur concerns, for instance, publishes a catalogue to inform customers just what they are actually buying. Alaska bear, for example, is the best Minnesota raccoon, colored a dark brown; Adelaide chinchilla is the fur of a selected, soft-haired and delicately colored Australian opossum; French ermine is the fur of the white hare of France; Baltic fox is the fur of a large hare of northern Europe; Iceland white fox is white Thibet lamb, combed until the hair is straight; Kamchatka fox is the fur of the northern timber wolf;

Manchurian fox is the fur of a variety of half-wild dog from Manchuria; Yorkford lynx is Canadian wild cat; Baltic lynx is the large Belgian hare; Finland lynx is a species of Australian kangaroo; Siberian pony is selected Russian calf skin; Hudson seal is muskrat skins of selected quality, and inland seal is the skin of selected French white hare.

¶The recent Clinical Congress of Surgeons of North America, held in New York, set a new record for operations, the number being 3,000.

*Albrecht & Son
St. Paul
C. C. & Munnico*

TIRE AUTOMATICALLY CLOSSES PUNCTURES

A motorcycle tire that automatically closes any ordinary puncture it receives, thus preventing deflation, has been placed on the market. In this tire the tread portion is thicker than in the ordinary product, and when vulcanized, the tube is turned inside out. This, it is claimed, results in a sufficient compression of the rubber to securely close a puncture. The compression of the rubber is aided by an insertion of a high-grade nonelastic fabric.

MAKING GOLD SOFT

Pure gold can be softened by heating it for four days at the boiling point of water. At higher temperature it softens much more rapidly, taking but a few seconds at 400 deg. F. It takes much longer to soften alloys, however, and since gold and silver coins are not pure metals, it takes a considerable period for the softening. It requires 575 deg. F. for a period of 16 days to soften gold coins.

British Institute of Metals

CRAB USES THIMBLE AS A SHELL

A little crab that adopted an old brass thimble as an armor is shown in the accompanying illustration. This species of crab, which abounds on the shore of the Society Islands, in the Southern Pacific, must have some kind of house on its back as a protection, as its hind quarter is jellylike and very

Societe Tahiti d'Etudes



A Crab That Housed Its Hind Quarter in an Old Brass Thimble

soft. It usually obtains the required protection by killing a small shellfish and walking off with the shell.

STEALING WITH THE HEEL OF A SHOE

One of the most novel aids developed by the jewelry thief is a pad of soft leather fastened to the bottom of the



The Soft-Leather Heel Pad, Designed as an Aid in Stealing Jewelry

heel. When he or she, for both sexes are in the "game," nears the small object to be "lifted" it is knocked on the floor accidentally. If the "accident" is not noticed, the heel of the foot is placed on the object, the pressure of the foot sinking it into the soft pad, where it remains until a convenient time arrives for its removal to a safer place.

Nearly 50 tons of water had to be raised out of the mines of South Staffordshire, Eng., last year to every ton of mineral.

676

A "PERAMBULATING" MACHINE SHOP

A large machine-repair shop, 50 ft. wide by 80 ft. long, one of the units of a large factory, had to be moved to a new site, a little more than half a mile distant. It was not possible to dismantle the shop while moving it, unless all the machinery were

fields, but during the entire moving the machinery was kept running without intermission, day and night, and the full quantity and quality of work was turned out. About 15 men worked in the shop each shift, and each day, on quitting work, these men found themselves consid-

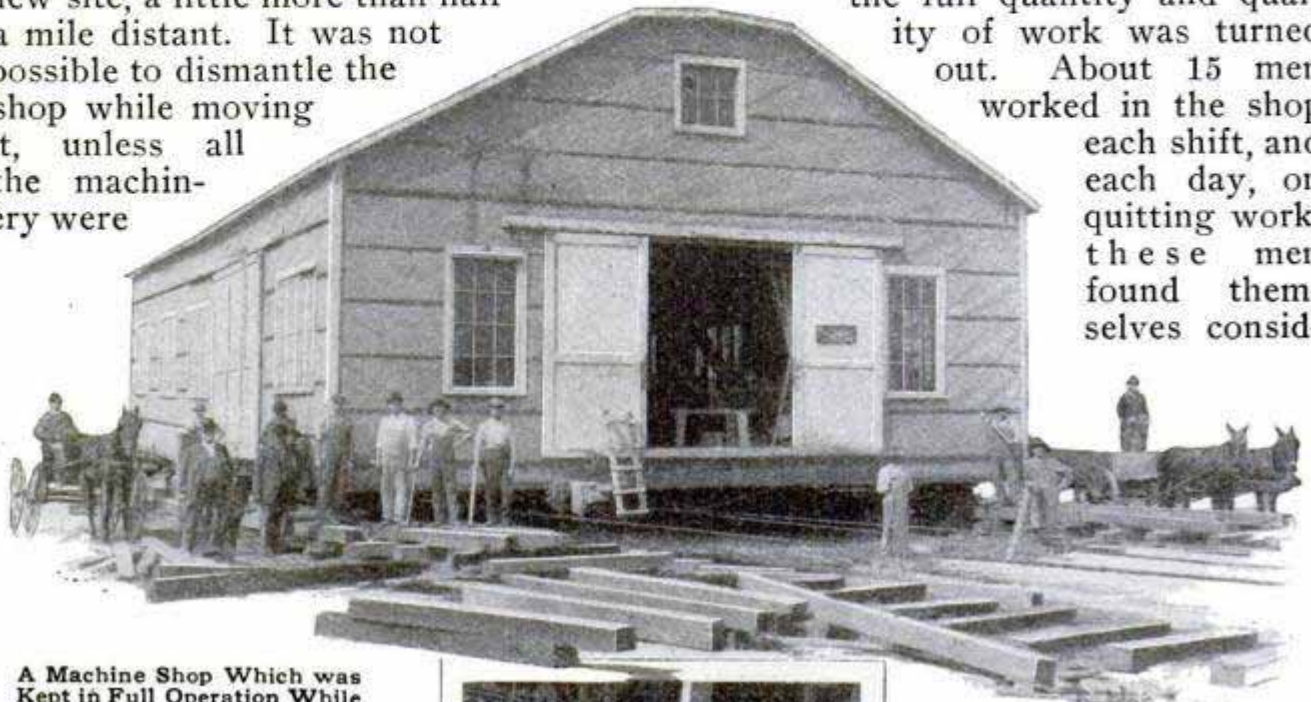

A Machine Shop Which was Kept in Full Operation While It was being Moved Half a Mile to a New Site

temporarily erected where it could be used, and, as this would have entailed a large expense, it was decided to move the structure with all machinery in place, and attempt, at least, to operate the machinery during the moving.

The plan was carried through without a hitch, due to the fact that all the machinery is driven by electric motors. The building was jacked up, loaded on two longitudinal timbers, one under each wall; long coils of line wire were connected up between the power supply and the electric motors, and the moving began. The moving operation took 10 days, and the building had to be drawn up and down hill, across railroad tracks, streets, and planted

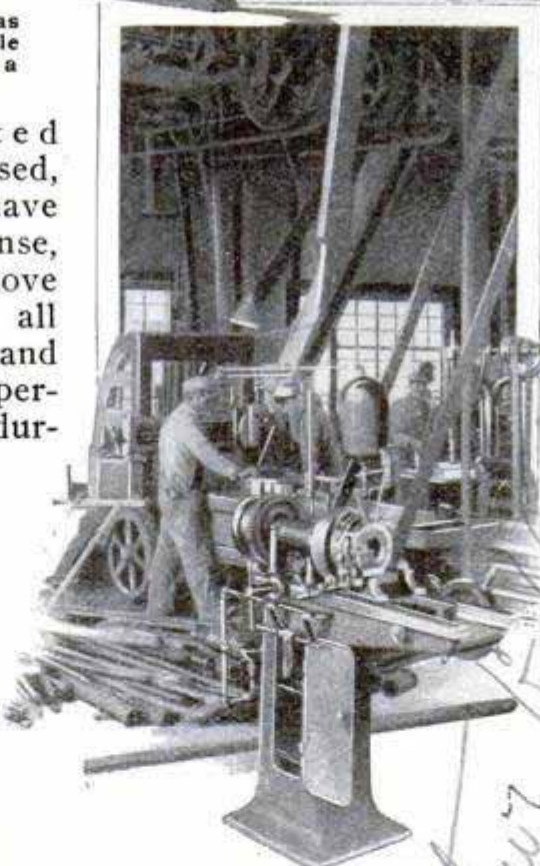

Men at Work in the Machine Shop While It was Being Moved

erably nearer home than when they went to work.

769

AIR GUN STORES POWER FOR SIXTY SHOTS

An air gun which can shoot 60 bullets before the air compressor need be recharged is soon to be placed on the market. By a clever system of valves, the air chamber, which is charged by a few strokes of a lever, becomes a miniature storehouse of energy, just a portion of which is used for each shot.

The little round bullets are fed from the ammunition tube to the breech by an automatic device which makes rapid discharge of the gun possible. The ammunition tube has a capacity of more than 60 bullets.

Scott Wash. 1910. Leuchter. V. Leuchter. W. Arthur.

690

Elephants
Hauling and
Pushing a Boiler
to a Tea Estate in
the Interior of Ceylon

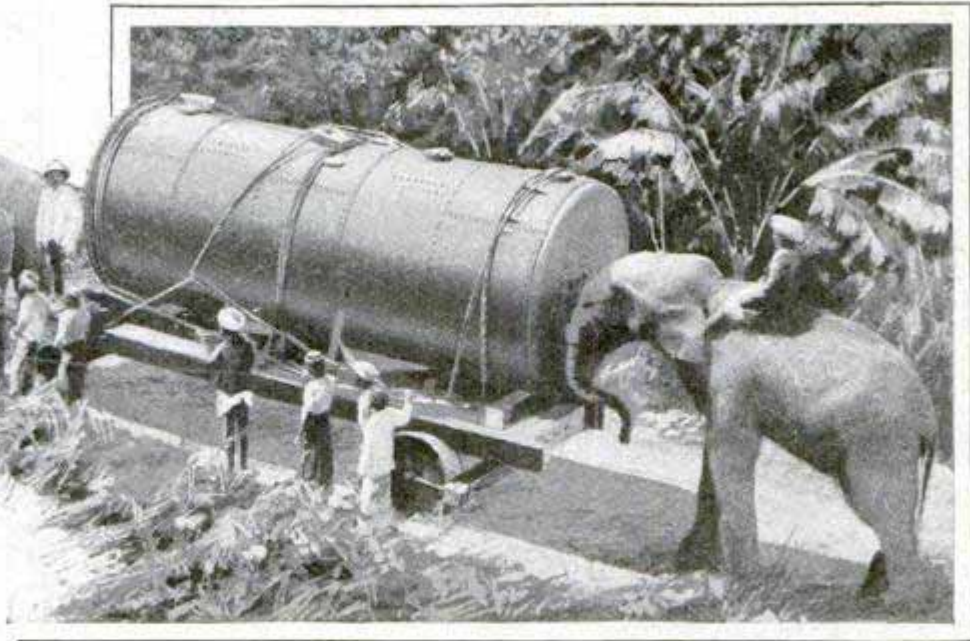

ELEPHANTS HAUL BOILER THROUGH JUNGLE

The transportation of heavy articles into the interior of Ceylon is usually accomplished by means of elephants, an excellent example of the procedure being shown in the accompanying illustration. The large boiler was transported through the jungle to a tea estate, four elephants drawing the heavy truck on which it was loaded, and a fifth pushing with its head against the rear end of the boiler where the road grade was steep.

MOTOR MAIL COLLECTING MADE EASY

Two inventions of a physician of Washington, D. C., which will revolutionize the mail collections in cities and net a great saving to the postal service in both time and money, have been adopted by the postoffice department. These devices include a new drop-bottom street mail box and collection motorcycle.

With the installment of this new system, the city carrier will not have to stop the machinery of his motorcycle or dismount to make collections from boxes. The three-wheeled motorcycle is equipped with a 5-hp. engine and carries a big bin in front. The collector retains his seat, works a lever which drops or opens the bin,

then turns the lock in the letter box, the bottom of which drops at an angle of 45 deg., forming a chute which sends the entire contents of the box into the bin of the collecting motorcycle without handling.

A turn of a lever locks the mail receptacle on the motorcycle, and the closing of the mail box operates a mechanical device which indicates the day, hour and minute of the collection.

By the adoption of these devices city mails will hereafter be more quickly



New Mail-Collection
Device, the Letter Box
Forming a Chute into
the Collector's
Motorcycle Box

Copyrighted by G. V. Buck, Wash., D. C.

collected and an absolute check on the carriers as to the exact time of collections will be had.

FREIGHT TRANSPORTATION IN ALASKA

1726 The transportation of freight into the country around Nome, Alaska, is carried on with considerable difficulty in both summer and winter. In winter, of course, it is a problem of snow, and sleds are used, some of which are drawn by horses as well as dogs. In the illustration of winter transportation, the forward or lead sled is carrying a load of three tons.

The big-



Horses Drawing Heavily Loaded Sleds in Alaska

wheeled "spider" shown in the other illustration is used for hauling heavy pieces of machinery across the marshy country around Nome in the summer time. This vehicle, which carries its load swung under the rear axle, has a capacity of 25 tons. The rear wheels are 8 ft. in diameter, and have a rim 2 ft. wide. The axle is 4 in. in diameter. The ground in the vicinity of Nome is so soft and spongy that a narrow-wheeled wagon would break through the surface, but this spider rolls over leaving scarcely a mark and is comparatively easy to draw. The small front wheels carry practically no weight.

NEW LAST-RESORT METHOD OF RESUSCITATION

A method has recently been devised by Dr. Joseph Erlanger, of artificially producing normal heartbeats by applying electrical stimulus directly to the fibers in which the heart impulse originates.

This treatment may be employed after other methods of resuscitation have failed, or it may be used in connection with massage and other measures. It consists in passing a tube-like electrode, attached to the positive pole of the battery, through a small incision between the third and fourth ribs close to the left side of the breastbone, and applying it directly to the portion of the heart above referred to, while the other electrode is placed



A "Spider" Used for Transporting Heavy Machinery in the Vicinity of Nome

wherever convenient on the body. This starts the contractions in the two upper chambers and stimulates the action of the two lower ones, until soon the whole heart is beating, and revival occurs.

It may be said, with some reason and not irreverently, that this method in connection with artificial ventilation of the lungs by passing a steady stream of air into them through a rubber tube in the windpipe, by which a

person may be kept alive for hours without a motion of breathing on his part, almost amounts to raising the dead.

FULL ELECTRIC SERVICE IN TOWN OF THREE HUNDRED

A 24-hour electric service in a town of only 300 residents is what the little community of Perry, Kas., prides itself upon. The current is obtained from a 17-kw. oil-engine-driven generator, and, as the maximum transmission distance is only 1,300 ft., a 125-volt two-wire direct-current system is used for distribution. The 30-hp. engine uses kerosene for fuel, and is run during the five hours of the night when the load is heaviest. During the rest of the 24 hours storage batteries are drawn on for energy. Energy is furnished 41 customers, including a motion-picture show.

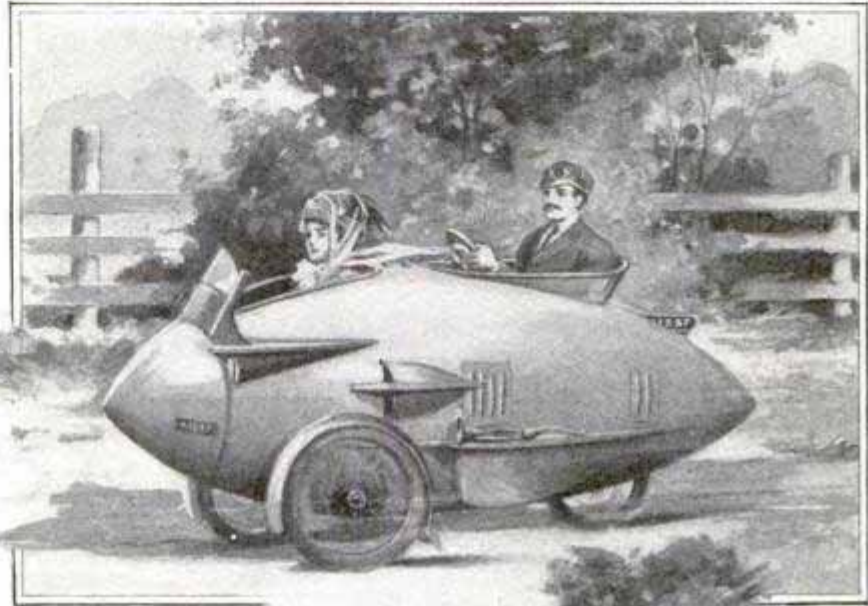

The Freak Motor Car That Caused London Experts to Experience a Shock

AEROPLANE REPORTS WAR MOVES BY WIRELESS

During recent military maneuvers in France a wireless outfit was fitted to a Farman biplane and reports of the movements of troops were constantly sent to General Gallieni by this means. The following messages are some of those sent to headquarters from the air:

8 a. m. Noyant.—A battery entrenched, a group leaves on Noyant road. 8:05 a. m.—Hostile aviation park on the border of the Maure-Sépures road. 8:07 a. m.—La Celles-Saint-Avant. Nothing on the road since Saint Maure. 8:10 a. m.—Port-de-Piles. An infantry column, about a brigade, coming from Dange. 8:25 a. m.—A cavalry regiment passes Dange moving toward Port-de-Piles, upon the Dange-la-Hayes-Descartes road.

The Aeroplane 10/3/12

LONDON HAS THE PRIZE FREAK AUTOMOBILE

Motor-car experts of London have recently been given a shock from which they are slowly recovering. The cause of the disturbance was the appearance on the streets of the British metropolis of a car of the most freakish appearance. In shape it resembled a cross between a fish and a torpedo.

It had three wheels, carried one passenger who sat in front of the driver, and was facetiously described by its maker as having been designed to meet all the various conditions London has experienced during the past summer. So far as is known it was not the contention of the builder of the car that it represented any particular type of construction or was designed to accomplish any other purpose than head the long list of freaks that have put in their appearance since the horseless vehicle became popular.

ⒸAn electric searchlight of 72,000-candlepower intensity and a range of 5 nautical miles (about 5.8 statute miles) has been recently installed on the Hamburg-America liner "Kaiserin Augusta Viktoria" as an additional safeguard against collision with icebergs.

HUGE FLAGPOLE FOR EXPOSITION

59 A perfectly straight log of Douglas fir, 220 ft. long and 5 ft. in diameter at the butt, tapering evenly to a diame-

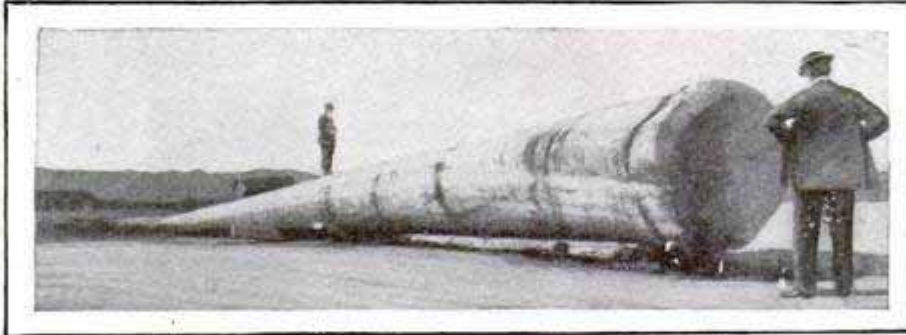

A 220-Ft. Douglas Fir to be Used as a Flagpole at the Panama-Pacific Exposition

ter of 2 ft. at the top, lies at the Panama-Pacific Exposition grounds waiting to be erected as the lower portion of what will probably be the biggest flagpole in the world. It was brought down the Pacific coast from Washington as part of one of the giant rafts of logs for which that section is noted.

691 FOUR-GUN TURRETS FOR FRENCH BATTLESHIPS

The new battleships of the French navy are to have three turrets, each of which is to mount four 12-in. guns. As these vessels will be the first to carry four guns to a turret, the experiment will be watched with considerable interest by the rest of Europe and also by the designers of the American battleships. The gun mountings will have to be of extraordinary weight, and

there are other difficulties to be met, but if the four-gun turret proves a success, the smashing power of a comparatively short ship with three such turrets mounted on the middle line, will be enormous, as this would make all 12 big guns available for every broadside.

SETTLING CEMENT DUST BY ELECTRICITY

The cement-making industry is growing so rapidly that any improvements in its method of manufacture are very important. Of particular interest to this industry during the past few years have been the objections arising to the dust which is given off from the great cement kilns and spreads over the surrounding country. In southern California, two enormous cement plants have been forced to find some means of preventing the escape of this

dust, since the farmers in the vicinity claimed that their orange and lemon groves were being ruined, and this problem thus became extremely important. Each of the great kilns used at these plants gives off nearly a billion cubic feet of gas per day, and thus carries four or five tons of dust out into the atmosphere. Since there are ten kilns, it will be seen that a very large amount of dust would be thrown out. The difficulty in getting the dust

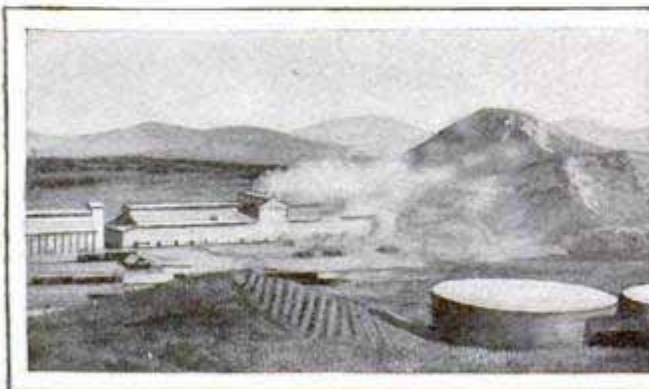

View of Dust Cloud over Cement Factory before Settling Apparatus was Installed

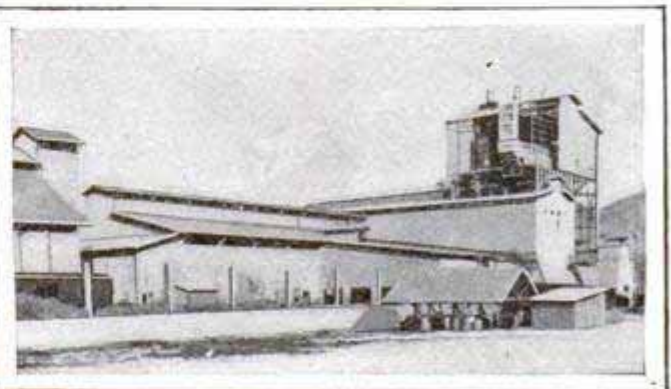

Same Factory with Apparatus for Settling Dust by Electricity in Operation

out of these gases is caused not only by the enormous volume of gas, but also by its very high temperature (about 850 deg. F.). Recently, however, Walter A. Schmidt of Los Angeles has succeeded in precipitating all of this dust by passing an electric discharge through the hot gases, according to the method devised by Sir Oliver Lodge, for precipitating the dust from the smoke of smelters. Sir Oliver did not succeed in the practical application of his process, but it was made a commercial success by Dr. F. G. Cottrell.

By passing electricity through the gases at a high voltage (what is called a glow discharge) the particles of dust become charged with electricity, and are attracted to electrically charged plates of metal. The dust thus collected is cleaned off every three or four hours by a mechanical rapping or striking of the plates, the machinery being run by an electric motor.

The method is in itself very economical, and the cement companies may even find that they make money by being forced to collect the dust, for it has been found to be very valuable as a fertilizer, containing a large percentage of potash.

COLOSSAL STATUES CARVED FROM SINGLE BLOCKS

The first of the six mammoth statues which are to occupy positions above the entrance of the Union Station in Washington was hoisted into place recently. The statue is said to be among the largest in the world cut from a single block of stone. It is about 25 ft. high and weighs more than 25 tons.

The six statues represent the last work done by the late Augustus Saint-Gaudens, the famous sculptor. The one that was recently placed in position is symbolical of Truth. The other five are to represent Fire, Electricity, Old Mechanics' Arts, Freedom, and Imagination.

In order to hoist the statues into position the most massive derrick ever used in Washington was employed. The pedestals which the statues are to

occupy are nearly 60 ft. above the street level. The derrick is about 90 ft. high.

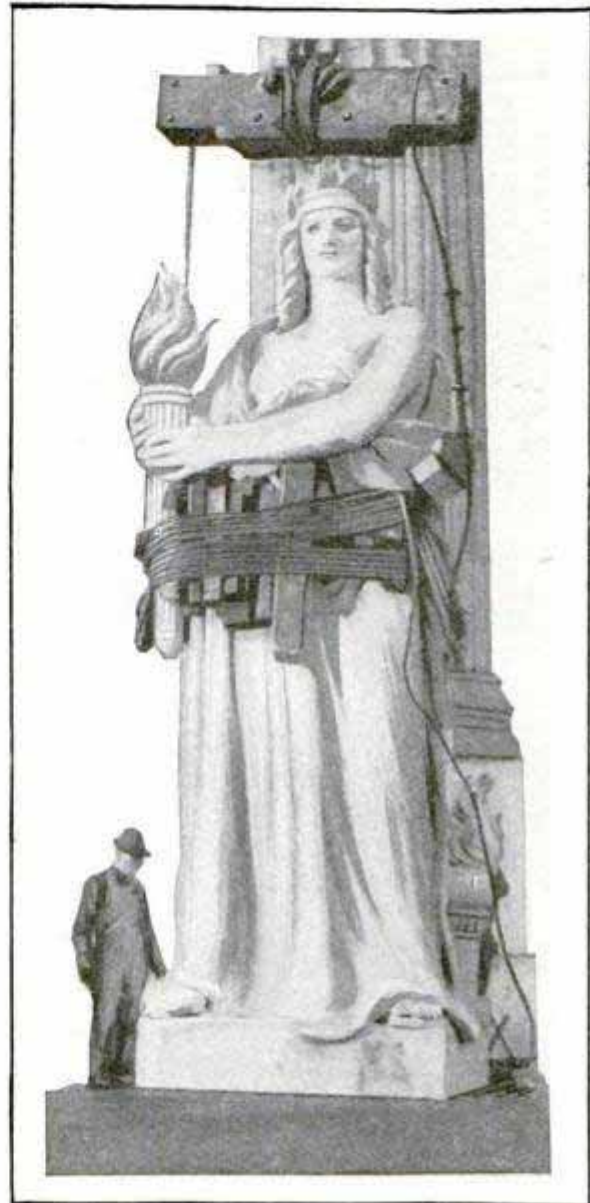

"Truth," by Saint-Gaudens, One of Six 25-Ft. Statues, Which are to Adorn Entrance of Union Station, at Washington, D. C.

The statues have been carved from blocks of Northfield, Vt., granite weighing 90 tons.

THE WATER CLAIMED TO BE SAFER THAN LAND OR AIR

The loss of life on oceans, lakes, bays and rivers, is, according to the ~~Marine~~ Journal, 50 per cent less than that on land conveyances. Attention is also drawn to the fact that, although submarine navigation is about as dangerous as the, to man, equally unnatural navigation of the air, the loss of life in the former has been considerably less, proportionally, than in the latter.

The 10/10/12

TROPHY OF MERIT FOR PARK EMPLOYEES

The park commissioners of Los Angeles allot a bronze tablet which stands

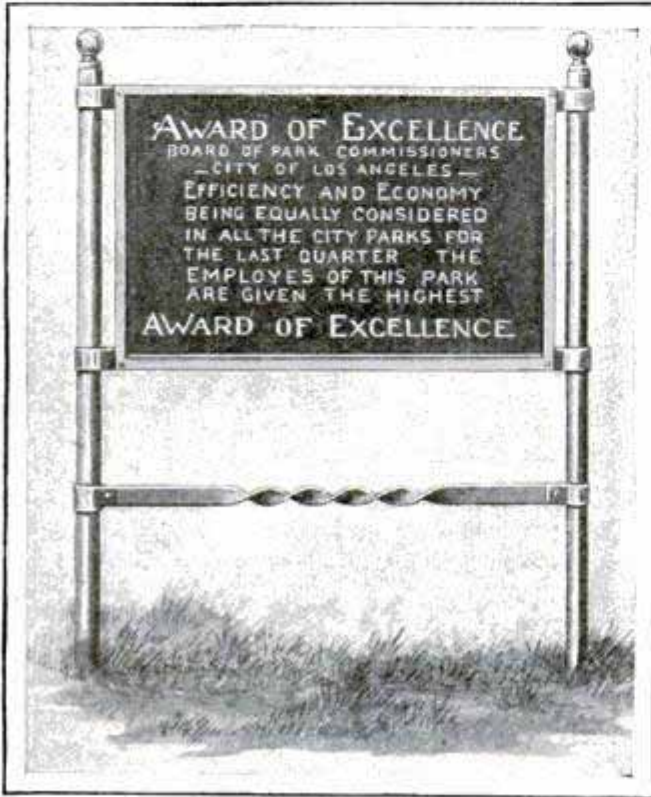

Tablet Awarded Every Three Months to the Employees of the Best Cared-For Park in Los Angeles

as an award of excellence in the park which was most efficiently cared for in the past quarter. This trophy has the dimensions of about 1½ by 2 ft. and is mounted on an ornamental support of iron. Every three months it is placed in the recreation ground which has shown the best results in the preceding 90 days, and in addition to this honor, the employees of that park receive a bonus of \$5 each. The system works for the betterment of the park service and is highly commended by the commission.

OLDEST BLAST FURNACE DISMANTLED

754 With the dismantling of the Cedar Point furnace, Port Henry, N. Y., what is believed to be the oldest original blast-furnace shell in operation in this country ended its period of usefulness. It was erected nearly 40 years ago, and was the first furnace to use the

Whitehall hot-blast stoves, which were imported at a cost of over \$100,000.

THE NEW SAFETY RULES FOR TRANSATLANTIC LINERS

765 The lesson of the "Titanic" disaster has borne fruit at last, at least as far as rules and regulations are concerned. The British Board of Trade has issued its new requirements. All foreign-going passenger steamers, emigrant ships, and foreign-going sailing ships carrying passengers must provide sufficient lifeboat accommodation for all on board. All lifeboats must be of prescribed build, and must be fitted with protective fenders. The term "lifeboat" includes the "deck lifeboat," but the collapsible lifeboat is no longer to be allowed. Existing collapsible boats, however, are to be allowed to count for a certain period, after which they must be replaced. A larger number of motorboats is to be allowed. The equipment for lifeboats is somewhat enlarged, and all of it must be in the boats when the ship leaves harbor. The number of persons to be carried must be marked on each boat. The rule now existing which gives permission to carry a lesser number of boats in the event of the ship being divided into efficient watertight compartments is abolished.

The new rules for life jackets and life buoys require that they must be suitably placed, and that at least half the life buoys must have ignition apparatus attached.

The date set for these rules to go into force was Jan. 1, 1913, but they are not to apply where they involve structural alterations to the ship until her next annual survey by the board.

Preliminary steps are being taken to deal with the question of improving the existing arrangements for reporting the movements of ice in the North Atlantic. The report concludes by expressing the hope that the question of steamship routes and the speed of steamships in the vicinity of ice will be the object of international discussion.

AVIATION NOW AS SAFE AS FOOTBALL

Commencing with the death of Lieut. Thos. E. Selfridge, at Ft. Myer, Va., on Sept. 17, 1908, and continuing down to Nov. 22, 1912, man's conquest of the air by engine-driven aeroplanes has been attended by 224 fatal accidents, in 23 of which a passenger as well as the pilot was killed.

In addition to the deaths caused by power machines, there have been five fatalities from glider experimentation—Otto Lilienthal, at Gross Lichterfeld, Germany, Sept. 21, 1896; Percy Sinclair Pilcher, at Rugby, England, Oct. 30, 1899; John Maloney, at Santa Clara, Cal., April 18, 1905; Eugene Speyer, at San Francisco, Cal., June 17, 1910, and Prof. John James Montgomery, in the Evergreen Hills, Cal., Oct. 31, 1911.

The annual division of the fatal accidents is, one in 1908, four in 1909, 30 in 1910, 77 in 1911, and 112 in 1912—up to Nov. 22.

For the figures following, the fatal accidents are the basis, on the theory that the death of the pilot is the essential part of the statistics, and deaths of passengers, while recorded in the separate list of deaths, are not properly included in a consideration of flight mileage per fatality.

The aggregate mileage of all flying

Austria, 100 Pilots, 1 in 20 Killed



Belgium, 100 Pilots, 1 in 25 Killed



Russia, 200 Pilots, 1 in 17 Killed



United States, 300 Pilots, 1 in 7 Killed



Italy, 300 Pilots, 1 in 20 Killed

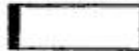

England, 350 Pilots, 1 in 18 Killed

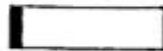

Germany, 1,500 Pilots, 1 in 28 Killed



France, 3,000 Pilots, 1 in 41 Killed



done throughout the world has been conservatively estimated as follows: during 1908, 1,000 miles; during 1909, 28,000 miles; during 1910, 600,000 miles; during 1911, 2,300,000 miles, and during 1912, 12,000,000 miles. It is not claimed that these figures are absolutely complete, but they include only carefully observed and definitely tabulated performances, so the inclusion of more complete data could only increase, rather than decrease them.

The number of airmen during each year, including all others as well as the licensed pilots, works out pretty closely to five in 1908; 50 in 1909; 500 in 1910; 1,500 in 1911, and 5,800 in 1912.

Now, making a few simple deductions from the foregoing data, it is easy to calculate that in 1908 there was a fatality for each thousand miles of flight; in 1909, one for each 7,000 miles; in 1910, one for each 20,000 miles; in 1911, one for each 30,000 miles, and, in 1912, one for each 107,000 miles. It is equally evident that in 1908, one in five of the airmen were killed; in 1909, one in 12; in 1910, one in 17; in 1911, one in 20, and in 1912, one in 51.

On the face of it, then, aviation has consistently and rapidly improved in safety from year to year, until now it is at least ten times as unlikely to kill a person engaged in it as it was in 1908. And in spite of this reduced danger per individual, there is a still greater reduction of danger per unit of mileage, 107,000 miles of flight being now accomplished with the same toll of human life that only four years ago was paid for each thousand miles.

Yet ninety-nine persons out of every hundred are impressed with the idea that aviation, which had killed less than half a dozen individuals four

Diagram of Fatal Accidents to Aviation Pilots in Four Years. The Long Strips Represent the Number of Pilots Flying, and the Black Sections at the Left Represent the Proportion of Pilots Killed

AVIATION DEATHS IN 1912

NAME	PLACE	DATE	MACHINE
— Ruchonnet	La Vidaméc, France	Jan. 12	Monoplane
— Wagner	Juvisy, France	Jan. 20	Biplane
Lieut. Boerner	Senlis, France	Jan. 21	
Rutherford Page	Los Angeles, Cal.	Jan. 22	Biplane
Lieut. Pomentonia	Pau, France	Feb. 2	
Capt. Le Maguet	Saint-Cyr, France	Feb. 4	
Albert Schmidt	Oberschonweide, Germany	Feb. 16	Biplane
Grahame Gilmour	Brooklands, England	Feb. 17	Monoplane
Lieut. Ducourneau	Pau, France	Feb. 23	Monoplane
— Fraschi	Turin, Italy	Mar. 3	
Mlle. Suzanne Bernard	Etampes, France	Mar. 10	Biplane
Lieut. Sevelle	Pau, France	Mar. 13	Monoplane
Gustave Witte	Teltow, Germany	Mar. 15	Biplane
Lieut. Bertoletti	Villola-Ticino, Italy	Mar. 15	Monoplane
Lieut. Albo Kaiwow } Mechanician }	Sebastopol, Russia	Mar. 23	
— Rost	Harburg, Germany	Mar. 25	
— Kleine	Dusseldorf, Germany	Mar. 26	
Capt. Jost	Villesauvage, France	Mar. 30	
— Schmidt	Johannisthal, Germany	Apr. 3	
Calbraith P. Rodgers	Long Beach, Cal.	Apr. 3	Biplane
Lieut. Boncour	Laimont, France	Apr. 13	Monoplane
John Verrept	Versailles, France	Apr. 17	Monoplane
Lieut. Ville-d'Avray	Verdun, France	Apr. 19	
— Hoestli	Johannisthal, Germany	May 1	
Count de Robillard	Nice, France	May 4	
Mlle. Galanschkee	Riga, Russia	May 5	
— Olbrechts	Saint-Job, Belgium	May 6	
— Pachmeyer	Johannisthal, Germany	May 7	
Lieut. Depersis	Pordenone, Italy	May 10	
— Schmigulski	Kassel, Germany	May 12	
Ray Wheeler	Kinlock Park, Mo.	May 13	
E. V. B. Fisher } Victor Mason }	Brooklands, England	May 13	Monoplane
Capt. Echeman	Etampes, France	May 14	Monoplane
Fred J. Southard	Osborn, Ohio	May 21	Biplane
— Hoff	San Francisco, Cal.	May 25	
Lieut. Von Schlichting	Johannisthal, Germany	May 25	
Harry Turner	Mineola, N. Y.	May	
Albert Buchstaetter } Lieut. Stille }	Bremen, Germany	June 1	
Philip Parmelee	North Yakima, Wash.	June 1	
Edward Reby	Juvisy, France	June 1	
Levasseur	Champagne, France	June 8	
— Kimmerling } — Tonnet }	Mourmelon, France	June 9	Monoplane
Lieut. L. W. Hazelhurst } A. L. Welch }	College Park, Md.	June 11	Biplane
Julia Clark	Springfield, Ill.	June 17	
— Yamish } — Leon }	Sebastopol, Russia	June 19	
Capt. Dubois } Lieut. Albert Peignian }	Douai, France	June 19	Biplane
Lieut. von Falkenhayn	Doberitz, Germany	June 19	Monoplane
Engineer Schlegel	Gotha, Germany	June 24	
Lieut. Etienne	Guyancourt, France	June 25	
Lieut. Schadt	Muhlhausen, Germany	June 28	
Capt. Bayo	Madrid, Spain	July 1	
Benno Koenig	Langenfeld, Germany	July 1	
Harriet Quimby } A. P. Willard }	Boston, Mass.	July 1	Monoplane
M. Pecker	Mourmelon, France	July 2	
Lieut. Cavanda	Bucharest, Roumania	July 5	Biplane
Capt. Loraine } Sergt. Wilson }	Stonehenge, England	July 5	
René Bedel	Mourmelon, France	July 9	Monoplane
Victor Morris Smith	Ravenswood, Cal.	July 13	
Gaston-Fernand Oliveres	Bourges, France	July 15	Biplane
Lieut. Zakotsky	Sebastopol, Russia	July 16	
Lieut. Preusser	Leipzig, Germany	July 18	
— Hansen	Norway	July 20	Monoplane
— Fischer } — Kugler }	Munich, Germany	July 27	
Sergeant Lachmann	Doberitz, Germany	July 30	
Lindsay Campbell	Byfleet, England	Aug. 3	Monoplane
Gottlieb Rost	Hamburg, Germany	Aug. 12	

NAME	PLACE	DATE	MACHINE
— Toth	France	Aug. 12	
W. Fenwick	Salisbury, England	Aug. 13	Monoplane
Lieut. Manzini	Tripoli, Africa	Aug. 24	
Fung Guey	Canton, China	Aug. 25	
L. F. M. Chandenier	Crecy-sur-Serre, France	Aug. 28	Biplane
Lieut. Garino	Vercelli, Italy	Sept. 1	
Lieut. Steger	Oberwiesenfeld, Bavaria	Sept. 6	Biplane
Capt. Patrick Hamilton } A. Wyness Stuart }	Hitchens, England	Sept. 6	Monoplane
E. H. Hotchkiss } C. A. Beddington }	Woolvercote, England	Sept. 10	
Alexander Karamanlaki	Gulf of Corinth, Greece	Sept. 11	Monoplane
Lieut. Siebert	Dresden, Germany	Sept. 11	Monoplane
Wm. B. Chambers	Greene, N. Y.	Sept. 11	
Paul Peck	Chicago, Ill.	Sept. 12	Biplane
Alexander Borie	Bornhem, Belgium	Sept. 13	
Howard Gill	Chicago, Ill.	Sept. 15	Biplane
— Lanciano	Italy	Sept. 15	
— Wenzel	Wiener-Neustadt, Austria	Sept. 18	
Russell Blair	Shenandoah, Iowa	Sept. 20	
H. D. J. Astley	Belfast, Ireland	Sept. 21	
Lieut. Berger } Lieut. Junghans }	Freiburg, Germany	Sept. 21	Monoplane
Lieut. Thomas	Bar-le-Duc, France	Sept. 25	
Lieut. Reggadoni	Mirafiori, Italy	Sept. 25	
Capt. Bambaugh	North Manchester, Ind.	Sept. 27	Biplane
Lewis C. Rockwell } Frank S. Scott }	College Park, Md.	Sept. 28	
John J. Longstaff	Hempstead, N. Y.	Sept. 28	Biplane
Geo. Underwood	Berrier, Mo.	Sept. 30	
Lieut. Wm. Hofer	Tannenburg, Germany	Oct. 1	
Chas. F. Walsh	Trenton, N. J.	Oct. 3	Biplane
— Happe	Buc, France	Oct. 3	
August Birkmaier	Hanover, Germany	Oct. 4	Monoplane
Ernest Alig }	Johannisthal, Germany	Oct. 6	Monoplane
— Libau }			
Mahohisa Kondo	Savona, N. Y.	Oct. 6	Biplane
Mechanician	Malpensa, Italy	Oct. 7	
— Visseur	Betheny, France	Oct. 10	
Alexander Takacs	Rekos, Austria	Oct. 14	
Henri Cobbioni } M. Bippert }	Chaux-de-Fonds, Switzerland	Oct. 15	
Maurice Blanc	Chalons, France	Oct. 17	Monoplane
Lieut. Weissbarth } Lieut. Lang }	Giengen, Germany	Oct. 19	
Amedée Lacour	Massidant, France	Oct. 20	
Louis Mitchell	Montgomery, Ala.	Oct. 23	Biplane
Russian Officer	Tarnow, Austria	Oct. 26	
— Siebert	Germany	Oct. 30	
Moritz Hamburger	Oberwiesenfeld, Germany	Oct. 30	
Lieut. Poutrin	France	Oct. 31	
Nicholas Popoff	Adrianople, Turkey	Nov. 7	
André Frey	Reims, France	Nov. 22	

years ago, has grown into something terribly dangerous, when, as a matter of fact, aviation commenced as something very hazardous and has developed already into something fully 99 per cent less risky, until now a flight in an aeroplane is far safer than a ride in a racing automobile, and is only about as hazardous as participation in a football game, which, for numbers and time of individuals engaged, rolls up substantially an equal fatality list.

Much might be urged concerning the relative importance to human progress of aviation and football, but this

may be left to the impartial reader, despite the frequent newspaper standpoint, which plays up the spectacular aviation fatality and subordinates the commonplace football mishap, until a wholly wrong impression is produced.

Much also is to be said concerning preventable deaths of airmen. The most striking insight into this phase of the matter is probably to be gained from a comparison of the deaths in the eight principal countries, in which over nine-tenths of all the aviation accidents have occurred. From this comparison it is learned that, in Aus-

tria, with 100 pilots, there have been five deaths, or one in 20; in Belgium, with 100 pilots, four deaths or one in 25; in Russia, with 200 pilots, 12 deaths, one in 17; in the United States, with 300 pilots, 43 deaths, one in 7; in Italy, with 300 pilots, 15 deaths, one in 20; in England, with 350 pilots, 20 deaths, one in 18; in Germany, with 1,500 pilots, 54 deaths, one in 28; and in France, with 3,000 pilots, only 73 deaths, or one in 41.

The criminally bad showing of the United States, with a fatality rate still almost as high as when aviation was pure experimentation, instead of a well-formulated engineering science,

is unquestionably to be ascribed to the policy prevailing in this country, of leaving flight development so much in the hands of untrained club members, showmen, and reckless youths, instead of organizing it under the direction of engineers and scientists, as is done in France and Germany. That the distinction of the United States in this connection is even more unenviable than might otherwise appear, is to be inferred from the fact that, in addition to the excessive proportion of American airmen who have been killed, the American flight mileage per airman is away below the average of the important European countries.



The Steeplejack Resting upon the Top of the 600-Ft. Wireless Tower
On the Right—Steeplejack Perched on the Top of the Flagstaff
of the Highest Tower, 635 Ft. above the Ground

FAR-FLUNG MESSAGES OF GOVERNMENT WIRELESS

Exceptional power has been shown by the great government wireless station erected at Arlington, Va., just across the Potomac from Washington, and but recently placed in operation. The honor of catching the first wireless message flashed across the continent from this station belongs to operator Anderson, in charge of the Mare Island wireless station. The distance is in the neighborhood of 3,000 miles. A few nights later, messages were exchanged between the Arlington station

and the station at Point Loma, Cal., a distance across country of approximately 3,500 miles. The signals are usually distinct.

The Arlington station consists of three towers, arranged in an isosceles triangle, erected on a hill which rises 250 ft. above Washington. The tower forming the apex of the triangle is 600 ft. in height, and the two others 450 ft. high. In the illustrations is shown a steeplejack who was employed to paint the flagstaves of the towers.

Electrical World
4/2/11
540

COMMENT AND REVIEW

THE most interesting school I ever visited was on board an American battleship—the “Massachusetts.” Not that this particular vessel is different in this respect from her sisters in the

*Fine
Example of
Concentration*

battle fleet, for she is not. The time was last summer, when the midshipmen from the Naval Academy were afloat on various craft. On the quarter deck, protected by generous awnings and with a cool sea breeze blowing, were groups of young men, each in charge of an instructor. The men sat upon the deck, forming a circle around their officer, who lectured beside a blackboard on which he illustrated or to which he hung printed charts and maps. Every man had his note book, in which he made frequent entries. Other groups were going through flag practice and wigwagging. Meanwhile puffing steam launches were constantly landing and departing from the ship's side, and officers and men on leave were coming and going. Something was doing all the time, but so far as the students were concerned they would apparently have been no more isolated had they been at the North Pole or on some uninhabited island. The interest and energy with which they entered into their study was surprising to a landsman.

To the officer who was conducting me I remarked on the industry which these young men applied to their work, and mildly suggested that the average college student would not get very far under such distracting conditions. “Oh, that is nothing,” he replied, “come with me.” We started for what proved to be one of the mess rooms, from which came sounds quite like a county fair on a pleasant day. There were about 30 men there. Half that number were seated at a long table, each with his leather-covered note book, and sheets of paper on which problems were being worked out and transferred to the book. The problems were the real thing, involving algebra and geometry, the sort the land-lubber tackles in solitude and quiet. But these boys were working like race horses, and the results were entered with rapidity, but extreme neatness. They seemed to actually enjoy the doing of these hard things. I couldn't hear all the officer said, who stood close to me, for in one corner of the room, which would be considered small on land, was an upright piano. It was one of those able-bodied, reinforced instruments that one can hear when played by a young athlete in his shirt sleeves. And gathered about the piano were a dozen other muscular men of the same healthy build. The song was a spirited ragtime, with plenty of regularity, movement and volume — about 200 lb. to the square inch, I should

judge. Some of the singers not only sang, but as many as could find room also danced, which did not add to the solemnity of the occasion. I inquired if this strenuous occupation was compulsory. No, just some of the boys off duty enjoying themselves.

Meanwhile their companions at the mess table, absolutely oblivious, continued to work equations and various kinds of roots, and continued to transfer the results into the note books with that same regular, rapid and certain movement.

The great guns, the massive machinery, the enormous floating mass of iron—all are impressive. But most impressive of all was the wonderful self-control of these trained human machines, expressed in that one word “concentration.”



FOR long centuries the world dreamed of mastery of the air. Learned men had placed the stamp of impossibility on its accomplishment. For centuries success seemed most unpromising.

A
*Humiliating
Condition*

The educated and the unlearned scoffed together at the very idea. One day a strange whirring noise appeared. It was a new, peculiar sound, entirely unlike any other which man had ever heard. The nations looked on every side but found nothing to explain the mystery. Then they looked into the sky and saw for the first time the conqueror of the air.

And he was an American.

Scientists declared him the creator of one of the Seven Wonders of the Modern World.

For a time the nations waited for the great people whose nationality he bore to go on and develop this fledgling discovery. They naturally expected men who had invented telegraphs, harvesters, cotton gins and ocean cables, electric lights and phonographs, telephones and skyscrapers, and all manner of wonderful machines to annihilate distance and lessen the drudgery of the toiler, to develop and perfect this newest machine that laughed at gravity and called upon the wind to follow. For a brief time only they waited, and then set desperately at work to surpass us. As their study of the problem progressed it became evident that it was a science, and ultimate success could be attained only through scientific methods. But the highest universities were fellow students also and could not teach what they themselves had yet to learn. Special laboratories in which to experiment and then test the experiment were imperative. And there were no laboratories. Then the French people said among themselves, “We must have such institutions,”

but their government, like our own, did not hear the call. Determined that the new art should not languish, the French people opened their purses and a million dollars poured into the fund, which provided the first opportunity for scientific study. And the inevitable result followed:—France today leads the world in aviation.

Later, the French government took up the work it should have assumed earlier, and all their airmen can test their ideas to a satisfactory conclusion. Other governments, including Japan, Germany, England and Italy, have recognized the importance of keeping abreast of the times, and are spending large sums annually on this branch of the service.

And so we trail behind, while America, the birthplace of Wilbur Wright, begrudges a pittance which is less than some backwoods congressman secures to dredge Muddy Creek.



A CERTAIN hardware store of my acquaintance is to all appearances a model of its kind. The stock is well selected and up-to-date; everything is in the best of order. The floors are clean and the show cases bright. You can walk through the aisles without colliding with sharp-edged tools or bundles of barbed wire. The owner is pleasant and accommodating, and so are his clerks, yet the store has lost one regular customer and this is how it happened. A customer was entering the place when a man crowded past in the doorway, carrying in his arms what appeared to be a wooden soap box filled with large yellow candles. No second glance was needed to realize that it was what is called "powder" by the initiated, and known to the rest of us as dynamite. However, the worst was to happen. The customer passed in and stepping up to the counter was about to give his order when he noticed the clerk throwing some of the same yellow candles into a box. "Isn't that dynamite?" he inquired. "Yes," cheerfully answered the clerk. "Don't you think you are a bit reckless having it around like this?" "Oh, no," was the ready assurance, "this can't explode," and lest his statement might be doubted he gave the counter a couple of vicious whacks with the stick he had in his hand. The clerk seized another stick and was about to make a drum of the counter when my friend assured him no further demonstration was necessary. It really seemed unwise to question the word of a man who wanted to drive nails with dynamite.

*One Way
to
Lose Trade*

As the customer beat a hasty retreat the clerk called out to

learn what he wanted, and the answer was, "I want to get out of here," which he did and never came back. Now as a matter of fact, what the clerk did was supposed to be a perfectly safe thing to do, but the customer could not forget visions of tons of solid rock hurled high into the air while the earth trembled far around. The shock he received was not the same kind, but it kept him out of that store ever after. Other dealers and firms have similar smart young men, who as thoughtlessly, in other ways, are accomplishing the same result for their employers, quite as effectively as though they pounded nails with dynamite sticks.



THERE is immediate need for state laws providing severe penalties for stealing automobiles and motorboats. Even the cheapest car or boat represents a cost of several hundred dollars, and the average car would certainly be in excess of \$1,500. In many states, however, the penalty for stealing a valuable car is only a fine and that a ridiculously small amount. In every state the penalty for stealing a horse, worth perhaps \$100, runs from one to ten years in the penitentiary, while in some states the penalty for stealing a \$5,000 automobile is a fine not to exceed \$35. Owing to the large number of cars of the same make, size and color in every city, the thief is able to make the object of his theft the vehicle for his escape with it. It will carry him hundreds of miles at high speed in only a day or two. The absence of distinguishing features, such as characterize a horse, and the ease of substituting the license tag of one state for another, combine to make detection extremely difficult.

*Auto Theft
a
Farce*

In the case of motorboats the favorite method is to so change its appearance by a coat of paint, which can be applied in an hour, that its owner could not recognize it at a short distance. In Ohio a bill will be introduced making the penalty for convicted theft of a motor vehicle, valued at \$35 or more, imprisonment for not less than one year nor more than seven years; for motor vehicles of less value than \$35, a fine not to exceed \$200 or imprisonment up to 30 days.

The measure should pass without delay, and such other states as have not already provided for this same condition should promptly do the same. The Ohio bill also provides a fine of \$25 for failure of the driver of any vehicle on public streets or highways to display lights between sunset and sunrise.

H. H. WINDSOR

EIGHTEEN TONS OF IRON LOST DAILY BY RUST

One large railway system suffers a loss of more than 18 tons of metal daily, due solely to the effect of rust. Thus far, the only known preventive is to keep the metal surface always covered with a suitable paint. Some idea of the costliness of this remedy, however, may be gained from the fact that it requires about \$10,000 annually to paint one large railway bridge alone. A typical case of this kind is the Brooklyn bridge, upon which a corps of painters are constantly employed, as the weather makes repainting of one end of this large structure necessary before the workers have reached the other. Although experiments have demonstrated that pure iron surrounded by oxygen does not rust, and that some acid, especially carbonic acid, is necessary for the production of rust, the secret of manufacturing rustless steel and iron remains to be discovered.

790

SCENES ATTENDING THE WAR IN THE BALKANS

So far, two mechanical or scientific features stand out vividly in the great Balkan war. These have to do with the wonderful help given the Balkan army strategists by the military aeroplanes, and the remarkable effectiveness of the modern rapid-fire field guns of the allies, as compared with the poorer showing of the just as modern rapid-fire guns of the Turks, the supremacy of the one type of gun over the other being ascribed to structural differences. The field guns used by all the allies, with the exception of Montenegro, are the French Schneider-Creusots, while the Turkish guns are the German Krupps. This war is the first in which modern quick-firing

VOTING TENTS USED IN LOS ANGELES

734

Special voting tents, placed on the sidewalks or in vacant lots, were used extensively in Los Angeles in the last

Clean and Compact Tent Erected on a Sidewalk in Los Angeles as a Voting Place

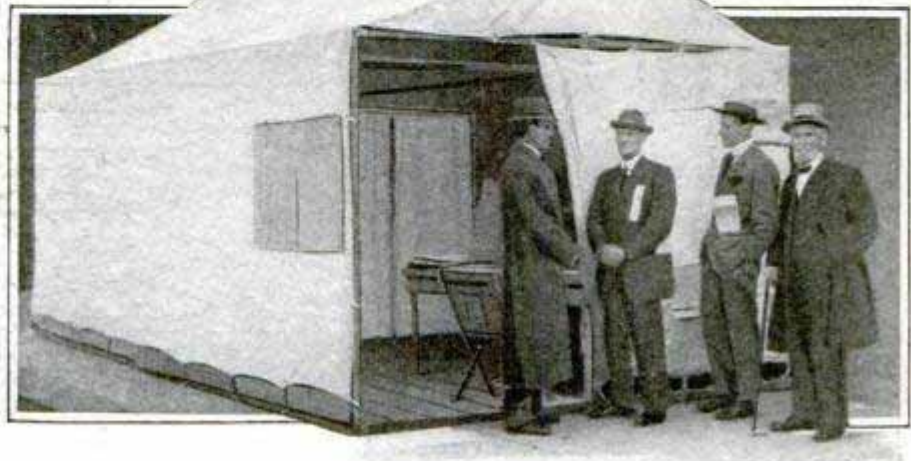

election. These tents save rentals and also provide clean, commodious quarters without interference from other business. The Australian voting booths inside the tents are also of canvas. The voting tent seems an excellent method of solving the problem of clean voting places, particularly in states where women vote.

guns have been used by both sides, and France is jubilant that the type of guns used by her own army has apparently proved superior to those of the Germans.

The breech of the Creusot gun opens at the back like a door, being hinged on one side. The Krupp gun, on the other hand, has a breech opened and closed by a wedge much resembling a bolt. The body of the gun at the base is slotted out at right angles to the bore, and the bolt or breechblock moves in this slot, and has a portion cut away to correspond with the bore of the gun, the shell being pushed through this opening past the wedge, which is then driven home.



Umbrellas and Guns. Wild Malissores, Allies of Montenegro

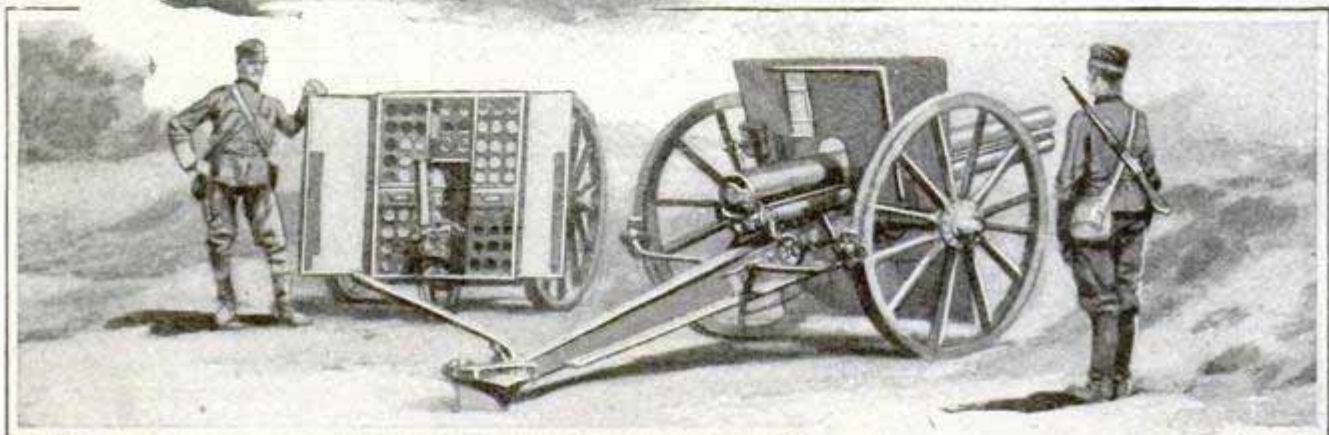

The French Guns so Effectively Used by the Balkan Allies

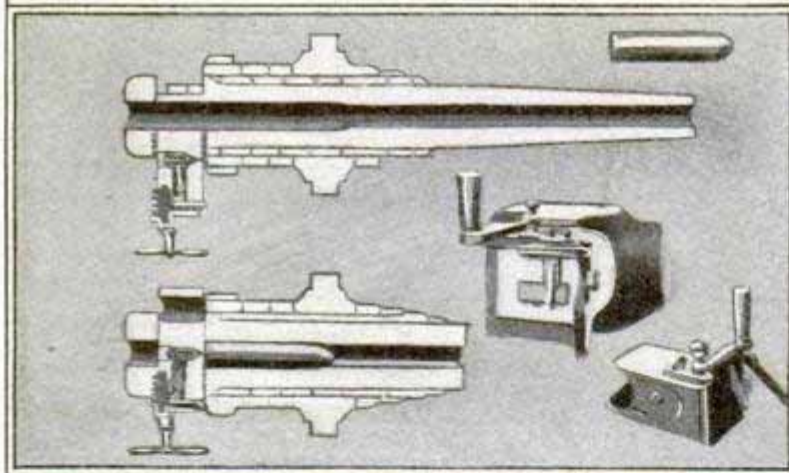

Breech of German Gun Shown Open for Loading and Closed after Shell has been Inserted

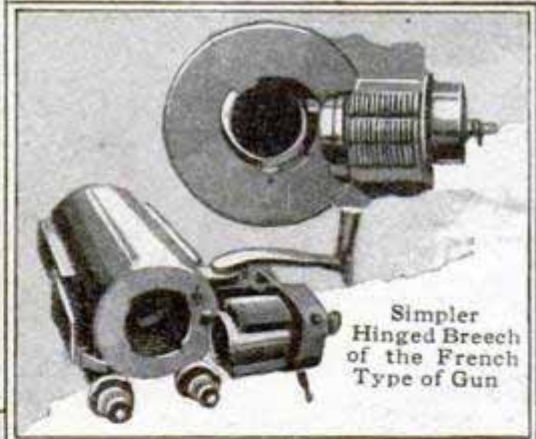

Simpler Hinged Breech of the French Type of Gun

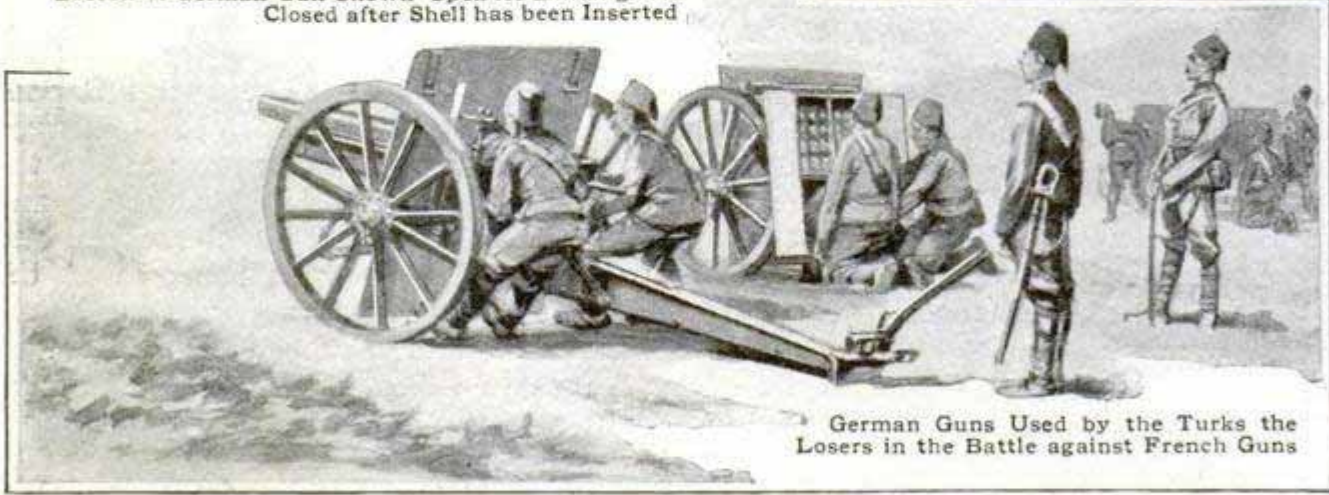

German Guns Used by the Turks the Losers in the Battle against French Guns

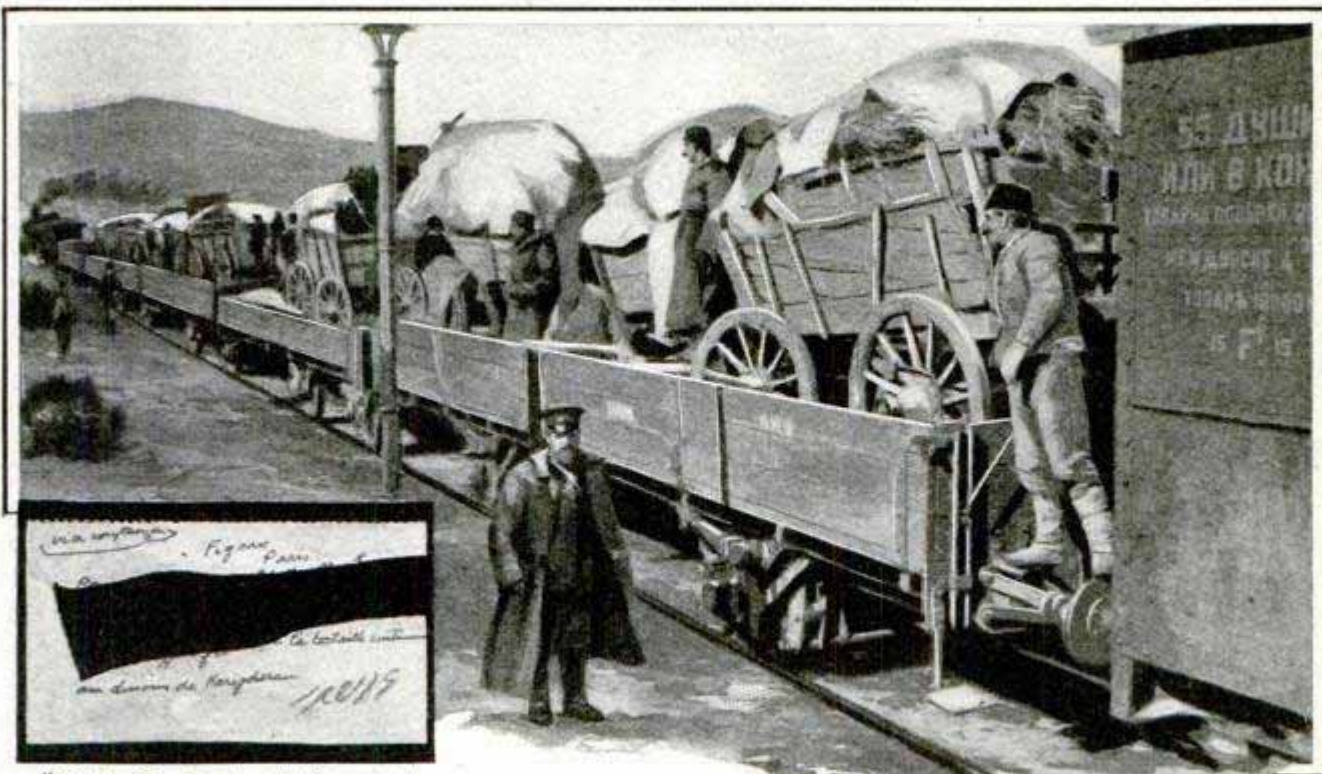

"Battle Continuing:" Censored War Dispatch

A Red Cross Train of Wagons and Supplies Arriving at Stara Zagora



Type of Monuments the Servian Peasantry Erect to Relatives Killed in Battle



Fragment of Bulgar War Song Translated into English

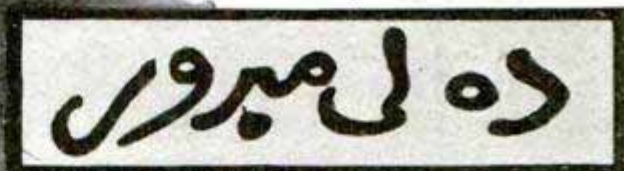

A War Correspondent's Badge in Turkish



War Correspondents with the Turkish Army. Note the Motor Side-Car Used by One of Them

Courtesy Sphere, London

STREAMLINE FORMS AND NOVEL ENGINES

By VICTOR LOUGHEED

From the standpoint of the aviation enthusiasts, the year's development of flight engineering, as epitomized in the aviation show just closed in Paris, is a subject for both criticism and congratulation.

Most striking in the way of prog-

reason for the increased power of the modern aviation motor, which, however marvelously it may meet the demands made upon it, is unfortunately permitting, for the time being, the evasion of problems of efficiency, which, without it, would have to be solved.

As inexplicable as the disregard of other factors of efficiency is the lack of thought that seems to be given to the question of wing forms, for as long as designers are going to persist in the use of square-ended, uniform-section "planes," and similar monstrosities, so long will unsafe equilibrium, large sizes and small loadings,

and poor horsepower-weight ratios, be the rule, in place of the bird efficiency and safety that are ultimately probable.

In the matter of structural details there is great improvement, and, barring the lack of girder depth, that is an inherent rather than an avoidable defect with the common types of wings, the best machines display a quality of material and workmanship that it will be hard to improve.

The hydro-aeroplane shows a great

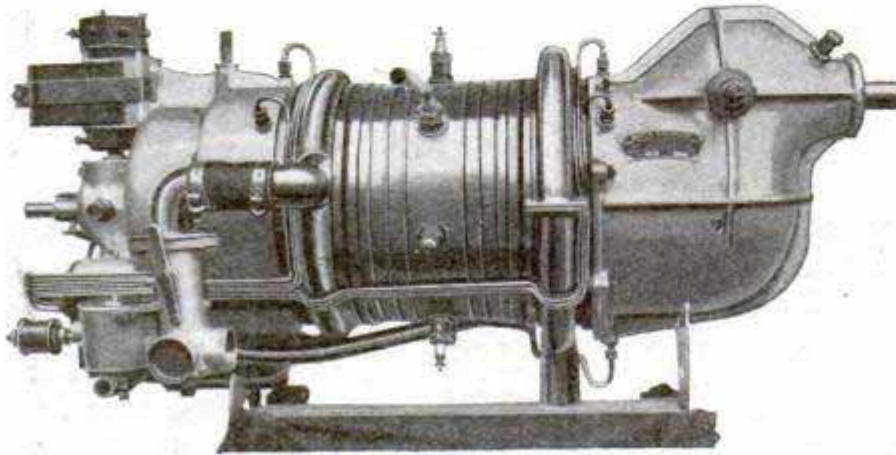

Salmson Motor of Revolver-Barrel Type, with Its Cylinders All Parallel in the Case

ress, perhaps, is the now settled trend toward the universal adoption of "streamline" body forms. Even Bleriot, for example, the pioneer French monoplane builder, and for long an advocate of openwork structures, has at last fallen in line with a characteristic example of the "monocoque." On the other hand, there is everywhere in evidence a singular indifference, even on the part of the foremost constructors, to the resistances set up by multiplied

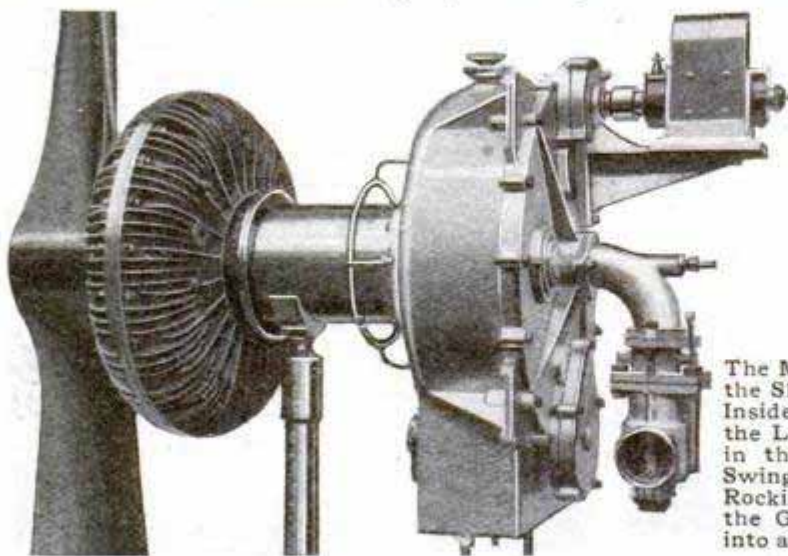

The Motor Feature of the Show, the Esselbe. Inside the Round Case at the Left are Two Arms Like a Letter X, as Shown in the Smaller Picture. Explosions Alternately Swing These Arms Together and Apart and This Rocking Motion is Transmitted along the Shaft to the Gear Case at the Right, Where Gears Turn It into a Rotary Motion

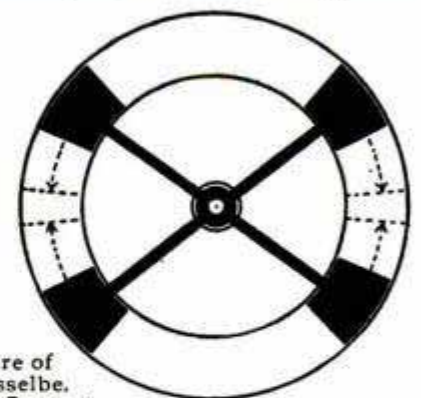

and complicated systems of stays, struts and running-gear elements, though these undoubtedly are a chief

increase in popularity, due, beyond a doubt, to its superior safety, and nearly every manufacturer displays one or

ARE PROGRESS MARKERS IN AVIATION SHOW

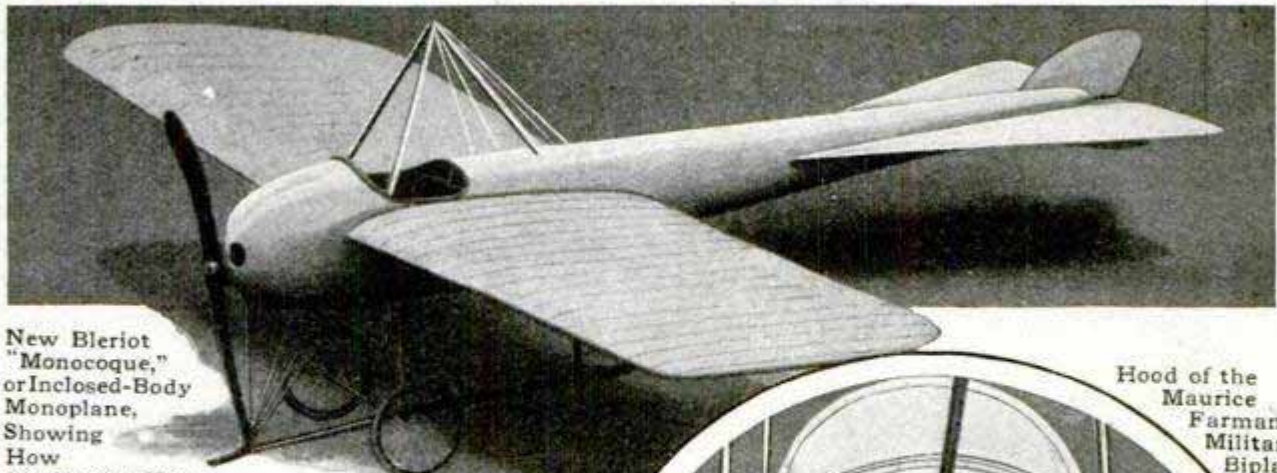

New Bleriot "Monocoque," or Inclosed-Body Monoplane, Showing How Bleriot has Now Adopted Streamline Form of Body

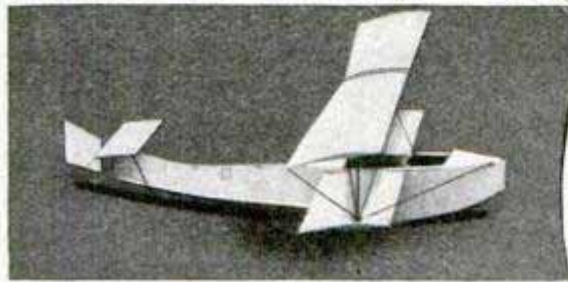

Fish-Shaped Body of the D'Artois Naval Hydro-Aeroplane

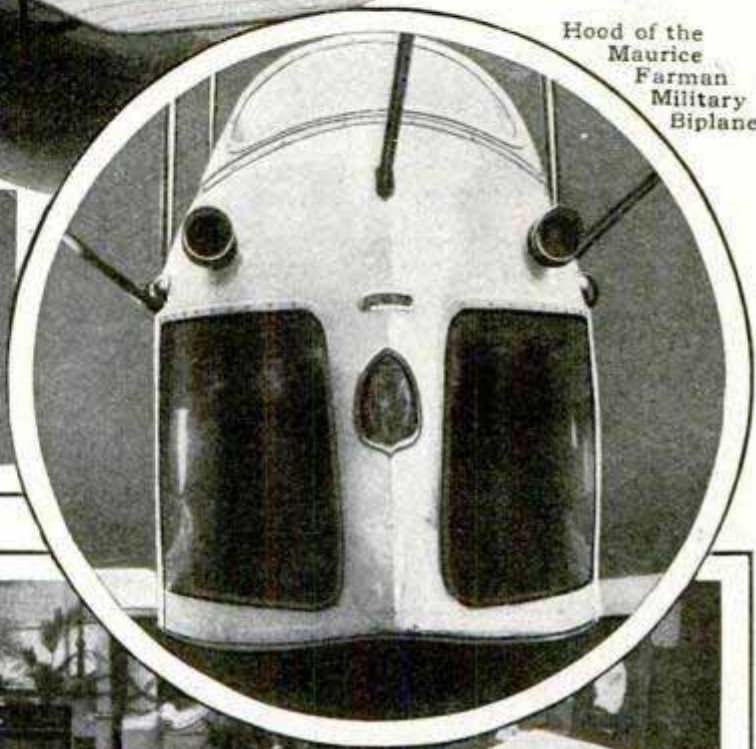

Hood of the Maurice Farman Military Biplane

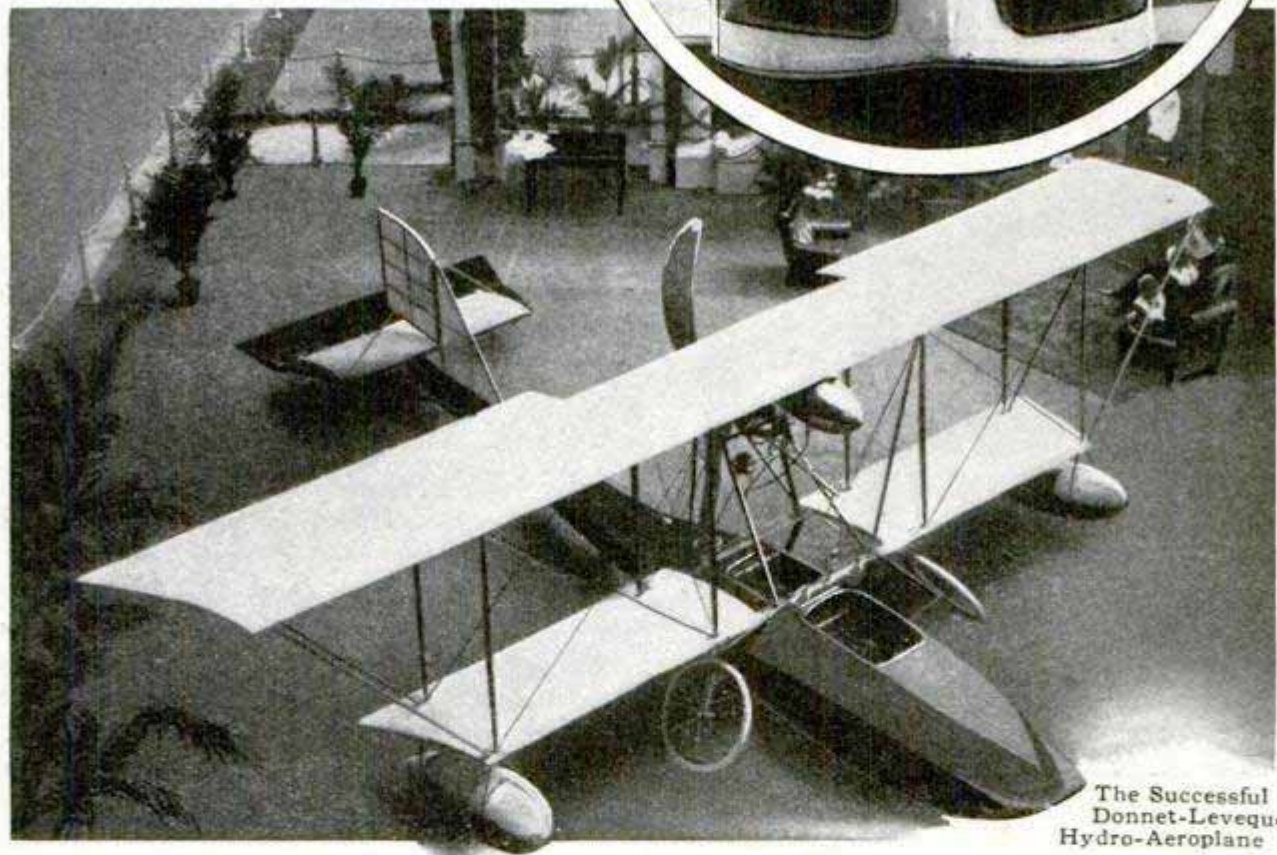

The Successful Donnet-Leveque Hydro-Aeroplane

more examples. In the evolution of this type of vehicle, the policy of building substantially instead of flimsily, up from the water instead of down from the air, is becoming universal, with

the result that the structures on float-terminated stilts manifestly lose by comparison with the more businesslike "flying boats," some of which are thoroughly seaworthy even in rough water.

Ever since the Gnome motor, by the application of clever innovations in design and an unprecedented quality in construction, proved the means of evolving a long-condemned type of freak gasoline engine into one of the most practical and valuable contributions that has been made to modern flight engineering, shrewd inventors have been industriously canvassing other old ideas in the hopes of discovering new merits. One of the most promising of these, realized into concrete and operative form, is the Esselbe, exhibited at the present aeronautical salon. In this new motor, which is pictured herewith, the essential feature consists of four pistons at the extremities of arms arranged like an articulated letter X, which swing alternately together and apart in a cylinder which revolves at constant speed, while the X-arms within it are back-gearred so as also to undergo a continuous rotary progression, at a slower rate. This curious and clever scheme enables the four spaces between the pistons to be simultaneously performing the four func-

tionings of a four-cycle motor—suction, compression, explosion, and exhaust—with the result that there are four explosions to each revolution, affording a considerable flywheel mass in combination with an impulse frequency the equivalent of that in an ordinary eight-cylinder motor. Further contributing to simplicity and reliability is the fact that only one spark plug is used, it firing the compressed charges as it passes them, one after another, by virtue of the higher speed of the cylinder as compared with that of the reciprocating parts. Cooling is said to be effective, vibration almost totally absent, and fuel and lubricant economy very high, while the weight of a model with a bore of 2.56 in., delivering 60 hp. at a speed of 1,200 revolutions a minute, is only 209 lb.—3½ lb. per horsepower.

Other novelties among the motors shown at the salon are the "parallel-cylinder," or "revolver-barrel" type Salmson engine, a number of new rotating motors of the Gnome type, and an 18-cyl., 180-hp., Rhone motor.

Marquam Olds

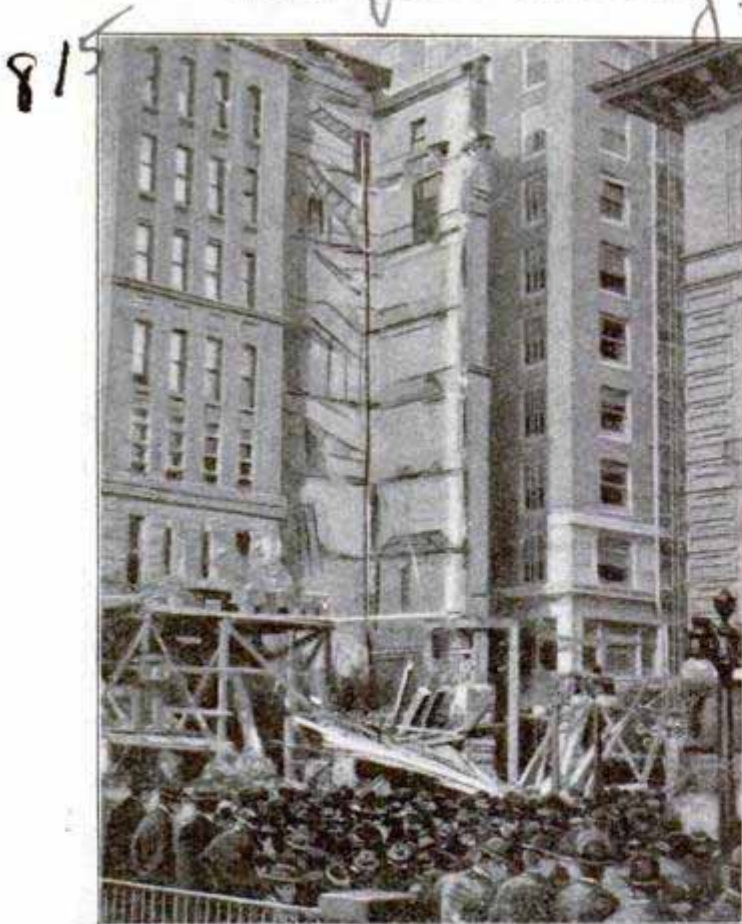

TEN-STORY OFFICE BUILDING COLLAPSES

This illustration shows what happened to a 10-story brick office and theater building in Portland, Oregon, when the wooden underpinning, used as a support while steel foundation columns were being placed, gave way.

The first crash came, luckily, at 4 o'clock in the morning, when none of the offices were occupied, a section of brick wall, 16 ft. wide, extending to the fifth floor, collapsing. Then, a few hours later, another larger section fell, ripping out floors and offices as it went crashing into the street. The only serious injury was to a woman who was trampled by the roped-off crowds when the second section fell.

☞ More patents are issued for beds than for any other article of household furniture, and most of them are for freak forms of beds in disguise.

THE GOVERNMENT AS AN EXPRESS COMPANY

The establishment of a parcel post in this country, which makes the post-office department a great express company in addition to its activities of the past, will work considerable change in the carrying equipment now used by rural carriers and star-route men. At present mail is

delivery cart and small automobile will prove inadequate in many dis-



Automatic Computing Scale Bought by the Government for Parcel-Post Branch of the Large Postoffices



Light Parcel-Post Rural-Delivery Automobile, Designed for Postoffice Service

delivered by nearly 43,000 rural carriers, on horseback, in buggies, two-wheeled carts, motorcycles and automobiles. The horse and motorcycle may have to go, and even the rural

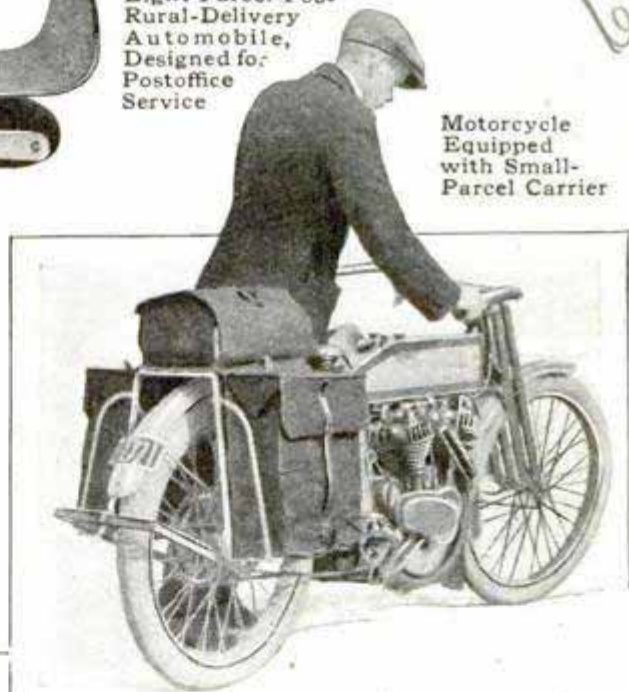

Motorcycle Equipped with Small-Parcel Carrier

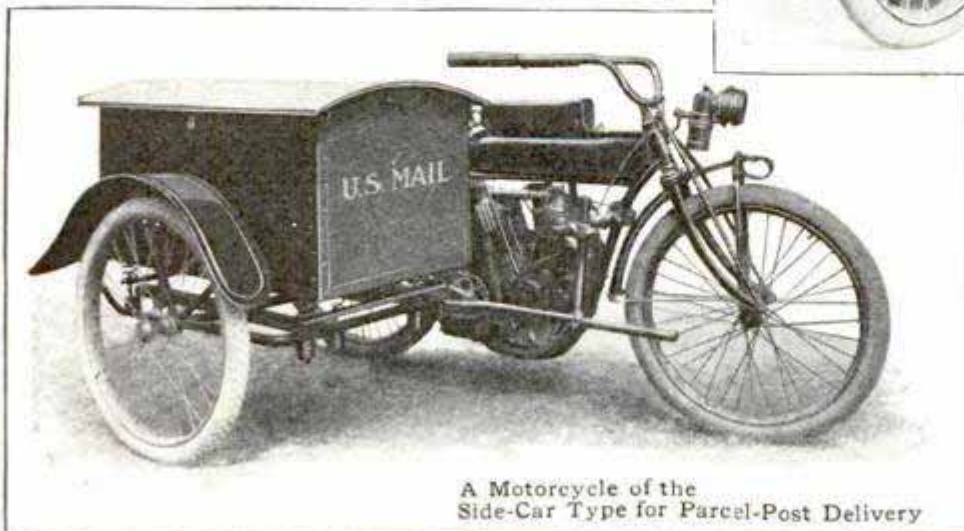

A Motorcycle of the Side-Car Type for Parcel-Post Delivery

tracts. When the new service is well under way, the Postmaster-General believes that express motor trucks and large wagons will have to be used to take care of the delivery of goods, but motorcycles of the tri-car type, shown in one of the

*6. B. J. M. Co
Warner & Bayard
Baltimore*

Boeing

*Harley Davidson Motor Co.
392 13. St.
Milwaukee Wis*

illustrations, will be used, where possible, as will the lighter type of parcel-post automobile, also shown, which was designed particularly for rural delivery.

For office equipment, the government has purchased 125,000 scales. Two hundred of the largest postoffices,

will have automatic computing scales, the next class of offices, numbering 10,000, will be equipped with high-grade beam scales, while fourth-class offices, numbering about 55,000, will be furnished with the best spring-balance scales obtainable. These small scales have a capacity of 20 lb.

HYDRO-AEROPLANE LAUNCHING WAYS FOR BATTLESHIPS

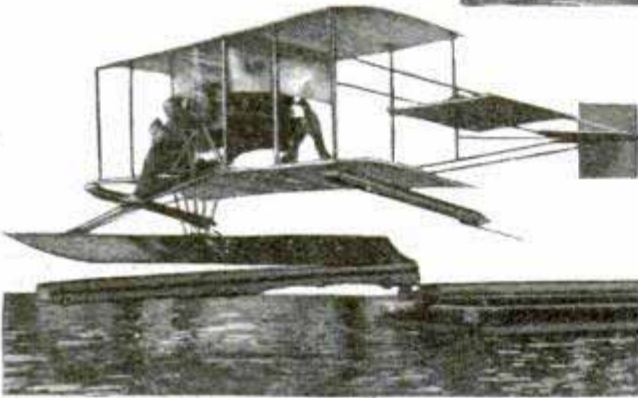

Apparatus Tested, the Aeroplane Rising from the Sliding Car

Launching ways for hydro-aeroplanes, occupying so little space that they may be swiveled on a big-gun turret, or moved to any desired location on a ship, have been devised by Captain W. I. Chambers, U. S. N., who is in charge of navy aviation work. Such a device, which may be dismantled and stowed in a space no more than 8 ft. long and wide, is an interesting departure from the cumbersome and unwieldy apparatus previously designed for aeroplane launching.

The Chambers apparatus, which is called a catapult, comprises a wooden car, upon which the aeroplane rests, a swivel track, and mechanism for projecting both car and aeroplane from the track with ample and smoothly increasing force. The propelling mech-

Compressed-Air Cylinder Ready to Force Forward a Sliding Car Loaded with Sand Bags

anism may be a spring, a weight, an electric motor, or, as at present demonstrated, a compressed-air cylinder and piston actuating, through multiplying gear, a wire rope attached to the car. Compressed air is used for power because all ships carrying torpedoes are supplied with air compressors.

In preparing for a launching, the aeroplane is strapped on the car and swiveled toward the wind. The aeroplane engine is started, the propellers turning at full speed, and when the pilot is ready to depart a balanced air valve is turned, the piston of the launching cylinder moves faster and faster as the valve is further opened, a flying speed is attained in less than two seconds, and the car and aeroplane are projected from the track, the car being automatically released from the aeroplane and falling into the water, while the aeroplane soars away. The car, to which a rope is attached, is then drawn back aboard ship.

¶ Fifty-eight blackfish, or pilot whales, were recently driven ashore at Indian Neck, Wellfleet, Mass. This was the first appearance of the fish in that section in nearly 30 years.

PORTABLE CONTROL FOR ELECTRIC CRANES

573 A portable electric control, in the form of a box that may be hung by straps from the shoulders of the operator, has been specially designed for controlling cranes in the loading and unloading of ships. The operator stands at a convenient place beside the hatchway of the ship, where he can see what is going on in the hold, or can walk around freely, the control box being connected with the crane mechanism by means of a flexible armored cable. The controller is provided with two handles, one for controlling the hoisting and lowering motions, the other for the slewing or swinging of the crane, and an emergency button by which the current can be cut out and the crane brought instantly to rest.

Although the crane motors may be worked from a 500-volt supply, only 100 volts are used in the portable controller, a small motor generator being placed in the crane cabin for the provision of this low-voltage current.

MAKING EM- BROIDERY EASY

A simple little device economizing woman's time and woman's nerves has just been put on the market. Heretofore, the most arduous part of the trying pastime for woman, embroidery, has been outlining and giving backing to the pattern, by means of rough stitches.

The device which promises to do away with this work consists of paper

pulp pressed into the shape of the pattern, with the flat side gummed so that it can be fastened on the garment to be embroidered, and the finishing stitches are made over this backing. Those who have tried the device claim that it reduces

By Means of the Portable Control, the Operator, from the Most Advantageous Location, Directs the Loading and Unloading of the Ship

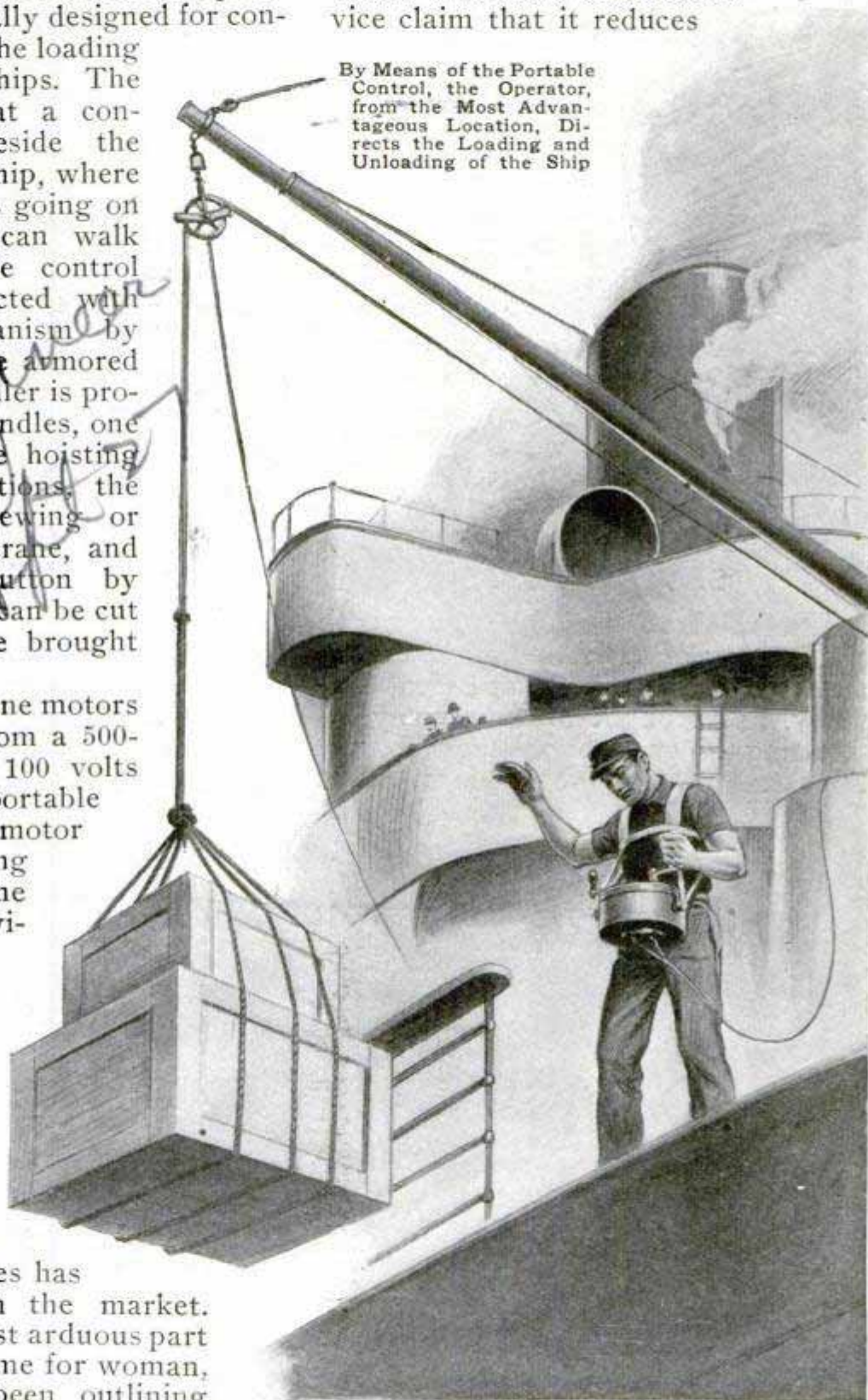

the work about half and that the finished embroidery is much more even.

These paper scallops and alphabet designs are now on sale.

In the turning out and testing of the various pieces of ordnance, the great German manufacturers overlook no detail, no matter how trivial it might seem, to make their

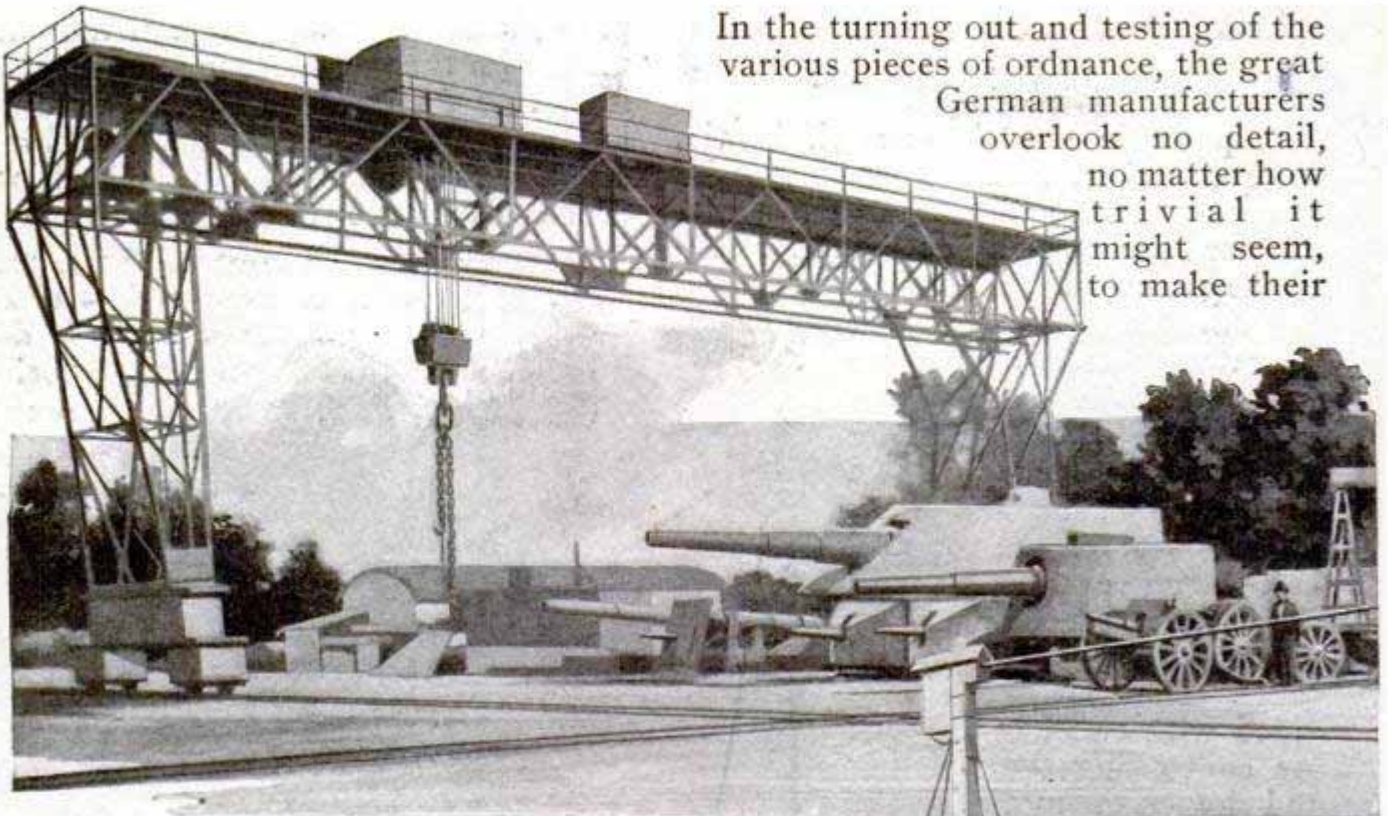

KRUPPS SUBJECT GUNS TO SEVERE TESTS

The celebration of the hundredth anniversary of the founding of the famous Krupp steel works at Essen, Germany, has brought to light many interesting things, but none more so than the extraordinary care that is exercised

A Line-Up of Big Guns, Field Fortifi

Guns in Turrets, Rapid-Fire Pieces and Coast-cation Guns

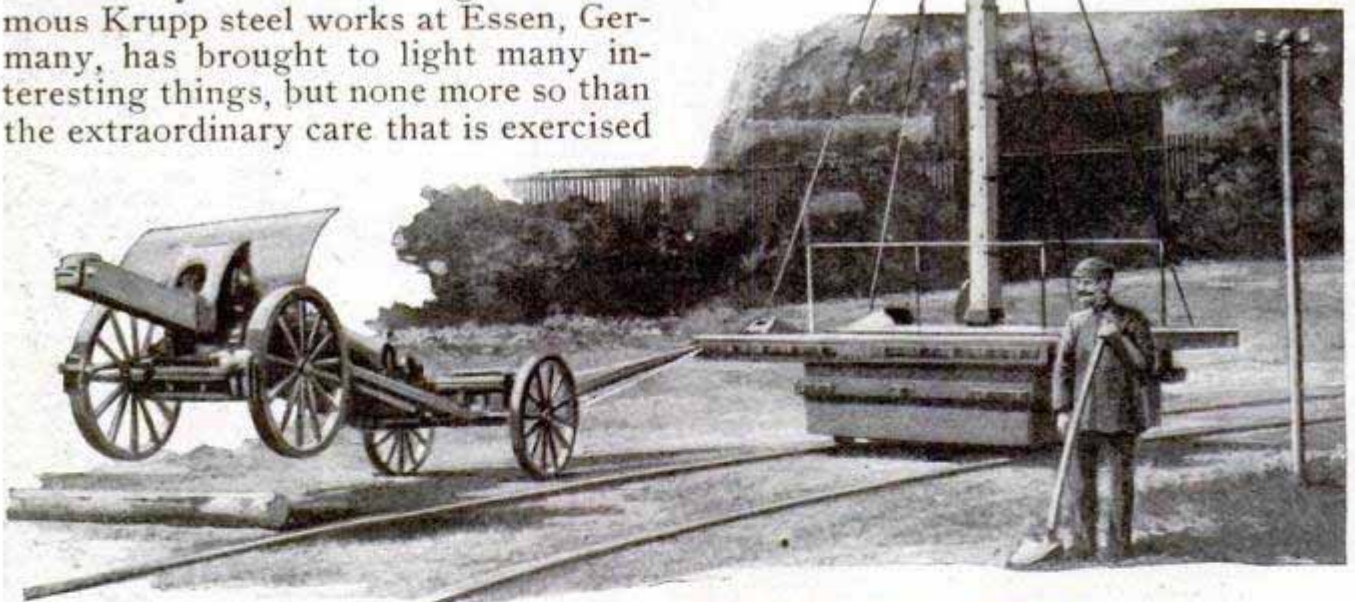

by the famous founders in testing the various kinds of guns and gun mounts manufactured by them for various governments. Krupp guns are used in every section of the world and are recognized as the highest type of the gun-makers' art. Even in this country there is at least one battery of Krupp guns in an American fortification.

Testing Gun Carriages by Attaching Them to a Trolley Car Which Runs around a Circular Track. Small Logs are Laid Down as "Bumps"

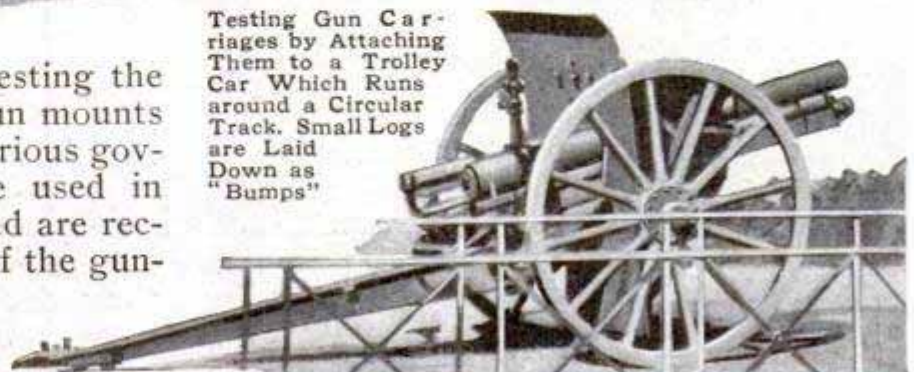

Two Guns Lined Up before One of the Big Target Walls of the Krupp Works.

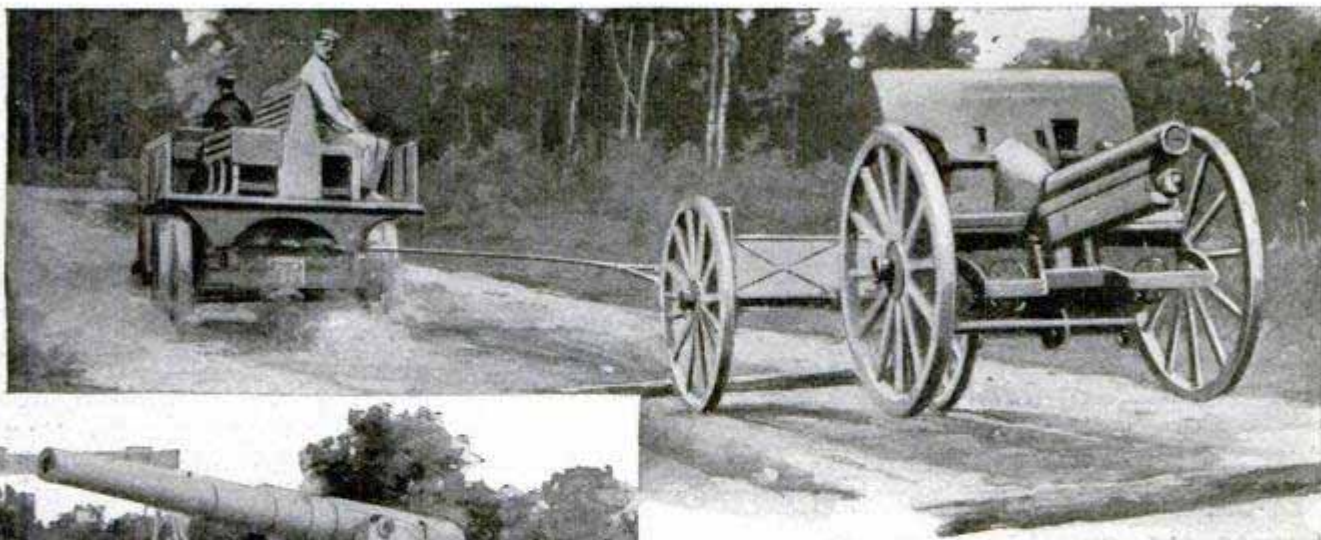

Another "Bumpy"-Road Test for Gun Carriages, the Guns being Towed by a Motor Truck

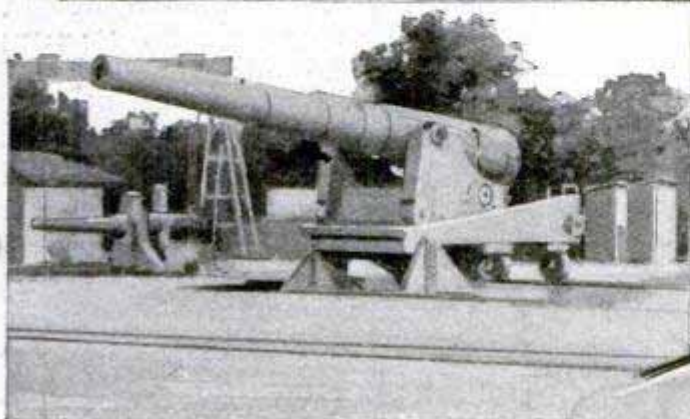

product as perfect as human brain and brawn can produce. The proving ground for the big guns covers an enormous space and the most ingenious devices are used for the tests. Huge embankments of earth, steel and concrete receive the shells from the guns, big and little. One of the most peculiar tests is that to which carriages for field guns are subjected to prove whether or not they will be able to withstand the banging and bumping they will receive in

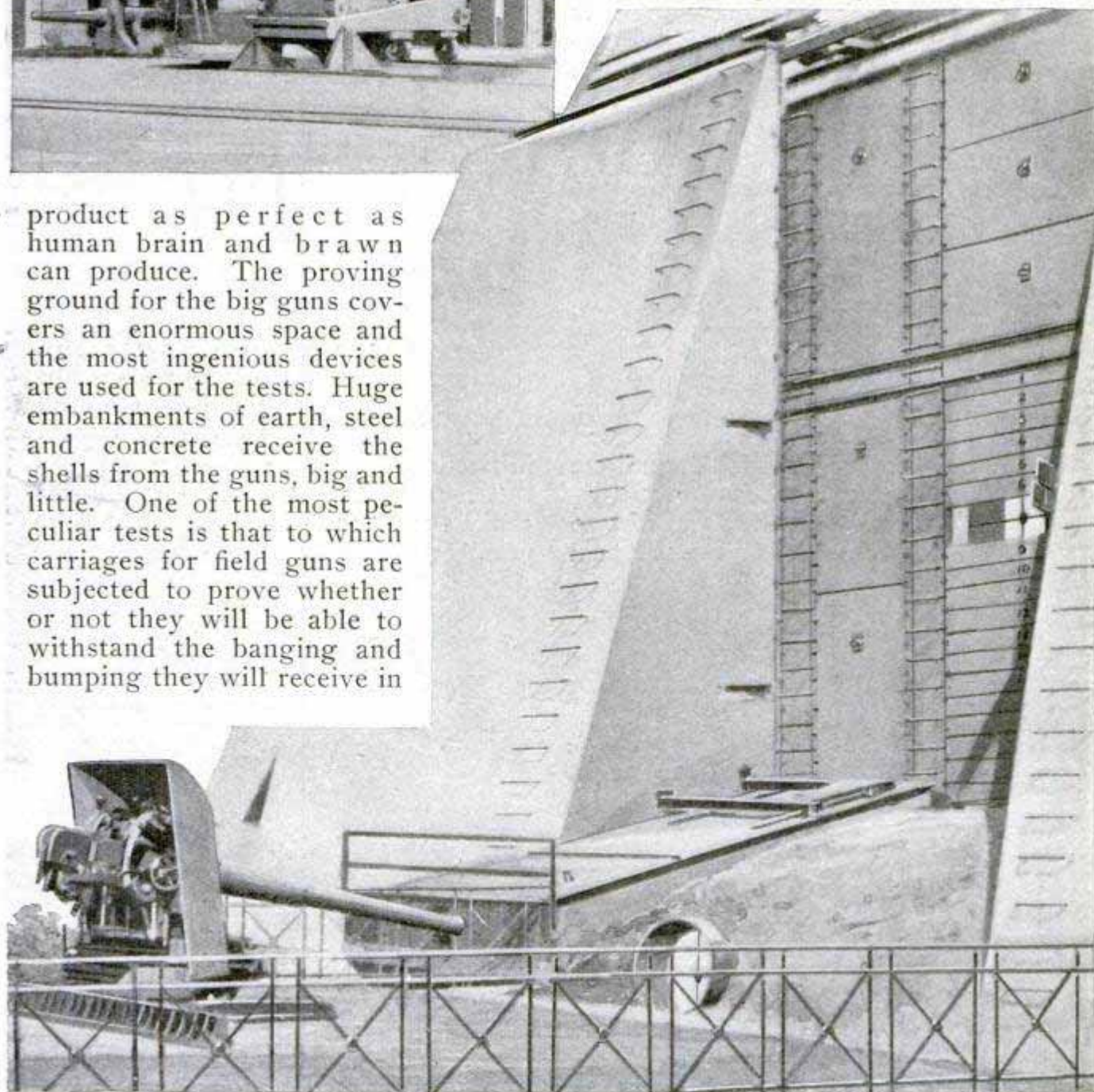

Gun Nearest the Target is a Rapid-Firer for Battleships; the Other is One of the Latest Types of Light Field Artillery

actual service. These tests are carried out on a circular track. This is a circle of rails on which a towing device is run by means of a long arm extending from an electric motor in the center. The gun carriage with the gun mounted is secured to the towing car and is whirled around the circle. The path over which the gun carriage must go is strewn with big stones, logs and all manner of obstructions, and the carriage is supposed to go over all these things at high speed and come through in perfect condition. Sometimes the carriage is thrown several feet into the air when it strikes a particularly heavy obstruction. There is also a secondary test of the same nature on a regular roadway when the gun carriage is towed by an automobile at high speed. The gun carriage is so attached to the automobile that it travels on a track beside the roadway and obstructions are placed in its path.

GATES FORM RUNAWAY-STOPPING CHUTE

Along one side of the elevated approach to the Williamsburg bridge, across the East River, New York, is a unique runaway-stopping device in the form of two electrically operated

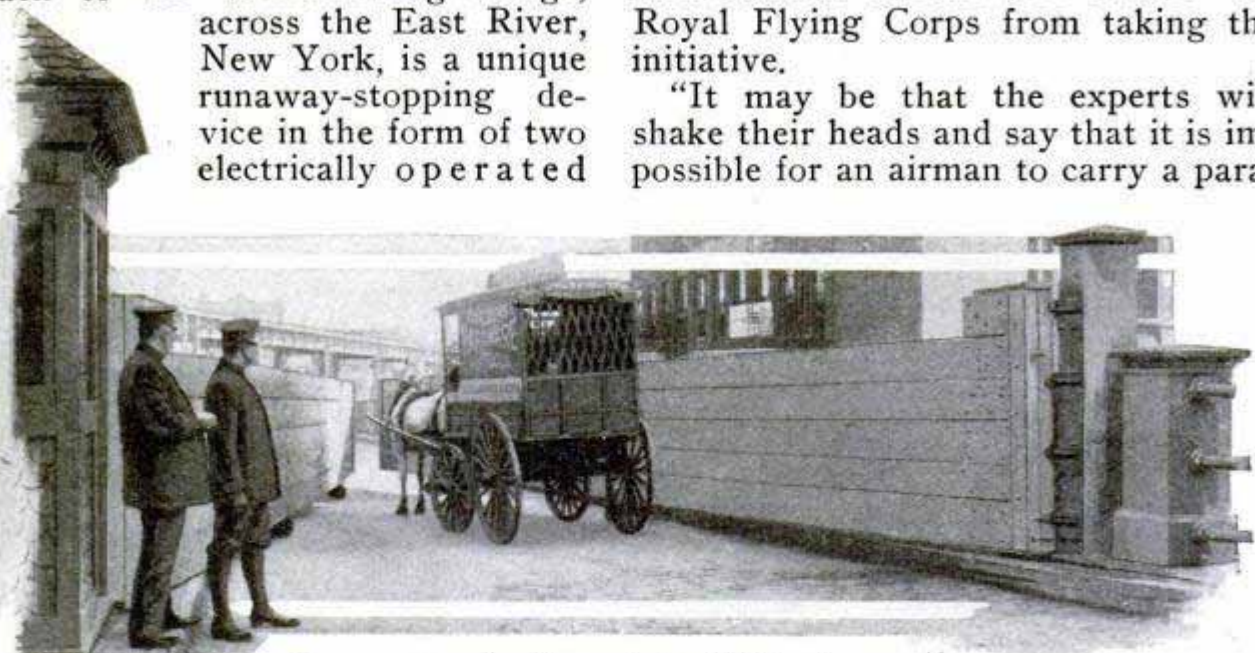

Runaway-Stopping Chute at the Williamsburg Bridge, New York, has Stopped Many Runaways

gates, which form a chute into which the frightened horse or horses run and are brought to a stop, without serious injury to either horse or vehicle.

When a runaway starts, and there are a great many runaways near this bridge, the driver heads for the runaway chute, the policeman stationed at the gate makes ready, and, when the animal passes a certain point, throws over his electric controller. Slowly the big gates swing into the position shown in the illustration. Before the horse can possibly reach the small opening, the sides of the gates catch the vehicle, give sufficiently to assure that the stoppage be not too abrupt, and the runaway is brought to a stop without injury to driver, animal, or vehicle.

FLYING CORPS ASKED TO TRY PARACHUTES

The large number of fatal accidents recently depleting the ranks of the Royal Flying Corps of England has caused The Motor, London, to make an appeal to those in charge to carry out parachute experiments. It is presumed by this magazine that time and expense are the factors which have prevented civilian English airmen from tackling the parachute problem, but such factors should not excuse the Royal Flying Corps from taking the initiative.

"It may be that the experts will shake their heads and say that it is impossible for an airman to carry a para-

640
The Motor, Sept. 1912

chute," says The Motor. "Against this we are in a position to state that the Russian government has carried out some successful experiments with dummy men and parachutes, and fairly

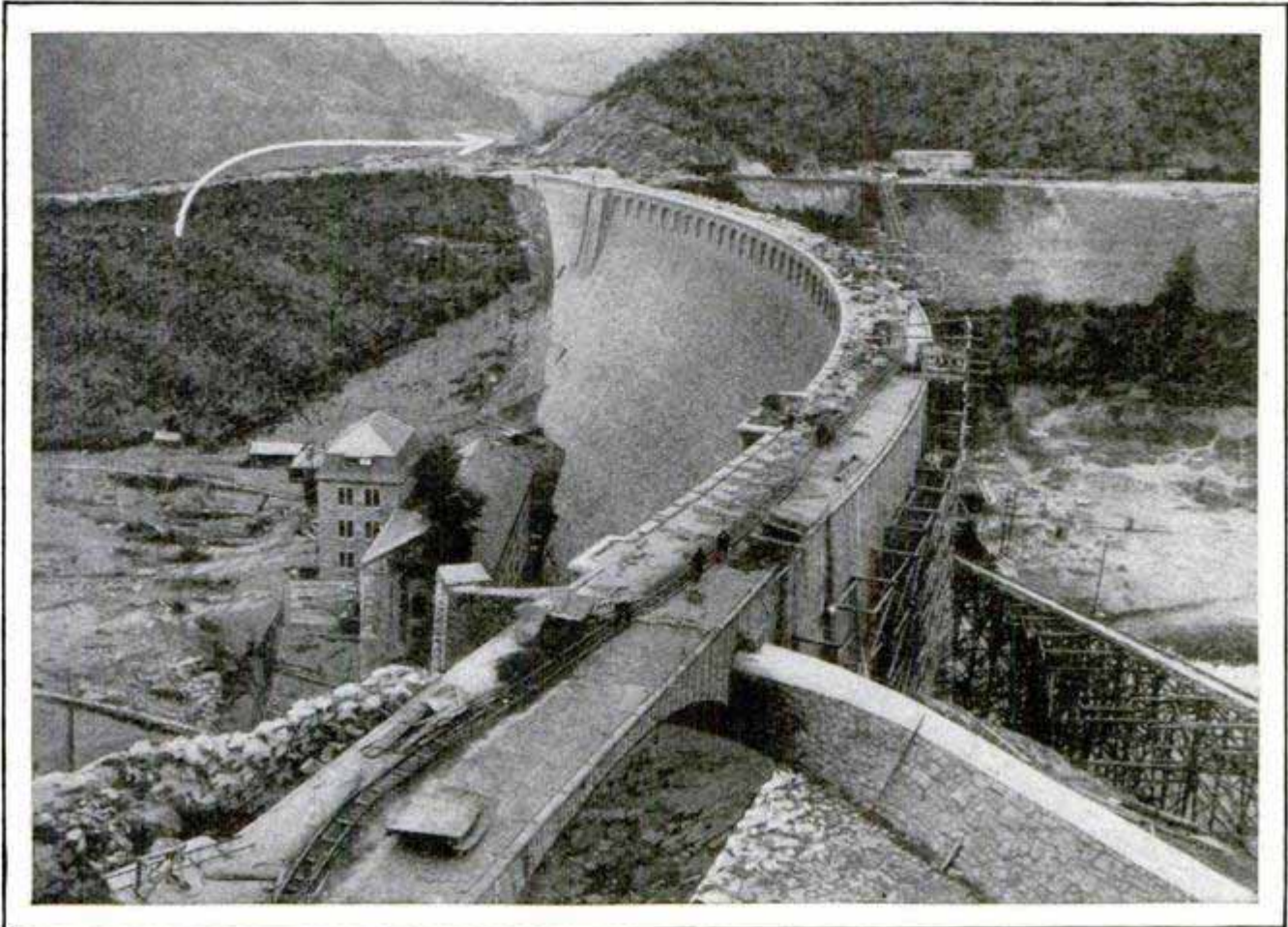

Germany's Largest Dam, Which will Furnish Hydroelectric Power for the Greater Part of Silesia and Form a Protection against Danger to Life and Property in Flood Times. Arrow Points Down a Valley into Which Excess Water will be Diverted, should It Rise to Too Great a Height

satisfactory results have been obtained in France. So it seems that the idea is worth, at any rate, some initial experiments. Assuming a man's weight to be from 150 to 180 lb., then, for him to land safely through the medium of a parachute, there must be an air-resisting area of approximately 500 sq. ft., or, in other words, the parachute must be about 25 ft. in diameter. Now, the question of how such a large parachute is to be carried seems at first sight to be a formidable one, but it is not so impossible as it looks. If the parachute be made of high-grade fine silk and is rolled in a special manner, in such a way as those versed in the subject know how to roll it, then, including the necessary cordage, etc., it can be arranged so as to come into a roll about 18 in. long and not more than 7 in. in diameter. Such an outfit could be carried in a box on the airman's shoulders, a broad strap passing around his chest and under the armpits."

GREAT GERMAN PROTECTING 66/ AND POWER DAM

A great dam has been built at Mauer, near Hirschberg, in Silesia, Germany, to shut off a valley, the waters of which caused much loss and danger during flood times, and to impound a supply of water sufficient to provide the greater part of Silesia with hydroelectric power. Work on the dam was started eight years ago.

This dam, which is the largest in Germany, is 918 ft. long, 196 ft. high, 164 ft. wide at the bottom, and 23 ft. wide at the top. The valley closed by it will form a reservoir having a capacity of 1,800,000,000 cu. ft. of water, impounding the waters of the Bober River.

⌈The value of steel exports of the United States, according to the government statisticians, now amounts to a million dollars a day.

TELEPHONING FIFTY MILES BY WIRELESS

612 Although there has as yet been no really successful practical application of the wireless telephone, and no commercial instrument successfully operating for over 10 miles, it is claimed that, in an early test, the wireless telephone installation at Seattle, Wash., broke all records for distance in talking between Seattle and Tacoma. The wireless telephoning took place between J.

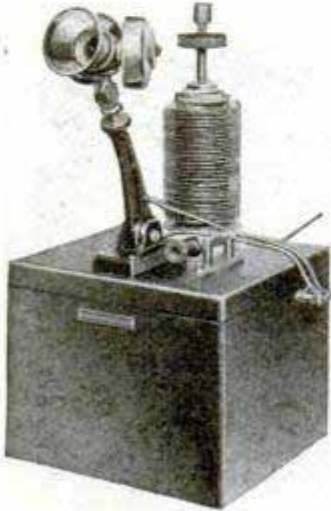

B. Annis, of the U. S. Signal Corps, at

the Bremerton Navy Yard wireless station, and the laboratory of the wireless telephone company in Seattle, over mountainous land, the distance of the transmission being about 50 miles.

The transmitter developed by this wireless-telephone company is shown in the accompanying illustration. Mounted at the back of the transmitter arm is the oscillator, provided with radiating flanges to keep it cool. The transmitter is of a double-diaphragm type, so arranged that the diaphragms vibrate against each other.

¶The White Star liner "Olympic," sister ship of the "Titanic," will be laid up the coming winter for a thorough reconstruction, intended to increase its safety. The work will mainly involve the construction of a complete inner hull, the cost being estimated at over \$1,000,000.

TEMPORARY BURIAL PLACE FOR PANAMA CHINESE

694 A great number of Chinese live in the city of Panama and the Canal Zone, and, as it is part of the Chinese religion that burial outside of the "Ce-

lestial Kingdom" means being shut out of heaven, the structure shown in the illustration was erected as a temporary burial place. It is constructed on the "pigeon-hole" system, and when a sufficient number of deceased has accumulated to justify the expense, a ship will be chartered and a cargo of corpses sent back home.

A "Pigeon Hole" Mausoleum for the Temporary Burial of Chinese in Panama City

Copyrighted by Brown & Dawson, Stamford, Conn.

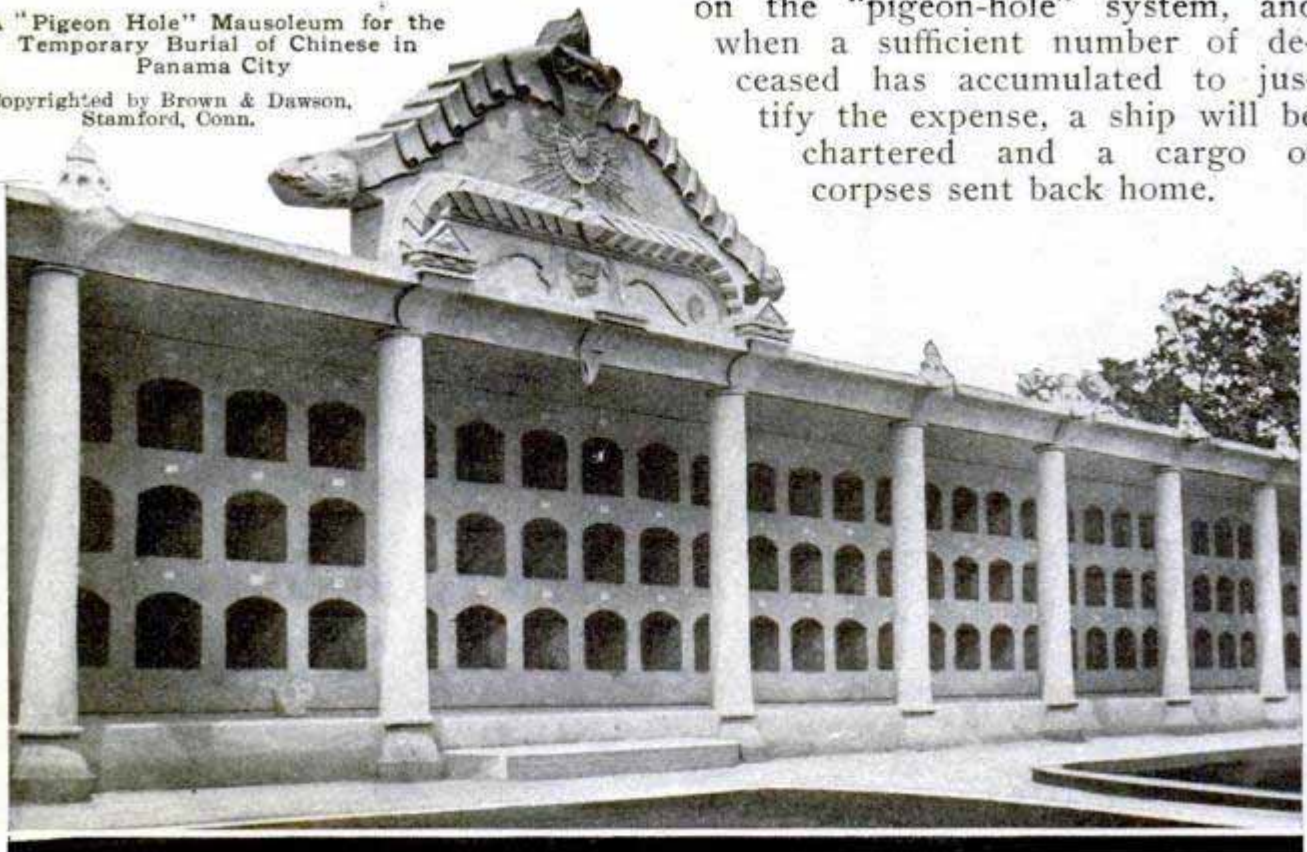

The rear wall of this mausoleum is about 10 ft. thick and is perforated with three rows of holes, each just large enough to hold a body. After the coffin is inserted, the hole is sealed up with cement.

GLASS TUBES FINER THAN HAIR

To produce glass tubes three one-hundred thousandths of an inch in inner diameter and with the walls only four millionths of an inch thick would seem beyond human skill, but it is not only possible but, one might even say, comparatively easy. The apparatus by which this was accomplished was recently shown before a convention of scientists.

It consists of a small electric furnace—a rectangular box of mica—which incloses a small, vertically placed spiral of platinum wire. The glass tube to be drawn out is placed inside this spiral, and in order that only a little of the tube be exposed to the heat when current is passed through the platinum wire, it is for the greater part of its length protected by a brass covering. To the lower end of the glass tube is welded a metal cylinder—of course outside of the mica box—which plunges into a long tube filled with glycerine and water. When the current is turned on, the exposed part of the small glass tube becomes heated, the metal cylinder at its lower end, by reason of its weight, drawing it out slowly and gradually sinking into the glycerine solution. New parts of the glass tube are thus continuously brought out of the protecting brass tube, heated and drawn out, until tubes of the above-mentioned dimensions can be obtained.

These fine tubes are used for the suspension of the coils of very sensitive galvanometers, and can be made conductors of the electric current by silvering or by filling them with mercury. They have a surprising strength, reaching 5 grams for the dimensions given, which corresponds to over 12,000 lb. per square inch.

U.S. Pat. 1912.
Invented by California
A "BOOMERANG" BLOW

602 PIPE GLIDER

One of the new glider toys placed upon the market this year is a whirling-wheel glider which describes an arc over the person blowing it into the

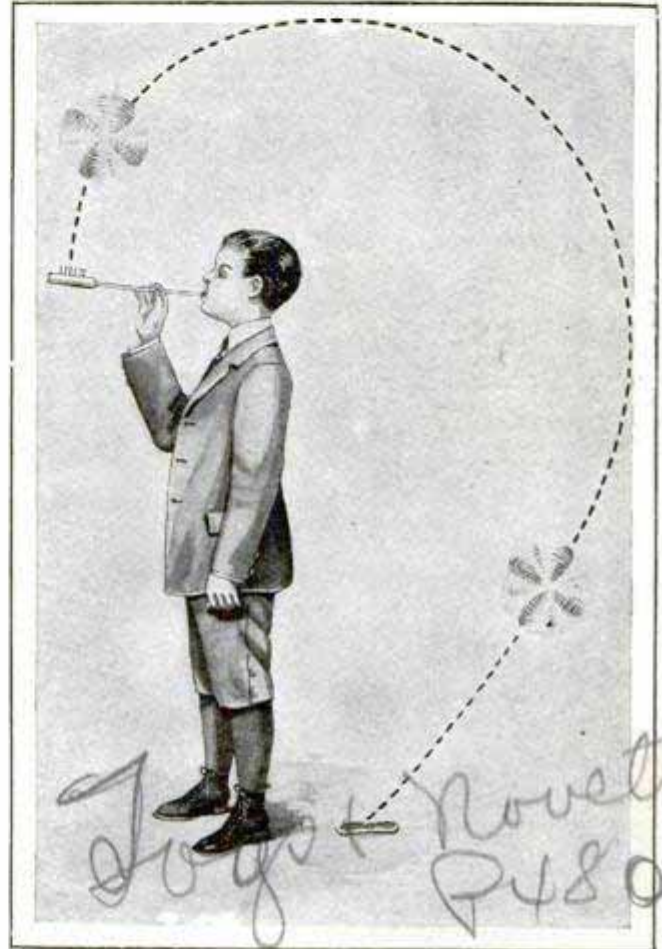

A Blowpipe Glider Which Returns to the Feet of the Player

air and returns to his feet from the rear. The glider is in the form of an elongated plate with ends turned down and is somewhat similar to a pinwheel. It is set upon pegs at the outer end of a blowpipe, and when air is puffed through the latter it rises into the air.

Ⓒ About one per cent of the total wealth of the United States as a whole is invested in church property, but, according to Dr. Booker T. Washington, more than eight per cent of the wealth of the negroes of the country is invested in 35,000 churches and church institutions which have a membership of 3,700,000.

AUTOMOBILE HEADLIGHT AS TROUBLE SIGNAL

During some recent army and militia maneuvers, in which motorcycle and automobile scouts took part, the



Signaling for Help by Directing a Headlight into the Air

method shown in the accompanying illustration was suggested as a means of signaling to other scouts, should a car run out of gasoline or break down. The idea is to swing one of the headlights upward on its mounting until the beam of light rises vertically into the air. The same scheme can be followed out with ordinary pleasure cars that meet with trouble on the road, if the purpose of the vertical beam becomes generally known to motorists.

NEWLY DISCOVERED YEAST USEFUL FOR DYEING

Kazuo Ando, a Japanese chemist, has announced the discovery, in Japanese breweries, of a fungus closely related to the yeast fungi. It is remarkable not only on account of the fact that it does not cause fermentation, but also because it is a beautiful

red in color, and because the extract from the yeast dyes silk a light rose color.

If these yeasts are grown in a solid gelatine, they cause it to turn into a liquid. At first it was thought that they might do considerable damage to beer, but now it is found that they are harmless in this respect. He has made many experiments with them as a dye, though there is no immediate prospect of their being commercially available for this purpose.

PORTABLE RETORT FOR SURGEONS

In order to enable a surgeon, in a case of emergency, to quickly produce a quantity of distilled, germfree water for the dressing of a wound, or the like, a surgical firm has brought out a portable distillation apparatus.

The retort proper is heated either electrically or with an alcohol lamp and the receiver, which rests in a small inclosed tank holding about 1 qt. of water, is provided with tubular canals running through it, to increase the cooling effect of the water. About a pint of pure water can thus be obtained very quickly. The retort and receiver are first strongly heated to insure

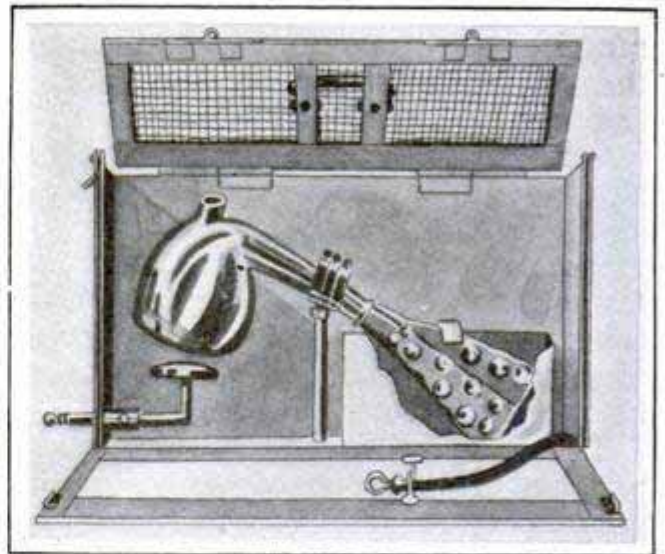

Device by Which a Surgeon may Quickly Obtain Distilled Water for Use in Connection with Operations

sterilization and, being made of a special glass, endure this treatment without danger of being damaged.

**MEMORIAL TO "TITANIC'S"
WIRELESS OPERATOR** 690

A rectangular cloister, 120 ft. square, is to be the memorial to John George Phillips, the wireless operator of the "Titanic." It will be erected upon land given for the purpose at Godalming, Eng., which was the home of Phillips, and the structure will face the main Portsmouth road. On entering the inclosure, there will be a wide paved space with a small, square middle garden consisting of beds of dwarfed shrubs and flowers with grass between, and a central circle will contain a fountain. The sides to the right and left of the entrance will consist of an unbroken cloister, but the wall of the further side will be arcaded instead of cloistered, giving a singularly beautiful view, through the arches, of the meadow and woods beyond. There will be seats under the cloisters, some portion of which will always afford comfortable protection from the weather, no matter in what direction the wind is.

**AEROPLANE LANDING OF
PHILADELPHIA HOTEL** 482

When the new addition, now under construction, of a well-known Philadelphia hotel is completed, airmen will

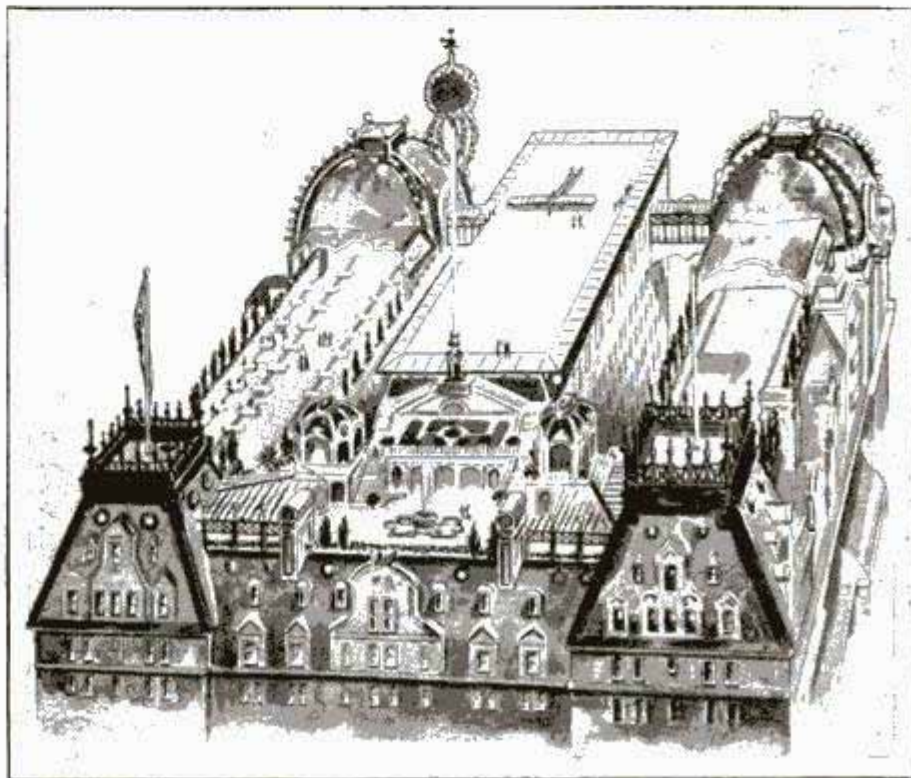

The Aeroplane Landing of a Philadelphia Hotel

be able to fly over the city and land on the roof. The landing platform will be 100 ft. long by 50 ft. wide, a series of buffers, with sandbags attached, will be utilized to break the momentum of the machines, and a trap will catch the aeroplanes and prevent them from falling off the roof.

If the innovation proves popular, the management of this hotel, which likewise operates one of the large New York hostleries, will construct a landing on the roof of the latter, so that flights can be made between the two establishments.

**A "RAINCOAT" FOR THE
STRAW HAT** 603

Believing that the damage done to straw hats by rain warrants a special "raincoat" for their protection, a southern concern has placed such an article on the market. The rubber hat cover, which weighs next to



nothing, can be rolled up and tucked into the corner of a pocket.

China is the greatest consumer of old newspapers, according to the Shanghai Review; the port of Niuchwang alone having imported no less than 1,918 tons in 1911. The Chinese middle class use it for wall paper because it is stronger than the home article and is supposed to exclude fleas effectively. They also make underclothing of it.

Patent Rubber Hat Protector Co. Nashville Tenn

Nashville Rubber Hat Protector Co

PONTOON BRIDGE AT BAGDAD

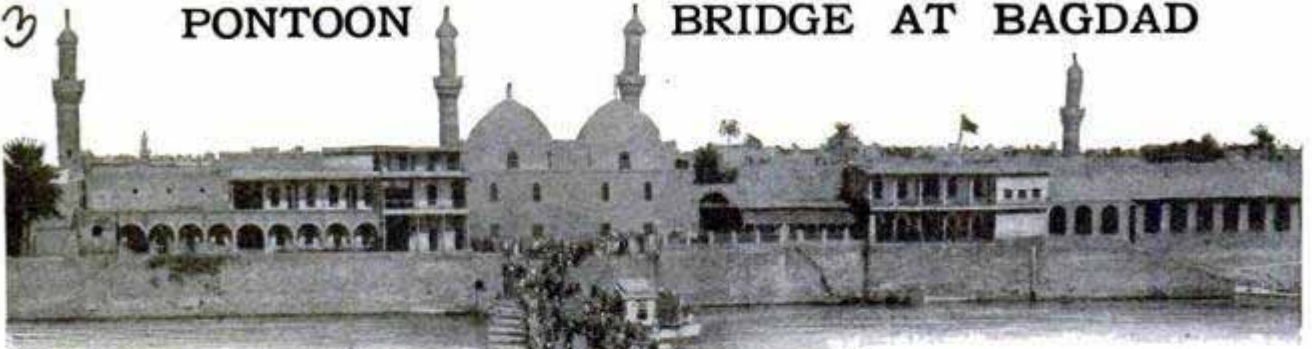

653

A novel pontoon bridge crosses the Tigris River, connecting the east and west parts of the ancient Arab city of Bagdad. This bridge is coupled in the middle, where each part is also anchored, but in flood times, should the current become so strong as to threaten the bridge, it is uncoupled and the two parts swing downstream and rest against the banks on each side.

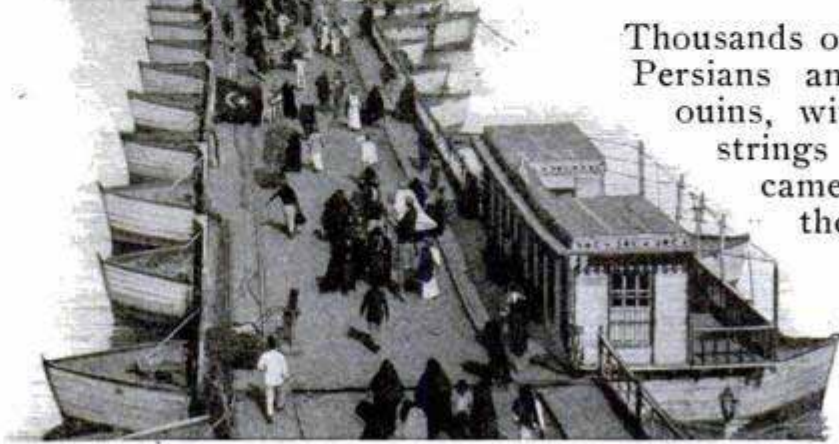

Thousands of Arabs, Persians and Bedouins, with their strings of pack camels, cross the bridge daily.

Pontoon Bridge is the Main Connecting Link of the Western and Eastern Parts of Bagdad

Foot walks are provided for pedestrians on each side, but these are seldom used unless the bridge is crowded.

PNEUMATIC WOODCARVING TOOL

559

A line of pneumatic carving tools, especially adapted for working in wood, is now being marketed by a concern which has been furnishing the

stoneworking trades with a pneumatic tool for some time. The former, in fact, are simply adaptations of the latter. It is claimed that the pneumatic woodcarving tools will do work of any description turned out in the past with hand chisels.



The Pneumatic Woodcarving Tool in Use

CORK WADDING FOR SHOT CARTRIDGES

A new wadding for shotgun cartridges, made of granulated, very elastic cork from which all grit and hard substances have been mechanically eliminated, has recently been brought out in France. The cork particles are ground, impregnated with paraffin, molded, and talcum powder rubbed into the outside.

Official experiments, at the gun factory of Saint-Etienne, are said to prove that even if the cartridges are overcharged with powder, thus giving the shots a considerably greater penetra-

Thos. H. Baller Co

tive effect, there is produced no pressures dangerous to the huntsman; the recoil is rather below normal and the internal pressure somewhat less than the average.

ELECTRIC TOWBOAT USED ON FRENCH CANALS

A new type of electric towboat for use on the French canals, which are primarily intended for freight traffic and very shallow, is shown in the accompanying illustration.

By its power and the perfection of its machinery it is considered by French builders one of the best of this class of vessels. In accordance with traffic regulations of the Saint-Quentin canal, where it is at present in service, its prow and stern are exactly alike and each provided with a rudder and propeller. Its power equipment consists of two 50-hp. electric motors operating the towing-cable drums, and two motors of the same power for the propellers. It is 82 ft. long and draws 4 ft. of water. The supply of electric current is taken from overhead wires, a storage battery being also installed for emergency service. It is built of steel and divided into seven water-tight compartments.

RAINCOAT CONVERTED INTO MOTORCYCLE SUIT

654 An old raincoat, mackintosh, or like garment, can be made into an excellent outer garment for motorcyclists, according to a motorcycle enthusiast who accomplished the conversion in the following manner. He slit his raincoat down the back about the length of the regular overcoat vent, sewed five buttons on each edge, and attached clasps corresponding to the buttons on each side of the front of the coat. When buttoned together, the one-piece suit so made completely covered his "good" clothes, and was trim in appearance, also.



Raincoat Cut Over and Fitted with Buttons, to Form a One-Piece Suit

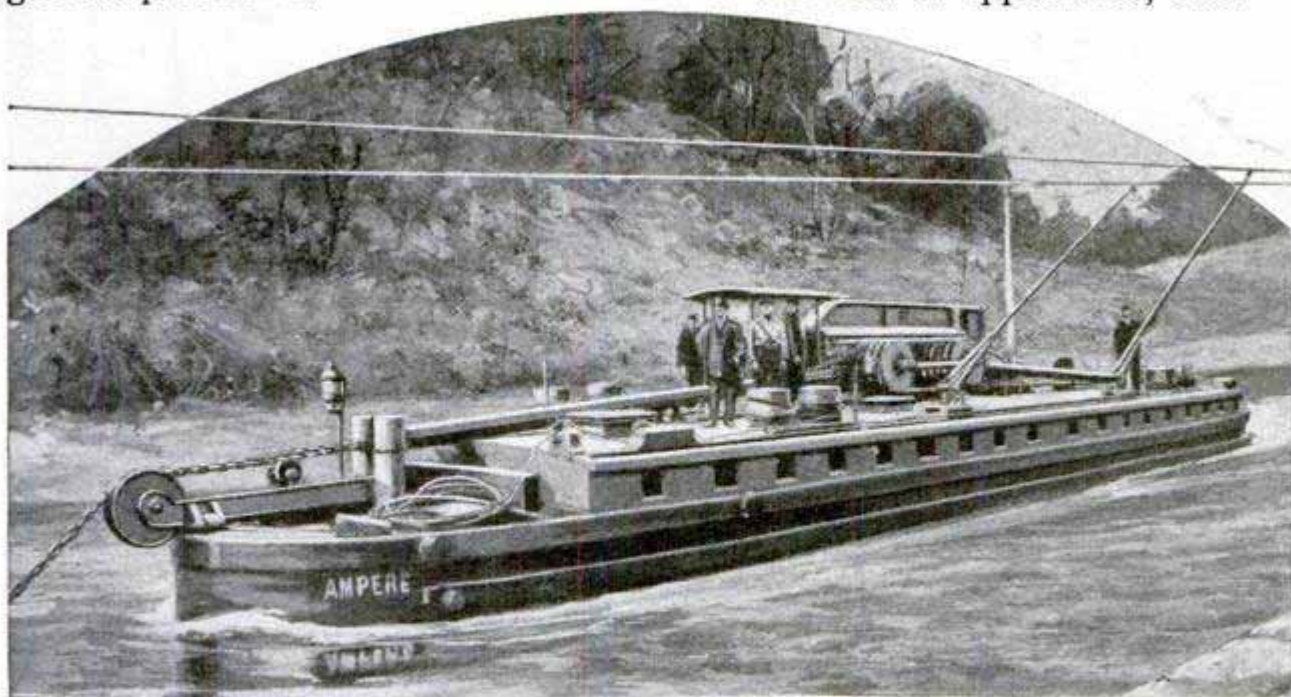

Electric Towboat Just Built for French Canal

A NEW TYPE OF PROPELLER

427
429

A new type of propeller for air or water, which its inventor calls a "non-gyro" propeller, is shown in the ac-

New Type of Propeller, with Blades Set on the Shaft at Different Angles

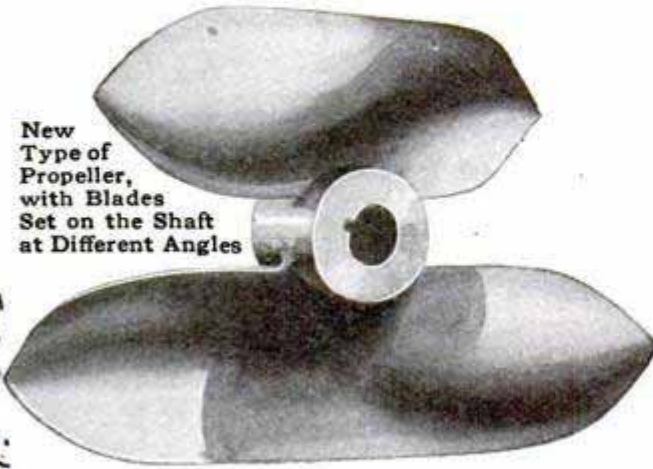

companying illustration. This propeller is based on the idea that the most efficient blade has a spiral-like curve at one point and is concave at another. The water is picked up at the first-mentioned point and carried the extreme length of the blade. It has been run in weeds without picking them up.

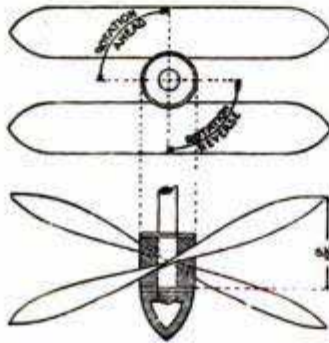

Last winter the inventor constructed an ice boat and mounted a 6-ft. air propeller of this type upon it. Turning at a speed of 950 revolutions per minute, it drove the boat at a speed of 40 miles an hour.

COTTON ROPE DOES NOT BECOME TIRED

Cotton ropes used for power-transmission purposes do not seem to be so exposed to mechanical "fatigue" or weakening through long-continued use, as one would naturally suppose this not very strong material to be. At least this appears to be proven by experiences with such ropes in England, where, in one instance, 24 cotton ropes, 1 3/4 in. in diameter, employed for direct transmission of 820 hp. from a 28-ft. flywheel, have performed service for 34 years and are still in good condition. There have been several other instances of this sort noted in engineering publications and it is regarded as a common thing for cotton rope to last from 11 to 15 years. As the cause of such longevity is suggested their chance of rapid recovery from strain, since they pull only on one side of their travel and rest on the other.

ENGLAND LOSES ANOTHER SUBMARINE AND CREW

Another submarine disaster has been added to the steadily growing list of such accidents in the British navy. Submarine "B2," carrying officers and crew to the number of 16 men, was struck amidships by the Hamburg-American liner "Amerika" off Dover, and sank like a stone in 120 ft. of water. The only survivor was Lieut. R. L. Pulleyne, who was on the deck of the submarine when she foundered. He

Ans. A. Steering mechanism. It is

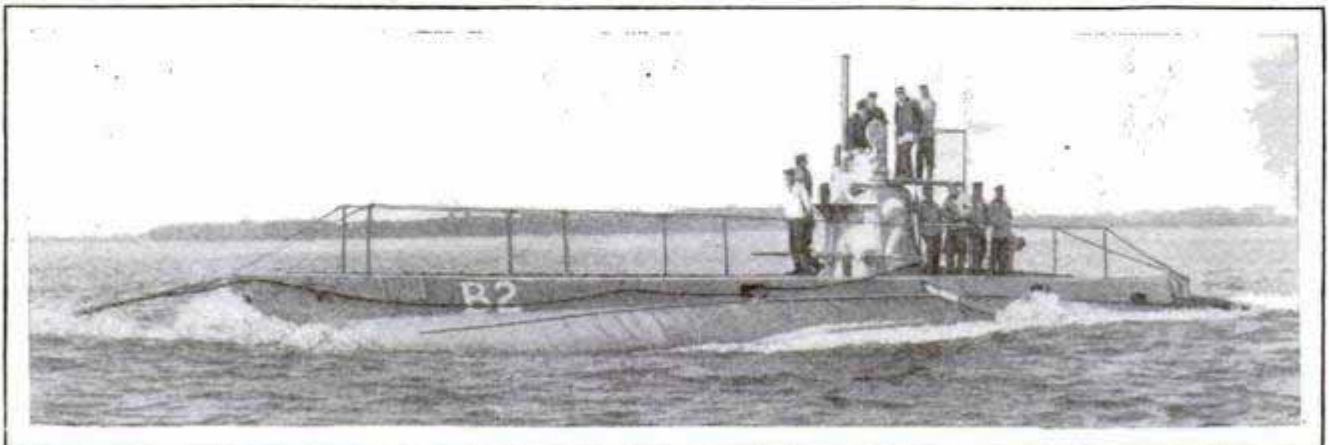

British Submarine Sunk by a Transatlantic Liner with a Loss of 15 Men

Motorcycle Sept 20
 was sucked down with the submarine and reached the surface again with just enough breath to say: "Submarine cut in two. I went down a mile."

552 **NEW SILENCER FOR MOTOR-CYCLE ENGINES**

The simple method by which a new motorcycle-engine silencer obtains a maximum radiating surface for cooling the gases, with the object of reducing the noise of the cylinder explosions, is here shown. From a plate in the top of the casing are suspended a great number of short flat rods, each passing through a slot in the plate. They thus hang loosely in the plate,

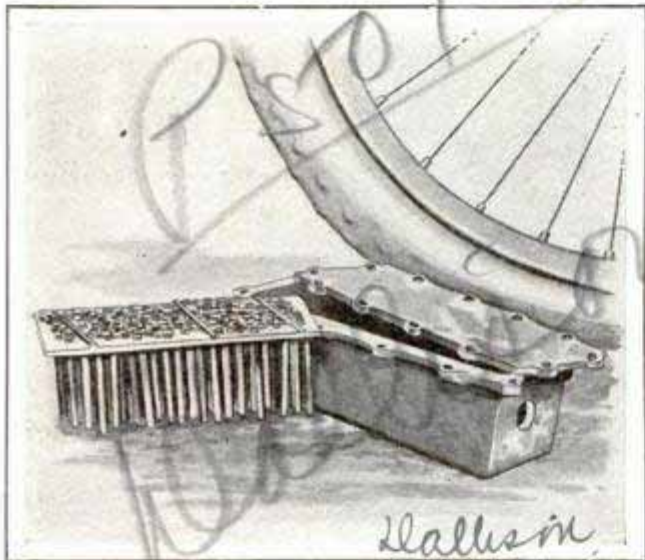

A New Motorcycle Exhaust Silencer Which is Claimed to be Very Effective

but their movement is sufficiently restricted to prevent undue jangling. The bars provide an exceptionally large cooling area for the gases, and it is claimed that the silencing of the exhausts is accomplished with much less loss of power than with other types.

625 **COMBINED MERCURY-VAPOR AND TUNGSTEN LAMP**

Following a number of experiments which showed that mixing the lights of the tungsten and mercury-vapor lamps in the right proportions would provide a color apparently not far removed from daylight, the lamp here shown has been developed. It is a tungsten

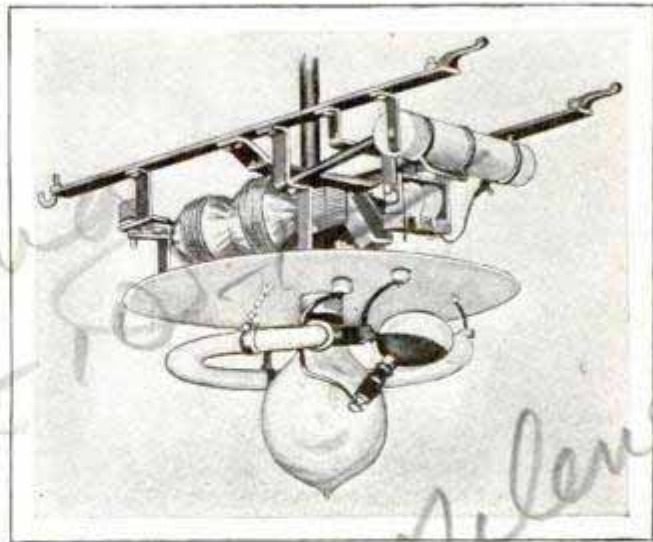

The Tungsten Lamp and the Mercury-Vapor Lamp Combined in a Compact Unit

and mercury lamp combined in a very compact form of unit, the mercury tube being circular, with the tungsten lamp mounted at its center. The two lamps are in series, the tungsten filament being arranged to act as ballast resistance, thus reducing the amount of power usually lost in this way.

FRAGMENT OF ARMOR PLATE AS MEMORIAL 657

On the quarter-deck of the Russian cruiser "Oleg" is a tragic memorial of the Russo-Japanese war in the shape of a fragment of armor plate, which was pierced by a Japanese shell, inscribed with the names of those who were killed.

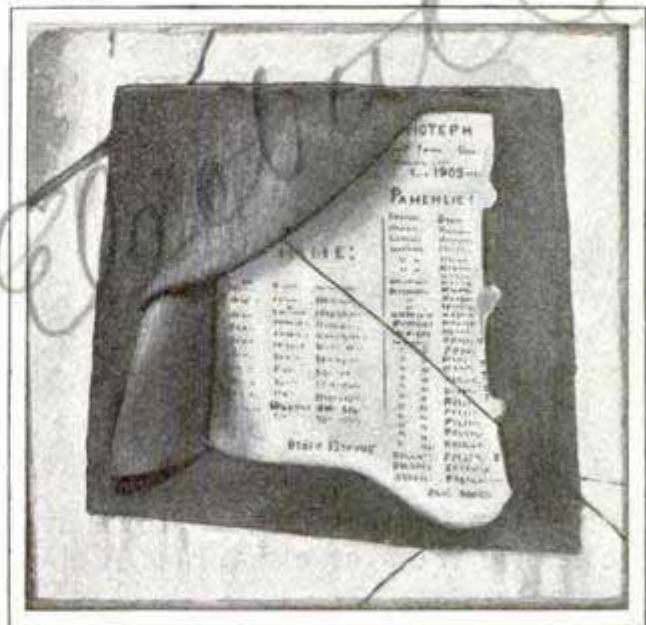

Fragment of Armor Plate of Russian Warship as a Memorial to the Dead

FOUR-COMPARTMENT SIDE-DUMPING MOTOR TRUCK

A motor coal truck having four compartments, each of which may be dumped separately, is shown in the accompanying illustrations. The dumping of the compartments is accomplished separately, is shown

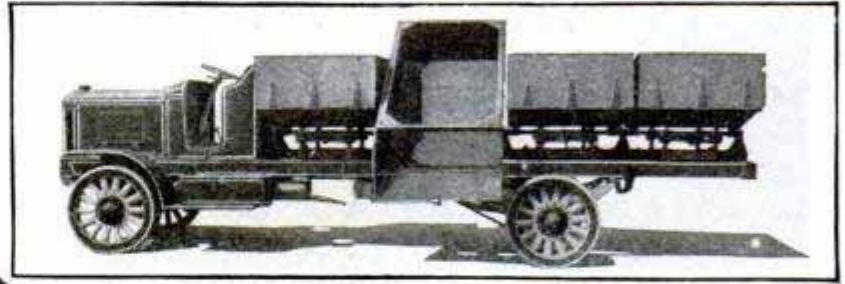

New Motor Coal Wagon with One of the Compartments Tilted

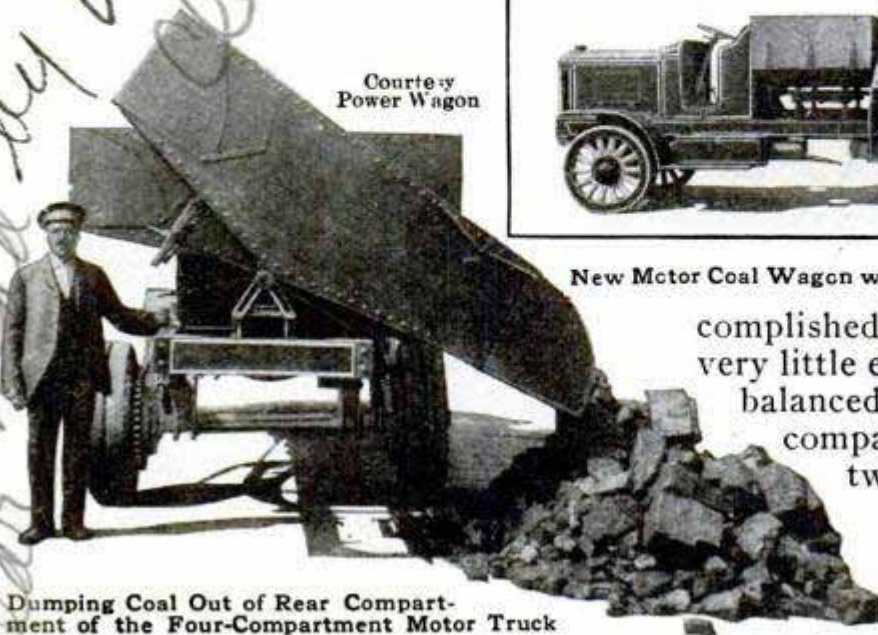

Dumping Coal Out of Rear Compartment of the Four-Compartment Motor Truck

Courtesy
Power Wagon

575
accomplished by hand, but this requires very little effort, as the load is perfectly balanced. To tip any particular compartment, the driver releases two supporting clamps placed at opposite sides under the body, and a slight push upward suffices to unbalance the weight.

A MECHANICAL ANVIL HAMMER

An ingenious mechanical anvil hammer has recently been constructed and put on the market. The speed of the hammer, the head of which weighs 40 lb., is 95 to 100 blows per minute. An

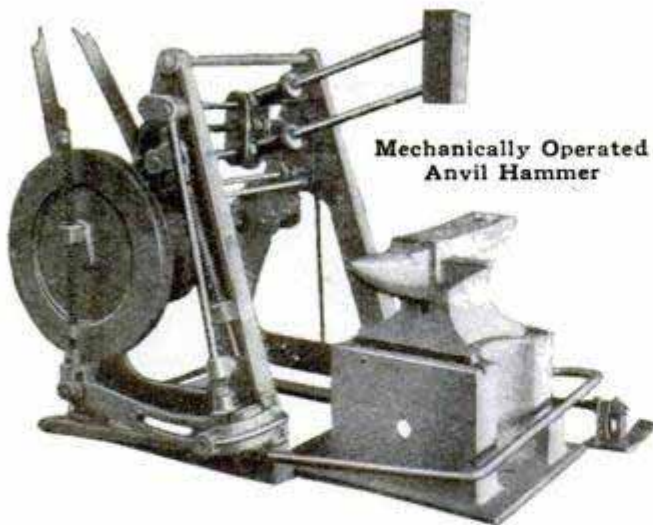

Mechanically Operated
Anvil Hammer

ing, swaging, heading, or any work of similar character to be done. The operator can regulate the striking of the hammer so as to make a heavy blow or a series of light ones by simply moving a rod, and he can work the hammer from the front, or either side of the anvil, by depressing the surrounding foot rail. Immediately the foot rail is released, the hammer comes to rest. There are no obstructions, such as standards or slides, to interfere with the work.

COLORS USED TO IDENTIFY AEROPLANES

interesting feature of the hammer is the lateral transverse motion.

The hammer head will travel either right or left, any distance required, over the anvil, thus enabling punch-

Tests of a new system for identifying aeroplanes were recently made at a French aerodrome. The under side of the wings were painted in strongly contrasting colors, yellow and black, white and red, for instance, in stripes or simple geometrical figures. In spite of unfavorable weather conditions, aeroplanes, flying as high as 1,500 ft. and more, could be easily distinguished from one another.

MARBLE MOSAIC FOR WINDOWS

Beautiful mosaics in varicolored marbles are common sights as interior wall decorations in public and many private buildings, but it is only recently that it has become possible to produce, industrially, sheets of marble so thin that they are transparent and adapted to replace art glass in decorative windows.

The originator of this manufacturing process, Dr. Alfred Pfaff, of Oberlahnstein, Germany, states that those marbles which naturally possess little or no transparency, make the best panes for the purpose, transmitting a soft light and giving the most beautiful color effects. The panes can be made in thicknesses as slight as .02 to .008 in., and in sizes 20 to 35 in. square. Canada balsam, which is quite colorless when dry, is used to hold the various pieces of marble together.

Some idea of the artistic possibilities of this new material is conveyed by the illustrations which represent marble mosaics which were exhibited at Darmstadt last summer.

Based on their calculations on radioactive phenomena, Prof. R. J. Strutt, of the Imperial College of Science and Technology, London, and Prof. C. G. Darwin, of the Manchester University, assert that the earth is at least 711,000,000 years old.

PRIMITIVE WELL BORING IN CHINA

In the province of Szechuen, China, are oil, gas, and salt wells over 2,000 ft. in depth which have been drilled by hand through the solid rock. When everything goes satisfactorily, the work advances at the rate of 2 ft. in 24 hr., so that about three years are required to dig a well.

The manner of drilling these wells is as follows:

If there is a depth of 3 or 4 ft. of soil above the underlying solid rock, the Chinese plant in the earth a tube of hollow wood, the lower end touching the rock. A large stone through which a hole 4 or 5 in. in diameter has been cut, is placed above the upper end of the tube, the hole in the stone being

directly above the hollow tube. The boring machinery is next erected. A large hoisting drum is set up vertically a little way from the well. The axle of the drum is 7 to 8 ft. long, made of wood, and terminates in an iron pin at each extremity, the lower pin working in a dressed stone, the

upper in a strong crossbeam mounted on two firmly fixed wooden tripods. At about 5 in. from either end of the axle there is a row of wooden spokes projecting 4 to 4½ ft., and to the outer ends of these are affixed upright rods parallel with the axle. The skeleton drum is thus formed, and upon it is wound the cable used in raising and

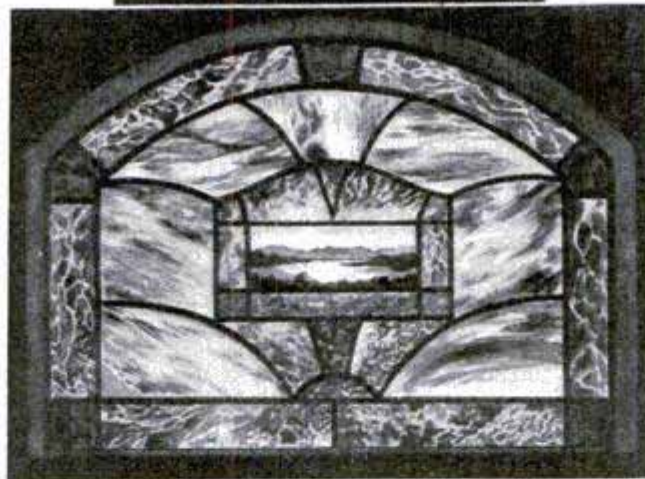

Upper View—Window of Transparent Marble
Lower View—A Lake Scene, Represented
in Transparent Marble

lowering the drill. This cable, of rattan cord, passes from the drum to a wooden lever resting on a wooden frame, where it is attached by means of a swivel. It next passes down the hollow tube, its end being attached to the boring bit, an iron rammer weighing from 200 to 400 lb., which is notched and made a little concave above and convex below. The length of the cable is so adjusted that the lever is horizontal when the bit is just resting on the bottom of the well. To depress the lever and raise the bit, two sets of men jump from side platforms onto the lever and back again to the platforms. Sometimes, however, only one man is employed. The bit is raised about 2 ft. and then let fall by its own weight. About 720 to 900 strokes per hour are delivered. While the bit is in the air, another man twists the swivel a little so that the teeth of the bit strike on a fresh surface. This

man, also, from time to time, throws into the hole a few pails of water to soften the material composing the rock, and reduce it to pulp, which is removed by lowering a cylinder of about 60 lb. weight in which is cut large cup-shaped grooves, into the well. The pulverized rock is forced into the channels of the cylinder by moving the cylinder up and down a few times, whereupon it is drawn up and the powdered rock removed.

To draw water from the well, a 24-ft. tube of bamboo, at the bottom of which is a valve or sucker, is sunk into the well until it reaches the bottom. A strong man works a rope connected with the valve so that every shake opens the latter and permits the water to rise in the tube. The tube being full, a great spindle-shaped cylinder upon which the rope of rattan is wound, is turned by two or more buffaloes until the tube is drawn up.

630

DISINFECTOR MOTOR CARS FOR USE IN GERMANY

Under the new plans of the health authorities in Germany, large districts are to be placed under a central sanitary administration, and three disinfector automobiles of the type shown in the accompanying illustration are to be used to enable a comparatively small staff of health officers to handle the work of disinfection necessary in cases of contagious and infectious diseases.

The use of the disinfector automobiles will make it possible for the officers to follow up the notifications received from physicians quickly, and to go long distances if necessary.

GEORGE WASHINGTON WAS ALSO A FIREMAN

It is not generally known that Gen. George Washington received a portion of his training in coming to the aid of people and communities and rescuing them from danger through service as a volunteer fireman. It probably takes a long stretch of the imagination to picture the "Father of His Country" garbed in a red flannel shirt, an inverted-coal-scuttle hat and a long pair of boots valiantly pushing his way through smoke and flame to save the family portraits from the devouring elements—and yet exact history will show that he did this very thing. He enrolled as a member of the volunteer fire department of Alexandria, Va., as early as 1750, some 25 years before the beginning of the Revolutionary War.

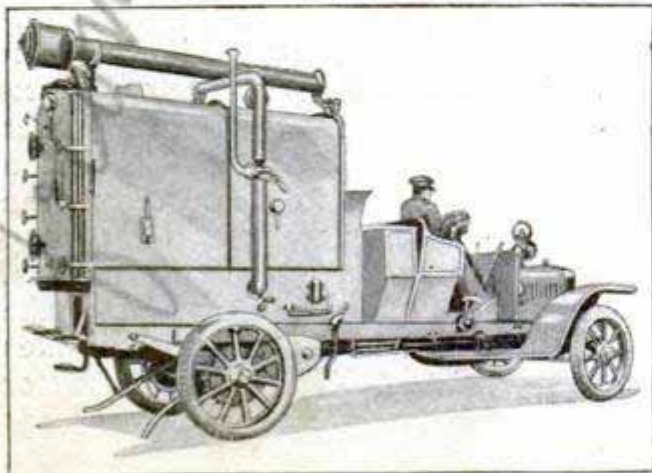

A Disinfector Automobile to be Used in Germany in Cases of Contagious and Infectious Diseases

German to disinfectant (1918)

Built at the Osing-
 ...

The Fireman's Herald

UPHILL SAFETY TRACKS STOP RUNAWAY TRAINS

A most remarkable and perhaps unique railroad construction to insure the safety of heavy trains on a steep down-grade is to be found in North Carolina on a section of the Asheville-Spartansburg line from Saluda, at an altitude of 2,200 ft., to a point three miles distant and 732 ft. lower, the average grade thus being 244 ft. to the mile.

While the passenger trains, which are equipped with air brakes of sufficient capacity to make a runaway practically impossible, safely descend the grade, it is not so with the freight trains with their heavy cargoes of coal and old-style hand brakes,

track, onto which a descending train may be switched, should the engineer lose control over it or consider its speed too great to safely permit continued descent. The points where these tracks branch out are selected at

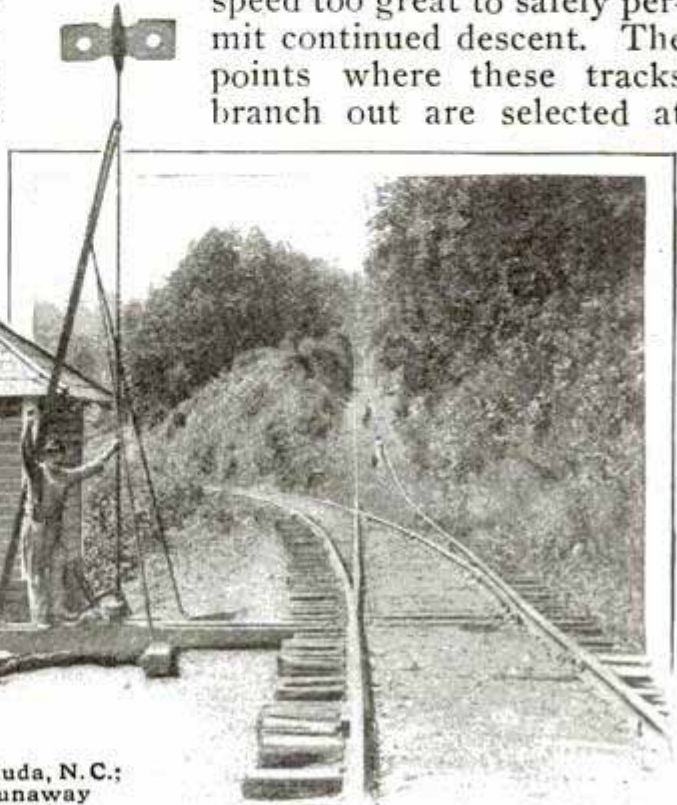

First "Landing" near Saluda, N. C.;
Switch Set to Stop Runaway
Train by Running It Up
Steep-Grade Branch

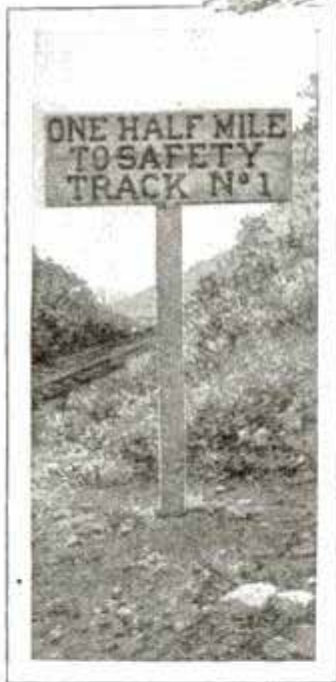

One of the Signs along Main
Track, Showing Distance
to Nearest Safety Track

although four extra brakemen are employed on the downhill trip; and runaways are quite common, but their danger is altogether eliminated.

There are no bridges or tunnels on this section, nor any sharp curves, and it has, therefore, been possible to provide what

slight curves of the main track so that the down-going train runs straight onto the safety track. There are two of these safety tracks, $1\frac{1}{4}$ miles apart, and signs along the road give the distance to the nearest, so that the engineer has ample time to decide whether to let his train "take a rest" or not. The switch is normally set to run the train onto the safety track, and an "open track" signal is necessary if the engineer desires to pass the switch.

Ascending trains likewise must signal for "open track," and it is needless to say that both freight and passenger engines in going up must have a "helper" engine and sometimes two. Even so, the uphill trip requires from 15 to 20 minutes.

Since the installation of these safety tracks only one accident has been recorded. In that case an extra heavy train reached the end of the safety track and jumped off with two cars. It required two locomotives to haul the wrecking engine up the steep grade.

might be termed landings, as in a staircase, on which the momentum of a descending train is spent before it continues its downward run.

These landings consist of branch tracks, 1,200 ft. long, running uphill at almost twice the grade of the main

FIREPROOF CLOTHES FOR THE FUTURE

Dr. William H. Perkin, the English chemist, who has done much remarkable work on the synthesis of rubber, has now found a method of making cotton cloth absolutely fireproof, so that it will not burn even when held in a gas flame. At the same time it is softer and more beautiful than the cotton cloth from which it is made, and, the inventor believes, free from the objections to fireproof cloth heretofore manufactured.

Fireproof cotton cloth, as formerly made, was harder than ordinary cloth, more expensive, and the fireproofing material washed out the first time the cloth was sent to the laundry. The new cloth, on the other hand, is quite different. Doctor Perkin showed one garment made of it which was unharmed by 20 washings, and another which had been worn for two years and washed every week. Neither could be burned, though the latter was worn almost to rags.

This fireproof cloth costs about two cents a yard more than untreated cloth, and this may at first limit its use, but as soon as the public becomes acquainted with its remarkable properties and also with the fact that it really is as cheap as ordinary cotton cloth, since it wears one-fifth longer, it will, no doubt, find a ready market.

Not only will this fireproofed material be found suitable for the manufacture of clothes for firemen, but it may also be used by women for the finest party dresses, the most delicately colored fabrics being unharmed by the process and even given a softer appearance. For children's clothes it should be particularly desirable, since it is likely to prevent many accidents.

The new process is very simple, and consists in soaking the ordinary cloth in a solution of sodium stannate (a combination of sodium and the acid of tin), and then drying it. Then it is put in a solution of sulphate of ammonium, dried, and heated to a moderately high temperature.

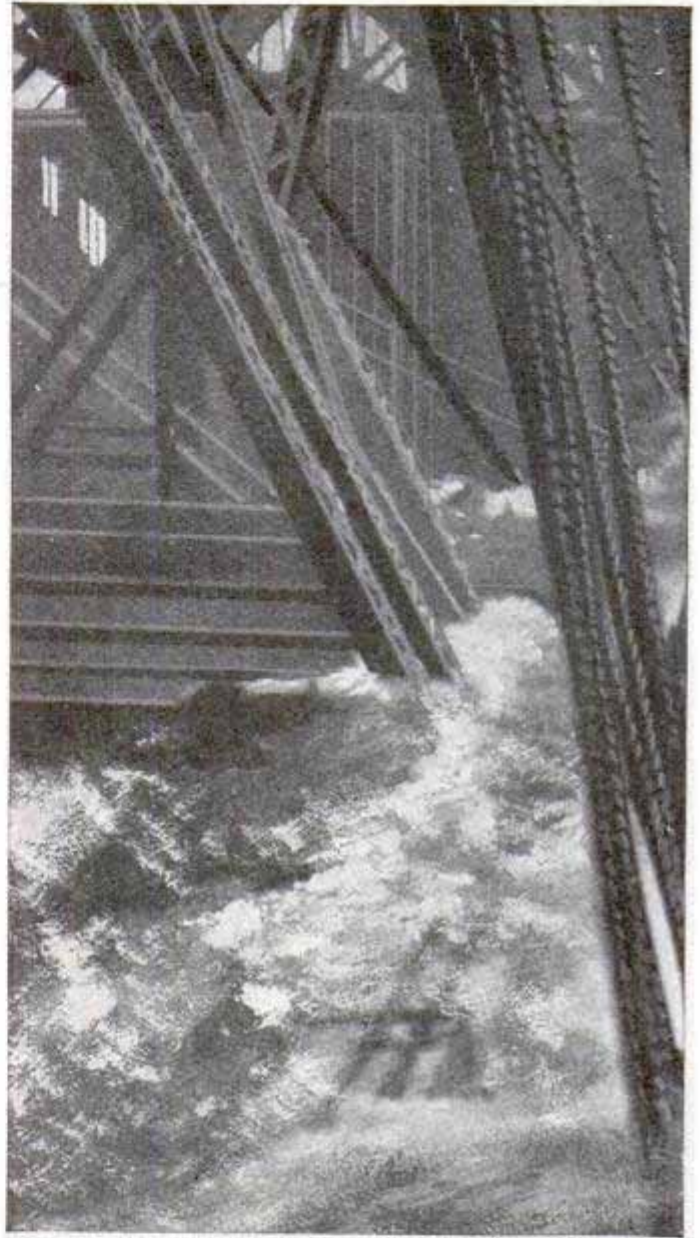

Sea Water to the Amount of 1,700 Tons
as the Heavily

"NEPTUNE" IN A HATTERAS NORTHWESTER

One of the first pictures ever taken showing to the full the tremendous fury of storms off Cape Hatteras was made by a naval attaché, who passed this fated point on the Atlantic coast aboard the big collier "Neptune" recently.

During this storm, which was not of unusual violence for Hatteras, the "Neptune," a vessel of large capacity, fully loaded with coal for the fleet at Guantanamo, Cuba, was at times almost entirely submerged in heavy seas that broke above her freeboard. It is

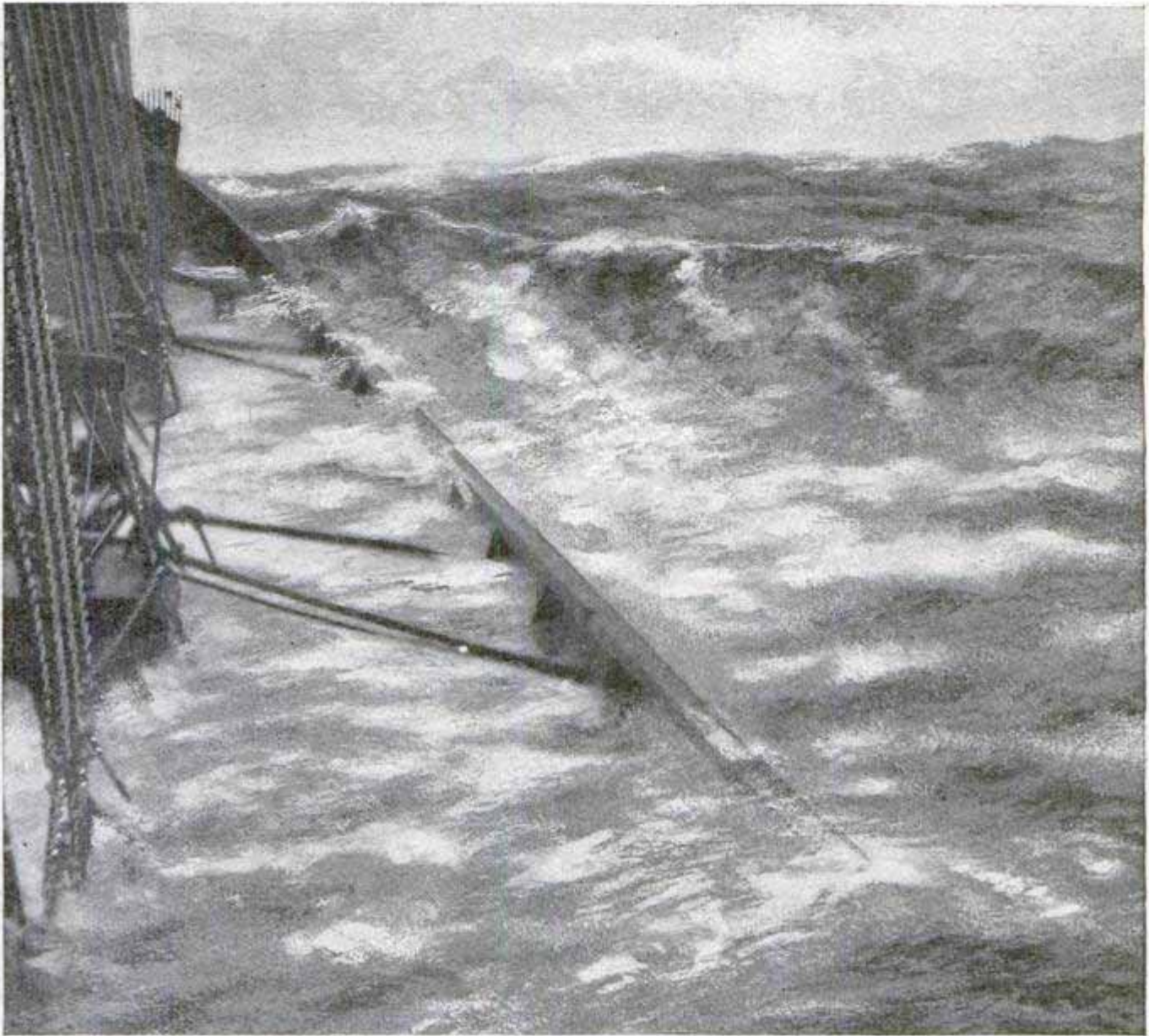

Was on the Deck of the Collier "Neptune" When the Photograph Reproduced Here was Taken, Loaded Vessel was Passing Cape Hatteras in a Recent "Nor'wester"

estimated that throughout the storm of 24 hours' duration, the "Neptune" had 1,700 tons of sea water in her well deck continuously. Besides her own weight, the ship had on board 12,000 tons of coal, 1,500,000 gal. of oil, and 40,000 gal. of fresh water.

Photographs taken from a position on the poop deck show great waves breaking over the ship and filling the well deck to the top of the taffrail or to a depth of fully 5 ft. At times nothing but bow and stern of the vessel were showing, and she was entirely submerged amidships.

When one stops to think that the distance from the rail to the waterline of

this vessel is 18 ft. and that the sea was lashed in mountain shape to heights approximately 30 ft. from the crest of the wave to the trough, it can be more easily understood how seriously her precious cargo of life and property were involved. Had any of the hatches accidentally come loose over the coal hold, it is certain that the vessel would have been lost.

The pictures, taken with a kodak, show a great wave just breaking over the rail at the poop deck, and its predecessor racing off the bow. The storm was a "nor'wester." The iron-work superstructure shown is the Lidgerwood system, for coaling at sea.

OIL-BARREL ORIGIN OF AUTOMOBILE SHAPE

Few of the automobilists who gaze so disdainfully from the luxurious rear seats of their touring cars are aware that the tonneau in which they are so comfortably placed received its name from the meek and lowly barrel. In fact the word tonneau is the French word meaning the kind of a barrel

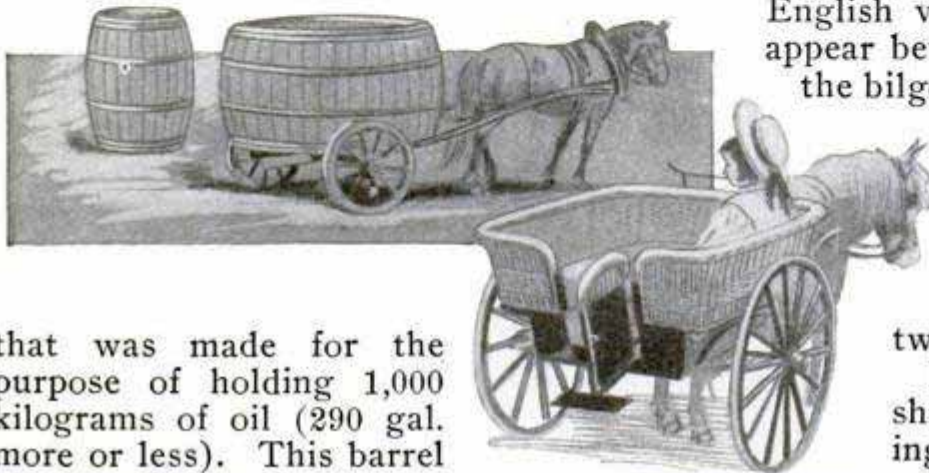

that was made for the purpose of holding 1,000 kilograms of oil (290 gal. more or less). This barrel was mounted on a pair of wheels and drawn by a horse. A carriage maker designed a vehicle which had the outward appearance of an oil tonneau and this carriage, known in England as a "governess" car, was referred to as a "tonneau." When the automobile was developed, the same term was applied to it because of its resemblance to the governess car, on account of the fact that it, like the governess car, was entered from the rear. The term stuck even after the rear entrance was abolished, and tonneau today is universally accepted as the proper term for the rear section of a large automobile body.

☞ An effective fish spear, recently found in use on Square Lake, Me., by a game warden, has six teeth and is constructed upon the same principle as a hanging deer trap. It can be easily set, and as soon as it strikes a fish, the jaws close upon it. It is fastened to a pole and is used like an ordinary spear or gaff, but is said to be far more positive.

CORRUGATED HULLS FOR BATTLESHIPS

Corrugated hulls for battleships have shown such possibilities for increased speed on the same amount of fuel that United States navy officers are to test out the idea this winter in Washington.

England has four such vessels, but none, either commercial or naval, has been built in this country. In the English vessels the corrugations appear between the load line and the bilge. On the recently built "Monitoria" there are two curves extending 23 in. out from the frames and a correspondingly deep concavity between them.

It is claimed that the ships so built show a saving in coal, that there is increased cargo space, that the hull is much

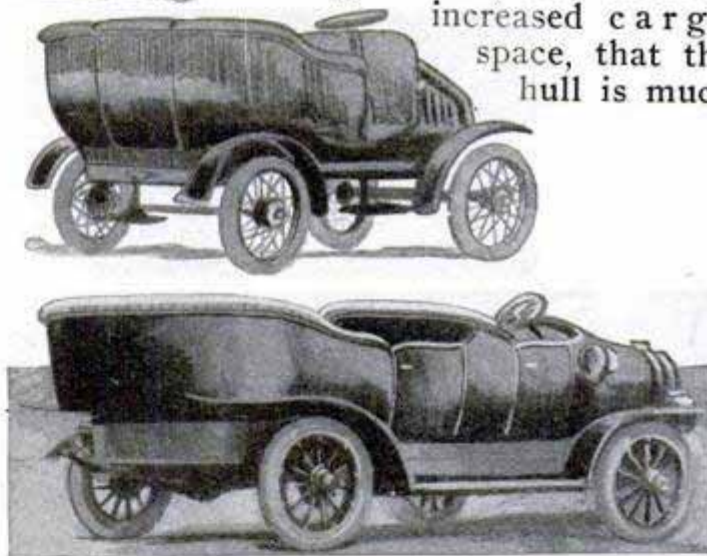

Evolution of the Oil Barrel to the Tonneau of the Fashionable Touring Car

stronger, and that the vessel is less sensitive to the action of the waves. Owing to the added strength given the hull by this adaptation of the tube principle, the stringer plates may be dispensed with. This increases the space available for bulk cargo and permits the ship to be unloaded more readily. Vessels so constructed are also given a better rating by Lloyds'. This is said to be one of the chief considerations. It is believed that the

added steadiness of such a vessel will provide, in warships, a steadier gun platform, with increased effectiveness of gun fire.

COLLISION OF AUTO FIRE ENGINES WRECKS HOUSE

While racing to a fire in Oklahoma City, two fire autos, one running north at a high rate of speed, collided just as the other turned north from a crossing street. The former, which was the heavier machine, was thrown from its course, striking, head-on, the supporting column at the entrance of a shop and wrecking the front of the building. The front part of the machine itself was practically demolished. On the other hand, the lighter engine, although it was spun around several times by the impact of the collision, did no dam-



Heavy Fire Auto, Thrown Off Its Course by Lighter Engine, Wrecks House Front in Oklahoma City

age and sustained no serious injuries. No one was killed in the accident.

CONCRETE SLABS AS FINE AS PORCELAIN

Concrete bricks and slabs, said to be as fine in grain, texture and finish as high-grade porcelain, are now being produced by grinding all the materials to as fine a powder as cement. The mixture, consisting of one part cement to as high as 12 of the other materials, is dampened just enough to pack well when pressed in the hand. It is then subjected to a pressure of 5,000 lb. to the square inch in strong iron molds, the pressure being applied in four or more strokes, in each of which the pressure is increased until the maximum is reached. The pressure plate is removed after each stroke to allow the air to escape.

DWARF SUSPENSION BRIDGE IN LONG SERVICE

Spanning a picturesque little run which forms a part of Mill Creek, a

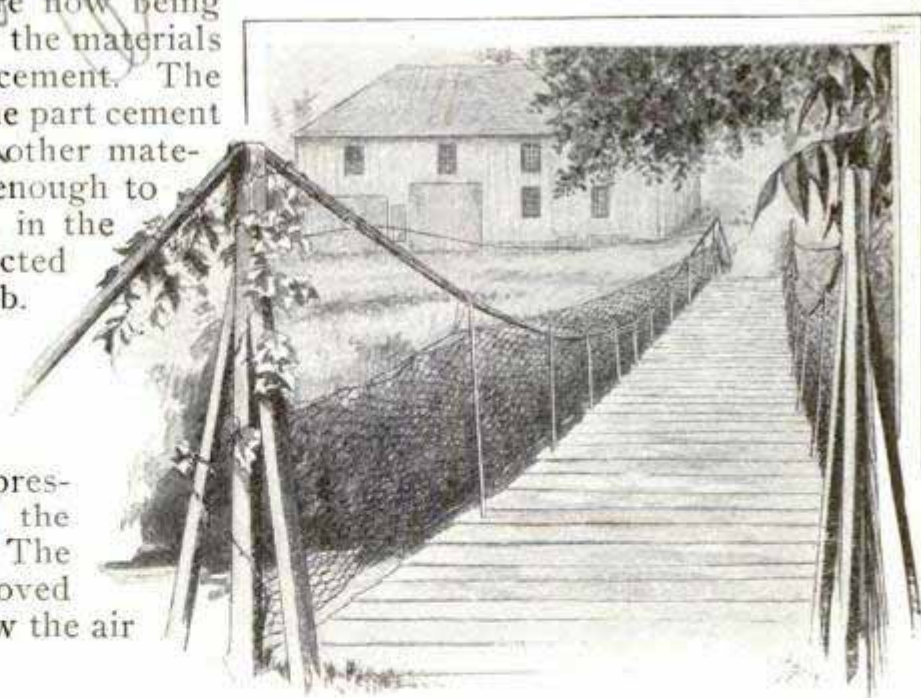

View across Suspension Bridge Built on the Plans of the Niagara Bridge, before the Latter was Completed

One of the trains running from Chicago to Minneapolis is provided with sanitary bubbling fountains. All the thirsty patron has to do is push a button and the cold water bubbles out.

stream best famed as the one at whose mouth "Eliza" crossed the floating ice, in the Uncle Tom's Cabin tale, at Mt. Healthy, a suburban hamlet a few miles

*Europe
October 1912
P. 25*

from Cincinnati, there still remains in constant use one of the oldest suspension bridges in the country.

The old estate, on which the bridge is found, is still known, locally, as the "Lane place," for old Clarke Lane, the founder of the family here, who came to Mt. Healthy about 1813.

Clarke Lane was an inventive genius, and one of the products of his skill is this suspension bridge. It was made by him and a son—William by name—from memory, they having seen a model of the suspension bridge soon to be erected over Niagara. Bearing this model well in mind, the Lanes made their bridge, finishing it long before the other, larger bridge was completed. That they built well will be seen when it is stated that aside from a few iron girders, added to strengthen the sides, the bridge remains substantially as they left it.

WOOD FOR REINFORCING CONCRETE

Concrete beams can be successfully reinforced with wood instead of iron, if the proper proportion of wood is used, according to an engineer who has studied the problem. In many places where wood is plentiful it is difficult to obtain the iron needed for such reinforcement. He found that nine per cent of wood is needed to properly reinforce, to every one per cent of iron which would ordinarily be used.

☞The first tunnel under the Pyrenees, which has just been pierced, has a length of nearly 5 miles, and when finished, will be the connecting link in a Franco-Spanish railroad from Pau, in southern France, to Saragossa, on the river Ebro in Spain.

TESTING THE GONDOLA OF THE BRUCKER AIRSHIP

A peculiar launching took place recently in the harbor of Kiel, Germany, which must have caused the uninitiated spectators much wonder. What seemed to be a small motorboat was seen suspended 15 or 20 ft. above the water by eight steel cables from a crane. Suddenly the boat was seen to drop into the water throwing a giant wave to right and left. At the same moment the

steel ropes were automatically released, and the boat moved away by its own power. This motorboat is to serve as the gondola or nacelle of the dirigible in which the German-American newspaper man,

Joseph Brucker, proposes to cross the Atlantic from Tenerife, one of the Canary Islands, to America, and the unusual launching method was adopted to illustrate the manner in which

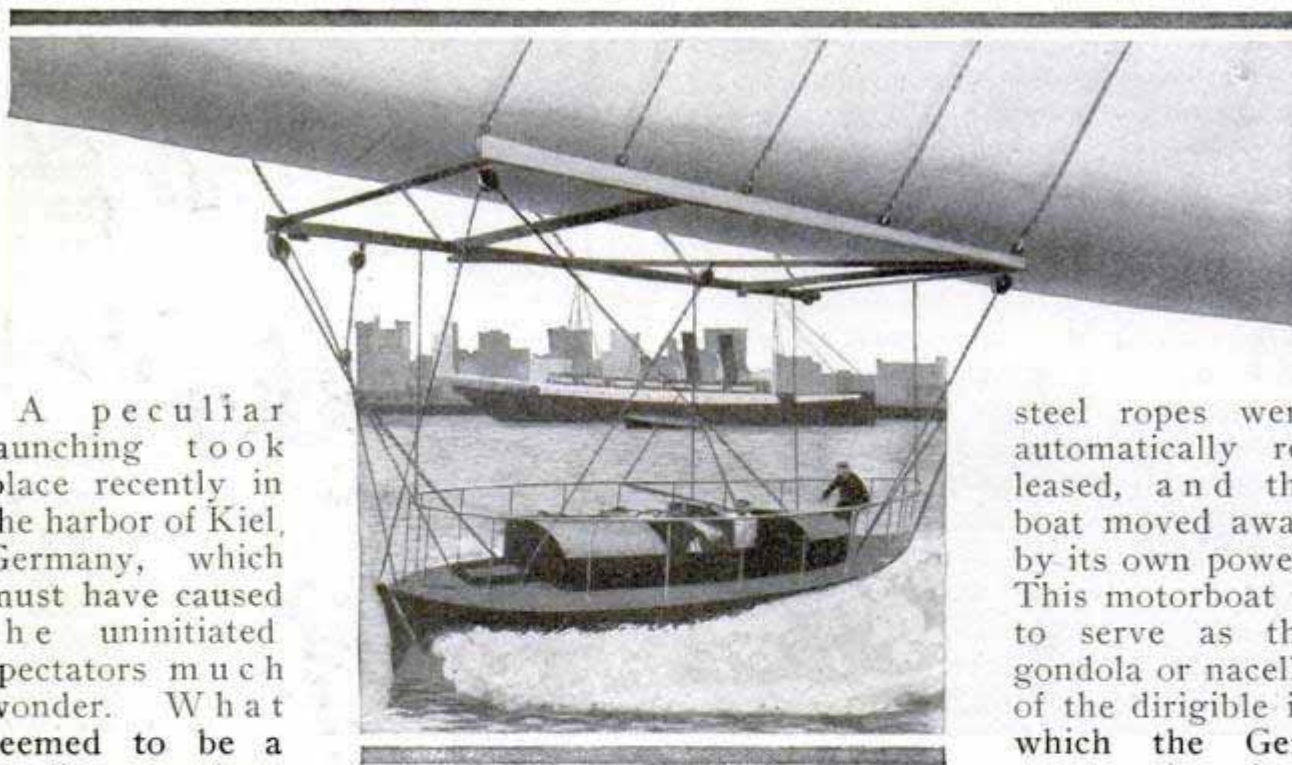

Gondola of Airship Tested by Dropping It from Crane into Water

*Sept 20/11
d nu Lewis Sydney 65*

Brucker intends to free the nacelle from the gasbag, should such a necessity arise, and to test the automatic devices provided for the purpose.

A FORMIDABLE MUSICAL INSTRUMENT

55 | All the information available about this musical instrument is that it is called a "follyphone," and that it was

BEST WOOD PULP MADE BY DULL GRINDSTONES

A study just made of methods of making the paper for newspapers or magazines by grinding up wood on a grindstone, in the government laboratory at Madison, Wis., has shown that a dull stone will make the best paper. The grindstone grinds the wood into wood pulp. If it is rotating in thick pulp, the pulp, water, and stone are kept hot; if it is revolving in water, the wood is ground in the cold. Before grinding, the log is always kept in steam for a few hours.

In one illustration is shown the form of the fibers which are produced when the wood is ground on a dull stone, and in the second the fibers are of wood ground on a sharp stone. In each case the figures show the fibers magnified 15 times. Even a person not expert in paper making can easily see that the fibers produced by the dull stone would make much the better paper. It takes, however, much more power to produce it.

Green wood gives a paper of a much better color than seasoned wood, and the paper is stronger if the wood is steamed before it is ground than when it is ground in the natural state.

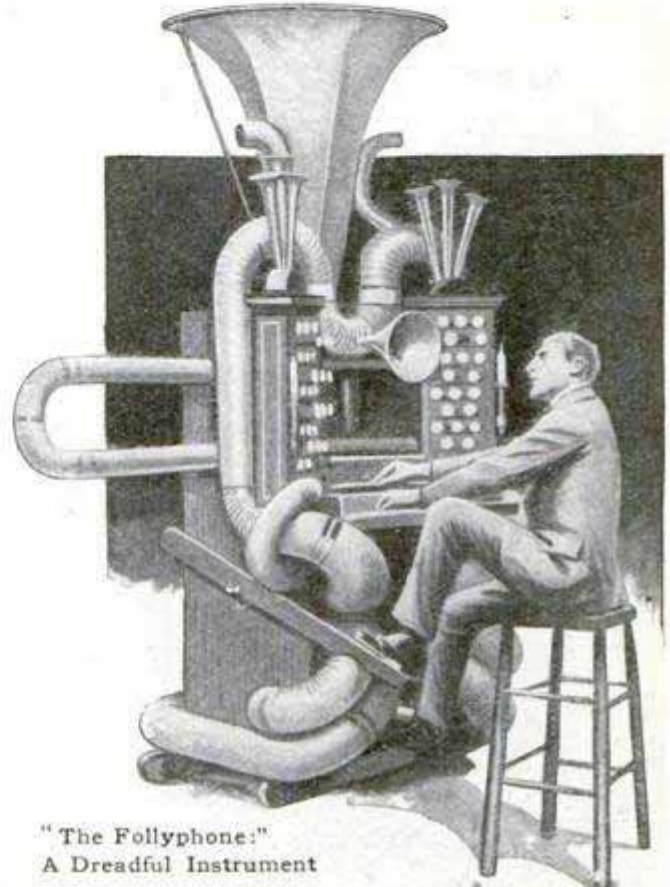

"The Follyphone:"
A Dreadful Instrument

played with great success at Mr. Pellissier's recent esplanade concert at the Queen's Hall, London. It might, judging from the dreadful look of it, be an instrument for producing the "futurist" type of music which is so raucous that nearly all who hear it are impolite enough to hiss.

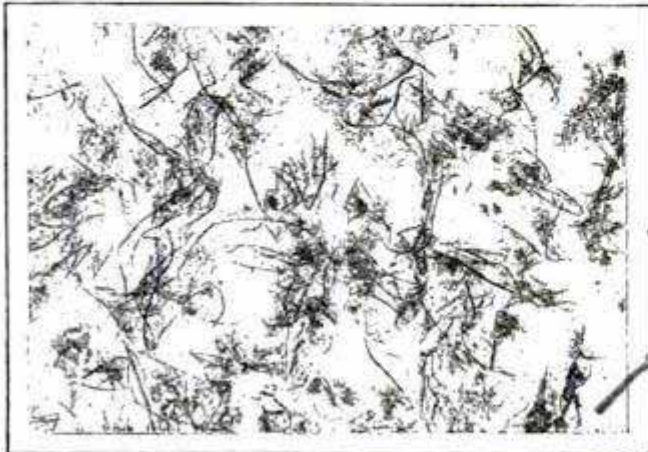

Photomicrograph of Paper Fibers Obtained by Grinding Wood on a Dull Stone



Fibers of Less Strength Obtained by Grinding on a Sharp Stone

*Photo of the Follyphone
played with great success at Mr. Pellissier's recent esplanade concert at the Queen's Hall, London. It might, judging from the dreadful look of it, be an instrument for producing the "futurist" type of music which is so raucous that nearly all who hear it are impolite enough to hiss.
Photo of the Follyphone
played with great success at Mr. Pellissier's recent esplanade concert at the Queen's Hall, London. It might, judging from the dreadful look of it, be an instrument for producing the "futurist" type of music which is so raucous that nearly all who hear it are impolite enough to hiss.*

Feb. 18, 1912

OLD TANK REJUVENATED BY USE OF CONCRETE

677 A large galvanized-iron tank, warped out of shape, standing unprotected from heavy rains and the heat of the

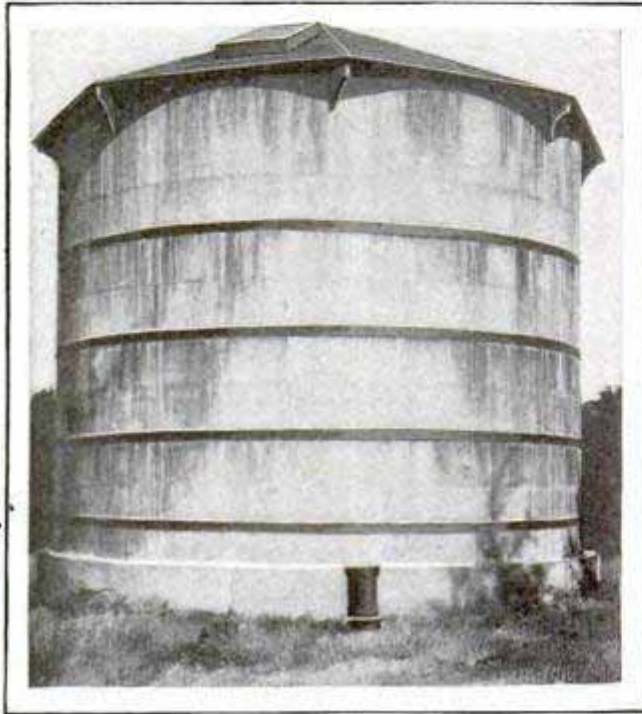

An Old Iron Water Tank Which, Concreted, will See Many Years More of Service

655 sun, and abandoned as useless several years ago, was recently rejuvenated by the use of concrete. The old tank was placed upon a circular foundation of concrete, and then walled up on the inside with cement, thus being converted into a fine concrete reservoir. The only framework necessary to the operation was a large circular frame inside the tank. After the concrete had thoroughly set, the inside was given a coat of asphalt paint, and the tank was ready for water. The top was roofed over with rafters and shingles, with a suitable opening left, screened over, to let in light and air.

PASSENGER STATIONS HAVE WHITE "DEAD LINE" 771

A broad white "dead line," painted the full length of every station platform parallel with the tracks, 5 ft. from the edge of the platform and 7 ft. from the nearest rail, is an idea of one of the western railroad systems for warning employes and passengers against moving trains. General orders provide that no truck shall be allowed beyond this line when a train is moving. All trucks may be used between the line and the tracks when the train has stopped, but must be back of it again before the train starts.

There is no rule governing the movement of passengers beyond the "dead line," but it is found that the greater number of them grasp the significance of the white streak and stay on the safe side, even when the platform is crowded.

MOTOR TRUCK TO PENETRATE VENEZUELA INTERIOR

686 One of the motor-truck concerns in Ohio recently received an order from a firm in the interior of Venezuela for a 2-ton truck. The order requested that the truck be shipped "knocked down" and boxed in packages not to exceed 140 lb. each, as pack horses were the only available means of transportation inland, and each horse could carry no heavier load.

As several parts of the truck weigh considerably more than 140 lb., the maker decided to ship the machine assembled, and to attempt to send it through to the interior under its own power.

655 SUBMARINE WRECKED IN THE SURF

Submarines, out at sea, can escape the worst of a heavy storm by proceeding under water at a depth where the ocean is undisturbed, and there are many instances in which this has been

done, but when the sea is met with above a shallow, sloping beach it is a different proposition. The submarine "F1," which holds the world's record for deep diving, having descended to

*Cont. Monroe Woolley,
Dr. Art Carey Wash.*

*Herom Motor Truck Co.
Lima, Peru*



Wreck of the Record-Holding Submarine "F1" in the Breakers on Monterey Bay

a depth of 283 ft., slipped her mooring while at Port Watsonville, Monterey Bay, Cal., and ran into the breakers. Of the 17 men on board, 15 succeeded in swimming out, the two others being drowned.

EFFECT OF AUTOMOBILES ON PASSENGER TRAFFIC

Just how great a loss in passenger traffic results to railroads through the use of the automobile is the subject of an interesting investigation by the Union Pacific Railroad. An inquiry was addressed to all the agents on the Union Pacific and Oregon Short Line, much of which is in a prosperous territory well adapted to the use of automobiles. It was found that there were over 16,000 automobiles owned along the two lines, including those in the cities of Denver and Salt Lake City, but not including Kansas City and Omaha.

Out of 50 replies from agents on the main line through Nebraska, 33 stated that the machines affected the local earnings from "slightly" to 50 per cent, while 17 reported prac-

tionally no loss. In Colorado, 16 out of 27 agents estimated the effect from slight to one-third the local business. In Kansas, 14 out of 45 main-line agents stated that short-haul business was being seriously affected, while, in Wyoming, 24 out of 31 thought the automobiles had no perceptible effect.

The principal wholesale houses in the territory were also questioned, and this brought out the fact that many houses had bought automobiles for their salesmen, and that others contemplated doing so.

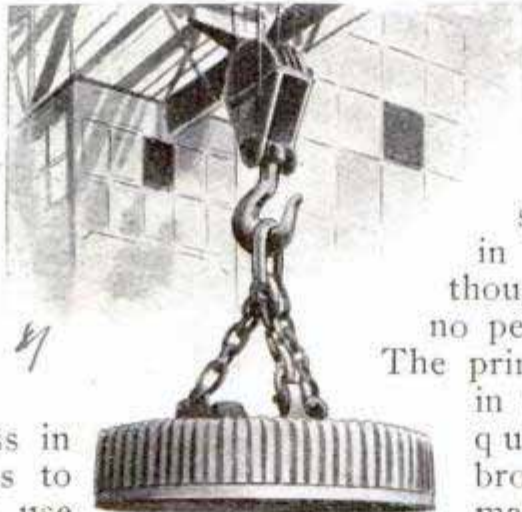

JACK-AND-THE-BEANSTALK CHAIN TRICK

While the accompanying picture seems too much like the story of the beanstalk Jack climbed to be true, the photograph was taken at an electric-crane factory and illustrates in a remarkably striking manner the wonderful nature of electromagnetic force. A chain, provided with a ball of iron at one end, was anchored with the other end in the ground and the lifting magnet suspended above, until its

Railway Age Gazette.

attraction lifted the ball and chain to an upright position, the chain being held so taut that a full-grown man had no difficulty in climbing it and hanging onto its top link without bringing it down.

COALS IDENTIFIED BY COKING TEST

As important in its possible bearing on the coal industry in general as it is interesting from a scientific point of

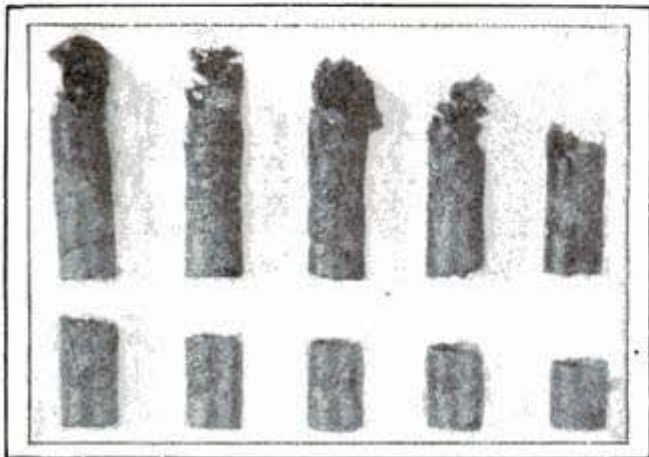

Fig. 1—Outside Appearance of Ten Different Coal Samples after the Test

view, the recent discovery by Dr. R. Lessing, London, of a simple test by which it is possible to determine from what mine or even seam of coal any sample of coal originates, is bound to arouse wide attention.

Doctor Lessing announces that his discovery was a by-product of investigations in search for a method of distinguishing coals best suited for coking from others not so good for the

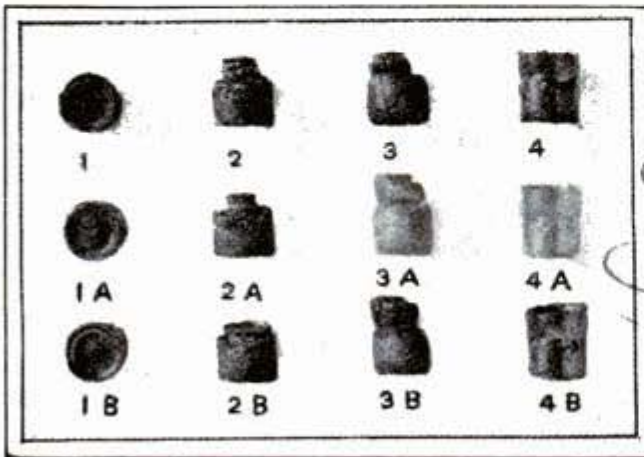

Fig. 2—Coal Samples from Four Mines Show Same Characteristics in Three Tests

purpose. His experiment was conducted as follows:

A small quantity of the coal to be tested (about 1/30 oz.) was heated in a metal cylinder, 4 in. in diameter, a piston being closely fitted on top of the coal. After heating, the coke formed, or what was left of the coal, was taken out of the crucible. It was then found that the various samples of coal looked very different after undergoing this treatment, as shown in Fig. 1, which is reproduced from a photograph of 10 samples of coal subjected to the test, each piece being easily distinguished from all the others.

It may seem that these differences are accidental, but Fig. 2 demonstrates that this is not so. Here four different samples of coal were each tested in three separate tests. It will be seen that in each of the three tests on any one sample of coal, as 1, 1A and 1B, the appearance of the test piece is almost exactly the same.

The importance of such tests is self-evident, since they will enable the buyer of coal to determine from what mine his coal has come; all samples from one mine, so long as the grade of coal does not change, giving very similar test pieces; and since it will no longer be possible for the dealer to substitute coal from another mine, or of another grade, without detection.

SMALL GASOLINE ENGINE STARTS "BIG BROTHER"

The starting of tractor gasoline engines of about 100 hp. is usually somewhat difficult, as such engines are large and heavy, due to the fact that it is impracticable with such machines to obtain great power by running at high speed, and that high power at slow speed necessitates cylinders of considerable size. To "turn over" such an engine by hand is no small task, so the manufacturers of one of the new makes of tractors are equipping them with small air-cooled engines for the purpose. The little engine drives the crankshaft of the large engine through a chain and suitable gearing.

Hammer & Co.

Hammer engine

SCOUTING THE BORDER ON A MOTORCYCLE

Since the law making opium contraband at the international boundary the price of the drug has gone so high that it puts a premium on smuggling. The government officials have been put to a great deal of trouble to detect the illegal traffic. Smugglers not only would slip over the line on foot but by train and automobile. Those in autos could open the throttle and escape with little difficulty on seeing a customs man or detective.

To meet this situation, the government has equipped the office at Blaine, Wash., with a high-speed, 2-cyl. motorcycle with which it is possible to pick up any suspected "border runner," even if he is in the fastest of automobiles. The motorcycle can go at a rate of 60 or 75 miles an hour on roads so rough that no four-wheeled machine could approach that speed, and consequently has become a source of terror to the smuggling culprits.

One of the customs detectives has

been able to seize, at different times and by various devices, \$15,000 worth of the contraband drug in operating from the one port of entry at Blaine, Wash. One haul alone of 240 tins of opium was worth nearly \$6,000. On another occasion, thousands of dollars worth of diamonds which were being



U. S. Customs Inspector Has Motorcycle for Catching Opium Smugglers

smuggled along with \$800 worth of opium fell a prey to the keen-eyed detective.

The accompanying picture shows Detective Hughes with his machine on the "line" ready for patrol duty. A batch of "dope" which he seized near this point comprised 40 tins of the opium worth \$20 per tin.

PHOSPHORESCENT FISH OF THE DEEP SEA

Certainly among the most remarkable of fishes are those which

cesses of the bottom of the deep ocean where no ray of natural light from above can penetrate. A model of one of these fish, notable for their phosphorescent organs, is on exhibition in the United States National Museum.



Electrically Lighted Model of Deep-Sea Phosphorescent Fish

are provided with lanterns of their own and which swim around the dark re-

the photograph, while in addition there is a large luminous area, like a lantern,

on the top of the head. This extraordinary creature must present a singular appearance when swimming in the dark abysses of the ocean. In the model the luminous spots on the sides are represented by buttons of glass, connected with the interior by tubes. The luminous protuberance on the head is molded in gelatin and tinted. The interior of the model is so equipped with electric lights that a distinct glow appears in the side spots, and the frontal "lantern" produces a very striking representation of the appearance of a living phosphorescent deep-sea fish.

TWO MOTION-PICTURE SHOWS IN ONE THEATER

A double-show motion-picture theater, claimed to be the first of its kind, has been opened in Cleveland. It is equipped with two picture curtains or screens, and two picture machines, and two shows are run simultaneously. The patrons enter the theater and take seats on the right side, from which position one screen is in view. When the complete program has been shown on this screen, it is only necessary to move to a seat on the opposite side to see an entirely different program, and all for a single admission.

WHITE PATCHES AS WARNING TO AUTOMOBILISTS

That pedestrians, using an automobile-infested country road at night, wear white bands upon their arms, or pin a white patch to the back of the coat, is advised by the London Times in a recent editorial. This editorial also draws attention to the fact that pedestrians along English country roads are deserting the loose-gravel footpaths for the smoother tar-treated roads. This, of course, they have full privilege to do, but it is considered dangerous unless white be displayed. It is likewise suggested that the hubs and backboards of slow-moving horse-drawn vehicles be painted white, so as to be more clearly visible from an approaching automobile.

A MONO-GYROPLANE BUILT FOR OCEAN TRIP

The curious machine shown in the accompanying illustration, which its inventor, a Roumanian living in Chicago, calls a mono-gyroplane, is to be used by him, it is said, in an attempt to fly across the Atlantic. The machine measures 50 by 40 ft. and carries two vertical and two horizontal propellers. It is equipped with a 170-hp. engine.

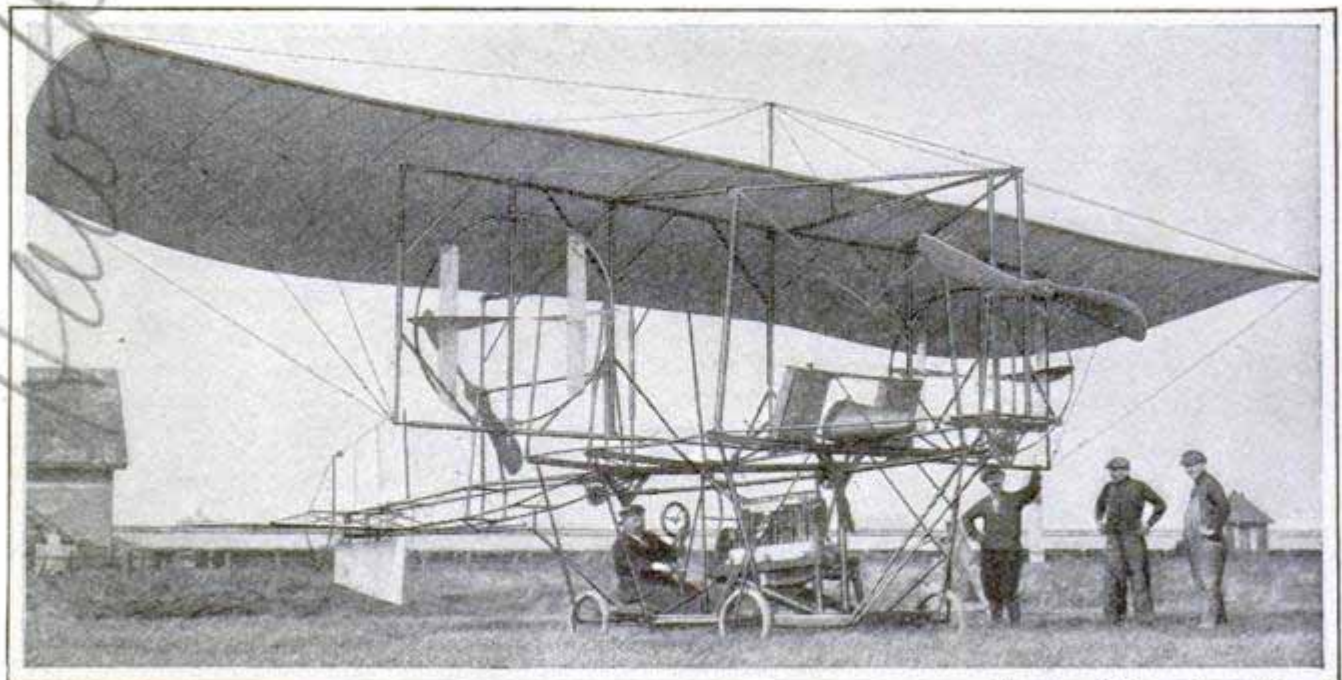

Courtesy Chicago Record-Herald
 Flying Machine Invented by a Roumanian Living in Chicago Has Two Vertical and Two Horizontal Propellers

Alexander Kopessa

Alexander Kopessa

The Oxford at Antares

BINNACLE WITH DOUBLE LIGHTING SYSTEM

A novel type of binnacle provided with oil lamps as well as electric lighting is shown in the accompanying illustration. Both sources of illumination are located below the compass, the oil lamps being hurricane-proof and so arranged that no smoke can penetrate into the compass chamber proper, while the electric lights, contained within the binnacle, are most accessibly placed and easily regulated by means of a controlling switch to give reduced light for taking night bearings. This binnacle has been especially constructed for housing a modernized type of the so-called light-card compass, invented by Sir William Thomson, and commonly used in the British navy and merchant marine.

CORRECT STAIR CLIMBING TAUGHT CHILDREN

Teaching children how properly to walk up and downstairs is the latest physical instruction course to be adopted by American public schools. The course has been experimented with in the District of Columbia schools for several weeks, and has been pronounced by the instructors one of the most valuable ever adopted.

Avoid shuffling; ascend and descend with the body erect, by lifting the knee at each upward step, and omit awkward swaying from side to side. This, in brief, is the verbal instruction given the 50,000 Washington school children. Practical application of these principles constitutes the step-climbing course.

Under Dr. Rebecca L. Stonerod, and a corps of athletic instructors, with now and then a professional athlete, the

children first are shown how to get the most out of ascending and descending the steps, and then are required to give practical demonstrations.

Teaching children how properly to walk up and downstairs is recognized as an educational matter by the instructors. It is more than calisthenic exercises. No one can get away entirely from climbing and descending steps.

"Keeping the body erect is important in going downstairs," Dr. Stonerod says. "Few persons pay any regard to their carriage in descending steps. Because gravity helps one down, it is regarded as so easy a matter that no attention is paid to how it is done. Walking up and downstairs is a good exercise. It has been

held to be injurious to women, but it is not, if they keep the body erect, and thus avoid cramping themselves. It is as good exercise for women as for men. This exercise calls into play first the flexor muscles of the leg, and then the extensor muscles which lift the whole body weight. It is a heart stimulant and circulation inducer."

Washington is primarily a city of apartment houses. In comparison to the population and amount of space covered, there are more buildings of that character in the national capital

than in any other city in the country. For some unexplained reason, a large percentage of these are elevatorless. Consequently, the Washington resident is required to be a "walking" person. For that reason, the school authorities maintain, it is necessary that the population be taught the step-climbing and descending art.

☛The new dreadnoughts of the German navy will be equipped with 15-in. guns, throwing projectiles of 1,650 lb.

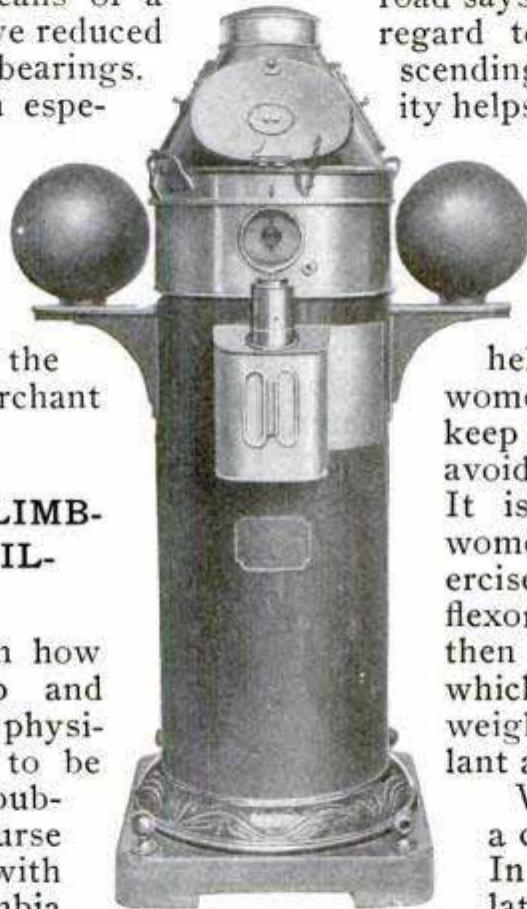

New Binnacle with Oil-Lamp and Electric Illumination

SUSTAINING LIFE WITH COLD

By AL H. MARTIN

THE next time a poorly ventilated room makes you gasp like a stranded fish, don't blame it on the lack of oxygen. Science has shattered the old time and fondly cherished theory that impoverished air is the basis of such discomforts and danger. The real danger lies in overheating the confined atmosphere, and it is now proposed to subjugate the poisonous elements of the air by cooling them. Electric fans, cold water and ice will be used in the future to aid in vivifying the so-called "dead" air.

The shattering of the old theory and inception of a new doctrine follow the exhaustive experiments of Dr. Leonard Hill, the eminent English physiologist. For years he has been endeavoring to learn the real cause of the smothering sensation attending breathing of air in a crowded theater, room, or church, and by a series of protracted tests and experiments has apparently solved the all-important question.

In constructing the modern skyscraper, the ventilating and heating engineer has considered the air question effectively solved when the chemical purity of the atmosphere is maintained and a uniform draftless summer temperature secured. The exigencies of modern city life force many people to live and sleep in veritable caves of brick and steel located below the surface of the street, with free air circulation practically impossible. Although the chemical purity of air is maintained in modern building construction, Doctor Hill noted that people living therein were enervated after a residence of a few months. The percentage of oxygen was found to be ample, and it was evident the destruction of the healthful elements of the breathed atmosphere was due to other causes. It is well known that the percentage of oxygen in the air decreases with a gain in altitude, yet mountain air is considered exceptionally healthful. Anal-

ysis of the air in the worst-ventilated schoolroom, theater or church, demonstrates that the oxygen is never lessened by more than one per cent, the ventilation through doors, windows, chimney, porous brick walls and chinks sufficing to prevent a greater diminution. Doctor Hill states that where there is only sufficient oxygen present to purify the venous blood as it arrives in the lungs there cannot be any lack of oxygen, properly speaking. Yet an atmosphere containing a plentiful percentage of oxygen may cause not only serious discomfort, but be positively dangerous to the breather.

To study the relative effects of temperature and chemical purity of atmosphere, Doctor Hill contrived a small experimental air-tight wooden chamber, fitted with large glass observation windows. On one side of the chamber were placed two small electric heaters, and a vessel containing water. This was located on the heaters in order to saturate the atmosphere with water vapor. On the opposite side of the chamber a radiator was installed, to permit circulation of cold water when it was desired to reduce the temperature of the compartment. Three electric fans were placed in the roof, so that the air could be agitated when desired. In some of the experiments, seven or eight students entered the chamber and the electric heaters were permitted to disseminate heat and steam from the pans of water. As the temperature rose, the students ceased to talk, their faces became flushed and breathing deepened. In some instances attempts were made to smoke cigarettes, but the matches went out as fast as lighted. The electric fans were then put into action, and the distress of the students was relieved to a remarkable extent. With the fans keeping the air agitated, no depressing effect was experienced from the confined air. With the fans idle, students were permitted to breathe the outside pure air

through tubes, without gaining relief from the oppressive confined atmosphere. Likewise, the breathing of the confined air by persons standing outside the chamber caused no discomfort.

In other tests, students confined in the chamber experienced no discomfort from the confined air while the fans were operated and the cold water was circulated through the radiator. The same air was breathed again and again, but the low temperature had the effect of keeping its elements in a salubrious condition. The experiments were conducted under constantly changing conditions, and always the result was the same—the deadly properties of confined air were found to originate from heat rather than from diminution of oxygen. Whenever the oppressive atmosphere was cooled, the stale air had absolutely no depressing effect.

As a result of these tests, Doctor Hill predicts a new era in building ventilation. Instead of the modern method of numerous vents for air, and a stagnant heat wave, ventilating engineers will provide means for keeping the air in motion. Constant agitation of the atmosphere is more imperative than the admission of small quantities of still air, as now prevails. In theaters, factories, churches and other public buildings, the heat caused by overcrowding of people will be reduced by whirling fans, and by cold water circulating freely through the walls.

English physiologists regard Doctor Hill's discoveries as among the most important ever made in the realm of hygiene, and predict the principles involved will ere long be commercially applied.

ALASKAN STEAMER HIGH AGROUND

720

The steamer "City of Seattle" ran on the beach at high tide while running through Tongaas Narrows, near Ketchikan, Alaska, and when the tide went out was left high and dry as shown in the accompanying illustration. She rested on an even keel, and,

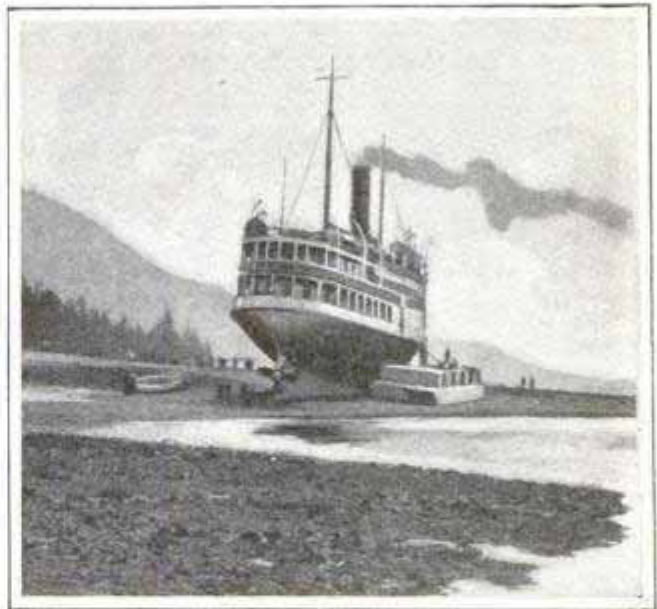

Alaskan Steamer Left High and Dry by the Out-Going Tide

although it was extreme high tide when she went ashore, she was floated again by the returning tide, having in the meantime unloaded some of her cargo. The large scow beside the vessel was stranded at the same time.

THE NEW MILITARY DOUBLE-SEATED MONOPLANES

727

A new seating arrangement has been developed in the construction of the English military monoplanes of the Bristol type, that is said to be far superior to the old. The customary seating arrangement for pilot and passenger on a monoplane is tandem, that is,



The New Seating Arrangement for Pilot and Passenger Developed in an English Military Aeroplane

Capt. Penfold, Australian Aermant
 Sydney, Australia

one behind the other. In the new arrangement the seats are side by side,

The speedy vessel is provided with a flush deck throughout, having practically a straight sheer, and for a distance of about one-quarter the length from the bow, the freeboard is raised to form an upper fore-castle, as is done in modern torpedo-boat destroyers. This type of construction provides sufficient free-

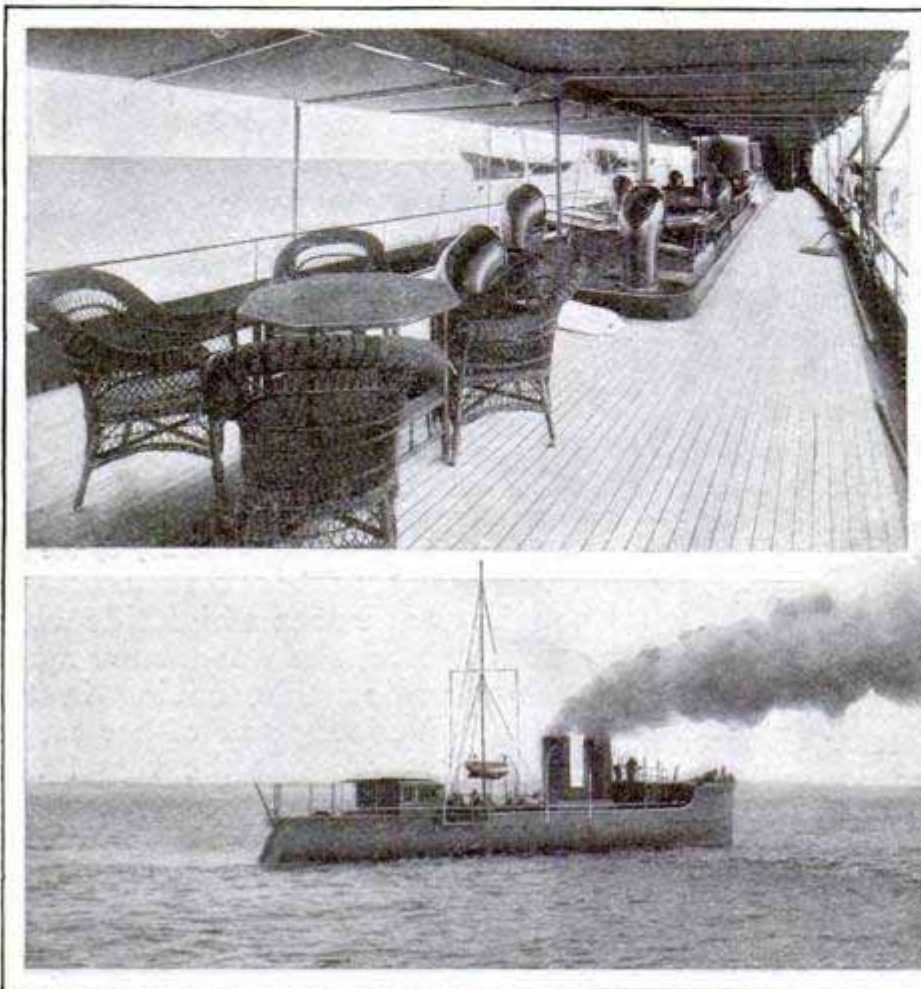

The Long Narrow Sweep of the Deck of the "Winchester" Looking Forward
The "Winchester," an Oil-Burning Turbine Yacht Having the Lines of a Torpedo-Boat Destroyer

like the front seats of an automobile. The latter arrangement gives the passenger a far better opportunity for observation.

The man in the left-hand seat in the illustration is Vincent P. Taylor, who was well-known as a parachute-descension aeronaut under the name of Captain Penfold, and who but recently took to flying instead of floating up into the air.

TURBINE YACHT RESEMBLES TORPEDO DESTROYER

The new oil-burning turbine express yacht, built for P. W. Rouss, of New York, is unusual in appearance, being 205 ft. in length, with a beam of only 18½ ft., and resembling a torpedo-boat destroyer more than any other type of craft. Her contract speed is 32 knots (36.84 miles) an hour.

board forward to allow the vessel to be driven comfortably at high speed, even in rough weather.

HATPINS CUT TO MEASURE

The menace of the protruding hatpin will become a danger of the past if a little machine now receiving publicity is adopted by the stores. This machine, which is 10½ in. high, is designed to be mounted on the store counter, and its mission is to cut hatpins to measure. When a hat is bought, it is placed on the purchaser's head and the hatpins are run through to determine the required length. The surplus is then snipped off, a twirl of the machine turns a new point in place of the removed part, another twirl polishes it, and the pin is delivered to the customer just long enough to protrude but a fraction of an inch.

Builder - Mess. Garrow & Co., Scotstoun
Paramo 60 turbine
Mess. Cox & Stevens

743

68 Rue des Journalles
Paris⁷⁵

POPULAR MECHANICS

FINDING OF SILVER COINS CAUSES PANIC 636

An interesting story of how the discovery of pirate's gold resulted in more damage than the find was worth comes from New Haven, Conn. Pasquale Valenti, a laborer, dug into an iron pot in excavating for the foundations of a new building on Meadow Street, and found it filled with silver coins bearing dates of the middle of the nineteenth century. The coins, about a thousand in number, have a face value of 60 cents. Valenti had the presence of mind to rush away with the coins to a place of safety for their examination, but when he discovered the value, so the story goes, he became temporarily insane and ran through the streets until captured. When the news of his discovery became known, more than 300 people rushed to the foundations of the building, and, jumping in, began to dig. Before the police could drive them away they had dug under the foundations and caused them to collapse, resulting in damage of several hundred dollars.

On the site where the treasure was discovered, stood, until a few months ago, a house which was built in 1790.

DRAFT PRODUCER FOR CHIMNEYS 75

A chimney top designed to produce a good draft is shown in the accompanying drawing. It is of French make, and, unlike the majority of devices for the purpose, is immovable. It allows the wind, from whatever direction it may come, to enter its interior through staggered openings in its surface out of which metal tongues project. These tongues extend

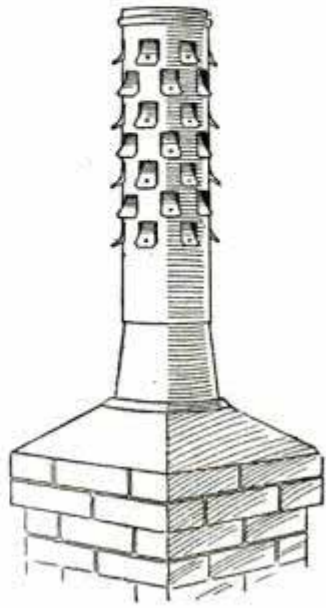

upward inside the pipe in such manner that rain falling into it is caught and carried by them to the outside, yet at the same time the arrangement provides an easy escape for the smoke and gases out of the top. The wind entering the tongue provided openings creates a strong upward draft.

15 ELECTRIC POWER PLANT FOR THE KITCHEN

Practically every machine that can be used in the kitchen or about the home is now harnessed up to electricity and being marketed by electrical companies, but the most practical all-

round mechanical assistant so far designed for the kitchen is the portable power table. This table stands 30 in. high, and is 26 in. long and 18 in. wide. It is made of oak and has a non-rusting nickeloid top.

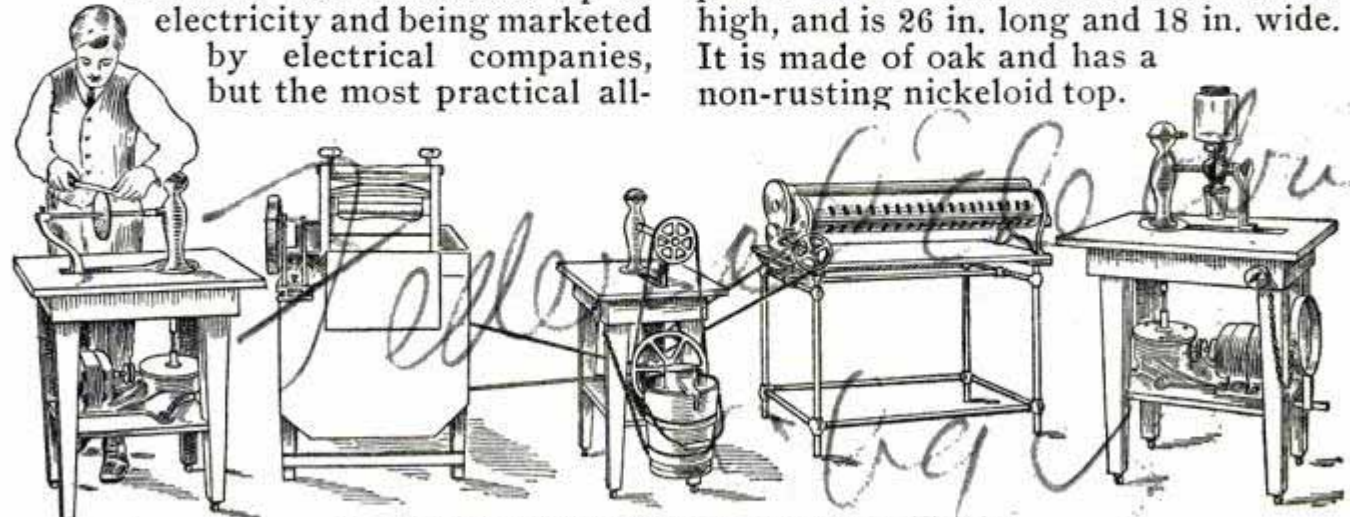

Sharpening Knives

The Power Table Operating Ice-Cream Freezer, Washing Machine and Mangle

Grinding Coffee

Federal. Sign System

Mounted on the lower shelf, where it is protected from spilled foods and dangling apron strings, is a $\frac{1}{4}$ -hp. motor, with gears entirely inclosed by heavy metal casings.

This power table may be moved from place to place and harnessed up to the numerous utensils and machines designed for electric operation. An egg beater, coffee grinder, bread mixer,

knife sharpener, cake mixer, vegetable and fruit peeler and slicer, and like utensils, may be attached to the shafting above the table top, while the sewing machine, ice-cream freezer, washing machine, or clothes mangle may be connected up by belting. Two or three of them, for that matter, may be harnessed up at once and a large amount of work accomplished.

GLASS-BOTTOMED BOAT FOR SEA-FORMATION STUDY

363 A 50-ft. motorboat, provided with two glass-bottomed wells, has been constructed for the purpose of scientific research of the sea bottom in Bermuda waters. The boat has a width of 15 ft., this unusual breadth being for the purpose of giving steadiness while on the ocean engaged in the work of studying the sea bottom.

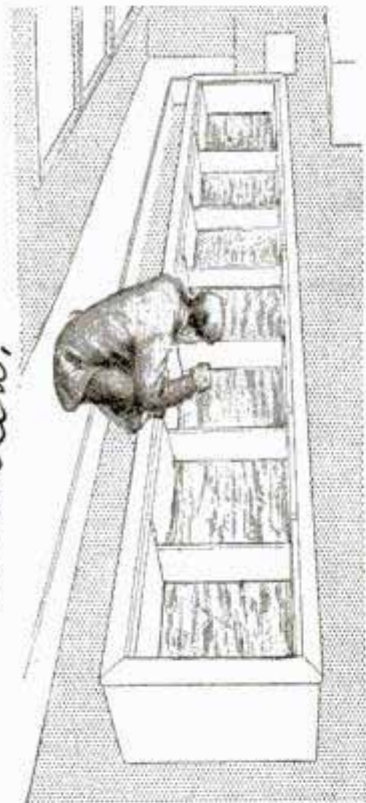

The glass-bottomed wells, each of which is 19 ft. long, are located on either side of and parallel with the keel. They are so arranged that a large party can study the sea formations beneath the boat at the same time. Light is thrown upon objects in the water by means of 12 fixed reflectors, and an adjustable searchlight can be let down with a cord.

The glass-bottomed wells, each of which is 19 ft. long, are located on either side of and parallel with the keel.

They are so arranged that a large party can study the sea formations beneath the boat at the same time. Light is thrown upon objects in the water by means of 12 fixed reflectors, and an adjustable searchlight can be let down with a cord.

☐The fastest train in Germany runs between Berlin and Hamburg, a distance of 178 miles, at an average speed of 55.17 miles an hour.

NEW SPECIFICATIONS FOR SCOUTING AEROPLANES

The War Department has issued new specifications for scout military aeroplanes, both one and two passenger, according to which the extreme width of the supporting surfaces is restricted to 40 ft., exclusive of ailerons. This limit has been fixed because larger machines cannot be handled conveniently when shipped.

The machines for which specifications have been newly drawn will be purchased from the \$100,000 appropriation made available by the last Congress. A new wrinkle in the specifications for a two-passenger machine is a limitation of speed to 65 miles an hour. A minimum speed of 40 miles must be developed. Other specifications for this type of machine are: Control must be capable of use by either operator from either seat, machine must ascend at least 2,000 ft. in 10 min. while carrying a weight of 600 lb., including aviator and passenger, 150 lb. of gasoline and extra weight to make 600 lb. All the extra weight must be carried on the engine section during tests. The machine must be easily transportable, and the starting and landing devices capable of manipulation by one person. The engine must be of American manufacture and capable of throttling at reduced speed. An interesting test provided for this machine is that of landing and starting, with the full extra weight of 600 lb., on a plowed field. The aeroplane must be capable of executing a figure eight within a rectangle 1,500 by 750

Vide - full at Mathis Shipyards Camden.

One du Bois, Levallet - Perret

Paris, France

ft. and without decreasing its altitude more than 100 ft. at the completion of the figure. This test will be made by the aviator alone without the extra weight required during other tests.

The general specifications for the new one-passenger machine comprise the following points: It must ascend 1,500 ft. in 3 min., carry fuel for a three-hour flight, develop a speed of at least 65 miles an hour and be capable of executing a figure eight within the limits prescribed for the two-passenger machine. Other tests and requirements are identical.

the pump receives the pull, which is thence transmitted to the pistons, forcing them downward so that the air in

PUMPING TIRES FROM PROPELLER SHAFT

A power pump for motor-car tires of French manufacture and very simple in design is shown in the accompanying illustration. Power is obtained from the automobile-engine propeller shaft. A pulley is mounted on the shaft so as to form an eccentric, which, once every revolution, bears on a flexible steel band running from the side of the pump to the holder at the opposite side of the frame. When the engine is started and the pulley bears on the steel band with maximum pressure, the ring of

the cylinders is compressed. The pump swings downward to a certain extent by means of a swivel coupling. When the revolving pulley gets out of contact with the steel band, the spring of the pump draws the pistons upward and a new charge of air is thereby obtained.

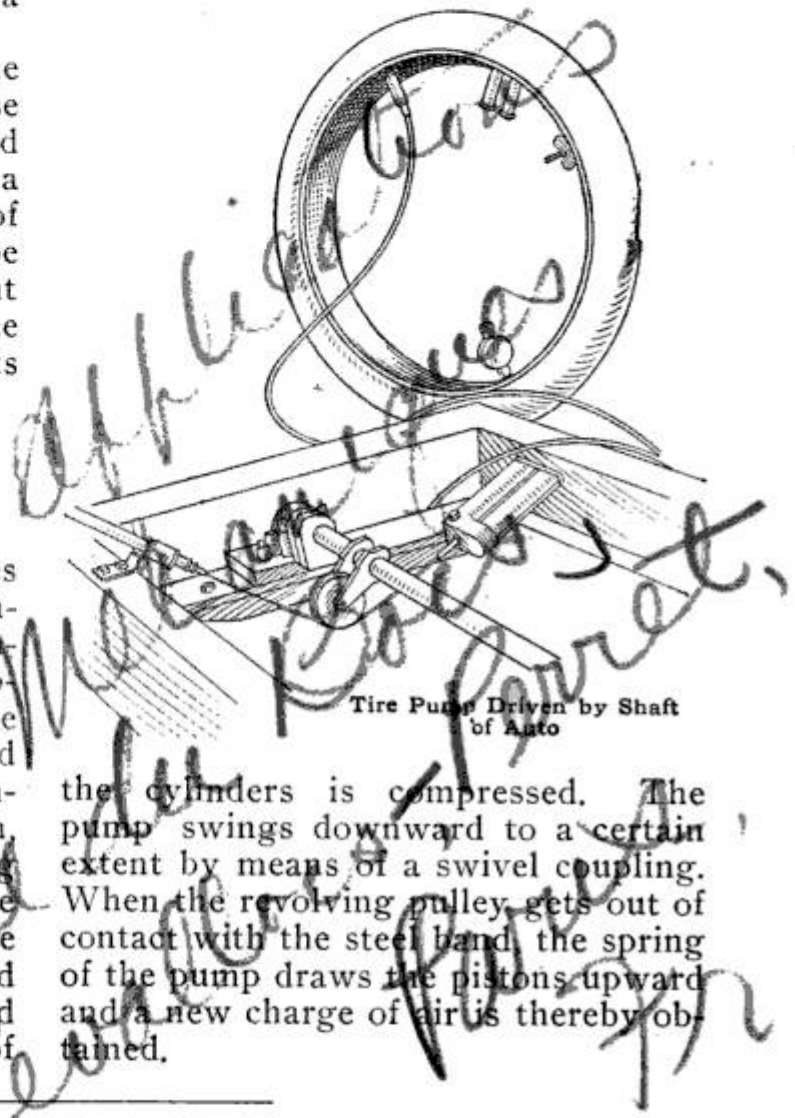

Tire Pump Driven by Shaft of Auto

NEW LIGHTING UNIT GIVES WIDE DISTRIBUTION

The combination of the three distinct requisites to obtain perfect illumination is believed to have been reached in a new shade made to be used in connection with a tungsten light. The light itself, a reflector and a diffuser are the necessary parts of all perfect illuminating apparatus, but it is seldom that they are to be found in a single unit. In the ordinary lamp there is a certain amount of reflection and diffusion, but the capacity of the lamp is limited in these respects. The bare light is frequently blinding so that it must be softened in some manner. In the new shade the principle is a combination of an upper reflector and

a lower glass distributor. These totally inclose the source of the light so

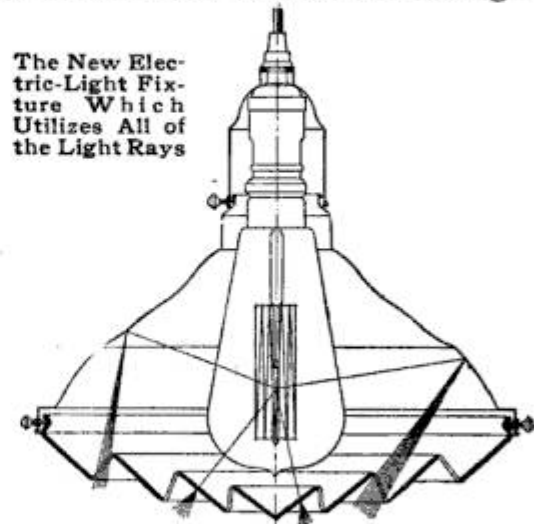

The New Electric-Light Fixture Which Utilizes All of the Light Rays

Courtesy of Electric Review and Western Electrician

that no direct rays from the filament leave the fixture without coming from

one or the other supplementary diffusing surfaces. The lower or glass-disk section of the fixture is made up of concentric inverted and erect cones. These so diffuse the light that it is distributed in a soft radiance over a wide

area. The arrangement of the surface of the inner reflector is such that practically all of the light rays are utilized in illumination, and the result is a diffusion of light practically impossible with the ordinary type of fixture.

609

AN INGENUOUS GERMAN ELECTRIC BELL

A single-coil bell of ingenious construction is shown in the accompanying diagram. In place of the usual

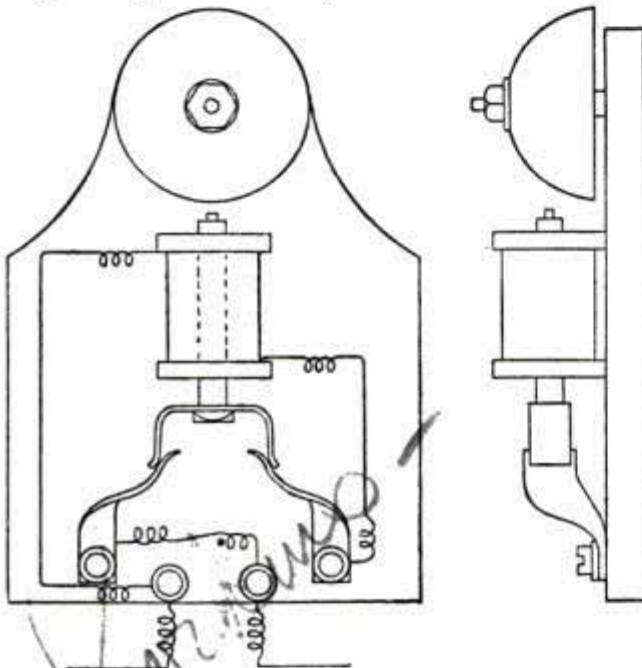

An Electric Single-Coil Bell Whose Core Strikes the Gong

spring-supported hammer there is a solenoid core, which is used to strike the bell gong, being raised by the attraction of the electric coil when the bell circuit is closed. As the core rises, it opens the bridge contact, and, the solenoid circuit being thus opened, the core falls by its own weight to its former position. This action is indefinitely repeated as long as the bell push is pressed. It is claimed that this bell is much cheaper than the ordinary double-coil trembling-hammer bell.

CA beryl crystal, weighing no less than 220 lb. and nearly 36 in. long, found in Madagascar, was recently presented to the French Academy of Sciences. The beryl is a semiprecious stone related to the emerald and the aquamarine.

TARGET PRACTICE OF THE ATLANTIC FLEET

650

The target practice of the Atlantic fleet last fall embodied several important departures, which will also be maintained during the practice next spring. These include firing at real torpedo boats instead of canvas targets in night practice; firing real torpedoes, minus explosives, at real ships, and firing on the old "San Marcos" wreck at short instead of at long range.

Orders were issued some time before to prepare three of the old and out-of-date torpedo craft of the reserve division for service as target vessels. The specifications included the building up of these little vessels amidships to give them the high freeboard and general appearance of the modern torpedo-boat destroyers, and their filling with cork to keep them afloat as long as possible.

ELECTRIC "DAYLIGHT" EGG TESTER

Testing eggs outdoors or in a room having ordinary light, where eggs may be sorted and crated at the same time, is possible with the machine here shown. The outfit is about 3 ft. long,

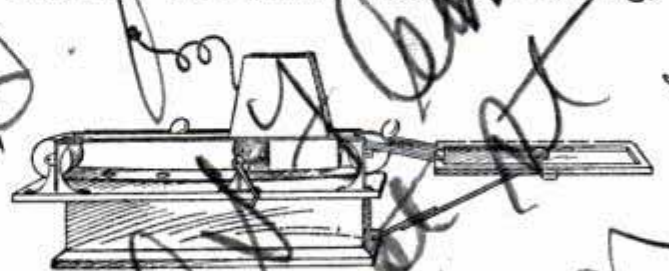

An Electric "Daylight" Egg Tester Having Interesting Automatic Features

with a roller at each end over which an endless canvas belt moves. About 6 in. apart on this belt are small metal saucers, each of which holds an egg.

Ant. Frank C. Verheij

cloud. egg tester

Handwritten scribbles and notes covering the bottom right section of the page, including the words 'egg tester' and 'cloud'.

Centrally located above the belt is an electric lamp, receiving current from a regular lighting circuit, or from 24 dry batteries, and over the lamp is placed a hood having an opening in the top.

The belt is run by turning a crank, and the electric lamp automatically lights when an egg passes over it, revealing the condition of the egg to the person looking into the hood. Another interesting feature of the machine is the automatic turning of the egg upon the belt, thus enabling the tester to examine it on all sides. The age may be determined by the way the egg has settled in the shell. A perfectly fresh egg shows a clean, deep orange color, while a bad one is almost black.

As the eggs pass under the hood, the good ones are left to roll out on a canvas extension table, while the bad ones are removed by hand.

BICYCLE HANGER ON FRENCH POLICE AUTOMOBILE

Several of the police automobiles of Paris are provided at the rear with a metal hanger on which as many as

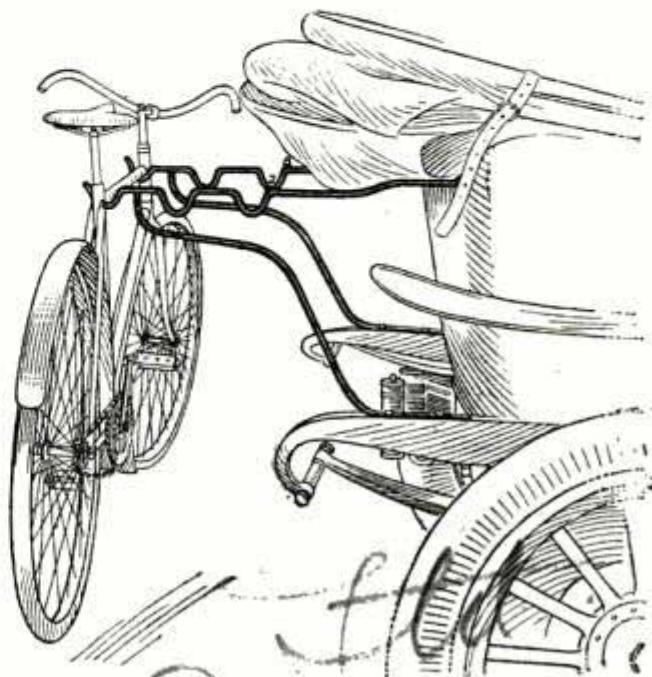

Bicycles are Carried at the Rear of Paris Police Automobiles

LEATHER HOLDER FOR SPARE WHEELS

A neat and serviceable holder and protector for a spare wheel of either the wire or wooden-spoke variety is here shown. It is made of polished black leatheroid, and in two sections, of which the lower is slipped up, and the upper down over the wheel, overlapping the lower section. The two are then strapped together at the middle, completely inclosing the wheel and the tire.

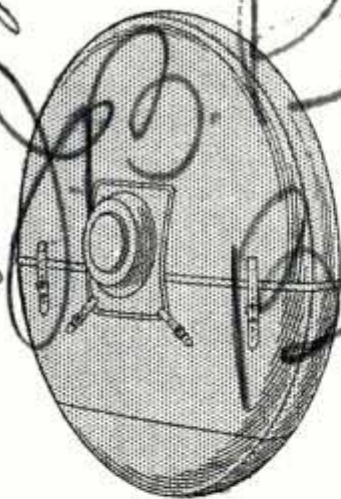

three bicycles may be carried. When the automobile, loaded with police officers, reaches the location where a thief or other offender is to be sought, three of the officers mount bicycles and hurry to designated points presumed to be strategic in surrounding and capturing the offender.

SPECIAL TELEPHONE SET FOR PARALYTIC

An unusual telephone set was recently designed for the use of a paralytic who, except that she retained a very slight use of the arms, was absolutely helpless. The object of the arrangement was to enable the patient, should she be left occasionally alone, to call "Central" if anything happened. For this purpose, a collapsible swing arm was fastened



⌈The total length of railway in the world, according to the German Bureau of Railway Economics, is 638,611 miles, of which 326,357 miles are in America, the term America here meaning both North and South America.

Birmingham, Eng

Handwritten notes and signatures at the bottom of the page, including 'James' and 'A. J.'

near the head of the bedstead, and to it was attached a telephone set of special construction. This consisted of a regular breast-transmitter mouthpiece fitted in an inverted position at the bottom of the instrument, a head receiver and an ordinary receiver, and an electric-light switch of the pull type, which was fastened to the bed. The switch is placed in the transmitter circuit, and is not used unless the patient is to be left alone. When this becomes neces-

sary, however, the attendant fits the head receiver on the patient, pushes the swing arm together, until the inverted mouthpiece is brought close to her mouth, loops the cord of the electric-light switch around one of her fingers, opens the switch, and takes the regular receiver off the hook. If the patient wishes to call central, she pulls the string closing the switch. When through talking, she pulls it again, thus ringing off.

Canada
558
STREET FERRIES FOR USE AT CROWDED CROSSINGS

A resident in a small Canadian community was startled recently, when visiting in Detroit, by the way people

ELECTRICITY PUMPS WATER TO IRRIGATE RICE

The farmer has at last discovered that one of the most profitable crops he can raise is electricity and while he was slow to arrive at this conclusion, he is now carrying the utilization of the electric current manufactured in the home plant to the utmost limits. Recently there has been installed on an immense rice plantation in Texas a system of irrigation which is operated almost entirely by electricity. And the operation is performed at the central station or power

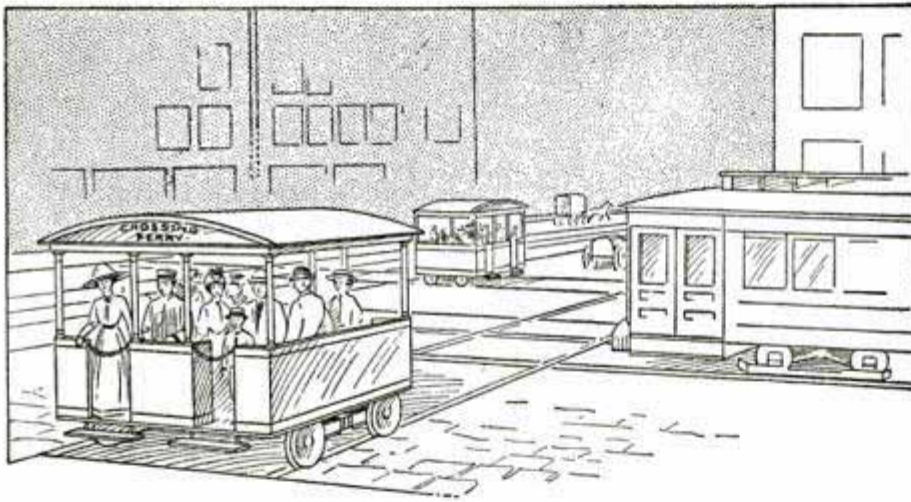

A Visitor to Detroit from a Canadian Town Suggests Crossing Ferries to Enable Pedestrians to Get Safely across the Busy Streets

were risking their lives every minute in crossing the busy streets. Realizing that the same state of affairs existed in all large cities, the idea came to him that crossing ferries might solve the difficulty. A wide platform car, negotiating the perilous passage every three or four minutes, and in which the passengers could stand, would, in his estimation, be a boon to the people, and hinder traffic less than the stream of crossing pedestrians.

house situated at the main farm buildings. With a pole line the farmer owning this place has connected a series of centrifugal pumps so that he can pump water from wells on several sections of his place at once, or on such sections as he chooses, by the simple manipulation of a switch in the power house. An oil engine furnishes the power that generates the current. One of the wells is one mile and a quarter from the power house. When water is needed, the current is turned on and the pumps do the work. When a well ceases to deliver water a new one can be sunk near it—the current from the power house being also used to operate the well-digging machinery.

ⒸThe German dirigible "Hansa" recently set a record by carrying 42 persons, passengers and crew, on an aerial trip.

A. S. Thomas, Route 4, Leordon, And.

SPOTTING THE ANTICS OF DISTANT CYCLONES

A barocyclonometer, an instrument which indicates the position of the center of a cyclone at a distance of several hundred miles and permits the calculation of the direction in which the riot of wind is moving, will shortly be installed on the "Connecticut," the flagship of Rear-Admiral Osterhaus, in command of the Atlantic squadron of the United States navy. This instrument, invented by Father Jose Algue, S. J., former director of the Philippine weather-bureau service, is being made in London. It is confidently predicted by naval officers that the instrument will eventually be installed on every naval vessel. Commercial lines are also showing interest in the device and are only awaiting the outcome of naval trials before using it themselves.

Cyclones, typhoons and other storms tend to move spirally toward a vortex. The delicate instrument, which is a combination of the aneroid barometer and the cyclonometer, will enable the captain of a vessel to learn not only where the center of a cyclonic area is located, but also in what direction the destructive center of the storm is moving. Around the dial of the barometer, which is graduated in English and metric units, is a movable ring, which

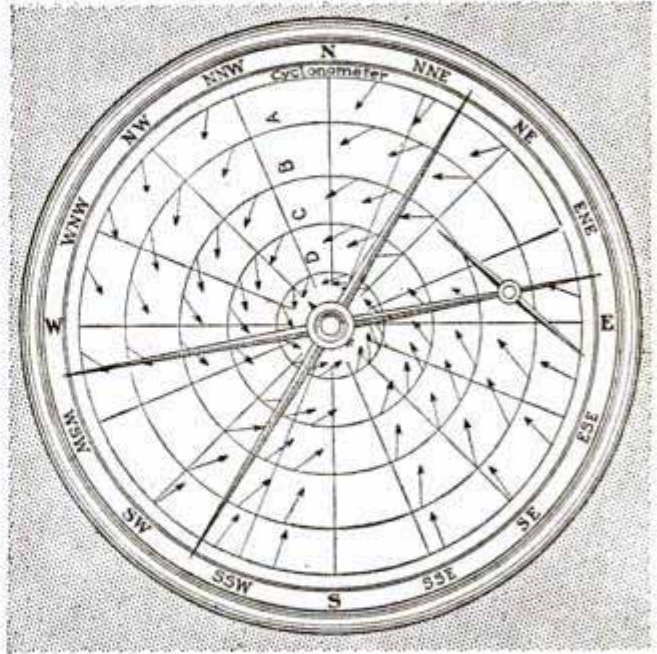

The Wind Disk of the Cyclonometer, the Little Arrows Showing the Normal Direction of Winds That Converge to Make a Cyclone

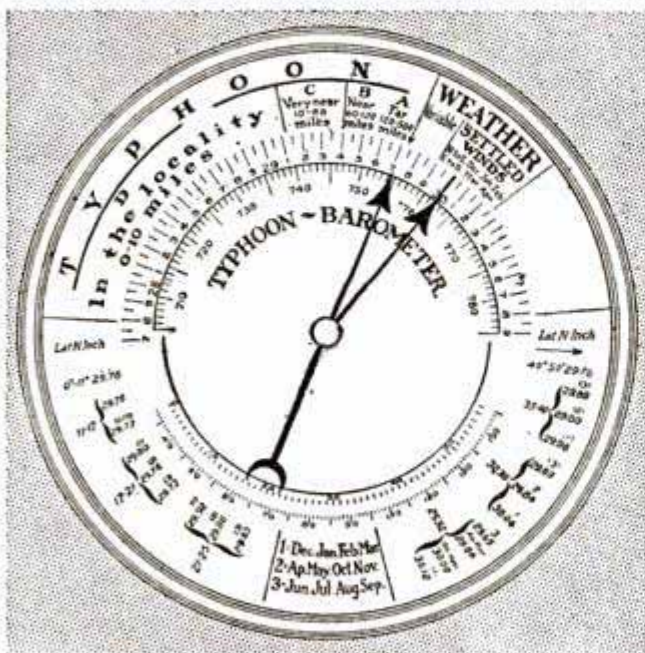

The Barometer Dial Which Indicates Whether a Vessel is Within a Cyclonic Area or Not

first must be set according to directions engraved on its lower half. These have reference to varying zones of latitude and seasons, for each of which there is a definite pressure above which the conditions may be considered normal, that is, no cyclone within 500 miles need be feared. The ring is turned until a red arrow—that to the right of the segment marked "variable"—points to this normal pressure. If, as in the sketch, the barometer needle is to the left of the red arrow, the vessel must lie within a cyclonic area. The proximity of a storm being thus ascertained, the cyclonometer, by proper setting of its movable parts in conjunction with mathematical formulas and tables, will furnish a means of determining in which direction the storm center lies from the ship and in which direction it travels. By the use of the latter instrument, which is rather involved and cannot be fully described here, the captain or observer can calculate, within a very few miles, his distance from the storm center.

The instrument which will be installed on the "Connecticut" or the "Wyoming" is being made abroad, because, the naval observatory officials reluctantly admit, foreign makers of

aneroid barometers make better instruments than Americans. At first, construction of the instruments was in-

trusted to German makers, but later a London manufacturer offered to do the work at a much more reasonable price.

ELECTRIC CURRENT FROM BICYCLE WHEEL

An electric lamp for motorcycles and bicycles, receiving its current through the revolution of the front wheel, is

An Electric Bicycle Lamp Receiving Current through the Revolution of the Bicycle Wheel

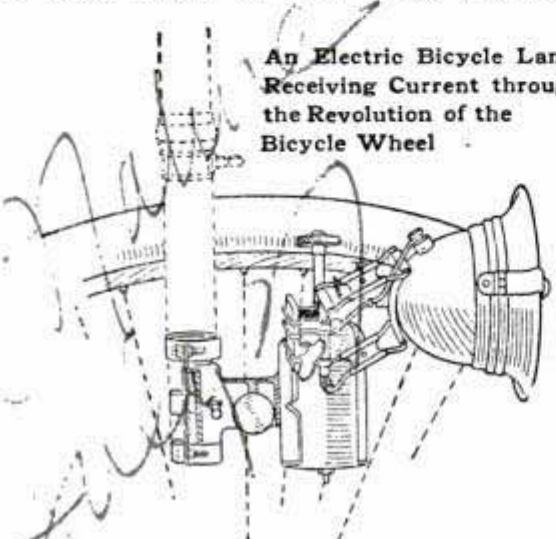

the invention of a German engineer. The current is generated by a dynamo, which consists of a fixed field magnet in which the armature is revolved. The shaft of the armature receives its rotary motion through a small horizontal wheel, which is in frictional contact with the tire. The complete apparatus clamps to the fork of the machine.

MAKING A JAWBONE FROM A RIB

We have it on good authority that the first woman was made from a man's rib, and the job was a successful one. No less successful was the work of Doctor McWilliams, as reported in the Annals of Surgery, who made or repaired the jawbone of one of his patients by splicing onto it part of one of the patient's own ribs. In this instance a portion of the seventh rib was removed by sawing it out with a chain saw, without opening the chest cavity, the necessary length being determined by a rubber-tissue pattern. The edges were freshened up and six

holes were drilled into it at various distances apart so that nourishment could get into the interior of the bone. One end was then fastened to the remaining portion of the lower jaw by means of catgut passed through a hole in the rib and through the fibrous tissue surrounding the lower jaw. The other end of the rib rested in a cavity in front of the external opening of the ear, under the soft tissues, of course. The curve of the rib was just sufficient to fill out the curve of the cheek. Two months after the transplantation, the rib had solidly united to the jaw in front, and the bone was alive and in a healthy condition. Doctor McWilliams also attempted to transplant whole joints, but in this he did not succeed, although successful results in animals have been reported by other surgeons.

NEW FORM OF INSERT FOR CONCRETE WALLS

One of the difficulties experienced in the construction of factory buildings with reinforced concrete is the necessity for careful consideration of the location of the hangers for shafting and

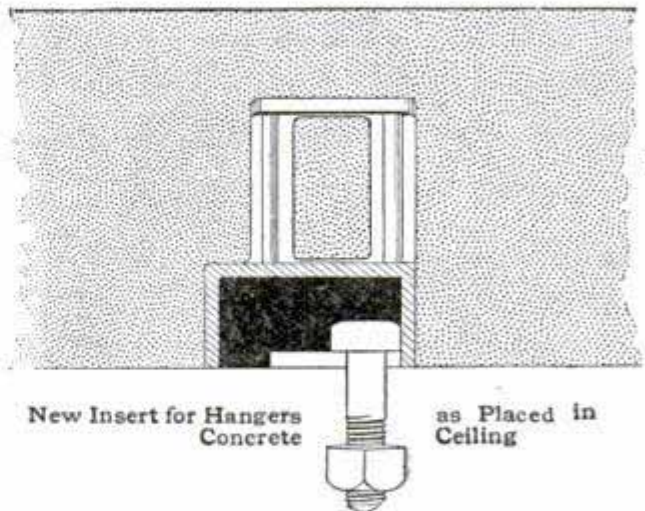

pulleys on the walls, in the ceilings and for foundations in the flooring. Up to the present time considerable

La nature 7/27/12

Wayton Gannery Steinmetz

annoyance was caused in placing inserts of the ordinary type because of the difficulty experienced in getting proper adjustment after the concrete had set. A form of insert made of cast iron has been devised which does away with this trouble. The new insert is so made that the bolt placed in it to secure the machinery in place can be adjusted in any way desired, and at the same time the device will be so firmly held by the concrete that the bolt itself will break before the insert will work loose. As shown in the illustration, the insert is securely imbedded in the concrete and, once in place, will not loosen.

A "FORE-AND-AFT" DIRECTION INDICATOR

A direction indicator, operated by a foot arrangement, and having a dial at the front of the automobile as well as at the back, is shortly to be manufactured in Canada. The method by which the hand of each dial is turned to indicate that the car is to continue ahead, turn to the left or right, or stop, is shown in the diagram. At night, green, red and white electric lights are used to indicate what course the car is going to take. The operation of the indicator does not interfere with

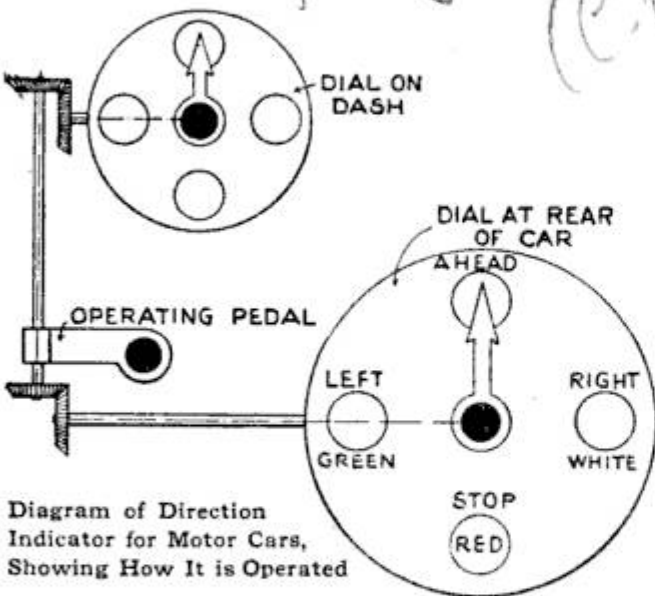

Diagram of Direction Indicator for Motor Cars, Showing How It is Operated

the operation of the car, as its warning is supposed to be given a minute or two before the actual movement indicated is performed.

Ans. H. H. Truett

EXCHANGEABLE HARD-STEEL TREADS FOR RAILS

Rails with exchangeable treads, consisting of a number of strips of very hard steel alloy sunk into their head, is a recent invention by a French engineer. The object is to make that part of the head which is normally in contact with the wheels more wear-resisting, an end which cannot be attained by hardening the whole rail, for the shocks and stresses to which it is subjected make it imperative that it be of not too hard steel. The new rail is made in two forms; one, as shown by the sketch, for light traffic, having the hard-steel strips sunk into the head and held by setscrews; the other, for heavy traffic, consisting of three parts bolted together, the strips being held between the two parts of the head. Another feature of this rail is that the hard strips may be so laid in, that web plates, holding the ends of two lengths of rails together, become superfluous, thus insuring shockfree, smooth and noiseless running.

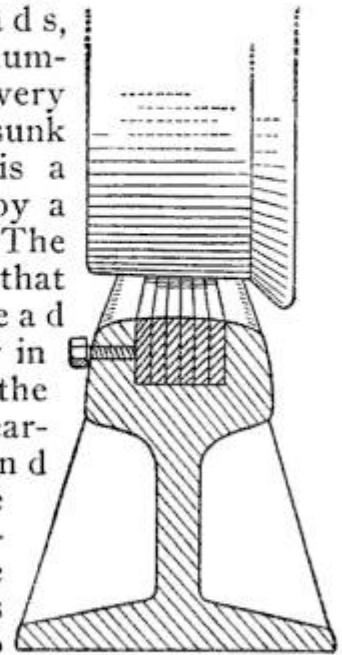

GYROSCOPES TESTED ON U. S. DESTROYER

The gyroscope method of preventing the rolling of ships is being tested out by the U. S. Navy on the torpedo-boat destroyer "Worden." Two gyroscopes were placed on the main deck forward, one on the port and the other on the starboard side. The type of apparatus being tested on the "Worden" was invented by a naval officer, and is said to be far more active and satisfactory in its effect than the gyroscopes used with considerable success on several German vessels.

THERMOMETER REPRESENTS COSTLY RESEARCH

The thermometer which is pictured on this page is not a real thermometer, but a device used by Dr. J. A. Harker,

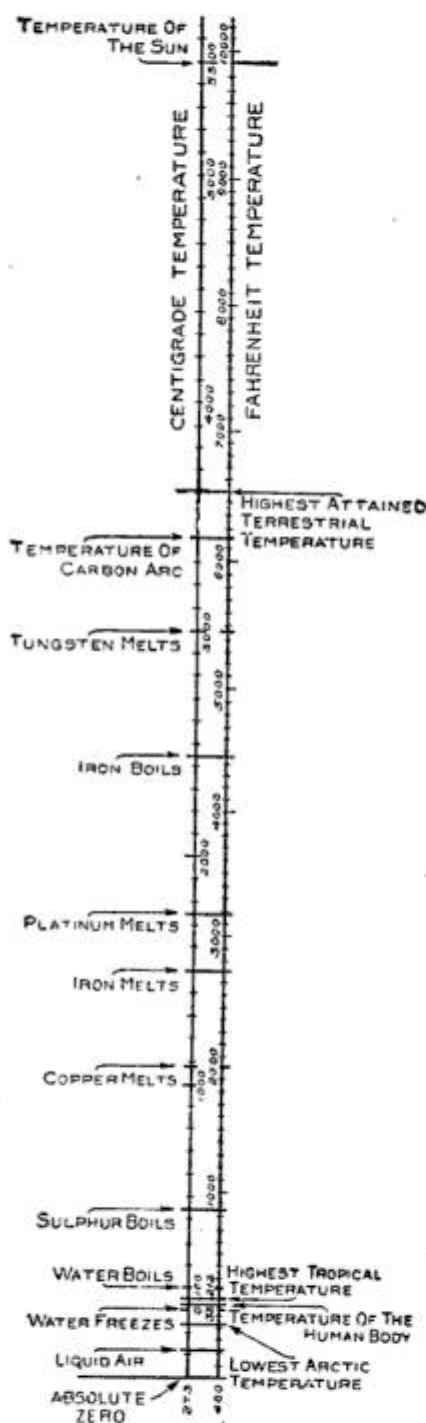

so commonly used in electric lamps, very large errors were made. Some measurements made not longer than two years ago were nearly 1,000 deg. off, while the results obtained this year are probably not more than 100 deg. wrong.

Supposing a thermometer used to measure the temperature of some ice

water, which, as nearly everybody knows, is 32 deg., should register the temperature of the ice water as 1,000 deg.! One would not think much of that thermometer, but such mistakes were made by the best scientists only a few years ago at temperature ranges between 5,000 and 6,000 deg. Beside the scientific value, it is actually a matter of dollars and cents to be able to measure such temperatures accurately, and hundreds of thousands of dollars have been spent in the work represented by this "thermometer."

water, which, as nearly everybody knows, is 32 deg., should register the temperature of the ice water as 1,000 deg.! One would not think much of that thermometer, but such mistakes were made by the best scientists only a few years ago at temperature ranges between 5,000 and 6,000 deg. Beside the scientific value, it is actually a matter of dollars and cents to be able to measure such temperatures accurately, and hundreds of thousands of dollars have been spent in the work represented by this "thermometer."

In explanation of the thermometer, it should be noted that at the bottom the temperature is given as 460 deg. F. below zero (equaling 273 below zero centigrade), which is the theoretical point at which heat ceases to exist. One of the most remarkable scientific achievements of the year 1912 was that of reaching a temperature only 2 deg. F. above this so-called absolute zero, which was done by Prof. H. Kamerlingh Onnes, of Leyden, when he succeeded in liquefying the rare gas helium, this low temperature being developed at the subsequent evaporation of the liquid helium. This marks the low limit of temperature so far obtained on the earth. The highest temperature ever attained is that of an electric arc, produced in a closed vessel containing gas under enormous pressure. The temperature so reached was 6,500 deg. F. Thus by artificial means man is able to change the temperature about 7,000 deg. A glance at the thermometer will show that this is a very great range compared with the natural range of temperature on the earth, from the lowest arctic to the highest tropical. The heat of the sun, according to Doctor Harker, is 10,000 deg., or 3,500 deg. higher than any artificially produced temperature.

CA new Zeppelin-type dirigible, being built for the French army, is designed to carry fuel for 60 hr., to have a speed of about 56 miles an hour, and a radius of action of from 1,600 to 2,000 miles, depending on weather conditions.

**GROWING TROPICAL FRUITS
IN WASHINGTON**

The United States Government's first attempts to grow a variety of tropical plants to the fruiting stage are being made in Washington in a mammoth greenhouse just erected. With a view of giving the federal plant experts in Washington an opportunity of studying the growth of the tropical plants and fruits, transplanted in a northern clime, and at a much closer range, the government has spent thousands of dollars in the erection of the greenhouse.

Hitherto, the foreign-plant office of the Department of Agriculture, which has greenhouses all over the country, has devoted its time to growing the plants only. After these have reached the stage where it is advisable to remove them, they are distributed. The new plan is to allow the plants and trees to remain in the greenhouse in Washington until maturity. A new house, 15 ft. high at the center ridge, has been constructed for this purpose, and the trees can spread their branches as far as necessary. Practically all tropical fruits claiming Central America as their place of nativity, as well as scores of trees from tropical climes of other countries, are being nurtured. The only collection of growing tropical fruit trees of any consequence in any North American city is that now operated in Washington.

See Beetles, Cigar July 14-77

**585 X-RAYS USED IN CIGAR
MANUFACTURE**

One of the new and interesting uses found for the X-ray machine has to do with the making of clear-Havana cigars. Its purpose is the discovery and extermination of the tobacco beetle. It is said that the special apparatus has given perfect satisfaction.

**PITLESS TURNTABLE FOR
AUTOMOBILES**

A pitless turntable, designed especially for private garages and for automobile salesrooms, is meeting with

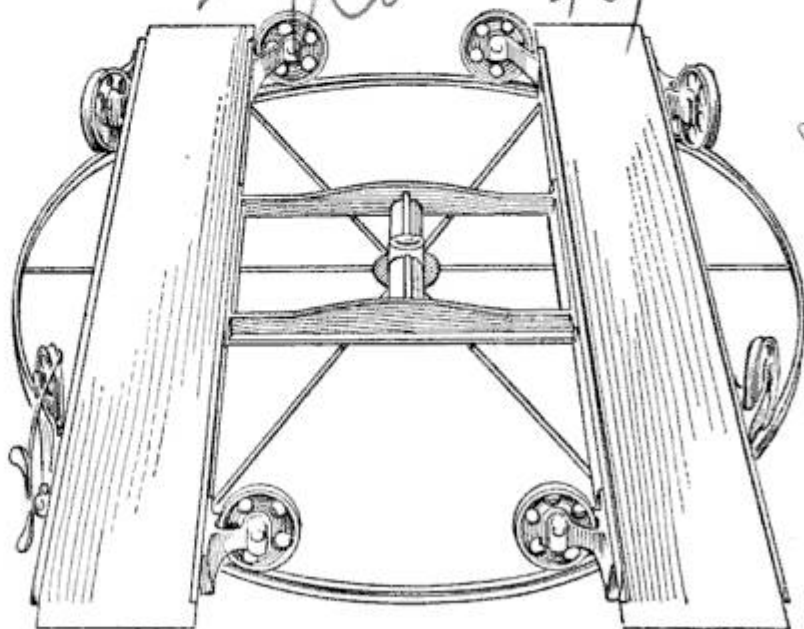

Pitless Turntable for Garages and Salesrooms

considerable favor. The turntable comprises a circular base, braced by diametrical stayrods, and two narrow runways attached to a frame which is pivoted to the center of the base. At the ends of these runways, which are set just the required distance apart to receive the wheels of the automobile, are ball-bearing casters, which run on the track provided by the smoothly ground surface of the circular base.

**BOATS FOR PARIS STREETS
IN CASE OF FLOODS**

The exceptional wetness of last summer has reminded Paris that there is a possibility of the repetition of the disastrous floods of 1910, particularly as the \$4,000,000 raised for protection has been spent, principally upon repairing the damage caused by the last floods, and but very little of it devoted to works of protection. The head of the Paris police department, however, has made arrangement to organize a service of boats, should street navigation become necessary.

*Pitless Auto Turntable Co., Inc.
1376 W. 9th / Kansas City, Mo*

*The Engineer
20 11 12*

Herr Von Busch
TRAFFIC SEMAPHORES FOR BUSY CROSSINGS

An aid for the traffic policeman, in the form of a semaphore, is shown in the accom-

45
Schuman well
172 C. Ford
Wye
panying drawing. It comprises a standard 4 ft. in height, the base of which, in actual service, is to be imbedded in the asphalt or other pavement surface; a rod rising 4 ft. above the standard, and a "Go ahead" and "Stop" sign attached to the rod at right angles

to each other. The "stop" sign is painted a vivid red, and the other is painted green. The rod carrying the signs is caused to turn, presenting the signs first in one direction and then the other, by means of a lever of the pump-handle type mounted on the standard within easy reach of the policeman in charge.

636
DISTRIBUTION OF THE "TITANIC" FUND

The great fund for the relief of the dependents of the victims of the "Titanic" disaster, and known as the Mansion House Fund, is to be distributed in the following manner, if the scheme submitted to the Mansion House Committee by C. J. Stewart, the public trustee, is adopted. The fund, amounting to \$2,070,500, will be used for the benefit of 2,296 persons. The basis of calculation for the distribution of the fund is that the widows or other de-

pendents of the sailors and officers who went down in the "Titanic" should receive a weekly grant approximately equivalent to half the victim's income. This basis is easily applicable to the members of the crew, but in regard to the passengers the difficulty was much greater. There are claims from the relatives of first-class passengers, for instance, which prove that the victim was in receipt of a considerable income, although he had not taken the precaution to insure his life or otherwise provide for those dependent on him, with the result that they are now destitute. In such cases the half-income basis is inapplicable, so it is proposed that the maximum weekly grant to a childless widow be fixed at \$10, and the minimum at \$3. If the victim of the disaster left one child, the allowance to the widow or other dependent will be increased by about 90 cents per week; if two children, by \$1.40 per week; and if three or more, by \$1.75.

The proposed annuities are, generally speaking, for life, but there are some exceptions, however, such, for instance, as remarriage of the widow. In the case of children, the allowance will, as a rule, cease when they have attained the age of eighteen years.

COMBINATION TWENTY-FOUR AND TWELVE-HOUR WATCH

Because of the recent adoption of 24-hour time in France, the French timepiece makers are turning out watches having combination dials and three hands.

The main dial carries only hour numerals from one to 24. In front of this dial, and slightly raised above it, is a smaller dial having just the 12 hour numerals and minute divisions of the ordi-



Magazine
15

nary watch. The dials, of course, have individual hour hands, but the minute hand of the smaller dial suffices for both.

As shown in the illustration, the hands of the 12-hour dial indicate that the time is 3:34 o'clock. The hour hand of the 24-hour dial has passed the numeral 15. This, with the minute hand of the 12-hour dial, shows the 24-hour time to be 15:34 o'clock, the fact that the hour number is higher than 12, showing that the time indicated is in the afternoon.

COMBINED ELECTRIC COMB AND CURLING IRON

A new combination in hairdressing implements, consisting of an electric comb and curling iron, is now being marketed. The comb, which is intended for use in drying the hair, is

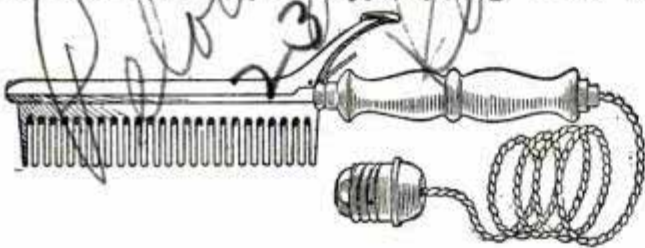

An Electric Curling Iron with Comb Attachment for Drying the Hair

heated by means of the heating element within the curling iron proper, and when the device is to be used for curling, the comb portion can be readily detached. The temperature is automatically regulated, and it is claimed that there is no possibility of burning the hair. *Palouze mfg B.*

VENTILATORS SCREENED TO KEEP OUT FOG 638

The dense fogs of London and other English cities interfere to such an extent with proper indoor working conditions when any opening is allowed for its entrance, that the electric fans used for drawing in fresh air are equipped with fog screens. Where electric ventilation fans are installed, the windows are kept closed, particularly during fogs, all the supply of fresh air entering by way of the fans.

James Keith - Blackman Co.

PEN-PULLING DEVICE

A simple but effective device for removing the pen from a penholder without bending or otherwise harming the point, regardless of how solidly the pen may have wedged or rusted in the holder, is being sold by novelty stores in Paris. The device is slipped over the pen, the lever portion is pushed down by pressure of the thumb, and a steady pull is exerted. The outer end of the pen puller terminates in a bend, which provides a substantial fingerhold.

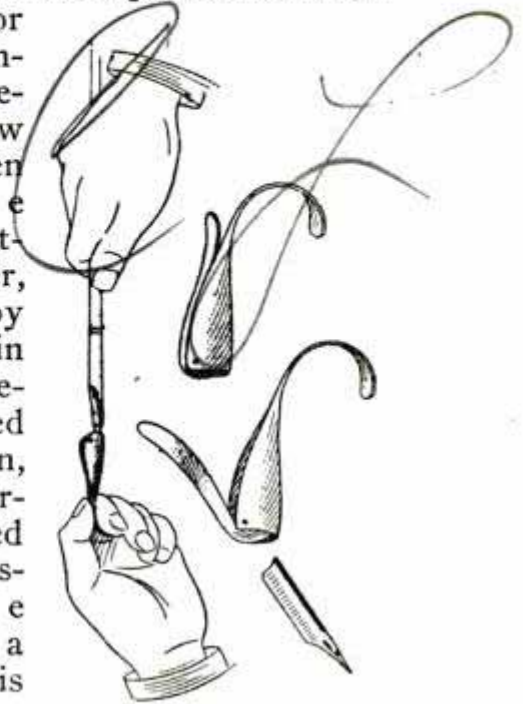

AUTOMOBILE JACK THAT FITS SMALL SPACE

The size and shape of the ordinary automobile jack makes it very inconvenient to stow away in the average tool box. An ingenious Englishman has just perfected a jack which has none of the objectionable features as to size and shape, and possesses a

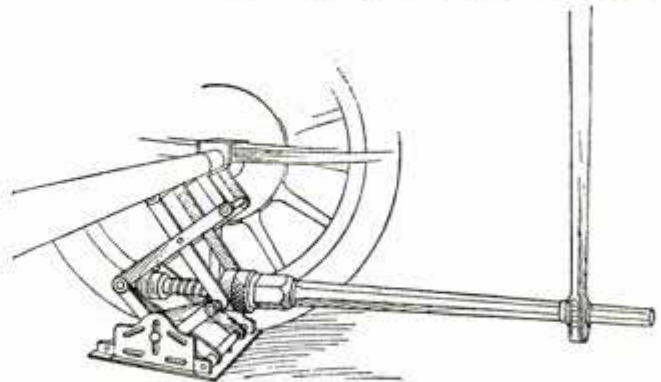

Newest Type of Jack for Automobilist Which Overcomes Many Difficulties

remarkable range of uses. It can be used on cars of all types, no matter how small the clearance, its range of action extending from the lowest to

**AEROPLANE-WING. COVERS
MADE OF STEEL** 12

Aeroplanes with steel wing covering are likely to become factors in the development of aviation, if the work of certain British investigators accomplishes the results they expect. A steel fabric for covering wings has recently been made which, it is believed, will add materially to the strength of aeroplanes and at the same time make them much safer. The wings will at least be safe from the splitting and tearing that now occasionally happens. The basis of the new fabric is a steel gauze of very fine mesh. This is treated with a preparation which makes the gauze a solid mass and is absolutely impervious to water and air. Wings of this fabric, of course, weigh more than those heretofore used, but not enough to make any material difference in machines weighing 1,200 to 1,500 lb., whereas the additional strength is so obviously advantageous, that the idea is well worthy of careful investigation.

**PRIZE-WINNING DESIGN FOR
SAFETY LAMP** 17

The electric safety lamp for the use of miners, shown in the accompanying illustration, won the \$3,000 prize in a competition recently held in England. It is the invention of a German. The lamp surmounts a compact and substantial base wherein is inclosed a storage battery of sufficient power to supply current to the lamp for many hours.

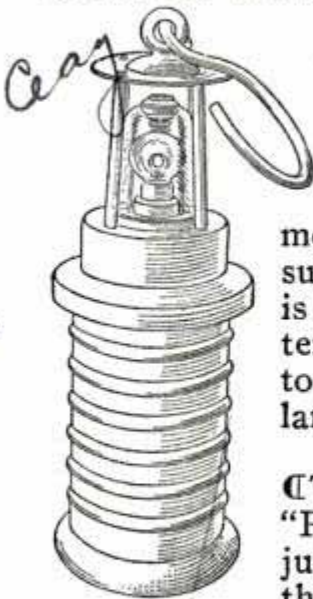

The oil-tank steamer "Petroleum," which has just been purchased by the British navy, has been equipped with a flexible-hose device that will make it possible to pump oil to a battleship on the open sea in any weather.

H. Haerber,

**VALVE-CLOSING ELECTRIC-
CONNECTION BOX** 250 N

An automatic, valve-closing, water-tight floor-plug box for electrical connections, designed to take the place of the old-style combination switch and receptacle, with a cap to screw over the opening left by the removal of the plug, is finding a ready market, both for floor connections and for marine installations. With the old type of connection there is always danger of the connection receptacle being left open, permitting the entrance of water into the box and conduit system, thereby rapidly destroying the interior fittings and wire, as the caps are seldom properly screwed back into place, whether because the threads of the box have been stripped or become clogged with paint, or because the operator did not take the time to put the cap back on.

With this device, the opening left by the breaking of the connection is automatically closed by a spring-operated valve, thus making it impossible to leave the box in other than a water-tight condition. Another feature of the device lies in the fact that no switch is required, as it is just as easy to turn the plug in and out of position as it is to turn a switch handle, the action of the valve and spring serving the double purpose of making or breaking the connection, and of making the box water-tight.

A new method of preserving oil paintings, recently patented in Germany, consists of inclosing the entire picture in a case having a glass front and filled with nitrogen.

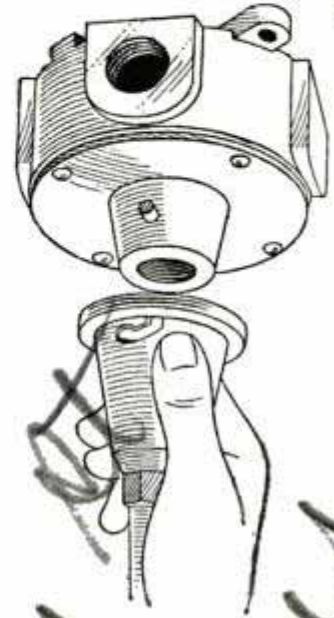

8.00

43 Murray
New York

HOW TO PREDICT CHANGES IN THE SEASONS

A foreknowledge of the changes of season would mean a great deal to the average business man, but it is

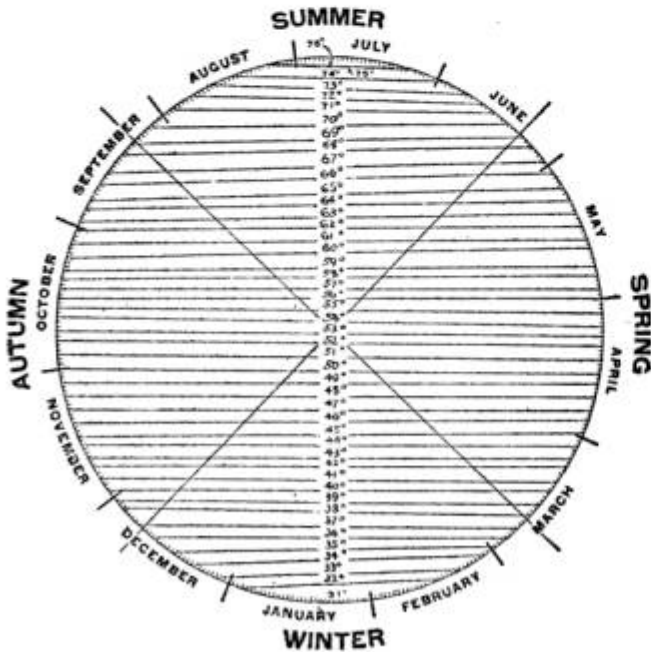

Chart Showing the Average Temperature of 30 Years for Various Dates of Each Month in Philadelphia

scarcely possible to predict, with any degree of accuracy, just when these changes will come. It is possible, however, to gain such knowledge in an approximate degree.

In a recent issue of the Heating and Ventilating Magazine, Wm. Campbell states that he has been able to get a fairly close prediction as to the time when seasons change and when to expect high or low temperatures, through a chart which he has prepared. The chart gives the average temperatures at different times in the year ranging through a period of 30 years, thus enabling a man whose business is affected by changes of seasons to foretell with some degree of sureness the various changes in temperature that may be expected, and arrange his business accordingly. The data from which the chart was constructed were furnished by the weather bureau. It must be understood that the temperatures recorded are the average for 30 years and, therefore, are not the temperatures of any particular year. The making of a similar chart for any city

is merely a matter of paper, pencil and rule, after the figures as to the average temperatures have been obtained.

FLIGHT OF 630 MILES WITHOUT LANDING

The longest flight without landing was made in September, when the French airman Fourny piloted a Farman biplane for a distance of 1,010 kilometers, nearly 630 miles, in 13 hr. 18 min. at an average speed of 49.7 miles an hour. This is the first time an airman has flown over 600 miles without interruption, and it is interesting to recall, in this connection, that it is only six years since Santos-Dumont flew a little over 700 ft., and four years since the 100-kilometer mark (62.1 miles) was exceeded.

SIMPLE AND EFFECTIVE INSULATOR

A compact insulator which secures the wire firmly without the use of tools has been produced by a London manufacturer. As shown in the accompanying illustration it is comprised of three pieces. The wire is laid in the groove, the small section laid in the slot and the cap screwed down. The cap coming into contact with the rounded top of the slot section permits a degree of pressure which grips the wire firmly. In the manufacture of the insulator every gauge of wire is provided for. The insulator is so simple in

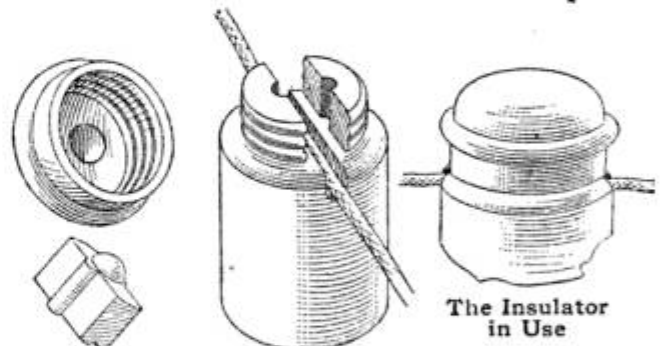

Three-Piece Insulator of Novel Type. Smallest Section is Placed in Slot and Cap Screwed Down

construction that it may be attached by men unskilled in the lineman's craft with the assurance that it will prove entirely effective.

"HOUNDS AND HARES" GAME ON MOTORCYCLES



Members of a motor club in England make good fun out of the game of "hounds and hares," playing it on motorcycles. The man and woman riding the side-car motorcycle shown in the illustration are the "hares." The woman carries a bag of torn paper, handfuls of which she throws out at intervals to give the

The "Hares" Throwing Out Torn Paper in a Motorcycle Adaptation of the Game of "Hounds and Hares"

taken, the "hares" had a start of 10 minutes and were not caught.

"hounds," likewise riding motorcycles, the line of the run. The day on which the illustration was

GROWING FLOWERS THAT WILL KEEP FRESH

Growing flowers and fruits in such a way as to lengthen the time in which they will keep fresh after being picked, is one of the new interests of scientific agriculture, and already carnations have been grown which will last one-fifth longer, or even more, than carnations ordinarily grown. "It is not improbable that the next generation will see the production of a peach which will last a year, without the use of cold-storage methods which injure the flavor," is the statement of an agricultural chemist on the new study.

The New Hampshire Agricultural Experiment Station has just made a study of the keeping qualities of carnations. If the carnation plants are grown by the use of a bone-meal fertilizer, not only is the number of

carnations increased, but the flowers are found to last one-fifth longer after they are picked.

Potassium chloride also increases the keeping qualities of these flowers, but seems to be of no use as a fertilizer. Hen manure, on the other hand, though a good fertilizer applied in very small quantities, greatly injures the keeping qualities of the flowers, when too much is used.

At an average selling price of four cents each for carnations, very nearly \$5,000,000 worth of these flowers are sold in the United States and Canada in one year, for more than 120,000,000 carnations are grown annually. Thus, if carnations are valuable according to the time which they last, this increase in keeping qualities alone, without tak-

ing into account the production of a greater number of flowers, means an increase of one million dollars per year in the carnation crop.

Such experiments as these show that future researches may enable us to ob-

tain fruits and flowers which will have far greater keeping qualities than those which are grown under present methods. These improvements will come by the use of proper fertilizers, and by selection.

MANICURING AN OCEAN LINER AT HER DOCK

If the development of apparatus for the improvement of shipping continues, it may not be necessary for vessels to

work brushing off the ship's bottom all the time. The machine is provided with a small propeller which turns while the brushes are under water and in this way forces the machine against the ship at all times.

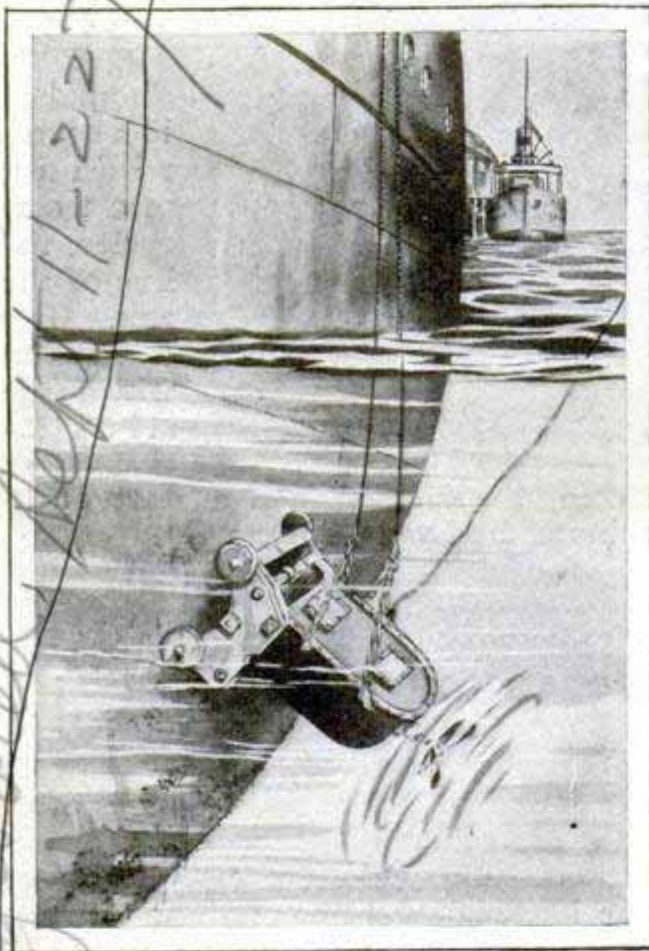

Machine That Brushes Marine Growths from Ships' Bottoms without Necessitating Docking

undergo the expensive operation of docking so frequently to keep their bottoms free from marine growths. An inventor has recently perfected a device for cleaning off a ship's bottom while the vessel is moored to a dock or a buoy discharging cargo. This device consists of a series of brushes operated by a submersible electric motor. While in a harbor, in the waters of which marine growths abound, this device may be kept at

USING EGGS AS GERM DESTROYERS

Are eggs antiseptic? Can they kill the ubiquitous microbe? If so, why do they spoil so soon? Some experiments of Drs. L. F. Rettger and Joel A. Sperry in the Sheffield laboratory, at Yale, seem to prove that the white as well as the yolk of eggs has some power to kill bacteria of various kinds, including some that produce serious diseases, such as typhoid fever and other intestinal troubles.

It is known that bacteria will soon penetrate the shell of the egg, especially if it has been cracked or washed, which latter seems to remove a protective coating which the egg possesses when laid. In order to confirm or disprove the findings of the Russian scientist, who first announced that eggs had antiseptic properties, they opened fresh eggs under sterile conditions as follows: The eggs were soaked in alcohol and then one end was passed through a flame; the end opened with sterile scissors; the contents, removed by means of a sterile tube, put into sterile test tubes, inoculated with pure cultures of various bacteria, and then placed in an incubator at body heat. They then examined the cultures at various intervals. In all instances except one, the number of germs progressively decreased, and in some instances the tubes became sterile almost immediately. This explains why the white of egg makes a good protective dressing for wounds, burns, etc.

386 INCANDESCENT MANTLES FOR
AUTOMOBILE HEADLIGHTS

A new automobile headlight, which uses alcohol as fuel and is of the incandescent-mantle type, has made its appearance on the market. The alcohol is carried in a small vessel under the lamp and is forced to the burner by air pressure, the air having been pumped into the container by means of a hand pump. The alcohol is vaporized and burned in a small, thick incandescent mantle claimed by the maker to be shock-proof. One filling of the alcohol container is said to be sufficient to keep the light burning for 20 hours.

GERMAN WINGLESS
AEROPLANE

One of the most ancient aeroplane-construction ideas—that embodying the lifting of a heavier-than-air body into the air by means of propellers whose blades revolve horizontally—is being experimented with by a Dresden engineer. The flying machine of this inventor has no wings or planes, the supporting means being the blades

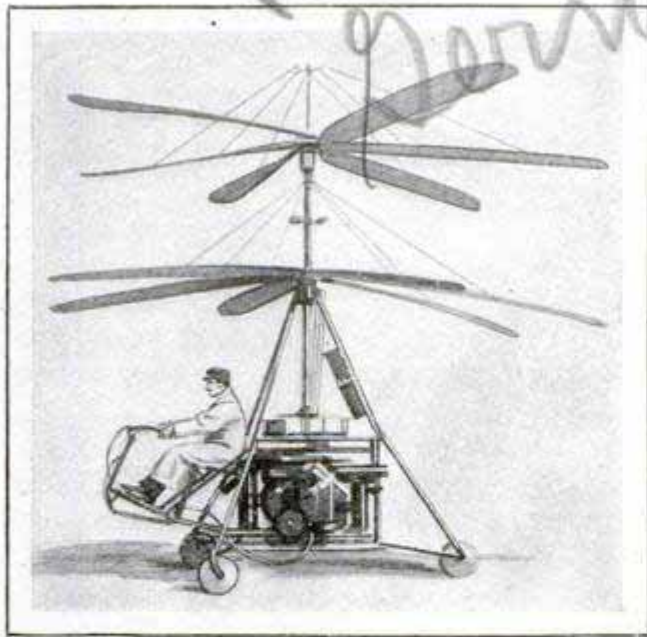

A Wingless Aeroplane Designed to be Lifted and Supported in the Air by the Blades of Its Two Propellers

of two six-bladed propellers, mounted one above the other on a shaft rising vertically above the motor.

OLDEST RAILROAD TICKET
OFFICE STILL STANDS

The residents of Newcastle, Del., claim to have an interesting relic of early railroad days in the shape of the

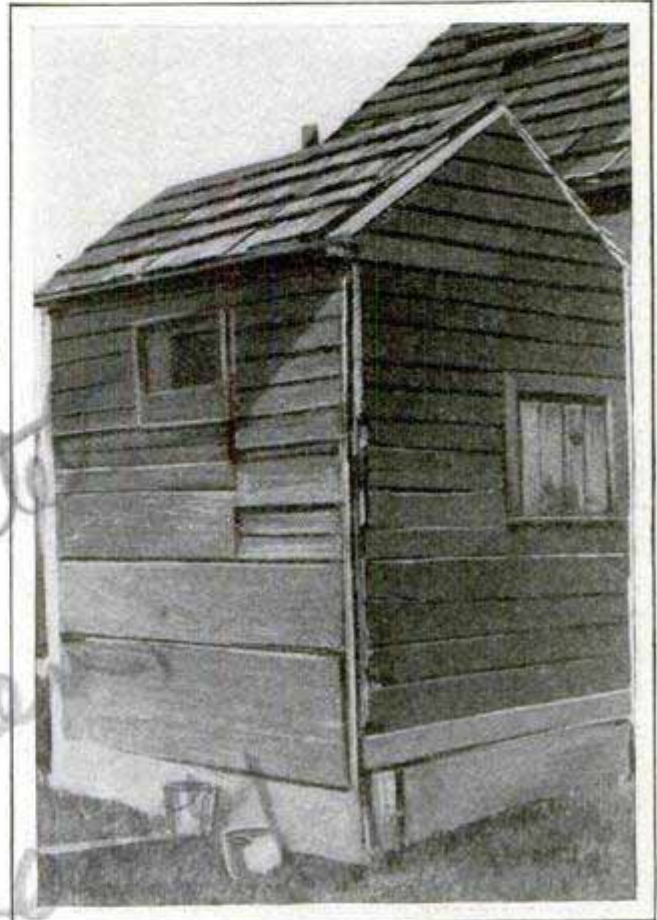

Remains of Railroad Ticket Office Built at Newcastle, Del., in 1832, Said to be the Oldest in the World

first railroad ticket office ever erected in the United States. This office was built for the Newcastle and Frenchtown railroad in 1832 and is still standing, although it has long since gone out of business as a ticket office. The character of the structure has not been changed during the entire 80 years of its existence, however, and though the window where tickets were sold is now covered with boards, its shape can be seen.

Since the establishment of the Chinese Republic the telephone is rapidly being introduced. Thus, in Peking, the government has built an exchange which already has 6,400 subscribers, 3,000 of whom are native residents of the Chinese and Tartar sections of the city.

668. cmo. Otto Baumgarten

HOW THE SPIDER USES STRUCTURAL

By J. E. MURPHY

*Associate Member American Society
of Civil Engineers*

An elaborate network of steel cables, 336 ft. in height, erected in place by one man without the assistance of hoisting engine, block and tackle, or other mechanical accessories, would be a marvel in the construction field, and would be written up in the greatest detail in the technical papers. Yet the equivalent of this process is going on unnoticed in the angles of our back porches and in the trees and shrubbery, every day during the autumn.

There is no more industrious or ingenious builder in the world than the spider, whose web furnishes an example of the highest skill, from an engineering point of view, of the same type of engineering that is displayed in skyscrapers and bridges. To appreciate what this common object, the spider web, means to its builder, one must take the builder's point of view. The webs illustrated in this article are all vertical webs of the orb weaver, the common variety of spider of the temperate zone of North America. The orb weavers, observed in gathering the data, averaged slightly less than $\frac{3}{4}$ in. from front to back claws, and had therefore about 1-112 the reach of the average man. In considering these structures as they appear to the builders, it is necessary to apply a unit of measure proportioned to the size of the builders—that is, a foot measure equal to 1-112 of the standard foot. On this basis, the web A is 280 ft. in height; the web B, 336 ft., and the web C, 120 ft.

While there are minor differences in the construction of webs, due to local conditions or the preferences of the individual builder, the general form is the same in all. At the center of the snare is a space filled with material that to us is a fluffy mass of fine lines, but to the builder a network of large rope, with an outside diameter of about 10 ft. Outside of this is a comparatively open space in which only the radial lines of the snare are found.

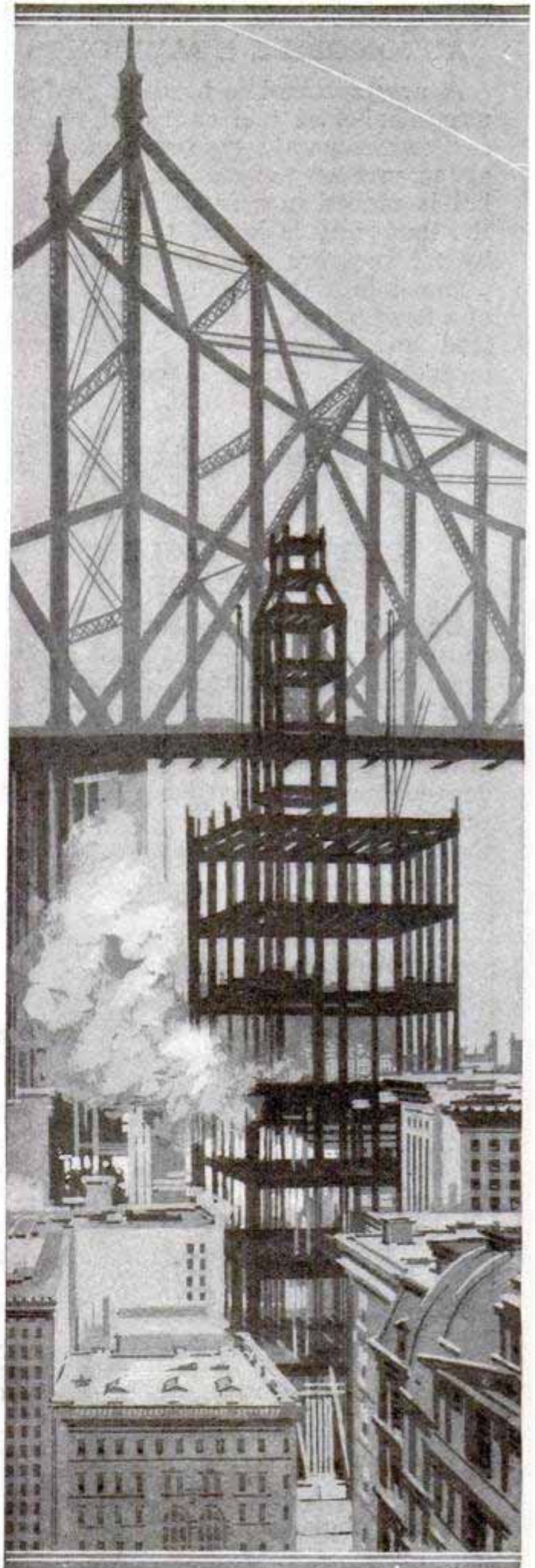

PRINCIPLES LIKE A SKILLED ENGINEER

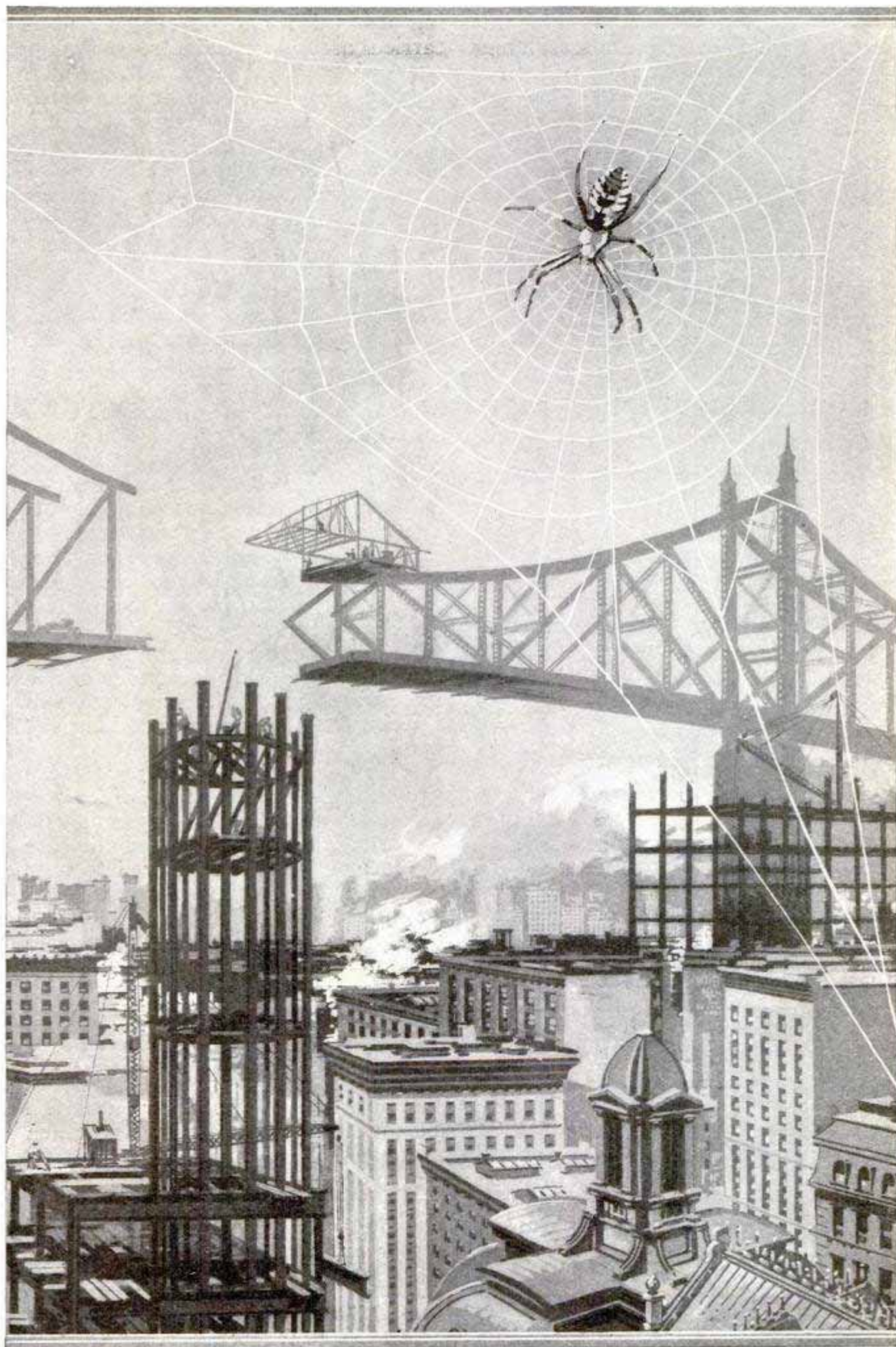

Beyond the open space is a spiral structure which serves as a scaffolding for the true snare. To the builder the

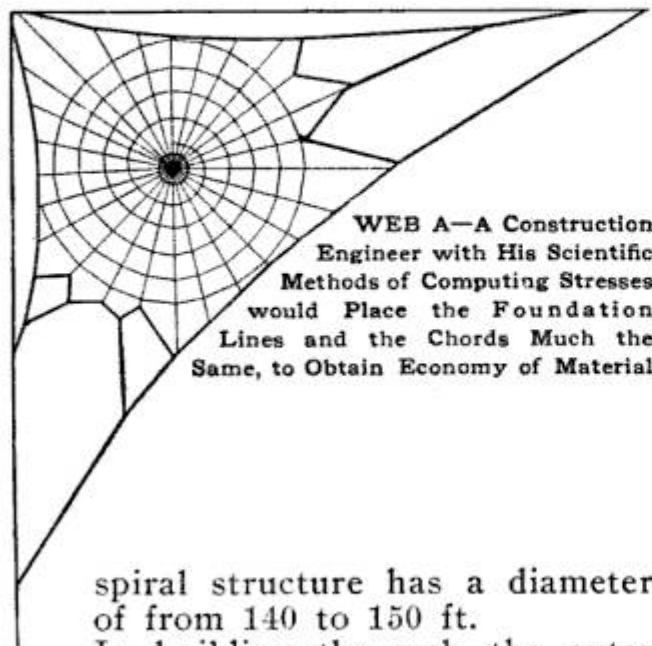

WEB A—A Construction Engineer with His Scientific Methods of Computing Stresses would Place the Foundation Lines and the Chords Much the Same, to Obtain Economy of Material

spiral structure has a diameter of from 140 to 150 ft.

In building the web, the outer or foundation lines are first erected. Usually a number of guy lines are required for holding the foundation lines to the right position. Sometimes these guy lines are incorporated into the snare as radial lines, but more often they are cut away at a later stage of construction. With the foundation lines all in place, the center of the snare, from which lines radiate in all directions, is first established. A vertical line is dropped from the top of the structure to the center, and continued downward to a connection with the lower foundation line. Lines are then thrown out from the center to the right and left alternately. Care is observed to keep the structure well balanced during construction. There is no uniform angular spacing between the radial lines, nor is any exact order observed in placing these lines. But at every stage of the process a balance in stresses is maintained, and, in contrast with the situation met with in the erection of some steel structures, there is never a time when there is danger of collapse from eccentric loading or the overloading of a weak member. With the completion of the radial lines the structure is ready for the spiral scaffolding. In placing this, a line is started on the vertical extend-

ing upward from the center and is carried around repeatedly, spreading outward in spiral form to the outer limit of the snare, this line being permanently attached to each radial line as it is crossed. This completes the real structure of the snare. The spaces between the spiral lines are afterward filled with the fine, beaded, viscid lines that serve to entangle and hold the hapless prey.

The spider is able to build this complex structure single-handed and without the aid of mechanical accessories because of just two natural faculties. One is his ability to drop vertically with a line as he spins it, and the other is his skill in climbing in any direction, spinning a line as he goes and holding it out with one claw so that it will not foul with the line he is climbing on. The fresh-spun line is very elastic. It is often stretched to three or four times its natural length and then snapped into place after the builder has climbed around some corner in his structure. In this process he shows himself to be an excellent judge of distance, knowing just when to quit spinning and to begin stretching the line.

While the snare is a remarkable structure, it is in the system of foundation lines that broad judgment and something akin to technical ability are to be found. It may be well to note the somewhat disappointing fact that the most perfect webs are built by young spiders. The old-timer, who has been through the process many times, and who has lost, perhaps, the enthusiasm of youth, is likely to become careless in placing his lines, and will often trust to luck that a weak line will hold. The young spider, on the contrary, will place his lines with the greatest care and will strengthen any that seem in doubt.

Foundation lines, unlike the single-strand radial and spiral lines, are built to stand permanently, consisting of five or six strands each. All parts of the structure are in tension, and the system of bracing consists, therefore, of diagonal tension members so placed

as to supply the necessary reaction against unbalanced loads.

A remarkable feature in foundation systems is the skill shown in the economical use of material. Material, for the spider, is a matter of labor in placing; but as each foundation line consists of five or six strands, the necessity for economy is apparent. Two methods are used in accomplishing this end. The most common method is the concentration of the stresses from a number of radial lines into a main foundation line through a system of two or more secondary foundation lines. The other method, which is, perhaps, the most interesting, consists of a broken or zigzag chord running between main foundation lines and intersecting three or more radial lines. This chord is braced where necessary by secondary lines connecting with the main foundation lines. Excellent examples of this method of treatment are to be seen in the webs A and B. A competent engineer, with his scientific methods of computing the direction and intensity

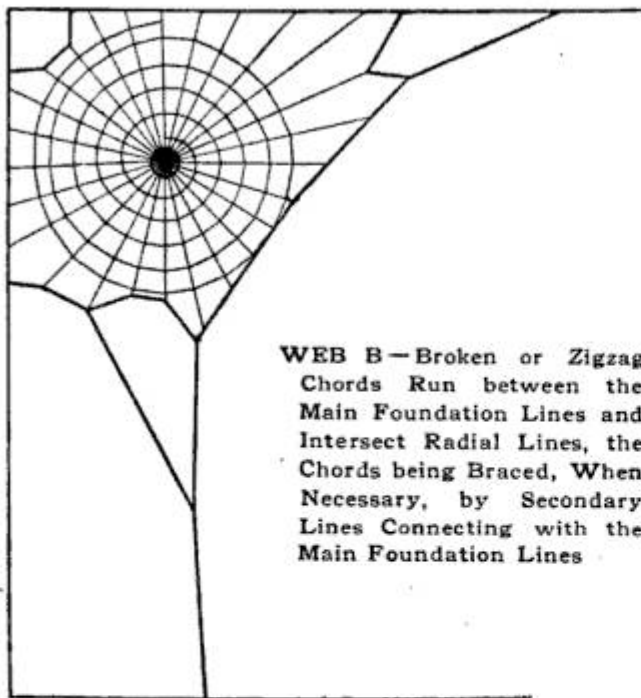

WEB B—Broken or Zigzag Chords Run between the Main Foundation Lines and Intersect Radial Lines, the Chords being Braced, When Necessary, by Secondary Lines Connecting with the Main Foundation Lines

of stress, would place these lines very nearly as shown.

This arrangement of foundation lines adds also to the elasticity, and, therefore, the life, of the structure. Such a web as A, with the radial lines

carried on strong foundation lines, will have, under all conditions, a more even distribution of stresses than one like B, in which about 50 per cent of the

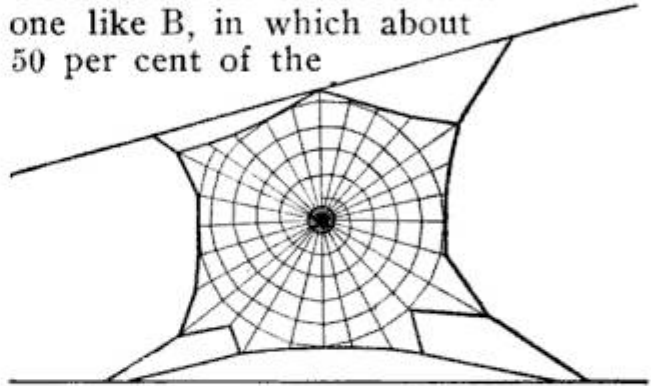

WEB C—An Adjustment of Theory to Practical Conditions. If the Upper Foundation Line had been Allowed to Sag, It would Not have Permitted Room for the Whole Web Below, So the Middle of the Foundation Line was Attached to the Upper Beam, as an Engineer would Do

radial lines have a rigid support. Since an individual spider will follow consistently one or the other method, we find, in this humble field, what are virtually two schools of construction.

The web C is remarkable for its adjustment of theory to practical conditions. The builder was evidently a believer in elastic supports. But owing to the limited space available, it was impossible to suspend the snare from a single foundation line (which would have had a considerable curve downward) and keep the snare clear of the lower beam. In attaching the middle of this foundation line to the beam, the builder did what most engineers would have done under these conditions. It is to be noted that there is nothing haphazard in this construction. The space available was evidently estimated in advance, and a method that would best meet the conditions was adopted.

Snares are subject to many vicissitudes, often being damaged by heavy rains or wrecked by birds or larger insects. But a strong set of foundation lines is comparatively permanent, unless wrecked by some force, equivalent, considering its scale of strength, to an earthquake or a destructive hurricane.

A good foundation system is therefore regarded by the builder as a "good property," and, as conditions require, is built upon repeatedly.

GIRAFFE MARKED LIKE PICTURE PUZZLE

There recently arrived in Hamburg from Abyssinia an entirely new species of giraffe. As it was secured by Mr.

The "Hagenbecki" Giraffe, a Newly Discovered Species Which is More Marked Than the Previously Known Kinds

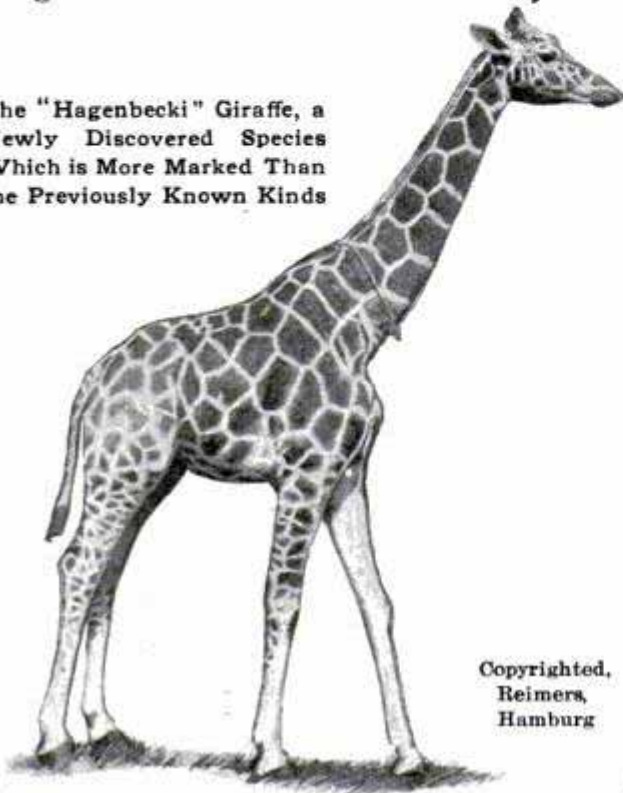

Carl Hagenbeck's travelers, the new species has been given the name of "Hagenbecki." Hitherto only two species of these long-necked African animals have been recognized, the northern or Nubian giraffe and the southern or Cape giraffe. The former is marked with fine light lines on a chocolate-colored ground and possesses three "horns" or stumps upon its head. The southern giraffe is covered with brown blotches on a buff ground and has two horns. The giraffe "Hagenbecki" is much more definitely marked than these two, the patterns being bolder and much larger. The lines, though light, are very distinct and the ground very dark. The specimen is quite young and, when full-grown, is expected to reach a height of 18 or 19 ft.

¶The teaching section of a French association for the advancement of sciences has recommended slanting in preference to vertical handwriting in the schools of that country.

SHIPPING GOLD ACROSS THE ATLANTIC

It would be natural to suppose that shipments of gold bullion back and forth across the Atlantic on the big liners would be attended by considerable precaution, requiring the vigilance of many men, but this is not the case. There is probably no other place in the world where the transport of great wealth is carried on with such simplicity.

As a case in point, one of the great liners has two strong rooms, the smaller being in close proximity to the captain's quarters, while the other is next to the provision department. The small strong room has its walls, floor and ceiling lined with 2-in. steel plate, and contains nothing in the way of furnishing other than shelves. This has more than once contained enough gold to buy the liner many times over. The locks, which are of the double variety, are rendered still more secure by covering the keyholes with steel hasps, which are themselves locked in place with massive padlocks. This strong room, being located in the most frequented portion of the ship, is being passed by persons at all hours of the day and night, which, after all, is the great protection.

The strong room located near the provision department is 12 ft. long by 4 ft. wide, and it often happens that both these rooms are filled to capacity with gold bullion. On one occasion the two rooms contained \$50,000,000 in gold bullion, packed in small kegs bound with steel hoops.

MACHINE ISSUES STREET- CAR TRANSFERS

A machine which, by the operation of a lever, prints and issues a transfer has been constructed for street cars. The transfer thus issued direct to the passenger contains all the information necessary, such as time, direction, date, and the like. The machine also makes a record of all transfers issued.

Champion Recording Co.
Pittsburgh, Pa.

647
Copyrighted American Industries

REMOVABLE LININGS FOR HOSPITAL AMBULANCES

A novel ambulance for the transportation of persons suffering from contagious diseases has recently been put into service in Buffalo with

an ambulance for each kind of disease, and yet that is what physicians say should be done. In lieu of this, Doctor Goodale has caused to be constructed a set of five of these steel linings, each

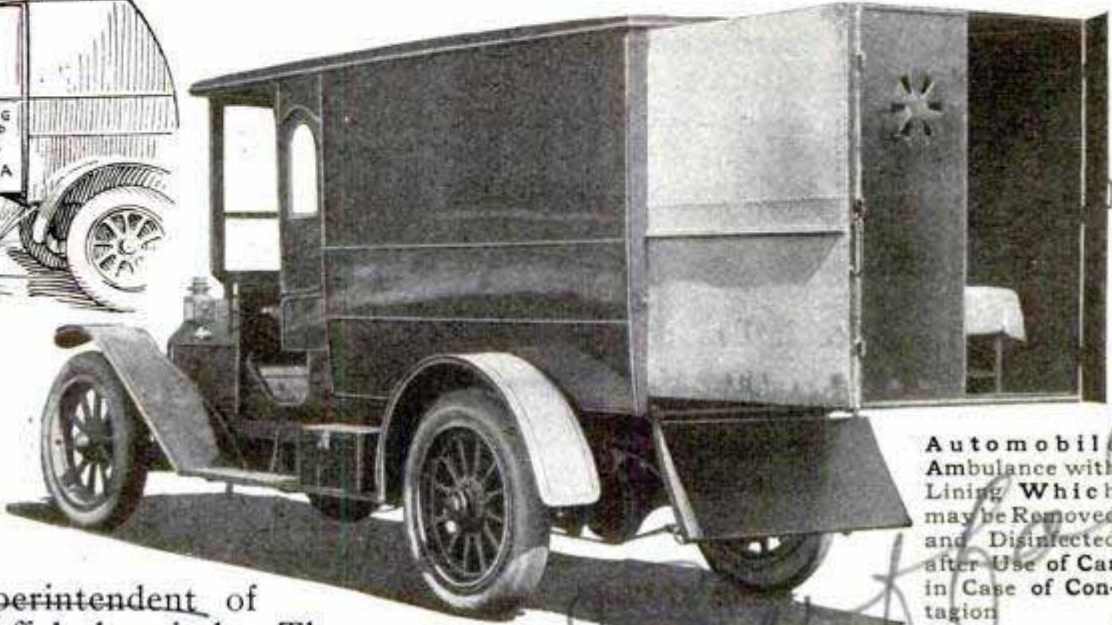

Automobile Ambulance with Lining Which may be Removed and Disinfected after Use of Car in Case of Contagion

highly successful results. It is the invention of Dr. Walter S.

Goodale, superintendent of one of the Buffalo hospitals. The innovation lies in the removable lining which can be taken out and thoroughly disinfected after each trip. The lining is made of channel steel and aluminum and weighs about 300 lb. Its interior dimensions are 6 ft. 8 in. by 5 ft. 3 in. and the construction is such that it exactly fits inside the wooden body of an ambulance.

In such institutions as that under Dr. Goodale's care, patients are received suffering from a variety of contagious diseases. It is manifestly impossible for any hospital to maintain

being used for a specific disease. An infected lining can be removed and replaced with a clean one in about five minutes.

The extra linings are stored in five air-tight metal compartments built on a semicircular platform placed on the edge of the garage turntable. The linings are mounted on wheels and when a lining is needed two men wheel it into the ambulance, which then calls for the patient. Upon returning from the call, the lining is taken out, fumigated and restored to its compartment.

OUR CANAL BUILDERS TO ENGLISH EYES

It is the American builders of the Panama Canal, the men on the job, that seem to most impress English tourists and investigators of the works, and this view is strikingly presented by an English journalist, John Foster Fraser, who is now writing for the London Daily Mail a record of his thoughts and studies on the ground. Following are some extracts from his articles:

"'Yes,' observed the American en-

thusiast, 'it is a great ditch. You see those flat cars piled with dirt? Well, by the time the Atlantic joins the Pacific we shall have removed as much dirt as would fill such a train of cars 96,000 miles long, which is getting pretty near four times round the earth. Yes, it is a great ditch!'

"This is the spirit of the 35,000 men who, between Colon and Panama, are digging and blasting, damming rivers,

of above hospital

Buffalo, N.Y. 1908
Wm. S. Goodale
Superintendent of Buffalo Hospital

fighting landslips, and building locks so that the great canal shall be finished long before the official opening day, which is in 1915.

"It is a big thing. The world is looking on. It is an enterprise which fits the American temperament. It is a dramatic as well as a colossal undertaking. Others have tried to build canals across the Isthmus. The French came to failure. The Americans are going to succeed. Everybody is working at top speed, and the end is within sight."

"Then you reach the Culebra Cut, the thing of which the Americans are proudest because it has caused them most trouble. This cut is nine miles long, hills on each side, and the cubic yards of earth and rock cut away run into dozens of meaningless millions."

"For several days I have been jogging up and down the drunken construction line, now along the bed of the finished way—outside the locked region it is 40 ft. below sea level—now scrambling over 'slides,' then wandering through the large white casements of concrete locks.

"The noise is tremendous. Bells clang and engines shriek and cars piled with excavated earth are rumbling off to aid in the construction of a dam or a great 'spit' on the Pacific side. All the rock and soil are volcanic and gray and red and irregular. Boom, boom, go the dynamite explosions and a chunk of a hillside is disintegrated. A monster of an engine shovel, almost uncanny in its movements, comes reeling forward over the uneven way. It

bends its head and sticks its snout into the debris. There is a clatter, it jerks back its head, and in its maw is four tons of broken rock. It heaves on one side, and from a door, under its chin as it were, it dumps its load on one of the long cars. Then it plunges for another mouthful.

"The cars are ugly and battered. They have a fence only on the side away from the shovel. Between each car and the next is a steel plate, so that it is just like a long ribbon of a car. When the shovel has deposited its mouthful, a bronzed and sweating American, with his blue shirt open at the throat, gives the waggle of a yellow flag, and the engine driver hauls along a few yards so the next mouthful may have room. Thus it goes on with clang and clamor until the train is loaded.

"Away it rolls. The 'dirt' is wanted for a dam in a declivity between the hills."

"There is the lithe, chewing American, clear-skinned, clear-eyed, really feeling joy in what he is helping to accomplish. There are the sluggish Spaniards, more sluggish mixture of Spaniard and native, but kept at it under the stimulating tongue of the gang boss. There are the niggers, easy-going, and a considerable number of them from the British West Indies; there are Italians and Scandinavians; there are Chinese; there are even slim-limbed, gentle-featured East Indians, with heads voluminously swathed in dirty turbans. The labor of the world has been placed under contribution to build the Panama Canal."

TWO-SPAN AERIAL RAILWAY IN RIO DE JANEIRO

From the top of Sugar Loaf Hill, the famous conical mountain that rises to a height of 1,260 ft. from the promontory Morro da Urca to the west of Rio de Janeiro Bay, a magnificent view is presented of this most beautiful natural harbor, but its ascent is very difficult and dangerous, so that the great ma-

jority of tourists must necessarily miss the sight. For this reason the aerial tramway shown in the illustration was recently installed. It has two spans, the first from the beach of the bay to a bluff near the mainland and the other from this point to the top of the Sugar Loaf, being, respectively, 1,886 and

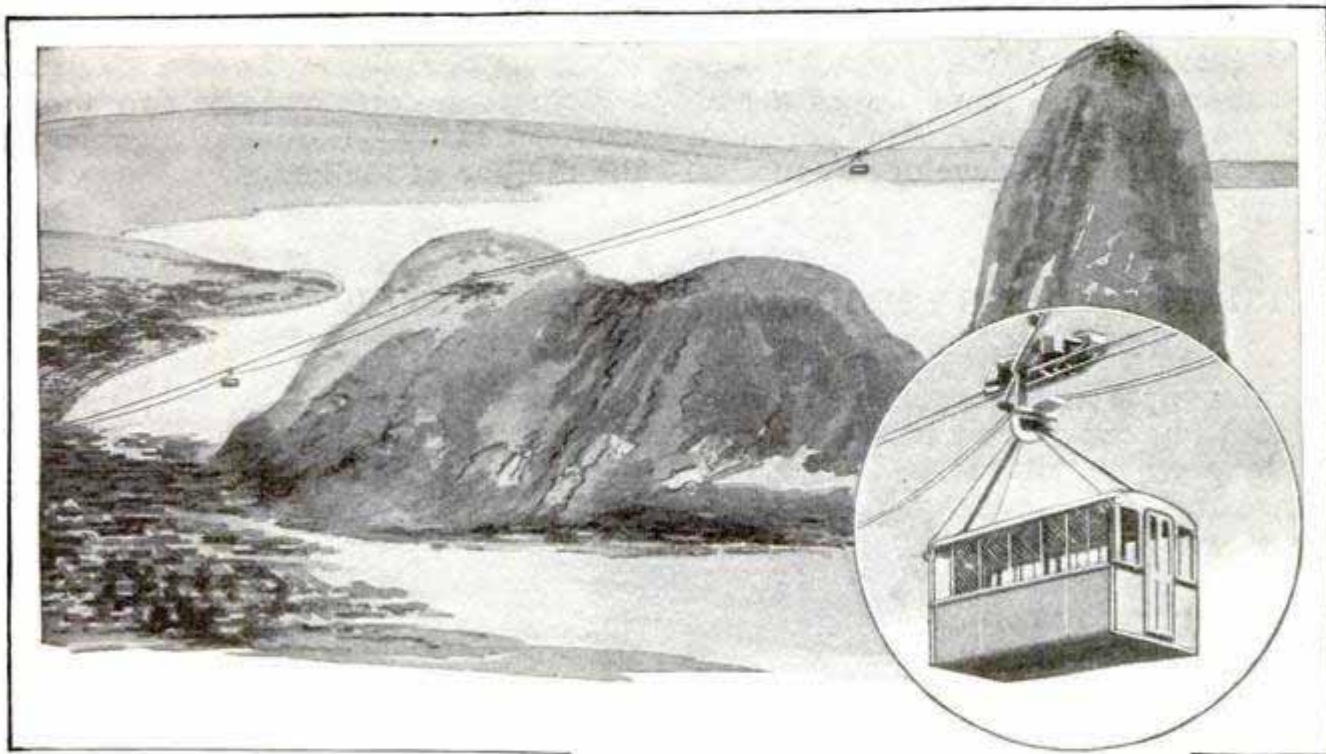

Aerial Tramway Connecting Rio de Janeiro with Top of Sugar Loaf Hill

2,624 ft. long and independently operated. The car accommodates 16 passengers and the conductor.

Particular attention has been paid to

the safety of the passengers, the car in this case running along two cables, each of which is strong enough to carry the loaded car alone.

ARTIFICIAL COW'S MILK MADE FROM BEANS

705 An artificial milk, which is said to contain all the elements of the best cow's milk and be usable for the same purposes, is being manufactured from soya beans, according to an article in the Journal of the American Medical Association. It is also stated that this artificial product is more digestible than ordinary milk and its cream more nourishing. It can be used for all cooking purposes and good cheese can be made from it, but it will not produce butter. Being germ-free, it will keep longer than cow's milk.

The process of making this soya-bean milk was discovered by three Germans, who have spent three years perfecting the apparatus. The manufacture is said to be simple, and the product is always uniform. It can be sold at good profit for six cents a quart, which is cheaper than milk in many localities.

A MAN WITHOUT COLLAR BONES

561 One of the rarest congenital defects of the human body is the total absence of both collar bones, there being, it is believed, only two previously recorded, although 22 cases have been noted in which the defect is incomplete. To the record of the two complete defects, however, must be

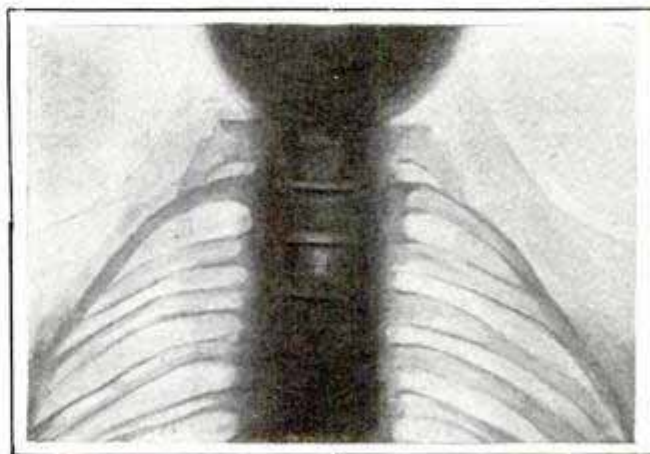

An X-Ray Photograph Showing the Complete Absence of Both Collar Bones in an Otherwise Normal Man

Journal A.M.A.
1912

Nov. 2 1912

added another, that of a patient of Dr. Max Eichmann, of Chicago. This case is a merchant, 32 years old, of a normally developed family. He is of small size, but has well-developed muscles,

but neither collar bone exists. In the place of these bones, however, can be felt a strong cord, and the two shoulders can easily be brought together in the midline of the body.

FIR-TREE ODOR DISGUSTS BOLL WEEVILS

The simple and inexpensive remedy of planting cedar or fir trees about the fields in which cotton is grown is the latest treatment the Department of Agriculture is experimenting with in its efforts to stamp out the boll weevil. This little insect damaged the cotton crop of the South to the extent of \$150,000,000 last year, it is estimated. A series of experiments has been conducted by Dr. Joseph Thompson, of Hyattsville, Md., and the cedar-fir remedy has shown possibilities.

There is something about the odor, or pollen, or some other emanation, from trees of these species that is so repugnant to the insect that it is not comfortable in the vicinity and the influence of the tree is far-reaching. The idea first was suggested by observation that where the fir and cedar flourished, the boll weevil was wholly absent, but that where growths of these trees were cut out, the pest came in great numbers.

Several hives of a shipment of bees on the Great Northern Railway were smashed in transit, the bees took possession of things, and a near-panic was caused among the railroad hands for a short time.

SPIRAL STAIRS CONVERTED INTO FREIGHT CHUTES

A freight chute of novel construction, used on the Southern Pacific piers at New York for the

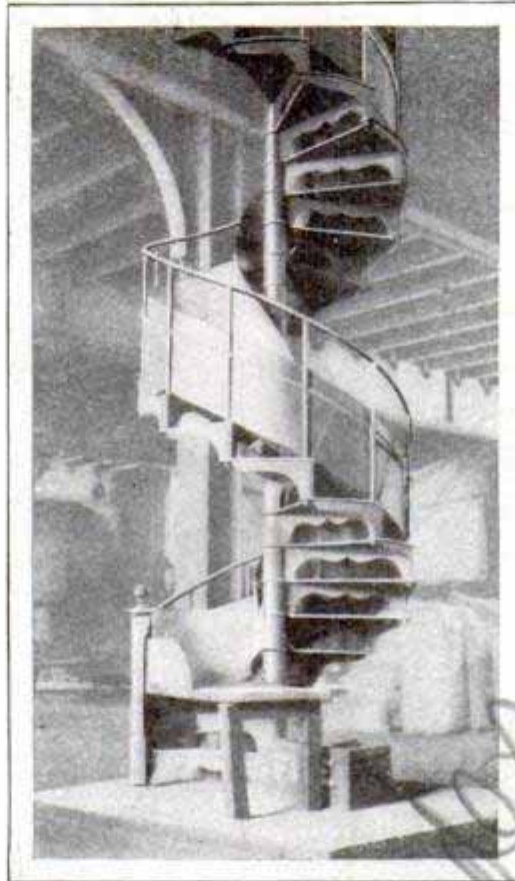

Spiral Staircase of New York Warehouse Adapted for Use as Freight Chute

delivery of small freight from the warehouse lofts to the main floor of the piers, is shown in the accompanying illustration. These chutes are simply the spiral iron staircases between the floors adapted for their new use by fitting them with a galvanized iron trough in which small freight safely descends from floor to floor. They have been found much more satisfactory than the straight wooden chutes formerly used, in which latter small bags of rice, beans, dried fruits, meal, or the like, and freight shipped in boxes and cases of light construction were often damaged by reason of the too great rapidity of the descent.

construction were often damaged by reason of the too great rapidity of the descent.

MACHINE TO MAKE A RUG A MINUTE

An invention creating considerable interest among textile men is a rug-making machine that will make clipped hearth rugs, 30 in. wide by 6 ft. in length, at the extraordinary rate of 60 an hour. When it is considered that no less than 2,520 cloth clips are needed for each rug, and that these are picked

Wood Street, Boston, Malta, Eng.

up automatically by the machine, placed in the canvas, and the rug completed all within the space of one minute, the capability of the machine must indeed be great.

The only manual labor connected with the rug making is said to be the cutting of the cloth clips. An idea of the saving both in time and cost may be gained from the fact that at present it takes one rug maker four hours to produce one rug, and the cost is \$36.50 per hundred. It is said the new machine will produce them at a cost of \$6.09 per hundred.

The most interesting feature of the machine is the spring clips, which automatically pick up the cloth strips from the flexible platform and convey them to the machine.

FARMAN BIPLANE HAS DETACHABLE CABIN

The latest type of Farman biplane has a shell-like cabin for pilot and passenger which can be put on or taken off as desired. It provides the operator of a biplane with a riding space as comfortable and well protected as such accommodation is, customarily, on a

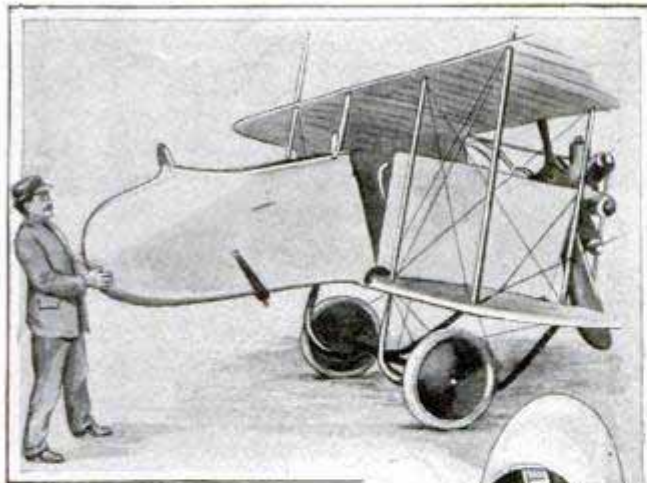

The Comfortable and Well Protected Detachable Cabin of the New Farman Biplane



monoplane. The rounded end of the cabin is, of course, the front end. The detachable feature adds considerably to the convenience of transport.

NEW "SAFETY" CRANK FOR AUTOMOBILES

A new type of safety automobile crank, the handle of which automatic-

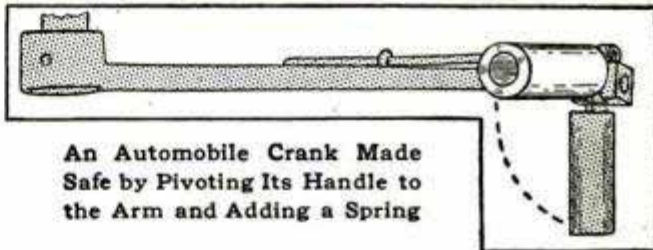

An Automobile Crank Made Safe by Pivoting Its Handle to the Arm and Adding a Spring

ally and instantly folds out of the way in case of a back fire, is now being marketed. The safety feature is accomplished by pivoting the handle and attaching the spring. In the lower illustration the handle not dotted is in its normal position, where it is in the same plane as the crank arm itself, and this is the position it takes should a back fire occur. When the engine is to be cranked, all that is necessary is to pull the handle around, and when released it is sprung back again.

2106 Superior
V. Maduel
Cleveland, O.
\$ 5.00 Pat pending

—
Motion pictures are doing much to acquaint foreign peoples with the United States, the number of films exported from this country being extraordinary as compared with the films we receive from other countries. Some 15,000 miles of films were exported in the last fiscal year, valued at \$6,800,000, and only 3,000 miles were imported.

AERIALY PROPELLED BICYCLE-SLEDGE

A novel assembling of parts of different types of craft to give birth to a still different type of craft is shown in



An Odd Sledge Which will Run on Bare Ground or on Ice

the accompanying illustration, the result being an aerially propelled sledge that will, it is claimed, run on bare ground or on ice at a fair rate of speed. Attached to the under sides of the run-

ners are little wheels of the caster type. Mounted on the rear sled is a bicycle frame, which carries, forward of the handlebars, an aerial propeller, which is driven by the pedals of the bicycle.

DIESEL TYPE OF ENGINE FOR FARM TRACTORS

After several years of quiet development, a concern in England has brought out an agricultural tractor equipped with a Diesel-type internal-combustion engine, which has shown surprising efficiency under test. This engine is said to be the first operating on the Diesel principle to be applied to a road vehicle, and will, according to the Motor World, thrive on thick, stumpy oil as black as a hat and nearly as repugnant as the slime that collects at the bottom of stagnant pools. The fuel it will use successfully is virtually the residue after practically all of the good has been extracted from crude petroleum. This means that it will run on the cheapest kind of fuel, and, even of that, its wants are extremely moderate, a little more than half a pint per horsepower being its requirement.

534 **DETROIT'S DOG-CATCHING AUTOMOBILE**

A dog automobile that is luxurious, although primarily intended for taking

the service of the city of Detroit. This machine, which cost \$4,000, has a double-deck body, provided with doors on all sides, through which the dog cages can be slipped in and out.

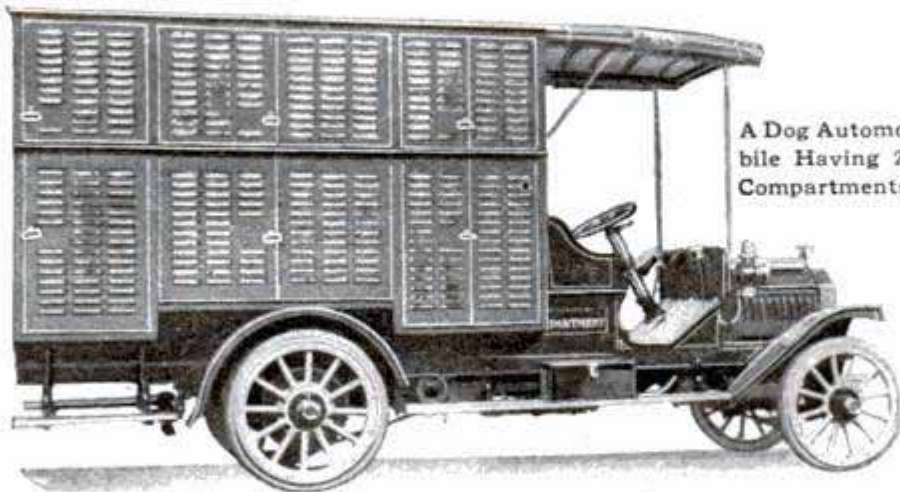

A Dog Automobile Having 22 Compartments

There are 22 compartments in this body, and each is fitted up with a brass drinking vessel. A fresh-water tank provides the prisoners with water at all times. Especial attention is paid to the ventilation.

stray and unmuzzled dogs to execution, has been added to the vehicles used in

a full kit of veterinary surgical instruments, along with such medicines as

built by General Motors, at Pontiac, Mich

Lead
Walsh + Clark

might be needed for first-aid purposes, as it is also the intention to use the vehicle as a hospital van.

QUEER MONOPLANE HAS JAPANESE ENGINE 413

It would not, in Japan, strike a tourist as strange to find an aeroplane of

PERFORATIONS USED FOR NUMBERING PAPERS

In these days of card-index systems and office records of all kinds it is necessary to obtain a permanent record of all sorts of papers and to make many different papers for identification. A new system of perforating such papers with numbers and dates has just been perfected. The work is done with a machine and papers can be numbered and dated as fast as they can be fed into the machine, the number automatically changing with each impression. A number of papers can be also numbered at the same time with the same number. The machine has been developed after much study and experimenting, and in tests that have been made has been found to be most satisfactory in operation.

American Perforator Co., 631 W. Jackson Blvd. Chicago

PAPER INSULATION LASTS TWENTY-THREE YEARS

Despite the lack of knowledge in handling high-tension electric currents that existed in the early days of electrical development, a recent examination of the works of a big electric-supply concern in England showed parts of a cable, insulated with specially prepared paper and carrying a current of 10,000 volts, to be in the best condition, although it had been in constant use for 23 years. Leading scientists and electrical experimenters had declared that it was im-

possible to handle such a voltage on the cable, but it was constructed never-

theless. It consisted of a copper tube having a cross section of .25 sq. in. Over this was laid layer after layer of paper impregnated with an especially prepared wax applied under pressure. The paper insulation was 1/2 in. thick and over this was slipped another copper tube. The entire cable was then placed in a die which pressed the outer tube until it gripped the paper tightly. Lengths



The Paper-Insulated High-Tension Cable Which Carried the First 10,000-Volt Current 23 Years Ago. The Picture Shows Actual Size of the Cable

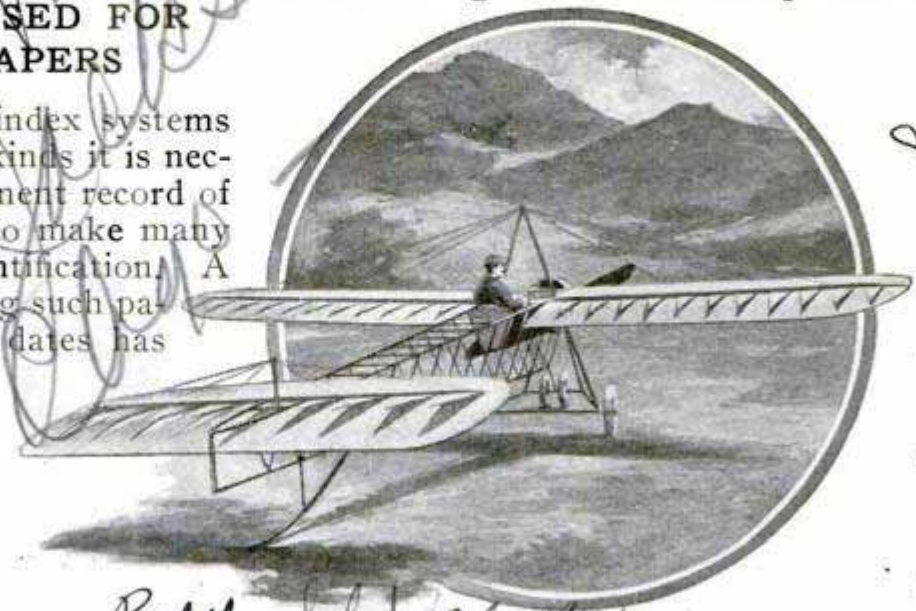

Patd. Sept. 26, 1911.

An Irish Monoplane Having Curious V-Shaped Openings in Its Sustaining Surfaces, and Equipped with a Japanese Motor

that country powered with an American or European engine, but it is certainly unexpected to find a new monoplane designed by an airman of Londonderry, Ireland, equipped with an engine of Japanese make.

Mr. Cordener, Londonderry, Ireland.

of 20 ft. were made at a time, and the sections joined by forcing a 10-in. copper rod for a distance of 5 in. on either side into the inner copper tube of two adjoining lengths. As stated, some of this cable is still in use and giving good service.

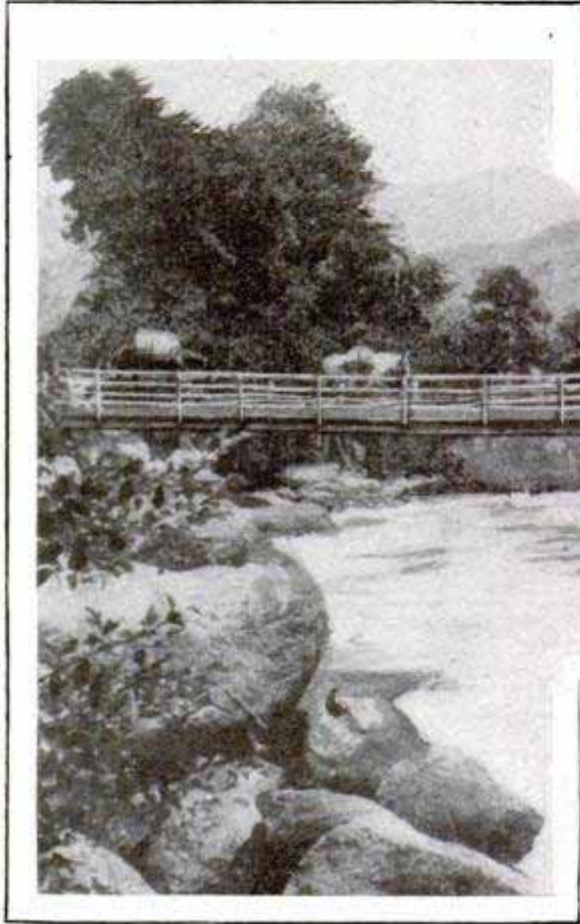

was transported from a distance, swung across stream and solidly fixed into place sufficiently high above the flood mark to escape the pressure of the water. The log at its smallest end is 4 ft. wide, hewn flat on the upper side, making a 3-ft. pathway. On account of its great length, although it rests at one point near the middle on a large stone, it sways and rocks considerably when several animals are crossing at the same time, and so side

Bridge, Made of Single, 100-Ft. Log, across Rapids of San Joaquin River

HUNDRED-FOOT LOG BRIDGE SPANS RIVER

In its upper reaches the San Joaquin River, California, rushes along through mountain gorges and rocky canyons, a dashing turbulent stream, alike unfordable and impossible of crossing by boat. Later on it becomes quiet enough as it debouches onto the valley plain. The bridges thrown across at different points are usually swept away, almost every year, when the San Joaquin comes down in flood from the melting of the vast banks of the Sierra snows.

This photograph shows an unusually substantial bridge which crosses the river at a point in the Sierra National Forest. It is made of a single huge log, more than 100 ft. in length, which

rails have been tacked on to lend an appearance of safety. The cost of erecting this bridge was about \$1,000.

LEADED SILK AS SAFEGUARD FOR X-RAY OPERATORS

An improved material for safeguarding X-ray operators from the danger to which they are subjected has been announced at the French Academy of Sciences. It consists of silk, heavily impregnated with lead and other substances, the result being an armor impenetrable by the rays. In the experiments with this lead-absorbed silk, gloves were made consisting of six thicknesses of it, and these gloves were used successfully. Gloves made of this material possess the advantage of being supple as well as providing adequate protection.

☞ New York City has 750 hotels—not counting the so-called Raines law hotels—with accommodations for 350,000 guests.

Handwritten notes:
 1. 100 ft. log
 2. 100 ft. log
 3. 100 ft. log
 4. 100 ft. log
 5. 100 ft. log
 6. 100 ft. log
 7. 100 ft. log
 8. 100 ft. log
 9. 100 ft. log
 10. 100 ft. log
 11. 100 ft. log
 12. 100 ft. log
 13. 100 ft. log
 14. 100 ft. log
 15. 100 ft. log
 16. 100 ft. log
 17. 100 ft. log
 18. 100 ft. log
 19. 100 ft. log
 20. 100 ft. log
 21. 100 ft. log
 22. 100 ft. log
 23. 100 ft. log
 24. 100 ft. log
 25. 100 ft. log
 26. 100 ft. log
 27. 100 ft. log
 28. 100 ft. log
 29. 100 ft. log
 30. 100 ft. log
 31. 100 ft. log
 32. 100 ft. log
 33. 100 ft. log
 34. 100 ft. log
 35. 100 ft. log
 36. 100 ft. log
 37. 100 ft. log
 38. 100 ft. log
 39. 100 ft. log
 40. 100 ft. log
 41. 100 ft. log
 42. 100 ft. log
 43. 100 ft. log
 44. 100 ft. log
 45. 100 ft. log
 46. 100 ft. log
 47. 100 ft. log
 48. 100 ft. log
 49. 100 ft. log
 50. 100 ft. log
 51. 100 ft. log
 52. 100 ft. log
 53. 100 ft. log
 54. 100 ft. log
 55. 100 ft. log
 56. 100 ft. log
 57. 100 ft. log
 58. 100 ft. log
 59. 100 ft. log
 60. 100 ft. log
 61. 100 ft. log
 62. 100 ft. log
 63. 100 ft. log
 64. 100 ft. log
 65. 100 ft. log
 66. 100 ft. log
 67. 100 ft. log
 68. 100 ft. log
 69. 100 ft. log
 70. 100 ft. log
 71. 100 ft. log
 72. 100 ft. log
 73. 100 ft. log
 74. 100 ft. log
 75. 100 ft. log
 76. 100 ft. log
 77. 100 ft. log
 78. 100 ft. log
 79. 100 ft. log
 80. 100 ft. log
 81. 100 ft. log
 82. 100 ft. log
 83. 100 ft. log
 84. 100 ft. log
 85. 100 ft. log
 86. 100 ft. log
 87. 100 ft. log
 88. 100 ft. log
 89. 100 ft. log
 90. 100 ft. log
 91. 100 ft. log
 92. 100 ft. log
 93. 100 ft. log
 94. 100 ft. log
 95. 100 ft. log
 96. 100 ft. log
 97. 100 ft. log
 98. 100 ft. log
 99. 100 ft. log
 100. 100 ft. log
 101. 100 ft. log
 102. 100 ft. log
 103. 100 ft. log
 104. 100 ft. log
 105. 100 ft. log
 106. 100 ft. log
 107. 100 ft. log
 108. 100 ft. log
 109. 100 ft. log
 110. 100 ft. log
 111. 100 ft. log
 112. 100 ft. log
 113. 100 ft. log
 114. 100 ft. log
 115. 100 ft. log
 116. 100 ft. log
 117. 100 ft. log
 118. 100 ft. log
 119. 100 ft. log
 120. 100 ft. log
 121. 100 ft. log
 122. 100 ft. log
 123. 100 ft. log
 124. 100 ft. log
 125. 100 ft. log
 126. 100 ft. log
 127. 100 ft. log
 128. 100 ft. log
 129. 100 ft. log
 130. 100 ft. log
 131. 100 ft. log
 132. 100 ft. log
 133. 100 ft. log
 134. 100 ft. log
 135. 100 ft. log
 136. 100 ft. log
 137. 100 ft. log
 138. 100 ft. log
 139. 100 ft. log
 140. 100 ft. log
 141. 100 ft. log
 142. 100 ft. log
 143. 100 ft. log
 144. 100 ft. log
 145. 100 ft. log
 146. 100 ft. log
 147. 100 ft. log
 148. 100 ft. log
 149. 100 ft. log
 150. 100 ft. log
 151. 100 ft. log
 152. 100 ft. log
 153. 100 ft. log
 154. 100 ft. log
 155. 100 ft. log
 156. 100 ft. log
 157. 100 ft. log
 158. 100 ft. log
 159. 100 ft. log
 160. 100 ft. log
 161. 100 ft. log
 162. 100 ft. log
 163. 100 ft. log
 164. 100 ft. log
 165. 100 ft. log
 166. 100 ft. log
 167. 100 ft. log
 168. 100 ft. log
 169. 100 ft. log
 170. 100 ft. log
 171. 100 ft. log
 172. 100 ft. log
 173. 100 ft. log
 174. 100 ft. log
 175. 100 ft. log
 176. 100 ft. log
 177. 100 ft. log
 178. 100 ft. log
 179. 100 ft. log
 180. 100 ft. log
 181. 100 ft. log
 182. 100 ft. log
 183. 100 ft. log
 184. 100 ft. log
 185. 100 ft. log
 186. 100 ft. log
 187. 100 ft. log
 188. 100 ft. log
 189. 100 ft. log
 190. 100 ft. log
 191. 100 ft. log
 192. 100 ft. log
 193. 100 ft. log
 194. 100 ft. log
 195. 100 ft. log
 196. 100 ft. log
 197. 100 ft. log
 198. 100 ft. log
 199. 100 ft. log
 200. 100 ft. log
 201. 100 ft. log
 202. 100 ft. log
 203. 100 ft. log
 204. 100 ft. log
 205. 100 ft. log
 206. 100 ft. log
 207. 100 ft. log
 208. 100 ft. log
 209. 100 ft. log
 210. 100 ft. log
 211. 100 ft. log
 212. 100 ft. log
 213. 100 ft. log
 214. 100 ft. log
 215. 100 ft. log
 216. 100 ft. log
 217. 100 ft. log
 218. 100 ft. log
 219. 100 ft. log
 220. 100 ft. log
 221. 100 ft. log
 222. 100 ft. log
 223. 100 ft. log
 224. 100 ft. log
 225. 100 ft. log
 226. 100 ft. log
 227. 100 ft. log
 228. 100 ft. log
 229. 100 ft. log
 230. 100 ft. log
 231. 100 ft. log
 232. 100 ft. log
 233. 100 ft. log
 234. 100 ft. log
 235. 100 ft. log
 236. 100 ft. log
 237. 100 ft. log
 238. 100 ft. log
 239. 100 ft. log
 240. 100 ft. log
 241. 100 ft. log
 242. 100 ft. log
 243. 100 ft. log
 244. 100 ft. log
 245. 100 ft. log
 246. 100 ft. log
 247. 100 ft. log
 248. 100 ft. log
 249. 100 ft. log
 250. 100 ft. log
 251. 100 ft. log
 252. 100 ft. log
 253. 100 ft. log
 254. 100 ft. log
 255. 100 ft. log
 256. 100 ft. log
 257. 100 ft. log
 258. 100 ft. log
 259. 100 ft. log
 260. 100 ft. log
 261. 100 ft. log
 262. 100 ft. log
 263. 100 ft. log
 264. 100 ft. log
 265. 100 ft. log
 266. 100 ft. log
 267. 100 ft. log
 268. 100 ft. log
 269. 100 ft. log
 270. 100 ft. log
 271. 100 ft. log
 272. 100 ft. log
 273. 100 ft. log
 274. 100 ft. log
 275. 100 ft. log
 276. 100 ft. log
 277. 100 ft. log
 278. 100 ft. log
 279. 100 ft. log
 280. 100 ft. log
 281. 100 ft. log
 282. 100 ft. log
 283. 100 ft. log
 284. 100 ft. log
 285. 100 ft. log
 286. 100 ft. log
 287. 100 ft. log
 288. 100 ft. log
 289. 100 ft. log
 290. 100 ft. log
 291. 100 ft. log
 292. 100 ft. log
 293. 100 ft. log
 294. 100 ft. log
 295. 100 ft. log
 296. 100 ft. log
 297. 100 ft. log
 298. 100 ft. log
 299. 100 ft. log
 300. 100 ft. log
 301. 100 ft. log
 302. 100 ft. log
 303. 100 ft. log
 304. 100 ft. log
 305. 100 ft. log
 306. 100 ft. log
 307. 100 ft. log
 308. 100 ft. log
 309. 100 ft. log
 310. 100 ft. log
 311. 100 ft. log
 312. 100 ft. log
 313. 100 ft. log
 314. 100 ft. log
 315. 100 ft. log
 316. 100 ft. log
 317. 100 ft. log
 318. 100 ft. log
 319. 100 ft. log
 320. 100 ft. log
 321. 100 ft. log
 322. 100 ft. log
 323. 100 ft. log
 324. 100 ft. log
 325. 100 ft. log
 326. 100 ft. log
 327. 100 ft. log
 328. 100 ft. log
 329. 100 ft. log
 330. 100 ft. log
 331. 100 ft. log
 332. 100 ft. log
 333. 100 ft. log
 334. 100 ft. log
 335. 100 ft. log
 336. 100 ft. log
 337. 100 ft. log
 338. 100 ft. log
 339. 100 ft. log
 340. 100 ft. log
 341. 100 ft. log
 342. 100 ft. log
 343. 100 ft. log
 344. 100 ft. log
 345. 100 ft. log
 346. 100 ft. log
 347. 100 ft. log
 348. 100 ft. log
 349. 100 ft. log
 350. 100 ft. log
 351. 100 ft. log
 352. 100 ft. log
 353. 100 ft. log
 354. 100 ft. log
 355. 100 ft. log
 356. 100 ft. log
 357. 100 ft. log
 358. 100 ft. log
 359. 100 ft. log
 360. 100 ft. log
 361. 100 ft. log
 362. 100 ft. log
 363. 100 ft. log
 364. 100 ft. log
 365. 100 ft. log
 366. 100 ft. log
 367. 100 ft. log
 368. 100 ft. log
 369. 100 ft. log
 370. 100 ft. log
 371. 100 ft. log
 372. 100 ft. log
 373. 100 ft. log
 374. 100 ft. log
 375. 100 ft. log
 376. 100 ft. log
 377. 100 ft. log
 378. 100 ft. log
 379. 100 ft. log
 380. 100 ft. log
 381. 100 ft. log
 382. 100 ft. log
 383. 100 ft. log
 384. 100 ft. log
 385. 100 ft. log
 386. 100 ft. log
 387. 100 ft. log
 388. 100 ft. log
 389. 100 ft. log
 390. 100 ft. log
 391. 100 ft. log
 392. 100 ft. log
 393. 100 ft. log
 394. 100 ft. log
 395. 100 ft. log
 396. 100 ft. log
 397. 100 ft. log
 398. 100 ft. log
 399. 100 ft. log
 400. 100 ft. log
 401. 100 ft. log
 402. 100 ft. log
 403. 100 ft. log
 404. 100 ft. log
 405. 100 ft. log
 406. 100 ft. log
 407. 100 ft. log
 408. 100 ft. log
 409. 100 ft. log
 410. 100 ft. log
 411. 100 ft. log
 412. 100 ft. log
 413. 100 ft. log
 414. 100 ft. log
 415. 100 ft. log
 416. 100 ft. log
 417. 100 ft. log
 418. 100 ft. log
 419. 100 ft. log
 420. 100 ft. log
 421. 100 ft. log
 422. 100 ft. log
 423. 100 ft. log
 424. 100 ft. log
 425. 100 ft. log
 426. 100 ft. log
 427. 100 ft. log
 428. 100 ft. log
 429. 100 ft. log
 430. 100 ft. log
 431. 100 ft. log
 432. 100 ft. log
 433. 100 ft. log
 434. 100 ft. log
 435. 100 ft. log
 436. 100 ft. log
 437. 100 ft. log
 438. 100 ft. log
 439. 100 ft. log
 440. 100 ft. log
 441. 100 ft. log
 442. 100 ft. log
 443. 100 ft. log
 444. 100 ft. log
 445. 100 ft. log
 446. 100 ft. log
 447. 100 ft. log
 448. 100 ft. log
 449. 100 ft. log
 450. 100 ft. log
 451. 100 ft. log
 452. 100 ft. log
 453. 100 ft. log
 454. 100 ft. log
 455. 100 ft. log
 456. 100 ft. log
 457. 100 ft. log
 458. 100 ft. log
 459. 100 ft. log
 460. 100 ft. log
 461. 100 ft. log
 462. 100 ft. log
 463. 100 ft. log
 464. 100 ft. log
 465. 100 ft. log
 466. 100 ft. log
 467. 100 ft. log
 468. 100 ft. log
 469. 100 ft. log
 470. 100 ft. log
 471. 100 ft. log
 472. 100 ft. log
 473. 100 ft. log
 474. 100 ft. log
 475. 100 ft. log
 476. 100 ft. log
 477. 100 ft. log
 478. 100 ft. log
 479. 100 ft. log
 480. 100 ft. log
 481. 100 ft. log
 482. 100 ft. log
 483. 100 ft. log
 484. 100 ft. log
 485. 100 ft. log
 486. 100 ft. log
 487. 100 ft. log
 488. 100 ft. log
 489. 100 ft. log
 490. 100 ft. log
 491. 100 ft. log
 492. 100 ft. log
 493. 100 ft. log
 494. 100 ft. log
 495. 100 ft. log
 496. 100 ft. log
 497. 100 ft. log
 498. 100 ft. log
 499. 100 ft. log
 500. 100 ft. log
 501. 100 ft. log
 502. 100 ft. log
 503. 100 ft. log
 504. 100 ft. log
 505. 100 ft. log
 506. 100 ft. log
 507. 100 ft. log
 508. 100 ft. log
 509. 100 ft. log
 510. 100 ft. log
 511. 100 ft. log
 512. 100 ft. log
 513. 100 ft. log
 514. 100 ft. log
 515. 100 ft. log
 516. 100 ft. log
 517. 100 ft. log
 518. 100 ft. log
 519. 100 ft. log
 520. 100 ft. log
 521. 100 ft. log
 522. 100 ft. log
 523. 100 ft. log
 524. 100 ft. log
 525. 100 ft. log
 526. 100 ft. log
 527. 100 ft. log
 528. 100 ft. log
 529. 100 ft. log
 530. 100 ft. log
 531. 100 ft. log
 532. 100 ft. log
 533. 100 ft. log
 534. 100 ft. log
 535. 100 ft. log
 536. 100 ft. log
 537. 100 ft. log
 538. 100 ft. log
 539. 100 ft. log
 540. 100 ft. log
 541. 100 ft. log
 542. 100 ft. log
 543. 100 ft. log
 544. 100 ft. log
 545. 100 ft. log
 546. 100 ft. log
 547. 100 ft. log
 548. 100 ft. log
 549. 100 ft. log
 550. 100 ft. log
 551. 100 ft. log
 552. 100 ft. log
 553. 100 ft. log
 554. 100 ft. log
 555. 100 ft. log
 556. 100 ft. log
 557. 100 ft. log
 558. 100 ft. log
 559. 100 ft. log
 560. 100 ft. log
 561. 100 ft. log
 562. 100 ft. log
 563. 100 ft. log
 564. 100 ft. log
 565. 100 ft. log
 566. 100 ft. log
 567. 100 ft. log
 568. 100 ft. log
 569. 100 ft. log
 570. 100 ft. log
 571. 100 ft. log
 572. 100 ft. log
 573. 100 ft. log
 574. 100 ft. log
 575. 100 ft. log
 576. 100 ft. log
 577. 100 ft. log
 578. 100 ft. log
 579. 100 ft. log
 580. 100 ft. log
 581. 100 ft. log
 582. 100 ft. log
 583. 100 ft. log
 584. 100 ft. log
 585. 100 ft. log
 586. 100 ft. log
 587. 100 ft. log
 588. 100 ft. log
 589. 100 ft. log
 590. 100 ft. log
 591. 100 ft. log
 592. 100 ft. log
 593. 100 ft. log
 594. 100 ft. log
 595. 100 ft. log
 596. 100 ft. log
 597. 100 ft. log
 598. 100 ft. log
 599. 100 ft. log
 600. 100 ft. log
 601. 100 ft. log
 602. 100 ft. log
 603. 100 ft. log
 604. 100 ft. log
 605. 100 ft. log
 606. 100 ft. log
 607. 100 ft. log
 608. 100 ft. log
 609. 100 ft. log
 610. 100 ft. log
 611. 100 ft. log
 612. 100 ft. log
 613. 100 ft. log
 614. 100 ft. log
 615. 100 ft. log
 616. 100 ft. log
 617. 100 ft. log
 618. 100 ft. log
 619. 100 ft. log
 620. 100 ft. log
 621. 100 ft. log
 622. 100 ft. log
 623. 100 ft. log
 624. 100 ft. log
 625. 100 ft. log
 626. 100 ft. log
 627. 100 ft. log
 628. 100 ft. log
 629. 100 ft. log
 630. 100 ft. log
 631. 100 ft. log
 632. 100 ft. log
 633. 100 ft. log
 634. 100 ft. log
 635. 100 ft. log
 636. 100 ft. log
 637. 100 ft. log
 638. 100 ft. log
 639. 100 ft. log
 640. 100 ft. log
 641. 100 ft. log
 642. 100 ft. log
 643. 100 ft. log
 644. 100 ft. log
 645. 100 ft. log
 646. 100 ft. log
 647. 100 ft. log
 648. 100 ft. log
 649. 100 ft. log
 650. 100 ft. log
 651. 100 ft. log
 652. 100 ft. log
 653. 100 ft. log
 654. 100 ft. log
 655. 100 ft. log
 656. 100 ft. log
 657. 100 ft. log
 658. 100 ft. log
 659. 100 ft. log
 660. 100 ft. log
 661. 100 ft. log
 662. 100 ft. log
 663. 100 ft. log
 664. 100 ft. log
 665. 100 ft. log
 666. 100 ft. log
 667. 100 ft. log
 668. 100 ft. log
 669. 100 ft. log
 670. 100 ft. log
 671. 100 ft. log
 672. 100 ft. log
 673. 100 ft. log
 674. 100 ft. log
 675. 100 ft. log
 676. 100 ft. log
 677. 100 ft. log
 678. 100 ft. log
 679. 100 ft. log
 680. 100 ft. log
 681. 100 ft. log
 682. 100 ft. log
 683. 100 ft. log
 684. 100 ft. log
 685. 100 ft. log
 686. 100 ft. log
 687. 100 ft. log
 688. 100 ft. log
 689. 100 ft. log
 690. 100 ft. log
 691. 100 ft. log
 692. 100 ft. log
 693. 100 ft. log
 694. 100 ft. log
 695. 100 ft. log
 696. 100 ft. log
 697. 100 ft. log
 698. 100 ft. log
 699. 100 ft. log
 700. 100 ft. log
 701. 100 ft. log
 702. 100 ft. log
 703. 100 ft. log
 704. 100 ft. log
 705. 100 ft. log
 706. 100 ft. log
 707. 100 ft. log
 708. 100 ft. log
 709. 100 ft. log
 710. 100 ft. log
 711. 100 ft. log
 712. 100 ft. log
 713. 100 ft. log
 714. 100 ft. log
 715. 100 ft. log
 7

OPENING THE WAY FOR GLASS HOUSES

Glass might be used to build houses if it could be made stronger and manufactured more cheaply than at present. Even now it is used much more than a few years ago, and Robert L. Fink, in a paper read before the recent International Congress of Applied Chemistry in New York City, predicts that not only will the house of the future be made of glass, but also pipes for water and many other articles of common use. The principal materials from which glass is manufactured are sand and lime, and these are the cheapest raw substances from which any building materials can be made.

Ordinary glass would be very much cheaper than it now is if it could be made entirely by machinery without too great breakage, and Mr. Fink has just made an important investigation of the reasons why glass breaks. In working with machine-made window glass, he found that 70 per cent of all the panes were broken before they were ready for market, and on some days it seemed as though all the glass made were lost, the breakage rising to 95 per cent.

Window glass is blown in the shape of



Strong Sheet-Glass Surface

as Seen Under Microscope



Weak Glass Surface

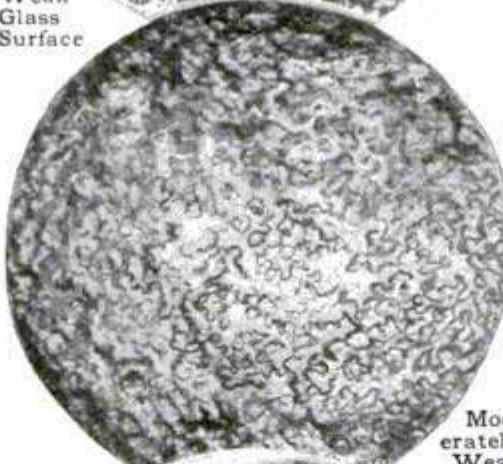

Moderately Weak Piece of Glass

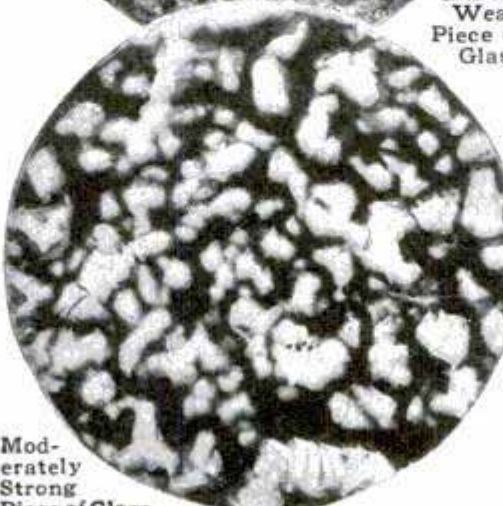

Moderately Strong Piece of Glass

long cylinders, which are cut open along one side, and then placed on a stone in a hot furnace, where they gradually collapse and flatten out into a big sheet of glass. Often the glass breaks during this process, or even explodes, forming thousands of pieces which shoot in all directions. Almost every one has seen "strings" in window panes, or lines where the glass is thicker. These often cause the glass to crack; in fact, whenever the entire pane of glass is not of exactly the same thickness, it is very likely to break. Fortunately for the buyer, very imperfect window glass usually breaks before the manufacturer gets rid of it.

The outward appearance of glass is, however, no sure indication of its strength and soundness and two pieces of window glass, looking exactly alike, may be very different in structure. By corroding the smooth outside surface of the pieces of glass with hydrofluoric acid and viewing them through a magnifying glass, these differences in structure and consequently in strength become evident.

The first illustration shows how the surface of a piece of very

strong glass, treated in this manner, appears under the magnifier, while the second is a picture of a very weak piece of glass. The latter kind usually breaks all to pieces before leaving the glass works. The appearance of the roughened surface of window glass of intermediate strengths is shown in the other illustrations. Thus the experienced investigator is enabled to tell whether the glass is likely to break or not.

By only making very strong sheets of glass, it is possible to reduce its thickness and, therefore, its cost, and a reduction of the breakage in the glass works would also make the glass very much cheaper. When glass can be made by machinery with only a very small amount of breakage, one may expect the glass houses of fancy to become a reality.

ANTI-HATPIN CRUSADE IN BAVARIA

In Munich there are regulations against wearing unprotected hatpins of dangerous length, the policemen and conductors of public conveyances being the arbiters who draw the "danger line." These officials are provided with



Conductor "Disabling" the Hatpin of Woman Passenger in Munich Street Car

protectors which they may attach, at their discretion, to the offensive end of the feminine passenger's or pedestrian's hatpin.

"EXPLOSION" LOCOMOTIVES FOR DESERT RAILWAYS

539 That locomotives of the internal-combustion, or "explosion" type may come into general use on railroads which pass through desert regions, where water is not easily obtainable, is being predicted by engineers. The Continental Railway of Australia, for instance, is an example of a line which, because of lack of adequate watering facilities along its right-of-way, has adopted gas and oil engines.

While the oil-fueled internal-combustion locomotive is economical in fuel consumption and operation generally, besides being practically smokeless, the high speed at which it must be run in order to produce a steady tractive effort is said to be a decided disadvantage, requiring special mechanism for the transmission of power to the driving wheels. Slow speeds are not possible for the reason that the intervals between the impulses on the pistons, caused by the successive explosions, would become too long and the momentum of the engine would not be sufficient to carry the drive wheels around, resulting in a jerky motion. Such difficulties may be avoided, however, by the use of electric motors, driven by the oil engine, and used only in starting the train, in hill climbing, and under other conditions that necessitate slow speeds. This method is adopted on certain South African railways.

ORCHARD TRACTOR DRIVEN BY BOY

658 A small orchard tractor, but 4 ft. in height, and driven by a boy, is shown in operation in the accompanying illustration, breaking ground in an orchard. It passes under the lowest limbs of the trees without causing dam-

Geo. H. Jones

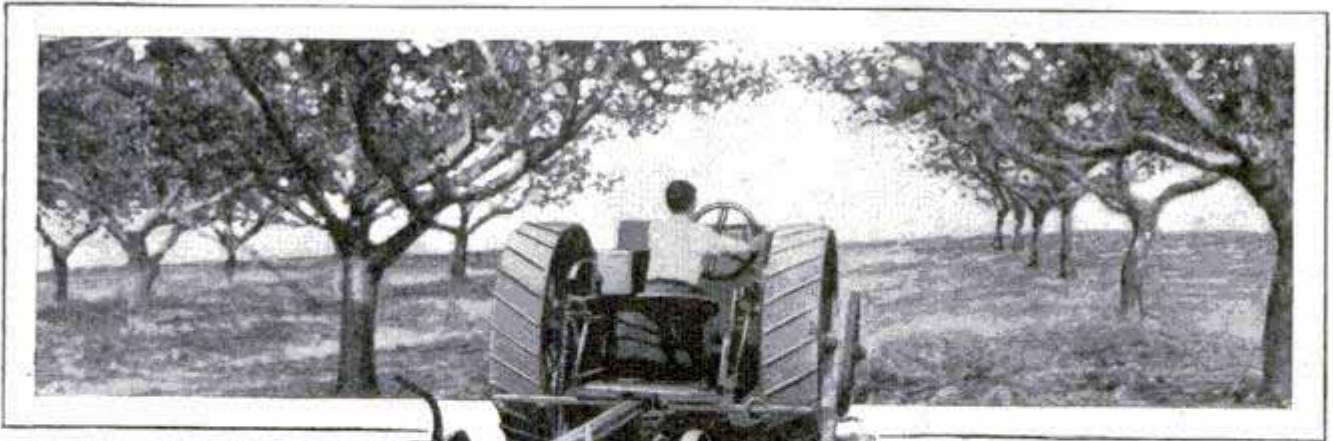

Small Orchard Tractor Operated by a Boy Who Finds This Kind of Farming a Joy

age. The machine is 11 ft. long by 6 ft. wide, and weighs 4,000 lb. It is driven by a 12-hp. engine, has a working speed of $2\frac{1}{2}$ miles an hour, and can be turned, with a number of plows or other implements attached, in a 24-ft. circle.

STUDYING THE COLORS IN BRICK

Probably everyone has wondered why some bricks are red, and others are buff, yellow, white, brown, or some other color.

In different parts of the United States the brick colors are strikingly different, at least in the brick used for ordinary walls and not for front facing, so that an observant person who has lived in Boston, Washington and Chicago, for instance, would recognize which of these cities he was in if he were blindfolded and taken to an unfamiliar part of any one of them. Charles F. Binns and C. H. Makeley, of Alfred, New York, have just made an experimental study of the colors of brick. Bricks are made from clay and sand. Two of the most important constituents in clay are aluminum and iron. When bricks are made from clays which contain a large amount of aluminum and very little iron they are white, or nearly white; if moderate amounts of iron are present they are pale yellow to buff, while if the clays

contain little aluminum and much iron, the bricks are red. However, if this latter clay contains considerable lime as well, the bricks burn yellow, or very light yellow.

According to another investigator the colors due to iron may range through every shade from white to orange, red, blue, brown and even to black. The hotter the temperature at which the brick is burned, the darker is the color. At high temperatures, when very much iron is present, violet black or black bricks can be produced.

Binns and Makeley endeavored to produce red bricks by using a clay which gave a white brick and adding iron in the form of ferric oxide (rust), but they obtained the surprising result that the bricks were not at all red but only a pinkish gray. Therefore, they concluded that iron will not color bricks red unless it is present in a form which permits a more intimate mixing with the clay. When iron was used in the form commonly known as "fool's gold" (iron pyrites) a very interesting series of bricks in different shades of buff was obtained.

The colors of bricks which seem to be a bright light green or blue are usually due to a colored substance which is added to the enamel, but the colors which are here described are to be found inside as well as outside the bricks. When the art of coloring bricks by adding coloring substances is better understood, it will be possible to make the bricks themselves of almost any color.

606 IMPRESSIONS OF AERONAUT TURNED AIRMAN

The intensely interesting impressions of an aeronaut on first taking to the air in aeroplanes are here set down

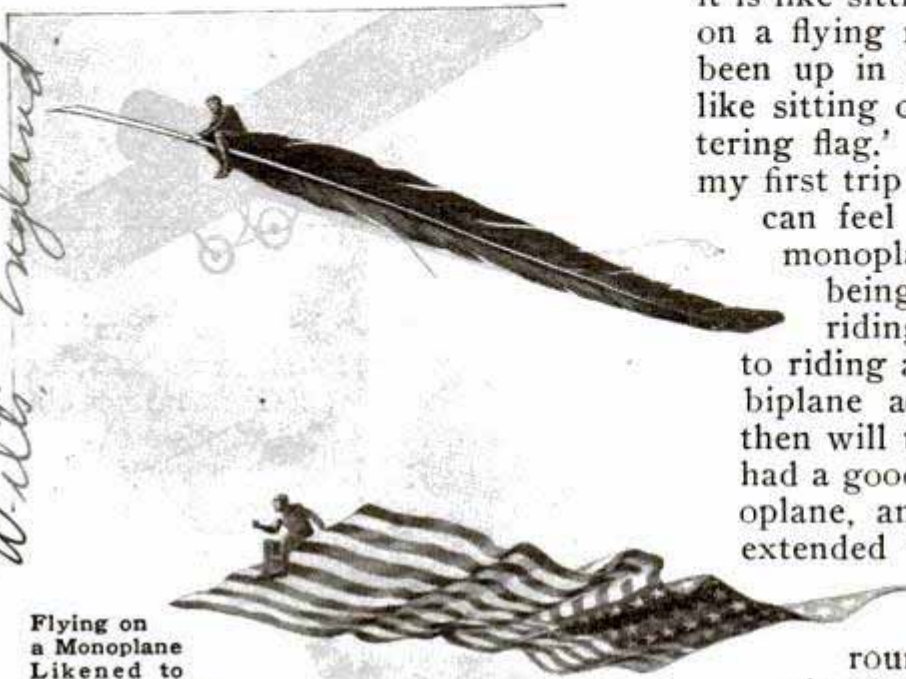

Flying on a Monoplane Likened to Riding a Feather and on a Biplane to "Sitting on the Edge of a Fluttering Flag"

as extracted from a letter received from Captain Penfold, the well-known Australian balloonist. Captain Penfold spent some time in England recently, as a student of aeroplane flight, his first aerial journey on a heavier-than-air machine being with Hotchkiss, a British army airman who was killed with a companion just a few days later.

"The military airmen I have met in England," says Captain Penfold, "are fine in a good-natured, friendly way. I feel, myself, that the elements of danger bring out the good qualities of a man." And then he continues: "Let's hope I develop some myself;" which, since Penfold has for years flown in balloons, might raise the question, whether or not flying in aeroplanes develops different qualities than making a parachute drop from a gas-filled bag.

"In my first trip up," says Captain Penfold, in describing his sensations, "I felt the speed and wind against my face, but by the third trip was quite at

home, although I had also to become accustomed to the noise of the propeller. I have heard people say that it is like sitting on a blancmange to be on a flying machine, but I, who have been up in a fair breeze, consider it like sitting on the 'top edge of a fluttering flag.' A day or so ago, I had my first trip up on a monoplane. You can feel the least movement of a monoplane, and, compared with being on a biplane, it is like riding a feather as contrasted to riding a house. I intend to fly a biplane at first in Australia, and then will take to the monoplane. I had a good look around on the monoplane, and seemed to get a more extended view as regards distance than on a biplane. Perhaps the absence of surrounding wires gives a clearer view."

NEW SUPERDREADNOUGHT LAUNCHED IN ENGLAND

Great Britain's largest battleship, the superdreadnought "Audacious," was launched not long ago, at Birkenhead, in the presence of 1,000 invited guests and many times that number of spectators who crowded pleasure boats and the wharves. The "Audacious" is a sister ship of the "Ajax," but she is better equipped than the latter in the matter of armor, her side armor being 12 in. thick and extending nearly two-thirds the length of the vessel. Forward and aft the plate is 6 in. thick. The ship will be able to fire a broadside of 12,500 lb. from ten 12-in., 45-caliber guns as compared with the broadside of 6,800 lb. of which the ships of the dreadnought type are capable. The displacement of the "Audacious" is more than 23,000 tons, and she will attain a speed of 21 knots (24.18 miles an hour). She is fitted with four screws. The total cost of this giant among battleships will reach close to \$10,000,000, exclusive of her armament.

Aeromant, Post office Amesbury W. Vt. England

MEASURE WIND VELOCITY WITH ELECTRICITY

Electrical measure of wind velocities is now possible with a device utilizing the conflicting properties of platinum and manganin. The flow of current through platinum is easily affected by changes in temperature while the flow through manganin remains practically even. Therefore what is known as a Wheatstone bridge is made with two arms of platinum and two of manganin wire. If after the current flow through the two substances has been balanced, the apparatus is exposed in a current of air, the wires will be cooled, an operation which does not affect the manganin but does affect the platinum, lowering its resistance and allowing more current to flow through it. To restore balance, the current through the manganin arms must be increased. This increase in current is therefore a measure of the cooling effect or velocity of flow of the wind, and the apparatus, being extremely sensitive, will thus furnish a means of computing very accurately slight variations in the wind velocity.

UNDER-WATER SIGNAL SYSTEM FOR NAVY

Experiments were made recently by the navy with a submarine signal system, designed especially for use should the wireless outfit be shot away, and brought to this country from Hungary by Count Szechenyi.

In the installation of the apparatus on battleships, the sending is accomplished by stretching a wire from side to side of the vessel at such tension that it will produce a high musical note when vibrated by an alcohol-soaked, silk-covered disk, revolving at high speed. The sides of the vessel act as a sounding board. The water is, of course, a splendid transmitting medium. The receiving apparatus of the outfit is the ordinary sensitive microphone of the wireless operator. Levers and springs control the application of the motor-driven disk to the wire.

MOTOR-CAR LOCK GRIPS CLUTCH LEVER

An ingenious lock has been devised for automobiles, which secures the clutch of the car so that it cannot be

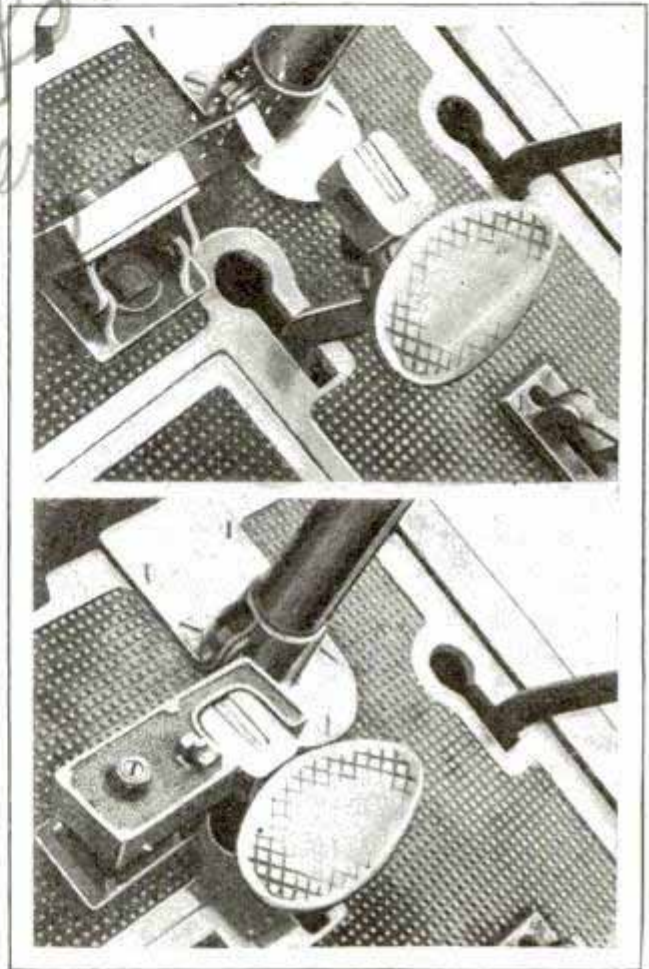

Automobile Locked by Device Which Secures the Clutch Lever. Above, the Lock Open; Below, the Clutch Locked

started without unlocking with a key. When not in use, it is thrown out of the way, but as it is hinged to the foot-board of the car it is always ready for use. The lock is of bronze, and of a stout construction that prevents it being easily broken or filed.

CHURCH CARVER SHOWS FOX PREACHING TO GEESE

There are many quaint things to be found in the old churches of England and this is especially true of those structures having heavily carved decorations of wood. One of the oddest spectacles is found in an old London edifice where the ends of the pews and benches are elaborately carved. In this particular instance the end of a bench

Wireless Co

Handwritten note: A no. a Hungarian, Vice-President

furnished the raw material for the carver's work, and he has shaped a most curious and seemingly out-of-place ornament. The figures show a fox in a

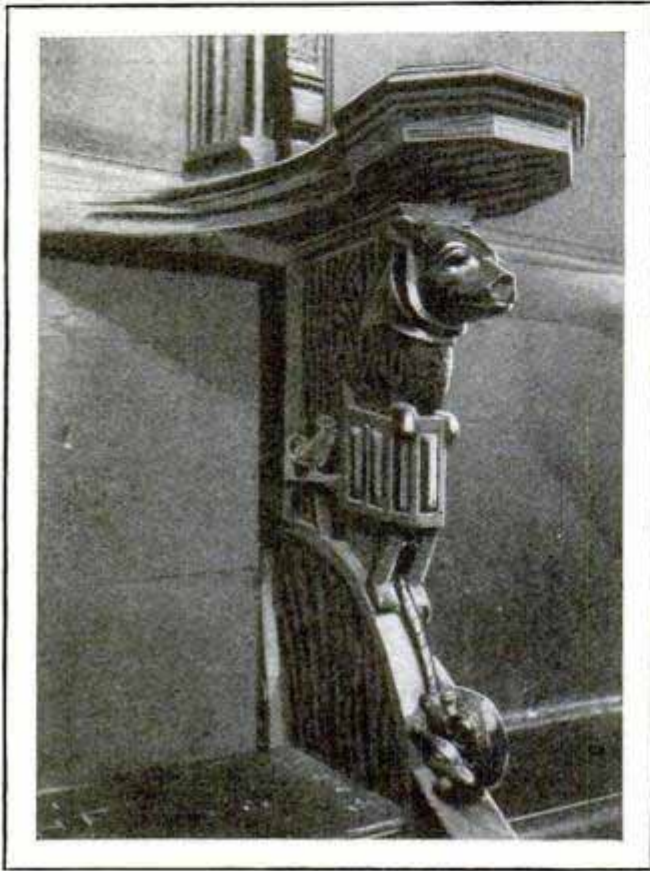

Carved Bench End in English Church Which Shows a Fox Preaching to a Congregation of Geese

monk's cowl occupying a pulpit and preaching to a lot of geese which are held together with a string which passes into the pulpit. Mounted in the background is the figure of a rooster crowing. There is nothing to indicate the carver had any reference to the reverend gentleman who occupied the pulpit at the time his work was done or to the members of the congregation.

REPAIRING ARTERIES WITH GLASS TUBE

Among the latest experiments of Dr. Alexis Carrel, recently awarded the Nobel prize for notable achievements in surgery, are some on animals, in which he used rubber, glass and metal tubes in the chest portion of the aorta, the large artery which carries the blood from the heart. Sometimes this portion of the aorta becomes enormously dilated into a sac called an "aneurism,"

which sooner or later will burst, causing instant death.

Previous attempts to cure this condition have consisted in passing a coil of fine silver wire into the sac with the idea of causing the blood to first clot, then organize into solid tissue, thus partially obliterating the sac but allowing the blood current still to pass through it. Carrel's experiments have been conducted on dogs with the idea that it might be possible to cure an aneurism by substituting a glass or metal tube for the dilated portion of the vessel. The chest is opened by an incision between two ribs, and held open by means of so-called retractors. Silk ligatures or threads are passed around the aorta and an incision of the required length is made, lengthwise of the aorta, and while the blood flow is stopped in the vessel by means of clamps on each side of the incision, the glass, aluminum or goldplated aluminum tube is passed in and the silk ligatures then tied around each end of the tube, whereupon the incision in the artery is sewed up.

In one instance a portion of the wall of the aorta of a dog was cut out and a piece of rubber inserted and covered with tissue. Fifteen months afterward the blood was circulating through it in a normal manner. In another instance a piece of vein was substituted for a portion of the descending or abdominal portion of the aorta of a dog. The animal died two years afterward of an epidemic disease and his aorta was found to be working all right up to his death. Eleven experiments were performed with glass or metal tubes on the chest portion of the aortas of dogs and during the first week following the operations nearly all the animals were in excellent condition. On seven animals glass tubes were used; on three, aluminum tubes, and on one, a goldplated aluminum tube. The animals died in from five to 97 days after the operation, and in each instance it was found that the death was caused by a blood clot due to too large a tube, to the rough edge of the tube or to corrosion of the metal tubes, all of which are conditions

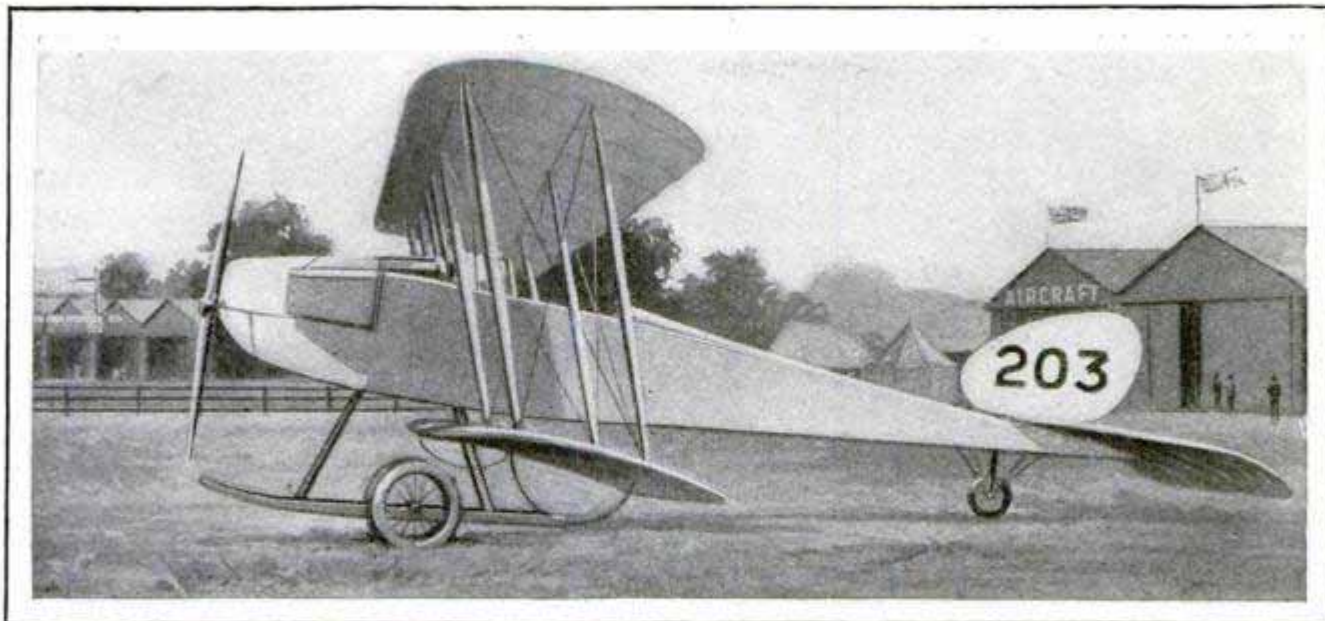

British Military Biplane of the Type Constructed in the Government Shops

easily preventable by the use of properly constructed tubes of just the right size. Doctor Carrel says the permanent intubation of a large artery is a comparatively simple operation; that it is probable that the use of smooth-edged gold tubes, or of tubes lined with a vein, will be followed by better results; and then the application of this method to human surgery may be considered.

MOTOR CARS TWO TO ONE ON MASSACHUSETTS ROADS

Two-thirds of the vehicles passing over the highways of Massachusetts are automobiles, according to the count made recently by the highway commission of that state. For the entire 155 stations on the state roads where count was made, the percentage of motor vehicles was 67, to 33 for horse-drawn vehicles. A total of 60,200 vehicles were counted, of which 40,391 were motor-driven, and 19,809 horse-drawn. Of the motor-driven vehicles, 32,072 were of the touring-car type, 6,555 were runabouts, and 1,764 were motor trucks.

The scarcity of motor trucks is attributed to the fact that the majority of the trucking by motor is done within the limits of cities, comparatively few running regularly over state highways, and none of them operating on park roads.

BRITISH MILITARY BIPLANE OF ADVANCED TYPE

By reason of the fact that the British war office barred the use of monoplanes in the grand maneuvers in England because of the death of several officers of the army in accidents with these machines, the biplanes owned by the government and especially those built by the war office workmen, came in for thorough testing. All of the machines behaved well, but the army officials were especially pleased with the machine built at the royal aircraft shops.

The machine most liked was a biplane of the tractor type in which the streamline form was followed not only in the construction of the body but of the struts as well. The maneuvers were brought to a sudden close because of the extreme usefulness of the aeroplanes, the movements of both armies being so plainly seen by the aerial scouts that there was no chance for working out problems on the ground.

☞The universal garden about American dwelling houses and the absence of fences or hedges were the things the hosts of scientific foreign visitors to the United States last fall found here that attracted their attention most particularly.

Boston Transcript

**GREAT ROCK RESEMBLES
HUMAN HEAD**

667

A great rock, rising out of the water on the coast of Oregon, near Brandon, is a striking example of nature's often

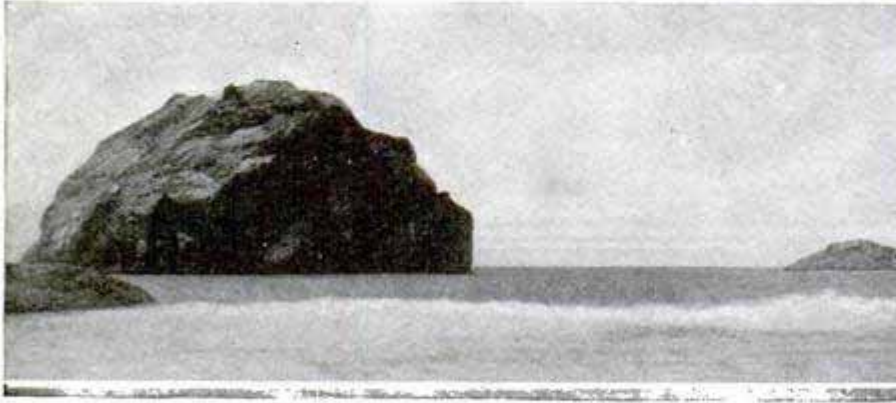

Great Rock Shaped by Nature into the Form of a Face and Head

demonstrated aptitude as a sculptor. The lines of the face and reclined head are clear-cut and excellently proportioned. It is called "Sphinx Rock."

**THE ACTION OF RADIUM
ON DIAMONDS**

W03

That the effect of radium on diamonds is marked has been shown by Sir W. Crookes, who imbedded several stones in radium bromide. One of these diamonds was originally of the purity of water, but the radium caused it to assume a beautiful color, which is very pronounced, and has proved to be unaffected by long-continued heating in strong nitric acid and potassium chlorate, as well as by heating it to red-

ness. The diamond brought into prolonged contact with radium also becomes radioactive to an extent, which persists after drastic treatment.

**BULLOCK POWER ON ROOF OF
TURKISH BATH**

521

Bagdad, in Asiatic Turkey, is noted for its baths, maintained for both men and women. On the roof of one of the bath buildings in the town of Koot, an Arab suburb of Bagdad, is an inclined runway on which a bullock is used in drawing water from a well for the baths.

A Bullock on a Bathhouse Roof, Drawing Water for the Bathers

This primitive system of elevating water by means of a skin used as a bucket and a rope running over a wheel, is widely known in Arabia and is called the "cherrid." These cherrids are common along the Euphrates and Tigris Rivers, where they are used for irrigating the date gardens.

CA pigeon recently flew from Niagara Falls to New York City in 6 hr. 33 min., making an average of 70 miles an hour.

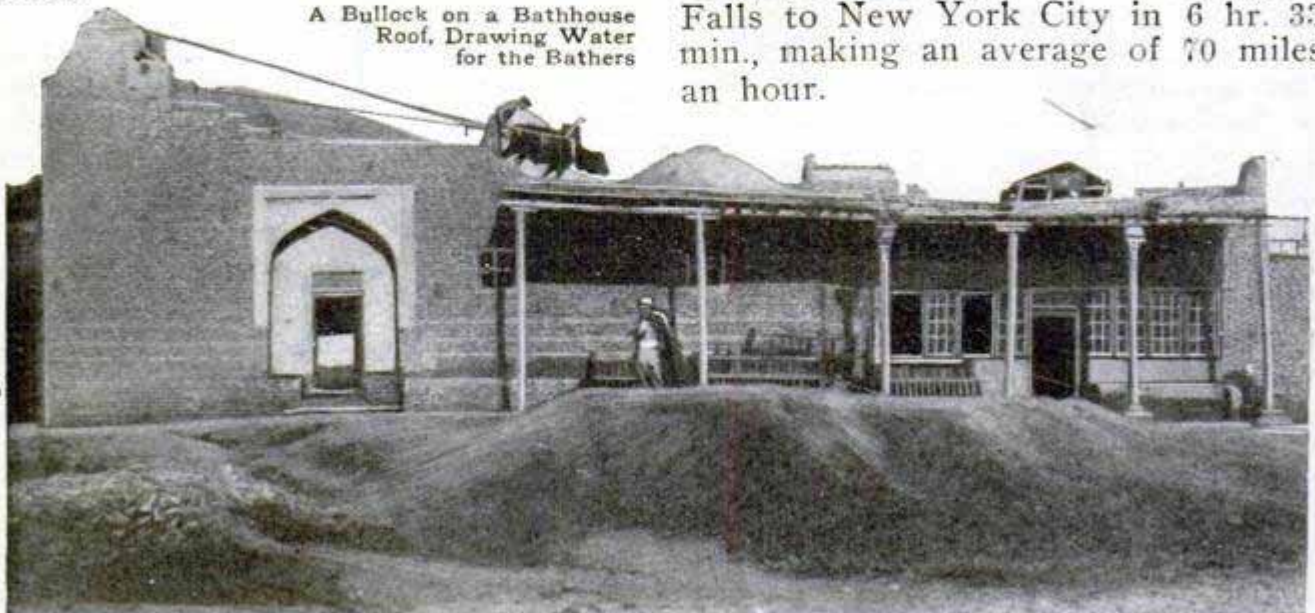

mt. Fred Smith American
mular Service, Chas. A. ...



IS YOUR INTENDED HOME WELL BUILT?

By M. W. DOUGLAS

“HOW can I tell whether or not a house I want to buy is well built, so it will not require repairs that amount almost to rebuilding?” asked Mr. Neidow of his visiting uncle, an architect of experience.

“If you have one in mind, we will look it over together,” he offered.

“There are several I am thinking of, particularly a bungalow near here, though I may decide to build, or simply to lease.”

“Then let’s look over the bungalow, and let me tell you as we go over it what to look for in the case of almost every home, and you can apply much of it to the others,” suggested the elder Neidow.

By telephone, permission to look over the bungalow was obtained, and in a few minutes they reached it, and were welcomed into the little home.

“Let us start at the cellar,” suggested the elder Neidow, “though it is more customary for a prospective buyer to be shown the prettiest parts of a house first.”

As soon as they reached the cellar, the elder Neidow, taking a rule from his pocket, measured the height from floor to ceiling, stating that the height of the basement ceiling should be at least 7 ft. where a furnace is used, in order to allow the hot air to travel upward and give the flues sufficient pitch. If in an ordinary dwelling the basement height is less than 7 ft., sufficient ventilation cannot be obtained if the basement is used for laundry or other purposes.

“An important point in buying a house,” he said, “is to see that the footings and foundation are substantially constructed, because the entire superstructure depends on the foundation. If possible, ascertain the depth

of footings under porches and depth of foundation walls, to see whether they will be affected by frost in any way. Also see whether the wall will be affected by water seeping through from outside.

“Where a concrete foundation is used, see that the walls are made of a dense mixture and that they are plastered on both sides clear down to the footing.” (The foundation of this particular bungalow was of stone, and the elder Neidow stepped out to see whether the outside at least was plastered.) “The mortar used for brick or stone foundations should be a pure cement mortar, and unless it is of dark gray, you can be positive that there is a percentage of lime water mixed in, which always weakens the foundation wall. Care should be taken to see that the foundation wall is of sufficient width to support the weight it carries. Damp soil affects the foundation and, no matter of what material the foundation is composed, dampness will invariably penetrate the foundation and cause an unhealthy cellar. For damp-proofing in an ordinary dwelling, where the rains penetrate the earth and settle around the basement wall, one of the best methods is to lay farm tile around the building and branch off about 40 ft. away to lower ground. The tile should not be closely jointed together, and it is necessary that they be covered on top so that no soil or sand can penetrate to the interior. The sides are to be left open so that water can flow into them. The top of the tile should be covered up to the grade with clean beach gravel. A stone foundation should also be plastered $\frac{1}{2}$ in. on each side with a mixture of sand and cement, after which a coat of asphalt should be applied on

the outside wall clear down to the bottom of the footings.

"If stone sills are used in the foundation, they should be thoroughly inspected for rot and disintegration. Stone sills should also be laid according

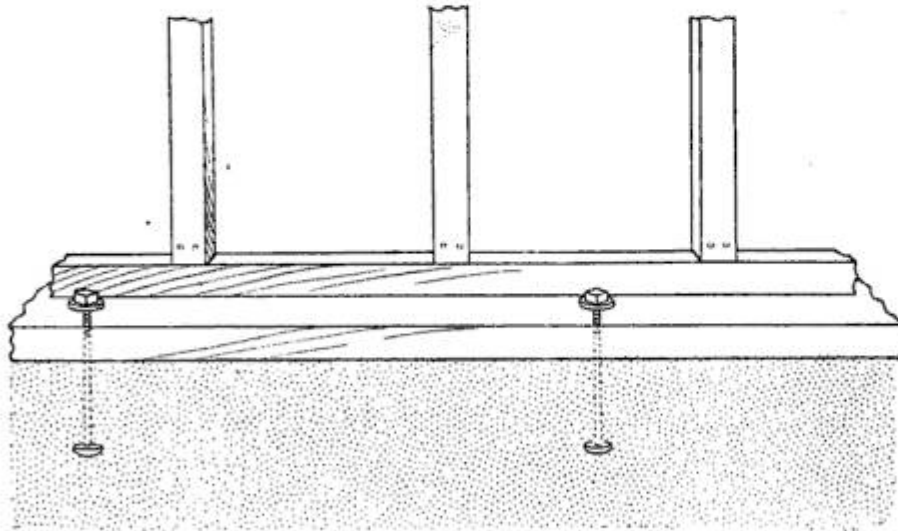

Wall Plates should be Anchored to Foundations to Prevent Shifting in a Gale

to stratification or their natural bed. The floor of the basement, if of cement, should be fairly tested."

This was done by taking a block of wood, weighing about 20 lb., and dropping it upon the floor in different places.

"If the floor sounds hollow, there is insufficient concrete below the finished surface, whereas, if the floor has a solid, substantial, dead sound you can be certain that the concrete is of sufficient thickness.

If the heating system is installed, the ceiling of the basement directly above the furnace should be plastered with cement plaster on metal lath so as to protect the joists from heat. Ascertain, if possible, whether the wall plates are anchored to the foundation wall and bolted. This is frequently neglected, but is necessary for even the simplest dwellings. I have known cases where an ordinary 10-mile gale has shifted buildings to the extent of one or two inches by the sliding of the wall plates.

"If the joists are not visible, their size can be ascertained by measuring the ceiling and deducting the difference for floors. The floor load is figured at 60 lb. per foot for an ordinary building

and, according to this assumed load, the joists should be of sufficient size to carry the load; thus 2 by 8-in. joists, spaced 16 in. from center to center, with plaster below, should not run over 12 ft. in length; 2 by 10-in. joists, similarly spaced, should not run over 16 ft. See,

if possible, whether the headers around stairwell openings, fireplaces, etc., are double or triple. It is necessary that they are at least double. Also joists under partitions should be double or triple. Examine the joists carefully, to see whether they have been cut for piping. See that the joists are well bridged and that spans of 12 ft. and over have

at least two rows of bridging.

"The ceiling joists, if there is no attic in an ordinary dwelling, carry a 20-lb. load, including their own weight, lath and plaster; and a 2 by 4-in. joist for this purpose should not exceed 11 ft. If there is a floor in the attic, the joists should, of course, be increased in size to carry the floor and a 20-lb. floor load in the attic besides. Also look up the carrying capacity of beams and timbers when inspecting a residence.

"Now, let us take the size of studing into consideration. A 2 by 4-in. stud is sufficient for an ordinary bungalow of this kind. In the examination of a bungalow, the framing of the studs should be carefully inspected. The next step is to look for defective timber. Note how the ribbons or girths are framed. Examine the junction of joists, at girth or ribbon, for the possibility of plaster cracking. Also note how the studs are held in position by the joists.

"Sheathing paper should be selected for its warmth and durability. A waterproof paper is necessary in a damp climate. The ordinary red-rosin paper has proved to be satisfactory in the central states. The studdings af-

fect the plaster and the settlement of the building as much as the joists, and if not braced in a substantial manner, a jar or vibration will cause the plaster to loosen. When inspecting framing material in general, a person should bear in mind the properties of different woods grown in the United States. The order of the various woods arranged according to general strength and carrying capacity is as follows:

"Hard pine or southern yellow pine, beams; white oak, red oak, spruce, Oregon pine or fir, hemlock.

"There is no test on hemlock material for framing, but it is known to have only one-half the strength of southern yellow pine. Oak is seldom used for framing, as it is undesirable for many reasons, the main reason being that it bends very easily. Yellow pine, of all American woods, is considered the best obtainable for framing purposes, on account of its great carrying capacity. Knots are permissible in framing lumber, but large, loose knots, dry rot, sap and pitch pockets should be avoided.

"Now let us go up to the attic and examine the construction of the roof. One of the most important parts of a building is the roof and one of the greatest faults, in the ordinary dwelling, is the skinning of the roof by spacing the rafters too far apart, by not putting in sufficient collar beams and not nailing hip rafters and jack rafters well. To obtain a substantial roof and one that will bind the building together as it should, where the span of rafters is over 12 ft., they should be of 2 by 6-in. material, placed 16 in. from center to center.

"A 2 by 4-in. rafter can be used for spans shorter than this, but it should be placed 16 in. on centers; in fact, care should be taken that all rafters are placed 16 in. on center, especially if 1 by 4-in. material is used for roof

sheathing and shingles. A roof that is not solid and one that vibrates can never be relied upon wherever the rafters are spaced too far apart, even though they are braced in some places, as it allows a bending of roof boards, which of course displaces the shingles to a certain extent, and allows nails to pull themselves out eventually. The above defect should be avoided, and as a roof rafter is usually visible in the attic, it is an easy matter to determine whether you have a substantial roof or not.

"Dressed and matched roof sheathing is essential only where a plastered ceiling is required in the attic. Then it is necessary to place a waterproof paper over the roof boards, so that there will be no moisture or drippings to dampen the plaster. A spaced roof sheathing

is more desirable where an open attic is preferred, as it allows shingles to dry out below as well as on top after a rainstorm. If slate is used, care should be taken that the rafters are of sufficient strength to

carry the extra weight of this material. Solid roof sheathing should be used for this purpose and heavy slater's felt should be placed upon it. A rigid inspection should be given the slates. There are many poor slate roofs on account of inferior slate being used. Hence it is necessary to test the slate before accepting it. A good slate should be hard and tough and should give a sharp metallic ring when struck with the knuckles. Softness or liability to abrasion does not indicate inferior roofing slate. A common and easily applied test for roofing slate is to place one on edge to one-half its depth in water, and if in 12 hours the line of absorbed water approaches the top, it should be rejected. If it does not rise over $\frac{1}{8}$ in., the slate may be considered as practically nonabsorbent and safe.

The Joist Header of a Stairway Opening should be Double

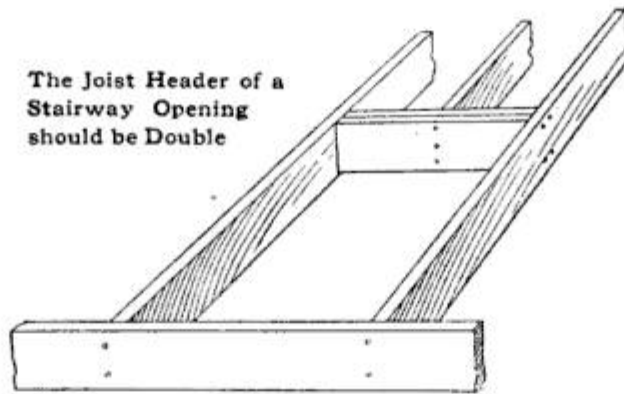

"Now let us go out and examine the porch framing. Our first step is to see that the roof girder is of the proper size and is put up substantially. All porch ceilings and soffits should be finished with ceiling about $\frac{5}{8}$ in. thick, driven up close and blind-nailed with the proper-size nails. The porch flooring must have at least a $\frac{1}{4}$ -in. drop to every foot in depth so that water will flow off easily. Also see that all the columns, newels, rails and balusters are well nailed and put up in a proper manner.

"The material for outside finish is the next important thing to consider. There are various kinds of wood used for this purpose, but the best obtainable at the present time is cypress, the so-called wood eternal. If this wood is properly painted and taken care of immediately after it has been nailed on the building, it will last indefinitely. When we come to examine cypress, we must see that it is free from wind shakes and heart shakes, these being two of the most important defects of this wood.

"While we are talking about outside finish, let us take the matter of window and door frames into consideration, as they are most usually made of the same class of lumber as the outside finish. A frame with outside casing made of clear cypress and the pulley stiles of clear yellow pine is the most desirable, as these two woods are noted for their strength and durability. Where casement windows are used in a bungalow, a watertight sill is essential. Let us examine the frames and see whether they are set correctly, and that the sill is of the proper pitch.

"Now let us go back inside and look over the interior trim, doors and windows. It is an easy matter to detect the poor quality of material used for the interior, as it is very hard to stain

or varnish oak or yellow pine so that the defects of the wood will not show. The majority of bungalows at the present time are trimmed in oak throughout and also, with few exceptions, we can find that the dining room, sitting room and, in fact, all rooms, with the exception of the kitchen, pantry, closets, bedrooms and attic, are trimmed in oak."

They found that the floor was of quartered white oak, being well laid. The elder Neidow tested the floors by jumping on them and trying to cause a vibration, which will show up weak spots of a floor, if there are any.

"Where there is a deflection, even of $\frac{1}{32}$ in., there is danger of plaster falling off the ceiling below," he explained.

"While the moldings and trim of a

room are the most important features, still nothing adds more beauty to a room than a well manufactured door," he continued. "The eye is attracted by the beautiful grain in the panels and it is a sort of aid to the surroundings. There are very few

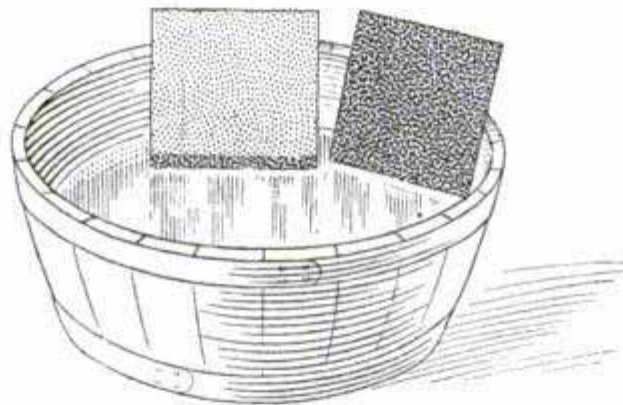

By Half Immersing Slates in a Tub of Water the Quality of the Slate may be Determined

homes where the important feature of doors and windows has not been neglected. The great majority of people are not in a position to acquire the necessary information, and it is not due entirely to lack of artistic temperament, but rather because the selection in many cases is left to others who are not familiar with the subject.

"The windows or sash should be made of clear white pine, at least $1\frac{3}{8}$ in. thick, being well manufactured and properly fitted with durable hardware. Where the sash are not divided into small lights, they should be glazed with double-strength glass.

"The cabinet work, that is, window seats, mantel shelves and buffets, should also be thoroughly examined. If the material used in construction of these

cabinets is not thoroughly kiln-dried, the panels will warp and the drawers will swell.

"Let us examine the plastering and lath. White pine is generally considered the best wood for lath, but spruce and hemlock are also used a great deal. If you should notice stains on the plaster, you can, in nine cases out of ten, lay the blame on the bark on the laths. All lath should be well seasoned, free from sap and dead knots. Three coats of plaster are necessary for a first-class job, and each coat should be permitted to dry before the next is applied; and under no circumstances should the finish coat be applied before the second is thoroughly dry.

"The fireplace should be selected not only for ornamentation, but also for heating and ventilation. For ventilating purposes alone, a fireplace is a valuable asset to any residence. One must be careful to see that the damper is properly located and of sufficient size to carry off all smoke and impurities. There should be a smoke pocket constructed just above the damper, to create extra draft. All linings should be examined, to see that the fireplace is perfectly fireproof. The hearth should be solidly constructed and an ash dump provided. When a fireplace is used for coal and wood, it should have a solid foundation and the floor joists and headers should be doubled and tripled around it.

"The plumbing and sewerage is one of the most important parts of a residence, as it has a great deal to do with the health of a tenant or owner of a dwelling. The arrangement of sewerage and reventing of same should be carefully studied so that there will be no chance of any sewer-gas leakages. Each bathtub, lavatory and toilet should have a separate revent so that

all gas will be carried to the roof at the highest point.

"On the whole," concluded Mr. Neidow, "this house is well built. I shouldn't be surprised to learn that it had been erected by a builder for his own home, and you would make no mistake in buying it.

"Now, let me make out for you when we are back home a simple table of the things to consider, in order to keep clear the points we have noted here," said Mr. Neidow, and later he gave his nephew the following memoranda:

- Footings: Kind of soil and supposed pressure; depth of footings necessary; width of footings necessary.
- Foundation Walls: Examination of material used in construction; how made; how soil will affect same; damp proofing.
- Construction of Outside and Inside Walls: Size of studs; kind of sheathing paper and siding and how laid; effect on plaster and settlement of building.
- Roof Construction: Loads to carry; kind of roof; spacing of rafters; testing of slate, etc.; effect of weather.
- General Framing: Kind of material; how framed; headers and trimmers; examinations of openings and corners.
- Porch Framing: Girders; joists and bearings.
- Material for Outside Finish: Kind of material; weathering properties; condition of material.
- Material for Inside Finish: Appearance; joints; how finished; flooring.
- Kind of Doors and How Hung: Make of doors; kinds of wood; size and thickness; door jambs; hanging.
- Kind of Windows and Sash and How Hung: Kind of wood; how made; thickness; glass and glazing; hanging.
- Kind of Frames: Material used; pocket room; pitch of sill; weathering properties; setting of frames.
- Lath: Kind; spacing of same; nails; corners and angles.
- Plaster: Material; application; finish.
- Chimneys and Flues: Framing around same; linings and size of them.
- Fireplace: Kind; throat, flues and arches; dampers, etc.
- Cabinets: Examination of doors and drawers; construction; thickness of shelving and other parts; tendency to warp.
- Ventilation: Location of windows and doors; kind of heat; height of ceiling; circulation of air.
- Light: Number of windows and location; position of building; kind of light and lighting fixtures.
- Heat: Kind; radiation and location of registers or radiators; kind of radiators.
- Electrical Wiring: Kind permitted; conduit; location of outlets and switches; kind of wiring and gauge of wire.
- Gas: Testing of pipe and examination of fixtures; location of outlets.
- Plumbing: Reventing system; location of bathroom and fixtures; sewerage and disposal of same; water supply and fixtures.
- Interior Decorations: Wall paper; staining; color schemes.
- Painting: Kind; color.



GERMAN "AIR-YACHT" CLUB PENNANTS

Every province and large city in Germany has one or more societies devoted to aerial navigation with the



lighter-than-air types of aerial craft. Each of these societies has its special badge or pennant, which is worn by the members, appears on its stationery and official communications, and is flown from the balloons and dirigibles. In this, the aeronautical clubs, composed of men who sail the air, follow the practice of yacht clubs. Likewise, in both the aerial and the water clubs are many members who take interest without active participation, and these are spoken of as members of the "rocking-chair fleet."



CHINESE REPUBLIC ENDS OLDEST NEWSPAPER

The suppression of the Chinese newspaper "King-Bao," the title page of which was reproduced in this magazine a year or so ago, by Yuan Schi Kai, president of the Chinese Republic, ends the career of the oldest newspaper in the world. For approximately 1,500 years



it has published the more important news of China, and lately also of foreign countries. The paper was started in the year 400 A. D., and issued regularly until recently. The first edition was printed on 10 sheets of yellow silk, neatly tied together, and was sent to all the high officials of the empire.

OPERATING HOTEL WITH TELAUTOGRAPH

Instead of telephoning to various departments in a great hotel now being erected in Washington, all orders will be sent around by the telautograph, a machine which writes out at one station what an operator writes on a pad at another station. Ninety instruments will be used at the start, with the idea of eventually extending the service to every guest room. Every girl at the telephone switchboard will have a transmitter at her right hand. As orders come from guests, they will be written on the transmitter, near which will be a switch enabling the operator to send the message to any one of 14 places in the hotel or to several of them at the same time. Telautographs will be installed in the bar, the baggage room, the kitchen, the dining room, the ball rooms, at the desk of the head bell boy, at the clerk's desk, at the cashier's desk, in the chief porter's office and in the writing room.

All orders involving paid service will be transmitted to the cashier's desk, where, as in other hotels using the system, every chargeable item will be recorded so that it cannot escape the notice of the cashier or bookkeeper.

USING PRESSED STEEL IN AUTO ENGINES

Pressed steel as a substitute for heavier cast or forged parts on motor cars has been used very effectively, but that pressed-steel connecting rods could give satisfactory service would, in view of their extreme lightness as compared with the drop-forged variety, seem doubtful. Yet in England pressed-steel connecting rods are used in a number of the best makes of motorcycle motors, and the results obtained are said to be even more satisfactory than with the heavier rods, for while they are sufficiently stiff to withstand all strain, the lightness makes for the production of a smooth-running motor and renders the bearing wear very slight.

*Scientific American
10-1-1912*



A Wagon Brake

While traveling through the mountains with a horse and carriage, I found the brake shown in the illustration exceedingly useful. It is constructed as follows: The base is made of an iron wagon tire, 28 in. long and 3½ in. wide, with a slight curve on the front so that it will not catch in stones or other obstacles which are firmly set in the roadbed. The sides are made of 1-in. square hickory sticks bolted to the base with three bolts for each guide, the rear ends being curved to allow the wheel to enter easily, and a hole is punched in the front for a rope or chain, the other end of which

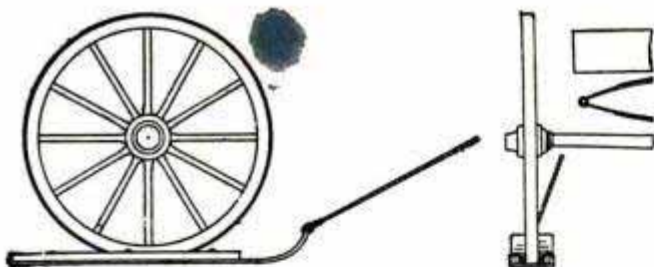

The Wheel is Easily Run on the Brake Which Drags on the Ground

is attached to any stationary part of the wagon. If the wheel is allowed to rest in the center of the brake it will effectively hold the wagon on a steep grade.—Contributed by W. C. Thompson, Millington, N. J.

To Keep a Reserve Supply of Gasoline in a Tank

Provide an extra hole in the bottom of the tank and insert a piece of pipe A. The pipe should extend 2 or 3 in. above the bottom of the tank or sufficient to make the desired amount of reserve supply. The connecting pipe to the engine is attached to this with

a globe valve B. The gasoline is drawn from this connection first and after the gasoline has reached the level of the pipe A there will be sufficient gas-

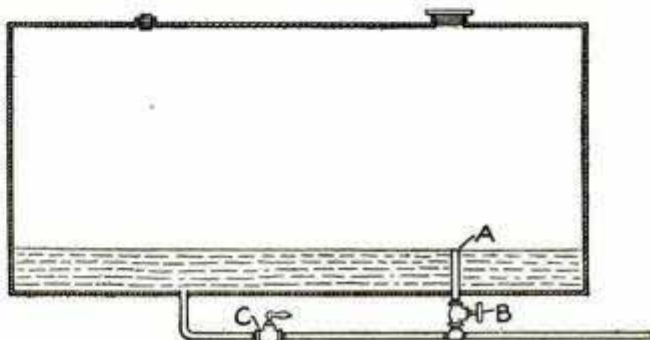

The Pipe Extending into the Tank Provides a Reserve Supply of Gasoline for Emergency Use

oline left in the bottom to run a car several miles, or to the nearest place where a supply can be obtained. The reserve supply is drawn through the valve C.—Contributed by J. H. Stearns, Dayton, O.

To Fasten Covers on Shipping Boxes

This device for fastening the cover of a shipping box is intended to make it easier to open the box than if it were nailed or screwed in place, besides which the box will be undamaged and can be used over and over again.

The device consists of a U-shaped

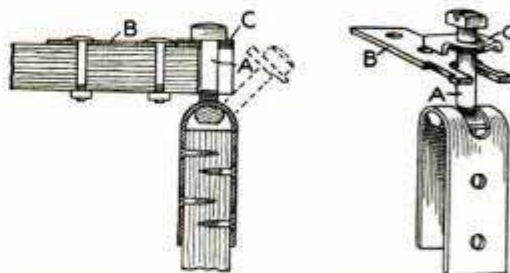

Boxes Equipped with These Fasteners can be Used for Shipping Goods Over and Over Again

iron band, fastened to the sides of the box, having at the upper curved end a slot wide enough to admit the T-

shaped head of the bolt A, which is a trifle longer than the thickness of the cover. On top of the latter is bolted a piece of band iron, B, slotted at the front end to admit the screw bolt, A, and with cut-outs on the side edges in which the turned-down edges of the plate C become engaged when the screw-bolt A is screwed down, thus locking the device.

In order to prevent the opening of the box in transit, a piece of wire may be inserted through a hole in the head of the screw A and another in the locking plate B, and the two ends sealed with a lead seal similar to freight-car door seals.

New Form of Dry Battery for Long Life

Procure a glass jar, 3 in. in diameter and 6 in. high. Place a zinc cylinder, A, $2\frac{1}{8}$ in. in diameter and $5\frac{1}{8}$ in.

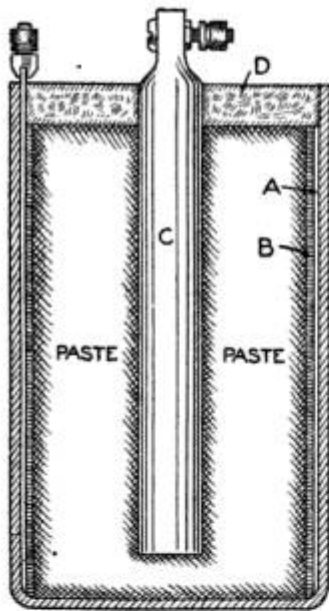

long, in the jar. Line this on the inside with thick blotting paper, B, and set a carbon, C, in the center — a carbon from a discarded dry cell will do. Make a paste as follows: Mix three parts water and one part muriatic acid by adding the acid to the water. Next thoroughly mix

four parts of crushed charcoal, two parts flour, and one part plaster of Paris, all parts being measured by volume, not by weight. Then, thoroughly mix this powder with the liquid and fill the jar up even with the top of the zinc. Finish by filling the jar with sealing wax, D, and the cell will be ready for use two hours after completed.

The ordinary dry cell would last much longer but for the evaporation of the acid after it eats through the

zinc. The battery described will give current until all the zinc is consumed. —Contributed by G. Henry Jones, Auburn, Ala.

Applying Gravel to Roads with a Manure Spreader

In a locality where a large mileage of gravel and rock roads had been constructed, farmers discovered a method of laying the material uniformly and with a minimum of afterwork.

Several of the farmers owned manure spreaders of the kind that have low-hanging, easily detached beaters, and automatic tail gates. They removed the beaters, took the loads of the material they could haul, drove out upon the road to be treated, threw the machines in gear at a speed that was required to make the proper application of the material, and it was spread in a uniform layer on the roadbed.

Some of the men with an implicit faith in their machines did not even go to the trouble of removing the beaters. — Contributed by Louis Schneider, Clinton, Mo.

A Countersink

Carpenters and cabinetmakers have considerable trouble to countersink a hole in wood for the head of a screw, as the grain of the wood is liable to run in any direction and throw the countersink off center. The illustration shows a tool that has proved invaluable in making a true and clean countersunk hole.

The tool can be made of tool steel, if desired, but the one I have is turned from a piece of machine steel and case-hardened. The end A is turned to fit

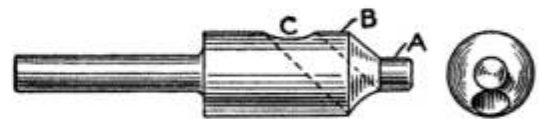

The Shape of the Cutter and the Manner of Relieving the Chips Make the Countersink Cut Straight

the hole in the wood and the part B is the size of the screw head. A hole, C, is drilled diagonally through the metal, the diameter being the distance

from the shoulder A to the outside of B on the tapering surface. The tool will cut whichever way it is turned.—Contributed by C. Cain, College Point, Long Island.

A Brush Bridle

Many devices have been made to take the place of the old-time twine bridle on paint brushes. Some of these devices have been patented and others have been given free to the public. Here is an idea that, as far as I know, is new in making a bridle of thin metal, such as tin or brass, with the edges filed off slightly to prevent them from cutting the bristles. The shape of the piece of metal for the bridle is shown in the sketch. The size can only be determined by the size of the brush on which it is to be used.

The metal is placed around the part of the bristles next to the stock, and is fastened by inserting the tongue A

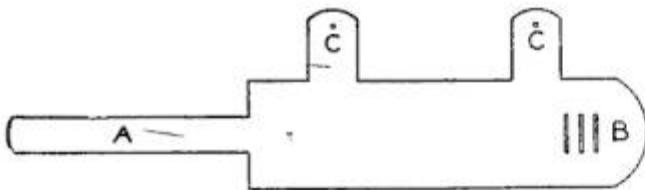

The Shape of the Sheet Metal as It is Cut to Form a Bridle for a Brush

into and through the slits at the end B. The projections CC are tacked to the top of the stock in the place where twine bridling is usually fastened.—Contributed by A. A. Kelley, Malvern, Pennsylvania.

A Gasoline-Engine Valve Lifter of Large Capacity

The valve lifter shown in the sketch was especially designed for use on a large gasoline engine used on a tractor. The tool is about 9 in. long, the rod is $\frac{3}{8}$ in. in diameter and 7 in. long with a thread cut for 4 in. of its length, the remaining unthreaded portion being formed into a crank. The loose nut fits into a socket on the inside of one of the arms, which prevents it from turning with the crank. The

two nuts which are turned up against each other, are locked on the rod so that they turn with it. They also form

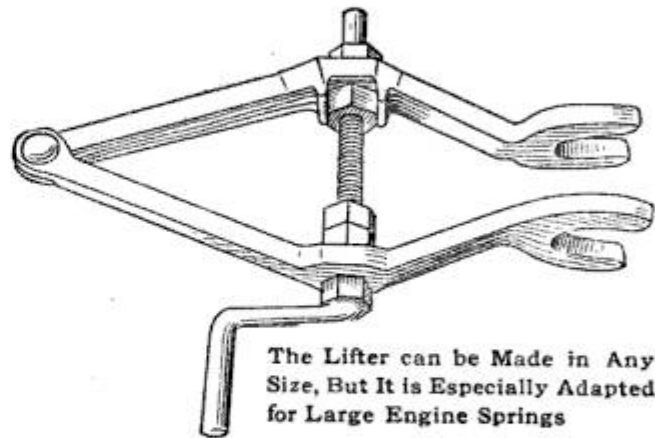

The Lifter can be Made in Any Size, But It is Especially Adapted for Large Engine Springs

a shoulder which faces against the lower arm when the tool is opened. The loose nut forms the shoulder against the upper arm.—Contributed by A. B. Webb, Richardton, N. D.

To Make Cement Tests

When the winter weather sets in, a large number of mechanics start experimenting with anti-freezing compounds for use with cement to prevent concrete from freezing before it sets. To obtain accurate tests a uniform mold must be used.

The illustration shows a form for making briquettes for testing. The mold is made from fairly heavy sheet metal, preferably brass, and is bent into the shape shown in the sketch. A piece of metal is soldered on the out-

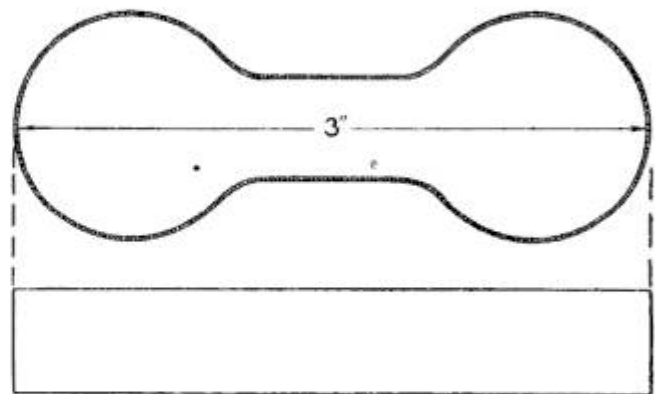

The Shape of This Mold Gives $\frac{1}{4}$ Sq. In. of Cement for Making a Test

side of the joint so that the form will be even and smooth on the inside. A piece of glass is used for the bottom, the form simply resting upon it and

a spatula is used to smooth off the top. The mold is 3 in. long with the narrow part $\frac{1}{2}$ in. square. This gives $\frac{1}{2}$ sq. in. to test and two ends on which to apply weight. Tensile-strength tests per square inch are as follows:

Time of Test	NATURAL CEMENT		PORTLAND CEMENT	
	Neat	Cement, 1 Part Sand, 2 Parts	Neat	Cement, 1 Part Sand, 3 Parts
1 day	65 lb.		150 lb.	
7 days	120 lb.	50 lb.	450 lb.	140 lb.
28 days		100 lb.	540 lb.	220 lb.

When making briquettes for testing purposes, a crushed quartz or Ottawa sand should be used which will pass a No. 20 sieve but be held on a No. 30.

All neat briquettes should be immersed in water as soon as set, and those made of mortar should be im-

mersed in water 24 hours after being made. All briquettes are kept in water until ready to be broken and to undergo the above tests.

The initial set of first-class Portland cement should not take place in less than 30 minutes, and the final set in not less than 3 nor more than 8 hours. The initial set of natural cement should not take place in less than 10 minutes.

This information can be used for a base from which to test with various chemicals, etc., always making a briquette of clear cement and sand, with which to compare the tests after submitting them to the same weather conditions.

Packing Flour in Sacks

Flour may be easily packed in sacks, ranging in size from 6-lb. to 48-lb. capacity, with the use of a packer such as shown in the illustration, which is an invention of a correspondent of the American Miller. The packer consists of a tube and a double spiral conveyor with a flanged top. The flour will be packed before it leaves the tube

at the bottom. The operation of the device is obvious.

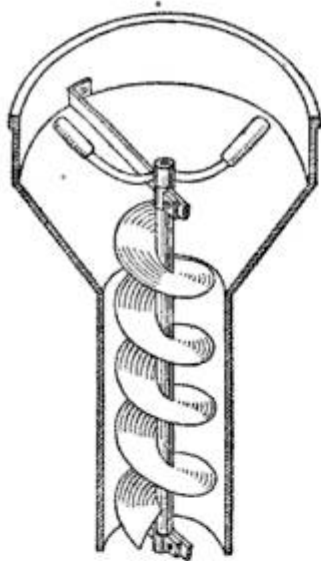

Purifying Air in Rooms

To purify the air in offices or sick-rooms, use the following method: Soak a few pieces of ordinary brown wrapping paper in a solution of saltpeter and then allow them to dry. When desired for use, lay a handful of flowers of lavender on a tin pan with a few pieces of the paper and light them. The aroma is refreshing and agreeable, and

drives away insects. Another good way is to put a few drops of the oil of lavender into a glass of very hot water. This purifies the air at once and rids the room of flies and insects. Rooms treated in this manner are kept free from these pests for several days.

A Sandpaper Stick

A convenient way to use sandpaper on model work, patterns, etc., is to have a sandpaper stick. A good stick may be made of soft pine of convenient size, or several can be made of different sizes. The stick is cut out as shown in the illustration, with a tapering grip or handle at one end, which has a saw cut on one side and two corners rounding. A piece of sandpaper wide enough to extend around the stick and allowing sufficient end for fastening it in the slot, is folded and slipped on the end of the stick.

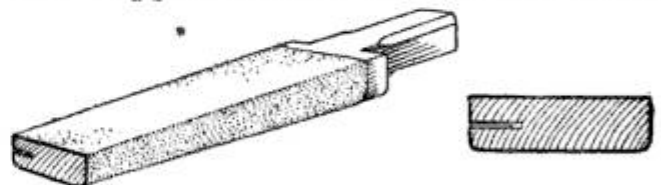

The Sandpaper is Wrapped around the Stick and Kept in Place by the Taper and Slot

The paper is securely held by the taper fit. The stick has one flat side, two flat edges, two sharp corners and two round corners, which may be of

different radii, making a very handy combination. Where considerable work is to be done, a stick for each grade of paper is most convenient.

Bands for Pipe Covering

While applying asbestos covering on heating pipe, the workmen ran short of holding bands and instead of taking time to procure them, the few necessary to complete the job were made up as follows: One end of a strip of tin, cut as wide as the desired band, was split in the center as shown by the dotted line in Fig. 1, and the two parts bent outward and hammered down flat. After placing the band around the covering, the opposite end was laid across the two parts, as shown in Fig. 2, and their ends turned over

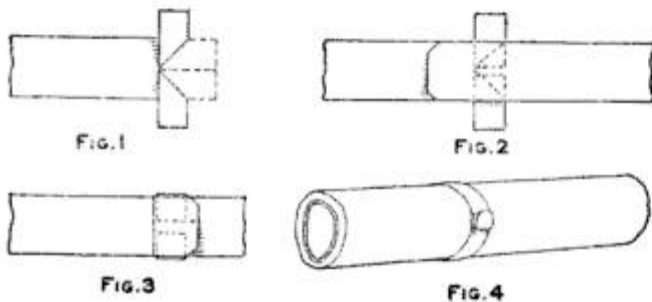

One End of a Tin Strip is Cut and Formed to Hold the Opposite End When Placed around the Covering

as shown by the dotted lines in Fig. 3. Then the end of the strip was turned back after drawing the band up tightly. The substitute band, in place, is shown in Fig. 4. This band, while only a substitute, will hold the covering as firmly as the ordinary band.—Contributed by Geo. Gluck, Pittsburgh, Pa.

Filling Steam Lubricators When the Oil is Cold

When both the lubricator and the oil have been allowed to cool, it is rather hard to fill the reservoir. A good way to do this is to open the valve at the bottom, allowing the water to run out, and at the same time begin pouring in the oil. The water running out will draw the oil into the reservoir.—Contributed by Kenneth Moore, Byron, Ill.

Spraying Insulation Liquids into Armature Windings

The sprayer is made of a piece of $\frac{1}{4}$ -in. brass pipe, 21 in. long, bent at right angles at a point 9 in. from the threaded end.

In making the bend the metal will flatten on the upper side, as at A, part of which is filed away to make a narrow opening the width of the pipe.

Thoroughly blow out any dust from the windings of the armature with compressed air, then screw the short threaded end into the end of the air hose. Turn on the air and place the long end in a vessel of air-drying insulating paint—a quart bottle, or anything easily held in the hand, will do to hold the paint. The result is a spray of paint driven to every part, thoroughly insulating the creases and crevices that cannot be reached with a brush. The paint, as it comes prepared, is usually too thick and must be thinned with gasoline. A little experimenting will enable one to prepare it so that the sprayer will drive the liquid easily. After spraying the windings, allow the armature to dry for over a half hour before using it.—Contributed by L. E. Jay, Elyria, O.

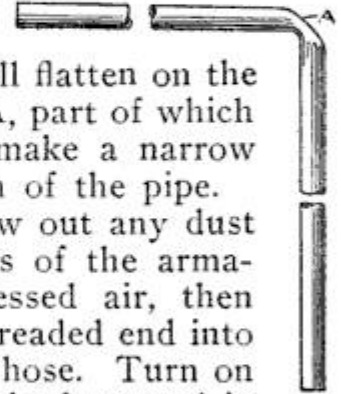

Cooling a Hot Bearing

A temporary remedy for a hot bearing, where the machinery cannot be stopped for the time, is to cool it in the manner shown in the sketch. A

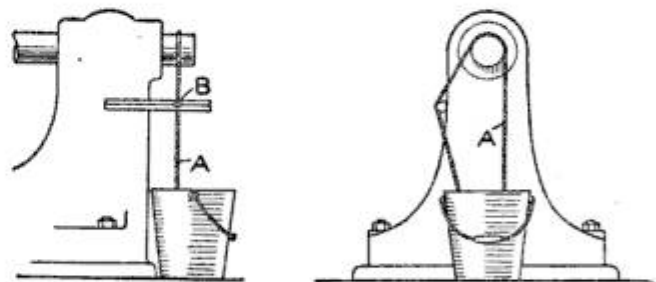

The Belt Running in the Cold Water Carries a Portion of It Up on the Revolving Shaft

small rope or leather belt, A, is placed over the end of the shaft or where it is near the heated bearing and its lower

end hung in a pail of cold water. A stick with a notch, B, for the belt is attached to the machinery to keep the belt traveling near the bearing on the shaft. The cooling water will be carried up on the shaft by the belt. A bearing can be kept sufficiently cool by this method until the machine can be stopped for more permanent fixing.—Contributed by P. C. Fish, Kansas City, Mo.

Oil-Can Holder for an Automobile

This handy and simple little device to keep the oil can of an automobile from moving about was designed by

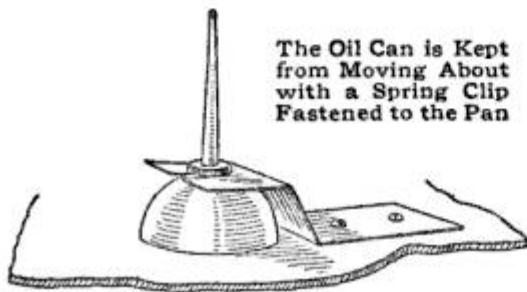

The Oil Can is Kept from Moving About with a Spring Clip Fastened to the Pan

a correspondent of the Automobile Dealer and Repairer. It consists of a brass clip fastened to the pan beside the engine, on the steering side, by means of two small bolts and nuts, and so shaped that the spring in the metal will hold the can securely.

A Tube-Cutting Tool

Having about 8,000 No. 20 gauge brass tubes, 1 in. in diameter, to cut exactly 8 in. long, I designed the following tool which was used very successfully in a hand milling machine. A piece of tool steel, A, was turned a running fit for the inside of the tube to

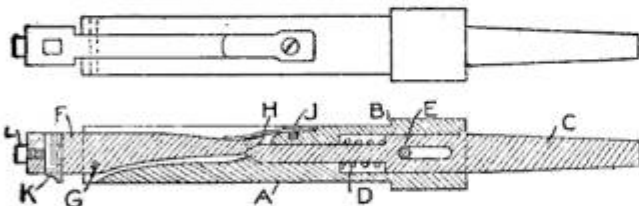

The Tube to be Cut is Pushed on the Tool, Which Cuts Off the Metal Automatically

be cut as far as the shoulder B. At this point the diameter was increased $\frac{1}{4}$ in. This was drilled to receive the plunger C, which was fitted to the

taper in the milling-machine head. A compression spring, D, throws the sleeve A forward against the pin E, which is a driven fit in the plunger C. A tool holder, F, pivoted on the pin G, is kept tightly against the end of the part C with a flat spring, H, fastened to the part A with a screw, J. The cutting tool K is made of high-speed tool steel and is fastened in the holder with the setscrew L.

The distance from the shoulder B to the inside of the tool K must necessarily be the required length of the tube to be cut. In action, the tool is placed in the head of the milling machine which is set in motion. The tube is held in the hands and slipped on the part A until it strikes the shoulder B. A little pressure applied causes the cutter to be forced outward into the metal. When the metal is cut through, the springs D and H return the parts to a position ready for the next cut.—Contributed by W. B. Studwick, Minneapolis, Minn.

A Knife for Extracting Slivers

To extract a sliver that is imbedded deeply in the flesh prepare a knife blade as follows: Take the penknife to be used for the purpose and place the blade on an oilstone and draw it from the heel to the point, raising the handle as the blade is moved over the stone. This rolling motion will produce a hooked feather edge near the point, which, when caught against the sliver, will draw it out while the ordinary edge would slip off.—Contributed by M. E. Tyler, Batavia, N. Y.

Line for Drawing Electric Wires in Conduits

A piece of chain such as used on the "pull" electric-light sockets, about 3 ft. long and attached to the end of an electrician's "fish line," will prove a great help when fishing through very crooked conduits, fixtures, etc. The nature of the chain allows it to lead around bends very easily and its weight will keep the line taut.

A Private Ice House

By FRANK L. RUSSELL

The suburbanite or the country dweller who has no way of securing ice during the summer months finds the use of an ice house indispensable to keep dairy products, fruits, etc. A house from 10 by 12 to 12 by 14 ft. and 8 or 10 ft. high will cost very little to make, and the owner will be well repaid in the results secured by having ice for use at all times. Such a house can be filled during the winter at a reasonable price, and the ice stored will be sufficient to take care of all the refrigeration for any ordinary household during the summer season.

The ice must be well protected from heat, air and moisture, and in order to do this the walls must be well insulated to prevent heat entering at the sides, the space above the ice well ventilated to remove the moisture from the air, and the drainage perfect to remove any dampness from beneath. Houses may be built of stone, brick, concrete or wood, the latter being preferable, as dead air spaces can be formed, which are the best non-conductors of heat and cold, thus lessening the thickness of the wall and making more space available for ice storage. The ice that is best to store is that which is frozen solidly, as it keeps much better than packed-snow ice or honeycomb ice.

It will be seen that the method of sill construction is quite materially changed from the ordinary, for the purpose of making two air spaces, beginning on top of the plate resting on the concrete or stone foundation, whichever it may be, and extending to the plate on top of the studs, forming a double space without any chance of circulation. The studs, instead of standing with their edges out and in, are placed flatways with the side of the building and set staggering to make the triple wall. The boards forming these walls may be ordinary undressed lumber, but it is best to use matched material, and for this reason

the accompanying material list will name, in all instances, the best for this building. In either case, the boards should be covered on one side with a good grade of tar paper, and the paper should be tacked to the studs on the inner side of the outside studs before the boards are nailed in place. The outside sheathing is put on, then a layer of paper before nailing on the siding boards. The paper is put on the inner surfaces of the inside row of studs and the wall boards are then nailed in place. Care taken in making the three walls as nearly air-tight as possible will prevent great loss of ice in the hot season of the year.

The drawings show the construction of a house having a cold-storage room beneath the ice room, and a small room at the end for a stairway to enter the cold-storage room, also an ice-washing sink with plenty of extra room for a refrigerator or dairy utensils, as the case may be. If the builder does not care to have a cold-storage room or the small room at the end, the house need not be any larger than the size of the ice-storage room, and the roof may be put on as in making an ordinary house, with the exception of the crosspieces which carry the chain hoist, and the ventilator at the center of the ridge. Of course, double doors must be hinged at the upper part of one end or in the gable through which the ice cakes are taken

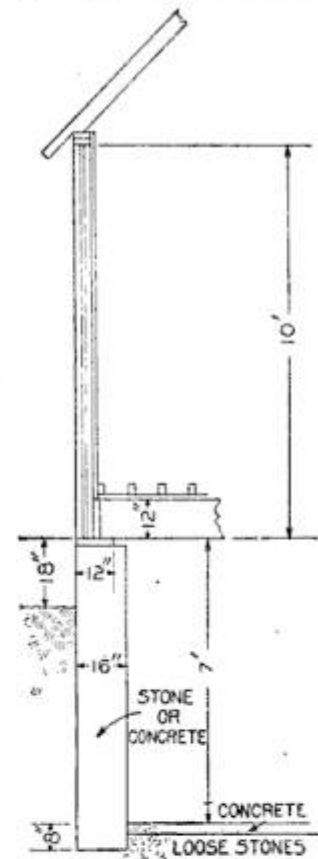

Section Showing Detail of Wall Construction

the accompanying material list will name, in all instances, the best for this building. In either case, the boards should be covered on one side with a good grade of tar paper, and the paper should be tacked to the studs on the inner side of the outside studs before the boards are nailed in place. The outside sheathing is put on, then a layer of paper before nailing on the siding boards. The paper is put on the inner surfaces of the inside row of studs and the wall boards are then nailed in place. Care taken in making the three walls as nearly air-tight as possible will prevent great loss of ice in the hot season of the year.

by the traveling chain hoist. The roof is extended outside of the first pair of rafters to form a covering and a support for the end of the track for the hoist, which must extend outside of the house at least 4 ft.

The excavation for the storage room is 6 ft. 2 in. in depth and 12 by 14 ft. outside measurements. The floor of this room is made of concrete, laid over a bed of loose stones. If the bed of loose stones is made deep enough and a drain tile laid in them and connected to an outside drain, so much the better, as this will provide a way for drainage for the whole structure, and make it completely sanitary.

When a cold-storage room is built beneath the ice room, the floor of the latter must be so constructed that it will carry away any dripping water from the ice above. One of the sketches shows the construction of this floor. After laying the joists in the usual manner, they are further built up of 2 by 4-in. pieces so as to make the floor slope from both ends toward the center of the room. The floors should be made up of slats, about 1 in. wide and $\frac{7}{8}$ in. thick, and in nailing them in place a 1-in. space should be allowed between the pieces. These are then covered with sheet zinc and the joints soldered. The joints should all be turned and a seam made as in laying a tin roof. At the center, which will be the lowest point in the floor, the zinc sheets are joined to the sides

of a zinc trough sloping to one side of the building. At this point it is connected to a drain pipe, having a trap to prevent any air from entering. The lower end of the pipe is run through the concrete floor of the cold-storage room and into the loose stones, where the dripping water is carried away into the drain tile or taken up by the earth. Care should be taken to have the joints in the zinc floor, trough and drain pipe soldered tightly to make it air and water-tight. The ice should not be laid upon the zinc floor, as it is apt to tear the metal, and as a protection, 2 by 4-in. pieces are laid on the zinc, as shown, running from the ends to the center, or drain trough. The pieces should not be nailed through the zinc floor, but are held upright by crosspieces placed between them near their ends. The weight of the stored ice makes it necessary to place a sill through the center beneath the joists to prevent them from sagging. The sill should be supported at the ends by setting them in the wall and in the center by a post which rests upon a good-sized stone or concrete base placed in the earth beneath the concrete floor.

The cold-storage room should have two openings, one on each side, through the foundation walls above the surface of the earth, for windows, which are fitted with frames and double sash. This construction may be better understood by the detail of the corner of the building. The entrance door

List of Material

FLOOR JOISTS AND SUPPORTS

- 1 sill, 8 by 8 in., 14 ft. long.
- 1 post, 6 by 6 in., 7 ft. long.
- 27 joists, 2 by 12 in., 12 ft. long.

STUDS

- 141 studs, 2 by 4 in., 10 ft. long.
- 34 studs, 2 by 4 in., 16 ft. long.

MATCHED WALL BOARDS

2,500 sq. ft.

ROOFING

Prepared roofing sufficient to cover 520 sq. ft.

SIDING

Enough to cover 720 sq. ft.

TAR PAPER

Sufficient to cover 1,600 sq. ft.

ZINC

Sufficient sheet zinc to cover 168 sq. ft.

FINISHING BOARDS

- 12 boards, $\frac{3}{4}$ by 6 in., 10 ft. long, S-4-S.
- 8 boards, $\frac{3}{4}$ by 12 in., 12 ft. long, S-4-S.
- 2 boards, $\frac{3}{4}$ by 12 in., 14 ft. long, S-4-S.
- 12 boards, $\frac{3}{4}$ by 4 in., 12 ft. long, S-4-S.
- 2 boards, $\frac{3}{4}$ by 4 in., 14 ft. long, S-4-S.

WINDOWS AND DOORS

- 2 window frames and sash to fit.
- 1 door frame and door to fit.

FLOOR STRIPS

- 72 strips, $\frac{3}{8}$ by 1 in., 14 ft. long.

ICE HOIST

- 1 chain hoist and traveler or bay-fork traveler.

FOUNDATION-WALL MATERIAL

- 100 bags of cement.
- 10 cu. yd. of sand.
- 20 cu. yd. of aggregate.
- The aggregate should have all the dust screened out and no stones larger than 1 in.

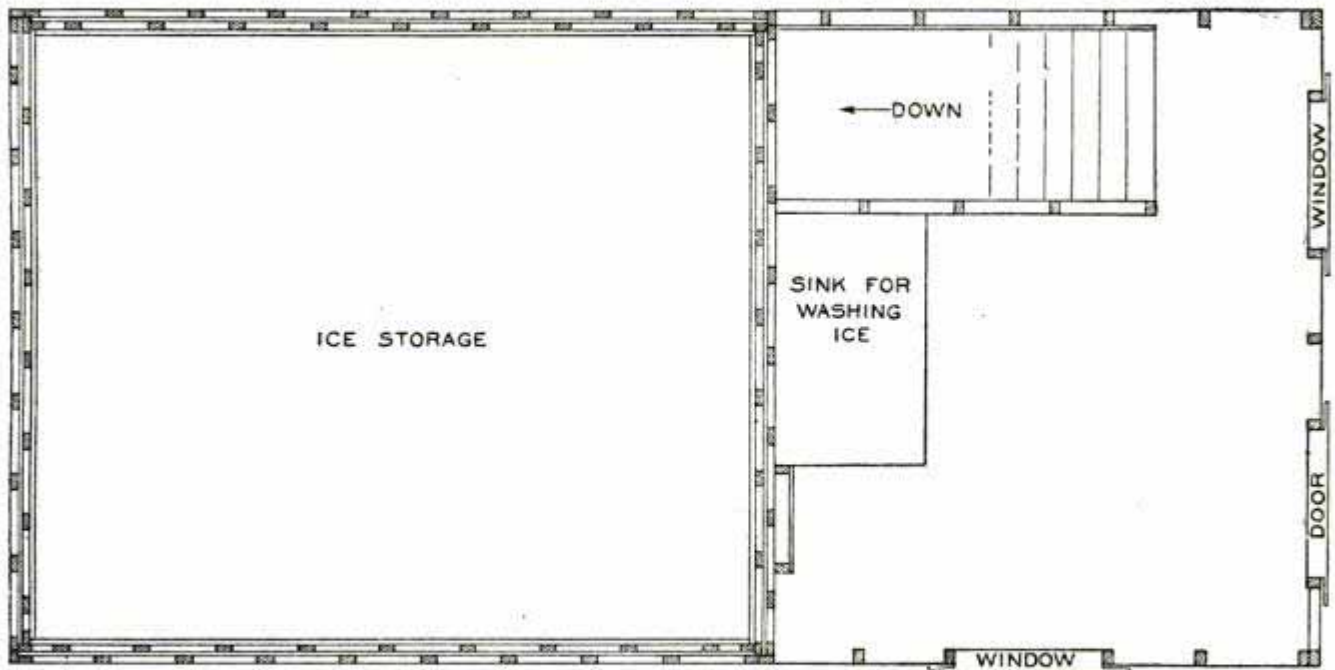

Floor Plan of a Building in Which a Small Entrance Room is Provided for a Stairway, Washing Sink and Refrigerator or Dairy Utensils, in Connection with the Ice-Storage Room

through the foundation wall, at the bottom of the stairway, should be made double and fit closely in its frame. If there is not room enough at the bottom of the stairway for a landing before entering the storage room, a latch can be made so that the person entering can open the door before the bottom of

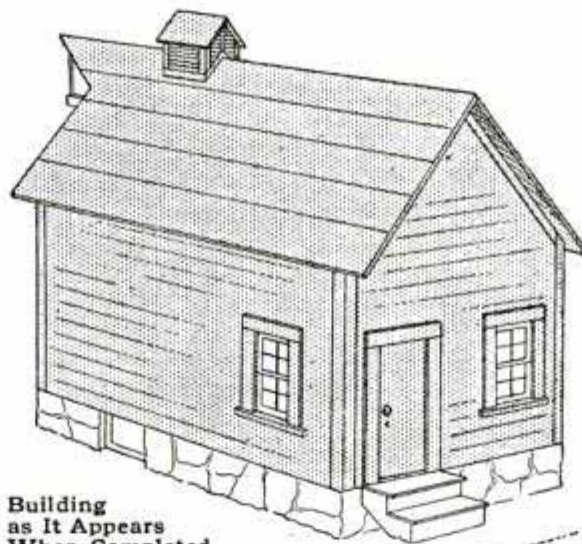

Building as It Appears When Completed

to the top of the door within easy reach of a person standing two or three steps above the bottom.

The small room may be arranged to suit the builder. The stairway is so placed that a window lights it to the bottom. An ice-washing sink is placed in the center and against the partition between the rooms. The sink is simply a table, about 3 ft. high, 4½ ft. long and 3 ft. wide. The sides of the table are built up about 4 in. high, and the inclosure lined with heavy zinc, soldered at the joints, and a drain connected so that

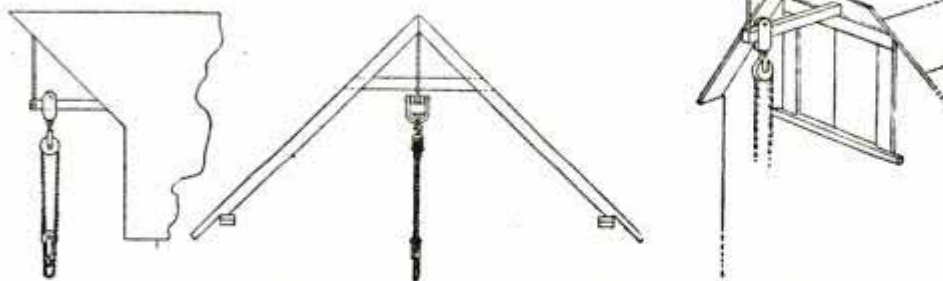

Detail of the Hoist and Traveler on the Track, Also the End of the Building Where It Projects over the Track End

the stair is reached. This can be accomplished by levers, or by means of a chain-actuated latch with a handle or knob fastened



Each Joist is Built up So That the Floor Slopes toward the Center of the Room Where a Drain is Provided to Take Care of the Drippings

the whole table forms a sink in which the ice cakes taken from the storage can be washed before taking them to the refrigerator or elsewhere for use in other ways. The drain should be

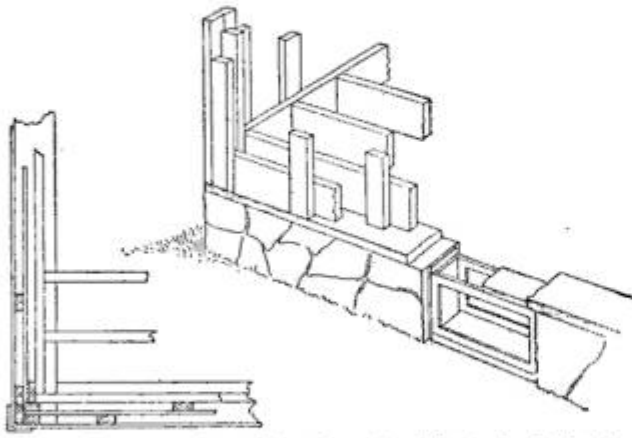

Corner Construction Showing the Method of Setting the Studs Flatways to Form a Triple Wall

provided with a fine screen covering, to prevent stoppage from sawdust particles.

A ladder is provided on both sides of the partition, which is only built up to the plate at the lower end of the rafters, for use in entering the ice-storage room. The ice is taken from the room with the chain hoist in the same manner as when storing it. The cakes are hoisted above the partition and then the traveler on the track is pushed along over the sink where the ice is lowered and washed in the sink.

In constructing this house, it must be taken into consideration that the cold-storage room will cause the ice to melt much quicker and, therefore, its size is such as to provide for this extra refrigeration; but this is no waste, for it must be borne in mind that this refrigeration keeps edibles at a lower

temperature and less ice is required in the kitchen refrigerator for the things being made ready to serve. Such a room will keep a quarter of a beef or a whole pig, and all kinds of perishable articles can be kept through summer and winter. The chilling of the room takes place automatically.

When placing the cakes of ice in the storage room, be sure to have them cut squarely so that they will fit closely together. They are placed on the 2 by 4-in. pieces of the floor, without any sawdust or insulation of any kind, the sides being the only place where the sawdust is used, when a cold-storage room is below. If there is no cold-storage room below, then place a layer of sawdust on the bottom and build up the ice cakes upon it. A small space—about 4 in.—is left at the sides and ends of the room, and this is kept filled with sawdust tightly packed as the layers of ice blocks are built up within the storage room. When the room is filled with ice, the top is covered with sawdust at least 1 ft. thick, and it is also well to place some hay loosely on top of the sawdust. This latter will take care of any moisture that rises from the ice, and is, in its turn, dried out by the air currents which pass out through the ventilator at the ridge of the roof.

Before filling the room each year, any left-over ice should be taken out, the room thoroughly aired and cleaned, and the sawdust laid out on a cloth or boards to be dried out and aired. If these simple rules are observed, the house will be kept in good condition and will last for years.

Antidotes for Poisons

The following is a good and effective set of antidotes to use when a person is accidentally poisoned. The first thing to do is, of course, to send for a physician, but while waiting for him induce vomiting by tickling the throat with the finger.

For specific poisons the following are recommended as best first aids, and as a general rule it should be remem-

bered that acids are antidotes for alkalis, and vice versa. For muriatic, oxalic, acetic, sulphuric and nitric acids give drinks of soapsuds, magnesia solutions, or lime water. For prussic acid give ammonia in water and dash cold water in the face. For carbolic acid give whiskey or alcohol freely, flour and water, mucilage, Epsom or Glauber's salts in water. For potash,

lye, hartshorn or ammonia give vinegar or lemon juice in water. For arsenic, rat poison or Paris green give milk, raw eggs, sweet oil, lime water or flour and water. For bug poisons, lead, saltpeter, corrosive sublimate, sugar of lead or blue vitriol give whites of eggs or milk in very large doses. For chloroform, chloral or ether give dashes of cold water on the head and chest, and produce artificial respiration. For carbonate of soda, copperas or cobalt give soapsuds and mucilaginous drinks. For iodine, antimony or tartar emetic give starch and water, astringent infusions or strong tea. For mercury and its salts give drinks of mucilage, milk or whites of eggs. For opium, morphine, laudanum, paregoric, soothing powders or syrups give strong coffee, hot baths and keep the patient awake and moving at any cost.—Contributed by Loren Ward, Des Moines, Iowa.

A Line Spreader

A convenient way to attach a line spreader to a hame, for shifting from field work to work requiring a wider spread of the horses, is shown in the sketch. Procure a strap 1 in. wide and 15 in. long and attach a ring to one end and a snap at the other. Run the strap through the top loop in the upper end of the hame. The width of the spread can be changed by attaching the snap in some of the other hame loops.—Contributed by G. H. Holter, Jasper, Minn.

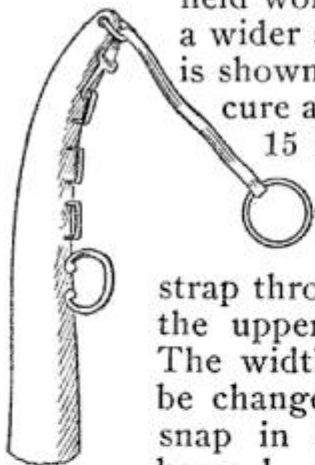

Homemade Registering Gauge for Liquids

This gauge, which is described by a correspondent of a French magazine, possesses the advantage of being simple, strong, easily made, much cheaper than manufactured gauges and giving as exact results.

The collecting tank for the liquid is

provided at the bottom with a U-tube, one branch of which is rather wide and this is partly filled with mercury. Each time any additional fluid is

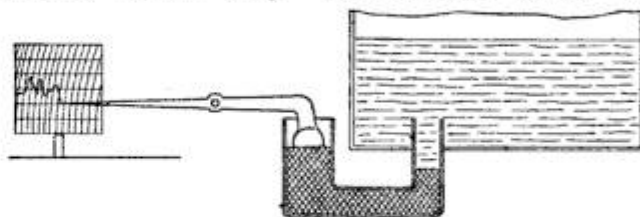

The Weight of the Fluid Causes the Arm to Move in Relation to Its Depth

poured into the tank, the mercury column in the outer branch of the tube rises, but of course less than the increased height of the liquid in the tank; the relation between these heights being inversely that of the specific gravities of the mercury and the fluid. Now by placing a float in the mercury which acts upon a lever, fulcrumed at such a point that its two ends are in length proportional to the specific gravities of mercury and the liquid to be measured, the height of the liquid within the tank is recorded by the pen point at the outer end of the longer arm on the drum, which is rotated by clockwork, and thus the amount of liquid is easily computed. The paper on which the record is made must be calibrated to zero when the tank is empty.

To Hold the Ends of Boards on a Small Strip

On some work it is very difficult to nail the ends of boards securely on a small or narrow strip, as the nail is liable to split the wood. If an ordinary nail is equipped with a small piece of metal, as shown in A of the

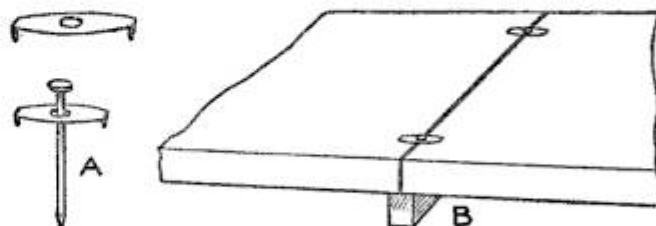

The Metal Clip Allows the Nail to be Driven in the Center of the Strip between the Board Ends

sketch, it can be driven between the ends of the boards into the strip and the pointed metal will overlap and hold the boards.

Straightening a Motorcycle Fork

A motorcycle having a sprung fork was brought to my shop, and as it had to be repaired quickly I set about to

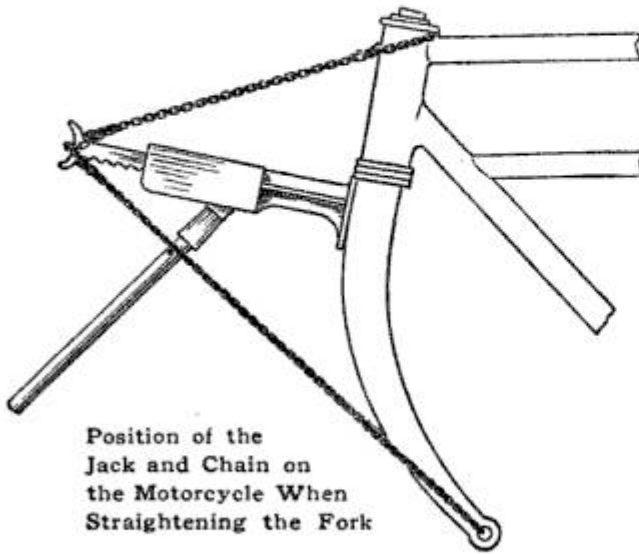

Position of the Jack and Chain on the Motorcycle When Straightening the Fork

straighten the fork with the use of an automobile jack. The jack was set on the fork and a chain attached as shown in the sketch. It was only necessary to work the jack out until the fork was straight.—Contributed by J. N. Bagley, Superior, Neb.

Laying out Sections for a Hollow Metal Ball

Draw a circle, Fig. 1, the diameter of the ball and divide the circumference into any even number of spaces,

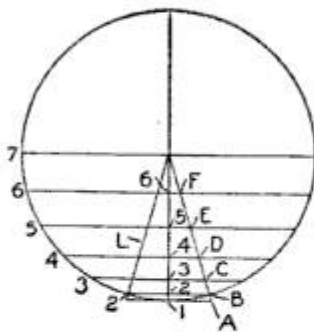

FIG. 1

The Circle with Division Lines and the Stretchout Used to Make the Pattern for a Section

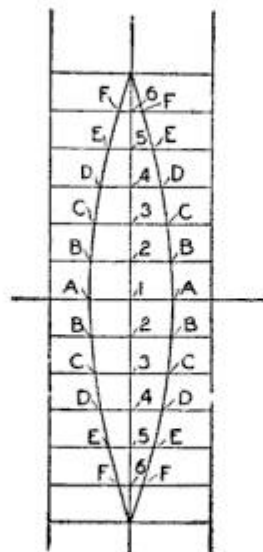

FIG. 2

the more the better, as at 1, 2, 3, 4, 5, 6, 7, and so on. The circle shown would have 24 spaces on its entire cir-

cumference. Then draw parallel lines at the division marks across one-half of the circle as shown, and a center line at right angles to the division lines. Two lines, L and A F, are next drawn from the center of the circle to those points on the circumference that mark the first horizontal line, or to 2 and B, these lines being then extended until they cross a line drawn tangentially to the circle at point 1.

Draw three parallel lines for the stretchout, Fig. 2, one center line and two outside lines, the latter being far enough apart to make one section. Space off evenly on the outside lines 12 divisions the same width as those on the circumference of the circle, and join the divisions with parallel lines as shown. These lines are marked 2, 3, 4, 5 and 6 above and below the middle line 1. Now mark off on line 1 and on either side of the center line, two points, AA, the same distance from the center line as the length of line 1A in Fig. 1. Next the length of line 2B, Fig. 1, is set off on lines 2, Fig. 2, in the same manner, and so on, until points FF are marked on lines 6. Join the points from A to F, above and below the line 1, and on each side of the center line, with a curved line, and by finally joining the points FF with the points where the center line intersects the unnumbered lines at top and bottom of stretchout, as shown, a pattern for one section of the ball will be outlined. There are 24 divisions on the circumference of the circle, but only 12 sections cut as shown will be required to complete the ball.—Contributed by S. C. Shipman, St. Petersburg, Florida.

An Unusual Conduit Crossing

While on a power-conduit job through the heart of one of the finest residential sections of a city we were brought to a halt by a viaduct, a series of which had been but recently completed by a trunk railroad and a city belt line tracks. The manner of crossing the viaduct, finally adopted by the engineers of the city, railroad and

power company, is shown in the illustration.

The work was accomplished under rather trying circumstances, the trains running very frequently at this point, and the entire trench having to be cut

as it does when present in wood. This may be avoided by painting the surface of the concrete with white vitriol, chemically known as zinc sulphate. It is inexpensive and may be purchased at any drug store. Use a 10-per-cent

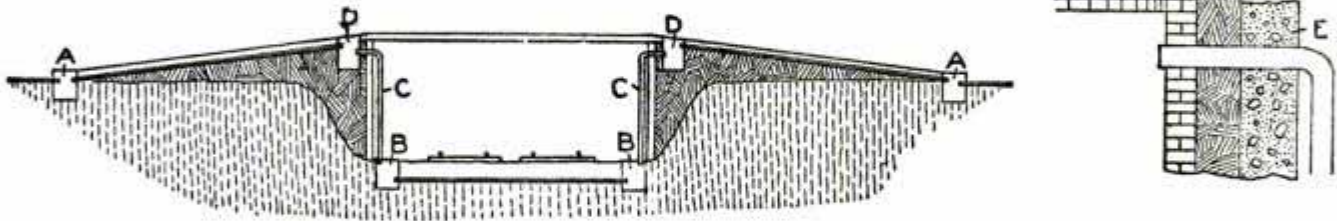

The Location of the Manholes and the Line of the Conduits, and the Manner of Inserting the Pipes through the Abutment Walls and into the Manholes

through rock by hand, as it could not be blasted out on account of disturbing the tracks. The weather conditions also increased the difficulties, as it was zero weather and very windy.

Two manholes, AA, were first constructed at the foot of the approach and tile runs of ten ducts in two units, one 6-way and one 4-way, were put in to the top of the guard on both sides of the open cut. Manholes, BB, were then built on each side of the tracks at the foot of the abutments, and iron pipes, CC, ten in number, were run from the manholes DD at the top of the grade to those beside the tracks. To accomplish this, holes, E, as shown in the cross-section sketch, were drilled through the retaining walls, and each pipe placed in position against the walls and held by clamps. Expanded metal was then used to cover all of the pipes and this, in its turn, was covered with a plaster coat of concrete, which made a neat, symmetrical job and covered the pipes completely. With the laying of the connecting pipes under the tracks, the job was completed.—Contributed by Geo. M. Petersen, Buffalo, New York.

Painting Concrete

Much difficulty is usually experienced in painting concrete. The alkali acts on the linseed oil chemically and destroys it, while the moisture coming out causes blistering and peeling, just

solution, that is, one made of 10 parts of zinc sulphate and 90 parts of water. Apply this solution with a brush and let it dry, after which paint will adhere readily and will not come off.

Rotary Cutting Tool for a Wood-Turning Lathe

A rotary tool for cutting wood in a turning lathe is the invention of a Frenchman. It consists of a disk having the cross section of an ordinary cutting tool and is mounted on a spin-

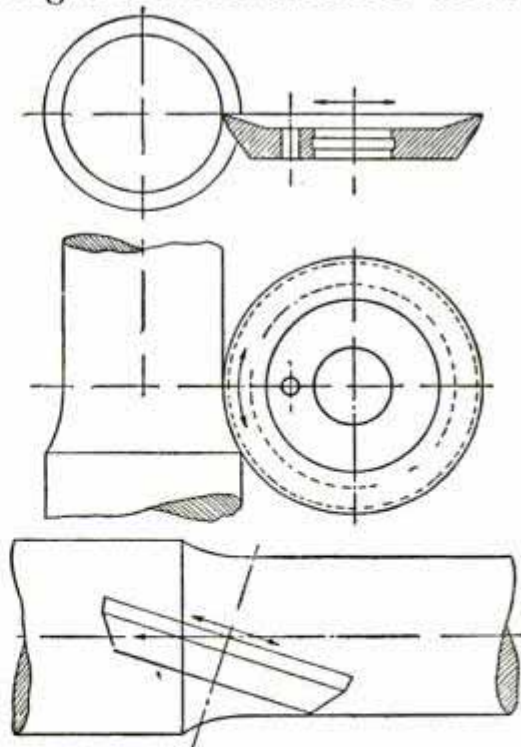

The Cutting Edge of the Tool is on the Periphery of the Steel Disk

dle which is driven by a proper connection to the lathe gears.

The claim is that, as the cutting

point of this rotary tool is constantly changing, it will not become unduly heated, and much greater working speed can be attained; also that the turned surface will be much smoother than if an ordinary tool were used.

Radiating Bend in a Stovepipe

When a stove is employed for heating purposes a very good way to save about one-third of the fuel is to place

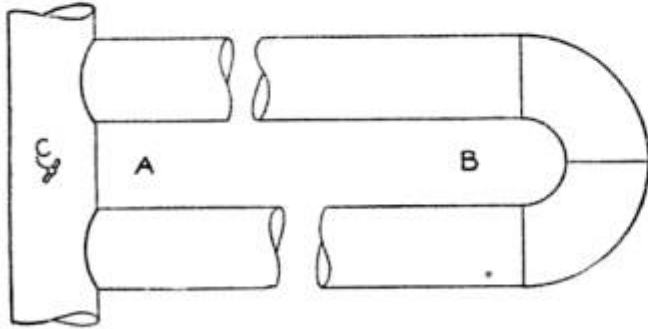

The Heat from the Escaping Gases may be Utilized by Turning Them into the Radiating Bend

a heat-radiating bend in the stovepipe. This consists of two joints having tee connections placed in the pipe A and two or more joints joined in a U-shaped piece, B, with two elbows. A damper placed in the pipe at C directs the escaping gases either into the chimney or into the radiator. The damper placed in the pipe is left open only when starting a fire. In this manner heat is used that would otherwise be wasted.

Center Rest for Long Milling-Machine Work

An improvement over the ordinary form of center rest used to support long slender work when milling be-

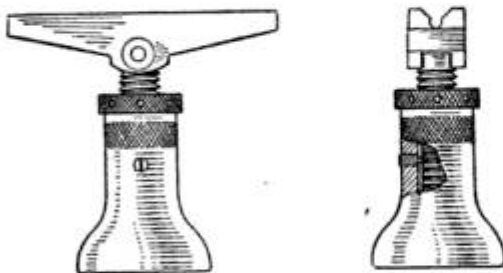

An Adjustable Center Rest, Having a Long Bearing Surface to Place against the Work

tween centers, is shown in the accompanying illustration. In the ordinary rest the top of the screw has a diam-

eter of about $\frac{3}{4}$ in. and provides the only surface on which the work can be supported. In the rest illustrated, on the other hand, the screw carries a hinged member at the top which, when brought up into contact with the under side of the work, offers a bearing for a much greater length than the old style, permitting less spring, and allowing heavier cuts and faster feeds. The expense of changing a regular rest to the form shown is slight compared with the advantages gained.—Contributed by Chas. F. Scribner, Hartford, Connecticut.

Temporary Repair on a Valve

The accompanying sketch shows how a correspondent of Power repaired a disabled valve so that it could do temporary service. The thread in the valve stem would not hold the valve disk to its seat. A $\frac{5}{8}$ -in. rod was bent as shown in the sketch, one end sawed for half of its length and the parts spread wide enough apart to fit over the valve bonnet, back of the stuffing nut. The valve wheel was removed and the point of the threaded

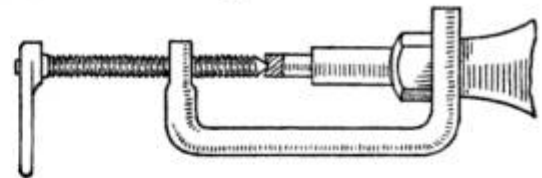

Pressure Clamp Used to Seat a Valve Where the Threads on the Stem were Worn Off

screw was seated in the end of the valve stem. As the screw fitted in a tapped hole in the outer end of the clamp, the valve could be closed at any pressure by turning the screw, and the pump pressure would open the valve when the screw was backed out.

Repairing a Leak in a Water Jacket

When the water jacket of a motor cylinder is cracked, it is not always convenient to take the engine down for brazing or welding. If the owner does not object to a patch, the jacket may be repaired as follows: Cut two strips of packing from sheet asbestos, large enough to extend almost $\frac{1}{2}$ in. from

the crack in all directions. Soak one piece in white lead and oil for a couple of hours. Apply this strip to the outside of the jacket, cover it with the other piece and lay a piece of stove-pipe iron, the same size or a trifle larger than the packing, over both. Wire this on the cylinder, and a patch is secured that will hold indefinitely. Where the thickness of the walls or of the adjacent parts are sufficient, two small bands of iron can be fitted over the patch and held with screws turned into the jacket metal. When painted the patch will be as neat as any repair of that kind.—Contributed by Donald A. Hampson, Middletown, N. Y.

Starting a Tap True with the Work

A good method of starting a tap so that it will cut the thread square with the surface of the work, is to use a guide nut. A nut that fits the tap and has the same number of threads per inch, is faced in a lathe on a mandrel to make the surface perfectly perpendicular to the thread. The nut can then be run up on the starting tap a little beyond the first thread and when pressed to the surface of the work, it will guide the tap straight into the hole drilled for it in the piece of work.

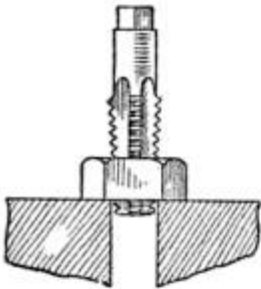

Wagon-Tire Fasteners

Where it is desired to fasten a tire without resetting it, the method shown in the sketch is quite effective. Pieces are cut from sheet metal, as shown in Fig. 1, and slipped between the tire



FIG. 1

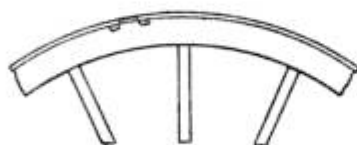

FIG. 2

Shape of the Metal Clip and How It is Placed on a Tire and felloe, the tire occupying the space shown between the dotted lines. The

long center part on each edge is turned up on the tire, and the short ends, on the felloe, as shown in Fig. 2. As many of these clips are placed on the tire as are necessary to hold it.—Contributed by Irl R. Hicks, Hallsville, Mo.

Protecting Windows While Painting

When spraying buildings with paint or whitewash, a very good way to keep the liquid from splashing the windows

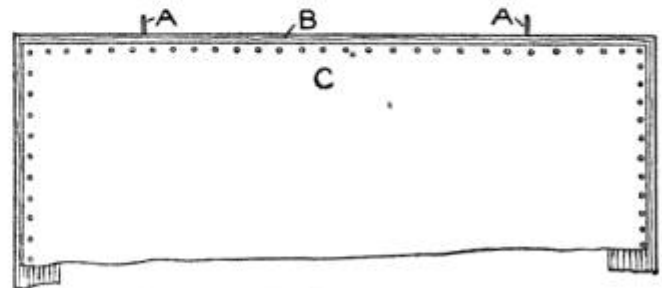

A Frame Covered with Roofing Paper to be Hung in Front of a Door or Window

and doors is to make a frame B, cover it with roofing paper, C, turn two screwhooks, AA, into the top piece of the frame and hang the cover thus made on the window or door casing. The cover is easily applied and taken away.

Valve for a Gasoline-Tank Vent

It is dangerous as well as annoying to have gasoline splashing from the air vent in the cap of an automobile or motorcycle gasoline tank. Some users stop up the hole and then have carburetor troubles. The best way is to make a valve, A, of a small disk of leather and fasten it to the vent hole with a strong thread. The thread is run through the hole and knotted. This valve will prevent the gasoline from escaping, yet provides a way to admit air to the tank.—Contributed by Aden K. Runkle, Kinsman, O.

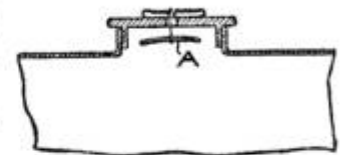

ⓄThe silver dime is 10 per cent alloy, and its weight is 38½ grains. This amount of silver melted and fused with 10 ordinary brass pins makes a good silver solder.

Drawing Board for Long Drawings

The illustration represents a drawing board which can be used for making drawings of any length. The at-

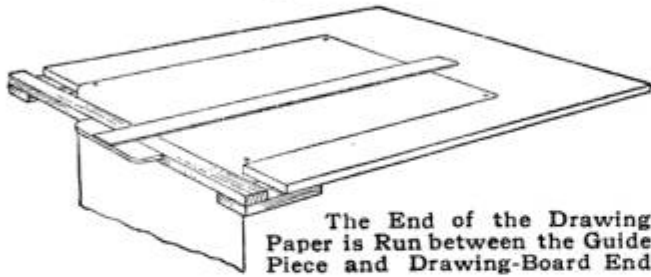

tachment was devised by a correspondent of the American Machinist. The opening between the board and the T-square rest enables the draftsman to draw the paper through as shown, so that the drawing may be made of any desired length.

Square Attachment to Determine Die-Clearance Surfaces

In filing the clearance in dies, all cutting surfaces may be accurately determined by using the attachment shown in the sketch on a square. It is made of a piece of metal as long as the post

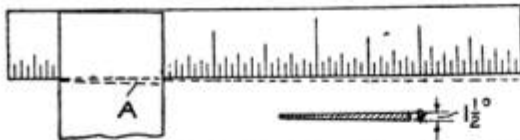

The Slope of the Blade Produced by the Wedge is Just Right to Test the Die Edges

of the square is wide and filed to an angle of $1\frac{1}{2}$ deg., then fitted to the slot A in the post of the square. The wedge thus formed is used beneath the edge of the square blade to give it the proper slope for testing the edge of the die.—Contributed by J. F. Tholl, Detroit, Mich.

Wire Joints Soldered with Heat from a Motorcycle Engine

The "telephone trouble shooter" who rides a motorcycle can make use of a hot engine for heating a soldering iron. When copper wires are to be soldered before placing them on a pole or in a box, lay the joint on the hot cylinder until it melts the solder.

Fuses and telephone transmitters can be repaired in this manner. I have many times lighted my alcohol torch with a spark from the spark coil by touching it to the frame of the motorcycle.—Contributed by C. F. Higby, Redlands, Cal.

Cutting Circles without a Compass Saw

The slip of a compass saw often spoils a circular cut, but if lines are sawn at a tangent to the circle, Fig. 1, and the remaining projections, Fig. 2, rasped off, a good circle will be the result.

If a tapering piece (Fig. 3) is to be

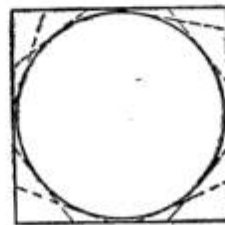

FIG. 1



FIG. 2



FIG. 3

Lines are Sawn Tangent to the Circumference and the Remaining Projections Rasped to a Circle

cut, find the centers of both sides of the board, lay out the circles, then cut and rasp into shape. The more cuts that are made with the saw the less rasping will be required.—Contributed by Jos. M. Kane, Doylestown, Pennsylvania.

Eye Shield for Gun Sighting

A little shield that will greatly assist hunters in shooting against a strong wind can be made of a small piece of mica or celluloid mounted in a frame as shown at A, the device being attached to the gun stock with a support, as shown at B. The shield

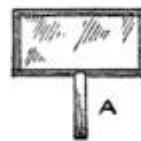

The Transparent Shield is Placed on the Gun Stock Just in Line with the Sights

should be set on the gun stock so that it will be just in front of the eye when the gun is held in position ready for firing.

How to Make a Fluting Machine for Small Columns

The owner of a small shop, sometimes having orders for small fluted columns, can make a machine for the purpose of parts found about most shops. The cutter head used for such a machine can be taken from a molder or matcher. In constructing our machine we used the side head from a matcher that had been discarded. The head was complete with yoke, boxes, etc., and only needed to be fastened to a frame or table about 2 or 3 ft. square, which had a top made of birch strips glued together and dressed off true. The spindle was placed at one side, with the lower edge of the head $\frac{1}{4}$ in. below the surface of the table top. The table makes a very good shaper for working small lots of molding for pilasters, bases and caps.

The frame for supporting the carriage which holds the column, while being fluted, is made, as shown in Fig. 1, of 2 by 8-in. material, framed and bolted together, with legs and braces, and should be twice as long as the longest column to be worked. The top pieces, $1\frac{3}{4}$ by 6 in., should be of oak or cypress and must be jointed straight from one end to the other, as this makes a runway for the carriage. The outside piece A, Fig. 2, should have the outside edge raised $\frac{1}{4}$ in., so

ered table on the spindle side and far enough away to clear the pulley and belt driving the spindle. On the top pieces of the supporting frame, B, Fig. 1, the carriage is placed for holding the column. This carriage should be as long between the heads as the longest column to be fluted, and is constructed of pieces of $1\frac{3}{4}$ by $2\frac{1}{2}$ -in. oak, perfectly straight and framed edge-wise with crosspieces and bolted, to make it rigid. The side pieces have a $\frac{5}{8}$ -in. slot, $\frac{1}{2}$ in. deep, running on the inside $\frac{3}{4}$ in. from the top edge for their full length, as shown at C, Fig. 1. These slots are for engaging the crosspiece of iron D, Fig. 2, which fastens the heads to the carriage. In the side pieces of the carriage E, Fig. 3, holes are bored every 12 in. to receive $\frac{3}{8}$ -in. iron rods threaded, 6 in. on one end, for two thumbnuts and arranged as shown. These $\frac{3}{8}$ -in. rods are fastened on their other end to a piece of $\frac{1}{4}$ by 2-in. flat iron placed on the outside of the carriage and running its full length, as shown by F, Fig. 3. The thumbnuts are used to adjust the guide bar to the slope of the column, and as the carriage is pushed along on the cutter head, the guide bar F, Fig. 3, presses against an adjustable stud G, Fig. 2, opposite the center of the

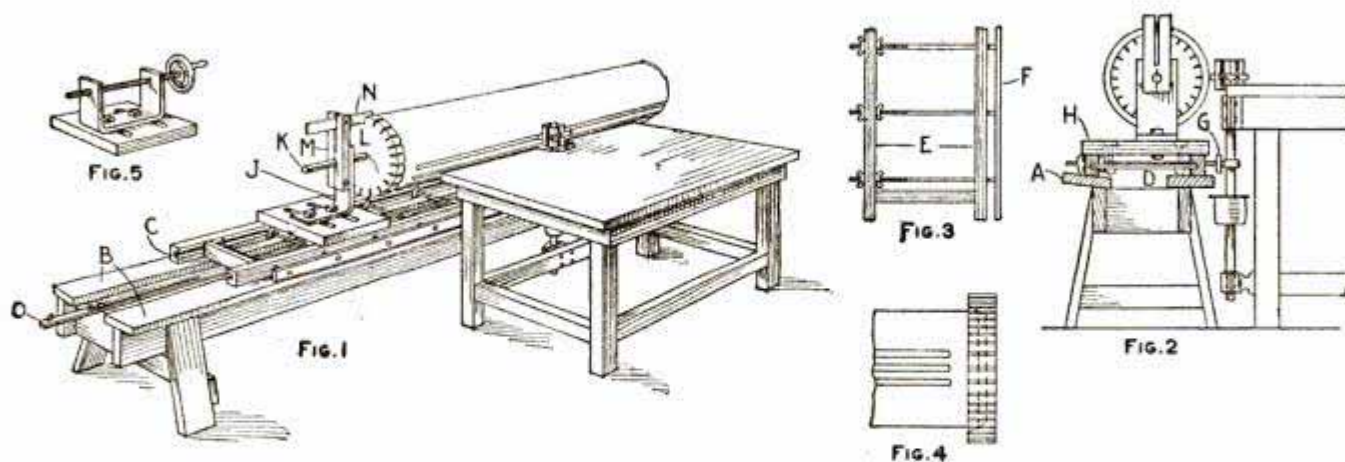

An Inexpensive Column-Fluting Machine Which can be Made of Discarded Parts That Usually are Found About Any Small Shop. The Parts are Not Dimensioned and can be Made in Sizes to Suit Conditions

that the carriage will tend to slide toward the head as the column is being fluted.

The frame is bolted to the birch-cov-

cutter head. By moving the stud in or out, the depth of the cut can be regulated without changing all the thumbnuts on the guide bar.

The head for swinging the column is placed on the carriage and fastened with bolts, passing through the piece H, Fig. 2, and into the iron bar D, which engages in the slot C, Fig. 1, on the inside of the carriage frame, making the head adjustable for different lengths of columns. On this piece is an iron upright, shaped as shown in J, Fig. 1, which is adjustable across the carriage by slots, to accommodate different diameters of columns. The upright J has a center pivot, K, to center the fluting head L on the end of the column, and also an adjuster, M, which is friction-tight on the pivot-point shaft and moves over or back, to bring the proper place in the stave of the column to the center of the cutter head. This can also be accomplished by so constructing the head that it can be raised or lowered on the spindle.

On the upper end of the adjuster is placed a spacer latch, N, Fig. 1, which engages in slots in the fluter head or column. This latch is adjustable to raise or lower it for different diameters of columns. The spacing head, for regulating the number of flutes, is turned in a lathe to get it true, and, to make it self-centering, is shaped, as shown in Fig. 4, with a tapered recess turned out on the inside to fit over the end of the column. It is very important that the column be centered so as to make the ribs or fillets between the flutes the same width.

The heads are laid out accurately by stepping the spaces with a divider on their outer edge, and cutting the notches with a hand saw to fit the end of the latch N. These heads are divided for numbers of flutes in the column, which should be 24 for the Ionic order, 20 for Doric, and 22 for Corinthian.

This machine will prove superior to others for the reason that it will protect the sharp edge or arris at the meeting of the flutes of the Doric order, because there is nothing to rub or mar them as on the shaper or jointer. Thus the shape of the column can be kept better, as everything is open so

that the operator can see the depth of the cut the machine is making.

The number of cones or neckmolds on a column do not interfere with fluting on this machine, as the column swings clear. The rear head, Fig. 5, is fastened to the carriage in the same manner as that described for the head for the end. It is a self-centering head for the end of the column, is also adjustable across the carriage, and has a threaded tail screw to facilitate the handling of the column.

To regulate the length of the flute, for starting and stopping the carriage, a slotted stop, O, is placed on each end of the frame, between the pieces B. The cutter head should be as small as possible and should be of the solid-cutter type, which is sharpened only on the face. However, the square-slotted head with knives will do, although it would require a number of different thicknesses of solid cutters to make the different widths and styles of flutes on columns ranging from 4 to 14 in. in diameter.—Contributed by Chas. M. Allen, Knoxville, Tenn.

Cutting the Rust from Bolt Threads

If the threads on a bolt or nut are covered with rust, or fit tightly, clean them out with a mixture made as follows: Mix some powdered emery with any kind of grease and smear the threaded parts both inside of the nut and on the bolt, then turn the nut on the bolt and run it back and forth over the threads. This method will be found effective even in the most stubborn cases.—Contributed by G. N. Beebe, Benning, D. C.

Brace Chuck Used as a Small Vise

While out on a job I had to cut off a number of screws, and having no vise to hold them, I put them separately into the chuck of a carpenter's brace, which held them securely while they were cut to the desired length with a file.—Contributed by H. C. Heidt, Chicago, Ill.

Air-Cooled Commutator Brushes

The ordinary commutator brushes, made of carbon-graphite or a mixture thereof with metal powder, are able to carry but a very small current or else become heated too quickly, and to cool them with an air blast is impractical because the material has only a low conductivity of heat, so that they do not get cooled fast enough. To overcome this trouble, a German concern has brought on the market slotted brushes as shown, which, it is said, through the greatly increased surface



The Slots in the Carbon-Graphite Brush Tend to Cool the Brush as the Commutator is Rapidly Revolving

on which the air acts are efficiently cooled by the air current created by the revolutions of the commutator.

An Emergency Four-Jawed Chuck Made of a Faceplate

Four parts are made as shown in Fig. 1, their size depending on the size of the faceplate where they are to be used. The shank should be a close fit for the slots in the faceplate. The

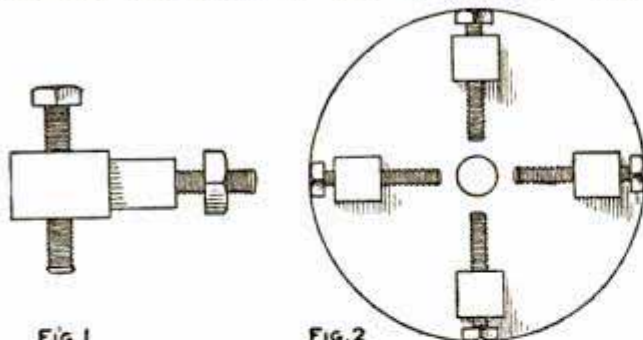

The Makeshift Jaws are Placed in Four Slots of the Faceplate to Form a Chuck

manner of using them on a faceplate is shown in Fig. 2.—Contributed by Fred Dowle, Springfield, Mass.

Storage-Bin Marker Plate for Twist Drills

The usual tool-room storage bin is equipped with compartments marked with a plate which carries a hardened steel bushing of the proper diameter

in addition to having the size stamped upon it. Before the keeper hands out

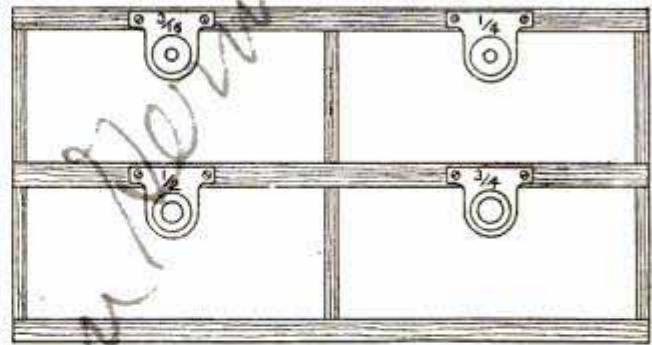

The Marker Plate and Sized Holes Designate the Size of the Drills in Each Compartment

a drill it is tried in the bushing, thus eliminating any mistakes in sizes. The drill is also tried in the bushing when it is returned to the bin.

A Battery Charged in a Hurry

A storage battery can be safely charged in the shortest time possible by using a heavy current at the beginning and reducing the strength as it fills, says Motor World. The last half of the charging should never be done at a high rate, and near the end the charging must be slow to prevent injury to the plates.

Connecting Ends for Coil Springs

It is difficult to shape the ends of a coil spring made of 1/4-in. wire into convenient forms, such as loops or eyes, for connection to other parts, and if the spring is made of 3/8 or 1/2-in. wire, it is impossible. For such springs make a threaded piece to fit into the ends of the spring, the pitch of the thread, which should be semi-circular in cross section, being the same as that of the spring. One of these pieces is shown at A and is screwed into the end of the spring, as shown at B, then fitted with an eyebolt. If the piece A is made a good



The Expanding Spring Tends to Close the Coils, Thus Gripping the End Piece Tightly

fit, it will never loosen, as, in expanding, the spring only gets a firmer grip on it.

A Vegetable Slicer

A practical little device for cutting vegetables into slices of uniform thickness, which can be easily made at

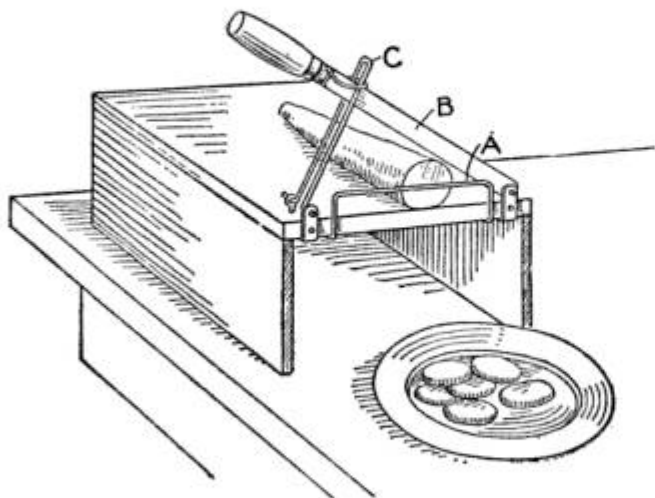

The Guide may be Set to Cut a Slice of Any Thickness

home, is shown in the illustration. It is made of a box of suitable size with one end open. A U-shaped wire, A, bent up at its closed end, is attached to the under side of the top on the box so that it can be adjusted for various thicknesses of slices. The cutting knife B is pivoted at the end of the blade, which runs through a double guide wire, C, which is held closely to the handle with a loop as shown, to make the knife blade cut squarely through the vegetable.

An Anvil Calking Tool

The hardy and die shown in the sketch was originated by a correspond-

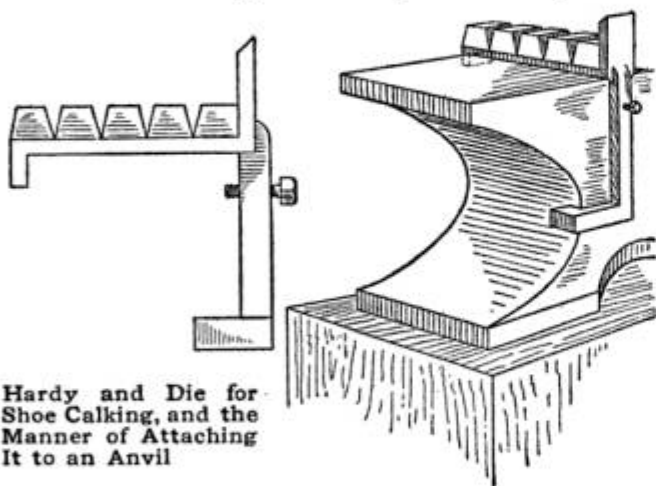

Hardy and Die for Shoe Calking, and the Manner of Attaching It to an Anvil

ent of the Blacksmith and Wheelwright, for toeing and calking shoes. The shank of the tool is made of 1 by

1½-in. steel and long enough to fit over the anvil as shown. The block is made of tool steel. This makes a handy tool for forming the calks on shoes.

Special Index for Magazines

Before I begin reading any journal or technical magazine, I paste a sheet of writing paper inside of the front cover like a leaf. When I find a thought, suggestion, or paragraph that interests me so that I may want to refer to it again, I pencil-mark it, then make a note of it on the leaf, giving the page number. This is much better for my particular purpose than the printed index, as it gives me just what I want and in my own words.—Contributed by D. Andrew McComb, Toledo, O.

A Paint-Pot Stand

The painter working on a scaffold or side wall must stoop to dip the

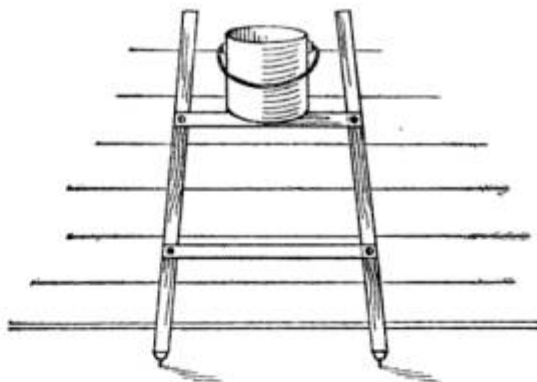

The Pot Stand can be Used When Necessary to Step Upon in Reaching High Places in Gables

brush in the paint pot. To do away with this stooping I built a pot stand of oak-barrel staves, ripped to 1½ in. in width. The crosspieces are 12 and 18 in. long, respectively. If the paint pot is large, the bottom rests on the top piece and against the wall. This stand also comes in handy many times as a stepladder to reach high places in gables. Spikes are fastened in the lower ends to keep them from slipping. When moving the scaffold up or down, the stand is hung on the guard rope or rail.—Contributed by Aug. Meyer, McCloud, Cal.

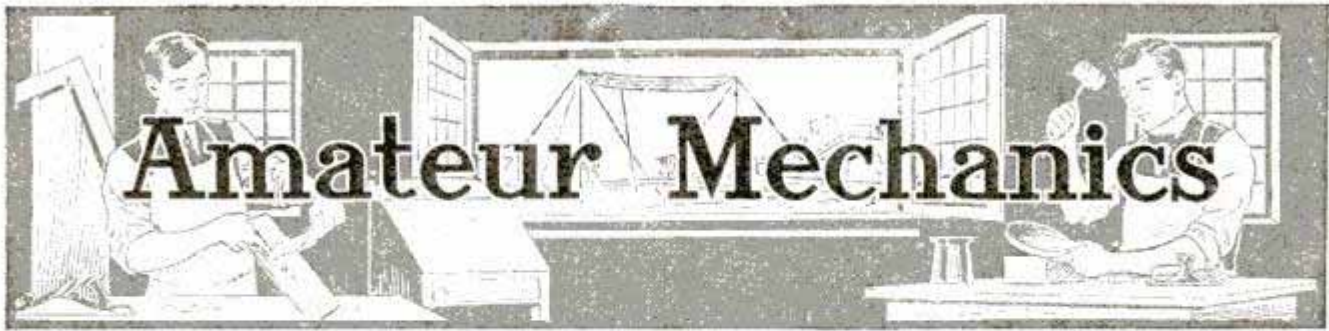

A Flash-Light Telegraph on a Kite Line

An ordinary pocket flash lamp is prepared in the following manner: A brass spring, as shown in the sketch, is bound tightly to the flash lamp with a cord, and two wires, one at each end, are twisted around the lamp's body, forming two loops at the top. The kite string is run through the loops and over the spring. The lamp is then placed near the kite. The ordinary pull on the kite string does not close the spring, but a sharp jerk will pull the string in contact with the push button and its slight pressure

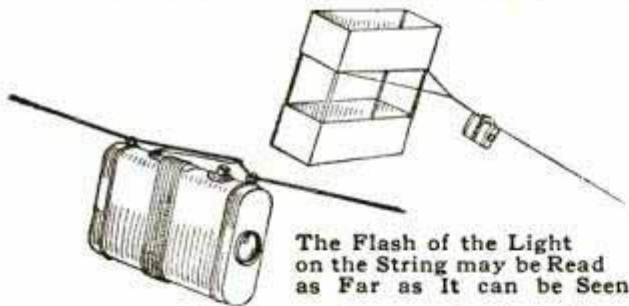

The Flash of the Light on the String may be Read as Far as It can be Seen

causes an instant flash of the light. By this method words may be spelled out in the telegraph code.—Contributed by Joe V. Romig, Allentown, Pa.

Hangers for Barn Tools

Means should be provided to have a place for all the tools used in and about a barn. The forks and shovels are usually stood up in a corner, but they can be more conveniently taken care of by making a hanger for them. The illustration shows how a hanger can be easily made and screwed to the wall of a barn. The hanger is cut from a piece of board and has a hole bored into it the size of the handle on the fork or shovel, then a notch is sawn

into the hole to pass the handle through. The board may contain one

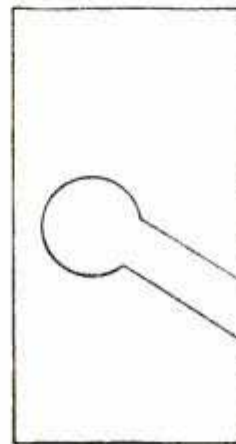

A Notched Board Provides a Way to Hang All the Tools Used about a Barn

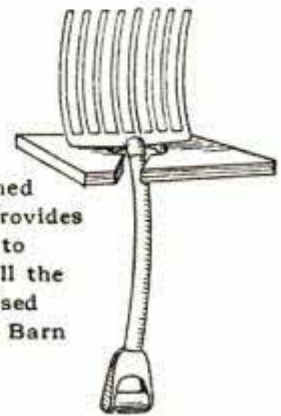

or as many notches as there are forks and shovels to be hung on it. The implements are hung with the fork or shovel end upward.—Contributed by R. Snyder, Glidden, Ia.

Guide Ropes on a Bobsled

The sketch shows the front end of a bobsled or double runner made of a plank bolted upon two sleds. The front sled is so pivoted on the bolt A that it may be turned to steer the bob, and to accomplish this result the steersman ordinarily sits with his feet braced against the projecting ends of

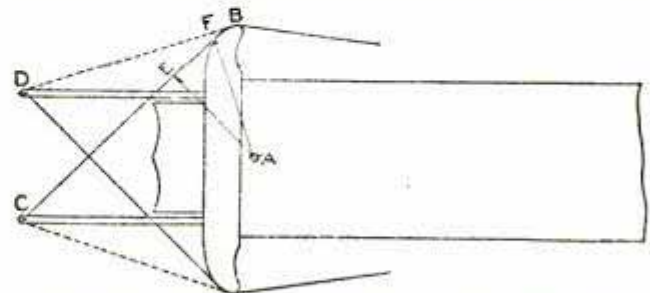

The Most Efficient Way of Attaching Ropes to the Guiding Runners of a Bobsled

the crosspiece and passes the steering ropes outside of his feet, with the ropes crossed as shown. The crossing

of the ropes is supposed to add leverage, but that is quite wrong.

The rope, running from B to C, has a lever arm from A to E. If the ropes were not crossed, the rope would lie along the dotted line BD, whose lever arm is the distance AF, which is always greater than AE, therefore the uncrossed ropes have more leverage.

Observe what takes place when the sled is steered to the left: The distance AE decreases much more rapidly than AF, and when the crossed ropes have lost all their power, the uncrossed ropes are still useful. Many a spill has been caused by turning the sled to a position from which the crossed ropes were unable to restore it to a central position, and most of such spills would have been avoided if the ropes had not been crossed.—Contributed by R. R. Raymond, Wilmington, Del.

Brush Hanger for a Dark Room

Necessity may be the mother of invention, but it is also the grandmother of application, and application is the practical side of invention. Both the amateur and the professional photographer have been bothered by spotting and unequal development of negatives and prints in tray development, due to various causes, and sometimes by the presence of dirt particles or the unequal or incomplete flowing of the developer over the surface of the sensitive emulsion.

Most professionals and many amateurs are familiar with the use of the camel's-hair brush to avoid failures of this character, and many of them use a brush for local development in certain cases where it is necessary or desirable. Usually the brush is kept in a small glass cup, somewhere close

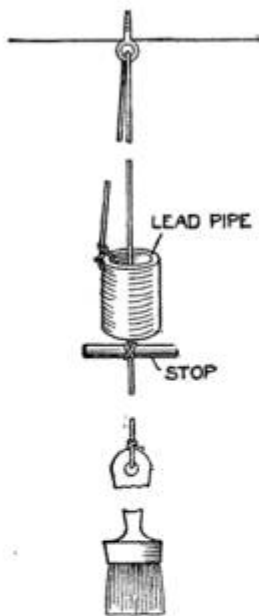

to various causes, and sometimes by the presence of dirt particles or the unequal or incomplete flowing of the developer over the surface of the sensitive emulsion.

Most professionals and many amateurs are familiar with the

at hand, but it is often in the way when not wanted and misplaced when most needed. The brush can be kept within reach and handy for the operator by arranging a light counterweight and pulley with a string attached to the brush, so that, normally, the brush will hang from the ceiling directly over the developing tray and can be obtained for use when desired.

The detail of this brush-string and counterweight combination was deliberately appropriated from the old plan of suspending the piece of chalk over a billiard table, so that the players could easily reach it, when needed, while, when released, it would be pulled out of the way by the counterweight. The developing brush thus suspended is always ready, never misplaced, nor in the way for other operations. This arrangement is particularly convenient where a bathroom is used as a dark room, and the shelf space is limited.

This same manner of counterweighting chalk on the billiard table may be applied to a stove-lid lifter, to keep it within easy reach and always cool enough to handle. The simplest and most inexpensive way of making this apparatus is to cut off a small piece of lead pipe for a counterweight, and, in the absence of a suitable pulley, use an ordinary screw-eye fastened in the ceiling. The latter is really better than a pulley because the string cannot run off the screw-eye. The arrangement is better understood by referring to the sketch.

Lighting a Basement Light

There was no switch at the basement door and it was difficult to find the droplight in the dark. Instead of going to the expense of placing a switch, the contrivance illustrated and described was rigged up and proved equal to the requirements.

A $\frac{7}{8}$ -in. piece of wood was cut about 6 in. long by 2 in. wide and a recess made at one end for the socket, as shown. A $\frac{1}{8}$ -in. hole was drilled in the center, about 2 in. from one end, and

another, large enough to receive the projection from a pull socket, about 2 in. from the other end, or the end to be used as the bottom of the block. A clamp made of spring brass, as shown, was screwed securely to the board, to clamp the socket firmly. A wire was passed through the small hole and stretched across the room from the door at a height to bring the light about 6 ft. from the floor. Then the socket was clamped to the strip with the chain passed through the hole cut for it. The cord attached to the chain was run to the door casing, passed through a screweye and weighted with a nut or some light object, to keep it taut. To light the lamp or put it out only a pull on the string was necessary.

The light can be slid along on the wire from one end of the room to the

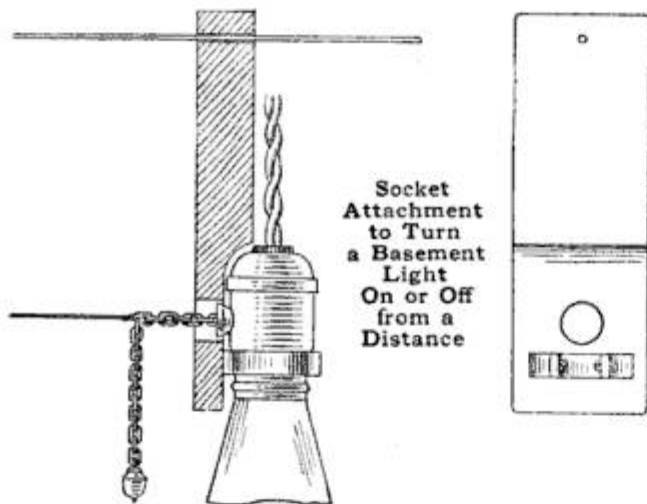

other, or can be detached from the strip when desired by unhooking the cord from the chain and taking the socket from the clamp. If more desirable, the block can be fastened permanently to some object instead of being on the wire.—Contributed by L. M. Eifel, Chicago.

Projecting Protractor Readings

A simple and efficient means of projecting protractor readings to a larger size is shown in Fig. 1. One point of the compass is placed at the center of the protractor and an elastic band is looped between the points. Then the points are spread to the ra-

dus desired, and the protractor is read where the elastic band crosses its scale. A light band should be used, and



The Extension Marks can be Easily Read on the Protractor under the Elastic Band

looped as shown in Fig. 2. In this way a circle of any size may be quickly divided, if a pencil mark is made each time the band comes over the proper figure.—Contributed by Thos. L. Parker, Wibaux, Mont.

Removing Grease from Paint

When removing grease from paint by using ordinary cleaners, the paint is liable to come off in the washing. A good and cheaply applied method is to rub the painted surface with a paste of ordinary whiting. This is allowed to dry and when it is rubbed off with a cloth the dirt and grease is taken away with it. The whiting is cheap and can be purchased at any drug store.

A Door Stop

A very good door stop can be easily made of a piece of metal as shown in the sketch. The metal is bent and fastened with screws to the wall against which the door swings. The extending end fits under the door knob and prevents it from striking the wall.—Contributed by C. R. Poole, Los Angeles, California.

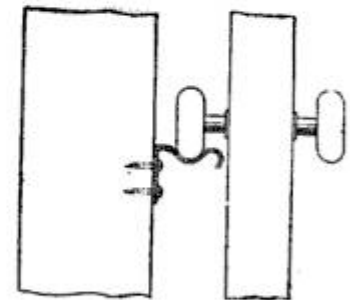

Time Indicator for Medicine Bottles

The time to give a patient the next dose of medicine can be set on the indicator, as shown in the sketch, and retained without fear of its being changed until the dose is again given. The indicator consists of a strip of paper which will reach around the bottle neck and is divided into 24 equal parts representing hours and half hours. The paper is then pasted to the bottle neck. An ordinary pin is then pushed into the cork as shown. After a dose of medicine is given to the patient the cork is replaced so that the head of the pin will indicate the time for the next dose. By this method, an accidental shifting of the indicator is almost impossible.



A Washtub Stand

Usually two old chairs or an old box makes the stand for the washtub, and these are not always the right height. A stand, like that shown in the illustration and having the proper height for the one who does the washing, can be easily made of 2 by 4-in. material and a few boards. As it is shown, the

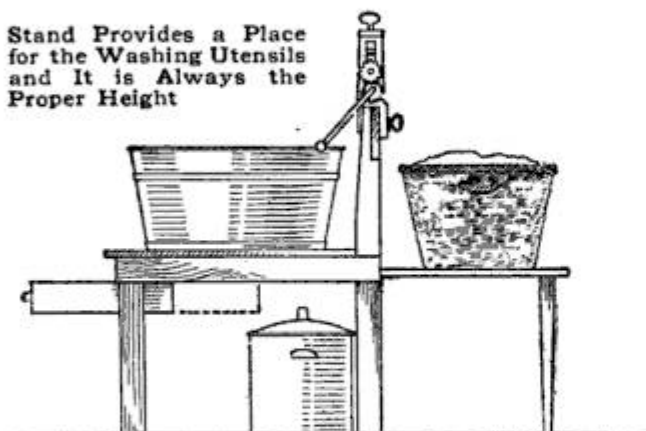

wringer is fastened on top of the back and may remain there all the time, it being out of the way, always in its proper place, and held very firmly.

A light bracket, on which to set the

clothes basket, can be made and fastened on the back of the stand, connected with two hinges and supported by a leg hinged to the bracket, the lower end of the leg resting on the floor back of the stand.

A small drawer may also be provided in the front, in which to put away the soap and brushes, and the wash boiler can be set underneath. When one is through washing, the bracket at the back is let down, the washstand set up against the wall out of the way, and everything is then in its place, ready for the next wash day. —Contributed by Chas. Homewood, Waterloo, Ia.

Pipe Used as a Leather Punch

The sketch shows how a very cheap and serviceable leather punch can be made of an old pipe nipple. Pieces of pipe of almost any size can be found around a shop, and it is, therefore, usually possible to quickly make a punch of the required size. The cutter end can be ground very thin to prevent an over-cut, while a small slot cut a little above it will allow the removal of the leather slugs. For its purpose, this homemade tool is all that can be desired in cheapness and utility.

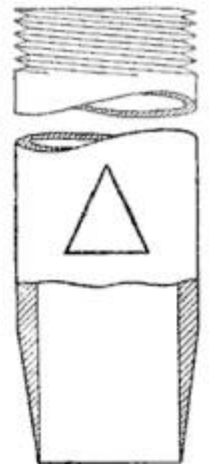

To Prevent Oilcloth from Cracking

A good method to prevent oilcloth from cracking, when it is used on shop tables or counters, is to first cut a paper cover for the table on which to place the oilcloth and prepare it as follows: The paper should be well oiled with common machine oil and placed smoothly on the table to be covered. The oilcloth is then smoothed out on top of the paper and stretched tightly. The oiled paper tends to keep the under side of the cloth moist, which prevents cracking. The cloth wears much longer because the paper acts as a pad.

Combination Lock for a Drawer

The principal parts of the combination lock are the five disks shown in Fig. 1. These are best made of sheet brass, about $\frac{1}{16}$ in. thick and $1\frac{1}{2}$ in. in diameter. The pins for turning the disks are each made a driving fit for a hole drilled through the metal at a point $\frac{1}{32}$ in. from the center. Notches are cut in the disks C, D and E, Fig. 1, to receive the latch end, and the disk B is made like a cam, its use being to raise the latch into its keeper when the handle is turned backward. The disk A is without a notch and has only a pin for turning the other disks.

The disks are mounted on the inside of the drawer front in a U-shaped piece of metal, F, Fig. 2, which carries a $\frac{1}{4}$ -in. pin, G, as their bearing. The disks are placed on this pin with rubber washers, H, J, K, L and M, between them. These serve the purpose of preventing the disks from turning too freely. The disk A is fastened tightly to the end of the rod N, which is $\frac{1}{4}$ in. in diameter. The outer end of this rod is fitted with a handle or turning head as desired. That shown at O is made of two pieces of wood screwed together, with a pointer, P, placed between them. A washer, R, is placed between the drawer end and the handle to take up any looseness and to allow the free turning of the rod.

A dial, S, is made of paper and the division marks and numbers placed upon it. The latch T is fitted in a U-shaped piece of metal, U, which is fastened to the inside of the drawer end where its heel will rest on the edges of the disks. When the right combination is made by turning the handle first one way and then the other, the latch will drop into the notches of the disks as they will be all in one place.

When the drawer is to be locked, turn the handle back from the last turn made for the combination and the latch will be driven upward into its keeper and the notches scattered so that the latch will not drop until the combination is again set.

The numbers for the combination

can be found after the disks are in place and by turning the handle until the notch comes up to the place for the

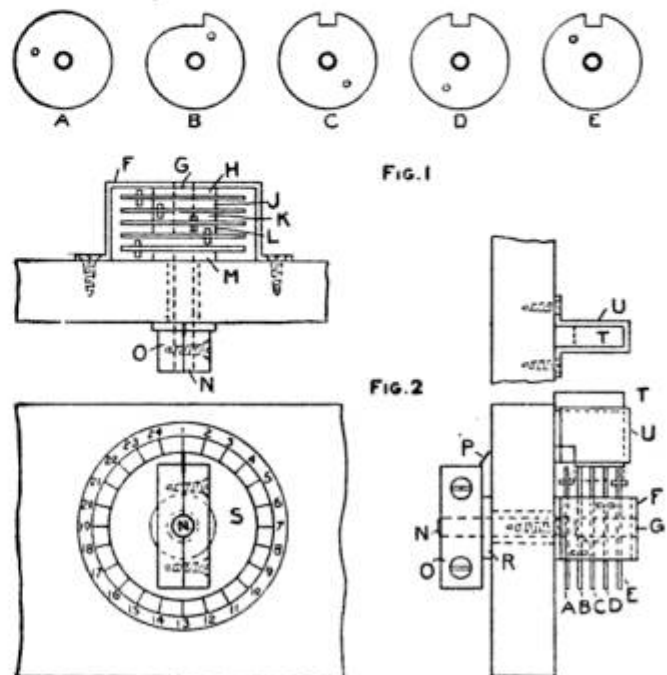

The Parts as They are Attached to a Drawer Front to Make a Combination Lock

heel of the latch. The number beneath the pointer is noted; then the next turned up in a like manner, all being done while the drawer is open and the disks in plain sight. The combination can be changed only by changing the location of the pins in the disks.—Contributed by C. B. Hanson, Fitchburg, Massachusetts.

How to Start Small Machine Screws

Small machine screws are sometimes very difficult to start, especially when used in parts of a machine that cannot be easily reached with the fingers. A good way to start them is by means of a piece of fine wire wound snugly around the screw under its head. They



can be placed and started by means of the wire and when the first threads have caught the screw it can be held by the screwdriver while the wire is withdrawn.—Contributed by F. W. Bently, Huron, S. D.

An Umbrella Holder for Display Purposes

A holder that is especially adapted for use in hanging umbrellas for display in a store can be easily made of a piece of wire wound in a coil, as shown in the sketch, to fit over the end on the umbrella stick. The coil at one end of the spring is formed into a hook so that the umbrellas may be hung in screweyes or on a line, as the case may be. The end of the umbrella is stuck into the spring, as shown, which grips it tightly.—Contributed by Abner B. Shaw, N. Dartmouth, Mass.

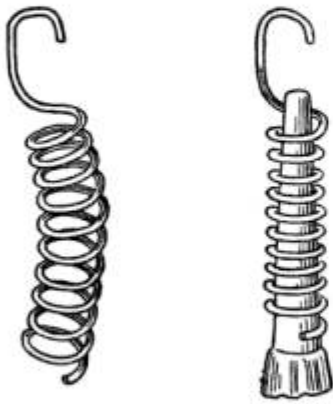

Holder for a Milk Card

It is the general practice of milkmen to furnish a monthly card on which the housewife marks the needs of the day and then hangs it outside of the door for the information of the driver. This card also serves as a record for checking the accounts of the milk delivered during the month, and therefore it is desirable to protect it from snow and sleet.

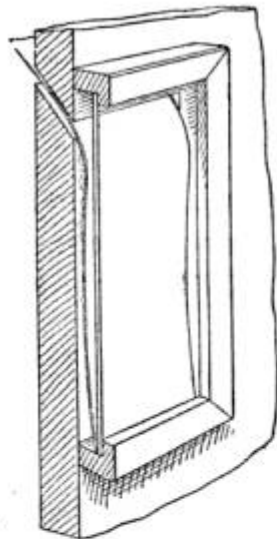

In order to furnish this protection and at the same time make it unnecessary for any one to go outside of the door to hang up the card on stormy days, one of our readers has submitted the following plan which he has used for some time.

On the outside of the kitchen door, where the milkman is to deliver his bottles, this man has fastened an ordinary picture frame with glass but

no backing except the door. Through the door and just below the upper edge of the glass is cut a thin slot inclining downward and outward so that the milk card can be easily pushed through the slot and thus be displayed behind the glass in the frame. By this protection it is kept free from mud, snow and ice. It is not necessary to step outside to place the card in the frame.

Frame for Printing Post Cards from Negatives

As I desired to print only a portion of some of my 5 by 7-in. plates on post cards and the part wanted was near the edge of the plate, I cut out the printing frame, as shown at A in the sketch, to accommodate that part

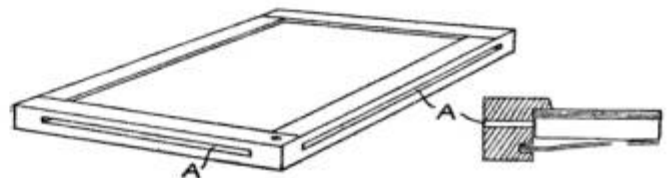

Slots Cut in the Frame to Receive the Post Cards without Bending Them

of the card I reserved for a margin. This permitted the card to be placed in the frame without making a bend.—Contributed by J. H. Maysilles, Rochelle, Ill.

Finger Protection on Laboratory Vessels

A simple way of protecting the fingers against being burned by laboratory vessels in which liquids are boiling or chemical reactions producing great heat are going on, is shown in

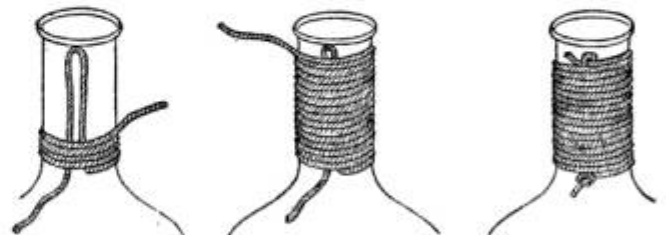

The Ends of the Cord are Held Tightly and the Winding Protects the Hands

the sketch. A rather thick cord or yarn is wrapped around the neck of the vessel in the manner shown, the

upper end being drawn through the loop at the top and cut off, and the lower end then pulled out and a knot tied in it close to the windings of the yarn.

Inlaying Metals by Electroplating

Very pretty and artistic effects of silver or nickel inlay on bronze, copper, etc., or copper on dark oxidized metals, may be obtained by means of etching and electroplating.

The metal on which the inlay is to be used is first covered with a thin coating of wax and the design scratched through to the metal with a sharp, hard point of some kind. The design is then etched in slowly with well diluted nitric acid, allowing the etching to penetrate quite deeply. The metal is then taken out and after a thorough rinsing in water is hung in the plating bath.

As the wax has been left on, the plating will fill the lines of the design only, and will not touch the covered surface. When the etched lines are filled, the object is taken out of the bath and the wax removed.—Contributed by S. V. Cooke, Hamilton, Can.

A Novel Show-Window Attraction

This moving show-window attraction can be simply and cheaply made. The things necessary are a small battery motor, a large horseshoe magnet and a large polished steel ball, perfectly true and round, such as used in bearings. The other materials usually can be found in any store. Procure some thick cardboard and cut two disks, 8 in. in diameter, and two disks, 7½ in. in diameter. Glue these together to make the wheel A, the larger disks forming the flanges. Make a smaller wheel, B, the size of which will be governed by the speed of the motor used. The wheel A is mounted in a box to run with its surface close to the under side of the cover, which should be of a thin, stiff cardboard. The wheel B is mounted on an axle that runs in metal bearings. The magnet D is

placed on the wheel A. The steel ball E is put on the thin cover of the box, and the magnet causes it to roll around as the wheel turns. The box

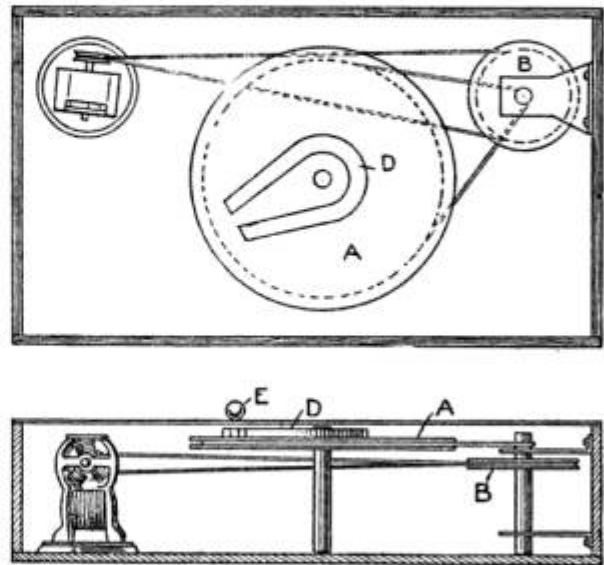

The Steel Ball is Caused to Roll Around on the Cover by the Moving Magnet

inclosing the mechanical parts should be placed out of sight when used in a window.—Contributed by Clarence Guse, Spokane, Wash.

How to Make a Mop Wringer

A mop wringer may be made and attached to an ordinary pail in the following manner: Two pieces of metal, A, are attached securely at opposite sides of the edge of the pail, holes being drilled in their upper ends to serve as bearings for the roller B. The piece of metal C, which is duplicated at the opposite side of the pail, is pivoted on a bolt. These pieces also carry a roller, E, at their upper ends,

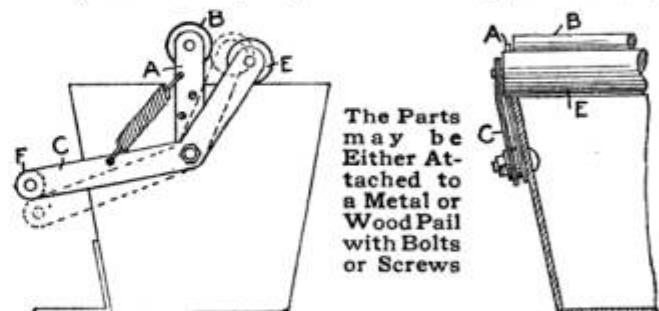

and have a crosspiece, F, at their lower ends. Discarded wringer rollers can be used for B and E. A coil spring is attached as shown, to keep the rollers separate and in a position to receive the mop. When the mop is placed be-

tween the rollers they are brought together by a pressure of the foot on the crosspiece F.—Contributed by J. Dennis McKennon, New Britain, Conn.

A Vise Used as a Caliper Gauge

Not infrequently it is desired to know the distance from one side to another of some part that cannot be

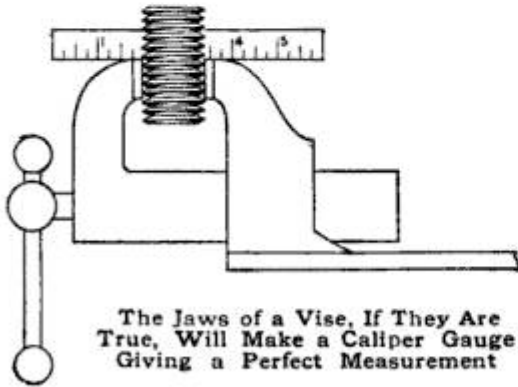

directly measured with a rule, and when no calipers are at hand. But with a vise handy, the measurement can be made with ease and with sufficient accuracy for all practical purposes if the vise is not too worn. This trick is particularly adapted for calipering threaded parts, as threads cannot be measured readily with ordinary calipers. How this may be done is shown in the sketch, which illustrates the method as applied to a screw. The work is gripped between the jaws of the vise and the opening then measured with a rule.—Contributed by Donald A. Hampson, Middletown, New York.

Homemade Tack Puller

A very handy tack puller can be made of a round-head bolt. On one side of the head file a V-shaped notch and screw a wood handle on the



The Shape of the Head Permits a Leverage Action That Lifts the Tack Easily

threads. This makes a very powerful puller that will remove large tacks from hardwood easily.

How to Make a Radium Photograph

The radium rays, like the X-rays, affect the photographic plate, as is well known, but it would naturally be supposed that the enormous cost of radium would prevent the making of such a photograph by the amateur.

It is a fact, however, that a radium photograph can be made at home at practically no cost at all, provided the amateur has patience enough to gather the necessary material, which is nothing else but broken incandescent gas mantles. These (especially Welsbach mantles) contain a salt of the rare metal thorium, which is slightly radioactive. The thing to do, then, is to collect a sufficient quantity of broken mantles to cover the bottom of a small cardboard box—a dryplate box, for instance—with a layer of powdered mantle substance. Upon this layer and pressed tightly against it is placed a piece of cardboard; then some metal objects, a button, hairpin, a buckle, or the like, are laid on the cardboard and covered with a sensitized paper. This is again covered with a piece of cardboard and the box filled with crumpled paper to the top. The cover is then put on, the box tied up with a piece of string and set in some place where it is sure to be left undisturbed.

The radium rays from the powdered mantles readily penetrate the cardboard and paper, but not the metal articles. Being very weak, the rays must be given four weeks to accomplish their work. After that time, however, if the sensitive paper is taken out, pictures of the metal objects in white on a dark background will be found on it. These pictures will not be so sharp as ordinary photographs, because the rays are not focused, but they fairly represent the originals and the experiment is an interesting one.

☞ A good imitation mahogany stain consists of 1 part Venetian red and 2 parts yellow lead, mixed with thin glue size, and is laid on with a woolen cloth.

Fountain for an Ordinary Pen

Fill the hollow end of an ordinary penholder with cotton—not too tightly—and one dip of the pen will hold enough ink to write a full page. The cotton should be changed each day. A small piece of sponge will answer the same purpose. It is necessary to dip the pen deeply into the ink.—Contributed by J. E. Noble, London Junction, Ontario.

Pulling Wire through Curved Electric Fixtures

To facilitate the running of electric wires through curved fixtures, nick a heavy shot, A, and fasten it on a cord,

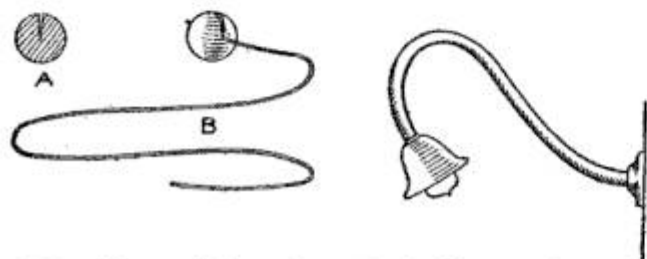

A Shot That will Pass through the Fixture Arm will Carry a Cord for Pulling in the Wires

B, in the same manner as a fishline is weighted. The shot will roll through the fixture tube, carrying the cord with it. A cord strong enough to pull the wires through can be easily drawn through the opening in this manner. The shot should, of course, not be so large that it can possibly bind in the tube.

An Automatically Closing Drawer

A very ingenious way to have a drawer close automatically is to attach a weight so that the rope or cord will pull on the rear end of the drawer. The sketch clearly shows the device which is an attachment similar to that used for closing gates. This can be

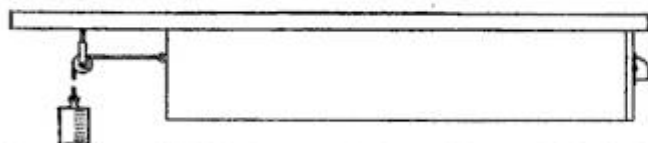

The Rope and Weight Attached to the Back End of the Drawer Pulls It Closed

applied to drawers that are frequently drawn out and in places where a person is liable to have the hands full.

A Cork Puller

The stopper of any ordinary bottle can be easily removed with a puller such as shown in the sketch. The puller is inserted between the stopper and the neck of the bottle until the hook

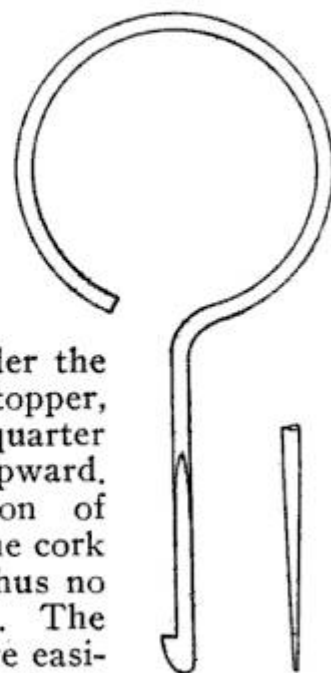

end will pass under the bottom of the stopper, then given a quarter turn and pulled upward.

The construction of the puller vents the cork as it enters and thus no vacuum is created. The cork is pulled more easily than with an ordinary corkscrew, and there is no danger of tearing the cork to pieces.

Uses for a Bamboo Pole

Select a good bamboo pole, about 18 ft. long, and cut it into three lengths as follows: A piece from the top, $2\frac{1}{2}$ ft. long; the next length, $5\frac{1}{2}$ ft. long, and the remaining end of the pole, about 10 ft. long. The $2\frac{1}{2}$ -ft. length is



FIG. 1



FIG. 2



FIG. 3

A Bamboo Pole Cut in Three Pieces Makes a Window-
Shade Stick, Duster Holder and Clothesline Pole

equipped with a screw hook in the smaller end, as shown in Fig. 1. This stick is useful in lowering window shades that have a ring or screw eye attached to the lower part of the shade. When the stick is not in use, it is hung on the edge of the window casing.

The $5\frac{1}{2}$ -ft. length makes the long handle for a duster. Procure an old-style lamp-chimney cleaner, wind a cord around the wires a few inches below the point where they begin to

spread to keep them from coming apart, then cut or file the wires off 2 in. below the winding. This leaves a straight shank, over which a ferrule is slipped before it is inserted into the small end of the pole. Fill the remaining space in the pole end with plaster of Paris, and when it has set, slip the ferrule into place on the pole end. If a ferrule is not at hand, a fine wire can be wound around the end to prevent the pole from splitting. When using this pole to dust hardwood floors, tops of doors, window casings and picture frames, put a dusting cloth into the claws and slide the ring into place, as shown in Fig. 2.

The longer and larger end of the pole is used as a clothesline pole. One end of this pole is fitted with a yoke made of No. 6 gauge galvanized wire, as shown in Fig. 3. The wire for the yoke is 10 in. long, and after bending it in shape, the two upper ends should be 2 in. apart and the yoke 2 in. deep. Insert the straight end of the wire into the smaller end of the pole and set it in firmly with plaster of Paris. The end of the pole should be securely wound with wire to keep the bamboo from splitting.—Contributed by Gertrude M. Bender, Utica, N. Y.

Making Common Lock Less Pickable

The ordinary lock can be readily changed so that it will be quite impossible to pick it with a common key.

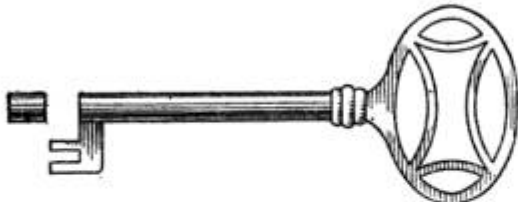

The Small End Cut from the Key is Fastened on the Pin of the Lock

The way to do this is to cut off the small hollow portion of the key that fits over the pin. This part is placed on the pin of the lock and soldered, or fastened by any other means, so it cannot come out of the lock. This will prevent any ordinary key from entering the keyhole.—Contributed by A. J. Hamilton, Benton, Ark.

To Color Tan Leather Black

An inexpensive and effective way to blacken tan leather is as follows: The leather is first rubbed with a 10-per-cent solution of tannic acid, which may be purchased at any drug store. This treatment should be applied and the leather well dried. It should be rubbed with a cloth hard enough to produce a polish, then apply a 10-per-cent solution of iron sulphate. A chemical reaction takes place as the last solution is rubbed into the leather, making it black. After this is dry, the leather can be polished in the usual way.

To Prevent Corks Sticking in Bottle Necks

Corks will always adhere to the necks of bottles containing glue or other sticky liquids, with the result that it becomes necessary to cut or dig the cork into small pieces in order to remove the contents from the bottle.

A simple and effective way to prevent a cork from sticking is to place a small piece of waxed paper on the bottle opening so that when the cork is pressed in, the paper will be between the cork and glass, as shown.

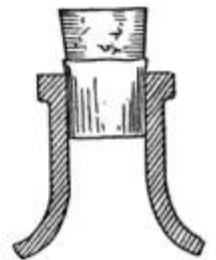

To Remove Rust Stains from Clothing

Many times when working around machinery, the clothes will come in contact with iron and get rust stains. These may be removed by using a weak solution of oxalic acid which must be applied carefully as it is highly poisonous. Sometimes the stain can be removed by washing the spot in buttermilk, in which case rubbing is necessary.

Small bits of onion placed in a room will absorb the disagreeable odors of paint and turpentine.

Eraser Holder

Any small piece of steel with a point, similar to that shown in the sketch, will make a good eraser holder. The saving of erasers is nothing compared to the convenience of having a small eraser with a chisel edge or point when delicate erasing is required. It is not clumsy as the usual chunk of rubber with a blunt point, for the person erasing can see what he is doing. I use a leg of an old pair of dividers and cut my erasers in four parts in shapes similar to that shown in the sketch by the dotted lines, and can use them easily until they are about



A Very Small Eraser can be Held on the Point and Used for Delicate Erasures

the size of a pea. The friction between the rubber and steel, after the point has been inserted into the rubber, holds the two together nicely.—Contributed by James F. Burke, Lakewood, O.

Bleaching Ivory

A good method to bleach ivory ornaments is to rub on a solution made of a small quantity of unslaked lime, bran and water. The mixture should be wiped off after the ivory has become sufficiently bleached, and the surface then rubbed with sawdust or magnesia, which gives it a brilliant polish.

A Soap Shake

To utilize scraps of soap, make a soap shake of a medium-size baking-powder can, as shown in the sketch.



Punch holes in the can with an ice pick or some other sharp-pointed instrument, and attach a large wire to the center, twisting the ends to form a handle.—Contributed by Elizabeth P. Grant, Winchester, Virginia.

Ear Repair on a Bucket

A broken ear for a bail on a metal pail or bucket can be replaced with a window-shade fastener, such as shown at A in the sketch.

The base of the fastener is turned down flat and attached with screw bolts or rivets, as shown

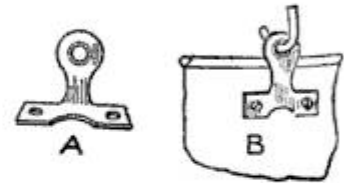

at B.—Contributed by Harold Robinson, Suffern, N. Y.

Cleaning Dirt from Tufts in Upholstering

A handy device for cleaning furniture upholstery and vehicle-seat tuftings may be easily made as follows:

Take an ordinary round paintbrush and cut the handle off, leaving it about $1\frac{1}{2}$ in. long, then saw a V-shaped notch in it, as shown in Fig. 1. Attach the brush to the ratchet screwdriver, Fig. 2, by inserting the screwdriver blade in the notch of the brush handle, and secure it by wrapping a strong cord around the handle. Place the brush in the tuft and work the screwdriver handle, as in turning a screw. A few quick turns of the brush will throw out the dirt which is impossible to remove with a straight brush.



FIG. 1



FIG. 2

Painting Lead Pipe

The paint applied to lead pipes will chip and peel off, and to prevent this I first cover the lead surface with a thin coat of varnish, then apply the paint on the varnish. A lead pipe painted in this way will retain its coating.—Contributed by F. Schumacher, Brooklyn, N. Y.

Substitute for a Rubber Stamp

A large number of coupons had to be marked, and having no suitable rubber stamp at hand, I selected a

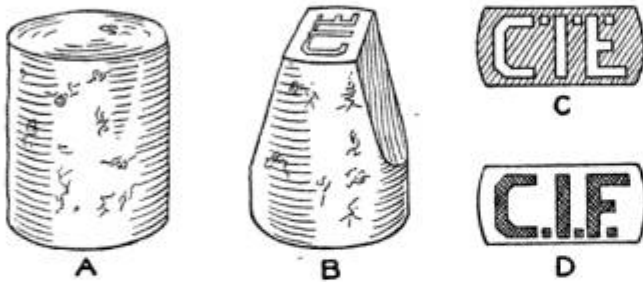

Initials Cut in a Cork Served the Purpose in the Absence of a Rubber Stamp

cork with a smooth end and cut the initials in it. I found that it worked as well, not to say better, than a rubber stamp. An ordinary rubber-stamp pad was used for inking. Angular letters will cut better than curved ones, as the cork quickly dulls the edge of any cutting tool.—Contributed by James M. Kane, Doylestown, Pa.

A Furniture Polish

A good pastelike furniture polish, which is very cheap and keeps indefinitely, can be made as follows: Mix 3 oz. of white wax, 2 oz. of pearlash, commonly known as potassium carbonate, and 6 oz. of water. Heat the mixture until it becomes dissolved, then add 4 oz. of boiled linseed oil and 5 oz. of turpentine. Stir well and pour into cans to cool. Apply with a cloth and rub to a polish. The paste is non-poisonous.

A Hanging Vase

A very neat and attractive hanging corner vase can be made of a colored bottle. The bottom is broken out or cut off as desired and a wire hanger attached as shown. The opening in the neck of the bottle is well corked. Rectangular shaped bottles fitted with hangers can be used on walls.—Contributed by A. D. Tanaka, Jujiya, Kioto, Japan.

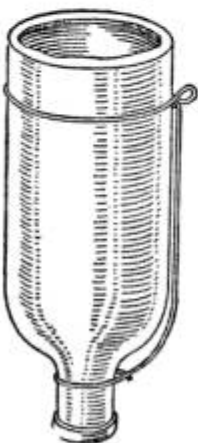

Filing Soft Metals

It is well known to mechanics that when lead, tin, soft solder or aluminum are filed, the file is soon filled with the metal and it will not cut. It cannot be cleaned like the wood rasp by dipping it into hot water or pouring boiling water over it, but if the file and the work are kept wet with water, there will be no trouble whatever. Both file and work must be kept thoroughly wet at all times.—Contributed by J. H. Beebee, Rochester, N. Y.

Locking Screws in Door Hinges

When screws once work loose in hinges of doors they will never again hold firmly in the same hole. This trouble can be avoided if the screws are securely locked when they are first put on the door. The sketch shows a

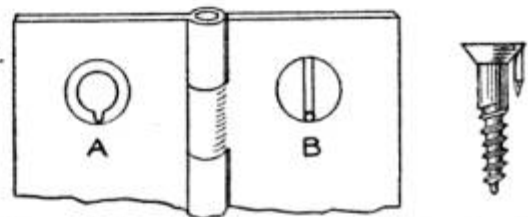

The Screw is Permanently Locked with a Small Nail Driven into the Slot Prepared for It

very successful way to lock the screws. The hole in the hinge for the screw is filed to produce a notch, as shown at A, deep enough to receive a small wire nail or brad, which is driven through the slot in the screw head at one side, as shown at B.

To Remove Grease from Clothing

Equal parts of ether, ammonia and alcohol make a solution that will readily remove grease from clothing. The solution must be kept away from fire, and should be contained in corked bottles as it evaporates quickly, but can be used without danger. It removes grease spots from the finest fabrics and is harmless to the texture.

☞ Jeweler's rouge rubbed well into chamois skin is handy to polish gold and silver articles with.

PATENTS, PRACTICAL
NORFOLK, VA
OR UNIQUE



Fig. 1

EAR ATTACHMENT FOR MEGAPHONES (Fig. 1)—A provision that makes the megaphone an aid in the receiving of sound as well as in its transmission is here shown.



Fig. 2

DOUGH RAISER (Fig. 2)—This illustration shows a dough-raising attachment for kitchen tables, and comprises a receptacle underneath the table top and a lamp and an arrangement for transmitting the heat from a lamp into this receptacle.



Fig. 3

MEASURING THE STRIKING FORCE OF GOLF CLUBS (Fig. 3)—Believing it desirable to ascertain the striking force of golf clubs, an English inventor has designed a club having a blow-measuring mechanism.

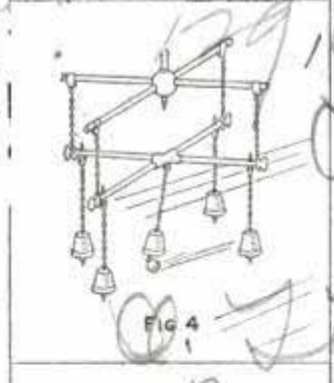

Fig. 4

A BELL GAME FOR BILLIARD TABLES (Fig. 4; British patent)—In a bell game for billiard tables, a number of bells are supported above the table in such a manner that the points of the hammers may be struck by the billiard balls, thus sounding the bells.



Fig. 5

EYEGGLASS CASE AND SCREWDRIVER (Fig. 5)—The wearers of eyeglasses often have need of a tiny screwdriver for use in tightening a loose screw or making an adjustment, but it is seldom that such a screwdriver is at hand. To make sure that such a tool be available, however, one inventor has designed a combined eyeglass case and screwdriver. The handle of one of the hinges is a tube for the screwdriver.

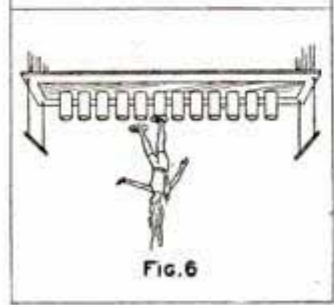

Fig. 6

WALKING ON THE CEILING (Fig. 6)—An apparatus for prope performance by means of which they may walk upside down in imitation of a fly on a ceiling is here illustrated. A series of vacuum cups, open at their bottoms, are attached to the under side of an air chamber containing air at atmospheric pressure, and the performer, with disks attached to the soles of his shoes, walks along upside down by inserting these disks first in one vacuum cup and then another.

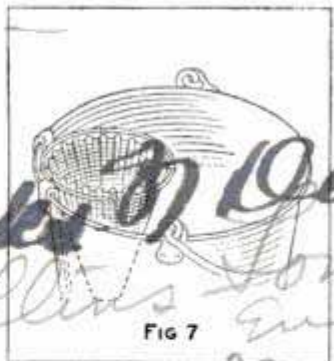

Fig. 7



Fig. 8

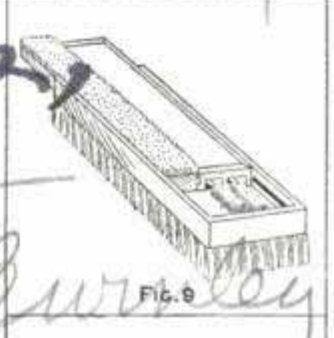

Fig. 9



Fig. 10

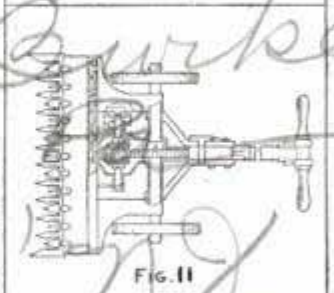

Fig. 11

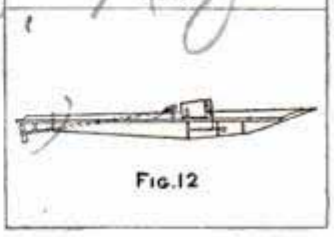

Fig. 12

MOP WRINGER (Fig. 7; British patent)—The inverted-cone mop wringer, designed to be detachably supported on one side of the pail, has a vertically fluted inner surface. The mop is inserted in the cone, forced downward and twisted around, the water thus wrung from it dropping through the opening in the bottom of the cone into the pail.

DUSTER FOR VACUUM CLEANERS (Fig. 8)—A duster mat which may be flicked over the surface to be dusted, disturbing the dust, which is then drawn through the mat into a hollow handle and thence to the dirt receptacle of the vacuum outfit, is here shown. The material forming the duster mat is kept from being drawn into the hollow handle by means of a globular wire protector.

NESTED CLOTHES BRUSHES (Fig. 9; British patent)—This full-sized clothes brush has a lid divided longitudinally, one part forming a narrow brush for cleaning the brim of a hat, and the like, while the remaining portion of the sliding lid has channels in which smaller brushes are held when not in use.

COMBINED LIFE BUOY AND BATHING SUIT (Fig. 10)—This bathing suit comprises a combination of a detachable buoyant garment fitted next to the body. The buoyant front and back portions for the body and legs are connected together into a harness by elastic bands.

HAND-PUSHED MOWING MACHINE (Fig. 11)—This little mowing machine is designed especially for the mowing of small areas, such, for instance, as yards or strips of parkway where the grass has grown too long to be cut by the ordinary lawn mower. It is pushed over the ground in the same way as the latter, the revolving wheels actuating mechanisms which operate the cutting teeth.

A NEW HYDROPLANE DESIGN (Fig. 12; British patent)—This hydroplane has a hull having the form of an elongated arch, the crown of which is inclined downward from bow to stern, and the sides of which are provided with lateral planes. When moving forward, the tendency of the air beneath the arch is to raise the vessel out of the water. Horizontal fins are provided whereby the bow of the vessel may be raised or depressed.

H. M. van Weede

MR. LEWIS WHITE ALLEN, the Denver physiologist, was giving an informal talk on physiology upon the windy, sea-fronting porch of an Atlantic City hotel.

"Also," he said, "it has lately been found that the human body contains sulphur."

"Sulphur?" exclaimed a girl in a blue and white blazer. "How much sulphur is there, then, in a girl's body?"

"Oh," said Dr. Allen, smiling, "the amount varies." "And is that," asked the girl, "why some of us make so much better matches than others?" Exchange.

Some salesmen are equal to almost any emergency and do not spare the "other car" when occasion requires.

"But the Blank car is guaranteed for life," protested a prospective purchaser to a salesman of the sort.

"Yes, I know it is," retorted the quick-witted salesman, "but our car is guaranteed for a whole year."

It required several moments for the prospective purchaser to see the point.—Motor World.

The story goes that the celebrated violinist, Wilhelmy, had been engaged to play at a private party given by a banker in Vienna. He was "hired" to play from seven o'clock to ten. The wealthy host, it must be premised, had no knowledge whatever of music. The great violinist began his performance by playing the andante of the Mendelssohn's concerto. The man of money was dumfounded, and turning to his guests said, in a sort of stage aside, "Excuse me, you see what these musicians are; I engage him to play by the hour and he plays slowly!"—The Violinist.

Donald and Jeanie were putting down a carpet, Donald slammed the end of his thumb with the hammer, and began to pour forth his soul in language befitting the occasion. "Donald! Donald!" shrieked Jeanie, horrified, "Dinna swear that way!" "Wummun," vociferated Donald, "gin ye know ony better way, now is the time to let me know it!"

"I see you've taken out a license for a motor car, Bill," said Jimpson. "I didn't know you had a car."

"I haven't," said Bildad.

"Then what the dickens has induced you to take out a license?" demanded Jimpson.

"Oh, it's sort of pleasant to feel that I can have one if I want to," said Bildad.—Harper's Weekly.

Willie finally persuaded his aunt to play train with him. The chairs were arranged in line and then he said:

"Now, you be the engineer and I'll be the conductor. Lend me your watch and get up into your cab." He then hurried down the platform, timepiece in hand.

"Pull out there, you red-headed, pie-faced jay!" he shouted to the astonishment of the young woman.

"Why, Willie!" she exclaimed in amazement.

"That's right, chew the rag," he retorted. "Pull out. We're five minutes late already."

They have had to forbid his playing down by the tracks.—Illinois Central Employees Magazine.

An Italian who kept a fruit stand was much annoyed by possible customers who made a practice of handling the fruit and pinching it, thereby leaving it softened and often spoiled. Exasperated beyond endurance, he finally put up a sign which read:

If you must pincha da fruit—

pincha da cocoanut!—Lippincott's.

We hear that the management of the Louvre have now made it possible for all comers to procure portable stools on which to sit while viewing the masterpiece.

It is hoped that this innovation will render it unnecessary for visitors to take the pictures home to study, as was done in the case of Leonardo's "Mona Lisa."—Punch.

In a fashionable restaurant a new multi-millionaire with no knowledge of French and no desire to expose his ignorance, pointed to a line on the menu and said to the waiter:

"I'll have some of that."

"I'm sorry, sir," the waiter answered, "but the band is playing that."—Ladies' Home Journal.

While I was running a bolt cutter at the Rock Island shops in Chicago,

writes a contributor to Railway and Locomotive Engineering, I boarded at a house much frequented by locomotive engineers and firemen. These men talked a great deal about their tremendous feats in getting over certain hills without the help of a second locomotive.

My opposite neighbor at a table, a young fellow who ran a lathe in the shop, grew tired of this monotonous bragging; he thought he was entitled to do a little talking himself. One evening he called out to me:

"Well, I went over and saw that new machine today, and it's astonishing the fine work it does."

"How does it work?" I inquired.

"Well," said James, "by means of a pedal attachment, a fulcrum lever converts a vertical reciprocating motion into

a circular movement. The principal part of the machine is a huge disk that revolves in a vertical plane. Power is applied through the axis of the disk, and when the speed of the driving arbor is moderate, the periphery of the apparatus is traveling at a high velocity. Work is done on this periphery. Pieces of the hardest steel are by mere impact reduced to any shape the skillful operator desires."

"What in the name of sense is that machine, anyway?" demanded Tom Briggs.

"Oh, it's a new grindstone," replied James, and a silence that could be cut with a butcher knife fell upon the crowd.

"I've a kitchenette in my flat. What's the feature of yours, Jones?"

"A cellarette. And of yours, Smith?"

"I've got a suffragette in mine."—Exchange.

"You may give three important illustrations of the power of the press," says the teacher to the class.

The pupil who has not hitherto distinguished himself is first to reply:

"Cider, courtship and politics."—Judge.

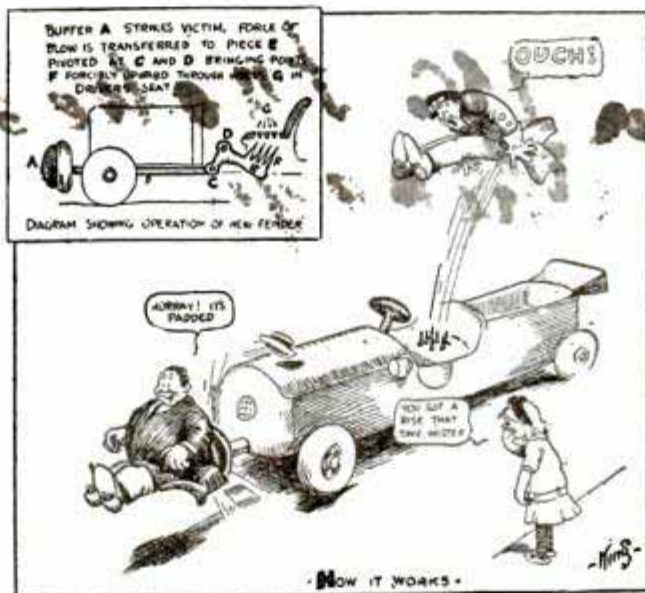

The Victim's Revenge—A Chicago Inventor's Suggestion

—Chicago Tribune

A Book of Valuable Ideas for Beautifying the Home **FREE**

Stop in today and ask your dealer for the 1913 Edition P. A. 1 of our free book "The Proper Treatment for Floors, Woodwork and Furniture." He will give you also, two samples of Johnson's Wood Dye and Prepared Wax.

With these you can prove, for yourself, the wonderful aid in Home Beautifying, which comes with the use of Johnson's Finishes.

Johnson's Wood Dye In 16 Shades

is a **dye**, not a "stain." It sinks deep down, bringing out the **natural** beauty without that artificial grained effect. In half an hour it will be perfectly dry; no dust sticks; no streaks show. It is not only beautiful, but **lasting** and easy to use.

No. 126 Light Oak

No. 123 Dark Oak

No. 125 Mission Oak

No. 140 Early English

No. 110 Bog Oak

No. 130 Weathered Oak

No. 131 Brown Weathered

No. 132 Green Weathered

No. 121 Moss Green

No. 122 Forest Green

No. 127 Extra Dark Mahogany

No. 172 Flemish Oak

No. 178 Brown Flemish

No. 120 Fumed Oak

No. 128 Light Mahogany

No. 129 Dark Mahogany

Johnson's Prepared Wax

can be used successfully over all finishes, varnish, shellac, oil, etc. Apply with a cloth—it gives a velvety protection to any wood. We want you to try Johnson's Wood Dye and Prepared Wax at our expense.

*If your dealer cannot supply you,
Please Use the Free Coupon Today.*

**S. C. Johnson
& Son**

Racine, Wis.

"The Wood
Finishing
Authorities"

COUPON

I accept your
offer of Free
Book Edition P.
A. 1 and samples of
Johnson's Prepared
Wax and Wood Dye,

shades No. and

No.

Name

Address

City and State

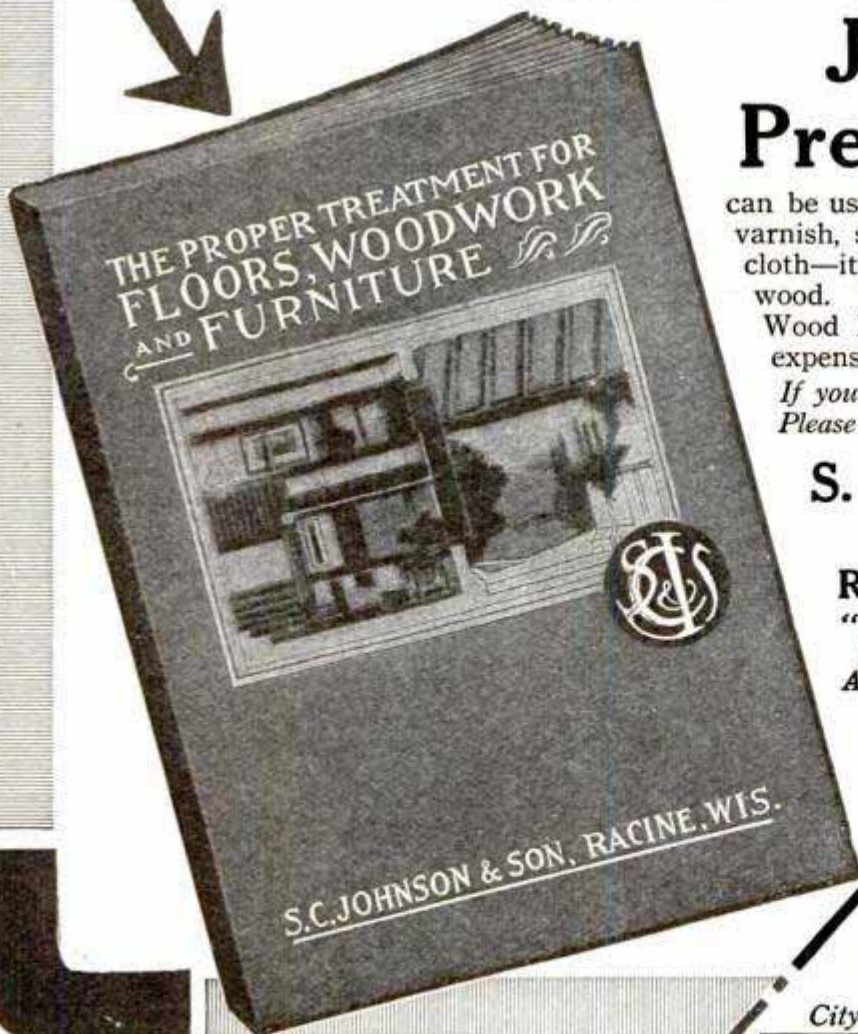

Is the Money

YOUR special training—or lack of it—hits you right in the money pocket. With everything going up but the salaries of *untrained* men, with competition becoming keener all the time, with the many wants that each day brings, and the time when there'll be nothing coming in—with all these conditions staring you in the face, you've got to decide mighty quick whether you're a success or not—and if *not*, how you *can* make friends with success and bid failure "good-bye."

IT's a serious proposition when you stop to think about it—this *big* spending and *little* earning. Yet, it needn't worry you one bit if you can increase your *earning* capacity far beyond your *spending* requirements. It's simply a matter of making your brain work instead of your body. Head work earns more than body work. *You've* got some good ideas—and you know it. The International Correspondence Schools will help you turn those ideas into cash.

SELECT from the attached coupon the well-paid occupation you like best, mark the coupon as directed, and mail it today. That's all you have to do to learn *how* the I. C. S. can train you at home and in your spare time—no matter where you are, what



Always There?



You can't afford to overlook this opportunity to increase your salary. Mark and mail the coupon NOW.

you do, what your age. *If you can only read and write, the way is open.*

DON'T worry as to *how* the I. C. S. can help you. The I. C. S. has already helped so many other ambitious men that it surely can do the same for *you*. The I. C. S. removes all obstacles—makes everything easy—smooths the road.

YOU'VE got to look this *earning* and *spending* proposition squarely in the face *some* time. Do it **NOW** and *decide* now how to get the better of it. Let the I. C. S. advise and *help* you. Earning with your head is far more congenial and profitable than toiling with your body. Which will you choose?

INTERNATIONAL CORRESPONDENCE SCHOOLS

Box 872, SCRANTON, PA.

Explain, without further obligation on my part, how I can qualify for the position before which I mark X.

Electrical Engineer
Elec. Lighting Supt.
Electric Car Running
Electric Wireman
Telephone Expert
Architect
Building Contractor
Architectural Draftsman
Structural Engineer
Concrete Construction
Mechan. Engineer
Mechanical Draftsman
Refrigeration Engineer
Civil Engineer
Surveyor
Mine Superintendent
Metal Mining
Locomotive Fireman & Eng.
Stationary Engineer
Textile Manufacturing
Gas Engines
Automobile Running

Civil Service
Railway Mail Clerk
Bookkeeping
Stenography & Typewriting
Window Trimming
Show Card Writing
Lettering & Sign Painting
Advertising
Salesman
Commercial Illustrating
Industrial Designing
Commercial Law
Teacher
English Branches
Good English for Every One
Agriculture
Poultry Farming
Plumbing & Steam Fitting
Sheet Metal Worker
Navigation
Languages
Chemist

Spanish
French
German

Name _____

Present Occupation _____

Street and No. _____

City _____ State _____

Put the "Winslow Smile" on Your Boy!
HE knows which skates the "fellers" wear!

WINSLOW'S Skates

THE BEST ICE AND ROLLER SKATES

Write for new catalogue No. 12, containing rules of leading Hockey Associations.

THE SAMUEL WINSLOW SKATE MFG. CO.

Factory and Main Offices: Worcester, Mass., U. S. A.

Sales Rooms: New York, 84 Chambers St.

Pacific Coast Sales Agency: Phil. B. Bekeart Co., San Francisco

Stocks to be found at LONDON, 8 Long Lane, E. C.; PARIS, 64 Avenue de la Grande Armee; BERLIN; SYDNEY and BRISBANE, Australia; DUNEDIN, AUCKLAND and WELLINGTON, New Zealand.



Be the "BUNGALOW BUILDER" of Your Town



DESIGNED BY
JUD YOHIO

Design No. 446
Estimated Cost \$1,800

Showing the newest designs for Craftsman and Pacific Coast Bungalows; artistic and comfortable, suited to any climate. Contains exterior and interior photos of 40 Bungalows, with floor plans, size rooms, cost, etc. Our 1913 Edition de Luxe, (96 pages, largest exclusive Bungalow Book published) the cream of 1000 Bungalows actually built for \$400 to \$4,000 with floor plans, size rooms, cost, etc. Offer

Special 50c
Special \$1
Send M. O. check or stamps. Money back if not satisfied.

CRAFTSMAN BUNGALOW CO., 423 Leary Bldg., Seattle, Wash.

Fighting the Architect's Trust

(ESTABLISHED 1875)

Charles Buck Tools

Highest Award World's Columbian Exposition
Highest Award World's Centennial Exposition

Send name of your dealer and we
will send you our new art catalog.

Charles Buck Edge Tool Co., Millbury, Mass., U. S. A.

PATENTS

ELECTRICAL AND MECHANICAL
EXPERT

WILLIAM C. LINTON
910 G Street, WASHINGTON, D. C.

Send today for FREE booklet, how to obtain them

STILLWELL BUNGALOW BOOKS

Your own home — the design and plan — concerns you vitally. Genuine Bungalows are most profitable investments, combining the beautiful and practical with low cost. If artistic homes mean anything to you, the pictures, floor plans, and descriptions in our Bungalow Books will be intensely interesting.

"REPRESENTATIVE CALIFORNIA HOMES"—Price 50 Cents

50 Bungalows and two story houses of 5 to 10 rooms, costing \$1600 to \$6000

"WEST COAST BUNGALOWS"—Price 50 Cents

50 one story Bungalows of 4 to 6 rooms, costing.....\$500 to \$2000

"LITTLE BUNGALOWS"—25 costing \$400 to \$1200, Price 25c

SPECIAL OFFER—All 3 books sent postpaid for ONE DOLLAR

E. W. STILLWELL & CO., Archts., 217-A Henny Bldg., Los Angeles



THIS BUNGALOW \$900 CAN BE BUILT FOR

This and many others in my new book, Building Plans for Modern Homes, will save you hundreds of dollars. One of the most complete and comprehensive books of plans ever published by any architect. Fifth edition just off the press. One hundred and fifty floor plans and photographs of bungalows, etc., costing from \$250 up; gives sizes and cost to build. Sent postpaid for \$1.



FREDERICK H. GOWING
ARCHITECT
18 Tremont St. BOSTON

HETTY GREEN ON HOUSEKEEPING—"A woman can't run her house properly unless she does her own marketing. I don't think very much of this suffrage matter. I always believed with my daddy, that a woman's place was in the home, and that a woman should be married and have a family. Let the man do the voting and make the money and let the woman keep house and do the cooking. If a woman will feed a man properly she will get all she wants. Just give him enough to eat and woman's woes will pass."

Let Your Engine or Motor Do the Work

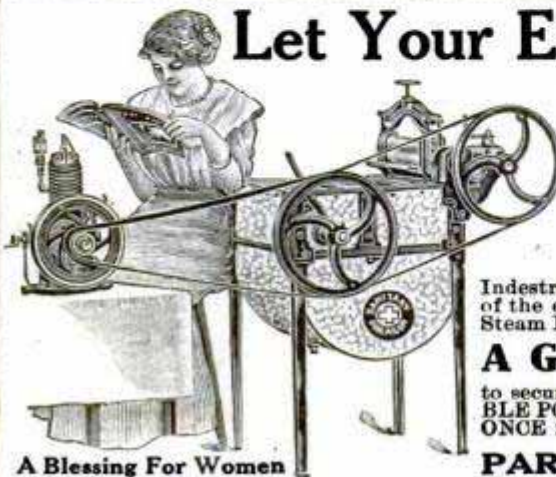

A Blessing For Women

and make an end to washday drudgery in YOUR home. Of course, NONE of the unsanitary, old-fashioned wooden rotary washers will do. ONLY THE MOST UP-TO-DATE machine ought to be good enough for YOUR wife. EXPERTS will tell you that NO MORE DURABLE and PRACTICAL washer can be found than the famous

All Metal Sanitary Paragon Revolving Cylinder Power Laundry Machine

Indestructible. NO WOOD used in any part. The PARAGON is a true reproduction of the expensive and powerful Cylinder Washers exclusively and successfully used in Steam Laundries, Hotels and Hospitals. Over 100,000 Paragon Washers used in the U. S.

A Golden Opportunity for 30 Days Only

to secure one of these wonderful genuine laundry machines, complete with REVERSIBLE POWER WRINGER at a very considerable REDUCTION in price, if you write AT ONCE for Catalog No. 1 and further details of the most generous proposition made.

PARAGON MFG. CO., 2401-03 W. 14th St., CHICAGO

HARLEY-DAVIDSON

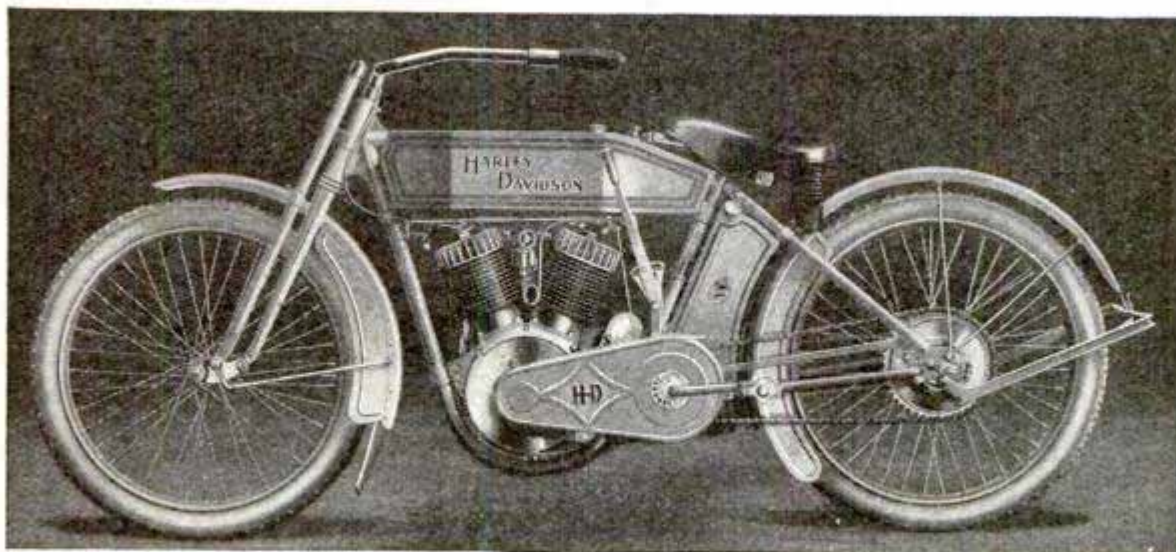

700 Used by One Corporation

AFTER the Bell Telephone Company had convinced themselves absolutely that one man with a motorcycle could do the work of from three to five men with teams, they carefully investigated the various makes of motorcycles. Several of the most desirable were selected for try-outs in their own work. When results were compiled the showing of the

HARLEY-DAVIDSON

was such that today there are more Harley-Davidsons to be found in the service of the Bell Telephone Company, than all other makes combined. Their records substantiated our claim that the Harley-Davidson was the most economical motorcycle made, which claim was based on the official World's Economy Record established by the Harley-Davidson more than four years ago—a record which still stands unequalled by any other make of motorcycle.

The Harley-Davidson is the only motorcycle that the National Federation of American Motorcyclists has ever awarded a diamond medal and a 1000 plus 5 score in any endurance contest—the plus 5 was given because of the exceptional showing of this machine.)

It is the only motorcycle which has the Full-Floating Seat and Free-Wheel Control, (both patented features) two of the greatest comfort factors known in the motorcycle world.

Call up the Harley-Davidson dealer in your vicinity and ask for demonstration or send for illustrated catalogue.

HARLEY-DAVIDSON MOTOR CO.

276 B STREET

MILWAUKEE, WIS.

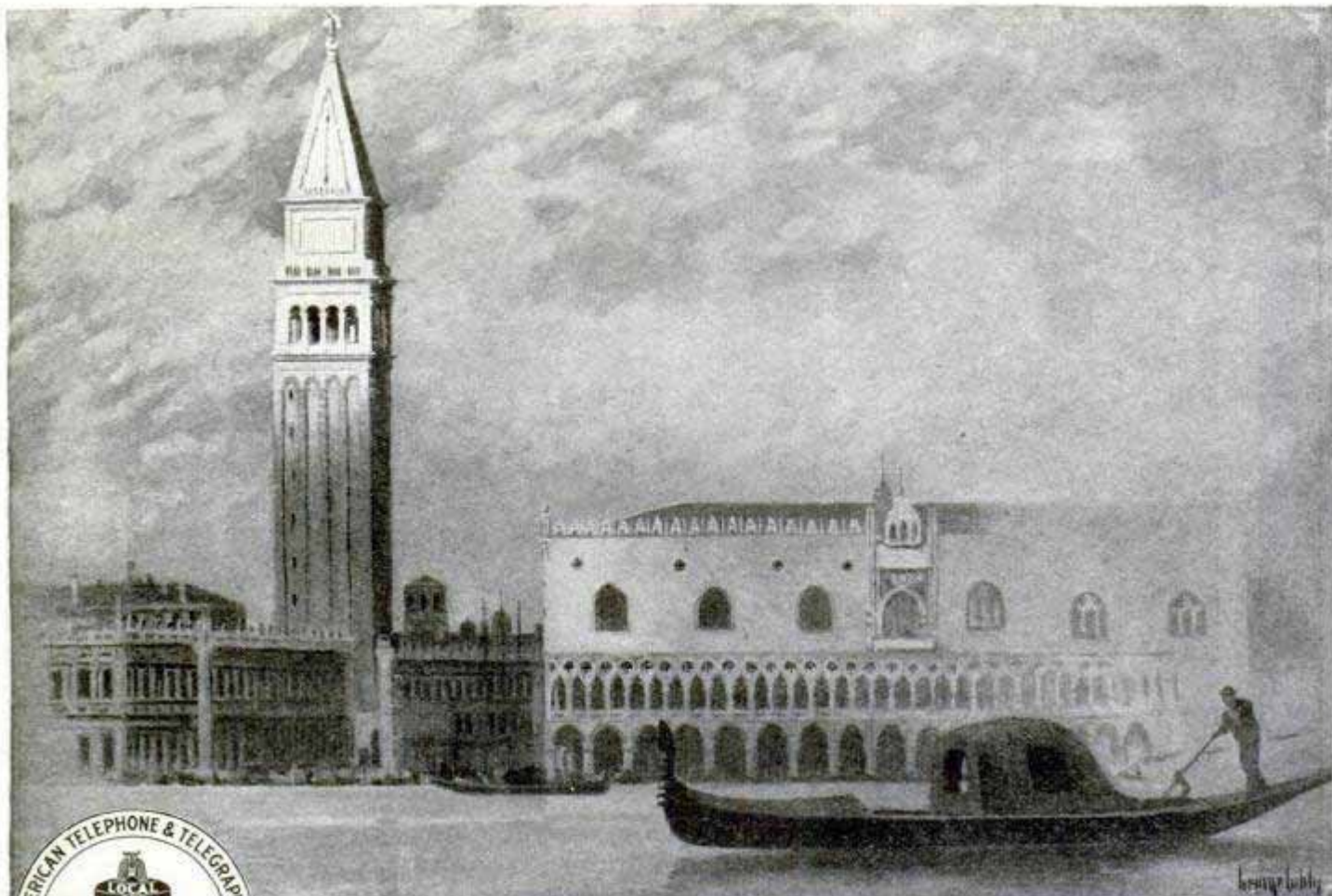

Seven Million Watch-Towers in the Bell System

The original campanili were the watch-towers of old Venice, guarding the little republic from invasion by hostile fleets.

Later, bells were mounted in these same towers to give warning of attack and celebrate victories.

Judged by modern telephone standards, such a system of communication seems crude and inadequate.

In the civilization of to-day, a more perfect intercommunication is

essential to national safety, convenience and progress.

The Bell System binds together a nation of nearly one hundred million people, by "highways of speech" extending into every nook and corner of this great country.

Seven million Bell telephone stations are the watch-towers which exchange, daily, twenty-five million messages for the happiness, prosperity and progress of all the people.

**AMERICAN TELEPHONE AND TELEGRAPH COMPANY
AND ASSOCIATED COMPANIES**

One Policy

One System

Universal Service

Please Mention Popular Mechanics

Startling Watch Offer

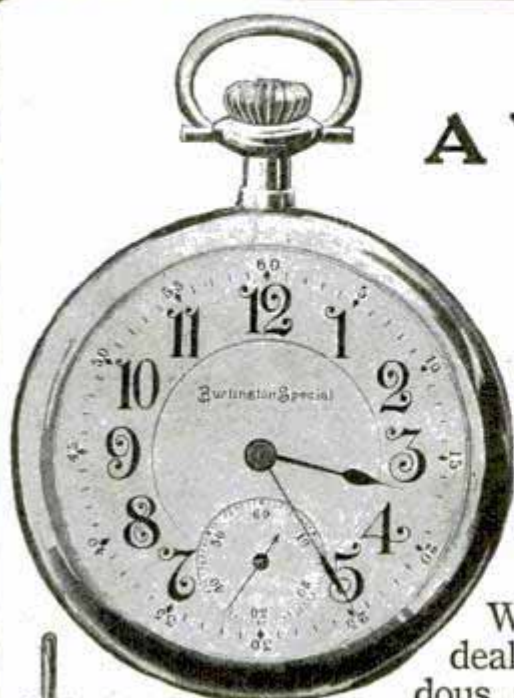

READ!

A Watch Offer Without Parallel

Write for our **FREE** book on watches; a book that posts you on watches and watch values—explains reasons for our most remarkable rock-bottom-price offer **DIRECT TO YOU** on the highest grade Burlington.

IF YOU WANT a highest grade watch (ladies' or gentlemen's), or if you ever expect to own such a watch, write **NOW** for the **FREE Burlington** book. See coupon below.

We won't "knuckle down" to selling systems among dealers, so we have decided to make such a tremendous and wonderful offer direct to the public on a first-class time piece, that no trust, no dealers under contract will or can stop us. **You too** will seize this opportunity to get the "Burlington Special" direct on this wonderful offer.

You should not buy a worthless watch just because it is cheap. Nor need you pay trust prices now for a top-notch watch. The free Burlington book explains.

\$2.50 a Month at the Rock Bottom Price

\$2.50 a month for the world's most superb time piece? The easiest payments at the rock-bottom price—the **Rock-Bottom** price. *To assure us that everybody will quickly accept this introductory direct offer, we allow cash or easy payments, just as you prefer.*

No Money Down

We ship the watch on approval, prepaid (your choice of ladies' or gentleman's open face or hunting case). You risk absolutely nothing—you pay nothing—not one cent unless you **want** the great offer after seeing and thoroughly inspecting the watch.

Now Write for the free book. It will tell you what you ought to know before you even examine a watch. It will tell you the inside facts about watch prices, and will explain the many superior points of the Burlington over the double priced products. Just send your name and address today.

Get the Free Burlington Book

THIS BOOKLET will quickly convince you too that you **DO** want an independent watch—made in the independent factory that is fighting the trust as best it can by giving better quality and superior workmanship throughout; we will quickly convince you that the Burlington watch, on which there is only **one** rock-bottom price (the same rock-bottom price everywhere), is **THE** watch for the discriminating buyer; that it is **THE** watch for the man or woman who wants, not the largest selling brand which everybody has, but the **best** watch, the watch bought by experts, **THE** watch that is absolutely perfect in its many points of superiority—the **Burlington Watch**. You will be posted on **inside facts** and prices when you send for the Burlington Company's free book on watches.

BURLINGTON WATCH CO.

Dept. 1191, 19th and Marshall Blvd.

CHICAGO, - ILLINOIS

Please send me (without obligations and prepaid) your free book on watches and copy of your \$1,000 challenge, with full explanations of your cash or \$2.50 a month offer on the Burlington Watch.

No Letter is Necessary. **COUPON** Will Do

NAME.....

ADDRESS.....

BURLINGTON WATCH COMPANY

Dept. 1191 19th and Marshall Blvd., Chicago, Ill.

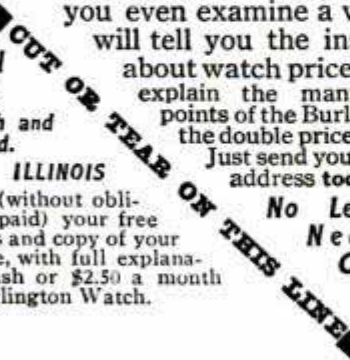

2c a Week Pays Wash Bill!

Write for
FREE Book

Electricity or Water-Power Does the Work

Just a "Twist of the Wrist" Starts or Stops the Machine!

The 1900 Motor Washers are now at work in thousands of homes. They are doing the work formerly done by women, at a cost of 2c a week for power! Saving thousands upon thousands of dollars in wash bills. Saving worlds of wash-day troubles. Leaving the women free to do other work while the machines are doing the washing.

The 1900 Motor Washer

Washes a Tubful in Six Minutes!

1900 Water Motor Washer
Can be connected with
any water tap instantly



Handles Heavy Blankets or Dainty Laces

The outfit consists of the famous 1900 Washer with either Electric Motor or Water Motor. You turn on the power as easily as you turn on the light, and back and forth goes the tub, washing the clothes for dear life. Then, turn a lever, and the washer does the wringing. All so simple and easy that it is mere child's play.

A Self-Working Wringer Free With Every Washer!

The motor runs the washer and wringer. We guarantee the perfect working of both. No extra charge for wringer, which is one of the finest made. Write for FREE BOOK and 30 Days' FREE TRIAL OFFER! Don't doubt! Don't say it can't be done. The free book proves that it can. But we do not ask you to take our word for it. We offer to send a 1900 Motor Washer on absolute Free Trial for an entire month to any responsible person. Not a cent of security—nor a promise to buy. Just your word that you will give it a test. We even agree to pay the freight, and will take it back if it fails to do all we claim for it. A postal card with your name and address sent to us today will bring you the book free by return mail. All correspondence should be addressed to

Doing the wringing with
1900 Electric Motor Washer



1900 WASHER CO., 5099 Court St., Binghamton, N. Y.

Or, if you live in Canada, Write to the Canadian Washer Co., 355 Yonge St., Toronto, Canada. (23)

ASTRONOMICAL TELESCOPE

Length 36 3/4
inches. 2 inch
object glass

Complete with Case, Sun Shade,
Sun Glass and Extra Eye Piece
for Night Observation. **\$18**



One of these superb instruments will give material enjoyment. It will enable you to pick out the smallest Boats on the Horizon, tell the time by a clock many miles distant, and view the country

for fifty miles around. This telescope is made for Astronomical Work. With its aid the Mountains in the Moon, Jupiter's Moons and Saturn's Rings are clearly discernible.

Prof. Hicks, of Word and Works Almanac, says it is far superior to others he has examined at twice the price.

CATALOGUES SENT FREE ON APPLICATION

A. S. ALOE CO., 515 Olive St., ST. LOUIS, MO.

A prism glass bulb for tungsten electric lamps has been patented. It is said to diffuse the dazzling light from the tungsten filament without incurring the loss of illumination which accompanies the use of shades or ground glass bulbs, and thus to furnish a more agreeable as well as more economical light.



TYPEWRITERS ALL MAKES

All the Standard Machines SOLD or RENTED ANYWHERE at 1/4 to 1/2 M.P.P.'S PRICES, allowing RENTAL TO APPLY ON PRICE. Shipped with privilege of examination. Write for Illustrated Catalog L.

TYPEWRITER EMPORIUM, 24-26 W. Lake St., CHICAGO



TYPEWRITERS ALL MAKES

\$10.00 to \$45.00 for Underwoods, Remingtons, L. C. Smiths, Oliverts, etc. Visible or otherwise. Every typewriter in perfect condition and Guaranteed 2 Years.

OVER 500 TYPEWRITERS AT \$18.00 while they last. Send this ad and get \$1.00 Typewriter Ribbon FREE

ALL-MAKES TYPEWRITER EXCHANGE, 171 No. Dearborn St., Chicago, Ill.

New Typewriter

\$18

in U.S.A.

Built by a mechanical wizard. Has only 250 parts. Other machines have 1700 to 3700 parts. This sensational simplicity is the secret of the unheard-of selling price of \$18. It's built in famous Elliott-Fisher Billing Machine factory and sold on a money-back-unless-satisfied-guaranty. 26,000 in use.

The Bennett \$18 Portable Typewriter

does work of high-priced machines. Every big improvement: visible writing,

standard keyboard, reversible ribbon. Wt. 4 1/2 lbs. Easily carried. Write for catalog

Q-Y BENNETT TYPEWRITER CO.
366 B'dway New York
Foreign Add.: 75 Cannon St. London, E.C.



We can use a few more live agents



3 PENNIES A DAY

One Dollar a Month

Buys a Standard Typewriter

Your choice, Remington, Oliver or Smith Premier. Prices lower than other cash prices. Perfect machines only — guaranteed.

TYPEWRITER INSTALLMENT CO.
P 180 N. Dearborn St., CHICAGO

3000 Typewriters \$10 and UP
All Standard Makes



Slightly used and Factory Rebuilt — good as new. Fully guaranteed, shipped to you for FREE TRIAL. Write today.

E. C. UNDERWOOD & CO.
P. M. 170 Randolph St. CHICAGO

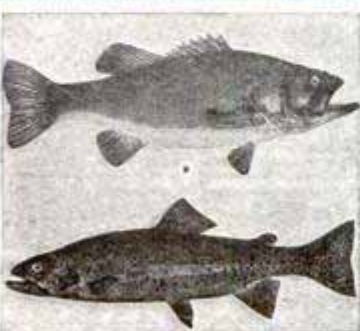
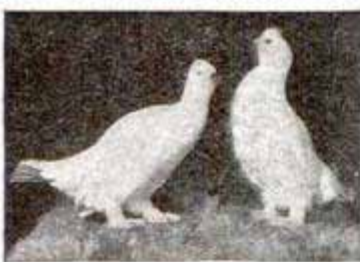

Learn to Mount Specimens Like These

This advertisement is for every *sportsman* and *nature lover*, everywhere. *Write to-day. Send the coupon* for our *free books*. They contain something of great value to hunters, trappers and all people who love the out-of-doors. *You should have this book. Write for it today.*

Do You Shoot or Fish?

If so, you should be able to save your beautiful and valuable trophies. *We can teach you how.* We have taught over 35,000 of the best sportsmen of the country, and they are now doing their own taxidermy work with wonderful success. They save taxidermists' bills and enjoy their spare time as never before. Taxidermy is the most fascinating of all professions. *We can teach you to mount all kinds of game specimens* absolutely true to life, by the latest and best methods. Easily, quickly and perfectly learned, in your own home *during your spare time.* No need of leaving your present employment. You can decorate your home with Nature's best art; you can double your interest in sportsmanship. Let your gun and rod pay for your vacation.

BIG PROFITS You can easily make from \$25 to \$50 a month during your *spare time*, practicing Taxidermy, or if you go into the work as a profession you can make \$5,000 or more per year. You can sell your own mounted specimens for big profit. You can make big money doing mounting for others. You should investigate this remarkable offer.

This Taxidermy Book FREE

We will send you this book on taxidermy absolutely free. It tells you all about our school and the most fascinating profession of Taxidermy. It will tell you how you can learn to become an expert taxidermist in a few months—*by mail—in your own home*—during your spare time. You need this book and *it costs you absolutely nothing.* Merely send in the *free coupon.* Write for it today—it is free—we will also send you the famous *Taxidermy Magazine* and hundreds of letters from our delighted graduates. Write today—*now—immediately—before you lay aside the paper.*

**NORTHWESTERN
SCHOOL OF TAXIDERMISTRY
1191 Elwood Building
OMAHA, NEB.**

"A school for sportsmen
by sportsmen."



**FREE
COUPON**

Northwestern School
of Taxidermy
1191 Elwood Bldg.
Omaha, Neb.

Gentlemen:—Please send me your new book on Taxidermy and the Taxidermy Magazine, also full particulars of your special offer. All Free and prepaid. No obligations on me whatsoever.

Name.....

Address.....

20¢ Anti-Nicotine "JIMMY" Pipe

3 for 50c

A sample can of my famous Community Mixture FREE when 3 pipes are ordered.

THIS will be your "Jimmy" pipe after the first smoke. No matter if you own a hundred pipes, you will reach for your "Jimmy" pipe every time.

Talk all you want to about the flavor, aroma and smoothness of tobacco. I know this—a lot of that flavor, a lot of that aroma—a lot of that smoothness—is made or killed by the pipe. In this "Jimmy" pipe you get all of the flavor, all of the aroma, and all of the smoothness, and at the same time robbing the tobacco of its nicotine poison.

There's no guess-work about this pipe.

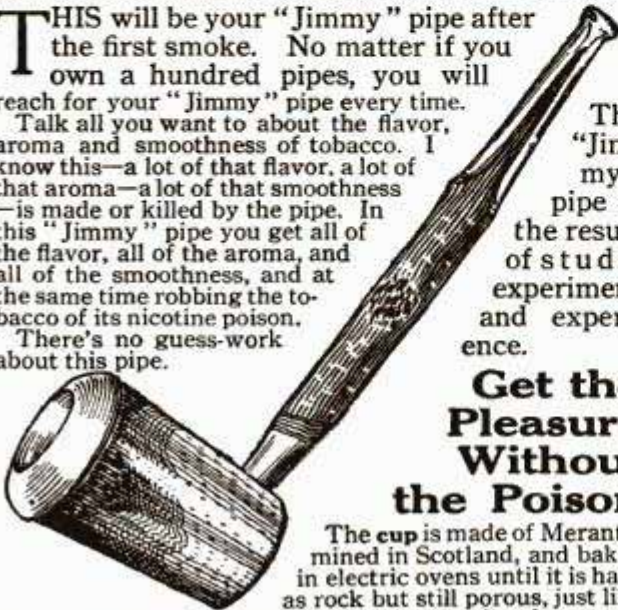

The "Jimmy" pipe is the result of study, experiment and experience.

Get the Pleasure Without the Poison

The cup is made of Meranto, mined in Scotland, and baked in electric ovens until it is hard as rock but still porous, just like the finest meerschaum, which absorbs the dangerous nicotine. The stem is of sweet-tasting Weichsel wood, grown in the German forest. The bowl is made from choice second growth hickory. The combination forms that sweet, mellow taste which is the perfection of pipe smoking.

It isn't the prettiest pipe you ever saw, but it is the sweetest, coolest and all-around, most enjoyable pipe you ever smoked. "Jimmy" pipe is the right name. **Prove this at my risk.** Send me 20c for one pipe or 50c for three, and if you don't agree with me, say so, and I will return your money.

To show my heart is in the right place, I will send a sample can of my famous Community Mixture if you order three pipes. My 1912-13 Smokers' Guide is free with every order.

H. MENGES, The Smokers' Friend
324 Menges Bldg. St. Louis, Mo.



Convert Your Bicycle into a Motor-Cycle

using our Attachable Outfit. Fits any wheel. Also Marine and Stationary Motors and Finished Castings. Stamp for catalog. **STEFFEY MFG. CO.** Girard Ave. and 30th St., PHILADELPHIA, PA.



Solar Motorcycle Lamps

are the neatest looking, strongest and most efficient lamps made. The product of light specialists, makers of 90% of the automobile lamps used on the high grade cars of America. Catalog shows many styles—gas, oil and electric. Write for it today.

BADGER BRASS MFG. CO.
Kenosha, Wis. New York City, N. Y.



RANGER BICYCLES

Have imported roller chains, sprockets and pedals; New Departure Coaster-Brakes and Hubs; Puncture Proof Tires; highest grade equipment and many advanced features possessed by no other wheels. Guaranteed 5 yrs. **FACTORY PRICES** direct to you are less than others ask for cheap wheels. Other reliable models from \$12 up. A few good second-hand machines \$3 to \$8.

10 DAYS' FREE TRIAL We ship on approval, freight prepaid, anywhere in U.S., without a cent in advance. **DO NOT BUY** a bicycle or a pair of tires from anyone at any price until you get our big new catalog and special prices and a marvelous new offer. A postal brings everything. Write it now. **TIRES, Coaster-Brake Rear Wheels, lamps, parts, sundries, half usual prices.** Rider Agents everywhere are coining money selling our bicycles, tires and sundries. Write today.
MEAD CYCLE CO., Dept. H 108, CHICAGO

Comfort, Power Reliability

meet their highest motorcycle development in

THE FLYING MERKEL

COMFORT:
A unique Spring Frame construction absorbs vibration and eliminates jolting.

POWER:
The most powerful motor of its size made—ball-bearing—remarkably flexible—economical.

RELIABILITY:
Absolutely dependable—investigate its endurance records.

Free Engine Clutch permits starting like an auto. "The Flying Merkel" affords real satisfaction. Send today for free Motorcycle book.

THE MIAMI CYCLE & MFG. CO.
350-370 Hanover St., MIDDLETOWN, O.

HUMIDITY—Humidity is a term which is coming into general use, and is often spoken of without a definite understanding of what it means. It refers always, of course, to the moisture in the atmosphere, but does not always mean the same proportion.

There is at all times some moisture in the air, and the amount, expressed in the number of grains to the cubic foot of air, is the absolute humidity, a term seldom used. When we speak of it we usually

5 H. P. 1913 Peerless Motorcycle



With Free Engine Idler and Bosch Magneto, together with the best there is in motorcycle construction—Power, Silence, Endurance, and those Wearing Qualities so essential for low cost of maintenance.
5 MILES FOR ONE CENT
Agents Wanted—Liberal Discounts

PEERLESS MOTORCYCLE CO., 179 Huntington Ave., BOSTON, MASS.



WE SELL YOU AT WHOLESALE

Agents' Price One **AMERICAN Motorcycle or Bicycle**

Honest hand-made machines at factory cost. Write now for catalog. Say whether interested in Motorcycle or Bicycle.
\$139⁸⁵ \$18⁸⁵
AMERICAN MOTOR CYCLE CO., 1001 American Bldg., CHICAGO



Motorcycle Supplies

We Make the Price

To get our latest book FREE, give name of your motorcycle. This is the most complete exclusive motorcycle accessory catalog ever published. You can't afford to be without it. Address us today.

Motorcycle Supply Department
Kansas City Automobile Supply Co.
1501 Grand Ave., Kansas City, Mo.

"A Kalamazoo And Gas Stoves Too Direct to You" Too

Cash or Credit Freight Prepaid

Will You Write a Postal To Save \$5 to \$40?

That will bring the Kalamazoo Stove Book FREE with full particulars of the \$5 to \$40 saving, the \$100,000 bank bond guarantee, 400 stoves priced and described.

30 Days' Free Trial
360 Days' Approval Test. Prompt shipment, 170,000 customers testify this is the greatest stove offer and the Kalamazoo the finest stove made. Ask for Catalog No. 473.

Big Free Book

Kalamazoo Stove Company, Mfrs. Kalamazoo, Michigan



Save One-Quarter

the purchase price of motor cycle accessories and parts. We sell guaranteed goods twenty-five per cent cheaper than any other house.

The Motor Cycle Co-Operative Co.
650 Woodward Ave., DETROIT, MICH.

Henderson Motor Cycle

4 cylinders, 7 horsepower chain-driven, select - \$325

Henderson Motorcycle Company, 1158 Cass Avenue DETROIT, MICH.

mean the relative humidity, which is the difference between the amount of moisture in the air and the amount it could hold at the present temperature if it were saturated.—Kansas City Star.

"Count the Indians on the Road!"

SEND FOR FREE CATALOG

THE HENDEE MANUFACTURING CO. 871 State St., Springfield, Mass.
Makers of the Indian Motorcycle.

REO THE FIFTH Mr. Olds' finest creation—his FAREWELL CAR—with center Cane-Handle Control.

R. M. Owen & Co., General Sales Agent for REO MOTOR CAR CO., LANSING, MICH.

GOOD YEAR AKRON, OHIO. **NO-RIM-CUT TIRES**

10% Oversize—save half on tire bills—Write for latest Tire Book.

THE GOODYEAR TIRE & RUBBER COMPANY, Main Office and Factory, Akron, Ohio
Branches and Agencies in 103 Principal Cities. More Service Stations than Any Other Tire

Hupmobile "looms head and shoulders above the common herd of cars."

"32" Roadster, fully equipped, \$975, F. O. B. Detroit. "32" Delivery, fully equipped, \$950, F. O. B. Detroit. "20" H. P. Runabout, fully equipped, \$750, F. O. B. Detroit.

WRITE FOR DETAILS

Hupp Motor Car Co. 1299 Milwaukee Ave. DETROIT, MICH.

\$30 a week starting now \$3000 a year if you make good

Would you like a steady job selling my goods, starting right away, earning \$30 a week, with a chance to be promoted to a position paying \$3,000 yearly. No experience is required. My agents have steady employment the year round, I am ready to give you a position right now where you can make **big money quick**. Just write me a letter or postal today sure and say: "Mail particulars about the position you offer" and mark the address

Personal for **E. M. DAVIS, President**
E. M. DAVIS CO., 438 Davis Block, CHICAGO

This Great Electrical Library at Almost Half The Regular Price

This seven volume set of electrical books—the most complete and up-to-the-minute reference work of its kind ever published—now offered at a discount of almost 50%. You, whether student, worker or expert, can gain from these books an intimate knowledge of your work—knowledge which will eventually mean success and higher pay. The work of thirty-two experts, this library is recognized as a standard reference work by technical schools, libraries and practical men throughout the country. It is the accumulated knowledge of the whole electrical world, a store of information from which you can continually draw knowledge—power.

The American School's Cyclopeda of Applied Electricity

contains 3,200 pages, 7x10 inches; 2,600 illustrations, full page plates, diagrams, etc.; hundreds of valuable tables and formulas; carefully cross-indexed for quick, easy reference. The books are substantially bound in half red morocco, gold stamped, and are printed in large clear type on special quality paper.

Important Subjects Covered by These Great Books

Theory, Calculation, Design and Construction of Generators and Motors—Electrical Measurements—Electric Wiring—Electric Welding—Types of Generators and Motors—Management of Generators and Motors—Storage Batteries—Electric Lighting—Alternating-Current Machinery—Station Appliances—Power Stations—Power Transmission—Central Station Engineering—Electric Railways, including Single-Phase—The Electric Telegraph—Telephone Equipment, Systems and Operation—Wireless Telegraph and Telephone—Teleautograph, Telegraphone, etc.

Sent Absolutely Free — Express Prepaid

The complete seven volumes, not a sample volume, will be sent, express prepaid, for seven days' free examination; returnable at our expense if the books do not contain the information you want. If you keep the books, pay \$2.00 seven days after receipt and then \$2.00 a month until you have paid the special introductory price of \$19.80. The regular price of this great Cyclopeda is \$35.00.

Just fill in and mail the coupon. It won't cost you a cent to examine the books. We know they'll be worth many times their cost to you. Mail the coupon now and you will receive your books promptly.

Another Great Free Offer

With every set is included a year's Consulting Membership, regular value \$12.00, entitling you to the free advice of a staff of expert Electrical Engineers. This will give you practical help in handling working problems which are too specific to be taken up in detail in the cyclopeda. There will be no limit to this service. A single problem solved for you might be worth more than the first cost of the books.

American School of Correspondence
CHICAGO U. S. A.

NAME
ADDRESS.....
OCCUPATION.....
EMPLOYER.....

Pop. Mech. 1-13 A. S. of C.

Please send me Cyclopeda of Applied Electricity for seven days' free examination. I will send \$2.00 within seven days and \$2.00 a month until I have paid \$19.80; otherwise I will notify you and hold the books subject to your order. Title not to pass until fully paid.

SPECIAL PRICE COUPON

Please Mention Popular Mechanics

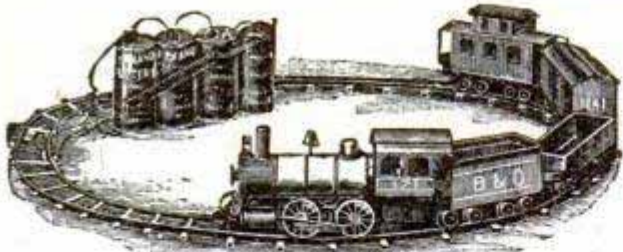

Electrical railways, tracks, switches, trolley cars, dynamos, motors, dynamo castings, gas engine castings, everything for the young electrician. Send for our complete catalog "B."

The Carlisle & Finch Co.
262 E. Clifton Ave. Cincinnati, Ohio

Experimenters in Wireless

Our brand new CATALOGUE "B" is just off the press; is replete with things of interest to the amateur experimenter. Prices and quality are both right and a 2c stamp brings you same by return mail. Send for it NOW.

DAWSON & WINGER ELECTRIC CO.
729 So. Dearborn St., CHICAGO, ILL.

ELECTRIC LIGHT PLANTS Complete gasoline engine, dynamo, switchboard and storage battery \$240.
Agents wanted. American Battery Co., 1139 Fulton St., Chicago (Estab. 1889)

ELECTRIC House Lighting Plants, Telephones, Dynamos, Fans, Lamps, Engines, Motors, Meters, Batteries, Belts, Bells, Books. Catalog 3c. **Ohio Electric Works, CLEVELAND, OHIO.**

Notice Printer
This is the part of
the "ad"
which
we want
every reader
to see. See? E.T. Co.

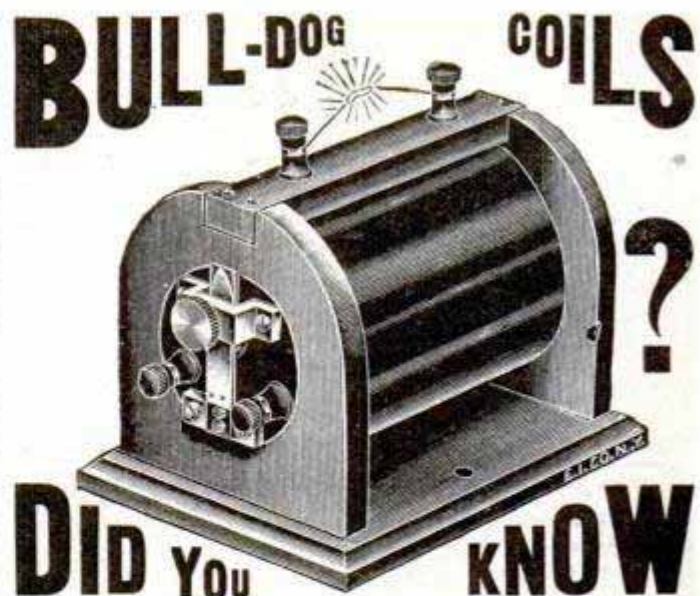

that the Spark Coil is the most wonderful of electric apparatus known? Did you know that **Wireless** and the X-Ray would not have been possible without the spark coil? Did you know that with our spark coils and a few dry cells you can conduct more excitingly interesting experiments than with any other electric apparatus? Here are a FEW as described in our free cyclopedia:—The Fire Ball. The green, yellow and blue spark. The Ladder-shape spark. Lighting a candle with the spark. **Preparing cigarette paper or a cigar which no one can smoke, nor can explain why.** (A great hit.) Lighting an old BURNT OUT electric bulb. The scattered oil drop. The surprised dog. Lengthening Spark four times its length. **The Ghost near the Ceiling**, and thousands of other wonderful experiments, which require but a few dry cells and ANY of our **BULL-DOG** coils, even the smallest. **The best all around size is our 1" type.**

SPECIAL PRICES FOR THIS MONTH

3/4 inch spark length.....	\$2.00	1 1/2 inch spark length.....	\$5.40
1 inch spark length.....	\$2.60	2 inch spark length.....	\$7.25
1 1/4 inch spark length.....	\$3.90	3 inch spark length.....	\$13.90

All coils guaranteed or money back.
Send today 4c stamp for our famous 200 page Electrical Cyclopedia No. 11 with 400 illustrations and 1600 electrical articles, instructive information, and experiments on electrical and wireless subjects. No postals answered. Ask for our free 160 page wireless course in 20 lessons. **THE ELECTRO IMPORTING CO., 233A Fulton St., NEW YORK**
"Everything for the Experimenter"

According to a German biologist, man made a mistake when, centuries ago, he changed himself from a quadruped to a biped, the contention being that many present day ills are due to carrying the spine in an upright position, when it was intended to be carried horizontally.

DUCK'S BIG 325-PAGE CATALOG ELECTRICAL & WIRELESS

Will be mailed to you upon receipt of 6c, stamps or coin, which you may deduct on your first purchase of \$1. Great cost of catalog and low prices prohibit distribution except to those really interested. *Most elaborate catalog in its line.* **SAVE 25% ON STANDARD GOODS.** Catalog contains over 100 pp. Wireless Instruments for commercial and experimental use, with complete diagrams, etc. 15 pp. Telegraph Instruments; 25 pp. Toy and Commercial Motors; 175 pp. flash lights, lighting plants, ammeters, automobile accessories, launch lighting outfits, tools, pocket knives, Victrolas, microscopes, railways, and electrical and mechanical books.
THE J. J. DUCK COMPANY, 390-392 St. Clair Street, TOLEDO, OHIO

ERICKSON LEG Does not chafe, overheat or draw end of stump. **SEND FOR CATALOG**
Arms, Wheel Chairs, Crutches, Stockings. **SOLD ON EASY TERMS**
E.H. ERICKSON ARTIFICIAL LIMB CO., 17 Wash. Av. N., MINNEAPOLIS, MINN. Largest Limb Factory in World.

This book is brimful of information on **ELECTRICITY** Motors, Dynamos, Wireless, Miniature Railways, etc., and parts. It's a valuable, up-to-date catalog of one of the largest, most reliable electrical manufacturers in the country. You can get it by sending 6c in stamps to pay postage, which will be refunded on your first order of 50c or over. **NO POSTALS ANSWERED**
Voltamp Electric Mfg. Co., Voltamp Block, Baltimore, Md.

INVISIBLE SUSPENDER BELT

Fits instantly inside waist band, entirely out of sight. Does away with unsightly suspenders and uncomfortable belts. Keeps trousers up neatly, securely. Keeps shirt down, preventing "bagging." Wonderful for fat men or thin men. A Necessity for all men—mechanics, farmers, office men, professional men. **TRAVELING MEN**—The Ko-Ko-Mo Suspender Belt is a real side line. Write "quick" for terms and territory. Send



50c and your waist measurement for sample belt—or \$1 for silk belt—and full details. Money returned if you are not entirely satisfied.

KO-KO-MO BELT CO. KOKOMO, INDIANA

BRIGHTEN YOUR WITS

with our brain tickling puzzles. Sample for 10 cents or three good ones for 25 cents. Catalog included.
WONDER NOVELTY CO., Dept. I, Box 123, St. Paul, Minn.

Our Immense Factory Can Save You Money



on Stampings, Porcelain Enameling. We specialize in Drawing, Stamping and Spinning—Aluminum, Brass, Copper, Tin Plate, Monel Sheet, Steel and Cupror. Japanning in all colors, Tinning and Hot Galvanizing. Jobwork. Right Prices, Quick Delivery are insured by a modern up-to-date plant with a floor space of 12 acres. Let us figure with you and point out a saving.
GEUDER, PAESCHKE, & FREY CO.
Contract Dept. Milwaukee, Wis.

POWER for YOU!

Power from within! Strength that is **more** than mere muscular strength—the strength of perfect health, abundant nerve force—the strength of the **perfect man** now within your reach through **Vibration!** Nine people out of every ten are only **half alive**. They exist—they do not really live. How about yourself. Listen—

All the Benefits of Life—Strength—Youth

may be returned to you through **Vibration**. For **Vibration is Life itself**. It will chase away the years like magic. Every nerve, every fibre in your whole body will fairly tingle with the force of your own **awakened power!** Stagnation simply cannot exist. You are made over—new—from head to foot. Your blood is sent humming along through every vein, artery and tiny capillary. Poisonous matters in your system are **washed away**. Your self-confidence—**your self-respect**—are increased a hundred fold. Yes, **Vibration** will do all this and more, **much more**. And it is within your reach. You can enjoy its wonder-working powers right at home, right in the privacy of your own room. You can give yourself the same identical treatments that you would receive in the offices of the world's most famous specialists—all without extra charge.

You may give yourself Swedish Movement, Vibrating Chair Treatments, Electric Baths, Faradic or Galvanic Electric Treatments—just such treatments as you would have to pay from \$2.00 to \$3.00 for—yours without charge through the White Cross Electric Vibrator.



The White Cross Electric Vibrator

is the result of years of work and experiment. It is absolutely perfect. If you have your house wired for electricity, you can connect it up as easily as an electric lamp; if not, it will run perfectly on its own batteries.

Special Offer for a Limited Time

For a short time only we are making a remarkable Special Introductory Offer on the White Cross Electric Vibrator, in order to place at least one of these splendid instruments in every city, town and village in the country—an amazing offer to those who write at once—amazing discounts—actual rock bottom prices direct if you act at once.

FREE BOOK Sign coupon and mail it today. Get our splendid big **FREE** book telling you all about the marvels of **Vibration**. Read what great scientists say. Post yourself on what it will do for you. Learn all about the **White Cross Electric Vibrator** and our limited offer. No obligations at all—send coupon, post card or letter today.

Lindstrom, Smith Co.

Desk 1191, 218 So. Wabash Ave., Chicago, Ill.

Send for
This Book

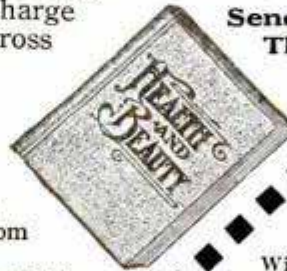

**FREE
BOOK COUPON**
**LINDSTROM,
SMITH CO.**
Desk 1191
218 So. Wabash Ave.
Chicago, Ill.

Without any obligation at all, please send me, free and prepaid, your free book on **Vibration**, full particulars of the **White Cross Vibrator** and your **Special 60 Day Offer**.

NAME.....

ADDRESS.....

Cut this out and mail it today

Send for Copy of Our New Wireless Manual P1

It contains 96 pages and tells how to erect and maintain wireless telegraph stations. Shows a number of diagrams. Has the Morse and Continental Telegraph Codes. Illustrates the best instruments to use; tells what they are for and how to use them. Do not wait until some other time, but sit down now and send your name and address, and get one. It costs you nothing.



Send for Our Pocket Catalog P26

It contains 212 pages, with over 1,000 illustrations and describes in plain, clear language all about Bells, Push Buttons, Batteries, Telephone and Telegraph Material, Electric Toys, Burglar and Fire Alarm Contrivances, Electric Call Bells, Electric Alarm Clocks, Medical Batteries, Motor Boat Horns, Electrically Heated Apparatus, Battery Connectors, Switches, Battery Gauges, Wireless Telegraph Instruments, Ignition Supplies, etc.

It Means Money Saved to You to have our Manual and our Catalog when you want to buy

MANHATTAN ELECTRICAL SUPPLY CO.

NEW YORK, 17 Park Place

CHICAGO, 114 S. 5th Ave.

ST. LOUIS, 1106 Pine St.

An Electric Bell Without Batteries

A new and practical system that does away with the constant annoyance and expense of new batteries. Needs no attention after being installed—fool and time proof. Always ready and rings every time.

Generates its own current and rings loud and as long as the knob is turned. Can be installed by any one any place.

No More Battery Trouble or Expense

No more "out of order" bell when you want and need it most. No special wire required—use the old wire. Place the bell wherever you want it. The generator [for a door] is placed inside the door casing. That's all there is to it and you have a bell that will ring every time all the time and needs no attention. Guaranteed for 10 years. Complete outfit prepaid.

We have an attractive proposition for dealers and agents.
SEARLES ELECTRIC CO.
1154 Monadnock Block, CHICAGO

\$3.50



NEW BIG 1913 CATALOGUE JUST OUT

Showing a complete line of Electrical and Gas Supplies, Wireless Material, Novelties,

Christmas Tree Outfits Lionel Trains and Electrical Toys

Mailed upon receipt of ten cents in stamps, for which we will include with the Catalogue 20 Coupons entitling you to our Free "Wireless Course" in 20 lessons and rebate memo covering the 10 cts. in stamps, which you may use as part payment with your first order of \$1.



No. 2. Complete Electric Train Outfit, consisting of Locomotive, Tender, 2 trailers, and set of third rail track (2 straight and 4 curved). Will operate on 1 or 2 dry cells. Holiday price, complete, by express \$1.85
No. 3. Same Outfit with Electric Headlight..... 2.35
No. 9. Larger Locomotive with headlight, larger trailers, and 4 sections straight and 4 sections curved track. Price complete... 3.90
Extra sections (1 foot) third rail track15

CHRISTMAS TREE OUTFITS

One-half regular price. Quality the best. 8 light battery outfit, complete with 3 dry batteries..... **\$2.35**

FOR 110 VOLT CIRCUITS

8 light.....\$2.40 16 light.....\$3.90 24 light.....\$5.65

ASSORTED FRUIT

8 light.....\$3.25 16 light.....\$6.30 24 light.....\$8.50

Extra lamps supplied with each eight lamps.

Western Agents for Electro Importing Co. on Wireless Goods
Same Catalogue. Same Prices

ANDERSON LIGHT & SPECIALTY CO., Chicago, Ill.
134-6 No. La Salle St. Dept. A Opposite City Hall

AT LAST a Practical and Efficient WIRELESS OUTFIT \$8⁹⁵

AT A PRICE YOU CAN AFFORD TO PAY

Regular \$15.00 Value

Special Price

An Ideal Set. Complete—Portable. Sends 8 to 15 Miles. Receives 600 to 800 Miles.



Every wide awake young man in America should own and operate this set. An educational and fascinating sport. An ideal gift for

parents to make. This complete set is mounted on oak base 8½ x 16 inches and consists of one inch coil giving 1½ inch spark, primary condenser, high capacity secondary condenser and switch, key, sending helix, zinc spark gap, highly efficient tuning coil, fixed condenser, exceptionally sensitive 1000 ohm telephone receiver and cord, universal detector, aerial switch, double pole, double throw, 120 feet aluminum aerial wire and insulators, codes. Simple as A B C to operate. Send your order in to-day. Complete set, special price, \$8.95. Equipped with 2000 ohm wireless receivers and headband, \$12.25. Receiving sets, \$1.95 upwards. Sending and receiving sets, \$3.90 upwards. Send at once for Circular S, and Morse, Navy, Continental and International Codes. **IT'S FREE.**

HUNT & McCREE (The House of Wonderful Values) 92-94 Murray St., NEW YORK

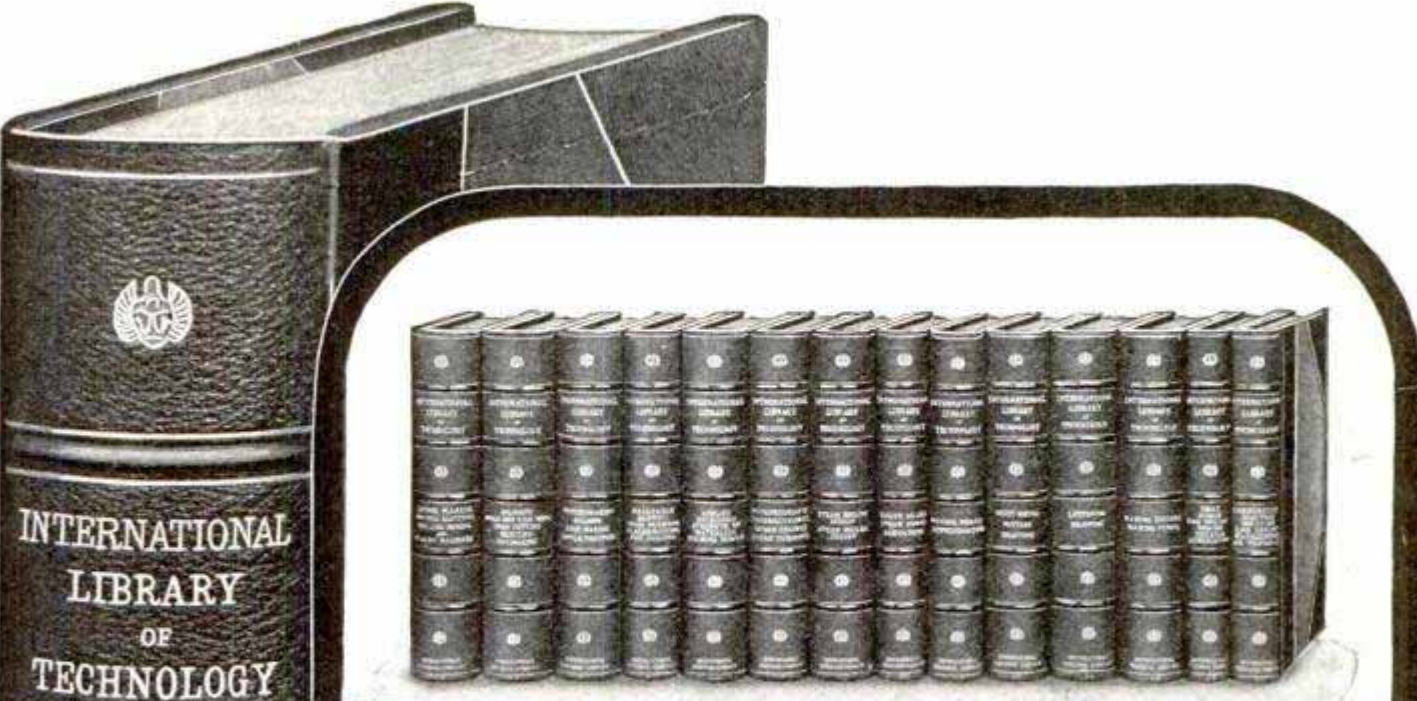

INTERNATIONAL
LIBRARY
OF
TECHNOLOGY

APPLIED
MECHANICS
STRENGTH OF
MATERIALS
MACHINE DESIGN

INTERNATIONAL
TEXTBOOK COMPANY
5 B

The Greatest Mechanical Library in the World

The Mechanical Engineering Library is part of the International Library of Technology that cost \$1,500,000 in its original preparation. It contains the knowledge given from the life experience of some of the best mechanical engineering experts in the country, edited in a style that nineteen years of experience in publishing home-study textbooks has proved easiest to learn, to remember, and to apply. There is no other reference work in the world that so completely meets the needs of the mechanic as the Mechanical Engineering Library. The volumes are recommended by the highest authorities and are used in nearly all the leading universities and colleges. They treat of practical mechanical methods, starting from the simplest problems and comprehensively covering every branch of the work. Not only can they be used to great advantage by superintendents, foremen, and engineers as an authoritative guide in their work, but since they can be so clearly understood even by persons having no knowledge of higher mathematics, they can be used by all classes of mechanics that are desirous of advancing to higher positions. The Mechanical Library contains 14 volumes durably and handsomely bound in three-fourths red morocco, stamped and numbered in gold. The books are printed on a high-grade book paper, and the type is large and easy to read. Each volume is 6 by 9 inches in size. If you wish to know more about the greatest and most practical mechanical library in the world, mark and mail the coupon NOW.

INTERNATIONAL TEXTBOOK COMPANY

Box 872, Scranton, Pa.

Please send, without further obligation to me, full particulars in regard to the International Library of Technology, with special reference to the Library of Mechanical Engineering.

Name _____

St. & No. _____

City _____ State _____

Billiard Players!

This Free Catalog is for You!



It tells how
to own a

BURROWES

Billiard and Pool Table

at very small expense

You will be astonished to learn how little it will cost to have your own Table and play these great games at home instead of in a public poolroom. It will surprise you to know that you need no special billiardroom, that the Burrowes Table can be set on dining-room or library table or on its own legs or stand. Do you know that leading experts use Burrowes Tables for home practice?

No other indoor games compare with these for wide-spread popularity. Everybody enjoys them. You and your friends will get more fun out of a Burrowes Table than from any other source of entertainment.

This catalog contains full descriptions of all our styles and sizes of Tables. It tells how to own one on very easy payments. Write for it today.



\$1.00 DOWN

Prices are from \$15 up, on easy terms of \$1 or more down (depending on size and style), and a small amount each month. Balls, cues, etc., free.

FREE TRIAL—NO RED TAPE

Catalog contains order blank. On receipt of this, with first installment, we will ship Table. Play on it one week. If unsatisfactory return it, and on its receipt we will refund your deposit. This insures you a free trial. Write for the catalog today.

THE E. T. BURROWES CO.
164 Spring St. PORTLAND, ME.

Please Mention Popular Mechanics

Learn to Play the Violin or Cornet



Flute, Clarinet, or some other instrument. You'll get enjoyment from it all your life and can make good money playing in Bands or Orchestras if you wish. We include with every instrument an **Instruction Book and Lessons** (by correspondence) free. Thousands have learned by this method. Our prices are very low on all musical instruments. We import our Violins direct from best European makers. Our **Special Complete Violin Outfits at \$10 are great value**. Others from \$2.50 to \$25 and up. Cornet Outfits, complete, \$9.25 up. **Band Instruments** of all kinds sent on **Six Days' Trial**. We sell for cash or monthly payments. **Satisfaction guaranteed**. Write for free catalog and mention what instrument you are interested in.

W. J. DYER & BRO. (Estab. 1870) Dept. 101, St. Paul, Minn.

Better Chicks

And More of Them



Big, strong fellows that are easily raised because hatched under right conditions. Every hatch proves it. Investigate the

QUEEN Incubator

28 points of Superiority

The machine good for 25 years and no better hatcher at any price. Sold at lowest possible price on liberal trial plan. Quick deliveries in extreme East and West through my branch houses. My large, fine Poultry Guide and Catalog free. Write for it.

P. M. WICKSTRUM, Incubator Man
Box 177, Lincoln, Neb.

200 EGG

INCUBATOR, \$3. Actual hen controls all. Over 550,000 sold. Thousands of testimonials. Agents wanted. Catalog free. Natural Hen Incubator Co., Sta. H, Dept. 27, Los Angeles, Cal.

At Woodbrooke, England, there is a school for social service, where men and women from all parts of the world study various kinds of social work. The institution is affiliated with Birmingham University.

A new railway in Mexico, the Durango-Llano Grande road, is expected to make available the vast quantities of iron ore in the Cerro Mercado, or Iron Mountain, which is estimated to contain 500,000,000 tons of iron ore. This has not been profitable to mine heretofore because of its inaccessibility.

How I Bred \$50 to \$1,600 in 2 years

I want to tell you how one man took \$50 worth of my kind of poultry and in two years multiplied them to **sixteen hundred dollars** in value. He was a novice and started in a box stall. **A true and convincing story**, told by the man himself. You can do the same, or start smaller and grow. More experiences of the same kind, illustrated. Ask me for the book. **It is FREE.**

RICE, 229 Howard St.,

MELROSE, MASSACHUSETTS.



GREIDER'S FINE CATALOGUE

and calendar of pure-bred poultry for 1913, large, many pages of poultry facts, different breeds in natural colors. 70 varieties illustrated and described. Incubators and brooders, low price of stock and eggs for hatching. A perfect guide for all poultry raisers. Send 10c for this noted book.

B. H. GREIDER, Box 2, RHEEMS, PA.

SHOEMAKER'S BOOK on



POULTRY

and Almanac for 1913 has 224 pages with many colored plates of fowls true to life. It tells all about chickens, their prices, their care, diseases and remedies. All about incubators, their prices and their operation. All about poultry houses and how to build them. It's an encyclopedia of chicken-dom. You need it. Only 15c.

C. C. SHOEMAKER, Box 1107, FREEPORT, ILL.



MONEY IN MUSHROOMS

MAKE BIG INCOME
Men and Women can do this all the year at home growing mushrooms in cellars, stables, sheds, boxes, etc. Crop sells for \$5.00 to \$1.00 a lb. \$20.00 a week easily made. Great demand, markets waiting. **Start Now.** Write for big 32 page **Free Illustrated Booklet** and learn how to do it. **NAT'L SPAWN CO., Dept. 12, BOSTON, MASS.**

WANTED-IDEAS

Manufacturers are constantly writing me for patents procured through me. The demand for good ideas

Protected by Owen Patents

is greater than ever before. Send for my free books and read the letters from the greatest manufacturers in this country. Read their requests for Owen Patents and see for yourself what ideas they want. You can help supply the unceasing demand for good inventions.

My clients are provided with free manufacturing facilities, and I aid them in **many ways, without charge**, to sell their patents. **Applications** filed through me advertised free.

You will get a strong patent or I will get no compensation. Your interests are my interests.

FREE!

A simple request will bring you the following three finest patent books published **absolutely** free—you will incur no obligation by writing me.

"SUCCESSFUL PATENTS"—a new 72 page guide book; tells how to proceed to be successful; describes my advantageous business methods.

"STEPPING STONES"—gives lists of over 200 inventions wanted; gives forecasts by Edison and many other authorities; tells the plain truth about prizes of millions of dollars for inventions.

"PATENT PROMOTION"—tells you how to promote your invention; why some inventors fail; the value of your rights, etc.



Write for these books today—NOW! Advice costs nothing

VERY HIGHEST REFERENCES

Columbia National Bank,
Washington, D. C.
American Loktile Co.,
Alexandria, Va.
National Metal Tile Co.,
Washington, D. C.
National Supply Co.,
Berlin, N. H.

Louden Machinery Co.,
Fairfield, Iowa.
Antholene Mfg. Co.,
Hutchinson, Kans.
Whitehead Hosiery Mills,
Burlington, N. C.
Dickinson Mfg. Co.,
Des Moines, Iowa.

SPECIAL!

Send me a sketch or model of your invention and I will make a search of the U. S. Patent Office Records **FREE OF CHARGE** and report to you concerning patentability, practicability, etc.

And an immense number of others whose letters are printed in my booklets.

Your work will receive my **PERSONAL** attention—but my fees are no higher than others.

RICHARD B. OWEN 9-303 OWEN BLDG.
WASHINGTON, D. C.

Inventors submitting their inventions to me are protected in a tangible manner until their applications are filed.

PATENT YOUR IDEAS

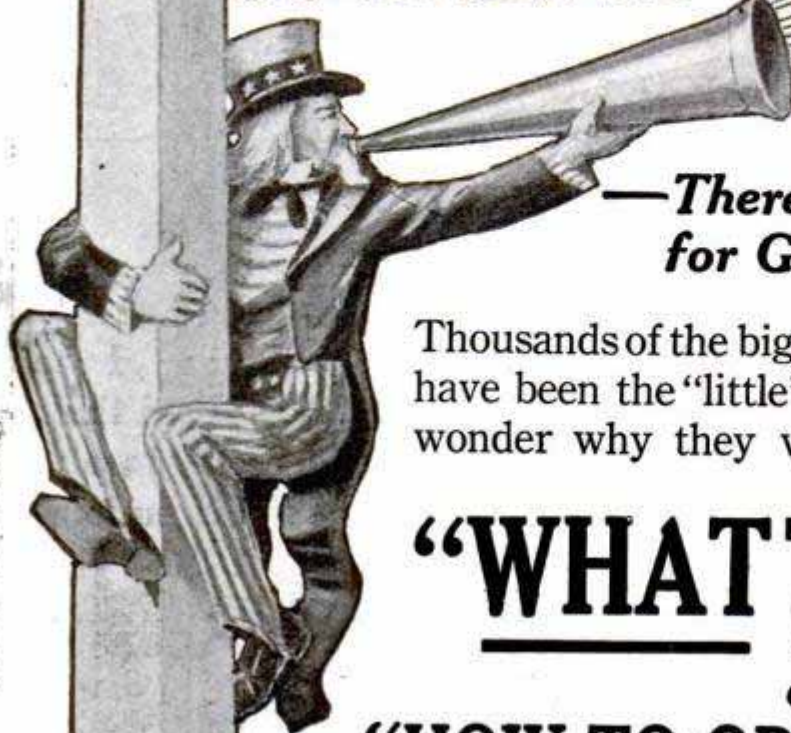

*—There is a Constant Demand
for Good Inventions*

Thousands of the biggest money-making inventions have been the "little" things that have made people wonder why they were never thought of before.

"WHAT TO INVENT"

and

"HOW TO OBTAIN A PATENT"

These Books Sent Free

If you have an invention send us a sketch, photograph or model of it. We will give you a report as to its patentability absolutely free. If you have no invention send for our book, "What to Invent." It contains hundreds of valuable suggestions. We are recognized authorities on patent matters and have helped hundreds to find a ready and profitable market for their ideas. We can prove it. If you wish to sell your patent we will advertise it in manufacturers' journals at our expense.

Don't Wait—Find Out NOW!

Your idea will never do you any good if some one else patents it ahead of you. Act quick! Let the other fellow say "he thought of it a long time ago." You reap the profit. Let the others wish they had.

Advice Free—All Matters Confidential

We have secured patents for thousands of inventors and have many letters proving the value of our services. Write us. Send rough drawing or model of your invention for our opinion. We will guard it carefully and report quickly. You are under no obligations to proceed further. Our plan is simply a square deal to all. Our books, "What to Invent" and "How to Obtain a Patent" are the best publications written for the man who has an idea to patent, or who is of an inventive turn of mind. They show just how to proceed with your idea and tell of hundreds of things to invent. We gladly send these books free. The sooner you write for them the sooner you will know all about patents and the many different lines in which new inventions or improvements may be made.

If you have an invention send us a sketch of it for report and ask for the books at the same time.

CHANDLEE & CHANDLEE, 970 F Street, Washington, D. C.

REGISTERED ATTORNEYS

(Combined with H. Ellis Chandlee & Co.)

Patents

Trade Marks and Copyrights Secured or Fee Returned

Special Offer—Free Search of Patent Office Records

Send us a model, photograph or sketch and description of your invention, and we will make a *Free Search* of the *Patent Office Records* to ascertain if it is patentable. If we report the invention patentable, we will guarantee to obtain a patent or return our fee, and furnish a certificate of patentability backed by a bonded contract to that effect.

This Certificate of Patentability will protect the inventor and serve as proof of the invention until the case can be filed in the U. S. Patent Office.

Obtaining Assistance for Inventors

Our certificate is of great assistance to inventors who require financial aid to obtain patents. It is useless to attempt to interest capital unless evidence is furnished that the invention is patentable. Our certificate gives this necessary assurance.

Our Four Books Mailed Free

to any address. Send for these books—the finest publications ever issued for free distribution.

How to Obtain a Patent

Our illustrated eighty-page Guide Book is an invaluable book of reference for inventors, and contains 100 mechanical movements illustrated and described.

Fortunes in Patents

Tells how to invent for profit, and gives history of successful inventions.

What to Invent

Contains a valuable **LIST OF INVENTIONS WANTED** and suggestions concerning profitable fields of invention; also information regarding prizes offered for inventions, among which is

Prize of One Million Dollars

offered for one invention, and \$10,000 for others.

Patents That Pay

Contains fac-similes of unsolicited letters from our clients who have built up profitable enterprises founded upon patents procured by us; also endorsements from prominent inventors, manufacturers, Senators, Congressmen, Governors, etc.

List of Patent Buyers

Containing personal requests and letters from Manufacturers and Patent Promoters for patents secured by us, and suggestions as to improvements desired and new ideas they wish to purchase.

We Advertise Our Clients' Inventions Free

In a list of Sunday newspapers with two million circulation, in manufacturers' journals and in the *World's Progress*. Sample Copy Free. We not only save you time and money in securing patents, but obtain patents which **PROTECT** the invention and **PAY**. After the patent is granted we assist you **TO SELL YOUR PATENT**.

Foreign Patents

WE HAVE DIRECT AGENCIES IN ALL THE PRINCIPAL FOREIGN COUNTRIES and can secure **FOREIGN PATENTS** in the shortest possible **TIME** and at the **LOWEST COST**. We **GUARANTEE TO SECURE THE FOREIGN PATENTS OR RETURN OUR FEES**. Write for our Illustrated Guide Book on Foreign Patents, sent free to any address.

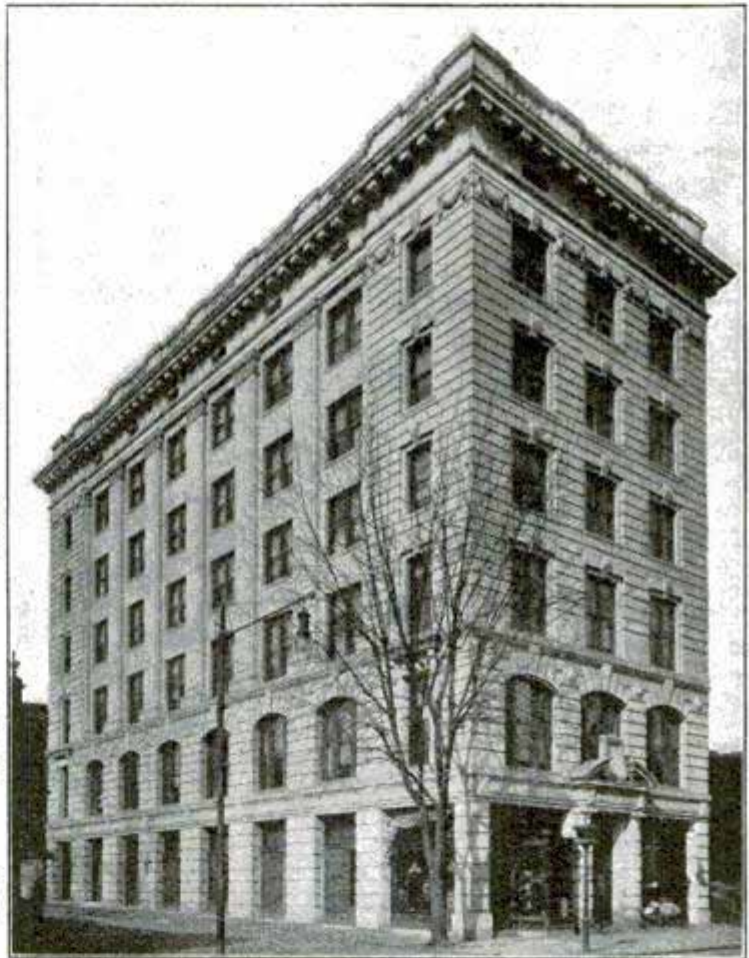

VICTOR BUILDING

Our new \$150,000 building opposite U. S. Patent Office
SPECIALLY ERECTED by us for OUR own use

REFERENCES

Second National Bank, Washington, D. C.
C. K. Lassiter, Mechanical Engineer, Schenectady, N. Y.
Pitner Gasoline Lighting Co., Chicago, Ill.
Sprout, Wardon & Co., Mfrs. of the Monarch Feed Governor, Muncy, Pa.
The L. B. Dozier Co., Mfrs. of Plumbing Supplies, Columbia, S. C.
B. B. Earnshaw and Bro., Mfrs. "Cream Blend" Flour, Washington, D. C.
R. G. Dun & Co., Washington, D. C.
National Savings and Trust Co., Washington, D. C.
Smethport Glass Co., Smethport, Pa.
Lawrence Mills, Mfrs. Bed Spreads, 51 Brooke Ave., Englewood, N. J.
The Melvin Gauge and Signal Inst. Co., Scranton, Pa.
Damon Mfg. Co., Mfrs. Flour Mill Disintegrators, Bowling Green, Ky.
Chamber of Commerce, Washington, D. C.
Union Savings Bank, Washington, D. C.
Lincoln National Bank, Washington, D. C.
Modern Canner Co., Bridgeport, Ala.
M. Winter Lumber Co., Sheboygan, Wis.

VICTOR J. EVANS & CO., Patent Attorneys

NEW YORK OFFICES: 132 Nassau St.

PHILADELPHIA OFFICES: 1429 Chestnut St.

Main Offices: 724-726 9th St., N. W., WASHINGTON, D. C.

← PROTECT YOUR IDEA! →

PATENTS THAT PAY

\$497,530.00 Made by Clients

"MY TRADE-MARK"

\$497,530.00 Made by Clients

Proof back of it—write for my FREE literature—it will pay!



BOOK "What and How to Invent—Proof of Fortunes in Patents"—FREE

Containing: Views of Prominent Men and Publications on Inventions; "Patents Wanted"; "How to Advertise Your Patent"; "How to Secure Money to Procure a Patent"; Suggestions as to what to Invent; What my clients have done; Women Inventors, etc.

I have received one of your 127-page books entitled "What and How to Invent—Proof of Fortunes in Patents" and I would not take \$5.00 for it if I could not get another copy.
(Signed) CHAS. F. WENSLEY,
Huntington, L. I., N. Y.
May 31, 1912.



\$10,000.00 PRIZE: WRITE FOR INSTRUCTIVE CIRCULAR GIVING FULL INFORMATION FREE
EXPERT—PROMPT SERVICES
112-page Guide Book for Inventors, FREE. **E. E. VROOMAN,** Registered Patent Attorney
871 F Street, N W Wash., D. C.
Old-established branches throughout the world

PATENTS

C. L. PARKER
Formerly Member Examining
Corps, U. S. Patent Office
PATENT LAWYER
210 MCGILL BLDG.
WASHINGTON, D. C.

Patents, Trade Marks, Copyrights, Patent Litigation

Handbook for Inventors, "Protecting, Exploiting and Selling Inventions" sent free upon request.

PATENTS

PROCURED AND SOLD;

Easy terms; careful, conscientious work; advice

FREE; new **BOOK FREE;** correspondence solicited; highest references; send sketch to-day.

H. J. SANDERS SUITE A CRILLY BLOCK Chicago, Ill.

PATENTS

BUILD FORTUNES FOR YOU

Our free booklets tell how, what to invent, How To CHOOSE AN ATTORNEY, and save you money.

Prosperous clients in all states. Best bank and other references. **WRITE TODAY**

D. SWIFT & CO., 317 SEVENTH ST., WASHINGTON D. C.

LEARN HOW A PATENT MAY BE MADE VALUABLE

Send for this **FREE BOOK** { What You Should Know
What To Invent
What NOT To Invent
which tells you { How To Sell Your Patent

Copies of nearest Patents and report in every case without charge
H. L. WOODWARD, 9th & G Sts., Washington, D. C.

Inventions Sought by Capital. Write for free Book,

PATENTS that PAY BEST

R. S. & A. B. Lacey, Dept. 45, Washington, D. C.

AMERICAN MODEL AND TOOL WORKS

617-631 W. Jackson Blvd., CHICAGO

WE MAKE MODELS, TOOLS, DIES, MOLDS, PATTERNS AND MODEL PARTS. EXPERT GEAR CUTTING.

Inventions developed and simplified, also manufacturing.



SETS OF CASTINGS OF
MODEL ENGINES
500 1/2" FOR \$6 PRICE
ALL CASTINGS
ALSO TOOLS
GEAR WHEELS & PARTS OF MODELS
WILSON H. WIGHTMAN & CO.

MECHANICAL
SUPPLIES AND MATERIAL
of all kinds.
EXPERIMENTAL AND
LIGHT MACHINE WORK
to order.
132 MILK STREET, BOSTON

KING OF THE BARBERS—The sudden death of Chaudri Lala Meah, the head barber of Madras, at Veerappa Varar, Coil street, Mylapore, recently, has disclosed interesting details about the working of the barber fraternity of Madras. The fraternity has been in existence for over 120 years. Chaudri is commonly known in the North of India as barrister, or vakil, but the post among the barbers of Madras carries a much higher position. He is their head and their judge. He has eight councilors, or jurors, and he decides cases that come up before him with their aid. The Chaudri's



DON'T DISCARD BROKEN PARTS

Have them welded together by the Oxy-Acetylene Process. Steel, Cast Iron, Bronze, Copper, Aluminum and all other metals can be welded. Manufacturing quoted on. Welding equipments for repair shops or large plants supplied.

DAVIS BOURNONVILLE CO.
105 West St., NEW YORK; 505 So. Laflin St., CHICAGO

PATENTS THAT PROTECT and PAY

Send for FREE 96-page book. Advice free. Terms reasonable. Highest references. Best results.

Send sketch or model for FREE examination and opinion.

Recommended Patent Lawyer in the Bankers' Register and special list of selected lawyers. Also in Martindale's Law Directory, Sharp and Alleman's Directory of Lawyers, The Gast-Paul Directory of Lawyers, and Kime's International Law Directory.

ALL BUSINESS GIVEN PROMPT AND PROPER ATTENTION

A large list of strong recommendations furnished free

WATSON E. COLEMAN, Patent Lawyer, 622 F St., N.W., Washington, D.C.

See Our Bulletin 24
Before you buy any
**Electrical
Machinery**
of any sort

We sell for cash or on
time, and pay spot cash for
any motor or dynamo you may
have outgrown. We put the same broad guarantee on rebuilt machinery that



MOTOR AND DYNAMO BARGAINS

we do on new. Our rating guarantees the guaranty.

Repair Work demanding skill and promptness is sent us from all over the U. S. We are fitted to do rush work promptly.

The F. Bissell Co., 226 Huron St., Toledo, Ohio

Get Our Offer
Before you sell any old
or outgrown
**Electrical
Apparatus**

We do not
handle novelties
or toys



VACUUM PUMPS

For Powerful Portable and Stationary
Vacuum Cleaning Plants.
They take up their own wear.
Powerful; Noiseless; can't
get out of order.

GET CATALOG No. 23

LEIMAN BROS., 62P John St., NEW YORK

WANTED To manufacture **METAL SPECIALTIES**, 20 years experience in making Dies, Tools and Special Machinery. Expert work. Complete equipment. **NATIONAL STAMPING & ELECTRIC WORKS** 412 S. Clinton Street, Dept. 3 Chicago, Ill.

Union Model Works

Established 1882
GEORGE H. ROWE, Proprietor
119 So. Clark St., Chicago, Ill.

The oldest, most reliable, most efficient Model Making and Experimental house in the West. In the future Special attention will be given to **Electrical and Magnetic Development** work and tests. New Machinery. New Instruments. Terms Reasonable.

post is a life appointment. When he dies, forty days after his death a mass meeting of barbers is held, and the vacancy is filled. The elected man from precedence should have been a juror, and should be a man of good birth, education, and character. The barber fraternity of Madras now consists of 160 Mohammedan barbers, and will meet at the Mohammedan barbers' mosque in Portuguese Church street, North George-



BRASS GEARS

Cut by an entirely new process. The most accurate made and at prices that cannot be equalled by others. Every gear has a hub, center painted ebony black, edges turned true, highest grade brass, and much heavier than others. We carry the largest stock in the world and every gear listed is always shipped on date of order.

SEND FOR CIRCULARS

Reynolds Dull Flasher Co.
16 So. Fifth Ave., Chicago

INVENTORS

Our Brain Belongs to You. Our Ideas Are Free of Charge. All we want in return is to build your model, special machinery, dies, tools and jigs to manufacture sheet metal goods, etc. We are expert mechanics, over thirty years experience and have one of the best equipped shops in the country. Ask for Booklet No. 17. Consultation free. Experimental work strictly confidential.

A. NACKE & SON
236-242 S. 9th St., Philadelphia, Pa.

WE will turn your idea into a reality and make you a model for patenting. Dies, **MAKE** Tools and Metal Specialties are manufactured by us in the best equipped factory for this work in the world. Send us your models for estimate. **KOHLER DIE & SPECIALTY CO.** 823 W. Washington Blvd., Chicago



LET THE RED DEVIL WATER MOTOR DO YOUR WORK

6-inch Motor

Improved construction, absolutely perfect, runs your washing machine and a hundred other things. Power for small tools. $\frac{1}{4}$ horse power on $\frac{1}{2}$ -inch pipe, 80 pounds pressure; 1 horse power on 2-inch pipe, 60 pounds pressure. New net price, \$5.00 cash with order.

No. 1492 4-inch Motors for grinding, polishing and buffing. Runs sewing machines, fans, bottle washers, etc. Price with emery, buffing wheel, silver polish and pulley, \$3.00. No. 1493 Motor and pulley only, \$2.50. $\frac{1}{2}$ horse power on 80 pounds pressure. Improved construction. Speeds, 3,000 to 5,000 revolutions per minute. Only scientifically and mechanically perfect small water motor manufactured. Patented construction makes it possible. Tremendous output warrants the price. Money back for any reason.

CATALOGUE AND LARGE SHEET FREE

DIVINE WATER MOTOR CO.

Dept. T UTICA, NEW YORK, U.S.A.

For the name of your local hardware or tool dealer, we will send you free booklet on "Theory and Design of Water Motors."



6-Inch
Bucket
Wheel

All The Water You Want - No Fuss Or Bother

Simplest thing in the world to have abundant water supply in and about the home - with a Jarvis Water Supply System. Nothing complicated about it - a woman or child can operate it. Supplies water when and where you want it. No hand-pumping. Install a

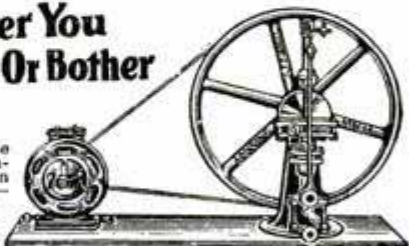

JARVIS POWER PUMP

Do it yourself, easily and quickly. We supply everything necessary - pipes, fittings, fixtures, etc. Run it by electricity - costs less to run than the cost of repairs on "water lifts" and "water motors." Run it by gasoline engine that is doing other work at the same time and the cost is next to nothing. Modernize your home with a Jarvis - do away with the back-breaking hand pumps. Catalog 14 is a valuable text book on water supply systems for the home - a copy FREE.

JARVIS ENGINE & MACHINE WORKS, Lansing, Mich.

FREE

An interesting booklet describing **The Best**

Garage Lathe Made

Send us this coupon, whether you already have a lathe, want to buy one, or just thinking about it. All Garage men should have this interesting booklet. Cut out the coupon and mail it to-day.

SPECIAL BOOKLET COUPON

THE SEBASTIAN LATHE CO.,
107 Culvert St., Cincinnati, O.

Please send me free booklet describing the Sebastian Garage Lathe.

- I AM IN THE MARKET FOR A LATHE
- I WILL BE IN THE MARKET LATER ON
- I ALREADY HAVE A LATHE

Name.....

Address.....

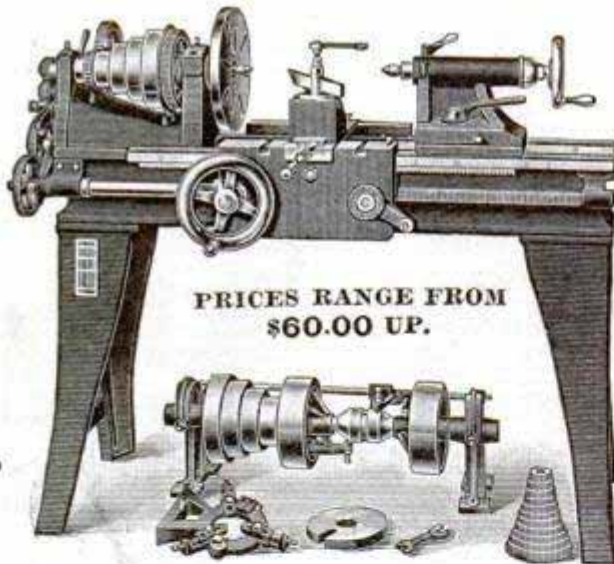

PRICES RANGE FROM
\$60.00 UP.

WE MAKE NO SHIPMENTS OUTSIDE THE LIMITS OF THE UNITED STATES.

BUY A GUARANTEED ACCURATE LATHE

YOU RECEIVE FIRST QUALITY AT LOWEST PRICES WORKMANSHIP UNEXCELLED

WRITE FOR Machinery Catalog No. 9 MAILED FREE

ADDRESS SEARS, ROEBUCK AND CO., CHICAGO

"IDEAL" Lawn Mower Grinder

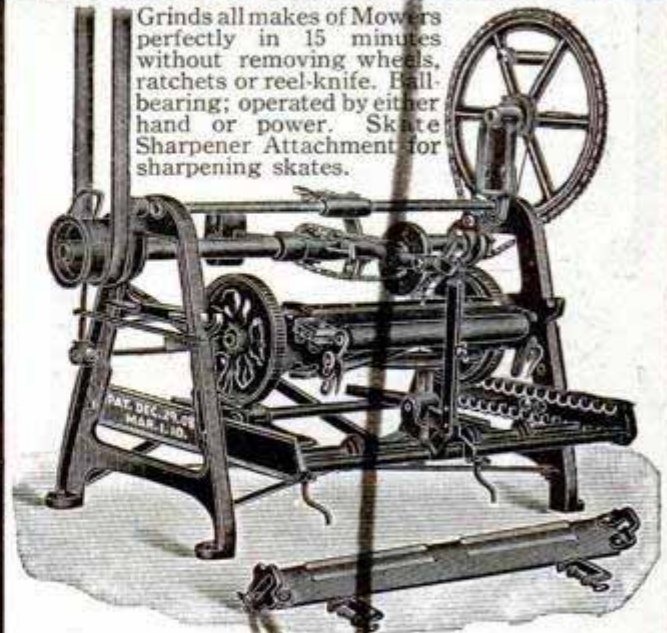

Grinds all makes of Mowers perfectly in 15 minutes without removing wheels, ratchets or reel-knife. Ball-bearing; operated by either hand or power. Skate Sharpener Attachment for sharpening skates.

"You Grind It As You Find It."

WRITE TODAY for full information of this great labor-saver and money-maker. Will do the work so much better, quicker and easier you cannot afford to do without it. The only practical machine for sharpening Lawn Mowers on the market. Over 5000 in use. Fully warranted. Sold on easy-payment terms. Write today. Don't delay.

HEATH FDY. & MFG. CO., Plymouth, Ohio

town, which is supported by the Mohammedan barbers of Madras, and by the fines levied by the Chaudri, to elect their Chaudri from one of the jurors, and place on the jury one of their own men.—New York World.

Electricity will be the only power used at a lock large enough for vessels 1,000 ft. long that will be built at the Pacific end of the Panama Canal.

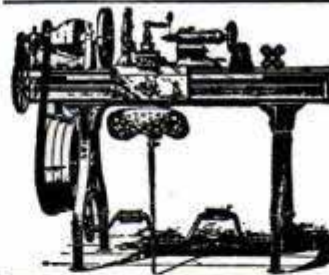

LATHES

9 to 13-inch Swing

List price \$75 and up according to size. When ready to buy send for Lathe Catalog and prices.

W. F. & John Barnes Co.
100 Ruby Street, ROCKFORD, ILL.



LATHES

\$75 Screw Cutting Foot or Power
9 to 13 inch

CATALOG FREE

SOUTH BEND MACHINE TOOL CO., 423 Madison St., South Bend, Ind.



The Crescent Universal Wood Worker

is giving such absolute satisfaction that you could not help but be pleased with it if you want a substantial, durable, convenient combination wood worker. Get our catalog telling all about it, and describing our line of band saws, saw tables, shapers, jointers, borers, planers, planers and matchers, disk grinders, variety wood workers band saw blades

THE CRESCENT MACHINE CO.
93 Columbia St., LEETONIA, OHIO

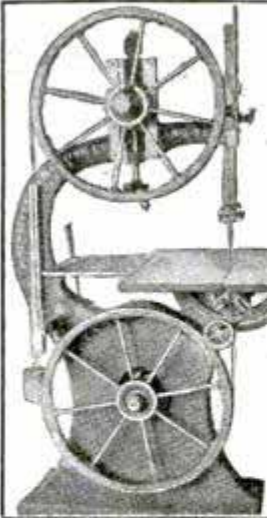

Here is Our "Superior" 20" Tilting Table Power Band Saw

Complete with rubber covered wheels, guides; iron table tilts to 45° and 2 saws, all ready to run, modern in every respect. The finest little tool you ever saw. Will do all kinds of work that a large one will do. Don't miss this.

Price F. O. B. Chicago **\$39.75**

On the right we show our "Superior" Iron Frame Adjustable Combination Power Saw Table. This machine is well built throughout, frame all one piece, strong and durable. Iron top well finished. Adapted for all kinds of general work. One of the nicest little machines we build. Don't let this get away from you. Price F. O. B. Chicago

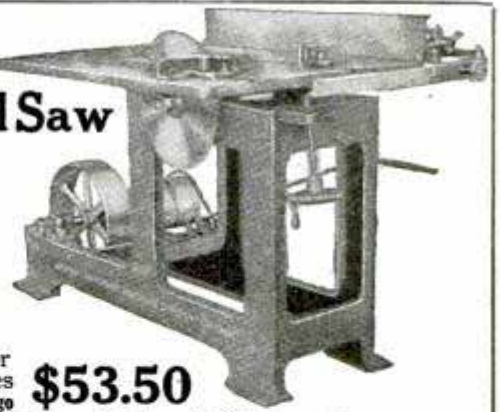

\$53.50

The above prices are good until Jan. 25th, 1913, only

Our machines are shipped direct from our factory to the user. We are the largest manufacturers of wood-working machinery in Chicago. Catalogue on application.

W. A. JONES FOUNDRY & MACHINE CO., 1400 North Ave., Chicago

FOR EVERY GUN

Every gun owner everywhere needs "3 in One" oil all the time. No other oil on earth is so good for lubricating lock, trigger, ejector, break-joints. It goes right into contact point, removes dirt and grease, reduces friction and makes every action part do its work easily, accurately, surely, at the right time. Moisten cleaning rag with "3 in One" and rub inside of barrel. This removes all residue of burnt powder, prevents leading, pitting and rust. "3 in One" cleans and polishes wooden stock.

FREE Write at once for free sample bottle and "3 in One" dictionary. **3 IN ONE OIL CO.** 42 CNG, Broadway New York City

AMATITE ROOFING

Mineral surfaced. Needs no painting. Send for free sample. **BARRETT MANUFACTURING CO.,** New York, Chicago

An estimate of the length of railways in the world has been made by the German Bureau of Railway Economics. According to this there are 638,611 miles in existence, 326,357 of these being in America, 206,987 in Europe, 63,188 in Asia, 22,850 in Africa and 19,229 in Australasia.

FOR SEWING LEATHER

The Speedy Stitcher is the latest and best of anything ever offered for \$1.00.

Agents make over 200% profits.

Send at once for catalog and terms.

AUTOMATIC AWL CO., 26 Gardner Terrace, WORCESTER, MASS.

Grobet Swiss Files

and other high-class Tools are shown in "THE TOOL-MONGER" — its 375 pages, and will be mailed on receipt of 5 cents in stamps.

MONTGOMERY & CO., 107 Fulton Street, NEW YORK CITY

SENT ON 30 DAYS' TRIAL TO RESPONSIBLE PERSON

The Handiest Tool Holder Made

Constructed of hardened steel, well and truly made. Holds any shape of stock down to No. 60 Drill. Write for Catalog E.

B. MORGAN, Manufacturer of SPECIALTIES, Bellevue St., NEWPORT, R. I.

Install in Your Country Home a Water System that Requires No Attention

from one end of the year to the other. The simplest, surest and most economical method of supplying water is by the

RIFE Pneumatic WATER System

Delivers water automatically day and night, winter and summer, and will maintain ample air pressure in tank.

First cost is low.

No operating expenses.

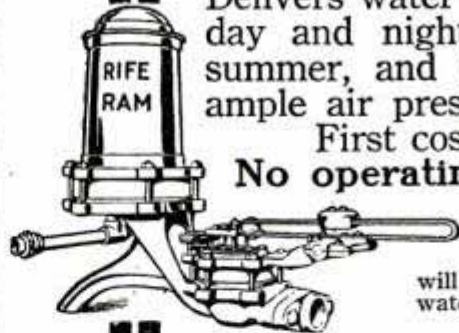

Write for catalog giving full details of this system. It will solve many of your water supply problems.

RIFE ENGINE CO.

2131 Trinity Bldg., NEW YORK

This Machine Will Earn \$20 to \$50 a Day for You

Owners report daily profit of \$20, and upwards. Some as high as \$50. One reports \$243 in 90 days; another a \$90,000 government contract after severe tests on product. Start a concrete factory and do as well. Little capital and no experience required. Only machine necessary is



The HELM PRESS

80,000 lbs. pressure, no tamping, easy work, automatic, makes highest grade cement blocks and brick known at greatest speed and lowest cost. 1000 blocks or 10,000 brick daily. Salable everywhere. You should know about

The Helm DRY WALL Building System It will get you in business. SAVES MONEY for builder, as no furring and lathing are required. Endorsed by architects, contractors and builders

Send for the **FREE Concrete Book** and learn the details of this system and about Helm presses. Tells what articles pay best, how made, cured and sold. Write today; do it now.

Queen City Brick Machine Co., 521 Bank Bldg., Traverse City, Mich.



REG. U. S. PAT. OFF.

This trade-mark "The MARK of the MAKER" is a bond of integrity in material and workmanship. It is stamped on every P. S. & W. Guaranteed Hand-Tool, including

The 1819 Original P. S. & W. Co. Snips

The first high-grade snips manufactured in America, they are still, after 94 years, the best-known and best-made snips on the market.

A Useful Tool for Mechanic or Householder

From the expert tinsmith to the householder who values good tools every one can use a good pair of snips.

The P. S. & W. Snips last a life-time — because they are made in the one right way, of genuine Norway Iron with the finest tool steel laid deep into the blade. For cutting qualities and long life they have no equal.

Write for the "Mechanics' Handy List," a 170-page hand-tool catalog with 35 pages of valuable shop tables and handy information.

The Peck, Stow & Wilcox Co.

MFRS. of the Largest Line of Mechanics' Hand Tools Offered by Any Maker

SOUTHINGTON, CONN. NEW YORK, N. Y. CLEVELAND, O.
Address 20 Murray St., New York City

"Vulcan"

We are the only mf'rs of this Simplest form of Safety

Lathe Dog

Capacity increases with the facility with which you can do your work safely.

"VULCAN" DOGS

will increase your capacity for greater earnings.

Safety Dog Wrench

Get Free, Forged Tools Catalogue

J. H. WILLIAMS & CO.

Superior Drop-forgings
47 Richards St.
Brooklyn, N. Y.

INDIA'S BUTTER TREES—By far the most remarkable of edible flowers is that culled from the butter tree of India. The blossoms of this singular tree are the chief means of subsistence with the Bhils and other Indian hill tribes. An average tree yields from 200 to 350 lbs. of pulpy, bell-shaped flowers, that, when they drop off during March and April, the hot months of the Indian year, are eagerly gathered by the natives. They have, when fresh, a peculiar and luscious taste, but the fragrance of them is not pleasant, and is best and most briefly described as "mousy." Usually they



Tool Cases for Machinists & Toolmakers

You need one of the many styles shown in our free catalogue. They are the best built and most practical on the market and it's the up-to-date way to keep tools in good condition and orderly arranged. We ship direct to you and guarantee complete satisfaction.

A. Gerstner & Sons

Mfrs. of Mechanics' High Grade Tool Cases
819 Germantown Street, DAYTON, OHIO

REGISTERED

"Ohio" Tools

Insist on them—it will pay you.
Carefully made from specially selected steel—*fully warranted.*
Write for complete catalog of

"Ohio" Planes, Chisels, Drawing Knives, Auger Bits, Screw Drivers, etc.

OHIO TOOL CO. Department 3
Columbus, O.

Starrett Tools

ELECTRICIANS!

You need a screw-driver that will combine perfect insulation with convenience and strength.

Starrett

Electricians' Pocket Screw-Driver

is made especially for electricians. It has four blades of different widths carried in a magazine handle. This handle is hardened rubber, giving perfect insulation. The screw-driver will stand for good long hard service. You need it. Send for Catalog 19 A.P. It shows other tools you need.

The L. S. Starrett Co., Athol, Mass.

42-122



are cured in the sun, shrivel to one-fourth of their size, and then resemble nothing so much as raisins. The natives prepare them for food by boiling, or using them in sweetmeats.—Suburban Life.

There are 429 establishments in the United States for the manufacture of perfumery and cosmetics, 195 conducted by individual proprietors, 65 by firms and 169 by corporations. The employes and wage earners number about 4,000.

FOR MENDING HARNESS

shoes, tents, awnings, pulley belts, carpets, saddles, suit cases, buggy tops, dash boards, or any heavy material. Stewart's Automatic Awl is the only perfect Sewing Awl.

It takes a wax thread, feeds from spool and does the work of any harness maker machine. It is indispensable for farmers. Agents wanted. Sent prepaid for \$1.25. Send at once for catalog.



STEWART-SKINNER CO.
26 Hermon Street
Worcester, Mass.

Do You Work in Copper?



\$1.50 for rising block, hammer and full directions for making

Write for Catalog No. 34

Brass and Copper Bowls

Fern Dishes, Lamp and Candle Shades and many other articles for household use

We carry a large stock of

ARTS and CRAFTS SUPPLIES



ORR & LOCKETT HARDWARE CO.
14-16 West Randolph Street, CHICAGO, ILLINOIS



No. 99
Drawers fitted with locks

A Complete Home

is always provided with a work bench on which to do the numerous "odd jobs" about the house. Make your work at home a pleasure. **Spend Your Christmas Money** and buy a

Grand Rapids Home Bench

that will enable you to do your work as it should be done—one that is convenient and satisfactory in every way.

You couldn't please the boys more.

Made the same as those we supply the best Manual Training Schools and Cabinet Shops.

Many styles for all needs. Our catalog tells you—better send for it to-day.

GRAND RAPIDS HAND SCREW CO., 1620 Front Ave., GRAND RAPIDS, MICH.

If you want one of our Stone Blotters send 15c when writing for catalog

Ask any hardware dealer to show you this line.

Our complete catalogue mailed FREE to any address.

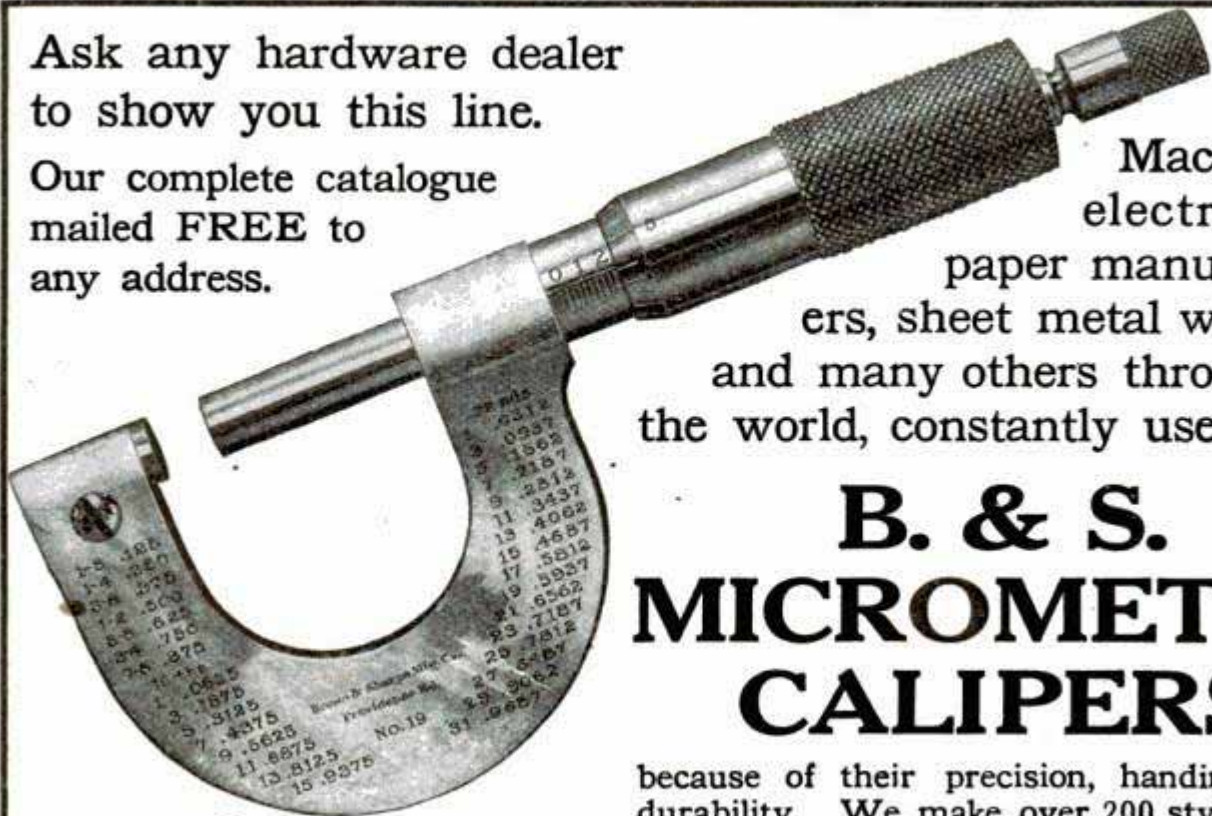

Machinists, electricians, paper manufacturers, sheet metal workers, and many others throughout the world, constantly use

B. & S. MICROMETER CALIPERS

because of their precision, handiness, and durability. We make over 200 styles measuring all sizes from 3/10 to 24 inches.

BROWN & SHARPE MFG. CO.
PROVIDENCE, R. I., U. S. A.

There is a caliper for nearly every purpose for which one is needed

THE EXCELSIOR BRAD SET. PRICE 25 CENTS

Takes No. 18 and No. 20 Brads from 1/4 to 3/4 in. long



THIS END IS MAGNETIZED

The tool illustrated above will be indispensable to the Pattern Maker, Cabinet Maker, or Picture Framer who purchases it. It will set brads in places that would be inaccessible without it, and dispenses with the bradawl and nail set. If, after a fair trial, you are not satisfied that you have received your quarter's worth, your money will be promptly returned to you on receipt of tool. **Standard Tool Supply Co., 42 W. 15th St., New York City**

THE MAN BEHIND in his calculations finds in the Richardson Slide Rule the desired answer

There seems to be a misunderstanding about what the Slide Rule will accomplish, many think it an instrument, the use of which is applicable only to Engineers and Technical men. So frequently have I heard this remark that I have completely re-written and enlarged my instruction book, which shows the actual setting of the rule by 78 full size engravings, each engraving and example is explained and "written so you can understand it." In fact any person who has never seen a Slide Rule, and not a technical person, could not help but learn its use. The examples selected and shown by illustrations are those which frequently come up for solution by the Banker, Broker, Auditor, Inventory Man, Cost Estimator, Printer, Paper Mfr., Contractor, Salesman, Time-Keeper, Bookkeeper, Lumber, Land, and other merchants too numerous to mention.

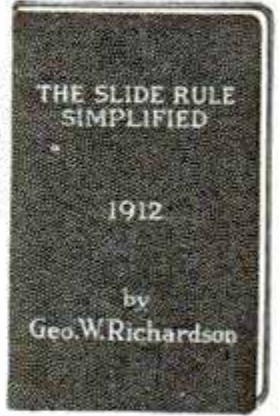
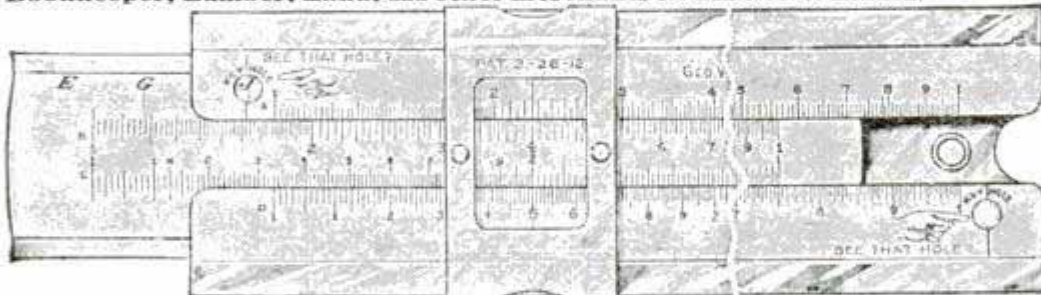

This Slide Rule will multiply, divide, solve proportion, extract the square and cube roots, find the decimal equivalent of vulgar fractions or "vice versa," calculate interest, percentage. Also the mensuration of superficies, and the rule of three. For Engineers, Electricians, Draftsmen, Superintendents, Master Mechanics, etc., the rule is indispensable in their work. It is one of the most valuable instruments ever offered to mankind. For Electricians it is a complete wire table in itself, calculates the size of a motor to run a pump, shows percentage a customer's recording meter is either "slow or fast." The Richardson Direct Reading Slide Rule is specially designed for those who wish to learn its use. Its operation being very simple. You simply place the key to the problem wanted in the keyhole (the key is printed in red on slide, see cut) and answer is given direct; such as the Horse Power of Engines, Pumps, Boilers, Belts, Water Falls; size of duct for ventilating; radiation and size grate, and steam main required; change gear and pulley problems; areas, circumference and diameter of circles. This Rule is my 1912 type now being placed on the market for the first time. Made in two sizes, coat and vest pocket 11x1 1/4 and 5 1/2 x 1 1/4. No wood in their construction, scales white celluloid, printed from engine divided plates in two colors, and washable, secured by an improved locking device in an absolutely non-corrodible Aluminum and Monel Metal framing. Durable cardboard case for large rule, and neat leather case for vest pocket size. Special case for large rule end-flap and button fastening 25c extra. Full leather case 50c. If ordered now I give free a copy of my new book **The Slide Rule Simplified**. Price of either above rules \$2.50. A limited number 10 inch Student Rules with cardboard scales Given Free to each purchaser of above book. Price of book without rule, paper cover \$1.00. Flexible silk cover \$1.50. **GEO. W. RICHARDSON, Consulting Engineer, Ex-Chief Electrician, U. S. Navy, 4215 24th Pl., Chicago, U. S. A.**



**A Handy Drill
for Every Use**

A quality tool that will perform good service always—

HAND DRILL No. 3

is 11 inches long and has a chuck that holds from 0 to 3-16 inch drills. Entire weight 21 ounces. Has hollow handle to hold drill points with a unique, quick and convenient method of removing and attaching handle to get at drills. **PRICE \$1.00.**

Write for our catalog and instructive Book "Tool Practice"—both FREE

Millers Falls Co. 28 Warren Street
NEW YORK CITY

They're All Using It Now!

and they say it's the finest plier ever produced. We know it is.



Yes this "Red Devil" No 1650 is bonded for two years' service. This covers the entire subject. It insures your satisfaction as no other side cutter ever has. Ask your local tool dealer for No. 1650 8" "Red Devil" Bonded Plier. Read the guarantee bond. Put the plier to any legitimate test. You will then appreciate "Red Devil" tool quality. If your local dealer cannot supply you, send us \$1.75 and one only, sample pair, will be sent you prepaid.

SMITH & HEMENWAY CO., 051 Chambers St., NEW YORK

"SIMONDS SAWS"

"Are the BEST and
They ARE the best."

Our aeroplane industry is beginning to show up in the figures. In the last year we exported 27 machines, valued at \$105,000, while we imported 17, valued at \$60,000.

Experiments made at the health congress at Washington showed that man as a machine has an efficiency of about 20 per cent; that is, for every unit of muscular work developed by the body a total of five units of food energy must be supplied.

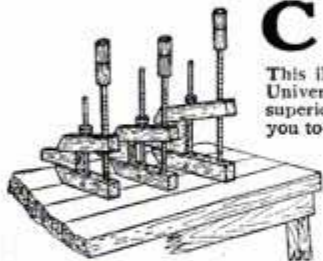

CLAMPS

This illustration shows The Ducharme Patent Universal Clamp, and a glance at it will show its superiority over the old-style clamps, as it allows you to set your work upright and clamp upright, and at the same time to stack them side by side on the bench or shelf while the glue has a chance to set. Write for Circular C and Price List.

MANUFACTURED BY
THE DUCHARME MACHINE CO.
389 Riverside Ave., Medford, Mass.

By Getting a Work Bench Like This



you will be able to do most any kind of work around the house. The bench is 4½ ft. long, 22 inches wide and 32 inches high, made of hard maple, has 2 Patent Wood Screw Vises. The cabinet has three drawers, each 16 inches long, 18 inches wide and 5 inches deep, fitted with locks. The cupboard is 18 1-2 inches long, 18 1-4 inches high, and 10 inches wide, with lock on door, and will be shipped you at once on receipt of **\$14**

C. CHRISTIANSEN
MANUFACTURER
2219 Grand Ave., CHICAGO, ILL.

Stanley Tools

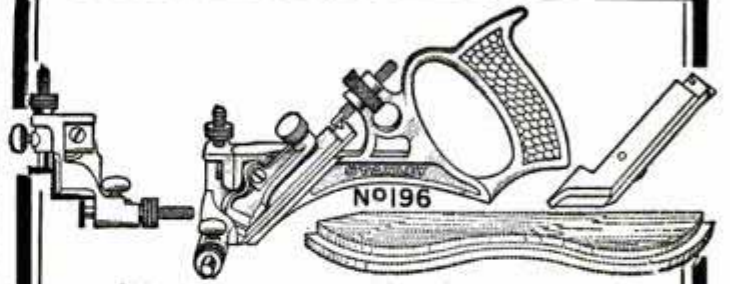

Stanley Curve Rabbet Plane

Another New Stanley Plane

That Will Undoubtedly
Be of Great Interest to
All Workers in Wood

IT WILL cut rabbets on circular or other curved and irregular edges. It works equally well whether the rabbet is to be cut on the outside edges of the work or on the edges of openings cut out of the surface of the work. It is provided with two cutters fastened together by a screw in such relation one to the other as the work in hand requires. The upper cutter acts as a spur for the lower and also cuts the side of the rabbet. The lower cutter is a skew cutter which follows the spur and cleanly cuts the bottom of the rabbet. The stock and handle are cast in one piece. The plane is fitted with an adjustable depth gauge. The fence is also adjustable and has a curved face.

The Entire Tool is Handsomely
Nickel Plated

If you cannot procure one of these planes at your regular hardware dealers write us direct.

ADDRESS

Stanley Rule & Level Co.
NEW BRITAIN, CONN. U.S.A.

Please Mention Popular Mechanics

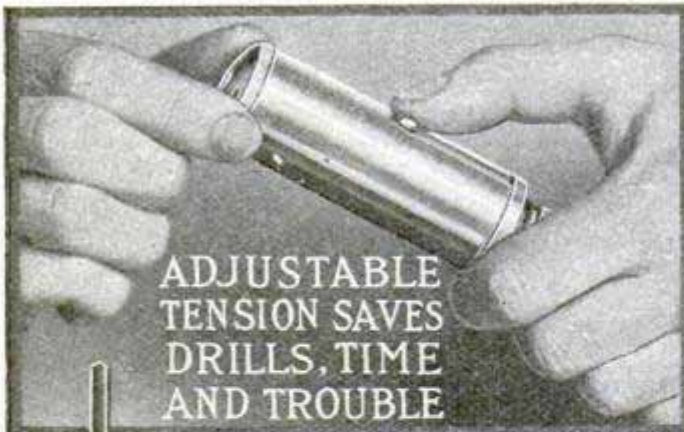

ADJUSTABLE TENSION SAVES DRILLS, TIME AND TROUBLE



THIS improved push drill (YANKEE No. 44) offers the advantage of a graduation of tension from high to low, thus suiting the tool to *varying* requirements met with in work of every description.

By turning the cap (as illustrated) the spring in the handle is compressed or extended and the tension increased or reduced, with the result that the drill-point feeds with greater or less pressure—as is best for the work in hand: whether in hard or soft wood; with large or small drills.

The spring is held at any desired tension by a lock-bolt which engages in the cap and which is operated, as shown, by the small knob on handle.

Eight "Yankee" Drill Points—1/16" to 1 6/4"—are supplied with this tool. A further improvement is the arrangement of the magazine containing the drill-points, the opened end of magazine being *up* the same as chuck, as the tool is held to insert or change drills.

"YANKEE" Automatic Push Drill No. 44 Price \$1.75



Your dealer can supply you

FREE TOOL BOOKS. Mechanics and handy men: Write for "YANKEE" Tool Book," illustrating and describing the many ingenious "YANKEE" Tools and their uses.

Automobilists: Write for "YANKEE" Tools in the Garage."

NORTH BROS. MFG. CO. PHILADELPHIA

"YANKEE" TOOLS
Make Better Mechanics

Hand Knurling Tool

A small Knurling Tool, seven inches in length, to be held in the hand and is especially adapted for quick, accurate knurling on the smallest possible piece required up to its full capacity of three-fourths of an inch in diameter. Is an addition to the kit that makes the eye sparkle every time it is brought into use. There is no limit to the length of the pieces which can be knurled, the work being well supported between the three knurls. The handle from which adjustments are obtained is hollow and contains the extra set of three knurls, a coarse and fine set being furnished with each Knurling Tool.

Price, \$5.00

FOR SALE BY EDGAR T. WARD & SONS, 25 Purchase Street BOSTON, MASS.



LUFKIN

Measuring Tapes

Standards of efficiency for the Amateur and the Expert. The big improvement in markings, **instantaneous readings**, saves time and avoids error. Send for sample piece of tape and our complete catalogue.

THE LUFKIN RULE CO.

SAGINAW, MICH. New York London, Eng. Windsor, Can.

THE VANISHING PIGTAIL—A large number of Shanghai officials, merchants and others have now cut off their queues, and every day the new fashion is coming more into popular favor.

Time was, and that within the last two years, when any reference to this subject among representative people in this country was taboo, while today it is a sub-



Portable Cases

FOR TOOL MAKERS AND MACHINISTS

Twelve styles, felt lined drawers, solid brass trimmings, best of material, beautiful finish, low prices, satisfaction guaranteed. Ask for booklet of cases built for service.

The Pilliod Lumber Co. SWANTON, OHIO



BAR BENDERS

For Concrete Reinforcements

WRITE FOR OUR BENDING TOOL CATALOGUE.

Wallace Supply Co. 124 No. Jefferson St., Chicago 26 Cortlandt St., New York City

AGENTS—Make \$30 per Week

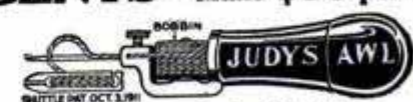

JUDY'S CLAMP
JUDY'S AWL
This AWL sews a lock stitch like a machine. Best thing ever made for repairing Harness, Shoes, etc. A dozen exclusive features. Demand is immense. Sales astounding. Roy Sage writes, "Received Awl, sold 5 in 15 minutes." L. Perrine says, "Sold 9 on way home with sample." Low price, big profit, great value, quick sales. Drop everything; write for sample and instructions.
W. S. JUDY, Mgr. Dept. 1441, DAYTON, OHIO

Would You Buy a Bench



equipped with a vise having Racks, Pawls and Triggers, if you could get one equipped with a vise without these unnecessary parts, a vise that has a phosphor Bronze Nut engaging the entire circumference of the screw and operating the entire length?

Then get acquainted with Richards-Wilcox Rapid Acting Vise—Our catalogue gives complete information about our vises and home benches. Write

RICHARDS-WILCOX MANUFACTURING CO.
147 Third Street AURORA, ILL., U. S. A.

Make Things of Leather



No. 1 Double Ended Leather Working Tool, 50c

You can make hand bags, pocket books, card cases, a hundred useful and attractive things in leather. It's fun and it's easy to learn. An investment of 50 cents in tools will start you. Send for our Arts and Crafts Catalog 24.

ORR & LOCKETT HARDWARE CO.
14 W. Randolph Street, CHICAGO

ject of comprehensive discussion, and similarly to the vicious practices of opium smoking and foot binding, the wearing of a "pigtail" is rapidly becoming bad form. —New York World.

GASOLINE SOLDERING IRON BLOW TORCH

This is it. Have you seen it? Address Department L.

EMMELMANN BROS. MFG. CO., INDIANAPOLIS, IND., U.S.A.



DUPLICATE KEYS

made in little over a minute by the **HARRISON M. I. P. KEY FILING MACHINE**

Yales, Corbins, Russell & Erwins, Norwalks, Readings, etc. The greatest invention of the age, price within the reach of the masses. Master Mechanics, Hardware Stores, Superintendent of Buildings, Locksmiths, etc., cannot afford to be without this tool. Price \$3 complete by mail free. Send for circular.

HARRISON & CO., 81 1/2 New Street, New York

\$1.00

Postpaid Myers' Wonderful Sewing Awl

sews leather, canvas, shoes—anything, heavy or light. Complete repair shop in itself. Saves many trips to town. Mends harness saddles, wagon covers, blankets, buggy tops, belts, etc. Can't get out of order. Original and only awl with diamond point full grooved needle to protect the thread. **BIG MONEY FOR AGENTS.**

C. A. MYERS CO., 6339 Lexington Ave., Chicago, Ill.

STOP THAT LEAK

Solderene

and a Candle are all you need to make a permanent repair.

Full directions with each stick. It requires no skill. Anybody can use it. Price, Ten Cents.

SOLDERENE MFG. COMPANY, 90 Portland St., BOSTON, MASS.

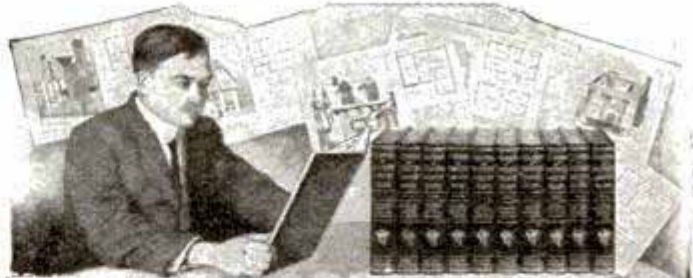

FREE to Carpenters, Contractors and Builders

A new and useful plan book, "Modern American Homes," containing hundreds of valuable suggestions, besides 108 plates, complete plans for every style of the modern American home from the medium priced cottage to the most palatial suburban and city residence also a large variety of tent houses, garages, boat houses, apartment buildings, libraries, churches and institutional buildings—the best in modern architecture by the greatest American Architects. This great book of plans is 9 1/2" x 13" in size, printed on special paper and substantially bound.

Knowledge of present day building construction and familiarity with every detail of modern architecture is essential to the success of the up-to-date carpenter or contractor. Nor should the builder—the man whose money is behind the job—be without some information regarding the work, information which will enable him to judge whether or not he is getting value received for every dollar spent. The American School's Plan Book and their great **Cyclopedia of Architecture, Carpentry and Building**, will give you the information you need in the most accessible form.

THE CYCLOPEDIA OF Architecture, Carpentry and Building

consists of ten massive volumes; 4,760 pages, 7x10 inches; 4,000 illustrations, full page plates, building plans, diagrams, etc.; hundreds of valuable tables and formulas; carefully cross-indexed for quick, easy reference.

This great work covers everything in the building professions, from the first rough sketch of the architect to the acceptance of the finished structure. It includes wood, stone, steel and reinforced concrete construction; estimating and contracting; a study of the Greek and Roman Orders; interior finishing and decorating; and modern house lighting and sanitation.

Partial Table of Contents

Mechanical, Freehand, Perspective and Architectural Drawing, Lettering, Pen and Ink Rendering, The Orders, Superintendence, Strength of Materials, Masonry, Reinforced Concrete, Carpentry, Steel Square, Stair-Building, Hardware, Steel Construction, Roof Trusses, Practical Problems, Estimating Contracts, Specifications, Building Law, Sanitation, Sheet Metal Work, Electric Wiring and Lighting.

The Plan Book Sent FREE

With every order for the American School's Cyclopedia of Architecture, Carpentry and Building we will include the Plan Book, absolutely free of charge and send you the Cyclopedia and the Plan Book, express prepaid, for seven days' free examination. You keep the books a full week—examine them thoroughly at your leisure—and if they don't meet with your expectations they may be returned at our expense. Remember—the complete set, Cyclopedia and Plan Book, are sent free upon receipt of the coupon below and we pay express charges both ways if they are not satisfactory.

Another Free Offer With each set is included a year's Consulting Membership, regular value \$12.00, entitling you to the free advice of a corps of Expert Architects. This will give practical help in handling building problems which are too specific to be taken up in detail in the Cyclopedia. This service alone is worth more than the first cost of the books.

American School of Correspondence, Chicago, U. S. A.

FREE PLAN BOOK COUPON

American School of Correspondence, Chicago, U.S.A.

Please send Free Plan Book, also Cyclopedia of Architecture, Carpentry and Building for seven days' examination. I will send \$2.00 within seven days and \$2.00 a month until I have paid \$4.00 for Cyclopedia (Plan Book included free), or notify you and hold books subject to your order. Title not to pass until fully paid. Pop. Mech. 1-13

NAME

ADDRESS

OCCUPATION

EMPLOYER

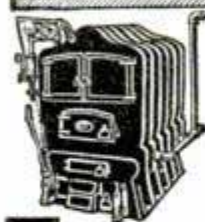
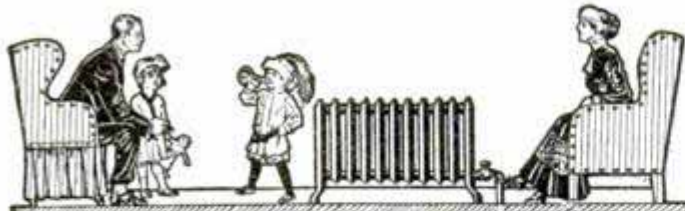

Install Your Own Heating Plant

Save cost of skilled labor. Save on all material. Post yourself on the new method—the practical Gibbons method.

My book explains how you can install hot and cold running water, bath-room outfit, modern heating plant, also electric or acetylene lighting plant, at an amazingly low cost. Make your home more comfortable and valuable. My wonderful book tells you how. Send for this valuable book.

Book Free

My new book gives you greater buying power than your local dealer. It is the most valuable catalog for you ever issued. Thousands of things illustrated and priced. Hot water and steam heating plants, plumbing systems, gasoline engines, hydraulic rams, pipes, pumps, valves, electric lighting plants, acetylene lighting plants, all accessories. Everything guaranteed. High quality at direct, rock-bottom prices. You certainly ought to have this valuable book. Write today for it. Just ask for Gibbons book. It will save you money.

Write Today Send your name and address today. See for yourself how easy it is to make improvements about your home with the aid of my new book. The low prices of my high quality material will astound you. Home owners, contractors, builders, need my wonderful book. Write today. Just send your name. It is post-paid, free to you.

M. J. GIBBONS, Dept. 5245, Dayton, O.

IRON WITHOUT A FIRE

Cut out the drudgery. Save time—labor—fuel. No walking back and forth to change irons—always the right heat for the best work if it's an

IMPROVED MONITOR SAD IRON

Self Heating. Satisfaction Guaranteed

Over half a million Monitors in use. Strong, simple, easy to operate. Heat regulates instantly, no dirt, no odor.

Agents, Salesmen **\$10 to \$20 a Day**
Managers wanted

No experience required. Every household a prospect. Sells almost on sight. **NOT SOLD IN STORES.** Martin, Tenn., made \$5000 in 1 year. Trimmer, Ill., writes, "I sold 12 in 10 hours." Mrs. Nixon, Vt., made \$100 in half a day. You can do it too. Send for a colored circular, shows iron full size, explains everything. Exclusive selling rights—no charge for territory.

The Monitor Sad Iron Co., 203 Wayne St., Big Prairie, O.



12 Art Panels 50c

Beautiful Duo Tint Reproductions of Famous Paintings—Panel Size 7x10

These pictures are real gems—the most exquisite portrayals of

"WOMAN BEAUTIFUL"

ever shown in one collection. We send a full set of 12 in handsome Art Portfolio, packed flat and safe delivery guaranteed, together with lifelike miniatures of 70 other beautiful and catchy den pictures, for only 50c. coin, money order or U.S. stamps. **Send at once. Money back if not satisfied.** Or send \$1.25 for same set hand-colored.

Florentine Art Company
Dept. U1, 808 Schiller Bldg., CHICAGO, ILL.

FREE Order panels at once and we will include "Free" a beautiful den picture in colors.

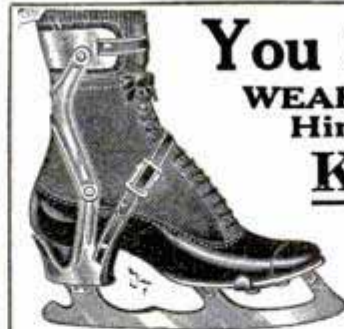

You CAN Skate

WEAK ANKLES don't Hinder with the **KENNEDY SKATE**

The Kennedy brace makes your ankle as strong as the steel itself without hindering the free movement. Clothing conceals the small

extra parts. It is fastened in 10 seconds and will improve your skating 100 per cent at once. Weighs less than the ordinary skate. Prices \$3.50 and \$4.50. Ask to see the **KENNEDY TWO-WHEEL ROLLER SKATE**. Same principle as ice skates. They make roller skating a delight. Price \$5.00. **KENNEDY SKATES** are sold at department, hardware and sporting goods stores or sent prepaid on receipt of price by

KENNEDY SKATE CO., 817 W. Washington Boul., Chicago
WRITE FOR CATALOGUE NO. 1

HESS FURNACE



We will deliver a complete heating equipment at your station at factory prices and wait for our pay while you test it during 60 days of winter weather.

The entire outfit must satisfy you or you pay nothing. Isn't this worth looking into? Could we offer such liberal terms if we didn't know that the Hess Furnace excels in service, simplicity, efficiency, economy?

We are makers—not dealers—and will save you all middlemen's profits. No room for more details here. Write today for free 48-page booklet which tells all about it.

Your name and address on a post card is sufficient.

HESS, 910 Tacoma Bldg., Chicago

No. 48
"Leader" Hess
Steel Furnace
Price \$49
Delivered East of Omaha and
North of Ohio River
Pipe and Registers Extra

Large corporations, comprised mainly of Englishmen, are now making Oriental rugs in a wholesale way, according to a writer in one of the magazines. These corporations, located mainly in Turkey, gather the rug-makers from different places, set up looms for them, and give them regular pay. The workers copy handsome antiques, and in this way the price of fine rugs has, it is asserted, been much reduced.

BUY PLUMBING SUPPLIES AT WHOLESALE

Will Save You 30%



Don't pay retail prices. Full stock on hand for prompt shipment. Send for free catalog.
B. P. KAROL, 768 to 772 West Harrison St., Chicago

CACHOO! Make the whole family and all your friends "just sneeze their heads off" without knowing why, with **CACHOO**, the new long distance harmless snuff. Sent anywhere for 10c, 3 for 25c, 90c a dozen. Catalog included FREE.
PEERLESS TRICK & NOVELTY CO., Dept. B, CHICAGO



To Entertain 311 Jokes and Riddles, 73 Toasts, 91 Parlor Amusements, 21 Puzzles, 15 Tricks with Cards, 7 Comic Recitations, 3 Monologues, 12 Funny Readings, 8 Fortune Secrets, 52 Money Making Secrets. All 10c postpaid.
J. C. DORN, 709 S. Dearborn St., Dept. 17, CHICAGO, ILL.

Boys' Own Toy Maker
Tells how to make a Talking Machine, Camera, Electrical Motor, Bicycle Boat, Canoe, Boomerang, Bobsled, Wind Mill, Microscope, Water Wheel and Motor, Stilts, Toboggan, Snow Coaster and Sail Boat, Telephone, Electric Bell, Railroad, Wind Mobile, Paddle Raft, Traps, Kites, etc. All 10c, postpaid.
J. C. DORN, 707 So. Dearborn St., Dept. 38, CHICAGO, ILL.

I will send as long as they last my 25 Cent Book
STRONG ARMS

For 10c in stamps or coin

Illustrated with 20 full page halftone cuts, showing exercises that will quickly develop, beautify, and gain great strength in your shoulders, arms, and hands, without any apparatus.

PROF. ANTHONY BARKER
647 Barker Bldg., 110 W. 42d Street, New York



THE WIZARD LIGHT

These LATEST INVENTIONS represent the ACME of Perfection in Artificial Lighting.

After once installed the INSTANTANEOUS System requires no generation, as lamps are operated by pull of the chain and as conveniently as electricity at one-tenth the cost.

The "QUICKLIT" lamps are lit with an ordinary match; therefore are operated as conveniently as city gas.

All our lamps and systems represent the highest standard of quality, are fully guaranteed and are so simple that anyone can operate same. For further particulars and complete illustrated catalog describing the above and also the Air Light or Tube System, "Hollow wire Inside and Outside Arcs and lamps with automatic cleaning needle," Boulevard Arc Lamps, Outside Lamps, Upright Lamps, etc., address

THE NAGEL-CHASE MFG CO.
The Largest Manufacturers of Gasoline Lighting Devices in the World
153 W. OHIO ST., CHICAGO, U.S.A.

Japan is doing a great business exporting cotton underclothing, an industry which has sprung up in a very short time.

The replica of Henry Hudson's Half Moon, which was one of the features of the Hudson-Fulton celebration, has been overhauled and given a permanent anchorage off Yonkers in the Hudson River.

BEAUTIFUL PORTABLE LIBRARY LAMP

made of Mission Weathered Oak; hand rubbed wax finished; shade of four panels of Cathedral Art Glass, of tints of green and white; makes a splendid wedding gift; always useful and in perfect harmony with its surroundings. Made for electricity, gas or oil.

"MUNYBAK" Guaranteed Product. Price Only \$2.75

Write for complete Free illustrated catalog telling about our fine Lighting Fixtures and Furniture.

WE SAVE YOU ONE-HALF

MUNYBAK CO., 110 Main St., BLUFFTON, IND.

Height 24 in.
Shade 14 in. Square
7 in. Deep.

Nulite Portable Parlor Lamp

The cheapest, best and most beautiful light obtainable for town or country. Makes and burns its own gas; 300 C. P. 5 hours for 1 cent. Can be used anywhere with amazing results. Low in price. Thoroughly reliable. Many new and exclusive features. Best proposition of the year for agents.

WRITE TODAY FOR FULL DETAILS

National Stamping & Electric Works
422 S. Clinton Str., Chicago

Triumph Light

EVERYBODY WANTS BETTER LIGHT. HERE IT IS

This new 100 to 200 candle power light turns up and down like gas. One-third cost of electricity, gas or kerosene. For home, church or store. Anyone can operate. Perfection guaranteed or money back. Write for catalog (P. O. P.), Dept. 1. Agents Wanted.

BRILLIANT GAS LAMP COMPANY
No. 182 North State Street, Chicago, Illinois

Make 30 to 60 Weekly

No Wick, No Chimney, No Smoke, No Odor, No Mantle Trouble.

selling our new and unequalled portable gasoline table and hanging lamp for lighting city and rural homes, stores, halls, churches. Most powerful light known. Absolutely safe.

WE LOAN YOU SAMPLE

More brilliant and many times cheaper than gas or electricity. Guaranteed five years. Everyone a possible customer. No experience necessary. Large commissions. Exclusive territory free. Write today.

SUNSHINE SAFETY LAMP CO.
341 Factory Bldg., Kansas City, Mo.

Costs 1 Cent Per Night. A Perfect Light for Every Purpose.

Standard Lamp 300 Candle Power FREE

To One Agent in Each Locality

Turns night into day. Gives better light than gas, electricity or 18 ordinary lamps at one-tenth the cost. A miniature portable lighting plant for every purpose. Makes its own light from common gasoline. ABSOLUTELY SAFE.

COSTS 1 CENT A NIGHT

We want one person in each locality to whom we can refer new customers. Take advantage of our special offer to secure a STANDARD LAMP FREE.

STANDARD LAMP CO.
712 Standard Bldg. KANSAS CITY, MO.

Beacon Burner FREE!

Fits Your Old Lamp

100 Candle Power Incandescent pure white light from (kerosene) coal oil. Beats either gas or electricity.

COSTS ONLY 1 CENT FOR 6 HOURS

We want one person in each locality to whom we can refer new customers. Take advantage of our Special Offer to secure a Beacon Burner FREE. Write today. AGENTS WANTED.

HOME SUPPLY CO., 11 Home Bldg., Kansas City, Mo.

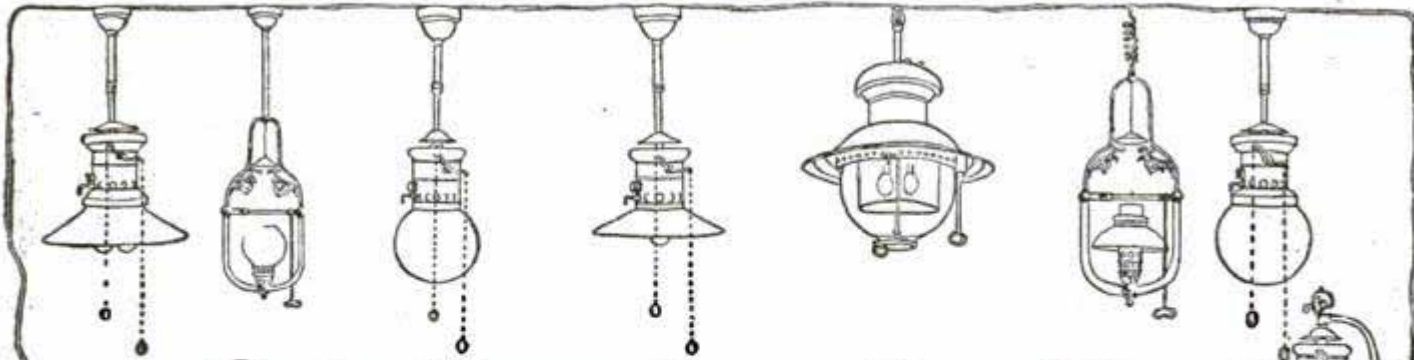

Own Your Own Gas Plant

For Lighting, Cooking, and Heating Purposes

No walls, floors, or ceilings to tear up. Plants all fitted at the factory. Anybody can install a two or three light plant in an hour's time. No deadly carbide; no danger. Power not required. Brightest light known and at a fraction of what electricity or any other method will cost you. So cheap to install that everybody can afford a complete plant. One of these Systems will not only light your house in brilliant fashion from cellar to garret, but will furnish you hot water, do your cooking and serve various other purposes in which an extra fine quality of gas is most useful. Cost of operation is less than ordinary kerosene lamps. Five hundred beautiful fixtures to select from. Write today for free copy of our large new catalogue, No. 17, containing 164 pages and 400 illustrations. Address in full, as follows:

AMERICAN GAS MACHINE CO., 193 East Clark St., Albert Lea, Minn.



YALE INDEPENDENT GAS PLANT MAKES ITS OWN GAS

GASOLINE LIGHTING SYSTEMS FOR EVERY NEED



AGENTS WANTED EVERYWHERE

Why You Should Sell the Yale Line Because the Yale Hydro Carbon Gas System of lighting is known from coast to coast. **It has withstood the test of time.** Thousands are in daily use. **It is a live wire proposition, one of permanency.** Our line is complete for the home, store, church, hall, etc., 1000 candle power light, 2c per hour, 1/5 cost of **Electricity or Gas**, sold on a money-back guarantee, no experience or mechanical knowledge required. Be independent, build up a business for yourself. We will help you, write today for catalog and proposition.

P. M. YALE MFG. CO., CHICAGO, ILL.

AGENTS—BIG MONEY

Experience unnecessary. Sell the everlasting guaranteed Steel Mantle Light Burners. Make coal oil produce gas. Give 3 times the light of old style. No smoke; no smell. Every home buys 3 to 6 and more. Repeat orders certain. Sample complete 25c. Particulars FREE. Write today.

The Steel Mantle Light Co., 399 Huron St., Toledo, O.

3 YEARS TO PAY

Meister Piano 30 days free trial in your or a home

\$1 A WEEK or \$5 A MONTH Price \$175.00

No cash payment down. No interest—no extras. Piano stool and scarf free.

ROTHSCHILD & COMPANY
Dept. C 16 CHICAGO, ILL.

FREAK SHOES—All efforts of physicians and others to educate the American public to a realizing sense of the importance of wearing correctly shaped, properly fitting shoes appear to have been lost on some people. The retail shoe dealers assert that their loss on freaks and changes in styles is one of the prime causes for the increasing prices of shoes. In brief, the losses on those accounts must need be made up in some way, and the consumer pays the freight.

SONG POEMS WANTED. NEW PLAN. BIG MONEY. Free Book tells all. **HAYWORTH MUSIC CO., 6606, WASHINGTON, D. C.**

The "BEST" LIGHT



Used in every civilized country on earth. Best and cheapest light for homes, stores, factories and public buildings. Makes you independent of lighting companies. Over 200 styles. Every lamp warranted. Makes and burns its own gas. 100 to 2,000 candle-power. Agents wanted. Write to-day for catalogue and prices.

THE BEST LIGHT CO.
324 East 5th Street,
Canton, O.

No Dirt
No Grease
No Odor

2¢ a week

WURLITZER FREE CATALOG

Musical Instruments

282 Pages. 2561 Articles described. 788 Illustrations. 67 Color Plates. Every Musical Instrument. Superb Quality. Lowest Prices. Easy Payments. Mention instrument you are interested in. We supply the U. S. Government.

THE RUDOLPH WURLITZER CO.
308 S. Wabash Av., Chicago 101 E. 4th Av., Cincinnati

NEW COAL OIL LIGHT

Beats Electric or Gasoline

Powerful white brilliant light, burns over 50 hours on one gallon kerosene. No odor or noise, simple, clean. Won't explode. Guaranteed. Take advantage of our big introductory offer and secure

ONE BURNER FREE We want one person in each locality to whom we can refer new customers. Ask for free offer and agents' wholesale prices.

Agents Wanted. MANTLE LAMP CO., 448 Aladdin Bldg., CHICAGO

Anyone Can Install This Simple LIGHTING SYSTEM in Two Hours' Time



The Short Cut to Light

Lights that can be switched on or off instantly. Artistic fixtures for all purposes, such as the lighting of stores, homes, churches, halls, streets, etc. Nothing to wear out or get out of order. A positive guarantee for a life-time furnished with each system.

Resident Agents Wanted An opportunity of a life-time is offered to get into a permanent money-making business. Every system installed sells others. Every user an enthusiastic booster. WRITE AT ONCE.

Gloria Light Co., 1272 Washington Blvd., Chicago, Ill.

HOW IT IS DONE

From a tank placed anywhere most convenient a small, flexible, hollow wire, no larger in diameter than a match, is used to convey the gasoline from the tank to the different lamps, where it is converted into gas and mixed with 94% of air. A few strokes of a small pump once a week is all that is necessary to produce the softest, steadiest and most brilliant light known to science. Safer from an insurance standpoint than electricity, gas, gasoline engine, kerosene or acetylene. No unsightly black pipes or insulated wires to be seen. Anyone can install and operate them. **It does not require a mechanic to run this wonderful system.** Five-Hundred Candle Power two hours a night for a NICKEL A WEEK. Send for our thirty day trial introductory proposition and complete descriptive matter.

Flies can enter a garbage can that a New York man has patented, but as they try to get out they are caught in a wire trap, which can be detached and the insects destroyed.

Pulleys and cords have been combined by a California inventor into a machine to teach a person the correct swimming motions while he lies on a cushion, safe on dry land.

Signal Coat Shirts

are the most comfortable and lasting shirts for railroad wear. They are absolutely rip and tear proof; won't fade or shrink; an extra button and a 3-inch overlap keeps them from gaping at waist.

We send a couple C. O. D. The price is \$1.00 per garment (\$1.25 west of Missouri River). If your dealer hasn't them, write us for a couple C. O. D. If not satisfied, return at our expense. We also make Signal Coats and Overalls.

HILKER-WIECHERS MFG. CO., 1256 Mound Avenue, Racine, Wis.

Health? Take Turkish Bath at Home—Only 2 Cents



Physicians are abandoning drugs for this new treatment. If your mind or body is tired, open your pores and feel the rapid change in your condition, at cost of 2c a bath. The Robinson Bath Cabinet is the only scientifically constructed bath cabinet ever made for the home. Great \$2 Book Sent Free—"The Philosophy of Health and Beauty". Write today. Agents Wanted. **ROBINSON MFG. CO., 319 Robinson Bldg., Toledo, O.**



THE "GOLDEN GEM" \$10 ADDING MACHINE Only \$10

We have been making adding machines for ten years—and have sold over 30,000. "THE PROOF" on request. The "GOLDEN GEM" is Our Latest Production You can keep it right on your desk or take it with you on the road. It saves brain work—avoids mistakes—it suits the average man's needs as well as high priced machines. It is supplied in a pebbled morocco leather case for only \$10. Send your remittance to-day—your MONEY BACK if machine does not make good. SALES AGENTS: The "Golden Gem" Sells Itself Address: **E. GANCHER, A. A. M. Co., 319 Broadway, NEW YORK**

"Fill-in Steel Cement Has a Hundred Uses Around the House"



Get a can today and see how quickly it will save you time and money. Don't send for the plumber or gas man—plug that leaky water or gas pipe with

Paxson's "Fill-in Steel Cement"

Repair your own gas engine or that leaky pipe connection. "Fill-in" Steel Cement positively prevents leaks and is inexpensive on account small amount necessary to use. 1/2 lb. 30c, 5 lb. cans 25c lb., prepaid.

J. W. PAXSON COMPANY, Mfgs., 1021 N. Delaware Ave., Phil.

Costs you only 30 cents to try this guaranteed remedy for leaks

LET US GIVE YOU THIS TRANSPARENT CELLULOID TRIANGLE

It is 4 inch size, 30°+60° angles. Lowest retail price. 25 cents. Absolutely essential to everyone who draws. We make this offer to introduce our new catalogue showing

SPAULDING'S NEW CARRYING CASES AND COMPLETE OUTFITS

for designers, architects, engineers and students—compact, durable and convenient. Spaulding's Carrying Cases are made light and strong. They provide well arranged compartments, including space for drawing board and T square. Handled like a suit case; unique, practical, inexpensive. Outfits include all necessary equipment. If you draw, send us five 2-cent stamps to-day to pay postage and get the free triangle and the catalogue.

SPAULDING PRINT PAPER CO. 44 Federal St. BOSTON

**Here is Our
New Army
Style**

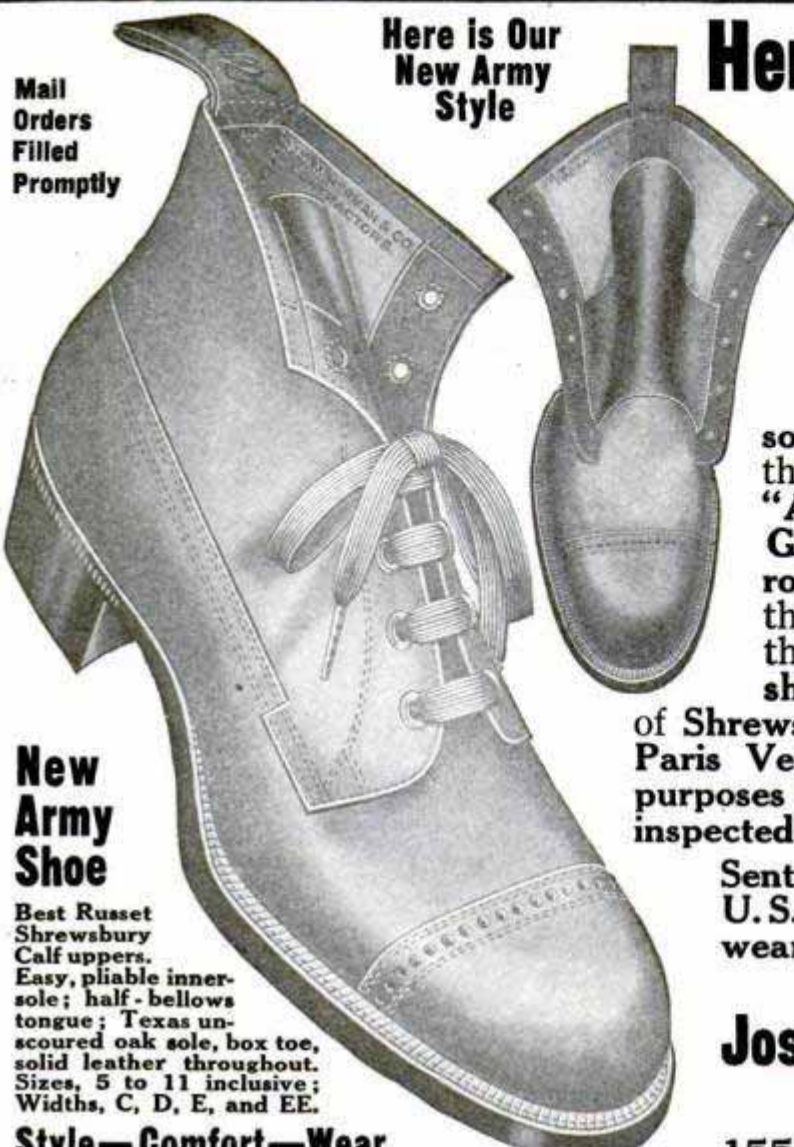

**New
Army
Shoe**

**Best Russet
Shrewsbury
Calf uppers.
Easy, pliable inner-
sole; half-bellows
tongue; Texas un-
scoured oak sole, box toe,
solid leather throughout.
Sizes, 5 to 11 inclusive;
Widths, C, D, E, and EE.**

Style—Comfort—Wear

Herman's Combination Garrison and Marching New Army Shoe

Study the **comfort-giving** lines of this new shoe that army surgeons designed after years of experiments with U. S. Army soldiers. This new style combines the **best outdoor features** of the "Army Marching" and the "Army Garrison" shoes. Note the **broad, roomy toe, the half-bellows tongue, the perfection of finish.** We prophesy that this will be the **most popular shoe** in the entire army line. Made of **Shrewsbury calf leather** from imported **Paris Veals** especially tanned for Army purposes and with **Government standard inspected workmanship** throughout.

Sent prepaid anywhere in U. S. or possessions, fit and wear guaranteed, on receipt of

\$4²⁵

Ask your dealer or write direct to

Joseph M. Herman & Co.

Army Contractors
MAKERS OF THE BOY SCOUT SHOE
155 Lincoln St. BOSTON, MASS.

BE A PHOTOGRAPHER AND MAKE FROM \$15.00 TO \$35.00 PER DAY!

The Latest Invention, the **GLOBE PHOTO POST CARD CAMERA**, makes photos direct on post cards without the use of a negative, in less than 30 seconds, automatically. It is simple, practical and very easy to operate. No experience in photography necessary.

The latest invention in street tin type cameras, is our **AUTOMAT, Model B.** It takes pictures on plates size 1 3/4 x 2 1/2, AUTOMATICALLY. It weighs only 4 1/2 pounds. Price \$15.00. Send for 1912 catalogue describing machines and supplies. We are the largest manufacturers and distributors of tin type and post card machines and supplies in the world.

THE NEW YORK FERROTYPE CO. (INC.)
168 1/2 Delancy St., Dept. 72, New York City, U. S. A.
Branch: 1113 So. Halsted St., Chicago, Ill.



ANCIENT TOOTHACHE CURES—If it be true that ancient remedies are always the best, it may be of interest to those afflicted with dental troubles to know how the ancient Romans dealt with such ills. The Quirites recognized two types of treatment, the magical and the medical. The following are some of the prescriptions advised by the magicians: Take the head of a dog that has died of rabies, mix the ash with oil of Cyprus and inject the product into the ear of the affected side. A water snake's vertebra will serve to scariify the gum, provided that it be obtained from a white-skinned snake. Or for the same purpose may be used a lizard's

AGENTS \$5 a Day



Selling our guaranteed hosiery for men, women and children. Every style and grade. Guaranteed to last four months without holes or a new pair given free. Easy Seller. Big profits. Repeat orders. Sell every day in the year. All want guaranteed hosiery. Don't miss this chance. Act quick. Write for terms. Free sample to workers. Send no money. A postal will do.

THOMAS MFG. CO.
3248 Barney St., DAYTON, OHIO

Your Picture in a Postal Card IN ONE MINUTE

The pictures are developed, toned and finished in a single developing solution. No experience is necessary. Price of machines \$7.50 and \$15.00—circulars describing our machines sent free. We are also headquarters for supplies for all minute picture machines.

AMERICAN MINUTE PHOTO COMPANY
Dept. Z 252, 2214 Ogden Ave., Chicago, Illinois
The largest manufacturers and distributors of minute picture machines and supplies in the world.



Only \$36.00 The Wonderful ILLUSTRATOR LANTERN

With our improved famous **ALCO RADIANT LIGHT.**

This new 1912 Model has many improvements and double brilliancy. Write for illustrated circular of this and Lanterns of all styles and lights at bottom prices. **IF YOU OWN A LANTERN** we should have your name to mail to you our regular announcements of new slides and lecture sets. 75,000 Lantern Slides to rent. **POST CARD MAGIC LANTERN** reflects image of postcard or any other picture or object. Prices, \$2.75, \$12.50, \$25.00, \$50.00, express paid.

WILLIAMS, BROWN & EARLE, Inc., 918 Chestnut St., Philadelphia, Pa., Lantern Dept. 20
Engineering, Microscope, Optical, Scientific, Photo Lantern Slide Supplies



Remoh Gems

Look and Wear Like Diamonds

A Marvelous Synthetic Gem Not Imitation

—the greatest triumph of the electric furnace. **Will cut glass**—stands filing, fire and acid tests like a diamond—guaranteed to contain no glass. Remoh Gems have no paste, foil or backing—their brilliancy is guaranteed forever. One-thirtieth the cost of a diamond. These remarkable gems are set only in 14 Karat Solid Gold Mountings.

Sent On Approval Anywhere In U. S.

—your money cheerfully refunded if not perfectly satisfactory. Write for our 4-color De Luxe Jewel Book—yours for the asking. Address

Remoh Jewelry Co.,
622 Washington Ave., St. Louis

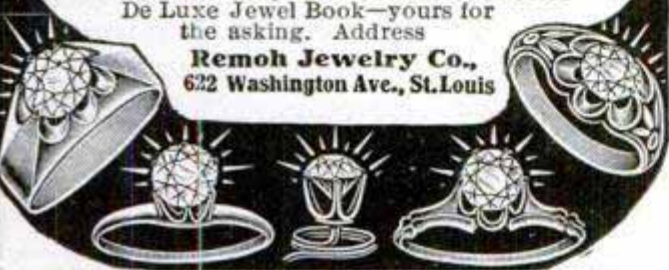

frontal bone obtained when the moon is full, or, if that fail, a chicken bone will do, provided that it be dried in a hole in a well and thrown away immediately after use. It is good treatment to inject into the ear oil of lemon, in which has been macerated either mallow bugs

SPARE-TIME EARN \$10 TO \$15 AND A WEEK HOLD YOUR PRESENT POSITION

DOLLARS

WE start you in a permanent business with us and furnish everything. We have new, easy selling plans and seasonal leaders in the Mail Order line to keep factories busy. No canvassing; Small Capital; Large profits; Spare time only required; Personal assistance. Write today for plans, positive proof and sworn statements.

J. M. PEASE MFG. CO., 13 Pease Bldg., Main St., Buffalo, N. Y.

OVER \$400 Made in One Day Operating the

CIRCLING WAVE, the catchy amusement device that combines the pleasure of the merry-go-round with the joy of boating on the gently rolling lake or bay. At Eagerton, Ind., Booher Bros. made \$350.90 in six hours, and one day at Crawfordsville, \$402, and another made \$380 in six hours. **You can do this also** and employ only one assistant.

Write today for description of the CIRCLING WAVE and its wonderful money-making power.

ARMITAGE & GUINN, 159 Mill St., Springville, Erie Co., N. Y.



The engineer's expert assistant

stands ready to settle the difficult problems of steam engineering. Few engineers can hope to overcome, unaided, all of the obstacles arising in their daily work, yet many have no opportunity of securing expert advice and are forced to experiment at the expense of valuable machinery. It is for these men—men in charge of the operation of stationary, locomotive and marine engines and boilers or gas and gasoline engines; also central station men—that these books have been compiled. With this expert engineering library at your elbow you can act for yourself, confident that you are backed by the knowledge of **twenty-seven of the biggest engineering experts in the country.**

The American School's Cyclopaedia of Steam Engineering

contains 3,300 pages; 2,500 illustrations, full-page plates, diagrams, etc.; hundreds of valuable tables and formulas; carefully cross-indexed for quick, easy reference. The seven large volumes are bound in half morocco and are printed in large, clear type on special quality paper.

READ THIS SYNOPSIS

Construction of Boilers — Boiler Accessories — Fuel Economizers — Mechanical Stokers — Steam Pumps — Steam Engines — Indicators — Valve Gears — Steam Turbines — Gas and Oil Engines — Fuels — Automobiles — Carbureters — Locomotive Boilers and Engines — The Air-Brake — Single-Phase Electric Railway — Elevators — Marine Boilers — Marine Engines — Heating and Ventilating — Compressed Air — Transmission — Absorption and Compression Refrigeration — Ammonia Machines — Direct Current Dynamos and Motors — Management of Dynamos and Motors — Electric Wiring — Electric Lighting, etc.

This Complete Cyclopaedia Sent Free

The complete seven volumes, not a sample volume, will be sent, express prepaid, for seven days' free examination; returnable at our expense if the books do not contain the information you want. If you keep them, pay \$2.00 seven days after receipt and then \$2.00 a month until you have paid the special introductory price of \$19.80. The regular price of this great Cyclopaedia is \$35.00.

Just fill in and mail the coupon. It won't cost you a cent to examine the books. We know they'll be worth many times their cost to you. Mail the coupon now and you'll receive your books promptly.

\$12.00 Consulting Membership Free

With every set is included a year's Consulting Membership, regular value \$12.00, entitling you to the free advice of a staff of Engineering Experts. This will give you practical help in handling working problems which are too specific to be taken up in detail in the Cyclopaedia. There will be no limit to this service. A single problem solved for you might be worth more than the first cost of the books.

American School of Correspondence, Chicago, U. S. A.

FREE EXAMINATION COUPON

American School of Correspondence, Chicago, U. S. A.

Please send set Cyclopaedia of Engineering for seven days' free examination. I will send \$2.00 within seven days and \$2.00 a month until I have paid \$19.80; or notify you to send for the books. Title not to pass until fully paid.

Pop. Mech. 1-13

NAME

ADDRESS

OCCUPATION

EMPLOYER

SENT FREE—NO PAYMENT DOWN

ILLINOIS

Best WATCH on Earth NOW SOLD ON CREDIT

For the first time in history the great, genuine **ILLINOIS** Watch is now sold exclusively by us by mail on credit. This is the greatest public triumph of the age—it will revolutionize the Watch business. For over 40 years the **ILLINOIS** Watch has been acknowledged the standard Watch worn by America's great men and women. No man or woman should now be without a famous **ILLINOIS**.

Iron-Clad Guarantee

Part for part—in accuracy, wear, finish, beauty, material and workmanship, the **ILLINOIS** is superior to any other Watch at any price. Both the makers and we stand back of this Watch with a guarantee that absolutely protects you. We are one of the largest Watch Distributors in the world. For over 35 years we have sold all kinds of Watches, and honestly tell you that the **ILLINOIS** is the best at any price.

NO MONEY DOWN

The famous **ILLINOIS** costs you less than inferior makes. Nowhere else can you buy exclusively a genuine **ILLINOIS** on credit. No dealer can undersell us even for cash. Sent on approval—you take no risk—pay as you please.

Our **FREE**, beautiful, profit-sharing book, describing the **ILLINOIS** Watch, easy credit terms, and reproducing many handsome styles, awaits you. Send name and address today.

FREDDRO WATCH CO., Dept. 300, St. Louis, Mo.

Take Your Own Time To Pay





1/4 Carat Diamond

Brilliant White Stone, in 14-Karat Solid Gold

RING \$23.00

of Genuine Worth and Beauty, for

References: Any Bank in Kansas City.

Your opportunity to buy a genuine fine diamond ring at such a bargain. We sell at actual **WHOLESALE PRICES**. At retail this ring would cost you \$46.00. Money refunded if not satisfied. Prompt service.

FREE! Our expensive 372-page 16th annual Catalog for 1912-13 now ready; a complete jewelry store in book form, superbly illustrated—quoting our wholesale prices. Send us your name and address today for a copy.

MARGOLIS JEWELRY CO., 1023 Main Street, Kansas City, Mo.

Get This Elegant \$10 Per Suit and Make—10 Day

Valuable Prizes Given Away

Make big money—quick—easy. Wear the swellest suit in your town. Made to your exact measure. Any cloth and style. Needn't cost you a cent. Be our agent and make \$10 a day showing your suit, taking orders for elegant made-to-measure suits . . . **\$750 and Up**

We Pay Express Charges

We are spending \$30,000.00 to secure an agent in every town. Your profits are so big—confidential terms so liberal we can explain them only in a letter.

Big Pay for Easy Work

No money or experience required. We want your spare time—not your money. We back you with our capital—teach you everything—start you on the road to wealth.

Big Outfit Free

Get the exclusive agency in your town. Write quick. Get the whole proposition, fine outfit—everything **FREE**. Write today—now.

CHICAGO WOOLEN MILLS CO., 845 Jackson St., CHICAGO, ILL.



Now Ready! Our New Big Free Bargain List of Unredeemed Pledges

JOS. DE ROY & SONS
BARGAIN BULLETIN OF UNREDEEMED PLEDGES
We Will Show Any Article With Proofs of Examination

YOU SAVE 1/2 REGULAR PRICES

Write today for your free copy of our big bargain bulletin. It illustrates and describes hundreds of bargains in unredeemed diamond, watch and jewelry pledges, the low prices of which will amaze you—prices cheaper than dealer's actual cost. For over 60 years as "**HEADQUARTERS FOR LOANS**" we have advanced money on diamonds, watches, etc. Thousands of these pledges remain on our hands unredeemed. We can afford to dispose of them at prices which represent only a fraction of their real value. Hence the wonderful bargains listed in our big free bulletin. Don't buy a diamond, watch, or piece of jewelry until you get your copy.

Note These Specimen Bargains Hundreds of Others Just as Attractive



Bulletin No. 6024



Bulletin No. 6055

Unredeemed Pledge. Bulletin No. 6024—\$105 value. 1 2—1/16, 1.64 kt. solitaire, extra fine pure white diamond. Guaranteed Loan \$45. Unredeemed price.....**\$56**

Unredeemed Pledge—Bulletin No. 6034. A 3/4—1/16, 1.64 kt. gorgeous solitaire bluewhite diamond gem, \$175 average retail value (\$85 guaranteed loan), offered in this regulation ladies' ring at our unredeemed price.....**\$100**

Unredeemed Pledge—Bulletin No. 6055. 1—3/16, 1/32 kt. The total weight of two exceptional quality extra fine pure steel white solitaire diamond gems in this ring. Guaranteed loan \$84. Original cost \$173. Unredeemed price.....**\$98**

Unredeemed Pledge—Bulletin No. 6560. Celebrated 17-jewel adjusted B. W. Raymond grade Elgin movement in genuine 20 year gold filled case complete. \$32 regular price. Unredeemed price in brand new condition.....**\$13.50**

Money Back Guarantee We guarantee your money back in every purchase if not pleasing, even though exactly as represented. This is backed by our \$750,000.00 capital.

SIXTY YEARS IN OUR LOCATION is our proof of absolute reliability. We have thousands of satisfied customers all over the world.

JOS. DeROY & SONS
SMITHFIELD ST. 301 DeRoy Bldg. PITTSBURGH, PA.
REFERENCES: Farmers' Deposit National Bank, Marine National Bank, Dun's, Bradstreet's

or sparrows' dung, even should this last give rise to itching. A worm fed on a particular herb or a cabbage caterpillar can conveniently be placed in a hollow tooth, but it is equally simple to chew an adder's heart. Prevention being better than cure, a sovereign prevention will be found in the eating of two rats a month.—Dundee Advertiser.

WHITE VALLEY GEMS IMPORTED from FRANCE

SEE THEM BEFORE PAYING!

These gems are chemical white sapphires—**LOOK like Diamonds**. Stand acid and fire diamond tests. So hard they easily scratch a file and will cut glass. Brilliance guaranteed 25 years. All mounted in 14K solid gold diamond mountings. Will send you any style ring, pin or stud for examination—all charges prepaid—no money in advance. Write today for free illustrated booklet, special prices and ring measure.

WHITE VALLEY GEM CO., Dept. A-901 Saks Bldg., Indianapolis, Ind.

BARODA DIAMONDS

Flash Like Genuine ANY STYLE

at 1/40 the cost—IN SOLID GOLD RINGS

Stand acid test and expert examination. We guarantee them. See them first—then pay. Special Offer—14k Tiffany ring 1 ct. \$5.98. Gents ring 1 ct. \$8.98. 14k Stud 1 ct. \$4.88. Sent C.O.D. for inspection. Catalog **FREE**, shows full line. Patent ring gauge included, 10c. The Baroda Co., Dept. 75, Leland & Dover Sts., Chicago

AGENTS COIN MONEY

Selling Golden Rule Cutlery

Transparent Handle Pocket Knives and Razors with name and address, photo, lodge emblems, etc., on handle. Every knife guaranteed. Full line of razors, strops and cutlery specialties. Quick sales. Big profit. Exclusive territory. Write today for terms and catalogue.

We Want Wide-awake Agents Everywhere. Experience Unnecessary. We Teach You How.



Golden Rule Cutlery Co., 552 W. Lake St., Dept. 198, Chicago, Ill.



Wonderful Offer

High Grade Violins On 30 Days' FREE Trial

Here is positively the most startling, the most liberal offer ever made on violins of high grade. Your choice from a large, carefully graded stock of representative instruments from the best foreign violin makers, on an absolutely free trial.

OUR GREAT OFFER Write at once and we will send you a free copy of the new Lewis catalogue of our superb instruments. This book explains why our hand made tone violins for professional use are of exceptional value and far superior in quality and power of tone to the average old violin at four times the price. This book posts you thoroughly on violin values, tells you how to judge them and why we send our instruments on free trial. Send your name and address at once.

10 TO 30 DAYS' FREE TRIAL

We want you to try your choice of any instrument in our stock before you decide to buy. Don't buy any kind of a musical instrument in any other way. You can't tell anything from a book description, or a few minutes' trial in a showroom. We insist that you shall be satisfied, and if you are not satisfied with the instrument you select, you may send it back to us at our expense.

WRITE TODAY for our Free Catalog. Your name and address is all that is necessary. If you have an idea of ever buying a stringed instrument you need this book. Write now.

WM. D. LEWIS & SON, Makers and Importers
(Est. 1869) 225 So. Wabash Avenue, Chicago, Ill.

VIOLIN MAKERS!—We make a specialty of Imported Woods, Varnishes and Tools.

A HANDY LIFE-INSURANCE POLICY—A curious festival takes place annually in the village of Isobe, in the southern province of Japan. The festival is called the Omita, and attracts large crowds from the neighboring districts. The young men, stripping off their clothing, take their positions in a rice-field, where they struggle violently with one another for possession of a decorated bamboo pole. The man who succeeds in pulling the



"ZIPP—It Lights"

The Magic Household Lighter
No matches—a bright flame. Thousands of lights without refilling. A truly remarkable opportunity for Agents to make money fast. Write today.

Every housewife will want one the minute she sees it. Sent postpaid on receipt of price.

25c **NOVITAS SALES CO., Sole Manufacturers**
148 High St., WALTHAM, MASS.



AGENTS BIG PROFITS

Nuburn Aluminum Kettle Bottom makes it impossible to burn meats, fruits and vegetables. Made of pure aluminum. Fits inside any kettle. Raised buttons prevent contents touching bottom. Saves its price every day. This is the **best household article you can handle**. Every woman buys two or four. Samples (2 sizes) prepaid for 30c. Particulars FREE. Act on this.

THE GIER & DAIL MFG. CO.
Dept. "G", Lansing, Mich.



AGENTS \$50. to \$100. EVERY WEEK

And if you are a live hustler I will gladly pay you more. I've got the slickest money making proposition in the country for wide-awake agents. Carpenter averaging 250 sales weekly. **Only Scientific Automatic Razor Sharpener** made. Gives barber's stroke, both hones and shaves all standard razors and safety blades. Guaranteed for life. Men buy on sight. \$2.00 complete. 100% profit. It means big money for you if you act promptly. Get exclusive territory NOW. Write me today how to get FREE—finest and largest outfit. Secretary, The Victor Co., 732 Victor Bldg., Canton, Ohio



"THE CRISIS"

From the Painting by Charles Everett Johnson.

The Xmas Gift Most Prized by Man or Boy

Among all the Christmas gifts for men or boys, a beautiful Brunswick Home Billiard or Pocket-Billiard Table is surest to "cap the climax."

The name "Brunswick" on a billiard table is the symbol of perfection. The prices and easy terms are very attractive. Every man has promised himself a billiard table "some day." Let that red letter day be *this Christmas!*

Billiards is the ideal pastime for the home circle—
—A game that keeps the boys home nights and royally entertained. A veritable "Home Magnet."

It offers the physical exercise and mental relaxation that keeps men "in fighting trim."

Brunswick Baby Grand Home Billiard or Pocket-Billiard Table

World's finest Home Billiard Table. Genuine Mahogany, Inlaid Design, handsomely finished. Vermont Slate Bed. Baby Monarch Cushions. Concealed drawer holds Playing Equipment. Scientifically constructed. Perfect playing qualities.



Our Combination Dining-Billiard and Davenport-Billiard Tables

are furnished in various styles, each serving a *double purpose*. Equal in playing qualities to the "Baby Grand" styles.

COMPLETE PLAYING OUTFIT FREE Outfit includes cues, balls, bridge, rack, markers, rules and Book, "How to Play."

OVER A YEAR TO PAY

Purchaser has the option of paying all cash or in small payments extending over a year.

Book "Billiards—The Home Magnet" Free

Shows all styles of Brunswick Home Billiard Tables in actual colors. Moderate prices, easy terms. Our sixty years of billiard table supremacy is your guarantee of quality. (54)

THE BRUNSWICK-BALKE-COLLENDER CO.
Dept. C-E, 324-328 S. Wabash Avenue, CHICAGO

Please Mention Popular Mechanics

KING OF HOUSEHOLD FINISHES

JAP-A-LAC

Renews

EVERYTHING FROM CELLAR TO GARRET
SOLD AT PAINT, DRUG, HARDWARE AND DEPT. STORES

The GLIDDEN VARNISH CO.

Glidden
QUALITY

CLEVELAND — TORONTO

LOOK FOR

GREEN LABEL

Why Not
Own a
Real
Watch?



If you have been carrying a watch that is only partly to be relied upon, that needs constant repairing, here is your chance to secure a perfect time-piece that will be a dependable companion for life.

This Genuine Illinois 3c a Day

If you can set aside 3 cents a day, you can have this perfect Illinois watch. That is all the monthly payment of 90 cents figures up. Everyone knows the high character of the celebrated Illinois. It is the highest grade watch built, and we give you an entire year to pay for it, asking less than you would pay in cash for a first grade watch anywhere else. Our prices run \$9.75 and up. We sell everything on credit and allow our customers a year to pay. If you want a really fine watch for yourself or for a gift, the Illinois at our price and terms is a bargain you should not overlook.

Send for Big Free Watch and Jewelry Catalog, showing diamonds and every sort of Jewelry sold on liberal credit terms.

Spiegel, Mau, Stern Co.

3960 Wall St., Chicago

(302)



Never Mind
the Weather

Step right out into the rain or snow.

LEAKANOT
KEEPS
THE FEET DRY

You won't
need rubbers.

A liquid, waterproofing dressing for shoes or anything leather. Made with a base of pure rubber, the only real waterproofer. Colorless, odorless, invisible—Leakanot will not discolor tan shoes—it is equally effective on black or tan leather. Soaks into the pores, seams and stitches and makes the leather soft and pliable—rubberizes it and lengthens its life.

One application will last a long time—the best protection against wet feet—doesn't prevent a brilliant shine.

Buy of your druggist, shoe store, grocer, general store, or send us 50c for a 7 oz. can. National Rubber Co., 105 Narco Bldg., St. Louis, Mo.



pole down promptly cuts it into pieces, which he distributes among his less fortunate competitors, retaining a portion for himself. It is believed that if anyone meets with a storm out at sea he can easily save himself from a watery grave by simply throwing a portion of this pole into the sea. With a handy life-insurance policy of this kind to be obtained at the price of a little effort, it can be understood that the struggle for the pole is a distinctly strenuous one.

Your teeth are meant to last you a lifetime—and with care they will. Clean them twice-a-day with the dentifrice that is not only efficient but delicious. Send 2c stamp for a trial tube of the delicious and efficient Ribbon Dental Cream.

Address: COLGATE & CO., Dept. 81
199 Fulton Street NEW YORK CITY

CONGRESS
GOLD EDGED
PLAYING CARDS

AIR-CUSHION FINISH



For Social Play
Artistic Designs
Rich Colors
New Each Year
Club Indexes

THE
OFFICIAL RULES
OF
CARD GAMES

HOYLE UP-TO-DATE
ISSUED YEARLY
SENT FOR 15¢ IN STAMPS

BICYCLE
CLUB INDEXED
PLAYING CARDS

IVORY OR AIR-CUSHION FINISH

Special Skill and
Years of Experience
Have Developed Their
Matchless Playing Qualities
For General Play



50¢ PER PACK

THE U.S. PLAYING CARD CO. CINCINNATI, U.S.A.

25¢ PER PACK



BARNEY & BERRY

ICE SKATES

"The Practical, Pleasure-Giving Gift"

Let's Go Skating

A shining present that will last a lifetime

Every boy and girl knows when they see the name *Barney & Berry* on skates that they are the best obtainable.

Select the style you desire from our catalog sent free upon request. It also contains hockey rules, skating program and directions for building an ice rink. Your dealer will supply you with just the style you desire. Otherwise write us.

BARNEY & BERRY
137 Broad St., Springfield, Mass.



The wires are "open" to Happytown

No cutoffs, or sidetracks—if you smoke Queen Quality. Nothing like a good, fat fascinating Queen Quality hand-made cigarette to "oil you up" and make things run smoothly.

The tobacco's a dream and the price is remarkably low—the Blue Bag yields you up twelve cigarettes for one cent! Each Blue Bag—at a nickel—carries *Sixty Satisfying Cigarettes or Twenty Plentiful Pipefuls*

QUEEN QUALITY TOBACCO

QUEEN QUALITY TOBACCO

Queen Quality's cut *granulated*—made o' purpose for the chap who rolls his own cigarettes and wants 'em all the time just his own way. You can get a Blue Bag at the very next tobacco store you see. Try the Queen just once and you'll keep going right back for more. For she's a pippin—true blue to the very last puff.

FREE!—A stunning silk Art Kerchief—**FREE!**

For the fronts of 25 Queen Quality bags we'll give you absolutely free a superbly colored silk art kerchief wonderful for making bed spreads, pillows, kimonos, etc.

Save the labels of the Blue Bag!

(Offer expires June 30, 1913)

F R Penn Tobacco Company
The American Tobacco Company, Successors

AND LISTEN! Let us give you **FREE** a full-sized sample bag of Queen Quality Tobacco. Just cut out and mail us coupon at corner of this advertisement.

MAIL TODAY!

"Queen Quality" Department Drawer "S" Jersey City, N. J.

Please send free of all charge to me, a full sized sample Blue Bag of Queen Quality Tobacco.

Offer expires March 31, 1913 Good only in U. S.

FILL IN: Name
CUT OUT: Street
City State

"Please introduce me to the Queen"

Please Mention Popular Mechanics

Class Pins and Medals

COLLEGE-CLUB & FRAT. PINS
Catalogue in Color Free. **EVERY PIN PERFECT.**
Chas. K. Grouse Co. Mfgs.
NORTH ATTLEBORO, MASS. Box A10

EARN \$3 TO \$9 A DAY



Mechanics, Millmen, and Shopmen make extra money during spare time selling Photo Knives and Razors with Scientifically Tempered Blades. Sales easily made. Special agents instructions. Write today for Special Outfit offer.

CANTON CUTLERY CO., Dept. 259, CANTON, O.

SOLID GOLD FILLED GUARANTEED 20 YEARS \$5.95

Elegant thin model, open face, 20 year gold filled (guarantee stamped in case), plain polished or engine turned, screw back and bezel, dust proof, 14 size for men and boys or 9 size for ladies, fitted with 7 ruby jeweled adjusted patent lever movement, gold sunburst or white enamel dial, warranted a correct timekeeper.

\$5.95 VERY THIN MODEL **GOLD**

Stem Wind & Stem Set

IF YOU SEE IT YOU WILL BUY IT Let us send it without expense to you C. O. D. for examination at your nearest express office and if you think it a bargain and equal in appearance to any \$35.00 gold filled watch pay the express agent our special sales price \$5.95 and express charges and it is yours. Address

MUTUAL SALES CO., B29, Washington Bldg., CHICAGO, ILL.



New Opportunity To Make Money



Wonderful discovery. A new, scientific process of photography with a world of money-making opportunities for ambitious men with small capital and

No Experience.
Investigate Today The
MANDEL POST CARD MACHINE

A wonderful machine that takes, finishes, and delivers original post card photos in one minute—RIGHT ON THE SPOT, by the new "Mandel" Positive Process WITHOUT PLATES, FILMS or PRINTING. The machine makes five different styles of pictures in three sizes: Post cards, 3x4 1/2 inches; miniature post

6-Pound Portable Post Card Gallery

cards, 2x3 inches; and one inch photo buttons. Makes portraits, groups, scenes—anything that can be photographed. Photo post cards are popular everywhere. Big money at picnics, carnivals, fairs, on the streets, in the country, small towns and cities—everywhere. Hundreds are getting rich—why not you? Sturgill, of Utah, made

\$1200 IN 4 MONTHS

Simmons, Georgia, writes: "I make \$10 a day." Lopez Diego, Texas, writes: "Made \$581 profit in three months." Hundreds of similar letters on file. Be a one minute "post card photographer." Complete instructions with outfit—you begin work at once. Small investment starts you in this new, pleasant, money-making business. The sale of your first supplies practically gives you back entire original investment. Write today for complete free information. Address either office.

THE CHICAGO FERROTYPE CO.
416 Ferrotpe Bldg., Chicago, Ill. or Dept. 416, Public Bank Bldg., New York, N. Y.

(ESTABLISHED 1842)

Reed & Sons Pianos

Highest Award World's Columbian Exposition

Now Sold Direct to You from Factory

30 DAYS' FREE TRIAL IN YOUR HOME. Take your own time to pay. No payment in advance required. For free book address

REED & SONS PIANO MFG. CO.

Dept. Q17 Cor. Jackson Blvd. and Wabash Ave. CHICAGO

Write for FREE ILLUSTRATED CATALOGUE showing the largest line and latest inventions in gasoline lighting; Generator instantly interchangeable, lamps guaranteed to excel any other in power, economy and service. Exclusive territory to responsible, energetic salesmen

Doud Lighting Co., 174 N. Sangamon St., CHICAGO, ILL., U. S. A.



The Truth About Mushrooms

Big, Quick Profits. Small Capital. Now Is Best Time.

Biggest, quickest, surest and easiest money-maker is growing mushrooms. Bigger money is being made in mushrooms now than ever before, by those who are today putting in practice the great revolutionary improvement in mushroom culture explained in our new book, "The Truth About Mushrooms." Open your eyes to an opportunity you never realized. No matter what your occupation or location, you can now

Add \$10 to \$70 a Week to Your Income

without interference with present work. Small capital to start. Men and women can easily do it. Now is time to start. This great book explains everything from A to Z, and things which even many mushroom growers never knew before. Get first-hand information from the greatest practical authority. Start in the world's best-paying business now. Grow in cellars, sheds, boxes, etc., or increase your profits many fold if you are already a grower. Send for the free book today sure.

Bureau of Mushroom Industry, Dept. 10, 1342 N. Clark St., Chicago, Ill.

WHERE THEY IRON WITH THEIR FEET—One of the most curious sights which I beheld in Cairo was men ironing with their feet! They had not been mixing their drinks; it is simply a custom of the country. These men were employed in the native tailoring establishments. Except for a long iron handle, the irons were shaped like the ordinary flatiron, only larger. A solid block of wood rested on the top of the iron, and on this the men placed one foot, guiding the iron in the direction desired by means of the handle. For the sake of con-

Polarine The Standard Oil for Motors
FOR SALE EVERYWHERE BY ALL REPUTABLE DEALERS.

FARMING WITH **DU PONT DYNAMITE**
To learn how to do this safely, easily and cheaply, write today for Farmers' Handbook No. 248.
DU PONT POWDER CO., WILMINGTON, DEL.

AGENTS
SALESMAN MANAGERS
YOUNG OR OLD
NEW BUSINESS



NEW BUSINESS JUST OUT

DROP THE DEAD ONES. AWAKE! START WITH THIS NEW INVENTION, THE 20th CENTURY WONDER

Get started in an honest, clean, reliable, permanent, money-making business. Sold on a money-back guarantee

The Blackstone Water Power Vacuum Massage Machine
For the Home. No Cost to Operate. Lasts Life-Time

LISTEN No Competition, New Field, New Business. Price within reach of all. That's why it's easy to sell. Endorsed by Doctors and Masseurs. Removes Wrinkles, rounds out any part of the face or body, brings back Nature's beauty. Almost instant relief can be given all kinds of pains. A demonstration convinces the most skeptical person. Sales easily made.

Read On! What Others Do, So Can You.

Parker writes, sold eight machines first day. Margwarth, says, I am making \$19.00 per day. Schermerhorn, eight dozen machines first month. Shaffer writes, am selling four out of five demonstrations. Vaughn, orders one dozen, four days later wires "ship six dozen by first Express." Lewis, sells four first hour. Men, women, everybody makes money. No experience necessary. Protected territory to active workers. We own all patents. Big book entitled, "The Power and Love of Beauty and Health" Free. Investigate now, today. A postal will do. A big surprise awaits you. Address,
BLACKSTONE MFG. CO., 610 Meredith Bldg., TOLEDO, O.

AGENTS
GENERAL AGENTS
ROAD MEN
MAKE MONEY HERE
Start Now—Today



Be a Draftsman

Draw \$125 to \$175 a Month



Wonderful opportunities now at hand! Write today. Work is light —pleasant and profitable.

Personal Instruction by Chief Draftsman

Yes, I instruct each one of my students personally. I give you practical training. If your work is right I tell you so—if it is wrong, I show you where it is wrong. For twenty years I have been doing the **highest paying expert drafting work.** My object is to supply the big demand for trained, practical draftsmen. At this time I can accommodate a few more men (ages from 16 to 40) in my spare time. **Will give you individual and personal instruction.**

FREE \$15.00 Drawing Outfit

If you enroll **at once.** An extra special inducement at this time to get draftsmen. I will train you right in your own home at a small expense. Pay as you wish.

I Guarantee
To instruct you until you are competent and placed in a position paying \$125 to \$175 a month.

Write at Once For my valuable book, "Successful Draftsmanship." Also full information about my special offer. No obligations. Write today—**now**—immediately while I am making this special offer. Earning while you learn.

Chief Draftsman, Division 1191
Engineer's Equipment Co. (Inc.) Chicago, Ill.

venience the ironing-boards were raised only a few inches above the ground. The men ironed with great rapidity, and, however strange the method may seem to our ideas, it certainly does the work very well and expeditiously.—Wide World Magazine.

The Russian government recently ordered for its army aviators 200 silk parachutes of a type that is expected to open automatically and save a man should he fall.

6% NET For 36 years we have been paying our customers the highest returns consistent with conservative methods. First mortgage loans of \$200 and up which we can recommend after the most thorough personal investigation. Please ask for Loan List No. 721. **\$25 Certificates of Deposit also for saving investors.**
PERKINS & CO. Lawrence, Kans.

Money in This PRINT YOUR OWN CARDS, circulars, book, newspaper, PRESS \$5, larger \$18, Rotary \$60. All easy, rules sent. Print for others, big profit. Write factory for press catalog, TYPE, cards, paper, etc.
THE PRESS CO., Meriden, Conn.

NO MORE BALD HEADS

When our VACUUM CAP is used a few minutes daily. We accept no pay until you have tried the Cap 60 days and are satisfied. The Vacuum Cap is an appliance that draws the blood to the Hair Roots and starts a new healthy crop of hair. It stops Dandruff, stops the hair from falling out. Bought by Doctors and men who know that it is the only reasonable HAIR GROWER known to science. No Drugs Used. Write for application blank, testimonials, and booklet on "HAIR," sent sealed in plain envelope, FREE.

THE MODERN VACUUM CAP CO.
P. 559 BARCLAY, DENVER, COLO.

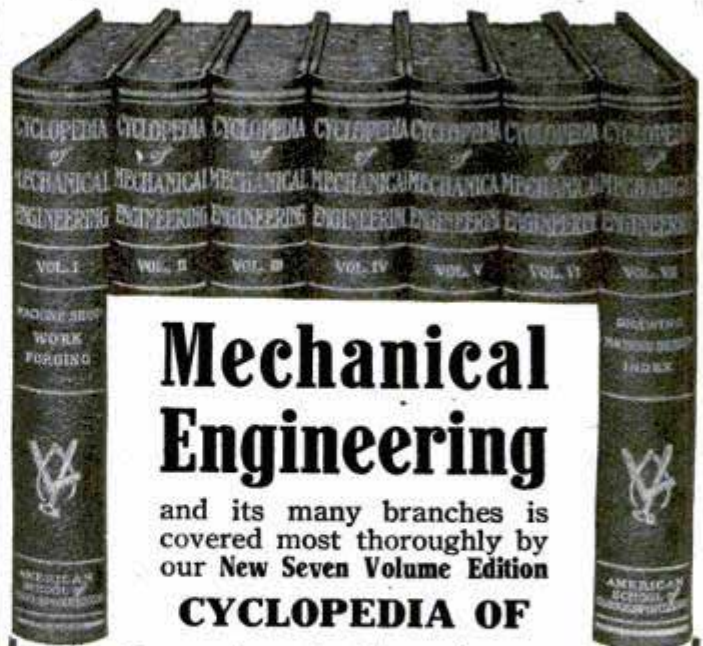

Mechanical Engineering

and its many branches is covered most thoroughly by our New Seven Volume Edition

CYCLOPEDIA OF

Mechanical Engineering Gas Engine Operation and Modern Shop Practice

In this wonderful work will be found instruction in Gas Engine Operation and Manufacture; Machine Shop Work; Assembling of Machinery; Tool Making and Shop Management in such simple and comprehensive form that the student cannot fail to benefit by it. Every detail of mechanical engineering is thoroughly analyzed and treated, rendering the books of unusual value to the experienced mechanic and shop manager, as you will note by reading "Subjects Thoroughly Covered."

The Cyclopedia contains 3,092 pages and is supplemented with a series of practical test questions, including over 2,327 full-page plates, illustrations, tables, formulas and "shop kinks."

Subjects Thoroughly Covered

Machine Shop Work — Vertical Milling Machine — Motor-Driven Shops — Shop Lighting — Forging — Electric Welding — Tool Making — Metallurgy — Manufacture of Iron and Steel — High-Speed Steel — Flaws in Castings — Electric Lifting Magnets — Magnetic Clutches — Making a Machinist — The Ideal Foreman — Pattern Making — Foundry Work — Automatic Coal and Ore Handling Appliances — Machine Parts — Construction of Boilers — Types of Boilers — Boiler Accessories — Steam Pumps — Air Compressors — The Steam Engine — The Steam Turbine — Indicators — Valve Gears — Refrigeration — Gas Producers — Gas Engines — Automobiles — Elevators — Sheet Metal Work — Practical Problems in Mensuration — Mechanical Drawing — Drafting Room Organization — Machine Design.

WE'LL PROVE THEIR VALUE TO YOU

by sending you the complete Cyclopedia absolutely free for examination —just mail the coupon. Keep the books seven days—test every formula. You will agree that they are all we state, and more. Send \$2.00 after examination and \$2.00 a month until you have paid the special price of \$19.80. The regular list price is \$36.00. If the books do not meet with your requirements, advise us and we will remove them at our expense.

ANOTHER GREAT OFFER With each set is included a year's Consulting Membership, regular value \$12.00, entitling you to the free advice of a staff of Mechanical Engineers. This will give you practical help in handling working problems which are too specific to be taken up in detail in the Cyclopedia. A single problem solved for you might be worth more than the first cost of the books.

FREE EXAMINATION COUPON

American School of Correspondence, Chicago, U. S. A.

Please send set Cyclopedia of Mechanical Engineering for 7 days' free examination. I will send \$2.00 within 7 days and \$2.00 a month until I have paid \$19.80, or notify you and hold the books subject to your order. Title not to pass until fully paid. Pop. Mech. 1-13

NAME.....
ADDRESS.....
OCCUPATION.....
EMPLOYER.....

ELGIN WATCHES ON CREDIT



Thin Model 12-Size 17-Jewel

This Month, we want to send you this fine **\$30.00 Elgin Watch**, a very thin model, 12-Size, 17-Jewel—the Classiest Gent's Watch made today and yet one that has long been the **Standard Watch of the World**, complete with Double Strata Gold Filled Case, fully Guaranteed for Twenty-Five Years, on



FREE TRIAL \$19⁷⁵ || \$2⁵⁰ A MONTH

P. S. HARRIS,
Pres. Harris-Goar Co.

This is the watch that will appeal to you instantly—and if you yourself don't say it is the biggest Elgin Watch bargain you ever saw, send it back at our expense. If you wish to keep it the way is easy. Pay us only \$2.50 and the rest in similar amounts each month. **No interest—no security**—just common honesty among men. We want you to see for yourself that this fine 17-Jewel Elgin is better than other watches costing twice or three times as much. **Send for Our Big Free Catalog**

WRITE TODAY for particulars and we will send you our new FREE WATCH AND DIAMOND BOOK, also our book called "Facts vs Bunc" or all about the watch business both at home and abroad. Write today, **HARRIS-GOAR CO., Dept. 661, Kansas City, Mo.**



The House That Sells More Elgin Watches Than Any Other Firm in the World.



Amazing Profits In Mushrooms

Anybody can add \$8 to \$40 per week to their income, in spare time, entire year growing mushrooms in cellars, sheds, barns, boxes, etc. I tell you where to sell, at highest prices.

Free Illustrated Instruction Booklet
HIRAM BARTON
Desk 2, 329 W. 48th St., New York

The AutoStop Safety Razor Guarantees 500 Shaves Ask Your Dealer About It

DOCTOR OF AGRICULTURE—The time is coming when every rural community of sufficient size will have one or more agricultural experts—men professionally trained to serve in an advisory way all of the farmers of the community for a fee. These men will understand the chemistry of the soil and of plant growth. Their laboratories will be busy with soil analysis and the study of local plant disease. They will be entomologists and bacteriologists, and their value will be obvious to the

BUY YOUR FURNACE \$10 DOWN \$10 A MONTH



Our monthly payment plan of selling direct saves you the dealer's profits and charges for installation. The

JAHANT FURNACE

with the patented "Down Draft System" is best for residences, schools, hotels, churches, etc., because it delivers plenty of heat wherever and whenever desired at a saving of 1-3 to 1-2 in fuel bills. Install the Jahant yourself. We send complete outfit, freight prepaid, with special plans, detailed instructions and all necessary tools for installation. Satisfaction guaranteed or money refunded.

Write for free illustrated book.

THE JAHANT HEATING CO.
25 Mill Street AKRON, OHIO

Save 1/3 to 1/2 on Fuel Bills



Do Your Ironing on a Machine

in 1-10 the time that it takes with flat irons. Saves fuel, work and your back.

Machine as Per Cut **\$14.50**
SPECIAL PRICE \$14.50

Has 24" x 4 1/2" rolls, cured and dried hard maple, no varnish on same. Send order in now with cash, if it does not suit your money returned.

Domestic Manufacturing Company
RACINE, WIS.

RED OR BLACK
LONG OR SHORT

"VULCAN INK PENCILS"

The ONLY perfect, non-leakable ink pencils at a moderate price.

A smooth, perfect pen unequalled for writing, ruling and manifolding.

TWO SIZES
4 1/4 x 5 1/2
INCHES



\$1⁰⁰

LASTS A LIFETIME.

(Extra size, 8 inches (black only) **\$1.25.**)

By mail, postpaid upon receipt of PRICE.

J. C. ULLRICH & CO., 27 Thames St., New York **Established 1884 AGENTS WANTED**

EQUIPMENT FOR BUSINESS

WHAT would you think if a man handed you a piece of brown paper with his name written on it, as his business card? You'd be rather nonplussed, wouldn't you? At least you would have a serious doubt as to his desirability as a business connection. In other words, his equipment for business does have an effect on you. You do judge him by his equipment.—and every man is judging you in the same way. Just remember that!

Just as a card is an advance over a piece of brown paper with written name, so the

Peerless Patent Book Form Card

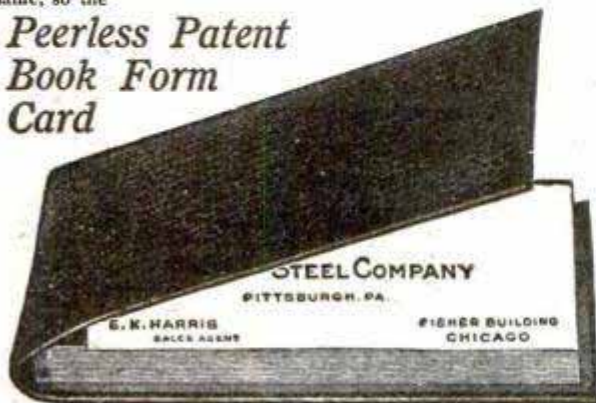

is an advance over the printed, loose card. You need this peerless card in your business equipment—and you need it because it is the best and cheapest. Cheapest because every card can be used—none to throw away because they have become soiled in the pocket or case—none lost. Every card you pay for is available for the use for which it is intended.

Send today for a sample of tab and see what the card is, and how it is detached from the book form with a smooth edge. You will be surprised and pleased.

The JOHN B. WIGGINS COMPANY
Engravers Die Embossers Plate Printers
62-64 East Adams Street CHICAGO

enlightened farmers of a new age. These farmers, no longer content to depend on the free clinic of the state experiment station, will seek the advice and prescription of the local Doctor of Agriculture. The dignity and the rewards of this profession are bound to increase, for it is founded upon the basis of our greatest industry.—World's Work.

South Africa produced gold worth \$125,560,000 in the first eight months of 1912.

HARTMAN'S - CHICAGO 1,000,000 Customers

FREE 388-Page 7000 Bargains Book Sent For a Postcard! Answer this little ad and find the wonderful 15 to 50 per cent savings you can make direct on all Home Furnishings ON CREDIT

Just send name and address. All is confidential. Easiest long-time payments. Greatest real bargains in everything you need. Your credit is good. Year to pay. Established 55 years. Write **HARTMAN FURNITURE AND CARPET CO.** 3945-3947 Wentworth Ave., Chicago



Your Brains Are In Your Hands

When You Wear Hansen's Gloves

IN shape, fit and style a Hansen Glove is built so that your hands immediately second every motion of your head.

They allow perfect freedom of fist, wrist and finger, giving automatic and instant response.

Hansen's Gloves

"Built Like a Hand"

are constructed to fit every man according to his task. Made of the best horsehide leather, tanned by special process.



Hansen's "Protector" One of a hundred styles.

Railroad men, linemen, lumbermen, doctors, hunters—men of all professions, trades and sports—each find in the Hansen the glove that precisely suits his needs. For the autoist and motor cyclist, there is the "Folding Cuff" Gauntlet, and a wide list of styles.

Send for the Free Book of Gloves stating your own special demands. Address

O. C. HANSEN MFG. CO.,
291 Milwaukee St. Milwaukee, Wis.

O. C. HANSEN MFG. CO.,
291 Milwaukee St. Milwaukee, Wis.

Send, without cost to me, your Free Book of Gloves. I am interested in gloves for the following purpose:

.....
Name
Address

GENUINE Perfect Cut DIAMONDS Direct from the Importer

9750 PER CARAT

The BASCH Plan wipes out the middleman, hands you as a cash saving his losses, expenses and profits—making our prices 40% lower than jewelers must ask, 15% less than they can buy, wholesale! **Send no money!** No deposit or reference needed. See our diamonds, compare our prices with others, at our expense! We ship any diamond, set in your choice from thousands of 14K solid gold mountings, for you to examine, on approval without cost to you, risk or obligation to buy!

BASCH Money Back Guarantee:—a legal contract to buy back from you any diamond we sell and pay you 90% in cash; to allow you the full purchase price on all exchanges, any time! Quality, value and Carat Weight legally certified. Backed by our reputation for unequalled values and liberal dealings for 34 long years and by our enormous capital. Read in the BASCH Diamond Book the many other wonderful benefits you receive from our Money Back Guarantee.

This Basch Diamond Book Free

104 pages, beautiful illustrations from 1,000,000 stock. Contains information absolutely necessary to intelligently buy a diamond. Ready to mail to you FREE on receipt of your name. Mail this Coupon, NOW!



You Can Own and Wear DIAMONDS!—Give them for Xmas



- 331. 14K shirt stud 3/8c dia. \$33.50
- 332. 14K ear s. two 3/8c dia. \$38.00
- 333. 14K solitaire 3/8c dia. \$71.25
- 334. 14K scarf pin 3/8c dia. \$50.00
- 335. 14K solitaire 1c dia. \$103.00

L. Basch & Co. S. State Street. CHICAGO, ILL. Dept. Y347

Name
Address.....
Please send me BASCH Diamond Book Free, without obligating me.
Dept. Y347 S. State Street, Chicago, Ill.

Factory Prices for the Asking— on Genuine Witte Engines

FREE
Engine
Book

THE genuine Witte—conceded the best farm engine in America—now offered at actual wholesale prices. Yes, this is the engine that has led the gasoline engine field for 25 years. Dealers have been getting the highest prices for the Witte. Now you can get one at actual factory price—what the dealer paid—and have the finest engine in your county.

Our Gas Well Saves You Many Dollars More

We do more than give you ordinary factory prices. We are the *only* manufacturers who have our own gas well. Power, testing, forge, foundry and heating fuels cost us nothing. You get the benefits. But you couldn't afford to own any other engine even if the Witte cost twice as much—because an average of 1 cent for every horse-power per hour *cuts gasoline bills in half*—pays for your engine in no time. Every part *guaranteed 5 years—full rated horse power on minimum gasoline* guaranteed too. Built in all sizes from 1½ to 40 h. p., every one *tested to 10% overload*.

WRITE FOR 60 DAYS FREE TRIAL OFFER

and complete, direct, factory price proposition with catalog and special offer bulletin. We expose engine secrets in this bulletin that will startle you. Remember, it's your first chance at an engine of quality, standing and reputation at a small price. Mention size needed or work to be done.

WRITE AT ONCE

WITTE IRON WORKS CO.
1742 Oakland Ave., Kansas City, Mo.

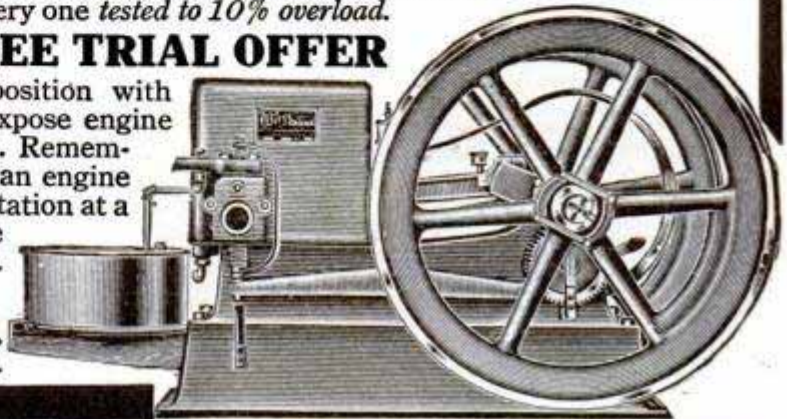

Every Part
Guaranteed
5 Years

Awake the "Edison"



in your boy by giving him the gift that is as instructive and useful as it is entertaining. Our small engines or power plants are unusually interesting for the mechanically or electrically inclined boy. And they may be profitable, too, in the hands of any

bright boy. One young man is helping pay his college expenses by charging ignition storage batteries with our baby motor. Our engines will furnish power to grind skates, a house lighting dynamo; drive a motor ice boat, canoe, boy's auto, or help mother run the washing machine, cream separator, sewing machine or pump. Start the boy right by getting one of our engines. Ask for catalogue A to-day.

ELGIN WHEEL & ENGINE CO.
ELGIN, ILL.



FORCED CIRCULATION WORTHLESS—In a recent article on "What Twenty-Four Years Have Brought Forth," I. C. McChesney, president of the Association of National Advertising Managers, wrote:

"A third important difference between the days of twenty-four years ago and to-day is the methods employed by publications to get larger circulations. Twenty-four years ago ninety-five per cent of the patrons of a paper or magazine were such because, of their own volition, they wanted to be. They sought the pub-

SMALL ENGINES

1-8 H. P.
UP

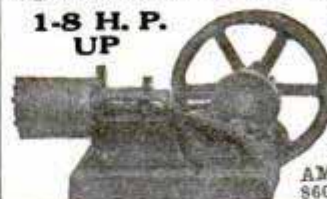

Steam, Gas and Gasoline. For Amateurs and Mechanics. Circulars for Stamp, Big Catalogue Engines, Small Power Machinery and Electric Light Plants, 2 Lights up. Sent for 10c (coin preferred). Refunded first order.

AMATEUR MECHANICS SUPPLY CO.
860 G Monadnock Bldg. CHICAGO

3 to 12
H. P.

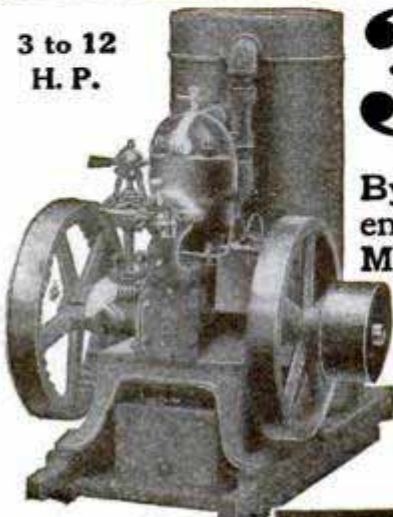

34c

**Runs this 6 H. P. Engine for a
10 hour day on KEROSENE**

By means of the patent throttle you can run it as a 4 H. P. engine for 23 cents a day, or as a 2 H. P. for 12 cents a day. Many other strong points; force-feed lubrication; uniform speed; sight-feed fuel supply; automobile muffler; no cranking; runs either way; uses any fuel oil satisfactorily. And it's **Guaranteed for 10 Years**. Write for catalogue and 30 days' free trial.

WE PAY THE FREIGHT

ELLIS ENGINE CO., 65 Mullett St., Detroit, Mich.

2 1/4 HORSE POWER

Here's the most reliable farm or shop engine in America.

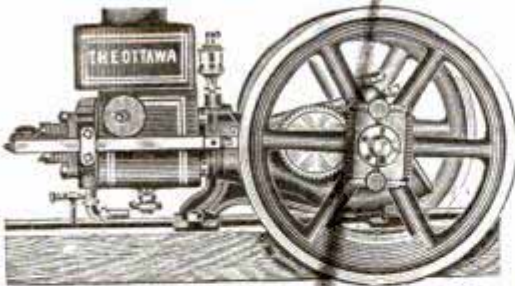

I absolutely know that it will wear longer and do more work than any other engine of the same size you ever used. That's why we can say to you TAKE IT — USE IT. Send us just one-half of the purchase price or

only **\$24⁷⁵**

and the balance to suit yourself, small monthly payments or a six month's note, just as you like.

No Limit Guarantee! Every OTTAWA ENGINE is guaranteed to be perfect in construction and the greatest value that you can secure for the money. No 60-day or 90-day, or one-year guarantees. No matter when—5 years or 10 years from the time you buy your engine—if it proves defective in any way, we will make it good.

Big 48 Page Catalog FREE!

If you are thinking of buying an engine any size from 1 1/2 to 12 H. P. don't invest a single dollar until you get our prices—the lowest you ever heard of—and our big 48 page 4 color Special Engine Catalog. It will save you from \$20 to \$100 sure. FREE—send for it today.

**GEO. E. LONG, General Manager
OTTAWA MANUFACTURING CO.
946 King Street, OTTAWA, KANSAS**

lication. They did not have it literally crammed down their throats as is so largely the practice today. Twenty-four years ago, if an advertiser could ascertain the exact circulation of a publication, he knew that it represented that number of interested readers—the circulation was ninety-five per cent 'pure.' Today he can learn more accurately about the quantity of circulation, but he knows little about its percentage of purity. He knows that from twenty-five to seventy-five per cent of it has been gained by a forcing process that gets quantity, but

ADD TO YOUR INCOME

The "AMERICAN" KEY-CUTTER is a little wonder, the only machine that cuts keys with angular, square, or round slots; write and we will tell you all about it. Don't forget to ask us about the "AMERICAN" Razor honing and safety blade sharpening machines; they are money-makers.

**AMERICAN SHARPENING MACHINE CO. (Inc.)
Dept. 1 184 W. Washington Street CHICAGO**

Model Aeroplanes

Standard Fittings — Supplies

Second Edition 1912 Catalog "S." A perfect Hand Book on Models. Free on request.

Eight 3 foot Flyers, all original. Curtiss Hydro, (rises from the water). Langley Tandem Monoplane. Nieuport Racer, (very fast). Wright, double chain drive. Antoinette. Bleriot. 1000 foot White Racer. White Flyabout.

The White Aeroplane Co., Wading River, L. I., N. Y.

STOP THE LEAKS

in any household utensil of tin, copper, brass, etc. Send 15c for one ounce tube of **ALLEN PRESTO SODER**

—Its base is Allen — Flux — Standard the world over. Sold by Hardware, Electrical and Auto Supply Dealers; Department Stores, Grocers and Druggists. If your dealer hasn't it send his name and address.

**L. B. ALLEN CO., Inc.
4530 No. Lincoln St. CHICAGO, ILL.**



Fifty Cents a Week Employs These Eight Engineering Experts

50c a week—\$2.00 a month for but one year—will bring to your door a work which contains the condensed knowledge and experience of over a score of Civil Engineers—a work which will give you, without loss of time and at no expense, advice and assistance equal to that of the best experts and consulting engineers. With these books in your office—eight faithful, efficient and tireless assistants—you are prepared to cope with any difficulty, however great, that may arise.

The American School's Cyclopaedia of CIVIL ENGINEERING

is compiled from the instruction papers used in the regular correspondence work of the school; contains 3,900 pages; 3000 illustrations, folding maps, diagrams, etc., with a special cross index for quick reference. The eight large volumes are bound in half morocco and are printed in large, clear type on special quality paper. This great work—a most complete review of Civil Engineering—will solve every problem likely to confront you in your daily work and will place the solution before you so clearly and concisely that you cannot fail to understand and profit by it.

Sent Absolutely Free—Express Prepaid

The complete eight volumes, not a sample volume, will be sent, express prepaid, for seven days' free examination; returnable at our expense if the books do not contain the information you want. If you keep them, pay \$2.00 seven days after receipt and then \$2.00 a month until you have paid the special introductory price of \$24.80. The regular price of this great Cyclopaedia is \$40.00.

Just fill in and mail the coupon. It won't cost you a cent to examine the books. We know they'll be worth many times their cost to you. Mail the coupon now and you'll receive your books promptly.

Some Important Subjects Covered

Drawing, Plane Surveying, Plotting and Topography, Strength of Materials, Masonry, Reinforced Concrete, Hydraulics, Waterways, Water Supply, Irrigation, Water Power, Sanitation, Highway Construction, Steel Construction, Roof Trusses, Practical Problems, Bridge Engineering, Railroad Engineering, Cost Analysis, Harbor and River Improvement.

\$12.00 Consulting Membership Free

With every set is included a year's Consulting Membership, regular value \$12.00, entitling you to the free advice of a staff of Civil Engineering Experts. This will give you practical help in handling working problems which are too specific to be taken up in detail in the Cyclopaedia. There will be no limit to this service. A single problem solved for you might be worth more than the first cost of the books.

American School of Correspondence, Chicago, U. S. A.

FREE OFFER COUPON

American School of Correspondence, Chicago, U. S. A.

Please send Cyclopaedia of Civil Engineering for 7 days' free examination. I will send \$2 within 7 days and \$2 a month until I have paid \$24.80; otherwise I will notify you and hold the books subject to your order. Title not to pass until fully paid. Pop. Mech. 1-13

NAME.....
 ADDRESS.....
 OCCUPATION.....
 EMPLOYER.....



WORK OUT YOUR PLANS IN YOUR OWN SHOP

If the power question has prevented you from starting a shop of your own; if you have hesitated because of the cost of equipment or maintenance; if you have paid others a profit for power because you were not sure of getting a reliable engine at a fair price—try again. Consider carefully an

I H C Oil and Gas Engine

Every city is dotted with small shops run by IHC engines whose owners would not trade them for any other known power. They take up little space, are clean, easy to manage, inexpensive to run, durable, and dependable. They run small and large shops. They are used in laundries, bakeries, and many other businesses requiring steady power. They give satisfaction wherever used. Buy an IHC engine, and settle your power problems right.

IHC engines are made in every size, from 1 to 50-horse power, and in every style, horizontal and vertical, air and water-cooled, stationary and portable, to operate on gas, gasoline, kerosene, distillate or alcohol. A post card will bring you a most interesting catalogue.

**International
Harvester Company of America
(Incorporated)**
16 Harvester Building Chicago U S A

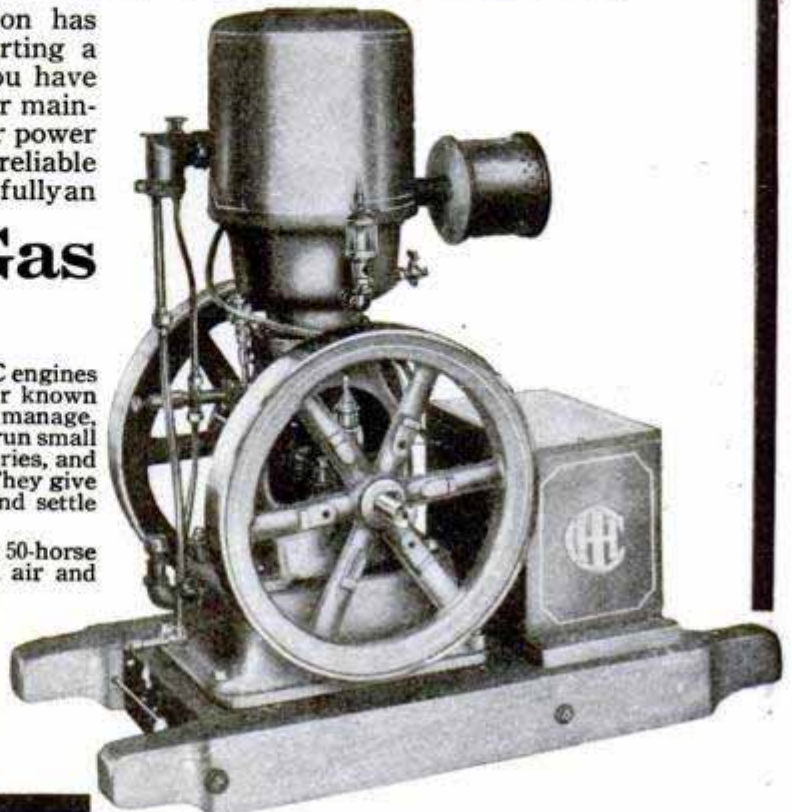

\$50 to \$300 SAVED

We are manufacturers, not merchants. Save dealers', jobbers' and catalog house profit. 10 or more men in every township can save \$50 to \$300 on my High Grade Standard Gasoline Engines from 1 1/2 to 15 H-P, price direct to you lower than dealers or jobbers pay for similar engines in car-load lots for spot cash.

GALLOWAY

Price and quality speak for themselves and you are to be the sole judge. Sell your poorest horse and buy on

30 Days Free Trial

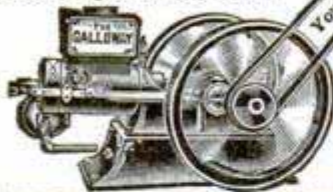

You Can Make From \$5 to \$10 a Day

**Direct
From My
Factory
Satisfaction
or Money Back**

Write for special proposition to 10 or more men. Send for my big **BOOK FREE.**

WM. GALLOWAY, Pres.
WM. GALLOWAY CO.
1965 Galloway Station
WATERLOO, IOWA

of its quality he knows little. He does not know the percentage of interested readers decreases as the quantity increases. The forced circulation is a reversal to the doubtful ethics of twenty-four years ago. Present-day circulations stand in the same position as did much of the advertising of 1888. 'Let the buyer beware' applies just as much to the artificial circulation of today as it did to a great part of the advertising of twenty-four years ago. The science of getting people to take publications they don't want, don't need and don't read

I Am Yours for \$1950

Try me for 10 days

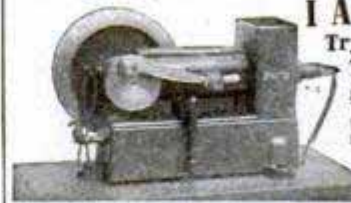

This is our 1-2 horse power Gasoline Engine fully equipped. Switch, Coil, Spark Plug, Gasoline Tank, Mixing Valve all ready to run. Fully Guaranteed. Return if not satisfactory and money refunded. Will run Washing Machines, Cream Separators, Butter Churns, or any light machinery where small power is required.

SIEVERKROPP ENGINE CO., 1224 18th St., Racine, Wis., U. S. A.

This Extraordinary Engine

Single and Double Cylinders — Burns Gasoline, Kerosene, Gas or Distillate — Simplest, Most Powerful, Reliable and Economical Engine Made. All Sizes, 1 1/2 to 50 H. P. We Will Trust You.



**Saves
1/2
Fuel
2/3
Weight
Gives
Most
Power**

The Only Engine that Has Solved the Problem of Violent Vibration

This is the famous TEMPLE which stands on its feet — the up-to-date *Economical Engine* that has won every prize contest against well known makes. *Practically no vibration!* Explosions take place low down close to the ground which absorbs and does away with the shock and strain on the engine. In every other engine explosions occur high up, causing violent vibrations that reduce life of engine. Crank Shaft over Cylinder secures perfect lubrication by gravity. No other engine has this! "TEMPLE," alone, has downward lubrication — hence *less friction and greater power from every pint of fuel!*

30 Days' Free Trial—Easy Terms

Don't buy an Engine until you have investigated the "TEMPLE." Most powerful, economical, reliable, easiest starting, strongest engine built. Prove these claims by 30 days' free trial test. Your credit is good.

Write today for Big Special Offer and Full Particulars

THE TEMPLE PUMP CO. (60 Years in Business) 102 Meagher St., Chicago, Ill.

YOU CAN TEST IT 30 DAYS FREE

Fairbanks-Morse Eclipse Engines

Handy, Reliable, Powerful

Pump water, run churn, cream separator, ice cream freezer, printing press, linotype machine, etc. A pint of gasoline will run the No. 1 Eclipse Engine an hour and will pump 3000 gallons of water.

Eclipse engines are as simple as is possible to make a practical, powerful engine. Manufactured in our immense factory on latest automatic machines. All parts absolutely interchangeable. Large, dust proof bearings. Thorough lubrication. Valve operating mechanism and ignition timing device remarkably simple. Fully guaranteed.

The No. 2 Eclipse is a larger engine and is recommended for deep well pumping, wood sawing, feed grinding, etc.

Write for Catalog No. 449WI

Fairbanks, Morse & Co.
900 S. Wabash Ave., Chicago, Ill.

Fairbanks Scales, Oil and Gasoline Engines, Oil Traction Engines, Pumps, Water Systems, Electric Light Plants, Wind Mills, Feed Grinders.

No. 1 Eclipse Engine attached to ordinary wind mill pump.



has developed a condition that may be likened to the sunflower in the rankness of its growth and the fragrance of its flower."

London has more than 900,000 partially or wholly deaf residents.

GRAY MOTORS FOR BOATS

Made in the Largest Plant in the World devoted to manufacturing 2-cycle marine gasoline engines.

3 H.P. with Complete Outfit ready to install \$55
ALSO 3 1/2 TO 36 H.P.

Guaranteed by a big responsible concern. Write for big catalog—tells and shows you all about these high grade motors and how they are made.

GRAY MOTOR CO., 198 G. M. C. Bldg., DETROIT, MICH.

Use Kerosene Engine Free

The "Columbia" Kerosene Engine shipped on 15 days' FREE Trial, proves kerosene cheapest, safest, most powerful fuel. If satisfied, pay lowest price ever given on reliable farm engine; if not, pay nothing. No waste, no evaporation, no explosion from coal oil.

GASOLINE GOING UP!

Gasoline is 9c to 15c higher than coal oil. Still going up. Two pints of coal oil do work of three pints gasoline.

"COLUMBIA"

SIZES 2 to 16 H. P.

— only engine running on coal oil successfully; uses alcohol, gasoline and benzine, too. Starts without cranking. Only three moving parts—no cams—no sprockets—no gears—no valves—the utmost in simplicity, power and strength. Mounted on skids. All sizes, 2 to 20 h. p., in stock ready to ship. Engine tested before crating. Comes all ready to run. Pumps, saws, thrashes, churns, separates milk, grinds feed, shells corn, runs home electric lighting plant. Prices (stripped), \$29.50 up. Sent any place on 15 days' Free Trial. Don't buy an engine until you investigate money-saving, power-saving "COLUMBIA." Thousands in use. Costs only postal to find out. If you are first in your neighborhood to write, you get special extra low introductory price. Write!



COLUMBIA ENGINE CO., 547 Bellevue Ave., DETROIT, MICH.



Use This Camera 10 Days FREE

Do not send us a penny, merely send your name, address and nearest express office on coupon below, and the genuine No. 9 Folding Ansco, the camera with a national reputation, will be sent to you *express prepaid*. Try it for ten days, see how splendidly it works, note the high grade rapid symmetrical lens, Cyko automatic shutter, brilliant reversible finder that works either horizontally or vertically, two tripod sockets, and improved spool holder—for either six or ten exposure films. This is an ideal camera, high grade, post card size—3 1/4 x 5 1/2; use it for pleasure or profit; take pictures for making money, or take pictures for fun or study. It is a great pastime and a liberal education.

If at the end of ten days, you find that it's just the camera you want, send us \$2.00, and thereafter \$2.00 a month for nine months—\$20.00 in all. If you do not want it, simply return the camera at our expense. You take no risk.

This is the Greatest Camera Offer Ever Made in America

This celebrated Ansco No. 9 Folding Camera sells for \$20.00 cash everywhere in the world, that's the standard price—we offer it to you at the same price on the easy-payment plan, only \$2.00 a month. This is the first time you have ever had the opportunity to buy a standard high grade camera on the easy-payment plan.

Special Film Offer You will need one or more rolls of film to try out this camera, and we are making a special offer: Send us 50c and we will send you a roll of films that will take 6 pictures; after you have taken the pictures, send the roll to us and we will develop and print them and send them to you without any additional charge.

National Camera Company
301 Liggett Bldg. St. Louis, Mo.

Fill Out This Coupon Today and try the wonderful Ansco No. 9, for 10 days, free. We will send it to you prepaid. You take no risk at all.

Send me for ten days free trial Ansco No. 9 Camera. If I am satisfied with it, I will send you \$2.00 as first payment, and then \$2.00 per month for nine months.

If I do not wish to keep the camera, I will return it to you within ten days at your expense. (I enclose 50c for your special film offer).

National Camera Company
301 Liggett Bldg. St. Louis Mo.

NAME

ADDRESS

EXPRESS OFFICE.....

Please Mention Popular Mechanics

Fairbanks-Morse Marine Engines

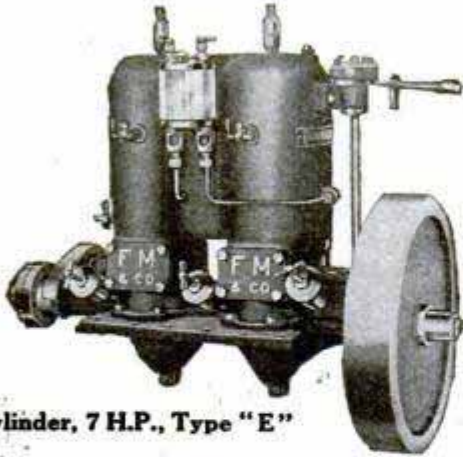

Two Cylinder, 7 H.P., Type "E"

Reliable—Economical—Efficient

The perfected result of over thirty years of engine-building experience. Designed and built for hard service. Meet all requirements.

Start easily without cranking. Develop more than rated power and can be depended upon whenever you want service. All parts easily accessible and all interchangeable. Three types.

High Speed Engines 3 1/2 to 24 H. P. Low Speed Engines 7 1/2 and 15 H. P. Catalogue No. CV449 describes them. Write for it.

Agents Wanted

Fairbanks, Morse & Co.

900 So. Wabash Ave., Chicago, Ill.

The Canadian Fairbanks-Morse Co., Limited, Agents for Canada
St. John, N. B., Montreal, Toronto

THE ONLY AIR-COOLED VERTICAL AEROPLANE MOTOR MANUFACTURED IN AMERICA

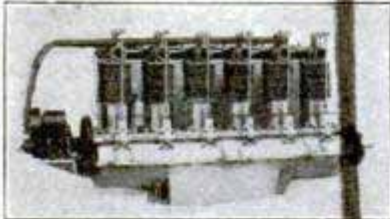

The Kemp Air-Cooled, the most efficient and reliable motors, are built by the best skilled mechanics, only the best materials and equipments being used; guaranteed to give absolute satisfaction; are light and strong, one of the

first steps considered by Aeronauts. The simplicity and ease of adjustment is another great factor; they contain longer bearings and less parts than any other aeronautical motor manufactured; have no radiator, therefore no radiator head resistance, no pump, no water; an economical fuel saver, easy to start and control; can be mounted on any plane with ease. Send for our catalogue and most liberal prices before buying elsewhere.

KEMP MACHINE WORKS MUNCIE, INDIANA U. S. A.

WHEN YOU WANT ANYTHING AND DON'T KNOW WHERE TO FIND IT
WRITE BUREAU OF INFORMATION,
POPULAR MECHANICS CHICAGO

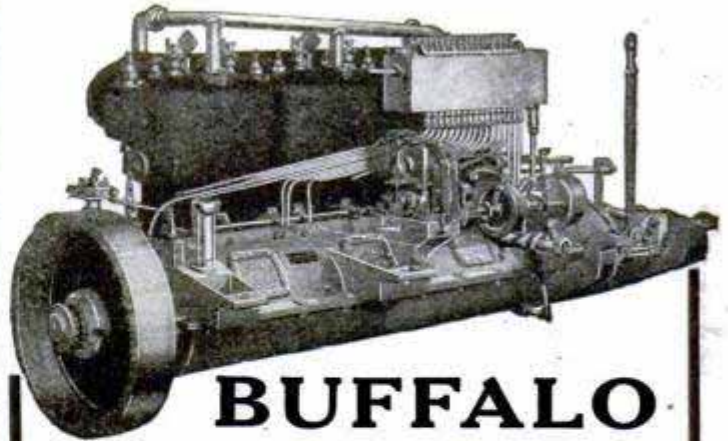

BUFFALO MARINE ENGINES

are all of the four stroke type, slow speed, medium speed, high speed—3 to 125 H. P.

They Excel in Reliability

The Buffalo Book tells the whole story. If you want it, send us your name and address.

The Engine of Constant Service.

PACIFIC COAST AGENTS:

San Francisco—Buffalo Gasolene Motor Co., Jas. B. Blair, Mgr.
Seattle—Woodhouse Gasolene Engine Co., 62 Marion Street.
Vancouver, B. C.—Vancouver Ship Yard, Ltd.
Victoria—G. Harold Grant, Grants Wharf, Ellice Point.

Buffalo Gasolene Motor Co.
1293-1305 Niagara Street, Buffalo, N. Y.

To prevent the starched bosom of a dress shirt climbing out over a low cut vest an inventor has brought out a shirt that is combined with a pair of short drawers.

Get This Power Boat at Maker's Prices

BUY DIRECT FROM MANUFACTURER AND SAVE DEALERS' PROFITS



This Toppan Power Dory as illustrated above is made of best guaranteed materials and is the standard rough water boat of the

world. Safe and reliable—used by U.S. Government in all departments. Send 4c in stamps for catalogue. Ask for prices and facts about Toppan Reversible Motors, built with 2, 3, 5, 8 and 12 Horse Power—and if you want to build your own dory, saving exactly HALF, ask for **TOPPAN BOAT MFG. CO. FREE KNOCK-DOWN BOAT QUOTATIONS.** 3 Haverhill St. BOSTON, MASS.

PALMER MOTORS AND LAUNCHES

Ask for free Engine or Boat Catalog. Address Dept. K
Engines, 2 to 40 H.P., 2 & 4 cycle, always in stock

PALMER BROS., Cos Cob, Conn.



On or Off in Five Minutes

Makes a Motor Boat of ANY Boat
AND also "makes good" on shore

Here is the famous original Portable marine motor, now adapted for also running a hundred different small machines ashore. Simple—light—strong
—SOLD ON THIRTY DAYS TRIAL.—Money back if you say.

"PORTO" the Marine and Stationary Engine Combined—TWO MOTORS IN ONE

A reliable 2 h. p. motor that will drive an 18 ft. rowboat 7 miles per hour for 4 hours on a gallon of gasoline, or in five minutes can be mounted for use in shop, laundry, barn, or any other place desired. Write Quick for new "Two-in-one" catalog, mailed free. Orders filled in order of receipt. Don't delay.

WATERMAN MARINE MOTOR CO.

1507 Fort St., W., DETROIT, MICH.

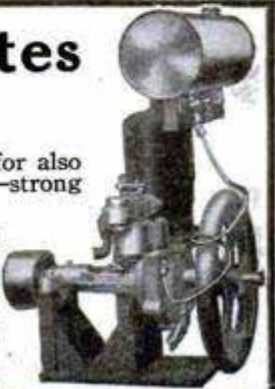

THE SCRIPPS COMPLETE MARINE POWER PLANT

On September 12th the 35 foot motor boat "Detroit," equipped with a 16 horse power, two cylinder

Scripps engine, completed its 7000 mile voyage from Detroit to St. Petersburg, successfully accomplishing a feat unequalled in the history of motor boating. Crossing the Atlantic, the "Detroit" averaged 6 miles an hour, the motor turning over approximately 480 revolutions a minute: traveling from New York to Queenstown in 21 days and 16 hours. No marine motor has ever before been given such a strenuous test. Some idea of the work done will be gained when it is stated that the motor made a total of 28,799,960 revolutions and each piston traveled over 5453 miles. The power plant used was a regular stock model. SCRIPPS MOTOR COMPANY, 650 Lincoln Ave. Detroit, Mich.

Scripps motors are carried in stock in New York by Bowler, Holmes & Hecker Co., 142 Liberty St., N. Y. In Boston by Walter H. Moreton, 218 State St., Boston, Mass.



THE POWER OF WATER—A sure-thing wager sprung on curious visitors by the engineers of some of the big water-power projects of the far west is that a 200-lb. man, swinging a 4-lb. ax with all his might, cannot make a dent in the water as it emerges from the nozzle at the power house. Burying an ax in a stream of water looks like child's play, and the average 200-lb. visitor is likely to bite. He invariably loses. So great is the velocity of the water emerging from the nozzle in these up-to-date power plants that an

WATKINS' SPECIAL MOTORS

3 H. P. Single Cylinder . . . 30 lbs.
6 H. P. Double Cylinder . . . 60 lbs.
12 H. P. Four Cylinder . . . 100 lbs.
A strictly HIGH GRADE Motor that will give CONSTANT and EFFICIENT service. Especially adapted for CANOES and LIGHT BOATS. Aluminum base, copper water jacket, steel shaft, bronze bearings.

THE WATKINS MOTOR CO.
837-839 West Sixth Street CINCINNATI, OHIO



"INGECO" ENGINES

1 1/2 to 350 H. P.
Gas, Gasoline,
Oil and
Producer Gas

Includes all types and sizes to meet every engine need. Simple to operate—low fuel cost—substantial construction. Perfectly balanced, smooth, steady, reliable. Sales branches and stocks everywhere. If you expect to buy an engine our expert will tell you what is best and cheapest for you.

INTERNATIONAL GAS ENGINE CO.,
116 Hellhoff Pl., CUDAHY, WIS. (Suburb of Milwaukee)

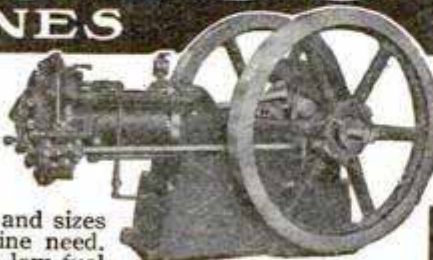

Deaf People Now HEAR

Distinctly!
Clearly!
Perfectly!



In The Hollow of Your Hand

every kind of sound with the aid of the latest marvelous invention, the remarkable

New 4-Tone Mears Ear Phone

The great, new electrical marvel for the deaf. Perfect hearing at last! This remarkable invention has four different sound strengths, four different adjustments, instantly changed by a touch of the finger. You regulate the instrument by a tiny switch to meet any condition of your ear or to hear any sound—low pitched conversation near you or sounds from any distance. The whole range of hearing of the healthy, natural ear is covered by this new 4-Tone Special Model Mears Ear Phone.

Special Limited Offer

Write at once for our Sensational Introductory Offer on this new wonder. To advertise and quickly introduce this greatest of all inventions for the deaf, we are going to sell the first lot of these new four-tone phones DIRECT from our laboratory to users at the confidential jobber's price. This offer applies only to the first lot finished—a limited number. Write today—send the coupon—and you can save more than one-half the retail price. A few dollars, payable on easy terms, if desired, secures you complete relief from your affliction. But the jobber's price is confidential. You must write for it. Do it now and save both wholesaler's and retailer's profits.

Try it 10 Days in Your Own Home FREE

Every Mears Ear Phone is sold only on Free Trial. Ask about our great free trial offer. Test this amazing instrument on your own ears, under any conditions of service for ten days. Nothing to pay for the trial. The Mears Ear Phone is the only scientific and perfect hearing device for the deaf. Already 14,000 Single Tone Mears Ear Phones have been sold.

Send Coupon Now For Free Book

The Mears Ear Phone book explains all the causes of deafness; tells how to stop the progress of the malady and how to treat it. Send the coupon at once for Free Book and our great Confidential Introductory Offer. Send at once.

COUPON

Mears Ear Phone Co. Suite 813

45 W. 34th Street New York, N. Y.

Gentlemen: Please mail me, free and post-paid, your Mears Ear Phone Booklet and particulars of your Special Introductory Offer on your new model Four-Tone Mears Ear Phone and Free Trial Offer.

Mears Ear Phone Co., Suite 813
45 W. 34th Street
New York, N. Y.

Name.....
Address.....

1913 CAILLE Here's the Achievement of a
PERFECTION Mechanical Ideal,
 the success of which
 guarantees an Efficient
 motor boat, in that it permits
 the conservation of your motive power.

Power when and where you want it—real full rated horsepower harnessed into one complete, accurately balanced power unit—straight line drive transmission system and a drive shaft that is all twist, all energy, all leak-proof—that's the Caille Perfection Marine Engine for 1913. A triumph of engineering skill that has excited the wonder and admiration of the entire engineering profession.

This Engine 100% Right The Sensation of 1912

The Caille Perfection Igniter was the sensation of 1912. The Igniter obviates the use of magneto, timer, batteries and coils and insures you a trouble-proof engine. This Igniter equipment is embodied in the 1913 Caille—why not get the free catalog for complete details and description.

Send for Our 1913 Catalog Today

Caille Perfection Motor Company
1207 Caille St., Detroit, Michigan

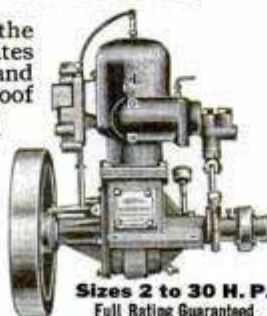

Sizes 2 to 30 H. P.
Full Rating Guaranteed

FREE Our new 1913 Catalog

For Boating Enthusiasts

Our catalog will be sent free upon request to any address. It contains illustrations of our 17 different models of the most efficient engine in this country. It gives you detailed descriptions of the **Strelinger** four cycle, heavy duty Marine Engines, 4 to 40 H. P. Of our **Little Giant** two cycle, three port, general utility Marine Engines, 1 to 16 H. P. and of the **Junior** line of Stationary, four cycle engines, 1 to 11 H. P. This catalog is concisely and clearly written and contains information that you should have—write for it now while you have it in mind.

STRELINGER MARINE ENGINE CO.
171-175 Woodbridge W. DETROIT, MICH.

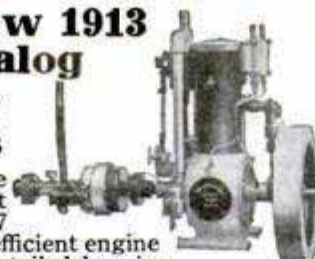

STRELINGER
4 to 6 H. P.

Put \$12.00 in Your Pocket

Act as your own agent and buy your marine motor direct from the factory. No need to pay the other fellow commission for telling you what you want.

L. A. Motor and Complete Outfit \$34⁷⁵
as Shown, Direct from Factory to You

Sold on thirty days' trial and a year's guarantee, direct from factory to you. We take the risk. This motor sells itself. You cannot buy its equal elsewhere for a third more.

Write Today for Our Free Trial Offer

And remember this is a high grade, guaranteed, 1½ h. p. motor, suitable for any small boat up to eighteen feet. We make also several larger models, all sold strictly on trial. Get posted.

Lockwood-Ash Motor Company, 108 Horton Street, Jackson, Mich., U.S.A.



SOME SERVICE

Especially when you know that this a 52 ft. coal Barge loaded with 16 tons of coal and her engine a 10 H. P. Roberts. This 10 H. P. Roberts is a two-cylinder 4x3½ and weighs only 260 lbs.

Roberts REFINED MARINE MOTORS
"THE MOTORS THAT NEVER BACKFIRE"

21 models, 3 to 125 H. P., 1 to 6 cylinders

Roberts Aeroplane Motors

4 cyl. 50 H. P. 6 cyl. 75 H. P. 6 cyl. 125 H. P.

MARINE OR AERO MOTOR CATALOG FREE
ON REQUEST TO

THE ROBERTS MOTOR CO.
1419 Columbus Ave., SANDUSKY, O., U.S.A.



ax, no matter how keen an edge it may have, is whirled from the hands of the strenuous axman at the instant of contact with the water. The water travels under a pressure of upward of 500 lbs. to the square inch in many instances, and no power on earth can turn it off at the nozzle, once it gains momentum. It has the same effect on one's fingers as a rough emery wheel, and will shave a plank with the nicety of a razor-edged plane. When, as frequently happens, it is necessary to shut down a power plant operated by one of these

"Ideal" Plans and Drawings are accurate and are accompanied by clear, concise building instructions, postpaid, at the following prices: Wright 3 ft. Biplane, 25c; Eleriot 2 ft. Monoplane, 15c; "Ceclil Peoli" Champion Racer, 25c; Curtiss Convertible Hydroaeroplane (new), 30c; 3 ft. Racer, 15c. COMPLETE SET OF FIVE \$1. postpaid. Send 5c for 40 pp. catalog of "Ideal" Model Aeroplane Supplies.



IDEAL AEROPLANE & SUPPLY CO., 82-88 West Broadway, New York

Remington Arms—Union Metallic Cartridge Co.
Arms and Ammunition

299 Broadway, New York

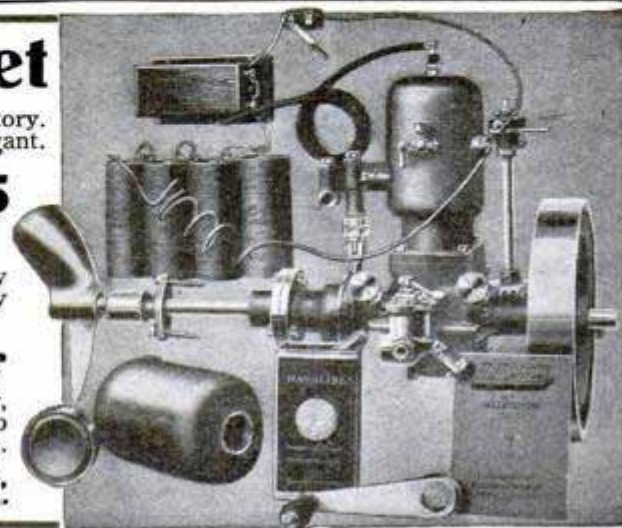

DIAMONDS - WATCHES ON CREDIT

Holiday Presents - Send for Catalog

This Diamond Ring, enlarged to show the handsome mounting, is our great special. Finest quality pure white Diamonds, perfect in cut and full of fiery brilliancy. Specially selected by our diamond experts, and skilfully mounted in our famous Loftis "Perfection" 6-prong ring mounting, 14k. Solid Gold. Cased in dark blue velvet ring box. The four rings here shown are the most popular, although we show all sizes and styles in our large Catalog.

- 640-- \$25. Terms: 5 Down, \$ 2.50 a Month
- 641-- 50. Terms: 10 Down, 5.00 a Month
- 642-- 75. Terms: 15 Down, 7.50 a Month
- 643-- 100. Terms: 20 Down, 10.00 a Month

Send for this Free Holiday Catalog, telling all about our Easy Credit Plan. Over 2000 illustrations of Diamonds, Watches, Jewelry, etc., at bargain prices for Holiday presents. Select anything desired, have it sent to your home or express office, all charges prepaid. If entirely satisfied, send us one-fifth of the purchase price and keep it, balance in eight equal monthly amounts. We give better values and easier terms than any house in America. Write for Holiday Catalog today. Don't delay.

Loftis Bros. & Co., Diamond Merchants,
DEPT. H 894. 100 to 108 N. State St., CHICAGO, ILL.
Branch Stores: Pittsburgh, Pa., and St. Louis, Mo.



The Best Gift of All



Rex Motors

You may have a good motor. But you haven't got the best unless it's a REX. Sturdy, dependable, the Rex is the last thought in a two-cycle motor engine. Descriptive, illustrated catalog tells the whole story of the engine that is ahead of the times. You will be interested in the advanced information it contains. Ask us today for free copy.

REX MOTOR COMPANY, 40 Central St., Boston, Mass.

BAY STATE MOTORS



"Perfect Simplicity" and "Simple Perfection" are the results, embodied in these Motors, of 15 years devoted to the developing of these essential characteristics, which enable us to put on the market a reliable and economical motor at a reasonable price. Write for catalog, stating size and type (2 or 4 cycle) of motor wanted. We also furnish castings for these motors.

BAY STATE MOTOR WORKS
Successor to
A. J. HOULE MOTOR WORKS
580 South East Street, HOLYOKE, MASS.

streams, the nozzle is deflected by means of a powerful set of gears.

The dead are evicted from their holdings in great cities with much more difficulty than the living. A cemetery in New York City which had been unused since 1851 has just been sold. Three times the opposition of descendants of persons buried there has held up the sale.

BOATS OF QUALITY



Build Your Own Boat

Save the boat builder's profit and excessive freight rates on finished boats. With ordinary care you can build as perfect a craft as you can buy. Every Dunphy frame is set up in shop, each rib is properly bent in place, bevels, keels and securely stayed, keel is finished complete, full instructions with each frame. We also have a complete line of finished boats in stock. Write for catalog.

DUNPHY BOAT MFG. CO. Department D
EAU CLAIRE, WIS.

GET THIS CATALOG

FULL OF VALUABLE INFORMATION TO EVERY BOAT OWNER ON

RACING PROPELLER WHEELS,
REVERSE GEARS AND
MARINE ACCESSORIES

LARGE CATALOG FREE. SEND TODAY
MICHIGAN WHEEL CO.
1139 MONROE AVE. GRAND RAPIDS, MICH.



ANTI-CRANK

LACKA-MOTORS

2 to 45 H. P. for all boats. Complete Outfits ready for Rowboat or Schooner. GUARANTEED TWELVE YEARS building, perfecting, success with THE ONE TYPE. Write to Originators of VALVELESS for new "MARINE BOOK," a liberal Educator to all, free. Address Department M, LACKAWANNA MFG. CO., Office and Factory, Ballston Spa, N. Y.

THE WORLDS SIMPLEST

Installed Operated by anyone.

Going to Build?

Want to actually save 33 1/3% to 50% on your building material bill? Then write us at once, today—and get our two Great Books. Catalog of Millwork contains over 8,000 Big Bargains—everything brand NEW (no wreckage) and absolutely guaranteed! We sell



Everything in Lumber, Flooring, Roofing, Doors, Windows, Mouldings, Porchwork, Building Paper, Home and Farm Furniture, Hardware, Tinwork and Paints at Wholesale Prices!

We ship direct to you, eliminating all middlemen's profits. You get mill prices. We ship you complete material for building house, barn, garage or outbuildings, etc. Total cost of our materials on above house (see picture) only \$971.00. Our handsome Book of Modern Plans shows splendid views and floor plans of 50 beautiful up-to-date houses. Shows you how to build at much less than you expected. Complete working blue prints, specifications, etc., furnished free to our customers. But get our 2 Great Books—Big 176-Pg. Catalog No. 103 and Book of Plans No. 113—right away. Don't plan on any building, repairing or overhauling without our help. Quality, safe delivery and satisfaction absolutely guaranteed. If plan book is desired, enclose 10c for postage and mailing—order by above number.



Chicago Millwork Supply Co.
1444 W. 37th St.
Chicago

Try This Engine at Our Expense for 30 DAYS

If you want a good engine bad enough, you'll try the American—ready to run and easily installed. Yes, we want

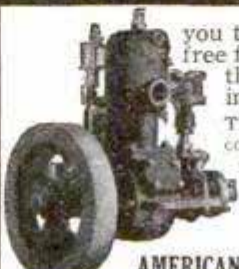

you to try this American Marine Engine free for 30 days—one whole month. Make the American plug and work for you in the roughest sea you care to.

The fundamental idea behind this free offer is to convince you that the American is exactly what we claim it to be—the greatest engine value ever placed on any market.

Write today for full particulars of this free 30 day trial offer—see the new catalog of American models for 1913—Write now.

AMERICAN ENGINE CO., 450 Boston St., Detroit, Mich.

The Pictorial Review of Current Events

Cartoons

15 Cents a Copy

Published Monthly

THE growth of CARTOONS magazine in the past year is the best argument that can be put forward in support of the contention that the cartoonists and their daily pictures in the newspapers have succeeded the editorial writers in educating the newspaper reading public and swaying popular opinion.

Today nearly every daily paper in the country prints a cartoon on its front or an inside page. The editors demand the pictures of the cartoonists because the public demands them of the editor.

The result is that more than ten thousand cartoons are printed in the United States each month. You want to see as many of these cartoons as you possibly can. You could see but few of them under ordinary circumstances but CARTOONS has made it possible for you to do so.

All of these cartoons are collected by the editors of this magazine and from the ten thousand or more are selected two hundred of the best drawings of the month. These

cartoons are selected for you and they are presented for your entertainment and education each month by CARTOONS.

By merely turning the pages of CARTOONS you have before you the cartoons "worth while." The work of the artists of the old world is not neglected and their striking cartoons are included in the contents of the magazine.

Each month this magazine prints interesting histories of the careers of two of the cartoonists, with photographs of the men whose drawings are known to you, and several pages of short stories by the cartoonists, and other interesting reading matter.

BOUND VOLUME ONE NOW READY

The first six numbers of Cartoons, containing over 1200 illustrations, have been bound in an artistic and durable cover and the bound volume is now ready for the friends of the magazine. Red and gold is the color scheme of the cover.

Sent express charges prepaid to any address in the United States or its possessions upon receipt of ONE DOLLAR

Send your order to CARTOONS, 318 W. Washington Street, Chicago, Ill.



What Y' Doin' Now, Bill?

You don't have to ask that question of the trained man, because you know what he is doing—you know his position is a permanent one—and you know his position is one that pays a good salary. You also know that the trained man is not at the mercy of conditions that affect the untrained man.

You can always be sure of a good position and a good salary if you have the special training that puts and keeps you in demand. The International Correspondence Schools will bring special training to you, no matter where you live, or how little spare time or spare cash you have.

How many untrained men are constantly watching the "want" columns of the newspapers—only to be painfully reminded of the positions they can't fill and the work they can't do! Engineers are wanted; Mechanics are wanted; Electricians are wanted; Builders are wanted; Draftsmen are wanted; Advertising Men are wanted; and the Government offers big pay to those qualified for Civil Service positions. But there is seldom a chance for the untrained man. Because of his lack of training he must stay at uncongenial and unprofitable work.

For more than 20 years the I. C. S. have been helping men to qualify for more congenial occupations and better salaries.

To learn how the I. C. S. can help you and how you can easily qualify for success in your chosen occupation, mark and mail the attached coupon today. Doing so costs you only postage and will bring to you stories of success of thousands of I. C. S. students. You assume no obligation in asking for information.

**But Mark the Coupon
NOW**

International Correspondence Schools

Box 872, Scranton, Pa.

Please explain, without further obligation on my part, how I can qualify for a larger salary and advancement in the position, trade, or profession before which I have marked X.

Electrical Engineering
Electric Lighting
Electric Railways
Electrician
Electric Car Running
Dynamo Foreman
Wireman
Mining Engineer
Telephone Expert
Surveyor
Civil Engineer
Automobile Running
Agriculture

Mechanical Engineer
Mechanical Draftsman
R. R. Constructing
Concrete Construction
Architect
Contracting and Build'g
Architectural Draftsman
Plumbing & Heating
Chemist
Bookkeeper
Advertising Man
Civil Service Exams.
Salesmanship

Name _____

St. & No. _____

City _____ State _____

Present Occupation _____

\$ MAKE 250.00 A MONTH REPAIRING AUTO-MOBILE TIRES

This Man Is Making Money

Business Keeps Coming

The New Money Making Business. Start Now.



Put Yourself Where This Man Is.

This Bunch of Tires Will Make Several Dollars Profit

Be first to enter this new big paying business in your town. Open your pockets. Let the dollars pour in. Act quick. Every auto sold means more tires to mend. Automobile business is growing fast—enormous field for tire repairing. Punctures and blowouts are common. Tires need retreading and vulcanizing. Something going wrong all the time. Thousands forced to buy new tires because they can't get old ones fixed. Think of the old bicycle days—repair shops on every corner—all making money—busy day and night. Autos make same proposition over again—only ten times bigger and better. Users of Haywood Tire Repair Plants are making big money. Johnson, Tex., writes "I made as high as \$18 profit in a day." Another man who bought a plant September 1911, writes he has cleared over \$3000.00. That's going some! Operate a plant as side line in connection with auto business—garage or as an independent business. Find neighborhood where there's a bunch of autos—get all the steady business besides transient work. Experience unnecessary. You learn quick. Simply follow directions—practice a few days on a couple of old tires and you'll be ready to coin money. Business comes fast and easy.

Repair Tires at Home. Young men! and boys repair father's tires—get money he pays garage man. Get the neighbors work. Make money to attend college or to start a garage and repair business. **Auto owners—** repair your own tires—save money—pay for your outfit in short time. We have outfits for home use. Any how investigate. Send today for catalogue. See the wonderful possibilities in this marvelous field. Learn of the enormous money making opportunities in this fascinating new business.

HAYWOOD TIRE & EQUIPMENT CO. 538 N. Capitol Ave., Indianapolis, Ind.

PIKE INDIA

How to Sharpen

PIKE SHARPENING STONES

A pocket KNIFE SHARPENER FREE

The tough, sharp crystals of a Pike India Oilstone just eat steel. It's fun to see how quickly they put a dandy, keen edge on carvers, kitchen knives, tools, etc. No other stone cuts so fast without losing its shape. Adopted now by manual training schools, big machine shops, etc. Nothing like it. This is only one of the famous



PIKE SHARPENING STONES

"The only line that includes every sharpening substance—natural or artificial—each the best for some sharpening need."

Every home needs one. Hardware and tool stores everywhere sell them. Let us mail you a Pike India Vest Pocket Stone for pocket knives, office use, etc. Just send your dealer's name and 4c for packing and mailing. We'll include "How to Sharpen"—greatest book ever written on sharpening and how to select and care for oilstones. You'll be pleased. Write today.

PIKE MANUFACTURING CO.
101 Main St., Pike, N. H.

MECHANICAL PERFECTION

in writing equipment is guaranteed in the World's Standard **WATERMAN'S IDEAL FOUNTAIN PEN.**
SOLD BY LEADING DEALERS EVERYWHERE.

AUTOMOBILE ARTILLERY—Efforts are being made by the Powers toward the adaptation of the automobile to the transportation of field artillery. It has been pointed out that the idea of a self-moving gun carriage for field guns was suggested as early as the year 1769 by the engineer Cugnot. At present efforts are principally directed to the perfection of a form of

ADDING MACHINES

\$1.00 and \$3.50

They add quickly, easily, accurately. Durable; easily reset. Capacity 8 columns. None better for the price. 17,000 sold. Delivery prepaid. Guaranteed as represented. The \$3.50 adder is **SELF INDICATING.** Order today. Agents Wanted. J. H. Bassett & Co., Dept. 47A, 5921 Indiana Ave., Chicago

Our 1913 Poultry Book

IT'S FREE—the most complete and practical guide to money-making poultry raising yet published. *Eight new special chapters*—worth hundreds of dollars to you. 244 pages actual experiences, illustrations, advice.

CYPHERS AND BROODERS

INCUBATORS
World's Standard Poultry Equipment. Book tells about Cyphers Company's Free Bulletin and Personal Letter Service. Prepare for *America's greatest poultry year*—highest prices, low cost production. Send postal for **Big Free Book** today. Address

CYPHERS INCUBATOR CO.
Dept. 161 BUFFALO, N. Y.



MAKE YOUR BIKE A MOTORCYCLE



at a small cost, by using our attachable outfit. Fits any Bicycle. Easily attached. No special tools required.

"I Like Your Motor Fine"

Mr. Seal, of Nebraska, writes: "I like your motor fine. It is a good hill climber and is all that is claimed for it."

Mr. Sparrow, of Canada, says: "I started to put your attachment on my bike at 2 o'clock and was running around town at 5 the same day."

FREE BOOK Write today for bargain list and free booklet, fully describing the SHAW Bicycle Motor Attachment. Motorcycles all makes, new and second-hand, \$35.00 up.

SHAW MANUFACTURING CO.
Dept. 6 GALESBURG, KANSAS

Grab's Combination Automatic Lighter and Ash Tray

Something Entirely New and Practical

Instantly appeals to every smoker because of its convenience and efficiency and to every housewife because it prevents muzzing up the home with matches and ashes. It does away with matches entirely. Gives a large steady flame. Press the lever—patented lighter does the rest. 1,000 lights for 1 cent. Lighter detachable from ash tray. Always ready—will last a lifetime. Sent anywhere on receipt of price—\$1.25 prepaid. Money back if not satisfied. Order today.

VICTOR M. GRAB & CO.

Patentees and Sole Manufacturers
L22 Ashland Block, Chicago

Beautifully Nickel Plated — 3 Cigar Rests



automobile suitable to take the place of horses in drawing the artillery wagons. Many different forms of iron-clad automobiles, carrying light guns, have already been invented and tested, with more or less success, but, it is said, the main problem is to adapt the automobile to the transportation of guns mounted, as at present, on their own carriages.—Detroit Free Press.

Save Your Dimes

Lucky Horseshoe Bank will do it. Smallest bank in the world. Carried in pocket or worn as watch charm or locket. Holds ten dimes—tenth dime opens it. Great novelty. Price, nickel plated, 10c; gold plated, 25c. Sent prepaid. Agents wanted; exclusive territory.

Address LUCKY HORSESHOE BANK, Room 823, Flatiron Building, NEW YORK

THIS JOB PAYS \$25-\$50 Weekly



You Can Be An Auto Expert

We teach you the entire subject by mail in 10 weeks' spare time, and assist you to secure good position. Demand for trained men can't be filled. Simple, practical and personal instruction. **Free auto model to each student.**

FIRST LESSON FREE—WRITE FOR IT NOW

Owners—we supply competent men

Empire Auto Institute, 212 Empire Bldg., Rochester, N. Y.

The Original Automobile School

NEW HAND BOOKS FOR HOME STUDY

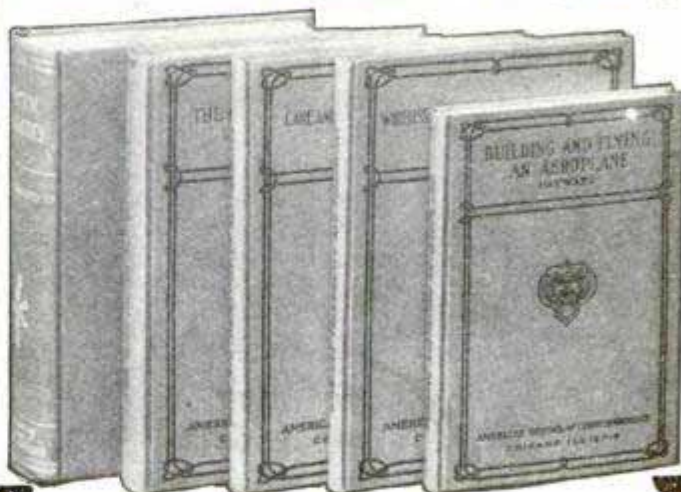

JUST OFF THE PRESS

Nine new books just added to our practical handbook series.

- Care and Operation of Autos . . . \$1.00
- The Gasoline Automobile . . . 2.00
- Building and Flying an Aeroplane 1.00
- Practical Aeronautics . . . 3.50
- Descriptive Astronomy . . . 1.50
- Wireless Telegraphy & Telephony 1.00
- Modern American Homes . . . 2.50
- Alternating Current Machinery . 3.00
(New Edition)
- Motion Pictures . . . 4.00

Owing to a constant and increasing demand for single volumes treating on the above subjects and on special phases of Engineering and Business, we are selling through the leading book stores in the United States and Canada a series of 70 handy handbooks written by experts and selling at \$1.00 to \$4.00 each. They are the best, most authentic and up-to-date books on Automobile, Aeronautical, Electrical, Civil, Steam and Mechanical Engineering and Business, that have ever been written. They are suitable for the use of the student or practical man or can be used as a quick and ready reference by the skilled worker.

Send for our new catalog listing these single volumes. If your dealer does not have the particular book of this series that you want, ask him to order it for you or order it direct from us yourself. Any book ordered direct will be sent postpaid upon receipt of price and may be returned after a five-day examination if not suited to your needs in every way. Upon its receipt we will refund your money promptly.

Sold by the leading bookseller of your city. Ask to see them — satisfy yourself of their value.

American School of Correspondence
CHICAGO, U. S. A.

GOOD LUCK in Every WATERLOO BOY MACHINE

FOUR LEAF CLOVER LUCK

ECONOMICAL

DEPENDABLE

DURABLE

LOW COST

Good Luck is the product of good judgment. If you choose farm machines for the good material and good construction in them you'll get good service—and that will be "lucky" for you.

WATERLOO BOY MACHINES Embody 20 years of honesty—20 years of Experience in building the best—20 years of leadership all over the world, proving their quality. And you can buy them for less money in first cost, less in operating cost, and less in the long run, than any other dependable machines on the market.

INVESTIGATE AND CONVINCE YOURSELF.

The Waterloo Boy GASOLINE ENGINE In its 20 years on the market, has gone into every civilized country; is recognized the world over as the lowest priced high-grade engine built.

The Waterloo Boy CREAM SEPARATOR Is chosen by tens of thousands of shrewd buyers who will not buy a cheap, short-lived machine which will waste half the butter fat. Nor will they buy the higher priced machine which is no better and often not so good.

The Waterloo Boy Low-Down, all steel MANURE SPREADER Is light weight, light draft, strongly and simply built, low standing and easy to load, smooth spreading. Sells at the lowest price ever made on a machine of this class.

The Waterloo Boy 1-MAN FARM TRACTOR Is designed for all farm work from plowing to harvesting. Has pulling power of 12 good horses. Many important new features make it far superior to any others. Sells at low price.

We have a message of importance for you. Write for FREE Catalog and full information.
WATERLOO GASOLINE ENGINE CO., 1021 W. 3rd Ave., WATERLOO, IOWA.

OUR BINDING 5-YEAR GUARANTEE COVERS EVERY PART OF EVERY MACHINE WE MAKE



Hot Water Steam

Heating Plant \$95

Complete in every detail including: Boiler, Radiators, Pipes, fittings, and everything you need. You can install it yourself by following our simple working plans and save \$60 to \$100. Your job will stand every test and inspection.

Bathroom Outfit . . . \$35 **Water Supply System \$40**

Our complete catalogue illustrates and describes heating plants, bathroom outfits, water supply systems, etc. It is free on request.

Factory Prices We are big manufacturers; we sell wholesalers, dealers, plumbers and big contractors. We give you the same prices. Save You 30% to 60%. You can put from 30 to 60 cents on each dollar into your own pocket instead of the middleman's.

Guarantee — Examine your shipment — if not satisfactory we refund money and pay freight both ways. We replace anything damaged any time if due to manufacturing defects.

Send today for Free Catalogue

Chelsea Manufacturing & Supply Co.
No. 135 West 24th Street, Dept. D, New York

AGENTS WANTED

I want good agents in every county to sell a new, guaranteed Automatic Razor Strop. Sample furnished free. Exclusive territory. No deposit required. Complete information free. Write today. Make \$40 to \$80 a week.

L. C. WORST, Pres.
114 State Street **FREMONT, OHIO**



The Fire Gun Electrene
An Improved Fire Extinguisher

Approved by United States Steamboat Inspection Board
Standard of New York and Washington Fire Departments

Simply Turn the Nozzle

Especially adapted for automobiles and motor trucks. Electrene a non-conductor. Will put out fires from Electricity.

Western Electric Company
Distributors to Electrical Trade

ELECTRENE CO.
Whitehall Building
NEW YORK CITY



**A Half Inch of Cream
A Few Movements of the Brush
A Perfect Lather**

Mennen's Shaving Cream

"The Perfect Shaving Medium"

Applied directly on the face—lathers freely and instantly. **Contains no free caustic** and absolutely will not dry on nor smart the face—softens the beard without the usual "rubbing-in" with the fingers—extremely economical—100 shaves per tube—no waste—sanitary—antiseptic.



Mennen's Shaving Cream is not the hasty product of a day, but the result of three years' careful investigation and experimenting. The name Mennen is behind the cream.

For sale everywhere, 25c.
Sample Tube, Free.

GERHARD MENNEN COMPANY
Newark, N. J.

Makers of the Celebrated Mennen's Toilet Powder.

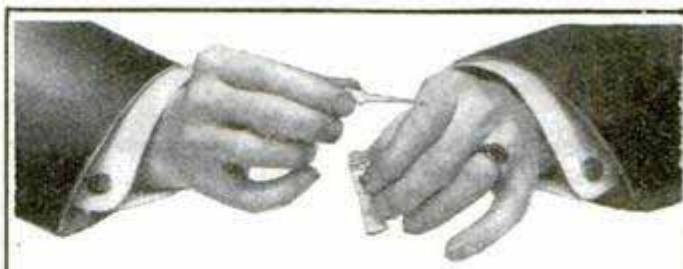

**New-Skin
For Cuts**

New-Skin is an antiseptic liquid for use on cuts, scrapes, etc. It forms a waterproof film, flexible and transparent. This protects the hurt and allows it to heal. Carry New-Skin with you for emergencies. Always have a bottle in the house.

Pocket size 10c, home size 25c. At druggists. See directions and circular.

NEWSKIN COMPANY

98-100 Grand Avenue, Brooklyn, New York

AMERICAN SHOES POPULAR IN RUSSIA—
American made shoes are finding a market in Southern Russia. Shoes of American makes obtained from Berlin have had a small market, but one large retail shop in the city of Baku recently placed an order for 1,000

I WILL START YOU
earning \$4 daily at home in spare time, silvering mirrors; no capital; send for free instructive booklet, giving plans of operation.
G. F. REDMOND, Dept. 306-A, BOSTON, MASS.

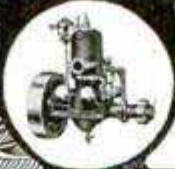

TOLEDO MARINE MOTORS

The kind that make boating a pleasure. When you start you know there'll be no engine troubles to mar the trip. A marvel of smooth working simplicity that the non-mechanical can easily understand and operate. Complete, guaranteed. 2 cycle, 2 port, 3 1-2x3 1-2, 4 1-2x4 1-2. Write today for catalog
THE UNIVERSAL MACHINE CO., Pike Ave., HOWLING GREEN, O.

3 H. P. 2 cyl.,	\$ 65.00
6 H. P. 1 cyl.,	84.00
6 H. P. 2 cyl.,	125.00
12 H. P. 2 cyl.,	160.00
18 H. P. 3 cyl.,	250.00

POULTRY FLATS

Build an OTT POULTRY FLAT and you will always be glad—completely satisfied. Not half the work, and that done under cover. Need not move three feet from one spot to water, feed and clean. No exposure to weather. No brooders to buy. Each flat will accommodate 600 chicks. Raise all you want. Thousands will be built in the next 24 months. Yours ought to be one of them. Start now and make money. Send us 50c, the regular yearly subscription price to our elegant Journal, and get Book "Poultry Flats" free. Send 25c and get book alone, which contains 96 pages. Address: INLAND POULTRY JOURNAL, 29 Cord Building, INDIANAPOLIS, INDIANA.

MOTION PICTURES DEMAND YOUR ATTENTION

Industrial concerns all over the country are using moving pictures as a medium for advertising their product. 75% of the moving pictures you see are made on the celebrated "WILLIAMSON MOVING PICTURE CAMERAS"
Your local theaters will pay big prices for moving pictures of local events. We pay big prices for moving pictures of National interest. Send for catalog today.
WHYTE-WHITMAN CO., Camera Dept., 36 East 23rd St., New York, N. Y.
Largest Importers of moving picture supplies in the United States

This Up-to-date Sanitary Bath Room

Anybody can install this outfit
Outfit, complete Standard Make, ONLY



\$35



I am the Man

30 gallon copper Boilers complete, \$11
Two-part set Tubs, warranted, \$6, etc.
All joints are threaded or slip.

Estimates free on any kind of new Plumbing Material. Crated and shipped to all parts on receipt of money order.

THE BARRY PLUMBING SUPPLY
326 Dorchester Ave. So. Boston, Mass.



Guaranteed 5 Years—Engraved FREE

Our one object in making this wonderful watch offer is to distribute our attractive Catalog No. 22 of Elgin Watches — we'll send this gentleman's open face watch, postpaid, with your initial engraved on back, upon receipt of this advertisement and only 98c. It is guaranteed a perfect timekeeper; stem wind, stem set, case highly polished — full nickel, will not tarnish or wear off—guaranteed 5 years. Cut out this advt. today, mail with 98c and this watch is yours. This offer will positively be withdrawn just as soon as our Catalogs are distributed: so act at once. Satisfaction guaranteed or money back. Address

FIELD & HOWARD, 21 E. Van Buren St., CHICAGO, ILL.

Your Initial Engraved FREE 22

I've a Big New Proposition To Make You, Man to Man

I Want to Start You in The Same Business That Made Me Wealthy — W. Z. Long



I want you to come to see me at my expense. I want to meet you face to face and show you the wonderful possibilities in the business. Once I was a struggling candy maker. Profits from Crispettes, the wonderful, new, delicious popcorn confection, made with my Crispette Machine, built a big business for me. I want to start you the same way I started. Long winter months are ahead. Don't slave them away for someone else. Start a business of your own — be independent. I'll teach you how to start — show you how to make Crispettes by my special secret formula — personally or by mail. But I repeat — I want you to



This is a recent picture of the man who made \$1500 in one month with a Long Crispette machine, in a store window.

Come To See Me At My Expense

Learn all about the proposition. I'll show you records that will thrill and inspire you. I'll read you letters from users of my machine that will take your breath away. You'll see that what I say is true. Don't say you're coming. Drop in quietly. Call on any banker or merchant. Ask them about Long — about my store — my crispette business. Ask them if what I say isn't the truth — right from the shoulder. Look into my reputation. See if folks think I'll give you a square deal. Then come and see my store — see that it's just like the picture in this advertisement. See the machine. See crispettes made — make a batch yourself. Learn the business. Get my pointers on how to succeed. Up to a distance of 300 miles I'll pay all your traveling expenses, if you buy a machine. You'll see, know — learn everything. It's simple — easy. Won't take you a day. I'll be glad to see you — glad to show you the store and have a good talk with you. You'll go home ready to make more money than you ever made in your life.

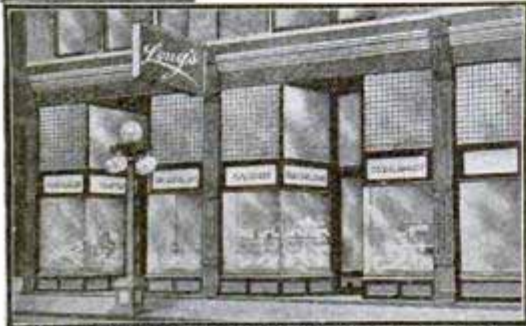

A Picture of My Big Store in Springfield

Every Nickel You Take in Nets You Almost Four Cents Profit

Think of it! Think of the fortunes made in 5 cent pieces. It's one business in a hundred. Everybody likes crispettes. One sale always means two — two means four. So it goes. It's a great business. I found it so — so should you.

FREE My book "How to Make Money in the Crispette Business" — 48 pages illustrated — complete information and story of how I built my business. Write for it today. Read it and then come to Springfield.

W. Z. Long, 700 High St., Springfield, O.

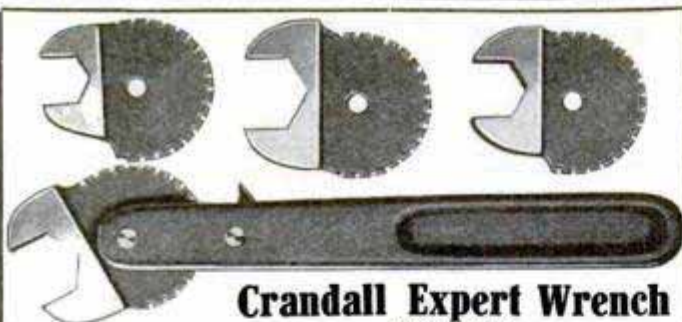

Crandall Expert Wrench (PATENTED)

Here is the wrench you have been waiting for. Goes into all the close and difficult places. Ratchet can be worked in one inch of space. Does what 56 solid wrenches can't do. Changes jaw sizes in 5 seconds without extra tools. Drop forged steel and case hardened. 4 sizes jaws and handle in neat duck case, only \$2.50 the set, at your dealer's or sent direct, charges paid on receipt of price.

Ask for descriptive circulars. Live salesmen wanted
EXPERT UTILITY CO., 224 E. 4th Ave., Cincinnati, O.

pairs of shoes with a manufacturing concern in Boston. This is about the first order for shoes for Baku placed directly with manufacturers in the United States.

American-made shoes will have to compete in the Baku market with "American shoes" made in Germany, which follow closely the style of last made in the United States. "American shoe" is a style with the German shoe manufacturer, and the shoe displayed in the shops is accompanied by an American flag, also of German manufacture.

It is probable no attempt is made by the German

New Waljar Pipe \$1

Durable, simple; cleaned in a jiffy. Always a cool, sweet smoke. Has Genuine Briar Bowl, with Sterling Silver Ferrule, Patent Hard Rubber Mouthpiece, and with German Silver Cleaning Spoon.

FREE This heavily nickel-plated Pipe Lighter, with pocket clip, strikes like a match. **Good Live Agents Wanted**
WINSOR SUPPLY BROS., 7251 Bond Ave., Chicago

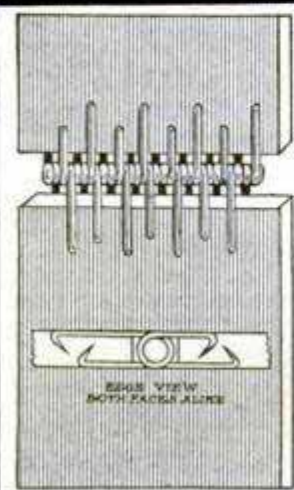

Webb's "Hinge Joint" Belt Hooks

For high speed and over-and-under belts
Beaten in with a hammer

- No. 5** Box contains 1000 double hooks in sections of 1 in., 1½ in., and 2 in. for one-ply leather belts; makes 12 feet **\$1.75**
- No. 6** Box contains 1000 double hooks in sections of 2 in., 2½ in., and 3 in. for two-ply leather belts; makes 13 feet **\$2.00**
- No. 7** Box contains 1000 double hooks in sections of 2½ in., 3 in., and 4 in. for heavy two-ply leather belts; makes 15 ft. **\$2.25**

A multiple of any of the above sections are used for any width of belt.

Sent by **PARCELS POST** in U. S. on receipt of price

WEBB HINGE BELT HOOK CO.
BOONTON, NEW JERSEY



Come in riveted sections ready for instant use



By turning each alternate hook back

Don't Fail to Get Prices on Edwards STEEL Shingles

If you only *knew* how *cheaply*, *quickly* and *easily* you can roof your buildings with genuine Edwards STEEL Shingles, you wouldn't fool with any more prepared roofing or inflammable wood shingles.

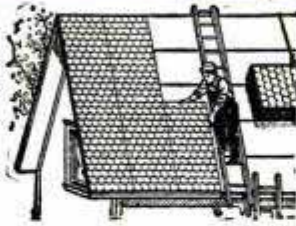

Don't you know Edwards sells the world's finest roofing direct from factory at lowest price ever known? Don't you know Edwards pays freight clear to your station and guarantees prompt, safe delivery? And don't you know that more than 100,000 Edwards roofs have been put on and that never a one has failed to give PERMANENT satisfaction? Don't you know that *any* man can easily lay Edwards STEEL Shingles right over old roof or on sheathing? Don't you know that Edwards STEEL Shingles are

Rust-Proof, Fire-Proof, Rot-Proof

Don't you know Edwards uses a secret process which absolutely prevents rust from ever getting a foothold; that Edwards has patented an Interlocking Device which makes a permanent water-tight joint? Don't you know Edwards uses only the finest open-hearth steel for his shingles; that Edwards Galvanized STEEL Shingles never need painting nor repairs? Don't you know that Edwards gives every buyer a signed \$10,000 guaranty against fire by lightning; that Edwards STEEL Shingles not only make the most handsome roof but outlast THREE wood-shingle roofs and FIVE prepared-paper roofs?

Well, then—why don't you write Edwards a postal this minute and get by return mail his latest catalog 150 and astounding factory prices? If you'll give the SIZE of your roof, Edwards will make you a lump price on the job. Get Edwards PATENTS at once. (86)

THE EDWARDS MANUFACTURING CO.
100-150 Culvert Street, CINCINNATI, OHIO

manufacturer to pass his "American shoe" off as an American-made shoe. There is noticeable, however, a frequent confusion of the terms in the mind of the average retailer and a greater confusion in the mind of the ultimate consumer. Shoes of American shapes made in Russia are also sold.—Philadelphia Record.

SELF-SELLING INVENTION \$50 TO \$100 PER WEEK FOR YOU

Marvelous new invention gives better and cheaper light for country and suburban homes—beats electricity or gas. Thousands already in use. Thousands of homes near you need it—are waiting for it. Show this wonderful new light and it **sells itself**. No previous experience necessary. We give you exclusive territory—start you right with complete outfit and instructions. Appoint and control sub-agents—get in business for yourself and be independent.

Splendid New Cash Bonus Plan

Besides the big profits you can earn cash bonus every month. Only chance to lose is by delay—write **NOW—QUICK**—somebody else may get your territory. Exclusive territory and a big, growing business for first comers. W. H. Phillips of Ohio made \$75.00 the first week; C. W. Hunter of Alabama made \$400.00 spare time in one month. Get busy!—the opportunity waits. Write me at once.

H. H. SEELEY, President
SUPERIOR MANUFACTURING COMPANY
294 Second St., Ann Arbor, Mich.

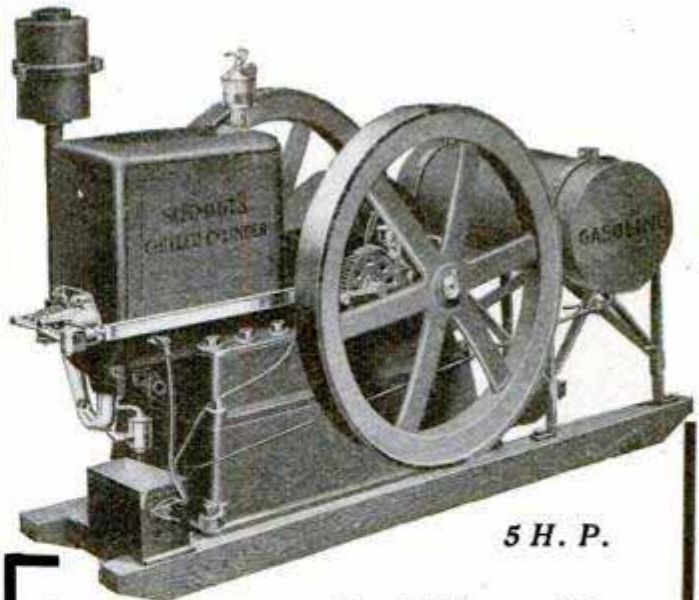

5 H. P.

\$750 And You Keep This Great Engine

We will ship you any one of Schmidt's Chilled Cylinder Gasoline Engines for a 10 days free trial. Your choice of sizes, horizontal or upright, water cooled or air cooled. Then, if you don't want it send it back at our expense. If you wish to keep it, pay as low as \$7.50 and you can pay rest in easiest monthly payments. You get the engine at the Rock Bottom Price—the same price that even the wholesale dealer has to pay. Send coupon or a postal card for full particulars.

Ten Days' Trial FREE

Think of it. You may try out a genuine Schmidt's Chilled Cylinder Gasoline Engine on your own place for 10 full days absolutely FREE. We want you to see for yourself the wonderful Chilled Cylinder, Ben Schmidt's new oiling device, the valveless carburetor and the other exclusive features that make Schmidt's Chilled Cylinder engines the simplest and most efficient engines in the world. Your choice of sizes—horizontal or upright—water cooled or air cooled.

All Kinds of ACCESSORIES

We carry a complete line of engine accessories—pulleys, shafting, belts, pumpjacks, sawing outfits, washing machines, feed grinders, etc. You may have your choice of any of them at the rock bottom price. Pay for them on the easiest kind of payments. Send the free coupon for catalog.

Take a Long Time to Pay

If you like the engine after trying it out for 10 whole days keep it and take a long time to pay for it on easy monthly payments. You pay only the rock bottom price

—the same price that even the wholesale dealer must pay. Schmidt's Chilled Cylinder Gasoline Engines are absolutely guaranteed five years. The biggest bank in Iowa backs our \$1000 challenge offer.

Send the Free Coupon for Ben Schmidt's Book

Just put your name and address on the free coupon and we will send you Ben Schmidt's new book "How to Use Power." Tells you about gasoline engines and their uses—gives many pointers that you should have. We will also tell you all about our wonderful offer and about Schmidt's Chilled Cylinder Gasoline Engines. Do not delay. Send the free coupon today—now—immediately while this offer lasts.

FREE BOOK COUPON

Schmidt Bros. Co.
Engine Works
Dept. 1191
Davenport, Iowa

GENTLEMEN:—Please send me description of your wonderful Chilled Cylinder Gasoline Engines, also your book, "How to Use Power", also Schmidt Bros. catalogs and full particulars of your free trial and easy payment plan. All free and postpaid.

Schmidt Bros. Co.
Engine Works
Department 1191
Davenport,
Iowa

NAME.....

ADDRESS.....

*It Cuts Like a Diamond, Does
Twice the Work in Half the
Time—and, Does it Better—*



Carborundum Round Combination Stone

for Carpenters and Woodworkers —
insures a perfect edge on your tools

The Shape gives greater sharpening surface and permits of the rotary motion so essential to the proper sharpening of chisels and other tools of that character.

Carborundum is as hard and as sharp as a diamond.

It is made into stones of all sizes and shapes and grits for thousands of sharpening refinements.

Good hardware dealers everywhere sell Carborundum Sharpening Stones. Be sure to ask for them.

The Carborundum Company

NIAGARA FALLS, N. Y.

Please Mention Popular Mechanics

Paris Diamonds

See One Free

Its beauty will astound you. Sent to you free for your inspection and examination. The marvelous Paris Diamond, the brilliant gem produced by scientists in the mighty heat of the electric furnace. Cuts glass like a diamond. Resists fire, file and acid tests like a diamond. You can't tell this wonderful gem from a diamond. Its diamond-like brilliancy is guaranteed to last forever. Paris Diamonds sent now on approval for your inspection without one cent of money down on this special offer. Write today for beautiful new catalog and free inspection offer.

Send no money Your name and address will bring to you our magnificent Paris Diamond catalog, showing all artistic designs and amazing low prices on very latest Paris Diamond Jewelry. Get this new book of fine jewelry to see the latest styles and our amazing low prices. Your name and address brings this book post-paid free.

Write today Send your name on a post card today. Get our new Paris Diamond catalog in colors, also particulars of this special offer on the beautiful substitute for the diamond. See our astounding low prices. Write today, now.

PARIS DIAMOND CO., Dept. 5245, CHICAGO, ILL.

KEITH'S 20 WONDER HOUSES



M. L. KEITH, 425 McKnight Bldg., Minneapolis, Minn.

A New Book of 20 Plans showing photo views as actually built and large floor plans for 20 selected types of Keith's best ideas in Bungalows, Cottages and Houses, costing \$2,000 up. They are Wonder Houses for practical, inexpensive homes. Send silver or stamps.

10c

Safety Razor Blades

—RESHARPENED—

"Good as New—Many Say Better"



At 30c per doz. by exclusive Keen-edge Process known thru-out U. S. Send blades today with remittances or write for easy mailing wrapper. Money refunded if unsatisfactory. Six years in business and 100,000 satisfied customers testify to our success.

KEENEDGE CO., 100 Keenedge Bldg., Chicago, Ill.



Square Deal Miller

DIAMONDS WATCHES JEWELRY
On Easy Monthly Payments

TERMS SMASHED

On Waltham, Elgin, Howard, Hamilton Watches. The very finest made. No matter where you live **YOUR CREDIT IS GOOD.** Lower prices than all cash houses. Write for **Big Free Catalog** and great Credit Plan.

SQUARE DEAL MILLER, Pres., Miller Hoefler Co.

74 MILLER BLDG., DETROIT, MICH.
Canadian Branch, Windsor, Ontario, Canada





For Solid Enjoyment

there is nothing like a really good rifle, whether used for indoor or outdoor shooting. You can invest in no better weapon than the

B. S. A. Air Rifle

A serious practice arm. Will last a lifetime. Kills clean at 50 yards. "Adder" Pellets, made especially for B.S. A. weapons, cost almost nothing. Little noise—no smoke—no fire—no cleaning troubles.

Special models for Ladies and Boys

Send now for circular price list
—mailed free on application.



THE BIRMINGHAM SMALL ARMS CO., Ltd.
Birmingham, : : ENGLAND

Representative
HENRY SMAIL, 106 Worth St., New York

FIRST RECORDED ALIMONY—An Egyptian mummy now on exhibition in London was wrapped in papyrus which scholars have found to be covered with inscriptions. Among others is one which indicates that at least one lady of the Pharaonic period failed to agree with her life partner. The document is a petition to the proper authorities for justice against a spendthrift and abusive husband. "When I married Heracleides," writes the petitioner, "I brought two

STUDY AT HOME

**Commercial Law—Banking
Bookkeeping—Shorthand**

Taught in your home. Newest texts. Best instruction.
Easiest terms. Write now for catalog.

CHICAGO COLLEGE OF CORRESPONDENCE
"FOR THE AMBITIOUS" Box 26 H CHICAGO, ILL.

**MAKES A
PHONOGRAPH
SOUND LIFE-LIKE**

The Morse Clarifier

A remarkable little device made to fit in tube adjoining reproducer of any make of machine. It renders the sound *loud, clear, lifelike* and eliminates that un-

pleasant metallic effect. Thousands of satisfied users. Easily inserted and everlasting.

\$1.00 MAILED PREPAID

Send dollar bill, 2c stamps or check at our risk.

GUARANTEED absolutely satisfactory or money refunded. References, any bank in Minneapolis. Fits all cabinet as well as horn machines. State make and style and if a cylinder whether rubber or metal connection to horn. Information matter free. Dealers write.

Morse Brothers, Manufacturers and Distributors

450 N. W. F. & M. Bldg.

MINNEAPOLIS, MINN.



**This New
EDISON
Shipped
FREE!
Read This
Great Offer**

Shipped FREE!

The latest and greatest offer on the **Genuine Edison**. This offer is for every one who has not yet heard the Edison in his own home—for you to hear concerts and entertainments by the world-famous musicians—just such entertainments as the metropolitan theaters are producing.

The Edison Offer

We will send you your choice of Mr. Edison's new outfits for an absolutely Free Loan. Each outfit is complete with records that you select yourself. Ready to talk, play and sing the minute you get it.

Why We Want to Lend You This Phonograph

We know there are thousands of people who have never heard the Genuine Edison Phonograph. Now, there's only one way to convince people that the Edison is superior, and that is to let them actually see and hear this remarkable instrument for themselves. That is why we are making this offer. The only way to make you actually realize these things for yourself is to loan you a Genuine Edison Phonograph free and let you try it.

All You Need Do is to invite as many as possible of your friends to hear this wonderful New Edison. We feel absolutely certain that out of the number of your friends who will hear your machine there will be at least one and probably more who will want an Edison of his own. And if there isn't (and this sometimes happens) we won't blame you in the least. You won't be asked to act as our agent or even assist in the sale of a single instrument.

If You Want to Keep the Phonograph that is if you wish to make the phonograph your own, you may do so. Either remit us the price in full, or if you prefer, we will allow you to pay for it on the easiest kind of payments.

Our Easy Payment Plan Two dollars a month pays for an outfit. There is absolutely no lease or mortgage of any kind, no guarantee from a third party, no going before a notary, no publicity of any kind, and the payments are so very small, and our terms so liberal you never notice the payments.

FREE Just sign this coupon now and mail it to us. We will send you our Edison Phonograph Catalog, the very latest list of records (1500 of them) and our Free Trial Certificate entitling you to this grand offer. Sign this coupon or send postal or letter. No obligations. Get catalog

F. K. Babson, Vice Pres. & Mgr.

**BABSON BROTHERS
Edison Phonograph Distributors**

Dept. 1191, Edison Block, Chicago

Western Office: 65 Post Street, San Francisco, California. Canadian Office: 355 Portage Ave., Winnipeg, Canada.

**F. K. BABSON,
Vice Pres. & Mgr.
Babson Bros.
Edison Phonograph Distrs.
1191, Edison Bldg. Chicago**

Please send me, without any obligation, your New Edison Phonograph Catalog, list of Amberol Records and Free Trial Certificate entitling me to your grand offer, all free.

Name.....

Address.....

This will clinch an increased Henderson popularity

¶ The 1913 Henderson — with greater power and with the exclusive features proved by a year's use — will be even more popular than its predecessor.

¶ In a way possible in no other type of construction it combines power and comfort, the two essentials most desired by the particular motor-cycle buyer.

Write now for the catalog and nearest dealer's name

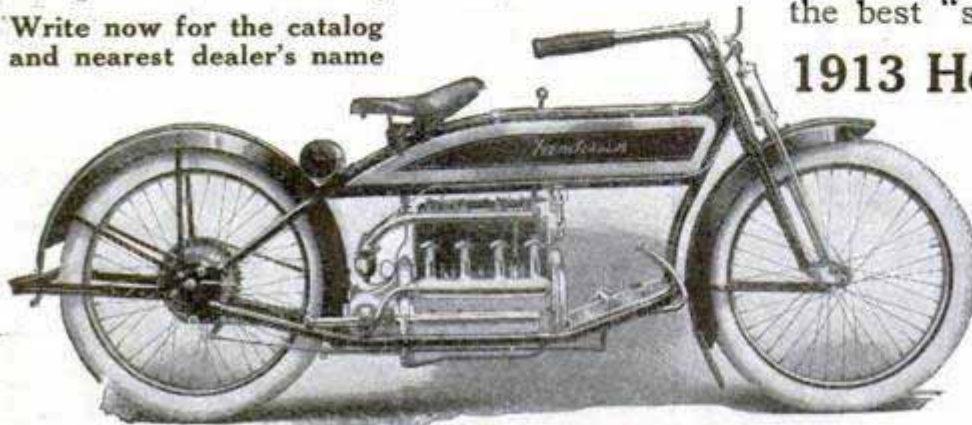

¶ In addition, it gives a power application that is continuous and silent; it runs without vibration; it is started with a crank; it has footrests properly placed, instead of pedals.

¶ It is a machine that you should investigate before you buy, because it affords advantages that you cannot get with the best "single" or "twin" built.

1913 Henderson 8 H. P.

Four cylinders
Chain drive
Triple stem fork
Starting crank
28 x 3" tires

\$325

HENDERSON MOTOR CYCLE COMPANY, 1158 Cass Ave., Detroit, Mich.

Prest-O-Lite



The Only Practical Light for Motorcycles

Prest-O-Lite is the only lighting system that makes night riding possible, pleasant and SAFE.

This ready-to-use gas costs no more — usually costs less — than the carbide a generator consumes.

The first cost is low (\$10). Prest-O-Lite never gets to be second-hand, and is always a READY CASH ASSET.

You can easily afford it. You cannot afford to be without it if you ride at night. One accident might cost you more than years of Prest-O-Lite service.

Easily attached to any motorcycle. We will arrange for immediate exchange service for anyone, anywhere.

See any motorcycle (or automobile) dealer, or write us.

DON'T ACCEPT AN IMITATION!

The genuine Prest-O-Lite, when empty, can be immediately exchanged for a full one, ANYWHERE AND ALWAYS. Imitations cannot.

The Prest-O-Lite Co., Indianapolis, Ind.

Branch offices and Service Stations in all principal cities. Charging plants in all parts of the country.

Exchange Agencies Everywhere

hundred drachmas as a dowry. Besides this, my husband, when he lost his property, found a home in the house of my parents. In spite of this Heracleides, after he had run through my dowry, cursed me, beat me, deprived me of the necessities of life, wickedly deserted me, and left me in misery. I pray you to force him to appear before you, and to cause him to return to me the dower I gave him, increased by half." — American Sunday Magazine.

Build YOUR OWN Side Car Motorcycle

Side Cars two parts. Your models to choose from. Send \$65⁰⁰ for Catalogue and terms.

AGENTS WANTED

Baxter Side Car Co., 119 Broadway, Cambridge, Mass.

\$40 Motorcycle



We have the largest line of new and used motorcycles in the country at the lowest prices. Every machine has been put in the best possible condition in our

shops, and we guarantee all machines to be in good running order when shipped and to give good service when handled according to instructions.

We have extensive shops for doing all kinds of repair work and are in position to repair and overhaul your machine promptly at a reasonable price. Send us your machines for estimate. We exchange motorcycles. Motors and castings for airships and railway velocipedes.

SEND FOR CATALOG

Harry R. Geer Co., 888 McLaren Ave., St. Louis, Mo.

DELHI DIAMONDS



See This Gem At Our Expense

The marvelous Delhi Diamond sent to you absolutely free for inspection to prove that this brilliant rival of the diamond is all and more than we claim for it. The Delhi Diamond resembles the diamond so closely in radiance, lustre and hardness that you can't tell the difference. Cuts glass and stands diamond tests. Set in guaranteed solid gold mountings. Send today for particulars of this free offer.

Free Examination

We make this sensational free inspection offer to prove that the Delhi Diamond is the most perfect substitute for a diamond ever offered to the world. See this marvel of beauty before you think of buying. If it is not more diamond-like than you expected it to be send it back at our expense.

Write Today Send your name today and get full particulars of this sensational offer and our new catalog showing all designs in Delhi Diamond Jewelry and amazing low prices. We pay postage.

Delhi Diamond Co.

Dept. 5245 CHICAGO, ILL.

CANAL-ZONE FOOTWEAR—The rope-soled slippers, with cloth uppers, known as Spanish alpargatas, and worn by practically all the European and colored laborers in the canal zone, are imported all the way from Spain in such quantities that they can be retailed at the low price of 20 cents a pair.

The European laborer wears them 12 months in the year on the Isthmus, and over 1,000,000 pairs are sold annually by the commissary. Alpargatas are durable, and have been adopted by Isthmian bathers as the most convenient form of beach shoe.—Chicago Inter Ocean.



Only \$25

for the knockdown frame of this 23-foot motor boat, including full-sized patterns and illustrated instructions to finish—speed 9½ to 14 miles an hour—12 passengers. Now's the time to start assembling your boat. Write for Free Boat Book.

BROOKS MANUFACTURING CO. 9½ to 14 Miles an Hour
8201 Sidney St. SAGINAW, MICH.

Spend 50c—Save \$50

The Complete Household Record contains an exact record of household expenses, with Daily, Monthly and Yearly Summaries, Servants' Accounts, etc., and lists Household Effects and their cost. It should be in every home. Every housewife wonders where her money goes. Stop the little leaks; know just what your living is costing and have

MONEY IN THE BANK

at the end of the year. Book with heavy ledger back, bound in leather, sent prepaid on receipt of 50c (stamps accepted). We guarantee to refund your money if the book is not entirely satisfactory.

CHRISTOPHERSEN NOVELTY CO.

2511 Maplewood Avenue CHICAGO, ILL.

AGENTS GET OUR TERMS. Carry an article you can sell to any housewife anywhere.



One of 38 Styles of Wing Pianos

Rock Bottom!

Yes, Rock-Bottom Prices, and On a Piano of the Highest Quality

This is positively the greatest piano offer ever made—rock-bottom prices—easy payments, if you wish—absolutely free trial—a four week's free trial in your own home. You will be amazed at the direct-from-the-factory prices on the famous Wing Piano. We positively save you from \$150 to \$250 on the purchase of this magnificent instrument. We will convince the purchaser by shipping your choice of a piano on approval—all freight prepaid in advance—an absolutely free trial for four weeks in your own home. If you write at once you may have the Wing equipped with our wonderful Instrumental Accompaniment, without extra charge—giving the effects of the guitar, harp, zither, banjo and mandolin.

Every Discount Goes Direct To You

The Wing Piano is sold direct at the wholesale price from the factory—yes, direct from our exclusive piano factory without going through the hands of a single middleman. When you buy a Wing Piano you pay no salesman's, dealers' or middlemen's profits. We have cut out all middlemen and you put the discounts in your own pocket. And even at the rock-bottom prices, the Wing is sold on easy terms—if you prefer not to pay cash. We guarantee the Wing for 40 years.

Remember, we pay all freight. No interest charged. These prices include everything. No deposit. Not a cent till the end of four weeks' free trial, and then nothing unless you are absolutely satisfied—and you are the judge.

Send Coupon (or Postal) NOW for "The Book of Complete Information About Pianos."

The New York World says: "This is a book of educational interest everyone should own." Would you like to know all about pianos, how to judge the fine points of quality and price in buying a piano? Then send the coupon for the piano book which we are sending out free for the present. You will be astonished at the amount of information about piano quality and piano prices, and how to avoid the deceptions of the piano salesman. This magnificent 156-page book, a complete encyclopedia on the piano posts you on the making of a piano from start to finish and how to judge the fine points of a piano. Free and prepaid, provided you write at once. With this piano book we will send our beautiful catalog showing new art styles and full explanation of our Rock-Bottom Prices on the Wing Piano.

WING & SON

Est. 1868

Wing Building

Ninth Ave. & 13th St.

Dept. 1191
NEW YORK, N.Y.

FREE COUPON

WING & SON
(Est. 1868)

Wing Bldg., 9th Av. & 13th St.
Dept. 1191, New York, N. Y.

Gentlemen: Without any obligations to purchase or to pay for anything, please send me free and prepaid, "The Book of Complete Information About Pianos," also your catalog showing latest art styles and full particulars of Rock-Bottom prices on the Wing.

Name.....

Address.....

Quality Through and Through

Keen Kutter tools are on sale in practically every city, town and village in the United States. Such a permanent, nation-wide demand for one particular brand has been created through the manufacture of quality tools during a period of over 45 years.

KEEN KUTTER Quality Tools

cost less than ordinary tools because they last much longer and give better service. Keen Kutter superiority means the finest grade steel, fine cutting edges and general finish. Scientifically correct in "hang" and "balance," these tools make for easy work.

If not at your dealer's, write us.

"The Recollection of Quality Remains Long After the Price is Forgotten."
Trade Mark Registered. —E. C. SIMMONS.

SIMMONS HARDWARE COMPANY, Inc.

Carpenters' Pincers
No. KS10
Price \$0.60

Firmer Chisel
No. KSB1
Price \$0.75

Tack Claw
No. K5
Price \$0.15

Hammer
No. K612
Price \$0.70

Square No. K3
Price \$1.35

Plumb and Level
No. KK30
Price \$1.50

Smooth Plane
No. K3
Price \$1.90

Brace
No. KN110
Price \$2.00

Auger Bits
No. KS
Prices \$0.25 to \$0.85

Half Hatchet
No. KH1
Price \$0.80

Draw Knife
No. KS
Price \$1.00



EXTRA! \$25.00 Tuition Credit in Drafting Given FREE!

Offer limited—so hurry! Most wonderful opportunity for ambitious men (ages 16 to 60) to become expert Draftsmen and Designers! Learn right at home. Keep your present position. Write at once for full particulars.

Be a Draftsman Earn \$75.00 to \$200.00 Per Month

Right at start. Not enough Trained Draftsmen to fill high salaried positions open. We teach you to become Expert Draftsmen in a short time. Experts give you "Personal" Instructions. Excellent opportunities for men who possess the kind of training we give you—big salaries at start—rapid advancement.

Position Guarantee
We guarantee to instruct you until placed in a position paying \$75.00 to \$200.00 per month. Our Employment Bureau furnishes Positions to Students Free.

\$17.50 Set of Drawing Instruments FREE!

If you enroll now we will give you FREE a \$17.50 Set of Drawing Instruments. Finest German Silver—handy size leather bound case.

Offer Limited—Hurry! Write Today for Free Book

and full particulars. Take advantage of this great opportunity NOW. Send post card for free book and full particulars of this great Free Tuition Credit offer. No obligations, so write IMMEDIATELY.

Address: CHIEF ENGINEER
Room 502 Engineering Bldg., CHICAGO, ILL.

A novel meter for electric automobiles registers the amount of electricity that is put into and taken from the storage batteries, enabling the owner of a car to know how much he needs or has available.

Have You Ever Mislaid an Important Document?

Keep Contracts, Notes, Mortgages and Ins. Policies safe in a Barler Document File.

\$1.25 Express Paid

Will last a life-time

Guaranteed Satisfactor or Money Returned

Made of steel, covered with keratol leather. 20 strong manila pockets, 4 1/2 x 10 3/8 in., with metal eyelets. Cord allows expansion, and holds without tying. BARLER FILE CO., 56 W. Lake St., CHICAGO



GO INTO THE Moving Picture Business

From \$50 to \$75 starts you and you will earn as much in 1 or 2 nights

\$25 And more per night can be made exhibiting with our machine in halls, schools, churches, theaters, etc., in your own and surrounding towns. We furnish everything—rent films, too. Only a small payment required to get this new and unexcelled machine. Balance may be paid in easy installments. Write for particulars



P. & W. Sales Company
443 So. Dearborn St., Chicago, Ill.

GREAT MONEY MAKER FOR



AGENTS

Sell Magnetic Combs and get rich; agents wild with success. They remove dandruff; stop falling hair; RELIEVE HEADACHE; never break. Send 2c stamp for sample.
PROF. LONG, 950 Ash Street, PEKIN, ILLINOIS

Pipe Threading Tools



Hand, belt and motor machines.

The biggest line of all kinds and sizes of pipe threading equipment designed or manufactured.

The Oster "Bull Dog" Line

Known throughout the world. Recommended by eighteen years of success in the best plants, where highest efficiency is daily demanded.

Reasonable price, accomplished by the elimination of complicated parts. Simplicity of design, and consequently a simplicity of operation—making it unnecessary to employ an expert operator. Anyone can accomplish perfect results and high speed upon an Oster, without previous experience.

Self-locking dies. No resetting for each cut. No turning back over the finished threads. One movement of the hand opens or closes the dies. Every contractor, every shop, and every individual, who is interested in hand or power pipe threading equipment, should have the new Oster catalogue. Sent free by mail, postpaid. Ask for it today.

THE OSTER MFG. CO.
2100 East 61st St., Cleveland, O.

The Machinist

is among those most apt to become

DEAF



When the eyes are strained they become weak and the sight is impaired. The same principle naturally applies to the delicate tissues of the drums of the ear. When constantly exposed to loud and rasping noises and extreme vibrations they are overtaxed—become weakened and deafness follows. Why shouldn't you then protect from rough usage the hearing so necessary to you—just the same as you do your clothes from the oil and wear of the shop? My little "wireless phones for the ear" will afford the protection you require—if you are already deaf they will assist you to hear. Among the thousands of people they have enabled to hear perfectly there has been every condition of deafness or defective hearing. No matter what the cause or how long standing the case the testimonials sent me show marvelous results.

Common-Sense Ear Drums

wonderfully helped my own case—that's how I happened to discover the secret of their success in my own desperate endeavors to be relieved of my deafness after physicians had repeatedly failed.

Common-Sense Ear Drums are made of a soft, sensitized material, comfortable and safe to wear. They are out of sight when worn, and easily adjusted by the wearer.

It is certainly worth your while to investigate. Before you send any money just drop me a line. I want to send you free of charge my book on deafness and plenty of evidence to prove to you that I am entirely worthy of your confidence. Why not write me today?

GEORGE H. WILSON, President WILSON EAR DRUM CO. (Inc.)
737 Inter-Southern Bldg., LOUISVILLE, KY.

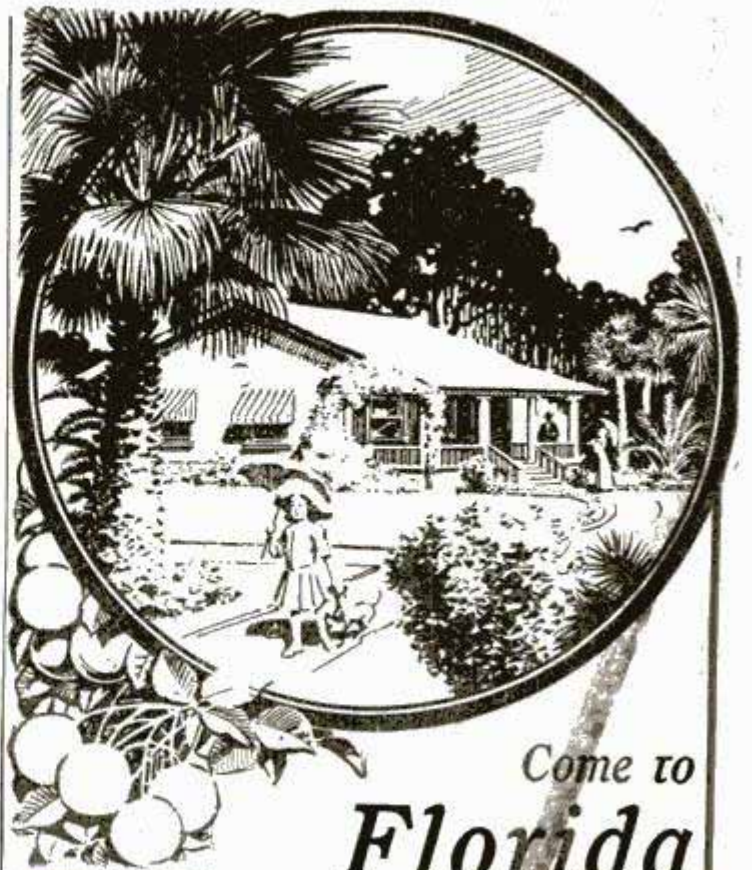

Come to Florida and Live Like a Prince

among the grapefruit and the palms and the perpetual sunshine of beautiful North Tampa.

On one of these rich 10-acre fruit or truck farms, you can build up a real bank account, for your harvest is not merely an annual crop, but several crops a year. And the cost is only 3½ cents a day on each acre—less than a single carfare up in the shivering North!

Year after year you've envied your wealthier neighbors their winter trip to balmy Florida. Here's your chance to go them one better—to make your money under smiling skies instead of just running down here to spend it.

North Tampa at a Glance:

This one county alone, as shown by the U. S. Government reports, produces over \$68,000,000 worth of grapefruit in a year. Fruit and vegetables thrive amazingly here; several big crops every year. The highest priced markets in the world lie at your very door, ready and waiting for your crops of fruit, truck and poultry. Demand exceeds supply.

The bustling city of Tampa, within easy walking distance, gives you the advantages of the metropolis with the comfort of the country. Merchandise in the local stores is cheaper than in the North. 3 important railroads cross the property, 8 railroad stations adjoin it. Schools, churches, soil, water, climate—you must read our free book on Florida to thoroughly grasp all these advantages. Ask for specimen letters from those who have bought in this tract—they're chock full of inspiration.

Your money back if you want it. Take ample time for investigation, but make your reservation now.

Don't let your chance slip by you this time! Send us today (protected by our broad, straightforward Money-Back Guarantee) your remittance for \$1 per acre on as many acres as you think you want. Or fill in and mail the attached coupon: it entitles you, as a reader of POPULAR MECHANICS, to one of the most accurate and interesting books on Florida ever published.

NORTH TAMPA LAND COMPANY
1128 Com'l Nat'l Bank Bldg.
CHICAGO

P. M.
NORTH
TAMPA LAND
COMPANY, Commercial
Nat'l Bank Bldg., Chicago, Ills.

Send me FREE your interesting book about FLORIDA LAND.

NAME

TOWN

STATE

STREET

Will You Drive Six Screws To Save \$13.25?

It takes six minutes to drive these six screws. Now, if your time is worth more than \$2.21 a minute, don't read any further. This advertisement is for those who want high grade furniture at rock bottom prices, who love beautiful things in the home, who appreciate choice designs, know solid worth, and approve of a selling plan that saves them fully one-half store prices.

COME-PACKT Sectional Furniture is such furniture. Take this table, for example. It is Quarter Sawn White Oak, with rich, deep natural markings, honestly made, beautifully finished to your order, in your choice of eight finishes. Measure out its dimensions with a tape measure — compare it with any piece equally good, at any dealer's. It saves you more than one-half.

How! By coming to you in five sections, packed in a compact crate, shipped at knock-down rates. **Come-Packt** keeps no men on the road, has no stores, no dealers. You save all these big savings — freight, traveling men's and dealers' expenses and profits—a total of one-half or more. **With a screw driver and six minutes, you buy a \$25 table for \$11.75.**



300 Library Table

Dealer's price, \$25.00

Come-Packt price . . . \$11.75

Height, 30 inches; top, 44x28 inches; legs, 2½ inches square. Two drawers, choice of Old Brass or Wood Drawer Knobs. Shipping weight, 150 lbs.

Sold on a Year's Trial—Money Back Any Time

Honest furniture and an honest selling plan, as thousands have proved. Our free catalog — the most beautiful furniture book ever given away — tells all the details, gives you a choice of more than 400 pieces, and color plates show the exquisite finish and upholstery.

Write for this beautiful big book today. Mailed free.

Come-Packt Furniture Co.



101 Fernwood Avenue
TOLEDO, OHIO

Come-Packt Sectional Furniture is not handled by dealers. You buy at factory prices.



This \$300 Motor Boat, \$98⁷⁵

We will sell one person in each community this very latest disassembled 18-foot famous Truscott fast family runabout, with a 3½ x 3½ — 4 H. P. up-to-the-minute motor, ready to install — and the complete frame work and all fittings for this wonderful boat, also the patterns for planking and full instructions how to assemble, **at special lowest agent's price.** You can put the boat together as well as we can, and you save \$200. Everything cut to size. No special tools and no experience needed. Remember, we sell one person in each community.

Write today.

TRUSCOTT BOAT CO. MUSKEGON, MICH.

Let Me Send You My **FREE** STARCK PIANO

FOR THIRTY DAYS' TRIAL IN YOUR HOME

Write now for my big piano book, showing the beautiful Starck Styles, also containing the low **FACTORY PRICES AND SMALL PAYMENT PLAN**

Together with full information how to get **FIFTY MUSIC LESSONS FREE. WRITE TODAY.**

P. A. STARCK, PRES. P. A. STARCK PIANO CO., Manufacturers, 381 STARCK BLDG., CHICAGO



Be An **Expert WRESTLER**

Farmer Burns, the greatest of all wrestlers, trainer and manager of the mighty world's champion, **Frank Gotch**, will teach you *by mail*, all the wonderful holds and defenses known to the art. Greatest opportunity ever offered for those

who want to become an expert wrestler, or to be a great athlete. Investigate! Write now—**TODAY**—for full particulars—sent **FREE.** Burns School of Wrestling, 205 B Range Bldg., Omaha

Jackson Measure comfort by the high Jackson standard

*No hill too steep
No sand too deep*

Once you have seen the Jackson and ridden in it, you will judge the comfort of other cars by what you found in the Jackson.

You are likely to be surprised, first, at the Jackson's riding ease and second, at the fact that other cars from which you expected much do not approximate it.

And if you seek the reason you will discover we have devoted more thought and ingenuity to providing comfort than the average manufacturer has.

In some plants our efforts in this direction would be called specialization. Not so here.

For we believe the passenger's ease as important as power, or speed, or safety, or beauty of body design.

So we build for comfort, too, and we get it by the use of four full elliptic springs, long wheelbases, correct distribution of weight, 10-inch upholstery, tilted seat cushions, shoulder-high seat, backs, and plenty of leg room in tonneau and in front.

Experience is always valuable; and experience has taught us how best to combine the features that make for comfort.

A telephone appointment with the Jackson dealer for a demonstration, will be your first step forward if you are inclined to be skeptical.

A postcard request brings you the complete catalog.

New York Show—January 11th-18th, Madison Square Garden,
Space 111, Elevated Platform

Chicago Show—Feb. 18th, First Regiment Armory, Space B-2,
immediately to right of Michigan Avenue Entrance

Jackson Automobile Company
1301 E. Main Street, Jackson, Mich.

Jackson—"Olympic"—\$1500

Four cylinders, 35 horsepower; unit power plant; long stroke motor, 4 $\frac{1}{2}$ x 4 $\frac{1}{2}$ inches; 115-inch wheelbase; 34 x 4-inch tires. Complete equipment, including Disco starter. Black and nickel trimmings.

Majestic—4-cylinders—\$1975

Sultanic—6-cylinders—\$2650

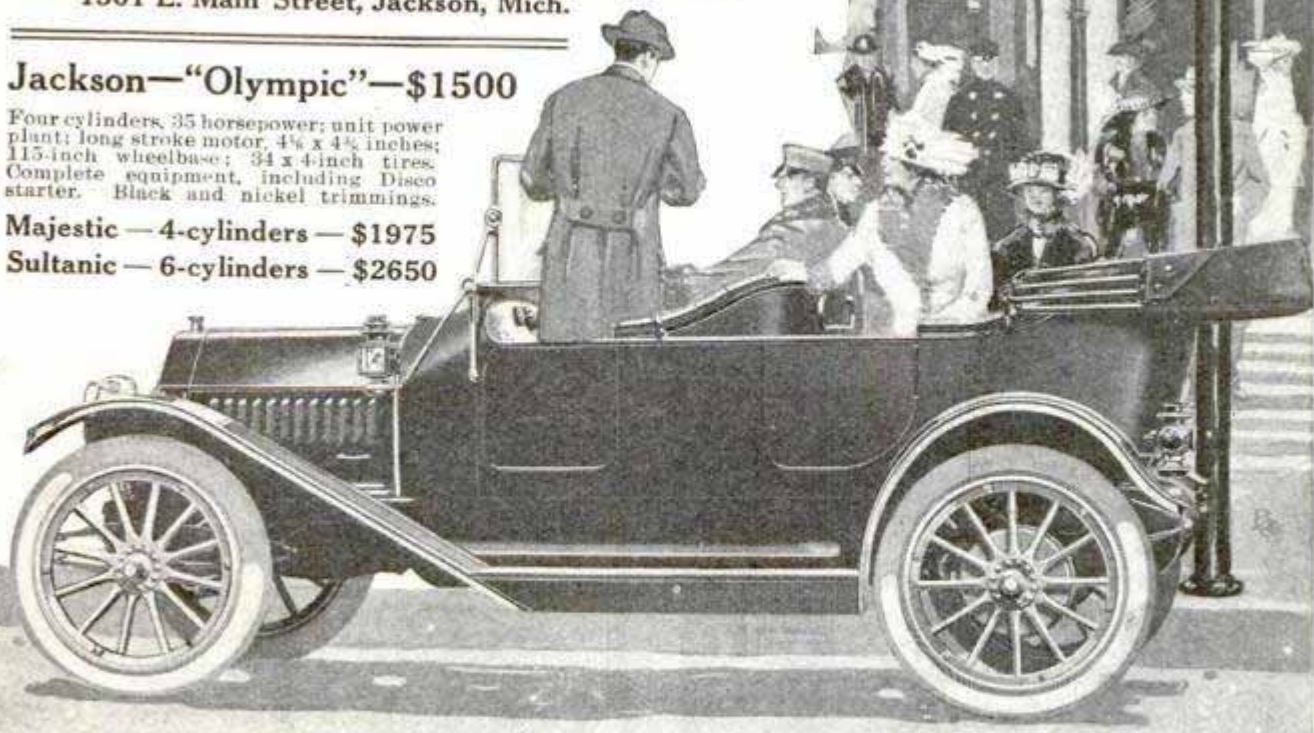

YOU CAN GET

\$500 1st Month
\$1500 3rd Month

\$1000 2nd Month
\$5000 ALTOGETHER

Reader, this offer says you—means you—this money—the cold cash—can be yours. You and you alone by waiting too long can lose it. Be sure we hear from you first—send your name and address—but **NO MONEY**—this very minute.

YOU MAY BE INEXPERIENCED OR EMPLOYED OR WITHOUT CAPITAL

but don't worry—don't find excuses—we can and will fix it for you to get this money. You don't have to wait a month—not even a week—payments can start the first day—and continue daily up to \$500 first month, \$5000 for you altogether. For years we have been quietly picking men from all walks of life, ministers, clerks, farmers, preachers, doctors, lawyers, teachers and so on—enabling them with our co-operation and **\$50,000.00 appropriation** to get what we here offer and can do for you—\$500 first month, \$5000 altogether. Some of these men you may know—possibly have envied without understanding the reason of their prosperity.



INVESTIGATE AND BE AMAZED Demand absolute proof—accept no other kind. Either we have the best thing that ever happened or we're colossal liars. Ask Schleicher, minister, whether it's true that he received

\$195 TWELVE HOURS AFTER APPOINTMENT;

Langley, liveryman, \$115 first day; Rasp, agent, \$1685 in 73 days; Beem, solicitor, \$164.25 weekly for 12 weeks; Korstad, farmer, \$2212 in a few weeks; Zimmerman, farmer, \$3856 in 30 days; Stoneman, photographer, \$3841 in 60 days; Juell, clerk, \$6800; Hart, farmer, \$5000; Wilson, cashier, \$3000 in 30 days. Let us refer you to these men, to the U. S. government, to banks, business houses, noted people at home and abroad. Heed this caution from Chas. Starr, of Mich., who writes: "Sorry this field is closed. Should have acted sooner but was skeptical. Your local man's great success has set everybody talking and proves I was a chump. Wonderful what a man can do with a real opportunity." Then read this from Lodewick who acted quickly: "Lucky I answered ad. It's great. Money coming fast." Which will you be, Starr, a victim of "neglected opportunities," or Lodewick, the "early worm." To escape Starr's fate, send your postal this very minute—

SPEND ONE CENT TO MAKE THOUSANDS

Ever hear of Allen's Wonderful Bath Apparatus? If not, listen. Gives every home that long-desired blessing, a modern bathroom with hot and cold running water facilities for only \$6.50. No plumbing—no water works—self-heating. Only ten minutes to install. Gives cleansing plus friction, massage and shower bath in any room. Equivalent to any \$200 bathroom. Over 200,000 delighted users. Used by U. S. government.

More remarkable than this invention is our startling plan of universal distribution through special representatives who become virtually profit sharing partners in a business that's immense—exciting—fascinating—dignified—and above all, has enabled them, will enable you to get \$500 first month, \$5000 altogether. Asking to be shown doesn't obligate you one bit. Investigate today by all means.

ALLEN MFG. CO., 359 Allen Bldg., TOLEDO, O.

PENNSYLVANIA

OIL-PROOF

VACUUM TUB TIRES

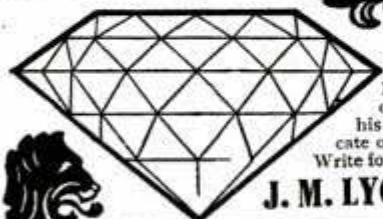

Diamonds on Credit

20% Down; 10% a Month

Every customer is protected by our written guarantee to refund his money if his dealer can duplicate our diamond at our price.

Write for Illustrated Catalog No. 3.

J. M. LYON & CO., 71-73 Nassau St. New York City

GOLDMAN'S

Arithstyle

Handiest, Fastest, Cheapest, COMPUTING MACHINE

Adds, Subtracts, Multiplies, Divides.

Carries Automatically. Resets Instantly.

Easily moved over page, fixed to desk, carried in hand or pocket. 5 in. x 2 1/2 in. x 1 in. Weight, 36 oz. Write for Booklet. Attractive Agents' Proposition. ARITHSTYLE CO., Suite 100, 118 E. 28th St., N.Y.

A BOOK OF New Mission Furniture Designs

IS NOW READY

Part 3—Mission Furniture HOW TO MAKE IT

A 128 page collection of excellent new designs that have never before been published and that are entirely different from those in the books Parts One and Two previously issued.

This new number has just been published and those already in possession of Parts One and Two will find this an even greater value in variety and excellence of the plans.

A feature of the new book is a
Complete Set of Dining-Room Furniture
Designed to Harmonize Perfectly

Here is the complete list of pieces:

Arm Chair—Arm Dining Chair—Hall Bench—Piano Bench—Book Rack—Book Stand and Music Rack—Book Trough—Chafing Dish Buffet—Folding Card Table—Side Chair—Writing Desk—Dictionary and Magazine Stand—Round Dining Table—Princess Dresser—Fern Stand—Foot Warmer—Hall Tree—Library Table—Magazine Rack—Magazine Stand—Pedestal—Plate Rack—Porch Swing—Screen—Serving Table—Settee—Sewing Table—Sewing Box—Wall Shelf—Sideboard—Umbrella Stand—Den Table—Oak Table—Tabouret—Wardrobe—Window Seat

36 Designs—50c Postpaid

128 Pages

Handsome Cloth Binding

If you are at all handy with tools, you will find that the plainly written directions, dimension drawings and half-tone illustrations will enable you to

Make Your Own Furniture and Save Two-Thirds

The many who use tools for pleasure will find this book a working guide which will furnish many moments of delightful and profitable occupation while several of our readers have been able to devote their entire time to this work by disposing of what they have made at a nice profit. One man made and sold \$400 worth of one piece alone.

Parts One and Two in this series are also 50 cents each postpaid

ASK YOUR BOOK DEALER

Or address the publishers

Popular Mechanics Book Dept.
318 W. Washington St. CHICAGO

Please Mention Popular Mechanics

Wanted

AGENTS & SALESMEN



THE SWEDISH VIBRATOR

An amazing scientific invention. Endorsed by physicians, athletes, actresses, judges, and thousands of men and women who have used it. Agents and Salesmen are wiring orders. Enthusiasm is unbounded. Every man and woman making money fast and easy. 100,000 already sold, 1,000,000 to be sold this year. Secure territory at once. Mail your application today, stating county you desire. This is the one important thing today—do it now.

This is an opportunity for you to make \$5000 this year as a high grade salesman. **No experience necessary.** No delay. No charge for Territory. No competition. **Exclusive field.** Success assured. **Remarkable offer.** Read every word carefully. Get an appointment and get started without delay.

We are appointing men every day to manage our business in local territories. **We need good, honest men who are willing to work**—and we will give you today this opportunity to

Make \$5000 This Year

It is the chance of a lifetime. You will be in business for yourself. **You will be your own boss— independent, abundant money, pleasant position**—and your time will be your own. **At home or traveling— all or spare time**—get an appointment immediately and commence earning money next week.

The Swedish Vibrator

Most amazing seller ever invented. **A new proposition for salesmen.** Endorsed by the highest authorities of the world. A machine for home massage and vibratory treatment. Can be operated by simply attaching to electric lamp socket, or by ordinary dry batteries—**in cities, towns, country—any where, everywhere.** Needed by every man, woman and family. **Anyone can use it.** Get complete literature free and learn the wonders of this brilliant invention—a machine that gives 30,000 thrilling, invigorating, penetrating, revitalizing vibrations per minute. One-minute demonstration gets the order. **Irresistible desire to own it once you feel the living, pulsing touch of its rhythmic vibratory motion.** Sold upon five-year, cash certificate guarantee and 30 Days' trial.

150% Profit

Throw away the little novelties upon which you have to make ten or twenty sales a day to pay expenses. Become a real salesman and make real and quick and big money. **One sale a day means \$90 net profit a week.** Many averaging four, five and even ten a day. **This is actually the most brilliant, easy and high class proposition that has ever been offered to wide awake agents, general agents, and managers.**

Don't Delay

Get free literature and complete information at once. Send just your name and address on a postal card and all will be mailed free immediately. **Agents' sample furnished at wholesale price.** Investigate. It costs you nothing to find out. Territory being rapidly assigned. **But one man allowed in a field.** Give the name of your county. Send your name and address today. This is a brilliant opportunity. Do not neglect. Do not put it off. **Act immediately.** Address



FRANK CHANCE, Manager Chicago National League Ball Team says: "After seeing how it removes stiffness and soreness from my arms, legs and fingers, each player absolutely insisted on having one; and had it cost twice as much they would have had it."



ELSIE JANIS, the dainty and popular actress, says: "The nice things I could do and do say about your vibrator, I cannot write, as I would not have space enough."



JULIA SANDERSON says: "I don't see how I got along without it. It certainly is far better than anything I ever tried for the throat and vocal cords."



WM. H. CRANE, the famous American actor, says: "I have been using your vibrator for several weeks for nervous trouble, circulation, etc., and found it exceedingly beneficial. It is all that you claim for it."



Champion Wrestler of the World uses the Swedish Rhythmic Vibrator and says:

"For limbering up, keeping in condition and strengthening the muscles, there is nothing that equals or excels the use of the Swedish Electric Vibrator. I always use one in my training and I certainly find it a wonderful help. It reaches the seat of all stimulation and gives me a perfect circulation. Its use gives all the muscles elasticity, makes one powerful, quick and active."

"Being a firm believer in vibratory massage, I tried various makes of Vibrators, but did not find one of enough efficiency to withstand the severe use I put them to until I purchased yours. You have, in my opinion, the only perfect Vibrator on the market, and I can consistently recommend its use to all athletes and those who desire health and strength."

THIS OPPORTUNITY

is open to anyone who wants to make money and who is willing to work. We furnish complete instructions that enable you to start immediately. Nothing difficult. No experience required. We want applications from men and women in unoccupied territory everywhere—clerks, teachers, mechanics, farmers, etc., etc.—all can make money on this grand, new, easy selling plan. Act today. Put your name and address on a postal card and mail it at once. Find out all about this tremendous opportunity.

THE SWEDISH VIBRATOR CO., Dept. 44, 215-230 Schiller St. CHICAGO, ILL.

700 Things That a Boy Can Make

1000 Illustrations That Thoroughly Show How



\$1

THE handsome set of four books—"Mechanics for Young America" and "Amateur Mechanics" (Nos. 1, 2 and 3)—each book bound separately in Illuminated Covers, and the whole set enclosed in a heavy Bristol Folding Case with extension clasp—will be sent prepaid to any address for \$1.00.

\$1

The Ideal Books for the Wide-Awake American Boy Thoroughly Practical and Instructive



Besides telling how to make scores of things useful about the house, full and complete directions are given on constructing the following and hundreds of other things which appeal to the heart of every boy.

Electric Appliances—Steam and Gas Engines—Motors—Wireless and Morse Telegraph—Self-Propelled Vehicles—Toboggans, Bobsleds, Ice-Boats—Boomerangs—Paddle Boats, Canoes, Rowboats—Camping Outfits—Cabins—Tents—Fishing Tackle—Magic Lanterns—Searchlights—Cameras—Telescopes—Gliders and Aeroplanes—Kites and Balloons—Aquariums—Electric Furnaces—Electroplating Outfits—Lathes—Foundry Work at Home—Iron, Copper, Brass and Other Metal Work—Bookbinding—China and Pottery Kilns—Parlor Magic Tricks, etc.

Each book sold singly at 25c postpaid or the complete set for \$1.00

POPULAR MECHANICS BOOK DEPARTMENT

318 W. Washington Street, CHICAGO

SHOP NOTES for 1913

The New Year Book IS NOW READY

All the articles which have been published during the year past in the "Shop Notes Department" of POPULAR MECHANICS MAGAZINE have been reprinted and bound in one handsome volume of

224 Pages

595 Articles 503 Illustrations
Price 50 Cents

This is Vol. IX of the series and contains entirely new matter. The seven page index makes it handy of reference and we will mail the book to any address upon receipt of 50 cents, or it can be bought of your book or newsdealer at the same price.

Popular Mechanics, Publishers
318 W. Washington Street, CHICAGO, ILL.

4595 EASY WAYS TO DO HARD THINGS \$4.50

A collection of the most useful experience of years of hundreds of the most successful mechanics, "boiled down" and "Written So You Can Understand It."

Shop Notes Year Books—Vols. I to IX

4595 Articles — 1988 Pages — 4503 Illustrations

50c Per Volume, Postpaid **\$4.50** Per Set of Nine Books in Case, Prepaid

The contents of these books are similar to the articles appearing in this magazine under the heading "Shop Notes."

Order through your dealer or direct from the publishers
POPULAR MECHANICS BOOK DEPT., CHICAGO

FOR SALE—A Limited Number of Complete Files of

Popular Mechanics Magazine

For 1910-1911 and 1912

These consist of the twelve monthly issues of the magazine for each year and are suitable for binding.

Price \$1.50 Each Postpaid

If copies of the two complete indexes for each year's magazines are desired send 20c additional.

POPULAR MECHANICS CO.

318 W. Washington St.

CHICAGO

Facing The Future Fearlessly

By FRANKLIN O. KING

"Ring Out the Old; Ring In the New. Ring Out the False; Ring in the True." It Rings in Your Ears, and Well it May. Tennyson never Wrote a More Beautiful Poem, and You never Read a More Helpful One. Read It Over Again. Every Man should Strike a Balance on New Year's Morning, even Though He May Have Been a little Off his Balance New Year's Eve. It's Easy to Turn Over a New Leaf, but It Takes a Real Man to Keep it Turned. "Eternal Vigilance" is the Price, not Only of Liberty, but of Habits, Health and Happiness — Now and Hereafter. Good RESOLUTIONS will Become REALIZATIONS only when Backed up By PERSISTENT PURPOSE.

How about Your Balance Sheet for 1912? Haven't You charged off a Lot of Things to "PROFIT and LOSS" that Ought to Be On the Credit Side of the Ledger? Haven't You Frittered away a Great Deal of Your Hard Earned Cash for Petty Pleasures, or Lavish Luxuries, when You Could Have Laid By Something for the Inevitable "RAINY DAY?" How Much Better Off are You than Last Year, or the Year before That? True, You have "Kept the Wolf from the Door," but by a Little Economy and Self-Denial You Might have Begun the Erection of a Fortification that would Forever Free your Family From Fear of Its Ferocious Fangs.

Your Good Job may not Always Last. Some of These Days a Younger Man May Fill Your Place. I said a "Younger," not a **Better** Man. The Gray is Creeping into Your Hair, and the BOSS is Likely to Forget the Splendid Things You Did—Once Upon a Time. "Yo' Ben a Good Old Wagon, But Yo' Dun Broke Down." The World Wants a WINNER, and Won't Worry Along With Wornout Workers.

"Parted From the Pay Roll" is a Little Drama in which You may Expect to Play the Principal Part Some Sad Saturday, P. M. Then the "Good Fellows" who Helped You Spend your Money Will Likely Pass By on the Other Side, and the Only Place You can Look for **Sympathy** will be In the Dictionary.

Let US, therefore, "Ring Out False Pride," and Hereby Firmly Resolve to Establish a New Record for 1913, which Will Enable You to FACE the FUTURE FEARLESSLY. Strikes, Lock-outs, Panics and Periods of Financial Depression

Cannot Depress You, if You Will Make It a Rule to Save a Little Something Every Day. Again I Repeat It—**Saving** is the Antidote for Slaving.

The Best Incentive to Persistent and Systematic Saving is the Desire to Get a Home. The Best Place I Know of to Get a Home is in the Rain Belt of Gulf Coast Texas, where You can Grow Three Big Money-Making Crops a Year, and where Irrigation and Fertilization do Not Eat Up the Profits Your Hands Create.

I believe you could save Twenty-five Cents a Day if You tried. I know you would Try if you Realized that our Growers of Figs, Strawberries and Early Vegetables clear a net profit of \$300 to \$500 an Acre. Men have Realized more than \$1,000 an Acre growing Oranges in our Country. Remember that our Early Vegetables get to Northern Markets in Mid-Winter and Early Spring, when they command Top Prices.

One German Truck Grower on adjoining lands this spring realized nearly \$500 from three-fourths of an acre of Strawberries. You could do as well if you only Tried, and on a Ten-Acre Tract **Find Financial Freedom.**

The Biggest Price paid for a car of watermelons on the Houston Market this year was \$140. The car was shipped by the Danbury Fruit and Truck Growers' Association.

We are situated within convenient shipping distance of Three Good Railroads, and in addition to this have the inestimable Advantages of Water Transportation through the Splendid Harbors of Galveston and Velasco, so that our Freight Rates are Cut Practically in Half. The Climate is Extremely Healthful and Superior to that of California or Florida — Winter or Summer — owing to the Constant Gulf Breeze.

Our Contract Embodies Life and Accident Insurance, and should You Die, or become

totally disabled, Your family, or anyone else You name, will get the Farm without the Payment of Another Penny. If You should be Dissatisfied, we will Absolutely Refund your Money, as per the Terms of our Guarantee.

Write for our Free Book, which contains nearly 100 Photographs of Growing Crops, etc. Fill out the Blank Space below with your Name and Address, plainly written and mail it to the Texas-Gulf Realty Company, 1349 Peoples Gas Building, Chicago, Illinois. Read it Carefully, then use your Own Good Judgment.

* * *

Please send me your book, "Independence With Ten Acres."



Two Texas Gulf Coast Products

YOU Can be Drawing

Easily \$125 to \$175 Per Month to Start

I know you would like to draw such a salary and more, and you positively will earn this amount easy when you are a thorough

Practical Trained Draftsman and Designer

The constant demand for my trained men always exceeds the supply. Many positions paying \$75 to \$100 per week remain open on account of the shortage of the proper men to fill them. Some weeks over 250 positions paying the highest salary in all parts of the country are open and I would like to prove this to you by sending you one of my regular weekly lists of open positions.



Chief Draftsman Will Train You Personally and Instruct You Properly

On practical Drafting room work UNTIL you are absolutely competent in every respect as a first class Draftsman and UNTIL you are placed in a permanent paying position at a salary paying at least \$125 per month. This is a most exceptional opportunity for just a limited few selected ambitious men, between the ages of 16 and 40, whom I will train personally and give individual Instruction as required in order to fill the constant demand for properly trained men in this line.

Absolutely FREE! this Complete \$15 Draftsman's Working Outfit
IF You Write to Me **AT ONCE**

By sending the FREE COUPON on bottom of this page for my most liberal FREE OFFER for the \$15.00 Draftsman's Working Outfit, and also for my special offer to be

Earning Good Money at Once While Learning at Home

I offer these special and most excellent inducements only to the right kind of men, that have ambition and back-bone, that want to climb higher and advance further to the front. I want LIVE pushers, workers, producers, that are full of ginger and that will appreciate the opportunity of receiving such personal and practical working training as I furnish. Because I give EACH of my students my own PERSONAL ATTENTION—therefore, I limit the number of my students and if you desire to be one of the lucky ones to deserve such an opportunity then get busy NOW and WRITE TO ME AT ONCE. Don't wait until tomorrow, but do it TO-DAY Don't worry about paying expenses. You can earn much more than the small amount I charge for my spare time and personal training. This is not a money making correspondence school. We NEED good men to fill good paying positions and my practical working training is the outcome of the most urgent need for Draftsmen.



With my twenty-two years' experience as Chief Draftsman in handling men, I know exactly how urgent good men are needed all the time, and I will give you the benefit of my twenty-two years' experience at this work and will make you as good and high grade a man as you desire to be. You can draw \$125 to \$175 per month and steadily keep on going higher, as many good men draw \$5,000 per year in this line. You can do the same if you will grasp this opportunity to let me help you up into a higher atmosphere.

Remember: You can be earning good money while you are learning at home to do the practical Drafting room work.

FREE BOOK and EARNING while LEARNING Offer Coupon

**Chief Draftsman,
Division 1191,
Engineer's Equipment Co.,
Chicago, Ill.**

Without any obligation on me whatsoever, please mail your book "Successful Draftsmanship" and full particulars of your liberal "Personal Instruction" offer to a few students. It is understood that I am obligated in no way whatever.

Mail FREE COUPON at once for my book "Successful Draftsmanship," also list of open positions and for the free offer to be earning good money at once while you are learning at home. This offer is positively limited and in order to benefit thereby you must act AT ONCE—not tomorrow but TO-DAY.

**Address: Chief Draftsman
Engineer's Equipment Co. (Inc.)
Division 1191 CHICAGO, ILL.**

NAME.....

ADDRESS.....



I Guarantee

To instruct you UNTIL competent and placed in a permanent paying position at a regular Draftsman's salary of at least \$125 to \$175 per month and guarantee to furnish you free the complete Draftsman's working Outfit at once from the start.

Save money, time and shop equipment 30 Days Free Trial

HERE is a tool grinder with artificial diamond wheels that makes tool sharpening amazingly easy—and the low cost extra attachments transform it into 17 other machines—jig saw, rip saw, forge, lathe, drill, etc. Try it free for 30 days. Then, after 30 days' free trial, send it back at my expense if you feel you can afford to do without it.

LUTHER SHOP TOOL GRINDER

DIMO-GRIT, the new artificial diamond sharpening substance, cuts steel as emery cuts soft copper. No danger of drawing temper, no water cooling needed. Just a light touch of the wheels peels the steel away in tiny shavings. 25 times faster than grindstone, 10 times more efficient than emery. DIMO-GRIT Wheels will not wear lopsided or glaze. They outwear any number of grindstones, which is one money-saving—they make tools last longer and save time, another money-saving. They make tool sharpening so easy that your tools are always in perfect edge, making all your general work easier, quicker, and increasing production, which means **money-making**.

The Luther Shop Tool Grinder, foot and engine power—is built of steel and iron—nothing to wear out—enclosed shaft drive like an automobile, dust-proof bearings—runs easy as a sewing machine—DIMO-GRIT Wheels turn 2500 revolutions per minute—every part built like a high grade lathe. Tool rests and sharpening attachments enable anyone to do difficult grinding such as sharpening twist drills, chisels, plane bits, gumming saws, etc.

This outfit saves work, time and money more ways than any other machine in your shop. Write for free book and pick out the outfit you want for 30 days' free trial.

**LUTHER GRINDER
MFG. CO.**

1509 Michigan St., MILWAUKEE, WIS.

**30
Days
Free Trial**

No money needed, no promises to make—return this coupon and get Free 40 page book, and pick out the outfit you would like to try. I will send it to you free—use it like your own for 30 days—sharpen all your tools—then if you do not wish to keep it, return it at my expense. No hard feelings if you do.

The wonderful scientific story of artificial abrasives is told in this free book—a marvelous story of science.



14 Tools in One

The Luther shop outfit includes 14 attachments and accessories.

- 1—Fine Dimo-Grit wheel. 2—Coarse Dimo-Grit wheel. 3—Universal tool rest. 4—Chisel and plane bit guide. 5—Dimo-Grit razor hone. 6—Dimo-Grit scythe stone. 7—Dimo-Grit saw gunner. 8—Felt polishing wheel. 9—Medium Dimo-Grit wheel. 10—Cloth buffing wheel. 11—Dimo-Grit oil stone. 12—Dimo-Grit pocket hone. 13M—Plane bit honing attachment. 14M—Twist drill sharpening attachment.

The 17 extra attachments, jig saw, drill, forge, lathe, etc., enable you to get a full shop equipment at amazingly low cost.



LUTHER GRINDER MFG. CO.

1509 Michigan St., Milwaukee, Wis.

Please send me 40-page free book from which I can select a Luther Grinder outfit for 30 days' free trial, should I decide to do so. This puts me under no obligations of any kind.

Name.....

Address.....

Oh, you friend of mine!



Velvet

THE
SMOOTHEST TOBACCO

WHEN your day's work is over, when you're comfortable at home, when your pipe is charged with "The Smoothest Tobacco"—then you think great thoughts. And Velvet helps—always—either at home or at the office.

Grown in favored Kentucky—in the best of the Burley country. Then aged till it's mellow—till it's just right.

This is the *only* way to ripen the flavor and take out the bite.

Try it.

Velvet in full size two-ounce tins, for pipe smokers—10c. Velvet is excellent rolled as a cigarette—it is packed in one-ounce 5c bags for this purpose—convenient for the pocket. Can also be had in sixteen-ounce glass jars—with moistener top.

Liggett & Myers Tobacco Co.



What of Your Future?

ARE you doing work which is laying the foundation of a successful, happy life? Or are you just drifting along, doing any work that you can get, whether you like it or not?

You can't afford to disregard the future. If you are between 17 and 25, the age when you lay the foundation of your life's success or failure, you should be at work where everything you do counts.

If you feel that your present job will not lead you well on to the road to success, find out what the U. S. Navy will do for you. Call at the nearest Navy Recruiting Station (we will send you the address) and get the complete story.

Find out everything about Navy pay, hours, promotion, the healthy life, perfect physical training, and fine class of men with whom you'll be associated. Get full details about chances to learn a trade, to see the world and to save up money. The officers and men at the Recruiting Station will answer every question. You'll enjoy meeting them and be glad you called, even if you decide not to enter the Navy.

UNITED STATES NAVY

Send for "The Making of a Man-of-Warsman," a free book which describes the daily life of Navy men, in simple language and interesting photos. Write your name and address on a post card asking for this book *now*—so you won't put it off and forget. Send to

BUREAU OF NAVIGATION, Box 69, NAVY DEPT.,
WASHINGTON, D. C.

*Target Practice
at Training
Station*

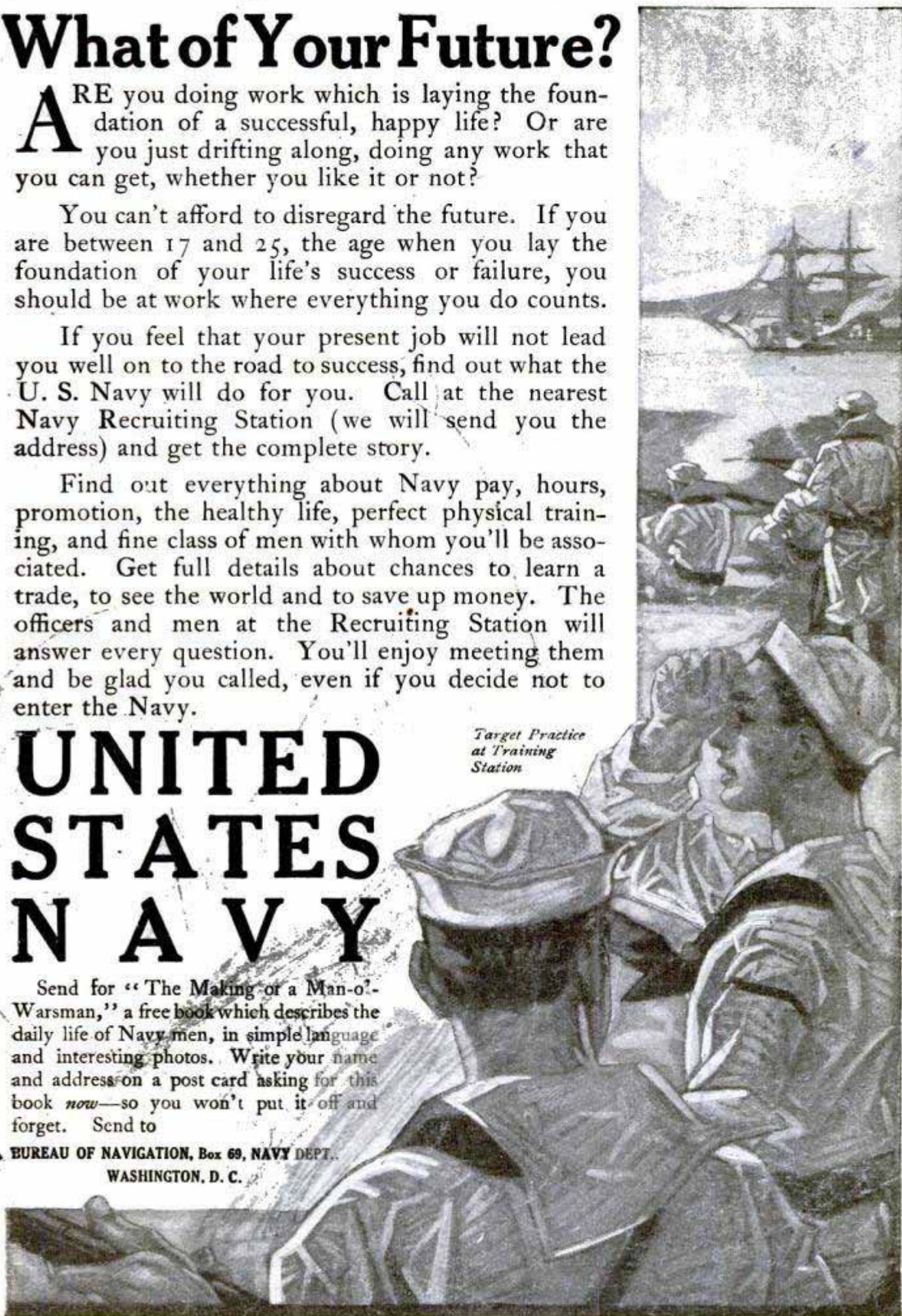

HE WHO USES CYPRESS BUILDS BUT ONCE

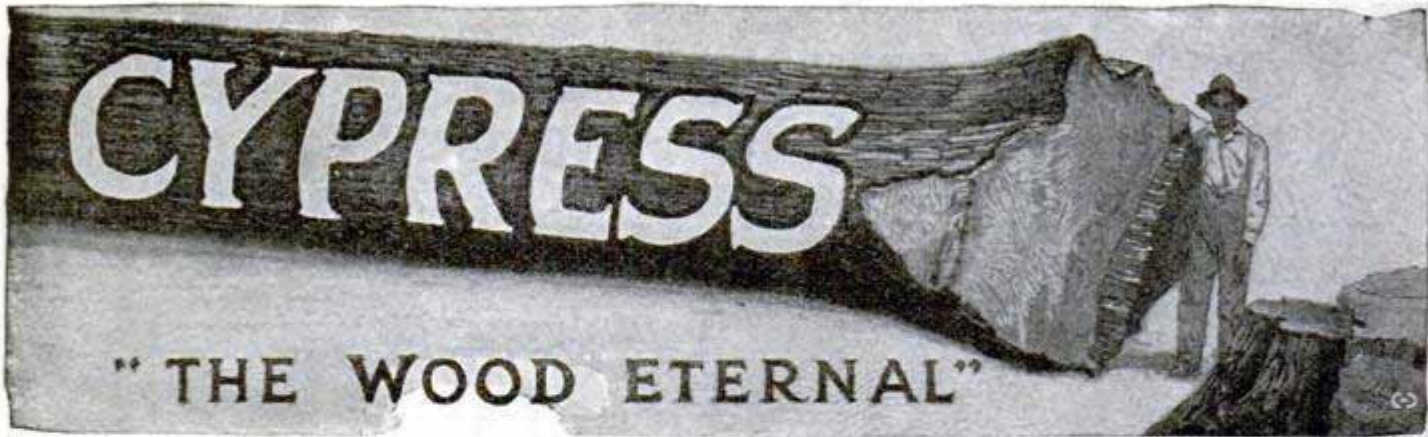

SO MANY PEOPLE KNOW
so little about woods
(and their relative values—How is it with you?)

SO MANY PEOPLE THINK
that "LUMBER IS LUMBER"—(How often do YOU
specify the kind of wood you want used by your builder?)



SO MANY PEOPLE BELIEVE

that frequent *Repair Bills* are "*Necessary Evils*"—

that we believe we are doing a public service in informing you and other intelligent people on

CYPRESS

("THE WOOD ETERNAL")

HERE IS CYPRESS VS. AN IRON PLUG:

About 110 years ago, when Louisiana was a French Province, the Water Mains of New Orleans were CYPRESS logs, 18 feet long by 22 inches diameter, with a 5-inch hole bored lengthwise. These were joined by short iron tubes, tapered at both ends. A few years ago these were replaced by the most modern system. Below is a photograph of a section of one of the CYPRESS mains just as it was dug up—as sound as ever after 100 years' contact with wet earth.

Below is a photograph of one of the iron connections just as dug up—most of them rusted past all usefulness.



HERE IS CYPRESS VS. WEATHER:

A photograph of a CYPRESS SHINGLE from the Austen Homestead, Staten Island, N.Y. built in 1710, and at last accounts still occupied by descendants of its original builders, with the original CYPRESS roof practically intact.

"*He who uses CYPRESS builds but once.*"



CYPRESS is in truth "the wood eternal." If you are putting up a palace or a pasture-fence, and want to build it "FOR KEEPS"—USE CYPRESS

There is a liberal education (and a wonderful INVESTMENT value for you) in this CYPRESS advertising—and in the detailed information and reliable counsel to be had promptly *WITHOUT COST*, if you will *WRITE US YOUR OWN NEEDS* (big or little), and *ASK YOUR OWN QUESTIONS* of the "ALL-ROUND HELPS DEPARTMENT" of the

SOUTHERN CYPRESS MANUFACTURERS' ASSOCIATION

1219 HIBERNIA BANK BUILDING, NEW ORLEANS, LA.

Probably your lumber man sells CYPRESS; if not, WRITE US, and we will tell you the dealer handiest to you.

Please Mention Popular Mechanics

Popular Mechanics Magazine

318 W. Washington Street, Chicago, U. S. A.

EDITED BY H. H. WINDSOR

ISSUED MONTHLY

SUBSCRIPTION:

SINGLE COPY, 15 CENTS

In United States, and its possessions, Cuba and Mexico, per year, postpaid - - - - \$1.50

To Canada - - - - - 1.75

To all other countries in the Postal Union - - - - - 2.00

All subscriptions are discontinued at expiration. Please examine the date printed on your wrapper.

Entered as Second Class Matter Sept. 15, 1903, at the Postoffice at Chicago, Illinois, under Act of March 3rd, 1879.

Published monthly by POPULAR MECHANICS CO.

Copyrighted 1913, by H. H. WINDSOR.

The attention of prospective advertisers is called to the policy of this magazine in accordance with which the publisher waives all claim for payment of any advertisement appearing in any issue where the number of copies actually printed and circulated is less than the number printed on the front cover page.

Contents for February, 1913

Diving Motor Car for Deep-Sea Divers.....	155	The Sand-Clay Roads of North Carolina.....	192
Auto Stage Has Smoking and Baggage Rooms.....	156	Comment and Review.....	193
Looking Down on the Fire-Control Squad.....	157	By H. H. Windsor	
Aviettes Growing Up from Bicycle Models.....	158	Massive Legs of Statue of Norwegian Hero.....	197
Winter Gales and the New Skyscrapers.....	160	Steel Hand that Lifts Fifty Tons.....	198
Checks and Bank Notes that Speak.....	162	Long Reinforced-Concrete Viaduct in Cincinnati.....	198
Three-Horsepower Central Electric Station.....	162	Training Canaries in a Death Chamber.....	198
Novel Collapsible Body for Automobiles.....	163	Airman Photographed Falling to Death.....	199
An Electric-Wire Fatality.....	164	Gasoline-Electric Car with Roof Radiator.....	200
Fire at the Bank of England.....	164	An Unusual "Spite-House" Idea.....	200
Australia Has Talking Sign in England.....	164	Cavalry Equipment is Brought Up to Date.....	201
Enormous Gas Holder for Baltimore.....	165	Cable Runway Launches Hydro-Aeroplane.....	203
"Knockdown" Concrete Bungalow.....	165	Paris Has Steam Street-Railway Service.....	203
Harnessing the Mississippi for Hydroelectric Power.....	165	Men Wear Blinders as Object Lesson.....	204
Catching Grasshoppers with Suction Wagon.....	168	Modern Rifle Wounds in the Balkan War.....	204
Mine Telephone Operated by Throat Vibrations.....	169	Typewriting 593 Words a Minute.....	205
British Dirigible with Torpedo-Shaped Car.....	169	Automobile Equipped with Wireless Telephone.....	205
Businesslike Costume for Feminine Climbers.....	170	An Arab "Wind Tower".....	205
An Aeronaut Explodes His Balloon with Dynamite.....	170	Stands on His Head on Skyscraper.....	206
Railroad Furnishes Stump Pullers to Farmers.....	170	New Zeppelin Dirigible Breaks All Records.....	206
Electric Drill Held in Place by Magnet.....	171	Power Development at Niagara Falls.....	206
Molding Lead into Works of Art.....	172	Faster Bullets for New Army Rifle.....	207
Terrific Speed Made by Automobile.....	172	Boston's New Electric Mail Tubes.....	207
Stepless Storage-Battery Cars for New York.....	172	Highest Tower in World Proposed for Germany.....	208
The "Bookless" Library of "Castlegould".....	173	"Walking Club" Organized to Find City's Faults.....	208
Sponge Farming in the Ocean.....	173	Measuring Wind Pressure on Aeroplanes.....	208
Large Chinese "Junk" for Panama Exposition.....	174	Quick-Action Drill for Brickwork.....	209
Using Electricity in Excavation.....	174	Pressure Gauges of Big Floating Dock.....	209
Oiling Locomotive Wheel Flanges with Spray.....	175	Two-Passenger Single-Seat Motorcycle.....	210
Balanced-Beam Bridges over English Canal.....	175	How Seals Cut Steps in Ice Cakes.....	210
Automobile Fitted to Carry Bicycle.....	175	Field Telephone of the Mexican Army.....	210
Automatic Fire-Sprinkler Demonstration.....	176	Girls Cross River on Two-Rope Bridge.....	211
Chameleon Effects for Coming Dresses.....	176	Practical Demonstration of Auto Mud Slinging.....	211
The Manhood Dance of the Amaxosa Tribes.....	176	A Portable Outfit for Pigeon-Photographers.....	212
Gun Caisson Converted into Tower.....	177	The United States Army's "Flying Boat".....	212
Bungalow Constructed of Irrigation Piping.....	178	Luxurious Motor Car for Touring.....	213
Electrocution for Diseased Animals.....	178	Growing Three Oaks for Town Symbol.....	213
Vessel Launched with Steam Up.....	179	Struggling to Feed the Voracious Oil Engine.....	215
The Government's Rack of Precious Mugs.....	179	By J. C. Miller, M. E.	
Calliope Mounted on Steam Roller.....	180	Fifty-Five Miles an Hour on Soup-Bowl Track.....	217
Fire Photographed by Its Own Light.....	180	Artistic Picture Made of Paper.....	217
How Far Light Beams can be Thrown.....	180	Postage-Stamp Vending Machine Adopted.....	218
Electric Furnace for Producing High-Grade Steel.....	181	New York's Skyscraper Apartment Houses.....	218
Columbus Goes into McKinley Statue.....	182	Enormous Power from Water Mains.....	219
Scenes from the Balkan War.....	183	Bulldoz Chimney with Wagon Wheel.....	220
Lighting the Panama Canal.....	186	Saved from Death by a Match.....	220
High-Pressure Gas-Lighting Tests.....	187	Fatal Head-On Collision at Indianapolis.....	221
Acetylene Railway Signal.....	187	Cash Register Mounted on Rear of Automobile.....	221
Skyscraper Which was Not Fireproof.....	188	The Lantern Ceremony of Bryn Mawr College.....	222
Testing Hardness of Rails by Ball Pressure.....	188	A Birthday Cake for a City.....	222
Novelties at the French Automobile Show.....	189	Water-Pipe Leaks Found with Blue Solution.....	222
Battleships Too Big to Enter Ports.....	190	Trophy for Long Flight Awarded.....	223
Valveless Pump Creates Highest Vacuum.....	190	Live Dog as Part of a Muff.....	223
Aerially Propelled Hydrocycle.....	192	Aeroplane Photograph of Aeroplane Plant.....	224
		Court Decides that Ditch is not Part of Road.....	224
		Keeping Tab on Birds by Leg Bands.....	224

[Continued on Page 6]

Popular Mechanics offers no premiums; does not join in "clubbing offers," and employs no solicitors to secure subscriptions. It is for sale by nearly every newsdealer in the United States and Canada.



Cleaning Up Everything

SILVER
WRAPPER



BLUE
BAND

One touch of that big cake makes the whole world clean. The Sapolio fraternity of particular homekeepers is bringing down the high cost of clean homes because the great cake **CLEANS, SCOURS, POLISHES** all through the house, and in both effort and money it

WORKS WITHOUT WASTE

ENOCH MORGAN'S SONS COMPANY, Sole Manufacturers

Let Us SHOW YOU
Hundreds of Other
Testimonials. Write
now for Free Book



WOULD YOU GIVE \$12 TO LEARN THE AUTO TRADE? Then READ Carefully—

\$50 would not buy my course. After I got through Book 4 of instructions 13 and 14, 15 and 16, I had a job grinding valves. I did the job in four hours. Next day I put on four piston rings, which took six hours. These two jobs paid for my Course. I am now overhauling an engine for a party. I am not afraid to tackle any job now. If I get stuck I am sure I can find the remedy in the instructions. I knew nothing at all about an auto before, and I want to thank you for helping me.—Henry G. Ehredt, 523 E. 8th Av., Homestead, Pa.

If we *prove* to you that we have started hundreds of others into the repair business and as chauffeurs—who had no previous experience and who knew no more about an auto than you do right now—will you enroll?—of course you would. Now the next thing for you to do is to write me just as quick as possible and *let me prove it*.

H. M. Fewins and S. T. Slayback, both graduates, are now running a Garage and Repair Shop at Woodbine, Iowa.
E. Dwyer, 31 N. Willow St., Montclair, N. J., 19 years old, receives \$25 a week and board.

Harry J. Herbin, Jamestown, Kans., was a farmer, but has doubled his income repairing and selling autos.
W. R. McClelland, Astoria, Ill., was an auto driver. Became professional chauffeur and more than doubled his salary.
Donald Stewart, Oakland City, Ind., became a chauffeur at \$25 a week.
And we could continue until we had filled this and several more pages.

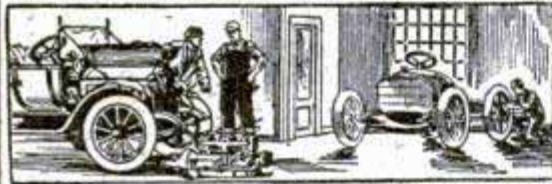

Our book of testimonials, showing photos of students and their shops—free.

Open a Repair Shop of Your Own

We can so thoroughly train you that you can open a repair shop or drive a car and make many times more than you are making now. Don't forget, we help you get your start with our *Employment Plan*, if you want it.

DYKE'S NEW IDEA OF TEACHING BY MAIL WITH WORKING MODELS

is something new. We use *real* working models—not just one but *five*. On these models you get actual practice, see the actual operation and learn more than you could from the auto itself—it's easy and quick. You don't have to study hard with this system—we teach through the eye—a new idea. We are the originators of the system of teaching by mail with models. We also use charts—175 of them and a 16 page manikin. Our 40 instructions and Repairman's Instructions are simplicity itself—simple as A B C.

Our Employment Plan for Students

This represents years of work to provide something that no other school had, namely, a way for the graduate to get acquainted with auto and garage owners, to prove his ability and to immediately secure profitable employment.

Mr. Dyke has been identified as a pioneer inventor, supply man, etc., with the auto industry since its beginning. He originated the first auto supply co. and published the first book on autos in America. No other man with such experience is today teaching others. And all the experience and inside information of the auto business he has thus gained, is embodied in this *Employment Plan*.

WRITE TO-DAY for Details of Employment Plan and THIS FREE BOOK

It is instructive and interesting—does not cost you a cent and places you under no obligations whatever—You need it for your own sake, not mine. Don't wait—there's no profit in waiting—WRITE NOW and learn how you can obtain all this training for only \$12, if you act immediately.

HOW TO GET INTO THE AUTO BUSINESS AND ITS OPPORTUNITIES

DYKE'S CORRESPONDENCE SCHOOL OF MOTORING Box 88, Roe Building, ST. LOUIS, MO.

NOTE.—This is a chance you may never have again to get into the fastest growing, best paying industry the world has ever known, a field that is growing faster than men can qualify for the work.

Please Mention Popular Mechanics

LEARN TO REPAIR AND RUN AUTOMOBILES

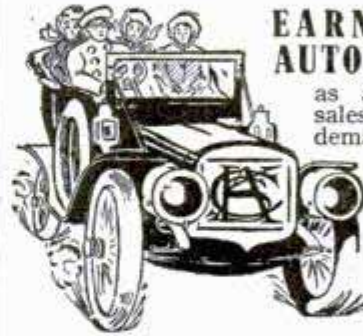

EARN BIG MONEY IN AUTOMOBILE BUSINESS

as a chauffeur, repairman, salesman. Work pleasant. Big demand for trained men. Fine chances for starting automobile liveries, agencies, taxicab and repair companies. Learn the automobile—every part, and its mechanical operation thoroughly and practically in a few weeks. Write today for our interesting free book and learn about the tremendous opportunities everywhere in

this new business and our excellent course of training.
KANSAS CITY AUTOMOBILE SCHOOL
(Conducted by CLIFF HOGAN)
(Largest and Best Equipped Automobile School in America)
2108 E. 15th Street, Kansas City, Mo.

This book makes it *easy* for anyone to do *good* lettering
12,000 copies sold



Contents:

Block Letters:
Heavy, Outline, Condensed, Expanded, Fancy, Shaded and Italics.
Gothic:
Condensed, Expanded, Italics.
Roman:
Fancy, Italics, Script: Modern, Architectural.

12th Edition—JUST OUT

Contains 40 different alphabets—four of which are new.

55c postpaid

Well printed on fine paper and handsomely bound in cloth
Spon & Chamberlain 125 P.M. Liberty St., NEW YORK, U.S.A.

Learn to be An Auto Expert

Six weeks from the day you commence your studies at this great practical school you will be able to repair any make of automobile and drive any car on the market.

Earn \$75. to \$200. a Month

Many of our graduates make even more than this. Big demand for competent repairmen, demonstrators, garage managers and chauffeurs. All practical work. No books used. No tools to buy. Write today for big illustrated free book. Address,

AUTOMOBILE TRAINING SCHOOL, 1185 Locust St., Kansas City, Mo.



BE AN ILLUSTRATOR by mail how to draw for magazines and newspapers.

Learn to draw. We will teach you School of Illustration 112 Page Bldg. Chicago, Ill.

Send for Catalog



IF YOU STAMMER

Attend no-stammering school till you get my large FREE book and special rate. Largest and best school in the world curing by natural method. Write today. Leo Wells Millard, Pres., North-Western School for Stammerers, Inc., 917 First St., Milwaukee, Wis.



ADVANCE OF THE GRAND ARMY

NAPOLEON'S name fills more pages in the world's solemn history than that of any other mortal. The advance of his Grand Army into Russia is the turning point in his career and marks the beginning of his downfall. The picture shown herewith from Ridpath's history, the original of which was displayed at the World's Fair at Chicago, marks but one event out of thousands which are fully described and illustrated in the world-famed publication,

Ridpath's History OF THE World

We will name our special low price and easy terms of payment only in direct letters. A coupon for your convenience is printed on the lower corner of this advertisement. Tear off the coupon, write your name and address plainly and mail. We do not publish our special low price for the reason Dr. Ridpath's widow derives her support from the royalty on this History, and to print our low price broadcast would cause injury to the sale of future editions.

Mail Coupon for 46-Page FREE Booklet

We will mail you our beautiful forty-six page free booklet of specimen pages from the History without any obligation on your part to buy. Hundreds who read this have thought that sometime they would buy a History of the World and inform themselves on all the great events that have made and unmade nations. Don't you think it would be worth while to at least send the coupon and find out all about our remarkable offer?

Ridpath's Graphic Style

Ridpath's enviable position as an historian is due to his wonderfully beautiful style, a style no other historian has ever equaled. He pictures the great historical events as though they were happening before your eyes; he carries you with him to see the battles of old; to meet kings and queens and warriors; to sit in the Roman Senate; to march against Saladin and his dark-skinned followers; to sail the southern seas with Drake; to circumnavigate the globe with Magellan. He combines absorbing interest with supreme reliability, and makes the heroes of history real living men and women, and about them he weaves the rise and fall of empires in such a fascinating style that History becomes as absorbingly interesting as the greatest of fiction.

Mail the coupon for full information. Address

**WESTERN NEWSPAPER ASSOCIATION
CHICAGO**

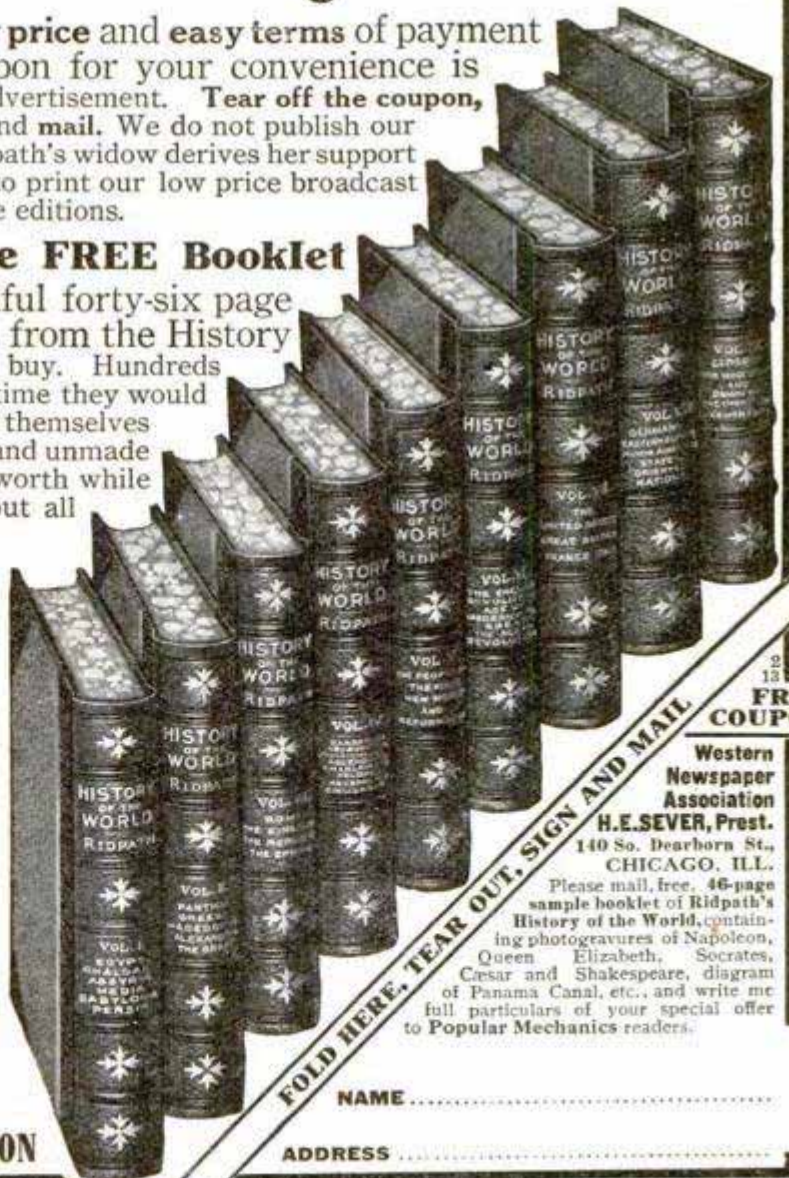

FOLD HERE. TEAR OUT, SIGN AND MAIL

NAME

ADDRESS

**FREE
COUPON**

Western
Newspaper
Association
H.E. SEVER, Pres.
140 So. Dearborn St.,
CHICAGO, ILL.

Please mail, free, 46-page sample booklet of Ridpath's History of the World, containing photogravures of Napoleon, Queen Elizabeth, Socrates, Caesar and Shakespeare, diagram of Panama Canal, etc., and write me full particulars of your special offer to Popular Mechanics readers.

Our Supreme Offer, Starting Now, of Our Latest, Greatest Business Books, Untold Value, at 60 Cents Each

Yours, the Mighty Total Experience of Generations in Thousands of Businesses in Ten Powerful Volumes, almost FREE

1497 Vital Business Secrets

Here are the plans, the rules, the answers of business which put men right in their struggle for success

If you only knew! If you could only realize that this offer places within your reach the knowledge which will straighten out snarls in your business life, make the way plain. Here are 1,497 real money methods, proved by thousands of businesses for every business man, big or small, steel man or grocer, manager or bookkeeper. Since the first edition, this remarkable Business Man's Library has been purchased by 39,463 concerns and by many of the greatest business men living.

One little sentence in one of these books may break down a barrier between you and success

60-Cent Price the Result of 10 Years of Striving

A short time ago many thousands paid us \$27 for a set of books similar to these, but we were impatient that more thousands, who could not afford them at that price, might obtain them. We find that the first edition sales absorbed practically all of the editorial cost, so that we need make the price of this edition only on the raw product—paper, printing, binding and shipping—and the mere cost of telling you about them. We searched the world for a light, strong paper to take good printing, to reduce binding and shipping expenses—and we found it in Germany. Then we reduced the margin on plates, binding and packing. Offering 30,000 sets of these Business Man's Libraries at 60 cents a volume, now means practically giving away complete business experience which 999 out of 1000 persons could not ordinarily obtain after long years of up-hill work.

The things which have cost men dearly in fortunes and careers are made plain to you in the brilliant pages of business secrets. Out of the struggles of modern business, the failures as well as the monumental achievements, comes this message to millions, as the answer to daily questions, doubts, ignorance—at a price which does not approach the value of many a single paragraph! This is the greatest offer we can possibly foresee for this decade.

These books present 2,079 pages jammed full of new ways of making money told by the Master Minds of Business. This set is a guide to the man in the private office, and to the worker it gives the short cuts to better days, larger salaries and eventual success. Why waste years plodding and blundering along, spoiling opportunities and wasting chances when you can get inside knowledge of business, of the executive board, the departments, the factory, of financing and selling and advertising? What power can hold you back from accepting this offer at only 6 cents a day spread over only four months?

Is a small self-limited job keeping you from seeing and knowing? Find out from 112 great, big men—not mere writers, but national business men, whose names inspire admiration and confidence—Alexander H. Revell, Founder and President of the great firm bearing his name; Sears, Roebuck & Company's Comptroller; Montgomery Ward & Company's Buyer; John V. Farwell & Company's Credit Man; Sherwin-Williams Company's President; and 107 others. Let them place at your disposal the crystallized experience of the whole world of business.

Then add the help which you will get from SYSTEM, which stands pre-eminent, the Magazine of Business, with 260 to 356 Pages in every issue and 750,000 regular readers. Whether you own your own business or are employed—SYSTEM will show you new ways of saving time and cutting out drudgery. It has helped hundreds to better salaries, bigger profits that would have been impossible, undreamed of, without SYSTEM. Read our offer now and accept priceless help at trifling cost—less than you pay for coffee or cigars, distributed over four months only.

Our Supreme Offer:

We offer you for 6 cents a day, term only four months, these 10 substantial volumes, published in an attractive 30,000-set edition, printed in large bold type on fine light-weight paper, full cloth bound with covers in four colors—suitable for any library or desk. And this 6-cent offer includes an 18 months' subscription to SYSTEM (price \$3.00). That's \$9.00 only in all, spread out this over four months. Your check or money order, or a dollar bill, today will start the books to you tomorrow, transportation charges fully prepaid, and give you SYSTEM for eighteen months. One dollar now and \$2.00 a month until \$9 is paid. (West of the Rockies, \$10; Canada, \$11). Long before the first month is out, these books will have a chance to put into your pocket many times their cost. Send without delay as this Edition is going to disappear the fastest of any we ever put out.

Simply tear this ad out now, say "I accept your offer in Popular Mechanics, February, 1913", write your name and address on a piece of paper, pin all together with your dollar and send to SYSTEM, Wabash and Madison Sts., Chicago

How to Sell Goods

How to stir up a sales force—How to do business in dull seasons—How to route, handle and check salesmen—How to train, develop and coach a sales force—How to win the dealer's cooperation and support—How to meet objections and how to be a good "closer"—How to handle wholesalers and retailers to the best advantage—How to judge a good salesman—How to work the "big stick" plan of selling goods to retailers—How to analyze your proposition and pick out its selling points—How to make the consumer influence dealers to buy your goods—How to get out of the ranks of the "clerk" and become a real salesman.

And hundreds of other vital pointers and plans for clerks, salesmen, retailers, wholesalers, manufacturers, mail order houses, etc.

How to Buy at Rock Bottom

How to know to a nicety what stock is on hand—How to keep track of promises, agreements, deliveries, etc.—How to play one salesman against another and take advantage of every opportunity to get a lower price—How to thoroughly master the ins and outs of the buyer's position so that you can meet the crack salesmen in every line on equal terms—How to devise a simple system which will bring to your notice automatically, all data, prices, etc., about a given article—How to formulate a complete purchasing and record system for a mail order house, a factory, or a retail, or wholesale store.

And other priceless pointers on purchasing that business men should know about.

How to Collect Money

How to judge credits—How to collect by mail—How to handle "touchy" customers—How to be a good collector and how to hire one—How to organize a credit and collections department—How to weed out dishonest buyers from the safe risks—How to get quick, accurate, inside information about a customer's ability to pay—How to write smooth, diplomatic letters that bring in the money without giving offense—How to devise a simple and effective system of insuring prompt and periodical collections of all your accounts. And valuable information obtainable in no other way, for credit men, collectors, accountants and every business man interested in this vital department.

How to Advertise a Business

How to plan and lay out an advertising campaign—How to judge and select the right medium to reach any given class—How to write, refine, illustrate, display, place, and check advertisements—How to develop a crisp, hard-hitting, goods-selling style of expression—How to prepare bold, original head lines—How to conduct a magazine campaign—How to "drive home" its effect on dealers, wholesalers and consumers simultaneously—How to make a smart appropriation count—How to advertise for inquiries and turn them into sales.

And an infinite variety of other practical points on every phase of advertising.

How to Meet and Handle Men

How to develop strong individual personality—How to approach and impress men—How to attract, interest, persuade, conciliate and convince men—How to break down the walls of reserve and prejudice in an interview and turn enmity into cordiality and respect—How to pick men—How to weigh, judge, analyze ability in a prospective employe—How to train and coach new employes—How to inspire men with separate determination and trying loyalty to work, to think, to act, even to fight in your behalf—How to keep in personal working touch with an entire working force, making each man feel your special interest in him. And section after section meeting and managing, directing and controlling, inspiring and enthusing all sorts and dispositions of human nature.

How to Manage a Business

How to keep track of stock—How to figure and charge estimates—How to check deliveries and mistakes—How to get the most out of those under and around you—How to size up the money-making possibilities of new ventures—How to detect and eliminate needless items of expense and waste—How to get up blanks, forms, records and simple systems for all kinds of businesses—How to devise a perpetual inventory system that will tell you every day the value of all material on hand—How to turn a losing business into a profitable one—How to make a profitable business more profitable. And countless other things that every man in an executive position needs in his daily work.

How to Get Money by Mail

How to write ads—How to begin a letter—How to turn inquiries into orders—How to formulate a convincing argument—How to get your reader to ACT at once—How to cover territory salesmen can't reach—How to keep tab on results of all mail work—How to key ads, circulars and all mail sales—How to prepare an enclosure for a business-getting letter—How to supplement the efforts of salesmen with a business-getting letter—How to answer, file and follow up inquiries from advertisements and those which come in the regular course of business. And page after page of practical working detail—not only for mail order firms but particularly helpful to those not making a specialty of mail order business.

How to Stop Cost Leaks

How to detect waste—How to make an inventory—How to figure overhead expenses—How to systematize an entire factory or store—How to cut out red taps in a simple cost system—How to keep close watch on material and supplies—How to apportion the right number of employes to a specific job—How to decide between piece-work, day wages and bonus systems—How to keep tab on productive value of each machine and employe—How to figure depreciation, burden, indirect expense, upkeep, profit, loss and cost. And chapter after chapter of priceless plans for practically every kind of business in which an accurate cost system is essential to money-making success.

How to Get and Hold a Position

How to apply for a position and get it—How to answer a want ad., in person or by letter—How to compose a strong, original letter of application—How to secure the highest market price in selling your services—How to prepare and apply for advancement—How to quickly gain and hold your employer's confidence—How to master the entire routine, the science, the duties, the problems of an executive, a department head, a general manager—How to study the work of the man above you, without offending or antagonizing him.

Not good advice merely, but practical, down-to-the-earth instruction in the branches of business that will enable the ambitious employe to actually earn more—have more—be more.

Office and Accounting Methods

How to keep office accounts—How to devise and install a complete record and accounting system—How to take loose leaf trial balances—How to devise a system that will give you your monthly statement on time—How to install a simple system that will give you a daily report of your business condition—How to use the loose leaf in handling collections—How to manage and systematize an office—How to speed up an office force to top-notch efficiency—How to keep exact office costs—How to handle a stock-keeping and shipping department, with complete inventory, receiving and shipping blanks and forms for each. How, in fact, to enjoy peace of mind, comfort and satisfaction, in the certainty that there are no faulty methods throughout your entire office organization.

India Paper Edition**The
First****Webster's****And
Best****Universal Dictionary****This dictionary is not published by the original publishers of Webster's Dictionary or by their successors.**

This is a new Dictionary. It is printed from new type, new plates and is an entirely new work. It contains no supplement, no words added at the bottom of page. Being new, every word is in its proper alphabetical order. It is complete and unabridged. The printing of this work on thin India Paper is the greatest innovation in the history of bookmaking. The exclamation of everyone is: "Why has it never been done before?" The old style Dictionary measures nearly six inches in thickness and weighs from twelve to fifteen pounds. Printing the same work from the same plates on the beautiful India Paper reduces the bulk to only one and a half inches in thickness and the weight to within four pounds. Read our Special Advance Offer below.

Old Style
Edition

Weight 15 lbs.

India Paper
Edition

Weight 4½ lbs.

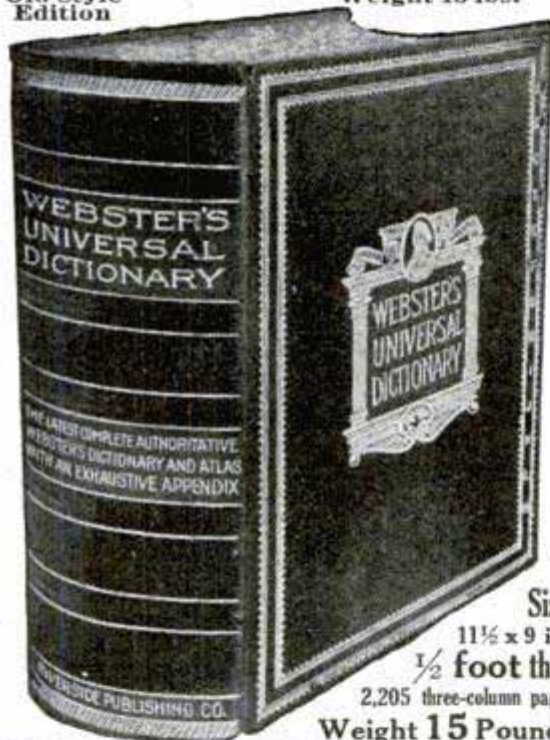

Size

11½ x 9 in.

½ foot thick

2,205 three-column pages

Weight 15 Pounds

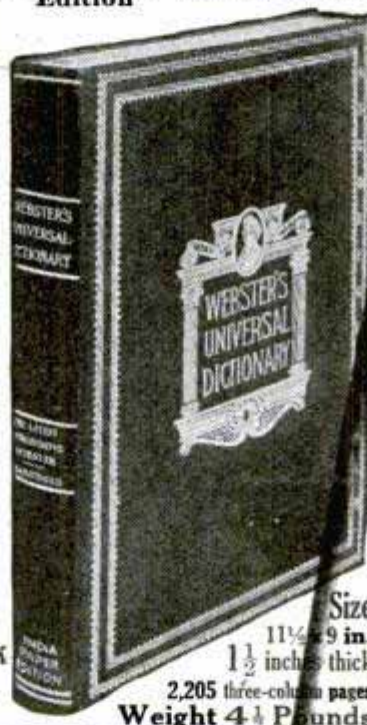

Size

11½ x 9 in.

1½ inches thick

2,205 three-column pages

Weight 4½ Pounds

15 Books in One

1. Complete Dictionary of the English Language.
2. Modern Gazetteer of the World.
3. Dictionary of Authors with Titles of Works.
4. Dictionary of Noted Names in Fiction.
5. Dictionary of Foreign Words and Phrases.
6. Dictionary of Scripture Proper Names.
7. Dictionary of Greek and Latin Proper Names.
8. Dictionary of Abbreviations and Contractions.
9. Pronouncing Dictionary of Biography.
10. Signs and Symbols Used in Writing and Printing.
11. Marks Used in Proof-reading.
12. Values of Standard Foreign Coins.
13. List of Amended Spellings.
14. Faulty Diction and How to Correct it.
15. Complete Atlas of the World. 64 Maps.

India Paper Edition

THIS beautiful India Paper Edition is complete and unabridged. It is bound in full Russia, and is so light that it may be held in one hand while turning the leaves with the other. Who has not wished for a lighter, more easily handled Dictionary when lugging the heavy unabridged Dictionary from the library? It is about like having your wife or daughter lug a sack of flour from the pantry. What is the use? Why weigh them down with a Dictionary that you can hardly carry when you can buy the beautiful India Paper Edition in so light and handy a form? The illustration shows the Dictionary printed on regular book paper and the same work containing the same number of pages printed on India paper. **Take your choice.** In this advance offer by mail a very substantial saving may be had, since no agents' commission or dealers' profit is involved in the transaction. Read our Special Advance Offer.

Special Advance Offer

WE will enter your order for this beautiful India paper Dictionary, bound in full Russia leather, and ship for your examination, for a payment of \$1.00 on approval and \$3.00 per month thereafter for five months, until our Special Advance Offer Price of \$16.00 is paid. This is but little more than the price of one of the old style editions of Webster's Universal Dictionary printed on plain book paper, although the manufacturing cost is almost double. This price is strictly limited to the small edition now being printed. Mail application promptly.

Approval Order

The Riverside Publishing Co.,
Marquette Building, Chicago

Popular Mechanics
2-13

Please ship for my examination Webster's Universal Dictionary, India Paper Edition, patent thumb index, bound in full Russia leather. If after five days' examination I am entirely satisfied with the work, I will send you \$1.00 as first payment and \$3.00 per month thereafter for five months until your Special Advance Offer Price of \$16 is paid. If not satisfactory I will notify you within five days and return to you as soon as I receive shipping instructions. A discount of 5 per cent will be allowed customers who remit cash with order. Money refunded if volume is unsatisfactory.

Name _____

Address _____

Enclose business card, letter head, or give references

PAD Boston Garter

Velvet Grip

HOLDS YOUR SOCK SMOOTH AS YOUR SKIN

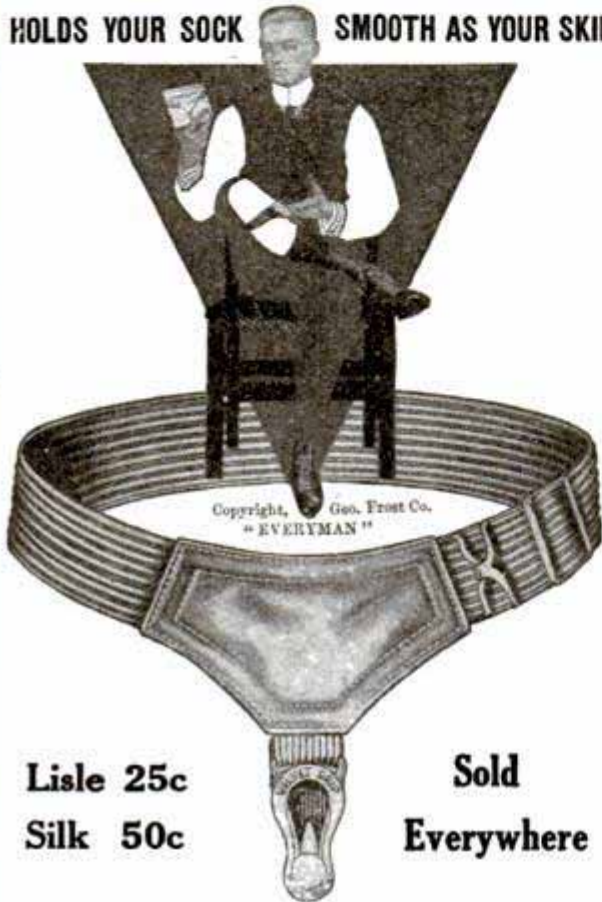

Lisle 25c
Silk 50c

Sold
Everywhere

To say "Sold by all dealers" is justified only if true. When we refer you for **Boston Garter** to all dealers in men's wear, we know you will not be disappointed. We also know a trial will convince you that **Boston Garter** excels in comfort and reliability.

GEORGE FROST CO., MAKERS, BOSTON



200 KINDS IRON, WOOD, WIRE & STEEL PUZZLES

Sample with Catalog, 10 cents or 3 leaders for 25 cents.

WESTERN PUZZLE WORKS
St. Paul, Minn.



MAGIC Tricks, Books and Supplies

Amateurs supplied as well as the great Professionals

Easy, interesting and entertaining. Mystify and astonish your friends. Large, illustrated professional catalogue of wonders. Price 10c
Read & Covert, 821 E. 43d St., Chicago, Ill.



Every Boy His Own Toymaker

Greatest boys' book ever written. Tells how to make a Steam Engine, Telephone, Magic Lantern, Boats, kites, balloons, electrical and mechanical toys, traps, fishing tackle. 200 illustrations; also catalog of 150 puzzles, Keller's Magic Ace Trick Card and "DOUBLE THROAT" warbler and bird call all for only 10c. WESTERN PUZZLE CO., ST. PAUL, MINN.

MONTHLY CASH PRIZES

Until further notice in this magazine the Editor of Popular Mechanics will pay two cash prizes each month for the best original contributions to its

SHOP NOTES DEPARTMENT

\$10 for the Best Contribution
\$5 for the Second Best

THIS IS IN ADDITION to our usual rates for such contributed articles.

Quality, not length counts. Checks will be sent on the last day of each month for the prize articles received during that month. Publication in the magazine will follow in about two months.

PRIZES AWARDED FOR DECEMBER, 1912

- First Prize—HENRY J. MARION, Pontiac, Mich. \$10
"Separating Steel Balls of Different Sizes"
Second Prize—FRED L. KING, Islip, N. Y. \$5
"Drawers in Stair Steps"

EXTRA AWARD

On account of there being five contributions this month each of which deserved second prize, we have made an EXTRA AWARD of four additional second prizes, as follows:

- ALEX MIKULAN, Seattle, Washington \$5
"A Hat-Pin Protector"
F. H. TILLOTSON, Sycamore, Ill. \$5
"Lock for a Miter Joint"
EDW. MENGER, San Antonio, Tex. \$5
"Compression Spring for an Oil-Can Bottom"
HOWARD WEDDLE, Dinuba, Cal. \$5
"Preventing a Handsaw from Slipping When Standing on End"

All accepted contributions to our departments, "SHOP NOTES" and "AMATEUR MECHANICS," are paid for immediately; checks for prize awards are sent at the end of each month.

Address, EDITOR POPULAR MECHANICS
318 W. Washington St., Chicago

WHEN YOU WANT ANYTHING AND DON'T KNOW WHERE TO FIND IT
WRITE BUREAU OF INFORMATION,
POPULAR MECHANICS CHICAGO

Chart of a Modern Submarine

Price 25c Postpaid

Showing and naming over 200 parts. Size 14 x 28 inches. Printed on Plate Paper.

POPULAR MECHANICS BOOK DEPT.
318 W. Washington St. Chicago



A SCHOOL WITHIN ITSELF

There are XX chapters in all, XIX carrying you from the fundamental principles of electricity on through the various branches to a point where the careful student comprehends the complete designing, care and operation of a dynamo or motor, and one chapter on electric automobiles, outlining their construction, care and operation, and all about storage batteries and how to handle them. Each subject is carefully written and to the point. After a student studies a subject, he is questioned on that subject in such a manner as to bring clearly to his mind the points he needs to know regarding same. The book contains a dictionary defining 1500 Electrical Words, enabling the reader to ascertain the meaning of any electrical word, term or phrase used in this book, as well as hundreds of others in common use. All required tables necessary in the study are in it.

\$2.00 PER COPY—SIXTH EDITION—30,000 COPIES SOLD.

The offer we make of re-funding money if book is not satisfactory upon examination is AN UNUSUAL ONE in connection with the sale of a book. But we have no fear of its return. Your decision will be what thousands of others have been. Money would not buy it if it could not be duplicated. We could print testimonials by the hundreds. It is best to order and be your own judge of its merits.

CLEVELAND ARMATURE WORKS, 49 & St. Clair Ave., Cleveland, Ohio

Armatures and Fields Wound - Commutators Filed
AMERICA'S GREATEST REPAIR WORKS

This Book Will Help You

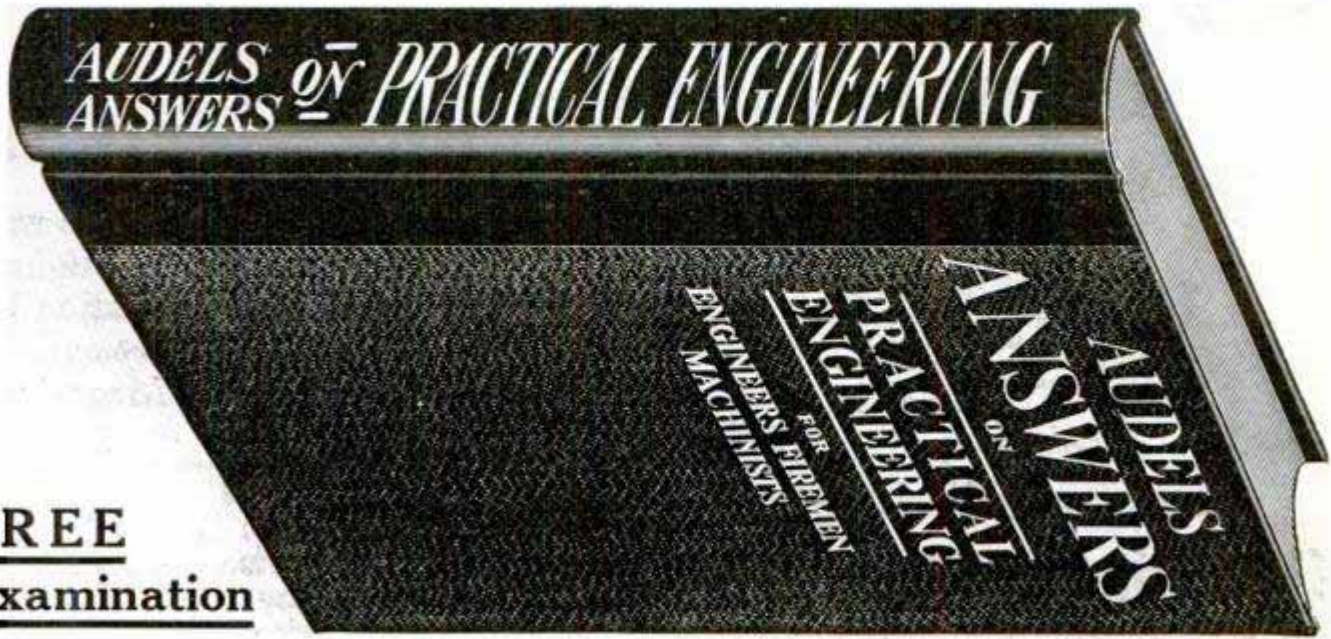

FREE
Examination

The Man Best Informed Wins Out

EVERY ENGINEER should make it a point to know the theory of what he is doing. It is not enough to do what you are told. A man can do what he is told for ten years without making any satisfactory progress in his occupation.

When you are told to do a thing, it means that some one else has done the thinking, weighed the evidence, and decided on the course to pursue. Of course, if that be your work, the only thing is to do it when you are told. But don't deceive yourself into thinking that ten years of experience of this kind will give you as much ability as if you did at least some of the thinking and planning for yourself. The way to advance is to think and know what ought to be done, and why it ought to be done a certain way.

Try to get a broad view, not only of your own part of the work, but of everything that in any way comes in contact with it. Understand the framework of which your work is but a cross bar. Know something of the cause of which your work is but an effect. Know something of the effect of which your work is the cause. And, above all, know why it is done one way, and not another.

Learn the Theory Underlying the Work

Good books that teach, no matter what they cost, will earn you more money than anything else you could buy.

If You Are Interested

sign, and mail the coupon, and it will bring to your plant a book of sterling merit, for free examination. You can have one week in which to dig out the mine of valuable information contained in its 200 or more pages.

Please send me for examination one copy
Audels Answers on Practical Engineering
If I keep the book, I promise to send you within 7 days after receiving it ONE DOLLAR, in full payment; if I do not keep it, I will mail it back to you within 7 days.

PLAIN FACTS

that you should know, plainly explained in Audels Answers on Practical Engineering

- 1, Answers on Air. 2, Water. 3, Steam. 4, Fuel and Heat. 5, Steam Boilers. 6, Boiler Construction. 7, Water Tube Boilers. 8, The Steam Gauge. 9, The Safety Valve. 10, Properties of Steam. 11, Installation of Boilers. 12, Management of Boilers. 13, Engineers' Law. 14, Firemen's Law. 15, Steam Engines. 16, The Valve and Valve Gear. 17, The Corliss Engine. 18, Engine Arithmetic. 19, Lubricators. 20, Installation and Operation of Engines. 21, Steam Pumps. 22, Injectors. 23, Feed Water Heaters. 24, Steam Heating. 25, Steam Traps. 26, Belts, Gears, and Pulleys. 27, Steam Turbines. 28, Refrigeration. 29, Practical Electricity. 30, Elevators.

When you spend your good hard earned money for books, always make sure that you are going to receive something that will assist you in bettering your position.

Carry It in Your Pocket for One Week

and at the end of the time, if you do not think the book is worth one dollar, mail it back to us. If it is, you can mail us \$1.00 in payment for your copy. If you fail to consider this liberal offer you are not dealing fairly with yourself. We take all risk that "Audels Answers on Practical Engineering" is a book you should own. Act now before you forget it.

THEO. AUDEL & CO., 72 5th Ave., NEW YORK
Signature.....
Occupation.....
Address..... P.M. Feb. '13

Special Offer!

This \$25.00 Tuition Credit in
Drafting and Designing FREE!



Offer Limited—Write at Once!

Most wonderful opportunity for men ambitious to succeed! Learn to be an expert draftsman **right in your own home**. Keep your present position—just devote your spare moments to this work. Send the free coupon right away for free book and complete information.

Be a Draftsman!
Earn \$75 to \$200 per Month

That's what men earn who possess the training we give you on this most liberal offer. Big companies pay handsome salaries to get the right kind of men. The work is light, profitable and interesting. You are paid for what you **know**, not the quantity of hard work you do. Our practical method of instructions enables you to **become an expert draftsman and designer** in an amazingly short time. Learn just as

Guarantee

We guarantee to instruct you until placed in a position paying from \$75 to \$200 per month. Our Employment Bureau places students in positions—FREE!

quickly and easily at home as in the drafting room. Expert draftsmen and designers give you "personal" instructions.

**\$17.50 set of
Drawing
Instruments
FREE!**

If you write at once we will give you in addition to the tuition a magnificent set of drawing instruments valued at \$17.50, handy size leather bound pocket case. You can use this set of instruments for years—when you are occupying a high salaried position as expert draftsman.

Mail This Coupon

**FREE
COUPON**

Chief Engineer
Room 512
Engineering Building
Chicago, Ill.

DEAR SIR: Without any obligations on me please send me your free book and complete information about your great \$25 free tuition credit offer.

Don't pass this exceptional opportunity! Be one of the men whose services are always in demand at a big salary. If you write at once you will receive this \$25 tuition credit Free! Send the coupon for our free book and details of this great offer. No obligations—so send it immediately.

**Chief
Engineer**
Room 512
Engineering
Bldg.
CHICAGO
ILL.

NAME.....

ADDRESS.....

Cash Prizes

for our
Young Readers

THE following cash prizes will be paid for the 10 best original articles suitable for publication in the *Amateur Mechanics Department* of Popular Mechanics Magazine:

First Cash Prize . . .	\$25
Second Cash Prize . . .	15
Third Cash Prize . . .	10
Fourth Cash Prize . . .	5
Fifth Cash Prize . . .	5
Sixth Cash Prize . . .	5
Seventh Cash Prize . . .	5
Eighth Cash Prize . . .	5
Ninth Cash Prize . . .	5
Tenth Cash Prize . . .	5

CONTEST CLOSES MARCH 31st, 1913

To be available the descriptive articles must be new, original and suitable for publication in the Amateur Mechanics Department. Where necessary to a better understanding by our readers, photographs, plans or pencil sketches should accompany the manuscript. We do not want mere descriptions of things that have been done, unless they are such as young people generally would be likely to make and can be built with ordinary tools and materials.

Contributors may submit as many articles as desired, but no person will be judged to receive more than one prize.

Articles failing to win one of the prizes, but suitable for publication will be promptly paid for at usual rates; all others will be returned.

Mark your article "For Prize Contest Amateur Mechanics Dept.," and mail to Editor
Popular Mechanics Magazine
318 W. Washington St., CHICAGO

"The Chaldean Story of the Flood"

Dug Up From the Ruins of Ancient Chaldea

DO YOU KNOW that there has been dug up from the ruins of old Chaldea a complete story of the Flood—the same in every detail as Moses' account in Genesis—and that it was written thousands of years before his version appeared? Hardly one in a million has ever had an opportunity of seeing this startling story—*HAVE YOU?* But it is one of the many thousand curiously interesting accounts in

The Library of Original Sources

now for the first time available to the general public. Up to the present this remarkable Library has only been sold by subscription, but by taking over the *entire unsold edition* from the publishers we secured it at an *absolutely unheard of bargain*. Therefore we are able to offer the few remaining sets to POPULAR MECHANICS readers

AT LESS THAN IT COST TO MAKE THEM

Send us the attached coupon **AT ONCE**, and we will tell you how to get the Library on **EASY MONTHLY PAYMENTS**, and mail you **FREE** a book of rare documents showing curious inscriptions of the Ancients. Remember there are only a limited number of sets, so act quickly. Mail the coupon **NOW**. You assume no obligation. No salesman will call. The book is **FREE**.

THIS MARVELOUS WORK is revolutionizing modern thought. It's turning upside down old notions and ideas. It gives the authoritative, rock-bottom sources of our knowledge on **ALL SUBJECTS OF HUMAN INTEREST** from the earliest civilization down to to-day—the inside facts which the average person has never even heard of.

OVER 100 RESEARCH SPECIALISTS spent 10 years gathering the contents of this great work. Ancient and remote and forgotten civilizations in all parts of the globe were uncovered, and age-buried hieroglyphics on monuments, tablets, sun-baked bricks and palimpsests yielded their secrets; untiring workers ransacked the hidden literature of every age, ancient, mediaeval and modern, to find the "original documents" that shaped the civilization and influenced the thought and life of the world. Nothing like it has ever been attempted or thought of before. You'll be amazed at the wealth of information this unique library contains.

DO YOU KNOW that the old Egyptians, 5000 years B. C., had a Bible which they called the "Book of the Dead"?—Do you know that the Assyrian sacred literature gives the story of the Creation?—Do you know that books and newspapers were printed in Asia thousands of years before printing was invented by Gutenberg?—Do you know that Columbus wrote a journal of his voyages to the new world and that it has been found, translated and published?—**DID YOU EVER READ** the "Ball and Tyler Rebellion"? Luther's "Ninety-five Theses"—which he nailed to the church door—or Machiavelli's "Prince"?

YOU'LL FIND THEM ALL—and thousands of others equally as curious and important—in the Library of Original Sources. Every document is in the exact words of the original, translated; every contribution is from the actual eyewitness or person who took part; every idea is in the words of the thinker, investigator, discoverer or inventor.

JACK LONDON SAYS:—"It is a whole library in itself. I certainly never could spare these books from my shelves."

10 sumptuous, massive volumes, bound in rich, deep red Morocco; full-page illustrations. Pure silk headbands, printed in large, clear type on hand-made paper, gold tops—a triumph of the bookmaker's art.

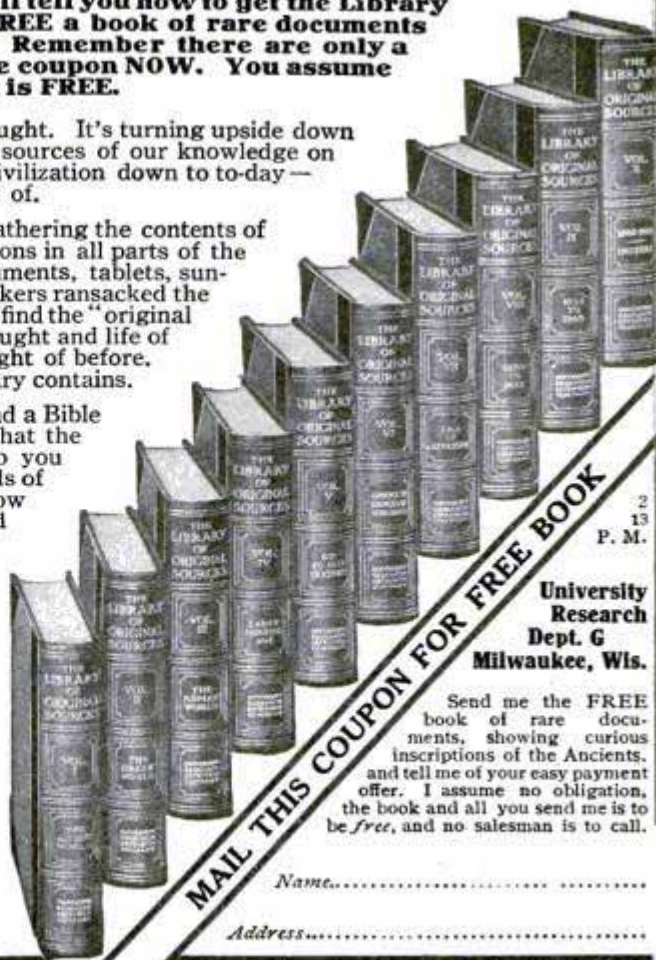

2
13
P. M.

University
Research
Dept. G
Milwaukee, Wis.

Send me the **FREE** book of rare documents, showing curious inscriptions of the Ancients, and tell me of your easy payment offer. I assume no obligation, the book and all you send me is to be *free*, and no salesman is to call.

Name.....

Address.....

MAIL THIS COUPON FOR FREE BOOK

The Pictorial Review of Current Events

Cartoons

15 Cents a Copy

Published Monthly

[Published by H. H. WINDSOR, Editor Popular Mechanics Magazine]

A brief review of the contents of CARTOONS for January will convince you that this is one of the magazines for your reading table.

**Here are some of the features to be found
in the January number:**

An interesting article on the value of the cartoon by Lucian Cary, of the Chicago Evening Post; a paper of interest to artists and art students, by Professor Alfred M. Brooks, of the Indiana State University; an explanation of the origin of his "Anxious Moments" cartoon series, by George W. French, of the Chicago Record-Herald; the experiences of a sketch artist, by Matthew T. Caine, of the St. Paul Pioneer Press; little stories of their mascots, by Edgar F. Schilder, of the Indianapolis Star, and Edward S. Reynolds, of the Portland Oregonian; a trip back into the past for an intimate visit with the great Thomas Nast, by Henry C. Williamson; photographic reproductions and sketches of the lives of Frank Warren Hopkins, of the Denver Times, and Frank M. Spangler, of the Montgomery Advertiser.

All this in addition to the scores of full-page reproductions of the best cartoons that have been printed in the daily papers of the country and publications of the old world.

These reproduced cartoons are selected from a collection of more than ten thousand each month.

Bound Volumes One and Two NOW READY

These two bound volumes, of six numbers each, contain more than 2,000 reproductions of the very best cartoons that have been printed during the past 12 months. A collection of more than 120,000 cartoons was made in order to secure them. Bound in the two volumes they make an "instant history" of the year 1912 for they are a pictorial record of the events of the world during the past year.

These two books, artistically and durably bound, are now ready for distribution and will be sent all express charges prepaid to any address in the United States or its possessions upon receipt of

One Dollar Each

Send your order to CARTOONS, 318 W. Washington Street, Chicago, Ill.

YOU MUST READ BALZAC

Nowhere in the literature of any country on the face of the globe are there any books like Balzac's. His is the greatest name of his day in the literature of France and he has won a permanent place among the world's greatest writers. His powerful imagination and his intimate knowledge of life enable him to scale every height and sound every depth of the passions of human character and he truly called himself the "Secretary of Society."

If you would read the **book of life**, then you must read Balzac; but if you must see and read only what is **superficial** then do not read Balzac. He deals not with things as they should be, but with things as they are, and his university is the **great university of human experience**.

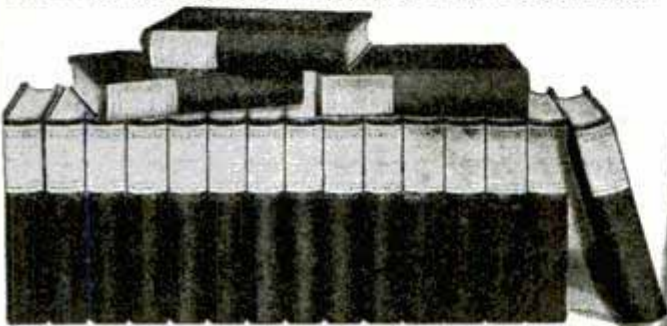

THIS ENTIRE SET OF 18 VOLUMES, SENT ON APPROVAL

18 Superb Library Volumes

This library edition consists of 18 beautiful volumes, complete and unabridged. Each volume measures 8¼ by 5¼ by 1⅝ inches and is bound in a substantial, genuine English cloth, deep blue in color, and with gold dust proof tops, and head bands. The entire set consisting of 18 superb volumes, will be sent for seven days' examination to those sending coupon below.

Special Low Price and Terms

To introduce this handsome Library Edition of Balzac's Complete Works, we will, for a short time, accept orders at nearly one-half price on terms of only \$2.00 a month. The regular price of this complete Library Edition is \$54.00—now offered you at \$29.50 and sent on approval. We do not ask for any deposit or any guarantee. Just tear off and mail coupon and we will ship the entire set to you for seven days' examination in your own home. You can then examine the volumes carefully and if they are satisfactory, send us \$1 as first payment and \$2 a month, until the special price of \$29.50 is paid. But, if the books are not satisfactory and you do not wish to keep them, then notify us and we will send you shipping instructions for the return of the set, at our expense. Could anything be more fair? Mail coupon below at once.

EXAMINATION REQUEST

2-13

THE THOMPSON PUBLISHING CO.
1127-29 Pine Street, St. Louis, Mo.

Send me for seven days' examination, one set of Balzac's Complete Works in 18 volumes Library Edition. If I am satisfied with the books, I will send you \$1 as first payment and \$2 a month thereafter, until the special price of \$29.50 is paid. If I do not wish to keep the books, I will notify you within seven days and the books are then to be returned at your expense, as offered Popular Mechanics readers.

Name.....

Address.....

The Ideal Books

For the Wide-Awake American Boy

The handsome set of four books—"Mechanics for Young America" and "Amateur Mechanics" (Nos. 1, 2 and 3)—each book bound separately in Illuminated Covers, and the whole set inclosed in a heavy Bristol Folding Case with extension clasp—will be sent prepaid to any address for

\$1



700 Things a Boy Can Make

1000 Illustrations Showing How

Thoroughly Practical and Instructive

Besides telling how to make scores of things useful about the house, full and complete directions are given on constructing the following and hundreds of other things which appeal to the heart of every boy.

Electric Appliances—Steam and Gas Engines—Motors—Wireless and Morse Telegraph—Self-Propelled Vehicles—Toboggans, Bobsleds, Ice-Boats—Boomerangs—Paddle Boats, Canoes, Rowboats—Camping Outfits—Cabins—Tents—Fishing Tackle—Magic Lanterns—Searchlights—Cameras—Telescopes—Glanders and Aeroplanes—Kites and Balloons—Aquariums—Electric Furnaces—Electroplating Outfits—Lathes—Foundry Work at Home—Iron, Copper, Brass and Other Metal Work—Bookbinding—China and Pottery Kilns—Parlor Magic Tricks, etc.

Ask Your Book Dealer or Address the Publishers

POPULAR MECHANICS BOOK DEPARTMENT

318 W. Washington Street, CHICAGO





FREE

This \$15 Drawing Outfit

But you must write at once. Offer expires in 30 days. I make this most exceptional great offer only to a limited number of

selected students.—Just think of it! A complete, regular Draftsman's \$15 Working Outfit with high grade Imported German Silver Set of

INSTRUMENTS—ALL FREE

Be a Draftsman!

Draw \$125 to \$175 per month at once

There is an urgent demand always for skilled draftsmen. Our companies are issuing calls every day for men to fill positions paying from \$125.00 to \$175.00 per month. Many positions paying \$75 to \$100 per week always open. Work is light, pleasant and profitable. Unlimited opportunities for expert draftsmen and designers. Mail coupon for valuable book, "Successful Drafting." It explains how you can become a skilled draftsman in a short time. It's free—Just think:



Chief Draftsman Will instruct you personally

A most wonderful opportunity for a limited and selected number of ambitious men! For over twenty years I have been doing the highest paying expert drafting work. I am Chief Draftsman of a large and well known company. Long ago I saw the urgent demand for practical, trained draftsmen and I organized my practical method for ambitious men whom I trained personally. Each month the demand for practical, trained draftsmen is growing—higher salaries are being paid right along. Never before have we felt the need as we do today for men who really know practical drafting—the way I am training my students. At this time I can accommodate a few more men (from the ages of 16 to 40) in my spare time. If you write me at once I will send you my book, "Successful Drafting," with full particulars—all free. But you must write to me—or send coupon now.

I Guarantee

To instruct you until competent and placed in a position at a regular salary, paying from \$125.00 to \$175.00 per month and furnish you free \$15 Working Outfit at once.

FREE Outfit Coupon

Earn Big Money at once while Learning at home

Yes, my friend, you can make big money at once right at home from the very start,—as much as \$5 to \$10 per day I will pay you, while learning.

Chief Draftsman: ENGINEER'S EQUIPMENT CO. Div. 1192 CHICAGO, ILL.

Without any obligation on me, please mail your book "Successful Draftsmanship" and full particulars of your liberal "Personal Instruction" offer to a few students. It is understood that I am obligated in no way whatever.

Mail Free Coupon Now

Mail this Free Coupon at once and I will send you my book "Successful Draftsmanship" and full particulars—all FREE.

I will send my book if you write at once, absolutely free—also particulars about my offer to a few ambitious men who want to make from \$2,500 to \$5,000 a year. No obligations whatever on you in sending the coupon.

NAME

ADDRESS

Address **Chief Draftsman**

Division 1192, Engineer's Equipment Co. (Inc.)
CHICAGO, ILL.

AUTOMOBILES

AUTOMOBILES are now made with large wheels and solid rubber tires, doing away altogether with punctures and blowouts. They have light but powerful engines, air cooled. In place of gears, transmissions, etc. is the "roller drive" which is perfect and fool-proof. These cars have large wheels, like buggies, so that they travel more comfortably on ordinary roads than do any of the smaller automobiles with pneumatic tires. They are called "motor-buggies," but are high grade automobiles. They weigh from eight to ten hundred pounds. Price two passenger, \$487.50; four passenger, \$537.50. Send for catalogue. C. K. Duryea Motor Company, Saginaw, Michigan.

GUARANTEED 5,000 miles without puncture. If your tires are old, don't throw them away, or you'll throw away \$50 to \$200. With Durable Treads we give you a written guarantee for 5,000 miles without puncture. This is binding whether your tires are new or old-tread-worn, rim cut or rut worn. Durable Treads cost only half as much as tires. Write for booklet and special discount at once to Colorado Tire & Leather Co., 1010 Broadway, Denver, Colo., 532 W. 34th St., New York City, N. Y.

FORD owners wanting five electric lights available any time, using Ford magneto for charging a storage battery (self contained system). Write American Battery Company, 1129 Fulton St., Chicago.

YOUR Auto Top made look like new; our leather dressing also softens and preserves the leather. Formula and full instructions, \$1. Full particulars for stamp. Formula Sales Co., Racine Jct. Sta. Racine, Wis.

CHAUFFEURS—Before taking examination send fifty cents for Questions and Answers. L. I. Lutes, ex-State Examiner of Chauffeurs, Utica, N. Y.

TIRE air pressure is important. Only guaranteed pocket tire air pressure gauge on sale. Price \$1. Budke Auto Co., University City, Mo.

STEVENS-Duryea model X, \$650. Stevens 30-60, \$600. Both good condition. R. Y. Sanders, Atlanta, Georgia.

AUTOMOBILE dealers, reach country readers through ads in Boyce's Weeklies. Circulation 1,000,000 weekly. Send for free Result Checking Book. Use letter-head. Classified Dept., 500 Dearborn Ave., Chicago, Ill.

BIG reduction in pleasure and commercial cars, new and used. Write for prices on what you want. Eureka Auto Co., Beavertown, Pa.

TWO cylinder, five passenger, "Northern" automobile in good condition. \$500. Want cheap land. Chas. Bailey, Garner, Iowa.

ONE new 30 H. P., 2 or 4 passenger Duryea Roadster, \$500. Chesney L. Jones, Haskell, New Jersey.

BUICK Roadster, 2 cylinder, 22 horsepower, "powerful," good condition. \$275, or will exchange for automobile sundries. Kearns Typewriter Exchange, Beavertown, Pennsylvania.

WELDING by oxy-acetylene process—How construct and use plant from materials handy. Scale drawings, fluxes, chemicals, formulas. 50c prepaid. American, Publishers, Aberdeen, S. D.

WHITE Steam Automobiles, second-hand and new; all second-hand parts. Whites, Stanleys, Locomobiles, or other Steam Automobiles. Prices reasonable. State your wants. Lake View Garage, Lake View, New Jersey.

FOR Sale. Stanley Steam Racer. A "peach." \$600. Lucas & Son, Bridgeport, Conn.

MAXWELL Touring Car, \$390. A. D. Spencer, Charlevoix, Pa.

LEARN How To Run An Auto. Audel's Answers on Automobiles will teach all about Carburetors, Ignition, Timing, Engine Troubles, Overhauling and Driving. A complete course of 500 pages with 375 diagrams highly endorsed by men who know. \$1.50 to any address. Money back if not pleased. Theo. Audel Co., 72 Fifth Ave., New York.

Classified Advertisements

Advertisements in this section, 15 cents per word, each insertion, minimum 10 words, payable in advance. To insure ads being inserted under proper classified head in the March issue, copy must reach this office not later than February 1st.

Chicago, Illinois, October 1, 1912.

Popular Mechanics Magazine, Chicago, Ill.

Gentlemen: Our trial classified ad in the Popular Mechanics not only paid for itself, but gave us a profit of \$75. Since that time, whenever we have tried to save by cutting down our ad in your magazine, we have simply robbed ourselves, and so now, instead of grudging the money we pay you at the first of each month for our ads, we feel more like appearing to be what some might call reckless, and letting right go of a big roll, as we are sure of its coming straight back, together with an enormous interest. One thing is certain—advertising in Popular Mechanics can't be overdone. Yours very truly,

(Signed) POPULAR SHOW CARD CO.

AUTOMOBILE SUPPLIES

\$5 WORTH of value for \$1. Greatest advertising value stunt ever offered to quickly introduce the marvelous merit of Orient preparations. On receipt of \$1, we send material for making pint "Mystic" liquid Silver Plater, the world's best for silver plating brass, copper, etc. Auto lamps and trimmings; easily applied, producing most brilliant shine. Also pint Orient High Gloss Body and Furniture Cleaner and Polish, removes dust, grease, oil without use soap or water, leaving most brilliant high gloss; does not leave greasy surface to catch dust. Also pint Magic Metal Polish, contains no gasoline or acid, producing easily and rapidly most brilliant lustre of any metal polish in the world. We can not sell but one lot to a person on this special introductory offer, which is good only to those ordering prior to Mar. 15th. Money back if not delighted. Agents wanted; order quick. Orient Chemical Co., 640 Gumbel Bldg., Kansas City, Missouri.

KEROSENE for automobiles. Air-Friction Carburetor, new "Model B" uses successfully half and half mixture lowest grades kerosene and gasoline. Starts easy at Zero. One-third more power. One-third more economy. Satisfaction guaranteed or money refunded. Suits all automobile and marine motors. Special agents' prices. Department "A," Air-Friction Carburetor Co., Dayton Ohio.

FOR Sale. Two cylinder, 12 hp. Holman air-cooled opposed gasoline engine complete and in running order \$40. Also 6 hp. single cylinder water-cooled engine complete and in running order \$25. Also 20 hp. White compound steam engine, generator and burner, good condition, \$50. 1423 North Ave., Bridgeport, Conn.

MAKE your auto pump water, saw wood, etc., by using Quick Detachable Pulley. Clamps on rear wheel. Postal brings illustrated circular with prices. Simplex Co., 5001 Victor Building, Washington, D. C.

YOUNG MAN, would you accept and show a fine tailor-made suit just for showing it to your friends? Or a Slip-on Raincoat Free? Could you use \$5 a day for a little spare time? Perhaps we can offer you a steady job. If you live in a town smaller than 10,000, write at once and get beautiful samples, styles and this wonderful offer. Banner Tailoring Company, Dept. 29, Chicago.

CHARGE the battery yourself. "American" rectifiers—all sizes. Storage batteries—all sizes. American Battery Company, 1127 Fulton St., Chicago.

ON account of change of business will sell stock of Hemmeter Spark Caps at half wholesale price. C. D. Stone, 609 Jefferson Ave., Toledo, Ohio.

ANTI-FREEZE protects your radiator from freezing. Two expert formulas for 50c. Chemist, 1535 Grand, Kansas City, Missouri.

FILL your own tires. Full directions, including receipt, 20 cents. Lucas & Son, Bridgeport, Conn.

RE_MAGNETIZING COIL (with dynamo) for charging magnetos. \$75. F. J. Lamb, 162 Baldwin Ave., Detroit, Mich.

DON'T throw away your old dry batteries. Recharge them cheaply. New discovery. Instructions 20c. Smith Bros., Box 126, Winfield, Kans.

WELDING Broken Parts. Broken cylinders and crankcases can be made good as new by autogenous welding at fraction of replacement cost. No charge unless satisfactory. Absolutely guaranteed. Let us send you detailed information. Scored Bores Repaired, \$12. Our special process applies only to cylinders scored from loose wrist pin. Bore not enlarged—no need for new pistons and rings. If your cylinder is damaged in this manner we offer you an economical and satisfactory remedy. Re-Boring Worn Cylinders. We will rebore your cylinder and fit new pistons and rings so that your motor will again be as powerful and quiet as when new. You cannot afford to send your cylinders to any jobbing machine shop—it requires skill and experience to insure a first class job. Let us explain why we think we can serve you best. Our charges are reasonable. Consider This. Above all else you need to know that the firm you entrust with your cylinders is reputable and responsible. Motorists in nearly every state know us favorably from experience. Let us give you references from your vicinity. Ask about us of any Waterbury bank or manufacturer. If you require such services as we offer write for complete information and estimates. Waterbury Welding Company. Waterbury, Conn.

WINTON Motor Truck. Bargain. George Wills, Canal Dover, Ohio.

GET Our Free Catalog. Consolidated Kerosene Engine Works, Detroit, Mich.

TOURING Car fully equipped \$225. Walter Robb, Canal Dover, Ohio.

VULCANIZE your own tubes. The Gasoline Vulcanizer will enable you to put a hot patch on your tube in fifteen minutes. No experience necessary. Complete in every detail, for \$1.25, postpaid. Budke Sales Co., University City, Mo.

"THE How and Why of the Automobile"—A 200-page book of practical information for seekers after the fundamental facts regarding the gasoline engine and its application to the motor car. Interesting and instructive to both the beginner and the expert. Bound in full cloth—250 illustrations. Price, \$1 postpaid. Popular Mechanics Book Dept., Chicago.

AUTOMOBILE model. Every part shown and named. You can to all intents and purposes take off the wheels, raise the hood and remove the body; exposing to view the vital parts. The only practical method of studying the automobile. Price, 50 cents postpaid. Popular Mechanics Book Dept., Chicago.

AUTOMOBILE instructions, four weeks' course covering shop and road work—provision for out-of-town men. Send for booklet. P. M. West Side Y. M. C. A. Automobile School, 318 West 57th St., New York, N. Y.

FOR Sale—One Thomas 40, 5 passenger auto, full equipment. One rear axle, one four speed transmission, and engine parts. H. W. Baum, Evans Mills, N. Y.

SIMPLEST way on earth to time valves and spark on automobile and gasoline engines, 25c. "Strong," Homer, Mich.

WE sell for less. Original mail order Auto House. 32x3 1/2 tires—Guaranteed—\$14; Silk Mohair tops—\$10; Side lamps—\$1.75; Head lights (pair)—\$5; Tail lamps—\$1; All size wheels—\$2; Wind shield—\$7.50; Speedometer—\$8; 1" Carburetor Puritan—\$1; Ford Model "T" radiator—\$18; Ford Model N-S-R Radiator—\$23; Runabout Body—\$30; Touring Car Body, 2 door—\$35; Touring Car Body, 4 door—\$40; Touring Car Body, 4 door, 5 passenger—\$52.50; Oval gasoline tanks—\$3.75; Buick Model 10, Radiator—\$26; Bosch Magneto—\$24; Splittorf Type Magneto and Coil—\$22; Puritan Machine Co., 51 to 57 Tenth St., Detroit, Mich.

TIRES—Guaranteed 3,500 miles. Standard manufacture. 28x3—\$9.10; 30x3—\$10.15; 30x3 1/2—\$14.80; 32x3 1/2—\$15.70; 34x4—\$21; 35x4—\$21.75. Other sizes accordingly. 10% with order, balance C. O. D. Examination privilege. Schelp-Budke Co., 3500 Lindell, St. Louis, Mo.

18 H. P. RAMBLER engine, carburetor, coil, transmission, differential, tank, \$50. 14 hp. Autocar engine, carburetor, coil transmission, differential, copper tank, radiator, \$75. All in good condition. G. A. Holmes, R. 31, Beloit, Wis.

MAKE big money, making and selling Brilliant Metal Polish. Profit over 300 per cent. Every auto owner buys at sight. Secret obtained from city steam fire engine employee. Full recipe and instructions for \$1. C. B. Dalton, 803 Fidelity Building, Portland, Maine.

MAKE your own Carbon remover. 50c package of "Carbo-Solvent" makes over two gallons. Carbo-Solvent Co., Dept. 4, 1080 Boylston St., Boston, Mass.

THERE'S big money making your own Brass Polish, Body Polish, Tire Fillers. See my "ad" in miscellaneous Column "High Grade Formulas," etc.

COMPLETE Steam Power Plant for small Runabout. Price \$50. Write, E. B. Fisher, Greensburg, Pa.

AUTOMOBILE and Motorboat owners: Here is a real self-starter that will start your engine without cranking. Uses gasoline the natural fuel. Adapted to Fords. Only \$17.50. Guaranteed. Write today for free circular. Northern Laboratories, Chicago.

A FORD Valve Grinder will grind valves without removing cylinder heads. Automatic rotating motion. Attached in a moment. A new and practical guide for the owner. Will last a lifetime. Fully guaranteed. Write for circular and price. J. H. Wall, 290 Hope St., Bristol, R. I.

VULCANIZERS Auto owner or shop. Catalogue Vanderpools. Springfield, Ohio.

OLD Tires Look New and Mileage Increased with Rubberized Tirepaint. Big profits selling it. Formula for \$1. Chemist, 1535 Grand, Kansas City, Mo.

REPAINT your car yourself—with our materials and full instructions, you can repaint your car as well as a regular painter and save from \$25 to \$50, depending on its size. Previous experience unnecessary. Latest colors. Write today for full information and color cards. We also make Liquid Gun Metal, the National Brass Enamel, \$1 a can, express prepaid. The only article of proven merit for lamps, radiators, etc. No polishing. Arsenal Varnish Co., Dept. P, Rock Island, Illinois.

TIRE Specials. Guaranteed Tires. 1912 fresh stock; just bought an entire surplus stock. Order today while they last; 28x3—\$8.90. Tubes, \$2.40; 30x3—\$9.60—\$2.53; 30x3 1/2—\$12.75—\$3.35; 32x3 1/2—\$14.20—\$3.55; 34x4—\$21.25—\$4.80. Other sizes, prices in proportion. Write for complete list. We ship C. O. D. subject to examination upon receipt of express charges. Para Auto Tire Co., 1425 Michigan Ave., Chicago, Ill.

FOR Sale. 50 small steam auto engines, \$5 to \$10 each. Lucas & Son, Bridgeport, Conn.

STEAM auto boilers bought, sold and repaired. J. L. Lucas, No. 2 Fox St., Bridgeport, Conn.

CYLINDER rebored, including new piston and rings; \$8 to \$12 a cylinder. Sterling Engine Co., 331 S. Clinton St., Chicago, Illinois.

AUTO tires mended in one minute. Write for particulars. M. R. Silvernail, Altamont, N. Y.

TIRES—New fresh stock, while they last; 28x3, \$7.75; 30x3, \$8.60; 30x3 1/2, \$11.50; 32x3 1/2, \$12.40; 34x4, \$18; other sizes, prices accordingly; write for complete catalog. 10% with order, balance C. O. D.; examination allowed. Para Auto Tire Co., 1417 Michigan Ave., Chicago, Ill.

MOTORCYCLES AND BICYCLES

FOR Sale—1912 magneto Pope \$125. 1910 battery Curtiss \$60. 1911-4 Indian magneto and clutch \$125. 1911 twin 7 Merkel clutch and magneto \$120. 1910 battery single Merkel \$85. 1910 battery Yale \$55. 3-1912, 4 Indian \$140. 3-1912 twin Indian \$175. 1912 twin Indian two speed \$210. All machines above, guaranteed. Ernest & Craddock, 24 N. 52d St., Phila. Pa.

WE buy, sell and trade used motorcycles; sell low as \$25. Build, repair or supply any parts. Get our offer on your old model. Wagner Rebuilt Motorcycle Works, 1429 Carroll Ave., Chicago, Illinois.

MOTORCYCLES. Guaranteed used motorcycles. Cut prices for 60 days. M. M., 4 hp., \$80; Indian 4, '12 \$95; Excelsior 4, 1910, \$90. Send for complete list. Sauffley Supply Company, Kansas City, Mo. Motorcycle Dept.

1911 INDIAN Twin, ridden 800 miles, perfect condition, horn, speedometer, headlight, generator, steel studded detachable tread, one extra new tire. A bargain at \$175. Peirson, 240 West Somerset St., Philadelphia.

NOTICE—\$50 takes 1909 magneto motorcycle, \$65 takes 1910 model, \$85 for 1911, \$120 for 1911 twin. M. M.'s. Anderson's Motorcycle Store, Batavia, Ill.

INDIAN \$40. Merkel \$50. Yale \$60. Peugeot \$60. N. S. U. \$85. Excelsior \$75. Feiler, 2121 N. Broad, Phila. Pa.

WANTED—Second-hand motorcycles. Must be in good condition and cheap. William Bogue, Box 381, Keokuk, Iowa.

FOR Sale—Nine twelve 4 cylinder Pierce. First class condition, best offer over \$250 takes it. O. F. Gloystem, Twin Falls, Idaho.

SINGLE 4 hp. M. M. Motorcycle. Lamp. Fine condition \$85. Earl J. Spencer, Lebanon, Ohio.

ELECTRIC Light for Motorcycles. Storage battery built right. \$5. American Battery Co., 1131 Fulton St., Chicago.

FOR Sale—1912 Four cylinder Pierce Motorcycle—fully equipped. F. H. Wilcox, Greenfield, Mass.

1910 "THOR" Motorcycle, new tires. Guaranteed. Eugene Ruhlender, Staunton, Ill.

TIRES. Another lot of bargains, all makes. 26x2 1/4, \$4.75. 26x2 1/2, \$5.75. 26x2 3/4, \$6. 28x2 1/2, \$6.50. 28x2 3/4, \$7.75. Tubes all sizes, \$2. All first grade, guaranteed the best. Tire seconds new, \$3.50. Get our bargain list now. Erickson, 8039 Parnell Ave., Chicago.

MOTORCYCLE sidecar attachment will fit any machine, looks like new, \$35. Grover Kortonic, 4353 Warner Road, Cleveland, Ohio.

1909 ARMAC motorcycle in good running order for sale, or trade for moving picture machine. A. R. Moore, Eustis, Nebr.

SALE—Thor 3 1/2 hp. \$75. Clarence Oswald, 1323-6th Ave. N., Great Falls, Mont.

1912 INDIAN Seven, \$130. Merkles, single and twin, cheap. Box 53, Altoona, Pennsylvania.

FOR Sale. Ten motorcycles, Excelsiors, Indians; also Lathe and Emery Wheel. Must sell. Burke Cook, Warsaw, Ind.

TWIN Indian, five horse, \$85. Photo on request. Everitt Heimendinger, Britt, Iowa.

BARGAIN, 4 1/2 Peerless 1912, with magneto. John Greytak, 817-8th Ave., Great Falls, Mont.

PERFECTO tall lamp protects you. Write Erickson, 8039 Parnell Ave., Chicago.

TWIN Curtiss racer \$75. New Iver-Johnson \$175. Raymann Weaver, Copley, Ohio.

FOR Sale Minneapolis, also Harley Davidson, good condition, bargain. Brems, Corona, N. Y.

INDIAN 1908, engine perfect \$28. G. French, Melrose Hlds., Mass.

PIERCE four cylinder motorcycle; bargain, \$175. Nichols, Chilli, N. Y.

FOR Sale: Pierce four cylinder run only 500 miles, tires new \$150 Cash, in perfect condition throughout. Edw. P. Seeber's, 704 Main St., Buffalo, N. Y.

1912 THOR V. Run 150 miles \$185. C. F. Hess, Monroeville, Ohio.

FOR Sale: Several shop worn Pierce bicycles thoroughly guaranteed perfect in every particular 25% discount. Send in deposit to insure one of these bargains. E. P. Seeber's, 704 Main St., Buffalo, N. Y.

MOTORCYCLE Riders, Send 25c one years subscription. Has Motorcycle and Gas Engine Department, etc. Digest, Grand Rapids, Mich.

WANTED—First class motorcycle. Model 1911 or 1912. E. Bordahl, Wahpeton, N. D.

FOR Sale: 5-hp Pierce single, guaranteed a bargain throughout \$125. Reading Standard single, and Thor single in first class condition \$75. E. P. Seeber's, 704 Main St., Buffalo, N. Y.

1911 HARLEY single, guaranteed perfect, must sell, \$145. Adolph Liebrum, Taylor, Texas.

GREATEST bargain list of Motorcycles ever issued, be sure to get it before buying. Inclose stamps. Wolker Cycle Co. Louisville, Ky.

FOR Sale: Reading Standard Twin, just overhauled, new sprockets, chains, bearings and tires; renicked and re-enamelled \$100 cash. Edw. Seeber's, 704 Main St., Buffalo, N. Y.

1911 5-H.P. INDIAN. Price \$115. John Small, La Salle, Ill.

1912 INDIAN 7-hp. Price \$185. David Fotheringham, Emington, Ill.

MOTORCYCLE engine, 2 H. P. Good condition. Bargain. Edward Payne, Covington, Ky.

BIG bargains in good motorcycles we have taken in exchange on new ones. Send for special bargain list. Shaw Mfg. Co., Galesburg, Kansas.

DON'T buy a Bicycle Motor Attachment until you get our catalog and prices. Shaw Mfg. Co., Dept. 27, Galesburg, Kansas.

MOTORCYCLE and Bicycle Repairing—a 300-page book of up-to-date practical information. Profusely illustrated. Price, \$1 postpaid. Popular Mechanics Book Dept., Chicago.

MOTORCYCLE Manual—Construction and operation of a motorcycle fully described and illustrated; complete trouble chart; 125 pages; cloth bound, 50 cents postpaid; paper covers, 25 cents. Motorcycle Manual, 31 Chambers Street, New York City.

SAVE \$25 to \$50 by buying your motorcycle now. Our list comprises late models Harley, Excelsior, Indian, Triumph, Marsh, Armac, Scrivens, Ashtabula, Ohio.

1912 HARLEYS, Excelsiors, Triumph; 1911 Harley, Excelsior, Indian. All guaranteed perfect. Our prices lowest. Scrivens, Ashtabula, Ohio.

THE Simplex Sight Gauge for Harley-Davidson, Excelsior, Flanders and other motorcycles. Shows oil level in engine at all times; keeps clean; Agents wanted; postal brings catalog. Buck Sales Company, 211 N. 12th St., St. Louis.

AERONAUTICS

I HAVE aeroplane but need \$400 for aviation school expenses. Will give 40% of year's earnings. 10% for \$100. Guarantee \$800 to \$2,000. Write for particulars. Frank Orndorff, Mattoon, Ill.

MODEL Aeroplanes. 1913 Hewlett racer, 27" in length, \$2. Also exhibition models. Send for free catalogue. H. & H. Aeroplane Co., Box 293, Bath, N. Y.

BUILD a glider. Blueprints showing every detail accompanied by complete instructions, \$250. Guaranteed flyer. Very inexpensive. Lock Box 119, Onda, South Dakota.

SECOND Hand Grey Eagle Motors at bargain prices. Motors have been taken in trade for larger size and are guaranteed same as new. See our ad for new models on page 153. Kemp Machine Works, Muncie, Ind.

FOR Sale—A 30-40 hp. air-cooled aeroplane motor \$300. Write quick. G. C. Walter, 935 Broadway, Denver, Colo.

ELASTIC 1/16" 15"—10c. Supply Circulants 2c. "Lea," Brunswick, Mo.

COMPLETE Plans, drawn to scale, including concise building instructions: Wright Biplane, 25c. Bleriot Monoplane 15c. "Cecil Peoli" Champion Racer, 25c. Curtiss Convertible Hydroaeroplane, 25c. "Ideal" Racer, 15c. All three foot flying Models. Set of five—\$1. 40 pp. Model Aeroplane Supply catalog, 5c. Ideal Aeroplane Supply Co., 82½ West Broadway, New York.

30 HORSE aeroplane motor water cooled, complete, \$175, fine order. Aviator Nelson, New Britain, Conn.

SEE! Our 1913 aeronautical Catalogue. Most complete ever produced. Hot off the press. Sent anywhere for six stamps. Heath Aerial Vehicle Co. Chicago.

TRACTOR type biplane slightly used, equipped complete with new model F-6 motor. Also tent. Complete outfit \$1150. Kemp Machine Works, Muncie, Ind.

PATENTS secured on Aeronautical Inventions. C. L. Parker, 910 G St., Washington, D. C.

"VEHICLES of the Air," the newest and only up-to-date contribution to the literature of aeronautics, contains large working plans of all successful modern flying machines. This book of 500 pages, 140 half-tone photographs and 130 drawings is the only book published containing every known fact of this interesting subject. Size, 9x 5½ inches. Price \$2.50 net, postage 25 cents extra. Popular Mechanics Book Dept., Chicago.

MODEL Aeroplanes, How to Make and Fly Them. By W. Twining. Consisting of 5 sheets of scaled drawings, showing three different models, with descriptive booklet. By mail, 55c. Popular Mechanics Book Dept., Chicago.

BOOKS AND PERIODICALS

DON'T buy that book. We loan standard books by mail. You can buy or return them. We plan short courses of reading for you free. Self-help; business; health; house, home and field; economic and social problems; books for writers and speakers; religion; science, etc. Lists and bi-weekly Library Critic on request. State subjects in which interested. Oriental Esoteric Library, 119, Washington, D. C.

FOX and Hound and Trappers World—Monthly Magazine about Fox, Coon, Rabbit, Skunk, Mink, Opossum and Wolf Hounds; has good Beagle Department; tells how to hunt, trap and sell furs; tells of good locations for Hunters, Trappers and Fishermen; \$1 per year; sample free. Fox and Hound, North Main St., Decatur, Illinois.

DIETERICH'S 50 Perpetual Motions. Tells all about Perpetual Motion, illustrates 50 different forms. Tells about Patent Office Practice in regard to same. Very interesting. Sent by mail postpaid on receipt of 25c, coin or stamps. F. G. Dieterich, 65 Ouray Bldg., Washington, District of Columbia.

"THE Amateur Craftsman" tells how to make Aeroplane, Canoe, Telephone, Furniture, Toys, Traps. Illustrated. 10 cents postpaid. W. Miller Co., St. Paul, Minn.

NEW Book, "Jane," 10c. Catalog of books and den pictures free. Bond Pub. Co., A 5, Columbus, O.

FASCINATING Books "Her Secret" 25c. Catalogue for stamp. Duff, 2713 Mozart, Chicago.

BOY'S Book of New Inventions—A story of the adventures of a boy who went to the workshops of inventors, aviators, electricians, and photographers accompanied by a scientist to explain things. Told in a fascinating way and deals with wireless telegraphy, aeroplanes, photography, motion pictures, etc. Price \$1.60 postpaid. Popular Mechanics Book Dept. 318 W. Washington St., Chicago.

"TELEPHONE Troubles and How to Find Them," (56 pages). 25c. Hyde Co., 183 5th St., Milwaukee, Wis.

STEEL Tempering Book for mechanics and Mechanical Digest one year, special offer, 25c. Mechanical Digest, Grand Rapids, Mich.

"SHIP Ahoj" is a unique narrative of personal experience, by an ex-clergyman who enlisted in the U. S. Navy as a coal passer. Information, humor, pathos, entertainment. Postpaid twenty-five cents. Bennett & Co., 319 Muirhead Building, San Francisco, Cal.

BUILD yourself a boat. A racing cat or speed launch. Send for catalogue. Yacht and Boat Building Books, Rudder Publishing Co., 2½ Hudson St., New York, New York.

ENGINEERS' questions and answers for license, by Hobson, for twenty-five cents, postpaid. Send stamps. Reilly's Book Store, Philadelphia, Pa.

DON'T fail to read Independence and Fortune under Business Opportunities.

1,200 CARTOONS for \$1. A Panorama of World events, Political, Industrial, Social, Humorous, Tragic—all of intense human interest. Six numbers of Cartoons Magazine (January to June, 1912, inclusive) representing the best work of over 100 of the best cartoonists and handsomely and durably bound in book form; will be sent prepaid to any address for \$1. Cartoons, 318 W. Washington St., Chicago.

FOR Sale—Copies of the August, 1912, number of Popular Mechanics Magazine containing the complete articles on the Seven Wonders of the Modern World as selected by an international poll of the greatest Scientists. Price, 15c per copy, postpaid. Popular Mechanics Co., 318 W. Washington St., Chicago.

GAS for power is taking the place of steam for reasons of economy. Learn all about this great change by reading our new non-technical book on this subject, written by a first-class authority for the practical man. 192 pages, profusely illustrated, cloth binding. Price, \$1 postpaid. Popular Mechanics Book Dept., Chicago.

"METAL Spinning" is the name of the only book published on this interesting art. A concise working manual both for those who desire to spin metal as an art recreation and to follow this work as a trade. 80 pages, 33 illustrations. Price, 50 cents postpaid. Popular Mechanics Book Dept., Chicago.

BACK Numbers of Popular Mechanics Magazine—We can supply the regular monthly issues of this magazine as far back as January, 1911, for 15 cents a copy postpaid. Popular Mechanics Co., 318 W. Washington St., Chicago.

GAS Engine Troubles and Installation. Cloth, \$1; flexible leather, \$1.50; Automobile Troubles and How to Remedy Them. Cloth, \$1; leather, \$1.50. Eight other practical and reliable mechanical books. Send for circular. Chas. C. Thompson Co. Dept. C, 1126 S. Wabash Ave., Chicago.

BOOKS. Any kind published. Catalogue free. Reese Publishing House, Mount Pleasant, Pennsylvania.

READ "The Widow," 10c. Catalogue other books and pictures free. Gem 3 Co., Ypsilanti, Mich.

MECHANICAL Books, Latest. Send stamp for catalogue. Crescent Book Store, 329 South Halsted, Chicago.

MECHANICAL Books, 100 titles. Best prices. Send for circulars. The Proctor Book Co., 559 C-W, Lake St., Chicago, Ill.

3,000 RECIPES, Formulas 40c. Roadman's Guide—100 Money-making Schemes 25c. Scientific Book Shop, Syracuse, N. Y.

EDUCATIONAL AND INSTRUCTION

YOUNG men, clerks & painters learn the art of practical lettering. You can do it in a few hours with our Patented Spacing Compasses for Lettering and you cannot make them wrong. By this system you can learn to letter windows, cards, signs or monuments correctly. Easiest system you ever saw. Send stamp for particulars. E. H. Stover, Mt. Sterling, Illinois.

DO You Need Help? Questions on Chemistry and Electrochemistry answered. Experimenters Chemicals. Formulas. Chemical Advice. Frederick Wirthman, Chemist. 1535 B. Grand, Kansas City, Mo.

SHORTHAND. Unigraph is quickly learned, rapid and readable. Excels all others. Pays best. Beginner's Booklet 10c. Unigraph Co., Omaha, Nebr.

FOR Sale: International Correspondence School Course in Shorthand and Touch Typewriting. Typewriter Included. Cheap. Frank Ackerman, Pearl St., Marion, Ohio.

GET Ready Now for 1913 Registration. We will prepare you for entrance to Medical, Law, Pharmacy or Engineering Schools. Individual Instruction—Residential or Home study. Brooks Classical School, Dept. PM, Schiller Bldg., Chicago.

LEARN Show Card Writing and be your own boss. Show Card Writers earn \$75 to \$150 monthly. Our course teaches this profession thoroughly and complete. Regular price \$30. We sell the same complete course for \$4. Circular free. Thompson & Company, 3159 La Salle St., Chicago.

FOR Sale—\$40 Lettering Course; \$20 Shorthand Course. Box 86, French Lick, Indiana.

UNCLE Sam is a liberal employer. Qualify for a Government position. We prepare you by mail for any Civil Service Examination. Write today for free Booklet 32, Capital Civil Service School, Washington, District of Columbia.

YOU can draw cartoons and comics. Beginners learn thoroughly under our perfected system. Learn high-salaried, uncrowded profession. Particulars free. Hamilton School, 209 E. Ontario St., Chicago, Ill.

1,000,000 COUNTRY and small town homes reached weekly by a classified ad in Boyce's Weeklies. Ask for free result book. Use letterhead. Classified Dept., 500 Dearborn Ave., Chicago, Ill.

FIRST \$45 takes complete I. C. S. Metal Mining Course never used, fully paid, \$110 originally. Benson, Jeffris, La.

ANYONE can learn mechanical draughting with my patented device. Send for a circular. S. Knapp Studio, 236 Jefferson Ave. E. Detroit, Mich.

HOW to make printing cuts—"Paint 1c lb." 200 formulas, all 20c. Publishers, 49 Clinton St., Albany, N. Y.

CANDY making—\$15 course 50c. Circular free. Eagle Co., "L," Quincy, Mass.

LEARN Drafting at home. Your spare time will secure you a fine position. Instruments free. Write for catalogue. Maxton Institute, 158 Lawrence Street, Brooklyn, N. Y.

COURSES By Mail: Civil Service, Normal, Academic, Business, Law, Real Estate, and Engineering. 60-page Bulletin free. Write for it today. For "Special Tuition Scholarship," apply Carnegie College, Rogers, Ohio.

YOU can earn \$90 to \$175 a month immediately on leaving our School. We teach you at small expense to become expert Electrician, Plumber, Bricklayer, Painter, Decorator, Draftsman or Moving Picture Operator. Write immediately for catalog and full particulars. Coyne National Trade School, Dept. 9192, 51 E. Illinois Street, Chicago, Ill.

YOU can write 100 words a minute without knowing Shorthand. My new method, Abbreviated Longhand, simpler than the simplest shorthand, tried and approved by thousands. Your money back if not delighted. Sample lesson 20c. Full particulars free. Write today. A. B. Weaver, Court Reporter, Dept. C., Buffalo, N. Y.

SIMPLIS Shorthand by Mail. Easiest learned. The fastest writers use "Simplis." Write today. C. Churchill Business Institute, Grand Rapids, Mich.

AMERICA'S finest penman teaches by mail successfully. Your name on a card and Journal free. Write before bedtime, tonight. Francis B. Courtney, Box A. 492, Detroit, Michigan.

IMPROVE Your Manners—Be popular—Win friends. Happiness and wealth. Write Wagner, 1243 Lexington Avenue, New York.

RESIDENTIAL course in Chiropractic at half tuition. Write for particulars. Antigo School of Chiropractic, Antigo, Wis.

DON'T fail to read Independence and Fortune under Business Opportunities.

THE Seven Wonders of the Modern World—What are they? Do you agree with the selection resulting from the international poll of greatest scientists taken by Popular Mechanics Magazine? The complete result of this vote showing the selection of the wonders together with a historical sketch of each one reprinted in pamphlet form mailed to any address for 10 cents in stamps. Popular Mechanics Co., 318 W. Washington St., Chicago.

PLASTER and concrete casting, instructions, \$1 (ornamental), 12,000 words, 200 illustrations, clear, simple, concise; treatise on manufacturing artificial marble, paper mache, casting marble dust, modeling, coloring, gold leaf gilding and burnishing, elastic moulds, casting from life, casting without skill garden furniture, fountains, benches, etc.; interior decorations, rich ceiling beams, wall panels, columns, figures, etc.; renovating old buildings with stucco, concrete and plaster to mansions. 2,000 word illustrated description free. Mahler, 117 Russell St., Brooklyn, New York.

1,200 CARTOONS for \$1. A Panorama of World Events, Political, Industrial, Social, Humorous, Tragic—all of intense human interest. Six numbers of Cartoons Magazine (January to June, 1912, inclusive) representing the best work of over 100 of the best cartoonists and handsomely and durably bound in book form will be sent prepaid to any address for \$1. Cartoons, 318 W. Washington St., Chicago.

MATHEMATICS made easy for all by Repp's Calculator. Figures out, in the twinkling of an eye, every conceivable problem that occurs in the Office, Store, Shop, Bank, Farm or Factory. Greatest time and labor-saving work on figures in the world. Copyright 1912. Price, \$1. Vest pocket size, 50c. Popular Mechanics Book Dept., 318 W. Washington St., Chicago.

STOP working for wages. Learn a profession in 180 hours which will make you independent for life. Booklet, "How to Succeed," sent postpaid. Address Dept. P. M., Weltmer Institute, Nevada, Mo.

BRIEFHAND enables you to write 100 words a minute, using longhand characters. In order to introduce this latest substitute for shorthand we are distributing 5,000 copies of the complete self-teaching Briefhand Manual, containing 2,900 illustrations, for 25 cents each. Order one today before all are taken. Premier Briefhand School, Box 97, Washington, D. C.

THE Mastery of Words. How to command the right word. Invaluable. Write E. D. Snow, Main St., Hornell, N. Y.

TRADE SCHOOLS

MAKE \$5 to \$8 a day as skilled Electrician, Plumber, Draftsman, Moving Picture Operator. We teach you in short time at small expense, profitable trades. Free employment bureau places graduates in good jobs. Special limited offer now. Write at once for catalogue and full particulars—no obligations. Dept. 8192, Coyne National Trade School, 51 E. Illinois St., Chicago, Ill.

LEARN To Be An Automobile Expert. Our experts will train you on real automobiles to become successful chauffeur, repairman, tester, demonstrator or salesman. Practical experience guaranteed. Our graduates succeed. Send to-day for terms and catalogue D. Peoria School of Motoring, H. F. Edwards, Educational Director, 824-826 Main St., Peoria, Ill.

YOU Can Learn to be a Chauffeur or Repairman in five weeks by "Y. M. C. A. System." Shop-work, Lectures, Driving, Repairing. Fifth Successful year. Over 1,000 Successful graduates. Send for Booklet B. Y. M. C. A. Automobile School, Seventh and Walnut, Cincinnati, Ohio.

PRACTICAL Steam Engineering taught by practical steam engineer; steam engines, boilers, pumps, indicator diagrams, etc., small cost, easy payments. Two cent stamp for particulars. Correspondence School of Steam Engineering, 857 Second St., Fall River, Mass.

TRADE Schools are very successful advertisers in Boyce's Weeklies. Circulation 1,000,000 per issue. Write for free Result Checking Book. Use letterhead. Classified Dept., 500 Dearborn Ave., Chicago, Ill.

A COMPLETE course in interior decorating in all its branches. Practical work. Enter any time. Write for further information. Kalamazoo School of Interior Decoration, Academy of Music, Kalamazoo, Michigan.

PAINTING, Decorating, Paper Hanging taught by actual practice. Free catalogue. Chicago School of Painting, 414 Dearborn Ave., Chicago.

AUTOMOBILE School. You learn with your hands under the superintendence of the best instructors obtainable at the Chicago School of Motoring. Write for particulars. The F. E. Edwards Automobile School & Motor College, Dept. B., 1429 S. Wabash Ave., Chicago, Ill. Phone Calumet 3684.

PICTURES AND POST CARDS

THE Latest Picture Hits. "My Champagne Girlie" and "La Belle Danseuse," 15c each, or the Two complete with 100 other "Catechy Art Ideas" for 25 cents. Union Art Co., 585 M., Garfield Ave., Jersey City, N. J.

COLLECT postcards! Great fun! Receive cards from everywhere! Your name inserted free in exchange list if you send 10c for 4 months' subscription to 20 page magazine. 1 year 25c. Elite Exchange, R 9, 3827 N. 44th Ct., Chicago.

POET Longfellow Postals. Ten cents dozen, with free Calendar. Printer, 69 Deering Street, Portland, Maine.

64 STATE Capitol views, mailed in folder, 15c. Beautiful women postcards, hand-colored, 7-25c. Chicago postcards 6-5c. Elite Exchange, R 9, 3827 N. 44th Ct., Chicago.

JOIN Florida Correspondence Exchange. Membership 10 cts. P. O. Box 1342, Jacksonville, Fla.

PANAMA—A souvenir from the Canal with pamphlets, 10c. Panama Souvenir Co., Bas Obispo, Canal Zone.

NIFTY Photos—10 for 25c. Paul Duff, 2713 Mozart, Chicago.

UNEXCELLED! The World's Most Famous Paintings, reproduced on postcards, faultlessly printed, magnificently colored. 25 for 32c; 50 for 60c. Post Card Co., 207 Wall, Syracuse, N. Y.

FREE—10 Beautiful Viewcards of Philadelphia to all trial members. Fee 10c. International Postcard Exchange, Fairhill Station, Philadelphia, Pa.

POSTCARD Collecting's Extremely Interesting. Membership 10c, three months 25c. Mention P. M. World Collectors' Club, Hartford, Conn.

22 NEW York views, colored, 10c; 99-25c; all different. Landsman, 1380 Prospect Ave., New York.

EARN money weekly writing at home, full details, 2c stamp. Ross Charles, Dept. 9, Roxbury, Mass.

10 PERFUMED Postcards, your name in gold 10c. N. Bloomington Co., Bloomington, Ill.

JOIN Hoosier Card Exchange, membership 10c. Terre Haute, Ind.

BEAUTIFUL, Illuminated Text and Facsimile Pictures 10c each. High grade postcards, 10c per dozen. Booklets and Valentines. Illustrated circular free. Reilly Company, 4017 N. Franklin Street, Philadelphia, Pa.

ARTISTIC hand-colored Photos. Beautiful landscapes. Oil Painting and Water Colors. Write today. August Duna, 138 Zeigler St., Boston, Mass.

RARE circus postcards, 25c set. S. Arnold, Montgomery, Ala., Gen. Del.

SPECIAL Ten colored postcard views of Oregon for ten cents postpaid. Brinckerhoff Supply Co., Carlton, Ore.

POST Cards; 10 Assorted and Pluto and Proserpine—Dime. Good Sense Supplies. French Lick, Indiana.

5 DANDY Hand-Made Comic postals (colored) for 10c, wish you'd see them. Post-Card Artists, 2226 Barry Ave., Chicago.

16 GUARANTEED Nickel grade postcards 10c. F. Franz, Goodthunder, Minn.

35 DIFFERENT views 25c. W. Ohlund, Mountain Ave., Dorchester, Mass.

JOIN Barrows Postal Club, Dodge, Massachusetts. Cards and list free. 10c.

POST CARDS—Hundreds of notable and historic scenes in Ireland, England and Scotland—Add some of these beautifully colored views to your collection; interesting and instructive. Catalog and one sample card sent for 5 cents in American stamps. Strain, P. M., The Lighthouse, Belfast, Ireland.

If you really want to exchange post cards, try our splendid club. Lists circulate in many countries. Membership, 10c. Halcyon Club, Box 133, Erie, Pa.

25 BEAUTIFUL High Grade Souvenir Post Cards. Also our new illustrated catalogue for only 10c. The Rehm Co., Weehawken, N. J.

READ Pictures Instead of Words—The current history of the world in cartoons. 1,200 cartoons for \$1. Jan. to June, 1912, inclusive issues of Cartoons Magazine, handsomely and durably bound in book form will be sent to any address prepaid for \$1. Cartoons, 318 W. Washington St., Chicago.

CARDS exchanged for results. 10c membership in Pacific Card Exchange, Bryn Mawr, Wash.

PHOTOS. "Beautiful women;" 36 beauty poses, 10c. Curtis Co., J. I. Englewood, Chicago.

POSTALS. "Pretty Girls;" 4 bewitching posts. 10c. 12 for 25c. Curtis Co., L2, Englewood, Chicago.

OUR members in Norway, Switzerland and everywhere would like to exchange cards with you. Membership 10c. International Post Card Exchange, 2917 Washington Blvd., Chicago, Ill.

YOU'LL get cards from everywhere. Membership 10c. Idaho Card Exchange, Dept. K, Box 906, Boise, Idaho.

CAMERAS AND PHOTO SUPPLIES

"CASH and the Camera" contains 247 money-making ideas. I find buyers for all prints I deem worthy of publication. Send instantly for particulars and valuable Leaflet of Instruction free. A. S. Dudley, Photographic Expert, Box 775G, Philadelphia, Pa.

LEARN Transphotography. Make beautiful colored transparent photographs, on watch cases, dials, chinaware, mirrors, etc., with or without camera. Fascinating, inexpensive, profitable. Course of Instructions 25c. Greenhalgh, 816 58th Street, Brooklyn, N. Y.

BARGAIN 2,000 ft. frame mouldings at 4c per ft. 8x10 Portrait Camera \$11. Voightlander Portrait Lens \$32, 1/2 size Golsen \$8, background \$3, two Shutters \$5, card paper cutter \$75. Gale V. John, Richwood, O.

MOVING Picture Camera takes standard size picture same as you see in theatres. Bargain. O. Picketman, 3612 E. Washington St., Indianapolis, Ind.

FILMS Developed Free. Prints 3c up. Send two negatives, any size, for sample cards. Monroe Co., Jamestown, N. Y. Professional Experts.

WE buy, sell and exchange—Bargains in Microscopes, Telescopes, Field Glasses, Cameras, etc. Bargain list free. Kahn & Co., established 1850, 26 John St., New York.

WANTED—Good post card size Camera. 195 Mulberry, Ind.

KODAK Films Developed, 10c per roll, any size. Prompt attention given mail orders. Prints 2 1/4 x 3 1/4 to 3 1/4 x 4 1/4, 3c; 4 x 5 to 3 1/4 x 5 1/2, 4c. J. M. Manning, Box B, 1062 Third Ave., New York City.

MONEY in Photography. I start amateurs making money at home taking portraits; become professionals. Studio secrets, retouching, etc., fully explained. Wells Studio, East Liverpool, Ohio.

BIG Money Saved on Photographic Lenses and Apparatus—goods exchanged; repairing done. Ralph J. Golsen, 65 East 46th Street, Chicago, Department P.

NEW York's largest photographic store will take your old Camera or anything photographic in exchange toward any new Kodak or new Camera of any make or size, or high grade Anastigmat lenses; send today for the largest photographic bargain list. Koehler's Camera Exchange, 7 East 14th Street, New York City.

ANY roll film developed 5c; all prints 3c. Photo postals 3c each; 100, \$1.50. 8x10. Enlargements 20c. Caulkins Photon Works, Oneonta, N. Y.

MOTION PICTURES

A VOLUME of practical information for Motion Picture Operators and Beginners. How to avoid trouble and produce clear, steady pictures, and take care of machines. Highly recommended by expert operators throughout the United States. 20c postpaid, stamps or coin. J. W. Bulckerood, Bound Brook, N. J.

DOUBLE Your Income—Write Motion Picture Plays. Easy work, literary skill unnecessary. Send \$1 for complete copy-righted course. Students' questions answered and work criticised free. Our service satisfies or your money back. United Play Brokerage, Desk A, Fostoria, Ohio.

POWERS No. 6 Moving Picture Machine, new \$145. No. 5 used, \$60. Fredericks, 2017 North Twelfth, Philadelphia, Pa.

MOVING Picture outfits bought and sold. Bargain list. National Employment Co., Duluth, Minn.

\$25. TO \$100 Paid for Photoplays. You can write them in spare time. Demand increasing. Your ideas are valuable. Beautiful illustrated book, containing valuable information, free. Authors' Motion Picture School, 1533K First Nat. Bank Bldg., Chicago.

FOR Sale—Moving Picture films from 1/4 to 1 cent a foot. One 2 pin Edison \$75. Two Powers No. 5, \$85 each. One Standard, \$150. Stereopticons, Gas Outfits and slides, all bargains. United American Film Brokers, American Bank Bldg., Knoxville, Tenn.

WANTED. Kinetoscopes. Machines sold. Fred L. Smith, Amsterdam, N. Y.

MOTION picture plays wanted. You can write them. We teach you by mail. No experience needed. Big demand and good pay. Details free. Ass'd M. P. Schools, 601 Sheridan Rd., Chicago.

WRITE Moving Picture Plays; \$10 to \$100 each; all or spare time; experience of correspondence course unnecessary. Details free. Atlas Publishing Co., 304, Cincinnati, Ohio.

\$5 TO \$40—Moving Picture Machines—Send for catalogue. Ralph J. Golsen, 65 East 46th Street, Chicago, Department P.

WRITE Moving Picture Plots. Good Pay. We will show you how. Ripless Co., Brockton, Mass.

DUPLICATORS AND DEVICES

MULTI-Copy Typewriter for sale, cheap, with equipment. Letter set in typewriter type. Prints thru wide ribbon by roller. 1,500 typewritten letters (not imitations) per hour. Write Marble Arms & Manufacturing Company, Gladstone, Michigan. (Sporting Goods Catalog Free!)

HOW to get a Hektograph that will make 150 copies in 10 minutes; letter size, \$2. Write for circular. Heyer Duplicator Co., 118 No. La Salle St., Chicago.

TO MANUFACTURERS

MANUFACTURERS—Inventors—We want several specialties to sell. Our force of agents can sell goods of merit. Give full details in first letter. Simplex Mfg. Co., Kewanee, Ill.

ENTERING Mail Order Business, will consider your proposition. Explain fully. Box 214, Wimsboro, Texas.

WANTED—Exclusive agency high grade proposition for Northwest or Pacific Coast. Box 633, Seattle, Wash.

BLACKSMITHS

BLACKSMITHS—Here is your opportunity to be an expert blacksmith without help as life is short. Try Toy's Modern Methods doing hard jobs easy. Forging and welding all kinds of steel solid, and tempering and hardening all tools to a standard by colored charts. This is real information, not theory. All for one dollar. Send for free samples. W. M. Toy, Sidney, Ohio.

BUSINESS OPPORTUNITIES

MAKE More Money! Operate a good substantial Mail Order business—our "Silent Salesman" system—can easily be done in spare time yet the possibilities are unlimited! For years "Booster" has actually and accurately led thousands like you over the Successful Road to Wealth. To succeed you've got to read The Booster Magazine for "Booster" is Opportunity and starts you in business for yourself—tells you how to get the dollars—puts you next to the best money making propositions on earth—ones that really get you the money! Send 10c for two months trial subscription. Booster Magazine, Northwestern Building, Chicago.

MAIL Order Dealers! Advertisers! You need our 1913 Advertising Rate Book with the latest Dollar-making feature "Ads That Pay." Hot from the press! Gives you cost of Advertising in 2000 recognized magazines and newspapers, location, circulation, closing dates and other useful knowledge. Includes thirty original Mail Order propositions, winners every one of them. A \$10,000 investment at your service. You can make a legitimate profit of 95c on every dollar order. This very valuable manual sent prepaid to you for 10c. Write now! Dearborn Advertising Agency, 521 Dearborn St. Chicago.

YOU can make \$50 weekly, in spare time, manufacturing Tip-Top the new delicious, pop corn confection—the finest you ever tasted—simply melts in your mouth. No capital or experience required—great opportunity to start a big business of your own and make money easy and quick. Formula and complete directions for manufacturing ten cents silver. U. S. Specialty Co. Dep. 29, New Philadelphia, Ohio.

YOUR opportunity—Become manufacturer. Experience unnecessary, no canvassing. \$25 weekly easily earned, at home, during spare time. Sample and particulars free. Dezell Manufacturing Company, 448 1/2 South Mathews, Los Angeles, California.

A Bit Shy on Salary? I pick up \$1,500 yearly additional from newspaper correspondence. My book tells what's news, how to get it, where to sell. Newspaper directory included. No correspondence school expense; only 50 cents. Morris White, Station, 50, Detroit, Mich.

CHICAGO Quiz Bureau? 1707 Washington bou., Chicago answers all questions from Chicago, addresses of individuals, firms, or factories, where best to buy—sell—or have articles made. Enclose 25c coin with Query, also special researches made. Saves you Time and Trouble. Try it.

AGENTS wanted: Men or Women now employed to work one hour a day to sell "Clearall." Indispensable for storekeepers, railroads, street car Cos., automobilists, etc. Quick seller. 100% profit. Send 25 cents (coin) for large sample and full details. Northern Laboratories, Chicago.

I WANT You to handle "Successful Brauns" and my other Mail Order books—they are the best on earth—millions of copies should be sold on merits alone—fortunes should be made by those who heed their teaching! Write me and I will make it to your advantage to sell these, my newest and best books, by furnishing you circulars and books at the right figure. May I send you confidential Mail Dealers prices? Weissgerber, Northwestern Building, Chicago.

BUSINESS Opportunities for you—with money making methods in Digest you can make \$88. One year subscription only 25c. Digest, Grand Rapids, Mich.

LEARN Auctioneering by correspondence. P. O. Box 72 B, Attica, Ind.

LIVE Wire Mail Order Proposition. You sell Business Houses. No Catch Penny Scheme. R. D. Martin, Plainfield, New Jersey.

SELL your formulas, ideas, plans and knowledge by mail. Some make \$1,000 monthly. Instructive booklet for stamp. Information System, 286, Marietta, Ohio.

"THE Art and Process of Dry Cleaning." A fascinating and profitable occupation. 25 cents postpaid. Auburn Supply Co., Dept. EE, 7746 Peoria St., Chicago.

GUARANTEED Remington typewriter free with \$1 monthly Typewriting Course. Merit Service, Oshkosh, Wis.

START a formula business, make \$50.00 weekly, 50 cents brings complete instructions and 25 best formulas. C. Parker, Box 28, Columbia, Tenn.

USE your spare time to build up a mail order business of your own. We help you start for a share in profits. 27 opportunities. Particulars free. Mutual Opportunities Exchange, Buffalo, N. Y.

RESILVER mirrors and make plenty of money. Full instructions, 25 cents. Auburn Supply Co., Dept. CC, 7746 Peoria St., Chicago.

ANYONE, Anywhere \$5 daily replating silverware. Samples free. E. Fiske, 101 Sheffield Ave., Buffalo, N. Y.

SEND me a dollar bill and I will send you manufacturer's recipe for making an article used in nearly every household in America. Can be made by anyone at home. Easily sold. Your profit from 300 to 500%. Business can be started with a few dollars. Your field—the United States. I am proprietor of manufacturing company, also a large business well known in the east. This proposition should make you big money. Your dollar cheerfully returned if not satisfied. C. H. Winkelman, 1833 N. Western Avenue, Los Angeles, Cal.

BE Independent. Make \$50 weekly with a New Invention, just patented. 8c profit on every dime. Small investment. Experience unnecessary. Circulars mailed free. International Metal & Ferrotype Company, Dept. B12, Chicago, Ill.

SEND me 25 cents and I will show you one of the best money making plans in existence. Can be operated entirely during spare time. Suitable for men and women. This is no scheme, outfit or instruction school. Send at once and be convinced. B. Lessig, 3859 Coral St., Phila.

YOUR classified ad can be placed in 1,000,000 small town homes at low cost every week. Ask for free Result Checking Book. Use letterhead. Classified Dept., Boyce's Weeklies, 500 Dearborn Ave., Chicago, Ill.

FINISHED and unfinished stock, patterns, tools, etc., for making an improved paperhanger's tool. Exceptional opportunity for mechanic having \$150 for immediate investment. Address Box 5, Station G, Southbridge, Mass.

DO you want to own a silver plating business, or manage a shop for half the profits? Instructive pamphlet free; write today. Milliken Co., Davenport, Iowa.

PATENT on draft operating device. Can be retailed complete for six dollars with big profit. \$800 cash takes it. No triflers. Victor Cozine, Gloversville, N. Y.

SHEET Bluing, Mending Tissue, Gold Eyed Needles, for Mail Order and Trust Scheme Dealers. Samples Free. Frank Shilling Co., Navarre, Ohio.

I MAKE \$3.50 a day at home, spare time, mailing booklets. You can do as well. Booklet explaining all for stamp. John Menihan, 218 S. 4th St., St. Louis, Missouri.

A new business is springing up all over the country. In the New England States hundreds are making big money in the Wet Wash business doing 30 pounds of washing for 50 cents, returning to the housewife washed and extracted. Cost of washing 6 cents; 30 cents profit in a wash. In every household a prospective customer. Small capital needed to begin with for machinery. Write me for particulars. William Johnson, 150 N. Division St., Buffalo, N. Y.

\$15 CAPITAL will start you in business as manufacturer's agent. The Family Tooth Powder. Is the greatest tooth cleaning preparation in the world. The retail price for a 4 1/2 oz. bottle is 25c or \$3 per doz. You can buy a gross for \$15. Leave a dozen at \$2 per doz., in 12 drug stores on 60 days' consignment, and after the first few bottles are sold watch it sell itself. Send 25c for a bottle to try, postpaid. Address J. N. Forrest, M. D., D. D. S., San Francisco, California.

TURN your spare time into money. Join us in a profitable mail order business, one that you can operate at home. Large profits; quick returns; small investment. Our 10 years' successful manufacturing experience, personal assistance and new ideas assures you success. Write for positive proof and free booklet. Pease Mfg. Co., incorporated, 144-148 Broadway, Desk A, Buffalo, N. Y.

MAKE \$1 earn \$50. Razor Blade Sharpening pays large profits. Easily handled in spare time at practically no expense. Three million owners use four million blades weekly. Big demand for sharpening. Booklet "How to Operate a Sharpening Business" free. What others have done you can do in your town and by mail. Nice money making opportunity for those who apply now. G. A. Haynes, Boston, Massachusetts.

BE first from your locality to represent me and make \$1,000.00 to \$3,000.00 per year Extra Money. Write today. You will receive a wonderful offer. Edwin Pauley, Erie Bank, Buffalo, New York.

HERE'S Your Chance. \$10 starts as clean, legitimate and independent a mail order business as you can put your name to. Indisputable proof, facts and details free on request. Address Expert, 420 Home Bank, Baltimore, Md.

EARN \$7 to \$12 daily, restoring faded colors in rugs and carpets. Whole or spare time. Original American Process. Great demand. No capital. Full particulars free. Eldred, Dept. 75, Detroit, Michigan.

FREE—For 5c to cover advertising, etc. I'll send, sealed, sample circular and full instructions for operating scheme that brought me \$2 an hour. If satisfactory, remit \$1; if not, return. Robert Fink, Kane, Penna.

LEARN the truth about Mail Order Business before buying outfits. Valuable information and particulars free. Mail Order Library, P. Tompkinsville, New York.

GUARANTEE anyone \$50 weekly from start, without capital. No canvassing. Something new. Better investigate quick. Make your spare time profitable. L. N. Todd & Co., Holladay, Va.

START an anti-fly crusade and make money manufacturing traps. Our plans make success easy. Enclose 10c. A. E. Chapman, Official Fly Catcher, Redlands, California.

MAKE \$10 daily restoring colors to faded rugs and carpets. Spare time. Tremendous opportunity everywhere. Simple, easy. Mirror Silvering course free. Free particulars. Coxe, Dept. MD., Omaha, Neb.

FOR Sale—Drug Store on one of the best corners in Louisville, Ky. Exceptional opportunity. For particulars address Crescent, 250 S. Hite Ave., Louisville, Ky.

CONDUCT Paying mail order business from your home. \$5 starts business, complete course \$1. Particulars free. Box 115 Brooklyn, N. Y.

BE a manufacturer! Big profits. Easily done. Your kitchen will serve as a factory. Sample formula, lists and plans 10c. The Anjo Company, Box 497, Galesburg, Ill.

START a mail order business. Reliable guide tells how, where to buy, 25c. Geo. R. Allen, Bound Brook, New Jersey.

LEARN the "Dry Cleaning" business. Complete instructions 20c. Profitable Service Bureau, 4333 N. Sawyer Ave., Chicago.

MAKE money winter evenings. Turn your time into cash. Small capital. Particulars free. P. Benson, Stewartville, Minnesota.

MAIL Order Business. I start you free. P. Newnham, Waukegan, Ill.

SOUTH America's gigantic money making opportunities for large and small capitalists—and for colonists—send 10c for copy of consular report and booklet on Peru. Stevo. Seljan, Official Immigration agent for government of Peru, 1441 A, Old Colony Bldg., Chicago, Illinois, U. S. A.

SPECIAL Offer—Your name in our directory. Big mail for you. If interested in the mail order business; agents opportunities; plans, formulas, etc. Subscribe to our magazine three months, 10c. The "Lever" Mail Trader, 44 Elizabeth, New Jersey.

BE Your Own Boss. Start mail order business. We teach you. 20 years established. Everything furnished. "Starter" free. Krueger Co., Dept. 2B, 167 W. Washington, Chicago.

WIDE-Awake inventors, men with ideas and small manufacturing concerns may obtain financial assistance from the Kenton, Ohio, Commercial Club. Visit Kenton immediately if you mean business. Harry Hopwood, Sec'y.

1,000 MANUFACTURING mail order secrets 25c. Stevens & Co., Buffalo.

SEND for my booklet "How you can become your own master," without capital in a business in which there is no competition. E. Daugherty, 1236 W. Madison St., Chicago, Ill.

ADVERTISERS, Mail Order Men, Circular Mailers. Join the Mail Order Business Club, particulars free. Circulars mailed, 15c 100. John Griesmaier, 5952 Lowe Ave., Chicago, Ill.

BIG Money in the Mail Order Business. Experience unnecessary. Small capital. Instructions free. Keith, 719 Central Bldg., Rochester, N. Y.

DISTRICT managers (men or women) wanted to handle our line of quick selling specialties through sub-agents. Small capital required. Big profits assured. Get busy now for territory. Sanito Co., Rochester, N. Y.

ESTABLISHED business in Grand Rapids, Mich. \$2,500 cash or time. Would take automobile or diamonds as part pay. F. J. Lamb, 162 Baldwin Ave., Detroit, Michigan.

WANTED—Good automobile mechanic, with little capital to invest in growing business. Address Expert, 6th floor, 318 W. Washington St., Chicago.

MAKE your advertising pay better by placing it through a reliable, legitimate agency, at no extra cost to you. Get our advice about your proposition. Pevear & Co., Rochester, N. Y.

SEND for my circulars of new money making ideas. Postal will do. Chas. Metz, P. O. Box 87, Times Sq. Station, New York.

QUIT Wage Slavery. Own a Business. We start you. No capital required. Free particulars. Home Supply Co., Springfield, Missouri.

BE a chewing gum manufacturer at home, no machinery necessary, complete formula \$1. Particulars for stamp. A. J. St. Germain, 72 Canal St., Lewiston, Maine.

START a Money-Making Mail Order Business on \$5 to \$10 capital. Particulars free. National Sales Co., Peoria, Ill.

PATENTABLE Ideas Wanted—Send for 3 free books. R. B. Owen, 39 Owen Bldg., Wash. D. C.

MAKE money. Sharpen safety razor blades. This device sharpens any style blade. 50 cents prepaid. Free circular. Jens Mfg. Co., 1164-39th St., Brooklyn, New York.

INDEPENDENCE and fortune quickly attained in the Manufacturing Mail Order business. I furnish Formulas, Manufacturing Processes and Trade Secrets in all lines. Sold under positive guarantee; 18 years' practical experience. Revision and improvement of Formulas and Processes—reduction of manufacturing cost—utilization of waste materials, etc., a specialty. Booklet, Formula List, and Valuable Information Free. W. L. Cummings, Ph. D., 127 Standard St., Syracuse, N. Y.

BIG Profits for You! Manufacture Barley Crisp. New confection. 5c package costs you 1c. Machine, instructions complete \$7.50 prepaid. Send 10c for samples. Barley Crisp Co., 1605 Hyde St., San Francisco.

STOP Here! Let me start you in a home business that will bring you money every day. Experience unnecessary. Spare time. No canvassing. I furnish everything and guarantee success. Send for proofs. Voorhies. Desk C. R., Omaha, Neb.

BE a Mirror Expert. \$3-\$10 day; spare time home at first; no capital; we train, start you making and silvering mirrors; French method. Free prospectus. W. P. Derr, Pres., 87 Saratoga Ave., Brooklyn, New York.

I WILL start you earning \$4 daily at home in spare time, silvering mirrors; no capital; send for free instructive booklet, giving plans of operations. G. F. Redmond, Dept. 306, Boston, Mass.

MANUFACTURE Gold Letters for signs—\$100 per month easy. I start you. Experience unnecessary. Take like wildfire. Prospectus free. J. F. McPherson, 673 Brown Avenue, Butler, Pa.

PATENTS Secured—C. L. Parker, 910 G St., Washington, D. C.

OPERATE Hahn's Premium Machines. Let them gather pennies for you. The best seller for cigars and candies. J. L. Hahn, 1016 Germantown Ave., Philadelphia, Pa.

FORM a corporation—Congress Law for D. C. and all States; cheap. Raise money easily. U. S. Legal Corporation, Washington, D. C. Representing \$1,225,000,000.

COLLECT money by a sure, simple, system. Income \$1,000 to \$5,000 a year. Quick results. No capital required. Instructive book. "Skillful Collecting," free. National Collectors Ass'n., Long Street, Newark, Ohio.

FORMULAS furnished by expert chemists, for manufacturing Toilet, Household, and Technical products. Government serial numbers obtained. Catalogue for stamp. B. Mystic Company, Washington, D. C.

WE Help Raise Capital at once to start you in retail—manufacturing—patent—real estate—mail order or any legitimate business by means of "Our Practical Method." Particulars free. The Business Aid Co., K594, Detroit, Mich.

AN intelligent person may earn \$100 monthly corresponding for newspapers. No canvassing. Send for particulars. Press Syndicate, 700, Lockport, N. Y.

I Made \$50,000 in five years with a small mail order business; began with \$5. Send for free booklet. Tells how. Heacock, 5074, Lockport, N. Y.

FOR ADVERTISERS

YOUR 30 word ad in our 20 Page Postcard Magazine, 15c. Display, 50c inch. Elite Exchange, 3827 No. 44th St., Chicago.

PLACE your advertising through a reliable, legitimate, recognized agency, at no extra cost to you. Our expert knowledge of advertising and selling is at your service. What is your problem? Pevear & Co., Rochester, N. Y.

YOUR ad placed in nearly fifty magazines, 3 months, 5 cts. per word. Give us a trial ad. A. S. Mankin & Co., Alexandria, Va.

"THE Ad Writers' Assistant"—Book containing 350 phrases, headlines, suggestions, interesting opening chapters, each illustrated with appropriate cut, mailed, 25c. Cuts supplied. F. S. Ailes, Drexel Building, Philadelphia.

BARGAIN Advertising Rate—Just to get acquainted—15 words, one insertion, guaranteed 10,000 copies printed, and one year's subscription 25c. Digest, Grand Rapids, Mich.

STRONG, Persistent and Convincing copy for Form Letters, Followups, etc. Marshall Hathaway, Rolling Prairie, Ind.

500 GREAT advertising secrets, postpaid 25c. Morris, 617 Passyunk Ave., Philadelphia, Pa.

MECHANICAL ENGINEERS

ELECTRIC Light and Power draughting solicited. Robert Mather, Windsor Locks, Conn.

MACHINE designing and building our specialty. Consulting Mechanical and Electrical Engineers. Pullman-Field Machine Co., Sodus, N. Y.

MACHINE designing, working drawings, experimental machinery. Cary L. Abbott, Mechanical Engineer, 1341 Unity Bldg., Chicago.

IDEAS developed. Patent and working drawings. Blue printing. Julian Forrest Company, Desk H, Box 362, Providence, Rhode Island.

CEMENT

CONCRETE Building Block Machines and moulds. Free catalogue. 5 Market St., St. Louis, Mo.

CEMENT Finishing Tools. Eighteen \$3; worth \$14. Catalogue. Ernest Benninghofen, Hamilton, Ohio.

If you want the best information on cement and concrete construction, subscribe for Concrete-Cement Age, leading cement and concrete monthly. Sample copy, 10 cents. Yearly subscription, \$1.50. Concrete-Cement Age, 135 Newberry Bldg., Detroit, Mich.

ADJUSTABLE Burial Vault Moulds, new and simple. Make the best vault known and offers big profits for right man. Write for booklet, A. S. V. Co., Peru, Ind.

MACHINE making Building Stones, fifty cents. William Barten, Gordon, Nebraska.

COLLECTIONS

CLAIMS; all kinds, collected anywhere. Fidelity Credit Co., Richmond, Va.

AGENTS WANTED

AGENTS Wanted—Here's big money for you—and a stylish nobby suit absolutely free. \$40 a week easy. Many are making more. Nothing to learn. Nothing to buy. Nothing to invest. No capital required. We furnish everything free—even the suit of stylish clothes you wear. Our men are the swell dressers and it don't cost them a cent, and they make big money every week. Get in now. Now is the time for the big money. Your name on a postal brings everything free. The hand-somest lot of samples of the latest suitings you ever looked at to choose your suit from. And a book of fashion plates showing the very latest, nifty, nobby styles; also measuring blanks and everything needed—all free. We pay expressage on everything. Send that postal now—don't wait. This is your chance—grasp it. American Woolen Mills Co., Dept. 214, Chicago.

AGENTS—To sell the newest electric appliance on the market; sold everywhere there is electricity, in the home and office; liberal profits; sales-driving sample, weighs a pound, no experience or knowledge of electricity required; it shows how to use one light instead of two and get the same results; sells for \$3.50 and saves the purchaser an investment of \$25. Write for particulars. The Handy Light Co., 13 Handy Light Block, Cincinnati, Ohio.

BE Independent. Make \$50 weekly with a New Invention, just patented. 8c profit on every dime. Small investment. Experience unnecessary. Circulars mailed free. International Metal & Ferrotyping Company, Dept. B13, Chicago, Ill.

"AGENTS Wanted" advertisers are most successful and enthusiastic users of advertising space in Boyce's Weeklies. The 1,000,000 circulation pays big. Write for free Result Checking Book. Use letterhead, 500 Dearborn Ave., Chicago, Ill.

HAVE you a few hours to spare? We want man or woman in each town. No capital needed. An hour's work shows dollars earned in spare time. Pocket sample. 400% profit. G. C. Mfg. Co., (Dept. 191), 29 Warren St., N. Y.

AGENTS—Sell our high-grade line of perfumes, toilet articles, soaps and combination boxes. 150% profit. We are manufacturers. Hopfinger & Roth, 218 N. 2nd St., St. Louis, Mo.

SIGN letters. Every firm wants them. Something entirely new. Nice, pleasant business. Paul Jacob, 25 Third Ave., New York.

KEY Checks—\$1.45 per 100. Dies for stamping names on checks, fobs, umbrella plates. Wholesale prices—Collar clips, sewing awls, etc. We show you how to make \$5 per day. Pease Die Works, Dept. M., Winchester, N. H.

AGENTS—Fine opportunity to make good money; brand-new, clean-cut proposition; want hustlers. Send for particulars today. Stewart Specialty Co., Chittenden Ave., Columbus, Ohio.

AGENTS Wanted for new rapid selling household specialties; particulars, catalogue and samples free. Fairchild Specialty Co., 3910 Bell St., Kansas City, Mo.

\$21 PROFIT six hours; made by agents demonstrating most perfect hand power vacuum cleaner—made (carpet sweeper type). Liberal commission and cooperation. Exclusive territory. Yaxley Mfg. Co., 1035 Wash. Blvd., Chicago.

INVISIBLE Pen-Pencil Holder. Holds several. Unique. Agents over hundred per cent. Sample 10 cents. Nouveau Sales Co., Raleigh, N. C.

AGENTS—Manufacture Excelsior polishing cloth. Formula, 25 cts. postpaid. Leroy Gibson, Rockland, Me.

GUILFORD Kerosene Mantle Lamps—America's largest variety. Burners fit ordinary lamps. The agents' sure money makers. Guilford Co., Seville, Ohio.

ORGANIZER'S Bonanza. Everybody wants land on the Co-operative Homestead Plan. A. Hawk, Crystal Springs, Fla.

AGENTS—New patent, just out, has unlimited field. Over 80% profit. Good side line. F. Huxley, 6032 St. Lawrence Ave., Chicago.

F. E. FUCHS, 38 Park Row, New York, wants agents who can sell a staple article. Both sexes.

\$4 DAILY. Indestructible pens, outwear all others. Pkg. 10c. P. M. Miles Co., Lynn, Mass.

MAKE \$21 next Saturday. Sell startling new invention—just out. Combination Burner and Filler for all Coal Oil Lamps. Unbreakable steel mantle. Big white powerful light. No smoke or smell. Fills Lamps quick. No dirty hands—no slopping oil. Low in price—selling like wildfire. Agents coining money. Johnson, Fla., cleared \$40 first week. Hess, Iowa, made \$7 one day. Exclusive territory and protection free. Not sold in stores. Send no money but write quick for details. Fairchild Co., 512 Nasby Bldg., Toledo, Ohio.

AGENTS with executive ability wanted to sell a mechanical device that positively removes shine from clothing. Case is highly-polished aluminum, and contains abrasive rollers. Same size as a cake of soap. A high-grade article, and owing to its usefulness and appearance it is selling rapidly. Send 50 cents for sample machine. Money back if not satisfied. Exclusive territory. Our proposition is liberal. Write now. L. D. Berger, 59 North 2nd Street, Philadelphia, Pa.

YOUNG Man, would you accept and wear a fine tailored suit just for showing it to your friends? Or a Slip-on Raincoat Free? Could you use \$5 a day for a little spare time? Perhaps we can offer you a steady job. If you live in a town smaller than 10,000 write at once and get beautiful samples, styles and this wonderful offer. Banner Tailoring Company, Dept. 27, Chicago.

SALESMEN, get our dazzling "Book of Gold" Men's Free Tailoring Outfit. Classiest ever attempted—the absolute limit of sartorial supremacy. Success sure. Our men coining money daily—hourly: "Book of Gold"—your gorgeous free suit—\$5,000 cash satisfaction bond—smash competition. Get our wonderful Big Free Offer Quick! Postal brings everything for comparison; then see how measly otherwise are. Great Central Tailoring Co., Dept. 320 Jackson Blvd., Chicago.

WANT three swell made-to-measure shirts? Show our samples to friends, take a few orders easy and make enough profit to get yours free. New fancy patterns, made just as you want them. One good agent wanted in each town, spare time or all time. Write for beautiful samples, wholesale and retail prices and our liberal offer. Peerless Shirt Makers, Dept. 3, Chicago.

AGENTS—Be quick—get the agency—never such a seller—make \$100 a week—Model Vacuum Cleaner—carpet sweeper type—wonderful suction—Sells for \$8.50—your profit over 100 per cent—no competition—patented—we start you—the Cleaner sells itself—free samples to workers. Model Vacuum Co., D30, Cincinnati, O.

OUR wonderful stove lid saves one-half of coal; hundreds in use; requires only ordinary mechanical ability to install; demand tremendous; the biggest seller of the year; 150 per cent profit for agents; write quick for full particulars, testimonials, etc. Pre-Heated Air Co., Room 627, 1011 Chestnut St., Philadelphia.

AGENTS—Would You Take a Steady Job where you can make \$30 weekly and chance to work up to district manager with yearly profit of \$3,000 or more? No experience required. My goods are snappy self-sellers that make and hold customers. Need fifty more agents now. If you want to make big money quick, write today. E. M. Davis, 1038 Davis Block, Chicago.

\$50 A WEEK upwards; agents wanted for the sale of electric light intensifiers; a new invention which doubles the light without extra current; interesting to every user of electric light; limited territory reserved for agents; apply at once. Intensifier Light Co., New Britain, Conn.

YOUR Boy's Spending Money—Boys, also men, wanted in every city, village and rural district to put up the Never Slip Clothes Line Holder. Big profits. Send 15c for complete working outfit. Address C. N. Allerding, Mansfield, Ohio.

THOUSAND Agents immediately. New device. Repairs puncture in one minute. Automobile owners delighted. Agents make day's wages every sale. L. M. Zinser, Monte Vista, Colorado.

\$1,000 EARNED by three people within thirty days selling our Fire Extinguishers. Buyers everywhere; protected territory; 500% profit. Local and State Agents wanted. United Manufacturing Company, 1242 Jefferson, Toledo, Ohio.

AGENTS Wanted—We want a live man in every town to act as a sales manager. We want you in your town. Devote your spare time to our business and you will make bigger money than you ever made before. Give us all your time and we will make you rich. These are facts, not promises. \$50 a week at the start. Besides, a nobby free suit—and all the clothes you want at less than wholesale price. Wear one of our free suits as an advertisement and people will flock to you to buy a suit like it and you will coin money. Get our money making proposition and beautiful book of samples. Just send a postal card. We pay express charges on everything. Join the live wires—send us a postal today. Paragon Tailoring Co., Dept. 214, Chicago.

AGENTS own your own business; no capital needed; steady income selling our new changeable signs, gold and silver letters; in demand everywhere. Write for catalogue. Climax Novelty Co., 703 Gay Bldg., St. Louis.

AGENTS—We have a proposition that appeals to every live agent. Write immediately for full particulars. Cowal Specialty Company, Department AC, Box 847, Richmond, Virginia.

SELLING Agents Wanted for "Fire Out." Best selling small fire extinguisher. A real money maker for you. Our proposition won't disappoint you. The Inst. Lighter Co. Dept. M., Columbus, Ohio.

AGENTS—Guaranteed Shoes, "must give satisfaction" or new pair free. All styles. Fit guaranteed. 98c profit on every sale. Quick seller. Write today for complete outfit. Guaranteed Shoe Co., 2262 Third St., Dayton, O.

AGENTS Wanted—Send 35 cts. for 1 tube of water proof shoe polish in aluminum case with dauber and polisher complete, and one of each of our catalogues, of rubber stamp, novelties, etc., with agent's terms. A. S. Mankin & Co., Alexandria, Virginia.

AGENTS—Get particulars of one of the best paying propositions ever put on the market. Something no one else sells. Can make \$4,000 yearly. E. M. Feltman, Sales Manager, 6124 Sycamore St., Cincinnati, O.

AGENTS on salary or commission. The greatest agents' seller ever produced; every user of pen and ink buys it on sight; 200 to 500 per cent profit; one agent's sales amounted to \$620 in six days; another \$32 in two hours. Monroe Mfg. Co. N. 6, La Crosse, Wis.

\$10 TO \$15 per day easily made, 15% profit, exclusive territory; our new cleaning, polishing, and dustless mop is the big money getter and record breaker. Duncan Bros., 2910 N. Troy St., Chicago.

AGENTS—Something live—something fresh—something new. Something that's a seller, and bringing our boys \$35 a week and up. National Manufacturing Co., Lemont, Ill.

AGENTS—Get busy; latest invention. Fix It. Millions being sold; orders coming fast; act quick; big profit. Sample 10 cents. Eastern Specialty Co., Hoboken, New Jersey.

AGENTS—\$50 to \$75 weekly guaranteed—General Agents to handle our Special Accident Policies, issued at \$1 to \$5 per year. Address Wm. Okey Weaver, Mgr., Schultz Building, Columbus, Ohio.

SALESMEN wanted to handle our specialty; sells at sight; earn big money easily; write for free instructions. American Specialty Co., 5 Mechanic St., Bradford, Pa.

AGENTS wanted for best automobile accessory proposition ever offered. Power Tire Pump to sell for ten dollars. F. E. Lortz Co., 2503 E. 55th St., Cleveland, Ohio.

AGENTS—Every home wants our specialty. Quick sales; \$4 to \$7 daily made. Fall leader sample free. W. E. Yates & Co., 1818 Clawson St., Upper Alton, Ill.

BURGLARS Beware! Best alarm invented, lever action, no wires, fires blank cartridge; sleep peacefully, intruders fly. Secure agency, make money, sells itself. Send 35c for nicked sample. MacCarthy Co., 361 7th St., Brooklyn.

AGENTS—Stop canvassing. Our district managers are making big money employing sub-agents. You can also. We show you how. Write for particulars stating territory preferred. Sanito Co., Rochester, New York.

MEN, Women, one-half is yours. Something old. Good seller. Good repeater. Not sold in stores. It's Forkia. Bacorn Co., Elmira, N. Y.

WASHING Done By Vacuum, no rubbing, sells on sight, \$2.25. Sample to agents, \$1.25. Woman's Labor Saving Device Co., Box 541, Minneapolis, Minn.

SILPLATE plates brass, copper, etc., with one rub. Guaranteed. Send for 50c bottle and agents' proposition. Wirthman Laboratories, Sixteenth and Grand, Kansas City, Mo.

AGENTS send for catalogue of household novelties, quick and easy sellers. Martin L. Zerega, Dorchester, Mass.

AGENTS—My Twelve "Moneymakers" bring repeat orders. Easy selling plans. Big profits. A. Rolfe, 923 N. Alder, Philadelphia, Pa.

SMALLEST alarm clock, Bible and telescope, 10c each prepaid. W. H. Gardner, A 1408 W. 22nd St., Los Angeles, Cal.

AGENTS—Advertising Pencils, Sample stamped with your name, etc., 10c. Randall Novelty Co., Nashua, N. H.

LADY Agents Wanted. Englewood Distributing Co., 5952 Lowe Ave., Chicago, Ill.

BIG money makers, particulars for red stamp. Detroit Filter Co., Detroit, Mich.

WHERE did your money go? Find out. Begin any time with our Daily Expense Record. It will keep you posted and reduce expenses. A very interesting and complete book—50c. Agents wanted. Auburn Supply Co., Dept. HH, 7746 Peoria St., Chicago.

HUSTLERS to sell splendid article, needed in every home and office, sure repeater, great money saver, salesmen coining money, 100% profit; Leroy Specialty Company, Desk 1, Huntington, Ind.

AGENTS! 1000% profit selling our beautiful religious masterpiece "Christ at Golgotha." Size 14x28 inches, beautiful colors. Sells like wildfire for 25c. Your cost \$2.50 per hundred. Sample 10c. Merchants Specialty House, 521 Dearborn St., Chicago.

CHANDELIER Clothes Dryer—Pulls up to ceiling on porch or in house. Clothes out of way. Holds good size washing or ironing; weighs three pounds; sent prepaid. \$1.50. Every home will buy one. Agents wanted—Auburn Supply Co., Dept. DD, 7746, Peoria St., Chicago.

SELL dealers, make 50 per cent on sales; good article, attractively displayed. Retails 10c; send 5c for sample. Rawlings, Box 1053, Central Station, St. Louis, Mo.

AGENTS—New Invention—Electric Cigar Lighter—Used on cigar cases. Sell to stores—best seller—big profits. Write for special starting offer. Drake Mfg. Co. 142 Reed St. Milwaukee, Wis.

AGENTS Wanted: sell our mission furniture. Big commission; exclusive territory. Dept. F. Lewis, Grove & Co. P. O. Box 183. Bluffton, Ind.

AGENTS—Big profits selling California Honey. Permanent business; steady repeat orders. Leaflet free. Spencer Apiaries Co., Box 199. Nordhoff, Calif.

CASH for names, addresses, information, etc. Steady income at home. Instructive booklet for stamp. Information System, 287 Marietta, Ohio.

AGENTS—Start now, just in season, big profits, easy sales. H. Vale cleared \$2,100 last year, McFadden \$1,800 selling Photo handle knives and razors. Write United Cutlery Co., E. Fourth, Canton, Ohio.

SIDE line—office specialty. Sells from pocket. 150 to 200% profit. Bayless Sons Company, Muncie, Indiana.

AGENTS and canvassers for books write for particulars. Kirk A. Box 3002, Philadelphia, Pa.

READ the Agents Magazine. Make more money. 2 months 10c. Agents Magazine, Chicago.

SIGN Agents—Painters—Something new and better. Attract ready-made Gold and Silver letters. 21 kinds, easily applied. Make big money lettering store windows, making signs, and selling our line of flashing, sparkling chipped glass name-plates. No experience needed. Write for sample letter and catalogue and start at once. Address Attracto Sign Co., 2655 North Clark Street, Chicago, or 519 Pacific Bldg., San Francisco.

LEARN Telegraphy at home—get salary \$100 month. Write now—Telegraphy—Box 481—Minneapolis, Minn.

\$50 A MONTH earned at your own home! No canvassing or collecting required. All our work may be done in any room of the house in spare time without interfering with your regular duties and without your nearest neighbor knowing you work for us. New system of business and the greatest offer ever made. Write now before it is too late! Blye & Co., Dept. 31, Terre Haute, Indiana.

MAN wanted as exclusive agent. We manufacture six styles Self-wringing Mops, for all purposes, including an absolutely new combination Scrubbing, Brushmop that is Self-Wringing. Every woman wants this proven success. New inexperienced men make \$9 per day. One man made \$120 the second week. No investment. Send for catalogue and exclusive territory proposition that will make you independent. Hilker Mop Co., 1200 Grand Ave., Chicago, Ill.

YOU can make big money handling our proposition—something unique—an article that can be sold in every house. The business can be worked by you either along Mail Order or Agency lines with unusual profit. Send ten cents for sample and wholesale prices or write for our literature; it's free. Northern Supply Co., 3453 N. Hamilton, Chicago.

MAKE \$5 to \$25 weekly in spare time as my representative. I manufacture three household articles every woman needs and buys. My prices are the lowest and Agents make over 100 per cent profit. Write today for particulars. J. C. Hoag, 553 Carpenter St., Mt. Airy, Pa.

BEST Yet, \$6 Profit on Each Sale. One lady agent took 5 orders first morning without experience. Rev. Waterman of Iowa sold 39 in 5 days. Any one can do it. Best and easiest operated Double-suction cleaner made, guaranteed 5 years. Warner Vacuum Cleaner Co., Box "Z," Muncie, Indiana.

NEW Invention—Flat Collar Button; lies flat; takes pressure from back of neck; constant pressure injurious; coat collar sets better; ties slip easier; agents coin money; new self selling plan; no canvassing; samples 10c. Carl Brown, Dept. P1, Columbus, Ohio.

AGENTS. More than double the sales in 1912 over 1911. If your locality is not now covered we can give you an agency which will net you \$15 to \$35 per week. Only people with good references need apply. Condifely Co., Box 1166, Boston, Massachusetts.

AGENTS—\$20 to \$40 weekly selling Hosiery, Underwear, Sweaters. Samples free to hustlers. Large line. Liberal commission. Sales Manager, Room 62, 54-60 Worth St., New York.

DID you ever hear of anyone selling Popular 25c Sheet Music at 5c? You can do it, and make 300 per cent. Four sample copies and proposition, 10c. Chicago Book & Music Co., 535 S. Wabash Ave., Chicago.

70c COMMISSION on \$1 pictures; new, beautiful; sell quickly into Catholic homes; profitable employment for reliable men and women everywhere. William F. Butler, Dept. J, Milwaukee, Wis.

WE furnish you capital to run a profitable business of your own. Become our local representative and sell guaranteed sweaters, shirts, neckties, underwear and Hosiery direct from our factories to the homes. Write, Steadfast Mills, Dept. 10, Cohoes, N. Y.

AGENTS sell rich looking imported 36 x68 rug \$1. Carter, Tenn., sold 115 in 4 days. Profit \$57. You can do as well. Write for selling plan. Sample offer. Exclusive territory. Sample rug sent by prepaid parcel post \$98. Condon, Importer, Stonington, Me.

\$2.50 PER day paid one man or woman in each town to distribute free circulars and take orders for concentrated flavoring in tubes. Permanent position. J. S. Ziegler Co., 443-D, Dearborn St., Chicago.

AGENTS. If you don't make \$4 profit the first day selling Tate's Guaranteed Dust Absorbing cloths, brushes, mops, etc., return sample outfit. Many agents make \$25. Write quick for particulars. Dept. A-4. Consumers Direct Supply Co., Boston, Mass.

SELLING our exclusive linen heel and toe guaranteed hosiery direct from mill to wearer. Pays big profits. Customers waiting. Re-orders insure permanent, increasing income. Exclusive territory. Credit. N. Parker Mills, 720 Chestnut St., Phila., Pa.

SALESPeople everywhere will wish to find out why agents of the "Ever Ready" Specialties are doing better than others. A postal will bring all particulars. A. Lowell Mfg. Co., 108 Fulton St., New York City.

EARN \$7 to \$12 daily, restoring faded colors in rugs and carpets. Whole or spare time. Original American Process. Great demand. No capital. Full particulars free. Eldred, Dept. 75, Detroit, Mich.

MAKE \$10 daily restoring colors to faded rugs and carpets. Spare time. Tremendous opportunity everywhere. Simple, easy. Mirror Silvering course free. Free particulars. Cox, Dept. MD., Omaha, Neb.

400% PROFIT. Quick Sales! Sell our Beautiful Air Brush Design Show Cards. 350 subjects, all businesses. Merchants buy on sight. Three big premiums free, just to get acquainted. Write today for catalog and premium offer. Merchants Specialty House, 523 Dearborn, Chicago.

AGENTS male and female wanted, for established proposition (Medical), stand strictest investigation, legitimate, good seller, splendid profits, write for samples, Edward Mulligan, Congers, N. Y.

AGENTS and Representatives Wanted. Non-Tarnishable Gold and Silver Window Letters, 70c per 100. H. Alexander, Manufacturer, 328 E. 59th St., New York. Established 1905.

AGENTS—100% profit—sell to saloons—machine a whirlwind seller. Free sample and salesmanship course. Two sales a day \$15 profit. Write. Simplex Mfg. Co., Dept. 7, Kewanee, Ill.

AGENTS make 500% profit selling our gold window letters, novelty signs and changeable signs. 300 varieties in enormous demand. Catalogue free. Sullivan Co., 1238 Van Buren St., Chicago, Ill.

AGENTS—We have ready winter sellers. Agents make big money. Write for our large new catalogue. Edward J. Perrin, 2106 Bank Street, Louisville, Ky.

GUARANTEED Boy's Watch or Girl's Gold Plated Bracelet, given for introducing our seed in your neighborhood. Outfit free. P. Peoples Co., B-89, York Haven, Pennsylvania.

QUICK selling Vacuum Cleaner, powerful sweeper type. Free sample to hustlers. Make big money employing sub-agents. Experience unnecessary. Vacm Co., 1488 Security Bldg., Chicago.

BIG money in Essex Fan Motors, run by gas or gasoline. Winfield H. Smith, 10 Lock Street, Buffalo, N. Y.

SALESMEN wanted to sell advertising novelties, nail File and Tooth Picks in leather cases, 25% commission, 2 samples 10c. Joel Kenyon, Owego, N. Y.

AGENTS—Either sex. Handle three articles housewives use weekly. Unique selling plan. Constant repeaters. Permanent income. Attractive proposition. Leibman Mfg. Co., Richmond Hill, New York City.

AGENTS—Send today for my new proposition. Appeals to everyone. 100% profit. Raymond Pfau, Wenatchee, Wash.

WE Pay \$80 A Month Salary and furnish rig and all expenses to introduce our guaranteed poultry and stock powders. Address Bigler Company, X368, Springfield, Illinois.

AGENTS—men and women, newest invention. Wing Self Heating Gasoline Flat Iron; guaranteed, sells everywhere. Women delighted. Write for particulars. Wing Mfg. Co., 1608 Fulton St., Chicago.

ONE Million Agents Wanted. Fast sellers costing 2c, selling 25c, in quantities to \$50. Every firm needs. Postal brings samples. Embossed Co., 240 West Illinois St., Chicago.

AGENTS—Make \$2 each selling our wonderful luminous crucifixes; nothing to sell six a day; absolutely new; shine all night in darkest room. Pioneer Portrait Co., 1259 W. 63rd St., Chicago.

SIGN Painting Agents. 1000% profit. Best and cheapest window letters made. Mounted sample free. Success positively guaranteed. Embossed Letter Co., 245 West Illinois St., Chicago.

YOU can make more money operating a Mail Order business, but before taking any chances invest 10c for two samples of "Booster"—the one bonafide Mail Order and Agents publication on earth—a magazine that has for years actually and accurately started others like you in business for themselves by publishing the best money making propositions on earth—ones that really get the money! Send 10c today—its worth dollars to you. **Booster Magazine**, Northwestern Building, Chicago.

\$61.50 WEEKLY introducing and selling a new Gas Light Burner for Kerosene Lamps. Beautiful light. No chimney. No mantle. Perfectly safe. Simple in construction. Nothing to get broken or out of order. Will not burn out. Durable. Will last for years. Low price. Easy to sell. 200 per cent profit. Experience not necessary. Sample free. Why not try one on your lamp? Beware of imitations. No branch offices. **Luther Manufacturing Co.**, Dept. 189, Cincinnati, Ohio.

AGENTS sell Pals Changeable Scarf Pin, make \$30 weekly, send stamp for free sample. **Pals Manufacturing Company**, 25 East 14th Street, N. Y. City

"KNIFE and Fork Cleaner" made of cork, felt and steel. Great, new agents' article. Sample 10c. **Bauer**, 135 East 34th, New York.

SHOW Card Agents making barrels of cold cash. Great two color catalog free. Write today. **Popular Show Card Co.**, Dept. FB, 1235 Michigan Ave., Chicago.

AGENTS—Big profits selling herb medicine. Repeat orders. **Knox Mfg. Co.**, Peoria, Ill.

SALESMEN—Make big money selling our devices. **Waage Electric Co.**, 680 W. Madison, Chicago.

ANYONE can make big money easy selling the Aladdin Kerosene Mantle Lamp. No experience necessary. A demonstration sells a lamp in nine out of ten homes. One agent sold over 1,000 on money-back guarantee, not one returned. Another made over \$300 in 15 days. Hundreds doing as well. Evenings may be made profitable. Special introductory offer to the first man in each neighborhood who writes for agency proposition. **Mantle Lamp Co.**, 351 Aladdin Bldg., Chicago, Ill.

AGENTS—\$50 weekly; we manufacture the best needle case made, a wonderful seller; 200 to 500 per cent profit; talking unnecessary; our copyrighted "Trust Scheme" Envelopes do the work; general agents can make over \$100 weekly; send 10c for a 25c sample containing 115 needles; particulars free; buy direct from the factory at wholesale. **Paty Needle Co.**, 102 Union Sq., Somerville, Mass.

AGENTS—County and State; men and women everywhere to sell the Pinless Clothes Line; a practical labor saving invention, lasts life-time, sells on sight, gives perfect satisfaction. Agent Sutton of Georgia, sold over million feet; 100% profit; write quick for exclusive territory; information free; sample prepaid 25c stamps. **Pinless Clothes Line Company**, 520 Wilcox Bldg., Portland, Oregon.

BEAUTIFUL Embossed Gold Window Letters make 1000% profit without experience. New easy proposition. Signs always needed. Ours last for years. Rock bottom prices. Essentials to work with mailed free. **Embossed Letter Co.**, 235 W. Illinois St., Chicago.

AGENTS. One cent invested in a postal card will bring you a \$35.00 to \$60.00 a week proposition. **Sterling Aluminum Co.**, Canal Station, Chicago, Ill.

AGENTS. Cost 2c, sell 25c. Sign letters put on with roller. Samples free. **Embossed Letter Co.**, 230 West Illinois St., Chicago.

SHAVEZY Guard makes Safety Razor of your own favorite blade. Excellent line for shopmen everywhere. Sample 25c. Particulars, red stamp. **Keon Mfg. Co.**, Waltham, Mass.

BOKARA Diamonds—Agents, everyone, to wear and sell our famous Bokara Diamonds. Write for sample offer and catalogue free. **Northwestern Jewelry Co.**, 52 Northwestern Bldg., Chicago.

\$10 A DAY for Agents. Selling the New 1912 Fall Style Silk Neckties and giving free with each purchase a beautiful Monogram Roman Gold Finish Cuff Link and Stick Pin Set. Samples free. **Dayton Neckwear Co.**, Room 25, Dayton, Ohio.

BE Independent! Start a mail order business in your own home. We tell you how, and furnish everything needed wholesale. An honorable and profitable business for man or woman. Particulars free. Many make \$3,000 a year. **Murphy Mfg. Co.**, South Norwalk, Conn.

MEDALLIONS sell at sight, 300 per cent to 500 per cent profit. Make up your own goods and be independent. "It's easy." Catalog free. **Fred Resag Co.**, 1205 W. Randolph St., Chicago.

AGENTS—700 Things a Boy Can Make—Can you beat it? Set of 4 books that sell for only \$1. Everyone is interested. Enough to keep a boy busy until he grows up. Parents want them for their lads. Good liberal commission. Exclusive territory. Write to **Popular Mechanics**, Book Dept., 318 W. Washington St., Chicago.

AGENTS—Easily earn \$25 to \$40 per week selling **Kno-Darn Guaranteed Hosiery**; direct-from-the-mill proposition; 20% better; costs less; **M. Garwood** sold \$400 worth in six weeks; send for free sample; no money required. **Kno-Darn Hosiery Mills**, Desk 15, Dayton, Ohio.

WE are the largest manufacturers of Twisted Wire Brushes in America. Highest grade goods, best service, highest profit. Write for our new catalog. You are sure to win. **Fuller Brush Co.**, 33 Hoadley Place, Hartford, Conn. Western branch, **Wichita, Kansas**.

AGENTS make big money selling our new gold letters for office windows, store fronts and glass signs. Any one can put them on. Write today for free sample and full particulars. **Metallic Sign Letter Co.**, 406 N. Clark St., Chicago.

AGENTS—We manufacture glass paper. Plain glass windows made to look like real stain glass; something new; easily applied; big money maker; two sample sheets of paper, with catalogue in colors and discount sheet, for 10c. **S. H. Parrish & Co.**, 202 S. Clark St., Chicago.

AGENTS Wanted—Mechanics and shopmen make over \$100 a month in spare time selling transparent handled novelty knives and razors. Big profits. Sales easily made. Write for terms today. **Novelty Cutlery Co.**, 67 Bar St., Canton, O.

YOU can make \$\$\$\$ as our general or local agent. Household necessity; saves 80 per cent; permanent business; exclusive territory; salary or commission; free sample; credit. **J. Pitkin**, 113 Redd St., Newark, N. Y.

500% PROFIT selling our wonderful sign letters for office windows, store fronts and glass signs; resembles finest gold leaf; easily applied; samples free. **Metallic Letter Co.**, 406 N. Clark St., Chicago.

STOP Here! Let me start you in a home business that will bring you money every day. Experience unnecessary. Spare time. No canvassing. I furnish everything and guarantee success. Send for proofs. **Voorhies**, Desk C. R., Omaha, Neb.

AGENTS—What size Silk Hose do you wear? Send no money. Write today. Offer expires 30 days. Agents wanted in every town. Large profits. Beautiful line. **Triple-Wear Mills**, Dept. D., 112 So. 13th St., Phila., Pa.

AGENTS—Handkerchiefs, dress goods. **Carleton** made \$8 one afternoon; **Mrs. Bosworth**, \$25 in two days. Free samples. Credit. Stamp brings particulars. **Freeport Mfg. Company**, 59 Main St., Brooklyn, N. Y.

AGENTS—Portraits 35c. Frames 15c. Sheet Pictures 1c. Stereoscopes 25c. Views 1c. 30 days' credit. Samples and catalog free. **Consolidated Portrait Co.**, Dept. 1196, 1027 W. Adams St., Chicago.

PORTRAIT Agents—Send for free catalog Portraits, Frames, Medallions, Pillow Tops, Sheet Pictures, etc. Prices, quality considered, lowest of any. **Pioneer Portrait Co.**, 1265 W. 63d St., Chicago.

AGENTS—Our **Columbia Folding Hand Bag** is the best proposition on the market. Not sold in stores. Big profit. Write for terms and other big sellers. **S. V. Diamond**, 35 West 21st St., N. Y. C.

I WILL start you earning \$4 daily at home in spare time, silvering mirrors; no capital; send for free instructive booklet, giving plans of operation. **G. F. Redmond**, Dept. 306, Boston, Mass.

AGENTS—250% profit. Wonderful little article. Sells like wildfire. Can be carried in pocket. Write at once for free sample. **H. Mathews**, 1962 Third St., Dayton, Ohio.

AGENTS—Ask us about our snappy household specialty line which will clear you \$50 to \$80 weekly. **American Aluminum Co.**, Div. 7, Lemont, Ill.

I WANT salesmen to sell an advertising novelty of merit. Side line or exclusive. Sample free. Desk 1, **Andrew Paysen**, Clinton, Iowa.

AGENTS make \$30 week by selling our 500 handy household articles; catalogue free. **Scheff Co.**, Desplaines, Illinois.

AGENTS—Do you want to make big money? Then write today for our plan and be independent. **Benjamin Ray & Co.**, Box 479, Lumpkin, Ga.

DON'T fail to read **Independence and Fortune** under **Business Opportunities**.

AGENTS—Ladies or gentlemen, to sell the highest grade toilet goods, flavoring, etc., direct to families. High class house; fair dealing; repeat orders sure; large cash commissions. Address **Kingham Bros.**, Indianapolis, Ind.

HOT Seller. Over 100% profit. House door guard. Every housewife wants one or more on sight. \$1 a dozen, \$10 gross. Sample postpaid, 20c. **Allen Door Guard**, 215 Loomis Street, Chicago.

400% PROFIT selling **Gordon Photo Pillow Top**. High grade work. Samples and catalogue free. **Luther Gordon Co.**, Northwestern Bldg., Chicago.

REPRESENTATIVE wanted in every city and town—whole or part time—to handle best paying business known. Legitimate—new—exclusive control—no canvassing. Address **Drawer 165D**, New Haven, Conn.

PERFECTION Pocket Adding Machine. Lightning seller. Agents wanted. **Cincinnati Specialty Mfg. Co.**, Dept. B, Cincinnati, Ohio.

AGENTS—Mail Order Men. Your 25 word ad in 100 Magazines, \$1. Box 22, Station B, Worcester, Mass. **The Williams Specialty Co.**

AGENTS in every town, best selling household articles. Start at once. Large demand for goods. \$25.00 to \$50.00 a week. Success assured. Investigate today. **Main Specialty Co.**, Dept. H, Williamsport, Pa.

AGENTS wanted for Oriental novelties, never before seen in America. Quick sellers. Repeaters. Immense profits. **Shaw Kanematz**, Box 529, Portland, Oregon.

1500% PROFIT selling our **Gold Sign Letters**. We'll show you how. Sample free. **Johnston Co.**, Quincy, Ill.

PHENOMENAL Success awaits salesmen with our sales-driving specialties. **Emporium Co.**, Minneapolis, Minn.

HELP WANTED

WE train detectives. You can be one. Splendid opportunities. Travel. Earn \$100 to \$300 monthly. This fascinating profession taught practically and scientifically by mail at a nominal cost. **American School of Criminology**, Dept. F, Detroit, Mich.

GET Away from wage slavery—make more money! Operate a good substantial Mail Order business—our "Silent Salesman" system—can easily be done in spare time yet the possibilities are unlimited. For years "Booster" has actually and accurately led thousands like you over the Successful Road to Wealth. To succeed you've got to read **The Booster Magazine** for "Booster" is Opportunity and starts you in business for yourself—tells you how to get the dollars by putting you next to the best money making propositions on earth—ones that really get YOU the money! Send 10c for two months trial subscription. **Booster Magazine**, Northwestern Building, Chicago.

SALESMEN—You can do a wonderful business with the Jewel Vacuum Sweeper (3 sizes.) It is the perfect non-electric household cleaner. Slightly, attractive, light, strong and absolutely efficient. Our salesmen are "cashing in" on its merit. We give you merchants' standing—with credit to do big business and advertise the Jewel in your local newspapers over your own name. A big offer for able men or women. Exclusive territory. Address General Appliance Factory, 1372 Main Street, Marinette, Wis.

MEN and Women Wanted for Government Positions. \$90 month. Thousands of Parcels Post Positions open. Annual vacations. No "layoffs." Common education sufficient. Influence unnecessary. Farmers eligible. Send postal immediately for free list of positions open. Franklin Institute, Dep't K 21, Rochester, N. Y.

YOUNG Man, would you accept and wear a fine tailored suit just for showing it to your friends? Or a Slip-on Raincoat Free? Could you use \$5 a day for a little spare time? Perhaps we can offer you a steady job. If you live in a town smaller than 10,000 write at once and get beautiful samples, styles and this wonderful offer. Banner Tailoring Company, Dept. 28, Chicago.

GET Your Preparation for the United States Civil Service Examinations from former United States Civil Service Secretary Examiner. "One Who Knows." Free Booklet. Arthur R. Patterson, Rochester, New York.

500 MEN 20 to 40 years old wanted at once in every state for Electric Railway Motormen and Conductors; \$60 to \$100 a month; no experience necessary; fine opportunity; no strike; write immediately for application blank; address Manager, W 11, Dwight Bldg., Kansas City, Mo.

U. S. GOVERNMENT needs thousands Railway Mail Clerks—Carriers—to handle Parcels Post. \$90 month. Vacations. Examinations everywhere soon. Common education sufficient. Write for list of positions open. Franklin Institute, Dep't K 21, Rochester, N. Y.

BIG Money Writing Songs—We pay hundreds of dollars a year to successful writers. Experience unnecessary. Song poems wanted with or without music—will pay one-half of profits if successful. Send us your work today. Acceptance Guaranteed if Available. Largest concern in the country. Free particulars. Dugdale Co., Dept. 265, Washington, D. C.

YOUNG men to learn shorthand. Big salaries. Assistance securing positions. Correspondence course by world's greatest court stenographer. Catalogue M free. Osgoodby School Stenography, Rochester, New York.

RAILWAY Mail Clerk examinations everywhere soon. Parcels Post requires thousands. Write for dates. Franklin Institute, Dept. K 21, Rochester, N. Y.

A MONEY Proposition—Represent me for half of the profits. Printing matter furnished free. Full particulars of my successful Mail Order Business on request. Hazen A. Horton, Desk 617, Tekonsha, Michigan.

GOVERNMENT Railway Mail Clerk examinations everywhere soon. Get prepared by former Government Examiner. "Real Courses." Write now for free booklet. C. Patterson Civil Service School, Rochester, New York.

PARCELS Post Jobs open. Write for list. Franklin Institute, Dep't K 21, Rochester, N. Y.

AGENTS make big money and become sales managers for our goods. Fast office sellers. Fine profits. Particulars and samples free. One Dip Pen Company, Dept. 2, Baltimore, Md.

BE a Detective; Big pay. Easy, pleasant work. Traveling everywhere. Write National Detective Agency, Department 2, Houseman Block, Grand Rapids, Mich.

GOVERNMENT Jobs Open to Men and Women. \$90 month. Write for list of positions open. Franklin Institute, Dep't K 21, Rochester, N. Y.

BIG Profits. Open a dyeing and cleaning establishment, little capital needed. We teach by mail. Write for booklet. Ben-Vonde System, Dept. C, Charlotte, North Carolina.

EARN \$10 to \$15 a week, and hold your position besides. No canvassing. We, as manufacturers of patented just-in-season specialties, have new easy mail order plans to keep factories busy. We furnish everything. Large profits. Small capital. Experience unnecessary. If you are one of the want-to-go-ahead kind, write for our most modern (copyrighted) plans. Sworn Statement. J. M. Pease Mfg. Co., 540 Pease Bldg., Main St., Buffalo, N. Y.

LOCOMOTIVE Firemen and Brakemen for all railroads, \$80 to \$100 monthly. Age 18 to 35. Experience unnecessary; no strike. Promotion, Engineer, Conductor. Railroad Employing Headquarters—over 400 men sent to positions monthly. State age; send stamp. Railway Association, Dept. 89, 227 Monroe Street, Brooklyn, N. Y.

CANVASSEERS, \$30-\$60 weekly selling distinctive, individually tailored raincoats. No capital required, pocket samples, prices low, whole or part time. Write Sanitary Coat Specialists, New York.

ENTER the Merchant Tailoring Business for yourself. Learn to cut men's clothes by our easy system. Big profits—no investment. Full particulars free. Write today. Success School of Cutting, Dept. 11, Jackson, Mich.

DRAFTSMEN—A few slightly soiled copies "Dimensions, Pipe Fittings and Valves" 30c. "Structural Drafting" 75c, both \$1. National Book Co., Collinwood, Ohio.

DETECTIVES earn from \$100 to \$500 per month. How much are you earning? Write for particulars. Interstate Detective School, Peoria, Ill. Suite 25, McDougal Bldg.

REPORT local information, name, etc., to us. Big pay. Confidential. Enclose stamp. National Information Sales Co., AFR, Cincinnati.

SECURE position you desire, get my book, explains how. Particulars free. Stafford Publishing Co., 44 Madison Ave., Bridgeport, Conn.

Distributors of advertising matter everywhere. American Distributor, Blairsville, Pennsylvania.

If you want help, tell your wants in 1,000,000 rural homes simultaneously. Use Bogge's Weeklies. Write for free result Checking Book. Use letterhead. Classified Dept., 500 Dearborn Ave., Chicago, Illinois.

BIG money collecting and selling names. Either sex, any locality. Send 25c (coin) for names of firms that buy names. W. R. Summerhayes, Tama, Iowa.

MEN and Women Wanted for Government Positions. \$90 month. Parcels Post means thousands of appointments. Write for list of positions open. Franklin Institute, Dep't K 21, Rochester, N. Y.

SONG Poem Wanted. New Plan. Big money. Free book tells all. Hayworth Music Co., 660 G, Washington, D. C.

WANTED—Railway Mail Clerks. \$75 month. Examinations everywhere. Coaching free. Franklin Institute, Dep't K 21, Rochester, N. Y.

WANTED—A high class reliable sales manager for a store fixture without competition. Commissions \$300 to \$500 per month. Address The Buckley Specialty Co., Lima, Ohio.

TRUSTWORTHY agent for ideal Raincoat proposition of highest order. Large commission basis; pays big. No cash with order. English Raincoat Tailors Co., Ltd., New York.

BE your own Master! Stop Wage Slavery! Formulas and instructions for manufacturing Six Big Sellers and 100 Business Opportunities sent for 10c. Particulars free. M. Iverson, 819 N. St. Vrain St., El Paso, Texas.

CASH for information, names, formulas, and ideas. Steady, profitable home business. Instructive booklet for stamp. Information System, 288, Marietta, Ohio.

START "New Specialty" mail order business at home evenings and spare time. Very profitable. Everything furnished Particulars free. Box 134A, Newport, Ky.

SALESMEN to sell guaranteed brooms. Stores or private. Good commission. Excellent opportunity. Palma Atlas Broom Works, Palm, Penna.

WANTED—Distributors, men or women to give away free packages our famous Perfumed Borax Soap Powder; no money or experience needed; good pay. Ward & Co., 1775 Berneau Ave., Chicago.

ANY intelligent person many earn good income corresponding for newspapers. Experience unnecessary. Address Press Correspondence Bureau, Washington, D. C.

EARN \$7 to \$12 daily, restoring faded colors in rugs and carpets. Whole or spare time. Original American Process. Great demand. No capital. Full particulars free. Eldred, Dept. 75, Detroit, Mich.

MAKE \$30 to \$60 weekly—Representing us. Permanent business with dignity and prestige. Standard Safety Lamp Co., 157 W. Randolph Ave., Chicago, Ill.

MAKE \$10 daily restoring colors to faded rugs and carpets. Spare time. Tremendous opportunity everywhere. Simple, easy. Mirror Silvering course free. Free particulars. Coxe, Dept. MD., Omaha, Neb.

WANTED—Hustling man, every town, and country community. Who wants to get ahead, learn, and earn more. Fine chance. Write quick for full particulars. Box A2-293, Covington, Ky.

LADIES—Earn money coloring pictures and postcards; samples and instructions. 20c. Dept. 61, Roxbury Card Co., Roxbury, Mass.

HERE'S Your Chance—Full course of instruction in Silvering Mirrors, for 50 cents. Max Swift, 158 Suffolk St., New York City.

SALESMEN—Several good men; oils, paints; no experience. Signet Oil Co., Cleveland, Ohio.

GOVERNMENT Examinations. Most thorough preparation; \$5; returned if not appointed; particulars free. American Civil Service School, Washington, D. C.

WANTED one thousand chauffeurs and repair men. Our demand for automobile engineers exceeds the supply. Calls for men of intelligence and mechanical bent capable of commanding \$100 to \$150 per month upon graduation. Resident course \$20 to \$60. Home Correspondence course completed by practical road and shop work at this school, highly successful. Look this up. Auto Schools of America, Dept. T, 1660 Michigan Ave., Chicago.

WANTED—Agents, Machinists, Attention! Increase salary, new revised Saunders' Hand-Book of Practical Mechanics. Best ever ready reference. Thousands in use. Postpaid \$1 cloth; \$1.25, \$1.50 leather flap. Big profits. E. H. Saunders, 216 Purchase St., Boston, Mass.

WANTED—A man or woman, all or spare time, to secure information for us. Work at home or travel. Experience not necessary. Nothing to sell. Good pay. Send stamp for particulars. Address M. S. I. A., 522 L Building, Indianapolis, Indiana.

THE demand for cartoonists is increasing. Many young men have talent, but not the opportunity of developing it. We can suggest an inexpensive method that will aid anyone anxious to take up the study of drawing. Send your name and address to box 223, Glencoe, Ill.

STOP Here! Let me start you in a home business that will bring you money every day. Experience unnecessary. Spare time. No canvassing. I furnish everything and guarantee success. Send for proofs. Voorhies, Desk C. R., Omaha, Neb.

GO on the Stage. Vaudeville career offered you. Experience unnecessary. Managers endorse my method. Instructive vaudeville book free. Write today. Frederic LaBelle, Sta. 10, Jackson, Mich.

I WILL start you earning \$4 daily at home in spare time, silvering mirrors; no capital; send for free instructive booklet, giving plans of operations. G. F. Redmond, Dept. 306, Boston, Mass.

DON'T fail to read Independence and Fortune under Business Opportunities.

MEN and boys to learn automobile repairing, driving on up-to-date cars; electricity, civil engineering, surveying. Methods most practical. Room and board while learning. Positions secured; satisfaction guaranteed; catalog free. National School of Engineering, 2110 W. 7th, Los Angeles.

WANTED—First Class Gridley and Brown & Sharpe Automatic Screw Machine Operators, also Hand Screw Machine Operators and Tool Setters. Apply by letter to the Employment Department, Westinghouse Electric & Mfg. Company, East Pittsburgh, Pa.

WANTED Salesmen—Earn \$250 per month, sell dealers highly advertised article. Samples not necessary. Elato Co., Station L, New York, N. Y.

YOU can make big money writing letters for us during spare time. We furnish everything. International Mercantile Alliance, 125 Bloomfield Street, Hoboken, N. J.

BE a Detective—Earn \$150-\$300 monthly. Greatest opportunities. Write Frederick Wagner, 1243 Lexington Avenue, N. Y.

SITUATIONS WANTED

INVENTOR desires position with manufacturer or such. G. A. Rousseau, 12 Harmony St., New Bedford, Mass.

WANTED—Position as trench-machine operator. Experienced on Austin. H. Diggins, Harvard, Ill.

EXPERIENCED mechanical inventor desires position; very practical and original. A. Payne, Duncan, B. C. Can.

MACHINERY, TOOLS AND SUPPLIES

FREE—"How to Run and Install Gasoline Engines." Greatest little book ever published on this subject, sent free with year's subscription to Gas Energy. Learn how to solve all knotty Gas Engine problems in few moments. O. L. Stevens, Ind., writes, Gas Energy is best magazine published. Send 50c for year's subscription. Book free. Gas Energy, 28 Murray St., New York.

LATHES 11 to 30 inch, millers, drills, shapers, wood working machinery, new combination woodworker, jointers, sanders, punches and shears. Bicknell, Janesville, Wisconsin.

ONE seven hp. Portable Coil Boiler \$20. One seven hp., two cylinder steam engine \$20. Used very little. Sandusky Vulcanizing Co., Sandusky, Ohio.

PULLEYS, Gears, Sprockets, Shafting, Hangers; see page 132. W. A. Jones Foundry & Machine Co., Chicago.

40 H. P. OIL Engine, used but little. Guaranteed as good as new. Geo. A. Peckens, Fowlerville, Mich.

MECHANICS' Tool Case, Yours free for a little work. Particulars for stamp. H. L. Depay, Muncie, Ind.

HOW to make Dynamo—and Digest Publishing 100 Mechanical Kinks, etc., monthly. One year, 25c. Digest, Grand Rapids, Mich.

1½ H. P. GASOLINE engine complete on skids. Practically new \$20. A. M. Kirk, 6733 Vincennes Ave., Chicago.

FOR Sale—Flour City 11x14 portable gasoline engine \$285. Fred Fuller, Lafayette, Ill.

LATHE for Sale—10x36 in. Nearly new, Harlan Edgington, Mapleton, Iowa.

FOR Sale—1 Buckeye Steam Engine, 12 x24, Automatic Cut-Off, only six weeks in use; 1 Boiler 66" x 18ft. Must be sold since we are going out of business. Apply National Box Co., Cleveland, O.

MACHINISTS, send for free treatise "How to turn up or repair a crankshaft" with Warnock's combination lathe dogs. H. A. Warnock, Chicago, Ill.

WE pay Cash for second-hand or new machinery, motors, belting. We will buy one machine or entire plant. Lambert & Co., 241-243 Centre St., New York.

BARGAINS in new and second-hand stationary gasoline engines. Affiliated Mfgs., Milwaukee, Wis.

FOR Sale, Pratt & Whitney 2" cutting off machine, in perfect condition, \$35. Lucas & Son, Bridgeport, Conn.

ELECTRIC motors, Bargains up to one H. P., new, stamp. 2643 E. Union, St. Louis.

FOR Sale, Air cooled engine 4 cyl. 24 hp. complete; bargain. Write H. Schaefer, Box 407, Cresco, Iowa.

LATHE screw cutting, 19" by 11" \$185. Pinner, 122 Water Street, New York City.

SCREW machine wire feed 1" capacity \$200. Pinner, 122 Water Street, New York City.

30 HORSE Power vertical engine \$175. Pinner, 122 Water Street, New York City.

FOR Sale—Gasoline engines, automobiles, marine and stationary, also castings. Second-hand ones taken in exchange and for sale. Apply with stamps. B. W. Richardson, R. No. 36, Peoria, Ill.

REBUILT Engines—We have on hand a number of rebuilt "Buffalo" engines, guaranteed, at greatly reduced prices. Write for bargain list. Buffalo Gasoline Motor Co., 1293-1305 Niagara Street, Buffalo, N. Y.

FOR Sale—Engine lathe, swings 9½ in. takes 25 in. between centers. Complete with full set change gears to cut all size threads, 3 to 40 in.; price only, \$43.50. Address L. P. Grammes & Sons, Allentown, Pa.

LATHE for sale—For bargains in small lathes write South Bend Machine Tool Co., Dept. L, South Bend, Ind.

SCREW Machine, Hartford, 1½ in. capacity, \$125; 14 inch speed Lathe, \$22. 3145 Penn Avenue, Pittsburgh, Pa.

PATTERN makers! A book devoted to the principles of pattern and core making and molding. Written by G. H. Willard, a practical pattern maker of years experience. This book, just published, treats the subject in a much more simple, direct and effective manner than most books along this line. 224 pages, 312 illustrations. Price \$1 postpaid. Popular Mechanics Book Dept., Chicago.

SERIES of 7 lithographic models—Steamship, automobile, gas engine, steam engine, steam turbine, wireless telegraph and dynamo. Size 8x14 inches. All parts of these machines are shown and numbered to correspond to printed keys of names. Price each, 50 cents postpaid, or set of 7, \$3 postpaid. Popular Mechanics Book Dept., 318 W. Washington St., Chicago.

THE latest improvement in Test Indicator, every machinist and toolmaker should send for booklet. C. E. Robinson Co., 96 West River St., Orange, Mass.

MANUFACTURING MACHINERY

WE manufacture anything, can furnish patterns, of brass or wood. Castings in brass or cast iron and aluminum. Our shop is equipped with heavy engine lathes, drill presses, new milling machines, (universal). Quotation furnished without cost to you. Write. Practical Gas Engine and Machine Works, North Chicago, Ill.

WE make working models of any description, also tools, dies, punch-press work, and special machinery. Send us drawing or rough model for estimate. Send for catalogue of model supplies. The Pierce Model Works, 3405 Pierce Ave., Chicago, Illinois.

MANUFACTURER of brass specialties having ample capital and excellent selling facilities, wishes to take up patented article in brass on royalty basis. Send full description of article. Address E. H. Heller, Sec'y, 18 E. Kinzie St., Chicago, Ill.

SPECIAL machinery designed and built, ideas developed on contract. Estimates from blue prints or sketches. G. Lange & Co., 635 W. 49th Street, New York City.

WANTED, Experimental work, dies and small manufacturing. For further information and reference address Judson Kreger, Goshen, Ind.

MAKE a Turret Lathe of engine or speed lathe by using a Baker Semi-Automatic Turret Head Tool Holder. Self locking, rapid, smooth in action, automatically releases on back stroke. Send for descriptive folder. W. Baker, Manufacturer, 7015 Kimbark Ave., Chicago, Ill.

WANTED—Machinery or parts to manufacture on contract. Inventions perfected and built. Pullman-Field Machine Co., Sodus, N. Y.

CLEVELAND Specialty & Manufacturing Co., Cleveland, Ohio, Manufacturers of Water Motors, Fans, Tapping Machine, Magnet Winders. Inventions developed. Special articles to order.

DIES, tools and working models made. Stamping and press-punch work reasonable. Will manufacture your novelty or invention under contract. The Monarch, Onawa, Iowa.

IRON brass and aluminum castings, Metal specialties. Patterns, models, polishing, plating and japanning. Send for catalogue of pattern shop and model supplies. North Chicago Tool Works, 15 Grove Ave., North Chicago, Ill.

INVENTORS. We manufacture Metal Specialties of all kinds to order; largest equipment; lowest prices. Send perfect sample for low estimate and best expert advice free. The Eagle Mfg. Co., Dept. B, Cincinnati, O.

WANTED, medium weight machinery to manufacture on contract. Special machinery built, pattern work. J. T. Schaffer Mfg. Co., Rochester, N. Y.

PUNCH Press Tools, Jigs and Fixtures made accurately and promptly. McCall Machine Works, Rochester, N. Y.

FLOUR AND FEED MILLING MACHINERY

SPECIAL bargains in second-hand: Attrition mills, burr mills, crushers, corn shellers, bran dusters, dust collectors, purifiers, reels, double, single, 2 and 3-pair high roller mills, sieve bolters, receiving separators, scourers, etc. Write for description and prices. Sprout, Waldron & Co., P. O. Box 429, Muncy, Pa.

ENGINE CASTINGS AND BLUE PRINTS

ENGINE castings, 1½ horse vertical gasoline, air-cooled, \$7. Three-horse marine water-cooled, \$9 cash; drawings included; catalogue for stamp. Novelty Manufacturing Co., 853, West Sixth St., Cincinnati, Ohio.

BOATS AND LAUNCHES

THE Ne Plus Ultra Life-Preserver, Ptd. Hollow aluminum ribs, strong flexible covering, noncorrosive air-valve and fasteners. Self-inflating on adjustment. Weighs 1½ lbs. Folds to 5x6 in. Water, acid, rust and rot proof. Practically indestructible. Assures perfect safety and comfort in water. Convenient to travelers and lovers of aquatic sports. Price \$5. Highly illustrated booklet 10c. Auto-Pneumatic Swimming Belt, Inc., 309 Broadway, New York.

FOR Sale—Sample Launches with or without Engines—also several second-hand bargains in all sizes. Send for list. Everett Hunter Boat Co., McHenry, Ill.

CHART of a modern submarine boat showing and naming over 200 parts. Size, 14x28 inches. Printed on plate paper. Shows clearly and distinctly all the interior. Mailed in a tube for 25c. Popular Mechanics Book Dept., 318 W. Washington St., Chicago.

MOTORCRAFT Encyclopedia—A 150-page book that tells 1001 things every motor boatman should know. How to overcome engine troubles. Price \$1, postpaid. Popular Mechanics Book Dept., Chicago.

WANTED

WANTED to buy all kinds of old money and stamps. We pay highest cash premiums up to \$1,000 on rare money to 1909. Send only 4c for our Large Illustrated Coin Circular. It may mean your fortune. The Numismatic Bank of Texas, Dept. H2, Fort Worth, Texas.

HARP. Must be fine modern double action instrument. F. J. Lamb, 162 Baldwin Ave., Detroit, Mich.

WANTED—Good business opening or farm for cash. Will deal only with owner. Send full description. Address Retired Merchant, Box 1308, Cherry Valley, Illinois.

SALE OR EXCHANGE

SALE or Trade. Electric light plant. Population of town 600; well patronized. Electric Light Plant, Davenport, Neb.

FOR Sale or Exchange—An automatic card Printing Press. Cost \$165. Sacrifice for \$90. Fine condition. Edward Clemson, Marengo, Iowa.

INDIAN Motorcycle. Toledo vacuum cleaning outfit on truck. Printing press outfit. Typewriter. Ulysses Fortier, Tulsa, Oklahoma.

SMITH Premier typewriter, good condition, will trade for second-hand motorcycle. Geo. Moebeck, Ulen, Minn.

FOR SALE

WE bought at bargain from Bankrupt factory 500 fine Mohair tops, \$10 kind, will sell at \$10 each, cash, complete with curtains, covers and wind shields. This price will move quick so get your order in early. Puritan Machine Co., 57 Tenth St., Detroit, Mich.

VACUUM Cleaner parts. Pumps, hose, tools, etc., wholesale. Build your own wagon machine or residence stationary plant. Saves over half. We furnish any or all parts. Vacuum Supply Co., Ann Arbor, Mich.

FOR Sale—1 100 Light Pilot Acetylene Generator; 1 Acetylene Gas Range with oven; 21 Side Brackets complete with shades and burners; 1 2 Light Fixtures. Used about 9 months, good as new, \$100; 1 6 H. P. Stickney Gasoline Engine, never been used, \$50; 1 Holland Calorific Hot Air Engine used 2 years, \$25; 1 1 1/2 H. P. Olds Engine used 2 years, \$25. Write for further information. W. B. Hayden & Sons, Cassopolis, Mich.

VACUUM Cleaner parts and tools at wholesale. Build your own machine. Write for prices. Vacuum Supply Co., Ann Arbor, Mich.

FISH aquarium, kodak, blue print frame, scientific books, correspondence courses, engineering magazines, electrical apparatus. I may have just what you want. Write for list. G. T. Roberts, 501 Park Ave., Racine, Wis.

FOR Sale—Stereopticon, 82 slides, songs, 20x20 screen, lecture light, best cash offer, Clarence Baum, Danville, Ill.

AMERICAN, Jr., safety blade sharpening machine; also Piano tuning course, including tools. F. H. Sharpe, Luverne, Minnesota.

FOR Sale—Electric Vibrator. Cost new \$100. Will sacrifice for \$35. J. G. Sproul, Lima, Ohio.

FOR Sale—Wind mill, tower, tank, and piping. \$35. Lucas & Son, Bridgeport, Connecticut.

BLACKSMITH, woodwork and horse-shoeing shop, new building, work two men, up to date equipment, good six room house. For particulars address W. H. Sitzenberger, Norwood, Ill.

GAS Generator—Incandescent, with tank and inclosure; will furnish 5,000 candle power. Cost \$75. Bargain \$35 cash. Bressler's Shoe Store, 7310 Manchester Ave., Maplewood, Mo.

FOR Sale. 50 mounted specimens, fine condition. R. Saylor, 499 So. Broadway, Dayton, Ohio.

AUTOMATIC cream separator for sale, cheap. G. A. P., Box 346, Fowlerville, Michigan.

FOR Sale, one 12" Scheldel Western Induction coil, with single point interrupter, rectifier, etc., suitable for wireless or X-Ray work. First Money Order for \$50 gets outfit. The Pope Sanatorium, 115 W. Chestnut, Louisville, Ky.

ELECTRIC Motors drive Sewing machines 110 volts D. C., 1/4 hp. \$7.25, 1/2 hp. \$13.80; 1/3 hp. \$19.80. For 110 volts A. C., 133 cycles 1 hp. \$66, 3 1/2 hp. \$120. Cosmos Electric Co., 136 N. Liberty St., New York.

PHONOGRAPHS \$5. Records 10c exchanged. Typewriters \$8, rent, payments. Motorcycles \$35. Knights, 299 12th St., St. Louis, Mo.

BLUE-Prints, battery switchboard. New idea gives capacity like battery plus dynamo. 50c. Baby, Norvell, Mich.

FOR Sale—Large Bull Elk Head \$50. Also large Bull Moose Head \$10. R. Saylor, S. Broadway, Dayton, Ohio.

ROYAL Plater, complete. Samples free. E. Fiske, 101 Sheffield Ave., Buffalo, N. Y.

FOR Sale—Steam boiler and engine 3 hp. New. Will ship on approval. Send for particulars. H. R. Shockey, 705 Church Street, Hannibal, Mo.

LAW Library—12 volumes—cost \$72. Sell for \$25. Interested in law? Chance for ambitious person to acquire practical and theoretical knowledge of law and become a lawyer at very small cost. Dennis Shea, 47 Newton, New Bedford, Mass.

FOR Sale—Light manufacturing business patents, stock and tools of a novelty in daily use; can be sold by mail or agents; a good business for a small investment. H. E. Grebner, Beverly, Mass.

VACUUM pumps for vacuum cleaning outfits; also used for blowing; the only pumps that take up their own wear; can't get out of order; belt it to your engine or motor; make a wagon outfit and do your neighbor's cleaning; big profits. Leiman Brothers, 62 P. C. John St., New York City.

DIAMONDS, WATCHES, JEWELRY

BUY genuine perfect cut diamonds direct from the importer at the lowest prices in the world; 1/4 carat, \$8.25; 1/2 carat, \$17.50; 3/4 carat, \$45; 1 carat and over, \$97.50 per carat. Written contract to buy back every diamond for 90% in cash and allow full price paid on all exchanges. Send no money. We ship C. O. D. privilege of examination without deposit and without obligating you to purchase. Send for big Basch Diamond Book. Free! Established 33 years. See our display ad on page 171. Address L. Basch & Co., Dept. M310, S. State St., Chicago, U. S. A.

ELGIN Watch \$4.25. Quarter Carat Diamond Ring \$17.50. Fred F. Wollert, Centerville, Iowa.

PATENTS

EXPERIMENTER—Inventors. The very latest. Place an automatic folding table on the arm of your Morris or Mission chair or any chair with wooden arm of Mission style, in ten minutes. Friend always by your side in leisure or studious moments. A study for inventors or experimenters in ingenious folding simplicity that can be adapted anything mechanically foldable. Tat, is adaptation No. 20. Highly finished to harmonize with home surroundings. Satisfaction guaranteed. Postpaid \$1.50. Nolan Universal Folding Device Co., 87 Prospect St., Woburn, Mass.

PATENTS Sold. I do the business—not merely collecting advance fees. If you own a valuable patent send for a free booklet, "How I can get cash for Your Invention." No charges made for listing. Patent Advertising & Sales Co., Frankford, Phila.

SAFETY Elevator Manufacturers and manufacturers in general investigate patented safety elevator. Accidents entirely eliminated. Roussel, 1101 Diamond Bank Bldg., Pittsburgh, Pa.

INVENTORS. My Patent made a fortune. Particulars free. I want good inventions. Eugene Pearl, P23 Union Sq., New York.

SEND for free booklet. All about Patents and Their Cost. Shepherd & Campbell, Patent Attorneys, 500A Victor Bldg., Washington, D. C.

PATENTABLE Ideas wanted—Send for 3 free books. Richard B. Owen, 30 Owen Bldg., Washington, D. C.

PATENT Folly. Few inventions make money. Why? Get my interesting story, "My First Invention." Henry C. Thomson, "Invention Adviser," twenty-five years experience as inventor and manufacturer of patented devices. P. O. Box 3547, Boston, Mass.

WE sell patents. Established 1900. Experience. Highest references. To buy or sell, write Charles A. Scott Co., 1096 Granite Bldg., Rochester, N. Y.

PATENTS secured—Reports on patentability, validity and infringement. Patent suits conducted. C. L. Parker, 910 G St., Washington, D. C.

BEFORE patenting your invention, get line on its commercial possibilities. I've had many years experience selling patents. For \$1.00 I'll give you benefit of it. Charles A. Scott, Granite Bldg., Rochester, N. Y.

PATENTS without advance attorney's fees. Send sketch for free report. Books free. Fuller & Fuller, Washington, D. C.

PATENT ATTORNEYS

PATENTS obtained. Forty years practice. Reliable references. Valuable book free. Fees low. W. X. Stevens, 76 Adams St., Washington, D. C.

PATENTS procured and sold if the idea has merit; all countries; satisfied clients my best references; send sketch today; book free. Sanders, 7 Crilly Building, Chicago, Ill.

FIND out for yourself what to invent and how to procure and sell a patent for the same. My book, "Inventor's Universal Educator," covers the matter from A to Z. 140 pages elegantly bound. Also contains 600 mechanical movements and 50 perpetual motions. Price \$1, postage free. Money returned if not more than satisfactory. F. G. Dieterich, 651 Ouray Bldg., Washington, District of Columbia.

PATENTS, electrical and mechanical a specialty. Book Free. Joshua R. H. Potts, Patent Lawyer, 8 Dearborn St., Chicago; 805 G St., Washington; 929 Chestnut St., Philadelphia.

PATENTS and Patent Possibilities is a 72-page treatise which tells all about patents, what to invent and where to sell it. It gives honest advice to inventors, and is full of valuable and interesting information. Write for it today! It is free. H. S. Hill, 905 McLachlen Bldg., Washington, D. C.

PATENT Books Mailed Free—showing 100 mechanical movements invaluable to inventors and mechanics—and telling what is patentable, how to obtain patent or partner, etc. Free on request. Chas. E. Brock, 701 Eighth St., Washington, D. C.

INVENTIONS Patented and made salable. Four departments at your service, Patent, Developing, Exploiting, Legal. Free booklet, "Reasons Why." Inventors Service Co., Washington, D. C.

PATENTS Explained in my Free Books telling what you should know—what to invent—what not to invent—how to sell your patent, etc. Write today. H. L. Woodward, 902 G Street, Washington, D. C.

PATENT What You Invent. It may be valuable. Write me. No attorney's fee until patent is allowed. Estab. 1882. "Inventor's Guide" Free. Franklin H. Hough, 522 Loan & Trust Bldg., Washington, D. C.

PATENTS, trade-marks, copyrights, patent litigation. Book and advice free. William C. Linton, Mechanical and Electrical Expert, 301 McGill Bldg., Washington, D. C.

SEND for free booklet. All about patents and their cost. Shepherd & Campbell, Patent Attorneys, 500 A Victor Bldg., Washington, District of Columbia.

PATENT your invention. First get free "Inventor's Primer" with statistical data. Milo B. Stevens & Co., Estab. 1864, 685 F St., Wash.; 353 Monadnock Bldg., Chicago.

PATENTABLE Ideas wanted—Send for 3 free books. Richard B. Owen, 30 Owen Bldg., Wash., D. C.

PATENTS of Value. Prompt and efficient service. No misleading inducements. Expert in Mechanics. Book of Advice and Patent Office Rules free. Clements & Clements, Patent Attorneys, 704 Colorado Bldg., Washington, D. C.

THE Patentome is interesting and instructive. A liberal education in patents and how to get them. Free on request. Established 1865. Anderson & Son, Patent Solicitors, 707 G St., Washington, District of Columbia.

REACH the country inventor at low cost by using Boyce's Weeklies. Circulation 1,000,000. Ask for free result Checking Book. Use letterhead. Classified Dept., 500 Dearborn Ave., Chicago, Ill.

PATENTS Secured and Trade-Marks registered. You get honest personal work backed by 10 years' experience. Write today! George A. Hutchinson, 730 Loan & Trust Building, Washington, D. C.

PATENTS—Herbert Jenner, patent attorney and mechanical expert, 608 F St., Washington, D. C., established 1883. I make a free examination and report if a patent can be had and exactly what it will cost. Send for circular.

PATENTS that protect and pay. Advice and books free. Rates reasonable—highest references: best results. Watson E. Coleman, Patent Lawyer, 622 F St., N. W., Washington, D. C.

C. L. PARKER, Patent Attorney, 910 G St., Washington, D. C. Inventor's handbook "Protecting, Exploiting and Selling Inventions," sent free upon request

INVENTORS On American and foreign patents, and trademarks, consult Benjamin Roman, Park Row Building, New York.

NO attorney's fees until patent allowed. Free search and books. Fuller & Fuller, Washington, D. C.

PATENTS FOR SALE

FOR Sale—Patent No. 939,727, Snap Hook. Employs no springs. Can be locked against opening. Is self-locking. Address, Matti Maki, Belden, North Dakota.

PATENT for Sale. Very valuable and useful; just Patent and Pending Patent on royalty or reasonable offer. Floor scrubbing, wiping, cleaning, drying and brightening machine. Boon to everybody. Everybody needs it. Easy to make; Gold Mine to manufacturers. Address S. Selwa, 2336 Elyria Ave., Lorain, Ohio.

OVERSHOE Retainer, U. S. No. 993,212, a device appealing to any person accustomed to wearing overshoes in damp weather. Big demand in market. Only \$750. W. G. Wheeler, Ashland, Ky.

PAT. No. 682,496. Will sell all rights for \$700; or any State for \$50. New game, better than pool. Cook, 726 W. 7th, Los Angeles, Cal.

PATENT 782880. The Sip Floating Bottle Holder Fire Extinguisher. 1/2 gallon up. Sip Manufacturing Co., Jersey City, N. J.

FOR Sale or royalty Patent Automatic Door Guide for sliding barn doors. A real necessity. John D. Wiese, Mans. O. Iowa.

FOR Sale. Mouse trap invention. For particulars write Leo Nebel, Lake Preston, South Dakota.

FOR Sale. U. S. Patent No. 721,613 wire clothes basket with clothes pin basket removable; a useful and handy invention; a money maker for the buyer. Something that every housekeeper will buy. Mrs. L. J. Georgie, 836 Acoma St., Denver, Colo.

NEW gas engine valve patent for sale, valuable features and new departure, fully demonstrated on kerosene. Get particulars. Box 326, Oshkosh, Wis.

PATENT on draft operating device. Can be retailed complete for six dollars with big profit. \$800 cash takes it. No triflers. Victor Cozine, Gloversville, N. Y.

AUTOMATIC coupler for traction engines, patent No. 669,376. Best offer takes it. Address Frank Dempewolf, Bellevue, Iowa.

FOR Sale. Patent 1018323, Draft rigging for Railway cars; investigate this. John Jerome, 811 19th Ave., So. Minneapolis, Minnesota.

SHOE Shiner. American and Canadian Patents for sale, exchange or royalty. Will furnish patterns for manufacturing. Sonntag's Patent Agency, Balboa Building, San Francisco, California.

PATENT for sale. Adjustable curtain fixture, simple, practical and needed. Particulars, E. Chabot, 86 Fairview St., Providence, R. I.

VALUABLE Patents. Automatic rocking chair, razor stropping machine, and hat pin protector. See inventor, P. Alpp, 147 E. 54th St., New York.

FOR Sale. U. S. Patent No. 1014500. For Package-Binders issued Jan. 9, 1912. A No. 1 proposition. Will sell at a reasonable price. Alfred E. Morgan, 24 Atwood St., Hartford, Conn.

FOR Sale. U. S. Patent No. 1028002. Pool Cue Tip Fastener. Tip hold fast without glue. Tips replaced in a second. T. N. De Witt, 1803 N. Wolfe St., Baltimore, Md.

FOR sale, royalty or partner. Improved hot and cold water faucet. Edward Godleske, Burnham, Pa.

FOR Sale—Patent churn in U. S. and Canada. Patterns made ready to manufacture. Ad. Chas. Austin, Ava, Ill.

FOR Sale. Patent advertising novelty combination tool. C. T. Brown, 3396 I Street, San Diego, Cal.

PATENTED—Lamp Chimney Lock. Price reasonable. Charles Francis, Conway, Ark.

MAIL order novelty, great merit. E. Work, 8343, Garesche, St. Louis, Mo.

HOUSEHOLD article, sample 25c silver. F. M. Furber, Beaumont, Mass.

MUST sell; improved door latch. Practical device; cheap. Martin Ostul, Ghent, Minnesota.

FOR Sale or Royalty. Patent spring device for children's folding push chair, etc. Will double life of tires, chair, and child's comfort. Best offer takes it. Alan Woodford, 145 Foundry Lane, Southampton, England.

FOR Sale or Exchange—Patent No. 902964. With gated patterns and rubber mold. Will take lathe, gasoline engine, milling machine, shaper, or automobile at their value. C. P. Hatfield, Lebanon, Ohio.

FIVE new patents; folding armchair, folding desk; value \$40,000; will sell for \$20,000; folding rocker; also new kind of window sill and window; folding, changeable and operating table. J. S. mechanic, 3616 N. Broadway, St. Louis, Mo.

REAL ESTATE—FARM LANDS

SUBURBAN Homesites \$1 Cash. Balance easy monthly payments—at Dalworth Park, Texas, suburb on Interurban, midway between Dallas and Ft. Worth, the fastest growing cities in the Great South-west. Millions going into new sky scrapers, hotels, factories in the two cities and population has trebled in ten years. Fortunes will be made here in suburban properties. Early buyers will make enormous profits. Dalworth Park offers best opportunity, being on Interurban, which is to be double tracked, and on railroad and Automobile Pike. \$100,000 already spent on waterworks, natural gas, street improvements, etc. 43 trains daily. Beautiful, large homesites only \$50 and up, in this special sale. \$1 makes first payment. Write today before price advances, for free booklet, showing views, maps and all particulars. The Dalworth Company, 70 Stewart Title Bldg., Dallas, Texas.

LET Your Dollars Work In California. You will follow them sooner or later and they will yield you good earnings with safety, through the steady and constant increase of land values. Opportunities for small monthly savings as well as for principal sums. Send for free copy "Capital Building." Provident Investment Co., 617 E. S. Hill St., Los Angeles, Cal.

BARGAIN—20 acre selected Pecan land, near Jacksonville, Florida; \$40 per acre. Berg, 1927 Oakdale Ave., Chicago, Ill.

CHOICE city lots A. No. 1, investment. Write today for particulars to T. Harold Knight, Racine, Wisconsin.

VIRGINIA Fertile Farm Lands \$15 per acre and up. Easy payments. Send names of two friends interested in Virginia and receive our beautiful magazine one year free. F. H. LaBaume, Agr'l Agent, Norfolk & Western Ry. Bldg., Room 84, Roanoke, Va.

IF you act at once you can buy tracts of rich level Wheat or Alfalfa land in Cheyenne County, Nebr., that will pay you from 40% to 80% on an investment of only \$20 to \$35 per acre. E. C. Stockdick, Sidney, Nebr.

FORTY million feet timber. Have finest tract timber anywhere Eastern North Carolina, consisting pine, oak, red gum and cypress. If interested, write Henry Clark Bridgers, Tarboro, N. C.

FLORIDA—Citrus fruit and agricultural land on Gulf Coast. Healthiest place in Florida. \$30 acre, easy terms. Free literature. Port Richey Company, Tampa, Florida. Investigate.

OWN 4 Missouri, 3 Kansas farms, nice home Kansas City, Kans.; exchange for mdse. John Brokmeyer, Eldon, Mo.

8,080-ACRE stock ranch for half its value for quick sale; address owner for information. A. J. Johnson, Merchants' Nat. Bank Bldg., Springfield, Mo.

\$5 MONTHLY for eighty months pays for twenty acres healthy West Florida fruit and farm land; no interest. "Facts about Fla." free. W. S. Reeve, Pensacola, Fla.

SPECIALTIES—Ontario summer homes, fruit lands or suburban properties. Write your requirements to Ford Robertson, 18 Toronto Street, Toronto.

\$2,500 IN 3 days selling Real Estate. Will lease my plans. Write for particulars. W. Alton Clifton, Eufaula, Ala.

PROBATE Court Sale. To close an estate, the probate court and trustees have authorized me to sell 150 choice residence lots at North Racine, one-quarter mile north of city limits of Racine. Population 45,000 on through interurban and steam lines between Chicago and Milwaukee. Two million dollars now being spent in new factory buildings. Attractive surroundings. Ten minutes to center of the city. Lots \$99 each. \$1 down, 47c per week. No interest. No taxes. Own your own home. Write at once. Chas. R. Davis, Mitchell Building, Milwaukee.

SUBURBAN home sites on electric line at Manitowoc Beach on Lake Michigan, three miles from growing cities of Manitowoc and Two Rivers at \$100 each, \$5 down, \$5 monthly. No interest, no taxes. Charles R. Davis, 214 Mitchell Bldg., Milwaukee.

ESCAPE the cold winters. Locate on a southeastern farm. Profitable lands \$10 to \$30 an acre—easy terms. Poultry, truck, and fruit pay \$50 to \$300 an acre. Unexcelled living conditions. Land lists and the "Southern Field" magazine free. M. V. Richards, Land and Industrial Agent, Southern Railway, Room 64, Washington, D. C.

80 ACRES good land; four miles sta.; Cross County, Arkansas; no overflow; school on land; small payment; balance suit purchaser; 6%. Morgan Jolly, Cotter, Arkansas, Owner.

MEN wanted—Hundreds of skilled workmen needed in South Milwaukee, Wis., at once. Big wages, living cost low. Small growing city—every city convenience. Near Milwaukee and Chicago. A real home city. Sites at \$1 down, \$1 a week. Write at once for information to Chas. R. Davis, Dept. A, Milwaukee, Wis.

OPENING Sale of Lots at League City Heights-on-the-Interurban, midway between Houston and Galveston. Interurban station on property, large, beautiful suburban homesites—50x125 feet. League City has 1000 population, 50 trains daily. Three steam railroads and Interurban. First 100 lots only \$40 each. Payments \$2 cash and \$2 monthly. Buy now while price is low and values along Interurban line makes rapid increase. Suburban property near Houston best investment in South. \$17,000,000.00 spent on new buildings in Houston, past two years. Send \$2 now and get choice location, or write today for particulars. Address, Galveston-Houston Interurban Land Co., 940 Union National Bank Bldg., Houston, Texas.

SUBURBAN Acre Homes \$2 Monthly—Opening sale Suburban Acre Homes, 35 minutes from Central station in Houston, Texas. Adjoining Suburban Townsite, railroad and shell boulevard to city. \$125 each. Terms only \$2 cash, \$2 monthly. Ideal poultry farms or suburban home. Good soil, plenty rainfall. Also Five and Ten acre tracts at low prices. This special price for short time only. Write at once for free illustrated literature, maps, plats, etc. Address, C. W. Hahl & Co., Owners, 734 Commercial Bank Bldg., Houston, Texas.

"FOLLOW the Lead of Wise Buyers"—Go to Los Indios, Isle of Pines—the beautiful, fertile, American inhabited tropical island only 180 miles from Key West, Fla. June climate year round—no frosts. Abundance of rain—no irrigation. Big profits in oranges, lemons, grape-fruit, pineapples, etc. American stores, schools, churches, banks, newspapers, etc. Our lands surround Los Indios, the only deep-sea harbor on the island. Unusual opportunity for home or investment. 10 acres will make you independent. Easy terms. Prices now low—land rapidly increasing in value. Titles guaranteed. Write for complete information. Cañada Land & Fruit Co., 117 Wisconsin St., Milwaukee, Wis.

GROW apples and grow rich in the glorious fruit district of Southern British Columbia. Our choice lands \$10 cash and \$10 monthly, without interest. Annual profits \$500 to \$1,000 per acre. Orchard, garden, poultry; scenery, hunting, fishing, boating; warm climate; school, postoffice, store; sawmill; daily trains; close to markets; unlimited demand for products. Write quick for maps, photos, free information. West Kootenay Fruit Lands Company, Dept. Z, Box 1087, Nelson, British Columbia.

CASH For Your Business and Real Estate. I bring buyers and sellers together. If you want to buy, sell or trade any kind of business or property write me today. Established 1881. Frank P. Cleveland, Real Estate Expert, 1308 Adams Express Building, Chicago.

MONEY Making Farms; 17 States; one to 1,000 acres, \$10 to \$50 an acre; live stock, tools and crops often included to settle quickly. Mammoth Illustrated Catalogue No. 35, free. E. A. Strout Farm Agency, Station 3043, 47 West 34th St., New York.

TEXAS school land on market now; you can buy good land at \$2 per acre; pay 5c per acre cash and no more for 40 years, but 3 per cent interest on the balance. Send 6 cents postage for further information. Investor Publishing Co., Dept. 3, San Antonio, Tex.

CHEAP patented state school lands, South Texas, \$1 an acre cash, balance ten years. For all particulars write F. A. Connable, Trustee, 491 Commercial Bank Bldg., Houston, Texas.

SELL your property quickly for cash, no matter where located. Don't pay big commissions. Particulars free. Real Estate Salesman Co., Desk B, Lincoln, Nebr.

SASKATCHEWAN, Canada, good farms \$15 to \$35 per acre on easy crop payments if desired. B. Nedam, Pipestone, Minnesota.

DOGS, BIRDS, POULTRY, ETC.

SILVER Campines—Beautiful, the rich man's hobby; useful, the poor man's friend. Everlasting layers of large white eggs. Circulars. Dr. H. J. Purdhomme, Thurmont, Md.

FROGS—Investigate bullfrog breeding. Immense demand. Supply inadequate. Poultry no comparison. Particulars. Aqua Life, Seymour, Conn.

FOR Sale. Pit bull terrier pups. Out of game stock, the win or die kind \$5 to \$10. Pair airedales, unrelated, pedigreed, eligible to registration, 8 months old, partly trained \$30. Walter Yockey, Clay Center, Kan.

SCOTCH Collie, Airedale Terriers. Send for list. W. B. Watson, Box 139, Oakland, Iowa.

REGISTERED English Bloodhounds—Puppies and grown dogs, best blood. Max J. Kennedy, Freedonia, Kan.

SPORTING and pet dogs, list free. Beechhurst, Shelbyville, Ky.

CANARIES that sing, Parrots that talk, Fancy birds, dogs, pet stock and pet stock supplies, shipped with safety anywhere. Illustrated Catalogue and an amusing novelty mailed upon receipt of 2c stamp. Edwards Bird Store, 129 Mich., Detroit.

FULL blooded Single Comb White Leghorn Cocks, breeders, \$5. Curtiss strain. Six month cockrels \$2.50. 1 Single Comb Brown Leghorn cock \$5. Guaranteed stock. Earle Gage, Ashville, New York.

AIREDALES—All ages, best breeding, watch dogs, hunters, collies, puppies, grown dogs. State wants. Phil Savage, St. Charles, Ill.

PURE Rose Comb Wht. Minorca, and Wht. Wyandotte males, also S. C. Buff Orpingtons. E. H. Blayne, W. Alexander, Pa.

FOR Sale. Bradley Strain Barred Plymouth Rocks, stock and eggs at reasonable prices. Satisfaction guaranteed. Write me. Leo Nebel, Lake Preston, S. D.

GREAT Dane puppies by Champion "Marco VI" out of "Ella" von Wutemberg a winner in Germany. Very fine, promising stock. A. Entenmann, 2611 N. Hutchinson St., Phila., Pa.

POODLES, Spaniels, Boston Bulls, Fox Terriers, Bull Terriers, Great Danes, Collies, Fox Hounds, Beagles, Setters, Pointers, Coach Dogs, Grey Hounds. Harry Reeder, Thorndale, Pa.

POULTRY Paper, 44—124 page periodical, up to date, tells all you want to know about care and management of poultry, for pleasure or profit, 4 months for 10c. Poultry Advocate, Dept. 3, Syracuse, N. Y.

FOR Sale—Pedigreed Airedales. W. F. Goodin, Columbus, Mont.

FORMULAS

BOOK filled with hundreds of valuable formulas. Yours for 20c. Profitable Service Bureau, 4333 N. Sawyer Ave., Chicago.

215 SELECTED formulas, hints, etc., mirror silvering, paint removers and many others. 25c coin. Kirk A. Box 3002, Phila., Pa.

VALUABLE coal saving formula. Will save you many dollars. Sent for only 25c, silver. M. J. Mangerud, Compton, California.

OVER 500 rare, valuable, money-making formulas only 25c. Descriptive circular for 2c stamp. Elco Publishing Co., Buffalo, N. Y.

FORMULAS—3,000 Formulas and Digest Publishing 100 formulas, etc., monthly. One year 50c or Silvering Formulas and Digest, one year 25c—or 200 Formulas and Digest, one year 25c. Digest, Grand Rapids, Mich.

ELECTRICIANS. Two guaranteed formulas for renewing old dry-cell batteries at low cost. Both 10c (silver.) Post-office Box 101, Montgomery, Ala.

TRANSPARENT Toilet Soap manufactured from common laundry soap. Formula, 4 dimes. The Formulary, Box M206, Lewistown, Pa.

500 SUCCESSFUL money-making formulas and trade secrets, postpaid 25 cents. Charles Dynes, Winchester, Ind.

WHY buy furniture polish when you can make it yourself very cheap. Price of formula \$1. J. F. Fournet, 135 Washington Ave., Crookston, Minn.

BEST Black Paint, Metal Buildings—roofs \$1. Crown Chemical Co., Hamilton, Ohio.

COAL saving formula used by Board of Education, New York City \$2. Guaranteed 20% to 50% saving. F. E. Fuchs, 38 Park Row, N. Y. City.

210 MONEY Making Formulas and Ad-Age four months for 15c. Ad-Age, Big Flats, N. Y.

SILVERING mirror or any formula desired, 20c. Scientific Bureau, W. Lynn, Massachusetts.

10,000 FORMULAS. New Book 800 pages. Price \$3. Circular free. B. Newham, Waukegan, Ill.

RESILVER Mirrors. Best Formula ever originated, 20c. Profitable Service Bureau, 4333 N. Sawyer Ave., Chicago.

SMOKELESS Powder. Make your own Smokeless Powder. Formula, postpaid, 75 cents. Houston Formula Co., 1708 Washington Ave., Houston, Texas.

LADIES and Gents. Economize, make your own Shoe and Store Polishes. Both formulas 10c. "Madrian," 66 Sumner Ave., Brooklyn, N. Y.

PAINTERS Friend is a book of Formulas and up-to-date instructions in Painting, Tinting, etc., for painters and others. Price \$1. J. Duval, Grand Junction, Colo.

FOR MEN

THREE shirts to measure, \$5—Express prepaid. Better grades, \$2.50 and \$3 each. Superior quality; high-grade workmanship; faultless laundry work and perfect fit assured. Send for samples, with measuring instructions and booklet, "Shirt Tales." Money returned if not satisfied. Frank W. Hadley, Mfg'r, Dept. H, Norwalk, Conn.

STRATHMORE cigars: Havana filler, Sumatra wrapper. A mild smoke. Send me \$2 for a box 25. Or \$3.50 for 50 Perfectos. Strathmore Cigar Co., 62 State St., Rochester, N. Y.

MR. Smoker. 25 sample box of "Figola" clear Havana cigars, \$1 prepaid. Money back if not satisfied. Beaver Cigar Co., Canton, Ill.

GOOD Dressers—Order a combination collar fastener and tie slide. Prevents the tie from binding, holds collar perfectly, small, easily adjusted, saves many times its cost in collars and fancy ties. Send 25c for sample and terms to agents. Money refunded if not satisfactory. Address, Wilson Sales Co., Box 99, Kokomo, Indiana.

MEN—Safety Razor Blades (any make) sharpened better than new on latest improved Odell machines. Each blade hair-tested. Single edge 25c dozen; double edge 35c dozen. Send money with order. Blades returned postpaid promptly. Vest Pocket Blade Holder Free. Copeland & Co., 76 Dorrance St., Providence, R. I.

SPECIAL—Three Silk Cravats, \$1 prepaid. \$3 value. Order today. Agents wanted. "Royal," Greenwich, Ohio.

SAFETY razor blades sterilized and sharpened better than new; 2 cents each. Five years' success. Send for blade box and circular. Electro Stropping Co., 134 Shelby St., Detroit, Mich.

FOR Sale—10,000 pounds best leaf tobacco, mail stamps for samples. Anton Wavrin, Franklin, Ky.

FOR THE HOME

GOOD Candy! Get busy and learn how to make your own candy. A splendid and complete course, 30c postpaid. Auburn Supply Co., Dept. GG, 7746 Peoria St., Chicago.

BUY the strongest 8 day alarm clock, guaranteed or money back. Price \$2.50. Express prepaid. F. Wilk Co., 1706 S. William St., South Bend, Ind.

COAL Saver. Cheap, easily handled. Instructions how to make it, 15c. Lycke-Bilz Co., Omaha, Nebr.

MAKE your own ice—simplest device yet—make it yourself—illustrated instructions 25c, or complete outfit \$2. Ausdale Co., Mansfield, O.

IMPORTED Japanese hand painted vases, 25c each. "Juron" 1400 Noble, Chicago.

"FASTENERS" for loose chair rounds. J. N. Hieronymus, Fairbury, Ill.

MAKE your own mission furniture at the minimum of expense. Our 3 books "Mission Furniture. How to Make It." Parts 1, 2 and 3, tell in plain, simple language just how to make 86 different pieces. Full dimension working drawings and half tones of finished articles. Price, 50 cents each or \$1.50 for the three volumes, postpaid. Popular Mechanics Book Dept., Chicago.

METAL Work and Etching—A 96-page handbook for art metal workers telling how to make a great variety of useful and ornamental objects such as desk sets, arts-crafts jewelry, etc. Price 50c, postpaid. Popular Mechanics Book Dept., Chicago.

BEAUTIFUL arts-crafts lamps—Anyone can make them out of paper, cardboard and wood. 16 designs. Inexpensive yet artistic. Complete book of instructions. Price, 50c, postpaid. Popular Mechanics Book Dept., Chicago.

TELEGRAPHY

LEARN Telegraphy by mail at home. Our wonderful self-teaching instruments send messages any speed while you copy. Taught by expert telegrapher. Fine illustrated catalog free. Southwestern Telegraph Institute, 336 Academy, Grand Saline, Texas.

TELEGRAPHY—Morse and wireless—Railway accounting (Station Agency) taught quickly. Railroad Dispatchers' and Western Union Wires and complete Wireless Station in school. Splendid opportunities. Graduates assisted. Living expenses low—may be earned. Largest and oldest school—established 38 years. Investment, \$25,000. Correspondence courses also. Catalog free. Dodge's Telegraph, Railway and Wireless Institute, 15th St., Valparaiso, Ind.

TELEGRAPHY taught in the shortest possible time. The Omnigraph Automatic Transmitter combined with standard key and sounder. Sends you telegraph messages at any speed just as an expert operator would. Five styles, \$2 up, circular free. Omnigraph Mfg. Co., 41 G. Cortland St., New York.

WIRELESS

THE best 25c wireless books published. "How to Make Wireless Instruments," by 20 wireless experts, 96 pages, 75 illustrations. "Wireless Telephone," by H. Gernsback, 80 pages, 57 illustrations. "Construction of Induction Coils and Transformers," by H. W. Secor, 100 pages, 72 illustrations. "Wireless Hook-ups," 100 pages, 161 illustrations. Price, 25c each or the four for 75c, prepaid. Wireless Association, 229 Fulton St., New York.

WIRELESS Set, How to Make—96-page book telling how to construct at small cost an outfit suitable for transmitting four or five miles. Price 50 cents, postpaid. Popular Mechanics Book Dept., Chicago.

GAMES AND ENTERTAINMENTS

FREE—1913 magic catalogue, 208 pages, 350 illustrations, 800 tricks, puzzles, illusions for parlor or stage entertainment. Positively the largest assortment in the world. Buy direct from the manufacturer, cheaper and better apparatus. 30 years in magic. Performer and inventor. Reference Prof. Kellar, Thurston, Houdini. We teach amateurs and professionals. Send 6c (stamps) for Souvenir Pocket Trick, Bargain List and particulars. Magic Co., Dept. 10, 249 West 38th St., New York.

HANDCUFF Acts, Mind Reading Acts, Spirit Cabinets, Magician's Tricks, and Complete Outfits of every description. If interested in Magic, or want to start in the Show Business, our Prices will interest you, and our Instructions will start you right. Particulars for stamp. Geo. A. Rice, Dept. 5, Auburn, New York.

EARN \$5 to \$10 an evening. Easy work and lots of fun. Complete instructions. How and what to do and what to say. Best book published on "Parlor Magic." Postpaid 25 cents. Andrews Publishing Company, Box 539 M, Albany, N. Y.

HOW to entertain. Book containing 900 jokes, riddles, magic experiments, fortune telling, money making secrets; to introduce mammoth catalog, all for 10c. National Company, 305 East 51st Street, Chicago.

LOADS of fun with every pinch. Cachoo—long distance sneeze powder. Fool family and friends. They'll never get wise. Sample vial, with two catalogs, 10c; three for 25c. Doz. 90c. American, 8 Judge Street, Brooklyn, N. Y.

250 MAGIC Tricks for 12c, to introduce our mammoth catalog of tricks and novelties. National Company, 305 East 51st St., Chicago.

153 TRICKS with two catalogs 10c. American, 8 Judge St., Brooklyn, N. Y.

MAGIC Tricks, Books & Supplies. Largest line in the world. Old reliable firm. Mammoth catalogue, ten cents. See our ad on page 12. Read & Covert, 821 East 43d Street, Chicago, Illinois.

LEARN Ventriloquism. Anyone can learn it by my method. Complete course of twelve lessons \$1.25. Skeels, "The Magician," Storm Lake, Iowa.

13 FUNNY Love Letters (read two ways), all new, 10 cents; J. Hardway Co., 207 S. Lee St., Bloomington, Ill.

200 MAGIC Tricks and Catalogue 10c. Curtis P., Englewood, Chicago.

MEPHISTOPHELES'S Vanishing Tumbler, non-detectable, 75c. "Magic," 5225 Lexington Ave., Chicago.

PLAYS, Vaudeville Sketches, Monologues, Dialogues, Speakers, Minstrel Material, Jokes, Recitations, Tableaux, Drills, Musical Pieces, Entertainments for all occasions. **Make Up Goods, Large Catalog** free. T. S. Denison & Co., Dept. 11, Chicago.

YOU can be a magician, travel, give shows, earn money. I tell how. Send stamp. Prof. Rapp, Box 1115 F, Madison, Wis.

NEW and Novel Jokes—great fun producers. So simple a child can operate them. 1. The Spilt Jam (Look what you've done to the table cloth!!!). 2. Red Hot Cinder (Drop it on the rug or floor in front of fireplace). 3. Damaged Finger (Deceptive blood-soaked bandage. Great sympathy is expressed by your friends). 4. Blot of Ink (The Bookkeeper goes mad. Mother is frantic). Price 10 cents each, postpaid. Address Popular Mechanics Book Dept., 318 W. Washington St., Chicago.

DIMINISHING Card, Twister-scope, ring and finger, immovable card, quarter trick, jumping string. Apparatus for all, 10 cts. Merlin, 3218 Snyder Ave., Brooklyn, N. Y.

SPIRIT pictures, 35 subjects—easy to do—10c. Klein, 1193 Broadway, N. Y.

WIGS and Makeups for theatrical and street use. Percy Ewing, Decatur, Ill.

KER-CHU powder. A pinch blown into the air makes everyone just sneeze their heads off without knowing why. Great fun. Absolutely harmless. Sample vial, 10 cents, three for 25 cents. Catalogue included. Joseph Methieu, 203 Court St., Brockton, Mass.

TRICKS—Tricks—Tricks. Largest assortment of tricks, jokes and novelties in the world. Send 2c stamp for illustrated catalogue. C. J. Felsman, Chicago, 164 N. Clark St. (Main Store), 115 State St., (Palmer House Lobby.)

STAMP COLLECTING

STAMPS, 15 varieties, South and Central America, 4c. sent with our net approvals. Palm Stamp Co., 249 No. Carondelet St., Los Angeles, Cal.

FINE approvals, 60% discount. Orange Stamp Co., 492 Mountain View Ave., Los Angeles, Cal.

100 FOREIGN Stamps, all different, some very rare in each set, 25c. Auburn Supply Co., Dept. FF, 7746 Peoria St., Chicago.

100 ALL different for 10c. 200 all different for 40 cents. Some good. Approvals at fifty off. Brinckerhoff Supply Co., Carlton, Ore.

100 STAMPS and Album 7 cents. Edward Lufbery, Wallingford, Conn.

U. S. BARGAINS 50c—\$1, 1909—50c; 1912 (Initials), 23c; (Alaska-Yukon) and (Hudson-Fulton), imperforate pairs, 17c. Lists free. Ohlman, 59 Nassau St., New York City.

100 DIFFERENT United States free. Remit 25c six months' subscription. McKele's Stamp Weekly, Boston, Mass., Album for 1,200 stamps if preferred.

5 RARE Stamps, 25 U. S., 25 Foreign, 3 unused, all for 12c. F. L. Bamerick Co., 207 Wall, Syracuse, N. Y.

WHOLESALE Stamps, 25 packets, 50 varieties foreign, or 60 packets, 25 varieties, \$1. William Barrows, Box 12, Hartford, Connecticut.

STAMPS, New issues, etc., on approval. Reference required. Why not write me? M. W. Taylor, 41 Wethersfield, Hartford, Conn.

FIFTY different U. S. 25 cents. No trash. Stamps on approval. McCann, 321 Newton, Minneapolis, Minn.

STAMPS—One cent approvals, biggest bargains ever offered. References required. L. Moulton, Boulder, Colo.

300 DIFFERENT Foreign stamps 20c. Ask for approvals. H. T. Belden, 129 Thompson St., Springfield, Mass.

150 ATTRACTIVE foreign revenue stamps 35c. Sell, exchange, buy. Oscar Hartmann, 1534 26 Ave., Denver, Colo.

STAMPS free—8 different Costa Rica, or 3 different Soudan (camel), big stamp lists, etc., for 2c postage. If you collect stamps, write us. Old collections bought. W. C. Phillips & Co., Glastonbury, Conn.

500 FOREIGN Stamps and hinges, album, 10c. Essex Co., 4730 Chickering Ave., Cincinnati, Ohio.

PACKET of 23 stamps; no two countries alike, 500 hinges. Set of \$1 and \$2 U. S. Rev., all for 5c. Miami Stamp Co., Toledo, Ohio.

FREE—8 varieties unused for name, address three collectors, 3c postage. Utica Stamp Co., Utica, N. Y.

STAMPS, 100, all different, free. Postage 2c. Mention paper. Quaker Stamp Co., Toledo, Ohio.

STAMPS—105 China, etc., stamp dictionary and list, 2c. Bullard, Sta. A, Boston.

24 VARIETIES Cuban stamps 10 cents. List of 6,000 low-priced stamps free. Chambers Stamp Co., 111 P. Nassau St., New York City.

FINE unsorted mission stamps, many countries; eleven pounds, \$4.60 free, anywhere. Cash with order. Ern Willemas, Pacification, Ghent, Belgium, Europe.

STAMPS—Old Stamps Purchased. Highest prices paid. Poole, Altadena, California.

RARE COINS

OLD Coins Bought and Sold—60 page Spring Coin Selling Catalog just out. Free to collectors only. Buying Coin Catalog, quoting prices I pay, 10 cents. William Hesslein, Malley Bldg., New Haven, Conn.

GREENBACKS—Pack of \$1,200 Stage Bills and present, 10c; 3 packs 25c. Send for a pack and show the boys what a wad you carry. Arthur Nichols, Chili, New York.

4 HANDSOME Foreign Coins Free. If you send 10 cts. for curious coin Pocket Piece. R. Chapin, New Berlin, N. Y.

COINS—California Gold, 25c size, 40c 50c size, 75c—Coin 1,500 years old, 15c. Ray Chapin, New Berlin, N. Y.

10 DIFFERENT large Cents 50c, 10 different foreign coins 15c. C. Burgess, 522 Beacon, Toledo, Ohio.

\$100 PAID for 1894 Dime S. Mint, \$8 for certain 1853 Quarters, \$100 for certain 1853 Half Dollars, \$2 for 1885 Dime S. Mint, \$6 to \$750 for certain \$5 gold without Motto, etc. We pay highest cash premiums on thousands of coins to 1909. Keep all old money and send only 4c for Large Illustrated Coin Circular. You have nothing to lose. The Numismatic Bank of Texas, Dept. H, Fort Worth, Texas.

COINS. I pay from \$1 to \$600. for thousands of rare coins, stamps and paper money to 1894. Send stamp for illustrated circular, get posted and make money quickly. Vonbergen, the Coin Dealer, Dept. P, Boston, Mass.

\$7.75 PAID for Rare Date 1853 Quarters, \$20.00 for a Half-Dollar. We pay a cash premium on hundreds of coins. Keep all money coined before 1900, and send 10 cents at once for our New Illustrated Coin Value Book; size 4x7. It may mean your fortune. C. F. Clarke Co., Coin Dealers, Box 15, Le Roy, N. Y.

COINS—20 different foreign 25c, 10 different bills 25c, 200 different stamps 15c. F. L. Toupal Co., Chicago Heights, Ill.

COINS—California Gold, 25c size, 40c, 50c size, 75c—Coin 1,500 years old, 15c. Ray Chapin, New Berlin, N. Y.

MUSIC

SHEET Music. Something new. "Always Think of Mother." Best song ever written. Will be sung in 3 million homes. Try a copy. Only 25c. W. H. Kessler, Leoti, Kan.

SONG Poems Examined Free. Send yours, make money. We get results. Music Clearing House, 147 West 45th, N. Y.

DOES one thing only and does it well. McQuade's note reader for memorizing notes. Especially for beginners. Postpaid, quarter. F. J. Pieper, Alton, Ill.

ILLUSTRATED Charts for learning Violin or Mandolin 25c. Mayberry, 179-6th Ave., New York.

"BESIDE the Old Mill Stream," Latest song hit, 20 cents. Nermer Decamp, Toms River, N. J.

POEMS wanted. Cash for good talent. Send Ms. to Inland Music House, Chicago.

SHEET music at wholesale. To introduce proposition will send three big hits postpaid for 10 cents. Co-operative Music Exchange, 133 Meserole St., Brooklyn, N. Y.

THE Song with sweet, clinging refrain. "My heart goes out to you," will be mailed to any plainly given address upon receipt of thirty cents. Address Sunny-Songs Pub. Co., Box 373, Chicago, Ill.

PLATES and Copyright for greatest song out, \$85. Dime for copy. Kelstrom, Maywood, Ill.

SELL sheet music—profitable latest song and particulars 10c. Pop. Durham Co., Corry, Pa.

FREE—Big song hit. We want your name. Send 2 Two-Cent stamps to cover wrapping and mailing. Bostonia Pub. Co., Worcester, Mass.

SONG Poems Wanted—Send us your song poems or melodies. They may become big hits and bring thousands of dollars. Past experience unnecessary. Available work accepted for publication. Instructive booklet and information free. Marks-Goldsmith Co., Dept. 20, Washington, D. C.

SONG Poems wanted. Cash or royalty paid for popular hits. Particulars free, with bulletin of latest gems. Agents make \$10 daily selling our music. Needham Music House, 61 Pierce, St. Louis, Mo.

RAG-TIME piano playing taught by mail. Book free. Christensen, 84 Auditorium Bldg., Chicago.

ALL the favorite old songs. Words and music complete in book form with attractive cover; size 7½x9½ inches; good value. Price 50 cents, postpaid. Popular Mechanics Book Dept., Chicago.

PIANOS AND MUSICAL INSTRUMENTS

IF your Talking Machine does not play as good as you could expect, consult Kuenstler the Talking Machine Expert, for the reason. Send stamps for reply. 3251 Lexington St., Chicago.

VIOLIN for sale cheap. Excellent toned. Sent on trial. Miss Bertha Mardes, Route 5, Rosedale, Kansas.

BEAUTIFUL upright piano, brand new, was never unpacked. Cost \$298, will accept half or any reasonable cash offer. Albert Petran, Neffs, Ohio.

FOR Sale—Five Wurlitzer electric pianos, need slight repairing, \$500. Cost \$2,000. Address Kirkegaard, 897½ Trumbull Ave., Detroit, Mich.

FINE mahogany phonograph, cabinet, 81 records. \$125. Bargain. E. H. Fredrick, Defiance, Ohio.

PRINTING AND ENGRAVING

ENVELOPES, letterheads, cards, statements printed \$1.20 the 1,000, sample 100 of either above printed and sent postpaid 32c. Andrew Brems, Corona, N. Y.

SAVE money on your Printing. 1,000 bond letterheads \$1.75. Samples free. Write us your wants. The Letterhead Shop, 4105 Colorado Ave., Chicago.

GUMMED Stickers—3,000 \$1. Catalogue free. MacTaggart, 1235 Arch, Philadelphia, Pennsylvania.

100 WHITE Envelopes thirty cents. Novelty Printing Co., Burlington, Iowa.

150 LETTERHEADS and 150 Envelopes (white, blue, pink or golden rod), printed to order for \$1 postpaid. Guaranteed. Samples for stamp. Union Publishing Co., Dept. M., Uniondale, Indiana.

100 "NOVELTY Wireless Messages," 75 words, with printed "Telegram" Envelopes 85c. Additional hundreds 55c, prepaid. Samples. Adolph Menzel, Oshkosh, Wis.

GUMMED Labels the Better Kind, 1,000 for 50c. Catalogue free. Standard Label Co., 1011 Chestnut St., Phila. Pa.

\$15 TAKES Rotary Printer; 3,500 Types. Bargain. Goldschwitz, 4052 Lake St., Chicago.

TO introduce our work, 1,000 envelopes, 1,000 letterheads, 1,000 business cards sent prepaid for \$5. Bunch of samples 10c. Eastern Printing Co., Eastern Ave., Baltimore, Md.

1,000 COLORED Bond Art Ad Slips—150 words—\$1 postpaid. Imitation typewritten letters \$1.50 to \$3. Elegant samples free. Good's Printery, Harrisonburg, Virginia.

1,000 CIRCULARS, or labels 3x4 in., 65c prepaid. P. Hummel, 3025 Germantown Ave., Philadelphia, Pa.

500 BOND letterheads and 500 bond envelopes for \$2.60 postpaid. Echo Printery, Gladstone, Mich.

100 CARDS, name and address 30c. Business cards, 45c. 100 envelopes, 35c. 100 letterheads, 60c. Elite Exchange, Dept. T4, 3827 No. 44th Ct., Chicago.

1,000 GUMMED labels, 2x1, 50c postpaid anywhere; we print anything; catalogue free. Walter's Printery, 35 Myrtle Ave., Brooklyn, N. Y.

ALL for \$1.10: 100 letterheads, 100 envelopes, and 100 business cards printed to your order on bond paper. Prepaid. Samples free. Carter Co., Rochester, N. Y.

BETTER Printing for less, prepaid; Gummed Labels, Stickers. Price list. Established 18 years. Bonnell Printing Co., Ashtabula, O.

PRINTING Outfit for sale cheap. Write for list. A. A. Middaugh, Sugar creek, Ohio.

PRINTING Presses, type, supplies. Catalogue free. L. M. Carroll & Co., 326 Madison St., Chicago.

PRINTING—500 either envelopes, note-heads, statements, cards \$1.00; 1,000, \$1.50. 1,000 envelope slips \$1.00. 500 linen finish letterheads or envelopes \$1.50; 1,000, \$2.50. Imitation typewriter letters \$2.00 per 1,000. Model Company, Manchester, Iowa.

GOOD Printing at low prices. 1,000 good letterheads, envelopes, cards, billheads, labels, circulars, \$2.50. Samples free. Catalogues, booklets, and circulars our specialty. Ernest L. Fantus Co., 523 S. Dearborn St., Chicago.

100 CAMBRIC Bond letterheads and 100 envelopes, prepaid for \$1. People's Press, Preston, Minn.

MULTIGRAPH form letters—\$3 for 1,000. Includes stock, letter, letterhead—sent prepaid in U. S. Specimens free. Perfection Letter Company, Muncie, Indiana.

ACME Coin Mailables—\$2.60 per 1,000. For 6 coins \$3. Any printing desired. Samples free. Dodd Printing Co., Fort Madison, Iowa.

1,000 BOND 3¼x6 circulars, prepaid, \$1. Smith Supply, Waukegan, Ill.

LOOK here—100 letterheads, 100 envelopes, 100 return envelopes or business cards, printed for \$1 postpaid. Walden Press, Roxbury, Mass.

PRINTING and Lithographing samples, 4c. Otter Press, 563 Lexington Ave., Brooklyn, N. Y.

ELECTRICAL

RENEW Old Dry Batteries; three best methods with complete instructions, all for 20c. Guaranteed. Profitable Service Bureau, 4333 N. Sawyer Ave., Chicago.

ELECTRICITY. Just what you have been looking for. Our Modern Blue Print Chart Method of Electrical Wiring Diagrams. Thoroughly explained so that you can easily understand them. All kinds of Bell Wiring, Annunciators, Telephones, House Wiring, Conduit, Theatre, Isolated Plants, Dynamos, Transformers, Arc Lights, Special Treatise on Motor Wiring. Write now for information, Electrical Wiring Diagram Co., Box A, 173, Altoona, Pa.

RENEW old dry batteries; complete instructions 25c. Guaranteed. Clark, 1613 North 13th, Philadelphia.

STORAGE battery plates 7c each. F. A. Eberhardt, 938-30th St., Milwaukee, Wis.

TYPEWRITERS AND SUPPLIES

REBUILT typewriters, all makes, at wonderful savings. Must dispose of immense stock, will sacrifice and give \$5 worth of supplies. Write for "Specials." Consolidated Typewriter Exchange, Inc. (Established 1882), 245 Broadway, New York City.

SPECIAL Typewriter Sale. Remington No. 6—\$15. Smith Premier No. 2—\$14.50. Underwood No. 4—\$35. Guaranteed one year. Ritzhelmer Typewriter Company, 53-3 Park Row, New York.

UNDERWOOD No. 4 typewriter Guaranteed Perfect. Shipped on approval. H. J. Postlewaite, Hammond, Indiana.

\$18 TAKES visible typewriter; bargain. Goldschwitz, 4052 Lake St., Chicago.

ONE hundred typewriters, taken on debt, being sold regardless of cost. Visible writers and others, get list. Ayer's Investment Co., 430 2nd Ave., So. Minneapolis.

TYPEWRITER—Having no further use for my Underwood, will sell reasonable. Hal Day, Canton, O.

BANKRUPT Sale—Greatest in history, all standard makes, all good condition. Low as \$10. Get one now and save 25 to 75%. Sent free trial. Write for Catalogue 16. Typewriter Inspection Co., 227 W. 4th St., Cincinnati, O.

HAMMOND Universal Typewriter for sale. Good condition. \$15. C. E. Groff, Guernsey, Iowa.

TYPEWRITERS \$10 up. Free Trial. Express Prepaid. Guaranteed two years. Price list free. Payne Company, Rosedale Branch, Kansas City, Kansas.

SAVE \$25 to \$50 on manufacturers' prices. Buy our Factory Rebuilt Typewriters. Nearest-to-new on the market. Have trademark and guarantee. Like new machines. Are thoroughly rebuilt, highly polished, and perfect in appearance. Satisfaction guaranteed. We are the largest rebuilt typewriter concern in the world. Branch stores in leading cities. Write for catalogue of standard makes. American Writing Machine Co., Inc., 345 Broadway, N. Y.

TYPEWRITERS—Every kind on the market. Write today for best bargain you ever secured. Shipped anywhere on approval. \$10 up. Fletcher Typewriter Co., 207 N. 7th St., St. Louis, Mo.

NEVER buy a typewriter until you get my complete catalogue and price list of all standard makes. A. E. Atchison, 4127 West 21st St., Chicago.

OFFICE EQUIPMENT

SCREW division pins double the practical use of desk drawers. Envelopes, blanks, papers, keep their place—no "mix-up." Box 25c. Circular free. M. W. Chapin, 218 Eleventh St., Toledo, Ohio.

RUBBER Stamp—Name, business, address, with inked pad, 30c; catalog 2c. Pop. Durham Co., Corry, Pa.

PUT Atchison's "Shock Absorber Cushion" under your typewriter. Saves your nerves; stops the noise. 25c, postpaid. A. E. Atchison, 4127 W. 21st St., Chicago.

MAILING LISTS

WE will mail free to any business man a copy of our comprehensive "Silent Salesman" containing over 2,000 different classifications of Mailing Lists with the number in and price of each list. This price list contains information which should be in the hands of every business man and this generous offer should be accepted. Trade Circular Addressing Company, Desk G, 164½ W. Adams Street, Chicago.

MISCELLANEOUS

HIGH Grade Formulas for Automobile Specialties. I offer a collection of 13 formulas for turning the finest goods possible. "Blazon" Brass Polish; Auto Veneer body polish; "Carbon-Off" decarbonizer; "Silkmap" Top Dressing; "Presto" Chauffeur's paste soap; "Beeo" Soldering Paste; "Kantfreeze" Compound; "Babnol" Lubricant; No-Dk Tire Powder and Paint; Selden's Auto Soap. "Vulkine" Self Vulcanizing Tire Cement; All-in-One Oil; "Relisto" The New Tire Filler Compound. Complete \$1.50 post-paid. Satisfaction guaranteed. Write me regarding any formula or preparation. Liscombe F. Miller, E. Chemical Co., Marietta, Georgia.

CARD Case, Seal Leather, six pockets, name in gold. Catalogue free. Salford Manufacturing Company, 5943 Summer St., Philadelphia, Pa.

RELIC hunters—Write. Something historical, mentioned in school history. Sell or trade. News, Fargo, Okla.

MAKE full rigged ship, inside bottle. Directions complete. One dime and two cent stamp. Sam Monroe, Box 212, Allendale, New Jersey.

SILVERING Mirrors. Full course of instruction for 50 cents. Max Swift, 158 Suffolk St., New York.

FELT college or school pennants large size sent for 20 cents. All colors. Jens Mfg. Co., 1164-39th St., Brooklyn, N. Y.

YOUR name on 10 Rubber Tipped Pencils 50c postpaid. Osborne, Camden, New York.

PARKHILL'S Universal Pitch Gauge marks more roof-framing in less time than any other tool or method. More pitches. More framing for each. Any pitch—of 100—in 5 minutes, even by unskilled framers. Stair and brace Gauge, prepaid for \$1.50. If returned money refunded. Agents wanted. John Parkhill, Rochester, Minnesota.

A Train Load of Books

I started my mail order book business ten years ago, and during the last eight years I have sold more than a train load of books each year—more books than any other man in America. Why? Because I buy so I can sell cheaper than the others, and every book is shipped subject to return at my expense if not satisfactory.

Publishing books is a precarious business. Many publishers and booksellers fail. I make a specialty of buying bankrupt stocks of new books at my own price, and regular stock in quantities so I can retail at wholesale prices. I now have a big stock of over 6,000 different fine library sets of the works of standard authors and single volumes on every subject, which I offer to close out this season at 10 cents to 50 cents on the dollar.

Be fair to yourself. I can save you money. Drop me a postal card and get my prices before buying.

Sample Prices

DeLuxe 3/4 Morocco Bound Sets Shakespeare, 20 vol., \$90.00; my price, \$14.40. Plutarch, 6 vol., \$22.50; my price, \$4.65. Also Dickens, Emerson, Stevenson, Kipling, Scott, DeMaupassant, Hugo, Dumas, Eliot, Carlyle and a hundred others at 25 cents on the dollar of publishers' prices.

Single Volumes Koran, 1/4 mor., \$2.00; my price, 48c. Dante's Inferno, \$6.00; my price, 90c. Origin of Species, and 500 other good titles, \$1.00; my price, 43c. Josephus, \$2.50; my price, 98c. Handbook of Oratory, \$5.00; my price, \$1.60. Gift books, children's books, instruction books, law and medical books, humor, history, biography, science, etc., etc. All subjects and at bargains.

Regular Stock—My Prices Their Yesterdays, 90c. Winning of Barbara Worth, 90c. Shepherd of the Hills, 35c. Calling of Dan Matthews, 35c, and many others.

Free Bargain List

Before ordering send for my free Bargain List of all my thousands of bargains and see how I ship books on approval, to be paid for after examination or returned at my expense if not satisfactory. Send for my Bargain List now. Postal card request will bring it.

DAVID B. CLARKSON, The Book Broker
240 Clarkson Bldg., Chicago, Ill.

SHOP NOTES for 1913

POPULAR
MECHANICS
YEAR BOOK



Vol. IX POPULAR MECHANICS 50 Cts

The New Year Book Is Now Ready

All the articles which have been published during the year past in the Shop Notes Department of POPULAR MECHANICS MAGAZINE have been reprinted and bound in one handsome volume of

224 Pages

595 Articles 503 Illustrations

Price 50 Cents

This is Vol. IX of the series and contains entirely new matter. The seven page index makes it handy of reference, and we will mail the book to any address upon receipt of 50 cents, or it can be bought of your book or newsdealer at the same price.

Popular Mechanics, Publishers
318 W. Washington Street, CHICAGO, ILL.



Fifty Cents a Week Employs These Eight Engineering Experts

50c a week—\$2.00 a month for but one year—will bring to your door a work which contains the condensed knowledge and experience of over a score of Civil Engineers—a work which will give you, without loss of time and at no expense, advice and assistance equal to that of the best experts and consulting engineers. With these books in your office—eight faithful, efficient and tireless assistants—you are prepared to cope with any difficulty, however great, that may arise.

The American School's Cyclopaedia of

CIVIL ENGINEERING

is compiled from the instruction papers used in the regular correspondence work of the school; contains 3,900 pages; 3000 illustrations, folding maps, diagrams, etc., with a special cross index for quick reference. The eight large volumes are bound in half morocco and are printed in large, clear type on special quality paper. This great work—a most complete review of Civil Engineering—will solve every problem likely to confront you in your daily work and will place the solution before you so clearly and concisely that you cannot fail to understand and profit by it.

Sent Absolutely Free—Express Prepaid

The complete eight volumes, not a sample volume, will be sent, express prepaid, for seven days' free examination; returnable at our expense if the books do not contain the information you want. If you keep them, pay \$2.00 seven days after receipt and then \$2.00 a month until you have paid the special introductory price of \$24.80. The regular price of this great Cyclopaedia is \$40.00.

Just fill in and mail the coupon. It won't cost you a cent to examine the books. We know they'll be worth many times their cost to you. Mail the coupon now and you'll receive your books promptly.

Some Important Subjects Covered

Drawing, Plane Surveying, Plotting and Topography, Strength of Materials, Masonry, Reinforced Concrete, Hydraulics, Waterways, Water Supply, Irrigation, Water Power, Sanitation, Highway Construction, Steel Construction, Roof Trusses, Practical Problems, Bridge Engineering, Railroad Engineering, Cost Analysis, Harbor and River Improvement.

\$12.00 Consulting Membership Free

With every set is included a year's Consulting Membership, regular value \$12.00, entitling you to the free advice of a staff of Civil Engineering Experts. This will give you practical help in handling working problems which are too specific to be taken up in detail in the Cyclopaedia. There will be no limit to this service. A single problem solved for you might be worth more than the first cost of the books.

American School of Correspondence, Chicago, U. S. A.

FREE OFFER COUPON

American School of Correspondence, Chicago, U. S. A.

Please send Cyclopaedia of Civil Engineering for 7 days' free examination. I will send \$2 within 7 days and \$2 a month until I have paid \$24.80; otherwise I will notify you and hold the books subject to your order. Title not to pass until fully paid. Pop. Mech. 2-13

NAME.....
ADDRESS.....
OCCUPATION.....
EMPLOYER.....

Continued from Page 34

MAKE More Money! Operate a good substantial Mail Order business—our "Silent Salesman" system—can easily be done in spare time, yet the possibilities are unlimited! For years "Booster" has actually and accurately led thousands like you over the Successful Road to Wealth. To succeed you must read The Booster Magazine for "Booster" is the opportunity that starts you in business for yourself which is the time you begin accumulating wealth—it tells you how to get the dollars—puts you next to the best propositions on earth—ones that really get you the money! Send 10c for two months' trial subscription. Booster magazine, Northwestern Building, Chicago.

RAINCOATS at Manufacturers' Prices for men and women. Durable and stylish in tan or gray. Plaid lining, military collar, adjustable wrist straps, slashed pockets. Sizes 14, 16 & 32 to 44. Sent prepaid for \$2.85. Money back if not satisfactory. B. & J. Rubber Co., Dept. 30, 161 Summer St., Boston, Mass.

PENNANTS—Sample, with list 25c. Southern Specialty Co., Nashville, Tenn.

GENUINE Mexican Cherry opals, round or oblong cut, size about four karats each. \$1 postpaid. The Bennett Indian Trading Co., Albuquerque, New Mexico.

CALIFORNIA gem crystals and minerals for sale direct from the mines. Approval lots sent with good reference. Albert Everett, Escondido, California.

EGYPTIAN Transfer. Wonderful invention for transferring pictures. Instructive and interesting, child's delight. Price 15c. Pulver Bros., Allen St., Hudson, N. Y.

GENUINE Navajo Indian lucky rings, coin silver. Guaranteed Navajo hand work. 60c postpaid. The Bennett Indian Trading Co., Albuquerque, New Mex.

TOBACCO Cure, full details, etc., and one year subscription to Digest 25c. Digest, Grand Rapids, Mich.

EARN \$15 to \$25 a week as our mail order dealers. Right from your own home. Hold your position until entire time is required. We are manufacturers and owners of Patented just-in-season, repeat order specialties. If you are just starting a mail order business or if already established, you can't afford not to handle our patented money making getters. We sell and furnish everything. No canvassing. Small capital. Experience unnecessary. Write today for latest patented leader and manufacturers easy selling (copyrighted) mail order plan backed up by "whole truth," positive proof and sworn statement. J. M. Pease Mfg. Co., 552 Pease Bldg., Main St., Buffalo, N. Y.

YOUR ad goes into 1,000,000 rural homes every week if you use Boyce's Weeklies. Low rate and big returns. Write for free Result Checking Book. Use letterhead. Classified Dept., 500 Dearborn Ave., Chicago, Ill.

DENTISTS' Secrets; surprising disclosures worth thousands of dollars to a public being imposed upon by so called Dentistry. Send 25 cents. Dental Information, 550 12th St., Milwaukee, Wis.

THE Macrophone. A loud speaking telephone. Delivers all sounds loudly. Full tone of piano reproduced at any distant point. One piano can supply 100 lines. 170 Purchase St., Boston.

INDELIBLE Linen Marking Outfit, including name on rubber stamp, 40c. Barstow Co., 514 23rd Street, Oakland, Cal.

THE Art of Tattooing. Complete book 25c silver. H. W. Rebec, Cedar Rapids, Iowa.

PENNANTS, college or word sewed, 48 cts. stamps. Best felt, 12x36. Indiana Pennant Factory, Linton, Ind.

RECEIVE enormous mail for 25c. Directory, 1305 Ashmun, Burlington, Iowa.

RAILWAY Mail Clerks Wanted—\$75 month to commence. Advance \$100 each year. Every second week off at full pay. Steady work. Examination everywhere soon. Thousands of Parcels Post appointments. Common education sufficient. "Pull" unnecessary. Farmers eligible. Write immediately for free specimen questions and schedule of examination places. Franklin Institute, Dept. K 22, Rochester, New York.

INCREASE your business. Your letters and your advertisements in Spanish will be read by many millions of Spanish speaking people. We translate as low as 50 words at the rate of \$2 per thousand. We guarantee fine work. We supply 8,000 up to date addresses of best people, for \$1. International Commercial Co., Box 2541, 4a, Mesones St., No. III, Mexico, D. F.

FELT pennants. All colleges, 40c each. Larger sizes, 50c. Elite Exchange, Dept. P., 3827 No. 44th Ct., Chicago.

RADIUM. A few dollars will buy enough to make different experiments. Radium ore to make radiographs \$1. Radium Bank, Grand Junction, Colo.

FREE yourself from tobacco thru my common-sense cure. No drugs. Positive cure. A scientific system, the result of long and careful study. Send today. Price \$1. K. D. Thompson, Austin, Texas.

READ The Ginseng Journal 12 mo. for 50 cents. Full of interest to ginseng and golden seal growers. Sample free. Penn Kirk, editor, Arrowsmith, Ill.

DRAFTSMEN, Engineers. An Integrating Planimeter, for finding areas and developing curves, \$1. Instruction book 10c. Clair Gilson, East Lansing, Mich.

TATTOO machines, ink and full directions, 50c. Electric machines and supplies. H. W. Rebec Mfg., Cedar Rapids, Iowa.

ACCOUNTANT—Retailers requiring improvement of bookkeeping system, address Chas. Hughes, New Hartford, N. Y. Charges reasonable.

AUTO Tire repair shop pays big everywhere. Small floor space required. Quickly learned by anyone. Steam vulcanizing outfit (including instructions), sold on easy payments. Particulars free. E. Taylor Co., Cleveland, Ohio.

I WILL start you earning \$4 daily a home in spare time, silvering mirrors; no capital; send for free instructive booklet, giving plans of operation. G. F. Redmond, Dept. 306, Boston, Mass.

TOBACCO Cure. One box cures. Guaranteed or money back. Established 1894. Write for special offer. Allen Distributing Co., 319 Altman Bldg., Kansas City, Mo.

RARE Books. Swedenborg's "Heaven and Hell," 400 pages, 15 cents postpaid. Pastor Landenberger, Windsor Place, St. Louis, Mo.

BROTHER—Accidentally discovered root will cure tobacco habit. Gladly send particulars. F. Stokes, Mohawk, Florida.

DON'T fail to read Independence and Fortune under Business Opportunities.

BEN Franklin printing office complete, \$1.50. Juron & Co., 1400 Noble, Chicago.

MATHEMATICS made easy for all by Ropp's Calculator. Figures out in the twinkling of an eye, every conceivable problem that occurs in the Office, Store, Shop, Bank, Farm or Factory. Greatest time and labor-saving work on figures in the world. Copyright, 1912. Price, \$1. Vest pocket size, 50c. Popular Mechanics Book Dept., 318 W. Washington St., Chicago.

1,200 CARTOONS for \$1. A Panorama of World Events, Political—Industrial—Social—Humorous—Tragic—all of intense human interest. Six numbers of Cartoon Magazine (January to June, 1912, inclusive) representing the best work of over 100 of the best cartoonists, and handsomely and durably bound in book form will be sent prepaid to any address for \$1. Cartoons, 318 W. Washington St., Chicago.

PATENTS secured—C. L. Parker, 910 G St., Washington, D. C.

NIAG-Rine. A Wonderful Ink. New discovery. For expert drawings or writing use. Does not corrode or blot. Chemical proof, water proof, non-poisonous and will not stain fingers. Give it a trial. Large bottle or tube postpaid, only 20c. More facts and pens free. Address Chas. Haeusser, 1267 Broadway, Albany, N. Y.

ANYBODY can make good cuts with my simple zinc etching process; price, \$1; specimens and particulars for stamp. T. M. Day, Box M, Windfall, Ind.

BE a Handcuff King. Earn big money on the stage. Vaudeville Circuits pay \$100 week up. I teach everything in this line. For particulars, address Box 902, Springfield, Mass.

Additional Classified Ads Page 168 Back Advertising Section

AGENTS—SURE MONEY

Showing the "NU-PANTZ" Creaser

Find out *now* about this new, exclusive article. Aluminum self-heating outfit, creases trousers, sleeves, etc., almost automatically. Sells at \$3.50, saves customer \$15.00 to \$30.00 a year. Five sales a day nets \$162.50 a month. Hustlers sell five in half a day. "Nu-Pantz Salesmanship" given in first letter, insures sales from the start, and means money to the live man who acts to-day—while it is new. Address

Racine Creaser Co., 43rd St., Racine, Wis.



When you want anything and don't know where to find it—write Bureau of Information, Popular Mechanics, Chicago

IF IT ISN'T **AN EASTMAN** IT ISN'T A KODAK

"Slip-On" Raincoat FREE

Would you accept this guaranteed waterproof raincoat from us **absolutely free** (we prepay the express) just for showing it to your friends? Would you like tailoring styles that everyone goes wild about? Could you use \$5 a day for a little spare time? If so write and say: "Send your offer" and you will receive a beautiful set of samples and styles to pick from (suit or raincoat) and an offer so good you can hardly believe it. No money or experience needed. **Write now—sure.** Address

BANNER TAILORING CO., Dept. 26, CHICAGO



1000 SETS

Here is an offer of startling interest to every man—and particularly to every business man—who wants to know his legal rights and how to avoid losses and lawsuits without the expense of hiring a lawyer. Every one knows that the average man in business is constantly incurring legal risks and losses on matters concerning contracts, leases, collections, management, insurance, shipping, freight rates, claims for damages, etc., unless he is able to retain the close active service of competent lawyers.

In order to supply absolutely sound and practical legal guidance and advice of the very highest authority to every one, 26 of America's most noted lawyers, legal authorities and foremost special writers on legal questions, recognizing this pressing need, have co-operated to produce what is unquestionably the greatest Quick Reference Law Library ever known. This wonderful work, "American Law & Procedure," is in a class by itself—the one and only layman's non-technical law library that answers every legal question with supreme authority.

Prepared after several years of careful and exhaustive research at

a cost of \$40,000.00 for editorial work alone, these 14 volumes of legal knowledge systematized and reduced to a practical every-day working basis, represent one of the greatest public benefactions ever undertaken.

A magnificently bound edition of 1000 sets just off the press, is now being distributed at a temporary financial sacrifice in order as quickly as possible to get the work in the hands of 1,000 business men and others, who will at once realize its great practical value and through their enthusiastic endorsement cause a wide spread demand for future issues.

The preliminary advertising plan is this: We will ship these 1000 sets in order of application express prepaid, absolutely free and without obligation of any kind, for seven (7) days' examination in home or office. Not a penny deposit will be required. We are so sure of the favorable reception this great work will receive that we do not hesitate a moment in making this wonderfully liberal offer. Send no money. Just your name and address on coupon below will bring the entire 14 volumes to your door, prepaid, at our risk.

LaSalle Law Library FOR EVERY Business Man



American Law and Procedure

14 Volumes; Over 5000 Pages, Full Standard Law Size, 6 1/2 x 9 1/4 — 3/4 Sheep, 15,000 Cited Cases.

Cost \$40,000.00 To Prepare For Publication

Answers All Your Legal Questions

The uses for this law library are practically unlimited. It is the only non-technical work ever published which covers the entire field of American Law touching the individual at every possible point. It should be in every home and office. Invaluable to the business man and affords safe, sure, quick and easy answers to every legal question that can arise in family, civic and public life affecting the rights of individuals, public officials, corporations, schools, churches, societies, etc., etc. Ignorance of the law excuses no one. Avoid losses and law-

suits. These books tell you quickly how to act—interesting, simple, plain, quick, easy, accurate, authoritative. Business men lose millions annually through legal mistakes. Stop the risk and loss so far as it affects you and your interests. This great law library at your elbow for constant consultation will keep you out of trouble. It makes available to you at any moment the services of 26 of the world's greatest legal experts and specialists.

NEVER BEFORE Such Authorities as These

distinguished legal minds gathered together in behalf of such a vast, far-reaching public enterprise. Edited by James P. Hall, A. B., LL. B., Dean of Law School, University of Chicago; and James DeWitt Andrews, LL. D., Author of "Andrews' American Law," Editor "Andrews' Stephen's Pleading," "Cooley's Blackstone," "Wilson's Works," etc. Subject matter of the entire 14 volumes prepared by following eminent contributors, whose names and titles speak for themselves.

Harry S. Richards, Ph. B., LL. D., LL. B., (Harvard) Dean of College of Law, University of Wisconsin; Roscoe Pound, Ph. D., LL. M. (Northwestern) Professor of Law, Harvard University; George L. Clark, A. B., LL. B., (Harvard) Professor of Law, University of Michigan; Elliot J. Northrup, A. B., LL. B. (Cornell) Associate Professor of Law, Tulane University; Albert M. Kales, A. B., LL. B. (Harvard) Professor of Law, Northwestern University; Charles A. Huston, A. B., J. D. (Chicago) Associate Professor of Law, Stanford University; John R. Rood, LL. B. (Michigan) Professor of Law, University of Michigan; Ernest B. Conant, A. B., LL. B. (Harvard) Professor of Law, University of Nebraska; James P. Hall, A. B., LL. B. (Harvard) Dean of Law School, University of Chicago; Percy Bordwell, Ph. D., LL. M. (Chicago) Professor of Law, University of Iowa; Frank W. Henricksman, A. B., J. D., (Chicago) Lecturer in Law, University of Chicago; William U. Moore, A. M., LL. D., (Columbia) Associate Professor of Law, University of Wisconsin; Arnold B. Hall, A. B., J. D., (Chicago) Instructor in Public Law, University of Wisconsin, and 12 others of similar high standing.

FREE LEGAL ADVICE The regular price for the complete 14 volumes which is \$75.00, is only made possible by selling direct and saving usual dealers' profits. However, on these preliminary 1,000 sets to be distributed on this Special Advertising Plan, a deduction of \$26.00 will be made, leaving the actual net cost to those who send in the coupon in time to get one of the 1,000 edition, only \$49.00 for the entire 14 volumes, on small monthly payments. And to these one thousand we will give in addition, free legal advice. We will give a free Consulting Membership Certificate along with each of the one thousand sets entitling the holder to consult either in person or by mail with our legal experts and receive free advice upon any and all questions of law—this service strictly limited to these advertising sets. This free service alone is unheard of in its liberality and magnitude.

SENT FREE EXPRESS PREPAID

examination. All you need do to take advantage of this remarkable coupon and you will receive the set by return express, all charges paid. Then read the books, examine them carefully, show them to your friends or neighbors, ask the opinion of others, and after you have taken seven whole days, if necessary, to make up your mind, just decide whether or not "American Law and Procedure" is the work you have always wanted. If not, send back the set and we will pay the return express charges so that you will not be out one single penny either way. If you desire to keep the work, simply send us the first payment of \$4.00.

Remember it costs you nothing to get this complete LaSALLE LAW LIBRARY in your home or office. We send it absolutely free, express prepaid, for your careful inspection and offer is simply sign and mail the coupon. Then read the books, examine them carefully, show them to your friends or neighbors, ask the opinion of others, and after you have taken seven whole days, if necessary, to make up your mind, just decide whether or not "American Law and Procedure" is the work you have always wanted. If not, send back the set and we will pay the return express charges so that you will not be out one single penny either way. If you desire to keep the work, simply send us the first payment of \$4.00.

LaSalle Extension University, Dept. 300 Chicago, Ill.

Gentlemen:—Please send me at once, set of American Law and Procedure, 14 Vols., bound in 3/4 sheep, for seven days' Free Examination. I understand the regular price to be \$75.00, but that I am to get it for \$49.00 Special Introductory Price. If I am satisfied, you are to accept this coupon as credit for \$26.00 and I will send you \$4.00 within seven days and \$3.00 each month until I have paid a total of \$49.00. If I decide not to keep the law library, I will notify you within seven days and hold the books subject to your order. Title not to pass to me until the books are fully paid for.

Mail Coupon Today Remember there are only 1,000 sets on this offer. There is not the slightest question that when the public becomes informed of this opportunity thousands will grasp our offer. We will file the coupons in order of receipt and guarantee to immediately fill orders for the PRELIMINARY THOUSAND SETS strictly in order of application without favor to any one as long as they last.

Clip off this Direct-Sale Introductory Coupon and mail it right now so that you can at once avail yourself of the privilege of examining this great Law Library in your home or office at this advertising price. Not sold by dealers, only to be had from

LaSALLE EXTENSION UNIVERSITY Dept. 300 CHICAGO, ILL.

NAME.....
 Occupation.....
 Address.....

Be a Draftsman

Draw \$125 to \$175 a Month



Big demand now for skilled Draftsmen at \$125 to \$175 per month to start. Thousands of men making \$3,000 to \$5,000 a year. The work is light, pleasant and profitable. Unlimited opportunities for expert draftsmen and designers. Mail coupon for valuable book, "Successful Draftsmanship." It explains how you can become a skilled draftsman in your own home, during your spare time. The book is free now—write at once.

Personal Instruction by Chief Draftsman

I am Chief Draftsman of a large and well known firm. Long ago I saw the urgent demand for practical trained draftsmen. Each month the demand for practical trained draftsmen is growing—higher salaries are being paid right along. I give my students just the kind of training they need. **Special offer for those who write at once.**

FREE \$15.00 Drawing Outfit IF YOU WRITE AT ONCE



On account of the urgent demand for more and better men in the drafting field, I will give **absolutely free** this \$15.00 drawing outfit if you enroll at once. It is a practical outfit. The same kind of an outfit that I use myself. I have been doing practical drafting work for twenty years and I know the

kind of instruments you should have. They are not toys, but are **genuine working instruments** selected from the line of one of the largest manufacturers in the country. This is the outfit that I give you **absolutely free** if you enroll now.

I Guarantee
To instruct you until you are competent and placed in a position paying \$125 to \$175 a month.

Earn While Learning

Yes, my friend you can make big money at once right at home—as much as **\$5 to \$10 per day**. I will pay you while learning.

Mail FREE Coupon for My New Book

FREE Book Coupon
Chief Draftsman,
Engineer's Equipment Co.
Division 1192

Without any obligations on me whatsoever, please mail me your book; "Successful Draftsmanship" and full particulars of your liberal "Personal Instruction" offer to students. It is understood that I am obligated in no way whatever.

Absolutely no obligations of any kind. The book is absolutely free and prepaid. It tells you dozens of things you should know about drafting work and it tells you just exactly the kind of personal instruction that I give you. I will also send you a list of the positions that I know are open.

Do not delay. Your name and address on the coupon is the first step towards success. Mail the coupon at once—now—while I am making this great special offer.

Chief Draftsman,
Engineer's Equipment Co.
Division 1192
CHICAGO, ILL.

Name

Address

First of All, He Should Have a Carborundum Sharpening Stone



THE technical school student—or any mechanically inclined youth—cannot learn too soon to properly care for his tools—he should begin right by having a Carborundum Sharpening Stone on his work bench—the stone that always cuts free, fast, and clean—that leaves a smooth, keen edge—an edge that will last.—Carborundum is hard, sharp, diamond-like—it is the most wonderful of all sharpening agents—every Carborundum Stone cuts—it doesn't merely rub the edge on the tool.—Every Carborundum Stone is durable, uniform, and it won't fill or glaze.

Carpenters, cabinet makers, mechanics all find the Carborundum Combination Stone a great stone for general use.

- Carborundum Oblong Combination Stone,
No. 109, \$1.00
- Carborundum Round Combination Stone,
No. 107, 1.00
- Carborundum Pocket Stone in neat case, .35

*At your hardware dealers
or order direct*

The Carborundum Company
Niagara Falls, N. Y.



Be a Doctor of Chiropractic

The New Drugless Healing Science OF SPINAL ADJUSTMENT

A Dignified, Profitable Profession Easily Learned at Home. Steady Demand for Practitioners Everywhere—Our Students Surprisingly Successful.

Make \$3000 to \$5000 a Year

Your income as a Chiropractor can be this much or more year after year. At the same time you will be serving suffering humanity. Dr. Walter made \$500 the third month after starting; R. M. Johnson has added over \$3,000 a year to his income; Vern Sharpsteen makes \$40.00 a day. In addition, this fascinating profession is building up for these former students of ours a splendid social and professional reputation.

We taught these men in their spare time by correspondence, and in class, to be Doctors of Chiropractic—the

NEW DRUGLESS HEALING SCIENCE of Spinal Adjustment

—and thereby made them independent for life. We will guarantee to teach you with equal success. A common school education is all you need to begin—our simplified training does the rest.

Sample lesson sheets and illustrated book giving full instructions how to get into this well-paid, uncrowded profession at once—mailed

FREE

National School of Chiropractic, Dept. 130, 1553 W. Madison St., Chicago



Salesmen Wanted

DO YOU WANT A GOOD POSITION WHERE YOU CAN EARN FROM \$1,000.00 TO \$5,000.00 A YEAR AND EXPENSES?

There are hundreds of such positions now open. No former experience as a salesman required to get one of them. If you want to enter the world's best paying profession our Free Employment Bureau will assist you to secure a position where you can earn good wages while you are learning Practical Salesmanship. Write today for full particulars; list of good openings and testimonial letters from hundreds of our students for whom we have recently secured good positions paying from \$100.00 to \$500.00 a month and expenses. Address nearest office, Dept. 122

National Salesmen's Training Association

Chicago New York Kansas City San Francisco New Orleans Toronto

DRAWING

Caricature, Cartoon, Comic, Commercial, Fashions, Lettering, Newspaper, Magazine and General Illustrating taught by mail. Booklet 6c. Boston School of Drawing, Albion Bldg., Boston, Mass.



WORK FOR UNCLE SAM

Government positions offer pleasant employment with good pay. Custom House, Internal Revenue, Bookkeeper, Railway Mail and Post Office Examinations everywhere soon. Any American citizen, 18 or over, eligible. Common education sufficient. Our free booklet shows how you can prepare under personal supervision of former Secretary of Civil Service Examiners. Write for Booklet to-day. PATTERSON CIVIL SERVICE SCHOOL, 100 Irving Place Rochester, N. Y.

YOU CAN EASILY MAKE \$30 TO \$50 PER WEEK

as a Chauffeur, Mechanic or All Around Automobile Man

SEND TODAY for our free, illustrated Book with information regarding our method of up-to-date simplified instruction. Free Model to All Students. We assist you to secure position.

N. Y. SIMPLEX AUTO SCHOOL, Singer Bldg., N. Y.



"Perfectly simple. You can do it. If I can."



J. L. Laird, B. D., B. S.
President and Mgr.



Dr. A. A. Brigham



Dr. J. A. Widtson



Prof. E. T. Robbins



Prof. L. R. Tall



Prof. N. F. Mayo



Prof. E. R. Root



Prof. J. V. Bopp



Prof. A. M. Ten Eyck



Prof. E. W. Hamilton

These Men Teach



FARMING By Mail

They and 14 other agricultural experts of national reputation, who know Scientific Farming and how to teach it, compose the Faculty of the original and largest school in the world devoted exclusively to teaching farming by mail. Our students include farmers and prospective farmers in every state in the Union and 23 foreign countries. Only spare time required. Keep on salary while you learn farming. We teach you the practical methods of modern farming in any branch. If at all interested in farming, or you expect to be later, send today for our

VALUABLE FREE BOOK "How to Make the Farm Pay More"

It points a safe way out for city folks weary of the struggle and grind for mere existence. It shows the farmer how to increase his crops. Everybody is sending for it.

Have an agricultural college at home. Make money out of your spare time. Don't go on in the same old way. Learn Scientific Farming—the new profession—one that is not crowded, is mighty profitable and becoming more so. Isn't it time you were getting ahead and laying away something for a rainy day and old age?

Our courses and Consultation Department will help you to *Better Methods, Bigger Crops, Less Toil, Shorter Hours, Larger Profits, Time for Recreation, Time for Improvement, Better and Happier Homes*. We can make you a successful farmer. Consult our free Employment Department, if you want capable help or a good job on a farm.

It costs nothing to investigate. Just mail the coupon today. It may be the first step leading to greater financial success for you. Don't hesitate to write us fully of your present farming interests or your future hopes and plans. We shall be glad to advise you. (No land to sell. No agents.)

American Farmers School

286 Laird Building Minneapolis, Minn.

FREE BOOK COUPON

AMERICAN FARMERS SCHOOL, Minneapolis, Minn.

Check which course interests you, and receive free our valuable book "How To Make the Farm Pay More"

- General Farming
- Truck Farming (South)
- Truck Farming (North)
- Fruit Growing
- Soils and Fertilizers
- Poultry Culture
- Small Farm Course
- Farm Crops
- Live Stock
- Farm Engineering
- Farm Management
- Grain Farming
- Dry Farming
- Irrigation Farming
- Dairying
- Farm Veterinary
- Farm Book-keeping
- Bee Keeping
- Greenhouse Management
- Flowers for Profit
- Feeds and Feeding
- Stock Judging
- Short Course—Swine, etc.
- Traction Engine
- Agricultural Journalism
- Mushroom Culture
- Ginseng Culture
- Melon Culture
- Rural Minister's Course in Agriculture

Do You Want a Free Sample Lesson?

Name _____

Town _____ State _____

Street or R. F. D. _____



We have successful graduates in nearly every State in the Union.

THE OLDEST AND BEST

Automobile School

Incorporated for \$10,000.00. The largest, best equipped and MOST RELIABLE automobile school in the country. Unlimited practical instruction on everything pertaining to automobiles. We guarantee to make a chauffeur, repairman, tester, salesman and demonstrator out of you in a short time or we will Refund Your Money. We have arranged with several of Detroit's largest factories to employ our graduates.

COME TO DETROIT, the "Automobile Center," and Learn the Business 67 out of every 100 autos in the country are made in Detroit's 35 auto factories

ADDRESS DEPARTMENT P

MICHIGAN STATE AUTOMOBILE SCHOOL
11-13-15-17 Selden Ave., Near Woodward, DETROIT

Parcels

Post

Positions

Open



You Get a Government Job Thousands of Appointments Coming

No "layoffs" without pay, because of strikes, financial flurries or the whims of some petty boss. If you want immediate appointment, send TODAY for our schedule showing locations and dates of the coming examinations. Any delay means the loss of just so much time in preparing yourself for examination.

We Prepare Candidates Free

Send

Coupon Below

Franklin Institute

(The pathway to plenty)

Dept. L 106, Rochester, N. Y.

The coupon, filled out as directed, entitles the sender to free sample questions; a free copy of our book, "Government Positions and How to Obtain Them," and to consideration for Free Coaching for the examination here checked.

COUPON

- | | |
|--|---|
| ... Bookkeeper (\$900 to \$1800) | ... Stenographer (\$800 to \$1500) |
| ... Postoffice Clerk (\$600 to \$1200) | ... Internal Revenue (\$700 to \$1800) |
| ... Postoffice Carrier (\$600 to \$1200) | ... Clerk in the Depts. at Washington (\$800 to \$1500) |
| ... Rural Mail Carrier (\$500 to \$1100) | ... Canadian Government Positions |
| ... Customs Positions (\$800 to \$1500) | |
| ... Railway Mail Clerk (\$900 to \$1800) | |

NAME.....

ADDRESS..... L 106

Use this before you lose it. Write plainly.

Learn to Write

BEGIN TODAY
WRITE FOR MY FREE BOOK

I can make a good penman of you at home during spare time. Write for my free book, "How to Become a Good Penman." It contains specimens and tells how others mastered penmanship by the Tamblin System. Your name will be elegantly written on a card if you enclose stamp to pay postage.

FREE BOOK

Write for it Today

F. W. Tamblin, 418 Meyer Bldg. Kansas City, Mo.

Complete Scholarship IN ART FREE SPECIAL LIMITED OFFER



We mean just what we say. We are determined to prove to the public generally, the wonderful success of our exclusive methods. If you love the beautiful, we guarantee to teach you Art. You learn right at home, by mail and in your spare time. Great artists your instructors. Same methods employed as are used in the great ateliers of Paris. WRITE at once for beautifully illustrated Prospectus and full explanation of our Free Scholarship Offer. Remember, this offer is limited to a few in each locality who answer at once. So write today.

FINE ARTS INSTITUTE, Studio 9112

OMAHA, NEB.

LEARN THE AUTOMOBILE BUSINESS

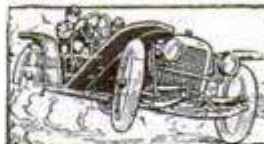

In four weeks; our guaranteed course \$7.50 leads to steady jobs as chauffeur, mechanic, etc. FREE. Simply send name for wonderful new book

"SECRETS OF THE AUTOMOBILE BUSINESS"

Reveals inside workings of auto schools. Also get free "Trouble Chart" which tells immediately how to locate any trouble in the car.

Midland Auto Association 110 Midland Bldg. KANSAS CITY, MO.

TYPEWRITING SPEED PAYS

Study the TULLOSS TOUCH SYSTEM. Gain speed — accuracy — ease of writing. Spare time study. No interference with regular work. Will bring the speed and the salary of the expert. Tulloss writers are fastest and best paid. Send for our

64-Page Book, Free

It fully describes this fast and accurate method. Filled with new ideas and valuable helps. Tells how high speed is gained — how to avoid errors — what practice work is best — 64 pages of vital, helpful facts. Worth dollars to any typewriter user. Sent absolutely free. If you want more speed; more accuracy; more salary — send for this book today — NOW.



"Every Finger Specially Trained"

The Tulloss School of Touch Typewriting
142 College Hill
SPRINGFIELD, O.



BE A BANKER

Learn a profession that will give you standing and independence. Splendid opportunities. Pleasant work, short hours, all holidays off, yearly vacation with pay, good salary. Diploma in six months. Text books by Edgar G. Alcorn. Catalog free.

AMERICAN SCHOOL OF BANKING, 119 McLene Bldg., COLUMBUS, OHIO

CORNET FREE! We guarantee to teach you give you a Beautiful Cornet or any Band Instrument absolutely FREE. You pay weekly as lessons are taken. Instrument is sent with first lesson. Write today for our booklet and wonderful tuition offer.

INTERNATIONAL CORNET SCHOOL
852 Musical Hall, Boston, Mass.

DRAFTING

Good Positions Big Salaries



Complete Outfit FREE to Home Study Students



Draftsmen are in constant demand and receive big salaries. YOU can qualify for a good position. Don't be content to receive a paltry salary when a little ambition and study will quickly multiply your income.

Mechanical, Structural and Architectural Drafting and Design, Contractor's Courses, etc.

Chicago Technical College

Day and Evening Classes. Home Study Courses.

Gives thorough courses, full or partial. Students study blue prints of buildings and machinery actually being constructed. Your work approved by leading Chicago architects and engineers. Correspondence courses in these subjects taught by the same experienced instructors. Low tuition, easy payments. Free employment bureau. Mention course desired and state whether you would attend the college or take home study work.

603 Athenaeum Building, Chicago, Ill.

The New York Electrical School

Offers a theoretical and practical course in applied electricity without limit as to time.

Instruction individual, day and night school, equipment complete and up-to-date. Students learn by doing, and by practical application are fitted to enter all fields of electrical industry fully qualified. School open all year. Write for free prospectus.

44 West Seventeenth Street NEW YORK

LEARN WATCHMAKING

Engraving and Jewelry repairing. Earn while learning. Our school endorsed by leading jewelers. Positions secured for graduates. Send for Free catalogue.

CHICAGO SCHOOL OF WATCHMAKING
Dept. 20, 59 E. Van Buren St. CHICAGO

LEARN TO WRITE ADVERTISEMENTS

EARN \$25 to \$100 A WEEK. We can positively show you by mail How to increase your salary. BOOK MAILED FREE. PAGE-DAVIS CO., 112 Page Building, Chicago, Ill., or 150 Nassau St., New York

BE A DETECTIVE

Earn from \$150.00 to \$300.00 per month; travel over the world. Write C. T. LUDWIG, 1600 Scarritt Bldg., Kansas City, Mo.



STAMMER

My book "How to Stop Stammering"—a treatise on "Scientific Talking"—direct to the point.

Write M. L. HATFIELD, 1918 Grove St., OAKLAND, CALIF.

SPECIAL LAW SCHOLARSHIP OFFER NOW OPEN!

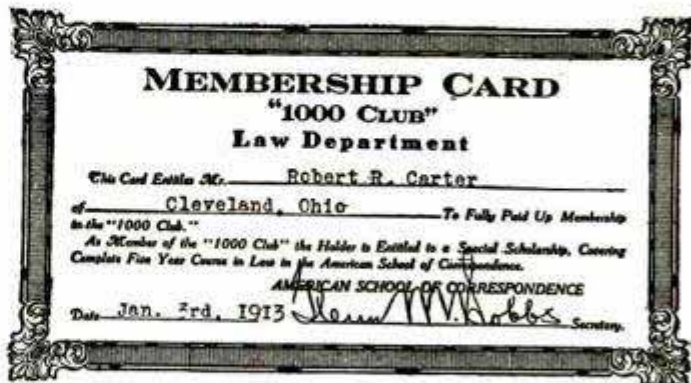

Join The "1000 Club"! Get Your Instruction in our Great Law School F-R-E-E!!

First 1000 students to enroll in 1913 receive SPECIAL SCHOLARSHIPS! Write at once for free membership in the "1000 Club"! Send no money. As a member of "1000 Club" you receive scholarship covering complete five-year course in law—also your choice of special course. This great offer is limited—mail the coupon immediately for full particulars.

The University Brought Right to Your Home.

No need to give up your present position. Learn the law right at home on this great offer just as easily and thoroughly as though you attended a resident law school.

Our graduates as successful in passing bar examinations as the graduates of the best resident schools.

Our course indorsed by renowned educators and lawyers. American School of Correspondence chartered by law as an educational institution—the same as your State University. Instruction papers prepared by famous law authors. Course prepares for Bar in ANY STATE.

We Furnish Fifty-Six Textbooks with Every Special Scholarship!

Not twelve or fifteen—but fifty-six. Written in clear, concise manner—neatly bound—handy size. You receive any "individual" or "personal" instruction necessary.

Business Law. Our complete course in General Law is most valuable to business men. On this great offer you can also specialize in subjects such as Commercial and Business Law, Banking and Trust Law, Real Estate Law, etc. Even though you do not expect to become a practicing lawyer—get full details of this great offer. Only cost to members of "1000 Club" is for textbooks and postage.

Mail this Special Coupon Immediately

Write for school catalogue and full particulars of this Special Scholarship offer. You assume no obligations whatever in sending the coupon. Remember the Club is limited to 1000 members. You must hurry if you want to be one of those to receive this scholarship! Sign and mail the coupon immediately.

Special Scholarship Coupon
AMERICAN SCHOOL OF CORRESPONDENCE Chicago Illinois
American School of Correspondence CHICAGO, ILLINOIS
Without any obligations on me whatever, please send me your school catalogue and complete information of your "1000 Club" offer. Pop. Mech. 2-13

NAME
ADDRESS

Please Mention Popular Mechanics

EARN TELEGRAPHY

(Wire and Wireless) and Station Agency Work

These three branches of study taught in a more thorough, complete and comprehensive manner than by any other school in America. We have graduated *more* successful students—secured them better positions at more pay than any other institution. Established 38 years.

Easy, Interesting Work—Good Wages—Excellent Future

Greatest demand for Agents and Operators in 25 years; big demand for Wireless Operators also. Railroad, Wireless and Telegraph Officials endorse us and employ our graduates. We own and occupy exclusively two of the largest and most modern buildings devoted to telegraph instruction. Equipped with Western Union and R. R. Train Dispatcher's Wires and Complete Wireless Station, all representing an investment of more than \$25,000.00. Expert Teachers, *Low Tuition*—which will be refunded if position is not secured when qualified. *Living expenses may be earned while learning.* Correspondence courses if desired. Write me today, personally, for FREE Illustrated Catalog and Testimonials.

GEO. M. DODGE, President

Dodge's Telegraph, Railway & Wireless Institute, 8th Street, VALPARAISO, IND.

Send Today for FREE Catalog Now!

FREE INSTRUCTION

IN THE OPERATION OF THE

Curtiss Flying Boat

will be given to those taking a regular course of training at the

Curtiss School of Aviation, San Diego, Cal.



First Hydroaeroplane Races at Hammondsport, N. Y.

David McCulloh in his "Flying Boat" leads; he is accompanied by Mr. Curtiss; Lincoln Beachey is second, accompanied by Lansing Callan, while Francis Wildman, instructor at Hammondsport School, is third with the standard hydroaeroplane.

AMONG the men who have learned aviation at Curtiss Schools are: Lieut. T. G. Elyson, now in charge of the aeroplanes of the U. S. Navy; Lieut. J. H. Towers, who just established a new world's Hydroaeroplane record of 6 hrs. 10 min. 38 sec.; H. Robinson, who recently introduced the Hydroaeroplane in Europe and is now instructor in a Curtiss School; C. C. Wiltner, now in St. Petersburg demonstrating Hydroaeroplanes to the Russian Navy and Army; Lieut. J. W. McCluskey, instructor in a Curtiss School; Lincoln Beachey, "The World's Greatest Aviator"; S. C. Lewis, now instructor in the Morane School in France; J. Lansing Callan, now an instructor in a Curtiss School; Francis Wildman, now instructor in a Curtiss School; Beckwith Havens, now a demonstrator; W. B. Atwater, now demonstrating to the Japanese Government, besides, a score of men who own their own machines and fly in contests and exhibitions and a dozen others have taken positions with either manufacturers or exhibition concerns.

OUR San Diego, Cal., Aviation Training Grounds, situated on North Island, in San Diego Harbor, are the finest in America, if not in the world. North Island is leased by us exclusively for Aviation purposes, and comprises one thousand acres of flat, level sand, unobstructed by rock, tree, or building, thus offering every advantage as a flying course. The island is entirely private, yet within a few minutes of San Diego, one of the most progressive and attractive cities on the Pacific Coast.

Classes will form the 14th and 28th of February

\$100.00 deposit will reserve a place for you in either of these classes. Mail or wire it to-day. Our Booklet "TRAINING" mailed upon request.

The Curtiss Aeroplane Co., Hammondsport, N. Y.

COPY THIS SKETCH

and let me see what you can do with it. You can earn \$20.00 to \$125.00 or more per week, as illustrator or cartoonist. My practical system of personal individual lessons by mail will develop your talent. Fifteen years successful work for newspapers and magazines qualifies me to teach you. Send me your sketch of Governor Wilson with 6c in stamps and I will send you a test lesson plate, also collection of drawings showing possibilities for you.

The Landon School of Illustrating and Cartooning
1438 Schofield Building, CLEVELAND, O.



WHY NOT BE AN ARTIST?



STUDY drawing at home under Expert Faculty. We have successful students in every part of the world. Turn your Talent into money. Our Students are filling high salaried positions. 14 years successful teaching. Endorsed by high authorities. 18 Courses in Commercial and Illustrative Drawing. Teachers' Normal and Applied Art, Profit or Culture.

Thoroughly Equipped Residence School

Artist's Outfit FREE to Enrolled Students

SCHOOL OF APPLIED ART, 755 Applied Art Bldg., Battle Creek, Mich.

Free Automobile

to Students who qualify. Ride around taking orders in "COEY FLYER" 6 cylinder—5 passenger car. We teach you to make big money in automobile business. Easy lessons—free model—no experience necessary.

First Lesson FREE to everyone answering this ad.

C. A. COEY'S SCHOOL OF MOTORING

1424-26 Michigan Avenue
Department 210 CHICAGO, ILL.

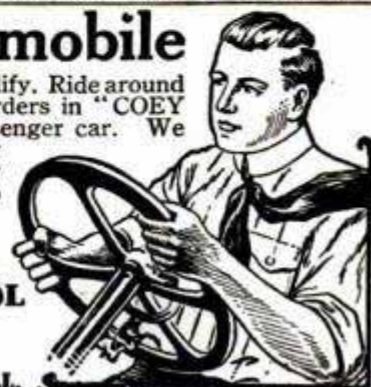

THE WORLD'S BEST SYSTEM

of shorthand taught by Expert Shorthand Reporters. The best course for beginners. A thorough post-graduate course for stenographers. Hundreds of graduates in expert reporting; thousands in civil service and high salaried positions. Individual instruction by mail.

SUCCESS SHORTHAND

BEST FOR

YOU

Write today for our free catalog

World's records for speed and accuracy. Experience given in expert work. Satisfaction guaranteed or money back.

SUCCESS SHORTHAND SCHOOL
W. L. James, Chief Instructor

DEPT. 103 SCHILLER BUILDING, CHICAGO

WE CAN MAKE YOU EARN \$125 TO \$150 A MONTH

Light, pleasant work. Study in your spare time. Be a Draftsman. Demand greater than the supply. Positions always open. Catalog sent Free, telling you how.

COLUMBIA COR. SCHOOL, Dept. P, Drexel Bldg., PHILADELPHIA

ADVICE

Information and counsel on any subject under the sun. No matter what you want to know, no matter what your present condition, our big organization can help you.

WRITE TODAY FOR BEAUTIFULLY ILLUSTRATED BOOK FREE
NATIONAL BUREAU OF ADVICE AND EDUCATION, 527 Ashland Block, CHICAGO

STAMMER NO MORE

I can cure you. Reputation world-wide. Established 16 years. Trial lesson explaining Home Instruction, with 200-page book, FREE. Answer at once.

George Andrew Lewis, 178 Adelaide Street, Detroit, Mich.

ARITHMETIC SELF-TAUGHT

A plain, easily-understood volume for all who have not had the opportunity of learning this subject thoroughly, or who have forgotten what they once learned. 257 Pages. Requires no teacher. This great little book sent postpaid for 60 CENTS. Stamps accepted, leather binding \$1.

GEO. A. ZELLER BOOK CO.
Est. 1870. 4473 W. Belle Place ST. LOUIS, MO.

SPANGENBERG'S
PRACTICAL
ARITHMETIC
Self-Taught

Learn Electricity

Earn \$5.00 to \$8.00 Per Day



Make Your Services More Valuable

and get a better job as Electrician, Plumber, Mechanical Draftsman, Moving Picture Operator or Bricklayer. The demand for good men in these trades is greater than the supply. We assist our graduates to good jobs or we will start you in business for yourself.

Our school is the oldest, largest and best equipped trade school in the world. We occupy the entire large building illustrated above. Our instructors are all practical men—expert in their trades. We teach you quickly, practically and thoroughly by actual work. Tools instead of books.

Don't be satisfied with small pay.

The money you now earn won't satisfy you forever. You must increase your earnings. It costs more to live now than it used to. Get out of the small pay class. You can do it and we can help you. *Send us the coupon below.*

\$5.00 to \$8.00 per day

You can earn this and more if you are skilled in the way we teach trades. Our students always successful. You are not fulfilling your whole duty to yourself if you do not send the coupon attached to this announcement at once.

FREE TOOLS AND MATERIAL

You have nothing extra to pay in this school. All your tools and materials are furnished free—absolutely without cost to you. Do not delay about sending the free coupon.

Here Are the Trades We Teach

Electricity offers the greatest field in the world today. Thousands more skilled electrical men are needed. Wages are high and work steady, while the future offers the richest prizes in research work and new adaptation of electric power.

Plumbing offers easy work, short hours, big pay and steady work. It's

almost impossible now to learn the trade as an apprentice. Even then it will take years and perhaps you will never thoroughly master it. Plumbers are always in demand.

Moving Picture Operating is practically a new business and good operators are so scarce that unusually high wages are enjoyed. You can soon go into business for yourself.

FREE COUPON to Popular Mechanics Readers SEND IT QUICK!

We are making a special proposition to the readers of Popular Mechanics—a special limited offer, so cut out the free coupon which we are printing here and mail it to us today. School open all the year. You can enter any time. We have students 16 years of age to 60. Day and night sessions. Free Employment Department. Tuition and expenses very low. **Easy payments if desired.** Drawing and estimating a part of each course. Delightful opportunity for general and social culture. Ten minutes' walk to the heart of Chicago's business center. Send coupon now. Get our special offer today.

Address, L. L. COOKE, Director

Coyne National Trade Schools

Dept. 1192, 39 to 51 East Illinois Street, Chicago, Illinois

"The Oldest Practical Trade School in America"

Mechanical Drawing There is always a big demand for good mechanical draftsmen. Engineering firms, contractors, railroads, etc., are always on the lookout for good mechanical drawing experts.

Bricklaying A highly paid, fine, healthy, out-

door occupation. Builders are always on the watch for competent Bricklayers. You can develop into contracting work where there is no limit to your profits.

FREE COUPON
L. L. COOKE
Director

Coyne National
Trade Schools,
Dept. 1192
39 to 51 E. Illinois St.
Chicago, Ill.

Gentlemen: Without any obligations on me, please send me your school catalogue and full particulars of this special offer to men—all FREE.

Name

Address

CUT OFF AND MAIL TODAY



I'll Double Your Earning Ability in Six Weeks

Learn the Automobile Business A trade where you are in demand 12 months in the year. Work pleasant—big demand for trained men. 90% of the automobiles in daily use are not in proper adjustment on account of shortage of experienced automobile mechanics.

Everybody in the Automobile Business Today is Making Big Money

I want you to come to my school; I want you to see for yourself, how thoroughly and practically I teach all about the automobile. Six weeks after the day you enroll in my great practical Automobile School you will be prepared to properly repair any automobile made and drive any car or truck or open a garage and repair shop of your own. You can learn the automobile business thoroughly in my school because I have been years in working out for quick, thorough instruction, the

"Sweeney System" of Practical Automobile Instruction

It is today the most thorough, practical, comprehensive and interesting course of automobile instruction, and embraces every point worth knowing, including vulcanizing, brazing, oxy-acetylene welding, lathe work, machine shop practice, testing and road work, etc. **The First and Only Automobile School to Include a Course on Gas Tractor Engineering and to own for demonstrating purposes a \$2000 Traction Engine.** You learn by doing the actual work on real cars with your own hands under the watchful eyes and ready suggestions of experienced instructors.

Send Today for free catalog and we will place your name on our mailing list for our monthly school magazine which we will also send you absolutely free. I want every man thinking of learning to become an Auto Expert to have my new, big Illustrated Catalog. Write for this great book. Send today—this very minute—NOW.

EMORY J. SWEENEY, Pres.

Sweeney Automobile School The School of Practical Experience
1467 Woodland Ave., KANSAS CITY, MO.

Experienced chauffeurs, repair men, truck drivers and demonstrators furnished

No Books Used Tools Furnished FREE

The tuition is low and, after you have paid that, you do not have another cent of expense in the school. You do not learn from books, but by practical work on real automobiles in everyday use.

A Rising Profession

YOU MEN on Salaries



You want to earn more; you want to be promoted; yet you seem to be anchored in your present position. Do you know why? I am going to tell you. It's because you do not know enough to command advancement.

Plain talk, isn't it? But it's true. The way to a larger salary is through your brain; you must learn something that your employer wants, that he needs, that he **must have**.

Every employer who is engaged in manufacturing, buying, or selling merchandise—and this includes most of them—is shipping and receiving freight. This is his big item of expense and he knows very little about it. He wants a traffic manager, he needs a traffic manager, he **must have** a traffic manager. A traffic expert can save him thousands of dollars every year. No wonder a traffic manager is paid a big salary; he **earns** it.

We train you to take a position like this by correspondence. You have your choice of **forty-three** different lines of business. I can't tell you all about it here; I want you to write today for our booklet. Don't put it off; it only means that you must wait another day for promotion. Fill out the coupon now. Address

VICE-PRESIDENT

NATIONAL TRAFFIC COLLEGE
12 South La Salle St. CHICAGO

Vice-President NATIONAL TRAFFIC COLLEGE
12 S. La Salle St., Chicago

Send me your booklet. I want to earn a larger salary.

NAME

OCCUPATION

STREET AND NO.

TOWN AND STATE

Please Mention Popular Mechanics

THE UNIVERSITY OF CHICAGO

HOME STUDY

20th Year U. of C. (Div. 20) Chicago, Ill.

Correspondence-Study Dept.

offers 350 class-room courses to non-resident students. One may thus do part work for a Bachelor's degree. Elementary courses in many subjects, others for Teachers, Writers, Accountants, Bankers, Business Men, Ministers, Social Workers, Etc. Begin any time.

MAKE UP TO \$75 A WEEK

as a Watchmaker and Start Your Own Jewelry Business

Write me today! Let me explain our plan whereby you can become an expert watch repairer in three months—making \$25 to \$75 a week—and own your own jewelry business. I can teach you—I mean YOU—the whole watch repairing business by mail. Write right now!

ROGERS, THURMAN & CO., 1660 Mallery Bldg., CHICAGO

LAW Study at Home Scholarship FREE

Yes, free on this great offer. You pay for is text books and postage. Graduate correspondence students most successful at bar exams. Course covers same grounds as Harvard, Michigan and other law colleges. Guarantee to coach, free, students failing to pass bar examinations; you only pay for text and postage. Act quick. Write today. National Correspondence School of Law, Dept. 290, Chicago, Ill.

MUSIC TAUGHT FREE AT YOUR HOME

Write Today for our booklet. It tells how to learn to play Piano, Organ, Violin, Mandolin, etc. Beginners or advanced pupils. AMERICAN SCHOOL OF MUSIC, 50 Lakeside Bldg., Chicago, Ill.

LEARN WATCHMAKING EARN BIG SALARIES

College famous for teaching highest art of watch work, jewelry, engraving, optics. 18 years' success. Graduates command big salaries. Moderate rates. Boarding homes nearby. Special book ready. Write PHILA. COLLEGE OF HOROLOGY, 1338-48 Somerset St., PHILA., PA.

Be an Electrical Engineer!

Earn \$150.00 to \$250.00 a Month

WRITE TODAY! NO EXPERIENCE NECESSARY to enter this wonderfully fascinating, high salaried work. You should earn **BIG MONEY IMMEDIATELY**—on completing our Electrical Courses.

The great engineering companies of the country are **ALWAYS** searching for **PRACTICAL, TRAINED ELECTRICAL ENGINEERS**. Excellent positions open all the time. We teach you to be an expert electrical engineer in a short time **AT SMALL EXPENSE**.



Thomas A. Edison says:

There is no limit to the field of Electricity—you men who take up this work now will discover uses for this great force now unheard of.

Besides the high salaries paid to electrical engineers—the big money you can make by starting an electrical business of your own—great fortunes are to be made through electrical inventions in the future.

Earn While You Learn

No need to give up your present occupation. Just devote your spare time during the day or evening to this interesting work. It is no task to learn Electricity. As you read through the

pages of our courses, you will find yourself simply "wrapped up" in the work. And you can draw your present salary while you learn—by means of this home study course.

The only expense will be the nominal charge for our complete tuition.

Pay as You Wish! Don't hold back because of the money. We will arrange for you to pay as best suits your needs.

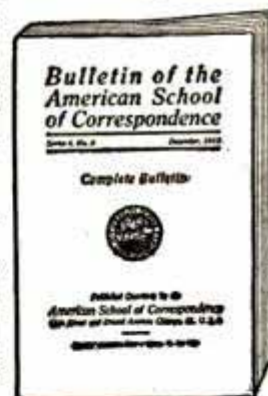

GUARANTEE:

The world-wide reputation of the American School of Correspondence for integrity and efficiency, together with its thousands of successful graduates, gives you an unqualified guarantee of Success.

This Book contains Valuable Information—it's Free

Our School Bulletin gives complete information concerning our courses and explains how **YOU** can become an expert Electrical Engineer.

Mail this Free "Success" Coupon

—No obligations, so mail at once. Your name and address on this coupon brings to you our School bulletin (catalogue) and complete information. Decide now to take this great step toward Success. Don't be a drudge all your life. Be one of the men "higher up"—the man who is paid for what he **KNOWS**, not for the hard work he actually does. No obligations in sending the coupon—so mail today—immediately.

**Free
Success
Coupon**

American School of
Correspondence, 5791
Drexel Ave., Chicago, U. S. A.

Without any obligations on me whatsoever, please send to me your School's complete bulletin and full information telling me how I can become an expert electrical engineer.

American School of Correspondence

5791 Drexel Ave.

CHICAGO, U. S. A.

NAME.....

ADDRESS.....

BULL-DOG COILS

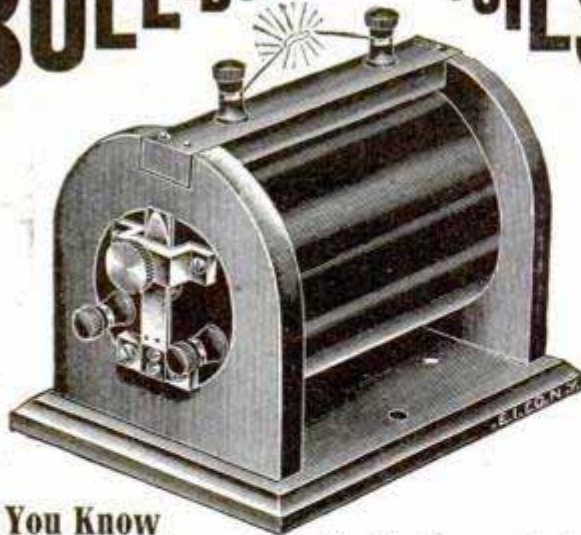

Did You Know

that the Spark Coil is the most wonderful of electric apparatus known? Did you know that have been possible with our spark coils and a can conduct more excitingly interesting experiments than with any other electric apparatus? Here are a FEW as described in our free cyclopedia:—The Fire Ball. The green, yellow and blue spark. The Ladder-shape spark. Lighting a candle with the spark. Preparing cigarette paper or a cigar which no one can smoke, nor can explain why. (A great hit.) Lighting an old BURNT OUT electric bulb. The scattered oil drop. The surprised dog. Lengthening Spark four times its length. The Ghost near the Ceiling, and thousands of other wonderful experiments, which require but a few dry cells and ANY of our BULL-DOG coils, even the smallest. **The best all around size is our 1" type.**

3/4 inch spark length.....	\$2.20	1 1/4 inch spark length.....	\$6.50
1 inch spark length.....	\$3.10	2 inch spark length.....	\$9.00
1 1/2 inch spark length.....	\$4.50	3 inch spark length.....	\$18.00

All coils guaranteed or money back.

Send today 4c stamp for our famous 200 page Electrical Cyclopedia No. 11 with 400 illustrations and 1600 electrical articles, instructive information, and experiments on electrical and wireless subjects.

No postals answered. Ask for our free 160 page wireless course in 20 lessons.

The Electro Importing Co., 233A FULTON ST., NEW YORK
"Everything for the Experimenter"



This book is brimful of information on **ELECTRICITY** Motors, Dynamos, Wireless, Induction Coils, Rheostats, Miniature Electric Railways and parts, etc.

It's a valuable, up-to-date catalog of one of the largest and most reliable electrical manufacturers in the country. **Send for it**—6c in stamps or coin, which will be refunded on your first order of 50c or over. No postals answered. Voltamp Electric Mfg. Co., Voltamp Block, Baltimore, Md.

3 **Genuine French Briar Anti-Nicotine Pipes** **\$1**

Electrically sealed and need no breaking in. Vegetable Compound nicotine Cartridge. Patent mouthpiece; vent on top. Heavy nickel mounting. Guaranteed not to burn out in 5 years.

50 CENTS EACH OR THREE FOR \$1

Choice of bent or straight stem—state which in ordering. Satisfaction guaranteed or money refunded. 10 cartridges free with 3 pipes.

H. MENGES, 315 Menges Building, ST. LOUIS

The Machinist is among those most apt to become DEAF



When the eyes are strained they become weak and the sight is impaired. The same principle naturally applies to the delicate tissues of the drums of the ear. When constantly exposed to loud and rasping noises and extreme vibrations they are overtaxed—become weakened and deafness follows. Why shouldn't you then protect from rough usage the hearing so necessary to you—just the same as you do your clothes from the oil and wear of the shop? My little "wireless phones for the ear" will afford the protection you require—if you are already deaf they will assist you to hear. Among the thousands of people they have enabled to hear perfectly there has been every condition of deafness or defective hearing. No matter what the cause or how long standing the case the testimonials sent me show marvelous results.

Common-Sense Ear Drums

wonderfully helped my own case—that's how I happened to discover the secret of their success in my own desperate endeavors to be relieved of my deafness after physicians had repeatedly failed.

Common-Sense Ear Drums are made of a soft, sensitized material, comfortable and safe to wear. They are out of sight when worn, and easily adjusted by the wearer.

It is certainly worth your while to investigate. Before you send any money just drop me a line. I want to send you free of charge my book on deafness and plenty of evidence to prove to you that I am entirely worthy of your confidence. Why not write me today?

GEORGE H. WILSON, President WILSON EAR DRUM CO. (Inc.)
778 Inter-Southern Bldg., LOUISVILLE, KY.

THE SEA OTTER'S PECULIARITIES—The sea otter combines the habits of a seal with the intelligence and amusing character of the otter. When met in herds far out at sea, which is but seldom now, they are commonly seen swimming on their backs. They even eat their food lying in this position on the water and nurse their young ones on their chests between their paws, exactly as a South Sea island mother swims with her baby in the water. When swimming in this attitude they even shade their eyes with their paws when the sun dazzles them.—Fishing Gazette.

NOTE THE SIMPLICITY



Of making perfect duplicates with the **Daus' IMPROVED Tip Top Duplicator**. No intricate mechanism. No printer's ink. Always ready. 100 copies from pen-written and 50 copies from type-written original. Useful in any business. Sent on Ten Days' Trial Without Deposit. Complete duplicator, cap size (prints 8 3/4 x 13 inches). Contains roll of "Dausco" Oiled Parchment Back duplicating surface which **\$5.00** can be used over and over again. Circular of larger sizes free on request.

FELIX A. L. DAUS DUPLICATOR CO., Daus Building, 111 John St., New York

Send for Copy of Our New Wireless Manual P1

It contains 96 pages and tells how to erect and maintain wireless telegraph stations. Shows a number of diagrams. Has the Morse and Continental Telegraph Codes. Illustrates the best instruments to use; tells what they are for and how to use them. Do not wait until some other time, but sit down now and send your name and address, and get one. It costs you nothing.



Send for Our Pocket Catalog P26

It contains 212 pages, with over 1,000 illustrations and describes in plain, clear language all about Bells, Push Buttons, Batteries, Telephone and Telegraph Material, Electric Toys, Burglar and Fire Alarm Contrivances, Electric Call Bells, Electric Alarm Clocks, Medical Batteries, Motor Boat Horns, Electrically Heated Apparatus, Battery Connectors, Switches, Battery Gauges, Wireless Telegraph Instruments, Ignition Supplies, etc.

It Means Money Saved to You to have our Manual and our Catalog when you want to buy

MANHATTAN ELECTRICAL SUPPLY CO.

NEW YORK, 17 Park Place

CHICAGO, 114 S. 5th Ave.

ST. LOUIS, 1106 Pine St.

SHORTHAND

Now Taught By Mail—In 18 Easy Lessons!

You positively can learn shorthand right at home complete in 18 lessons. We guarantee it. The new and wonderful shorthand taught by us is now used in more than 2000 resident schools and colleges—including the public schools in Boston, Denver, Spokane, Seattle, Minneapolis, St. Paul, Omaha, Buffalo, Kansas City, Rochester, N. Y., Evansville, Ind., and nearly 600 other cities in the U. S. The remarkable results attained with the shorthand we teach have made it the most popular system in America today. Simple, legible, accurate—pronounced by shorthand experts to be the easiest to learn, to read, and to write. No shading, no positions, no arbitrary outlines to memorize, no tedious study and practice as with other systems. Words never heard before can be written scientifically and read like print. The monthly shorthand magazine supplied our students is read by nearly 50,000 men, women and children. Contains masterpieces of literature and articles on science, business, etc., all written in shorthand. Thousands have been fascinated and benefited by this novel means of mental training and development.

Everybody Can Use SHORTHAND



Private Secretaries Make Big Money

Expert stenographers are in great demand and earn handsome salaries as Private Secretaries to Bankers, Merchants, Railroad Executives, Publishers and others occupying important positions in the business world. The Private Secretary comes into personal contact with **big men** and has unusual opportunity for advancement.



The Ideal Work for Women

Stenography is the most attractive and profitable profession open to young women. Capable women stenographers earn more money than school teachers, trained nurses, dress makers or clerks. Easy hours—unusual opportunities for advancement. The private secretary to one of the Standard Officials earns \$10,000 a year.



Court Reporter—Profession of Big Incomes

Court reporting is one of the best paid professions in America. Many earn \$5,000 to \$15,000 a year. In this field, as in all other kinds of stenographic work, women have equal opportunities with the men. Many brilliant court reporters are women.

CHICAGO UNIVERSITY OF COMMERCE
Box 1032, CHICAGO, U. S. A.

Make up your mind to learn shorthand—today, now. It is more than a wonderful money-making profession—it is a remarkable accomplishment, a business asset, a time-saver and daily aid to ministers, lawyers, students, newspaper reporters, authors, and men and women required to do writing in any form. Woodrow Wilson wrote his entire "History of the American People" in shorthand before it was typewritten. Mrs. William Jennings Bryan learned stenography in order to be of greater personal service to Mr. Bryan. Shorthand is a tremendous advantage in taking minutes of conversations, public speeches, meetings, lectures, telephone messages, memoranda, private data, etc.

The Stepping-Stone to Success

Shorthand has been a big factor in the success of many men and women foremost in business, political, and professional life. Among the conspicuous examples of men who have risen to prominence, power and wealth by aid of shorthand are: **Geo. W. Perkins**, partner of J. Pierpont Morgan and organizer of the Harvester Trust; **Wm. H. Newman**, Pres. N. Y. Central Lines; **Hon. Frank S. Black**, Ex-Governor of N. Y.; **Darius Miller**, 1st Vice Pres. Burlington Railroad; **Geo. B. Cortelyou**, Priv. Secretary to Presidents McKinley and Roosevelt, Member of Roosevelt's Cabinet, and now President of the Consolidated Gas Co., New York; **Edward Bok**, Editor of the Ladies Home Journal.

To the young man or woman seeking profitable employment and rapid advancement we say—**LEARN SHORTHAND!** It is the short cut to success. To any man or woman, ambitious for *self-improvement* and greater *business power*, we say—**LEARN SHORTHAND!**

Learn Right at Home No need to give up your present work. Earn while you learn. Give us your spare time only. Personal instruction by experts. Surprisingly low cost. **Easy Payments.** We offer complete stenographic courses by mail—Shorthand, Typewriting, Office Practice, Dictation, Business English, Secretarial Work, Court and General Reporting. Typewriters furnished. Stenography has advanced thousands from poverty and hard work to fine salaries and easy hours. Positions everywhere. If you earn less than \$25 a week write today for

FREE Shorthand Book telling of the wonderful opportunities offered those having a knowledge of shorthand and typewriting. Mail the coupon at once and we will send this handsome, illustrated booklet free. Get into a fascinating profession that pays big money and leads to the high places. Don't stick to a poorly paid job until too late to change. Any person 15 years of age with a common school education can take up our courses. A 19 year old writer of the system we teach established a world's record for speed and accuracy in public contest with the speediest shorthand experts of the world. Send today for list of official court reporters and particulars of remarkable feats young people have accomplished with the shorthand taught by us.

C.
U. of C.
Box
1032
Chicago, Ill.

GENTLEMEN: Please send me free of all charge, Booklet and particulars regarding your home-study shorthand and stenographic courses.

Mail the free coupon or send postal card now.

NAME

ADDRESS

CITY STATE

Wonderful BOOK FREE!!

Explains Everything You Should
Know About

How To Study

LAW

Any one ambitious to study law and become a successful practicing lawyer at the bar, should not hesitate to send for this GREAT FREE BOOK, which explains exactly what you ought to know before taking up this fascinating and valuable study.

This Book Starts You Right

It shows you how to become a thoroughly competent lawyer—explains the requirements step by step in a plain, simple, direct way that will start you right and save you a lot of time, trouble and expense. There can be no possible failure with this Wonderful Guide to follow. It puts you at once in the path followed by America's Foremost Lawyers—men who have themselves gone through such steps as they now recommend for you. This Free Book shows you

How To Study Law At Home

Under the World's Greatest Masters of Law—how to utilize your spare moments in preparing yourself for a great profession at very small cost—how to prepare for bar examinations in any State—how to increase your mental powers by training that will make you a leader in your community. If you contemplate studying law, you surely want to master the best course in the shortest time at least expense. This Free Book is invaluable to you, no matter what course or school you have in mind, and you might as well send for it—no risk, expense or obligation—and become thoroughly posted.

Save Half Your Tuition

We will not only send you this Wonderful Guide to the Law—absolutely free—but will also point out a way by which you can save half your tuition charges. We are in position to do this for a certain time, so it will be just like keeping a lot of money in your own pocket, if you answer this promptly. Remember, we save you half.

SEND NO MONEY Just your name and address in letter, postal, or on the Free Coupon below, will promptly bring everything Free by return mail. You will find this Guide to the Law an invaluable aid in putting you on the right track. Don't fail to send for it now!

**How to Become
a Lawyer**

(Tear Off and Mail This Free Coupon Now)

LaSalle
Extension
University,
Dept. H, Chicago, Ill.

Please send me—FREE—Valuable Law Guide and tell me how to save half on my tuition.

NAME.....

ADDRESS.....

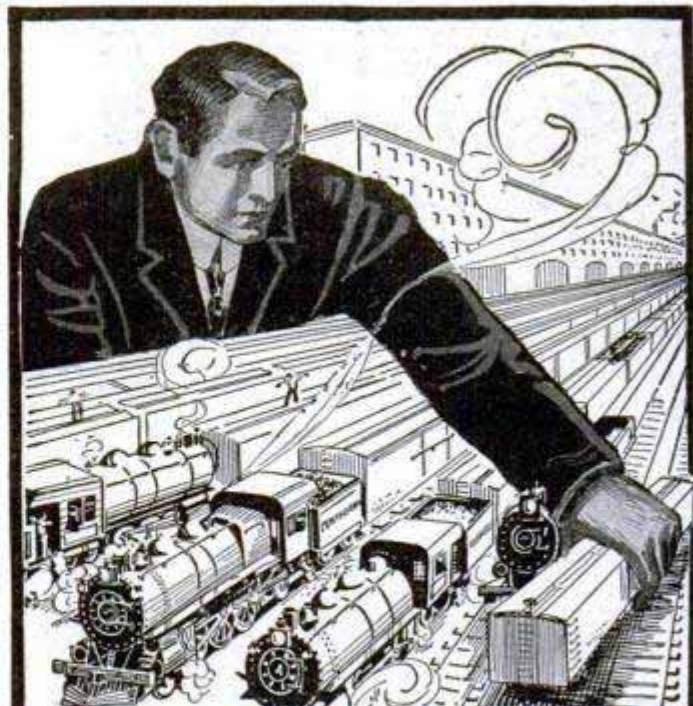

NEW JOBS NOW OPEN

Earn from \$35 to \$100 Weekly as a

TRAFFIC MANAGER

Modern transportation is a jungle of routes and rates calling for specialists who, like the pathfinders of old, have expert knowledge of the trails of traffic. How to route shipments to obtain shortest mileage and quickest deliveries and how to classify goods to obtain lowest rates are two vital factors in business competition. The man who knows how is so valuable to his employer that he commands respect and big remuneration.

Big Salaries Paid to Traffic Managers

Expert traffic managers command from \$2,500 to \$25,000 a year. Why not prepare yourself to fill one of these lucrative positions?

New and Uncrowded Profession

There are half a million LARGE SHIPPERS in the United States. Practically every one of them needs an expert traffic man, and this need is recognized as never before because of the recently enacted railroad rate laws and interstate commerce regulations. The demand for trained and efficient traffic men is many times greater than the supply. There's room for you.

Study Traffic and Interstate Commerce

Decide now to become a traffic man. Our Interstate Commerce Course enables you to study AT HOME, without leaving your occupation or sacrificing present income, and to become thoroughly versed and proficient in the strategy of shipping, including routes and classifications, interstate commerce rules and regulations, etc. The instruction is given by some of the biggest traffic managers in the country. The course is easy to grasp and thoroughly practical. Anyone with ordinary intelligence, with reasonable application, can master this new profession.

FREE PORTFOLIO Clip coupon below, sign and mail at once, and we will send you FREE, postpaid, a handsome portfolio containing complete information concerning the opportunities and requirements of this attractive profession. Get posted at once. Clip coupon.

LA SALLE EXTENSION UNIVERSITY, Dept. 418, CHICAGO

**FREE
PORTFOLIO**

COUPON

La Salle Extension University
Dept. 418, Chicago, Ill.

I am interested in the new profession—
Traffic Management. Please send me full in-
formation and Traffic Book, free of all cost.

Name.....

Occupation.....



Write Address on the Margin Plainly



This Man Marked the Coupon

—and now he is a specialist in his particular line of work. Knowledge is the directing power in every industrial field in the world.

Thousands of I. C. S. students are today specialists in the largest manufacturing, inventive, constructive, and business enterprises. And for 20 years it has been the business of the I. C. S. to prepare men for such positions. But today there are more businesses than ever, more opportunities than ever, and there must be more trained men than ever to fill the many positions.

Great employers indorse the method of I. C. S. training and readily accept I. C. S. students because trained men are scarce, and they know that I. C. S. training is REAL TRAINING.

If you want to know how you can benefit by this great system that is in successful operation all over the world, mark on the coupon the kind of work you desire to follow, and mail the coupon to the International Correspondence Schools. It is well worth your time and postage to get full information about the position in which you are most interested.

Mark and Mail the Coupon TODAY

International Correspondence Schools
Box 872, Scranton, Pa.

Please explain, without further obligation on my part, how I can qualify for a larger salary and advancement to the position, trade, or profession before which I have marked X.

Electrical Engineering
Electric Lighting
Electric Railways
Electrician
Electric Car Running
Dynamo Foreman
Dynamo Tender
Wireman
Mining Engineer
Telephone Expert
Civil Engineer
Automobile Running

Mechanical Engineer
Mechanical Draftsman
R. R. Constructing
Concrete Construction
Architect
Contracting and Build'g
Architectural Draftsman
Plumbing & Heating
Chemist
Bookkeeper
Advertising Man
Civil Service Exams.

Name _____
St. & No. _____
City _____ State _____
Present Occupation _____



Be Boss In the New Profession

Thousands of men are needed. The new profession that is **paying big money** wants you and needs you. Here is your opportunity to get into it **now**. You don't need to leave your present employment. Just a few hours a day in your own home and soon you get your diploma and are a full-fledged Meter Engineer.

Be a Meter Engineer

The profession of Meter Engineering is now in its infancy. It is calling for men. The Central Electric Stations **must** have Meter Engineers, because without them they cannot operate. Thousands of positions now open. Wonderful opportunities. You can get into the profession. It is calling **you**.

A \$3000 Job for YOU

Meter Engineering is one of the best paying professions in the electrical industry. We can show you hundreds of men who are making better than \$3,000 a year. How would you like to have a \$3,000 job six months from now? Just put your name and address on the free coupon and get full particulars absolutely free. Send it now—today.

Special

For a limited time we are making a special reduced price offer in order to induce men to start the study of Meter Engineering right away. Write for full particulars at once.

Send the Coupon and Get 40-Page

Book FREE

Do not delay an instant. Just put your name and address on the coupon and mail it to us at once. We will send you absolutely free and post-paid, 40-page book on Meter Engineering. It tells you all about the New Profession and about our school. It tells you how you can learn to become a Meter Engineer in your own home during your spare time. Absolutely no obligations of any kind in getting the book. Just your name and address is enough. But write today—now—immediately while we can still make this great special offer.

FREE Book Coupon

Ft. Wayne Correspondence School Dept. 1192 Fort Wayne, Ind.

Gentlemen: Please send absolutely free and prepaid your book on Meter Engineering. Also send me full particulars of the great special offer that is now being made to induce men to study Meter Engineering. I assume no obligations of any sort.

Fort Wayne Correspondence School
Dept. 1192
Fort Wayne, Indiana

Name _____
Address _____



**SHOW CARD WRITERS
EARN FROM
\$21 TO \$50 PER WEEK**

LEARN ABOUT OUR FREE COURSE IN SHOW CARD AND SIGN WRITING

A Great Opportunity! We are offering, for a limited time, a complete course in show card and sign writing to those purchasing our assortment of "Litholia" Ready-to-Use Colors. This is a great opportunity for ambitious persons, either sex, to increase their earning capacity. Good show card writers in demand at \$21 to \$50 weekly, salary or in business for yourself. Our show card course is not a book of alphabets. It's a complete course in lettering compiled by an expert New York show card artist for us. "Litholia" is the only liquid pigment water paint ever manufactured, used the same as cake, distemper or tube colors, but far superior to either. "Litholia" lasts longer, always ready. "Litholia" is the best for the show card writer, the artist, or the interior decorator. A letter of request brings booklet, circulars, and full information.

LITHOLIA PM. COLOR CO., 71 to 81 W. 23rd Street, NEW YORK CITY



We Can Increase Your Income

No matter where you live, if you are honest, ambitious and determined to succeed in business—a business absolutely your own—send your name and address and we will mail you our **Big Free 64-Page Book**, showing how you may earn

Our President

\$3,000 to \$10,000 a Year

in the Real Estate, Brokerage and Insurance Business.

Our system is a positive success. We will teach you by mail, appoint you a

Special Representative

in your town of the oldest and largest co-operative realty and brokerage company in the world, start you in a profitable business of your own and help you to make money from the beginning.

Exceptional Opportunity for Men Without Capital

Write Today

International Realty Corporation,
1536 Manhattan Building, Chicago, Ill.



THIS JOB PAYS \$25-\$50 Weekly

You Can Be An Auto Expert

We teach you the entire subject by mail in 10 weeks' spare time, and assist you to secure good position. Demand for trained men can't be filled. Simple, practical and personal instruction. **Free auto model to each student.**

FIRST LESSON FREE—WRITE FOR IT NOW

Owners—we supply competent men

Empire Auto Institute, 228 Empire Bldg., Rochester, N. Y.

The Original Automobile School

Please Mention Popular Mechanics

TELEGRAPHY

The Only Trade that is not Crowded. It insures steady employment and good wages. Promotion is assured for the ambitious. We are official instructors for the Western Union Telegraph Co., and the only school instructing Western Union employees. Largest attendance of any Telegraph school; also authorized school for Illinois Central Railroad Company. Agency course free. Practical instructors; main line wires. Employment furnished to earn expenses if desired. State your age.



Jones School of Telegraphy, E. M. 305 S. La Salle St., Chicago, Ill.

LEARN WATCHMAKING AT HOME

You can learn by our modern and original system of instruction every part of the Watchmaker's Trade at home as good or better than at a shop. You can earn money while learning and secure a well paying position or start in business after completing our course of instruction. Good watchmakers are always in demand and earn from \$20 to \$35 per week. For particulars apply to the WISCONSIN SCHOOL OF WATCHMAKING, Stroh Bldg., MILWAUKEE, WIS.



Learn Moving Picture Operating

EARN \$75.00 TO \$150.00 A MONTH

Thousands of positions open. Big demand for competent men. YOU can get in the \$2,000.00 class at home during your spare time. Work easy, pleasant and profitable.

WRITE TODAY for special offer and free information. A post card is enough, but be sure to write today—now.

MOVING PICTURE SUPPLY HOUSE
Dept. 1192, Engineering Bldg. CHICAGO, ILL.

This Valuable Booklet Sent Free to All Music Lovers



We want every reader of Popular Mechanics who is interested in music to send for this handsome booklet, which fully describes the "University Musical Encyclopedia" published in ten volumes. This work covers the entire field of musical knowledge—Low in cost and sold on our easy payment plan. Write for Booklet today.

UNIVERSITY SOCIETY, 44 East 23rd St., N. Y. City

BOOKKEEPING TAUGHT IN 20 LESSONS

New and valuable plan by Expert Accountant—"Bookkeeping in a Nutshell"—practical, simplified system giving every essential in 20 snappy lessons at a very small cost. Unique Course—different, original—winnows the wheat from chaff—quick, easy way to master—no drudgery, no waste of time—saves money to business man—only real system for beginner, revelation to the experienced. Everybody needs this. Booklet fully describing everything Free for name and address. Send for it today.

THE WILLARD AUDIT ASSOCIATION, 1536 Manhattan Bldg., CHICAGO

The Best Book for Beginners

A Practical Course in Mechanical Drawing

By Wm. F. Willard

Price 50c Postpaid

POPULAR MECHANICS BOOK DEPT.
318 W. Washington St., Chicago

Startling Watch Offer



READ! A Watch Offer Without Parallel

Write for our FREE book on watches; a book that posts you on watches and watch values—explains reasons for our most remarkable rock-bottom-price offer DIRECT TO YOU on the highest grade Burlington.

IF YOU WANT a highest grade watch (ladies' or gentlemen's), or if you ever expect to own such a watch, write NOW for the FREE Burlington Book. See coupon below.

We won't "knuckle down" to selling systems among dealers, so we have decided to make such a tremendous and wonderful offer direct to the public on a first-class time piece, that no trust, no dealers under contract will or can stop us. You too will seize this opportunity to get the "Burlington Special" direct on this wonderful offer.

You should not buy a worthless watch just because it is cheap. Nor need you pay trust prices now for a top-notch watch. The free Burlington book explains.

\$2.50 a Month at the Rock Bottom Price

\$2.50 a month for the world's most superb time piece? The easiest payments at the rock-bottom price—the **Rock-Bottom** price. To assure us that everybody will quickly accept this introductory direct offer, we allow cash or easy payments, just as you prefer.

No Money Down

We ship the watch on approval, prepaid (your choice of ladies' or gentlemen's open face or hunting case). You risk absolutely nothing—you pay nothing—not one cent unless you want the great offer after seeing and thoroughly inspecting the watch.

Get the Free Burlington Book

THIS BOOKLET will quickly convince you too that you DO want an independent watch—made in the independent factory that is fighting the trust as best it can by giving better quality and superior workmanship throughout; we will quickly convince you that the Burlington watch, on which there is only one rock-bottom price (the same rock-bottom price everywhere) is THE watch for the discriminating buyer; that it is THE watch for the man or woman who wants, not the largest selling brand which everybody has, but the best watch, the watch bought by experts, THE watch that is absolutely perfect in its many points of superiority—the Burlington Watch. You will be posted on inside facts and prices when you send for the Burlington Company's free book on watches.

Now Write

for the free book. It will tell you

what you ought to know before

you even examine a watch. It

will tell you the inside facts

about watch prices, and it

will explain the many superior

points of the Burlington over

the double priced products.

Just send your name and

address today.

**No Letter Is
Necessary.**

**Coupon
Will**

Do!

Do!

Do!

Do!

Do!

Do!

Do!

Do!

Do!

Do!

Do!

Do!

Do!

Do!

Do!

Do!

Do!

Do!

Do!

Do!

Do!

Do!

Do!

Do!

Do!

Do!

Do!

Do!

Do!

Do!

Do!

Do!

Do!

Do!

Do!

Do!

Do!

Do!

Do!

Do!

Do!

Do!

Do!

Do!

Do!

Do!

Do!

Do!

Do!

Do!

Do!

Do!

Do!

Do!

Do!

Do!

Do!

Do!

Do!

Do!

Do!

Do!

Do!

Do!

Do!

Do!

Do!

Do!

Do!

Do!

Do!

Do!

Do!

Do!

Do!

Do!

Do!

Do!

Do!

Do!

Do!

Do!

Do!

Do!

Do!

Do!

Do!

Do!

Do!

Do!

Do!

Do!

Do!

Do!

Do!

Do!

Do!

Do!

Do!

Do!

Do!

Do!

Do!

Do!

Do!

Do!

Do!

Do!

Do!

Do!

Do!

Do!

Do!

Do!

Do!

Do!

Do!

Do!

Do!

Do!

Do!

Do!

Do!

Do!

Do!

Do!

Do!

Do!

Do!

Do!

Do!

Do!

Do!

Do!

Do!

Do!

Do!

Do!

Do!

Do!

Do!

Do!

Do!

Do!

Do!

Do!

Do!

Do!

Do!

Do!

Do!

Do!

Do!

Do!

Do!

Do!

Do!

Do!

Do!

Do!

Do!

Do!

Do!

Do!

Do!

Do!

Do!

Do!

Do!

Do!

Do!

Do!

Do!

Do!

Do!

Do!

Do!

Do!

Do!

Do!

Do!

Do!

Do!

Do!

Do!

Do!

Do!

Do!

Do!

Do!

Do!

Do!

Do!

Do!

Do!

Do!

Do!

Do!

Do!

Do!

Do!

Do!

Do!

Do!

Do!

Do!

Do!

Do!

Do!

Do!

Do!

Do!

Do!

Do!

Do!

Do!

Do!

Do!

Do!

Do!

Do!

Do!

Do!

Do!

Do!

Do!

Do!

Do!

Do!

Do!

Do!

Do!

Do!

Do!

Do!

Do!

Do!

Do!

Do!

Do!

Do!

Do!

Do!

Do!

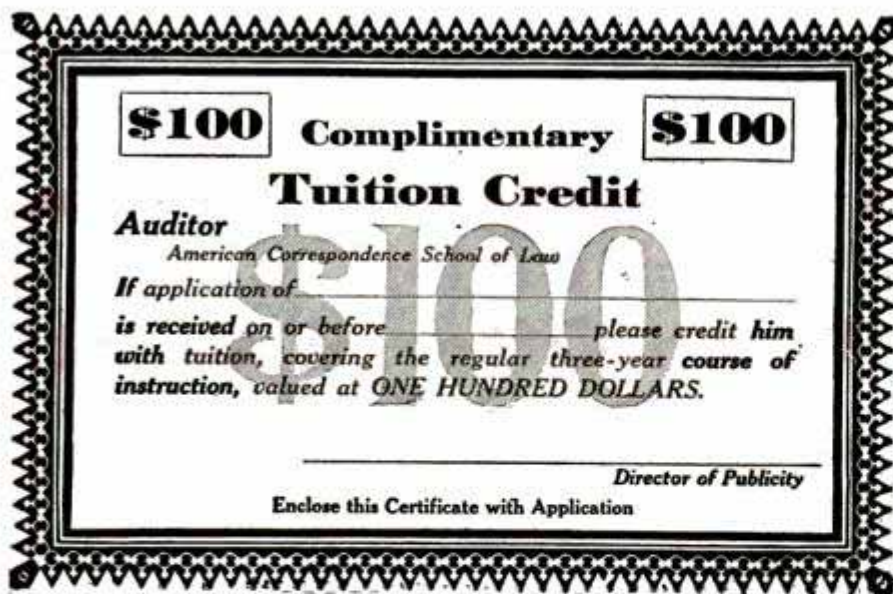

This Tuition
CREDIT
FREE

Offer Reserved for Thirty Days So Write at Once

A tremendous—positively tremendous offer for ambitious men. Here is an opportunity to get your tuition in a great law school positively **without a cent of cost to you**. Read—Read the offer which we make on the Complimentary Tuition Credit valued at \$100 which we picture here. These Complimentary Tuition Credits will be given out in all localities now. We reserve the right to withdraw this offer absolutely in thirty days. So if you want to be one of the lucky ones to get a three years' course in law absolutely free, don't wait, but mail the coupon to us **at once**.

We Guarantee

to coach free any graduate failing to pass a bar examination. Our course covers all branches of American law and includes the same studies as the large resident law colleges. Abraham Lincoln, Henry Clay, James A. Garfield, Edward H. Harriman, Thos. H. Ryan and thousands of our most prominent men **STUDIED LAW AT HOME**. Send the coupon at once for full information.

Special Business Law Course

We have arranged to give you a special course in business and commercial law. Know your rights. Avoid expensive lawsuits. Know just what to do. We will give you the fundamental foundation and the principles of law. **You should know the law in order to protect yourself**—In order to know what to do when you are confronted with any problem.

Study Law at Home on this Great Offer

Many of our country's greatest men such as James A. Garfield, Abraham Lincoln, Edward Harriman and many others **studied law at home**. In order to be a successful lawyer today you do not have to be an orator—no need to even go into court. Many of our great Corporation lawyers never step inside the courtroom. A knowledge of the law will enable you to more profitably carry on your business transactions. Graduate correspondence students hold high records and are successful in passing bar examinations. Our complete home-study law course includes the same studies as **Harvard, Chicago, Michigan, Columbia** and other leading law schools; covers all branches of American Law. Recognized by great lawyers and schools as the leading home-study law course of its kind in the world.

AMERICAN CORRESPONDENCE SCHOOL
 MANHATTAN BUILDING

LAW University Instruction at Home

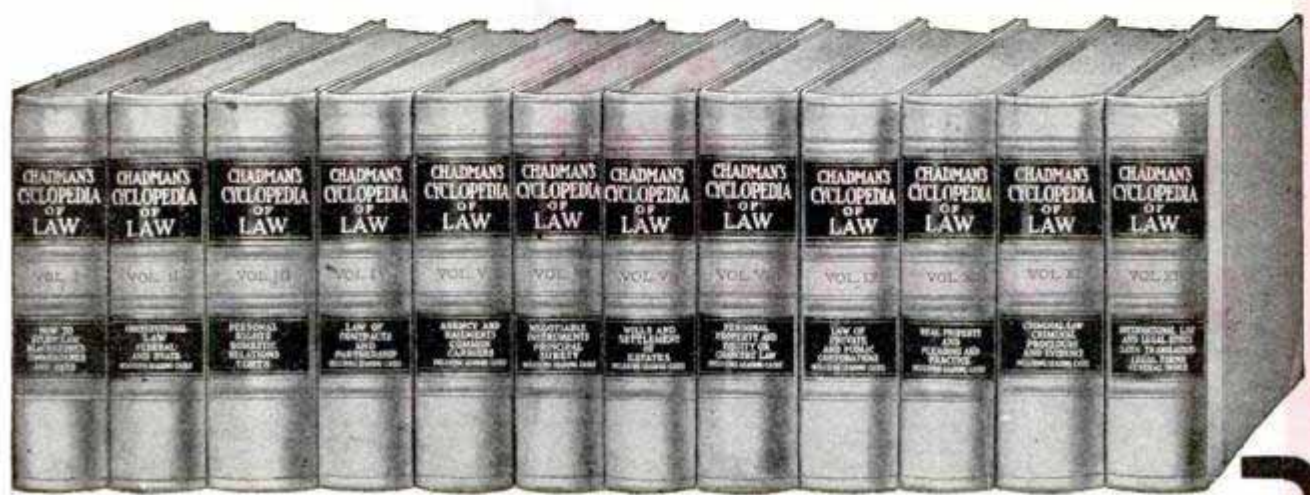

We Furnish this Magnificent Law Library with Every Free Tuition Credit

Twelve of the most magnificent law books published. With each of these splendid volumes, and the splendid lessons and lectures you will master the most difficult law problems in a very short time. Let this opportunity go by and you will always regret it. Send the coupon now. **Every one should have a knowledge of the law.** It is the basis of all government—the foundation of our entire existence—the greatest of all business helps. The only cost to the students who get the tuition credits is for text and postage.

Mail This FREE Coupon Today For Big New 132-Page Law School Book

Put your name and address on this coupon and mail it in to us today. We will send you our big 132-page Law School Book and full particulars of this greatest law school offer. We mean exactly what we say. We will give you just exactly what we tell you we will give you—a complimentary tuition credit valued at \$100 covering the regular three years' course of instruction. Do this now—right away. Remember, those who get the complimentary tuition credit pay absolutely not one cent for tuition. Just send the coupon and we will tell you all about this great offer which we are making to readers of this magazine. **No obligations - so send the coupon at once.**

FREE Coupon

American Correspondence School of Law, Dept. 1192 Manhattan Building, CHICAGO, ILL.

Gentlemen: Without any obligation or expense to me, please send me your 132-page Law School Book and full particulars of your free tuition credit offer.

OF LAW CHICAGO, ILL.

Dept. 1192

Name.....

Address.....

Stop Forgetting!



**Make
your
Mind
a File
—not
a Pile**



THE average person's mind resembles a scrap-pile more than anything—heaped high with a vast miscellany of unrelated, unclassified, unindexed facts. To summon *on the instant* from this disordered pile a needed name, date, fact or circumstance is as uncertain a process as seeking in a big library for an unindexed book. A world of information in the storehouse of your mind is as valueless as undiscovered gold—if this accumulated wealth of thought is not systematically on tap.

**I will make your mind as well-ordered
as a cross-indexed, classified file**

I will make you master of your mind's infinite ramifications instead of a victim of its disordered details. My systematic course of memory training accomplishes this for you. You can grasp its essentials by ten minutes of pleasurable, interesting, concentrated daily study for just a few weeks. As you progress you will surprise yourself continually by the facility of thought and speech which you acquire. The added degree of confidence—and

all loss of self-consciousness—with which you address your colleagues in the business and social world will also be a source of much gratification to you. You will find yourself able to speak on your feet when suddenly called on by your fellowmen at meetings or assemblages of any sort—whereas you probably gurgled foolishly—turned pink—then white—and sat down—before.

The Key to Success

A good memory is as necessary to success as trained muscles are to the athlete. They are acquired in the same way: That is—through systematic exercise. A good memory means more than mental systematization. It means logical, forceful thinking that is the result of the well-ordered mind. It means positive control of self—and ability to influence others through the medium of mental domination.

Now I have told you of some things that will make or mar your success—and all of these factors are things *within your own control*. A little determination on your part, a little effort, a little scientifically directed training, and you rise 'way above the mediocre to a position of success and satisfaction.

Don't condemn my method until I can explain it. There is more in it than you think. Thousands have pronounced my training the turning point in their success. Write me personally if you want the details—or if more convenient—signing and mailing the coupon will do. After you get my plan is time to decide it is not meant for you—not before. Will you write me—now?

This Valuable Book —“How to Remember—FREE”

Simply clip the coupon—and mail it—or drop me a letter or postal now—just as it is most convenient for you. You will receive my booklet by return mail. Read this booklet carefully—then let me have your application by an early mail. If I receive it within ten days of the date of this offer I will mail you a de Luxe Edition copy of my handsomely-illustrated, richly-bound volume—free of charge.

**Send the Coupon or
Postal Today**

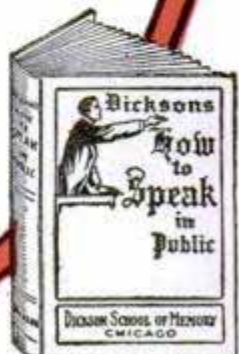

**Prof.
Henry
Dickson**

America's foremost authority on Memory Training, Public Speaking, Self Expression, and Principal of the Dickson Memory School, Auditorium Building, Chicago.

Prof. Henry Dickson, Principal Dickson School of Memory, 705 Auditorium Bldg., Chicago, Ill.

Send me free Booklet, "How to Remember", also full particulars how to obtain a free copy of Dickson's "How to Speak in Public."

Name _____

Street _____

City _____

State _____



EARN A SPLENDID SALARY

Let us train you in our splendidly equipped shops for a good position as automobile mechanic, salesman or chauffeur. Thousands of graduates are earning big salaries. Complete training in 4 weeks, including extensive practice in repairing and driving high powered cars. Tuition and board reasonable.

Send to-day for catalogue and list of graduates

CLEVELAND AUTOMOBILE SCHOOL, 2341 Euclid Ave., CLEVELAND, O.

7 DAYS— All You Need To Learn PARAGON SHORTHAND

Sounds incredible, but absolutely true. Remarkable invention of expert. Simplest system ever devised. Speed capacity beyond reach of the hand. Easy to read. Is being used in service of U. S. Government, in offices of Railroads, Banks and other big corporations, Law Reporting, etc. **POSITIVE PROOF OF NO MONEY.**

Write For Free Formulas Today! Now!

PARAGON INSTITUTE, 200 Coliseum Pl., New Orleans, La.



HOLD THE THROTTLE

of a MONSTER LOCOMOTIVE on a great American Railway — travel 30,000 miles a year and receive from \$100 to \$200 a month. Our HOME STUDY COURSE tells HOW to be a Fireman and then an Engineer. Particulars FREE.

THE PRIOR SYSTEM, 1711 Republic Bldg., CHICAGO

EARN WHILE YOU LEARN BE A WATCHMAKER



Watchmakers and all 'round Jewelers' repairers — in demand now. Six

months' course fits you for a position — earn while you learn, too! Write for FREE book — it explains all.

STONE'S SCHOOL OF WATCHMAKING
912 Globe Bldg. ST. PAUL, MINN.

LEARN WATCH REPAIRING

Be a watchmaker—you can learn this profitable trade by correspondence in a few weeks in your own home by the DeSelms Chart System. After you complete the course you will know a watch from A to Z. You will know just what the matter is and how to repair one. When you graduate you will be a practical watchmaker and repairer and competent to fill any position. Positions for our graduates.

Ask for our Free Book. It explains our system and terms.

THE DeSELMS WATCH SCHOOL
23 Perry Street ATTICA, INDIANA



I TEACH SIGN PAINTING

SHOW CARD WRITING or LETTERING by mail and guarantee success. Only field not overcrowded. My instruction is unequalled because practical, personal and thorough. Easy terms. Write for large catalogue.

CHAS. J. STRONG, Founder

DETROIT SCHOOL OF LETTERING
Department 102 Detroit, Mich.

"Oldest and Largest School of its Kind"
"Thoroughly Equipped Residence School"

LEARN TO RUN AND REPAIR AUTOS.



Be an auto expert. We teach you at home. No need to leave your work while learning. Our course is so simple and thorough that you become an expert in 12 lessons. Free auto model furnished to each pupil. Diplomas issued and graduates assisted to positions. There is a big demand and big pay for Chauffeurs, Mechanics, Demonstrators, and Salesmen. Our 38-page book containing employment plan, sample lessons, with many sets of charts and diagrams, is free. Write for it—today—now.

PRACTICAL AUTO SCHOOL, 68 Beaver Street, New York

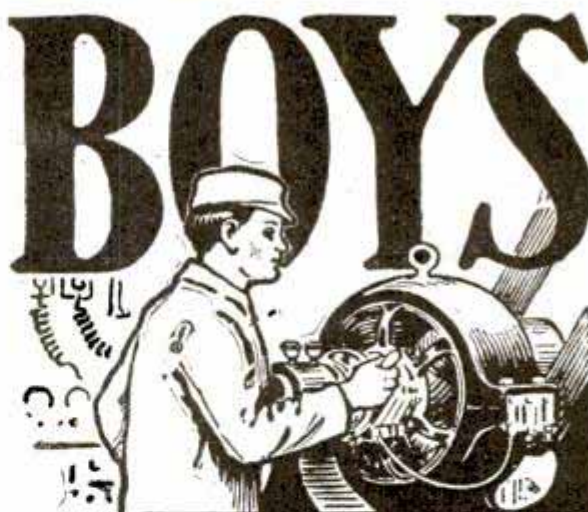

Big Money in Electricity

The electrical field affords a wonderful opportunity to boys with a liking for electrical work. The salaries paid are large—promotion rapid, and, best of all, the profession is not overcrowded.

The International Correspondence Schools of Scranton can make you an expert in the line of electrical work you like best. Hundreds of boys have already won success through I. C. S. help. You can do the same. Everything is made so clear that you can learn in your spare time, regardless of where you live or what you do. No books to buy. See your parents about it—they want you to succeed.

There's big money in electricity. Get after it by marking and mailing the attached coupon to-day. Finding out costs you nothing.

INTERNATIONAL CORRESPONDENCE SCHOOLS

Box 873, SCRANTON, PA.

Explain, without further obligation on my part, how I can qualify for the position before which I mark X.

- | | |
|-------------------------|-------------------------|
| Automobile Running | Civil Service |
| Mine Superintendent | Architect |
| Mine Foreman | Chemist |
| Plumbing, Steam Fitting | Languages |
| Concrete Construction | Commercial English |
| Civil Engineer | Building Contractor |
| Textile Manufacturing | Industrial Designing |
| Stationary Engineer | Commercial Illustrating |
| Telephone Expert | Window Trimming |
| Mechan. Engineer | Show Card Writing |
| Mechanical Draftsman | Advertising Man |
| Architectural Draftsman | Stenographer |
| Electrical Engineer | Bookkeeper |
| Elec. Lighting Supt. | Poultry Farming |

Name _____
 Present Occupation _____
 Street and No. _____
 City _____ State _____

Please Mention Popular Mechanics

SHORTHAND IN 30 DAYS

We absolutely guarantee to teach shorthand complete in thirty days. You can learn in spare time in your own home, no matter where you live. No need to spend months as with old systems. Boyd's Syllabic System is different in principle from all other systems. The first radical improvement in shorthand since 1839. It is easy to learn—easy to write—easy to read. Simple. Practical. Speedy. Sure. No ruled lines—no positions—no shading, as in other systems. No long list of word signs to confuse. Only nine characters to learn and you have the entire English language at your absolute command. The best system for stenographers, private secretaries, newspaper reporters. Lawyers, ministers, teachers, physicians, literary folk and business men may now learn shorthand for their own use. Thousands of business and professional men and women find their shorthand a great advantage. The Boyd System is the only system suited to home study. Our graduates hold lucrative, high-grade positions everywhere. Send today for free booklets, testimonials, guarantee offer, and full description of this new Syllabic shorthand system. Address—
CHICAGO CORRESPONDENCE SCHOOLS, 969 Chicago Opera House Block, CHICAGO, ILL.

SPEAK ANOTHER LANGUAGE

ENGLISH · GERMAN · FRENCH
 ITALIAN · SPANISH

CORTINA-PHONE

"The Original Phonographic Method"

Awarded Medals—Chicago, 1893; Buffalo, 1901

DO you want to learn a foreign language by listening to it, without a costly teacher, without loss of time from regular work and at a trifling expense? If so, write at once for a Cortinaphone booklet describing this marvelous method invented by the world famous scientist, Raphael D. Cortina. The outfit consists of the Cortina textbooks, a magnificent phonograph of the two and four minute type, and thirty everlasting non-breakable records.

IDEAL HOME-STUDY METHOD

Thousands have learned a foreign language by our method—just as a child learns its mother tongue—by listening to it. Always ready when you have a few moments to spare. You can learn to speak any language with its help. Write for testimonials from leading University professors and others who have used our method.

RECORDS FURNISHED IN ANY LANGUAGE

We will send the complete outfit, and if you like it you can pay for it in easy installments.

Write for booklet giving full particulars

CORTINA
ACADEMY OF LANGUAGES

Established 1882.

924 Mecca Building
 1600 Broadway, near 48th St.
 NEW YORK



CORTINAPHONE

BE AN ENGRAVER

LEARN AT HOME—EARN \$25 to \$50 WEEKLY. We give personal instructions and furnish necessary tools FREE. Terms reasonable. Complete particulars by mail.

Chicago Engraving School, Dept. 20, Athenaeum Bldg., Chicago



LEARN PIANO TUNING AT HOME

You can learn quickly and easily by devoting your spare time to the study of our Correspondence system. Our wonderful invention, the Tune-a-Phone, gives the exact number of beats that should occur in the test intervals. With it the student knows what the result should be. It eliminates guess work. Our graduates earn \$5 to \$10 a day the year round. We furnish full-sized action model and necessary tools. Write for valuable book FREE.

Eles Bryant School of Piano Tuning, 47 Fine Arts Bldg., Battle Creek, Mich., U.S.A.

The Great Wizard's Knowledge
 SIMPLIFIED FOR YOU

The Electrical Standard Library

Lessons for Beginners

Expert Knowledge for Electrical Workers

Eight volumes (convenient in size) cover every subject. Hundreds of illustrations and diagrams make the explanations clear as daylight. We will send this library express paid upon approval. If satisfactory send us \$1.75 and \$2.00 per month until a total of \$24.75 has been paid.

NATIONAL INSTITUTE OF PRACTICAL MECHANICS
 Desk 21 1325 Michigan Ave. Chicago, Ill.



STUDY LAW AT HOME

The oldest and most successful school in the world, teaching law by the correspondence plan, will send Free its beautiful catalog and testimonials showing how thousands of ambitious men, through its Regular College Course, became successful practitioners, and how other thousands climbed to commanding business positions by taking The Business Law Course. Easy Payment Plan.

THE SPRAGUE CORRESPONDENCE SCHOOL OF LAW
 257 American Building DETROIT, MICH.

Learn Electric Signalling

At Home—By Mail

A splendid profession. Great opportunity. Big demand by railroads for sign-
 the time to fill vacant

nal engineers. More men needed all positions. You can keep present position while learning.
\$1,800 TO \$4,500 PER YEAR

Rapid advancement from the first. Easy to learn. Takes but short time. Write today for free booklets. Do not put this off. Special offers to new students.

DEPARTMENT OF SIGNALLING, Desk 1192, 491 Cass St., CHICAGO

LEARN JEWELERS' ENGRAVING

A high salaried and easily learned trade, taught thoroughly by mail. We will teach the beginner better engraving than he can gain in years of rigid apprenticeship. We will also improve the skill of any engraver. Send for our catalog. The Engraving School, 112 Page Bldg., Michigan Ave., Chicago, Ill.



MEN WANTED

Prepare as Firemen, Brakemen, Electric Motormen, and colored Train Porters. Hundreds put to work—\$65 to \$150 a month. No experience necessary. 500 more wanted. Enclose stamp for Application Blank. Name position you want.

I. RAILWAY C. I. Dept. 35 Indianapolis, Ind.



VENTRILOQUISM

LEARNED BY ANY MAN OR BOY AT HOME SMALL COST

Send today 2c stamp for particulars and proof.
 O. A. SMITH, Room D 75, 823 Bigelow St., PEORIA, ILL.

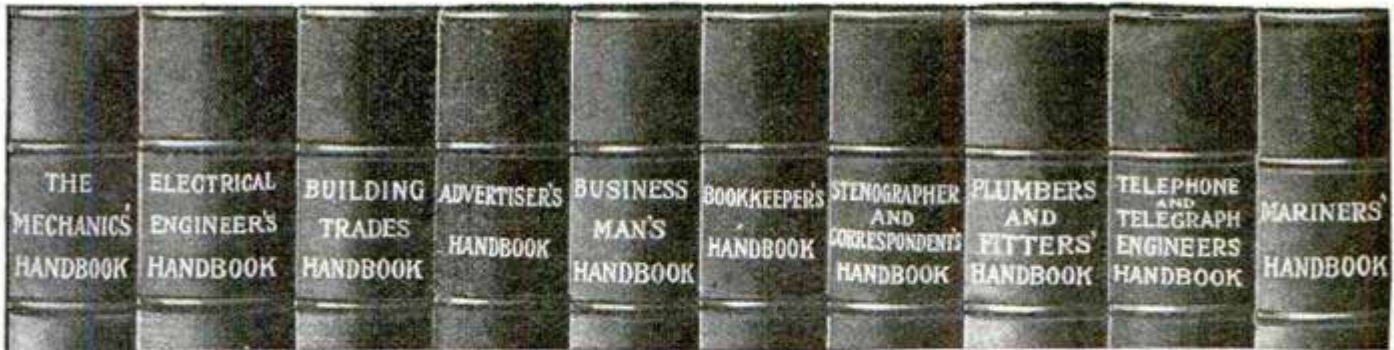

\$1.25 Handbooks for 50c.

No books in existence contain in so small space as much information about the trades and professions of which they treat as do these Handbooks. They are little giant encyclopedias of practical knowledge giving data and information that is hard to find in ordinary books. These Handbooks have been prepared by the well-known textbook writers of the International Correspondence Schools whose textbooks are recognized the world over as the most practical treatises on applied sciences ever published. These Handbooks are consulting experts of the highest rank, and are the most powerful force in the world for the promotion of ambitious men. They are an indispensable help to quicker and better work that will command advancement. They are printed on a high-grade book paper in clear type, and durably and handsomely bound in cloth with gilt titles; contain on an average of 364 pages and 175 illustrations and are regularly sold for \$1.25 each.

SPECIAL OFFER.—We are selling these Handbooks, durably bound in cloth with gilt titles, at a special price for each Handbook of 50 cents.

Mechanics'—Tables; formulas; measurements; belting; mechanical powers; hydro-mechanics; strength of materials; shafting; boiler design; care of boilers; power of boilers; chimneys; exhaust heating; machine design; machine tools; slide valve; pulleys; cylinders and steam chests; pistons; gearing; transit surveying; triangulation; curves; radii and deflections; earth work; track work; electricity; etc.

Advertiser's—How to plan and write an advertisement; type and type measurements; points on printing style; display; preparation of manuscript; proof reading; engraving and printing methods; electrotypes; matrices; advertisement illustrations; magazines; newspapers; retail, department-store, general, trade-paper, and mail-order advertising; trade marks; circulars; advertising agencies; etc.

Stenographer's & Correspondent's—Advice to beginners; shorthand speed; letters of application, punctuation; correct and faulty diction; business correspondence; type-writing; abbreviations; addressing; mailing; rates of postage; duplicating work; etc.

Telephone and Telegraph—Useful tables; mechanics; electricity; magnetism; primary batteries; storage batteries; electrical measurements; telephony; tests with magnetogenerator and bell; telegraphy; Morse telegraph systems; multiplex telegraphy; etc.

Electrical Engineer's—Mechanics; electricity; electrical units; symbols and quantities; physical and electrical properties of metals and alloys; wire gauges; magnetism; dynamos and motors; electric batteries; alternating current apparatus; alternators; transformers; wattmeters; electric transmission; electric lamps; wiring; electric heating and welding; electromagnets; controllers; car wiring; etc.

Business Man's—Arithmetic; tables; business forms; card systems; measures of extension; weight and capacity; time; value of foreign coins; duties on imports; bookkeeping; stenography; correspondence; postal information; financial terms; money and the money market; brokers and brokerage; patents; copyright and trade marks; corporations; business law; publicity; etc.

Plumbers and Fitters'—Arithmetic; involution and evolution; powers, roots, and reciprocals; circles; decimals; geometrical drawing; weights and measures; formulas; mensuration; mechanics; hydro-mechanics; building construction; heating and ventilation; gas-fitting; plumbing; etc.

Mariners'—Logarithms; trigonometry; navigation; terrestrial navigation; celestial navigation; organization of a man of war; naval ordnance; explosives; torpedoes; ship building; speed, tonnage, and fuel consumption; ropes; wind and weather; signals; nautical memoranda; etc.

Building Trades—Loads and structures; strength of materials; properties of sections; strength of rivets and pins; materials of construction; footings and foundations; masonry construction; woods used in building; qualities of timbers; joinery; framing; estimating; elements of architectural design; drainage systems; plumbing fixtures; plumbers' tables; heating and ventilation; gas and gas-fitting; etc.

Bookkeeper's—Arithmetic; formulas; tables; money; percentage; interest; equation of accounts; money and the money market; business law; financial terms; banks and banking; postal information; distances and time between various places; bookkeeping; business forms; card systems; modern office methods; cost accounting; bank bookkeeping; clearing house methods; etc.

International Textbook Co.

Box 872, SCRANTON, PA.

I enclose \$_____ for which please send me the books BEFORE which I have marked X.

- Mechanics' Handbook
- Elect. Eng. Handbook
- Bldg. Trades Handbook
- Plum. & Fit. Handbook
- Tel. & Tel. Handbook
- Advertiser's Handbook
- Business Handbook
- Bookkeeper's Handbook
- Sten. & Corr. Handbook
- Mariners' Handbook

Name _____

St. and No. _____

City _____ State _____

STUDY LAW

AT HOME

Become an LL.B.

The Only Law School of its Kind in America

Special and Exclusive Features

ONLY recognized resident law school in the United States conferring Degree of Bachelor of Laws—LL.B.—by correspondence. ONLY law school in U. S. conducting standard resident school and giving same instruction, by mail. ONLY law school giving over 450 class-room lectures to its extension students. ONLY law school giving a full 3-year, University Law Course, by mail, having an actual faculty of over 30 prominent lawyers, (3 of whom are Asst. United States' Attorneys) in active practice. ONLY law school in existence giving Complete Course in Oratory and Public Speaking, in conjunction with its law course. (This course is free to all students and is second only in importance to the law course itself.)

Other Good Features

In addition to the above, the Hamilton College of Law (note this IS a College of Law—not an institute, correspondence school, etc.) has many valuable features not possessed or offered by other law schools. We guarantee to prepare our students to pass bar examinations. This course is intensely interesting and fascinating—not dull and dry like the ordinary correspondence course. Our system of conducting examinations is the most thorough, complete and expensive (to us) of any examinations ever given. A student can, if he chooses, take part of our course by mail and finish in our resident school, where he will receive full credit for all work done by mail. Our resident school is recognized by all standard law schools in the United States.



Our Degree Bachelor of Law, LL.B. NOT a Diploma or Certificate



From Lecture Room to Student No Other Law School Can Use This Illustration

leges) who are now earning their Degree LL.B. A Probate Judge (one of our students) says: "I am delighted with the course prescribed and your method of teaching law. It is far in advance of what I expected to receive."

Law Library FREE This library consists of 12 volumes of standard text books, used in conjunction with our class-room lectures. These law books, if purchased at retail, would cost almost one-half the cost of our entire 3 year course.

Price and Terms

The price of this comprehensive, ideal and incomparable law course, including the Law Library, over 450 Class-Room Lectures, Course in Oratory and Public Speaking, and everything complete, is considerably less than the tuition alone of any resident law school, and is no more than that charged by the many make-shift law courses (issuing diplomas, certificates, etc.) now offered the public. The terms of payment are so easy that the course is within reach of all.



These 12 Volumes are Free to Students

Illustrated Prospectus Free Also a great deal of "Evidence" substantiating all our claims. Send today and get the complete story—all the facts—then judge for yourself. A postal will do. The answering of this ad may mean the turning point in your career.

HAMILTON COLLEGE OF LAW

1106 Ellsworth Bldg. Chicago, Ill.

NOTE: We have prepared and offer to business men five special and distinct business courses as follows: Business Men's, Bankers', Commercial, Real Estate, and Credit Men's Law Courses. These are fully described in our regular prospectus.

A Course of Lessons

In Drugless Healing

(Mechano-Therapy)

FREE



Not one cent to pay either now or later—no obligation of any kind.

Just your simple request will bring you this valuable course of 62 lessons by return mail without cost. This offer is strictly limited. We reserve the right to withdraw it at any time without notice. So don't wait a minute. Send your acceptance right away.

Why We Are Making This Offer

We want the public to know the real truth about Drugless Healing. Besides, these free lessons will demonstrate just how thoroughly, and in what a surprisingly short time you can master this wonderful new profession, at home or in class, without interfering with your regular occupation.

If You Want to Earn \$2500 to \$6000 a Year

if you want an established profession that is remarkably profitable, if you want to become master of your own and others' health and happiness, then send for the free course and see what Drugless healing has to offer you. Hundreds of successful graduates demonstrate the wonderful efficiency of our methods. How about yourself? Are you satisfied—healthy—happy—making all the money you want? If not, get posted on Drugless Healing right away.

Remember--This Offer is Limited Write NOW for FREE course of lessons. Don't wait to think it over. Get the facts—the real truth—learn what you can earn as a Mechano-Therapist. The FREE 62-lesson course and our free book explain all. Send a postal or letter RIGHT AWAY.

AMERICAN COLLEGE OF MECHANO-THERAPY
Dept. 722, 81 W. Randolph Street Chicago, Ill.

CIVIL SERVICE

positions are very desirable. Good salary, short hours, easy work, pleasant surroundings, life positions, steady work, thirty days vacation and thirty days sick leave annually with pay. 46,202 appointments made last year. No political pull needed. Common school education sufficient. Must be 18 years or over. Full information about how to secure these positions and questions used by the Civil Service Commission free.

COLUMBIAN CORRESPONDENCE COLLEGE, WASHINGTON, D. C.

WHY NOT TAKE A COURSE BY MAIL?



Pres. GALBREATH

Normal Academic Professional Poultry	Penmanship Type-writing Short-hand Domestic Science	Book-keeping Agricultural Law Civil Service Drawing English	Engineering Real Estate
--------------------------------------	---	---	-------------------------

Tuition very low to first applicants.

Sixty page Bulletin free; write for it to-day.

For "Special Tuition Scholarship", apply

CARNEGIE COLLEGE
No. 19D St., ROGERS, Ohio.



DO YOU LIKE TO DRAW?

That's all we want to know

Now we will not give you any grand prize—or a lot of free stuff if you answer this ad. Nor do we claim to make you rich in a week. But if you are anxious to develop your talent with a successful cartoonist, so you can make money, send a copy of this picture with 6c. in stamps for portfolio of cartoons and sample lesson plate, and let us explain. The W. L. Evans School of Cartooning 321 Ball Bldg. Cleveland, O

Learn Automobile Driving and Repairing

We give you driving lessons and teach you all the technical parts to prepare you for a good paying position. Write for Booklet P. Day and Evening Class.

NORTHWESTERN MOTOR INSTITUTE, 228-230-232 Wisconsin St., MILWAUKEE, WIS.

WINDOW TRIMMING



Advertising and Card Writing are the best paid professions in the world. Interesting prospectus FREE tells you all about it. KOESTER SCHOOL, 306 Jackson Boulevard, CHICAGO





HIGHLAND PARK COLLEGE DES MOINES IOWA

Enter Any Time. 2000 Students Annually

One of the most completely equipped ENGINEERING SCHOOLS in the country. Students may enter any time they are ready to come.

COURSES OFFERED

1. CIVIL, ELECTRICAL AND MECHANICAL ENGINEERING COURSES. Standard courses are offered in Civil, Electrical and Mechanical Engineering. Special opportunity is offered for making up work or for taking a complete course preparatory to the standard Engineering Courses. Shop work from the beginning comes in preparatory courses. See our new Engineering Catalogue.

2. SHORT COURSES
1. One Year Electrical Engineering Course
 2. One Year Telephone Engineering Course
 3. One Year Steam Engineering Course
 4. One Year Machinists' and Automobile Course
 5. One Year Course in Mechanical Drawing

Just a fair common school education is all that is required for entrance to these courses. These courses are very practical and are intended for those who have but limited education and do not see their way clear to take a complete Engineering Course. The Machinists' Course is especially practical. The new machine shops are the most complete to be found in connection with any Engineering School in the United States.

SPECIAL COURSES

1. TRACTION ENGINEERING. This is the most complete course in Traction Engineering offered by any Engineering School in the country. It may be completed in three months. Students are taught how to make all repairs on engines as well as to handle them. Four traction engines used for experimental purposes.

2. GASOLINE AND AUTOMOBILE COURSES. These courses will be completed in three months. They are exceedingly practical. Complete Chauffeur practice. Just a fair common school education is all that is necessary to enter.

3. FARM BLACKSMITHING, FARM CARPENTRY.

Mention course in which you are interested. Address,

O. H. LONGWELL, Pres. DES MOINES, IA.

LEARN TO BE A WATCHMAKER

BRADLEY POLYTECHNIC INSTITUTE

Horological Department, Peoria, Illinois



Largest and Best Watch School in America
We teach Watch Work, Jewelry, Engraving, Clock Work, Optics. Tuition reasonable. Board and rooms near school at moderate rates. Send for catalog of information.
BRADLEY, Dept. S., PEORIA, ILL.

LEARN DRAFTING AT HOME

Your spare time this winter will secure you an excellent position. Instruments free. Small tuition. Write for catalogue.
MAXTON INSTITUTE
158 Lawrence St., BROOKLYN, N. Y.



This man makes Big money Do You?

The Automobile Man enjoys the free'st, healthiest, most interesting and best paying position of ANY wage earner to-day. Our free 32-page booklet, "How to Drive," explains How and Why our practical methods produce EXPERTS. Send for it NOW.

GREER COLLEGE OF MOTORING

1457 Wabash Avenue, CHICAGO, ILL.

We teach by practical instructor, with actual repair shop experience.



HERE YOU ARE BOYS A medallion pin of Foxy Grandpa. Everyone will notice it on the lapel of your coat and try to get a closer look at it. All you have to do is press the bulb.—Foxy Grandpa will finish the job by squirting a fine stream of water over the inquisitive one. Will squirt 20 feet. Greatest joke out. Order one today and fool your friends. Price 15c. Foxy Grandpa and Hooligan both for 25c. 5 for 50c or 1 doz. for \$1.00. A beautiful fountain pen free with every \$1.00 order.

AMERICAN SUPPLY CO., 918 Union St., St. Paul, Minn.



Try One and you will say
"That's The Most Comfortable Collar I Ever Had 'Round My Neck."

But that isn't all you can say, for it's the most economical collar you can buy. Just think, only 25 cents for a box of 10 at the stores. If you can't get them there we'll mail 10 for 30 cents or a single sample for 6 cents in U. S. stamps. Tell us what size you wear and what style you want.

These collars are made of fine cloth, starch-finished:—they look just like linen. You can reverse and wear the other side when soiled. For your own comfort and economy you should try them at once. Write us.

Beautiful Catalogue Free

REVERSIBLE COLLAR COMPANY

Department U, BOSTON, MASS.



ELECTRICITY

Complete in One Year

SCIENTIFIC ELECTRICITY
IN ALL ITS BRANCHES

Bliss Electrical School

Studies restricted to theoretical and practical electricity, mechanical drawing and necessary engineering work. Teaches simplicity, concentration, hard work. For young men of energy and character. 20 years of greatest success. Graduates hold first-class positions. 21st year begins Sept. 24, 1913. Write for catalog.

15 Takoma Ave., WASHINGTON, D. C.

LEARN WATCHMAKING

refined, profitable labor—Competent men always in demand. We teach it thoroughly in as many months as it formerly took years. Does away with tedious apprenticeship. Money earned while studying. Positions secured. Send for catalog.
St. Louis Watchmaking School, St. Louis, Mo.



Learn a Paying Profession

that assures you a good income and position for life.
For seventeen years we have successfully taught

PHOTOGRAPHY

Photo-Engraving and Three-Color Work

Our graduates earn \$20 to \$50 a week. We assist them to secure these positions. Learn how you can become successful. Terms easy—living inexpensive. Write for catalogue—NOW!

ILLINOIS COLLEGE OF PHOTOGRAPHY, 999 Wabash Avenue, Effingham, Ill.

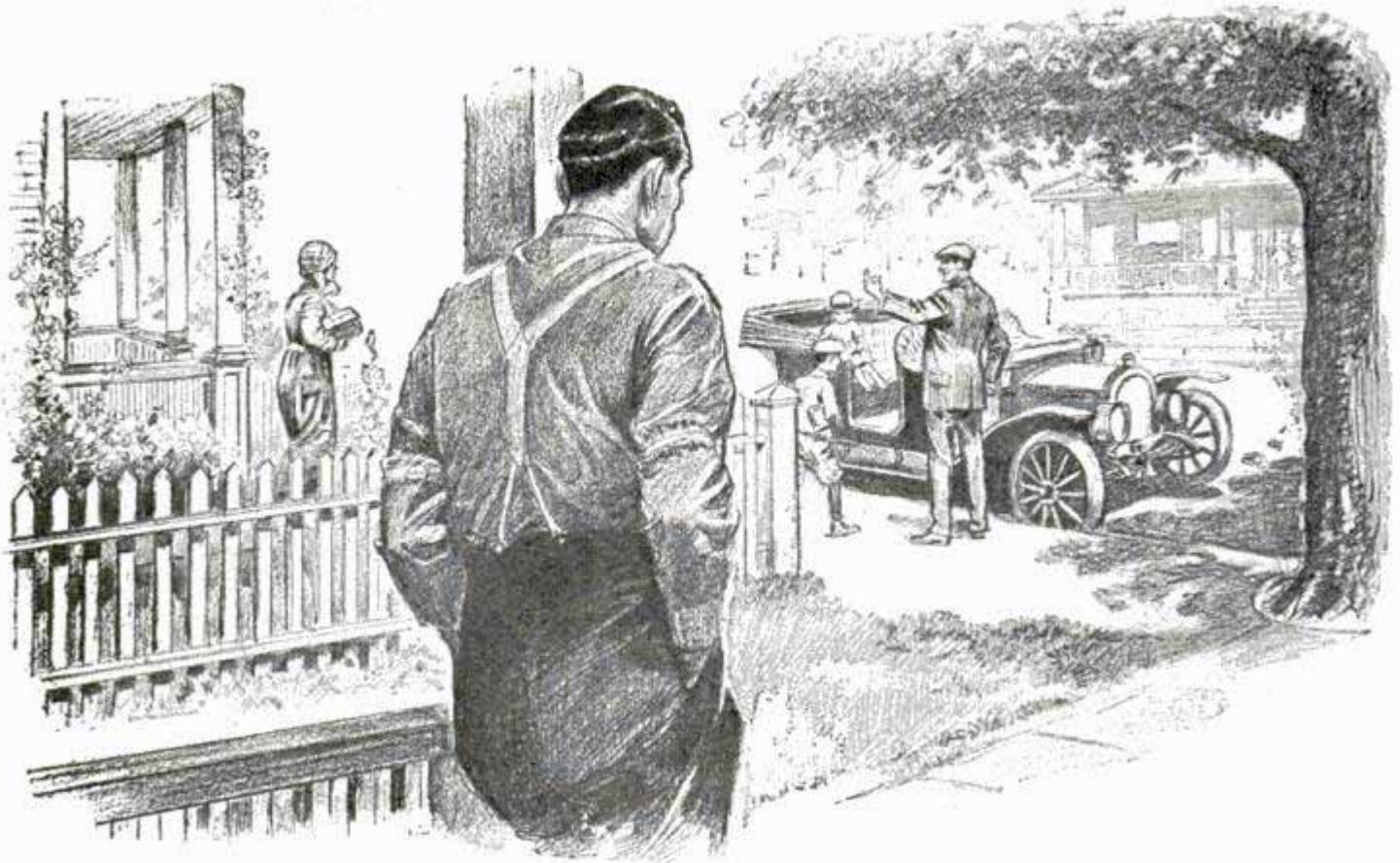

Don't envy the trained man—be one

No use envying the man who has made good. Don't think he got where he is because he had a "pull." A "pull" doesn't amount to much unless you can deliver the goods, and the best "pull" in the world is **training**.

Just make up your mind today—**right now**—that you are going to be a **trained man**—that you are going to get the money and hold a good job. **You can do it.** The **American School of Correspondence** will show you how. This great school, with its sixty-five complete courses in **Engineering, Business and Law**, can soon give you the training necessary to become a successful man—a man who will be envied as you, perhaps, now envy the men above you.

Your Opportunity Coupon

Check the course you want and mail the coupon now

American School of Correspondence, Chicago, U. S. A.

Please send me your Bulletin and advise me how I can qualify for the position marked "X." Pop. Mech. 2-13

....Electrical EngineeringLawyer
....Elec. Light & Power Supt.Bookkeeper
....Electrical WiremanStenographer
....Telephone ExpertPrivate Secretary
....ArchitectAccountant
....Building ContractorCost Accountant
....Architectural DraftsmanCert'fd Public Acc't
....Structural EngineerAuditor
....Concrete EngineerBusiness Manager
....Civil EngineerFire Ins. Inspector
....SurveyorFire Ins. Adjuster
....Mechanical EngineerFire Ins. Expert
....Mechanical DraftsmanMoving Picture Op'r
....Steam EngineerSanitary Engineer
....Stationary EngineerReclamation Eng'r
....Gas Engine EngineerTextile Boss
....Automobile MechanicianCollege Preparatory

NAME

ADDRESS

How the American School Will Give You the Training You Need

The American School of Correspondence was established fifteen years ago for the benefit of ambitious men and women everywhere. This school makes it possible for you to obtain the education and training you need without leaving home or giving up your work. It will bring a practical college course to you right in your own home.

No matter where you live, the American School will train you in any branch of **Engineering, Business and Law**, or prepare you for entrance into any resident college. Remember: no need of your leaving home or giving up your present job.

Write the American School now, while the subject of making more money is on your mind. State how far you went in the public schools, what you are doing now, and what you would like to be. Your case will receive special attention.

The American School will tell you the best and quickest way to better your condition and get more money. Check the coupon and mail it now. Don't let this matter drag another day. Another year might slip by and find you at the same old job and prospects for a raise very slim.

American School of Correspondence
CHICAGO, U. S. A.