

September

This Issue 315,000

15 Cents

POPULAR MECHANICS

WRITTEN SO YOU CAN UNDERSTAND IT

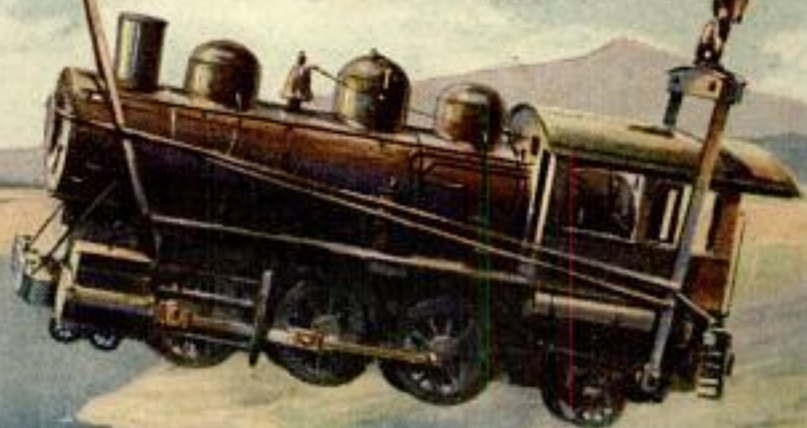

**\$785 Buys the Material
To Build
This Home**

**NO MONEY
IN ADVANCE**

We Save Home Builders 30% to 50%



Design No. 152-D
Seven rooms and bath,
modern, up-to-date interior,
a beautiful home, 28x38.



Design No. 117
\$635 Six Rooms and
Bath. A Modern Bungalow,
Excellent Interior. Size, 39
feet, 6 inches by 27 feet.



Design No. 85
\$655 Six Rooms and
bath, all rooms
convenient and
roomy. Size 22 ft. by 31 ft.



Design No. 50
\$872 Eight Rooms
and Bath, very
attractive Exterior,
Five Closets, Airy
Balcony. Size 28 ft. by 28 ft.



Design No. 53
\$960 Seven Rooms,
Bath, Large
Living and
Main Bedroom, Modern in
every respect. Size 27 x 30 ft.

The Chicago House Wrecking Co. would not dare ship you a carload of building material, valued anywhere from \$500 to \$1,000 *without one cent down*, if we misrepresented one single item. You are perfectly safe, we take all the risk.

No one else in all the world can make such low prices on new Building Material. Our reputation as cash buyers places at our command, first—every bargain worth having. We are satisfied with one small profit—let the in-between profits remain in your pocket—means an immense saving—that means all previous

New Building Material Prices S-M-A-S-H-E-D

Then, when our expert knowledge of what to buy and how to buy at the right prices is combined with the expert knowledge of our most complete Architectural Department, the result is practical, modern, beautiful buildings, constructed absolutely without waste—to satisfy all tastes and all pocketbooks.

We not only save you from 25% to 50% on your completed building, but we give you all the assistance you need for its proper and economical construction, free of charge—Blue Print Plans, prepared by expert architects, Specifications and Material Lists, together with *any other information* you may need.

Compare our offers and you will be satisfied that none can compete with our price—and none can equal our service.

**\$10,000 BOOK OF PLANS
Mail the Coupon Today FREE**

A truly wonderful book given away Free. One hundred pages of modern, up-to-date designs. Free to all parts of the United States. Other points upon receipt of 25c.

**\$2 Brings Complete \$50 Set Blue
Prints and Specifications for
Any of These Beautiful Homes**

The object of this advertisement is not to sell plans, but if you are interested in any of the designs shown on this page, we will, to save time, send a complete set of Plans, Specifications and full descriptive Material List, showing sizes, style, quality and catalog number of the material that we furnish. The best part of it is, that the entire \$2 will be credited on your order, or if plans do not suit, you may return them and all but 50c will be refunded. In addition, we will also name, upon request, delivered prices for complete Plumbing Outfit and Heating Plant of any kind and furnish complete specifications free of charge.

FREE Price Wrecking Catalogs

Send for our Special Building Material Catalog No. 100, Plumbing Catalog No. 128 and Heating Catalog No. 129 showing a complete line of construction of house, barn, or any other building. The newest and latest features in each line at low prices.

Read Our Guarantee—It Is Your Protection

Our guaranteed proposition to you is to furnish the material as specified in the Material List in *all brand new stock*, of the grade, sizes, style, quality and catalog number mentioned, and in quantities sufficient to complete the design strictly according to the plans. We also guarantee prompt shipment of order. All material loaded in one car from our plant here. **Our Paid-Up Capital Stock, \$2,000,000**



Heating Plants
Write for our prices on our complete bathroom outfit. We guarantee a saving of 30% to 50%.

Plumbing Material
Steam, Hot Water and Warm Air. Let us estimate on your requirements. Big saving.



**Chicago House Wrecking
Dept. F.7, Company,
Chicago, Ill.**

Send me your \$10,000 Plan Book FREE. I am also interested in

NAME.....

TOWN.....

County..... State.....

**Chicago House Wrecking
Company, Dept. F-7
CHICAGO**

Popular Mechanics Magazine

318 W. Washington Street, Chicago, U. S. A.

EDITED BY H. H. WINDSOR

ISSUED MONTHLY

SUBSCRIPTION:

SINGLE COPY, 15 CENTS

In United States, and its possessions, Cuba and Mexico, per year, postpaid - - - \$1.50
 To Canada - - - - - 1.75
 To all other countries in the Postal Union - - - - - 2.00

All subscriptions are discontinued at expiration. Please examine the date printed on your wrapper.

Entered as Second Class Matter Sept. 15, 1905, at the Postoffice at Chicago, Illinois, under Act of March 3rd, 1879.

Published monthly by POPULAR MECHANICS CO.

Copyrighted 1912, by H. H. WINDSOR.

The attention of prospective advertisers is called to the policy of this magazine in accordance with which the publisher waives all claim for payment of any advertisement appearing in any issue where the number of copies actually printed and circulated is less than the number printed on the front cover page.

Contents for September, 1912

Memory Machine that Stays on the Job.....	311	"Shoo Fly" Guard to Help Screen Doors.....	352
Grotesque Bird's-Head Umbrella Handles.....	312	Catching Grasshoppers in Vacuum Cleaner.....	352
Breathing Ozonized Air Increases Weight.....	312	Rapid-Fire Guns for Aeroplanes.....	353
Electrical Accidents Show No Increase.....	312	Look-Out-for-the-Car Sanitary Cups.....	354
Motor Gets Power from Steam Flow.....	313	Hydroelectric Power on a Farm.....	354
"Hurdling" with a Motorcycle.....	314	The Making of Gnome Motors.....	355
Making Overexposure Impossible.....	314	A Measuring Device for X-Rays.....	355
Grading a Railroad through Ant Hills.....	315	Sandstone Knob as Bandstand Foundation.....	355
Eruption of Alaskan Volcano.....	317	An Artistic French Highway Bridge.....	356
One Aeroplane in Flight Photographed from Another Aeroplane Flying Higher in the Air.....	318	U. S. Government Largest Dredging Concern.....	356
Locomotives at Each End of Trains.....	318	Motion-Picture Records of Reclamation Work.....	357
Vibrationless Concrete Tables.....	319	Compact Luncheon Set for Motorists.....	357
Labor-Saving Devices in an Inventor's Kitchen.....	320	Creating a Capital City for Australia.....	358
Picture-Show Electric Plant in Automobile.....	321	Player Piano Used with London Orchestra.....	359
Rivalry of Motormen to Save Power.....	322	New Automobile Cap and Goggles.....	360
Fire or Panic Menace to Skyscrapers.....	322	Submarine Imprisoned at Great Depth.....	360
International Wireless Regulations.....	323	New Idea in Extension Tables.....	360
Dynamite in Bridge Construction.....	323	Fire-Station Map Shows Unprotected Territory.....	361
A Dummy Village as Artillery Target.....	324	Artist and Scientist Try Night Painting.....	362
Italian Mail Boxes Excel American.....	324	Pouch Arrangement for Anglers and Hunters.....	363
London Church Spire as Lincoln Memorial.....	326	Russia to Spend Vast Sum on Navy.....	363
Electrical Brains for Locomotive Engineer.....	326	U. S. Treasury Installs New Money Laundry.....	364
Egg Gathering with Wheelbarrows.....	327	The Hydro-Aeroplane for Passenger Carrying.....	365
Using Earth as Conductor of Heavy Currents.....	327	Distinctive Coloring for Industrial Plant Pipes.....	365
Motor Cars for Red Cross Work.....	328	Behavior of Metal Tubes under Compression.....	366
Dust Catcher for Miner's Drill.....	329	The Water Automobile of the Everglades.....	367
Around-the-World Wireless.....	331	The Russian Government as a Tea Grower.....	368
By Frederick Minturn Sammis		Tactics in Actual Aerial Warfare.....	369
Hiding the Dots in Half Tones.....	334	"Rolling" a Roof.....	370
Unique German Bee Colony.....	335	Library of Electrical Science.....	370
Fire-Alarm Gong Operated by Sprinkler System.....	335	Aeroplane Collides with Stone Wall.....	371
Luminous Outfit for Night Marching.....	336	A Nova Scotian Automobile Family "En Tour".....	372
Getting Ready for Aerial Invaders.....	337	Wireless Masts Built in Four Days.....	372
Asks Bids Ten Years in Advance.....	337	Underground Lake Source of Water Supply.....	373
Sky-Scraping Photographs of Sky-Scraper Builders.....	338	Bamboo Shelter for Lawns and Gardens.....	373
Microbes from Dogs to Prolong Life.....	340	Fire Extinguisher for Cable Boxes.....	373
Most Powerful Locomotive in the World.....	340	Photographic Studio in "Darkest" Africa.....	374
Street Paving like Mosaic Floor.....	340	New Records Established by Skyscraper.....	374
The King's Barge for the Henley Regatta.....	341	Comment and Review.....	375
Transmitting Sketches by Wireless.....	341	By H. H. Windsor	
An Improvised Motor Ambulance.....	342	Ripening Dates in an Incubator.....	377
Photographing Animals under Water.....	342	Legal Status of Airmen in England.....	377
Carrying a Locomotive on a Cableway.....	343	A New English Fire-Escape Truck.....	378
Grotesque Make-Ups for Bicyclists.....	343	Special Drill for Canal-Lock Gates.....	378
Vari-Colored Searchlight Display in Baltimore.....	344	Concrete Work Cracks Being Studied.....	378
New Gas Engine for Battleships.....	344	Carp Fishing in Los Angeles Park.....	379
Artistic Umbrella Roller.....	345	Baggage Room of an Aerial Express.....	380
Short-Circuit Fire Caused by Birds.....	345	Lubricant Tests Made by Machine.....	380
Electric Bells without Batteries.....	345	Filtering Air for Dynamo Rooms.....	380
Moto. r Furnishes Power for Pylon Beam.....	346	New Ocean Liner will have Tank-Top.....	381
British U-Fuel Locomotive.....	347	Ski Running on the Water.....	382
Protect. ules' Eyes in Coal Mine.....	347	Salad Dish with Ice Cooler.....	382
Double- l. Bascule Bridge for "L" Traffic.....	348	"Atmosphere" in Stage Lighting.....	383
Railroad bogging on Pike's Peak.....	350	Liftboat Lesson in Shipyard.....	383
Warship's Armor Plate Stands Collision.....	351	Monster Metal Plume for Irrigation.....	383
		Reinforcing Steel Water Tanks with Concrete.....	384
		Effect of Dredging on "Swell".....	384

(Continued on Page 6)

Popular Mechanics offers no premiums; does not join in "clubbing offers," and employs no solicitors to secure subscriptions. It is for sale by nearly every newsdealer in the United States and Canada.

Contents—Continued

Edible Bouquets Replace Boxed Sweets.....	384
The Wonders of Light.....	385
By J. Gordon Ogden, Ph. D.	
Domestic Hot-Water Tanks Heated by Electricity.....	390
The Smooth Running of English Trains.....	390
Out-of-Door Trap for Flies.....	391
Urged to Take Explosives from the Air.....	391
Musical-Bell Attachment for Pianos.....	391
Solid Rubber Tire for Emergency.....	391
An Electric Fan which Runs Around a Track.....	392
Cows Shelter under an Aeroplane.....	392
Concrete Chimney of Interesting Design.....	392
Motion Pictures Shown on Electric Party Car.....	392
An Invention for the Assistance of Man.....	393
Homemade Wrapping-Paper Stand.....	393
Motorcycle Equipped with Wireless.....	394
Origin of "Horsepower" as a Power Unit.....	394
An Interesting Fly-Killing "Gun".....	394
Ingenious Projecting Microscope.....	395
Highway Tunnel Proposed for San Francisco.....	395
Couch Hammock for Porch or Garden.....	396
France Aims Blow at Advertising Signs.....	396
Caterpillar-Drive Army Truck.....	396
Lead-Coated Steel for Roofing.....	397
New Form of Metal Lamp Filaments.....	397
Meat Chopper Operated by Motorcycle.....	397
An Unusual Ice Crystal.....	397
Cylinder-Blast Forge of Portable Type.....	398
Automatic Electric Mine Locomotives.....	398
The Proposition to Certify Oysters.....	399
New Idea for Making Cheap Automobile.....	399
Illuminated Route Card for Motorcycles.....	400
Unconnected Electric Wires Give Shock.....	400
Numbering of Farm Houses Suggested.....	400
Champagne Jug with Ice Chamber.....	400
European Aeronautical Laboratories.....	401
By Dr. A. F. Zahm	
Ice Floes as Refuge for "Titanic's" Passengers.....	407
Canvas Housing on Street Sweeper.....	407
Combination Lock for Umbrellas.....	408
Using the Old Auto Piecemeal.....	408
Exhaustive Utilization of Springs.....	409
Charging Batteries by Means of Light.....	409
Ammunition Trays for Queen's Pathway.....	410
Aeroplane Rises from Roof of Building.....	411
Russian Dancing Grotesques.....	411
Bridge of Modern Liner.....	412
Iron-Welding Process Used by Romans.....	413
Military Aeroplane with Folding Wings.....	414
"Jay Walking" Stopped in Kansas City.....	414
Horseless City Planned in Indiana.....	414
Hansom Cab Takes Place in Museum.....	415
A Spear Sharpener of the Romans.....	415
The Infinitely Great and the Infinitely Small.....	416
By Forest Ray Moulton	
England's New Floating Drydock.....	417
Seaweed-Trimmed Hat for the Seashore.....	418
German Surface Gauge.....	418
Fire Exposition to be Held in New York.....	418
Six-Wheeled Motor Busses.....	418
Anthracite Coal Made in Laboratory.....	419
Sketching Board for Military Airmen.....	419
Ice-Breaking Steamer of Great Power.....	420
Latest British Military Automobile-Wireless.....	420
Making Exact Duplicates of Rock Writings.....	421
Two New Devices for Polo.....	421
Big Drum for Musical Festival.....	422
Compression of Lung as Tuberculosis Cure.....	422
The Battle-Cruiser Rivalry in Europe.....	422
Artificial Rubber from Sea Fish.....	423
New Idea in Gasoline Funnels.....	423
Seven-Ton Dumping Motor Truck.....	423
New "Beware-of-the-Dog" Sign for Doors.....	424
Diseases of Ancient Egyptians.....	424
A Mercury Game Popular in France.....	424
Winners of Czarina's Red Cross Prizes.....	425
New York's First Electric Fire Engine.....	426
New French Monoplane Piloted by Boy.....	426
Revolving Electric Floor Scrubber.....	426
New "Rainbow" Electric Lamps.....	427
German Passenger Automobile Body.....	427
"Factors of Safety" in Living Creatures.....	428
By John B. Huber, A. M., M. D.	
An "S O S" Bell for Wireless Stations.....	429
Rubber Obtained from "Tirucalli" Tree.....	429
Electric Driers for Hosiery.....	429
An Aviation Signpost in England.....	429
Funnel-Shaped Concrete Water Tank.....	430
A South African Shaft-Sinking Record.....	430
Pneumatic Hammer for Driving Nails.....	430

SHOP NOTES

Auxiliary Gasoline Tank for an Automobile.....	431
Aid in Mowing Fodder.....	431
Ventilating Apple Bin.....	431
Raising a Flag.....	432
Cleaning Gun Barrels.....	432
Grinding Twist Drills.....	432
Baluster Design to Fit Any Pitch of Stairway.....	433
Repairing a Worn Friction Disk on an Automobile.....	433
Cleaning Brass.....	433
Truing Collector Rings.....	434
How to Build a Motorcycle Garage.....	434
To Hold Spokes of Wheels in Wood Patterns.....	436
Water from a Drainpipe Leak Absorbed with a Brick.....	436
Cutting Piston and Valve Stem Packing.....	436
How to Clean Portable Farm Engines.....	437
To Make Worn Threads of a Bolt Hold.....	437
Double-Blade Hacksaw Frame.....	437
How to Measure a Resistance with a Voltmeter.....	437
License-Number Holder for an Automobile.....	438
Ink Fountain for Covering Large Surfaces on Tracings.....	439
Sizing Mandrels.....	439
Wood Tap on a Concrete Floor.....	439
A Homemade Tampoer.....	440
Reading Rules from Both Ends.....	440
To Fit Loose Piston Rings.....	440
To Keep a Protractor from Soiling a Drawing.....	440
Equalizing Clamp for Spring Hangers.....	441
Homemade Pipe Vise.....	441
An Auger Stop.....	441
How to Make a Pair of Climbers.....	441
Aluminum Polish.....	441
Lighting a Match in the Wind.....	442
Saving Gold with Oil.....	442
How to Adjust a Spark Coil.....	442
Handle Shapes for Wheelbarrows.....	443
A Sliding Door Lock.....	443
A Cup on a Decorator's Scraper.....	443
Renewing Fuse Plugs.....	444
Holder for a Barn Door.....	444
Stopping a Weld.....	444
Disinfectants for Various Articles.....	444
How to Build a Greenhouse.....	445
Scraper for Brass Work.....	449
Boring and Turning Long Pieces.....	449
Cold-Storage Temperatures.....	449
A Machinery Guard.....	450
An Effective Screwdriver.....	450
A Spatula Holder.....	450

AMATEUR MECHANICS

To Hold a Negative in a Printing Frame.....	451
How to Make an Electrolytic Interrupter.....	451
A Homemade Hand Drill Press.....	452
A Hose Nozzle.....	452
An Electric Water Heater.....	453
Frosting Glass.....	453
Long Handle for a Dustpan.....	453
To Fasten Chair Legs.....	453
To Tie a Hammock.....	454
An Inexpensive File.....	454
Window-Shade Guides.....	454
Watering Plants at the Roots.....	454
How to Make a Dry Cell.....	455
A Hose-Nozzle Handle.....	455
Anchor Posts for a Lawn Swing.....	456
Automatic Filter.....	456
Grinding Scissors.....	456
To Repair a Leak in a Canoe.....	457
Holder for a Loose Window Glass.....	457
A Homemade Bench Vise.....	457
A Cover Strainer.....	457
Picture Frame and Triangle Clamp.....	458
Exterior Sliding Fly Screen.....	459
Bushing a Stovepipe in a Chimney Hole.....	459
A Screwdriver.....	459
Supporter for a Double Clothesline.....	460
Encushion for the Arm.....	460
Electric Test for Fixtures.....	460
Opening for Steam in a Utensil Cover.....	460
Drying Seeds.....	460
A Dissolving Coin Trick.....	461
A Fruit Jar Opener.....	461
Anti-Tangle Safety Pin.....	461
How to Nickel or Silverplate Iron by Friction.....	461
Interesting Patents, Practical or Unique.....	462

SAPOLIO

The
Big Cake
that means
Little Work

Solid Cake ~
No Waste
Economical ~
Effective

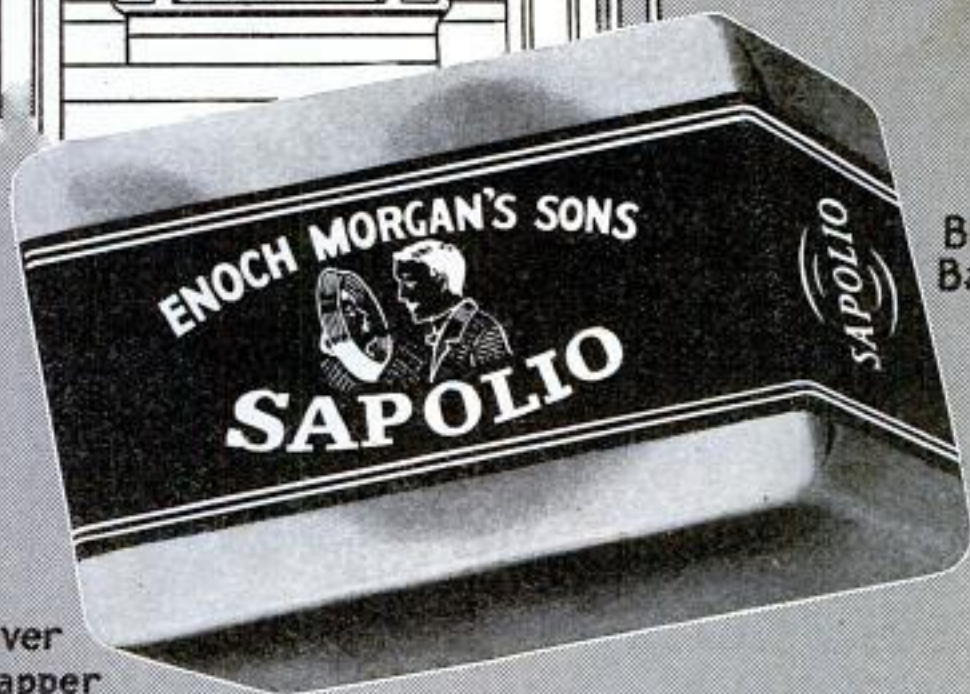
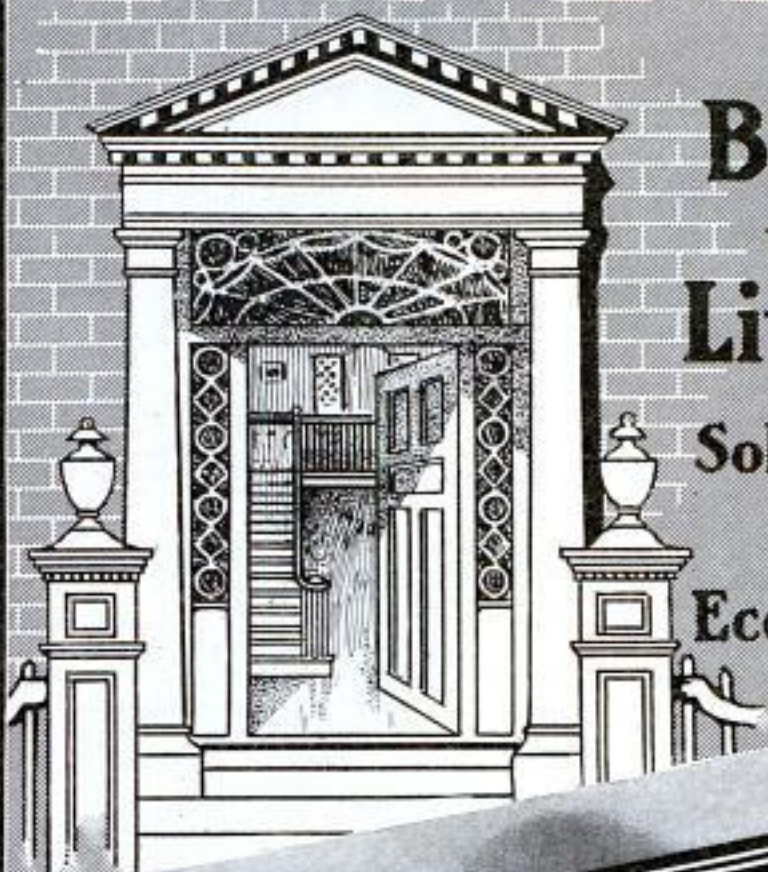

Blue
Band

Silver
Wrapper

ENOCH MORGAN'S SONS COMPANY
SOLE MANUFACTURERS

Please Mention Popular Mechanics

This One



7ARS-KDD-XLJ6

**NOW PROPRIETOR
REPAIR SHOP**

I am now running my own repair shop—making money. Started without capital or any previous knowledge of automobiles. Learned with Dyke's Working Model System. Got my start through Dyke's Employment Plan.
The kind of testimonials we want to show you—actual proofs.

I give your course credit for having started me in the auto repair business. I do repair work for auto owners. The enclosed photo shows a job I am doing for Mr. Frank Sellers at his home on his Overland car. I make a specialty of grinding valves and overhauling cars and always have work ahead. I sometimes buy used cars and overhaul them to sell. I am now making preparations to go into the business on a larger scale and take the agency for a car. Hoping this letter will be of service to you. I remain, yours gratefully,
E. A. LAMB, proprietor of Lamb's Auto Shop,
(Feb. 12, 1912.)
1221 Buchanan Street, Moberly, Mo.

Why Such Results

Such success is not the result of a mere correspondence course. The Dyke system is that, but a great deal more in addition. Mr. Frederick Marwick of Scranton, Pa., said, "As a practical man, I find in your models the real key to touching by mail—this makes the course interesting as well as instructive." And he hit it exactly right.

Dyke's Wonderful Working Models

(The original and only system of its kind. Patent applied for.)
with real metal movable parts are the true secret to the success of students of the Dyke System. On these models you get actual practice, see the actual operation of the different parts of the auto, and learn more than you could from the auto itself. That is why so many of our graduates immediately start repair shops or step right into positions as chauffeurs without a day's experience, after they finish Dyke's Course—and it would surprise you how quickly and easy you will learn with this system.
If you think Mr. Lamb's case is an exception, read below some

More Proof

E. Dwyer, 31 N. Willow St., Montclair, N. J., 19 years old, receives \$25 a week and board.
Harry J. Herbin, Jamestown, Kans., was a farmer, but has doubled his income repairing and selling autos.

W. R. McClelland, Astoria, Ill., was an auto driver. Became professional chauffeur and more than doubled his salary.

Donald Stewart, Oakland City, Ind., became a chauffeur at \$25 a week.
E. M. Fearing and S. V. Slayback, both graduates, are now running a Garage and Repair Shop at Woodbine, Iowa.

And we could continue until we had filled this and several more pages.



Our book of testimonials, showing photos of students and their shops—free.

All the Result of the Dyke System

You can obtain the same start these men had—all the help and more, because we have just brought the instruction up to date, enlarged the books, added a new manikin of the assembly of the auto and the power plant. None of these men had the help of

Our Employment Plan for Students

This represents years of work to provide something that no other school had, namely, a way for the graduate to get acquainted with auto and garage owners, to prove his ability and to immediately secure profitable employment.

Mr. Dyke has been identified as a pioneer inventor, supply man, etc., with the auto industry since its beginning. He originated the first Auto Supply Co. and published the first book on autos in America. No other man with such experience is today teaching others. And all the experience and inside information of the auto business he has thus gained, is embodied in this Employment Plan. If these men whose endorsement are here given, could make so much money out of this System without other help, think how much more you should do with the assistance of this Employment Plan.

Not one of these men lost a day's income training for the new work. Under the Dyke System the entire course, models, etc., are sent to you at one time, you then take your time to study the instructions and obtain experience on the models right in your own home during spare time. (On completion of Course you are awarded a handsome Diploma.)

Even the regular price of this training is only \$15, but if you write at once we will explain a special proposition whereby you can secure all the textbooks, the five real working models, the manikin and all the features for

Only \$12 Right Now

This is a chance you may never have again to get into the fastest growing, best paying industry the world has ever known, a field that is growing faster than men can qualify for the work.

WRITE TO-DAY for Details of Employment Plan and THIS FREE BOOK

It is instructive and interesting—does not cost you a cent and places you under no obligations whatever—You need it for your own sake, not mine. Don't wait—there's no profit in waiting—WRITE NOW and learn how you can obtain all this training for only \$12, if you act immediately

DYKE'S CORRESPONDENCE SCHOOL OF MOTORING

Box 88, Roe Building, ST. LOUIS, MO.

We have started more young men in the auto business than all other schools combined. Our system is a NEW IDEA and original and different from others.



EXPERIMENT WITH WIRELESS



**ENTERTAINING
INSTRUCTIVE
INEXPENSIVE**

This book of 96 pages explains in an understandable manner the construction of an outfit suitable for transmitting four or five miles. The set can be

easily constructed at a small cost by any boy of ordinary ability.

How to Make a Wireless Set

By ARTHUR MOORE

96 pages. Illustrated. 5x7. Cloth. **50c**
PRICE POSTPAID,

ORDER OF YOUR DEALER OR

POPULAR MECHANICS BOOK DEPT.

318 W. Washington Street, CHICAGO



How to Design and Build Aeroplanes

BY

VICTOR LOUGHEED
PRACTICAL EXPERT

THIS book, which is just new from the press, and is therefore the latest and

most up-to-date contribution to flight engineering, is particularly interesting in that it goes deeply into the questions of aeroplane efficiency, particularly with regard to the theory and the practical application of streamline form and sections, along the same lines as have been suggested by Mr. Loughheed recently in articles in Popular Mechanics, except that, of course, in the book the data given is greatly amplified, in both text and illustrations. Most of the information herein contained is not only new and important, but covers researches that have been duplicated by no other authority, and that can be secured nowhere else except in this book.

75 Original Drawings. Pocket Size
Cloth \$1.00. Morocco \$1.50. Postage 7c extra

POPULAR MECHANICS BOOK DEPT.

318 W. Washington St., CHICAGO

First Printing One Half Million Copies

¶ The best work—by far—yet done by the author of That Printer of Udell's, The Shepherd of the Hills, The Calling of Dan Matthews, The Winning of Barbara Worth, etc.

Harold Bell Wright's ←

New Story Exalting Life and Love

THEIR YESTERDAYS

¶ Tender with sentiment, pathos, realism. Honors the home, supremely glorifies the wife and mother—delightfully wholesome.

Illustrations in Colors by F. Graham Cootes. Cloth, 12mo. \$1.30 Net
Bound uniform with "Barbara Worth"

Harold Bell Wright's Latest and Biggest Novel
The Most Popular Book in All the World

THE WINNING OF BARBARA WORTH

"A book that will mould and make nations."

A Present-Day Story of Reclamation and Love

Illustrations made on the scenes of the story by F. Graham Cootes
Cloth, 12mo. \$1.30 Net

¶ Boston Globe—To the reader the characters will appear as real as friends they know—all of their aims, and likes and hatreds being portrayed as true to life as snapshots caught by moving-picture cameras.

¶ Cleveland Plain Dealer—"Dan Mathews" was a fine tale. "The Shepherd of the Hills" was an inspiration. And now he sends us "The Winning of Barbara Worth" * * * a twentieth century epic.

Other Novels by Mr. Wright Uniform With Above

That Printer of Udell's, The Shepherd of the Hills, The Calling of Dan Matthews

Harold Bell Wright's Famous Allegory of Life **The Uncrowned King**

¶ Philadelphia Sunday Dispatch—"The secret of his power is the same God-given secret that inspired Shakespeare and upheld Dickens."

¶ Grand Rapids Herald—"It is the greatest story since 'Bunyan's Pilgrim's Progress.'"

Illustrations by John Rea Neill. 16mo. Cloth 50 Cents Net, Full Leather \$1.00 Net

ANNOUNCEMENT

To be published in August, 1913—Harold Bell Wright's Next Novel—A Real Love Story
THE EYES OF THE WORLD
First Printing One Million Copies
Advertising Appropriation \$100,000

IMPORTANT NOTICE

¶ The Shepherd of the Hills, dramatized by Harold Bell Wright and Elsbery W. Reynolds, is now being produced under leased rights by Gaskill and MacVitty Company and every infringement will be prosecuted.

BOOK CATALOG FREE Our mammoth catalog, size 8½x5½ inches, advertises books of all the publishers at big savings. Bibles, Periodicals, etc. Write us for it today. Bargains on every page. Books on all subjects. **Hundreds of Fine Sets and Fine Bindings for your library.** Every book carried in stock. Catalog sent postage prepaid, free on request.

The Book Supply Company Publishers and Booksellers **Chicago**
231-233 West Monroe Street
Established 1895 E. W. REYNOLDS, President

Over Three Million Harold Bell Wright Books Have Been Sold
For Sale at All Bookstores Or by the Publishers—The Book Supply Company



Brain Partners for Busy Men

How would you like to have always at your command, the expert advice of a corps of Civil Engineers? Men who would be ever ready to untie hard knots, to settle doubtful points, to give you the final word, the absolute answer to every question that comes up. Would you not become a bigger man mentally than you are now? Would you not consider yourself more valuable to your employer? You can have this help, you will find just the information you need contained in

The Complete Cyclopedia of **CIVIL ENGINEERING**

This cyclopedia is *not* a collection of theories, but the actual, crystallized, tried and tested experience of the greatest engineers the world has known. It is *not* a dictionary of disjointed facts, *not* a dry and technical work, but a clear and simple exposition of every phase of practical engineering. These eight volumes teach the handling of men as well as the strength of stone and steel; they describe modern feats of irrigation as well as the building of mills and factories; the latest triumphs of cement and concrete construction as well as the laying of tracks of steel over mountain and plain. The eight volumes are handsomely bound in half Morocco and contain 3,900 pages, with over 3,000 illustrations, folding maps, diagrams, etc.

SOME OF THE IMPORTANT SUBJECTS COVERED

Plane Surveying — Mechanical Drawing — Plotting and Topography — Railroad Engineering — Statics — Strength of Materials — Roof Trusses — Mill Building Construction — Cost Analysis in Relation to Engineering — Masonry and Reinforced Concrete — Steel Construction — Practical Problems in Construction — Bridge Engineering — Highway Construction — Hydraulics — Water Supply — Irrigation Engineering — Water Power Development — Sewers and Drains — House Drainage and Sanitation — River and Harbor Improvements.

Pop.
Mech.
9-12

A. S. of C.

Please send set of Cyclo-
pedia of Civil
Engineering for 7
days' FREE ex-
amination. I will
send \$2.00 within 7
days and \$2.00 a month
until I have paid \$24.00,
otherwise I will notify you
and hold the books subject to
your order. Title not to pass
until fully paid.

NAME.....

ADDRESS.....

EMPLOYER.....

OCCUPATION.....

FREE OFFER COUPON

Examine These Books Free of Charge

We want you to at least SEE these books to judge their worth. We want to send them to you at OUR risk, for you to examine at your leisure, and then if you don't believe them to be ACTUALLY WORTH TWICE THE INTRODUCTORY PRICE WE ASK, if you don't believe them to be worth to YOU IN COLD DOLLARS AND CENTS TWELVE TIMES \$2.00 a month, then notify us—we'll send for the books at OUR expense.

American School of Correspondence
CHICAGO, U. S. A.

Please Mention Popular Mechanics



Henry Dickson, America's foremost authority on Memory Training and Principal of the Dickson School of Memory.

This Dollar Memory Book For a Dime

This is an unusual offer—accept it today—you owe it to yourself to know what memory training really is and how vitally important is a perfect memory.

Prof. Henry Dickson's Lecture on "Memory," delivered before The Executive Club, and by request repeated before many prominent societies and at the Auditorium, Chicago, tells you just how easily and quickly you can acquire those retentive and analytical faculties

which contribute so much to your business, political or social success.

No matter who you are, what you do or where you live, you should read this book and learn just how a perfect memory will help you to greater success—you are no greater intellectually than your memory.

This book is finely printed on heavy paper, bound with Deckle Edge, published to sell at \$1. Fill out the coupon below, enclosing a dime and obtain a copy. Its reading points out the beginning of greater things than you ever dreamed of before.

Who is Prof. Dickson?

He was one of the first educators to discover the universal and primary need of systematizing the faculties of memory. He was the pioneer in the application of this newly discovered principle, that exercising the faculties of memory was absolutely necessary for a successful career.

Prof. Dickson is backed by a national reputation and experience as a teacher, extending over 20 years, in the leading Universities and Schools of the land. His students learned so much more easily and so thoroughly retained their acquired knowledge, that his methods of Memory Training attracted world wide attention.

The result was the foundation of the Dickson School of Memory. The fame of this school and its unique and successful system of home instruction has spread over the entire country and its successful graduates fill every walk in business, political and professional activity.

While the weakest memories can be strengthened, you must not imagine that Prof. Dickson's system of home instruction is applicable to this class only. Many of the most intellectual men of the day have availed themselves of Memory Training.

How He Can Help You

As he has helped thousands of successful men and women, so he can help you. His system teaches you—How to remember names and faces, facts and figures—How to focus your mind instantly on the small but vital points of a business proposition, to use it effectively without burdening the memory—How to think on your feet and make an extemporaneous speech and deliver it unhesitatingly—How to overcome bashfulness and to converse in the natural, easy, interesting way that wins friends—How to acquire the faculty of systematizing your memory so that no matter what your vocation may be, you are assured a greater success.

There are no tedious lessons or long hours of study, just a simple, unfailing memory system. Easy to learn and easy to adopt.

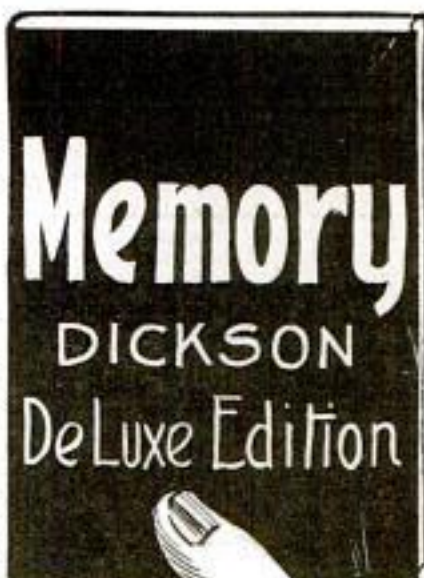

"The Key to Success"

**Fill Out the Coupon
Mail It Today—It Means Success**

PROF. HENRY DICKSON,
705 Auditorium Building, Chicago

Enclosed you will find 10c for which please send me the De Luxe Edition of your lecture on "Memory."

Name.....
Street.....
City.....
State.....

Please Mention Popular Mechanics

Classified Advertisements

Advertisements in this section, 10 cents per word, each insertion, minimum 10 words, payable in advance. To insure ads being inserted under proper classified head in the October issue, copy must reach this office not later than September 1st.

Popular Mechanics Magazine, Chicago, Ill.

Gentlemen: The fact that I keep my ad in the Popular Mechanics is evidence that I am well pleased. I have got a good number of answers to my little ad. But this is not the nicest part of the ad. I nearly always sell them and I don't find so many cheap buyers. Don't seem to be any cheap \$5.00 men that write to me that see the ad in Popular Mechanics. I have sold one dog, a fine fellow, for nearly \$100.00 and have sold two more for \$50.00 and better from my ad, so I for one am well pleased. Yours truly,
(Signed) W. R. WATSON.
Oakland, Iowa.

AUTOMOBILES

GUARANTEED 5,000 miles without puncture. If your tires are old, don't throw them away, or you'll throw away \$50 to \$200. With Durable Treads we give you a written guarantee for 5,000 miles without puncture. This is binding whether your tires are new or old, tread-worn, rim-cut or rut-worn. Durable Treads cost only half as much as tires. Write for booklet and special discount at once to Colorado Tire & Leather Co., 1010 Broadway, Denver, Colo.

FOR Sale—Automobile; Logan 30 hp. 5 passenger touring car, excellent condition for \$250 cash. Woodward Machinery Co., 621 Main St., Cincinnati, Ohio.

CAMELION Cell and Battery, sparks gasoline engines on 4 1/2 batteries. Big gasoline, enormous battery saver, \$10. John Cameron, Jr., 90 Pleasant St., Easthampton, Mass.

FOR Sale—New frame, transmission, wheels and steering gear, also steam engine, burner and pump. A bargain for party building auto. A. & J. Manufacturing Co., 357 W. Lake St., Chicago, Ill.

AUGUST Special. New Inter-State Roadster. Fully equipped. Regular price, \$1,850. My special price \$1,500. C. Garfield Cross, 3327 Locust St., St. Louis, Missouri.

AUTO Owners Attention: How to renew old dry batteries as good as new, at cost of 2c each. Send 20c coin to Box 44, Millinburg, Pa.

FORD owners wanting five electric lights available anytime, using Ford magneto for charging a storage battery (self contained system). Write American Battery Company, 1129 Fulton St., Chicago.

WEEKLY list all auto registrations Washington State, giving details, for \$2.50 a year. State Capitol Record, Olympia, Wash.

FOR Sale—Thomas six forty demonstrator, 1912 model, \$3,500; Thos. four sixty, 1907 model, \$1,000; Cadillac 30, 1909 model, \$850; Rambler, 1907 model, \$150. J. O. Leinart, 881-803-805 Chestnut St., Chattanooga, Tenn.

MAGNETOS; carburetors; spark coils; reverse gears; rear starters; force feed oilers. Cheap, new, guaranteed. Bill Ferguson, Waterloo, Iowa.

WHITE steam car, 5 pass. Just replaced a new boiler, in good order. Just painted, run two summers. First \$300 takes it. G. E. Conley, 80 St. Patrick St., St. John, N. B.

FOR Sale—Combination business and pleasure car, 30 hp., new, run 100 miles. \$1,100. Borbein Auto Co., St. Louis, Mo.

FORD, 4 cylinder, fully equipped; good tires. Perfect running condition. Bargain. Borden, Campbell, N. Y.

AUTOMOBILE and motor boat owners. Your car or boat is not complete without a self-starter. We will send you for \$1. complete set blueprints and instructions, how to make and install a gasoline self-starter that will work under all weather conditions. Don't spend \$30 or more for a starter that is not efficient and liable to injure your motor. Send us one dollar (not stamps) and we will mail you blue prints and full instructions. Northern Laboratories, 750-443 S. Dearborn St., Chicago, Ill.

\$675—CADILLAC 1910 touring car, complete. Great bargain. \$800 for Midland touring car, complete; run less than 2000 miles. S. Breakstone, 1714 Michigan Ave., Chicago, Ill.

BUTCK with two bodies, touring and runabout, 4 cylinder, 30 horsepower, magneto, two tops, Vasco windshield, Klaxon horn, electric lights, clock and tools. Condition of car, tires good as new. All \$200. Particulars, W. 45 Sheridan Boulevard, Far Rockaway, New York.

BARGAIN—Baker Electric Runabout, just overhauled and equipped with new batteries, complete charging outfit, all for \$395. One Bradley Stencil Making Machine, cost \$85, only used two months. Price, \$50. A. C. Benson, Talladega, Ala.

FOR Sale—New, high grade 30 and 40 hp. four cylinder auto engines with magneto and coil. Prices very low. F. E. Alford, Goshen, Ind.

8,000 SHEETS music and oak music shelving value \$500. Exchange. Want auto or what. 1241 Michigan Avenue, Chicago.

FIVE pint Ofeldt fuel automatic, cheap. Box 129, Denver, Colo.

NEW Auto, Buggy, \$135. Stanley Droun, Duncan, Nebr.

BROKEN cylinders and crankcases expertly welded by oxy-acetylene process and guaranteed one year by experienced and reputable company. Absolutely convincing proof, estimates, and other details on request. Charges average only 1/4 cost new parts. Also repair cylinders scored by loose wrist pin \$12. Automobile springs, all designs, at 25% off car makers lists. References—Dun and Bradstreet, or any Waterbury bank. Waterbury Weld Company, Waterbury, Conn.

FOR Sale. Motor truck. Ewing Model A. 1,000 lbs. capacity. Closed body 71x46x58 inches. 35 horse-power motor. New. Listed at \$2,000. Will sell for \$1,200. Photo and full specifications on request. The C. F. Jackson Co., Findlay, Ohio.

AUTOMOBILE bargains. Lowest prices and largest list in the world. All guaranteed, shipped freight prepaid, get my prices before purchasing. Runabouts, Oldsmobile, Reo, Cadillac, \$50; Fords, Buicks, \$150; Touring cars, Cadillac, \$90; Reo, \$150; Buick, \$175; Winton, \$275; Pope Toledo, \$300; Ford, \$300; Maxwell, \$275. I have all makes on hand, I desire agents to sell my cars, write for Special Agents proposition at once. F. M. King, 217 West 125th St., New York City.

STEAM Car Correspondence School. Particulars, 520 Fourteenth St., Denver, Colo.

IMPROVEMENTS in Automobiles and parts wanted; send sketch. Sanders, 17 Crilly Block, Chicago.

SIMPLEST way on earth to time automobile engine, 25c. "Strong" Homer, Mich.

"THE How and Why of the Automobile"—A 200-page book of practical information for seekers after the fundamental facts regarding the gasoline engine and its application to the motor car. Interesting and instructive to both the beginner and the expert. Bound in full cloth—250 illustrations. Price \$1.00 postpaid. Popular Mechanics Book Dept., Chicago.

AUTOMOBILES. Sacrifice sale on new and used cars. Box 275, Burlington, Wis.

STEAM car owners. Myers Kerosene Burner, something new; write for circular. 937 Osceola Street, Denver, Colo.

AUTOMOBILE model. Every part shown and named. You can to all intents and purposes take off the wheels, raise the hood and remove the body; exposing to view the vital parts. The only practical method of studying the automobile. Price 50 cents postpaid. Popular Mechanics Book Dept., Chicago.

AUTOMOBILE SUPPLIES

PELLET'S Magneto Exchange, 1463 Michigan Ave., Chicago. All makes bought, sold, exchanged, repaired and remagnetized. Repairs guaranteed. Parts and coils in stock for all makes of magnetos. Agents for Eisenmann Magneto Co. Connecticut Telephone & Electric Co. Atwater Kent Unisparkler. Gray & Davis Lighting System.

FORD, Buick, Overland, E. M. F., Maxwell, Air-Friction Carburetors, drive your cars three miles per hour on high. Much more speed; much less gas. Starts easy in cold weather. Satisfaction or refund money. Air-Friction Carburetor Co., Dayton, Ohio.

NEW tires, 28x3, \$7.85; 30x3, \$8.75; 30x3 1/2, \$11.75; 32x3 1/2, \$12.50. Other sizes accordingly. Get latest price bulletin, 10% with order; balance C. O. D. Examination allowed. Auto Tire Brokerage Company, 1355 Michigan Ave., Chicago.

AUTO tires mended in one minute. Write for particulars, M. B. Silvernail, Allamont, N. Y.

\$2 BUYS the best automobile lock made. The "Watch Dog." Send for descriptive circular, S. Breakstone, 1791 Michigan Ave., Chicago, Ill.

MODEL T Ford Owners—Our oil groups on your car shows you at a glance the amount of oil in crankcase. Stops smoking. Saves oil. Sent postpaid, \$1. Guaranteed. M. Billinger & Son, Saranac, Mich.

FOR Sale—Knox single cylinder gasoline engine, 10 hp., air cooled with coil and carburetor. Price, \$20. 1423 North Ave., Bridgeport, Conn.

KEWANEE vertical 5 hp. boiler, complete, \$100. 1,200 feet 1 1/2"x22 seamless steel tubing, 3c foot. Mercury rectifier, \$25. National electric laundry wagon without battery, \$100. Graham, 1241 Michigan Ave., Chicago.

TIRES—All makes, all guaranteed. 28x3 1/2, \$4.50; 30x3, \$6; 30x3 1/2, \$11. Write for our complete list of tires and tubes before purchasing. We ship C. O. D. Guarantee Tire Company, Dept. 34, 213-219 West 125th St., New York City.

TIRE Specials. Guaranteed Tires. 1912 fresh stock; just bought an entire surplus stock. Order today while they last: 28x3—\$8.90. Tube, \$2.40; 30x3—\$9.60—\$2.53; 30x3 1/2—\$12.75—\$3.35; 32x3 1/2—\$14.20—\$3.55; 34x4—\$21.25—\$4.80. Other sizes, prices in proportion. Write for complete list. We ship C. O. D. subject to examination upon receipt of express charges. Para Auto Tire Co., 1425 Michigan Ave., Chicago, Ill.

AUTO guaranteed tires. 28x3 \$9.85, tube \$2.75; 30x3 \$10.50, tube \$2.85; 30x3 1/2 \$14.95, tube \$3.75; 32x3 1/2 \$15.75, tube \$4.25; 34x4 \$21.15, tube \$5.60; 34x4 \$22.25, tube \$5.75. These tires are all No. 1 free from flaws or blemishes. They have the white tough tread. I am getting orders from customers that have used them; the kind I want to sell. I ship on receipt of 10% amount of order and allow examination. Send for complete list. Vanderpool's, Springfield, Ohio.

WE make a better unguaranteed Automobile Tire than most guaranteed tires. You get exactly what you pay for. Gums, Fabrics and Mechanical goods. National Company, 1409 Clybourn Place, Chicago, Ill.

STEAM auto boilers bought, sold and repaired. J. L. Lucas, No. 2 Fox St., Bridgeport, Conn.

TIRES, Para Brand. Guaranteed 3,500 miles. 28x3, \$10.50; 30x3, \$11.90; 30x3 1/2, \$15.25; 32x3 1/2, \$16.52; 34x4, \$24.85; 36x4, \$26.60. 30% discount on tubes. Other sizes in proportion. Write for complete list. Para Auto Tire Co., 1423 Michigan Ave., Chicago, Ill.

MOTORCYCLES AND BICYCLES

BICYCLES Tires. I want every bicycle rider who reads the Popular Mechanics to ride a pair of my Aladdin bicycle tires. As an introductory offer I will send you a pair by express paid to any city or town in the United States, upon receipt of money order for \$4.50. Reference Merchants National Bank, P. I. Willis, Pres. Aladdin Rubber Works, 116 W. Market St., Indianapolis, Ind.

WANTED—Secondhand motorcycles for cash, any make and horsepower. Condition no object. Send description and price, and we will give you shipping instructions. Harry B. Geer Co., 888 McLaran Ave., St. Louis, Mo.

FOR Sale—1912 Merkel, 7 hp. chain with tandem, Presto tank, head and rear lights, horn and cyclometer, \$250. Bidden 250 m. 1912 Yale single, battery \$175. 1912 Pope Magneto, \$135. 1908 Harley-Davidson, \$50. All guaranteed. George Reinders, Elm Grove, Wis.

MOTORCYCLE Manual—Construction and operation of a motorcycle, fully described and illustrated; complete trouble chart; 125 pages; clothbound, 50 cents postpaid; paper covers, 25 cents. Motorcycle Manual, 51 Chambers Street, New York.

FOR Sale—Bicycle, Hensley Special. Cost \$40, used one month, special equipment. \$32. Motorcycles—Excelsior, \$100, \$135; Wagner, \$50. Write for full particulars. James Kidd, Burlington, Indiana.

PIERCE Motorcycles, 1912 models, at wholesale prices direct to riders in unclosed territory. This offer is for a limited period only to introduce Pierce Motorcycles. Write for catalog and special prices. The Pierce Cycle Co., Buffalo, N. Y.

SUPPLIES—One thousand guaranteed articles shown in our big free catalog P. at rock bottom prices. Kellers 25c booklet, construction, management and care, now 15c. Motorcyclist, dollar magazine, 25c for trial half year. Indian Mica Spark Plugs two for \$1. Motorcycle Equipment Co., Hammansport, N. Y.

MOTORCYCLISTS—Delivery charges paid to any part of U. S. on our accessories. Send for "Sun Specialties" catalog and special discount offer. Sun Motor & Supply Co., 307 Amsterdam Ave., New York.

28x2 1/2 G. & J. studded motorcycle casings, while they last \$6. Fresh stock. Carlson-Williams Co., s. e. cor. 22d St. and Michigan Ave., Chicago.

FOR Sale—Pierce single cylinder motorcycle; 1911 model, never unraced, \$135. Wiley Latschaw, Carlisle, Ind.

DOUBLE LIGHT—Does not blow out, new article, get Agents sample and particulars. General Agent, Fort Schuyler Bldg., Utica, New York.

EXCHANGE for good motorcycle: Motorboat, 22x4 1/2, copper bottomed, 6 horse, gear, automobile control. No water here. Lee E. Anthony, Clay Center, Kans.

SHAW Motor outfit, almost new, \$35. E. H. Gilmer, Princeton, Ia.

3 HORSEPOWER H-8, motorcycle, good condition, \$55. Ralph Feagans, Washington, Ind.

STOP. Look. Listen. Everybody rides motorcycles at cut prices; 2 1/2 horsepower Indian, \$40; 3 1/2 horsepower Curtiss at \$75; 4 horsepower Harley-Davidson at \$90; 3 horsepower Thien at \$60; 3 horsepower Yale at \$75; 28x2 1/2 casing, \$4.50. Deniners, 335 North St., Rochester, N. Y.

TIRES. Bargains; all makes; 26x2 1/2, \$5; 26x2 3/4, \$6; 26x2 3/8, \$6.50; 28x2 1/2, \$3.50; 28x2 3/4, \$6.50. Tubes, \$2—\$2.25; first grade; guaranteed. Get our prices. Erickson, 7040 Halsted St., Chicago.

A SNAP—1912 White Thor, 4 hp. motorcycle; fully equipped. Stewart Speedometer; Prestolite tank; big lamp; Y-A shock absorber; luggage carrier. Fine condition. Speedy. \$150. Must sell. Otto Merker, 1921 S. Central Park Ave., Chicago, Ill.

1911 M. M. (Imperial) for sale—4 hp.; Bosch magneto; Eclipse free-engine clutch; in perfect condition. Price, \$100. F. R. Goodwin, Genoa, Neb.

2 1/2 H. P. Indian. May be seen running. New tubes and shoes. Owner cannot use. First check for \$45 takes it. V. W. Ferris, 1 West 34 Street, New York.

LOOK. Act quick. One N. S. U. motor cycle magneto model, belt drive; cost \$250. First check for \$75 takes it. Deniners, 335 North St., Rochester, N. Y.

AMMETERS guaranteed battery testers, 25c. See advertisement under "For Sale."

MOTORCYCLES secondhand for sale on part payments; cheap; write, \$95, Dillonvale, O.

PATENTS Bring Wealth, Proof and advice free. Wedderburn, Patent Attorney, Washington, D. C.

MOTORCYCLES. I have all makes; I can save you dollars, my illustrated catalogue is the largest published, mailed free. Marshes, \$20 up; Indians, \$25 up; shipped freight prepaid and guaranteed for six years, send for my lists before purchasing. P. M. King, 213 West 125th St., New York City.

WANTED—1000 Motorcycles immediately. Get our cash offer before you sell. We will purchase 1 or 1000. Motorcycles, 219 West 125th St., New York City.

MOTORCYCLE Tires, all makes, all guaranteed. From \$2.75 up. Get our prices before purchasing any tubes or tires. We can save you money. Guarantee Tire Company, 213-219 West 125th St., Dept. M, New York City.

BIG bargains in second-hand motorcycles, \$25.00 up. Indians, Harleys, Thors, Excelsiors and Merks. Write for full descriptions. Howard A. French & Co., Baltimore, Md.

MOTORCYCLES cheap—50 secondhand motorcycles that must be sold to make room for new Shaw Motorcycles. Send for special bargain list. Shaw Manufacturing Company, Dept. 20, Galesburg, Kansas.

PIERCE Single and Four-Cylinder Motorcycles, slightly shopworn, for sale at bargain prices. William B. Colbourn, 18 Hanover St., Buffalo, N. Y.

IMPROVEMENTS in Motorcycles and parts wanted; send sketch. Sanders, 18 Crilly Block, Chicago.

DON'T buy a Bicycle Motor Attachment until you get our catalog and prices. Shaw Mfg. Co., Dept. 27, Galesburg, Kansas.

MOTORCYCLE and Bicycle Repairing—a 200-page book of up-to-date practical information. Profusely illustrated. Price \$1 postpaid. Popular Mechanics Book Dept., Chicago.

AERONAUTICS

JUST off the press! Building and flying an Aeroplane, by Chas. B. Hayward. A practical hand-book covering the building of small models and of full-sized gliders and machines; also detailed drawings with dimensions of all parts, methods of shaping struts and ribs, form of running gear, form and size of ailerons and rudders, stretching fabric, mounting motor and assembling complete machine. General instructions for flying are carefully laid down; method of control, banking on the turn, and what to do in case of failure of any part or the stopping of the motor. 160 pages, 5 1/2 x 8 1/2; fully illustrated. Price, \$1. Published by American School of Correspondence, Chicago.

"AMERICAN Monoglider." Easiest flown. Most successful. Guaranteed. Wings, 20' x 5'. Length, 14 1/2'. Weight, 40 pounds. Immediate delivery! Assembled, \$22. Knockdown, \$16. "Yardwide" Blueprints, Details, Dimensions, Specifications, \$1. "Wright" glider (New design—latest improvements), "Nieuport" Eleven horsepower monoplane, "American Monoglider." Aviation Director, Lawrence, Kansas.

NEW Aerial Propeller. Produces more thrust per hp. under actual flying conditions, than any other propeller now made. Has proved up against all foreign makes. Light, durable and lasting. Write us. Double Stamp Aerial Propeller Co., 301-503 Upper 3rd St., Evansville, Ind.

BIRD-FLYER—The most natural, and scientific Flying Machine model in the world. (Patented.) Most interesting for enthusiasts, and experimenters who cannot be without it. Power model, 25c; Glider, 15c. Idea is worth the money. Ernst Ebbinghaus, 516 East 33rd St., New York.

FOR Sale Cheap—One H. Farman type biplane without power plant, used only few times. Good as new. Address, Alexander Hamilton, c/o Brooks Mfg. Co., Saginaw, Mich.

LARGEST supply house, hence lowest prices, best service. Immediate shipment from stock. Heath Aerial Co., 3403 Southport, Chicago, Ill.

BARGAIN—Light four cylinder air cooled aeronautic motor; complete equipment, \$150. William Goodwin, Box 192, Montpellier, Ind.

FOR Sale—30-40 horsepower Maxmored Curtiss type biplane, guaranteed flyer. Kenneth Jay, Mason City, Iowa.

LARGE aeroplane factory wants few bright young men, apprentices. A. V. Co., 1252 Roscoe, Chicago, Ill.

AEROPLANE supplies at prices that cannot be duplicated. Large stock of woodwork and metal fittings on hand, for all types of machines. Prices and assortment will astonish you. Bleriot and Curtiss Knock-Down outfits our specialty. Prompt deliveries our motto. A trial will convince. We sell professionals that break records. Why not you? Blue prints for all machines. Our 22 page catalogue "P" sent upon receipt of 6 cents. New York Aeronautical Supply Co., 50 Broadway, New York.

COMPLETE plans drawn to scale, accompanied by clear building instructions—Wright 3 ft. biplane, 25c; Bleriot 3 ft. monoplane, 15c; "Cecil Proll" champion racer (official record 1,691 ft.), 25c. Send 5c for our new 40 pp. illustrated catalog, most complete, including Rules for Model Contests. Ideal Aeroplane & Supply Co., 82 1/2 West Broadway, New York.

BANKRUPT Sale, Rubel Companies Stock, aeroplanes, motors, propellers, supplies. Sacrifice prices. List for stamp. State your requirements. "Aero," Louisville, Kentucky.

BUILD an "Ideal" three foot Racer and win prizes, 1000 feet guaranteed. Complete building materials, including drawing and finished propellers, \$2 prepaid. Plan only, 15c. Ideal Aeroplane Supply Co., New York.

LEARN to fly, \$100 required. Book on How to Control an Aeroplane, 25c. Aviators Exchange, 58 W. Washington St., Chicago.

"GRAY Eagle" Aero Motors are strong and efficient alcohol motors that deliver the thrust. Two sizes. Write for particulars. Kemp Machine Works, Muncie, Ind.

FLY with bicrle monoplane; blueprints, 20c. Thomas Hofmeister, Overlea, Maryland.

WILL exchange aeroplane motor for automobile. B. 2743 Ave. D., Brooklyn, N. Y.

PATENTS Bring Wealth, Proof and advice free. Wedderburn, Patent Attorney, Washington, D. C.

LEARN to fly, build an aeroplane or keep posted on aviation. Aerial Age, America's leading aviation monthly, tells all about models, aeroplane schools, motors, races, and money making opportunities in aviation. 10 cents in stamps brings sample. Aerial Age, The Auditorium, Chicago.

BAMBOO Special grades for Aeronautic Work, Reed, Kattan and Split Bamboo for Models. Tonka Kattan for Shafts 1 1/2 inch and under. Deltour, 804 Jefferson St., Hoboken, N. J.

COMPLETE catalog, Aeroplanes and hydroplanes for stamp, Models included. Chicago Aero Works, 164 North Wabash.

WE train men for exposition flying. Aero-Craft Co., 117 N. Dearborn, Chicago.

IMPROVEMENTS in Aeronautics wanted; send sketch. Sanders, 18 Crilly Block, Chicago.

PATENTS secured on Aeronautical Inventions. C. L. Parker, 910 G. St., Washington, D. C.

"VEHICLES of the Air," the newest and only up-to-date contribution to the literature of aeronautics, contains large working plans of all successful modern flying machines. This book of 500 pages, 140 half-tone photographs and 150 drawings is the only book published containing every known fact of this interesting subject. Size, 9x 5 1/2 inches. Price \$2.50 net, postage 25 cents extra. Popular Mechanics Book Dept., Chicago.

MODEL Aeroplanes, How to Make and Fly Them. By W. Twining. Consisting of 5 sheets of scaled drawings, showing three different models, with descriptive booklet. By mail, 35c. Popular Mechanics Book Dept., Chicago.

DUPLICATORS AND DEVICES

MALALANE duplicators—Our note size 6x9 only \$1. Ask circular. Malalane, 1222 Southern Boulevard, New York.

HOW to get a Heliograph that will make 150 copies in 10 minutes; letter size, \$2.00. Write for circular. Hoyer Duplicator Co., 118 No. La Salle St., Chicago.

BOOKS AND PERIODICALS

STANDARD business books loaned by mail, for return or purchase at option. Advice on short reading courses free. Personal Training; salesmanship; advertising; bookkeeping; banking; investments; choosing a career; systems and efficiency; agriculture; popular law; business letter writing; speakers' and writers' books, etc. Also, health; house and home; public questions; science; religion. Ask for lists and Library Critic and state subjects in which interested. Oriental Esoteric Library, 119, Washington, D. C.

ENJOY life, be successful. Read "How to be Happy though all goes wrong." Beautifully illustrated, downright practical. Positively Creates Success and Happiness despite adversities. 50c prepaid. Your money back immediately if you're not absolutely satisfied. Bode, 561pm Main St., Hartford, Conn.

MOTOR Wagons—Read the "Power Wagon" for reliable information concerning machines employed for business purposes. Issued monthly; single copies, 20 cents; \$2 a year. The most valuable journal of its kind published. The Power Wagon. McCormick Bldg., Chicago.

MECHANICAL books, any kind, stamp fetches catalogue. Crescent Book Store, 329 South Halsted, Chicago.

3,000 RECIPES, New Edition, 40c. Roadman's Guide—100 money-making schemes, 25c. Scientific Book Shop, Syracuse, N. Y.

STEEL Tempering Book for Mechanics, and Mechanical Digest one year, special offer, 25c. Mechanical Digest, Grand Rapids, Mich.

BEAUTIES all over Stage Pictorial, New footlights magazine. Stars, show girls, play scenes, etc., 10 cents copy; 25 cents three months; 50 cents six months; \$1 year. Stage Pictorial, 1493 Broadway, New York.

READ the Agents Magazine. 2 months, 10c. Agents Magazine, Chicago.

PHYSICAL perfection: How to Attain It. Regular price, \$1.50; our price, 50c (postage, 1c). A course of lessons by Sylvester J. Simon, well-known physical culturist. Teaches how to obtain the maximum of physical and mental health, strength and vigor; how to acquire personal magnetism and poise, how to develop nerve force and brain power—all by rational and scientific methods. Silk cloth, 291 pages, 41 full-page illustrations. The Library Shelf, 851 McClurg Bldg., Chicago.

FASCINATING Books; "Cleopatra," 25c. Stamp brings catalogue. Paul Duff, 2713 Mosart, Chicago.

IT'S a treat. "Kate," 10c. Cat. other books and pictures free. Alox Co., C 1, West Jefferson, O.

"THOTS are things," by Edward Walker, 100 pages, 10c. Teaches you the Power of Thought and how to realize your hopes, desires, ambitions and make you master of yourself and outside things. The Library Shelf, 851 McClurg Bldg., Chicago.

RHYMES of David. Rare, true to nature, \$1 postpaid. Fetter Sales Agency, Robinson, Md.

FOX and Hound—Monthly magazine about hunting, fishing, camping and sporting dogs; pit bull department; \$1 year. Sample free. Fox and Hound, Decatur, Illinois.

NEW Book, "Jane," 10c. Catalog of books and den pictures free. Bond Pub. Co., A 5, Columbus, O.

GAS Engine Troubles and Installation. Cloth, \$1.00; flexible leather, \$1.50; Automobile Troubles and How to Remedy Them. Cloth, \$1.00; leather, \$1.50. Eight other practical and reliable mechanical books. Send for circular. Chas. C. Thompson Co., Dept. C, 1126 S. Wabash Ave., Chicago.

LEARN to be a chauffeur. An up to date book which tells in plain language how to operate, repair and take care of an automobile. Sample copy this month by mail only 10 cts. Pike Pub. Co., So. Norwalk, Conn.

ENGINEERS' questions and answers for license by Hebbon, for twenty-five cents, postpaid. Send stamps. Reilly's Book Store, Philadelphia, Pa.

SEND 50c for booklet "How to Run and Install Gasoline Engines," and year's subscription to Gas Energy, 28 Murray St., New York.

"**METAL** Spinning" is the name of the only book published on this interesting art. A concise working manual both for those who desire to spin metal as an art recreation and to follow this work as a trade. 80 pages. 33 illustrations. Price, 50 cents postpaid. Popular Mechanics Book Dept., Chicago.

GAS for power is taking the place of steam for reasons of economy. Learn all about this great change by reading our new non-technical book on this subject, written by a first-class authority for the practical man. 192 pages, profusely illustrated, cloth binding. Price \$1.00 postpaid. Popular Mechanics Book Dept., Chicago.

EDUCATIONAL AND INSTRUCTION

PRACTICAL Mechanical Drawing taught by mail. Draftsmen make \$100 to \$150 monthly, always in demand. Tuition less than 1/2 that of other schools, course more practical. Model engine furnished for instruction purposes. Common education sufficient. Write for free specimen drawing and booklet. Practical Correspondence School, Franklin, Texas.

IN 4 weeks you can learn the world's fastest system of shorthand without a teacher. Can be used on any typewriter. Writes over 300 words a minute. Textbook, \$1. Rent a typewriter and send 2c stamp for circular. Tipton Shorthand Co., Columbus, Ohio.

WAIT a minute, read this! Become a draftsman in 25 lessons for \$3, advanced work for \$5, no time limit, work when you feel like it, instruction free with all lessons. Address: The Simple System of Mechanical Drawing, Box 635, Berwyn, Ill.

UNIGRAPH—Shorthand in 7 lessons—60c. Most rapid readable system. Most quickly learned. Increases salaries. Saves time. Send 10c now, and 50c in 5 days, or return booklets. Unigraph Co., Omaha, Neb.

LAND Surveying Taught by Mail. Very liberal offer to those who enroll before Sept. Address, 855 East 66th St., Chicago. National Correspondence School.

VOICE Production—The Open Throat Method, taught by mail. Four lessons mailed on receipt of \$1. A. Francke, Voice Specialist, 512 Kimball Hall, Dept. "M" Chicago, Ill.

LEARN Show Card Writing. Big demand; 24 lessons at reduced rates. Particulars free. DeWitt Co., Box 293, San Fernando, Calif.

LEARN at home a salary-raising handwriting from America's finest penman; elegant specimen and journal free. Francis B. Courtney, Box A 492, Detroit, Mich.

TRIGONOMETRY by construction; how to make a portable sextant and Sundial; Latitude; Time; \$1.50 each. Circular free. Box 448, Willets, Cal.

PLASTER Casting, instructions and material \$1; interior decorations, casting from life, flexible mosaics, coloring in marble, ivory, antique, pompelan bronze, ebony, bronze gilding, gold leaf burnishing; information sent. Mahler, 117 Russell St., Brooklyn, New York.

LEARN show card writing and earn \$25 to \$35 weekly. Our course teaches this fascinating profession thoroughly and completely. Regular price, \$30. You can get it now for \$5. Particulars and testimonials free. L. B. Higgins, 114 S. Adams, Peoria, Ill.

SIMPLE Shorthand: New invention. Shortest and easiest learned mail course. Send 2c for first lesson. Churchill Business Institute, Dept. C, Grand Rapids, Mich.

IN connection with your clerical work we show you how to earn \$10 to \$15 per week and hold your position besides. No canvassing. We, as manufacturers of patented specialties, have new easy mail order plans that can be carried on in your own home to keep the factories busy. Large profits. Small capital. If you are one-of-the-want-to-go-ahead kind write today for catalogue (copyrighted) plans and sworn statement. J. M. Pease Mfg. Co., 555 Pease Bldg., Michigan St., Buffalo, New York.

YOU can write 100 words a minute without knowing Shorthand. My new method. Abbreviated Loughran, simpler than the simplest shorthand, tried and approved by thousands. Your money back if not delighted. Sample lesson 20c. Full particulars free. Write today. A. B. Weaver, Court Reporter, Dept. C, Buffalo, N. Y.

CROSS Real Estate Course, \$3. George Winstel, 1624 Pleasant Street, Cincinnati, Ohio.

BEST Shorthand Book for home study. Thousands of successful stenographers learned from it; so can you! Pitman system complete, cloth bound, handy size, finest engraving, specially arranged for self-instruction. Price, \$1. Every book contains coupon entitling the purchaser to receive one month's practical instruction by mail. Lessons given by the author, Eldon Moran, our best known American Shorthand Instructor. Students are introduced and correspond with each other. The time to begin is Now. Young people succeed well. Book well worth \$1; besides, mail lessons worth \$2 will be received without extra cost. Book and lessons sent immediately upon receipt of order. Address Popular Mechanics Book Dept., Chicago.

TRADE SCHOOLS

WANTED—Men and women; for government positions. \$80 month. Annual vacations. Short hours. No "layoffs." Common education sufficient. Over 12,000 appointments coming. Influence unnecessary. Farmers eligible. Send postal immediately for free list of positions open. Franklin Institute, Dept. E 23, Rochester, New York.

WHY not learn Photoengraving. Photography. (Commercial Desizing.) High salaries; 32d year. Bartholdis' Trade Schools, 92 5th Ave., New York.

PAINTING, Decorating, Paper Hanging taught by actual practice. Free Catalogue. Chicago School of Painting, 414 Dearborn Ave., Chicago.

BE an auto expert. Fine positions open. Easy work, big pay. We teach you at home by charts, diagrams and model. Highest endorsements. Small payment to start. Write for 1912 book—free. Practical Auto School, 117 Pearl St., New York.

AUTOMOBILE School. You learn with your hands under the superintendence of the best instructors obtainable at the Chicago School of Motoring. Write for particulars. F. E. Edwards, Inst., Dept. "B," 1619 Michigan Ave., Chicago, Ill.

CAMERAS, PHOTO SUPPLIES

ENLARGEMENTS made from film and plate negatives, pictures and photographs. Work guaranteed. Write for price-list. Address T. H. Knight, Dept. C, Racine, Wis.

BIG money saved on Photographic Lenses and Apparatus—goods exchanged. Ralph J. Golsen, Chicago.

100 GLACE Photos. Postage stamp size. Perforated; gummed; guaranteed. One dollar prepaid. From Photo, film, etc. Zadis, Photographer, Long Island City, New York.

KODAK Films Developed, 10c per roll, any size. Prompt attention given mail orders. Prints 2 1/4 x 3 1/4, 3 1/4 x 4 1/4, 4 x 5 to 3 1/2 x 5 1/2, 4c. J. M. Manning, Box B, 1062 Third Ave., New York City.

\$35 CAMERA sell for \$20. John Gregory, Chapman Quarries, Pa.

KNOW the best photography. Magnificent reproductions of selected American and foreign pictures each month in The Photographic Times. Over thirty years the leading American photographic magazine. Tells how, when and where unique and artistic results are accomplished. Splendid articles on practical and timely photographic subjects. Gives Camera Club happenings and exhibitions. Don't miss ideal photography any longer. Subscribe now. \$1.50 a year. Write for sample copy. The Photographic Times, 135 West 14th Street, New York.

WE buy, sell and exchange—Bargains in Microscopes, Telescopes, Field Glasses, Cameras, etc. Bargain list free. Kahn & Co., established 1850, 26 John St., New York.

DEVELOPING—Printing—Enlarging. Best Work, Quick Delivery, Low Prices. Developing 10 cents per roll. Prints 3 cts up. Send 2 negatives for Free prints. H. A. Clark, 1 Plaza Street, Brooklyn, N. Y.

LEARN to Transfer Photos to watch cases, chinaware, sofa pillows, etc. Five excellent formulas and complete instructions, 25 cents. P. Benson, Stewartville, Minn.

GOING to buy a camera? Postal brings catalog and full information. L. J. Peabody, 278 Devonshire St., Boston.

AMATEUR Photographers—Make money taking portraits; work for yourself; be independent. We tell how; professional secrets, retouching, etc., fully explained. Wells' Studio, East Liverpool, O.

HIGH grade enlargements 25c each from negatives. Developing and printing equally low. Prompt service. All work done and examined by experts. Diamond's Photo Shop, 416-6th Ave., N. Y.

KODAK Films developed free. All prints to 5x7 size, 40c per dozen. Postcards same price. Work guaranteed. 20 years' experience. Davidson, 13 McVickers Theater, Chicago.

PICTURES AND POST CARDS

POSTCARD Collectors. 10c will bring our magazine and insert your name in large exchange list for 4 months. Elite Exchange, Dept. R 4, 3327 No. 44th Ct., Chicago.

STAGE Beauties. Four entrancing, full-length Stage Beauty Poses in sparkling colors, fourteen inches high, sent prepaid together with 101 life-like illustrations and Photographic Miniatures of Stage Beauties, Bathing Girls, Ballet Dancers, "Pipe Dreams," Artist Model Poses, "Gems of Art," etc., for only 25c (coin or stamps). Gordon Art Co., Dept. P., New York City.

BIG list, circulated among soldiers everywhere. Camp Life, Manuevers, Membership, ten cents. Military Exchange, Fort Casey, Wash.

1,000,000 MEMBERS wanted at once. Membership, 10c. Review Post Card Exchange, 5118 Wabash Ave., Chicago, Ill.

22 VIEWS of Chicago, all different, put up in neat folder for 10c. Other Chicago views, 7 for 5. Motto, flower, greeting and bathing girl postals, 1c each. Stamp brings sample. Elite Exchange, Dept. R 4, 3327 No. 44th Ct., Chicago.

SEND dime for ten comic and courtship cards. Get acquainted everywhere. Box 136B, Memphis, New York.

SECRET writing Code. 10c. Souvenir Co., 4332 Wolff, Denver, Colo.

GERMAN postcards of Rhine, peasant costumes, historic and scenic; German views, 25c and 50c dozen. A. M. Kelley, Oceanville, Calif.

20 COMIC post cards, new, dandies, 10c. Acme House, 409 Chestnut St., Milwaukee, Wis.

SIX views of Panama Canal for 25c in coin. Box 29, Coronado, C. Z.

JOIN the World's Fair Post Card Club. 1154 Market, San Francisco. Life membership, 25c.

YOU will get lots of cards from our foreign members by joining the Travelers' Post Card Exchange. List 10c. 3508 Carroll Ave., Chicago, Ill.

ART pocket mirrors, celebrated actresses in costume, 15c; two, 25c. Collins, 629 Baxter, Louisville, Ky.

PHOTOGRAPHS of Artists' Models, Art Gems, 3 for 25c. One 4x8 Firestone free with 50c order. Royal Art Co., Dept. J., Grand Rapids, Mich.

100 CARDS, 10c. Flowers, birthday, and other cards. Allie Hammond, Dept. X, Spangler, Pa.

IF you really want to exchange post cards, try our splendid club. Lists circulate in many countries. Membership, 10c. Halsey Club, Box 133, Erie, Pa.

PHOTOS—"Beautiful women," 26 beauty poses, 10c. Curtis Co., J-146, West 73d St., Chicago.

JOIN Booster Card Exchange Membership. 10c. Terre Haute, Indiana.

RECEIVE beautiful views from everywhere. Membership, 10c. International Post Card Exchange, Endicott, New York.

FASCINATING pictures—pretty girls in "bewitching poses," 10 for 25c. Curtis Co., L-145 W. 73d St., Chicago.

PANAMA Canal souvenirs job or hatpin for 25 cents. Also have Panama pennants, post-cards, etc. Box 477, Atlantic City, New Jersey.

FRAMES for post cards, make them yourself with our outfit, \$1. Unlimited capacity, simple operation, half cent each, retail finished 15c apiece. Send for free photograph of frame. Mahler, 117 Russell St., Brooklyn, New York.

YOU'LL get cards from everywhere. Membership, 10c. Idaho Card Exchange, Dept. K, Box 906, Boise, Idaho.

BUSINESS OPPORTUNITIES

"SUCCESSFUL Brains"—My mail order book that I want you to handle—it's the best one on earth—millions of copies should be sold on merits alone—fortunes should be made by those who heed its teaching! Write me and I will make it to your advantage to sell this, my newest and best book, by furnishing you circulars and books at the right figure. May I send you confidential Mail Dealers prices? Weissgerber, Northwestern Building, Chicago.

MAIL order ads that pay. 20 different propositions fully explained. All bona fide, sure-fire Money-getters. Each one the foundation of a successful Mail Order business. Send 10c for full particulars and regular bulletin of new propositions. Mail Dealers Wholesale House, 450 Franklin Bldg., Chicago, Ill.

MAKE More Money! Start Mail Business—operate "Silent Salesman" system—can be done in spare time and the possibilities are unlimited. But don't invest any money in the Mail Business until you read "Booster" for The Booster Magazine starts you in business for yourself—puts you next to the best money making propositions on earth—ones that really get you the money. Get away from wage slavery! Send 10c for two months trial subscription. Booster Magazine, Northwestern Building, Chicago.

MAIL Order Men: Get quick cash returns. We manufacture and distribute new specialties. Start high class M. O. Business. Small capital. Copyrighted prospectus free. No scheme. Box M 235, Pittsburg, Kansas.

WE Help Raise Capital at once to start you in retail—manufacturing—patent—real estate—mail order or any legitimate business by means of "Our Practical Method." Particulars free. The Business Aid Co., K504, Detroit, Mich.

ADDRESS: Expert, 420 Home Bank, Baltimore, Md., and receive as clean a mail order proposition, as you can put your name to; free of charge. Protected merchandise, enormous market, effective selling plan. \$5 and less will start this reliable proposition.

FOR Sale—Electric Light and Ice Plant in good live town on Frisco R. R. Cost \$25,000 with Machinery, Building, etc. Everything A1 condition; practically new. Plant doing good business. \$12,000 cash takes it. Don't write; come and see the plant. First man with money gets it. W. H. Skinner, Pocatemo, Ark.

BE your own boss. Start mail order business. We teach you. 20 years established. Everything furnished. "Starter" free. Krueger Co., Dept. 2B, 167 W. Washington, Chicago.

YOU can make \$10 daily restoring colors to faded rugs and carpets in spare time; tremendous opportunity in your community; simple, easy; free particulars. Cox, Dept. MA, Omaha, Neb.

CANDY making simply, practically taught. "750" Choice Candy Recipes, full instructions, \$1.50. Candy Kitchen profits, \$35-\$50 weekly. Particulars free! Frenchetti's School Candy Making, Box 160, Chicago, Illinois.

SAFETY Elevator (Patented). Manufacturers Investigate. Accidents entirely eliminated. Bousset, 1101 Diamond Bank Bldg., Pittsburgh, Pa.

DON'T slave for wages, start a home business and be independent. Particulars free. R & L Co., 317 First National Bank, Lincoln, Neb.

\$1 A WEEK will start you in a big money-making mail order business—with the best line—in spare time. Particulars free. Nadico Company, 1664 Belmont Ave., Chicago.

AFTER

type	sale	Type
writers	and	and
other	out	ut

YOU'LL get cards from everywhere. Membership, 10c. Idaho Card Exchange, Dept. K, Box 906, Boise, Idaho.

MONETARY

made	o.
gained.	time brings
Wm. Waelder,	Hamilton, Mo.

KENTON, Ohio Commercial Club will give financial assistance to new industries. Do you want a company organized to manufacture your patent? Harry Heywood, Secretary.

\$ DOLLAR \$ Getting \$ Secrets \$ Send stamp at once for six valuable Trade Builders; start a profitable business of your own and make more money. G. Edward Harrison, Baltimore, Md.

START a Magazine on \$1; particulars and sample magazine, 5c. Life Pub. Co., St. Louis.

WANT powerful business-pulling letter? Read New York Editor's advertisement under "Patents For Sale."

BE your own manufacturer, appoint your own agents. Latest device for sewing machines. Send 25 cents for samples and full instructions. Clark & Co., 112 North 14 St., Boise, Idaho.

TURN your spare time to build a business of your own. We help you. "Pointers" free. Acme House, 409 Chestnut St., Milwaukee, Wis.

READ the Agents Magazine, 2 months, 10c. Agents Magazine, Chicago.

WELL-known mail order house offers to establish you in legitimate mail business of your own. We need dealers as outlet for our protected line; will instruct fully and furnish highest character selling assistance. Investment, though very small, fully protected by goods furnished. Complete details free, just send address. Bixby Publishing Company, Box H 134, Buffalo, New York.

QUICK Acting Monkey Wrench. This wrench may properly be termed automatic. It is the quickest, strongest and easiest wrench to manipulate ever invented. It can be adjusted from a one-fourth inch nut to a three-inch nut in one second; and is extremely simple in construction and contains the least number of parts possible in a wrench. Can be manufactured for \$1.20 per dozen. Finished wrench sells for \$1.25. Big profit. Molded in steel molds at any steel foundry. Send for cuts and description. T. W. Harber, 820 Belmont Ave., Springfield, Mo.

WE start you in business, furnishing everything; men and women, \$50 to \$200 weekly operating our Original "New System Specialty Candy and Popcorn Crispette Factories" home or small room anywhere. Opportunity lifetime, booklet free. W. Ragsdale Co., East Orange, N. J.

TWO dollars stocks and starts profitable Mail Order or Local Business; free booklet tells how; write for it today. William Hinds, 354 Ogden Ave., Jersey City, New Jersey.

A Bit Shy on Salary? I pick up \$1,500 yearly additional from newspaper correspondence. My book tells what's news, how to get it, where to sell. Newspaper directory included. No correspondence school expense; only 50 cents. Morris White, Station 50, Detroit, Mich.

BE a Mirror Expert. \$3-\$10 day; spare time home at first; no capital; we train, start you making and silvering mirrors; French method. Free prospectus. W. P. Derr, Pres., 87 Saratoga Ave., Brooklyn, New York.

BE your own manufacturer and keep all the profit. Make and sell Chemical Dry Fire Extinguishers. Ordinary chemicals bought in home town. 100 per cent profit. Complete making and selling directions, 25c. California Sales Co., 450 I. W. Hellman Bldg., Los Angeles, Cal.

INCREASE Your Business! Try my advertising pencils. Arthur E. Atchison, Room 24, 112 North La Salle Street, Chicago.

ANY man can start profitable business in his own town, making and installing the simplest, and most efficient self-starter, for automobiles and motor boats. Send us one dollar (not stamps) and we will mail you blueprints and full instructions. Northern Laboratories, 750-443 S. Dearborn St., Chicago.

FLORIST'S business, \$10,000 yearly guaranteed. 6,000 square feet glass, eight-room modern house, two-story office, barn. Chicago suburb. \$3,500, one-half down. E. C. Cleveland, Wheaton, Ill.

MAIL Order Business in its true light and particulars how you can obtain a loan of all advertised mail order instructions and "schemes" free, by addressing Library Dept. 5, "The Mail Order News," Fishkill, New York.

\$2,500 secures \$4,000 optical business; profits over \$5,000 a year. (Purchaser instructed free.) Royal College of Science, Toronto, Canada.

CHEMICAL analyses, researches, experiments. Parobek Chemical Laboratory, Trenton, New Jersey.

GUARANTEED high-grade typewriter free with \$1 monthly Typewriting Course, Merit Service, Oshkosh, Wis.

SUCCESSFUL mail order business. Particulars for stamp. George R. Allen, Bound Brook, N. J.

PATENTS Bring Wealth. Proof and advice free. Wedderburn, Patent Attorney, Washington, D. C.

INCORPORATE your business under Arizona laws. Cost small. No franchise tax. Stockholders exempt from corporate debts. Do business anywhere. Laws and forms free. Southwestern Securities & Investment Company, Box D488, Phoenix, Arizona.

FORMULAS furnished by expert chemists, for manufacturing Toilet, Household and Technical products. Government serial numbers obtained. 14 years experience. Catalogue for stamp. B. Mystic Company, Washington, D. C.

AN intelligent person may earn \$100 monthly corresponding for newspapers. No canvassing. Send for particulars. Press Syndicate, 100 Lockport, N. Y.

START a mirror factory! We teach and trust you! 10c brings sample lesson. \$10 to \$25 daily easily. Hullingers School, Francesville, Ind.

RAISE Glenseng, \$1 per ft. of ground. 1/2 A. \$25,000. Write, Glenseng Gardens, Shaboggan, Wis.

I MADE \$50,000 in five years with a small mail order business; began with \$5. Send for free booklet. Tells how. Bearcock, 5074 Lockport, N. Y.

WE start you in a permanent business with us and furnish everything. We have new easy selling plans and seasonal leaders in the Mail Order line to keep the factories busy. No canvassing. Small capital. Large profits. Spare time only required. Personal assistance. Write today for (copyrighted) plans, positive proof and sworn statements. J. M. Pease Mfg. Co., 541 Pease Bldg., Michigan St., Buffalo, New York.

USE your spare time to build up a mail order business of your own. We help you start for a share in profits. 27 opportunities. Particulars free. Mutual Opportunities Exchange, Buffalo, N. Y.

MAKE yourself independent for life raising Glenseng. Requires little capital and spare time only. Worth \$6 a lb. Yields 5,000 lbs. to the acre. I'll teach you free and buy all you raise. Write T. H. Sutton, 1069 Sherwood Ave., Louisville, Ky.

OPERATE Hahn's Premium Machines. Let them gather pennies for you. The best seller for cigars and candies. J. L. Hahn, 1016 Germantown Ave., Philadelphia, Pa.

MAIL Order Business. I start you free. No investment but postage and stationary. P. Neunham, Waukegan, Ill.

HAVE you a mechanical device, toy, novelty, household or mail order article? If so, patent it through me and start in business with it. I show you how; book free. Sanders, 33 Crilly Block, Chicago.

INDEPENDENCE and fortune quickly attained in the Manufacturing Mail Order business. I furnish Formulas, Manufacturing Processes and Trade Secrets in all lines. Sold under positive guarantee; 15 years' practical experience. Revision and improvement of Formulas and Processes—reduction of manufacturing cost—utilization of waste materials, etc., a specialty. Booklet, Formula List, and Valuable Information Free. W. L. Cummings, Ph. D., 127 Standard St., Syracuse, N. Y.

STOP here! Let me start you in a home business that will bring you money every day. Experience unnecessary. Spare time. No canvassing. I furnish everything and guarantee success. Send for proofs. Voorhies, Desk C. R., Omaha, Neb.

FORM a corporation—Congress Law for D. C. and all States; cheap. Raise money easily. U. S. Legal Corporation, Washington, D. C. Representing \$1,225,000.000

COLLECT money by a sure, simple, easy way. Income \$1,000 to \$5,000 a year. Quick results. No capital required. Instructive book, "Skillful Collecting," fr. National Collectors Ass'n., Long Street, Newark, Ohio.

I WILL start you earning \$4 daily at home in spare time, silvering mirrors; no capital; send for free instructive booklet, giving plans of operation. G. F. Redmond, Dept. 306, Boston, Mass.

HAVE you anything to advertise? Our Rate Book tells you all about advertising mediums, rates, circulation, closing dates, etc. Sent for 10c. Worth dollars. Folder free. Correspondence invited. Dearborn Advertising Agency, 455 Franklin Bldg., Chicago.

PATENTS secured—C. L. Parker, 810 G St., Washington, D. C.

PATENTABLE ideas wanted—Send for 3 free books. Richard B. Owen, 39 Owen Bldg., Washington, D. C.

SELL your formulas, ideas, plans and knowledge by mail. Some make \$1,000 monthly. Instructive booklet for stamp. Information System, 271 Marietta, Ohio.

AGENTS WANTED

GET an Elegant Suit and make \$10 a day, acting as our representative in your town. Wear the swiftest suit your town ever saw—made to your exact measure, from your choice of cloth and styles. It need not cost you a dollar. Make \$10 a day showing your suit—taking orders for elegant Made-to-Measure Suits, delivered express paid for \$7.50 and up. We are spending a big sum to secure and assist a representative in every town. We make prices so low—your profits so big—confidential terms so liberal—that we can explain these only in a letter. No money or experience required. We want your spare time—not your money. We back you with our capital—teach you everything—give you the Big Outfit Free. Do you want the Exclusive Agency in your town? Then write quick and get the whole proposition, outfit and everything—absolutely free. Chicago Woolen Mills Co., 834 Jackson St., Chicago.

WANTED one good man in each town to take orders for men's tailoring; beautiful styles; very low prices; orders come easy; high class; permanent business; fine profits, \$10 a day and up; no money or experience needed. We ship on approval express prepaid, and guarantee perfect fit. Write for free sample outfit and inside prices on suit for yourself. Banner Tailoring Co., Dept. 726, Chicago.

100 PERCENT profit. Samples, ten cents. Sip Manufacturing Co., Jersey City, New Jersey.

SPECIAL Sales Manager wanted in your town right away. Plenty of money for you to spend. Hottest tailoring offer ever made. Orders turned over to you. Make \$50 a week at the start. Only part of your time. Your hobby free suit will attract so much attention that orders will simply roll in. Every order means dollars to you. Other good features. Paragon suits sell like wildfire. We prepay all express charges, too. Now is the time to get in. Be the first in your town to get this great offer. An opportunity to make the biggest success ever. Send post card with your name and address for our book of beautiful samples and full particulars. All free, so write at once. Paragon Tailoring Co., Dept. 1196, Chicago, Ill.

AGENTS—Live hustling men to canvass the homes and offices, selling my new electric device. Cuts electric bills in half. A demonstration sells it. Repeat order getter. You can make big money without previous experience. Complete outfit and selling instructions \$5.45, and I guarantee money back if not satisfactory. Exclusive territory is going fast. Write me today for my proposition. Stanley B. Fredberg, 950 Eighth St., East Cincinnati, Ohio.

YALE Automatic Adding Machine, all parts made of steel, nickel plated and warranted accurate \$1 prepaid. Yale Mfg. Co., Dept. 99.

HUSTLERS are making big money with the Fuller—the best and quickest selling line of sanitary household brushes made. Write now. Catalog free. Sample sent. Fuller Brush Co., 33 Hoadley Place, Hartford, Conn., Western Branch, Wichita, Kansas.

MEN wanted to show samples of strictly all wool union made clothing to their friends and take orders for real merchant tailored garments, not the common kind but the clothes "that make the man." Experience unnecessary. Popular prices. Write immediately for advance sample outfit, also full particulars regarding elegant dealers outfit free. Lees Tailoring Co., 23 So. 5th Ave., Chicago.

AGENTS—Make big money with our line; permanent customers; regular income; we help you build profitable business in your territory. Novelty Sales Company, Box 98, Pawtucket, R. I.

DID you ever hear of anyone selling Popular 25c Sheet Music at 5c? You can do it, and make 300 per cent. Four sample copies and proposition, 10c. Chicago Book & Music Company, 535 So. Wabash Ave., Chicago.

AGENTS—To sell the newest electric appliance on the market; sold everywhere there is electricity, in the home and office; liberal profits; sales-driving sample, weighs a pound, no experience or knowledge of electricity required; it shows how to use one light instead of two and get the same results; sells for \$3.50 and saves the purchaser an investment of \$35; write for particulars. The Handy Light Co., 711 East Eighth Avenue, Cincinnati, Ohio.

SALESMAN—Send your name and address to Raymond E. Wood, 900 East Eighth St., Cincinnati, Ohio. I am the manufacturer's Sales Manager for the best household and office electric specialty ever invented. Sells for \$3.50 and \$2.50. Guarantee for credit or deposit required. Capable men only need apply. I want only a few men. The work is permanent, profitable and high-grade. You will be given territory and expected to produce business.

100% PROFIT—Gliding Casters—New Invention. No rollers. Homes buy 6 to 40 sets. Hotels 50 to 500. Anyone can attach. Noiseless. Wont scratch floors. Saves carpets and furniture. Set costs 2c. Sells 10c to 25c. Exclusive territory. Samples 4c. Evergrip Caster Co., 20 I. Warren St., N. Y.

AGENTS and Salesmen—Just out. Marvellous automatic Self-Soaping Bath Brush. Uses liquid soap. Sanitary, clean, perfect. Needed everywhere; especially by travelers. Big field. \$10 day easy. \$1.75 profit each sale. Handsome demonstrating sample and bottle pure liquid soap, only \$1.50. Booklet Free. Burner Mfg. Co., Dept. 1, Toledo, O.

AGENTS—Prices smashed; never such an opportunity to get in on the ground floor. General Agents, here is a snap; Model Vacuum Cleaners operate like a carpet sweeper; powerful suction. Sells for less money than similar machines; gives both you and your sub-agents more money; don't pay big profits, make big profits. Write at once and be convinced. We are a satisfaction or money back concern. Model Vacuum Co., L 85, Cincinnati, O.

100 PER cent profit with this article. Never fails to sell everywhere. Repeat orders sure. Write for free particulars. Ellsworth Company, 163 W. Santa Clara Street, San Jose, Calif.

AGENTS—Send for free particulars in regard to fastest selling proposition on the market today. Forrest & Nazarene, Dallas Center, Iowa, Dept. E.

AGENTS—A pair of silk hose free this month only. Send no money, state size. Agents wanted in every town. Write today. Beautiful line. Large profits. Triple-Wear Mills, Dept. D, 112 So. 13th St., Philadelphia, Pa.

AGENTS wanted to sell glassstick labels in spare time. \$4 a day commission. Write for particulars. Warren Novelty Co., 5615 Chester Ave., Philadelphia, Pa.

YOU can make \$10 daily restoring colors to faded rugs and carpets in spare time; tremendous opportunity in your community; simple, easy; free particulars. Cox, Dept. MA, Omaha, Neb.

WRITES with water—The Helios Pocket Pens with compressed ink; beats fountain pens ten times its cost. Sample 25c. Big proposition to agents. William Muller, Security Bldg., San Francisco.



FREE, swell suits to wear—plenty of money to spend as our special manager in your town. Make \$40 a week easy. Suits sell like hot cakes. Your own free suit will get leads or orders from your friends. Only part of your time. No money out experience necessary. All orders we take in your section turned over to you. This is a most stupendous opportunity for one man in each town. Get in quick! We pay express on everything. Send a post card with your name and address for beautiful samples and full particulars, all free. Entirely new plan. Chance of a lifetime. Don't miss it. No obligations. Hurry! Write today. American Woolen Mills Co., Dept. 1196 Chicago, Ill.

AGENTS—250% profit. Wonderful little article. Sells like wildfire. Can be carried in pocket. Write at once for free sample. H. Mathews, 1962 Third St., Dayton, Ohio.

AGENTS—Sell your own goods, make all the profit. My home manufacturing proposition is a winner. It's profitable, permanent and pleasant. Once started it grows itself. Send for descriptive matter. J. Serrett Anderson, Minneapolis, Minn.

AGENTS Wanted—Everywhere, for our fast, easy selling proposition; write today for free particulars. Magic City Specialty Co., 1331 N. 36th St., Birmingham, Ala.

MAIL Order Men Get quick cash returns. We manufacture and distribute new specialties. Start high class M. O. Business. Small capital. Copyrighted prospectus free. No scheme. Box N-235, Pittsburg, Kansas.

AGENTS—Sell Air Brush Design Show Cards. Price tickets and other specialties for merchants. Big profit. Catalog free. Merchants Specialty House, 520 Franklin Bldg., Chicago.

OUR patented household articles sell like wildfire. Send 10c (mailing cost), catalog and sample. Delzell Mfg. Company, 445 South Mathews, Los Angeles, California.

AGENTS—100% profit. Every gentleman needs one in his vest pocket. Easy quick seller. Dignified work. Sample 10c. W. Alton Clifton, Dawson, Ga.

HAVE you any article you want manufactured? If so, send us sample or drawing to estimate from. Schultz Patent Office, Cincinnati, Ohio.

AGENTS—If you don't make \$1 profit the first day selling Tate's Dust Absorbing Dust Cloths, etc., return samples. Many Agents made \$25. Write quick for particulars. Dept. B-4, Consumer's Direct Supply Co., Boston, Mass.

WE want one selling agent in each town to represent the Magic Electric Suction Cleaner. This is a high grade proposition for high grade men only—that's really worth while investigating. Rosenfield Manufacturing Co., 12 Abingdon Square, New York City.

AGENTS—Push something that pays big profits. Necessities every Housekeeper buys on sight. New selling plan—Sure Winner—Permanent business; investigate now. Robert Blumer, 3422 Lincoln Ave., Chicago.

AGENTS—Valentine (dust) Absorbent Dusters, Mops, Brushes. Order by name from your supply house or direct from P. M. Valentine Mfg. Co., (Allston) Boston, Mass. or Urbana, Ohio. No animal or vegetable oils to cause spontaneous combustion.

DOUBLE your income by manufacturing your own goods. Send for list of plans and formulas. Birk Co., Peoria, Ill.

AGENTS—Free sample. A live seller. Work two hours a day. \$7 a day regular. Every family needs. Sunbeam Supply Co., Box 51, Coleraine, Minn.

SELL silk and hosiery, straight from manufacturers, every agent makes at least \$3 per day, many \$8 to \$15. Our hose pluses, our prices astonishing, everybody buys. Agents terms free—see how easily you can make money. Sample pair 40c, hose and outfit 25c. Service Hosiery Mills, Pectstown, Pa.

AGENTS—Get busy; latest invention. Fix It. Millions being sold; orders coming fast; act quick; big profits. Sample 10 cents. Eastern Specialty Co., Hoboken, New Jersey.

AGENTS—Big money easily earned handling Rogers guaranteed table Silverware; attractive new free deal plan; every woman buys on sight; quick repeater; exclusive territory to hustlers. Write today for free Special Offer. Commercial Supply Co., 516 Cambridge Bldg., Chicago.

ARITHMETIC—Handiest, fastest, cheapest. Computing Machine. Portable, durable, reliable, carries automatically, resets instantaneously! Calculates everything; saves work, worry and mistakes! Reliable agents desired everywhere. Three selling plans. Request full particulars. Arithmetic Co., 118 E. 28th St., New York.

AGENTS make big money selling our new gold letters for office windows, store fronts and glass signs. Any one can put them on. Write today for free samples and full particulars. Metallic Sign Letter Co., 406 N. Clark St., Chicago.

WE pay the largest commissions, make instant delivery. Guaranteed hosiery, year-wear shoes and silk knit neckties, free sample plan. Credit allowed. The Direct Company, 11 South St., Boston, Mass.

AS you can clear \$30 weekly year round mailing music evenings, why look further? Send 10c for facts, proof and beautiful new sheet music to Weber Music Co., Dept. 2527, Boston, Mass.

AGENTS—Portraits 35c. Frames 15c. Sheet Pictures 1c. Stereoscopes 25c. Views 1c. 30 days' credit. Samples and catalog free. Consolidated Portrait Co., Dept. 1196, 1027 W. Adams St., Chicago.

Be Independent! Start a mail order business in your own home. We tell you how, and furnish everything needed wholesale. An honorable and profitable business for man or woman. Particulars free. Many make \$1,000 a year. Murphy Mfg. Co., South Norwalk, Conn.

CHAUFFEURS make money with high grade \$5 automobile specialty; 66% profit. Ask Paul Charles Henry Co., Derby, Conn.

WANTED—Manufacturers, agents, etc., to handle new Patented office specialty never been seen, sells on sight in every office, factory and home; also advertising proposition. Address for territory. Double-Phone Mfg. Co., Inc., Boston, Mass.

AGENTS don't have to pay for a sample, when you join the Standup Scrubber sales organization, which is the best paid force of house-to-house salesmen in America. Write quick and give two references if you want to get in. Elmer E. Stevens, Inc., 1189 River Street, Aurora, Illinois.

AGENTS make 300% profit selling our gold window letters, novelty signs and changeable signs. 800 varieties in enormous demand. Catalogue free. Sullivan Co., 1238 Van Buren St., Chicago, Ill.

AGENTS—100% profit on Rope Maker. Sells like hot cakes. Makes rope any length. Sares buyer 200 to 400%. Free sample. Write. Simplex Mfg. Co., Dept. A, Kewanee, Ill.

REPAIR Kit, repairs puncture in one minute. Automobile owners want it. Write immediately for honest, profitable proposition. Don't miss it. William H. Eckow, Redlands, Cal.

AGENTS wanted to handle "Century Publishing Cloth" for sifter. Send 25c for sample and agents price list. J. L. Connor, 519 Ivy St., Pittsburgh, Pa.

PORTRAIT Agents for good work; write to W. J. Benedict, Chicago, Ill.

AGENTS: Our specialties spell cash. Adam Fisher Mfg. Co., 61-15, St. Louis, Missouri.

AGENTS—Sell to Saloons—Machine sells like a whirlwind. 100% profit. Free sample and course in salesmanship. Only two sales a day means \$15 a day for you. It's easy. Write. Simplex Mfg. Co., Dept. B, Kewanee, Ill.

"BOOSTER"—The magazine you need! Send 10c for two months trial. Booster Magazine, Northwestern Building, Chicago.

AGENTS—\$4 to \$10 a day sure; easiest money maker ever produced. Write quick. Empire Supply Co., Jamestown, N. Y.

AGENTS—Reliable house. New catalogue; 2 leaders; best on earth; bar none. Big household line. J. W. Wadsworth Co., Harland, Me.

SELF threading needles, 10c a paper. Agents' samples and terms free. Ladies' Art Co., Dept. 41, St. Louis, Mo.

AGENTS—We have best line patent household articles. Not sold in stores. Send for catalogue. Central Sales Co., Dept. B, Lincoln, Nebr.

Big money selling typewriters. Read our advertisement under "Typewriters." Minnesota Typewriter Exch., Minneapolis.

AGENTS—Weeping Doll, patented, very laughable. P. Box 7, Rosindale, Mass.

READ the Agents Magazine, 2 months 10c. Agents Magazine, Chicago.

AGENTS—Repeater, costs 5c sell for 50c. Sample free. Thorber Laboratory, Ferris, Ill.

AGENTS—Earn \$3 to \$6 per day. If you are ambitious here is your chance. Catalog and particulars free. Garland Supply Co., 309 Helen Ave., Detroit, Mich.

AGENTS—\$20 daily easily made with our fast selling specialty. Catalogue free. Newell Specialty Co., Box 103, Muskegon, Michigan.

HOORAY Boys—Look at this winner. I offer it to you. Take hold now; profits big; easy work. Free particulars. David Supply Co., Box 199, Casper, Wyo.

To sell our Gun Sights, \$3. Commission. Williams & Sons, Wintenberg, Wis.

A LIGHTNING seller. Needed in every home. Agent made \$37.50 one day. Particulars free. S. Q. Kline, 933 H St., North, Washington, D. C.

REPUBLICAN, Democratic Campaign Watch Fobs; whirlwind sellers. Samples ten cents with catalogue. Agents Winners. Paris Company, Melrose, Mass.

Sign Agents—Painters: Something new and better. Attracto ready-made Gold and Silver Letters. 21 kinds, easily applied. Make big money lettering store windows and selling sparkling chipped glass nameplates. Catalogue and sample letter free. Attracto Sign Co., 2655 N. Clark St., Chicago.

Portrait agents, 10x20 crayon, sepia, pastels, bromide, 40c. Big money in our convex portrait; delivery guaranteed or money back; portrait and frame catalogue and samples free. Siegfried Portrait Co., Dept. P. M. 3, 3219 Ellis Ave., Chicago.

WANTED—Local or Traveling Salesmen making small towns to handle our new, attractive, pocket saddle, quick shipments, prompt commissions, no collecting. State territory covered. For particulars, address Peerless Mfg. Co., 216 Steel St., Chicago, Ill.

Be our Sheet Music Salesman in your town; 100% profit. 3 sample copies late this, 10c. Write for our liberal proposition. Addison, Crilly Bldg., Chicago.

CUT out fads and fancies. Handle a sensible line of patented household necessities. Send for catalogue and unique selling plan. Lyon-Edwood Mfg. Co., East St. Louis, Ill.

AMERICAN Lady Fibre Brooms—replace corn brooms everywhere. Guaranteed one year. Exclusive agency means a monopoly and life independence. For sixty cents I send sample, instructions and reserve territory. F. L. Hurt, 2255 S. State St., Chicago.

You can sell this Office Specialty—Demonstration—No talk does it. Sell from your pocket, easy and quickly. 200% profit. Winner for 3rd line. Particulars free. Bayless Sons Company, Muncie, Indiana.

QUICK selling vacuum cleaner, powerful sweeper type, double suction; \$75 to \$100 weekly; exclusive territory, wholesale prices to hustlers. Varm Co., 1488 Security Bldg., Chicago.

WE furnish you capital to run a profitable business of your own. Become our local representative and sell guaranteed Sweaters, shirts, Neckties, underwear and hosiery direct from our factories to the homes. Write. Steadfast Mills, Dept. 12, 17 Courtland St., Cohoes, N. Y.

AGENTS—Sign painters. Cost 2c, sell 25c. Something new. Guaranteed Sign Letters mounted with kerosene and roller. Grip outfit free. Boss Letter Co., 2497 Milwaukee Ave., Chicago.

AGENTS—Men or women to handle our supplies. All or spare time. Pleasant and very profitable. We gladly aid you to build up a good business; write us today. The Charles W. Reed Co., 805 East Capitol St., Washington, D. C.

AGENTS—Men and women. Be the first to sell Only Self Oiling Mop on market. Household necessity. Big money maker; write at once. Eureka Sales, 116 So. Michigan, Chicago.

AGENTS—No experience necessary to make big money every day with most useful article on the market; write today. Fisher Specialty Co., Box 422, Geneseo, Ill.

STOP—Agents—Big money for you. 5 wonderful sellers; samples and particulars for 15c; act now. Novelty Company, Room 711, 210 S. Dearborn St., Chicago.

WE manufacture five fascinating gam. boards; 150% profit; orders repeat; best side line with cigars, candy, etc. Particulars. Bechter Game Co., Independence, Iowa.

AGENTS wanting big money quick; get the latest publication, "Stewart's secret formula and recipe book." Recipes that have made fortunes for the manufacturers. Sells, \$1.50; send 50 cts. for original copy, every one wants it, \$2 an hour each. Carlos Stewart, Chemical Specialist, Connersville, Ind.

BEAUTIFUL, embossed gold window letters, make 100% profit without experience. Signs always needed. Ours last for years. Rock bottom prices. Essentials to work with mailed free. Embossed Letter Co., 2494 Milwaukee Ave., Chicago.

HUSTLING agents wanted everywhere, to sell our daily expense record. Everybody needs it, sells on merit, 100% profit. If you wish to earn \$25-\$50 per week, send 50 cents for sample and particulars. Southern Sales Co., Rome, Ga.

CANVASERS to sell automatic Screen Door Catches; quick, easy sales, big profits; simple catch postpaid for 25c in stamps. You can have exclusive territory. Superior Door Catch Co., Superior, Wis.

YOU are looking for more long green. You doubtless deserve it, and willing to work for it. Our soap and toilet article combinations have every ear-mark of being the real Coin Getters—we can prove that they are. Write for our convincing proofs. Davis Soap Works, 264 Davis Bldg., Chicago.

WANTED Agents—Boys and girls earn a gold ring by selling twenty packages of Chewing Gum. We send gum free with catalogue of presents. Write a postcard today for gum. The Columbus Gum & Premium Company, P. O. Box 36 Station A, Columbus, Ohio.

AGENTS—140% profit selling Steel Wool Dish Cleaner. Large demand. Housekeepers say, "Superior to other cleaners." Test free sample and prove our statement. Write today. P. C. Hanson, Southbridge, Mass.

AGENTS—Make \$5 daily handling our up-to-date Door Plates, Name Plates, House Numbers, Signs, etc. Samples free. Brett Bros., Boston, Mass.

\$2.50 PER DAY. Paid one man or woman, in each town, to distribute free circulars and take orders for concentrated flavoring in tubes. Permanent position. J. S. Ziegler Co., 445-D Dearborn St., Chicago, Ill.

SWEEP in the \$ \$ \$ with our "Wonder-broom"—made of India Bassine. Superior to finest broom-corn. Absolutely new. C. Krebs, 2249 Archer, Chicago.

\$50 EASILY made is better than \$50 saved for. You've got the goods in Ortol Vacuum Cleaners. Demonstration makes a sale; works better than expensive machines. Write Park Specialty Co., Harris, Iowa.

TWO crackerjack sellers. Patent Retort Pipe Cleaner, Aluminum Plant or Clothes Sprinkler; samples 15c, both 25c; particulars free. George Hubert, Yonkers, N. Y.

AGENTS—Every smoker wants, and buys on sight, our self-lighting windproof cigar lighter; you can make big money selling them. No talking sells itself. Rathbun M. Co., Indianapolis, Ind.

AGENTS—New fiber home brooms; costs same as good broom; outlasts four. Sold only by agents. Guaranteed. Hilker Mfg. Co., 1260 Grand Ave., Chicago.

FOR big money, nothing like our up-to-the-minute window letters. The Slann Sign System, Detroit, Mich.

AGENTS—Cost 2c, sell 25c. Window letters you can put on with roller. Postal brings free mounted samples. Ward Letter Co., 2569 Milwaukee Ave., Chicago.

SILVER Plater. Pure silver plating on metal; costs 3c, sells 25c. Instructions and secret formula for only 2 this dime, 20c. Sterling Co., 231 Bld'g, Denver, Colo.

AGENTS—You can easily earn \$20-\$50 a week selling our new household article. Repeat orders; sample, 35c. Nagel-Gerth Co., 3433 Drake Ave., Chicago.

AGENTS coinng money, newest article out; doubles life of auto tires. Send \$3 for \$5 outfit. Write today. Williams Specialty Co., Buffalo, N. Y.

AGENTS—Our patented specialties sell rapidly. Send for catalog and free sample. Baker Supply Co., 709 Marin St., Vallejo, Cal.

PATENTS Bring Wealth. Proof and advice free. Wedderburn, Patent Attorney, Washington, D. C.

SMALLEST Alarm Clock, 10c postpaid. W. H. Garner, 119 South Lafayette St., Evansville, Ind.

AGENTS—Everybody wears Hose. Sell direct consumer; the line that repeats. Credit plan helps you. Exclusive Agency to Hustlers. Address D 2 Lehr Mfg. Co., Denver, Colo.

WANTED Salesmen—Earn \$250 per month, sell dealers highly advertised article. Elato Co., Station L, New York, N. Y.

\$40 PROFIT on each case. Best proposition on earth. Samples and particulars, 10c. Mullin Co., 4410 Princeton Ave., Chicago, Ill.

MAKE your own rubber stamps. Complete outfit, \$10. Circular free. Stamp Works, Newcastle, Ind.

\$5 TO \$10 a day for reliable men and women agents; sample and complete outfit free; credit given; easiest, fastest, best sellers ever offered; a sale for every call. Alts of Moline, Ill., averaged near \$1 an hour; Wicht of St. Paul, Minn., working only part time, averaged \$135.00 month for six months; Still of Latexo, Texas, made \$12.50 in eight hours and says "anyone willing to work can make \$5 to \$10 a day." 400 per cent profits for you; full details free. Address Dow Sales Co., Dept. 83, Topeka, Kan.

AGENTS on salary or commission. The greatest agent's seller ever produced; every user of pen and ink buys it on sight; 200 to 500 per cent profit; one agent's sales amounted to \$420 in six days; another \$32 in two hours. Monroe Mfg. Co., X, 6 La Crosse, Wis.

AGENTS—Make \$2 each selling our wonderful luminous crucifixes; nothing to sell six a day; absolutely new; shine all night in darkest room. Pioneer Portrait Co., 1259 W. 63rd St., Chicago.

AGENTS—\$25 a week for 2 hours work a day. A brand new hosiery proposition that beats them all. Write for terms and free sample if you mean business. Guaranteed Hosiery Co., 1062 Third St., Dayton, O.

FREE—Safety Razor, Fountain Pen.—other valuable premiums. Just a few hours spare time. Particulars free. Em-Co., 94, Duluth, Minn.

AGENTS—700 Things a Boy Can Make—Can you bear it? Set of 4 books that sell for only 1¢. Everyone is interested. Enough to keep a boy busy until he grows up. Parents want them for their lads. Good liberal commission. Exclusive territory. Write to Popular Mechanics, Book Dept., 318 W. Washington St., Chicago.

AGENTS—\$15 to \$30 a week. The vest pocket coat and hat hook sells at sight. Easy work. Big profits. 10c brings sample and terms. Lynch Mfg. Co., 1824 Scott St., Wilmington, Del.

MY new Census Business Guide. Fastest selling book on earth. Agents making \$10 daily. Outfit free. Prof. Nichols, Dept. 6, Naperville, Ill.

IDEAL Mail Box. The best sanitary, suitable Mail Box manufactured. New idea, patented. Valuable Premiums. Write for sample and Big Free Catalogue. Unlimited opportunity for agents. Sample Box, prepaid, \$1.25. Standard Sales Co., Rockingham, N. C. R. 2.

AGENTS—One cent invested in a postal card will bring you a \$35 to \$60 a week proposition. American Aluminum Company, Division 7, Lemont, Ill.

HUSTLING Agents Wanted for our fast selling sanitary Household Brushes. Steady work. Big profits. Postal brings particulars. Dept. C. Hale & Kavanah, New Britain, Conn.

SELL dry goods remnants. We can start you in new, profitable business. Remnant Store, Dept. 10, Cincinnati, O.

MAKE yourself independent by silvering mirrors. Send for booklet. M. K. Thompson Co., Dept. K, Akron, Ind.

AGENTS to represent manufacturer. Lot-ton, Waverly St., Buffalo, N. Y.

BOKARA Diamonds—Agents, everyone, to wear and sell our famous Bokara Diamonds. Write for sample offer and catalogue free. Northwestern Jewelry Co., 52 Northwestern Bldg., Chicago.

AGENTS—Our new De Luxe Steel Mantle Burner. Fastest seller on market. Fits all lamps. Converts kerosene into gas. Smokeless, odorless. Guaranteed perfect white light. Sample burner postpaid 25c. Lyndhurst Burner Co., Dept. B, Lyndhurst, N. J.

EARN \$15 to \$25 a week or more as our Mail Order Dealer Right from your own home. Hold your position until entire time is required. We are manufacturers and owners of patented just-in-season specialties. If you are just starting a Mail Order Business or if already established, you can't afford not to handle our Patented Money-Making Getters. We sell exclusively to our Mail Order Dealers. We protect them. We carry stock and furnish everything. No canvassing. Small capital. Experience unnecessary. Write today for Latest Patented Lender and Manufacturer's Easy Selling Mail Order (copyrighted) plan backed up by "Whole Truth." Positive Proof and Sworn Statement. J. M. Pease Mfg. Co., 533 Pease Bldg., Michigan St., Buffalo, N. Y.

MR. Agent may we interest you in three of the best selling and most profitable articles ever offered. Would 400% profit make you "take notice"? For samples enclose 4c postage. United Sales Agency, Franklin, Pa.

1500% PROFIT selling our sign letters. We'll show you how. 100 varieties; sample free. Johnston Co., Quincy, Ill.

AGENTS—Our Sun-Ray incandescent kerosene mantle burners guaranteed, best on market; 100 candlepower light. Gallon kerosene lasts 68 hours. Particulars free. Simplex Gaslight Co., Dept. P, New York.

AGENTS are successful handling our automatic razor stropper—easy seller—satisfaction guaranteed. Retail \$1.50. Profit 100%. Write for terms. Auburn Supply Co., 7746 Peoria St., Chicago.

CASH for names, addresses, information, etc. Steady income at home. Instructive booklet for stamp. Information System, 272, Marietta, Ohio.

AGENTS—\$50 weekly; we manufacture the best needle case made; a wonderful seller; 200 to 500 per cent profit; talking unnecessary; our copyrighted "Trust Scheme" Envelopes do the work; general agents can make over \$100 weekly; send 10c for a 25c sample containing 115 needles; particulars free; buy direct from the factory at wholesale. Pity Needle Co., 102 Union Sq., Somerville, Mass.

AGENTS—County and State; men and women everywhere to sell the Pinless Clothes Line; a practical labor saving invention, lasts life-time, sells on sight, gives perfect satisfaction. Agent Sutton of Georgia, sold over million feet; 100% profit; write quick for exclusive territory; information free; sample, prepaid 25c stamps. Pinless Clothes Line Company, 520 Wilcox Bldg., Portland, Oregon.

AGENTS—We manufacture glass paper, Plain glass windows made to look like real stain glass; something new; easily applied; big money maker; two sample sheets of paper, with catalogue in colors and discount sheet, for 10c. S. H. Parrish & Co., 202 S. Clark St., Chicago.

AGENTS are making \$50 a week selling Steel Mantle lamp and lantern burners. Sample burner mailed to your address for 25c. Particulars free. Steel Mantle Light Co., 329 Huron St., Toledo, O.

YOU can make \$355 as our general or local agent. Household necessity; saves 80 per cent; permanent business; exclusive territory; salary or commission; free sample; credit. J. Pitkin, 113 Redd St., Newark, N. Y.

AGENTS Wanted:—Mechanics and shopmen make over \$100 a month in spare time selling transparent handled novelty knives and razors. Big profits. Sales easily made. Write for terms today. Novelty Cutlery Co., 47 Bar St., Canton, O.

500% PROFIT selling our wonderful sign letters for office windows, store fronts and glass signs; resembles finest gold leaf; easily applied; samples free. Metallic Letter Co., 406 N. Clark St., Chicago.

AGENTS Wanted—Sell Rich Looking, Imported 3x6x8 rugs, \$1 each. R. H. Carter, Milan, Tenn. sold 115 in four days; big profits, \$57. You can do as well. Write for sample offer and unique selling plan; exclusive territory. A. Condon, Rug Importer, Stonington, Maine.

SALESMEN wanted: A reliable, permanent business, selling Koeth's Combination Kit, the most wonderful tool ever invented. Six pairs drop forged tool steel jaws, one pair handles makes pliers, pinners, punches, wrenches, etc. Invaluable for mechanic, farmer, chauffeur, handy man. Currier-Koeth Mfg. Co., 52 West Street, Coudersport, Pa.

AGENTS make \$30.00 weekly selling our 500 Handy Household Articles; catalogue free. Scheff Co., 1137 Wells St., Chicago.

AGENTS: Our Columbia Folding Hand Bag is the best proposition on the market. Not sold in stores. Big profit. Write for terms and other big sellers. S. V. Diamond, 35 West 21st St., N. Y. C.

MEDALLIONS sell at slight, 500 per cent to 500 per cent profit. Make up your own goods and be independent. "It's easy." Catalog free. Fred Besag Co., 1205 W. Randolph St., Chicago.

WE manufacture six fascinating game boards, 100% profit. Orders repeat. Can be carried as side line where Candy, Pipes and Cigars are sold. Particulars free. Unique Novelty Co., Independence, Ia.

AGENTS—Unusual sellers. Big profit payers. Novelty jewelry, perfumery, hosiery. Price list, particulars free. Block Bros., 471 Eighth Avenue, New York.

PERFECTION Pocket Adding Machine. Lightning seller. Agents wanted. Cincinnati Specialty Mfg. Co., Dept. B, Cincinnati, Ohio.

\$100 MONTHLY and expenses to trust-worthy men and women to travel and distribute samples; big manufacturer. Steady work. S. Scheffer, Treas., G. W., Chicago.

STOP here! Let me start you in a home business that will bring you money every day. Experience unnecessary. Spare time. No canvassing. I furnish everything and guarantee success. Send for proofs. Vocables, Desk C. R., Omaha, Neb.

400% PROFIT selling Gordon Photo Pillow Top. High grade work. Samples and catalogue free. Luther Gordon Co., Northwestern Bldg., Chicago.

I WILL start you earning \$4 daily at home in spare time, silvering mirrors; no capital; send for free instructive booklet, giving plans of operations. G. F. Redmond, Dept. 396, Boston, Mass.

KEY tag—German silver—marked with your name and address, with key ring. 15 cents. We want you to take orders. 100% profit. We sell blank tags, steel letters, key rings, etc. Pease, Die Maker, Winchester, N. H.

AGENTS make enormous profit handling our quick-selling imported Oriental staples and novelties. Never been advertised. Re-orders. Exclusive territory. Write for particulars. Shaw Kanematz, Box 329, Portland, Oregon.

HELP WANTED

SONG Poems Wanted—Connect with Washington's Big Publishers. Best chances for success through our selling plan; complete introductory service through our field agents. Illustrated Book Free. Haworth Music Publishing Company, 4226, Washington, D. C.

WANTED—Men and women: for government positions. \$89 month. Annual vacations. Short hours. No "layoffs." Common education sufficient. Over 12,000 appointments coming. Influence unnecessary. Farmers eligible. Send postal immediately for free list of positions open. Franklin Institute, Dept. E 21, Rochester, N. Y.

YOUNG Man—Would you accept and wear a fine tailor-made suit just for showing it to your friends? Could you use \$5 a day for a little spare time? Perhaps we can give you a steady job; write at once and get beautiful samples, styles and this wonderful offer. Banner Tailoring Co., Dept. 727, Chicago.

FREE Illustrated book tells about over 200,000 protected positions in U. S. service. More than 40,000 vacancies every year. There is a big chance here for you, sure and generous pay, lifetime employment. Easy to get. Just ask for booklet A 29. No obligation. Earl Hopkins, Washington, D. C.

U. S. GOVERNMENT wants Railway Mail Clerks—City Carriers—Postoffice Clerks. \$80 month. Short hours. Steady work. November examinations everywhere. Coaching free. Write immediately. Franklin Institute, Dept. E 21, Rochester, N. Y.

TRAVELING salesmen answer this. Best side line yet. Brand new. Pays full travelling expenses, \$4 per order. Two to four orders a day sure. Consign goods. Pocket sample. Prompt commission. Dyer Mfg. Co., 2903 S. Michigan Ave., Chicago, Illinois.

AGENTS make big money and become sales managers for our goods. Fast office sellers. Fine profits. Particulars and sample free. One Dip Pen Company, Dept. 2, Baltimore, Md.

REPRESENTATIVES Wanted. Your chance. Take it now. Easy work listing names and property. Send dime for particulars and contract. "National Exchange," Box 72, Waterloo, Iowa.

WANTED—Railway Mail Clerks—City Carriers. \$89 month. Examinations everywhere soon. Coaching free. Franklin Institute, Dept. E 21, Rochester, N. Y.

GO on the Stage. Vaudeville career offered you. Experience unnecessary. Managers endorse my method. Instructive vaudeville book free. Write today. Frederic LaDelle, Sta. 19, Jackson, Mich.

BOILER Room Specialty. Leading manufacturer wants an exceptionally high grade salesman, capable of selling \$100 specialty to large power plants. Minimum com. on each sale, \$25. Ladd, 885 Niagara St., Buffalo, N. Y.

MAKE money writing short stories. Big pay. Free booklet tells how. United Press Students, San Francisco.

GOVERNMENT Wants Help. Write for list of positions open. Franklin Institute, Dept. E 21, Rochester, N. Y.

ANY intelligent person may earn good income corresponding for newspapers. Experience unnecessary. Address Press Correspondence Bureau, Washington, D. C.

WANTED salesmen everywhere, to sell entirely new articles for the household, office and factory, 100 to 200% profit, ready sellers. Jackson Mfg. Co., Memphis, Tenn.

MEN and women wanted for government positions. \$89 month. Thousands of appointments coming. Write for list of positions open. Franklin Institute, Dept. E 21, Rochester, N. Y.

\$5 FOR Four Hours' Work—Proposition for chauffeurs or mechanics. H. Davis, 55 E. Main St., Columbus, Ohio.

YOU can make \$10 daily restoring colors to faded rugs and carpets in spare time; tremendous opportunity in your community; simple, easy; free particulars. Cox, Dept. MA, Omaha, Neb.

YOU are wanted for government job. \$89 month. Send postal for list of positions open. Franklin Institute, Dept. E 21, Rochester, N. Y.

SALESLADY wanted for Highgrade Corset, not sold in stores. Best corset, best proposition to salesladies. References. Wade Corset Co., Station 1, New York.

SIDELINE, new advertising novelty. Sells in every town. Large commissions. Central Sales Co., Dept. A, Lincoln, Neb.

BE a Detective. Write Johnson's Detective Training Correspondence School, Houseman Bldg., Grand Rapids, Mich.

READ the Agents Magazine. 2 months 10c. Agents Magazine, Chicago.

WE teach you a trade in a few months' time; no expense but your work. Electricity, automobiles, plumbing, bricklaying. 100 satisfied workmen today; 40 jobs going. Catalog free. United Trade School Contracting Co., Los Angeles.

BIG Money Writing Songs. Hundreds of dollars have been made by writers of successful words or music. Past experience unnecessary. Send us your song poems, with or without music, or write for free particulars. Acceptance guaranteed. If available, by largest publishers in Washington—only place to secure copyright. H. Kirkus Dugdale Company, Dept. 265, Washington, D. C.

WE train detectives. You can be one. Splendid opportunities. Travel. Earn \$100 to \$500 monthly. This fascinating profession taught practically and scientifically by mail at a nominal cost. American School of Criminology, Dept. P, Detroit, Mich.

UNCLE Sam is a liberal employer. Qualify for a government position. We prepare you by mail for any Civil Service Examination. Write today for free booklet 32. Capital Civil Service School, Washington, District of Columbia.

WANTED—Young men to take subscriptions in their locality for a well known mechanical trade publication. Liberal inducements; a chance of permanent employment for capable men. Domestic Engineering Co., 445-447 Plymouth Court, Chicago.

7,000 GOVERNMENT jobs open. Write for list. Franklin Institute, Dept. E 21, Rochester, N. Y.

WANTED—Men and women to earn \$4 to \$15 per day. Send stamp for particulars. M. S. I. A., Indianapolis, Indiana.

PATENTS Bring Wealth, Proof and advice free. Wedderburn, Patent Attorney.

EARN \$10 to \$15 a week and hold your position besides. No canvassing. We, as manufacturers of patented just-in-season specialties, have new easy mail order plans to keep factories busy. We furnish everything. Large profits. Small capital. Experience unnecessary. If you are one of the want-to-go-ahead kind, write for our most modern (copyrighted) plans. Sworn statement. J. M. Pease Mfg. Co., 549 Pease Bldg., Michigan St., Buffalo, N. Y.

WANTED—Distributors of advertising matter everywhere. American Distributor, 100 Mount Pleasant, Pennsylvania.

WANTED one thousand chauffeurs and repair men. Our demand for automobile engineers exceeds the supply. Calls for men of intelligence and mechanical bent capable of commanding \$100.00 to \$150.00 per month upon graduation. Resident course \$28.00 to \$50.00. Home Correspondence course completed by practical road and shop work at this school, highly successful. Look this up. Auto Schools of America, Dept. T, 1690 Michigan Ave., Chicago.

STOP here! Let me start you in a home business that will bring you money every day. Experience unnecessary. Spare time. No canvassing. I furnish everything and guarantee success. Send for proofs. Vocables, Desk C. R., Omaha, Neb.

I WILL start you earning \$4 daily at home in spare time, silvering mirrors; no capital; send for free instructive booklet, giving plans of operation. G. F. Redmond, Dept. 396, Boston, Mass.

BE an electrical meterman—\$60 to \$1,800 a year. New field. Demand for competent metermen greater than supply. Personal, practical mail instruction qualifies you for splendid position. Graduates assisted. Write for particulars. Fort Wayne Correspondence Schools, Dept. 20, Fort Wayne, Ind.

WANTED—Hustling man in each locality. Join this Society. Sick, accident, death benefits. Introduce our Memberships. Spare time to start. \$50 to \$300 a month. Write, Box JF-293, Covington, Ky.

WANTED, Agents, Machinists, Attention! Increase salary, new revised Saunders' Hand-Book of Practical Mechanics. Best ever ready reference. Thousands in use. Postpaid \$1.00 cloth; \$1.25, \$1.50 leather flap. Big profits. E. H. Saunders, 216 Purchase St., Boston, Mass.

GOVERNMENT post office examinations everywhere soon. Get prepared by former U. S. Civil Service Examiner. Write today for free booklet. Patterson Civil Service School, Box 426, Rochester, N. Y.

MEN and boys to learn automobile repairing, driving on up-to-date cars; electricity, civil engineering, surveying. Methods most practical. Room and board while learning. Positions secured; satisfaction guaranteed; catalog free. National School of Engineering, 2119 W. 7th, Los Angeles.

CASH for information, names, formulas, and ideas. Steady, profitable home business. Instructive booklet for stamp. Information System, 273, Marietta, Ohio.

CEMENT

ADJUSTABLE Burial Vault Molds, new and simple. Makes the best vault known and offers big profits for right man. Write for booklet, A. S. V. Co., Peru, Ind.

IF you want the best information on cement and concrete construction, subscribe for Concrete-Cement Age, leading cement and concrete monthly. Sample copy, 10 cents. Yearly subscription, \$1.50. Concrete-Cement Age, 135 Newberry Bldg., Detroit, Mich.

CONCRETE Building Block Machines and molds. Free catalogue. 5 Market St., St. Louis, Mo.

MOTION PICTURES

MOVING Picture Films and Equipment of all kinds appertaining to the business. For sale over one million feet of film listed in our new catalogue. Acme Film Co., 125 West 37th Street, New York.

MOTION picture plays wanted. You can write them. We teach you by mail. No experience needed. Big demand and good pay. Details free. Asa'd M. P. Schools, 601 Sheridan Rd., Chicago.

POWERS No. 5 Moving Picture Machine, \$99, or will exchange best offer. Martin Fredericks, 2017 North Twelfth Street, Philadelphia, Pa.

WANTED—Picture Play Writers. Big pay. We'll teach you how. United Picture Play Association, San Francisco.

BUY the Junior guaranteed Professional Moving Picture Film making outfit for special events. Eberhard Schneider, 219 Second Ave., New York.

FOR Sale—Slightly used Moving Picture Machines. One Edison machine, \$68. Chas. Teigarden, Greenville, O.

MACHINERY, TOOLS, SUPPLIES

REWARD—We wish to purchase some good Second Hand Machinery for Iron and Brass working and will pay a Cash Reward for first information as to where same can be found provided we purchase. Chicago Machine Tool Company, 125 North Canal Street, Chicago, Illinois.

FOR Sale—Two American Saw-Mill Machinery Co. 6 inch water turbines, one with and one without cast iron casing. Address F. E. L., 5540 Woodlawn Ave., Chicago, Ill.

FOR Quick Sale 11 inch engine lathe, \$69; 12", \$80; 12" Mechanics drill, \$27.50; planer, engine, fox, bench lathes, arch, horn, apron, punch and kick presses, power sq. shear, grinders, tire bender, etc. Fred C. Dickow, 35 So. Desplaines, Chicago.

NEW Vertical Boilers, 1½ hp. complete, \$37. Send for sixty-four page Catalog of Machinery bargains: Boilers, engines, electrical machinery, machine tools, etc. Wickes Brothers, Saginaw, Mich.

MANUFACTURING concern reducing equipment of Chas. E. Wright Metal Band Saw Machines, desires to dispose of 25 machines all in A-1 condition. Any reasonable offer accepted. Address Machinery, 819 Broad St., Newark, N. J.

FOR Sale—Upright Boiler, 8 hp., splendid condition, completely equipped, cost \$280, will take \$125. Photograph. Benedict, 1069 Davis St., Evanston, Ill.

FOR Sale—6x8 single, Climax Power Air Compressor. Cost new, \$250. Fine condition. \$100 immediate sale. Empire Type Foundry, 1038 Elliott St., Buffalo, N. Y.

MANITOU Marine Motors, 5 hp., \$62; 10 hp., \$104; 25 hp., \$189. Satisfaction guaranteed. Rough and Machined castings of same for sale. Richards Engine Works, Manitowoc, Wis.

FOR Sale—2 hp. motor, 4 ceiling fans; direct current. Will exchange for alternating. E. K. Balligh, Prairie City, Ia.

HOW to run and install gasoline engine; booklet and Digest one year, 25c. Has gasoline engine department, Digest, Grand Rapids, Mich.

GASOLINE Engines: New 4 cylinder, 45 hp. New 35 hp. New 22 hp. Cheap. Guaranteed. Host of automobile. Bill Ferguson, Waterloo, Iowa.

½ H. P. GASOLINE engine castings, \$5. Complete engine \$22.50. Stamp for circular. Crown Motor Works, Elgin, Ill.

FOR Sale—Small electric motors; bargain; write for information. Henry Gonsalves, Turtle Creek, Pa.

22 H. P. Vanduzen Gasoline Engine, \$400. What have you to trade? Frank Suffern, Decatur, Ill.

ONE lathe 16" swing, 8' bed. Cheap. Minn. Eng. & Mach. Co., 2389 University, St. Paul, Minn.

FOR SALE—20 hp., 4-cyl., marine engine. Good condition. \$150. E. Larson, Rice Lake, Wis.

FOR Sale—One 30 K. W. engine and dynamo, 125 volt; one two side planer, 20 in. Geo. J. Adams, 39 South St., New York.

FOR Sale—One six horsepower vertical Alamo gasoline engine; never used. W. B. Connally, Trenton, Ga.

CASTINGS, ¼ horsepower, water cooled, two cycle, with drawings, \$4. ½ horsepower, \$5. Mustin Mfg. Co., Newport, Kentucky.

FOR sale or exchange. 10 Horse Stanley engine and boiler. W. J. Moran, 4525 Kennerly Ave., St. Louis.

\$20 **TAKES** 2 hp. dynamo or motor. Hall, 632 W. 62nd St., Chicago.

7 H. P. Portable Olds Engine, running order. Bargain at \$25. Ralph Cowles, Canton, Conn.

6 H. P. Watkins, 2 cylinder for \$100. Evan Owen, Weems, Va.

GASOLINE Engines, new way, almost new—7 Horse, \$100; 2½ Horse Ideal, \$40. Concrete mixers, hoists, block and brick machines; trucks, scales, Standard Scale Co., 1345 Wabash Ave., Chicago.

PULLEYS, Gears, Sprockets, Shafting, Hangers; see page 144. W. A. Jones Foundry & Machine Co., Chicago.

PATENTS Bring Wealth. Proof and advice free. Wedderburn, Patent Attorney, Washington, D. C.

FOR Sale—45 hp. Atlas engine; 66 Enterprise meet chopper; silent cutter, jacket kettle, rendering outfit, 3,400 lbs., norm. geared elevator 50 ft., 15 in. leather belt; all good as new. D. Hereley, Harvard, Illinois.

60 H. P. Fitzgibbons boiler. Seven years used; good condition. Was insured and inspected by Hartford E. Gutsch, Buffalo Center, Ia.

FOR Sale—One 10 hp. single cylinder marine engine. Price, \$70; also one 5 hp. Price, \$40. Split & Boettcher, Manitowoc, Wis.

UNIQUE engines are small, powerful and compact. See our ad on page 144. Amateur Mechanics Supply Co.

25 **HORSE** power gas or gasoline engine, 400 light dynamo, suitable for nickelodeon; good order; cheap. 1727 5th Ave., Pittsburgh, Pa.

FOR Sale—One iron planer, one drill press. W. J. Ferrell, Barberton, O.

WE are headquarters for Machinery for sheet metals—Presses, Punches, Shearing Machines, Timmers' tools, Dies, etc. First class goods at reasonable prices. Niagara Machine & Tool Works, Buffalo, N. Y.

DON'T keep that "good idea" in your head because you cannot develop it. My experience and machine shop will help you. Drop me a line. S. Mason, Jr., Germantown, Philadelphia, Pa.

REBUILT Engines—We have on hand a number of rebuilt "Buffalo" engines, guaranteed, at greatly reduced prices. Write for bargain list. Buffalo Gasoline Motor Co., 1293-1305 Niagara Street, Buffalo, N. Y.

ENGINE castings, 1½ horse vertical gasoline, air-cooled, \$7. Three horse marine water-cooled, \$9 cash; drawings included; catalogue for stamp. Novelty Manufacturing Co., 353 West Sixth St., Cincinnati, Ohio.

FOR Sale—Gasoline engines, automobiles, marine and stationary, also castings. Second-hand ones taken in exchange and for sale. Apply with stamps. B. W. Richardson, R. No. 38, Peoria, Ill.

FOR Sale—Engine lathe, swings 9½ in. takes 25 in. between centers. Complete with full set change gears to cut all size threads, 3 to 40 in.; price only, \$43.50. Address L. F. Grammes & Sons, Allentown, Pa.

STEAM boiler outfits, complete; 1½ horse power, 20" diam., 51" high, \$40. Page Boiler Company, 815 Larrabee St., Chicago.

FOR Sale—Rebuilt: Throttling, Automatic and Corliss engines, boilers, pumps, heaters, machine tools, tanks, saw mills, and general machinery, at bargain prices. Let us know your wants. The Randle Machinery Co., 1761 Powers St., Cincinnati, Ohio.

SIMPLE mechanical inventions wanted; send sketch. Sanders, 29 Crilly Block, Chicago.

SEND 50c for booklet "How to Run and Install Gasoline Engines," and year's subscription to Gas Energy, 28 Murray St., New York.

LATHE for sale—For bargains in small lathes write South Bend Machine Tool Co., Dept. L., South Bend, Ind.

PATTERN makers! A book devoted to the principles of pattern and core making and molding. Written by G. H. Willard, a practical pattern maker of years experience. This book, just published, treats the subject in a much more simple, direct and effective manner than most books along this line. 224 pages, 312 illustrations. Price \$1.00 postpaid. Popular Mechanics Book Dept., Chicago.

SERIES of 7 lithographic models—Steamship, automobile, gas engine, steam engine, steam turbine, wireless telegraph and dynamo. Size 8x14 inches. All parts of these machines are shown and numbered to correspond to printed keys of names. Price each, 50 cents, postpaid or set of 7, \$3.50 postpaid. Popular Mechanics Book Dept., 315 W. Washington St., Chicago.

MANUFACTURING MACHINERY

DIES, models, stamping and special metal articles made; undeveloped inventions worked out. Low cost and strictest confidence. Expert Patent Attorneys furnished. Write now for estimates and free advice. Metal Novelty Co., 1921-23 Olive St., St. Louis, Mo.

INVENTIONS skillfully perfected and manufactured. Also high grade compound sub die work with best references. E. C. Brull, 4328 Iowa St., Chicago, Ill.

BUILD your Machines at our Works. Why? Because our shops are equipped with practical machinery. We employ practical men, of many years experience. We make our own tools for every job. We return your patterns promptly when job is completed, when requested to. We don't manufacture or imitate your goods. We are the manufacturer for the manufacturer. Write today. Practical Gas Engine & Machine Works, North Chicago, Ill.

WE make working models of any description, also tools, dies, punch-press work, and special machinery. Send us drawing or rough model for estimate. Send for catalogue of model supplies. The Pierce Model Works, 3405 Pierce Ave., Chicago, Ill.

INVENTORS. We manufacture Metal Specialties of all kinds, to order; largest equipment; lowest prices. Send perfect sample free for low estimate and best expert advice free. The Eagle Mfg. Co., Dept. B, Cincinnati, O.

I MAKE tools, patterns, models, manufacture special machines and articles to order. Inventions developed. Carl Baerwalde, Cleveland, Ohio.

WANTED small articles to manufacture. R. M. Hesse, Morrison, Illinois.

PATENTS Bring Wealth. Proof and advice free. Wedderburn, Patent Attorney, Washington, D. C.

WANTED, medium weight machinery to manufacture on contract, special machinery built, pattern work. J. T. Schaffer Mfg. Co., Rochester, N. Y.

MODEL Making. By a mechanical expert. 25 years experience. Reference. Correspondence solicited. Lyons Machine Works, Lyons, Iowa.

INVENTIONS perfected and manufactured. Reference: Your Banker. F. K. Russell Machine Co., Dallas, Texas.

DIES, jigs and tools built for stamping, cutting and drawing sheet metal. McCull Machine Works, Rochester, N. Y.

IRON brass and aluminum castings. Metal specialties. Patterns, models, polishing, plating and japanning. North Chicago Tool Works, North Chicago, Ill.

MECHANICAL ENGINEERS

MACHINE Designing, Inventors' Ideas developed, Working Drawings, Machinery designed to order. Cary L. Abbott, Mechanical Engineer, 1241 Unity Bldg., Chicago.

FLOUR & FEED MILLING MACHINERY

SPECIAL bargains in second-hand: Attrition mills, burr mills, crushers, corn shellers, bran dusters, dust collectors, purifiers, reels, double, single, 2 and 3-pair high roller mills, sieve bolters, receiving separators, scooters, etc. Write for description and prices. Sprout, Waldron & Co., P. O. Box 429, Muncy, Pa.

BOATS AND LAUNCHES

MOTORCRAFT Encyclopedia—A 150-page book that tells 1001 things every motor boatman should know. How to overcome engine troubles. Price \$1, postpaid. Popular Mechanics Book Dept., Chicago.

CHART of a modern submarine boat showing and naming over 200 parts. Size, 14x28 inches. Printed on plate paper. Shows clearly and distinctly all the interior. Mailed in a tube for 25c. Popular Mechanics Book Dept., 318 W. Washington St., Chicago.

WANTED

WANTED—Manufacturer to manufacture children's convertible sleighs and carriages. For further particulars write to John G. Hatfield, 119 Loomis St., Little Falls, N. Y.

WANTED—Specialties for mail order business. Northern Mail Order Co., Box 467, Saranac Lake, N. Y.

WANTED—One 3 K. W. 110 V. D. C. Fly wheel generator. W. B. Connally, Trenton, Ga.

WANTED—Sample copies and advertising rates of mail order publications. All publications carrying a classified section preferred. Johnson, 4250 N. Kimball Ave., Chicago.

FOR SALE

FOR Sale—Engrave your name on your knife blade and all tools. Complete outfit for 10c. Reichart Electric Manufacturing Company, Lafayette, Indiana.

BICYCLES and Motorcycles—good secondhand bicycles—excellent condition, \$7 and up, also Pope, Indian and Thor motorcycles—bargains; write for description. Covington Cycle Works, Covington, Ky.

FOR Sale—Drawing and Surveyors' Instruments, slightly used, bargains. Architects and Engineers' Supply Company, Kansas City, Missouri.

TWENTY-eight dozen "Common Sense" pencil sharpeners. Worth a quarter each. C. F. Widman, McGregor, Iowa.

LETTER duplicator with motor, also Bellknapp addressograph, cheap, or trade. Blatter, 932 W. 19th St., Chicago.

MOTORCYCLE—Engine, Thomas, 2 hp., has gasoline tank and carburetor, \$20; will express for examination. Ed Payne, Covington, Ky.

FOR Sale—Wagon Shop, Ben Greenbaum, 145 W. Monroe St., Chicago.

VENEERS, Mahogany, Quartered Oak; 5c sq. ft. W. H. Snyder, 838 Jefferson Ave., Indianapolis, Ind.

VACUUM Cleaners, useful anywhere, working order guaranteed, like brand new, 28" high, 10" diam., complete with hose, tube, nozzle. Special bargain for hotels, theatres, stores and apartments. Job lot 66 apparatus, \$14.70 each. Cosmos Electric Co., 136 N. Liberty St., New York.

AMMETERS, watch size, nickel-plated, guaranteed. Battery testers in chamolite leather cases. Read 0-30 amperes, 25c, postpaid. Stamps taken. E. W. Electrical Co., 3525 Broadway, New York.

FOR Sale—High power gasoline self propelling vacuum cleaner. Used one season. Mrs. Huddy, Box 125 Ann Arbor, Mich.

COMPLETE outfit for manufacturing rubber stamps, less than half cost. Frank Kerr, Newcastle, Ind.

\$100 TYPEWRITER, \$10-\$20. Every make. Rent payments. Phonographs, motorcycles, Knights, 201 12th, St. Louis, Mo.

KEY check stamping outfit, cheap. Zerbe, Sacramento, Penn.

SALE OR EXCHANGE

EDISON Moving picture machine. Photo button camera, Typewriter, Camera. Toledo Vacuum cleaner outfit on truck. What have you? Ulysses Fortier, Tulsa, Oklahoma.

CIVIL Service Course & Printing Press. C. Williams, Jr., Wittenberg, Wis.

SELL or trade. Watson and Sons London Binocular Microscope, 1/8, 1/5, 1 inch objectives, mahogany case for serviceable typewriter, Doctor, 119 Clayton Street, Waukegan, Illinois.

SALE or trade. New vulcanizing plant, complete. Haswood make, with good boiler. James B. Engles, 120 N. 7 St., Terre Haute, Ind.

NEW 3A. Kodak complete outfit, balance cash for engine lathe. Jno. S. Erickson, Ironwood, Michigan.

WANTED to exchange Indian Motorcycle, in good condition, for Iron Lathe. E. M. Hawse, Morrison, Illinois.

PHOTO tent and outfit, exchange for runabout or good motorcycle. J. Delgard, Granton, Wis.

DIAMONDS, WATCHES, JEWELRY

BUY genuine perfect cut diamonds direct from the importer at the lowest prices in the world: 1/4 carat, \$8.25; 1/2 carat, \$17.50; 3/4 carat, \$45.00; 1 carat and over, \$97.50 per carat. Written contract to buy back every diamond for 99% in cash and allow full price paid on all exchanges. Send no money. We ship C. O. D. price less of examination without deposit and without obligating you to purchase. Send for big Basch Diamond Book. Free! Established 33 years. See our display ad on page 139. Address L. Basch & Co., Dept. G. 346 S. State St., Chicago, U. S. A.

IT'S Different: Sphinx Scarf Pin; dull green gold finish; exquisite colored stone. Illustrated folder on request. Warren C. Gares, Columbus, Ohio.

OLD GOLD

WE pay \$1 per set for old false teeth. Old gold, silver and jewelry bought. Money sent at once. Mail yours today. Est. 20 Years. Philadelphia Smelting & Refining Co., 507 Chestnut St., Philadelphia, Pa.

PATENTS FOR SALE

NEW York Editor will write, for \$2, letter so clear and powerful it is bound to bring business, sell your invention, or get what you want. Particulars free. H. C. Silver, Rutherford, N. J.

\$600 BUYS Valuable Patent. Device needed in every home. Good agents' article. Manufacturers, investors, write. Victor Cozine, Gloversville, N. Y.

FOR Sale—Patent saw-set; all saws. Mrs. Wm. J. Boynton, 5708 So. Alaska St., Tacoma, Wash.

FOR best offer; Pat. 1028047, R. R. Cattle Guard, Ed Engle, 212 E. 19 St., Pittsburg, Kan.

TICKET Holder, best and cheapest on market. Blekastad, Harper, Wash.

TROUSERS creaser patent. Outright or royalty. Creases perfectly without heat. No wear or injury to garment. Takes 3 minutes to insert trousers; 10 seconds to remove. Thoroughly practical. Costs 23c, sells for \$1. Those interested and meaning business, address, H. O. Stamp, Milwaukee, Wis.

PATENT for Adjustable Curtain Bracket. Stamped of sheet metal, very cheaply, demand unlimited. Particulars. E. Chabot, Providence, R. I.

WANTED—Partners able to finance three useful inventions, or will sell. Paine Brier, 2661 Forest St., Denver, Colo.

DISH Washer, wonder, superior, unexcelled attraction, cheap. Krieger, Wooster, Ohio.

NON-DERAILABLE R. R. Truck and spring steel tired motor truck. Isalah De Pew, Palma Sola, Fla.

FOR Sale—U. S. Patent No. 984,289 for door and sash holding means. Rion Heel, 420 Hubbard, Detroit, Mich.

FIVE (5) new patents on different kinds of concrete machinery for sale cheap on account of poor health. Wm. L. Keller, Kearney, Nebr.

PATENTS

INVENTORS—The Ohio Sales Co. Manufacturers and selling agents of patented articles of merit. We find the market and push the sales. If you have anything good write us and send sample. 545 Wyandotte Bldg., Columbus, Ohio.

PATENT books mailed free—showing 100 mechanical movements invaluable to inventors and mechanics—and telling what is patentable, how to obtain patent or partner, etc. Free on request. Chas. E. Brock, 701 Eighth St., Washington, D. C.

INVENTIONS patented free; sold on commission. Fine inventions for sale. Adam Fisher, 61-3, St. Louis, Mo.

WANTED—Correspondence with purchasers of meritable domestic patents. Brokers exempt. Address Wm. J. Duncan, Wardner, Idaho.

WANTED—Someone to receive one-half interest in patent for furnishing attorneys fees. Please address, H. J. Boyd, Virginia, Nebr.

NINE Inventions Wanted by my manufacturing clients. Must be practical and patentable. All correspondence confidential. Research Engineer, 1519 Marquette Bldg., Chicago.

PATENTS of value. Prompt and efficient service. No misleading inducements. Expert in Mechanics. Book of Advice and Patent Office Rules free. Clements & Clements, Patent Attorneys, 704 Colorado Bldg., Washington, D. C.

PATENTS Bring Wealth. Write for proof and new book which tells the kind that pay. Your idea may make your fortune. Alexander Wedderburn, Atty., Dept. P, Washington, D. C.

INVENTIONS patented free—Marketed on commission. Address Inventors' Agency, Chicago. Also valuable inventions constantly for sale. Promoters investigate.

WANT recent patents on automobile accessories. Royalty or purchase, with full particulars, address, H. B., 749 Kelly Street, New York City.

FIND Out For Yourself what to invent and how to protect it. My book, "Inventors' Universal Educator," covers the matter from A to Z; also gives 609 Mechanical Movements and 50 Perpetual Motions. Price \$1.00, postage free. Money returned if not more than satisfactory. F. G. Dietrich, 651 Ouray Bldg., Washington, D. C.

PATENTS secured—Reports on patentability, validity and infringement. Patent suits conducted. C. L. Parker, 910 G St., Washington, D. C.

SEND For Free Booklet, All About Patents and Their Cost. Shepherd & Campbell, Patent Attorneys, 504A Victor Bldg., Washington, D. C.

PATENTABLE ideas wanted—Send for 3 free books. Richard B. Owen, 39 Owen Bldg., Wash., D. C.

WE sell patents. Established ten years. To buy or having one to sell write Charles A. Scott Co., 1996 Granite Bldg., Rochester, N. Y.

PATENTS without advance attorney's fees. Send sketch for free report. Books free. Fuller & Fuller, Washington, D. C.

PATENT ATTORNEYS

PATENTS procured and positively sold if the idea has merit; all countries; satisfied clients my best references; a good invention properly protected by patent should prove very profitable to the inventor; protect your business against competition by patenting any new manufacture, process, formula, or article associated with it; capitalize your ideas; perfect, patent and market your new ideas; send sketch today; book free. H. Sanders, 7 Crilly Building, Chicago, Ill.

PATENTS—Every inventor should have our "Inventor's Primer," contains statistics of interest to all. Sent free, with square deal contingent fee plan if desired. Milo B. Stevens & Co., Estab. 1844, 685 F St., Washington, 353 Monadnock Bldg., Chicago.

PROTECTIVE patents procured promptly. Our books telling how to obtain and realize therefrom sent on request. Write today. Trade Marks Registered. Beeler & Robb, 211-215 Southern Bldg., Washington, D. C.

"**PATENTS** and Patent Possibilities." is a 72-page treatise which tells all about patents, what to invent and where to sell it. It gives honest advice to inventors, and is full of valuable and interesting information. Write for it today! It is free. H. S. Hill, 905 McClachlen Bldg., Washington, D. C.

PATENTS—Herbert Jenner, patent attorney and mechanical expert, 608 F. St., Washington, D. C., established 1835. I make a free examination and report if a patent can be had and exactly what it will cost. Send for circular.

THE patentome is interesting and instructive. A liberal education in patents and how to get them. Free on request. Established 1865. Anderson & Son, Patent Solicitors, 107 G St., Washington, D. C.

PATENTS Bring Wealth. Proof and advice free. Wedderburn, Patent Attorney, Washington, D. C.

PATENT books on How to Obtain and Sell Patents, containing exhaustive information on these subjects, with 100 mechanical movements, mailed free on request. F. G. Dieterich & Company, 600 Ouray Bldg., Washington, D. C.

WANTED—People with original ideas. Ideas have made fortunes. If your invention has merit, protect it—turn it into money. My free booklet tells how. Write today. Wm. N. Roach, Jr., 502 Metzger Bldg., Washington, D. C.

PATENTS secured or fee returned. Send sketch for Free Expert Search and Report as to patentability. Books on inventions and patents and reference book sent free. John S. Duffie & Co., Dept. 1, Washington, D. C.

PATENT what you invent—It may be valuable. Write me. No attorney's fee until patent is allowed. Estab. 1882. "Inventor's Guide" free. Franklin H. Hough, 522 Loan & Trust Bldg., Washington, District of Columbia.

PATENTS that protect and pay. Advice and books free. Rates reasonable—highest references; best results. Watson E. Coleman, Patent Lawyer, 622 F St., N. W., Washington, D. C.

C. L. PARKER, Patent Attorney, 910 G St., Washington, D. C. Inventor's handbook "Protecting, Exploiting and Selling Inventions," sent free upon request.

SEND for free booklet. All about Patents and Their Cost. Shepherd & Campbell, Patent Attorneys, 509A Victor Bldg., Washington, D. C.

PATENTABLE ideas wanted—Send for 3 free books. Richard B. Owen, 30 Owen Bldg., Washington, D. C.

NO attorney's fees until patent allowed. Free search and books. Fuller & Fuller, Washington, D. C.

REAL ESTATE—FARM LANDS

SUBURBAN Lots \$25—\$1 Monthly. Houston, Texas, is having the most wonderful growth of any city in the U. S. Population increased from 45,000 to 110,000 in seven years. Predicted by conservative business men that it will go to half million, \$17,000,000 spent on new buildings in past two years. Magnificent skyscrapers, hotels, etc. 300 factories. Rice University, endowed with ten millions, opens this year. Government improving Ship Channel to bring ocean liners to meet our 17 railroads. Fortunes will be made by investors in suburban property. We have just opened for sale the Townsite of Satsuma, beautiful suburb of Houston, 35 minutes from heart of city, on railroad and boulevard. Lots 56x160 feet. First 200 go at \$25 each. Terms \$1 cash and \$1 monthly. No interest. Price will be advanced after first 200 are sold. Write for full particulars or send \$1 cash and get choice location. C. W. Hahl & Co., 175 Commercial Bank Bldg., Houston, Texas.

TEXAS school land on market now; you can buy good land at \$2 per acre; pay 5c per acre cash and no more for 49 years, but 3 per cent interest on the balance. Send 6 cents postage for further information. Investor-Publishing Co., Dept. 3, San Antonio, Tex.

CALIFORNIA fruit land at \$25 per acre will soon double in value; prospective new railroad, Panama canal and exposition. Write today for illustrated free booklet. Shasta Land Company, Anderson, California.

OKLAHOMA Farms. Corn, wheat, oats, clover, timothy and alfalfa lands. New-comer & DeLozier, Adair, Oklahoma.

800, 80 acres. Wisconsin. 20,000 acres 75 miles Twin Cities. State map. 45 page book mailed for 25 cents. Hobart Land Co. Responsibility \$100,000. Minneapolis, Minn.

FARMS bought, sold, exchanged. No matter where located. Chas. Phillips, 388 Pleasant Ave., New York.

40 ACRES for sale. Kuhn Irrigation Project, good black soil. Write to W. Missman, Willows, Calif.

TYPICAL New England farm, near Mansfield, Conn.; 58 acres, ten-room house, barn, fruit, \$2,500, \$1,000 down. E. C. Cleveland, Weston, Ill.

TILE factory and coal plant combined. Thriving business. For sale or exchange. "Cyclone," Urbana, Indiana.

BANK in liquidation, owns fourteen different dairy farms. I am authorized to sell for cash or good paper. Prices right, write for lists. F. A. Farrow, Clear Lake, Wis.

TOWN Lots—Prices \$17.50 to \$50. Terms, one-tenth monthly, no interest. Choice locations in rapidly growing little city. Address J. W. Baughman, Plains, Kansas.

CO-OPERATIVE colony, locating here. Co-operators invited. Edward Miller, Crystal Springs, Fla.

CASH for your business or real estate. I bring buyers and sellers together. No matter where located if you want to buy, sell or trade, any kind of business or property, write me. Established 1881. Frank P. Cleveland, 1908 Adams Express Building, Chicago, Illinois.

TO buy, sell or exchange property, any kind, anywhere. Address Northwestern Business Agency, Minneapolis, Minn.

DELAWARE Farms. Money making farms throughout the entire state, \$15 an acre up; live-stock, implements and crops often included. We offer best bargains, and pay buyer's railroad fare. Catalog free. Ford & Reis, Inc., Dept. 43, Wilmington, Del.

SELL your property quickly for cash, no matter where located. Don't pay big commissions. Particulars free. Real Estate Salesman Co., Desk B, Lincoln, Nebr.

DOGS, POULTRY, LIVE STOCK

POULTRY Paper, 44—124 page Periodical, up to date, tells all you want to know about care and management of poultry, for pleasure or profit, 4 months for 10c. Poultry Advocate, Dept. 3, Syracuse, N. Y.

WELSH and Shetland Ponies for sale. Highest type. Purest breeding. Nash P. Sneed, Cartersville, Va.

PEDIGREED Collies \$8 up. Rainbow Kennels, Rainbow, N. Y.

A BOOK on Cape Birds, 120 pages, 150 illustrations. How to breed them for profit, hints on their diseases and how to cure them. A most complete book on the subject. Mailed for 15c. Oregon Bird Co., Box 745, Dept. P, Portland, Ore.

AIRDALE Terriers—Scotch Collies. Pups—grown stock, by Champion Sires. P. L. Savage, St. Charles, Ill.

AIRDALE'S for sale. Write Wm. S. Norton, Flat Rock, Ill.

FORMULAS

STAIN Formulas. Eighteen, best formulas for bleaching and staining wood, including all colors, sent postpaid to any address, upon receipt of fifty cents. Money order or coin. No stamps accepted. Houston Formula Co., 203 San Jacinto St., Houston, Texas.

PAINT—Without lead or oil. Wears like iron. Formula, 50c. C. K. Beyer, 114 Harrison Ave., South Bend, Ind.

200 FORMULAS and Digest, publishing 100 formulas, etc., monthly, one year, 25c. Digest, Grand Rapids, Mich.

3,000 FORMULAS, new edition and Digest, publishing 100 formulas, etc., monthly, one year, 50c. Digest, Grand Rapids, Mich.

FORMULAS—Any formula you want for 25c each; two for 45c. Satisfaction guaranteed. Frank Schneider, Beardstown, Ill.

VANILLA Extract—25c for formula for commercial or home use. W. Missman, Willows, Calif.

SILVERING Mirrors Formula, and one year's subscription to Digest, 25c. Digest, Grand Rapids, Mich.

HUNDREDS of formulas; valuable; 25c. Johnston, Front & Couch Sts., Portland, Ore.

FOR MEN

YOU and every man who wants to discard suspenders and secure positive belt comfort this summer should send for descriptive circular of the most practical and durable nonslipping, natural fitting, invisible belt that has been on the market for three years. Sold only by agents or postpaid for \$1. L. & N. Belt Co., 1257 N. Clark, Chicago.

SAFETY razor blades sterilized and sharpened better than new; 2 cents each. Five years' success. Send for blade box and circular. Electro Shaving Co., 134 Shelby St., Detroit, Mich.

SOMETHING new, Rifle Bullet Cigar Lighter, 50c. Wm. Liveridge, 9 Storey Ave., Newburyport, Mass.

"PUCK," all silk Four-in-Hand thirty-five cents, value fifty cents; three for one dollar; all colors, plain or fancy; order today. William Hinds, 621 Broadway, New York. References, Mercantile Agencies.

FOR THE HOME

ICE Machine for the home—"Excelsior"—Patented in the United States, France, etc. Is the only perfect machine for the making in your own home of ice-cream, for the freezing of fruit juices, etc. No ice needed, freezes directly. Uses moulds of all shapes. Prospectus free. J. E. Schaller, 1 rue Franco-Ponsard, Paris.

METAL Work and Etching—A 96-page handbook for art metal workers telling how to make a great variety of useful and ornamental objects such as desk sets, arts-crafts jewelry, etc. Price, 50c, postpaid. Popular Mechanics Book Dept., Chicago.

BEAUTIFUL arts-crafts lamps.—Anyone can make them out of paper, cardboard and wood. 16 designs. Inexpensive yet artistic. Complete book of instructions. Price, 50c, postpaid. Popular Mechanics Book Dept., Chicago.

MAKE your own mission furniture at the minimum of expense. Our 2 books "Mission Furniture. How to Make It." Parts 1 and 2, tell in plain, simple language just how to make 50 different pieces. Full dimensioned working drawings and half tones of finished articles. Price, 50 cents each or \$1.00 for the two volumes, postpaid. Popular Mechanics Book Dept., Chicago.

GAMES AND ENTERTAINMENT

THE Magic Colner, a mystifying trick, complete for 19c. R. Armstrong, Meyran Ave., Pittsburg, Pa.

YOU can be a magician, travel, give shows, earn money. I tell how. Send stamp. Prof. Rapp, Box 1115 F, Madison, Wis.

LEARN ventriloquism at home. My instructions complete. Particulars for stamp. Oliver N. Prince, Box C193, Birmingham, Ala.

250 MAGIC Tricks, one dime. Donnersbach, 330 Lisbon St., St. Paul, Minn.

165 GOOD tricks, with 3 catalogues, 25c. Joklein, 1193 Broadway, N. Y.

1400 CONUNDRUMS, Riddles, 10c. Tricks with coins, 25c. 350 Toasts, 10c. Hilton Co., Osawa, Iowa.

MAGICAL apparatus for sale. Sixty great bargains, new goods, full set curtains, Organ Pipes, Handkerchief and Card Tricks. Complete list 4c. Robert C. Fay, Rockford, Illinois.

ANIMATED Picture Board: Amuses everyone by the hour, fine for rainy days and long evenings, 10c (silver). Chas W. Carey, Box 30, Washington, D. C.

FREE: Good card trick. Send 2c for our Bargain Catalogue and get this trick free. Eagle Magic Co., Minneapolis, Minn.

NEW and Novel Jokes—great fun producers. So simple a child can operate them. 1. The Split Jam (Look what you've done to the table cloth!!!). 2. Red Hot Cinder (Drop it on the rug or floor in front of fireplace). 3. Damaged Finger (Deceptive blood-soaked bandage. Great sympathy is expressed by your friends). 4. Plot of Ink (The Bookkeeper goes mad. Mother is frantic). Price 10 cents each, postpaid. Address Popular Mechanics Book Dept., 318 W. Washington St., Chicago.

KER-CHU powder. A pinch blown into the air makes everyone just sneeze their heads off without knowing why. Great fun. Absolutely harmless. Sample vial, 10 cents, three for 25 cents. Catalogue included. Joseph Mathieu, 203 Court St., Brockton, Mass.

MAGIC Tricks, Books & Supplies. Largest line in the world. Amateurs supplied as well as the Great Professionals. Easy. Interesting. Entertaining. Mammoth, illustrated, professional catalogue of clever tricks for the pocket, parlor and stage, price ten cents. The old reliable firm. Read & Covert, 821 East 43d St., Chicago, Illinois.

FREE—1912 magic catalogue, 288 pages, 350 illustrations, 890 tricks, puzzles, illusions for parlor or stage entertainment. Send 6c stamps for particulars and sample pocket trick. Buy direct from the manufacturer, cheaper and better apparatus. Wholesale Magic Co., 270 W. 39th St., New York.

WIGS and Makeups for Theatrical and Street Use. Percy Ewing, Decatur, Ill.

RARE COINS AND STAMPS

5 FRENCH Colonial Stamps for the names of two collectors and 2c. 5 different foreign post cards, 5c. Catalogues free. Approvals 50%. Sample copy "Stamp and Coin Collector" free. A. Kraus, 662 Kraus Bldg., Milwaukee, Wis.

STAMPS free. Animal packet, Ant Eaters, Emu, Camels, Lion, Dragon, Tigers, Springbok, Parrot, Swan, etc. 2c (stamp) postage. American stamps bought. Buying list 19c. Lightbown Stamp Co., Palmerston Rd., Southsea, England.

STAMPS free—8 different Costa Rica, or 3 different Soudan (camel), big stamp lists, etc., for 2c postage. If you collect stamps, write us. Old collections bought. W. C. Phillips & Co., Glastonbury, Conn.

FREE! Dandy packet 50 stamps for 2c postage. Lists free. "Hawkins," Baton, New Mexico.

\$3.00 PAID for the rare cent of 1856, \$25.00 for the rare silver dollar of 1858. Keep money dated before 1890 and send 10 cents for new coin value book. A. Kraus, 299 Kraus Bldg., Milwaukee, Wis.

FREE: 100 Foreign Stamps. Edward Lufbery, Wallingford, Ct.

FREE—8 varieties unused for name, address three collectors, 3c postage. Utica Stamp Co., Utica, N. Y.

DON'T sell your cancelled postage stamps until you get our catalogue. It's free. Acme House, 409 Chestnut St., Milwaukee, Wis.

60% DISCOUNT to agents selling our stamps on approval. Our stamps are good sellers. Molsant & Leclair, Kankakee, Illinois.

COINS—20 different foreign, 25c; 5 different Confederate state bills, 15c. Retail price list free. \$5, \$10, \$20 confederate bills, 15c. F. L. Toupal Co., Chicago Heights, Ill.

24 VARIETIES Cuban stamps 10 cents. List of 6,000 low-priced stamps free. Chambers Stamp Co., 111 P. Nassau St., New York City.

PACKET of 23 stamps; no two countries alike, 500 hinges. Set of \$1 and \$2 U. S. Rev., all for 5c. Miami Stamp Co., Toledo, Ohio.

STAMPS 100, all different, free. Postage 2c. Mention paper, Quaker Stamp Co., Toledo, Ohio.

STAMPS—105 China, etc., stamp dictionary and list, 2c. Bullard, Sta. A, Boston.

MUSIC

POETS—Authors: Get cash for your songs and stories. Music Sales Co., 61-4 St. Louis, Mo.

THE Secret of Song Writing, booklet full of useful information by an expert, 25c postpaid. Chas. Metz, 396 East 88th St., New York.

SINGERS: 50 latest songs with music, 25c to advertise. Needham Music House, 61-13, St. Louis, Mo.

TO introduce our catalogue will send 2 Song Hits for 19c. Gem Music Co., New Berlin, N. Y.

SONG Poems Wanted. Cash or royalty to you. Needham Music House, 61-5, St. Louis, Mo.

IF you want the latest sheet music and a better and larger assortment for less money than elsewhere; write for our price list. Sample's Music House, 264 West Ave., Norwalk, Conn.

WE will supply any Popular Sheet Music you want at 15c a copy. Remember 15c per copy post-free on everything in Popular Sheet Music wherever published. Willis Woodward & Co., 1197 Broadway, New York.

POEMS wanted. Big money for composers. Send MS. to Inland Music House, Chicago.

LATEST hits. "Tennessee Rag" 5c to introduce our big offer. Addison, Crilly Bldg., Chicago.

RAG-TIME piano playing taught by mail. Book free. Christensen, 84 Auditorium Bldg., Chicago.

PIANOS AND MUSICAL INSTRUMENTS

A BARGAIN. 625 Edison records, nearly new, of popular songs and band pieces, Edison Standard Phonograph complete with brass horn and stand, all boxed and delivered at R. R. or express here, for \$100. W. Frank West, 5 Pleasant St., Newport, R. I.

TELEGRAPHY

TELEGRAPHY—Morse and wireless—Railway accounting (Station Agency) taught quickly. Railroad Dispatchers' and Western Union Wires and complete Wireless Station in school. Splendid opportunities. Graduates assisted. Living expenses low—may be earned. Largest and oldest school—established 38 years. Investment, \$25,000. Correspondence courses also. Catalog free. Dodge's Telegraph, Railway and Wireless Institute, 15th St., Valparaiso, Ind.

LEARN Telegraphy. Positions guaranteed. Catalogue free. Northwestern Telegraph School, Eau Claire, Wis.

TELEGRAPHY taught in the shortest possible time. The Omnigraph Automatic Transmitter combined with standard key and sounder. Sends you telegraph messages at any speed just as an expert operator would. Five styles, \$2 up, circular free. Omnigraph Mfg. Co., 41 G. Cortland St., New York.

ELECTRICAL

ELECTRICITY. Are you interested? If so we can learn you all kinds of wiring, from the simplest to the most complicated. By our Blue-print-chart-method. It is so simple any one can understand it. We show you how to wire for all kinds of bells, annunciators, telephones, house wiring, conduit, theatre, isolated plants, dynamos, transformers, arc lights, special treatise on all kinds of motor wiring. Write now for information. Electrical Wiring Diagram Co., Box 173, Alhambra, Pa.

FOR Sale—1 1/2 hp. 2 ph. 220 volt A. C. motor, \$35; 2 wide spark coils, \$2.50 each; 3 cylinder Splittdorf coils, \$20 each. Send for list. J. C. Kendall, Hancock, Mich.

AMMETERS, guaranteed battery testers, 25c. See advertisement under "For Sale."

WIRELESS

BOYS—Vertical adjustable zinc spark gap, mount it yourself, 50c. No postals. Mite Novelty Wks., Box 161, Santa Barbara, Calif.

WIRELESS Set, How to Make—96-page book telling how to construct at small cost an outfit suitable for transmitting four or five miles. Price 50 cents, postpaid. Popular Mechanics Book Dept., Chicago.

BLACKSMITHS

I GUARANTEE with Toy's Modern Methods on Steel Work, you can do all hard jobs easy. All welds will be solid, and all tools tempered to a standard, by colored tempering charts. That means better salaries and better positions. All for one dollar. Send for valuable samples free. W. M. Toy, Sidney, Ohio.

PRINTING AND ENGRAVING

1000 IMITATION typewritten letters, heading black, body purple, \$3. 1000, 3 1/2 x 5 1/2 art ad slips, \$1 postpaid. Circulards, stationery, small papers, lowest prices. Samples free. Good's Printery, Harrisonburg, Va.

PRINTING—500 either envelopes, note-heads, cards, \$1; 1,000, \$1.50; 1,800 circulars, \$1; 500 linen finish letterheads or envelopes, \$1.50; 1,000, \$2.50; 1,000 typewriter letters, \$2. Samples. "The Model," Manchester, Iowa.

WE started it: Others followed it: 100 of each note-heads, envelopes and cards (300 pieces) all neatly printed to your order, \$1 prepaid. Samples free. Union Publishing Co., Dept. M, Uniondale, Indiana.

GUMMED stickers, 3,000, \$1, two colors. Advertising specialties; catalogue free. MacTaggart, 1235 Arch, Philadelphia, Penna.

50 BUSINESS or calling cards, 25c postpaid. Patterson Press, Beaver Falls, Pa.

FINE halftone and line cuts, 2 1/2 x 3, \$1. Free signature cut with \$4 order. Gregson Engraving Co., Gazette Ave., Lexington, Ky.

100 CARDS, name and address, 25c. Samples free. Riverside Press, Hackensack, N. J.

PRINTING presses and supplies. Sacrifice \$50 outfit half cash, half trade. 13 page list for stamp. Popular Bargains, Richland, Pa.

GUMMED Labels—3,000 for \$1.00, 1x2 1/2, any printing. Postpaid, 20 different styles and sizes; some in two colors. Before ordering labels of any kind, get our prices. Terrace Manufacturing Co., Pittsburgh, Pa.

1,000 3 1/2 x 5 CIRCULARS, book paper, prepaid \$1.00. Smith Supply, Waukegan, Illinois.

PERFECTION Multigraphed form letters are perfect imitations. 1,000, \$3, or 500, \$2. Including stock, letter, head—delivered in U. S. Send for specimens. Perfection Letter Company, Washington St., Muscine, Indiana.

PRINTING Presses, type, supplies. Catalogue free. L. M. Carroll & Co., 326 Madison St., Chicago.

LOOK here—100 letterheads, 100 envelopes, 100 return envelopes or business cards, printed for \$1, postpaid. Walden Press, Roxbury, Mass.

TYPEWRITERS

I WANT to correspond with persons who are about to buy a high-grade typewriter, and object to paying the high prices generally asked by manufacturers and dealers. Any make on approval. Catalogue, bargain list and valuable information sent free. A. E. Atchison, 4127 West 21st St., Chicago.

ABSOLUTELY reliable, sensational sale; talk of New York; Underwoods, Oliviers, Smiths, Remingtons; \$10 to \$35; worth double. Sent on approval; 30 years, satisfied customers. Old Reliable Consolidated Typewriter Exchange, 245 Broadway, N. Y.

3 PENNIES a day, one dollar a month buys a standard typewriter. Your choice Remington, Oliver or Smith Premier. Prices lower than other cash prices. Perfect machines only—guaranteed. Typewriter-Installation Co., G 180, N. Dearborn St., Chicago.

LATEST Model Five Oliver, world's best visible writer, \$55; easy payments. Write today. Typewriter Salesmen's Association, 112 LaSalle St., Chicago.

MUST sacrifice. Remington typewriter, good as new, \$17.50. Thomas Williams, 721 Dearborn Ave., Chicago, Ill.

REMINGTON and other typewriters, sold on easy payments anywhere. No lease to sign. Lowest of low prices. Larkin Typewriter Co., 125 Chambers St., N. Y. City.

FOR Sale—Monarch (visible) typewriter. Mechanism, finish and writing perfect. \$55. I guarantee it. Write James Kidd, Burlington, Indiana.

WANTED—Agents to sell typewriters. Get agents' prices and secure territory. Minnesota Typewriter Exchange, Minneapolis, Minn.

TYPEWRITER Bargains. All makes, \$10 up. Ten days free trial. Guaranteed two years. Express prepaid. Price list free. Frank Payne Company, Rosedale Branch, Kansas City, Kansas.

TYPEWRITERS—Save \$10 by buying a typewriter now. Greatest sale in history, bankrupt stock, standard makes, like brand new, low as ten dollars. Write for special price list No. 16. We pay expressage and allow 3 days trial. Typewriter Inspection Co., 235 W. 4th St., Cincinnati, Ohio.

REMINGTON Typewriter \$12; Calligrapha \$6; Hammonds, Yost, Densmore \$10; Smith Premier and Jewett \$15; Oliviers, Underwoods, L. C. Smith and Royals \$25. Fifteen days free trial, and one year's guarantee; don't purchase until you get our prices. Harlem Typewriter Exchange, Dept. M, 217 West 125th St., New York City.

STENOGRAPHER must sell her Remington Typewriter, \$9. Miss King, 2210 Seventh Ave., New York City.

TYPEWRITERS—One Oliver latest model No. 5—and one Underwood latest model No. 4—like brand new. Only \$35, cost \$100. No further use. Sent for trial, my expense. J. S., Box 10, Plainville, Ohio.

GENUINE typewriter bargains, no matter what make, will quote you lowest prices and easiest terms. Write for big bargain list and catalogue 17, L. J. Peabody, 278 Devonshire St., Boston.

TYPEWRITERS—Every kind on the market. Write today for best bargain you ever secured. Shipped anywhere on approval, \$10 up. Fletcher Typewriter Co., 207 N. 7th St., St. Louis, Mo.

OFFICE EQUIPMENT AND SUPPLIES

SEE what I say under "Typewriters." Big bargains. Atchison.

MAILING LISTS

WE will mail free to any business man a copy of our comprehensive "Silent Salesman" containing over 2,000 different classifications of Mailing Lists with the number in and price of each list. This price list contains information which should be in the hands of every business man and this generous offer should be accepted. Trade Circular Addressing Company, Desk G, 144½ W. Adams Street, Chicago.

MISCELLANEOUS

Henry's brilliant gold, silver, fire, crimson, blue, green, violet and orange metallic water colors. Have no equal for illuminating, card lettering, gilding, etc. In pans, ready for use, 15c each, postpaid. Henry Chemical Co., Vallejo, Calif.

ESTATES settled. Claims collected. Fifteen years successful experience. Pay us out of what we make you. Expert legal service in foreign countries. References best. Spellman & Smith, Chamber of Commerce Bldg., Chicago.

GINSENG worth \$7 per lb., 1,000 roots, \$9. Explanatory booklet free. Schwartz Bros., Dept. B., Spring Green, Wis.

POCKET Compass in nickel case with mirror back, the handiest possible thing to have around. 25c postpaid. Rex, 104 Leeward, Detroit.

GINSENG—Large profits made growing Ginseng and Golden Seal. Send at once for my free descriptive booklet of Ginseng and Golden Seal Culture with prices of roots and seed. Alban Taylor, Box 714, East Rochester, Ohio.

CHEMICAL analyses, researches, experiments. Parobek Chemical Laboratory, Trenton, New Jersey.

144 PENCILS with any 4 line ad only \$1.70, cash with order. Crescent Pencil Co., Thibodaux, La.

YOUR name and address stamped on German silver key chain, 25c. Silver Key Chain free. L. D. Thompson Co., 3159 La Salle St., Chicago.

WONDERFUL aeroplane puzzle, 10 cents silver. Fred Fulgura, Box 550 C., North Diamond Station, Pittsburgh, Pa.

MONEY-making farms throughout 17 states; one to 1,000 acres, \$10 to \$50 an acre; live stock, tools, and crops often included to settle estates quickly. Mammoth Illustrated catalogue No. 35 free. E. A. Strouth Farm Agency, Station 5043, 47 West 34th St., New York.

TOBACCO Cure. One box cures. Guaranteed or money back. Established 1894. Write for special offer. Allen Distributing Co., 319 Altman Bldg., Kansas City, Mo.

RAIL Section Watch Fobs. Nickel plated. Everybody wants one. So do you. Send 30c today and have your initials put on fob. K. & K. Specialty Co. Box 892, Joliet, Ill.

LEGAL advice almost free! Reliable, satisfactory, prompt. Circulars free. Legal Aid Bureau, Alliance, Ohio.

BROTHER—Accidentally discovered root will cure tobacco habit. Gladly send particulars. F. Stokes, Mohawk, Florida.

GOLDEN Seal, the Golden Harvest, \$6.50 per acre. Easily grown. Explanatory booklet 10c. Buckeye Gardens, 200 Main, Cincinnati, O.

WONDERFUL Advertising Offer—Advertisements placed in fifty magazines, 3 cents; three months, 5 cents per word. Record, 8 Judge St., Brooklyn, New York.

FOR Sale, nicely mounted birds and animals. Henry Henderson, Taxidermist, Columbiaville, N. Y.

"BOOSTER"—The magazine you need! Send 10c for two months trial. Booster Magazine, Northwestern Building, Chicago.

COLLEGE Pennants, all principal colleges, 40c. Guy Dushman, Urbana, Indiana.

YOUR AD in 100 Weekly Newspapers, 1c a line each. Life Pub. Co., St. Louis.

READ the Agents Magazine, 2 months 10c. Agents Magazine, Chicago.

25c POCKET knife free if you send 5 names of friends who read and 10c postage. Morris, 525 Bainbridge, Philadelphia, Pa.

LEARN to metalize flowers, insects, etc., for jewelry. Pleasant and profitable. Dime brings beautiful sample pin and particulars. F. Benson, Stewartville, Minn.

WANT Information? If you want information of any kind, any place, if you want to buy anything of any kind, write us. National Information & Buyers Agency, Denver, Colorado.

FALSE teeth cannot slip or fall if you use "Teethold," 50c by mail. Mr. Smythe, 17 Bromfield St., Boston.

EARN \$15 to \$25 a week as our mail order dealers. Right from your own home. Hold your position until entire time is required. We are manufacturers and owners of patented just-in-season, repeat-order specialties. If you are just starting a mail order business or if already established, you can't afford not to handle our Patented Money Making Getters. We sell and furnish everything. No canvassing. Small capital. Experience unnecessary. Write today for Latest Patented Leader and Manufacturers' Easy Selling (copyright) Mail Order Plan backed up by "Whole Truth" positive proof and sworn statement. J. M. Pease Mfg. Co., 552 Pease Bldg., Michigan St., Buffalo, N. Y.

ANYBODY can make good cuts with my simple zinc etching process; price, \$1; specimens and particulars for stamp T. M. Day, Box M, Windfall, Ind.

I WILL start you earning \$4 daily at home in spare time, silvering mirrors; no capital; send for free instruction booklet, giving plans of operation. G. F. Redmond, Dept. 306, Boston, Mass.

YOUR 25 word advertisement in 35 magazines—3 times and my money-making magazine one year for only \$1.50. H. Lutz, Atlantic City, N. J.

PATENTS secured—C. L. Parker, 910 G St., Washington, D. C.

TATTOOING. Improved electric tattooing machine, \$2.50 each. Sold with a guarantee. Cheapest and best line of Tattooing Supplies on the market. Send 15c for 6 beautiful hand colored Tattoo designs. Write now for free price list. J. F. Barber, 1019 Vine St., Cincinnati, Ohio.

TOO LATE TO CLASSIFY

ENGINEER'S Transits—For sale; and levels; all kinds; second-hand. W. F. Sprengnether, 263 N. 16th St., St. Louis, Missouri.

"Nu-Pantz" Creaser on Approval

Crease Your Trousers in Five Minutes

with the "NU-PANTZ" Creaser. Also presses ties, creases coat sleeves, removes wrinkles, etc. Does the work just as your tailor does it, by heat and pressure. Self-heated any time, any place, in three minutes. Pressure exerted by spring tension; simple and easy to operate, with perfect results. Complete aluminum outfit weighs but two pounds.

Save Half the Expense of Being Well Dressed
One suit with the "Nu-Pantz" gives more real service than two without. Save two-thirds the usual pressing and always appear neat and well-kept. Soon repays its cost many times and adds hundreds of dollars to personal appearance.
FIVE DAYS' TRIAL. Send \$3.50 for the "NU-PANTZ" Creaser, express paid. Use it five days; if you wish to part with it we will pay return express and refund your money.

Write at once for full description and approval offer.

Racine Creaser Co., 5th St., Racine, Wis.



Cheap Fire Insurance!

Matchless Wall Lighter

No more matches in your home! No more match heads to break off, burn holes in clothes, carpet, or set fire to house. No more burnt matches to sweep up. Lasts forever. Never fails to light. Solid brass, satin finish; ornamental to any room. Money back if dissatisfied. Postpaid, only 60c. Agents Wanted.

AMERICAN PYROFOR CO., Dept. P, 5841 Calumet Ave., CHICAGO, ILL.

"How to Sharpen" Send a postal today for this famous book. Pike Mfg. Co., Pike, N. H.

VELVET—The Smoothest Tobacco—10c

IF IT ISN'T AN EASTMAN IT ISN'T A KODAK

"Don't ENVY a Use Pompeian and HAVE one." good complexion.

Alco Self Heating Curling Iron

AGENTS MEN & WOMEN WANTED

A Big Summer Money Maker.

Agents Making \$5 to \$10 a day. Every woman wants one. Positively sells on sight. Send 25c today for agent's sample. Exclusive territory.

THE SELF-HEATING CURLING IRON MFG. CO., Inc.
909 Manhattan Bldg. CHICAGO, U. S. A.

Absolutely New. This self-regulating alcohol iron cannot burn or singe the hair, because it cannot overheat. Produces a beautiful Moist Curl. A Necessity for every Woman. Ideal for Home or Traveling. Heavily nickel plated, fine black ebony/red handles. Each one in a handsome box. Satisfaction guaranteed. Money refunded. Good salaries for Salesmen.

Matchless Pocket Lighter

Durable and waterproof, with perfect ignition. Satisfaction guaranteed or money refunded. Sent postpaid, complete with pocket clip, 35c, 4 for \$1.00. Live agents and dealers wanted.

A perfect lighter. Occupies no more space in the pocket than a pencil. Indispensable to every smoker, hunter, fisherman, and automobilist. Heavily nickel plated and made of finest material.

SCHILLER MFG. CO., Dept. 106, Schiller Building, Chicago



America's Greatest Historian

JOHN CLARK RIDPATH is universally recognized as the greatest historian of our time. Other men have written histories of one nation or period—Gibbon of Rome, Macaulay of England, Guizot of France—but it remained for Dr. Ridpath to write a History of the **entire World**, covering all nations from the beginning of civilization down to the present time.

Endorsed by Thousands

Ridpath's fame is now safe and secure. His History has been purchased and is strongly endorsed by Presidents of the United States, practically all University and College Presidents, and by more than a quarter of a million Americans who own and love it. More sets of Ridpath's History have been sold than of any other set of books published in America, the Bible alone excepted. If you would know the History of mankind, every sacrifice for principle, every struggle for liberty, every conflict and every achievement, then embrace this opportunity to place in your home the world famed publication.

Ridpath's History ^{OF} THE World

We will name our special low price and easy terms of payment only in direct letters. A coupon for your convenience is printed on the lower corner of this advertisement. Tear off the coupon, write your name and address plainly and mail. We do not publish our special low price for the reason Dr. Ridpath's widow derives her support from the royalty on this History, and to print our low price broadcast would cause injury to the sale of future editions.

Mail Coupon for 46 Page FREE Booklet

We will mail you our beautiful forty-six page free booklet of specimen pages from the History without any obligation on your part to buy. Hundreds who read this have thought that sometime they would buy a History of the World and inform themselves on all the great events that have made and unmade nations. Don't you think it would be worth while to at least send the coupon and find out all about our remarkable offer?

Ridpath's Graphic Style

Ridpath's enviable position as a historian is due to his wonderfully beautiful style, a style no other historian has ever equalled. He pictures the great historical events as though they were happening before your eyes; he carries you with him to see the battles of old; to meet kings and queens and warriors; to sit in the Roman Senate; to march against Saladin and his dark-skinned followers; to sail the southern seas with Drake; to circumnavigate the globe with Magellan; to watch that thin line of Greek spearmen work havoc with the Persian hordes on the field of Marathon. He combines absorbing interest with supreme reliability, and makes the heroes of history real living men and women, and about them he weaves the rise and fall of empires in such a fascinating style that history becomes as absorbingly interesting as the greatest of fiction.

**WESTERN NEWSPAPER ASSOCIATION
CHICAGO**

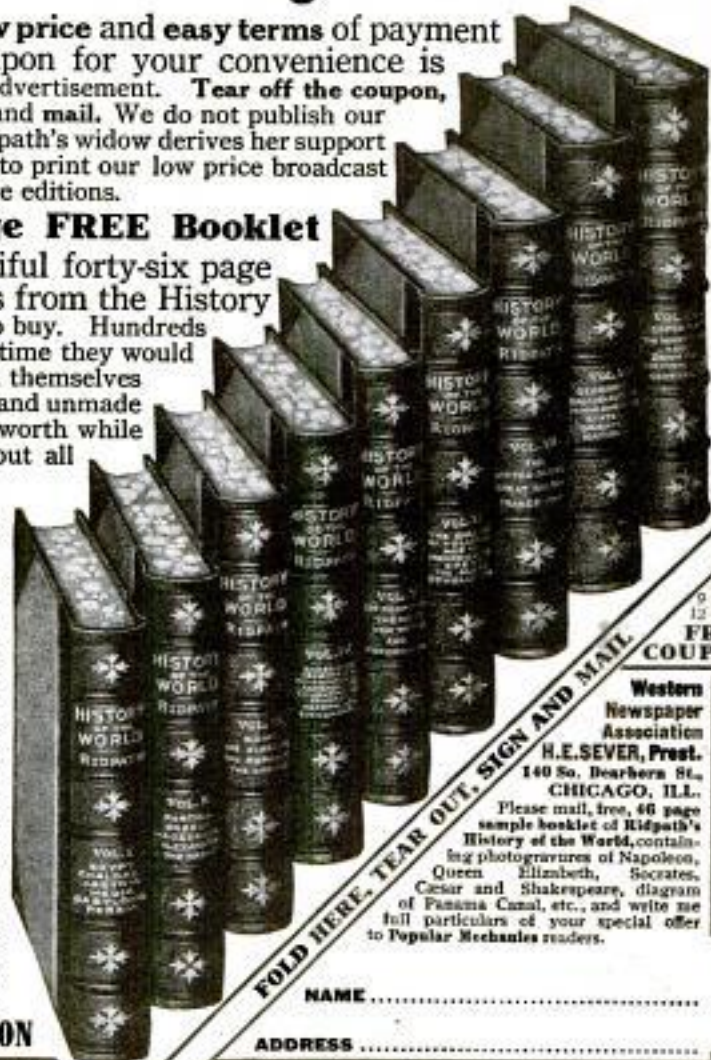

9
12
**FREE
COUPON**

**Western
Newspaper
Association
H.E. SEVER, Pres.
140 So. Dearborn St.,
CHICAGO, ILL.**

Please mail, free, 46 page sample booklet of Ridpath's History of the World, containing photogravures of Napoleon, Queen Elizabeth, Socrates, Caesar and Shakespeare, diagram of Panama Canal, etc., and write me full particulars of your special offer to Popular Mechanics readers.

NAME

ADDRESS

FOLD HERE, TEAR OUT, SIGN AND MAIL

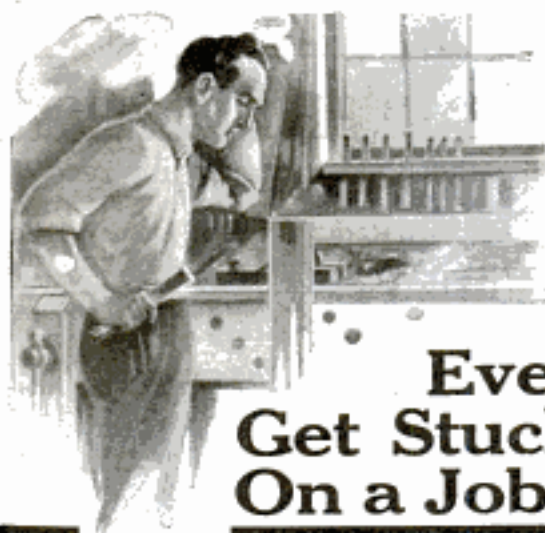

Ever Get Stuck On a Job?

WERE you ever confronted with an emergency job where something unusual had to be done quickly with the few tools at hand or no tools at all? You could have done that unfamiliar job in a jiffy if only some one could have informed you how he did it.

¶ Has it occurred to you that every day, everywhere, men in every department of mechanics, engineers, firemen, carpenters, machinists, plumbers, painters, iron and wood workers, electricians, masons and in fact men in all the trades are meeting and solving these problems in economical, time and labor saving ways?

¶ If a collection of all this useful experience of years, of hundreds of the most successful mechanics could be made, "boiled down" and written so it could be readily understood by anyone who uses tools, would it not be of priceless value to the owner?

¶ This is just what **Popular Mechanics Magazine** has been doing for years, and now our

Series of Shop Notes Year Books

constitutes a veritable encyclopedia of

Easy Ways to Do Hard Things

¶ Naturally these books must be handy of reference to be of value and this feature has not been overlooked as each volume is indexed fully and with great care, so that any subject may be turned to at once.

¶ Why not save yourself the trouble of puzzling out the "kinks" and "short-cuts" when someone has already done it for you? Some one little suggestion may be worth more to you than the price of the entire set of books.

Shop Notes Year Books

VOLS. I TO VIII INCLUSIVE

CONTAIN

4000 Articles—1764 Pages—4000 Illustrations

Size 6 x 9 in. Bristol Covers.

PRICE

50c PER VOLUME Postpaid

\$4 PER SET of eight Books in Handsome Case Prepaid

Order or complete your set to-day

Popular Mechanics Book Dept.
318 W. Washington St. CHICAGO



Every Essential Step

in wood-working is given in the book

Wood-Working for Amateur Craftsmen

By IRA S. GRIFFITH, A.B.

The chapters dealing with making special articles bring out every cut, joint and process used in this important trade, and the proper use and care of tools, working up of materials, etc., are treated thoroughly and plainly.

CONTENTS:

Making Out a Stock Bill—Laying Out Rough Stock—Hand Saws—Sawing with Hand Saws—Planes: How to Set and Adjust the Irons—Squaring Up Mill Planed Stock—Separating Up Rough Stock—Whetting Plane Irons and Chisels—Grinding Plane Irons and Chisels—Making a Bird Box—Making a Tabouret—How to Make an Umbrella Stand—Making a Magazine Stand—Making a Table—Making a Cabinet.

128 pages—125 illustrations—[67]—Cloth.

PRICE 50 CENTS POSTPAID

Order of your dealer or

POPULAR MECHANICS BOOK DEPT.
318 W. Washington St. CHICAGO

WHEN YOU WANT ANYTHING AND DON'T KNOW WHERE TO FIND IT
WRITE BUREAU OF INFORMATION,
POPULAR MECHANICS CHICAGO

MONTHLY CASH PRIZES

Until further notice in this magazine the Editor of Popular Mechanics will pay two cash prizes each month for the best original contributions to its

SHOP NOTES DEPARTMENT

\$10 for the Best Contribution
\$5 for the Second Best

THIS IS IN ADDITION to our usual rates for such contributed articles.

Quality, not length counts.
Checks will be sent on the last day of each month for the prize articles received during that month. Publication in the magazine will follow in about two months.

PRIZES AWARDED FOR JULY, 1912

First Prize—J. W. SHANNON, Babcock, Ga. \$10
"Homemade Bath Water Heater"

Second Prize—ROY D. ERWIN, Philadelphia, Pa. \$5
"Substitute Remover for Crown Tops on Bottles"

EXTRA AWARD

On account of there being five contributions this month each of which deserved second prize, we have made an EXTRA AWARD of four additional second prizes, as follows:

H. J. HOLDEN, Ontario, Cal. \$5
"Repairing Leaks in Range Boilers"

G. B. WRIGHT, Middletown, Conn. \$5
"Arm for Holding a Telephone"

C. F. FULLER, Pontiac, Mich. \$5
"Locating Leaks in Gasoline-Engine Intake Connections"

F. H. TILLOTSON, Sycamore, Ill. \$5
"Protecting the Fingers from Chemicals"

All accepted contributions to our departments, "SHOP NOTES" and "AMATEUR MECHANICS," are paid for immediately; checks for prize awards are sent at the end of each month.

Address, EDITOR POPULAR MECHANICS
318 W. Washington St., Chicago



GOOD NEWS for WIRELESS OPERATORS

A. F. Collins, America's greatest authority on wireless apparatus, has written a book that tells in plain, every-day language and shows by simple, easily understood diagrams how to make experimental and one to five mile wireless sets that will do real work. This book places at the disposal of every amateur the boiled-down experience of a world-famous wireless authority. Stop working in the dark. Send 25c To-day for This Book and START RIGHT.

Spon & Chamberlain, 123 P. M. Liberty St. NEW YORK, U.S.A.

The New York Electrical School

Offers a theoretical and practical course in applied electricity without limit as to time.

Instruction individual, day and night school, equipment complete and up-to-date. Students learn by doing, and by practical application are fitted to enter all fields of electrical industry fully qualified. School open all year. Write for free prospectus.

44 West Seventeenth Street NEW YORK

SUCCESS SHORTHAND

The best system for beginners; a post-graduate system for stenographers. Highest world's records for speed and accuracy and a greater number of court reporters than any other system in the last seven years. Instruction by mail; satisfaction guaranteed. Write for FREE Catalogue.

SUCCESS SHORTHAND SCHOOL

W. L. JAMES, Chief Instructor

Suite 109, Schiller Bldg. CHICAGO, ILLINOIS

STUDY AT HOME

Commercial Law—Banking
Bookkeeping—Shorthand

Taught in your home. Newest texts. Best instruction. Easiest terms. Write now for catalog.

CHICAGO COLLEGE OF CORRESPONDENCE
"FOR THE AMBITIOUS" Box 26 H CHICAGO, ILL.

BE A DETECTIVE

Earn from \$150.00 to \$300.00 per month; travel over the world. Write

C. T. LUDWIG, 1600 Scarritt Bldg., Kansas City, Mo.

LEARN JEWELERS' ENGRAVING

A high salaried and easily learned trade, taught thoroughly by mail. We will teach the beginner better engraving than he can gain in years of rigid apprenticeship. We will also improve the skill of any engraver. Send for our catalog. The Engraving School, 112 Page Bldg., Michigan Ave., Chicago, Ill.

Wanted. Automobile Student!

If you want to become an Expert Automobile Repair Man, Salesman or Driver, write me today. I have a special proposition for you. H. J. RAHE, 1185 Locust St., Kansas City, Mo.

LAW

LINCOLN
was a **LAWYER**
— HOME TRAINED

STUDY AT HOME

Write today for our Complimentary Scholarships offer. These Scholarships are open now.

Graduate correspondence students hold highest records, are most successful in passing bar examinations. Our Complete Home Study Law course covers the same ground as HARVARD, CHICAGO, SULLIVAN, COLUMBIA and other leading law schools of the country. Recognized by great jurists, lawyers and universities as the greatest home study law course in America.

We Guarantee to coach FREE

any graduate failing to pass bar examination. Our course covers both theory and practice—prepares for bar in any state. Abraham Lincoln, Henry Clay, John Marshall, Jas. A. Garfield, Edward H. Harriman, Thos. W. Ryan and thousands of our most noted men and lawyers STUDIED LAW AT HOME.

Decide now to study law at home. Make this great step toward a successful business or professional career.

Special Business Law Course

PATRICK HENRY said that there is only one lamp to guide your footsteps, the lamp of experience; only one way to judge the future, by the past. Know just what to do. Avoid expensive lawsuits. We teach you a thorough knowledge of commercial law; we give you the fundamental foundation and principles of business.

FREE Scholarships

Write today. FREE Scholarships open. Scholarship students pay only for text and postage. This is a very extraordinary opportunity. We want a large number of students quickly, and hence this chance we are giving to a very few. If you want this opportunity, be quick. Answer at once, for we reserve the right to withdraw the offer at any time.

Send Free Coupon

Sign and mail this coupon today. Get the most remarkable offer ever made by a big law college. Our Scholarship entitles you to a full three years' course. Get also our free catalog and full particulars. Don't wait. Send the coupon now, while this remarkable offer lasts.

AMERICAN
CORRESPONDENCE
SCHOOL OF LAW
Manhattan Building
Dept. 1196
Chicago, Ill.

FREE COUPON

American Correspondence School of Law, Manhattan Bldg., Dept. 1196 Chicago.

Gentlemen: Without any obligations on me whatsoever, please send me your Catalog and full particulars of your Free Scholarship Offer.

Name _____

Address _____

Please Mention Popular Mechanics

Let Us Show You How to Earn \$3,000 to \$10,000 a Year in the Real Estate Business



**Our
President**

If you are ambitious to better your condition—if you want to establish yourself in a splendid paying business requiring no capital—send us your name and address and we will mail you—*free*—a valuable **62-page prospectus** explaining our system of money-making, without interfering with your present occupation. We have perfected a thoroughly practical scientific method of teaching by mail the

Real Estate, Brokerage and Insurance Business

Under our plan, we teach these big money-making branches. When you are thoroughly qualified to make a success of the business, we appoint you

Special Representative

This gives you a chance to identify yourself with the oldest and largest Co-operative Real Estate and Brokerage Company in America. By our system you can—if you will—be making money in a few weeks without conflicting in any way with your regular work. Our Co-operative Department will give you more choice, salable property to handle than any other concern in the world. So the sooner you investigate our plan, the sooner you will get your name on your own real estate signs and be ready for business.

Valuable Commercial Law Course Free

To each of our representatives we also give a thorough course in commercial law without cost. The instruction is indispensable to any man who wants to make his way in the business world. We teach you, free, everything you need to know to successfully meet legal problems that may arise in any business transaction. And we also furnish you free legal advice whenever you require it.

Send For This Book Now

Our Big 62-Page Free Prospectus will prove of great interest and real value to anyone, but it is of vital importance to office employees, salesmen, agents, clerks, solicitors and others who are ambitious to enter the realms of better things in business. This book is an inspiration to the indifferent, a spur to the laggard, and a stimulant to the ambitious. It deals with the great problems of business, and points the only sure way to the complete mastery of Real Estate, Brokerage and Insurance, three of the most profitable branches of modern business, which have made many millionaires and brought great prosperity to tens of thousands of active, energetic men all over the land.

MAIL THE COUPON TODAY

Don't procrastinate. Act! Anything that is worth doing is worth doing promptly. Resolve to send for this big free prospectus, and send for it right now, while the matter is before you. "I'll do it tomorrow" has been the grave of countless good intentions. "I'll do it today" is the solid rock on which to build the only enduring success.

Just clip the coupon, fill it out, sign and send today. By return mail you will receive free the invaluable book, which to thousands of ambitious men has proved the key that opens the door of great achievements in business.

INTERNATIONAL REALTY CORPORATION
1036 Manhattan Building, Chicago



COUPON

The International Realty Corporation.

1036 Manhattan Building, Chicago

Please send me, by return mail, your big 62-page Free Prospectus and oblige.

Name.....

Address.....



**THIS JOB PAYS
\$25-\$50 Weekly**

YOU CAN BE AN AUTO EXPERT

We teach you the entire subject by mail in 10 weeks' spare time, and assist you to secure good position. Demand for trained men can't be filled. Simple, practical and personal instruction. Free auto model to each student.

FIRST LESSON FREE—WRITE FOR IT NOW

Get started at once. Write The Original Automobile School Empire Auto Institute, 152 Empire Bldg., Rochester, N. Y. Owners—we supply competent men.



This man makes Big money
Do You ?

The Automobile Man enjoys the free'st, healthiest, most interesting and best paying position of ANY wage earner to-day. Our free 52-page booklet, "How to Drive," explains How and Why our practical methods produce EXPERTS. Send for it NOW.

GREER COLLEGE OF MOTORING

1457 Wabash Avenue, CHICAGO, ILL.

NOT A CORRESPONDENCE SCHOOL. We teach by practical instruction with actual repair shop experience in resident courses ONLY.



IF YOU STAMMER

Attend no stammering school till you get my large FREE book and special rate. Largest and best school in the world curing by natural method. Write today. Leo Wells Millard, Pres., North-Western School for Stammerers, Inc., 817 First St., Milwaukee, Wis.

MEN WANTED!

SOUND MEN—21 to 40 years old—wanted at once for Electric Railway Motormen and Conductors in every state. Wages \$60 to \$100 a Month. Experience Unnecessary. Permanent employment, no strike. Write immediately for Application Blank. No colored men hired. Address **Manager Employment Department, Room 589 Dwight Bldg., Kansas City, Mo.**

LEARN TO WRITE EARN \$25 to \$100 A WEEK

How to increase your salary. BOOK MAILED FREE. PAGE-DAVIS CO., 112 Page Building, Chicago, Ill., or 150 Nassau St., New York

REDUCE THE COST OF UP-KEEP OF YOUR AUTOMOBILE



Audel's Answers On Automobiles

gives full details on successful care, handling, how to locate trouble and remedy it. Begins at the very first principles and then forward to the principles used in every part of a motor car. It is a thorough 1913 course in the Science of Automobiles. Contains 516 pages of intensely practical time and money saving information, clearly and simply written. 380 illustrations. Indexed for ready reference. Highly endorsed by manufacturers. Invaluable to owners, intending owners, repair men and chauffeurs. Examine and use this book 7 days free by sending coupon.

\$1.50

Theo. Audel & Co., 72 Fifth Ave., New York

Kindly mail me copy of Audel's Answers on Automobiles and, if found satisfactory, I will immediately remit you \$1.50, or return the book to you.

Name _____

Occupation _____

Address _____

Sept. P.M.

SENT ON APPROVAL—NO MONEY DOWN

LAW

STUDY AT HOME



Administration Building

We Make Your Home a University

Graduate correspondence students hold highest records and are most successful in passing bar examinations. Leading home study law course in America—recognized by bench, bar and noted educators. Our own modern texts—lately prepared by Deans and Professors from leading university law schools—Harvard, University of Chicago, Michigan, Wisconsin, Illinois, Iowa, Leland Stanford, and others. We guarantee to coach free any graduate failing to pass bar examination.

Legally Trained Men Achieve Greatest Success

in business and public life. Abraham Lincoln, Edward H. Harriman, Thomas F. Ryan, Robert S. Lovett, John Mitchell, Samuel Gompers, John F. Dillon, and thousands of our most noted men and lawyers have studied law without attending a resident college.

President Taft Says:

"Every man who expects to achieve substantial success in the business or professional world should be legally trained." DECIDE NOW to study law, and thus make the first step toward a great and successful business or professional career. Extremely low cost—easy monthly payments. Send free coupon for catalog.

Our Great Offer

Write at once and learn how to save over half the cost by enrolling now. Greatly reduced scholarships offered at this time to secure a large enrollment quickly. We reserve right to withdraw offer at any time; be quick, send in the coupon right away and secure full particulars of the most remarkable offer ever made by an institution of learning.

Special Business Law Course

for those desiring a knowledge of commercial law. Know your rights; keep out of lawsuits. Send coupon today. Don't wait until the offer is withdrawn and it is too late.

Send Free Coupon

Cut out and mail this coupon today for free 112-page catalog and full particulars of our great offer to new students. Don't delay—send at once—right now.

FREE COUPON

LA SALLE EXTENSION UNIVERSITY

LA SALLE EXTENSION UNIVERSITY
Box 1199, CHICAGO, ILL.

Box 1199
CHICAGO
ILL.

GENTLEMEN: Please send at once particulars and complete catalog FREE, regarding Special Advertising Scholarships offered in your Department of Law.

NAME.....

STREET & NO.....

CITY.....STATE.....

The Pathway  to Plenty

HELP WANTED
AVERAGE \$9000 MONTH
by U.S. "GOVERNMENT"

Railway Mail Clerks
 Custom House Employees
 Internal Revenue Employees
 City Carriers—Postoffice Clerks
Examinations Everywhere Soon
Over 15,000 positions will be filled
 No "Layoffs" without pay, because of strikes, financial failures or the whims of some petty boss. Excellent opportunities for quick advancement to Higher Government Positions. If you want immediate appointment, send Today for our schedule showing locations and dates of the Fall Examinations. Any delay means the loss of just so much time in preparing yourself for examination.

We Prepare Candidates Free

Send Today
FRANKLIN INSTITUTE
 Dept. F 108, Rochester, N. Y.

The coupon, filled out as directed, entitles the sender to a free copy of our book, "Government Positions and How to Obtain Them," free sample questions, and to consideration for Free Coaching for the examination here checked.

..... Railway Mail Clerk (\$2000 to \$1400) Customs Positions (\$800 to \$1500)
 Postoffice Clerk (\$800 to \$1200) Internal Revenue (\$700 to \$1800)
 Postoffice Carrier (\$800 to \$1200) Stenographer (\$800 to \$1500)
 Rural Mail Carrier (\$500 to \$ 900) Clerk in the Departments at Washington (\$800 to \$1500)
 Bookkeeper (\$800 to \$1800) Canadian Government Examinations

NAME.....
 ADDRESS..... F108

Use this before you lose it. Write plainly

FRENCH, GERMAN, SPANISH, ITALIAN



Can be learned quickly, easily and pleasantly, at spare moments, in your own home. You hear the living voice of a native professor pronounce each word and phrase. In a surprisingly short time you can speak a new language by the

LANGUAGE-PHONE METHOD

recombined with
ROSENTHAL'S PRACTICAL LINGUISTRY
 Send for Booklet and Testimonials
The Language-Phone Method
 918 Putnam Building, 2 West 45th Street, N. Y.

Learn Electric Signalling



At Home—By Mail

A splendid profession. Great opportunity. Big demand by railroads for signal engineers. More men needed all the time to fill vacant positions. You can keep present position while learning.

\$1,800 TO \$4,500 PER YEAR

Rapid advancement from the first. Easy to learn. Takes but short time. Write today for free booklets. Do not put this off. Special offers to new students.

DEPARTMENT OF SIGNALLING, Desk 1196, 491 Cass St., CHICAGO



HIGHLAND PARK COLLEGE DES MOINES IOWA

Enter Any Time. 2000 Students Annually

One of the most completely equipped ENGINEERING SCHOOLS in the country. Students may enter any time they are ready to come.

COURSES OFFERED

1. CIVIL, ELECTRICAL AND MECHANICAL ENGINEERING COURSES. Standard courses are offered in Civil, Electrical and Mechanical Engineering. Special opportunity is offered for making up work or for taking a complete course preparatory to the standard Engineering Course. Shop work from the beginning comes in preparatory courses. See our new Engineering Catalogue.

2. SHORT COURSES
 1. One Year Electrical Engineering Course
 2. One Year Telephone Engineering Course
 3. One Year Steam Engineering Course
 4. One Year Machinists' and Automobile Course
 5. One Year Course in Mechanical Drawing

Just a fair common school education is all that is required for entrance to these courses. These courses are very practical and are intended for those who have but limited education and do not see their way clear to take a complete Engineering Course. The Machinists' Course is especially practical. The new machine shops are the most complete to be found in connection with any Engineering School in the United States.

SPECIAL COURSES

1. TRACTION ENGINEERING. This is the most complete course in Traction Engineering offered by any Engineering School in the country. It may be completed in three months. Students are taught how to make all repairs on engines as well as to handle them. Four traction engines used for experimental purposes.

2. GASOLINE AND AUTOMOBILE COURSES. These courses may be completed in three months. They are exceedingly practical. Complete Chauffeur practice. Just a fair common school education is all that is necessary to enter.

3. FARM BLACKSMITHING, FARM CARPENTRY.

Mention course in which you are interested. Address,

O. H. LONGWELL, Pres. DES MOINES, IA.



LEARN WATCHMAKING

Watchmaking pays and you can earn while you learn. Write for FREE BOOK, "How to be a Watchmaker." Postal brings it.

STONE'S SCHOOL OF WATCHMAKING
 912 Globe Bldg. ST. PAUL, MINN.



I TEACH SIGN PAINTING

SHOW CARD WRITING or LETTERING by mail and guarantee success. Only field not overcrowded. My instruction is unequalled because practical, personal and thorough. Easy terms. Write for large catalogue.

CHAS. J. STRONG, Founder

DETROIT SCHOOL OF LETTERING
 DEPARTMENT PM. DETROIT, MICH.

"Oldest and Largest School of its Kind"



SHOW CARD WRITERS
EARN FROM
\$21 TO \$50 PER WEEK

LEARN ABOUT OUR FREE COURSE IN SHOW CARD AND SIGN WRITING

A Great Opportunity! We are offering, for a limited time, a complete course in show card and sign writing to those purchasing our assortment of

"Litholia" Ready-to-Use Colors

This is a great opportunity for ambitious persons, either sex, to increase their earning capacity. Good show card writers in demand at \$21 to \$50 weekly, salary or in business for yourself. Our show card course is not a book of alphabets. It's a complete course in lettering compiled by an expert New York show card artist for us. "Litholia" is the only liquid pigment water paint ever manufactured, used the same as cake, distemper or tube colors, but far superior to either. "Litholia" lasts longer, always ready. "Litholia" is the best for the show card writer, the artist, or the interior decorator. 4 cents in stamps brings booklet, circulars and full information.

LITHOLIA Pm. COLOR CO., 247 West 125th Street, NEW YORK CITY

BE A LAWYER



FOR over fifteen years the American School of Correspondence has been pre-eminent as a correspondence school of Business and Engineering. Its efficiency is recognized by professional and business men of the highest type. Its courses and consulting department are made use of by successful business men and engineers desiring to "polish up" on particular lines, as well as by thousands of young men who have obtained from this school their entire training for their life work. The same resources and the same thorough methods which have been used in placing the business and technical instruction of this school on a plane by itself have now been directed to organizing a new

Department of Law

This Department is the result, not only of the American School's years of experience in teaching by mail, but of the closest study and analysis of the needs of the law student. The courses are written, not simply with a view to what students will buy and study, but with the idea of furnishing the **Best Correspondence Law Course** that has ever been offered or that it is possible to produce.

Instructors: The instructors of the American School are men pre-eminent in the various subjects they teach. Our instruction papers are prepared by the greatest living authorities, by men at the head of, or professors in the best resident schools in the country—University of Chicago, University of Michigan, Wisconsin, Iowa, Illinois, Harvard, etc., men who are now engaged in teaching law at these great resident colleges.

Lincoln didn't have your chance—he studied law by the light of a pine knot and from books he borrowed. The American School brings a complete University Law Course to you in your own home; you won't have to quit work—just a small part of your spare time will do. All of our greatest statesmen and many of our most successful business men obtained their start through the practice or knowledge of Law. This is your chance to "learn the greatest of professions."

Why not make the start today by signing and mailing the coupon now—today?

American School of Correspondence
CHICAGO, U. S. A.

Special Offer Coupon

American School of Correspondence, Chicago, U. S. A.

Gentlemen:—Please send me complete Law Bulletin, and information regarding your University Law Course.
Pop. Mech. 9-12

NAME.....

ADDRESS.....

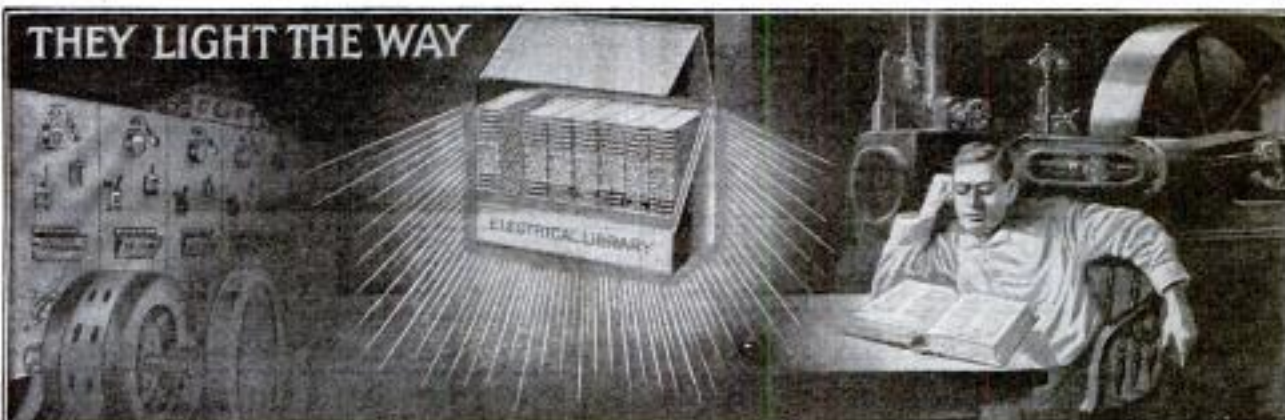

Electrical Workers' Standard Library

Text books with which to easily and quickly master the Electrical profession. A Complete Course of Easy Lessons. Arranged in progressive order in Questions and Answers. Plain everyday English. Hundreds of diagrams and drawings make everything so clear that even a boy can understand.

Specialized knowledge embodying the research and life-time experiences of foremost practical experts

Eight volumes, pocket size, about 380 pages each, profusely illustrated with diagrams, drawings and plates. One has about 750 pages and covers everything connected with up-to-date American Telephone practice. This volume alone has upward of four hundred engravings. Also a Complete Electrical Dictionary and the Civil Service Examination Questions and Answers.

The FREE CONSULTATION SERVICE of this Institute for a term of **THREE YEARS** is at the command of every purchaser.

Elegant in appearance. The books are bound in full leather, round corners, and red edges. Complete in cloth-covered Case as shown above.

COUPON

National Institute of Practical Mechanics, P.M.

Without any obligation on my part to purchase please send me particulars, price, and easy payment terms of the Electrical Workers' Standard Library with the Consultation Service of your Institute.

NAME.....

ADDRESS.....

AGE.....

OCCUPATION.....

EMPLOYER.....

National Institute of Practical Mechanics
1225 Michigan Avenue Chicago, U. S. A.



I'll Double Your Earning Ability in Six Weeks

Learn the Automobile Business A trade which you are in demand 12 months in the year. Work pleasant—high demand for trained men. 90% of the automobiles in daily use are not in proper adjustment on account of shortage of experienced automobile mechanics.

Everybody in the Automobile Business Today is Making Big Money

I want you to come to my school; I want you to see for yourself, how thoroughly and practically I teach all about the automobile. Six weeks after the day you enroll in my great practical Automobile School you will be prepared to properly repair any automobile, make and drive any car or truck or open a garage and repair shop of your own. You can learn the automobile business thoroughly in my school because I have been years in working out for quick, thorough instruction, the

"Sweeney System" of Practical Automobile Instruction

It is today the most thorough, practical, comprehensive and interesting course of automobile instruction, and embraces every point worth knowing, including vulcanizing, brazing, oxy-acetylene welding, lathe work, machine shop practice, testing and road work, etc. You learn by doing the actual work on real cars with your own hands under the watchful eyes and ready suggestions of experienced instructors.

Send Today for free catalog and we will place your name on our mailing list for our monthly school magazine which we will also send you absolutely free. I want every man thinking of learning to become an Auto Expert to have this big, illustrated catalog. Write for this great book. Send today—this very minute—NOW.

EMORY SWEENEY, Prés.

Sweeney Automobile School The School of Practical Experience
1462 Woodland Ave., KANSAS CITY, MO.

Experienced chauffeurs, repair men, truck drivers and demonstrators furnished.

No Books Used Tools Furnished FREE

The tuition is low and, after you have paid that, you do not have another cent of expense in the school. You do not learn from books, but by practical work on real automobiles in everyday use.



DO YOU LIKE TO DRAW?

That's all we want to know

Now we will not give you any grand prize—or a lot of free stuff if you answer this ad. Nor do we claim to make you rich in a week. But if you are anxious to develop your talent with a successful cartoonist, so you can make money, send a copy of this picture with 1c. in change for postage of cartoons and sample lesson plate, and let us explain. The W. L. Evans School of Cartooning, 321 Ball Bldg., Cleveland, O.

STOP! READ! Train for Opportunity, Efficiency, PROMOTION. Ten Business Courses offered. Trained teachers. Consultation specialists at your services. We co-operate with you. **Common Sense Business School, 8, Bixby City, Nebraska.**

THE VERMONT ACADEMY for Boys

Saxtons River, Vermont. An ideal school for wholesome training and thorough education. Special attention to life in the open. Certificate to colleges. Lower school for younger boys. Terms, \$400-\$500.

GEORGE B. LAWSON, A. M., D. D., Principal.

BE A SALESMAN

Do You Want a Good Position Where You Can Earn From \$1,000 to \$5,000 a Year and Expenses?

There are hundreds of such positions now open. No former experience as a Salesman required to get one of them. If you want to enter the world's best paying profession our Free Employment Bureau will assist you to secure a position where you can earn good wages while you are learning Practical Salesmanship. Write today for full particulars; list of good openings and testimonial letters from hundreds of our students for whom we have recently secured good positions paying from \$100 to \$500 a month and expenses.

Address nearest office. Dept. 123

National Salesmen's Training Association

Chicago, New York, Kansas City, Seattle, New Orleans, Toronto.



WORK FOR UNCLE SAM
Government positions offer pleasant employment with good pay. Custom House, Internal Revenue, Bookkeeper, Railway Mail and Post Office Examinations everywhere soon. Any American citizen, 18 or over, eligible. Common education sufficient. Our free booklet shows how you can prepare under personal supervision of former Secretary of Civil Service Examiners. Write for Booklet to-day. **PATTERSON CIVIL SERVICE SCHOOL, 900 Livingston Bldg., Rochester, N. Y.**

STAMMER My book "How to Stop Stammering"—a treatise on "Scientific Talking"—direct to the point.
Write **M. L. HATFIELD, 1918 Grove St., OAKLAND, CALIF.**

ADVICE Information and counsel on any subject under the sun. No matter what you want to know, no matter what your present condition, our big organization can help you.
WRITE TODAY FOR BEAUTIFULLY ILLUSTRATED BOOK FREE
NATIONAL BUREAU OF ADVICE AND EDUCATION, 527 Ashland Block, CHICAGO

WINDOW TRIMMING Advertising and Card Writing are the best paid professions in the world. Interesting prospectus FREE tells you all about it.
KOESTER SCHOOL, 306 Jackson Boulevard, CHICAGO

Prepare for College at Home You can prepare for College or complete your high school work at home by our simplified correspondence methods. Our courses meet

all entrance requirements; they are written by members of the faculties of Columbia, Cornell, Pennsylvania, Mass. Inst. of Technology, Illinois, Chicago, Michigan and other leading universities. The American School is one of the largest educational institutions in the world and employs no agents, solicitors or collectors. Write for special College Preparatory Booklet.

AMERICAN SCHOOL OF CORRESPONDENCE
5791 Drexel Avenue Chicago, U. S. A.

Don't Be a Half-Way Man —Learn a Trade!



Make \$5⁰⁰ to \$8⁰⁰ a Day At Start

Every day the demand for trained men is growing. Never before were such high salaries paid. **YOU ARE WANTED.** Jobs—good jobs—are open now. \$5.00 to \$8.00 a day right from the start. No experience necessary. Unlimited future. Success certain.

Here's Your Guarantee:

C. N. T. S. Gentlemen:— I finished my course in your plumbing school two years ago. Am in business for myself here and have five plumbers going. Can use two of your graduates at once. Have them write me.

Your student,

Syracuse, N. Y. JACOB S. SWANSON

C. N. T. S. Gentlemen:— Have been working every day since leaving school. Am getting \$6.00 a day at Electrical work here with one of the big Electrical firms. Expect to get into business for myself this fall. You have the best Electrical school in America and I'll always recommend it.

Yours truly,

B. W. STEVENS

546 Arlington Pl., Chicago.

Mr. L. L. Cooke:— Many thanks for the job which you got us. Getting along fine. There are five bricklayers on the building and all Coyne men. Best regards to yourself and instructors.

Yours truly,

Lexington, Ky. PATRICK SULLIVAN

C. N. T. S. Gentlemen:— Have more business here this spring than I can handle. Your Painting and Decorating course can't be beaten. I can do any kind of work now in this line. Am going to send you two painters apprentices this winter to take a course.

Yours truly,

Flanagan, Ill. H. L. HEROD

Dear Mr. Cooke:— Am now working for The Illinois Steel Co. as draughtsman at \$130 per month. That's going some, and only out of your school three months. Your drafting course is fine and the instruction the best. Am sending my brother to your school next month. Yours truly, C. W. JACKSON
2122 Sherman Ave., Evanston, Ill.

We teach you **Electricity; Plumbing; Bricklaying; Painting; Decorating; Drafting and Moving Picture Operating.** Teach you in a short time at **small expense.** Give you the **actual work** to do right in our school, besides teaching the theory and fundamental principles of these trades. More requests for trained men come to our **Free Employment Bureau** than we can fill—hence we are making a **Very Special Offer** at this time. Send the free coupon for full information **at once.**

Start a Business of Your Own— \$3,000 to \$5,000 a Year

Many of our graduates go into business for themselves upon leaving school. Make \$3,000 to \$5,000 a year. You can do the same. We'll give you every assistance possible. Our School is the

Oldest, Largest and Best Equipped Trade School in America

You can enter any time. Open all the year round. Day and night sessions. Tuition **VERY LOW** at this time. Easy payments if desired. We will help you pay your way through school.

Free Tools We will furnish **FREE** all the tools and equipment you use while taking course. No expense to you.

Mail Coupon Right Away

Start on the right road to success **NOW.** If you want to rise above the untrained class; if you want to assure your future—if you want your knowledge and services to be in demand **MAIL THIS COUPON AT ONCE.** Come to busy Chicago. These trades pay \$6.00 a day—8 hours work. Get our Catalog and full particulars. No obligation on you at all—so mail the coupon immediately.

L. L. COOKE, Director

Coyne National Trade Schools

Dept. 1196, 39-51 E. Illinois St.
CHICAGO

Free Coupon

L. L. Cooke, Director
**Coyne National
Trade Schools**

Dept. 1196, CHICAGO, ILL.

Please send me **FREE AND PREPAID** your School Catalog and full particulars about learning a trade. I assume no obligations.

NAME.....

ADDRESS.....

Please Mention Popular Mechanics

How You Can Get An Automobile FREE

We want honest, sober young men in every county to learn at home to repair, run, and to teach others, and then sell the COEY "FLYER," a 6 cylinder, 50 H. P., 5 passenger Automobile—"The World's Best Value." Write for full particulars how you can get one free—address:

C. A. Coey's School of Motoring

Dept. 205
1424-26 MICHIGAN AVE.
CHICAGO, ILL.



BE AN ELECTRIC MOTORMAN

GOOD PAY

Steady, healthful and pleasant employment. Positions open in every state. Our easy method teaches at home in spare time.

Small Cost. Particulars Free

National Institute of Practical Mechanics
1325 Michigan Ave. - CHICAGO, ILL.

Get This Free Book

FORTY pages with illustrations of truest, most valuable and interesting information on Electricity ever published. Should be read by every ambitious man in America. If you are seeking a vocation, interested in, working at, studying or about to study

ELECTRICITY

you need this book. It shows why you should, and how you can, develop yourself to master electricity and its functions and become an expert electrician and electrical engineer in from one to three years. Write for copy right now.

School of Engineering of Milwaukee
The Electrical School That Graduates Experts
161-171 Michigan St. MILWAUKEE, WISCONSIN
New Term Begins September Third



EARN A BIG SALARY Be An Auto Expert

Big demand and big pay for chauffeurs, repairmen, and salesmen. Our system of individual instructions by mail enables you to complete the course in 12 simple lessons at home. Send To-day for Free Book, particulars, and endorsements of 10 leading automobile makers. We assist graduates to get positions. **FREE MODEL FURNISHED EACH PUPIL.**
Practical Auto School, 65 Beaver St., N. Y. City



LEARN WATCH REPAIRING

Be a watchmaker—you can learn this profitable trade by correspondence in a few weeks in your own home by the DeSelms Chart System. After you complete the course you will know a watch from A to Z. You will know just what the matter is and how to repair one. When you graduate you will be a practical watchmaker and repairer and competent to fill any position. Positions for our graduates.

Ask for our Free Book. It explains our system and terms.

THE DESELMS WATCH SCHOOL
23 Perry Street ATTICA, INDIANA



BE AN ENGRAVER

LEARN AT HOME—EARN \$25 to \$50 WEEKLY. We give personal instructions and furnish necessary tools FREE. Terms reasonable. Complete particulars by mail.

Chicago Engraving School, Dept. 20, 110 W. Chicago Ave., Chicago

LEARN a Profitable Profession

EARN \$3000 TO \$5000 YEARLY
We teach you by mail. In a few months you can begin practicing Mechano-Therapy—an elevating and highly paid profession for men and women. Simpler than Osteopathy. Endorsed by physicians. Easy to learn. We guarantee success in the study. Only ordinary education required. Authorized diplomas to graduates. Work very interesting. Vast opportunities for social and financial betterment. Special terms now. **Write today for our illustrated prospectus—sent FREE.** Address: AMERICAN COLLEGE OF MECHANO-THERAPY, 81 W. Randolph St., Chicago, Ill.

Learn The Auto Business

EARN A SPLENDID SALARY

BIG Opportunities for salary, travel, advancement or to enter business await our graduates. We have trained thousands for success as chauffeurs, repairmen, testers, inspectors and demonstrators. By our unique system of actual practice in driving and repairing we give the most complete course in 4 weeks. Tuition low. Extensive equipment. Expert instructors. 100 men wanted for Sept. Write today for free catalog and special offer.

CLEVELAND AUTOMOBILE SCHOOL, Inc.
Not a Correspondence Course.
2341 Euclid Avenue, Cleveland, Ohio



Please Mention Popular Mechanics



Learn a Paying Profession

that assures you a good income and position for life.
For seventeen years we have successfully taught

PHOTOGRAPHY

Photo-Engraving and Three-Color Work

Our graduates earn \$20 to \$30 a week. We assist them to secure these positions. Learn how you can become successful. Terms easy—living inexpensive. Write for catalogue—NOW!
ILLINOIS COLLEGE OF PHOTOGRAPHY, 999 Wabash Avenue, Effingham, Ill.

ELECTRICITY



Complete in One Year

SCIENTIFIC ELECTRICITY
IN ALL ITS BRANCHES

Bliss Electrical School

Studies restricted to theoretical and practical electricity, mechanical drawing and necessary engineering work. Teaches simplicity, concentration, hard work. For young men of energy and character. 20 years of greatest success. Graduates hold first-class positions. Opens Sept. 25. Write for new catalog.

15 Takoma Ave., WASHINGTON, D. C.

LEARN TO BE A WATCHMAKER

BRADLEY POLYTECHNIC INSTITUTE

Horological Department, Peoria, Illinois



Largest and Best Watch School in America
We teach Watch Work, Jewelry, Engraving, Clock Work, Optics. Tuition reasonable. Board and rooms near school at moderate rates. Send for catalog of information.
BRADLEY, Dept. S., PEORIA, ILL.

Stop! Read! and Consider!!

Which is the better off, the man who has a good trade, or he who belongs to the vast army of unskilled workers? The New York Trade School, founded in 1881, and endowed, provides practical instruction in various trades for young men. Full day courses, \$25 to \$45; evening classes, \$12 to \$16. Illustrated catalogue, showing trades taught and giving full particulars, mailed free on application. Address, 1262 First Avenue, New York City.



QUICK, THOROUGH ELECTRICAL INSTRUCTION

A complete college course in two years. Time and money saved. Taught by graduate engineers. Practice on apparatus and machines—construction, operation and repair. Every branch of generation, transmission and application. Graduates in leading electric companies. New classes July and September.

WRITE FOR DETAILS

BRYANT & STRATTON COLLEGE
No. 111, College Building BUFFALO, N. Y.

NATIONAL TRADE SCHOOLS

WANTED—Young men to learn machinist's trade, complete course, up-to-date equipment, tuition reasonable, term starts September 11th, 1912. For particulars write to Member Dept. NATIONAL TRADE SCHOOLS INDIANAPOLIS, INDIANA



Learn Telegraphy

MORSE and WIRELESS

At My Practical School. Splendid demand for operators and agents. We also teach Station Agency Work. Graduates assisted. We occupy our own 3 large modern buildings equipped with R. R. Dispatchers and Western Union Wires and Wireless Station. Endorsed by Railroad, Wireless and Western Union Officials. Exclusive Methods. Teachers are practical experts. Living expenses earned. Max payments. Catalogs Free. Correspondence course if desired. GEORGE M. DODGE, Pres., Dodge's Institute, 8th St., Estab. 1874, Valparaiso, Ind.

This booklet will give you your start



Send for it

You can qualify as a traffic Expert

In your spare time—at home—you can thoroughly master a new profession. Expert traffic men will help you—will show you the way to lucrative employment in a dignified, pleasant and uncrowded calling.

A big field opened to you through our correspondence course of instruction

It is only recently that manufacturers and shippers generally have considered traffic in its true light. Yet transportation is the largest single item of expense in the world. Each year it totals 2,000 million dollars—five times the surplus and capital of all our national banks. Of this amount, it is conservatively estimated \$50,000,000.00 is wasted—lost to shippers through ignorance of the new Government Freight Rates. The demand for men who can save this waste—who understand the traffic business is way in excess of the demand. This in spite of the fact that these jobs pay the highest kind of salaries.

Manufacturers and Shippers

Just recently one manufacturer lost \$421.95 on a single carload shipment through ignorance of a special commodity rate. A traffic expert could have saved this. Another lost a big order because his competitor quoted a price based on a lower freight rate. Such things are regular occurrences. Transportation becomes more complex from day to day. You can anticipate your future needs—or satisfy a present

one—by suggesting to some likely employee the bright future traffic affords. Speak to some one about it—TODAY.

FREE Traffic Book

Here is a book that has started many a man to the right kind of a job. It is a common-sense talk on opportunity via the traffic route. We have given the book this very name. It tells how you can qualify as a traffic man.

The opportunity is ripe for the field is uncrowded. Big firms watch the development of every newcomer in the business—ready to pay a big salary to the right man. They are waiting for you. Be a traffic man. Make signing the coupon the first step. Then mail it at once—Today.



National Traffic College Dept. A

10 S. La Salle St., Chicago, Ill.

Gentlemen—Send me your free booklet, "Common Sense Talk on Opportunity via the Traffic Route" and other descriptive matter. I'm interested.

Name.....

Address.....

City.....State.....

Business.....

Present position.....

National Traffic College

Incorporated Dept. B

10 South La Salle Street
CHICAGO

Please Mention Popular Mechanics

The Curtiss Summer Training School

at Hammondsport, New York

Now Open

*New Hangars, new equipment,
experienced instructors.*

Aeroplane and Hydroaeroplane Courses

The Curtiss Schools are the largest in America. Seventeen pupils obtained their pilot's licenses at our San Diego school between January first and March fifteenth. Summer classes are filling rapidly.

**WRITE OR WIRE YOUR
ENROLLMENT TO-DAY**

Prices and particulars
upon request.

**The Curtiss
Aeroplane Co.**
Hammondsport, New York
(The Home of Curtiss
Aeroplanes and Motors)



I TEACH BY MAIL

WRITE FOR MY FREE BOOK
"How to Become a Good Penman"

and beautiful specimens. Your name elegantly
written on a card if you enclose stamp. Write
today. Address F. W. TAMBLYN, 418 Meyer Bldg., Kansas City, Mo.

LEARN WATCHMAKING AT HOME



You can learn by our modern and original system of instruction every part of the Watchmaker's Trade at home as good or better than at a shop. You can earn money while learning and secure a well paying position or start in business after completing our course of instruction. Good watchmakers are always in demand and earn from \$20 to \$35 per week. For particulars apply to the WISCONSIN SCHOOL OF WATCHMAKING, 518th St., MILWAUKEE, WIS.

COPY THIS SKETCH

and let me see what you can do with it. You can earn \$20.00 to \$125.00 or more per week, as illustrator or cartoonist. My practical system of personal individual lessons by mail will develop your talent. Fifteen years successful work for newspapers and magazines qualifies me to teach you. Send me your sketch of President Taft with 6c. in stamps and I will send you a test lesson plate, also collection of drawings showing possibilities for YOU.

THE LANDON SCHOOL OF ILLUSTRATING
AND CARTOONING
1438 Schofield Building, Cleveland, Ohio.



LEARN PIANO TUNING AT HOME

You can learn quickly and easily by devoting your spare time to the study of our Correspondence system. Our wonderful invention, the Tune-a-Phone, gives the exact number of beats that should occur in the test intervals. With it the student knows what the result should be. It eliminates guess work. Our graduates earn \$5 to \$10 a day the year round. We furnish full-sized action model and necessary tools. Write for valuable book FREE.

Niles Bryant School of Piano Tuning, 47 Pine Arts Bldg., Battle Creek, Mich., U.S.A.

SHORTHAND IN 30 DAYS

Boyd Syllabic System—written with only nine characters. No "positions"—no "ruled line"—no "shading"—no "word-signs"—no "cold notes." Speedy, practical system that can be learned in 30 days of home study, utilizing spare time. For full descriptive matter, free, address
CHICAGO CORRESPONDENCE SCHOOLS
969 Chicago Opera House Block CHICAGO, ILL.

LAW STUDY AT HOME BECOME AN LL.B.

Only recognized resident law school in U. S., Conferring Degree of Bachelor of Laws—LL. B.—by correspondence. Only law school in U. S. conducting standard resident school and giving same instruction, by mail. Over 450 class-room lectures. Faculty of over 30 prominent lawyers. Guarantees to prepare graduates to pass bar examination. Only law school giving Complete Course in Oratory and Public Speaking. School highly endorsed and recommended by Gov. Officials, Business Men, Noted Lawyers and Students. Send today for Large Handsomely Illustrated Prospectus. Special courses for Business Men and Bankers.
HAMILTON COLLEGE OF LAW, 1102 Ellsworth Bldg., Chicago, Ill.

LEARN THE EXPORT BUSINESS

Get into something new—where competition is practically unknown. Big manufacturers are searching the country for competent men to handle their Export Departments. We are the only School in America that teaches how to handle Foreign Trade. Find out more about this new career.

Write for our booklet—NOW.

JANSSENS SCHOOL OF FOREIGN TRADE
211 W. Schiller St., CHICAGO

THE UNIVERSITY OF CHICAGO

Correspondence-Study Dept.
HOME STUDY offers 350 class-room courses to non-resident students. One may thus do part work for a Bachelor's degree. Elementary courses in many subjects, others for Teachers, Writers, Accountants, Bankers, Business Men, Ministers, Social Workers, Etc. Begin any time.
20th Year U. of C. (Div 20) Chicago, Ill.

STUDY LAW AT HOME

22 YEARS OF SUCCESS. Instruction by mail adapted to everyone. FOR AMBITIOUS MEN who want to prepare for practice or who want to take our business law course so as to better their business prospects. Take spare time only. Can refer to successful graduates located in every section of the country. Handsome catalogue and Easy Payment Plan free.

The Sprague Correspondence School of Law
257 American Bldg., DETROIT, MICH.

LEARN WATCHMAKING

refined, profitable labor—Competent men always in demand. We teach it thoroughly in as many months as it formerly took years. Does away with tedious apprenticeship. Money earned while studying. Positions secured. Send for catalog.
St. Louis Watchmaking School, St. Louis, Mo.

LEARN WATCHMAKING Engraving and Jewelry repairing. Earn while learning. Our school endorsed by leading jewelers. Positions secured for graduates. Send for Free catalogue.

CHICAGO SCHOOL OF WATCHMAKING
Dept. 20, 59 E. Van Buren St. CHICAGO

MUSIC LESSONS FREE AT YOUR HOME

WRITE TODAY for our Booklet. It tells how to learn to play Piano, Organ, Violin, Mandolin, etc. Beginners or advanced pupils.
American School of Music, 50 Lakeside Bldg., Chicago, Ill.

BE AN ILLUSTRATOR by mail how to draw for magazines and newspapers. Send for Catalog

Learn to draw. We will teach you School of Illustration 112 Years Bldg. Chicago, Ill.



LEARNED BY ANY MAN OR BOY AT HOME SMALL COST
VENTRILOQUISM
Send today 2c stamp for particulars and proof.
O. A. SMITH, Room D 46, 823 Bigelow St., PEORIA, ILL.

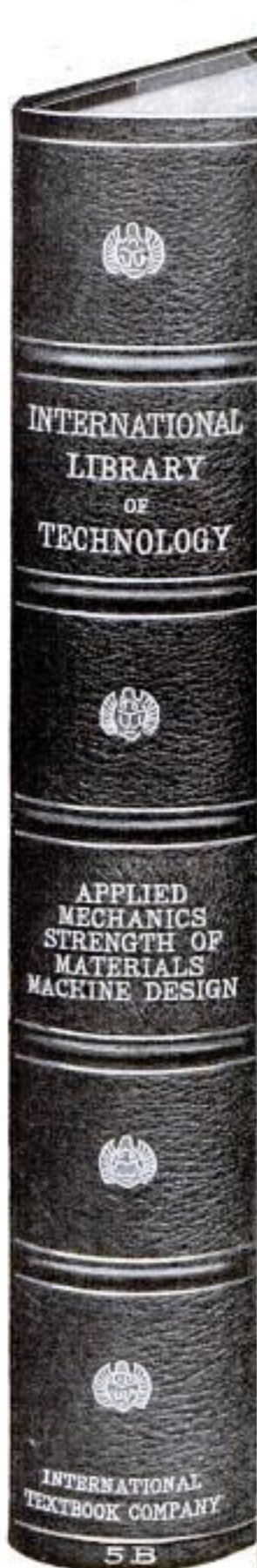

The Greatest Mechanical Library in the World

The Mechanical Engineering Library is part of the International Library of Technology that cost \$1,500,000 in its original preparation. It contains the knowledge given from the life experience of some of the best mechanical engineering experts in the country, edited in a style that nineteen years of experience in publishing home-study textbooks has proved easiest to learn, to remember, and to apply. There is no other reference work in the world that so completely meets the needs of the mechanic as the Mechanical Engineering Library. The volumes are recommended by the highest authorities and are used in nearly all the leading universities and colleges. They treat of practical mechanical methods, starting from the simplest problems and comprehensively covering every branch of the work. Not only can they be used to great advantage by superintendents, foremen, and engineers as an authoritative guide in their work, but since they can be so clearly understood even by persons having no knowledge of higher mathematics, they can be used by all classes of mechanics that are desirous of advancing to higher positions. The Mechanical Library contains 14 volumes durably and handsomely bound in three-fourths red morocco, stamped and numbered in gold. The books are printed on a high-grade book paper, and the type is large and easy to read. Each volume is 6 by 9 inches in size. If you wish to know more about the greatest and most practical mechanical library in the world, mark and mail the coupon NOW.

INTERNATIONAL TEXTBOOK COMPANY

Box 872, Scranton, Pa.

Please send, without further obligation to me, full particulars in regard to the International Library of Technology, with special reference to the Library of Mechanical Engineering.

Name _____

St. & No. _____

City _____

State _____

Please Mention Popular Mechanics

—ARE YOU LOOKING FOR— MECHANICAL INFORMATION?

Our book catalogue shows just where to find that particular help you are in need of on any of the following subjects:

Aeronautics
Air Brakes
Amateur Mechanics
Architecture
Automobiles
Boats
Boilers
Bricklaying
Building
Business
Camping
Carpentry
Cement, Concrete, etc.
Designing
Dies
Dyeing
Electric Railways
Electricity
Electroplating
Enameling
Engineering
Estimating
Fishing
Foundry Work
Gas Engines
Hand Forging
Heating
Hunting
Industrial Progress
Inventions
Lathe Practice
Lettering
Locomotive Engineer'g

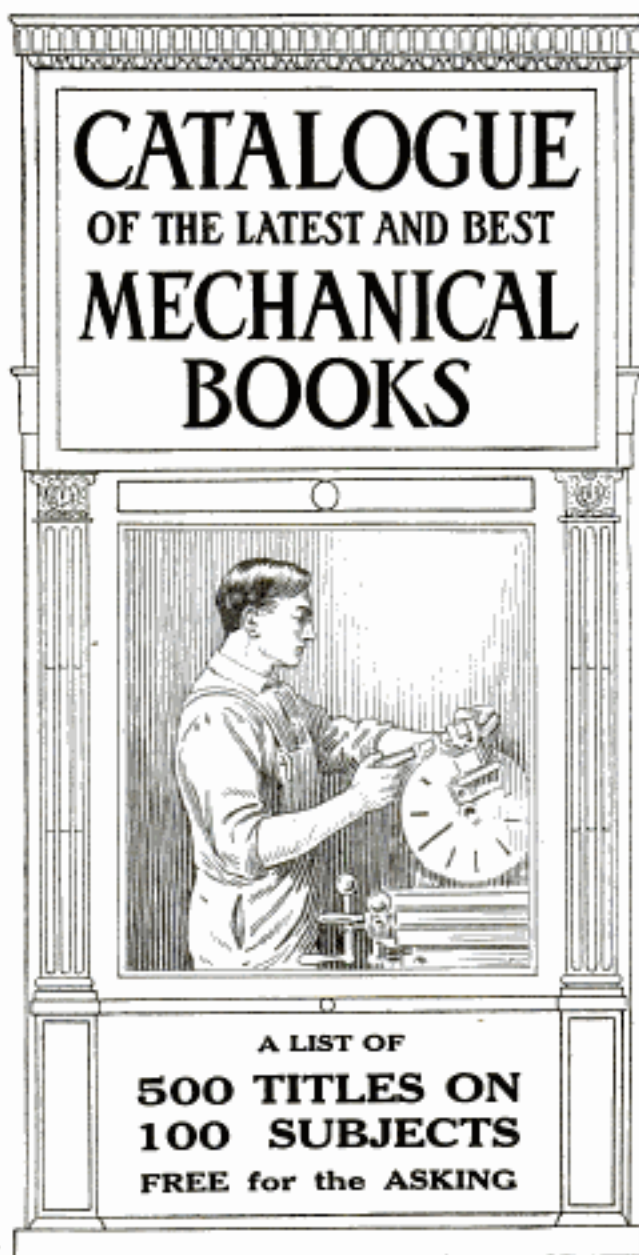

Machine Shop Work
Masonry
Mechanics
Mechanical Drawing
Metal Working
Millwrighting
Mission Furniture Making
Motorcycles
Painting
Pattern Making
Plumbing
Power
Pumps
Railroading
Recipes
Refrigeration
Science
Sheet Metal Work
Shop Notes
Sign Painting
Slate Roofing
Steam Engineering
Steam Turbines
Steel
Telephones
Tools
Trapping
Ventilation
Welding
Wireless
Woodworking
Wrought Iron
Ornamental Work

96 Pages—Vest Pocket Size—Indexed—Handy to Keep—Handy to Refer to

This catalog is not a hit or miss collection of book titles, author's names and prices, but consists of intelligently prepared *descriptions* of good books. In many instances, complete lists of contents are given; the aim being to tell enough about a volume to enable anyone to determine whether or not it contains the information he is seeking.

SENT FREE UPON REQUEST BY

Popular Mechanics Book Dept., 318 W. Washington St., Chicago

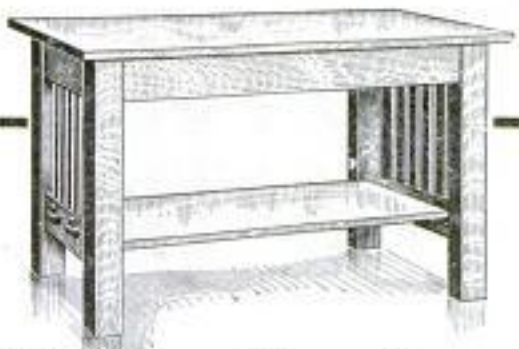

Mission Furniture HOW TO MAKE IT

50 Designs for \$1.00

What one man accomplished
with the aid of these books:

Popular Mechanics Co., H—, Miss.
318 W. Washington St., Chicago.
Sirs: Please send me Part Two, Mission Furniture: How to Make It, by mail postpaid. I have Part One, and have made and sold \$400.00 worth of one piece of furniture, and I am not a carpenter either, but with the instructions "Written so I can understand it," I have a business of my own.
Yours truly,
JOHN S. COLEMAN.

TWO VOLUMES

PART ONE | PART TWO

21 Designs. 96 Pages. | 32 Designs. 128 Pages.

Cloth Cover. Price 50c Each, Postpaid.

POPULAR MECHANICS BOOK DEPT.
318 W. Washington Street, CHICAGO



200 KINDS Iron, Wood,
Wire & Steel PUZZLES
Sample with Catalog 10 cents,
or 3 leaders for 25 cents.
WESTERN PUZZLE WORKS
St. Paul, Minn.



Every Boy His Own Toymaker

Greatest boys' book ever written. Tells how to make a Steam Engine, Telephone, Magic Lantern, Boats, Kites, balloons, electrical and mechanical toys, traps, fishing tackle, 300 illustrations; also catalogue of 150 puzzles, Keller's Magic Ace Trick Card and "DOUBLE THROAT" warbler and bird call all for only 10c. WESTERN PUZZLE CO., ST. PAUL, MINN.

WHEN YOU WANT ANYTHING AND DON'T
KNOW WHERE TO FIND IT
WRITE BUREAU OF INFORMATION,
POPULAR MECHANICS CHICAGO

Chart of a Modern Submarine

Price 25c Postpaid

Showing and naming over 200 parts. Size 14 x 28
inches. Printed on Plate Paper.

POPULAR MECHANICS BOOK DEPT.
318 W. Washington St. Chicago



Send for Sample

You will never know what real comfort and economy are until you wear Linene collars, particularly the turn down styles, Rubens, Raphael and Angelo. Pick out any one of the styles shown in this advertisement, tell us what size you wear and we will send sample collar for 6 cents in U. S. stamps or 10 collars for 30 cents. Price at the stores 25 cents for a box of ten. We also make cuffs and bosoms.

These goods are made of fine cloth with a flexible stiffening material between, they are finished in pure starch so that they look just like linen. A new LINENE collar costs about the same as the laundering of a linen collar. But the LINENE collar can be worn both sides—costing but 1-4 cents for each side—and then thrown away when soiled. We publish a beautiful catalogue showing 12 styles of collars, 2 styles of cuffs and 3 styles of bosoms. Send for it even if you don't order samples, now,—it is free. You will be sure to order after you get the catalogue.

REVERSIBLE COLLAR COMPANY, Dept. U, Boston, Mass.



HERE YOU ARE BOYS

A medallion pin of Foxy Grandpa. Everyone will notice it on the lapel of your coat and try to get a closer look at it. All you have to do is press the bulb.—Foxy Grandpa will finish the job by squirting a fine stream of water over the inquisitive one. Will squirt 20 feet. Greatest joke out. Order one today and fool your friends. Price 15c. Foxy Grandpa and Hooligan both for 25c. 5 for 50c or 1 doz. for \$1.00. A beautiful fountain pen free with every \$1.00 order.

AMERICAN SUPPLY CO., ST. PAUL, MINN.



BOYS—MAKE YOUR OWN TOYS

The Toymaker, greatest boys' book ever written, tells how to make a steam engine, telephone, magic lantern, boats, kites, balloons, electrical and mechanical toys, traps, fishing tackle, 300 illustrations. Send for the book, ventriloquist whistle, novelty catalogue—all for 10c.

American Supply Company, St. Paul, Minnesota

ARITHMETIC SELF-TAUGHT

A plain, easily-understood volume for all who have not had the opportunity of learning this subject thoroughly, or who have forgotten what they once learned. 257 Pages. Requires no teacher. This great little book sent postpaid for 60 CENTS. Stamps accepted, leather binding \$1.

GEO. A. ZELLER BOOK CO.
Est. 1876. 4473 W. Belle Place ST. LOUIS, MO.

SPANGENBERG'S
PRACTICAL
ARITHMETIC
Self-Taught



A SCHOOL WITHIN ITSELF

There are XX chapters in all, XIX carrying you from the fundamental principles of electricity on through the various branches to a point where the careful student comprehends the complete designing, care and operation of a dynamo or motor, and one chapter on electric automobiles, outlining their construction, care and operation, and all about storage batteries and how to handle them. Each subject is carefully written and to the point. After a student studies a subject, he is questioned on that subject in such a manner as to bring clearly to his mind the points he needs to know regarding same. The book contains a dictionary defining 1500 Electrical Words, enabling the reader to ascertain the meaning of any electrical word, term or phrase used in this book, as well as hundreds of others in common use. All required tables necessary in the study are in it.

\$2.00 PER COPY—SIXTH EDITION—30,000 COPIES SOLD.

The offer we make of refunding money if book is not satisfactory upon examination is AN UNUSUAL ONE in connection with the sale of a book. But we have no fear of its return. Your decision will be what thousands of others have been. Money would not buy it if it could not be duplicated. We could print testimonials by the hundreds. It is best to order and be your own judge of its merits.

CLEVELAND ARMATURE WORKS, 49 & St. Clair Ave., Cleveland, Ohio

Armatures and Fields Wound—Commutators Filled
AMERICA'S GREATEST REPAIR WORKS

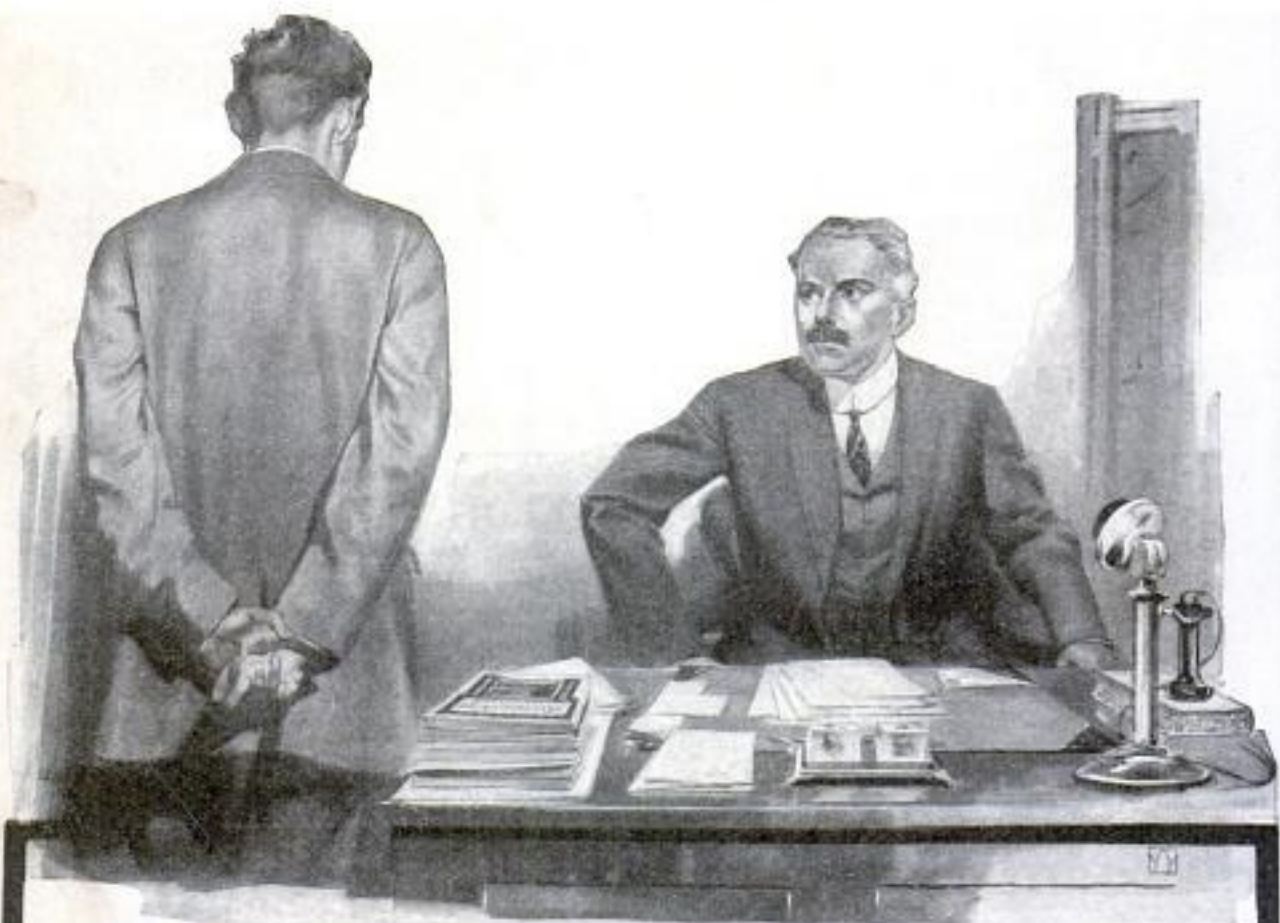

The Importance of Training

Here is a man who was in line for a better job, but, like the great majority, had not been training himself to "fill the shoes" of the man above him; he always thought that if the time ever came he could just bluff it through—special training wasn't necessary. There's where he made *his* mistake, and there's where you will make *your* mistake if you are not a trained man. The boss had only to ask a few questions to find that the man did not know anything about the other fellow's work; that he had been wasting his time instead of improving it—that he was just one of the fellows who get into a rut and stick because he didn't have sense enough to plan for the future.

The time to plan is right now; the opportunity will come when you are ready

Don't think, as this man did, that it is simply a matter of absorbing knowledge and as a matter of course promotion will follow. Don't argue with yourself "There's no opportunity here—no incentive to do better work—I have gone as high as I can in this firm—I know as much as the boss and don't see why I can't get the money."

If the opportunity for advancement is not right ahead of you with your own firm, then it is with another. There is always an opportunity—always a chance for a better job, for better pay—yes, just the job you have often wished you had—but mere wishing will never get you anywhere; you must get the training.

The American School of Correspondence was founded to help just such men as you. It is one of the largest educational institutions in the world. If you will write and tell us what you want to be, how much of an education you already have, and how much time each day you are willing to devote to bettering your condition, we will send you, absolutely free of charge, our complete bulletin describing sixty-five courses of study. We will tell you how you can pay for the course you want by the week or by the month. We will do everything we can to get you started right.

If anyone offered you \$500 for two hours overtime every day for a year, you would jump at the chance, wouldn't you? Two hours study every day for the next year or two will mean more than \$500—it may mean \$1,000; that depends entirely upon yourself.

The American School does not employ agents or collectors to bother you in your home or at your work. It brings a complete college course to you in your own home, and all work is carried on privately and quietly, strictly by correspondence.

Won't you check, fill in, and mail the coupon?

AMERICAN SCHOOL OF CORRESPONDENCE
CHICAGO, U. S. A.

Opportunity Coupon

American School of Correspondence, Chicago, U. S. A.

Please send me your Bulletin and advise me how I can qualify for the position marked "X."

Pop. Mech. 9-12

.....Automobile OperatorLawyer
.....DraftsmanFire Ins. Engineer
.....ArchitectTelephone Expert
.....Building ContractorMoving Picture Op'r
.....Structural EngineerBookkeeper
.....Civil EngineerStenographer
.....Electrical EngineerAccountant
.....Elec. Light & Power Supt.Cost Accountant
.....Master MechanicCert'd Public Acct't
.....Sanitary EngineerAuditor
.....Steam EngineerBusiness Manager
.....Reclamation EngineerCollege Preparatory

NAME

ADDRESS

Please Mention Popular Mechanics

Popular Mechanics Magazine

WRITTEN SO YOU CAN UNDERSTAND IT

Vol. 18

SEPTEMBER, 1912

No. 3

Memory Machine That Stays on the Job

THE first mechanical apparatus intended to prevent the busy man from forgetting any of his engagements has just been devised by a New York inventor. It is the idea of Harry Bates, who is the inventor of several mechanical devices already in use, among them being typewriter pay stations introduced throughout the country. The new memory device is operated by a large spring, released at predetermined intervals by an ordinary clock. It is a desk fixture which keeps accurate time and occupies a desk space

andum of it on a card and drops it into the case in the pigeon hole set aside for that purpose. No matter whether the engagement is for a year ahead, or for the next 15 minutes, a bell rings when

only 6 in. in height and 8 in. long.

It has the appearance of a desk clock with three sets of pigeon holes, one series for the months of the year, another for the days of the month, and the third for each quarter of an hour of the day.

A busy professional, or business man wishing to be reminded of something he is to do in the future, makes a memor-

that particular time comes and a card automatically drops down before him. Naturally, after this he has no excuse for forgetting. The device can thus be filled with cards recording the various duties of the office force for the next day, and in the absence of the head of the office each clerk will be reminded at the proper time of just what he has to do. No alarm ever comes from the case unless there is a memorandum in it, and it can be operated by one

girl in the office to keep all the engagements of every one in the office.

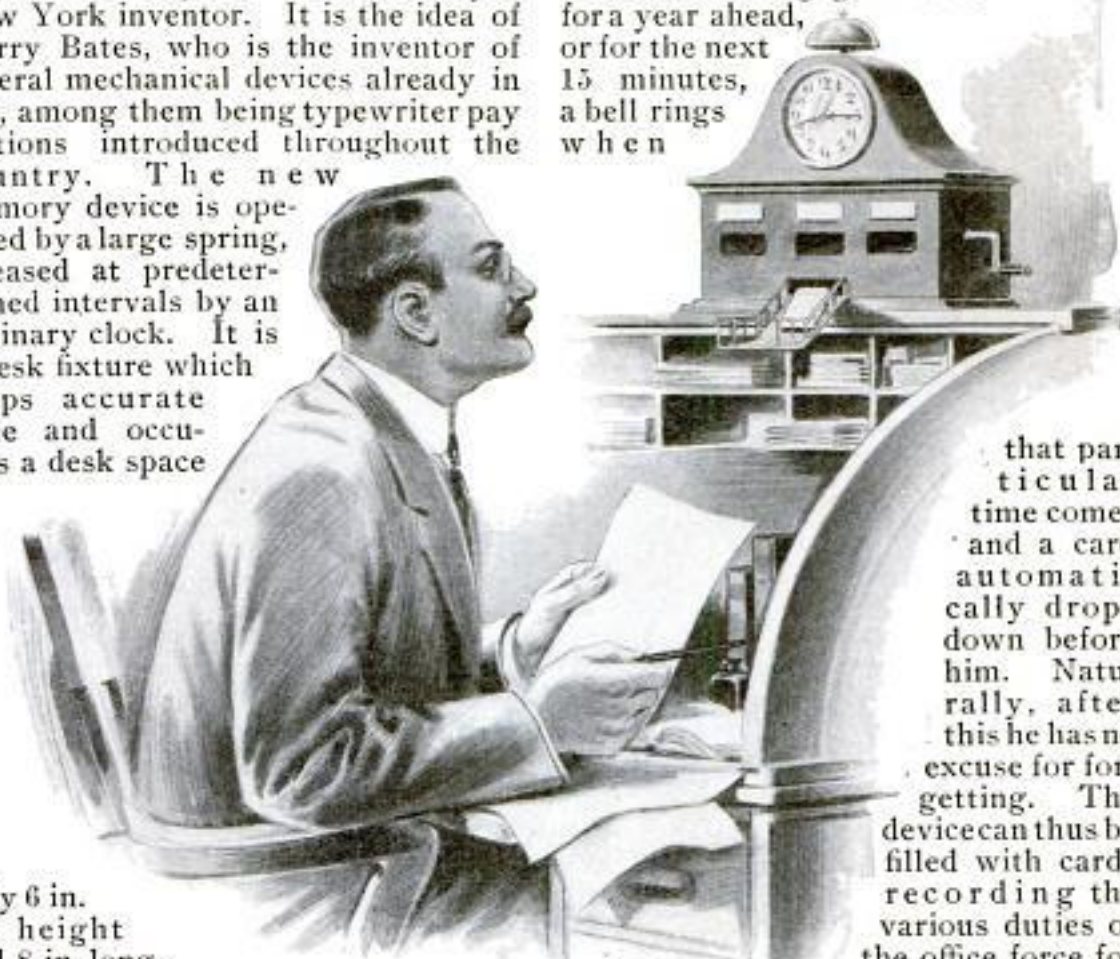

	1	2	3	4	5	6	7	8	9	10	11	12	13	14	15	16	17	18	19	20	21	22	23	24	25	26	27	28	29	30	31	
JAN					MON	1	35																									
FEB					TUE	2	30*																									
MAR					WED	3	45																									
APR					THU	4																										
MAY					FRI	5																										
JUN					SAT	6																										
JUL					SUN	7																										
AUG*						8																										
SEP						9																										
OCT						10																										
NOV						11																										
DEC						12																										

*Meet Jones
Union
Station*

GROTESQUE BIRD'S-HEAD UMBRELLA HANDLES

The Parisian always enjoys the grotesque, which finds its way into many fashions and novelties. This time it is an umbrella grotesque, and all fem-



Bird's-Head Umbrella-Handle Designs Amuse Paris

inine Paris has the rage. The umbrella heads represent different birds smiling a stupid smile which is guaranteed to make one laugh, even though depressed. The bird heads are designed by various well-known French caricaturists and bear their autographs, which makes them interesting objects for examination and comparison.

BREATHING OZONIZED AIR INCREASES WEIGHT

Recent tests made upon men employed in the First National Bank of Chicago have shown that ozonizing the air increases the weight of clerks who breathe the mixture, by promoting deep and exhaustive breathing.

The men upon whom the experiment was tried were at work in the bank's vault, a place the ventilation of which has always been a difficult problem. The ozone was produced in the room by means of several electrical machines placed in the corners.

The weight and chest measurement of each man employed in the vault were taken when the ozonizers were installed, and again after the machines had been in operation for two months. It was found that in this short space of time, every man had gained in weight as well as in chest measurement. And the benefit was not confined to the physical side of the man; the mental faculties as well were quickened by the inhalation of the pure fresh air. The men themselves were enthusiastic about the success of the new system.

The process is familiar. The ozone, which is simply a special form of free oxygen, is produced in the atmosphere by the silent discharge of electricity.

ELECTRICAL ACCIDENTS SHOW NO INCREASE

Reports of factory inspectors in London have brought out some remarkable figures on the increased use of electricity as power. During the last 10 years, the report shows, the use of electric power from the public plants alone has increased from 30,000 hp. to 74,000 hp. This in itself is not so astonishing as the fact that since 1907 the total number of accidents annually has not increased at all. In the opinion of the inspectors such accidents as did occur were not so much due to the ignorance, or incompetence, of em-

ployes handling electrical machinery as to the carelessness of employers in failing to provide proper safeguards for its use. As an example, it is pointed out that the sparking of electrical apparatus in a dusty oil-cake mill was responsible for an explosion and consequent loss of life, but might have been avoided if precautions had been taken to prevent the sparking.

ELECTRIC MILKING IN THE PASTURE

Milking the cows in the pastures by means of electrical milking machines is being successfully tried on the great farm near Berlin which is operated by that city. Cables carrying power are laid out to the pastures and the motor and milking apparatus all in one machine is easily carried around. It has been found that one man can take care

of the operation of six milking machines out in the fields. Electricity is used in every possible way on the farm,



and for this purpose a network of transmission wires covers the farm, so that short flexible cables for motors will bring power to any desired spot from the feed wires.

MOTOR GETS POWER FROM STREAM FLOW

A hydroelectric power machine, which the inventor claims will be an important factor in the manufacture of electricity by water power, has just been tested in the Chicago Drainage Canal at Joliet, Ill., with results satisfactory to the inventor. He states he received the suggestion for the machine from an article

which appeared in Popular Mechanics Magazine a year ago.

The machine consists of two cog-wheels, one 20 ft. and the other 12 ft. in diameter, over which run two chains 50 ft. long, equipped with 12 steel paddles. The paddles are swung upon bars and are bent outward in the middle so that they carry but half a pint of

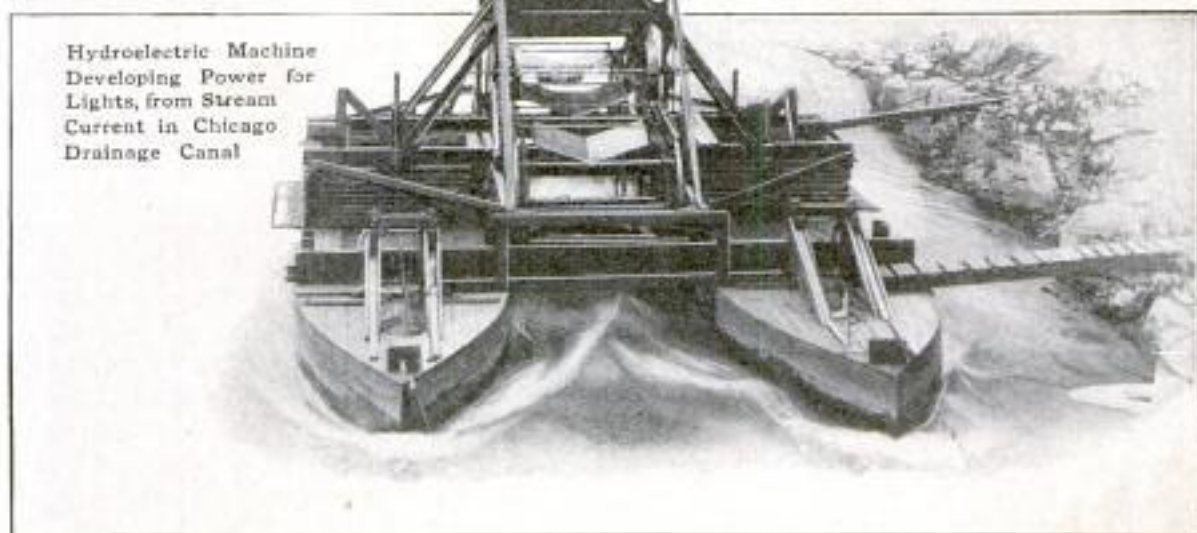

water after leaving the stream. A frame fits over the wheels and chain, and above it is placed an electric motor connected, by means of a chain, with a flywheel, which in turn is connected with the smaller of the two water wheels. The entire frame rests upon two barges and is lowered into the water so that the smaller wheel, which faces the stream, is almost submerged. At the initial try-out the machine showed 48 per cent efficiency in an eight-mile current, according to the inventor.

The motor was connected with a dynamo and electric current generated. Ten arc lights, a number of incandescent lamps and two searchlights were wired up to the generator and light was furnished for an evening band concert in the city park of Joliet.

"HURDLING" WITH A MOTORCYCLE

The very interesting illustration accompanying this article shows the so-called hurdle test for spring forks, which is carried out at the factory of one of the well-known motorcycle concerns in this country. The test consists in driving the cycle around an oval test track at a speed of about 40 miles an hour, across which a 4 by 4-in. timber obstruction has been laid. On striking this, the machine with its rider jumps about 2 ft. into the air and alights some 10 ft. away, thus subjecting the forks to a greater shock than they are ordinarily liable to suffer in regular service.

Testing the Strength of the Front Fork of a Motorcycle by Running at High Speed against an Obstruction



Three Photographs of the Same Test, Fitted Together

MAKING OVEREXPOSURE IMPOSSIBLE

Photographic plates in the use of which overexposure is impossible, have recently been put on the market by an English manufacturer. The improvement is due to the addition of certain chemicals (hydrazine and hydroxylamine derivatives) to the sensitive film. The speed of the plate is not adversely affected by the new method. In landscape photographs it is possible to include the sun itself without danger of "fogging." If, however, the exposure has been more than 40 times the normal, a special developer is required, the formula for which has been provided by the manufacturer. In all cases of shorter exposure the ordinary developer is found satisfactory. With the new plate it is possible to photograph a room with a brightly lighted window, notwithstanding its acute contrast with the interior. In instances of this character, of course, it is necessary to prolong exposure in order to obtain detail in dimly lighted portions of the picture.

Another development in photography is the production, also by an English manufacturer, of a print paper which is termed cream-canvas bromide and gaslight paper. As indicated by the name the paper is of cream color over which is spread the canvas grain which gives the finished print the appearance of a one-color painting. The tone of the paper is suited to effects obtained by sunlight, and for figure studies in strongly lighted studios.

GRADING A RAILROAD THROUGH ANT HILLS

Ant hills are furnishing a considerable portion of the work for contractors on the present extension of the

the ant hills which are encountered, but as all the earthwork is done by hand labor, much time is spent tearing



Cape-to-Cairo road in Africa, which is now proceeding from Elizabethville in the Congo to Bunikeia, for this stretch of several hundred miles is over a plain varied only by the enormous ant hills which in some instances rise 60 ft. high.

Observatories intended primarily for surveying purposes have been built by the contractors on these ant hills. The preparation of the roadbed through this section requires only the cleaning out of the jungle along the right of way, and the destruction of



Upper View—Laborers Tearing Down a Great Ant Hill on Level Plain in Congo to Make Way for Cape-to-Cairo Railway Roadbed

Lower View—Monster Ant Hill on the Cape-to-Cairo Railroad near Elizabethville, Congo, Which is being Used by Surveyors as an Observatory

down the ant hills. The ants are white, and well under an inch in length. They are very destructive, ruining almost anything they encounter except metal, and frequently they travel in armies which do great damage. They destroy only the parts of an article which are not exposed to the open air, so that the surveyors have found that when they left shoes where the ants could reach

them, the soles were entirely eaten away by the insects while the uppers were left.

VAST SECTION COVERED WITH ASHES FROM

A mighty volcanic eruption which covered a vast section with volcanic ashes, all on United States territory, this summer, passed almost unnoticed due to the fact that it occurred in the sparsely settled southwestern Alaska. News comes out of that region so slowly and so incomplete that facts of the extent of the eruption, its damage, and photographs of its progress are difficult to obtain. Yet its magnitude is indicated by the fact that the clouds of volcanic ashes were observed as far away as Prince Rupert, British Columbia, a thousand miles from the scene of the disturbance in the Aleutian Range.

Mt. Katmai and Mt. Peulik of this range were both charged with the eruption, Peulik being the first considered as there is little knowledge about the mysterious Katmai, far in the mountain wilderness, but the later evidence all points to Katmai being the disturber, located not far from the seashore settlement of Katmai, a short distance north of Mt. Peulik and Cold Bay. Reports based on unsatisfactory and distant views of Mt. Katmai are to the effect that the mountain now has three craters.

On June 6 the mighty cannonading of Katmai "blowing off its head" was heard over a great section of southwestern Alaska, and by night the rain of volcanic ashes came. The nearest village of any size is Kadiak, on Ka-

diak island, which has a population of about 500, most of the people living on the fish-canning industry. For three days following the outbreak of Katmai, gray volcanic ashes filled the air so that one could not see more than five feet. The entire population was taken on board the revenue cutter "Manning" and taken out to sea to escape suffocation.

The ashes covered Kadiak to a depth of from one to four feet, and appeared to be in three layers, powdered pumice stone at the bottom, yellow sulphuric ash, and then the gray volcanic ash on



Lower View Shows Volcanic Ashes One to Four Feet in Depth over Kadiak Village



ERUPTION OF ALASKAN VOLCANO KATMAI



Near View of Katmai

Katmai in Eruption

Reindeer Seeking Shelter

ried in boats to Kadiak and out on the open straits. A mother and her child are known to have lost their lives in Katmai village.

Photographs of the distant mountain in eruption were obtained from the deck of the steamer "Dora," between Kadiak and Afognak islands, on June 6, until, by 4:30 in the afternoon, daylight was blotted out and electric lights had to be used, in a season when daylight is almost continuous.

After the heavy rain of ashes came rainstorms, which were in the end providential to the inhabitants. The rain appeared to bring down some element which burned the skin, and blackened brass work on steamers, the explanation accepted on shipboard being that the element was of a sulphurous nature. However, the rain rapidly washed the ashes away in the thinner places, making it possible to resume agricultural operations. Stock had to be fed on baled hay for a few days, and then grass began to push up in places with great luxuriance. The rich volcanic soil of Kadiak and the adjoining shores will be improved measurably by the volcanic ashes, in the opinion of the inhabitants of the section, after rains have completed the work of beating this fine ash into the soil.

top, constituting the larger portion of the coat. The roof of one of the canneries gave way under the weight. As far away as Cook Inlet, 400 miles to the northeast, the ashes in some places accumulated to a depth of a foot.

Inhabitants of Katmai village fled by boat, at the beginning of the eruption to the island of Afognak across Shelikof Strait, and from the settlements of Cold Bay, Kanatuck, Douglas, Kanganute and Savanoosky the frightened fishermen and ranchers hur-

Smoke-abatement laws have been rigorously enforced in the Bengal province of India for the past 7 years.

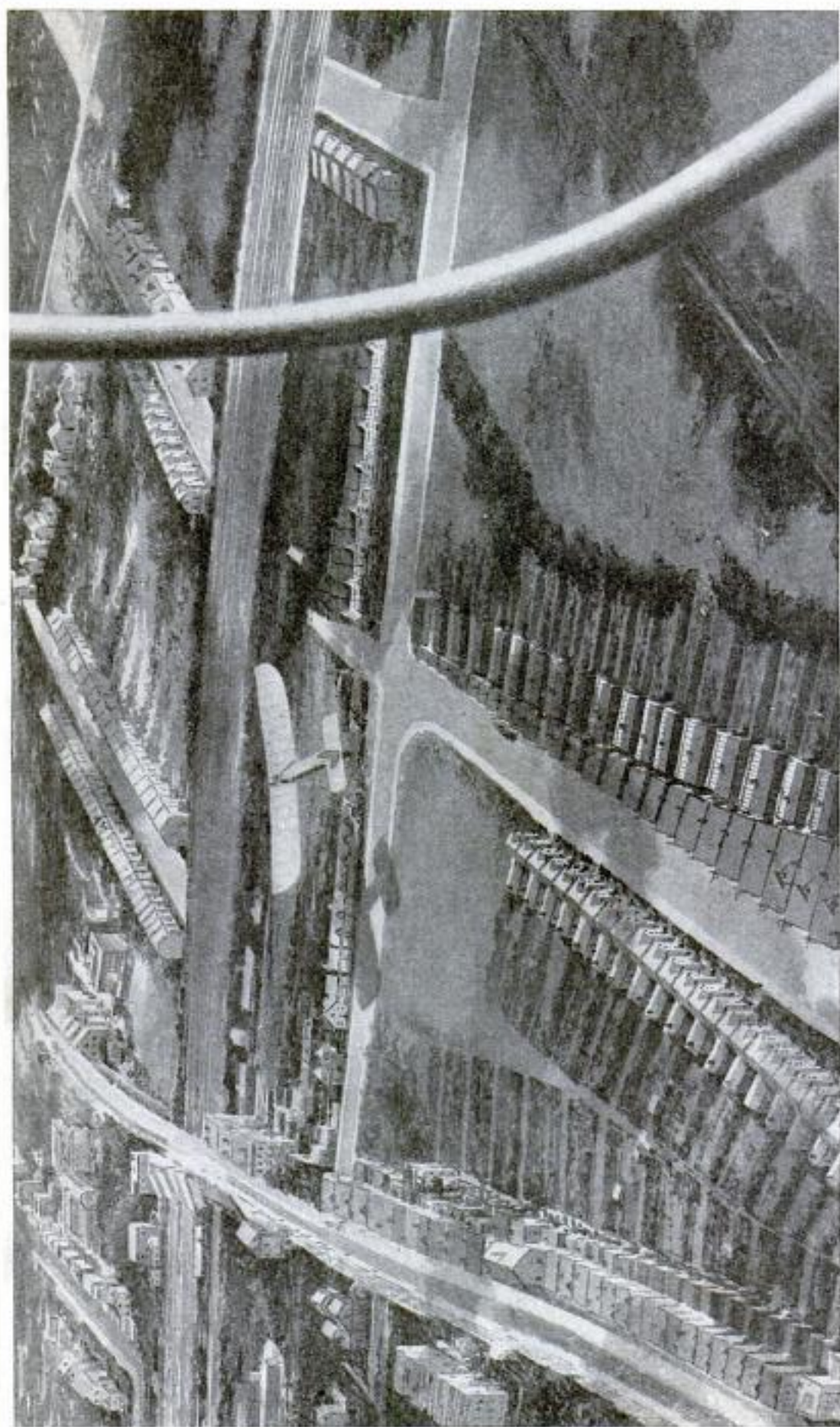

ONE AEROPLANE IN FLIGHT PHOTOGRAPHED FROM ANOTHER AEROPLANE FLYING HIGHER IN THE AIR
In a recent aeroplane meet near London many striking views were taken from competing machines, this one being taken by a passenger in M. Verrier's biplane, flying at a height of about 2,000 ft., over Ealing, a suburban residence section. The monoplane pictured was at a height of about 400 ft.

MISSION LAMP STANDARDS FOR STREET LIGHTING

The residents of a small and exclusive residential tract in Los Angeles have set up especially designed mission lamp standards at the corners in place of the ordinary cast-iron lamp posts commonly used. These standards do much to beautify the neighborhood.

Five rectangular lanterns of bronze and glass inclose the electric bulbs, and these are supported by a framework of unpainted timbers, which surround a substantial standard of dull red bricks, the whole resting upon a concrete foundation above the curb.

LOCOMOTIVES AT EACH END OF TRAINS

In changing from steam power to electric power for its enormous city and suburban passenger traffic, the Berlin Stadtbahn has decided to use electric locomotives, one at each end of all long trains, instead of having each coach fitted with motors to run separately. It is said 557 locomotives will be used with 690 passenger coaches and 29 repair cars. When two or more locomotives are coupled to the same train, as circumstances demand, these will be operated by one man by means of a simplified multiple-unit system. The assertion is made that experience gained with electric locomotives in Germany shows that maintenance costs are below those of motor coaches. The locomotive has large hauling powers and

one such engine can therefore take the place of many motor coaches. Added to this, the motors and other electrical gear are very accessible, which is an important item from the point of cleaning and repairs. It also appears that since the motors of electric locomotives are spring-borne and placed high up in the body, there is less noise and vibration, as compared with motor coaches,

and that they do less damage to the track. During the busiest hours of the day, when the traffic is heaviest, the trains will be made up of 13 six-wheel coaches, which will be propelled by two locomotives, one at each end of the train. At other times, when the railway is less busy, the trains will consist of five or eight cars, which will be coupled to a single locomotive. Trains made up in this manner can be driven from either end by fitting the last coach with a controller.



Artistic Mission Lamp Standards Used for Street Illumination in a Residence District of Los Angeles

VIBRATIONLESS CONCRETE TABLES

Concrete tables to give absolute freedom from vibration have been constructed for the Butte School of Mines, as standards for laboratory balances. The concrete pillar is built up from the solid earth through the floor, to the required table height, and the balances are placed on the top of the pillar. For convenience in operating the balances, a wooden table is built up from the floor around the pillar, but kept entirely free of the pillar on all sides, lest vibration be communicated.

LABOR-SAVING DEVICES IN AN INVENTOR'S KITCHEN

A Los Angeles inventor has busied himself lately with the problems of the housewife, endeavoring to plan con-

cold-water faucets are in the wall over one end of the sink.

In the combined gas stove and fireless cooker the gas plate is boxed in a wooden case, lined with mineral wool and provided with an inner casing of zinc. When the hinged lid is thrown back, the device serves as an ordinary gas stove. Food which requires hours of cooking is brought to the proper temperature and then the cover is dropped into place, the gas being allowed to burn a minute or two longer



The Folding Kitchen Sink in Place for Dishwashing

veniences which will make the lot of the worker in the kitchen easier. He has carried out the ideas in his own home and the result, although not perfect, contains in a rough-and-ready fashion ideas which may be developed into really practical labor and space-saving devices.

Included in these ideas is a disappearing sink, the combination of a fireless cooker with a gas stove, and a folding ironing board having an attachment for ironing sleeves. The sink folds back against the wall when not in use and is concealed by a door. When dish-washing time arrives, the door is opened downward and becomes a support for the sink, which is at a height enabling the housewife to be seated while at work. The hot and



Folding Ironing Board, Showing Attachment for Ironing Sleeves, and the Clothesline

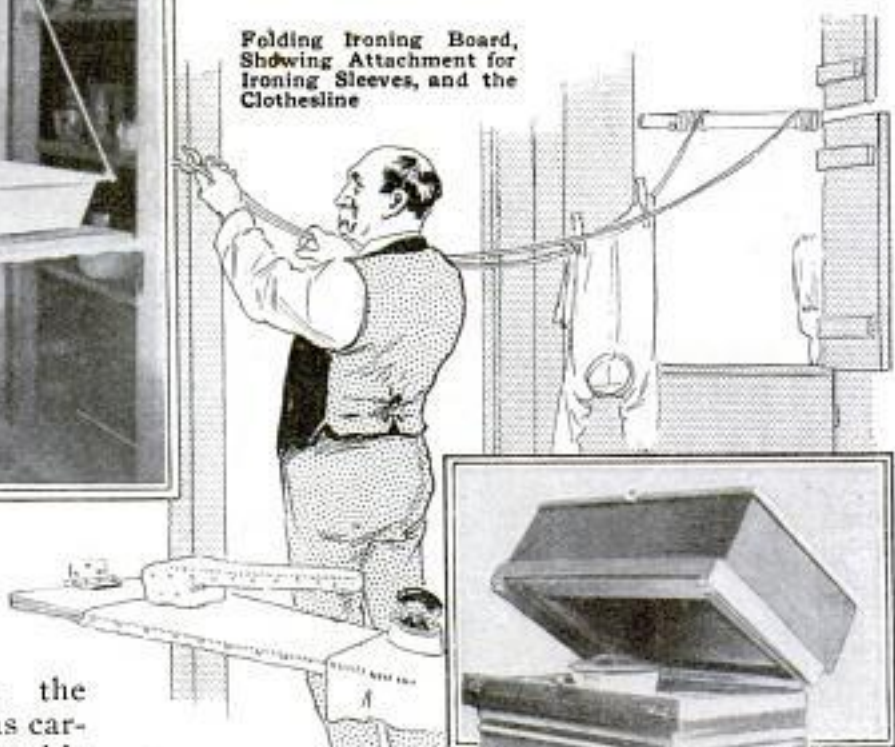

The Combined Gas Stove and Fireless Cooker Which may be Operated as Either



to thoroughly heat the interior. A special intake and outlet for air is provided for the brief time during which the gas burns while the cover is down.

The ironing board folds back against the wall when not in use. In connection with it is a double clothesline on a spring reel. In use the loop end of the line is slipped over a hook at the farther side of the kitchen.

EYE INJURIES TO ECLIPSE OBSERVERS

Eye affections, resulting from looking at the sun during a recent eclipse visible in Germany, were common in Berlin following close after the event. On the day of the eclipse the sky was clear and the maximum obscuration took place at the noon hour when thousands were on the streets. Some persons used smoked glass while others, ignoring newspaper warnings, viewed the sun through a hole pierced in pasteboard. Not a few gazed at the mighty orb without any protection and these suffered most. Many cases of injury done to the eyes were reported by oculists and physicians, one surgeon reporting 14 cases.

Besides ordinary cases of inflammation, instances of more serious visual disturbances were noted, many fearing at first that they were becoming totally blind. Some patients admitted they had stared a full minute at the sun while others declared they had looked at "Old Sol" not more than a few seconds. Fortunately most cases made a relatively quick recovery, but it is predicted that the next eclipse of the sun visible in the German capital will be viewed with extreme caution.

PICTURE-SHOW ELECTRIC PLANT IN AUTOMOBILE

A motion-picture showman, who travels from place to place, giving shows in a tent, has equipped his automobile with an electric plant for the operation of the motion-picture machine and for the 45 electric lamps in and around the tent and on the automobile itself. The electric plant consists of a 60-volt slow-speed dynamo

which runs at 700 revolutions per minute.

The owner of the outfit and his wife travel from town to town in the automobile, which has covered over 14,500 miles, and the tent, seats and other



The Automobile Electric Plant Which Furnishes Current for a Traveling Motion-Picture Show

heavy equipment of the show are shipped by rail.

ICE-COOLED DRINKING FOUNTAIN

A bubbling drinking fountain with an arrangement for cooling the water by ice in a cooling tank is shown in the accompanying illustration. The cooling tank, which has a thick, cork-packed jacket, is equipped with a coil of brass pipe, and through this coil passes the supply of fresh water. The apparatus has a 1½-in. pipe standard and the waste bowl is of cast iron with vitrified porcelain enamel on the inside. The water supply is controlled by a self-closing



bibb and the water is furnished through a bubbler which regulates within itself the height of the flow of water. After adjustment, the height of the water remains essentially constant and is regulated so as to prevent contact between the mouth and the appliance.

RIVALRY OF MOTORMEN TO SAVE POWER

To reduce the cost of electrical energy and at the same time make the number of fares run as high as possible, the manager of an English street-railway system put into effect with good results a bonus system for the motormen and conductors. The saving in electrical energy is reported to have been 25 per cent.

The system was worked out on the basis of a 12-weeks' run, and first, second and third prizes in cash were offered for the best showing by motormen of each route at the end of that time. Consolation prizes were offered to motormen who made a showing below the car-mile average of the 12-week period. Meters were used to record the operation of each car. In order to make the test as fair as possible, each motorman was allowed to handle the same car throughout the period.

When this portion of the scheme was first put into effect, such keen rivalry developed among the men that they rushed by corners and failed to pick up passengers

with the result that the savings made on electrical energy were lost in the passenger receipts.

The manager, however, had wit enough to put an end to this. He offered similar prizes to conductors turning in the most cash during the 12 weeks, over and above the average daily receipts on their routes. The result was the crew of each car came to an understanding. They agreed that they would both try to win prizes and split the money equally between them at the end of the period. The outcome of the double scheme was fine team work, more cash receipts, and the saving of "juice."

FIRE OR PANIC MENACE TO SKYSCRAPERS

Fire drills in every high building are urged by city building inspectors and others who have given thought to the dangers confronting the thousands hived in 20 and 30-story skyscrapers. The chief inspector of buildings for the Borough of Manhattan recently prophesied a disaster that will stagger humanity unless needed precautions are soon taken. So far as the construction of these buildings is concerned they are stated to be absolutely safe, but the disaster which is foretold is to come through fire or panic. It is pointed out that the proximity of stairways in many buildings to elevator shafts is one serious source of danger as, in case of fire, the shafts are likely to become



Suppressing the Revolt
against the French in Mo-
rocco—A Chain of Prisoners
being Taken to the Court Martial

roaring chimneys. Other stairways and fire escapes are so constructed that a panic would almost certainly arise if they were used except where there is general knowledge of what to do in such an emergency. The feeling is rapidly growing that fire drills of some sort should be made compulsory by law in every high building, no matter how it may be occupied.

INTERNATIONAL WIRELESS REGULATIONS

An echo of the "Titanic" disaster is found in the resolutions passed at the recent International Radio Telegraph Conference held in London. It was decreed that the wireless station of a ship at sea should remain silent for a certain period of each hour, during which the operator should be watching for distress signals only. In such cases the distressed ship should control the field within her radius, and should it happen that a number of boats answer her distress call she shall determine, in order to avoid confusion, which of those responding is to remain silent. With respect to weather observations, it was decided these should be given right of way over commercial dispatches. Representatives of the United States, Great Britain, Russia, Germany, France, Italy, Spain and Portugal signed the resolutions.

PUTS AN END TO BAGGAGE SMASHING

Baggage smashing will soon become one of the lost arts if the simple and effective device shown in the accompanying illustration is put into general use. The cushion, or mat, upon which the trunk descends in unloading, recently was adopted by the Cumberland Valley Railroad and that company reports that it has proved very efficacious. The photograph shows it in use at one of their stations.

The cushion is composed of four strips of hard wood to which are

nailed 24 pieces of scrap air-brake hose. The hose lengths are held in place by

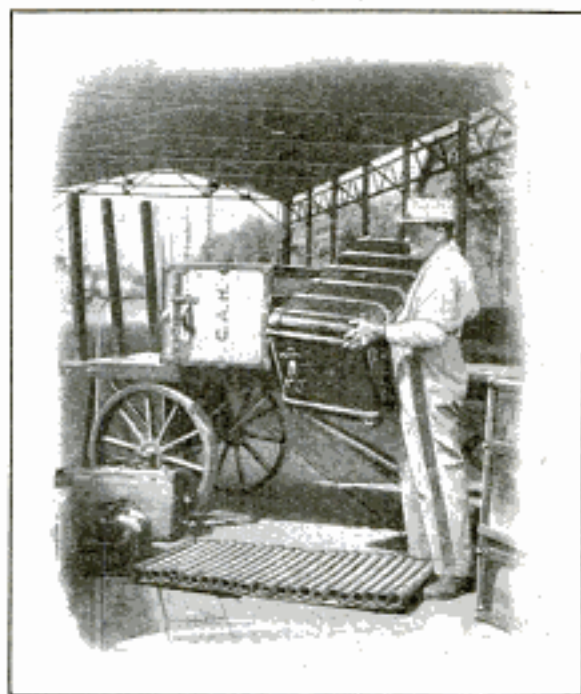

Cushion Baggage Protector Made of Wood and Scrap Hose

$1\frac{1}{2}$ -in. clout nails, driven through the strips of wood and clinched to the hose by means of an iron rod inserted while the nails are being driven. The cushions are $22\frac{1}{4}$ in. wide by 4 ft. 4 in. long.

DYNAMITE IN BRIDGE CONSTRUCTION

Railroading in the West continually presents new problems to the construction engineer, but the use of dynamite in place of a saw was tried for the first time on a Santa Fe bridge over the San Joaquin River, near Fresno, California.

Concrete abutments and piers had been built under an old wooden trestle-type bridge and the principal girders of the new steel structure prepared and riveted together at a distance ready to be lowered into place from derrick trains. All the earlier stages of the new bridge had been constructed with the wooden bridge as a falsework and without interruption to traffic. But the floor of the wooden bridge was 15 ft. higher than the new steel

structure was intended to be. To shorten the supports by sawing would take several days and tie up traffic.

The engineers got around the difficulty by running the derricks out to the proper points and then placing a small charge of dynamite in each of

the wooden supports of the old bridge just 15 ft. below the roadbed. The dynamite shots were discharged simultaneously, the old bridge fell, and the entire steel structure dropped into place at once. It took but three hours then to lay the ties and rails.

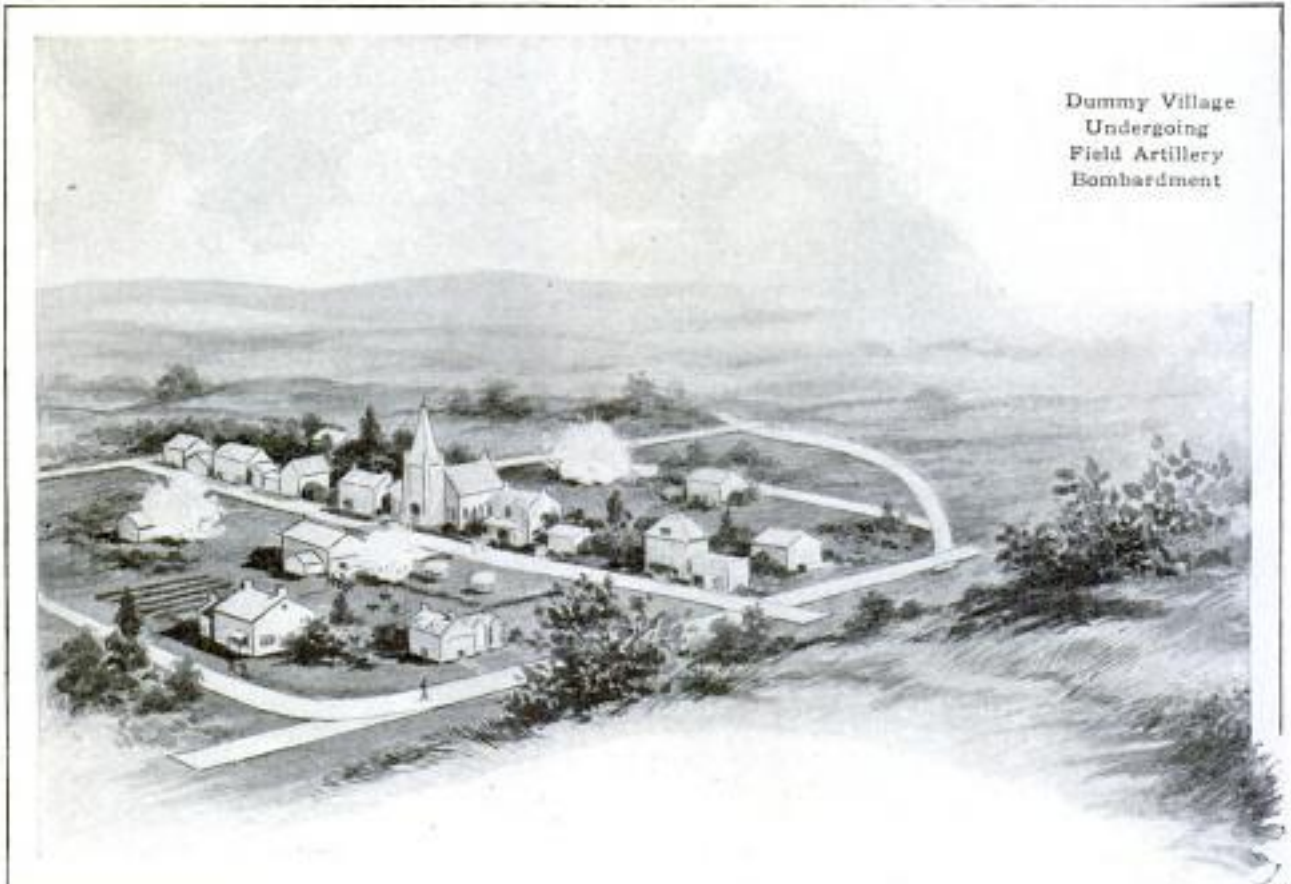

Dummy Village
Undergoing
Field Artillery
Bombardment

A DUMMY VILLAGE AS ARTILLERY TARGET

A fine example of the steadily developing idea of "more realism" in artillery target practice is forthcoming from England, where a dummy village was recently built as a target to be demolished by artillery fire. The village,

constructed of canvas, comprised several cottages, barns and outhouses, an inn, school, hospital, and a church having a spire 36 ft. high.

The dummy village was constructed near Okehampton, in a rolling country, and the batteries were concealed two miles away. On a hill a mile and a half away from the doomed village were stationed military observers with range-finding instruments, to direct the fire, and to watch the progress of destruction.

By the time three batteries had completed practice everything was demolished with the exception of the church

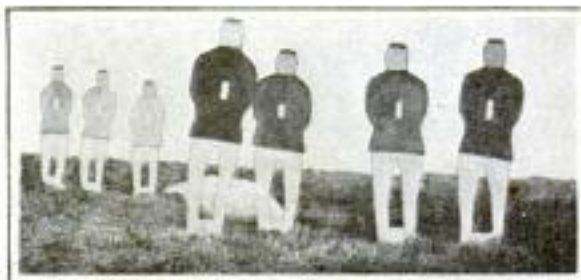

Dummy Men before Bombardment of Village

with its Red Cross flag flying, and the lyddite shells had blown great trenches in the street.

AN American breakfast-food concern is considering the advisability of manufacturing a variety of their staple product from the taro root of Hawaii, which is used by the natives for the making of their well-known delicacy, "poi."



Shell Exploding. Photograph by Observer Half a Mile Away

ITALIAN MAIL BOXES EXCEL AMERICAN

Apartment houses in Milan and Genoa are equipped with mail boxes which in many respects are superior to those found in American buildings of similar type.

The apparatus is situated in the halls or vestibules and has the front appearance of a door, the upper part of which consists of individual letter boxes, one for each tenant, besides which there is a separate box provided for outgoing mail to be collected by the postman. Each letter box is numbered and each tenant has an individual key which cannot open any of the other boxes. The postman carries a pass key which

opens all the boxes along his route. With one turn of his key he opens all the slits of the boxes as well as the collecting box, and causes to be thrown into view under the slits names of all the tenants. The placing of a piece of mail in a box automatically notifies the tenant by means of an electric bell. Simultaneously a white indicator drops underneath the slit of the box so that an absent tenant upon his return will know there is mail in the box, thus avoiding opening the box unnecessarily. The indicator disappears when the mail is withdrawn.

After distributing and collecting, a

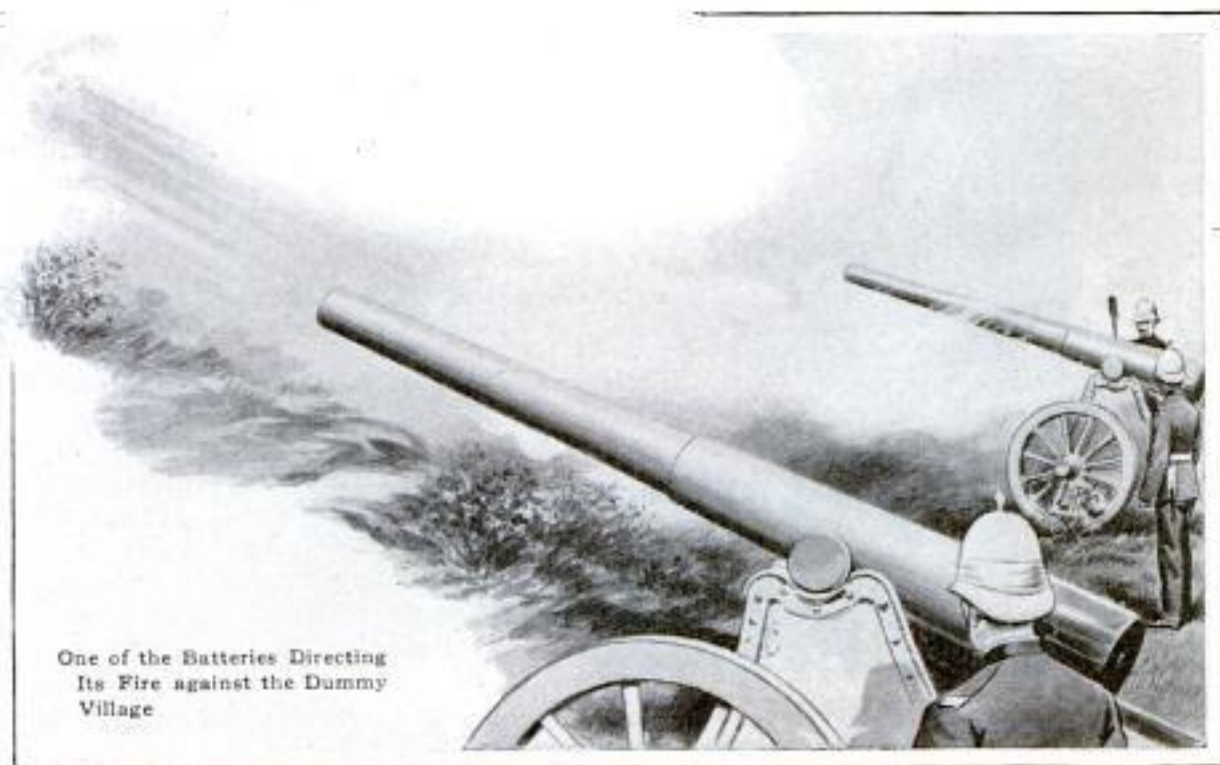

One of the Batteries Directing Its Fire against the Dummy Village

touch of a lever at the base of the apparatus closes all the slits and the names disappear. The device assures safety and privacy, making it impossible for peddlers or solicitors to obtain the names of tenants, or local tradesmen to clutter boxes with advertising matter. Just how it would appeal to the man looking for a friend at midnight with only a street address to guide him is another story.

LONDON CHURCH SPIRE AS LINCOLN MEMORIAL

The American tourist, entering or leaving London from the Waterloo station, gets a close view of the church spire shown in the accompanying illustration. If the tourist is wide-awake and receptive, he or she may give a start of surprise. It has actually got stars on it, likewise stripes, but it is probable that no one on the train could tell off-hand what it means.

It is one of the ironies of history that this spire, erected in memory of Lincoln and remarkable as one of the most noticeable memorials to any native-born American outside the United States, stands half-forgotten already after so short a lapse of time. It rises to a height of 220 ft., surmounting Christ church, Westminster Bridge Road, made famous

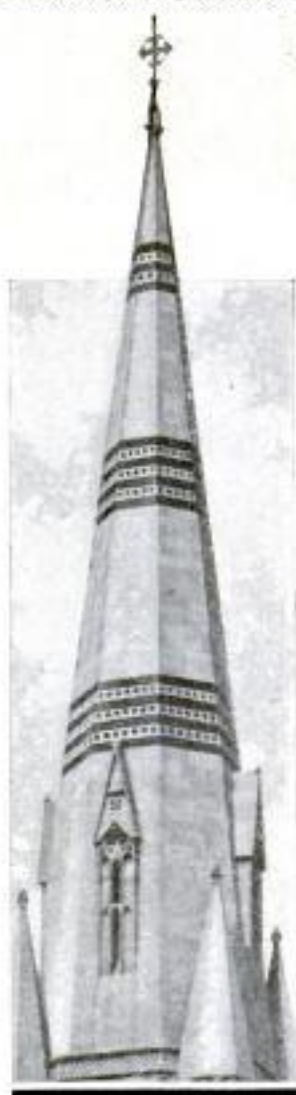

for the preaching of the Revs. Newman Hall, F. B. Meyer, and other divines well known on both sides of the Atlantic, and was built by the united subscriptions of Americans and British in 1874. It cost \$35,000.

ELECTRICAL BRAINS FOR LOCOMOTIVE ENGINEER

An Australian inventor who has been working on the familiar lines of automatic stops for railroad trains has brought out an electrical signaling device which appears to do everything but think. The chief claim for it is that it will prevent the locomotive engineer from disregarding block signals. The tests which have been made of it seem to indicate that it will almost entirely remove the human element from block signaling and at the same time be free from many of the defects found in the systems now in use.

Suppose the apparatus were installed on a mile of single track between two sidings and that this track ran north and south. There is a train at each end approaching the single track. The station master decides that the northbound train shall have priority and so sets the control box at his end of the line. This control box is connected by a dead telegraph wire with "ramps" at each end of the section.

The northbound train proceeds and enters the section. The southbound train approaches the last part of the section on which it stands. As it does so it passes over one of the "ramps" and a shoe under the engine strikes it. Instantly a bell in the southbound engine cab rings an alarm. If the engineer ignores it, he is in trouble, for he passes over another ramp immediately and this automatically closes the throttle and applies the brakes. He can not get out of this predicament until he obtains a key to unlock the apparatus.

Meanwhile the northbound train has reached the ramps at the end of its section and received a warning of the same nature that the track ahead is



A Few of the Albatross Who Industriously Lay Eggs on Layson Island

The Eggs, Thicker Than a Bumper Crop of Potatoes, are Gathered in Wheelbarrows and Loaded into Trucks

not clear. If no attention is paid to the warning, the steam is cut off and the brakes applied.

Should an engine start out with a weak battery, should the telegraph wire be cut, or a short circuit result from any cause, the apparatus automatically stops the engine until repairs are made. Each time a stop of this kind is made the engineer must go to some authority for a key to unlock the mechanism, which would of course compel him to make a complete explanation.

The source of all power for this peculiar automatic signaling apparatus is a battery or generator carried on the engine. Batteries have been used on the engines which made the test on a standard-gauge track. There are no outdoor or fixed signals and this is said to reduce the cost of the equipment. Of course the trackwalker must be depended upon to keep the "ramps" free of snow in the winter time, but that is practically the only human element in the system.

EGG GATHERING WITH WHEELBARROWS

Egg gathering on Layson Island, a small rock in the Pacific not far from the Hawaii group, is a strenuous task, not in the seeking, but in keeping up with the egg producers and carting the eggs away. Millions of wild sea fowl, principally the albatross, make this island their home, and the eggs of this bird are collected in wheelbarrows, and loaded in trucks for transportation to the shipping point. About half a million albatross eggs are sold to the natives of Honolulu alone every season.

USING EARTH AS CONDUCTOR OF HEAVY CURRENTS

In adopting the Thury system of electrical supply for West London, experiments were carried on to determine the value of the earth for carrying heavy currents, which is a feature of this system. The object was to make sure that such use would not

cause interference with other electrical systems nor result in damage to property. M. Thury had employed the method under consideration in Lausanne, Switzerland, with success, but in view of the different geological formation in London further experimentation was deemed necessary. It was decided that, in any event, the earth plates should be situated at a considerable depth below the surface and that connection with them should be made by insulated cables in order to avoid stray currents in the neighborhood of the plates. The experiments were aimed to ascertain to what depth the plates should be buried in order to escape induction, the size of plates to be used and their number,

the distance apart at which the plates should be placed and the strength and permanence of the earth resistance. Holes were bored, each having a diameter of 7 in. and an approximate depth of 35 ft. This gave a current of 33 amperes per plate and it was considered that the plates could carry this current for temporary use. For permanent use it was thought six plates would be required so as to reduce the current one-half. The earth plates consisted of cast-iron pipes having an outside diameter of 6 in. and a length of 9 ft. In one district of London the plates were buried in London clay, and at the other experimental point in fine gravel, which was in the main very dry.

MOTOR CARS FOR RED CROSS WORK

A surgical operating room equipped with many of the latest and most valuable appliances for aseptic surgery, all in a motor car, was one of the features of the recent French maneuvers. The car itself has a 40-hp. engine and can travel 20 miles an hour.

The big car has three compartments, the main room being the operating room, equipped with a modern operating table. Light is from above and around the sides are steel racks and closets for storing instruments

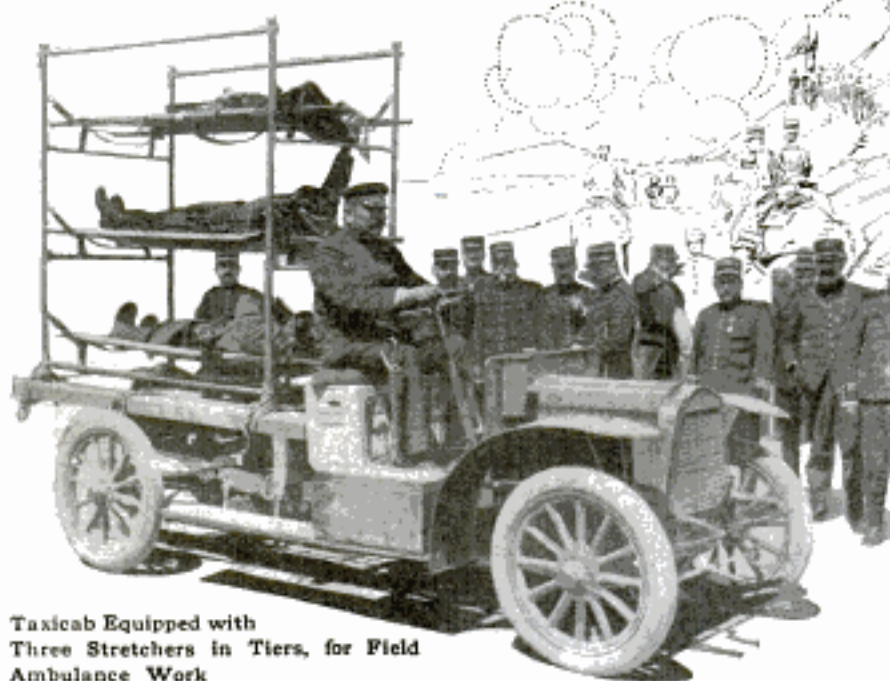

Taxicab Equipped with
Three Stretchers in Tiers, for Field
Ambulance Work

and other necessities. In a rear room is an X-ray apparatus, which, by an invention of M. Boulant, the designer of the car, can be used for making an X-ray examination of the patient while he is on the operating

table. In the front of the car is an electric dynamo, operating from the main engine of the car, for furnishing light and also current for an ultraviolet-ray water-sterilizing apparatus, which supplies water for hospital use and also for drinking pur-



Motor Car in French Maneuvers Equipped with All Modern Appliances for a Surgical Operating Room

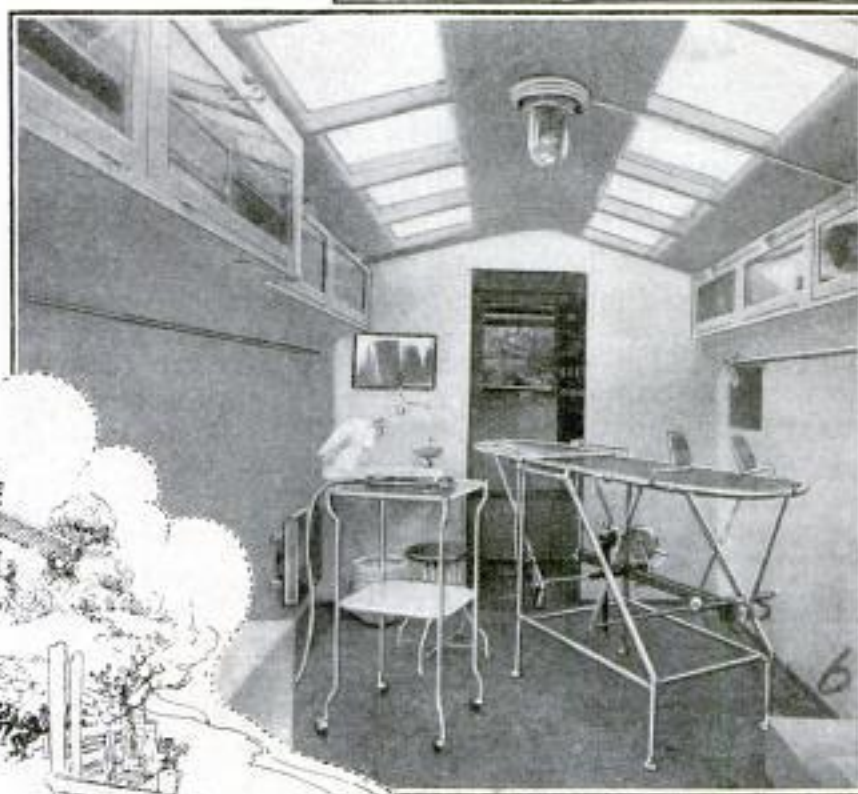

Operating Room in the Motor-Car Hospital, Showing Operating Table and Overhead Light

of the car a tent can be stretched out, furnishing room for cots for patients awaiting operations.

Many automobile ambulances for field use were tried at the same maneuvers, most of the attention being given to carrying as many stretchers as possible without crowding. One specially equipped car carried six patients, and a taxicab carried three stretchers in tiers.

poses, and has a capacity of 3,750 gallons in 24 hours. From each side

The most noteworthy of these ambulances are shown in the illustrations.

DUST CATCHER FOR MINER'S DRILL

Dust from the operation of hammer drills in a mine is so apt to be a serious hindrance to work that a dust catcher has been devised in Leadville, Col., to be used when drilling in ore. It is said to increase the efficiency of the hammer drill 50 per cent and to minimize the danger from miner's consumption.

When the dust catcher is to be used, the hole is started with a bit, which drills a perfectly round hole to a depth of about 3 in., and the cone-shaped tube for dust catching is driven into this hole. The shank of the ordinary drill is then passed through a washer in the rubber end of the bag, the other end of the drill inserted in the tube and

the narrow end of the bag slipped onto the tube, whereupon the drill is fas-

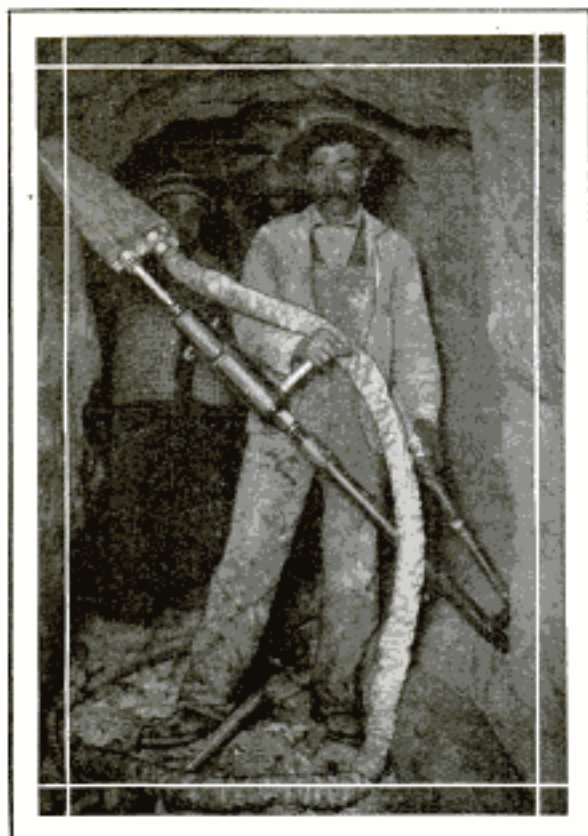

Dust Catcher Attached to Miner's Hammer Drill Ready for Drilling Operations

tened in the chuck of the machine, and the work can go on.

It is claimed that the elimination of the dust is practically complete in the drilling that follows.

Until a few years ago hammer drills were scarcely used, so that the miner had little or no dust to contend with, but with its introduction trouble began. The miner is injured by "eating dust" which eventually may develop into miner's consumption; the mine owner suffers loss of money, because whenever a miner drills a hole and is ready to change the drill, he must leave his work and get fresh air before he can continue, which means a loss of from 15 to 30 minutes on each hole drilled.

☐ Former Fire Chief Edward F. Croker of New York is constructing a residence for himself that will be absolutely fireproof.

SWEDEN PROFITS BY WATERFALLS

That strict conservation of its water power is the aim of Sweden is shown by the maintenance of a waterfalls board which is engaged actively in the development of this source of national wealth. During the next 10 years several million dollars will be expended in carrying forward the plans for development outlined by the board. This expenditure is placed at about \$4,000,000 for each of the years 1913-14-15; and between \$2,500,000 and \$3,000,000 for 1916 and 1917. For the remaining part of the decade the expenditures will not exceed \$2,000,000 a year. The estimated revenue shows a continuous and rapid rise, from about \$300,000 for 1913, to over \$2,000,000 in 1923. Of course, only a nominal revenue will be received from falls bought for generating current until they are adequately exploited, but the board may decide to take over for development other falls for electrification of certain sections of state railways.

PLATFORM SCALES IN SIMPLE FORM

The increasing practice of people of weighing themselves daily, preferably after rising each morning and before dressing, has led a Frenchman to devise a scale which takes up very little room and is not expensive. The scales are of the same appearance as ordinary letter scales, though built very strongly so as to carry and register 275 pounds. A mirror inclined at an angle of 45 deg. enables the person standing on the platform to read the figures indicated by the pointer on the dial. An arrangement is attached by which the spring can be adjusted after continued use has altered its original tension.

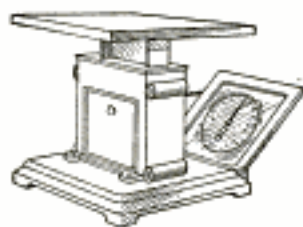

AROUND-THE-WORLD WIRELESS

By FREDERICK MINTURN SAMMIS

Marconi's Chief Engineer in America

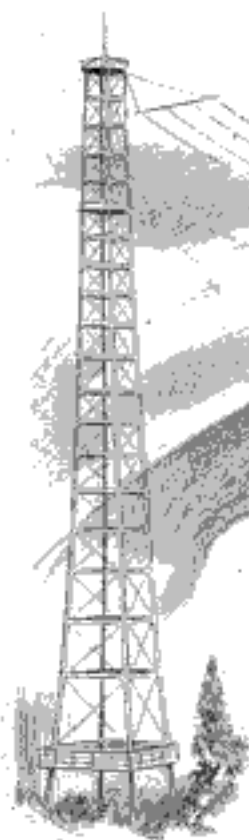

ALTHOUGH wireless telegraphy is a comparatively new art, and has grown prodigiously during the 15 years it has been in use, it may be said to be still in its infancy.

Within the last few months plans have been consummated for completely encircling the earth with a great chain of high-power Marconi stations.

In 1901 Mr. Marconi had completed a station at Cornwall, England, which for those days was considered colossal. From this plant of a hundred horsepower the initial experiments across the Atlantic were conducted. Mr. Marconi proceeded to Newfoundland and by means of a kite succeeded in elevating a copper wire to a considerable height and with this temporary receiving antenna he was able to detect the now famous letter "S," that was being sent by the powerful transmitter in England. At Glace Bay, Nova Scotia a powerful station was then erected after much testing and remodeling, was opened for commercial service and for the past few years has worked daily, across the 1,700 miles of ocean, with the station at Clifden, Ireland. An additional site has just been acquired a few miles from the present Glace Bay station in order to make possible the simultaneous transmission and reception of messages, thus duplexing the

circuit and doubling its earning power. Further, the English government has arranged with Mr. Marconi to erect six high-power stations to be located at London, England; Cyprus, or Egypt; Aden, on the Red Sea; Bangalore, India; Pretoria, South Africa, and Singapore. The work of selecting the sites and the preparation of the huge quantity of material, consisting of masts, engines and apparatus, has already begun and some idea of the magnitude of this work may be gained when it is considered that about 500 hp. will be required to operate each of these stations and that, exclusive of land, buildings and foundations for machinery, they will cost \$300,000 for each station.

To the layman, a wireless station consists of a small and insignificant hut containing the wireless equipment and one or two masts or towers supporting the aerial wires, but it is probable that comparatively few readers have seen any of the really large Marconi transatlantic stations. These monuments of the inventive mind and untiring zeal of Guglielmo Marconi cover tracts of land over a mile in length upon which are erected a large number of huge steel masts which, in some instances, are 400 ft. high. The masts support a network of copper wires. These wires perform a dual function. When they are connected with the transmitting apparatus or spark gap they shake, with a mighty electrical force, the ether surrounding them and cause electromagnetic waves

to become detached and travel away into space. When connected to the receiving apparatus they become the ear instead of the voice of the system and collect the vibrations that have been hurled into space at lightning

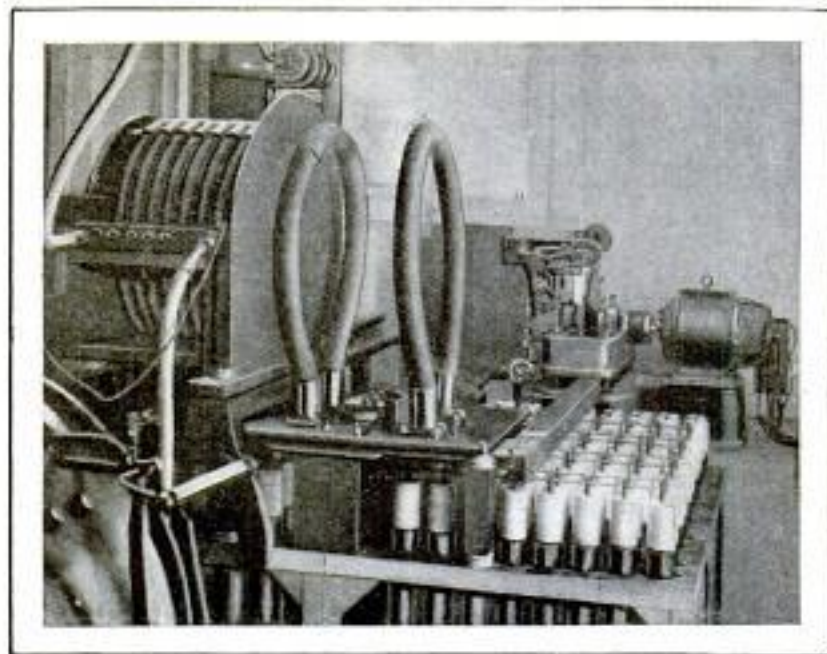

To Help Out the Big Stations are Medium-Power Feeder Plants, of Which This is an Example

speed by the distant station and lead them down to the sensitive receiving apparatus which corresponds to the drum of the human ear.

It has been found practicable, by arranging the aerial wires in a particular direction, to cause the waves to travel almost entirely toward one point, whereas the old method sent them out in all directions like the waves caused by dropping a stone in the center of a pond. It will, of course, be evident that this improved method of working can only be utilized where fixed stations are concerned, and that ship stations and those shore stations that work with the ships must continue to use the original antenna, or aerial, that works equally well in all directions.

Until the present time our country has not been entitled to boast of a real high-power station, but now plans have been finished that will place the United States in the first rank with respect to both size and number of these modern high-power stations, and

which, in conjunction with the stations being erected for the English government already referred to, will provide a commercial service that will encompass the earth. This station will be near New York City, at Belmar, N. J.,

where 500 acres of land have been acquired upon which the masts and plants will be erected. Transmission will be effected to the Panama Canal Zone and thence to Hawaii.

The Hawaiian station will be one of the most powerful of the entire group, for besides communicating with the station at Panama, it will be capable of working with San Francisco and the Philippine Islands, and with a station to be erected later in New Zealand. The Manila station is the last of the

American group and will connect to the east with the Singapore station of the English group. Unbroken communication will be maintained successively through the stations at Bangalore and Aden. At the latter station we may turn southward over the huge mountains of Abyssinia and the wilds of German East Africa to communicate with Pretoria in South Africa. It is probable that the station at Pretoria will be called upon to communicate with the proposed high-power station at Buenos Ayres, soon to be started.

Retracing our steps to Aden on the Red Sea, we may talk with the station in Egypt to the north, and thence, by one tremendous leap, hurl a message with such force that it will cross the wide Mediterranean, ascend the boot of Italy, scale the ice-crowned Alps and drop quietly into London, all in less than one two-thousandth of one minute. Having arrived in England, we may take the present busy route from Clifden, Ireland, to Glace Bay, Nova Scotia, in order to talk with our

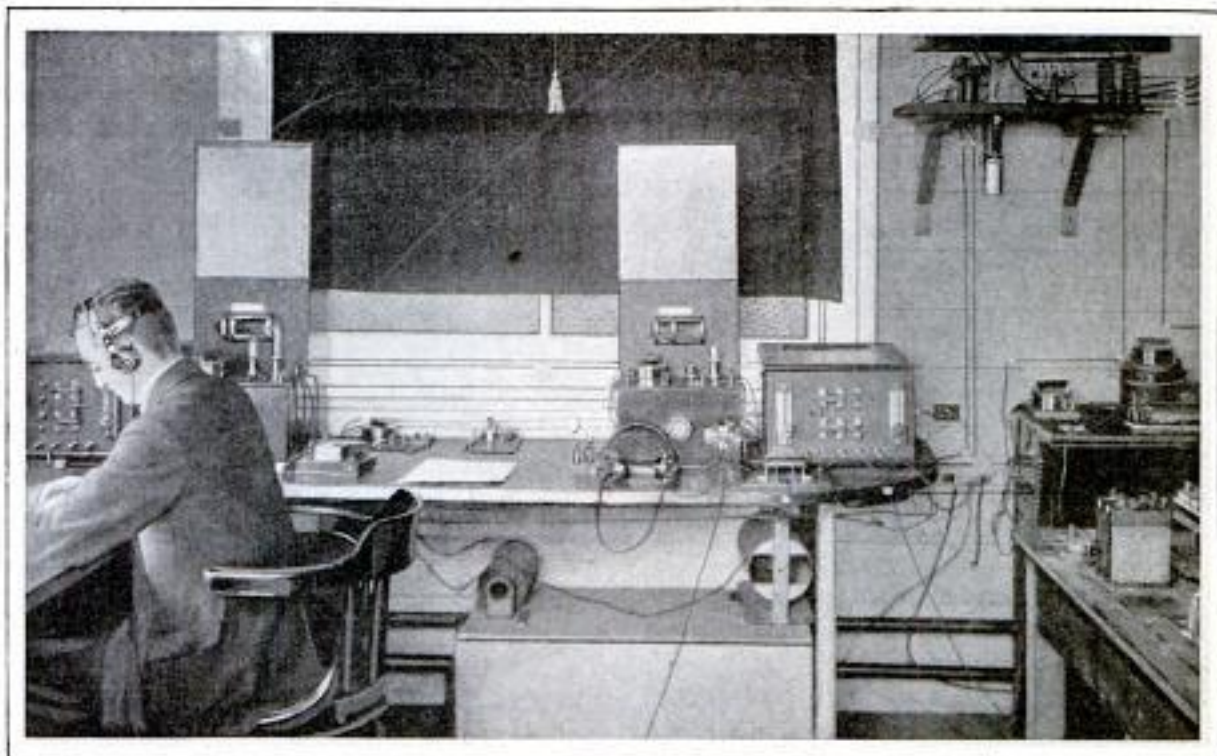

One of the "Stepping Stones" in the Wireless Circuit of the Globe: the Operating Room of the Clifden, Ireland, Station

Canadian neighbor, or we may utilize the new and more powerful station at London. By this means we arrive once more at our starting point at Belmar. Thus with but nine stepping stones, we may trip around the earth. Still further stations are contemplated: in fact, the chain that girdles the globe will be but the main artery of a great system. Feeders and branch stations will be established in all countries and a very comprehensive chain will be erected in South America in the near future.

With the establishment of this great network of stations will come an era of cheap communication, for wireless telegraphy may easily reduce the present cable rates. The cost of a submarine cable to cover a distance of 3,000 miles is anywhere from \$7,000,000 to \$10,000,000, while the total cost of a pair of wireless stations to do the same work is but \$600,000. The cable must handle a half million dollars worth of business in order to earn enough to keep it in repair, while two per cent of this amount will take care of the same item for the wireless. Two million words at 25 cents a word will earn only a sufficient sum to cover depreci-

ation of the cable, while the same number of words at half rate by wireless will produce enough to pay the depreciation charge and 35 per cent on the investment besides.

I have purposely omitted the cost of operation for there is little difference between the two systems. It is true that the actual cost of operation of the wireless system is higher than that of the cable, but the cost of repairs and upkeep on the cable are vastly higher than with the newer system. A cable company must keep a repair steamer, worth some \$250,000, ever ready to sail out over the 3,000 miles of submerged cable in order to locate a break or fault and make the repairs, while the wireless station covers but a few acres and repairs are quickly and cheaply made.

The wireless system, in using nature's ether as a conductor, has provided itself with a medium that requires no repairs. At a high-power station one cannot help experiencing a weird sensation at this power to communicate from one continent to another over vast stretches of ocean with naught between, other than nature's ether. Without wire or cable to convey an electric current and a complete

absence of anything that is perceivable by the five senses, it seems a marvelous thing to be able to communicate with a distant land. Yet it is more easily understood when we consider that we have borrowed for our use a voice of lightning that will speak thousands of miles with a single flash, and with apparent ease send its unseen and unheard vibrations through daylight and dark, through storm or calm, over mountains and seas and even directly through those substances which we have learned to think of as solids, with the exception, however, that they refuse to penetrate conductors of electricity.

Surely, we have here an accommodating servant by means of which we may from a single station talk with nations, north, east, south and west; we need no wires, no cables, no right of way and none of the expensive upkeep or repair that the older forms of communication require.

The engine room of the great station at Clifden, Ireland, is a fair example of the stations now planned. Each station has a complete duplicate set to guard against interruption of the service by accidental breakdown, for the handling of messages must continue day and

night from one year's end to another, and even an engine and dynamo are sufficiently human to require an occasional rest. Near the engine is located the buildings that house the condensers. A condenser in wireless telegraphy is a device that stores up the electric energy until the operator by pressing his key sends it hurrying away to do his bidding. The entire plant, which may cover many acres of ground, is at the instant control of the operator who is stationed in a little bungalow quite separated from the power plant, but in absolute control of its machines by means of underground cables that operate switches in the main power plant.

Certainly the operator at such a station as the one building in Hawaii is an autocrat. He may tell the far-away station in the Philippines to proceed or to wait, or he may at the same moment talk to the San Francisco station and receive from the Philippines, or he may so arrange his automatic transmission and recording apparatus as to receive simultaneously messages from Colon and the Philippines, while at the same moment transmission to San Francisco is taking place from his own station.



HIDING THE DOTS IN HALF TONES

Such obvious disadvantages, indicated by newspaper pictures, are inherent in the ordinary half-tone engraving process, by which the picture

is made up of tiny dots in straight lines, that investigators all over the world are seeking an improved method. A new idea has been worked out by

Dr. Hans Strecker, according to the *Scientific American*,

He first prepares a mixture of gelatine and gum arabic, the gum forming in tiny globules, instead of mixing with the gelatine. The mixture is then coated over a copper or zinc plate which has been made sensitive to light in the usual manner. The coat hardens and so forms a film over the plate, of transparent gelatine, filled with tiny globules of gum, very uniformly distributed, but not very transparent. A photograph is then taken on this coated copper or zinc plate, the light affecting the plate through the transparent gelatine, but not through the globules of gum, exactly as an ordinary half-tone plate is photographed through a screen to get the dots. In the case of the new process, the image on the plate is also in dots, of course, but not in a regular pattern. The plate is then etched with acid in the usual

A Wooden Lion Whose Interior is a Beehive



manner, leaving an engraving cut which also gets its printing effect from tiny dots, but by reason of the less orderly distribution of the dots, they do not attract the eye so strongly as those of the common half tone, and the resulting print takes on a more lifelike appearance.

It is possible to vary the distance apart of the tiny dots so as to adapt the engraving cut to any kind of print paper.

UNIQUE GERMAN BEE COLONY

Instead of the usual simple hives, all alike, a German keeper of bees has provided them with real residential abodes, as well as hives in the shape of wooden "wild" animals. In the gar-



One of the Beehive Residences of a Quaint Bee Colony in Germany

den are several miniature houses representing an inn, castle, railway station, and residences grouped around them. All the small details, such as chimneys, doors, windows, and the like, are carefully modeled in architectural proportion.

FIRE-ALARM GONG OPERATED BY SPRINKLER SYSTEM

An eastern firm has recently placed on the market an automatic device to be used in connection with a sprinkler system which will ring a gong on the outside of a building as soon as the fire starts the sprinkler working. A valve, installed in the main pipe of the sprinkler system, is subject to the entire water pressure as soon as the sprinkler starts to work, and this allows a small portion of the water to drop on the buckets of a water motor inside the wall. The shaft of the motor extends through the wall and brings a rotating striker in contact with the gong.

LUMINOUS OUTFIT FOR NIGHT MARCHING

Luminous field compasses, luminous marking disks to be worn on the backs of the column leaders, and



Compass Made Luminous by Radium for Military Operations at Night

Column Leader Wearing Luminous Disk as Guide for Following Soldiers

pocket electric lights which will enable mounted troops to march on the darkest nights with the same accuracy as during daylight, will be adopted by the United

States cavalry, if experiments which are now being made at Fort Oglethorpe, Ga., prove their worth. The new appliances and equipment have been recommended by the Cavalry Equipment Board which recently met at the Rock Island arsenal where preliminary tests were made. The tests at Fort Oglethorpe will extend over six months and be made under conditions as severe as any encountered in actual warfare.

The equipment board has recommended that hereafter each regimental and squadron headquarters be supplied with luminous compasses of a type similar to those supplied to the armies of other countries, which have been found to be of great value in marching across a dark and unknown country at night. In the compasses, the usual in-

dex line and outside circle of degrees is retained, but instead of the dial being painted with luminous paint, which needs exposure to the sunlight or to a magnesium ribbon in order to render the compass luminous at night, the index line is treated with a composition in which radium enters as a constituent and which needs no exposure but is always ready for night work and retains its luminosity for an indefinite period.

In the tests at the Rock Island arsenal the luminous compass was used on a 500-mile march and also luminous disks of considerable brilliancy, made of waterproof cardboard, thickly coated with luminous paint and attached to the back of a column leader by means of pieces of tape. It was found that by these means the mounted troops could march with great accuracy and speed. When soiled the disk can be sponged off with lukewarm water and used many times before repainting is required. To excite luminosity, the disk must be exposed to bright daylight.

The use of pocket electric lights about 5 in. long and covered with durable leather is also recommended. It is believed the light will be useful to troop commanders in conducting night operations with other troops or even independent night operations on a small scale; and in reading dispatches, examining crossings and banks of streams before fording. The lights will be so constructed as to be proof against wet weather and tropical temperatures.

The board has also recommended that the bayonet be added to the trooper's equipment, so that in case he is unhorsed, he will be as efficient as an infantryman. The type of bayonet recommended is not unlike that used in other branches of the service, but about 4 in. shorter and not quite so heavily constructed.

CA western railroad company has not only given its employes thorough instruction in first aid to the injured, but has equipped its trains with the so-called "first-aid" packages.

PREVENTING EROSION OF PROPELLERS

"Turbodium" is the name given an alloy, produced after numerous tests, which is now successfully used to prevent erosion of propellers of turbine-driven vessels. In laboratory tests it showed an endurance of 140 hours, as against 24.7 hours for the ordinary high-tension bronze, which also has been used for the same purpose. The test has been confirmed by use of the alloy for periods of six months to three years, propellers so protected having shown no evidence of erosion after the lapse of these varying periods. Before turbines were introduced, manganese bronze temporarily solved the problem of preventing erosion in the earlier type of propellers, but with the use of the new-style engines, an alloy of greater resistance was required.

GETTING READY FOR AERIAL INVADERS

The possibility of an aerial invasion of England has occupied the attention of British military authorities since the first aeroplane crossed the English Channel. The accompanying il-



Model Aeroplane Target with Dummy Pilot in Full Flight as It Would Appear to Marksmen on the Ground

The Way in Which the Model Aeroplane is Attached to the Rope Before it is Released to Become a Target

lustrations, used by courtesy of the Illustrated London News, show that preparations are being made to give the first soldier-birdman a warm reception.

To gain practice for such a contingency a model aeroplane, 10 ft.

long, has been mounted on a wire stretched across the rifle range in Broadhead Valley, Entwistle, near Bolton. The model carries a dummy pilot which becomes the target during maneuvers. In practice the model, out of sight of the attacking force, is released by means of a rope and passes over the riflemen at full speed. During a recent trial the "pilot" was hit by a bullet at a distance equivalent to 1,000 yd. for a full-size aeroplane. Another shot struck the machine but missed the dummy driver.

ASK BIDS TEN YEARS IN ADVANCE

The city of Dublin in asking bids on arc lamps has given the manufacturers a big problem. The specifications call for bids on 500 lamps to be delivered at the rate of 50 a year for 10 years. The lamps are to burn in series of 22, and the makers have been asked to submit one series for a six-months' free test on the same circuit as the lamps now in use. These difficulties might have been overcome, but the makers refused to bid when they found that the specifications provided that each light must have a heavy sheet-copper case. They said it was impossible to forecast the price of copper for 10 years in advance.



SKY-SCRAPING PHOTOGRAPHS



These pictures of structural steel workers at work were taken at a greater height than any photographs of this kind ever were before. In this particular instance the camera man mounted to the top of the central tower of the lofty new Woolworth

Photos Copyrighted

OF SKY-SCRAPER BUILDERS

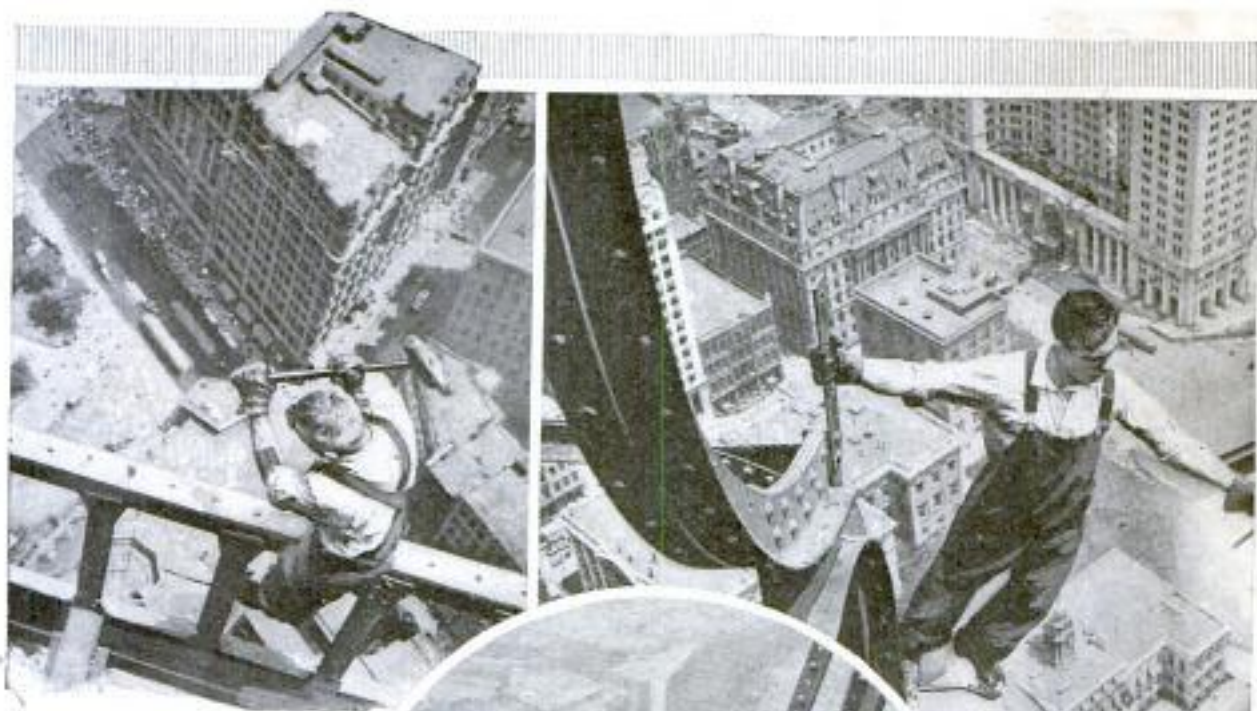

Building in New York and made snapshots of the workmen around and below him, the man who seems to be on top of a tower being at the apex of one of the four smaller pinnacles, while the others are at various points along the giant frame.

Brown Bros., New York



MICROBES FROM DOGS TO PROLONG LIFE

In making his recent announcement that he had found microbes in the intestines of dogs which are hostile to



Culture of Life-Prolonging
Microbes Found in Dogs

the microbes charged with bringing on premature old age, Prof. Eli Metchnikoff showed the French Academy of Sciences cultures of these friendly microbes. Professor Metchnikoff considers this discovery of his a long forward step in his famous efforts to find means of extending what is the present apparent normal span of life.

Professor Metchnikoff and Doctor Wollman, his collaborator, have become convinced in the course of their recent investigations that it is in the herbivorous or non-flesh-eating animals the harmful microbes are developed in greatest numbers, and that this will apply to people who are strict vegetarians, while in persons using a mixed diet comparatively few are found. In announcing his discovery of the friendly microbes in dogs Professor Metchnikoff issued a warning against considering his discovery as yet anything more than laboratory experience, and entirely preliminary, and against any unscrupulous exploitation of his discovery.

MOST POWERFUL LOCOMO- TIVE IN THE WORLD

The Mallet locomotives just built for the Virginian Railway are claimed to be the most powerful in the world. The locomotive and tender weigh 752,000 lb., the fire box is large enough to hold a donkey switching engine, and the weight on the 16 driving wheels is estimated to be 479,200 lb. It is estimated that these locomotives will haul 155 loaded 50-ton freight cars at 10 miles an hour.

STREET PAVING LIKE MOSAIC FLOOR

Because of repeated unsuccessful efforts to find a satisfactory pavement for heavy traffic, the engineers of the city of New York are preparing to lay a new form of granite block, known in Europe as "durax pavement." In the continental cities it has proved stronger and more durable than any other type of paving, and New York hopes to benefit by their 20 years' experience with it. Its lasting qualities are due to the fact that the surface blocks are small, carefully fitted by hand, and so arranged that none of the joints is at right angles to the moving lines of traffic. This produces an almost noiseless surface and gives a good foothold for horses. The blocks are made of granite, cut in cubes about 3 in. on each side. On a bed of ordinary dirt or clay, which is pounded down hard with a 10-ton roller, a foundation of concrete, 6 in. or more according to the weight of the traffic, is laid, and over this is a 1/2-in. bed of granite chips. The granite cubes are then laid on top and fitted together as evenly as possible. The interstices are filled with pitch. When completed, the street looks like a great piece of mosaic, the lines of the cubes curving off into regular arcs in various directions. The surface at first is slightly rough, but after a few days or weeks it becomes very smooth.

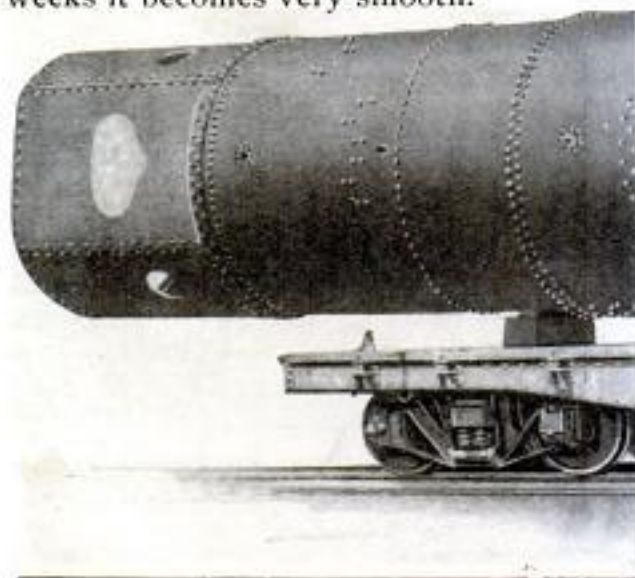

THE KING'S BARGE FOR THE HENLEY REGATTA

The royal barge which was originally built by William III, of England, for the use of his consort, Queen Mary,

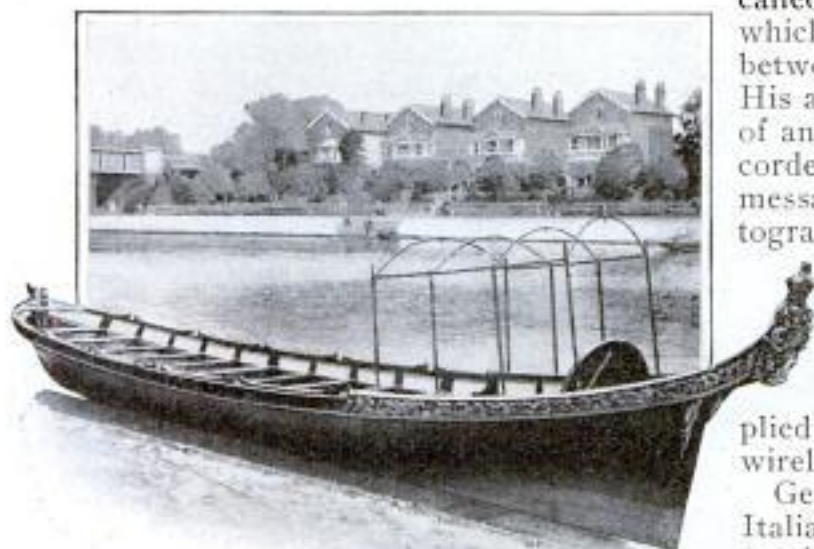

The Royal Barge of William III, of England, Undergoing Redecoration for King George

some 200 years ago, was thoroughly overhauled before the Henley Regatta, which is the premier water event of the season in England.

TRANSMITTING SKETCHES BY WIRELESS

Surprising results are being obtained by means of the new invention of an Italian youth, Francesco di Bernocchi, called the wireless iconograph, which has recently been tested between Milan and Turin. His apparatus is far in advance of anything of the kind yet recorded. Besides ordinary messages, it also transmits autographs, shorthand characters and all sorts of designs. So simple is the arrangement that the transmitter and receiver of this instrument may be applied with ease to any ordinary wireless telegraph plant.

General Spingardi, the Italian minister of war, is so much impressed by the enormous advantages of the wireless iconograph for transmitting orders and conveying sketches in time of war with

the utmost secrecy, that steps were immediately taken to secure for the Italian government exclusive possession of the patent.

Boiler of Most Powerful Locomotive in the World. The Fire Box is Large Enough to Hold a Donkey Switching Engine

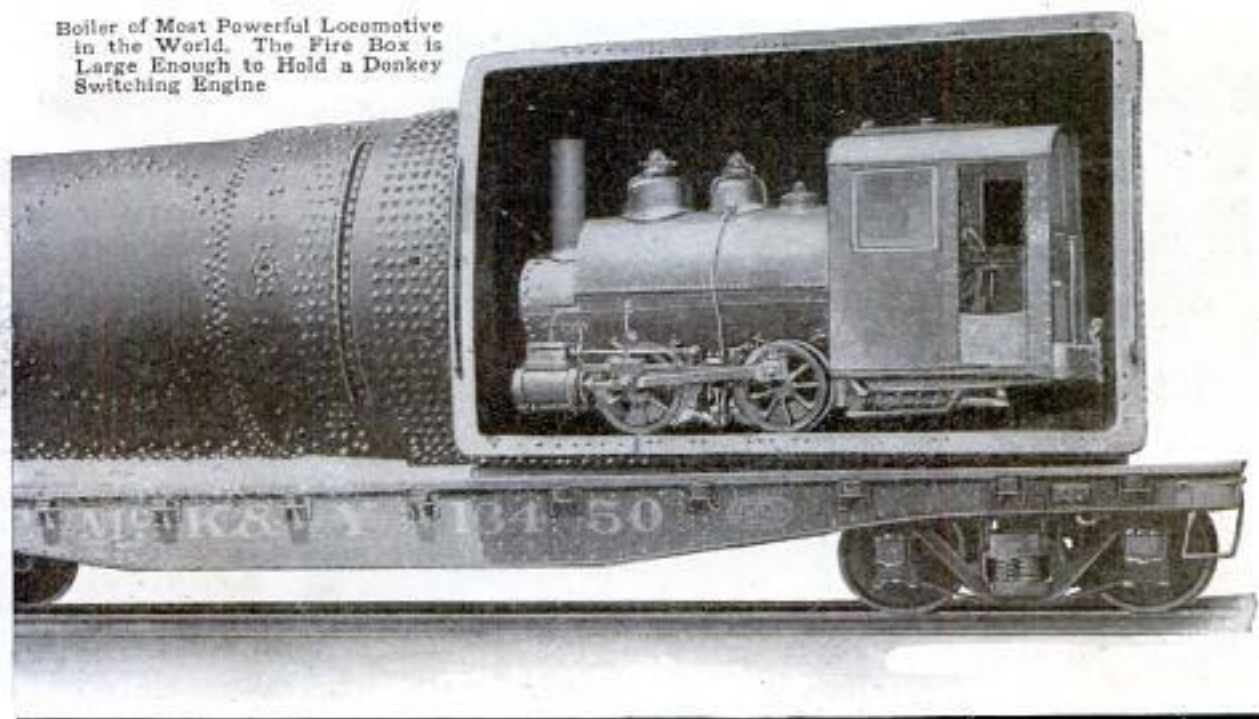

AN IMPROVISED MOTOR AMBULANCE

A physician at Wildwood, N. J., has converted an automobile into an ambulance, as shown in the accompanying photograph. The rear end of the ambulance is 3 ft. high with isinglass set in the top cover to give light to the patient. An opening back of the seat permits conversation between physician or driver and the patient. The ambulance is used in connection with a seashore emergency hospital.

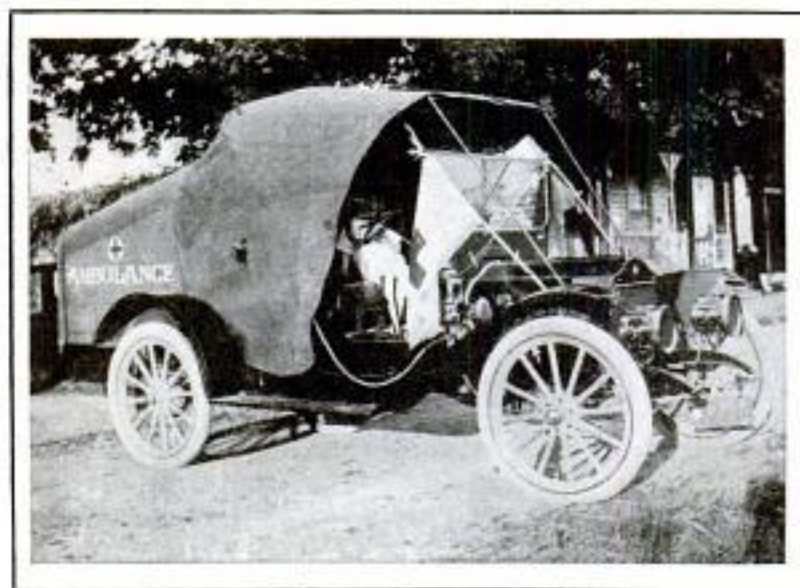

Physician's Motor Car Converted into Ambulance

DYNAMITE DOES WORK OF SLEDGE

Expedition in making repairs is a thing devoutly wished when the water supply of a big industrial plant is temporarily shut off. With this in mind the waterworks manager of Birmingham, Ala., has adopted the use of dynamite in place of sledges for breaking cast-iron pipes when it becomes necessary to dislodge them. A quarter to one-third of a stick of 40 to 60 per-cent dynamite is placed on top of the main and covered with clay. Usually the blast blows out a small hole or starts a crack. Further shots are then exploded, working toward each end of the pipe. In some instances pipes thus removed were 2 in. thick and the dynamite

method was found much more rapid than the old way of attacking the pipe with sledges. In doing this work electric exploders are recommended as they may be used with greater safety and are more convenient than fuses.

PHOTOGRAPHING ANIMALS UNDER WATER

Photographs of otters and water birds of various kinds have recently been obtained with a moving-picture camera by Dr. Francis Ward, of Ipswich, Scotland. In order to get the pictures and remain unobserved by the animals Doctor Ward built a concrete tank fitted with a window and mounted his camera in an underground room behind the aperture.

Among the pictures obtained are those of an otter engaged in a fish hunt, herons, penguins, black-backed gull and a water hen. The penguin was observed as a fisher, the photographs disclosing clearly how the bird uses his wings

as oars both on the surface and while under the water. The air bubbles in the feathers of the water hen convert it into a mirror in which are reflected the colors of its surroundings. The fish are seen swimming around the legs of the heron which piece of carelessness enables the bird to gain a square meal without undue exertion.

DISINFECTING WATER BY ELECTRICITY

Satisfactory and economical disinfection of swimming tanks has been accomplished by the municipality of Poplar, England, by means of an electrical discharge into the water which renders it sterile. The cost of the in-

stallation required for this purpose, it is said, was more than repaid by the saving of expense for disinfectants of the usual kind that had been employed previously. The effect on the water is not such as to make it unpleasant for the bathers. An English physician states that considered as a possible means of infection, it is a matter of surprise that comparatively little attention heretofore has been drawn to the dangers lurking in swimming baths.

CARRYING A LOCOMOTIVE ON A CABLEWAY

The giant hands that are refashioning the surface of the earth at man's bidding do something more than merely pile up heaps of rock in river courses that the streams may be diverted to fields where water is needed, or tunnel through mountains, or level off hills. Recently it was necessary to carry a railway locomotive from one side of the Rio Grande River to the other in connection with the construction of the Elephant Butte dam. To run the engine on rails to the nearest switching point and thus get it to its destination would take too long. So the power that has been trained to exert itself at the twist of a switch or the turn of a throttle was called into play and it picked up the engine and carried it across the river. There was a cableway of steel ropes stretched from one side of the river to the other for the purpose of transporting material as needed. The cable swings 300 ft. above the surface of the river. The locomotive, a 20-ton affair, was equipped with slings which were in turn attached to the travelers on the cable and it was easily and quickly transported from one side to the other.

☞ The illustration of the Galveston causeway in the August issue of this magazine, through an error of omission was not credited as it should have been, "Copyrighted, by Maurer, Galveston."



Copyright by Illustrations Bureau, London

Canary in Bird Cage, Appearing in English Bicycle Meet

GROTESQUE MAKE-UPS FOR BICYCLISTS

Bicycle meets still persist in England. Two quaint figures mounted on bicycles were features of the fifteenth annual meet of cyclists held recently at Woodford, England. One of the riders represented a canary, while the Mother Goose character, Humpty-Dumpty, mounted on the famed wall, operated the pedals of the other bicycle.



Copyright by Illustrations Bureau, London

Humpty-Dumpty Sitting on His Wall and Riding a Bicycle

VARI-COLORED SEARCHLIGHT DISPLAY IN BALTIMORE

Shafts of white, red, green, orange, pink and yellow light, projected by an immense searchlight mounted on top of the Fidelity Building, one of the highest points in downtown Baltimore, have been attracting the attention of visitors in that city. The desire to produce spectacular effects other than those attainable with white light led to the construction of the apparatus that afforded an alternating rainbow of light more startling than the coat of Joseph.

The apparatus, which is shown in the accompanying photograph, consisted of a supporting platform, the searchlight proper, a motor for revolving the light, four large oscillating mirrors and four color screens. The mirrors were placed one each at the four corners of the platform railing. Each mirror was held by a universal-jointed frame so constructed that any or all of the mirrors could be set at any desired angle to the beam of light. Over the center of the searchlight was hung a horizontally revolving wheel or frame carrying the color screens. Each of the screens projected perpendicularly downward a sufficient distance so that its center corresponded with the cen-

ter line of the horizontal searchlight beam. With the searchlight revolving automatically in connection with the inclined mirrors the operator rotated his color screens. Instantly the beam, however deflected, became surcharged with color. The beam of light projected was 24 in. in diameter.



Searchlight Color-Flashing Apparatus on High Baltimore Building

NEW GAS ENGINE FOR BATTLESHIPS

The new marine engine, invented by Dr. H. Junkers, professor of the Aachen (Germany) Technical Highschool, is advocated by its creator as being suited not only to commercial vessels but also to battleships. In a paper read by Professor Junkers before a technical society recently he indicates how his engine was evolved from an earlier German type of

gas engine. Included in his paper were drawings showing the theoretical distribution of engines for a 26,000-ton battleship of 45,000 hp. Four shafts are provided, each unit consisting of a six-crank engine with its compressors. Comparison is made between the Junkers engine, which in this case

is of the tandem type, and engines of the ordinary double-acting variety, the power per crank in each case being assumed to be 1,875 hp. Objection has been made to the Junkers engine by engineers who have asserted that it would be very high and therefore suited only to big cargo vessels of comparatively low power. In these plans the adoption of a short stroke, rendered possible by the double-piston principle, makes the engine lower than the double-acting type.

ARTISTIC UMBRELLA ROLLER

An umbrella folded clumsily is about as ungraceful an object as may be found. The novel umbrella folder shown in the accompanying photograph does the work better and more quickly than it

can be done by hand.

The folder is made of aluminum

Ornamental Umbrella Attachment, Serving to Roll Up the Umbrella Tightly and Much Better Than if Rolled by Hand

covered with leather upon which the owner's initial or monogram is stamped. The tube is held in one hand while with the other the umbrella is inserted, lower end first, after which it is slowly turned until the upper part of the "shower-stick" is reached. The folder is an English invention.

SHORT-CIRCUIT FIRES CAUSED BY BIRDS

Panic among a flock of starlings, brought about by the attack of a sparrow hawk, was the extraordinary cause of a series of fires breaking out simultaneously in Württemberg, Germany. The starlings flew blindly toward a transformer house and some of the birds became entangled between the

inductance spirals and the insulator pins. As a result the transformer-house tower was connected with a 10,000-volt line and, it is said, if the ground connection had been effective the rush of current would have been sufficient to open the main-station breakers. Unfortunately, only one ground plate had been provided and after an exceptionally dry period this was found to be in dry soil, hence the high-tension charge took the easiest way to earth which happened to be by way of various house installations. Immediately several fires resulted and in attempting to extinguish them with water a number of persons received violent shocks. None was seriously injured, however, and only one house suffered damage of consequence.

ELECTRIC BELLS WITHOUT BATTERIES

A batteryless electric doorbell, which was recently put on the market, makes use of a compactly designed magneto generator, which is operated through gearing from a small handle that replaces the ordinary push button.

The magneto generator is provided with an extension shaft, so that it can be installed

on a door casing of any thickness, with only the handle, which has the appearance of an oblong door knob, and the escutcheon plate showing from the front. The generator itself may be mounted on the inside edge of the door jamb, it being very neat in appearance; or, if desired, it may be mortised in the brick or woodwork, the escutcheon plate being of ample size to cover the opening for it.

Wires are run from the generator to a bell, which may be located anywhere, with respect to the generator. The bell operates very easily, only a small part of a turn of the handle being required when it is desired to sound the signal.



MOTOR CAR FURNISHES POWER FOR PYLON BEAM

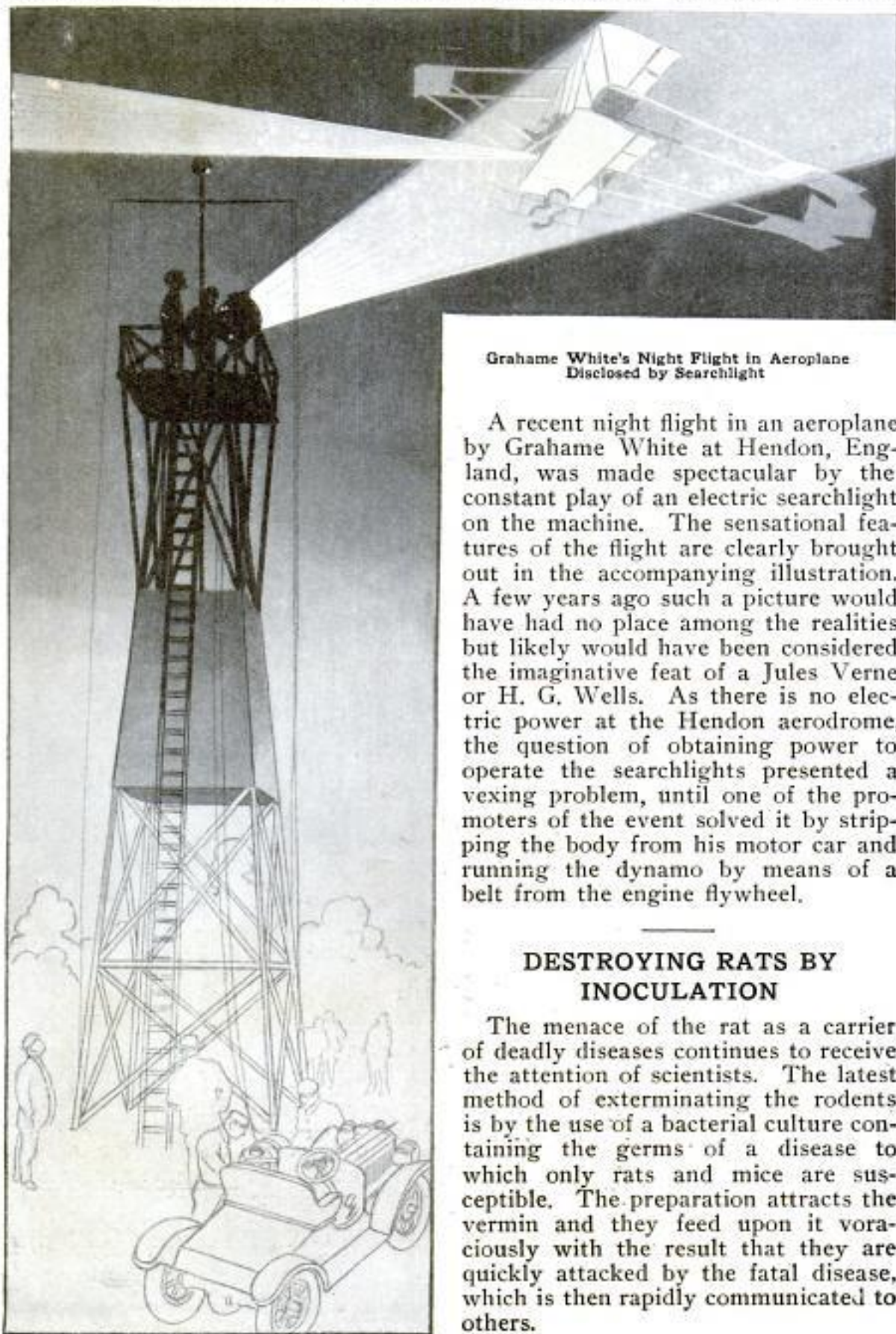

Grahame White's Night Flight in Aeroplane
Disclosed by Searchlight

A recent night flight in an aeroplane by Grahame White at Hendon, England, was made spectacular by the constant play of an electric searchlight on the machine. The sensational features of the flight are clearly brought out in the accompanying illustration. A few years ago such a picture would have had no place among the realities but likely would have been considered the imaginative feat of a Jules Verne or H. G. Wells. As there is no electric power at the Hendon aerodrome, the question of obtaining power to operate the searchlights presented a vexing problem, until one of the promoters of the event solved it by stripping the body from his motor car and running the dynamo by means of a belt from the engine flywheel.

DESTROYING RATS BY INOCULATION

The menace of the rat as a carrier of deadly diseases continues to receive the attention of scientists. The latest method of exterminating the rodents is by the use of a bacterial culture containing the germs of a disease to which only rats and mice are susceptible. The preparation attracts the vermin and they feed upon it voraciously with the result that they are quickly attacked by the fatal disease, which is then rapidly communicated to others.

TRANSPLANTED RUBBER TREES THRIVE

Experiments covering a number of years in transplanting rubber trees from the original stock seem now to have justified the efforts of the growers. The former supply came almost entirely from the district bordering the Amazon and its feeders but in recent years transplanting has been practiced on a rather large scale, the original stock having been taken from the old rubber districts and cultivated in portions of Brazil remote from the big river. One company, during the last year, gathered 193,750 lb. of rubber compared with 41,983 lb. in 1910. The estimate for the current year is 325,000 lb., all of which comes from the interior, far from the Amazon.

BRITISH OIL-FUEL LOCOMOTIVE

In the accompanying illustration is shown one of the great number of oil-burning locomotives at present in use on the Caledonian Railway, operating trains through England and Scotland. The oil is stored in a cylindrical tank carried on the tender where coal is ordinarily stored. The oil flows from the tank to the engine injectors which force it into the fire box at two separate points, where it mingles with steam from the boiler.

PROTECTS PONIES' EYES IN COAL MINE

A new law in England has been enacted to enforce humane treatment of the "pit ponies"—as the horses are called that are employed in coal mines. The new law has inspired the invention of the eye guard shown in the accompanying illustration. Before the law went into effect, many ponies became blind through injuries caused by projecting coal seams and rocks that protruded into the subterranean passages of mines, all previous efforts to protect them having failed.

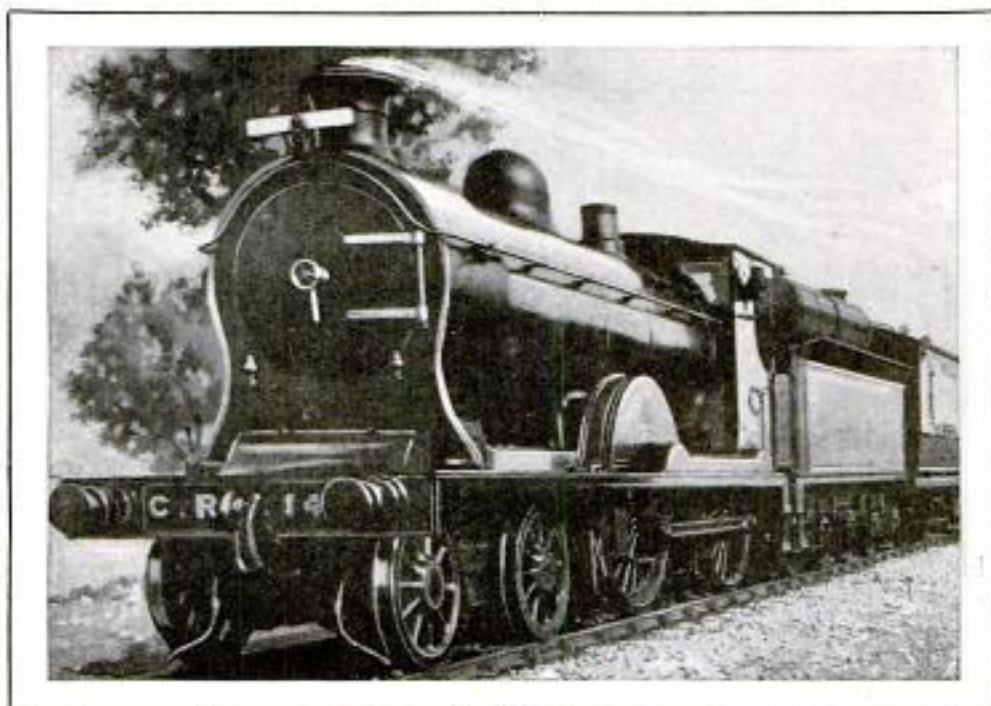

New Type of Oil-Fuel Locomotive, Adopted by One of the Great British Railroads, the Fuel being Kept in a Cylindrical Tank on the Tender

DOUBLE-DECK BASCULE

Chicago's bridge and harbor engineer has put up to the contractors a brand new problem in the construction of a bascule bridge, the type of drawbridge where the main part of the bridge bends up like a jackknife. Here is the problem:

Give us bids on the construction of a two-leaf bascule with a 200-ft. span and double-decked to accommodate an "L" line above, a street railway below, two wagon ways and two footwalks. Prepare to build it as rapidly as possible at the exact spot of the present swing bridge without interrupting the traffic on the "L," the surface lines, the streets, the river or in

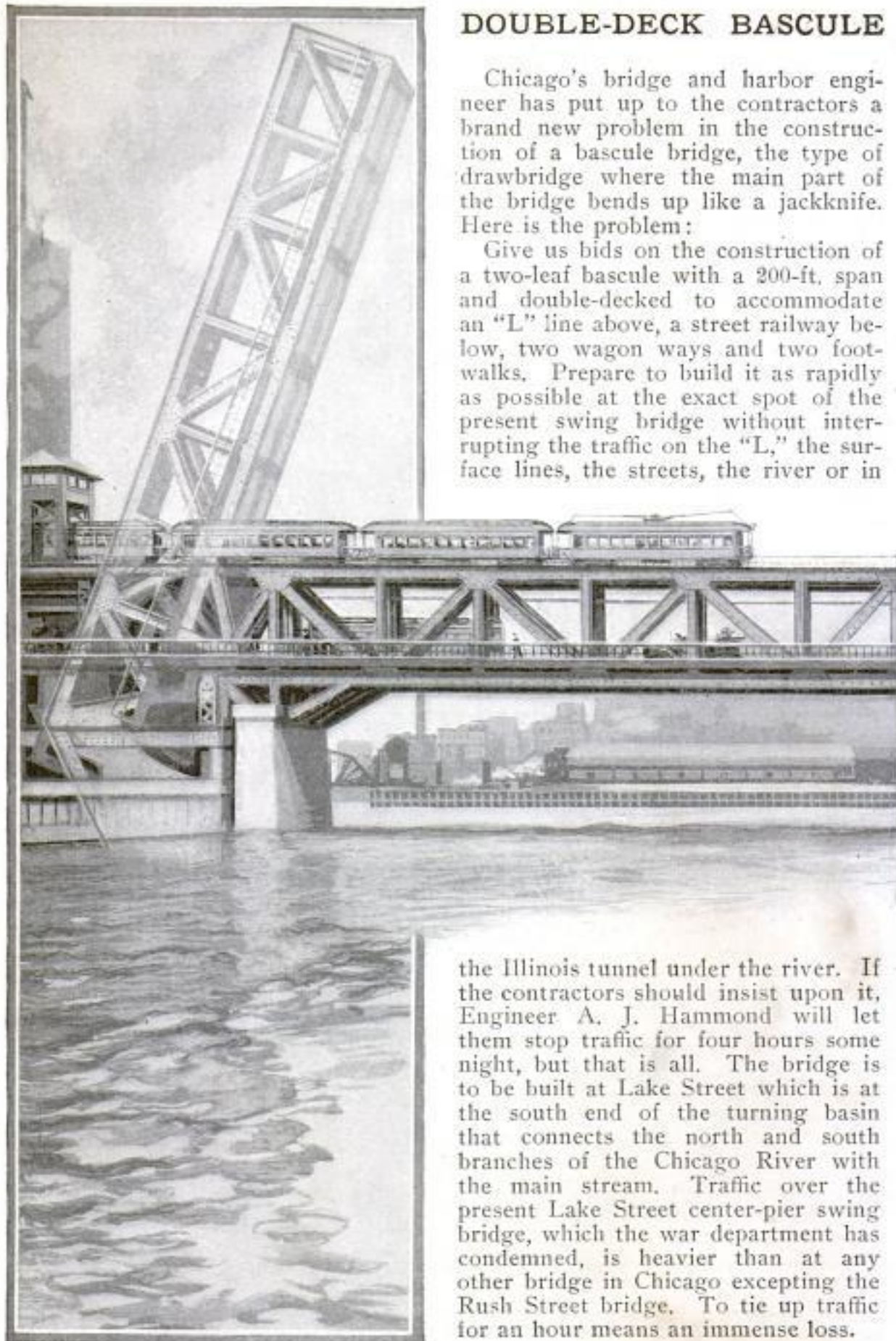

the Illinois tunnel under the river. If the contractors should insist upon it, Engineer A. J. Hammond will let them stop traffic for four hours some night, but that is all. The bridge is to be built at Lake Street which is at the south end of the turning basin that connects the north and south branches of the Chicago River with the main stream. Traffic over the present Lake Street center-pier swing bridge, which the war department has condemned, is heavier than at any other bridge in Chicago excepting the Rush Street bridge. To tie up traffic for an hour means an immense loss.

BRIDGE FOR "L" TRAFFIC

This is the first time in the history of Chicago,—and the city engineer says in the history of bridge building,—that an attempt has been made to erect a double-decked bascule for heavy traffic. Some idea of the tremendous strength required of the bridge may be obtained when it is understood that the structure must be capable of bearing the weight of two "L" trains, eight heavy street cars and all the tonnage of a continuous stream of teams and motor vans.

The engineering department will require the superstructure contractors to build the leaves of the bridge in the air, so that traffic on the surface,

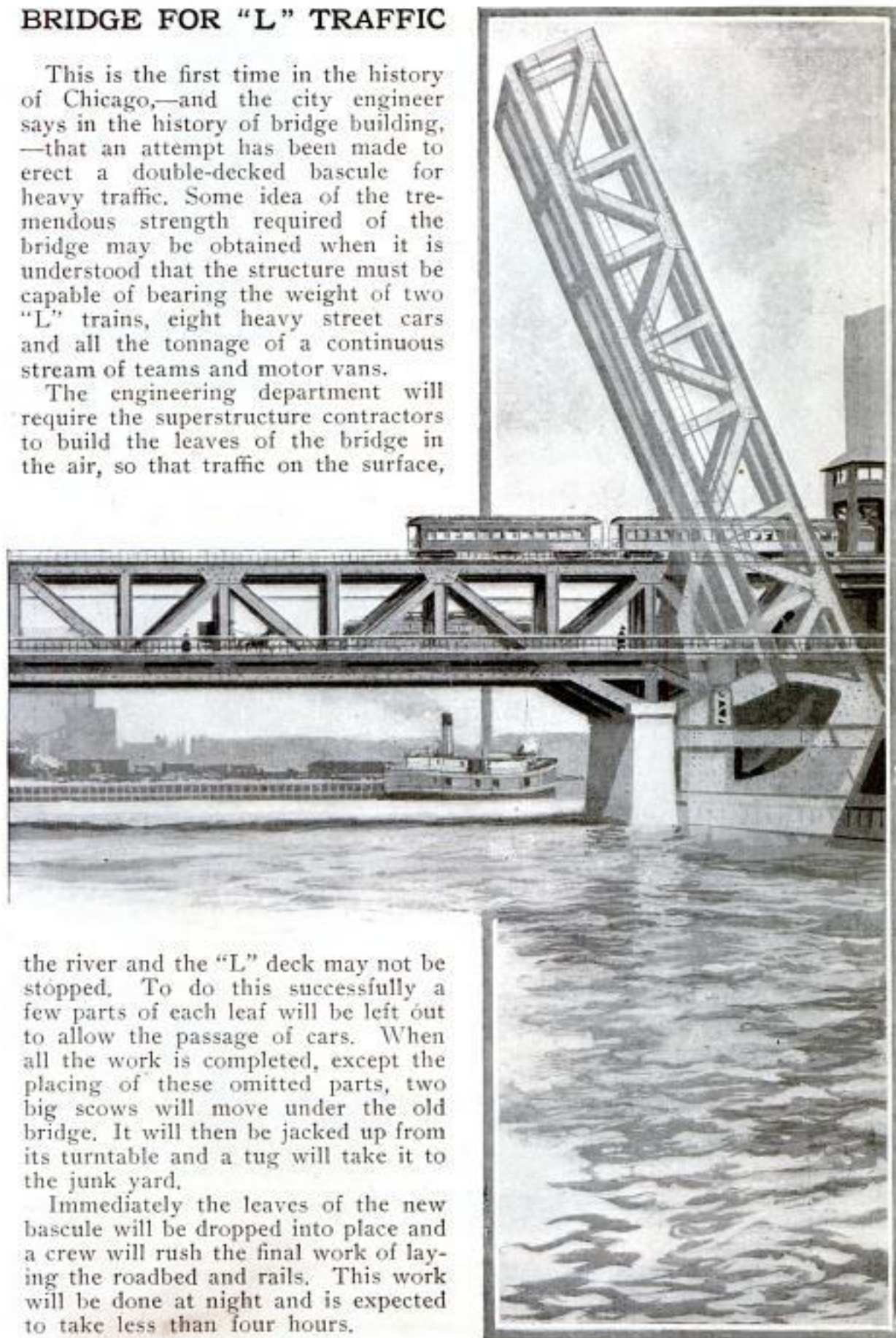

the river and the "L" deck may not be stopped. To do this successfully a few parts of each leaf will be left out to allow the passage of cars. When all the work is completed, except the placing of these omitted parts, two big scows will move under the old bridge. It will then be jacked up from its turntable and a tug will take it to the junk yard.

Immediately the leaves of the new bascule will be dropped into place and a crew will rush the final work of laying the roadbed and rails. This work will be done at night and is expected to take less than four hours.

RAILROAD TOBOGGANING ON PIKE'S PEAK

Two parts novelty and one part danger is the formula that makes many sports attractive. Combine this with the fact that the railroad toboggan is a great labor-saving device, and one can readily understand why this unique tobogganing down the cog railway which climbs Pike's

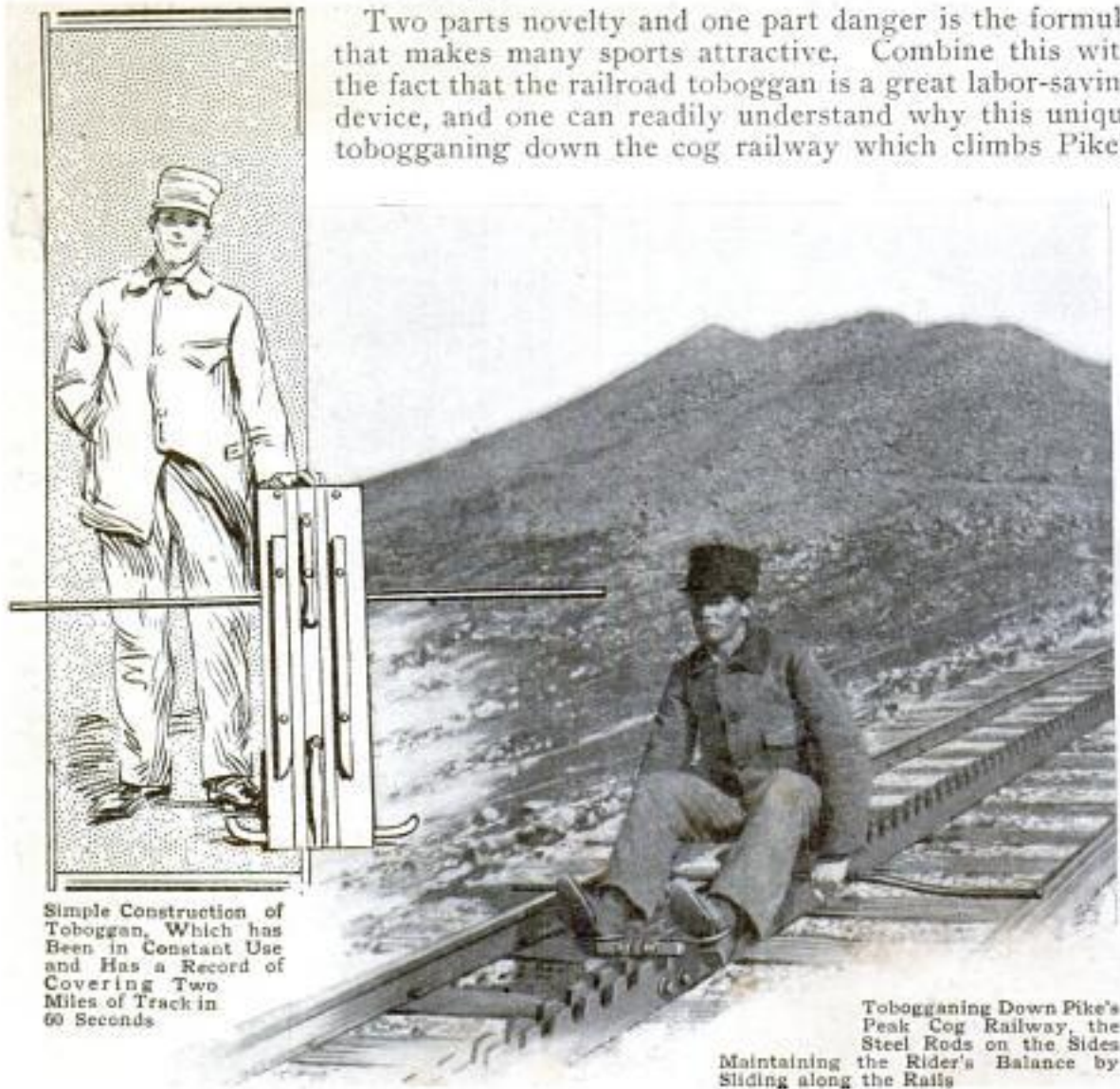

Simple Construction of Toboggan, Which has Been in Constant Use and Has a Record of Covering Two Miles of Track in 60 Seconds

Tobogganing Down Pike's Peak Cog Railway, the Steel Rods on the Sides Maintaining the Rider's Balance by Sliding along the Rails

Peak, Colorado, is so fascinating. To make a drop of nearly a mile and a half in a distance of nine miles of track, sometimes at a speed of two miles a minute, is the reason why the railway toboggan has come into use, for the employes find it far more exhilarating to slide down the mountain than to go on foot. When a tired and hungry workman quits work at the summit at six o'clock and is due at the Saddle House, two and a fourth miles below, for supper, he usually prefers to "slide down the banister" rather than to "go down the stairs" from tie to tie in his descent. This practice has been responsible for sev-

eral deaths and many serious injuries, yet it continues, although the authorities have attempted to discourage its use.

In riding the toboggan the operator sits upright, much as a boy would in guiding a bobsled, but there is no guiding to be done, for the machine is made to follow the tops of the cog rails. The toboggan itself is a board 3 ft. long and 1 ft. wide. A steel-shod cleat, about $1\frac{1}{2}$ in. wide, runs in the center of the under side for its entire length. When the machine is in place on the cogs this cleat fits in between the cog rails, which are parallel with each other and close together, midway

between the main rails of the track. Near each edge of the board is another cleat, about 18 in. long, also shod with iron, and movable. These form the brakes and are operated by a powerful lever from the upper side of the board, the pressure applied in this manner on the sides of the cog rails being sufficient to bring the toboggan to a stop on the steepest grade.

The Pike's Peak toboggans have established a record of an 11-minute run over the nine miles from the summit of the mountain to Manitou at its foot. A two-mile stretch on the steepest part of the grade has been made in one minute.

WARSHIP'S ARMOR PLATE STANDS COLLISION

The accompanying photographs show the unique results of the collision between the United States battleship "New Hampshire" and the Fall River steamship "Commonwealth," at Newport, R. I., in July. The conclusion drawn from these pictures which most interests naval constructors is that the armor belt of the battleships can withstand the most severe impacts.

The "New Hampshire" was lying at anchor in Newport harbor when the collision occurred. There was a dense

Battleship "New Hampshire,"
Showing Crushed Portion of
Stern above Water Line

Bow of Steamship "Commonwealth,"
Showing Part below Water Line
Crushed by Battleship's Armor

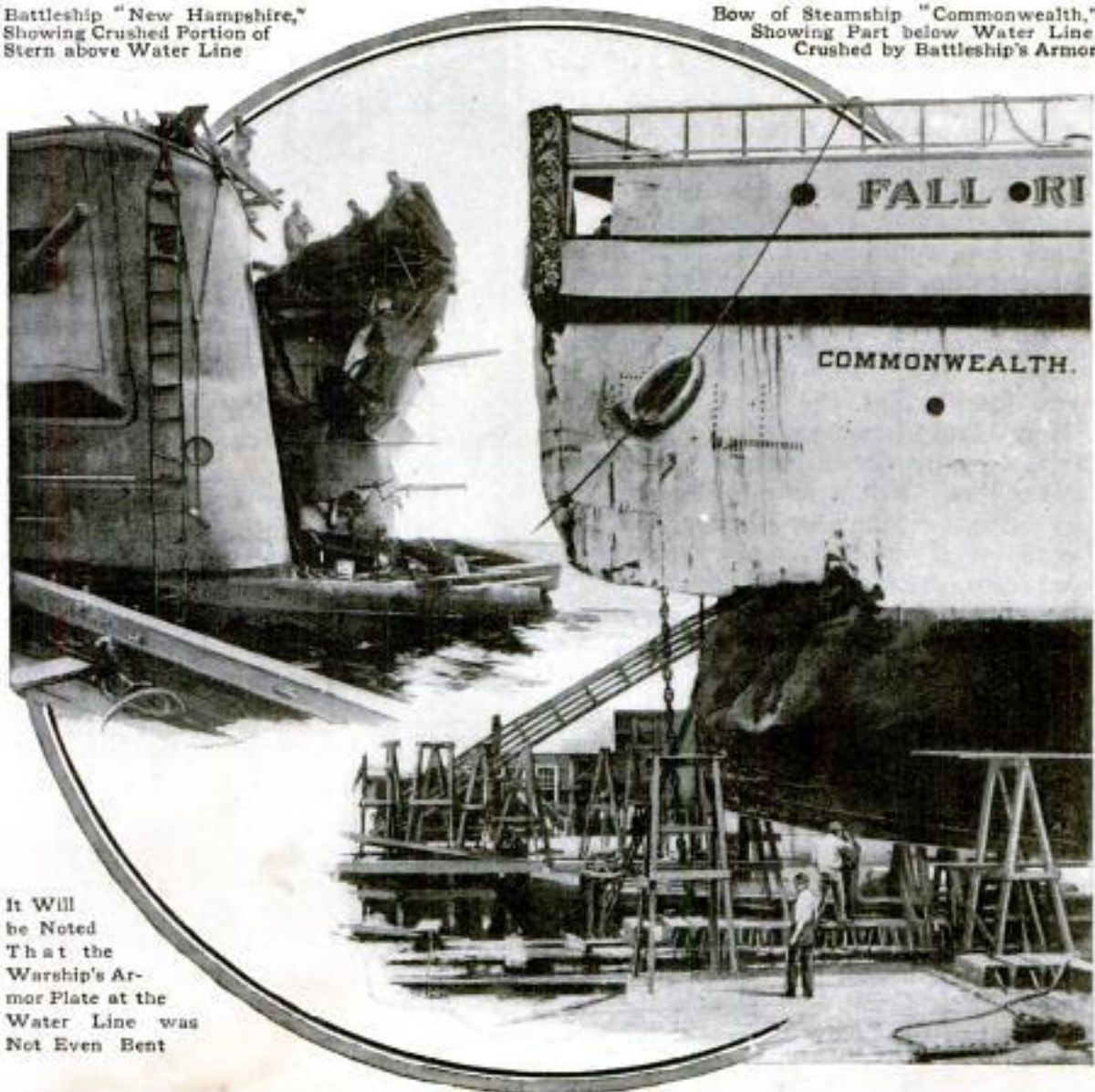

It Will
be Noted
That the
Warship's Ar-
mor Plate at the
Water Line was
Not Even Bent

fog, and before the lookouts on either ship discovered the proximity of the other, it was too late to avoid the crash. The passenger steamship plunged, bow on, into the stern of the "New Hampshire" almost on the center line of the ship.

When the vessels separated after the crash, apparently the "Commonwealth" had sustained no damage, while it was seen that the stern of the "New Hampshire" was almost demolished above the water line. The bow of the "Commonwealth" penetrated the stern of the battleship a distance of about 20 ft. The steel plating was folded in, decks torn up, and the captain's cabin was demolished.

Comparison of the effects of the collision upon the two ships, so far as the damage done to both was visible as they lay in the water, resulted at first in the severest criticism of the battleship's construction. Amazement was expressed that the prow of a passenger steamer, even though she be a steel ship, could so crush the stern of a battleship, supposedly built to withstand heavy shell fire.

Further examination of the two ships, however, turned the tables. It was found that the damage to the "New Hampshire" ended at the armor belt, two or three inches above the water line. Not a single plate of the armor was broken or displaced. The more vital portions of the ship's structure, then, remained intact. Only the upper works, the thin sheathing, which is designed merely to finish off the stern of the battleship and withstand the sea, was injured, and the damage, while it looked so serious, was in reality rather superficial. Not even the watertight bulkhead was broken through, so that the damage was confined to the sternmost compartment.

When the "Commonwealth" was docked, however, it was discovered that the portion of the bow, below the water line, which had struck the armor belt of the "New Hampshire," was fearfully mangled. The steamer was thus rendered unseaworthy to a much

greater extent than was the "New Hampshire."

"SHOO FLY" GUARD TO HELP SCREEN DOORS

An interesting device designed to keep the flies from entering the house or store when the screen is opened to let people in and out is here shown.



Attached to the top of the door and extending a foot or two down its outer side is a screen attached to metal supports which are bent or curved outward. To the bottom of a portion of this screen are attached a number of cloth bands. One of the illustrations shows the guard in the position it occupies when the door is closed. When

the door is pushed or pulled open the top of the guard screen is restrained sufficiently by a checking attachment to make the lower end, with its tasseled strip of cloth, swing outward about 2 ft. in advance of the door, thus dispersing the flies that might otherwise enter. The screen portion of the guard above the door is calculated to keep flies from entering over the door.

CATCHING GRASSHOPPERS IN VACUUM CLEANER

Catching grasshoppers with a vacuum cleaner is an idea worked out successfully by a California man. He found that grasshoppers from the alfalfa were a serious pest in the house gardens, so he rigged up a sled for the vacuum cleaner, and proceeded to capture the insects from the fields. The hoppers jumped as the sled approached, but were then sucked up by the cleaner.

RAPID-FIRE GUNS FOR AEROPLANES

No branch of the science of aviation is receiving closer study in army circles than that tending to the development of armaments for aeroplanes. New ideas in rapid-fire guns, or adaptations of the old, are being experimented with by the military experts of all the great powers; and of the guns now creating interest an American gun is one of the most important.

The gun in question is a new type of automatic, invented by Lieut.-Col. I. N. Lewis, of the coast artillery corps, who has designed many useful military implements. One of the important features of this gun, which may be held to the shoulder like an ordinary rifle when being used to attack aerial fighters from the ground, is the automatic device by which the barrel is kept continually cool by



New Rapid-Fire Gun
Tested by Army Aviation Corps for the Two Uses of Firing at Aeroplanes from the Ground and Firing from Aeroplanes

a blast of air. After a certain temperature is reached, an increased rapidity of fire tends to reduce the temperature. Another distinguishing feature is the circular magazine feed, which is placed directly over the center of the gun, and consequently does not disturb the aim.

The weight of the gun is but slightly more than 25 lb.; it fires 250 shots per minute, and the magazine, which contains 50 rounds of ammunition, can be quickly detached to allow the substitution of a loaded magazine. The feed is positive, and the gun may be fired at any angle, up or down.

During one of the experiments made by Captain Chandler, the empty shells ejected during the firing were caught by a current of wind that carried them into the propellers. When the machine came down, the wooden propellers were found to have been scored or gouged as if a vandal had attacked them with a chisel.

The French have adapted a Hotchkiss rapid-fire rifle for attachment to the under framework of an aeroplane where it may be trained on the enemy below.

ANCIENT BRONZE GUNS USED IN ENGINE MANUFACTURE

One of the interesting things that a writer in the Engineer, London, found in the course of a visit to the Diesel



Ancient Bronze Cannon Bought Up to Provide Bronze for Diesel Engines

engine plant in Turin, Italy, was a collection of ancient bronze cannon which had been bought up to be melted and converted into crank casings and bed-plates. One of the guns seen was a

beautiful piece of work, dated 1717, and had the name of King Philip V of Spain on the breech. It was worthy, the writer believes, of a better fate.

"LOOK-OUT-FOR-THE-CAR" SANITARY CUPS

The necessity of providing its passengers with sanitary drinking cups has been utilized by the Beaver Valley Traction Company of New Brighton, Pa., as a means of impressing them with accident-preventing "don'ts."

On the sides of the paper sanitary drinking cups is printed such advice as "Stop—Look—Listen," "Look out for automobiles and cars from opposite direction," "Never step on or off a car while in motion," "Don't allow children to play in streets on which electric cars run."

HYDROELECTRIC POWER ON A FARM

Electricity is becoming more and more a desirable prime mover on the farm, and one of the most interesting

of a small stream running through the farm.

The reinforced concrete dam is about 100 ft. in length and gives an 8-ft. head of water for operating two small water turbines. These turbines drive two vertical-type, 35-kw., 250-volt generators. There are six circuits leading from the powerhouse to various buildings and parts of the farm, and five



Views of the Reinforced Concrete Dam and Reservoir of the Hydroelectric Installation on Henry Ford's Farm near Detroit

recent installations in the United States is the hydroelectric plant in operation on Henry Ford's farm, near Detroit. It represents what might be termed the height of development in the utilization of small water power in the operation of a private plant, the power being provided by the damming



of these circuits are laid underground. The longest circuit is $2\frac{1}{2}$ miles, and

operates the machinery of the dairy farm. The house and barns are all electrically lighted, there being 60 incandescent lamps in the barns and 14 in the house. Another circuit is a mile long, and operates the machinery of the stock farm as well as illuminating the cattle and horse barns. The other lines operate the machinery in the repair house, the pump house, etc., and illuminate and provide power for numerous cooking, heating and household utensils in Mr. Ford's summer home.



The Circular Steel Blocks, Weighing 81 Lb., Used in the Making of the Cylinder of the Gnome Motor

THE MAKING OF GNOME MOTORS

The Gnome motor with its revolving cylinders, is probably the most famous and most universally used of all aeroplane motors, particularly in Europe. In one of the illustrations may be seen one of the circular steel blocks used in the making of the cylinders. They are of nickel steel, and weigh 81 lb. each. In the boring and the finishing, these cylinders are reduced in weight from 81 lb. to only 6.16 lb. The interiors of the cylinders are polished by high-speed emery wheels until they are as smooth as the surface of a mirror.

A MEASURING DEVICE FOR X-RAYS

A scientist of Berne recently demonstrated before the Röntgen Congress in Berlin an instrument for measuring the action of the X-ray on deep-seated organs. The device gives direct readings of the intensity of the rays at the depth required, and can be used with any type of X-ray installation.

The introduction of an absolute scale of measurement in place of

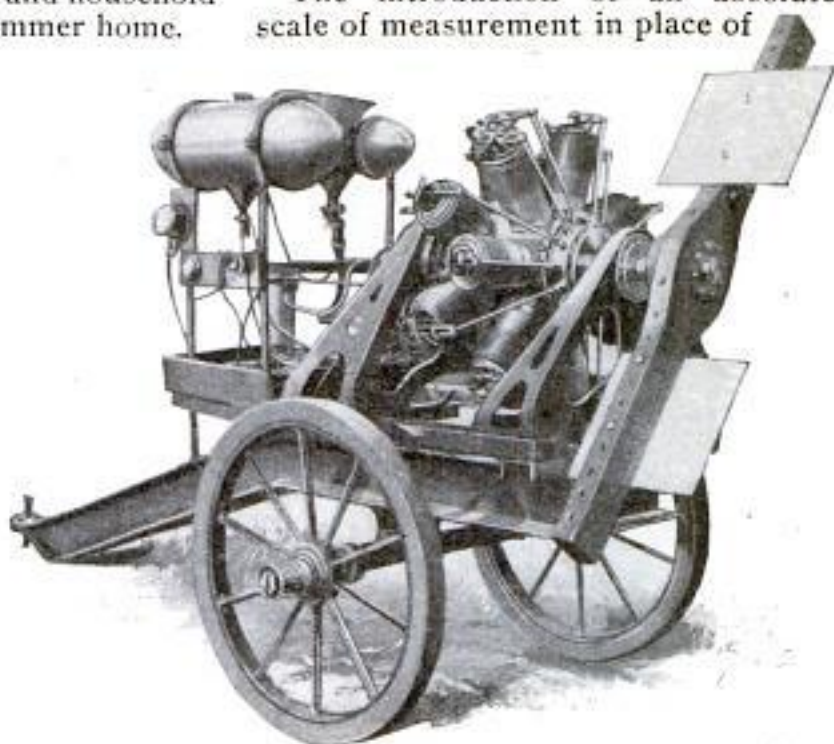

A Finished Motor Mounted on the Test Car Preparatory to a Long-Duration Run

the arbitrary scales used in different X-ray laboratories is said to be a great boon, as it makes it possible to calculate the most efficient irradiation, and determine the correct dose for treating subcutaneous organs. It is claimed that this has hitherto only been possible when surface tissues have been treated.

During the first five months of the present year there were 85,300 motor vehicles registered in the state of New York, of which number 76,164 are pleasure cars and 7,320 commercial vehicles, the remainder being dealers' cars, or exempt from taxation.

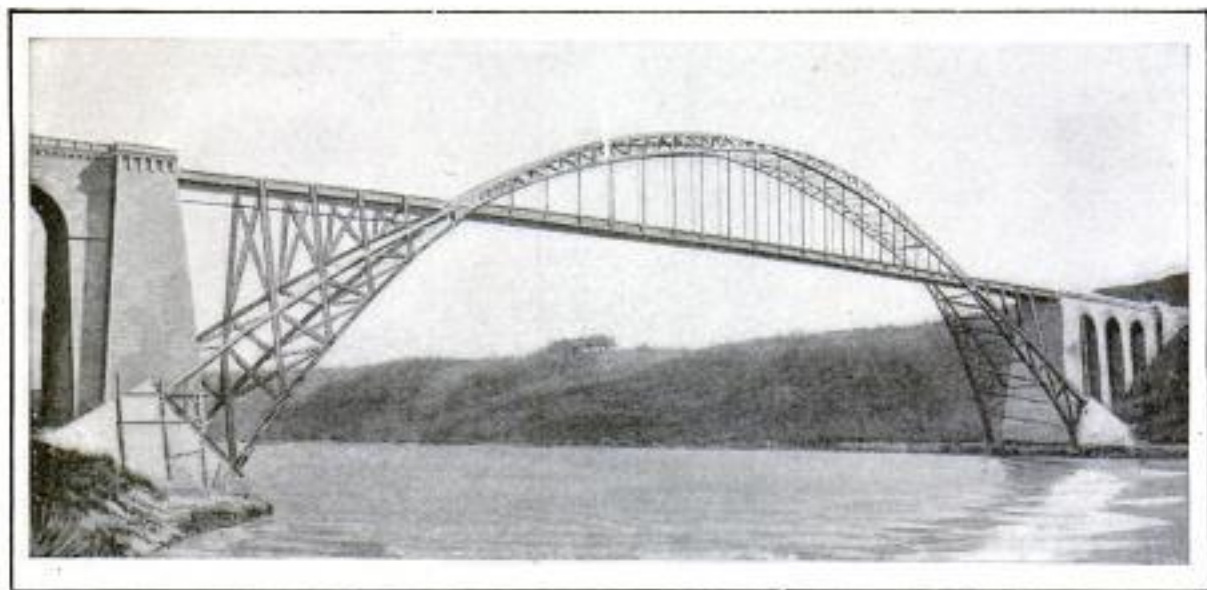

An Exceptionally Light and Graceful Bridge Crossing the River Vilaine, France

SANDSTONE KNOB AS BAND- STAND FOUNDATION

A novel use has been found for one of the water and weather-worn sandstone formations so common along the shores of the upper peninsula of Michigan. The knob in question is located at St. Ignace, and on its top the band



A Bandstand on the Top of a Sandstone Knob at St. Ignace, on the Straits of Mackinac, Michigan

organization of that upper peninsula town has erected a bandstand. The stand commands a fine view of the straits and Mackinac Island.

AN ARTISTIC FRENCH HIGHWAY BRIDGE

The national highways of France are kept as fine as the best examples of city boulevards in America, and the bridges are usually in keeping with the roads. The new bridge across the River Vilaine, on the highway connecting the cities of Nantes and Brest, Brittany, is an excellent example, being extremely light and graceful in appearance.

The length of the bridge proper is 656 ft., the free span being reduced by the cantilever arches to about 367 ft. The height of the roadway above the river, at normal level, is 114 ft.

U. S. GOVERNMENT LARGEST DREDGING CONCERN

Attention is drawn by the Engineering News to the fact that the United States government is the largest dredging concern in the world, having a vast dredging fleet engaged in river and harbor improvement work. The fleet consists of 61 bucket and dipper dredges, 53 hydraulic pipe-line dredges, 23 seagoing hopper dredges, 60 snag boats, 164 screw-propeller and paddle-wheel boats for towing and survey work, 54 derrick boats, 49 pile drivers, and numerous other boats which bring the total up to 855 vessels.

MOTION-PICTURE RECORDS OF RECLAMATION WORK

As part of the movement to give publicity through motion pictures to all important works carried on by the government, a series of pictures have been recently made of the work on the Engle Dam, at Elephant Butte, New Mexico, which is part of the Rio Grande reclamation project.

Of all the motion pictures taken, probably the most interesting are the series photographed from a basket suspended from a cableway across the Rio Grande. The operator, with his camera in operation, was lowered into the foundation pit at the west bank of the river, and then, with the basket raised 400 ft. above the bottom of the pit, took pictures while three heavy blasts were fired. The basket was then moved over the river and lowered almost to the surface of the water, during which descent, the camera was turned through a complete circle so that the views would take in the entire work. The pictures will be exhibited generally in America and Europe.

☞The Post Office Department is conducting a series of experiments in various parts of the country to determine whether or not the motorcycle can be used more economically for collecting mail than either the horse-drawn vehicle or the automobile,

COMPACT LUNCHEON SET FOR MOTORISTS

One of the most elaborate luncheon sets for motorists now on the market is the so-called motor restaurant, a

Luncheon Chest for Motorists Which Opens Up as a Table



complete outfit which packs compactly in the form of a chest for transportation in the car. The outfit costs \$125 or \$150, depending upon whether it is fitted for four or six persons. When the spot for the luncheon is reached, the chest is taken from the car, opened up and made into a table, as shown in the illustration. Across the top in the center is a rack, on which glasses, cups, etc., may be placed within easy reach of the users.

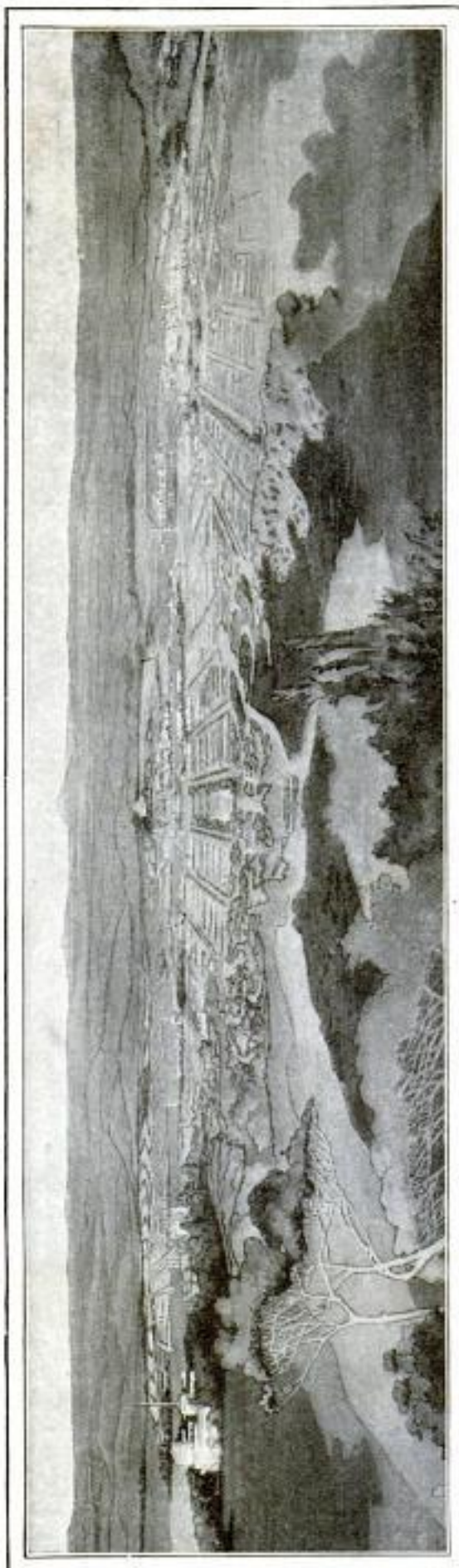

Australia's New Capital City from Mount Ainslie, the Capitol Building being in the center

CREATING A CAPITAL

In a picturesque mountain valley 2,000 ft. above sea level and now practically a wilderness, a new capital city for the Commonwealth of Australia is to be created. As the result of a competition in which more than a hundred of the leading architects and landscape gardeners of the world competed, this city is to be built in accordance with the plans of an American architect, Walter Burley Griffin, of Chicago, who was awarded a prize of £1,750, equivalent to about \$8,500. The site of the new city is midway between Melbourne and Sydney and 75 miles from the sea coast, and work is to begin immediately.

The plan embodies the most advanced theories in city planning. The different functions of the city are grouped at specific centers, each arranged roughly in the form of an octagon, with main avenues radiating in all directions. Such a theory has never before been worked out in complete form, although Haussmann applied it in a limited way in the rebuilding of Paris, and L'Enfant, in his plan of Washington, provided diagonal avenues intersecting a checkerboard system of streets.

The practice of walking from point to point is rapidly becoming obsolete with city dwellers and there is an increasing tendency to use means of rapid transit. For this reason the different centers in the Australian capital have been placed at considerable distances apart. In a capital city the federal center is the one of first importance. This center comprises the octagon and triangular group of buildings south of the central lagoon. At the center of the octagon, occupying a prominent elevation, are the federal executive buildings. On the sloping ground extending to the lagoon, and arranged in terraces, are the parliament and department buildings, and courts of justice. On the opposite side of the lagoon are the stadium, museum, theaters, and other places of amusement.

North of the federal center, and across the lagoon from it, is the mu-

CITY FOR AUSTRALIA

nicipal center, the one next in importance. At the center occupying the third angle of this triangle are located the central railway station and retail market. The manufacturing district lies at the northern edge of the city, and the agricultural suburb, consisting of several centers, at the southeast. The principal residence district is west of the federal center, on high ground affording an unobstructed view of the mountain range to the southwest. The federal university is located to the west of the municipal center on the slope of a mountain.

Main avenues are planned for a width of 200 ft., divided by parkways into three arteries of travel: one for street cars, one for automobiles, and the third for slower vehicles. The steam railway is to be depressed below street level with street crossings carried on viaducts.

A striking feature of the plan is the advantage taken of the natural conditions of the site. A small stream known as the Molonglo River is used in the development of a series of lagoons that form the central feature in the general architectural effect. Prominent elevations, of which there are a number, will be utilized as sites for public and monumental buildings. Mountain peaks will close the vista of each important avenue, while Mount Bimberi, one of the highest peaks of the Australian range, will be visible from all parts of the city.

PLAYER PIANO USED WITH LONDON ORCHESTRA

A recent concert of the famous London Orchestra, conducted by Nikisch, was unique in that it was the first time, in England at least, that a mechanically played piano was used as part of a great symphony orchestra. The pianoforte part of Grieg's Concerto in A Minor and in Liszt's Hungarian Fantasia is said to have been performed by the player piano with perfect effect.



NEW AUTOMOBILE CAP AND GOGGLES

Among recent importations of wearing apparel for motorists are the goggles and cap shown in the accompanying illustrations. The cap is adjust-



Goggles with Adjustable Awning-Like Eye Shades



A Cap Which may be Adjusted to Fit Any Head

able to heads of different sizes by means of the cloth strap which passes around its rim and is provided with a buckle. The goggles have awning-like eye shades which can be folded back when not needed.

SUBMARINE IMPRISONED AT GREAT DEPTH

Contrary to general practice in testing submarines at great depths, the new U. S. submarine "Carp" was recently sunk to a depth of 200 ft. at San

Francisco with a crew of eight men on board, and an accident which might have ended disastrously kept the little vessel at the bottom for over an hour. The trouble was due to fouling of the hawser pipe of the submarine by an anchor chain, which for a time prevented a return to the surface. During the time the submarine was thus caught telephone

communication was maintained with the officers in charge of the test at the surface.

The service of the crew was voluntary, and a considerable bonus was offered.

NEW IDEA IN EXTENSION TABLES

A dining-room table which is, in appearance, like an ordinary extension table, but which may be extended without the use of

any loose leaves, has made its appearance in the furniture world. The center or extension section is concealed under the top of the table, when this is closed up, and in order to make this possible has hinged portions at its shorter ends, which normally hang down. When extending the table, its end sections are drawn apart and the center section is raised about 1 1/4 in. to the level of the top.



Extension Dining Table, the Central Portion of Which, Operated by a Lever, Can be Lowered so That the End Sections Slide Together over It

The hinged portions at each side are then raised so as to make the center

section the full width of the table, and the sections

are forced together, the dowels entering the holes and locking as in other extension tables.

When the table is to be shortened, the end sections are pulled out two or three inches, the center section lowered the required 1 1/4 in., and the hinged side portions dropped. Then the end sections are pushed together over the center section. No hint of its unusual mechanism is seen in the closed table.

FIRE-STATION MAP SHOWS UNPROTECTED TERRITORY

When a big fire occurs in any section of a large city, all the fire apparatus in that section, and often from adjacent sections, are called into service, and frequently this causes considerable difficulty in distributing the remaining companies and apparatus to the best advantage. In handling such situations in

By means of this system, a glance at the map suffices to show the unprotected territory, and the fire apparatus not in actual use are distributed accordingly. The illustration shows the map in the position it occupies on the wall of the fire-alarm headquarters. This is one of the first maps of this type in America. They have been used for some time

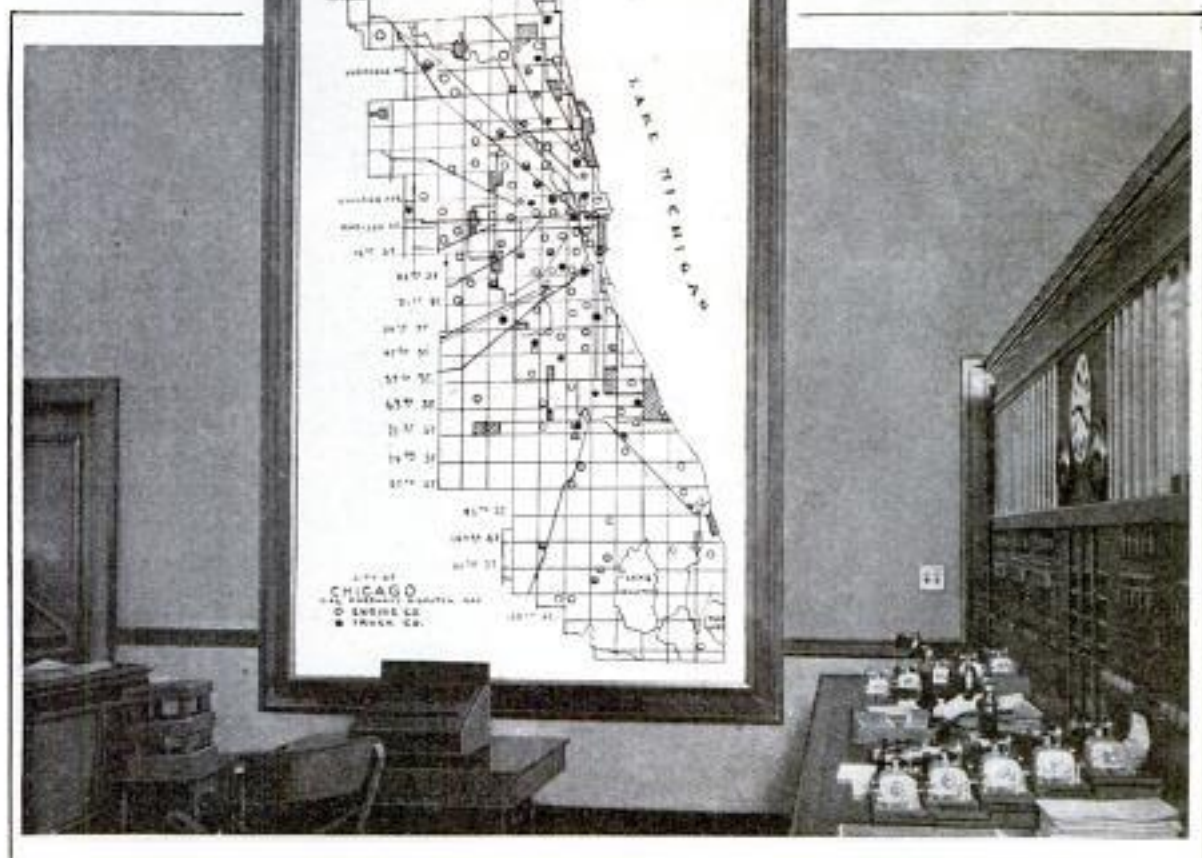

The Illuminated Fire-Station Map in the Fire-Alarm Headquarters of the Chicago Fire Department

Chicago, the fire-alarm headquarters in the city hall is provided with a map of the city on which each fire house is designated by a small electric-light bulb, operated by a switchboard. These bulbs are illuminated during the time the apparatus of each fire station is in its house, but as soon as the apparatus leaves its house, a plug bearing the number of the station in question is removed from the switchboard and the bulb designating this station on the map becomes dark.

in Germany. Milwaukee has a fire map of a somewhat similar type.

AN American sailing vessel, the "Erskine M. Phelps," made a voyage from Honolulu to Philadelphia in 110 days, and she has to her credit also a voyage from Norfolk to Honolulu in 97 days, the fastest time ever made around Cape Horn by a sailing ship. Her latest voyage is the fastest time ever made by a sailing ship on the eastern voyage.

NEWEST WAY OF WEARING A BOUQUET

One of the latest fads in flower adornment is to wear the bouquet on



The Shoulder Bouquet, with an Accompanying Initial Worked in White Silk Cord

the right arm at the shoulder. It is placed on the sleeve in conjunction with a neat little initial worked with white silk cord. The effect is most pleasing, and, to the girl endowed with artistic fingers, many pretty arrangements or variations will suggest themselves.

ARTIST AND SCIENTIST TRY NIGHT PAINTING

How to obtain satisfactory light for portrait painting at night is being studied scientifically by a young Chicago artist, Mosheim Craig, with the advice and assistance of one of the

leading scientists of the country. The scientist became interested in painting, using Mr. Craig's studio, and as he had little time for this avocation except evenings, the problem of illumination was forced on him. The two have worked together for a solution, to some extent covering the same experimentation ground as the investigators who have been seeking artificial daylight for use in stores.

The artist claims that there is a certain æsthetic value to painting done at night. But when he tried to mix oil paints by artificial light, he found that the color values were lost and that the work when viewed the next morning was practically worthless. The youthful collaborator with the scientist sought a light which would "take the yellow" out of the rays from a tungsten cluster. The first effort was very nearly a success. A large tank was built. A 500-watt tungsten lamp was placed in the rear of it. The reflectors threw this light forward through two pieces of plate glass. The secret of the light lay in the substance between these pieces of glass. It was clear water tinged to a violet color with an aniline dye. This accomplished the purpose of producing the colors of daylight. But the experiment failed for one very simple reason; after the light had sifted through the colored water it was too weak to reach the painter's easel and his palette.

For a time Craig tried to produce the same result by wearing automobile goggles of blue glass. He sought a violet-tinted glass, but no optician could supply it. With the blue glasses he painted two portraits, one of Judge Kenesaw Mountain Landis, but when he exposed these to daylight he found that they were "too gray." The colors lacked brilliancy.

The scientist has now suggested that the problem can be solved by securing from Germany a certain violet-tinted gelatine film, colored under the artist's personal direction. This will be placed in the light box in lieu of the water tank and the tinted water—which, by the way, had a habit of steaming. Both

experimenters believe they will then have found the answer to their riddle. Should this also fail, they have other plans which are not being discussed at this time.

The experiments have already proved of value in a mechanical way. The light blue glasses for example gave a sufficiently accurate color value for matching of cloths and for the use of decorators who work at night under the ordinary incandescent lamp. If such a glass is used on the stage or in a department store over a brilliant yellow lamp the result to the ordinary observer is artificial daylight. The woman who bought a costly delicately tinted gown under such conditions, however, might be disappointed when she looked at it in daylight.

ARTIFICIAL SILK MADE FROM VEGETABLE

In Muskegon, Mich., is a knitting mill which manufactures artificial silk out of vegetable fiber, and uses it to make hosiery and underwear. The artificial product is soft and silky like worm silk, but is claimed to have more body or firmness.

The underwear and hosiery are made in all weights from gauze to winter wear. The vegetable silk fiber is brought to the knitting room on large reels, ready to be put on the electrically operated machines when needed.

The basis of most artificial silk is wood pulp. Cotton has proved satisfactory for the purpose, however, although the cost has been a serious drawback. The vegetable silk is the latest innovation. Any substance susceptible of chemical conversion into cellulose is available.

POUCH ARRANGEMENT FOR ANGLERS AND HUNTERS

A Missouri sporting goods concern is marketing a high and dry pouch and harness for anglers and hunters. It consists of two large pouches, one in front and the other in back, strapped

over the shoulders and around the chest. On the outer surface of the front pouch are two small pockets for



Pouch for Anglers and Hunters Arranged for Carrying Tackle and Ammunition Well above Water

carrying small fishing or hunting accessories, such as flybooks, and the like. The position of the pouches is well above the waist line, so that they remain dry even during deep wading.

RUSSIA TO SPEND VAST SUM ON NAVY

The Russian Duma has voted the enormous sum of \$619,200,000 to be used during the next five years to restore the naval position of that country. About \$57,960,000 is to be spent in construction in 1913, \$48,000,000 per year for the years 1914-15-16, and \$43,200,000 in 1917. In addition to this, the Minister of Marine requires \$374,000,000 for the completion of ships now building and for current expenses.

U. S. TREASURY INSTALLS NEW MONEY LAUNDRY

After experiments covering a period of three years the Treasury Department has set up a money laundry that will wash and iron old bills, making them almost as good as new. It is estimated that about 60 per cent of the bills sent to the department can be saved by this machine, the 40 per cent remaining being so worn that the treatment would destroy them.

The bills, fed to the machine by a

young woman operator, are carried between two 10-in. tapes into a tank of boiling water, and then through a solution which, when heated to the boiling point, forms peroxide of hydrogen. This destroys the germs that may have collected on the bills while in circulation. The bills pass from the disinfecting tank to a rinsing tank, and thence to a pair of large gas-heated cylinders, the passage between which smooths out all wrinkles. The bills require about 2½ min. to pass completely through the machine and emerge ready for circulation again.

The machine can wash and iron from 30,000 to 35,000 bills in an 8-hour day, and it is estimated that it will save the government more than \$500,000 a year in the manufacture of new money. The machine is the invention of a scientist in the government's employ.

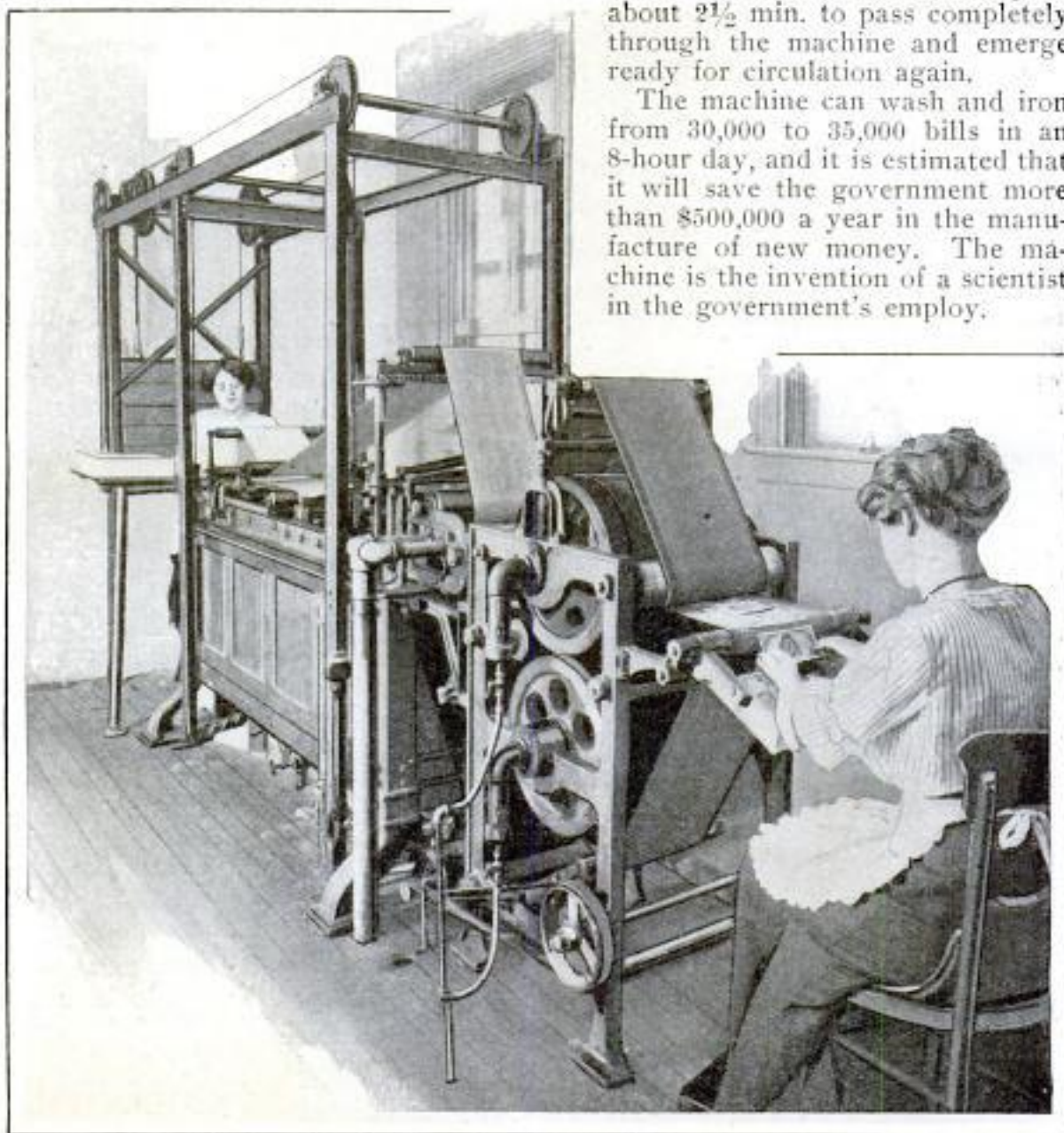

The U. S. Treasury's Money Laundry in Operation. The Endless Band may be Raised to Top of Frame to Permit Examination of Money Passing Through

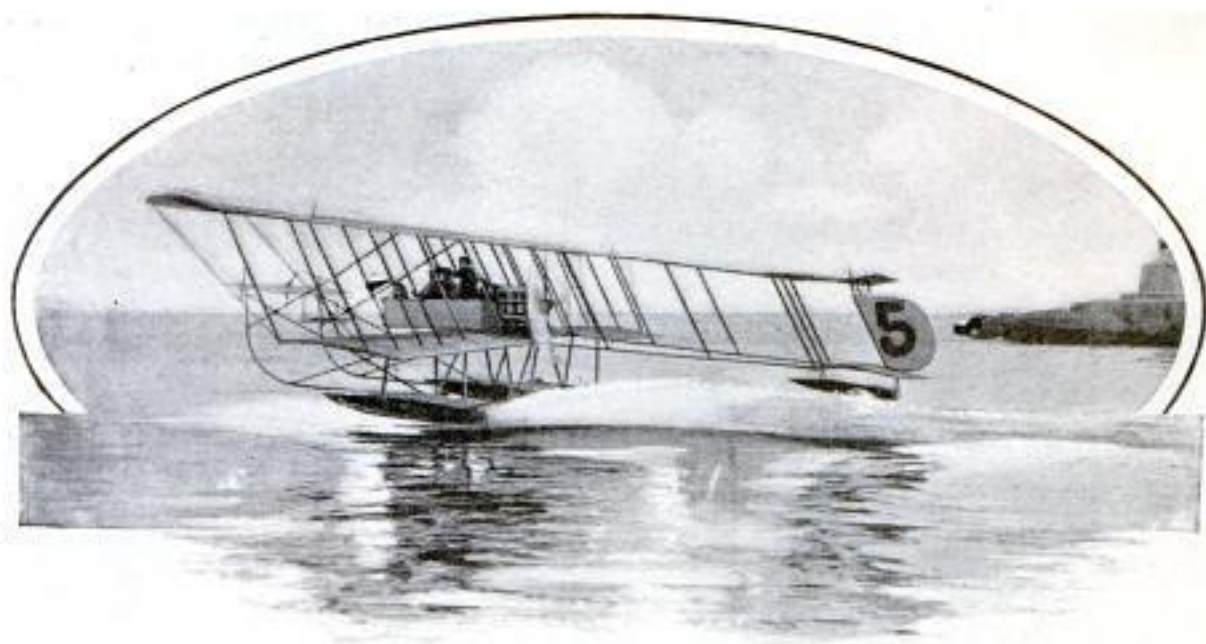

Hydro-Aeroplane at Monaco Carrying a Paying Passenger Who Desired to Enjoy Aeroplane Flight without Much Danger

THE HYDRO-AEROPLANE FOR PASSENGER CARRYING

The recent hydro-aeroplane competition at Monaco, while it did not bring forth anything especially novel in the way of new constructions, and resulted in no important records, was very interesting because of the large number of passengers carried by the different machines without a single accident.

In fact, so absolutely reliable did the combined air and water vehicle prove itself on this occasion, that it seems certain that a most profitable application of flight engineering in the very near future may be passenger carrying by hydro-aeroplanes at

amusement parks, summer resorts, etc.

Running in to Shore at Monaco after Trial Flight, to Pick up Paying Passenger



Water surfaces being comparatively soft and safe to alight upon, and so level and unobstructed that there is no occasion for attempting flight over them at any considerable height, the possibility of a serious accident with a well-built and competently piloted machine, and with the passengers perhaps protected by life preservers, seems so remote as to scarcely demand consideration by even the most timid.

FLEXIBLE WIRE SCREEN AS WINDOW PROTECTION

Instead of barricading the show windows with wooden or corrugated-iron shutters at night, several of the large retail stores in Berlin have lately

adopted a flexible large-mesh screen made of 0.4 to 0.6-in. iron wire, which, while affording an effective burglar



Flexible Wire Screen Placed Inside Window and Door Casings, so as to Obtain Protection while Windows and Doors are Open

protection, permits the window displays to be viewed. The screen shutters are raised, lowered, and locked in place from the inside.

The same type of screen shutter is also claimed to have many advantages which make it desirable for use on country houses in more or less lonely districts. By its use, windows and doors may be barricaded against intrusion and still remain open to allow the entrance of fresh air.

DISTINCTIVE COLORING FOR INDUSTRIAL-PLANT PIPES

It is proposed in Germany to develop a uniform system of distinctive coloring for the piping in industrial plants, and the idea is being received with favor. According to the system, the pipes carrying water would be

painted green; the gas pipes, yellow; air pipes, blue; steam pipes, white; oil pipes, brown; pipes carrying tar mixtures, black, and pipes carrying acids would be distinguished by being painted rose with red stripes.

A fuller indication of the contents of the pipes, indicating dangerous pressures, temperatures, impurities, etc., may be effected by a combination of the basic colors, such for instance as stripes of red for danger, black for impurity, white for presence of steam, or some such manner.

BEHAVIOR OF METAL TUBES UNDER COMPRESSION

The behavior of metal tubes under compression has been the subject of interesting experiments by a French scientist, who has made tests with metal cylinders as tiny as 0.023 in. in diameter, 0.027 in. high and with walls only 0.00004 in. thick. These little tubes were submitted to compression in a hydraulic press, the piston of which moved at a constant slow rate of speed. The gradual changes in the shape of the tubes were photographed by a motion-picture camera. The illustrations here shown are greatly enlarged.

The experiments demonstrated a remarkable regularity in the folds or corrugations resulting from the compression. These corrugations, while varying with the diameter of the tube, the thickness of the walls and the nature of the metal,



were always identical in tubes of the same dimensions and material. Another curious and unexpected fact brought out by the tests was that the folds or corrugations produced were

the same in number and in shape, whether—other conditions being equal—the compression was the result of a sudden shock or a slow steady pressure.

THE WATER AUTOMOBILE OF THE EVERGLADES

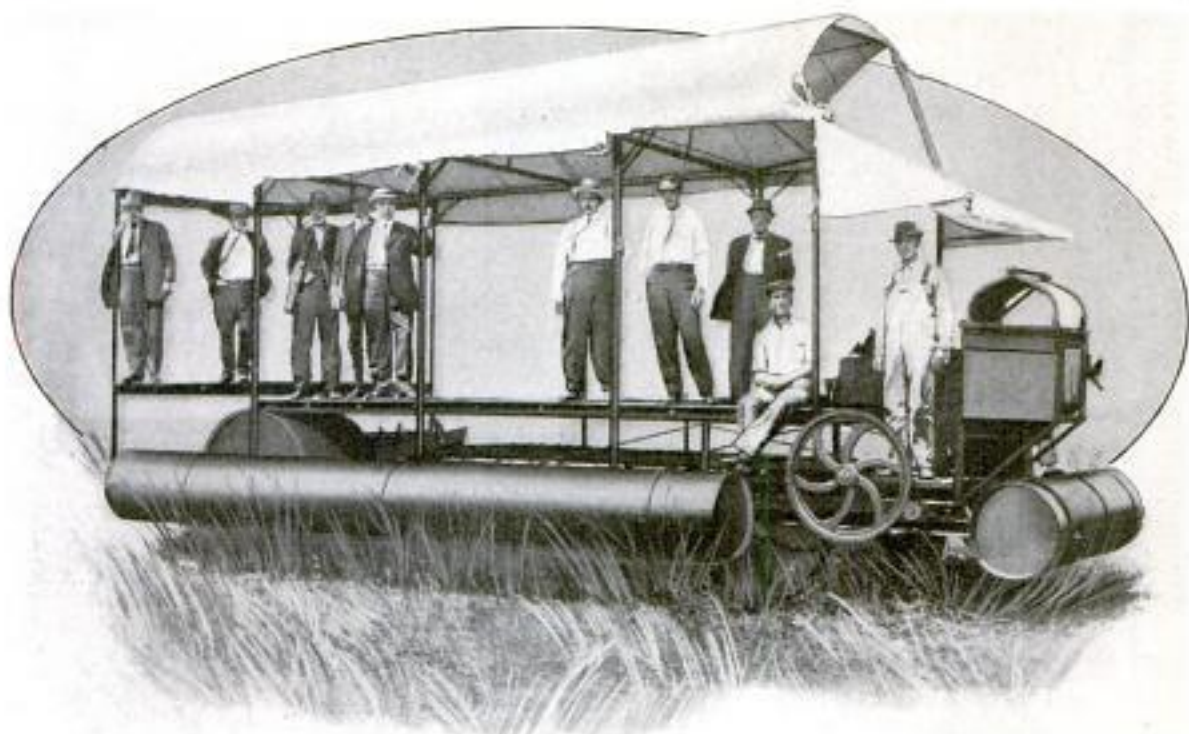

Engineers and Surveyors on Board the Water Automobile That Navigates the Florida Everglades

A really practical water automobile has solved one of the hardest problems incident to the draining of the Everglades of Florida: that of running the survey lines through the vast swamp. The machine, which so far has been given no name, was designed and constructed by Maj. J. O. Wright, chief engineer of the State of Florida. He built it because it was necessary in his business, and today engineers and surveyors running lines through the Everglades are blessing his name as they work in safety and comfort from the platform of the strange craft.

So slow and painful was the work of running the lines to mark the great canals designed to grade the Ever-

glades, that Major Wright was sorely puzzled, and on several occasions almost discouraged. Then he put his wits to work, determined not to be beaten by a lot of water and a few millions of acres of soft, black mud, and as a result the water automobile came into existence.

The machine was not built for beauty, nor for speed, and it glides over the glades and through the water at a rate of only three miles an hour, but it has proven itself effective. It consists of a framework of light steel and oak, 25 ft. long and 8 ft. wide, mounted on three wheels, the two in front being of iron and very wide-rimmed, so as not to cut into the soft mud over which the machine has to

pass. The rear wheel is a large wooden roller or drum, designed to crush down the tall saw grass as the craft proceeds. Surrounding the framework, and only a few inches above the ground, is a large air-filled steel cylinder, which keeps the machine afloat while crossing sheets of water. In the "bow" of the craft is a gasoline engine, which transmits power to the front wheels when the machine is crossing surfaces on which the wheels may be driven, or to an ordinary screw propeller, such as used on motor-

boats, for propulsion through the water. This propeller is under the machine, back of the front wheels, well out of the way when the machine is traveling as a land automobile.

On the framework of the machine is a platform, strong enough to hold a score of men. Here the engineers and the surveyors work, eat and sleep, an awning keeping off the direct rays of the sun. Two men are required for operating the machine, which is doing in a day work that formerly required a week or more.

THE SHIELDS OF THE PARIS POLICE

In the August issue of this magazine was published a short article with illustrations of the riot shields designed



A Type of Shield being Used by the Paris Police in Sieges Directed against Bandits and Rioters

for the Liverpool police following riots in which many members of the constabulary were severely injured by bombardments of bottles, brickbats, and other missiles.

In the accompanying illustration is

shown the same protective idea, as adopted by the Paris police for use in fighting barricaded bandits. The shields were used in a recent siege of automobile bandits and proved practical. Although much more unwieldy than the English shields, they provide protection for the entire body, when set on the ground in front of the user. They are not, however, designed to be carried about on the back of an officer, as are the English shields.

THE RUSSIAN GOVERNMENT AS A TEA GROWER

Near Batum, on the east coast of the Black Sea, the Russian government is busily engaged in the cultivation of tea. About 200,000 lb. per year is now grown, and the tea plantations are being extended at the rate of about 135 acres each year.

The government land devoted to this experiment in tea cultivation, and also to the cultivation of oranges and other fruits, and of bamboo, consists of 43,000 acres, which was formerly a hopeless tangle of rank vegetation. A considerable portion has already been cleared, the tea plantations covering about 1,400 acres at the present time.

Among the most important exports from Strassburg, Germany, are listed clocks, hair nets, goose-liver pies and rabbit skins, a queer assortment, but extremely valuable to the thrifty Germans.

TACTICS IN ACTUAL AERIAL WARFARE



the strong adverse air currents, for the pursuer to inflict any serious damage by means of projectiles, while the fleeing machine could easily do considerable damage.

The advantages claimed for the fleeing aeroplane would consist not only in the longer range of its projectile (the difference was calculated by one expert to be at least 130 ft.), but also in the fact that an aeroplane rushing against a projectile



The question of which aeroplane, the pursuer or the pursued, would have the advantage in an actual aerial combat was recently asked by the French aviation journal *L'Aero*. The question was formulated as follows:

"Assuming that two aeroplanes be flying at the same speed, the same altitude, and with equal armament, one pursuing the other; which, the pursuer or the pursued, can damage the other with the least risk of being itself damaged?"

The experts requested to answer this question included engineers, scientists, artillery officers, etc., and the answers, some of which were accompanied by detailed and intricate calculations, were almost unanimous in declaring that the fleeing aeroplane would have all the advantages. It would be practically impossible, they agreed, in view of the great speed of the machines and

would naturally be liable to greater damage than one running away from it at great speed. It was concluded, in fact, taking into consideration the nature of projectile most likely to be discharged from aeroplanes, that the fleeing aeroplane would scarcely sustain serious damage even if hit. This was the opinion not only of officers of the army and navy, and of gunnery experts, but renowned mathematicians reached the same conclusions through considerations of a strictly theoretical nature.



"ROLLING" A ROOF

Steam rollers in paving and politics are common enough in America but a man-power roller of the type shown in the photograph is entirely unknown. One must needs go to the Orient to witness the scene here reproduced. It represents a resident of Bireh, Palestine, north of Jerusalem. The roof is of earth and the efforts of the fez-topped individual are directed toward making it rain-proof.

LIBRARY OF ELECTRICAL SCIENCE

Thirty thousand books and pamphlets, three-fifths of which deal with electrical science, have recently been added to the library of the Massachusetts Institute of Technology. The collection, which was once the property of the late George Edward Dering, an English inventor, noted for his eccentricities, was purchased by Theodore N. Vail, president of the American Telegraph and Telephone Company, and by him presented to the Massachusetts institute. The collection is valued at about \$100,000. For its maintenance Mr. Vail added several thousand dollars to his gift.

The claim is made that the Dering

library is the most complete collection of recent works on electricity in the world, a possible exception being the library of the Institute of Electrical

Engineers in London. Mr. Vail, the donor of the library, is not a technical man nor has he any connection with the Massachusetts institute, save in the employment of many of its graduates in his company. Mr. Dering, the collector, was a unique character. He was wealthy, but for many years lived practically a recluse. He spent more than 40 years acquiring the library and it became his chief hobby. He

placed an unlimited order with a London bookdealer for all books on electricity, in whatever language offered. In addition

he attended sales and obtained books from many other sources. It is said that probably 14,000 of the volumes had never been opened by him. The books in the collection not dealing with electricity are concerned with iron and steel.

The total number of volumes contained in the library of

the institute now reaches 100,000.

CA three-deck pontoon, 100 ft. long, has been built entirely of reinforced concrete for the Manchester ship canal.



A Native of Palestine Rolling His Dirt Roof to Make It Rain-Proof

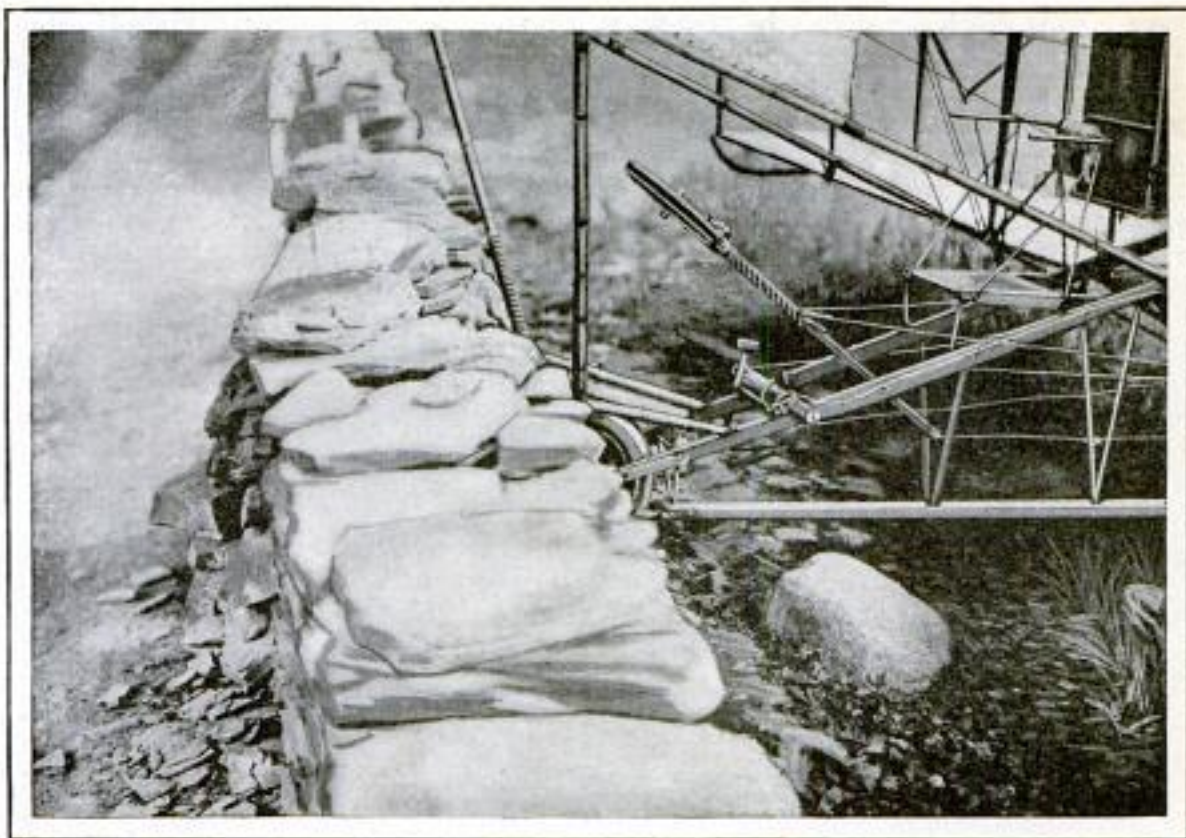

An Aeroplane Which Came Out Better than a Stone Wall in a Collision at Hammondsport, N. Y.

AEROPLANE COLLIDES WITH STONE WALL

The operator of an aeroplane flying above the Hammondsport, N. Y., aviation field, failed to shut off his power early enough on making a landing and the machine ran into a stone wall. Although an aeroplane is usually credited with being of very delicate construction, the stone wall received the worst of the bargain. The collision moved approximately one ton of stone about 12 in., yet the only apparent damage to the aeroplane was a broken front wheel.

SPRING WATER FLOWS OUT OF TREE

A spring of clear, cold, sparkling water is always a welcome natural resource, but such a spring discharging its water out of the trunk of a stately elm tree is of unusual interest.

The tree-spring in question is near Lafayette, Ind., back of which are

hills containing several large springs. Some years ago one of these springs was piped to the foot of the tree, which had an opening in its base extending to



A Spring of Sparkling Water Discharging from an Elm Tree near Lafayette, Indiana

a considerable height in the trunk. The pipe was run underground into this opening and then up into the trunk. Then nature quietly concealed the work of man, and today there is no visible evidence of it.

The tree stands at the edge of one of the most frequented automobile roads in Indiana. Many automobile tourists see the water gushing from the tree, stop to investigate, but usually go away without having been able to solve the puzzle.

A NOVA-SCOTIAN AUTOMOBILE FAMILY "EN TOUR"

Miniature automobiles for children have ceased to be particularly rare in that the number of them is steadily growing, but the little machine used by Eva and Gladys Rafuse, of Windsor, Nova Scotia, is of considerable interest because it is part of the family caravan. The parents of the children ride in one of the smallest types of automobiles made for grown-ups, and this little "grown-up" car, running along a country road with the children's car leading the way, never fails to arouse admiration. The children's car, which is as complete in every detail as the larger car,

is operated by the elder of the children. Its power is derived from a 2½-hp. motorcycle engine, and is sufficient to negotiate any hill in the vicinity.

WIRELESS MASTS BUILT IN FOUR DAYS

The Marconi station at Poldhu, Eng., which has recently been adapted to receiving as well as sending messages, has established a record in erecting masts to support the aerial. Six masts, two of steel and four of wood, were put up in four days. The steel masts are 265 ft. high and the wooden ones somewhat shorter. The old wooden lattice columns have been demolished.

The two steel masts stand next the sea and support the triple stay of the aerial at a height of 250 ft. The wires run back from this in two groups of eight to stays supported by the wooden poles. No scaffolding was used in the erection of the tubular-steel poles. Instead they were put up section by section. Each section was 10 ft. long and semicylindrical in shape, with a flange at each end and longitudinal flanges down the sides. The halves of each cylinder were bolted together and then set on the flange of the one below

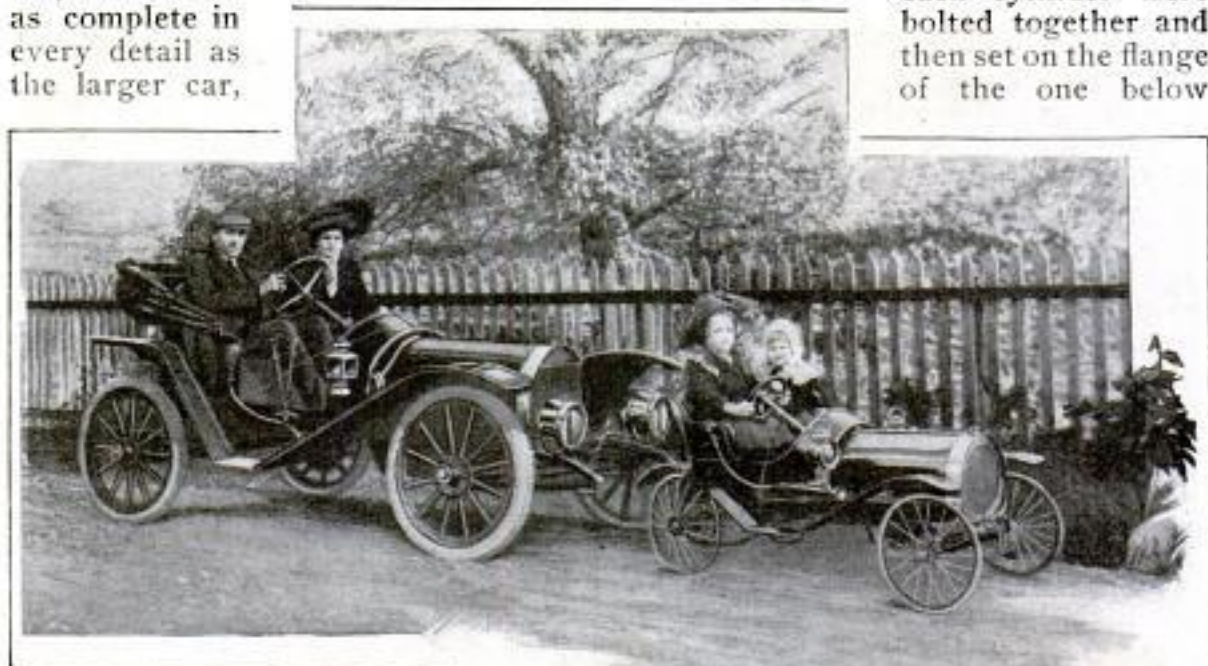

The Children Lead the Way in a 2½ Hp. Automobile, and the Parents Follow in the Smallest of "Grown-Up" Cars

and bolted to it. As each tubular section was put in place, a wooden pole was inserted in the upper end and used as a derrick to draw up the two semi-cylinders of the next section. These

were held on each side of the wooden pole until bolted together and fastened to the lower section. Then the wooden pole was withdrawn and the process repeated.

UNDERGROUND LAKE SOURCE OF WATER SUPPLY

For three years a commission of engineers have been attempting to solve the problem of obtaining for the Campine coal district of Belgium a supply of water from a subterranean lake discovered just prior to the appointment of the commission. A recent report states that the underground reservoir has an area of over 160,000 acres at a depth of from 80 to 100 ft., and that with a width of $1\frac{1}{4}$ to $2\frac{1}{2}$ miles it extends over the territories of eleven communities. At present Lower Belgium is dependent on rain water for its supply. The subterranean lake is said to provide the only source capable of supplying water to the population of Antwerp and Flanders, which in 25 years is expected to reach 4,000,000. To procure water from the subterranean source a system of filtering well shafts is recommended as allowing the water to be collected at a great depth without risk of contamination or of any change in its temperature. While the collected water is exceedingly pure, owing to the filtering properties of the soil, it contains a certain amount of iron from which it will have to be freed.

☐The British government has recently launched a motorboat of 200 tons' register, designed for the use of its consular service on the Congo River.

BAMBOO SHELTER FOR LAWNS AND GARDENS

A particularly practical and artistic portable garden house or shelter, oriental in general design, has been

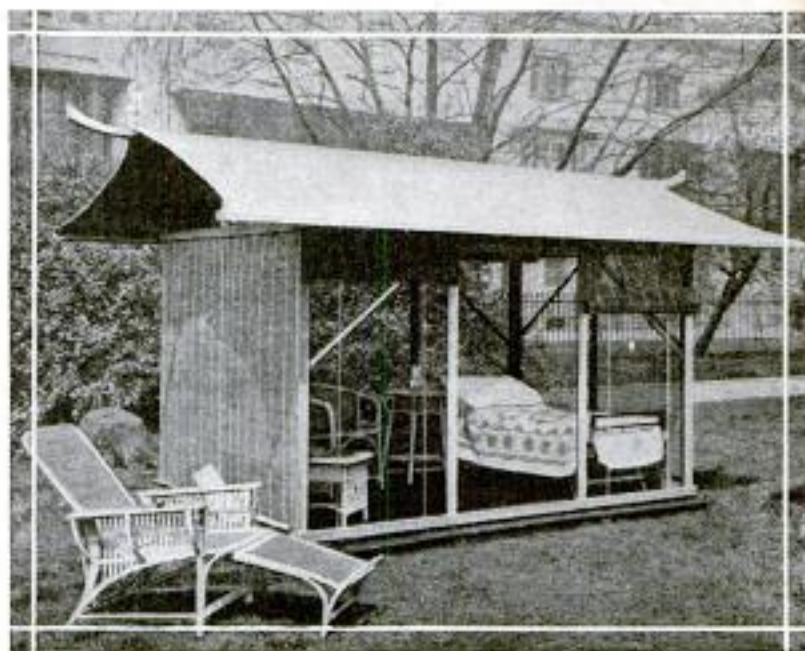

An Artistic Portable Shelter for Town and Suburban Lawns

popular in England during the summer months. It is easily erected and moved, substantial in construction, and is made in sizes ranging from 5 by 7 ft. to 7 by $10\frac{1}{2}$ ft. Split-bamboo adjustable blinds are fitted on all sides, and may be raised or lowered by pulling the cords.

FIRE EXTINGUISHER FOR CABLE BOXES

A novel method of fighting fires which originate in telegraph, telephone and similar installations has been invented and gives promise of proving effective. In such installations bundles of cables are placed in boxes which render them almost inaccessible.

Short circuits, due to various causes, frequently occur and serious fires have resulted. Water cannot safely be used for extinguishing a blaze of this character as that would increase the danger of further short-circuiting. The inventor's method of extinguishing such fires includes a system of pipes by which two different extinguishing gases are conducted to the point of the

fire. There the gases combine, forming a powdery substance which stops the progress of the blaze. The gases are not retained in the pipes constantly, but when fires occur, the pipes are filled with the gases which are discharged at the required places. The gases employed are composed of ammonia and carbonic acid, or ammonia and sulphur dioxide.

PHOTOGRAPHIC STUDIO IN "DARKEST" AFRICA

Near Elizabethville, Congo, is a photographic studio in which white man or native can sit for a photograph and



rely upon a first-class likeness. The studio, which is constructed of bamboo poles and has a grass roof, was established a few years ago by an Englishman, who lays claim to be the pioneer photographer of Darkest Africa. He states that his most critical clients are the dark maidens of Congo, who are as particular about getting a good likeness as their white sisters, and who delight in posing.

NEW RECORDS ESTABLISHED BY SKYSCRAPER

The builder of the new 30-story office building on West Fortieth Street, New York City, makes claims of supremacy for it in several respects. While it does not attain the height of several other New York "scrapers," he declares it is the tallest building ever erected on so small a plot of ground—90 ft. by 98 ft. 9 in. In making this claim he adds others, including the following: That the new building is the only building of this height having an absolutely fireproof and smokeproof tower with entrance from the exterior, connecting at the bottom with the street; the tallest building ever erected on a side street; the only office building having every suite above the fifth floor a corner suite; that it has the largest number of windows of any building in proportion to size; more windows than any other building of any description ever erected in proportion to area of ground covered, and, "probably," is the only building in the world that has not one particle of wood in its construction. No one has disputed these remarkable claims to date.

COMMENT AND REVIEW

NOT all persons upon becoming the owner of a motor vehicle imagine the price paid for the machine includes ownership of the streets, but a good many seem to have that impression. The change from dodging a car to being dodged is apt to be one in which the rights of the pedestrian are quickly forgotten. In our large cities the loss of life from automobiles and motorcycles has grown to be something frightful, and largely unnecessary. In some European cities the remedy is to arrest and fine the one who is so slow and stupid as to get run over—that is, if he survives. But no such process of law will be tolerated here, nor should it. On the other hand, motor cars are a modern necessity and the streets are no longer a safe place in which children can play. There must be moderation and caution on the part of both.

How Speed Mania was Cured

The enforcement of a reasonable speed reduces the accident and death rate to a minimum, and Chicago has demonstrated that such a reform can be easily accomplished in a few days. Several deaths each week from motors had rolled up a total of 75 in a short time, and something had to be done. This is the cure, and it was accomplished in a few days: While 15 miles an hour is the legal high speed, 20 miles was unofficially assumed to be the limit. Anyone exceeding that speed was promptly arrested and fined heavily, with the promise that the amount would be doubled for a second offense. Instead of the cases being brought before some friendly magistrate in the district where the arrest was made, all cases were heard by one judge. This permitted a system of records, with the promise that something beside fines would be imposed after the second offense. For about a week the fines aggregated over \$500 a day and then suddenly dropped. The effect was very noticeable after the third day; at the end of the first week there was really very little violation of the rules. The reform was accomplished so easily and quickly, that there seems no need for any other speed-infested city to longer tolerate such a needless condition of danger.



FLOOD control of the Mississippi valley was declared to be an engineering project second only to the Panama Canal, by the Deep Waterways Commission held in Chicago. It was agreed that only through Government control be secured, but that returns from water powers thus created, and the sale of reclaimed lands would go far toward capitalizing the enterprise. The increasing volume of the annual floods was shown to be due not to any material increase in their original form of rain or snow, but to artificial conditions. In the northern states thousands of miles of tiling have been laid by farmers to drain swamps, low lands and small lakes, which enables the rapid escape of excessive water. Thus thousands of small harmless floods are dumped into the Mississippi to unite and descend in one overwhelming disastrous avalanche of water.

Control of Floods

It was shown that the remedy for this need not be the discontinuance of drainage of northern low lands, but the construction of enough reservoirs to hold and control the abnormal spring freshets near their source. Also that

great good could be accomplished if northern state farmers would plow their land from 12 to 18 inches deep, instead of 5 or 6 inches as at present. This would give the soil an opportunity to absorb and retain a much larger quantity of moisture, amounting to as much as 40 to 50 tons of water per acre, and which, it was claimed, would increase the value of crops throughout these states fully threefold.

One of the interesting developments of the convention was the announcement that there are three possible routes for the diversion of excess water of the upper Mississippi by canals to Lake Michigan: First, from St. Paul to Green Bay, 259 miles; second, LaCrosse to Milwaukee, 185 miles; and third, Galena to Chicago, 152 miles.

The damage caused by the 1912 flood is estimated at \$200,000,000. Two such floods alone cost as much as the Panama Canal.

The subject is one which is bound to receive attention from now on, and will be considered at the meeting of governors at Richmond, at which time a permanent board will be appointed to investigate and report.



THE destruction of the great aircraft "Akron" was accomplished with a suddenness which is appalling—being reduced to nothingness literally in the twinkling of an eye. The event is doubly deplorable, chiefly for the loss of its brave men, but also for the failure to accomplish that greatest of attempted aerial feats—the crossing of a vast ocean. In all probability safety devices were responsible for the disaster—and what was calculated to save life operated with contrary result. To prevent the bursting of the envelope when the contained gas expanded from the sun's heat, six safety valves were installed to relieve unusual pressure.

*Future
of the
Dirigible*

These valves, it seems, exhausted gas at points perilously near to the engine exhausts, which frequently spit sparks and fire. If the undertaking was destined to end so tragically, we may be thankful to be spared the long days and nights of uncertainty which followed André in his disappearance.

If the ocean could be crossed at this time by any man in a dirigible, surely Vaniman with his training and experience was well qualified to accomplish it. And while the disaster will likely defer the time of another similar effort, it by no means follows that no more attempts will be made.

The "Akron" undoubtedly embodied the best that experience could suggest, skill could fabricate, or money buy.

The final cruise of the "Akron" has resulted in little more than emphasizing the difficulties and dangers of piloting a big dirigible across the Atlantic. That they played and lost should not detract from that measure of admiration which is due the brave young men who staked their lives on the chance to write their names high in history. America is indebted also to those other men who provided the princely fortune that was spent in building the huge aircraft. Evidently we are yet knocking at the outer gate of air conquest, and many more brave lives must be yielded up before the secret of scientific aviation is wrested from its stronghold.

H. H. WINDSOR

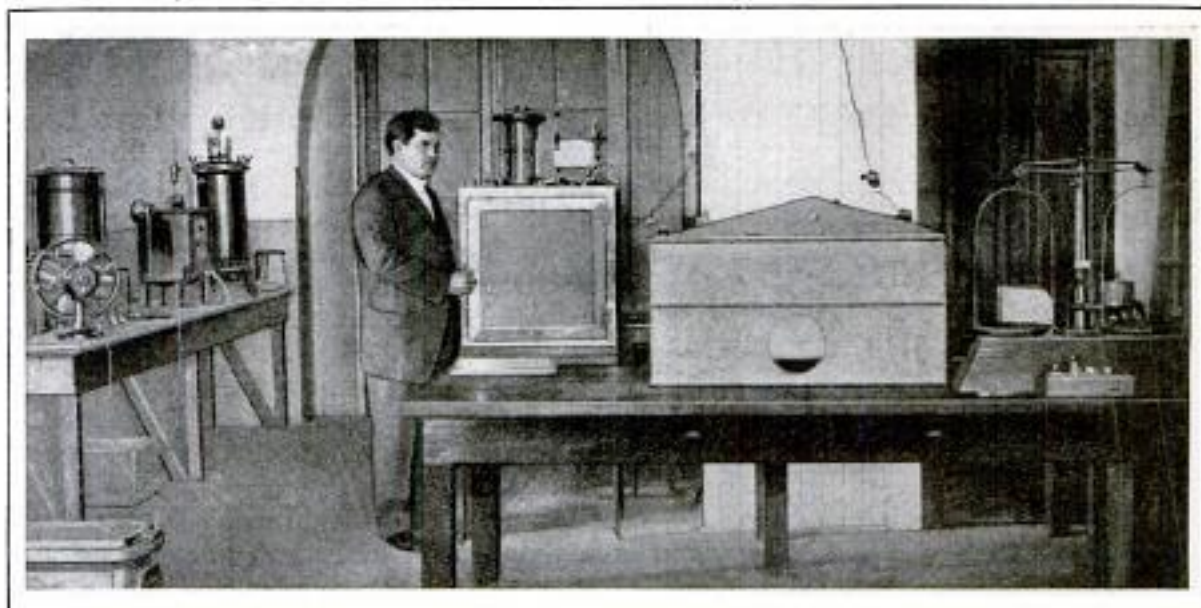

Experimental Apparatus for Artificially Ripening Dates, Showing Electric Ovens

RIPENING DATES IN AN INCUBATOR

The discovery of Prof. G. F. Freeman, of the Arizona state experimental station, that the incubator will ripen dates to a perfection that rivals the fruit brought direct to the Paris markets from Africa has revived the interest of the fruit growers of the Salt River Valley in Arizona, and today the fruiting date palm is being extensively cultivated.

When, some 10 years ago, the United States Department of Agriculture sent a large consignment of the choicest varieties of date palms to Arizona they were planted, but when the fruit began to develop, difficulty was experienced in securing a date that was of value commercially.

Hot water, vinegar, gasoline, and a score of other substances were found that would ripen dates artificially. Of these vinegar was found best suited for practical work, but still the experimental station was not satisfied with the result.

It remained for Professor Freeman to attempt submitting ripening dates to the heat of the incubator, and the experiment was a pronounced success. Now the dates are picked when they show the first signs of ripening; are washed and placed in an oven where

they are kept in a moist atmosphere and held at a temperature of between 110 and 115 deg. F. for three days. At the end of this time they are fully ripened.

LEGAL STATUS OF AIRMEN IN ENGLAND

In spite of the great strides which have been made toward complete conquest of the air, the flyer is as yet almost an unknown quantity with regard to his rights and privileges in legal circles. This fact was brought out in a recent suit for damages instituted by Alfred Rawlinson, an English airman, against the promoters of the air meet at Bournemouth in July, 1910. Rawlinson charged that the starting ground was not properly prepared and as a result he met with an accident in which his leg and shoulder were broken. At the hearing dense ignorance of airmanship was displayed by both judge and counsel, the former stating that he knew nothing about flying, and Rawlinson's own lawyer said he believed "the aeroplane was attached to hooks in the ground" before starting.

A NEW ENGLISH FIRE-ESCAPE TRUCK

The fire department of Birmingham, Eng., has been testing a new type of fire escape by which the persons res-



The Cradle or Cage of a New Type of Truck Fire-Escape Tested in England

cued reach the ground in a cage or cradle raised and lowered by means of a cable, and guided by side cables. The apparatus is run to a fire in the same manner as a ladder truck, the escape tower is then extended up along the building, and the cradle is raised and lowered like an elevator cage.

The cradle is provided with an automatic brake which fixes the cradle on the guide cables should the lifting cable break.

Hubert Latham, one of the pioneer airmen who quit flying because of the danger, was recently killed by a wild buffalo while hunting in the Chari River district of French Sudan.

SPECIAL DRILL FOR CANAL-LOCK GATES

Sixteen electric machines have been specially built for use in drilling and reaming rivet holes in the lock gates of the Panama Canal and are now in operation. The machines are of such a character that they can readily be adapted to similar use on other large contracts after the canal is completed. They are not the first pieces of machinery which have been created especially for use at the "big ditch," but they possess several improvements.

Each of the machines weighs 6 tons and is designed to run on a standard-gauge track which is placed on a stage and swung from the top of the big steel gate on chains and brackets. It is claimed that each machine does the work of five ordinary reamers. Each machine is provided with four changes of power which are instantly available by means of a quick-change gear. The two distinguishing features of the machines are the range of nine speeds, and the fixed spindles arranged to space the rivet holes in the lock gates uniformly.

CONCRETE-WORK CRACKS BEING STUDIED

Cracking of concrete due to variations in temperature is deemed a matter important enough to receive attention from the National Bureau of Standards, of the Department of Commerce and Labor. In order to obtain statistical data, reference marks have been placed on typical old and new concrete work in Wayne County, Mich., and at Greenwich, Conn. During the summer and winter measurements will be taken to determine the expansion or contraction caused by high and low temperatures. The change of volume taking place during the hardening process will also be considered. The lock walls of the Panama Canal and various other structures from which data valuable to builders will be collected have been similarly marked.



Children Fishing for Carp in a Los Angeles Park

CARP FISHING IN LOS ANGELES PARK

Thanks to an over-production of carp in the Los Angeles parks, the children of that city were recently given an unexpected fishing treat. The lakes at Echo, Eastlake and Westlake Parks were opened to anglers under 16 years of age, and hundreds of children responded to the invitation of the park commission. The limit for each catch was 12 fish, but as the carp weighed from a half to more than a full pound, this was a liberal allowance and no one objected to the restriction.

The banks of the little lakes or ponds were for days lined with happy youngsters armed with all kinds of tackle, from the bent-pin, cotton-string and broken-branch variety to the split-bamboo pole and braided-silk line borrowed from "dad's" vacation outfit.

Dough or bread was the most acceptable bait, and the carp fought greedily for it the first few days, and fishing was rapid-fire work. Toward the end of the first week, however, they became more wary, and the children learned the lesson of fisherman's patience.

THE NEW OPEN-WORK STOCKING

The up-to-date open-work stocking, fashionable this summer, differs from its predecessors in the past in the great size of the mesh. An English magazine characterizes it as "one of the net results of fashion," and it certainly is netlike in appearance, closely resembling a veil.

Can an interesting result of the "Titanic" disaster is the determination of the family of the late Isador Straus to perpetuate the name of the famous merchant and philanthropist who sank with the big ship, by always having an Isador Straus in the family.



Courtesy the Sketch, London

BAGGAGE ROOM OF AN AERIAL EXPRESS

Provision for the carriage of baggage is as necessary on an aerial express as on a land express, and in the



Courtesy the Sketch, London
Small Baggage, Piled in the Baggage Section of the "Clement-Bayard IV"

illustration may be seen the baggage section of the "Clement-Bayard IV," one of the latest of this famous type of dirigible balloon. Traveling bags, rolled steamer rugs, and canvas bags are piled at one end of the car.

LUBRICANT TESTS MADE BY MACHINE

The quality of lubricants used on fine machinery of various kinds is a matter of great importance and one that has long engaged the attention of engineers. To avoid the necessity of testing the lubricants on expensive machinery, and to economize time, an English concern has developed a machine which is used exclusively for this purpose.

Steam is used in the process of determining the quality of various oils and showing to what degree, if any, dis-

integration and formation of sediment takes place. After the test is completed the oil is blown onto a slip of paper, and the changes it has undergone during the test are then disclosed. A further test follows, to determine what alterations affecting its lubricating properties result from the effect of heat. With automatic precision the machine indicates, on the same slip of paper, the degree of friction and the temperature of the frictional surfaces, as well as the absolute and relative values of the oil under test. The number of revolutions made by the machine in testing the oil also is indicated.

FILTERING AIR FOR DYNAMO ROOMS

All air that enters rooms where electric generators are operating is kept clean by a novel filtering apparatus in the great electric-railroad power plant at Altona, Germany. The elimination of dust from around dynamos is no new idea, and is of great value in the operation of the machinery, but in this

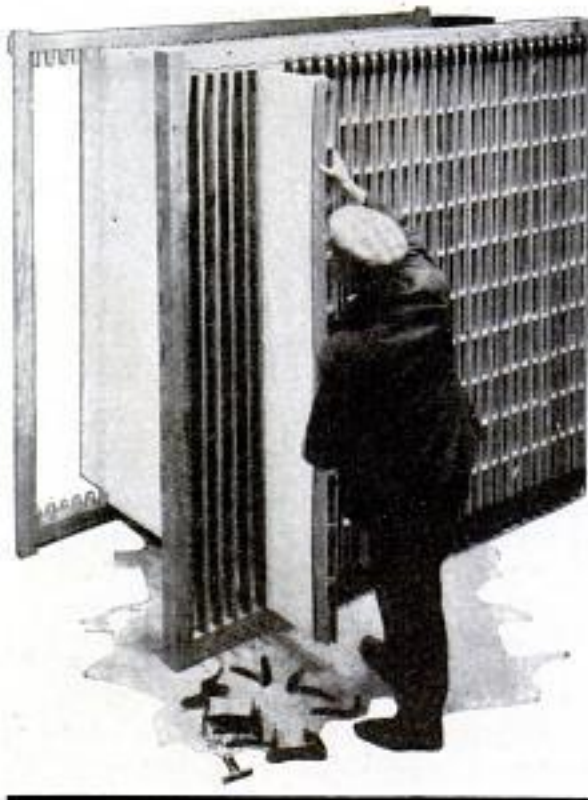

Inserting a Clean Cloth-Covered Pocket in an Air Filter Built Up in Sections

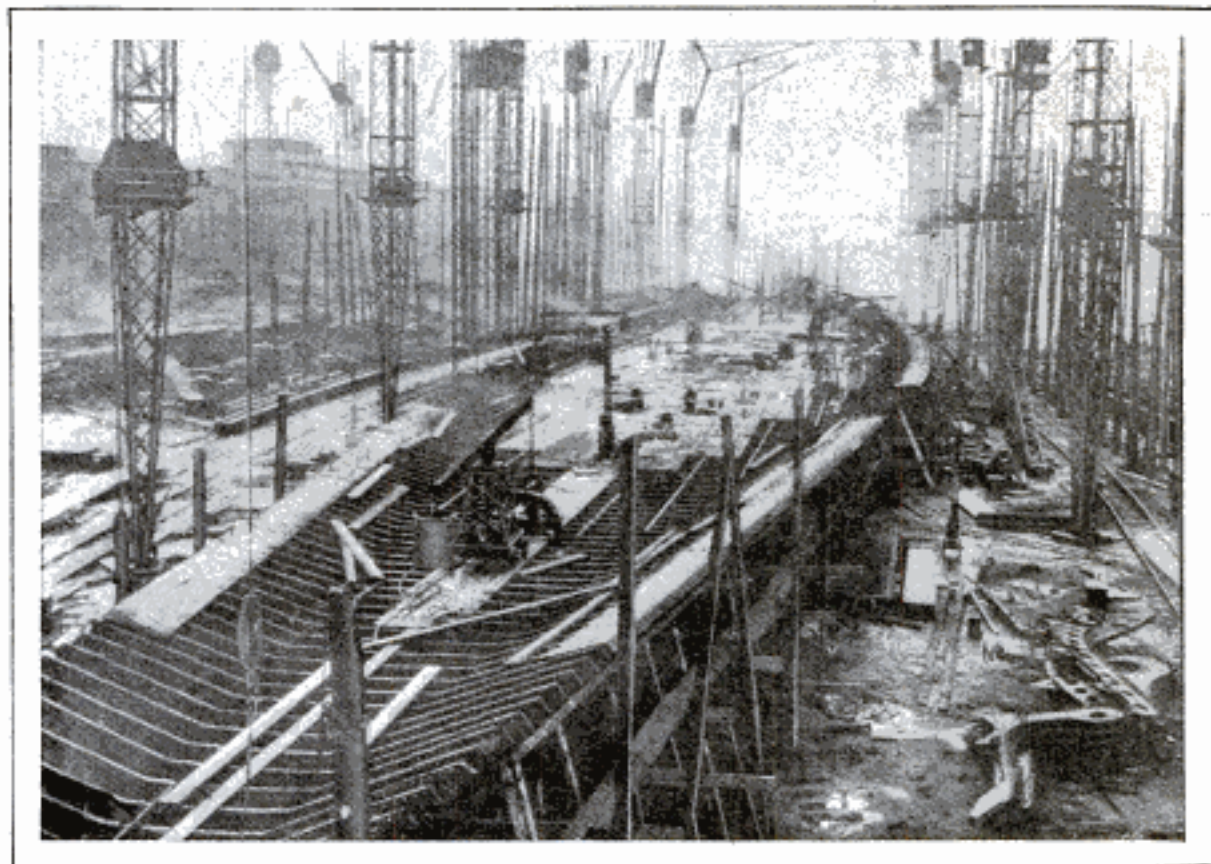

View of the Watertight "Tank Top" on the "Aquitania," Now Building in England, Which is to be the Largest Liner

instance the idea has been worked out so that the filtering will take comparatively little attention.

Wooden cases which contain the dust-proof cloth are built so that each separate filtering pocket can be removed from the frame without disturbing the others, thus making it possible to easily remove soiled or damaged pockets. As each pocket, covered with cloth, is inserted in the frame, the necessary tension to the cloth is developed automatically, and no eyelets are needed in the cloth, thus avoiding trouble in laundering or in cleaning with a vacuum cleaner. Another advantage is that the filter can be increased or decreased readily in size by adding or taking away pockets at the ends.

Although the automobile may be displacing the horse, it is interesting to note that no less than \$4,000,000 was given for prizes at horse races in the United States and Canada last year.

NEW OCEAN LINER WILL HAVE "TANK TOP"

Details of the construction of the "Aquitania," which is to be even bigger than the "Imperator," the largest ocean liner now afloat, are being withheld by the Cunard line, but some of the facts about the new vessel have come out, the most interesting being that the liner will have a tank top, so that there will be a watertight tank in the bottom of the vessel extending the entire length and breadth. The naval architect of the line testified at the British "Titanic" hearing that the "Aquitania" was to have a continuous watertight deck, presumably this being the top of the "tank."

The size of the vessel is not definitely known, but it is generally understood that it will be at least 10 ft. longer than the "Imperator," or 891 ft. The "Aquitania" will be driven by turbines of the Parsons type working four propeller shafts, the wing propellers being 86 ft. forward of the rear pair.



Courtesy the Sketch, London
Water Running with Aquatic Shoes at One of the German Watering Places

SKI RUNNING ON THE WATER

Many attempts have been made to design a water shoe which would be practical for everyday use, but practically all of them have failed because too heavy and cumbersome. The water-running shoes now being turned out by a German firm, however, are

said to overcome these difficulties, and are being used to a considerable extent at one of the German water resorts. The water shoes are about the size of snowshoes, and pointed at the ends. They are inflated with air before using.

SALAD DISH WITH ICE COOLER

Ice-cooled salad, without contamination by direct contact with the ice, is made a simple matter by the device shown in the illustration. The dish is constructed double, so that the ice may be placed between the inner and outer bowls, and the salad kept cool in the inner bowl.



ⒸThe use of the aeroplane and the need for better materials in its construction than have heretofore been necessary have brought into existence a steel wire to be used for guys which has a tensile strength of 350,000 lb. per square inch, despite the fact that it is only from $\frac{1}{50}$ to $\frac{1}{10}$ of an inch in diameter.

PREDICTING EARTHQUAKES

That earthquakes of the future may be accurately predicted is again promised, this time by M. Koeveslighety, a scientist who has been investigating the origin of the phenomenon. He does not claim the problem is entirely solved, but announces that with means already available, quakes may be foretold with a degree of accuracy. He considers the primal cause of the earthquake not an external factor, whether of the earth's crust or due to atmospheric conditions. These elements, in his belief, merely precipitate the shock, which is actually due to excessive tension at some point, the essential thing being to determine where such tension exists. The speed with which ordinary earth waves travel, as recorded by a seismograph, will indicate

the amount of tension, and thus furnish the basis for predictions.

"ATMOSPHERE" IN STAGE LIGHTING

Fortuny, a Parisian scenic artist, has invented a new and wonderful stage-lighting arrangement, differing entirely from the methods hitherto in vogue. His scheme, which has been successfully introduced in the Royal Opera House, Berlin, and is now being installed also in the new Comedy House at Frankfort-on-the-Main, consists of an arrangement of white muslin, covering the stage and forming a hemisphere upon which the light is projected. The claim is made that

this produces a more natural diffusion of light and makes possible intricate lighting effects which could not otherwise be obtained. On account of the equalization of the projected light on all parts of the stage through the new method, even the time-honored footlights are rendered useless and will be abandoned. Moving clouds, waves and other effects are easily obtainable by throwing the proper slides on the hollow hemisphere of muslin and colored effects are produced by passing the light rays through suitably colored cloth screens.

LIFEBOAT LESSON IN SHIPYARD

The lesson of the value of lifeboats, in spite of all the contentions that a lifeboat is too unstable to do more than satisfy the anxieties of passengers, has been present all this year in the yards of a shipbuilding concern in Delaware, and forms an excellent answer to some of the testimony developed in the British "Titanic" hearing. It is a boat which withstood three

days of storms on Lake Erie last December and was still seaworthy when picked up by a passing steamer. The boat had been launched from the steamer "Marquette Bessemer No. 2" when that vessel was foundering, and when picked up by the "Commodore Perry" the nine men who manned it had all died from the intense cold.



Lifeboat of "Marquette Bessemer No. 2" Which Floated through Three Rough Days out on Lake Erie

Yet, without any crew to steer the boat, and in spite of the lack of balance, due to the uneven distribution of the bodies, the boat had kept up.

MONSTER METAL FLUME FOR IRRIGATION

A monster iron flume has been erected by the United States Reclamation Service at Belle Fourche, S. D., which measures 1,300 ft. in length and 10 ft. 10 in. in diameter and is made of No. 16 gauge so-called Toncan metal. This is a very pure iron which, although made by improved methods and on a large scale, is said to be almost identical in composition with irons produced by the slow and complicated processes of centuries ago, but which had more lasting qualities than the modern product.

A large proportion of the flumes installed during the past year were of this type, including one in Massachusetts, where irrigation is a rarity. A mile of twin flumes of a diameter of 9 ft. 6 in. each, which will eclipse the Belle Fourche flume in length, are now being installed for irrigation service.

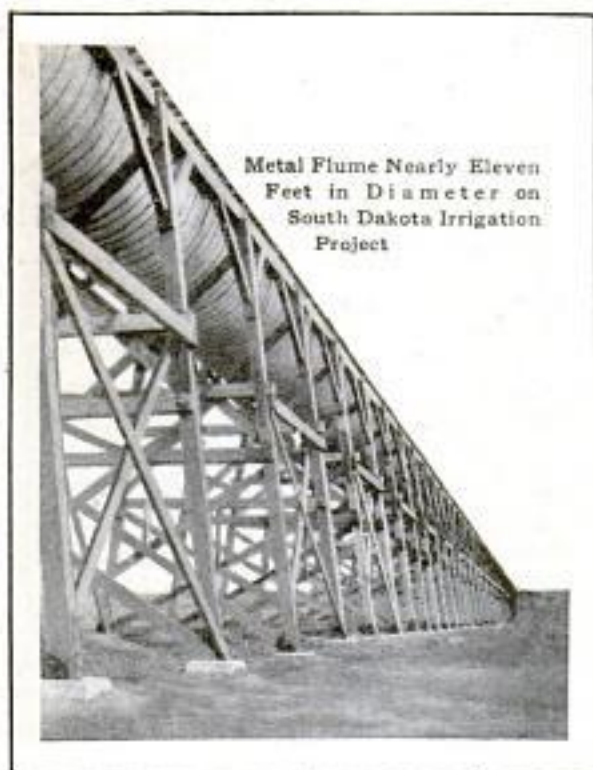

Metal Flume Nearly Eleven Feet in Diameter on South Dakota Irrigation Project

These iron flumes were designed and constructed in sections at Denver, Colorado, and are galvanized to resist corrosion.

REINFORCING STEEL WATER TANKS WITH CONCRETE

Recent unexplained failures of large steel water tanks in various parts of the country have caused the Los Angeles water department to reinforce a 528,000-gal. steel tank with concrete. The capacity of the tank was increased to 593,000 gal. by adding 5 ft. to the height, and the steel shell was incased in reinforced concrete having sufficient strength in itself to withstand the hydraulic pressure with an ample factor of safety.

The jacketing of the black steel shell is also a great improvement from an artistic standpoint, as the tank is visible for many miles up the San Fernando valley. The ordinary tank in such a location is distinctly an eyesore.

EFFECT OF DREDGING ON "SWELL"

During the last four years the River Weir Commission of Sunderland, Eng., has been watching the effect of deepening the harbor, by dredging, on the swell which has been conspicuous at that point. A pier of which 2,676 ft. had been completed, leaving 168 ft. to be constructed, was left untouched during this period in order to ascertain what effect, if any, the increased depth of water and expansion of navigation channels would have in leading the swell into the harbor. It has now been found that the dredging has not resulted in any appreciable difference. In view of this result the pier will not be extended beyond its present length more than may be necessary to complete the unfinished end in a permanent manner.

EDIBLE BOUQUETS REPLACE BOXED SWEETS

The fashionable feminine theatergoer in Paris no longer carries a box of sweets with her, but is provided by her escort with a dainty bouquet of crystallized flowers, such as violets, rambler roses, etc., artistically mounted on stalks, with petals made of thin



The Candied Bouquet Which is Taking the Place of Boxed Sweets for the Theatergoer

strips of candied peel. This bouquet is picked to pieces and eaten during the performance, all of it being edible.

ⒸCongress has been asked to authorize international gold notes for the convenience of travelers with values printed in currency terms of all nations.

THE WONDERS OF LIGHT

VII—The Magic of the Rainbow

WE do not know what primitive man thought of the rainbow. Probably much the same as his descendants of a hundred thousand years later. The average man of today accepts the rainbow as a simple matter of fact, just as he does a sunrise, a star, or a flower. It has no deeper meaning for him, nor does he take the time and thought necessary to understand what is really a puzzle to him. Familiarity with any of the wonderful phenomena of nature is too often mistaken for understanding.

The great bow of gorgeous colors far-flung across the sky is one of nature's most impressive object lessons. And yet, in all the ages that have elapsed since man appeared, history tells us but little of any progress made in the explanation of the mysterious arch of colors. It was accounted an object of superstitious awe, a portent of the gods, a riddle too complex for man to unravel, or else, because it was seen so often, it had become commonplace like many another of nature's phenomena.

Color was considered as a property of matter. Everyone had observed the beautiful colors in splintered ice, the chromatic glories of a diamond or cut-glass prism,

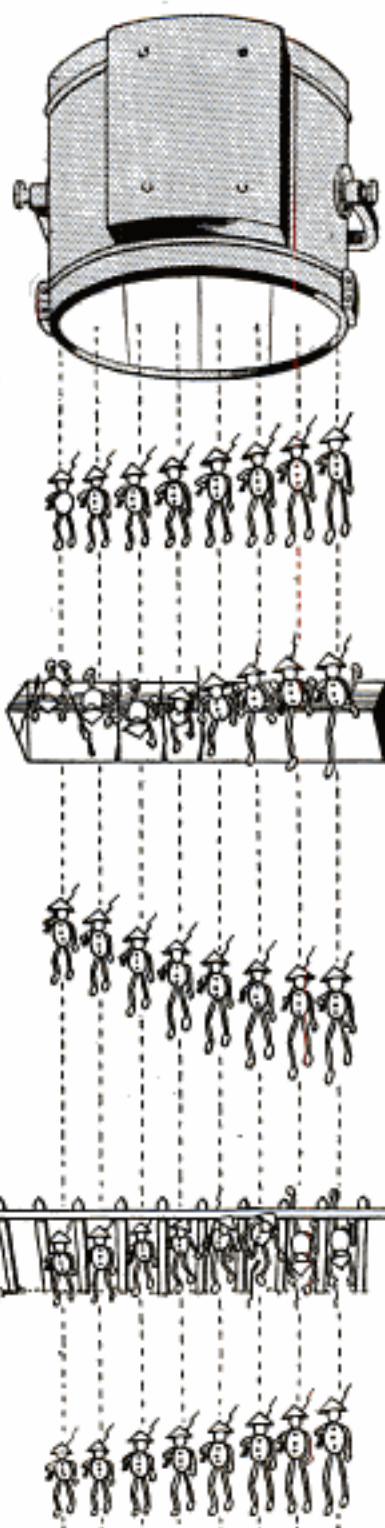

The Brotherhood of Light Rays. The top row represents one white ray of light, symbolized by a platoon of soldiers, of the various elements of a white ray, marching in perfect alignment, although some have longer legs (longer wave lengths) than their brothers. Obstructed by a prism of glass, the long-legged ones get over first, and so form a curved line—the spectrum of a ray of white light. It is possible to turn a spectrum back into a ray of white light, symbolized here by sending the soldiers under a low fence.

By
J. GORDON OGDEN, Ph. D.

the iridescence of a polished shell, the shining luster of a film of oil on water, the marvels of a soap bubble, and the myriad hues of a rainbow, but no one thought that all these color phenomena were closely related. No one imagined them to be children of the same parent, and that the redness of a blush rose is due to the same cause that produces the wondrous harmonies of a sunset, the flush in the cheek of a maid, and the glittering brilliancy of an Arcturus billions of miles away in the depths of the ether. And not even in the most fantastic dreams of the poets and philosophers of old was there anything remotely prophetic of the fact that one day these colors would reveal the chemical components of the universe, and enable man to analyze in his laboratory, suns and stars, flashing afar in the infinite realms of space.

Kepler, a celebrated German astronomer (1571-1630) was probably the first to describe the effect of a prism upon white light, while Sir Isaac Newton (1642-1727) was the first to offer a scientific explanation of what takes place when a beam of white light is splintered into the wonderfully pure and beautiful colors,

identical with those of the rainbow. Newton's description of his famous experiment is worth reading, and we

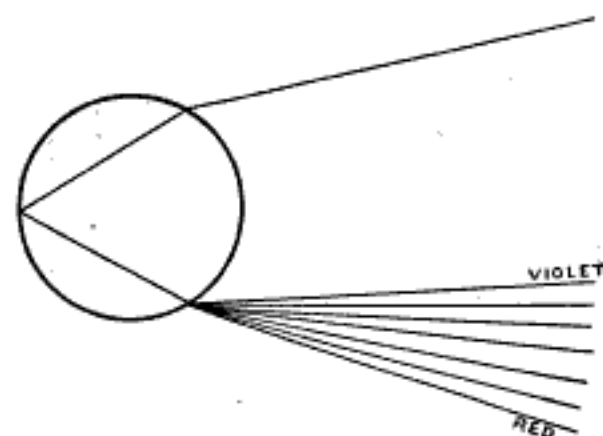

Fig. 1—A Ray of White Light Entering and Leaving a Drop of Water

therefore reproduce it, using his own words and spelling:

"In a darkened room make a hole in the shutter of a window whose diameter may conveniently be about a third part of an inch, to admit a convenient quantity of the Sun's light; and there place a clear and colourless Prisme, to refract the entering light towards the further part of the Room, which, as I said, will thereby be diffused into an oblong, coloured Image. Then place a Lens of about three foot radius (suppose a broad Object glass of a three foot Telescope), at the distance of about four or five foot from thence through which all these colours may at once be transmitted, and made by its Refraction to convene at a further distance of about ten or twelve feet.

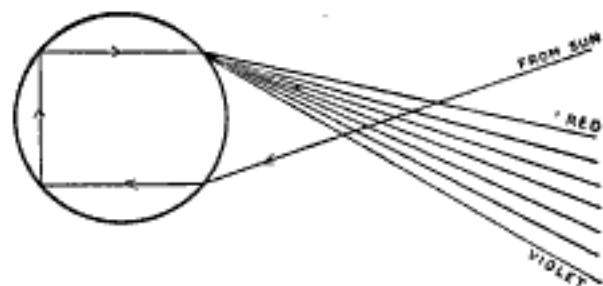

Fig. 2—A Ray of Light Entering a Drop of Water from Below is Twice Refracted

If at that distance you intercept the light with a sheet of white paper you will see the colour converted into whiteness by being mingled. But it is requisite that the Prisme and Lens be placed steady and that the paper on

which the colours are cast be moved to and fro; for by such motion, you will find not only at what distance the whiteness is most perfect, but also see how the colours gradually convene and vanish into whiteness, and afterwards, having crossed one another in that place where they compound whiteness, are again dissipated and severed and in an inverted order retain the same colours which they had before they entered the composition. You may also see that, if any of the colours at the Lens be intercepted, the Whiteness will be changed into other colours. And therefore, that the composition of whiteness be perfect, care must be taken that none of the colours fall beside the Lens."

Newton, however, since he was an advocate of the corpuscular theory of

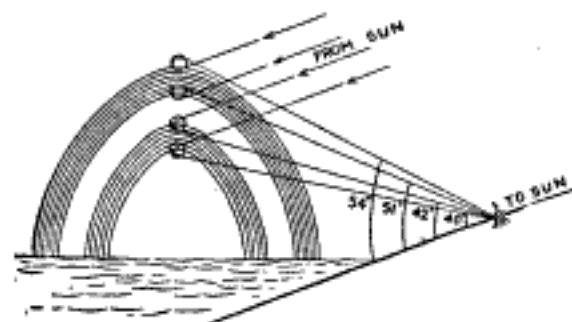

Fig. 3—Primary and Secondary Rainbows with the Angles at Which the Various Colors are Seen, Violet being 54 Degrees in the Secondary

light, could not give a correct explanation of the phenomena he had witnessed, as the undulatory theory of light is essential for a full understanding of this beautiful dispersion of white light into the rainbow hues.

Even as the alchemists of old named the vapor that distills from a solid or liquid when heated, a "spirit," and as Van Helmont gave the name "gas," from the German word "Geist," a ghost, to the invisible something that is mysteriously given off when certain substances are heated, so Newton gave the name, "spectrum" identical with our word "specter"—an apparition—to this band of colors, and so it has been termed ever since. It is also claimed that Newton named seven colors in the spectrum for the reason

that the number seven was a significant and peculiarly sacred number to the alchemists and astrologers of the time.

As a matter of fact, there are at least two millions of separate and distinct colors in the solar spectrum, and the common division into seven is meaningless.

And now, what is a rainbow? Whence the colors? Why is it always an arc? In a former chapter we discussed the effect of a prism on light, and studied the cause of the bending or refraction thus produced. We are now ready to study another effect of this same bending or refraction when white light is permitted to pass through a prism. White light is really a brotherhood made up of every wave length capable of affecting the optic nerve. Short waves, $1/64,000$ of an inch in length, long waves, $1/34,000$ of an inch, together with myriads of waves intermediate between these two lengths, travel through the vast abysses of the ether with precisely the same velocity. The tiny violet waves make just as good time as their big brothers, the red waves. Trouble comes to the brotherhood when it strikes a medium different from the ether—glass, for example. The red waves, being longer, pass on

more or less entangled with the electrons of the glass, and are bent away from their original course much more

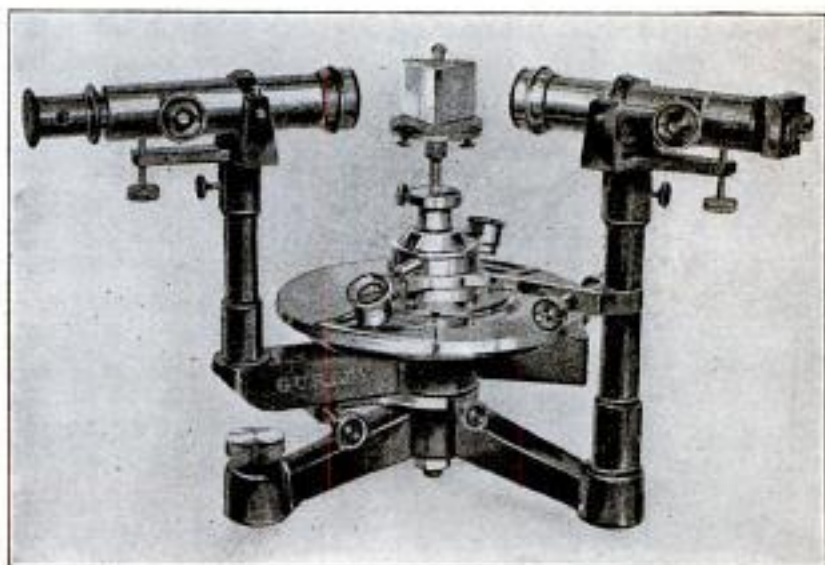

The Spectroscope, by Means of Which the Spectrum of a Ray of Light is Studied

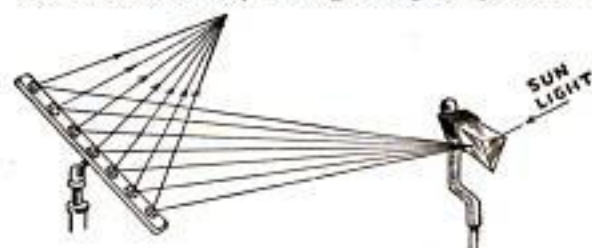

Fig. 4—The Dispersion of a Ray of White Light Passing Through a Prism and Subsequent Uniting of the Rays

through a glass prism without much difficulty, the only noticeable effect being a slight change in direction after emerging from the glass. The other waves, violet most of all, seem to be

than the red waves. Hence when all the waves finally emerge, the brotherhood is broken up. This phenomenon is known as dispersion, and is illustrated in Fig. 4. This at least is the popular conception of what takes place in a prism. Strictly speaking, there are no colors in white light—just waves of different lengths. Color is subjective, and as we have shown, exists only in the brain. White light is a sequence of irregular wave trains, and a prism simply analyzes them into simpler trains that we recognize as colors. These simpler trains may be still further divided into their components, and it is quite impossible to say where this analysis must cease. The difference between sunlight and colored light may be understood by comparing the effect produced by forcing a yardstick down on the keyboard of a piano, and afterward striking a single key with the finger. White light is a discord wherein all the color tones are blended. A pure color is a single tone in the scale—a single wave length.

What has all this to do with a rainbow? Simply this: A raindrop is a double convex lens, made up of two prisms placed base to base. These prisms are just as much prisms as

though they were made of glass. The brotherhood of light is broken up by the raindrops, and each of the brethren, free from one another, races down to the eye of the observer, and causes the sensation of color. As we see an object in the light that comes from it, the various drops of rain, seen at slightly different angles, seem to be colored—and we have the rainbow.

Figure 1 represents what happens to a ray of light when it enters a drop of water at the proper angle. It enters from above, is slightly bent, then totally reflected at the far side of the drop, and then leaves the drop just below the point of entry, bending again as it passes out, producing dispersion. Rays of light that enter the lower part of the drop are refracted twice, and totally reflected twice (Fig. 2). These latter rays create what is known as the secondary bow, which lies outside the primary bow. The secondary bow is always dimmer than the primary since the light passing through it is twice reflected, there being a loss at each of the so-called "total" reflections.

In the primary bow the light from the violet drop must enter the eye of the observer at an angle of 40 deg. to the line drawn from the eye of the observer to the sun, as shown in Fig. 3. The light from the red drop must enter at an angle of 42 deg. Similarly, in the secondary bow, the angle for the red must be 51 deg., while the violet must be 54 deg.

It is quite evident "that those drops whose direction from the eye makes any particular angle with the line drawn from the eye to the sun, must lie on a circle whose center is on that

line. Hence we see a circular arc of light which is violet on the inner edge, and red on the outer edge in the primary bow, and red on the inner edge and violet on the outer edge in the secondary bow."

The rainbow shimmering high in the heavens is more than a mere arch of glowing colors. It is a royal ambassador from the kingdom of nature, a herald bearing a message of vast importance to mankind. Written upon its brilliantly hued, shining archway, is a truth that man has finally appreciated after the countless ages that have passed since the first rainbow glorified the heavens. And this truth is what? Nothing less than the revelation of the component elements that constitute the sun and stars and the dim-shining nebulae lost in the farthest hiding places of the universe. By means of this truth, written large upon the raindrops, we know more about the composition of the sun, 93,000,000 miles from the earth, than we do about the world on which we dwell. Let us review our knowledge of this wonderful property of light. It is not hard to understand.

Just one hundred and thirty years after Newton's famous experiment, in other words in the year 1802, Doctor Wollaston, an English philosopher, discovered, on repeating Newton's experiment with the prism, a peculiar difference in the spectrum when the light was allowed to enter the prism through a narrow slit, instead of a round hole. The spectrum appeared to be no longer continuous, but was broken, here and there, by numerous dark, threadlike lines extending across it in a direction

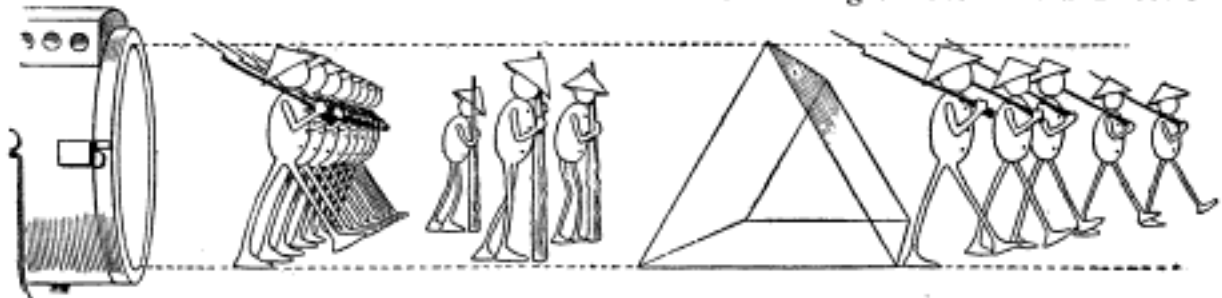

How the spectrum shows what gases a ray of white light has passed through. If a ray of white light, indicated by the line of little soldiers, passes through some glowing gaseous element, some of the brotherhood are killed. Then when the line of soldiers passes the prism and is thrown into a curved front—the spectrum—it is immediately noticeable which are missing. The scientist knows just what gases would account for the killing of any little soldier.

parallel to the ends of the prism. Newton had not observed this phenomenon although he, too, had used a slit in his further experiments in dispersion. Considerable attention was attracted to this curious discovery, but no one understood its wonderful significance. In 1815, Fraunhofer, an optician of Munich, studied these lines with extreme care. He mapped no less than 700 of them, designating eight of the most conspicuous by letters of the alphabet. These positions follow:

- A—Beginning of Red
- B—Middle of Red
- C—Beginning of Orange
- D—Middle of Yellow
- E—Middle of Green
- F—Beginning of Blue
- G—Middle of Indigo
- H—Middle of Violet

What is the meaning of these Fraunhofer's lines? What is their cause? Evidently something happens to sunlight when it passes through a prism, that does not happen to the light from a candle or lamp when it is treated in the same manner. A candle, lamp, or arc light will produce a continuous spectrum, without any sign of a dark line. What becomes of the lost sunlight that properly belongs where the dark lines appear? Let us perform a simple experiment that will put us in the way of finding out the truth. If light from an alcohol lamp whose wick is strongly impregnated with common salt is passed through a prism, an intensely bright line, yellow in color, will be its spectrum. Now, if sunlight is passed through a prism and its spectrum thrown directly above or below the spectrum from the burning salt, so that the two spectra may be compared, it will be found that exactly opposite the bright yellow line produced by the salt, or sodium spectrum as it is termed, a dark line appears in the sunlight spectrum. This is the "D" line in Fraunhofer's classification,

and is really a number of lines very close together. This "D" line is therefore a bright line in the sodium spectrum, and a dark line in the sunlight spectrum. Now, if this "D" line is due to sodium, it is evident that the sodium

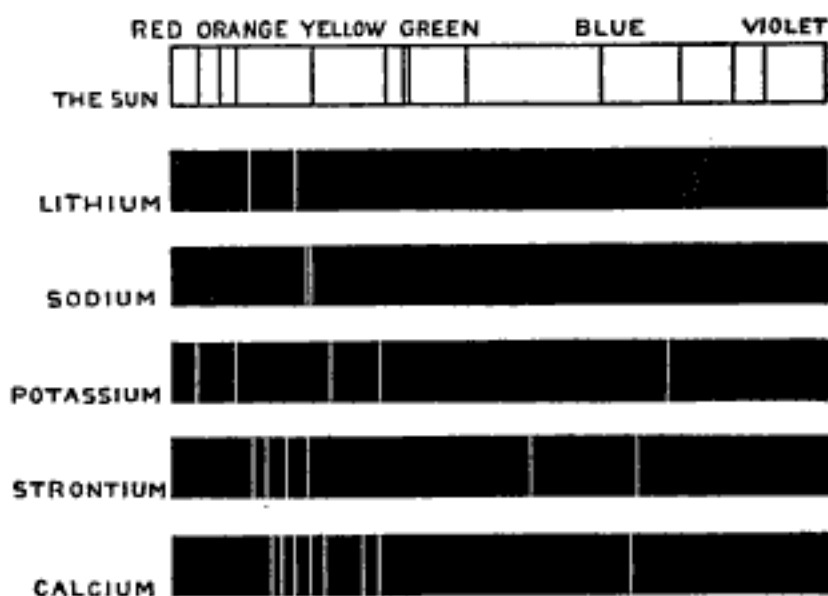

Fraunhofer's Lines, in a Spectrum, Showing Location of Lines Which Indicate the Ray of Light Passed through the Elements Named

light has been taken out of the sunlight, in some way or other. Let us go on with our experimentation. Suppose we pass a beam of strong, white light from an arc lamp through a prism and thus obtain a continuous spectrum. Then let us interpose between the arc light and the prism, a glass tube or other transparent holder, containing the highly heated vapor of metallic sodium. Instantly a dark line appears in the very place where the bright yellow line appeared in our first experiment with the alcohol and salt. The sodium vapor has absorbed or quenched precisely those rays which the vapor itself gives out when it is glowing. And now, since the sunlight was robbed of this same yellow line, does it not follow that the light from the sun must have passed through a glowing vapor which contained sodium? Is it not reasonable for us then to believe that sodium exists in the sun's atmosphere?

By the same reasoning we are able to demonstrate the presence of many other elements in the sun. Iron, for

example, gives 460 bright lines when its spectrum is viewed through a good spectroscope. Every one of these bright lines is exactly matched by dark lines in the sun's spectrum. This could not be accidental. There must be iron in the sun's atmosphere.

Upward of 2,000 lines have been measured and defined in the sun's spectrum, and many of them have been identified with terrestrial elements. We are certain that iron, sodium, nickel, calcium, hydrogen, chromium, copper, and barium exist in the sun's atmosphere—just as certain as we are that they exist in the earth's crust. Gold and silver have not yet been discovered in the sun, but they may exist there, even though their lines have not yet been identified. Helium, on the other hand, was first discovered in the sun's atmosphere, and afterward Ramsay proved its presence in the earth's crust.

It is a comparatively simple matter,

therefore, to determine the composition of a sun, star, or nebula. Even a comet and "shooting star" have been made to tell their story. The light from them is passed through a good spectroscope, the number and position of the dark lines or bright lines noted, and then these lines are compared with the lines of known substances, just as one would match ribbons in a draper's shop.

The presence in the photosphere of the sun of upward of 40 different elements has been determined. The stars, that from the beginning of time had refused to answer all questions, have gracefully yielded up the secrets of their composition, and man has advanced thereby one step nearer to the solution of the mystery of his environment.

And all this wonderful story of the spectrum had been emblazoned upon the sky each time the "magic of the rainbow" glorified the heavens, but man was slow to understand.

DOMESTIC HOT-WATER TANKS HEATED BY ELECTRICITY



A small family in Niagara Falls doing all its cooking by electricity wished to use the current for heating the necessary water for the household as well, and the electric-light company, in making arrangements for such an installation, decided that it would be practical to use the ordinary domestic hot-water boiler or tank already installed. A 750-watt heating unit was inserted in the feed pipe, and the tank was completely covered with a coating of asbestos, 2 to 3 in. thick, to prevent radiation of heat.

The arrangement in the house produced such excellent results that a similar installation was made in a barber shop which was temporarily with-

out a hot-water supply, the hotel in which it was located being closed for the winter. In this case two 750-watt heating units were introduced into the water system.

THE SMOOTH RUNNING OF ENGLISH TRAINS

Money sticks in some pockets and in some hands, but it is doubtful if money could stick long on one of the steps of a fast-moving American passenger train. Indeed, it would in all likelihood be dislodged a few moments after the train started. Yet two instances of coins being dropped upon the footboards of Great Western passenger expresses in England are given as examples of the smooth running of that road.

Both instances relate to the recovery of coins dropped upon the footboards of trains at the moment of departure. In one, a ticket collector dropped half a sovereign (\$2.50) on the footboard of a train running from Paddington station, London, to Birmingham. The

train started away before he was able to pick it up, but the coin was still in position when the train reached Birmingham two hours later. Another coin was similarly recovered when one of the fast trains stopped at Reading after a speedy run from London.

OUT-OF-DOOR TRAP FOR FLIES

The large-sized fly trap here shown is designed to catch flies outdoors, and particularly for service in places near garbage cans, stables, meat markets, grocery stores, and the like. The trap is 26 in. high and 11½ in. in diameter. Some suitable substance, such as a mixture of sugar, water and vinegar, is placed in the dish under the trap, and the flies, after feasting, naturally fly upward, land on the wire dome,

and then crawl upward to escape but instead find themselves caught in the trap proper.

URGED TO TAKE EXPLOSIVES FROM THE AIR

At a recent meeting of the executive committee of the British Science Guild in London an appeal was formulated to urge the British government to take steps to produce explosives from the air, regardless of financial considerations. It was pointed out that explosives were being largely manufactured on the Continent from atmospheric nitrogen, and that England should do likewise, as the sources abroad from which England obtains the raw material for explosives might be cut off in the event of war.

MUSICAL-BELL ATTACHMENT FOR PIANOS

A piano attachment for musical electric bells, designed particularly for

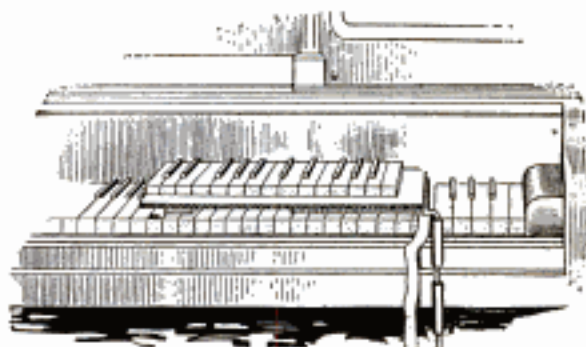

An Arrangement by Means of Which the Pianist may Play Musical Electric Bells

motion-picture theaters and similar places where only a pianist is employed, is just being marketed by a Wisconsin manufacturer. A small keyboard swings into position as shown in the drawing, and by means of it the pianist can operate the musical bells, playing loudly or softly as desired.

SOLID RUBBER TIRE FOR EMERGENCY

An easily attached solid rubber tire, designed to be used in the place of a pneumatic tire in emergencies, is being marketed by an American concern. It is so flexible as to be easily rolled up for storage in a small space, and, upon damage occurring to a hollow tire, can be quickly clamped on over the rim in its place. It is claimed that with but one regular tire removed, the use of the hard rubber tire in its place will scarcely be noticed, so far as any difference in the comfort of riding is concerned.



AN ELECTRIC FAN WHICH RUNS AROUND A TRACK

The proprietor of a small store in Chicago has devised a novel show-window display of the "action" va-

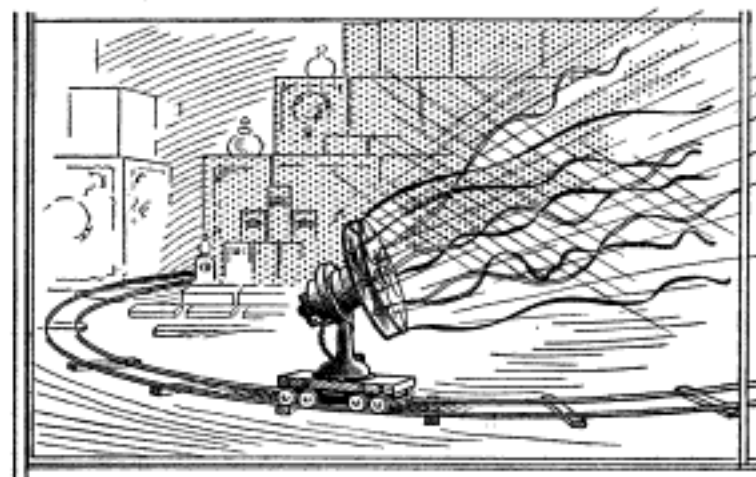

Electric Fan on Wheels Propels Tiny Car on Tracks around a Store Window, Drawing Power through the Rails

riety with a simple electric fan, a circular track of the type used for the operation of toy trains, and a little truck. The rails of the track are connected into an electrical circuit, which is completed by passing the current from one rail through the truck to the motor of the fan, which is set on the truck, and back to the other rail.

The revolutions of the fan drive the truck around the track.

COWS SHELTER UNDER AN AEROPLANE

A rather unusual scene, incident to an aeroplane accident, was recently witnessed in England. Major Lyle, a pupil of Grahame White, fell with his machine, and although he escaped injury, the aeroplane was wrecked. It was raining at the time, and when the mechanics arrived a short time later to remove the wreck, they found a number of cows sheltering beneath it.

CA former sea captain has invented a sea anchor for lifeboats that has an attachment to be filled with oil which can be poured upon the sea.

CONCRETE CHIMNEY OF INTERESTING DESIGN

A concrete chimney recently erected at a steel plant near Hamburg, Germany, has many interesting features besides its great height of 328 ft. Among these are its acid-resisting lining, made absolutely necessary because the purpose of the chimney is to carry away smelter-furnace gases; the special heat-resisting lining which extends from the top of the base to a height of 66 ft., and the massive nature of the chimney's base.

The chimney, which is round in shape, tapers from an outside diameter of 30 ft., at the base, to 11 ft., at the top, where the free opening is 9 ft. in diameter.

Immediately below the chimney proper is an underground vault, 13 ft. in height, which serves as an inlet for the gases. This is octagonal in shape, 36 ft. in diameter, at the base, and 31 ft. in diameter, at the top, and rests on a concrete block, 7 ft. thick and 42 ft. in diameter, which is in turn supported by 237 wooden piles, the space around and between which is filled in with concrete.

The reinforcing of the chimney consists, in part, of forged-iron rings imbedded in the concrete at intervals of about 6 ft. throughout the entire height.

MOTION PICTURES SHOWN ON ELECTRIC PARTY CAR

The new "party car" of an electric interurban railway running out of Pittsburgh, designed especially for theater and other parties who wish a private car, has been equipped with a motion-picture machine, which is operated while the car is making its trip. With the electric lights in the car turned off and the window curtains pulled down, the car becomes a cozy little motion-picture theater on wheels.

When it happens that a party is so large as to require two special cars, half the party occupies the motion-picture car on the outward run, and the other half on the return journey, thus giving the entire party an opportunity to enjoy the pictures.

AN INVENTION FOR THE ASSISTANCE OF MAN

Sets of so-called "twin buttons," designed to take the place of hooks-and-eyes, and safety pins, is a recent



French invention, which, according to a French magazine, should appeal to women and men alike, and especially to such of the latter who have had "prolonged" experience in hooking a woman's dress up the back.

The invention consists of two small pieces of celluloid, provided with holes for conveniently sewing them to a garment, each piece having a snap button and an eye at opposite ends. The sets are attached in such position that the button of each piece engages the eye of the other. They are pressed together in the same way as a glove snap.

The sets are provided in various colors, so that they may be almost invisible when used with thin dress goods of similar colors.

HOMEMADE WRAPPING-PAPER STAND

A homemade wrapping-paper stand constructed by the proprietor of a hardware store in Sioux Falls, S. D., when it was found that the necessary shelf space could not be given up for wrapping, is shown in the accompanying drawing. The frame of the stand is made of 1 1/4-in. gas pipe, the top, 3 ft. long by 2 ft. wide, being 3 ft. above the

floor. The upper paper-rack brackets are fastened underneath the top by screws, while the smaller rack is bolted

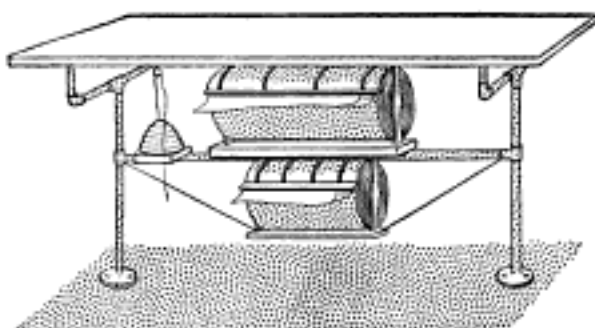

A Practical Homemade Wrapping-Paper Stand

to the cross or tie-rod of the frame, the twine holder being mounted on this cross rod at one end.

RIB GRIP FOR UMBRELLAS

A handy little rib grip for umbrellas is now being manufactured. It snaps

onto the umbrella rod instantly, and then the cord attached to it is passed around the rib ends and caught under the hook. It is a practical little device also for a new umbrella, and its usefulness is particularly marked on an umbrella which has had its regular rib-fastening tab torn off during long service.

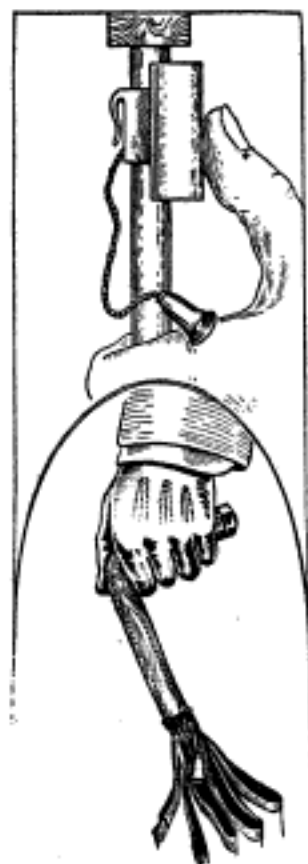

Among the old ships the Navy Department has on the sales list this year is the "Yankee," the hulk of which lies in Buzzard's Bay, Mass., the sum of \$2,010 having been bid for it, at which figure it will probably be sold.

MOTORCYCLE EQUIPPED WITH WIRELESS

A resident of Nottingham, Eng., who has an enthusiasm for both motorcycling and wireless telegraphy, has

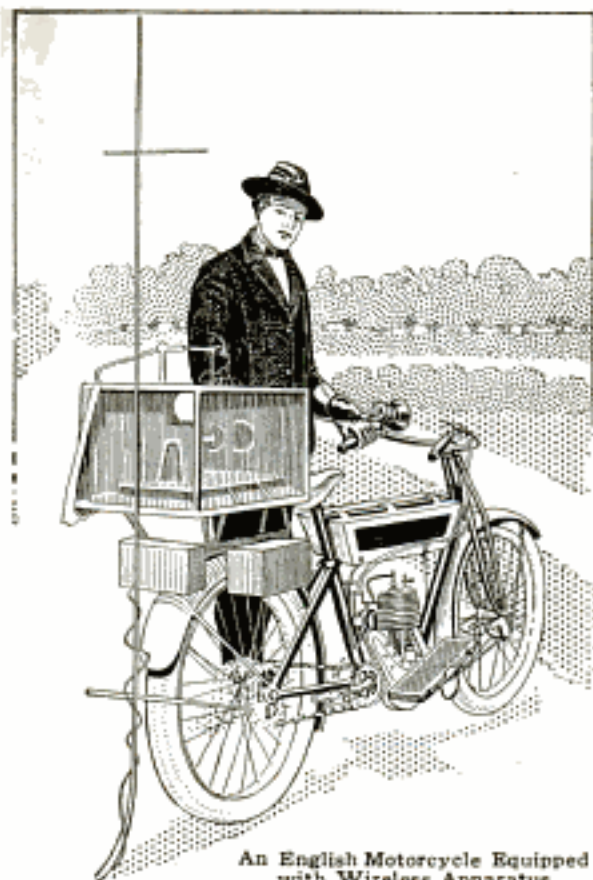

An English Motorcycle Equipped with Wireless Apparatus

equipped his machine with a wireless outfit which does not in any way interfere with the former's operation. The apparatus is mounted on a rack over the rear wheel. The operator, who is G. F. Champion, has succeeded in receiving messages while traveling at a high rate of speed.

ORIGIN OF "HORSEPOWER" AS A POWER UNIT

The multitude of automobiles, motors and power-machinery of all kinds in our days has caused the word horsepower to become part of the daily vocabulary of almost everybody. Nearly as well-known is perhaps the fact that James Watt, the father of the modern steam engine, was the first to measure power by this unit and to establish its

value. But the reason why he happened to consider the work performed by a horse as a power unit instead of some other arbitrary value may not be generally known.

The fact is that one of his first orders for a steam engine was given him by a brewer, with the specification that the engine should be capable of pumping daily at least as much water from a well into the brewery as a horse, the power previously used.

A price was agreed upon and the quantity of water to be delivered had to be fixed. The brewer, a canny Scot, put his strongest horse to work for eight hours, driving him all the time to the limit of his endurance. Thus the horse in that time pumped up so much water, that it, with due consideration of the depth of the well, corresponded on an average to the lifting of a weight of some 30,000 lb. to a height of one foot in one minute. This exceeds by nearly one-third, the work capacity of the average horse, but Watt, knowing with whom he was dealing and desirous to more than fulfill the specifications of the contract, so calculated the engine that it would safely perform 33,000 foot-pounds of work in one minute; and henceforth used this unit, which was called, first in England and then all over the world, horsepower, for measuring the work or power of an engine.

AN INTERESTING FLY-KILLING "GUN"

Although not quite so proficient in number of executions as the "swat-the-fly" type of fly killer, this little Eng-



"Fly Gun" Which Provides Its Own Killing Base

lish device, called a fly gun, is of particular usefulness in certain conditions. It is true that it must be quickly

brought into a fairly exact position in order to kill, while it is only necessary to "swat" with the swatting type of killer, but, on the other hand, the fly gun is provided with its own killing base, which saves the wallpaper, tablecloth or window pane from most of the "spatter" incident to the slaughter.

The upper part or flap of the fly gun is drawn up by a spring, and the pulling of a trigger allows it to descend upon the bottom plate with rapidity and force. The flaps or plates are perforated to prevent air disturbance during the operation.

INGENIOUS PROJECTING MICROSCOPE

A clever projecting microscope, called a projectomicroscope, has recently been installed in St. Bartholomew's Hospital, London, where it is proving of the greatest assistance to the student in the course of his studies. The apparatus consists of an inverted high-power microscope arranged in

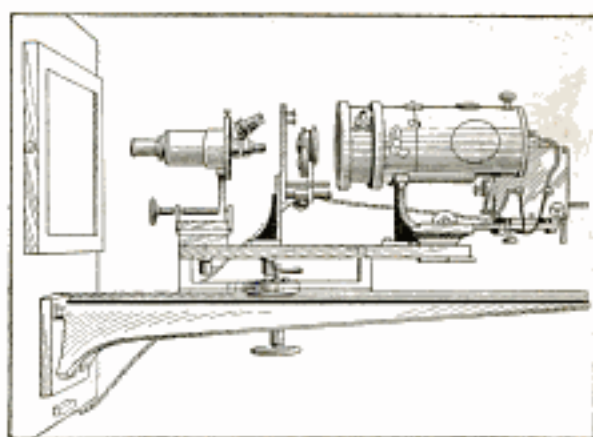

This Projecting Microscope Throws an Enlarged Image on a White Screen

connection with a powerful arc light. By its use an enlarged image of the specimen under study is projected on a white screen.

Orders have been issued to place the revenue-cutter service on an efficient war footing and to this end the various ships will be equipped with modern six-pounders and will hold regular target practice.

HIGHWAY TUNNEL PROPOSED FOR SAN FRANCISCO

The Devisadero Street Improvement Association of San Francisco has been agitating the construction of a high-

proper would be 2,950 ft. in length, and the approaches 2,390 ft. The Panama-Pacific Exposition tract is just one and one-half blocks beyond the north end of the proposed tunnel, so that the project, if carried through, would greatly improve the exposition transportation facilities.

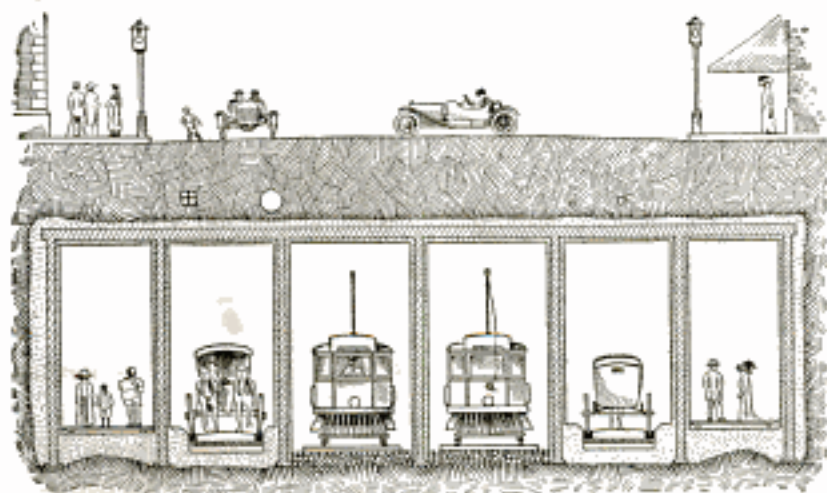

Plan of a Proposed Highway Tunnel Connecting Two Sections of San Francisco

way tunnel under that street to connect the districts known as the "Happy Valley" and "Harbor Hill." The subway

good foothold and with steel ways for vehicle wheels. The footways would be each 8 ft. wide, the wagon ways 9

ft., and the street-car sections 10 ft. The tunnel would be built on a rather steep grade, giving a difference in elevation of 130 ft. between the two ends.

COUCH HAMMOCK FOR PORCH OR GARDEN

A couch hammock, having no wires, ropes, pegs or posts to fix, and designed for the garden or porch, is



A Simple Folding Couch Hammock

shown in the accompanying drawing. It folds flat when not in use, and opens as simply as a folding chair. The head can be either raised to form a lounge or lowered to form a bed.

LOCUSTS MENACE SPANISH AIRMAN

While flying at the Bajo aerodrome, near Madrid, an airman named Jean Mauvaise flew into a cloud of locusts which nearly caused his death. With the mild winter and spring at 96 deg. F., in the shade, locusts have become prevalent in Spain, and when at a height of 60 ft., the aviator met an invasion of these insects in the air, causing the aeroplane to fall. Mauvaise is said to have had a miraculous escape, but his machine was wrecked.

FRANCE AIMS BLOW AT ADVERTISING SIGNS

The French government has inaugurated a scheme for the suppression of advertising signs which does not depend upon prohibitive legislation, but prohibitive rentals.

During the past two years billboard advertising has become so popular near Paris that it is now difficult to obtain an uninterrupted glimpse of country on any of the roads leading out of the city. Only a small tax has been levied on such boards in the past, but the government has now increased the tax to a figure which is expected to prove prohibitive. In the future a little more than \$3 will be charged per square foot on boards of less than 18 ft. square, \$13 per square foot for boards of from 30 to 60 ft. square, and \$18 per square foot for boards of still larger size. This tax is to be doubled if the board contains two advertisements, trebled if there are three, and so on.

CATERPILLAR-DRIVE ARMY TRUCK

The caterpillar form of automobile, which has been described in this magazine several times, and in which the machine virtually lays its own track as it moves along and then runs over it, is recommended by Lieut. B. F. Miller, U. S. A., as the type of service truck most nearly approaching the requirements of the army.

The recommended type of machine, however, as described in a recent issue of *Motor Age*, differs a little from other caterpillar.

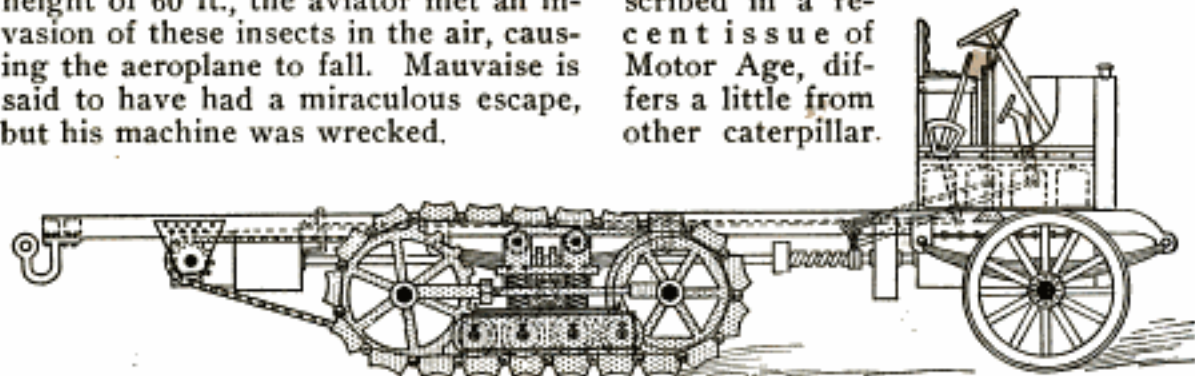

Caterpillar Truck Suggested by Lieutenant Miller, U. S. A., as Ideal for Military Service

vehicles in that it is provided with an ordinary set of wheels in front. The arrangement is such, however, that the steel-rimmed front wheels are intended simply for steering and for carrying the weight of the engine, which is located over them. The transmission is located back of the rear axle.

LEAD-COATED STEEL FOR ROOFING

A new type of metal roofing, consisting of sheet steel, coated with pure lead, is claimed to have many advantages over other similar types of roofing. Among the claims set forth are, that it is not subject to cracking or flaking; that it is not readily susceptible to chemical influences, and that it will not resist painting as does a zinc surface. It can be painted without the use of acids, may be easily soldered, and is not liable to rust.

NEW FORM OF METAL LAMP FILAMENTS

With a view to obtaining a better natural downward distribution of light than is possible in the ordinary metal-filament electric lamps, without the use of shades or reflectors, a European inventor is constructing lamps in which the filaments form the envelope of an inverted cone.

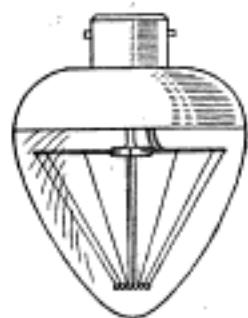

The results of comparative tests between the new type of lamp and one in which the filaments were of the ordinary cylindrical shape is claimed to have shown a 20-per-cent superiority for the conical form.

☞The submarine boat "Seal" in a government test was submerged to a depth of 256 ft. and remained at this depth for a period of 31 min., rising promptly to the surface at the end of that time.

MEAT CHOPPER OPERATED BY MOTORCYCLE

Motorcycles have often been harnessed to small machines in times of emergency, such, for instance, as when the electric power fails for a few hours or days, and it is also quite probable that they are sometimes used as the

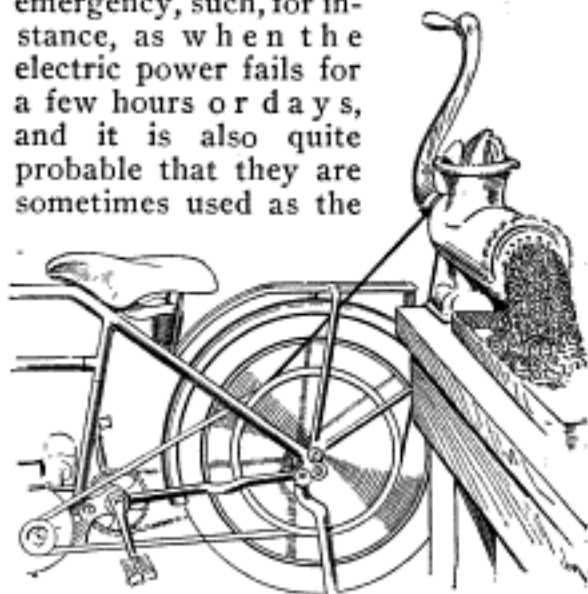

Motorcycle Harnessed to a Meat-Chopping Machine

regular power plant for such machines. An instance of regular instead of just emergency installation of a motorcycle as a power producer is here illustrated. The proprietor of a butcher shop in Chicago has been using his motorcycle for the past year to operate a meat-chopping machine. He also uses the motorcycle for business trips about the city and suburbs, and finds that the arrangement cuts down his operating expenses materially.

AN UNUSUAL ICE CRYSTAL

An unusual, if not unique, snow or ice crystal (not to be confused with a snow flake) was found by a correspondent to the French scientific magazine *La Nature*, during a trip through the Pyrenees. Its peculiarity is not in the shape, which is the regular hexagonal of all such crystals, but in the exceptional thickness, which exceeded half the diameter of



its surface. An ordinary ice crystal is so extremely thin that it melts instantly on being touched by a finger.

The unusual crystal was found at an altitude of about 5,000 ft., the temperature at the time varying between 23 and 27 deg. F.

CYLINDER-BLAST FORGE OF PORTABLE TYPE

A portable forge with a blast produced by a piston operating in a cylinder has been patented by an Eng-

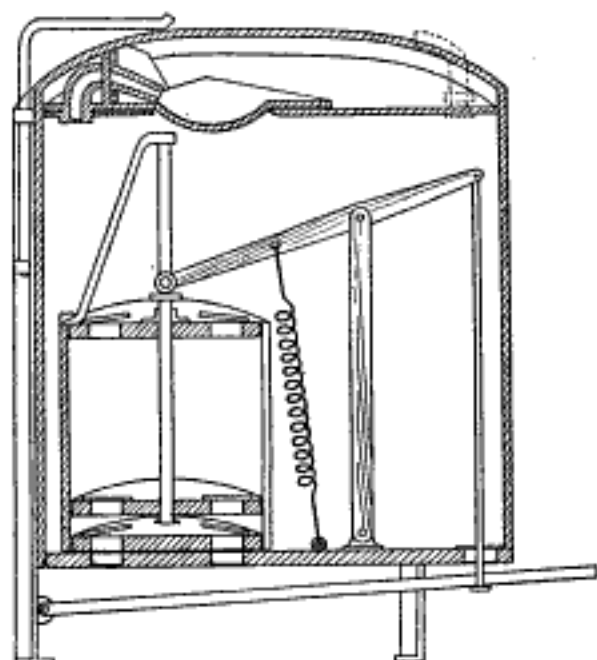

A Portable Forge with a Blast Produced by a Piston Working in a Cylinder

lish inventor, who claims that the large volume of air thus compressed in the reservoir makes the blast much more even than in forges operated by bellows only. Within the body of the forge, which is the compressed-air reservoir, is the compressing cylinder and piston. When the pedal is pressed downward by the foot of the operator the piston in the cylinder is raised, causing air to be sucked in through flap valves in the bottom. When the pressure on the pedal is released, the spring draws the piston back to the bottom of the cylinder again, and continuation of the operation causes a pressure to be set up within the reservoir.

AUTOMATIC ELECTRIC MINE LOCOMOTIVES

An electric storage-battery locomotive, entirely automatic in operation, has been in use for some time in a German coal mine and is said to have given excellent results as to simplicity, economy of operation, and safety.

The most interesting feature of the installation is the device which almost instantly stops the locomotive when an obstacle on the track is encountered. This device consists of a wooden frame mounted on the front of the locomotive in such position that it will come in contact with any object lying on the track. When the frame strikes an obstacle, such as a man, for instance, the frame slides backward, breaks the electric circuit and causes the brakes to be applied, thus bringing the locomotive to a quick stop. When the obstacle is removed, the frame is forced forward again by a spring mechanism, the brakes are released, the circuit closed, and the locomotive moves on again. The frame is removable and can be mounted at the rear when the locomotive is running in the opposite direction.

The switching of the locomotive is also automatic, and is accomplished by means of rings attached to brackets mounted on the front. Each switch lever is provided with a crossbar which will engage with the ring carried by a certain bracket. If the ring is not on the bracket, the particular switch it serves is passed over without being actuated; but if the ring is in position, the crossbar is engaged and the switch thrown.

The locomotive weighs $2\frac{1}{2}$ tons, and travels at a rate of about $2\frac{1}{4}$ miles an hour.

¶The greatest depth of the sea that has yet been measured was reported by the survey ship "Planet" to be at a point 40 miles off the northern coast of the Island of Mindanao, one of the Philippine group, where a depth of 32,089 ft. was registered.

THE PROPOSITION TO CERTIFY OYSTERS

All the oyster fisheries in this country have been urged by Dr. W. T. Sedgwick, of the Massachusetts Institute of Technology, to work for an arrangement by which all oysters would be "certified," the certification to be made by a board of health or other authority.

According to this plan there would be three grades of oysters, only oysters in the shell being in the first grade. The second grade of oysters, although not of the highest quality, could be eaten raw as well as cooked, and the third grade, although fairly suitable for food, however prepared, should be marked "for use only when cooked."

¶The "Lusitania" and "Mauretania" now have two captains each, one being a "staff captain" who relieves the captain-in-chief of much of his work without further burdening the first officer or mate.

NEW IDEA FOR MAKING CHEAP AUTOMOBILE

A very clever innovation in automobile design, for the purpose of creating a type capable of being built at

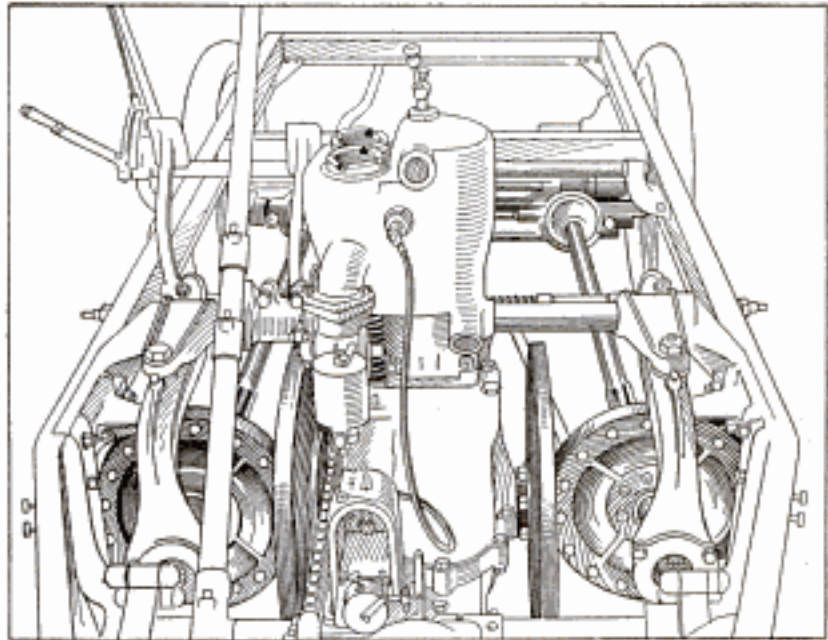

Front View of the Power Plant of New Automobile, Showing the Two Flywheels, with the Friction Disks Pressing against Them

exceedingly low cost, is being tried in France. The essential novelty in this car is best shown in the top view of the chassis, in which it is seen that the final drive is by two propeller shafts extending to two bevel-gear pairs on extensions of the rear-wheel hubs. The forward ends of the propeller

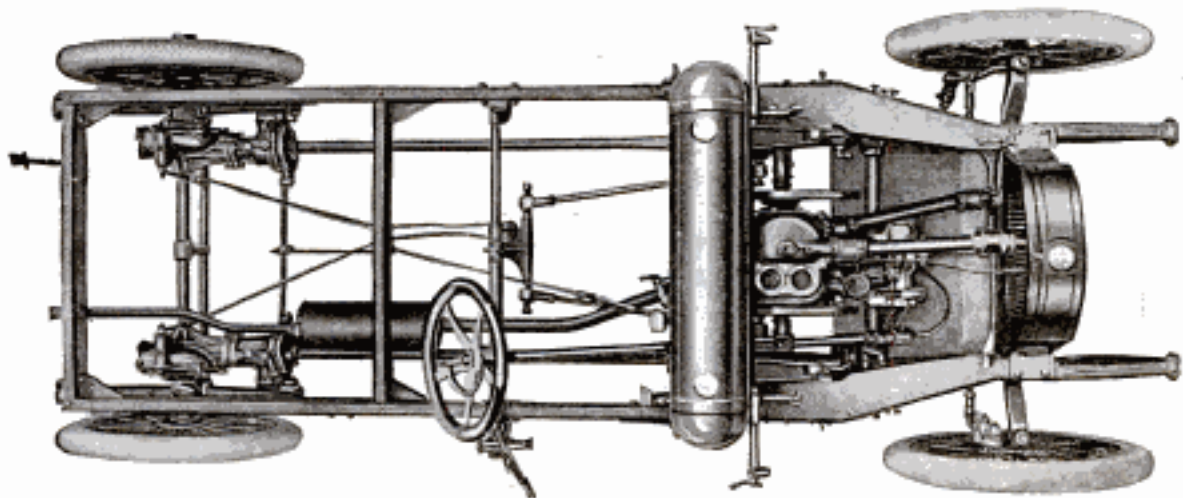

Top View of New Cheap Automobile, Showing the Separate Propeller Shafts for Each Rear Wheel Which are Driven by Friction Disks Pressing against the Two Flywheels

shafts are directly driven by friction disks that press against the smooth surfaces of the two flywheels, one on each side of the one-cylinder vertical engine.

All changes of speed, as well as the reverse, are readily produced by sliding the friction disks forward or backward by a simple controlling device.

ILLUMINATED ROUTE CARD FOR MOTORCYCLES

After all, it is at night that the route card is most necessary and valuable to the motorist and motorcyclist, and

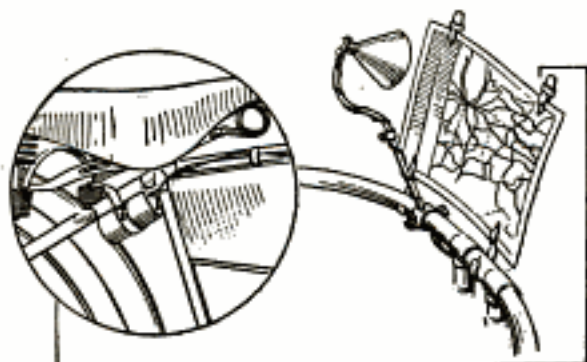

Route-Card Illumination on a Motorcycle

the night use of such guides requires illumination. At the start of a recent motorcycle run from London to Edinburgh several interesting fittings were to be seen on some of the machines, and among them was a route-card holder mounted on the handlebars, and a neat little electric lamp so mounted as to illuminate the card. A small dry battery under the seat supplied the current.

UNCONNECTED ELECTRIC WIRES GIVE SHOCK

A group of telegraph wires on the railway station of Clichy-Levalois, at the gates of Paris, gave severe shocks to a number of electricians who touched them, although these wires were not yet connected with any system.

The phenomenon was so strange that the matter was reported, and the subsequent investigation revealed the

startling fact that the shocks were due to Hertzian waves sent out from the powerful wireless station at the Eiffel Tower. A receiving station was then established by way of a test, and the wireless messages dispatched from the tower and other stations were intercepted. This proved that the group of wires, through pure hazard, filled all the conditions of height, distance and position necessary to receive the Eiffel Tower's communications. This was considered particularly interesting because a wireless tower erected on the roof of a normal school in the vicinity had never succeeded in intercepting these messages.

NUMBERING OF FARM HOUSES SUGGESTED

If the plan of the Automobile Club of Kenosha, Wis., is worked out as expected, all the country roads in the vicinity will be named and blocked off in distances of certain length; and every farmhouse or farm will be given a number. These names, numbers and distances will be made available by the publishing of a guide map. Automobile and other vehicle travel in Kenosha County will thus be greatly facilitated and it will be as easy to find a farmhouse as it now is to find a city residence.

CHAMPAGNE JUG WITH ICE CHAMBER

Champagne cooled in a jug or pitcher, instead of inserting the bottle in a bucket of ice, is one of the numerous articles advertised as suitable for wedding gifts by a large London shop. The ice is contained in a central chamber, and the jug is of crystal glass ornamented with silver mountings.



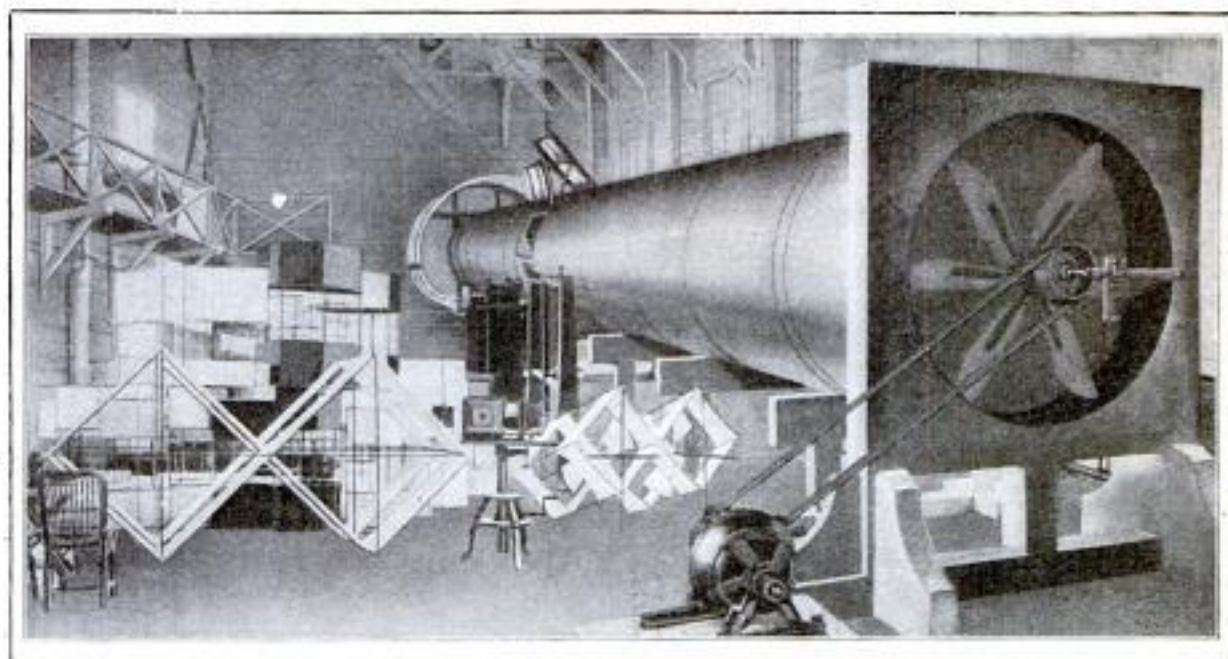

Fig. 1—Wind Tunnel of the Aerodynamic Institute at Koutchino, Russia

EUROPEAN AERONAUTICAL LABORATORIES

By DR. A. F. ZAHM

Chairman of the Aerodynamic Committee of the Aero Club of America

There is in America a strong and general sentiment favoring the establishment of a national aeronautic institute commensurate with the best in Europe. For it is noted that exhibition and prize flying, however munificently rewarded, have but disclosed the limitations of our aeroplanes, not the science of perfecting them. The cut and try, the rough pioneer work, has been cleverly performed by our chief aero inventors, and is practically terminated.

The art of mechanical flight has now to be placed on a rational, an exact, an engineering basis, through investigation of the correct principles of design, and by rigorous tests of actual machines and their accessories. These ends can be attained best in institutions specifically arranged for the purpose, and adequately endowed. We have, in fact, either to resume in America the kind of investigations abandoned by Dr. Langley, for want of funds, or borrow from other nations their exact science of aeronautical engineering. The feeble and fortuitous experiments of our amateurs, pottering in poor laboratories, can not keep us abreast of

the more enterprising countries. We may therefore with profit glance at the chief foreign establishments for an intimation of what is needed at home.

The institute here contemplated is primarily for producing rather than teaching aeronautical science. Schools of aviation are already training aviators; courses of aeronautical engineering, though popular in Europe, are at present not greatly needed in America.

In Europe two kinds of aeronautical-research institutions are in active operation; the one kind privately endowed and managed in the interest of science and the art of construction; the other kind supported by governmental appropriation, and conducted largely in the interest of the military service, though frequently publishing valuable data which may be available to the world at large. We may devote our attention at present to the private and civil institutions, since their status and operation have been more fully made public.

Near Moscow, in Russia, is the celebrated Institut Aerodynamique de Koutchino, under the directorship of

D. Riabouchinski, established by him in 1904 at a cost of 100,000 roubles and provided with an annual income of 36,000 roubles, or about \$18,000. This laboratory is intimately coordinated with the University of Moscow, and is devoted to the greatest variety of investigations in pure and applied aerodynamics, meteorology and aeronautics generally.

The personnel of the institute comprises a group of competent scientific men and skilled mechanics. Dr. Riabouchinski, a patron of aeronautics both wealthy and versed in the science, is the leading spirit. With him is directly associated Mr. Kousnetsov, assistant director. There is a business manager, an assistant manager, a computer and a librarian. Prof. Joukovski, of the University of Moscow, an honorary member of the above scientific staff, agreed to make a theoretical study of a part of the experiments, and his students were encouraged to conduct researches in the laboratory at Koutchino. In the workshops are nine skilled mechanics and six laborers.

The institute comprises four buildings surrounded by ample grounds in the open country. There is a commodious dwelling and office building for the technical staff, a dormitory for the workmen, a main laboratory and a power house. The main laboratory is a two-story building measuring about 50 by 115 ft., and having at one corner

a tower 65 ft. high; it comprises an ample machine shop and carpenter shop well furnished with hand tools and power tools, various minor rooms, and a large two-story experimental room. This latter is equipped with a wind tunnel (Fig. 1) and sundry measuring apparatus mostly constructed at the

institute. The power house is a one-story structure measuring about 35 by 60 ft.; it comprises a boiler, dynamo and engine room, an accumulator room, and a forge room.

The original program of investigations comprised three principal sections. The first section, devoted to studies of air resistance, included determinations of coefficients of resistance of various shapes; determinations of the center of pressure on various models; determinations of the lift, tractive force and stability of models in flight, etc. The second section, devoted to practical applications of the laws of air resistance, included the construction and test of helicopters, kites and aeroplanes of various types; the lifting of loads, signaling

and photographing by means of kites, etc. The third section was to be devoted to the scientific exploration of different strata of the atmosphere. The program has been carried out with great skill and care. The results are published in excellent form, from time to time, in the elegant bulletins of the institute.

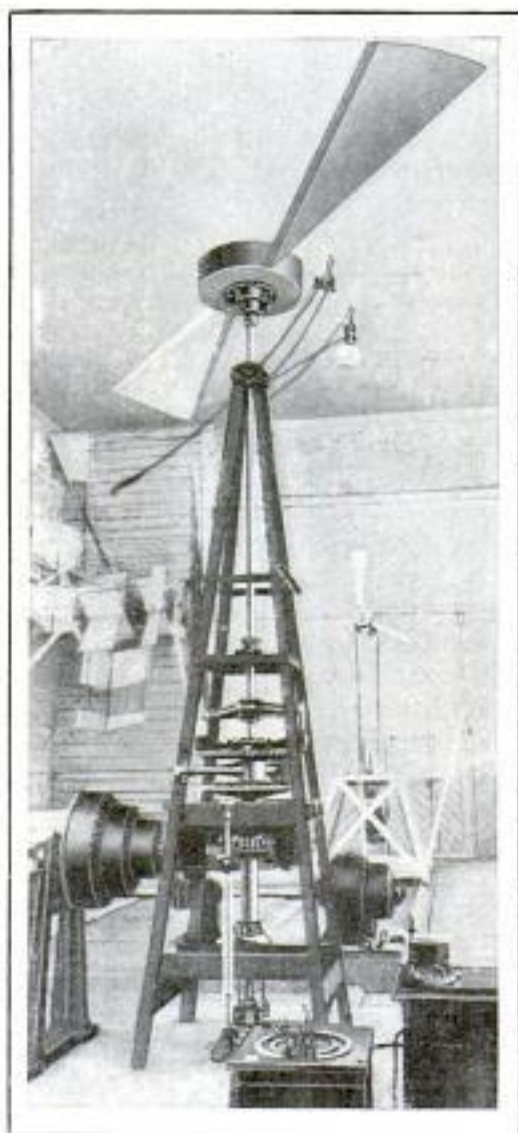

Fig. 2—Propeller-Testing Apparatus of the Aerodynamic Institute at Koutchino

In Germany a well equipped aerodynamical laboratory, endowed with an income of \$7,000 per year, has been established at the University of Göttingen, and has been in practical operation for three or four years. It is under the direction of Prof. Prandtl, who holds the chair of aeronautics in the university. He is assisted by various private lecturers, and has as technical advisers men prominent in mathematical and physical science and engineering. The endowment was furnished primarily by private individuals, and has been supplemented by governmental appropriation. It may be remarked that the sum of \$7,000 a year in Germany has the purchasing power of almost twice that amount in America.

The experimental laboratory of the Göttingen establishment, apart from the constructional and executive departments, is a one-story building, in size about 30 by 40 ft., comprising a wind tunnel and two rooms, one for desk work, the other for instrumental observations. The wind tunnel of the laboratory, consists of a continuous closed channel, two meters (6.56 ft.) square in cross section and as long as the building. Through this tunnel the air is forced in steady closed circulation by a screw ventilator about 6.5 ft. in diameter, actuated by an electric motor of 30 hp. A wind speed up to 10 meters (32.8 ft.) per second is thus available when the motor is running at half load.

In order to insure perfect uniformity of flow in the air stream all over its cross section, special guide and equalizer surfaces were devised. At each bend of the stream a number of turbine-like blades divert the air gently

through 90 deg., thus obviating the whirlpools which would otherwise occur. On leaving the ventilator the vexed and turbulent stream passes through a sheet-metal "honeycomb" (Fig. 3), comprising 400 cells, each about 4 in. square by 20 in. long. Later it passes through a second "honeycomb," comprising 90,000 cells proportionately smaller in section and about half a foot in length. Thus ironed out, the air flows in a steady uniform horizontal, rectilinear current through that portion of the tunnel where models are to be inserted to have their resistance investigated.

With this equipment the technical staff of the laboratory has made many important investigations. The lift and resistance of inclined-plane and arched plates have been measured at many angles of incidence, and with various ratios of length to breadth of surface. The effect of rounding and sharpening the front and rear edges of such plates also was studied. The vertical action of the aeroplane wake on the rear horizontal rudder was investigated. The resistance of wires, cords

and ropes likewise has been measured at various wind speeds up to 10 meters (32.8 ft.) per second.

Perhaps the most interesting of the early researches in the Göttingen wind tunnel pertain to hull forms, or "balloon models," as they were called. Various torpedo-shaped copper shells, formed by electrodeposition, were suspended by fine wires in the uniform air blast, to determine their resistance. Then as successive holes in the shell from prow to poop were solitarily opened, the internal pressure of the shell was measured with a delicate

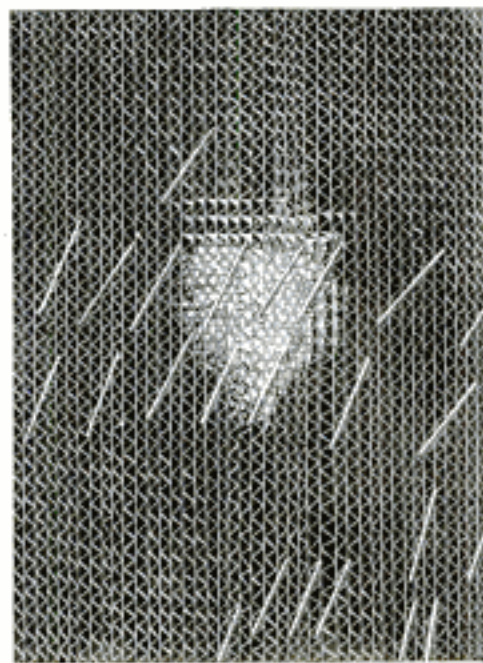

Fig 3—Honeycomb Sections of the Göttingen University Wind Tunnel, Which "Iron Out" the Wind, the Irregular Strips Correcting Inequalities

gauge. Thus the external surface pressure at each hole became known. Summing the local pressures all over the model gave the entire resultant

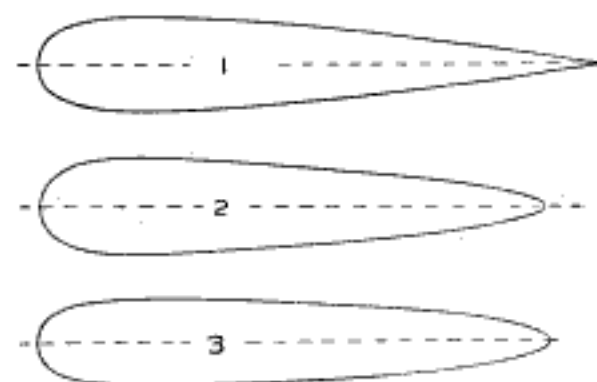

Fig. 4—Hulls of Easy Shape Tested in the Göttingen University Wind Tunnel

wind pressure, independently of the air friction along its surface. Subtracting the resultant wind pressure from the whole wind force on the model gave the resultant wind friction.

Of the models investigated, and shown in Figs. 4 and 5, the form of least resistance, for moderate wind speeds, is the whale-shape, No. 4. Next in order of efficiency are 6, 5, 1, 3, 2. The pressure at each point of a longitudinal line of model 6 is shown in Fig. 6, where positive wind pressures are indicated by distances above the axis of the figure, negative pressures, or suction, by distances below that axis. As both prow and poop show positive

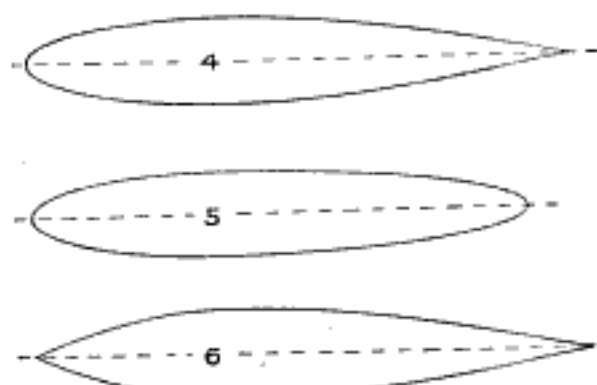

Fig. 5—Other Hulls of Easy Shape, No. 4 being the Shape of Least Resistance

pressures, the model is manifestly resisted in front and boosted behind. The suction exerts a propulsive effort be-

fore the major section, a retarding effort behind. The most efficient shape, 6, has at the higher speeds given about 1/18 the resistance of its major circle exposed squarely to the wind. In the interest of rapid transit, these researches should be extended to speeds exceeding 100 miles an hour.

In France, Mr. Basil Zaharon has given \$140,000 to found a chair of aeronautics in the University of Paris, and Mr. Deutsch de la Meurthe has donated to the University the Institut Aero-technique de Saint-Cyr, Fig. 7, near Versailles, founded at a cost of \$100,000, and endowed by him with an income of \$3,000 a year for maintenance. The establishment was ready to begin active operations in July, 1911. Its director is M. Maurain, Doctor of Sci-

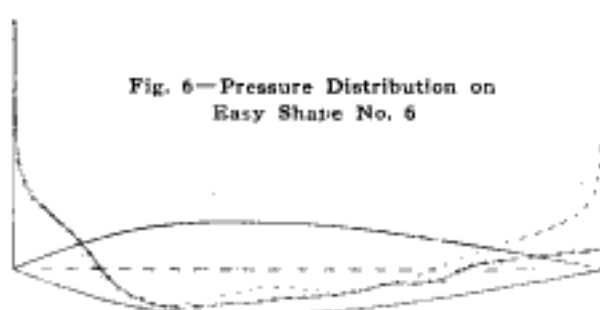

Fig. 6—Pressure Distribution on Easy Shape No. 6

ence, and former professor in the faculty of sciences of Caen. He has on his advisory committee many of the most eminent scientific and aeronautical experts in France together with prominent representatives of the University of Paris, the Aero Club of France, and various civil and military departments of the government.

The institute comprises nearly 20 acres of clear, dead-level-land adjoining the maneuver ground of the government military school, at a convenient railway center a few miles from Paris. Some 12 acres are reserved for buildings; the rest forms a narrow strip 4,400 ft. long containing an electric road (Fig. 8) for transporting models at various speeds when studying their resistance in free air.

The first structure erected is the main building which measures over all some 260 ft. long by nearly 200 ft. wide. This has a main testing hall over 60 ft.



Fig. 7—General View of the Aerotechnical Institute at Saint-Cyr, France, Founded by Deutsch de la Meurthe

wide, running nearly the full length of the building, and having grouped about it the store rooms, workshops, power plant, chemical and physical laboratories, etc. Two large square towers on the front corners of the structure, three stories high, serve as headquarters for the administrative and technical staff, together with the library, drafting room, museum, etc.

Among other buildings in the original plan are dwellings for the persons in charge, and a large roundhouse one story high. The roundhouse, which measures nearly 120 ft. in diameter, was designed to shelter a whirling table, the extremity of whose whirling arm was to describe a circle some 300 ft. in circumference and carry various models subject to aerodynamic study. This can be used in any weather, while the electric road can be used only at special times, and mostly during fair and extremely calm weather.

The character and scope of the work of the Aerotechnical Institute are all that can be desired. Both governmental and commercial, both private and institutional investi-

gations and tests are conducted. The results are made public or kept confidential as desired by the persons immediately concerned. Apparently, therefore, it meets all the needs of thorough science and practical industry.

Prior to Deutsch de la Meurthe's magnificent endowment, another wealthy and liberal patron of science in France, G. Eiffel, the famous builder of the Eiffel Tower, won renown for his country and himself by elaborate researches in aerodynamics made at his own expense, and with the aid of two capable engineers associated with him. He first determined the resistance of bodies falling from the tower through still air; then he studied the behavior of models held in moving air in a wind tunnel of his design. From the ex-

perience so acquired, he, in 1912, built an entirely new aerodynamical laboratory containing two wind tunnels, a large and a small one, in which to prosecute with better advantage his splendid investigations.

This maturer type of the Eiffel wind tunnel is shown in Fig. 9. A screw suction fan, driven by an

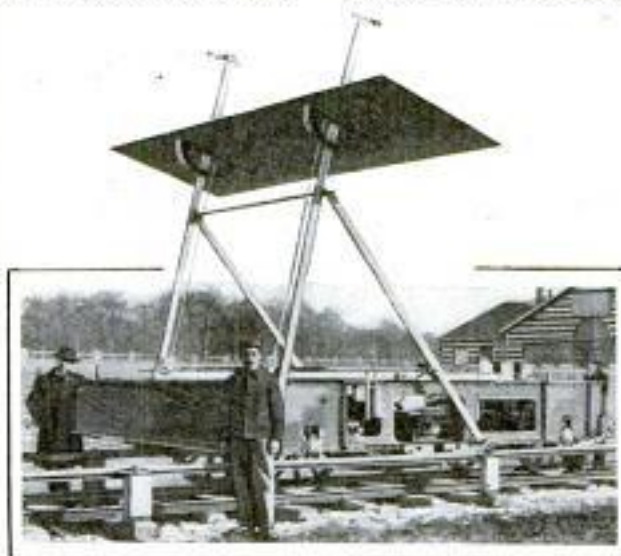

Fig. 8—Electric Car for Air-Resistance Measurements, Aerotechnical Institute at Saint-Cyr

electric motor, causes air to flow through the long tube, as shown by the arrows, and to return on its out-

an interesting evolution from the experience of Eiffel and his predecessors in aerodynamic research.

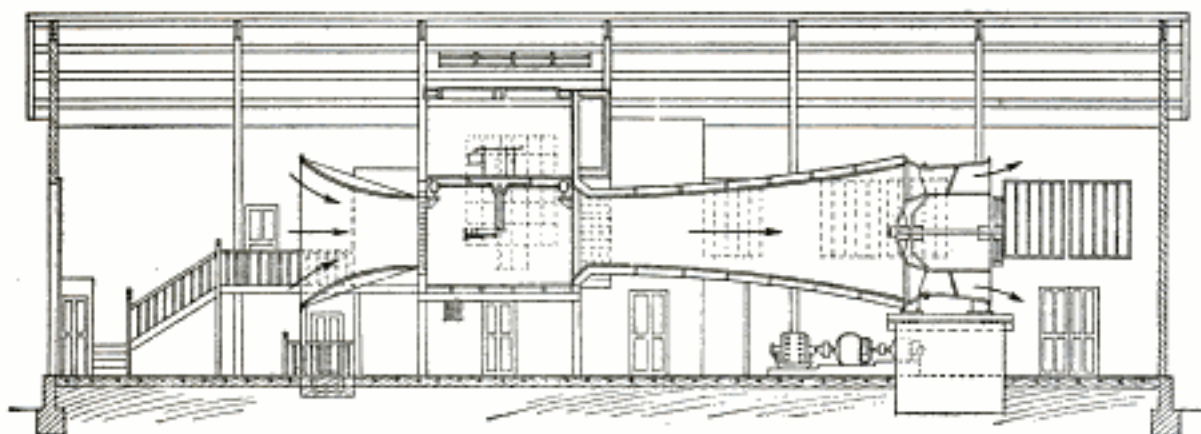

Fig 9—Longitudinal Section of Eiffel's Wind Tunnel, the Course of the Wind being Shown by Arrows; the Little Black Figure in the Center Chamber being the Model Which is to be Tested

side in symmetrical flow through the room containing the tube. The current enters the tunnel by a large conical mouth containing a "honeycomb" partition at its smallest section, passes, in smooth and uniform stream, through the honeycomb into an experimental chamber, thence into the exhaust cone as seen in the illustration. Thus, for reasons that are obvious, a continuous closed circulation is maintained at a minimum cost of motive power. The models to be studied are placed in the wind stream where it emerges from the honeycomb. Their lift, their resistance and their center of pressure are determined by

With an equipment similar to this, Eiffel and his engineers made many important investigations, particularly on plane and arched plates set at various angles to the current. Figure 10, for example, shows the distribution of pressure found on a wing shape at the angles of incidence shown. The lines projecting downward from the under surface indicate the intensity of the wind pressure at those points, while the lines projecting above the upper surface indicate the intensity of suction. The pressure or suction at any point was found by perforating the surface there, and connecting the interior of the perforation with a delicate manometer. The negative figures indicate

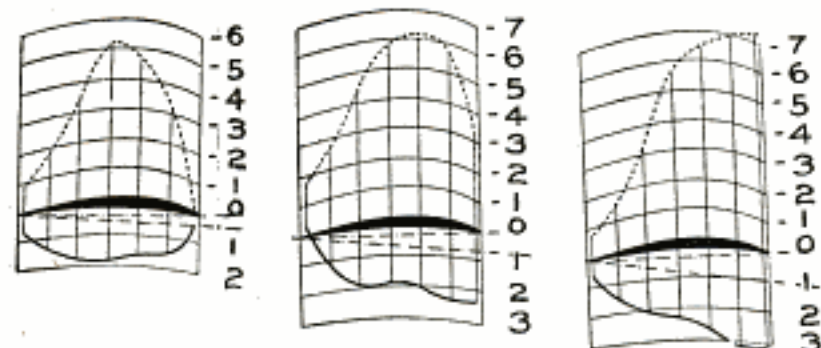

Fig 10—Pressure Distribution on a Wing Shape at Various Angles of Incidence, as Found by Eiffel by Means of Wind-Tunnel Studies

a special balance which supports them during an experiment. The pressure at every point of their surface is measured as explained in describing the Göttingen laboratory. This tunnel is

The negative figures indicate suction intensities. By summing the point pressures so found, the resultant pressure could be determined in both magnitude and position. The particular diagrams here given show that the lift of such a wing is due much more to suction above than to pressure beneath its surface.

Similar diagrams were obtained for a great variety of wing forms, and happily enough it was found that from the study of such models in the laboratory the behavior of full-size aero-

planes can be accurately predicted. Well equipped aerodynamical laboratories similar to those heretofore described, but in governmental service, have been in operation for some years in Italy and England, the former as a part of the military establishment, the latter as a part of the British National Physical Laboratory. Space will not permit an account of them in this article. But enough has been said to indicate the liberal and serious nature of the aeronautical laboratories of Europe. America is the only first-class nation without

an aeronautical institute. It is to be hoped that when the American Aeronautical Institute is finally established, its endowment will be commensurate with the wealth and population of our country, and that its contributions to aeronautical science will rank with the splendid achievements of our pioneers in the practical development of aviation. The founding of such an institute, or one laboratory thereof, should appeal to any lover of mechanical science who would establish a monument of great permanent value to his country, and worthy to perpetuate his name.

ICE FLOES AS REFUGE FOR "TITANIC'S" PASSENGERS

It seems incredible, according to the Hon. P. T. McGrath, a member of the legislative council of Newfoundland, that in all the multitude of people on the "Titanic" no one thought of the ice floes as a means of saving all on board. There is widespread regret among the hardy fisherfolk of Newfoundland that this, to them, obviously simple and effective method of saving all on board was not utilized. Their idea is that the ice floes could have been used as gigantic rafts, the boats being used to convey passengers and crew to them, to remain until rescue ships arrived.

The idea is one, says P. T. McGrath, that would have immediately commended itself to a Newfoundlander, and it is one that has already won historical recognition. He here refers to the famous ice-floe journey of the survivors of the Arctic steamer "Polaris," who, in April, 1873, were picked up from an ice floe on the Grand Banks after drifting six months and covering 1,600 miles.

CANVAS HOUSING ON STREET SWEEPER

The street sweeper used in Klamath Falls, Ore., is provided with a rather unusual housing to prevent the dust from flying. Built around the rear por-



The Canvas Housing on the Rear of the Street Sweeper Keeps the Dust from Flying

tion of the machine, wheels and all, is a light framework covered with heavy canvas. The canvas drops close to the surface of the road, and effectively confines the dust, even when the machine is used on absolutely dry streets.

Incubators are used in South Africa not only in raising ostriches, but for hatching alligators, the latter being bred in large numbers to supply the demand for alligator hides.

COMBINATION LOCK FOR UMBRELLAS

An umbrella made thief-proof by being locked in such manner that it cannot be opened has been invented by a coat-room attendant of a London cafe. That it will really keep an umbrella from being "borrowed," however, is to be questioned, for, as is shown in the series of illustrations, it is very likely to be taken and then, when the borrower finds he cannot open it, dropped disgustedly in the street, which does not preserve it for the owner.

The locking device consists of a metal collar, one end of which may be slipped down over the rib tips, and is securely locked to them by revolving the three metal rings. These rings bear the letters and numerals of the secret combination.

A Combination Lock Which Confines the Rib Tips of an Umbrella.

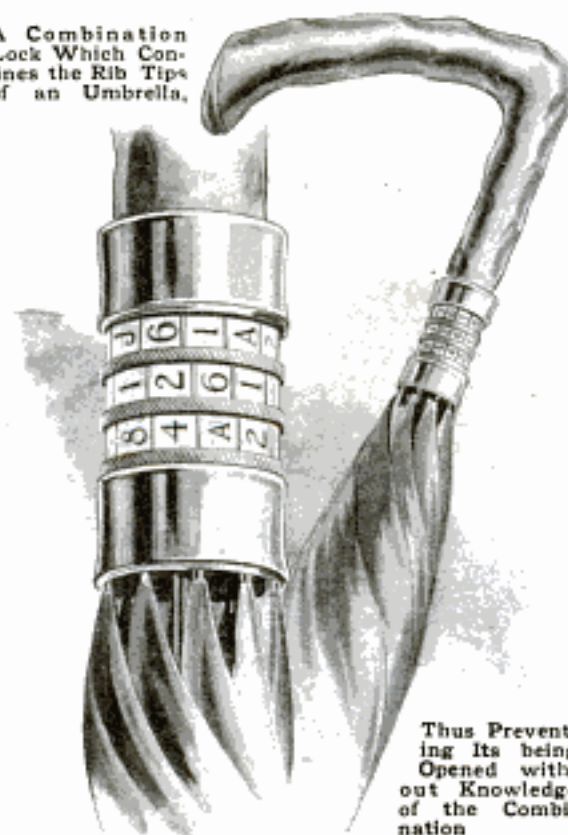

Thus Preventing Its being Opened without Knowledge of the Combination

USING THE OLD AUTO PIECEMEAL

How to put to practical use the parts of an old automobile has been ingeniously worked out by an Oregon man on his country place, according to a description given

in Motor World by a visitor who was astonished at some of the results. In the living room a "lazy seat" of peculiar shape but obvious comfort turned out to be the tonneau of the old car. The leather of the seat was almost as good as new, the upholstery deep, and the settee was very roomy and inviting.

In his incubator house was a hot-water radiator which supplied the necessary heat in winter so that the heating within the incubators should not be too difficult, and this radiator was another part of the old car, the engine radiator connected up by pipes with the hot-water system of the house kitchen.

The old four-cylinder motor was set up in the basement and connected with a little dynamo, developing enough power to light the whole house. In order to obviate the necessity of running the motor and dynamo continuously, the owner had installed four accumulators or storage batteries which furnished the lighting current direct, and only needed occasional charging by the dynamo—an economical arrangement.



EXHAUSTIVE UTILIZATION OF SPRINGS

Water farming is the name that may properly be applied to the operations of an enterprising man in North Providence, Rhode Island, for he utilizes the water of two springs to supply a bottled-spring-water trade, to keep a swamp where he grows watercress for the market properly saturated, and to furnish a steady flow of pure water to a trout hatchery. Further along the little stream the overflow is dammed and supplies power for a laundry, besides which the mill pond gives a crop of fine ice every winter. All the branches of his farm are showing profits.

CHARGING BATTERIES BY MEANS OF LIGHT

The possibility of some day being able to charge electric storage batteries by exposing them to the sun, or, in other words, to economically transform the



Trout Hatchery on Water Farm, Using Overflow from the Springs

light energy of the sun's radiations into electric energy, is being advanced by a German scientist who has succeeded



Reservoir on Water Farm from Which Ice Crop is Obtained



Shop for Bottling Spring Water

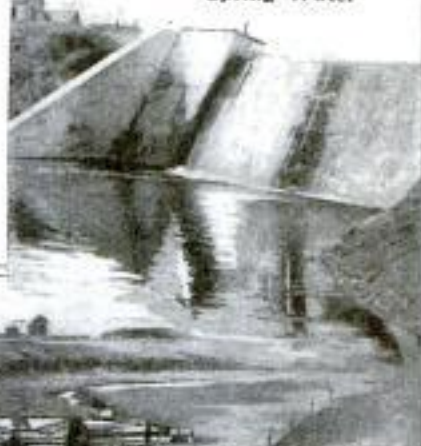

Dam Which Makes Available Power for Operating Laundry

in charging his experimental batteries by means of ultraviolet rays.

The charging of an electric battery consists in producing through electrolysis a chemical reaction

in it, which is the reverse of that which takes place when the battery is discharging or producing an electric current. Inasmuch as light, or rather the ultraviolet rays, is capable of inciting chemical reactions, it would seem, according to the French scientific magazine *Cosmos*, that a storage battery could be constructed which, after exhaustion, could be recharged by the influence of light.

In the experimental battery recently made by the German scientist, all that is necessary for charging is to submit the two chemicals in which its two platinum electrodes are immersed, to the action of ultraviolet rays from a mercury-vapor lamp.

So far the battery is only a labora-

tory curiosity without any pretense to immediate industrial use. The cell has the usual form of a glass jar, and it would require thousands of them to produce a power of one watt, and millions to produce one horsepower.

The German scientist has also experimented with solar light, but this, with the present apparatus, gives four or five times less than the power obtained by means of the ultraviolet rays from the mercury-vapor lamp.

AMMUNITION TRAYS FOR QUEEN'S PATHWAY

History returned to the business of repeating itself in order to make the recent visit of Queen Wilhelmina of Holland to Paris memorable, and the annals of the day written into future histories may place the Dutch Queen in the same category as Queen Elizabeth, giving the place occupied on a certain memorable occasion in the latter's life by Sir Walter Raleigh to the soldiers of a French artillery regiment. The Queen of Holland accompanied the President of France on an inspection of troops in the field and during the inspection a heavy rain fell, turning portions of the field into a morass. In order that the fair royal visitor should not get her feet wet the French artillerymen robbed their guns of am-

munition trays with which they made a walk for her majesty all the way across the field. As there were only a few trays it was necessary for the soldiers to constantly pick up those that had been passed over and lay them in front of the queen as she progressed in her walk. The wooden pins on the trays to hold cartridge shells in place sank into the soft mud and held the improvised walk firmly in place.

“It's raining kilowatt hours,” is an expression that is being used in Norway during heavy rains, referring to the fact that every inch of rainfall helps to keep filled the reservoirs which feed the great electric-power plants there.



Courtesy Illus. London News
Soldiers of France Save the Shoes of Holland's Queen by Making a Pathway for Her across a Muddy Field

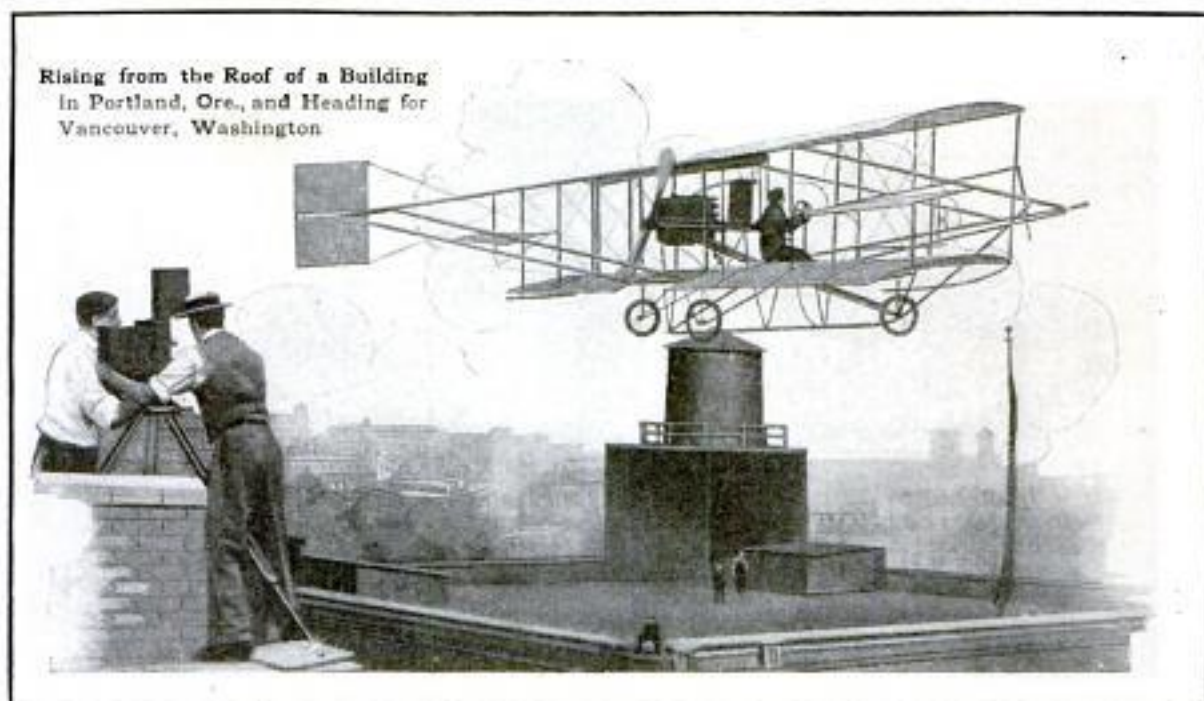

AEROPLANE RISES FROM ROOF OF BUILDING

That the provision of roof landing places on some of the latest hotels now erected or about to be erected may some day be of real practical use, instead of being just a good feature for advertising purposes, as at present, is attested to by the accompanying illustration. It shows Silas Christofferson, a young Portland, Ore., airman, rising into the air from the roof of a Portland building. A track was laid on the roof and the machine ran along this until about 25 ft. from the edge, then rose into the air, and started for Vancouver, Washington. Faulty air currents which airmen expect close to buildings did not give him much trouble.

RUSSIAN DANCING GROTESQUES

Apparently even the Russian dancers whose wonderful art has held supreme sway in European capitals, and particularly London, for the past year or two, must present novelties along with more serious work to hold the interest of the general public. At least it would seem so, for in one of the ballets presented at Covent Garden, London's

premier opera house, this summer, the three dancing grotesques shown in the illustration made their appearance.

These, however, were only an insignificant part of the ballet, the greater part of which displayed the art of



The Dancing Monsters of a Ballet Presented in England by the Russian Dancers

which Pavlova and Nordkin are still, although not now dancing together, the most famous exponents.

BRIDGE OF MODERN LINER, SHOWING POSITION

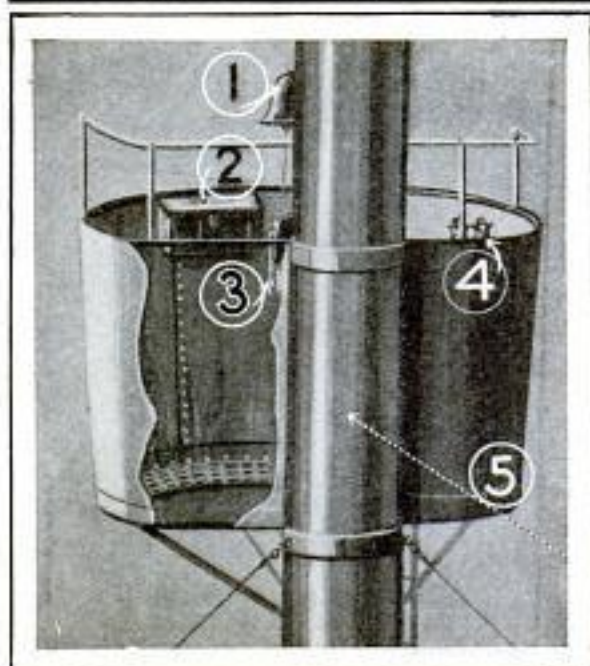
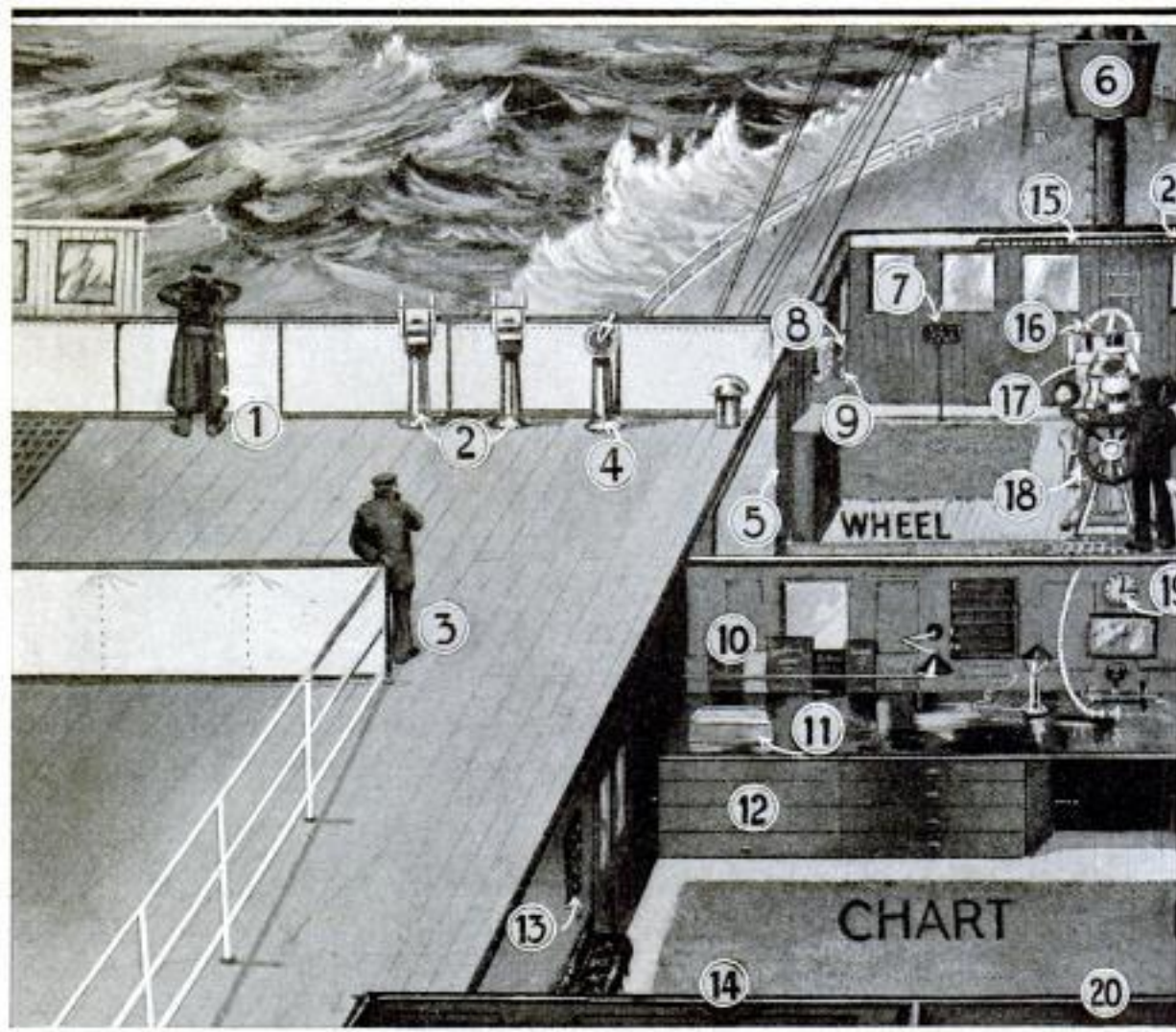

The Typical Crow's Nest. 1, Bell, rung every half hour; 2, Box for binoculars; 3, Telephone to bridge; 4, Speaking tubes; 5, Distance to bridge, 125 ft.

The interest evinced by the general public in steamship construction, routine, and navigation since the "Titanic" disaster has naturally been greater and more widespread than ever before. In the accompanying illustration, reproduced by courtesy of the Sphere, London, is shown in detail the positions of the officers and men of the watch, and the location of the navigating apparatus on a modern transatlantic liner. It shows, in fact, the arrangement of the bridge of the "Olympic," the sister ship of the "Titanic." 1, Fourth officer (on duty); 2, Port engine and docking telegraphs; 3, Relief quartermaster; 4, Telegraph for watertight doors, etc.; 5, Sliding door; 6, Crow's nest on forward mast, with two men always on duty; 7, Bulkhead telltale, which indicates condition of bulkheads; 8, Submarine signaling receivers; 9, Engine room and crow's nest telephone; 10, Logbooks; 11, Magnetic clock case; 12, Drawers for charts; 13, Bridge switchboard; 14, Chief officer's cabin; 15, Telltale points; 16, Hydraulic ram for governing steering engine; 17, Binnacle; 18, Wheel; 19, Clock; 20, Officers' quarters; 21, Pointer; 22, Fire-alarm bell, ringing throughout the ship; 23, Quartermaster at helm; 24, Shutters pulled down at night; 25, Chart spread on plate glass; 26, Captain's cabin; 27, Ordinary seaman on bridge;

OF NAVIGATORS AND NAVIGATING APPARATUS

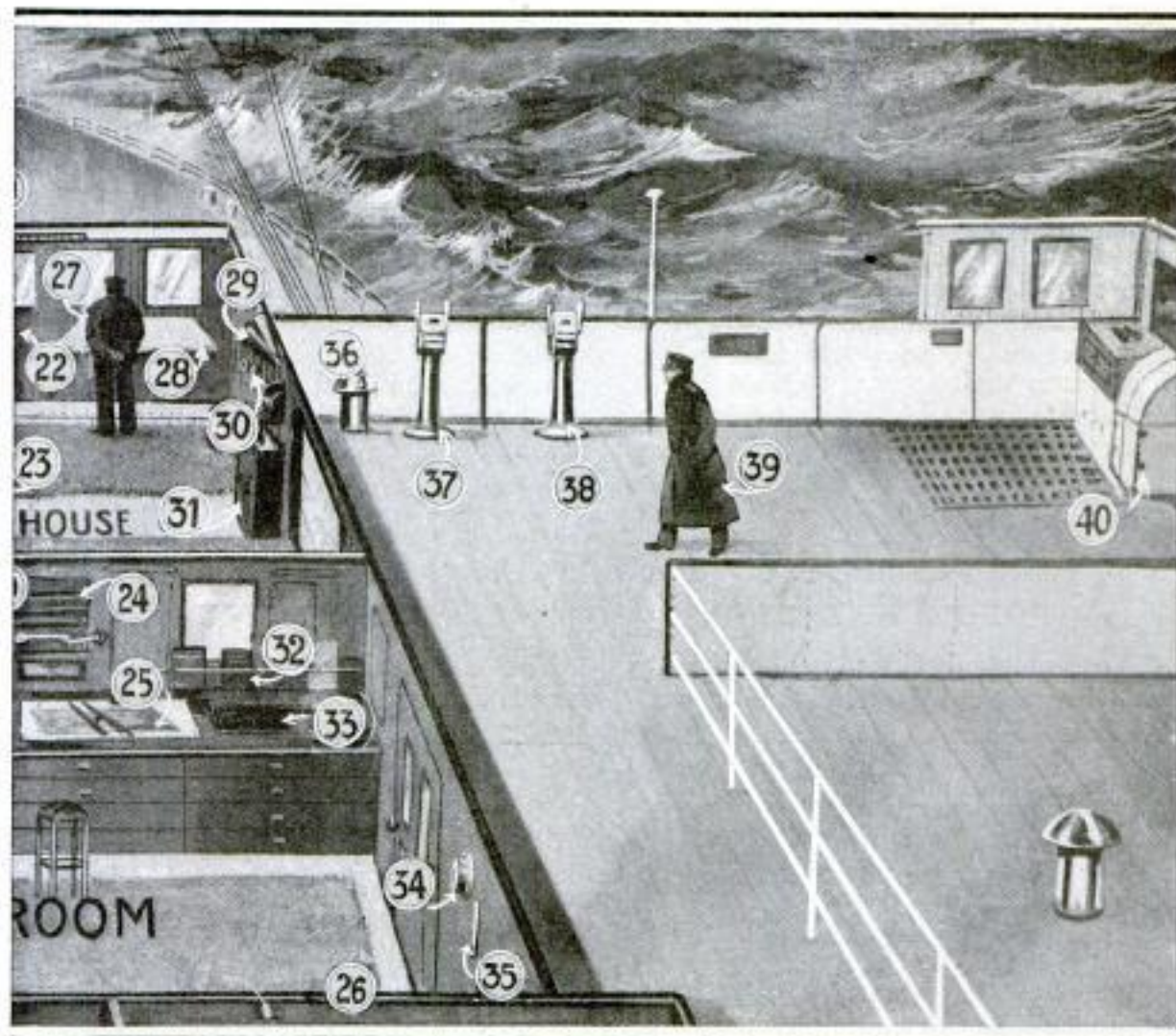

22, Work table; 23, Megaphone; 24, Poop telephone; 25, Signal locker; 26, Compass table; 27, Chronometers; 28, Barometer; 29, Thermometer; 30, Ventilator; 31, Starboard docking telegraph; 32, Starboard engine-room telegraph; 33, Chief officer of the watch; 34, Starboard lamp box; 35, 36, 37, 38, 39, 40.

IRON-WELDING PROCESS USED BY ROMANS

Methods employed by Romans, during their occupation of England, in welding iron have come to light through recent investigations by British scientists following the discovery of one of the largest masses of Roman wrought iron ever found in England. This was unearthed at the site of an ancient Roman town west of the village of Corbridge, on the Tyne. The block of iron was 3 ft. 4 in. long by 7 in. square at one end, which was rough and rather spongy, tapering down to about 4½ in. square at the other end,

which was well rounded. It appeared that the block was made by welding together comparatively small lumps of iron produced by a direct reduction process in small charcoal fires. The block was sawed through its entire length and the cut faces planed, polished, photographed and afterward etched with a solution of nitric acid and water and again photographed.

After the faces had been strongly etched, it was easy to trace the lines of welding, not because of the imperfection of the welding, which was gener-

ally very good, but on account of the slight physical difference in character of the metal on the sides of the junctions. From these sections it was perfectly clear how the pieces were joined together. In general terms, slabs approximately lenticular in section were employed. After the smaller end was made, the piece at this stage probably had a similar appearance and shape to the upper end of the block in the condition in which it was found in the furnace with projecting taper pieces. After forming the foundation piece,

two slabs must have been inserted and the mass then heated to welding temperature, after which it was removed and welded by hammering, but by what kind of implements there is no evidence. Step by step this process was repeated until the block of the size and dimensions as described was obtained, plus, of course, the portion which had been removed by subsequent rusting. It seems probable that the block was in course of further development at the time it was left in the furnace.

MILITARY AEROPLANE WITH FOLDING WINGS

The difficulty of hauling aeroplanes along a road and over fields is a prob-



A French Military Aeroplane Whose Wings can be Folded When the Machine is being Hauled over Roads or Fields

lem considered of no small importance in French army circles, and one way developed to do away with much of the difficulty is here shown. The machine is a Moineau biplane, whose planes may be readily folded for road haulage without detracting from the strength and stability of the machine when in flight.

A school to teach women to be carpenters and bricklayers is to be started at Winfield, Long Island, this fall and it is reported that 40 women have already enrolled as students.

"JAY WALKING" STOPPED IN KANSAS CITY

The city pedestrian who cares not for traffic regulations at street corners, but strays all over the street, crossing in the middle of the block, or attempting to save time by choosing a diagonal route across a street intersection instead of adhering to the regular crossing, is designated as a "jay walker," in Kansas City.

Kansas City recently adopted a new ordinance for the control of foot traffic as well as vehicles, and "jay walking" is to be prevented

as rigidly as "jay driving."

HORSELESS CITY PLANNED IN INDIANA

Horses will be barred from the new town of Speedway, laid out in the environs of Indianapolis. By autumn, it is said, the new city will be well under way and it is expected that the place will become an important industrial center, devoted exclusively to interests allied with the motor-car trade.

It is admitted that the humble equine is aiding in building the new town, but after it is completed, neither

he nor any of his four-footed fellows will be permitted to enter the city sacred to motor-driven vehicles. Leases will stipulate that horses must not be used for any purpose; and the butcher, baker and grocer will necessarily have to resort to the motor truck for delivery purposes. The fire department will be wholly equipped with motor-driven apparatus, and the patrol wagons will race down the streets without clatter of iron-shod hoofs.

The government of Speedway will be intrusted to men identified with the motor trade, and the streets will bear names illustrious in the motor world.

The principal part of the new city will be directly south of the Indianapolis motor speedway, while part of the town will be west of the famous track. No factories will be admitted in Speedway unless they are in some manner identified with the motor-car trade.

Another feature of the horseless town is that it will be constructed throughout of concrete, rendering it fireproof. It is predicted the motor fire department will have little to do.

A SPEAR SHARPENER OF THE ROMANS

Among the recent discoveries at Wallsend, Eng., at the end of the great



Courtesy Illustrated London News

A Stone Found in England and Probably Used by the Romans for Sharpening Spearheads

Roman wall which stretched across Britain, is a stone which is believed to have been used by the Romans to sharpen their spears. The hollow in the middle probably contained water in which the spearheads were dipped before being sharpened by being rubbed on the sides of the two other cavities.

HANSOM CAB TAKES PLACE IN MUSEUM

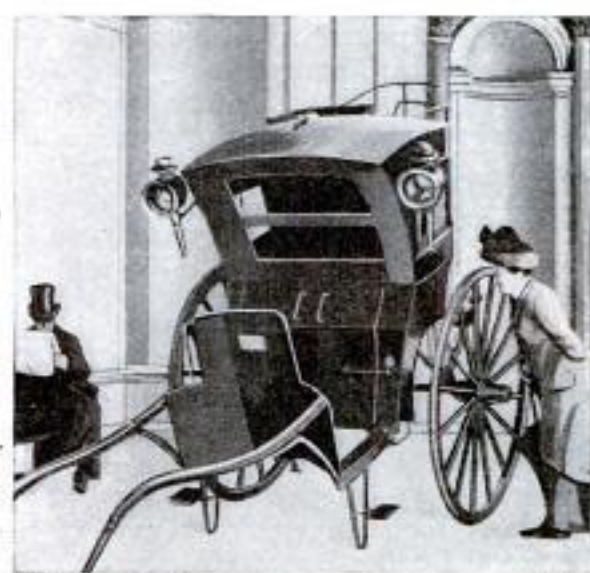

The Hansom Cab is so Nearly Extinct in London that One of Them has been Placed as an Exhibit in the London Museum

That the hansom cab, whose real home was London, should have become so rare in that city that one has actually been installed in the London Museum as a curiosity, may seem startling even to some Londoners at home, to say nothing of the Englishmen who have been away from home even no longer than four or five years and still keep vividly in mind London as they last saw it.

Although "hansom, sir?", is still heard once in a while in London, this type of vehicle is almost extinct, and its complete disappearance is expected in the near future.

⌈The trackless trolley system has been adopted, after thorough tests, for the haulage of freight in Altona, Germany.

THE INFINITELY GREAT AND THE INFINITELY SMALL

By FOREST RAY MOULTON

THE discoveries of modern science have astonished men both by revealing how enormously large the universe is, and also by showing how infinitely small the minutest particles of matter are.

The earth is very big and, until two or three centuries ago, was supposed to be the largest thing in the universe. But the sun is a million times as large as the earth; the whole solar system is 800 million times as big as the sun; the Orion Nebula is 16,000 million times as big as the solar system; and that part of the universe which is now within the range of astronomers' telescopes is 100 million times as big as the Orion Nebula.

While the earth is infinitesimal when compared to the universe beyond, it is yet of enormous dimensions, for there are in it 2,000 million cubic miles of matter. The average weight of a cubic mile of the earth is 23,000 million tons. In each ton there are on the average 10,000 cubic inches. The smallest object visible through a powerful microscope has a diameter of about one ten-thousandth of an inch. There are one trillion of these units in a cubic inch. The material of which the earth is composed is made up of small units of many kinds of matter called molecules. The investigations of Lord Kelvin have shown that it would take 50,000 molecules placed in a row to make a line one ten-thousandth of an inch long. Therefore, in one microscopical unit of material, there are 125,000 billion molecules. The molecules are made up of from two to a hundred smaller masses which the chemists call atoms. Probably an atom is not over one thousandth the size of a molecule. Recent discoveries respecting radium have proved that the atoms themselves are made up of very many smaller particles called electrons, or corpuscles. In an atom there are from 1,000 to 200,000 of these electrons, and on the average the volume of each electron is prob-

ably not greater than one one-hundred-thousandth of that of an atom. From this it is apparent that the infinitely small is as astonishing as the infinitely large.

A little reflection on the very large and the very small leads to some most astonishing conclusions. It is found that things are not great or small in the absolute, but only relatively to ourselves and the things with which we are most familiar. To illustrate this, suppose that on some night every person in the world should become unconscious and that, by some miracle, everything in the world and beyond it should become just one-half as great in length and breadth and thickness as it is now. The question is whether a person would detect any difference when he awoke in the morning. He would find his clothes only half as large in each direction, but they would fit him just the same because he would be only half as large in each direction. His chair would be only half as high, but it would seem just as high to him because he would be only half as tall. When he left the house to go to the car, the distance would be only half as far, but it would seem just as far because his steps would be only half as long. In fact, everything would seem just the same to him, and it can be absolutely proved that there would be no way whatever for anyone to find out that there had been a change. This is, of course, under the hypothesis that only the lengths, breadths, and thicknesses are divided by two, while everything else remains unaltered.

Now, it is clear that there is no reason why it should be supposed that everything is divided by exactly two. The results would be the same if it were supposed that, instead of being divided by two, everything were increased by the factor two, or even to such an extent that a man would be as big as the earth is now. Other men and things would be increased in the

same proportion and he would seem to himself no larger than he does at present. Or, if everything were diminished so that a man became the size of a microbe, he would notice no change and would feel just as big and important as he does now.

It is not in space alone that matters are purely relative. In time the situation is exactly the same. If the earth and celestial bodies moved twice as fast, if clocks ran twice as fast, and if our thoughts came twice as fast, we should not be able to detect any change. If, indeed, everything should run so fast that the experience of a life time would be concentrated into what is now one second, a man would seem to himself to live just as long as he does under present conditions. When misfortunes or troubles overtook him, the hours would seem to drag along as slowly as they do now.

Or, on the other hand, if things should go more slowly, time would seem to pass as fast as it does at present.

It can be gathered from these illustrations that what is great or small, or long or short, is purely so relatively to our experiences. It follows that time, for example, in its most fundamental sense is not measured for a thinking being by clocks and watches or a circling world, but by the number and variety of thoughts that flash in his consciousness. Hence there can be no doubt that a life in its true measure is long or short according to its intellectual experiences.

¶The horse butchers of France have recently held a meeting for the purpose of requesting the government to enforce a tariff on imported horse meat in order to protect the native butchers.

ENGLAND'S NEW FLOATING DRYDOCK

In the accompanying illustration is shown the almost completed floating drydock, which was constructed to accommodate the largest battleships of the British navy. It has a lifting capacity of 32,000 tons. The dock was launched in two portions, the launching of one of which was illustrated in a recent issue of this magazine. The immense dock will be located in the estuary of the Medway River, which is one of the important harbors for the British navy, and, in fact the nearest to London of England's great naval bases.

It is the first dock in the vicinity large enough to accommodate the huge super-dreadnoughts of the British navy, and its construction was imperative.

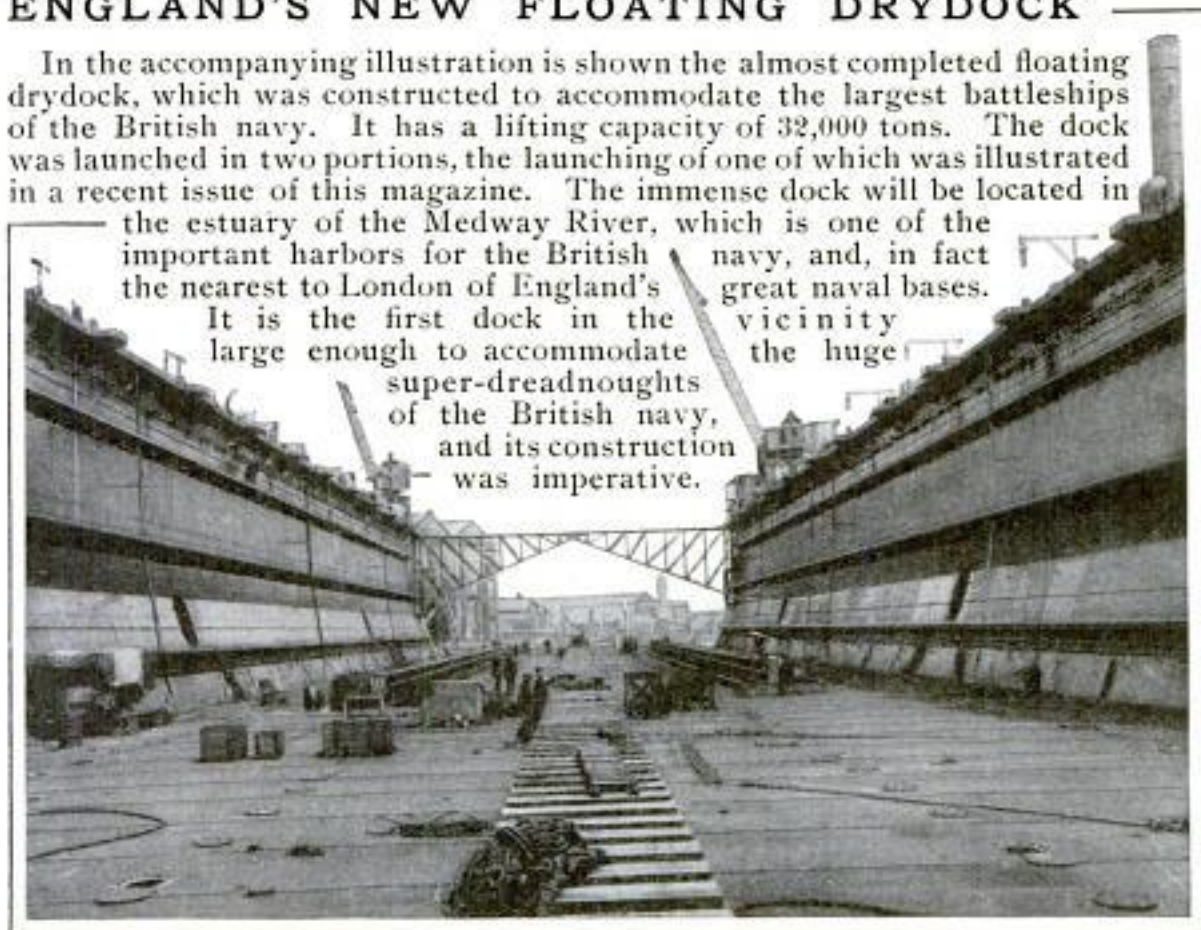

The Floating Drydock Which Will Accommodate England's Largest Battleships

SEAWEED-TRIMMED HAT FOR THE SEASHORE

One of the latest fads at English seaside resorts is the seaweed-trimmed hat, an example of which is shown in



A Novelty in Hat Trimming; Straw Hat Decorated with Seaweed and Shells

the illustration. The straw hat is trimmed entirely with seaweed and shells. The seaweed is dried by a special process, and, when prepared, has all the "life" and luster of fresh seaweed. The sea shells are used to decorate the crown.

GERMAN SURFACE GAUGE

An ingenious surface gauge or level, manufactured in Germany, is shown in this drawing. Adjustably mounted on an upright, the gauge is moved over the surface to be tested so that the pin

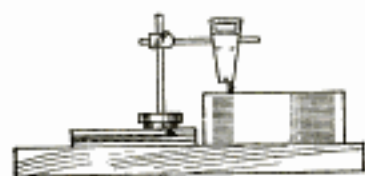

just touches it, and by a properly arranged system of levers, the motion, if any, of the pin is magnified a hundred times. Thus, if there is an unevenness in the surface, the indicator hand will be deflected to one side or the other of the zero point, according to whether there is a depression or a ridge on the surface. The gauge is made in various forms for different purposes.

FIRE EXPOSITION TO BE HELD IN NEW YORK

The first international conference of men interested in the ways and means of fire prevention and extinction, and exhibition showing methods of fire prevention, fire protection and fire fighting, is to be held in New York during the early part of October. Fire chiefs and commissioners from nearly all the principal cities of the United States will be present as delegates; and awards will be made for new inventions.

During the exhibition daily sessions will be held for the consideration of means of fire prevention and protection, addresses being made by builders, architects, engineers, fire chiefs and fire fighters, and insurance men. Fire-proof building construction, fire-alarm systems, automatic sprinklers and fire extinguishers, fire escapes, motor fire apparatus, and, in fact, practically every device for fire prevention and fire fighting will be exhibited and demonstrated.

SIX-WHEELED MOTOR BUSSES

Motor omnibuses with three pairs of wheels will soon be seen on the streets of Paris if the plans of the General Omnibus Company are carried out. Only a small number will be put into use at the outset. The middle pair of wheels will serve as drivers, while the steering will be done by both the front and rear pairs. The objects attained are increased carrying capacity, ability to turn in a small space and the avoidance of skidding. It is pointed out, however, that the spring suspension of the three axles presents a problem which has not heretofore been satisfac-

torily solved. In the new design only the two rear pairs of wheels will have connected spring suspension while the front axle will remain independent. It will depend on the experiences made with the present system of spring arrangement, whether more busses of this type will be put in service or some modification therein devised, before they can be generally adopted.

ANTHRACITE COAL MADE IN LABORATORY

What geologists say nature took millions of years to produce, a German scientist has accomplished in hours in his laboratory. He has made hard coal from peat and even from cellulose, which is the chief part of the solid framework of plants, by heating it in a specially constructed apparatus under great pressure. At a temperature of 590 deg. F., cellulose was converted into coal in 64 hours; and at 644 deg., in eight hours.

From data obtained by a series of such experiments, the scientist has deduced the length of time necessary for the formation of coal beds in nature, and his result tallies closely with that calculated by geologists from entirely different considerations.

SKETCHING BOARD FOR MILITARY AIRMEN

The value of the military aeroplane for scouting purposes has been considerably enhanced by the adoption, in the United States army, of a weighted sketching board by means of which the airman can communicate his information to the forces in the field without descending to the ground. Private Harold Wiedenfeld, of the U. S. Signal Corps Aviation Detachment, is the inventor of the board which is so arranged as to enable a military observer in an aeroplane to mark down all possible information as to the location of the enemy's lines; distance of opposing troops; approximate strength of his

army; conditions of country surrounding position occupied by opposing army; roads leading to advantageous points, and other information that may be gathered while flying. The observations completed and the notes recorded on a special blank and sketching form,

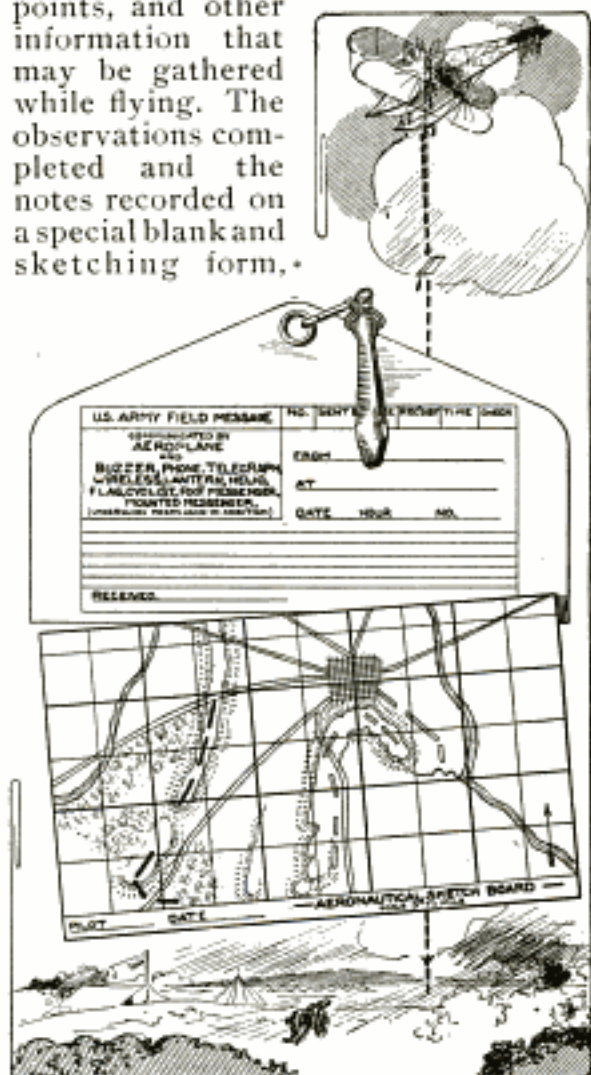

Army Sketching Board Used by Military Observers to be Dropped from Aeroplanes

the board is dropped to the ground, a weight being attached to it that it may fall as close to the desired point as possible.

Experiments with the device have been conducted by Capt. Frederick B. Hennessy and Capt. Charles DeForest Chandler. Both men have gone up, spun around the College Park, Md., aviation field, observed locations of roads, and then dropped the board within 10 ft. of a given spot. In a campaign, it is believed the sketching board would prove of great value to an army in the quick manipulation of troops.

ICE-BREAKING STEAMER OF GREAT POWER

An ice-breaking steamer of unusual design for use in the harbor of Riga, Russia, was completed last spring at Gotenburg, Sweden. Though only 182 ft. long over all, the depth of the boat is 27 ft. 6 in., with a draft of 21 ft. 4 in., so as to put the screws well below the ice line. The beam is 50 ft. 10 in. and the displacement 1,900 tons. From the water line the bow slopes back at a flat angle, so that the keel length is only about 130 ft., and at the junction of the bow and keel is a small

screw (housed under the hull) which serves to disturb the water and ice packs. This is driven by an engine of 1,200 hp., while the main propelling screw is driven by an engine of 2,500 hp. Both engines are triple-expansion and steam is supplied by four boilers. The designed speed is $12\frac{1}{2}$ knots (14.4 miles an hour), but on the trial the vessel developed $14\frac{1}{2}$ knots and 4,000 hp. for the two engines. Flat surfaces are avoided, to reduce the liability of the vessel being caught in the ice, and numerous tanks formed in the hull provide for varying the floating line or "trimming" the vessel, as seafolks say.

In the tests at Riga, ice packs 25 to 30 ft. thick were dispersed by trimming the ship and by the work of the forward propeller, so that the ice breaker could go through the pack with only half its normal power.

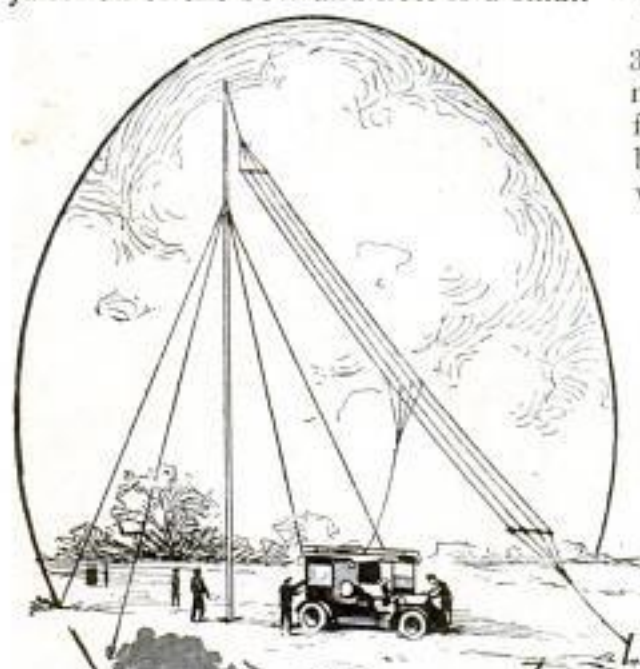

LATEST BRITISH MILITARY AUTOMOBILE-WIRELESS

The British army is experimenting with a new automobile wireless outfit for use in the field. The pole for erecting the aerial is made up in sections of such length that they can be placed in brackets along one side of the automobile and thus trans-

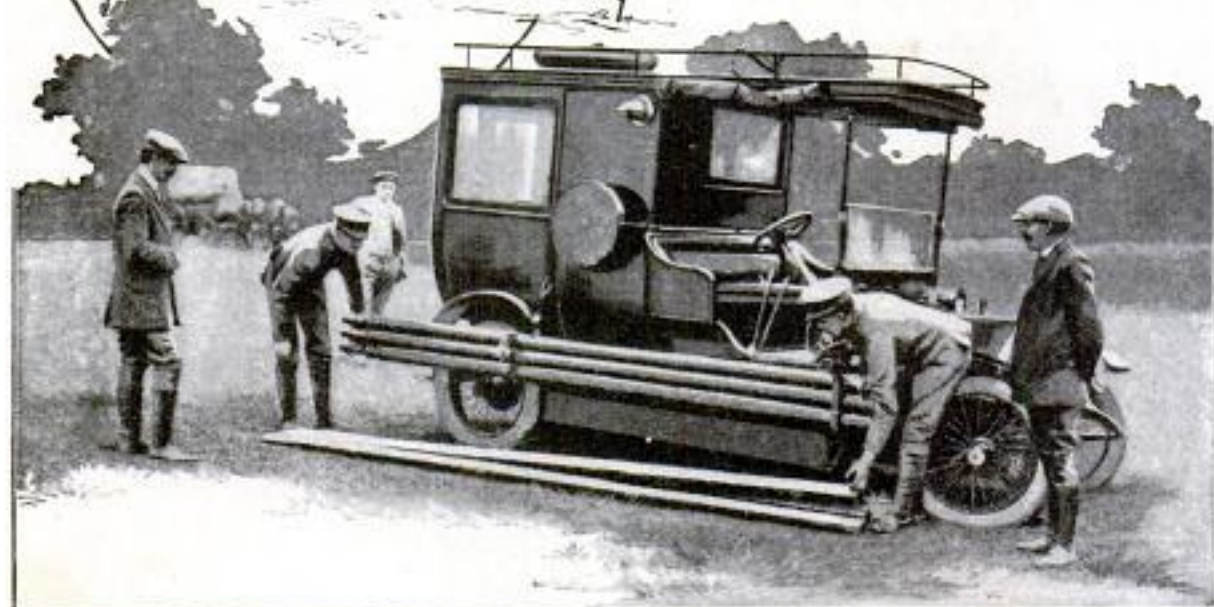

The British Army's Automobile-Wireless

ported. The illustrations show the pole sections being taken from the automobile for erection, and the aerial erected and connected up with the receiving and sending apparatus located within the body of the car.

MAKING EXACT DUPLICATES OF ROCK WRITINGS

The United States National Museum utilizes a very ingenious method of preserving the inscriptions and pictures

A Canvas-Covered, Weighted-Bottom, Safety Goal Post for Polo, Invented by an Army Officer

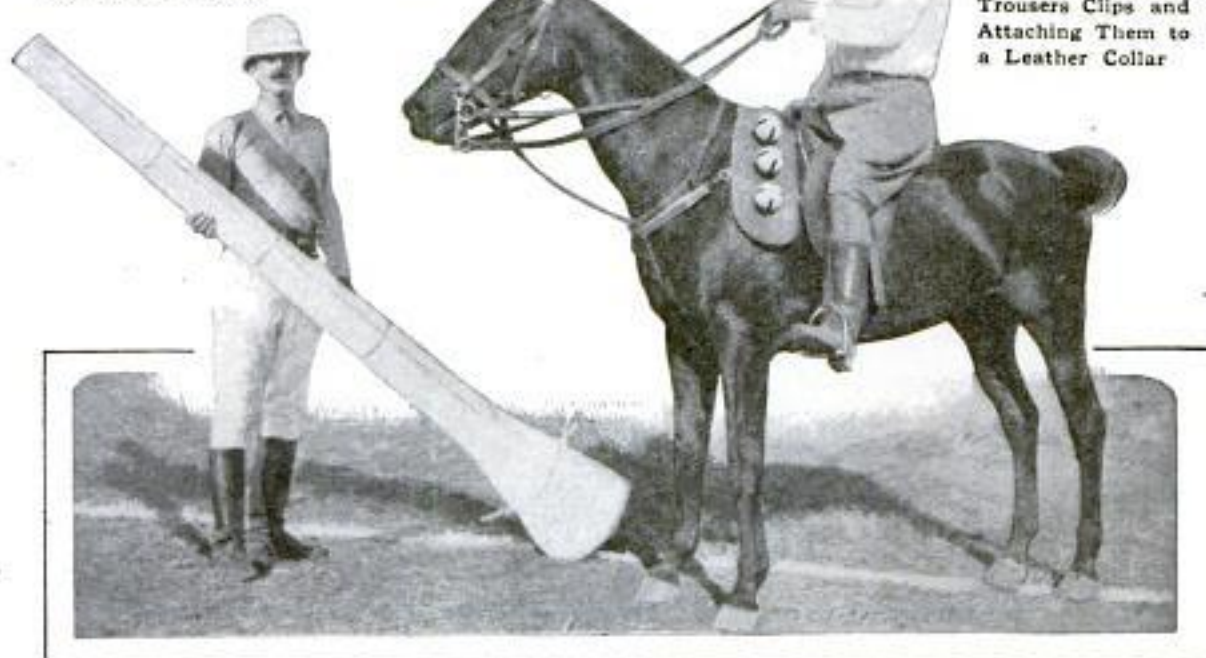

Ball-Holding Device for the Referee, Made by Crossing Bicycle Trousers Clips and Attaching Them to a Leather Collar

hewn or graven into rocks by the Indians of the southwest. Molds are taken of the pictures by means of wet sheets of paper pressed into the cavities until every part of them is entirely filled. The paper when dried and removed gives a perfect matrix, reproducing even the grain or texture of the stone. Any number of duplicates can thus be made for the use of scientists and institutions, and authentic reproductions of the inscriptions kept, even should the original be effaced from the rock by climatic agencies or by vandals. It is planned to collect as many of these impressions as possible for the museum.

TWO NEW DEVICES FOR POLO

Two new polo features have been introduced by Col. C. G. Treat of the 3rd Field Artillery, stationed at Fort Sam Houston, Texas. One of them is a goal post made of wood, skeleton construction, with a wide tapering base which is heavily weighted with lead, the entire post being covered with canvas, painted white. The weighted bottom makes the post stand

firmly, but allows it to yield when struck by horse or player without doing serious injury to either, as sometimes occurs with the stationary posts. It has been tried in practice and found to work well.

The second device is a ball holder for the referee, and is an excellent example of how a device designed for a certain use can be adapted for other uses. The ball holder is made of heavy leather in the form of a flat collar, attached as shown in one of the illustrations. Each side of the holder is equipped with three ball containers, made by crossing a set of trousers clips of the kind used by bicycle rid-

ers. These are attached to the leather collar by small leather strips and rivets. The hardest riding cannot dislodge the balls from these clips, yet they are easily removed when needed.

BIG DRUM FOR MUSICAL FESTIVAL

In the accompanying illustration is shown a big drum, about 10 ft. in diameter, built especially for the Handel

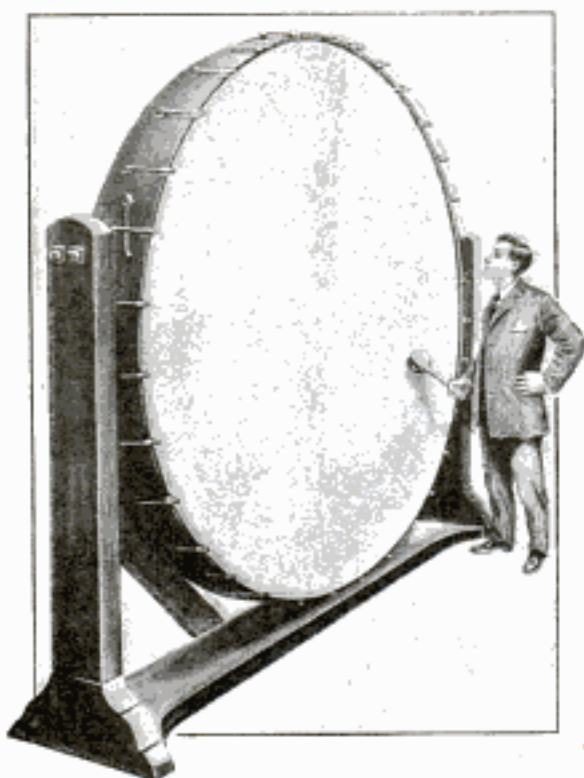

The Great Drum Built Especially for the Handel Musical Festival in England

del musical festival, recently held in London. The great festival chorus included considerably more than 3,000 voices, and the total number of performers was 4,000.

COMPRESSION OF LUNG AS TUBERCULOSIS CURE

Treatment of tuberculosis by nitrogen-gas compression of the lung recently has been revived after falling into disuse since it was first introduced by a Chicago surgeon 15 years ago. Successful results have been reported by physicians in Europe and America. The method employed is compression

of the lung so that no air gets into it, and it is thus given complete rest, with a minimum of blood on which the germs can grow. Frequently the patient's condition improves. Authorities state that it can be used only in one-sided cases with not many adhesions between the lung and chest wall. The apparatus consists of a water-locked tank similar to a gas receiver, a tank of compressed nitrogen and the necessary tubes and needles for injecting it into the cavity between the lungs and the wall of the chest. One physician recently reported that the tubercular process was arrested in an astonishing percentage of cases in which it was employed by him.

THE BATTLE-CRUISER RIVALRY IN EUROPE

The rivalry between England and Germany in the construction of battle-cruisers, the wonderful new type of fighting ship developed by England and imitated by Germany, is, if anything, more tense than was the rivalry in dreadnoughts.

A battle-cruiser is a ship possessing the battleship's armament of heavy guns, but comparatively lightly armored, defensive strength being sacrificed for aggressive qualities. With their great speed, extended steaming radius, and powerful guns they can roam the seas unmolested except by other ships of their own class. Even the dreaded torpedo-boat destroyers are no menace, the sustained speed of the battle-cruiser at sea being higher than that of any present-day ocean-going destroyer.

When Germany produced in the "Moltke" the fastest battle-cruiser in the world, with a speed of 29.5 knots (33½ miles an hour), England pinned her hopes on the new "Lion," and she was not disappointed. This remarkable vessel succeeded, under very trying conditions and with coal only as fuel, in making the phenomenal speed of 31.5 knots (35.75 miles an hour). Under favorable conditions, and using oil, it is believed that the "Lion" can

make about 33 knots (38 miles). The next German battle-cruiser, which was laid down last year, but as yet is not far enough advanced to be known otherwise than as "K," much is expected. Just how much is not clear, for secrecy is rigidly maintained in the German navy, but it is believed that she will be driven by engines of at least 90,000 hp., as compared with the 80,000 hp. of the "Moltke," and that she will carry 14-in. guns. This vessel is expected to be more powerful and faster than the British "Lion," the "Princess Royal," and the "Queen Mary," the latter being a little larger and more powerful than the "Lion."

England, however, will probably have completed her "Tiger" by the time the German "K" is ready, and thus Germany will remain behind in the race, as this ship will, it is believed, develop 100,000 hp. It is also believed that she will be longer than 725 ft., that she will be a 32,000-ton ship, and that her speed will be greater than 33 knots.

ARTIFICIAL RUBBER FROM SEA FISH

According to the British Consul at Amsterdam, a factory is being built at the fishing harbor of Ymuiden for the manufacture of artificial rubber from sea fish. The process was invented by an Amsterdam physician, and he claims that the product has the same qualities as real rubber and is not affected by benzine or heat.

Estimates show that the fish rubber can be produced at a cost representing only about one-sixth of that required for the manufacture of real rubber, due in part to the manufacture of a valuable by-product in the shape of a concentrated tonic food containing phosphor albumen.

NEW IDEA IN GASOLINE FUNNELS

A funnel which requires no chamois-skin strainer to eliminate water and sediment from gasoline as it is poured into the tank of a car, is another novelty for motorists. The gasoline is poured into the large top opening and must flow from the surface

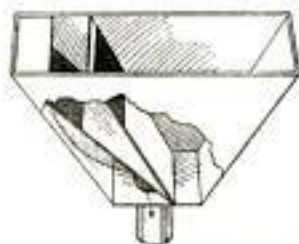

through two special copper screenings before reaching the outlet in the bottom of the funnel. The claim is that, the screen being so fine, not a particle of water can flow through it, although gasoline passes readily.

SEVEN-TON DUMPING MOTOR TRUCK

A motor coal truck of seven tons' capacity, which can be dumped by one man, is being turned out by an eastern automobile concern. The ease and expedition with which a single man can dump a full load by operation of the hand mechanism, is due to the fact that the load-carrying body is balanced near its middle. All that is necessary is to turn a crank

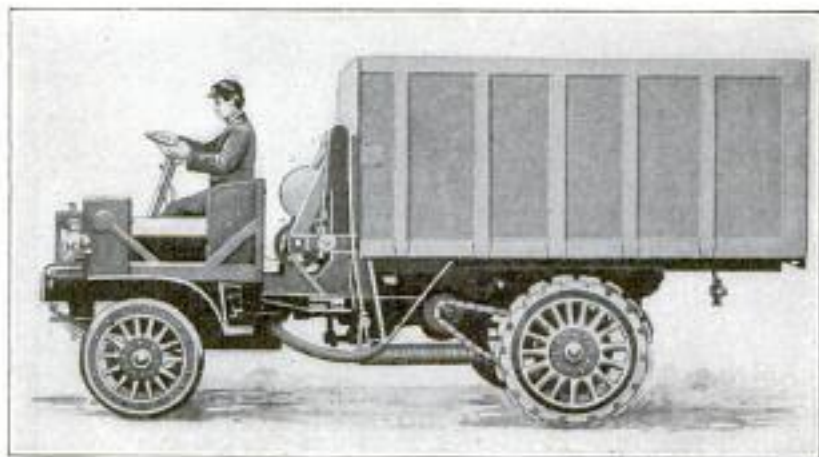

A 7-Ton Coal Truck Having a Hand-Dumping Body

until the center of gravity of the almost balanced weight falls back of the pivot,

the tipping then being automatically completed by the load itself. The whole load is, of course, carried over the rear wheels, which are heavily reinforced.

NEW "BEWARE-THE-DOG" SIGN FOR DOORS

Many kitchen doors or doors of entrances for the use of tradesmen in England are now found bearing a



"The Dog Behind This Door Bites" is a New Substitute for the Stereotyped "Beware the Dog"

novel warning sign against dogs, with a more ingenious legend than the old "Beware the Dog," which has become so stereotyped as to command but little attention and usually fails to serve its purpose.

DISEASES OF ANCIENT EGYPTIANS

Studies of mummies and skeletons from the tombs and excavations of Egypt, which have been carried on at a medical school in Cairo by Drs. Elliott Smith and Marc Armand Ruffer, have disclosed many points of identity

of the diseases of from two to four thousand years ago and the diseases of the present day, as well as marked differences. Gallstones and similar concretions were common, and evidences of bacterial infections were found in some bodies. Malignant diseases, gout, leprosy, infantile paralysis, and appendicitis seem to have existed in the days of the Pharaohs, while hardening of the arteries due to age was common then as now.

In the study of skeleton remains, which are the most satisfactory of all for historical study, there is confirmation of the previously demonstrated fact that an inflammatory condition of the joints resulting in deformity was remarkably prevalent in the Nile Valley, both during the earliest times and later; the spinal column, the finger and toe bones being very often so affected. So far no evidence of tuberculosis of the bones has been found in old Egyptian remains. Dental disease was prevalent, the molars, as now, suffering most. The old tradition that the ancient Egyptians were skilled in dentistry is not substantiated, however, by recent investigations.

A MERCURY GAME POPULAR IN FRANCE

A mercury game requiring steady nerves and much patience has recently become popular in Paris. It is played

with a rectangular glass-covered box having a portion of the bottom raised slightly above the remainder. The upper, circular part of the raised portion is provided with a number of holes

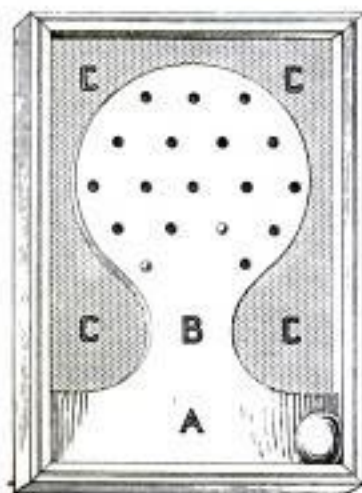

or cups. A ball of mercury is placed

in the box on the part marked A, and the purpose of the player is to roll the mercury over the portion marked B, and then successively over the holes in such manner as to fill them with mercury without the ball splitting up in several parts or any part of it rolling down into the lower portion of the bottom.

The difficulty increases, of course, the closer the holes are to the edge,

and higher values are therefore given to these holes than to those nearer the center, the central hole having the lowest value.

To anyone who has observed the seemingly uncontrollable nature of mercury, it would appear almost impossible to play the game successfully, but it is asserted that with some practice all the mercury can be disposed of in the holes in three or four minutes.

WINNERS OF CZARINA'S RED CROSS PRIZES

One of the important features of the International Red Cross Conference recently held in Washington was the award of the prizes given by the Empress of Russia for devices

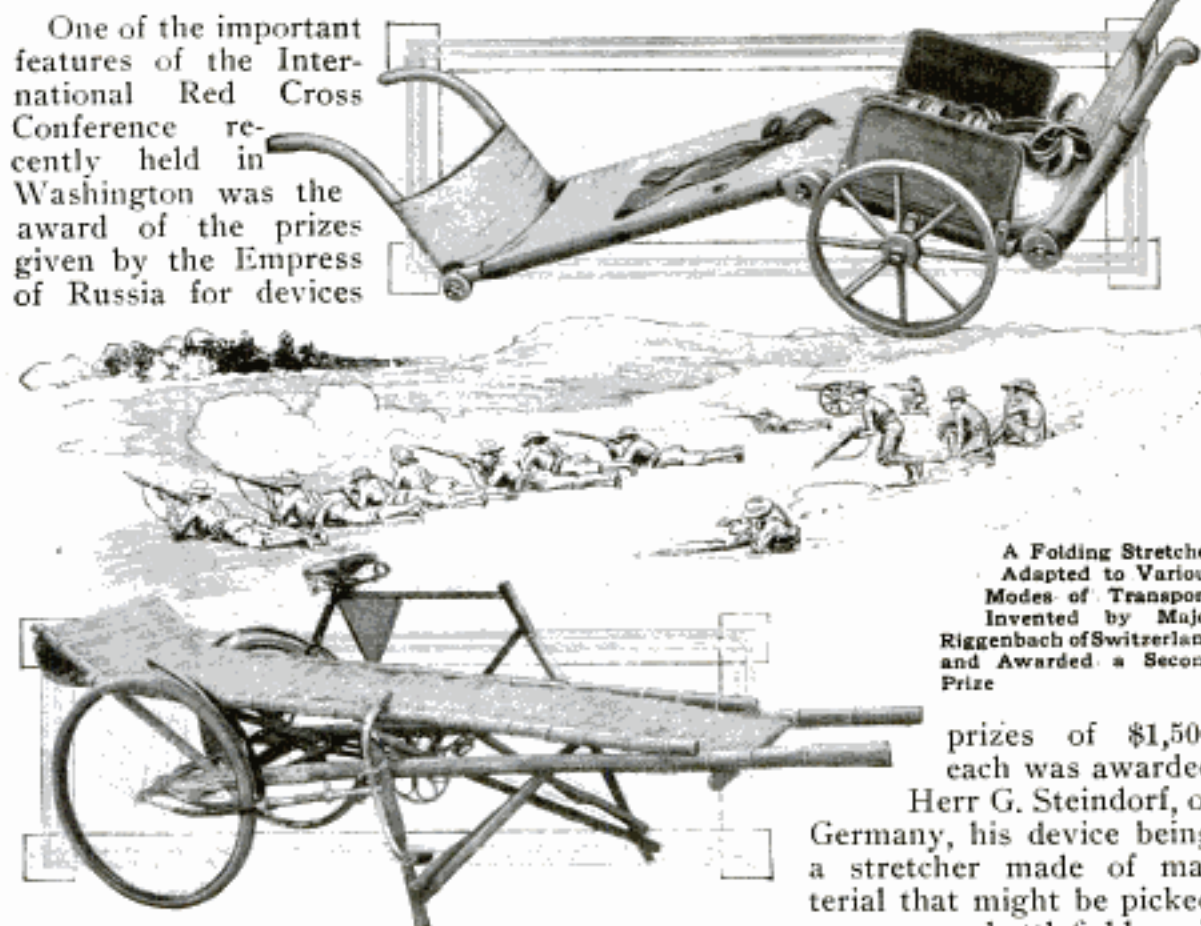

Stretcher Using Bicycle Wheels, and Made of Material Taken from the Field—Invented by Herr Steindorf of Germany, Awarded Second Prize

for the care of wounded on the field of battle. There were nine prizes in all, each consisting of a sum of money, the award being made by a committee of the International Red Cross. Dr. Louis Lesage, of the Necker Hospital, Paris, was given the first prize of \$3,000 for an X-ray laboratory automobile designed by him. One of the two second

A Folding Stretcher Adapted to Various Modes of Transport, Invented by Major Riggenschach of Switzerland and Awarded a Second Prize

prizes of \$1,500 each was awarded Herr G. Steindorf, of Germany, his device being a stretcher made of material that might be picked up on a battlefield and mounted on the wheels of a bicycle. The other second prize was given Major Riggenschach, of Switzerland, for his invention of a folding wheeled stretcher that can be used for a variety of modes of transportation. Two American army surgeons, Maj. Paul S. Halloran and Capt. Henry L. Brown, were among the six persons awarded third prizes.

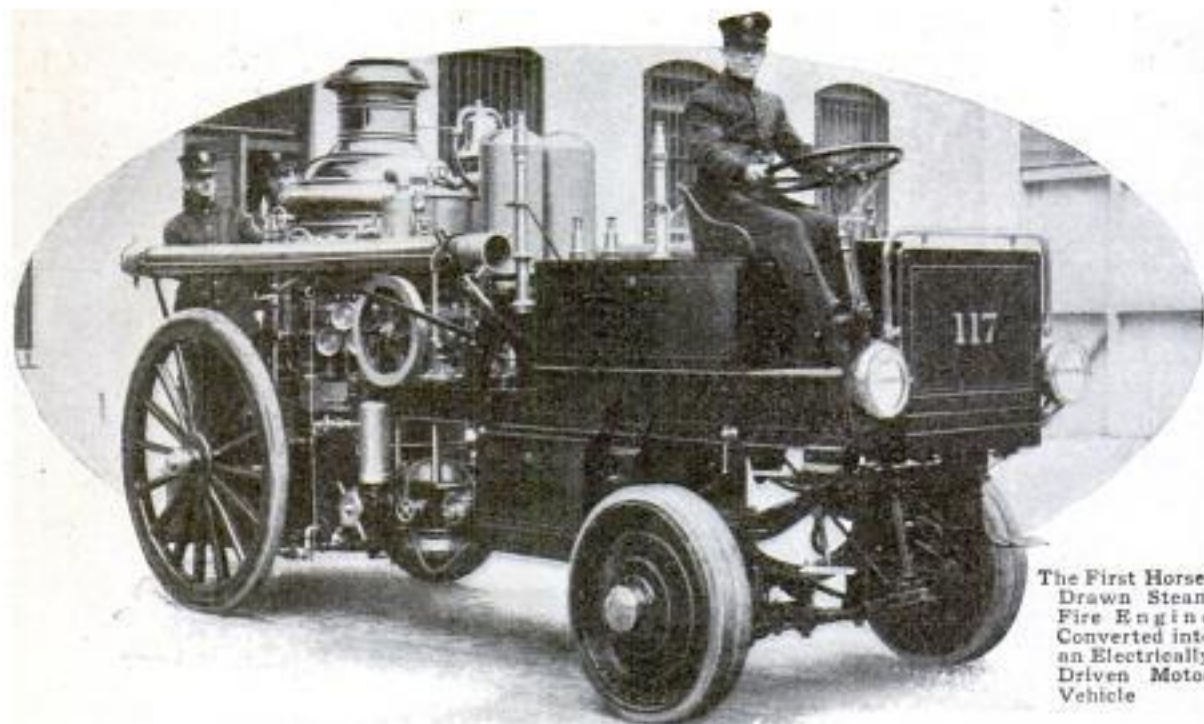

The First Horse-Drawn Steam Fire Engine Converted into an Electrically Driven Motor Vehicle

NEW YORK'S FIRST ELECTRIC FIRE ENGINE

Many old horse-drawn steam fire engines have been converted into motor-driven vehicles by equipping them with gasoline power plants, and their number is steadily growing, but the first fire engine to be converted into a motor vehicle by the installation of electric motors is now in operation in New York. Its runs average about one

per day, and it has a speed of 20 miles an hour over smooth, hard roads, and takes grades with ease.

The weight of the engine before conversion was 9,800 lb., as compared with its present 15,000 lb. An 80-cell 11-plate battery is used, which will run the machine 20 miles on a single charge.

NEW FRENCH MONOPLANE PILOTED BY BOY

A new French aeroplane, known as the Jourdan monoplane, and piloted by Jean Jourdan, a boy only 16 years



A Hooded French Monoplane Piloted by a 16-Year-Old-Boy

old, is shown in the accompanying illustration. It has a wing span of about 45 ft., a length of 32 ft., and is

driven by a 70-hp. Gnome motor. The interesting feature of the design is the hooded central section.

REVOLVING ELECTRIC FLOOR SCRUBBER

An electric floor-scrubbing machine, the brush of which is cylindrical in shape and revolves instead of being rotary in its action, has been successfully used in the Roosevelt hospital, New York. It was invented by an attendant of this hospital.

The machine supplies water to the floor which it scrubs and then takes up the dirty water. The water-supply tank holds about 5 gal. Under the tank is a 1/4-hp. motor which drives the brush at a speed of 400 revolutions

per minute. The brush is 7 in. in diameter, so its bristles travel about 700 ft. per minute, sweeping the water up into detachable receptacles. By a simple system of gears the brush can be adjusted to press lightly or heavily against the floor.

The machine works as well in either direction, thus obviating the necessity of turning it around. When the end or side of the room is reached all that is necessary is to swing the handle over. This reverses the action of motor and brush, and shuts off the clean water on one side and starts the flow on the other. The reversing of the brush also tends to keep the bristles straight.

☐ Watermelon seeds are considered a delicacy in China and are served at meals much as salted almonds are served in the United States.

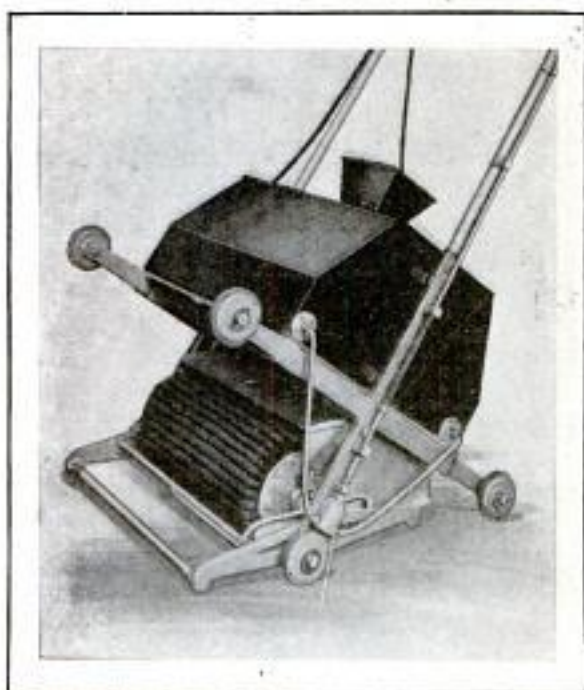

A Revolving, Electrically Driven Brush for Scrubbing Floors

NEW "RAINBOW" ELECTRIC LAMPS

A multi-color or "rainbow" electric lamp is being marketed by an English concern. In general appearance it resembles an arc lamp, but it is fitted with an opal globe inside of which are three metallic-filament lamps of 25 cp., having red, blue and yellow globes respectively. Inside the case and immediately above the lampholders are three thermo-flashers, with adjustable platinum contact points, set to connect the lamps in and out of circuit, and in such a way that either one, two or three are alight at a time. With the different lamps going out or coming on, different combinations of colors are produced, which are evenly diffused by the opal globe. Inasmuch as the flashers are not synchronized, the colors are constantly changed. Of course, when only one lamp is alight, only the particular color of its bulb is shown.

GERMAN TWO-PASSENGER AUTOMOBILE BODY

A new two-passenger automobile recently delivered to Prince Gwoff, Germany, has an interesting type of body

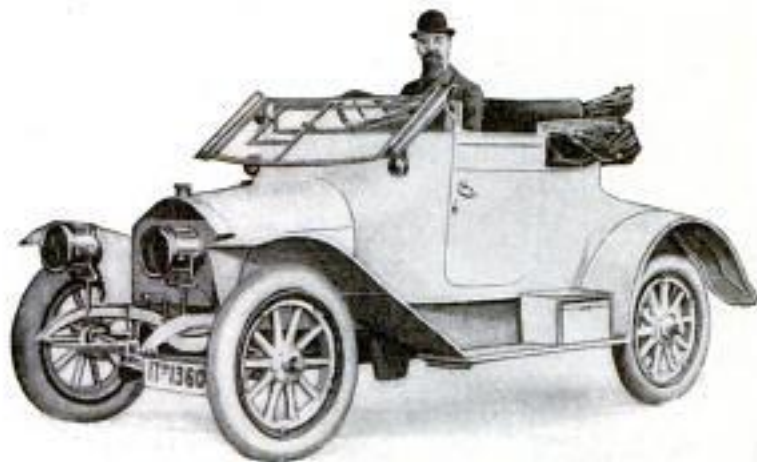

A Two-Passenger Convertible-Body Automobile, Owned by Prince Gwoff, of Germany

designed by a Stuttgart firm. This body can be so easily converted that it is a simple matter to operate the car either as a closed or open one, the mechanism effecting the conversion being of simple character. Either a baggage carrier or a rumble seat may be used at the back of the car.

"FACTORS OF SAFETY" IN LIVING CREATURES

By JOHN B. HUBER, A.M., M.D.

After the last Harvard-Yale boat race it was the losing crew which gave the greatest evidence of exhaustion. In one instance the Yale men were so utterly "all in" that they had to be lifted out of their boat. One might have expected just the reverse,—that the Harvard men, having taken the extra exertion necessary to win, had worked more nearly to the limit of their powers and should have been more played out than the Yale men in consequence.

But to think that way is not to take into account the stimulus of victory on the one hand, and the depressing effect of defeat on the other. It has been estimated that the mortality from wounds in a defeated army is in proportion to that of the victors as four to three or even as three to two. The science of psychology gives the explanation. Success brings into play the factors of safety in the living body; failure has the reverse effect to weaken these factors.

What, then, are those factors of safety? They are our reserve forces, which avail us in times of inordinate stress and strain; and they keep our bodies in fairly normal condition in spite of many injurious external agencies. The term was borrowed from the mechanical engineer by Dr. J. S. Meltzer, when he addressed the Harvey Society in New York City on the "Factors of Safety in the Animal Structure and the Animal Economy." The mechanical engineer deals with factors of safety in estimating the margin of safety required in constructing engines, bridges, houses, and so forth. In mechanics it is calculated that structures should be capable of withstanding not only the stresses of reasonably expected maximum loads, but also those of six or seven times such loads. The factor of safety is founded upon human ignorance of what might happen; and upon a wise desire to provide against such contingencies.

So, in the human machine, the potential energy of many organs, as the heart, for instance, far exceeds the needs of normal everyday humdrum existence. In the case of many of our functions the necessary mechanisms are doubled and even trebled. And the function of one organ is often assisted by other organs. Living tissues, such as make up our bodies, are abundantly provided with one factor of safety which is peculiar only to living things, and to no other kind of machinery—that is, the mechanism of self-repair. These factors of safety promote the integrity of life, the perpetuation of the species, and have an important bearing on the process of natural selection.

Nature is never stingy; indeed there never was a more extravagant dame; her gifts are far beyond the requirements of sentient creatures. The roe of a single fish, for example, often contains millions of potential fish lives; and if the law of the survival of the fittest became inactive for a single season no vessel could make its way through the fish that would choke up the ocean.

Medical history furnishes countless instances of physical endurance, apparently superhuman, that can be explained only by reference to factors of safety. For example: Who is not thrilled in reading how Napoleon led his army across the Alps, to the point where his troops believed themselves absolutely spent; not another step could they carry their panting bodies! But here that magnificent, though untutored psychologist, had his band play "La Marseillaise." Its strains amid those snow-capped heights were a mighty stimulus to courage and patriotism, whereby such reserve strength was awakened as the rank and file had not dreamed themselves possessed of; so that with triumphant shouts they finished the titanic task their determined general had laid upon them.

AN "S O S" BELL FOR WIRELESS STATIONS

While testifying at the "Titanic" inquiry in London Marconi told of an invention he is now perfecting that will cause an alarm bell to ring at all wireless stations receiving a danger signal sent out by a ship in distress.

By the ringing of this bell, an ordinary seaman stationed near the wireless apparatus of the ship while the operator is off duty would know that some ship was sending out a distress message and notify the operator. In order to make the idea effective Mr. Marconi says it would be necessary to alter the wireless regulations formulated by the international convention, so that the "S O S" danger signal could be accompanied by a long dash or sequence of waves, lasting for a period of 15, 20 or 30 seconds. This would cause the bell to give a prolonged ring, enabling anyone on duty nearby to know that a ship required assistance.

RUBBER OBTAINED FROM "TIRUCALLI" TREE

A new source of rubber has been found in the "tirucalli" tree of Natal, according to a French magazine. This tree has hitherto been regarded as commercially useless, and it was but lately discovered that it yields a juice which contains rubber.

A company was organized to work a concession in the Tugela Valley, and has been exporting about a ton a week of the crude material to London where it has been found useful for electrical insulation and for mixing with Para rubber. There are an unlimited number of "tirucalli" trees in Natal, and their recuperative qualities are so great that they can be tapped once a month.

ELECTRIC DRIERS FOR HOSIERY

An electric method of drying and finishing hosiery has been developed by an electric company in the east for



A Battery of Electrically Heated Forms for the Drying and Shaping of Stockings

the use of stocking-manufacturing concerns and for laundries. The stockings are drawn over electrically heated forms which both dry and shape them.

AN AVIATION SIGNPOST IN ENGLAND

On the top of a motor-repair shop and garage at Bromley South, on the main road between Hastings and London, Eng., has been erected a unique



An Aeroplane Signpost as an Advertising Scheme

aviation signpost. The summit of the post carries a small model aeroplane of the biplane type, while the direction arms carry a monoplane and a racing automobile.

FUNNEL-SHAPED CONCRETE WATER TANK

In Victoria, Australia, is a water tank the shape of which is probably unique among such constructions.

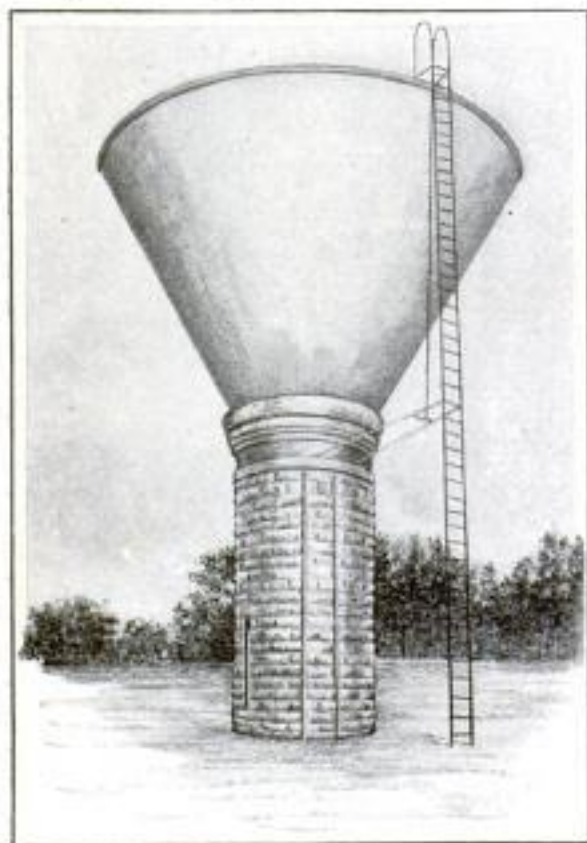

An Unusual Water Tank Constructed of Brick and Concrete

The funnel-shaped tank, which has a capacity of 3,150 gal., is constructed of reinforced concrete, while the lower section is of brick masonry.

A SOUTH AFRICAN SHAFT-SINKING RECORD

A new record for shaft-sinking in the Rand mines has recently been made, according to the South African Mining Review. It states that the southeast shaft of the Government Gold Mining Areas Consolidated was sunk 233 ft. during March, exceeding

the previous record of 213 ft., made at the Brakpan mines in July, 1907. Another record performance was the sinking of 583 ft. during the first quarter of the year at the State mines. The shaft measured 45 by 10 ft. and from it 8,155 tons of muck were removed during the month, equivalent to 35 tons per foot. The sinking was done between the 1,738-ft. and the 1,971-ft. levels through 155 ft. of rock and 78 ft. of shale. Natives did all the hand drilling and shoveling; 82 natives and a white assistant comprising the sinking crew for one shift.

PNEUMATIC HAMMER FOR DRIVING NAILS

A pneumatic nail-driving hammer, particularly designed for use by carpenters in nailing laths, has been patented by an inventor of Zion City, Ill. The apparatus may also be used in connection with various classes of pneumatic tools, such as rock drills.

Attached to the tube containing the piston or hammer is a nail box or hopper, having a capacity of about 250 nails. The vibrating of this hopper causes the nails to be tripped up and forced, one at a time, into a rubber tube, through which they are forced to the head of the hammer by the compressed air. Protruding slightly over the head of the hammer is a trip rod which, when forced against the wall or object to be nailed, allows the nail to be set in the hammer head, and also releases the trigger which allows the compressed air to pass into the power chamber. The piston rod, striking the hammer, then drives the nail home.

The weight of the hammer is about $3\frac{1}{2}$ lb., and a speed of 100 nails a minute can be attained.





Auxiliary Gasoline Tank for an Automobile

The regular supply tank on the automobile is fitted with a partition at such a distance from one end that the space thus provided will hold approximately 1 gal. of oil. About 2 in. from the top make a hole 1 in. in diameter and connect the compartments with pipes and fittings as shown.

Gasoline overflows into the auxiliary tank when the main tank is filled. This provides a reserve supply of 1 gal. of oil, which will run a car at least 10 miles. As the tank is automatically filled, it requires no attention except when the supply in the main tank runs

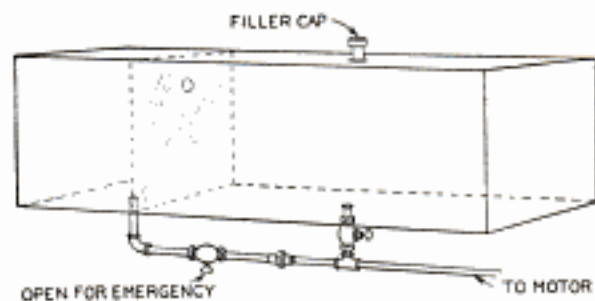

The Small Auxiliary Tank is Automatically Filled and Kept Ready for an Emergency

out, then, if one happens to find himself where no oil can be obtained, the emergency valve is opened and the reserve supply used.—Contributed by James McCaffrey, Pawtucket, R. I.

Aid in Mowing Fodder

It is often necessary to put shock fodder in a mow, and by loading the shocks whole, looping a rope around each and attaching the apparatus shown in the illustration in place of the regular hayfork, the fodder can be handled as easily as hay.

The device is shown set to receive the loop end of the rope in Fig. 1, and

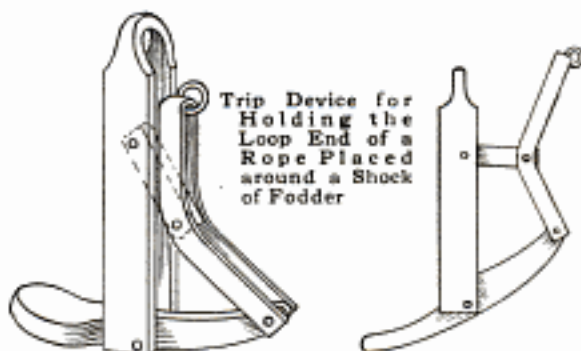

FIG. 1

FIG. 2

tripped, in Fig. 2.—Contributed by Stanley M. Hadley, Danville, Ind.

Ventilating Apple Bin

Apples placed in large bins will not keep well, unless they are well ventilated. Effective ventilation can be accomplished by making cylinders of slats and placing two of them in a bin 8 ft. square. The disks for the cylinders are 12 in. in diameter with holes in the center, as shown in the

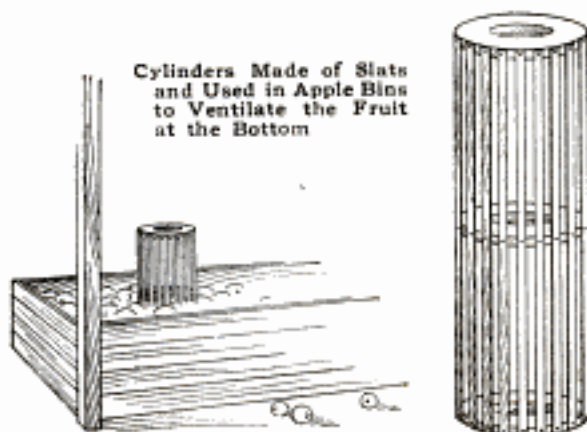

sketch. The manner of using the cylinders is obvious.—Contributed by R. L. Keenan, Sabula, Iowa.

Raising a Flag

The proper method of storing and raising flags, ensigns, etc., is illustrated in the sketch. The manner of rolling

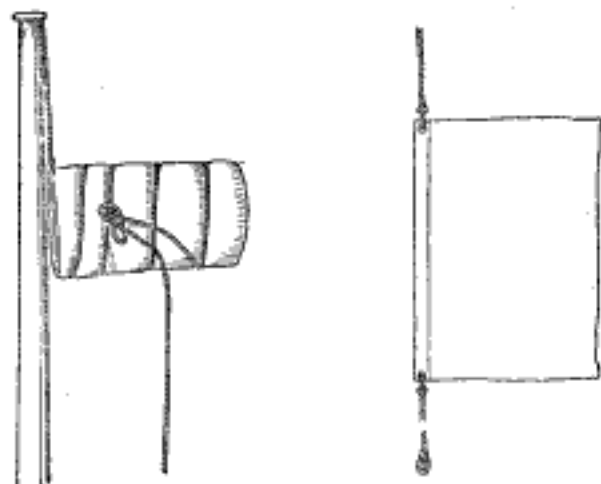

The Rope as It is Tied about a Folded Flag for Raising It to the Top of a Pole

a flag for storing is shown in the first sketch, while the second shows the usual equipment for a flag. The flag is attached to the signal halyard with a snap hook in the upper grommet. The grommets are fastened to the canvas heel of the flag.

The flag is made up as shown in the first sketch and when hoisted to the truck, a pull on the down haul releases it and allows the flag to break out. A number of flags may be made up in this manner and be broken out simultaneously, or they may be hoisted and broken out one at a time by doing each one up separately. A sharp pull on the down haul will then release the lower one, another pull, the next one, etc. The flags should be stored away all rolled up as in the first sketch.—Contributed by Geo. M. Petersen, Buffalo, N. Y.

Cleaning Gun Barrels

Lead and powder residue as well as rust can be easily removed from rifle and gun barrels, and if the barrel is not badly pitted, it can be restored to its original brightness and cleanness by using ordinary steel wool in cleaning. Take a wad of the steel wool just

as large as can be conveniently drawn through the barrel and attach it to a stout cord or a small wire and draw it back and forth in the barrel. All rust and residue will be thoroughly removed from the barrel in a few minutes.

The steel wool will not scratch or injure the barrel in the least. The No. 0 steel wool is the most desirable to use, and it can be obtained at almost any hardware store.—Contributed by H. A. Jonset, Faulkton, S. Dak.

Grinding Twist Drills

Few operations on tools in the shop are more frequently disappointing than the grinding or sharpening of drills. That the cutting edges have a correct and uniform angle with the longitudinal axis of the drill, that they be exactly equal in length, and that the lips of the cutting edges be sufficiently backed off or cleared, are points generally understood as essential, though not always attained.

If the clearance of a drill is insufficient or imperfect, it will not cut. When force is applied, it resists the power of the machine and is crushed or split. After grinding a drill by hand, it is well to start it and observe the character of the chips.

The grinding lines of a drill are placed slightly above the center to allow for the proper angle of the point, which is an important factor. This

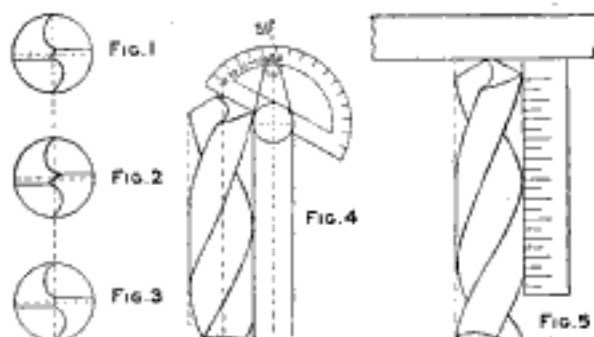

A Drill must Have the Cutting Edge with the Proper Angle and Clearance to Produce a Perfect Hole

angle is an index of the clearance. If the angle is too great, the drill will not cut right; if too small, it may not cut at all. The proper angle is shown

in Fig. 1. Too sharp an angle is shown in Fig. 2, and an angle that lacks clearance is shown in Fig. 3. Drills properly ground have their cutting edges straight when ground to the proper angle, which is 59 deg., as shown in Fig. 4. Grinding to a less angle leaves the lip hooking, which is likely to produce a crooked or irregular hole.

An effective method of determining the clearance is to set the point of the drill on a plane surface and hold the scale as shown in Fig. 5. The clearance is easily shown by revolving the drill. This will also show whether the height of the cutting lips and the length of the cutting edges are equal. In grinding a drill, preserve its original form which will usually insure rapid and satisfactory work.—Contributed by W. H. Addis, Lafayette, Ind.

Baluster Design to Fit Any Pitch of Stairway

In making cast-iron balusters for stairways, the general construction of which is shown in Fig. 1, I found that scarcely any two flights of stairs had the same pitch, and the workmen constantly had to change the pattern to suit the pitch of stairs. As this work caused considerable expense, I designed a baluster that could be made up and carried in stock ready to fit any pitch of stairway. The general design was not changed, but the upper end, to which the rail is attached, was

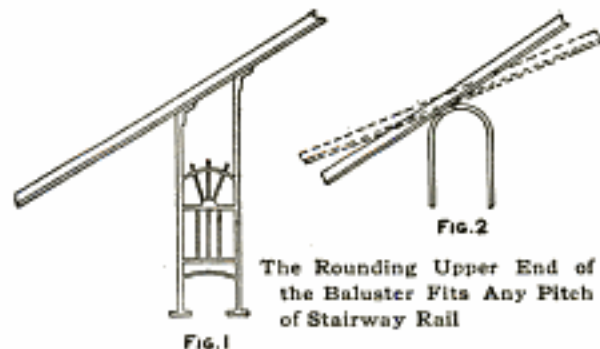

made semicircular in outline, so that it would fit any pitch of rail, as shown in Fig. 2.—Contributed by Jas. F. Napier, Montreal, Can.

Repairing a Worn Friction Disk on an Automobile

The aluminum disk A on my friction-drive automobile became worn around the edge, which prevented the necessary pressure at the rim of the disk.

To overcome this difficulty I undertook to build the plate up true. The metal could not be dressed off true because this would make it too thin, and furthermore it would be too expensive as the machine would have to be taken apart.

The repair was easily accomplished in the following manner: I secured a piece of saw steel, C,—an old circular saw would answer well—about $\frac{3}{16}$ in. thick, and drilled $\frac{3}{16}$ -in. holes through the steel, $\frac{3}{4}$ in. from the edge, countersinking the holes to receive $\frac{3}{16}$ -in. tire bolts.

The space between the disk A and the plate C was filled with a paper friction ring at B, thick enough to let the steel plate just touch the center. The parts were clamped together and the holes continued through the paper ring and the aluminum disk. Tire bolts were put through the holes and drawn up evenly all around and the heads filed off even with the surface of the plate. The bolts should be cut off short and burred to prevent the nuts from backing off. The repair cost about \$3, while a new disk would have cost \$15. The steel gives better satisfaction than the aluminum.—Contributed by Chas. A. Pettit, Rossville, Maryland.



Cleaning Brass

Small brass castings can be cleaned by heating them slightly and then dipping them in a solution of sal ammoniac. The pieces will come out as bright and clean as if new. This cleaning process is the same as that used in cleaning a soldering iron.

Truing Collector Rings

The machine shown in the sketch was fitted up by a correspondent of the Engineer for truing up badly worn collector rings on

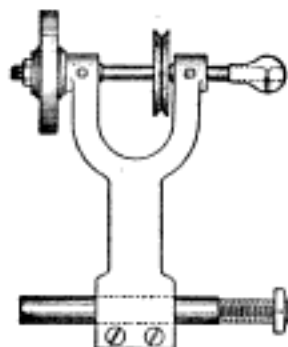

a compensated revolving field alternator. He describes its operation as follows:

The emery wheel is passed across the rings while the machine is running slowly. The wheel is run at a speed of 3,000 revo-

lutions per minute by a small motor. It puts the rings in fine shape and saves taking the head to a machine shop. Then, too, while turning the rings, they are liable to get out of place. Strips are bolted in the place of the brush holder and the rig clamped to the bolt by two screws, the bottom of the casting being split to insure a tight grip, will serve the purpose.

☞ An easy way to trap vermin is to place an ordinary steel trap in the center of a tile, placed in such a position as to serve as an entrance to their prey.

How to Build a Motorcycle Garage

The owner of a motorcycle does not always have a suitable place to keep his machine. The hall or back porch affords no place and the basement air is usually too damp, and rusts the metal parts as well as being injurious to the tires. The need of a small garage, in which there is ample room to do small repairs, is realized by most riders, but few know that the material for a small house can be bought for less than \$25.

The average rider is usually mechanically inclined, at least sufficiently so to be able to build a small garage, if

suitable plans are at hand. While the following material list and accompanying plans are for a house 6 by 8 ft., the builder can alter them if a larger garage is desired, but it must then be taken into consideration that the cost increases more rapidly than the length of the boards and timbers.

The sill foundations are built up of brick or stone, preferably red brick, on the place selected for the garage. The foundations are located at each corner and under each stud. Care should be taken to have the tops of the foundations level and high enough

LIST OF MATERIAL FOR A 6 BY 8-FT. GARAGE

SILLS	FLOOR
2 pieces, 2 by 4 in., 8 ft. long.	Sufficient tongue-and-grooved boards to cover 50 sq. ft.
JOISTS	ROOFING
6 pieces, 2 by 4 in., 6 ft. long.	Sufficient prepared roofing material to cover 120 sq. ft.
STUDS	FINISHING MATERIAL
10 pieces, 2 by 4 in., 6 ft. long.	4 fascia boards, S-4-S, 1 by 4 in., 6 ft. long.
NOGGING PIECES	2 door facings, 1 by 4 in., 6 ft. long.
2 pieces, 2 by 4 in., 8 ft. long.	1 door header, 1 by 4 in., 3 ft. long.
2 pieces, 2 by 4 in., 6 ft. long.	2 pieces for window facings, 1 by 4 in., 6 ft. long.
PLATES	7 corner boards, 1 by 4 in., 7 ft. long.
2 pieces, 2 by 4 in., 8 ft. long.	WINDOW
2 pieces, 2 by 4 in., 6 ft. long.	1 single casement.
RAFTERS	DOOR
12 pieces, 2 by 4 in., 6 ft. long.	1 paneled door, 2½ by 6 ft.
BENCH MATERIAL	HARDWARE
1 piece, 2 by 4 in., 10 ft. long.	1 pair of door hinges.
2 pieces, 2 by 4 in., 6 ft. long.	1 pair of window hinges.
5 pieces, 2 by 6 in., 6 ft. long, S-4-S.	1 window bolt.
SIDING AND ROOF	1 door lock.
Sufficient tongue-and-grooved boards, S-4-S, to cover 300 sq. ft.	4 lb. of 20-penny nails.
	8 lb. of 8-penny nails.

to prevent rotting of the lumber from the moisture of the ground.

Cut the sills and joists to length, taking into consideration that allowance must be made on the joists for the thickness of the sills, to make the over-all measurement 6 ft. in width. In some instances the joists and sills can be notched, but a more substantial way is to cut them as shown in the floor plan and drive large spikes through the sills into the ends of the joists.

The 10 studs are cut to length and the pieces for the plates mitered on the ends. The location of the studs are marked on the sills and end joists, the two intermediate studs being set so that their inner surfaces, which receive the window sash, are each 30 in. from the end, or outside. After marking the locations for the studs on the joists



Floor Plan in Which the Two Sills are Shown Spiked to the Ends of the Joists

and sills, the plates are marked to match them and then spiked to the upper ends of the studs. The two sides are raised first, and the studs toe-

nailed to the sills, then plumbed and braced temporarily. The ends are raised in the same manner, the stud in

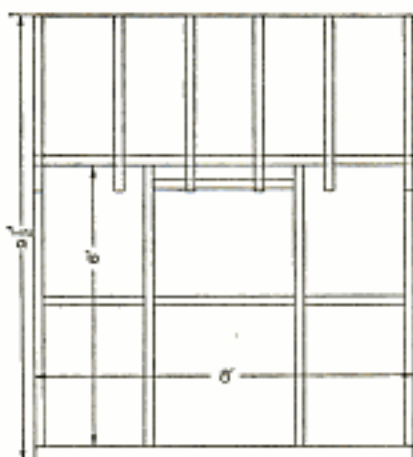

Side and End Elevation, Showing the Location of the Bench

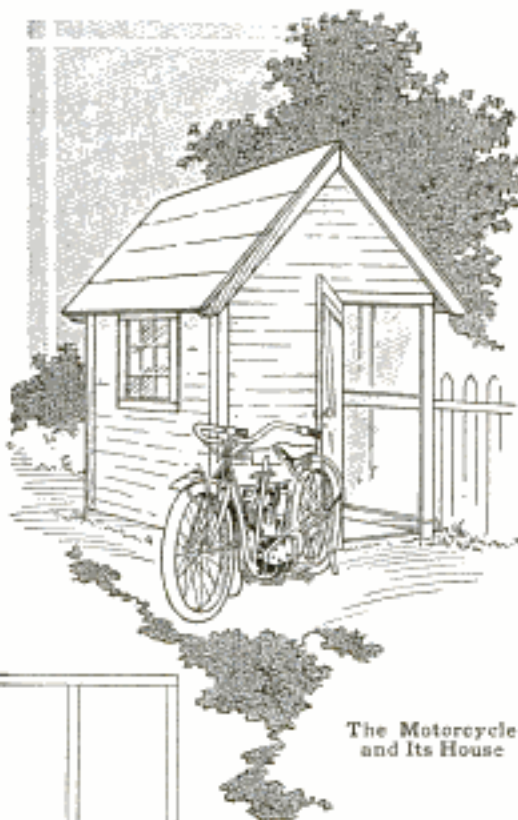

The Motorcycle and Its House

each being set in the center. The mitered corners of the plates are spiked in a manner similar to that in which a picture frame is nailed together. The nogging pieces are cut to fit in between the studs and fastened on them halfway between the top and bottom.

The roof is a half-pitch and the rafters are cut on a miter at the upper ends, the lower ones being notched out to form a projection for the eave. The two end pairs of

rafters are fastened on the plates and plumbed with their outside surfaces at right angles to the outside of the end studs. The other four pairs are spaced evenly between them.

In nailing on the roof boards, the work should be begun at the bottom, and 1 ft. of the boards should be allowed to project over the end rafters. The boards are then covered with the prepared roofing.

The siding boards are nailed on in a vertical position, allowing openings for the door and window. The door is so hung on the center end stud that it swings outward.

The bench is built up level with the nogging pieces on the side having the window. The crosspieces, holding the top planks of the bench, are spiked to the studs just under the nogging pieces, and the inside ends are supported on posts. The planks are spiked to the crosspieces.

To Hold Spokes of Wheels in Wood Patterns

The spokes in a pattern for a wood wheel are very difficult to fasten at the hub so as to make them hold like

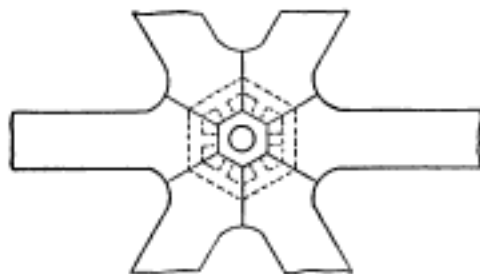

The Metal Forms a Hexagon Which Holds the Ends of All the Spokes

one piece. I use the method shown in the sketch, which not only draws them tightly together, but holds them firmly. This method is very simple. A hole is bored through the end of each spoke and another hole bored to intersect it at right angles, as shown by the dotted lines. After the spokes are in position melted babbitt metal is run into the holes. As the metal cools it shrinks, thus drawing the joints closely together.—Contributed by Chas. R. Poole, Los Angeles, Cal.

Water from a Drainpipe Leak Absorbed with Brick

An emergency call to repair a leak in the drainpipe under the bathroom floor of a fine residence, came to our shop just as we were leaving on Saturday evening. Upon examination it was found that a permanent repair could not be made without putting in

a new piece of lead pipe and wiping at least two joints.

We decided to try to leave the job if possible until the next workday. The leak was closed as much as possible by hammering the metal, but we could not close the aperture to keep it from leaking. The drops were noted and it was estimated that a pint would leak out in about 12 hours. As there was a space only about $4\frac{1}{2}$ in. between the pipe and plaster and an opening in the floor, 4 by 12 in. in size, it was out of the question to get a pan large enough under the leak to hold the water.

When looking around in the basement we found a pan, 1 in. deep and 9 by 12 in. in size, also some dry soft brick. We placed the pan on the plaster and the brick in the pan. For two days the brick absorbed the water as fast as it dropped from the leak. This method can be used by plumbers in many places.—Contributed by C. H. Bierly, Zanesville, O.

Cutting Piston and Valve-Stem Packing

The sketch illustrates a simple device for cutting round or square ring piston or valve-stem packing. It is always a more or less difficult matter to cut the ring exactly correct in length, to say nothing of getting each end the proper angle so that they will match when closed around the rod. This wood gauge or mandrel obviates all difficulties, giving size of packing, size of rod and angle of cut. The sawed slot, Fig. 1, for cutting may be at any angle desired. The cut is made as shown in Fig. 2. This little device will save the engineer much valuable



FIG. 1



FIG. 2

The Wood Mandrel with Knife Slot and Packing Groove and Manner of Cutting Packing

time, as usually several rings of packing are cut and thrown away before the proper size has been obtained.

How to Clean Portable Farm Engines

This method of cleaning farm engines is from the Thresherman's Review: Dissolve 1 lb. concentrated lye in about 2 gal. water, and with a mop saturate the engine with the liquid, being careful that it does not get into the oil holes of the journals and bearings. After the lye has eaten all the grease and gum from the surfaces, clean thoroughly by scraping and brushing, and after the iron is dry and free from grease, apply a thin coat of lead paint. When this is perfectly set, paint the iron a deep black and varnish heavily. Coloring, striping or decorating should be done before varnishing. Then the engine can be easily and quickly cleaned with a dusting cloth, and escaped oil can be wiped off.

To Make Worn Threads of a Bolt Hold

Where it is necessary to use a screw or bolt having worn threads, slot the threaded end and drive a flat wedge into the opening as shown in the sketch. This will make the bolt or screw hold almost as well as if new threads had been cut on it.—Contributed by Edward Matthews, New York City.

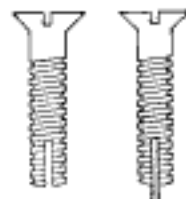

Double-Blade Hacksaw Frame

The purpose of the double-blade hacksaw frame shown in the illustration, is to dispense with extra frames for holding saw blades of different grades of fineness. This frame will hold a coarse and a fine-tooth blade at the same time.

The crosspieces carrying the blades are made of brass, 5 in. long, and the center rod is of steel, $\frac{3}{8}$ in. in diameter and 12 in. long. A flange is brazed on the rod just in front of the cross-piece at the handle. The other end of the rod has a long thread to fit in a threaded hole of the end cross-piece.

This is for drawing the blades tight by turning the handle. The blades

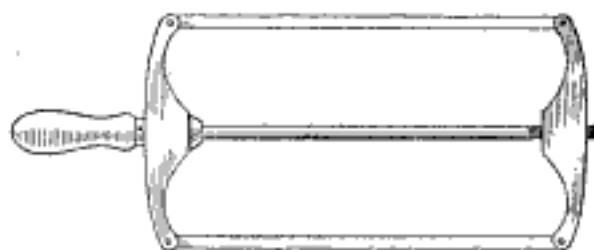

Two Blades are Placed in the Frame and Tightened Equally by the Handle on the Rod

are held in slots with pins, in the usual manner.—Contributed by P. H. Tierney, Lynn, Mass.

How to Measure a Resistance with a Voltmeter

A voltmeter, whose resistance is known, and some source of electrical pressure are all that is required to measure a resistance by this method. The voltmeter is first connected across the terminals of the source of pressure and the value of the total pressure in volts determined. It is then connected in series with the resistance to be measured, and the combination connected to the source of pressure. The connections of the voltmeter for measuring the total pressure are shown in Fig. 1 by the dotted lines, and the full lines indicate the connections when the unknown resistance is in circuit. The first reading of the voltmeter,

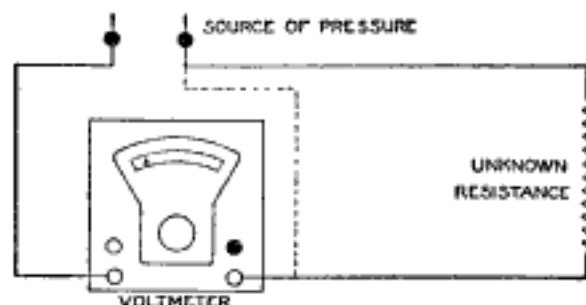

Fig. 1

The Ordinary Wiring Diagram and the Connections of a Voltmeter for Measuring the Total Pressure

which is the total pressure, we shall call E_t , and the second reading, or the one obtained when the voltmeter is in series with the unknown resistance, we will call E_v . Assuming the total pressure to remain constant, the

pressure over the unknown resistance, which we will call E_x , can be determined by subtracting the value of E_v from the total pressure, E_t , or

$$E_x = E_t - E_v$$

In any series circuit in which there is a direct current, the drop in pressure over the various parts bear the same

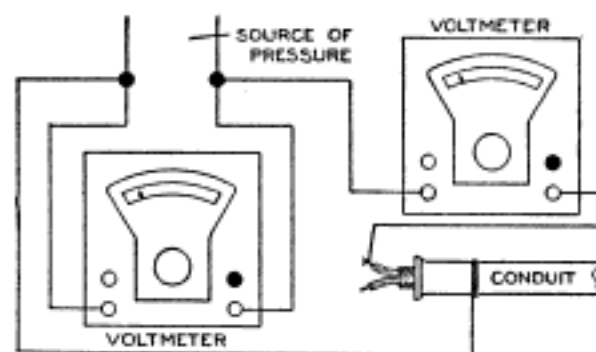

FIG. 2

Connections for Measuring the Insulation Resistance between a Circuit and the Conduit in Which the Circuit is Placed

relation to each other as exists between the resistances of these parts. Since the resistance of the voltmeter, R_v , the drop in pressure over the voltmeter E_v , and that over the unknown resistance, E_x , are all known, we can determine the value of the unknown resistance, R_x , by substituting in the following equation:

$$\frac{E_v}{E_x} = \frac{R_v}{R_x}$$

Solving this equation for R_x gives

$$R_x = \frac{E_x \times R_v}{E_v}, \text{ and}$$

since $E_x = E_t - E_v$, we have

$$R_x = \frac{[E_t - E_v] R_v}{E_v}$$

This method of measuring resistance is usually employed in determining the value of high resistances where a very great degree of accuracy is not required, such as the insulation resistance of a lighting or power circuit, insulation resistance between the field or armature windings of a machine and the metal parts of the machine, etc. The connections for measuring the insulation resistance between a circuit and the conduit in which the

circuit is placed, are shown in Fig. 2. Each wire can be measured separately, and the side having the greatest leakage should be connected to the terminal of the generator that is permanently grounded, if one side is grounded. By making the connection as indicated above, the leakage on the line will be less than if the connections be reversed.

The nearer the resistance of the voltmeter to the value of the unknown resistance, the more accurate is the result. If the value of the total pressure is continually changing, two voltmeters should be employed, one being permanently connected across the source of pressure, and the other in series with the unknown resistance. The resistance of the voltmeter across the line need not be known.

License-Number Holder for an Automobile

The new perforated license numbers are intended to be placed in front of the radiator on an automobile. A much neater method than the old way of fastening it close to the radiator with wire, is to make a bracket from a piece of band iron, which is easily bent

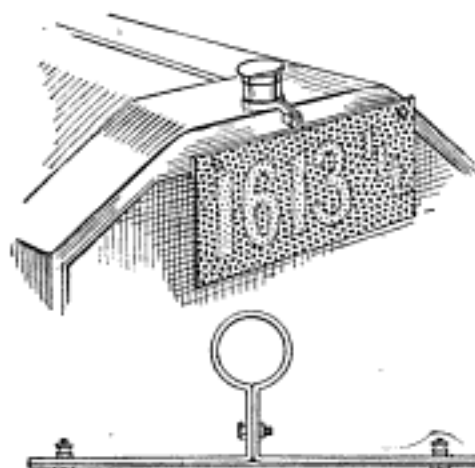

The Perforated License Tag is Held Firmly and Clear of the Radiator by the Bracket

to the shape desired. It should be made in accordance with the pattern in the sketch, but the dimensions will, of course, be governed by the size of the tag and of the radiator water cap. Three holes are drilled after the

strip has been cut and bent to shape, one through the double strip between the loop and straight part, and one at each end, as shown. Small bolts are used in these holes for attaching the tag to the bracket, and to hold the bracket on the filler cap.—Contributed by E. K. Marshall, Oak Park, Ill.

Ink Fountain for Covering Large Surfaces on Tracings

Draftsmen sometimes find it necessary to cover considerable spaces, such as wall sections, shadows, etc., with ink. To do this with a pen is very tedious work and also injures the tracing cloth. A brush is not always obtainable, but a scrap of paper can be had anywhere. Roll the paper up into a sharply tapering cone, as shown in

The Paper Point will Hold and Spread the Ink on Tracing Cloth Better than a Pen



the illustration, and tie it when a good point is obtained. This will make an implement for spreading ink which is far better than a brush. Dip the point into the ink and apply it to the parts to be covered.—Contributed by R. F. Pohle, E. Lynn, Mass.

Sizing Mandrels

It often happens that a mandrel may be necessary for a certain repair job, when there is none at hand to fit the work. The old method of enlarging a mandrel, when found a little too small, was to cover its surface with center-punch marks. I find, however, that the two methods now to be described are far superior to the use of center-punch marks.

In the one shown in Fig. 1 a common knurling tool is used on that part of the mandrel where the close fit is required. The second, Fig. 2, is to roll a series of grooves or corrugations with the corner of a roll, such as is used to finish axle journals. In either method,

the enlarging of the mandrel is supposed to be accomplished without any tempered or casehardened surface, so

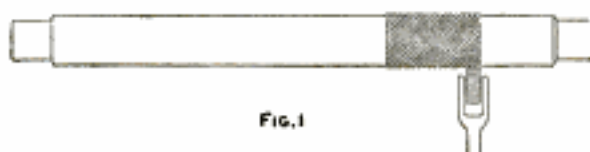

FIG. 1



FIG. 2

Mandrels may be Enlarged a Trifle by Knurling or Rolling Corrugations on Their Surfaces

that the metal will be shaped by the rolling process.

The knurling method has been successfully used to enlarge bushings that were turned too small.—Contributed by J. H. Maysilles, Rochelle, Ill.

Wood Top on a Concrete Floor

The accompanying sketch shows a concrete floor designed for use in a yarn mill. The problem was to provide a floor, resting on concrete, to which machinery could be easily and securely attached, says a correspondent of Industrial Engineering.

Planed, dovetailed nailing strips, or sleepers, 2 by 3 in., were accurately set with centers 18 in. apart, and concrete was poured around them, so as to completely fill the space beneath, and lock them into the mass of the slab. The illustration shows the sleepers and one system of reinforcing bars in cross section, and also shows how the sleepers were placed, without interfering with the reinforcing scheme, parallel



Wood Strips Molded in the Concrete to Make Holders for the Flooring Nails

to the bars of the upper course, and with three bars to each space between sleepers. The ends of the bars were

butted halfway between the sleepers, and they were even nailed thereto with two 4-in. nails at each bearing. On top of the planking, and at right angles to it, was laid a floor of $\frac{7}{8}$ -in. square-edged maple. Machines can be readily and firmly attached to this floor by lag screws. It has a degree of elasticity not possessed by concrete, and is much more comfortable for the workers.

A Homemade Tamper

A serviceable tamper can be made of an old shovel handle and a block of wood. The block can be of any convenient hard wood, about 6 in. square and from 12 to 16 in. long. Bore a hole in one end of the block to receive the round part of the shovel handle. The handle is sawn off, inserted in the hole and securely nailed. The end of the block is covered with a piece of sheet metal.—Contributed by Otto Kling, Ada, Ohio.

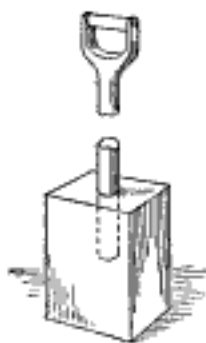

Reading Rules from Both Ends

Desk rules and folding rules are made with the figures reading from left to right and sometimes, when measures have to be taken from right to left, it is inconvenient, if not awkward, to read off measurements without error. I have adopted a plan by which the figures on rules can be read either way. With a small plane I cut off the figures on my desk rule and substituted open-faced figures from



The Numerals Marking the Inches on a Rule Run Consecutively Beginning from Both Ends

right to left, to the left of each line indicating inches, and for the reading from left to right full-faced figures were put on, so as to make a distinc-

tion and prevent errors. These two rows of figures could also be made in different colors.—Contributed by R. Roy, Ottawa, Can.

To Fit Loose Piston Rings

The piston rings in my motorcycle engine became worn so that there was an up-and-down play of about $\frac{1}{32}$ in., causing the engine to knock and lose compression. As I did not care to stand the expense or take the trouble of fitting new rings, I remedied the difficulty in the following manner:

Some thin rings cut from sheet metal were fitted in beside the old rings, care being taken to have them the same diameter to prevent scoring the cylinder. The engine runs as smoothly and quietly as when new.—Contributed by C. F. Rowe, Stephentown, N. Y.

To Keep a Protractor from Soiling a Drawing

Every draftsman realizes how difficult it is to keep drawings clean while working on them. The principal source of trouble is the excess of lead deposited from the pencil, which is spread over the surface of the paper by the triangles, straightedge (or T-square) and protractors. The worst offender in this respect is the steel protractor, on account of its weight and true flat surfaces.

The best way to overcome this difficulty is to decrease the amount of surface contact with the paper. This is accomplished by drilling three small holes in the protractor to receive $\frac{1}{8}$ -in. steel balls tightly. The protractor being only .12 in. thick, the balls will project a trifle on each side. This arrangement gives a minimum surface contact, yet keeps the instrument close enough to the paper to admit of accuracy and speed.—Contributed by J. C. Wilson, W. Lynn, Massachusetts.

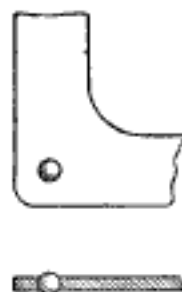

Equalizing Clamp for Spring Hangers

A very handy device for use in railroad shops for equalizing spring hangers is shown in the sketch. It is constructed of two bars, $\frac{1}{2}$ by 3 in. by 5 ft., and two crosspieces. The bars have slots, cut to coincide with each other, to receive the crosspieces, which are $1\frac{1}{4}$ by 2 by 7 in. One of the crosspieces is fitted with a screw as shown. This device will clamp a spring hanger



The Bars and Crosspieces in Their Positions as if on a Spring Hanger

and hold it while making necessary repairs.—Contributed by A. A. Attheide, Evansville, Ind.

Homemade Pipe Vise

As I had some pipe to cut and thread and no vise to hold the pipe, I made a temporary arrangement of angle iron that served the purpose well. The two pieces, A A, were cut from the end of an angle iron and holes drilled through one side of each to receive the largest pipe I had to cut. The angle irons were fastened to the bench about 2 ft. apart, with $\frac{1}{2}$ -in. bolts.

Two dogs, B, were attached to each piece of angle iron. Three holes were drilled for each dog so that they could be adjusted to receive and hold smaller pipes. The holes in the angle irons

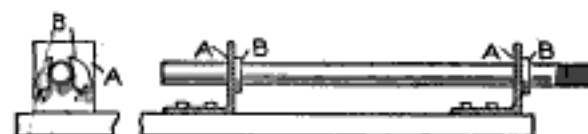

The Pieces of Angle Iron as They are Attached to a Board or Bench

were fitted with bushings for smaller pipes.—Contributed by Stanley S. Jimmy, Harvey, Ill.

An Auger Stop

The stop is made of a piece of pipe, A, that will slip over the bit and of a length to stop the bit when it has entered the material to the desired depth.

This is an effective stop to prevent an auger from passing too far through the material, and also to enable the opera-

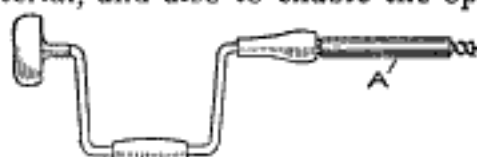

The Stop on an Auger Bit to Prevent It from Boring a Hole too Deep

tor to clean the edge of the hole by continuing to turn the auger after the stop strikes the surface of the material. A few pieces of different lengths and of a size to slip over the bits will be found very useful.

How to Make a Pair of Climbers

Finding myself in need of a pair of pole or tree climbers, I came to the conclusion that a pair could be made very easily without much expense. I procured six old 10-in. files and used three of them to make each climber. The illustration plainly shows the manner of shaping and fastening them together. The files are first heated and bent into shape, then thoroughly annealed.—Contributed by Ambrose Zierck, New York City.

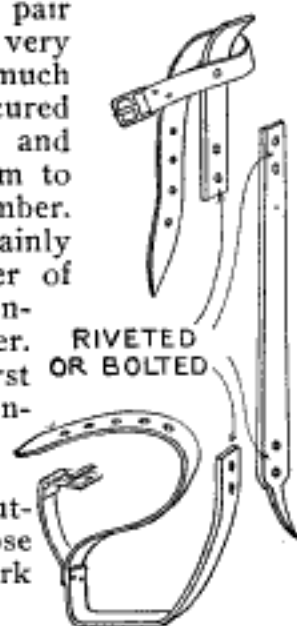

Aluminum Polish

An emulsion of equal parts of rum and olive oil can be used for cleaning aluminum, says Blacksmith and Wheelwright. Potash lye, not too strong, is also effective in brightening aluminum, and benzol can be used for the same purpose.

A good polish for aluminum consists of a paste formed of emery and tallow, the finish luster being obtained by the use of rouge powder and oil of turpentine.

Lighting a Match in the Wind

The accompanying drawings illustrate two methods of lighting a match in the wind. The match box as shown

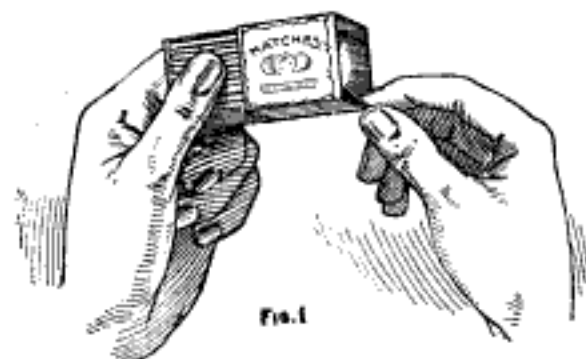

Fig. 1

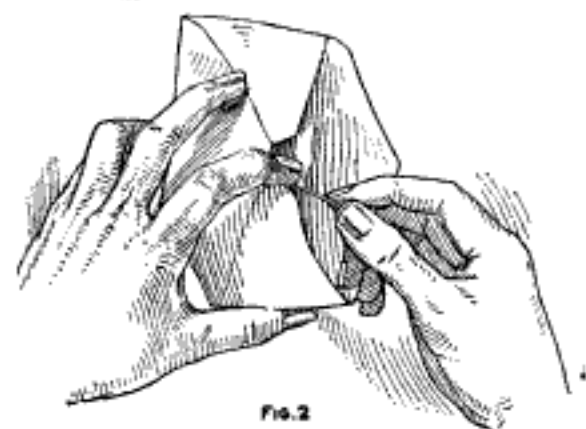

Fig. 2

Two Methods of Keeping the Flame of a Match Burning in a Strong Wind

in Fig. 1 is used as a shield, the thumb being pressed on the head ends of the matches within the box, to prevent igniting them. In Fig. 2 an envelope is used to shield the flame from the wind.—Contributed by James M. Kane, Doylestown, Pa.

Saving Gold with Oil

The fact that oil can be used for the purpose of saving filings and other small particles of gold and other precious metals, in jewelers' shops, is probably not generally known. It can be easily demonstrated by filling a glass half full of water and pouring kerosene on top of the water to a height of about 1 in. If then some very fine gold particles are dropped into the glass, it will be found that they will lodge at the water line.—Contributed by Wendell Rice, Caldwell, Idaho.

How to Adjust a Spark Coil

A recent careful investigation of a large number of so-called battery complaints on automobiles, led to the discovery that more than 90 per cent of them were due to an improper adjustment of the spark coil. The first thing the average motorist does when his car is not acting right, is to change the adjustment of the coil, and then when no spark is produced he blames the battery, when in reality the cause of the original trouble was elsewhere. A half turn of the adjusting screw on a coil will often increase the current required by the coil from one-third of an ampere up to one and one-half ampere, or nearly five times the actual current required.

A wrongly adjusted coil will cause one or more of the following cases of trouble: Great reduction in useful life of the batteries; rapid deterioration of the contacts on the coil; unsatisfactory operation of the motor; general dissatisfaction on the part of the operator.

Adjust the coil according to the following directions, and do not allow anyone to change the adjustment for any reason whatever:

First, remove the vibrator contact screw, marked A in the accompanying illustration. Second, smooth the point of the screw A and the platinum surface on the vibrator spring with a very fine file or a piece of very fine emery paper. Third, adjust the vibrator spring so

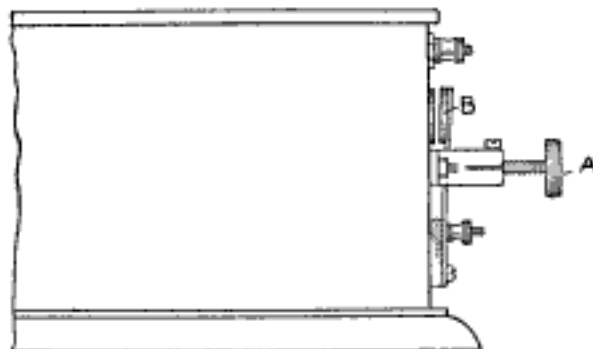

End of the Spark-Coil Box with the Vibrator Parts and Binding Posts for the Line

that the hammer or piece of iron on the end of the vibrator spring stands normally about $\frac{1}{8}$ in. from the end of

the coil. This piece of iron is marked B in the illustration. Fourth, turn in the contact screw until it just touches the platinum contact on the vibrator spring very lightly, then start the engine and if it misses, tighten, or turn in the contact screw corresponding to the cylinder that is missing, just a very small amount at a time, until the engine runs without missing explosions.

If the carburetor is properly adjusted and the coil windings and circuits are in good shape, there will be an ample spark with the smallest possible consumption of battery energy. A high-grade coil will usually save its price in one season, through the economy effected in batteries.

Handle Shapes for Wheelbarrows

If the handles of a wheelbarrow are altered to the shape shown by the dotted lines AA in the sketch, a grip for

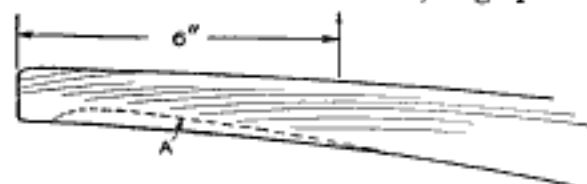

The Handles are Dressed to a Shape Similar to That of an Ax Helve, Producing a Knob on the End

the hands will be provided that greatly assists the laborer and causes fewer blisters than the ordinary handle.

The cause of its superiority seems to be the knob on the end which is similar to that on an ax helve. The tops of the handles are left untouched, the sides are sheared off for about 6 in. so as to give them an oval instead of a circular cross section. The under side is still more changed. About $\frac{3}{4}$ in. from the end of the handle the wood slopes sharply, showing a difference in circumference of about 1 in. between the knob and the smallest part. From this point it gradually slopes to the normal size at about 6 in. from the end.—Contributed by S. H. Packard, Boston, Mass.

A Sliding Door Lock

A very simple sliding door or gate lock that has been used with satisfaction is shown in the illustration. This

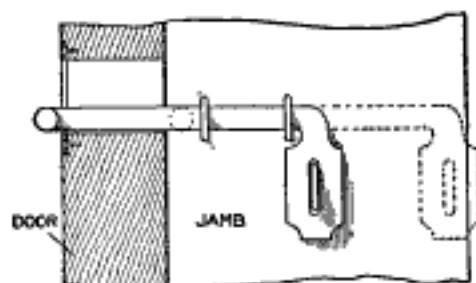

The Bent End on the Bolt Holds the Door Tightly against the Jamb When in a Locked Position

lock has a feature that is not found in most locks of this character—that of keeping the door tightly against the jamb besides locking it. The illustration shows the bolt in a locked position ready to receive a padlock.

To operate the lock, lift the hasp from the staple bringing the bent end of the bolt in line with the slotted hole in the door. This will allow the bolt to be drawn through and left in an unlocked position, as shown by the dotted lines.—Contributed by W. H. Wake, Paterson, N. J.

A Cup on a Decorator's Scraper

When washing or scraping walls, ceilings or other surfaces previous to redecorating, the refuse is usually allowed to fall anywhere, so that considerable cleaning and scrubbing of the floors become necessary. If the little device shown in the sketch is attached to the scraper, it will catch all the scrapings and keep the rooms tidy for

A Tin Receptacle Bolted to a Decorator's Scraper Saves Work

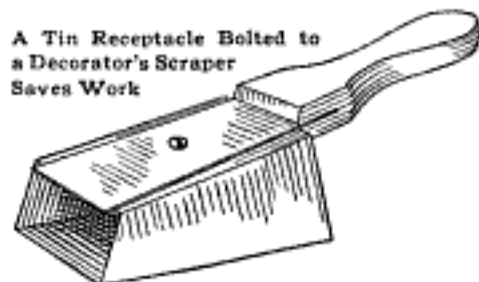

the decorator. The device can be made of a piece of tin and attached to the scraper with a stove bolt.

Renewing Fuse Plugs

Having a number of fuse plugs on hand which I desired to renew, I first removed the old rivet at the bottom of the plug and put

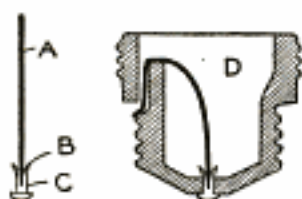

in a piece of fuse wire, A, with a split rivet, C, soldered to it at B. It is only necessary

to bend the fuse wire over and solder the other end as shown in D, and the plug is as good as new. A number of these fuse wires with rivets attached are kept ready, and one of them can be attached in a short time.—Contributed by W. C. Heidt, Chicago.

Holder for a Barn Door

A door hung on rollers is easily kept open or shut, as the case may require, by notching the track, as shown at A in the sketch, to fit the circumference of the wheel. The door will remain at the point of the notch when the wheel sinks into the notch, but it can also be easily pushed over the depression in opening or closing the door.—Contributed by Earl R. Hastings, Corinth, Vt.



Stopping a Weld

A weld can be stopped at any point by placing a piece of paper in between the pieces just before they are brought to a welding heat. The metal will



A Piece of Paper Placed between the Red-Hot Parts will Stop a Weld at Welding Heat

not run together where the paper is placed.—Contributed by A. S. Thomas, Gordon, Ont.

Disinfectants for Various Articles

A deodorizer is not necessarily a disinfectant as well, nor is the reverse true. Strong-smelling substances are not usually the best disinfectants. The germicides or disinfectants best suited for some particular purposes, are given herewith.

Bedsteads—Hot carbolic acid or corrosive sublimate. The carbolic acid should be 5-per-cent, and the corrosive sublimate, a 0.001-per-cent solution.

Bedding—Steam them, boil, or use a strong formalin solution.

Brushes and Brooms—Those of a good grade may be steamed or boiled, while the cheaper ones should be washed in strong alkaline soap and soaked in carbolic acid of 5-per-cent strength.

Books—Put them in a closed place and treat with formaldehyde gas.

Dead Bodies—Wrap in sheets wet with corrosive sublimate, carbolic acid, or tricresol.

Clothing—Steaming, boiling or exposing to formalin gas is good.

Carpets—Steam them, or sprinkle formalin under them.

Draperies—These should not be allowed to remain in a sick-room. If they have been exposed to infection, they should be boiled; but if such treatment would ruin them, nothing remains to do but burn them.

Floors—All floors should be washed well with carbolic acid (5-per-cent) and corrosive sublimate (0.001-per-cent) or tricresol.

Furniture, etc.—Formaldehyde gas is good. Glassware should be boiled. Leather, skins, and other articles being partly made thereof, should be washed in a 5-per-cent carbolic-acid solution. Money, paper or coin, may be boiled, and as it is often very badly contaminated, this should not be overlooked.—Contributed by Loren Ward, Des Moines, Iowa.

☞ Pulverized or floss asbestos, mixed with a little plaster of Paris and water, makes a good paste for stopping holes in stoves.

How to Build a Greenhouse

By PHILIP L. McKEE

A summer garden patch affords pleasure and profit to many people and almost everybody has either owned, or worked, or helped to work such a garden, but how many people know about the "winter garden patch." It is just as easy to grow lettuce, radishes, tomatoes, cucumbers, melons and even flowers during the winter as it is in the summer if you have a small hothouse, or greenhouse.

It is surprising what can be done with just a small greenhouse. A house, 10 ft. wide and 20 ft. long, will produce all the vegetables an average family will use during a winter season, and enough over to pay much of the expense of growing. In addition to the vegetables a great many flowers can be grown, and the greenhouse affords an excellent place for storing the house plants in the cold winter months. It will be a good place to put the geraniums, the rubber tree, the ferns and such other plants as it may be desired to keep.

The pleasure side of the greenhouse is very attractive to those who enjoy watching things grow. The work is very interesting and instructive; it brings one close to nature, and the lessons learned are from first-hand sources.

Owing to the high cost of living the profit side will probably be of most importance, and let it therefore not be overlooked that a house of the size mentioned will surely pay a dividend above the stock of vegetables for the table, if it is given just ordinary care and attention. The commercial vege-

table grower, the man who grows for the market, figures a clear profit of 50 cents for every square foot of growing space in his greenhouses, and at this rate a house 10 by 20 ft. would net \$75.00 above expenses. The house be-



A Small House with a Floor Space of 200 Sq. Ft. will Produce All the Vegetables a Small Family can Use During the Winter Months

ing small, the expenses will be greater in proportion to the quantity of vegetables produced, but on the other hand, they can be sold direct to the consumer at far better prices—probably twice as much as the truck gardener gets.

Anyone who is at all handy with tools can erect the house and put in the heating system. The materials can be had from the manufacturers who

make a specialty of this line of work, at very reasonable prices, or they can be made by some local planing mill.

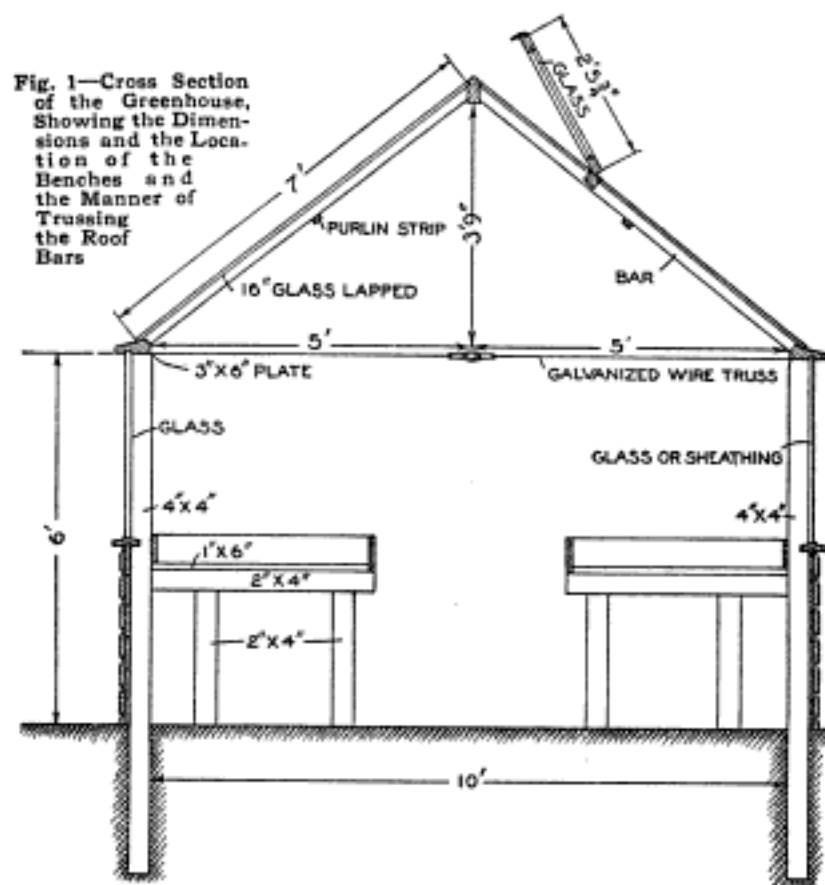

Fig. 1—Cross Section of the Greenhouse, Showing the Dimensions and the Location of the Benches and the Manner of Trussing the Roof Bars

Cypress is the best wood to use, but if this cannot be had, a good grade of pine or fir will do. The heating system should be either hot-water or steam, the former preferred.

How to Commence Work

The tools needed to complete the entire house are the following: Saw, hammer, level, square, homemade miter box, 18-in. pipe wrench, 12-in. monkey wrench, pipe cutter and a pipe threader that will thread pipe up to 2 in. in size. If all of these tools are not at hand, they can be purchased for little money new, and very cheap second hand. It may also be possible to borrow one or two for a day or so, thus saving some of this expense.

The sketch, Fig. 1, showing cross section, will give a good idea of how the house is to be framed and of its general features. By carefully studying this drawing anyone should be able

to understand it without difficulty. For a house of this size the posts, Fig. 2, for the walls should be of 2-in. pipe, as this makes the best wall and gives the neatest appearance, but they can be of wood, Fig. 3, if pipe is not easily had at a reasonable cost. If wood posts are used, they should be square and planed on all sides so paint can be applied easily and to give a nice appearance. If round posts are the only ones to be had, a slab should be taken off on one side to give a nailing surface for the sheathing of the wall. The kind of posts to be used, should be decided, the posts made ready, the post holes dug, a brick or piece of stone put at the bottom of the hole and the posts set in place. These posts should be set 3 ft. deep

in the soil and placed 5 ft. 2 in. apart, center to center. After the first line is set for the proper length of the house, carefully set the line for the width. If pipe posts are used, be careful when setting them to get the tops all in line and level. If the posts are wood, they can be sawn off in line after they are firmly tamped in place in the soil. A good height for the walls is 6 ft., but they may be lower or higher just as desired. Of course in setting posts, they must be arranged for pitch for the water to drain

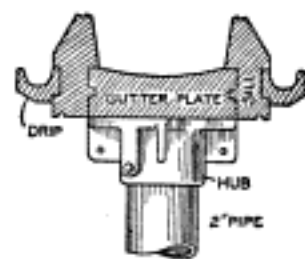

Fig. 2

off in the gutter, unless an eave plate is used, in which case the wall should be level. Give all the material two

coats of paint before erecting the house, using white lead and oil or a good mixed paint.

Framing the Roof

After all the posts are set, they are ready for the roof framework. If the posts are of pipe, an iron flange or casting must be used on the top for fastening the eave plate or gutter in place; if wooden, simply nail the plate or gutter in position, using three 20-penny spikes at each post.

The gutter or plate may be made as shown in Fig. 3, or in any other suitable manner. After this has been done, the roof bars and the ridge should be put up. The bars should be rabbeted on each side as shown in Fig. 3, and the ridge should have a groove in each side for the glass to fit into.

Nail one bar on each side of the ridge at each end and then set in place so that the lower end of each bar rests in position on the eave plate or gutter. Nail the lower ends fast, using one 6-penny finishing nail on each side of the bar and a 4-penny on top through the tongue of the bar. Nail the intermediate bars in place, being careful to space them the proper distance apart. Mark off the places for the bars on the ridge and at the eave, or cut a small block of wood $\frac{7}{16}$ in. longer than the width of glass being used and use this as a template for spacing the bars.

When the bars are in place, fasten the hinges to the ventilator sash to be used at the top of the roof. Hinge the sash in position on the roof (Fig. 4), first nailing the little header pieces between the bars as a stop for the glass in the rows just below the ventilators.

The roof can now be glazed. Use good putty, running it along the glass rabbet on the bars with the fingers, and bedding the glass down tightly into it. Start at the lower end of the bar and work toward the ridge giving the lights of glass a lap of $\frac{3}{16}$ to $\frac{1}{4}$ in. Use one single light between the bars in the ventilators if possible, but if not, give the glass a lap the same as on the roof. Fasten the lights in place with $\frac{3}{4}$ -in. No. 16 galvanized brads or brass shoe nails, and then scrape off

the surplus putty from underneath the glass. Do not use putty on top of the glass as in glazing sash for a residence. A good size of glass to use is 16 by 18 in.

Gable Ends and Sides

One gable end should be glazed and the other should adjoin the residence, barn or other building in which the

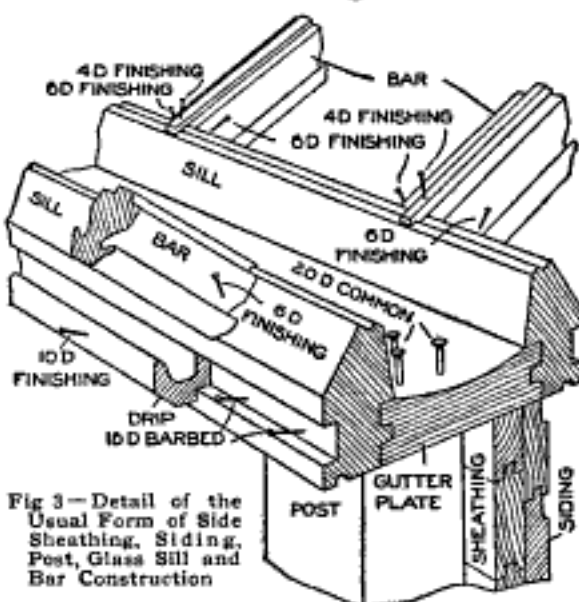

Fig. 3—Detail of the Usual Form of Side Sheathing, Siding, Post, Glass Sill and Bar Construction

small heater is located that is to keep the greenhouse warm. For the glazed end use wood posts and, if desired, put in a door frame made of 2 by 4-in. studs, and a small door. Cut off the upper ends of the upright glazing bars for the end, to suit the pitch of the roof, using the miter box for this work. Glaze in the same way as the roof, but just butt the lights of glass end to end in place of giving them a lap as before.

For the walls it will be cheaper to have sheathing from the ground to the eave, but, if desired, glass can be used in one wall to get light (Fig. 5). If the house is placed east and west, use glass in the south wall. If pipe posts are used, it will be necessary to first fasten a 2 by 2-in. piece on the outside to get a nailing surface for the sheathing. If the wall is to be boarded up solid, the post blocking will run full height, but if glass is used, it will be only long enough for the height of the sheathing.

For glass in the wall a sill is necessary for the side bars to rest on, and

it should be beveled to shed the water. Nail the side bars to this sill and to the eave, just as for the roof bars and

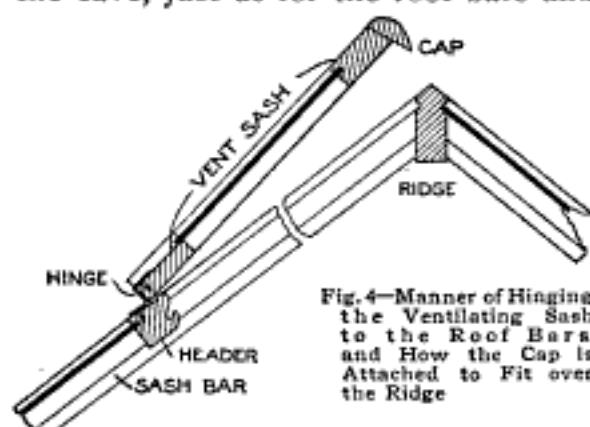

Fig. 4—Manner of Hinging the Ventilating Sash to the Roof Bars, and How the Cap is Attached to Fit over the Ridge

glaze in same manner as for the gable end.

Nail the sheathing with 8-penny common nails. Use any common lumber for first sheathing, but have it a different width than the second, or outside sheathing, so the wall will be tight. After the first sheathing is on, use a layer of good building paper and then cover it with drop siding or clapboards. The sides and ends should be boarded alike and corners finished off by nailing the pieces upright to conceal the joint.

Benches or Tables

These can be built of common rough, pecky cypress or hemlock, using 1 by 6-in. and 2 by 4-in. material. Benches should be 36 in. high from the ground to the top. Make the legs of 2 by 4-in. material, cut 2 ft. 6 in. long, and nail them on the end of the crosspieces, cut of same material to the right length for the width of bench. The 1 by 6-in. pieces are used for the bottoms and sides. They should be placed about $\frac{1}{4}$ in. apart for the bottom to allow for drainage. Benches should be level. Set the legs on bricks to prevent settling. For the house described use two benches, each about 3 ft. 8 in. wide.

Heating

This house, 10 by 20 ft., will require only a small amount of radiation and can be heated by a medium-sized hot-water laundry stove. This heater should be set about 3 ft. lower than

the greenhouse floor, if possible. If necessary it can be placed on the same level but this will not produce a good circulation throughout the system.

From the heater run a 2-in. flow pipe into the greenhouse just beneath the ridge, or along under one of the eaves, carrying it to the far end of the house. At the far end take off two branches, one on each side, of $1\frac{1}{2}$ -in. pipe, leading to the return pipes under the two benches. To get an inside temperature of 60 deg., at zero outside, 9 lines of 2-in. pipe are needed for this house, or 11 lines of $1\frac{1}{2}$ -in. pipe. After deducting the 2-in. flow pipe there are 8 lines of 2-in. pipe to put under the benches, four on each side, or 10 lines of $1\frac{1}{2}$ -in. pipe, using five on each side. The lines of pipe under the benches can be made up with manifolds or tees and nipples. On the near end of the greenhouse two $1\frac{1}{2}$ -in. branches will again connect the coils to a 2-in. pipe for the main return. For steam use one $1\frac{1}{4}$ -in. flow pipe and six lines of $1\frac{1}{4}$ -in. returns, three on each side, with a 1-in. pipe for the main return.

About Buying Materials, etc.

The best plan will be to get the materials from a greenhouse manufacturer as the cost will be less and every-

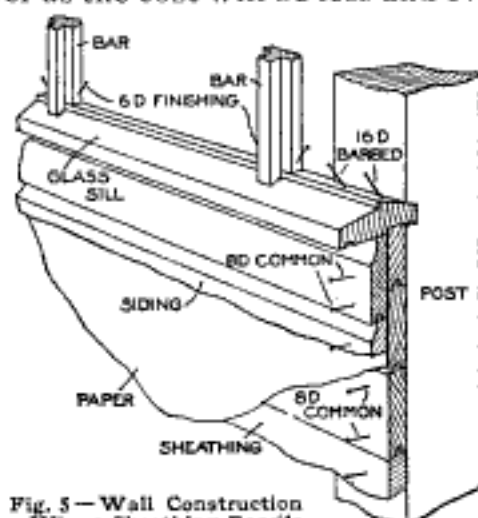

Fig. 5—Wall Construction Where Sheathing Boards are Used on the Bottom Part and Glass above the Benches

thing can be had cut and fitted ready to be set in place. He will also furnish plans and printed instructions telling how to erect everything, and thus time and money will be saved.

Scraper for Brass Work

When scraping brass boxes and other brass or bronze parts with the ordinary scraper, it will be observed that the tool digs in and makes rough work or chatter marks. This is due to the nature of brass which demands that, to cut smoothly, any tool, whether hand, or for use in a machine or drill, must have a straight top face or negative rake. A good brass scraper may be made from any flat or square file by simply grinding off the teeth, leaving the edges square. In use, the back edge should rest on the work as well as the straight edge, thereby lending support to the tool and helping to cut smooth.

Boring and Turning Long Pieces

I inclose a drawing illustrating how to bore and turn a piece longer than the lathe, or, at least, the way I did one long job.

There came into the shop one day a roll that had a broken journal, as shown in Fig. 1. There was a "hurry up" tag on the piece. When clinched, the roll, minus the journal, was as long as our lathe; so no help from the tailstock or carriage could be looked for. So we moved the table, or block, of the radial drill over to the end of the lathe and fastened it snugly. As it weighed 500 lb., it only needed wood

clamps to keep it from pushing away. Then a planer center was mounted on parallel blocks, as in Fig. 2, and the end drilled out for a tap the size of the broken journal. After hand tapping

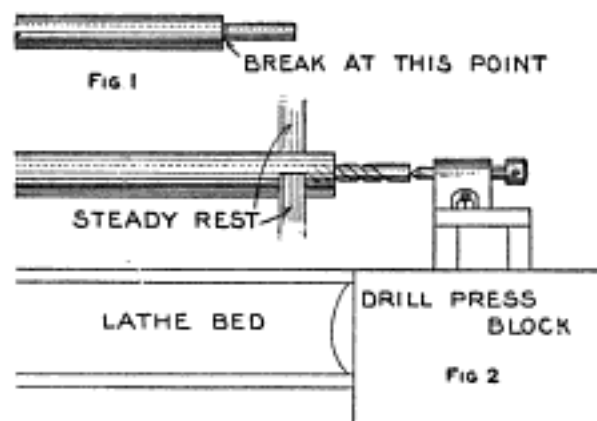

The Extension on the Lathe Bed Forms a Block to Hold the Tailstock of the Lathe

the journal hole, a new piece was screwed in very tightly—a piece with the free end slightly larger than the required finished size. Then a compound rest from another lathe was bolted to the block, a center put in the new end, the planer center run into this, and the journal turned off to size, using the hand feed in the compound rest. This job might have been done in other ways, but the one illustrated was, under the circumstances, fairly quick and accurate and saved sending the piece to a shop having larger tools.—Contributed by D. A. Hampson, Middletown, N. Y.

Cold-Storage Temperatures

In the following list is given a number of articles together with the

approximate temperature, in degrees Fahrenheit, at which each is best kept:

Ale	33	Cheese	34	Honey	38	Pears	35
Apples	35	Cider	33	Hops	36	Pork—fresh	32
Asparagus	34	Cigars	35	Lard	32	"—salt	36
Bananas	35	Dates	50	" oil	40	Porter	33
Beet—fresh	35	Eggs	32	Lemons	36	Potatoes	36
"—salt	36	Fruits—dried	38	Livers	25	Parsnips	34
"—dried	40	Fish—dried	35	Maple syrup	40	Sauerkraut	35
Beans	36	"—fresh	28	Milk	34	Sausage Casings	20
Beer	33	Flours	40	Nuts in shell	36	Sheep	32
" bottled	45	Furs	32	Onions	33	Sweet Corn	35
Berries	36	" undressed	35	Oleomargarine	20	Syrup	38
Butter	20	Game to freeze	15	Oranges	36	Tenderloins	33
Cantaloupes	35	" after frozen	28	Ox Tails	30	Tobacco	35
Carrots	34	Ginger Ale	37	Oysters in shell	32	Tomatoes	35
Celery	34	Grapes	35	" in tubs	25	Walnuts	35
Cabbage	33	Hams—brined	36	Poultry scalded	20	Watermelons	34
Calves	33	" not	20	Poultry dry picked	28	Wines	45
Canned Goods	35	Hogs	30	Peaches	35	Woolens	32

A Machinery Guard

The accompanying sketch shows how a guard to set around machinery may be made. It was designed by a correspondent of *Power*. The posts

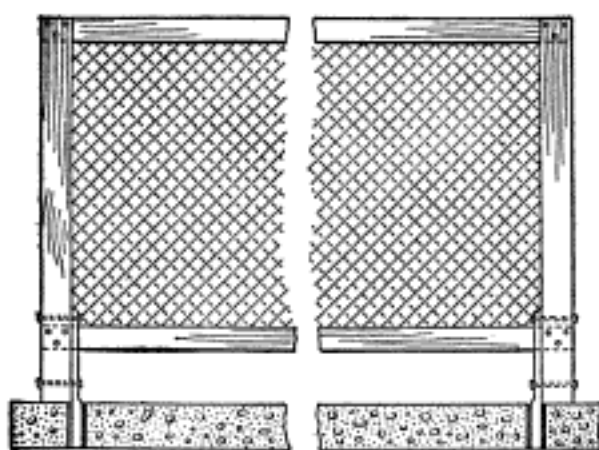

The Frames Have Metal Posts That Fit into Metal Tubes Set in the Concrete Floor

are of $1\frac{3}{4}$ by 4-in. dressed hard wood. The side strips are $\frac{3}{4}$ by 3 in. and of the same material. For a 6-ft. wheel the frame is made 6 ft. long, 4 ft. 4 in. high, and the lower side strip is set into the posts with its lower edge 8 in. above the floor. The top strip is fastened to the top of the posts as shown.

The floor irons are made of $1\frac{1}{4}$ -in. pipe, cut to the desired length, and after the concrete floor has been drilled, the $1\frac{1}{4}$ -in. pipe sleeves are set and cemented in place. The irons used on the frames are of 1-in. pipe, drawn out flat for about one-half their length. Holes are drilled in the flattened part for $\frac{1}{4}$ by $2\frac{1}{2}$ -in. carriage bolts to secure them to the frames. After the frames are made, they should be painted to match the color of the engine, and, when dry, they are covered with steel-wire fencing, 48 in. wide. When any work on the machinery is required, the frames can be removed without leaving any projections on the floor.

ⒸA very effective fish bait is made by inclosing a live minnow in a short section of glass tube, which is filled with water and both ends closed with corks. Fasten this to the line in place of the spoon.

An Effective Screwdriver

When a screw cannot be turned with an ordinary screwdriver, the following method is usually successful. Put the cutting edge of a cold chisel in the slot of the screw head and slightly turn the chisel in the direction to loosen the screw. This will cause the chisel to "climb" out of the slot a trifle. Hit the head of the chisel a light, sharp blow which will cause it to bottom in the slot, but the inertia of the chisel in turning to its original position will cause the screw to turn a small amount in the desired direction. By repeating this several times the screw can be loosened so it is easily turned with a screwdriver.—Contributed by C. A. Gilson, E. Lansing, Mich.

A Spatula Holder

A druggist desiring to keep his spatulas bright and clean made a place on a shelf as shown in the illustration. It is simply two shelves placed close together, with the space A between them slightly tapering from one end to the other. Before fastening the shelves in place the surfaces facing each other were covered with fine emery cloth.

After using a spatula, it is wiped clean, then run in and out the space

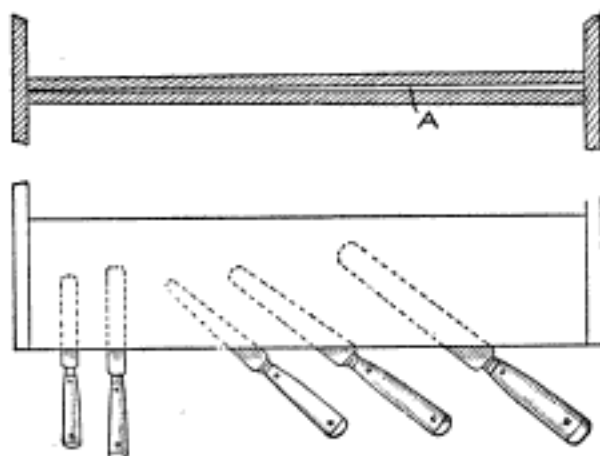

The Tapering Space between the Shelves is Lined with Fine Emery Cloth on Both Sides

where it fits most closely. This will keep it bright and clean, and it may then be left in the opening until needed again.



To Hold a Negative in a Printing Frame

When printing postal cards and working fast, it always bothered me to hold the negative in the printing frame while removing the card. To overcome this trouble I decided to contrive some arrangement to hold the negative in the frame when the back was removed. The device I made consists of a thin, flat spring, about $\frac{1}{8}$ in. wide and as long as the width of the frame opening. Two lugs are formed and soldered to the ends, as shown in Fig. 1, for holding the plate, and a central lug is soldered on to provide a means of fastening the spring in position. A groove, about $\frac{1}{8}$ in. deep, was cut in the opposite end of the frame to receive one end of the negative.

In use, slide the plate into the frame and into the lugs on the spring, and push the spring upward until the plate can be slipped into the slot at the opposite end of the frame. The pressure of the spring, as shown in Fig. 2, will hold the plate securely. The



FIG. 1



FIG. 2

The Spring with Its Clips and Manner of Holding a Negative in a Printing Frame

frame can be handled quite roughly and as fast as desired without any danger of the plate falling out.—Contributed by Thos. L. Parker, Wibaux, Montana.

CA number of bright tin disks tied to the limbs of a fruit tree will prove an efficient means of driving away infesting birds.

How to Make an Electrolytic Interrupter

Obtain a glass jar or wide-mouth bottle about one-quart size. An ordinary round bottle will serve very nicely by having the top cut off, thus forming a glass jar. Make a top

for the jar from a piece of $\frac{1}{2}$ -in. pine similar to the one shown in the illustration. The lower portion extends down inside the jar and serves to hold the top in place. Cut a slot in this top, $\frac{1}{8}$ in. wide and 2 in. long. This slot should be cut at right angles to a diameter of the top and extend 1 in. on either side of the diameter. It should be about $\frac{1}{2}$ in. from the center of the top. Directly opposite the center of the slot drill a $\frac{3}{8}$ -in hole, $\frac{1}{2}$ in. from the center of the top. Drill a $\frac{1}{4}$ -in. hole in the center of the top to give ventilation to the jar. Boil the completed top in paraffin for a few minutes.

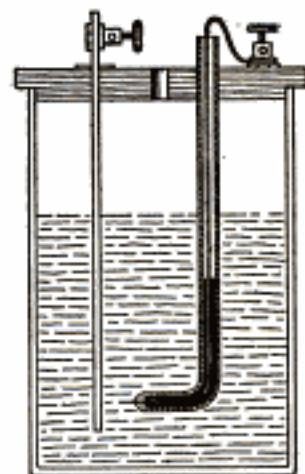

Obtain a piece of $\frac{1}{8}$ -in. sheet lead, 2 in. wide and about $\frac{1}{2}$ in. longer than the depth of the jar. Mount a small binding post on one end of this piece of lead and then support it in the slot in the wooden top by means of two metal pins. The lower end of the piece of lead should be at least $\frac{1}{2}$ in. from the bottom of the jar. Next get a piece of $\frac{3}{8}$ -in. glass tube and fuse a piece of platinum wire into one end.

Make sure the inside end of the platinum wire is not covered with the glass, and that the outside end protrudes a short distance beyond the end of the glass tube. Now bend about $\frac{3}{4}$ in. of the end of the glass tube which has the platinum in it over at right angles to the remainder of the tube. The tube should then be placed in the opening on the wooden top provided for it and a rubber band placed around it to prevent it dropping through the opening. The lower end of the tube should be a little higher than the lower end of the sheet of lead. A small quantity of mercury should be placed in the tube and a bare copper wire run down inside. The mercury affords a connection between the piece of platinum in the end of the tube and the copper wire. Connect the outside end of the copper wire under a binding post and

the interrupter is complete with the exception of the solution.

The solution for the interrupter is dilute sulphuric acid made by mixing about four parts of water and one part of acid. In preparing this mixture, be sure to pour the acid into the water, not the water into the acid. The jar should be about two-thirds filled. At least 40 volts will be required for the satisfactory operation of the interrupter. The distance between the platinum point and the lead sheet may be adjusted by simply turning the glass tube.

No condenser will be required in operating an inductor coil with an interrupter of this kind. The make-and-break interrupter, if there is one in circuit, should of course be made inoperative by screwing up the contact point against the spring.

A Homemade Hand Drill Press

The little use I had for a drill press did not make it advisable to purchase one, so I constructed a device for drilling iron and brass which answered all purposes. A broken carpenter's brace furnished the chuck, which was fastened to a $\frac{1}{2}$ -in. shaft having a detachable crank. The shaft turns in a

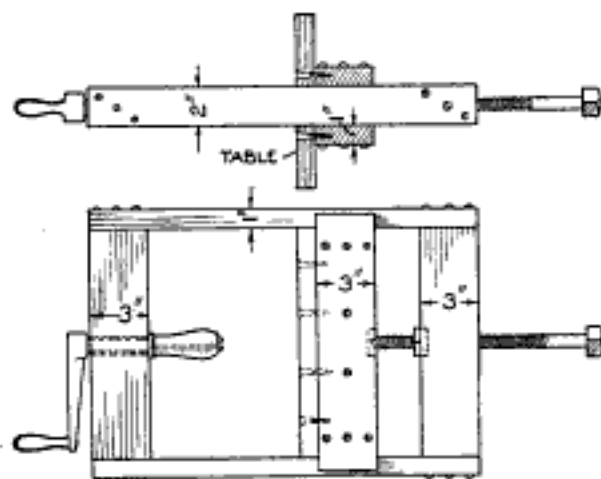

A Very Inexpensive Drill Press Frame Which Answers the Purpose Admirably

brass tube which is fitted tightly in a hole bored in the upright. The sliding part or table is forced up against the drill with a $\frac{1}{2}$ -in. machine bolt.

The bolt turns in a square nut fastened in the opposite post. The end of the screw bears on a plate fastened on the under side of the table to prevent wear. A crank could be attached to this bolt so that it may be turned more easily.

The sliding or table part is made of a post similar to the end posts, but with guides attached so as to keep it in place. The holes for the chuck shaft and bolt should be bored on a line and exactly in the center of the posts.—Contributed by L. R. Kelley, Philadelphia, Pa.

A Hose Nozzle

The nozzle shown in the accompanying sketch was made from an empty tobacco can having an oval shape. I cut the can in two near the center and punched small holes in the bottom. I then cut a piece of $\frac{1}{2}$ -in. board to fit tightly in the end of the can and turned the edges of the tin down to hold it in place. A hole was bored in the center of the wood and a $\frac{1}{2}$ -in. hose coupling fitted in it. The water will swell the wood enough to make an absolutely watertight joint, but by using a

little care in fitting it, the joint will be watertight without the swelling.

The holes being punched in straight lines, the nozzle throws a rectangular section of fine streams, which makes it possible to sprinkle close up to walks without wetting them. The friction is much less than in the ordinary hose nozzle, and consequently this nozzle delivers more water and also materially

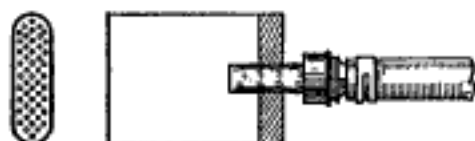

The Oval Form of the Box Makes It Possible to Sprinkle Close Up to Walls

reduces the strain on the hose.—Contributed by J. B. Downer, Seattle, Washington.

An Electric Water Heater

A simple electric water heater may be made as follows: Procure two sheets of copper, each 4 by 6 in., and place pieces of wood or other insulating material at the corners to keep them about $\frac{3}{4}$ in. apart. Bind them with cords, or, if the wood pieces are large enough, use screws so that there will be no contact between the plates. Attach wires to the plates with solder as shown, and make connections to a plug. Pour water in an earthenware



An Inexpensive Electric Water Heater Made of Two Copper Plates

jar, place the plates in it and turn the plug in a lamp socket. Do not use a metal vessel.—Contributed by G. Henry Jones, Sylacauga, Ala.

Frosting Glass

Procure a piece of flat iron similar to an iron hoop, bend it, as shown in the sketch, to make a piece 3 in. long and $1\frac{1}{4}$ in. wide and file one edge smooth. Sprinkle some fine lake sand over the glass, dampen the sand and rub the

smooth edge of the iron band over the glass. It requires only a short time of



The Filed Edge on the Coiled Metal Retains the Sand Particles as It is Rubbed over the Glass Surface

rubbing to produce a beautiful frosted surface on the glass.—Contributed by M. E. Duggan, Kenosha, Wis.

Long Handle for a Dustpan

The dustpan is a rather unhandy utensil to use, especially for stout persons. One porter overcame this difficulty by attaching a long handle to the pan as shown in the illustration. The handle was taken from a discarded broom and a yoke of heavy wire was attached to it, the ends being bent to enter holes punched in the upturned edge of the pan. A stout cord, fastened to the handle and tied into the ring of the dustpan handle, keeps the pan from turning backward, and it is thus possible to push it or carry it with the long handle.



To Fasten Chair Legs

Chair legs often become loose when chairs are handled roughly, so that the glue is broken up. A small device made from a piece of pointed metal, A, which is securely fastened to the end of the chair leg by means of a screw, will hold the legs more firmly than wire or glue. When the

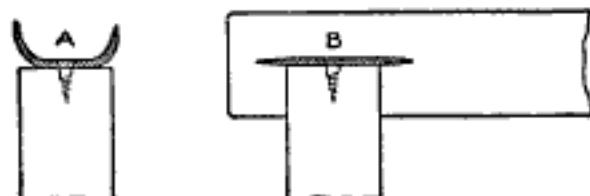

The Metal on the End of the Leg Fastens It Solidly in Place

leg is driven into the hole, the points are pushed into the wood B as the metal flattens.

To Tie a Hammock

A method not generally known to quickly and securely hitch up a hammock between two trees, in camp or elsewhere, is shown in the sketch. Each end rope is given one or more turns around a tree trunk and then tucked under, as shown. The pull on the rope will draw it tightly against the rough bark on the tree. The harder the pull, the tighter the rope binds against the tree trunk. In this manner a hammock can be put up in a few moments and it is as readily taken down.—Contributed by Bert Morehouse, Des Moines, Iowa.



An Inexpensive File

Envelopes make a very inexpensive as well as a neat file for papers and letters if they are arranged and fastened together so that they can be kept in one packet. In making such a file procure as many envelopes as there will be headings in the file, also a number of strips of gummed tape, about $1\frac{1}{2}$ in. long. There must be twice as many of these strips as there are envelopes.

Bind the backs of two envelopes, A and B, together leaving a space of $\frac{1}{8}$ in. between the envelopes. Bind a

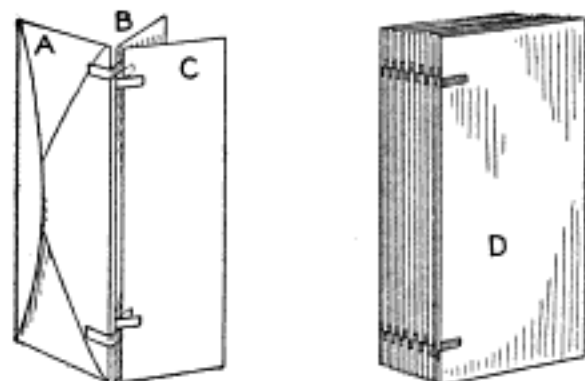

The File is Built Up of Envelopes Joined Together with Small Strips of Tape

third envelope, C, to B, and so on. The strips of tape from A to B and from B to C are on opposite sides of the envelope B. Continue binding un-

til the required number of envelopes have been joined together. Assign a heading to each of the envelopes, and the file is ready for use. When completed it should appear as shown in D.—Contributed by Alfred Rice, Syracuse, N. Y.

Window-Shade Guides

The annoyance of a shade that will not run true on the roller and flops in the wind coming through an open window can be overcome by using guide wires as follows:

The stick in the hem on the lower edge of the shade is supplied with a screw-eye, A, at each end. A wire is run through the screw-eye and fastened in a vertical position on the casing

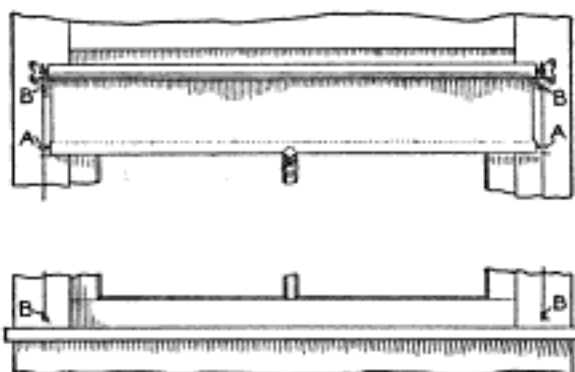

Two Parallel Guide Wires Hold the Stick of the Shade in Its Proper Place

with screweyes as shown by B, B. A second wire is similarly attached on the other side of the shade, taking care to have both wires parallel and true with the ends of the roller.—Contributed by George Lue, San Francisco, California.

Watering Plants at the Roots

An effective way to water rose bushes, shrubs or plants is to place an old cowhorn in the earth so that the small end will be near the roots of the plant and the large end level with the surface of the ground, and fill the horn with water. The small end of the horn should be cut off at such a point that the hole will be about the size of a lead pencil.—Contributed by Chas. L. Richards, Philadelphia, Pa.

How to Make a Dry Cell

The containing vessel for the cell should be made from sheet zinc. It should be cylindrical in form, approximately 2½ in. in diameter and 6 in. long. This vessel is to form the negative terminal of the cell and a suitable connecting device, similar to the one shown in the sketch, should be provided and securely fastened to the upper edge of the vessel. The vessel should be lined with some heavy blotting paper, both sides and bottom.

Place into a glass jar a small quantity of chloride-of-zinc crystals, and pour over them ½ pt. of distilled water. Allow the crystals to dissolve at least one-half hour. If the crystals all dissolve, add more until some remain in the bottom of the jar, or until the liquid is saturated. Pour off the solution and dilute it by adding an equal part of distilled water. Add to this solution sal ammoniac, in the proportion of 1 lb. of sal ammoniac to every 2 qt. of liquid. Fill the dry-cell vessel with this solution and allow it to remain until the blotting paper is completely saturated.

Obtain a good size electric-light carbon, about ⅝ in. in diameter, and file one end down as shown. Drill a hole through the carbon and mount a terminal.

Make a mixture of equal parts of finely powdered carbon and manganese dioxide of sufficient amount to almost fill the vessel. Add to this mixture some of the solution and thoroughly mix them. Continue adding solution until a thick paste is formed.

Pour the solution out of the vessel and allow the latter to drain for a few minutes in an inverted position. Place the carbon rod in the center of the vessel and pack the paste down around it, being careful not to move the carbon rod from its central position. The vessel should be filled with the paste to within about ⅝ in. of the top. The lower end of the carbon rod should not be nearer the bottom of the vessel than ½ in. Over the top of the paste place

a mixture of equal parts sand and fine sawdust and then, over this, a layer of pitch, which acts as a seal for the cell. A layer of blotting paper should

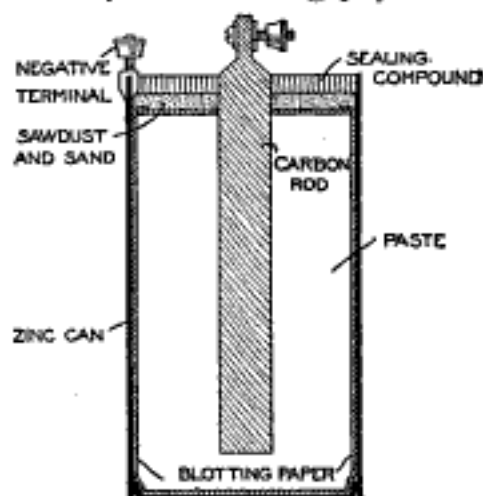

Cross Section through the Cell, Showing the Construction and Location of the Parts

be placed between the sand-sawdust mixture and the carbon-manganese mixture. The side lining of the vessel should be turned in before the sand-sawdust mixture is placed in the top of the cell. The outside of the cell should be covered with some heavy pasteboard, which will serve to insulate the negative terminal from the surface upon which the cell rests.

A Hose-Nozzle Handle

A handle for a garden-hose nozzle is easily made of a piece of wire and the wooden part of a package carrier. The wire is bent to receive the hose at A, and, after the handle is slipped on, the other end is formed to fit tightly over the brass nozzle at B.



The Handle is Made of a Piece of Wire and a Package Grip

The hose nozzle can be easily carried with the handle, which will keep the hand dry.—Contributed by F. G. Marbach, Cleveland, O.

Anchor Posts for a Lawn Swing

A very substantial and convenient base for a lawn swing can be made by using four anchor posts of cement, as

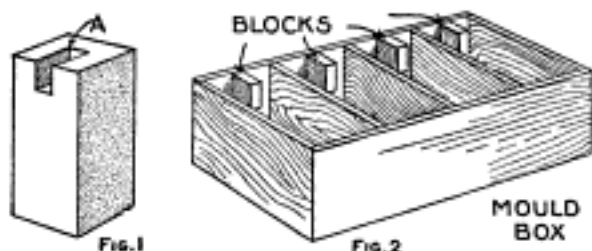

An Anchor Post of Cement and a Mold Box for Shaping Four Posts at a Time

shown in Fig. 1. The posts are made with a recess, A, to receive the legs of the swing, and of any suitable size. They may be placed with the upper face on a level with the lawn, or higher if desired.

A rough mold box, Fig. 2, lined with paper, will do for making the posts. The box does not require any top or bottom; it is simply placed on a board and lifted away when the blocks are thoroughly dried. If the blocks are leveled when placed in the earth, the swing may be taken down and erected again without the usual leveling and bracing.—Contributed by James M. Kane, Doylestown, Pa.

Automatic Filter

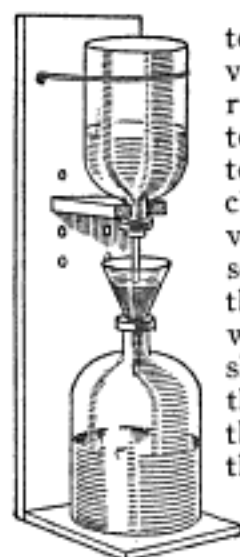

two brackets, one to fit the neck of the upper bottle and the other used

This funnel-filling filter automatically prevents the solution from running over if the filtering is slow or the filter substance becomes clogged. The upper inverted bottle holds the solution to be filtered, the cork being fitted with a glass tube as shown, and when in use the cork is forced into the neck of the bottle so that no air can enter between it and the glass. The support for holding the bottles has

as a shelf for the receiving bottle. In operation, the solution runs from the upper bottle into the funnel, holding the filter paper, but it cannot fill the funnel completely, because the end of the glass tube is lower than the edge of the funnel, and as soon as the liquid in the funnel covers the end of the tube, all inflow of air into the upper bottle is stopped, and, thereby, further flow of the solution into the funnel prevented, until enough has filtered through to uncover the end of the tube and thus permit air to again enter the upper bottle.—Contributed by G. Simons, Chicago.

Grinding Scissors

Whether a pair of scissors be ground or filed, the marks or scratches left from the contact with the abrasive should all extend across the bevel in

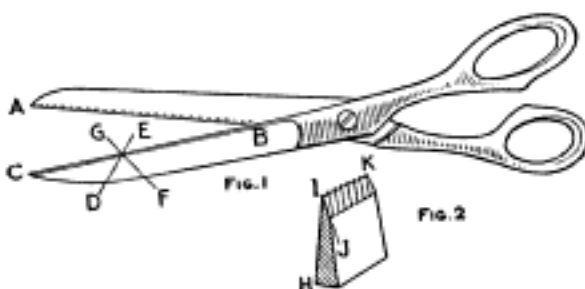

The Direction of the Grinding Tool should be Slightly Sloping Toward the Handles

the direction of the line ED, Fig. 1, and never in the direction of the line GF. If the cutting edge be examined under a magnifying glass, the tool marks or scratches left by the sharpening process will be very plainly seen, and where these scratches intersect with the face HI, Fig. 2, of the blade, they will appear as teeth along the cutting edge IK.

As a pair of scissors close, the natural tendency is to thrust the material to be cut out of the angle ABC, Fig. 1, but if these small teeth formed on the cutting edge point in the direction of the line ED, this slipping action is prevented or retarded because the fibrous material adheres to the fine teeth on the cutting edge of the blades.

Wet paper, silks, mohair cloths, etc., can be sheared with perfect ease and

dispatch, when scissors are sharpened in this manner. The same principle holds good for metal snips.

The angle HIJ, Fig. 2, varies according to the material to be cut, and the type of shear. A greater angle is required on metal shears than on shears for domestic uses.—Contributed by A. Clifton, Chicago.

To Repair a Leak in a Canoe

After striking some rocks with our canoe, it sprung three very bad leaks. These were effectively patched with pieces of cheesecloth, well soaked in liquid shellac, which were pasted on the outside of the leak. After allowing this to set for a few hours, it will be almost impossible to remove the patch. This is an inexpensive and almost invariably a sure remedy for leaks. When the cloth is dry, paint it over with the same color as the boat, and the repair can scarcely be seen.—Contributed by William B. Smith, New York City.

Holder for Loose Window Glass

When the putty becomes loose and the glazing points work out on window glass, temporary repairs may be made by using a small piece of tin or sheet iron bent as shown in the sketch. The clip is inserted under the edge of the glass and hooked over the back of the sash parts. This will hold the glass firmly in place and also prevent rattling.

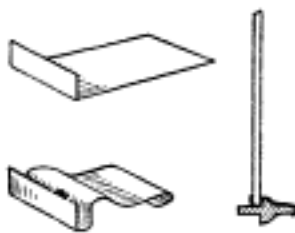

A Homemade Bench Vice

A form of a bench vice that can be easily made and attached to a workbench is shown in the illustration. This vise requires no screw, and the parts can be made from scrap material.

The substitute A for the screw is a

rectangular piece of wood and is fastened with a tenon in a mortise cut in the vise jaw B. The clamping ar-

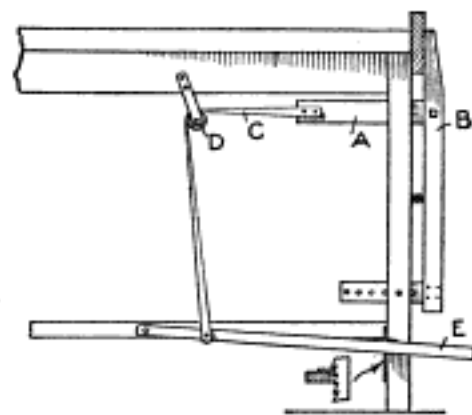

The Vise Jaw as It is Attached to the Bench and the Substitute Screw Arrangement

angement consists of a strap, C, attached to the piece A, then run over a pulley, D, and fastened to a foot pedal, E. The foot pedal is fulcrumed on a crosspiece of the bench and has a ratchet so as to hold it when the vise is set. The lower end of the vise is fitted with the usual form of device for parallel adjustment. A coil spring is located in the center for use in quickly opening the vise when the foot pedal is released.—Contributed by A. C. Westby, Porter, Minn.

A Cover Strainer

Quite frequently the cook or housewife wishes to pour the hot water or liquid from boiling vegetables or other foods without removing the solids from the kettle. This is easily accomplished, if small holes are drilled in the cover as shown in the sketch. The saucepan or kettle can be tilted and the liquid drains through the holes. Further, the steam from cooking food



A Sufficient Number of Holes are Drilled in the Edge of the Cover to Make a Strainer

can readily escape through the holes, thus preventing the cover from vibrating, or the liquids from boiling over.

Picture-Frame and Triangle Clamp

A picture frame or triangle is quite difficult to hold together when fitting the corners. It is still more difficult to hold them together while the glue dries. The clamp illustrated will be found quite satisfactory in solving this problem, and at the same time is very simple to construct and easy to manipulate. The material list for making the clamps and corner blocks is as follows:

- Picture frame clamp:
 4 pieces, $1\frac{1}{4}$ by $1\frac{1}{4}$ by 15 in.
 2 pieces, $1\frac{1}{4}$ by $1\frac{1}{4}$ by 5 in.
 Triangle clamp:
 3 pieces, $1\frac{1}{4}$ by $1\frac{1}{4}$ by 10 in.
 1 piece, $1\frac{1}{4}$ by $1\frac{1}{4}$ by 4 in.
 Corner blocks:
 4 pieces, $\frac{3}{8}$ by $3\frac{1}{2}$ by $3\frac{1}{4}$ in.
 8 pieces, $\frac{3}{8}$ by 1 by 2 in.
 The pieces mentioned are of oak, S4-S.
 1 piece $\frac{3}{8}$ -in. maple for dowels
 Hardware:
 10 bolts, $\frac{1}{4}$ by 2 in.
 4 bolts, $\frac{1}{4}$ by 3 in.
 2 bolts, $\frac{3}{8}$ by 6 in.

The picture-frame clamp consists of the four arms A, B, C and D, Fig. 1. A $\frac{1}{4}$ -in. hole is bored in one end of each piece, $\frac{1}{2}$ in. from the end. A series of $\frac{3}{8}$ -in. holes, 1 in. apart, are bored along the center in each piece. The two short pieces, E and F, have two $\frac{1}{4}$ -in. holes bored in their centers, $\frac{1}{2}$ in. from each end. These pieces are bolted to the four arms with $\frac{1}{4}$ -in. bolts as shown in the sketch. A $\frac{3}{8}$ -in. hole is bored in the middle of

it with the end projecting $1\frac{1}{4}$ in. on the under side and level with the surface on the upper side. Each of the corner blocks is fitted with two pieces like X, Fig. 2. Each of these pieces has one end round or a semicircle, and in its center a $\frac{1}{4}$ -in. hole is bored. The other end has a $\frac{3}{8}$ -in. hole bored $\frac{1}{2}$ in. from the end.

After making the small pieces, take the four corner blocks G, H, I and J and draw a line on the upper side in the center, with the grain of the wood, and mark the angles as follows, so that one-half the angle will be on each side of the centerline: On one end of the pieces G and H mark a 90-deg. angle, on the other end a 45-deg. angle, on the piece I mark a 90-deg. and 30-deg. angle and on J mark a 90-deg. and 60-deg. angle. Mark the number of degrees of each between the sides of the angle. Place two of the pieces marked X, Fig. 2, on each of the corner blocks, one piece on each side between the different angle lines, so their round ends will be toward the center and toward each other with a space of $\frac{1}{4}$ in. between them. Clamp the pieces to the corner blocks and bore the $\frac{1}{4}$ -in. holes through them to secure perfect alinement. Put the bolts in and turn

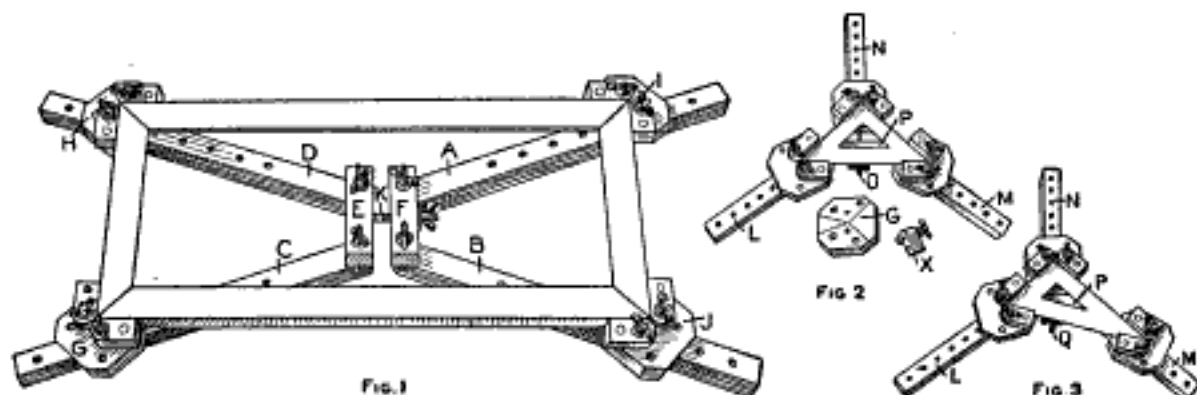

The Corner Blocks on Both Picture Frame and Triangle Clamps are so Constructed That They Hold the Molding together While Fitting the Corners and also Hold Them Securely While the Glue is Hardening

each piece E and F for one of the 6-in. bolts K.

The four corner blocks G, H, I and J, Fig. 1, have a $\frac{3}{8}$ -in. hole bored in the center of each and a dowel glued into

the pieces first to one angle and then the other, and while in the respective positions, bore the $\frac{3}{8}$ -in. deep in the corner blocks. Glue a dowel in each $\frac{3}{8}$ -in. hole of the small

pieces, allowing it to project $\frac{1}{4}$ in. on the under side so it will fit in the $\frac{3}{8}$ -in. hole in the corner block. Be sure to countersink the holes for the heads of the bolts. All bolts should be fitted with wing nuts. All that is necessary to change from one angle to another is to loosen the nuts and swing the small pieces around so the dowel pins will drop into the other holes, then tighten the nuts.

The triangle clamp is made in the same manner as the picture-frame clamp, except that the arms L and M, Figs. 2 and 3, are half-lapped into the crosspiece P. The bolt O is $\frac{3}{8}$ in. and the head is cut off. Drill a $\frac{1}{8}$ -in. hole in the bolt, $\frac{1}{4}$ in. from the end, and bore a $\frac{3}{8}$ -in. hole in the end of the arm N. Insert the headless bolt O in this hole and drive a nail through the side of the arm N, so it will pass through the hole drilled in the bolt. This keys the bolt in the end of the arm N.

To clamp a picture frame, set the corner blocks G, H, I and J to the 90-deg. angles and adjust them on the arms A, B, C and D to accommodate the size frame to be made, as shown in Fig. 1. Tighten the thumbnut on the bolt K, and this will draw all four corners together with the same pressure. The corners can then be examined to see if they fit properly. If they do not, saw in the joints with a backsaw until they do fit.

The triangles are clamped in the same way. The corner blocks are set to take the proper angles. The ends of the bolts should be slightly burred over so that the thumbnuts cannot be turned off.—Contributed by Chas. A. Pettit, Baltimore, Md.

Exterior Sliding Fly Screen

The method shown for fitting fly screens on the outside of the upper and lower sash permits the screen to be raised and held at different heights. Screweyes are turned into the outer strips, as shown in Fig. 1. The sides of the screen frame are grooved, Fig.

2, to allow it to slide up and down on the screweyes.

The screen can be raised and two of the screweyes turned from the normal vertical position, A, Fig. 3, to a hori-

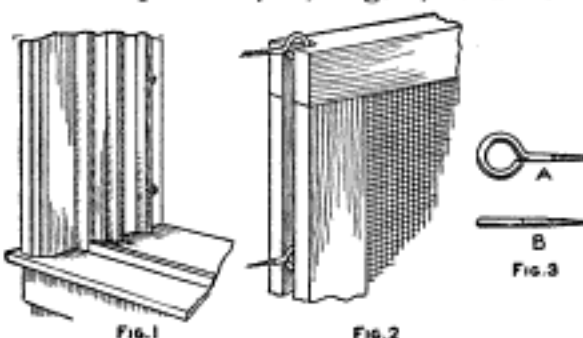

The Heads of the Screweyes in the Window-Frame Stop Slide in a Groove Cut in the Screen Frame

zontal position, B, to hold the frame at that point. By the use of a greater number of screweyes more places can be provided to support the screen at different heights.—Contributed by James M. Kane, Doylestown, Pa.

Bushing a Stovepipe in a Chimney Hole

When a stovepipe is too small for the hole in the chimney, a bushing can be made of the kind of metal tobacco boxes that are curved to fit in a pocket. Remove the tops and bottoms of the boxes and shove them in around the pipe. If such tobacco boxes are not at hand, tin cans of any kind can be used by melting off the tops and bottoms and bending the remaining cylindrical shells into proper shape.—Contributed by Elmer McConaughy, Dayton, O.

A Screweye Driver

An ordinary wire nail, 3 in. long, bent as shown and with its head filed square, makes a good tool for turning in screweyes. The square head is readily held in the chuck on most braces. The screweye can be turned in with greater speed than by the ordinary method.—Contributed by Robert T. Johnston, Buffalo, New York.

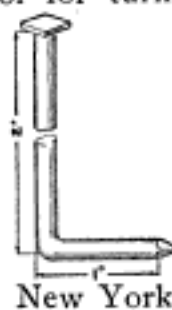

Supporter for a Double Clothesline

A double clothesline of any length should have a supporter in the center to keep the line from sagging when the clothes are hung on the lower one. The supporter shown in the sketch saves the wear from the strain on the lines. It also keeps the clothes in a higher current of air so that they dry quicker.

The supporter is made of two nickel-plated rings measuring 2 in. in diameter. They are bound together as shown. The rings being nickelplated, the supporter will not rust the clothes. The clothes should be arranged on the lower line so that the supporter will rest in the center.—Contributed by Katharine D. Morse, Syracuse, New York.



Pincushion for the Arm

Those that have trouble in keeping the pincushion within reach while sewing, can remedy the trouble by making one to fit the wrist or arm. An ordinary pincushion is attached to a piece of cardboard and an elastic sewed to the cardboard edges so that it will fit on the arm. The pincushion is not in the way and is readily worn so that the pins are easier to reach than if pinned to the dress.—Contributed by Frank Sterrett, Portland, O.

Electric Test for Fixtures

A very useful device for testing out fixtures before they are connected up

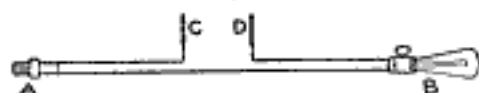

One Line of the Two Connecting Wires is Broken and the Ends Used as Terminals on the Fixture

can be easily made as follows: Two wires are run from a plug, A, one to a socket, B, and the other to terminate

at C. The line from the other side of the socket B terminates at D.

In testing a fixture, the plug A is turned into a socket of some source of current, and a lamp is turned into the socket B. The terminal C is held to the metal covering of the fixture, while the end D is held to one of the wires. If there is a leak of current, the lamp at B and those of the fixture will light up.—Contributed by Fred Schumacher, Brooklyn, N. Y.

Opening for Steam in a Utensil Cover

When cooking certain foods the ordinary cover on a vessel confines too much steam, while if no cover at all is used, too much will escape, hence a cover which is provided with a vent is very desirable. The cover attachment shown in the illustration is evidently well adapted for service on such occasions and can be easily made as follows:

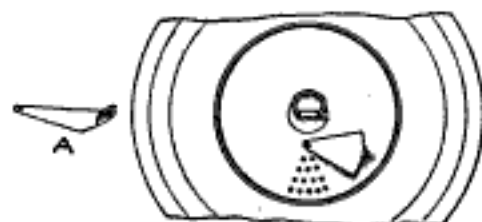

The Small Triangular Surface Provided with Holes for Releasing Surplus Steam is Covered with a Cap

Lay out a small triangle on some level part of the cover and punch several holes inside of the lines. Cut a cap, A, from a piece of tin to cover the holes. A small projection on the edge of the cap serves to swing it one way or the other, as needed, and it is fastened loosely to the cover with a soft-copper rivet, so that it may be easily opened.

Drying Seeds

A good way to dry tomato, cantaloupe, and other seeds is to put them on blotters. They will quickly dry in this manner and will not become moldy, as the blotter soaks up the moisture.—Contributed by Theodore Becker, Kansas City, Mo.

A Dissolving Coin Trick

This is a very simple and effective trick. The articles required to perform the trick are, a glass of water, a silver dollar, a handkerchief and a watch crystal, or round piece of glass, the size of a silver dollar. Conceal the crystal in the palm of the hand and show the audience the dollar. Hold the handkerchief in one hand and place the hand holding the silver dollar and crystal under it so that the crystal can be grasped by the hand holding the handkerchief. Remove the dollar by holding it in the palm of the hand and slip it, unobserved, into a pocket.

Ask some one in the audience to hold the handkerchief with the inclosed crystal and ask him to let it drop into the glass of water as the handkerchief covers both. The falling glass can be heard, but upon removing the handkerchief nothing can be seen of the dollar or watch crystal. The circular glass disk cannot be seen in the water.—Contributed by Albert Biery, Spokane, Wash.

A Fruit-Jar Opener

The accompanying sketch shows a handy device for turning up and unscrewing the covers on glass fruit jars. The loop is slipped over the cover and the handle turned in the direction of the arrow. To unscrew the cover, the tool is turned over and the handle turned in the opposite direction.

The loop should be just large enough to slip over the cover easily.

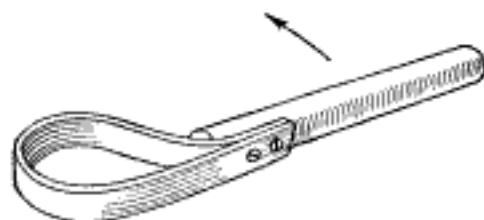

The Loop in the Leather Grips the Cap Tightly When the Handle is Turned as the Arrow Indicates

It is made of leather and fastened to the wood handle with screws.—Contributed by J. B. Downer, Seattle, Wash.

Anti-Tangle Safety Pin

A small disk of rubber or leather, placed on a safety pin as shown in Fig. 1, will prevent the fabric which is fas-



The Small Disk on the Pin Prevents the Goods from Becoming Tangled in the Coil

tened by the pin from becoming tangled in the spring loop. The manner of using the pin is shown in Fig. 2.

How to Nickel or Silverplate Iron by Friction

The following methods of plating iron with nickel and silver appeared in a recent issue of a German paper. In nickelplating iron, a thin coating of copper is first produced on it by rubbing on a solution of 20 parts sulphate of copper, 5 parts sulphuric acid and 100 parts of water. After the copper plate has been formed rub over it, with a rag, a solution of 3 parts tin, 6 parts nickel and 1 part iron in 100 parts of hydrochloric acid and 3 parts of sulphuric acid. If finally the object is rubbed with a rag that has been dipped in finely pulverized zinc, a nickel deposit will be formed on the copper. The thickness of the deposit of nickel can be increased by repeating the two last operations.

According to a recent patent, a silver coating can be produced by dissolving freshly precipitated chloride of silver in a solution of hyposulphite of soda, 1.1 parts to 10 parts of water, and adding to this solution 180 parts spirits of sal ammoniac and then stirring in 800 parts of finely washed chalk. This mixture is applied and rubbed until it dries on the object being silvered, and the result is a brilliant deposit of pure silver.

CA good filling for cracks in old furniture is made of shellac, either melted by heat or dissolved in alcohol to make a thick paste.

INTERESTING PATENTS, PRACTICAL OR UNIQUE

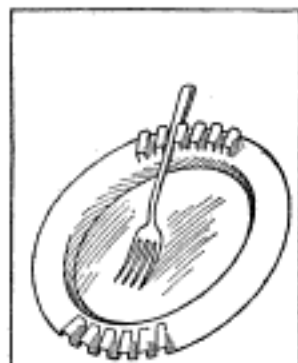

Fig. 1

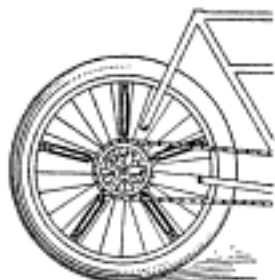

Fig. 2

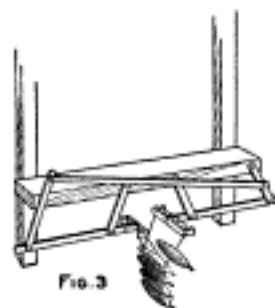

Fig. 3



Fig. 4



Fig. 5

PLATES WITH CUTLERY GROOVES (British patent)—A plate having grooves to receive knives, forks and spoons on the border or rim and to retain them there until required by the user is shown in Fig. 1. The idea is particularly designed for the self-serving type of restaurant.

RESILIENT DRIVE FOR MOTORCYCLES—In Fig. 2 is shown an interesting resilient or elastic driving arrangement for motorcycles, made possible by loosely mounting the sprocket wheel on the drive-wheel hub. Plunger rods are pivoted to the sprocket wheel, and operate in casings pivotally connected with the rim of the wheel. Springs are provided to exert tension upon the plunger rods.

SEED-CORN STRINGER—A simple stringer for seed corn is illustrated by Fig. 3. The operation of the top bar causes the crossheads at the inner ends of the lower bars to move simultaneously across each other and back, thus causing the corn-supporting strands to cross and recross over the ears of corn.

MUDGUARD FOR SHOES (British patent)—A rear mudguard for shoes is shown in Fig. 4. It consists of a properly shaped piece of leather or rubberized fabric permanently attached to the shoe between the heel and the upper. It may be turned up so as to lie flat against the upper when not in use, and is provided with a clip for retaining it in this turned-up position.

SWIMMING SADDLE—Figure 5 illustrates a swimming apparatus having a form that vaguely reminds one of a Mexican saddle. It is, in fact, a water saddle in which an inexperienced swimmer may ride the waters in safety. A weighted keel keeps the device upright, with the front and rear buoys floating on the surface, and the remainder of the apparatus under water. The user straddles the saddle, with the body bent forward and the chin resting on the unsubmerged portion in front.

REVERSIBLE GLOVE—An idea that would seem to be particularly adaptable for baseball gloves is illustrated by Fig. 6. It is a reversible glove; that is, a glove which can be worn on either the right or the left hand. This is made possible by the provision of two thumbs, each of which has an outside pocket into which it can be tucked when not in use. The glove is shown in the drawing as used for the left hand.

SEPARATE STALL FOR BIG TOE (British patent)—The chafing of the big toe against its nearest neighbor among the little toes, often the cause of bunions or corns, has caused an English inventor to design Oxfords, slippers and sandals with a separate stall for the offending "big brother." In the case of the sandal, the big toe slips into a separate strap, but in the Oxfords and slippers a separate soft-leather compartment is provided.

CAN WITH SELF-CLOSING COVER—Lack of care in replacing the cover of the garbage can, with the result that such a can becomes a fine open-air restaurant for swarms of flies, makes the self-closing lid shown in Fig. 8, or some similar contrivance, particularly advisable for such receptacles. A pull on the handle of this self-closing cover causes it to move straight upward until free of the can-body and then swing away from the can to render the latter accessible. When the grip on the handle is released, the cover automatically swings back and descends onto the can, closing it tightly.

POTATO DIGGER (British patent)—The rotary potato digger shown in Fig. 9 is provided with a rotary brush which sweeps the earth displaced by the soil-breaking plow point within reach of the rotating forks, which lift out the potatoes.

NUT-GRIPPING VEHICLE WRENCH—A wrench which saves considerable time and trouble in greasing buggies is shown in Fig. 10. A spring grip takes substantial hold of the axle nut when the wrench head is engaged with it, keeping the wrench from slipping off the nut.



Fig. 6



Fig. 7

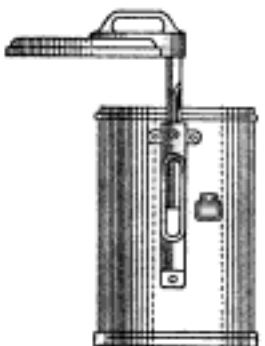

Fig. 8



Fig. 9



Fig. 10



Fig. 11



Fig. 12



Fig. 13

ADJUSTABLE CLEANING BRUSH FOR BOTTLES (French patent)—Figure 11 illustrates a new French bottle-cleaning brush with which it is possible to reach the interior of bottles of almost any shape. The lower brush is pivotally attached to the stem or handle of the upper, the stem being a hollow tube inclosing a screw. Midway of the tube is a cut-out or hole so that the user may reach the screw with thumb and forefinger in order to alter the inclination of the adjustable brush.

A BUNTING BASEBALL BAT—A baseball bat which has a feature that makes it particularly adaptable for bunting, without, it is claimed, making it in any way inferior to the ordinary bat, is shown in Fig. 12. The two slots extending lengthwise from the striking end for about a third of the total length of the bat contain nonresilient strips, such, for instance, as cardboard. When the bat is held so that the ball is struck with the cardboard strips lying edgewise to it, the force of the rebound of the ball is claimed to be substantially the same as that obtained with the ordinary bat, but when the ball is struck with the plane of the cardboard strips presented to the ball the resultant rebound is considerably deadened.

COMBINED SOAP DISH AND FLESH BRUSH (British patent)—Figure 13 shows a combined flesh brush and soap dish made of india-rubber. The studded rim of the bowl forms the brush. In the center of the bowl, under the soap, is a well into which the water drains when the device is used as a soap dish, and which may contain a washing mixture when it is used as a brush. The base of the bowl is formed with a vacuum cup to hold the device upright.

INGENIOUS TRACK LEVEL—A simple little level, which saves the section foreman from leaning over the rail to sight the level of the track, and which may be carried in the pocket, is illustrated by Fig. 14. It is claimed that with this level the section foreman can sight from 30 to 125 ft. of track by simply attaching it to the track and standing over it. In looking into the glass, he will see lines, running crosswise of the glass, which must be directly over each other and on a line with a small target placed between the two points he wants to have level. It saves the labor of stooping over so often and kneeling on damp, cold ground.

SIDE STEERING GEAR FOR AUTOMOBILES—Figure 15 is of interest because of the similarity of the steering mechanism to that of a boat. The steering wheel, attached to the outside of the driver's seat is genuinely nautical in appearance. The wheel is turned by means of the spoke handles extending from the rim of the wheel.

MAGNIFYING ATTACHMENT FOR SPECTACLES (British patent)—The combining of a magnifying glass with ordinary spectacles in such manner that the former may be readily moved into and out of the line of vision is shown in Fig. 16. The magnifying glass is mounted in a frame similar to that of the spectacles, and this frame is hinged to a block secured to the hinge bracket of the spectacles by a screw. This block, which is shown in the smaller drawing, is provided with a hole that passes over the arm of the spectacles.

LOCK FAUCET—A means of preventing waste of water through faucets located in more or less public or accessible places is shown in Fig. 17. A spring-pressed bolt normally locks the faucet plug in closed position, but the operation of the key withdraws the bolt from its hole and permits the rotation of the plug to open the faucet.

FLOATING COUCH (British patent)—This drawing (Fig. 18) shows a floating couch designed particularly for invalids undergoing a water cure, and also as a comfortable floating device for bathers. It is made in three sections, hinged together. The middle or seat portion is provided with vertical side frames inclosing air cushions, and the head portion also carries air cushions. Cords, passing over pulleys, connect the head and foot sections, so that the user can raise the head-supporting frame and lower the foot section by pressure of the feet, thus gaining an upright position.



Fig. 14



Fig. 15

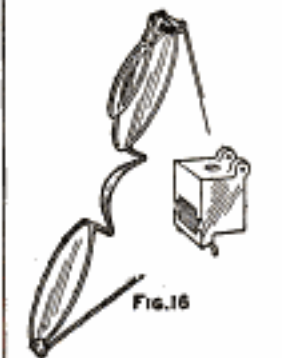

Fig. 16

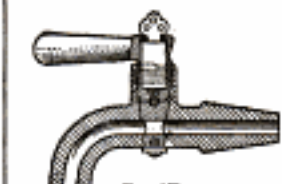
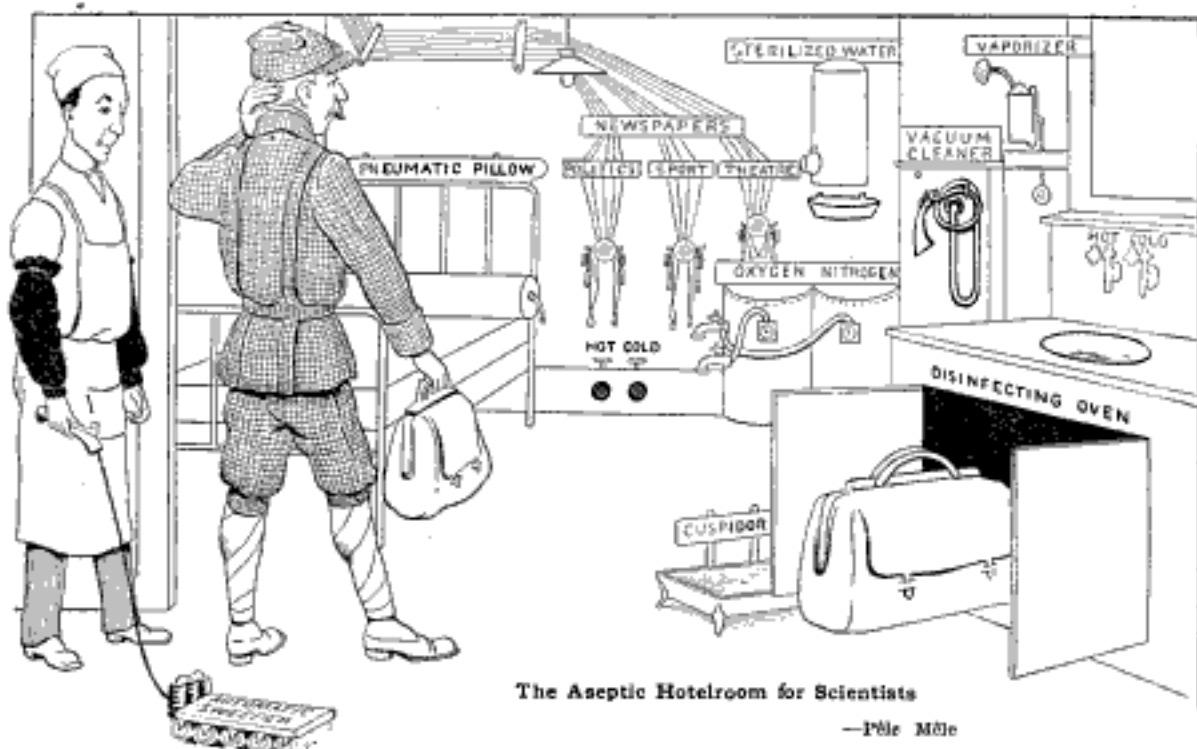

Fig. 17



Fig. 18



The Aseptic Hotelroom for Scientists

—Pôle Mille

"I JUST saw your wife in your neighbor's auto. Why don't you take her out in yours?"
 "Oh, we've just made our wills in favor of each other."—The Motor Age.

Grocer—"What are you doing there?"
 Clerk—"Mr. Jones has ordered a bushel of potatoes, and I'm looking him up in Bradstreet."—The Railway Age-Gazette.

Small Boy—Pa, how did they first discover iron?
 Pa—I have heard that they smelt it.—The Country Gentleman.

Gibbs—"I can't find 'aeroplane' in this dictionary."
 Dibbs—"Have you looked on the fly leaf?"—Boston Evening Transcript.

It was in the Intervale of the White Mountains. "What is the train schedule, Uncle Hi," asked a tourist of the factotum of the small summer hotel, "between here and Portland?"
 "Hit's this-a-way," was the drawing answer. "Take the stage, and it hits the train. Take the train, and it hits the boat. And hit starts at quarter arter, harf arter, quarter to, and at."—Forward.

NEW BOOKS RECEIVED

HOW TO USE THE MICROSCOPE, A Guide for the novice—By Rev. Charles A. Hall, 88 pages, cloth, 5x7, 20 full-page illustrations, and 25 line drawings, indexed. Adam and Charles Black, London, The Macmillan Co., New York.

MODERN ILLUMINATION THEORY AND PRACTICE—By Henry C. Horstman and Victor H. Tousley, 273 pages, 4½x6¾, flexible leather, illustrated and indexed, \$2.00. Frederick J. Drake & Company, Chicago.

ELECTRICAL INJURIES, Their Causation, Prevention and Treatment—By Charles A. Lauffer, A. M., M.D., 77 pages, 4x6¼, cloth, 50 cents net. John Wiley & Sons, New York.

PRACTICAL AERONAUTICS—By Chas. B. Hayward, 769 pages, 6½x9½, cloth, 310 illustrations, \$3.50. Published by American School of Correspondence, Chicago.

HISTORY OF BRIDGE ENGINEERING—By Henry Grattan Tyrrell, C. E., 479 pages, 6x9, cloth, illustrated and indexed, \$4.00. Published by the author, 540 Judson Ave., Evanston, Ill.

FARM GAS ENGINES—By H. R. Brate, 195 pages, 5x7, cloth, illustrated and indexed, \$1.00. The Gas Engine Publishing Co., Cincinnati, Ohio.

MOLDING CONCRETE FLOWER POTS, BOXES, JARDINIÈRES, ETC.—By A. A. Houghton, and

MOLDING CONCRETE FOUNTAINS AND LAWN ORNAMENTS—By A. A. Houghton, each 5x7, paper, 50c; being numbers 10 and 11, respectively, of "Concrete Workers Reference Books," published by The Norman W. Henley Publishing Co., New York.

RUBBER HAND STAMPS AND THE MANIPULATION OF RUBBER—By T. O'Connor Sloane, A.M., E.M., Ph.D., 167 pages, 5x6¾, cloth, illustrated and indexed, \$1.00. The Norman W. Henley Publishing Co., New York.

PRIMER OF SCIENTIFIC MANAGEMENT—By Frank B. Gilbreth, M.E., 108 pages, 5x7½, cloth, indexed, \$1.00 net. D. van Nostrand Company, New York.

BUILDING AND FLYING AN AEROPLANE—By Chas. B. Hayward, 142 pages, 5½x8½, cloth, illustrated, \$1.00. Published by American School of Correspondence, Chicago.

DIARY OF A ROUND HOUSE FOREMAN—By F. S. Reilly, 158 pages, 4½x6¾, cloth, \$1.50. The Norman W. Henley Publishing Co., New York.

A Book of Valuable Ideas for Beautifying the Home FREE!

We will send you FREE our book "The Proper Treatment for Floors, Woodwork and Furniture" and two samples of Johnson's Wood Dye and Prepared Wax

(This text book of thirty-two pages is very attractive—it contains eighty illustrations, forty-four of which are in color)

You will find this book particularly useful if you are contemplating building—if you are interested in beautiful interiors—if you want to secure the most artistic and serviceable finish at least expense. This book is full of valuable information for everyone who is interested in their home. Mail coupon for it today.

With the book we will send you samples of two shades of Johnson's Wood Dye—any shade you select—and sample of Johnson's Prepared Wax—all FREE



Johnson's Wood Dye

shall not be confused with the ordinary water stains which raise the grain of the wood—or oil stains that do not sink beneath the surface of the wood or bring out the beauty of its grain—or varnish stains, which really are not stains at all but merely surface coatings which produce a

cheap, pearly effect.

Johnson's Wood Dye is a dye in every sense of the word—it penetrates deeply into the wood bringing out its natural beauty without raising the grain. It is made in fifteen beautiful shades, as follows:

No. 126 Light Oak
No. 123 Dark Oak
No. 125 Mission Oak
No. 140 Early English
No. 110 Bog Oak

No. 128 Light Mahogany
No. 129 Dark Mahogany
No. 130 Weathered Oak
No. 131 Brown Weathered
No. 132 Green Weathered
No. 121 Moss Green
No. 122 Forest Green
No. 172 Flemish Oak
No. 178 Brown Flemish
No. 120 Fumed Oak

HALF GALLONS \$1.60

Johnson's Prepared Wax

a complete finish and polish for all wood-floors, woodwork and furniture—including pianos. Just the thing for Mission furniture. Johnson's Prepared Wax should be applied with a cloth and rubbed to a polish with a dry cloth. It imparts a variety protecting finish of great beauty. It can be used successfully

over all finishes. Johnson's Artistic Wood Finishes are for sale by all leading drug and paint dealers. If your dealer hasn't them in stock he can easily procure them through his jobber.

Fill out the attached coupon for booklet and free samples.

S. C. Johnson & Son
Racine, Wis.

The Wood
Finishing
Authori-
ties

Please
Use This
Free Coupon

I accept your offer of Free Booklet Edition P. A.—D and two sample bottles of Johnson's Wood Dye, Send me shades Nos.

and one sample can of Johnson's Prepared Wax.

Name.....

Address.....



Please Mention Popular Mechanics

"That's the Cloth"

AN unfinished worsted, made right, is one of the finest fabrics ever put in a man's suit. Always appropriate for business or semi-dress, it is dignified, rich, tailors splendidly and wears well.

Your guide to the best unfinished worsted is this name stamped on the back of the cloth—

A.W. CO.
WASHINGTON
 1789
UNFINISHED WORSTED
 REG. U. S. PAT. OFF.

WASHINGTON 1789 is a highest-grade style fabric for men who appreciate thoroughbred clothes. It is pure wool, has a beautiful surface and does not wear shiny. London shrunk, 56 to 58 inches wide

OSWEGO SERGE for Fall and Winter wear is a distinctive blue serge of superb quality. Tailors splendidly and retains its smart appearance through long wear.

Ask your tailor or clothier to show you WASHINGTON 1789 and Oswego Serge. They are featured by good custom tailors and used by manufacturers of high-grade ready-to-wear suits. If you cannot find them, send us check or money-order for quantity required (3½ yards for man's suit), at \$1.25 per yard for Washington 1789, and \$1.00 for Oswego Serge, and we shall see that you are supplied through regular channels, as we do not sell at retail.

American Woolen Company
Wm. K. Wood, President.

*Selling Agency: American Woolen Company of New York,
 American Woolen Bldg.
 18th to 19th Street on 4th Avenue, New York*



Please Mention Popular Mechanics



A True Help

In all Hand Writing

A ready pen is a necessity in the present day institutions of learning. It helps to better work and more of it, and minimizes expense and inconvenience.

Waterman's Ideal Fountain Pen

WRITING is an art; Waterman's Ideal is a part of the art. This pen has doubled man's writing capacity and saved vastly on previous methods. Every part of Waterman's Ideal is a thorough development of our close study of infinite individual requirements. The patented features and "Waterman" ideas are recognized throughout the world for their efficiency. Rigid inspections of quality and finish, under which every Waterman's Ideal has to pass, are the foundation of success, for millions of pens, in every country of the world, in satisfying and helping each particular owner. Illustrated booklet on request.

From the best stores in every community in the world

L. E. Waterman Company, 173 Broadway, New York
Boston Chicago San Francisco Montreal London Paris



Please Mention Popular Mechanics

\$ 600

**for
Your Body**

You belong either to the headless army of losers, or to the "heads, I win" class.

As a member of the headless army you are a piece of mechanism with an earning capacity limited to about \$600 a year—with the scrap heap at the end of the road.

As a *head* man you can multiply that income by ten, and more—and meet *success now*.

You *can* join the *head* class. Don't argue, don't hesitate, don't compromise with failure by saying "I can't." Get on the *positive* side of yourself. Just think of the four hundred and more once poorly paid men who, every month, voluntarily report to the International Correspondence Schools advancement in salary and position *due to I. C. S. help*. Some of these stories of success read like veritable romances.

Please Mention Popular Mechanics



for Your Head

Back of them is the sturdy "I can" spirit, and the ability to read and write.

These successful men come from the city, town, village, countryside, office, factory, shop, store. Many had long hours, short pay and little spare time. Yet without leaving home or neglecting work they won success through I. C. S. help.

The same road is open to you—no matter who you are, what you do, where you live, what you earn, or for what well-paid occupation you wish to qualify. It's for **you** to decide whether you shall mark time with the headless army, or rise to positions of command and respect.

It costs nothing to find out how **you** can qualify through I. C. S. training.

Mark this coupon and learn how to make your **HEAD** earn ten times as much as your **BODY**

INTERNATIONAL CORRESPONDENCE SCHOOLS

Box 872, SCRANTON, PA.

Explain, without further obligation on my part, how I can qualify for the position before which I mark X.

Electrical Engineer	Civil Service
Elec. Lighting Supt.	Railway Mail Clerk
Electric Car Running	Bookkeeping
Electric Wireman	Stenography & Typewriting
Telephone Expert	Window Trimming
Architect	Show Card Writing
Building Contractor	Lettering & Sign Painting
Architectural Draftsman	Advertising
Structural Engineer	Salesman
Concrete Construction	Commercial Illustrating
Mechan. Engineer	Industrial Designing
Mechanical Draftsman	Commercial Law
Refrigeration Engineer	Teacher
Civil Engineer	English Branches
Surveyor	Good English for Every One
Rise Superintendent	Agriculture
Metal Mining	Poultry Farming
Locomotive Fireman & Eng.	Plumbing & Steam Fitting
Stationary Engineer	Sheet Metal Worker
Textile Manufacturing	Navigation
Gas Engines	Languages
Automobile Running	Chemist
	Spanish
	French
	German

Name _____

Present Occupation _____

Street and No. _____

City _____ State _____

Please Mention Popular Mechanics



Assuan Dam, part of the Nile system, one of the greatest engineering projects of its kind.

The Nile System—The Bell System

For thousands of years Egypt wrestled with the problem of making the Nile a dependable source of material prosperity.

But only in the last decade was the Nile's flood stored up and a reservoir established from which all the people of the Nile region may draw the life-giving water all the time.

Primitive makeshifts have been superseded by intelligent engineering methods. Success has been the result of a comprehensive plan and a definite policy, dealing with the problem as a whole and adapting the Nile to the needs of all the people.

To provide efficient telephone service in this country, the same fundamental principle has to be recognized. The entire country must be considered within the scope of one system, intelligently guided by one policy.

It is the aim of the Bell System to afford universal service in the interest of all the people and amply sufficient for their business and social needs.

Because they are connected and working together, each of the 7,000,000 telephones in the Bell System is an integral part of the service which provides the most efficient means of instantaneous communication.

**AMERICAN TELEPHONE AND TELEGRAPH COMPANY
AND ASSOCIATED COMPANIES**

One Policy

One System

Universal Service

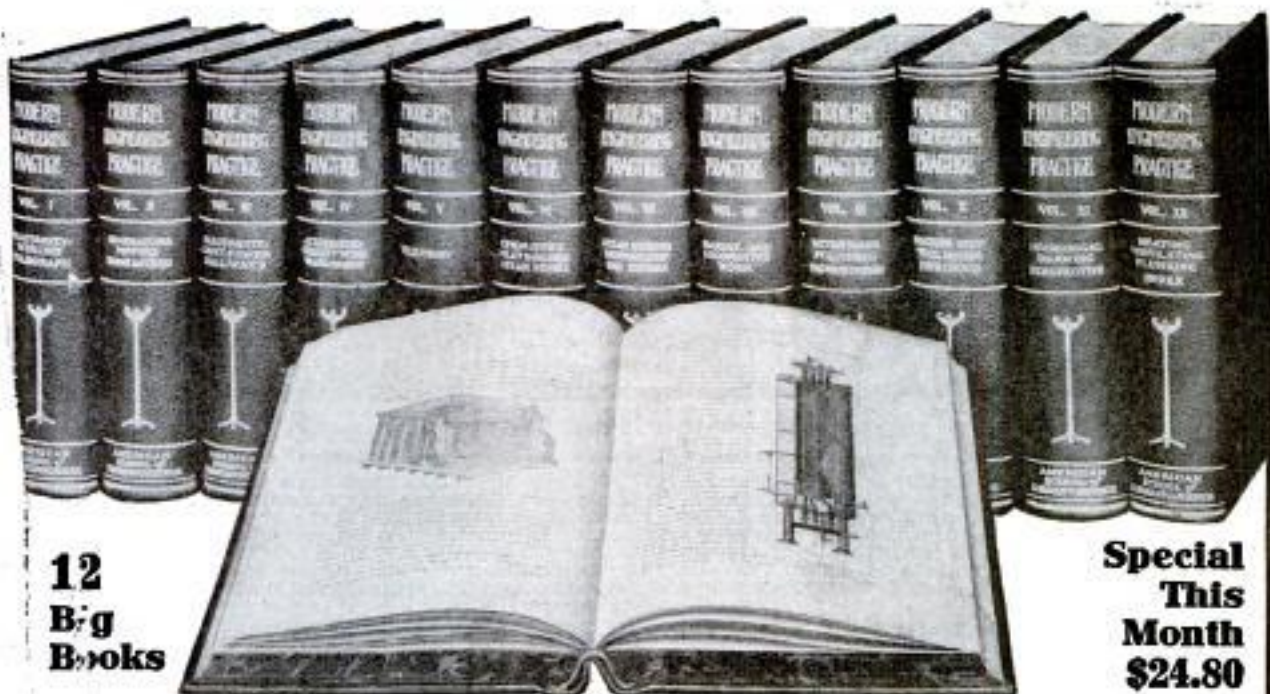

**12
Big
Books**

**Special
This
Month
\$24.80**

The Greatest Engineering Library At Less Than Half-Price

The American School's Cyclopedia of Modern Engineering Practice is the greatest ever published because it is the only one covering the entire field and every phase of up-to-date engineering practice. This library is the combined work of over 200 experts—every one a master of his subject—men who through study or practical experience, are able to give it to you in the most authoritative, and yet the most simple, practical and understandable form. This work contains 6,600 pages—5,000 illustrations—printed on special paper in large, clear type—bound in half red morocco, with gold titles and marble edges.

Partial Table of Contents

Boiler Testing; Construction of Boilers; Types of Boilers; Boiler Accessories; Gas and Oil Engines; Gas Producers; Steam Pumps; The Steam Turbine; Steam Engine Indicators; Valve Gears; Locomotive Boilers and Engines; Heat; Chemistry; Dynamo-Electric Machinery; Types of Dynamo-Electric Machinery; Management of Dynamo-Electric Machinery; Power Stations; Central Station Engineering; Alternating-Current Machinery; Power Transmission; Modern Central Station Design; Direct Current Motors; Storage Batteries; Elements of Electricity; The Electric Current; Electrical Measurements; Electric Bell Wiring; Electric Welding Development; Insulators for Transmission Lines; Machine Shop Work; Pattern Making; Foundry Work; Tool Making; Forging; The Air-Brake; Automobiles; Mechanical Drawing; Machine Design; Drafting-Room Organization; Heating and Ventilation; Steam and Hot-Water Fitting; Plumbing; Refrigeration; Metallurgy; Automatic Appliances for Handling Coal and Iron Ore; Electric Lighting; Shop Lighting; Hewitt Mercury-Vapor Converter; Electric Wiring; Motor-Driven Shops; Electric Railways; The Single-Phase Electric Railway; Telephony; Automatic Telephony; Wireless Telephony; Telephone Line Protection; Quality of Telephone Service; Automatic vs. Manual Exchanges; The Electric Telegraph; Wireless Telegraphy; The Telautograph.

The Complete Set Sent Absolutely Free—Express Prepaid

The complete twelve volumes, not a sample volume, will be sent, express prepaid, for seven days' free examination; returnable at our expense if the books do not contain the information you want. If you keep the books, pay \$2.00 seven days after receipt and then \$2.00 a month until you have paid the special price of \$24.80.

Another Great Free Offer

With each set is included a year's Consulting Membership entitling you to the free advice of 7 of Engineering Experts. This will give you practical help in handling working problems which are too specific to be taken up in detail in the Cyclopedia. A single problem solved for you might be worth more than the first cost of the books.

AMERICAN SCHOOL OF CORRESPONDENCE

CHICAGO, U. S. A.

NAME.....

ADDRESS.....

OCCUPATION.....

EMPLOYER.....

Pop.
Mech.
9-12
A. S. of C.

Please send Cyclopedia of Modern Engineering Practice for 7 days' free examination. I will send \$2.00 within seven days and \$2.00 a month until I have paid \$24.80, or notify you and hold the books subject to your order. Title not to pass until fully paid.

Please Mention Popular Mechanics

IT'S
FREEWE
PAY THE
POSTAGEJUST
OUTOUR NEW
BIG BOOKSHOWING 7000
WONDERFUL BARGAINS
YOU CAN BUY ON CREDIT

UNIVERSITY
OF CHICAGO
The University of Chicago
Chicago, Ill.

15 to 50% Easily Saved

We guarantee to save you from 15 to 50% on home furnishings and gladly trust you for all the goods you want, no matter where you live or what your earnings are. This "Message of Joy" is being taken advantage of by over a million United States citizens, everywhere. This old reliable concern has saved millions of dollars for their customers by dull season, big quantity buying, then selling at factory prices.



No. S-205

Don't Miss This Rocker Bargain

Our new 1913 free catalogue lists the finest assortment of late designs in rockers ever shown. Quality guaranteed, 30 days' free test and examination. Note this magnificent, beautifully carved American quartered oak rocker, finished and polished to absolute perfection, upholstered in "Imperial" leather, with highest quality "Mensarch" spring seat. A big bargain at

Send us
50c
and we
will ship
you this
**LUXURY
ROCKER**

Order This Money-Saving Dining Set

It consists of seven pieces. Made of American quartered flaky oak. Polished to a mirror-like brightness. The pedestal 6 ft. extension table is massive. The six elegant chairs are strongly built and handsomely finished. This splendid set is illustrated in our new catalogue and is but a sample of the wonderful money-saving opportunities offered in this new free book "The Key to Home Happiness." Set complete

\$16.85
TERMS: \$1.00 Cash, \$1.00 a Month

The World's Finest Furnishings

We show 7000 world's finest home furnishing bargains in our new beautiful catalog, all priced to you at an actual saving of as high as 50%. You get a pure and simple factory to family deal, besides the pleasant credit we extend and it stands to reason that a big reliable firm like Hartman's, offering such grand inducements, is the best firm for you to deal with. We invite you to join our big happy throng—start today.



Price
\$16.85

No. S-307

Price of Table alone, only \$8.75
Terms: 50c cash; 50c a month
Price of Chairs alone only \$9.10
Terms: 50c cash; 50c a month

**Our Long Time Credit Terms
The Sensation of the Century**

It is the easiest and fairest of all credit plans and absolutely free to you for the asking. There's no extra charge or interest to pay, nothing but a square, honest plan of naming you rock bottom prices and low monthly payments. It provides for every possible means of helping you furnish your home in comfort and with the least possible worry about paying the bill. It is a plain charge account with a years time in which to send us the money as you earn it.

30 Days' FREE Examination

Anything illustrated in this advertisement or in our 356 page catalog will be sent for 30 days' free examination, so that you can test our qualities and compare our prices right in your own home where you can consult with your family. You take absolutely no risk by ordering from us. Our multi-million dollar organization, together with a bona-fide-legal-lawful guarantee of satisfaction or money back, protects you.

**We've Proved Ourselves
To a Million Customers**

The largest, oldest and most dependable home furnishing concern in the world and can prove ourselves to you. So don't hesitate about becoming a Hartman patron; send us a trial order from this Ad. Test the old reliable Hartman way of dealing honestly with the people.

**No. S-150 Room Rug at Factory Cost**

This exquisite 8x12 ft. Kerman Seamless Brussels rug is a fair example of the astonishing factory cost bargains we offer in our free mammoth 1913 home furnishing catalog. It is of everlasting quality. A rich Oriental pattern in a combination of dark tan, blue and green colors. Order it sent on approval; the high quality and low price will surprise you. Price

\$12.75
TERMS: Send \$1 cash, Pay \$1 Per Month

HARTMAN FURNITURE CO.
& CARPET CO.
3945 Wentworth Ave., CHICAGO, ILL.

SEND
A POSTAL
FOR THIS
MONEY SAVING
BOOK
ITS THE KEY TO
HOME
HAPPINESS

Let
Hartman
Feather Your
Nest



ESTAB.
1855

57 Years
of
Success

Please Mention Popular Mechanics

American Model Builder



Let Your Boy Learn Mechanics with This Wonderful Game

Here is the most fascinating and instructive mechanical toy ever invented. A game that combines wholesome fun with valuable instruction. It will keep the boys amused by the hour, while at the same time it develops the mind along mechanical lines.

All boys love to build. The American Model Builder enables them to build something real. It teaches them to work in metal. It enables them to build for themselves actual working models of scores of modern mechanical wonders. It trains the boy to invent things himself.

The American Model Builder

is recommended and used by leading educators. Schools, Y. M. C. A's., etc. are putting in outfits on account of the great educational value.

This is the age of steel. Let your boy learn the joy of working in metal, creating things with his own hands. By making his own playthings, with the American Model Builder he will understand mechanics, become quick with his hands and learn self-reliance and resourcefulness.

The American Model Builder is furnished in seven different sized sets. You can select any size and then add to it as your boy progresses. Prices range from \$1 up per set. Complete Manual of Instruction, showing how to build scores of models, free with each set.

And remember, our outfits contain more parts and will build more models, while our prices average lower than any other similar toys or games, on the market.

For sale by leading dealers in toys and sporting goods. Write for our illustrated catalog No. 20.

THIS picture shows some of the models a boy can build with the American Model Builder. This wonderful outfit contains exact duplicates of the main parts used in machinery and structural steel work. Each set includes beams, braces, pulleys, gears, bolts, nuts, etc.—with the necessary tools for putting them together.

With these parts any bright boy can build actual working models of every modern mechanical device—bridges, trestles, railroads, derricks, swings, trucks, windmills, and scores of others. Completed models can be taken apart and new ones made.

American Model Builder outfits are absolutely indestructible, being made of brass and steel, accurately machined, heavily nickel plated and polished. Gears are perfectly cut and furnished with collars and set screws to ensure positive fastening. Everything about the Model Builder is workmanlike and thoroughly mechanical.

THE AMERICAN MECHANICAL TOY COMPANY, 420 East First St., DAYTON, OHIO

WHERE THE NATIONS GET THEIR COAL—The total coal production of the world for 1910, according to statistics compiled by the British Board of Trade, was 1,035,000,000 tons. The chief coal-producing countries contributed as their share: United States, 447,840,000 tons; Great Britain and Ireland, 264,430,000; Germany, 150,370,000; France, 37,255,000; Belgium, 23,530,000 tons.

England produced 6 tons for each inhabitant; the United States, 5 tons; Belgium, $3\frac{1}{8}$ tons; Germany, 2

3 Genuine French Briar Anti-Nicotine Pipes **\$1**

Electrically sealed and need no breaking in. Vegetable composed nicotine cartridge. Patent mouthpiece; vent on top. Heavy nickel mounting. Guaranteed not to burn out in 5 years.

50 CENTS EACH OR THREE FOR \$1

Choice of bent or straight stem—state which in ordering. Satisfaction guaranteed or money refunded. 10 cartridges free with 3 pipes.

H. MENGES, 315 Menges Building, ST. LOUIS

\$25⁰⁰
Per Week

If You Earn Less
We can DOUBLE your salary or income

by teaching you how to write catchy, intelligent advertising. Our system of instruction by Mail has the hearty endorsement of the great experts and publishers. Illustrated Prospectus Free.

We will show you how to earn \$25 to \$100 per week. Write TODAY to
Powell School of Advertising
1616 Meyrowitz Bldg., Fifth Avenue, New York
ESTABLISHED 1901



It Rivals Daylight

Threading a needle at night is typical of work that is easily possible in the home illuminated by a

Fairbanks-Morse Electric Light Plant

It is a lighting system that contributes to comfort and health as well as adding to the attractiveness of the home. Plant consists of a 2 H. P. engine, dynamo, switchboard, storage battery and 50 Mazda lamps and fixtures. Furnishes abundant light for residence, barn, garage, dairy, etc. Easily installed; inexpensive to operate; absolutely safe. Thoroughly reliable in every respect.

WRITE FOR CATALOG NO. 449 KD.

Fairbanks, Morse & Co., 900 S. Wabash Ave.
Chicago, Ill.



Please Mention Popular Mechanics

Bissell BARGAINS

Motors and Dynamos NEW AND USED

Write today for our Bargain Bulletin 23 and see for yourself the Attractive Bargains offered.

You can't afford to invest your money in motors, dynamos or electrical machinery of any kind until you have learned our prices on your requirements.

You can sell (for cash) buy, rent or trade, electrical machinery, by dealing with us. We'll do business your way. All Used Machinery carries the same liberal and binding guarantee, that we and others give on new.



Our Repair Department has a national reputation for its efficiency in high grade rush work. No matter where you are located or what your needs—we can supply them to your complete satisfaction. WE DO NOT DEAL IN NOVELTIES OR TOYS

The F. Bissell Company, 226-230 Huron Street, Toledo, Ohio



ILLINOIS

Best WATCH on Earth NOW SOLD ON CREDIT

For the first time in history the great, genuine ILLINOIS Watch is now sold exclusively by us by mail on credit. This is the greatest public triumph of the age—it will revolutionize the Watch business. For over 40 years the ILLINOIS Watch has been acknowledged the standard Watch worn by America's great men and women. No man or woman should now be without a famous ILLINOIS.

Iron-Clad Guarantee
Part for part—in accuracy, wear, finish, beauty, material and workmanship, the ILLINOIS is superior to any other Watch at any price. Both the makers and we stand back of this Watch with a guarantee that absolutely protects you. We are one of the largest Watch Distributors in the world. For over 35 years we have sold all kinds of Watches, and honestly tell you that the ILLINOIS is the best at any price.

NO MONEY DOWN
The famous ILLINOIS costs you less than inferior makes. Nowhere else can you buy exclusively a genuine ILLINOIS on credit. No dealer can undersell us even for cash. Sent on approval—you take no risk—pay as you please.

Our new, beautiful, profit-sharing book, describing the ILLINOIS Watch, easy credit terms, and reproducing many handsome styles, awaits you. Send name and address today.

FREDDO WATCH CO., Dept. 300, St. Louis, Mo.
Successors to The American Watch Co. of St. Louis.

Take Your Own Time To Pay

SENT FREE—NO PAYMENT DOWN

Save One-Quarter

the purchase price of motor cycle accessories and parts. We sell guaranteed goods twenty-five per cent cheaper than any other house.

The Motor Cycle Co-Operative Co.
650 Woodward Ave., DETROIT, MICH.

BUY PLUMBING SUPPLIES AT WHOLESALE

Will Save You 30%



Don't pay retail prices. Full stock on hand for prompt shipment. Send for free catalog. E. P. KAHOL, 768 to 772 West Harrison St., Chicago

1-3 tons, and France less than one ton.

The production of coal in the same year was, by countries, as follows: United States, 434,815,000 tons; England, 179,960,000; Germany, 130,230,000; France, 54,860,000; Belgium, 23,850,000 tons.

The consumption of coal per inhabitant was as follows: United States, 4.72 tons; England, 4.01; Germany, 2.03; Belgium, 3.17; France, 1.40 tons.

The United States, England and Germany are the only important nations that produce enough coal for their own consumption. France has to import about one-third of its coal.—New York World.

I Want a Representative in every city and county—F. A. M. men or motorcyclists preferred.

JULIUS J. EYRING, Sec'y

Dept. A 513-515 Sycamore St. BUFFALO, N. Y.

MY NEW BOOK

"Building Plans for Modern Homes"

containing this and 150 other photographs and floor plans of bungalows, cottages and apartment houses sent post paid for \$1. Gives ideas and cost to build. Complete building plans, \$10. The most complete book of plans ever published by any New England architect. Will save you hundreds of dollars in extras.

Frederick H. Gowing, Architect
18 Tremont Street, Boston, Mass.



Perfection Spring Winder

MADE IN 3 SIZES

No. 1 cap to	3/32 wire	\$1.00 each
No. 2 " "	3/16 " "	1.50 " "
No. 3 " "	5/16 " "	3.00 " "



The only Practical Spring Winder on the market. Makes springs any length, diameter or pitch, any gauge wire, flat or square stock. The only tool suitable for making right or left hand, extension, compression or torsion springs. Winds to last inch of stock. No waste. Should be in all garages and repair shops.

EDGAR T. WARD & SONS, SMALL TOOL DEPT.
23 Purchase St. BOSTON, MASS.

AGENTS \$50. to \$100. EVERY WEEK

And if you are a live hustler I will gladly pay you more. I've got the slickest money making proposition in the country for wide-awake agents. Carpenter averaging 250 sales weekly. Daily Scientific Automatic Razor Sharpener made, gives barber's stroke, both home and shops all standard razors and safety blades. Guaranteed for life. Men buy on sight. \$2.00 complete. 100% profit. It means big money for you if you act promptly. Get exclusive territory NOW. Write me today how to get FREE—fast and largest outfit. Secretary, The Victor Co., 732 Victor Bldg., Canton, Ohio



PATENT YOUR IDEAS



*—There is a Constant Demand
for Good Inventions*

Thousands of the biggest money-making inventions have been the "little" things that have made people wonder why they were never thought of before.

"WHAT TO INVENT"

and

"HOW TO OBTAIN A PATENT"

These Books Sent Free

If you have an invention send us a sketch, photograph or model of it. We will give you a report as to its patentability absolutely free. If you have no invention send for our book, "What to Invent." It contains hundreds of valuable suggestions. We are recognized authorities on patent matters and have helped hundreds to find a ready and profitable market for their ideas. We can prove it. If you wish to sell your patent we will advertise it in manufacturers' journals at our expense.

Don't Wait—Find Out NOW!

Your idea will never do you any good if some one else patents it ahead of you. Act quick! Let the other fellow say "he thought of it a long time ago." You reap the profit. Let the others wish they had.

Advice Free—All Matters Confidential

We have secured patents for thousands of inventors and have many letters proving the value of our services. Write us. Send rough drawing or model of your invention for our opinion. We will guard it carefully and report quickly. You are under no obligations to proceed further. Our plan is simply a square deal to all. Our books, "What to Invent" and "How to Obtain a Patent" are the best publications written for the man who has an idea to patent, or who is of an inventive turn of mind. They show just how to proceed with your idea and tell of hundreds of things to invent. We gladly send these books free. The sooner you write for them the sooner you will know all about patents and the many different lines in which new inventions or improvements may be made.

If you have an invention send us a sketch of it for report and ask for the books at the same time.

CHANDLEE & CHANDLEE, 984 F Street, Washington, D. C.

REGISTERED ATTORNEYS

(Combined with H. Ellis Chandlee & Co.)

→ **Protect Your Idea!** ←

PATENTS THAT PAY

\$427,530.00 Made by Clients

"My Trade-Mark"

\$427,530.00 Made by Clients

Proof back of it—write for my FREE literature—it will pay!



BOOK "What and How to Invent—Proof of Fortunes in Patents"—FREE

Containing: Views of Prominent Men and Publications on Inventions; "Patents Wanted"; "How to Advertise Your Patent"; "How to Secure Money to Procure a Patent"; Suggestions as to what to Invent; What my clients have done; Women Inventors, etc.



I have received one of your 127-page books entitled "What and How to Invent—Proof of Fortunes in Patents" and I would not take \$5.00 for it if I could not get another copy.
(Signed) CHAS. J. WENSLEY,
May 31, 1912.
Huntington, L. I., N. Y.

\$10,000.00 PRIZE. Write for instructive circular giving full information FREE

Highest References:

"Over ninety (90) manufacturers intrust ALL their patent work to me."—E. E. V.

Lincoln National Bank,
Washington, D. C.

NOTE: When writing these clients send two-cent stamp for reply.

Little Giant Hay Press Co.,
Dallas, Texas.

American Railway
Appliance Co.,
Oil City, Pa.

B. F. Goodrich Co.,
Akron, Ohio

Susquehanna Silk Mills,
New York

Griffin Mfg. Co.,
New York, N. Y.

Warsaw Paper Box Co.,
Warsaw, N. Y.

Wm. H. Page Boiler Co.,
New York, N. Y.

Butler Engineering Co.,
Akron, Ohio

Klebold Press,
New York, N. Y.

Garl Electric Co.,
Akron, Ohio

Gray Lithograph Co.,
New York, N. Y.

Reading Re-enforced
Cork Co.,
Reading, Pa.

New Era Mfg. Co.,
Fairfield, Iowa.

Bernhard Furst,
Vienna I.

A. J. Corsi,
Irish Town,
Gibraltar

Otto von Rottenburg,
Schwindstrasse 20,
Frankfort A. M.,
Germany

H. A. Fonseca,
Ribeira Dos Ourives 20,
Sobrado, Rio de Janeiro,
Brazil

Electro Importing Co.,
New York, N. Y.

Rex Electric Co.,
St. Louis, Mo.

Sam'l Allen & Son Mfg. Co.
Danville, N. Y.

Gas Range & Heater Co.,
So. Pasadena, Cal.

Camp Conduit Company,
Cleveland, Ohio



My Office and the Patent Office
(I give you proof of my location)

PATENTABILITY REPORT

Send by registered mail data of your invention for my opinion as to the *probable* patentability of same; if you want a careful examination of the Patent Office records made (a full report) as to the patentability of your invention, then send with the data \$5.00 to cover cost of this examination, and in the event you proceed with the filing of your U. S. application, I will credit the \$5.00 (as an advanced payment) upon my attorney's fee.

Foreign Patents a Specialty

If you have a U. S. application write me for **excellent** literature and terms for promoting your **Foreign Patents**. Liberal discounts.

Across the street from the U. S. Patent Office. **High-Class Work—Excellent Testimonials**
Expert—Prompt Services 112-page Guide Book for Inventors, FREE 871 F Street, N. W.

E. E. VROOMAN, Patent Lawyer Wash., D. C.
 Registered Patent Attorney. Patent Litigation

Old-established branches throughout the world.

Patents

Trade Marks and Copyrights Secured or Fee Returned

Special Offer—Free Search of Patent Office Records

Send us a model, photograph or sketch and description of your invention, and we will make a *Free Search* of the *Patent Office Records* to ascertain if it is patentable. If we report the invention patentable, we will guarantee to obtain a patent or return our fee, and furnish a certificate of patentability backed by a bonded contract to that effect.

This Certificate of Patentability will protect the inventor and serve as proof of the invention until the case can be filed in the U. S. Patent Office.

Obtaining Assistance for Inventors

Our certificate is of great assistance to inventors who require financial aid to obtain patents. It is useless to attempt to interest capital unless evidence is furnished that the invention is patentable. Our certificate gives this necessary assurance.

Our Four Books Mailed Free

to any address. Send for these books—the finest publications ever issued for free distribution.

How to Obtain a Patent

Our illustrated eighty-page Guide Book is an invaluable book of reference for inventors, and contains 100 mechanical movements illustrated and described.

Fortunes in Patents

Tells how to invent for profit, and gives history of successful inventions.

What to Invent

Contains a valuable **LIST OF INVENTIONS WANTED** and suggestions concerning profitable fields of invention; also information regarding prizes offered for inventions, among which is

Prize of One Million Dollars

offered for one invention, and \$10,000 for others.

Patents That Pay

Contains fac-similes of unsolicited letters from our clients who have built up profitable enterprises founded upon patents procured by us; also endorsements from prominent inventors, manufacturers, Senators, Congressmen, Governors, etc.

List of Patent Buyers

Containing personal requests and letters from Manufacturers and Patent Promoters for patents secured by us, and suggestions as to improvements desired and new ideas they wish to purchase.

We Advertise Our Clients' Inventions Free

In a list of Sunday newspapers with two million circulation, in manufacturers' journals and in the *World's Progress*. Sample Copy Free. We not only save you time and money in securing patents, but obtain patents which **PROTECT** the invention and **PAY**. After the patent is granted we assist you **TO SELL YOUR PATENT**.

Foreign Patents

WE HAVE DIRECT AGENCIES IN ALL THE PRINCIPAL FOREIGN COUNTRIES and can secure **FOREIGN PATENTS** in the shortest possible **TIME** and at the **LOWEST COST**. We **GUARANTEE TO SECURE THE FOREIGN PATENTS OR RETURN OUR FEES**. Write for our Illustrated Guide Book on Foreign Patents, sent free to any address.



VICTOR BUILDING
Our new \$150,000 building opposite U. S. Patent Office
SPECIALLY ERRECTED by us for OUR own use

REFERENCES

Second National Bank, Washington, D. C.
C. K. Lassiter, Mechanical Engineer, Schenectady, N. Y.
Pitner Gasoline Lighting Co., Chicago, Ill.
Syrout, Warden & Co., Mfrs. of the Monarch Feed Governor, Muncy, Pa.
The L. B. Dozier Co., Mfrs. of Plumbing Supplies, Columbia, S. C.
B. B. Earnshaw and Bro., Mfrs. "Cream Blend" Flour, Washington, D. C.
R. G. Dun & Co., Washington, D. C.
National Savings and Trust Co., Washington, D. C.
Smethport Glass Co., Smethport, Pa.
Lawrence Mills, Mfrs. Bed Spreads, 51 Brooke Ave., Englewood, N. J.
The Melvin Gauge and Signal Inst. Co., Scranton, Pa.
Damon Mfg. Co., Mfrs. Flour Mill Disintegrators, Bowling Green, Ky.
Chamber of Commerce, Washington, D. C.
Union Savings Bank, Washington, D. C.
Lincoln National Bank, Washington, D. C.
Modern Canner Co., Bridgeport, Ala.
M. Winter Lumber Co., Sheboygan, Wis.

VICTOR J. EVANS & CO., Patent Attorneys

NEW YORK OFFICES: 132 Nassau St.

PHILADELPHIA OFFICES: 1429 Chestnut St.

Main Offices: 724-726 9th St., N. W., WASHINGTON, D. C.

PATENTS THAT PROTECT and PAY

Advice free. Terms reasonable. Highest references. Best results.

Send sketch or model for FREE examination and opinion.

Recommended Patent Lawyer in the Bankers' Register and special list of selected lawyers.

Also in Martindale's Law Directory, Sharp and Alleman's Directory of Lawyers, The Gast-Paul Directory of Lawyers, and Kime's International Law Directory.

ALL BUSINESS GIVEN PROMPT AND PROPER ATTENTION

A large list of strong recommendations furnished free

WATSON E. COLEMAN, Patent Lawyer, 622 F St., N.W., Washington, D.C.

WANTED-IDEAS

Manufacturers are constantly writing me for new ideas protected by OWEN PATENTS. Send for my free literature and read their wants.

FREE! Three finest patent books published! 72-page guide "Successful Patents"; "Stepping Stones" (containing list of over 200 inventions wanted; about prizes, reward offers, etc.) and "Patent Promotion" (tells how to sell your rights; chief causes of failure, etc). All sent free upon request.

Very highest references. My personal services, I help my clients sell their patents or dispose of their applications. Advice free. No obligation incurred by writing me. Free manufacturing facilities. I secure patent or no fee. No charge for report as to patentability, practicability, etc.

RICHARD B. OWEN, 9 Owen Building, Washington, D. C.

PATENTS BUILD FORTUNES FOR YOU

Our free booklets tell how, what to invent, How To CHOOSE AN ATTORNEY, and save you money.

Prosperous clients in all states. Best bank and other references. WRITE TODAY

D. SWIFT & CO., 317 SEVENTH ST., WASHINGTON D. C.

PATENTS PROCURED AND SOLD;

Easy terms; careful, conscientious work; advice

FREE; new BOOK FREE; correspondence solicited; highest references; send sketch to-day.

H. J. SANDERS SUITE A CRILLY BLOCK Chicago, Ill.

PATENTS C. L. PARKER

Formerly Member Examining Corps, U. S. Patent Office
PATENT LAWYER
210 MCGILL BLDG.
WASHINGTON, D. C.

Patents, Trade Marks, Copyrights, Patent Litigation

Handbook for Inventors, "Protecting, Exploiting and Selling Inventions" sent free upon request.

Patents that PROTECT

For Facts about Prizes, Rewards, etc., send 8c stamps for our new 128 page book of intense interest to inventors.
R. S. & A. B. Lacey, Dept. 45, Washington, D.C., Estab. 1869

Active Powers of Inventive Genius

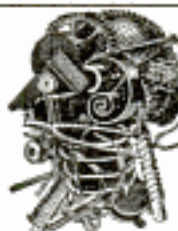

INVENTORS Our Brain Belongs to You. Our Ideas Are Free of Charge.

All we want in return is to build your model, special machinery, dies, tools and jigs to manufacture sheet metal goods, etc. We are expert mechanics, over thirty years experience and have one of the best equipped shops in the country. Ask for Booklet No. 17. Consultation free. Experimental work strictly confidential.

A. NACKE & SON
236-242 S. 9th St., Philadelphia, Pa.

AN IMPORTANT PATENT LAW DECISION—The United States Court of Appeals for the Seventh Circuit (Illinois) has recently decided an important point in patent law not heretofore passed upon in the form presented.

The facts in the case were, that A sued B for damages resulting from B's using a machine which infringed A's patent. Until the suit was brought, B did not know he was infringing A's patent, hence he was



MECHANICAL SUPPLIES AND MATERIAL of all kinds, EXPERIMENTAL AND LIGHT MACHINE WORK to order.

132 MILK STREET, BOSTON

AMERICAN MODEL AND TOOL WORKS

617-631 W. Jackson Blvd., CHICAGO
WE MAKE MODELS, TOOLS, DIES, MOLDS, PATTERNS AND MODEL PARTS. EXPERT GEAR CUTTING. Inventions developed and simplified, also manufacturing.

Let Us Do Your

Manufacturing

Buying material in large quantities and having a modern factory equipped with the latest machinery enable us to make almost anything in metal or wood at a very low price. Estimates free. We have a complete model and pattern department.

TINLEY PARK MFG. CO., 222 N. State Street, CHICAGO

WANTED To manufacture METAL SPECIALTIES, 20 years experience in making Dies, Tools and Special Machinery. Expert work. Complete equipment. NATIONAL STAMPING & ELECTRIC WORKS 413 S. Clinton Street, Dept. 3 Chicago, Ill.



A Talk to the Inventor

LEARN HOW A PATENT MAY BE MADE VALUABLE

If there is any basis for an application in your idea, I can find it. But I will explain it to you before filing your application.

Copies of Nearest Patents, and Report, in Every Case I have patented inventions reported unpatentable elsewhere

Send for FREE BOOK

What You Should Know
What to Invent
What NOT to Invent
How to Sell Your Patent

H. L. WOODWARD,

9th and G Sts., Opposite Patent Office.

WASHINGTON, D. C.

SEBASTIAN 15-INCH LATHE

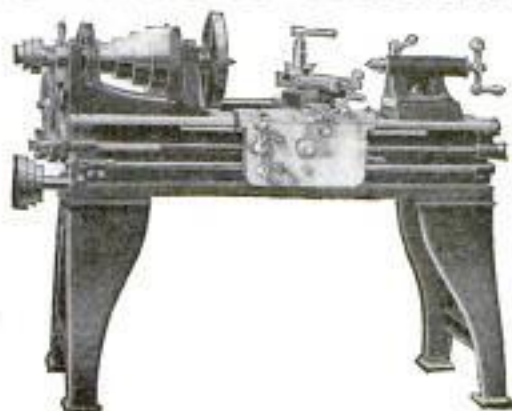

The Low Price, Perfect Quality lathe for the Garage, Automobile and General Repair Shop. If you are in the market for a lathe, be sure and investigate the merits of the Sebastian. We also build 9-inch and 10-inch foot power lathes.

Catalog mailed free on request

THE SEBASTIAN LATHE CO., 107 Culvert Street
CINCINNATI, O.



PRICES RANGE FROM
\$60.00 UP.

QUALITY AND PRICE ARE RIGHT

NO REASON WHY
YOU SHOULD NOT BUY

YOU SAVE **\$25⁰⁰** TO **\$75⁰⁰**

Ask for Our Machinery Catalog "G"
WRITE FOR IT TODAY! MAILED FREE ON REQUEST.
SEARS, ROEBUCK AND CO., CHICAGO

innocent of intentionally invading A's patent rights. Furthermore, B did not begin using his infringing machine until A's patent was 15 years old, and during these 15 years other machines for doing the same work in a better manner and producing a better result, had been invented and were being sold.

The Court held that B's machine infringed A's patent

Our Immense Factory Can Save You Money



on Stampings, Porcelain Enameling. We specialize in Drawing, Stamping and Spinning—Aluminum, Brass, Copper, Tin Plate, Monel Sheet, Steel and Cupron. Japanning in all colors. Tinning and Hot Galvanizing. Jobwork. Right Prices, Quick Delivery are insured by a modern up-to-date plant with a floor space of 12 acres. Let us figure with you and point out a saving.

GRUBER, PARSCHE, & FREY CO.
Contract Dept. Milwaukee, Wis.

DON'T DISCARD BROKEN PARTS



Have them welded together by the Oxy-Acetylene Process. Steel, Cast Iron, Bronze, Copper, Aluminum and all other metals can be welded. Manufacturing quoted on. Welding equipments for repair shops or large plants supplied.

DAVIS BOURNONVILLE CO.
105 West St., NEW YORK; 505 So. LaSalle St., CHICAGO

Erickson Leg

Does not chafe, overheat or draw end of stump.

Send for Catalog

SOLD ON EASY TERMS
The largest limb factory in the world.
E. H. ERICKSON ARTIFICIAL LIMB CO.
17 Washington Ave., N., MINNEAPOLIS, MINN.



LATHES



\$75 Screw Cutting
Foot or Power
9 to 13 inch

CATALOG FREE

SOUTH BEND MACHINE TOOL CO., 423 Madison St., South Bend, Ind.

LATHES

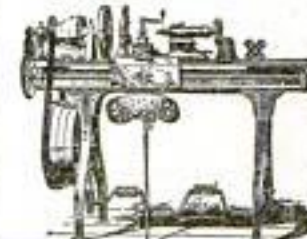

9 to 13-inch Swing

List price \$75 and up according to size. When ready to buy send for Lathe Catalog and prices.

W. F. & John Barnes Co.
100 Ruby Street, ROCKFORD, ILL.

\$25 to \$50 a Day PROFIT for Well Drillers

operating ARMSTRONG Machines. Our Patented Internal Compensating Band Wheel Clutch, the greatest improvement known, gives unequalled control over drilling motion. Ends lost motion. This and our improved, simplified Friction Hoists do away with all attachments, balance wheels, cast brakes, cams, bumpers, treadle beams, bumper sills, eccentric rollers, chains, springs, sprockets and ratchets. Stops expensive repairs and delays. Simplifies drilling. Only one gear and pinion used. By actual test, drills "more feet at less cost than any other machine yet constructed." Here is YOUR OPPORTUNITY for making big profits quickly.

Secure Our Valuable 184-Page Book on Well-Drilling—

A three-color, illustrated catalog and SUM-UP of well-drilling, costing over \$10,000 to produce. Full of big paying tips. You need it if interested in well-drilling. Send 12 cents for postage. Full (71)



"I clear \$50 a day above expenses, right along."
— THOS. KELLEY.

Armstrong Mfg. Company, 10 Clay Street, Waterloo, Iowa

It costs nothing to maintain a

RIFE Ram and Pneumatic Tank Water System



Moreover the first cost is low and no fuel or power other than the water itself is required.

It works automatically day and night, winter and summer, and you need never go near it.

Write for catalogue describing this water system which is unequalled in economy, simplicity and reliability.

RIFE ENGINE CO.
2131 Trinity Building, New York

LET THE RED DEVIL WATER MOTOR DO YOUR WORK

6-inch Motor

Improved construction, absolutely perfect, runs your washing machine and a hundred other things. Power for small tools, $\frac{1}{4}$ horse power on $\frac{1}{2}$ -inch pipe, 80 pounds pressure; 1 horse power on 2-inch pipe, 60 pounds pressure. New net price, \$5.00 cash with order.

No. 1492 4-inch Motors for grinding, polishing and buffing. Runs sewing machines, fans, bottle washers, etc. Price with emery, buffing wheel, silver polish and pulley, \$3.00. No. 1493 Motor and pulley only, \$2.50. $\frac{1}{2}$ horse power on 80 pounds pressure. Improved construction. Speeds, 3,000 to 5,000 revolutions per minute. Only scientifically and mechanically perfect small water motor manufactured. Patented construction makes it possible. Tremendous output warrants the price. Money back for any reason.

CATALOGUE AND LARGE SHEET FREE

DIVINE WATER MOTOR CO.

Dept. T UTICA, NEW YORK, U.S.A.

For the name of your local hardware or tool dealer, we will send you free booklet on "Theory and Design of Water Motors."



6-Inch Bucket Wheel

ASK TODAY FOR SPECIAL CATALOG



The Crescent Universal Wood Worker

is all the wood working equipment that is needed by many shops. It combines a complete wood working outfit in one machine that is durable, accurate and convenient. Considering the splendid quality of the machine the price is moderate.

THE CRESCENT MACHINE CO.
93 Columbia St., Leetonia, Ohio, U.S.A.

and enjoined B from continuing to use said machine, but A was allowed only nominal damages, because his patented machine was not as efficient as those patented later, and therefore A must be bound by the competitive effect of such later machines. In other words, as B received no real advantage from using a machine which infringed A's patent, as he could have bought noninfringing machines which would do better work than A's patented machine, the Court would not penalize B's acts by making him pay damages to A, although B's machine was held to be an infringement of A's patent.

The effect of the above decision is that the owner of a patent cannot recover damages from an infringer of

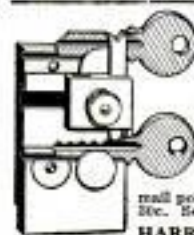

Duplicate Keys Made in One Minute By the Harrison Key Filing Machine

Invaluable for Machinists, Building Superintendents, Repair shops, Locksmiths, Carpenters, Master Mechanics, Janitors, Garages, etc. Anyone can make a perfect duplicate key without injury to original or master key. Fits any pin tumbler lock—Yale, Sargent, Morriss, Harding, Russell & Erwin Corbin, Yassar, Etc., Etc. A customer writes:—"We made 60 keys in 1 hour and 16 minutes. Can you beat it?" Price \$3.00 for machine complete with two filing guides and our new model clamp attachment. Remit by Post Office Money Order or New York Checks. Shipment by return mail postpaid. Diamond files furnished at cost if desired, price 25c. Send for circular telling all about this machine.

HARRISON & COMPANY, 81½ New Street, NEW YORK



L. HAGENOW, NEW HAVEN, CONN.



INTERIOR VIEW

Uses **LEIMAN BROS.** Size F **VACUUM PUMP** with 200 ft. hose and 3 horse power. These pumps take up their own wear. Used for portable and stationary outfits. Sizes 2 to 338 cubic feet per minute.

CATALOG No. 23

LEIMAN BROS.
62 P. John St., New York

Grow Mushrooms

Big and Quick Profits
Costs Little to Start a Safe Business



Increase your income \$5 to \$70 a week by learning mushroom culture from biggest mushroom man in the world. Fourteen years' experience enables me to give any man or woman practical instructions worth many dollars. Only spare time required. Can be grown in

sheds, old barns, or basements. I have started thousands and will show you how Free. This is your opportunity; send for Free Book giving particulars, how to start, etc. Address **JACKSON MUSHROOM FARM** 4220 N. Western Avenue CHICAGO, ILLINOIS

Swell, Nobby Suit

Made to Your Measure, Only **\$12.00**



Your tailor would ask \$25.00 to \$30.00 for a similar suit. Why should you pay him such an enormous price for no better garments?

Why continue to wear hand-me-down suits, when you can get tailor-made garments at less than ready-made prices? We deal direct with the consumer—no middlemen's profit to pay. We make you a stylish, perfect fitting, better wearing suit or overcoat than you can possibly buy from your local tailor or dealer, and prepay express charges.

Samples and Style Book FREE

Why continue to wear shoddy, ill-fitting clothes?

You just make your selection from our Style Book, which contains a complete line of cloth samples, the latest designs and Fashion Plates, showing the classiest, swellest styles ever created, that will mark you as a tasty, modish dresser.

Remember, we guarantee to fit you—we tailor to your exact measurement, cut and trimmed exactly as you want it. There is positively no chance for a mistake with our simple, yet perfect, system of home measurement.

\$7.50 English Slip-on Raincoat \$2.95
Absolutely Waterproof

To prove how close we sell direct to you, we will send you a handsome, durable \$7.50 English Slip-on Raincoat, absolutely waterproof, for **\$2.95**, with every order for a suit or overcoat.

The Fort Dearborn National Bank of Chicago will tell you that we are responsible. Be sure and send for our free Style Book today. Local Agents wanted in your territory.

Madison Tailors 275 Central Union Block, CHICAGO, ILLINOIS

said patent if the infringer could have avoided the patent by making or using noninfringing machines or articles which are better than that covered by the patent. B was obliged to stop using the infringing ma-



LYON & HEALY
25-31 E. Adams St., CHICAGO

will mail free, newly enlarged Catalog of Band Instruments. Hundreds of Fine Illustrations, describing every article for Bands or Drum Corps.

BIG BOOK FREE

Contains instructions for Amateur Bands, Exercises and Scales, By-Laws, Selected List of Band Music. Write today!



OVER 65 YEARS' EXPERIENCE

PATENTS

TRADE MARKS
DESIGNS
COPYRIGHTS, &c.

Anyone sending a sketch and description may quickly ascertain our opinion free whether an invention is probably patentable. Communications strictly confidential. **HANDBOOK** on Patents sent free. Oldest agency for securing patents. Patents taken through Munn & Co. receive special notice, without charge, in the

Scientific American.

A handsomely illustrated weekly. Largest circulation of any scientific journal. Terms, \$3 a year; four months, \$1. Sold by all newsdealers.

MUNN & CO. 359 Broadway NEW YORK

Branch Office, 625 F St., Washington, D. C.



The New Edison!

This Wonderful New Style Edison shipped **FREE**

Yes, you may have this wonderful new outfit or your choice of many others shipped *absolutely and positively* free as per offer below.

Mr. Edison Says:

"I Want to See a Phonograph in Every American Home"

For the phonograph is Mr. Edison's pet and hobby, and he knows of what immense value it is to have this wonderful entertainer in the home, with its variety of entertainments for young and old who gather in the evening.

The Edison Offer We'll send you the New Model Edison

phonograph and your choice of all the Amberol records on an absolutely free loan—no obligations, no deposit, no guarantee nor C. O. D. to us whatever. We want you to have all the waltzes, two-steps, vaudevilles, minstrels, grand operas, also the sacred music, etc., by the world's greatest artists. Reassure your family and your friends. Then—when you are through with the outfit—send it back to us.

Our Reason We are tremendously proud of this new instrument.

When you get it in your town we know everybody will say that nothing like it has ever been heard—so wonderful, so grand, so beautiful, such a king of entertainers—so we assure that at least some one—if not you, then somebody else, will want to buy one of these new style Edisons *especially as they are being offered now at the most astounding rock-bottom price—and on easy terms as low as \$2.00 a month.* Perhaps you yourself will be glad to keep the outfit. But even if nobody buys we'll be glad anyway that we sent you the new Edison on the free loan—for that is our way of advertising quickly its wonderful superiority.

Get the New Edison Catalog

We will send you our handsome new Edison book and full particulars of our wonderful free loan offer absolutely free and prepaid. Write today—do not delay. Get the free book and learn all about this wonderful free trial offer. Send your name and address on a postal card or letter, or just the coupon will do without any letter—but *write now.*

Edison Phonograph Distributors

Address **F. K. BARSON**
Vice Pres. & Mgr.
Edison Bldg., Dept. 1188
CHICAGO, ILL.
West-ra Office, 65
Post St. San Francisco; Canadian Office, 355 Post St. Toronto, Ont.
Winnipeg.

My Name.....

My Address.....

FREE COUPON

Edison Phonograph Distributors

F. K. BARSON, Vice Pres. & Mgr.

Edison Bldg. 1188 Chicago, Ill.

Gentlemen: Without any obligations on me, please send me your great Edison Catalogs, and also full particulars of your wonderful Free Offer on my choice of a new style Edison Phonograph.

Please Mention Popular Mechanics



**On that
Nice Model**

**Use a
Starrett
Scraper**

You'll be proud of the result

For producing beautiful smooth surfaces on all kinds of fine woodwork, there is no tool so convenient as this scraper.

In an instant you can have a new, sharp, true cutting edge by turning the handle with the ball joint connection.

You can get into corners or close up to walls without bruising your knuckles.

For sale at the nearest hardware store. Send for our Catalog No. 19AP.

THE L. S. STARRETT CO.
ATHOL, MASS. 42-10

FOR MENDING HARNESS

shoes, tents, awnings, pulley belts, carpets, saddles, suit cases, buggy tops, dash boards, or any heavy material. Stewart's Automatic Awl is the only perfect Sewing Awl.



It takes a wax thread, feeds it from spool and does the work of any harness maker machine. It is indispensable for learners. Agents wanted. Sent prepaid for \$1.25. Send at once for catalog.

STEWART-SKINNER CO.
26 Hermon Street
Worcester, Mass.

USE THE Van Expansion Bolt



Fastens all kinds of apparatus to Concrete, Brick, Stone, Marble, Tile, etc., and will not mar the surface. The VAN is not like ordinary bolts. There's no waste—no loose parts—no time spent assembling it. One piece composition metal—greater Holding Power. Temporary seal over bottom prevents clogging. Will not rust—loosen—or pull out.

Defies All Tests—Prove It to Yourself

Write for free sample and booklet "Does It Pay?"

C. B. VAN ANTWERP CO., 417 Fort Dearborn Bldg., CHICAGO

The IRWIN Bit
Reg. U.S. Pat. Office

(Be sure this identical brand is on the bit you buy)

You men who use tools
—when you buy your Auger Bit get the original IRWIN and look sharp for the brand. The toughest job the IRWIN perfects. Bores clean and swift through soft, hard or knotty wood.

IRWIN Auger Bit

will not bend or break or fail. Master Workmen choose it—they know its making. Extra high grade crucible auger-bit-steel in one piece. Lathe-turned by hand to the thousandth of an inch. Heads and cutters sharpened by *hand filing* Tempered by secret process unknown to imitators.

You get your money back on an IRWIN if it fails to suit you

The only solid-center-stem bit made in all styles and sizes for every use. Sold by dealers everywhere. If you fail to find the *Genuine, Guaranteed* IRWIN write us.

IRWIN AUGER BIT COMPANY
Largest in the World

STATION 1 12 WILMINGTON, OHIO

chine and also had to pay the costs of the litigation. Patentees who expect to recover damages from infringers of their patents should be in position to show that the inventions covered by their patents are better than similar inventions which are available to the infringers, and which do not trespass upon the patentee's rights.

New Jersey maintains its high standard of public schools at a cost of about 20 cents per day a pupil.

**WRITE FOR
CATALOGUE
44**



PHILLIP'S SPRING HAMMER

For drilling holes in Stone, Concrete, Brick, Marble, Tile, Conduit, etc.

Will drill 10 times faster than by hand

Strikes 800 to 2000 blows per minute. The spring does the work. Makes hole $\frac{3}{8}$ " to $1\frac{1}{8}$ " in diameter. This tool can save you money. Get it now.

ORR & LOCKETT HARDWARE CO.
14-16 W. Randolph St. CHICAGO, ILL.

THE EXCELSIOR BRAD SET. PRICE 25 CENTS

Takes No. 18
and No. 20
Brads from $\frac{1}{4}$
to $\frac{3}{4}$ in. long



The tool illustrated above will be indispensable to the Pattern Maker, Cabinet Maker, or Picture Framer who purchases it. It will set brads in places that would be inaccessible without it, and dispenses with the brad awl and nail set. If, after a fair trial, you are not satisfied that you have received your quarter's worth, your money will be promptly returned to you on receipt of tool. **Standard Tool Supply Co., 42 W. 15th St., New York City**

"Agrippa" the Master Clamp!

Cast Clamps are not reliable; not handy because of their excessive weight and not an economical investment. The logical alternative is now available in the Agrippa Clamps:



Agrippas are
Much lighter
Half the sectional area
Much stronger
Provide superior utility
Price is not greater

and, we guarantee them to perform the same service possible with the cast steel product.

J. H. WILLIAMS & CO.
Superior Drop-forgings
47 Richards Street BROOKLYN, N. Y.

JAP CHILDREN MAKE GARDENS—In Japan every one loves gardens, knows gardens, and makes gardens. The children amuse themselves with toy gardens instead of mud pies, and model relief maps in the sands of school playgrounds. In the recent wars the soldiers, after long marches, amused themselves by making little home landscapes before their tents.

In more remote times emperors and shoguns abdicated and joined or established monasteries in Kioto, that they might the better meditate upon the eternal truths and



Tool Cases for Machinists & Toolmakers

You need one of the many styles shown in our free catalogues. They are the best built and most practical on the market and it's the up-to-date way to keep tools in good condition and orderly arranged. We ship direct to you and guarantee complete satisfaction.

H. Fenster & Sons

Mfrs. of Mechanics' High Grade Tool Cases
210 Germanian Street, DAYTON, OHIO

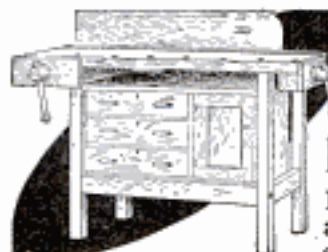

Only \$14.50

For this Home Bench

Besides its convenience and usefulness, you will save its price in a year

by doing repair work and "fixing things" that you now pay a carpenter or repair man to do. Thousands of homes have home benches we have furnished—why not you?

Top is 50 in. long, 20 in. wide, with a 13-inch glued-up portion of thick maple
Grand Rapids Hand Screw Co.
1420 Front Ave. North, GRAND RAPIDS, MICH.

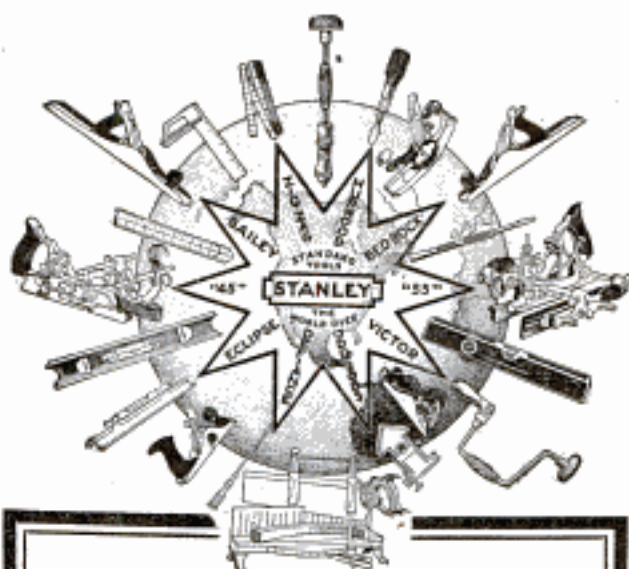

"Stanley" Tools

JUST PUBLISHED

A new Hand-Book full of interesting information for

Carpenters **Pattern Makers**
Machinists **Cabinet Makers**
Masons **Millwrights**
Plumbers **Wheelwrights**
Amateurs **Householders**

It not only illustrates and describes over four hundred Stanley Tools, but also contains a number of very handy tables.

Tables that you have to refer to time and again.

For instance:

Tables of *Measures and Weights*,
Long, Square, Cubic, Liquid, Dry, Avoirdupois, Troy, Apothecaries, etc.

Tables of *Circumferences, Areas, Squares, Cubes, Square and Cube Roots.*

A table of *Board Measure, Properties of Timber, etc.*

In fact there are twelve pages of special information that will help you on many a job.

Convenient size to carry in the pocket.

Sent postage prepaid to any part of the United States or Canada without charge.

ADDRESS

Stanley Rule & Level Co.
NEW BRITAIN, CONN. U.S.A.

GIVEN FREE A limited number 10-inch Student Rules with cardboard scales FREE to each purchaser of book below. Flexible silk cover, \$1.50. PAPER COVER \$1

There seems to be a misunderstanding about what the Slide Rule will accomplish, many think it is an instrument, the use of which is applicable only to Engineers and Technical men. So frequently have I heard this remark that I have completely re-written and enlarged my instruction book, which shows the actual setting of the rule by 78 full size engravings, each engraving and example is explained and "written so you can understand it." In fact any person who has never seen a Slide Rule, and not a technical person, could not help but learn its use. The examples selected and shown by illustrations are those which frequently come up for solution by the Banker, Broker, Auditor, Inventory Man, Cost Estimator, Printer, Paper Mr., Contractor, Salesman, Time-Keeper, Bookkeeper, Lumber, Land, and other merchants too numerous to mention.



This Slide Rule will multiply, divide, solve proportion, extract the square and cube roots, find the decimal equivalents of vulgar fractions or "vice versa," calculate interest, percentage. Also the mensuration of superficies, and the rule of three. For Engineers, Electricians, Draftsmen, Superintendents, Master Mechanics, etc., the rule is indispensable in their work. It is one of the most valuable instruments ever offered to mankind. For Electricians it is a complete wire table in itself, calculates the size of a motor to run a pump, shows percentage a customer's recording meter is either "slow or fast." The Richardson Direct Reading Slide Rule is specially designed for those who wish to learn its use. Its operation being very simple. You simply place the key to the problem wanted in the keyhole (the key is printed in red on slide, see cut) and answer is given direct; such as the Horse Power of Engines, Pumps, Boilers, Belts, Water Falls; size of duct for ventilating; radiation and size grate, and steam main required; change gear and pulley problems; areas, circumference and diameter of circles. This Rule is my 1912 type now being placed on the market for the first time. Made in two sizes, coat and vest pocket 11x1 1/2x1/4 and 5 1/2x1 1/2x1/4. No wood in their construction, scales white celluloid, printed from engine divided plates in two colors, and washable, secured by an improved locking device in an absolutely non-corrodible Aluminum and Monel Metal framing. Durable cardboard case for large rule, and neat leather case for vest pocket size. Special case for large rule end-flap and button fastening 25c extra. If ordered now I give free a copy of my new book *The Slide Rule Simplified*. Price of either above rules \$3.50. A limited number 10 inch Student Rules with cardboard scales Given Free to each purchaser of above book. Price of book without rule, paper cover \$1.00. Flexible silk cover \$1.50. GEO. W. RICHARDSON, Consulting Engineer, Ex-Chief Electrician, U. S. Navy, 4818 24th Pl., Chicago, U. S. A.

Do Your Own Soldering

No skill needed. Perfect work. Save the tinsmith's charges by using the modern combined solder and flux. Just apply and heat. Use a candle, gas jet, or the Tinol Alcohol Torch. No acid or re-heat. The Tinol flux is non-corrosive and cannot damage the most delicate work. If your hardware dealer does not handle Tinol, send us his name and \$1.20 for Tinol Torch and can of Tinol Paste. Literature free. HESS & SON, Dept. F, 1215 Filbert St., Philadelphia, Pa.

LUFKIN

Measuring Tapes

Standards of efficiency for the Amateur and the Expert. The big improvement in markings, instantaneous readings, saves time and avoids error. Send for sample piece of tape and our complete catalogue.

THE LUFKIN RULE CO.

SAGINAW, MICH.

New York

London, Eng.

Windsor, Can.

A Tool of Real Efficiency

This Bench Drill can be attached to any table or bench.

Bench Drill Press No. 23

is strongly constructed, has a sensitive lever feed. Is finished in Japan and bright nickel. The chuck will hold drills from 0 to 3/8 of an inch; 6 1/2 inches between chuck and table at highest point.

Price \$3.50

Send for a FREE copy of "Tool Practice"

MILLERS FALLS CO.
28 Warren St. NEW YORK



Portable Cases

FOR TOOL MAKERS AND MACHINISTS

Twelve styles, felt lined drawers, solid brass trimmings, best of material, beautiful finish, low prices, satisfaction guaranteed. Ask for booklet of cases built for service.

The Pilliod Lumber Co.
SWANTON, OHIO

enjoy gardens of their own designing. Priests, nobles, and court ladies all observed the conventions and practiced the rules of landscape art.

Of the making of gardens and illustrated garden books there was literally no end in the leisureed centuries before the restoration, writes Eliza Ruhamah Seidmore in the Century Magazine.

The state of West Virginia produces 65 times more coal than it did 30 years ago.

SENT ON 30 DAYS' TRIAL TO RESPONSIBLE PERSON



The Handiest Tool Holder Made

Constructed of hardened steel, well and truly made. Holds any shape of stock down to No. 60 Drill. Write for Catalog E.

B. MORGAN, Manufacturer of SPECIALTIES
Bellevue St., NEWPORT, R. I.



BAR BENDERS

For Concrete Reinforcements

WRITE FOR OUR BENDING TOOL CATALOGUE.

Wallace Supply Co. 121 No. Jefferson St., Chicago
26 Cortlandt St., New York City

For Sewing Leather



\$1.00 A perfect stitcher. Sewers or mends anything. Whole repair shop. Original perfect lock stitch. Diamond point grooved needle protects throat. Always ready. Sample prepaid. Agents get busy. Sells on sight. G. A. MYERS CO., 4529 Lexington Ave., Chicago, Ill. U. S. A.

"YANKEE" TOOLS *Make Better Mechanics*

This "YANKEE" Ratchet Breast Drill

can be worked in places and under conditions where it is impossible to operate any other drill or boring machine. The "YANKEE" improvements enable the user to instantly adapt the tool to the working requirements of any drilling or boring job.

Five Adjustments

Right, Left and Double Ratchet movements; Plain Drill; and gears locked.

Breast Plate can be turned to right angle of position illustrated.

Two Speeds. Changed at a touch of this little lever, at any point in revolution, without removing drill from work.

Two-Jaw Chuck

of new design, for round or square shanks. Jaws are accurate; securely hold drills, bits and other tools—centered absolutely. The hexagon permits use of a wrench for tightening large drills. "YANKEE" Breast and Hand Drills are made also with three-jaw chucks (for round shank tools only).

This Handle is made with a bit for use as a screw-driver for the tool.

AUTOMOBILISTS—Write for "YANKEE" Tools in the Garage.

This Shifter Controls the Adjustments

First notch—Plain Drill; Second notch—Left-hand Ratchet; Third notch—Right-hand Ratchet; Fourth notch—DOUBLE RATCHET; Fifth notch—gears locked. Changes made at a finger touch.

The DOUBLE RATCHET is a big time-saver and convenience when work is in close quarters; Every movement of the crank, forward and back, causes the drill to cut continuously. Twice the work is done, compared with a single ratchet. The drill is advanced as speedily as with a full revolution of the crank.

"YANKEE" Breast Drill: Price \$5.25 Length, 17 inches. Weight, 6½ pounds. Double speed. No. 555—Two-jaw chuck. No. 1555—Three-jaw chuck. Your dealer can supply you. Write for "YANKEE" Tool Book" illustrating and describing the various styles of "YANKEE" Ratchet, Breast and Hand Drills and other "YANKEE" Tools.

NORTH BROS. MFG. CO., PHILADELPHIA

FOOLING THE HENS—Owners of hens are frequently greatly annoyed by the persistent desire of their fowls to set, in season and out, on eggs, stones or other objects to hand, but a Western man has evolved a plan to circumvent the hen in this respect.

The cure consists of a cheap watch, with a loud and clear tick, inclosed in a case that is white and shaped like an egg. When one of the hens belonging to this Westerner manifests a desire to set out of season he gently places the bogus egg under her sheltering breast. The "egg" ticks cheerfully away, and soon the

GASOLINE SOLDERING IRON BLOW TORCH

A Little "Light"—On Some extra-Handy...Test. Free booklet.



EMMELMANN BROS. MFG. CO., INDIANAPOLIS, IND., U.S.A.

By Getting a Work Bench Like This

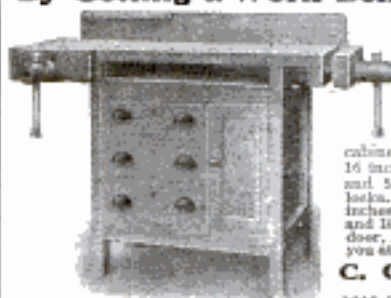

you will be able to do most any kind of work around the house. The bench is 4½ ft. long, 22 inches wide and 32 inches high, made of hard maple, has 2 Patent Wood Screw Vises. The cabinet has three drawers, each 16 inches long, 18 inches wide and 5 inches deep, fitted with locks. The cupboard is 18 1-2 inches long, 18 1-4 inches high, and 10 inches wide, with lock on door, and will be shipped to you at once on receipt of

\$14
C. CHRISTIANSEN
MANUFACTURER
2219 Grand Ave., CHICAGO, ILL.



"FILL IN" Steel Cement

For plugging small holes in castings, water pipe, gas pipe, connections, etc. Positively prevents leaks and is inexpensive, on account of small amount necessary to use. 1-lb. cans 30c lb. 5-lb. cans 25c lb.

J.W. PAXSON CO., Mfgs., 1021 N. Delaware Ave., PHILA.

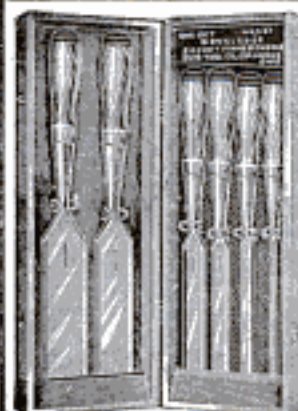

No. 501.

"OHIO" CHISELS

are made from high grade and specially selected tool steel, and the care, skill and experience of our 89 years in the Edge Tool business is put into every tool bearing our "Ohio" Trade Mark shown here. The result is a high grade and very satisfying tool, with a keen, tough and lasting cutting edge.

"OHIO" PLANES

are fitted with our special Extra Heavy Cutter, which prevents Chattering or Trembling when used in hard or knotty timber. High grade cutters, accurate adjustments and true faces are only a few of the points in which our planes excel and make it well worth your while to insist on having them from your dealer.

Write for our free Catalogue of High Grade Tools and Benches

OHIO TOOL CO. (Dept. 3)
COLUMBUS, OHIO



Steam Fitters and all Pipe Line Workers

Here is a tool that grips large size iron and steel tubing with the power of a giant—a fast and easy worker on any threaded pipe. Seven sizes: No. 10, 11, 12, 13, 13½, 14 and 15. Smaller takes ½ in. to ¾ in. pipe—largest, 2 in. to 12 in. This wrench has several distinct advantages. Jaws are interchangeable and so perfectly fitted against shoulder, which is forged on handle, that "pull" of the chain is not on the jaws or on a bolt, but on the collar forged with the handle. The chain of the

BONNER

"Victor" Chain Pipe Wrench

is hand made and swings from an eye forged in the end of handle, thus making the wrench instantly reversible. Like every other Bonner tool, this wrench is of highest quality. Tempering is done by an expert, and jaws can be sharpened only by filing. This is guaranteed as the most efficient and powerful chain pipe wrench made. If your local hardware store cannot supply you, send us dealer's name.

C. E. BONNER MFG. CO., Chicago, Illinois.

Makers of Bonner Fry Bars, Auto Kits, Farmer Kits and other special purpose tools.



Pipe Threading Tools

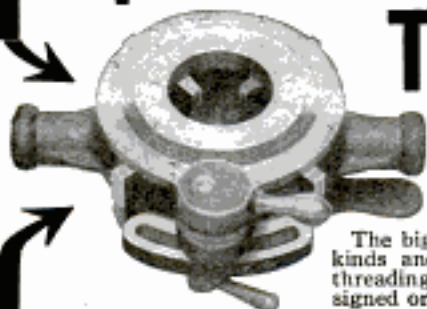

Hand, belt and motor machines.

The biggest line of all kinds and sizes of pipe threading equipment designed or manufactured.

The Oster "Bull Dog" Line

Known throughout the world. Recommended by eighteen years of success in the best plants, where highest efficiency is daily demanded.

Reasonable price, accomplished by the elimination of complicated parts. Simplicity of design, and consequently a simplicity of operation—making it unnecessary to employ an expert operator. Anyone can accomplish perfect results and high speed upon an Oster, without previous experience.

Self-locking dies. No resetting for each cut. No turning back over the finished threads. One movement of the hand opens or closes the dies. Every contractor, every shop, and every individual, who is interested in hand or power pipe threading equipment, should have the new Oster catalogue. Sent free by mail, postpaid. Ask for it today.

THE OSTER MFG. CO.
2100 East 61st St., Cleveland, O.

Mailed Free to Any Address



B.S.

B.S.

Aside from listing our entire line this catalogue contains much valuable information for both mechanic and apprentice. Send for one today.

Brown & Sharpe Mfg. Co.
PROVIDENCE, R. I., U. S. A.

hen begins to evince signs of uneasiness and stirs the noisy egg around with her bill, thinking, no doubt, that it is already time for it to hatch. She becomes more and more uneasy as the noise continues and soon jumps off the nest.—Pittsburgh Press.

"SIMONDS SAWS"

"Are the BEST, and
They ARE the best."

AGENTS BIG MONEY MAKER

Give automatic stropper free with every sale of Tungsten Steel Razor. Guaranteed. You make 98c on every sale. Field of Tex. sold 12 first day out. Every man wants one. Write quick for sample outfit. Enormous Demand. Easy Sales.

Thomas Razor Co., 6048 Barny St., Dayton, O.

LANSING DUSTLESS ASH SIFTER STOPS COAL WASTE

Do you know that 15 to 20 per cent of the coal you use goes through the ash-pit unburned? You can stop this waste with a Lansing Dustless Ash Sifter. It is a combination shovel and sieve that automatically sifts the good coal from the ashes. It is used in the ash-pit of your furnace. Easily handled. Makes no dirt. Does the work at one operation. Pays for itself in a month. Strongly and perfectly made of heavy sheet steel. Steel wire screen, ¼ in. mesh. Strong and durable. With ordinary usage Sifter will last a lifetime.

PRICES—Lansing Dustless Ash Sifter complete as above only \$1.75, at your Hardware Dealer's, or send direct to us. Money back if not as represented. Booklet Free.

DEALERS—Our advertising is creating a big demand for these Sifters. Better write for prices NOW.

THE GIER & DAIL MFG. CO., Dept. G, LANSING, MICH.



He Doubled His Salary and Became an Expert Engineer

Like thousands of other young men, he wasn't born rich and couldn't go to college. This did not keep him from getting an education. He worked hard during the day and studied at night. He took advantage of the opportunity which the American School offers every young man through correspondence instruction and their great technical library, consisting of ninety-eight volumes. These great cyclopedias are complete reviews of the actual, tried and tested experiences of the greatest engineers of the world. Read the letter below; this man tells what these books have done for him.

New York City, June 15th, 1912.

American School of Correspondence, Chicago, Illinois.

Gentlemen—With the help of your *Cyclopedia of Mechanical Engineering*, I have become familiar with all classes of machinery; this has enabled me to get a much higher salary. I have made all the drawings for a steam engine as well as the engine itself, a picture of which I am sending you.

I recommend this *Cyclopedia* and the American School courses as the greatest educators for any man who can't go to college. Your generous easy payment plan will enable any young man to do what I have done. Your methods of instruction are the best and easiest.

Very respectfully yours,

FRANK C. MEADINICK.

The New Seven Volume Edition Cyclopedia of Mechanical Engineering and Modern Shop Practice

Is one of sixteen complete cyclopedias published by the American School

In this wonderful work will be found instruction in Gas Engine Operation and Manufacture; Machine Shop Work; Assembling of Machinery; Tool Making and Shop Management in the most simple and comprehensive form. Every detail of mechanical engineering is thoroughly analyzed and treated, rendering the books of unusual value to the experienced mechanic and shop manager.

The Cyclopedia contains 3,992 pages and is supplemented with a series of practical test questions, including over 2,327 full-page plates, illustrations, tables, formulas and "shop kinks."

Subjects Thoroughly Covered

Machine Shop Work—Vertical Milling Machine—Motor-Driven Shops—Shop Lighting—Forging—Electric Welding—Tool Making—Metallurgy—Manufacture of Iron and Steel—High-Speed Steel—Flaws in Castings—Electric Lifting Magnets—Magnetic Clutches—Making a Machinist—The Ideal Foreman—Pattern Making—Foundry Work—Automatic Coal and Ore Handling Appliances—Machine Parts—Construction of Boilers—Types of Boilers—Boiler Accessories—Steam Pumps—Air Compressors—The Steam Engine—The Steam Turbine—Indicators—Valve Gears—Refrigeration—Gas Producers—Gas Engines—Automobiles—Elevators—Sheet Metal Work—Practical Problems in Mensuration—Mechanical Drawing—Drafting Room—Organization—Machine Design.

WE'LL PROVE THEIR VALUE TO YOU

by sending you the complete Cyclopedia absolutely free for examination—just mail the coupon. Keep the books seven days—test every formula. You will agree that they are all we state, and more. Send \$2.00 after examination and \$2.00 a month until you have paid the special price of \$19.80. The regular list price is \$36.00. If the books do not meet with your requirements, advise us and we will remove them at our expense. Also ask for information about our correspondence courses and easy payment plan.

Another Great Offer With each set is included a year's Consulting Membership entitling you to the free advice of a staff of Mechanical Engineers. This will give you practical help in handling working problems which are too specific to be taken up in detail in the Cyclopedia. A single problem solved for you might be worth more than the first cost of the books.

AMERICAN SCHOOL OF CORRESPONDENCE, Chicago, U. S. A.



Pop. Mech. 9-12
A. S. of C.

Please send me Cyclopedia of Mechanical Engineering for seven days' free examination. I will send \$2.00 within seven days and \$2.00 a month until I have paid \$19.80; otherwise I will notify you and hold the books subject to your order. Title not to pass until fully paid.

NAME.....

ADDRESS.....

OCCUPATION.....

EMPLOYER.....

Every Young Man Contemplating The Study of Engineering

should read ERNEST McCULLOUGH'S book

"ENGINEERING as a VOCATION"

because the author tells the truth about conditions surrounding this work even if they are sometimes at variance with commonly accepted ideas.

Price, \$1.00 Postpaid

Popular Mechanics Book Dept.
CHICAGO

Looking for Mechanical Information

500 Titles on 100 Different Subjects

OUR NEW REVISED

BOOK CATALOG

Shows just where to find that particular help you are in need of. SENT FREE on request.

Popular Mechanics Book Dept.
318 W. Washington Street, CHICAGO

KING OF HOUSEHOLD FINISHES

JAP-A-LAC

Renews

EVERYTHING FROM CELLAR TO GARRET
SOLD AT PAINT, DRUG, HARDWARE AND DEPT. STORES

The GLIDDEN VARNISH CO. *Glidden* CLEVELAND — TORONTO

LOOK FOR QUALITY GREEN LABEL



The Powder That Fills Your Game Bag

Make your hunting trip a success. Insist that your dealer supplies you with shells containing

INFAILLIBLE

Sporting Powder

Unrivalled for its moisture-proof, clean shooting and stable qualities,—important factors contributing largely to the success and pleasure derived from hunting.

Ask your dealer for *Infallible*.—Accept no substitute.
Send for *Sporting Powder Booklets*. FREE.

Address Dept. 248
Du Pont Powder Co., Wilmington, Del.

Save $\frac{1}{3}$ to $\frac{1}{2}$ on Fuel Bills



OUR MONTHLY PAYMENT PLAN makes it easy for you to purchase a

JAHANT DOWN DRAFT FURNACE

Have plenty of heat wherever and whenever desired. You are sure of satisfaction because we issue a 365 day Guaranty Bond. We sell direct paying freight and saving you dealer's profits. Install the Jahant yourself. We send complete outfit—furnace, pipes, registers, etc., with special plans, detailed instructions and necessary tools.

Send for free furnace handbook.

THE JAHANT HEATING CO.
25 Mill Street Akron, Ohio

BUY YOUR FURNACE \$10 DOWN \$10 A MONTH

IDENTIFYING A BIRD—A Missouri contractor now knows more about natural history than he did two weeks ago. This contractor on one of his jobs had erected a large wooden tank for water supply purposes. A few days ago he noticed a bird busily pecking away at the staves of the tank. He watched it awhile and then called his foreman. "That's a robin," said the latter. "Wrong," said the contractor, "it's a bluejay." A few minutes later he noticed that the bird had drilled a neat hole through the stave, and nothing daunted by its ill luck

A Postal Brings Grand Free Millwork Catalog

5,000 Bargains in Building Material!

Send at once for the great Catalog of 5,000 Bargains in the highest grade Guaranteed Millwork and Lumber. Issued by the Largest Building Material Plant in America. Buy Doors, Windows, Mouldings, Stair and Poreh Work—everything you need to build, remodel or repair—at 50 per cent saving! Quality, Safe Delivery and Satisfaction Guaranteed. (38)

GORDON-VAN TINE CO., 2761 Case Street, DAVENPORT, IOWA

AGENTS

Clauss NEVER FAIL Razor Sharpener

A Positive Automatic Razor Sharpener—Absolutely Guaranteed. The only machine made that Hones and Strips any razor—old style or safety. THE SELLING PROPOSITION OF THE DAY. ALL ON SPARE TIME—Actual Experience Not Necessary—Sells on Sight—100% Profit and More—Strike out for your self—Let us get the plan and the goods and will grant you ALL THE TERRITORY YOU CAN HANDLE—WRITE TODAY and get in right on the ground floor. MAKE MONEY—BIG MONEY—REAL MONEY. It's the opportunity FOR YOU. What others are making—you can make.

\$45 TO \$90 A WEEK

Here's Ireland, Iowa, who sold 13 Sharpener first day; Brown, Mass., who sold 31 first trip out; Bogby, Tx., ordered over 200 machines in 10 days. Grand Free Advertising Special Introductory Plan Starts You.

Send No Money—Send name and address at once and get complete information with Free Trial Offer.

ADDRESS SECRETARY

The NEVER FAIL is the only successful invention of its kind on the market. Developed to the Highest Degree of Efficiency. Highest possible grade Materials and Construction. Roller Bearings—Remarkably Easy Runner. Accurate, Automatic to the limit. A Keen Velvety, Superb Shaving Edge EVERY TIME You Use the NEVER FAIL. You can't Go Wrong on this STRAIGHT FORWARD ON-THE-SQUARE Proposition.



\$100.00

Reward For any Razor—old style or safety—that can't be sharpened and kept in best of condition on the Never Fail provided the blade doesn't need grinding.

THE NEVER FAIL CO., 1444 Colton Bldg. TOLEDO, OHIO

Weiss **\$22.00**
FILING DESK FREIGHT PAID
Files and desk combined
 YOUR CHOICE, *nine kinds* of drawers for filing business papers, Letters, Index Cards, Electros, etc. A very practical desk, substantially built of *Solid Oak*, beautifully finished Golden or Weathered. Top 28x52. Drawers on roller bearings. Any arrangement of drawers \$22.00. *Weiss Swinging Stand*, \$3.50, express paid in U. S. Free Catalog "D"—64 pages filing and office time saving devices. Booklet "Filing Suggestions" solves filing problems. Catalog "E" shows *Handsome, Inexpensive Sectional Bookcases*, (two styles).
 Freight Paid east of Mont., Wyo., Colo., Okla., Texas. Consistently low prices beyond.
The Weiss Man'g Co.
 47 Union St., Neuros, Mich.
 New York Office
 105 Fulton St.



TRY IT YOURSELF FOR 10 DAYS WITHOUT DEPOSIT



If not satisfactory, return it and no questions asked. **DAUS IMPROVED TIP TOP DUPLICATOR** with "Dausco" Oiled Parchment Back negative roll is the result of 25 years' experience and is used and endorsed by thousands of business houses and individuals. 100 copies from pen-written and 50 copies from typewritten original—Clear, Clean, Perfect. Complete Duplicator, Cap size (prints 8 1/2 x 13 in.), price — **\$5.00**

FELIX J. L. DAUS DUPLICATOR CO., Daus Building, 111 John St., New York

had resumed operations on the other side. The foreman plugged up the opening and drove the bird away, but it was back again in a few minutes as busy as ever. The contractor then shot it, and labored with his employe for half an hour trying to convince him that it was a bluejay. Finally he gave up in disgust, saying, "I'll take the bird into town today, and get an affidavit as to its name." That afternoon when he drove to town for his mail he took the bird with him. Inquiry of the postmaster developed the fact that a man sitting on the office steps was the local authority in natural history. The contractor brought his bird to this man and asked him what it was. The authority straightened up and queried, "Who shot it?" "I did," said the contractor, proudly;



TYPEWRITERS ALL MAKES

All the Standard Machines **SOLD or RENTED ANYWHERE** at 1/2 to 3/4 **RETAIL PRICES**, allowing **RENTAL TO APPLY ON PRICE**. Shipped with privilege of examination. Write for Illustrated Catalog L. TYPEWRITER EMPORIUM, 21-26 W. Lake St., CHICAGO

RED OR BLACK VULCAN INK PENCILS Only Perfect Non-Leakable Ink Pencils at Moderate Price



\$1.00

TWO SIZES, 4 1/4 AND 5 1/2 INCHES. AGENTS WANTED. POSTPAID
J. C. ULLRICH & CO., 27 Thames St., NEW YORK

LET US GIVE YOU THIS TRANSPARENT CELLULOID TRIANGLE

It is 4 inch size, 30°-60° angles. Lowest retail price, 25 cents. Absolutely essential to everyone who draws. We make this offer to introduce our new catalogue showing

SPAULDING'S NEW CARRYING CASES AND COMPLETE OUTFITS

for designers, architects, engineers and students—compact, durable and convenient. Spaulding's Carrying Cases are made light and strong. They provide well arranged compartments, including space for drawing board and T square. Handled like a suit case; unique, practical, inexpensive. Outfits include all necessary equipment. If you draw, send us five 2-cent stamps to-day to pay postage and get the free triangle and the catalogue.

SPAULDING PRINT PAPER CO.
 44 Federal St. BOSTON

It won't leak

MOORE'S THE ORIGINAL NON-LEAKABLE FOUNTAIN PEN

\$2.50 AND UP

When the cap is screwed on, the pen is as tight as a bottle. The ink must stay where it belongs, inside the barrel.

And in addition, Moore's

Can be carried anyway, anywhere, in pocket or bag. **It Won't Leak.**

It writes at the first stroke, without shaking, because when the cap is on, the pen resting in ink remains moist.

The easiest pen to fill, simply remove the cap and drop in the ink—no inky joints to unscrew, no danger of inking your fingers.

It writes continuously with an even flow of ink.

It will carry any kind of ink, even Higgins India Drawing Ink, the heaviest made.

It is made in the simplest manner of the fewest parts, nothing to get out of order.

It is the one pen without a fault.

Moore's is a habit that you never get over

Every Moore Non-Leakable Fountain Pen carries with it the most unconditional guarantee

For Sale by Dealers Everywhere

AMERICAN FOUNTAIN PEN CO.

Adams, Cushing & Foster, Selling Agents

168 Devonshire Street, Boston, Mass.

Please Mention Popular Mechanics



MAKE MONEY HERE

AGENTS! DROP DEAD ONES. AWAKE! GRAB THIS NEW INVENTION! THE 20TH CENTURY WONDER AGENTS!

LEARN the NEW WAY

Get started in an honest, clean, reliable, money-making business. Sold on a money-back guarantee.

World's magical gift realized by this new invention. The **BLACKSTONE WATER POWER VACUUM MASSAGE MACHINE** for the home. No cost to operate. Lasts life-time. Price within reach of all. No competition. New field. New business. That's why it's easy. Removes blackheads, wrinkles, rounds out any part of the face or body and brings back Nature's beauty. Endorsed by leading doctors and masseurs. Listen: Parker, Okla., says, "3 orders first day." Margwarth, Pa., writes, "I am making \$19.00 per day." Shea, "First order 12, second 36, third 72." Schermerhorn, Ia., orders eight dozen machines first month. Shaffer, Va., "selling 4 out of 5 demonstrations." Vaughn, Wash., orders one dozen. Four days later wires "Ship 6 dozen by first express." Spain, Tenn., started with sample. Orders one dozen, then 2 dozen, next 3 dozen. Lewis, Ind., sells 3 machines first hour. Says "Best article he ever saw for merit and money-making." No experience necessary. Territory with protection given free to active workers. Nothing in the world like it. Best agent's article ever invented.

We own all U. S. and foreign patents. Big book entitled, "The Power and the Love of Beauty and Health" Free. Investigate now, today. A Postal will do. A big surprise awaits you. Address: **BLACKSTONE MFG. CO.** 333 Meredith Bldg. TOLEDO, O.

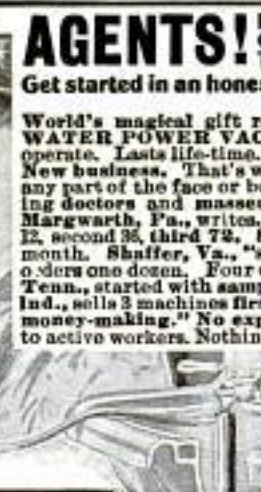

TAXIDERMY BOOK FREE

Learn this Great Profession by Mail

**MOUNT BIRDS****ANIMALS, GAME HEADS AND ALL TROPHIES**

The wonderful art of taxidermy which has long been kept a secret can now be easily, quickly learned by mail in your home in a few weeks. By an entirely new method you can now learn this money-making profession during your spare time. *Success guaranteed.*

You Can Make Money! There are big profits in taxidermy. Men, women and boys skilled in this art are in great demand. This is the time to learn. Trophies are sent hundreds of miles for the best Taxidermists to mount. A skilled Taxidermist, like a skilled doctor, can charge as much as he pleases.

BEAUTIFUL TROPHIES FOR YOUR OWN HOME

You can decorate your own home and den with your rare and beautiful specimens. Hunters, trappers and naturalists learn in a very short time. By our method the profession is simple. Success guaranteed or no tuition.

Great Book FREE—"How to Learn to Mount Birds and Animals." This beautifully illustrated book, a copy of *Taxidermy Magazine* and hundreds of letters from graduates sent free if you write at once. Make yourself independent by learning this profession. *Write for free book.*

N. W. School of Taxidermy, 1196 Elwood Bldg. Omaha, Neb.



WURLITZER FREE
WE SUPPLY THE U.S. GOVT.
New Band Catalog

300 pages. Thousands of illustrations. Every musical instrument. Highest quality and lowest prices. Easy payments. Write today and mention instrument you are interested in.

The Rudolph Wurlitzer Co.

304 S. Wabash Ave., Chicago 101 E. 4th Ave., Cincinnati

"winged him with my first cartridge; what kind of a bird is it?" "That," replied the man, "is a woodpecker. And it will cost you \$25 for shooting it; protected by the game law, you know," he added. "I'm deputy game warden, so we'll just walk down to the judge's and settle the case."—Engineering and Contracting.

Finnegan repaired a wrecked locomotive by jacking up the whistle and the smokestack, and placing a new engine under them.—From an ad.

I WILL START YOU
earning \$4 daily at home in spare time, silvering mirrors; no capital; send for free instructive booklet, giving plans of operation.
S. F. REDMOND, Dept. 305-A, BOSTON, MASS.



I will send as long as they last my **25 Cent Book STRONG ARMS** For 10c in stamps or coin

Illustrated with 20 full page halftone cuts, showing exercises that will quickly develop, beautify, and gain great strength in your shoulders, arms, and hands, without any apparatus.

PROF. ANTHONY BARKER
647 Barker Bldg., 110 W. 42d Street, New York



No 1309

No 1223 \$13.50

No 1248 \$20.00

\$40.00



No 1174 \$20.00

Diamonds on Credit I am smashing the terms on diamonds, besides giving **30 Days' FREE TRIAL.** I pay express charges. I trust you. Remember, my easy monthly terms can't be beat. Own a fine diamond or watch on terms that will astonish you. Write for my costly Art Catalog—it is a gem full of gems—address **Square Deal MILLER, Pres. Miller-Hooper Co., 20 Miller Bldg., Detroit, Mich.**

I Smash The Terms On Diamonds

I am smashing the terms on diamonds, besides giving 30 Days' FREE TRIAL. I pay express charges. I trust you. Remember, my easy monthly terms can't be beat. Own a fine diamond or watch on terms that will astonish you. Write for my costly Art Catalog—it is a gem full of gems—address Square Deal MILLER, Pres. Miller-Hooper Co., 20 Miller Bldg., Detroit, Mich.



Square Deal Miller



No 1120 \$42.00



No 1057 \$18.50



No 1216 \$12.75



No 1056 \$95.00



No 1103 \$35.00



No 1124 \$159.00



No 206 \$23.00

THE WIZARD LIGHT

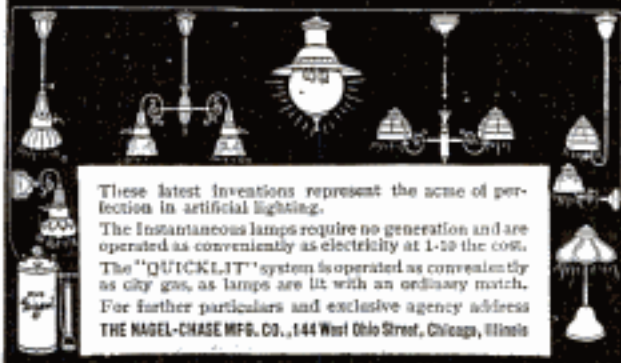

These latest inventions represent the acme of perfection in artificial lighting. The instantaneous lamps require no generation and are operated as conveniently as electricity at 1-10 the cost. The "QUICK-LIT" system is operated as conveniently as city gas, as lamps are lit with an ordinary match. For further particulars and exclusive agency address THE NAGEL-CHASE MFG. CO., 144 West Ohio Street, Chicago, Illinois

HESS Sent on Approval FURNACE



No. 48
"Lander" Hess
Steel Furnace
Price \$49
Delivered from Chicago and
North of Ohio River
Type and Engine Rates

We will deliver a complete heating equipment at your station at factory prices and wait for our pay while you test it during 60 days of winter weather.

The entire outfit must satisfy you or you pay nothing. Isn't this worth looking into? Could we offer such liberal terms if we didn't know that the Hess Furnace excels in service, simplicity, efficiency, economy?

We are makers—not dealers—and will save you all middlemen's profits. No room for more details here. Write today for free 48-page booklet which tells all about it.

Your name and address on a post card is sufficient.

HESS, 910 Tacoma Bldg., Chicago

HUMANE AND BLUE LAWS IN CONFLICT—The humane law of Boston, Mass., was recently relied upon as a defense when a large number of lobsters were saved from possible suffocation that they might meet a more appropriate end by being broiled or boiled alive. The incident occurred when a boat laden with lobsters arrived in Boston on Sunday. The stringent Sunday laws of the New England metropolis prohibited the immediate unloading of the vessel. If the lobsters were not immediately unloaded and placed in cold storage, however,

TRIUMPH STAND LAMP

A 300 Candle Power Lamp for Home, Store, Shop, work bench, library, desk, or wherever a stand lamp can be used. Can be turned up and down like gas, and carried around with more safety than a kerosene lamp, and gives 10 times the light at less than 1-4 the cost to operate. We have 6 distinct lines of gasoline hollow wire sockets and lamps. SMALL lamps for small rooms and LARGE lamps for LARGE rooms in most attractive styles at less than 1-2 the cost of gas or electricity. Our POP Catalog tells all about them. Get it now and decide which line you want.

BRILLIANT GAS LAMP CO.
Dept. 1, No. 182 N. State St., CHICAGO, ILL.



AGENTS AMAZING INVENTION!

An entirely new Lamp Burner. Changes ordinary kerosene illumination into beautiful large white light. Rivals gas or electricity. Scientifically made. Beats the old style lamp. Not a mantle. Can't break. **BIG PROFITS** Easy to show; quick to sell. \$8 to \$10 daily for you. Experience unnecessary. Sample outfit 35c prepaid. Particulars FREE.

THE RADIOLITE CO., Dept. 1, TOLEDO, OHIO

GET YOUR SHARE

Large profits—easiest—fastest—biggest seller on the market today. National Self-Heating Gasoline Iron sells everywhere—town or country. Join our force of enthusiastic agents now. No time to lose. Complete demonstrating outfit \$4.50. Write for the facts.

National Stamping & Electric Works
421 S. Clinton Street, Chicago, Illinois



These Books will place YOU ABOVE THE CROWD of COMMON WAGE EARNERS



If you want to **GET AHEAD—HERE'S YOUR CHANCE!** The knowledge, skill and experience of scores of well-known experts in Engineering is now placed at your disposal. If you are a beginner—or even if you consider yourself well up in Engineering—these books will prove of inestimable value to you. On every page you will find something that you should know—or that you have learned and forgotten. Now, read our liberal offer—how we place in your hands, for seven days free examination, this great new seven-volume

Cyclopedia of Steam Engineering

Compiled from the standard instruction text books of the AMERICAN SCHOOL OF CORRESPONDENCE, these books constitute, in themselves, a course of practical and systematic instruction in Engineering—placing before you the short cut to the big positions and big salaries.

The regular list price of this splendid set is \$35.00—but for a few weeks we will make the special price of only \$19.80 (nearly actual cost). If you want the books, after you have had them in your hands for seven days, at our expense, you can pay for them on the very easy arrangement of \$2.00 down and \$2.00 per month thereafter until paid for. And remember, that in letting us send you these books, for your examination, you

Do Not Pay One Cent Until You Notify Us That You Wish to Keep the Books

And if you do not desire to keep the books, after you have had them for the seven day period—simply notify us, and we have them returned, at our expense.

These seven magnificent volumes contain 3,300 pages (size 7x10 in.) and over 2,500 illustrations, full page plates, diagrams, etc. Printed on the best grade of paper, with large, clear type; superbly bound, in half-morocco; titles stamped in gold.

A Few of the Important Subjects Covered:

Construction of Boilers, Boiler Accessories, Fuel Economizers, Mechanical Stokers, Steam Pumps, Steam Engines, Indicators, Valve Gears, Steam Turbines, Gas and Oil Engines, Fuels, Automobiles, Carbureters, Locomotive Boilers and Engines, The Air Brake, Single-Phase Electric Railway, Elevators, Marine Boilers, Marine Engines, Heating and Ventilating, Compressed Air, Transmission, Absorption and Compression, Refrigeration, Ammonia Machines, Direct Current Dynamos and Motors, Management of Dynamos and Motors, Electric Wiring, Electric Lighting, etc.

Freewith every order received before October 1, 1912

With each set is included a year's Consulting Membership entitling you to the free advice of a staff of Engineering Experts. This will give you practical help in handling working problems which are too specific to be taken up in detail in the cyclopedias. There will be no limit to this service. A single problem solved for you might be worth more than first cost of the books.

Why Not Send the Coupon Today—

before you forget it—so that we can lay this magnificent cyclopedia in front of you, for seven days, at our risk? Remember: No obligation—no cost to you—no trouble on your part—simply mail us the coupon. And after you have carefully tested the books, don't keep them, if you don't want them—if you do not fully realize that they will help you to make a bigger man of yourself. Delay accomplishes nothing—action costs you nothing—act today. **Mail the Coupon.**

FREE EXAMINATION COUPON

American School of Correspondence
Chicago, U. S. A.

Please send set Cyclopedia of Engineering for 7 days' free examination. I will send \$2.00 within 7 days and \$2.00 a month until I have paid \$19.80, or notify you to send for the books. Title not to pass until fully paid.
Pop. Mech. 9-12

Name.....
Address.....
Occupation.....
Employer.....

\$3 AND YOU KEEP THIS 17 JEWEL ELGIN GUARANTEED 25 YEARS



STEVE HARRIS, Pres.

Says:—Before you buy any watch I want you to see this Thin-Model 17-Jewel Elgin. It's the latest and finest product of the Elgin Factory.

We want to Send You this Magnificent 16 size, Thin Model 17-Jewel Elgin, fully Adjusted to Temperature, Isochronism and Three Positions, Complete with fine Double Strata Gold Case, Guaranteed 25 Years on

30 Days Free Trial

And if you don't say this is the biggest Elgin Watch

bargain you ever saw, send it back at our expense. If you wish to keep it, the way is easy. Pay us only \$3.00, and the rest in similar amounts each month. No interest—no security—just common honesty among men. We want you to see for yourself that this fine Elgin is better than other Watches costing twice or three times as much.

Send for Our Free Catalog Write today for particulars and we will send you

OUR NEW FREE WATCH AND DIAMOND BOOK, also our book called "Facts vs. Bunco" or all about the watch business, both at home and abroad. **HARRIS-GOAR CO. Dept. 556, KANSAS CITY, MO.**

The House That Sells More Elgin Watches Than Any Other Firm in the World.



Guaranteed For 25 YEARS

BIG MONEY

With our Diamond Post Card Gun takes pictures without negatives. Postals, Buttons, all sizes in One Minute—Large profit. International Metal & Ferro Co. Dept. 149 Chicago, Illinois



\$7.50



PRINT YOUR OWN

Cards, circulars, books, newspaper. Press, \$5, Larger \$18, Rotary \$60. Save money. Big profit printing for others. All easy rules sent. Write factory for press catalog. TYPE, cards, paper, &c. THE PRESS CO., Meriden, Connecticut

the chances would be very much against their surviving until the warehouses could be opened without violating the Sunday laws, so the master of the vessel, having his profits in mind, took the law in his own hands and unloaded his boat on arrival.

He was promptly arrested for disturbing the Sabbath quiet and arranged before a magistrate. He offered no objection to the reading of the charge against him and admitted his guilt, but called the court's attention to the fact that he found himself caught between two evils and chose what he believed to be the less. Citing the

This Camera needs No Plates



The **PLATELESS TRADE MARK DAYDARK**

Will earn you

\$35 to \$75 a week

operating at Fairs, Carnivals, Picnics and other public gatherings. **Takes Pictures Direct on Post Cards**, no negatives, no printing, no dark-room, accurate, simple. A 10-year-old boy can successfully operate one. Takes full size post cards. **Portraits, Groups, Views, Buildings, Etc.** All done within the machine at the rate of **One a Minute. Be independent**, come and go when and where you please, be your own boss. **The Plateless Daydark offers this, our money back if not satisfied guarantee fully protects you.** Write to-day for particulars.

Do it now and start making money.

DAYDARK SPECIALTY CO., 1823 Cass Ave., St. Louis, Mo.
Dominion Daydark Co., 252 Victoria St., Toronto, Canada

GO INTO THE Moving Picture Business

From \$50 to \$150 starts you and just will earn you much in 1 or 2 nights



\$25 And more per night can be made exhibiting with our machine in halls, schools, churches, theaters, etc., in your own and surrounding towns. We furnish everything—rent film, too. Only a small payment required to get this new and specialized machine. Balance may be paid in easy installments. Write for particulars.

P. & W. Sales Company
614 D, So. Dearborn St., Chicago, Ill.

Your Picture in a Postal Card IN ONE MINUTE



The pictures are developed, toned and finished in a single developing solution. No experience is necessary. Price of machines \$7.50 and \$15.00—circulars describing our machines sent free. We are also headquarters for supplies for all minute picture machines. AMERICAN MINUTE PHOTO COMPANY Dept. Z 252, 2214 Ogden Ave., Chicago, Illinois The largest manufacturers and distributors of minute picture machines and supplies in the world.

Make \$10.00 to \$20.00 per day! With Anyone of Our Machines!

Are you looking for a good paying business this summer? Here is a chance. An investment of \$15.00 for one of our Post Card Cameras will start you in business. This machine makes photos direct on post cards without the use of a negative. NO DARK ROOM REQUIRED! EXPENSES (NECESSARY!) BY YOUR OWN LOSS. NO CASH MONEY, whether in a city, village or hamlet. Send for free catalogue describing our Post Card and Typewriter Machines and supplies. **JAMESTOWN FERROTYPE CO.** Dept. 47, 1113 S. Halsted St., Chicago, Ill.



This Swell Suit

Be Your Own Boss—\$10 A Day Easy—No Capital Needed—Thousands of Young Men Doing It. Your Chance of A Lifetime FREE

We have the most stupendous and gorgeous Agents Outfit you ever saw, all ready to ship to you, prepaid, without question, the moment we get your name and address on a postal saying: "Send me everything free."

Free Outfits Costs Us \$28,000

It is utterly impossible for anyone who receives this outfit to fail to take orders for our snappy, hand tailored, made-to-measure suits, overcoats and pants. Experience unnecessary. Our catchy, up-to-the-minute styles and money saving prices just wipe out all competition. Orders pour in.

Get Your Own Suit Free

Dressed like a gentleman—showing the clothes you wear knocks out the very last obstacle.

Send No Money

Get proof first hand. Compare our suit and our sample outfit with any other—see how much more attractive and classy are our stylish clothes and how easy we make it for you to take perfect measurements for clothes that set them all to talking. Also \$1,000 Cash Awards.

No matter who you're with compare ours—write now. **Great Central Tailoring Co., Dept. 77 Jackson Blvd., Chicago, Ill.**

FREE to You

This Wonderful BOOK 200 Samples 60 Fashion Plates



various laws for prevention of cruelty to animals and dumb beasts, and drawing a most graphic word picture of the sufferings the poor lobsters would have been compelled to endure, if kept aboard the ship until the law-



YOUNG MAN

Would You Accept

and wear a fine tailor-made suit just for showing it to your friends? Or a slip-on raincoat free? Could you use \$5 a day for a little spare time? (Perhaps we can give you a steady job at good pay). Then write us at once and get beautiful samples, styles, and an offer so good that you can hardly believe it.

BANNER TAILORING COMPANY Dept. 724 CHICAGO, ILL.

NO MORE BALD HEADS



When our VACUUM CAP is used a few minutes daily. We accept no pay until you have tried the Cap 60 days and are satisfied. The Vacuum Cap is an appliance that draws the blood to the Hair Roots and starts a new healthy crop of hair. It stops Dandruff, stops the hair from falling out. Bought by Doctors and men who

know that it is the only reasonable HAIR GROWER known to science. No Drugs Used. Write for application blank, testimonials, and booklet on "HAIR," sent sealed in plain envelope. FREE.

THE MODERN VACUUM CAP CO. L. 559 BARCLAY, DENVER, COLO.

Swell, Nifty Suits FREE!



Biggest Riproaring Tailoring Offer Ever Made. RUSH! RUSH! RUSH!

SEND COUPON AT ONCE

Shoot it in on the next mail. Get this most liberal, most startling tailoring offer ever made. It's a whirlwind! Simply marvelous! Enough coin to fill your pockets—flashy diamonds—splendid jewelry—stick pins—rings—superb watches—nifty, natty suits to wear—FREE!

Be Our Sales-manager

In Your Town—\$250.00 a Month

That's on the level, Bill. Sell all the suits in your little burg. It's easy—dead easy! Your free suit will attract so much attention that you'll be swamped with orders. Orders turned over to you, too. Make \$250.00 a month easy. No experience, no money, necessary, but get in quick. Rush! Rush! Rush!!!

\$2,500.00

Given in Prizes to Agents

Barrels of money—magnificent diamonds—jewelry—motorcycles—nifty suits—ALL FREE TO YOU. Help yourself, boys—they belong to you. But you've got to show some speed. Get the FREE coupon in QUICK!

We Pay Express on Everything

You pay nothing—absolutely nothing. We take all the risk—stand all the expense.

Mail Coupon at Once

Rush! Rush! Rush! Send it in this very minute. It brings you our great free offer and handsome new book of beautiful samples—ALL FREE. Just put your name and address on the coupon and shoot it in today.

AMERICAN WOOLEN MILLS COMPANY Dept. 9196 CHICAGO, ILL.



FREE COUPON

American Woolen Mills Co. Dept. 9196 Chicago, Ill.

Gentlemen—I want to get your big free offer and new sample book. Please send everything at once free and prepaid. I don't pay you a cent.

Name.....
Address.....

Please Mention Popular Mechanics

I SMASH The Terms

Watches
on
CREDIT

16 Size Thin Model



ELGIN
HAMILTON
HOWARD
ILLINOIS
Any Watch
You Want

on
30 Days' Free Trial

No Money Down

Express Prepaid In Advance by Me

That's the way I smash terms. That's the reason why I am doing the greatest credit watch and jewelry business. I am "Square Deal" Miller and I trust the people.

I do business on your terms, send you what you want. Suppose it is a watch. I have it for you, **no money down**, express prepaid by me, and a full month to carry it in your pocket. **That's the test that tells.** All these watches

Guaranteed 25 Years

Now for Business: Send me your name and address and I will send you my

Costly Catalog FREE

I want you to have our catalog. It is a gem, it illustrates all kinds of valuable watches, diamonds and jewelry on the easiest and most liberal terms ever offered.

You Take no Chance My terms are made to suit your convenience. I assume all the risk, you are the sole judge of value and quality. I prepay the charges, trust you, give you the easiest, best and squarest terms and live up to my title as "Square Deal" Miller. Write for this catalog today and get a letter from me that will make you a friend of mine from the start.

"Square Deal" MILLER, Pres.
MILLER-HOEFER CO., 19 Miller Building, Detroit, Michigan

BE A PHOTOGRAPHER AND MAKE FROM \$15.00 TO \$35.00 PER DAY!



The latest invention, the **GLOBE PHOTO POST CARD CAMERA**, makes photos direct on post cards without the use of a negative, in less than 30 seconds, automatically. It is simple, practical and very easy to operate. No experience in photography necessary.

The latest invention in street tin type cameras is our **AUTOMAT**, Model B. It takes pictures on plates size 3-4 x 2.1-2.2. **AUTOMATICALLY.** It weighs only 4 1/2 pounds. Price \$15.00. Send for 1912 catalogue describing machines and supplies. We are the largest manufacturers and distributors of tin type and post card machines and supplies in the world.

THE NEW YORK FERROTYPE CO. (INC.)
168 1/2 Delancy St., Dept. 72, New York City, U.S.A.
Branch: 1113 So. Halsted St., Chicago, Ill.

Rémoh Gems

NOT IMITATIONS
**LOOKS LIKE A DIAMOND
WEARS LIKE A DIAMOND**

A Marvelous Synthetic Gem

The greatest triumph of the Oxy-Hydrogen Furnace. Will cut glass. Stands filing, fire and acid tests like a diamond—guaranteed to contain no glass. Rémoh Gems have no paste, foil or artificial backing—their brilliancy is guaranteed forever. One thirtieth the cost of diamonds. Set only in 14-karat. Solid Gold Mountings. Sent on approval—your money cheerfully refunded if not satisfactory.

Book in Colors Free
Write for our De-Luxe Jewel Book, handsomest ever published.

Remoh Jewelry Co.,
429 N. Broadway, ST. LOUIS, MO.



ful opening of the warehouses. There were 5,000 dozen lobsters in the lot, the court was informed, and the fisherman felt it would be criminal to permit them to die in crates when it was so easy to place them in a cooler place. The court was touched by the plea of the humane fisherman and dismissed the case against him.

Licorice grows in abundance in the Ural territory of Russia.

BARODA DIAMONDS. Flash Like Genuine
ANY STYLE at 1/40 the cost—IN SOLID GOLD RINGS
Stand acid test and expert examination. We guarantee them. See them first—then pay.
Special Offer—14k Tiffany ring 1 ct. \$3.98. Deuts ring 1 ct. \$5.98. 14k Stud 1 ct. \$4.98. Sent C.O.D. for inspection. Catalog FREE, shows full line. Patent ring gauge included, 10c. The Baroda Co., Dept. A5, Leland & Dover Sts., Chicago

AGENTS COIN MONEY

Selling Golden Rule Cutlery

Transparent Handle Pocket Knives and Razors with name and address, photo, lodge emblems, etc., on handle. Every knife guaranteed. Full line of razors, strops and cutlery specialties. Quick sales. Big profit. Exclusive territory. Write today for terms and catalogue.



Golden Rule Cutlery Co., 552 W. Lake St., Dept. 190, Chicago, Ill.

Only \$36.00 The Wonderful ILLUSTRATOR LANTERN



With our improved famous **ALCO RADIANT LIGHT.**
This new 1912 Model has many improvements and double brilliancy. Write for illustrated circular of this and lanterns of all styles and lights at bottom prices.
IF YOU OWN A LANTERN we should have your name to mail to you our regular announcements of new slides and lecture sets. 75,000 Lantern Slides to rent.
POST CARD MAGIC LANTERN reflects image of postcard or any other picture or object. Prices, \$2.75, \$12.50, \$25.00, \$50.00, express paid.

WILLIAMS, BROWN & EARLE, Inc., 918 Chestnut St., Philadelphia, Pa., Lantern Dept. 20
Engineering, Microscope, Optical, Scientific, Photo Lantern Slide Supplies

DOES that appeal to you? We have shirts strong and comfortable to work in—also neat and dressy enough for home wear.

We make the Signal Semi-Dress Shirt in a variety of patterns, both light and dark, and with two detached hand-turned collars, or attached soft collar. You can wear it and be *well dressed*. Cut coat style—that makes it easy to put on and take off when you are *tired* or in a *hurry*. You probably say, "I like the coat style fine but they *gap* at the waist."

That's where the *Signal Coat Shirt differs*. It laps over *three inches* at the waist, and has an *extra button* to keep the *flap in place*. Every Signal Shirt has two pockets, sleeves slit in the sides to keep out the dirt, double strength seams to prevent ripping. They have other pleasant features that will go a long ways in making you our regular customer.

UNION MADE



Trade Mark
The Mark of
"QUALITY"

Signal Coat Shirts

in field, shop or home

"I always wear this brand."



Also makers of Signal Work Shirts and Overalls

Try a couple at our risk

Price \$1.00 (\$1.25 west of Missouri River) per garment. If your clothing man doesn't have Signal Coat Shirts, tell us his name and your size, and we will express you a couple C. O. D. Or write for folder showing styles. If you like them pay express man. If not satisfied, return at our expense.

HILKER-WIECHERS MFG. CO.,

1256 Mound Ave., RACINE, WIS.

The steam whaler "Unimak," of the Alaska Whaling Co., is at Akutan, having sailed several weeks ago from Seattle, Wash. The crew of the "Unimak" is to work on a lay. The whale gunner, upon whose skill and marksmanship depends the number of whales captured, receives the highest compensation. In addition to stipulated wages he will receive \$5.50 for every finback, \$10.50 for every humpback, \$13 for every blue whale and \$50 for every right whale landed upon the deck of the "Unimak." The crew, with the exception of the two engineers, receives \$1 for every humpback, \$1.50 for every blue whale, \$5 for every sperm whale and \$10 for every right whale.—Fishing Gazette.

WORK FOR US—\$50 to \$75 EVERY WEEK START NOW



Experience not necessary. Honesty and willingness to work is all we ask, selling **The Easy Wringer Mop** make \$5000 a year.

LISTEN! One man's orders \$2000 one month—profit \$1650. Merc boy in Pa., made \$9.00 in 2 1/2 hours. —It **sells itself**. No investment required. Sample free with first order. Valuable booklet **Free. Write Today.**



THE U.S. MOP CO., 1573 Dorr Street, Toledo, O.

Genuine Perfect Cut DIAMONDS

Direct from the \$66 to \$9750 PER CARAT IMPORTER to You

- 1-8 carat \$6.20
- 1-4 carat \$17.50
- 1-2 carat \$45.00
- 3-4 carat \$67.50
- 1-2 carat \$97.50
- 1-2 carat \$97.50
- 1-2 carat \$97.50

World's Lowest Price

Made possible by enormous sales and low expenses. L. Basch & Co. import direct from Diamond mines to you, saving you the 40% wasted by middlemen. Jewelers' price \$130, \$150, \$175 per carat. Buy your diamond **RIGHT** at our wonderful price!



1922 Basch Engagement and Solitaire Ring. Artistic design like large illustration, 1/2 carat diamond \$45. 1 1/2 carat solid gold mounting \$3.75 (manufacturing cost). Price complete \$48.75. For other size diamonds see prices on left.

Any article sent for your inspection on approval, careful nearest express agent or bank at our expense, without obligating you to buy. No deposit required.

922M—1 1/2K solid gold tooth mounting \$5.50 (manufacturing cost). Add to price of any size diamond shown at left. Example: compl. with 1-2 carat dia. \$50.50

The Basch Plan

enables you to select a diamond by mail at the world's lowest price: under a legal guarantee that makes disappointment impossible. We send any diamond to your city for inspection on approval at our expense. Send no money. L. Basch & Co. have been established for 34 years and have satisfied customers in every community. References, Union Bank of Chicago. Capital \$600,000.00.

The BASCH MONEY BACK GUARANTEE

A contract in writing to buy back every diamond we sell for 90% in cash, enables you to "get your money back" instantly in case of need. Proves our price is lowest and values greatest. Any diamond accepted in exchange at full purchase price, any time. Carat weight, quality and value guaranteed. Don't buy a diamond without these Basch Guarantees.

SEND NOW FOR THE BASCH DIAMOND BOOK (FREE!)



FILL OUT THIS COUPON or Write

FREE! This big complete 1923 Diamond Book now ready. Illustrated in color. Cost \$10.000 to produce. Shows thousands of latest styles in Diamond Jewelry, watches, gold and platinum jewelry. **FREE!**

Name _____
Address _____
Please send **FREE** Basch Diamond Book. I will pay for shipping and handling charges. **NAME**

L. BASCH & CO. Diamond Importers
Established 1879
Dept. T. 347 — S. State St. CHICAGO, U. S. A.

BASCH
Dept. T. 347 S. State St., Chicago, Ill.

New Catalog P26



electrical line, turn to its pages. You will find more than a thousand articles illustrated from photographic reproductions, supplemented by clear, concise descriptions. It contains

"Something Electrical for Everybody"

and is in fact a pocket encyclopaedia of standard, up-to-date electrical appliances to be consulted, referred to and depended on.

Send for it. It costs you nothing. The Prices are right and will save you something

MANHATTAN ELECTRICAL SUPPLY CO.

NEW YORK, 17 Park Place

CHICAGO, 114 S. 5th Ave.

ST. LOUIS, 1106 Pine St.

The "Electro" Static (Wimshurst) Machine

Guaranteed to generate in any kind of weather, no matter how foggy or rainy. We absolutely guarantee a fat, powerful 2 1/2-inch spark. Used successfully to operate Geissler and X-Ray tubes, firing powder, working wireless sets, raising a person's hair, etc. This wonderful machine is used to perform thousands of interesting experiments. Cut shows machine plainly, cast-iron base, cast-iron wheels, two fine Leyden jars and two "Electrite" plates revolving in opposite directions. Not a particle of wood used. Sizes all over 8" x 5" x 11". Weight is 3 lbs. Machine is guaranteed for one year. Nothing to wear out, no batteries, no trouble, simply turn the crank, machine does the rest. Price, \$4.00. Send at once for our free new booklet giving a lot of experiments to be performed with same.

Send today 4c postage for our famous 196-page Electrical Encyclopedia No. 10 containing over 400 illustrations and instructive information on electrical and wireless subjects, etc. Postal cards not answered.



THE ELECTRO IMPORTING CO., 233A Fulton St., NEW YORK CITY

"Everything for the Experimenter"



Perfect 110 Volt Electric Fan for \$6.50

Alternating or Direct Current

(Six inch size.) An eight inch fan for \$8.50. For Bracket of Desk, every conceivable adjustment; no better fans made. We guarantee, and include free double-covered silk cord with plug if you mention dealer's name. Six volt battery fans - not toys - same price. State voltage wanted. Satisfaction guaranteed or money back. Also small meters, original "IMP" fuses, toasters, irons, bell ringers, etc.

The Carleton Company

168 Sumner St., BOSTON, MASS.

BIG ELECTRICAL AND WIRELESS CATALOG

Mailed for 6c stamps or coin, which you may deduct from first order of \$1.00. Most elaborate catalog of its kind published. 250 PAGES. 75 p Wireless Instruments for commercial and experimental use; 20 p Telegraph, Radio, 20 p Motors, and dynamos all sizes; 15 p Flashlights and miniature lamps; 115 p Microscopes, lighting plants, lamp lighting outfits, miniature railways, mechanical tools, books and general electrical supplies. SAVE MONEY on ANYTHING ELECTRICAL by having this big catalog. **J. J. DUCK, 422-424 St. Clair St., TOLEDO, OHIO**

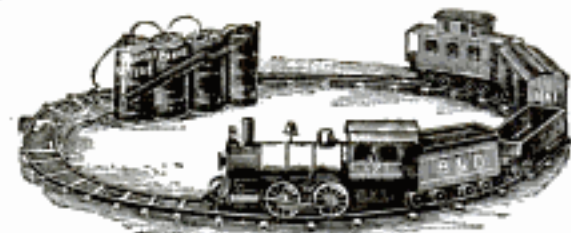

Electrical railways, tracks, switches, trolley cars, dynamos, motors, dynamo castings, gas engine castings, everything for the young electrician. Send for our complete catalog "B."

The Carlisle & Finch Co.
262 E. Clifton Ave. Cincinnati, Ohio

VOLTAMP ELECTRICAL APPARATUS AND SUPPLIES

are sold on their merits and under the VOLTAMP guarantee of quality. Write today for our complete, fully illustrated catalog of VOLTAMP Products which includes everything for experimental and general electrical work—motors, dynamos, induction coils, transformers; telephone, telegraph and lighting equipment; miniature railways, tools, toys, etc. Send 6c in stamps or coin for catalog, which will be refunded on your first order of 70c or over. No postals answered.

VOLTAMP ELECTRIC MANUFACTURING CO.
Voltamp Block BALTIMORE, MD.

CHINESE CEREMONIAL FORMS—The board of education of the Nankin government has issued a general order that the sacrifices to Confucius in his temple should be retained temporarily, as a set form of ceremonies has not been promulgated for the republic, but that the form of worship should be changed. The kowtow, that is, kneeling and bowing the head to the ground, should be changed and in its place three bows should be made, describes the Japan Advertiser.

As to other worships and sacrifices in vogue during the Manchu dynasty all worships in connection with superstition, the board thinks, should be abolished, but the question should be passed by the different assemblies in the provinces, as each has its own peculiar customary sacrifice.—St. Louis Post Dispatch.

ELECTRIC House Lighting Plants, Telephones, Dynamos, Fans, Lamps, Engines, Motors, Meters, Batteries, Belts, Belts, Books. Catalog No. **Ohio Electric Works, CLEVELAND, OHIO.**

GO INTO THE MOVING PICTURE BUSINESS

On Our Easy Payment Plan

Make \$20 to \$50 per night

With our Moving Picture Outfit We sell everything—Films, too.

Write for our Catalog

DEARBORN NOVELTY CO.

Dept. B, 219 So. Dearborn St., Chicago, Ill.



OVER \$400 Made in One Day

Operating the

CIRCLING WAVE, the catchy amusement device merry-go-round with the joy of boating on the gently rolling lake or bay. At Eagerton, Ind., Booher Bros. made \$350.00 in six hours, and one day at Crawfordsville, Ind., another made \$300 in six hours. **You can do this also** and employ only one assistant.

Write today for description of the **CIRCLING WAVE** and its wonderful money-making power.
ARMITAGE & GUINN, 159 Mill St., Springville, Erie Co., N. Y.



New Fields Open To You

Aviation—Automobile—Motorboat

Here are Three New Professions for Young Men—Professions that Command Big Pay

You can become an aviator, automobile operator, or motor boat engineer in a few weeks. It doesn't require a college education. The *American School* has paved the way and made it possible for any ambitious young man to learn a profession; one that can be put into practical use at once.

The demand for experienced men far exceeds the supply—\$6, \$7, \$8 and \$10 per day is possible after a few months of study and a little practical experience. You can learn all that it is necessary for you to know to become an automobile, motor boat, or airplane engineer, from the American School's new four volume 1912 edition.

CYCLOPEDIA OF AUTOMOBILE ENGINEERING

1,700 pages, 7x10 inches in size; with 1,500 illustrations, full page plates, diagrams, etc. Substantially and handsomely bound in half-morocco, printed on extra grade paper, in large, clear type—chock-full of detailed information, facts and figures covering the entire field of Aeroplanes, Automobiles, Motorcycles, Motor Boats, etc. Even if you merely operate a machine for pleasure, you can materially increase your enjoyment through the thorough and comprehensive knowledge, which you secure from these books. Every standard type of automobile and Gas Engine is illustrated and explained in a simple and non-technical way that everyone can readily understand. When you receive this set, and inspect it carefully, you will see that you have in your hands all the information that can be obtained.

We Send This Complete Set For Your Inspection—Express Prepaid

—the full set of four volumes—without one cent of expense—without obligation on your part—just mail us the coupon. We let you keep the books seven days, while you thoroughly examine them. Then—if you do not want them—notify us, and back the books come, at our expense. Or, if you wish to keep them, you can do so at the special low price of \$12.00, which we are just now offering them at; (the regular price of the set is \$20.00). Simply send us \$2.00 when writing that you wish to keep the books—then pay \$2.00 per month until paid for.

A FEW THINGS WHICH THESE BOOKS INFORM YOU ON

Gasoline Automobiles, Explosion Motors, Automobile Mechanisms, Electric Automobiles, Steam Automobiles, Types of Automobiles, Motorcycles, Commercial Vehicles, Automobile Garages, Home Repairs, Automobile Driving, Motor Boats, Types of Aeroplanes, Aeronautical Motors, Building and Flying an Aeroplane, Glossary of Automobile and Aeronautical Terms, Self Starters, Electric Lighting Systems, etc.

You will find a thousand and one details of information, which will instruct you. If you are at all interested in Automobile Engineering, Motor Boating or Aeroplanes, you cannot afford not to have this splendid cyclopedia. And if you want to learn Automobile, Marine or Aeroplane Engineering—these books will place you in possession of knowledge and ability which will largely increase your wage-earning capacity.

ANOTHER GREAT OFFER

With each set is included a year's Consulting Membership entitling you to the free advice of a corps of Engineering Experts. This will give you practical help in handling working problems which are too specific to be taken up in detail in the cyclopedia. A single problem solved for you might be worth more than the first cost of the books.

AMERICAN SCHOOL OF CORRESPONDENCE
CHICAGO, U. S. A.



Pop.
Mech.
9-12

A. S. of C.

Please send me
Cyclopaedia of
Automobile En-
gineering for seven
days' free examination.

I will send \$2.00 within
seven days and \$2 a month
until I have paid \$12.00;
otherwise I will notify you and
hold the books subject to your
order. Title not to pass until fully
paid.

7 DAY EXAMINATION COUPON

NAME

ADDRESS

OCCUPATION

EMPLOYER

Please Mention Popular Mechanics



How to Install Modern Heating Plant in Your Home

Save cost of skilled labor. Save on all material. Post yourself on the new method. The practical Gibbons method. My book explains how you can install hot and cold running water, bathroom outfit, a modern heating plant, also electric or acetylene lighting plant, at an amazingly small cost. Send for this valuable book.

BOOK FREE

My new book gives you greater buying power than your local dealer. It is the most valuable catalog for you ever issued. Thousands of things illustrated and priced. Hot water and steam heating plants, gasoline engines, hydraulic rams, pipes, pumps, valves, electric lighting plants, acetylene lighting plants, all accessories. Everything guaranteed, high quality at direct, rock bottom prices to you. You certainly ought to have this valuable book. Just ask for Gibbons' book.

Write Today See for yourself how easy it is to make improvements about your home with the aid of my new book. The low prices of my high quality material will astound you. Home owners, contractors, builders, need my wonderful new book. Write today. Just send your name. It is post-paid free to you.

M. J. GIBBONS, Dept. 5241, Dayton, O.

White Valley GEMS

Substitutes for Diamonds



Send for FREE Catalog!

showing wonderful White Valley Gems in Rings (Ladies or Gentlemen's), Scarf Pins, Studs, Brooches, Necklaces, Cuff Buttons, Lockets, Earrings—100 different articles and styles.

Not glass, not paste, not any kind of imitation, but beautiful, splendid gems. (White Sapphires chemically produced.) Look like finest diamonds. Will scratch tile, and cut glass. Stand acid test. Famous society women substitute White Valley Gems for real diamonds—or wear the two together confidently.

14-K. solid gold mountings. 25-year Guaranty Certificate with each gem. Ring measure sent with catalog. Will send any article in book O. D.—express prepaid—subject to examination—or by registered mail on receipt of price. Money refunded if not satisfactory.

WHITE VALLEY GEM CO.
501 Saks Bldg., Indianapolis, Ind.



\$68.75 PROFIT IN ONE DAY



That is what Elson, of N. Dakota writes. Bryant of Colorado, made \$16 in 6 hours. Sturgill, of Utah, writes: "I made \$1200 in 4 months."

One Minute Post Cards—One Minute Profits

Hundreds of letters and reports tell the records of quick, big, easy profits making photo post cards the new way with the

"MANDEL" POST CARD MACHINE

6-Pound Portable Post Card Gallery

A new business with an unlimited field for money making. The chance for any man, young or old, with small capital and ABSOLUTELY NO EXPERIENCE to own a business that will earn \$2000 to \$5000 a year. New discovery. A wonderful, scientific process.

Photos Direct on Post Cards—No Plates—No Films

The "Mandel" Post Card Machine takes, finishes and delivers 3 original photo post cards a minute RIGHT ON THE SPOT at a profit of 100 per cent. Makes two sizes of post cards and also photo buttons. This is not a tintype machine. Photo post cards popular everywhere. In the country, on the streets, at picnics, carnivals, fairs—the one minute post card man is in big demand and makes big money.

First sales from post cards shipped with outfit practically returns all money invested. Complete and simple instructions enable you to begin work immediately.

Write today for complete INFORMATION FREE. Address either office.

THE CHICAGO FERROTYPE COMPANY
245 Ferrotypes Bldg., Chicago, Ill. or Dept. 245 Public Bank Building, New York, N. Y.

THE BEAVER'S TOOTH—No carpenter's chisel can do more effective work than is turned out with ease and neatness by the beaver's tooth. This is the principal tool with which these patient, clever builders construct their dams. The outer surface of the tooth is a scale of very hard enamel, while the body of it is of softer dentine. As the softer substance wears away in use, the end of the tooth takes a chisel-like bevel, leaving a thin, slightly projecting edge of hard enamel as sharp as any

EVERYBODY'S DOING IT!

DOING WHAT? Our New Gear Puzzle. Send for a sample with our catalog of the latest puzzles and novelties. Sent Postpaid for 10 cents.

WONDER NOVELTY CO., Dept. 1, Box 123, ST. PAUL, MINN.

Folding BATH TUB

Costs little, no plumbing, requires little water. Weight 15 pounds, and folds into small roll. Full length baths, far better than tin tubs. Lasts for years. Write for special agents offer and full description. **ROBINSON MFG. CO., 2025 Adams Street, TOLEDO, OHIO. Manufacturers Turkish Bath Cabinets.**



BE PROSPEROUS

Grow Mushrooms at home all winter in cellars, stables, sheds, boxes, etc. Large demand. \$20.00 a week easily made. Only small space necessary. We are large growers, make best spawn, and insure your success. Write for big booklet and learn how.

NAT'L SPAWN CO., Dept. 12, BOSTON, MASS.

\$5.00 to \$10.00 A Day Made Easy

The "American" No. 3 Patented

Hones razors, sharpens all kinds of safety razor blades, clippers, scissors, etc. No make-believe, but the real thing. Complete outfit furnished with instructions how to do the work. No previous experience required.

Address, Mgr. Dept. 808, Illinois Cutlery Company, 134 Washington St., Chicago

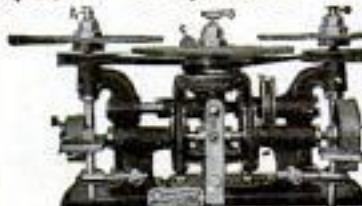

Write today
for Big
Illustrated
Engine
Book "S"

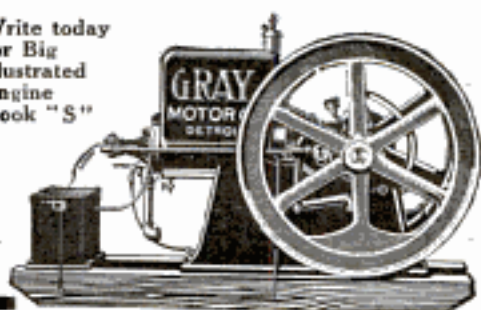

POWER FOR THE FARM, SHOP AND COUNTRY HOME

Complete ready to run—fuel tank in base—water cooled—wonderful economy, uses Kerosene or Gasoline—12 sizes, 1½ to 36 H. P. **30 DAYS TRIAL.**
GRAY MOTOR CO., 932 U. S. Motor Bldg., Detroit, Mich.

3 H. P. Model A Gasoline Engine Complete \$39.00

HERE is Power for you that can always be relied upon. The Colton Modern Engine is the most economical, simplest and most reliable Power Plant yet invented. Its many new improved patented features are most valuable and are not found on any other engine. Power is constant, speed regulated without stopping engine—adjusts itself instantly to any overload—no cranking to start it. Every Colton is sold under a positive, unqualified guarantee to give satisfactory service or money refunded. Our company has been established 27 years. Get it on trial and compare its simple, compact construction, superior quality materials and high grade workmanship. You will see it operate with less attention and furnish more power per rating than any engine you ever saw. Send for Free Engine Book at once.

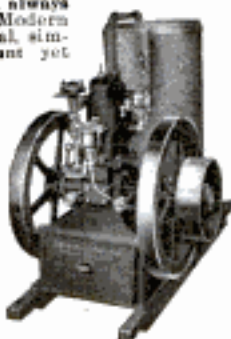

Arthur Colton Co., 182 Brush St. Detroit, Mich.

carpenter's tool fresh from the oilstone. The thin scale of enamel gives keenness, the softer dentine supplies strength, and thus the combination forms a formidable tool, which actually sharpens itself by use.—Railway Employer's Magazine.

You Can Produce Eggs At 10c Per Dozen

We tell you how in the Philo System Book, and will mail you a copy of the book, **POSTPAID ON APPROVAL.** When you are satisfied that the book is actually worth more than \$1 to you, or that by its use you can produce eggs for less than 10 cents a dozen, you may mail us \$1. Should the book fail to help you to better success with poultry and should it not be entirely satisfactory to you, you need not pay for it. Send a postal to-day asking for the Philo System Book on approval, and we will forward it by return mail.

E. R. PHILO, Publisher 8 Lake Street, ELMIRA, N. Y.

(ESTABLISHED 1842)

Reed & Sons Pianos

Highest Award World's Columbian Exposition
Now Sold Direct to You from Factory
30 DAYS' FREE TRIAL IN YOUR HOME. Take your own time to pay. No payment in advance required. For free book address
REED & SONS PIANO MFG. CO.
Dept. M 17 Cor. Jackson Blvd. and Wabash Ave. CHICAGO

DON'T PAY TWO PRICES

Save \$8.00 to \$22.00 on

Hoosier Heaters and Ranges

Why not buy the Best when you can buy them at such low unheard-of Factory Prices. Our new improvements absolutely surpass anything ever produced. Save enough on a single stove to buy your winter's fuel. Thirty Days Free Trial in your own home before you buy.

Send postal today for large free catalog and prices.

Hoosier Stove Co., 249 State St., Marion, Ind.

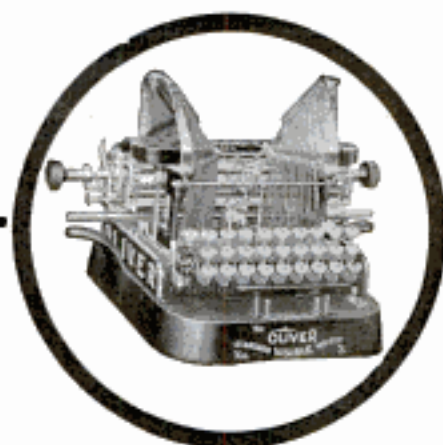

Rent 10 Months Then It's Yours!

This is the Offer that has Astounded the Typewriter World! A stupendous and far reaching inducement to encourage the use of typewriters.

The Famous Model No. 3 Oliver. The machine with the type bars that strike downward—that has made the "write-in-sight" principle mechanically practical. It is so simple children learn to operate it in ten minutes—faster than the fastest expert—possesses phenomenal strength and durability.

Fully equipped, just as perfect as though you paid cash—you get every perfection, every device, which ever went out with this model—you get all the extras, metal case, base-board, tools, instruction book, etc.—guaranteed flawless.

No Cash Until You See It—until you try it in your home or office, then you make your decision—no salesman to influence or hurry you—if you keep it, you pay only one month's rent down; it will earn its own way thereafter.

Stop Paying in Ten Months—no interest—no chattel mortgage—no collectors—no publicity—no delay. Positively the best typewriter value ever given—the best selling plan ever devised.

If You Own a Typewriter Now—trade it in as part payment—we will be liberal with you. If you are renting an old typewriter, you will want to send it back when you see this one.

Send your name and address on coupon and we will tell you more about this unusual offer—more about this splendid typewriter—it won't cost you anything and you will be under no obligation—we won't send a salesman. **Tear out the coupon now.**

Typewriters Distributing Syndicate
166TV No. Michigan Blvd., Chicago

COUPON

TYPEWRITERS DISTRIBUTING SYNDICATE
166TV No. Michigan Blvd., Chicago

You may send, without placing me under any obligation, further information of your typewriter offer.

Name.....

Address.....

My old machine is a.....No.....

Please Mention Popular Mechanics

PROMPT SHIPMENTS

Power Users

The service and goods we give is without doubt the best to be had. Buy your equipment from the manufacturer. For anything in the line of appliances for transmitting power—**"Jones Service"** and goods are unparalleled. No order too small for attention. No order too large to execute. Our catalog A-18 shows our complete line.

In Power Transmitting Machinery Jones Service is Unequaled

If you are not getting it—order direct from our factory. We are extensive manufacturers of Machine Moulded Pulleys, Gears, Hangers, Shafting, Bearings, Belting, Friction Clutches, Sprocket Wheels and Chain Belt.

"Jones Service" is Prompt Shipments. Reliable Goods. Right Prices

W.A. Jones Foundry & Machine Co.
Mail Order Department
1400 North Ave., Chicago, U.S.A.

Jones Service is Unequaled



Reliable Goods Right Prices

It is Remarkable

how easy it is to have plenty of water in and about the home—with a Jarvis Water Supply System. It is so simple that a woman can easily operate it. Does away with laborious handpumping—supplies water any place at any time. We furnish all the necessary pipe, fittings, fixtures, etc.—you can easily install

A JARVIS POWER PUMP

Cost of electric current less than repair bills on "water lifts" and "water movers." Costs practically nothing when run by gasoline engine doing other work. Write at Once for Complete Catalog 8—Sent Free. Dealers Wanted. Jarvis Engine & Machine Works Lansing, Mich.

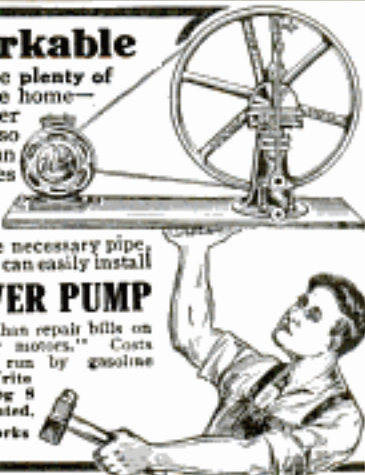

3 to 12 H.P.

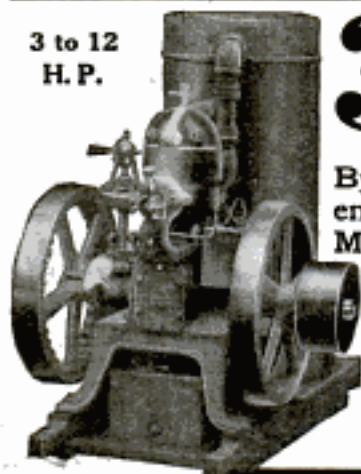

34c

Runs this 6 H.P. Engine for a 10 hour day on KEROSENE

By means of the patent throttle you can run it as a 4 H.P. engine for 23 cents a day, or as a 2 H.P. for 12 cents a day. Many other strong points; force-feed lubrication; uniform speed; sight-feed fuel supply; automobile muffler; no cranking; runs either way; uses any fuel oil satisfactorily. And it's **Guaranteed for 10 Years.** Write for catalogue and 30 days' free trial.

WE PAY THE FREIGHT

ELLIS ENGINE CO., 65 Mullett St., Detroit, Mich.

Cheaper Power for Every Purpose

The **WATERLOO BOY GASOLINE ENGINE** will run all day without attention, furnish exactly the power you need, maintain a uniform speed and save you money every hour it works. Uses either **Kerosene or Gasoline for fuel—equipped for both at no extra charge**

The recent award of **Gold Medal at Budapest, Hungary, in open competition with the best engines of all countries** is clinching proof that the **Waterloo Boy leads the World in Construction, Power, Service and Durability.**

Has many important exclusive features—Speed Lever works like throttle on a locomotive; old reliable fly ball governor, automatic feed regulation, open jacket, starts easy in Winter, interchangeable parts, etc. Lowest in price because made in largest quantities, at low manufacturing cost. **Guaranteed 5 Years.** Book free. Write today. **Waterloo Gasoline Engine Co.**

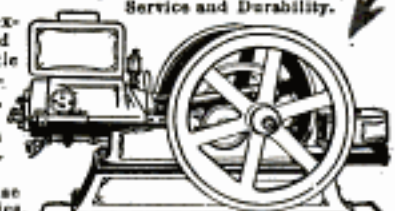

Awarded Gold Medal First Prize at the International Gasoline & Oil Engine Show Budapest, Hungary

2021 W. 3rd Ave. Waterloo, Iowa.

I Am Yours for \$1950 Try me for 10 days

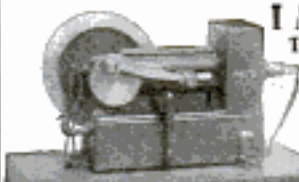

This is our 1-2 horse power Gasoline Engine fully equipped. Batteries, Switch, Coil, Spark Plug, Gasoline Tank, Mixing Valve, all ready to run. Fully Guaranteed. Return if not satisfactory and money refunded. Will run Washing Machines, Cream Separators, Barber Chairs, or any light machinery where small power is required. **Include 25 stamp for reply.**

SIEVERKROPP ENGINE CO., 1224 18th St., Racine, Wis., U.S.A.

PAPER BAG AS A KETTLE—"I had no hot water for shaving at the little country hotel, and therefore heated some in a paper bag," said a traveling man.

"Heated water in a paper bag?"

"Sure."

"How can that be done?"

"Take a stout paper bag—or an envelope will do as well—fill it with water and hold it over a gas flame or lamp. The water heats readily. The paper doesn't burn, because it is wet, and wet paper is a singularly tough and

SMALL ENGINES

1-8 H.P. UP



Steam, Gas and Gasoline. For Amateurs and Mechanics. Circulars for Stamp. Big Catalogue Engines, Small Power Machinery and Electric Light Plants, 2 Lights up. Sent for 10c (coin preferred). Refunded first order. **AMATEUR MECHANICS SUPPLY CO. 869 G Menardock Bk. CHICAGO**

An I H C Engine

Will Do Your Hardest Work

An I H C oil or gas engine furnishes the most satisfactory power for running model-making machinery, machines for confectioners, bakers, plumbers, laundries, printing offices, tin and sheet metal workers, and for all the various industries of cities, towns and farms. The power is steady, safe, reliable, and inexpensive. The engine can be started and stopped with the work, so that there is no waste of power or fuel. The first cost is very reasonable.

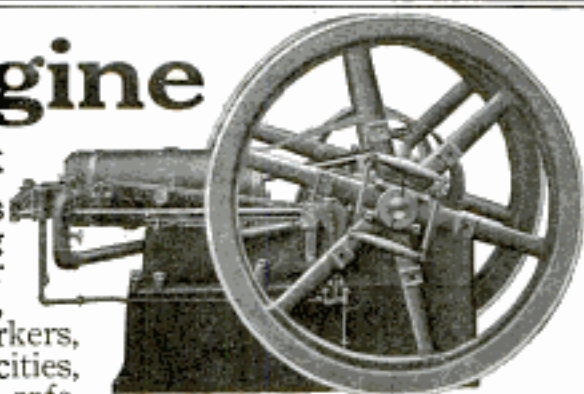

I H C Oil and Gas Engines

are made in all sizes, from 1 to 50-horse power, and every engine is thoroughly tested before shipment. They are made in all styles—horizontal and vertical, air and water-cooled, portable, stationary, and mounted on skids.

They operate on gas, gasoline, kerosene, naphtha, or alcohol, using whichever fuel is cheapest or most convenient for you. You can save money, time and trouble by installing an I H C engine to do your work.

Write for Catalogue and full information

INTERNATIONAL HARVESTER COMPANY OF AMERICA
(Incorporated)
16 Harvester Building Chicago U S A

non-combustible substance.

"Many and many a time have I heated over the gas jet an envelope or a paper bag of hot water for my shaving, and not once have I had an accident."—Kansas City Independent.

PALMER MOTORS AND LAUNCHES

Ask for free Engine or Boat Catalog. Address Dept. K
Engines, 2 to 40 H.P., 2 & 4 cycle, always in stock.

PALMER BROS., Cos. Cob, Conn.

\$50 to \$300 SAVED

We are manufacturers, not merchants. Save dealers', jobbers' and catalog house profit. 10 or more men in every township can save \$50 to \$300 on my High Grade Standard Gasoline Engines from 1½ to 15 H.P., price direct to you lower than dealers or jobbers pay for similar engines in car-load lots for spot cash.

GALLOWAY

Price and quality speak for themselves and you are to be the sole judge. Sell your present horse and buy an
30 Days Free Trial



Direct From My Factory Satisfaction or Money Back Write for special proposition to 10 or more men. Send for my big BOOK FREE.

WM. GALLOWAY, Pres.
WM. GALLOWAY CO.
1965 Galloway Station
WATERLOO, IOWA

DON'T BUY A GASOLINE ENGINE

tionizing power. Its weight and bulk are half that of single cylinder engines, with greater durability. Costs Less to Buy—Less to Run. Quickly, easily started. Vibration practically overcome. Cheaply mounted on any wagon. It is a combination portable, stationary or traction engine. SEND FOR CATALOGUE THIS IS OUR FIFTY-NINTH YEAR.

THE TEMPLE PUMP CO., Mfrs., 442 West 15th St., CHICAGO

TRY A COLUMBIA!

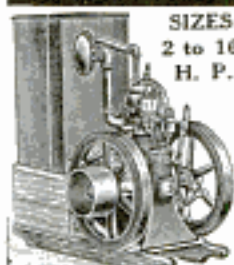

SIZES
2 to 16
H. P.

On the hardest job you can find. It won't buck or complain; feed it on kerosene, gasoline, distillate or any liquid fuel. Runs on natural gas as well—no waste—no repairs. Saves hired help—works night and day. Try it 15 days—if it don't suit, send it back. 7,000 in use—they don't come back. Right now you save big money on a Columbia if you act quick. Write today for 1912 plan and Free Book full of engine facts.

Columbia Engine Company
17 Fuller Street Detroit, Mich.

"INGECO" ENGINES

1½ to 350 H.P.
Gas, Gasoline,
Oil and
Producer Gas

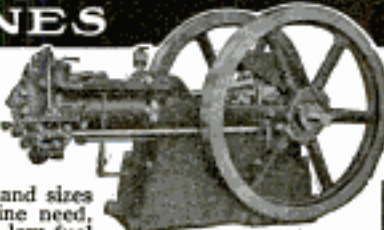

Includes all types and sizes to meet every engine need. Simple to operate—low fuel cost—substantial construction. Perfectly balanced, smooth, steady, reliable. Sales branches and stocks everywhere. If you expect to buy an engine our expert will tell you what is best and cheapest for you.



INTERNATIONAL GAS ENGINE CO.,
118 Kellott Pl., CUBANY, WIS. (Suburb of Milwaukee)

ROBERTS MOTORS

THE MOTORS THAT NEVER BACKFIRE

FOR AEROPLANES



Deadwyer Flying at Louisville, Ky.

THE ROBERTS MOTOR CO., SANDUSKY, O.

Gentlemen— I have flown in Europe since 1910 with the Gnome, Anzani and Argus motors so that from my past experience in this line, I am well qualified to speak. This flight with the Roberts motor, was my first in the United States and I want to say that I am pleased with its running qualities. In my opinion, the Roberts is an ideal motor, and it certainly is a pleasure to fly a machine propelled by such a motor.

Yours very truly,

ALBERT DENDUYVER, Licensed Aviator, Louisville, Ky.
4 cylinder 50 H.P.—6 cylinder 75 H.P.—6 cylinder 125 H.P.

Our Aviation Motor Catalog
will be mailed upon request

FOR BOATS



A. C. Ross winning 20 ft. championship at Savannah, Ga.

THE ROBERTS MOTOR CO., SANDUSKY, O.

Gentlemen— Enclosed find pictures of Muggs II, champion 20 footer of Savannah, Ga., equipped with one of your 1907 20 H.P. motors. I am travelling in fast company (60 H.P. Apperson and 90 H.P. Packard) but at that I am making it interesting for them with a five year old 20, which is a good recommendation for your engine. After five seasons' use, it is still in perfect running condition.

Yours truly,

A. C. Ross.

Our marine motors are built in twelve sizes— 8 to 125 H.P.— 1 to 6 cylinders—standard—acrolite and featherweight types.

Our Marine Motor Catalog
will be sent upon request

THE ROBERTS MOTOR CO

1419 COLUMBUS AVE., SANDUSKY OHIO

BAY STATE MOTORS

"Perfect Simplicity" and "Simple Perfection" are the results embodied in these Motors, of 15 years devoted to the developing of these essential characteristics, which enable us to put on the market a reliable and economical motor at a reasonable price. Write for catalog, stating size and type (2 or 4 cycle) of motor wanted. We also furnish castings for these motors.

BAY STATE MOTOR WORKS

Successor to
A. J. HOULE MOTOR WORKS
580 South East Street, HOLYOKE, MASS.

WATKINS' SPECIAL MOTORS

3 H. P. Single Cylinder . . . 30 lbs.
4 H. P. Double Cylinder . . . 40 lbs.
12 H. P. Four Cylinder . . . 100 lbs.

A strictly HIGH GRADE Motor that will give CONSTANT and EFFICIENT service. Especially adapted for CANNES and LIGHT BUSES. Aluminum base, copper water jacket, steel shaft, bronze bearings.

THE WATKINS MOTOR CO.

837-839 West Sixth Street CINCINNATI, OHIO

THE RIGHT MOTOR FOR YOUR BOAT

We manufacture Two and Four Cycle Engines from 1½ H. P. to 60 H. P., from \$31.50 to \$1500.00. Write us, tell us what you want—if we have it, we will give you all particulars and quote you a price that will meet with your heartiest approval—if we haven't got what you want, we will tell you so and advise you where to get it. Our catalog contains information of vital importance, information that YOU should have—GET IT!



THE STRELINGER



STRELINGER MARINE ENGINE CO.
171-175 Woodbridge W., Detroit, Mich.

CATALOGUES OF POSSIBLE BRIDES—Some of the plans to increase population that are actually being tried in various parts of Europe are ingenious. For instance at Mende, in the Auvergne, a "League Against Depopulation" has been formed, and this has just sent out to all the bachelors and widowers in the neighborhood a circular worded as follows:

"Dear Sir—In an essentially humanitarian and patriotic cause we have the honor to acquaint you with the

Rex Motors

You may have a good motor. But you haven't got the best unless it's a REX. Sturdy, dependable, the Rex is the last thought in a two-cycle motor engine. Descriptive, illustrated catalog tells the whole story of the engine that is ahead of the times. You will be interested in the advanced information it contains. Ask us today for free copy.

REX MOTOR COMPANY, 40 Central St., Boston, Mass.

TOLEDO MARINE MOTORS

Complete and Guaranteed

Don't buy any motor until you have read our Catalog C. telling you about "Toledo"	3 H.P. 1 cyl.	\$ 65.00
	6 H.P. 1 "	81.00
	6 H.P. 2 "	125.00
	12 H.P. 2 "	160.00
	18 H.P. 3 "	250.00

quality and the equipment we provide. Our motors are 2 cycle, 2 port, 3½ x 3½ and 4½ x 4½. Write today.

THE UNIVERSAL MACHINE CO., Pike Ave., Bowling Green, O.

Model E 4 cyl., 50 H.P. T-head

MAXIMOTOR

(List of 5 models this year) ranging 50-140 H. P. Just right for exhibition flights on standard Curtiss, Blériot, etc.

MAXIMOTOR MOTORS
New Catalog DETROIT Dept. 45



PERFECTION MARINE ENGINE 100% RIGHT

The big 1912 line of Caille Perfection Marine Engines from 2 to 30 H. P. give dollar for dollar more real service than most engines costing double their price—Perfection service is 100% right

Without a Rival

For yachts, cruisers and ferry boats, a Perfection power plant is without a rival and simply thrives on hard, tough work. It works equally well in fresh or salt water, tidewater or stream, calm or storm. It embodies more refinements than any other engine on the market. The Igniter Equipment with the 6 H. P. and 8 H. P. insures a water-proof ignition and does away with batteries, coils, magneto and timer.

Free Book of Engines

Our new 1912 Engine Prompt Book is free for the asking—refer to it any time for the true and correct meaning of Standard Construction; write today while you have the subject in mind—get book and refer to it, no matter what motor you buy. If your engine does not tally with this book, then you know you are not getting a Standard motor.

The Perfection owner could not buy a better engine.



Sizes 2 to 30 H. P. Full Rating Guaranteed

CAILLE PERFECTION MOTOR CO.
1207 Caille Street DETROIT, MICH.

names of the spinsters of Mende, aged eighteen and upward.

Yours, The Managing Committee."

Two hundred would-be brides furnish names and addresses, and there are others who do not desire their names to be printed.—Denver Times.

The Bell Telephone System in the United States operates 12,932,615 miles of wire and averages 24,128,088 connections per day.



2 to 45 H. P. THE WORLDS SIMPLEST installed Operated for all boats. Complete Outfits ready for Rowboat or Schooner. GUARANTEED TWELVE YEARS building, perfecting, success with THE ONE TYPE. Write to Originators of VALVELESS for new "MARINE BOOK," a liberal Educator to all, free. LACKAWANNA MFG. CO., Lackawanna Bldg., Greenwich & Liberty Sts., N.Y. City

Get This Power Boat at Maker's Prices

BUY DIRECT FROM MANUFACTURER AND SAVE DEALERS' PROFITS

This Toppan Power Dory as illustrated above is made of best guaranteed materials and is the standard rough water boat of the world. Safe and reliable—used by U. S. Government in all departments. Send for literature for catalogue. Ask for prices and facts about Toppan Reversible Motors, built with 2, 3, 5, 8 and 12 Horse Power—and if you want to build your own dory, saving exactly HALF, ask for TOPPAN BOAT MFG. CO. FREE KNOCK-DOWN BOAT QUOTATIONS. 2 Haverhill St. BOSTON, MASS.

2 HORSE POWER **AMERICAN \$38**
MARINE MOTORS COMPLETE
OTHER SIZES 2 TO 20 HORSEPOWER
PROPORTIONATELY LOW PRICES



GUARANTEED FOR LIFE.
AGENTS WANTED.

Send for complete marine engine book FREE.
AMERICAN ENGINE CO., 419 Boston St., Detroit, Mich.



These Books Solve Every Shop Problem

The man who holds down a job without having to be constantly "shown"—the man who, unaided, can tackle the most difficult problems and get results—is the man who gets ahead. Foremen and Superintendent have just such ability—that's why they are holding better positions and drawing bigger pay. You too, can fit yourself for just such a job—you can get the knowledge you need to give you confidence and make you the master of your own job—through the American School's great new

Cyclopedia of Modern Shop Practice

Four large, handsome volumes, bound in half red American Harpers, Gold stamped; 2,188 pages, 7 x 10 inches; 2,207 illustrations, full page plates, folding maps, diagrams, etc.; hundreds of valuable tables and formulas carefully cross-indexed for quick, easy reference.

The greatest and most practical work on Modern Shop Practice. Contains home study courses for student, machinist, or worker in any metal or allied trade. The writers are men of national reputation such as Howard M. Manros, B.S., Editor in Chief, Dean of Engineering, Armour Institute of Technology; Chas. I. Griffin, S. B., Ass't Engineer, The Solvay-Process Co.; Edward R. Markham, M. E., Consulting Expert in Heat Treatment of Steel; Oscar F. Peerrig, M. E., Consulting Mechanical Engineer; John Lord Bacon, Consulting Engineer; William C. Stimpson, Head of Foundry Work and Forging, Pratt Institute; Fred. W. Turner, Instructor, Machine Shop Work, Mechanics Arts High School, Boston.

List of Chapters

Machine-Shop Work; Machine-Shop Management; Tool Making; Forging; Electric Welding; Pattern Making; Metallurgy; Manufacture of Iron; Foundry Work; Mechanical Drawing; Mechanics; Sheet Metal Work. A total of seventeen hundred and sixty-six subjects indexed.

Sent Absolutely Free—Express Prepaid

The complete four volumes, not a sample volume, will be sent, express prepaid, for seven days' free examination; returnable at our expense if the books do not contain the information you want. If you keep the books, pay \$2.00 seven days after receipt and then \$2.00 a month until you have paid the special introductory price of \$12.00.

Another Great Free Offer

With each set is included a year's Consulting Membership entitling you to the free advice of a corps of practical shop men. This will give you practical help in handling working problems which are too specific to be taken up in detail in the Cyclopedia. A single problem solved for you might be worth more than the first cost of the books.

American School of Correspondence, Chicago, U. S. A.

FREE EXAMINATION COUPON

American School of Correspondence, Chicago, U. S. A.

Please send set Cyclopedia of Modern Shop Practice for seven days' free examination. I will send \$2.00 within seven days and \$2.00 a month until I have paid \$12.00 or notify you and hold the books subject to your order. Title not to pass until fully paid. Pop. Mech. 9-12

NAME

ADDRESS

OCCUPATION

EMPLOYER

Please Mention Popular Mechanics

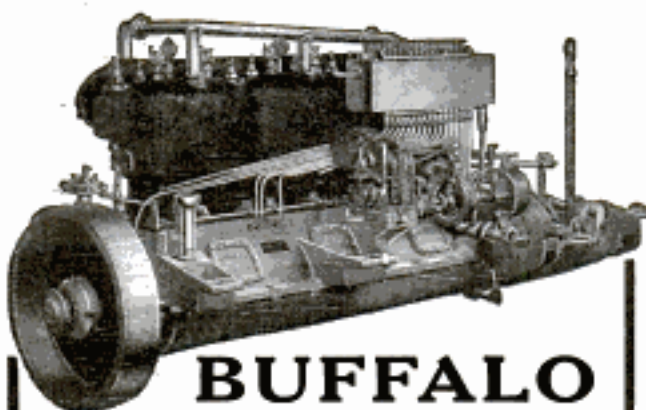

BUFFALO MARINE ENGINES

are all of the four stroke type, slow speed, medium speed, high speed—3 to 125 H. P.

They Excel in Reliability

The Buffalo Book tells the whole story. If you want it, send us your name and address.

The Engine of Constant Service.

PACIFIC COAST AGENTS:

San Francisco—Buffalo Gasolene Motor Co., Jas. B. Blair, Mgr.
Seattle—Woodhouse Gasolene Engine Co., 62 Marion Street.
Vancouver, B. C.—Vancouver Ship Yard, Ltd.
Victoria—G. Harold Grant, Grants Wharf, Ellice Point.

Buffalo Gasolene Motor Co.
1293-1305 Niagara Street, Buffalo, N. Y.



Learn to Play the Violin!

You can have your choice of the finest collection of Violins, Cellos, etc., in America on 30 Days' Trial

WRITE TODAY for Free Copy of the new Lewis Catalog of Violins, Cellos, etc. Don't think of buying a Violin, Viola, Cello, or other stringed instrument until you have seen this book. It will post you thoroughly on violin values; tells you how to judge a violin by the wood, varnish and construction; and why we send our instruments on free trial. Write now for this book. Don't pay enormous profits to jobbers, brokers and dealers. Every one of these gets a part of your money when you buy a violin in the regular way.

We MAKE and IMPORT All Our Own Instruments and SELL DIRECT, giving you the benefit of the regular middleman's discounts.

The Celebrated Lewis Own Make Violins are made in our own workshops by the best of foreign makers, and are far superior to most old violins costing two or three times as much.

On 30 Days' Trial Try any instrument in our stock before you decide to buy. Don't buy any kind of a musical instrument any other way. You can't tell anything from a printed description, or a few minutes' trial in a showroom. We insist that you shall be satisfied, and we will pay the express charges both ways on all returned instruments.

Write Today for our Free Catalog. Your name and address is all that is necessary. If you have an idea of ever buying a stringed instrument, you need this book. Write now.

WM. D. LEWIS & SON, Makers and Importers
(Est. 1869) 225 So. Wabash Avenue, Chicago, Ill.

VIOLIN MAKERS!—We make a specialty of Imported Woods, Varnishes and Tools.

Stay-Tight Fabric For Aeroplanes

That means fabric that affords greatest speed and safety. Goodyear Aeroplane Fabric stays tight because it is unaffected by heat, cold, moisture or water. It is rubberized. Moisture can't get to the fibre. So the fabric can't stretch nor shrink—mildew nor rot. It is reliable. Its strength is unequalled—constant.

Because of its strength, this fabric is used by all leading manufacturers and veteran aviators. They know it's the fastest and safest.

Goodyear Aeroplane Tires and Springs also have exclusive advantages. A full line for all type machines.

We also build balloons complete and on specification. Write for booklet telling all about

GOODYEAR
AKRON, OHIO

**Balloons
Aeroplane Accessories**

Goodyear pneumatic tires are guaranteed when filled with air at the recommended pressure. When filled with any substitute for air our guarantee is withdrawn.

The Goodyear Tire & Rubber Co.
AKRON, OHIO

Branches and Agencies in 103 Principal Cities

We make all Kinds of Rubber Tires, Tire Accessories and Repair Outfits

Main Canadian Office, Toronto, Ont. Canadian Factory, Bowmanville, Ont.

According to reports from Paris, music has been transmitted wirelessly over a distance of more than 400 miles from Fort de Leau in Algeria to the ship "Hirondelle" in the inner harbor of Toulon. The experiments were carried on in the daytime. The receiving apparatus included a mast on the ship only 120 ft. in height.

GRAY MOTORS FOR BOATS



Made in the Largest Plant in the World devoted to manufacturing 2-cycle machine gasoline engines.

3 H.P. with Complete Outfit ready to install \$55
ALSO 3 1/2 TO 36 H.P.

Guaranteed by a big responsible concern. Write for big catalog—tells and shows you all about these high grade motors and how they are made.

GRAY MOTOR CO., 992 U. S. Motors Bldg., Detroit, Mich.

GET THIS CATALOG
FULL OF VALUABLE INFORMATION TO EVERY BOAT OWNER ON
**RACING PROPELLER WHEELS,
REVERSE GEARS AND
MARINE ACCESSORIES**
LARGE CATALOG FREE. SEND TODAY
MICHIGAN WHEEL CO.
1139 MONROE AVE., GRAND RAPIDS, MICH.

Agents Wanted

**Postpaid
\$1.50**



HERE YOU ARE

Sharpen Your Own Razor or Safety Blades with Our
AUTOMATIC RAZOR SHARPENER

EASY, ACCURATE, GUARANTEED

AUBURN SUPPLY CO., Dept. D, 7746 Peoria St., CHICAGO

Prest-O-Lite Gas Tank



The Only Practical Light for Motorcycles

The Prest-O-Lite Gas Tank is the only lighting system that makes night riding possible, pleasant and SAFE.

This ready-to-use gas costs no more—usually costs less—than the carbide a generator consumes.

The tank itself costs little, never gets to be second-hand, and is always a **READY CASH ASSET**.

You can easily afford it. You cannot afford to be without it if you ride at night. One accident due to poor light might cost you more than years of Prest-O-Lite service.

Easily attached to any motorcycle. We will arrange for immediate exchange service for anyone, anywhere.

See any motorcycle (or automobile) dealer, or write us,

Don't Accept An Imitation!

The genuine Prest-O-Lite Tank, when empty, can be immediately exchanged for a full one, ANYWHERE AND ALWAYS. Imitations cannot.

The Prest-O-Lite Co., Indianapolis, Ind.

Branch offices and Service Stations in all principal cities. Charging plants in all parts of the country.

Exchange Agencies
Everywhere

GREAT SCIENTISTS FAILURES AS STUDENTS

—It is a remarkable fact that neither Darwin, Pasteur, Koch, Newton, Franklin nor Edison ever had a university education. A writer in a recent issue of American Medicine adds to this list the name of Ehrlich, whose eminence in the field of medicine has so recently

SUNSHINE LAMP FREE!



to try in your home 15 days, incandescent 300 Candle Power. Gives better light than gas, electricity, acetylene or 15 ordinary lamps at one-tenth the cost. Unequaled for fine sewing or reading. Burns common gasoline. Absolutely safe.

COSTS 1 CENT PER NIGHT

Guaranteed 5 years. No wick. No chimney. No mantle trouble. No dirt. No smoke. No odor. A perfect light for every purpose. Take advantage of our 15 day FREE TRIAL offer. WRITE TODAY.

SUNSHINE LAMP CO.,
151 Factory Bldg., Kansas City, Mo.

ASTRONOMICAL TELESCOPE

Length 36 3/4 inches. 2 inch object glass

Complete with Case, Sunshade, Sun Glass and Extra Eye Piece for Night Observation . . . **\$18**



One of these superb instruments will give material enjoyment. It will enable you to pick out the smallest Boats on the Horizon, tell the time by a clock many miles distant, and view the country

for fifty miles around. This telescope is made for Astronomical Work. With its aid the Mountains in the Moon, Jupiter's Moons and Saturn's Rings are clearly discernible.

Prof. Hicks, of Word and Works Almanac, says it is far superior to others he has examined at twice the price.

CATALOGUES SENT FREE ON APPLICATION

A. S. ALOE CO., 515 Olive St., ST. LOUIS, MO.

Live Closer to Nature —and Live Longer

No long drawn out, tiresome exercise, no drugs, treatments or fasting, no effort on your part, simply eat, once or twice a day, with your regular meal, a little of

Tyler's Macerated Wheat (or Pemmican)



Try it
at my
Risk

A raw food—delicious, appetizing and satisfying. Possesses all the organic vitality your blood and nerves demand. Will make you feel ten years younger and restore your weight to normal. Quit drugs and dope—get back to Nature's way—Nature likes to be coaxed, not forced. My raw foods help Nature—aid digestion and give you a natural, normal appetite—you eat your way to health, then eat more and stay well—simple but certain.

To prove it to you, as I have to thousands in the past twelve years, I'll ship you a 7-lb. pail or sack, express prepaid, to points east of Rocky Mountains for \$2.00—west (including Canada, Mexico and all other International Parcels Post countries) \$2.25—your money back if not satisfied. Send two cent stamp for Raw Food Book and Health Guide, or better still, send 25c for Book and enough of the Food for three meals. Order today. Bank reference—First National Bank, Kansas City, Mo.

BYRON TYLER

Food Specialist

82 Syndicate Bldg. Estab. 20 years KANSAS CITY, MO.



Amazing Profits In Mushrooms

Anybody can add \$5 to \$50 per week to their income, in spare time, entire year growing mushrooms in cellars, sheds, barns, boxes, etc. I tell you where to sell, at highest prices.

Free Illustrated Instruction Booklet

HIRAM BARTON

Desk 2, 329 W. 48th St., New York

Complete High Grade Bathroom Outfit \$35



These handsome high grade Plumbing fixtures are furnished complete, guaranteed, and sold direct, saving you all dealers profits. The Bath Tub and Lavatory are White Porcelain Enamelled over cast iron. The Closet is Vitreous China with Oak Seat and Copper Lined Tank.

A Complete Pneumatic Water Supply System for Your Home \$40

Black Steel Tank, 145 gallon capacity, 2 1/4 inch Brass Lined, Double Action, Combination Air and Water Pump, including all Pipe, Fittings, Valves, Gauges, etc.

HEATING PLANTS, \$95

You can save from 30 to 60 per cent on a modern Steam or Hot Water Heating System. Heating Plants complete for modern homes from \$25. up. By following our simple plans and instructions, you can install your own material, and eliminate the expense of Plumbers and Steamfitters.

DO NOT WAIT—but write to-day for our new beautiful **FREE** catalogue, which gives full descriptions and prices of Plumbing, Heating and Water Supply Systems. **NOW IS THE TIME.**

CHELSEA MANUFACTURING AND SUPPLY CO.
No. 135 West 24th St., NEW YORK. Dept. D.

*A sharp tool is half the battle
in the making of a good job*

A hundred thousand expert workmen—carpenters, mechanics, machinists, are keeping their tools in perfect condition by the use of

Carborundum Sharpening Stones

There is a Carborundum Sharpening Stone for every possible sharpening need—Almost eighty thousand different grades and grits and shapes, ranging from the fine, delicate razor hone all the way up to the coarsest ax or scythe stone.



Try Carborundum out—Find out for yourself the wonders of this remarkable sharpening agent.

—
**Ask Your Hardware Dealer
—or Write Direct**

The Carborundum Company, Niagara Falls, New York



**No Strain When High Nailing
DOUBLE CLAW HAMMER**

"for the mechanic with an ambition to succeed"

16 oz. or 21 oz. Head—WHICH?

\$1.50 at your dealer's

or from us, delivery prepaid.

Worth ten times more than the common hammer—costs three times more to make.

DOUBLE CLAW HAMMER CO.

START

453 Broadway
Brooklyn, N. Y.

OUT



**Pulls The
Nail Out
Straight
Without
A Block**



been emphasized by his discovery of "606" or salvarsan. "Paul Ehrlich," he says, "could not even graduate, and, horrors of horrors, in chemistry he was worst of all. He was always trying to do things differently from his teachers, who had never done an original thing themselves and were merely teaching him what had been taught to them. He was considered a failure as a student at the very time he was the best student of his decade. If education is merely pouring facts into the pupil's skull with a funnel, as the majority of teachers practice it, then we are training the memory alone; but, if it is to be a real drawing out of

MAKE UP TO \$75 A WEEK

as a Watchmaker and Start Your Own Jewelry Business

Write me today! Let me explain our plan whereby you can become an expert watch repairer in three months—making \$25 to \$75 a week—and own your own jewelry business. I can teach you—I mean YOU—the whole watch repairing business by mail. Write right now!

ROGERS, THURMAN & CO., 1561 Mallery Bldg., CHICAGO



AGENTS

Just out—new, quick selling invention. People amazed—all buy. QUEEN MASSAGE MACHINE for home use. Made of genuine aluminum and red rubber. Women delighted—rubs away wrinkles like magic—makes clear, perfect skin. All done at home. Low in price. Splendid money maker for Agents—Listen: McGrath, N. Y., averaged 18 machines a week for over six months. Howard, Ohio, made \$336 in three weeks. Reed, Idaho, sells 7 to 10 daily. No experience required—we show you how. Send no money. Territory is free.

WRITE AT ONCE

QUEEN MFG. COMPANY
1134 Nasby Bldg. Toledo, Ohio

DIAMONDS ~ WATCHES ON CREDIT



"There's the One I Want"

Send for These Two Books—
THEY ARE ABSOLUTELY FREE!

Write for our handsome free catalog. It contains over two thousand (2,000) beautiful illustrations of diamonds, watches, solid gold jewelry, silverware and novelties at bargain prices. Select any article desired, have it sent to your own home or express office—all charges prepaid. If it is entirely satisfactory, send one-fifth the purchase price and keep it; sending the balance in eight equal monthly amounts.

Our Blue Book, which tells "How Easily You can wear a diamond or Watch by the Loftis System," answers every question that a person could ask about our liberal credit plan or concerning the purchase of diamonds, watches and jewelry on credit. It is beautifully costumed in blue and gold and is worth its weight in gold to anyone interested in our line.

Both of these books will be sent to you Absolutely Free Upon Request. Write today.

LOFTIS BROS. & CO., Diamond Cutters
Dept. D 894 100 to 108 North State Street, CHICAGO, ILL.
Branch Stores: Pittsburgh, Pa., and St. Louis, Mo.



Man Wanted



to show samples of strictly all wool **UNION MADE** clothing to his friends. Orders come easy. No experience necessary. Real Merchant Tailored clothes to measure.

BIG MONEY MADE
during spare time

We urge you to send at once for our elegant folder showing 50 large exclusive designs in suitings and overcoatings, fashion plates, order blanks, etc., with **Dealers Net Wholesale Prices** and full particulars of our special proposition also privilege of buying sample suit for yourself at wholesale price. Write immediately for advance folder.
LEES TAILORING CO.
1106 Lees Bldg., CHICAGO

mental faculties, then the graduates may be permitted to be as ignorant of old, useless facts as Ehrlich was—and the world profit by it. Let us think a bit over this matter and then realize that we want workers and thinkers, not memorizers."—St. Louis Post-Dispatch.

The government of Uruguay plans to make the telephone business of that country a state monopoly.

BOW LEGS UNSIGHTLY

Those afflicted send for Booklet showing men wearing the Improved Perfect Leg Form and how they appear without them. Made of Aluminum.

PERFECT SALES CO.
3031 L Michigan Ave., CHICAGO

"Slip-On" Raincoat FREE



Would you accept this guaranteed waterproof raincoat from us **absolutely free** (we prepay the express) just for showing it to your friends? Would you like tailoring styles that everyone goes wild about? Could you use \$5 a day for a little spare time? If so write and say: "Send your offer" and you will receive a beautiful set of samples and styles to pick from (suit or raincoat) and an offer so good you can hardly believe it. No money or experience needed. Write now—sure. Address

BANNER TAILORING CO., Dept. 725, CHICAGO

Mount Your Vacation Pictures

With Engel's Quick Way
"Art Corners"

For temporary or permanent mounting of Photos or Post Cards in Album or Scrap Book. Quick, effective, artistic—no mess—no bother—so simple a child can use them. Superior to anything on the market for the purpose.

100 for 10c

Two styles—round or square in black, light or dark gray, sepia or white. 100 for package of 100 of a style and color, by dealers in photo supplies and post-cards, or mailed direct.

SPECIAL OFFER—Send 60c for 500 Art Corners and we will mail FREE a beautiful Art Study framed with Engel's Quick-Art Picture Framing. Write today.

ENGEL MFG. CO.
1404 Leland Av.
CHICAGO, ILL.



AMATITE ROOFING

Mineral surfaced. Needs no painting. Send for free sample. **BARRETT MANUFACTURING CO., New York, Chicago**

1900 Motor Washer Electric or Water Power on Free Trial to Readers of Popular Mechanics

Reduce household expenses by using this great laundry outfit. Cuts cost of washing to 2 cents per week. Write for Free Book, giving full details, to

1900 WASHER CO., 5081 Court St., Binghamton, N. Y.
Address Canadian 1900 Washer Co., 355 Yonge St., Toronto if you live in Canada

Tailoring Salesmen WANTED

We want live, energetic hustlers, men who can make good; who are ambitious to start in a business of their own. No canvassing; no experience required; no capital necessary. We furnish everything to start. **Hundreds are making from \$100 to \$200 per month and expenses.** We guarantee absolute satisfaction and take all the risk. We are one of the largest woolen mills in the country and positively have the only up-to-date, high-quality, low-priced tailoring on the market.

A GREAT MANY OF OUR MEN ARE MAKING FROM \$25 to \$50 Every Week

We furnish a complete agents' outfit, consisting of large sample book (not a folder), order blanks, tape measures, advertising matter—in fact everything essential to the conducting of a high-class tailoring business.

Write today for this big outfit It is sent express prepaid. Drop a postal and say "Send me your agents' outfit." We will start you at once on the road to Success. Be sure and write today.

DANIEL WOOLEN MILLS Dept. R 300 Green St., CHICAGO

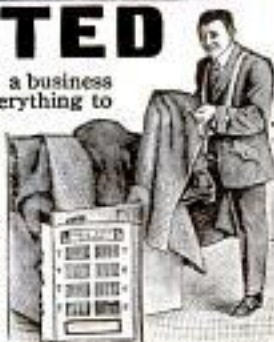

DRAFTSMEN WANTED

\$ \$

**ONLY
THE BEST
PRACTICAL
MEN WANTED**

**THAT CAN DRAW
THE HIGHEST
SALARY**

\$ \$

**MEN
WITH BRAIN
NOT WITH BOOKS
ONLY SUCCEED**

**Good Draftsmen are ALWAYS in Demand ALWAYS
Busy, ALWAYS Drawing Good Salary**

**The Work is Pleasant, Interesting, Clean
and Leads to Best Paying Highest Positions**

If you are ambitious, bright and anxious to learn I can train you at home on practical, actual Drafting room work in a short time for a position \$125-\$150 monthly. Only a limited number can receive my personal training.

I DON'T SELL YOU a lot of books to look at with disgust or to lay on a shelf to be covered with dust. You can't learn a trade out of books.
I DON'T SELL YOU printed school lessons or pictures to copy. You **MUST** learn on actual Drafting room work to get the required experience.
I DON'T SELL YOU or give you a worthless "cheap-skin" Diploma to hang on the wall and that will be all.
BUT I TRAIN YOU *until competent*; more than that, *until placed in position* at above salary.
AND I TRAIN YOU personally and individually to advance you as fast and far as you can go.
AND I TRAIN YOU on practical work to give you required **UP-TO-DATE, PRACTICAL WORKING EXPERIENCE.**

Remember:

I AM NOT teaching 227 different trades — **ONLY ONE** and **THAT ONE** right.

I AM NOT looking for students—they look for me, for I have been at this over 22 years.

I AM NOT accepting every one that has the price—only those anxious to succeed with me.

I rather satisfy a few than dissatisfy anybody.
 I furnish all Instruments and Working Outfit (not school set), this **HIGHEST GRADE FREE.**
 If you want to be a **GOOD DRAFTSMAN**, drawing good salary, write to me **AT ONCE.**

Address, **CHIEF DRAFTSMAN, Div. 19**
Eng's Equip't Co. (Inc.), CHICAGO



Please Mention Popular Mechanics

The Little Friend of the Deaf



Actual
Size

This ad is to deaf people who have about given up—who are failing in hope and in courage—people who think their cases unlike other cases which have been relieved. We don't want any money. Just send for a book that tells about "Wireless Telephones for the Ears"—little devices that 390,000 deaf people are using today because they HEAR with them. Think of it, men and women; these tiny wonders are so small that they fit in the ears *out of sight* and so *soft* that you never feel them, even when lying down! *Yet you hear whispers!* Is your case beyond such simplicity? Not a bit of it. One of the officers of this company is a deaf man. He became desperate, and in desperation developed this marvelous ear drum. It is one of the inventions of Mother Necessity—an *inspiration*. Talk to him today. You'd never even suspect his affliction. He's been improving this tiny "phone" for 20 years. There is nothing else to compare with it—anywhere. Don't you want the book he has written about it—a book by a man who understands deaf people because he is one of them? You do, if you want to improve your hearing. Just say, "Send the book," on a post card, and mail it to **WILSON EAR DRUM CO., 406 Todd Bldg., Louisville, Ky.**

EUROPEAN LANGUAGES—The following figures for the year 1901 will show the relative growth of the various European languages: English, 140,000,000; French, 52,000,000; German, 84,000,000; Italian, 35,000,000; Spanish, 46,000,000; Portuguese, 15,000,000; Russian, 85,000,000. The percentage of the English in 1801 was 12.7, but in 1901 it was 30. The gain of English is altogether out of proportion to the others, and the growth since 1901 has been even more phenomenal.—Los Angeles Times.



Cleans
like a
flash

Gears, Sprockets, Chains, Etc.



In Stock
and Made
to Order

Send for new 32 page catalog

WOBURN GEAR WORKS, Woburn, Mass.

Thin model,
19 jewels.
Adjusted to
the second.

25-year
guaranteed
gold strata
case.



Here is the Exquisite Ribbon Monogram Design—You may have your own initial handsomely engraved by hand on the superb gold strata case—guaranteed for 25 years. Your choice of scores of other handsome designs.

Startling Watch Offer

The Great Burlington Special at the Rock-Bottom Price

The world's masterpiece of watch manufacture now sold direct to the consumer at the same price that even the wholesale jeweler must pay. The superb Burlington Special—adjusted to temperature, isochronism and all positions—19 jewels, fitted at the factory into the superb gold strata case—now sold direct to you at the rock-bottom anti-trust price.

The Fight Is On!

We will not be bound by any system of price-boosting contracts with dealers. We will not submit to any "high profit" selling scheme. We will not be dictated to by ANY "system". No matter what it costs, we are determined to push our independent line even if we should have to fight a combination of all the watch manufacturers of the country.

And so we are making this offer—the most sweeping, astounding offer ever made on a high-grade watch. The famous Burlington direct and at the same price wholesale jewelers must pay. And in order to make the proposition doubly easy for the public we will allow this rock-bottom price, if desired, on terms of \$2.50 a month.

Get the Burlington Watch Co.'s Free Watch Book

Read our startling exposure of the amazing conditions which exist in the watch trade today. Read about the anti-trust fight. Read about our great \$1,000 Challenge. Learn how you can judge watch values. Send your name and address for this valuable **FREE BOOK** now—TODAY. Sign and mail coupon.

BURLINGTON WATCH CO.

Dept 1196
19th Street
and
Marshall
Blvd.
Chicago
Ill.

Please send me, without obligation and prepaid, your free book on watches and a copy of your \$1,000 challenge with full explanations of your cash or \$2.50 a month offer on the superb Burlington Watch

Name.....
Address.....
No letter necessary; coupon will do.

Please Mention Popular Mechanics

Are You Interested IN Cheaper Power?

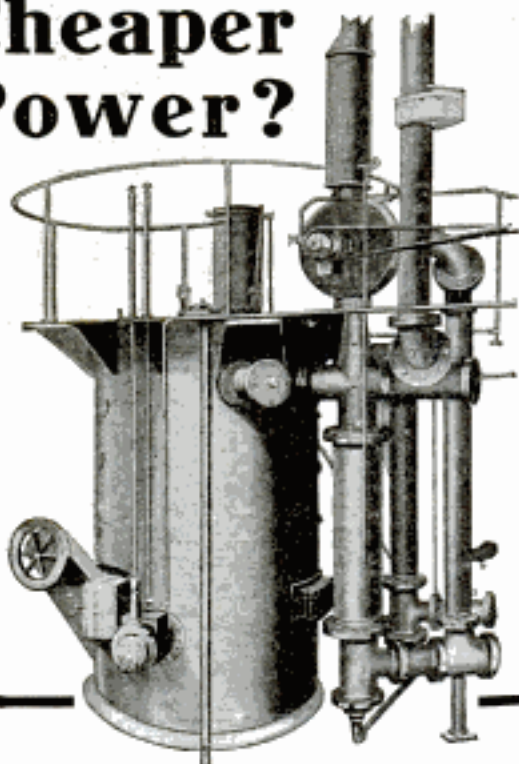

WOULD you like to know whether the installation of a gas producer and gas engine would be advantageous and save you any money? Would you like to make your decision based on your own judgment? Under certain conditions the gas producer makes a startling saving in the cost of power and it is worth every power user's time to know whether or not his present system is the best.

To meet this demand for information which has not been hitherto available except by the employment of an expert, we have been fortunate in securing the services of an eminent gas power engineer, Mr. J. C. Miller, M. E., who has written a book on this subject which we have recently published. It gives just the information a man wants to have, comparing the first cost of steam engines and boilers with the gas producer and gas engine, and the comparative cost of maintenance and operation. It tells all about the advantages and troubles of gas producers, and gives full details of how to run them. It is written in an absolutely impartial manner, and not with a view to increase the sale of gas plants, leaving the decision as to the advisability to the individual reader. It will also enable the **Steam Engineer** to understand thoroughly the working of the new system if the change is made, and to handle a plant competently and with confidence.

Power Gas and the Gas Producer

is a comprehensive treatise, clear of abstruse technicalities, in every way authentic, yet

"Written So You Can Understand It"

The work is in one handsome 12mo. volume of 200 pages, printed on the best quality of book paper, profusely illustrated with half-tones from photographs, diagrams, etc., and durably bound in extra cloth.

**Price \$1.00 Sent Postpaid 200 Pages
to Any Address**

**POPULAR MECHANICS BOOK DEPT.
318 W. Washington St., CHICAGO**

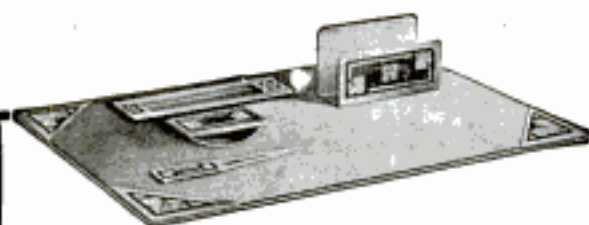

METAL WORK AND ETCHING

"WRITTEN SO YOU CAN UNDERSTAND IT"

By **JOHN D. ADAMS**

ONE OF THE LATEST of our series of industrial handbooks. A complete manual for art metal workers, giving every detail for making a great variety of useful and ornamental objects such as book ends, desk sets, pad corners, paper knives and letter openers, stationery racks, rocking blotter, desk calendars, match boxes, tie and pipe racks, whisk broom holders, candle sconce, arts and crafts jewelry, hinges, drawer pulls, etc.

96 Pages — RICHLY ILLUSTRATED — 5x7, Cloth

Price 50 Cents, Postpaid

Order of your newsdealer, bookseller, or
**POPULAR MECHANICS BOOK DEPT.
PUBLISHERS, CHICAGO**

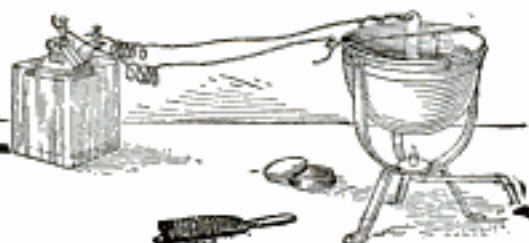

Practical Results

may be obtained by following
the directions in our handbook

ELECTROPLATING

By **HENRY C. REETZ**

Contains no more technical detail than is necessary for practical work, yet embodies such explicit directions concerning the actual operations as an old hand at the business thinks may be useful to the beginner.

CONTENTS:

Introduction—Electrical Equipment—Shop Equipment—Cleaning Goods before Plating—Copperplating—Nickelplating—Silverplating—Goldplating—Miscellaneous—First Aid to the Injured—Business Suggestions.

112 pages—62 illustrations—5x7—cloth

Price 50 Cents Postpaid

ORDER OF YOUR DEALER OR
**Popular Mechanics Book Dept.
318 W. Washington St. CHICAGO**

LEARN AND EARN

A Good Salary or Big Profits in the MOTION PICTURE BUSINESS

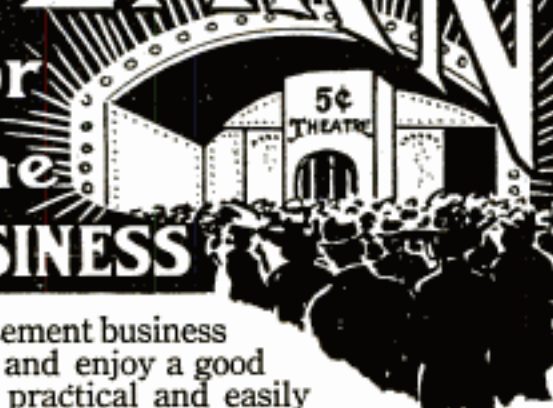

Get into the popular, money-making amusement business of the Century—be an **Operator** or a **Manager** and enjoy a good income. Our complete, thoroughly practical and easily learned **course of instruction by mail**, for home study, will make you an expert, during spare moments. Write today for our illustrated booklet: "**The Motion Picture.**" It explains our motion picture course fully—gives some valuable information about operating.



Also ask for information about our "**Cyclopedia of Motion Picture Work.**" Just off the press—the only complete work on the subject ever published. Fill in the coupon **now**, specifying whether you want books or course.

The American School of Correspondence
Chicago, U. S. A.

Please send me further information about your
 Motion Picture Course.
 Cyclopedia of Motion Picture Work.

NAME

ADDRESS

Pop. Mech. 9-12

200
Editorials
in Pictures

Cartoons

200
Editorials
in Pictures

"THE BOOK OF PICTURE EDITORIALS"

☐ The August number of *Cartoons*—now on the news stands—is the book for the busy business man. In it the man who has not the time to wade through columns of type reporting the doings of the politicians finds the political situation thoroughly covered from all view points and in an unbiased manner.

☐ It turns hours of tiresome reading of the newspapers into moments of pleasure studying the picture editorials. Rest for the tired mind and entertainment for the light-hearted are found in the pages of human interest cartoons. Foreign affairs are fully covered by the leading cartoonists of Europe.

The work of more than one hundred of the cartoonists of America and Europe is gathered in this August number

Ask your newsdealer for *Cartoons* and if he cannot furnish you a copy, suggest that he order one for you

Published the fifth of each month
 Single Copy - - 15 cents
 Yearly Subscription - \$1.50

Edwards "REO" Steel Shingles

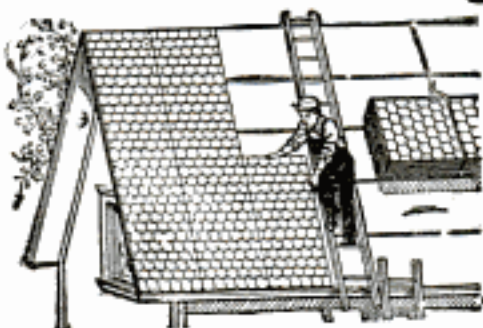

Beat Wood Shingles and Composition Roofing a Mile!

Cheaper, Too, and Easier to Put On

Any man who roofs his buildings with wood shingles or composition roofing is either crazy or never saw the genuine Edwards "Reo" Steel Shingles. There are 100,000 "Reo" Steel-Shingled Roofs in the U. S., yet who ever heard of one catching fire or getting rotten, rusty or leaky? No patching or painting, either. Easiest roof in the world to put on—nothing to do but nail it down.

Edwards "REO" Steel Shingles

are Open-Hearth Steel, made forever rust-proof by the famous Edwards "Tightote" Process. They come in large sheets all ready to apply. Sold at lowest factory prices, all freight paid. Don't cost one penny more than commonplace roofing materials. Made by the biggest, most experienced Sheet Metal Maker in the world. Postal sent today brings latest catalog 950 and prices by return mail. Send dimensions of your building and let us quote price delivered to your R. R. station.

THE EDWARDS MFG. CO. (83)

900-950 Culvert Street Cincinnati, Ohio



THE "GOLDEN GEM" ADDING MACHINE Only \$10

We have been making adding machines for ten years—and have sold over 30,000.

"THE PROOF" is on request.

The "GOLDEN GEM" is Our Latest Production. You can keep it right on your desk or take it with you on the road. It saves brain work—avoids mistakes—it suits the average man's needs as well as high priced machines. It is supplied in a pebbled morocco leather case for only \$10. Send your remittance to-day—your MONEY BACK if machine does not make good.

SALES AGENTS: The "Golden Gem" Sells Itself Address: E. Gischer, AUTOMATIC ADDING MACHINE CO., 319 Broadway, New York

Polarizing The Standard Oil for Motors
FOR SALE EVERYWHERE BY ALL REPUTABLE DEALERS.



MONEY FOR YOU!

Yes—money for you!—probably more than you ever dreamed of earning. It's yours if you'll reach out and take it. J. A. M., Maryland, took in \$250.00 in one day. In the last five years I've started many men on the road to money-making. Men who have made as much money in a month as they used to make in a year. My

Popcorn Crispette Machine

is a great invention. Makes the new, delicious popcorn crispettes from my secret formula. Everybody likes them. They're different. Sell for 5c. a package. Almost four cents profit. Easy, simple, pleasant business.

This is my big money-making Crispette Machine



W. Z. LONG

603 High St., Springfield, O.

SPANISH SOIL YIELDS \$656 AN ACRE—The most intensively cultivated region in Europe is that part of the province of Valencia, Spain, which lies between the mountains and the Mediterranean. It has a rainfall of only about 17 in. a year, but so fertile is the soil and so skilled are its workers that it produces crops worth an average of \$656 an acre, according to a report sent to Washington by Consul Robert Frazer, Jr.

There are districts, he says, where 100 acres support

"Ideal" Plans and Drawings

are accurate and are accompanied by clear, concise building instructions, postpaid at the following prices:

- Wright 3 ft. Biplane..... 25c
- Bleriot 3 ft. Monoplane..... 15c
- "Coed Pool" Champion Biner..... 25c
- Curtis Convertible Hydroaeroplane (new)... 35c
- "Ideal" three foot liner (new)..... 15c
- Complete Set of Five... \$1.00 Postpaid

Send for one now 50 up, catalog of "IDEAL" MODEL AERO-PLANE SUPPLIES. Fully illustrated. Be frugal! (Name free)

Ideal Aeroplane & Supply Co., 82-88 West Broadway, New York

DIAMONDS ON CREDIT

20% DOWN—10% PER MONTH

Why wait for your Diamond until you have saved the price? Pay for it by the Lyon Method. Lyon's Diamonds are guaranteed perfect blue-white. A written guarantee accompanies each Diamond. All goods sent prepaid for inspection. 10% discount for cash. Send now for catalogue No. 3. Established 1843

J. M. LYON & CO., 71-73 Nassau St., N.Y.

2317 \$25

2132 \$60

2315 \$35

2110 \$35

2156 \$20

6252 \$35

2159 \$35

3291 \$50

2113 \$50

2157 \$25

2385 \$40

Please Mention Popular Mechanics

Big Profits in CONCRETE SPECIALTIES



FLOWER BOX

Easy Work—Big Demand

Ornamental concrete articles are easy to make—ordinary care is all that is necessary. A big demand exists for ornamental moulds—they are suitable for lawns, gardens, parks, cemeteries, pergolas—every property owner can use some of these articles. They are readily sold everywhere.

Earned \$205 in One Week

Just as an example of what is being done in this line of work, we quote from a letter one man's experience. "My receipts for a single week were \$249.00, cost of material \$43.30, giving me a profit of \$205.70." We would like to tell you about hundreds of other successes just like this one.

Send for Ornamental Circular

It shows everything in the ornamental line. Flower boxes, flower pots, sun dials, jardinières, lawn vases, porch column moulds, railing moulds, baluster moulds, ball moulds, chimney moulds, coping moulds, gate posts, sewer post moulds, etc.

How to Start in the Business

Write and get our large circular which tells all about the manufacture of ornamental concrete specialties and gives complete data and cost of manufacture. Sent free on request. We also make a complete line of mixers and concrete machinery for building blocks, brick, burial vaults, sidewalk tile, fence posts, sewer pipe, drain tile, etc.

WRITE TODAY

Northwestern Steel & Iron Works
1103 Spring St. EAU CLAIRE, WIS.



100 families, and where single families live on the products of four-tenths of an acre. Farms are rented for \$29.50 an acre, and the tenant pays 45 cents an hour for pumped water, which flows in a stream of 200 gal. per minute.

Almost all farming is done by hand, as minute at-

THE PNEUMATONE

Carried in Vest Pocket



The smallest and most scientific band instrument in the world. Principle never before used. Plays sweetly, loud or soft, any tune, any key. No valve, string, stop or key. No tuning or fingering. Played with one hand—left or right. High register. Beautifully made. Everlasting. Fully guaranteed. Introductory price \$1 postpaid.

THE PNEUMATONE CO., Dept. M
937 East Sixth St. N., Portland, Oregon

Ann Arbor

"INSTANTO"
LIGHTING
SYSTEMS

Change from 150 C. P. to 2 C. P. in a jiffy. The most up-to-date and complete lighting system on the market. Just the thing for summer homes. Attractive high candle power, inverted arcs for stores, halls, etc. Best proposition for heating agents. Write today for terms and territory. Catalog free.

SUPERIOR MFG. CO., 284 2nd St., ANN ARBOR, MICH.



BETTER ENGINES-LOWER PRICES

(The days of big profits are past)

Our big new modern factory is turning out the Best Engine money can buy, guaranteed 5 years, with every advantage at big reduction in prices, no risk, guaranteed fulfilled or money refunded. Use distillate, gasoline and many other fuels. All sizes, 1 1/2 to 40 H. P., any style. Write quick for free catalog and new special prices, stating size wanted.

WITTE IRON WORKS CO.

1554 Oakland Avenue,

KANSAS CITY, MO.

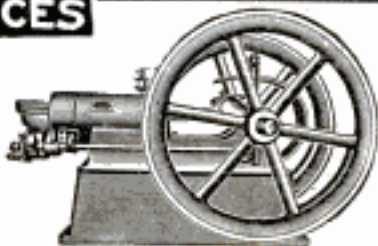

That
"Awful Smart"
Your Shaving Soap Did It

The free caustic found its way into the pores of your skin and that terrible smarting and drawing sensation resulted.

Use

MENNEN'S SHAVING CREAM

which contains no free caustic, and enjoy a cool, comfortable shave.

Mennen's Shaving Cream makes a lather which requires no "rubbing in" to soften the beard. You lather and then you shave. Saves time, and does away with tender faces.

For sale everywhere 25c

Sample Tube Free

GERHARD MENNEN CO.
Newark, N. J.



SAVE 50% ON YOUR CIGARS

My mail-order "factory-to-you" plan will save you from 50% to 75% on all your cigar costs. My prices range from 2 1/2c for 5c and 10c cigars up to 22c for 50c and 75c cigars—sold in lots of 100, express charges prepaid.

SPECIAL OFFER—Good up to Oct. 15

As a special offer, in order to "get acquainted," let me send you 100 Porto Rico smokers, 5 1/2" long, a fully-finished, hand-wrapped cigar—better than the finest 5c and equalling many 10c cigars, for \$2.50, express prepaid, and if you are not more than delighted, send them back and I'll refund your money. This is a special offer as I have a limited quantity of these Smokers on hand and will sell only 100 to a customer at this price. I furthermore reserve the right to withdraw the above offer after Oct. 15.

A postal brings you my catalog showing 38 bargains—a cigar for every smoker—send for it NOW.

MORTON R. EDWIN, 64 West 125th St., New York





*Somebody may—sometime—
make a better Wall Board
—Nobody has done it yet—*

UTILITY WALL BOARD

is a tough, durable fibre-board, that takes the place

of both lath and plaster. It is very easy to put on, makes no muss or dirt, doesn't have to dry, and once it is on it is there to stay as long as the house lasts.

Utility Wall Board is moisture proof—is not affected by extremes of heat and cold—will not warp or crack, and may be decorated in any style desired.

May we send you the book and a free sample?

THE HEPPES COMPANY, 4516 Fillmore St., Chicago, Ill.

Just Patented: The Ko-Ko-Mo Suspender Belt—does away with suspenders, instantly attached to inside of waist band. **INVISIBLE—ADJUSTABLE—COMFORTABLE** Trousers can't "sag down" nor shirt "crawl up." No straps or bands across the abdomen. In demand by mechanics and mill workers, as well as by office and



KO-KO-MO BELT CO. KOKOMO, INDIANA

professional men. Agents can sell to seven men out of ten. Send P. O. order and waist measure for Samp's Belt and terms to agents. Little 50c; Silk \$1.00. Money back if not satisfactory.

WEAR

Trade Mark
Registered

B.V.D. U. S. Patent Office
and Foreign Countries

UNDERWEAR

attention is given to crops and even to individual plants. The average production of the principal crops is as follows, in metric tons of 2,204 pounds: Oranges, 400,000 tons; olives, 65,000; carob beans, 72,000; peanuts, 13,500; melons, 36,000; grapes, 87,000; peppers, 12,000; tomatoes, 27,000; wheat, 62,000; barley, 18,000; corn, 38,000; rice, 200,000—Seattle Post-Intelligencer.

♦ ♦ ♦

Amulets and charms are still widely believed in, judging from the letters of recommendation in circulars sent through the mails by a Boston jeweler, who sells "lucky stones."

The Stepping-Stone to Wealth



is the systematic saving of money. You and members of your family can easily cultivate this admirable habit by putting a dime in

Grab's Keyless Basket Bank

every day. Your money accumulates rapidly. Deposit of each coin registered automatically. Capacity \$30. Bank opens when \$5 or multiple thereof has been deposited. Cannot be opened otherwise. Made of solid steel, oxidized copper finish. Size 2½x3¼ ins. Price \$1.00, prepaid in U.S. Money back if not satisfactory. Order NOW. VICTOR H. GRAB & CO., 844 Ashland Block, Chicago, Ill.



On or Off in Five Minutes

Makes a Motor Boat of ANY Boat
AND also "makes good" on shore

Here is the famous original Portable marine motor, now adapted for also running a hundred different small machines ashore. Simple—light—strong—**SOLD ON THIRTY DAYS TRIAL**—Money back if you say.

**"PORTO" the Marine and Stationary Engine
Combined—TWO MOTORS IN ONE**

A reliable 2 h. p. motor that will drive an 18 ft. rowboat 7 miles per hour for 4 hours on a gallon of gasoline, or in five minutes can be mounted for use in shop, laundry, barn, or any other place desired. Write Quick for new "Two-in-one" catalog, mailed free. Orders filled in order of receipt. Don't delay.

WATERMAN MARINE MOTOR CO. 1507 Fort St., W., DETROIT, MICH.





THE SCRIPPS

COMPLETE MARINE POWER PLANT furnishes one of the most reliable sources of power for a boat that I know of. It always comes out of every severe test with honors. It received a perfect score in the Great Lakes reliability run last summer, which was indisputably strenuous. It was the motor used by Captain Larson in the boat with which he successfully navigated the Niagara whirlpool and rapids. In the race across the Gulf of Finland; in the single hull competitive test in New Zealand, and in many other events in all parts of the world it has demonstrated its dependability and superiority."

Scripps marine power plants, the motor that really did master Niagara, are made in one to six cylinder sizes, 4 to 96 horse power. Write for special information on our heavy duty types.

SCRIPPS MOTOR COMPANY
650 Lincoln Ave. DETROIT, MICH.

Scripps Motors are carried in stock by

BOWLER, HOLMES & HECKER CO., 142 Liberty St., New York, N. Y.

MUSICAL PRODIGY—A 7-year-old boy of Rennes, France, is the latest musical prodigy to burst upon the world. He is an admirable, even a brilliant, pianist, but has genius for composition, and sonatas, symphonies, piano pieces of all kinds, flow from his pen. It is said to be pretty good stuff, too. A number of the great composers began to invent melodies before the age of 7.—Detroit Free Press.

Congress has been asked to commence the coinage of half-cent pieces and to begin recoinage three-cent pieces.

Do you know what you can do with this **RED DEVIL**?



It's an automatic feed, ball bearing *Chain Drill*. It's a portable drill press and with an ordinary bit brace you can drill a hole in ANYTHING, Iron, Steel, Slate, Marble. The Giant chuck holds bits or drills up to 1/2 inch. Every amateur or skilled mechanic should own one of these practical and labor-saving attachments. Your local hardware man has it or will get it for you. Just insist on RED DEVIL No. 2018. But if you can't get it locally, send us \$3.00 and his name, and one sample only will be sent you prepaid.

SMITH & HEMENWAY CO.
151 Chambers St., N. Y., U. S. A.

"ALL ABOARD FOR EUSTIS"



Eustis, Florida

The geographical center of the state. 180 feet above sea level. The Queen City of the famous lake region. More than 1000 clear water lakes in the county. Water communication with the Atlantic through the world renowned Ocklawaha and St. Johns Rivers. Long distance telephone, electric lights, public water supply, etc. No finer all year round climate in United States. Come and investigate. This is not a land speculating scheme.

For Booklets or other information address

EUSTIS BOARD OF TRADE

Write today for full particulars of this **WONDERFUL 3-H. P. ENGINE**

Very simple and easy to engineer, yet has the latest improvements of the day. Prices attractive. Shipped on trial.

MILWAUKEE GAS ENGINE WORKS
116 Grand Ave. MILWAUKEE, WIS.



No. 1 **Hang Your Pictures** (weighing up to 100 lbs.) with Moore Push devices. Their tool-tempered steel points will not disfigure plaster walls.

Moore Push-Pins

glass heads, steel points. Try them for calendars, small pictures, etc. Push them in; no hammering. Nos. 1 and 2, 1/2 doz. 10c.

Moore Push-less Hangers (brass hooks, steel points inclined downward) will support hall-racks, mirrors, etc. No moulding required; no picture wire need show. Easily put up. No. 25 (holds 20 lbs.), 1/2 doz. 10c.; No. 26 (holds 100 lbs.), 1/2 doz. 10c.

Moore Push Thumbtacks needle-like points firmly embedded in fat brass heads; useful everywhere. Three sizes: Nos. 31, 32 and 33, 1 doz. 10c. At stationery, hardware, photo stores or by mail. Send 10c. stamp for samples.

No. 25 **Moore Push-Pin Company, 1152 Sanson St., Philadelphia, Pa.**

\$13
in U.S.A.

Bennett



A Brand New Typewriter for \$18

That does work equal to any \$100 machine

That's what you get in this unique, wonderful little typewriter, so small it can be carried in pocket or grip, with every modern improvement. Standard keyboard 84 characters. **Use It 10 Days Free**

Get out letters, orders, records, etc., on train, in office, at home, everywhere—see the neat, rapid work the **Bennett** does—we know you'll decide to keep the machine. Write for catalog and free trial offer.

Foreign Address: 75 Cannon St., London, E. C.

Splendid chance for agents. **P. V. Bennett Typewriter Co., 366 Broadway, New York**



3 Years to Pay

for the Sweet-Toned

Meister

Piano

\$175

30 Days' Free Trial We Pay the Freight

You are not asked to deposit, or pay or advance a cent in any way until you write us and say that the MEISTER is entirely satisfactory and you wish to keep it. These are the terms of sale:

\$1 a Week or \$5 a Month

No cash payment down. No interest on payments. No extras of any kind. Piano stool and scarf free.

Sold direct from the maker to you at a guaranteed saving of \$100. No dealer's profit for you to pay. Send now for our beautiful Free Catalog, which shows eight styles of Meister Pianos.

Our resources exceed \$4,000,000. We sell more pianos direct to the home than any other concern in the world.

Rothschild & Company

Dept. 16Y, Chicago, Illinois

WHEN YOU WANT ANYTHING AND DON'T KNOW WHERE TO FIND IT—WRITE BUREAU OF INFORMATION, POPULAR MECHANICS, CHICAGO



YOU Can Build This Handsome Power Boat

Only \$25 for knockdown frames, patterns, and instructions for this 21 footer—speed 9½ to 14 miles an hour. Everything made simple. Easy to build if you can handle hammer, saw and screw driver. We also furnish complete knockdown boat. Or patterns alone at from \$2 to \$12 according to design. Thousands of Brooks boats in use and building now. It's fun—and profit—and pleasure to build a boat.

WRITE FOR BROOKS BOAT BOOK TODAY

Just a postal. Mailed free. Scores of Models and sizes of all kinds illustrated. Save ½ the boat builder's price. Get our offer. Address

Brooks Manufacturing Co., 8009 Rust Ave., Saginaw, Mich.

A Timely Book—Just Issued

Hand-Forging and Wrought-Iron Ornamental Work

By Thos. F. Googerty



Brief Outline of Contents

Introductory—The Spirit of Decorating—Correct Principles in Designing—Equipment—How to Draw the Iron—Working at the Forge—Various Processes described—Various Forms of Welding—Brazing—Twisting—Binding—Riveting—Scrollwork—Gilles—Welded Scrollwork—Box Forging—Embossing—Forms in Relief—Raised Forms—Special Designs—Drawer Pulls and Hinges, etc.—Door Plates—Iron Lamps.

208 Pages, 122 Illus., Price \$1 Postpaid

POPULAR MECHANICS BOOK DEPT.
318 W. Washington St., CHICAGO

MOTORCRAFT ENCYCLOPEDIA

The Standard Hand Book on BOATS and ENGINES

Written in popular language from a non-technical standpoint. Contains over 150 pages of valuable information. Twenty-seven chapters, covering every phase of motor boating. Tells a thousand-and-one things every motor boatman should know. Helps you to overcome all motor boat and engine troubles. Handsomely illustrated and bound in attractive three-color stiff board cover. A useful reference book for any library.

SUMMARY OF CONTENTS:

The evolution of the motor boat. Various types of motor boats in common use. The Built to Order, Stock and Knock Down Boat. How to select a motor boat. Points to be observed in buying a second-hand boat. How to build a motor boat. Smoothing off and calking. How to paint a motor boat. How to install a marine motor. The history of the internal combustion motor. Explanation of two and four-cycle motor. Internal combustion motor auxiliaries and their functions. How to operate an internal combustion motor. Engine trouble. Propeller wheels. Reversible equipment. Furnishings and fittings. Navigation rules. Distress signals. Harbor regulations. U. S. Life Saving Service signals. National Motor Boat Bill. What to do in case of accident. Rules for determining horse power. How to lay up boat and engine for the winter. How to remove carbon deposits, and other useful receipts. How to build a motor ice boat. Dictionary of Motor Craft terms.

TROUBLE CHART—Enables you to locate any ordinary engine trouble with dispatch.

Price \$1.00 Postpaid

POPULAR MECHANICS BOOK DEPT.
CHICAGO

Stoves on Credit Our \$1 Gift

Our new Stove Book shows 456 Heating Stoves and Ranges—the entire Empire line. Prices run from 89c up. Stoves for wood, coal, gas or oil.

It quotes these stoves at one-third less than store prices. It offers to send them on 30 days' trial, subject to return.

You can buy on credit, on open charge account. No interest, no security, no red tape. You can pay as convenient, a little each month. Take a year, if you wish, to pay. A million people buy home things here on credit.



Stove Book Free

If you ask for this Stove Book before Oct. 1 we will send a Dollar Certificate with it. We accept the certificate as part of the first payment—just the same as cash. We make this offer to get an early decision, for hundreds of orders every fall come too late to fill.

Write today and get this Dollar Gift. Simply say, "Send me your Stove Book." Address

3719 Wall St., Chicago

Spielgel-May-Stern Co.

AEROPLANE DAMAGED BY RIFLE SHOT—When the aeroplane of Dr. W. W. Christmas of Washington, which was to have begun an aerial mail service between New York and the capital, was being tried near New York, someone either through pure cussedness or foolishly mistaking the machine for a big bird shot at it with a rifle. He hit the propeller and broke it and put the engine out of business, so the aviator had to plane down to earth, narrowly escaping disaster. The bullet had gone through the thin wall of the engine cylinder and was found inside. Dr. Christmas has offered a reward of \$1,000 for the arrest of the man who fired the shot.—The Pathfinder.

ADD TO YOUR INCOME



The "AMERICAN" KEY-CUTTER is an easy money-maker—the only machine for cutting keys with either square or any other shape slots.

IT'S A LITTLE WONDER

Write and we will tell you all about it. Address

AMERICAN SHARPENING MACHINE CO., Inc.
Dept. 9, 184 W Washington St. Chicago, Ill.

Pat. pending



Circular Metal Cutting Saws

for Newton, Higley, Q & C, and other makes of machines

Hot Saws and Friction Discs

for cutting structural shapes and rails.

Circular and Band Wood Saws, Planing and Machine Knives. Shear Blades, Tools, etc., etc.

Write for Catalogue P. M.

C. A. HILES & CO.

14th St. and Western Ave., CHICAGO



One of Our 38 New Styles

Greatest of All Piano Offers

Here is truly the greatest offer ever made on a high grade piano. The new and perfected Wing piano—an instrument in a class with the few choicest makes, an instrument endorsed and used by famous artists—acknowledged by experts as the equal and considered by some experts as the superior to the other best makes. Shipped to you absolutely free.

THE WING—especially the New Wing, represents supreme piano quality throughout. This new Wing piano is offered direct at the very lowest price, and all middlemen's profits, the huge, enormous commission of dealers and music teachers are all cut off. Yes, you save all these big profits for yourself when you get the Wing.

Examine Our Great Offer!

Those who want a cheaply built bargain piano, with no power or sweetness of tone we cannot reach. But if you want a piano of quality—while saving hundreds of dollars—yes, hundreds of dollars, you should examine our offer.

We offer to ship you a Wing Piano on approval. We Pay All Freight

We will positively save you from \$150 to \$250 in the purchase of a piano of high quality and recognized merit. We offer to convince you by shipping your choice of a Wing Piano on approval. All freight prepaid—no money down—absolutely free trial—four weeks free trial in your home. Don't fail to investigate this great offer.

Send Free Coupon NOW

To every one interested in pianos who sends coupon now we will send one copy of "The Book of Complete Information About Pianos" FREE. A magnificent work of 156 pages. Full of valuable piano information from cover to cover. The New York World says: "A book of educational interest every one should own." Besides we send you a beautiful art catalog, illustrating Wing pianos. No obligations—just fill out coupon and send to-day while this offer lasts.

Remember, you get four weeks' free trial of the Wing. We ship you the piano before you pay one cent. **We pay all freight.** Send free coupon now.

WING & SON (Est. 1868)

WING BUILDING

9th Avenue and

13th Street

Dept. 1196

NEW YORK, N. Y.

FREE COUPON

Wing & Son

9th Avenue and 13th St.

Dept. 1196

New York City, N. Y.

Gentlemen:—This is no order for anything, but you may send me free and postpaid one copy of the "Book of Complete Information About Pianos." Also send free and postpaid your catalog of art styles, and full particulars of your Wing offer.

Name
Address

Please Mention Popular Mechanics

HANSON VISE



No. 1. An Anvil with Chilled Face



No. 2. Combination Anvil and Vise



No. 3. A Saw Clamp

5 Tools in 1

For Farm Tool and Shop Repairs, Mechanics, Garages and Manual Training Schools

This Handy Tool is a time saver and can be used for so many purposes that it pays for itself in a short time.

5 in 1
Anvil
Anvil Vise
Saw Clamp
Drill Press
Pipe Vise

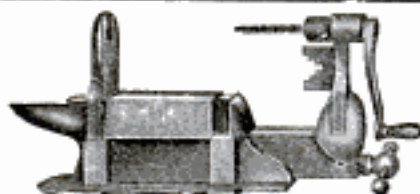

No. 4. A Drill Press



No. 5. A Pipe Vise

Thousands in Use

Money refunded if not as claimed after One Month's Trial

Price \$6.00

For Sale by the Hardware Trade or

Stowell Mfg. & Fdy. Co., Dept. P. M., So. Milwaukee, Wis., U.S.A.

In writing us please give name of your hardware dealer

YOU CAN BUILD THIS
"IDEAL" THREE-FOOT RACER
IN ONE HOUR AND FLY IT OVER 1000 FEET
Complete materials with instructive plan and finished propellers
PREPAID, \$2.00. 50c extra for "Ideal" Patent Friction Winder.
IDEAL AEROPLANE SUPPLY CO., 82-88 West Broadway, New York

SAVE 1/2 ON JEWELRY
Buy direct from manufacturer. Save middleman's profit. Immense catalog free. Send 10c to cover postage, packing, etc. Special offer: Genuine Arabian Diamond Stud or Pin (Retail at \$1) sent with catalog free.
CHAS. CUMINGS CO., 117 Lowell Bldg., CHICAGO

WHEN YOU WANT ANYTHING AND DON'T KNOW
WHERE TO FIND IT—WRITE BUREAU OF
INFORMATION, POPULAR MECHANICS, CHICAGO

ORIGIN OF BELLS—Bells tell a wonderful story of the power and persistence of the state of mind known as superstition. They had their origin in China a great many centuries ago, and their first use was to dispel and clear the air of "evil spirits," also to break up and drive away storms. From China bells were eventually introduced to the countries of Europe. Old English records tell us how the tolling of bells kept the "spirits of darkness" from assailing people while in the act of worship. Hence the connection of bells with churches. It was only at a comparatively late date that bells were used for calling people to church. For ages they were designed solely for keeping the "devils" at a safe distance.—Los Angeles Times.

How To Build

This Beautiful Home

For **\$3,000**
Only

Living Room, Dining Room and Kitchen Downstairs — Three Bedrooms and Bath Room on Second Floor

Completely Explained in Detail in

KEITH'S MAGAZINE

For September

The Leading Home Builders' Guide

At News Stands **20¢**

Keith's Magazine

Issued monthly—contains 72 pages or more, including 5 or 10 plans by leading architects. Keith's is the recognized authority on building and decoration. Subscription \$2.00 or at news stands per copy 20c.



KEITH'S BOOK OF PLANS

Keith's Architectural Studies giving views, large floor plans, cost, etc., at \$1.00 each. Any one of these \$1.00 plan books free with a year's subscription, \$2.00.

Keith's Book of 215 Bungalows and Cottages, postpaid for \$1.00

Keith's Book of 200 Attractive Homes, \$2000 to \$4000, postpaid for \$1.00

Keith's Book of 175 Attractive Homes, \$4000 to \$5000, postpaid for \$1.00

Keith's Book of 172 Attractive Homes \$5000 to \$6000, postpaid for \$1.00

Keith's Book of 125 Attractive Homes, \$6000 and up, postpaid for \$1.00

Keith's Book of 100 Cement and Brick, postpaid for \$1.00

Keith's Book of 50 Modern Garages, postpaid for \$1.00

Keith's Book of 250 Beautiful Interiors, postpaid for \$1.00

M. L. KEITH, 389 McKnight Building, MINNEAPOLIS, MINNESOTA

Please Mention Popular Mechanics



Planning Your Home—

Every ambitious young couple are planning upon owning a home sooner or later, and they should. The fact that you do own your own home, whether plain or palatial, gives you a feeling of independence. It is the foundation for future happiness.

How to Get the Best Results at Lowest Cost

Begin right. Know as much about the building material as you do about the plans—learn all the details, then you will know as much about material and the best way to build as your carpenter or contractor. You will know whether you are being "done" or not. You can check up the work every day. This is the only way to be on the safe side, the only way to get value received for every dollar spent.

First You Need This Plan Book The Americal School's new book, "Modern American Homes," is the most complete Plan Book that has ever been offered. It contains hundreds of valuable suggestions, besides 108 plates showing exteriors, plans, elevations, details and interior decorations. It gives the name of the architect, cost and date of erection, location, material, and in many cases, detailed estimates. This great book of plans is 9 1/2" x 11" in size, printed on special paper and substantially bound. Besides the large variety of modern homes, it also contains a variety of tent houses, garages, boat houses, apartment buildings, libraries, churches and institutional buildings. The best in modern architecture is shown by the greatest American Architects. It is the best plan book that has ever been offered because the selections were made from the best works of the best architects and because it is the only book of its kind ever gotten out with an idea of having it strictly up-to-date and with enough variety to suit every class of builder.

Then You Need This Great Cyclopedia of Architecture and Building

Ten massive volumes; 4,760 pages, 7x10 inches; 4,000 illustrations, full page plates, building plans, diagrams, etc.; hundreds of valuable tables and formulas; carefully cross-indexed for quick, easy reference.

The Cyclopedia of Architecture, Carpentry and Building covers the entire work of the building professions, from the first rough sketch of the architect to the acceptance of the finished structure. It includes wood, stone, steel, and reinforced concrete construction; estimating and contracting; a study of the Greek and Roman Orders; interior finishing and decorating; and modern house lighting and sanitation. See partial table of contents below.

PARTIAL CONTENTS OF CYCLOPEDIA:

Mechanical, Freehand, Perspective and Architectural Drawing, Lettering, Pen and Ink Rendering, The Orders, Superintendence, Strength of Materials, Masonry, Reinforced Concrete, Carpentry, Steel Square, Stair-Building, Hardware, Steel Construction, Roof Trusses, Practical Problems, Estimating, Contracts, Specifications, Building Law, Sanitation, Sheet Metal Work, Electric Wiring and Lighting.

Here is Our Big Free Offer With every Cyclopedia we will include the Plan Book absolutely free of charge and send you the entire set, express prepaid, for seven days' free examination. You keep the books a full week—examine them thoroughly at your leisure—and if they don't meet with your expectations they may be returned at our expense. Remember—the complete set, Cyclopedia and Plan Book, are sent free upon receipt of the coupon below and we pay express charges both ways if they are not satisfactory.

Another Free Offer

With each set is included a year's Consulting Membership entitling you to the free advice of a corps of Expert Architects. This will give you practical help in handling working problems which are too specific to be taken up in detail in the Cyclopedia. A single problem solved for you might be worth more than the first cost of the books.

American School of Correspondence
Chicago, U. S. A.



Pop.
Mech.
9-12

A. S. of C.

Please send Free Plan Book and Cyclopedia of Architecture, Carpentry and Building for seven days' examination. I will send \$2.00 within seven days and \$2.00 a month until I have paid \$4.00 for Cyclopedia (Plan Book included free), or notify you and hold books subject to your order. Title not to pass until fully paid.

NAME

ADDRESS

OCCUPATION

EMPLOYER



Please Mention Popular Mechanics

BOOKS-THAT-TELL-HOW-TO-DO-THINGS

One man made and sold \$400.00 worth of one piece

Mission Furniture, How to Make It IN TWO VOLUMES

PART ONE—Plain directions with working drawings and illustrations for making 21 different designs. 96 pages. PART TWO—32 additional designs treated in the same manner. 128 pages.

Artistic. Inexpensive. Easily made in the home

Arts-Crafts Lamps, How to Make Them

By J. D. ADAMS

Explicit instructions for making 16 different beautiful lamps out of paper, cardboard and wood. A working drawing and illustration accompany each design. 96 pages.

18 beautiful designs which the amateur can easily make

Lamps and Shades in Metal and Art Glass

By JOHN D. ADAMS

Four different kinds of construction, built up—soldered—etched and sawn shades are treated. The designs range from ordinary reading lamps to pretentious chandeliers. 128 pages.

Covers every essential step in wood-working

Wood-Working for Amateur Craftsmen

By IRA S. GRIFFITH, A. B.

Special chapters bring out every cut, joint and process, proper use and care of tools, working up of material, etc. 128 illustrations. 128 pages.

A complete handbook for art metal workers

Metal Work and Etching

By J. D. ADAMS

Gives every detail for making a great variety of useful and ornamental objects such as book ends, desk sets, jewelry, hinges, drawer pulls, paper knives, letter openers, match boxes, tie and pipe racks, pad corners, etc. 50 illustrations. 96 pages.

The only book published on this interesting art

Metal Spinning

By PROF. F. D. CRAWSHAW

A practical working manual for those who desire to spin metal as an art recreation or to follow this work as a trade. 33 illustrations. 80 pages.

Authorities proclaim it one of the best books on the subject

Electroplating

By HENRY C. REETZ

A treatise which will not only enable the humblest beginner to make a start, but which gives pointers of value to even the most experienced electroplater. 62 illustrations. 112 pages.

Any boy can construct this at a trifling cost

How to Make a Wireless Set

By ARTHUR MOORE

Explains in an understandable manner the construction of an outfit suitable for transmitting 4 or 5 miles. Fully illustrated. 96 pages.

A wonderful story

HEAT

By PROF. J. G. OGDEN

An immensely interesting and instructive book pertaining to heat and its relation to modern mechanics. 50 illustrations. 128 pages.

One of the most remarkable non-technical books written

The Kingdom of Dust

By PROF. J. G. OGDEN

The author deals with this vast kingdom as: A Boundless Domain, The Friend of the Housewife, The Foe of the Workman, The Skeleton in the Closet, The Right Hand of Death, Earth's Winding Sheet, Beginning and Ending of All Things Earthly. 40 illustrations. 128 pages.

A uniform series. Size 5 x 7 inches. Extra cloth covers.

PRICE EACH, 50 CENTS POSTPAID

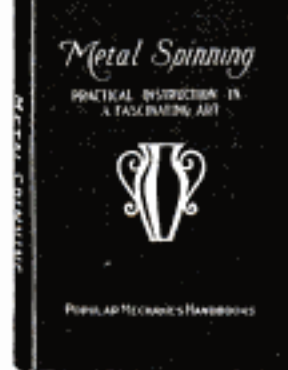
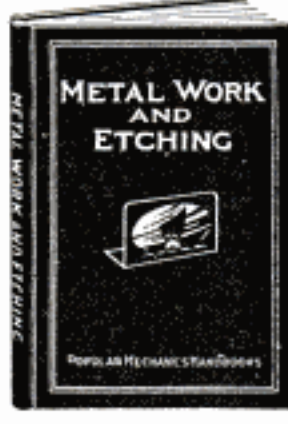
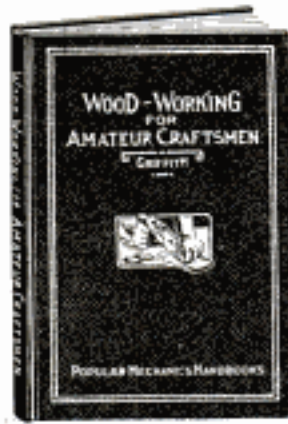
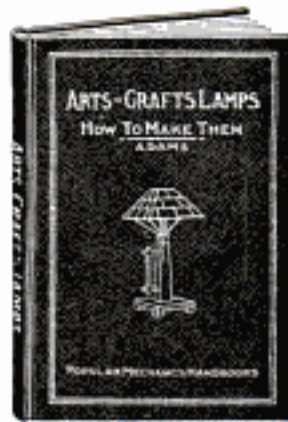

Popular Mechanics Book Department, 318 W. Washington St., Chicago



Hillery Beachey

flying Brooks Biplane at Chicago with both hands off the controls.

Let us send you our literature fully describing the types of aeroplanes we have developed.

Hydro-Aeroplane	Popular priced machine fully equipped
Biplane	\$1500.00
Tractor-Biplane	Immediate delivery; correspondence solicited. Alexander Hamilton, Constructing Engineer.
Monoplane	

Brooks Aeroplane Company
209 Rust Ave., Saginaw, Mich., U.S.A.

In the Port Antonio market, on the Island of Jamaica, negroes may be seen selling "rope" tobacco by the yard. It is smoked by the natives, and derives its name from the fact that it is twisted and put up in coils like rope, 200 yards to the coil.

A lost thumbnail will be generally replaced in five months and a great-toe nail required twice as long.



WOULD YOU

Show this wholly visible Typewriter to your friends and let them see wherein it excels any \$100 Typewriter made, if we would send one to you Free of One Cent of Cost for you to keep forever as your own? Then on a postal card, or in a letter to us simply say: Mail particulars.

EMERSON TYPEWRITER CO., Box 100, Woodstock, Illinois

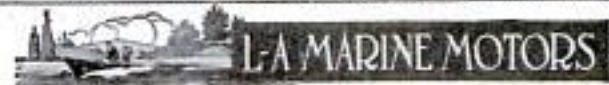

Good Times Guaranteed

If you put a Lockwood Ash Motor in your boat you are sure of pleasure unmarred by motor troubles. You will get the biggest value for your money because

We Sell on 30 Days' Trial

AND we guarantee every engine for a year besides. Guess our motors must make good—what? Ask any of our customers, whose names we will gladly send you—some near you, too. **PROMPT SHIPMENTS.** WRITE TODAY and get our handsome 1912 catalog. Tells everything—shows all parts—quotes right prices.

LOCKWOOD ASH MOTOR CO.
108 Horton St. JACKSON, MICH.

If Mercury and Air Didn't Go Up Fountain Pens Wouldn't Leak

WHEN mercury in a thermometer gets warm it goes up.

When air in a fountain pen gets warm in your pocket it goes up too—up the feed tube.

Now, this "going up" habit of air is what makes all the ink-smearing trouble.

It happens like this: When you set an ordinary fountain pen in your pocket, point up, some lazy ink stays up in the feed tube—won't all run down.

Up goes the heated air through the inky feed tube, pushing the lazy ink up and out, all over the writing end of the pen.

Now, George S. Parker, of Janesville, Wisconsin, said: "I'll get all the ink down out before the heated air goes up."

So he invented a curved feed tube, which bends and touches the barrel wall. This touch sucks all ink out of the feed tube and drops it in the reservoir below the instant you set a Parker Pen in your pocket.

That is what makes it impossible for air to force ink out on the writing end of a Parker Pen.

The curved feed tube is called the Lucky Curve, and that queer force, Capillary Attraction, which makes a sugar lump suck coffee, is what sucks the ink out of the Lucky Curve.

Parker Pens write smooth as glass, for the 14k gold pens are pointed with hardest Iridium. And the Parker Spear Head Ink Controller never allows any blotting or skipping.

PARKER

LUCKY CURVE

FOUNTAIN PEN

Standard Style Parker Lucky Curve Fountain Pens, \$1.50 to \$250.00, according to size and ornamentation.

New Parker Jack Knife Safety Pen won't leak in any position. Carry it upside down in pocket of your white vest. Pen knife size for lady's purse. Prices \$2.50 up.

New Parker Disappearing Clip



grips like a snapping turtle, but slides back into its shell when you want to write.

Dealers sell Parkers on 10 days' trial. If unsatisfactory your money quickly refunded.

If your dealer doesn't keep Parkers, send us his name. We'll send you catalog and fill your order direct. *Do it today.*

Parker Penn Co., 100 Mill Street
Janesville, Wisconsin

New York Retail Store
11 Park Row Opposite Post Office



VALPARAISO UNIVERSITY

(Accredited)

Valparaiso, Indiana

One of the Largest Institutions of Learning
in the United States

In 1873 the school had 3
Departments, 4 Instructors
and an annual enrollment
of 210 different students.

Now there are—

26 Departments
195 Instructors

and an annual enrollment last year of
5625 Different Students Excellent Equipments

The reason for this remarkable growth is in the fact that the
Institution is constantly increasing its facilities, strengthening
its courses of study and offering additional advantages, without
making the expense to the student any greater.



VALPARAISO UNIVERSITY BUILDINGS

DEPARTMENTS

Preparatory, Teachers', Kindergarten, Primary Education,
Manual Training, Scientific, Biology, Civil Engineering,
Classic, Higher English, German, French, Spanish, Italian,
Elocution and Oratory, Music, Fine Art, Law, Pharmacy,
Medical, Dental, Commercial, Penmanship, Phonography
and Typewriting, Review.

THE DENTAL DEPARTMENT

of the University, is the well-known Chicago
College of Dental Surgery, one of the oldest
and best equipped dental schools in the country.
Dr. Truman W. Brophy, Dean, Chicago, Illinois

MEDICAL DEPARTMENT

The course of study in the Medical Department is the same as
that of the best medical schools. The University owns its college
and hospital buildings both in Chicago and Valparaiso. Two years
of the work may be done in Valparaiso, thus reducing the expenses,
or the entire four years may be done in Chicago.

THE NEW MUSIC HALL

enables the School now to accommodate all who wish
work in music.

CIVIL ENGINEERING

The Revised Course in Civil Engineering is proving
a most valuable acquisition. No extra charge.

Free
Catalog
Coupon

The expenses are made so low that
any one can meet them.

Tuition, \$18 per quarter of 12 weeks.

Board and furnished room, \$1.70 to

\$2.75 per week.

Valparaiso
University
Valparaiso, Ind

Please send me your
Illustrated Catalog
Free as advertised in
Popular Mechanics.

Fill out and mail attached coupon
for FREE Catalog giving full par-
ticulars, or write today.

Address,

H. P. BROWN, Pres., or
O. P. KINSEY, Vice-Pres-

NAME

ADDRESS

The Fortieth Year will
open Sept. 17, 1912

Please Mention Popular Mechanics

YOU'LL NEVER HAVE A BETTER CHANCE To Become a Draftsman

FREE SCHOLARSHIP covering a Course of Instruc-
tion which will *thoroughly*
train any ambitious person as a first-class Draftsman.
The offer of this Free Course is made to gain new friends
and to show to a limited number the superior grade of
instruction furnished by this institution so that we can
have their assistance in obtaining new students for us.

This Offer Will Be Withdrawn Soon

Send for particulars at once to
STUDENTS UNION CORRESPONDENCE SCHOOLS
689 Mass. Ave., CAMBRIDGE, MASS.

AN ART SCHOLARSHIP FREE

WRITE AT ONCE for full particulars of this ex-
traordinary offer. No charge. No obligations.
Your Opportunity to learn a pleasant and profit-
able accomplishment. If you love the beautiful,
you possess artistic talent. **Secure a Scholarship**
and cultivate this talent. **Increase your income**
by making your natural ability bring you financial
returns. Learned at home during spare moments.
SUCCESS ASSURED. Offer includes Art Prospectus.
Don't wait. **WRITE TODAY.**

FINE ARTS INSTITUTE Studio 119F OMAHA, NEBR.

START A PROFITABLE BUSINESS OF YOUR

OWN at home, making and selling hand hammered copper
ware. It's easy to make trays, bowls, candlesticks,
jewel boxes, smoking sets, photo frames and many other orna-
mental and useful gifts. We give detailed instructions and
furnish the necessary tools and materials. Their cost is prac-
tically nothing in comparison with what you can sell your first
work for. Send for free booklet explaining the proposition.
THE KORO-KRAFTS SHOPPE, 8620 Superior Ave., CLEVELAND, O.

AN AGED GRAPEVINE—One of the most wonder-
ful plants in the fruit-bearing class is the scuppernon
grape. It is an old and excellent variety, and in a
number of instances the vine has been known to live
and bear fruit for many years.

When Sir Walter Raleigh's party sailed from England
to the new world in 1584 it is said they planted one of
these vines on Roanoke island in North Carolina.

This vine is still there and is bearing big crops of

Stereopticon Lanterns

for Societies, Churches, Halls and Theatres.
Electric Calcium and Acetylene
outfits. Oldest and most reliable
House in the country.



Moving picture machines and accessories,
new and second hand. Correspondence will
receive prompt reply.

The Stern Manufacturing Co.
109 No. 10th St., Philadelphia, Pa.
14 Years in the Business

Makes Old Style Razor \$1.00 Safer Than a Safety POST PAID

You cannot cut your face if you use a **Best Razor Guard**. Fits
any razor—slips on and off easily and quickly. **Reversible** and
adjustable, permitting shaving with either hand, "close" or
"once over." Nothing like it—light, simple, practical and dur-
able—lasts forever. Always ready—nothing to break—cannot
nick or dull blade. Any man can use it. Old style razors shave
the easiest—the "Best" Razor Guard makes them safe. Costs
only \$1.00—saves \$36.50 yearly barber expense. Sold only
direct. Heavily nicked, encased in handsome satin-lined
leatherette case, for \$1.00, postpaid.

FREE—Valuable book: "Advice to Shavers."
MONEY BACK GUARANTEE—Order now—if you are not sat-
isfied your money will
be refunded.

GIVEN AWAY—RAZOR
Ask us how we give
away genuine \$2.50 razors.
Send \$1.00 cash,
P. O. or express money
order. Agents wanted.
BEST SALES CO.
1403 Old Bldg.,
CHICAGO



Big Money MAKING CEMENT PIPE

There are openings in every locality for good cement pipe plants, making drain and sewer pipe, irrigation pipe, well casings, pipe for water mains, manholes, etc. A small investment will start you in this splendid paying business. You'll be surprised how much business there is to be had.

Few people realize the opportunities and the profits in this line. It only requires a few moulds, tools, sand and the labor to make them. It is the only business in which you can turn over your money four or five times in a year.

Figure the Profits for Yourself

With only one pipe mould two men can turn out from one to two hundred feet a day and with a profit of only \$1.64 per foot, which is very small, you would realize a net profit of from \$4 to \$8 per day, paying yourself and men good wages besides. On large sizes the profit is enormous—\$1.50 to \$2.00 per foot.

How to Start

Send for our 22 page catalog and get posted on this line. We furnish cuts and write-ups for your local newspapers, and assist you in different ways in starting the business. We have started over 3,000 men and firms in business, making cement sewer and drain pipe, most of whom make from two to five thousand dollars per year. We can tell you all about the secrets of this

most successful and attractive business. Particulars sent on request. The big *Northwestern* line includes also block and brick machines, mixers, lawn mowers, flower boxes, jardinières, burial vaults, tools,—in fact everything used in the manufacture of cement articles. Write today.

NORTHWESTERN STEEL & IRON WORKS
1102 Spring St. EAU CLAIRE, WIS.



This 30 year old pipe stood 33,200 lbs. pressure.



Be a Meter Engineer

Learn the new profession. Meter Engineers are in constant demand everywhere. Exceptional opportunities, big money. You can learn Meter Science right in your own home during your spare time. No necessity of leaving your present employment. Don't be just "one of the men"—learn how to use your brain.

Earn \$3000.00 a Year

Experts in the profession of Electrical Meter Engineering are scarce. Central Stations all over the country will pay high salaries for their services. Our graduates are everywhere holding responsible positions and making big money. You can do the same. Send the free coupon for full particulars.

Men Wanted—NOW!

Over 500,000 new electric meters are being installed this year—over 1,000,000 are now in use. Just think of the vast army of men that are needed to take care of them. It has been impossible to get enough Meter Engineers. They are needed in every state. Central Stations must have them. Get into the new profession—the profession that is not overcrowded. We can teach you Meter Engineering in your home by mail during your spare time.

40-Page Book FREE

Just put your name and address on the free coupon or on a postal or letter and send to us today. We will send you our 40-page book on Meter Engineering. It tells you all about the new profession. The book is free and prepaid. No obligations of any kind. Just your name and address on the coupon brings it to you.

Send the FREE Coupon

Do not delay a n instant. This is your opportunity to join the new profession while it is still young. Just put your name and address on the free coupon or a letter or a postal and we will tell you about the special offer that is now being made to induce men to study Meter Engineering. No obligations of any kind. Mail that coupon this instant.

Ft. Wayne
Correspondence
School

Dept. 1126

Ft. Wayne
Ind.

Name.....

Address.....

Free
Book Coupon

Ft. Wayne Correspondence
School Dept. 1126
Ft. Wayne, Ind.

Gentlemen: Please send absolutely free and prepaid your book on Meter Engineering. Also send me full particulars of the great special offer that is now being made to induce men to study Meter Engineering. I assume no obligations of any sort.

delicious fruit. It is a thrifty vine, and covers quite a lot of land with its fruit-bearing branches. The people who own it are taking the best of care of the highly prized relic of early history.

The men who planted it had no idea of the time it would live, and the wonderful progress the country would make before the vine saw the end of its usefulness.

Many persons have been offering good prices for vines started from this parent vine and for cuttings from its branches.—New York World.

MEN! MEN! MEN!

More Men Wanted Write Today—NOW

We want more men right away, and we will pay you big money—more money than you ever thought of making before. Just show our magnificent line of samples—the orders will come in a hurry. Exclusive territory open. Don't delay. Let us tell you how to get one of our handsome suits FREE. Write today.

Earn \$30 to \$50 a Week

Yes and then some. You can earn big money easily and quickly. No trouble at all in taking orders. Nice clean, easy work—short hours—and you are your own boss. Or you can keep your present position and make \$75.00 to \$100.00 a month on the side.

Let Us Start You in Business

Be your own boss. No need to trudge along on a salary. We'll start you in a business of your own—give you a chance to make big money easy. No money needed—no experience necessary. Write now!

Write Today Get full particulars of this exceptional offer right away. Just send post card or letter and we will tell you all about it. We send you all accessories—complete outfit free—for starting right in to make big money.

The Fidelity Tailors 651 South Fifth Ave.
Dept. 45, CHICAGO



700 Things That a Boy Can Make

1000 Illustrations That Thoroughly Show How



\$1

THE handsome set of four books—"Mechanics for Young America" and "Amateur Mechanics" (Nos. 1, 2 and 3)—each book bound separately in Illuminated Covers, and the whole set enclosed in a heavy Bristol Folding Case with extension clasp—will be sent prepaid to any address for \$1.00.

\$1

The Ideal Books for the Wide-Awake American Boy

Thoroughly Practical and Instructive

Besides telling how to make scores of things useful about the house, full and complete directions are given on constructing the following and hundreds of others things which appeal to the heart of every boy.

Electric Appliances—Steam and Gas Engines—Motors—Wireless and Morse Telegraph—Self-Propelled Vehicles—Toboggans, Bobsleds, Ice-Boats—Boomerangs—Paddle Boats, Canoes, Rowboats—Camping Outfits—Cabins—Tents—Fishing Tackle—Magic Lanterns—Searchlights—Cameras—Telescopes—Gliders and Aeroplanes—Kites and Balloons—Aquariums—Electric Furnaces—Electroplating Outfits—Lathes—Foundry Work at Home—Iron, Copper, Brass and Other Metal Work—Bookbinding—China and Pottery Kilns—Parlor Magic Tricks, etc.

Each book sold singly at 25c postpaid or the complete set for \$1.00

POPULAR MECHANICS BOOK DEPARTMENT

318 W. Washington Street, CHICAGO



A Valuable New Book on an Important Trade

PATTERN-MAKING

By G. H. WILLARD

With Additional Chapters on Core-Making and Molding

"WRITTEN SO YOU CAN UNDERSTAND IT"

A book for the man who does the work. Written by a practical pattern-maker of many years' experience. Gets right down to business in the first chapter and keeps it up throughout the book. Full of kinks and actual working information. Profusely illustrated.

Chapter Headings

I. Pattern-Making as a Trade. II. The Tools. III. Woods. IV. Joints. V. Turning. VI. Turning (Continued). VII. Turning (Continued). VIII. Turning (Concluded). IX. The Circular Saw. X. The Circular Saw (Continued). XI. Machine Tools. XII. Machine Tools (Continued). XIII. Simple Patterns. XIV. Simple Patterns (Continued). XV. Simple Patterns (Concluded). XVI. Crooked Patterns. XVII. Large Pattern Work. XVIII. Large Pattern Work (Continued). XIX. Crosshead Guide Patterns. XX. Sweep Work. XXI. Pipe Work. XXII. Stove Pattern Work. XXIII. Molding—Machine Work. XXIV. Molding Pattern Work.

Part II—Core-Making and Molding

Chapter I. Core-Making, Simple and Complex. II. Principles in Molding. III. Loam Patterns and Loam Molds.

Everyone following this trade, or intending to learn it, should have a copy of this valuable book. **Price, \$1.00 Postpaid**

Published by

POPULAR MECHANICS BOOK DEPT.

318 W. Washington Street, CHICAGO

Two Significant Opinions:

"I think the book is the best I ever saw for the price."
EDWIN SLUTTER, Construction Engineer, Burroughs Adding Machine Co., Detroit.

"I consider this is a valuable book and should be in the hands of all men engaged in this line of business."
E. W. CLARKE, Wilmington Malleable Iron Co., Wilmington, Delaware.

224 PAGES 312 ILLUSTRATIONS

CLOTH COVER



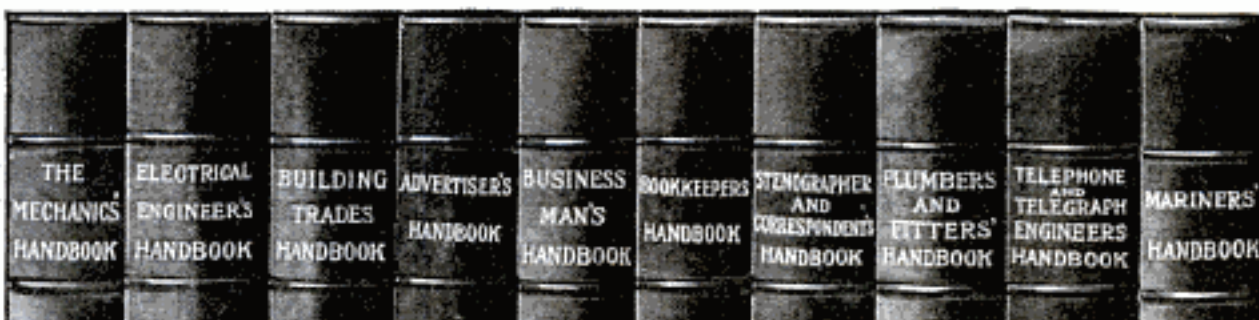

\$1.25 Handbooks for 50c.

No books in existence contain in so small space as much information about the trades and professions of which they treat as do these Handbooks. They are little giant encyclopedias of practical knowledge giving data and information that is hard to find in ordinary books. These Handbooks have been prepared by the well-known textbook writers of the International Correspondence Schools whose textbooks are recognized the world over as the most practical treatises on applied sciences ever published. These Handbooks are consulting experts of the highest rank, and are the most powerful force in the world for the promotion of ambitious men. They are an indispensable help to quicker and better work that will command advancement. They are printed on a high-grade book paper in clear type, and durably and handsomely bound in cloth with gilt titles; contain on an average of 364 pages and 175 illustrations and are regularly sold for \$1.25 each.

SPECIAL OFFER.—We are selling these Handbooks, durably bound in cloth with gilt titles, at a special price for each Handbook of 50 cents.

Mechanics'—Tables; formulas; measurements; belting; mechanical powers; hydro-mechanics; strength of materials; shafting; boiler design; care of boilers; power of boilers; chimneys; exhaust heating; machine design; machine tools; slide valve; pulleys; cylinders and steam chests; pistons; gearing; transit surveying; triangulation; curves; radii and deflections; earth work; track work; electricity; etc.

Advertiser's—How to plan and write an advertisement; type and type measurements; points on printing style; display; preparation of manuscript; proof reading; engraving and printing methods; electrotypes; matrices; advertisement illustrations; magazines; newspapers; retail, department-store, general, trade-paper, and mail-order advertising; trade marks; circulars; advertising agencies; etc.

Stenographer's & Correspondent's—Advice to beginners; shorthand speed; letters of application; punctuation; correct and faulty diction; business correspondence; type-writing; abbreviations; addressing; mailing; rates of postage; duplicating work; etc.

Telephone and Telegraph—Useful tables; mechanics; electricity; magnetism; primary batteries; storage batteries; electrical measurements; telephony; tests with magneto-generator and bell; telegraphy; Morse telegraph systems; multiplex telegraphy, etc.

Electrical Engineer's—Mechanics; electricity; electrical units, symbols and quantities; physical and electrical properties of metals and alloys; wire gauges; magnetism; dynamos and motors, electric batteries; alternating current apparatus; alternators; transformers; wattmeters; electric transmission; electric lamps; wiring; electric heating and welding; electromagnets; controllers; car wiring; etc.

Business Man's—Arithmetic; tables; business forms; card systems; measures of extension; weight and capacity; time; value of foreign coins; duties on imports; bookkeeping; stenography; correspondence; postal information; financial terms; money and the money market; brokers and brokerage; patents; copyright and trade marks; corporations; business law; publicity; etc.

Plumbers and Fitters'—Arithmetic; involution and evolution; powers, roots, and reciprocals; circles; decimals; geometrical drawing; weights and measures; formulas; mensuration; mechanics; hydro-mechanics; building construction; heating and ventilation; gas-fitting; plumbing; etc.

Mariners'—Logarithms; trigonometry; navigation; terrestrial navigation; celestial navigation; organization of a man of war; naval ordnance; explosives; torpedoes; ship building; speed, tonnage, and fuel consumption; ropes; wind and weather; signals; nautical memoranda; etc.

Building Trades—Loads and structures; strength of materials; properties of sections; strength of rivets and pins, materials of construction; footings and foundations; masonry construction; woods used in building; qualities of timbers; joinery; framing; estimating; elements of architectural design; drainage systems; plumbing fixtures; plumbers' tables; heating and ventilation; gas and gas-fitting; etc.

Bookkeeper's—Arithmetic; formulas; tables; money; percentage; interest; equation of accounts; money and the money market; business law; financial terms; banks and banking; postal information; distances and time between various places; bookkeeping; business forms; card systems; modern office methods; cost accounting; bank bookkeeping; clearing house methods; etc.

International Textbook Co.

Box 872, SCRANTON, PA.

I enclose \$_____ for which please send me the books BEFORE which I have marked X.

- Mechanics' Handbook Advertiser's Handbook
 Elect. Eng. Handbook Business Handbook
 Bldg. Trades Handbook Bookkeeper's Handbook
 Plum. & Fit. Handbook Sten. & Corr. Handbook
 Tel. & Tel. Handbook Mariners' Handbook

Name _____

St. and No. _____

City _____ State _____

Please Mention Popular Mechanics



THE SWEDISH VIBRATOR

An amazing scientific invention. Endorsed by physicians, athletes, actresses, judges, and thousands of men and women who have used it. Agents and Salesmen are wiring orders. Enthusiasm is unbounded. Every man and woman making money fast and easy. 100,000 already sold, 1,000,000 to be sold this year. Secure territory at once. Mail your application today, stating county you desire. This is the one important thing today—do it now.



Frank Gotch

Champion Wrestler of the World uses the Swedish Rhythmic Vibrator and says:

"For finishing up, keeping in condition and strengthening the muscles, there is nothing that equals or exceeds the use of the Swedish Electric Vibrator. I always use one in my training and I certainly find it a wonderful help. It reaches the seat of all stimulation and gives me a perfect circulation. Its use gives all the muscles elasticity, makes me powerful, quick and active."

"Being a firm believer in vibratory massage, I tried various makes of Vibrators, but did not find one of enough efficiency to withstand the severe use I put them to until I purchased yours. You have, in my opinion, the only perfect Vibrator on the market, and I can consistently recommend its use to all athletes and those who desire health and strength."

THIS OPPORTUNITY

is open to anyone who wants to make money and who is willing to work. We furnish complete instructions that enable you to start immediately. Nothing difficult. No experience required. We want applications from men and women in unoccupied territory everywhere—clerks, teachers, mechanics, farmers, etc., etc.—all can make money on this grand, sure, easy selling plan. Act today. Put your name and address on a postal card and mail it at once. Find out all about this tremendous opportunity.

THE SWEDISH VIBRATOR CO., Dept. 19, 215-230 Schiller St. CHICAGO, ILL.

This is an opportunity for you to make \$5000 this year as a high grade salesman. **No experience necessary. No delay. No charge for Territory. No competition. Exclusive field. Success assured. Remarkable offer.** Read every word carefully. Get an appointment and get started without delay.

We are appointing men every day to manage our business in local territories. We need **good, honest men who are willing to work**—and we will give you today this opportunity to

Make \$5000 This Year

It is the chance of a lifetime. You will be in business for yourself. You will be your own boss—**independent, abundant money, pleasant position**—and your time will be your own. **At home or traveling—all or spare time**—get an appointment immediately and commence earning money next week.

The Swedish Vibrator

Most amazing seller ever invented. **A new proposition for salesmen.** Endorsed by the highest authorities of the world. A machine for home massage and vibratory treatment. Can be operated by simply attaching to electric lamp socket, or by ordinary dry batteries—in cities, towns, country—anywhere, everywhere. Needed by every man, woman and family. **Anyone can use it.** Get complete literature free and learn the wonders of this brilliant invention—a machine that gives 30,000 thrilling, invigorating, penetrating, revitalizing vibrations per minute. One-minute demonstration gets the order. **Irresistible desire to own it once you feel the living, pulsing touch of its rhythmic vibratory motion.** Sold upon five-year, cash certificate guarantee and 30 Days' trial.

150% Profit Throw away the little novelties upon which you have to make ten or twenty sales a day to pay expenses. Become a real salesman and make real and quick and big money. **One sale a day means \$90 net profit a week.** Many averaging four, five and even ten a day. This is actually the most brilliant, easy and high class proposition that has ever been offered to wide awake agents, general agents, and managers.

Don't Delay Get free literature and complete information at once. Send just your name and address on a postal card and all will be mailed free immediately. **Agents' sample furnished at wholesale price. Investigate.** It costs you nothing to find out. Territory being rapidly assigned. **But one man allowed in a field.** Give the name of your county. Send your name and address today. This is a brilliant opportunity. Do not neglect. Do not put it off. **Act immediately.** Address

Wanted

AGENTS & SALESMEN



FRANK CHARGE, Manager Chicago National League Ball Team says: "After seeing how it removes stiffness and soreness from my arms, legs and fingers, each player absolutely insisted on having one; and had it cost twice as much they would have had it."



ELSIE HAIS, the dainty and popular actress, says: "The nice things I could do and do say about your vibrator, I cannot write, as I would not have space enough."



JULIA SANDERSON says: "I don't see how I got along without it. It certainly is far better than anything I ever tried for the throat and vocal cords."



WM. H. CRANE, the famous American actor, says: "I have been using your vibrator for several weeks for nervous trouble, circulation, etc., and found it exceedingly beneficial. It is all that you claim for it."

This Great Electrical Library at Almost Half the Regular Price.

This seven volume set of electrical books—the most complete and up-to-the-minute reference work of its kind ever published—now offered at a discount of almost 50%. You, whether student, worker or expert, can gain from these books an intimate knowledge of your work—knowledge which will eventually mean success and higher pay. The work of thirty-two experts, this library is recognized as a standard reference work by technical schools, libraries and practical men throughout the country.

The American School's Cyclopaedia of

Applied Electricity

is compiled from the instruction papers used in the regular correspondence work of the school; contains 3,200 pages; 2,600 full page illustrations, diagrams, formulas, etc., with a special cross index for quick reference. The seven large volumes are bound in half morocco and are printed in large, clear type on special quality paper.

Important Subjects Covered by These Great Books

Theory, Calculation, Design and Construction of Generators and Motors—Electrical Measurements—Electric Wiring—Electric Welding—Types of Generators and Motors—Management of Generators and Motors—Storage Batteries—Electric Lighting—Alternating-Current Machinery—Station Appliances—Power Stations—Power Transmission—Central Station Engineering—Electric Railways, including Single-Phase—The Electric Telegraph—Telephone Equipment, Systems and Operation—Wireless Telegraph and Telephone—Telautograph—Telegraphone, etc.

Sent Absolutely Free—Express Prepaid

The complete seven volumes, not a sample volume, will be sent, express prepaid, for seven days' free examination; returnable at our expense if the books do not contain the information you want. If you keep the books, pay \$2.00 seven days after receipt and then \$2.00 a month until you have paid the special introductory price of \$19.80. The regular price of this great Cyclopaedia is \$35.00.

Just fill in and mail the coupon. It won't cost you a cent to examine the books. We know they'll be worth many times their cost to you. Mail the coupon now and you'll receive your books promptly.

Another Great Free Offer

With every set is included a year's Consulting Membership entitling you to the free advice of a staff of Electrical Engineers. This will give you practical help in handling working problems which are too specific to be taken up in detail in the Cyclopaedia. There will be no limit to this service. A single problem solved for you might be worth more than the first cost of the books.

AMERICAN SCHOOL OF CORRESPONDENCE
CHICAGO, U. S. A.

SPECIAL PRICE COUPON

NAME

ADDRESS

OCCUPATION

EMPLOYER

Pop.
Mech.
9-12

A. S. of C.

Please send me Cyclopaedia of Applied Electricity for seven days' free examination. I will send \$1.00 within seven days and \$2 a month until I have paid \$19.80; otherwise I will notify you and hold the books subject to your order. Title not to pass until fully paid.

Please Mention Popular Mechanics

Look! The Lad's Car

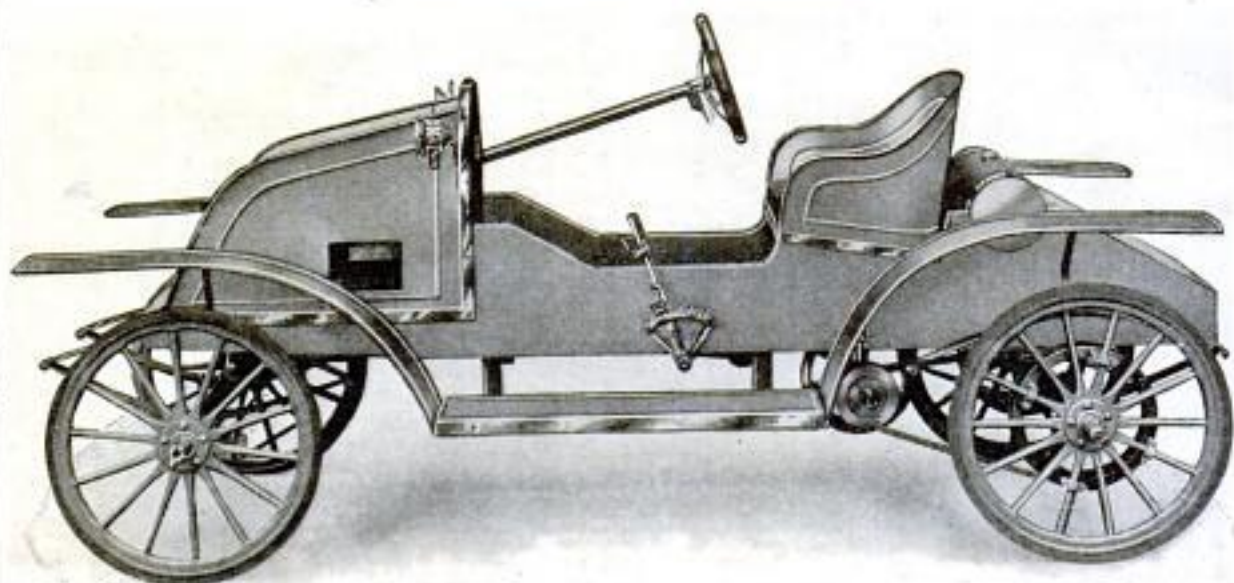

1913 Announcement—Renault Hood

Send twenty cents today for the book telling how to build this wonderful little automobile—Complete description of parts and sizes illustrated with diagrams and cuts made from photographs—We furnish all necessary parts at lowest possible prices—Any wide awake boy can build the car.

Special Inducements for the First Boy in Each Town

The Lad's Car is a first class Gasoline Automobile—It is within the reach of almost any live boy—The parts are simply and strongly made and will stand all kinds of hard usage. Considerable of the cost can be saved by buying the parts and building your own machine—The book tells how.

Dozens of boys are now using The Lad's Car for messenger service and light delivery—It pays for itself in this way in a short time. Two Philadelphia boys are touring across the continent in their small cars.

The Lad's Car is propelled by a three horse power four cycle gasoline engine—It will carry a passenger farther and cheaper on a gallon of gasoline than any other machine in the world.

The steering is of the standard rack and pinion type, same as used on large machines;

with aluminum spider, wood rim steering wheel with spark and throttle control levers on steering column—Speed changing lever on side,—All speeds with the one lever,—the simplest method of control possible.

Best grade full elliptic steel springs both front and rear, "1" beam steel front axle with set of steering knuckles and full "1" beam rear axle, equipped with 22 inch Artillery type automobile wheels, fourteen spokes—Equipped with the best grade Goodyear 1 inch solid tires which will wear for two or three years. The wheel base is seventy-two inches. *We have no agents — you buy all parts — or the complete Car, direct, thereby saving dealer commissions.* Deliveries are now being made on our 1913 model.

WRITE FOR BOOKLET TODAY

DEPARTMENT "A"

NIAGARA MOTOR CAR COMPANY

Successors to
(Niagara Motor Bob Company)

NIAGARA FALLS, N. Y.

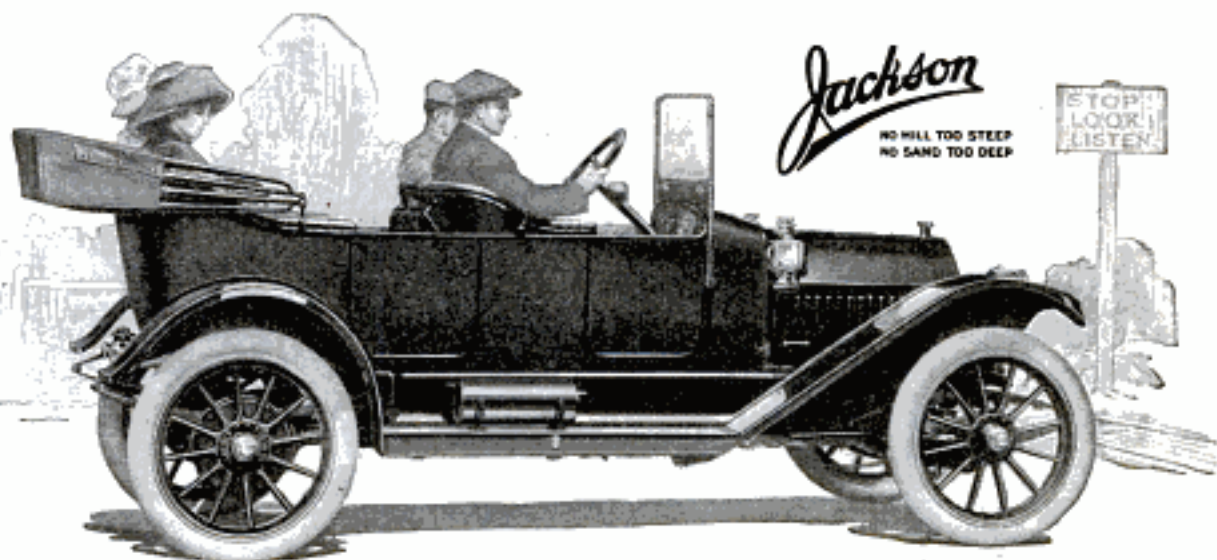

1913 Jackson "Olympic"—\$1500

35 H. P. Long-Stroke ($4\frac{1}{2} \times 4\frac{1}{2}$) motor; 34×4 inch tires; 115-inch wheelbase; full elliptic springs; deep, roomy body with 10-inch upholstery; black and nickel trimmings. Regular equipment includes Self-Starter, Mohair Top, Top Hood, Ventilating Windshield, Speedometer, Oil Gauge and Gasoline Gauge on Dash, Gas Tank, Demountable Rims, Extra Rim, Tire Carrier, Robe and Foot Rails in Tonneau, Pump, Jack, Tire Outfit and Tools.

Unsurpassed at any price— in comfort, riding ease and silence

Three things are yours in the Jackson "Olympic" to the same degree as in the highest priced and most luxurious car.

Perfect comfort in the tonneau, due to the roomy body and the extra deep upholstery.

Riding ease such as only full elliptic springs, front and rear, can give.

Absolute silence, from the radiator fan at the front of the motor to the driving gears in the rear axle.

Thus the Jackson "Olympic" places at your disposal the features which heretofore have made the costliest cars worth their prices.

We have made the upholstery luxuriously soft—10 inches deep.

We have made the seat backs shoulder high and tilted the seats slightly to the rear.

And the body is very wide—the sides extending beyond the wheels.

The spring action will be a revelation to you.

The four full elliptic springs possess from $33\frac{1}{2}$ to 100 per cent more ability to absorb road shocks than the ordinary motor car types.

You actually have to listen to hear the "Olympic" motor run.

You hear no click or slap of valves, because they are perfectly adjusted and enclosed. You do not hear the fan because of its extra-long plain bearing. You do not hear even the carburetor's intake of air.

The transmission is quiet because both shafts are mounted on bearings of the separated-ball type, that run in a bath of oil.

The rear axle does not hum because the gears are of correct pitch, fitted to a thousandth of an inch. There is no interval between the transfer of the load from one tooth to the next; and the gears run between long-roller bearings, with ball thrust bearings to preserve perfect adjustment.

In power and durability we sincerely believe the motor to be the best in the world. It has proved out in the hardest sort of service, and in the severest road and track racing.

Your local Jackson dealer has a specimen "Olympic" model.

He will gladly help you corroborate all we have said here. Call on him; or write us for details and his name.

OTHER MODELS

The "Majestic" at \$1850 has a long-stroke ($4\frac{1}{2} \times 5\frac{1}{4}$) motor of 45 H. P. Its wheelbase is 124 inches; tires, 36×4 inches; springs, full elliptic, front and rear. It is equipped with self-starter, mohair top, top hood, windshield, speedometer, oil gauge and gasoline gauge on dash, demountable rims, extra rim, tire holder, electric horn, foot rail, coat rail, pump, tools and jack. It has powerful electric headlights with parabolic reflectors, flush dashlights (electric) and an electric tail lamp. The current for the lights is supplied by a dynamo driven by the motor which charges a storage battery for use when the motor is not running. The car has black and nickel trimmings.

Watch for our new six-cylinder touring car. It will be announced in a few weeks, and will be ready for early delivery.

JACKSON AUTOMOBILE COMPANY

1301 E. Main Street

JACKSON, MICHIGAN

Please Mention Popular Mechanics



CHIEF DRAFTSMAN

Will INSTRUCT PERSONALLY a limited number selected, ambitious men in

Practical Drafting, Detailing, Designing

Draftsmen Drawing \$125-\$150 Monthly

Are NOT MADE in Schoolrooms,
 Are NOT MADE by reading books,
 Are NOT MADE by making Copies,
 Are NOT MADE at home drawing pictures
 from printed book lesson.

LET ME TELL YOU:

It requires actual, practical, up-to-date
 DRAFTING-ROOM WORK to train YOU
 to gain the PRACTICAL EXPERIENCE
 that your employer will demand of you.



FREE

This \$13.85
**DRAWING
 OUTFIT**

and **Free Position.**

As Chief Draftsman of Engineering firm I know exactly the Quality and Quantity of PRACTICAL training, knowledge and actual up-to-date experience (not school knowledge) you must have, in order to obtain a good position and advance to highest salary.

I give **INSTRUCTION UNTIL COMPETENT** and
PLACED in POSITION at above Salary.

DON'T waste TIME and MONEY trying to learn from books or printed "STUFF" you can only learn on PRACTICAL WORK which I furnish you.

Address **CHIEF DRAFTSMAN**

Div. 19, Eng's Equip't Co. (Inc.), Chicago

Please Mention Popular Mechanics

30 Days Free Trial

No promises! No money needed! No red tape! You can try this all steel, shaft drive grinder with its **Dimo-Grit** (artificial diamond grit) wheels for **30 days absolutely free**—then if you do not want to keep it return it at my expense. You can put **all your tools in bright, keen condition**, and you will be amazed at the ease and speed you can do it—grind all your chisels, twist drills, gum your saws, etc., for 30 days free.

DIMO-GRIT, "the wheel for steel"—25 times faster than the grindstone—10 times more efficient than emery—will not draw temper—no need of cooling with water.

Dimo-Grit is the new artificial diamond abrasive, a twin product of Carborundum you have heard so much about, but **Dimo-Grit** is especially adapted to steel, leaving the keenest, smoothest edge. **Dimo-Grit** cuts hardest steel as easily as emery does copper. The **Dimo-Grit** wheels of this grinder, turning 4000 revolutions per minute, make the hardest job of grinding but a few minutes easy work. Prove it by trying the outfit on your own tools 30 days free. **Dimo-Grit** crystals are really artificial diamonds as hard as real diamonds, fused in the marvelously hot electrical furnaces at Niagara Falls, in which fire brick melts like bees-wax and is vaporized like water in a kettle. Genuine South African diamonds could cut steel no quicker than **Dimo-Grit**. Carborundum wheels furnished if wanted.



Complete Shop Outfit

The Hummer complete shop outfit embraces 14 attachments and accessories, supplying every sharpening, grinding and polishing need. Tool rests and attachments enable the apprentice boy to do difficult grinding such as twist drills, gumming saws, chisels, etc., fully as well as a high paid mechanic—saves tools—saves time—saves money—makes all work easier. Return the coupon for Free Trial Offer and Free Book today.

Luther "Hummer" Tool Grinder

Mechanic's shop outfit includes 14 attachments—16 others to select from. No machine ever built is like the "Hummer,"—it makes tool sharpening child's play. Shaft drive like an automobile, dust proof ball bearings—runs by foot power as easily as sewing machine—engine power can be applied. From the extra attachments such as jig saw, rip saw lathe, drill, etc., you can select what you want. No other machine so moderate in price saves money in so many different ways. 5 years guarantee.

Return this coupon today for 30 Days FREE TRIAL

Send this coupon for 40 page free book and 30 days Free Trial Offer—then decide if you want to try our full shop grinding outfit 30 days free—you do not put yourself under any obligations by returning this coupon. Do it today.

Luther Grinder Mfg. Co.
1109 Michigan St., Milwaukee, Wis.

DIMO-GRIT Sharpening Stones

Ask your dealer for **Dimo-Grit** sharpening stones, fastest, smoothest cutting stones on the market. Look for the name "**Dimo-Grit**" on the stone.

Coupon

Luther Grinder
Mfg. Co.

1109 Michigan Street,
Milwaukee, Wis.

Please send without cost or obligation your 30 Day Free Trial Offer, and free Book telling the story of artificial diamond abrasives.

Name

Address

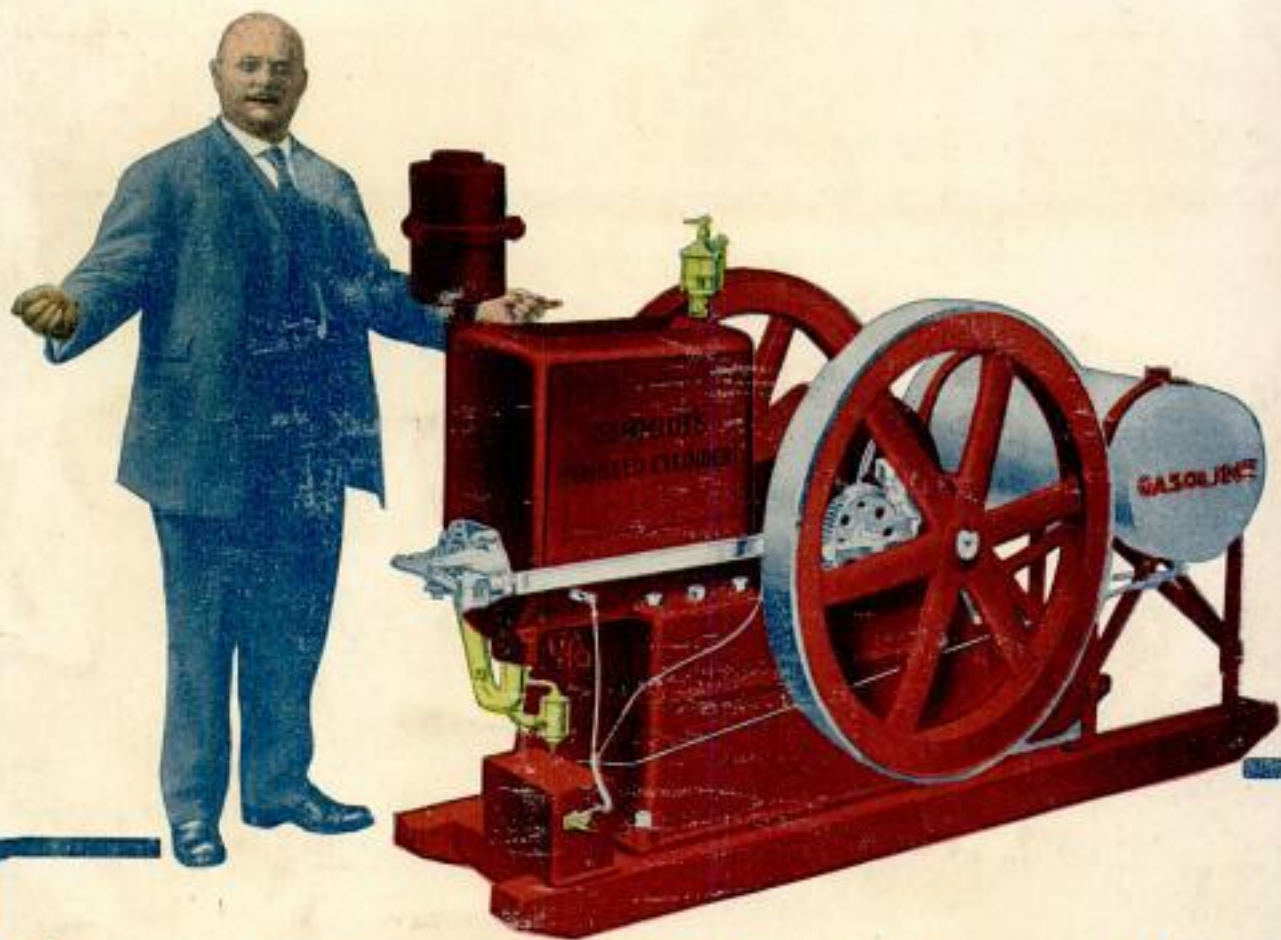

\$7⁵⁰ And You Keep This Great Engine

Yes sir—that's my proposition and it's the greatest gasoline engine offer ever made. No other manufacturer ever dared to make an offer like it. Think of it. Only \$7.50 and you may keep my genuine Schmidt's Chilled Cylinder 3 horse power engine. The remainder in the easiest kind of payments. Astoundingly liberal terms on 1½ H. P., 5 H. P., 7 H. P., 9 H. P., and 12 H. P. You can have your choice of sizes, water cooled or air cooled, horizontal or upright. Write today for our big catalog.

Ten Day Trial FREE Don't send me a penny. I will send you any one of my engines on an absolutely free trial for ten full days. I want you to see the wonderful Chilled Cylinder, my wonderful new oiling device—the valveless carburetor that is on the larger engines and the other features which go to make my Chilled Cylinder Engines the most simple and most efficient in the world. I want you to see how the governor regulates the supply of gasoline so that it is impossible to use more than the minimum amount. I want you to see one of my Chilled Cylinder Engines run all the machinery that you have. I want you to test it out in every way. Then if you are not more than satisfied send it back at my expense.

Rock Bottom Prices No dealer or middleman gets any profit on my Chilled Cylinder Engines. I am the manufacturer. You buy direct from me at exactly the same price that the wholesale dealer has to pay.

Easy Payments You can take a long time to pay for my engine. All you need to do is to send me a small payment after you are thoroughly satisfied that it is the greatest in the world. Your choice of terms. Get the free catalog and see all that you have to choose from.

Five Year Guarantee I am so sure that my engines are the best in the world that I send them out without a penny down and I back them up with a five year iron clad guarantee. The biggest bank in Iowa backs up our one thousand dollar challenge offer.

FREE Power Book Coupon

BEN SCHMIDT, Pres.
Schmidt Bros. Co. Engine Works, Dept. 1196, Davenport, Ia.

GENTLEMEN: Please send me your new Power Book and full particulars of your offer. The book and all the information is to be sent to me absolutely free and prepaid. No obligations of any kind.

Name

Address

Send the FREE Power Book Coupon

Do not delay. Just fill out the coupon and mail it to me today. I will send to you absolutely free and prepaid my new Power Book. Every one interested in "Power" should get this book. I will also send you full particulars of my offer and tell you all about the wonderful Chilled Cylinder. If you don't want to cut the magazine just put your name and address on a postal and say "Send me your Power Book and full details of your offer." But write today. Do not delay a minute.

BEN SCHMIDT, Pres.
Schmidt Bros. Co. Engine Works
Dept. 1196 DAVENPORT, IA.