

July

This Issue 307,000 -

15 Cents

POPULAR MECHANICS

WRITTEN SO YOU CAN UNDERSTAND IT



Popular Mechanics Magazine Offers No Premiums; Does Not Club, and Employs No Subscription Solicitors

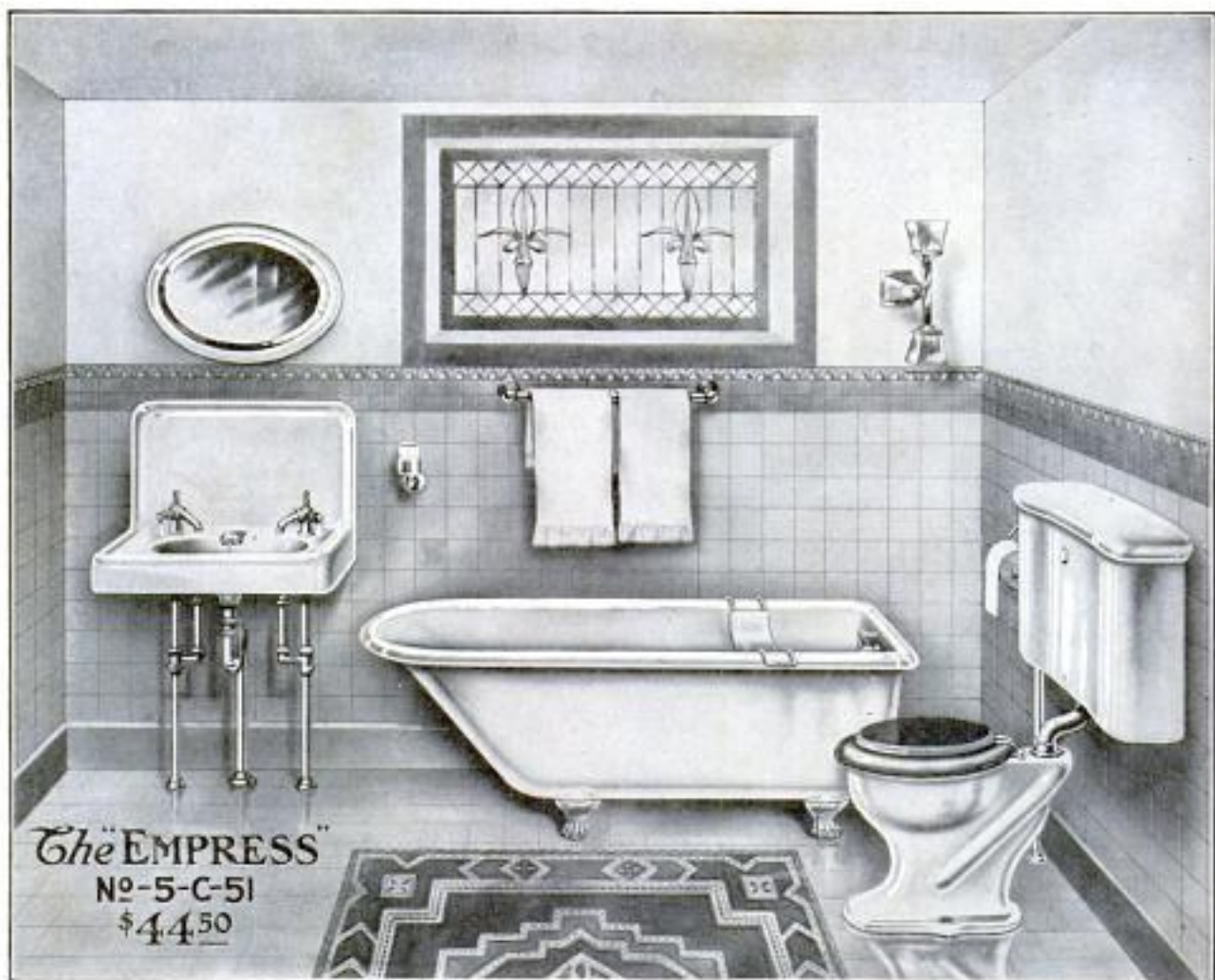

This Handsome Bathroom Outfit For \$44.50 THIS IS OUR CHALLENGE BATHROOM OUTFIT

Guaranteed strictly first-class in every particular.

This illustrates one of the ten different Handsome Bathroom Outfits carried in stock at our mammoth Chicago Warehouse and Salesrooms. A complete stock of everything needed to install Plumbing material from the cheapest to the very finest outfits.

We can furnish you similar outfits to that shown in this illustration at prices ranging from \$27.00 to \$150.00. It makes no difference how elaborate your ideas, we can supply your wants.

WRITE TODAY FOR OUR MAMMOTH HANDSOMELY ILLUSTRATED CATALOG ON PLUMBING MATERIAL AND APPLIANCES. Fill out the coupon shown in the lower left hand corner. Our catalog describes bath tubs, closets, lavatories, kitchen sinks, etc., etc. Also fully explains our Air Pressure Water Works Systems. Even if you have no city water supply, we can furnish you a complete Water Works System at a very low cost. **BE SURE TO WRITE US TODAY.**

Heating Plants from \$50 Upwards

If you are in the market for a Hot Air, Hot Water or Steam Heating Plant, send us a sketch or diagram of your house at once for an estimate. We will positively guarantee to save you from 30 per cent. to 50 per cent. Plants will be guaranteed up-to-date and satisfactory in every respect. Strictly BRAND-NEW material. Plants incorporate every modern feature. Our Heating Department is one of the largest departments of our institution. We have in our employ a large force of professional Heating Experts. You take no chances when you place your order with us. Our heating plants have an established reputation and we rank among the largest heating concerns in the country. Our name on a heating plant is an absolute protection against an unsatisfactory plant. Our plants are installed and giving excellent satisfaction in every part of this country. We have plants in successful operation even in Alaska.

We sell direct from factory to you. You pay no middlemen's profits. This is the secret of our low prices. Do you wonder that we can save you anywhere from \$150 to \$200? Give us the chance. Fill out the attached coupon at once. Our Heating Catalog will go to you by next mail. Contains full particulars concerning our plants besides being a mine of other useful heating information. Will tell you how to install your plant yourself. We guarantee success or refund your money. Get our figures now. A two-cent stamp will put you in immediate touch with our wonderful offer. Do not neglect this opportunity of saving money.

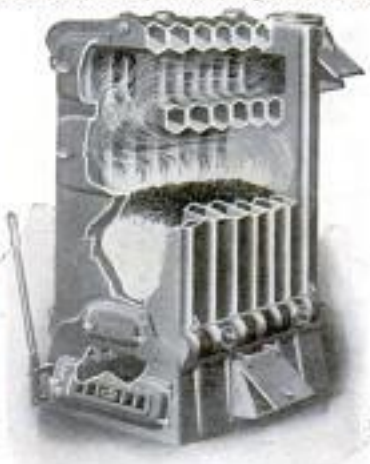

FILL OUT THIS COUPON 539

CHICAGO HOUSE WRECKING CO.
I saw this ad. in July Popular Mechanics,
Send me your Plumbing Catalog.....
" " Heating Catalog.....
NAME.....
Town.....
Co..... State.....

**Chicago House
Wrecking Co.**

**Thirty-fifth and
Iron Streets**

CHICAGO

Increased Opportunities For Young Men

After July 1st, 1912, there will be 4,000 additional places in the Navy for young men. Congress has authorized these vacancies; and has increased the pay of the Navy by nearly two million dollars, to provide for the additional men.

☐ These new positions will be open to young men of good character, over 17 years of age, who want permanent employment, and a chance to learn a useful vocation. There will be an increased need for skilled men—seamen, electricians, machinists, musicians, yeomen, and numerous other trades. **The Navy has special schools where these trades are taught**, the men's pay continuing while under instruction.

☐ Men in the Navy are graded according to their skill and ability; and there is every incentive for a young man to strive to improve himself. There are about seven steps of advancement between the pay of an apprentice seaman and the highest pay of a chief petty officer; and any man who exerts himself is **bound to advance**.

☐ **PARENTS** are assured that the associations in the Navy for their sons are wholesome, and that service in the Navy means **development**—in character, in physique and in efficiency.

**An honorable discharge from the Navy is
the best recommendation a man can possess**

☐ Send for the Navy's booklet, "The Making of a Man-O'-Warsman," fully illustrated, describing life in the naval service. **FREE** if you request it. Just tear off this coupon and paste it on a post card.

Address Box 68

**BUREAU OF
NAVIGATION**

Navy Department
WASHINGTON, D. C.

Please send your free booklet, "The Making of a Man-O'-Warsman" to

St. and No. or R. F. D. No.

Town or City

State

Age

This One



XABQ-XXQ-Q6ED

erial

No K6
Price
\$0.50

Tools that build a perfect job

Undertake the most intricate wood work with supreme confidence—when you use *Keen Kutter Tools*. Jobs where absolute trueness and real craftsmanship are necessary demand

KEEN KUTTER

Quality Tools

No matter how exacting the job—or how simple—*perfect* results come only from *perfect* tools. Buy Keen Kutter Tools with the distinct agreement that every one *must meet your severest tests*, or the dealer returns the price without question.

*"The Recollection of Quality Remains
Long After the Price is Forgotten."*

Trade Mark Registered.

—E. C. SIMMONS.

If not at your dealer's, write us.

SIMMONS HARDWARE CO., Inc.

St. Louis and New York
U. S. A.



No K H1
Price \$0.75

No K88/26
26 in.
Price \$2.00

No KK4
Price \$1.75

No
KSBI
Price
\$0.75
to \$0.90

Please Mention Popular Mechanics

Popular Mechanics Magazine

318 W. Washington Street, Chicago, U. S. A.

EDITED BY H. H. WINDSOR

ISSUED MONTHLY

SUBSCRIPTION:

SINGLE COPY, 15 CENTS

In United States, and its possessions, Cuba and Mexico, per year, postpaid \$1.50
To Canada 1.75
To all other countries in the Postal Union 2.00

All subscriptions are discontinued at expiration. Please examine the date printed on your wrapper.

Entered as Second Class Matter Sept. 15, 1911, at the Postoffice at Chicago, Illinois, under Act of March 3rd, 1879.

Published monthly by POPULAR MECHANICS CO.

Copyrighted 1912, by H. H. WINDSOR.

The attention of prospective advertisers is called to the policy of this magazine in accordance with which the publisher waives all claim for payment of any advertisement appearing in any issue where the number of copies actually printed and circulated is less than the number printed on the front cover page.

Contents for July, 1912

Passenger Uses Aeroplane to Overtake Liner	1	Famous Saint Mark's Campanile Restored	47
Life-Saving Motor Fire Truck	2	An Unusual Hotel Annex	47
New Non-Corrosive Alloy	2	Curious "Freak" of a Bullet	48
Electric Light without Heat	2	Whole City to be Heated by Electricity	48
Scheme for Converting Unmined Coal into Gas	3	Ty Cobb Twice: a Unique Photograph	48
Playing Golf in Armor	4	Motion in Art and in Reality	49
Tests Prove Bacilli Not Necessary to Life	4	A Jackdaw That Goes to School	50
Antics of Pet Ants Amuse Paris	4	Nettle a Substitute for Cotton	50
Big Ship Cuts through Dock and Sinks Vessel	5	Song of the Dynamite Blast (Poem)	51
A Greenhouse on Wheels	6	By J. W. Foley	
How Navy Gunners Use the Telephone	7	Railway Signal Man Has Baboon Assistant	52
Talking Monkeys and Teacher	8	New Game for the Seashore	52
Practical Proofs of Streamline Theory	9	Students Construct Outfit for Experimentation	52
By Victor Loughheed		A "Pushmobile" Automobile	53
Aeronautical Engineers Want a Name	15	Air-Propeller Alarm for Automobiles	54
Fish Tinted to Suit Buyer's Fancy	15	Taxicab Telephone System	54
Non-Spillable Flower Vase for the Waist	15	Street-Crossing Kiosks for Policemen	54
Working Model of Panama Locks	16	State College Has Poultry Hospital	55
Cannon Designed for Use on Aeroplanes	16	Railway on Which Cars Float above Rails	56
Bed Equipped with Electricity	16	Automobile Pumps Water	58
Some Farm Implements of French Design	17	The First American Aero Show	59
Armor for Motor Truck Dual Tires	18	By James R. Quirk	
The Floral-Loop Novelty	18	Transmitting Pictures by Wire	63
Odd Behavior of Metallic-Filament Lamps	18	Motor Trucks as Pole Erectors	64
World's Highest Voltage Transmission Line	19	Feeding Suffragettes through the Nose	64
Improved Motion-Picture Sound Maker	20	In the Center of the Wreck	65
War Aeroplanes as "Doves of Peace"	20	"Refined" "Rubber-Neck" Motorbus	65
How a Cat Turns Over	21	Boxing on Horseback	66
By Forest Ray Moulton		Transparent Glass of Great Strength	66
Automatic Track Scale	24	Moving Pictures of the Aurora Borealis	66
Motor Car for Horse Transportation	24	A Skyscraper for the Dead	66
The Largest Water Turbines	25	Electric Baby's Smile Twelve Feet Wide	67
German Armored Aeroplane	25	Johannesburg Race Course Has Palatial Stand	67
Machine for Turning and Boxing Wooden Wheels	25	A Famous Water Hole in California	67
Highest-Voltage Direct-Current Locomotive	26	Porte-Cochere Auto Garage	68
An Unusual Bridge-Moving Operation	26	Signal Disks Planned to Stop Joy-Riding	68
Awakening of Interest in Safety Devices	27	Tented "City" on Hotel Roof	69
Superdreadnought "Texas" Launched	31	Combined Floor Set, Nail Set, and Shield	69
Acquiring a Motorboat	35	French War Aeroplane	70
By George Fitch		The Westernization of the Holy Land	71
Comment and Review	39	By H. J. Shepstone	
By H. H. Windsor		Letter Sealing and Stamping Machine	74
Viewing the Sea Depths through Glass Shaft	43	Costliest Telephone Line Ever built	75
An Umbrella Carrier	44	Automobile Used to Light a Tram	76
A Resourceful "Engineer"	44	Violins Withstand Heavy Strains	76
Snail Walks Safely over Razor's Edge	44	Deflated-Tire Alarm for Automobiles	77
Concrete Arches Form Base for Tombstones	45	A New Outdoor-Indoor Bed	77
The Motor Car as a Cow Pony	45	Making a Clock Run a Year	78
Tiger's Head Outlined in Circassian Walnut	46	High Efficiency Water Wheels	78
New Type of Block Signal for Cold Weather	46	A Racing Duocar	79
		Barrel Float as Engine Control	79

[\[Continued on Page 61\]](#)

Popular Mechanics offers no premiums; does not join in "clubbing offers," and employs no solicitors to secure subscriptions. It is for sale by nearly every newsdealer in the United States and Canada.

- Contents—Continued

Belt Transmission Around a Corner.....	80	How to Sharpen a Gauge.....	127
Loss of Queues Causes Demand for Hats.....	80	Self-Adjusting Belt Tightener.....	127
Great Britain Organizes Air Navy.....	80	A Hedge Trimmer.....	127
Eight-Wheeled Electric Motor Truck.....	81	Emery-Cloth Holder.....	127
Gunpowder Used as Fertilizer.....	81	Fastener for Window Screens.....	128
Air-Cooled Spark Plugs.....	82	Removing Inner Band on Truck Wheels.....	128
Building Stone Made of Blast-Furnace Slag.....	82	Substitute for Thumb Tacks.....	128
Triplex Compound Locomotive.....	83	Preserving Surplus Stain when Staining Shingles.....	128
Heat Protection for Electric Flatiron.....	83	Tile Sewer Construction.....	129
Calculating the Circumference of the Universe.....	84	Weighting Triple Doors on Windows.....	132
By Forest Ray Moulton		Blue Letters on Steel Surfaces.....	132
An Elevating Device for Unloading Cars.....	85	Substitute Spanner Wrench.....	133
Pump Designed Specially for Sewage.....	85	Proper Shape of a Screwdriver Blade.....	133
Letters Stamped with Ink Instead of Stamps.....	86	An Auxiliary Drill Holder.....	133
New German Canal Proposed.....	86	Tug Holder for a Singletree.....	133
Absorption by Glass in X-Ray Photography.....	86	Homemade Thumbnut.....	133
Portable Grain-Loading Elevator.....	87	Cooling Engine Jacket Water.....	134
Thief-Proof Rack for Tools.....	87	Shop Signal for the Beltman or Electrician.....	134
Metal Work and Etching.....	88	An Emergency Lock.....	134
By John D. Adams		Shield to Protect Handsaw Teeth in a Tool	
Electric Wax Melter and Dropper.....	90	Chest.....	135
Coating Iron Pipes with Lead.....	90	Waterproofing Blueprints.....	135
Coaling Barge Mixes the Coal Automatically.....	90	Plant Pot in Cement Sidewalk.....	135
The Wonders of Light.....	91	Ruling-Pen Holder for Tracing Irregular Curves.....	135
By J. Gordon Ogden, Ph.D.		Special Molding Jobs from Standard Patterns.....	136
The Plaza Planned for Manhattan Bridge.....	97	Battery Economy.....	138
Electric Truck as Street-Lighting Demonstrator.....	98	Gear-Cutter Gauge.....	139
Electrically Operated Gas Meter.....	98	Humidifier for a Cigar Case.....	139
Town Sells Cement Walk for Advertising.....	99	Three-Point Bearing Clamps.....	139
Looking-Glass as Railway Tracksman's Tool.....	99	Handle for Heavy Doors.....	139
Ingenious Fire-Hose Reel.....	99	A Hand Dog.....	140
The Advertising Duck.....	100	A Strainer Frame.....	140
Railroad to be Built of Panama Canal Material.....	100	Twin China Closets.....	140
"Handcuff King" Escapes from Diving Suit.....	100	Steel Pen Used in Draftsman's Ink-Bottle Cork.....	140
Street of Abundance in Ancient Pompeii.....	101		
A Dutch Horseshoeing Cage.....	102	AMATEUR MECHANICS	
Remarkably Proportioned Gum Tree.....	102	How to Build a Simple Electric Motor.....	141
Algerian Grass for Paper Making.....	102	How to Make a Humidity Indicator.....	142
A Greenhouse Which Retards Growth.....	103	The "Q" Trick.....	142
New German Type of Automobile Body.....	104	To Keep Ants Away from Food.....	143
Effect of Paint on Corrosion of Iron.....	104	Vaulting-Pole Holder.....	143
Aeroplanes Suffer Strain from Above.....	104	Flying Model Aeroplane for a Display.....	143
Built-In Ironing Board.....	105	Drip-Pan Alarm.....	144
Detecting Thunder Storms by Wireless.....	105	A Live-Bait Pail.....	144
Transforming the Panama Dream into a Reality.....	106	A Mouse Trap.....	144
Aeroplane Bomb Tests with Real Bombs.....	106	Quickly Made Rheostat.....	144
Flower-Vase Censer.....	107	Leaded Glass Panels for Furniture.....	145
Sandals Given with Every Ticket.....	107	Raising Cucumbers on a Trellis.....	147
Pawnshops in China.....	108	A Barrel Boat.....	147
Actual Use of Dirigibles in Turko-Italian War.....	109	Electric-Light Mystery.....	148
The Troubles of the Patent Office.....	110	An Oar Holder.....	148
Loaded Cars Lifted Bodily by Electric Hoist.....	110	Cooking Food in Paper.....	148
Converting Flywheel into Fan.....	110	Washing Photograph Prints.....	148
Monte-Carlo from a Hydro-Aeroplane.....	111	A Toy Popgun.....	149
Photomicrographs as Art Patterns.....	111	A Non-Rolling Thread Spool.....	149
Motorboat Wrecked in a City Street.....	112	Shoe-Shining Stand.....	149
New Uses of Tungsten and Molybdenum.....	112	Cutter Made of a Wafer Razor Blade.....	149
Sanitary Toothbrush Holder.....	113	A Fish Stringer.....	150
Transformers Placed on a Float.....	113	Substitutes for Drawing Instruments.....	150
New Bottle Cap.....	113	How to Make an Aspirator.....	150
Nature as a Sculptor.....	114	A Key-Holder Hook.....	151
Largest Touring Automobile.....	114	A Hand Hoe.....	151
Great Discoveries Due to Happy Accidents.....	115	Seed Receptacle for Bird-Cages.....	151
By G. E. Chamberlain		Kitchen-Utensil Scraper.....	151
Peculiar Sandstone Formation.....	118		
Special Courier Autos for German Army.....	118	INTERESTING PATENTS, PRACTICAL OR	
Prehistoric Dinosaurs Found in Utah.....	119	UNIQUE	
By Hartley M. Phelps		Leg-Pulling Apparatus.....	152
Auto Furnishes Power for Pneumatic Tool.....	120	Arm-Operated Shoe Cleaner.....	152
"Automobile" in Siamese.....	120	Silver-Removing Tweezers.....	152
The Utilization of Iron Filings and Shavings.....	120	Combined Sickle, Corn Knife and Pruning Saw.....	152
		Hoof Support for Horseshoeing.....	152
SHOP NOTES		Lock for Wearing Apparel.....	152
Drawing Circles of Large Diameters.....	121	Bedclothes Fastener.....	152
A Carpenter's Door Holder.....	121	Golf-Stroke Teaching Apparatus.....	152
Truck for Spool Fence Wire.....	121	Roller Pole for Roller Skaters.....	153
A Small Needle Drill.....	122	Magnifying Glass for Needle Threading.....	153
A Spider for Lathe Work.....	122	Rubber-Protected Nursing Bottle.....	153
A Drawer Paper Protector.....	123	Bottle-Rinsing Faucet.....	153
A Window Reflector.....	123	Parachute Fire Escape.....	153
Indicating Outside Caliper.....	123	Divisional Toothbrush.....	153
To Prevent the Binding of Mast Hoops.....	124	Coat-and-Skirt Hanger.....	153
Whetting Plane Irons.....	124	Roller Flour Container.....	153
Simple Medicine Dropper.....	124	Swimming Mitt.....	153
Repairing a Crack in Cast-Iron Pipe.....	124	Shoe with Combination Elastic and Laced Upper.....	153
Measuring Water without a Meter.....	125		
Adjustable Horse for the Shop.....	126	Jokes.....	154
Tempering Small Articles Evenly.....	126	New Books.....	154
Gasoline Spray for Cleaning Machinery Parts.....	126		

Economical ~ Effective
Take No Substitute

Silver
Wrapper



Blue
Band

The Soap that Scours.
When nothing else will clean it

SAPOLIO

will easily do it.

Solid Cake ~ No Waste

ENOCH MORGAN'S SONS COMPANY
SOLE MANUFACTURERS

Please Mention Popular Mechanics

Would You Give \$12 to Learn the Auto Trade

AS CHAUFFEUR, REPAIRMAN, SALESMAN OR EXPERT?



Of course you would, if we could prove it. A camera can picture only what exists, so here's a photo engraving of one of our students who is making money and his investment represents only \$12. Below is the name and address of this man.

I give your course credit for having started me in the auto repair business. I do repair work for auto owners. The enclosed photo shows a job I am doing for Mr. Frank Sellers at his home on his Overland car. I make a specialty of grinding valves and overhauling cars and always have work ahead. I sometimes buy used cars and overhaul them to sell. I am now making preparations to go into the business on a larger scale and take the agency for a car. Hoping this letter will be of service to you, I remain, yours gratefully,
E. A. LAMB, proprietor of Lamb's Auto Shop,
1221 Buchanan Street, Motory, Mo.
(Feb. 12, 1912.)

Why Such Results

Such success is not the result of a mere correspondence course. The Dyke system is that, but a great deal more in addition. Mr. Frederick Marwick of Scranton, Pa., said, "As a practical man, I find in your models the real key to teaching by mail." And he hit it exactly right. Our

Dyke's Wonderful Working Models

(The original and only system of its kind. Patent applied for.) with real metal movable parts are the true secret to the success of students of the Dyke System. On these five models of the Engine, Magneto, Transmission, etc., you get actual practice, see the actual operation of the different parts of the auto, and learn more than you could from the auto itself. That is why so many of our graduates immediately start repair shops or step right into positions as chauffeurs without a day's experience. If you think Mr. Lamb's case is an exception, read below some

More Proof

E. Dwyer, 21 N. Willow St., Montclair, N. J., 19 years old receives \$25 a week and board.
Harry J. Herbin, Jamestown, Kans., was a farmer, but has doubled his income repairing and selling autos.
W. R. McClelland, Astoria, Ill., was an auto driver. Became professional chauffeur and more than doubled his salary.
Donald Stewart, Oakland City, Ind., became a chauffeur at \$25 a week.
H. M. Fewins and S. T. Slayback, both graduates, are now running a Garage and Repair Shop at Woodbine, Iowa.
And we could continue until we had filled this and several more pages.

All the Result of the Dyke System

You can obtain the same start those men had—all the help and more, because we have just brought the instruction up to date, enlarged the books, added a new manikin of the assembly of the auto and the power plant. None of these men had the help of

Our Employment Plan for Students

This represents years of work to provide something that no other school had, namely, a way for the graduate to get acquainted with auto and garage owners, to prove his ability and to immediately secure profitable employment.

Mr. Dyke has been identified as a pioneer inventor, supply man, etc., with the auto industry since its beginning. He originated the first Auto Supply Co. and published the first book on autos in America. No other man with such experience is today teaching others. And all the experience and inside information of the auto business he has thus gained, is embodied in this Employment Plan. If these men whose endorsement are here given, could make so much money out of this System without other help, think how much more you should do with the assistance of this Employment Plan.

Not one of these men lost a day's income training for the new work. Under the Dyke System you study the instruction and obtain experience on the models right in your own home during spare time.

Even the regular price of this training is only \$15, but if you write at once we will explain a special proposition whereby you can secure all the textbooks, the five real working models, the manikin and all the features for

Only \$12 Right Now

This is a chance you may never have again to get into the fastest growing, best paying industry the world has ever known, a field that is growing faster than men can qualify for the work.

WRITE TO-DAY for Details of Employment Plan and THIS FREE BOOK

It is instructive and interesting—does not cost you a cent and places you under no obligations whatever—you need it for your own sake, not mine. Don't wait—there's no profit in waiting—WRITE NOW and learn how you can obtain all this training for only \$12, if you not immediately.

DYKE'S CORRESPONDENCE SCHOOL OF MOTORING

Box 88, Roe Building, ST. LOUIS, MO.

We have started more young men in the auto business than all other schools combined.



GOOD NEWS for WIRELESS AMATEURS

A. F. Collins, America's greatest authority on wireless apparatus, has written a book that tells in plain, every-day language and shows by simple, easily understood diagrams how to make experimental and one to five mile wireless sets that will do real work. This book places at the disposal of every amateur the boiled-down experience of a world-famous wireless authority. Stop working in the dark. Send 25c To-day for This Book and START RIGHT.

Spon & Chamberlain, 125 P. M. Liberty St. NEW YORK, U.S.A.

Chart of a Modern Submarine

Price 25c Postpaid

Showing and naming over 200 parts. Size 14 x 28 inches. Printed on Plate Paper.

POPULAR MECHANICS BOOK DEPT.
318 W. Washington St. Chicago

The Best Book For Beginners

A Practical Course in Mechanical Drawing

Price 50c Postpaid

By Wm. F. Willard
POPULAR MECHANICS BOOK DEPT.
318 W. Washington Street, Chicago

MONTHLY CASH PRIZES

Until further notice in this magazine the Editor of Popular Mechanics will pay two cash prizes each month for the best original contributions to its

SHOP NOTES DEPARTMENT

\$10 for the Best Contribution
\$5 for the Second Best

THIS IS IN ADDITION TO OUR usual rates for such contributed articles.

Quality, not length counts. Checks will be sent on the last day of each month for the prize articles received during that month. Publication in the magazine will follow in about two months.

PRIZES AWARDED FOR MAY, 1912

First Prize—JAMES McCAFFREY, Pawtucket, R. I. \$10
"Auxiliary Gasoline Tank for an Automobile"
Second Prize—S. H. PACKARD, Boston, Mass. \$5
"Handle Shapes for Wheelbarrows"

EXTRA AWARD

On account of there being five contributions this month each of which deserved second prize, we have made an EXTRA AWARD of four additional second prizes, as follows:

P. H. TIERNEY, Lynn, Mass. \$5
"Double-Blade Hacksaw Frame"
EDWARD MATTHEWS, New York. \$5
"To Make Worn Threads of a Bolt Hold"
JAMES F. NAPIER, Montreal. \$5
"Baluster Design to Fit Any Pitch of Stairway"
R. F. POHLE, E. Lynn, Mass. \$5
"Ink Fountain for Covering Large Surfaces on Tracings"

All accepted contributions to our departments, "SHOP NOTES" and "AMATEUR MECHANICS," are paid for immediately; checks for prize awards are sent at the end of each month.

Address, EDITOR POPULAR MECHANICS
318 W. Washington St., Chicago

ARE YOU A MIND WANDERER?



A YOUNG MAN was recently selected for promotion to the managership of his firm's Pacific Coast branch. At a directors' meeting he was called in and introduced by the President. Twelve pairs of sharp eyes took his measure. His personality was distinctive. The first impression was a favorable one.

"How much business did we do on the Coast last year," he was asked by the Chairman.

"About,—er—well, I can't exactly remember," was the answer.

Another man whose memory was better got the position.

Now Memory is not a Gift, it is an Accomplishment. You are not born with a good or a bad memory. You are endowed with latent powers, it rests with you whether you let them lie dormant—or develop them to the degree that will make you a man way above the Common Herd. The **big men** everywhere, in Business, Science, Religion, Literature, Law or any other vocation are the ones

who have **developed** their powers of Concentration, Attention, and Retention. Their minds are not garbaged with rambling, unrelated, disconnected ideas. They have learned to direct and control their thoughts, **and so can you.**

Memory Training is not for a select few, it is for YOU. Let this thought encourage you, that YOU can attain your highest aims if you wish. HOW? Write NOW for my free booklet, "How to Remember," using coupon below, or drop a postal card.



Prof. Henry Dickson

America's foremost authority on Memory Training, Public Speaking, Self Expression, and Principal of the Dickson Memory School, Auditorium Building, Chicago.

De luxe edition handsomely illustrated, richly bound. Is exactly suited to meet the needs of the man or woman who desires to be a successful public speaker. The price of this 1911 de luxe edition is \$2.00. I will, however, present a copy absolutely **FREE** to every student who enrolls for my course of memory training within ten days after reading this offer.



How to get a FREE copy of this book

PROF. HENRY DICKSON

Principal, Dickson School of Memory
705 Auditorium Bldg., CHICAGO, ILL.

Send me free Booklet, "How to Remember," also full particulars how to obtain a free copy of "Dickson's How to Speak in Public."

Name

Street

City State

Classified Advertisements

Advertisements in this section, 10 cents per word, each insertion, minimum 10 words, payable in advance. To insure ads being inserted under proper classified head in the August issue, copy must reach this office not later than July 1st.

Popular Mechanics Magazine, Chicago, Ill.

Gentlemen: Replying to your favor of the 23rd inst., regarding advertising recently sent you by the writer for The Southern Typewriter Sales Company, I wish to state that this advertising came near getting us in trouble—it is a terrible thing to get "swamped" with letters, especially when one man has to be the whole works, such as it is in this case. I have no stenographer, but had the ad continued another month I fear I would have employed one.

The ad was indeed satisfactory so far as replies to some are concerned. I believe I received 150 letters, and they are still coming in at this late date, which proves to me that your magazine, "Popular Mechanics," is not glanced at and discarded, but is constantly read thoroughly. I have made a couple of sales so far and believe should make several more. One thing sure, the ad has served me well.

Rest assured you will be favored with another ad in the near future, and it is very likely that I will give you a larger ad next time and will continue to let same run.

Thanking you for your prompt attention and wishing you every possible success, I am,
Very truly yours, V. D. LIGGETT, Tyler, Texas.

AUTOMOBILES

LOOK—Closing out—8 hp. Oldsmobile Runabout, \$120; 12 hp. Cadillac Runabout, \$165; 14 hp. Autocar Runabout, \$185; 18 hp. Ford Touring Model, \$270. Every one in excellent condition. Here's your chance to get a good car cheap. Address Theo. L. Williams, Clermont, Fla.

1907 WHITE Steamer, perfect running order, paint good, five good tires worth \$75, extras worth \$50, all for \$135. Money refunded if not as represented. Demonstration given. Columbia Poultry Yards, Toms River, N. J.

FOR Sale—Axles, wheels, steering gear, new transmission from Premier car. Fine condition. Cheap. Also used large steering gear and radiator. Cut prices on motors, axles and transmissions. F. E. Alford, Goshen, Ind.

AUTOMOBILES: Biggest bargains ever offered; send for list and prices. D. M. Brown, 114 3rd St. South, Minneapolis, Minnesota.

FORD owners wanting fine electric lights available anytime, using Ford magneto for charging a storage battery (self contained system). Write American Battery Company, 1129 Fulton St., Chicago.

2 TON truck chassis less motor, \$75. Pugh, 384 Mass. Ave., Buffalo, N. Y.

SIX, eight and ten hundred capacity New 1911 Kearns delivery cars sold three. Sold three runabouts from \$275 to \$450. One 1910 Middlesex 30 H. P. 4 cylinder taxcab like new \$500. Eureka Auto Co., Beavertown, Pa.

FOR Sale—5 pass. Buick auto. Full equipment. Just overhauled and painted. \$250. Well worth more. Earl Ensign, Silver Lane, Conn.

AUTOMOBILE instructions, four weeks' course covering shop and road work—provision for out-of-town men. Send for booklet. P. M. West Side Y. M. C. A. Automobile School, 318 West 57th St., New York, N. Y.

AUTOMOBILE owners, get an Elder Power-transmission; make your automobile run your machinery. Agents wanted, Elder Manufacturing Co., Indianapolis, Indiana.

IMPROVEMENTS in Automobiles and parts wanted; send sketch. Sanders, 17 Crilly Block, Chicago.

FOR Sale—Mets automobile, fine condition, New tires, Electric lights, magneto, speedometer. \$235. Ray Ellis, Arkansas City, Kansas.

AUTOMOBILE—24 h. p.; as good as new; price \$425, 58 E. Second St., Covington, Ky.

SIMPLEST way on earth to time automobile engine, 25c. "Strong," Homer, Mich.

"THE How and Why of the Automobile"—A 200-page book of practical information for seekers after the fundamental facts regarding the gasoline engine and its application to the motor car. Interesting and instructive to both the beginner and the expert. Bound in full cloth—250 illustrations. Price \$1.00 postpaid. Popular Mechanics Book Dept., Chicago.

AUTOMOBILES. Sacrifice sale on new and used cars. Box 275, Burlington, Wis.

STEAM car owners. Myers Kerosene Burner, something new; write for circular. 987 Osceola Street, Denver, Colo.

SEE what we say under "Patents." Swift, Attorney, Washington, D. C.

AUTOMOBILE model. Every part shown and named. You can to all intents and purposes take off the wheels, raise the hood and remove the body; exposing to view the vital parts. The only practical method of studying the automobile. Price 50 cents postpaid. Popular Mechanics Book Dept., Chicago.

A. C. C. A. Prices Talk! Spring sale is on! Hundreds of runabouts, easy roadsters, five and seven passenger touring cars—elegantly and completely equipped! Guaranteed five years! Freight prepaid! We offer 20 runabouts formerly cost \$500 to \$1,000, now \$30 up! 18 roadsters, three and four passenger, formerly cost \$1,000 to \$2,000, now \$175 up! 26 touring cars, five, six and seven passenger, formerly cost \$1,500 to \$5,000, now \$200 up! All best American and Foreign makes, such as Packards, Pierce Arrows, Stevens, Wintons, Stouard Dayton, Peerless, Stearns, Pope Harfords, Locomobiles, White, Renaults, Buicks, Maxwells, Fords, etc. Write today for our Illustrated Catalog, the largest and most complete list of its kind ever published! The Automobile and Cycle Company of America, Dept. C, 1769-1787 Broadway, New York City.

TWO automobiles and portable garage sacrificed! One Oldsmobile "30-35" horsepower, luxurious five-passenger touring, four doors. Equipment includes everything. Cost nearly \$5,000. For quick sale \$400. One Autocar runabout (doctors model), top, windshield and full equipment, \$225. Fireproof portable garage \$25. Two barrels oil, \$10. Shonhard, 246 Lenox Ave., New York City.

SAVE middlemen's profits. Buy from factory distributor. Electric horns, complete, \$15, prepaid. Penetrating warning. Clear road. J. H. Rose, Omaha, Neb.

1911 METZ \$225, or trade for screw-cutting lathe and cash. Chas. B. Otis, Ann Arbor, Mich.

AUTOMOBILE SUPPLIES

TIRE Specials. Guaranteed Tires. 1912 fresh stock; just bought an entire surplus stock. Order today while they last: 28x3—\$8.90, Tube, \$2.40; 30x3—\$9.99—\$2.53; 30x3½—\$12.75—\$3.25; 32x3½—\$14.20—\$3.55; 34x4—\$21.25—\$4.80. Other sizes, prices in proportion. Write for complete list. We ship C. O. D. subject to examination upon receipt of express charges. Para Auto Tire Co., 1425 Michigan Ave., Chicago, Ill.

PELLET'S Magneto Exchange, 1463 Michigan Ave., Chicago. All makes bought, sold, exchanged, repaired and re-magnetized. Repairs guaranteed. Parts and coils in stock for all makes of magnetos. Agents for Eiseemann Magneto Co. Connecticut Telephone & Electric Co. Atwater Kent Unispark. Gray & Davis Lighting System.

AUTO guaranteed tires. 28x3 \$9.85, tube \$2.75; 30x3 \$10.50, tube \$2.85; 30x3½ \$14.95, tube \$3.75; 32x3½ \$15.75, tube \$4.25; 34x4 \$21.15, tube \$5.60; 34x4 \$22.25, tube \$5.75. These tires are all No. 1 free from flaws or blemishes. They have the white tough tread. I am getting orders from customers that have used them; the kind I want to sell. I ship on receipt of 10% amount of order and allow examination. Send for complete list. Vanderpool's, Springfield, Ohio.

24 H. P. four cylinder engine and auto running gears \$160, or trade 1911 motorcycle. B. Bockhaus, Halstead, Kan.

AUTOMOBILE cylinders reground, new pistons and rings fitted. Garage air compressors. Cast Iron Brazing Co., Manchester, N. H.

NEW tires, 28x3, \$7.85; 30x3, \$8.75; 30x3½, \$11.75; 32x3½, \$12.50. Other sizes accordingly. Get latest price bulletin. 10% with order; balance C. O. D. Examination allowed. Auto Tire Brokerage Company, 1375 Michigan ave., Chicago.

WE make a better unguaranteed Automobile Tire than most guaranteed ones. You get exactly what you pay for. Gums, Fabrics and Mechanical goods. National Company, 1400 Clybourn Place, Chicago, Ill.

TIRES, all makes, all guaranteed, 28x3, \$4.50; 30x3, \$6; 30x3½, \$13. Write for our complete list of tires and tubes before purchasing. We ship C. O. D. Guarantee Tire Company, Dept. M, 213-219 West 135 St., N. Y. City.

TIRES, Para Brand. Guaranteed 3,500 miles. 28x3, \$10.50; 30x3, \$11.90; 30x3½, \$15.25; 32x3½, \$16.52; 34x4, \$24.85; 36x4, \$26.60. 30% discount on tubes. Other sizes in proportion. Write for complete list. Para Auto Tire Co., 1423 Michigan Ave., Chicago, Ill.

FORD, Buick, Overland, E. M. F., Maxwell, Air-Friction Carburetors, drive your cars three miles per hour on high. Much more speed; much less gas. Starts easy in cold weather. Satisfaction or refund money. Air-Friction Carburetor Co., Dayton, Ohio.

REPAIR your puncture in one minute with the Clinch Tire Repair Kit. Agents price \$5.00. Buy direct from us \$3.50. The A. L. M. Company, Kansas City, Mo.

500 New Pressed Steel Auto Frames. 163 in. long, \$10 each. Send for sketch. Lucas & Son, Bridgeport, Conn.

NEW 19 H. P. four cylinder air cooled motor, \$75. Butts, Oxford, New York.

STEAM auto boilers bought, sold and repaired. J. L. Lucas, No. 2 Fox St., Bridgeport, Conn.

BEST spark made. Glass shows mixture. Americo, A. Stamford, Conn.

TIRE Bargains! A. C. C. A. Prices talk! Diamond-Goodrich and other standard makes—Guaranteed—Every size for every rim; 28x2½, \$5.00; 32x3, \$8.00; 30x3, \$7.00; 34x3, \$9.00; 29x3½, \$10. All other sizes and tubes proportionately low, shipped on approval. Write today for price list. The Automobile and Cycle Company of America, Dept. B, 1769 to 1787 Broadway, New York City.

ONE cylinder Oldsmobile engine \$15. Autocar, two-cylinder, \$50. Panhard, four-cylinder, \$95. All in running order. Write for particulars. W. D. Peck, 246 No. 15th St., East Orange, N. J.

10 HP. Stanley Steam Engine, fine condition, \$25. Also seat, wheels and other parts. P. S. Walke, 36 Earl St., Springfield, Mass.

FORD Automobile Owners. Send for our catalogue containing many useful "specialties" for Ford cars, which will save you money! Auto Improvements Co., 53-G Court St., Bristol, Rhode Island.

WANTED—Light solid tired gear, friction transmission, radiator, differential Jackshaft. Claude Orr, Kempton, Indiana.

CHARGE the battery yourself. "American" rectifiers. All sizes. Storage batteries, all sizes. American Battery Company, 1127 Fulton St., Chicago.

AUTO tires mended in one minute. Write for particulars. M. R. Silvernail, Altamont, N. Y.

MOTORCYCLES AND BICYCLES

MOTORCYCLE cases and tubes. Fully guaranteed Bailey type white tough tread. 28x2 1/2, \$8.30, tube \$2.65, by mail \$2.83. Send for complete price list. I ship on receipt of 25% amount of order and allow examination. Vanderpool's Springfield, Ohio, and Jacksonville, Fla.

PREPAID Motorcycle Supplies. Send for catalog listing every motorcycle accessory. All goods shipped prepaid. You will save money. Immediate shipment. Write a postal note. Sausley Supply Company, Kansas City, Mo.

MOTORCYCLES cheap—50 secondhand motorcycles that must be sold to make room for new Shaw Motorcycles. Send for special bargain list. Shaw Manufacturing Company, Dept. 36, Galesburg, Kansas.

1912 MOTORCYCLE Manual, a cyclopaedia of useful motorcycle information. Complete Trade Directory; Best Motorcycle Trouble Chart ever published. How to Tour, etc.; 125 pages. 25c a copy. Motorcycle Publishing Co., 51 Chambers St., New York.

SUPPLIES—The largest stock in America. Immediate shipment. Lowest prices. A hundred new ideas shown in our big free catalogue P. Keller's 25c book Care and Construction of the Motorcycle, now 15c. The Motorcyclist, a dollar magazine, trial half year, 25c. Motorcycle Equipment Co., Hammondport, N. Y.

WANTED—Motorcycle for \$75 type-writer, \$7.50 camera outfit, and \$25 violin. A. Ortlebe, Clara City, Minn.

FOR Sale—Good motorcycle cheap. Send stamp. Box 124, Stephens City, Va.

PIERCE Single and Four-Cylinder Motorcycles, slightly shopworn, for sale at bargain prices. William B. Colburn, 18 Hanover St., Buffalo, N. Y.

WANTED 1,000 Motorcycles immediately get our cash offer before you sell. We will purchase 1 or 1,000 Motorcycles, No 219 West 125th St., N. Y. City.

SALE—Twin Thor, fine condition, too fast. Bargain, photo. Everhart, Ft. Scott, Kans.

IMPROVEMENTS in Motorcycles and parts wanted; send sketch. Sanders, 18 Cully Block, Chicago.

MOTORCYCLES, all makes, \$25 and up. All machines guaranteed 1 year. Send for bargain list. H. W. Shockey & Company, 1019 South 14th St., Lincoln, Nebr.

1911 EXCELSIOR Motorcycle, A No. 1 condition, \$75. Photo on request. Elmer B. McDonough, Cheswick, Pa. Allegheny Co.

SALE—1911 "Minneapolis." Free engine, fine condition, \$147. Photo. Everett Blakeley, Ft. Scott, Kans.

MOTORCYCLE tires all makes, all guaranteed. From \$2.75 up. Get our prices before purchasing any tubes or tires. We can save you money. Guarantee Tire Company, No. 213-219 West 125th St., Dept. M., N. Y. City.

BARGAIN—Yale J. good order, \$50, \$10 deposit. W. S. Crossman, Terre Haute, Ind.

EXCHANGE peanut machine for motorcycle. Cost \$175. Box 71, Charleston, W. Va.

DON'T buy a Bicycle Motor Attachment until you get our catalog and prices. Shaw Mfg. Co., Dept. 27, Galesburg, Kansas.

MOTORCYCLE and Bicycle Repairing—a 300-page book of up-to-date practical information. Profusely illustrated. Price \$1 postpaid. Popular Mechanics Book Dept., Chicago.

LOOK—Closing-Out 2 1/2 hp. Columbia Motorcycle, \$45; 2 1/2 hp. Indian, \$55; 3 hp. Yale, \$85; 3 1/2 hp. Harley-Davidson, \$115; 6 hp. M. M. Twin, \$120; 7 hp. 4 cylinder Pierce, \$145. Everyone in excellent condition. Here's your chance to get a good Motorcycle cheap. Address: Thos. L. Williams, Clermont, Florida.

BIG bargains in second-hand motorcycles, \$25.00 up. Indians, Harleys, Thors, Excelsiors and Mercks. Write for full descriptions. Howard A. French & Co., Baltimore, Md.

MOTORCYCLE Bargains: Harley-Davidson; Indian; Thoma; Minneapolis. Get list and prices. D. M. Brown, 114-3rd St. South, Minneapolis.

DON'T buy a second-hand motorcycle. Get a new 1912 Pope for \$148. Wiley Latschaw, Carlisle, Ind.

FOR Sale 1911 5 hp. Twin Indian (blue) luggage carrier, prest-o-lite outfit. Guaranteed like new. Price \$175. Thos. J. Lawler, East Troy, Wis.

ALMOST new 5 hp. Magneto Motorcycle. Bargain for quick sale. Photo. Bowden, Campbell, N. Y.

NEW Side Car for Motorcycles, \$35. Herman Kaskel, Spencerville, Ohio.

VINCENT Bros., Cleveland, O., will save you money on motorcycles.

BARGAIN: 4 hp. Indian, magneto, One Hundred Dollars. F. Weisenabt, Rockford, Illinois.

MOTORCYCLE Tire Bargains! A. C. C. A. Prices Talk! Diamond, Goodrich, G. & J. and other Standard makes—Guaranteed—Griddiron, Basket and Bailey Treads—28x3 1/2, \$1.00; 28x2, \$4.95; 28x2 1/4, \$5.70; 28x2 1/2, \$6.20; 28x2 3/4, \$5.45; 28x2 1/2, \$6.20. Guaranteed. Tubes priced proportionately low. Shipped on approval. Don't buy until you receive our price list! The Automobile and Cycle Company of America, Dept. A, 1769 to 1787 Broadway, New York City.

BICYCLES, men's, boys and girls. Like new; puncture proof tires, cushion tires (never puncture), new casters, all sizes, \$10 up, etc.; \$5. Nice tandems, \$10; triplet \$15, racing triplet \$35. Old ordinaries \$10. William McDonough, 1118 N. Clark St., Chicago.

WANTED 500 Motorcycles immediately; any make, year, condition. We buy for cash! Let us make a cash offer for your motorcycle! A. C. C. A., 1769 Broadway, New York City.

A. C. C. A. Prices Talk. Endless variety. Latest models. Every make—Indians, Mercks, Harleys, M. M.'s, hundreds others \$20 up. Every machine guaranteed five years. Freight prepaid. Largest and only Illustrated Catalog published, sent free. The Automobile and Cycle Company of America, Dept. D, 1769-1787 Broadway, New York City.

1911, 5 HP. Indian, \$155. 4 hp. Indian, \$100. Both in excellent condition. John Small, La Salle, Ill.

READING-STANDARD, nearly new, equipped, \$180. Chas. B. Oils, Ann Arbor, Mich.

BARGAIN in motorcycle. Write for particulars. H. Pruett, La Salle, Ill.

AERONAUTICS

MUST sell: Fine monoplane, 1911 cross country type Bleriot, two seater, six cylinder 190 H. P. special built engine, full equipment of spare parts, tools, accessories and supplies. Entire machine but very little used and in first class condition, ready to operate upon assembling. A. V. Hartman, Jr., 5305 Delmar Boul., St. Louis, Mo.

CURTISS Military-type "Pigeon-tail." Blue prints scale drawn with minute specification. The only correct set on the market, also for Bleriot and Farman Machine. Only \$5 a set. Milwaukee School & College of Aviation, Milwaukee, Wis. See our display ad on page 32.

HOW to control an aeroplane. Price 50 cents. Used successfully by the largest schools. Aviators Exchange, 58 W. Washington St., Chicago.

BLERIOT Monoplanes will win more money in the \$100,000 Great American Circuit Race, than all other type aeroplanes combined. Four models, \$1,500 to \$10,000. Manufactured by American Aeroplane Supply House, Hempstead, N. Y. Illustrated catalogue free.

MILWAUKEE School & College of Aviation, Milwaukee, Wis., the oldest concern in the country. Backed by pioneer patents and seven years' active experience. We give full value and real knowledge. Just what you need. See our display ad on page 32.

BAMBOO Special grades for Aeronautic Work. Reed, Rattan and Split Bamboo for Models. Tonka Rattan for Skids 1 1/2 inch and under. Deltour, 504 Jefferson St., Hoboken, N. J.

BIRD-FLYER—The most natural, and scientific Flying Machine model in the world. (Patented). Most interesting for enthusiasts, and experimenters who cannot do without it. Power model 25c. Glider, 15c. Idea is worth the money. Ernst Ebbinghaus, 316 East 93rd St., New York.

WANTED: Men who want to learn the construction of aeroplanes and the art of flying. We can use some graduates in our own work. Write for our proposition. National Aeroplane Co., 404 So. Michigan Ave., Chicago, Ill.

"AMERICAN Record" Holder Monoplane Glider. Automatically controlled. Spread 22". Carries 250 pounds. Complete, \$22. Knockdown, \$15. Construction blueprints, \$1. "Standard Wright" Control Glider Blueprints, 50c. "Newport Seven" horse-power monoplane plans, \$1. Aviation Directory, Lawrence, Kansas.

HYDRO-AEROPLANES built to order, or any other type aeroplane at half price and twice the value. Our Basic Patents give you protection. Milwaukee School & College of Aviation, Milwaukee, Wis. See our display ad on page 32.

THE Benoist School of Aviation teaches students how to fly by allowing them to actually fly with the instructor. The only successful school in the country. Address: University City, St. Louis, Mo.

IMPROVEMENTS in Aeronautics wanted; send sketch. Sanders, 18 Cully Block, Chicago.

MOTOR—Imported French motor, four-cylinder, air-cooled; like new, perfect, cost over \$1,600; sacrifice for \$400. B. 2743 Ave. D, Brooklyn, N. Y.

METROSCOPE Case tells you in a minute how high, price \$1. Vanderpool's, Springfield, O.

AVIATORS wanted. We furnish competent graduates a standard-type aeroplane, practically without cost. Milwaukee School & College of Aviation, Milwaukee, Wisconsin. See our display ad on page 32.

SEE what we say under "Patents." Swift, Attorney, Washington, D. C.

PATENTS secured on Aeronautical Inventions. C. L. Parker, 919 G. St., Washington, D. C.

"VEHICLES of the Air," the newest and only up-to-date contribution to the literature of aeronautics, contains large working plans of all successful modern flying machines. This book of 500 pages, 140 halftone photographs and 130 drawings is the only book published containing every known fact of this interesting subject. Size, 6x 5 1/2 inches. Price \$2.50 net, postage 25 cents extra. Popular Mechanics Book Dept., Chicago.

MODEL Aeroplanes, How to Make and Fly Them. By W. Tulinig. Consisting of 5 sheets of scaled drawings, showing three different models, with descriptive booklet. By mail, 55c. Popular Mechanics Book Dept., Chicago.

COMPLETE plans drawn to scale, accompanied by clear building instructions;—Wright 3 ft. biplane, 25c; Bleriot 3 ft. monoplane, 15c; "Cochi Pool" champion racer (official record 1,691 ft.), 25c. Send 5c for our new 48 pp. illustrated catalog, most complete, including Rules for Model Contests. Ideal Aeroplane & Supply Co., 82 1/2 West Broadway, New York.

"GRAY EAGLE" Aero Motors, formerly sold by Rubel Co., Louisville, Kentucky, are now sold and guaranteed by Kemp Machine Works, the manufacturers of the motors, at Muncie, Ind.

FEATHER weight model propellers, hand carved, highly efficient. Sizes 6" to 12", at 3 1/2c an inch. Low quantity prices. Madrian Bros., 66 Sumner Ave., Brooklyn, New York.

GAS Turbine Perfected—Reduced to marvelous mechanical simplicity. World's lightest, most reliable aeronautical engine. Edgar E. Holmes, 350 Acorns, Denver, Colo.

\$250 FOR new uncrated Detroit Aeroplane motor carburetor, magneto and 7 ft. propeller. Emil Newton, 625 Moundtown Court, Madison, Wis.

GRAY Eagle Aeroplane engine, 30-40 hp., \$350. Complete, fine condition. Frank Heitz, Ashland, Ohio.

BLERIOT type Blueprints—Each set include four sheets, each sheet 21"x30" and drawn to the scale of one foot to the inch. Exhaustive details. Price \$1.50 per set. Aeronautical Eng. Co., 517 Crocker Bldg., San Francisco, Cal.

YOU ought to have Remon's Catalog. Chicago Aero Works, 164 N. Wabash Ave. Send stamp.

MOTORS: Nomie 1/2 hp. Rotary, Propellers 3c inch. Circular 2c. Charles Lee, Jr., Brunswick, Mo.

BOOKS AND PERIODICALS

GAS Engine Troubles and Installation. Cloth, \$1.90; flexible leather, \$1.50; Automobile Troubles and How to Remedy Them. Cloth, \$1.00; leather, \$1.50. Eight other practical and reliable mechanical books. Send for circular. Chas. C. Thompson Co., Dept. C, 1128 S. Wabash Ave., Chicago.

LEARN to be a chauffeur. An up to date book which tells in plain language how to operate, repair and take care of an automobile. Sample copy this month by mail only 10 cts. Pike Pub. Co., So. Norwalk, Conn.

DON'T Buy that book. We loan standard books by mail. You can buy or return them. We plan short courses of reading for you free. Self-help; business; health; house, home and field; economic and social problems; books for writers and speakers; religion; science, etc. Lists and bi-weekly Library Critic on request. State subjects in which interested. Oriental Esoteric Library, 119, Washington, D. C.

FOX and Hound—Monthly Magazine about Fox, Wolf, Coon, Possum, Mink and Rabbit Hoards; has Beagle Department; \$1 year. Sample free. Ask your news-dealer for a copy. Fox and Hound, Desk P, Decatur, Ill.

ENGINEERS' questions and answers for license, by Hobson, for twenty-five cents, postpaid. Send stamps. Belly's Book Store, Philadelphia, Pa.

SEND 50c for booklet "How to Run and Install Gasoline Engines," and year's subscription to Gas Energy, 28 Murray St., New York.

STEEL Tempering Book for mechanics, and Mechanical Digest one year, special offer, 25c. Mechanical Digest, Grand Rapids, Mich.

FASCINATING books: "Cleopatra," 25c. Stamp brings catalogue. Paul Duff, 2715 Mozart, Chicago.

IMMORTALITY Certain. Swedenborg's great work on life after death. 400 pages. Fifteen cents, postpaid. Pastor Landenberger, Windsor Place, St. Louis, Mo.

NEW Book, "Jane," 10c. Catalog of books and ten pictures free. Bond Pub. Co., A 3, Columbus, O.

"**METAL** Spinning" is the name of the only book published on this interesting art. A concise working manual both for those who desire to spin metal as an art recreation and to follow this work as a trade. 80 pages, 23 illustrations. Price, 50 cents postpaid. Popular Mechanics Book Dept., Chicago.

GAS for power is taking the place of steam for reasons of economy. Learn all about this great change by reading our new non-technical book on this subject, written by a first-class authority for the practical man. 192 pages, profusely illustrated, cloth binding. Price \$1.00 postpaid. Popular Mechanics Book Dept., Chicago.

MECHANICAL books, all kinds. Catalog for stamp. Crescent Book Store, 329 S. Halsted, Chicago.

TWO magazines for the price of one. Take advantage of our summer offers. Catalogue free. Norwalk Subscription Agency, Norwalk, Conn.

BARGAIN! New Volumes, Third Edition, Joshua Rose's "Machine Shop Practice." Low rates on Magazine Subscriptions. Pottstown Magazine Agency, Pottstown, Pa.

"**SCIENCE OF SUCCESS**," 120 pages, 25c. Satisfaction guaranteed. Book catalogue free. Popular Institution, Englewood, Chicago.

322 VALUABLE secrets and formulas, 15c. Catalog of Fascinating Instructive books free. White, Upland Place, Yonkers, New York.

TO MANUFACTURERS

WANTED reliable Agencies for anything suitable for the Island of Cuba. Bank references. H. Price-Williams, Martiano, Cuba.

CANADIAN agency propositions wanted P. O. Box 951, Victoria, B. C.

EDUCATIONAL AND INSTRUCTIONS

IN connection with your clerical work we show you how to earn \$10 to \$15 per week and hold your position besides. No canvassing. We, as manufacturers of patented specialties, have new easy mail order plans that can be carried on in your own home to keep the factories busy. Large profits. Small capital. If you are one-of-the-want-to-go-ahead kind write today for catalogue (copyrighted) plans and sworn statement. J. M. Pease Mfg. Co., 535 Pease Bldg., Michigan St., Buffalo, N. Y.

PLASTER casting, simplified instructions and outfit including model, mould, etc. \$1; make wall decorations, take a cast of your sweetheart's face. Unlimited possibilities. Write for information. Mahler, 117 Russell St., Brooklyn, New York.

YOU can write 100 words a minute without knowing Shorthand. My new method, Abbreviated Longhand, simpler than the simplest shorthand, tried and approved by thousands. Your money back if not delighted. Sample lesson 20c. Full particulars free. Write today. A. B. Weaver, Court Reporter, Dept. C, Buffalo, N. Y.

HOW to write catchy ads. Book 35c. Used successfully by Advertiser's, Show Card, Sign writer's and Merchant's. A. Nicodemus, 239 N. Sacramento Blvd., Chicago.

IN 4 weeks you can learn the world's fastest system of shorthand without a teacher. Can be used on any typewriter. Writes over 300 words a minute. Textbook, \$1. Rent a typewriter and send 1c stamp for circular. Tipston Shorthand Co., Columbus, O.

LEARN Japanese Oil Painting; inexpensive; talent unnecessary. Big money teaching others. Particulars for stamp. Hughes Co., Box 1567, Los Angeles, Cal.

CLAY Modeling, plaster casting, self taught (both sexes). Simple, advanced, reproducing lessons and tools complete, \$1.50. Modeling clay. Illustrated circular sent. Dotson Studio, Reading, Pa.

FLEXIBLE Sandstone, great curiosity—It bends—fine specimen, forty cents postpaid. Alexander, Jeweler, Asheville, N. C.

THAT Master Penman Francis B. Courtney teaches effectively rapid, tireless, business writing by mail. Illustrated journal free. Courtney's School of Penmanship, Box 492, Detroit, Mich.

BEST Shorthand Book for home study. Thousands of successful stenographers learned from it; so can you! Penman system complete, cloth bound, handy size, finest engraving, specially arranged for self-instruction. Price, \$1. Every book contains coupon entitling the purchaser to receive one month's practical instruction by mail. Lessons given by the author, Eldon Moran, our best known American Shorthand Instructor. Students are introduced and correspond with each other. The time to begin is Now. Young people succeed well. Book well worth \$1; besides, mail lessons worth \$2 will be received without extra cost. Book and lessons sent immediately upon receipt of order. Address Popular Mechanics Book Dept., Chicago.

BUSINESS correspondents earn fine incomes. Demand increasing. An expert will train you personally. Special proposition to first 100 students. A. Owen Penney, 684 11th Street, Washington, D. C.

LEARN from those who know. Courses covering every branch of the business world, or occupation. Write Common Sense Business School, Rising City, Nebraska.

CROSS Real Estate Course, \$3. George Winstel, 1624 Pleasant Street, Cincinnati, Ohio.

LEARN bookkeeping completely, thoroughly, scientifically and practically from an accountant's standpoint by doing 20th century actual work in fifteen lessons by mail, requiring 30 days' study. Lessons \$1 payable as you proceed. All material free. Memorizing antiquated, useless forms entirely avoided. Knowledge is power. Book-keeping properly understood increases opportunities. Consider. Investigate. Begin today. Austin's Accounting Academy, Dept. 3, Seattle, W. S. A.

DRAUGHTING, Individual instruction. Elementary and advanced courses. Short course for shop men. M. E. Kline, 824 Humbolt Ave., Detroit, Mich.

LEARN show card writing. Big demand. 24-lesson course of instruction at reduced rate. Particulars free. DeHoff Co., Box 268, San Fernando, Calif.

TRADE SCHOOLS

LEARN to operate Automobiles. Earn \$25 to \$75 weekly. We teach you at home or by mail to Drive, Repair or Assemble any Automobile. Auto Model Free to every student. Booklet free. Scientific College of Motoring, 3822-24 W. North Ave., Chicago.

WANTED: Men and Women; for government positions. \$80.00 month, Annual vacations. Short hours. No "layoffs." Common education sufficient. Over 12,000 appointments coming. Influence unnecessary. Farmers eligible. Send postal immediately for free list of positions open. Franklin Institute, Dept. C 22, Rochester, N. Y.

BE an auto expert. Fine positions open. Easy work, big pay. We teach you at home by charts, diagrams and model. Highest endorsements. Small payment to start. Write for 1912 book—free. Practical Auto School, 117 Pearl St., New York.

AUTOMOBILE School. You learn with your hands under the superintendence of the best instructors obtainable at the Chicago School of Motoring. Write for particulars. J. E. Edwards, Inst., Dept. "B," 1619 Michigan Ave., Chicago, Ill.

PAINTING, Decorating, Paper Hanging taught by actual practice. Free Catalogue. Chicago School of Painting, 412 Dearborn Ave., Chicago.

LINOTYPE instruction: day, evening courses: twelve weeks, \$80; thirty weeks, \$150. Empire School, 419 First Ave., New York.

CHAUFFEURS—Before taking State examination send fifty cents for printed questions and answers. L. I. Lutes, Ex-State Examiner of Chauffeurs, Utica, N. Y.

A COMPLETE course in interior decorating in all its branches. Practical work. Enter any time. Write for further information. Kalamazoo School of Interior Decoration, Academy of Music, Kalamazoo, Michigan.

PICTURES AND POST CARDS

POSTCARD Collectors. 10c will bring our magazine and insert your name in exchange list four months. Chicago views, motto, flower, birthday cards, 1c each. Folder of 22 different Chicago views 10c. Elite Exchange, Dept. B2 3827 North 44th Court, Chicago.

BEST Colored View Post Cards. Historical, scenic, all over the world, 10 cents for samples and catalogue, 20,000 subjects. Standard Card Co., Haverhill, Mass.

FRAMES for post cards, make them yourself with our outfit. \$1. Unlimited capacity, simple operation, half cent each, retail finished 15c apiece. Send for free photograph of frame. Mahler, 117 Russell St., Brooklyn, New York.

BEAUTIFUL Handcolored Scenic Postals. Genuine Photographs. Samples 10c. Colonial Art Company, 1516 St. Louis Ave., St. Louis, Mo.

IF you really want to exchange post cards, try our splendid club. Lists circulate in many countries. Membership, 10c. Halcyon Club, Box 133, Erie, Pa.

22 COLORED Views of Niagara Falls, 25c. Niagara Falls Novelty Co., Box 765, Niagara Falls, N. Y.

REAL photographs of beautiful women. Three poses for 25c; 7, including one 8 1/2 x 8 1/2 photo, 50c. Catalog of books and pictures free. Atox Co., A5, West Jefferson, Ohio.

SEND 25 cents for 5 fine photos, Great Mississippi River Flood. R. W. Stierrett, Box 134, Baton Rouge, La.

15 FASCINATING photos of beautiful women 25c, 5 for 10c. Real good. National Nov. Co., 421 K East 77th St., New York City.

FREE sample with list, send stamp. Photographs, Books, Etc. 16 samples 20c. H. Ord Co., Long Beach, Calif.

ARTISTIC pictures. Two fascinating, bewitching poses of beauties 10c. 8x 2 1/2. Great for desks. Litholtz, 4369 Poytania, New Orleans.

1,000,000 MEMBERS wanted. Membership list, certificate and five postcards all 14c. Postcard Exchange, Box 1013, Seneca, Pa.

ARTISTIC Pictures. Two fascinating beaching Poses of beauties 10c. 8ix 25c. Great for Dens. Litholl, 4509 Prytanla St., New Orleans, La.

RECEIVE post cards and letters from everywhere, membership 10 cents. Thomas Howard, 2305 Clark Ave., Spokane, Wash.

POSTCARDS—Wild Game cards (10), no two alike, prepaid, 25 cts. L. E. Welster, San Fernando, Calif.

SOMETHING new, beautiful quartered oak, mission finish post card racks, holds about 400. Set on table or shelf. Prepaid each, 60c. Two, \$1. Sawyer & Parker, DeWane, O.

SEND twenty-five cents for large photograph of the sailing of the battleship "Maine." A. Schaefer, 817 Michigan St., Buffalo, N. Y.

JOIN the largest, best and most interesting Postcard exchange. New plan. Membership, 10c. C. C. Club, 3929 Tracy, Kansas City, Mo.

YOU'LL get cards from everywhere. Membership, 10c. Idaho Card Exchange, Dept. K, Box 906, Boise, Idaho.

HIGH grade photo postals made from your pictures, 35c doz. A. Blad, Magnard, Massachusetts.

PHOTOGRAPHS of artists, models, actresses, commercial models. If you want only the best, enclose stamp for prices, staying kind wanted. Davidson Photographer, McVickers Theater, Chicago.

EXCHANGE post-cards with people from all parts of the country. Name inserted, list mailed you, one dime. Progressive Post Card Exchange, 436 E. 14th St., Buffalo, N. Y.

PHOTOS—Pretty girls in "beautifying poses," 12 for 25c, 4 for 10c. Curtis Co., 148 W. 73d St., Chicago.

POST Cards of the great Titanic, 12-set postpaid. Macrad, 70 Mott St., New York City.

FIFTY beautiful post cards, 25 cents. H. W. Booth, Utica, N. Y.

POST Card Club, largest in America—one of largest in world. Not a "3x3" affair. Very select. Trial 10c. World Wide Club, Perry, Oklahoma.

READ the rest, then join the best! Send 10c. Globe Postcard Exchange, 5228 Prairie Ave., Chicago.

CAMERAS, PHOTO SUPPLIES, ETC

FILMS developed, 10 cents per roll. All sizes. Prints, 2 1/2x3 1/4, 3 cents; 2 1/2x4 1/4, 3 1/2x5 1/4, 4 cents; 3 1/2x5 1/2 and 3 1/2x6 1/2, 5 cents. Highest grade of work.

AMATEUR Photographers—Make money taking portraits; work for yourself; be independent. We tell how; professional secrets, retouching, etc., fully explained. Wells Studio, East Liverpool, O.

8x10 PHOTOGRAPHIC Enlargements 25c each made from any size negative or film. All size 6 Exposure Kodak Films developed 3c a roll, 12 exposures 10c a roll. Send for complete price list and sample print. Scarlett Studio, 45-47-49 No. 13th St., Philadelphia, Pa.

FILMS Developed Free. Velox prints up to 4x5 Three Cents. "We Finish your Kodak Pictures Better." Colonial Art Company, 1516 St. Louis Ave., St. Louis, Mo.

KODAK Films Developed, 10c per roll, any size. Prompt attention given mail orders. Prints 2 1/2x3 1/4, 2 1/2x4 1/4, 3c; 4x5 to 3 1/2x5 1/2, 4c. J. M. Manning, Box R, 1062 Third Ave., New York City.

AMATEUR photographers attention! Brownie films, No. 1 and No. 2 developed. 5c per roll. Velox prints, 3c each. All other films 10c per roll. Velox prints, 4c each. Harold R. Parmelee, 108 Calhoun St., Springfield, Mass.

PHOTOGRAPHS Wanted by postmasters. I'll find a buyer for all prints I deem worthy of publication. Send your name on a postal for Leaflet of Instruction. A. S. Dudley, Photographic Expert, Box 775 G, Philadelphia, Pa.

FILMS: "Esmign" Double Instantaneous Non-Curlable orthochromatic. Better results, longer guarantee. G. Gemert, 24 & 26 East 13th St., Dept. G, New York.

GOING to buy a camera? Postal brings catalog and full information. L. J. Peabody, 278 Devonshire St., Boston.

5,000 PHOTOGRAPH Post Cards, 35c, 1,000—\$12, 100—\$1.50, 12—30c. Sample free from your films or plates. Canklins Photo Works, Box 323, Oneonta, N. Y.

HIGH grade enlargements 25c each from negatives. Developing and printing equally low. Prompt service. All work done and examined by experts. Diamond's Photo Shop, 416-6th Ave., N. Y.

KODAK Developing, Printing, Enlarging. Professional ten years. H. Wooding, Long Beach, California.

GET my list of cameras, lens, guns, photo secrets, etching, etc. Second hand, good order, and half price. B. P. Enright, Perry, Oklahoma.

GOOD, paying studio. Cheap. For particulars, write Hoffman's Studio, Denison, Texas.

5x7 NO. 5 Kodak Bell Film or Plates. \$15. Box 478, Jacksonville, Fla.

5x7 PRESS Graflex outfit cost \$210. Sell \$150. James Saunders, 1720 N. Wellington St., Philadelphia.

REGULAR Reflex, condition guaranteed. \$40. Daniel Flory, Piquette Creek, Pa.

FILMS developed 10c per roll. All sizes. Prints: 2 1/2x3 1/4, 3c; 2 1/2x4 1/4, 3 1/2x5 1/4, 3 1/2x5 1/2, 4c; 3 1/2x5 1/2 and 4x5, 5c. On post cards, 3c. Prompt returns. Highest grade work. Send 2 negatives and will print free as sample. G. R. Hoke, 1509 E. 63rd St., Chicago.

HEADQUARTERS for exchanging and selling second-hand cameras and lenses. Complete line of Kodaks, Century, Pramo and Graflex Cameras and supplies. For 3c in stamps we'll send you illustrated catalogue and special bargain list. "P." Gloeckner & Neerby, 171 Broadway, New York City.

FILM developed, 10 cents per roll. All sizes. Prints: 2 1/2x3 1/4, 3c; 2 1/2x4 1/4, 3 1/2x5 1/4, 3 1/2x5 1/2, 4c; Post Cards, 75c dozen. B. W. Smith, Jamesville, Wis.

8x10 CAMERA with extension 11x14, cost \$150, camera, lens, plateholders, tripod outfit for \$60. J. O. Reed, Howe Care, N. Y.

KODAK Films developed free. All prints to 5x7 size, 4c per dozen. Postcards same price. Work guaranteed. 20 years' experience. Davidson, 15 McVickers Theater, Chicago.

FILMS developed, all sizes, 5c. All prints, 3c. Enlargements, Get "B" list. Canklins Photo Works, Oneonta, N. Y.

PRINTS up to 4x5 1/2, 3c. Postals 3c. Zedig, Photographer, Long Island City, New York.

CEMENT

CONCRETE Building Block Machines and moulds. Free catalogue. 5 Market St., St. Louis, Mo.

If you want the best information on cement and concrete construction, subscribe for Concrete, leading cement and concrete monthly. Sample copy, 10 cents. Yearly subscription, \$1.00. Concrete, 135 Newberry Bldg., Detroit, Mich.

DUPLICATORS AND DEVICES

MALATANE Duplicators. Our Cap size 10x12 only \$2.50. Ask circular. Malatane, 1222 Southern Boulevard, New York.

HOW to get a photograph that will make 150 copies in 10 minutes; letter size, \$2.00. Write for circular. Hoyer Duplicator Co., 118 No. La Salle St., Chicago.

BUSINESS OPPORTUNITIES

WE start you in a permanent business with us and furnish everything. We have new easy selling plans and reasonable leaders in the Mail Order line to keep the factories busy. No canvassing. Small capital. Large profits. Spare time only required. Personal assistance. Write today for (copyrighted) plans, positive proof and sworn statements. J. M. Pease Mfg. Co., 341 Pease Bldg., Michigan St., Buffalo, N. Y.

HAVE you a mechanical device, toy, novelty, household or mail order article? If so, patent it through me and start in business with it. I show you how; book free. Sanders, 53 Crilly Block, Chicago.

INDEPENDENCE and fortune quickly attained in the Manufacturing Mail Order business. I furnish Formulas, Manufacturing Processes and Trade Secrets in all lines. Sold under positive guarantee; 18 years' practical experience. Revision and improvement of Formulas and Processes—reduction of manufacturing cost—utilization of waste materials, etc., a specialty. Booklet, Formula List, and Valuable Information Free. W. L. Cummings, Ph. D., 127 Standard St., Syracuse, N. Y.

MAKE mirrors at home. Big profits with little outlay. One 18x28-in. mirror costs \$2 to \$3. You can silver a glass this size for 20c. Send \$1 in stamps or money order and we will send you explicit directions how to do it; also how to emboss, grind, foil, gold leaf, frost, etch and make imitation stained glass. How to transfer photos on glass, bore holes in glass and cut skylights. George L. Patterson & Co., Dept. 3, Brookville, Ky.

HOW I made \$50,000 out of an idea and cash capital of \$50. You can do it. A safe road to wealth. An interesting story relating the actual experience of a young man. Send for this book, price 95c, postpaid. It tells how. Send money order or express order. No checks or stamps. Bank references: Colonial Trust Company, Pittsburg, Pa. Address—Frank Lewiston, Suite A 115 Bakerwell Building, Pittsburg, Pa.

MECHANICS, Electricians, Manufacturers. I have found a new method of building up the knurled disk on turnbuckles, thumb screws, etc. A turnbuckle that cost me 12c each I can make by this method for 1c. This method is valuable and the product is patentable. I will sell to the highest bidder. If interested write to Raymond Carroll, Orchard Homes, Missoula, Mont.

WANTED—Man with \$2,250 can buy \$2,600 stock in large, growing mercantile business. Stock worth twice actual cost. Company incorporated \$12,000, now worth near \$20,000. Man buying this stock gets good position with company and stands good chance become general manager. Excellent opportunity for hustling young married man with ability. Write for full particulars B. L. Connell, Clearmont, New Mexico.

PLASTER casting, instructions and outfit including model mould, etc., \$1. Casting from life. Send for information. Models for all purposes. Mahler, 117 Russell St., Brooklyn, N. Y.

STOP here! Let me start you in a home business that will bring you money every day. Experience unnecessary. Spare time. No canvassing. I furnish everything and guarantee success. Send for proofs. Vossiles, Desk C. R., Omaha, Neb.

LARGE and small Business Opportunities in all locations; profitable legitimate investments our specialty; let us start you in business; state how much money you wish to invest and in what line; give references; no triflers. Addison, 2 Crilly Block, Chicago.

MAKE \$50 to \$150 a month. Want active lodge man in every locality. To join this Society, Carry its sick, accident, death benefits. Get friends to join. Spare time. Write. Box RI-293, Covington, Ky.

INVENTORS desiring to market meritorious patented articles of general demand address National Mfg. & Sales Co., 308 National Union Bldg., Toledo, Ohio.

JEWELRY Store—For Sale, only one in good farming and lumbering town. Benson, haven't money to stock up. Arthur Beach, Winchester, Idaho.

FORM a corporation—Congress Law for D. C. and all States; cheap. Raise money easily. U. S. Legal Corporation, Washington, D. C. Representing \$1,225,000,000.

STOP dreading, use your brain to earn money, no capital required. Send 50c for book showing how. Prospect Specialties, 1094 Forest Ave., New York.

YOUR Brain can make \$200 while your muscles make fifty cents. Write for proposition. Dunning, Aulander, N. C.

88 PER day. You can make exactly that. No experience necessary. No investment proposition. Wonderful opportunity. Particulars free. J. M. Harrison & Co., Box 282, A-Hoxie, Ark.

FORTUNES are made in proprietary medical and toilet goods. Formula, labels, advertising originated. Small capital, wonderful profits. We guarantee success. Write for proof. Frank McNeer, Chemist, Owensboro, Ky.

HOW to raise the finest edible frogs in the world by the thousands in the city or country. A proposition for the man with little capital and small income. Write for free booklet. French Frog Farm, Monterey, Cal.

Be your own boss. Start mail order business. We teach you. 20 years established. Everything furnished. "Starter" free. Kueger Co., Dept. 2B, 167 W. Washington, Chicago.

\$ DOLLAR \$ Getting \$ Secrets 8 valuable Business Builders, 10 cents. (Refundable). Send Dime today and make more money. G. Edward Harrison, Baltimore.

ENCYCLOPEDIA of Business Chances—New money-making ideas; secrets of success; how fortunes grow from small amounts. Descriptive booklet free. Criterion Agency, 22 Broadway, N. Y.

COLLECT money by a sure, simple system. Income \$1,000 to \$5,000 a year—quick results. No capital required. Instructive book, "Skillful Collecting," free. National Collectors Ass'n., Long Street, Newark, Ohio.

OKY-ACETYLENE Welding. Make \$5,000 per year welding. Complete detailed instructions for building inexpensive welding plant; full instructions for use, making materials, etc., complete and guaranteed. Mail \$1 to J. M. Crowner, 112 So. Schuyler St., Ottumwa, Iowa.

BIG profits: Open a dyeing and cleaning establishment, little capital needed. We teach by mail. Write for booklet. Ben-Vonde System, Dept. C, Charlotte, N. C.

GATHERING information in any community pays good money. All or spare time, traveling or at home. Easy work. Either sex. Booklet Free. National Information Bureau, Station A12, Columbus, Ohio.

I WILL start you earning \$1 daily at home in spare time, silencing mirrors; no capital; send for free instructive booklet, giving plans of operation. G. P. Redmond, Dept. 208, Boston, Mass.

FREE sample goes with first letter. Something new. Every firm wants it. Orders from \$1 to \$100. Nice, pleasant, business. Big demand everywhere. Write at once for free sample and particulars. Metallic Sales Co., 406 N. Clark St., Chicago.

HAVE you anything to advertise? Our Rate Book tells you all about advertising mediums, rates, circulation, closing dates, etc. Sent for 10c. Worth dollars. Folder free. Correspondence invited. Dearborn Advertising Agency, 435 Franklin Bldg., Chicago.

BE Independent. Start Money Making Mail Order Business at Home. New Plans. Everything furnished. Only small capital required. Free Booklet & Particulars tell how. W. P. Miller Co., Box 251, Muskegon, Mich.

OUR mail order plans and specialties spell easy cash for you. Adam Fisher Mfg. Co., 61-12, St. Louis, Mo.

YOUR Ad placed in nearly fifty magazines 3 months, 5c per word. A. S. Manlin & Co., Alexandria, Va.

FOR RENT—Two-story brick factory. 7500 sq. ft. Plainfield, N. J. A. J. Brunson, Plainfield, N. J.

PATENTS secured—C. L. Parker, 910 G St., Washington, D. C.

SEE what we say under "Patents." Scriff, Attorney, Washington, D. C.

PATENTABLE ideas wanted—Send for 3 free books. Richard B. Owen, 20 Owen Bldg., Washington, D. C.

MAKE More Money! Start Mail Business—operate "Silent Salesman" system—can be done in spare time—possibilities up to hundreds weekly. But don't invest any money in the Mail Business until you read "Booster" for "The Booster Magazine" starts you in business for yourself—puts you next to the best money making propositions on earth—ones that get You the money. Get away from wage slavery! Send 10c for two months' trial. Booster Magazine, 360 Northwestern Building, Chicago, Ill.

DON'T you want to make Yourself a Real Estate Broker? We will make it easy for you without capital. You can be independent of bosses and have your own office instead of a job—swing big deals and make big commissions instead of working at details on a salary. Write today for booklet "P." No financial backing needed. U. S. Real Estate Institute, Box 46P, Asheville, North Carolina.

\$100 TO \$500 made monthly by anyone, operating honorable, legitimate business proposition, either locally or by mail, on \$1 capital. Guaranteed no "take" or "outright plan." Particulars free. Address J. K. Barr, Wellston, New York.

WE start you in business, furnishing everything; men and women, \$50 to \$200 weekly operating our Original "New System Specialty Candy and Popcorn Crispette Factories," home or small room anywhere. Opportunity lifetime; booklet free. W. Ransdale Co., East Orange, N. J.

WE start you in business for few cents. Big profits guaranteed or money back, selling window letters. Samples necessary to get orders mailed free. Standard Letter Co., 2500 Milwaukee Ave., Chicago.

WE Help Raise Capital at once to start you in retail—manufacturing—patent—real estate—mail order or any legitimate business by means of "Our Practical Method." Particulars free. The Business Aid Co., K394, Detroit, Mich.

MAIL Order Men: Quick Cash Returns! Brand New Mail Order and Agency Specialties! Factory Prices! Copyrighted. Prospectus and Sample Free; Box M 235, Pittsburg, Kansas.

TEN good factory sites for sale. Prices reasonable; fronting on two good railroads. Help plentiful. H. W. Brown, Forest City, Pa.

TWO Dollars will start and stock profitable Mail Order Business; let me tell you how. William Hinds, 354 Opden Ave., Jersey City, New Jersey.

MAKE yourself independent by silencing mirrors. Send for booklet. M. K. Thompson Co., Dept. K, Akron, Ind.

AN intelligent person may earn \$100 monthly corresponding for newspapers. No canvassing. Send for particulars. Press Syndicate, 760 Lockport, N. Y.

SELL your formulas, ideas, plans and knowledge by mail. Some make \$1,000 monthly. Instructive booklet for stamp. Information System, 271, Marietta, Ohio.

I MADE \$50,000 in five years with a small mail order business; began with \$5. Send for free booklet. Tells how. Hancock, Lockport, N. Y.

SPECIAL Offer! New book chock full of latest money-making plans, schemes and best formulas for local or mail business. Satisfaction guaranteed or money back. Regular price, \$1.00, but for limited time only, 25c. Address M. Hall, Saratoga, New York.

\$1,000 YEARLY profit from your back yard. Complete plan (170 pages), illustrated, and a profitable mail-order proposition, \$2. Sent for 30c and six stamped envelopes addressed to mechanics. Particulars free. Popular Institution, Englewood, Chicago.

ADVERTISING pencils are business getters. Extra fine quality, 100, \$2.50; 1,000, \$17.50. Write for samples. Arthur E. Atchison, P112 N. LaSalle St., Chicago.

BOOM your business by having a Chicago office also. Our mail service system makes it very easy and inexpensive. Fully explained for stamp. Model Service System, 538 S. Dearborn St., Chicago, Ill.

TWO partners cleared \$78 per week each last 14 months, still increasing, cannot organize in U. S., but will grant you this chance. Not for dreamers, or children. Particulars from The Specos Company, Box 112 St. Roch, Quebec, Can.

USE your spare time to build up a mail order business of your own. We help you start for a share in profits. 27 opportunities. Particulars free. Mutual Opportunities Exchange, Buffalo, N. Y.

INCORPORATE free; pay expenses; we take stock for services. Listed Securities Co., Elmira, N. Y.

WANTED—Reliable agents to handle an article designed for men. Notice Kokomo-Belt Co.'s ad, page 126.

AGENTS WANTED

AGENTS! Wild with excitement! Do you blame them? Of course you don't. Everybody eager to buy our beautiful artistic air brush design show cards. Agents making \$75 per week. Cards printed in colors, size 11x14, 350 varieties. No talking—simply show the show cards to storekeepers—the cards speak for themselves. Big profits, something new. Tide just setting in. The show cards are great, you'll say so, you can't help it. Wake right up, no time to argue. Do it now, send this very minute a letter or postal for free catalog and sample. Populair Show Card Co., Desk JL, 1235 Michigan Ave., Chicago.

MAKE More Money. Start Mail Business—operate "Silent Salesman" system—can be done in spare time and the possibilities are unlimited. But don't invest any money in the Mail Business until you read "Booster" for "The Booster Magazine" starts you in business for yourself—puts you next to the best money making propositions on earth—ones that really get You the money. Get away from wage slavery! Send 10c for two months' trial subscription. Booster Magazine, 360 Northwestern Building, Chicago.

BEAUTIFUL Embossed Gold Window Letters make 1,000% profit without experience. Signs always needed. Ours last for years. Rock bottom prices. Essentials to work with mailed free. Embossed Letter Co., 2494 Milwaukee Ave., Chicago.

AGENTS are successful handling our automatic razor stropper—easy seller—satisfaction guaranteed. Retail \$1.50. Profit 100%. Write for terms. Auburn Supply Co., 7746 Peoria St., Chicago.

HUSTLERS are making big money with the Fuller—the best and quickest selling line of sanitary household brushes made. Write now. Catalog free. Sample outfit. Fuller Brush Co., 35 Hoadley Place, Hartford, Conn., Western Branch, Wichita, Kansas.

WANTED—Agents to sell automobile and furniture polish. Handsome profits. Write for full particulars. Lowell Grievens, Lacon, Illinois.

AGENTS—Both sexes: Our Rough-Shod Sanitary Dish Cloth sells at sight. Intertown with copper. Can't rust. Orders repeat. Particulars free. Sample 15c. LeRoy Specialty Co., 74 Park Place, Room 32, New York.

1122 smallest Bible on earth! Send a postage stamp. New Testament, illustrated; 260 pages; sample 10c. Ways to start a mail order business with each order. Other specialties. Green Specialty Co., Dept. A, Peoria, Ill.

WE want one selling agent in each town to represent the Magic Electric Suction Cleaner. This is a high grade proposition—fee high grade men only, that's really worth while investigating. Rosenfield Mfg. Company, 12 Abingdon Square, New York.

HUSTLING Agents Wanted for our fast selling Sanitary Household Brushes. Steady work. Big profits. Postal brings particulars. Dept. C. Hale & Kavanek, New Britain, Conn.

POCKET light for cigars, autos, etc., 50c. Self-lighting marmies, 35c. Sparkler, lights all gas, much safer and cheaper than matches, 25c. Wizard for lights and stoves, 50c. Agents don't pass this. Thompson Parker Specialty Co., Elmira, New York.

LIVE proposition for hustling agents in towns where there are 500 or more telephones. Four red stamps bring samples. Clifford Craven, 35 East 21st, New York.

AGENTS—Make \$5 daily taking orders for door plates, name plates, house numbers, signs, etc. Samples free. Breit Bros., Boston, Mass.

CASH for names, addresses, information, etc. Steady income at home. Instructive booklet for stamp. Information System, 272, Marietta, Ohio.

AGENTS wanted for new Patent Household Articles. "Big Profit." Send for particulars. Adolph H. Klopper, 21 Cliff Street, New Rochelle, N. Y.

AGENTS wanted to sell ladies silk hosiery, sample, 50c. Particulars free. Glinther Supply Co., Dept. 8, Watertown, Connecticut.

AGENTS Wanted—For Gravity Spiral Hinge. Greatest seller of the year. Hooper Hinge Co., Gosport, Ind.

MAIL Order Men; Quick Cash Return. Brand new mail order and agency specialties; factory prices; copyrighted prospectus and samples free. Box N. 225, Pittsburg, Kansas.

MAKE \$3 a day at home; new trade, easily learned; no competition. Van Zandt, 1914 McKinney, Dallas, Texas.

AGENTS Male and Female to sell novelty pencil, supplies its own memorandum paper instantly. Catalogue, premiums offer and sample, 29c. Henry H. Dines, Brattleboro, Vt.

AGENTS—New Plan! Double Money! Double Premiums! Enormous Profits! Whirlwind Seller! Repeat Orders! Act quickly! Get Territory! Don't Wait! P-B Co., Dept. B, 12 N. Market St., Chicago.

BEST side line for agents, direct from factory at popular prices, more than double your money. Write today. Hunt Mfg. Co., Westboro, Mass.

HORRAY Boys—Look at this winner. I offer it to you. Take hold now; profits big; easy work. Free particulars. David Supply Co., Box 190, Casper, Wyo.

WHY work for others? Our plans require no experience or capital; legitimate; immense profits; stamp for reply. O. S. Judd, Marion, Ill.

WHY slave for wages. Why not be independent. Write for free particulars and begin at once. S. A. Wilson Specialty Company, Lock Box 280, Homestead, Pa.

GENERAL managers, exclusive territories, great fortune, selling new patented attachable fan for sewing machines. Retail \$1. Get information. Attachable Fan Co., 30 W. 124th St., New York City.

AGENTS—Sign Painters. Cost 2c, sell 25c. Something new: Guaranteed Sign Letters mounted with kerosene and roller. Grip outfit free. Boss Letter Co., 247 Milwaukee Ave., Chicago.

AGENTS—To sell the newest electric appliance on the market; sold everywhere there is electricity. In the home and office; liberal profits; sales-driving sample, weighs a pound, no experience or knowledge of electricity required; it shows how to use one light instead of two and get the same results; sells for \$3.50 and saves the purchaser an investment of \$25; write for particulars. The Handy Light Co., 711 East Eighth Avenue, Cincinnati, Ohio.

HERE'S one that's different. If you're a good square man in unoccupied territory, I will send you, without the usual deposit, without the payment of a cent except express charges, a sample Standup Scrubber, in a fine salesman's case, and give you exclusive territorial rights for the sale of the best floor-cleaning machine now on the market. Retail at \$1.50, and goes about as fast as they can be handed out. Apply now, state county wanted (not more than one county to an agent) give references, and look for outfit and full instructions within a week.—Elmer E. Stevens, Inc., 1189 River St., Aurora, Illinois.

CALIFORNIA red wood clothes chests, better than cedar, 1/4 cost. Beauty 4 feet long with arms for window seat, cedarized, moth proof, \$8.75. Keep fresh red wood bread box 50 cents. Colonial red wood candle sticks 25 cents, 6 \$1.00. Agents sample, no spring no scratch, patent broom holder sells rapidly 10 cents. Utility Products Mfg. Co., Tropic, Calif.

AGENTS—At Once—Something New. "Model Spring Winder." Makes springs any size from any kind of spring wire. Rapid, efficient and powerful. Indispensable to every factory, farm, shop, garage, printing office. Attaches to any workbench in a minute. Sell one, make \$2.50 profit. You can sell 10 a day easy. Let's get going. National Mfg. & Sales Co., 297 Huron St., Toledo, O.

NEW suit offer. Send name and address for wonderful suit offer and outfit to stov, samples, styles, etc. We want live agents. Can make \$1,000 to \$2,000 a year. All business your territory turned over to you. We pay all express charges. Only one suit offer in your town. If you want a suit write quick before someone else gets the prize. Paragon Tailoring Co., Dept 119Y, Chicago, Ill.

AGENTS on salary or commission. The greatest agent's seller ever produced; every user of pen and ink buys it on sight; 200 to 500 per cent profit; one agent's sales amounted to \$620 in six days; another \$32 in two hours. Monroe Mfg. Co., N. 6, La Crosse, Wis.

EARN \$15 to \$25 a week or more as our Mail Order Dealer. Right from your own home. Hold your position until entire time is required. We are manufacturers and owners of patented just-in-season specialties. If you are just starting a Mail Order Business or if already established, you can't afford not to handle our Patented Money-Making Getters. We sell exclusively to our Mail Order Dealers. We protect them. We carry stock and furnish everything. No canvassing. Small capital. Experience unnecessary. Write today for Latest Patented Leader and Manufacturers' Easy Selling Mail Order (copyrighted) plan backed up by "Whole Truth," Positive Proof and Sworn Statement. J. M. Pease Mfg. Co., 529 Pease Bldg., Michigan St., Buffalo, N. Y.

AGENTS—\$50 weekly; we manufacture the best needle case made; a wonderful seller; 200 to 500 per cent profit; talking unnecessary; our copyrighted "Trust Scheme" Envelopes do the work; general agents can make over \$100 weekly; send 10c for a 25c sample containing 115 needles; particulars free; buy direct from the factory at wholesale. Paty Needle Co., 102 Union Sq., Somerville, Mass.

AGENTS—County and State; men and women everywhere to sell the Pinless Clothes Line; a practical labor saving invention. Lasts life-time, sells on sight, gives perfect satisfaction. Agent Sutton of Georgia, sold over million feet; 100% profit; write quick for exclusive territory; information free; sample prepaid 25c stamps. Pinless Clothes Line Company, 529 Wilcox Bldg., Portland, Oregon.

AGENTS—Ladies or gentlemen, to sell the highest grade toilet goods, Favorites, etc., direct to families. High class house; fair dealing; repeat orders sure; large cash commissions. Address Kingham Bros., Indianapolis, Ind.

AGENTS—General Agents—Great Wonder Summer Seller. Biggest Summer profit maker ever placed in hands of agents. Patented. Right in season. Not sold in stores. Free sample for demonstration, \$5.00 to \$10.00 a day easily made. Get territory quick. Valuable "Money Making Hints" to agents free. Write today. A. G. McKinley Co., McKinley Bldg., 2176 Ogden Av., Chicago, Ill.

GREAT Suit Offer. Write us for starting offer on a suit for yourself, and outfit of samples, styles, etc. Only one suit offer in your town. We want you for agent so we can turn over all orders in territory to you. You get big business and easy money. Even new agents make \$10 a week. If you want great suit offer write today or someone may get in first. American Woolen Mills Co., Dept 119 Y, Chicago.

SALESMEN—Send your name and address to Raymond E. Wood, 500 East Eighth St., Cincinnati, Ohio. I am the manufacturer's Sales Manager for the best household and office electric specialty ever invented. Sells for \$3.50 and \$2.50. Guarantee for credit or deposit required. Capable men only need apply. I want only a few men. The work is permanent, profitable and high-grade. You will be given territory and expected to produce business.

BIG Profits—Easy Money, stamping names and addresses on key checks, umbrella plates, watch fobs, etc. Big demand. We sell blank stock and stamping outfits. Send 10c now for sample with your name on it, and full particulars. Hart Manufacturing Co., 293 F. Degraw Street, Brooklyn, N. Y.

500% PROFIT. Your opportunity. Act now. Buyers everywhere for our U. S. Fire Extinguisher. Lowest cost. Quick sales. Exclusive territory given local agents and State Managers. United Mfg. Co., 1291 Jefferson, Toledo, O.

MAIL order ads that pay. 20 different propositions fully explained. All bona fide, sure-fire Money-getters. Each one the foundation of a successful Mail Order business. Send 10c for full particulars and regular bulletin of new propositions. Mail Dealers Wholesale House, 459 Franklin Bldg., Chicago, Ill.

AGENTS—We manufacture glass paper, Plain glass windows made to look like real stain glass; something new; easily applied; big money maker; two sample sheets of paper, with catalogue in colors and discount sheet, for 10c. S. H. Parrish & Co., 292 S. Clark St., Chicago.

YOUR sales guaranteed. Sample free to hustlers. Men buy on sight. Only device that scientifically lures and drops any razor—old style or safety. Gives correct diagonal stroke. Famous Rubirundum Honing Strip in every machine. Sold on money-back guarantee. 100% profit. Write quick for particulars. Sales Manager, 709 Victor Bldg., Canton, Ohio.

AGENTS are making \$50 a week selling Steel Mantle lamp and lantern burners. Sample burner mailed to your address for 25c. Particulars free. Steel Mantle Light Co., 399 Huron St., Toledo, O.

YOU can make \$488 as our general or local agent. Household necessity; saves 80 per cent; permanent business; exclusive territory; salary or commission; free sample; credit. J. Pitkin, 113 Redd St., Newark, N. Y.

AGENTS—If you don't make \$4 profit the first day selling Tate's Dust Absorbing Dust Cloth, etc., return samples. Many Agents made \$25. Write quick for particulars. Dept. B-4, Consumer's Direct Supply Co., Boston, Mass.

AGENTS Wanted—Mechanics and shopmen make over \$100 a month in spare time selling transparent handled novelty knives and razors. Big profits. Sales easily made. Write for terms today. Novelty Cutlery Co., 47 Bar St., Canton, O.

WANTED—Live Tailoring Agents For Fall, 400 styles of woolsens, \$10.00 to \$30.00 wholesale. Fit and workmanship guaranteed. Only those who take at least ten orders per season for made-to-measure clothes need apply. My outfits are very elaborate and stitched without expense to you. Hustlers make big money and establish permanent business. Exclusive territory. Write today. Harry Sawyer, Merchant Tailor, 351 West Quincy Street, Chicago, Illinois.

MAKE 1500% profit selling our sign letters. We'll show you how. 100 varieties. Johnston Co., Quincy, Ill.

500% PROFIT selling our wonderful sign letters for office windows, store fronts and glass signs; resembles finest gold leaf; easily applied; samples free. Metallic Letter Co., 404 N. Clark St., Chicago.

A TWO Minute Demonstration. Makes Every Call a Sale, with large profits. Positively biggest agents' bonanza out. Free sample and particulars. G. V. Sales Co., 12-14 Spruce St., New York.

AGENTS—It costs me about \$2.00 to secure your name and ship sample machine, but it's a dead sure way of convincing you I've got best household invention on earth. Canvasers and crew managers make up to \$20.00 a day. Elmer E. Stevens, 1189 Adams Express Bldg., Chicago.

AGENTS make big money selling our new gold letters for office windows, store fronts and glass signs. Any one can put them on. Write today for free sample and full particulars. Metallic Sign Letter Co., 404 N. Clark St., Chicago.

AGENTS—Gasoline Filter for automobiles. Just out. Sells every auto owner. 100% profit. Make \$2.50 every sale. Note: but hustlers wanted. J. H. Brabazon Co., 166 Melrose Ave., Toledo, O.

AGENTS & Mail Dealers—Specialties that sell. Big profits. Easy sellers. No chance proposition. Success certain. Order pulling circulars furnished. Write for samples. A. S. Mankin & Co., Alexandria, Va.

GREATEST Sensation of the Year! New invention. Hemmeter Spark Gap positively eliminates all spark plug troubles; easy to demonstrate; every auto owner buys; agent's make 100% profit. Particulars free. Sample prepaid \$1. Buckeye Auto Accessories Co., Toledo, O.

AGENTS Wanted—Sell Rich Looking, Imported 36x38 rugs, \$1 each. R. H. Carter, Milan, Tenn., sold 115 in four days; his profits, \$37. You can do as well. Write for sample offer and unique selling plan; exclusive territory. A. Condon, Rug Importer, Stonington, Maine.

AGENTS make \$30.00 weekly selling our 500 Handy Household Articles; catalogue free. Scheff Co., 1137 Wells St., Chicago.

WE guarantee large weekly income to clever salesmen who can handle new patented device for fountains and bars. Sufficient goods given free, paying initial cost. Greatest offer made. Exclusive territory. Fulton-Bell Company, 2 Rector Street, New York.

SALESMEN wanted: A reliable, permanent business, selling Koeth's Kombination Kit, the most wonderful tool ever invented. Six pairs drop forged tool steel jaws, one pair handles makes pliers, pliers, punches, wrenches, etc. Invaluable for mechanic, farmer, chauffeur, handy man. Currier-Koeth Mfg. Co., 52 West Street, Coudersport, Pa.

AGENTS, Teachers, Students, here's your opportunity. Sanitary dustless rugs. Gem Ironing shoes. Many new household specialties that sell in every house, \$5.00 daily easily made. Now is the time to start and get in on the ground floor. For samples and particulars address Dexter Supply Co., 508 S. Dearborn, Chicago.

NEWEST Pocket pen. Writes with water. Always ready. Easiest seller, agents big profit. Sample 25c. Wolff, 4305 Prytanis, New Orleans.

AGENTS. The New Kleen-Eze outfit. The Wonder Worker. 200% profit. Eight combined cleaning utensils. A fortune for live agents. Exclusive territory. Charles Krebs, Secretary, 2268 Archer, Chicago.

AGENTS: To handle Auto specialty; sells on sight. Enclose stamp for particulars. Dept. M, Lewis R. Bailey, Chickasha, Oklahoma.

AGENTS our patented specialties sell like wildfire; send for free catalogue and sample, worth 10c. Watchung Specialty Co., Dept. D, Westfield, N. J.

AGENTS—Both sexes everywhere to sell our 15 and 25c novelties, orders repeat; big profits. Send for circulars. The Cres and Novelty Mfg. Co., 67 West 125th St., New York City.

I HAVE the greatest money maker on the market; customers delighted; particulars free. H. M., Box 115, Homewood Station, Pittsburgh, Pa.

WE pay the largest commissions, make instant delivery. Guaranteed hosiery, year-wear shoes and silk knit neckties, free sample plan. Credit allowed. The Direct Company, 11 South St., Boston, Mass.

\$3—OUR general and local agents make many dollars. Household necessity—Quick repeater—Permanent business—Exclusive territory—Big profits—Free sample. Lee-Pareet Co., Box 552, Syracuse, N. Y.

"ALCA," the famous \$6.00 Vacuum Cleaner, seeks a few more willing agents to show its merits and promises prosperity and success in return. Write for gift-edge proposition. Alca Co., 266 W. 50th St., (Dept. B), New York.

GENERAL Agents, and ladies in home towns, the French egg beater and butter blender; a fine side line or specialty, beats and blends any mixture. Sells on guarantee for 25c. Fine commission, quickly demonstrated, patented. Address with stamp, Mary E. French, Clyde, O.

FREE sample goes with first letter. Something new. Every firm wants it. Orders from \$1 to \$100. Nice, pleasant business. Big demand everywhere. Write at once for free sample and particulars. Metallic Sales Co., 406 N. Clark St., Chicago.

LIVE agents are coining money with our outfit, which doubles the life of auto tires. Sample outfit \$3. Write us. Steward Specialty Co., Steward, Ill.

AGENTS—100% profit and easy to sell. A splendid opportunity for young men and women to earn \$20.00 or more weekly. Our goods sell on sight, and you can be sure of repeat orders. Liberal proposition to workers. Write now. Velco Complexion Co., Dept. J, Wheeling, W. Va.

AGENTS—Handsome profits and rapid sales with our brand new, seasonable household specialty. Every woman wants several. Write for particulars. Graham Sales Co., Bloomington, Ill.

AGENTS: Our Columbia Folding Hand Bag is the best proposition on the market. Not sold in stores. Big profit. Write for terms and other big sellers. S. V. Diamond, 25 West 21st St., N. Y. C.

MEDALLIONS sell at sight, 500 per cent to 500 per cent profit. Make up your own goods and be independent. "It's easy." Catalog free. Fred Resag Co., 1265 W. Randolph St., Chicago.

OUR specialties sell at sight, experience unnecessary, no trouble to take repeat orders. Catalog sent free. Jno. H. Boyd, Dept. 10, Aurora, Indiana.

AGENTS—Make \$2 each selling our wonderful luminous crucifixes; nothing to sell six a day; absolutely new; shine all night in darkest room. Pioneer Portrait Co., 5609 Halsted St., Chicago.

WE manufacture six fascinating game boards, 100% profit. Orders repeat. Can be carried as side line where Candy, Pipes and Cigars are sold. Particulars free. Unique Novelty Co., Independence, Ia.

WRITES with water—The Helios Pocket Pen with compressed ink; beats fountain pens ten times its cost. Sample 25c. Big proposition to agents. William Muller, Security Bldg., San Francisco.

IT'S the greatest money maker! Get next quick! "A Yard of Kids." Every woman want one! Easiest seller. Retail 25c. Two samples for 25c (coin or stamps). None free! Very low price by dozen or thousand. Exclusive territory. Merit H. Sales Co., 271 W. 125th St., N. Y.

ANY agent with ordinary ability can make \$10 daily. New, attractive proposition. Write for free particulars. F. H. Montgomery, Burke, N. Y.

"SPOTOLA," removes grease spots or "Money Back." 50c box for 3 dimes, agents wanted. Spotola Co., Box E, Georgetown, Ill.

HOSIERY. Agents make 32% commission selling our Guaranteed Hosiery direct to consumers. Write us. Manufacturer, Box 238, Manheim, Penna.

WANTED—Active men in every locality. To join this Society. Carry its stock, accident, death Benefits. Get friends to join. Spare time. \$50 to \$150 a month. Write. Box RK-293, Covington, Ky.

AGENTS—Unusual sellers. Big profit prizes. Novelty jewelry, perfumery, hosiery. Price list, particulars free. Block Bros., 477 Eighth Avenue, New York.

AGENTS: Novelty sign cards spell easy cash. Adam Fisher Mfg. Co., 61-7, St. Louis, Mo.

AGENTS—Portraits 25c. Frames 15c. Sheet Pictures 1c. Stereoscopes 25c. Views 1c. 30 days' credit. Samples and catalog free. Consolidated Portrait Co., Dept. 119 Y, 1027 W. Adams St., Chicago.

PERFECTION Pocket Adding Machine, Lightning seller. Agents wanted. Cincinnati Specialty Mfg. Co., Dept. R, Cincinnati, Ohio.

AGENTS—\$200.00 per month, permanent business, no investment. We supply you with the best Vacuum Cleaner ever invented to sell at a price anyone can afford to pay. Settle with us weekly for machines sold. One Man to a County. Write at once. Braham Company, X15, Cincinnati, Ohio.

OTHERS are earning \$5 to \$25 daily with our new specialty, why not you? Send for our booklet. Wall, 224 Clark Ave., Austin, Chicago, Ill.

SALESMEN and agents write for our money-making offer. Selling oil direct to auto owners. Big profits. Easy sales. Weisman Mfg. Co., Marshalltown, Iowa.

AGENTS wanted everywhere for special and standard articles. Drop us a card. Particulars free. Hopkins Supply Co., Greenville, Pa.

AGENTS—\$5 daily selling our Handy Tool, 12 articles in one. Lightning seller. Sample free. Thomas Mfg. Company, 462 Third St., Dayton, Ohio.

TITANIC Disaster—Big \$1.50 book, retelling at \$1. Agents' price, 50c. Sample postpaid 10c. Send quick—canvassers making \$25.00 daily. Nichols & Co., Box 6, Nagerville, Ill.

AGENTS make 500% profit selling our gold window letters, novelty signs and changeable signs, 800 varieties in enormous demand. Catalogue free. Sullivan Co., 1238 Van Buren St., Chicago, Ill.

\$100 MONTHLY and expenses to trustworthy men and women to travel and distribute samples; big manufacturer. Steady work. S. Scheffer, Treas., 3. W., Chicago.

\$7 A WEEK will start you in a big money-making mail order business—with the best line—in spare time. Particulars free. Antiseptic Mfg. Co., 1864 Barry Ave., Chicago.

STOP here! Let me start you in a home business that will bring you money every day. Experience unnecessary. Spare time. No canvassing. I furnish everything and guarantee success. Send for proofs. Voorhies, Desk C. R., Omaha, Neb.

WANTED—One good man in each town to take orders for men's tailoring; beautiful styles; very low prices; orders come easy; high class; permanent business; fine profits; \$10 a day and up; no money or experience needed. We ship on approval express prepaid, and guarantee perfect fit. Write for free sample outfit and inside price on suit for yourself. Banner Tailoring Co., Dept. 577, Chicago.

AGENTS—Stop Here—three wonderful sellers—patented—Postal brings particulars—Act. Novelty Co., 219 S. Dearborn St., Chicago.

SALESMAN. Sell the best \$7.50 Hand Vacuum Cleaner Made. Our Cleaner and Commissions beat them all. Address, Excelsior Mfg. Co., Loganport, Ind.

40% PROFIT selling Gordon Photo Pillow Top. High grade work. Samples and catalogue free. Luther Gordon Co., Northwestern Bldg., Chicago.

LADIES earn money coloring post cards; send 10c for samples and instructions. Roxbury Card Co., Roxbury, Mass.

WE manufacture four fascinating game boards; 150% profit; orders repeat; best side line with cigars, candy, etc. Particulars. Bechter Game Co., Independence, Iowa.

BE Independent! Here's your chance. Mail order fashions, 22 snappy propositions. Brand new. Money-making. Particulars, 19c. Acme Sales System, 815 Summer Ave., Newark, N. J.

SEW threading needles, 10c a paper. Agents' samples and terms free. Ladies' Art Co., Dept. 41, St. Louis, Mo.

I WILL start you earning \$4 daily at home in spare time, altering mirrors; no capital; send for free instructive booklet, giving plans of operations. G. F. Redmond, Dept. 596, Boston, Mass.

EXCEPTIONAL Opportunity for Live Agents—Wonderful aluminum cooking utensil, entirely new. Positively saves user's time, labor, money. Moderate in cost, without complications. Every home a prospect. Agents making big incomes. Special proposition to those who can represent us. Attractive sample easily carried. Wizard Cooking Utensil Co., Tuscola St., Saginaw, Mich.

SEE what we say under "Patents." Swift, Attorney, Washington, D. C.

AGENTS—Big money distributing free plus Borax Soap Powder. Ward & Co., 1778 Berceau, Chicago.

AGENTS. Is "Sandling" the rage in your locality yet? Be the first to introduce it. A branch of the arts-craft. A golden opportunity for agents. Sell our outfits to housewives and boys and girls. Recorders constant. Sample outfit, 25c. John Carrell Novelty Co., Missoula, Mont.

START entirely new mail order plan. Write. B. Elkins, Farmington, N. H.

WE want to secure an agent in every town where the trade of pattern making is followed to sell the best book published on this subject. Sells for \$1.00, is a big value and ready seller. Everyone engaged in this trade or intending to learn it will want a copy. Liberal terms to agents. We protect you by appointing no one else in your community. Write for particulars. Popular Mechanics Book Dept., 318 W. Washington St., Chicago.

AGENTS—Wake up. \$20 weekly, combination key-ring, seven tools in one. Lightning seller. Sample 10c. A. Beers, Bradley Beach, N. J.

ANCIENT and modern tricks exposed; list for stamp. "Semiann." M 737 Ursuline St., New Orleans.

AGENTS, rapid seller, large profits. Sample 10c. Shurwin, Lock Box 422, Dept. 4, Grenada, Miss.

SIGN letter agents—Painters: Something new and better: Attracto Gold or Silver Letters, 21 different kinds. Anyone can apply them. Make big money lettering store windows and selling our sparkling, flashing chipped glass nameplates and signs. 1912 catalogue and sample letter free. Attracto Sign Co., 2655 North Clark St., Chicago.

Big Money in Selling Used Automobiles—No business so easy to learn, so profitable, so congenial. On \$50 to \$100 investment our agents make \$50 to \$100 per week. We furnish the cars and teach you how to drive, sell and repair them. Write today for particulars and territory. The Automobile and Cycle Company of America, Dept. 1, 1769-1787 Broadway, New York City.

MAKE big money—best opportunity; hustling agents now wanted to sell Pico. The best toilet soap paste manufactured. Indispensable household aid. We assume all risks. Write now for territory. Hopewell Brothers, Newton, Mass.

BOYS! Be your own boss and make \$25 to \$30 a week selling direct to owners of Autos, Launches and Garages our new 1912 Electric Auto Launch Light. Sells at sight. Beside the money you make selling the goods, we are going to give away as prizes, Bicycles, Cameras, Howard Gold Watches, Launches and Automobiles. Will you take one? Write now for full particulars. Don't wait. The W. A. Fenner Co., Providence, R. I.

KEY tag—German silver—marked with your name and address, with key ring, 15 cents. We want you to take orders. 100% profit. We sell blank tags, steel letters, key rings, etc. Pease, Die Maker, Winchester, N. H.

WANTED—Live agents to sell "The American Lady Fibre Broom" on 1 year's guarantee. Does away with corn brooms. Exclusive territory; free samples; big, permanent business; 1 man in every county. F. L. Burt, 2255 S. State St., Chicago.

PORTRAIT agents, 16x20 crayon, sepia, pasteline, bromide, 40 cts., big money in our convex portrait; delivery guaranteed or money back; portrait and frame catalogue and sample free. Siegfried Portrait Co., Dept. P. M. 3, 5219 Ellis Ave., Chicago.

CUT out fads and fancies. Handle a sensible, guaranteed line of newly-patented household inventions; permanent employment. Send for catalogue and unique selling plan. Lyon-Elwood Mfg. Co., East St. Louis, Ill.

BOKARA Diamonds—Agents, everyone, to wear and sell our famous Bokara Diamonds. Write for sample offer and catalogue Free Northwestern Jewelry Co., 52 Northwestern Bldg., Chicago.

LIVE agents are making big money selling our Latest Cigar Lighter—Why not you? Sells on sight. Sample 3c. Particulars free. Gott Sales Company, 5727 Lore Ave., Dept. C 48, Chicago.

AGENTS—The money is yours if you grab this winner. It sells to everybody. No talking necessary. Just show it and the sale is made. 100% profit. The wise agent will send for free particulars. C. S. Rush, Dept. A 694, N. St. Clair St., Pittsburgh, Pa.

AGENTS (either sex) for "Par-oxo," the peroxide washing helper. Repeat orders, exclusive territory, 10c sample for 5c postage. Thoreau Mfg. Co., 1062 W. Chicago Ave., Chicago.

CONSIDER the immense field for a fan motor operating by gas or gasoline and your agency application will be sent immediately. Essex & Smith Co., 8 Lock St., Buffalo, N. Y.

AGENTS make enormous profit handling our quick-selling imported Oriental staples and novelties. Never been advertised. Be orders. Exclusive territory. Write for particulars. Shaw Kanematz, Box 529, Portland, Oregon.

\$5.00 PER day easily made handling our specialty. Particulars free. Write us. White Specialty Company, 3659 Prairie Ave., Chicago.

AGENTS wanted in every county to sell Razorless Shaving Powder. From \$75 to \$200 a month can be made. Send 25c for twelve states and terms. Seelig & Washworth, Branchton, Pa.

EASY \$888. New specialty. Needed every home. Sells on sight. Biggest profits with Budlong's line. Budlong, Box 157, Providence, R. I.

ALUMINUM Plant or Clothes Sprinkler, fits any common bottle, sample 1c. Particulars free. Hubert, 8 Morris Crescent, Yonkers, N. Y.

LIVE agents make \$25 daily. Auto owners buy at sight. Send for particulars. Inquots Mfg. Co., Dept. 19, 262 Main St., Buffalo, N. Y.

MAKE money, sell our merchandise. Send 2c for Cowboy Bob and Chain. Arthur Rose, 431 Hanover, Baltimore, Md.

BRAND new agents specialty. Big seller. Send 10c quick for sample. Particulars free. R. H. Jorgensen, 2825 W. Diversey Ave., Chicago, Ill.

AGENTS to sell "The Story and Wreck of Titanic." Best discount and territory. Religious specialty, 3201 Cedar Ave., Cleveland, Ohio.

LIVE agents—Don't be idle, make big money; 25 excellent propositions. Hall Manufacturing Co., Merna, Nebr.

AGENTS wanted—100% profit selling Safety Razors. Agents' outfit 50 cts. Jacobson Specialty Co., N. Main St., Jamestown, New York.

HELP WANTED

WANTED one thousand chauffeurs and repair men. Our demand for automobile engineers exceeds the supply. Calls for men of intelligence and mechanical bent capable of commanding \$109.00 to \$150.00 per month upon graduation. Resident course \$20.00 to \$60.00. Home Correspondence course completed by practical road and shop work at this school, highly successful. Look this up. Auto Schools of America, Dept. T, 1690 Michigan Ave., Chicago.

AGENTS Wanted—We want a live wire agent, either engineer or specialty salesman in every town to furnish lists of names and take orders for Akron Metal Gaskets, the most complete line of metal Gaskets made. Write for our proposition. Akron Metallic Gasket Company, Dept. P. M., Akron, Ohio.

WANTED By U. S. Government: Mail Clerks; Carriers; Clerks in Patent Offices; Agriculture; Treasury; Army; Navy; and other departments at Washington. Excellent salaries. No "layoffs." Short hours. Annual vacations. Position would be yours for life. Examinations everywhere soon. Common education sufficient. Thousands of appointments coming. "Pull" unnecessary. Farmers eligible. Write immediately for sample questions and larger illustrated book telling duties and giving full particulars. Franklin Institute, Dept. C21, Rochester, N. Y.

SALESMEN Wanted. To sell the best line of Light Furniture and Piano Benches on the market, on a commission basis in Minnesota, Kentucky, Nebraska, Oklahoma, North and South Dakota, Missouri, Tennessee, Alabama, Georgia and Louisiana. Address Art Novelty Co., Goshen, Ind.

STOP here! Let me start you in a home business that will bring you money every day. Experience unnecessary. Spare time. No canvassing. I furnish everything and guarantee success. Send for proofs. Voochies, Desk C. R., Omaha, Neb.

GOVERNMENT wants postoffice clerks—carriers. \$85.00 month. Examinations everywhere soon. Coaching free. Franklin Institute, Dept. C21, Rochester, N. Y.

I WILL start you earning \$4 daily at home in spare time, silvering mirrors; no capital; send for free instructive booklet, giving plans of operation. G. F. Richmond, Dept. 206, Boston, Mass.

EARN \$10 to \$15 a week and hold your position besides. No canvassing. We, as manufacturers of patented just-in-season specialties, have new easy mail order plans to keep factories busy. We furnish everything. Large profits. Small capital. Experience unnecessary. If you are one of the want-to-go-ahead-kind, write for our most modern (copyrighted) plans. Sworn statement. J. M. Pease Mfg. Co., 549 Pease Bldg., Michigan St., Buffalo, N. Y.

MEN and women wanted for government positions. \$80.00 month. Thousands of appointments coming. Write for free list of positions open. Franklin Institute, Dept. C21, Rochester, N. Y.

YOU are wanted For Government job, \$80.00 month. Send postal for list of positions open. Franklin Institute, Dept. C21, Rochester, N. Y.

BE an electrical meterman—\$100 to \$1,800 a year. New field. Demand for competent metermen greater than supply. Personal, practical mail instruction qualifies you for splendid position. Graduates assisted. Write for particulars. Fort Wayne Correspondence Schools, Dept. 20, Fort Wayne, Ind.

BIG money writing songs. Hundreds of dollars have been made by writers of successful words or music. Past experience unnecessary. Send us your song poems, with or without music, or write for free particulars. Acceptance guaranteed if available. Washington only place to secure copyright. H. Kirkus Dupdale Co., Dept. 205, Washington, D. C.

WANTED—Men and women; for government positions. \$80.00 month. Annual vacations. Short hours. No "layoffs." Common education sufficient. Over 12,000 appointments coming. Influence unnecessary. Farmers eligible. Send postal immediately for free list of positions open. Franklin Institute, Dept. C21, Rochester, N. Y.

I MADE \$50,000 in five years with a small mail order business; began with \$5. Send for free booklet. Tells how. Hancock, 5074 Lockport, N. Y.

WANTED—Hustling man in each locality. Join this Society. Sick, accident, death benefits. Introduce our Memberships. Spare time to start. \$50 to \$300 a month. Write, Box JF-293, Covington, Ky.

MEN and women wanted for government positions. \$80.00 month. Short hours. Annual vacations. Thousands of appointments coming. Write for free list of positions open. Franklin Institute, Dept. C21, Rochester, N. Y.

FREE illustrated book tells about over 300,000 protected positions in U. S. service. More than 40,000 vacancies every year. There is a big chance here for you, sure and generous pay, lifetime employment. Easy to get. Just ask for booklet A29. No obligation. Earl Hopkins, Washington, D. C.

WANTED, Agents, Machinists, Attention! Increase salary, new revised Saunders' Hand-Book of Practical Mechanics. Best ever ready reference. Thousands in use. Postpaid \$1.00 cloth; \$1.25, \$1.50 leather flap. Big profits. E. H. Saunders, 216 Purchase St., Boston, Mass.

UNCLE Sam is a liberal employer. Qualify for a Government position. We prepare you by mail for any Civil Service Examination. Write today for free Booklet 32, Capital Civil Service School, Washington, D. C.

GOVERNMENT post office examinations everywhere soon. Get prepared by former U. S. Civil Service Examiner. Write today for free booklet. Patterson Civil Service School, Box 826, Rochester, N. Y.

MAKE money writing short stories. Big pay. Free booklet tells how. United Press Syndicate, San Francisco.

REPRESENTATIVES wanted everywhere—Here's your chance. Don't let it pass. Easy money, easy work listing names and property. A dime brings particulars and contract. "National Exchange," Box 72, Waterloo, Iowa.

SALESMEN—Two energetic, clean-cut men; Ohio, Grocers and Patrons. The Sigmet Oil Company, Cleveland, Ohio.

AN intelligent person may earn \$100 monthly corresponding for newspapers. No canvassing. Send for particulars. Press Syndicate, 745, Lockport, N. Y.

MEN and boys to learn automobile repairing, driving on up-to-date cars; electricity, civil engineering, surveying. Methods most practical. Room and board while learning. Positions secured; satisfaction guaranteed; catalog free. National School of Engineering, 2110 W. 7th, Los Angeles.

WANTED—Men at Los Angeles. Can learn trade. Fair wages after second month. Automobiles, electricity, plumbing, bricklaying. Practical work on actual jobs. 1,200 students last five years. Only few months required. United Trade School, Los Angeles.

CASH for information, names, formulas, and ideas. Steady, profitable home business. Instructive booklet for stamp. Information System, 273, Marietta, Ohio.

WANTED young men, mechanically inclined, to sell our Belt Oil to factories and demonstrate its efficiency and new Method of application. Sample outfit one dollar. King Mfg. Co., Chicago.

WANTED—5,000 Distributors of Advertising Matter everywhere. American Distributor, Mount Pleasant, Pennsylvania.

MEN wanted for firemen and bakemen on railroads in Chicago vicinity: \$89 to \$109 monthly; promotion, engineer-conductor; experience unnecessary; no strike; age 18-35. Railroad employing headquarters; over 5,000 men sent to positions on 1,000 official calls. State age. Address Railway Association, Dept. A, 257 Monroe St., Brooklyn, N. Y.

INVENTORS—Ideas mean fortunes. Often lost by delayed patenting. Mail description for free, temporary legal protection and secrecy till patenting. Have actually sold inventions for fortunes. Edward P. Thompson, M. E., (registered, as reliable and competent attorney in U. S. Patent Office) Dept. A, Victor Bldg., Washington, D. C.

MACHINERY, TOOLS, SUPPLIES

FOR Sale—16 in. Horizontal Boring Mill; Henley Pulley Lathe; 20 in. Barnes Upright Drill; Delano Pulley Drilling & Tapping Machine; Dbl. Head Milling Machine; Gould 43 in. Rack Cutting Machine; Allis Chalmers "B" Stone Crusher; Sand Papering Machine; Dbl. Head Electro-type Trimmer; Whitewashing Machine; Hustler Ash Sifter; 1 1/2 in. Gardner Governor. Write for description and prices. The Challenge Machinery Company, Grand Haven, Mich.

500 HORSEPOWER right-hand engine; simple Corliss heavy duty frame, size, 24x48, complete, including flywheel, 18 ft. diameter, geared for 14 turns 1 3/8-in. rope, American drive-steam receiver separator, 7-in. steam pipe including one long radius bend and flanges; can be seen in operation at our mill in Mt. Carmel, Ill. Address Bernet Craft & Kauffman Mfg. Co., Office 1016 Pierce Building, St. Louis, Mo.

REBUILT motors—We have a number of second-hand marine engines of our own and other makes, completely rebuilt and guaranteed by us. As the builders of "Buffalos" are not in the second-hand engine business, we will sell them at less than factory cost to make room. This is a rare opportunity to get the highest grade of engines—2 to 100-hp.—cheap. Buffalo Gasoline Motor Co., 1281-96 Niagara St., Buffalo, N. Y.

BOWSER Feed Mills—New No. 0, \$20; No. 3, \$32.50; No. 7, \$44.50. Limited number. Harris Machinery Company, Minneapolis, Minn.

MANITOU Marine Motors, 5 H. P., \$62; 10 H. P., \$104; 20 H. P., \$189. Satisfaction guaranteed. Rough and Machined castings of same for sale. Richards Engine Works, Manitowoc, Wis.

ENGINE castings, 1 1/2 horse vertical gasoline, air-cooled, \$7. Three horse marine water-cooled, \$1 cash; drawings included; catalogue for stamp. Novelty Manufacturing Co., 853 West 81st St., Cincinnati, Ohio.

FOR Sale—Tool Cases for Machinists, Tool-makers and Draftsmen at a sacrifice. The Ohio-National Mfg. Co., Chillicothe, O.

FOR Sale—Gasoline engines, automobiles, marine and stationary, also castings. Second-hand ones taken in exchange and for sale. Apply with stamps. B. W. Richardson, R. No. 36, Peoria, Ill.

FOR Sale—Engine lathe, swings 9 1/2 in. takes 25 in. between centers. Complete with full set change gears to cut all size threads, 3 to 40 in.; price only, \$43.50. Address L. F. Grammes & Sons, Allentown, Pa.

STEAM boiler outfit, complete; 1 1/2 horse power, 20" diam., 51" high, \$40. Page Boiler Company, 815 Lustrabe St., Chicago.

FOR Sale—Rebuilt: Throttling, Automatic and Corliss engines, boilers, pumps, heaters, machine tools, tanks, saw mills, and general machinery, at bargain prices. Let us know your wants. The Handle Machinery Co., 1761 Powers St., Cincinnati, Ohio.

AIR compressors. Small air cooled compressors, for use in garages and small shops. 6 sizes. Prices low. E. R. Caldwell & Co., Bradford, Pa.

MECHANICS: Build your own 2 h. p. water cooled gasoline engine. Castings \$7. Send 10c in silver, for blue print, photo and particulars. Vigneaux Machine Co., 240 Middle Bldg., Detroit, Mich.

FOR Sale. Two American Saw-Mill Machinery Co. 6 inch water turbines, one with and one without cast iron casing. Address P. E. L., 5540 Woodlawn Ave., Chicago, Ill.

SIMPLE mechanical inventions wanted; send sketch. Sanders, 29 Crilly Block, Chicago.

SEND 50c for booklet "How to Run and Install Gasoline Engines," and year's subscription to Gas Energy, 28 Murray St., New York.

FOOT Lathe—Screw cutting—Reverse head—Compound rest—Chuck—Tools—Dogs—Supplies. Rear of 209 E. 6th Ave., Cincinnati, Ohio.

BRITING—Bargains in Canvas stitched and Rubber Thresher Belts. Harris Machinery Company, Minneapolis, Minn.

VACUUM Cleaner Parts, Pumps, Tools, Hose, Tanks, etc., all sizes, at wholesale Write Koch Vacuum Machine Co., Ann Arbor, Mich.

POLISHED German Slicer Machines' Pocket Rules, graduated 1/16, 1/32, 1/64. Three inch 25c; four inch 35c. Noble & Westbrook, Hartford, Conn.

BEFORE you buy, get our big bargain list of new and used gasoline engines, 1 to 100 HP. Badger Motor Co., Milwaukee, Wis.

VERTICAL Boilers—1 and 1 1/2 H. P. \$28 and \$38 complete. Harris Machinery Company, Minneapolis, Minn.

WE buy and sell all kinds Iron Wood-working, Tinners' Machinery, Motors, etc. Molitor, 215 So. Clinton St., Chicago.

SMALL jobbing foundry and machine shop for sale. Address J. W. Fischer, Fayette, Mo.

FOR Sale—5 H. P. marine engine cheap. Joseph Busch, Maple Valley, Wash.

FOR Sale—14 inch Engine Lathe or trade in Automobile. Benjamin Skolans, Westbr. Wis.

LATHE For Sale, Screw-Cutting Foot-Power, New, Cheap, 9x15", Hayes, Union & Bircher, St. Louis, Mo.

FOR Sale—12"x12" Harrisburgh Ideal engine, \$275. 25 H. P., four cylinder, gasoline motor truck engine, \$150. Geo. J. Adams, 39 South St., New York.

LATHE for sale—For bargains in small lathes write South Bend Machine Tool Co., Dept. L., South Bend, Ind.

BARGAINS in rebuilt Palmer marine gasoline engines. Palmer Bros., 31 E. 21st St., New York.

FOR Sale—Cheap, 1 20-h.-p. New Era gasoline engine, in first-class condition. The Mason Fence Co., Leesburg, Ohio.

MEN. 10 tools in our handle. Handy pocket kit for all uses. 50c postpaid. Highland Supply Co., Box 484, Burlington, Ia.

PATTERN makers! A book devoted to the principles of pattern and core making and molding. Written by G. H. Willard, a practical pattern maker of years experience. This book, just published, treats the subject in a much more simple, direct and effective manner than most books along this line. 224 pages, 312 illustrations. Price \$1.00 postpaid. Popular Mechanics Book Dept., Chicago.

SERIES of 7 lithographic models—Steamship, automobile, gas engine, steam engine, steam turbine, wireless telegraph and dynamo. Size 8x14 inches. All parts of these machines are shown and numbered to correspond to printed keys of names. Price each, 50 cents, postpaid or set of 7, \$3.00 postpaid. Popular Mechanics Book Dept., 318 W. Washington St., Chicago.

CASTINGS for wood turning lathe, machined ready to assemble, \$2.50; including metal bed, \$3.50. Smaller size, \$1.50. Murray & Allender, 113 East Burl. St., Fairfield, Iowa.

PULLEYS, Gears, Sprockets, Shafting, Hangers; see page 144. W. A. Jones Foundry & Machine Co., Chicago.

200 RUNSEN Burners, special type. Heats 1250". Highly efficient. Each \$1.50 prepaid. Wallace Herman, 112 Alberta, Dayton, Ohio.

CASTINGS for 1/2 hp. marine engine, \$8. Murray & Allender, 113 East Burl. St., Fairfield, Ia.

FOR Sale—15 in. Sebastian screw cutting lathe with Chuck, set of Armstrong lathe tools also Goodell power hack saw. Cost over \$200, will sell for \$120. Otto Hamel, East Otto, N. Y.

CASTINGS for 4 horse marine engine \$14. Murray & Allender, 113 East Burlington St., Fairfield, Iowa.

WANTED—Gasoline engine electric lighting outfit complete, 10 to 25 lights, also dynamos, motors, gasoline engines, all types, 2 to 10 horsepower. Seattle Engineering School, Seattle, Washington.

LATHES, \$67, \$139, \$225, \$250; millers, \$125 up; drills, punches, grinders, planers, gear cutter, wood shaper, stickers, 27" planer, sander; all bargains. Bicknell, Janesville, Wis.

DON'T keep that "good idea" in your head because you cannot develop it. My experience and machine shop can help you. Drop me a line. S. Mason Fox, Germantown, Philadelphia, Pa.

FLOUR, & FEED MILLING MACHINERY

SPECIAL bargains in second-hand: Attrition mills, burr mills, crushers, cone crushers, bran dusters, dust collectors, purifiers, reels, double, single, 2 and 3-gear high roller mills, sieve bolters, receiving separators, sizers, etc. Write for description and prices. Spout, Waldron & Co., P. O. Box 429, Muncy, Pa.

BOATS AND LAUNCHES

FOR Sale, New Waterman 3 hp. boat motor with boat fittings. Weight of engine, 55 lbs. Price, complete, \$50. Motor Car Supply Co., 1453 Mich. Ave., Chicago.

MOTORCRAFT Encyclopedia—A 150-page book that tells 1001 things every motor boatman should know. How to overcome engine troubles. Price \$1, postpaid. Popular Mechanics Book Dept., Chicago.

CHART of a modern submarine boat showing and naming over 200 parts. Size, 14x28 inches. Printed on plate paper. Shows clearly and distinctly all the interior. Mailed in a tube for 25c. Popular Mechanics Book Dept., 318 W. Washington St., Chicago.

MANUFACTURING MACHINERY

PUNCHES, dies, tools, models and experimental work. Inventions perfected. Light manufacturing solicited. Kirkman Die and Tool Works, 1809 Market, Denver, Colo.

WE make dies, tools, special machine parts, and models. Perfect and manufacture inventions on contract. Do plating. Write for estimate. Hagsrom Bros. Mfg. Co., Lindborg, Kans.

WE want a line of medium weight machinery to manufacture on contract. Pattern work and special machinery built. J. T. Schaffer Mfg. Co., Rochester, N. Y.

DIES, models and special metal articles accurately made. Inventions perfected. Expert patent lawyers furnished. Metal Novelty Co., 1925 Olive St., St. Louis, Mo.

IRON brass and aluminum castings. Metal specialties. Patterns, models, polishing, plating and japanning. North Chicago Tool Works, North Chicago, Ill.

WE make jigs, fixtures and tools for metal stamping, cutting and forming. McCall Machine Works, Rochester, N. Y.

WE make dies and tools, models, metal stampings and hardware specialties to order. A. Amundson & Co., 542 W. Jackson Blvd., Chicago, Ill.

WANTED—Good specialties or machinery to manufacture. A. & E. Bess, Hamilton, Ohio.

AMERICAN Model and Tool Works, 617-631 W. Jackson Blvd., Chicago. We make models, tools, dies, molds, patterns and model parts. Expert gear cutting. Inventions developed and simplified.

WE make working models of any description, also tools, dies, punch-press work, and special machinery. Send us drawing or rough model for estimate. Send for catalogue of model supplies. The Pierce Model Works, 3465 Pierce Ave., Chicago, Ill.

MECHANICAL ENGINEERS

INVENTIONS developed, drawings, patents, machinery designed. Irwin D. Groak Engineering Co., Monadnock Building, Chicago.

MACHINE Designing, Inventors' ideas developed. Working Drawings, Machinery designed to order. Cary L. Abbot, Mechanical Engineer, 1241 Unity Bldg., Chicago.

MACHINE designing, ideas developed. High class work at lowest rates. E. B. Stauffer, Ephrata, Pa.

MOTION PICTURES

"MAKE your own films" of local interest—it will make your theater prominent by showing a local feature film from time to time. Buy the "Junior Professional Outfit," with which you can make films better than some of the manufacturers are turning out. The complete outfit can be bought outright, with full instructions how to take, develop and print, my own patents, scores of highly satisfied customers. N. Y. greatest Jobbing laboratory and mechanical workshop, special Films, Titles, cameras rented, special lenses, projecting machines and single arc dissolvers. All motion pictures and supplies, film stock, condensers, wire bags, expert picture machine repairing. Write me at once on what you are interested—for catalogues. Eberhard Schneider, 219 Second Avenue, near 11th St., New York.

HAVE a local motion picture taken. It will pay you. We make 'em. Write for terms. State how many feet you want. We do the rest. Moving picture cameras, and printers, bought, sold and exchanged. We rent Moving Picture Cameras. Special Event Film Mfg., 248 West 35th St., New York.

WRITE moving picture plays; \$25 weekly, spare time; literary ability unnecessary; free particulars. Atlas Publishing Company, 340 Cincinnati, Ohio.

WANTED—Picture Play Writers. Big pay. We'll teach you how. United Picture Play Association, San Francisco.

WRITE Moving Picture Plays; good pay; booklet for stamp. Photoplay, 214, Middleport, N. Y.

FOR Sale—Moving picture film, 16 foot, machines, \$40. H. Davis, Watertown, Wis.

WANTED

WANTED—Active man in every lodge. To join this Society. Carry its sick, accident, death Benefits. Get friends to join. Spare time. \$50 to \$150 a month. Write, Box RN-293, Covington, Ky.

SECONDHAND piano action course. E. A. M., 747 La Salle Ave., Chicago, Ill.

WANTED. Canning factory at Seadrift, Tex., in the Gulf Coast section, on San Antonio Bay. Anyone interested please correspond with Secretary Commercial Club, Seadrift, Texas.

WANTED. Press for forming sheet metal. Power Hack Saw, Brazing forge. John Whisler, Gibson, Iowa.

WANTED—A strong spring mechanism to run motion display—Send particulars. John Phillips, Jr., Mexia, Texas.

FOR Cash, number four Rivett bench lathe. J. H. Mosher, Glendale, Montana.

WANTED—Sample copies and advertising rates of mail order publications. All publications carrying a classified section preferred. Johnson, 4250 N. Kimball Ave., Chicago.

WANTED—Good ideas and improvements to manufacture on contract or royalty. Specialists in metal forming. Hunt Mfg. Co., Westboro, Mass.

WANTED—Mechanical Designing. Fairbairn, Assoc. Mem. Am. Soc. C. E., 819 Fairbanks Bldg., Springfield, Ohio.

WANTED—Victor phonograph and records D. M. Leadbetter, Arbor Vitae, Wisconsin.

FOR SALE

VENEERS—1/30" quartered oak, 3c; 1/30" mahogany, 5c; 3/16" poplar, 25c; 3/4" poplar, 3c per sq. ft., random widths 18" and over by 24" and up long. W. H. Snyder, 838 Jefferson Ave., Indianapolis, Indiana.

FOR SALE—One lot of re-built laundry machinery. Box 88, Hamilton, Ohio.

FOR Sale—General Store, good room; best location in town. A rare opportunity for man wanting to go into business. No better agricultural section in Ohio. Store at Jamestown, Ohio. Address owner, Vandepool, Springfield, Ohio. Will involve about \$2,500.

SAFETY Gates for freight elevators. Elder Manufacturing Co., Indianapolis, Indiana.

INTEREST in valuable invention to start manufacturing. Factory ready. Box 265, Barry, Illinois.

VACUUM cleaners. All sizes and parts for stationary house plants or wagons. Buy your parts and assemble machine. Saves half. Koch Vacuum Machine Co., Ann Arbor, Mich.

FOR sale, set of Printing plates in Colors; 12 different designs, can be used for any kind advertising propositions. Printed samples sent for 10c. A. Peter, 239 N. Sacramento Blvd., Chicago.

FOR Sale. General merchandise business house, warehouses, wharf and lands. Particulars of Ralph Brueger, Nelita, Washington.

SET Carlisle-Finch Toy Electric Railways. Good Condition. Cheap. Box 478, Jacksonville, Fla.

ILLUSIONS and Magical secret list—Pink Stamp—Nixon, 455 First St., Brooklyn, N. Y.

FOR sale. National vacuum cleaner, used less than one week. Alternating current. Cost \$99, take \$49. Model Cleaners, Brookfield, Mo.

MANDOLINBANDJO. New, 25-year Elgin Watch, Hand Painted Tankard. Kelly, 1 E. 22d, 4th Floor, Room 17, Chicago.

FOR Sale—Pneumatic Tire Bike Wagon, like new, 75 dollars. J. A. Stultz, Marietta, Pa.

ELECTRIC Fans, 12 inches, D. C., \$9.50; A. C., \$11.50; guaranteed. Battery Fans, 19 inches including 60 ampere hours storage battery and finished brass parlor stand to closet battery and hold fan in any position, \$14. Storage Batteries, first class 6 volts, reliable 60 ampere hours, \$7.25. Cosmos Electric Co., 136 N. Liberty St., New York.

TRICYCLE for sale—A Tinkham adult Tricycle all intact and in good running order except one tire needs slight repairs. Price \$30, crated for shipment. A bargain. Address Oldest Furniture House, Box 35, St. Augustine, Fla.

VACUUM Cleaner House installations or parts wholesale. Koch Vacuum Machine Co., Ann Arbor, Mich.

SALE OR EXCHANGE

FOR Sale or Exchange—Fine Bando with case for 1/6 or 1/4 hp. 110 volt direct current motor. Geo. Helmgartner, 5558 Ellis Ave., Chicago, Ill.

EXTRA fine Bleriot Monoplane, cost \$1,400. Cash \$250, or will trade for Show stuff. What have you? Herman A. De Vry Co., Tulsa, Okla.

EXCHANGE—Set watch repairing tools for motorcycle. F. E. Keller, Hallam, Nebraska.

GOOD Curtis twin cyl. motorcycle and moving picture outfit. Will trade for late model automobile runabout. R. Loving, Center, Texas.

EXCHANGE 1 cylinder 12 H. P. auto engine for motorcycle. A. Kiedinger, Pensacola, Fla.

ROTARY printing press, \$25, for typewriter. Shelly, Sheridan, Pa.

BLACKSMITHS

I GUARANTEE with Toy's Modern Methods on Steel Work, you can do all hard jobs easy. All welds will be solid, and all tools tempered to a standard, by colored tempering charts. That means better salaries and better positions. All for one dollar. Send for valuable samples free. W. M. Toy, Sidney, Ohio.

DIAMONDS, WATCHES, JEWELRY

BUY genuine perfect cut diamonds direct from the importer at the lowest prices in the world: 1/2 carat, \$8.25; 3/4 carat, \$17.50; 1 carat, \$45.00; 1 carat and over, \$97.50 per carat. Written contract to buy back every diamond for 96% in cash and allow full price paid on all exchanges. Send no money. We ship C. O. D. privilege of examination without deposit and without obligating you to purchase. Send for big Basch Diamond Book. Free! Established 23 years. See our display ad on page 135. Address L. Basch & Co., Dept. E 340, S. State St., Chicago, U. S. A.

EVERYBODY'S what? Interested and pleased with our new stick pins for gentlemen and ladies. Oxidized Silver or gilt finish, 4 designs. Daisy, Elk, Flower Girl and Stork. Introductory price 15 cts each, 2 for 25 cts. All 4 for 50c postpaid. You pay 50c and 75c each elsewhere. The Enterprise Company, 294 Woolner Bldg., Peoria, Ill.

PATENTS FOR SALE

MUST sell—Patent on very novel and practical commercial specialty. Can be made under contract at cost of \$3c, retails for \$1.00 through agents, mail order or dealers. No experiment—proven success. Exceptional chance for young man with small capital. Horre, Care of Brubaker, 16 Monroe Ave., Grand Rapids, Mich.

SELF Cleaning Filter and Faucet combined. A crying need in every house, yet so simple; permanent substitute for common faucets, durable, efficient, cheap; anti-splash, anti-freeze, anti-drip. Outright sale, royalty or manufacture bids for Mail Order business. For 10c. Particulars free. Guilmet, 3023 Mission St., San Francisco, Calif.

FOR Sale. Patent No. 759679, combination billing and day-book system, positively prevents errors, invented for private use but now ready to interest others. Address, E. W. Crankshank, MI. Washington, Balto Co., Md.

FOR Sale—Patent No. 1,408,257. Water Motor. Will sell for cash or two payments. Write for description of motor. Jose Gonzalez, No. 15, Water St., Laredo, Texas.

FOR sale or royalty. U. S. Patent No. 1,923,874. Sanitary drinking fountain attachment for hand pumps. For school pumps and public wells. The law has created a demand. Thos. J. Price, Orlong, Ill.

SAFETY elevator (patented), manufacturers investigate. Accidents entirely eliminated. Roussel, 1191 Diamond Bank Building, Pittsburgh, Pa.

FOR Sale—U. S. Patent on Exercising device for home or gymnasium. Nothing like it on the market. For particulars write Theodor R. Geisel, Springfield, Mass.

PATENT number 1,024,697—Non-sealing tea kettle "Lid." Agents article. Something new. O. Turner, 390 Williams Ave., Portland, Oregon.

FIVE (5) new patents on different kinds of concrete machinery for sale cheap on account of poor health. Wm. L. Keller, Kearney, Nebr.

FOUR patents on cooking utensils, cheap. Address, with stamp, Mary E. French, Clyde, Ohio.

FAN Attachment for Sewing Machines. Robert Landers, Blue Rapids, Kans.

FOR Sale, Patent; Automobile Fender. Seppala, 2466 Aubert Ave., Chicago.

PATENTED whip lock. If interested write George Lipp, Allen, Nebr.

FOR sale. Horse shoe patent. 2577 So. Halsted St., Chicago.

FOR Sale—U. S. Patent, combined bevel square and framing tool; perfect and practical tool. Good specialty. For information write M. Renner, 2330 N. Clark St., Chicago.

OUTRIGHT or royalty No. 1,021,699. Only artificial bait with invisible hooks. Weedless. Also No. 1,023,028. Address John Nordlund 538 Wrightwood Ave., Chicago, Ill. c/o Peterson.

PATENTS for sale on Coopersage Machinery Nos. 942,981; 880,967; 973,356; 1,404,546. Machines in operation showing spring over Twenty Dollars per day. R. D. Kinyon, 730 West 64th St., Chicago.

FOR Sale—U. S. Patent No. 986,289 for door and sash holding means. Rion Hoel, 44 Hubbard, Detroit, Mich.

FOR Sale—Pat. rights, cash or royalty on power manure loader. A good proposition for manufacturing companies. Address Verne Hensley, Central City, Nebraska.

FOR Sale—U. S. and Canadian Patent Packingless Globe valve; something new. Best offer takes it. A. L. Kerbaugh, 1510 1/2 Chew St., Allentown, Pa.

FOR Sale Outright—U. S. Patent 1,026,934 Bakers Peel. If interested write F. A. Hanel, 3916 E. 4 St., Los Angeles, California.

JUST patented, adjustable window shade and curtain pole hanger. No screws or nails. Put on or off in a second. Will consider manufacturers rights royalty price on dies and to manufacture for us. Photographs free. Fagan & Co., Barnesboro, Pa.

PATENTED—Burglar proof window lock for sale cheap. Splendid money maker. Address F. T. Feicht, 892 Louis Ave., Canton, Ohio.

FOR sale, patents on the only exposure meter of value ever invented. Wanted capital to manufacture. E. M. Woodworth, Lacolle, Quebec.

WILL sell patent just allowed and commercially good, cheap. Address Box 55, Clay Center, Kan.

DISH washer, boom, money maker, cheap. G. Krieger, Wooster, Ohio.

PATENTS

FIND Out For Yourself what to invent and how to protect it. My book, "Inventors' Universal Educator," covers the matter from A to Z; also gives 600 Mechanical Movements and 50 Perpetual Motions. Price \$1.90, postage free. Money returned if not more than satisfactory. F. G. Dieterich, 651 Ouray Bldg., Washington, D. C.

MR. Inventor: Let us co-operate with you in manufacturing and marketing your invention. Sheet Metal Specialty Co., Goshen, Ind.

WANTED, a Company to manufacture and market my improved patent insulator Patent No. 1,909,819, for telegraph and telephone lines. Sale of insulators unlimited. Foreign patents applied for. Address, T. H. Watkins, Wakarusa, S. D.

PATENTS. Send sketch or model for Free Advice on Patentability. Book telling truth about Patents. "No Patent, No Pay," sent free. John J. Thompson, Pat. Atty., Box P, 1110 F St., Washington, District of Columbia.

PATENTS build fortunes for you. Our free booklets tell how, what to invent, and how to choose an attorney. Best bank and other references. All business strictly confidential. Write today. D. Swift & Co., 317 Seventh St., Washington, D. C.

INVENTORS—Send copy of your patent, etc., and we will send contracts outlining our special offer to market your invention. Atlantic Supply Co., Long Branch, N. J.

PATENTS secured—Reports on patentability, validity and infringement. Patent suits conducted. C. L. Parker, 916 G St., Washington, D. C.

SEND For Free Booklet, All About Patents and Their Cost. Shepherd & Campbell, Patent Attorneys, 500A Victor Bldg., Washington, D. C.

INVENTIONS Patented free—marketed on commission. Address Inventors' Agency, Chicago, Ill. Also valuable inventions for sale to promoters.

PATENTABLE Ideas wanted—Send for 3 free books. Richard B. Owen, 30 Owen Bldg., Wash., D. C.

INVENTIONS patented free; sold on commission. Fine inventions for sale. Adam Fisher, 61-3, St. Louis, Mo.

WE sell patents. Established ten years. To buy or having one to sell write Charles A. Scott Co., 1096 Granite Bldg., Rochester, N. Y.

PATENTS without advance attorney's fees. Send sketch for free report. Books free. Fuller & Fuller, Washington, D. C.

PATENT ATTORNEYS

PATENTS obtained, trade marks registered. Copyrights entered. Thirty years' active practice. Experienced, personal, high-class service. Address Siggers & Siggers, Patent Lawyers, Suite 15 N. O. Bldg., Washington, D. C.

PATENTS secured and positively sold if the idea has merit; all countries; satisfied clients my best references; a good invention properly protected by patent should prove very profitable to the inventor; protect your business against competition by patenting any new manufacture, process, formula, or article associated with it; capitalize your ideas, perfect, patent and market your new ideas; send sketch today, book free. H. Sanders, 7 Crilly Building, Chicago, Ill.

"PATENTS and Patent Possibilities," is a 72-page treatise which tells all about patents, what to invent and where to sell it. It gives honest advice to inventors, and is full of valuable and interesting information. Write for it today! It is free. H. S. Hill, 905 McLachlen Bldg., Washington, D. C.

MONEY in good Ideas. My patents get it for the inventor. Twenty years' experience. Fees low—payments liberal. "The Truth About Patents" sent free. Jas. R. Mansfield, Dept. A, Washington, D. C.

MONEY In Ideas—My book "The Inventors' Assistant," tells how to get it out. Mailed free. Henry N. Copp, Registered Patent Attorneys, 51 Washington, D. C.

PATENT Books Mailed Free—showing 100 mechanical movements invaluable to inventors and mechanics—and telling what is patentable, how to obtain patent or partner, etc. Free on request. Chas. E. Brock, 701 Eighth St., Washington, D. C.

PATENTS Bring Riches when of value. Our free books cover the subject in a thorough manner. We give personal service. Wide experience. Trade Marks Registered. Write today. Beeler & Robb, 211 McGill Bldg., Washington, D. C.

PATENTS—Herbert Jenner, patent attorney and mechanical expert, 608 F. St., Washington, D. C., established 1883. I make a free examination and report if a patent can be had and exactly what it will cost. Send for circular.

PATENTS of Value. Prompt and efficient service. No misleading inducements. Expert in Mechanics, Book of Advice and Patent Office Rules free. Clements & Clements, Patent Attorneys, 701 Colorado Bldg., Washington, D. C.

PATENT books on How to Obtain and Sell Patents, containing exhaustive information on these subjects, with 100 mechanical movements, mailed free on request. F. G. Dieterich & Company, 609 Ouray Bldg., Washington, D. C.

WANTED—People with original ideas. Ideas have made fortunes. If your invention has merit, protect it—turn it into money. My free booklet tells how. Write today. Wm. N. Rosch, Jr., 502 Metzgerott Bldg., Washington, D. C.

PATENTS secured or fee returned. Send sketch for Free Expert Search and Report as to patentability. Books on inventions and patents and reference book sent free. John S. Duffie & Co., Dept. 1, Washington, D. C.

PROTECT your ideas. Inventor's Primer free. Free search and contingent fees. Milo B. Stevens & Co., estab. 1861. 685 F St., Washington; 353 Monmouth Bldg., Chicago. Guaranteed by Bankers Register.

PATENT what you invent—It may be valuable. Write me. No attorney's fee until patent is allowed. Estab. 1882. "Inventor's Guide" free. Franklin H. Bough, 322 Loan & Trust Bldg., Washington, District of Columbia.

THE Patenteur is instructive and interesting. A liberal education in patents. Free on request. Established 1845. Anderson & Son, Patent Solicitors, 727 G Street, Washington, D. C.

PATENTS that protect and pay. Advice and books free. Rates reasonable—highest references; best results. Watson E. Coleman, Patent Lawyer, 622 F St., N. W., Washington, D. C.

C. L. PARKER, Patent Attorney, 916 G St., Washington, D. C. Inventor's handbook "Protecting, Exploiting and Selling Inventions," sent free upon request.

SEND for free booklet, All about Patents and Their Cost. Shepherd & Campbell, Patent Attorneys, 500A Victor Bldg., Washington, D. C.

PATENTABLE Ideas wanted—Send for 3 free books. Richard B. Owen, 30 Owen Bldg., Washington, D. C.

IMPORTANT Notice—Read my page ad on page 114, Advertising Section of this magazine, relative to patents, trade-marks, etc. Special offer contained in the ad. E. E. Vrooman, Patent Lawyer, Washington, D. C.

FREE legal protection till patenting, besides advantages offered by best attorneys. Mail description. Edward P. Thompson, M. E. (Registered as reliable and competent in U. S. Patent Office) 504 F. Victor Bldg., Washington, D. C.

PATENTS, trade marks, etc., secured and sold, send for our free book and terms, practice in all courts. Williamson & Williamson, 1325 P-Arch St., Phila., Pa.

NO attorney's fees until patent allowed. Free search and books. Fuller & Fuller, Washington, D. C.

I PROCURE best protecting patents; rates reasonable; free information. Benjamin Roman, Park Row Bldg., New York.

MEN of Ideas and Inventive ability, write to Randolph & Briscoe, Patent Attorneys, 629 F Street Northwest, Washington, D. C., for list inventions wanted, and prizes offered by leading manufacturers.

REAL ESTATE—FARM LANDS

WRITE for description and prices of over 65 improved farms and 15,000 acres of wild land in dairy belt of Wisconsin. L. Rivard, Turtle Lake, Wis.

\$5 MONTHLY Buys Suburban Farm. Near Houston, Railroad and Shell Boulevard. Fruit, truck, or poultry farms near suburban station, only 35 minutes from the City of Houston, near Shell Boulevard direct to the city. Beautiful location, rich soil, plenty of rainfall, fine climate, two and three crops a year of potatoes, tomatoes, cabbage, and other vegetables which net growers from \$100 to \$300 per acre. Fine strawberry country, also in orange and fig belt, and is splendid poultry country. Live where you have a cash market in the city for everything you grow. Only a few five and ten acre farms at \$50 and \$55 an acre, no interest, no taxes. Five acres \$5 cash and \$5 monthly—ten acres \$10 cash and \$10 monthly. Write today before all are sold. This is your chance to own a home. C. W. Hahl & Co., Owners, 705 Commercial Bank Bldg., Houston, Texas.

BUY your a home, I can sell you a choice home, farm or timber tract in any state at a price that will please you. Don't fail to write to-day, stating where you wish to buy. Address S. P. Seawell, Rockingham, N. C., Route No. 2.

WANTED—Good motorcycle as part payment on some splendid cheap land in Itasca County, Minnesota. Can locate a few homesteaders. Ralph Richards, Deer River, Minn.

CASH for your business or real estate. I bring buyers and sellers together. No matter where located if you want to buy, sell or trade, any kind of business or property, write me. Established 1881. Frank P. Cleveland, 1508 Adams Express Building, Chicago, Illinois.

DELAWARE Farms, Money making farms throughout the entire state, \$15 an acre up; live-stock, implements and crops often included. We offer best bargains, and pay buyer's railroad fare. Catalog free. Ford & Reis, Inc., Dept. 43, Wilmington, Del.

WANTED—Men to become independent farmers in Eastern North Carolina. "The Nation's Garden Spot." A card brings information. Carolina Trucking Development Co., 812 Southern Bldg., Wilmington, N. C.

380 ACRES good buildings, 200 acres in crops; rich black soil, only \$37 per acre. 160-acre farm, highly improved, electric light, fine river bank, \$8,000. Worth, \$12,000. Jorgensen, Grand Haven, Mich.

HOUSES and Lands for Sale in the Valley of Virginia. Apply to Dr. M. L. Garrison, Front Royal, Va.

MAP—and all about Arkansas, homesteads, farm, fruit lands—15c. Hubert Hall, Waldron, Arkansas.

TO finish my home must sell my ten acres Florida Everglades, Richest Soil, Finest Climate, \$55 per acre. H. M. Davis, Ft. Lauderdale, Florida.

250 ACRES—An up-to-date farm, good buildings, \$5,000. Billings Farm Agency, Apalachin, New York.

DESIRABLE farming and grazing lands, \$6 up. Barnes, Pierre, South Dakota.

TO sell your property write Northwestern Business Agency, Minneapolis.

SELL your property quickly for cash, no matter where located. Don't pay big commissions. Particulars free. Real Estate Salesman Co., Desk B, Lincoln, Neb.

YOUR Brooklyn property sold for cash. Immediate results. Green Bros., 1517 Newkirk Ave., Brooklyn, N. Y.

FARMS bought, sold, exchanged. No matter where located. Chas. Phildus, 388 Pleasant Ave., New York.

FOR Sale—160 acres of timber land, two miles of railroad. Apply to Thos. S. Carlton, Arcadia, Fla.

DOGS—POULTRY—LIVE STOCK

A GUARANTEED talking Parrot for \$3.98. Safe arrival guaranteed anywhere. Two cent stamp for special offers on your hand raised parrots, mailed by Edwards Bird Store, Detroit, Mich.

AIRDALE Terriers and Scotch Collies—Pups, Brood Matrons—Make your wants known. Stud Dogs, R. L. Savage, St. Charles, Ill.

COLLIES—World's best. Registered pups, \$10. Catalogue free. Shirley's Collies, Brownsburg, Ind.

BARGAINS. Thirty breeds dogs, stock, catalog. Catalpa Kennels, Shelbyville, Ky.

WHITE China geese eggs for hatching, \$2 per 6, \$4 per 12. Freer Binholds, R. 1, Box 22, Forest Lake, Minn.

CLOSING Out Sale registered brood Mich Setters, one grand stud, twenty pups—several pure Llewellyns. Such blood as Whitestone, Gleam, Lingfield, etc. Address Ed. Woodin, Kirksville, Mo.

BUFF Wyandotte eggs and birds. F. E. Hartwell, Camonsburg, Mich.

REGISTERED English Bloodhounds—Puppies and grown dogs, best blood. Max J. Kennedy, Freedonia, Kans.

HOUNDS, bear, wolf, Deer, cat, fox and bloodhounds. 50 page illustrated catalogue, five-cent stamp. Rockwood Kennels, Lexington, Ky.

FOR sale, Thoroughbred pit bull terrier pups, pedigreed and eligible to registration. Address Horton & Horan, 819 1/2 Garrison Ave., Ft. Smith, Ark.

FORMULAS

3,000 FORMULAS, new edition and Digest publishing 100 formulas, etc., monthly, one year, 50c. Digest, Grand Rapids, Michigan.

SOLDER and flux combined—in paste form. Formula 100 tested. R. Knox, 317 N. Sherman, Colo. Springs, Colo.

FORMULA for removing ink stains from any kind of cloth without injury. Guaranteed. Price \$1. Lander Cleaning Works, Box 112, Lander, Wyo.

BOILER Incrustations Prevented. New effective formula, \$1. A. Levering, 3612 Stokley St., Phila., Pa.

SILVERING Mirrors Formula, and one year's subscription to Digest, 25c. Digest, Grand Rapids, Mich.

SEND 25c stamps—Morgan's book of over 500 valuable formulas, trade secrets, etc. The Morgan Press, 17 Harvard Place, Boston.

200 FORMULAS and Digest publishing 100 formulas, etc., monthly, one year 25c. Digest, Grand Rapids, Mich.

FORMULA for making Flexible Mirrors and Duplicator, 15c both. Hamblett, 19 Ellingsburg St., Lowell, Mass.

FOR removing grease oil, etc., cheap, invaluable to machinists, 25c—guaranteed. Chemist, Box 543, Pulaski, Virginia.

NEW Edition 3,100 Formulas, 40c. Scientific Book Shop, Syracuse, N. Y.

500 VALUABLE formulas, 25c. Process Company, 415 Ft. Dearborn Bldg., Chicago, Ill.

FOR goodness sake grab it. Nearly 400 formulas sent postpaid for 20c. Absolute satisfaction. Send at once to Johnson & Co., Box 231, Phoenix, Ariz.

FOR MEN

HOLD up your trousers with the L & N. The L & N meets the increasing demand for a durable and comfortable belt. Invisible, nonsliping, natural fitting, and quickly attached or detached. Sold only by agents or postpaid for \$1. Send for descriptive circular. L & N Belt Co., 1257 N. Clark, Chicago, Ill.

WANTED—Active man in every lodge. To join this Society. Carry his sick, accident, death benefits. Get friends to join. Spare time. \$50 to \$150 a month. Write, Box BP-293, Corning, Ky.

SAFETY razor blades sterilized and sharpened better than new; 2 cents each. Five years' success. Send for blade box and circular. Electro Strapping Co., 134 Shelby St., Detroit, Mich.

SAFETY Razors honed and stropped. Guaranteed perfect; 25c dozen. Robert Prowell Hardware, Birmingham, Alabama.

DISCARD your unsightly suspenders, and wear a Ko-Ko-Mo Suspender Belt. Keeps the shirt from "crawling up" at the same time supports trousers perfectly. Is worn successfully when all other belts fail. See cut on page 126. We will send belt pre-paid for 50c. Kokomo Belt Co., Kokomo, Ind.

MEN'S hose! Four pairs guaranteed hotproof four months \$1. Sizes 9 1/2 to 11 1/2. Balck, navy, tan or slate. Kant Tear Hosiery Co., Poststown, Pa.

PATENT retort pipe cleaner. It really cleans your pipe. Sample 15c. Particulars free. Hubert, 8 Morris Crescent, Yonkers, N. Y.

PIANOS—MUSICAL INSTRUMENTS

STRADIVARIUS Violin, excellent toned, good bow and case for sale cheap. Sent on trial. Miss Bertha Mardes, Route 5, Rosedale, Kansas.

FOR sale. Latest model Conn B. flat corner, silver plated, nearly new. Price, \$35. C. P. Taylor, Norwalk, Conn.

FOR THE HOME

SEND Photo of Child or any Home pet. Cat, Dog, Horse, etc., and will return beautiful Water Color sketch of same for \$2. Not a Photographic enlargement. Examined if pleased send money, if not return sketch to W. C. care of J. E. Burckhardt, Neptune Avenue, Coney Island, New York.

METAL Work and Etching—A 96-page handbook for art metal workers telling how to make a great variety of useful and ornamental objects such as desk sets, arts-crafts jewelry, etc. Price, 50c, postpaid. Popular Mechanics Book Dept., Chicago.

BEAUTIFUL arts-crafts lamps.—Anyone can make them out of paper, cardboard and wood. 16 designs. Inexpensive yet artistic. Complete book of instructions. Price, 50c, postpaid. Popular Mechanics Book Dept., Chicago.

MAKE your own maison furniture at the minimum of expense. Our 2 books "Maison Furniture. How to Make It." Parts 1 and 2, tell in plain, simple language just how to make 59 different pieces. Full dimensional working drawings and half tones of finished articles. Price, 50 cents each or \$1.00 for the two volumes, postpaid. Popular Mechanics Book Dept., Chicago.

GAMES AND ENTERTAINMENTS

MAGICIAN'S Bargains: Magician's Rising Cards, 30c; Magician's Trick Deck, 20c; Magic Die Through Hat, 20c; Vanishing Cards, 15c; Vanishing Handkerchief, 15c; 84 New Card Tricks, 8c; 250 Magic Tricks, 6c. Illustrated Catalogue free. Eagle Magic Company, Minneapolis, Minn. Wholesale and Retail.

STINK Them Out—Itching Powder-Bubler Tacks, 10c each; Sooner Dogs, 15c; Trembling Turtle, 5c. Latest Novelties Omaha Sales Co., Port Clinton, O.

LATEST domestic and imported novelties, jokers, magic tricks, puzzles, etc. Illustrated catalogue free. Joseph Mathieu, 203 Court St., Brockton, Mass.

MAGIC Tricks, Books & Supplies. Largest line in the world. Amateurs supplied as well as the Great Professionals. Easy, Interesting, Entertaining. Mammoth, illustrated, Professional catalogue of clever tricks for the pocket, parlor and stage, price ten cents. The old reliable firm. Read & Covert, 821 East 43d St., Chicago, Illinois.

FREE—1912 magic catalogue, 208 pages, 250 illustrations, 800 tricks, puzzles, illusions for parlor or stage entertainment. Send 6c stamps for particulars and sample pocket trick. Buy direct from the manufacturer, cheaper and better apparatus. Wholesale Magic Co., 270 W. 30th St., New York.

WIGS and Makeups for Theatrical and Street Use. Percy Ewing, Decatur, Ill.

LEARN ventriloquism at home. Particulars for stamp. M. Bailey, Box 253, 84, Paul, Minn.

105 GOOD tricks, with 3 catalogues, 30c. Joklein, 1193 Broadway, N. Y.

250 TRICKS, \$1.00. Magic. 5225 Lexington Ave., Chicago, Ill.

RARE COINS AND STAMPS

STAMPS free—8 different Costa Rica, or 3 different Soudan (camels), big stamp lists, etc., for 2c postage. If you collect stamps, write us. Old collections bought. W. C. Phillips & Co., Glastonbury, Conn.

\$3.00 PAID for the rare 1856 cent; \$25.00 for the rare silver dollar of 1858. Keep money dated before 1890, and send 10 cents for new coin value book. A. H. Kraus, 209 Kraus Bldg., Milwaukee, Wis.

FREE—200 Foreign Stamps, including Guadeloupe, Canton, Senegal, Gambia, Morocco, etc., 4c (stamps) postage. American Stamps bought; buying list 10c. Lightbown's Stamp Co., Southsea, England.

24 VARIETIES Cuban stamps 10 cents. List of 6,000 low-priced stamps free. Chambers Stamp Co., 111 P. Nassau St., New York City.

PACKET of 25 stamps; no two countries alike, 500 hinges. Set of \$1 and \$2 U. S. Rev., all for 5c. Miami Stamp Co., Toledo, Ohio.

STAMPS, 100, all different, free. Postage 2c. Mention paper. Quaker Stamp Co., Toledo, Ohio.

STAMPS—103 China, etc., stamp dictionary and list, 2c. Ballard, Sta. A, Boston.

FREE! 100 Stamps for 2c postage and 2 collectors' names. "Hawkins" Hatton, New Mexico.

1000 DIFFERENT stamps mounted for \$3.20. Vermont Stamp Co., Brattleboro, Vermont.

MEXICAN Revenues—50 different, 18c; 100, 50c; 250, \$2.50. Homburger, 101 W. 80, New York.

COINS—20 different foreign, 25c; 5 different Confederate state bills, 15c. Retail price lists free. 150 page premium coin book, 25c. F. L. Tougal Co., Chicago Heights, Ill.

5 FRENCH Colonial Stamps for names of two collectors and 2 cent postage. Catalogues free. Approvals 50% commission. Sample copy Stamp and Coin Collector free. A. Kraus, 602 Kraus Bldg., Milwaukee, Wis.

OLD Coins for Sale—5 different, 10c. L. J. Mathewson, Wauabay, S. D.

DANDY Stamps: 112, Japan, etc., 5c. Guy Dustman, Urbana, Indiana.

COINS—Eight different foreign, 10c; 20 different, 25c. Robert Blakely, Prescott, Arkansas.

IF you want the latest sheet music and a better assortment for less money than elsewhere, write for our catalog. Sample's Music House, 204 West Ave., Norwalk, Connecticut.

POINT Light March and Two Step. Latest instrumental hit. Ten cents. Robinson, Publishers, Warren, Maine.

ANY Popular Sheet Music you want. No matter where published, we will send postpaid for 15c per copy. Willis Woodward & Co., 1197 Broadway, New York.

"CARNATION Day." Just published. Dedicated to Miss Anna Jarris, founder of Mother's Day; suitable for church and home. Good words, pleasing music, everybody should have this. 7c copy. Robert Baxter, 2327 Sanson St., Philadelphia.

COMPOSERS—Song-writers: I can give valuable information on publishing your production. Prospectus. Wrightman, 129 Bryant St., Wash., D. C.

RAG-TIME piano playing taught by mail. Book free. Christensen, 84 Auditorium Bldg., Chicago.

DO you want your songs published free by reliable Publishers? Write us for particulars. Imperial Arr. Co., Suite 84, No. 25 W. 42nd St., New York.

SINGERS: 50 latest songs with music, 10c; to advertise. Needham Music House, 61-13, St. Louis, Mo.

THE Secret of Song Writing, booklet full of useful information by an expert. 25c postpaid. Chas. Metz, 306 East 88th St., New York.

POETS, authors: Get cash for your songs and stories. Music Sales Co., 61-4, St. Louis, Mo.

NEW song hits! "By-gone Days," "Dream of Loved One," 15c each. Effie E. Wheelock, Rushmore, Minn.

SONG poems wanted. Cash or royalty to you. Needham Music House, 61-5, St. Louis, Mo.

TITANIC song, "Just as the Boat Went Down," also "Submarine Swing," both 30c postpaid. Marvin Lee, 414 State St., Chicago.

LATEST song hit. "The Wreck of the Titanic," 12c postpaid. Macrini, 70 Mott St., New York City.

ALL the favorite old songs. Words and music complete in book form with attractive cover; size 7 1/2 x 9 1/2 inches; good value. Price 50 cents, postpaid. Popular Mechanics Book Dept., Chicago.

TELEGRAPHY

TELEGRAPHY—Morse and wireless—Railway, Accounting (Station Agency) taught quickly R. R. Dispatches and Western Union Wires and complete Wireless Station in school. Splendid opportunities—graduates assisted. Living expenses low—may be earned. Largest and oldest school—established 27 years. Investment \$25,000.00. Correspondence courses also. Catalogue free. Dodge's Telegraph & Railway Institute, 13th St., Valparaiso, Indiana.

TELEGRAPHY taught in the shortest possible time. The Omnigraph Automatic Transmitter combined with standard key and sounder. Sends you telegraph messages at any speed just as an expert operator would. Five styles, \$2 up, circular free. Omnigraph Mfg. Co., 41 G. Cortland St., New York.

LEARN Telegraphy. We secure you a position. Railroad Wires in School. Catalogue Free. North-Western Telegraph School, Eau Claire, Wis.

ELECTRICAL

WORNOUT Dry Batteries Made Better than new for 2c. Instructions, 29c. Williamson, Grampian, Pa.

SPARK coils in parts—We repair coils, magnets, etc. Send for circulars. Electrical Testing Co., Peoria, Ill.

RENEW old dry batteries; complete instructions, 25c guaranteed. Clark, 2030 Arch, Philadelphia.

Popular Mechanics Book Dept., Chicago.

ETHERIC Wireless Co., 80 W. 121th St., New York. Complete receiving sets from \$2. 1" spark coil, \$2.75. Complete hand phones, \$2. Catalogue, 2c.

TWO wireless sets 3" Ruhmkoff Induction Coils, bargain at \$20 each. W. P. Troughton, St. Joseph, Mo.

PRINTING AND ENGRAVING

PRINTING—500 either envelopes, note-heads, cards, 90c; 1,000, \$1.40; 1,000 circulars, 95c; 500 linen finish letterheads or envelopes, \$1.25; 1,000, \$2.15; 1,000 typewriter letters, \$1.45. Samples. "The Model," Manchester, Iowa.

PERFECTION Multigraphed form letters are perfect imitations. 1,000, \$3, or 500, \$2. Including stock, letter, head—delivered in U. S. Send for specimens. Perfection Letter Company, Washington St., Muncie, Indiana.

"MULTIGRAPHING" Perfect, genuine typewritten letters. Also postcards, price-lists, notices, etc. Reasonable prices. Lulu D. Springer, 212 W Taylor St., Shelbyville, Ind.

PRINTING Presses, type, supplies. Catalogue free. J. M. Carroll & Co., 326 Madison St., Chicago.

500 **XX** white 6 1/2 envelopes printed, \$1.15 prepaid. G. J. Myers, Codorus, Pa.

PRINTING presses, all sizes, type, supplies. Bargain list for stamp. Popular Bargains, Richmond, Pa.

25 **ENVELOPES** and 25 note heads, 25c. George Graham, Homestead, Penn.

100 **CARDS**, 25c. Name and address. Samples free. Riverside Press, Hackensack, N. J.

WE print anything! Good work, low prices. Stamp helms samples and price list. Eastern Printing Co., Eastern Ave., Baltimore, Md.

PRINTING—100 each envelopes, letter heads, and cards, \$1. Witherbee Press, Morristown, N. Y.

1,000 **COLORED** Bond Ad Slip, 3 1/2 by 7 1/2, 150 words, \$1, postpaid. Neat border, very attractive. Samples free. Good's Printery, Harrisonburg, Va.

LOOK here—100 letterheads, 100 envelopes, 100 return envelopes or business cards, printed for \$1, postpaid. Walden Press, Roxbury, Mass.

PRINTING—100 Noteheads, 100 Envelopes and 100 cards neatly printed to your order; prepaid, \$1. Sample for stamp. Union Pub. Co., Dept. M, Unfandale, Ind.

TYPEWRITERS AND SUPPLIES

GENUINE typewriter bargains, no matter what make, will quote you lowest prices and easiest terms. Write for big bargain list and catalogue 17. L. J. Peabody, 278 Devonshire St., Boston.

TYPEWRITERS—Every kind on the market. Write today for best bargain you ever secured. Shipped anywhere on approval, \$10 up. Fletcher Typewriter Co., 207 N. 7th St., St. Louis, Mo.

REMINGTON typewriter, \$12; Calligraphs, \$6; Hammonds, Vest, Dictamones, \$10; Smith Premiers and Jewetts, \$15; Oliviers, Underwoods, L. C. Smith and Royals, \$25. Fifteen days' free trial and one set our prices. Harlem Typewriter Exchange, Dept. P. M., No. 217 West 175th St., New York.

TYPEWRITER ribbons for any make of machine, four for \$1. Carbon paper, \$1 per hundred. Guaranteed. Peerless Ribbon Co., 217 West 155th St., N. Y. City.

TYPEWRITER Bargains. All makes, \$10 up. Ten days free trial. Guaranteed two years. Express prepaid. Price list free. Frank Payne Company, Rosedale Branch, Kansas City, Kansas.

REMINGTON, late model, sacrifice \$20. Cost \$100. Miss Wagner, Stenographer, 120 Elm, Arlington, N. J.

STENOGRAPHER must sell her Remington typewriter, \$9. Miss King, 2230 7th Ave., N. Y. City.

TYPEWRITER—Smith Premier No. 2, good as new. No further use; \$20. Bargain. J. S., 4203-28th St., Oakley, Ohio.

TYPEWRITERS. Greatest sale in history. Bankrupt stock, many like brand new, low as \$10. Write for special price list No. 16. Machines sent for trial our expense. Typewriter Inspection Co., 235 W. 4th, Cincinnati.

ABSOLUTE sacrifice, unusually fine Underwoods, Smiths, Remingtons, Oliviers, others, like new, except price, \$18.50, \$28.50, extraordinary values. Sent on approval. Write today. OGD reliable. Consolidated Typewriter Exchange, 245 Broadway, N. Y.

TYPEWRITERS: Underwood, \$82.50; Remington, \$79; Smith, \$77.50; Royal, \$69; Oliver, \$45. Used less than four months. Guaranteed two years. Machines used longer, \$10 up. Investigate. National Typewriter Syndicate, Utica, N. Y.

TYPEWRITER—Oliver, latest model No. 5, like brand new. Cost \$100, will sell \$35. Sent for trial my expense. E. S., 815 Betts, Cincinnati, Ohio.

MISCELLANEOUS

RETAILERS—I Can Double Your Business. Former Advertising Manager New York Corporation will write you two letters that will "pull" orders for \$5. One letter, \$3. I have solved hundreds of important sales problems; can solve yours. Send outline. References on request. Address H. A. Steen, Box No. 705, Monticello, N. Y.

500 **GINSENG** roots, 1,000 seed, \$12.50. Send for price list. Plymouth Ginseng Gardens, Plymouth, Wis.

"BOOSTER"—The magazine you need! Send 10c for two months trial. Booster Magazine, 360 Northwestern Building, Chicago, Ill.

ANYBODY can make good cuts with my simple zinc etching process; price, \$1; specimens and particulars for stamp T. M. Day, Box M, Windfall, Ind.

BASE Ball curver, worn on the hand, can give the ball a sharp twist thus causing a wide curve. It is so small it is not noticed and they all wonder where those awful curves come from. Price 25 cents. Curver Co., Box 125, Brady, Neb.

I WILL start you earning \$4 daily at home in spare time, silvering mirrors; no capital; send for free instruction booklet, giving plans of operation. G. F. Redmond, Dept. 308, Boston, Mass.

AUSTRALIAN OPAL. For sale 150 large specimens; price 250 lot. Sample pieces 10/00 (\$2.50) posted any address. Write for illustrated catalogue of beautiful "Black" Opals. N. H. Seward, 433 Bourke St., Melbourne, Australia.

YOUR 25 word advertisement in 35 magazines—5 times and my money-making magazine one year for only \$1.50. H. Latz, Atlantic City, N. J.

EARN \$15 to \$25 a week as our mail order dealers. Right from your own home. Hold your position until entire time is required. We are manufacturers and owners of patented just-in-season, repeat order specialties. If you are just starting a mail order business or if already established, you can't afford not to handle our Patented Money Making Getters. We sell and furnish everything. No canvassing. Small capital. Experience unnecessary. Write today for Latest Patented Leader and Manufacturers' Easy Selling (copyright) Mail Order Plan backed up by "Whole Truth" positive proof and sworn statement. J. M. Pease Mfg. Co., 552 Pease Bldg., Michigan St., Buffalo, N. Y.

THE Stanley Patent Safety Purse, best on the market. Cover fits the hand and forms a bill to make change. All leather, best Russian calf. Postpaid 75 cents. Guaranteed. Am. Purse Mfg. Co., Bellingham, Wash.

WANTED—Active man in every lodge. To join this Society. Carry its sick, accident, death benefits. Get friends to join, spare time, \$50 to \$150 a month. Write, Box RQ-293, Covington, Ky.

BROTHER—Accidentally discovered root will cure tobacco habit. Gladly send particulars. F. Stokes, Mohawk, Florida.

HOW To Get Plenty. My little booklet, price 10 cents, shows you how to obtain abundance of all good things in life, health, prosperity. It is for You. Plenty Publishing Co., 1749 Lanier Pl., Washington, D. C.

TATTOO machine ink, and full directions, 50c silver. Prof. Beebe, Manufacturer, Cedar Rapids, Iowa.

MOOSE heads, \$25; Elk, \$60; Buffalo, \$65; Deer, \$10. Taxidermy in all branches. Guaranteed Mole-proof. On approval. Brower, 3410 Grays Ferry Rd., Philadelphia.

EVA Tanguay Pencils, 5 cents each. Enclose 2 cents extra for postage. Address E. T. Novelty Co., 538 S. Dearborn St., Chicago, Ill.

CORPORATIONS organized in all states; reasonable, prompt and efficient services; inquiry limited. Alexander F. Garbe, 32 Nassau St., New York.

PAY cash liberally to Doctors, Lawyers, Merchants, Ministers and Farmers for some information. Ask particulars. Barnes Pierre, S. D.

BAMBOO Fishing Rods; four sections; cork grip, \$1.50. Steel—three sections, \$1.25. Prepaid. Kemokae Co., Box 999, St. Louis, Mo.

WATER Still! Pure Water for Household, Electrical, Medicinal or Photographic purposes. Price \$2.50. Guaranteed. T. Adams, 2025 Colorado Ave., Chicago.

MAILING lists and local information; county names a specialty—at reasonable prices. Address, List and Information Bureau, Box 51, Clarksville, Ga.

BOYS! Build your own Motor Boat (Automobile). Complete plans, 10c, silver. P. Avery, Ridgewood, N. J.

ONE dollar month buys this insurance. Three thousand dollars accidental death. Twenty-five dollars weekly, sickness or accident. Pauley Insurance Agency, Buffalo, New York.

YOUR advertisement in 100 magazines, covering United States, at 5c a word. W. Crawford, Box 24, Toronto, Canada.

SEE what we say under "Patents." Swift, Attorney, Washington, D. C.

GET One! Panama Pacific Expo. 1915 Watch Fob, 50c. Claire, 232 Beacon, San Pedro, Cal.

TOBACCO cure. One box cures. Guaranteed or money back. Established 1894. Write for special offer. Allen Distributing Co., 310 Altman Bldg., Kansas City, Mo.

FIND and sell genuine pearls and baroques. L. V. Mapes, Indiana Harbor, Indiana.

PATENTS secured—C. L. Parker, 910 G St., Washington, D. C.

CANDY Making—\$15 course, \$1. Eagle Co., "N" Quincy, Mass.

TATTOOING. Improved electric tattooing machine, \$2.50 each. Sold with a guarantee. Cheapest and best line of Tattooing Supplies on the market. Send 15c for 6 beautiful hand colored Tattoo designs. Write now for free price list. J. F. Barber, 1019 Vine St., Cincinnati, Ohio.

20TH century cigar-shaped pipe. The only pipe made that cannot be told from a fine cigar. Cool smoker, holding big pipe full of tobacco; will last years. Sample, including beautiful mouthpiece and catalog, 10 cents. Money back if dissatisfied. Joseph Mathieu, 203 Court St., Brockton, Mass.

RUBBER stamps 15c, name and address. "Our Special." Particulars free. Barstow, 514 23rd St., Oakland, Calif.

100 CORRECT addresses 20c silver. Send quick. Star, Gowrie, Iowa.

DON'T kill yourself smoking. Send 25c for complete cure. Thos. Williams, Clermont, Florida.

TOO LATE TO CLASSIFY

ENGINEER'S Transits—For sale; and lenses; all kinds; second-hand. W. F. Sprengnether, 203 N. 10th St., St. Louis, Missouri.

AN income for life. 10 acres in Florida will provide "an income for life" for you. We can tell you how to be successful and independent on ten acres of good land in this beautiful country at Harwood, Florida, the new city on the east coast; glorious climate; no snow in this "3-crop-a-year" country. You can be out on your land every day in the year and grow crops continuously. Poultry is a "money maker" here, chickens run out doors all the year. Write today for booklet and information. American Land Company, W. A. Pridmore, Pres., Harwood, Fla. Please mention this magazine.

MONEY-Making Farms throughout 17 states; one to 1,000 acres, \$10 to \$50 an acre; live stock, tools and crops, often included to settle estates quickly. Mammoth Illustrated Catalogue No. 35, free. E. A. Street Farm Agency, Station 3043, 45 West 34th St., New York.

COLLEGE and High School Fellows: Want an easy, pleasant job for vacation that pays big money? Letter windows and make glass signs with "Attracto" ready-made letters. Very little capital and no previous experience needed. Samples and catalogue free. Attracto Letter Co., 2653 North Clark, Chicago.

FORMULAS like these are seldom sold. 12 strictly high grade formulas for automobile specialties as brass polish (very fine), body and top polishes, de-carbonizer, tire powder, chain compound, auto soap, all-iron oil, solder paste, antifreeze. Flashlight hand soap, self-vulcanizing cement, any one 25c, or all for \$1.50. Satisfaction guaranteed. Reliable formulas and trade secrets furnished for any product. Write me. Liscombe Miller, Evak Chemical Company, Marietta, Georgia.

TURN your spare time into money. Join us in a profitable mail order business, one that you can operate at home. Large profits; quick returns; small investment. Our 19 years' successful manufacturing experience, personal assistance and new ideas assure your success. Write for positive proof and free booklet. Pease Mfg. Co., incorporated, 144-148 Broadway, Desk A, Buffalo, N. Y.

TOOLS—Reliable second-hand equipment at lowest possible prices. Liberal credit terms arranged if desired. Trials allowed. Satisfaction guaranteed. Following are bargains—Post power lathe; Scarrett bench lathe; Lodge and Shilby engine lathe; wood turning speed lathe; Barnes drill press; Post drill; Milling machine; Shaper. Saw table; Grain Universal woodworker; Forge; Gas engines 2, 5 and 10 hp. Write at once, stating exactly what you can use. Stuart Duncan, Old South Building, Bos-

PEERLESS Four Cylinder Tire Pump; Clamps on running board; turns with crank; weighs 9 pounds; inflates 4 inch tire in 4 minutes. Price \$15, delivered. Waban Webbing Bulletin Proof Bellows; prevent punctures and blow-outs: 32x3 1/2, \$2.49; 34x4, \$2.85, delivered. Other sizes in proportion. Pamphlet free. Automobile Tire & Vulcanizing Works, 624 E. 15th St., Kansas City, Mo. Distributors Shammut Tires.

YOU are looking for more long green. You doubtless deserve it, and willing to work for it. Our soap and toilet article combinations have every ear mark of being the real Coin Getters. We can prove that they are just what you are after. We have convincing proofs. Write for them. Davis Soap Works, 204 Davis Bldg., Chicago, Ill.

A HIT shy on salary? I pick up \$1,500 yearly additional from newspaper correspondence. My book tells what's news, how to get it, where to sell. Newspaper directory included. No correspondence school expense; only 50 cents. First sale returns investment. Morris White, Station 50, Detroit, Mich.

FOR Sale—Fine new 2-story residence with barn and outbuildings, excellent flowing water and 160 acres of improved land near Artesia, New Mexico, in the famous Pecos Valley. This very desirable property will be sold at a bargain to settle an estate. H. T. Windsor, Batavia, Ill.

ANY intelligent person can earn steady income corresponding for newspapers. Experience unnecessary. Address Press Correspondence Bureau, Washington, D. C.

SAVE 65% to 85% on a guaranteed typewriter, and make: Olivets, L. C. Smiths, Remingtons and Underwoods sold on two-years guarantee, choice of 300 machines \$10 to \$15. Send for Special Price List today. Universal Typewriter Distributors, 4862 Bishop St., Chicago.

FOR Sale—Six horse horizontal, \$45; ten horse vertical engine, \$60, governor and lubricator included. Both engines nearly new. 20 hp. boiler, good condition, \$90. Sprague Machine Co., So. Bethlehem, Pennsylvania.

BECOME independent through one hundred agents. Patented hardware specialty. One dollar or ten thousand will start you. Ideal for mail order. For detailed information address P. O. Box 283, Aurora, Illinois.

AN Unheard of Bargain—Standard make runabout in first class condition. Engine, paint and upholstery like new. Loss of horse reason for selling. Write for particulars and photo. The price will satisfy you. Woodburn Hale, Everett, Mass.

THE Bates Aeroplane Motor—Most reliable, best built and strongest flier in the world. Price \$375 with complete equipment. Write for circular. Herbert Doyle, 321 Lake Avenue, Rochester, N. Y.

I WILL, positively secure the position you desire or show you how to start a clean, legitimate, well paying mail order business; quickly, inexpensively, sensibly and above reproach. Mail stamp for free particulars and address: Expert, Home Bank, Baltimore, Md.

BE a hand-cuff king; make big money on the stage; all vaudeville circuits pay from \$50 per week up. I teach everything in this line. For particulars address, Box 302, Springfield, Mass.

DEVELOPING—Printing—Enlarging. Best Work, Quick Delivery, Low Prices. Developing 10 cents per roll. Prints 3 cts up. Send 2 negatives for Free prints. H. A. Clark, Plaza Street, Brooklyn, N. Y.

TOLEDO automatic computing grocer scale, gold finish, 13 lb. Cost \$95. Will sell cheap. Write for particulars. Indrikson, Helmetta, N. J.

PARTIES interested in the only patented Sanitary Public Drinking Cup correspond with inventor. A. Hartman, P. O. Box 384, Ontario, Cal.

FIFTY new foreign members in our May list from Holland, Mexico, India, etc. Membership 10c. Travelers' Post Card Club, 3508 Carroll Ave., Chicago, Ill.

MAIL Order Business. I start you free, no investment but postage and stationary. (Enclose stamp.) P. Newham, Waukegan, Illinois.

AGENTS—\$5 a day, all year round, demonstrating to housekeepers. Send for latest catalog and premium list. The Ridgeway Home Supply Co., 2354 So. Ridgeway Ave., Chicago, Ill.

EARN good money opening safes and setting combination. Write Wayne Strong, Tacoma, Wash.

FLORIDA Alligators, \$2 and up. H. M. Davis, Ft. Lauderdale, Fla.

\$1 STARTS home business. Stamp for particulars. Hobart, 3738 Penn Ave., Minneapolis.

WATER motors, fans, tapping machines, magnet winders. Special articles to order. Inventions developed. Cleveland Specialty & Manufacturing Co., Cleveland, Ohio.

CANADIAN Patent, 134076. Friction Transmission of Power. Applied anywhere. Edgar James, Lincoln, N. C.

SEND stamp for bargain list; Guns, Rifles, Kodaks. Wilkinson, 596 Masten, Buffalo, N. Y.

THREE Line Rubber Stamp—name, business, address—25c. Pads 10c. Dates 12c. Hollandsworth, Corinth, Miss.

GUARANTEED mosquito relief, 25c post-paid. Advertisers, 306 Market, St. Louis, Missouri.

LEARN Typewriting. \$1 monthly, mail course. Guaranteed typewriter free. Merit Service, Oshkosh, Wis.

WATER Filters, costing 2c, sells 15c; agents make \$15 per day; sample 5c; write for territory. Nosplash Company, Superior, Wis.

STAGE Beauties. Scores of 'em in beautiful magazine. Stars, show girls, etc. 10c copy; \$1 year; 25c three months trial. Stage Pictorial Magazine, 1493 Broadway, New York City.

HOW can I to the best advantage utilize waterpower that will produce 50 hp., located in eastern Pennsylvania. N. E. Keckner, Fleetwood, Pa.

SMALL Mysterious Novelty for coming election numbering into millions. Great money making chance. (Stamp for investment particulars.) Turk, 3133 Madison St., Chicago.

AGENTS—If you want \$7 daily and expenses just write the G. R. Penn Company, 515 P. St., N. W., Washington, D. C.

GLIDERS, Wright type, with wing warping and elevator controls, \$22. Central Aeronautical Supply Co., 7116 Princeton Ave., Chicago.

GOLDEN Seal the Golden Harvest, \$6,500 per acre. Easily grown. Exploratory booklet ten cents. Buckner Gardens, 200 Main St., Cincinnati, Ohio.

10,000 FORMULAS, trade secrets, etc. New book 800 pages, \$3. Circular Free. B. P. Newham, Waukegan, Ill.

"Don't ENVY a Use Pompeian and HAVE one."

LE PAGE'S GLUE—STRONGEST AND HANDIEST
Rush Cement Co., Gloucester, Mass.

"How to Sharpen" Send a postal today for this famous book. Pike Mfg. Co., Pike, N. H.

VELVET—The Smoothest Tobacco—10c
Matchless Pocket Lighter

Durable and waterproof, with perfect ignition. Satisfaction guaranteed or money refunded. Sent post-paid, complete with pocket clip, 35c, 4 for \$1.00. Live agents and dealers wanted.

SCHILLER MFG. CO., Dept. 102, Schiller Building, Chicago



Alco Self Heating Curling Iron

AGENTS WANTED

Absolutely New. This self-regulating alcohol iron cannot burn or singe the hair, because it cannot overheat. Produces a beautiful Moist Curl. A Necessity for every Woman. Ideal for Home or Traveling. Heavily nickel plated, fine black enameled handles. Each one in a handsome box.

A Big Summer Money Maker. Agents Making \$5 to \$10 a day. Every woman wants one. Positively sells on sight. Send 25c today for agent's sample. Exclusive territory.

THE SELF-HEATING CURLING IRON MFG. CO., Inc.
909 Manhattan Bldg. CHICAGO, U. S. A.

WHEN YOU WANT ANYTHING AND DON'T KNOW WHERE TO FIND IT—WRITE BUREAU OF INFORMATION, POPULAR MECHANICS, CHICAGO



**SHOW CARD WRITERS
EARN FROM
\$21 TO \$50 PER WEEK**

LEARN ABOUT OUR FREE COURSE IN SHOW CARD AND SIGN WRITING

A Great Opportunity! We are offering, for a limited time, a complete course in show card and sign writing to those purchasing our assortment of "Litholia" Ready-to-Use Colors. This is a great opportunity for ambitious persons, either sex, to increase their earning capacity. Good show card writers in demand at \$21 to \$50 weekly, salary or in business for yourself. Our show card course is not a book of alphabets. It's a complete course in lettering compiled by an expert New York show card artist for us. "Litholia" is the only liquid pigment water paint ever manufactured, used the same as cake, distemper or tube colors, but far superior to either. "Litholia" lasts longer, always ready. "Litholia" is the best for the show card writer, the artist, or the interior decorator. 4 cents in stamps brings booklet, circulars and full information. **LITHOLIA Pm. COLOR CO. 247 West 125th Street, NEW YORK**



Every Essential Step

in wood-working is given in the book

Wood-Working for Amateur Craftsmen

By IRA S. GRIFFITH, A.B.

The chapters dealing with making special articles bring out every cut, joint and process used in this important trade, and the proper use and care of tools, working up of materials, etc., are treated thoroughly and plainly.

CONTENTS:

Making Out a Stock Bill—Laying Out Rough Stock—Hand Saws—Sawing with Hand Saws—Planes: How to Set and Adjust the Irons—Squaring Up Mill Planed Stock—Squaring Up Rough Stock—Whetting Plane Irons and Chisels—Grinding Plane Irons and Chisels—Making a Bird Box—Making a Tabouret—How to Make an Umbrella Stand—Making a Magazine Stand—Making a Table—Making a Cabinet.

128 pages—125 illustrations—5x7—Cloth.

PRICE 50 CENTS POSTPAID

Order of your dealer or

POPULAR MECHANICS BOOK DEPT.
318 W. Washington St. CHICAGO

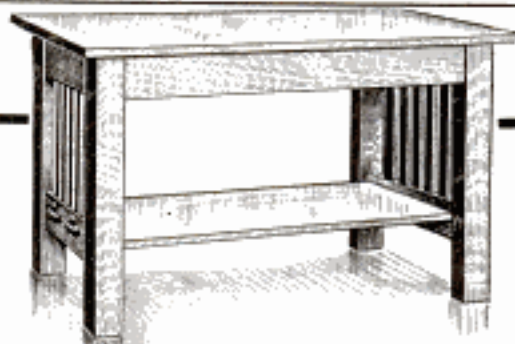

Mission Furniture HOW TO MAKE IT

50 Designs for \$1.00

What one man accomplished with the aid of these books:

Popular Mechanics Co., H———, Miss.
318 W. Washington St., Chicago.

Sir: Please send me Part Two, Mission Furniture: How to Make It, by mail postpaid. I have Part One, and have made and sold \$100.00 worth of one piece of furniture, and I am not a carpenter either, but with the instructions "Written so I can understand it," I have a business of my own.

Yours truly,

JOHN S. COLEMAN.

TWO VOLUMES

PART ONE

PART TWO

21 Designs. 96 Pages. | 32 Designs. 128 Pages.

Cloth Cover. Price 50c Each, Postpaid.

POPULAR MECHANICS BOOK DEPT.
318 W. Washington Street, CHICAGO

Amateur Mechanics No. 1

For both Old and Young

A VALUABLE BOOK

Price 25 cents postpaid

Of Exceeding Interest to the Practical Mind

Contains 174 ARTICLES — 165 ILLUSTRATIONS

"Amateur Mechanics" is a thorough, practical book for old and young. Tells how to make hundreds of different articles of daily use. Is of exceeding interest. This book should be in every American home.

"Written So You Can Understand It"

For sale by all news dealers or can be ordered direct from the Publishers

POPULAR MECHANICS BOOK DEPARTMENT, CHICAGO

The Big "Buzzacott" Book

4 Great Books in One Large Volume

1. **The Complete Camper's Manual**
Or, How to Camp Out and What To Do
2. **The Complete Hunter's and Sportsman's Manual and Trapper's Guide**
3. **The Complete Fisherman's and Angler's Manual—Or, How to Catch Fish**
4. **The Complete Big-Game Hunter's Manual—Or, The Rifleman's Guide**

4 Books for the Price of One \$2
544 Pages—1000 Illustrations

THIS book, now thoroughly revised, was used and endorsed by Presidents Roosevelt and Cleveland, War Correspondents Archibald and Richard Harding Davis, General Sir Robert Baden Powell and all the big authorities on outdoor sports. It tells more about Camping, Hunting, Trapping, Fishery Craft, etc., than any one book ever published. It is so arranged and classified that it is as necessary to the sportsman of today as rifle, tent, rod or shot-gun. It is the Standard Reference Book for Lovers of Outdoor Life. The Authors, Francis H. Buzzacott, and his father, Buzzacott, Senior, have been known for these generations as among America's most experienced guides, hunters, trappers, and trappers of big and small game.

Now and Always the Standard—Over 200,000 Copies \$2.00 have been Sold. Sent postpaid on receipt of price.

Popular Mechanics Book Dept., Chicago

MOTORCRAFT ENCYCLOPEDIA

The Standard Hand Book on BOATS and ENGINES

Written in popular language from a non-technical standpoint. Contains over 150 pages of valuable information. Twenty-seven chapters, covering every phase of motor boating. Tells a thousand-and-one things every motor boatman should know. Helps you to overcome all motor boat and engine troubles. Handsomely illustrated and bound in attractive three-color stiff board cover. A useful reference book for any library.

SUMMARY OF CONTENTS:

The evolution of the motor boat. Various types of motor boats in common use. The Built to Order, Stock and Knock Down Boat. How to select a motor boat. Points to be observed in buying a second-hand boat. How to build a motor boat. Smoothing off and calking. How to paint a motor boat. How to install a marine motor. The history of the internal combustion motor. Explanation of two and four-cycle motor. Internal combustion motor auxiliaries and their functions. How to operate an internal combustion motor. Engine trouble. Propeller wheels. Reversible equipment. Furnishings and fittings. Navigation rules. Distress signals. Harbor regulations. U. S. Life Saving Service signals. National Motor Boat Bill. What to do in case of accident. Rules for determining horse power. How to lay up boat and engine for the winter. How to remove carbon deposits, and other useful receipts. How to build a motor ice boat. Dictionary of Motor Craft terms.

TROUBLE CHART—Enables you to locate any ordinary engine trouble with dispatch.

Price \$1.00 Postpaid

POPULAR MECHANICS BOOK DEPT.
CHICAGO



Seven Electrical Experts

Here is a set of electrical books published especially for the student, worker and expert—every chapter written by an expert in his special line—every subject brought down to date—an absolute authority on everything electrical from wiring to alternating current machinery—from motors to power stations, etc. Read table of important subjects below.

The American School's Cyclopedia of Applied Electricity

is compiled from the instruction papers used in the regular correspondence work of the school; contains 3,200 pages; 2,600 full page illustrations, diagrams, formulas, etc., with a special cross index for quick reference. The seven large volumes are bound in half morocco and are printed in large, clear type on special quality paper.

Important Subjects Covered by These Great Books

Theory, Calculation, Design and Construction of Generators and Motors—Electrical Measurements—Electric Wiring—Electric Welding—Types of Generators and Motors—Management of Generators and Motors—Storage Batteries—Electric Lighting—Alternating-Current Machinery—Station Appliances—Power Stations—Power Transmission—Central Station Engineering—Electric Railways, including Single-Phase—The Electric Telegraph—Telephone Equipment, Systems and Operation—Wireless Telegraph and Telephone—Teleautograph, Telephonograph, etc.

Sent Absolutely Free—Express Prepaid

The complete seven volumes, not a sample volume, will be sent, express prepaid, for seven days' free examination; returnable at our expense if the books do not contain the information you want. If you keep the books, pay \$2.00 seven days after receipt and then \$2.00 a month until you have paid the special introductory price of \$19.80.

Just fill in and mail the coupon. It won't cost you a cent to examine the books. We know they'll be worth many times their cost to you. Mail the coupon now and you will receive your books promptly.

Another Great Free Offer

With every set is included a year's Consulting Membership entitling you to the free advice of a corps of Electrical Experts. This will give you practical help in handling working problems which are too specific to be taken up in detail in the cyclopedia. There will be no limit to this service. A single problem solved for you might be worth more than the first cost of the books.

American School of Correspondence
Chicago, U. S. A.

7 Day Examination Coupon

NAME.....
ADDRESS.....
OCCUPATION.....
EMPLOYER.....

Pop. Mech. 7-12

A. S. of C.

Please send the Cyclopedia of Applied Electricity for seven days' free examination. I will send \$2.00 within seven days and \$2 a month until I have paid \$19.80; otherwise I will notify you and hold the books subject to your order. Title not to pass until fully paid.

Please Mention Popular Mechanics

Boston Garter



Velvet Grip
Holds Your Sock Smooth as Your Skin

Made in two styles shown here.

Sold Everywhere

Every pair Guaranteed

SILK, 50c.
LISLE, 25c.
Sample pair sent postpaid on receipt of price.

GEORGE FROST CO.
Makers, Boston.

HYDRAULICS

AND ITS

APPLIED PRINCIPLES

Numerous
Important Tables
217 Pages

Cloth, \$2.50

Flexible
Leather, \$3.50

TO IRRIGATION,
DRAINAGE,
WATER SUPPLY,
SEWERAGE, ETC.

are put within reach of the average practical man by a new work

The Primer of Hydraulics

By FREDERICK A. SMITH, C. E.

(HYDRAULIC ENGINEER)

Heretofore, obscure and complicated methods of solution have made it practically impossible for anyone but the trained engineer to successfully handle hydraulic problems, but this book is well adapted for self instruction for those who have been deprived of training along this line.

BOOK SENT POSTPAID UPON RECEIPT OF PRICE BY
Popular Mechanics Book Department
CHICAGO

700 Things That a Boy Can Make

1000 Illustrations That Thoroughly Show How



\$1 THE handsome set of four books—"Mechanics for Young America" and "Amateur Mechanics" (Nos. 1, 2 and 3)—each book bound separately in Illuminated Covers, and the whole set enclosed in a heavy Bristol Folding Case with extension clasp—will be sent prepaid to any address for \$1.00.

\$1

The Ideal Books for the Wide-Awake American Boy

Thoroughly Practical and Instructive

Besides telling how to make scores of things useful about the house, full and complete directions are given on constructing the following and hundreds of others things which appeal to the heart of every boy.

Electric Appliances—Steam and Gas Engines—Motors—Wireless and Morse Telegraph—Self-Propelled Vehicles—Toboggans, Bobsleds, Ice-Boats—Motorboats—Paddle Boats, Canoes, Rowboats—Camping Outfits—Cabins—Tents—Fishing Tackle—Magic Lanterns—Searchlights—Cameras—Telescopes—Glanders and Aeroplanes—Kites and Balloons—Aquariums—Electric Furnaces—Electroplating Outfits—Lathes—Foundry Work at Home—Iron, Copper, Brass and Other Metal Work—Bookbinding—China and Pottery Kilns—Parlor Magic Tricks, etc.

Each book sold singly at 25c postpaid or the complete set for \$1.00

POPULAR MECHANICS BOOK DEPARTMENT

318 W. Washington Street, CHICAGO



Please Mention Popular Mechanics



YOU CAN BE AN AUTO EXPERT

We teach you the entire subject by mail in 10 weeks' spare time, and assist you to secure good position. Demand for trained men can't be filled. Simple, practical and personal instruction. Free auto model to each student.

FIRST LESSON FREE—WRITE FOR IT NOW

Get started at once. Write The Original Automobile School Empire Auto Institute, 148 Empire Bldg., Rochester, N. Y. Owners—we supply competent men

Looking for Mechanical Information ?

500 Titles
on 100
Different
Subjects

OUR NEW REVISED

BOOK CATALOG

Shows just where to find that particular help you are in need of. SENT FREE on request.

Popular Mechanics Book Dept.
318 W. Washington Street, CHICAGO

800⁰⁰ TO 1800⁰⁰
A YEAR
For LIFE

Thousands of Government Positions Open

Railway Mail Clerks, City Carriers, Clerks in the Departments at Washington, D. C., Postoffice Clerks

EXAMINATIONS ANNOUNCED EVERYWHERE JULY 15th

Rapid advancement to higher Government Positions. No "layoffs" because of strikes, financial troubles or the whims of some petty boss. Country and city residents stand the same chance for immediate appointment. Common sense education sufficient. Political influence **Not Necessary**. If you want immediate appointment, send coupon below for list of positions open in your section, for which examinations will be announced July 15th. This list gives the duties required and tells how to get the appointment.

We Coach Candidates Free of Charge

COUPON

FRANKLIN INSTITUTE, DEPT. D108, ROCHESTER, N. Y.

The coupon, filled out as directed, entitles the holder to a free copy of our book, "Government Positions and How to Obtain Them," (free sample questions) and to consideration for Free Coaching for the examinations, here checked:

..... Railway Mail Clerk (\$800 to \$1400) Customs Positions (\$800 to \$1500)
..... Postoffice Clerk (\$800 to \$1200) Internal Revenue (\$100 to \$1800)
..... Postoffice Carrier (\$800 to \$1200) Stenographer (\$800 to \$1500)
..... Rural Mail Carrier (\$500 to \$ 800) Clerk in the Departments at Washington (\$800 to \$1500)
..... Bookkeeper (\$800 to \$1800)

Name
Address D 108

Use this before you lose it. Write plainly.

200 Cartoons Tell More Than 200 Columns



Cartoons

Selected from the best dailies and weeklies published in the United States, London, Berlin,

Paris, Munich, Vienna, Warsaw, Budapest, St. Petersburg, Amsterdam, Turin, Rome, Stuttgart, Lisbon, Zurich, Tokio, Shanghai, Sydney, Canada and South America.

A Picture History of World's Events for Each Month

The Political Situation from Day to Day and to Date

ASK YOUR NEWSDEALER FOR CARTOONS

Single Copy 15c. Yearly Subscription \$1.50

Published on the 5th of each month. One free sample copy will be mailed by addressing the publisher

H. H. WINDSOR, 318 W. Washington St., Chicago



Young Men

Learn the Watchmaking, Engraving and Jewelry Business at home and BE INDEPENDENT. Make money while you are learning the trade.

It does not matter how you are situated or the nature of your occupation. If you are ambitious and want us to help you, we will start you in this money making business. Do not let anything interfere with your commencing now. In a few months time you should have a money making business of your own.

"I never made big money so easily in my life"

All the men who commence with us and who follow our instructions are successful. If you want a store of your own, commence now. We have taught hundreds of men who are now making this their life work and earning many times the money they made before they began with us.



Our Plan for establishing men in the watch repair and jewelry business is a simple one and by its workings we make it possible for any one who has the right stuff in him to get into a most profitable business for himself and in a very short time

to become the proprietor of a money making jewelry business.

Here is indeed the opportunity of a life time for an ambitious man. The men we start in business are fortified with a knowledge that makes their business a success.

We Help Men who are not afraid to try and with the keen, personal interest we take in each of our student partners, success is assured from the very start.

We have shown these men how to build up their business and make money while they were learning this profitable trade. We can do the same for you. The work is genteel, elegant and a great money maker.

Write today for wholesale catalog and full particulars. Learn more about this grand opportunity for yourself.

Rogers, Thurman & Co., 101-121 Mallery Bldg., Chicago



This photograph shows the store of one of our many pupils who now has a thriving prosperous business.

Here Are the Extracts from Letters from Some of Our Students:

"I am making money in this new business." — Albert Swanson. "My new business is making money." — T. Clancy. "I took in \$25.00 cash Saturday." — T. H. Robinson. "You have helped me get a start in a jewelry business and it has been very successful." — W. T. Warren. "Luck has been with me since I started with you." — J. E. Despara. "I am getting more work than I can do." — J. Trotter.



HIGHLAND PARK COLLEGE DES MOINES IOWA

Enter Any Time. 2000 Students Annually

One of the most completely equipped ENGINEERING SCHOOLS in the country. Students may enter any time they are ready to come.

COURSES OFFERED

1. CIVIL, ELECTRICAL AND MECHANICAL ENGINEERING COURSES. Standard courses are offered in Civil, Electrical and Mechanical Engineering. Special opportunity is offered for making up work or for taking a complete course preparatory to the standard Engineering Courses. Shop work from the beginning comes in preparatory courses. See our new Engineering Catalogue.

2. SHORT COURSES
1. One Year Electrical Engineering Course
 2. One Year Telephone Engineering Course
 3. One Year Steam Engineering Course
 4. One Year Machinists' and Automobile Course
 5. One Year Course in Mechanical Drawing

Just a fair common school education is all that is required for entrance to these courses. These courses are very practical and are intended for those who have but limited education and do not see their way clear to take a complete Engineering Course. The Machinists' Course is especially practical. The new machine shops are the most complete to be found in connection with any Engineering School in the United States.

SPECIAL COURSES

1. TRACTION ENGINEERING. This is the most complete course in Traction Engineering offered by any Engineering School in the country. It may be completed in three months. Students are taught how to make all repairs on engines as well as to handle them. Four traction engines used for experimental purposes.
2. GASOLINE AND AUTOMOBILE COURSES. These courses may be completed in three months. They are exceedingly practical. Complete Chauffeur practice. Just a fair common school education is all that is necessary to enter.
3. FARM BLACKSMITHING, FARM CARPENTRY.

Mention course in which you are interested. Address,

O. H. LONGWELL, Pres. DES MOINES, IA.

EARN A BIG SALARY

Be An Auto Expert

Big demand and big pay for chauffeurs, repairmen, and salesmen. Our system of individual instructions by mail enables you to complete the course in 12 simple lessons at home. Send To-day for Free Book, particulars, and endorsements of 10 leading automobile makers. We assist graduates to get positions. FREE MODEL FURNISHED EACH PUPIL. Practical Auto School, 68 Beaver St., N. Y. City



IF YOU STAMMER

Attend no stammering school till you get my large FREE book and special rate. Largest and best school in the world curing by natural method. Write today. Leo Wells Millard, Pres., North-Western School for Stammerers, Inc., 317 First St., Milwaukee, Wis.



WINDOW TRIMMING

Advertising and Card Writing are the best paid professions in the world. Interesting prospectus FREE tells you all about it. KOESTER SCHOOL, 306 Jackson Boulevard, CHICAGO



WHEN YOU WANT ANYTHING AND DON'T KNOW WHERE TO FIND IT
WRITE BUREAU OF INFORMATION,
POPULAR MECHANICS CHICAGO

Mechanics For Young America

A book which tells how to make scores of articles which delight the heart of the average boy. Price 25 Cents Postpaid

POPULAR MECHANICS BOOK DEPT.
318 W. Washington Street, CHICAGO



I'll Double Your Earning Ability in Six Weeks

Learn the Automobile Business A trade which you are in demand 12 months in the year. Work pleasant, as demand for trained men. 90% of the automobiles in daily use are not in proper adjustment on account of shortage of experienced automobile mechanics.

Everybody in the Automobile Business Today is Making Big Money

I want you to come to my school; I want you to see for yourself, how thoroughly and practically I teach all about the automobile. Six weeks after the day you enroll in my great practical Automobile School you will be prepared to properly repair any automobile, make and drive any car or truck or open a garage and repair shop of your own. You can learn the automobile business thoroughly in my school because I have been years in working out for quick, thorough instruction, the

"Sweeney System" of Practical Automobile Instruction

It is today the most thorough, practical, comprehensive and interesting course of automobile instruction, and embraces every point worth knowing, including vulcanizing, brazing, oxy-acetylene welding, lathe work, machine shop practice, testing and road work, etc. You learn by doing the actual work on real cars with your own hands under the watchful eyes and ready suggestions of experienced instructors.

Send Today for free catalog and we will place your name on our mailing list for our monthly school magazine which we will also send you absolutely free. I want every man thinking of learning to become an Auto Expert to have this big, illustrated Catalog. Write for this great book. Send today—this very minute—NOW.

EMORY SWEENEY, Pres.

Sweeney Automobile School The School of Practical Experience
1460 Woodland Ave., KANSAS CITY, MO

Experienced chauffeurs, repair men, truck drivers and demonstrators furnished.

No Books Used Tools Furnished FREE

The tuition is low and, after you have paid that, you do not have another cent of expense in the school. You do not learn from books, but by practical work on real automobiles in everyday use.



BE A METER EXPERT

Specialize in Electrical Instrument and Meter work. This is one of the most important branches in the great electrical industry. Instruments and Meters are used wherever Electricity is used. Big demand for competent men.

POSITIONS PAY \$900-\$1800 A YEAR

The work is pleasant and healthful. Advancement rapid and certain. D. M. Hastings, Jr., writes: "Am now employed as foreman of meter dept. at a 50% increase in salary." We have raised the salary of many others. Let us help you. Write today for free booklet telling all about this new work.

FORT WAYNE CORRESPONDENCE SCHOOL,

711 Trust Bldg. Fort Wayne, Indiana

LEARN THE EXPORT BUSINESS

Get into something new—where competition is practically unknown. Big manufacturers are searching the country for competent men to handle their Export Departments. We are the only School in America that teaches how to handle Foreign Trade. Find out more about this new career.

Write for our booklet—NOW.

JANSSENS SCHOOL OF FOREIGN TRADE
211 W. Schiller St., CHICAGO

Automobile School—Summer Rates

Special Low Rates for July and August. Write us today. Staff of Instructors and Equipment the best of any School in U. S. Big demand for our Graduates. Largest School in the world.

BIG CATALOGUE FREE

AUTOMOBILE TRAINING SCHOOL, 1185 Locust St., Kansas City, Mo.

WORK FOR UNCLE SAM

Government positions offer pleasant employment with good pay. Custom House, Internal Revenue, Bookkeeper, Railway Mail and Post Office Examinations everywhere soon. Any American citizen, 18 or over, eligible. Common education sufficient. Our free booklet shows how you can prepare under personal supervision of former Secretary of Civil Service Examiners. Write for Booklet to-day. PATTERSON CIVIL SERVICE SCHOOL, 100 Livingston Bldg., Rochester, N. Y.

How You Can Get

An Automobile FREE

We want honest, sober young men in every county to learn at home to repair, run, and to teach others, and then sell the COEY "FLYER," a 6 cylinder, 50 H. P., 5 passenger Automobile—"The World's Best Value." Write for full particulars how you can get one free—address:

**C. A. Coey's
School of
Motoring**

Dept. 203
1424-26 MICHIGAN AVE.
CHICAGO, ILL.



Learn Electricity

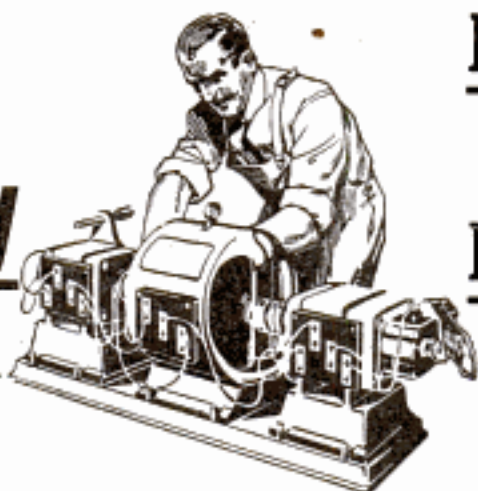

IN ALL ITS APPLIED BRANCHES

DON'T waste your time and money studying simply "wiring." You'll never get ahead in the Electrical field if "wiring" is all you know about Electricity. We teach a complete course in the practical study of dynamos, motors, telephones, wireless telegraphy, storage battery and third rail systems, interior light and proper wiring, estimating and contracting, illumination, etc.

HERE YOU LEARN BY DOING!

Our building is completely equipped with electrical apparatus and machinery. You get individual instruction from competent "know-how-to-do-it" teachers. No previous preparation or electrical knowledge necessary. You can start any time. You progress as fast as you are able. Day and night sessions.

Send for free illustrated catalogue that tells you all about this practical, small cost, "LEARN-BY-DOING" school

The New York Electrical School 44 West 17th Street
NEW YORK



LEARN PIANO TUNING AT HOME

You can learn quickly and easily by devoting your spare time to the study of our "Correspondence system. Our wonderful invention, the Tune-a-Phone, gives the exact number of beats that should occur in the test intervals. With it the student knows what the result should be. It eliminates guess work. Our graduates earn \$5 to \$10 a day the year round. We furnish full-sized action model and necessary tools. Write for valuable book FREE.

Miles Bryant School of Piano Tuning, 47 Pine Arts Bldg., Battle Creek, Mich., U.S.A.



I TEACH BY MAIL

WRITE FOR MY FREE BOOK

"How to Become a Good Penman"

and beautiful specimens. Your name elegantly

written on a card if you enclose stamp. Write

today. Address F. W. TAMBLYN, 418 Meyer Bldg., Kansas City, Mo.

Part Scholarship FREE

During the summer months we offer a limited number of part scholarships free to really ambitious young men who are anxious to become expert electricians or electrical engineers. We teach

Practical Electricity

by thoroughly practical methods under thoroughly practical conditions with just enough "book learning" necessary—and no more. Our students work with electrical tools and machines and learn by actually *studying* out with actual working tests under the guidance of an expert faculty. Write now about special offer and school catalog.

SCHOOL OF ENGINEERING OF MILWAUKEE
161-169 Michigan Street
Stroh Industrial Building, MILWAUKEE, WIS.



LEARN AUTOMOBILE BUSINESS

Demands for our graduates as chauffeurs, automobile salesmen and repairmen exceeds supply. We teach 8 branches of the business by mail in 12 weeks, furnishing you employment from which you should earn more than enough while studying to pay for course. Only school that loans each student working model of automobile while studying and gives preparatory training for auto factories. Write for Plan C10



Automobile College of Washington, Washington, D. C.

LEARN WATCHMAKING

refined, profitable labor—Competent men always in demand. We teach it thoroughly in as many months as it formerly took years. Does away with tedious apprenticeship. Money earned while studying. Positions secured. Send for catalog. St. Louis Watchmaking School, St. Louis, Mo.

ADVICE

Information and counsel on any subject under the sun. No matter what you want to know, no matter what your present condition, our big organization can help you.

WRITE TODAY FOR BEAUTIFULLY ILLUSTRATED BOOK FREE
NATIONAL BUREAU OF ADVICE AND EDUCATION, 527 Ashland Block, CHICAGO

BE A DETECTIVE

Earn from \$150.00 to \$300.00 per month; travel over the world. Write C. T. LUDWIG, 1600 Searritt Bldg., Kansas City, Mo.

Salesmen Wanted

DO YOU WANT A GOOD POSITION WHERE YOU CAN EARN FROM \$1,000.00 TO \$5,000.00 A YEAR AND EXPENSES?

There are hundreds of such positions now open. No former experience as a salesman required to get one of them. If you want to enter the world's best paying profession our Free Employment Bureau will assist you to secure a position where you can earn good wages while you are learning Practical Salesmanship. Write today for full particulars; list of good openings and testimonial letters from hundreds of our students for whom we have recently secured good positions paying from \$100.00 to \$500.00 a month and expenses. Address nearest office, Dept. 123

National Salesmen's Training Association
Chicago New York Kansas City Seattle New Orleans Toronto

BECOME A **Mail this Coupon—NOW**

La Salle Extension University, P. O. Box 1197, Chicago
Gentlemen: Send at once particulars and
112 page Catalog **FREE**, regarding
courses offered in your Dept. of Law.

LAWYER!

Read Law and be a leader! The big places in the business, political and financial world are filled today by legally trained men. Golden opportunities everywhere! Put yourself in the big-income class. Advance your position in life. Nothing will do it quicker than a knowledge of law.

Name.....

Address.....

City.....

State.....

We Offer the Leading Home-Study Course in America

No need to leave present occupation or go away to school. Use your spare time. Learn under our new extension method. With our plan you secure all the advantages of a University education—but you stay right at home. We bring the University to you. Graduate correspondence students most successful in passing bar examinations. Mail the coupon and get **FREE** particulars at once.

A

Over \$40,000.00 expended by us for new law text—14 vol. series. Owned exclusively by us. Prepared by noted Deans and Professors with leading resident law schools—Harvard, Univ. of Chicago, Mich., Wis., Ill., Iowa, Leland Stanford, Jr., and others. Remember this important fact—Ours is the only course in accordance with instructions now given by professors teaching at the big resident colleges. All texts required in the course furnished absolutely **FREE**. Over 6,000 pages, not including lecture series and other printed matter.

We Guarantee To Coach FREE Any Graduate Failing To Pass Bar Examinations

If you have not had a chance to go to school send the coupon at once and learn what we can do for you. Thousands who cannot give up their present positions or leave home have taken advantage of our excellent facilities. Our 112 page catalog will tell you all about our plan of home instruction and the courses offered in our Department of Law. The cost for an entire course including every expense—matriculation fee, tuition, text books, lectures, diploma, etc., etc., is easily within the reach of the most limited income.

The education of many young men has been cut short through unfortunate circumstances. You may be one of them. We can help you to realize your ambitions. What others have done you can do. What we have done for others we can do for you. The first step is to clip the coupon. Do it now. It costs nothing. All information is sent free. **DECIDE NOW TO STUDY LAW** and thus make the first step toward a great and successful business or professional career. **Extremely low cost—Easy Monthly Payments.** No Entrance Examinations. Put your name and address on the coupon and mail right away. Over 10,000 students enrolled.

La Salle Extension University P. O. Box 1197 **Chicago, Ill.**

W

Edgar G. Myers
Author of Course

BE A BANKER

Learn a profession in a few months that will give you standing and independence the rest of your life. No matter where you live or what your occupation we will teach you by mail. No business or profession offers better opportunities. The work is pleasant, hours short, salary good. Endorsed by leading bankers. Very low cost, easy payments. Write today for catalog.

AMERICAN SCHOOL OF BANKING, 119 McLeane Bldg., Columbus, Ohio

**DO YOU LIKE TO DRAW?**

That's all we want to know

Now we will not give you any grand prize—see a lot of free stuff if you answer this ad. Nor do we claim to make you rich in a week. But if you are anxious to develop your talent with a successful cartoonist, so you can make money, send a copy of this picture with 6c. in stamps for portfolio of cartoons and sample lesson plate, and let us explain. The W. L. Evans School of Cartooning
321 Ball Bldg., Cleveland, O.

**LEARN WATCHMAKING**

Watchmaking pays and you can earn while you learn. Write for **FREE BOOK**, "How to be a Watchmaker." Postal brings it.

STONE'S SCHOOL OF WATCHMAKING
912 Globe Bldg. ST. PAUL, MINN.

REDUCE THE COST OF UP-KEEP OF YOUR AUTOMOBILE**Audels Answers On Automobiles**

gives full details on successful care, handling, how to locate trouble and remedy it. Begins at the very first principles and then forward to the principles used in every part of a motor car. It is a thorough 1912 course in the Science of Automobiles. Contains 516 pages of intensely practical time and money saving information, clearly and simply written. 180 illustrations. Indexed for ready reference. **Highly endorsed by manufacturers.** Invaluable to owners, intending owners, repair men and chauffeurs. Examine and use this book 7 days free by sending coupon.

\$1.50

Theo. Audel & Co., 72 Fifth Ave., New York

Kindly mail me copy of Audels Answers on Automobiles and, if found satisfactory, I will immediately remit you \$1.50, or return the book to you.

Name.....

Occupation.....

Address.....

July
P.M.**SENT ON APPROVAL—NO MONEY DOWN****BE AN ELECTRIC MOTORMAN****GOOD PAY**

Steady, healthful and pleasant employment. Positions open in every state. Our easy method teaches at home in spare time.

Small Cost. Particulars Free

National Institute of Practical Mechanics
1325 Michigan Ave. - CHICAGO, ILL.

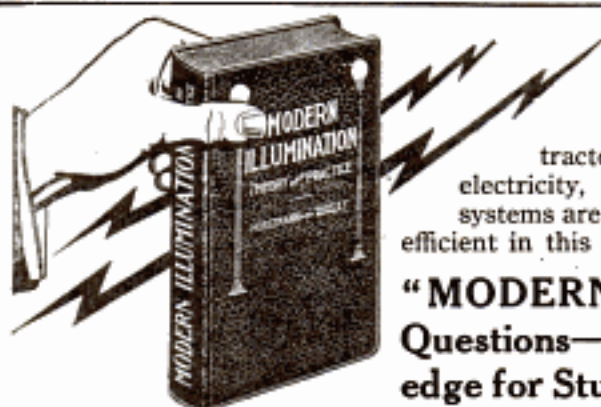

Know Electric Lighting

WHETHER you're electrician, con-

tractor, building manager or just a plain ordinary user of electricity, you need to be posted on what the best lighting systems are and how to install them, what kind of lights are most efficient in this type of building and what in that.

"MODERN ILLUMINATION" Answers Your Questions—It's a Book of Solid, Scientific Knowledge for Student, Electrician, Contractor and User

It's the last word in illuminating science and construction—chock full of the information you want—written in a way you'll understand.

THE AUTHORS, Henry C. Horstman and Victor H. Tousley, are recognized authorities on applied electrical science. Among the subjects they treat are: Nature and Properties of Light—Photometry and Illumination Calculations—Construction Uses, Advantages and Disad-

vantages of Different Types of Lamps—Reflectors—Fixtures—Location of Lamps—Indirect Lighting. One chapter discusses Practical Requirements for Different Rooms and Buildings—another, Directions for Drawing Up Plans and Specifications.

Modern Illumination is published in pocket size, for ready reference, handsomely bound in limp green morocco, stamped with gold, and is printed in clear type on good paper. It contains over 275 pages of reading matter, with practical tables, illustrations and diagrams.

ORDER A COPY ON APPROVAL—MONEY BACK IF YOU SAY SO Send us \$2 and we'll send you a copy of "Modern Illumination," charges prepaid. Look it through and if you don't believe it's worth the price, send it back at our expense and we'll refund your money.

DESCRIPTIVE FOLDER SENT ON REQUEST

FREDERICK J. DRAKE & CO., 1321-5 Mich. Ave., Chicago



EARN A SPLENDID SALARY

Let us train you in our splendidly equipped shops for a good position as automobile mechanic, salesman or chauffeur. Thousands of graduates are earning big salaries. Complete training in 4 weeks, including extensive practice in repairing and driving high powered cars. Tuition and board reasonable.

Send to-day for catalogue and list of graduates

CLEVELAND AUTOMOBILE SCHOOL, 2341 Euclid Ave., CLEVELAND, O.

NEWSPAPER ARTISTS

Earn \$25 to \$100 a Week

Get the inside facts about this wonderfully fascinating and profitable profession. A fully illustrated book, "How to Become a Newspaper Artist" tells what you should know in order to succeed—materials needed, assignments, technique, how to make lay-outs, cartooning and caricature, drawing from a model, animal drawing, etc. Prepared by artist now on a big city paper. Price \$1.00 Post paid.

THE COLEMAN AGENCY, 216 Pine St., ST. LOUIS, MO.



LEARN JEWELERS' ENGRAVING

A high salaried and easily learned trade, taught thoroughly by mail. We will teach the beginner better engraving than he can gain in years of rigid apprenticeship. We will also improve the skill of any engraver. Send for our catalogue.

The Engraving School, 112 Page Bldg., Michigan Ave., Chicago, Ill.

BE AN ENGRAVER

LEARN AT HOME—EARN \$25 to \$50 WEEKLY. We give personal instructions and furnish necessary tools FREE. Terms reasonable. Complete particulars by mail.

Chicago Engraving School, Dept. 20, 110 W. Chicago Ave., Chicago

AVIATORS WANTED

BECOME an Aviator. BECOME an Aeronautical Engineer. BECOME an Aeronautical Motor Expert. BECOME a Flying Instructor.

FORTUNES have been made in a season. WE ARE THE REAL WESTERN PIONEERS

Milwaukee School & College of Aviation

TO COMPETENT GRADUATES WE FURNISH A Standard Type Aeroplane Practically Without Cost

We Teach { GENUINE CURTISS } Machines
Flying on { GENUINE BLERIOT }

We MANUFACTURE ANY type HYDRO-AEROPLANES
aeroplanes and make a specialty of
We are looking NOW Exhibition Flights at Fairs and Meets, Aerial Advertising
Stunts for Merchants and Manufacturers. SPECIAL HOME-STUDY COURSE
for out-of-town students. Competent Aviators earn from \$100 a week UPWARD.

Address immediately for particulars: Department No. 20

S. E. Corner of Grand Avenue and Fifth Street, Milwaukee, Wis.
Hangars, Shops and Flying Field, Foot 64th Ave., West Allis, Wis.

LEARN TO FLY

The Curtiss Summer Training School

at Hammondsport, New York

Now Open

*New Hangars, new equipment,
experienced instructors.*

**Aeroplane
and Hydroaeroplane
Courses**

The Curtiss Schools are the largest in America. Seventeen pupils obtained their pilot's licenses at our San Diego school between January first and March fifteenth. Summer classes are filling rapidly.

**WRITE OR WIRE YOUR
ENROLLMENT TO-DAY**

Prices and particulars
upon request.

**The Curtiss
Aeroplane Co.**

Hammondsport, New York

(The Home of Curtiss
Aeroplanes and Motors)



QUICK, THOROUGH ELECTRICAL INSTRUCTION

A complete college course in two years. Time and money saved. Taught by graduate engineers. Practice on apparatus and machines—construction, operation and repair. Every branch of generation, transmission and application. Graduates in leading electric companies. New classes July and September.

—WRITE FOR DETAILS—

BRYANT & STRATTON COLLEGE
No. 111, College Building BUFFALO, N. Y.



LEARN WATCHMAKING AT HOME



You can learn by our modern and original system of instruction every part of the Watchmaker's Trade at home as good or better than at a shop. You can earn money while learning and secure a well paying position or start in business after completing our course of instruction. Good watchmakers are always in demand and earn from \$20 to \$35 per week. For particulars apply to the **WISCONSIN SCHOOL OF WATCHMAKING**, Stroh Bldg., MILWAUKEE, WIS.

LEARN TO WRITE ADVERTISEMENTS

**EARN \$25 to \$100
A WEEK**
We can positively show you by mail
How to increase your salary. **BOOK MAILED FREE.**
PAGE-DAVIS CO., 112 Page Building, Chicago, Ill., or 154 Nassau St., New York



STAMMER

My book "How to Stop Stammering"—a treatise on "Scientific Talking"—direct to the point.

Write **N. L. HATFIELD**, 1918 Grove St., OAKLAND, CALIF.

LAW Learn at Home

Graduate correspondence students most successful at bar examination. Cover same ground as Harvard, Michigan and other big law colleges. **Guarantee to coach free**, students failing to pass bar examination. **Scholarships are now open**. Scholarship students pay only for text and postage. **Write today** for catalog.

American Correspondence School of Law, Dept. 119Y, Manhattan Bldg., Chicago

Men Wanted ^{Right} _{Away}



**\$5.00
to
\$8.00
Per Day**

Big Demand for

Electricians

Plumbers

Bricklayers

Painters

Decorators

Draughtsmen &

Moving Picture Operators



No Experience Necessary

Take advantage of these big openings right now. More men are wanted for these trades all the time. We will help you earn from \$5 to \$8 per day or start a business of your own, so that you can earn from \$5,000 to \$50,000 per year. We will teach you in a few months' time, at small expense, one of the following profitable trades: **Electricity, Plumbing, Bricklaying, Painting and Decorating, Mechanical Drawing and Moving Picture Operating.** Unlimited opportunities for making big money. No experience necessary.

**Start Your Own Business—
\$3,000 to \$5,000 Per Year**

FREE TOOLS

We furnish all of the tools and equipment you use in our school absolutely free. No expense to you.

If you want to go into business we will equip you so that you can start right in for yourself, at very small expense, and make from \$5,000 to \$50,000 a year. Our school is the oldest, largest and best equipped trade school in the world. Open all the year round—enter any time at any age. Day and night sessions. Tuitions very low. Easy payments if desired. We will help you earn your way through school, too. And our employment bureau places students in big paying positions all the time.

Write Today Get our 1912 catalog which explains all about our practical course of instruction. Learn how students make big money—how you can insure your future by taking our course. Get this information at once. It's everything sent absolutely free. Just send us a post card. We will help you make a big success, so write today to

L. L. COOKE, Director

Coyne National Trade School

20 E. Illinois St., Dept. 119Y Chicago, Ill.

Oldest and Largest Practical Trade School in America



We
Occupy
This
Entire
Building
of
Over
30,000
Square
Feet

Please Mention Popular Mechanics

These Books will place YOU ABOVE THE CROWD of COMMON WAGE EARNERS



If you want to GET AHEAD—HERE'S YOUR CHANCE! The knowledge, skill and experience of scores of well-known experts in Engineering is now placed at your disposal. If you are a beginner—or even if you consider yourself well up in Engineering—these books will prove of inestimable value to you. On every page you will find something that you should know—or that you have learned and forgotten. Now, read our liberal offer—how we place in your hands, for seven days free examination, this great new seven-volume

Cyclopedia of Steam Engineering

Compiled from the standard instruction text books of the AMERICAN SCHOOL OF CORRESPONDENCE, these books constitute, in themselves, a course of practical and systematic instruction in Engineering—placing before you the short cut to the big positions and big salaries.

The regular list price of this splendid set is \$35.00—but for a few weeks we will make the special price of only \$19.80 (nearly actual cost). If you want the books, after you have had them in your hands for seven days, at our expense, you can pay for them on the very easy arrangement of \$2.00 down and \$2.00 per month thereafter until paid for. And remember, that in letting us send you these books, for your examination, you

Do Not Pay One Cent Until You Notify Us That You Wish to Keep the Books

And if you do not desire to keep the books, after you have had them for the seven day period—simply notify us, and we have them returned, at our expense.

These seven magnificent volumes contain 5,300 pages (size 7x10 in.) and over 2,500 illustrations, full page plates, diagrams, etc. Printed on the best grade of paper, with large, clear type; superbly bound, in half-morocco; titles stamped in gold.

A Few of the Important Subjects Covered:

Construction of Boilers, Boiler Accessories, Fuel Economizers, Mechanical Stokers, Steam Pumps, Steam Engines, Indicators, Valve Gears, Steam Turbines, Gas and Oil Engines, Fuels, Automobiles, Carbureters, Locomotive Boilers and Engines, The Air Brake, Single-Phase Electric Railway, Elevators, Marine Boilers, Marine Engines, Heating and Ventilating, Compressed Air, Transmission, Absorption and Compression, Refrigeration, Ammonia Machines, Direct Current Dynamos and Motors, Management of Dynamos and Motors, Electric Wiring, Electric Lighting, etc.

Free with every order received before August 1, 1912

With each set is included a year's Consulting Membership entitling you to the free advice of a staff of Engineering Experts. This will give you practical help in handling working problems which are too specific to be taken up in detail in the cyclopedias. There will be no limit to this service. A single problem solved for you might be worth more than first cost of the books.

Why Not Send the Coupon Today—

before you forget it—so that we can lay this magnificent cyclopedia in front of you, for seven days, at our risk? Remember: No obligation—no cost to you—no trouble on your part—simply mail us the coupon. And after you have carefully tested the books, don't keep them, if you don't want them—if you do not fully realize that they will help you to make a bigger man of yourself. Delay accomplishes nothing—action costs you nothing—act today. Mail the Coupon.

FREE EXAMINATION COUPON

American School of Correspondence
Chicago, U. S. A.

Please send set Cyclopedia of Engineering for 7 days' free examination. I will send \$1.00 within 7 days and \$2.00 a month until I have paid \$19.80, or notify you to send for the books. Title not to pass until fully paid. Pop Mech 7 12

Name.....
Address.....
Occupation.....
Employer.....

Please Mention Popular Mechanics

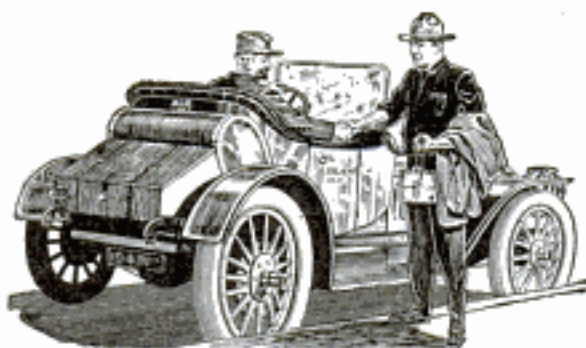

They Started Even

They worked side by side in the same shop. One was ambitious—grasped the opportunity—succeeded. He studied Chiropractic!

He is now independent.

The other was contented—he still works for machinist's wages—his family knows what high cost of living means.

Here's a great opportunity for every man or woman to enter a dignified, highly paid profession, Chiropractic, the new science which, without drugs or surgery, adjusts the causes of human ills.

Take the case of Chas. F. McCormick—a year ago he worked for \$2 a day. He studied Chiropractic and in less than a year built up a practice paying him \$150 a week. "Mao's" neighbors honor him for he accepted his chance; he made good!

So can you—you can learn Chiropractic at home through our home study course—250 lessons and 2500 photos from life. Start now. We could place 1200 graduates today, if we had them and the demand for them is growing fast!

Learn about this real opportunity to get out of the small income rut. Write today.

Palmer School of Chiropractic Home Study Department

"Chiropractic Fountain Head"

Dept. P. M.

Davenport, Iowa, U. S. A.

LEARN a Profitable Profession

EARN \$3000 TO \$5000 YEARLY

We teach you by mail. In a few months you can begin practicing Mechano-Therapy—an elevating and highly paid profession for men and women. Simpler than Osteopathy. Endorsed by physicians. Easy to learn. We guarantee success in the study. Only ordinary education required. Authorized diploma to graduates. Work very interesting. Vast opportunities for social and financial betterment. Special terms now. Write today for our illustrated prospectus—sent FREE. Address: AMERICAN COLLEGE OF MECHANO-THERAPY, 81 W. Randolph St., Chicago, Ill.

MEN WANTED!

SOUND MEN—21 to 40 years old—wanted at once for Electric Railway Motormen and Conductors in every state. Wages \$60 to \$100 a Month. Experience Unnecessary. Permanent employment, no strikes. Write immediately for Application Blank. No colored men hired. Address Manager Employment Department, Room 886 Dwight Bldg., Kansas City, Mo.

BE AN ILLUSTRATOR.

by mail how to draw for magazines and newspapers.

Send for Catalog

Learn to draw. We will teach you School of Illustration 122 Page Bldg. Chicago, Ill.



VENTRILOQUISM

LEARNED BY ANY MAN OR BOY AT HOME SMALL COST Send today 2c stamp for particulars and proof. O. A. SMITH, Room D 44, 823 Bigelow St., PEORIA, ILL.

SHORTHAND IN 30 DAYS

Boyd Syllabic System—written with only nine characters. No "positions"—no "ruled line"—no "shading"—no "word-signs"—no "cold notes." Speedy, practical system that can be learned in 30 days of home study, utilizing spare time. For full descriptive matter, free, address CHICAGO CORRESPONDENCE SCHOOLS 969 Chicago Opera House Block CHICAGO, ILL.

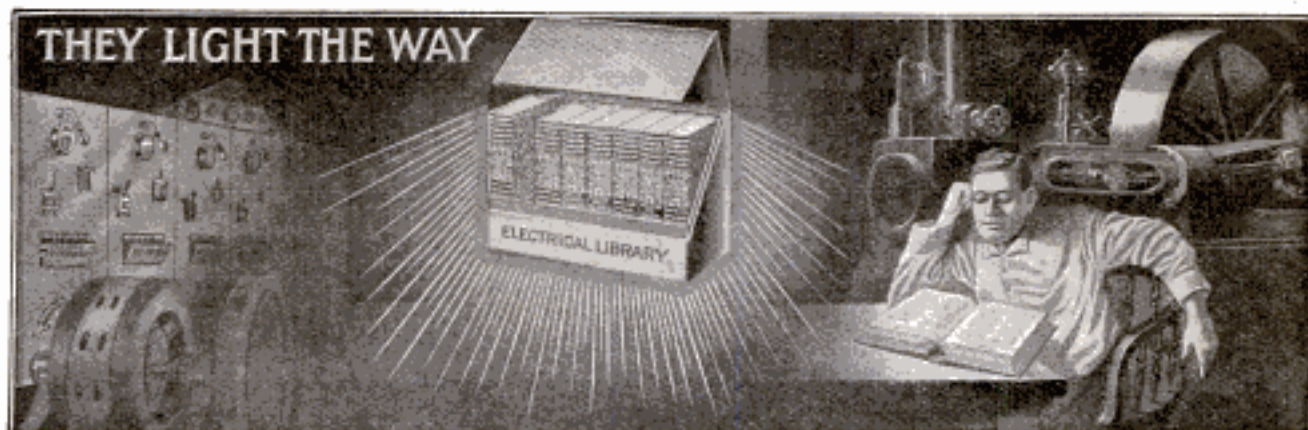

THEY LIGHT THE WAY

Electrical Workers' Standard Library

Text books with which to easily and quickly master the Electrical profession. A Complete Course of Easy Lessons. Arranged in progressive order in Questions and Answers. Plain everyday English. Hundreds of diagrams and drawings make everything so clear that even a boy can understand.

Specialized knowledge embodying the research and life-time experiences of foremost practical experts

Eight volumes, pocket size, about 380 pages each, profusely illustrated with diagrams, drawings and plates. One has about 750 pages and covers everything connected with up-to-date American Telephone practice. This volume alone has upward of four hundred engravings. Also a Complete Electrical Dictionary and the Civil Service Examination Questions and Answers.

The **FREE CONSULTATION SERVICE** of this Institute for a term of **THREE YEARS** is at the command of every purchaser.

Elegant in appearance. The books are bound in full leather, round corners, and red edges. Complete in cloth-covered Case as shown above.

COUPON

National Institute of Practical Mechanics, P.M.

Without any obligation on my part to purchase please send me particulars, price, and easy payment terms of the Electrical Workers' Standard Library with the Consultation Service of your Institute.

NAME.....

ADDRESS.....

AGE.....

OCCUPATION.....

EMPLOYER.....

National Institute of Practical Mechanics
1825 Michigan Avenue Chicago, U. S. A.

ELECTRICITY

Complete in One Year
SCIENTIFIC ELECTRICITY
IN ALL ITS BRANCHES
Bliss Electrical School

Studies restricted to theoretical and practical electricity, mechanical drawing and necessary engineering work. Teaches simplicity, concentration, hard work. For young men of energy and character. 29 years of greatest success. Graduates hold first-class positions. **Opens Sept. 25.** Write for new catalog.

18 Takoma Ave., WASHINGTON, D. C.

LEARN TO BE A WATCHMAKER

BRADLEY POLYTECHNIC INSTITUTE
Horological Department, Peoria, Illinois



Largest and Best Watch School in America. We teach Watch Work, Jewelry, Engraving, Clock Work, Optics. Tuition reasonable. Board and rooms near school at moderate rates. Send for catalog of information.
BRADLEY, Dept. S., PEORIA, ILL.

Rensselaer Established 1824
Troy, N. Y.

Polytechnic Engineering and Science Institute

Courses in Civil Engineering (C. E.), Mechanical Engineering (M. E.), Electrical Engineering (E. E.) and General Science (B. S.). Also Special Courses.

Unsurpassed new Chemical, Physical, Electrical, Mechanical and Materials Testing Laboratories.

For catalogue and illustrated pamphlets showing work of graduates and students and views of buildings and campus, apply to

JOHN G. NUGENT, Registrar

LEARN WATCHMAKING Engraving and Jewelry repairing. Earn while learning. Our school endorsed by leading jewelers. Positions secured for graduates. Send for Free catalogue.

CHICAGO SCHOOL OF WATCHMAKING

Dept. 20, Bush Temple

CHICAGO

LEARN WIRELESS-TELEGRAPHY

at my practical and superior school. Outlook in the Wireless field is excellent. Wages are good and the work pleasant, instructive and intensely interesting. My school is recognized by wireless, telegraph and railway officials as being the foremost one. Teachers are practical men with years of experience. This school owns and occupies exclusively, two large modern buildings with complete high power wireless station. Investment \$25,000.00. Oldest school in America—established 37 years. **Morse or Wire**

Telegraphy and Railway Accounting also taught. Graduates assisted to positions. Living expenses low and may be earned while learning. Easy payments. Correspondence courses also. Write today for free illustrated catalog and interesting testimonials.
G. M. Dodge, President, Dodge's Telegraph, Railway and Wireless Institute, Ohio St., Valparaiso, Indiana.



This Man Makes Big Money Do You?

Do YOU get paid for what you KNOW or what you DO?

THERE is not a trade in the world where the premium on a clear head and a steady hand is so high as in the Automobile Business. There is not an occupation where one gets paid so well for BOTH what he KNOWS and what he DOES. BUT when one is getting paid for what he knows, he must be "There" in order to "Collect."—Do YOU get the point?

We Teach Automobile Engineering PRACTICALLY!

As the largest dealers in the best automobile town on earth—CHICAGO, and the ONLY Automobile School actually engaged in the Automobile business, we offer earnest young men unlimited opportunities for practical experience. Two Entire Floors containing over 100 new and used cars, well equipped daylight repair shop in which there is plenty of machinery and 25 to 30 automobiles at all times, large staff of expert instructors and mechanics, size, reputation and excellence of equipment combine to make us the best and most recommended school teaching this trade. Write and learn "Why" our practical methods produce EXPERTS, and incidentally get our FREE 32 page booklet "HOW TO DRIVE"—It's worth writing for.

GREER COLLEGE OF MOTORING
1471-73 Wabash Ave., CHICAGO, ILL.

N. B. We don't believe in doing an awful lot of advertising BUT you ought to see the way we're delivering the goods.

COPY THIS SKETCH

and let me see what you can do with it. You can earn \$20.00 to \$25.00 or more per week, as an illustrator or cartoonist. My practical system of personal individual lessons by mail will develop your talent. Fifteen years successful work for newspapers and magazines qualifies me to teach you. Send me your sketch of President Taft with 6c. in stamps and I will send you a test lesson plate, also collection of drawings showing possibilities for YOU.

THE LANDON SCHOOL OF ILLUSTRATING
and CARTOONING
1438 Schfield Building, Cleveland, Ohio.



I TEACH SIGN PAINTING

SHOW CARD WRITING or LETTERING by mail and guarantee success. Only field not overcrowded. My instruction is unequalled because practical, personal and thorough. Easy terms. Write for large catalogue.

CHAS. J. STRONG, Founder

DETROIT SCHOOL OF LETTERING
DEPARTMENT PM. DETROIT, MICH.

"Oldest and Largest School of its Kind"



Learn a Paying Profession

that assures you a good income and position for life. For seventeen years we have successfully taught

PHOTOGRAPHY

Photo-Engraving and Three-Color Work

Our graduates earn \$20 to \$30 a week. We assist them to secure these positions. Learn how you can become successful. Terms easy—living inexpensive. Write for catalogue—NOW!

ILLINOIS COLLEGE OF PHOTOGRAPHY, 999 Wabash Avenue, Effingham, Ill.



J. H. JOYCE, Pres.

I Can Increase Your Earnings

No matter where you live, if you are honest, ambitious and determined to succeed in business—a business absolutely your own—send your name and address and I will mail you our Big Free 64-Page

Book, showing how you may earn

\$3,000 to \$10,000 a Year

in the Real Estate, Brokerage and Insurance Business.

Our system is a positive success. We will teach you by mail, appoint you a

Special Representative

in your town of the oldest and largest co-operative realty and brokerage company in the world, start you in a profitable business of your own, and help you to make money from the beginning.

Exceptional Opportunity for
Men Without Capital

Write Today

International Realty Corporation,
2736 Manhattan Building, Chicago, Ill.

WANTED Motion Picture PLAYS

YOU CAN WRITE THEM. We teach you by mail. No experience needed. Big demand and good pay. Details free. ASS'D M. P. SCHOOLS, 601 Sheridan Rd., Chicago

SHORT-STORY WRITING

A course of forty lessons in the history, form, structure, and writing of the Short-Story taught by J. Berg Esenwein, Editor, Lippincott's Magazine. 250-page catalogue free. Write to-day. The Home Correspondence School 141 Besse Place, Springfield, Mass.

MUSIC LESSONS FREE AT YOUR HOME
for our Booklet. It tells how to learn to play Piano, Organ, Violin, Mandolin, etc. Beginners or advanced pupils. American School of Music, 50 Lakeside Bldg., Chicago, Ill.

LEARN WATCH REPAIRING

Be a watchmaker—you can learn this profitable trade by correspondence in a few weeks in your own home by the DeSelms Chart System. After you complete the course you will know a watch from A to Z. You will know just what the matter is and how to repair one. When you graduate you will be a practical watchmaker and repairer and competent to fill any position. Positions for our graduates.

Ask for our Free Book. It explains our system and terms.
THE DeSELMS WATCH SCHOOL
23 Perry Street ATTICA, INDIANA



LEARN PLUMBING

A trade that will make you independent for life. Hours Shorter—Pay Bigger—Demand Greater than most any trade. You need no previous experience. Our practical methods enable you in a few months to hold position as skilled plumber or conduct your own business. Catalog sent free.

St. Louis Trades School
4430 Olive St. ST. LOUIS, MO.

**BIG
PAY
SHORT
HOURS**



\$1.25 Handbooks for 50c.

No books in existence contain in so small space as much information about the trades and professions of which they treat as do these Handbooks. They are little giant encyclopedias of practical knowledge giving data and information that is hard to find in ordinary books. These Handbooks have been prepared by the well-known textbook writers of the International Correspondence Schools whose textbooks are recognized the world over as the most practical treatises on applied sciences ever published. These Handbooks are consulting experts of the highest rank, and are the most powerful force in the world for the promotion of ambitious men. They are an indispensable help to quicker and better work that will command advancement. They are printed on a high-grade book paper in clear type, and durably and handsomely bound in cloth with gilt titles; contain on an average of 364 pages and 175 illustrations and are regularly sold for \$1.25 each.

SPECIAL OFFER.—We are selling these Handbooks, durably bound in cloth with gilt titles, at a special price for each Handbook of 50 cents.

Mechanics'—Tables; formulas; measurements; belting; mechanical powers; hydro-mechanics; strength of materials; shafting; boiler design; care of boilers; power of boilers; chimneys; exhaust heating; machine design; machine tools; slide valve; pulleys; cylinders and steam chests; pistons; gearing; transit surveying; triangulation; curves; radii and deflections; earth work; track work; electricity; etc.

Advertiser's—How to plan and write an advertisement; type and type measurements; points on printing style; display; preparation of manuscript; proof reading; engraving and printing methods; electrotypes; matrices; advertisement illustrations; magazines; newspapers; retail, department-store, general, trade-paper, and mail-order advertising; trade marks; circulars; advertising agencies; etc.

Stenographer's & Correspondent's—Advice to beginners; shorthand speed; letters of application; punctuation; correct and faulty diction; business correspondence; type-writing; abbreviations; addressing; mailing; rates of postage; duplicating work; etc.

Telephone and Telegraph—Useful tables; mechanics; electricity; magnetism; primary batteries; storage batteries; electrical measurements; telephony; tests with magnetogenerator and bell; telegraphy; Morse telegraph systems; multiplex telegraphy; etc.

Electrical Engineer's—Mechanics; electricity; electrical units; symbols and quantities; physical and electrical properties of metals and alloys; wire gauges; magnetism; dynamos and motors; electric batteries; alternating current apparatus; alternators; transformers; wattmeters; electric transmission; electric lamps; wiring; electric heating and welding; electromagnets; controllers; car wiring; etc.

Business Man's—Arithmetic; business forms; card systems; measures of extension; weight and capacity; time; value of foreign coins; duties on imports; bookkeeping; stenography; correspondence; postal information; financial terms; money and the money market; brokers and brokerage; patents; copyright and trade marks; corporations; business law; publicity; etc.

Plumbers and Fitters'—Arithmetic; involution and evolution; powers, roots, and reciprocals; circles; decimals; geometrical drawing; weights and measures; formulas; mensuration; mechanics; hydro-mechanics; building construction; heating and ventilation; gas-fitting; plumbing; etc.

Mariners'—Logarithms; trigonometry; navigation; terrestrial navigation; celestial navigation; organization of a man of war; naval ordnance; explosives; torpedoes; ship building; speed, tonnage, and fuel consumption; ropes; wind and weather; signals; nautical memoranda; etc.

Building Trades—Loads and structures; strength of materials; properties of sections; strength of rivets and pins; materials of construction; footings and foundations; masonry construction; woods used in building; qualities of timbers; joinery; framing; estimating; elements of architectural design; drainage systems; plumbing fixtures; plumbers' tables; heating and ventilation; gas and gas-fitting; etc.

Bookkeeper's—Arithmetic; formulas; tables; money; percentage; interest; equation of accounts; money and the money market; business law; financial terms; banks and banking; postal information; distances and time between various places; bookkeeping; business forms; card systems; modern office methods; cost accounting; bank bookkeeping; clearing house methods; etc.

International Textbook Co.

Box 872, SCRANTON, PA.

I enclose \$_____ for which please send me the books BEFORE which I have marked X.

- Mechanics' Handbook Advertiser's Handbook
 Elect. Eng. Handbook Business Handbook
 Bldg. Trades Handbook Bookkeeper's Handbook
 Plum. & Fit. Handbook Sten. & Corr. Handbook
 Tel. & Tel. Handbook Mariners' Handbook

Name _____

St. and No. _____

City _____ State _____

Please Mention Popular Mechanics

—THIS DIRECTORY OF— MECHANICAL INFORMATION

*Shows just where to find that particular help you
are in need of on any of the following subjects:*

Aeronautics
Air Brakes
Amateur Mechanics
Architecture
Automobiles
Boats
Boilers
Bricklaying
Building
Business
Camping
Carpentry
Cement, Concrete, etc.
Designing
Dies
Dyeing
Electric Railways
Electricity
Electroplating
Enameling
Engineering
Estimating
Fishing
Foundry Work
Gas Engines
Hand Forging
Heating
Hunting
Industrial Progress
Inventions
Lathe Practice
Lettering
Locomotive Engineer's



Machine Shop Work
Masonry
Mechanics
✕ Mechanical Drawing
✕ Metal Working
Millwrighting
Mission Furniture Making
Motorcycles
Painting
Pattern Making
Plumbing
Power
Pumps
Railroading
Recipes
Refrigeration
Science
Sheet Metal Work
Shop Notes
Sign Painting
Slate Roofing
Steam Engineering
Steam Turbines
Steel
Telephones
Tools
✕ Trapping
Ventilation
Welding
Wireless
Woodworking
Wrought Iron
Ornamental Work

96 Pages—Vest Pocket Size—Indexed—Handy to Keep—Handy to Refer to

This catalog is not a hit or miss collection of book titles, author's names and prices, but consists of intelligently prepared descriptions of good books. In many instances, complete lists of contents are given; the aim being to tell enough about a volume to enable anyone to determine whether or not it contains the information he is seeking.

SENT FREE UPON REQUEST BY

Popular Mechanics Book Dept., 318 W. Washington St., Chicago

EXPERIMENT WITH WIRELESS



**ENTERTAINING
INSTRUCTIVE
INEXPENSIVE**

This book of 96 pages explains in an understandable manner the construction of an out-fit suitable for transmitting four or five miles. The set can be

easily constructed at a small cost by any boy of ordinary ability.

How to Make a Wireless Set

By ARTHUR MOORE

96 pages. Illustrated. 5x7. Cloth. **50c**
PRICE POSTPAID,

ORDER OF YOUR DEALER OR

POPULAR MECHANICS BOOK DEPT.
318 W. Washington Street, CHICAGO

FOR SALE—A Limited Number of Complete Files

Popular Mechanics Magazine

For 1911

consisting of the 12 issues of the magazine with a complete index suitable for binding.

Price \$1.50 Postpaid

POPULAR MECHANICS CO.
318 W. Washington St. CHICAGO

WHEN YOU WANT ANYTHING AND DON'T KNOW WHERE TO FIND IT
WRITE BUREAU OF INFORMATION,
POPULAR MECHANICS CHICAGO



A SCHOOL WITHIN ITSELF

There are XX chapters in all, XIX carrying you from the fundamental principles of electricity on through the various branches to a point where the careful student comprehends the complete designing, care and operation of a dynamo or motor, and one chapter on electric automobiles, outlining their construction, care and operation, and all about storage batteries and how to handle them. Each subject is carefully written and to the point. After a student studies a subject, he is questioned on that subject in such a manner as to bring clearly to his mind the points he needs to know regarding same. The book contains a dictionary defining 1500 Electrical Words, enabling the reader to ascertain the meaning of any electrical word, term or phrase used in this book, as well as hundreds of others in common use. All required tables necessary in the study are in it.

\$2.00 PER COPY—SIXTH EDITION—30,000 COPIES SOLD.

The offer we make of refunding money if book is not satisfactory upon examination is AN UNUSUAL ONE in connection with the sale of a book. But we have no fear of its return. Your decision will be what thousands of others have been. Money would not buy it if it could not be duplicated. We could point testimonials by the hundreds. It is best to order and be your own judge of its merits.

CLEVELAND ARMATURE WORKS, 49 & St. Clair Ave., Cleveland, Ohio

Armatures and Field Wound—Commutators Filled
AMERICA'S GREATEST REPAIR WORKS

REVERSIBLE "Linene"

COLLARS
GENTS AND BOYS

Made for Comfort

Modeled to exact shape, but perfectly flexible. Finished in dull lustre. The ideal collar for traveling.

Price at the stores, 25 cents per box of 10, or by mail 30 cents in U. S. stamps. Sample by mail for 6 cents.

State Size and Style
BEAUTIFUL CATALOGUE FREE

REVERSIBLE COLLAR CO.
Department U BOSTON, MASS.



HERE YOU ARE BOYS A medallion pin of Foxy Grandpa. Everyone will notice it on the lapel of your coat and try to get a closer look at it. All you have to do is press the bulb.—Foxy Grandpa will finish the job by squirting a fine stream of water over the inquisitive one. Will squirt 20 feet. Greatest joke out. Order one today and fool your friends. Price 15c. Foxy Grandpa and Hoeligan both for 25c. 5 for 50c or 1 doz. for \$1.00. A beautiful fountain pen free with every \$1.00 order.

AMERICAN SUPPLY CO., ST. PAUL, MINN.



Every Boy His Own Toymaker

Greatest boys' book ever written, tells how to make a steam engine, telephone, magic lantern, boats, kites, balloons, electrical and mechanical toys, traps, fishing tackle, over 200 illustrations. Our big novelty catalog and extra 10c premium, all for 10c.

AMERICAN SUPPLY CO., ST. PAUL, MINN.



200 KINDS Iron, Wood, Wire & Steel PUZZLES

Sample with Catalog 10 cents, or 3 leaders for 25 cents.
WESTERN PUZZLE WORKS
St. Paul, Minn.



Every Boy His Own Toymaker

Greatest boys' book ever written. Tells how to make a Steam Engine, Telephone, Magic Lantern, Boats, Kites, balloons, electrical and mechanical toys, traps, fishing tackle. 200 illustrations; also catalog of 150 novelties, kites, pins, "Lactone-to-lett-me" and "Double Tattoo" warbler and bird call all for only 10c. WESTERN PUZZLE CO., ST. PAUL, MINN.



The Importance of Training

Here is a man who was in line for a better job, but, like the great majority, had not been training himself to "fill the shoes" of the man above him; he always thought that if the time ever came he could just bluff it through—special training wasn't necessary. There's where he made *his* mistake, and there's where you will make *your* mistake if you are not a trained man. The boss had only to ask a few questions to find that the man did not know anything about the other fellow's work; that he had been wasting his time instead of improving it—that he was just one of the fellows who get into a rut and stick because he didn't have sense enough to plan for the future.

The time to plan is right now; the opportunity will come when you are ready

Don't think, as this man did, that it is simply a matter of absorbing knowledge and as a matter of course promotion will follow. Don't argue with yourself "There's no opportunity here—no incentive to do better work—I have gone as high as I can in this firm—I know as much as the boss and don't see why I can't get the money."

If the opportunity for advancement is not right ahead of you with your own firm, then it is with another. There is always an opportunity—always a chance for a better job, for better pay—yes, just the job you have often wished you had—but mere wishing will never get you anywhere; you must get the training.

The American School of Correspondence was founded to help just such men as you. It is one of the largest educational institutions in the world. If you will write and tell us what you want to be, how much of an education you already have, and how much time each day you are willing to devote to bettering your condition, we will send you, absolutely free of charge, our complete bulletin describing sixty-five courses of study. We will tell you how you can pay for the course you want by the week or by the month. We will do everything we can to get you started right.

If anyone offered you \$500 for two hours overtime every day for a year, you would jump at the chance, wouldn't you? Two hours study every day for the next year or two will mean more than \$500—it may mean \$1,000; that depends entirely upon yourself.

The American School does not employ agents or collectors to bother you in your home or at your work. It brings a complete college course to you in your own home, and all work is carried on privately and quietly, strictly by correspondence.

Won't you check, fill in, and mail the coupon?

AMERICAN SCHOOL OF CORRESPONDENCE
CHICAGO, U. S. A.

Opportunity Coupon

American School of Correspondence, Chicago, U. S. A.

Please send me your Bulletin and advise me how I can qualify for the position marked "X."

Pop. Mech. 7-12

.....Automobile OperatorLawyer
.....DraftsmanFire Ins. Engineer
.....ArchitectTelephone Expert
.....Building ContractorMoving Pictures Op'r
.....Structural EngineerBookkeeper
.....Civil EngineerStenographer
.....Electrical EngineerAccountant
.....Elec. Light & Power Supt.Cost Accountant
.....Master MechanicCert'd Public Acct't
.....Sanitary EngineerAuditor
.....Steam EngineerBusiness Manager
.....Reclamation EngineerCollege Preparatory

NAME

ADDRESS

Please Mention Popular Mechanics

Popular Mechanics Magazine

WRITTEN SO YOU CAN UNDERSTAND IT

Vol. 18

JULY, 1912

No. 1

Passenger Uses Aeroplane to Overtake Liner

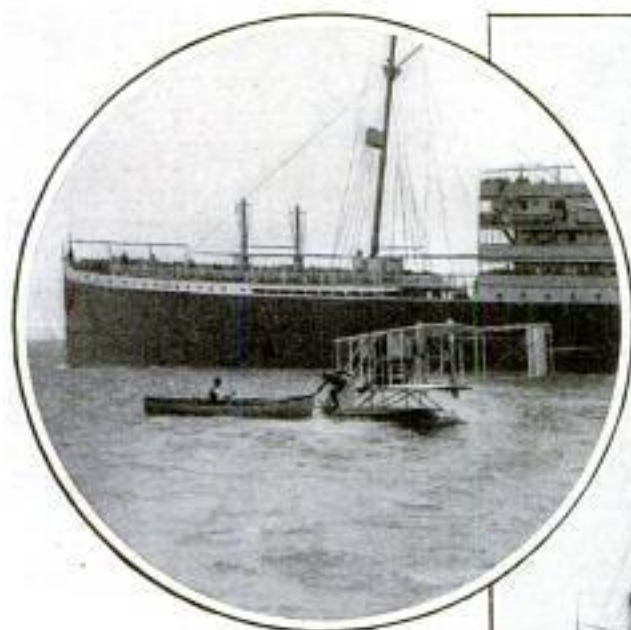

Belated Steamship Passenger Leaving the Hydro-Aeroplane Which Made It Possible for Him to Catch a Ship That had Sailed a Half Hour Previously

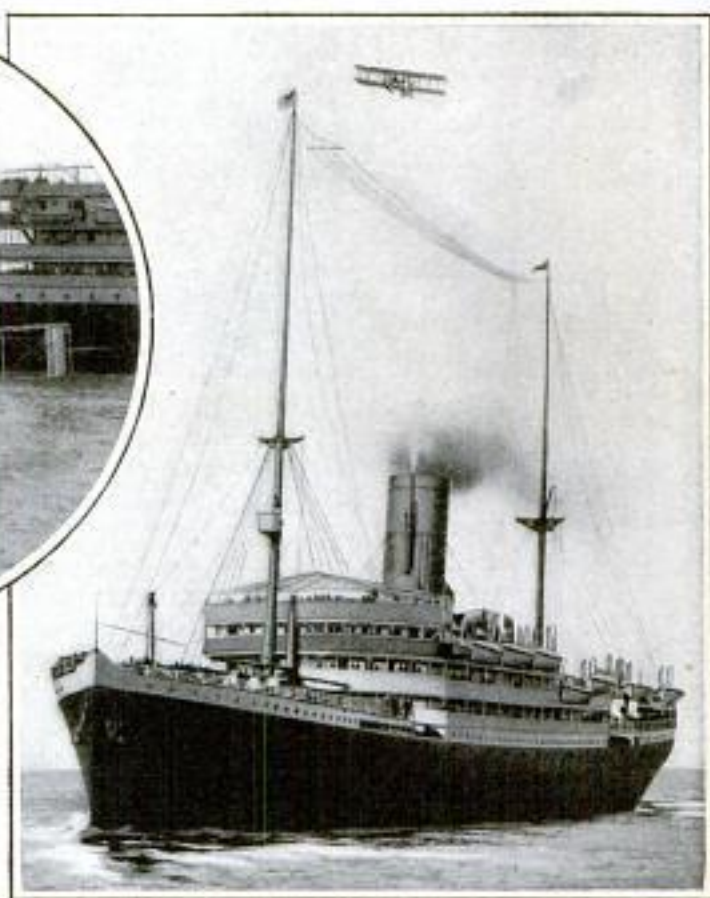

Coffyn's Hydro-Aeroplane Hovering Over a Transatlantic Liner to Which He Brought a Passenger Who had Missed the Steamer at the Dock

Photos Copyright by International News Service

AEROPLANES have not yet been listed as part of the dock equipment of the big steamship companies—to be used to catch departing vessels by belated passengers—but there may come a time when such a means of transportation will be provided. At any rate the idea is not a wild imaginary scheme, as it has been actually tried. A belated passenger in New York recently chased and overtook a steamer sailing for Europe and was put aboard, the aeroplane being the vehicle with which he accomplished his purpose.

The thing was done only a short time ago. The passenger was not really belated, as he could have reached the steamer in time for the sailing if he had not made arrangements to remain a little longer ashore. Thirty minutes after the boat left its dock the passenger and Frank Coffyn, the airman, set out in pursuit in the latter's hydro-aeroplane. The flying machine caught the steamer in a very few minutes after making a record trip down New York Harbor about 500 ft. from the surface. After circling the ship twice the hydro-aeroplane

dropped to the water and a boat was put off from the steamer for the passenger. When the passenger had been taken from his machine Coffyn rose in the air again and returned to his start-

ing point. This is the first time this feat has ever been accomplished, although once before an aeroplane was sent in pursuit of a steamship to deliver a package to a passenger aboard.

LIFE-SAVING MOTOR FIRE TRUCK

The latest acquisition of the Springfield, Mass., fire department, which is a pioneer in the use of motor fire ap-

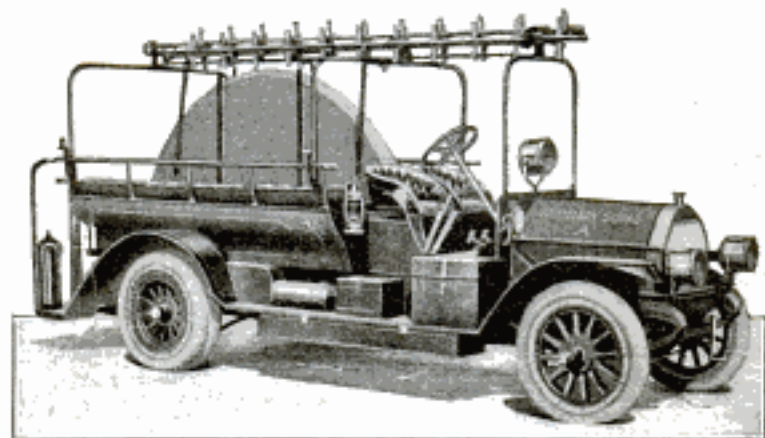

The Special Life-Saving Motor Truck of the Springfield, Mass., Fire Department

paratus, is a life-saving motor truck. In the center of the body, between the long side seats, is a life net, folded in so compact a form that it does not interfere with the carrying capacity of the machine. Three scaling ladders are carried on metal-rod supports above the life net. The other devices included in the equipment are a smoke helmet, an oxygen respirator for use in cases of partial suffocation, and a medical outfit.

NEW NON-CORROSIVE ALLOY

A patent has recently been given to the representative of a metal company in Philadelphia on a new white, non-corrosive, and malleable alloy of iron, nickel and copper. It is said that this alloy may be rolled into sheet, rods or bars, or drawn into wire, and may also be cast in sand.

ELECTRIC LIGHT WITHOUT HEAT

A flame that will not give off heat is claimed to have been derived by a French inventor, M. Dussaud, from electric energy. No details are given regarding this invention, however. M. Dussaud declares he has succeeded in communicating to a point of metal placed in a vacuum an electric intensity which he could not obtain with the filament of ordinary burners. This cold light can be placed without danger in close proximity to reflectors, condensers or diffusers, so that an apartment can be illuminated by an electric battery or box of accumulators, the electricity used being 200 times less than with the ordinary light.

A tiny point of cold light, given by an electric battery of only 30 watts, sufficed to replace a moving-picture lantern, and celluloid films can thus be used without danger. Owing to the smallness of the battery necessary, there is a great future for the "cold light" for stage purposes, a boy or girl being able to carry this tiny battery anywhere. It will also prove useful for medical purposes, claims the inventor, for when the lamp is placed in the hand, the blue veins are shown distinctly against the rose-colored background. Thus it will be possible to illuminate the lungs by the use of this invention.

ⒸThe word lens comes from the Latin word for lentil seeds which have a double convex shape like a lens.

SCHEME FOR CONVERTING UNMINED COAL INTO GAS

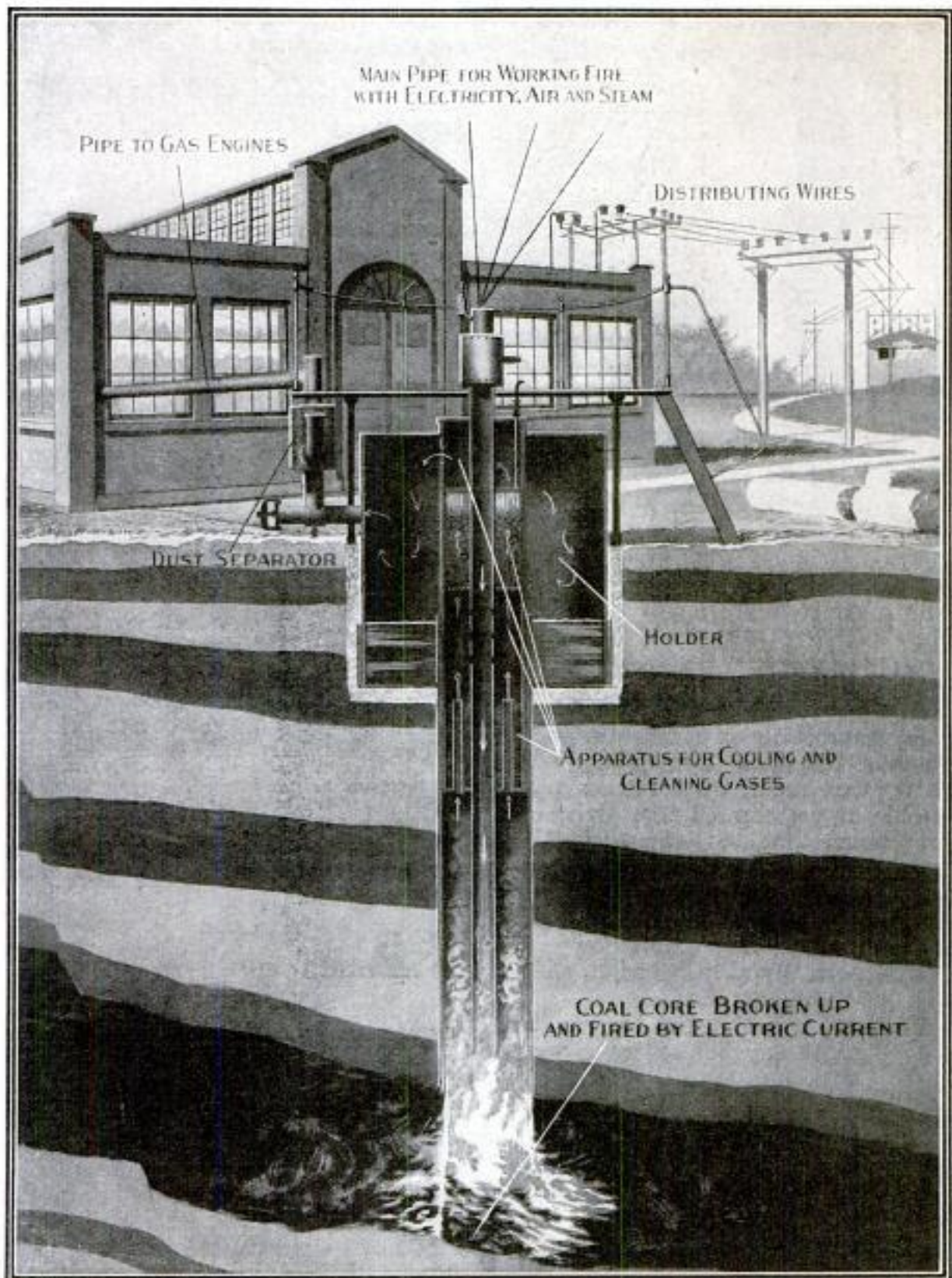

Sir William Ramsay, one of England's famous scientists, says there is absolutely nothing, so far as he can see, to prevent a bore-hole from being put down until the coal stratum is reached and the setting of the coal on fire by electricity, thus converting the coal in the bowels of the earth directly into gas. Air would be sent down to enable the coal to burn, the amount of air being restricted when sufficient heat had been engendered; steam would be sent down to provide a mixture of hydrogen and carbonic oxide, or water-gas; great gas engines would be mounted at the mouth of the pit or bore-hole, and the gas would be used to develop electric power for distribution throughout England.

PLAYING GOLF IN ARMOR



In the accompanying illustration is shown a well-known English baritone, who has been appearing in a London production as St. George, the patron saint of England, practicing golf strokes in his full stage suit of iron armor. On St. George's Day he played a nine-hole match on the Bushey Hall golf links, this being the first time that the Dragon-

slayer ever entered the list—or rather the links—of golf.

TESTS PROVE BACILLI NOT NECESSARY TO LIFE

In interesting experiments at the Pasteur Institute, Dr. Cohendy has shown that bacilli are not necessary to the life of vertebrates (the division of the animal kingdom comprising animals having a backbone of bony or cartilaginous vertebræ). By using chickens for his experiments he demonstrated that it is possible for vertebrates, normally rich in bacilli, to live without these organisms.

In these experiments he sterilized the eggs the day before the chickens



Dr. Cohendy, of the Pasteur Institute, Sterilizing Eggs a Day before the Chicks were Due

were due, placed them in a bronze incubator, and put this in a hermetically sealed casing, thoroughly sterilized. After the chicks were hatched out they were able to walk about inside the glass part of the apparatus, under conditions as nearly normal as possible, but with the sand, the air, the fresh water, and the food all rendered free from bacilli. The chicks were kept sterilized for six weeks and grew as vigorously as others living under the customary conditions. They were then removed and permitted to live the usual existence, and in less than 24

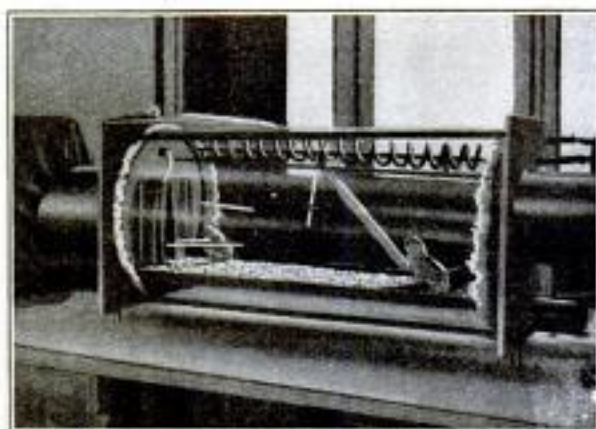

The Chicks in the Bacilli-Free Apparatus in Which They Thrived for Six Weeks

hours their organs were invaded by innumerable bacilli, and no ill results were suffered.

ANTICS OF PET ANTS
AMUSE PARIS

The latest fashionable pastime in Paris is watching ants work. The insects are placed in a small quantity of earth, under a glass cover, and it is quite interesting to see them install their new home. After a time a few strange ants are introduced into the colony, and then the original dwellers mobilize to receive the invaders, closing up their subterranean passage to prevent attack, while warfare is carried on by a chosen army. This fad has become quite popular, since first brought to the notice of society by a Parisian actress, and the new game is hailed with delight.

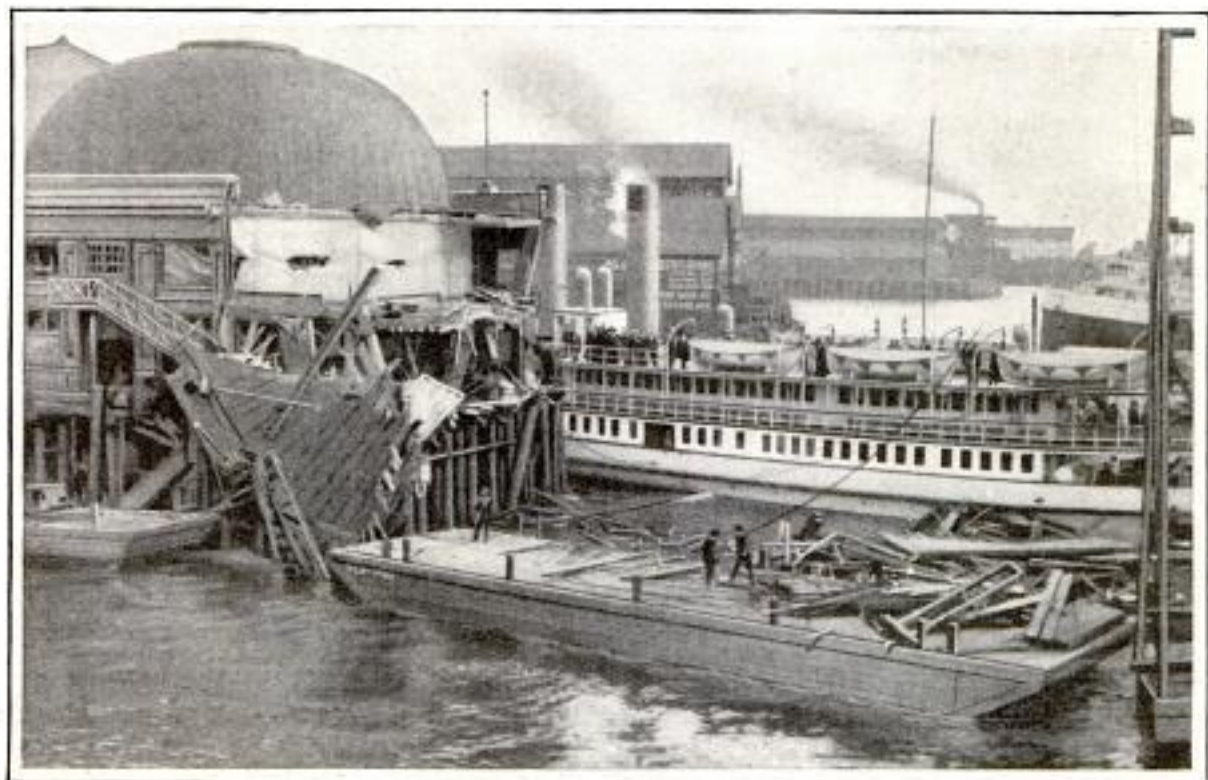

Wreck of Seattle Dock after it had been Demolished by Steamer. Pile Driver at Right Marks End of Pier before Accident

BIG SHIP CUTS THROUGH DOCK AND SINKS VESSEL

A striking illustration of the force of a steamship under way is afforded by a recent accident at Seattle, Wash., in which the steel steamship "Alameda," a vessel of 3,158 gross tons, through misinterpretation of engine-room signals, cut clean through a dock 60 ft. wide, amputating the outer end as neatly as a knife cuts cheese. Passing on through the dock the steel steamship cut an 8-ft. gash half way through the wooden stern-wheel steamboat "Telegraph," sinking her immediately.

The surprising part of the accident, from the mechanical view point, is that the steamship had barely got under headway. The "Alameda" was

light and was being warped into a slipway. The captain rang for half speed astern, and an assistant engineer threw the gear into full speed ahead. With about half her length in which to get under way, the steamship bore down upon the next dock, and despite the dropping of the starboard anchor, plowed clean through and deep into the wooden steamboat on the other side of the dock, carrying it across the slipway before headway was checked.

It appeared that the engines were not at full speed ahead for more than a couple of minutes before the error was rectified, and the signal "full astern" answered. The "Alameda" backed out of the

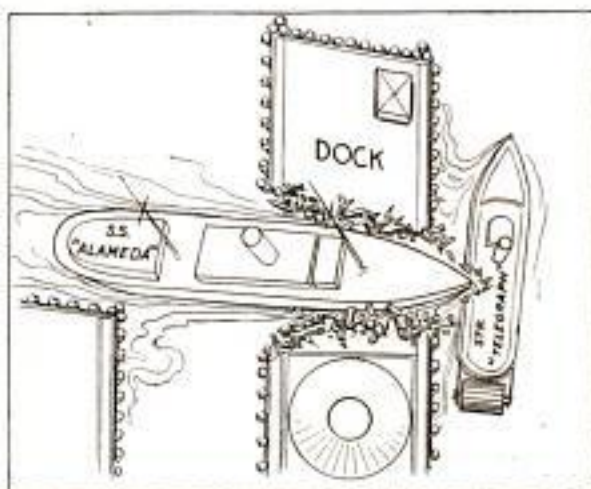

Sketch of the Pier When Accident Occurred, Showing How the "Telegraph" was Rammed by the "Alameda"

wreck almost uninjured, with a big wooden clock tower which had stood on the dock draped over her bows.

When one considers how difficult it was to check the headway of this steamship, 314 ft. long, it gives a

clearer idea of the difficulty of stopping a steamship the size of the wrecked "Titanic," if it were going at full speed, in time to prevent it hitting an iceberg sighted a quarter of a mile ahead.



A Complete View of the Wheeled Greenhouse, Which Covers an Area of Almost 25,000 Square Feet

A GREENHOUSE ON WHEELS

Ordinarily, carnation plants raised in the open during the summer months must be transplanted in a greenhouse for winter production, but one grower has developed a plan of transplanting his greenhouse instead of the plants. Five light tracks, placed on concrete foundations, were laid lengthwise of the carnation beds, and a greenhouse 174 ft. long by 35 ft. wide, consisting of four bays and covering a total ground space of 24,360 sq. ft., was built on wheels. Plants are set out in

the carnation beds in the spring and the traveling greenhouse is moved into position over them in the fall, thus allowing the growing process to continue without interruption.

Each bay of the wheeled greenhouse is supported by pipe posts, and the roof framework is securely trussed by means of steel T-iron and rods. All the heating pipes are carried overhead, and arrangements are made at each end for connection with the pipe lines leading from the heating plant.

HOW NAVY GUNNERS USE THE TELEPHONE

The ordinary layman who cannot hear what is being said over the telephone, if a heavy truck or a trolley car happens to be passing when he is trying to carry on a conversation over the wire, looks rather incredulous when he is told that orders to gunners in the navy and army are transmitted by telephone from the observation platform at the top of one of the ship's skeleton masts or the observer's tower in a fortification. How can the gunner hear what the spotter has to say in the terrible din of battle practice, he naturally asks. That is simple enough when explained. The telephones used are very different from those put in houses, in that they

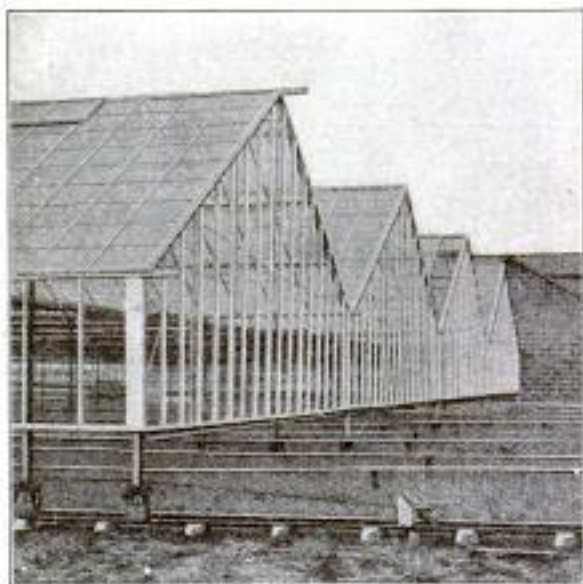

One End of the Traveling Greenhouse, Showing the Method of Drawing It over the Carnation Beds in the Fall of the Year



The Observation Platform at the Top of the Skeleton Mast of a Modern Battleship, Showing the Telephone Receivers and Transmitter on the Man Who Sights the Target, by Means of Which He Gives the Exact Position to be Fired Upon

have diaphragms constructed to magnify sound and the receivers are held close to the ears of the man taking the sight from the observer. The lat-

ter is equipped with a specially constructed transmitter which is so hung over his shoulders that the mouth-piece is close to his lips at all times.



Photos Copyright by Enrique Muller

A Deck Gun Station on a Modern Battleship Showing Gunner Receiving Information as to the Target from the Observer on the Skeleton Mast, the Long Cable Trailing behind Him Conveying the Telephone Wires

Receivers, which are bound with flexible rubber, are clamped tightly to the ears of both the gunner and the observer and the wires running from

the former's headpiece are incased in heavily armored cables of such length that the gunner can move about, dragging the cable after him.

TALKING MONKEYS AND TEACHER

Dr. William Furness, who is acknowledged to be a trained psychologist, skilled in modern critical technique, has, after two years of work in



Dr. Furness with His Two Talking Monkeys

the experimental department of the University of Pennsylvania, succeeded in teaching two big African chimpanzees to converse with a limited number of words over and above their native and phylogenetic (racial) sounds. In other words the instinctive calls of the hordes and families, tribes and individuals, have been definitely and positively excluded, and these two chimpanzees have been successfully educated to the point where they exhibit all of the earmarks of imagery, memory, and elemental conceptions.

Further than this, Dr. Furness has imported two other Borneo monkeys of the same species, which he intends to breed to the educated monkeys, and to teach the offspring, thus seeking to discover the relative facilities of the younger and older ones in acquiring a vocabulary independent of instinctive noises and jargons.

In his work Dr. Furness has used many of the newer psychological methods, many of them discovered by Dr. John Watson of Johns Hopkins University, of definitely associating a given image or object with a corresponding simple sound, different from, yet as simple as the native instinctive calls and speeches of the monkey family. Although the two chimpanzees have no large vocabulary, they have so far been successfully taught about 20 indubitable sounds that are objectively and exclusively associated with certain things.

Thus "gob" means food, "eech" means water, "rrb" means jump or run or walk, "rrgrrr" means mirror, "ssrrr" means box, and so on. Dr. Furness was careful to approach as close to the instinctive racial calls as possible, though never quite doing so. It is possible, according to Leonard Hirschberg, of Johns Hopkins University, for even a child to note the differences in quality, pitch and timbre of the two sounds, speech and instinct calls.

Dr. Furness, like other psychologists, says that no one can ever take the so-called monkey language of Professor Garner and others who live with the animals and interpret merely the animal means of notifying each other of fear, love, danger, food, drink, etc., as serious or scientific attempts at developing animal speech. The method must be the human pedagogical one. The animal must show curiosity toward an object, and then must always be given a strictly and exclusively associational vocal noise upon seeing or wanting the same object.

¶The United States and its dependencies produce one-tenth of the total amount of sugar manufactured in the entire world.

Practical Proofs of Streamline Theory

By VICTOR LOUGHEED

Such widespread attention was attracted among students of aviation science, by the articles in the December and January numbers of Popular Mechanics Magazine, in which there were made public for the first time the facts concerning certain phenomena of the streamline form in aeroplane designing, that it affords us much pleasure to publish herewith the visible evidence of the soundness of Mr. Loughheed's conclusions which is furnished in the accompanying photographs secured at French aviation fields. It will be remembered that the most important new discovery in the Loughheed researches was the "definite propelling effect exerted on the rear portion of a streamline form" by the compressed masses of air adjacent to the form. This effect, aptly termed by its discoverer the "reaction impulse," involves one of the fundamental principles in flight engineering, and accordingly is to be commended to the most critical consideration of all who are interested in the subject.—THE EDITOR.

TO have a merely technical and theoretical appreciation of a proved fact in engineering is one thing, and to possess the same conception in a definitely practical and visualized form, so that all of its significances are clearly apparent, is something distinctly different.



Fig. 1—Nieuport 20-hp. monoplane on the ground, showing tautness of the body fabric when the machine is at rest, thus proving, by contrast with the same machine in the air, the reality of the "reaction impulse."

To realize, for example, that objects of different forms and sections differ in the resistance they oppose to movement in the air is a simple, readily-understandable, and probably not even a very interesting proposition. But really to see in an illustration or, better



Fig. 2—The "reaction impulse" made visible on a Nieuport 20-hp. monoplane in the air, with the body fabric deeply sagged under the pressure that is the heretofore undiscovered secret of the efficiency of the streamline form.

still, in an actually operative machine, the absolute quantitative effect of these qualitative differences is to possess a type of knowledge that reaches

upon the poorer forms that have been experimented with for aeroplane elements is due to a retarding suction, supposed to manifest itself, if the air

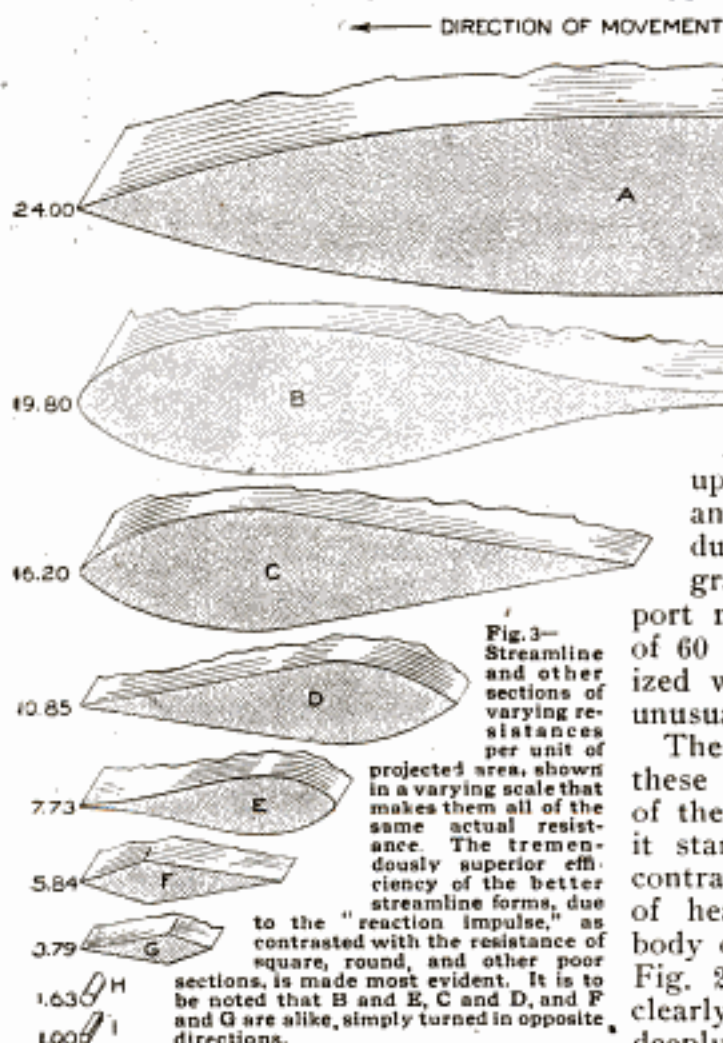

the average mind with an explanatory force, wholly lacking in text dissertations or tabular presentations of the same facts.

The writer recently published a claim to have discovered that the remarkable efficiency of streamline forms and sections is due to a propelling pressure, exerted on the tapered rear portions of these bodies by adjacent masses of air that are, for the moment—as a result of their initial separation by the front portion of the object—in a condition of dynamic and rapidly dissipating, but nevertheless very real and measurable pressure. In contradiction of this claim it has been asserted that the greater retarding effect of the atmosphere

streams are not allowed to flow freely together at the rearmost edges of tapering surfaces.

A complete quietus is placed upon these opinions by Figs. 1 and 2, herewith, which are reproduced from unretouched photographs of an early type of Nieuport monoplane with which a speed of 60 miles an hour was readily realized with a 20-hp. motor, despite an unusual bluntness in the body form.

The feature of special interest in these views, however, is the tautness of the body fabric of the machine as it stands on the ground, Fig. 1, as contrasted with the obvious evidence of heavy pressure acting upon the body of the same machine in the air, Fig. 2, in which the body fabric is clearly shown by the camera to be deeply sagged between the different elements of the wooden framing beneath it. Since the fabric is very stout, and is tightly stretched in applying, as is evident in the flat and uniform appearance presented when the machine is on the ground, it is certain that the dished-in appearance in the air can be due to nothing else than the dynamic pressure previously referred to, thus visibly acting on the wedge-like rear of the body.

Concerning the question of suction, as constituting a retarding influence upon the movement of any object through the air, it seems incredible that, in view of the trivial inertia and extreme mobility of masses of air, it is in any way possible to create a measurable vacuum in a free atmosphere.

Consider, for example, the condition of a piston being drawn out of a closed cylinder. In this case there is, of course, a high vacuum established,



Fig. 4—Comparison of streamline form with streamline section, both approaching the observer. Though the diameter a b , and the displacement of air c d , are of the same linear extent in both cases, the difference in the geometrical conditions involved compels the air at f f , in the case of B, to be compressed into one-half of the space it originally occupied, as against the compression into three-fourths of the original space at e e , in the case of A.

with a corresponding resistance to the movement of the piston. But if in place of the usual rigid cylinder there should be substituted some soft, flexible tube—like the thin inner tube of a very light bicycle tire, say—then, is it conceivable that any possible rapidity of piston movement could prevent the tube from caving in under the exterior atmospheric pressure behind the piston? To carry the reasoning further—when there is not even so frail and flexible a tube as that just premised, how can it be in

solite assurance that the most that can occur is for the moving object to drag with it a greater or smaller mass of air, too small in volume and too



Fig. 5—Side view of streamline body A compared with streamline section B, showing the shortening of the former to secure equivalent effects.

light in weight, in even the most extreme case, to add appreciably to the load.

Another point that is against the vacuum theory is the fact that the normal sea-level atmospheric pressure is materially over a ton to the square foot, so if the vacuum condition prevailed at all, it should be reasonably expected that the resistance due to it would be vastly higher than any that are now discoverable, for even with the most ill-designed machines that have been flown—at speeds as high as 100 miles an hour—the resisting pressure to the square foot of projected area in no case is as high as 30 lb. to the square foot—only 1/70 of atmospheric pressure.

Figure 3 is another startling exam-

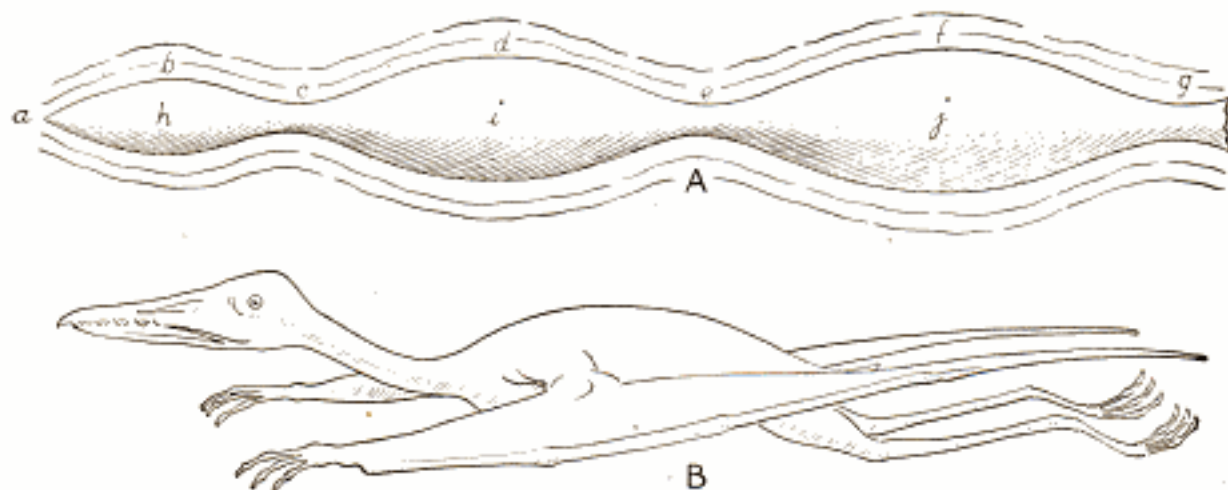

Fig. 6—At A is shown a plurality of streamline bodies, providing a succession of compressions, reactions, recompressions, etc. At B is pictured a reconstruction of the extinct pterodactyl, in which, as in many birds, the head and body constitute the first two elements of such a system of tandem streamline bodies as that sketched at A.

any way possible to produce a measurable retarding vacuum behind a moving object in the free atmosphere?

In fact, it can be stated with ab-

ple of what the "reaction impulse" really means to flight efficiency. This diagram is based directly upon researches made by Sir Hiram S. Maxim

in conjunction with his aeroplane experiments in England in 1893, and by him published—with a seemingly unaccountable failure to emphasize their full importance—on pages 53-55 of his book "Artificial and Natural Flight." Accordingly, the numerals appended to the different sections, from A to I inclusive, show the relative resistances of these different forms, without any change from Maxim's data, but the essential difference between this diagram and ones previously published consists in the reproduction of the different sections on a relative scale that is in inverse proportion to the relative resistances—

so that the various sections, with the sizes as shown, have all the same resistance. So in this presentation there is made most plain the tremendous importance of designing every part of an aeroplane, even including the struts and stay wires, in the most perfect streamline sections possible.

In Fig. 4 is shown an interesting and heretofore neglected distinction that it is necessary to make between streamline sections and streamline forms. In this diagram, A is a front view of a streamline body, or form, coming towards the observer, while B is an edge-on view of a strut of streamline section, similarly moving toward the observer. Now, assuming that the dimension ab —the diameter of the streamline form in the case of A and the maximum thickness of the strut in the case of B—is one inch and that the zone of air thrown

into measurable compression by the passage of the two objects extends from c to d , a distance of two inches, then a most interesting condition results. This is because in the case of A the air is displaced by the form radially, in all directions, into the annular space ee , which—because of the geometrical law that the areas of circles increase with the squares of their dimensions—is a space three times as great as that occupied by the form. In the case of B, however, the air is not displaced radially by the strut, but, because of this being of an indefinite length, is moved directly up and down

into the space ff , of an area and consequent volume only as large as that occupied by the form.

To sum up, it is now clear that the passage of the streamline form compresses the four volumes originally included in the larger circle at A into a space three-quarters as large as that they originally occupied, while in the case of B the passage of the streamline section compresses four volumes of air into a space only one-half as great as that originally occupied by them.

The inevitable conclusion, then, is that the passage of a streamline strut of a given section must, at a given speed of movement, produce a more positive dynamic pressure than can be realized by the passage of a similar streamline form, because the latter wedges a less amount of air into a larger space. And to secure equivalent compressions and

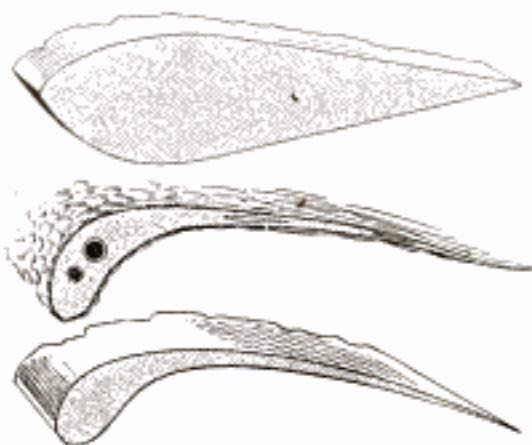

Fig. 7—Unsymmetrical streamline body and wing sections, the first being the body of a Nieuport monoplane, the second the section of a pelican's wing, and the third an aeroplane supporting surface.

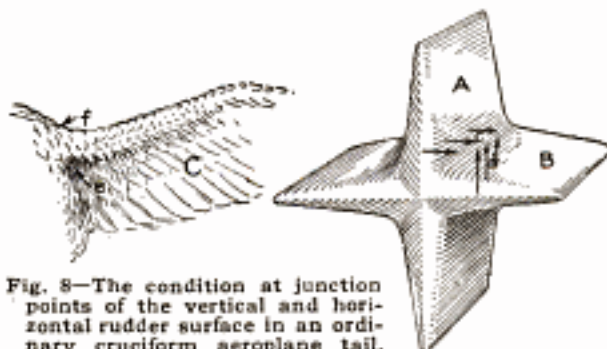

Fig. 8—The condition at junction points of the vertical and horizontal rudder surface in an ordinary cruciform aeroplane tail, showing the analogy between the filleting required as the result of the interfering movement of air, $c d$, with the abrupt enlargement at $e f$ in a bird's wing.

reactions from streamline forms and streamline struts, the forms must be made materially shorter and more abrupt in their curvatures, as is suggested at A and B, Fig. 5, so that the abrupt displacement of the air in the first case will compensate for the lower compression it otherwise tends to produce.

Moreover, to have recourse again to nature for the evidence with which to support a conclusion, it is to be noted that whereas the wings of birds are of considerably elongated streamline sections, of thicknesses ranging from $1/6$ to $1/10$ of the chord dimensions, the bodies of birds are relatively much shorter, of major transverse dimensions ranging from $1/2$ to $2/3$ of their length.

Another curious bearing of the streamline principle and of the "reaction impulse" it involves is suggested at A, Fig. 6, in which the construction is intended to suggest a plurality of streamline forms ranged one behind another like beads on a string. In such a case there is first the penetration of the air by the point *a*, with the consequent compression to *b*, followed by the "reaction impulse" to *c*,—from which point there would seem reasonably to take place a recompression to *d*, with another reaction to *e*, recompression to *f*, reaction to *g*, etc. Incidentally it is to be noted that, since the "reaction impulse" never can be 100 per cent efficient, there must be a slight loss each time, so that the logical way to compensate for this loss is by the expedient of making the successive forms each somewhat larger than the one preceding.

To progress from the theory to its application, it does not require more than the most casual consideration to realize that there are many birds and flying animals in which the head and body constitute the first two elements of such a system of tandem streamline forms. This is particularly evident in

the body of the extinct pterodactyl, sketched at B, Fig. 6.

Other examples of adaptation of the streamline principle to special cases are suggested in Fig. 7, in which there is shown first the body of a Nieuport monoplane and below it the sections of a pelican's and of an aeroplane wing. The first of these is an unsymmetrical streamline form, and the others are unsymmetrical streamline sections. The reason for the first would appear to be in some way related to the fact that when an aeroplane is in flight the air adjacent to the top surfaces is in a condition of lower compression than that underneath, which is loaded with the weight of the machine. Consequently it is not likely that a given reaction effect would be secured with the same curves and contours above as below, wherefore the unsymmetrical construction, which in this machine is an adaptation of the bird body form, seems completely justified.

In the case of the wing sections, it is here a necessary condition of operation that the air below the

wing should be compressed as intensely as possible, while that above is compressed very little—preferably not at all. In consideration of these points, it will be now realized that a wing section is virtually a streamline section bent into an unsymmetrical curve to produce an unsymmetrical effect.

Figure 8 is a sketch intended to illustrate the conditions that apply in the angles where vertical and horizontal rear-rudder surfaces of the common cruciform types come together. In this, the fact that the air moved by the surface A in the direction *c* must inevitably impinge against that moved by B in the direction *d*, results in an interaction increasing the compression above normal in the corners where the surfaces join together. This presumably can best be allowed for in an aeroplane structure by a modification of the filleting at the junction point,

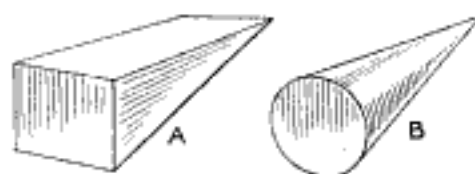

Fig. 9—At A is shown a streamline body tapering like a wedge, while at B is shown a cone-like body tapering to a point

much as is suggested by the similar modification in the wing-section curves at *ef* in the bird wing C.

Another point that aeroplane designers must take into consideration is the fact that a streamline form may terminate in either a wedge as at A or in a point as at B, Fig. 9. While the tapering to a point is probably the ideal, the tapering to a wedge has certain practical advantages, not the least of which is found in the superior security it allows for the means of rudder attachment. And what is lost in the "reaction impulse" sidewise probably is largely regained by the greater area exposed to the "reaction impulse" above and below.

An evidence, accessible to most observers, and which proves not merely the existence, but also suggests the quantitative value of the "reaction impulse," is found in the way in which birds when not in flight are affected by wind. It may plausibly be argued, and has been so argued, that the resistances of the bird to movement in flight are high, and are simply fought against by an amount of energy expended, which is presumed to be very great for the size of the animal. But, in winds so strong that they will compel a man to lean heavily into them to keep from being blown over, it is a fact that small birds on the streets, or larger birds perched on exposed places, while they invariably will take care to hop and move about so as always to face the wind, will rarely be observed to lean into the wind, or to be blown off their feet or out of their position by the impact of even the most violent gusts. The explanation of this phenomenon of the bird form, under a condition that bears no direct relationship to flight conditions, can exist in nothing but the "reaction impulse," of an efficiency so high as to nullify the "head resistance" almost completely.

In conclusion, to refer again to the particular example of the 20-hp. Nieuport monoplane, with its heretofore almost mystifying efficiency, it is calculated that the total projected area of the body is just about 10 sq. ft.

Against this, by accepted tables of wind pressures, the resistance at 60 miles an hour is about 170 lb. With an area in the rear portions of the body totaling about 100 sq. ft., at an average slant of about one in eight, a simple arithmetical application of the parallelogram of forces gives a pressure of about $13\frac{1}{2}$ lb. to the square foot, on the rear body surface, as the amount necessary to nullify completely the head resistance.

As a matter of fact there can be no such thing as a 100 per cent efficient nullification of the head resistance, so the actual pressure on the rear body of the small Nieuport must be less than the figure stated—probably no more than 10 lb. to the square foot, which would correspond in this case to a recovery of about 75 per cent of the energy involved in overcoming the head resistance.

A point of especial interest in connection with the subject under discussion is found in the fact that a certain degree of bluntness in a body form—instead of being as detrimental as might be supposed, in comparison with the more spindling shapes that are widely preferred—is of positive aerodynamic advantage. This is because it affords a sufficient abruptness of angle to realize efficiently the reaction impulse, which with a flatter wedge acts less effectively to force out the body from between the opposed pressures, just as it is found with slanted solid surfaces pressing together that there are angles so flat—below the "friction angle"—that lateral movement cannot occur.

In the cases of the best fliers among the birds, instead of an efficiency of only 75 per cent in the reaction impulse, the accuracy of the form, its perfect adjustment to the speed, and the exceedingly small magnitude of the skin friction—of the air flowing over the feathers—all combine to produce an efficiency of probably as high as 99.8 per cent or 99.9 per cent, if recent careful investigations are any criteria.

From all of which it must simply

and conclusively appear that the right road to efficiency in flying must lie, not in the direction of the ill-advised and too-common flimsy structures that by their small edge and projected areas *reduce* head resistance, but, on the contrary, is to be found in the use of

thick and substantial sections—like those of the bird wing and bird body—in which there is the altogether more essential provision of a type of form that efficiently *recovers* most of the energy expended in overcoming head resistance.

AERONAUTICAL ENGINEERS WANT A NAME

Some of the men who are attempting to solve the mysteries of the air are much exercised over finding a title by which their particular calling shall be known. There are all sorts of technical names for other kinds of engineers, but none has yet been developed for the man who deals with aeronautics.

There have been numerous discussions of the subject and the choice now appears to lie between "aeronautician" and "aeronician." "Aerotecnician" has also been suggested, and meets with favor when applied to the purely technical man. "Airman" still seems to be more popular for the man who actually runs a machine than "aviator," the first term employed. "Flight engineer" has the merit of being plain English, though it is scarcely as brief as might be desirable.

FISH TINTED TO SUIT BUYER'S FANCY

A large trade in goldfish is now being carried on in Sicily, the coloring being obtained by keeping silverfish in water containing certain chemicals, in the form of peat, chalk and iron. After a couple of weeks in this "mixture" the fish are transferred to another bath composed of iron and tan, which has the effect of coloring them red, or black and red, or black, red and silver—according to the length of time they are left in the solutions. These fish fetch a better price than the ordinary silverfish, found in large quantities in that region, but it is remarked that so far they die young.

NON-SPILLABLE FLOWER VASE FOR THE WAIST

An ingenious little flower vase, designed to be worn at the waist, has been invented by a flower-loving



Holder for Corsage Bouquet That Keeps
Flowers Fresh

Frenchwoman. Its purpose is to provide water for flowers during the time they are worn, and it is so constructed that the water will not spill, even though the wearer should bend as much as 90 deg. from an upright position. The open end of the vase has a construction similar to that of a non-spillable ink well, and the recessed central portion of the vase also aids to prevent any outflow of water.

WORKING MODEL OF PANAMA LOCKS

Complete working models of the Panama Canal were recently set up in the Commercial Museum, Philadel-

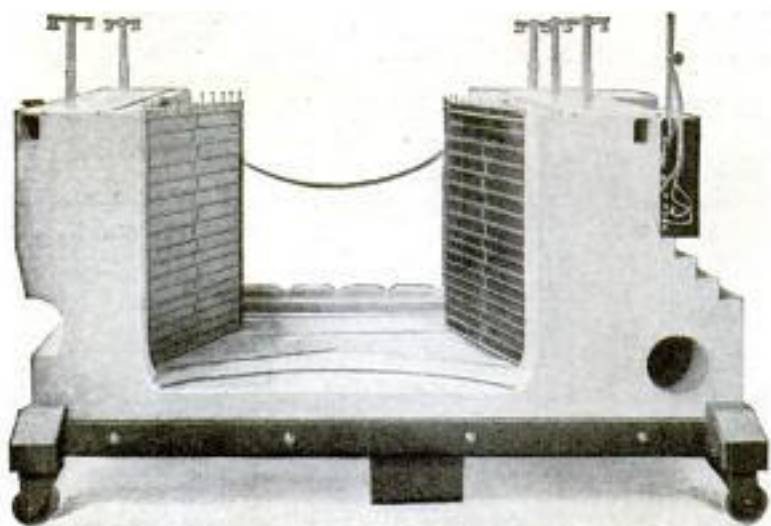

A Working Model of the Panama Canal Locks Which Shows the Operation of the Big Gates

phia. The purpose of the model here illustrated is to show the way the big lock gates are worked. This model is on a scale of half an inch to the foot and is complete to the smallest detail. It is worked exactly as the big gates will be worked in the canal locks, which will be opened and closed by electricity. The miniature electrical machinery within the walls of the model can be seen in action.

CANNON DESIGNED FOR USE ON AEROPLANES

A gun that weighs 150 lb. and is so delicately adjusted that it will not show an appreciable vibration though mounted on the most delicate steel springs, has been invented by Commander Cleland Davis of the U. S. Navy for use on aeroplanes. The new gun is 12 ft. long, is made of steel, and fires a 33-lb. projectile that has a muzzle velocity of more than 1,000 ft. per second. This is the largest gun that has ever been made for use on an aeroplane and seems to give to the airman another advantage over his foe on the ground. Heretofore it has been impossible to use a gun in the air, except the ordinary rifle, for the reason that the recoil would be so powerful as to cause the capsizing of the machine, whenever it should be discharged. Commander Davis has devoted considerable time to the development of artillery. In a test that was made the gun was mounted on delicate steel springs and when discharged had no recoil that could be measured by special instruments.

BED EQUIPPED WITH ELECTRICITY

A brass bed, especially equipped with electricity, has been built by a Cleveland manufacturing company. The tops of all four posts carry an electric-light bulb, an electric fan is mounted on one of the posts, an electric heating pad is plugged into a special outlet, and other outlets are arranged for the connecting up of devices such as a water heater and toaster. Switches for control of the devices are arranged on one of the bedposts.

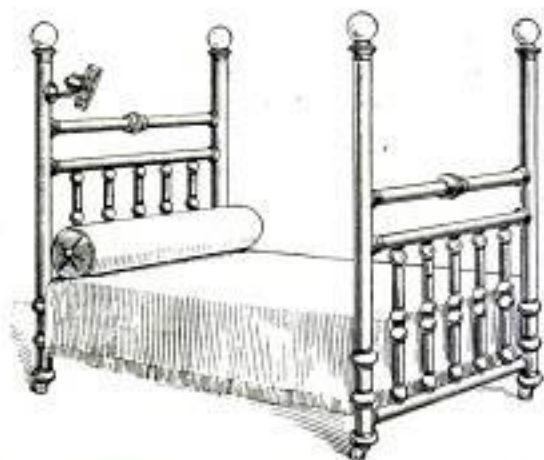

Bed Equipped with Electric Bulbs on Each Post, an Electric Fan, and a Heating Pad

SOME FARM IMPLEMENTS OF FRENCH DESIGN

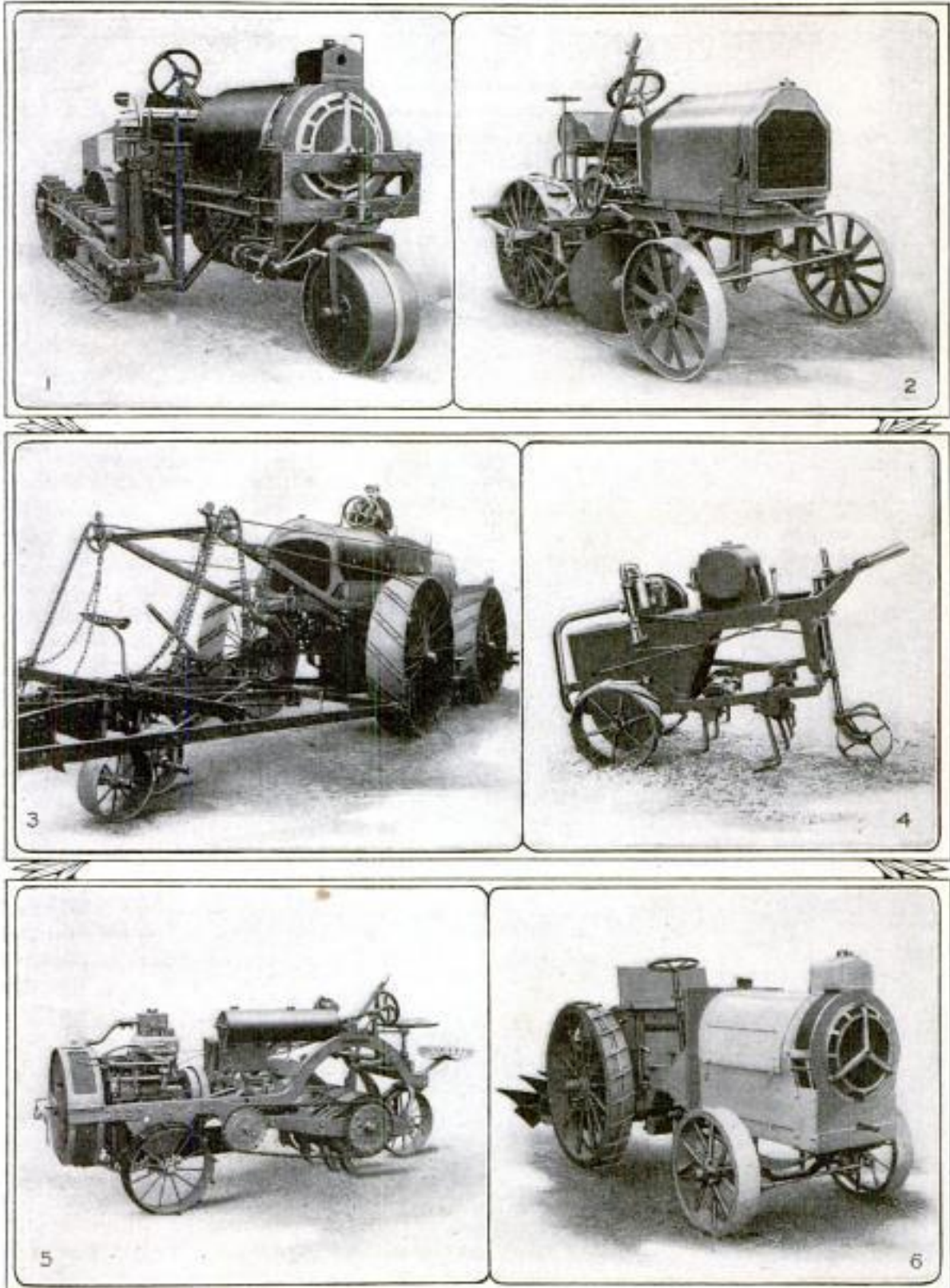

1—A Farm Tractor of the Caterpillar Type. 2—Plow with Single Row of Blades. 3—A 30-Hp. Machine Which will Plow About 30 Acres a Day. 4—A Harrow or Cultivator of Exceptionally Efficient Type. 5—Revolving Harrow That Breaks Up a Strip of Ground 3 Ft. in Width and is Operated with a Gnome Motor. 6—Deep-Cutting Motor Plow for Subsoil Work, but Which can Also be Used for Other Purposes

For many years the United States has been the unquestioned leader in the manufacture of farm implements, but France has entered into competition on motor farm implements, and some of the machines produced by the French manufacturers are shown above.

ARMOR FOR MOTOR TRUCK DUAL TIRES

An automobile accessories concern in Cleveland is manufacturing an armor which is designed to take the



wear off solid tires and at the same time provide a good traction surface on the tread. Arranged for dual tires, the armor consists of a series of steel plates with an indentation in the middle which

fits the space between the two treads. The plates are held in place by a band which passes around the circumference of the wheel, resting in the depression between the treads.

THE FLORAL-LOOP NOVELTY

An interesting jewelry novelty for evening wear is shown in the accompanying illustration in the form of a



The Floral Loop is an Interesting Novelty in Jewelry

floral jewelry loop arrangement. A neat gold chain is looped from a ring on the little finger to an arm bracelet, and a little bouquet is clipped to the center of the chain.

ODD BEHAVIOR OF METALLIC-FILAMENT LAMPS

No doubt everyone who has had occasion to turn on metallic-filament lamps, has observed that the luminosity of the filament, at first, seems stronger than later on. The explanation which first suggests itself as a solution of this phenomenon is that the filament has a much less resistance at low than at high temperatures, so that, at first, more current would flow through the filament and cause a higher degree of incandescence. If this explanation be accepted, it would follow that the temperature of the filament adjusts itself more rapidly than the resistance, or, in other words, that there is a lag in the change of the resistance behind that of the temperature. This does not seem probable, however, and therefore attempts have been made to explain the phenomenon in some other way.

It was suggested, at first, that the pupil of the eye failed to adjust itself properly. The pupil of the eye contracts when the light is turned on, and more light is received at first before the pupil has had time to respond than a moment later. Experiments made with photographic apparatus showed, however, that this could not be the correct explanation.

Another explanation, which seems to be more satisfactory, is that the true cause lies in the connections that are fused in the lamp bulb. It is suggested that the temperature of these leads rises more slowly than that of the filament, and for a very short time, at the instant of lighting the lamp, tends to decrease the total resistance, and thus cause an increased current. Still another suggested explanation is that the residual gas in the globe is the cause. The vacuum in the lamp is somewhat higher when the lamp is cold because the glass walls of the lamp absorb some of the gas. With an increase in heat, the gas expands and diffuses toward the center of the globe thus increasing the loss of heat by conduction.

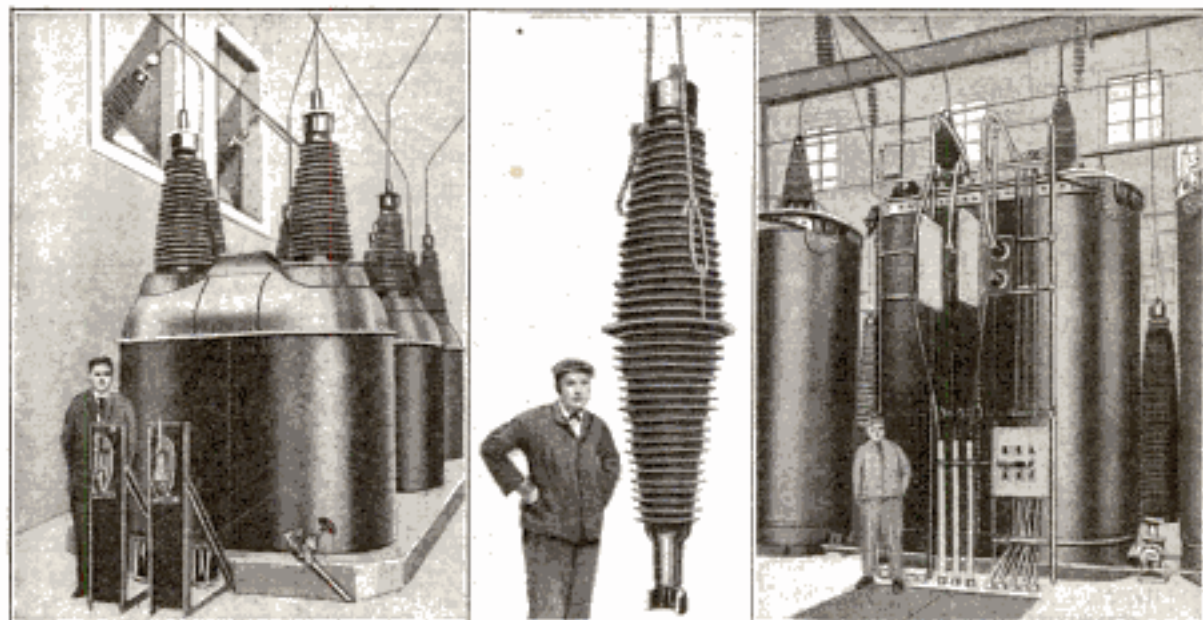

The 140,000-Volt Oil Switches

Terminal Bushing and Contact

One of the Huge Transformers

WORLD'S HIGHEST-VOLTAGE TRANSMISSION LINE

The 140,000-volt transmission line that was recently put into operation in the state of Michigan marks another step forward in the utilization of high voltage for the transmission of electric energy. In transmitting at 140,000 volts, the builders have effected a saving in copper of almost 50 per cent, as compared with the quantities used in the highest-voltage lines previously constructed.

The transformers, oil switches, and lightning arresters used in connection with this line had to be specially designed to withstand the exceedingly high electrical pressure to which they would be subjected.

The generators, which are driven by water turbines, deliver their output to

the transformers at 2,500 volts. The transformers, which are oil-insulated and water-cooled, raise the voltage from 2,500 volts to 140,000 volts, and deliver the electrical energy to the line through massive oil switches. The transformers are 19 ft. 6 in. from the floor level to the top of the high-tension terminals, and each weighs approximately 43 tons.

The transmission conductors, which are made up of seven No. 8 gauge wires, drawn according to special specifications, are supported on tripod steel towers, spaced about 500 ft. apart. The heights of the towers vary, depending upon the contour of the country; in one case the earth had to be excavated to clear the

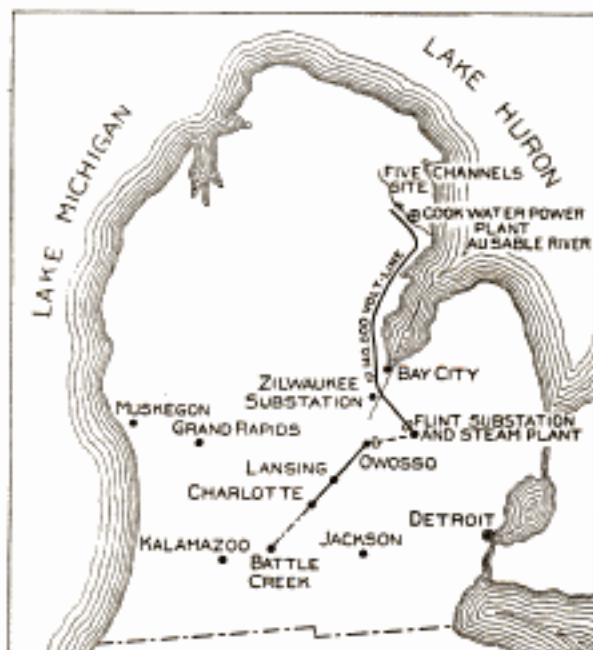

Map Showing the Michigan Cities and Towns Fed by the 140,000-Volt Line

wires, while 167-ft. towers support a 600-ft. span across a river. In hanging the conductors, each conductor being held to its crossarm by a string of ten 10-in. disk insulators, a dynamometer was used, and a pull of about 1,200 lb. made on each, which allowed approximately a 12-ft. sag in each span.

It is interesting to note that there is a rise in electrical pressure along

this transmission line, which is due to a property of the line called its condensive reactance, and amounts in this case to about 30,000 volts. It must be understood that the above is not a characteristic of this line alone, but of all high-tension transmission lines, nor does this rise in voltage represent a gain in energy. The effect of condensive reactance in this case exceeds that of any other line on record.

IMPROVED MOTION-PICTURE SOUND MAKER

The assembling together in one apparatus of the many mechanisms required to produce realistic imita-

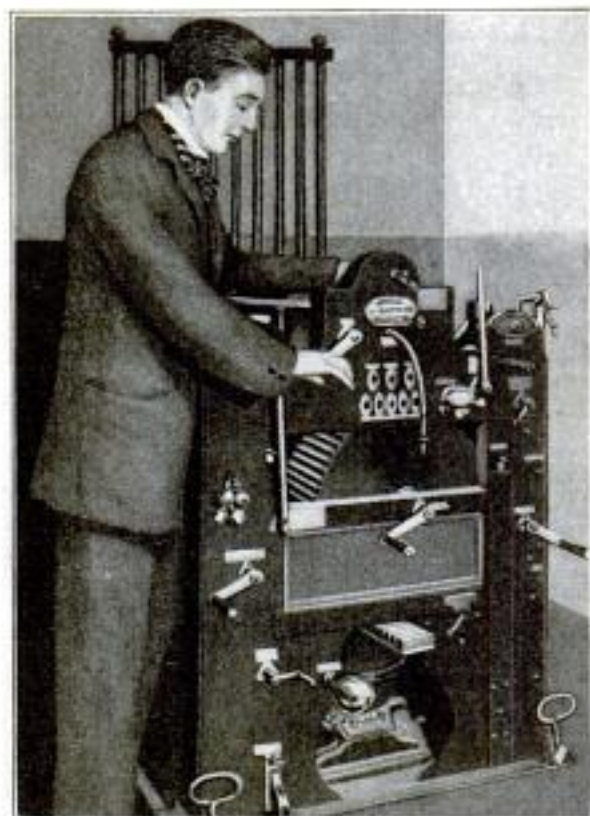

An Ingenious Sound-Making Machine for Motion-Picture Theaters

tions of all the sounds used in giving "life" to motion pictures has been ingeniously accomplished in the machine here shown. The sounds it can reproduce include the cries of a baby, the screech of projectiles fired from cannon, the warbling of a bird, the ring of the anvil, the rustling of leaves, the crashing of falling masses of metal or

wood, the engine noises of automobiles and motorcycles, the patter of rain, the rumbling of trains, the sound of waves, wind, hail, the puff of a railway locomotive, the breaking of crockery, the tolling of bells, the clang of fire bells, the clatter of horses' hoofs, the bark of a dog, the hissing and spitting of cats, the tinkle of sleigh bells, the "honk" of automobile horns, quick-firing guns in action, the clash of dueling swords, and the rattle of fetters.

The claim is made that despite its many functions it is very simple to handle.

WAR AEROPLANES AS "DOVES OF PEACE"

Unusual and remarkable as it may seem, the Italian war aeroplanes that have been almost constantly flying over the enemy's camps in Tripoli have recently been varying the diet of bombs by dropping pamphlets printed in Arabic. These pamphlets, addressed to the Turkish soldiers and their Arab allies, and to the inhabitants of Tripoli, Bengazi, Derna, Tobruk, and Fezzan, deal with the state of the war, telling of Italian victories and advising the laying down of arms.

A Berlin nerve specialist has reached the conclusion that knitting in bed is an excellent antidote for tired nerves, and has secured most satisfactory results by prescribing a course of knitting for worn-out society women of the German capital.

HOW A CAT TURNS OVER

A Man Falling from a Balloon Could Do the Same Thing,
and Our Latitude Could Be Changed by the Same Method

By FOREST RAY MOULTON,

University of Chicago

IT IS a common saying that if a cat is dropped in any way whatever, it will always alight on its feet. Since a man cannot lift himself by his boot-straps, or a boat cannot propel itself through the water except by pressing against the water in some way, one may well wonder whether this is not one of the common sayings which is fallacious. The general principles involved are of such interest that the question was taken up a few years ago for consideration at a session of a French scientific society.

It is a fact that it is dynamically possible for a cat to turn over no matter how dropped, and experiments have shown that they actually do it. If a balloonist, or airman, should fall from a great height and should find that he were descending so as to strike on his head, he could turn himself over so as to strike upon his feet, if he knew the proper means of accomplishing it. But the distance he would have to fall in order to have time to turn over would be so great that he could have only an academic interest in striking on his feet rather than on his head, for the final result to him would be the same in either case.

In order to make the principles which are involved perfectly clear, suppose A B C D (Fig. 1) is a portion of a wheel supported at O, and that it is mounted so that



it can be turned around O as an axis without any friction. Suppose A B C D is in a horizontal plane, and that on it two mice live and have their nest. Suppose they find that their nest is exposed to the north wind and that they wish to turn the portion of the wheel on which it rests around so that it will be protected from the wintry blasts and will be open to the sun's rays from the south. Suppose these mice are familiar with the principles of mechanics (having read *Popular Mechanics* every month) and that they undertake to turn their home around. Suppose they weigh but an ounce and that the weight of that portion of the wheel on which they live is 10 lb., or 160 oz.

Now the mice being wise will start at O and one will walk toward A and the other toward C so as to keep a balance. Their traveling along a radius of the wheel will have no effect upon it and will not turn it. After arriving at A and C they will walk toward B and D respectively. The way the mouse gets forward is by pushing back on the surface on which he is walking, just as a skater, in order to get forward on the ice, pushes back with the sharp edge of one skate as he makes the stroke with the other. This is a universal principle and is illustrated by a locomotive pulling a train. If the track is

slippery so that the drivewheels cannot push back upon it, the train cannot start. In order to secure the necessary friction, the engineer puts sand on the track.

When the mice were walking from O to A and C they were pushing back in opposite directions. But when they walk from A and C toward B and D respectively, they both push on the wheel in the same direction. Since the wheel can move without friction, it will move back a little in this direction. The amount it moves depends upon the force with which the mice push back. Since the wheel weighs 160 times as much as the mice, it will be pushed back $1/160$ as far as they go forward. (This is really under the assumption that the weight is all on the rim.) When they get to B and D the wheel has been pushed back $1/160$ of the distance AB.

It is very important for the understanding of the subject to notice one or two things. The momentum of the mice forward is always exactly equal to the momentum (technically moment of momentum) of the wheel backward. When they arrive at B and D they must stop before they can go toward O. In order to stop they must have some friction with the wheel, and in stopping they push on the wheel in the opposite direction to that which they pushed while they were walking. In stopping themselves they will push on the wheel exactly enough to stop it. Hence they start at A and C with the wheel at rest, and they end at B and D with it at rest. It has had no motion except in the direction opposite to that in which they traveled, and therefore it has rotated backward somewhat. The center of gravity of the two por-

tions of the rim and the mice has not changed; and since the mice have gone forward from A to B and from C to D the center of gravity of the parts AB and CD have moved back correspondingly. The wheel moved only when the mice moved, and stopped when they stopped. If the wheel were originally spinning round and round, the walking of the mice would change its position, but not its motion, after they stopped, precisely as is done when it is initially at rest.

After the mice arrive at B and D and stop, they go back to O. Then they go to A and C and repeat the whole process. By doing this a few score times, they can turn the wheel around

180 degrees and secure the results they desire.

Now suppose a man were standing over the point O. Under the same conditions as to the absence of friction, he could turn himself around by moving his arms. He would extend his hands to A and C and then swing them around to B and D. By doing

this, he would turn himself and the wheel on which he stood a little in the opposite direction. He would then pull in his arms to his body and put them out again in the direction AC, which would not turn the wheel. Repeating the process, he could turn the wheel as much as he wished.

Now suppose a man were falling from a great height. He would be perfectly free to turn in any direction, except for the slight resistance of the air to rotation, which can be neglected. If he were falling without turning over, he could work his arms so as to turn himself in any direction he desired, and the method which he would use is clear from the principles which have been explained. It has

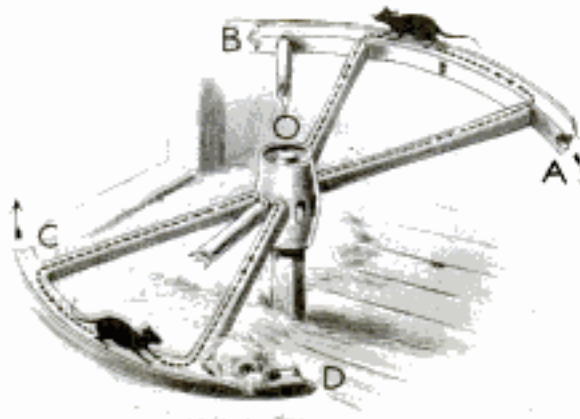

Fig. 1—Two Mice would be Able to Slowly Push a Broken Wheel Around by Running in Opposite Directions along the Rim Sections and Thus Change the Location of Their Nest

been found by careful observations of cats that they use their legs and head precisely in this manner to turn over when they are dropped. It is not, of course, to be supposed that the cats have any understanding of the mechanics of the problem; but that, by an instinct acquired by the cat family during thousands of generations, they naturally do what secures the results.

Everyone knows that our climate depends to a large extent upon our distance from the north pole. A glance at a map of North America shows that a large part of it is north of Chicago where sometimes for days and weeks the wintry blasts sift the snow through the streets. As the vast regions of Canada become more densely populated the rigors of its winters will be more and more deplored. The question arises whether it is not possible to tip the earth over so that the latitude of Canada will be less. This would bring Siberia and China nearer the pole, and the wind-swept and

barren wastes of Northern Asia would become even more desolate than they are at present. Tipping the earth over is, of course, a bold proposition; but science has had so many and so remarkable triumphs in the last hundred years that no problem seems too big for it to undertake. It is not altogether a wild dream that man will sometime control the great forces of nature, and even direct the cosmic processes.

A small change in the latitude of North America might have a great influence on its climate by changing the atmospheric and ocean currents. Suppose it is proposed to change its latitude one degree. For simplicity, suppose the earth is not rotating and that

it is possible to run a train around it from pole to pole along a meridian (Fig. 2). Suppose the track runs from the south pole to the north pole through North America and back to the south pole through Asia on the opposite side of the earth. If the train should pass northward on the American side, its wheels, pushing backward, would push this side of the earth away from the north pole; and, going southward on the Asiatic side, would shove that part of the earth toward the north pole. If the train should go round and round the earth enough times, the earth would be tipped over as far as might be desired.

Instead of being still, the earth is rotating; but this will not alter the effect of the train for, according to the principles which were explained in connection with the mice on the wheel, a rotation of the whole mass does not change the effect of a body moving on it, and after the moving body stops, its rotation is unchanged. Con-

sequently, the train alters the rotation of the earth only while it is moving. In the second place, it would not be possible to build a railroad track around the earth from pole to pole, but the difference in results would be slight if it were turned off to the east or west in high latitudes. For long distances the trains would have to be carried by boats, but this would have the same effects on the earth, for the boats push back on the water as the trains do on the railroad tracks.

Now the question is whether so large a mass as the earth can be changed sensibly by the means available to man. The seriousness of the proposition becomes evident when we find that the total mass of the earth is

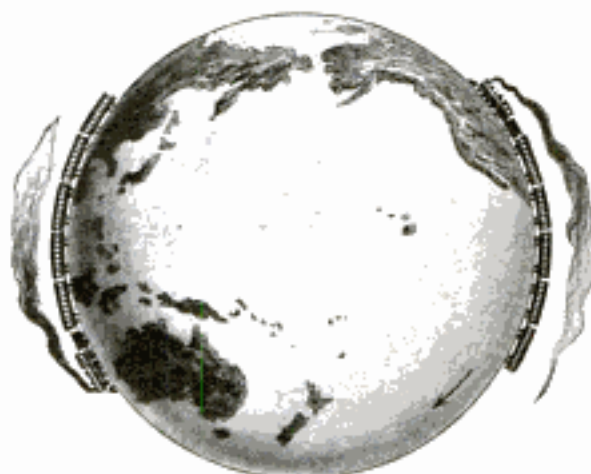

Fig. 2—The Earth might be Tipped Enough to Effect a Change in Latitude, if It were Possible to Run a Train around It Rapidly, along a Meridian between the North and South Poles

six thousand billion billion tons. This number is 6 with 21 ciphers after it. Computation shows that if a hundred trains of 3,000 tons' weight, including the load, were run a thousand miles each day in the manner described, it would require 100,000 million years to change the latitude of North America

one degree. Consequently, it seems that even though scientific men are bold, this is an undertaking which they cannot accomplish. There is more hope that, like the birds, we shall sometime be able to fly from the shores of the Arctic Ocean to the Caribbean with the change of the seasons.

AUTOMATIC TRACK SCALE

A new type of automatic self-registering track scale, which may be oper-

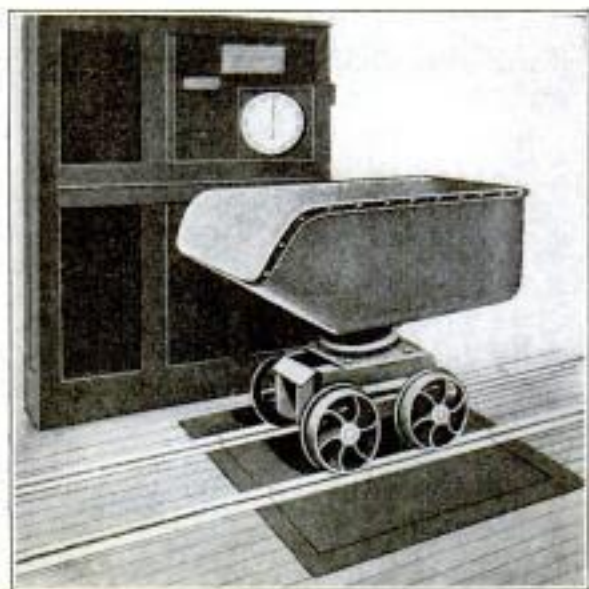

An Automatic Track Scale Which Indicates the Net Weight of Each Load, the Total of All the Net Weights, and Counts the Loads

ated by the movement of a hand lever or wheel, but preferably by a small

of which indicates the net weight of each load, the second records the total of all the net weights passed over the machine, and the third counts the number of loads.

The action of the loaded truck coming upon the scale platform starts the weighing and recording mechanism by closing a clutch, causing a worm which is part of the steelyard to revolve and carry the poise weight until it reaches the balancing point. The instant the beam drops this weight stops traveling, and thus the net weight of the load is instantly and accurately recorded. The poise weight returns at high speed to the zero position as soon as the load is removed, and the scale is ready to receive a new load.

MOTOR CAR FOR HORSE TRANSPORTATION

A well-known fox hunter of Bridlington, Eng., has had a special motor car constructed for the transportation

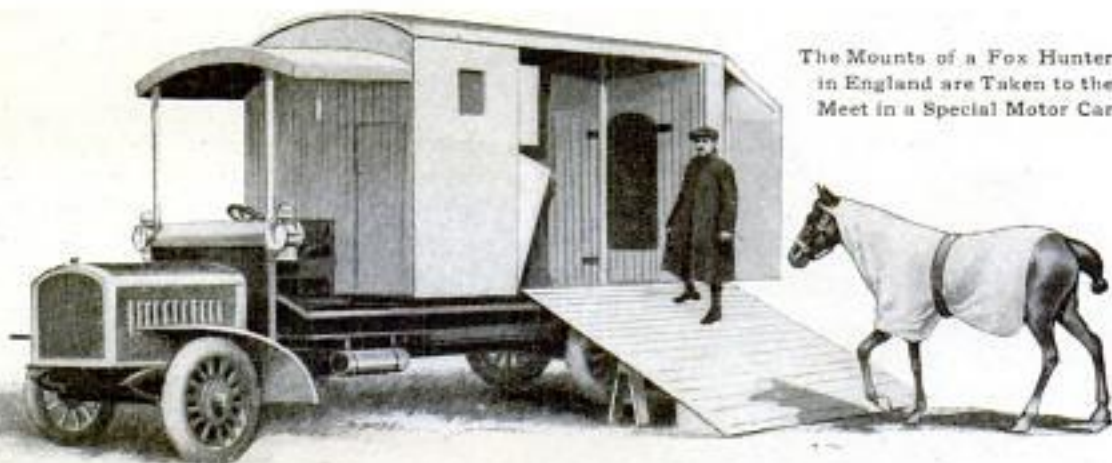

The Mounts of a Fox Hunter in England are Taken to the Meet in a Special Motor Car

electric motor, is being built by a scale company of Milwaukee, Wis. The scale is fitted with three counters, one

of his hunting horses to Scarborough Hall, near Beverley, for the meet of the Holderness Hunt. The car accom-

modates three horses. Part of one of the side walls is dropped down, and, supported by wooden legs, serves as the gang-plank by means of which the horses enter and leave the car.

THE LARGEST WATER TURBINES

The largest and most powerful hydraulic turbines in the world are operated by the Pacific Coast Power Co., of Seattle, in the hydroelectric development of the White River. Each turbine was designed to develop 18,000 hp. at 360 revolutions per minute under 440 ft. effective head, and 20,400 hp. at the same speed with a maximum head of 480 ft. In actual operation, however, the turbines are each

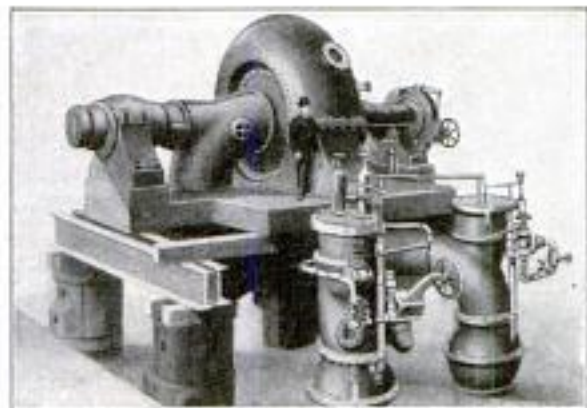

The Largest Water Turbine in the World. An Idea of Its Size may be Gained by Comparing It with the Man

carrying 20,800 hp. under 440 ft. effective head. From a dead short circuit to no load, which requires a full gate motion by the governor from wide open to closed, the maximum speed does not exceed 395 revolutions per minute, or about 10 per cent above normal.

GERMAN ARMORED AEROPLANE

One of the interesting armored war aeroplanes shown at the recent aviation exhibition in Berlin is of the "seagull" type. The interesting feature of this machine is the armored cylinder provided to house and protect the machine's mechanism, the pilot and the "fighting airman," or, in

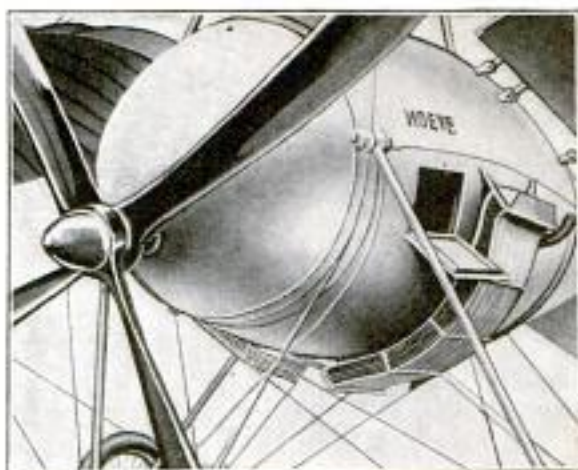

One of the Armored Aeroplanes Developed in Germany and Exhibited at the Recent Aeroplane Show in Berlin

other words, the officer whose duty is to operate the fighting mechanisms of the machine. The armored cylinder tapers to a point in front.

MACHINE FOR TURNING AND BOXING WOODEN WHEELS

An English manufacturing concern has recently placed upon the market an interesting machine, especially designed for turning up and finishing the rims, and for boring or boxing the hubs of wooden wheels. It will handle wheels up to 6 ft. in diameter. Two compound slide rests are provided, one for turning up the rims and faces of the wheels, and the other for

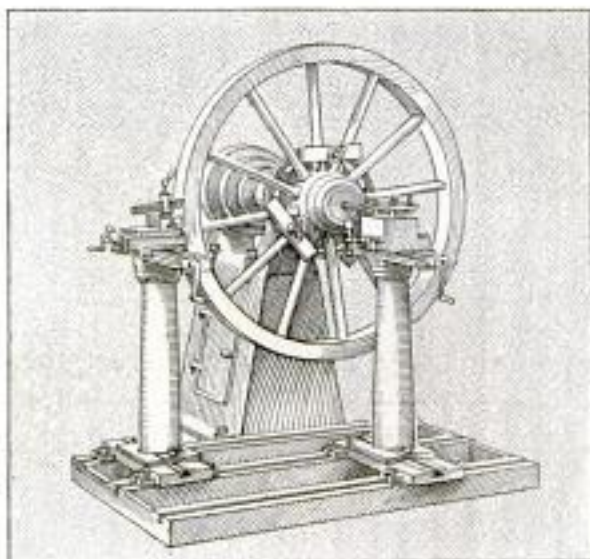

A Machine Which Turns Up and Finishes the Rims, and Bores and Finishes the Hubs of Wooden Wheels

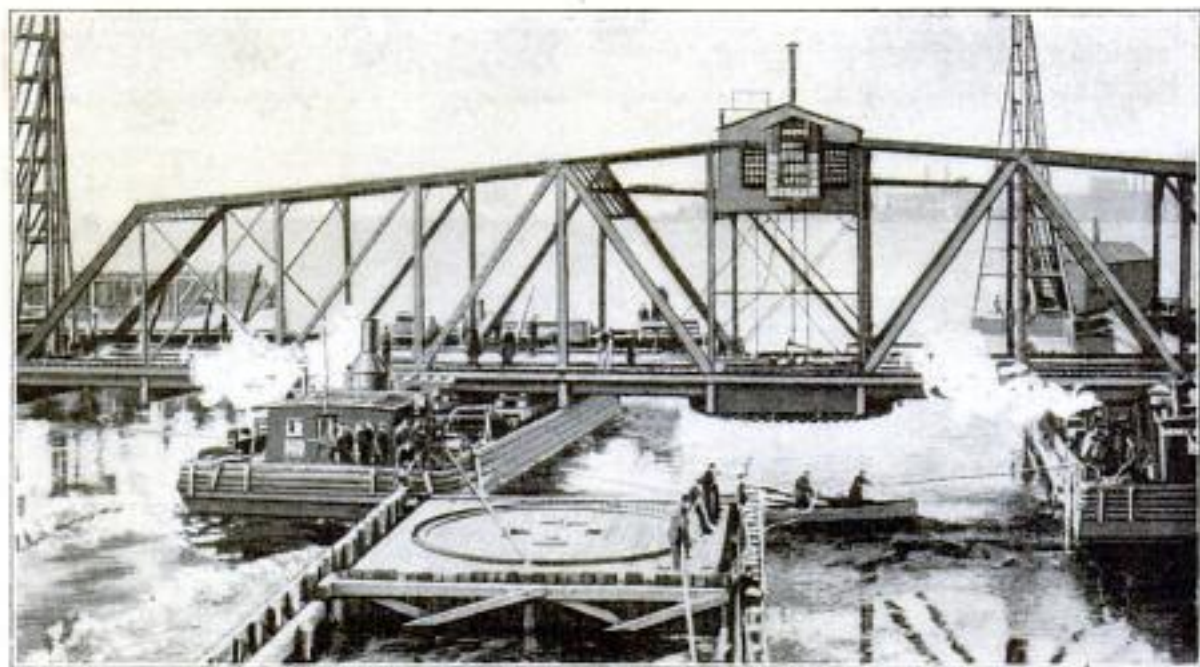

Shifting a 212-Ft. Span, Double-Track Railway Bridge to a New Location on the Passaic River, New Jersey. Service Over the Bridge was Interrupted Only One Day

boring and finishing the hubs. The columns which carry these slide rests can be clamped in various positions on the bedplate, which is attached to the main standard of the machine. They can be easily adjusted and locked in positions suited for wheels of different diameters.

HIGHEST-VOLTAGE DIRECT-CURRENT LOCOMOTIVE

There has recently been built, by one of the large electrical manufacturing companies, a number of high-voltage direct-current locomotives, which will operate on a traction road in South Carolina. These locomotives will be supplied with power from a 1,500-volt, direct-current circuit, which is said to be the highest direct-current voltage used by any electric railway in the United States. The locomotives weigh approximately 55 tons each, and are equipped with four 750-volt motors which have a rating of 180 hp. Two motors will be connected in series, and the combination then connected to the 1,500-volt circuit. It is claimed each locomotive will be able to haul 40 loaded freight cars on a straight, level track at a speed of 20 miles per hour.

AN UNUSUAL BRIDGE-MOVING OPERATION

Recent changes in the line of the Central Railroad of New Jersey between Jersey City and Newark included the shifting of a 212-ft. span, double-track bridge, crossing the Passaic River, to a new location about 185 ft. distant. When the new pivot pier and approaches were ready for the span, preparations were made for the shift and Sunday was decided upon for the work, there being less navigation in the river and fewer trains on this day.

The contractor's forces arrived on the scene at two o'clock in the morning, and pulled out about 30 piles which interfered with the movement of the two 650-ton scows on which the span was to be moved. The scows, filled with about 5 ft. of water ballast, were then floated under the bridge, marks on the cribbing indicating the exact location necessary. Then the 12 sets of blocking were built up, and the water was pumped out of the scows, which, with a rising tide, lifted the bridge clear of its foundations within a very few minutes. Signal and interlocking systems were restored and traffic was resumed at six o'clock in the afternoon.

AWAKENING OF INTEREST IN SAFETY DEVICES



Suggestions for improvement in means of life-saving at sea come thick and fast after great sea disasters, and the loss of the "Titanic" is far from proving an exception. Inventors are announcing new schemes from all parts of Europe and America, and there is an awakened interest in devices at present in use. In the above illustration may be seen a number of the collapsible lifeboats provided the "Olympic" immediately after the loss of her sister ship. It was the appearance of these boats, which look frail and unreliable collapsed, that caused the strike of a portion of the crew of the "Olympic." The men left the ship at the last moment, and the White Star Line had to cancel the sailing and transfer the passengers to other ships.



Heavily Loaded Life Raft Given a Test in Boston Harbor, Soon after the "Titanic" Disaster

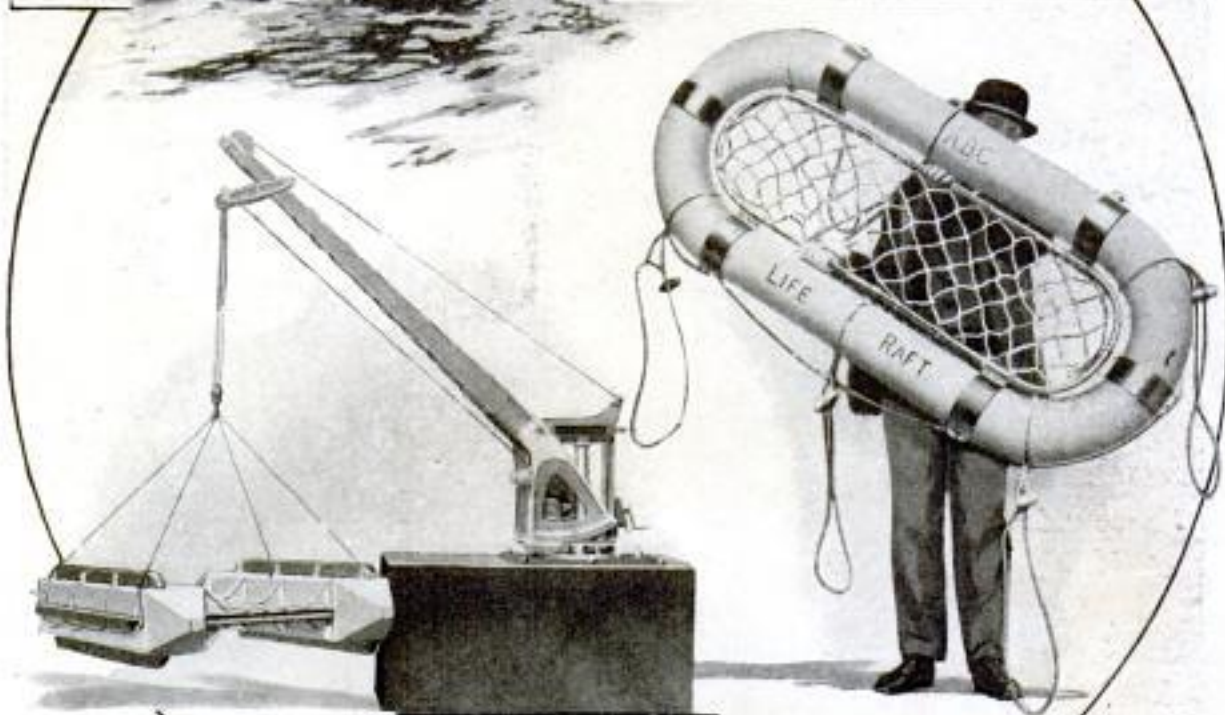

Single Davit with Light Life Raft Attached

A Life-Preserver Type Life Raft

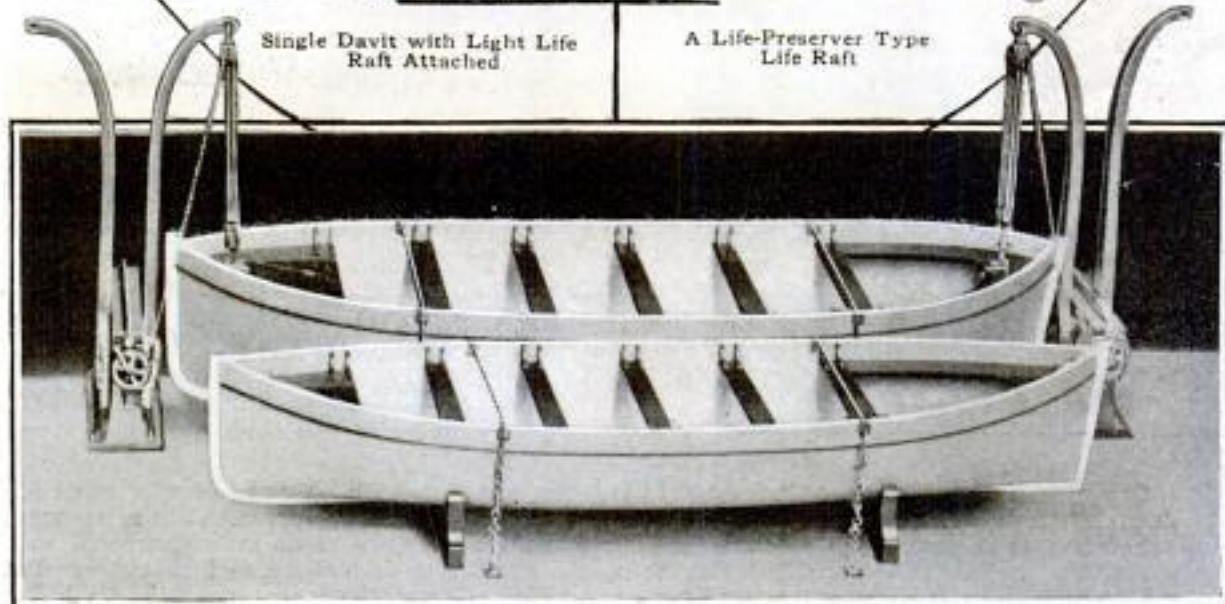

The "Titanic" was Equipped with More Davits than Boats. In This Illustration is Shown a Scheme for Providing Two Boats for Each Set of Davits

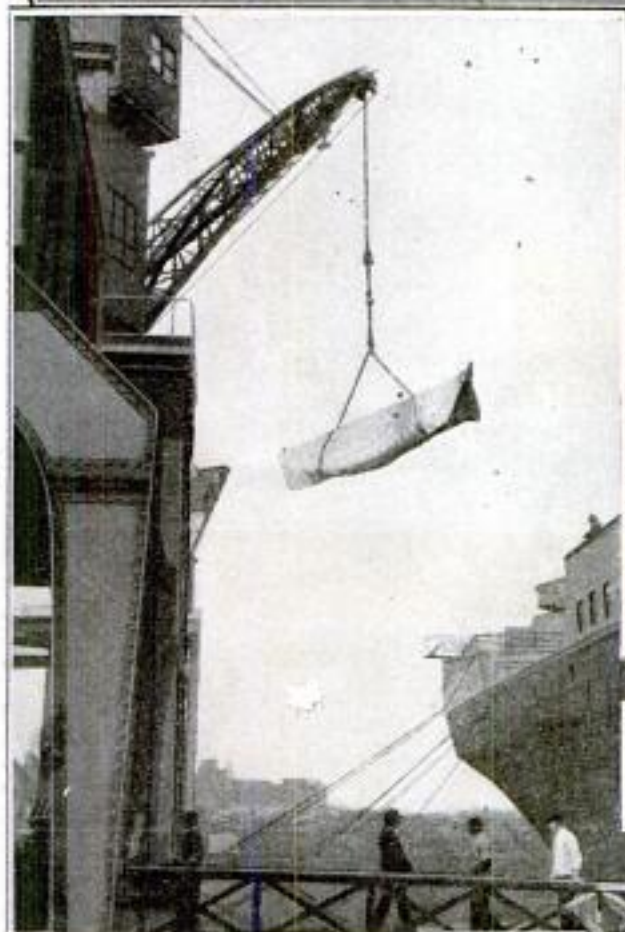
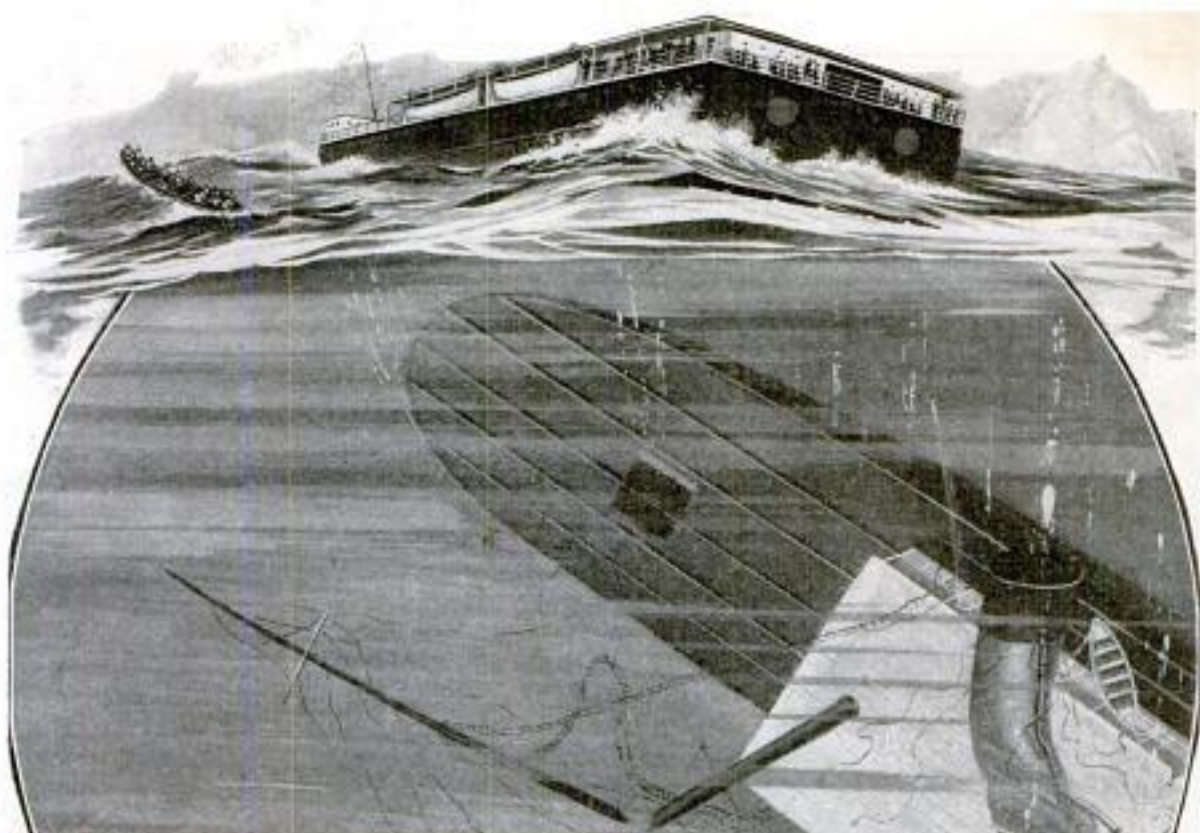

The Detachable Pentoon Idea; A Portion of the Upper Works so Constructed That It would Remain Afloat should the Vessel Sink

Placing Collapsible Lifeboats on Board the "Olympic"

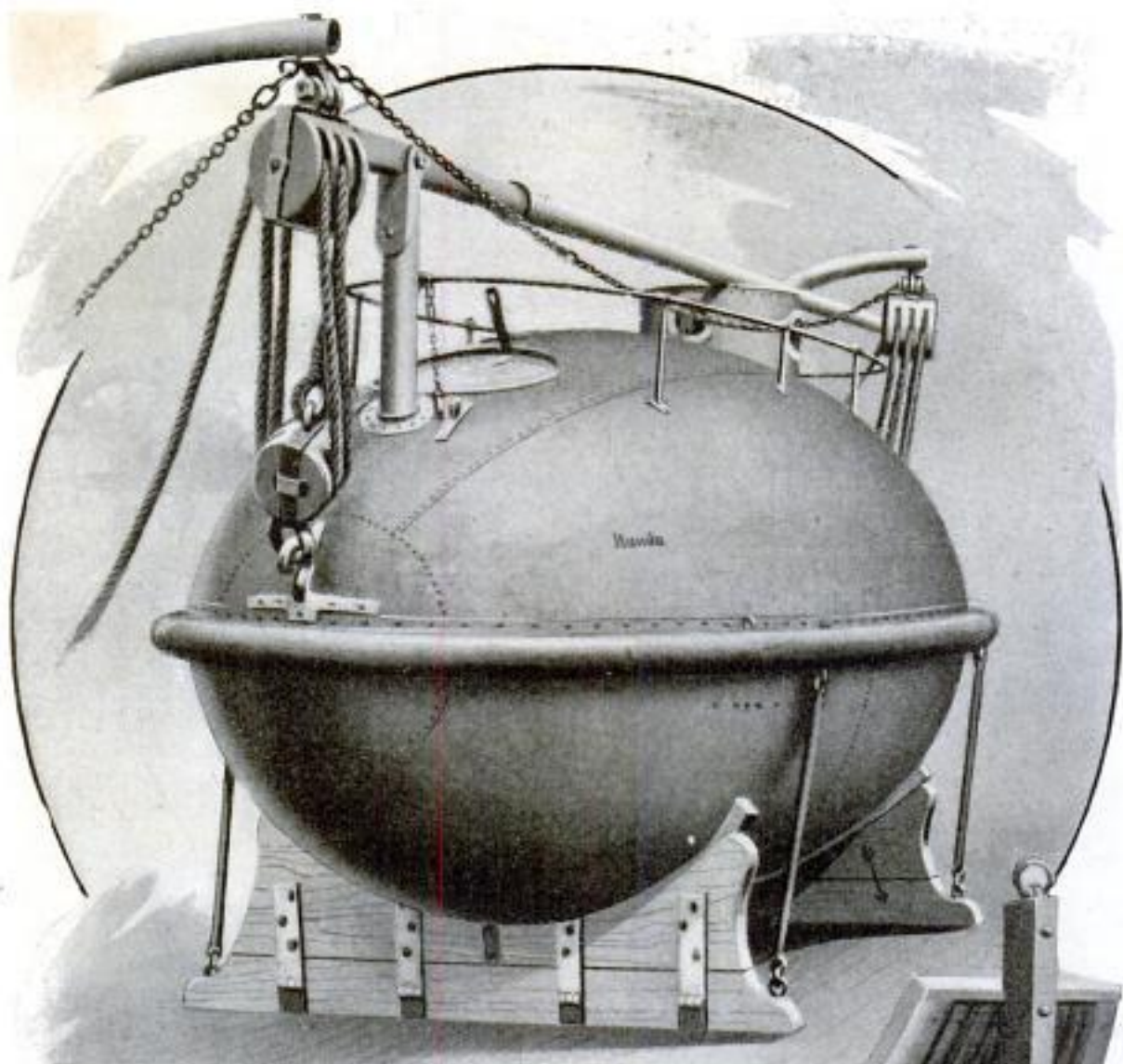

Lifeboat Built Like a Submarine. It can be Steered from Inside or Outside



Opening Out One of the Collapsible Lifeboats. Many Liners Took Them on as "Extras" after the "Titanic" Disaster



The wickerwork lifeboat is one of several carried by the "Batavier III," of one of the Dutch lines. It weighs about as much as the ordinary wooden lifeboat, and carries 35 people. The outer shell of wickerwork prevents injury should the boat strike heavily against the side of the vessel when being lowered into a rough sea. Inside the wickerwork is a wooden shell consisting of three layers of wood with canvas between.



It is suggested that two launching tubes be constructed, one on each side of the stern of the vessel, for the launching of completely covered, motor-driven lifeboats of the type shown in the illustration. All the boats would be disposed on tracks leading along the deck to the entrance of the tubes.

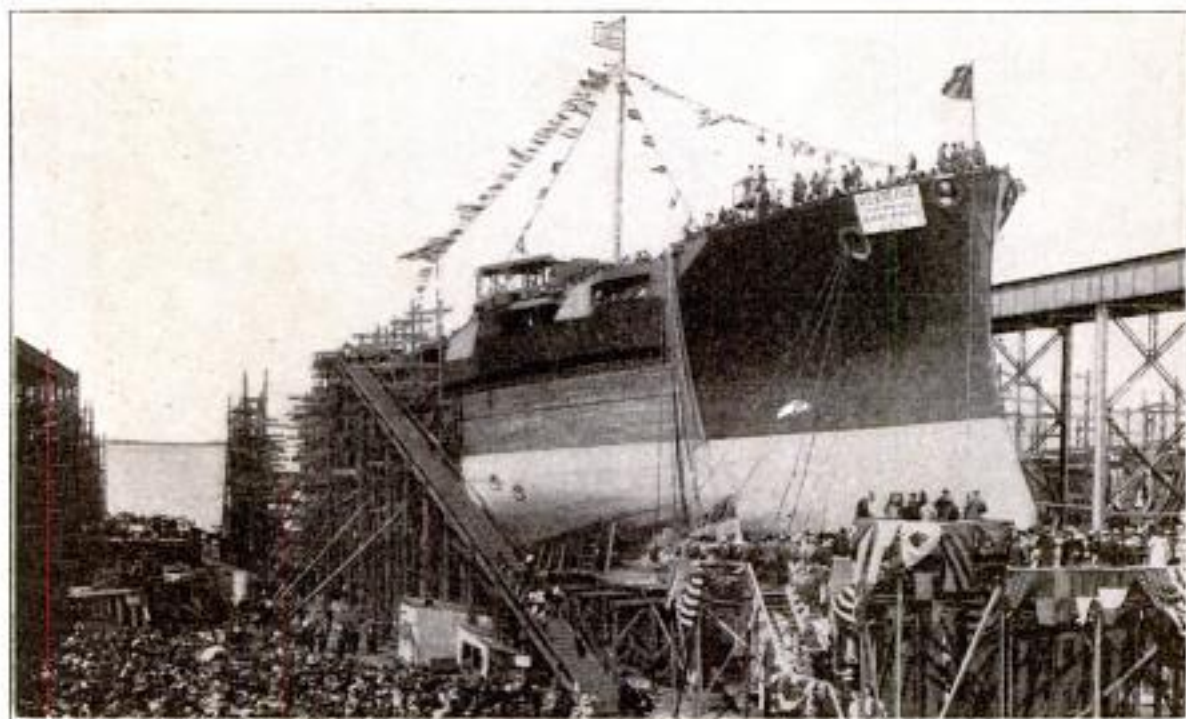

Copyright, 1912, G. V. Buck, Washington.

The superdreadnought "Texas," the most powerful battleship of the world yet launched, was slid into the water at Newport News, Va., on May 18th. She has a length of 565 ft., a beam of 95 ft. 3 in., a displacement of 27,000 tons, and a contract speed of 21 knots (24.18 miles an hour). Her main battery will consist of ten 14-in. guns, and the secondary battery is composed of twenty-one 5-in. guns.

His First Public Flight, Le Mans, 1908



Wilbur Wright

In His First
Glider, 1900

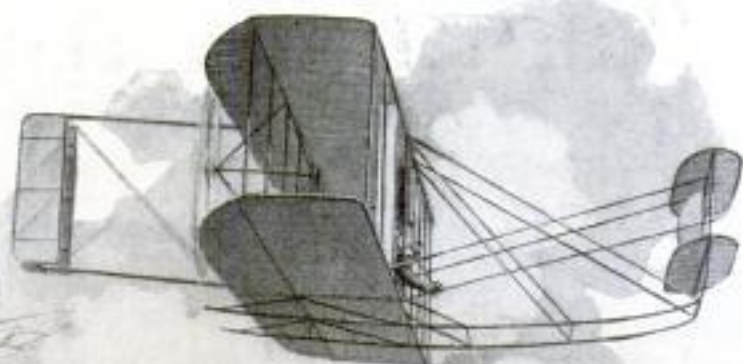

WHEN ROTHSCHILD, ROCKEFELLER, AND MORGAN ARE FORGOTTEN

Copyright, 1912, by John T. McCutcheon
— Chicago Tribune

WILBUR WRIGHT, INVENTOR OF THE AEROPLANE

BORN APRIL 16, 1867

DIED MAY 30, 1912

Acquiring a Motor Boat

by
George
Fitch

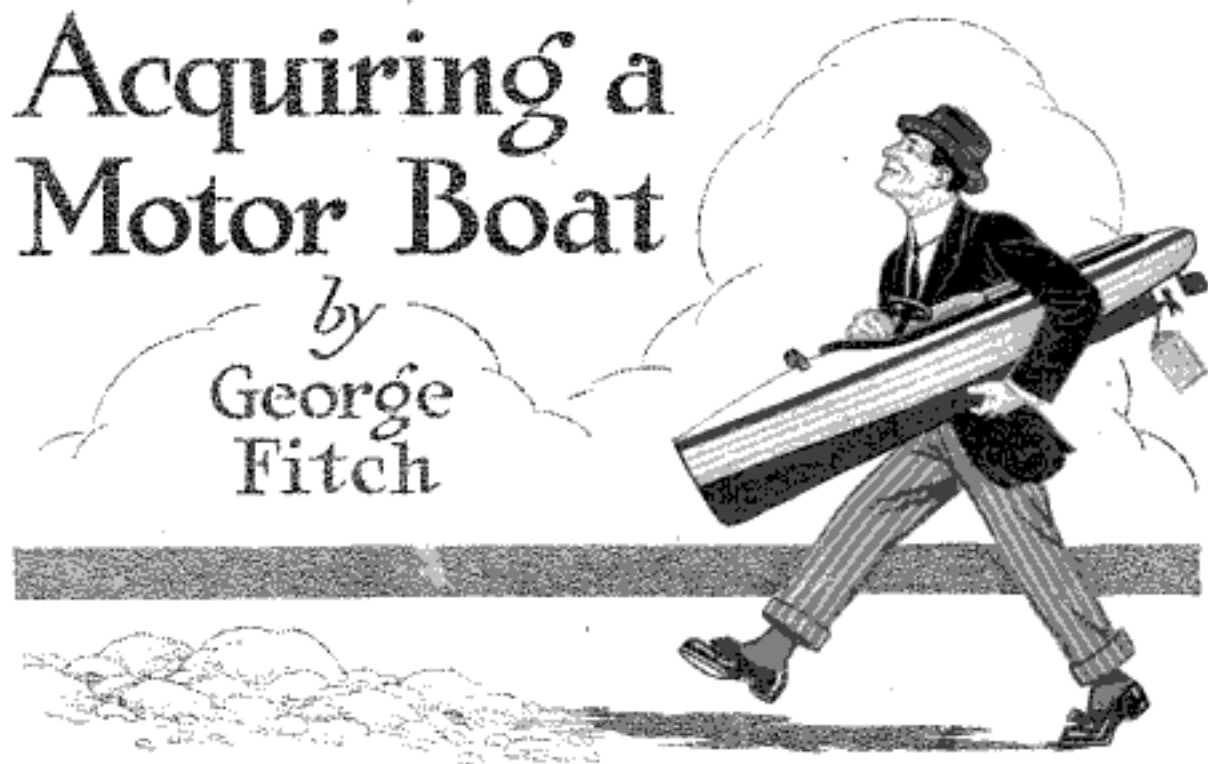

ONE of the greatest virtues of the motorboat is that almost anyone can own one. A motorboat is not an indication of an ungovernably large income. If a man cannot afford to buy a mahogany-skinned racer, with 200 horsepower stuffed into its narrow thorax, he can pick up a second-hand runabout, with an old four-cylinder engine which counts one and skips two until it has run a few miles and is thoroughly hot. If this is beyond him, he can pick up a homemade boat with two cylinders, a cast-iron propeller and a steering wheel made out of an old slat. If even this is too much luxury, he can beg or borrow a rowboat and install in it a mail-order engine which costs \$49.50, and on which he can lavish just as much care and exertion and ingenuity and hoarse, reverberating profanity as if it had cost \$7,000, and were built of aluminum and vanadium steel.

I was told the very best way to get a motorboat is to buy it second-hand. There are many reasons. In the first place the price of a motorboat decreases much faster than its efficiency. When a man has run a thousand-dollar motorboat a year, he has corrected most of its faults and has discovered all of the peculiar kinks in the disposition of the engine. The boat is really

worth more than it was when he bought it, but you can generally coax it away from him for \$400. A man who builds a boat himself—puts \$50 worth of lumber, \$300 worth of engine and \$1,000 worth of time and brains into it—will sell it with the utmost cheerfulness for \$250 just as soon as he has figured out a change of design which makes it imperative that he should build a new boat with a bigger engine. Often, too, you can discover some man who will never learn to run a motorboat because his brain wasn't made to focus on the subject. He is forever starting off with the water drained out of his engine, or with weak batteries, or with no gasoline, or without remembering to turn on the lubricating oil. He cranks his engine for two hours before he remembers to prime it. He spends a summer taking friends out to ride, and listening to their comments and jeers while he struggles with his stationary boat. There are times during the summer when he will sell that boat for \$50 and will think with gratitude of the man who buys it. It is well, therefore, to seek out these men and to linger near them with an expectant eye like an undertaker attending an automobile race.

It is even possible to obtain a boat

without any cost at all. But this is dangerous and the givee should beware. I myself was presented with a \$3,000 boat once. It hadn't cost all of that in the beginning, but the owner had spent that much money on it. He did not like me, so he gave me the boat. I was inexperienced and accepted it. I traveled nine miles in it that summer at an average cost of \$5 a mile, while the former owner sat on the bank and watched me with a grim, but happy smile. He said, the only pleasure he ever had out of that boat was watching me try to run it. In the case of boats you should look gift-horses in the crankshaft, the flywheel, the clutch, the commutator and the stuffing box, before accepting them.

Right in my own town another man has been trying, for three years, to give away a 48-ft. speed hull, built magnificently of oak timbers, with a 2 by 6 oak coaming, and ribs about as thick as corset steels. But he has made no headway, though he swears that it does not sag more than 6 in. in the middle with an engine in, and that the report that he had to feed it gasoline with a force pump is sheer slander.

Suppose you have reached that stage where life is no longer attractive unless you can soak it in gasoline, lubricating oil and river water, and you have determined to buy a motorboat. You have \$250 in cash. Can you sat-

isfy your yearning with this amount? Easily. But don't rush into the business recklessly. Buying a boat is more of a job than buying an automobile, or an aeroplane, or a house and lot. It requires caution. There are diplomatic possibilities to it. There are also other possibilities. You can very easily buy a \$125 boat for \$250. Lots of people do it. It doesn't take any practice at all on your part. Dealing with a boat owner is like dealing with the proprietor of a wall-eyed Connecticut horse. Cash is only the last item in the transaction. Conversation, and a plenty of it, comes first.

To begin with, don't buy the boat yourself. Find a friend who is a boat expert and let him do the negotiating for you, while you stand by with your checkbook hidden, but instantly available, ready to pull it out at the psychological moment, buy the boat and go away with it before the owner gets lonesome for it and refuses to carry out his bargain—for there are few boats which, with all their faults, aren't loved by the owners. More than one man has sold his boat and has bought it back eagerly for \$50 more the next week, after trying unsuccessfully to win the love of a strange and sullen engine in a new boat.

My first boat was a nervous little slim-waisted affair which I, together with another landlubber, bought from a man who had built her himself. He had built her in his cellar and owing to a slight inadvertence in failing to make the boat flexible, he had had to jack the house up off its foundations in order to get her out. He wanted to sell the boat in order to build another one with larger engine space. He had decked

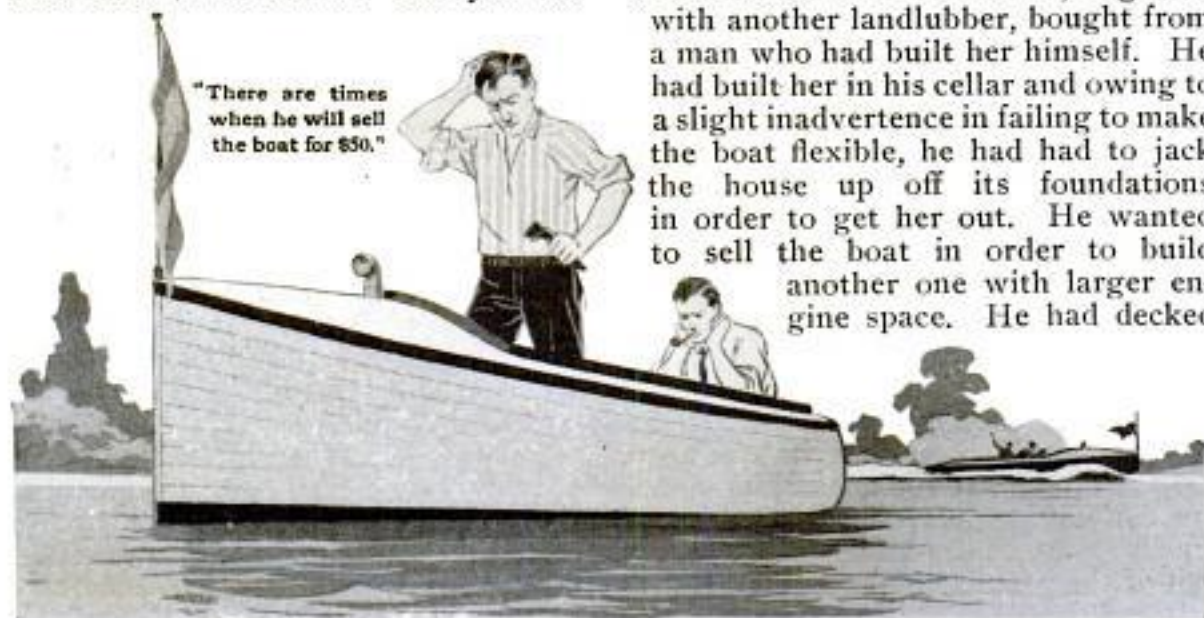

the engine in and, being a fat man, had had to use glove powder in squeezing past it in order to reach the crank. He was willing to sell for \$300, we understood, and we were willing to buy for that sum, having sequestered it from the voracious cost of living after a hard struggle. But when we told our plans to our friend Green, who knows motorboats as grandmothers know babies, he scoffed loudly. "It's lucky you innocents came to me," he declared. "I would never feel innocent again if I let you go off by yourselves and buy that boat. Give me your money and come with me. I'll buy it for you."

We followed Green up to the dock where the boat lay, and found her owner near by. Waving us aside, Green opened negotiations. He began cautiously, almost stealthily, approaching the subject from the rear, and with no indication of any interest in it whatever.

"We just dropped down to look at the boat," he said casually. "These queer old-timers are sort of interesting nowadays." He poked around her seams with a pen knife. "Pretty rotten, isn't she?"

"She was new last winter. I built her myself. I've put over \$22 of brand new equipment in her this year," said the owner promptly. "She's the steadiest boat on the river."

"Um," said Green, inspecting the engine. "I suppose she's as steady as any other dock. You don't presume to run her with that mess in there, do you?"

The owner was grieved. "Run her!" he shouted. "Why, man, she ain't missed a pop all summer. She's got a world of power. That engine has never failed to run. A quarter turn will start her every time—"

"You must have run her about 10,000 miles," said Green, examining some more. "That engine is on its last legs. There isn't a bearing left in her. She hasn't got as much compression as an old corset. It will take one hundred dollars to put that engine in shape, and it wasn't worth that new."

"It wasn't!" yelled the owner. "I paid \$225 for that engine and I got a dealer's discount at that; and I've put in a clutch and a new set of coils and a magneto since then, and a new storage battery—"

"You'd have done better to put in a horse," said Green, cruelly. "Where did you get your idea for this model? A houseboat would look like a racer beside this scow. You must have dreamed this plan after a lobster supper."

"She does eight miles an hour all day long with that little bit of an engine," snorted the owner, instantly abandoning the machinery and coming to the rescue of the boat. "She's the best model on the river. If I had any power in her she'd make 12 at least."

"Nice stern you've got," said Green. "Sort of a standing invitation for a sea to come aboard and make itself at home, eh? No wonder you built a chicken coop over your engine. You'd have to bail this thing with a steam pump in a sea. What do you want for her?"



"Seek out these men and linger near them like an undertaker."

By this time we two real buyers were looking nervously for a street car. We didn't want a death trap. We were grateful to Green, but we wanted to go away. The owner might try to give us the boat and we might be tempted to take it.

"She stands me in seven hundred, not counting my time," said the owner. "I wouldn't sell her for anything, but a fellow has given me a big engine and I want to build a speed boat. I'll take \$300 cash, and I'll paint her up first class."

"Three hundred!" yelled Green. "Three hundred for that ark? Why, it would cost that much to put her in shape so that she could beat a duck in a fair race."

The owner was pained. "Ding it! Man, she's in perfect shape," he protested. "I've just overhauled her. She's got brand new cork cushions, too, and a searchlight."

"She's got to be caulked and that rudder gear wouldn't be safe to use on a butter boat," said Green.

"A man offered me four hundred for her last week," said the owner, "but he wanted to use her for towing sand-barges and I wouldn't let her go for no such purpose. She's a bargain at three hundred. She's got a full charge in her storage battery and a nice flag."

"That gasoline tank's tin."

"The feed pipe's lead."

"She's hogged in the middle."

"I just put a new rudder on her, too."

"I'll give you \$150, and not a cent more," said Green. "We couldn't use her to run with, but we might get some salvage out of her brass."

"Two-seventy-five's my bottom figure. There's a fellow from Pekin wants her for three hundred, and he's coming tomorrow. She's got copper paint on her bottom."

"Yes, and that's about all the bottom



"He had built her in his cellar, and, owing to a slight had to jack the house up off its

she's got," said Green. "I'll give you \$225."

"Done," said the man with paralyzing swiftness. "I've got a blank bill of sale right here."

We watched proceedings somewhat dazed and made out the check as Green ordered. Then we shook hands over the bargain, and after he had left we took Green by the throat and asked him why he had bought a prehistoric death trap for us?"

"She's a peach of a boat," said Green, joyfully. "She's worth \$400 at the least."

"But she leaks, and her engine's no good, and she's got no bottom!" I objected.

"Shucks," said Green. "She's the best bargain on the river. But if you'd believed all he said you'd have had to pay \$500."

Gradually Green's method dawned on us and we were properly jubilant. "We've got \$75 left to run her on this



inadvertence in failing to make the boat flexible, he foundations in order to get her out."

summer," I declared joyfully. "We intended to spend \$300 on that boat."

"So you will," said Green menacingly. "That's just about what she will cost you."

Later we found that he came within five dollars of the truth. For when we went to get the boat we found that the owner had artfully removed such things as had not been mentioned in the bargaining, including all the tools, the acetylene tank, the batteries, the anchor, the side lights and the life preservers—and also that the boat had no propeller, and that the timer was a broken reed. But aside from that she was a very good boat and we enjoyed her frabjously.

It is astounding how much boat can occasionally be bought for a little money. Later on, my partner and I bought a 30-ft. cabin boat with a good, heavy-duty 8-hp. engine in it, magneto, storage batteries and kitchen outfit for \$200. The builder had put oak

frames and brass screws all through it, and had built it to ram battleships. But she was not malaria proof, so he sold her to a friend for \$600. This friend, who was eminently fitted for buying old masters and costly books, tried all one summer to make the engine run with a disconnected wire, and will not, even now, allow us to mention the boat in his presence. We have since run the boat upward of 1,500 miles during two seasons, at a total cost for repairs, dockage, improvements, and gasoline, of \$300.

That works out at the rate of 20 cents a mile, which is not exactly cheap traveling. But there is one comfort. You can travel all day in a boat of this sort and not use up more than 60 miles of the 1,500—and by the time you have towed the boat in from her anchorage, have made necessary repairs, have coaxed the engine out of the dumps, and have run five joyous, sea-splashed miles, you have put in a very pleasant afternoon for two, or four or six people—which is cheaper than going to vaudeville or baseball. We always figure on four miles for each gallon of gasoline—it takes more power to plow through water than to run over land—and on long trips we allow our guests to pay for the gasoline, and also to carry it down to the river from the supply stations. It gives them a sense of responsibility and personal interest and is really a favor to them.

The cheapness of second-hand boats, however, is only equaled by the hideous cost of engine repairs. I have learned to look at engine experts with fear and to shudder apprehensively whenever my engine develops any affection which may call for an operation. A year ago we wanted to have the bearings of the Siwash engine overhauled. The proprietor of a machine shop came up with a helper and

a horse and wagon—each separate item of the above drawing 80 cents an hour—and took the engine away to his lair. We tried several times to rescue it, but unsuccessfully. It had been dismembered and for a month it lay around the machine shop in fragments, while at odd times, when business was slack, the proprietor, or his assistant, or the drayman, or the delivery boy would go and do \$1.60, or \$2.40, or \$4.80, or \$6.40 worth of work on it. When it came back the bearings had been tightened, the flywheel loosened, the spark plugs polished, the crank-draw filed, the piston rings replaced, the gasoline connection lost, and the timer manicured. The bill was \$43.20 and when the thing refused to run the proprietor declined to come up and

look at the corpse for less than 60 cents an hour. He knocked off the 20 cents as a concession to old customers.

Since then we have made our own repairs and we have adhered rigidly to one rule. We do not repair the engine as long as it will run. When it ceases to run and makes funny noises in its abdomen, and spits blue smoke and flames at us, and finally becomes cold and dead and limp in the crankshaft, we reluctantly hold a post-mortem and allow an expert to enter the boat, under heavy guard, and with the threat that if he attempts to repair the water line, and the horizon, and the flag staff, over and above the specified job, death on the spot shall be his portion.



COMPULSORY DATING OF AUTOMOBILE TIRES

Bills have been passed, or are pending, in several of the state legislatures, notably those of Minnesota, Georgia and New York, to make the dating of automobile tires compulsory. The principal clause of the New York bill requires that "no person or corporation shall manufacture, sell, offer, or expose for sale a tire for use on a motor vehicle, unless the date when such tire was manufactured shall be impressed or branded upon the material whereof

such tire is constructed, or otherwise indicated by label securely attached thereto. Every person or corporation violating this section shall be liable to a penalty of \$50 for each violation."

An amendment tacked onto the bill, however, made the bill a joke, according to some critics. This amendment relieves the manufacturer from any responsibility for the dating of the tires and places it upon the retail dealer, who has no means of knowing the date of manufacture. This amendment also allows the dealer to apply the date with a rubber stamp.

COMMENT AND REVIEW

AFTER long deliberation and much experimenting England has finally acknowledged the necessity of the aeroplane in modern warfare, and has placed its seal of approval thereon with an initial order for 60 machines. This number will be increased to 100 just as soon as a sufficient number of sky pilots can be trained to navigate them. To fully appreciate the importance which this arm of the service has already attained one must note the appropriations for the current year, by the three great continental powers. France will spend \$6,250,000—a sum sufficient to build a very fair warship; Germany, \$3,500,000; and Britain, \$1,500,000. A total for three countries of \$11,250,000, thus illustrating the increasing and high cost of military living.

*Aeroplanes
Come
High*

THE floods which have swept down the thousand and more miles of Mississippi Valley this year have been unusual because of the more than ordinary loss of life and property. Each year, with patient regularity, about so many thousand settlers along the great watercourse leave their homes and betake themselves and families and live stock to points of land above normal high water. When the flood has passed they return to water-soaked homes, in good condition to contract the various types of sickness which always follow in the wake of an overflow. Even such a deluge as the long-to-be-remembered one of 1912 fails to dislodge any considerable number. Man has much of the habit of the wild animal in this respect, as shown in hamlets and towns rebuilt where the avalanche, flood, eruption, tidal wave and other convulsions of nature have blotted out existence. And in all these instances there is little or nothing the immediate sufferer can do to prevent a recurrence.

*Turn
Waste
into
Wealth*

Of the disasters mentioned, the flood alone is capable of prevention, and the remedy lies not where the flood is found, but back at its many sources. The undertaking in the case of the Mississippi is so vast that prevention is not likely to be attained for many years, though eventually it doubtless will, through an economic condition. If a sufficient number of controllable tributaries should be dammed to hold back one-half or even one-third of the water released each spring, it would not be difficult to handle the volume flowing via the Mississippi with comparative safety. The cost of this control would run into vast sums, and therefore can be accomplished but slowly. If, however, the entrained waters were released through turbines and thus made to produce power, and the same water used over and over again, a sufficiently large revenue might result to meet, or nearly so, the interest on the cost of such construction. And if this direct revenue could be supplemented by a part of the saving from what would otherwise be a large loss, the sum total should make the undertaking at least self-supporting. Obviously the plan could only be effectively worked through Federal control with the coöperation of the several states involved; but with the Panama Canal as an example, the project is far from impossible or impracticable. Perhaps the idea also contains a suggestion as to what to do with our convicts. In work of this nature they could be massed and kept employed for months or years in one place, under conditions which would be alike favorable to the State and to the prisoners.

A BILL was introduced in Congress the other day which confirms the growing belief that what this country needs in its legislative halls is fewer politicians and more men of practical business experience. The bill referred to is for the appropriation of One Hundred Thousand Dollars with which the Secretary of the Navy is to "ascertain whether the target practice of warships and the use of explosives dropped from airships" may supply a means of destroying icebergs. Even the freshest recruit on board ship might reasonably be expected to hit the April ice field which was reported to be 12 miles wide and 65 miles long; but with such a target as that the best gunners and the heaviest shot could effect about as much damage as a small boy with a bean blower. However the bill to bombard 'bergs had not advanced to the point of burning powder when these lines were written.

*Bill to
Bombard
'Bergs*



THE report of the Senate Committee on the "Titanic" disaster is satisfying to our own people. It should cause those British journals which have sought to pour ridicule upon the investigation, and especially upon Chairman Senator Smith, to realize how childishly they have acted. The report does not hesitate to place prime responsibility where it belongs—upon the unfortunate Captain Smith—but does it in no resentful or carping manner. The tenor of the report is to so present facts, based on undisputed testimony, that hereafter the passenger on Atlantic liners shall be safeguarded to the fullest extent possible.

*Senate
Committee
Report*

The British investigation, which is still in progress, started out with the evident intention to minimize responsibility and to whitewash the management, officers and crew. The results of the investigation on this side had, however, been published in England, and public opinion so strongly insisted on having the truth that after a few days of nibbling at the edges, the court ventured on fairly thorough work. It is evident, however, that in the absence of public information, made possible only by our Senate investigation, the full measure of incompetence, unpreparedness, and utter disregard of the rudimental laws of safety would never have been revealed.

The insults heaped upon Senator Smith by the British press serve but to emphasize the service he has done humanity in exposing conditions little dreamed of, and which, now known, will result in great reforms.



THE inestimable service which the wireless rendered in the rescue of the "Titanic" survivors is alone sufficient to immortalize the name of Marconi; in the confusion and excitement of events the daily press paid scant praise to the great inventor, who already has saved nearly 5,000 lives. It is very apparent, however, that the continued employment of beardless youths in the wireless station of passenger liners must cease. Positions involving so momentous responsibilities are not in the nature of things fully realized by boys in their teens. This is one of the reforms international conference must secure, and should require not only

*Wireless
Needs
Men*

examination as to wireless ability, but even more as to fitness of operators. That the mere sending or receiving of wireless is anything but difficult is attested by the thousands of grammar and high-school boys who are already operating for pleasure, but the qualities of mature judgment and endurance are a prime necessity. Moreover, a reasonable number of Atlantic steamers should, when crossing, be required to maintain unbroken attendance in the "spark house," not for their own advantage, but to provide for the receiving of distress messages from other vessels.

If governments should now impose upon ship stations conditions which seem onerous to steamship companies, the penalty is not undeserved. Hereafter it must be impossible for even the president of a steamship line to absolutely throttle the voice of wireless. Imagine a city of 2,500 souls swept with sudden disaster, with 1,800 residents dead or dying, and the mayor of the town or the president of the telegraph company controlling the one telegraph wire and withholding all details for four days!

Since the above lines were written the Senate of the United States passed a bill, without discussion and without one dissenting vote, requiring two or more wireless operators on every vessel carrying 100 or more persons—crew or passengers—landing at our ports. One operator to be always on duty, night or day. Other countries will doubtless soon enforce the same requirement.



AND while at-sea stations are being reorganized on a better basis, the question of auxiliary power to operate the wireless should not be overlooked. In the case in mind the electric plant was successfully operated up to the last moment. Had the ship swung on to the iceberg a second or two later than she did, the engine room instead of the forward compartments would have been flooded, immediately extinguishing all the lights and hushing the voice of the wireless. It may be recalled that this danger to the ship's station was commented on in these pages two years ago, at which time it was urged that an independent gas-engine power be provided on the upper deck in order to secure telegraphic communication to the very last instant. That this equipment will hereafter be secured seems likely, either by law, or voluntarily, as in the case of the "Megantic" now building.

*Auxiliary
Wireless
Power*



WHILE on the subject of wireless it is interesting to note the progress being made to extend the inter-continental service. Our own government through the Navy Department is already constructing the longest chain of wireless stations in existence. This system will permit Washington to communicate with our own stations in Alaska, the Panama Canal Zone, San Francisco, Pearl Harbor, Hawaii; Tutuila Island, in the Samoas; and Guam, and Luzon, in the Philippine Islands. Each of these stations is to have a sending radius of at least 3,000 miles.

*World-
Wide
Wireless*

For commercial service the Marconi Company have planned a series of stations which will entirely encircle the globe; and the work of construction will be begun in the near future. An American steam-

ship company has also announced its intention to proceed at once with the erection of three tower stations which will connect our Gulf coast with South America, thus furnishing communication with land stations there, for the first time. In a few years all the continents and the more important islands of the sea will be linked with an invisible network of communication. What a story of scientific and mechanical progress has been written from the days of the Spaniard Salva, who in 1795 dreamed of a submarine telegraph, to those of Morse in 1866, and now to the realization of a world-wide wireless system!



A CERTAIN new depot, recently completed in Chicago, is a wonderful exemplification of painstaking study to provide the traveling public with every possible convenience. Roomy elevators toss the passengers swiftly from street to train floor, bureaus of information supply an endless fund of knowledge, electric lights on stairway landings prevent stumbling, and of course restaurants, telephones, telegraphs, cabs, drug store, news stands and the like are convenient and ample. Even the large space set apart for immigrant passengers traveling second class must appear like a palace to these people, with its white tiling everywhere, and rest rooms, restaurant, baths, laundry, hospital, and, in fact, no reasonable want unprovided.

*To Please
the
Public*

But the thing which most impressed me was not the magnificence of the building which cost a lot of millions, nor the beautiful marble, nor the high arched waiting room. It was a plain mahogany box, fastened to the wall where everyone who goes in or out can see it. And on this box are the significant words:

"TO PLEASE THE PUBLIC

Drop your suggestions in this box."

Having supplied everything that the best engineers and builders in America and Europe could suggest, or money can buy, there is provided this simple, dignified invitation to its millions of travelers each year, this last word of invitation to suggest some improvement unthought of by its own officers and employes.

What a contrast the little mahogany box of today offers to the expressed policy of the greatest railroad owner of 40 years ago, who said, "The Public be——" Well, you know what.

H. H. WINDSOR



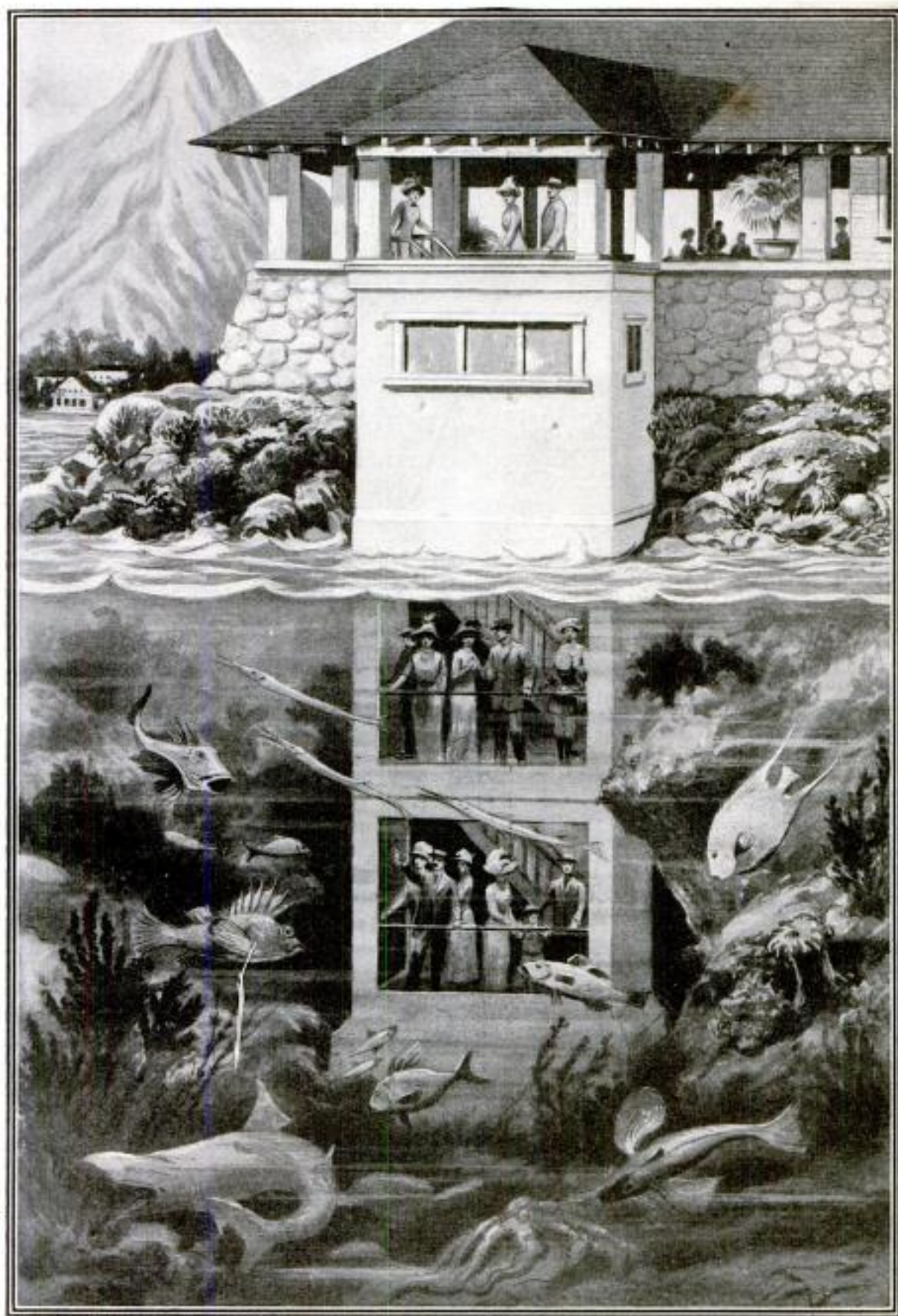

Business men of Honolulu, Hawaii, are preparing to build a modern hotel on the reef off Diamond Head, where the naval station is located. The most interesting feature of the hotel will be a glass-walled shaft which will extend down into the sea, allowing the guests to descend and observe the wonderful sea life in that locality.

AN UMBRELLA CARRIER

An ingenious carrier for umbrellas and parasols, designed to prevent the loss of this often forgotten article, has been invented by an English woman. It is a hanger made of cord designed to be passed around one shoulder, and the umbrella or parasol is hung from it in somewhat the same manner as a sword.



A RESOURCEFUL "ENGINEER"

The following story has been taken from Electrical Engineering, and is said to have been sent by a correspondent in Australia: There is a little town of 2,000 people, away back in the bush of New South Wales, which can boast of an antiquated electric-light station,

under the charge of a "chief electrical engineer," appointed by the aldermen of the district, and simultane-

ously performing the duties of stoker, wireman, and engine driver. He is also the leading and only electrical contractor in the town, and for some years past has reaped a very handsome income by selling metal-filament lamps to the farmers and other consumers at about 6s. each.

It happened not long ago that one of the farmers came to town, and was very much struck at the ridiculously low price for which he could obtain metal-filament lamps in the city, and on his advice the enterprising concern from which he obtained his lamps sent a traveler up to his town, and, in the absence of the previously mentioned "chief electrical engineer," disposed of some few hundred lamps at the ordinary selling price.

When our friend returned to his official duties, he realized that the sale of his expensive lamps had been considerably handicapped. But he was previously a marine engineer, and we all know that marine engineers are not to be easily cornered. The same evening, therefore, he thought it advisable to boost up his voltage, until every lamp in the town popped off. The next morning he took a push cart around town heavily laden with his own lamps, and told the poor farmers that if they would speculate on these inferior cheap German lamps they would have to stand the consequences.

SNAIL WALKS SAFELY OVER RAZOR'S EDGE

That snails can pass over such sharp implements as a razor's edge without the slightest harm has been demon-



A Snail Crawling Over the Sharp Edge of a Razor Without Cutting Itself

strated by a French scientist in the course of his study of these creatures, which are so well equipped for travel that they can move over surfaces exceptionally dangerous to seemingly better protected animals.

The snail walks with the whole under surface of its body, and is provided with means to lubricate the road on which it travels. A peculiarly complex system of muscles enables it to cling in any position to the smoothest objects. In lifting itself over the razor's edge it clings with the hind part of its walking surface to one side of the blade, and extends the fore part and bends it down onto the other side

without touching the edge, thus accomplishing without harm what would naturally seem impossible.

CONCRETE ARCHES FORM BASE FOR TOMBSTONES

An unusual and interesting application of concrete has been adopted in the old cemetery at Portsmouth, N. H., to make a marshy section of ground available for graves. A section of the eastern edge of the cemetery, which is not far from a salt marsh that stretches in from the sea, was recently purchased by the trustees of the Home for the Aged. This land had long been considered too low and wet for burial purposes, but the trustees made it available by sinking concrete columns to bedrock and resting concrete arches upon them, there being nine rows, and nine arches to each row. At the lowest point of the slope the arches rose to a height of 6 ft. above the sur-



Rows of Concrete Arches Erected in Low Ground of an Old Cemetery at Portsmouth, N. H., as Grave-stone Foundations

face, requiring a considerable earth fill to raise the ground level to a height of 6 in. above the rows of arches. The arches will be used as foundations upon which the gravestones will rest as needed, and it is calculated that the foundations so constructed are of sufficient depth and weight to withstand upheaval by the frost.

THE MOTOR CAR AS A COW PONY

Probably the most remarkable demonstration of an automobile to a prospective purchaser of the machine was made by Gordon Kelly, a Los Angeles motor enthusiast, to a Southern California ranch owner. The latter was interested in cars, and Mr. Kelly took one out to his

ranch to show what it could do. While driving it over the land, the rancher suddenly noticed that one of his half-wild cows had strayed from the herd and was making for the hills. None of the cowboys happened to be in sight and the owner, Mr. A. V. Jones, was annoyed at seeing his animal escape.



The Automobile as a Steed for the Cowboy: Roping a Cow from the Front Seat of the Machine

The motor salesman was equal to the emergency. "I will help you get that cow," he said, "if you will handle the rope." As Jones was a lariat expert, and happened to have a coil of rope in the car, he agreed. The automobile was speeded up and bumped over the rough ground at a pace too great for any wild cow. The animal was overtaken, and Jones whirled his noose in true cowboy style, catching the creature by the neck. Mr. Kelly, at the wheel, did his part like a veteran cow-puncher and brought the car around at the proper moment to throw the animal, which, once subdued, returned quietly to the herd.

Naturally the rancher was delighted at this exhibition of the car's adaptability to ranch life, and promptly made out his check, thus becoming the owner of the first "gasoline broncho" on record.

TIGER'S HEAD OUTLINED IN CIRCISSIAN WALNUT

A piece of Circassian walnut veneer, the natural markings of which showed one-half of a tiger's head, was recently discovered in a New York veneer plant. A long search was made to find



A Tiger's Head in the Natural Markings of Circassian Walnut Veneer

the duplicate, but only a near duplicate of the perfectly symmetrical veneer could be found. The two pieces were mounted as shown and placed in a window. It has attracted much attention as a freak of nature, and an offer was made for it by a man who intended presenting it to Tammany Hall.

NEW TYPE OF BLOCK SIGNAL FOR COLD WEATHER

During last winter the various railroads experienced considerable difficulty in operating their block signals with any degree of accuracy, on account of the accumulations of ice and frost on the signal lamps. An inter-urban electric railway company, operating in northern Ohio, claims to have overcome the difficulty and solved the problem of operating block systems in cold weather by the use of a new type of signal.

This new signal is arranged to be lighted by a 25-watt tungsten lamp, which in this particular case was supplied with electrical energy from the trolley wire, a suitable resistance being connected in series with it. The switch-controlling mechanism is operated by a small motor, which also derives its energy from the trolley wire, and is so designed that it will operate safely through a wide variation of line pressures. The heat generated in the lamp and the resistance in series with it, are ample to prevent the accumulation of ice on the lenses of the lamp and the switch-operating mechanism. Of course, in the case of a steam road, it would be necessary to install batteries of considerable capacity at different points along the road to supply energy to the lamp; and to provide sufficient resistance to bring about the desired results.

According to the law, as decided by the courts, an oil company can post a location notice on a tombstone in California, and sink an oil well within 20 ft. of the graves, even though the land be held under a federal patent.

FAMOUS SAINT MARK'S CAMPANILE RESTORED

The famous Campanile of St. Mark's, Venice, which fell to the ground in 1902, crushing with it the Sansovine Loggia, is now restored after 10 years of work. The new Campanile is in every detail of appearance like the old, but is constructed in the light of modern science and possibly with more enduring skill.

The old Campanile di San Marco, like others of its kind, was the work of many generations, having been started in the year 888, added to in 948 and 1148, and completed to the platform in 1170. Its foundation was a rectangular base of Istrian stone, and its brick walls tapered gently up to a height of 200 ft., in a series of eight stories pierced with windows. Above the platform rose an open loggia of marble, 50 ft. high, being the actual belfry, wherein hung five great bells of bronze.

The Famous Campanile of St. Mark's, Venice, as It Appeared a Short Time Previous to the Completion of Its Restoration

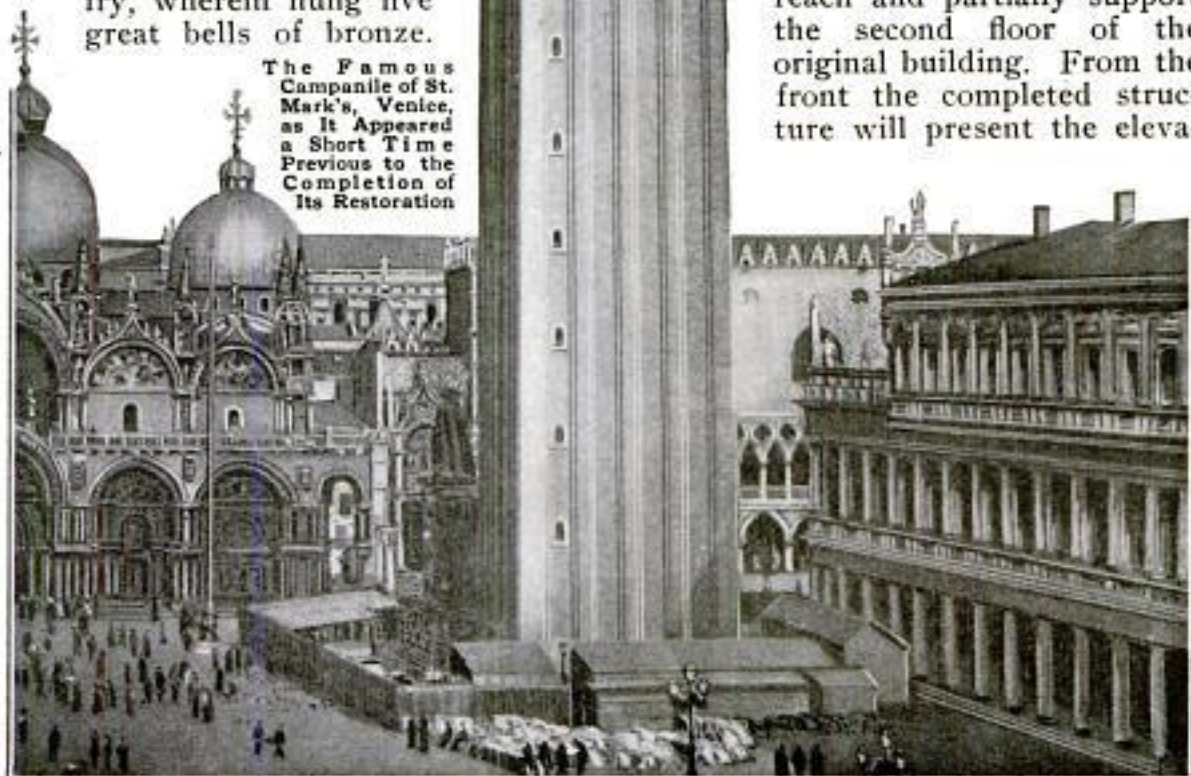

The high-pitched roof of the belfry was surmounted by the metal figure of an angel, 16 ft. high, the total height thus being brought to 325 ft.

AN UNUSUAL HOTEL ANNEX

An apartment hotel which stands on the top of a steep hill in Los Angeles is to have an annex, the construction of which turns ordinary construction methods topsy-turvy. The present building is four stories high and is reached by steps winding up a massive stone retaining wall. In the addition of an annex the retaining wall is to be removed, a section of the hill, 52 ft. wide by 40 ft. in depth, is to be cut out, and in the space thus created will be erected a five-story building that will just reach and partially support the second floor of the original building. From the front the completed structure will present the eleva-

tion of an eight-story building, with the upper stories set back some distance from the cornice level. The roof of the addition will constitute an open terrace in front of what will be the sixth story.

CURIOUS "FREAK" OF A BULLET

In shooting with a 38-caliber automatic revolver at a target made of a block of wood, 10 in. thick, the bull's-eye of which was a tin button, such as is used in fastening



tarred paper roofing, one of the marksmen succeeded in hitting a shingle nail, which was used to fasten the button, almost exactly in the center. Upon splitting the block of wood to recover the bullets, it was found that the bullet which hit the bull's-eye had penetrated 8½ in. into the wood, and, in its course, had enveloped the shingle nail and taken it with it. The manner in which the bullet enveloped the nail is shown in the illustration.

WHOLE CITY TO BE HEATED BY ELECTRICITY

Plans are being formulated to heat electrically the dwellings and business houses of Stavanger, in Norway, and the officials of the electric plant at that place have applied to the city council

for permission to carry out their proposed undertaking. The population of Stavanger is about 30,000 and there are ample water-power facilities available to develop at least 25,000 hp. for electrical purposes. As it is planned at present, no customer will be allowed a greater consumption than 100 hp., and owing to the exceedingly low cost of production, the price per horsepower for one year will be only about seven dollars. The city officials are also considering the advisability of heating the public buildings by means of electricity.

TY COBB TWICE; A UNIQUE PHOTOGRAPH

The photograph of the Detroit Tigers here reproduced has created much comment, in that Ty Cobb, considered one of the greatest, if not the greatest baseball player in the world today, appears twice. The way in which he succeeded in appearing twice, however, is a very simple matter. The camera used to take the picture was of the panorama type, which was made to revolve slowly from left to right, exposing but a small portion of the film at a time. Cobb stood third from the left end of the line of players shown in the illustration when the camera started and as soon as the lens had passed him he sprinted around back of the camera and was standing at the



Copyright, 1912, Duines & Co., Detroit

A Unique Photograph of the Detroit Baseball Team



The Epsom Race: after a Painting by Géricault

right of the line before the camera reached the end of the picture.

Some of the baseball fans surmise that he did not like the serious expression of his face when the camera first caught him and sprinted around to the other end to get his smile into the picture. Others remark that he is most of the team anyway and in full justice might have been taken four or five times instead of only twice.

MOTION IN ART AND IN REALITY

How far the means of visualizing swift motion usually adopted by painters differs from the actual performance in reality is well demonstrated in the accompanying illustrations. One of these is from a painting of the Epsom Race, one of the famous annual racing classics of England, painted by Géricault. It cannot

be denied that this painting conveys an impression of speed, yet there is not one attitude of the horse as shown



Motion Picture of a Galloping Horse

by the motion pictures that is anywhere near like that of any of the horses in the painting.



In Which Ty Cobb Makes His Appearance Twice

A JACKDAW THAT GOES TO SCHOOL

An unusual companionship between a small boy and a jackdaw exists in



The Jackdaw in His Master's Arms

the village of Upton, Berkshire, Eng. The boy is Joseph Butler, aged 12, and



Perched on the Desk and Looking Wise While His Master Recites

the jackdaw, which is now two years old, and which was found by him after falling from its nest while young, is never satisfied to let him out of sight. The bird is so fond of the boy that it goes to school and to church with him, pecks other boys who fight him, sits by him at meals, and sets up a mournful cawing when kept away from him. For over a year now the bird has gone to school with its young master, sitting quietly on his desk. The teacher allows the bird in the school, since, if she kept it out, its caws as it fluttered around the schoolhouse would disturb the other children.

NETTLE A SUBSTITUTE FOR COTTON

In the last few years a great many experiments have been made on various materials in an effort to find a suitable substitute for cotton. The most promising plant, on account of the strength of its fiber and its ready growth under very adverse conditions together with its large yield per acre, is the common nettle, and by a recently invented method of treatment which seems to have solved the problem, it now gives us a fair substitute for cotton in many of its uses.

In the new treatment the dried nettle stems are first boiled for a short time in dilute soda lye, which loosens the fibers from the woody stems. The fibers are then separated from the woody portions by means of brushes in a special machine and subjected alternately to boilings in dilute lye and thorough washings. The resulting product is a yellowish mass of fine fibers, which are entirely free from gum and may be bleached, combed and spun into yarn. This yarn is claimed to have the smoothness and softness of flax, and a strength greater than that of hemp; may be woven into damask, or used, alone or in combination with other threads, in making ribbons, upholstery, and numerous other fabrics.



Song of the Dynamite Blast

By J. W. FOLEY

I SLEEP, and I am still as death,
Inert and hurtless as a stone.
I wake, and in my flaming breath
Are rock-bound temples overthrown.
Caress me, and I lie as still
As when the adder slumbers deep;
But strike me, and I rise to kill
Who wakes me from my torpid sleep.

Asleep, I have no voice or will,
But strength that lies in me unspent.
Awake, I rend and maim and kill
Who may not fly. By me were rent
Those granite rocks, that long defied
The puny strength of man to mar.
I spake, and they were brushed aside
Like leaves, and split as faggots are.

From out my wakened throat a roar;
From opened eyes my flame-shot glare;
My arms hurl thunderbolts that score
The steel, and toss them high in air,
Those great, gray rocks, like pebbles flung
From slings; I crush them at my will,
And with a demon's angry tongue
Exult my ruin—and am still!

My putty-mass is soft and sleek
As is the drowsy tiger's paw;
But rouse me, and red scars I wreak
When I unsheathe my hidden claw;
I cleave the granite, twist the steel,
And lay the temple in debris;
I crush the rib and smash the keel,
For ruin hides, but bides in me.

Bind me with manacles of steel,
House me in narrow walls of stone;
Gird me with granite thongs, and feel
My sinews quiver; and the bone
And brawn of me in fury lay
In wreck what prison walls may be.
I smite, I strike, I split, I slay—
And I am—as I would be—free!





Young English Miners Playing Sand Billiards During the Recent Strike

RAILWAY SIGNAL MAN HAS BABOON ASSISTANT

Through an accident on the Transvaal Railway this man lost the lower part of both his legs, and when he recovered was given a position as signalman. In order to assist him in getting about on his truck he trained a young baboon, who faithfully pushes the truck along.



A Crippled Signalman on the Transvaal Railway and His Baboon Assistant

NEW GAME FOR THE SEASHORE

During the coal strike in England a number of young South Shields miners, seeking new ways of amusing themselves, invented a new game, or, at least, adapted an old one to new conditions. They leveled off a portion of the sand to represent a table and gouged out six or seven cups or holes at one end, each hole having a different value, according to its size. The object of the game is to roll the ball into one of the holes. They called the game sand billiards.

STUDENTS CONSTRUCT OUTFIT FOR EXPERIMENTATION

When the board of school directors of Antis township, Pa., failed to realize the importance of experimental work in agriculture and physics in the high school, because the equipment was too costly, Prof. J. L. Zerbe relied upon the ability and resources of his students. The students were eager to assist. The boys, at recess and noon periods, worked faithfully for two months in the cellar making models,

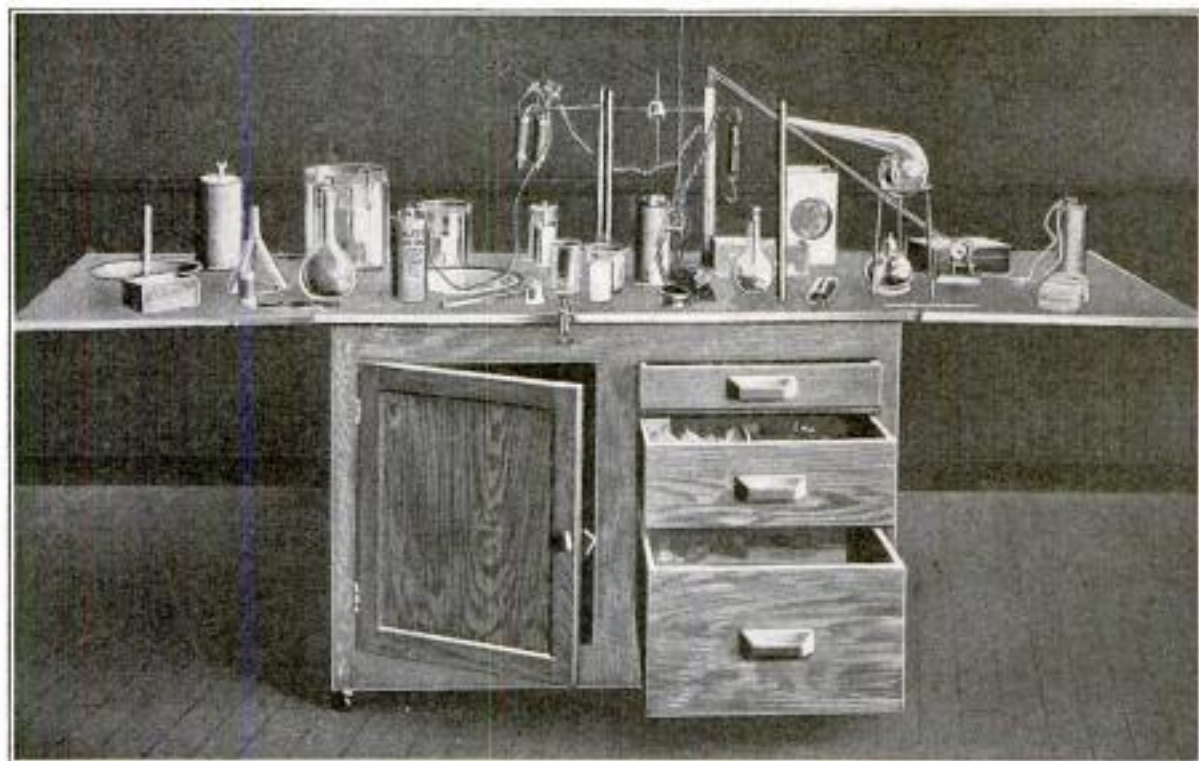

Experimental Apparatus and Case Made by Students When School Authorities Declined to Purchase Outfit

other equipment, and a case for the experimental apparatus, while the girls prepared the delicate parts and did most of the intricate mounting. The case, when open, has a working space of 30 by 88 in. It contains a sink connected with a reservoir from which the water is raised by a force pump. The equipment is complete, being sufficient to perform all experiments necessary for college-entrance requirements. The cost of the entire outfit did not exceed twenty dollars.

A "PUSHMOBILE" AUTOMOBILE

Two Philadelphia boys have combined a motorcycle engine with a "pushmobile" wagon and made preparations for an endurance run to Atlantic City. The illustration shows the little machine in detail. The own-



An Interesting Little Motorcycle-Engined Automobile Built by Two Philadelphia Boys

ers claim a speed of 18 miles an hour without much effort on the part of the little motor. The machine is started with a push. One boy sets it going, jumps in, and away they go.

AIR-PROPELLER ALARM FOR AUTOMOBILES

An ingenious propeller-driven alarm bell for automobiles has made its appearance in Paris. The shaft on which the propeller is mounted passes

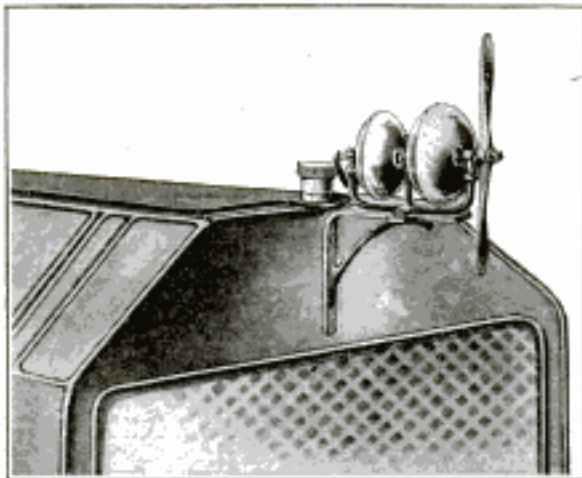

An Automobile Alarm Bell Rung by an Aerial Propeller Driven by the Resistance It Offers to the Rush of Air Against a Running Car

through the bells and has hammers mounted upon it in such manner as to keep striking as the shaft revolves. The outfit is mounted on an automobile so that, when the chauffeur operates the mechanism which releases the shaft, the propeller is whirled by the resistance it offers to the rush of air. The propeller whirls and the bell rings until the chauffeur operates the mechanism locking the shaft again.

TAXICAB TELEPHONE SYSTEM

In a great many cases, livery companies are unable to use their conveyances to the best advantage, owing to the fact that it is impossible to communicate with the drivers after they have started out with a fare. It quite frequently happens that a driver is sent to some remote part of the city with a fare and then must return empty, while another driver may be sent to a neighboring section for a

fare, and must go out empty. If, however, some means were provided for communicating with the first driver he might not need to return empty, nor would, perhaps, the second driver have to leave the station. This would result in a considerable saving in what is now known as "dead" mileage. For this reason a Pittsburg taxicab company is installing a telephone system, with telephone boxes placed at various points throughout the city, so that the driver of the taxicab may communicate with the company's central office before returning, in order to ascertain whether another fare may be picked up on the way back, thus eliminating the necessity of sending a second machine to the same neighborhood.

STREET-CROSSING KIOSKS FOR POLICEMEN

Street traffic in Paris has been controlled by policemen placed at crossings and provided with whistles, as has become the custom in several of the largest cities in America, but a new signaling system is now being tried out which makes use of an ornamental kiosk, the roof of which is equipped with signal boards. These kiosks, which are placed at the crossings, are glass-covered, and the policeman takes his stand on an elevation inside the structure, from which he has an unobstructed view of the traffic ways. Above the roof, mounted on a shaft, is a cube-shaped, box-like affair, painted white, which is provided with two wing-like extensions. The shaft is turned by a wheel inside the kiosk, and the direction in which the wings face indicates to traffic whether to stop or proceed.



STATE COLLEGE HAS POULTRY HOSPITAL

The Rhode Island Experiment Station has established, at the poultry department of the Rhode Island State College, the most unusual institution for the treatment of the diseases of poultry yet established. It is called the poultry "hospital" and owes its name to the fact that it is primarily an institution for the curing of poultry diseases, just as much as our own hospitals are for the advancement of science in curing the human ailments. This hospital consists of a house of modest appearance, where the patients are treated, and an extensive caged area where the patients may be turned out for exercise and sunshine. This provides for observation of the diseased inmates of the institution, as



The Poultry "Hospital" at the Rhode Island Experiment Station

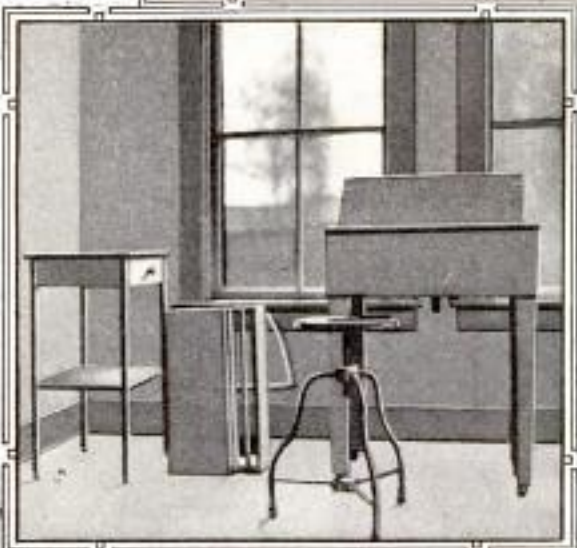

On Left—The Operating Room

nearly under normal conditions as possible.

The hospital building is a small one-story building and would scarcely attract the attention any more than the other buildings of the poultry plant. Yet, it is most interesting in the uses to which it is put. It is divided into four rooms, an office, a laboratory, an operating room, and a "patients' ward," or sanitary-pen room. In the office the head of the biological department of the experiment station, Dr. Philip B. Hadley, conducts the work of the institution. Here the data of the diseased patients are compiled together with the results which may be valuable in combating the diseases investigated. The

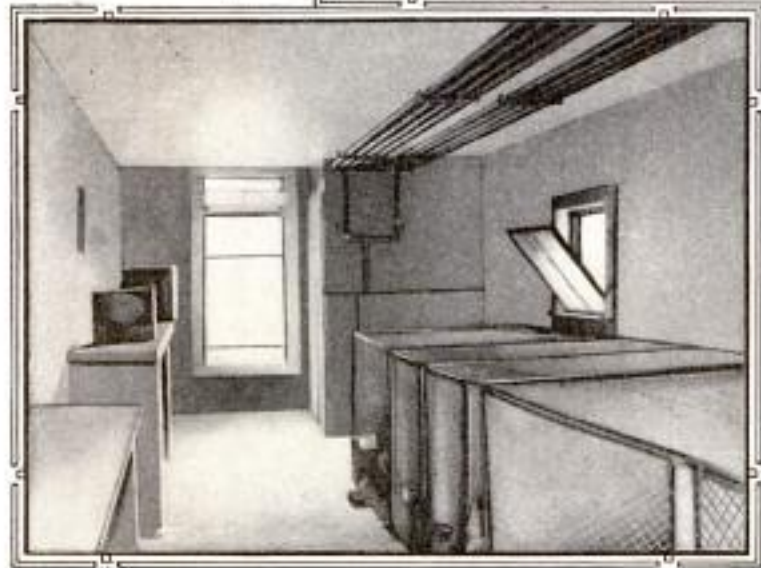

The Sanitary-Pen Room of the Poultry Hospital

interesting in the uses to which it is put. It is divided into four rooms, an office, a laboratory, an operating room, and a "patients' ward," or sanitary-pen room. In the office the head of the biological department of the experiment station, Dr. Philip B. Hadley, conducts the work of the institution. Here the data of the diseased patients are compiled together with the results which may be valuable in combating the diseases investigated. The

laboratory is equipped with various kinds of apparatus for the bacteriological investigations, and here is where all the cultures of the diseases investigated are kept and experimented with. Of course, it must be taken into consideration that the work of the institution is more for the prevention and cure of diseases than for the cure of the individual fowls afflicted. Yet the out-of-town patients are rather numerous, for feathered patients are often sent to the hospital to have their ailments diagnosed. In this way the institution is of great value to the state and aids in the suppression of poultry diseases, which would otherwise greatly handicap this most important New England industry. Besides the usual equipment the laboratory is provided with sterilizers, and workbenches offering facilities which are usually found only in the best bacteriological workrooms. The operating room is painted in white enamel and is well lighted for any operations on or inoculations of the feathered patients. As in institutions for humans, most of the furnishings are finished in enamel, and the operating tables are glass or porcelain-topped in

order to minimize the possibility of infection. A special apparatus has been devised to hold the fowls during the operations, and as anesthetics are used, the patients suffer little or no pain. The instruments are kept in a glass case and as carefully sterilized as in the best city hospitals, and during operations the attendants are obliged to wear the same sanitary cloak and observe the same precautions as required in hospitals for human beings.

In that department which might be called the "ward room," are a number of sanitary pens where patients may be kept. This room is finished in concrete and has a concrete floor, making it as nearly antiseptic as possible. Here suspected or innocuous patients are kept while being investigated for different diseases.

It is believed that much good may accrue from the investigations conducted by this addition to the station, which is at present the only one of its kind in the United States, if not in the world. The department is at present devoting its efforts to the discovery of means by which cholera among poultry may be prevented or cured.

RAILWAY ON WHICH CARS FLOAT ABOVE RAILS

Passenger coaches that float above and between guide rails, with nothing touching except the brushes that control the electrical current, is the dream of a Franco-American inventor of Mount Vernon, New York, who has succeeded in obtaining results with a model apparatus.

In this apparatus, the Foucault or eddy currents induced in a piece of metal placed in an alternating mag-

netic field are utilized to sustain, or, in other words, to make the car float between the guide rails. At frequent intervals upon the model roadbed are placed large electromagnets, so arranged that an alternating current may be passed through them. Only those magnets that are adjacent to the car are energized, the current being controlled by brushes attached to the car and making connection by touching the

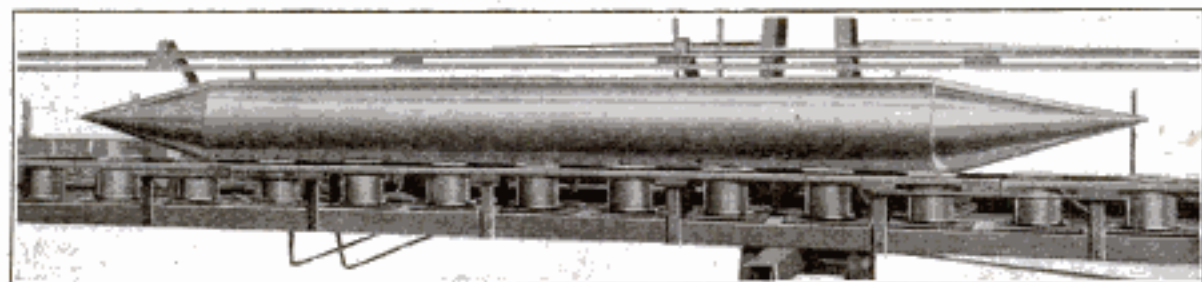

One of the Cylindrical Model Cars in Position over the Electromagnets

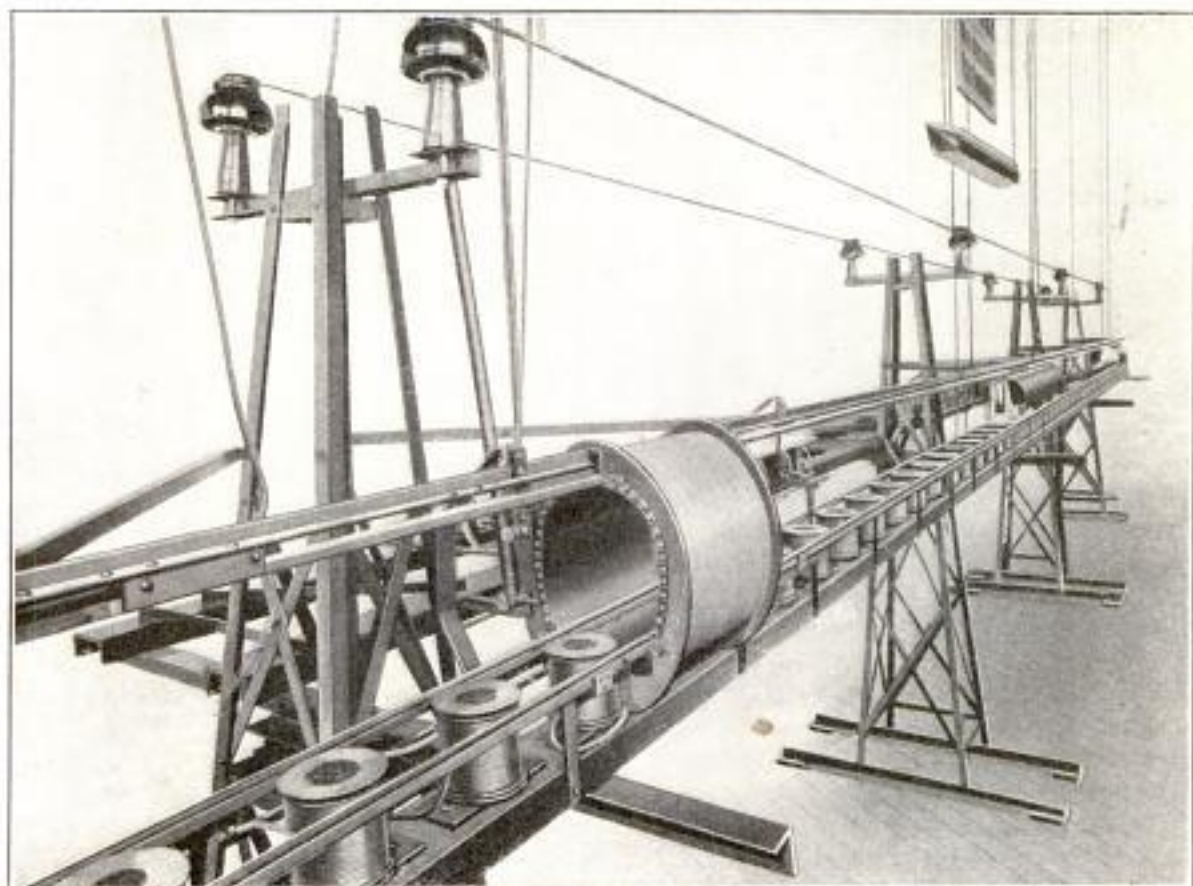

The Roadway, Showing the Single Line of Electromagnets Directly Above Which the Car Floats and is Drawn Along, and One of the Propelling Solenoids

guide rails. In addition to making the electric connection these brushes also serve as guides to keep the car directly over the electromagnets.

Two model roads have been constructed, one of which has the electromagnets in a line directly in the center of the roadbed, while the other has two rows, running parallel, above and between which the car is sustained. With the first-mentioned type of roadway the large aluminum plate which plays such an important part in the unique invention forms the base of the car, while in the second type the car is provided with two aluminum plates, arranged one on each side of the car, so that each line of electromagnets will have a plate directly above it. When the electromagnets are energized by an alternating current, the aluminum plate, or plates, are in a strong alternating magnetic field, which results in eddy currents being induced in the plate. These eddy currents react upon the magnetic field and produce the



This Illustration Shows the Type in Which a Double Row of Electromagnets is Utilized. The Child is Seated in a Chair Placed on an 18-Foot Model Car, the Whole Being Suspended in the Air by the Action of the Electromagnets. Notice Space between the Tops of the Electromagnets and the Aluminum Plates

force tending to raise and float the car. In addition to the single or double line of electromagnets, solenoids are located at regular intervals, the purpose of which is to provide propulsion for the car. As the iron car approaches, these solenoids become energized and draw it toward them, and the instant the car reaches a neutral position within them, the magnetic effect is reversed, the succeeding solenoids in the line in turn exerting the attractive force.

The inventor of this scheme claims that enormous velocities may be attained as the only friction to overcome is that of the air and the little friction due to the brushes on the rails. He proposes to reduce the friction of the air by making the ends of the car body conical in shape and the main portion cylindrical and very smooth.

The device may appear to practically eliminate mechanical friction, but it is reduced at an enormous cost. The inventor claims he can lift a weight

of about 12 lb. with one kilowatt of power. Neglecting the weight of the car and assuming there are 50 passengers in each car and each weighs 150 lb. we have a total of 7,500 lb. If one kilowatt will lift 12 lb., 625 kilowatts will be required to lift the above passenger load, which neglects the weight of the car, the propelling power required, etc. An electric locomotive that will develop about 2,000 hp. will haul a five-car passenger train up to a speed of at least 70 miles per hour. There would be 3,125 kilowatts or about 4,000 hp. required to lift 250 passengers, or the power required to merely lift the passengers in five cars would be about twice the power required to haul the entire train on an ordinary electric road. The gain in speed seems to be the greatest advantage possessed by the new scheme, but it must be remembered that air friction is not overcome and that this varies as the square of the speed, so it soon becomes exceedingly large.

AUTOMOBILE PUMPS WATER

The owner of a ranch in California recently built a large storage reservoir for irrigation purposes, and adopted a novel scheme for pumping into it. He runs his automobile into position as shown in the illustration, and makes a belt connection with a rotary pump by

means of a large band wheel attached to the driving axle outside one of the rear wheels. The statement is made that water is pumped at the rate of 250 gal. per minute by this arrangement. The storage reservoir will hold 500,000 gal.



An Automobile-Driven Rotary Pump Used to Fill an Irrigation Reservoir on a California Ranch

THE FIRST AMERICAN AERO SHOW

By JAMES R. QUIRK

THE United States may be lagging behind France, England, and Germany in number of aeroplanes in use, and, perhaps, in public interest in aviation, but the first American aeronautic show held recently at the Grand Central Palace, New York, furnished sufficient evidence that real progress in the art of aviation is being worked out in this country by American brains.

Responsibility for our position in the world of aeronautics cannot be placed upon the manufacturers for they but serve the public. Nor can it be blamed upon the public whose enthusiasm has apparently waned in the past year or so. It is but natural in this day of wonderfully fast development in the arts and sciences that the spectacle of man flight should, in a few years, become commonplace to such a degree that the public peers into the sky and views the maneuvers of an aeroplane with no more wonderment than that with which it gazes on an automobilist racing at high speed.

Blame has been placed upon the government for not encouraging aviation to the extent that some of the European countries do, but the gentlemen in Congress who hold the purse strings which even our War and Navy Departments cannot loosen, feel that there is no more reason for the United States joining in the European aviation competition than that we should compete with them in the size of the standing armies.

Sound construction and scientific design, based upon investigation and experience marked the majority of the machines at the American show, and there were but a few of the class which can be termed "freaks." This is an encouraging sign. The day has passed when an inventor can, with any hope of success, impose upon the credulity of the public in announcements of a discovery which will "revolutionize the art of aviation."

One of the important features of this show, as in the recent London and Paris exhibits, was the increasing

realization of the importance of the streamline form in the design of wings and body. A monoplane, designed and constructed by Edson Gallaudet, utilizes, probably to a greater extent than any other machine ever built, the advantages of this new theory. Many fine flights have already been made with it. Nieuport, whose recent untimely death was a blow to aviation, was one of the first designers to incorporate this theory in the design of his machines, and his monoplanes still hold world's records for speed. It is obvious that a realization of the great advantage of making the air pay back some of the force used in overcoming head resistance is having a potent influence.

Refinement of detail and increasing strength of structure are the only changes visible in the Wright and Curtiss machines. Reference to the illustration of the 1912 Wright biplane will show small, rectangular vertical planes on the front. This is one of the results of the classic Kitty Hawk experiments of last year.

The advent of the hydro-aeroplane, for which America can claim a large share of credit, is, in the opinion of many builders, a thing that may cause aviation to be taken up as a sport much sooner than it otherwise would, and the number of the combination water-and-air craft, was one of the most interesting features of the Central Palace Exhibit. A most interesting design is that credited to Grover C. Loening, a veritable winged boat.

The New York show demonstrated the extent to which the aeroplane has developed as a commercial factor. In addition to the scores of firms which have been organized for the purpose of manufacturing aeroplane engines and parts, a number of the largest concerns in the country are taking up the manufacture of materials and supplies. A few years ago it was considered almost impossible to secure good aviation engines in this country. Now this impression has vanished.

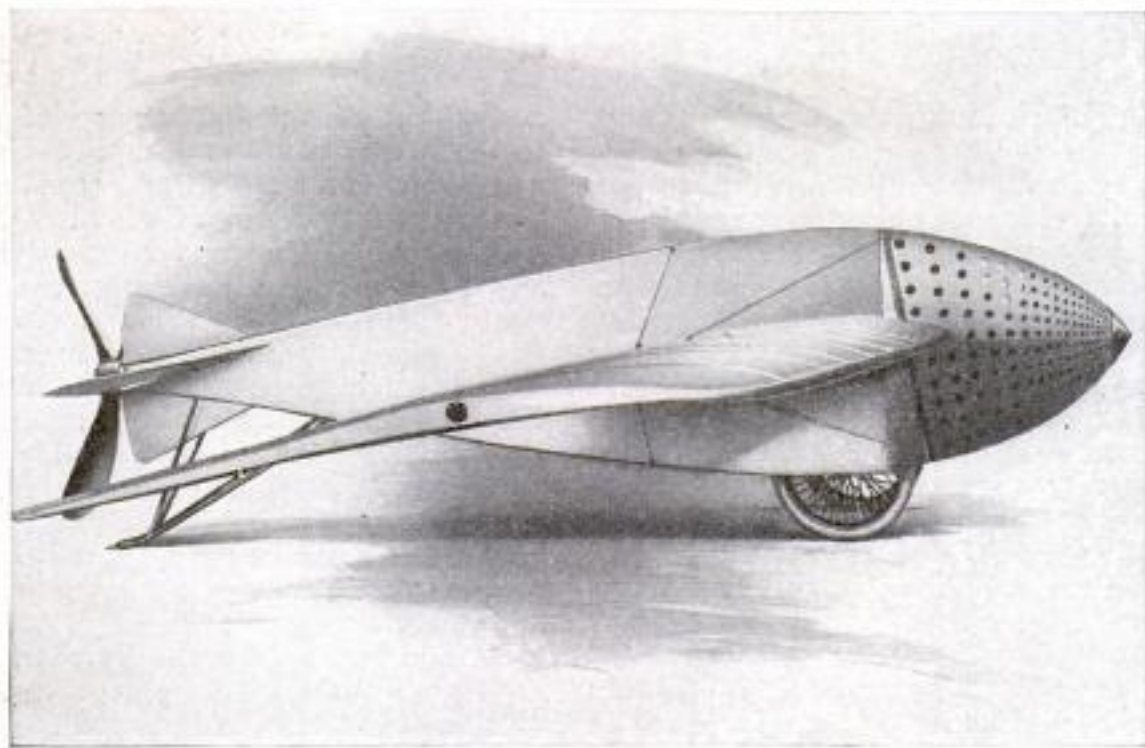

The Bullet, One of the New Machines at the Aeronautic Show. 100-Horsepower Air-Cooled Gnome Motor is Inclosed in the Blunt Head. A Three-Bladed Propeller is Driven by Shaft

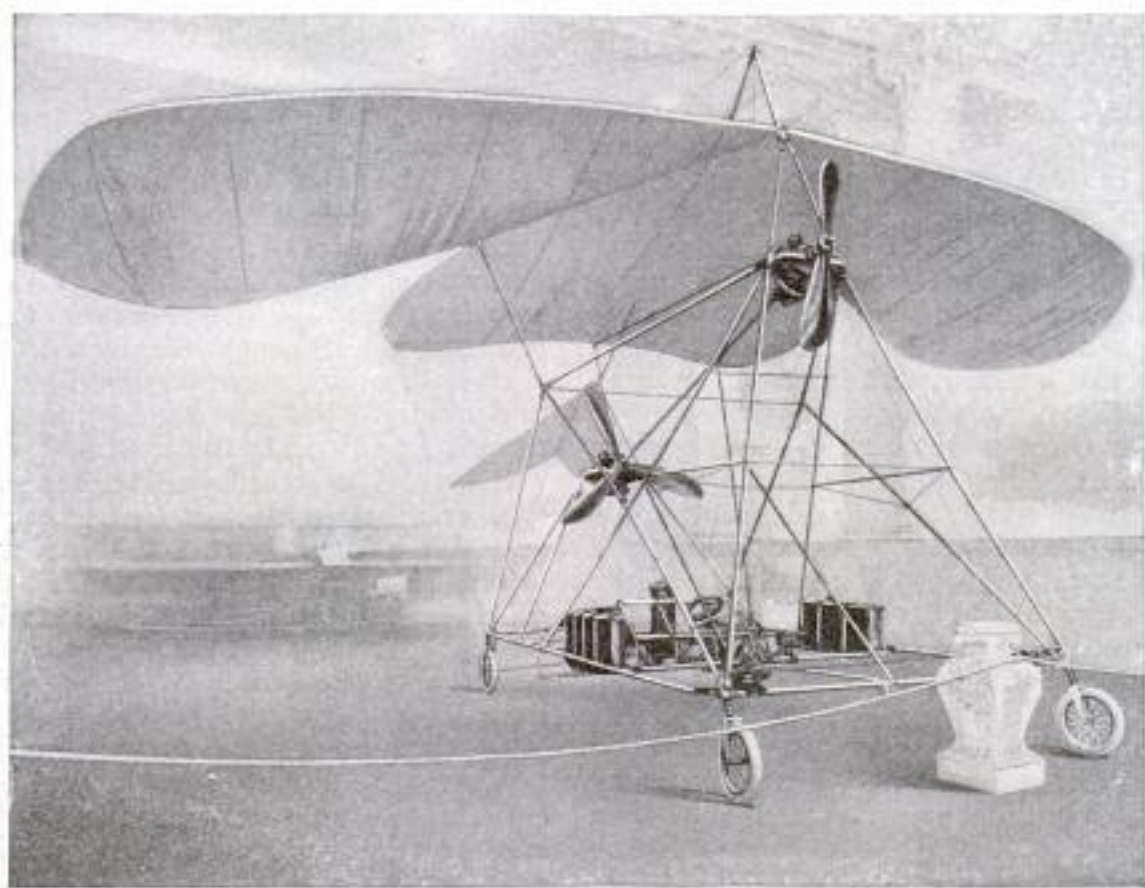

North Carolina Product Which Its Inventor Expects will Carry 7 Passengers and Freight. Although It has Never been Off the Ground to Any Considerable Extent, It is "Guaranteed to Fly"

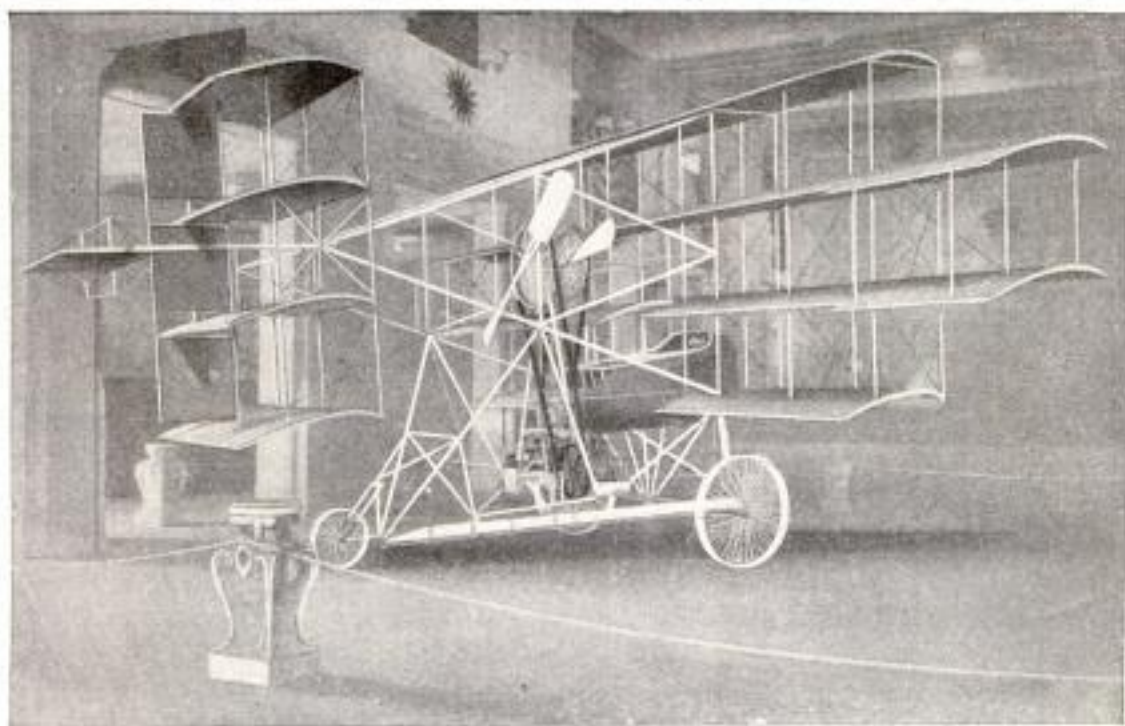

A Multiplane, Built by a Kansas Inventor and Exhibited at Aeronautic Show, Which has Not been Given a Chance to Make Records Yet, as It has Not Flown

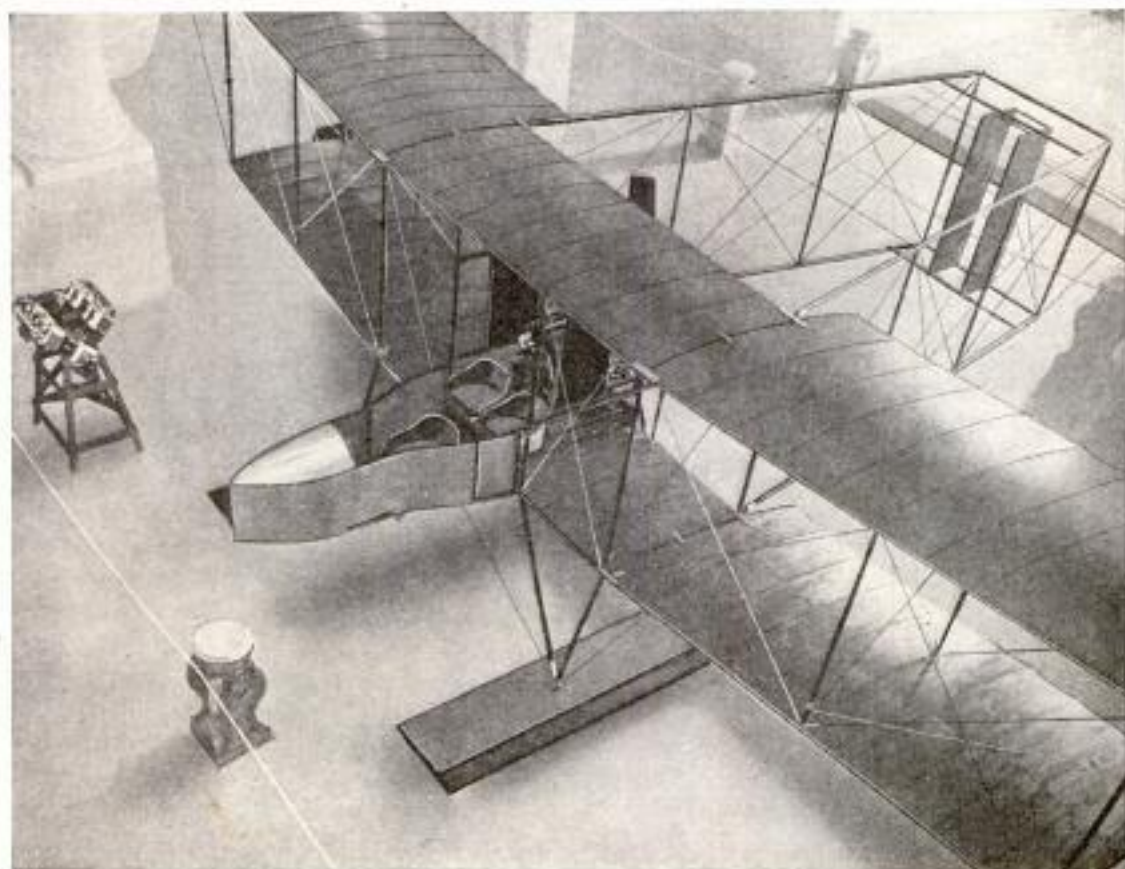

A New Hydro-Aeroplane Provided with Three Seats and Designed for the Purpose of Carrying Passengers

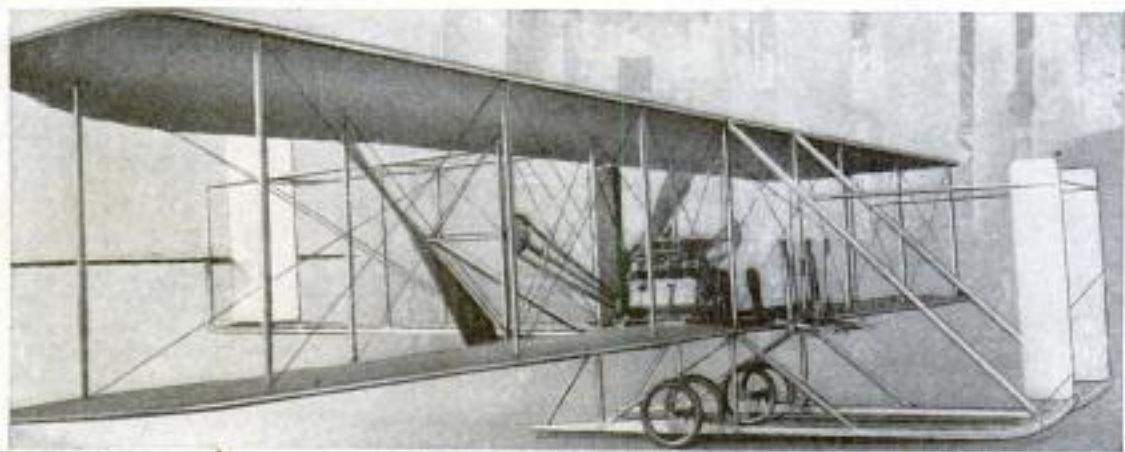

The Improved Wright 1912 Model at the Show; While Several Changes may be Noted, the Machine Clings Closely to the Original Wright Lines.

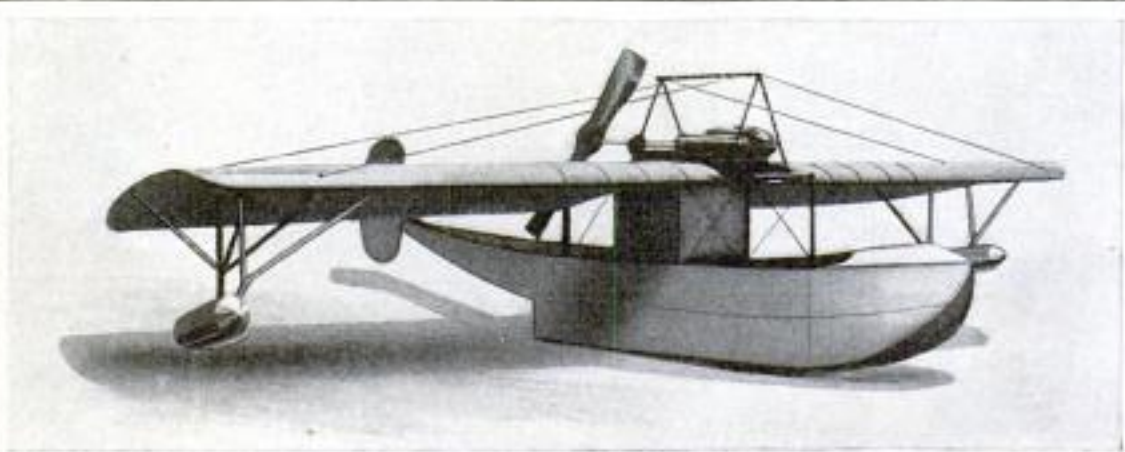

The Queen Aero Boat with a Boat Body Instead of Floats. A Radically New Type Designed by Grover Cleveland Loening

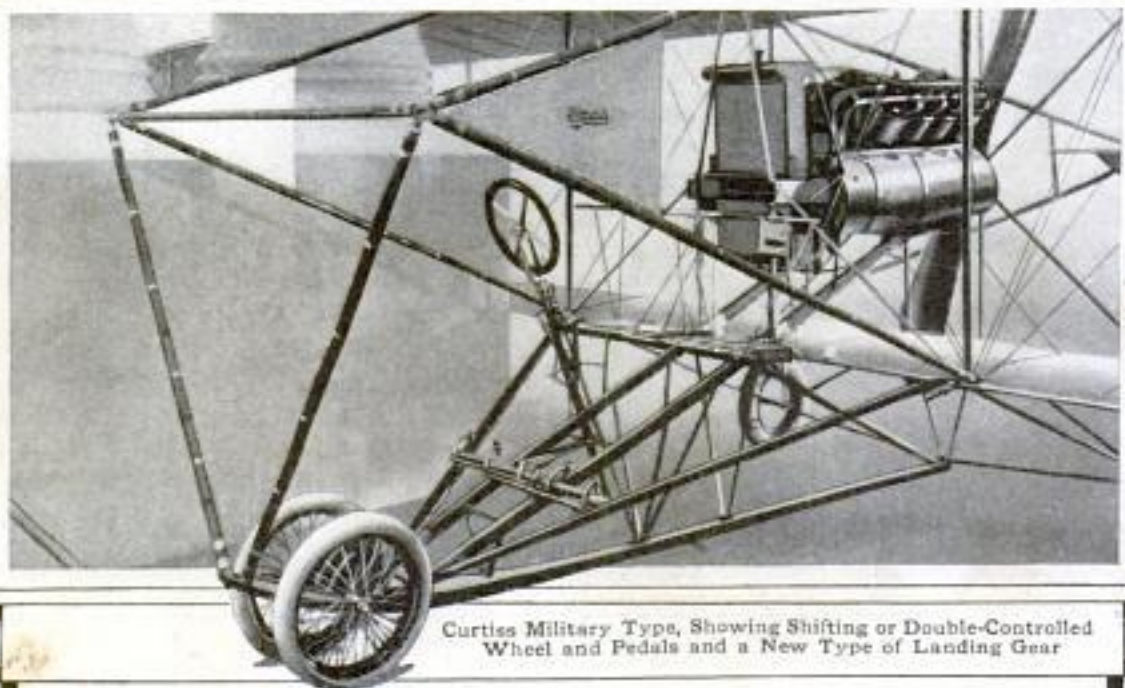

Curtiss Military Type, Showing Shifting or Double-Controlled Wheel and Pedals and a New Type of Landing Gear

TRANSMITTING PICTURES BY WIRE

One of the daily papers of Paris is now publishing half-tone engravings sent by wire from Monte Carlo and the south of France, a distance of about 500 miles, using the apparatus developed by Dr. Korn. The early troubles that prevented practical use of the picture-transmitting device are claimed to have been the great disturbances on the line rather than any fault of the apparatus, but in the present apparatus the transparent film is replaced by a copper film. This is rolled around a cylinder, and, while revolving, a metal point goes all over the image and makes electric contacts corresponding to the whites and blacks. The copper film is prepared entirely by photographic means, and is printed from a negative in such a way as to be covered with fine lines representing the dots of a half-tone. Such lines are thick or thin, according to the parts of the image, and are in insulating gelatine, while the whites are represented by the bare copper. When the point goes over the copper, a current flows; but when the point is passing over the gelatine, the current is interrupted, and this gives impulses on the line.

At the receiving end of the line is a revolving cylinder carrying a photographic film, on which a beam of light, coming through a pinhole, plays. A shutter operated by the line current controls this beam so that it produces

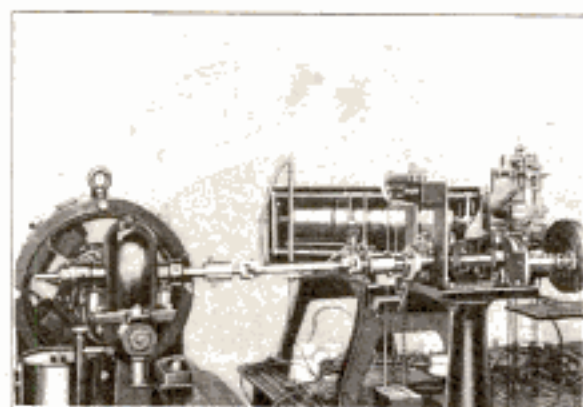

The Transmitting End of the Picture-Sending Apparatus

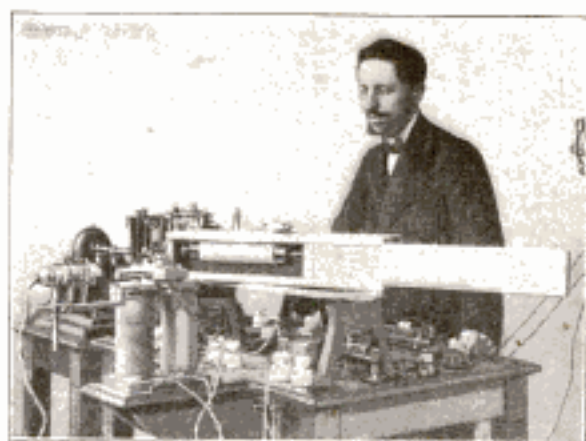

The Receiving End of the Apparatus. Showing the Cylinder with the Photo Film upon It

a picture like the one on the copper film, and this film is then developed and turned over to the photo-engraving rooms for reproduction in the newspaper.



An Aviation Picture Transmitted from Monte Carlo to Paris

Quick photographic reporting is thus made possible. During recent aeroplane events in the bay at Monaco, for instance, the operator took photographs in the afternoon, quickly prepared the copper film and placed it in the apparatus, and a few minutes later the reproductions were available for publication in Paris.

ⒸA New England manufacturer has just perfected an electric lighting plant for aeroplanes which has a dynamo that weighs 20 lb.

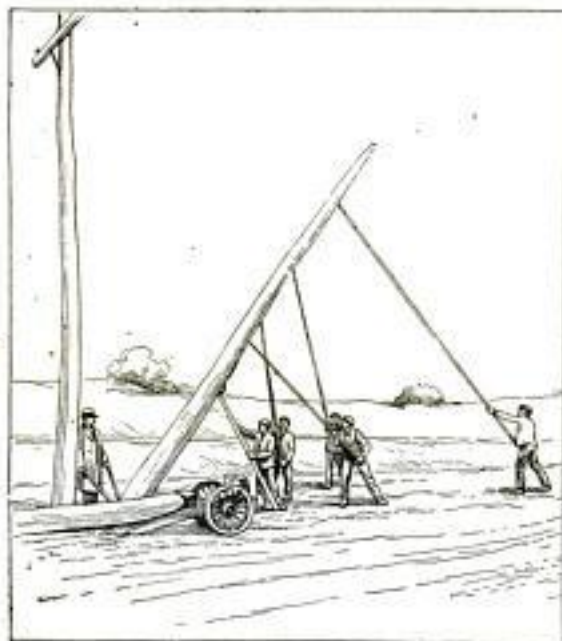

Placing a Telephone Pole in Position by the Old Method



Courtesy the Motor World
Setting a Telephone Pole in Place by Means of a Motor Truck

MOTOR TRUCKS AS POLE ERECTORS

The practicability of the motor truck as an engine for the erection of telephone poles has been clearly demonstrated by the New York Telephone

Company. The accompanying illustrations show the old way of erecting the poles, and the modern method of performing the same task.

FEEDING SUFFRAGETTES THROUGH THE NOSE



Courtesy Graphic, London
Feeding a Suffragette through the Nose; the Plan Adopted by the Prison Authorities to Break the "Hunger Strike"

The accompanying illustration, all external indications to the contrary, does not show a treatment for adenoids, but the forcible feeding through the nose of an English suffragette who refused to partake of food. This remarkable system of feeding is practiced by the English prison authorities, owing to the suffragettes adopting the "hunger strike" as a possible means of gaining their demands. The refusal to eat is not a protest against imprisonment, but an endeavor to obtain the treatment previously accorded to political prisoners.

¶The growth of the automobile business in the last 14 years is shown by the fact that in 1898 there were 25 concerns capitalized at \$2,000,000 making motor cars while in 1912 there are 300 concerns and the capital invested in the business is over \$200,000,000.

POPULAR MECHANICS

IN THE CENTER OF THE WRECK

During a recent meet at Brooklands, Eng., Lieutenant Parke, flying with a passenger in an Avro biplane, met with a bad spill while making a turn. W. H. Fayer, the passenger, is shown in the center of the wreck, viewing the damage.



The Passenger of a Wrecked Aeroplane Surveying the Damage

AN official agricultural bulletin states that 1,600,000,000 lb. of butter are made in this country annually.

"REFINED" "RUBBER-NECK" MOTORBUS

Efforts are being made toward refining the much abused "rubber-neck" motorbus, a vehicle that has been so joked about and laughed at that many people are ashamed to be seen riding in one. The illustration shows one of the new serviceable, yet good-looking, sight-seeing cars described as "refined." It is built to closely resemble the touring-car type of machine, em-

bodying graceful lines. It is said to be the first sight-seeing car of a full fore and side-door design on the market. The seats are so arranged as to comfortably accommodate 16 people.

The first of this type of car finished was shipped to Seattle, where it is being used in conducting parties through the famous Rainier National Park.

A New Type of Sight-Seeing Car, Having the Appearance of an Elongated Touring Car, and Comfortably Seating Sixteen People

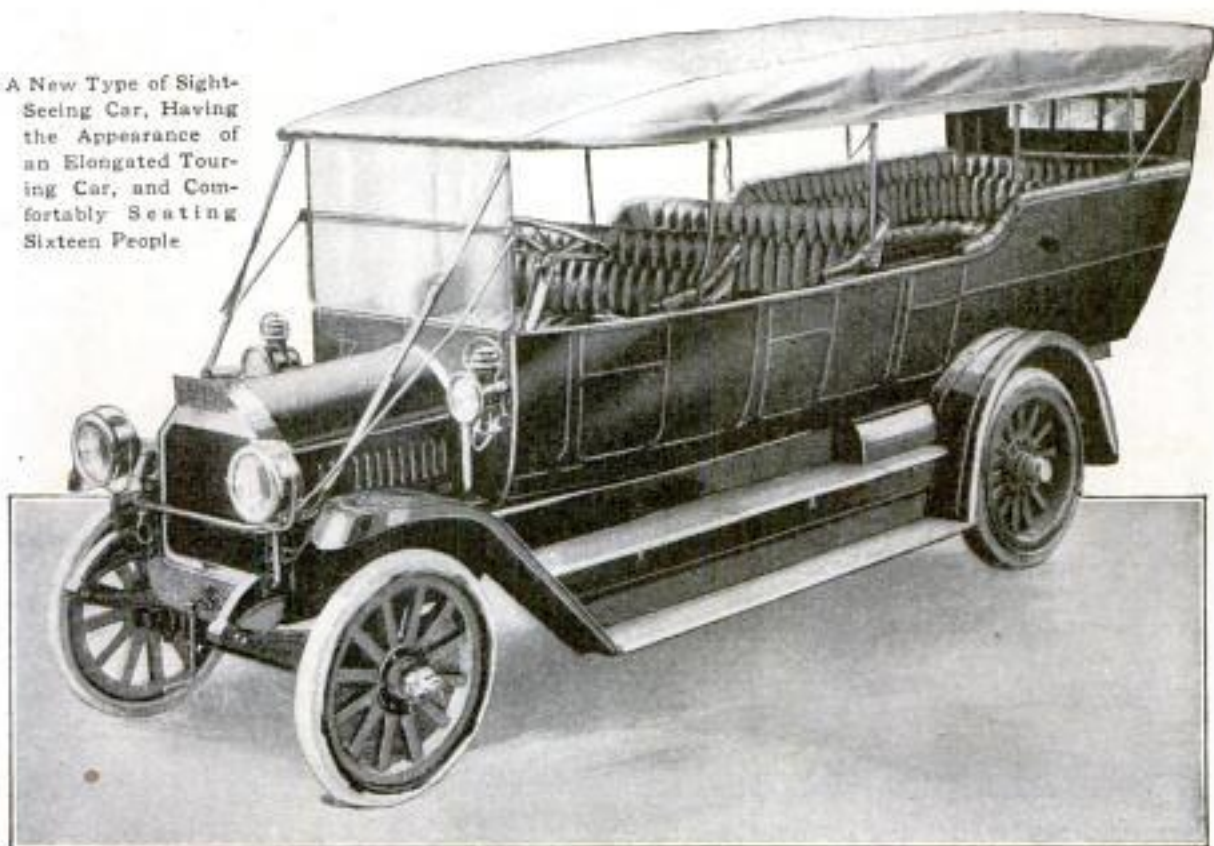

POPULAR MECHANICS

BOXING ON HORSEBACK

Boxing on horseback is a new sport novelty which was recently introduced in Germany by a German of-



Boxing on Horseback is a New Sport Novelty Recently Introduced in Germany

ficer who was a pupil of the Anglo-American Boxing Club of Berlin. The men shown in the illustration are Joe Edwards, a former welterweight champion of England, and Bobby Dobbs, at one time a well-known colored fighter in the United States, and now 53 years old. They are both connected with the boxing club in Berlin, which has had much to do with popularizing boxing in Germany.

TRANSPARENT GLASS OF GREAT STRENGTH

A French manufacturer has succeeded in producing a perfectly transparent glass of extraordinary strength, designed especially for use in automobile windshields, for windows in railroad cars, and other purposes where glass may be subjected to sudden shocks. Tests are claimed to show that even wire-reinforced glass has far less resistance than this new glass, the former having been completely shat-

tered by shocks which only succeeded in cracking the latter.

The new glass consists of two layers of glass having a transparent sheet of celluloid between them. The process of manufacture is a rather delicate one, as the two layers of glass have to be attached to either side of the celluloid sheet by means of a special adhesive substance, the whole being then passed through a hydraulic press.

MOVING PICTURES OF THE AURORA BOREALIS

A new camera for photographing the aurora borealis has just been constructed for Professor Carl Stormer, of the Christiania University. The apparatus will be used to measure the relative brightness of the Northern Lights at different periods, and to enable a cinematograph reproduction of the phenomenon to be made afterward. The pictures are to be taken at night, and will consequently require a long exposure, which will extend from two and a half to eight minutes each. It is expected that the results will prove of the greatest scientific value.

A SKYSCRAPER FOR THE DEAD

The accompanying illustration shows an unusual idea in a community mausoleum. It is a proposed skyscraper mausoleum having 10 stories, each of which has a wide balcony. According to the plans it will contain 532 private



Proposed Skyscraper Community Mausoleum



The Members' Stand on the Course of the Johannesburg Turf Club, South Africa

vaults, and a corridor connecting with a large reception room, several comfort rooms and a chapel equipped with an organ and seating 250 persons.

ELECTRIC BABY'S SMILE TWELVE FEET WIDE

The largest single electric sign in the world depicts a baby's face that alternately smiles and sheds tears on the crowds that throng Broadway, New York. The smile is some 12 ft. wide when it reaches its fullest development and each individual tear is 2 ft. long by 10 in. wide. The sign itself is 85 ft. high by 106 ft. wide and contains a total of 9,010 sq. ft. of space. The child's head is 40 ft. high. The sign weighs 80 tons and contains 4,050 electric lights.

It has cost the government \$1,931,208 more to build the battleship "Florida" at a government yard than it cost to build the "Utah" by contract.

JOHANNESBURG RACE COURSE HAS PALATIAL STAND

Horse racing in South Africa is a sport carried on as extensively as in Europe, and several of the race courses compare favorably with those of England. The illustration shows the newly erected members' stand of the Johannesburg Turf Club's course. This stand cost about \$60,000 and is one of the finest in the world devoted to such a purpose.

A FAMOUS WATER HOLE IN CALIFORNIA

Seventeen Palms Spring is one of the famous water holes of the Southern California desert, the vivifying water of which has brought renewed life and hope to thousands of desert travelers, while it has been likewise the un-reached goal of scores more whose bones have bleached the old overland trails—those who failed to get through.

The spring would be considered but a poor enough watering place by those



Seventeen Palms Spring, Southern California, Which Has Been a Welcome Sight to Many a Tired and Thirsty Pioneer

of us who know only the east with its multitude of water supplies, and who would deem it an almost unbearable hardship to travel afoot for a single day without water. But to those who have gone two days and nights, or possibly three, with no water and under a brazen sun and a mercury at 120 or

worse in the shade, the Seventeen Palms Spring is life itself. The palms which have given the place its name, seem to eke out but a precarious existence, and there are no longer 17 of them, some having died. Yet, sickly as they appear, they are a welcome sight to man and beast who travel this route.

PORTE-COCHERE AUTO GARAGE

An ingenious idea in automobile garages has been worked out by Dr. H. Leslie Moore, of Dallas, Texas. His garage is attached to the side of the house in the position that a porte-



The Porte-Cochere Garage of a Dallas, Texas, Physician

cochere would occupy if provided, and in appearance it very much resembles the latter. The inside door of the garage opens into a small hall leading into the rest of the house, and the doctor may step from it directly into his machine.

SIGNAL DISKS PLANNED TO STOP JOY-RIDING

The assistant manager of a New York detective agency has recently taken out a patent on a device intended to check joy-riding. It consists of a copper plate, which may be fastened to any part of the car where it will be clearly visible to the police. On this plate is a hinged metal disk, the hinge being bolted to the middle of the plate

in a substantial manner. When the owner of an automobile or his authorized agent is in charge of the car, the disk is turned down and locked in place, and in this position displays a black enameled circle. When the owner is through with the car and does not wish anyone to use it, he unlocks the padlock, turns up the disk until it lies flatly against the plate, and relocks it, the plate showing two bright red spots when in this position. The plan is to notify the police or others engaged in preserving the peace that there is something wrong when a car appears on the street with two red disks showing.

TENTED "CITY" ON HOTEL ROOF

The management of one of the big hotels at San Diego, Cal., has solved the problem of hotel congestion and satisfied the outdoor-air enthusiasts by erecting 22 large tents on the roof. Each tent contains a bed, washstand, dresser, wardrobe, and a chair. Many of the guests prefer the tents to the most luxurious rooms of the hotel.

COMBINED FLOOR SET, NAIL SET AND SHIELD

An ingenious device, designed to facilitate the laying of hardwood floors, was recently patented by an



A Device Which Materially Aids in the Laying of Floors

inventor of Lawrence, Kansas. It makes possible an accurate set of the boards, an accurate driving of the nails at the correct angle, and also protects the floor from being bruised during the operation of driving the nails through the holes.

¶The cost of stopping an ordinary train of passenger cars that is moving at the rate of 50 miles an hour is said to be \$1, the time lost being estimated at 145 seconds.



Twenty-Two Sleeping Tents on the Roof of One of the Big Hotels in San Diego, Cal.



Lieutenant Bousquet in His Biplane. The Officer Who Drops Bombs is Protected by a Windshield, and on Each Side of Him are Ammunition Boxes

FRENCH WAR AEROPLANE

Aeroplane tests are being conducted by the French army on the historic drill ground at Chalons in an endeavor to determine to what extent aeroplanes can be used as flying artillery.

The accompanying illustrations show an interesting aerial bomb-dropping equipment which was designed by Lieutenant Bousquet of the French army.

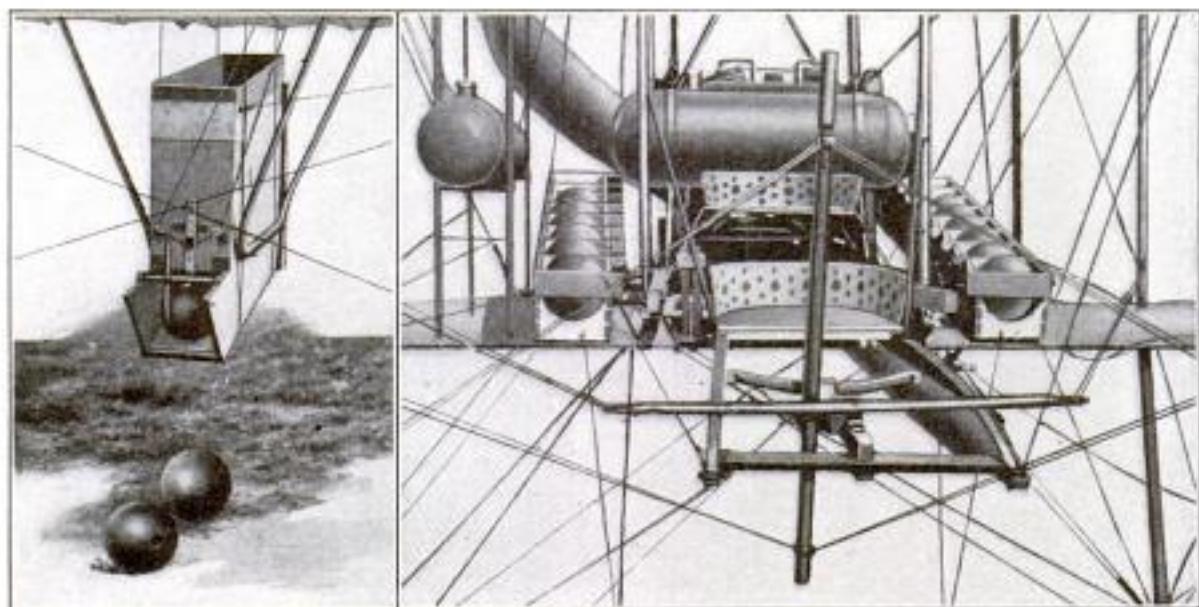

Bomb-Throwing Apparatus, Showing Two Bombs Just Discharged

A Close View of the Seating Arrangement, Showing the Cases Containing the Bombs Arranged along Both Sides

THE WESTERNIZATION OF THE HOLY LAND

By H. J. SHEPSTONE

VERY rapidly, and with so little publicity that the rest of the world scarcely recognizes it, the westernization of Palestine has been going on ever since the triumph of the Young Turkish party over Abdul Hamid, the late Sultan, some three years ago. In political, educational, and particularly in economic reforms, there has been a great deal of progress. Important railroad and transportation concessions have been granted, while Jerusalem, Jericho, and Palestine's newest city, Beersheba, have been given a much needed water supply.

Until quite recently the Holy City has been entirely dependent for its water upon the rainfall. Now it is brought to the city from Solomon's old pools, to the south of Bethlehem, by means of specially laid pipes. Thus the ancient cisterns, built to supply Jerusalem with water in Solomon's time, have been repaired and made to supply the Jerusalem of today with pure water. Then, what is believed to be the well used by Abraham at Beersheba now supplies that town with water by means of a modern motor pump, while Jericho obtains fresh water from Elisha's Fountain by means of specially installed pumps and pipes.

Both Damascus and Beirut have also recently had their water supplies greatly improved, and now boast of their electric tramway services. Damascus was the first city in bible lands to have electric trams and electric light. This is remarkable when we remember that it is the oldest city in the world, having been a place of great importance in the days of Abraham. In the near future, however, Jerusalem will undoubtedly possess electric trams, and representatives of an important American syndicate are now in the Holy City submitting plans for equipping it with an efficient tramway service as well as with electric light.

Indeed, in every department of com-

mercial enterprise and activity, modern methods are being rapidly brought into vogue. On the rich plains of Sharon and also on the tablelands between Jaffa and Jerusalem, steam-driven threshing machines and modern harvesters may be seen, taking the place of the primitive threshing floors. Then, all over the country, particularly in the orange groves, the primitive way of raising water for irrigation and other purposes is being superseded by pumps driven by kerosene motors.

Then, in Jerusalem itself much has been done in widening some of the narrower thoroughfares, particularly in the business quarters of the town. The city is now better drained and its streets better kept. Two modern water-carts were recently imported and are now being used and the municipality has been supplied with a modern steam fire-extinguishing pump. It was but recently also that the Turkish authorities granted a concession to several American and English companies for the construction and exclusive operation of telephones both in the Turkish capital and also in Jerusalem, while an English company is about to furnish the Jerusalem police with bicycles. The very latest appliances may be detected in the building operations that are now going on and reinforced concrete is being used in some of the more important edifices.

On that historic sheet of water, the Dead Sea, there is now a motorboat, the only self-propelled craft at present on Palestine waters. For permission to run this craft its owner pays the government a monthly rental of \$50. The authorities in Constantinople are now considering applications for permission to place similar craft upon the Sea of Galilee and the River Jordan.

Perhaps it is in transportation facilities that the development is most marked. One has only to add that when the Turkish parliament met in



The Opening of Modern Waterworks in Jerusalem was Attended with Elaborate Ceremonies Participated in by All Classes of the City's People



Power-Driven Threshing Machines and Harvesting Apparatus are Common Sights on the Plains of Sharon, between Jaffa and Jerusalem



Modern Watering Cart Sprinkling Streets of Jerusalem



Trolley Cars Now Traverse Streets of Damascus

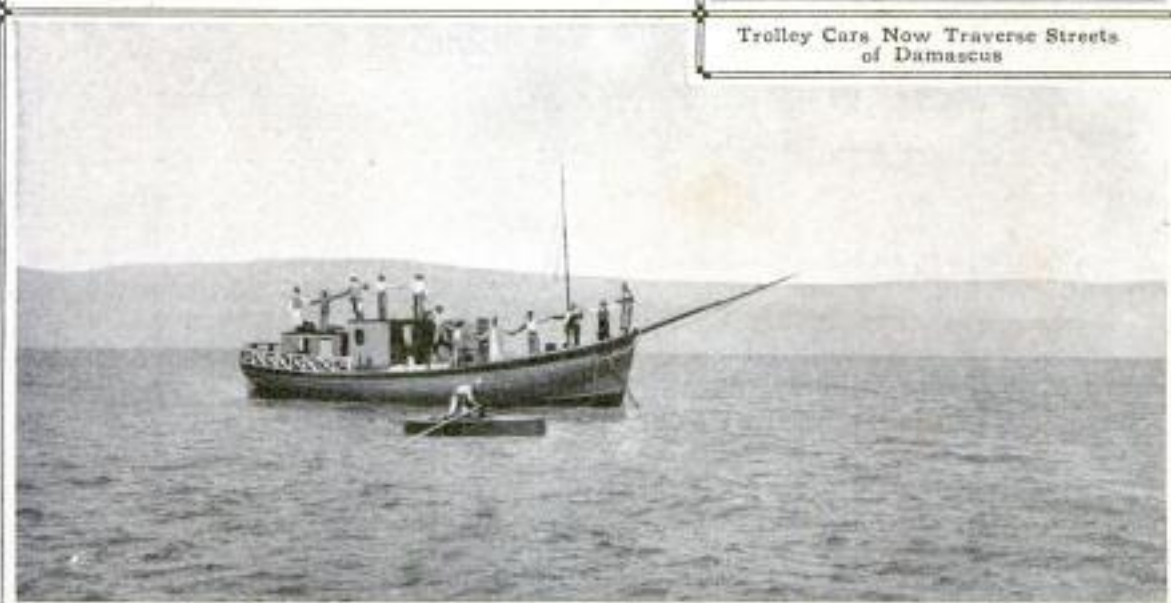

Motorboat "Sheikh Jolal," which Carries Passengers and Freight to Ports on the Dead Sea



One of the Four Pathway Lines in the Holy Land



Up-to-Date Reinforced Concrete Construction has been Adopted in Jerusalem

the spring, there were submitted to it plans for the construction of no fewer than 1,500 miles of railroad, with mineral and oil rights in the Asiatic dominions of the Sultan, to show the rapid development now going on in this part of the world. The lines of the Hedjaz Railroad are to be carried with all speed across the 285 miles of desert between Medina and Mecca. Starting from Damascus, this line runs almost due south through wild and sterile country for more than 820 miles to Medina, the burial place of Mohammed. It is principally used for carrying Mohammedan pilgrims. At many of its more important stations one can now send telegrams in any European language to all parts of the world. Until quite recently they had to be written in either the Turkish or the Arabic language.

This, of course, is by no means the only railroad in Palestine. The first to be opened was that which connects the seaport of Jaffa with Jerusalem. Then followed one from Beirut, on the coast, to Damascus, and more recently,

the line from Haifa, also on the coast, round the southern end of the Sea of Galilee to Damascus. Of the lines yet to be built in Asiatic Turkey, one will extend from Samsoun, on the Black Sea, in a southeasterly direction to a point near the Persian border. Another will start from some port on the Mediterranean, not yet determined, and stretch in a northeasterly direction to Lake Van, crossing the other line. When the famous Bagdad Railroad has progressed another 200 miles, with the Bosphorus spanned by a bridge, and the Hedjaz enterprise completed, Mecca will be in direct railroad communication with Constantinople, and also with the great centers of Europe. When the other lines now projected are completed, Persia will be connected with the Mediterranean Sea, and Nineveh, the ancient capital of Sennacherib, will be a halfway station between a reformed kingdom of the Shah and a Palestine which has been quickened to modern life by steel rails, telegraphs, telephones and western business methods.

LETTER SEALING AND STAMPING MACHINE

This machine, which is but little larger than a standard typewriter and weighs only 50 lb., is claimed to seal,

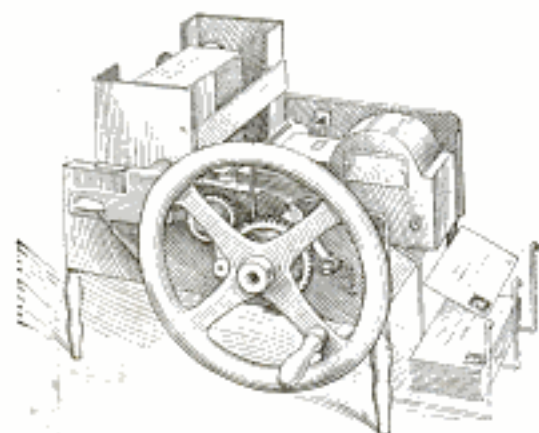

A Machine That Will Seal, Stamp and Count Several Thousand Letters per Hour

stamp and count as many as 7,000 letters per hour, handling envelopes of various size and thickness without ad-

justment. The letters are inserted, flaps down, in the box on the front of the machine, and a reciprocating feeding blade, from which the moisture for the envelope flap is taken, moves forward between the flap and the envelope proper, carrying the envelope forward to the soft-rubber sealing rolls. During this operation the stamp is fed forward from the roll of stamps in the fore part of the machine, where the stamp is moistened, then cut off and carried to the moving envelope, where the process of stamp application and letter sealing is automatically completed. The machine illustrated is driven by a hand wheel, but power may be substituted.

When the Panama Canal is finished, it will be the greatest coaling station in the world, it being estimated that the coal and oil traffic alone should amount to \$10,000,000 annually.

COSTLIEST TELEPHONE LINE EVER BUILT

The costliest mile of telephone line ever erected is the temporary line which the Japanese army experts constructed from the foot to the top of 203-Meter Hill, just outside of Port Arthur, during the siege in the Russo-Japanese war. It might also be asserted that few lines represented the expenditure of so much energy, resourcefulness and courage, to say nothing of human life,

four or five miles distant from their main objective, the town and fleet. Between them and their targets interposed this chain of hills, tall and almost impregnable. Hence, using the guns was purely guesswork, something like throwing a stone at a man on the other side of a house. The gunners could not get the slightest idea as to where their shells struck.

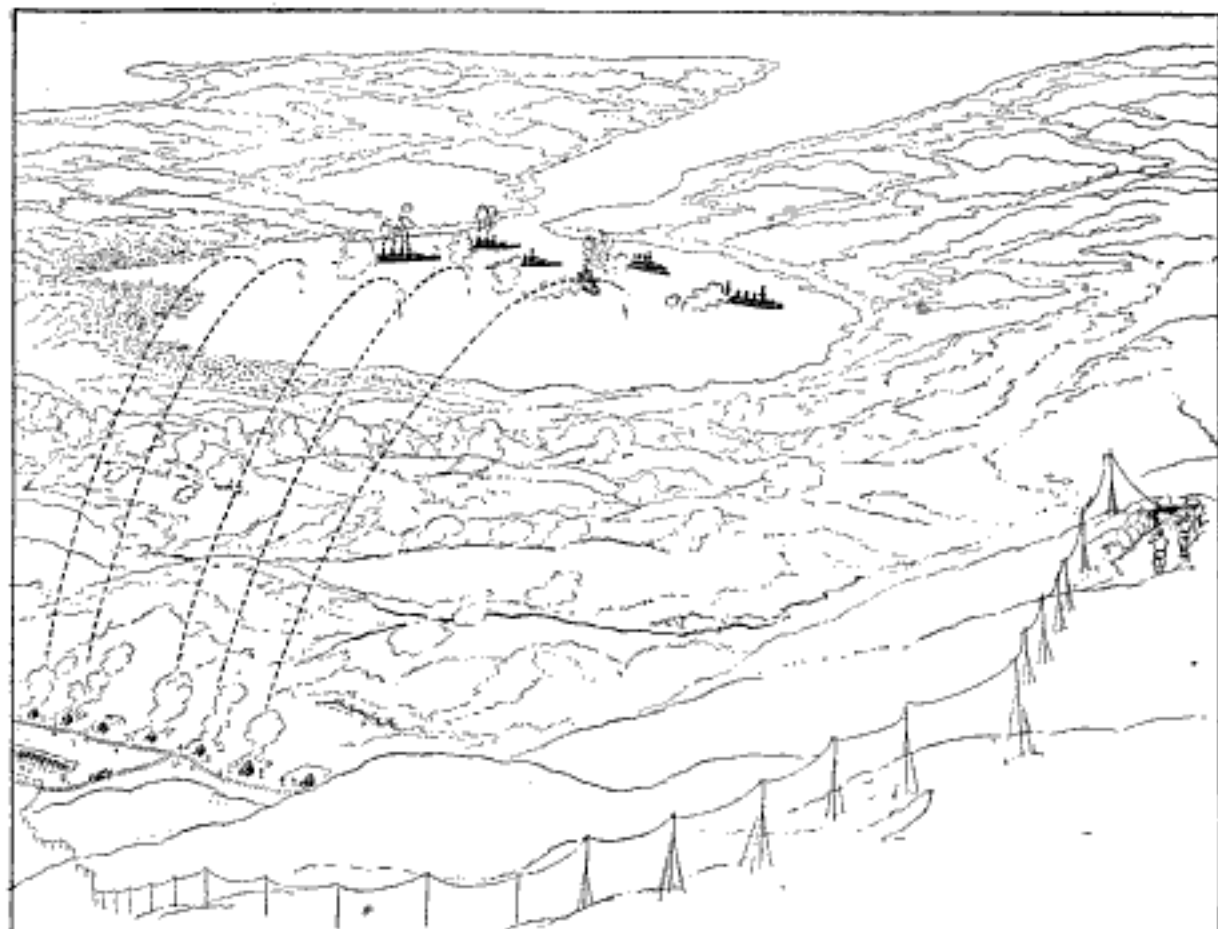

Topographical Map of Port Arthur and its Defenses, Showing Route of the Costliest Mile of Telephone Line Ever Constructed. Big Japanese Guns in Lower Left-Hand Corner, and Telephone Station at Right; Russian Fleet in the Distance

or were used for so short a space of time with such tremendous results.

Early in the siege of Port Arthur the Japanese, finding field guns wholly inadequate to reach the town and harbor, set up half a dozen or more great 10-in. guns, "Osaka babies" they called them. These were placed as near as possible to the main defenses of the town which were located along a semicircular chain of hills, surrounding the harbor. The guns were some

Far over to the Japanese right, near the end of the Russian hill forts, was the loftiest point in the district, 203-Meter Hill. From its summit one could look squarely down into the town and harbor of Port Arthur. It was strongly protected by fortifications and also flanked by other Russian forts.

To gain possession of the summit of that hill General Nogi addressed all his skill and force. Its sloping sides

were lined with intrenchments protecting thousands of Russian riflemen, while from either side the neighboring forts could pour shot and shell into any attacking force. For a few days the Japanese assaults were simply slaughters. At length Nogi obtained a foothold at the base, and slowly, day by day and by night as well, he worked his way up while 30,000 Russians and hundreds of guns poured their fire into him. Finally he gained the summit, built a small bomb-proof and left there—two men and a telephone!

That was all, but it was all he needed. Thousands of Japanese soldiers protected these two from Russian attacks, which continued ceaselessly, for those two men with the telephone could do more harm than all the rest of the Japanese army. Their telephone line ran down the hill and, thence, to the great "Osaka babies." At a signal from the man at the phone, great shells were flung over the hills toward Port Arthur. The men on the

hill watched their landing through field glasses; then they telephoned that gun No. 1 had struck too far right or left of some battleship or arsenal. Thus corrected, the next shots dropped closer; the telephone man again corrected the gunner. And so, through that single wire, the man at the phone directed the fire of the great guns until the Russian fleet, batteries, and arsenals, powerless against such an enemy, were abandoned.

The fate of Port Arthur was decided by the man at the phone. But it had cost dearly. What the Russian loss was is not exactly known, but the Japanese lost 10,000 killed and wounded, expended hundreds of thousands of rounds of ammunition, besides the time and energy of a great army for a period of more than a fortnight, in running that last mile of wire to the top of the hill. It is therefore safe to say that the cost of no other mile of wire ever even approached such a tremendous sum. But, from the Japanese point of view, it was worth it.

AUTOMOBILE USED TO LIGHT A TRAIN

One of the special trains used as a hotel during the automobile races recently held in Savannah, Ga., developed troubles in its electric generating mechanism, thus interfering with its lighting system. The difficulty was remedied by renting an electric automobile and connecting its batteries



An Electric Automobile Furnishing Current to Light a Special Train, Side-Tracked at the Savannah Automobile Races

with the lighting circuit of the train by cable. All lights were furnished

by this method during the time the train was side-tracked at the race course.

VIOLINS WITHSTAND HEAVY STRAINS

Few violinists give any thought to the amount of pressure exerted on the top of a violin by the bridge, and the amount of tension of violin strings, yet both are very considerable. The total pressure on the bridge, and thus on the top of the violin, is, according to the Violinist, nearly 25 lb., and it takes a pulling force at the pegs of nearly 64 lb. to bring the strings to "international" pitch. The downward pressure on the E-string side of the bridge is a trifle over 11 lb., and that of the G-string side, nearly 10 lb. This tension,

or pull on the string, is supported by four small pegs of wood relying on friction for their sticking qualities. This friction hold must exceed an average of 15 lb. for each peg, if the string is to hold. Yet the violin is considered to be the most delicate of musical instruments.

DEFLATED-TIRE ALARM FOR AUTOMOBILES

A French device that informs the driver of an automobile when a tire becomes deflated beyond a certain degree, is shown in operative position in the accompanying drawing. It is attached to the wheel rim, the vertical member being adjustable to any desired depth. When a tire becomes deflated to such an extent that this vertical member touches the ground, it strikes against a piece of spring steel, causing this to vibrate violently and produce a strident alarm sound once in each revolution of the wheel.

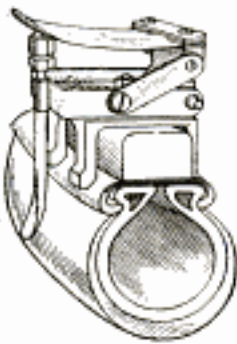

A NEW OUTDOOR-INDOOR BED

Beginning with the bungalow, Southern California home builders have become noted for the innovations they have made in dwelling-house architecture and built-in interior ef-

fects. The very latest of the latter is a bed which, at the will of the occupant, may be either in the room or



The Bed Inclosure, Appearing from the Exterior as a Balcony

outside in the open air, yet, paradoxical as it may seem, remain in the same place. This is accomplished by building the bed inclosure in the outer wall of the house or apartment, the inclosure, when the bed is closed, appearing as a davenport, inside the room, and from the exterior as a balcony. The inclosure projects, outside, from 30 to 36 in. from the wall.

Over the bed is a movable half-dome which may be lowered either over the outside end of the bed, effectually shutting off the outer air, rain or dust; or over the inside part, thus placing the sleeper entirely outside the room in the open air. From a hygienic standpoint, this new bed far surpasses the outdoor sleeping-porch bed, for the reason that when retiring to his sleeping chamber, the occupant takes with

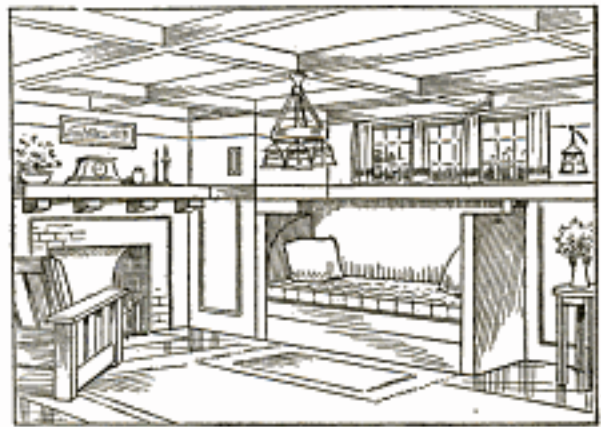
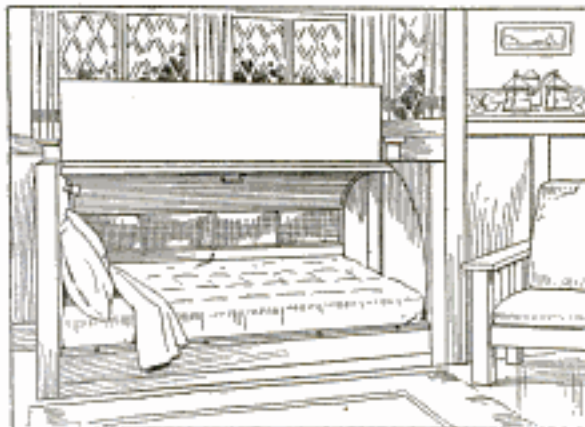

The Movable Half-Dome, Which may be Lowered Over the Outer Side of the Bed, or Over the Inner Side, the Latter Arrangement Placing the Sleeper Entirely Outside the Room. The Appearance Inside is That of a Davenport

him a volume of warm air from the room and thus experiences a gradual change of temperature, instead of the sudden transition from a warm room to a cold porch. In case of storm, the dome can be swung over completely to shut out the rain.

Another advantage of this bed is the saving in space, for the inside projection is utilized as a davenport and, as compared with the sleeping porch, there is a large saving in space outside.

The bed may be either installed in a house already completed, or built in while it is being erected.

MAKING A CLOCK RUN A YEAR

The attachment of a small device recently perfected by a Chicago clock expert will, if it accomplishes what is claimed for it, turn an ordinary eight-day clock of standard make into a clock that will run more than a year

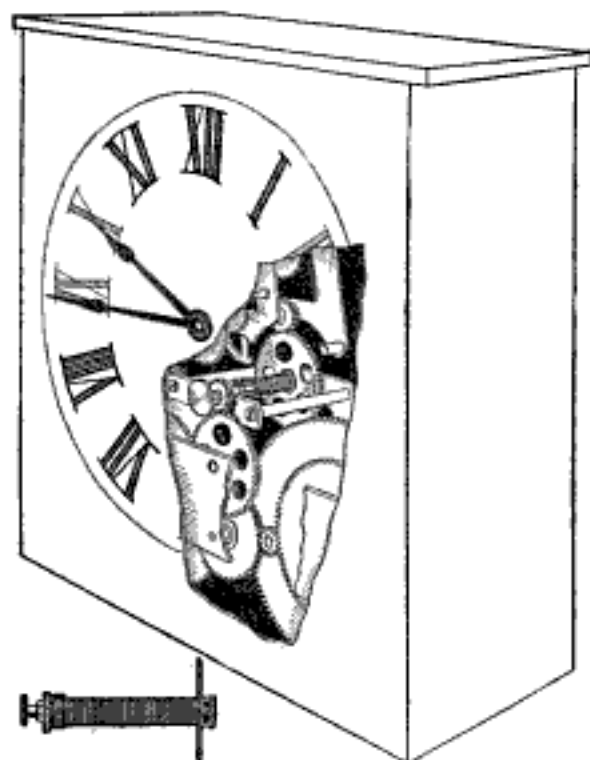

The Clock That Runs a Full Year without Stopping. Showing, Just under the Hands of the Clock Face, the Governor which Does the Work. A Side View of the Governor is Below

without rewinding. Not only is it claimed that the clock will run a year, but it is also stated that its power plant—its springs and the wheels that

transmit their action to the works of the clock—can be used to operate other mechanical devices that are made to run with clockworks. The device that accomplishes all this is called a "governor," and its use converts the clock into what is termed a "differential clock," because it permits the operation of other pieces of mechanism besides the time-measuring machinery.

The governor is a small steel shaft on which is mounted a helical spring. The shaft is so constructed that a portion of it can be expanded so that the amount of power from the helical spring can be regulated, and no more supplied to the mechanism actuating the time-measuring part of the clock than is absolutely necessary. The clock springs are so adjusted to the governor that when the shaft has been expanded and all the power in the unexpanded section has been used, these springs automatically turn the helical spring to give it additional power. In this manner the clock springs proper are called into action for time measuring only when the helical spring exhausts itself, and, therefore, will keep the clock going for a much longer period than without such a device as the governor. A clock equipped with a governor has actually run 418 days without rewinding. The tension of the helical spring is adjusted with a setscrew and it can be adapted practically to all standard makes of clocks.

HIGH-EFFICIENCY WATER WHEELS

The performance of three low-head water wheels designed by Prof. S. J. Zowski, of the University of Michigan, far surpasses the highest power of any other wheels given a recorded test. The wheel which previously held the record, was 28 in. in diameter, and, in the Holyoke testing flume, its best efficiency was 86.2 per cent, at 52.8 revolutions per minute, and 2.05 hp., under 1-ft. head.

The wheels designed by Professor Zowski, all of which were 30 in. in

diameter, were tested with the same draft tube and test arrangements, only the runner and guide vanes being changed. The first of these wheels showed a maximum efficiency of 87.2 per cent, at 49 revolutions per minute, and 3.18 hp., under 1-ft. head. The second wheel showed a maximum efficiency of 88.75 per cent, at 48 revolutions per minute, and 2.65 hp., under 1-ft. head, while the third wheel, designed to increase the power at maximum efficiency, showed a maximum efficiency of 89.2 per cent, at 50 revolutions per minute, and 3.26 hp., under 1-ft. head.

Chewing gum is said to be a peculiarly American habit, merchants having discovered that there is no sale for gum in foreign communities where there are no American residents or tourists.

BARREL FLOAT AS ENGINE CONTROL

An ingenious method of automatically controlling the speed of a 20-hp. slide-valve steam engine, used in keeping a small spring-fed lake clear of water, so that the marl could be shoveled from its bottom for use in making cement, is shown in the accompanying drawing. Owing to the many springs feeding the lake, it was necessary to keep the pumping plant in operation day

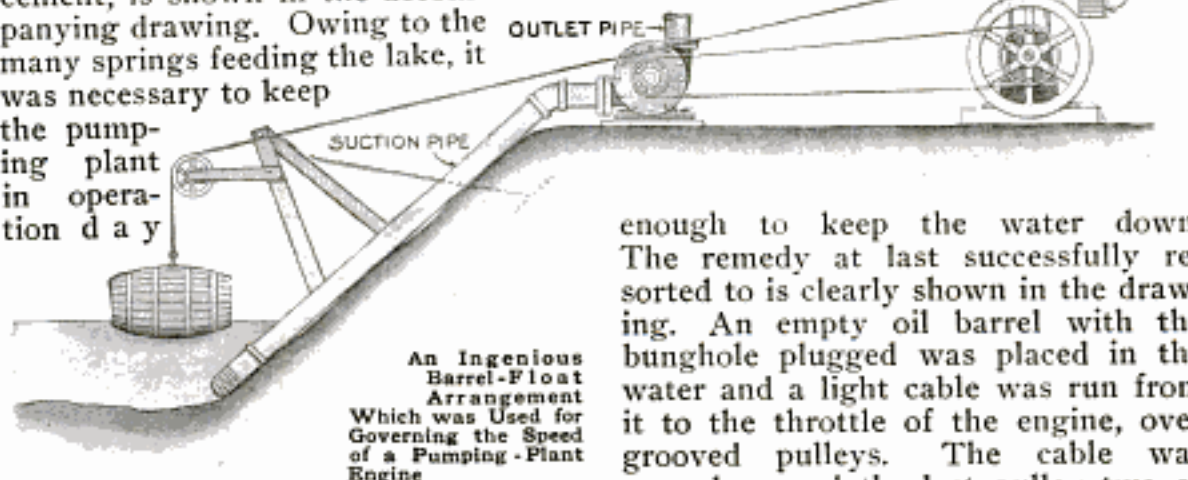

An Ingenious Barrel-Float Arrangement Which was Used for Governing the Speed of a Pumping-Plant Engine

and night, but, as the amount of water supplied by the springs varied greatly, and as the engine had no governors, much trouble was experienced in regulating the engine's speed. Sometimes the rotary pump would drain all the

A RACING DUOCAR

Races for duocars, the name given to the little three-wheeled machines

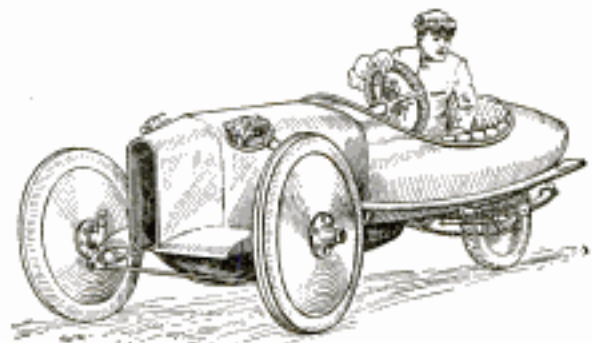

A Type of Racing Duocar

which form the connecting link between the motorcycle and the automobile, were recently held at the Brooklands motor course in England. An idea of how these little racing cars are constructed may be gained from the accompanying illustration.

water out of the hole and lose its priming, thus causing the engine to race, and at other times the engine would not be running fast

enough to keep the water down. The remedy at last successfully resorted to is clearly shown in the drawing. An empty oil barrel with the bung hole plugged was placed in the water and a light cable was run from it to the throttle of the engine, over grooved pulleys. The cable was wound around the last pulley two or three times and a weight was attached to the loose end, to counterbalance the barrel. The device is said to have worked perfectly, the engine speeding up when the water level rose and slowing down when it fell.

BELT TRANSMISSION AROUND A CORNER

A belt transmission that turns a corner is shown in the accompanying illustration. It connects up two shafts which are set a considerable distance

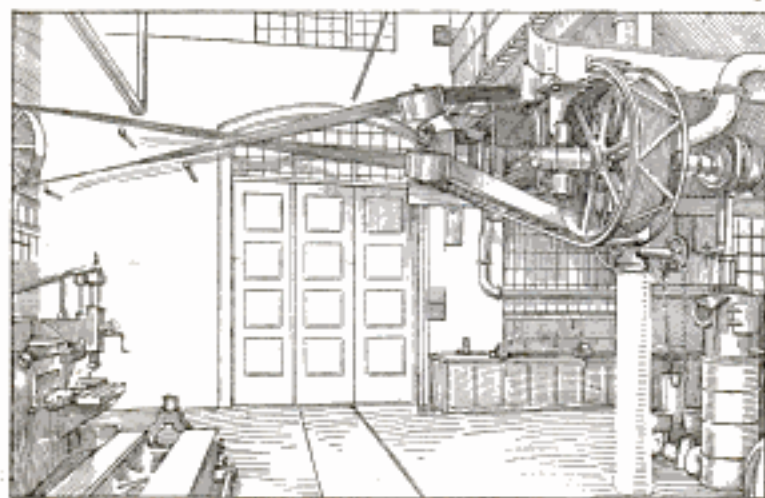

Interesting Belt Transmission between Two Shafts Set at Almost Right Angles and at Different Elevations from the Floor

apart at different elevations from the floor and at practically right angles to each other. It is claimed that a minimum obstruction of space and the free use of the doorway are thus obtained. The lattice work guard around one of the pulleys and the iron brackets driven into the wall near the other pulley are safety provisions designed to catch the belt should it break.

LOSS OF QUEUES CAUSES DEMAND FOR HATS

The wholesale cutting off of queues, which was a consequence of the revolution in China, cooled the heads, at least in a literal sense, of the Chinese to such a degree that there arose an enormous and unprecedented demand for head covering. The native hat industry, being but little developed, was unable to keep up with the demand made by the shears, and Japan, where the industry is flourishing, was flooded with orders. The Japanese factories have been working night and day for months to fill the unexpected need of the new republicans.

GREAT BRITAIN ORGANIZES AIR NAVY

Great Britain, at last realizing that an efficient navy of the air is no less urgent in her case than in that of the other great military and naval powers of Europe, has commenced the organization of an aeronautic service on comprehensive lines. With the issuing of a "White-Paper" from the War Office recently, the "Royal Flying Corps" takes its place definitely as a fighting arm. Not only is a reserve of flying men, which may be drawn on in an emergency, to be provided, but a force of "regulars" is to be organized. Aerodromes, landing places and sheds are to be constructed at intervals throughout the country, converting England into one vast airway system with fixed stations; under the auspices of the government, a school is to be opened on Salisbury Plain, and 37 aeroplanes have already been ordered.

The air navy, as initially planned, will consist of 364 men, seven air squadrons, each squadron comprising 12 aeroplanes; one airship squadron, and one kite squadron.

The course of the Salisbury Plain School will include progressive instruction in the art of flying; instruction in the general principles of mechanics and the construction of engines and aeroplanes; instruction in meteorology; training in observation from the air; instruction in navigation and flying by compass; training in cross-country flights; photography from aeroplanes; signaling by all methods, and instruction in types of warships of all nations.

A frank admission of inferiority is included in the government's announcement of the organization of the air corps. "The government has been impressed by the state of aerial navigation in this country, compared with the progress made by other great naval

and military powers. The efficiency of the aeroplane for purposes of military reconnoissance has been proved both in foreign maneuvers and in actual warfare in Tripoli."

EIGHT-WHEELED ELECTRIC MOTOR TRUCK

A new type of electric motor truck, having eight wheels, each provided with an individual motor receiving power from a gasoline-electric generating plant, and with rear wheels that turn automatically with the

a long series of heavy scientific investigations.

The Navy Department found itself possessed of a lot of old brown powder at the Indian Head factory, down the Potomac River, a short distance from Washington. It was of a kind that was used several years ago and made a lot of smoke. It is known as "cocoa powder" because of its color and also because in its manufacture shredded cocoanut husk was used as a binder.

The navy people tried to trade it off to a big South American firm for nitrate to be used in making the new

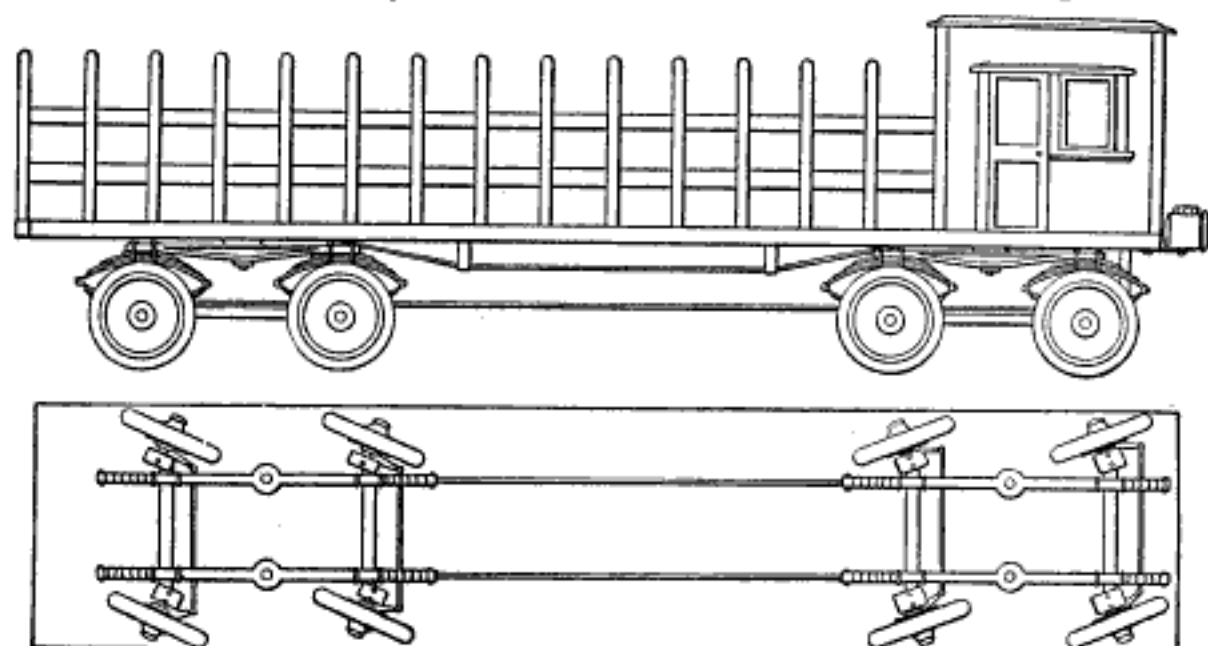

An Exceptionally Large Gasoline-Electric Truck Having Eight Steering and Drive Wheels. Each Wheel Has Its Own Motor, Located on the Steering Knuckle

front wheels in steering, has been designed by a Minneapolis, Minn., inventor. The motor for each wheel is located on the steering knuckle so that it swings with the wheel, thus doing away with the necessity of the universal joint and differential gear.

GUNPOWDER USED AS FERTILIZER

Gunpowder for raising crops is the latest thing under test in Washington, two great arms of the government, the Navy Department and the Department of Agriculture, being interested in the experiment. It all came about quite accidentally and was not the result of

smokeless powder, but the Chilean importers could not see it even though revolutions in that part of the world are not infrequent and most any kind of powder will serve for a hastily hatched uprising. A bright young naval officer determined to get rid of the powder. There was a million and a half pounds of it on hand and it contained about 80 per cent potassium nitrate, a most valuable fertilizer constituent.

The officer went to the Department of Agriculture and offered them the explosive. The scientists there said that theoretically such powder was a good fertilizer, but that they really did not care to try it at their experiment

farms, powder being decidedly out of their peaceful line of business. However, they were deeply interested and would like to see some of it tried on crops, suggesting Indian Head and some of the army posts as the most appropriate places for the trials.

So the navy folk mixed up a lot of the stuff with Potomac River water, fresh from the end of the wharf at Indian Head, and saturated the truck garden which is maintained there for the benefit of the officers and their families. The results were astonishing according to the Indian Head people. They grew vegetables which they declare vied in color and perfection with the choicest lithographed specimens which adorn the seed catalogues.

This year the experiment is being tried on a larger scale and with equal success on the gardens and lawns at Fort Hunt and Fort Washington, two of Washington's defenses down the Potomac. What might happen if officers should smoke on the parade grounds treated with the powder solution can only be guessed, but no one seems to be worrying about it. Meanwhile the conservative Agricultural Department looks on and applauds, but so far there has been no requisition on Indian Head for old powder for the experiment stations.

AIR-COOLED SPARK PLUGS

A spark plug described as "air cooled" has recently been placed on the market in Germany. Although differing little from the conventional pat-

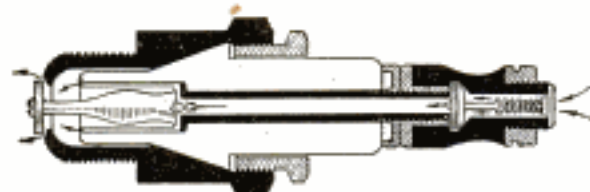

Air-Cooled Spark Plug Being Marketed in Germany

tern, this plug incorporates a distinct innovation, the central metal spindle, which carries the current to the interior of the cylinder, being bored for about three-quarters of its length, while at

the point where the hole terminates are two small perforations which extend to the outside. These small holes provide an escape for the air which is drawn through the spindle. A check valve, housed in the brass cap of the plug, permits the free ingress of a certain amount of air on the suction stroke of the motor, but closes tightly to prevent the escape of gas during the working stroke. It is claimed that the air so admitted maintains the plug at a temperature considerably below that of the ordinary plug.

BUILDING STONE MADE OF BLAST-FURNACE SLAG

An industry now assuming considerable importance in Germany is the manufacture of building stone from blast-furnace slag. According to The Engineer, London, the process is not patented, and is very simple in details. Practically all blast-furnace slag is suitable for stone making, but it must be in a granulated state, being unsuitable after it has been allowed to harden. All attempts to utilize slag that has been crushed or ground, after having been once hardened, have failed to produce a good solid stone.

In the process here referred to, the slag is granulated by the addition of water as it flows hot from the furnace. The granulated slag is then, after being thoroughly mixed with the required proportion of lime, allowed to stand one hour before being put through the forming press. After being pressed the stones are slacked in the open air, and, after three or four weeks, according to the weather, they are ready for use. Under low temperature they harden slowly, and if subjected to frost before thoroughly hardening, they crumble and are ruined. Otherwise, the stones grow constantly harder with time.

Ⓒ Russian laws dealing with false weights are so severe that in one province merchants who violate the law are prohibited from participating in any kind of trade.

TRIPLEX COMPOUND LOCOMOTIVE

The design of a locomotive, which is practically an ordinary Mallet with working tender, but instead of having the high and low-pressure cylinders of different size, has a pair of high-pres-

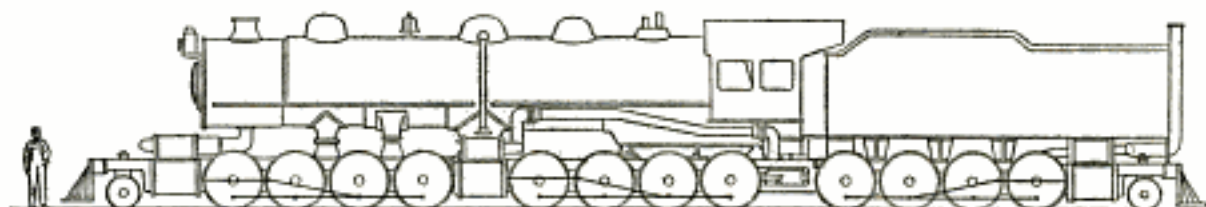

A Proposed Triplex Compound Locomotive

sure cylinders attached to the frames connected with the back part of the boiler, and two pairs of low-pressure cylinders, one in front and one at the rear of the tender, all the cylinders being of the same size, is shown in the accompanying illustration. With this arrangement a compounding ratio of two to one is obtained, and it is found that, with but a slight increase in the weight and cost, and without any increase in length, about 50 per cent more tractive effort is obtained, the working tender being so arranged that, with only 25 per cent of fuel and water remaining, there will be sufficient weight to give the full adhesion. The weight of such a tender with a 25-per cent load would be over 100,000 lb.

The horizontal pipe with a ball joint in the cylinder saddle, which takes the exhaust from the high-pressure cylinders, has, according to the *Railway Gazette*, given practically no trouble in Mallets now in service, and this is simply duplicated in the rear of the new design by making a pocket with a ball joint in the footplate and taking the exhaust steam from the high-pressure cylinders back to this footplate, as well as forward to the front cylinders. The object of placing the cylinders on the tender at the rear end, is to make the swivel pipe, which has the ball joint in the footplate and which corresponds to the receiver pipe, connecting the high and low-pressure cylinders at the front of the engine, of suitable length.

HEAT PROTECTION FOR ELECTRIC FLATIRON

A new type of electric iron, designed especially to meet the severe conditions which obtain in laundries and dry-cleaning shops, is shown in the drawing. It is fitted with a special at-

tachment arranged in such a manner that the combustible insulating covering of the flexible lead is protected at the points likely to become so hot that the insulation may be damaged. The two wires leading from the heating element A are brought into a porcelain connector, B, which consists of two solid-brass terminals imbedded in porcelain, the wires being held in position by setscrews, without soldering. These terminals are connected at the top by two copper wires, which are carried in iron tubing and are insulated by being

The Exterior of the Iron and a Section Diagram Showing the Protective Device

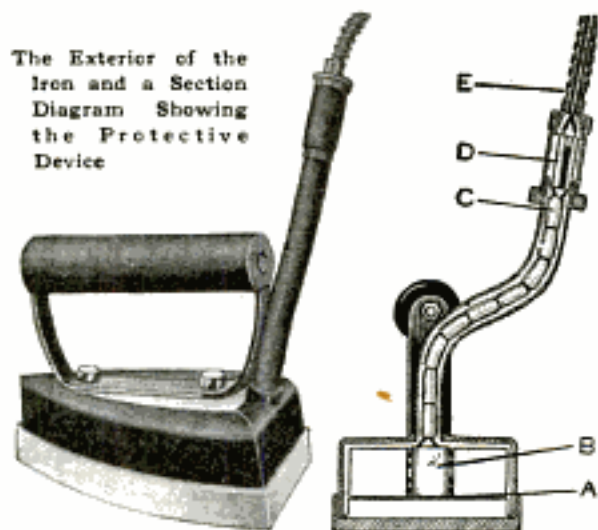

threaded through small pieces of porcelain, C. These pieces of porcelain abut closely together, so that there is no possibility of the two leads accidentally becoming short-circuited. The two copper wires terminate in a second connector, D, to which the flexible lead E is attached.

CALCULATING THE CIRCUMFERENCE OF THE UNIVERSE

By FOREST RAY MOULTON

The diameter of the part of the physical universe which has been penetrated by the most powerful telescopes of modern times is about the distance light travels in 10,000 years. Now light travels 186,330 miles per second, there are 86,400 seconds in a day, and there are $365\frac{1}{4}$ days in a year. If the diameter of the universe were exactly known, would mathematicians be able to compute its circumference with an accuracy meeting all requirements? For example, could they compute it within $1/100,000$ th of an inch, so that the error in their results could not be detected with the most powerful microscopes in existence?

The approximate length of the circumference of a circle is obtained by multiplying its diameter by $3\frac{1}{7}$. This result is a little larger than the true value. A more nearly correct result is obtained by multiplying the diameter by 3.1416. While this result is exact enough for most engineering and other practical problems, the error would be important in computing the circumference of the universe. A still more nearly correct value of the multiplier is 3.14159265, which is accurate enough for all ordinary scientific purposes of the present time, but the results are not absolutely correct.

One may ask, then, what number should be used in order to get the exact circumference when the diameter is given. Mathematicians have proved that, unfortunately, the exact number can not be expressed by a finite number of figures, either as a decimal or as an ordinary fraction. If the number were expressible as an ordinary fraction, then, when it is reduced to the decimal form, it would be found that the same figures repeat themselves in the same order over and over again. For instance, if the number were $3\frac{1}{7}$, in the decimal form it would be written 3.142857, where the omitted part consists of the figures

142857 repeated over and over indefinitely. In a similar manner, every other number which can be expressed as an ordinary fraction goes into a decimal which contains a similar cycle, generally of fewer figures. The number $1/5$ goes into a decimal whose repeating cycle is simply 0. Now, the number to be used to compute exactly the circumference of a circle cannot be expressed as an ordinary fraction or as a decimal which repeats in the manner indicated. Such numbers are called by mathematicians "transcendental numbers," and must be computed in detail as far as they are desired.

The number which must be used in finding the circumference of a circle from its diameter has been the object of much attention on the part of mathematicians and computers. It has been most exactly determined by W. Shanks, an Englishman, who computed it to 707 decimal places. This is not only far beyond the actual requirements of all science at the present time, but it seems certain that it will always remain so; for, it is found that if it were known only to 30 decimal places, the circumference of the universe could be computed with an accuracy so great that the error could not be detected with a microscope. Not only has the number been computed quite far enough, but mathematicians have wasted an enormous amount of time in getting the last 677 places.

☞ Headless safety matches have been manufactured for some time by a Danish match concern. One end of the little sticks of wood are dipped into a solution of chemicals for half a minute and then into water for a quarter of a minute. Like other safety matches, they cannot be ignited by friction in any way except against a specially prepared surface. The prepared end of the match is distinguished by being colored.

AN ELEVATING DEVICE FOR UNLOADING CARS

A car especially designed to elevate and dump cars loaded with coal, gravel, and like materials, is being used in Germany. It comprises a flatcar of especially strong construction, on which is mounted a turntable bearing rails. This turntable is capable of being swung completely around and can be tipped to an angle of 45 deg. Normally it is inclined at an angle of 30 deg., so as to form an unbroken line

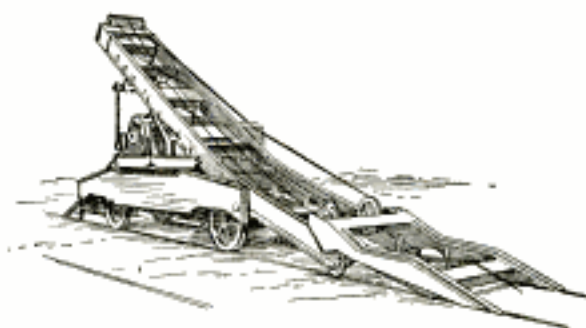

A Car for Elevating and Unloading Gondola Cars

with the approaches on which the cars are drawn onto the turntable for unloading and are run from it after the

operation. Cables, driven by a motor, draw a car at a time onto the turntable, the turntable is given a quarter turn,

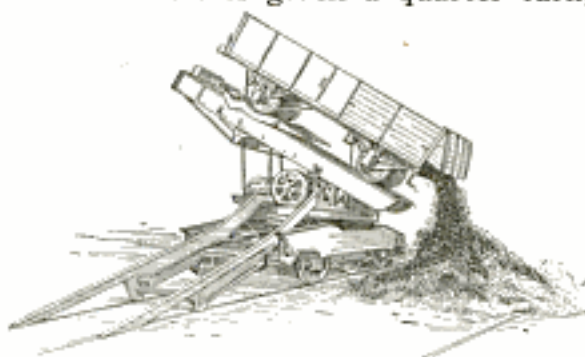

A Car Inclined by the Elevator and Discharging Its Load

its inclination is increased from 30 to 45 deg., and the load is allowed to discharge from the end of the car. Then the turntable is lowered again to the 30-deg. inclination, turned another quarter-revolution, and the empty car run off the table on a second set of approach rails. The operation of the turntable is executed by means of a second motor.

The idea is to provide each long coal train with an unloading device. It will elevate and unload six to eight cars an hour with ease.

PUMP DESIGNED SPECIALLY FOR SEWAGE

One of the greatest difficulties encountered in pumping sewage arises from the fact that great quantities of solid matter find their way into drain-

ever, a pump has been invented by an English engineer, which, it is claimed, will handle unscreened sewage of a consistency that would choke any

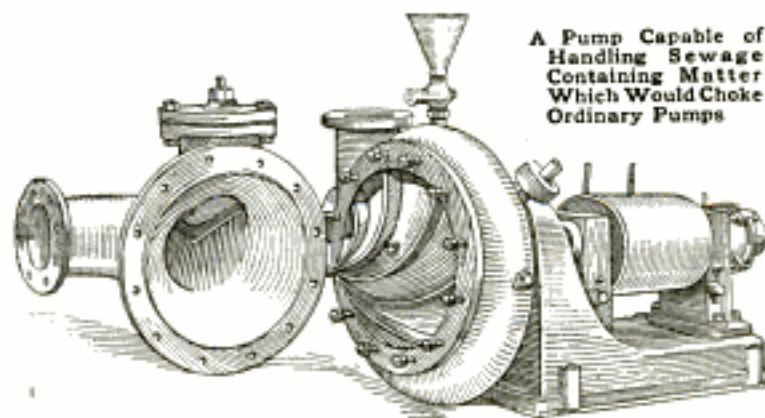

A Pump Capable of Handling Sewage Containing Matter Which Would Choke Ordinary Pumps

age systems, this matter often being of such nature as to interfere with the working of the ordinary reciprocating and centrifugal pumps. Recently, how-

other type of pump. It is a special form of centrifugal pump described as "an eater of solids." It is claimed to have an efficiency approximating that of the ordinary centrifugal pump. From the illustration it may be seen that the pump consists of a centrifugal with a conical impeller, the discharge being from a whirlpool chamber of gradually increasing size, as is usual. The impeller is provided with a number of spiral blades running out of the top of the cone, and is carried on a hor-

horizontal shaft provided with a long bearing, and also with the necessary thrust bearing. Unlike the outflow from the ordinary centrifugal, the fluid

forced through the pump does not leave the impeller at right angles to the spindle, but in a direction corresponding to the taper of the conical impeller.

LETTERS STAMPED WITH INK INSTEAD OF STAMPS

The latest type of slot machine for stamping letters to be tried in London does not stick the ordinary postage



An English Postage Slot Machine Which Stamps a Letter with Ink Instead of Sticking the Usual Postage Stamp Upon It

stamp on the letter but stamps the letter in the same manner as the stamping machines used in a postoffice to cancel stamps. That is, when the sender inserts his letter in the machine, and places a penny in the slot, the envelope is impressed with a circle of red bearing the words "London, 1d. [one penny] postage paid," and also with the numerals designating the section of London in which the letter was stamped.

¶The river Amazon, according to the United States Geological Survey, carries to the Atlantic Ocean 618,000,000 tons of solution and sediment, traces of which can be observed 100 miles from land.

NEW GERMAN CANAL PROPOSED

A number of the Chambers of Commerce and influential manufacturers of Germany are advocating the construction of a canal through German territory from the Rhine to a German port on the North Sea. The commission which has been intrusted with the negotiations and plans proposes that the canal start from the Rhine at Wesel, thence run in a northerly direction between the Netherlands frontier and the river Ems and finally join this river opposite the town of Leer, a few miles from the mouth. The length of such a canal would be about 120 miles. In addition to the great advantage to German shipping and the immense strategical value, the canal would also facilitate the cultivation of the fens through which it would pass.

ABSORPTION BY GLASS IN X-RAY PHOTOGRAPHY

One of the chief reasons why X-ray photographs have poorly defined outlines is that the glass ordinarily used in X-ray apparatus absorbs as high as 52 to 70 per cent of the rays, according to its thickness. Sir J. J. Thomson, the noted British scientist, has advanced the theory that the absorption is directly proportional to the atomic weights of the substances entering into the composition of the glass. Working upon this basis, German chemists have now produced a glass which absorbs only 10 to 15 per cent of the X-rays, scarcely becomes heated or fluorescent, and produces no secondary rays. The X-ray photographs taken with apparatus in which tubes of this glass were used, are said to be very clear and distinct. Also, much shorter exposures are needed.

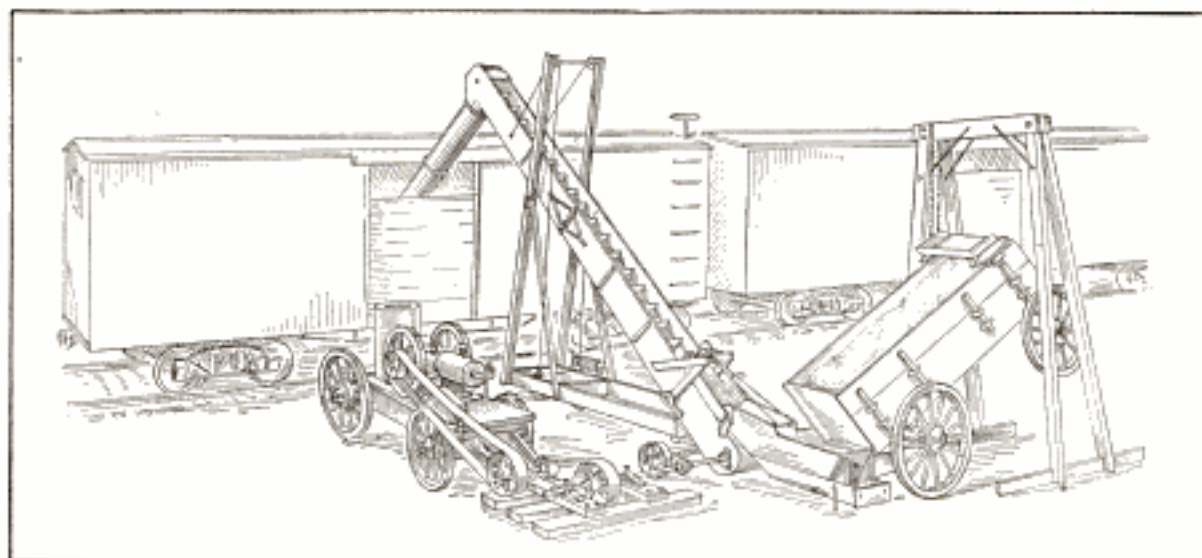

Loading Grain into Cars by Means of a Portable Elevator

PORTABLE GRAIN-LOADING ELEVATOR

Several portable grain-loading elevators, which may be operated by an electric motor or by a gasoline engine, are being used with considerable success by the Northern Illinois Electric Railway, which devotes special attention to the handling of grain on its line extending through the famous corn-belt of Illinois. Regulation steam-road freight cars, operated on the electric line, are placed on sidings, located at frequent intervals, and the farmers bring the grain to them in wagons.

The first of the elevators used was driven by a gasoline engine, but the lately installed similar machines are operated by electric motors, taking current from the trolley wire. The grain wagons are tilted in the manner shown, and the load feeds into the receiving box of the elevator. A wagon-load of grain can be transferred into a car in 10 min.

CA traveler recently returned from China states he was astounded to learn that people in the interior who can speak no language but Chinese are yet thoroughly familiar with the life and work of George Washington, excellent biographies and reviews of his achievements having been published in Chinese.

THIEF-PROOF RACK FOR TOOLS

A stand tool rack provided with a means for preventing the mysterious disappearance of shop tools is shown in the accompanying drawing. The larger tools are held in the circular rack by dropping the handles through the slots, and in the center is a shallow tray for smaller tools. The tools are locked in place by swinging a large circular steel cover over them and padlocking it.

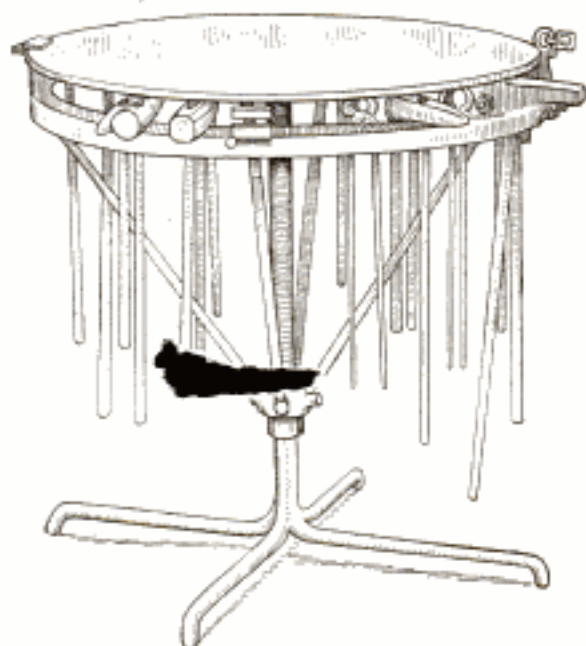

A Tool Rack Provided with a Top Which is Padlocked Over the Heads of the Tools to Prevent Their Removal

low tray for smaller tools. The tools are locked in place by swinging a large circular steel cover over them and padlocking it.



METAL WORK AND ETCHING

By JOHN D. ADAMS

PART X—Hinges and Drawer Pulls

THE making of arts-and-crafts furniture is now an important item in all manual training courses, and is probably one of the most popular of handicrafts among amateurs in general. This class of furniture demands a distinctive style of hardware. In fact, in the absence of the usual machine-made ornaments, the hardware is about the only added decorative feature.

The accompanying illustrations may serve to point out what can be done in the way of

hinges—either real or imitation. The latter, used in connection with butt hinges, are merely plates of brass or copper appropriately shaped and attached with large-headed nails. In making the real hinge, we must first make an accurate full-size drawing, showing the pattern and the projecting lugs as in the working drawing. As a rule, three of these are integral with the stationary portion, and

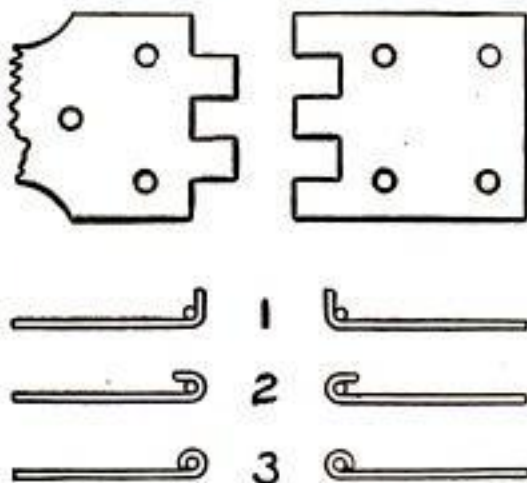

Hinge Patterns and Stages of Construction

the remaining two form a part of the swinging half.

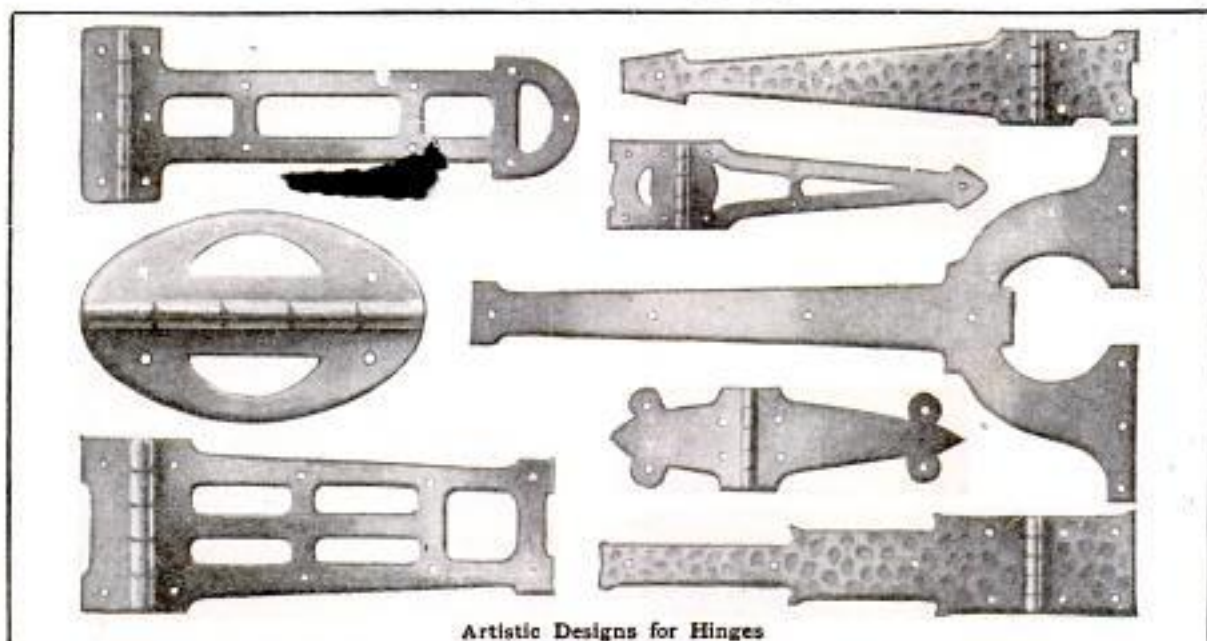

Artistic Designs for Hinges

With thin metal, say, No. 20 gauge, the piece may be cut out with the tin snips, but for the heavier gauges the saw must be used. Where portions are to be cut from the interior, a hole must first be drilled so that the saw blade can be inserted. A short piece of board, 3 in. wide, with a notch in the end, should be nailed or clamped to the bench, so as to overhang about 4 or 5 in. This will prove a great convenience when sawing, as it will firmly support the metal while the saw is moved up and down through the slot. Place the saw in the frame

so as to cut on the down stroke. On the larger hinges and where the shape will permit, the edges should be bent over slightly with the hammer, so as to give the appearance of thickness. When the projecting lugs are all filed up square and properly fitted, the bending should be done. The various stages are indicated in the drawing. After stage two has been reached, a straight wire nail should be inserted and the piece hammered closely around it. Some further filing will then be necessary in order to get the two sides to fit properly together. This accomplished, however, nothing more remains than to fit in the pin and trim off its ends, which should then be slightly burred to prevent it from falling out. The wire

nail used in forming the lugs may serve as a pin, provided it is perfectly straight and the head is cut off.

The etching process is rarely applied to hinges, but the several coloring solutions, heretofore described, may be applied according to the effect desired. Plain lemon brass and hammered copper are popular finishes. Lacquer is used in all cases.

Drawer Pulls

There is probably no article within the scope of home metal work, in the making of which the efforts of the amateur show up to better advantage

than in the case of arts-and-crafts drawer pulls. From the illustration of nine specimens some idea may be gained of the variety obtainable; and, as both brass and copper are available, and these in various finishes, the artistic possibilities will be evident. A piece of mission furniture of pleasing

design, though made by an amateur and from pine lumber, will, when properly stained and fitted with this handmade hardware, present an attractive appearance.

The gauge of the metal may be about No. 16 for average sizes. When it is desired to keep the piece perfectly flat, all the cutting should be done with the metal saw. Interior openings require the drilling of a hole for the insertion of the saw blade, the end of which is



Designs for Drawer Pulls

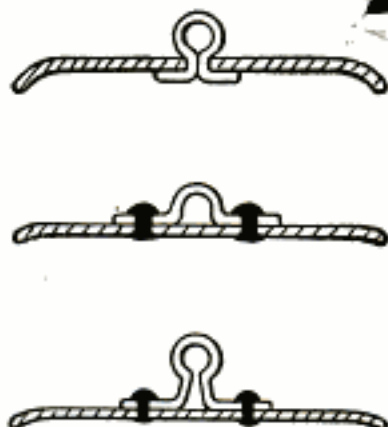

Cross-Sections Showing Construction of Drawer Pulls

then reconnected to its frame. The handles are of brass or copper rod, bent over wood and using a wooden mallet, so as to avoid marring them. These are connected to the plate by either of three methods, as shown. In the first method, the metal strip is first snugly bent around the handle and then the two ends are inserted into the small rectangular opening in the plate, where the ends are bent over and hammered flat. In the second method, a

plain riveted strap is used. In the third, the strap is closely fitted around the handle and the two ends spread apart and drilled for the rivets. Where the size and pattern permit, the edges of the plate are to be beveled over with the mallet so as to give the plate the appearance of having considerable thickness. If the pulls are to be used in connection with the hinges previously described, the finish and metal should, of course, be the same.

ELECTRIC WAX MELTER AND DROPPER

An electric device for melting and dropping the wax used in sealing letters or packages is being marketed by an electrical concern in Buffalo, N. Y.

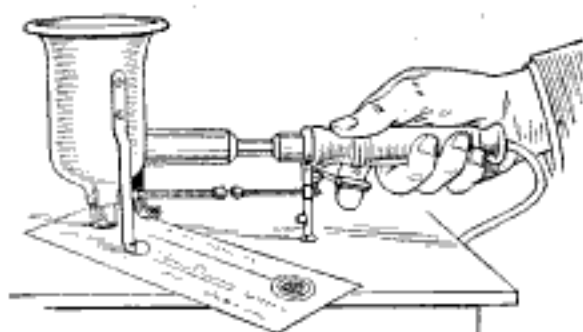

Wax Melter and Dropper for Putting Seals on Letters and Packages

It is designed especially for banks, express offices and shippers of large numbers of packages that require a wax seal, and is much cleaner and quicker than the old methods.

COATING IRON PIPES WITH LEAD

An English inventor has developed a new and cheap process by means of which a coating of lead of any thickness desired may be applied to iron. The weight of lead deposited can be varied from a fraction of an ounce to any weight up to several pounds per foot of surface. His process enables the coating to be applied to a variety of purposes, such as the lining of iron pipes, inside, outside, or both, used for the conveyance of corrosive

liquids; the lining of pumps, chemical vessels, etc.

Hitherto the coating of iron and steel surfaces with lead has been almost exclusively confined to the production of terneplate, as the thickness of lead which could be applied was within narrow limits.

COALING BARGE MIXES THE COAL AUTOMATICALLY

Economy in the steamship consumption of coal often requires that two kinds of coal be mixed in a certain fixed proportion, and to expedite coaling under such requirements a concern in Liverpool, England, has constructed several automatic coaling barges which mix two classes of coal in different proportions as required. In these barges an endless chain of buckets runs over and under the coal compartments, receiving coal as they pass under the compartments. The doors in the bottom of the compartments through which the coal drops into the buckets can be opened or shut instantaneously by operation from the deck. The coal undergoes an automatic mixing process in its progress through the compartments to the doors, and then the mixing process is made complete as the coal from the buckets passes through the chutes into a steamship's bunkers.

☞ The long-distance balloon record has been awarded by the Aero Club of France to Emile Dubonnet, for a flight of 1,214 miles.



The Wonders of Light

By J. GORDON OGDEN, Ph. D.

V—Vision

This is the fifth of a series of articles by the author of "Heat" and "The Kingdom of Dust," which have appeared in this Magazine. Dr. Ogden is professor of physics in the Fifth Avenue High School, Pittsburg, Pa.

LIKE every other function of the higher organisms, vision is a product of evolution. When we study the complicated parts and highly specialized mechanism of the human eye, we have only to turn to the seeing apparatus of the lower animals to perceive the beginnings of structures that reach their highest development in "the heir of all the ages, in the foremost files of time."

Life existed on this planet for myriads of centuries in total blindness. Formless masses of protoplasm in the slimy ooze of ancient oceans moved to and fro on the ocean bottom, without a vestige of an organ of vision. As we go down the steps of animal life as we know it to-day, one by one the marvelous differentiation, or setting apart, of certain portions of the organism for the purpose of vision disappear. Finally, in the very lowest forms of life, in the remotest and deepest subcellular of

creation, down at the bottom of the steps, we come to those curious beginnings of life—mere splotches of protoplasm, barely within the confines of living matter, and absolutely without visual apparatus. At least, the highest powers of the microscope fail to reveal anything of the kind.

For ages the beating of light waves upon these primitive smears of life had no effect other than that of, possibly, a slight stimulation on the rudimentary nervous system. Finally, through all the æons of time that our earth

has been in existence, this constant pounding on the closed doors of sense perception had its effect. The first eye to open could hardly be called an eye. A tiny speck of pigment appeared whose special function seemed to be that of responding to the incessant summons of the light waves. In Euglena, Fig. 1, a microscopic animal that gives a greenish color to the pools of water



According to the Theory of Mosaic Vision, Each of the Visual Rods in the Retina of the Eye Takes Up a Part of the Object Which We See, the Whole Being Blended Together

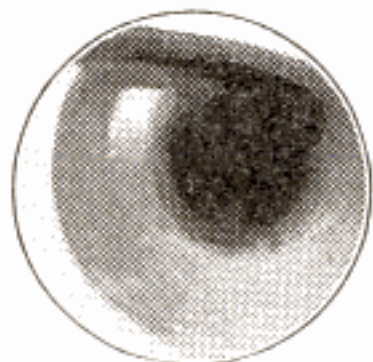

An Enlarged View of the Engraving of the Eye Shown Above. Dots cannot be seen in Top View, but are Very Plain in Lower. This is a Fine Illustration of the Mosaic Theory

that it inhabits, appears a tiny "eye spot" that seems to be the humble beginning of an organ designed for vision alone. It is the first step on the way to the development of a sense that gives to the living world the faculty of sight.

No one knows how many ages, how many cycles of time, elapsed before the human eye with its marvelous lens and magic retina made possible the glories of the rainbow, the wondrous colors of a sunset, and all the other beautiful phenomena attendant upon the tiny ether waves known as light.

It is quite probable that all eyeless animals have the power of distinguishing light from darkness. The maggots from which the common housefly originates will wriggle away from light and seek refuge in the darkest crannies. The hydra (Fig. 2), a tiny, green or yellow, fresh-water polyp, if placed in a black bottle filled with water, will attach itself to any part of the glass where the light may filter through. Even a plant will turn toward the light, as everyone knows who has observed a potato or geranium growing in a cellar window. This, however, is not vision. A picture-forming eye must have a lens in order that the light rays may be concentrated. Some form of nerve tissue is also needed in order that the light's tiny quiverings may be perceived.

The crayfish, commonly known as the "crawfish," has a wonderfully complex visual equipment. The two eyes possessed by this humble invertebrate, are really compound eyes. Figure 3 represents a vertical section of the eye stalk of the crayfish, and Fig. 4, a

highly magnified portion of the same stalk, showing the cones, spindles, and optic nerve. Each of the paddle-shaped crystalline cones is an eye in itself, separated from all the other eyes by a dark zone of pigment. These cones are not hollow tubes. On the contrary, they are solid rods of high refractive power. As many images are borne to the central nervous system of the crayfish as there are individual visual rods. Does the crayfish, therefore, see multiplied images of an object? When an enemy or friend approaches, does it see a legion of its acquaintances, and is its whole horizon taken up with tiny pictures of its casual callers?



Fig. 1—Euglena, Microscopic Animal with "Eye Spot"



Fig. 2—The Hydra, Low Form of Life Turning toward Light

When we consider that the common ant has 100 such eyes; the housefly 8,000, and the dragonfly, 28,000, the question of compound vision is interesting, to say the least. No wonder that a fly is so elusive with its tremendous battery of eyes, giving a range of vision through a very wide angle.

It is quite likely, as demonstrated by Johannes Müller, that compound eyes do not play the part of simple eyes. Each of the 8,000 images or pictures formed by the facets of a housefly's eyes is not an image of an entire object, but only of a part. These parts are fitted together in somewhat the same manner as the irregular bits of colored glass and stone are harmonized into the beautiful mosaic pictures of mediæval Italy. Figure 7 shows very clearly the principle of mosaic vision. Only a few rays of light from any point on an object can reach the optic nerve, and these rays must enter perpendicularly to the cornea. Hence, there is little or no confusion of images, and

each point in an object occupies the same relative position in the mosaic image thus formed.

The human eye, Fig. 8, while it appears to be quite different from the compound eye of the crayfish, has a fundamental resemblance to it, as Huxley has pointed out. In order that we may understand what is really a close relationship, let us review, briefly, the structure of the vertebrate eye, especially that of man.

A human eye is like a camera. It has a lens to gather the light rays to a focus. It has an adjustable screen, or iris, for regulating the amount of light that shall enter. It has a sensitive film affected by the physical or chemical action of the light. Like the camera and all other optical instruments, its interior is dark and lined with black, in order that there may be no unwanted internal reflections with consequent multiplied images. Again, unlike the camera, the eye does not depend upon the lens alone for its light concentration, for the thin, transparent skin which covers the pupil, and is known as the cornea, has also the power of refraction. Furthermore, two fluids in the eye, one in the front, known as the aqueous humor, and one in the main chamber, known as the vitreous humor and occupying about four-fifths of the bulk of the eye, have likewise the power of bending the light rays that pass through them. All of these refractive media work in conjunction, with each other and with the various muscles and nerves, to produce a sharp, clean-cut image upon the retina.

The retina, shown in cross section in Fig. 9, is, perhaps, the most complicated, the most marvelous, of all of nature's handiwork. It is the apex of the pyramid of creation. The retina of

the human eye, although it is but one-eighth of an inch in thickness, is made up of 10 distinct layers, each of which has some distinct function in the business of the eye—that of receiving the rays of light; permitting them to make certain, probably, chemical changes, and transmitting the effect to the brain.

While physiologists are not of one accord as to the effect of light waves upon the retina, it is generally admitted that the ninth layer, which is made up of rods and cones, has a most important part in the mechanics of vision. The retina is really a network of almost immeasurably small branches of the optic nerve. It is made up of delicate nerve fibers, numbering no less than 800,000. For each fiber there are seven cones, 100 rods, and seven pigment cells. Let the reader multiply the numbers of fibers, cones, rods, and pigment cells, and call to mind that this myriad of complex structures are packed into a space less than one-fivehundredth part of an inch in thickness, and he will gain some idea of the wonderfully intricate construction of the apparatus which serves the priceless gift of sight.

To gain a better conception of the rods and cones, and their functions, let us quote from Professor Bidwell, an English scientist of note: "Imagine a small portion of the inner surface of the eyeball, one-tenth of an inch square, to be magnified 2,000 diameters (four million times), and let the enlarged area be represented by a floor of a room, 17 ft. square. Procure a quantity of cedar pencils, and set them on the floor in an upright position and very close to one another. It will be found that the number of pencils required to fill the space will be about half a million. To make the analogy more complete, let



Fig. 3 (Upper View) - Magnified Vertical Section of Eye Stalk of Crayfish

Fig. 4 (Lower View) - Highly Magnified Portion of Same Stalk, Showing Cones and Spindles



some of the pencils be sharpened to a long tapering point at their lower ends, the greater number remaining uncut, just as received from the manufacturers. Neglecting details, which may be regarded as immaterial for our present purpose, we may consider the uncut points as representing, upon an enormously magnified scale, the rods of the retina, and the pointed ones, the cones. The flat upper ends of the pencils may be painted in different uniform colors, and arranged so as to form a large picture in mosaic; if this is looked at from such a distance that its image is a tenth of an inch square (which will be the case when the picture is about 40 yd. away), all possibility of distinguishing the separate elements which comprise it will be lost, and the picture will seem to be a perfectly continuous one. Although the light which enters the eye cannot reach the rods and cones until it has traversed all the other layers of the retina, yet these intervening layers, being transparent, offer little obstruction to its passage, and it can hardly be doubted that the rods and cones are the special organs upon which light exerts its action, the picture focused upon their ends being in truth an exceedingly fine mosaic."

There are various theories concerning what takes place when the ether waves enter the rods and cones. Some scientists hold the opinion that the energy of the light waves is transformed

into electrical energy, and that the visual stimulus is electrical. Others believe in the photo-mechanical theory, according to which the pigmented cells in the retina, forced out of their shape and volume by the mechanical action of light, press upon the rods and cones, thus producing a stimulation.

The most probable theory, however, is that which is known as the photo-chemical.

According to this theory the light waves produce a chemical change in the rods and cones, causing impulses which ascend the optic nerve to the brain. There is, in the retina, a peculiar substance known as rhodopsin or

"visual purple." It bleaches under the influence of strong light, but is regenerated quite rapidly. Boll, its discoverer, claimed that this vision purple furnishes absolute proof of the photo-chemical theory of vision. The elaborate researches of Kühne have weakened this belief considerably. The function of the purple seems to be that of rendering the eye sensitive to very faint light. All nocturnal animals, with the exception of the bat, possess this peculiar compound to a marked degree.

The photo-chemical function of the purple is shown in Fig. 10. If the strong light from a barred

window is permitted to fall upon the retina of a rabbit, the eye quickly removed, and the retina "fixed" with a solution of alum, the purple will show the barred effect portrayed in the il-



Fig. 5—Magnified View of Section of Simple Eye of Jellyfish

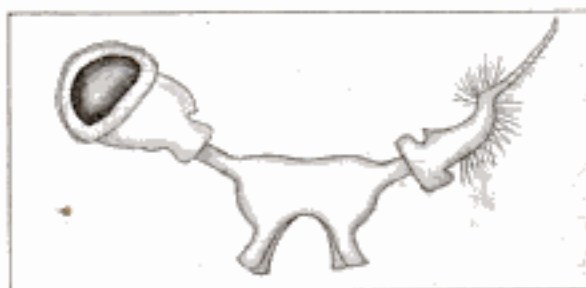

Fig. 6—Eye Stalks of a Decapod. The Compound Eye on the Right has been Lost, and in Its Place the Animal has Regenerated an Antenna—After Herbst

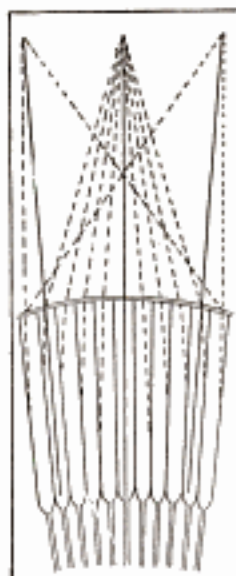

Fig. 7—Diagram Showing the Theory of Mosaic Vision. Practically Only One Ray of Light from Any Point may Enter the Visual Rods, Which are Supposed to be Hollow Tubes

lustration, a permanent "photogram." In the center of the retina, quite near to the optic axis, is the "yellow spot," the most sensitive area of the eye. In the center of the "yellow spot" the rods are absent. About a tenth of an inch from this point, the optic nerve enters the eye, and the retina is incomplete in this area, forming what is known as the "blind spot."

Figure 11 affords an opportunity of demonstrating the existence of the "blind spot," if the directions under the illustration are faithfully obeyed.

Man's eye is an improvement upon those of the lower forms of animal life, but it is by no means a new thing under the sun. As before noted, Huxley has called attention to the fact that it is not such a far cry from the wonderful eye of man to the equally wonderful eye of the crayfish.

It is quite likely that the human eye is at present in a transitional stage of development; otherwise it would be difficult to account for its many defects as an optical instrument, unless we

choose to regard these defects as the

results of compromises whereby the best average results are obtained.

An exposition of a few of these defects may not be uninteresting. For example, no human eye has any adequate means for the proper correction of what is known as "chromatic aberration" or, in plain language, it lacks the power of bringing all colors to the same focus. Were the eye corrected for this defect, vision would be

clearer. One would not see the violet haze around the opal globes of the arc light in the streets. A red spot upon a violet ground would not appear to be raised above the surface, nor would a violet spot upon a red ground appear to be depressed, if the eye brought all the colors to the same focus. A room that is papered or painted a blue-violet color appears to be larger than when its coloring is red. This is likewise a result of chromatic aberration.

Another defect of the eye is known as astigmatism. As the term is ordinarily used, astigmatism is caused by an irregularity

in the curvature of the cornea. The

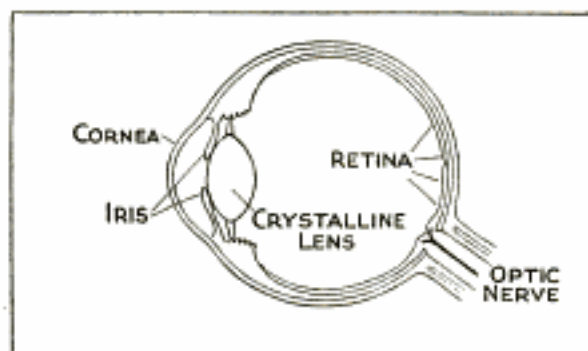

Fig. 8—The Human Eye, Normal Vision, Showing All the Important Parts

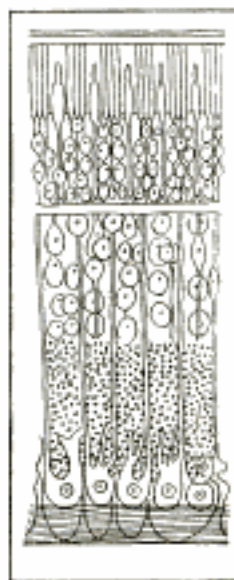

Fig. 9—Cross Section of Human Retina. Note Rods and Cones in the Upper Layer



Fig. 10—"Photogram," Showing the Effect Produced on the Visual Purple of the Retina of a Rabbit, by the Action of a Strong Light from a Barred Window

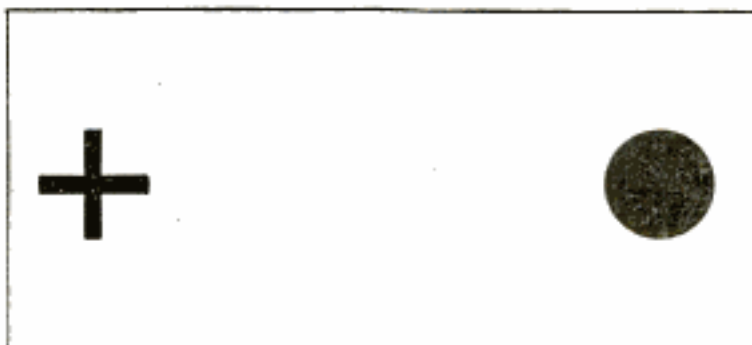

Fig. 11—The Blind Spot. Close the Left Eye. Look Steadily at the Cross. A Position can be Found, by Moving the Book toward or from You, Where the Circle will Disappear. The Image of the Circle is Then on the "Blind Spot"

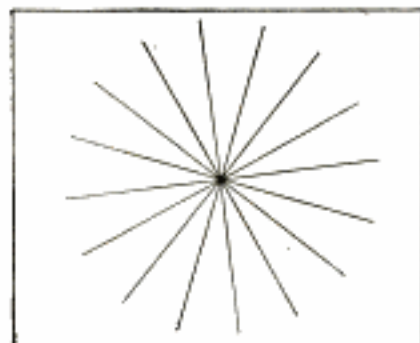

Fig. 12—These Lines are All of the Same Degree of Blackness. They Do not Appear so to an Eye Afflicted with Astigmatism



Fig. 13—Irregular Astigmatism. This Peculiar Effect may be Perceived by Looking at a Light through a Minute Circular Hole in a Piece of Tinfoil

cornea is shaped more or less like the bowl of a spoon, its curvature being greater vertically than horizontally. As a result the eye is unable to bring to a sharp focus all the parts of two lines crossing each other at right angles. One line generally appears to be heavy and distinct, while the other has a slightly hazy appearance. This form of astigmatism as revealed by Fig.

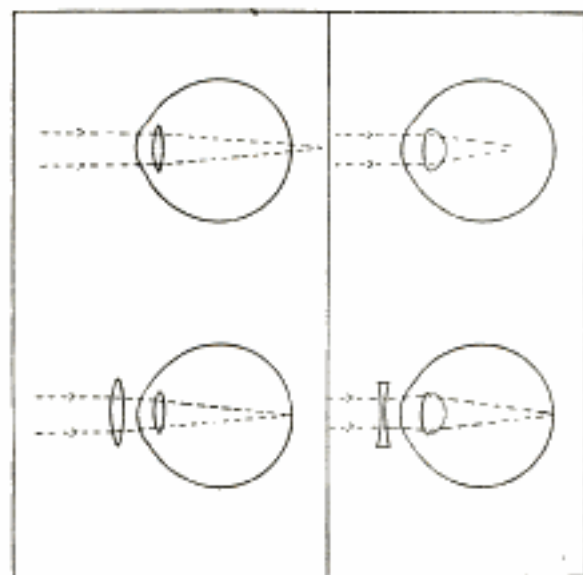

Fig. 14

Fig. 15

Fig. 14—"Far Sight," Due to Flattening of Crystalline Lens. The Lower Drawing Shows How This Defect may be Remedied with the Lens of Eyeglasses

Fig. 15—"Short Sight," Due to Extreme Curvature of Crystalline Lens. The Lower Drawing Shows How This Defect may be Remedied with Convex-Lens Eyeglasses

12 may be corrected by the use of cylindrical glasses.

There is another form of astigmatism, however, that cannot be corrected. It is known as "irregular"

astigmatism, and practically every man, woman, and child is a victim of it. Fortunately, it is not of much importance and bothers no one, unless it is very marked. It is usually due to the peculiar construction of the crystalline lens, in that this important part of the eye is not of the same density throughout, but is made up of a number of separate portions of different densities, pieced together. In other cases it may depend upon irregularities in the curvature of the cornea. The demonstration of irregular astigmatism is a very simple matter. With a fine needle, pierce a small, circular hole in a bit of tinfoil. Close one eye, and with the other, look at a bright light through the hole in the foil, keeping the foil about ten inches from the eye. The hole will not appear to be circular, but jagged and uneven. If you bring the foil an inch or two nearer, the hole will appear to be star-like in form, as shown in Fig. 13. Irregular astigmatism is responsible for the "star-like" appearance of the stars in the heavens, as with perfect vision, the stars would be simply luminous points, devoid of the "rays" that appear to emanate from them.

Other defects of vision are the familiar "far-sight" and "short-sight." They are generally ascribed to a congenital shortening of the whole eyeball, in the case of farsightedness in young people, and an elongation of the whole eyeball in myopes. Far-sight, in old people, again is ascribed to flattening of the lens,

caused by hardening and contraction thereof; which phenomenon also takes place in myopic people, so that the farsighted require convex lenses of increasing strength, while myopes require concave lenses of decreasing strength, and sometimes, in old age, have to use convex lenses. The application of suitable lenses for the correc-

tion of these defects is shown in Figs. 14 and 15.

Let us hope that in spite of the obvious misuse of our eyes, and the tendency to over-light our homes with the advent of cheaper and more powerful artificial illumination, the coming man will take better care of the "windows of his soul."



Beautiful Plaza Design Planned for New York End of Manhattan Bridge, Connecting New York City Proper with Brooklyn

THE PLAZA PLANNED FOR MANHATTAN BRIDGE

The plan for the Manhattan Bridge plaza, New York, is probably the most artistic treatment of a bridge entrance that has yet been attempted on this continent. In Europe such plazas have been given a great deal of attention, but up to the present time, with few exceptions, such artistic features have been neglected in America. The archway is somewhat similar to the arch at Porte St. Denis, Paris, and the treatment of it suggests the Arc de Triomphe. The elliptical effect will remind those who have been in Rome of the colonnade at St. Peter's.

The details of the plan call for sidewalks laid out with warm-colored

mosaics and crossings lined off in similar manner, which will add much to the appearance of the plaza. The plaza parks are planned to be raised above the adjoining streets to a height of from 5 to 8 ft., surrounded by granite walls with granite balustrades. Steps will lead up to the park space at several points. The main walks through the parks to the entrance of the bridge will be of bluestone flagging and the pathways of white pebbles.

The transportation facilities of the plaza were made the subject of much study, the architects and the engineers constantly cooperating. Subway

trains coming off the bridge on the lower four tracks will pass directly under the plaza and directly under the arch. The surface cars, which are shown on the easterly or upstream side of the bridge, pass around the colonnade to the east and are taken to Canal Street. The illustration shows the westerly or downstream tracks

placed on the upper deck devoted to elevated-train service. This is merely an alternative treatment to show how this connection can be made. The original plan showed a terminal building here for the Brooklyn surface lines, and the plaza has been treated so that it will be in harmony with either scheme.

ELECTRIC TRUCK AS STREET-LIGHTING DEMONSTRATOR

That the electric truck can be used with success as a demonstrator of street electric lighting has been shown by the contract department of the electric company furnishing Dayton, Ohio, with illumination. Also, it puts street illumination in the same class as commodities that are directly demonstrable.

Trotwood, Ohio, a little city eight miles north of Dayton, became interested in electric street lighting, and the Dayton company, on learning this, planned a demonstration to show the

people of the community just how the proposed illumination would look. A standard 60-cp., 75-watt series tungsten lamp was hung from a corner span rigged up for the purpose, and one of the company's electric trucks was driven over to Trotwood and its batteries were connected up to the lamp. This ingenious demonstration proved so successful that the Dayton company received a 25-year franchise, a 10-year street-lighting contract, and a pumping contract.

ELECTRICALLY OPERATED GAS METER

One of the large electrical manufacturing companies is making a gas meter, based on a principle quite different from that of the ordinary meter. In this meter the gas passing through it is heated, by an electrical heating unit, through a fixed small temperature range, usually about 2 deg. Fahr., and the electrical energy required to produce the change in temperature provides a measurement of the flow of gas through the meter.

The difference in temperature of the gas, before and after it passes the heating element, is controlled and kept constant by means of two resistance-thermometer screens which are placed on opposite sides of the heating element. The electrical energy required to raise the temperature of the gas a predetermined value is directly proportional to the mass of gas flowing through the meter, regardless of its temperature, pressure or volume. The energy input to the heating element is recorded on a watt-hour meter, or any suitable watt-meter, which can be cali-



Electric Truck Feeding a Street Lamp with Current as a Means of Demonstrating Electric Street Lighting to an Ohio Community

brated directly in cubic feet of gas at a standard condition of temperature and pressure. It is found that about 1 kw. hour is required for each 75,000 cu. ft. of gas passing through the meter.

TOWN SELLS CEMENT WALK FOR ADVERTISING

Wishing to extend a cement sidewalk a distance of three or four blocks to the new fair ground, and having no fund for the purpose, the town of Hope, Arkansas, constructed the extension by selling each outlined block of it as advertising space. A plat was made of the walk, showing it divided into numbered squares. A few of the squares were retained, on which to place a short history of the town, giving names of prominent men, various industries, population at dif-

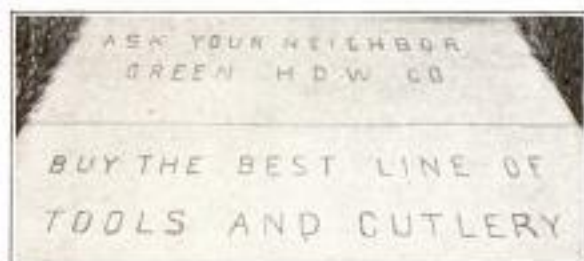

A Section of Cement Sidewalk in Hope, Arkansas, was Paid for by Selling It as Advertising Space

ferent dates, and the names of county and town officers at the time, and the remainder were sold for advertising.

In most cases the advertising was done by forming the letters in the top coat before the final set, but a few of the advertisers furnished aluminum letters and numerals, about 3 in. high. Although the sidewalk has now been laid for some time, the outlines of the letters are said to be as when first made.

LOOKING-GLASS AS RAILWAY TRACKMAN'S TOOL

A looking-glass at the end of a long handle is the simple and ingenious device by means of which the trackmen of the German electric railways examine the power cable. Before the



Examining the Cable of an Electric Railway in Germany by Means of a Looking Glass on a Stick

looking-glass came into use the examiners had to go down on hands and knees to peer under the guard of the cable.

INGENIOUS FIRE-HOSE REEL

In the accompanying illustration is shown an ingenious fire-hose reel for hotels, business places of all kinds, and for homes. Its important feature is that the hose upon it is ready for immediate service without having to be entirely unwound. The water connection is at one of the bearings of the drum, the reel being constructed with a wrought-iron center having a bored waterway. The hose used is of a non-collapsible type, and there is always a clear waterway, without danger of kinks, no matter how much or little of the hose is unwound.

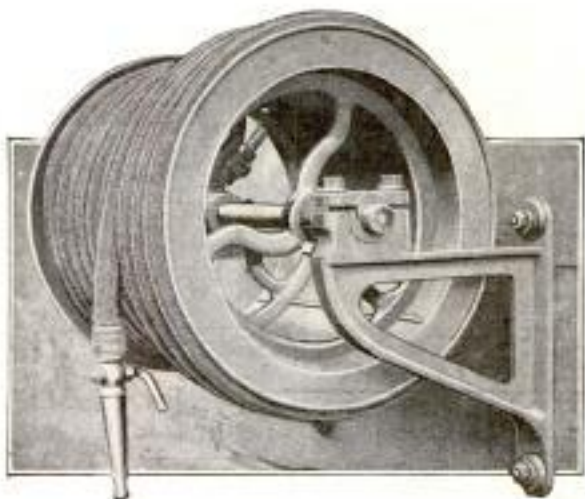

Any Length of Hose may be Unwound from This Reel, Water Being Supplied from Center

THE ADVERTISING DUCK

Shoppers on Broadway, Los Angeles, were amused recently by the appearance of a duck walking down the middle of the sidewalk, clad in bright scarlet overcoat. Many turned and smiled, a number of children followed it down the street, and one stout person wearing a purple necktie and a checkered vest



An Advertising Duck on a Los Angeles Street

was observed to clutch at a lamp-post, exclaiming, "Got 'em again." A duck in a scarlet overcoat is bound to attract attention, and that is what the local business man wanted when he put the little boy's pet to use by placing his advertisement on the garment. The fowl is devoted to its young master and follows him everywhere without a leading string.

RAILROAD TO BE BUILT OF PANAMA CANAL MATERIAL

Secretary of the Interior Fisher has suggested that when the Panama Canal is completed, the construction material used in that undertaking be utilized in building a railroad in Alaska from Seward to the Matanuska coal fields. There were about 375 miles of rails and ties, about 40 locomotives, and 700 flatcars used in the construction of the canal. This material will all be of no use to the government

when the canal is completed, and would no doubt be sold at a sacrifice, making ample allowance for depreciation. The cars that are used in the canal work could be converted into coal cars very easily, but the gauge of the cars and engines is 5 ft. instead of 4 ft. 8 in., which is the standard, and some difficulty might be experienced in trying to change the gauge. There is no doubt, as Secretary Fisher points out, that if the proposed road be constructed, it would open up a vast territory for development.

"HANDCUFF KING" ESCAPES FROM DIVING SUIT

When Harry Houdini, known as the "Handcuff King," was exhibiting recently in Norfolk, Va., he received a challenge from

members of the submarine flotilla at the Norfolk Navy Yard to attempt an escape from a navy deep-sea diving suit. The challenge was accepted, and men selected from the crews placed the suit on Houdini. His body was encased in the heavy, high-pressure, waterproof garment, which inclosed the entire body from the neck, down to and including the feet, the copper breast and neck plate



was put on and fastened to the lower garment with bolts, the brass and steel diver's helmet was placed over his head and secured with the usual brass wing-bolts and nuts, and then his feet were chained and his hands handcuffed. He escaped in 49 minutes.

STREET OF ABUNDANCE IN ANCIENT POMPEII

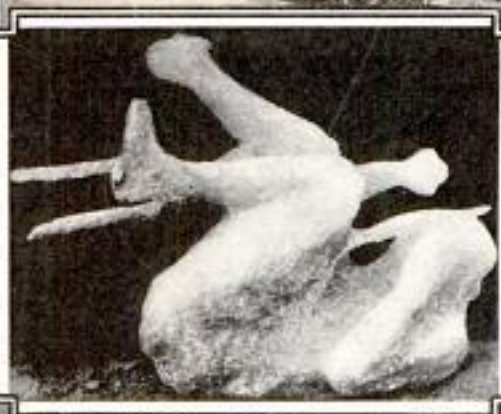
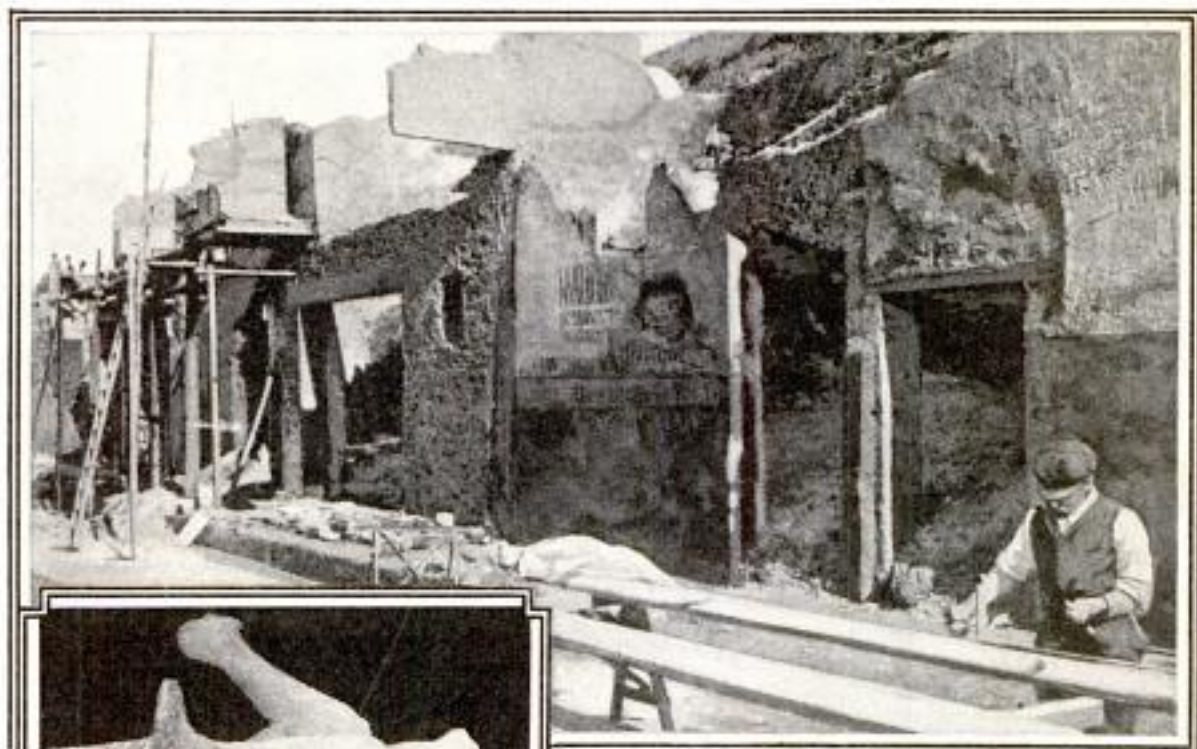

Upper View, General View of the Street of Abundance of Pompeii—On Left, Twisted Body of Man Believed to Have Attempted to Save His Life by Climbing a Tree



Exterior of Pompeian Wine Shop Recently Uncovered, Showing the Counter and Vessels Used for Wines

Archeologists have made a series of remarkable finds in the ruins of Pompeii within the last year. The most interesting discovery was the body of a man found in such a position that the scientists are convinced he was attempting to escape the rain of ashes and lava by climbing a tree when the city was destroyed 2,000 years ago. The street which has just been uncovered has been called the "Street of Abundance." A wine shop was found with many of the vessels intact and some unusual signs and frescoes were also discovered.

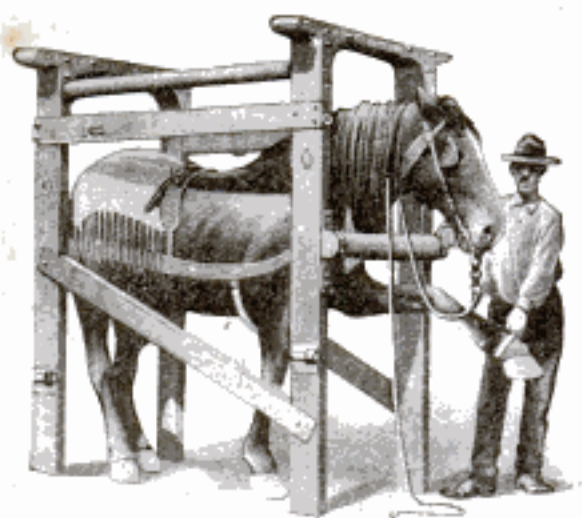

A Frame or Cage for Horseshoeing in Zeeland

A DUTCH HORSESHOEING CAGE

A horseshoeing scene in Zeeland, the Netherlands, is shown in the accompanying illustration. The horse is driven into a cage or frame, designed to keep the animal from breaking away or kicking during the operation.

CA California farmer works his farm 24 hours of the day, his farm hands being employed in regular eight-hour shifts, and his plows and other machinery of that sort being equipped with searchlights for use at night.

REMARKABLY PROPORTIONED GUM TREE

One of the most famous and unusual trees growing in Los Angeles is this remarkable gum tree of the lemon-scented gum variety, the foliage of which is as fragrant as that of the lemon-scented verbena. Planted 17 years ago in the city salesyard of a Los Angeles nursery, it has grown to a height of 130 ft., has a diameter of only $11\frac{3}{4}$ in. at its base, and has a tuft of branches which begins 120 ft. from the ground. The extremely thin trunk sways as much as 50 ft. from the perpendicular in a high wind.

The illustration shows a steeplejack climbing the tree to cut off a few straggling limbs, a calm day having been chosen for the operation.

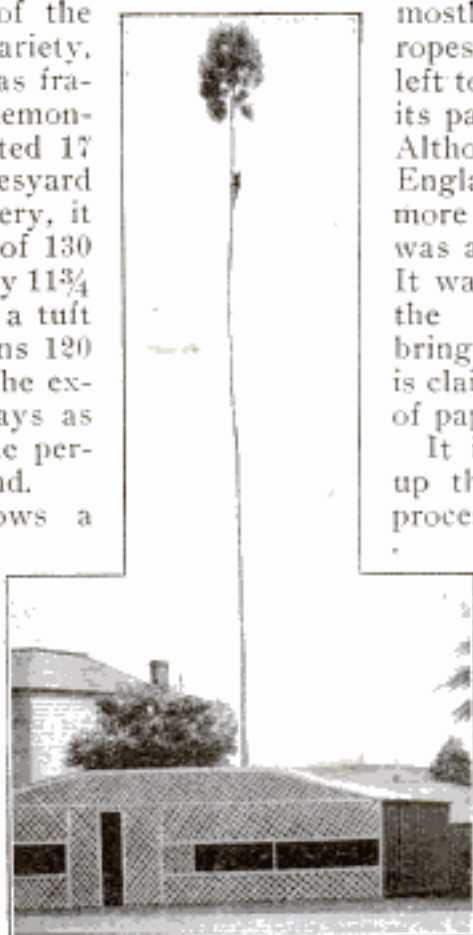

A Los Angeles Gum Tree 130 Feet in Height, with a Trunk but $11\frac{3}{4}$ Inches in Diameter at the Base. A Steeple-jack is Shown Climbing the Tree

to be destined to greatly cheapen the production of first-class paper throughout the entire world. It is esparto grass, and has never been grown in this country. In Algeria it is used

mostly for weaving baskets, ropes, cords, etc., and it was left to the English to discover its paper-making possibilities. Although only imported into England a short time ago, more than 2,500,000 tons of it was absorbed there last year. It was used in 50 per cent of the English paper mills, bringing down the prices, it is claimed, of the finest grades of paper to one half.

It is not necessary to cut up the esparto grass in the process of converting it into paper pulp, but merely to boil the whole plant in lye for about five hours. This dissolves the balsams, resins and coloring matter, and then the fibers are removed to the washing and bleaching machines, which convert the stock into a mass ready for pulping. The expense of pulping the grass is

ALGERIAN GRASS FOR PAPER MAKING

In Algeria there grows today over 12,000,000 acres of a grass which is said

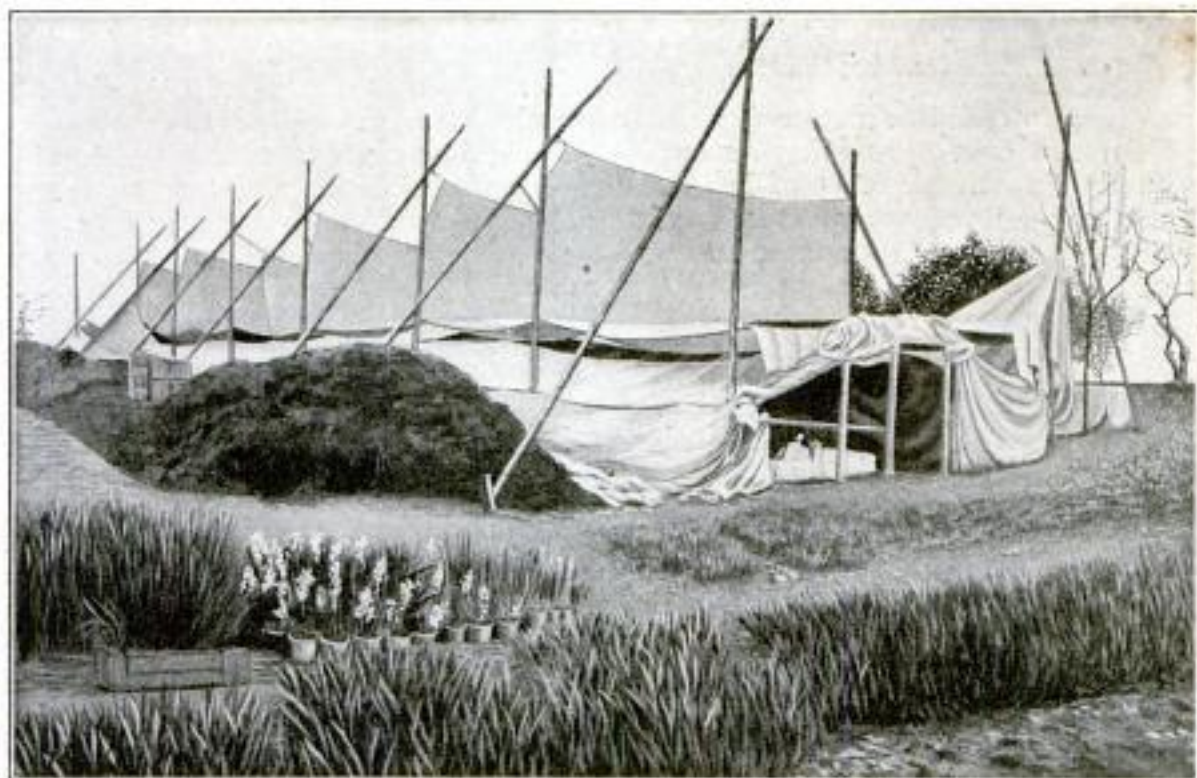

A Greenhouse Erected in London to Prevent Bulbs from Blossoming before the Time Desired

claimed to be much less than the pulping of rags, one great difference being in the chemicals. Only about 9 per cent of the lye required for rags is required for the grass. Special grades of caustic soda, absolutely free from lime, not only cheapen the cost of producing the pulp, but avoid the pollution of streams by mill refuse, and also make it possible for the paper manufacturer to use the same lye many times over again, merely by the addition of quantities of fresh caustic soda.

Two tons of raw esparto grass make one ton of pure white primary paper.

During the recent coal strike in Great Britain coal was selling at \$2,150,400 a ton. Certain wise jewelers of London conceived the idea of selling "Black Diamonds." The mineral was nipped into shape, polished and mounted as tie-pins. Thousands of these black diamond tie-pins were purchased as mementos of the great coal strike.

A GREENHOUSE WHICH RETARDS GROWTH

A Dutch landscape gardener in London who received quantities of Dutch bulbs for use in the gardens of the Dutch village, which was part of the Ideal Home Exhibition held recently at Olympia, constructed a greenhouse the purpose of which was to retard growth instead of to hasten it. This curious greenhouse was constructed of canvas instead of glass, and blocks of ice were laid all around the bulbs, so that the budding flowers would not blossom too quickly.



Cakes of Ice Placed Around Budding Flowers

NEW GERMAN TYPE OF AUTOMOBILE BODY

A new streamline automobile body of German make, providing an exceptionally smooth blending of hood and dash in its lines, which is a marked contrast to the abrupt angles and projections of the usual automobile body, is shown in the accompanying illustration. Other features are the placing of the steering wheel and the driver's seat in the center, where the driver's body will not prevent a clear view of the road ahead from the rear seats; and the deeply upholstered arm chairs substituted for the usual single wide seat. The two auxiliary seats in the passenger section of the machine are also of the arm-chair variety, and are arranged to swivel in order to facilitate entrance and exit. The single seat located centrally in the driver's compartment seems logical, as the extra seat beside the driver is seldom occupied by a passenger in a limousine type of car.

EFFECT OF PAINT ON CORROSION OF IRON

According to the rather surprising results obtained by two German chemists, M. Liebreich and L. Spitzer, of Berlin, who were experimenting with paint as a preventive of the corrosion of iron, it seems that one coat of good paint or varnish is much superior to two or more coats. In their experiments a second or third coat proved absolutely detrimental.

The experiments consisted in painting well polished steel bars with one or more coats and suspending the bars over boiling water for four days. Half of the coating was then removed and the bared metal well covered with vaseline to prevent oxidation. In each case where only one coat of paint

had been applied the bars remained as brilliant and rust-free as before the test, but in the case of two or more coats, corrosion had taken place.

The investigators would not commit themselves as to the explanation of this, but the French scientific magazine *La Nature* suggests it may be that a coating of several layers provides a less flexible cover, more liable to crack, thus allowing oxidizing agents to penetrate to the metal surface.

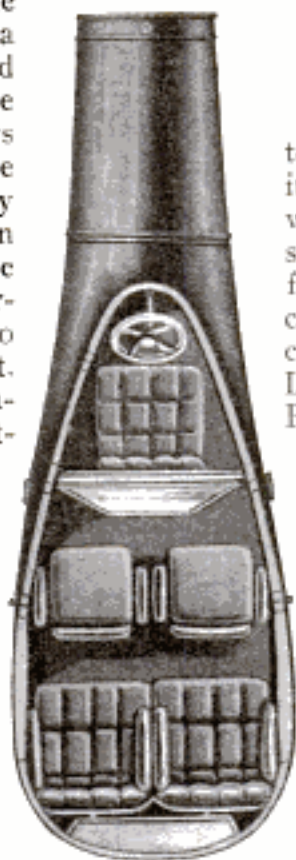

New German Model Having Interesting Lines, and a Single, Centrally Located Seat in the Driver's Compartment

AEROPLANES SUFFER STRAIN FROM ABOVE

Until Lieutenant Sevelle fell to his death recently in France it was not admitted that the wings of aeroplanes could be subjected to breaking strain from above, but this proved conclusively that such is the case. It has, according to Louis Bleriot, in *L'Aero*, Paris, explained a whole series of hitherto not well understood accidents, including those in which Chavez, then Blanchard, Lantheaume and Ducourneau lost their lives. Witnesses of the Chavez accident did say that the wings of his machine had broken and dropped downward, but this was thought to be a mistake or an optical illusion. However, this accident led constructors to strengthen the wings, and the strengthening was still more increased after the subsequent accidents to Blanchard and Lantheaume. But it was in a machine with the latest type of reinforced wings that Sevelle made his fatal flight, and all four upper guy wires were found broken as if cut by shears.

All the accidents referred to occurred under similar conditions and naturally led to the suggestion that the wings were submitted to forces from above, which they were not equipped to withstand. There is no

room for doubt that the accidents were caused by the breaking of the upper wires, and not, as was hitherto assumed, to the breaking of wings which had successfully withstood resistance tests from below.

"It would seem necessary, therefore," says Louis Bleriot, "also to test the resistance of wings against strains from above, in order to obtain upper wiring of sufficient strength. The relation between the strengths of the upper and under wiring should, in my estimation, be about as 3:5. However, as the inertia of an aeroplane is increased as the square of its speed, if one assumes a coefficient of safety of 5 as sufficient for a machine flying at 60 miles an hour, this coefficient should be increased to 20 in an apparatus flying with twice that speed.

"It must also be considered," says Bleriot, "whether the airman's body can resist the shocks that will be the consequence of such coefficients. I believe that the body of a seated man could not sustain a shock from above of more than twice his own weight without being thrown out of his seat, nor that it could resist a shock in the opposite direction of more than that corresponding to a coefficient of 5 or 6, without having his internal organs dangerously displaced. There is, therefore, no reason to insist on exaggerated values of these coefficients of safety. Their values must always be limited by the resistance of the airman's body."

"From the further study of these conditions," he concludes, "much should result that will tend to increase the safety in flight."

BUILT-IN IRONING BOARD

In the accompanying illustration is shown one end of the kitchen of a bungalow in Los Angeles, Cal., one of the kitchen-cabinet features of which is an ironing board that folds up into a cabinet in the wall. When the ironing is finished, all that is necessary is to push the board upward, the inner end being hinged to the bottom board

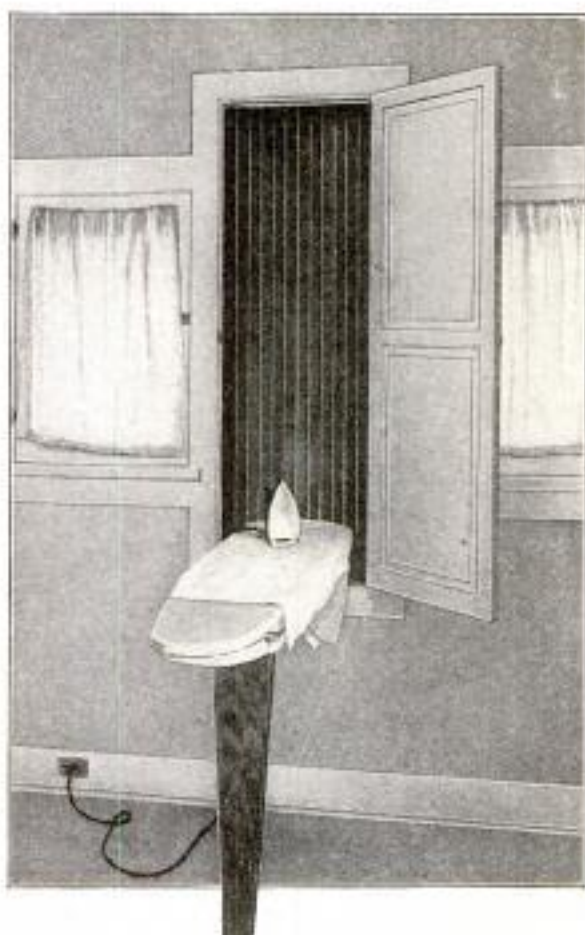

The Cabinet-Kitchen of a Los Angeles Bungalow with a Special Cabinet for the Ironing Board

of the cabinet. The leg naturally folds up against the board. The electric iron may be quickly detached from the wall socket and placed in the cabinet with the board. The arrangement of the numerous cupboards, drawers and cabinets of this kitchen is also interesting.

DETECTING THUNDER STORMS BY WIRELESS

By means of a modified wireless set recently installed in the observatory in Lyons, France, M. Flajolet has been able to note atmospheric electrical disturbances at a long distance. In some instances thunder storms have been detected when more than 300 miles away. A mineral detector is used in the set instead of an electrolytic detector, as the latter was found to be unsatisfactory for this kind of work, in which it had to be in circuit continuously and would get out of order.

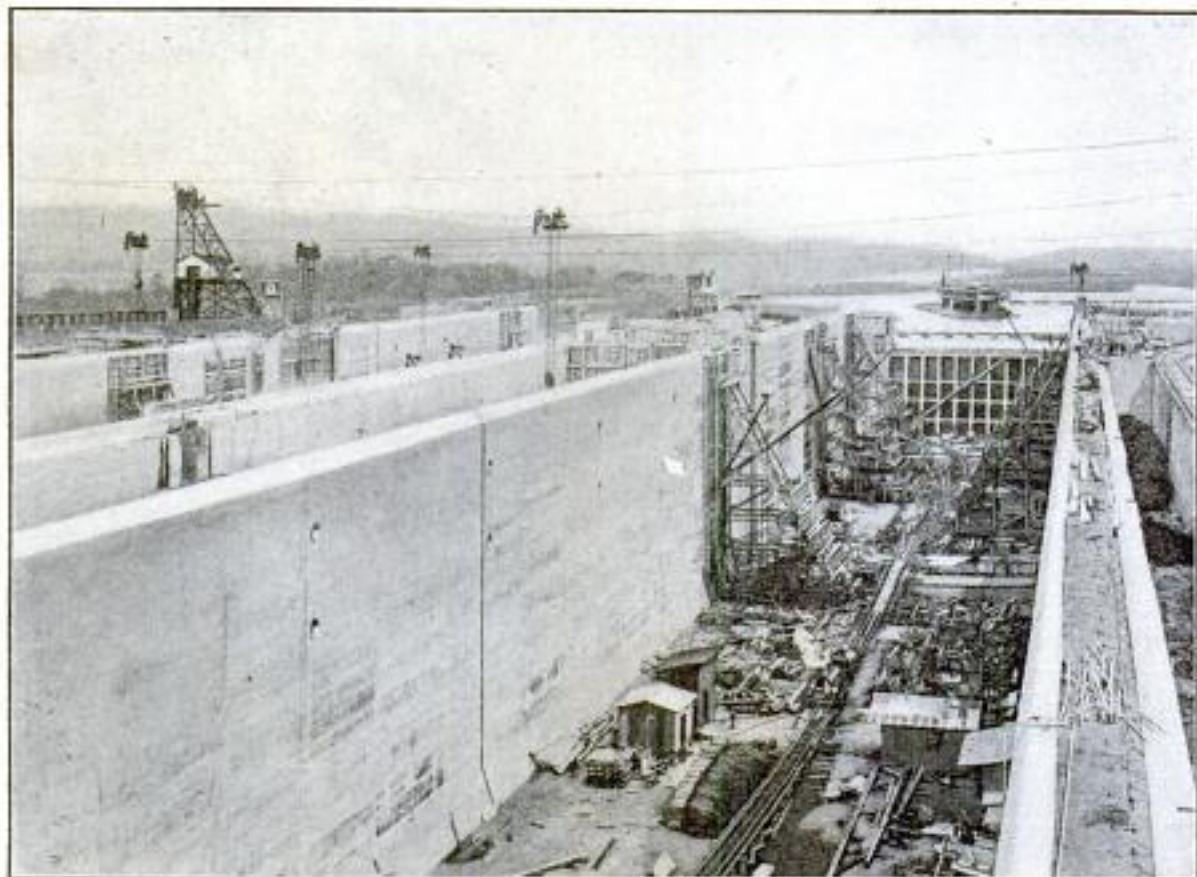

TRANSFORMING THE PANAMA DREAM INTO A REALITY

The latest photographs of the Panama Canal show how closely the engineers have gauged their ability in promising the completion of the big ditch by next year. This picture of one of the Gatun Locks was made a few weeks ago, and there seems to be little more to be done to it beyond removing the scaffolding and other construction aids, and material. This particular point along the canal will be one of the busiest on the Isthmus when the canal is finished. Ninety-eight electric motors will be in operation twice during each lockage at the Gatun Locks, in raising a ship through a vertical distance of 85 ft. from the sea level to the level of the lake. These motors are used in lowering fender chains, opening and closing six pairs of gate valves, 30 cylindrical valves, and six pairs of gates.

AEROPLANE BOMB TESTS WITH REAL BOMBS

A program of events of practically every aviation meet in this country and abroad in the past year or two has included bomb-dropping competi-

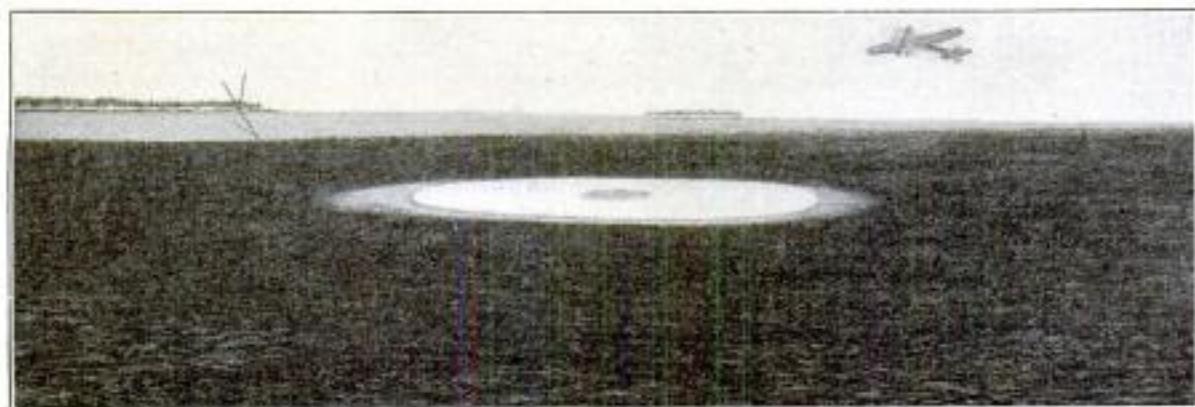

The Aero-Target Used in the Bomb-Dropping Test for the Michelin Prize



The Bomb-Proof Viewing Shelter Erected for the Judges

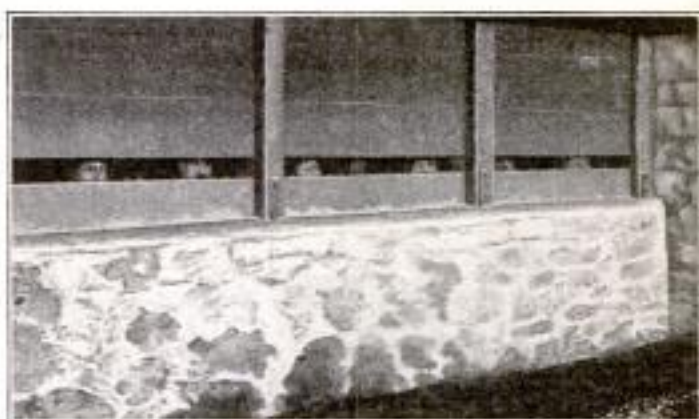

The Judges Watching the Competition through a Long Narrow Slit in the Wooden Portion of the Shelter

tions, but the bombs have usually been imitations instead of real explosives. In the recent bomb-dropping test in France, for the Michelin prize, real explosives were used, and the method of protecting the judges is interesting. The aero-target was of concrete, about 32 ft. in diameter, and near it was erected a bomb-proof viewing shelter for the judges. The judges watched the competition through a long narrow slit in the wooden portion of the shelter.

FLOWER-VASE CENSER

Seemingly a vase with an imitation flower in it, this Parisian novelty is in reality a censer in which a deodorizing fluid is burned, together with a special perfume representing the odor of the particular imitation flower which is used to form the top. It is made in a variety of styles and shapes.



ⓄThe new British battleships "Centurion" and "King George V" are to be fitted with anti-rolling tanks, these being the first warships to be so equipped.

'SANDALS GIVEN WITH EVERY TICKET

Loggers and woodsmen, wearing their heavy calked boots as they come out of the Puget Sound forests, have played havoc with the expensive car-

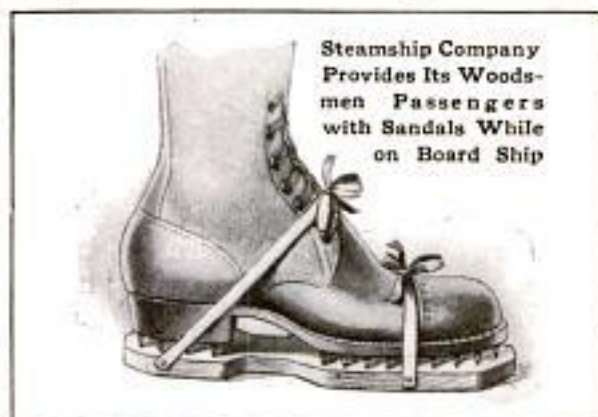

Steamship Company Provides Its Woodsmen Passengers with Sandals While on Board Ship

pets, hardwood floors and tiling aboard Sound steamers, many of which are very handsomely fitted for passenger traffic, and carry thousands of tourists during the summer months. The sharp calks on the loggers' boots cut the carpets to rags, gouge the floors and ruin the tiling.

One company, which controls much of the steamboat business on the Sound, is trying to solve the problem by the introduction of "loggers' sandals." For a long time loggers have been refused passage unless they would remove the calked boots, but as many of the men were just out of the woods and had no other boots or slippers to wear, this worked a hardship. The general manager of the transpor-

tation line invented the sandal, which is simply a thin wooden sole with tape ties. It can be quickly tied beneath the sole of the heavy boot, and the passenger can clump about with some degree of comfort.

Ticket agents are being supplied with stacks of the sandals. As they sell a ticket they scrutinize the passenger's boots, and if he wears the high-topped calked boot of the logging camps, he is handed a pair of sandals with his ticket. The immediate cause for the introduction of the sandals is that the company's boats have recently been refitted with carpets, and the floors varnished and repaired; and the owners did not care to take any chances of continuous damage.

PAWNSHOPS IN CHINA

Pawnshops, in China are of great antiquity, possibly antedating the Christian era. As a rule they are quite similar in appearance, in the country districts being almost invariably in the form of a square tower about four stories high. They are the most prominent objects in the landscape, looming up like the churches in the French Canadian hamlets of Quebec. A distinguishing feature is the lack of

windows, particularly on the lower floors, so as to offer as little opportunity as possible for forcing an entrance. It frequently happens in the country, after a bad harvest, that the people are on the verge of a famine, and after having pledged everything they possess that is pawnable, they storm the pawnbroker in his citadel.

Through experience the broker has learned to take precautions against a sudden attack or siege so that as soon as danger threatens, he barricades himself within, and all business, henceforth, is carried on from the roof or one of the uppermost windows by means of a basket lowered by a string. If the needy should actually be dying of starvation, custom prescribes that the pawnbroker must come to their assistance—experience probably having taught him, in the course of ages, that, were his clientele to die off he would have to go out of business.

The illustration shows a shop on one of the principal thoroughfares of Shanghai. As the city is under foreign control and efficiently policed, an ample doorway facing the street has been provided. This building is not as high as those in the country and lacks the small windows in the upper floors, probably for the reason that there are no quarters. The doorway can be efficiently barricaded at a moment's notice; but over and above this, further precaution is taken. The interior is fenced off by a heavy wooden grill, just back of which rises a structure not unlike a judge's bench, but higher. At this sits a clerk with several assistants to whom the client must pass up his pledge for examination.

The bookkeeping is so well systematized that even in case a ticket is lost, the full particulars concerning the pledge can be at once determined. The rate of interest varies, but for small loans is usually about one per cent a month. Foreigners frequently pawn their furs for safe keeping during the summer months. Excellent care is taken of them at very nominal expense as the loan may be almost as small as desired.



The Individual Architectural Characteristics of Chinese Pawnshops

ACTUAL USE OF DIRIGIBLES IN TURKO-ITALIAN WAR

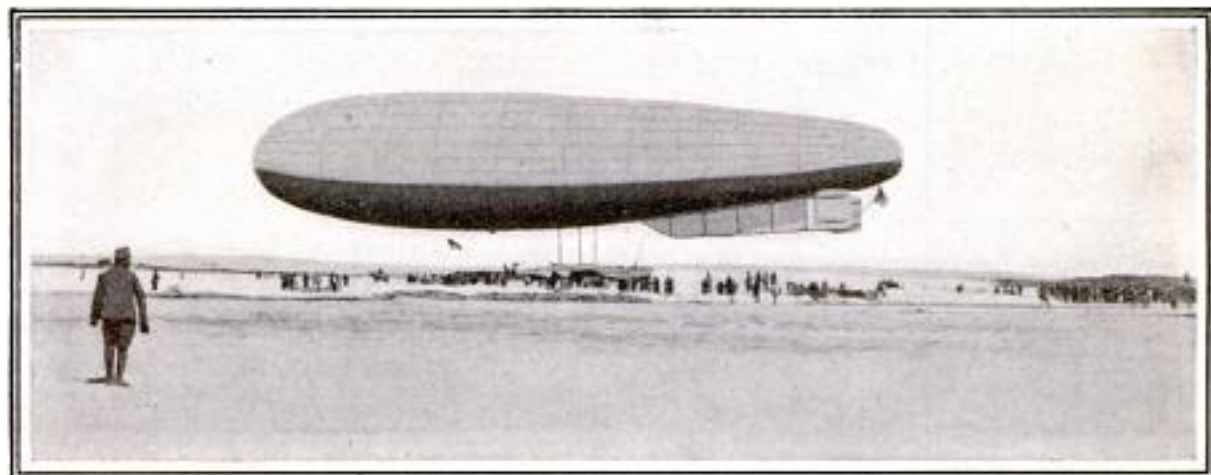

One of the Italian Dirigibles Ready for a Flight over the Turkish Lines



An Italian Dirigible Returning after an Aerial Bombardment of One of the Enemy's Camps

Illustrations have been previously published in this magazine showing how Italy is utilizing aeroplanes for actual service in the war with Turkey. She is also the first country to demonstrate the possibilities of the dirigible in war, and is now using a number of them. Two of Italy's military dirigibles made recent flights over the enemy's encampment at Zavia, dropping 25 bombs from a height of 2,000 ft., causing slaughter and confusion.

THE TROUBLES OF THE PATENT OFFICE

From basement to attic, in rooms and galleries, along corridors and under the steps of the Patent Office build-

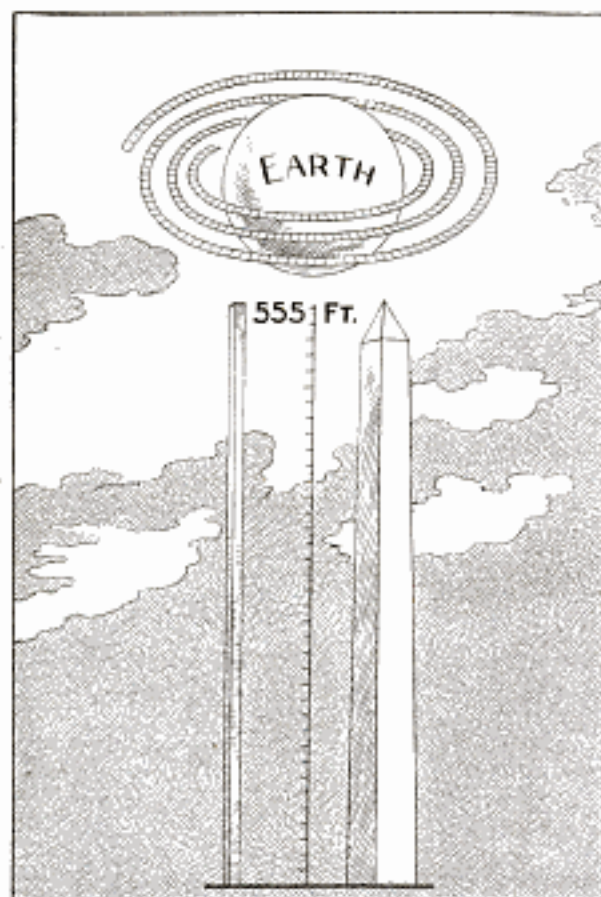

Patent Documents on File in U. S. Patent Office would Stretch Three Times around the World, or would Form a Mass 15 Feet Square, as High as Washington Monument

ing, the storage of patent documents has continued until there are now over two miles of cases, nine shelves high. If all the copies of patents stored in the building were laid end to end, they would form a strip 75,000 miles long, which would reach three times around the earth. Placed in a pile, they would form a mass 15 ft. square and as high as the Washington monument, and, if placed on one continuous shelf, a shelf 19 miles long would be required.

The quantity of the material, however, is not the only feature that troubles the department. The dust accumulates faster than it can be cleaned off, and the great quantity of paper and wooden shelves makes the danger of a disastrous fire always imminent.

An average of 800 patents are granted each week. An estimate of \$220,000 has been submitted to Congress for an appropriation for the construction of an additional wing.

LOADED CARS LIFTED BODILY BY ELECTRIC HOIST

The freight cars carrying material to be used in the construction of the approaches to the new St. Louis municipal bridge across the Mississippi River, were lifted by means of powerful electric hoists, load and all, from the main track to the level of the approach, 112 ft. above, and a switch engine then pushed them to the point where they were to be unloaded. Ordinary flatcars were handled in this way, their trucks being chained to the car-body before they were raised from the lower tracks. The weight of the car and its load often exceeded 75 tons. The object of handling the cars in this manner was to save time, the cars being deposited at the point where they could be unloaded a piece at a time, and the necessity of handling the load twice thus eliminated.

CONVERTING FLYWHEEL INTO FAN

At least one concern in the automobile industry is making an attempt to do away with the regulation fan for cooling the engine. They fit the flywheel with peripheral blades, thus cooling the engine direct from the flywheel.

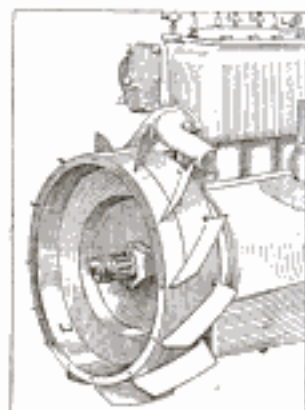

China's first trial by jury took place in Shanghai, March 25 of this year, under a new code of laws prepared by Dr. Wu Ting Fang, Minister to the United States of the Chinese Republic.



MONTE CARLO FROM A HYDRO-AEROPLANE

The Bay of Monaco has been the scene of the first hydro-aeroplane meet held in the world, and eight types of the air-and-water vehicle were displayed. During the course of the meeting a number of photographs were made from the machines while in flight, this one being one of the clearest and best as it gives an excellent view of the far-famed Casino and at the same time shows something of the surrounding buildings and parks. The Henri Farman type of hydro-aeroplane was considered by the judges the best shown. Maurice Farman's entry was second. Both are biplanes.

PHOTOMICROGRAPHS AS ART PATTERNS

As illustrative of the German tendency to utilize scientific progress in commercial production the accompanying illustrations are of special in-

terest. They represent photomicrographs of crystallization forms of chemical solutions as seen under the microscope. They are taken from a



This Photomicrograph of a Chemical Solution Provides a Beautiful Design for Cut Glass



Design That Would be Fine in Colors for a Vase

recent German work which is published for the sole purpose of furnishing new pattern and ornamentation designs for various arts and crafts.

Imagine for instance the beauty of a cut-glass dish in the pattern shown in one of the illustrations, and of the

other, for instance, in colors in a majolica vase. The designs thus obtained by photographing a drop of chemical under the microscope are just as available for designs in wallpaper, metal work, pressed leather, glass painting, textiles, etc.

MOTORBOAT WRECKED IN A CITY STREET

During a motorboat exhibition recently in Montreal, Canada, a truck which was transporting a 40-ft. raised-cabin cruiser collapsed and the boat



A Motorboat Stranded in a Montreal Street by the Collapse of a Wagon Axle

was pitched onto its side, half on the pavement and half on the sidewalk. The only apparent damage was some broken china and glassware in the cabin, and a scratching and rubbing which required nothing more than a new coat of paint on one side.

ⒸThough Philadelphia is noted as being a city of sober, abstemious people, the city directory just printed shows the names of a number of citizens that belie this reputation, as there are 8 Drinkhouses, 275 Bars, 9 Rummors, 7 Drinkers, 1 Drunk, 10 Drinkwaters, 9 Wets, 1 Dry, 5 Brews, 20 Beers, 9 Wines, 1 Gin, 255 Steins and 53 Seidels represented in the long list.

NEW USES FOR TUNGSTEN AND MOLYBDENUM

There were only two practical applications of the two metals tungsten and molybdenum previous to their production in a ductile form: in steel making, and in electric lamps, the tungsten being used for filaments and the molybdenum for filament supports. The drawn tungsten filament, being of greater strength, however, almost entirely replaced the earlier forms.

The electric furnace wound with tungsten or molybdenum wire has been found superior to the furnace wound with platinum wire, both because of the higher temperatures and quicker heating attained, and because these metals are cheaper than platinum.

They both serve as good substitutes for such metals as platinum, platinum-iridium and iridium, in make-and-break devices for electric circuits.

On account of its higher melting point, as compared with platinum, tungsten affords an almost indestructible target, upon which the cathode rays in the Röntgen tube may be more closely focused, which will result in a sharper definition and shorter exposure.

Careful consideration is being given at the present time to the possibility of using wrought tungsten for projectiles. It has a high specific gravity which will give it a longer range, and its hardness and great tensile strength should give it a better penetrating power than the

materials now used. It is suggested, however, that the small tungsten bullet of the same weight as the ones now in use would have the disadvantage of not producing as disastrous results to the victim, unless it should hit a vital spot.

SANITARY TOOTHBRUSH HOLDER

This sanitary toothbrush holder, which is of European origin, consists simply of a glass tube of sufficient diameter to admit an ordinary toothbrush, the upper end of the tube terminating in a cup-shaped receptacle containing an antiseptic tablet which gives off microbe-destroying vapors, or a wad of cotton kept saturated with some kind of antiseptic liquid.

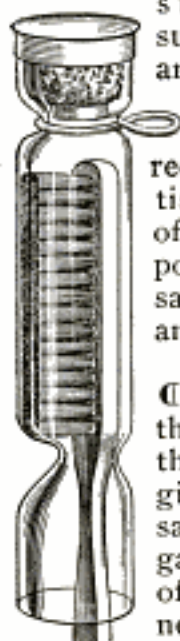

¶An English electrical authority announces that while the cost of cooking to a given degree would be the same with electricity as with gas, in order to obtain 12 lb. of cooked meat it would be necessary to put 17 lb. 2 oz. into the oven of a gas stove, while but 13 lb. 10 oz. would be required by an electric oven, the difference being the amount of moisture, etc., that would be extracted from the meat in the process of cooking.

TRANSFORMERS PLACED ON A FLOAT

An interesting installation of outdoor transformers used in the construction of the Los Angeles aqueduct, is shown in the accompanying illustration. The transformers were placed on a float and were towed from place to place as the work progressed, connection being made to an adjacent high-tension line. The high voltage was stepped down by these transformers for use on an electrically operated dredge.

The outdoor type of transformer is

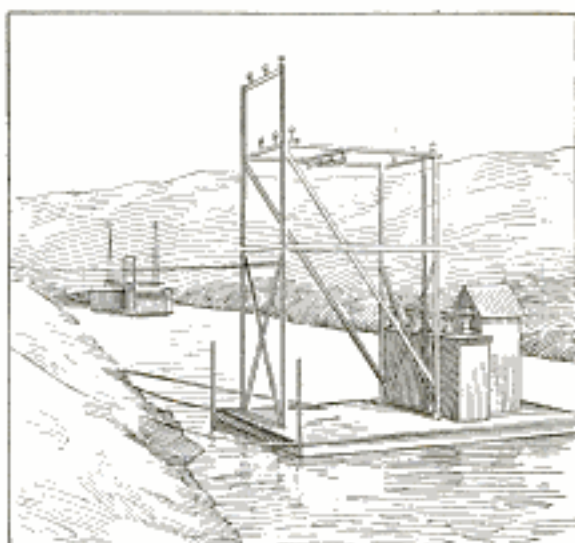

These Transformers, Placed on a Float, Stepped the Voltage of a High-Tension Line for the Operation of an Electric Dredge

a comparatively recent development in the electrical field, its special purpose being to distribute electric power from high-voltage lines for use in industrial plants and small towns where the small amount of power sold would not make the installation of a regular substation economically feasible.

NEW BOTTLE CAP

A French concern is manufacturing a new type of bottle cap or stopper, the feature of which is the ease with which it may be removed from the bottle. The metal cap in general use on beer bottles, and the like, in America requires some kind of opener for re-



Tab Affords Means of Readily Removing Metal Bottle Cap

moval, but this cap is provided with a metal tab which, when lightly pulled in the fingers, tears the rim of the cap off.



The Cowled "Monk's Head" of Cooney Canyon,
New Mexico

NATURE AS A SCULPTOR

Almost every western state has one or more natural statues; some are carved so perfectly by the action of the elements as to be startling in their expressions. One of the

most striking is the "Monk's Head," in Cooney Canyon, New Mexico, a freak of nature which brings out in clear relief a man's face, the head appearing to be hooded. The figure is of giant proportions and at a distance, sharply outlined against the sky, it seems impossible that it is not the work of some ancient people who may have wrought upon it with crude tools, yet obtaining a singularly strong and virile expression of countenance.

LARGEST TOURING AUTOMOBILE

The automobile recently delivered by a French company to the chief inspector of the finances of France is claimed to be the biggest touring car ever turned out. It is a six-cylinder model developing 160 hp., and has a wheel base of 198 in. It has an eight-passenger limousine body, the rear wheels are fitted with twin tires, and its lighting equipment includes electric head and side lamps and a powerful acetylene searchlight pivotally mounted on the dashboard.

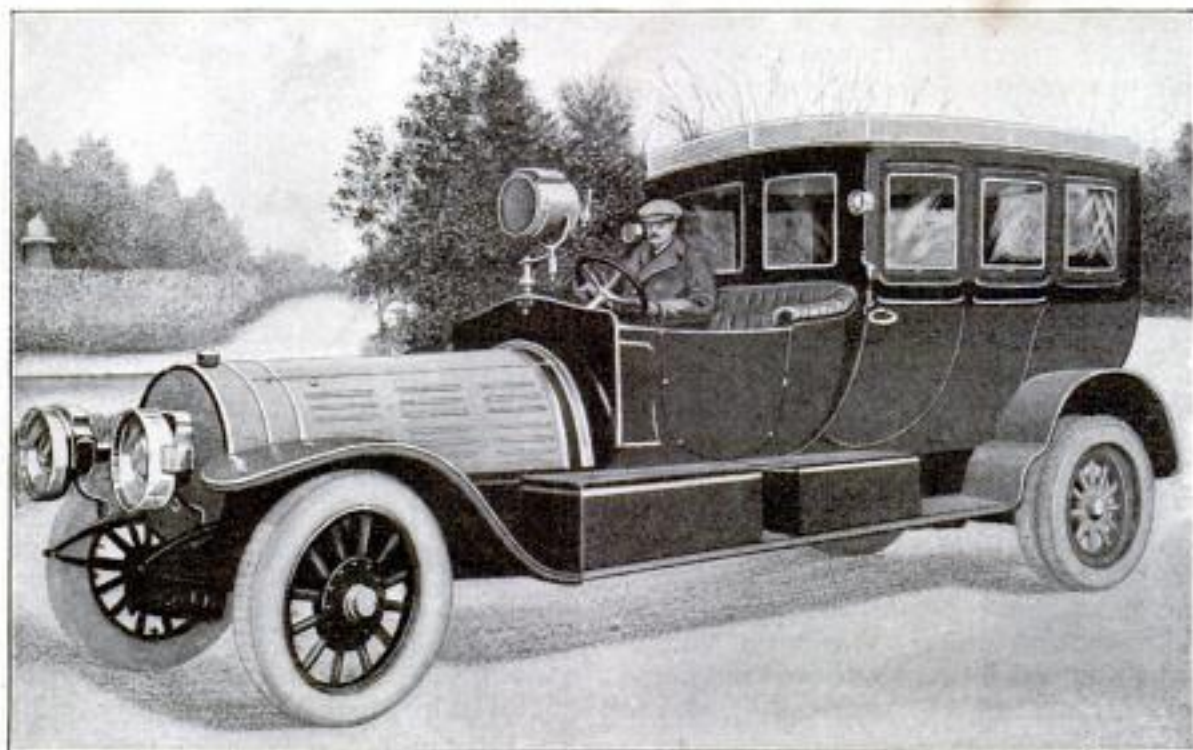

Exceptionally Large Touring Automobile Used by the Chief Inspector of French Finances

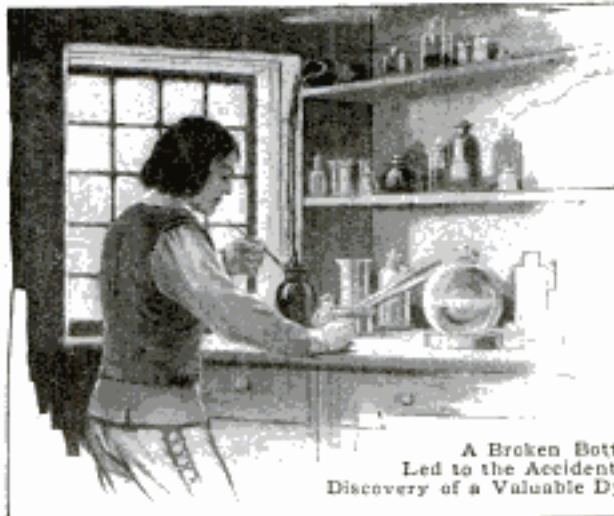

A Broken Bottle
Led to the Accidental
Discovery of a Valuable Dye

Great Discoveries

Due to

Happy Accidents

By

G. E. CHAMBERLAIN

IT IS repetitive history that many a person who has spent hours upon hours combining and recombining the factors of his problem, has had the solution thrust upon his attention by some casualty of daily life. Such occurrences are the spice of research and lead on many a weary investigator in hard and exacting labor. Here is the field where the trained observer has all the advantage. For how many fortunes may never have been realized only because no one had eyes to behold the revelation?

In our own time every beet-sugar factory was confronted with these two problems: How most cheaply to move the beets from the storage sheds to the slicers; and how to cleanse the beets from the dirt, small stones, and rubbish carried from the earth silos. A German factory happened to have a considerable quantity of beets piled alongside an open drain. A very heavy rainstorm came on, and when it was over, it was found that the beets had not only been carried to the very door of the factory, but were cleaned as well. From that time on every factory has flushed its beets from storage to plant and saved money by combining the two operations of transportation and washing.

Thomas Kingsford discovered the process of making starch from Indian corn by chance. Starch could be made from potatoes and from wheat, but it had always been found impossible to separate cornstarch from the accom-

panying gluten. The wheat-starch methods did not answer. Kingsford was a mechanic working long hours, and all his experiments were made in his own kitchen with his wife's pans, tubs, and buckets as his laboratory utensils.

The unsatisfactory result of one of his experiments—a mush of cornmeal and water—he disgustedly threw into a garbage tub. A little later his wife threw into the same tub some lye wastes. Upon emptying the tub the next day, Kingsford was surprised to find a small amount of fairly pure starch at the bottom. His wife fortunately remembered throwing in the lye, and thus the basic principle was discovered.

Kingsford soon worked out a practical process for making cornstarch commercially, and he not only made a great fortune for himself and his descendants, but laid the foundations of an industry which consumes 30,000,000 bu. of corn annually in the United States alone.

In 1742, Thomas Bolsover, a mechanic of Sheffield, Eng., discovered the art of silverplating. He was repairing the handle of a knife in which both copper and silver were used. Accidentally the two metals were fused together. Based upon this observation he developed the new process. Upon a thick ingot of copper he bound by iron wire a thinner ingot of silver. The whole was then heated in a reverberatory furnace until the edges of the silver ingot were observed to begin to

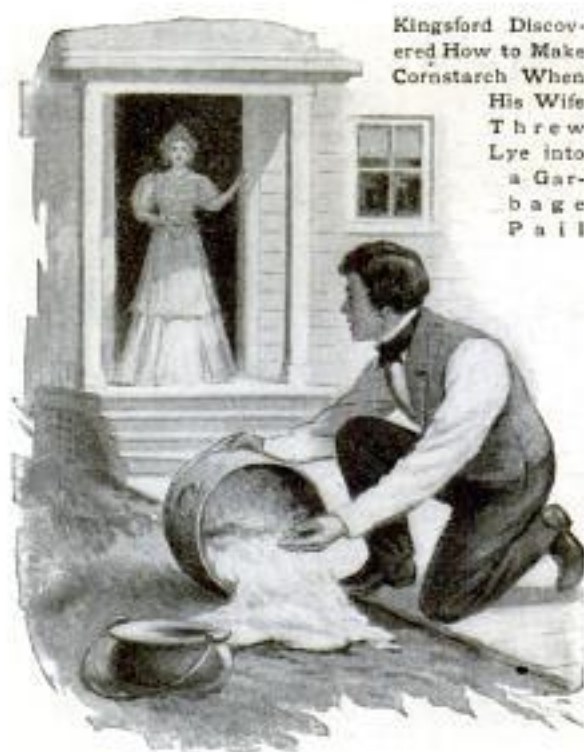

Kingsford Discovered How to Make Cornstarch When His Wife Threw Lye into a Garbage Pail

melt. The two ingots were then removed from the furnace, slowly cooled and pickled, cleaned and rolled to the desired thickness. The result was a plate of copper more or less thinly covered with silver on one side. This was the first Sheffield plate. For 50 years following, the copper was plated on one side only, and the cut edges showed the copper. Later, the process was so perfected that no copper was left exposed. All the silverplate of the world was made by this process, until electroplating was discovered and made commercial.

The many technical processes of the ancients were without doubt of accidental origin. Until comparatively recent times there was no groundwork of theory in either metallurgy or chemistry, and intelligent investigation, planned to accomplish a certain result, cannot exist without this groundwork. The only opportunity for technical progress was that afforded by chance in conjunction with a keen and inquiring observer. For instance, the Romans knew nothing

of the metal zinc. But some observing Roman mechanic had found that when stones of a certain kind were heated with copper, a hard, yellow metal was obtained. Thus brass was discovered and in this manner it was made for centuries. We know now that the stones which possessed these curious properties were the minerals calamine and smithsonite, the silicate and carbonate of zinc respectively. They occurred together in mines, which were, at that time, worked for the iron ores.

Vitruvius is our authority for the statement that the manufacture of red lead was the result of an accidental fire. He also tells us that red lead made by calcining white lead in a furnace was much superior to that obtained directly from the mines.

This is similar, in a way, to the legendary story of the discovery of glass by the Phœnicians. The tale runs in this way: Certain of their merchants, returning from Africa in a ship loaded with natron (crude mineral soda ash), found it necessary on account of bad weather to seek harbor. They found themselves on a sandy plain near Mount Carmel. They built fires on the sand and placed their kettles over the fires on lumps of natron. The heat fused the sand and natron together, forming the first glass. Whether or not the story be true in its details as handed down, the essence of it is certain, viz., that glass was discovered in this manner, probably at different times by men of different na-

According to a Legend, Glass was Accidentally Discovered by Phœnicians Who Placed Lumps of Natron on Fires Lighted on a Beach



tionalities, as its manufacture was known by many people at an early period.

Vitruvius again tells us that in Spain were found certain stones which, after having been "punished" (beaten) with iron rods, for a sufficient length of time, began to "perspire," and the "perspiration" was mercury. Certainly, it was a crude manner of reducing the mercuric ore, cinnabar, with metallic iron, but surely feasible.

He fails to tell, and one cannot but wonder, by what happy accident this method was discovered. Could it be that hammering stone was an official punishment then as it is now?

In setting or mordanting certain dyes, the salts of tin are indispensable. The origin of their use is but little known. Cornelius Drebbel, about the year 1610, was doing some work with cochineal. On a shelf overhead was a bottle of aqua regia, a mixture of nitric and muriatic acids. This bottle was broken and the acid trickled down a window frame and part of it ran into another bottle containing an extract of cochineal. A brilliant scarlet resulted. Drebbel later attempted to repeat the experiment by adding aqua regia to extract of cochineal but there was no change of color. After very careful study, he noticed that a part of the window frame down which the acid first ran was covered with tin. It appeared that tin was the active element, and further experiment confirmed this conclusion. As a result Drebbel owned the secret of making a dye having many new and valuable qualities, and today this is an important use of tin.



The Discovery of That Wonderful Aid to Science, the X-Ray, Was Due to a Fortunate Accident

Roentgen was not looking for X-rays but, after an experiment on an entirely different subject, he noticed that some photographic plates, which had been left near by, were fogged. He sought the reason and his great X-ray discovery was the result.

In 1884, Dr. Reusen was conducting an extensive research into a certain family of coal-tar derivatives. One of his students was a German, named Fahlberg. This

young man, one evening after returning to his boarding house, ate his dinner without having washed his hands. During the course of the meal in some manner he became aware that he had some extremely sweet substance on his fingers. He at once returned to the laboratory and tasted of every solution there. In a certain beaker he found the source of that sweetness.

He gave the new substance a commercial nickname, saccharin, and it was a wise action because its real name was "orthobenzosulphonimide." Whether the fortune he made was due to a lucky accident or his boarding-house training, remains a moot point among his contemporaries. It is also curious to note, in this connection, that after more than 25 years of general use by diabetic sufferers as a harmless substitute for sugar, this substance has recently been put under the ban by the Chemistry Bureau of the agricultural department. It is now forbidden not only to the sick, who consumed great quantities of it, but to the well who have unknowingly eaten their share under the guise of table syrups.

The pages of science are replete with similar instances, and that is one of the reasons why the hard and dreary outlines of technical research are softened and rendered alluring:

The chance of the great discovery, the possibility of great fortune or renown, the glamour, the enticing glamour that leads the student digging deep for nature's secrets ever on and on.

PECULIAR SANDSTONE FORMATION

In the region of the Black Buttes of Wyoming is found a large stretch of most peculiar sandstone formation.

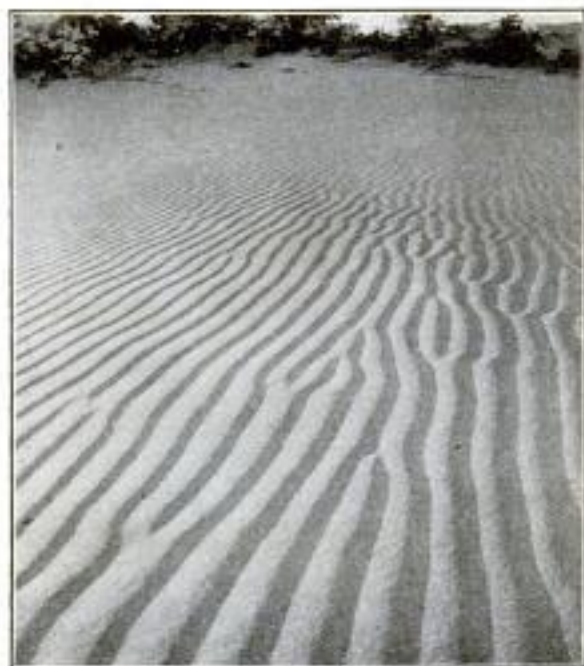

Sandstone Formation Resembles Sand Blown into Ripples by the Wind

Approaching it, the traveler assumes it to be, of course, sand, blown into ripple marks by the wind. It was, in truth, so formed by the wind, but many thousands of years ago, for it is hard sandstone. So deep and clearly cut are the ridges and trenches that it seems as though the stone must have been artificially chiseled by some human machinery.

It is in such sandstone formations that the fossil bones of many species of antediluvian animals are found, sometimes almost perfectly preserved. In very many parts of the world—the Old World, as well as America—the sandstone has proven a most efficient preserver of fossils and also of the

tracks of the various creatures which roamed the earth before the first human beings, or were contemporaneous with the early cave man with his crude club or stone axe.

SPECIAL COURIER AUTOS FOR GERMAN ARMY

One of the latest types of military automobiles developed in Germany is a light car especially designed for the use of couriers in carrying dispatches. The engine develops 16 hp., which is sufficient to drive the little car at a high speed. The rather high wheels, wide wheel base, etc., compared with the size of the body, were adopted

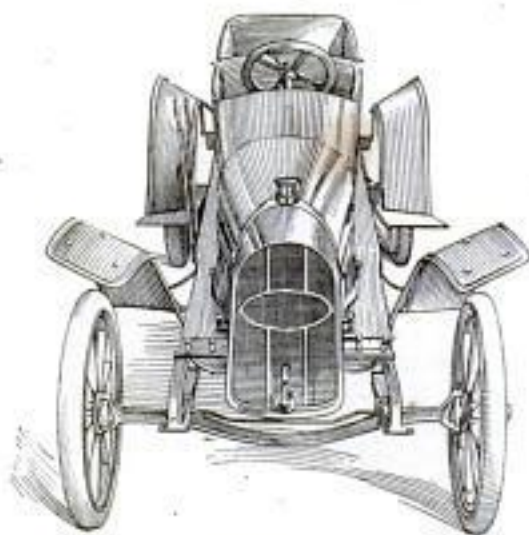

A Light German Military Automobile Designed Especially for Army Couriers

through consideration of the fact that such cars would have to do much work in difficult roadless country.

¶An American actress, who is working her way around the world on a wager, states she found it harder to obtain employment in London, Eng., than in any other city she visited.

PREHISTORIC DINOSAURS FOUND IN UTAH

By HARTLEY M. PHELPS

What is believed by paleontologists to be an important find of hitherto undiscovered species and genera of prehistoric land reptiles has been made by a research party sent out by the Carnegie Museum of Pittsburg, Pa. Twelve fossils or skeletons of dinosaurs, among them two complete brontosaurus—the largest animals that have ever lived—were unearthed from the side of a cliff nine miles north of Jansen, Utah, in what was, in distant ages, a river; as the cobbles, mussel shells and sand environing the bones showed. Besides these specimens of the extinct brontosaurus fossil, remains of several stegosaurus specimens were also brought to light. These are very rare. The stegosaurus was the most grotesque animal that ever existed.

Incomplete remains of a giant dipodocus, like the famous one in the Carnegie Museum, were found with the foregoing.

The research party was in charge of Earl Douglass of the museum staff, one of the men attached to the paleontological department. The party has been in the field for a considerable time, but it is decidedly slow work excavating fossils, as the greatest care must be exercised lest the rocks in which the remains are imbedded be cracked or injured. Then, when the fossils are cut away, there is an immense amount of tedious labor cleaning and assembling them. After that they must be carefully compared with existing specimens to determine whether they form a new genus or species. For these reasons scientists do not know absolutely whether the fossils discovered by the Carnegie Museum men represent hitherto undiscovered specimens. When the

rocks bearing the find arrive in Pittsburg this question will be determined.

The skeletons of the strange monsters belong to what are known as sauropoda dinosauria. Sauropoda is a suborder of the herbivorous dinosaurs or land reptiles. At first these sauropoda were carnivorous, that is, flesh-eating animals, but later became herbi-

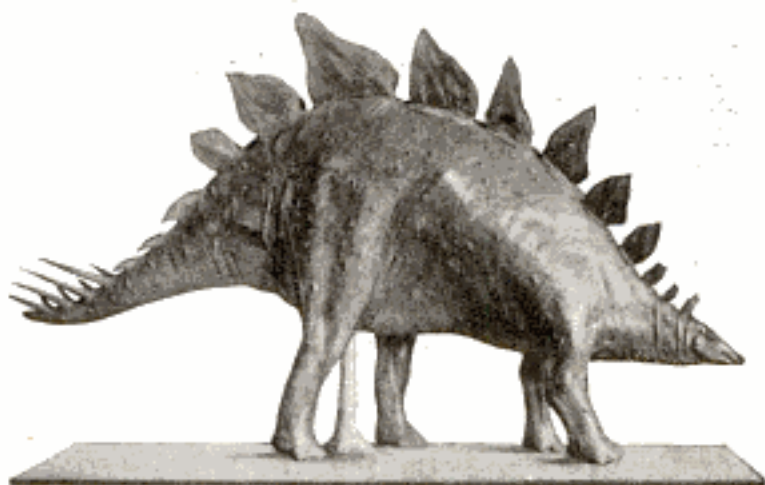

Model of Stegosaur, Most Grotesque Animal That Ever Lived. Remains of Some of These Great Reptiles Have Just Been Unearthed in Utah

vorous or herb-eating. The stegosaurus or stegosaurus unguulatus (the unguulata being hoof-footed animals) is always found in Wyoming, in the rocks of certain geological periods. It was a terrestrial reptile, frequenting the huge luxuriant forests prevalent in those days of four million years ago; and browsed on tender vegetation, of which the forests were full.

Its most remarkable feature is the double line of large bones sticking up on the middle line of its back; and with which it defended itself against its ferocious carnivorous enemies like the allosaurus. Its tail was armed with spike-like projections with which it impaled its assailants. It fought by presenting its tail and back to its foes, cutting and slashing with those terrible leaf-like bones on its back and those bony daggers in its tail. Scientists say it was a migrant from Europe.

The brontosaurus often attained a length of 80 ft.; but it had a small

head. Its neck and tail were short. Like the stegosaurus, it lived by eating succulent herbs. It had powerful legs, 10 ft. or so in length.

The diplodocus specimen in the Carnegie Museum is the only complete one ever found and has attracted world-wide attention. Replicas of it

have been presented to half a dozen nations. The diplodocus measured 70 ft. long, had an immense body, powerful legs, and an enormously long tail, and long neck, but a small head. It lived in swamps and ate waterweeds. Its remains have only been found on the slopes of the Rocky Mountains.

AUTO FURNISHES POWER FOR PNEUMATIC TOOL

The accompanying illustration shows an improvised, portable pneumatic granite-cutting plant devised by a monument maker for lettering stones after they are set in the cemetery. He



Chiseling a Monument by Means of an Automatic Tool Driven by Air Compressed by the Automobile Engine

mounted an air compressor on the back of his auto and connected it with the engine of his machine which furnishes ample power for operating the carving tool. Because of rough treatment given memorial stones in shipment, the inventor thought it a better idea to letter or inscribe the memorial after it was placed in the cemetery.

"AUTOMOBILE" IN SIAMESE

☞The Siamese word for automobile when printed in the form of a sign has all the appearance of an ad for the black art or some other such mystic performance. The sign usually is:

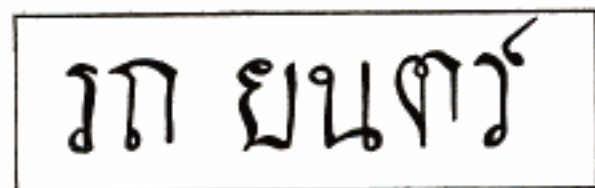

THE UTILIZATION OF IRON FILINGS AND SHAVINGS

The iron sweepings from shop floors, not long ago allowed to go to waste, are responsible for a new industry in Germany, represented by about a dozen plants, which has for its sole purpose the shaping of iron filings, shavings, etc., into briquettes. The briquettes go back to the furnaces to be converted again into commercial forms of iron.

Nearly all the plants of the steel industry in Germany send the sweepings from the shop floors to the briquetting plants, and the consignments from the various concerns are kept as carefully separate as the assayer of gold and silver keeps the sweepings and filings from manufacturing jewelers.

The sweepings are first passed through a strong draft of air, which frees them from dust, including much of the graphite particles contained in cast-iron shavings. Then the sweepings go to the magnetic separator, where brass and bronze particles, as well as the heavier dirt, are removed. After these two cleaning processes, the material arrives at the hopper above the briquetting press, flows down into the empty forms, and is pressed into bricks, which are carried to the loading wagons by a belt conveyor.

☞All horse-drawn carriages used in Burma, India, are equipped with rubber tires and have bells operated by the driver's foot to give warning of approach.



Drawing Circles of Large Diameters

The shop carpenter frequently has occasion to draw curves having a long radius, such as a form for a street-paving crown. These are usually drawn by the use of poles, but on a long radius it is not easy to fasten the poles together to get the length. To do away with the need of a pole, I use the attachment taken from a trammel on a steel tape as shown in the sketch.

The steel point of the trammel A was removed and a V-shaped notch filed in the front part. A small wood

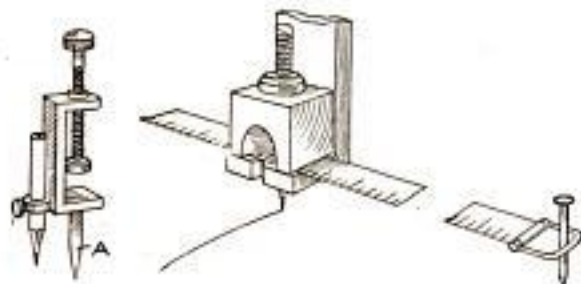

Trammel-Point Part and Manner of Applying It to a Steel Tape

block was then fitted as shown and a pencil inserted.

Take the tape and set the V-notch at the desired distance, then drive a nail at the point the radius calls for and proceed to draw the arc.

I have found this a great help and saving of time in my work. An arc can be quickly drawn and the line will be a true curve and not wavy as when drawn with the aid of a pole.—Contributed by H. J. Eccleston, Norwich, New Jersey.

ⒸThe jaws on a chuck should be "eased" up before taking the finishing cut.

A Carpenter's Door Holder

When hanging a door I make a clamp by using a 6-in. strap hinge attached to two pieces of 2 by 4-in. material, each about 6 in. long, which



The Weight of the Door Causes the Holder to Grip the Edge Firmly

are slightly raised by cleats nailed to the under side. The hinge is so attached to the pieces that a space is left between them equal to the width of the door. When the door is placed in the opening, its weight will cause the pieces to grip the edge and hold the door firmly while it is being planed.—Contributed by Eugene Otis, Chase, B. C.

Truck for Spool Fence Wire

In the accompanying illustration is shown a handy rig for carrying a spool of barbed wire when putting up a



Fence-Wire Truck, Similar to a Baggage Truck with a Rod between the Handles for the Spool

fence. The manner of construction is obvious. The spool of wire can be easily handled by one man with this device.

A Small-Needle Drill

A hand drill for very small work in metal can rarely be obtained at the hardware or tool-dealer's store, and, if it can, it is usually very expensive. A very efficient drill, that is easily made and costs but little, can be constructed in the following manner:

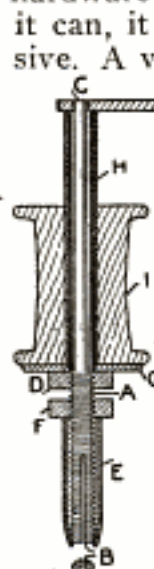

First take a bar of round steel, $\frac{1}{4}$ in. in diameter and $4\frac{1}{2}$ in. long, taper one end slightly as shown, and thread it for a distance of $1\frac{3}{4}$ in. Cut two slots in this end to a depth of $\frac{3}{4}$ in., as shown at B, with a thin hacksaw blade. The slots must cross each other at right angles. A shoulder is filed at the other end of the bar, at C, to receive the crank. An iron or brass nut, D, is screwed on the threaded end and soldered in place.

Procure a brass or iron tube, E, 1 in. long and fitting loosely on the shaft A. One end of this tube is swaged with a light hammer until it is too small to pass over the shaft, and the other end is firmly soldered to a brass or iron nut, F, so that when this nut is screwed upward on the threaded part of the shaft, the swaged end of the tube will force the jaws B tightly together, thus forming the chuck that will hold different-sized drills firmly.

Slip a washer, G, over the other end of the shaft. Procure a piece of brass tubing, H, about $2\frac{5}{8}$ in. long, which will fit the shaft loosely enough to allow the latter to turn freely. Slip this on the shaft down to the washer G. This should bring the top of the tube even with the shoulder C. An ordinary darning-cotton spool, I, is now forced tightly on this tube to form the pressure handle.

The crank, J, is made of a piece of iron or brass, $\frac{1}{8}$ in. by $\frac{5}{16}$ in., and 2 in. long. A small wood handle is riveted to one end and a hole is cut in the other end to fit over the end of the

shaft C. This can be made secure by soldering, taking care to keep the flowing metal away from the tube H, so it will be free.

The drill points are easily made of different-sized needles. Break off the eye, and the point where it starts to taper. Heat and flatten one end until it spreads out on either side, but do not make it too thin. This end is then pointed and sharpened the same as any ordinary flat drill. The shank may be left round, but will be held more firmly in the chuck, if it is made square. The drills should be tempered before using and care should be taken to slightly draw the temper from the shank to keep them from snapping off at this point. When drilling, do not exert too much pressure, as this has a tendency to make the drill bend toward one side or the other.—Contributed by F. L. Matter, Portland, O.

A Spider for Lathe Work

In turning, cutting off, threading, etc., on large pipes or cylindrical work of a like nature, the free end must be supported unless the piece is very short. An old as well as a simple way to hold the end is by means of a spider or casting shaped like a Greek cross, which is tapped at the end of the arms for setscrews and drilled in the center for the lathe center. All this is shown in the sketch, which also illustrates the spider in actual service inside a length of pipe. The other end of the pipe is gripped in the jaws of the chuck.

After setting the tailstock center in the hole of the spider, the work is

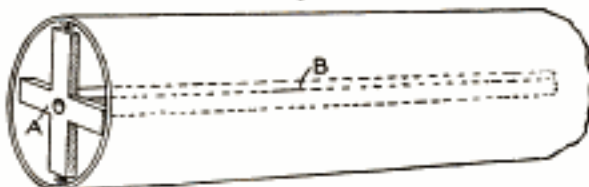

Spider in the End of a Cylinder with the Brace in Position to Take the End Thrust

trued up by adjusting the setscrews in or out, as the case may be. The work can be more quickly trued up, if the spider is set approximately true before running the tailstock center

into place. Locknuts can be used to hold the setscrews where large work is being turned.

In the sketch, A is the spider, and B is a brace made of wood, which is placed between the spider and the lathe chuck to take the end thrust of the tailstock.—Contributed by Donald A. Hampson, Middletown, N. Y.

A Drawer Paper Protector

An effective device to prevent papers or clothes from becoming creased or torn when opening a drawer is shown in the accompanying sketch.

The protector is made of copper wire, about $\frac{5}{16}$ in. in diameter, bent to the shape shown and held in place with two staples. The under side of the wire rests on the paper while the

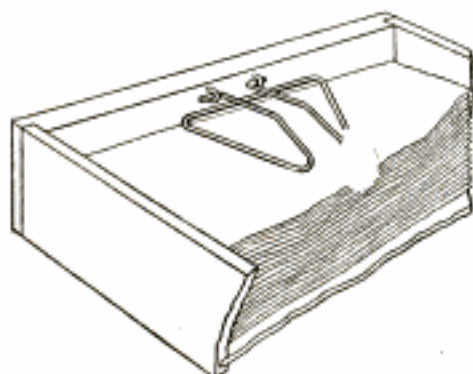

The Protector Holds the Contents While the Drawer is Pushed into Place

upper part is bent to come in contact with the top of the drawer slide. The protector holds the contents while the drawer is pushed into place. When the drawer is pulled out to remove the papers, the protector, which swings on the two staples, can be swung outside of the drawer where it is out of the way.—Contributed by Frank H. Mayoh, Pawtucket, R. I.

A Window Reflector

A room having a window opening into a court can be better lighted by making a reflector as shown in the sketch. A mirror is the best reflector, but, if it is considered too expensive, boards painted white will do almost as well. The bottom of the reflector is

kept away from the wall so that rain or snow can pass through the opening. This arrangement will reflect the light



Reflector Attached to the Outside of a Window to Deflect the Rays of Light into a Room

well and will also prevent persons at other windows in the court from looking into the room.—Contributed by S. Yamashita, Hoquiam, Wash.

Indicating Outside Caliper

The illustration shows how a simple indicating outside caliper may be made. The writer constructed a caliper like this from $\frac{1}{16}$ -in. sheet steel, and found it to be very useful in determining the diameter of small rods and wires. Care should be exercised in attaching the pointer P to the main portion, or base, B, to see that there is no lost motion in the joint. A small washer, W, may be placed on each side directly under the head of the rivet R. The scale should be ruled off last, and may be marked to read in fractions or decimal parts of an inch, or both. A sec-

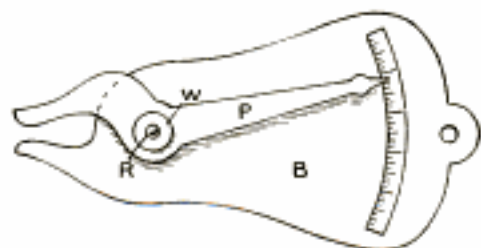

Caliper Made of Sheet Steel for Determining the Size of Small Rods and Wires

ond scale giving the gauge numbers will be very convenient in determining the size of wires.—Contributed by R. S. McClure.

CA slanting aerial in wireless is not as efficient as the horizontal parallel.

To Prevent the Binding of Mast Hoops

The continual binding of mast hoops

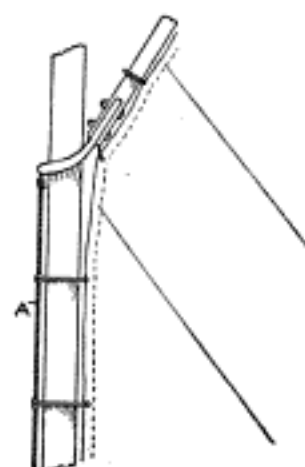

against the mast when hoisting a sail may be prevented in the following manner: A stout cord is attached to the gaff jaws and extended down the mast as shown by A in the sketch. Each ring is tied to the cord at its respective distance

to hold it horizontal.—Contributed by A. L. Chetlain, Chicago.

Whetting Plane Irons

The accompanying sketch shows a device for obtaining a perfect cutting edge on plane irons or chisels, which is almost impossible to secure by the most experienced mechanic in the usual way of sharpening by hand without a guide.

The device is very simple and may be easily made by anyone with little experience, it simply consisting of a piece of pine board, A, of the same thickness as the stone B, and a pine block cut at any desired angle or bevel in which a wood screw with a washer is placed to hold the plane iron. A chisel can be held with a screw on each side of the blade. A little paraffin used



Plane Iron on a Block Having the Proper Slope for the Angle of the Edge

on the two rubbing surfaces of the wood parts will give good action without friction.

When the fine feather shows on the cutting edge of a tool treated on this device, it is better to use a small hand

stone or a smooth steel instrument to turn it back than to attempt to reverse the whole block with tool attached, it being rather awkward to handle. The former method also eliminates the danger of rounding off the straight edge of the tool more or less.—Contributed by Herman Lindenberg, Jr., W. Hoboken, N. J.

Simple Medicine Dropper

When a medicine dropper is not at hand or when it is desirable for any reason to drop the medicine directly from the bottle, a very efficient dropper may be made from an ordinary cork stopper in the following manner: Cut two small grooves lengthwise of the cork opposite to each other. When using, hold the bottle in such a way that the air will enter one of the grooves, A, and the medicine will drop out of the other, B.

The size of the grooves will depend

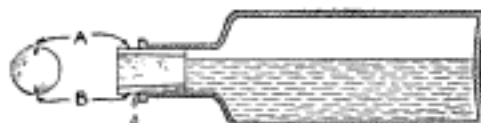

Two Grooves in a Cork, One for the Vent and One for the Fluid

upon the character of the liquid in the bottle. Alcoholic and light aqueous solutions require very small grooves, while for syrups and oils they must be made somewhat larger.—Contributed by W. C. Lane, N. Wilkesboro, N. C.

Repairing a Crack in Cast-Iron Pipe

A crack in a cast-iron pipe or a gasoline-engine cylinder, caused by freezing, can be repaired in the following manner, if the pressure the part has to withstand is not too great. Procure some sulphate of copper, commonly known as bluestone, and dissolve it in water. Clean the edges of the crack well with a file or sandpaper. Paint the iron with the solution several times until there is a coat of copper on it. The copper surface can be easily soft soldered, which will produce a satisfactory repair in many cases.—Contributed by Wm. W. Grant, Calgary, Can.

Measuring Water without a Meter

The amount of feed water pumped into a boiler is a point of interest to the engineer, says Power. If there is a water meter in the pipe line, this may be determined, but such an instrument is never correct and the reading must be multiplied with a certain coefficient in order to give the actual flow of water. To render the situation still more difficult, this coefficient varies with the speed of the meter and also with its age.

Assume that a 50-ft. pipe line is supplying a boiler with water. The amount of water flowing through the pipe may be determined in the following manner: Attach a $\frac{1}{8}$ -in. iron pipe in the far end of the supply pipe, as shown in the sketch by the small pressure pipe. Run this small pipe along the larger one to any convenient point near the boiler or other outlet, and connect it to a U-tube having a scale graduated in inches. Also connect the opposite end of the U-tube to the supply pipe and fill the bend half full of mercury.

When water is flowing in the supply pipe there will be a difference in pressure between the points where the small pressure pipe is connected to the supply pipe, causing the mercury to be elevated in one leg of the U-tube and depressed in the other. This pressure difference varies with the velocity of flow, and it is this fact which makes

which means maintaining the difference in pressures constant for a definite period, say 10 min., during which time the water is collected in a barrel and afterward weighed. For this pur-

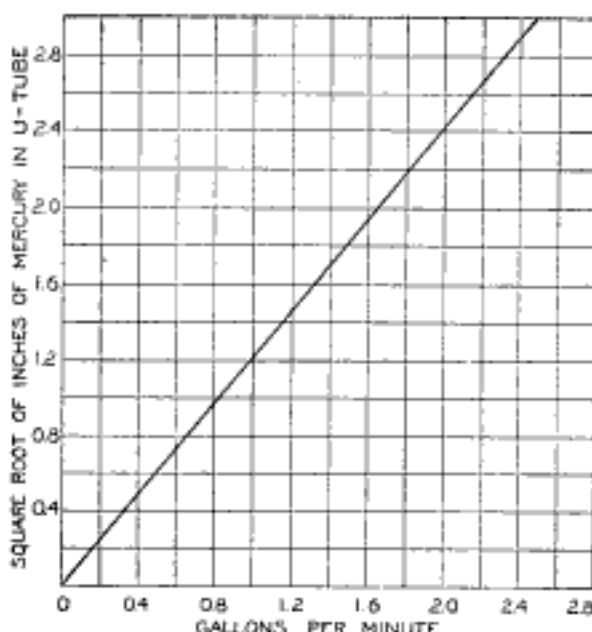

Curve Diagram

pose cut in at some point in the supply pipe back of the U-shaped tube and put in a tee as shown. This temporary connection is supplied with a three-way valve which is used so that, while the desired difference in pressure is being obtained, the water may be flowing through one opening of the three-way valve and into the sewer. When the desired pressures are secured, the

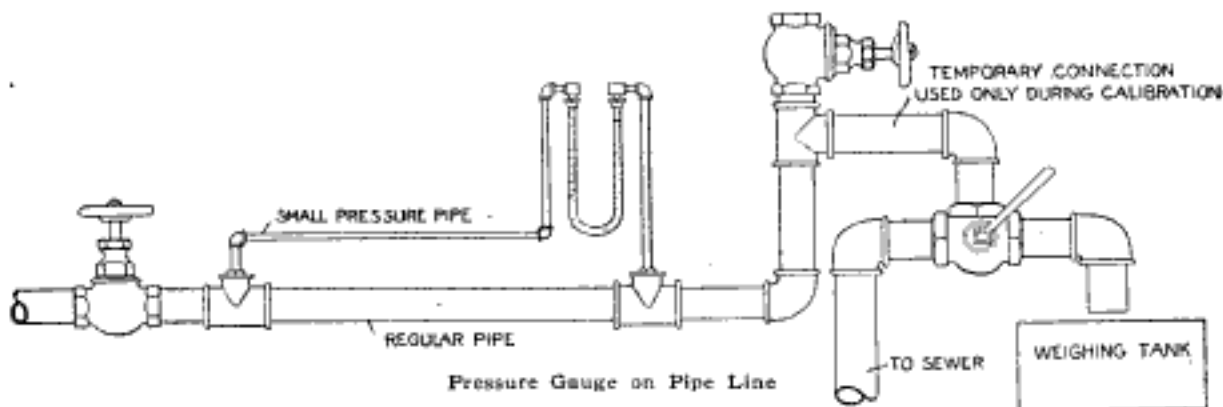

it possible to determine the volume of water passing through the pipe.

The arrangement must be calibrated,

handle of the three-way valve may be turned and the stream discharged into the empty barrel which has been pre-

viously weighed. At the end of the 10-min. interval, the three-way-valve handle is again turned, and the stream directed into the sewer. In this way a number of different pressures are taken and the water collected for each. The results should be plotted as shown in the curve diagram.

Such an arrangement is not only inexpensive, but has, besides, the great advantage that, when once calibrated, it may be depended upon for accuracy at all times. Another feature is that it is not affected by hot or dirty water, or by chemicals. The distance between the points of connection of the small pressure pipe on the supply pipe should not be less than 25 ft., but need not necessarily be straight.

Adjustable Horse for the Shop

Two necessary points in the construction of an adjustable horse are the ease of adjustment and the rigidity of the base. In most cases one is sacrificed for the other. The accompanying sketch shows the construction of about as handy an arrangement for general use as can be made for a wood-working shop. There are no parts with setscrews to come loose and allow the work to fall. The jack is instantly set and, because of the extent of the base,

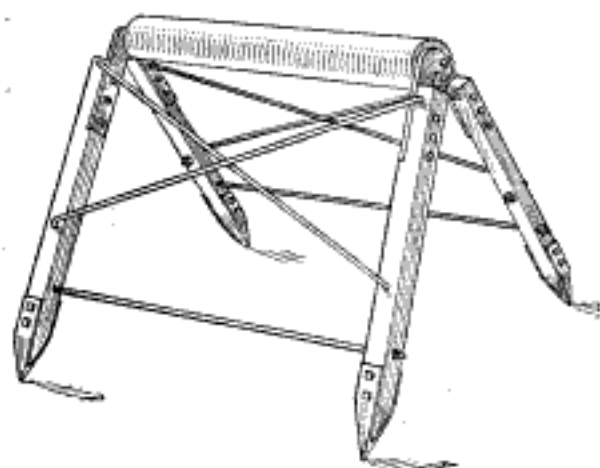

Roller with Adjustable Legs

it remains where set under a load, regardless of the tendency to tip as the work is moved either way over the roller.—Contributed by F. W. Bently, Huron, S. D.

Tempering Small Articles Evenly

It is quite difficult to temper a lot of small springs or other small articles and have the temper equal in all parts of each piece. The following process will be found to give an equal temper in every part of each article:

Obtain a small cup which is pressed from one piece of metal or a pieced cup with hard-soldered seams. Partly fill the cup with some animal or fish oil. Petroleum products are not good on account of their volatility.

The articles are heated to the usual color and plunged into the cup, which is to have sufficient oil in it to cover them. After being thus hardened, the cup with the oil and the articles is held over the fire until the oil takes fire and burns. After the temper has been drawn sufficiently, the cup is removed from the heat and a cover placed over it to quench the flames. When cool, the articles are removed. The articles will be found evenly tempered.

In tempering springs I usually allow the oil to burn about six minutes before quenching. As the oil can be heated to only a certain temperature, the articles receive a perfectly even heat. If the oil is burned off from the article while it is only smeared with oil, some parts will be heated more than others. If a spring is made of piano wire, it will be greatly stiffened and improved by heating it to an even blue after it is formed. The reason for this is that when the wire is coiled the metal is full of strains which the heat removes.—Contributed by J. H. Beebe, Rochester, N. Y.

Gasoline Spray for Cleaning Machinery Parts

In cleaning and repairing the machinery of an automobile, gasoline is used to cut out the thick and dirty lubricating oils in bearings. It is often difficult to get the gasoline into certain places to be cleaned, and this has brought out a syringe device for use in such places.

While cleaning some computing

scales, I desired to remove some oil and dirt from the parts, and the syringe idea obtained from the automobile-cleaning device led me to try out an ordinary blowtorch I had at hand. When I desired to use the gasoline for cleaning, I opened the valve and allowed a fine stream to squirt out, which was easily directed to the spot to be cleaned.—Contributed by Robert S. Cheney, Ashtabula, O.

How to Sharpen a Gouge

Place the gouge on the bench with the back up and the cutting edge extending about 3 in. over the edge of the table. Apply the whetstone with the right hand while holding the gouge level with the left; rub the stone back and forth at right angles to the gouge

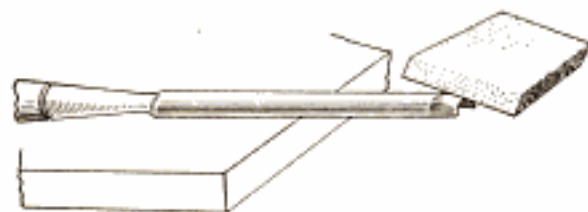

Whetting a Gouge

and at the same time roll it around the curve of the gouge. This method will take out nicks when using a coarse stone and also keep the cutting edge straight, which is difficult to do on a grindstone. A few strokes of a fine stone in the usual way will produce a good edge.—Contributed by L. R. Kelley, Philadelphia, Pa.

Self-Adjusting Belt Tightener

A small grinding machine, having two pulleys side by side for changing the speed, was run by a round belt. The belt was always loose on one pulley and tight on the other, and the belt would stretch so that it would slip. This was easily remedied by cutting out a piece of the belt about 5 in. long, and putting in a piece of coil spring a little shorter than the leather taken out. This spring keeps the belt tight on both pulleys.—Contributed by Newcomb D. Hollister, Truston, New Jersey.

A Hedge Trimmer

Hedge cutting or trimming with a sickle or with hand snips is very slow and tedious work. As I had considerable hedge to take care of, I made a

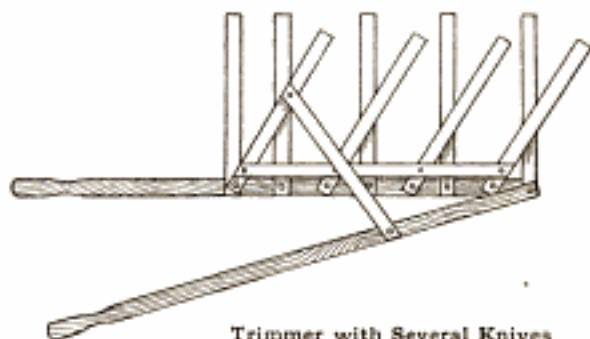

Trimmer with Several Knives

trimmer with several sets of blades similar to a regular trimmer. The blades were attached to a wood handle and operated with a wood lever as shown in the sketch. The operation is the same as when using the regular hedge trimmer.—Contributed by Herman Krouskoff, New Rochelle, N. Y.

Emery-Cloth Holder

As I had a number of dirty connecting rods to polish I naturally set about to do the work as quickly as possible and with the least exertion. Emery cloth is hard to hold with the fingers and keep flat on the rod. I procured two overall buckles and attached a round piece of wood to each buckle, with a cord. A strip of emery was placed in the buckles just as a strap. The device saved me considerable

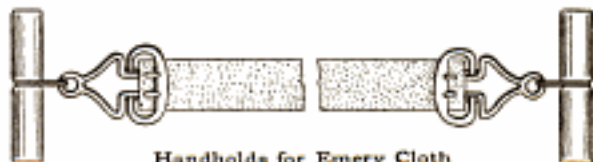

Handholds for Emery Cloth

time, and I could put on a better polish than when I held the emery cloth by hand.—Contributed by Wm. Schumann, New York City.

One of the objections to painting interiors with zinc white is that it will crack or scale, but, according to a Danish painter, this can be remedied by adding 10 per cent of whiting.

Fastener for Window Screens

An ordinary wood screw does not make a good fastening for screens, blinds, shutters and storm windows,

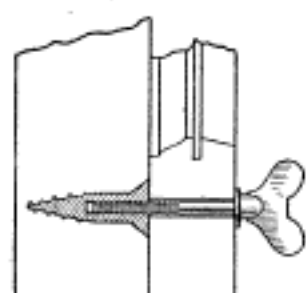

as the wood around the threads will become worn as the screw is removed and replaced. A good holding device is made of a short wood screw hav-

ing a large diameter into which a hole is drilled and tapped to take a thumb-screw of standard threads.

The wood screw is turned permanently into the window or door facing. The holes in the frame are bored to coincide with the threaded holes in the wood screws. It is an easy matter to turn the thumbscrew in place.—Contributed by W. C. Terry, Boston, Mass.

Removing Inner Band on Truck Wheels

Motor-truck builders and blacksmiths, in rebuilding truck wheels that have two bands, will find it a difficult matter to remove the inner band by heating, as both bands will expand alike, causing them to remain tightly together.

If it is desired to use one of these bands after the wheel is rebuilt, it will be a very easy matter to remove the inner band by driving a wedge between the two as shown in Fig. 1, making the opening the same all the

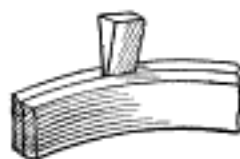

FIG. 1



FIG. 2

Driving the Wedge between the Bands, and Location for Striking the Inner One

way through. Stand the bands up and leave the wedge between them and strike the metal at A A with the peen end of a sledge hammer. A few blows

will cause the inner band to come loose. The band can then be heated and straightened.—Contributed by James E. Roy, Philadelphia, Pa.

Substitute for Thumb Tacks

In making patent drawings, or when a number of small drawings of the same size are to be made, I have found the attachment shown in the sketch to be a splendid substitute for thumb tacks. A drawing board on which thumb tacks are used soon gets full of holes and becomes useless.

The bent end A of the spring clip clamps the paper B by the pressure of the spring. The spring is fastened to the under side of the drawing board

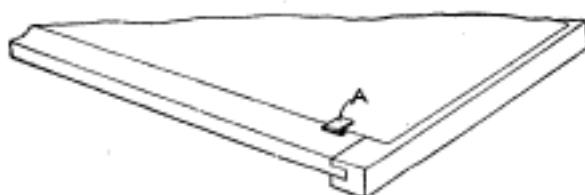

Spring Clips Used on a Board to Hold Drawing Paper of Uniform Size

C with two screws. A pressure of the finger on the under side of the clip raises it for the insertion of the paper.—Contributed by Chester E. Warner, Kalamazoo, Mich.

Preserving Surplus Stain when Staining Shingles

It is almost impossible to stain shingles without waste of staining liquid. To reduce this waste as much as possible, we used an old clothes wringer, attached to a tub, for pressing out all surplus stain at the time the shingles were dipped. As our washing machine and wringer were driven by electric motor, the latter was belted to the old wringer to drive it, while the shingles were fed into the rolls. A better job resulted when the large end of the shingles were started in first.—Contributed by Geo. Lindsay, Manitou Springs, Colo.

Tile Sewer Construction

By GEORGE M. PETERSEN

PART I

The construction of the different kinds of municipal improvements, such as sewers, streets, culverts, highway bridges, etc., are but vaguely understood by the average man. It is the purpose of this description to give facts from a practical view point so that such of the younger generation that are so inclined may obtain a good knowledge of the proper methods of doing this work, and be enabled to join the army of construction men with an amount of practical knowledge which is seldom attained except by experience.

Tile Sewers

In modern sewer construction there are several different classes of material used; the principal ones being brick, stone and concrete, for trunk sewers, while tile is used for branch or service construction. Tile is, however, generally used on small trunk sewers up to 2½ or 3 ft. in diameter. For large trunk sewers, brick is the most common material, the walls being built up of two courses. Stone

inverts or bottoms and brick arches are also used on large trunks while reinforced concrete is used for short drainage sewers and culverts. As it is the object of this article to deal only

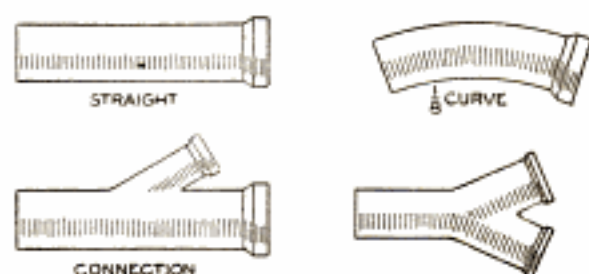

FIG. 1

Four Forms of Sewer Tile for Laying Straight Mains, Turning Corners and Making House Connections

with the construction of tile sewers, a few points bearing on the tile may not come amiss. Tile sewers have a carrying capacity of 100 per cent more than brick sewers of the same size, and the table herewith shows the rate of discharge for the various sized tile at different grades. Sewer tile is made in sizes from 3 in. to 36 in. in diameter and in "standard" and "double"

Size of Pipe in Inches	GALLONS DISCHARGE PER MINUTE							
	1 Inch Fall per 100 Ft.	2 Inch Fall per 100 Ft.	3 Inch Fall per 100 Ft.	6 Inch Fall per 100 Ft.	9 Inch Fall per 100 Ft.	1 Foot Fall per 100 Ft.	2 Foot Fall per 100 Ft.	3 Foot Fall per 100 Ft.
3	9	12	15	22	27	31	44	54
4	20	28	35	50	62	71	101	124
6	63	89	111	156	194	224	317	389
8	140	198	246	348	432	499	706	864
9	196	277	339	480	595	687	971	1180
10	261	369	457	648	803	928	1310	1610
12	432	612	758	1070	1330	1530	2170	2660
15	800	1130	1400	1980	2450	2830	4010	4910
18	1320	1860	2310	3260	4040	4660	6590	8080
20	1720	2500	3060	4330	5305	6130	8660	10610
24	2910	4110	5035	7191	8810	10270	14520	17790
27	4020	5680	6960	9840	12050	13920	19680	24110
30	5380	7618	9320	13180	16140	18640	26350	32280
33	6950	9840	12050	17040	20865	24090	34070	41730
36	8800	12450	15210	21565	26410	30500	43130	52820

Carrying Capacity of Brick Sewers = 50% of Above Quantities.

strength. The standard is usual for tile up to 15 in. in diameter, and double strength for larger sizes. Under extreme conditions double strength is

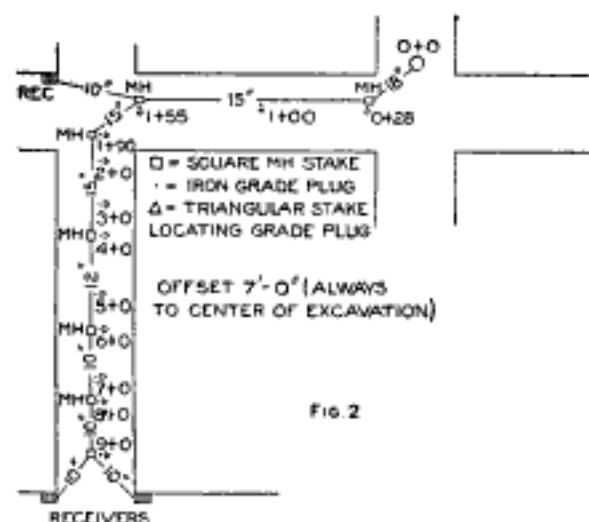

FIG. 2

The Layout Showing Depth of Cut Made by an Engineering Crew for a Street Sewer

sometimes used throughout. Sewer tile is made in forms, known as "straight," curves, connections and Y's, and shown in Fig. 1. Other shapes are made, but are seldom used.

Laying Out the Grade

The first step in the construction of any sewer is to obtain the grade, or fall. The method of determining this is as follows: The engineering crew first lays out the center line for the sewer and drives stakes at an "offset." The offset is usually from 5 ft. to 10 ft. from the edge of the proposed trench, although all offsets are figured from the center. Triangular stakes are usually used to mark the offset line and locate the grade plugs. When turning corners the stakes and plugs are set at the angles without regard to the distance, but on a straight run the stakes are placed on the even 100 ft. Each stake driven is called a station and marked as follows: 0 + 27, which means 27 ft. from the start, 1 + 89 means 189 ft. from the start, etc.; the number preceding the plus sign indicating hundreds, and the number following, the odd feet. After the stakes and grade plugs are driven, the manholes are laid out, and a square stake marked M-H is driven in the center

of the manhole. As the location can never be exactly right, a few inches or even 1 or 2 ft. change in location will not cause any trouble. The layout of the sewer would appear as shown in Fig. 2.

The grade plug is usually a $\frac{5}{8}$ -in. round iron rod about $1\frac{1}{2}$ ft. in length and is driven in nearly flush with the surface of the ground about 2 in. in front of the triangular stake. After all these stakes and plugs are placed, the levelman takes a level of all the plugs. The engineers then figure out the grade of the sewer and make up a list of "cuts" to be made at each station or plug. A list of cuts would appear as shown in the following table:

Station 0 + 0	Cut 8 ft. 6 $\frac{1}{2}$ in.
Station 0 + 28	Cut 8 ft. 5 in.
Station 1 + 0	Cut 7 ft. 11 in.
Station 1 + 55	Cut 8 ft. 3 in.
Station 1 + 90	Cut 8 ft. 7 in.
Station 2 + 0	Cut 8 ft. 4 in.
Station 3 + 0	Cut 8 ft. 2 in.
Station 4 + 0	Cut 8 ft. 10 in.
Station 5 + 0	Cut 9 ft. 3 in.

It will be readily seen that while 0 + 0 is actually the deepest point of the sewer, a steady rise being made from 0 + 0 to the far end, the cut is not as heavy as at station 4 + 0. This is often the case and one should not get confused if he seems to be going downward at the far end. If, however, the tile appears to be flat or with a dip toward the upper end, a level placed upon it will quickly show the actual condition.

After obtaining the list of cuts, make up a sight rod as shown in Fig. 3. As

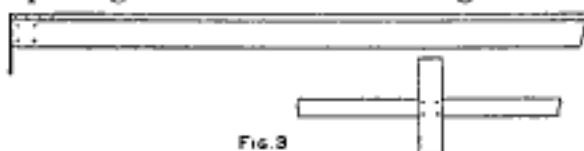

FIG. 3

The Sight Rod, with Shoe and Crosspiece, Used for Leveling Tile in Starting a Run

the deepest cut in the list is at station 5 + 0 the rod must be made accordingly. The cut being 9 ft. 3 in., the rod should be about 5 or 6 ft. longer, and a crosspiece fastened at the 13-ft. mark after the shoe is attached. Next a stake is driven into the earth di-

rectly out from the grading plug and from 4 to 5 ft. from the edge of the proposed excavation. These stakes should be made of 2 by 4-in. material, 8 ft. long, which should be pointed at one end. These are always driven in pairs as shown in Fig. 4. These pairs are called rangers. As the rangers must be set at a height of 13 ft., the "cut" must be subtracted from the 13 ft. and the crosshead attached. For example, set the rangers at station 0 + 0 and station 0 + 28. As the cut at station 0 + 0 is 8 ft. 6½ in., and this subtracted from the 13 ft. leaves 4 ft. 5½ in., a straightedge is marked 4 ft. 5½ in. and set upon the grade plug. Another straightedge and a level are used to transfer the 4 ft. 5½ in. mark over on the upright without er-



FIG. 5

The Men are Located on Stations and Dig the Depth of the Spade on Each One

ror. A crosspiece, about 10 or 12 ft. long, 7/8 in. thick and 6 in. wide, is now placed flush with the mark and fastened with a screw clamp. The straightedge is leveled and the other clamp attached. The complete ranger with crosshead is shown in Fig. 4. At station 0 + 28 the cut is 8 ft. 5 in., which subtracted from 13 ft., leaves a remainder of 4 ft. 7 in., or the distance for the marks above the plug. The rangers should always be checked by sighting over several of them together. It is good practice to have two or three rangers set ahead and leave one or two in the rear of the work. This allows four or five rangers in line all the time and affords an excellent check before starting the work in the morning by sighting all of them before commencing work. A variation of 6 in. is permissible and is very liable to creep in. One can never be too careful about setting rangers as exactly as possible.

Excavating

The excavation should always begin from the lower or deeper end and work up grade. The best way to ex-

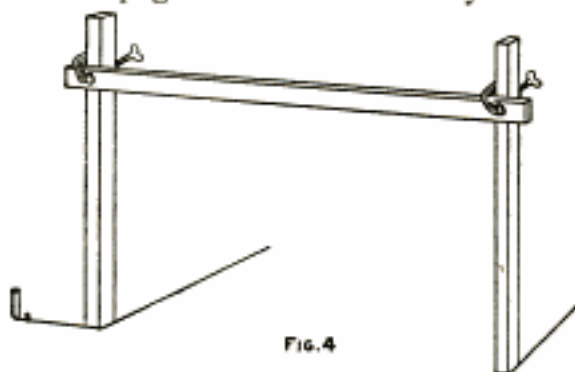

FIG. 4

Two Stakes are Set over the Location of the Trench and Called Rangers

cavate for a big, wide, deepcut sewer is with a mechanical trench digger or even a steam shovel. On small jobs or in isolated districts, however, when the job will not warrant the additional cost of transportation and running expenses of the machinery, the excavation may be done by hand. There is a difference of opinion as to the best methods of doing this work. The one described is the one most used.

The width of the trench must be first determined. This is governed by the size of the tile to be used and the depth of the excavation. For the job outlined, a trench should be dug about 30 in. wide for 18-in. tile; 24 in. wide for 15-in. tile; 23 in. wide for 12-in. tile, and 20 in. wide for 10-in. tile.



FIG. 6

FIG. 7

A Trench Narrowed at the Bottom, and Manner of Relaying Earth in a Deep Excavation

Lay out the sides of the trench and run lines along both sides as guides for the laborers so that they may excavate straight and true. The trench is marked out by two men following

the line and picking a small line in the earth with a pickax. Divide 200 or 300 ft. of the trench marked out into spaces of 20 ft. each and set a small stake. Place two men to work in each 20-ft. space. They should start the trench by working straight down to the bottom. Two men working a 20-ft. section are as good as four men working 10-ft. sections alone. Working in the manner described requires only one-half the number of pickaxes, and having more room, the laborers can naturally work faster and to better advantage. Each laborer can change from shovel to pick at half-hour intervals and do more work with less exertion. After the excavation is down to within about 4 in. of the true grade, the men are started ahead in pairs and work along as shown in Fig. 5, each pair taking a certain cut from 8 to 12 in. and working straight through on that level to the end of the entire excavation. This style of excavating is what is termed "progressive ditching."

The sides of the trench must be watched very closely as laborers have a tendency to "pull" the sides at the bottom, as shown in Fig. 6. A laborer

should be stationed about every 100 ft. on top of the trench after it has reached a depth of about $3\frac{1}{2}$ ft., to turn back the excavated earth and maintain a narrow pathway about 20 in. wide along the edge of the trench on both sides. This path is to allow for inspection of the trench and also to facilitate the handing of pipe and materials into the trench without knocking the excavated earth back into the trench. When excavating to a great depth by hand the trench must be wide enough to admit scaffolds on which the earth can be relayed to the surface as shown in Fig. 7.

The 4 in. of earth which remains at the bottom of the ditch are removed by the tile layer or an experienced man who immediately precedes him. If excavated by the tile layer, the earth is thrown over his head onto the tile already laid, thereby "backfilling" the trench without throwing the earth all the way out and then back. It is advisable, and in fact given in almost all specifications, to keep the excavating gang not more than 200 ft. ahead of the tile layers on account of the danger of the banks drying and caving in and filling the trench.

(To be continued.)

Weighting Triple Doors or Windows

In remodeling an old front, where there was not sufficient room between the center stiles for weights, I used the following method of weighting

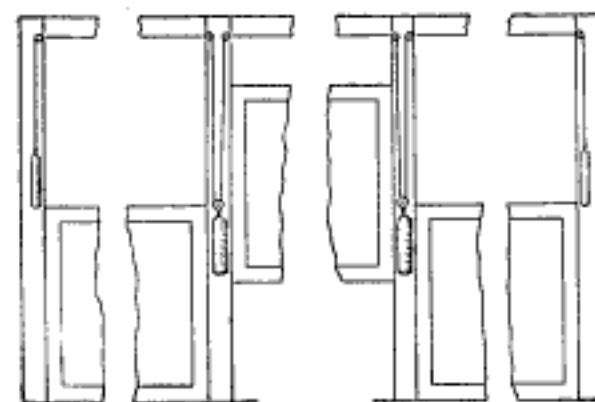

Each Center Stile has One Large Weight Which is Equalized by a Pulley and Rope

them. The doors were of heavy mesh wire and weighed 75 lb. each.

I used regulation weights on the outside of each outside door in the usual manner, and weighted the adjoining edges of both center and outside doors with one weight of 40 lb. in each stile, the weight being hung on an awning pulley swung on one rope, to equalize the weight on the doors.—Contributed by F. E. Brown, Los Angeles, Cal.

Blue Letters on Steel Surfaces

The steel is heated until blue, then the letters are applied by painting in oil colors with a small brush. As soon as the color is dry the steel is immersed in strong vinegar. The blue

will disappear on all the uncovered surface. The paint is then removed with a piece of soft rag dipped in turpentine. The protected parts will show the blue color obtained by the heat.

Substitute Spanner Wrench

Many times when we have had a job that called for a spanner wrench, none of the proper size was available. I have overcome this difficulty by making a temporary spanner of a short



When Necessary a Spanner Wrench can be Cut on the End of a Piece of Pipe

length of pipe having the proper diameter, and cutting the end with a hacksaw to make the projections. This will remove the nut without injuring it in any way.—Contributed by Jas. S. Frear, Sidney, N. Y.

Proper Shape of a Screwdriver Blade

All screwdriver blades are formed wedge-shaped as shown at A. When turning large or stubborn screws the blade has a tendency to climb out of the slot which results in damaging the screw head. The best way to overcome this trouble is to shape the blade as shown at B. The metal is slightly hollowed out, back of the edge, with a rat-tail file. When shaped in this manner, it requires no downward thrust to keep the blade in the screw slot.

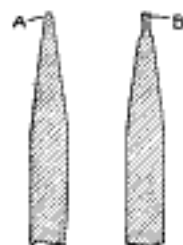

An Auxiliary Drill Holder

It often happens that the taper hole in the spindle of a lathe is not a standard taper, so that the drill shank will not fit properly. This can be easily remedied by making an auxiliary drill holder to fit the end of the spindle and having a standard taper hole for the drill shanks.

The end of the holder is bored out sufficiently to fit over the end of the spindle in A, and a key, C, the same

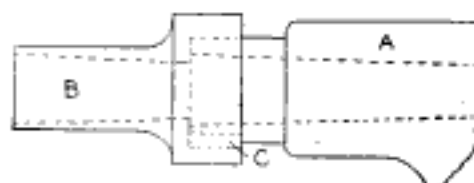

The Auxiliary Holder is Fastened on the End of the Tailstock Spindle

width as the key in the spindle, is put into it. The key prevents the holder from turning around and the holder can be slipped off and on the end without any trouble. The taper B is the same as for standard taper-shank drills.—Contributed by Chas. Homewood, Waterloo, Ia.

Tug Holder for a Singletree

Tugs on light harness to draw buggies have slots in their ends which slip over the ends of the singletrees.

These are apt to slip off when going down an incline unless something is provided to keep the tug end in place. A good way to do this is to attach a piece of leather strap to the wood as shown in the sketch. In hitching up, the tug is run through the strap loop and slipped on the singletree end.

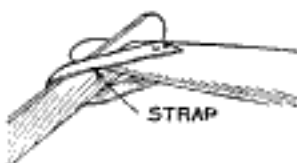

Homemade Thumbnut

A great many times a thumbnut is required when none is at hand. One can be quickly made in the following manner: Use an ordinary nut and make a wood button to fit over it, as shown in the sketch. In many places this will answer the purpose as well as the regular thumbnut.—Contributed by A. S. Thomas, Gordon, Ont.

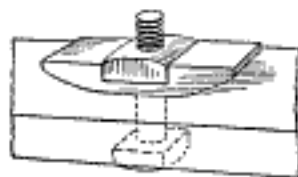

Cooling Engine Jacket Water

Frequently the supply of water for cooling a gas engine is limited or is expensive, and it is desirable to have some means of cooling the water so

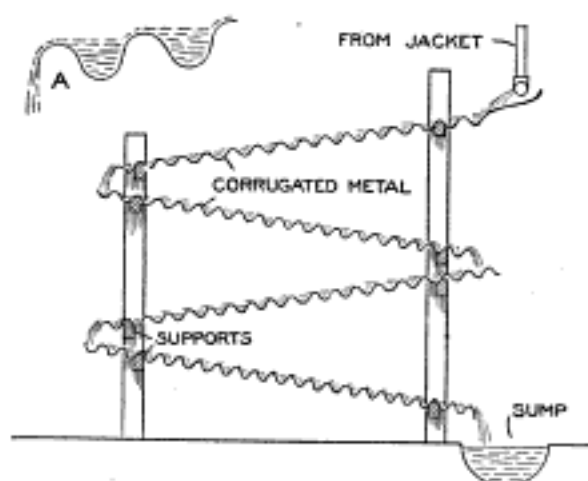

The Water Running over the Successive Corrugations of the Sheet Metal is Readily Cooled

that it can be used repeatedly. A correspondent of the Gas Engine presents a method which he used, in connection with a 30-hp. suction producer plant, to replace the tanks which are sometimes utilized for cooling the water by natural circulation.

The indicated horsepower was 40, and as it requires 5 gal. of water for each horsepower, this involved the use of 200 gal. of water an hour. Four old sheets of corrugated iron, each 20 by 8 ft., were secured from a junk heap and were erected as a series of inclined shelves, as indicated in the sectional sketch. Timber work was used as supports, the jacket water being sprayed on the topmost sheet from a pipe extending the full width of the sheet. In this pipe 36 holes, $\frac{1}{8}$ -in. in diameter, were drilled at equal distances apart along its whole length. The water runs over the different sheets successively, as shown, and finally falls into a cement sump, from which it is pumped to the engine jacket.

Sheets with deep corrugations are found to be more satisfactory, as they retain the water for a longer time, and can be set at a steeper angle. The sheets are spiked to the timbers, and each spike head should be surrounded

and covered with cement to prevent the water from dripping through and rotting the timbers. Each sheet should be cut so that it begins, at the upper end, with the concave part of the corrugation and ends, at the lower, with a convex part, as at A, thus causing the water to drop off the edge without backing up on the under side of the sheet.

Shop Signal for the Beltman or Electrician

Being in charge of the maintenance department in a large manufacturing plant, I experienced a great deal of trouble when wishing to find the beltman or electrician in a hurry. At times there would be two or three boys running around the plant looking for them.

I have been trying a new plan for the past year and found it much better. Two lights of different colors are placed in the center of the largest shop so they can be seen from almost any part of the place. The lights are turned on and a note giving instructions hung on a nail. Any number of lights can be installed in different parts of the shop where they may be easily seen.—Contributed by H. D. Harper, St. Louis, Mo.

An Emergency Lock

The ordinary door lock of the average hotel room cannot be depended upon for holding the door against intruders. The lock shown in the ac-

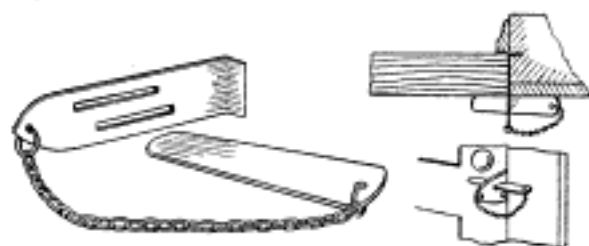

The Lock for Use in Emergency Cases and Its Application to Any Door

companying sketch makes it possible for the traveler to lock his door securely. The lock is made of two pieces

of sheet steel, formed as shown and fastened together with a small chain, so one part cannot be lost from the other. The manner of using the lock is clearly shown.—Contributed by George V. Sheridan, Brooklyn, N. Y.

Shield to Protect Handsaw Teeth in a Tool Chest

The shield is made of a small grooved stick of wood with a spring attached to hold it on the saw teeth. The spring is made of wire of the proper length with a coil at each end and fastened to the sides of the wood stick. The illustration shows the stick

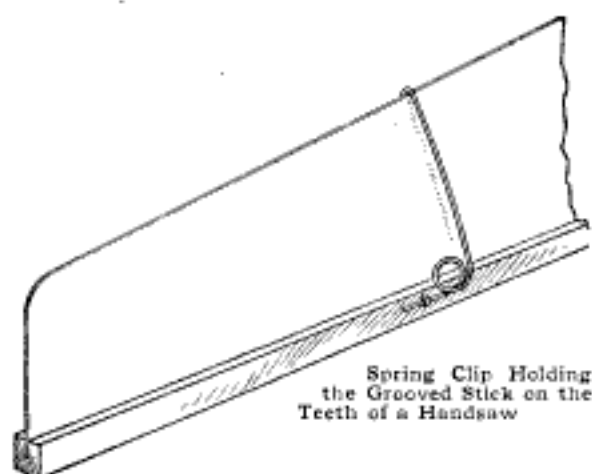

Spring Clip Holding the Grooved Stick on the Teeth of a Handsaw

and spring, and the manner of attaching the device to the saw.

The guard can be slipped on and off easily by pressing the spring forward with the thumb.—Contributed by J. H. De Lamatter, Aurora, Ill.

Waterproofing Blueprints

Immerse in melted paraffin until saturated a number of pieces of an absorbent cloth, 1 ft. or more square. When withdrawn and cooled they are ready for use at any time, says Railway and Locomotive Engineering. To apply to a blueprint, spread one of the saturated cloths on a smooth surface, place the dry print on it with a second waxed cloth on top, and iron with a moderately hot flatiron. The paper immediately absorbs paraffin until saturated, and becomes translucent and completely waterproof.

Plant Pot in Cement Sidewalk

The pot holding a plant or vine at the entrance of a residence in a crowded city is usually in the way,

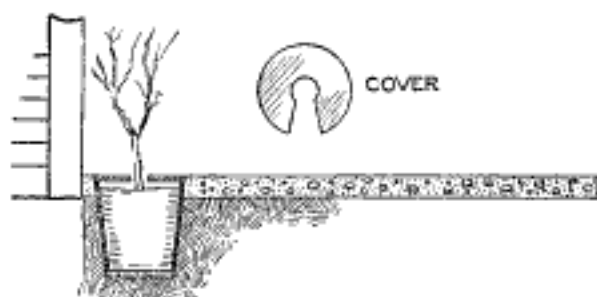

The Pot Being Placed in the Earth Keeps All Dampness Away from the Walk

and when the plant is watered the walks become wet. The illustration shows a good, cleanly way of arranging a pot or keg in the walk, so that it is out of sight, and the seeping water will be taken up by the earth. A cover may be made for the pot as shown,

Ruling-Pen Holder for Tracing Irregular Curves

Tracing indicator diagrams free-hand with a writing pen makes uneven lines of irregular thickness. Using the ruling pen free-hand is difficult because it is necessary to keep it turning in the fingers. This attachment holds the pen steady while the fingers can revolve it with ease as the point traces around the curves of the diagram. The construction can be readily understood from the sketch. A sharp-pointed nail forms the pivot

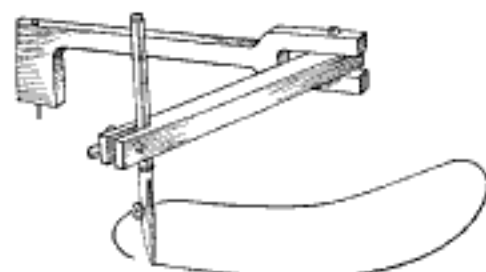

The Arm Holds the Pen Steady While It can be Turned by the Fingers

point, and a screw in the split end of the arm is used to adjust the rigidity of the pen.—Contributed by J. J. O'Brien, Buffalo, N. Y.

Special Molding Jobs from Standard Patterns

In a small shop having a varied stock of standard patterns the "stopping off" and "building on" in molds are neces-

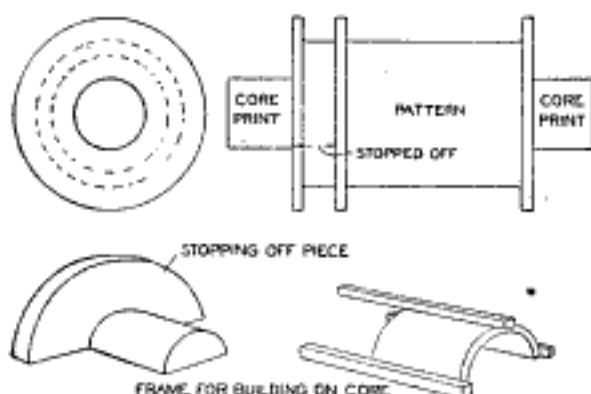
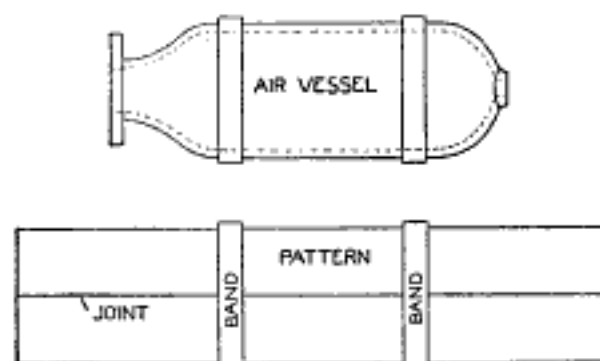

Fig. 1—Cylinder Pattern

sary on all special jobs. The patterns must be utilized as far as possible without changing them from the standard, and with a minimum of pattern work. In making changes, pieces for stopping off and building on are always used when conditions favor, and thus stock patterns are adapted to the needs of the hour with little change in their original form.

In Fig. 1 is shown a cylinder pattern with flanges on both ends and a chambered core. To shorten this cylinder, a flange is fitted around the barrel to make it the correct length and a stopping-off piece used. This is a half flange with core print attached, and is used by the molder in filling in that part of the mold not required for the



casting. The large part of the core is shortened by filling in the core box.

Such a pattern is lengthened by mov-

ing the flange out the required distance and filling in the intervening space to correspond with the barrel of the cylinder. If this space between the flanges is great enough to allow the sand to "stand" when the pattern is drawn, no stopping-off piece is used, but if there is not sand enough, or it is liable to "tear up" on the "draw," the stopping-off piece will be necessary. In extending the cylinder, the large part of the core must be lengthened as required. This is done with the frame for that purpose, before the cores are dried. The head of this frame, to which the three rails are attached with screws as shown, is made to fit over the small part of the core, while its outside diameter equals that of the

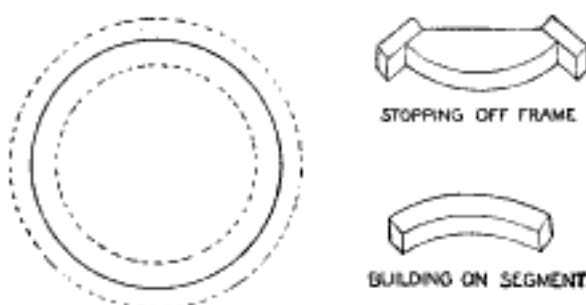

Fig. 3—Increasing or Decreasing Circular Plates

larger part. When the frame is placed on, and brought flush with the end of the core, there should be a space between the inner side of the head and the large part of the core, which, when

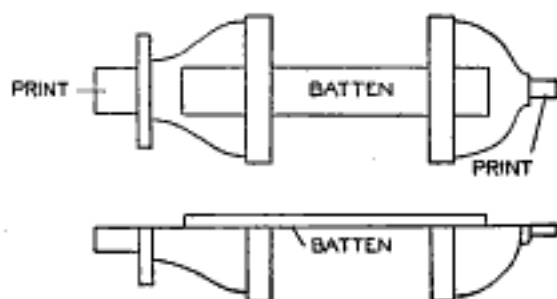

Fig. 2—Air-Tank Pattern

filled in, will make it the correct length. A small air tank is shown in Fig. 2, having a hemispherical end, stopped

from a piece of straight pipe or column. The only addition to this pattern is the bands that strengthen the casting

with a frame the reverse of the one shown. The segment for increasing the diameter of the plate is used while

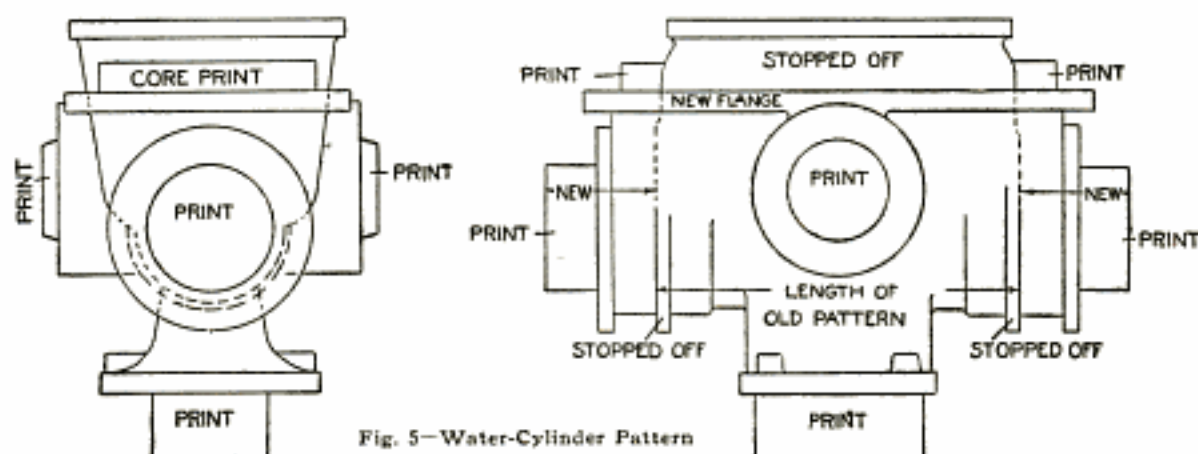

Fig. 5—Water-Cylinder Pattern

and also serve as a guide for the stopping-off piece. This is made, as the sketch shows, with two end pieces connected with a batten. This method can be easily used and the pattern adjusted to make tanks of different lengths.

Circular plates, cylinder heads, flywheels, etc., are increased or decreased in diameter as shown in Fig. 3. The black line shows the diameter of the plate pattern, while the dotted lines indicate the diameters to be stopped off or built on to produce the size required. The stopping-off segment is of a radius to correspond to the diameter of the plate required. The segment has end pieces attached to it for easy removal and to space equally all around the part to be filled in with sand. The end pieces are removed and the segment used without them while

the pattern is in the sand. The sand around the pattern is either dug away to accommodate the segment or a level

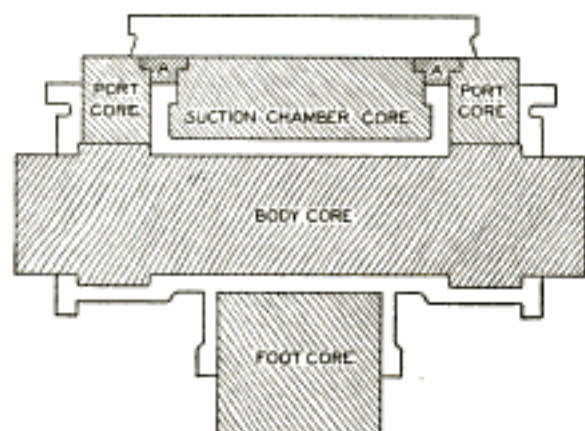

Fig. 6—Section through Mold

bed "struck up" and the diameter "rammed up" afterward. When increasing the diameter of a flywheel, where the inside of the rim provides a guide, a suitable segment is used after the pattern has been drawn.

In stopping off a square or rectangular plate, where there is nothing to locate the stopping-off piece, blocks, $\frac{3}{8}$ in. thick, are fastened to the pattern, and corresponding blocks fastened to the stopping-off piece, as shown in Fig. 4. This insures the stopping-off piece being set in the proper place.

The water cylinder, shown in Fig. 5, was lengthened and its style entirely changed, as shown in the drawing, in which is indicated the new pieces that were added to the old pattern. This

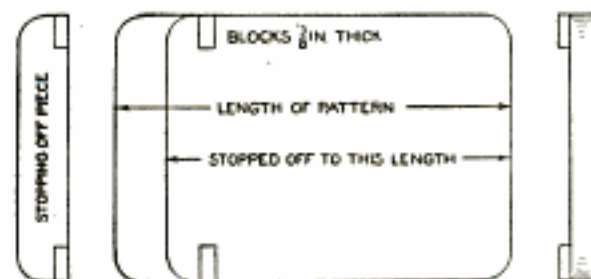

Fig. 4—Rectangular Plates

filling in the spaces left in the sand between the parts previously finished.

A round hole is increased in diameter

was a 24 by 30-in. cylinder, and eight castings, weighing over 6,500 lb. each, were made from the pattern. All the

side of the rails and making a bearing for the cores, which were "strickled" down to match. A piece of the proper

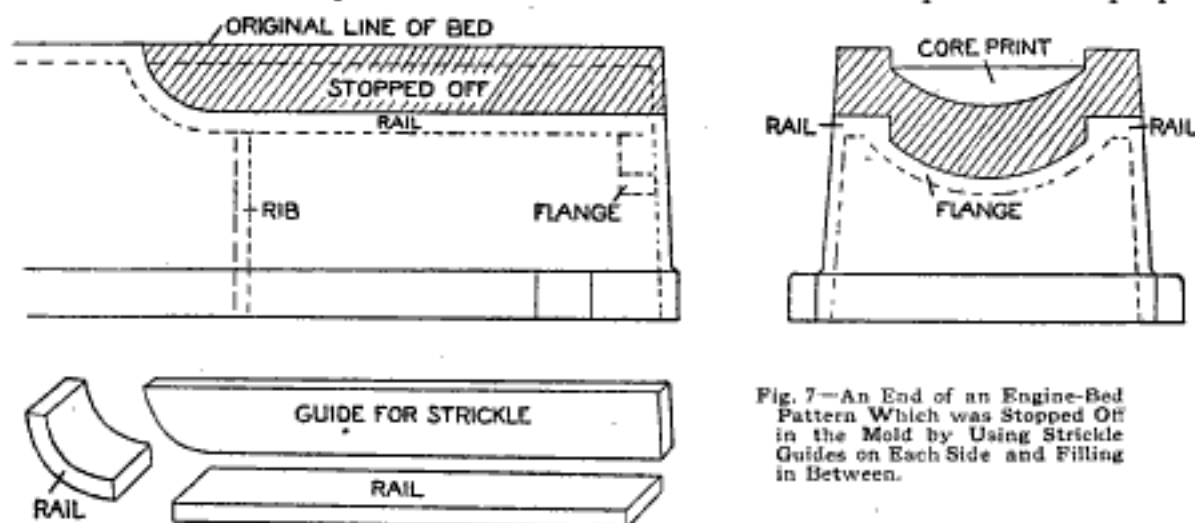

Fig. 7—An End of an Engine-Bed Pattern Which was Stopped Off in the Mold by Using Strickle Guides on Each Side and Filling in Between.

part above the new top flange was stopped off by making offsets in the port and suction-chamber cores and filling in with cores A A, Fig. 6, made for the purpose, as the plan of the mold shows. A piece as long and wide as the projecting flange was used to "strike up" a bearing for the cores.

Beds for use with different combinations of cylinders are made with a cored inside, as this form is better adapted to changes. The usual plan is to make a core box long enough for the longest core and stop the shorter cores from it. A drawing is furnished the molder, as the pattern only makes a bearing for the cores, and they must be set by measurement. The end of such a bed is shown in Fig. 7. This was stopped off for a special cylinder. The stopped-off portion was approximately 2 ft. wide, 5 ft. long and 6 in. deep. This was accomplished by placing the strickle guides in the mold at each side, then filling in between and striking off the top. The guides were then drawn and the spaces left by them filled in flush. This made a "bed" in the end of the mold the exact size and shape of the part to be stopped off. On this bed the rails were placed in their proper positions against the sides and a new bed "swept up" with the rails as guides. This finished the green sand mold, bringing it up to the in-

shape was fastened in the core box to form the inside of the flange on the end of the bed, and a separate core used on the outside.

Battery Economy

To those who prefer dry batteries for all electrical work, the following method of using them on closed circuits will prove valuable. This method permits the use of dry or other open-circuit batteries on telegraph or telephone lines where the circuit must be left closed.

The ordinary methods of doing this require sufficient battery power at each end of the line to operate the system. This doubles the necessary cost of batteries, says *Electrical Review*.

The better method is to get just enough batteries to operate the system, place half of them at one end of the line and one-half at the other, and connect the zincs at both ends of the wire to one line, and the carbons to the other, or to the ground. The voltages of both sets will then be equal and, therefore, no current flows on the line.

When either party wishes to call the other, he simply reverses the connections of his set of batteries and uses the instruments. By this reversal the current of both batteries flows through the line. When through talking, he

restores the connections to their original condition. The direction of the current through the line depends upon which party has called the other.

The apparatus may be grouped in any way, and distributed anywhere on the line. The only condition to be observed is that the open-circuit voltages of the two sets of batteries be equal, so that no current will flow until one set is reversed. Any kind of batteries may be used together.

Gear-Cutter Gauge

The illustration shows a gauge for setting a gear cutter in a milling machine. It is made of sheet metal, about $\frac{1}{8}$ in. thick. The two edges are filed so that they will be parallel to each other, and a line is then drawn across at right angles. Cut a 60-deg. V-notch on each side, centering the line as shown.

The gauge A is set on the index

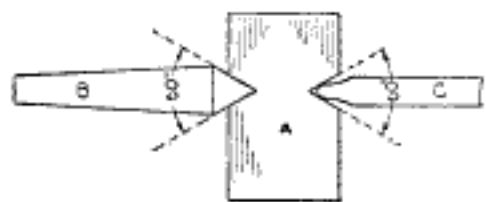

Gauge on the Center of a Lathe Setting a Cutter Exactly in the Center

head center B, and the cutter C is adjusted to the opposite V-notch. The gauge also can be used in setting the centers of the lathe.—Contributed by G. Bogen, So. Boston, Mass.

Humidifier for a Cigar Case

An enterprising owner of a cigar store kept his cigar cases moist by using a device described as follows: An



electric light was wrapped in sponges which were set in a dish partly filled with water. The heat of the light formed steam sufficient to keep the case moistened, with the current turned on only a few minutes each day.—Contributed by Patterson D. Merrill, Chicago.

Three-Point Bearing Clamp

An ordinary carpenter's clamp can be made to hold twice as much with half the pressure of the screw by sim-

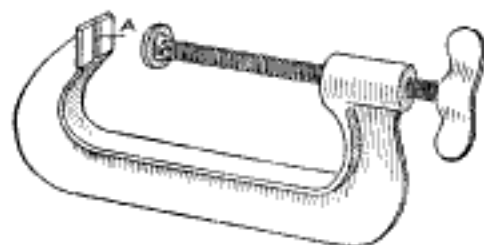

A Groove Filed in the Center of the Anvil to Increase the Holding Power of a Clamp

ply grinding or filing a groove in the center of the anvil, as shown at A. This gives a three-point bearing. No matter how much the screw is tightened on an ordinary clamp, it can be turned by taking hold of the back. This cannot be done with the three-point bearing clamp.—Contributed by F. G. Marbach, Cleveland, O.

Handle for Heavy Doors

The ordinary knob is entirely inadequate for use on the heavy doors of power houses and mills, and the cast-iron handle fastened on with screws is never satisfactory. With a badly stuck door a lever or tackle block applied to pull it open is very liable to pull off or break an ordinary handle.

An unbreakable handle that gives good results is shown in the sketch.

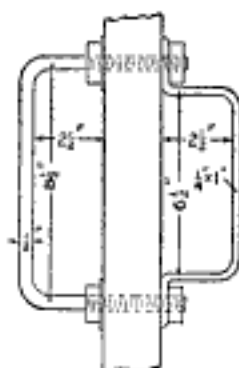

The dimensions given are those which actual use has proven satisfactory. The iron may be bent cold and should be smoothed up with a file after the bending. It will be seen that there are only few parts. The center of the handle should be $3\frac{1}{2}$ ft. from the floor and is located 3 in. from the casing, when the door is closed, to give safety to the fingers.—Contributed by Van Allen Lyman, Paynes Creek, Cal.

A Hand Dog

Frequently a very useful tool is also a very simple one, says American Machinist. The little hand dog shown in



Hand Dog for Holding Small Drills When Drilling in a Small Bench Lathe

the illustration is an example. The uses of this tool are numerous. It may be used for holding a large variety of drills when drilling in a bench or small engine lathe. It is also very handy for holding small round stock while centering. In short, it does most of the work of a common lathe dog.

The body and screw should be hardened. An attractive appearance may be given it if, in hardening, a mottled effect is added, provided it is machine steel. The handle may be made solid or skeleton, and the screw, either as shown or in the form of a thumbscrew.

A Strainer Frame

An ordinary globe holder with the screw holders, A, bent inward as shown at B makes a good strainer frame. The object of bending the screw holders is to get them in posi-

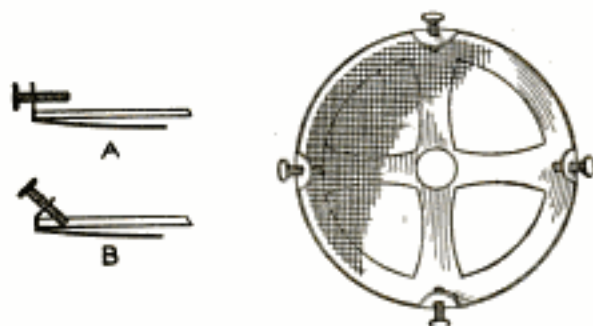

Frame Made of a Glass-Globe Holder for Holding Wire Screen to Strain Paint

tion to press on and fasten the screen securely in the frame. The screen should fit snugly.

This device will be found useful for straining paint, etc. Screens of different mesh can be used and when one becomes clogged it can be withdrawn and another inserted in its place.—Contributed by Jas. M. Kane, Doylestown, Pa.

Twin China Closets

Where a kitchen is back of the dining room a built-in closet will save the housekeeper many extra steps. The closets or cupboards are placed in the wall between the kitchen and dining room, each being a duplicate of the other from top to bottom, even to the drawers in the lower part which slide either way.

The woodwork of the closets with door catches and drawer pulls in both cases should match the woodwork and fittings of their respective rooms. The upper drawer of the cupboard for the silverware should be lined with unbleached Canton flannel. The other drawers are for the table linen.

The upper part is made with glass doors on the dining-room side, and wood doors on the kitchen side. Instead of carrying dishes back and forth they are placed on the lower shelf of the closet where they can be reached from either side. This cupboard closet thus takes the place of a serving table.

The silverware, dishes and table linen, when washed, should be put in their compartments on one side and taken out for use on the other.—Contributed by Katharine D. Morse, Syracuse, N. Y.

Steel Pen Used in Draftsman's Ink-Bottle Cork

A steel pen makes an ideal substitute for a quill in the stopper of the draftsman's ink bottle. The advantage of this substitute is that there is always one handy to replace a broken or lost pen, while it is not so with the quill.—Contributed by George C. Madison, Boston, Mass.



How to Build a Simple Electric Motor

By A. G. McCLURE

An exceedingly simple and inexpensive motor that may be used in operating small toys can be constructed as follows: First procure a good permanent magnet, about 5 in. long and about $1\frac{1}{2}$ in. between the inside edges at the open end. This magnet should be at least $\frac{1}{2}$ in. thick, and if it cannot be had in one piece, two or more may be placed side by side, like poles being placed together. The writer was unable to procure ready-made magnets, so one was formed and magnetized. Obtain a piece of tungsten or some other good-grade steel, $\frac{1}{2}$ in. by $\frac{1}{2}$ in., and about 11 in. long. Bend this piece into the form of a U, with the inner edges $1\frac{3}{4}$ in. apart. Square off both ends and drill two small holes in the outside surface of each end, at AA, about $\frac{3}{8}$ in. from the end. Tap these holes for small machine screws. Drill the hole B with a small drill, about $\frac{1}{8}$ in., in the center of the lower portion of the U and ream it out. The piece should now be clamped with a good pair of blacksmith's tongs,—a block of iron being placed between the ends to keep the pressure of the tongs from drawing them together—heated to a cherry red and then plunged into a bath of oil. It can then be magnetized by placing it in contact with a permanent magnet.

Next obtain a piece of $\frac{1}{8}$ -in. brass, about $\frac{1}{2}$ in. wide and $5\frac{1}{2}$ in. long. Drill two holes in each end of the piece to match those drilled in the ends of the magnet, also one in the center, and tap it for a $\frac{1}{8}$ -in. machine screw. Now bend this piece into the

form shown. Provide a machine screw, S, for the hole C and drill a small tapered hole in the end of the screw.

Obtain a small quantity of soft sheet iron and cut a sufficient number of pieces similar to that shown at D to make a pile $\frac{1}{2}$ in. high. Cut two

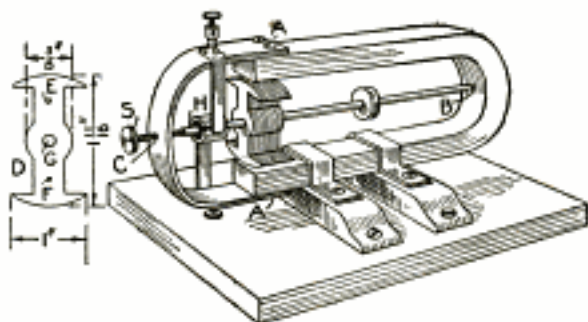

Detail of Armature Laminations, and Completed Parts Assembled, but without Armature Windings

pieces of the same size from some thin sheet brass. Now place all of these pieces in a pile, the brass pieces being on the outside, and clamp them securely, then drill the two small holes, E and F. Place two small copper rivets in these holes and rivet the heads down before removing the clamp. Drill a $\frac{1}{8}$ -in. hole, G, through this piece, the armature, for the shaft to pass through. Procure a piece of $\frac{1}{8}$ -in. steel rod, about 6 in. long. Sharpen one end so that it will enter the hole B, then cut the other end off and sharpen it so that it will enter the opening made in the end of the screw S. The armature may now be soldered to this shaft, its left-hand surface being flush with the ends of the magnet.

A small commutator, H, should now be made as follows: Obtain a piece of thin brass tubing about $\frac{5}{8}$ in. in diam-

eter. Turn down a piece of hard rubber so that the tube will fit tightly on it. Drill a hole in this piece of rubber of such a size that it will have to be forced on the steel shaft. Saw two longitudinal slots in the brass tube diametrically opposite each other and then bind these two pieces in place on the piece of rubber with some heavy linen thread wrapped around each end. The armature is now ready to wind. Get a small quantity of No. 22 gauge cotton-covered wire, solder one end to one of the segments of the commutator, then wind one end of the armature full and cross over and wind the other end full, soldering the end of the wire to the second commutator segment. Make sure to wind both ends of the armature in the same direction so the current in both parts of the winding produces magnetizing effects in the same direction. Insulate the winding from the core and the different layers from each other with a good quality of thin writing paper.

Two small brushes should now be made from some thin spring brass and mounted on the brass piece as shown. These brushes should be insulated from the piece of brass and two small binding posts should be provided for making connections to them. The position of the commutator and brushes should be such that the brushes move from one segment to the other when the ends of the armature are directly in line with the ends of the permanent magnet.

A small pulley should be mounted upon the shaft to be used in transmitting the power. The whole device may be mounted in a horizontal position on a wooden base as shown, and the motor is complete.

How to Make a Humidity Indicator

A simple weather indicator that may be used in determining the condition of the atmosphere may be made as follows: Dress a small figure, in the form of a doll, with a piece of cloth, previously dipped in the following solution: Chloride of cobalt,

30 parts by weight; sodium chloride, 15 parts; gum arabic, $7\frac{1}{2}$ parts; calcium chloride, $4\frac{1}{2}$ parts, and water, 400 parts. This cloth will change color as the amount of moisture in the atmosphere changes, the change being due to the cobalt salt, which, in dry air, is lavender blue. As the moisture in the atmosphere increases, the color changes first to bluish red, then light red and finally pink, according to the amount of moisture. With a decrease in moisture, the colors change in the reverse order to that given above, and the blue color returns when the air becomes dry.

The "Q" Trick

Lay out the form of the capital letter Q with coins on a table and ask someone in the audience to select a number and then

ask that person to count up from one until the number is reached, beginning at A and stopping on the circle, for instance at B, then counting back again beginning with one, but,

instead of counting on the tail, pass it and go around the circle, say, to C. The performer gives these instructions to the person doing the counting. The one selecting the number must not tell the performer what the number is, and the latter is to leave the room while the counting proceeds. The performer, before leaving the room, is to tell which coin will be the last one counted.

Take, for example, the number 7. Counting from A to B there are just 7 coins and counting back the last number or 7 will be at C. Try 9 for the number and the last one counted will also be C. The number of coins in the tail represents the number of coins in the circle from the intersec-

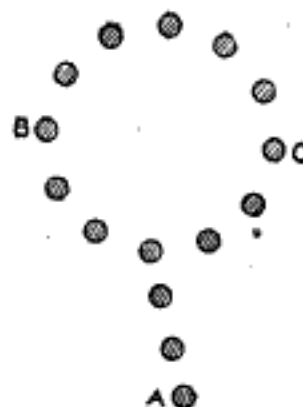

tion of the tail and circle to the last number counted. For instance, the sketch shows 4 coins in the tail, therefore the last coin counted in the circle will be at C or the fourth coin from the intersection of the tail and circle.

By slipping another coin in the tail the location of the last coin counted is changed, thereby eliminating any chance of exposing the trick by locating the same coin in the circle every time. This can be done secretly without being noticed.

To Keep Ants Away From Food

Suspend a shelf, breadbox or rack with wire around which is tied a piece of cotton cloth, saturated with a mineral oil. The ants will not cross the oil-soaked cloth.

Some strong wire hooks attached to the rack or shelf answer well to hang small articles on, such as bacon, bags of sugar, syrup cans, etc.—Contributed by C. B. Hosford, Swansea, Ariz.

Vaulting-Pole Holder

An adjusting device for a vaulting pole that can be easily fixed at any point on a round pole by using a wedge and ring, is shown in the sketch. The wedge carries a pin on which to place the cross pole. The

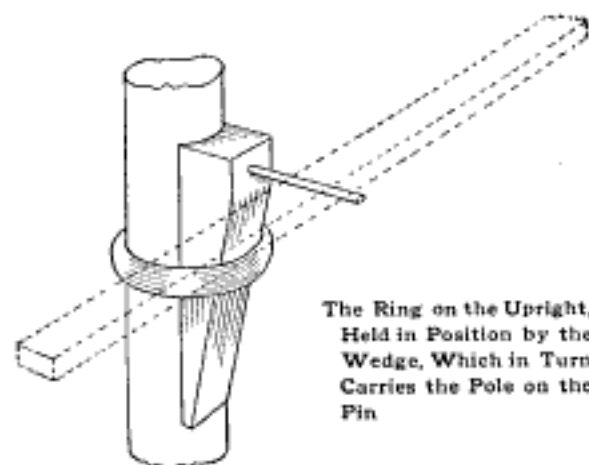

The Ring on the Upright, Held in Position by the Wedge, Which in Turn Carries the Pole on the Pin

manner of using this device as well as its construction is clearly indicated.—Contributed by Sterling R. Speirs, St. Louis, Mo.

Flying Model Aeroplane for a Display

A novelty for a window display is made of a model aeroplane flying by its own power. To control the direction and make the model fly in a circle

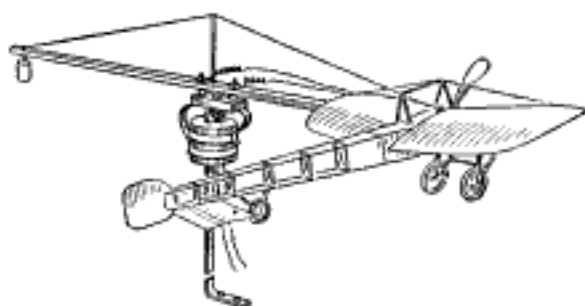
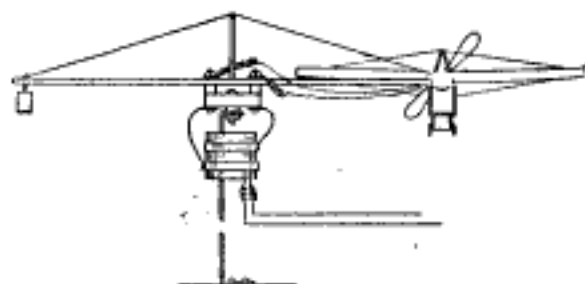

Detail of Parts Showing Wire Connections and Model in Flight around the Central Axis

it is fastened to a long stick or beam which is pivoted in the center. The one shown was pivoted to a roller-skate wheel which in turn was fastened to a metal standard. The beam was attached to the skate wheel with two small bolts which were insulated and carried two brushes as commutator contacts.

The commutator rings were made of heavy brass strips, fastened to a round piece of wood which was attached to the metal standard. The wires from the current supply were connected to the commutator rings. From the brushes connecting wires were carried along the beam to the aeroplane motor which was a small battery motor with propeller.

The opposite end of the beam was weighted to balance it. The first sketch shows the parts and the manner of making the connections. The aeroplane is driven in a circular path by its own power in a realistic manner.

Drip-Pan Alarm

The trouble caused by overflowing of the drip pan for an ice box or refrigerator can be overcome by attach-

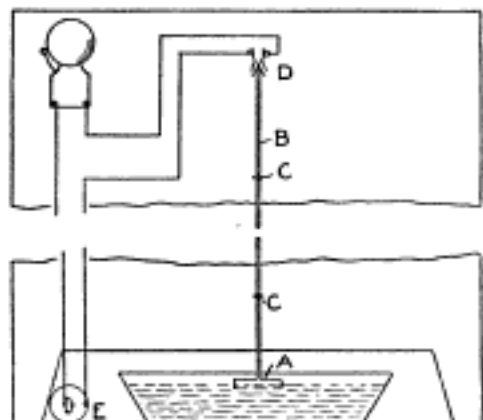

The Float in the Pan, and Contacts for Closing the Circuit to Ring the Bell

ing a device that will sound an alarm when the water reaches a level safely below the overflow point. A device of this kind may be attached to the back of the refrigerator as shown in the sketch. A float, A, is attached to the lower end of a rod, B, which slides through staples CC. At the upper end of the rod, a V-shaped copper sheet, D, is soldered. This makes the contact points in the electric wiring. The battery E can be placed under or back of the refrigerator as desired. The method of wiring is clearly shown.

A Live-Bait Pail

Every fisherman knows that live bait will soon die if they do not receive sufficient air. I have succeeded in

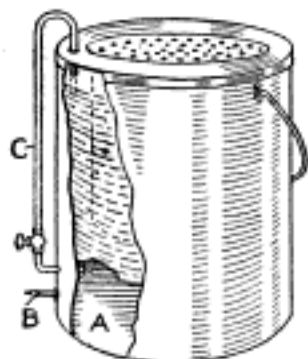

keeping bait alive and healthy by using a pail of my own construction, which is provided with a compressed-air space to force air to the surface of the water. The air space A takes up one-fifth of the interior at the bottom of the pail, and an ordi-

nary hand bicycle pump is used to fill it through a bicycle-tire valve, B. The pipe C from the air space extends up along the side of the pail and the upper end is bent so that it just touches the surface of the water. The pipe contains a valve to regulate the flow of air.

After the pail has been standing for an hour or more, the bait will rise to the top. The valve is then opened for a few minutes, and the minnows will soon swim around in the water as when this was fresh.—Contributed by T. Whelan, Paterson, N. J.

A Mouse Trap

After using various means to catch the mice in my pantry, I finally decided I could not catch them in the ordinary manner. Knowing that mice are not afraid of dishes but will run all over them, while they will stay away from other

things, I took a dinner plate, a bowl that held about 1 qt., a thimble, filled with toasted cheese, and arranged the articles as shown in the sketch, balancing the bowl on the thimble. When the mouse nibbled the cheese, the bowl came down on it, making it a prisoner. The whole was then dropped in a pail of water. Scald the dish and bowl before using them again to remove all traces of the mouse.



Quickly Made Rheostat

A short time ago I found it necessary to melt some silver, and in setting up an arc light to obtain the heat I made a rheostat by winding wire around a large earthenware jar. As the jar is a non-conductor and would not burn, it served the purpose perfectly. In winding the wire, be careful to keep the coils from touching each other.—Contributed by P. D. Merrill, Chicago, Ill.

Leaded-Glass Panels for Furniture

Certain kinds of furniture may be greatly improved in appearance by the use of simple glazed panels in the door frames. It would be inappropriate to have anything elaborate in a small cabinet for the reception of china as it distracts the attention from the contents, but a simple leaded diapering or pattern of small design, such as shown in Figs. 1 and 2, would be quite in place and have a good effect. For other purposes more elaborate effects can be worked out in deep shades, says Work, London.

A hanging cabinet with leaded panels is shown in Fig. 3. These panels for the doors are in the design shown in Fig. 2. Panels of this design can be used either for furniture or for small windows. The process of making these panels is not difficult and the ordinary workman can form them, the only difficult part being the soldering of the joints.

The beginner should confine himself to plain glazing, the design being formed by piecing together glass of different shades. The method of procedure is to first make a small sketch in color to a scale of about 1 in. to the foot, carefully arranging the parts and colors. A full-sized panel can be drawn from this sketch. The effect of

plain glazing depends entirely on the arrangement of the lead lines and the art glass. In the full-sized drawing

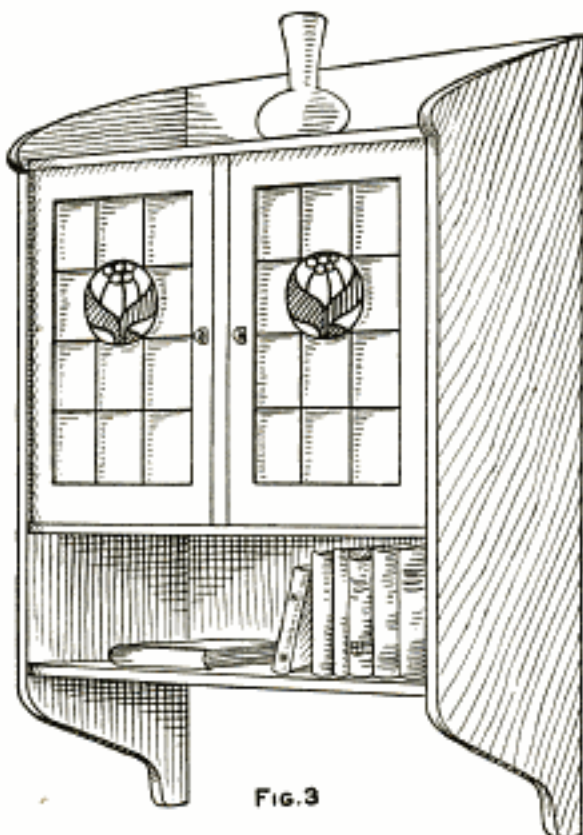

FIG. 3

A Small Hanging Cabinet with Doors Having the Leaded-Glass Design Shown in Fig. 2

the shapes are arranged so that they may be easily cut, all long forms being either avoided in the design, or divided by a cross-lead to guard against breakage in the cutting.

Two simple forms of glazing are shown in Figs. 1 and 2. The one shown in Fig. 4 is somewhat different, the top of the panel being decorated with simple curves. This general design is considerably elaborated in Figs. 5, 6 and 7. It is desirable to decorate only a part of a window so that the maximum of light may gain access.

Two simple treatments of a sailing craft are shown in Figs. 8 and 9. The effect of the introduction of this design in one of the panels of a small cabinet is shown in Fig. 1.

An example of plain glazing is shown in Fig. 10. This is a piece of

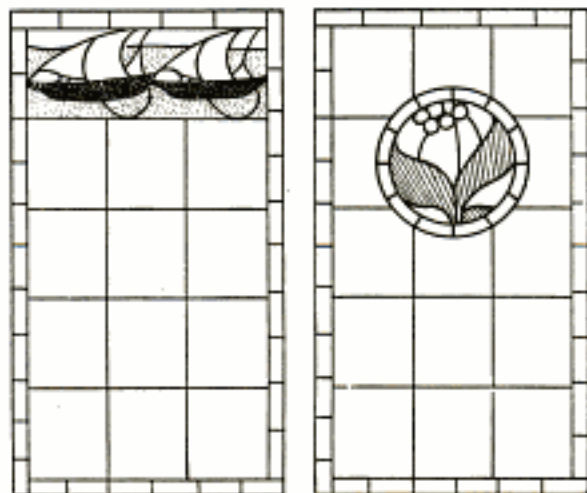

FIG. 1

FIG. 2

Simple Leaded Diapering of Small Design for a Small China Closet or Cabinet

simple leading and yet very effective, involving no difficulty of construction.

For this lead glazing a quantity of strip lead, the section of which is



FIG. 4

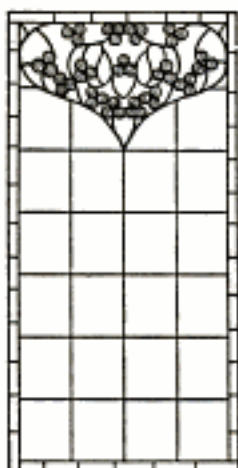

FIG. 5

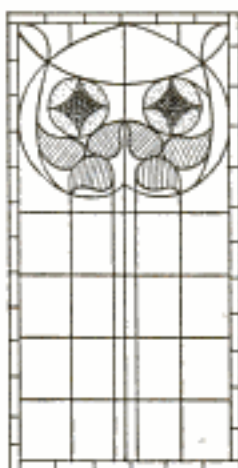

FIG. 6

Only a Part of the Top of Each Window is Highly Decorated so That the Maximum Light may Gain Access

shown in Fig. 11, will be required. This can be purchased from dealers in art-glass supplies. The lead is sold on spools and it must be straightened

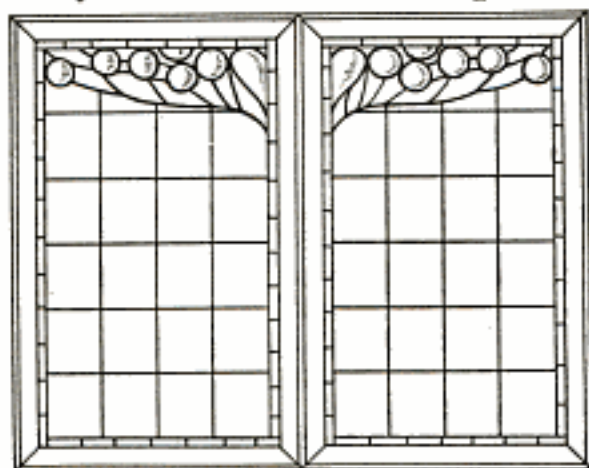

FIG. 7

Two Windows Placed Together May Have Their Tops Leaded to Produce a Combined Effect

before it can be worked. This is most easily done by fastening one end and pulling on the other. The glass for this work must be reasonably thin as no advantage is gained by the use of thick material, and it is difficult to cut. A piece of art glass has a right and a wrong side, the side on which the spots and streaks appear is the right side, and it is cut on this side. The tools required are a glass cutter, a heavy knife and soldering appliances.

Sketch out the lines of the design full size on paper, drawing in only one side of a symmetrical pattern and tracing the other. After the design has

been prepared, the next step is to make a cutting pattern. To do this, take a piece of tracing cloth and lay it on the drawing. Trace the lines and go over them with a brush dipped in black, making the lines exactly the same thickness as the core of the lead, or the thickness of the distance the glasses are separated from one another, as shown in Fig. 11. Each division is marked for the color it

is to be and the paper is then cut into sections on each side of the broad line. These pieces form the patterns for cutting similar shapes from heavy cardboard which serve as templates for cutting the glass.

Proceed to cut the glass by laying a pattern on the right side and scoring around with the cutter guided by the pattern. Little difficulty will be experienced in this work if the general design does not have very irregular shapes.

When the various pieces of glass



FIG. 8



FIG. 9

Two Designs for the Tops of Windows, Showing Treatments of Sailing Craft

have been successfully cut and are ready for leading up, arrange them in position on the preliminary sketch, and then measure the outside leads and cut one piece for each side, the lead being cut to fit against the core of the other at the joint, as shown in Figs. 12 and 13. Proceed to cut the lead for the long curves, obtaining the length by bending the strips along the lines of the design. As each is cut it will be found convenient to tack it in position on the working table by means of small brads, so as to simplify the measuring and cutting of the other parts. Continue until the panel is complete, when, after truing up, it is

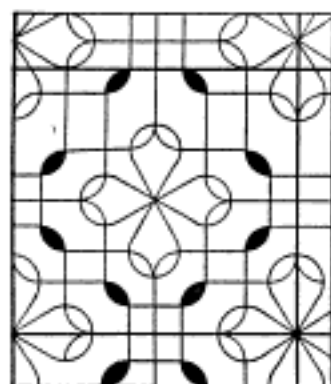

Fig. 10

Example of Plain Glazing with Cross Section of Glass and Lead Strip, also Showing Joint



Fig. 11



Fig. 12



Fig. 13

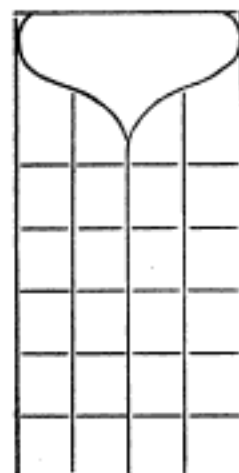

Fig. 14

The Lead Frame is First Made, the Long Lines are Put in and Then the Short, Horizontal Ones

ready for soldering. This is done in the usual way but requires extraordinary care to avoid the possibility of melting the lead. The overlapping parts of the leads are pressed well against the glass in each division to keep it from rattling.

In making up the squares and rectangles such as appear in Figs. 2, 4, 5, 6 and 7, lead the long lines first, adding the shorter, horizontal pieces last. The sketch, Fig. 14, will clearly illustrate this part of the work. The sketch shows the starting of the panel, Fig. 5.

Raising Cucumbers on a Trellis

A novelty in cucumber culture, tried recently with great success, is as follows: As soon as the vines are about 18 in. long, stretch wire mesh 24 in. wide on poles alongside the row of plants and train the vines on the wire. The cucumbers will grow larger and the plants will require less care than when they are on the ground.

A Barrel Boat

A boat that any handy boy can easily make is constructed of a barrel which is kept with the opening cut in one side up by two 4 by 6-in. timbers and two tie pieces, 2 by 4 in. The lengths of these pieces will depend on the size of the barrel.

A good watertight barrel should be

selected and an opening cut in the center between the hoops, of such a size as to allow the body of the occupant room for handling an oar. The timbers are attached to the barrel with iron straps—pieces of old hoops will do. The two tie pieces are put across the timbers at the ends of the barrel and spiked in place.

The boat is to be propelled with a single, double-end paddle. There is no danger of the boat capsizing or the water splashing into the barrel.

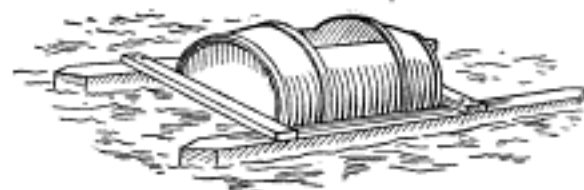

Boat Made of a Barrel Which is Kept from Capsizing by Timbers Attached

Electric-Light Mystery

A novel attraction for a window display can be made of a piece of plate glass neatly mounted on a wood base,

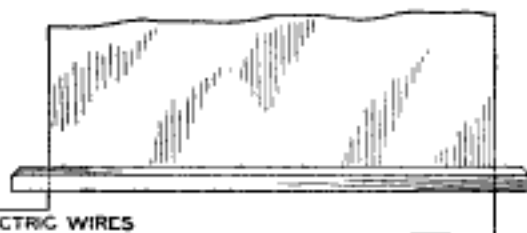
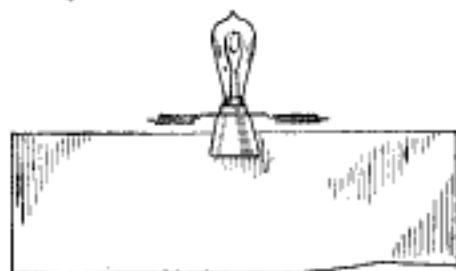

Electric Light Mounted on Top of a Plate Glass with Hidden Connections on the Glass Edge

and an electric light which is placed on the top edge and may be lighted apparently without any wire connections.

The method of concealing the connections is to paint the edges of the glass green, then, before the paint is quite dry, lay on a thin strip of copper, making the connections at the base on both sides, and to the lamp in the same manner. Another coat of paint is applied to cover the strip. The color should be an imitation of the greenish tint of glass edges. Any desired lettering can be put on the glass.—Contributed by O. Simonson, Brooklyn, N. Y.

An Oar Holder

Persons rowing boats, particularly beginners, find that the oars will slip out of the oarlocks, turn or fall into



The Screweye in Position on the Oar and over One Prong of the Oarlock

the water. This may be avoided by turning a screweye of sufficient size to prevent binding on the lock into the

oar and placing it over the lock as shown at A, so that the pull will be against the metal. The oars will never slip or jump out, will always be in the right position, and it is not necessary to pull them into the boat to prevent loss when not rowing. The locks will not wear the oars, as the pull is on the metal eye. Place the eye so it will have a horizontal position on the side of the oar when the blade is in its right position.

Cooking Food in Paper

A flat piece of paper is much more convenient to use than a paper sack in cooking, as it can be better fitted to the size of the article to be cooked. Wrap the article as a grocer wraps sugar, folding and refolding the two edges together until the package is of the proper size, then fasten with clips and proceed to close the ends in the same way. This avoids all pasted seams and makes the package airtight.—Contributed by J. J. A. Parker, Metamora, O.

Washing Photograph Prints

Photographic prints may be washed in a stationary washbowl with just as good results as if washed in a high-



A Medicine Dropper on a Faucet Produces a Whirling Motion of the Water in the Bowl

priced wash box, by cutting off the upper end of the rubber nipple on a bent glass medicine dropper and placing it on the faucet as shown in the illustration. This arrangement causes the water to whirl around in the bowl, which keeps the prints in constant motion, thus insuring a thorough washing.—Contributed by L. O. D. Sturgess, Arlington, Oregon.

A Toy Poppun

A toy popgun can be easily made of two blocks of hard wood, $\frac{1}{2}$ in. thick; a joint of bamboo, about $\frac{7}{8}$ in. in diameter and 6 in. long; a small hinge, a piece of spring steel, $\frac{1}{2}$ in. wide and 1 in. long, and a piece of soft wood for the plunger.

The plunger A is cut to fit snugly, yet so it will move easily in the piece of bamboo B. One of the blocks of hard wood, C, is bored to fit one end of the bamboo, the other block has a $\frac{1}{4}$ -in. hole bored, to center the hole in the first block. The two blocks are hinged and the spring latch attached as shown in the sketch. The spring has a hole drilled so it can be fastened with a screw to the outer block, and

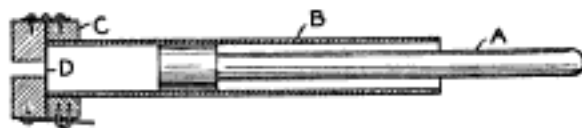

Detail of Poppun, Showing the Parts Assembled and Position of the Paper

a slot cut in the other end to slip over a staple driven into the block C.

A piece of paper, D, is placed in between the blocks while the plunger A is out at the end of the bamboo. A quick pressure on the plunger A will cause the paper D to break out through the small opening with a loud pop.—Contributed by Paul H. Burkhart, Blue Island, Ill.

A Non-Rolling Thread Spool

A spool of thread may be kept from rolling by gluing squares of cardboard to the ends. The squares should be a little larger than the spool. This will save many a step and much bending over to pick up the spool. The spool, when it falls, will stop where it landed.—Contributed by Katharine D. Morse, Syracuse, N. Y.

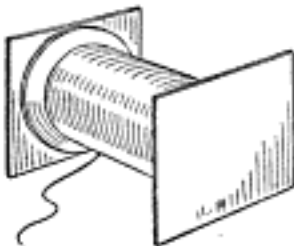

Shoe-Shining Stand

To anyone who finds it tiresome to shine his shoes while putting the foot on the rim of a bathtub, on a cook-

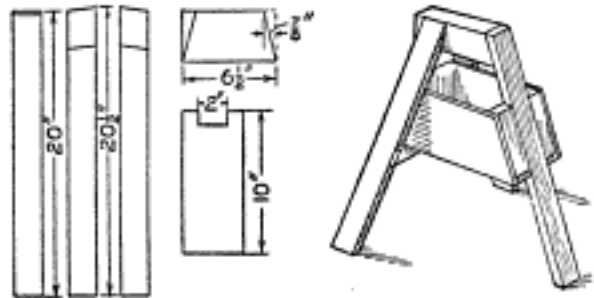

Dimensioned Parts and Completed Stand Which has a Box to Hold the Shining Outfit

stove or chair with a newspaper on it, the stand here described will afford relief and at the same time he will always have the shining outfit ready for use.

The whole is of pine, the foot rest being made of a piece 2 by 4 in.; the legs, of 1 by 2 in., and the bottom of the box, of $\frac{1}{2}$ by $4\frac{1}{4}$ in. All other dimensions are given in the sketch. After the legs are attached and the bottom of the box in place, the sides are fitted and fastened with nails.—Contributed by Samuel Hughes, Berkeley, Cal.

Cutter Made of a Wafer Razor Blade

A useful instrument for seamstresses and makers of paper patterns and stencils can be made of a piece of steel



The Wafer Blade Attached to the Handle, the Top Edge being Protected with a Cork

or iron and a wafer razor blade. The end of the metal is flattened and two holes drilled to match the holes of the razor blade. Small screw bolts are used to attach the blade to the handle. Place a cork on one edge as a protection for the hand of the user.—Contributed by Maurice Baudier, New Orleans, La.

A Fish Stringer

The illustration shows a very simple and inexpensive device for the angler to string and carry fish. It is



Inexpensive Stringer Made of a Pail Handle and Small Chain

made of a pail handle through which is passed a piece of soft wire, having sufficient length for bends or loops at each end, and a piece of chain. A chain 18 in. long is sufficient. One end of the chain is fastened in the loop at one end of the handle, and the other has a piece of wire attached for pushing through the gills of the fish. The other end of the wire through the handle is arranged in a hook to catch into the links of the chain.—Contributed by G. O. Reed, Stratford, Canada.

Substitutes for Drawing Instruments

Three of the most used draftsman's instruments are the compass, ruler and square or triangle. When it is necessary to make a rough drawing and no instruments are at hand, common and easily obtainable things can be used as substitutes.

A sheet of heavy paper folded as

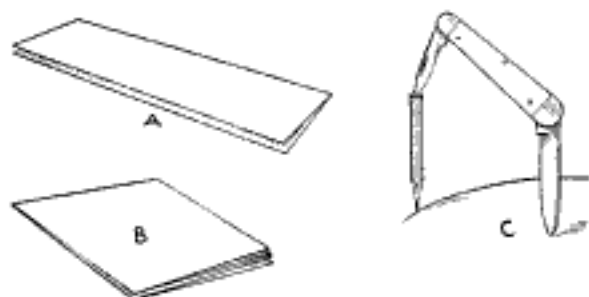

A Compass, Ruler and Square Made of Ordinary Things at Hand

shown at A will serve as a ruler, and the same sheet given another fold will make the square B. If given another fold diagonally, a 45-deg. triangle is

formed. A substitute compass is readily made of a short pencil and a pocket knife, as shown at C.—Contributed by Jas. J. Joyce, Olongopo, Philippine Islands.

How to Make an Aspirator

A simple aspirator that may be used for a number of different purposes, such as accelerating the process of filtering, emptying water from tubs, producing a partial vacuum in vessels in which coils are being boiled in paraffin, etc., may be constructed as follows: Obtain two pieces of brass tubing of the following dimensions: one 7 in. long and $\frac{3}{4}$ in. outside diameter, and the other, 3 in. long and $\frac{1}{4}$ in. outside diameter. Drill a hole in one side of the large tube, about 3 in. from one end, of such a diameter that

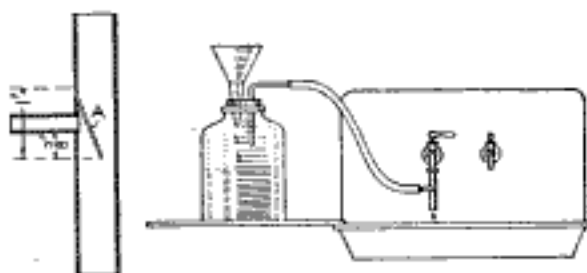

Detail of the Aspirator and Its Connections to a Faucet, for Increasing the Speed of Filtration

the small brass tube will fit it very tightly. Take an ordinary hacksaw and cut a slot in the side of the large piece, as shown at A. This slot is sawed diagonally across the tube and extends from one side to the center. Obtain a piece of sheet brass that will fit into this slot tightly, and then solder it and the small tube into the large tube. The slot and hole for the small tube should be so located with respect to each other that the small tube will empty into the larger one directly against the piece of sheet brass soldered in the slot.

The upper end of the large tube should be threaded inside to fit over the threads on the faucet, or an attachment soldered to it similar to those on the end of an ordinary garden hose. A rubber hose should be attached to the small tube and connected, as

shown, to a piece of glass tubing that is sealed in the cork in the top of the large bottle. The funnel holding the filter paper is also sealed into the cork. Melted paraffin may be used in sealing the glass tube, funnel and cork in place, the object being to make them airtight. The filter paper should be folded so that it sticks tightly against the sides of the funnel when the liquid is poured in, thus preventing any air from entering the bottle between the paper and the funnel. Turn on the faucet, and it will be found that the time required to filter any liquid will be greatly reduced. Be careful, however, not to turn on too much water, as the suction may then be too strong and the filter paper become punctured.

A Key-Holder Hook

A good hook for hanging keys, toothbrushes and other small articles



can be made from ordinary wire staples, as shown at A. One leg of the staple is cut away as shown at B and the other leg driven into the board as shown at C. These will answer the purpose as well as screw-hooks.—Contributed by W. C. Heidt, Chicago.

A Hand Hoe

A hand hoe, especially adapted for weeding or cultivating small truck, particularly onions, can be made of a piece of hard wood, $\frac{7}{8}$ by $1\frac{3}{4}$ in. by 4 ft. long, and a piece of old bucksaw blade. A blade, 18 in. long and 2 in.

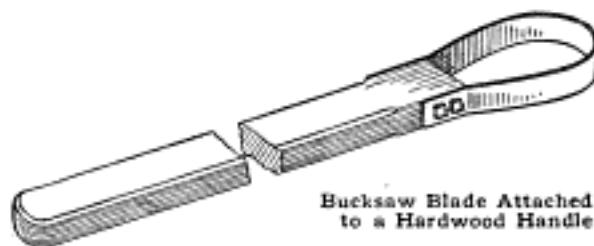

wide, bent into a loop is attached with bolts to the handle.—Contributed by Geo. H. Miller, Iowa City, Iowa.

Seed Receptacle for Bird-Cages

A handy seed and water container for a bird-cage can be made of a common spice tin. The receptacle can be

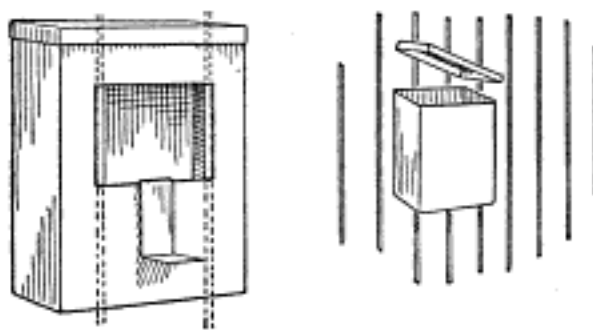

Spice Tin Attached to the Wires of a Bird-Cage for a Water or Seed Receptacle

filled without removal by simply taking off the cover. Thus the seed will not be scattered.

The tin is attached by cutting a hole in the back as shown, and bending the side edges to fit over the wires to hold it in place. The bottom strip is a support which rests on the floor of the cage and prevents the tin from slipping down on the wires.

Kitchen-Utensil Scraper

A flexible utensil scraper is one of the most useful articles I have in my kitchen. It covers such a large surface

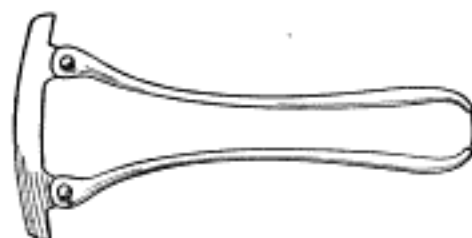

The Blade is Flexible so It can Readily Shape Itself to the Curves of a Kettle

in scraping pans, kettles, etc., that this most disagreeable part of the kitchen work is quickly and easily accomplished.

The flexible blade is attached to the tin handles with small rivets. The blade should be thin and narrow enough to allow it to bend. When the handles are pressed together, the blade curves to the shape of the utensil's surface.—Contributed by Mrs. Della Schempp, Brodhead, Wis.

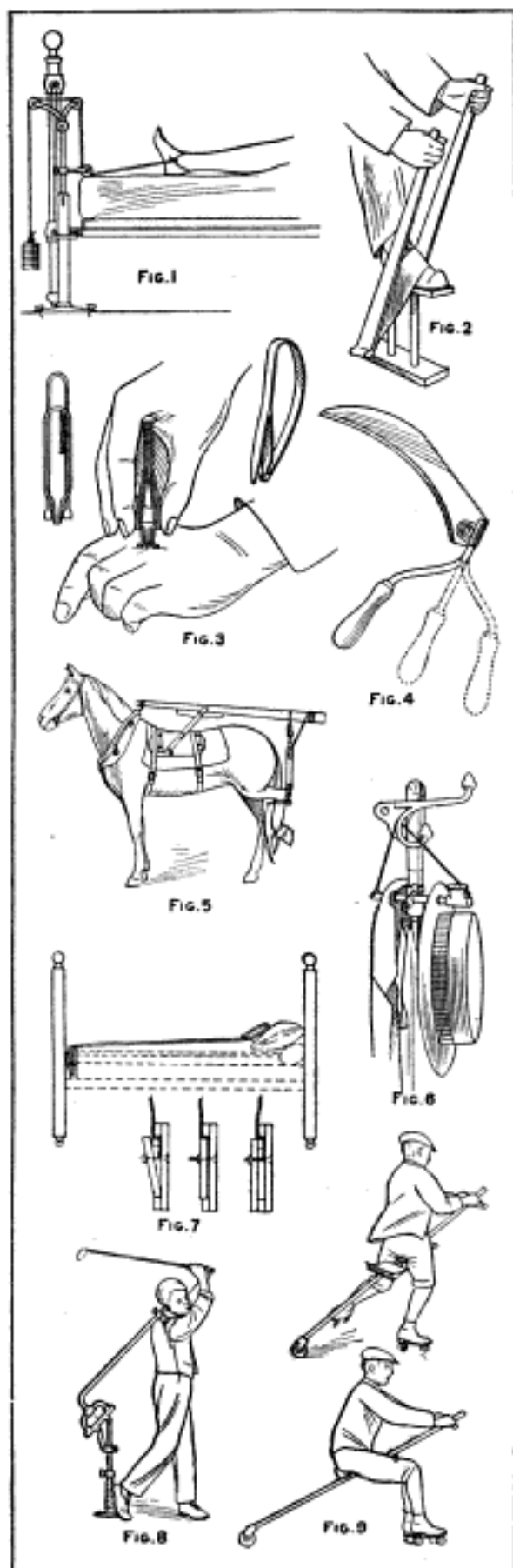

INTERESTING PATENTS,

LEG-PULLING APPARATUS—An apparatus for pulling or stretching the lower limbs of a person, a treatment used in certain hip diseases, etc., is shown in Fig. 1. A vertical post, carrying pulleys, is attached to the foot of the bed, and a cord, bearing weights on one end, is run over the pulleys and attached to the ankle of the subject. The weights, which are similar to those of a weighing scale, may be increased or decreased in number as the treatment requires.

ARM-OPERATED SHOE CLEANER (British patent)—Figure 2 shows a shoe-cleaning and polishing apparatus comprising a stand on which to place the foot, and a band of cloth with a wooden arm attached to each end. The cleaning or polishing cloth is worked over the shoe by means of the wooden arms, the purpose of which is to do away with the necessity of stooping down to reach the shoe. Some kind of a pulley arrangement that would allow the strip of cloth to be worked over the shoe by pulling and pushing the arms or levers, instead of working them loosely up and down, would seem to be a practical improvement.

SLIVER-REMOVING TWEEZERS (British patent)—A pair of tweezers, especially designed for the extraction of splinters, hair, etc., from the flesh, is shown in Fig. 3. The tweezers are provided with means for pressing on the flesh surrounding the splinter, thereby preventing the flesh from being pulled up with it, and also assuring, by pushing the flesh down from the splinter, a firm hold upon the latter. In the form of tweezers shown in operation, the pressure of the palm on the spring head holds down the flesh as the tweezer arms are raised upward in withdrawing the splinter. In the modification shown at the right, the points of one arm are adapted to grip the splinter and slide up the inclined arm when pressure is exerted, while the modification shown on the left is a form similar to the first, but having the spring connected to one of the pressing legs.

COMBINED SICKLE, CORN KNIFE AND PRUNING SAW—Figure 4 shows a combination tool which may be used for pruning small trees and shrubs, for cutting the grass of lawn borders, and as a corn knife. The handle is adjustable to the positions shown in the drawing.

HOOF SUPPORT FOR HORSESHOEING—A support adapted to hold either of the hind hoofs of a horse in raised position for shoeing is illustrated by Fig. 5. The apparatus comprises a saddle; a lever; a collar, to engage with one end of the lever, and a foot-supporting attachment fastened to the other end of the lever.

LOCK FOR WEARING APPAREL—Devices of several kinds for locking umbrellas to hooks or umbrella stands in restaurants and like places, have made their appearance from time to time. Figure 6, however, shows a device for not only safeguarding the umbrella, but the outer coat and the hat as well. It comprises a rod adapted to pass through eyes or other openings in the articles to be locked, and a lock designed to cap one end, after the articles have been placed on the rod. The rod is attached to one end of a chain and the cap to the other.

BEDCLOTHES FASTENER (British patent)—Any person who has experienced the disagreeable sensation which results from pulling or kicking the bedclothes from under the mattress at the foot of the bed on a cold night, will appreciate the endeavor of the British inventor of the device shown in Fig. 7, to prevent such an experience. It consists of two strips of wood or other suitable material adapted to be bolted together to clamp the bedclothes at the foot.

GOLF-STROKE TEACHING APPARATUS (British patent)—An apparatus for teaching the correct swing with a golf club is shown in Fig. 8. It comprises an arm pivoting on a spindle and attached by straps to the shoulders of the player's body. It constrains the player's body to move, when making a stroke, about an imaginary line passing from a point near the crown of his head and emerging near the base of his spine. Both the height of the rod and the inclination of the spindle may be adjusted. A wall bracket may be used instead of the column to support the apparatus.

PRACTICAL OR UNIQUE

ROLLER POLE FOR ROLLER SKATERS—When the very small boy who likes to play horse astraddle a broomstick becomes old enough to use roller skates, he may carry out the idea in a more practical way with a roller pole of the kind shown in Fig. 9. The device comprises a pole provided with a roller at one end, a seat near the center, a crosspiece for the hands at the other end, and a second crosspiece between the first mentioned crosspiece and the seat. This second crosspiece is to brace his knees against when he sits down on the seat after getting a good start.

MAGNIFYING GLASS FOR NEEDLE-THREADING (British patent)—The device shown in Fig. 10 is designed as an aid to the eyesight when it is necessary to thread a needle. It is a small magnifying glass which may be attached to the thumb by means of a spring clip, in the position shown.

RUBBER-PROTECTED NURSING BOTTLE—(British patent)—A boat-shaped nursing bottle protected by two large rubber rings projecting beyond the body of the bottle is illustrated in Fig. 11. The rings may be solid or hollow and are connected together by a sheath.

BOTTLE-RINSING FAUCET—Figure 12 illustrates a special cock arrangement for kitchen-sink faucets, the purpose of which is clearly shown. The bottle to be rinsed is slipped over the fixture and rests on a collar, in the sides of which portions are cut away to provide an escape for the water from the bottle.

PARACHUTE FIRE ESCAPE—Figure 13 is a curious parachute arrangement by means of which a person, shut off by fire or smoke from other ways of escape, is expected to drop to the sidewalk or ground in safety. The parachute apparatus is designed to be attached in operative position outside a window, the parachute being contained in a tubular protector. The person attempting to escape works himself to the outer edge of the window sill, places his arms through arm supports and slides off, the parachute opening to retard and brake the descent, so that the ground will be reached without any harmful shock.

DIVISIONAL TOOTHBRUSH—Figure 14 illustrates a toothbrush having its bristles arranged in different-sized tufts, so shaped as to reach every part of the surfaces of the teeth.

COAT-AND-SKIRT HANGER (British patent)—Coat hangers of many kinds and varieties have made their appearance on the market, but this hanger (Fig. 15) is a little different from others in that it is designed especially for women's wearing apparel and accommodates both the coat and skirt of a suit. The hanger comprises two hinged members, each of which is formed with two arms of different curvatures, the upper arms supporting the coat, and the lower arms, the skirt. The hanger may be folded about the hinge, which is just under the hook, and is prevented by stops from collapsing while in use.

ROLLER FLOUR CONTAINER—Figure 16 shows a rolling-pin flour container, the hollow body of which is perforated to allow a discharge of flour onto the surface over which the pin is rolled. One of the roller handles is also hollow, and in it is contained a dough knife.

SWIMMING MITT—A swimming mitt, having a body of a length and width to slip fairly closely over the four fingers of the hand, is shown in Fig. 17. The purpose of the mitt is to make possible a more effective stroke in swimming by preventing any flow of water between the fingers.

SHOE WITH COMBINATION ELASTIC AND LACED UPPER—A laced-upper shoe which may be drawn onto and removed from the foot without unlacing is shown in Fig. 18. The back portion of the upper is of elastic material, and around this passes a leather strap provided with a snap button, the purpose of the strap being to hold the upper snugly around the ankle. The strap may be unsnapped to ease the tightness of the shoe when the wearer is reclining in an easy-chair.

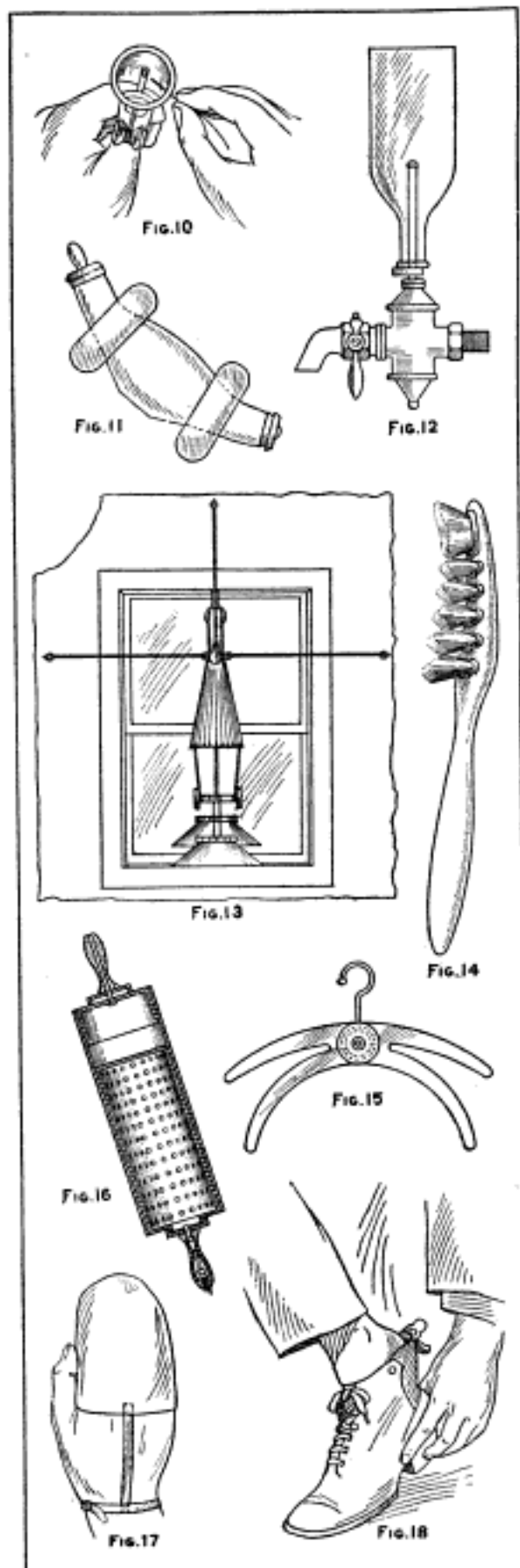

FOR the purpose of advertising fishing rods, a shopkeeper hung a large rod outside his shop, with an artificial fish at the end of it. Late one night Perkins, who had been dining a bit too well, happened to see the fish. Going cautiously to the door, he knocked gently.

"Who's there?" demanded the shopkeeper from an upper window.

"Sh-h! Don't make a noise, but come down as quietly as you can," whispered Perkins. Thinking something serious was the matter, the man dressed and stole downstairs.

"Now, what is it?" he inquired.

"Hist!" admonished Perkins. "Pull in your line, quick; you've got a bite."

"Mighty mean man I's wukin' fer."

"What's de mattah?"

"Took de laigs off de w'celbarruh so's I kain't set it down an' rest."

Recently in Seattle in a cigar-stand appeared the sign, "We give \$15.00 for 1909 Lincoln pennies." No less a person was attracted by this than Judge Watson. He walked up to the counter and laying down a penny triumphantly asked for \$15.00. The clerk took the penny, examined it closely, asked if it were genuine, and after several minutes sighed and said he guessed it was good.

"Certainly it is," answered the Judge. "Where is my \$15.00?"

"Where," said the clerk, "are the other 1908?"—*Life*.

He had dropped a nickel in the slot of a telephone pay station and stood patiently waiting. He was full to the brim. He read the instructions and took down the receiver.

"Number?" asked central.

"Five centsch."

"What do you want?"

"Spearmint."

A Harvard professor, noted for his severe way of examining students, tackled a raw-looking freshman: "I understand you attend the class for mathematics?"

"Yes." "How many sides has a circle?" "Two," said the student. "Indeed! What are they?" "An inside and outside!" was the prompt reply. "And you attend the moral philosophy class also?" "Yes."

"Well, no doubt you heard lectures on various subjects. Did you ever hear one on cause and effect?"

"Yes." "Does an effect ever go before a cause?"

"Yes." "Give an instance!" "A barrow wheeled by a man!" The doctor hastily sat down and put no more questions.

A Texan and a New Yorker were one day discussing the relative merits of their respective climates.

"Down where I live," said the Texan, "we grew a pumpkin so big that when we cut it my wife used one-half of it as a cradle to rock the baby in."

The New Yorker smiled. "Why, my dear fellow," he said, "that's nothing at all. A few days ago, right in New York City, three full-grown policemen were found asleep on one beat."

A new book of memoirs in England recalls what has been styled the most brilliant epigram ever written. It was written by one J. K. Stephen, Cambridge undergraduate, about a stout professor, Oscar Browning:

KINDLY WARNING TO A FAT MAN,

O. B., oh, be obedient

To Nature's stern decrees;

For, tho you be but one O. B.,

You may be too obese!

"Bill's goin' to sue the company fer damages."

"Why? wot did they do to 'im?"

"They blew the quittin' whistle whin 'e was carryin' a 'eavy piece of iron and 'e dropped it on 'is foot."—*Domestic Engineering*.

He had been to Europe and returned, and he was telling a friend on the car what he had seen, when a man with red eyebrows leaned across the rail and said:

"I beg your pardon, sir, but I should like to butt in. You have been to Europe?"

"Yes, sir."

"They knew you were an American?"

"They did."

"You talked with many men?"

"A great many."

"Did any of them refer to the political corruption in this country?"

"No."

"Nor to the cold-storage sharks?"

"No."

"The Beef Trust?"

"No."

"The coal robbers?"

"No."

"The extortion in express rates?"

"No."

"To the trusts in everything, even in coffins?"

"No."

"To the buying and selling of Senators?"

"No."

"Then, my sir, will you be kind enough to tell me in which direction Europe lies and how long it will take me to get there? I want to go there instead of to heaven."—*Rochester Democrat and Chronicle*.

Police Commissioner—If you were ordered to disperse a mob, what would you do?

Applicant—Pass around the hat, sir.

Police Commissioner—That'll do, you're engaged, sir.—*Pathfinder*.

The Visitor—Why are you here, my misguided friend?

The Prisoner—I'm the victim of the unlucky number 13.

The Visitor—Indeed; how's that?

The Prisoner—Twelve jurors and one judge.

Mrs. Bacon: "She's one of the most obstinate women I ever knew."

Mrs. Egbert: "Indeed?"

Mrs. Bacon: "Yes; why, I believe if she took laughing-gas she'd cry!"

NEW BOOKS

THE PRIMER OF HYDRAULICS—By Frederick A. Smith, Hydraulic Engineer, is a commendable work for anyone interested in the subject. The beginner, without any but a grammar-school education, will find in the first nine articles a clearly written, and easily understood introduction into the mathematical principles and methods, which must be comprehended, before the practical problems are approached; and the full-fledged hydraulic engineer will also find much in the work of great value to him in the use of the tables and methods of analysis contained therein. The book is fully illustrated and contains, besides an alphabetical index, all the tables required to solve working problems. 215 pages, 5x7½, cloth, \$2.50. D. H. Anderson, Chicago.

INTRODUCTION TO ANALYTICAL MECHANICS—By Alexander Ziwet, Prof. of Mathematics, and Peter Field, Ph. D., Assistant Prof. of Mathematics, in the Univ. of Michigan. A brief introduction to mechanics for junior and senior students in colleges and universities, without applications to engineering. The nature and purpose of the work have made it necessary to omit many important subjects, but the selection made seems, on the whole, fortunate, and well adapted to give the reader a general view of the science of mechanics as a whole, and a broad enough foundation for further study. 378 pages, 5x7½, cloth, illustrated and indexed. Price \$1.00 net. The Macmillan Company, New York and London.



NEWEST STYLES IN WATCH CASES—MONOGRAMS AND EMBLEMS
in Our Special 25-Year GOLD STRATA Cases.

IN connection with this great astounding offer on watches we are showing some beautiful novelties in cases. Most especially the magnificent new style ribbon and block monograms. Imagine your watch engraved with your initials. The styles above are a few of the 50 selected styles shown in our catalogue.

MONOGRAMS engraved as above cost from \$2.50 to \$3.50, sometimes more at a jeweler's. But in connection with our anti-trust price offer we are engraving monograms at 80c each, French and dragons \$1.00, etc. Write for catalog to get details. The movements in these watches are guaranteed the best, equal or superior to those of watches regularly sold at three times the price by trust goods dealers—yes three times the price. Every movement is

Adjusted to Isochronism A careful adjustment, so that the speed of a watch, when it is fully wound up, is the same when it is almost run down.

Adjusted to Temperature The watch is put into a refrigerator and run for twenty-four hours, then it is put into an oven of 110 degrees temperature and run for twenty-four hours then it is run in normal temperature for twenty-four hours. This process is continued until the watch runs the same in all temperatures. **Not 10 in 100 watches, i. e. not 10% even of the better grade watches are adjusted to temperature.**

Adjusted to Positions Adjusting a watch to positions is adjusting it so it runs the same in various positions. **Not one watch in 200; that is, less than 1/2 of 1% of even the better grade of watches are adjusted to positions. Only the Very Best.**

19 Jewels used are the finest grade of selected genuine imported ruby and sapphire jewels, absolutely flawless. Nineteen of these selected gems protect every point.

Double Jewels—that is, bearings with two jewels each are used in the Burlington. A watch so jeweled requires very much less attention than watches jeweled in any other way.

The U Spring Regulator allows adjustments to the smallest fraction of a second.

Factory Fitted Every Burlington Special movement is fitted into the case right at the factory where the movement was made, into a case made for that watch. No looseness or wearing of parts against the sides of the case. No rattle or jar.

For full description of these superb watches get our new catalog. Write now.

Write for our
STARTLING
Watch Book

See coupon below for explanation of the most **STARTLING** offer in the history of the watch business. **HERE is your opportunity!**—If you ever expect to own a high class watch write today for booklet, explaining this **unprecedented** offer.

Read: It has been decided to complete the overwhelming introduction of our great direct line by offering a watch of the highest quality direct to the public at the rock bottom price—a price unheard of before for a watch of this quality. And besides at the rock bottom price you may have the easiest kind of monthly payments. Your choice from a line of highest grade watches at the same price, the exact price that even the wholesale jeweler must pay. You get your watch to the penny at the exact price that we have been asking the biggest wholesale jeweler. **Take your choice of the watch you want as per our booklet.** Watches adjusted to temperature, adjusted to positions, adjusted to Isochronism, in short the world's first watches just now on the rock bottom price offer.

Startling Book SENT ON REQUEST

This book explains the great introductory offer and tells all about the wonderful watches you have to choose from.

BURLINGTON WATCH CO.

Dept. 119Y—19th St. and Marshall Blvd., Chicago, Ill.

Now, then, if you have been thinking of getting a thoroughly high class watch at some later time don't wait but write for this booklet **RIGHT NOW**—today.

In order to complete the introduction of our direct line we offer terms of \$2.50 a month at these same rock bottom prices; so that everybody who sees this offer will accept at once.

FREE
COUPON

Burlington Watch Company,
Dept. 119Y 19th St. and Marshall Blvd., Chicago, Ill.

Without obligating me in any way you may send me free your watch book and full details of your offer.

Name _____

Address _____

Please Mention Popular Mechanics

Panama
Canal
Engineers



DIGGING THE The Few Who Will Stay

When the Panama Canal is finished, the few to be retained will be the experts—the men on the “gold” pay-roll. The crowd who will go are the 28,536 untrained workers—the men on the “silver” pay-roll.

No more striking example of the relative value of trained and untrained men can be found anywhere than this. Here you see exactly what happens when a large working force is to be reduced. The *trained* men *stay*—the *untrained* go.

You don't have to be at the mercy of *lack of training*. **You** can get in the *trained* class where your services will always be in demand — *and where you can make a position for yourself*, instead of having to wait for a poorly paid “job” to develop.

Thousands of other ambitious men have succeeded through the help of the

International Correspondence Schools. It would surprise you to know how far away many of these men lived—how positively “hard up” some of them were—how little schooling many of them had—how little spare time most of them had. **Yet they won.** They had the good judgment to mark the coupon and learn how easy the I. C. S. way is, and how everything is simplified. Then they let the I. C. S. come to them and train them in their own homes without interfering with business or pleasure.

Right down in the very Panama Zone we're talking about you'll find such I. C. S. successes as those of Robert N. Boles—from carpenter to Master Carpenter—salary more than tripled; Charles Davis—rodman to Levelman—salary increased 25 per cent.; Luis Ernst—druggist to Laboratory Chemist—salary more

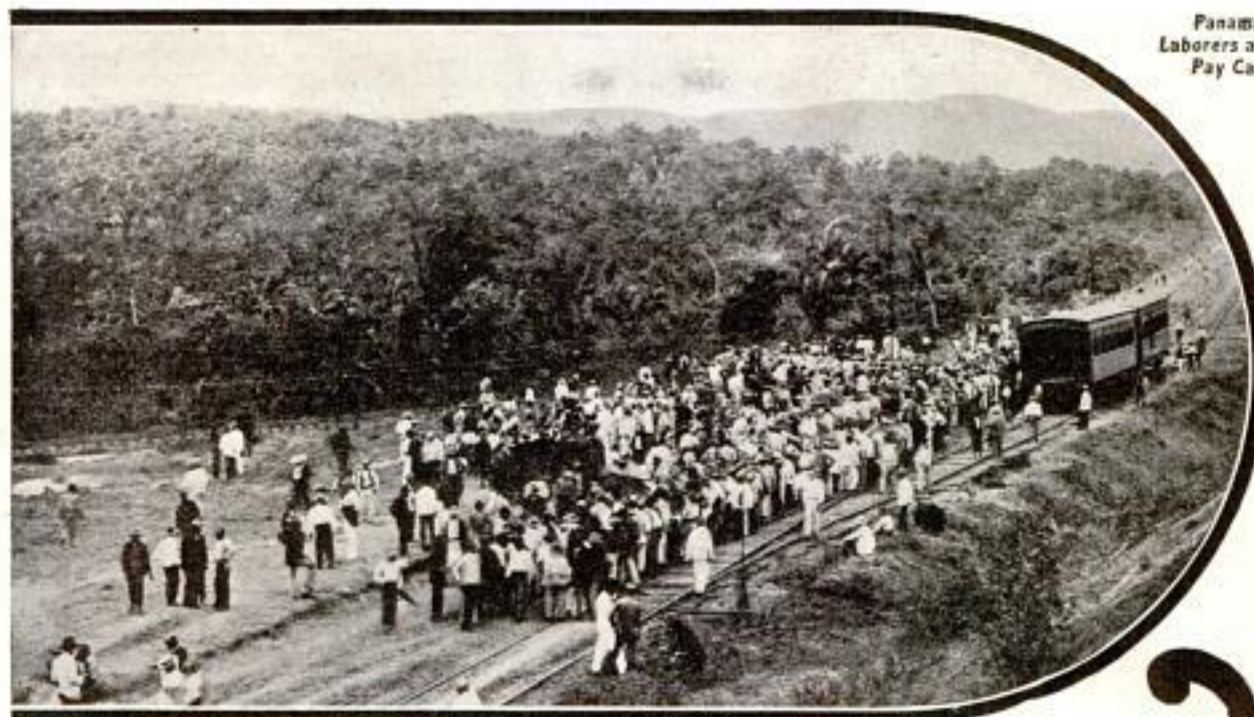
Panama
Laborers at
Pay Car

These photographs reproduced by courtesy of P. F. Collier & Son, Publishers

“BIG DITCH”

The Crowd Who Will Go

than doubled; V. A. Eberly—farmer to Draftsman; M. P. Benninger—messenger to First Class Wireman.

But you can get nearer home than this. If you will mark the attached coupon, the I. C. S. will send you names of people right in your own vicinity, who have won success through I. C. S. help.

Marking the coupon is easy. Doing it costs you only the postage. There is no further obligation on your part. Don't you want to get out of the crowd who will *go*, and join the *few* who will *stay*? You can do it, no matter who, what, or where you are, or what you do, or how little schooling you have had. To find out *how* you can succeed at the occupation of your own choice, mark and mail the coupon NOW.

INTERNATIONAL CORRESPONDENCE SCHOOLS

Box 874, SCRANTON, PA.

Explain, without further obligation on my part, how I can qualify for the position before which I mark X.

Automobile Running	Civil Service
Mine Superintendent	Architect
Mine Foreman	Chemist
Plumbing, Steam Fitting	Languages
Concrete Construction	Good English
Civil Engineer	Building Contractor
Textile Manufacturing	Architectural Draftsman
Stationary Engineer	Industrial Designing
Telephone Expert	Commercial Illustrating
Mechan. Engineer	Window Trimming
Boothical Draftsman	Show Card Writing
Electrical Engineer	Advertising Man
Elec. Lighting Supt.	Stenographer
Agriculture	Bookkeeper
Electric Railways	Salesmanship
Structural Engineer	Cotton Manufacturing
R. R. Construction	Wagon Manufacturing
Metal Mining	Toolmaking
English Branches	Foundry Work
Gas Engineer	Pattern Making
Foreman Plumber	Blacksmithing
	Surveyor
	Poultry Farming

Name _____

Present Occupation _____

Street and No. _____

City _____ State _____

Please Mention Popular Mechanics



The Right of All the Way

Railroad service and telephone service have no common factors—they cannot be compared, but present some striking contrasts.

Each telephone message requires the right of all the way over which it is carried. A circuit composed of a pair of wires must be clear from end to end, for a single conversation.

A bird's-eye view of any railroad track would show a procession of trains, one following the other, with intervals of safety between them.

The railroad carries passengers in train loads by wholesale, in a public conveyance, and the service given to each passenger is limited by the necessities of the others; while the telephone carries messages over wires devoted exclusively for the time being to the individual use of the subscriber or patron. Even a multi-millionaire could not afford the exclusive use of the railroad track between New York and Chicago.

But the telephone user has the whole track and the right of all the way, so long as he desires it.

It is an easy matter to transport 15,000 people over a single track between two points in twenty-four hours. To transport the voices of 15,000 people over a single two-wire circuit, allowing three minutes for each talk, would take more than thirty days.

The telephone system cannot put on more cars or run extra trains in order to carry more people. It must build more telephone tracks—string more wires.

The wonder of telephone development lies in the fact that the Bell System is so constructed and equipped that an exclusive right of all the way, between near-by or distant points, is economically used by over 24,000,000 people every day.

**AMERICAN TELEPHONE AND TELEGRAPH COMPANY
AND ASSOCIATED COMPANIES**

One Policy

One System

Universal Service

Please Mention Popular Mechanics



The Oil for Every Motor—for Every
Climate—Sold Everywhere, is

Polarine

FROST AND CARBON PROOF

The Standard Oil for Motors

Meets every gasoline motor need—both *four* and *two* cycle types.

Stands any heat that *any* motor will ever develop, lubricating perfectly in *summer* as well as in *winter* temperatures, flowing freely at zero.

—Always dependable—always the same.

All because we begin to perfect it at the point where most oils are deemed finished.

And because we bring to bear all our vast resources and *forty years of experience*.

Motorists know it's the "Cream of Motor Oils." It is "The Universal Motor Oil." It has been tested for you—in *all makes of cars*. We stand behind it. Try it.

For sale everywhere by all reputable dealers.

The tin seal intact under the screw-cap shows that the can was filled at the plant and that the oil is genuine Polarine. This protects the user, also the dealer who wants to give his customers the right oil every time.

Write for free booklet, "Motoring in Zero or Tropical Weather." It tells all about motor oils—Polarine in particular.

Try MATCHLESS LIQUID GLOSS for Polishing Automobile Bodies, Wind Shields, Windows, etc.

The Saving in Barrels

Those who usually buy oil in small amounts can save a neat sum buying by the barrel or half-barrel. It's economy for everyone who owns a gasoline car to buy this way.

Polarine Lubricants

Prepared in consistencies to meet individual preference—and mechanical conditions of transmissions, differentials, universal joints, ball and roller bearings, timing gears, etc.

"A" grade . . . Semi-Fluid Oil
"B" grade . . . Semi-Fluid Grease
"BB" grade . . . Semi-Solid Grease

Also include Cup Grease and Fibre Grease of high melting point.

All are called POLARINE and are the recognized standard greases for Motor Car and Motor Boat lubrication.

Each grade has superior merit in durability and cushioning properties.



Standard Oil Company (An Indiana Corporation)

2c a Week Pays Wash Bill!

Write for
FREE Book

Electricity or Water-Power Does the Work

Just a "Twist of the Wrist" Starts or Stops the Machine!

The 1900 Motor Washers are now at work in thousands of homes. They are doing the work formerly done by women, at a cost of 2c a week for power! Saving thousands upon thousands of dollars in wash bills. Saving worlds of wash-day troubles. Leaving the women free to do other work while the machines are doing the washing.

The 1900 Motor Washer

Washes a Tubful in Six Minutes!

1900 Water Motor Washer
Can be connected with
any water tap instantly



Handles Heavy Blankets or Dainty Laces

The outfit consists of the famous 1900 Washer with either Electric Motor or Water Motor. You turn on the power as easily as you turn on the light, and back and forth goes the tub, washing the clothes for dear life. Then, turn a lever, and the washer does the wringing. All so simple and easy that it is mere child's play.

A Self-Working Wringer Free With Every Washer!

The motor runs Washer and Wringer. We guarantee the perfect working of both. No extra charge for Wringer, which is one of the finest made. Write for FREE BOOK and 30 Days' FREE TRIAL OFFER! Don't doubt! Don't say it can't be done. The free book proves that it can. But we do not ask you to take our word for it. We offer to send a 1900 Motor Washer on absolute Free Trial for an entire month to any responsible person. Not a cent of security—nor a promise to buy. Just your word that you will give it a test. We even agree to pay the freight, and will take it back if it fails to do all we claim for it. A postal card with your name and address sent to us today will bring you the book free by return mail. All correspondence should be addressed to



Doing the wringing with
1900 Electric Motor Washer

1900 WASHER CO., 5078 Court St., Binghamton, N. Y.

Or, if you live in Canada. Write to the Canadian Washer Co., 355 Yonge St., Toronto, Canada. (23)

AMATITE ROOFING

Mineral surfaced. Needs no painting. Send for free sample.
BARRETT MANUFACTURING CO., New York, Chicago



I will send as long as they last my 25 Cent Book

STRONG ARMS

For 10c in stamps or coin

Illustrated with 20 full page halftone cuts, showing exercises that will quickly develop, beautify, and gain great strength in your shoulders, arms, and hands, without any apparatus.

PROF. ANTHONY BARKER
645 Barker Bldg., 110 W. 42d Street, New York

OVER 65 YEARS'
EXPERIENCE

PATENTS

TRADE MARKS
DESIGNS
COPYRIGHTS, &c.

Anyone sending a sketch and description may quickly ascertain our opinion free whether an invention is probably patentable. Communications strictly confidential. HANDBOOK on Patents sent free. Oldest agency for securing patents. Patents taken through Munn & Co. receive special notice, without charge, in the

Scientific American.

A handsomely illustrated weekly. Largest circulation of any scientific journal. Terms, \$3 a year; four months, \$1. Sold by all newsdealers.

MUNN & CO. 359 Broadway NEW YORK

Branch Office, 625 F St., Washington, D. C.

FALSE EYEBROWS—At a certain factory a number of young women were working at small tables, each table covered with little instruments and odd things, which only those who knew the business could possibly understand. At one table two girls were threading needles with fine, silky hair and sewing them in little squares on a thin, transparent gauze.

"Those girls," said the overseer, "are making some of those beautiful arched eyebrows you may sometimes see on the stage. They are frequently worn by both actors and actresses. These sewed on the net are the less expensive kind, and are only used on special occasions. The real brow is very expensive and can only be made by a person of great skill."—Chicago Inter Ocean.

BUY PLUMBING SUPPLIES AT WHOLESALE

Will
Save
You
30%



Don't pay retail prices. Full stock on hand for prompt shipment. Send for free catalog.
R. P. KAROL, 104 to 112 West Harrison St., Chicago



50c and You KEEP This SUPERB ROCKER

American quarter-sawn oak finish. Profusely carved, best grade Boston leather. Diamond Tuffed. Only 50c down and then 50c per month. Price \$1.95! No. A1264.

Easy Payments No matter what your salary let us write to us. Easiest terms use the goods while paying for them.

Write Now for big bargain catalog and special list today. Don't delay—write now.
STRAUS & SCHRAM (Inc.)
35th Street Dept. 919Y Chicago, Ill.



FAIRBANK'S
Pummo
A Glycerine-Pumice
SOAP

A man's soap
but good too for
the housewife

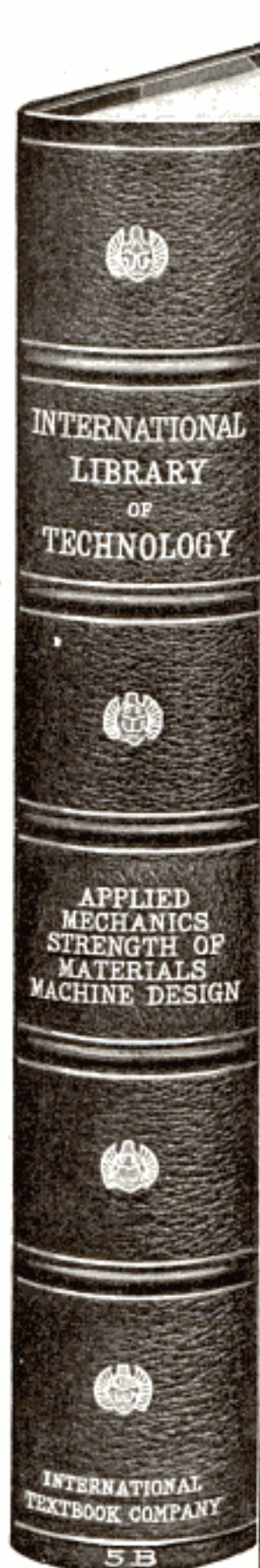

The Greatest Mechanical Library in the World

The Mechanical Engineering Library is part of the International Library of Technology that cost \$1,500,000 in its original preparation. It contains the knowledge given from the life experience of some of the best mechanical engineering experts in the country, edited in a style that nineteen years of experience in publishing home-study textbooks has proved easiest to learn, to remember, and to apply. There is no other reference work in the world that so completely meets the needs of the mechanic as the Mechanical Engineering Library. The volumes are recommended by the highest authorities and are used in nearly all the leading universities and colleges. They treat of practical mechanical methods, starting from the simplest problems and comprehensively covering every branch of the work. Not only can they be used to great advantage by superintendents, foremen, and engineers as an authoritative guide in their work, but since they can be so clearly understood even by persons having no knowledge of higher mathematics, they can be used by all classes of mechanics that are desirous of advancing to higher positions. The Mechanical Library contains 14 volumes durably and handsomely bound in three-fourths red morocco, stamped and numbered in gold. The books are printed on a high-grade book paper, and the type is large and easy to read. Each volume is 6 by 9 inches in size. If you wish to know more about the greatest and most practical mechanical library in the world, mark and mail the coupon NOW.

INTERNATIONAL TEXTBOOK COMPANY

Box 872, Scranton, Pa.

Please send, without further obligation to me, full particulars in regard to the International Library of Technology, with special reference to the Library of Mechanical Engineering.

Name _____

St. & No. _____

City _____ State _____

Please Mention Popular Mechanics

→ **Protect Your Idea!** ←

PATENTS THAT PAY

\$427,530.00 Made by Clients

"My Trade-Mark"

\$427,530.00 Made by Clients

Proof back of it—write for my FREE literature—it will pay!



BOOK "What and How to Invent— Proof of Fortunes in Patents"—FREE

Containing: Views of Prominent Men and Publications on Inventions; "Patents Wanted"; "How to Advertise Your Patent"; "How to Secure Money to Procure a Patent"; Suggestions as to what to Invent; What my clients have done; Women Inventors, etc.



Instructive 112-page Guide Book for Inventors mailed to any address upon request

Highest References:

"Over ninety (90) manufacturers intrust ALL their patent work to me."—E. E. V.

Lincoln National Bank,
Washington, D. C.

NOTE: When writing these clients send two-cent stamp for reply.

Little Giant Hay Press Co.,
Dallas, Texas.

American Railway
Appliance Co.
Oil City, Pa.

B. F. Goodrich Co.,
Akron, Ohio

Susquehanna Silk Mills,
New York

Griffin Mfg. Co.,
New York, N. Y.

Warsaw Paper Box Co.,
Warsaw, N. Y.

Wm. H. Page Boiler Co.,
New York, N. Y.

Butler Engineering Co.,
Akron, Ohio

Klebold Press,
New York, N. Y.

Garl Electric Co.,
Akron, Ohio

Gray Lithograph Co.,
New York, N. Y.

Reading Re-enforced
Cork Co.,
Reading, Pa.

New Era Mfg. Co.,
Fairfield, Iowa.

Bernhard Furst,
Vienna I,
Austria-Hungary

A. J. Corsi,
Irish Town,
Gibraltar

Otto von Rottenburg,
Schwindstrasse 20,
Frankfort A. M.,
Germany

H. A. Fonseca,
Eloa Dos Guirves 29,
Sobrado, Rio de Janeiro,
Brazil

Electro Importing Co.,
New York, N. Y.

Rex Electric Co.,
St. Louis, Mo.

Sam'l Allen & Son Mfg. Co.,
Danville, N. Y.

Gas Range & Heater Co.,
So. Pasadena, Cal.

Camp Conduit Company,
Cleveland, Ohio

COMPARE MY LOCATION WITH OTHERS MINE IS THE BEST



My Office and the Patent Office
(I give you proof of my location)

Across the street from the U. S. Patent Office

Expert—Prompt Services

E. E. VROOMAN, Patent Lawyer Wash., D.C.

Registered Patent Attorney. Patent Litigation
Old-established branches throughout the world.

PATENTABILITY REPORT

Send by registered mail data of your invention for my opinion as to the *probable* patentability of same; if you want a careful examination of the Patent Office records made (a full report) as to the patentability of your invention, then send with the data \$5.00 to cover cost of this examination, and in the event you proceed with the filing of your U. S. application, I will credit the \$5.00 (as an advanced payment) upon my attorney's fee.

Foreign Patents a Specialty

If you have a U. S. application write me for excellent literature and terms for promoting your Foreign Patents. Liberal discounts.

High-Class Work—Excellent Testimonials

871 F Street, N. W.

Patents

Trade Marks and Copyrights Secured or Fee Returned

Special Offer—Free Search of Patent Office Records

Send us a model, photograph or sketch and description of your invention, and we will make a *Free Search of the Patent Office Records* to ascertain if it is patentable. If we report the invention patentable, we will guarantee to obtain a patent or return our fee, and furnish a certificate of patentability backed by a bonded contract to that effect.

This Certificate of Patentability will protect the inventor and serve as proof of the invention until the case can be filed in the U. S. Patent Office.

Obtaining Assistance for Inventors

Our certificate is of great assistance to inventors who require financial aid to obtain patents. It is useless to attempt to interest capital unless evidence is furnished that the invention is patentable. Our certificate gives this necessary assurance.

Our Four Books Mailed Free

to any address. Send for these books—the finest publications ever issued for free distribution.

How to Obtain a Patent

Our illustrated eighty-page Guide Book is an invaluable book of reference for inventors, and contains 100 mechanical movements illustrated and described.

Fortunes in Patents

Tells how to invent for profit, and gives history of successful inventions.

What to Invent

Contains a valuable **LIST OF INVENTIONS WANTED** and suggestions concerning profitable fields of invention; also information regarding prizes offered for inventions, among which is

Prize of One Million Dollars

offered for one invention, and \$10,000 for others.

Patents That Pay

Contains fac-similes of unsolicited letters from our clients who have built up profitable enterprises founded upon patents procured by us; also endorsements from prominent inventors, manufacturers, Senators, Congressmen, Governors, etc.

List of Patent Buyers

Containing personal requests and letters from Manufacturers and Patent Promoters for patents secured by us, and suggestions as to improvements desired and new ideas they wish to purchase.

We Advise Our Clients' Inventions Free

In a list of Sunday newspapers with two million circulation, in manufacturers' journals and in the *World's Progress*. Sample Copy Free. We not only save you time and money in securing patents, but obtain patents which **PROTECT** the invention and **PAY**. After the patent is granted we assist you **TO SELL YOUR PATENT**.

Foreign Patents

WE HAVE DIRECT AGENCIES IN ALL THE PRINCIPAL FOREIGN COUNTRIES and can secure **FOREIGN PATENTS** in the shortest possible **TIME** and at the **LOWEST COST**. We **GUARANTEE TO SECURE THE FOREIGN PATENTS OR RETURN OUR FEES**. Write for our Illustrated Guide Book on Foreign Patents, sent free to any address.



VICTOR BUILDING

Our new \$150,000 building opposite U. S. Patent Office
SPECIALLY ERECTED by us for OUR own use

REFERENCES

Second National Bank, Washington, D. C.
C. K. Lassiter, Mechanical Engineer, Schenectady, N. Y.
Pitner Gasoline Lighting Co., Chicago, Ill.
Sprout, Wardon & Co., Mfrs. of the Monarch Feed Governor, Muncy, Pa.
The L. B. Dozier Co., Mfrs. of Plumbing, Heating and Machinery Supplies, Columbia, S. C.
B. B. Earnshaw and Bro., Mfrs. "Cream Blend" Flour, Washington, D. C.
R. G. Dun & Co., Washington, D. C.
National Savings and Trust Co., Washington, D. C.
Smethport Glass Co., Smethport, Pa.
Lawrence Mills, Mfrs. Bed Spreads, 51 Brooke Ave., Englewood, N. J.
The Melvin Gauge and Signal Inst. Co., Scranton, Pa.
Damon Mfg. Co., Mfrs. "Missing Link" Flour Mill Disintegrators, Bowling Green, Ky.
Modern Canner Co., Mfrs. Canning Machinery and Cannery Supplies, Bridgeport, Ala.
M. Winter Lumber Co., Sheboygan, Wis.

VICTOR J. EVANS & CO., Patent Attorneys

NEW YORK OFFICES: 132 Nassau St.

PHILADELPHIA OFFICES: 1429 Chestnut St.

Main Offices: Victor Building, 724-726 9th St., N. W., WASHINGTON, D. C.

PATENT YOUR IDEAS



*—There is a Constant Demand
for Good Inventions*

Thousands of the biggest money-making inventions have been the "little" things that have made people wonder why they were never thought of before.

"WHAT TO INVENT"

and

"HOW TO OBTAIN A PATENT"

These Books Sent Free

If you have an invention send us a sketch, photograph or model of it. We will give you a report as to its patentability absolutely free. If you have no invention send for our book, "What to Invent." It contains hundreds of valuable suggestions. We are recognized authorities on patent matters and have helped hundreds to find a ready and profitable market for their ideas. We can prove it. If you wish to sell your patent we will advertise it in manufacturers' journals at our expense.

Don't Wait—Find Out NOW!

Your idea will never do you any good if some one else patents it ahead of you. Act quick! Let the other fellow say "he thought of it a long time ago." You reap the profit. Let the others wish they had.

Advice Free—All Matters Confidential

We have secured patents for thousands of inventors and have many letters proving the value of our services. Write us. Send rough drawing or model of your invention for our opinion. We will guard it carefully and report quickly. You are under no obligations to proceed further. Our plan is simply a square deal to all. Our books, "What to Invent" and "How to Obtain a Patent" are the best publications written for the man who has an idea to patent, or who is of an inventive turn of mind. They show just how to proceed with your idea and tell of hundreds of things to invent. We gladly send these books free. The sooner you write for them the sooner you will know all about patents and the many different lines in which new inventions or improvements may be made.

If you have an invention send us a sketch of it for report and ask for the books at the same time.

CHANDLEE & CHANDLEE, 984 F Street, Washington, D. C.

REGISTERED ATTORNEYS

(Combined with H. Ellis Chandlee & Co.)

PATENTS THAT PROTECT and PAY

Advice free. Terms reasonable. Highest references. Best results.

Send sketch or model for FREE examination and opinion.

Recommended Patent Lawyer in the Bankers' Register and special list of selected lawyers. Also in Martindale's Law Directory, Sharp and Alleman's Directory of Lawyers, The Gast-Paul Directory of Lawyers, and Kime's International Law Directory.

ALL BUSINESS GIVEN PROMPT AND PROPER ATTENTION

A large list of strong recommendations furnished free

WATSON E. COLEMAN, Patent Lawyer, 622 F St., N.W., Washington, D.C.

Patents that PROTECT

For Facts about Prizes, Rewards, etc., send 8c stamps for our new 128 page book of intense interest to Inventors.
R. S. & A. B. Lacey, Dept. 45, Washington, D.C., Estab. 1869



DON'T DISCARD BROKEN PARTS

Have them welded together by the Oxy-Acetylene Process. Steel, Cast Iron, Bronze, Copper, Aluminum and all other metals can be welded. Manufacturing quoted on. Welding equipments for repair shops or large plants supplied.

DAVIS BOURNONVILLE CO.
105 West St., NEW YORK; 505 So. LaSalle St., CHICAGO

Appendicitis is by no means a modern ailment, according to a Chicago physician whose researches lead him to claim that it not only existed, but was accurately described in papyrus records said to have been made in Egypt 5,000 years ago.

Let Us Do Your Manufacturing

Buying material in large quantities and having a modern factory equipped with the latest machinery enable us to make almost anything in metal or wood at a very low price. Estimates free. We have a complete model and pattern department.

TINLEY PARK MFG. CO., 222 N. State Street, CHICAGO



BRASS GEARS

Cut by an entirely new process. The most accurate made and at prices that cannot be equalled by others. Every gear has a hub, center painted ebony black, edges turned true, highest grade rod brass, and much heavier than others. We carry the largest stock in the world and every gear listed is always shipped on date of order.

SEND FOR CIRCULARS
Reynolds Dull Flasher Co.
16 So. Fifth Ave., Chicago



INVENTORS Our Brain Belongs to You. Our Ideas Are Free of Charge.

All we want in return is to build your model, special machinery, dies, tools and jigs to manufacture sheet metal goods, etc. We are expert mechanics, over thirty years experience and have one of the best equipped shops in the country. Ask for Booklet No. 17. Consultation free. Experimental work strictly confidential.

A. NACKE & SON
234-242 S. 9th St., Philadelphia, Pa.



A Talk to the Inventor

SPECIAL THIS MONTH: Search and report free worth \$10

If there is any basis for an application in your idea, I can find it. But I will explain it to you before filing your application.
Copies of Nearest Patents, and Report, in Every Case I have patented inventions reported unpatentable elsewhere

Send for
FREE BOOK
What You Should Know
What to Invent
What NOT to Invent
How to Sell Your Patent

Send Sketch. **H. L. WOODWARD, 9th and G Sts., Opposite Patent Office, WASHINGTON, D. C.**

WANTED-IDEAS

Manufacturers are constantly writing me for new ideas protected by OWEN PATENTS. Send for my free literature and read their wants.

FREE! Three finest patent books published! 72-page guide "Successful Patents"; "Stepping Stones" (containing list of over 200 inventions wanted; about prizes, reward offers, etc.) and "Patent Promotion" (tells how to sell your rights; chief causes of failure, etc.). All sent free upon request.

Very highest references. My personal services. I help my clients sell their patents or dispose of their applications. Advice free. No obligation incurred by writing me. Free manufacturing facilities. I secure patent or no fee. No charge for report as to patentability, practicability, etc.
RICHARD B. OWEN, 9 Owen Building, Washington, D. C.

PATENTS BUILD FORTUNES FOR YOU

Our free booklets tell how, what to invent, How To CHOOSE AN ATTORNEY, and save you money.

Prosperous clients in all states. Best bank and other references. WRITE TODAY

D. SWIFT & CO., 317 SEVENTH ST., WASHINGTON D. C.

PATENTS C. L. PARKER

Formerly Member Examining Corps, U. S. Patent Office
PATENT LAWYER
210 MCGILL BLDG.
WASHINGTON, D. C.

Patents, Trade Marks, Copyrights, Patent Litigation

Handbook for Inventors, "Protecting, Exploiting and Selling Inventions" sent free upon request.

PATENTS PROCURED AND SOLD;

Easy terms; careful, conscientious work; advice FREE; new BOOK FREE; correspondence solicited; highest references; send sketch to-day.

H. J. SANDERS SUITE A CRILLY BLOCK Chicago, Ill.

SEBASTIAN 15-INCH LATHE

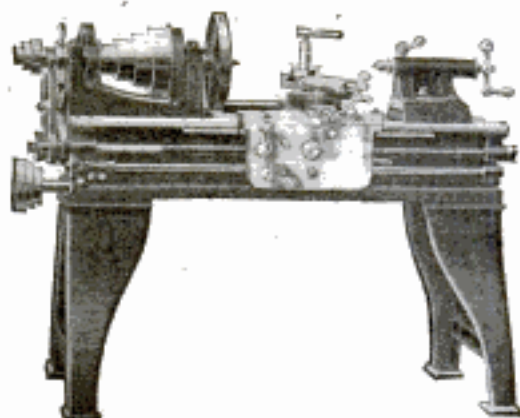

The **Low Price, Perfect Quality** lathe for the **Garage, Automobile and General Repair Shop**. If you are in the market for a lathe, be sure and investigate the merits of the **Sebastian**. We also build 9-inch and 10-inch foot power lathes.

Catalog mailed free on request

THE SEBASTIAN LATHE CO., 107 Culvert Street
CINCINNATI, O.

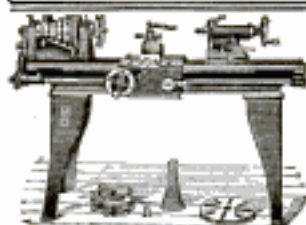

LATHES

\$75 Screw Cutting
Foot or Power
9 to 13 inch

CATALOG FREE

SOUTH BEND MACHINE TOOL CO., 423 Madison St., South Bend, Ind.

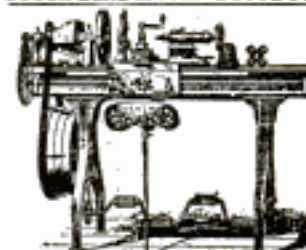

LATHES

9 to 13-inch Swing
List price \$75 and up according to size. When ready to buy send for Lathe Catalog and prices.

W. F. & John Barnes Co.
100 Ruby Street, ROCKFORD, ILL.

Gears, Sprockets, Chains, Etc.



In Stock
and Made
to Order

Send for new 32 page catalog

WOBURN GEAR WORKS, Woburn, Mass.



IF YOU NEED A LATHE

AND WANT TO SAVE **\$25.00** TO **\$75.00**

IN BUYING SAME

ASK FOR OUR MACHINERY CATALOG "B"

Write for It Today!
Mailed **FREE** on REQUEST.

SEARS, ROEBUCK AND CO., CHICAGO, ILL.

A new steamship in the course of construction for the West India trade is to be provided with anchors at the stern as well as at the bow so that the danger of drifting on rocks in certain exposed anchorages will be considerably lessened.

Rife Automatic Hydraulic Ram Pumps water by water power. No attention; no expense; 2 feet fall elevates water 50 feet, etc. Guaranteed. Catalogue free. **RIFE RAM COMPANY** 231 Trinity Building, NEW YORK CITY

DIES, FINE TOOLS SPECIAL
METAL SPECIALTIES MACHINERY.
MOORE & CO., 341 W. Indiana Street CHICAGO INVENTIONS
PERFECTED.



MECHANICAL
SUPPLIES AND MATERIAL
of all kinds.
EXPERIMENTAL AND
LIGHT MACHINE WORK
to order.
132 MILK STREET. BOSTON

WANTED To manufacture METAL SPECIALTIES, 30 years experience in making Dies, Tools and Special Machinery. Expert work. Complete equipment. **NATIONAL STAMPING & ELECTRIC WORKS** 413 S. Clinton Street, Dept. 3 Chicago, Ill.

Folding BATH TUB
Costs little, no plumbing, requires little water. Weight 15 pounds, and folds into small roll. Full length baths, far better than tin tubs. Lasts for years. Write for special agents offer and full description. **ROBINSON MFG. CO.,** 2025 Adams Street, TOLEDO, OHIO. Manufacturers Turkish Bath Cabinets.



BE PROSPEROUS

Grow Mushrooms at home all winter in cellars, stables, sheds, boxes, etc. Large demand. \$20.00 a week easily made. Only small space necessary. We are large growers, make best spawn, and insure your success. Write for big booklet and learn how.

NAT'L SPAWN CO., Dept. 12, BOSTON, MASS.

Why Don't You Go In Business For Yourself?

Read This Ad If You've Got Ambition — Find Out What It Means To You!

AREN'T you anxious to improve your present condition—to get more money? Then why not go in the well-drilling business? Well-drilling is a business open to men of all ages. It is a business that pays thousands of dollars annually. It is a business that anyone who understands machinery can succeed in. And if you are the kind of a man who wants to go in business, who wants to get ahead, we will sell you our

Cyclone Well Drills

on a plan that will make the machine pay for itself in a short time. Equipped with our drills you are prepared to do the highest class of work, please your customers and establish a permanent business in which there is big profit.

We will furnish you with FREE advertising matter—24x36 in. banners in 7 colors, large supply of post cards in two designs, business bringing booklets, etc.

We Will Teach You The Business From A To Z

To every purchaser of a CYCLONE outfit we present our book, "Drill Work, Methods and Cost" which is worth a **Thousand Dollars** to any man starting in this business. The book is 7x10 inches in size and contains 300 pages illustrating and describing every type of machine and how to handle it.

Heretofore many who wanted to engage in this business because of its big profits, have not done so because they supposed they would have to serve a long apprenticeship. We have changed this condition entirely. Our book will start you off on the "right foot" so that from the very outset you can make almost as much "hole" as an old timer.

Read What This Man Says—"I have made \$40.00 a day drilling here and did not work hard at that. I make it a point to do a first-class job and am getting more money per foot than my competitors, for the reason of my workmanship and that I get away quickly. No machine equal the Cyclone for speed and smooth running. They are money makers." **FRED MORROW, Bakerstown, Pa.** Write us at address given above illustration C. D. Co.

Your Opportunity Is Here

Danger lurks in shallow dug wells, springs and pools and the time is fast approaching when the law will compel the drilling of all wells. This is your opportunity to get established. Act at once. Tear out this ad—write name and address in margin for free book "How to Make Money in the Well Business." If you have not had a minute's experience, we can teach you how to become an expert. Address

CYCLONE DRILL CO.
Dept. 11 Oreville, O.

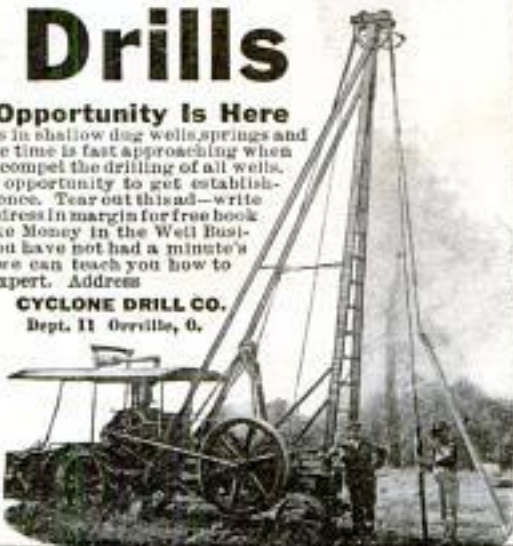

MAY ABOLISH POSTAGE STAMPS—Collectors of postage stamps will be interested in a proposal to adopt the New Zealand system and abolish the use of postage stamps altogether. If this is done, the value of many stamps now in the hands of collectors will soar amazingly.

The plan suggested is that instead of laying in a supply of postage stamps, or buying one or two at a time, you have a stamp meter installed in your office or home. A letter to be mailed is inserted in the meter



\$69.00 for a 1000 gallon Tank with Conical Roof, and a 20 foot Four Post Steel Tower. Tower with a substantial steel ladder from base to top of Tank. Guaranteed for five years. The "NOWETO" 2 H. P. water cooled Gasoline Engine for \$49.00. Pumps and any other equipment for Water Works.

Write for our circular "DC" showing the different types of Water Works Equipment

THE BALTIMORE COMPANY, BALTIMORE, MD.



VACUUM PUMPS

For Powerful Portable and Stationary Vacuum Cleaning Plants. They take up their own wear. Powerful; Noiseless; can't get out of order.

GET CATALOG No. 23

LEIMAN BROS., 62P John St., NEW YORK

Ask for Catalog No. 51



FOUR MEN Work on the No. 51 Universal Wood Worker at One Time

Each has absolute control of his machine and can start and stop it at will. This is the most complete and efficient combination wood worker on the market.

THE CRESCENT MACHINE CO.
93 Columbia St., Leetonia, Ohio, U.S.A.

LET THE RED DEVIL WATER MOTOR DO YOUR WORK

6-inch Motor

Improved construction, absolutely perfect, runs your washing machine and a hundred other things. Power for small tools. $\frac{1}{4}$ horse power on $\frac{1}{2}$ -inch pipe, 80 pounds pressure; 1 horse power on 2-inch pipe, 60 pounds pressure. New net price, \$5.00 cash with order.

No. 1492 4-inch Motors for grinding, polishing and buffing. Runs sewing machines, fans, bottle washers, etc. Price with emery, buffing wheel, silver polish and pulley, \$3.00. No. 1493 Motor and pulley only, \$2.50. $\frac{1}{2}$ horse power on 80 pounds pressure. Improved construction. Speeds, 3,000 to 5,000 revolutions per minute. Only scientifically and mechanically perfect small water motor manufactured. Patented construction makes it possible. Tremendous output warrants the price. Money back for any reason.

CATALOGUE AND LARGE SHEET FREE

DIVINE WATER MOTOR CO.

Dept. T UTICA, NEW YORK, U.S.A.

For the name of your local hardware or tool dealer, we will send you free booklet on "Theory and Design of Water Motors."



6-Inch Bucket Wheel

Everybody's Doing It! WHAT? Using Richardson's Slide Rules Making Calculations

There seems to be a misunderstanding about what the Slide Rule will accomplish, many think it an instrument, the use of which is applicable only to Engineers and Technical men. So frequently have I heard this remark that I have completely re-written and enlarged my instruction book, which shows the actual setting of the rule by 70 full size engravings, each engraving and example is explained and "written so you can understand it." In fact any person who has never seen a Slide Rule, and not a technical person, could not help but learn its use. The examples selected and shown by illustrations are those which frequently come up for solution by the Banker, Broker, Auditor, Inventory Man, Cost Estimator, Printer, Paper Mfr., Contractor, Salesman, Time-Keeper, Bookkeeper, Lumber, Land, and other merchants too numerous to mention.



Floating Slide

THE SLIDE RULE SIMPLIFIED

1912

by Geo. W. Richardson

This Slide Rule will multiply, divide, solve proportion, extract the square and cube roots, find the decimal equivalent of vulgar fractions or "vice versa," calculate interest, percentage. Also the mensuration of superficies, and the rule of three. For Engineers, Electricians, Draftsmen, Superintendents, Master Mechanics, etc., the rule is indispensable in their work. It is one of the most valuable instruments ever offered to mankind. For Electricians it is a complete wire table in itself, calculates the size of a motor to run a pump, shows percentage a customer's recording meter is either "slow or fast." The Richardson Direct Reading Slide Rule is specially designed for those who wish to learn its use. Its operation being very simple. You simply place the key to the problem wanted in the keyhole (the key is printed in red on slide, see cut) and answer is given direct: such as the Horse Power of Engines, Pumps, Boilers, Belts, Water Falls; size of duct for ventilating, radiation and size grate, and steam main required; change gear and pulley problems; areas, circumference and diameter of circles. This Rule is my 1912 type now being placed on the market for the first time. Made in two sizes, coat and vest pocket 11x1 1/4" and 5 1/2 x 1 1/4". No wood in their construction, scales white celluloid, printed from engine divided plates in two colors, and washable, secured by an improved locking device in an absolutely non-corrodible Aluminum and Monel Metal framing. Durable cardboard case for large rule, and neat leather case for vest pocket size. Special case for large rule end-flap and button fastening 25c extra. If ordered now I give free a copy of my new book *The Slide Rule Simplified* containing over 70 full size engravings showing just how to set the rule with explanation. Price of either rule \$2.50. Price of book without rule, paper cover \$1.00. Flexible silk cover \$1.50.

GEO. W. RICHARDSON, Consulting Engineer, Ex-Chief Electrician U.S. Navy, 4218 24th Pl., Chicago, U.S.A.

BAR BENDERS

For Concrete Reinforcements

WRITE FOR OUR BENDING TOOL CATALOGUE.

Wallace Supply Co. 121 N. Jefferson St., Chicago
26 Cortlandt St., New York City

and rubber-stamped with an official mark which serves the purpose of an ordinary postage stamp. The meter records the number of letters stamped in this way, and when the Government agent comes to read the meter he collects for the number of stamps in the machine.

The use of envelopes with a printed stamp in ordinary black type on the upper right-hand corner, instead of the colored adhesive stamp, has already appeared in this country, especially among large business houses.—New York World.



NEW IMPROVEMENTS NOW MAKE

The American Combined Level and Grade Finder Most Practical, Durable and Convenient Instrument Made

At one glance you can get the true slant on any line or grade either in degrees, inches or percentage, or all at the same time, and will at once give the exact distance needed to plumb up to a true level. The additional spirit level glass now placed in middle of instrument with points on dial will give 3 grades for leveling. The longitudinal excels shown in cut is well worth the low price of the instrument. Write AT ONCE for circular and Testimonials. Special Introductory Price given to First Applicants with privilege of taking Agency. Address EDWARD HELB, Mfr., Box 75, RAILROAD, PENNA.

A Handy Drill for Every Use

A quality tool that will perform good service always—

HAND DRILL No. 3

is 11 inches long and has a chuck that holds from 0 to 3-16 inch drills. Entire weight 21 ounces. Has hollow handle to hold drill points with a unique, quick and convenient method of removing and attaching handle to get at drills. PRICE \$1.00.

Write for our catalog and instructive Book "Tool Practice" — both FREE

Millers Falls Co. 28 Warren Street NEW YORK CITY

Portable Cases

FOR TOOL MAKERS AND MACHINISTS

Twelve styles, felt lined drawers, solid brass trimmings, best of material, beautiful finish, low prices, satisfaction guaranteed. Ask for booklet of cases built for service.

The Pillod Lumber Co. SWANTON, OHIO

For Sewing Leather

See that Fool. Natural Tension.

Myers Famous Lockstitch AWL

\$1.00 A perfect stitcher. Sews or mends anything. Whole repair shop. Original perfect lock stitch. Diamond point grooved needle protects thread. Always ready. Sample prepaid. Agents get busy. Sells on sight. G. A. MYERS CO., 6359 Lexington Ave., Chicago, Ill., U. S. A.

THE EXCELSIOR BRAD SET. PRICE 25 CENTS



The tool illustrated above will be indispensable to the Pattern Maker, Cabinet Maker, or Picture Framer who purchases it. It will set brads in places that would be inaccessible without it, and dispenses with the bradawl and nail set. If, after a fair trial, you are not satisfied that you have received your quarter's worth, your money will be promptly returned to you on receipt of tool. Standard Tool Supply Co., 42 W. 15th St., New York City

B. & S. Calipers & Dividers

Everyday and many times during the day, mechanics use both Calipers and Dividers.

B. & S. Calipers and Dividers are a combination of lightness and durability. The legs are steel drop forgings nicely finished. An unusually stiff spring insures rigidity.

Write for general catalogue descriptive of our entire line.



Brown & Sharpe Mfg. Co.
PROVIDENCE, R. I., U. S. A.

BRITISH SHIPS CARRY MOST FREIGHT—It is an interesting thought that American commerce would be almost impossible without British ships. Americans, on account of higher wages and keen competition, are not often able to make deep-sea freights profitable.

Buy Auto Tool Kits, Farmer's Tool Kits, Chain Pipe Wrenches, Pliers and Combination Fence Tools under the name

BONNER

\$5.00 to \$10.00 A Day Made Easy

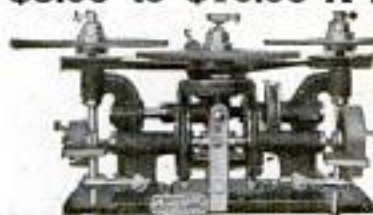

The "American"
No. 3 Patented

Hones razors, sharpens all kinds of safety razor blades, clippers, scissors, etc. No make-believe, but the real thing. Complete outfit furnished with instructions how to do the work. No previous experience required. Address: Mgr. Dept. 708, Illinois Cutlery Company, 134 Washington St., Chicago

Red Devil Side Cutters

Guaranteed Drop Forged Tool Steel



No. 1950
8 INCH

Every Genuine "RED DEVIL" Tool is guaranteed absolutely. These are the side cutters YOU should use and insist on getting. Your local dealer can supply you or will get them if you insist. If not, send us \$1.25 and his name and one only sample pair will be sent you post-paid.

SMITH & HEMENWAY CO., 15 Chambers St., New York

Every up-to-date mechanic will tell you "RED DEVIL" are the ONLY TOOLS. We make over 3,000 different kinds and sizes.

"YANKEE" TOOLS

Make Better Mechanics

THIS little hand drill —but 10½ inches long and weighing only 1¼ pounds, has all of the ratchet movements of the "YANKEE" Breast Drill already described in these pages, viz:

Right-hand, Left-hand and DOUBLE Ratchet, besides the Plain Drill and Locked Gears adjustments—all provided for by the "YANKEE" ratchet mechanism, and changed at a finger touch of the Shifter on the cylinder between the small gears.

In the "Double Ratchet" adjustment, invented for use in tight quarters, every motion of the crank forward and back, no matter how slight, causes the drill to cut continuously.

No similar tool ever made has the same range of usefulness —because no other has these adjustments.



Slips into the pocket



Handle is magazine for drill points



Weights but 1¼ lbs.



Chuck body is steel, polished and nickel plated. Jaws of steel, drop forged and hardened. Capacity 3-16 in.

"YANKEE" Ratchet Hand Drill No. 1530

Price \$2.80

Your Dealer Can Supply You

Write for "YANKEE" Tool Book" (free) illustrating and describing the many ingenious "Yankee" Tools and showing why they "Make Better Mechanics."

"YANKEE" Tools in the Garage" for the motorist.

NORTH BROS. MFG. CO., PHILADELPHIA

Please Mention Popular Mechanics

The Accuracy
required of
micrometers
used on your
fine work
demands the

Starrett

Micrometer

Known the world over to be perfect to the finest detail. Ratchet stop prevents excessive pressure against the work. Lock nut keeps micrometer at desired opening, making a gage of it. Supplied to read to $\frac{1}{1000}$ inch or to $\frac{1}{10000}$ inch. Also, graduated in Metric System.

Our catalog No. 19 A.P. describes this and other tools for the tool-room. Send for it.

THE L. S. STARRETT CO.
ATHOL, MASS. 42-13



MECHANICS' COMPOUND Lever Snip

A size larger than our "Vest Pocket," eight inches long, strong, powerful, durable. Forged from a solid bar finest crucible tool steel.

By mail Prepaid **\$1.50**



DETROIT SHEAR COMPANY
902 Greenwood Ave., DETROIT, MICH.

Only \$14.50

For this Home Bench

Besides its convenience and usefulness, you will save its price in a year by doing repair work and "fixing things" that you now pay a carpenter or repair man to do. Thousands of homes have home benches we have furnished—why not you?

Top is 50 in. long, 20 in. wide, with a 13-inch glass-top portion of thick maple

Grand Rapids Hand Screw Co.
1420 Front Ave. North, GRAND RAPIDS, MICH.



FOR all kinds of woodwork Master Carpenters and Craftsmen use the *Auger Bit* with this brand



Be sure this identical brand is on the bit you buy

The only solid-center stem bit made in all styles and sizes for every use—home, garage, farm, factory and shop. Swift, sure and clean, the IRWIN bores through the hardest or softest wood, takes knots with ease. Never stops or swerves. Never bends or breaks.

Sold Under Our Money-Back Guarantee

Experts depend on IRWIN quality. Every bit is made in one piece of extra high-grade, crucible auger-bit steel. Put through 5 handlings—tempered by a secret process. The difference between the genuine IRWIN and imitations is not always on the surface—it's in the tool and it comes out in the work. Sold by dealers everywhere. Write us if you can't get the genuine guaranteed IRWIN.

IRWIN AUGER BIT CO.

Largest in the World

Station G12 WILMINGTON, OHIO

American shipping on the seas has dwindled to a small tonnage. Consequently were it not for the British bottoms which carry almost one-half the world's tonnage, American products would not be carried beyond seas and the American market would be so restricted that

GASOLINE SOLDERING IRON BLOW TORCH

CUTS—the soldering business 50%—Get our FREE Booklet.



EMMELMANN BROS. MFG. CO., INDIANAPOLIS, IND., U.S.A.

"The File That Files"
and Wears Best by Test is a
Gold ★ Medal File

Made by
LIVERIGHT BROTHERS
Not in the Trust. PHILADELPHIA, PA.

LUFKIN

Measuring Tapes

Standards of efficiency for the Amateur and the Expert. The big improvement in markings, **instantaneous readings**, saves time and avoids error. Send for sample piece of tape and our complete catalogue.

THE LUFKIN RULE CO.
SAGINAW, MICH.

New York London, Eng. Windsor, Can.





STRIKE **LIFT** **DRIVE**

No Strain When High Nailing
DOUBLE CLAW HAMMER

"for the mechanic with an ambition to succeed"

16 oz. or 21 oz. Head — WHICH?
 \$1.50 at your dealer's
 or from us, delivery prepaid.
 Worth ten times more than the common
 hammer — costs three times more to make.

DOUBLE CLAW HAMMER CO.
 453 Broadway
 Brooklyn, N. Y.

START **OUT**

**Pulls The
 Nail Out
 Straight
 Without
 A Block**



production would have to be decreased.

The total earnings of British ships for a year have been figured at from \$500,000,000 to \$550,000,000. The United States, having huge exports and few ships, pays a large part of this total. But were the traffic confined to American ships, the toll would be even higher. Another advantage is that the earnings of the British bottoms do not go out of this country as cash, but are carried out of this country from the United States.—Cleveland Leader.



The Handiest Tool Holder Made

Constructed of hardened steel; accurately machined; and will hold securely, round, flat, square, hexagon, and shaped tools in the tool post, from the largest sized tool down to a No. 60 drill. Write for full particulars, and prices. Satisfaction guaranteed.

B. MORGAN, Manufacturer of SPECIALTIES
 Bellevue St., Newport, Rhode Island

FOR MENDING HARNESS

shoes, tents, awnings, pulley belts, carpets, saddles, suit cases, buggy tops, dash boards, or any heavy material. Stewart's Automatic Awl is the only perfect Sewing Awl.



It takes a wax thread, feeds from spool and does the work of any harness maker machine. It is indispensable for farmers. Agents wanted. Sent prepaid for \$1.25. Send at once for catalog.

STEWART-SKINNER CO.
 26 Hermon Street
 Worcester, Mass.



Toolmakers and Machinists. Here's a Portable Tool Case with a convenient arrangement of different sized drawers, all felt lined, with a place for every tool. No need of throwing one on top of the other. This Case will pay for itself in saving tools, time and storage expense. You need one of the many styles shown in our catalogue which we will mail free. No mechanic is up-to-date without a "Gerstner" Case.

Gerstner & Sons

Mfrs. of Mechanics' High Grade Tool Cases
 818 Germantown Street, DAYTON, OHIO

Stanley Tools

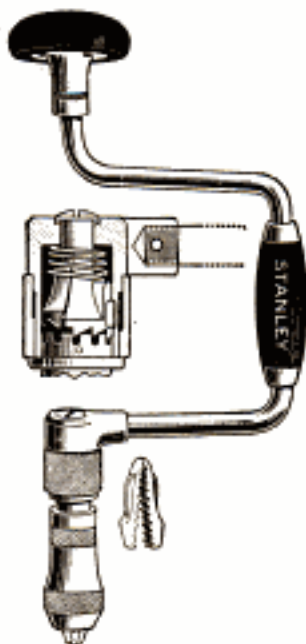

Concealed Ratchet Bit Braces

A New Idea in BIT BRACES

The Cam Ring which governs the ratchet is in line with the Bit — a great advantage in working.

Note the Ratchet Mechanism

The two piece Clutch is drop forged, machined and hardened.

When used as a Ratchet, five teeth are in engagement at one time — when used as a plain or non-ratchet Brace, ten teeth are engaged — in both cases insuring, even in the longer sweeps, a much stronger lock than is possible in any other form of Brace.

The Ratchet parts are entirely enclosed, keeping out moisture and dirt, retaining lubrication, and protecting the user's hands.

They have Cocobolo Heads and Handles, Ball-bearing Heads and all exposed parts are heavily nickel plated and highly polished.

For Sale by All Hardware Dealers

Stanley Rule & Level Co.
 NEW BRITAIN, CONN. U.S.A.

Please Mention Popular Mechanics



Write today for the **Grinder** book—and the wonderful story of Carborundum

There never needs to be a dull or unfit tool about the shop or home that has a

Carborundum Niagara Grinder

Small, compact, substantial—yet big enough to perform any ordinary grinding operation. The wonderful Carborundum Grinding Wheel, sharp and hard as a diamond, cuts faster and cleaner than any other grinding substance known—and lasts much longer.

☐ The gears and other mechanical parts are all made in our own shop and are superior in construction and finish to any other grinder we know of—The Carborundum Niagara Grinder is made in 15 or more styles—for hand and foot power.

Special styles for grinding sickle knives and other similar implements

Prices \$3.00 to \$15.00

The Carborundum Company
Niagara Falls, New York

"Agrippa" the Master Clamp!

Cast Clamps are not reliable; not handy because of their excessive weight and not an economical investment. The logical alternative is now available in the Agrippa Clamps:



Agrippas are,
Much lighter
Half the sectional area
Much stronger
Provide superior utility
Price is not greater

and, we guarantee them to perform the same service possible with the cast steel product.

J. H. WILLIAMS & CO.

Superior Drop-forgings

47 Richards Street

BROOKLYN, N. Y.

SHIP OFFICERS' POOR PAY.—The salaries paid to the captains and other officers employed by the great Atlantic shipping lines are furnished by our Liverpool correspondent. Captain Smith, the commander of the Titanic, received \$6,250 a year, but his salary was exceptionally large.

The following is a table of the salaries paid by two of the leading lines:

White Star—Captains, \$1,650 to \$5,000 per year. Chief officers, \$70 to \$100 per month. Second officers, \$45 to \$60 per month. Third officers, \$45 per month. Fourth officers, \$42.50 per month.

Cunard Line—Captains, \$1,375 to \$3,250 a year. Chief officers, \$80 to \$110 per month. Second officers, \$55 to \$60 per month. Fourth officers, \$40 per month.—New York Times.

"SIMONDS SAWS"

"Are the BEST, and
They ARE the best."

Solder It Yourself

Amateurs can solder perfectly without practice by using the modern combined solder and flux



TINOL

Paste and hollow wire forms. No acid or resin. Chemical cleanliness not needed. No risk of corrosion. "Just put it on the spot and heat it." Use a candle, gas jet, or the Tinol Alcohol Torch. Largely used in telephone and industrial work. Household can of Tinol Paste Solder and Torch, \$1.20.

LITERATURE FREE

HESS & SON, Dept. F
666 N. Broad St., PHILADELPHIA, PA.

Please Mention Popular Mechanics

\$581.00 PROFIT
IN 3 MONTHS

That is what Lopez de Diego earned over and above all hotel bills, railroad fares and other expenses while traveling in Mexico. Browning of Miss., says: "Made \$16.70 in 2 hours." William Baker says: "Made \$25 in 6 hours. It's the thing the people want."

**One Minute Post Cards—
One Minute Profits**

Hundreds of letters and reports tell the records of quick, big, easy profits making photo post cards the new way with the



**6-Pound Portable
Post Card Gallery**

"MANDEL" POST CARD MACHINE

A new business with an unlimited field for money-making. The chance for any man, young or old, with small capital and ABSOLUTELY NO EXPERIENCE to own a business that will earn \$2000 to \$5000 a year. New discovery. A wonderful, scientific process.

Photos Direct on Post Cards—No Plates—No Films
The "Mandel" Post Card Machine takes, finishes and delivers 3 original photo post cards a minute RIGHT ON THE SPOT at a profit of 100 per cent. Photo post cards popular everywhere. In the country, on the streets, at picnics, carnivals, fairs—the one minute post card man is in big demand and makes big money.

\$26 Starts You on the Road to Success

This buys a complete outfit. First sales from post cards shipped with outfit actually returns all money invested. Complete and simple instructions enable you to begin work immediately.

Write today for complete INFORMATION FREE. Address either office.

THE CHICAGO FERROTYPE COMPANY

288 Ferrotypes Bldg.
Chicago, Ill.

or Dept. 208 Public Bank Building
New York, N. Y.

The copper production of 1911 was a record breaker in the United States. Arizona, which leads all states, and Montana, which comes second, together produced more than half of the total amount.

By getting a work bench like this



you will be able to do most any kind of work around the house. The bench is 4 1/2 ft. long, 22 inches wide and 32 inches high, made of hard maple, has 2 Patent Wood Screw Vises, and will be shipped you at once on receipt of \$7.00

C. CHRISTIANSEN
MANUFACTURER
2219 Grand Ave., CHICAGO, ILL.

WRITE FOR
CATALOGUE
44



PHILLIP'S SPRING HAMMER

For drilling holes in Stone, Concrete, Brick, Marble, Tile, Conduit, etc.

Will drill 10 times faster than by hand
Strikes 800 to 2000 blows per minute. The spring does the work. Makes hole 3/8" to 1 1/2" in diameter. This tool can save you money. Get it now.

ORR & LOCKETT HARDWARE CO.
14-16 W. Randolph St. CHICAGO, ILL.



**From
Foundation
to Flagstaff**

Don't stick along at an under job through all the best years of your life. Don't let the humdrum drudgery of every-day routine CRUSH your ambition. Don't be satisfied with merely pushing a saw and driving nails. Learn to PLAN as well as to work—to use your BRAIN with the same skill that you use your hands. Learn to fill a BIG SALARIED job—the kind of a job that hundreds of other men, with no more natural ability than you, are filling with ease and success.

How You Can Learn More and Earn More

You can MASTER EVERY DETAIL of your line of work, EVERY BRANCH of building construction, EVERY ANGLE of architecture and carpentry—can do it in your spare moments and at almost no expense at all. You can have the knowledge and experience of over FOUR SCORE EXPERTS at your command ready for instant use whenever you want it—can fit yourself to fill any first-class position above you that you desire—simply by allowing us to place in your hands, this great ten-volume set, without your sending us one cent in advance.

**THIS CYCLOPEDIA OF
Architecture, Carpentry and Building**

is the most exhaustive, comprehensive and practical work on the building trades that has ever been published. It covers every detail of building construction from foundation to flagstaff, from common carpenter work to reinforced concrete and steel, from masonry to heating and ventilation; from specifications and estimates to building laws and superintendence. It covers all the PRACTICAL things that you WANT TO know, all the things that you've GOT to know if you're going in to be a success. It contains over 4,000 drawings, full page plates, diagrams, etc., has 4,760 pages, is bound in handsome half morocco and printed on special paper in large clear type. No CARPENTER, CONTRACTOR or BUILDING OWNER can afford to be without it a single day.

Get these books FREE and see for yourself

Just what they are before you send us a single cent. Look them over carefully at your leisure, keep them for seven days before you decide whether you want them or not, and then if you don't believe that each volume is actually worth more to you than the price of the entire set, send them back at our expense and the transaction won't cost you one penny. If you do decide to keep them, our charge will only be \$24.80, spread out this in easy payments of only \$2.00 a month. We don't ask you to buy these books on our description of them. We don't ask you to trust our judgment. We simply ask you to get the books and see for yourself.

Free with every order received before August 1, 1912

With each set is included a year's Consulting Membership entitling you to the free advice of a staff of Construction Engineers. This will give you practical help in handling working problems which are too specific to be taken up in detail in the cyclopedias. There will be no limit to this service. A single problem solved for you might be worth more than ten times the cost of the books. Order the books now.

American School of Correspondence, Chicago, U. S. A.

FREE EXAMINATION COUPON

American School of Correspondence, Chicago, U. S. A.

Please send set Cyclopedias of Architecture, Carpentry and Building for seven days' free examination. I will send \$2.00 within seven days and \$2.00 a month until I have paid \$24.80 or notify you and hold the books subject to your order. Title not to pass until fully paid.

Pop. Mech. 7-12

NAME.....

ADDRESS.....

OCCUPATION.....

EMPLOYER.....

Pipe Threading Tools

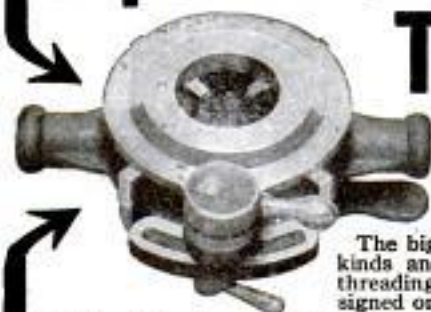

Hand, belt and motor machines.

The biggest line of all kinds and sizes of pipe threading equipment designed or manufactured.

The Oster "Bull Dog" Line

Known throughout the world. Recommended by eighteen years of success in the best plants, where highest efficiency is daily demanded.

Reasonable price, accomplished by the elimination of complicated parts. Simplicity of design, and consequently a simplicity of operation—making it unnecessary to employ an expert operator. Anyone can accomplish perfect results and high speed upon an Oster, without previous experience.

Self-locking dies. No resetting for each cut. No turning back over the finished threads. One movement of the hand opens or closes the dies. Every contractor, every shop, and every individual, who is interested in hand or power pipe threading equipment, should have the new Oster catalogue. Sent free by mail, postpaid. Ask for it today.

THE OSTER MFG. CO.
2100 East 61st St., Cleveland, O.

THE BEST IN THE WORLD at the PRICE OF THE ORDINARY

The health, comfort, safety and joy of Motorcycling are thoroughly proven. It is now only a question of selecting the best machine.

The M-M has the good features of other makes and many more which the others do not have. M-M Motorcycles do not jiggle or jolt but glide along the road like a boat on the water. 4 to 8 H.P. Some good open territory still left for agents. Prices \$140-\$225. Write today for booklet.



The M-M Twin taking N. H. mountain road at a 59-mile clip

M-M MFG. CO., Brockton, Mass.

Just Patented

The Ko-Ko-Mo Suspender Belt



does away with suspenders. Instantly attached to inside of waist band. Invisible or the shirt "crawl up." No straps or bands across the abdomen. Made in sizes for boys as well as men.

The Ko-Ko-Mo Suspender Belt

is designed to be worn by men in any vocation. If your dealer cannot supply you, send P. O. order for 50c, and your waist measure, and Belt will be sent prepaid. Money back if not satisfactory.

An excellent opportunity for live salesmen

ADDRESS

KOKOMO BELT CO., KOKOMO, INDIANA

The Board of Green Cloth is responsible for inventing "blackguard," a word that has strangely altered in meaning. In early times it was by no means a term of reproach, but referred to the calling of carrying coal in the king's household, explains the London Chronicle. Is there any other bad word in the English language that can boast of such a royal origin?

GOOD YEAR NO-RIM-CUT TIRES
10% Oversize—save half on tire bills—Write for latest Tire Book.

AKRON, OHIO
THE GOODYEAR TIRE & RUBBER COMPANY, Main Office and Factory, Akron, Ohio
Branches and Agencies in 103 Principal Cities. More Service Stations than Any Other Tire

Save One-Quarter

the purchase price of motor cycle accessories and parts. We sell guaranteed goods twenty-five per cent cheaper than any other house.

The Motor Cycle Co-Operative Co.

650 Woodward Ave., DETROIT, MICH.

\$3000.00 IN ONE YEAR



One man invested his SAVINGS in an Auto Tire Repair Plant and made \$3000.00 the first year and was worth \$10,000.00 at the end of the second year.

You can make money repairing tires and tubes as evening employment. As an independent occupation, you can turn out thousands of dollars gross business per year. We furnish complete instructions. Investment small. Write for information.

Haywood Tire & Equipment Co.
229 N. Capitol Ave., Indianapolis, Ind.



The A. B. C. Engine Driven Tire Pump

The A. B. C. way is the right way to inflate your tires and they can be kept always at the right pressure. Send us the make, model and year of your car and we will tell you more about it.

ARTIZAN BRASS CO.
226 North Jefferson St.
CHICAGO

"A friend indeed"

Give Your Boys and Girls Healthful Outdoor Exercise

The Medart Out-Door Gymnasium meets every need of a family of children and puts them on the road to health, fitting their bodies for useful and successful lives.



The Medart system appeals alike to children and adults; while it makes a game out of exercise, it teaches the little ones self-reliance and affords the natural animal spirit a healthy outlet. There are Swings and See-saws for the Girls, Horizontal Bars and Rings for the Boys, Teeter Ladder and Summer Toboggan for Both to Enjoy.

You can choose your children's play companions when you have them at home. The outfit is strongly built of heavily galvanized steel piping; perfect workmanship; is repair proof. It is easily set up and the various parts are easily adjusted as may be desired. Every outfit guaranteed. Write for illustrated Catalog M and for Free booklet: "The Health Story of a Home Gymnasium".

FRED MEDART MFG. CO.,
GYMNASIUM OUTFITTERS
3503 DeKalb St. • ST. LOUIS, MO.



Grab's Everlasting Lighter

No matches required. Pressing lever generates a spark and ignites the wick, which is supplied with fuel from reservoir tube at bottom of lighter. A very powerful light. Fill reservoir with benzine when needed. Portable, simple, economical—lasts a life time. Neat, attractive design, beautifully nickel plated. Invaluable in cases of emergency, sickness, getting up at night, etc. Price 50c each.

Write for FREE illustrated folder

Victor M. Grab & Co., L. 22 Ashland Block, Chicago



Over ninety persons partook at Gorleston, England, of a sea pie into the making of which there entered two stone of flour, six rabbits, six ox and sheep kidneys, twenty-eight pounds of beefsteak, two stone of green vegetables, half a stone of onions and two stone of turnips and carrots. The total weight of the pie was over two hundred pounds, and it took it two days to cook.

It is Remarkable

how easy it is to have plenty of water in and about the home—with a Jarvis Water Supply System. It is so simple that a woman can easily operate it. Does away with laborious handpumping—supplies water any place at any time. We furnish all the necessary pipe, fittings, fixtures, etc.—you can easily install

A JARVIS POWER PUMP

Cost of electric current less than repair bills on "water lifts" and "water motors." Costs practically nothing when run by gasoline engine doing other work. Write at Once for Complete Catalog 8—Sent Free. Dealers Wanted. Jarvis Engine & Machine Works, Lansing, Mich.

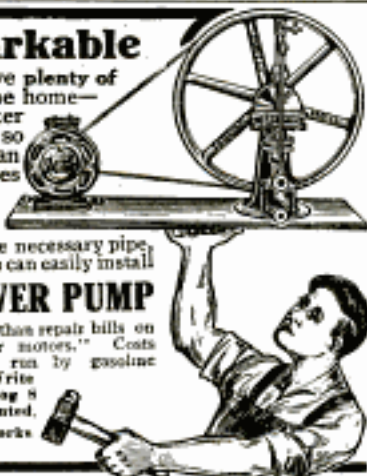

Look! Our 1913 Renault Hood NIAGARA MOTOR BOB

Send for Booklet Today with full instructions, diagrams, cuts made from photographs, and all sizes given so any boy can make his own automobile. We furnish all parts necessary at lowest possible prices. Send twenty cents for this book today. Be the first boy in your town to own our 1913 Renault hood type automobile. Special inducements.

We have no agents, selling direct to you at lowest possible price.



1913 American Hood Type

The ORIGINAL MOTOR BOB

is now a first class gasoline automobile, within the reach of every live wide awake boy of twelve years and over. All parts are simply designed and strongly made and will give surprising results and satisfaction. Boys all over the world are now building or driving the Niagara Motor Bob using our booklet which tells how and also gives full list of parts which we will mail post-paid for twenty cents in coin. Considerable of the cost can be saved by buying our parts and making your own machine.



New 1913 Model French Hood

WRITE FOR BOOKLET TODAY

DEPARTMENT A

Niagara Motor Bob Company, NIAGARA FALLS, N. Y.



This Signal Combination Shirt

Neat for work—stands hard wear

THIS shirt is made to serve two purposes. It gives you the neatness that you want in shop, office or home—it gives *long wear* for your money. Made of close-woven shrunk percale, light or dark colors, with double strength seams. Soft collar attached or two detached four-ply collars—as desired. Extra buttonholes for attaching white cuffs.

Cut Coat Style—for your comfort

Open all the way down. Slips on and off as easy as your glove. A three-inch overlap and an extra button at the waist keeps the flap in place. Sleeves are slit in the side—this protects your underwear.

Order two from us—no money required

Ask your clothing man first. If he hasn't Signal Coat Shirts tell us his name, your size and we'll express you a couple C.O.D. If you like them pay expressman \$1.00 per garment (\$1.25 west of Missouri River). Write for folder showing styles. Also makers of Signal Work Shirts and Overalls.

UNION MADE



Trade Mark
The Mark of
"QUALITY"

HILKER-WIECHERS MANUFACTURING CO.

1256 Mound Avenue

Racine, Wisconsin

GET YOUR SHARE



Large profits—easiest—fastest—biggest seller on the market today. National Self-Heating Gasoline Iron sells everywhere—town or country. Join our force of enthusiastic agents now. No time to lose. Complete demonstrating outfit \$4.50. Write for the facts.

National Stamping & Electric Works
421 S. Clinton Street, Chicago, Illinois

WASHING BY SEESAW—Mrs. Sarah Sewell, an Ohio woman, invented a device which cannot be called impractical even if at first blush it does not seem destined to produce an undue amount of cleanliness. Observing her small children at play on a seesaw, the while she worked hard revolving the mechanism of a wash-

Erickson Leg

Does not chafe, overheat or draw end of stump.
Send for Catalog

SOLD ON EASY TERMS
The largest limb factory in the world.
E. B. ERICKSON ARTIFICIAL LIMB CO.
17 Washington Ave., N., MINNEAPOLIS, MINN.



Complete High Grade Bathroom Outfit \$35



You can buy these handsome Plumbing Fixtures at factory prices, and save all dealers profits. The Bath Tub and Lavatory are White Porcelain Enameled. The Closet is a Vitreous China Low Down combination with Oak Seat and copper lined Tank.

A Complete Pneumatic Water Supply System for Your Home \$40

Black Steel Tank, 145 gallon capacity, 2-1/4 inch Brass Lined, Double Action, Combination Air and Water Pump, including all Pipe, Fittings, Valves, Gauges, etc.

HEATING PLANTS, \$95

We will save you 30 to 60 per cent on a modern Steam or Hot Water Heating System. Heating Plants complete for modern homes all the way from \$95. up. By following our simple plans and instructions, you can install your own material, thus cutting out the expense of Plumbers and Steamfitters.

Write to-day for our Plumbing and Heating catalogue, which gives full descriptions and prices of Plumbing, Heating and Water Supply Systems

THE CHELSEA MANUFACTURING AND SUPPLY CO.
No. 135 West 24th St., NEW YORK, Dept. D.

Your money will be promptly refunded if goods are not satisfactory

A Postal Brings Grand Free Millwork Catalog

5,000 Bargains in Building Material!

Send at once for the great Catalog of 5,000 Bargains in the highest grade Guaranteed Millwork and Lumber. Issued by the Largest Building Material Plant in America. Buy Doors, Windows, Mouldings, Stair and Porch Work—everything you need to build, remodel or repair—at 50 per cent saving! Quality, Safe Delivery and Satisfaction Guaranteed. (38)

GORDON-VAN TINE CO., 2759 Case Street, DAVENPORT, IOWA

WAGNOCO Sure Cure for Swearing



25¢ EACH

Does Not Wear nor Tear the Button Hole
For sale by leading haberdashers. If you are unable to procure a Wagnoco Easy-Lock Collar Button at your dealers, one will be sent postpaid on receipt of 25 cents.
WAGNER NOVELTY COMPANY, 3225 So. Park Ave., CHICAGO, ILLINOIS

Please Mention Popular Mechanics



No More Burning

With a Boss Oven, you can watch your baking or roasting through the glass door while you are doing your other work. You never have to snop. You can turn the Boss Oven at any angle so that from any part of your kitchen, you can see your baking.

The Boss Oven heats in 2 minutes; keeps an even heat; bakes absolutely uniformly; saves fuel, and being asbestos lined, it keeps in the heat, does not heat up the kitchen. The glass is guaranteed not to shatter upon break from heat. Be sure you see the name "Boss" on the front. Made in 3 sizes, it fits on top of your oil, gasolene or gas stove. 250,000 now in use.

Write today for the free Boss Catalog and Recipe Book, which shows all the new oven styles and gives 20 pages of new recipes. Address The Horenfeld Co., 3300 Straight St., Cincinnati, Ohio.

For sale by all good dealers

BOSS OVEN

The Oven with the Window

ing machine, she conceived the idea of making the seesaw do the work, giving her time to enjoy life. And the United States of America set its solemn seal of approval on this idea, giving her a patent for a combined seesaw and washing machine, the illustration of which shows the beauty of possessing at once several children and an inventive brain by which they may be made to wash their own clothes and at the same time have a good time.



AGENTS AMAZING INVENTION!

An entirely new Lamp Burner. Changes ordinary kerosene illumination into beautiful large white light. Rivals gas or electricity. Scientifically made. Beats the old style lamp. Not a mantle. Can't break. **BIG PROFITS** Easy to show; quick to sell. \$8 to \$10 daily for you. Experience unnecessary. Sample outfit 35c prepaid. Particulars FREE. THE RADIOLITE CO., Dept. 1, TOLEDO, OHIO

HESS FURNACE

We will deliver a complete heating equipment at your station at factory prices and wait for our pay while you test it during 60 days of winter weather.

The entire outfit must satisfy you or you pay nothing. Isn't this worth looking into? Could we offer such liberal terms if we didn't know that the Hess Furnace excels in service, simplicity, efficiency, economy?

We are makers—not dealers—and will save you all middlemen's profits. No room for more details here. Write today for free 48-page booklet which tells all about it.

Your name and address on a post card is sufficient.

HESS, 910 Tacoma Bldg., Chicago



No. 48
"Leader" Hess
Steel Furnace
Price \$49

Delivered Box of Bricks and
Bolt of Ohio Stone
Pipe and Register Stone



Let Us Show You How Little It Costs

To Get Light and Power The Bissell Way

Electricity is just as much a necessity to the up-to-date farmer as a gang plow or a cultivator. Why continue to use old-fashioned methods when you can have an abundance of bright electric light and enjoy city comforts at no greater cost than that of the oil, wicks and chimneys of the dirty, smoky lamps, which are a constant fire menace—and save all the cleaning, which is a lot of work?

You can actually get double the power service from your gasoline engine by harnessing it to a Bissell Electrical Light and Power Plant and, by distributing the power to individual motors, keep the separator, feed grinder, wood-saw, churn, pump, grindstone, washing machine, sewing machine, etc., where each can be used to best advantage.

Your own engine can be used without lessening its efficiency for other work—saving you just that much in cost of installation. Bissell Plants are so simple that anyone can install or operate them—and they last a lifetime. Write today for literature—you will be surprised to find out how very little it really costs to have Bissell Electric Light and Power always at your command.

The F. Bissell Co., Dept. C, Toledo, O.

LIGHT AS DAY

A BETTER LIGHT from any kerosene (coal oil) lamp or lantern than from electricity or gas. Our WHITE FLAME SMOKELESS BURNER scientifically GASIFIES the oil, CONSUMES the carbon and develops a brilliant, white, 52 candle power light. NEVER SMOKES. Safe and reliable. NO MANTLE TO BREAK. Satisfies every AGENTS WANTED. Earn \$6.00 to \$30.00 daily user. Everywhere. Sells on sight. Sample, postpaid, 35 cents, stamps or coin, 2 for \$1.00. MONEY BACK IF NOT AS REPRESENTED.



"G-C" LIGHT CO., 505 Baldwin Block, INDIANAPOLIS, IND.

TRIUMPH STAND LAMP

A 300 Candle Power Lamp for Home, Store, Shop, work bench, library, desk, or wherever a stand lamp can be used. Can be turned up and down like gas, and carried around with more safety than a kerosene lamp, and gives 10 times the light at less than 1-4 the cost to operate. We have 5 distinct lines of gasoline hollow wire wick lamps and lamps, SMALL lamps for SMALL rooms and LARGE lamps for LARGE rooms in most attractive styles at less than 1-2 the cost of gas or electricity. Our POP Catalog tells all about them. Get it now and decide which line you want.

BRILLIANT GAS LAMP CO.

Dept. 1, No. 182 N. State St., CHICAGO, ILL.



THE WIZARD LIGHT



These latest inventions represent the acme of perfection in artificial lighting.

The instantaneous lamps require no generation and are operated as conveniently as electricity at 1-10 the cost.

The "QUICKLIT" system is operated as conveniently as city gas, as lamps are lit with an ordinary match.

For further particulars and exclusive agency address THE NAGEL-CHASE MFG. CO., 144 West Ohio Street, Chicago, Illinois

This
Camera
needs
No Plates



The
PLATELESS TRADE MARK **DAYDARK**

Will earn you

\$35 to \$75 a week

operating at Fairs, Carnivals, Picnics and other public gatherings. *Takes Pictures Direct on Post Cards*, no negatives, no printing, no dark-room, accurate, simple. A 10-year-old boy can successfully operate one. Takes full size post cards. *Portraits, Groups, Views, Buildings, Etc.* All done within the machine at the rate of *One a Minute*. Be independent, come and go when and where you please, be your own boss. *The Plateless Daydark* offers this, *our money back if not satisfied guarantee*

fully protects you. Write to-day for particulars

Do it now and start making money.

DAYDARK SPECIALTY CO., 1810 Cass Ave., St. Louis, Mo.
Dominion Daydark Co., 246 Victoria St., Toronto, Canada

OWN YOUR OWN BUSINESS

LET us start you now. You can make big money all summer. Be independent—free from worry—have money in bank. Get in business for yourself—any Man or Woman—anywhere. All or spare time—traveling or at home. You can make \$8—\$10—\$20 a day easily. Own and operate a

Marvel Cone Machine makes new kind of ice cream cones and other specialties. Delicious—as good as candy. People walk miles to get them—come back for more and more. At last the perfect cone—the perfect machine. Amazingly simple—easy to operate—tremendous profits. You make

A Splendid Opportunity to make money. We furnish complete instructions—show you how to kill competition—so plain that any man or woman, without experience can begin making money right away. Big demand for this new confection—Fairs, Carnivals, Church Societies, Parks, Circuses, in windows, on street corners, Amusements, Pavilions—wherever there is a crowd. Hand them out right and left—nickels just pouring in—4c profit each one. But LISTEN! G. Edwards, Ohio, cleared \$17.50 in two days with one machine. Engle, Iowa, made \$75 in two days with three machines. Niles and Phillips of Nebr cleared \$70 to \$100 weekly all summer. Lots of men make enough in four summer months to keep them all winter. Get busy today—only \$10.00 will buy complete machine. Nice easy clean work. Let us show you actual figures on what you can do. Send no money, but write for complete proof. Act quickly—the season is now at hand.

4c on Every 5c Sale

FAIRCHILD COMPANY
105 Nasby Bldg., TOLEDO, OHIO



A Sure—Big Money Maker



Pound of sugar makes 30 five cent packages delicious candy—sells like wildfire—eighth season—thousands used—original investment returned many times over first season—

Empire Candy Floss Machine

making sure big profits everywhere. POPCORN—PEANUT ROASTER—ICE CREAM CONE MACHINE—Get catalog O. HOME ICE PLANT—sure winner.

Catalog 100 tells about it. Agents Proposition Extraordinary.

STEVENS MANUFACTURING AND SUPPLY CO.

Makers and Distributors Stevens' Pocket Lighter, Non-Leaking Tire Valve—Full Line Auto Accessories.

Dept. R—1225 Wabash Ave., CHICAGO, ILL.

RESTRICTIONS ON GROCERS IN SEVENTEENTH CENTURY—Shopkeepers in the seventeenth century were subject to other restrictions than those respecting prices. It was enacted that "any person using the Trade or Mystery of the Grocer should not either by themselves or any third party directly or indirectly keep more than one shop at the same time."

Grocers were also forbidden to sell any commodities except "raysons, currants, sugar, spice, soap, candle,

GO INTO THE Moving Picture Business

From \$50 to \$75 a night you and your wife can earn on each in 1 or 2 nights



\$25 And more per night can be made exhibiting with our machine in

halls, schools, churches, theaters, etc., in your own and surrounding towns. We furnish everything—rent film, too. Only a small payment required to get this new and unexcelled machine. Balance may be paid in easy installments. Write for particulars

P. & W. Sales Company
634 D. So. Dearborn St., Chicago, Ill.

The Real Money Winners Weighs 6 lbs.

EARN \$50 a Week with the "Diamond-Post-Card-Gun"

A Metal Post-Card Instrument. Takes large and small Paper-Post-Cards Direct on the Paper, without Plates or Films, takes also Button-Photos in one minute. Complete outfit to take and finish

600 Post-Cards, Gilt Frames and Button-Photos only **\$27.45**

Our "Take-Quick" Box Camera

sells with the complete outfit to take and finish 500 pictures including Postal-Mounts and pretty embossed mounts for only \$15.50. Start now with one of the two—they will lead you to success and independency. Send \$5.00 Deposit and we will collect the balance C.O.D. Circulars mailed free.

INTERNATIONAL METAL & FERROTYPE CO.
2323 W. 13th St., Dept. B. M. CHICAGO, ILL.



BIG PROFITS AGENTS

Nobura Aluminum Kettle Bottom makes it impossible to burn meats, fruits and vegetables. Made of pure aluminum. Fits inside any kettle. Raised bottoms prevent contents touching bottom. Saves its price every day. This is the best household article you can handle. Every woman buys two or four. Samples (2 sizes) prepaid for 25c. Particulars FREE. Act on this.

THE GIER & DAIL MFG. CO.
Dept. "G", Lansing, Mich.

Make \$10.00 to \$20.00 per day! With Anyone of Our Machines!

Are you looking for a good paying business this summer? Here is a chance. An investment of \$12.00 for one of our Post-Card Cameras will start you in business. This machine makes photos direct on post cards without the use of a negative. NO DARK ROOM REQUIRED! EXPENSIVE UNNECESSARY! Be your own boss. "COIN-ING MONEY" whether in a city, village or hamlet. Send for free catalogue describing our Post-Card and Tintype Machines and supplies

JAMESTOWN FERROTYPE CO.
Bldg. 47, 1113 S. Halsted St., Chicago, Ill.



Please Mention Popular Mechanics

THROUGH THESE BOOKS LIES THE HIGHWAY To SUCCESS and the FAT PAY ENVELOPE



If you desire
knowledge—a better position—more
salary—let us send you this magnif-
icent set of encyclopedias, for seven days free inspection.

READ THIS ANNOUNCEMENT IN FULL AND CAREFULLY—you
cannot afford to forego the opportunity of having this splendid

Cyclopedia of Mechanical Engineering (Including Modern Shop Practice)

In your home or shop. The set consists of seven large (7x10 in.) volumes, handsomely bound
in half-morocco; titles stamped in gold; 3,992 pages; over 2,327 illustrations, diagrams, plates,
formulas, etc. Each subject is systematically treated, in the most comprehensive manner—fully
covering the needs of both the beginner and the most advanced workman. These volumes are compiled
from the standard text books of the AMERICAN SCHOOL OF CORRESPONDENCE (authors of which are the
best informed men of the century, in the lines covered) and constitute a complete and easily mastered course
of home instruction. All the newest and most advanced ideas are incorporated—nothing out-of-date or obsolete.

Our Generous Offer to You: The regular list price of this splendid set is \$35.00—yet for a short
time (and merely to acquaint you with the methods of home instruction
of the American School of Correspondence) we offer them at only \$19.50—payable \$1.00 upon your
deciding to keep the books, and \$2.00 per month thereafter until paid for. And we do not ask you to
send us one cent, before you have the books in your own home and learn for yourself that they are just
what you want and need. We send them at our expense—then, after the 7 day free examination period,
notify us that you do not wish to keep the books, and we will have them returned to us at our expense.

Isn't It Worth Money to You to Know All About These Things:
Machine Shop Work, Vertical Milling Machines, Motor Driven Shops, Shop Lighting, Forging, Electric
Welding, Tool Making, Metallurgy, Manufacture of Iron and Steel, High-Speed Steel, Flaws in Castings
Electric Lifting Magnets, Magnetic Clutches, The Making of a Machinist, The Ideal Foreman, Pattern
Making, Factory Work, Automatic Coal and Ore Handling Appliances, Machine Parts, Construction of
Boilers, Types of Boilers, Boiler Accessories, Steam Pumps, Air Compressors, The Steam Engine, The
Steam Turbine, Indicators, Valve Gears, Refrigeration, Gas Producers, Gas Engines, Automobiles, Elec-
trical, Sheet Metal Work, Practical Problems in Measurement, Mechanical Drawing, Drafting, Room
Organization, Machine Designing.

Another Great Offer With each set is included a year's Consulting Membership entitling you to
practical help in handling working problems which are too specific to be taken up in detail in the Cyclopedia.
A single problem solved for you might be worth more than the first cost of the books.

All of these (and MUCH MORE) are told you—and in such manner that YOU CAN, if you WILL, become an expert.

Mail the Coupon at Once
if you want to have these
books for seven days FREE.
REMEMBER: no cost—no
obligation. Mail the coupon
today.

American School of Correspondence, Chicago, U. S. A.

Please send me Cyclopedia of Mechanical Engineer-
ing for 7 days' free examination. I will send \$2.00
within 7 days and \$2.00 a month until I have paid
\$19.50; otherwise I will notify you and hold the
books subject to your order. Title not to pass until
fully paid.

Pop Mech. 7-12

NAME

ADDRESS

OCCUPATION

EMPLOYER

molasses, gunpowder, shot, match, tar, pitch, rozen,
tobacco and pipes, cotton wool, cotton yarn, starch,
bluing, rice, linseed oil, white and red lead, olives,
prunes, figs, Spanish white alabaster, alum, almonds,
brimstone, lamp black and candle rushes."—London
Chronicle.

AGENTS \$50. A WEEK selling our wonderful sign
store fronts and glass signs. Resembles finest
gold leaf. Easily applied. Every firm wants them.
Samples free. METALLIC SIGN CO., 406 N. Clark, CHICAGO

**AGENTS THE BRAND NEW
VACUUM CLEANER**

Nothing like it. The dirt can't get away. Perfect
Suction—Light Weight—Every housewife wants this
labor saver. 250 per cent profit. Ralph Winters, Ohio,
wires, "Ship another dozen at once. Orders rolling in."
Tom Morris made \$37.50 last week. You can do as well.

THIS IS YOUR BIG OPPORTUNITY

Be the first in your County. Write today for
Exclusive territory, and free particulars.

B. B. SALES COMPANY, 4940 N. Western Ave., CHICAGO



**3 Genuine French Briar
Anti-Nicotine Pipes \$1**
Electrically sealed and need no breaking in.
Vegetable compound nicotine cartridge. Patent
mouthpiece; vent on top. Heavy nickel mounting.
Guaranteed not to burn out in 3 years.
50 CENTS EACH OR THREE FOR \$1
Choice of bent or straight stems—state which in order-
ing. Satisfaction guaranteed or money refunded.
10 cartridges free with 3 pipes.

H. MENGES, 315 Menges Building, ST. LOUIS

(ESTABLISHED 1842)

Reed & Sons Pianos

Highest Award World's Columbian Exposition
Now Sold Direct to You from Factory

30 DAYS' FREE TRIAL IN YOUR HOME. Take your own time
to pay. No payment in advance required. For free book address

REED & SONS PIANO MFG. CO.
Dept. J 17 Cor. Jackson Blvd. and Wabash Ave. CHICAGO

**Buy your Diamond \$97.50
Direct from the Importer at**

The new complete **Basch
Diamond Book** contains in-
formation that enables the
diamond investor to pur-
chase intelligently and with
perfect safety. Illustrated
in colors. Gives full par-
ticulars of the Basch Plan;
tells how we ship any
diamond on approval at
our expense, without de-
posit or references. De-
scribes the Basch contract
to buy back every dia-
mond for cash. Sent free
on receipt of your name.

L. BASCH & CO.
Diamond Importers

You can
now buy Genuine
Perfect Cut Diamonds
direct from the Importer
legally guaranteed, at these
prices:
1-8 carat, \$8.25 8-8 carat, \$31.25
1-4 carat, \$17.50 1-2 carat, \$45.00

**1 Carat and over,
\$97.50 per Carat**

These Importers' prices are 40
per cent less than in retail
stores. Our enormous cash
sales, eliminating all middle-
men, and low expenses
make these astonish-
ing low prices
possible.



Buy Diamonds by the Carat!

Here's a valuable "tip" to the diamond buyer. Always
buy DIAMONDS by the carat. Why do all jew-
elers buy diamonds by the carat and yet nearly all refuse
to sell on the same honest basis? Simply because they do
not want you to know the tremendous price per carat
they are really asking. L. Basch & Co. are practi-
cally alone in giving and guaranteeing in writing
the carat weight and price per carat of every
diamond. The Basch plan also enables you to
send for any diamond on approval for your
inspection at our expense. Send no de-
posit or references.

Our Legal Guarantee is a written
contract to buy back any diamond we
sell at any time for cash. It has given
us the confidence, friendship and
patronage of thousands of diamond
investors in every state. Full par-
ticulars in the Basch Diamond
Book (FREE).

Mail Coupon or write today.
Dept. R 347, S. State St., Chicago

Name
Address

\$3 AND YOU KEEP ELGIN THIS 17 JEWEL ELGIN GUARANTEED 25 YEARS



STEVE HARRIS, Pres.

Says:—Before you buy any watch I want you to see this Thin-Model 17-Jewel Elgin. Its the latest and best product of the Elgin Factory.

We want to Send You this Magnificent 16 size, Thin Model 17-Jewel Elgin, fully Adjusted to Temperature, Isochronism and Three Positions, Complete with fine Double Strata Gold Case, Guaranteed 25 Years on

30 Days Free Trial

And if you don't say this is the biggest Elgin Watch

bargain you ever saw, send it back at our expense. If you wish to keep it, the way is easy. Pay us only \$3.00, and the rest in similar amounts each month. No interest—no security—just common honesty among men. We want you to see for yourself that this fine Elgin is better than other Watches costing twice or three times as much.

Send for Our Free Catalog Write today for particulars and we will send you

OUR NEW FREE WATCH AND DIAMOND BOOK, also our book called "**Facts vs. Bunc**" or all about the watch business, both at home and abroad. **HARRIS-GOAR CO. Dept. 489, KANSAS CITY, MO.**

Write today. Do it now and get posted.

The House That Sells More Elgin Watches Than Any Other Firm in the World.



Guaranteed
For 25 YEARS

TOBACCO HABIT BANISHED

DR. ELDER'S TOBACCO BOON BANISHES all forms of Tobacco Habit in 72 to 120 hours. A positive and quick relief. A home treatment easy to take. Hundreds of letters from satisfied patients. We guarantee results in every case or refund money. Send for our Free Booklet giving full information. Write today, this hour.

ELDER'S SANITARIUM, Dept. 524, ST. JOSEPH, MO.



JOIN A BAND!

We Will Send **A Big Book Free**

which gives the lowest prices on reliable instruments, and also a wealth of information upon the formation and successful conduct of a band. This book is invaluable. Hundreds of illustrations.

WRITE TODAY

LYON & HEALY, 25-91 E. Adams St., Chicago

BUY YOUR PLUMBING GOODS AT MANUFACTURERS PRICES



**BATH TUB \$15.66
COMPLETE ONLY**

Full line of Plumbing Goods, Water Works Systems, Heating and Lighting Plants, Pumps, Windmills, Pipe & Fittings. Send for big Free catalog. **MISSOURI WATER & STEAM SUPPLY CO.**
646 South 6th Street St. Joseph, Missouri

Grow Mushrooms

**Big and Quick Profits
Costs Little to Start a
Safe Business**



Increase your income \$5 to \$70 a week by learning mushroom culture from biggest mushroom man in the world. Fourteen years' experience enables me to give any man or woman practical instructions worth many dollars. Only spare time required. Can be grown in

sheds, old barns, or basements. I have started thousands and will show you how Free. This is your opportunity; send for Free Book giving particulars, how to start, etc. Address

JACKSON MUSHROOM FARM 6194 N. Western Avenue CHICAGO, ILLINOIS

BE A PHOTOGRAPHER AND MAKE FROM \$15.00 TO \$35.00 PER DAY!



The latest invention, the **GLOBE PHOTO POST CARD CAMERA**, makes photos direct on post cards without the use of a negative, in less than 30 seconds, automatically. It is simple, practical and very easy to operate. No experience in photography necessary.

The latest invention in street tin type cameras, is our **AUTOMATIC**, Model H. It takes pictures on plates also 1 3/4 x 2 1/2. AUTOMATICALLY. It weighs only 4 1/2 pounds. Price \$15.00. Send for 1912 catalogue describing machines and supplies. We are the largest manufacturers and distributors of tin type and post card machines and supplies in the world.

THE NEW YORK FERROTYPE CO. (INC.)
168 1/2 Delancy St., Dept. 72, New York City, U. S. A.
Branch: 1113 So. Halsted St., Chicago, Ill.

CAUSE FOR HASTY FLIGHT—No elk have been seen in central Missouri since 1836. Prior to that time they were reasonably plentiful. They were attracted by the prevalence of the salt licks. Nathaniel Walker, or "Uncle Natty," as he was familiarly called, a famous

Elegant Thin Model 20 Year Watch \$3.75

finishing case beautifully engraved, gold finished throughout, stem wind and stem set, fitted with 7 jeweled American lever movement, guaranteed 20 years with long, gold finished chain for Ladies, vest chain or Job for Gents. IF YOU

\$3.75 Double SEE IT YOUR WILL BUY IT. Let us send it C. O. D. for examination of your nearest express office and if you think it a bargain and you'll disappear

Send once to any \$15.00 gold finished watch pay the express agent our special sales price \$3.75. Mention if you want Ladies', Men's or Boys' size.

DIAMOND JEWELRY CO., A. 9, 219 S. Dearborn St. CHICAGO, ILL.

Flash Like Genuine

BARODA DIAMONDS.

ANY STYLE at 1/40 the cost—IN SOLID GOLD RINGS

Stand acid test and expert examination. We guarantee them. See them first—then pay. **Special Offer**—14k Tiffany ring 1 ct. \$5.95. Gents ring 1 ct. \$5.95. 14k Stud 1 ct. \$4.85. Send C. O. D. for inspection. **Catalog FREE**, shows full line. Patent ring gauges included, 10c. The Baroda Co., Dept. A5, Leland & Dover Sts., Chicago

Send for Our Free Vibrator Book

describing the White Cross Electric Vibrator. This Vibrator is a rubbing machine which draws the blood to any aching part of the body to do its work. This machine rubs much better and much faster than the hands. While the hands are giving a few dozen rubs, the White Cross Vibrator gives several thousand. Send today for the Free Vibrator Book. It may mean health to you.

Lindstrom-Smith Co., 218 S. Wabash Ave., Chicago

GRAFLEX CAMERAS



PICTURES LIKE THESE
ARE EASY TO MAKE WITH A GRAFLEX

The image is seen on the ground glass, full size of negative, up to the instant of exposure, right side up.

There is no guess work—no estimating distances—no microscopic "finder."

The Graflex Focal Plane Shutter works at any speed from "time" to 1-1000 of a second.

Graflex Cameras from \$55.00 to \$200.00.

Send for our illustrated catalog.

FOLMER & SCHWING DIVISION

Eastman Kodak Co., Rochester, N. Y.

of every kind in India.

Probably there is no leader of British India whose good will is of greater value to England. Immensely rich, and counting his followers by the hundred thousand, the Aga Khan stands in very high official estimation in India. His position is unparalleled, inasmuch as there is no more powerful potentate in the Moslem world, in spite of the fact that he rules no territory of his own. Most of the very numerous body of men who are ready to obey his slightest wish are wealthy, educated and influential.—Columbus Dispatch.



"FILL IN" Steel Cement

For plugging small holes in castings, water pipe, gas pipe, connections, etc. Positively prevents leaks and is inexpensive, on account of small amount necessary to use. 1-lb. cans 30c lb. 5-lb. cans 25c lb.

J. W. PAXSON CO., Mfgs., 1021 N. Delaware Ave., PHILA.

New Typewriter

\$18

in U.S.A.

Built by a mechanical wizard. Has only 250 parts. Other machines have 1500 to 3700 parts. This sensational simplicity is the secret of the unheard-of selling price of \$18. It's built in famous Elliott-Fisher Milling Machine factory and sold on a money-back-unless-satisfied-guaranty. 25,000 in '24.

The Bennett \$18 Portable Typewriter

does work of high-priced machines. Every big improvement: visible writing, standard keyboard, reversible ribbon. Wt. 7 lbs. Easily carried. Write for catalog.

P. T. BENNETT
TYPEWRITER CO.
366 E'dway New York
Foreign Adl., 75 Cannon St. London, E.C.

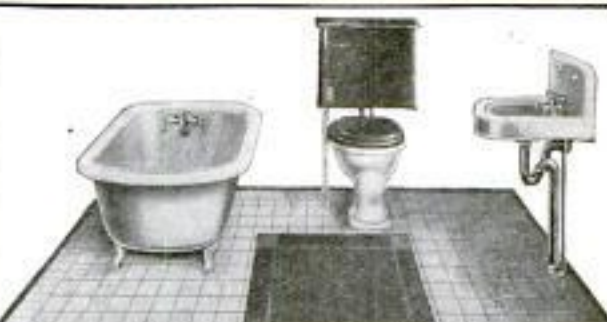

How to Install Your Own Plumbing and Heating Systems

Save all cost of skilled labor. Post yourself on the new method. The practical Gibbons method. Every detail explained in my new, big book. Every home, even the smallest cottage can now have running water and a modern heating plant. My book explains how you can afford these comforts and luxuries. My prices and my practical saving will astound you. Send for this valuable book and get it post-paid free.

Book Free

My new book gives you greater buying power than your local dealer. It is the most valuable catalog for you ever issued. Thousands of things illustrated and priced. Hot water and steam heating plants, gasoline engines, hydraulic rams, pipes, pumps, valves, electric lighting plants, acetylene lighting plants, all accessories. Everything guaranteed, high quality at direct, rock bottom prices to you. You certainly ought to have this valuable book.

Write Today See for yourself how easy it is to make improvements about your home with the aid of my new book. The low prices of my high quality material will astound you. Home owners, contractors, builders, need my wonderful new book. Write today. Just send your name. It is post-paid free to you.

M. J. GIBBONS, Dept. 524S, Dayton, O.

Please Mention Popular Mechanics

They Show and Name Every Part

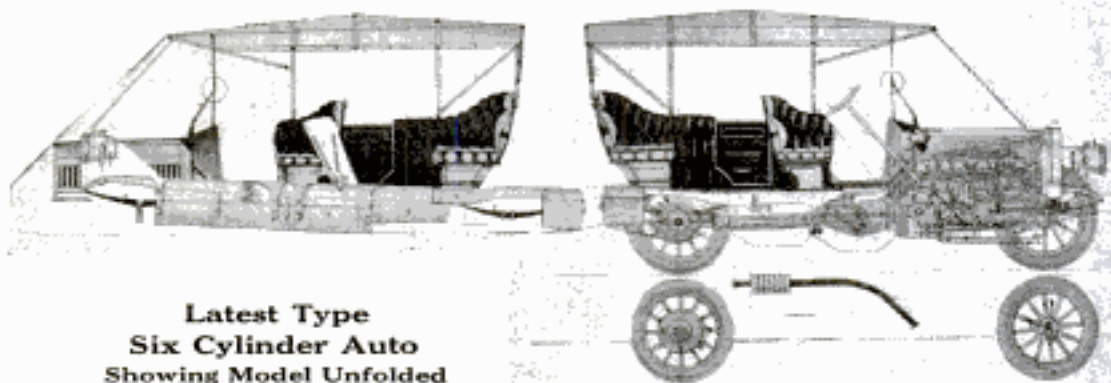

Latest Type
Six Cylinder Auto
Showing Model Unfolded

Series of 8 Lithographic Models

Automobile—Locomotive—Steamship (OCEAN LINER)

Wireless Telegraph—Steam Engine—Steam

Turbine—Gas Engine—Dynamo

Size Unfolded 9½ x 25 Inches

Price
50c Each
Set of Eight
\$3.50 Postpaid

The illustrations (actual photographs) convey some idea of the great amount of accurate detail of intricate mechanisms shown by our models. It is impossible by means of these small pictures, however, to show more than one set of flaps or folds turned outward, whereas, in reality, some of the models are composed of as many as 14 different layers each showing some part or set of parts.

The ingenious way in which all the interrelated mechanism is thus clearly shown can only be appreciated by seeing and examining the models themselves. The ease with which the detail may be studied will be readily understood as by turning the flaps the models can be practically disassembled and put together again. Each part is numbered to correspond with its name found on a printed key.

You can get more information about the construction and operation of these machines by use of the models than in any other way. No detail is omitted. Everything is accurate and in true proportion and they have the approval of the manufacturers of the machines represented. They are not toys in any sense but are educational in character and worth many times their cost.

Invaluable for individual study or supplementary to school courses.

Reduced Prices to Schools Ordering Quantities

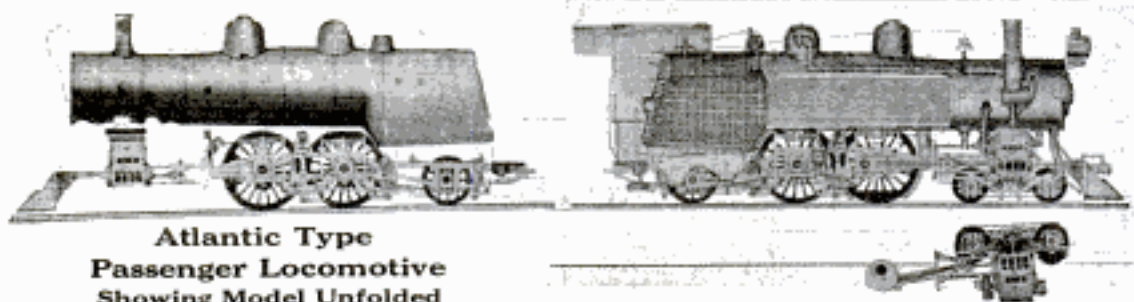

Atlantic Type
Passenger Locomotive
Showing Model Unfolded

POPULAR MECHANICS BOOK DEPARTMENT

SOLE AGENTS

318 W. WASHINGTON STREET

CHICAGO

Please Mention Popular Mechanics

\$100 A Day



A large number of men and women whom I have started in business, have earned far in excess of that amount for five and six weeks at a stretch.

I am the man who is responsible for three-fourths of all the Ice Cream Cone business of this and foreign countries. I can start a factory for you, place you at a park, summer resort or with a Traveling Carnival, Amusement or Exhibition Company.

Knapp, Mich., made \$2,000 in 9 days. Fadell, Toledo, made \$40.00 in six hours. Menues, Ohio, averaged \$40.00 per day for 45 days. Bahr, Va., sold 15,000 cones in 4 days, clearing over \$100.00 per day.

I also make Kotton Kandy, Pop Corn Fritter and other money winning machines.

Remember This is Presidential Campaign year and will be a record-breaker for refreshments. Get in now and reap the immense rewards. Money every minute. I teach you the whole business, give you a complete set of tools and enroll you as a member of the Sayso Advertising Club, thus enabling you to make extra money. My big 128 page book, explaining all, sent free. Write today. Postal will do.

A. T. DIETZ, 43 Sayso Bldg., Toledo, Ohio

In Borneo the bride and bridegroom sit on metal logs before the priest, who gives them cigars and betel while he blesses them. He waves above them two fowls bound together. The bridegroom then places the betel in his bride's mouth and a cigar between her lips. They are married.

Model Aeroplanes
Standard Fittings — Supplies
Second Edition 1912 Catalog "S."
A perfect Hand Book on Models.
Free on request.

Eight 3 foot Flyers, all original. Curtiss Hydro, rises from the water. Langley Tandem Monoplane. Newport Racer, (very fast.) Wright, double chain drive. Antoinette. Bleriot. 1000 foot White Racer. White Flyabout.

The White Aeroplane Co., 337 Adams Street, Brooklyn, N. Y.

AGENTS \$50. to \$100. EVERY WEEK

And if you are a live hustler I will gladly pay you more. I've got the slickest money making proposition in the country for wide-awake agents. Carpenter averaging 250 sales weekly. Only Scientific Automatic Razor Sharpener made, gives barber's stroke, both noses and shaves all standard razors and safety blades. Guaranteed for life. Men buy on sight. \$2.00 complete, 100% profit. It means big money for you if you act promptly. Get exclusive territory NOW. Write me today how to get FREE—free and largest outfit.

Secretary, The Victor Co., 679 Victor Bldg., Canton, Ohio

I TOOK IN \$8540 IN SIXTEEN MONTHS FROM THREE BOX BALL ALLEYS

says H. C. Freeman. Over \$20.00 per day. Many make full cost first month. Start this wonderful business in your town now. We sell only one party in each locality. New model better than ever—makes from \$25 to \$75 per week. Legitimate, honorable, clean. Best people play for physical exercise. Automatic—no expense but rent. Can use tent. Big success at resorts. NEW LIBERAL TRIAL OFFER. You can start with as little as \$125. Write today.

AMERICAN BOX BALL CO.
560 Van Buren St., Indianapolis, Ind.

White Valley GEMS

Substitutes for Diamonds



Send for FREE Catalog!

showing wonderful White Valley Gems in Rings (Ladies' or Gentlemen's), Scarf Pins, Studs, Brooches, Necklaces, Cuff Buttons, Lockets, Earrings—100 different articles and styles.

Not glass, not paste, not any kind of imitation, but beautiful, splendid gems. (White Sapphires chemically produced.) Look like finest diamonds. Will scratch file, and cut glass. Stand acid test. Famous society women substitute White Valley Gems for real diamonds—or wear the two together confidently.

14-K. solid gold mountings. 25-year Guarantee Certificate with each gem. Ring measure sent with catalog. Will send any article in book U. O. D. — express prepaid — subject to examination—or by registered mail on receipt of price.

Money refunded if not satisfactory.

WHITE VALLEY GEM CO.

501 Sales Bldg., Indianapolis, Ind.

\$1,000 YEARLY PROFIT FROM YOUR BACK YARD. Complete illustrated details (170 pages) together with a profitable MAIL ORDER PLAN \$2.00 sent for 30c and six stamped envelopes addressed to: **Winters, Tompkins & Co., 100 W. W. ST. CHICAGO, ILL.** Circular free. **SCIENCE INSTITUTE, P. O. BOX 204 W. 29th St., CHICAGO**

AGENTS Here's a winner. Get busy. Wonderful invention. The Easy-Wringer. Every woman buys. Think of it! A self-wringing mop. No putting hands into dirty water. No soiled clothes. Can use scalding water containing strong lye. Two turns of crank wrings out every drop of water. No talking necessary—just show it and take the order. Agents coining money.

WRITE FOR FREE BOOKLET AND INFORMATION TODAY.
THE U. S. MOP CO., 1573 Dorr Street, TOLEDO, O.

You Can Now Buy the World-Famous Illinois Watch ON CREDIT

If you are in the market for a watch, write for our watch catalog. Let us show you how we can save you big money on the World-Famous Illinois Watch and give you a year to pay for it. You have always heard about the Illinois Watch, the kind that most railroad men use. We have just made a special deal which enables us to offer extraordinary low prices.

Write for Our Big Watch Catalog Today, Now

Prices From \$9.75 Up

Three cents a day will pay for almost any Illinois Watch in our catalog, and besides, our prices are so low that everyone can now afford to own one of these grand watches. Get our Big Watch Catalog today. We will send any watch you want on approval, no obligation to buy. If you like it, we will give you a year to pay for it. Write a postal card today and say, "Send me your Free Watch Catalog." (227)

Spiegel, May, Stern Co.
3153 Wall Street, Chicago, Ill.

Aeronautics and Automobiling

Latest and Best Books



Aerial Navigation of To-Day

By C. C. TURNER

A popular account of the evolution of aeronautics. Cloth, 327 pages, 66 illustrations.

Price \$1.50. Postage 12c extra.

Aeroplane Designing for Amateurs

By VICTOR LOUGHEED

A comprehensive account of the practice of aeroplane designing and building and explaining the principles underlying flight by heavier-than-air machines. Written by a practical expert. 75 original drawings. Cloth. Pocket size, \$1.00. Morocco, \$1.50. Postage 7c extra.

Vehicles of the Air

By VICTOR LOUGHEED

A popular exposition of modern aeronautics with working drawings of modern types of successful aeroplanes. This book positively presents every known fact concerning aerial navigation. 500 pages. 270 illustrations. Cloth.

Price \$2.50. Postage 25c extra.

Monoplanes and Biplanes; Their Design, Construction and Operation

By G. C. LOENING

A practical book setting forth and discussing the prevailing practices in the construction and operation of these machines. Cloth, 340 pages, 278 illustrations.

Price \$2.50. Postage 20c extra.

Aerial Navigation

By ALBERT F. ZAHM

The latest word on aviation. The purpose of this work is to portray in popular terms the progress of aeronautics from its earliest beginning to the present perfection of practical air craft. Cloth, 132 illustrations.

Price \$3.00. Postage 22c extra.

The following books are offered as among the best available on their respective subjects:

Lithographic Model of an Automobile

Shows and names every part of a latest type six cylinder machine. Has flaps printed in colors which may be turned like the pages of a book. Size unfolded 9 x 25 in.

Price 50c postpaid.

The How and Why of the Automobile

Tells all about a motor car—how it works—how to drive it and how to take care of it. 200 pages, 250 illustrations. Cloth.

Price \$1.00 postpaid.

The Automobile Mechanician's Catechism

By C. F. SWINGLE

Over 400 questions and answers covering every detail of automobile work. An invaluable helper for student and chauffeur. Pocket edition. Full leather.

Price \$1.25 postpaid.

The Automobile Handbook

By L. E. BROOKES

A work of practical information for the use of owners, operators, and automobile mechanics dealing with all questions relating to construction, care and operation. 650 pages. 320 illustrations. Leather.

Price \$2.00 postpaid.

How to Run an Auto

This work is now the accepted standard on care and management of motor cars, explaining the principles in a clear and helpful way. 608 pages, 400 illustrations. Cloth.

Price \$2.00 postpaid.

Automobile Encyclopedia

By A. L. DYKE

On construction, operation, and repairing of automobiles and engines, including a large number of clear diagrammatic charts. All prepared in a simplified manner. 400 pages. Illustrated. Cloth.

Price \$3.00. Postage 25c extra.

ADDRESS:

Popular Mechanics Book Dept.
318 W. Washington St.
Chicago

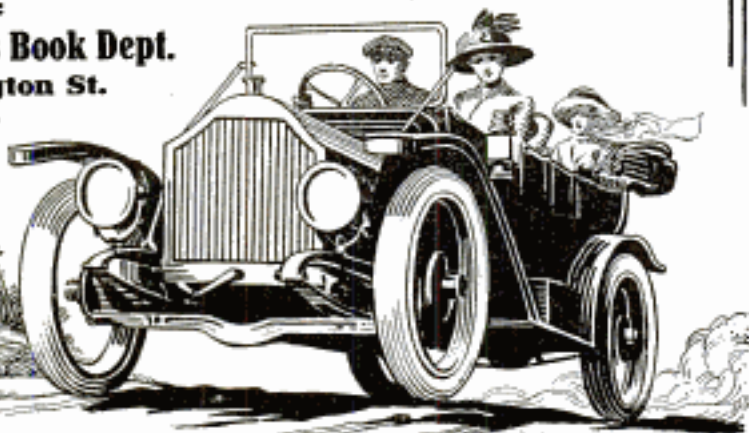

Please Mention Popular Mechanics

KEROSENE OIL ENGINES

Marine—Stationary—Portable

No Danger, Maximum Power. Minimum Weight. Durable, Reliable, Simple, Efficient. Operates on kerosene, gas oil, distillate, fuel oil, alcohol, and crude oil of suitable quality. Very economical. Not a gasoline engine with a vaporizer or kerosene attachment.

Write for Catalogue PM
HATCH OIL ENGINE COMPANY
8th Ave. and 18th St., BROOKLYN, N.Y., U.S.A.

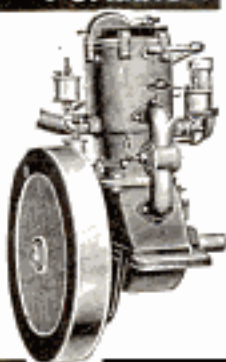

"Ohio" Tools

Are correctly made by skilled workmen, and fully warranted.

REGISTERED Ask your Dealer for "Ohio" Tools when buying

Auger Bits, Screw Drivers, Drawing Knives, Chisels, Planes, Benches, etc.
CATALOGUE FREE



OHIO TOOL CO. (Dept. 3)
Columbus, Ohio

KOREA'S WILD BEASTS—The mountainous province of North Pyongendo teems with wild beasts and the damage done by them annually is very great. According to an official report during last year tigers made their appearance in the province 147 times and killed an ox. Leopards made 415 raids and three cattle and seventy-six pigs were carried away by them and five cattle and twenty pigs were severely injured. Wolves raided the province 714 times, killing two persons, two cattle and 288 pigs and severely injuring five cattle and thirty-nine pigs. Bears made their appearance seventy times and killed six persons and injured three. Wild boars raided the province nine times.

Tent Catalog FREE If you want the newest and most up-to-date ideas about Tents, Camping Outfits and Supplies, write today for our new 1912 book, the finest and most complete ever published. Absolutely the lowest prices. Our book is full of facts every camper needs; tells about our new *Waterproof and Mildew Proof* Process. Enables you to buy direct from one of the largest, most reliable manufacturers in the country. Supplying the U. S. War Dept.

THE HETRICK BROS. CO.
1224 Fernwood Ave. TOLEDO, OHIO, U. S. A.

Model E 4 cyl., 50 H.P. T-head

MAXIMOTOR

List of 5 models this year ranging 50-140 H.P. Just right for exhibition lights on standard Curtiss, Eberhart, etc.

MAXIMOTOR MOTORS
New Catalog DETROIT Dept. 45

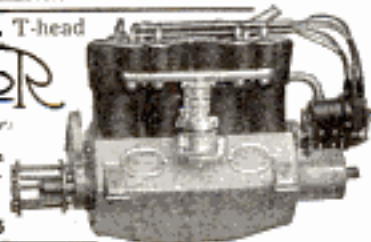

SMALL ENGINES

1-8 H.P. UP



Steam, Gas & Gasoline, see Professional and Amateur Mechanic. Write for circulars. Big Catalog listing Mechanics and Electrical devices. SMALL POWER MACHINES and Individual Electric Light Plants, 2 to 60 Lights, 15c. (coin preferred). Refunded on first order. No free list.

AMATEUR MECHANICS SUPPLY CO.
800-G Woodstock Bk., CHICAGO, ILL., U. S. A.

Let this Spark Plug solve your ignition troubles

The new principle embodied in the J-D Visible Gap Spark Plug enables you to locate ignition trouble at a single glance. Through the port in the porcelain—*outside* the motor—you see if the spark is jumping the gap in the central electrode. No more need to hunt and test and fuss. If the spark jumps, the plug must be fouled or carburetion is faulty; if not, then trouble is behind in wiring or coil or batteries. Knurled adjusting nut allows you to widen or close gap. Opened, it intensifies spark and cleans point automatically. Uses minimum current, makes timing of engine easy, and permits regulating of spark in any cylinder.



\$1.00

One look tells everything

Will you test a set of these unique plugs at our risk? We will send you a set prepaid upon receipt of price (specify size wanted and make of car.) Back of every plug we will put our ironclad guarantee, "absolute satisfaction or your money back." Your word goes. We make millions of plugs a year—nothing else—of finest materials, even importing our clays and other ingredients for our porcelain that defies heat. Price of this plug—just \$1.00, same as any good plug.

Will you write us today? And ask us too for our FREE book on ignition—a classic with motorists.

JEFFERY-DEWITT COMPANY
521 Butler Avenue, DETROIT, MICHIGAN

A REAL Baseball Curver

You can be good baseball pitcher, boys, and keep the batters guessing if you use the wonderful Vacuum Curver—the only effective curver on the market. Brand new invention patented May 7. A rubber vacuum cup worn on the hand which enables you to give the ball the proper twist for all curves. Valuable booklet "How to Play any Position in Baseball" with instructions for all curves FREE with each one. Price 25c. Your money back if not satisfied.

MERIDEN MFG. CO., Box 663. Dept. E. LINCOLN, NEBR.



\$65 brings a 4 h. p. Kerogas engine and a \$15 Friction clutch pulley. Guaranteed forever. Free trial if you want it. Runs on Kerosene, Gasoline, Alcohol, Distillate.
KEROGAS ENGINE CO.
744 Woodbridge St., Detroit, Mich.

A Lifetime Opportunity—Agents Make \$45. to \$90. a Week and More—

A revelation in agency work; **Clamox Never Fail Automatic Razor Sharpener**; sells at night; 100 Per Cent Profit and More; All or Spare Time; Wilson, N. H., sold 6 in 30 min.; Brockway, Cal., placed 6 doz. in 10 days; Brown, Mass., sells 31 first day out; You can equal what those men and hundreds of others are doing in every section. Get busy—be one of the 1000 men to start in next 30 days in exclusive territory. Only successful invention of its kind on market today; only one that Hones and Strops any razor, old style or safety; iron-clad Guarantee covers each machine—perfect, accurate, automatic. Phenomenal money-maker.

WRITE TODAY—FREE TRIAL OFFER—
NEVER FAIL CO., 1378 COLTON BLDG., TOLEDO, OHIO

TOLEDO MARINE MOTORS

"Nothing Cheap but the Price"

3 H. P. 1 cylinder complete	\$ 65.00
6 H. P. 1 "	84.00
6 H. P. 2 "	125.00
12 H. P. 2 "	160.00
18 H. P. 3 "	250.00

Fully guaranteed by a responsible concern, 3 cycle, 2 port, 3½x3½ and 4½x4½. Send for free catalog "C."

THE UNIVERSAL MACHINE CO., Pike Ave., Bowling Green, O.

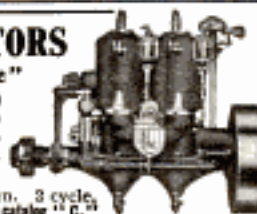

DON'T TAKE ANY CHANCES



Buying your equipment from unknown manufacturers. Get the well known service **JONES SERVICE** and save money.

Power Users The service and goods we give is without doubt the best to be had. Buy your equipment from the manufacturer. For anything in the line of appliances for transmitting power—"Jones Service" and goods are unparalleled. No order too small for attention. No order too large to execute. Our Catalog A-18 shows our complete line. "Jones Service" is Prompt Shipments, Reliable Goods, Right Prices:

Jones Service is Unequaled In Power Transmitting Machinery. If you are not getting it—order direct from our factory. We are extensive manufacturers of Machine Moulded Pulleys, Gears, Hangers, Shafting, Bearings, Belting, Friction Clutches, Sprocket Wheels and Chain Belt.

W. A. Jones Foundry & Machine Co., Mail Order Department 1400 NORTH AVENUE Chicago, U. S. A.

"INGECO" ENGINES

1 1/2 to 350 H. P.
Gas, Gasoline,
Oil and
Producer Gas

Includes all types and sizes to meet every engine need. Simple to operate—low fuel cost—substantial construction. Perfectly balanced, smooth, steady, reliable. Sales branches and stocks everywhere. If you expect to buy an engine our expert will tell you what is best and cheapest for you.



INTERNATIONAL GAS ENGINE CO.,
118 Walnut St., CUDARY, WIS. (Suburb of Milwaukee)

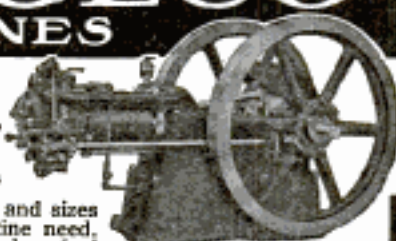

3 H. P. Model A Gasoline Engine Complete \$39.00

HERE is Power for you that can always be relied upon. The Colton Modern Engine is the most economical, simplest and most reliable Power Plant yet invented. Its many new improved patented features are most valuable and are not found on any other engine. Power is constant, speed regulated without stopping engine—adjusts itself instantly to any overload—no cranking to start it. Every Colton is sold under a positive, unqualified guarantee to give satisfactory service or money refunded. Our company has been established 77 years. Get it on trial and compare its simple, compact construction, superior quality materials and high grade workmanship. You will see it operate with less attention and furnish more power per rating than any engine you ever saw. Send for free Engine Book at once.

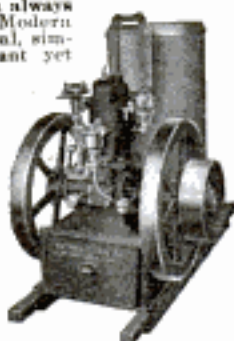

Arthur Colton Co., 182 Brush St., Detroit, Mich.

\$50 to \$300 SAVED

We are manufacturers, not merchants. Save dealers', jobbers' and catalog house profit. 10 or more men in every township can save \$50 to \$300 on my High Grade Standard Gasoline Engines from 1 1/2 to 15 H. P., price direct to you lower than dealers or jobbers pay for similar engines in car-load lots for spot cash.

GALLOWAY

Price and quality speak for themselves and you are to be the sole judge. Sell your poorest horse and buy on 30 Days Free Trial



Direct From My Factory Satisfaction or Money Back Write for special proposition to 10 or more men. Send for my big BOOK FREE.

WM. GALLOWAY, Pres.
WM. GALLOWAY CO.
1965 Galloway Station
WATERLOO, IOWA

LEFT-HANDEDNESS INHERITED—The questions as to whether left-handedness is inherited is still doubtful, but Jordan has investigated seventy-eight families, dealing with 3,000 individuals, and his evidence goes to show that the trait passes from father to son, cites Knowledge.

It is supposed that left-handedness is associated with the greater development of the right hemisphere of the brain. It is, however, important to distinguish between

Factories, Mechanics, Shop, Laboratory or Home



ALL—Everybody ought to KNOW and HAVE this GAS ENGINE.

The Plunket Jr. The engine that makes good always. The best 1-2 horse power high grade Gas or Gasoline Engine on the market today. IT IS SIMPLE, EFFICIENT AND DURABLE (equal to two extra men about the place); is perfectly governed by throttling governor and a wide range of speeds is always at operator's command. Write now.

Today. Send for circular and prices. Free for the asking.
J. E. PLUNKET, 1342 W. Lake Street, CHICAGO

3 to 12
H. P.

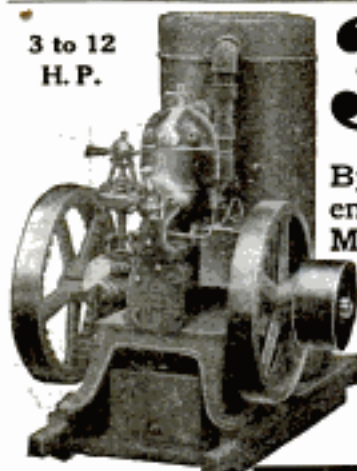

34c Runs this 6 H. P. Engine for a 10 hour day on KEROSENE

By means of the patent throttle you can run it as a 4 H. P. engine for 23 cents a day, or as a 2 H. P. for 12 cents a day. Many other strong points; force-feed lubrication; uniform speed; sight-feed fuel supply; automobile muffler; no cranking; runs either way; uses any fuel oil satisfactorily. And it's **Guaranteed for 10 Years.** Write for catalogue and 30 days' free trial.

WE PAY THE FREIGHT

ELLIS ENGINE CO., 65 Mullett St., Detroit, Mich.

Cheaper Power for Every Purpose

The **WATERLOO BOY GASOLINE ENGINE** will run all day without attention, furnish exactly the power you need, maintain a uniform speed and save you money every hour it works. Uses either **Kerosene or Gasoline for fuel—equipped for both at no extra charge.**

The recent award of **Gold Medal at Budapest, Hungary, in open competition with the best engines of all countries** is clinching proof that the **Waterloo Boy** leads the World in Construction, Power, Service and Durability.

Has many important exclusive features—Speed Lever works like throttle on a locomotive; old reliable fly ball governor, automatic feed regulation, open jacket, starts easy in winter, interchangeable parts, etc.

Lowest in price because made in largest quantities, at low manufacturing cost. **Guaranteed 5 Years.** Book free. Write today. **Waterloo Gasoline Engine Co.**



Awarded Gold Medal, First Prize at the International Gasoline & Oil Engine Show Budapest, Hungary

1021 W. 3rd Ave. Waterloo, Iowa.

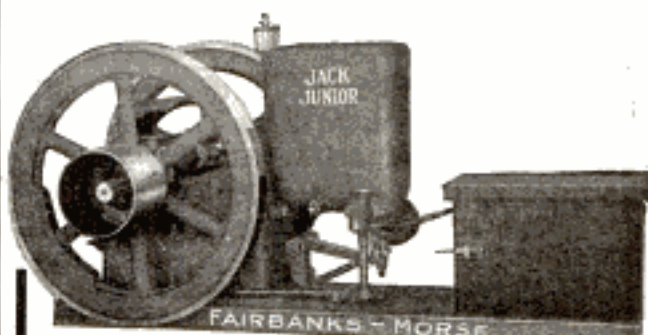

Simple, Reliable

Fairbanks-Morse JACK JUNIOR

The Right Engine at the Right Price

Steady Power for

Water Systems	Pumping	Spraying
Grinding	Churning	Cream Separating
Printing	Washing	Turning Lathe
Band Saw	Corn Sheller	Air Compressor

Get Catalog No. 449KM

Fairbanks, Morse & Co.
Wabash Ave. and Eldridge Place, Chicago, Ill.



BUFFALO Marine Engines

"Buffalos" are built in sizes from 3 to 125 h. p.—all four cycle—for work boats, speed boats, launches and cruisers. They operate on gasoline or kerosene. **"The Engine of Constant Service"**

Write for "The Buffalo Book." It is free.

BUFFALO GASOLINE MOTOR CO., 1293-1305 Niagara St., BUFFALO, N. Y.

DON'T BUY A GASOLINE ENGINE

until you investigate "The Master Workman," a two-cylinder gasoline kerosene or alcohol engine, superior to any one-cylinder engine; reversible; stationary or traction engine. SEND FOR CATALOGUE THIS IS OUR FIFTY-NINTH YEAR.

Costs Less to Buy—Less to Run. Quickly, easily started. THE TEMPLE PUMP CO., Mfrs., 442 West 15th St., CHICAGO

FAMOUS MICHIGAN SPEED WHEELS · REVERSE GEARS & MARINE HARDWARE

MOTOR BOAT MEN Send for our large catalog of valuable information on speed wheels, reverse gears and marine hardware. Everything new and up-to-date.

Prices Right. Satisfaction Guaranteed

We carry an immense stock and can make you prompt shipments and save you money. Send for our free catalog today!

MICHIGAN WHEEL COMPANY
565 Canal Street, GRAND RAPIDS, MICHIGAN

constitutional tendency and the result of education. Thus most parrots receive with the left foot, but that is because they are ordinarily approached in feeding with the right hand. When the left is consistently employed in the feeding the parrot responds with its right foot.

I H C Gasoline Engines Make and Save Most Money

They are most dependable, simplest, most economical, most efficient, most durable and strongest, and they are adaptable to most kinds of work. I H C Gasoline Engines are made in all styles, 1 to 45-horse power. Write today for the I H C catalogue, and read about the I H C engine that meets your needs best.

Address, INTERNATIONAL HARVESTER COMPANY of AMERICA (Incorporated)
16 Harvester Building Chicago U S A

Try the Wonderful Columbia Kerosene Engine at our Risk

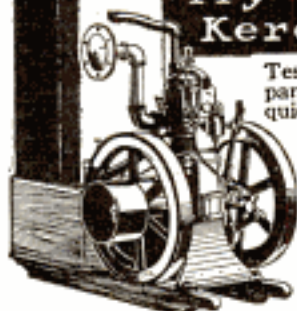

Test it out on your own place for fifteen days. Give it the hardest engine test you can think of. Compare it with any other engine. If the Columbia doesn't develop more power at less cost, send it back quick. No conditions. We are willing to let you be the judge and jury. Kerosene (common lamp oil) is by far the cheapest fuel today. The price of gasoline is climbing all the time, while kerosene remains the same, and in the right engine it lasts longer and produces more power per gallon than gasoline. You get ALL the power when you use a Columbia, because it is the right engine. It is the one really simple and perfect kerosene engine. It never bucks when you need it most. It is always on the job.

Write for Particulars of Our Big Special Offer

We are going to double our output for next year. We can do it easily. It is just a matter of getting engine users to test the Columbia for themselves. So we are making a great special money saving offer on Columbia Kerosene Engines. This offer is liable to be withdrawn at any time, so write today for full particulars, for it is a money saver you would hate to miss. Free Book No. 17 full of engine facts you need to know, sent free.

Sizes 2 to 16 H.P.

COLUMBIA ENGINE CO., 17 Fuller St.

DETROIT, MICH., U. S. A.

Please Mention Popular Mechanics

PERFECTION MARINE ENGINE 100% RIGHT

The big 1912 line of Caille Perfection Marine Engines from 2 to 30 H. P. give dollar for dollar more real service than most engines costing double their price—Perfection service is 100% right

Without a Rival

For yachts, cruisers and ferry boats, a Perfection power plant is without a rival and simply thrives on hard, tough work. It works equally well in fresh or salt water, tidewater or stream, calm or storm. It embodies more refinements than any other engine on the market. The Igniter Equipment with the 6 H. P. and 8 H. P. insures a water-proof ignition and does away with batteries, coils, magneto and timer.

Free Book of Engines

Our new 1912 Engine Prompt Book is free for the asking—refer to it any time for the true and correct meaning of Standard Construction; write today while you have the subject in mind—get book and refer to it, no matter what motor you buy. If your engine does not tally with this book, then you know you are not getting a Standard motor.

The Perfection owner could not buy a better engine.

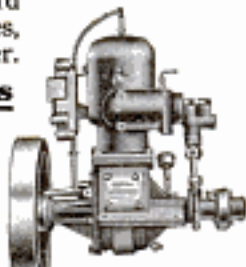

Sizes 2 to 30 H. P. Full Rating Guaranteed

CAILLE PERFECTION MOTOR CO.
1207 Caille Street DETROIT, MICH



WATKINS' SPECIAL MOTORS

3 H. P. Single Cylinder . . . 30 lbs.
4 H. P. Double Cylinder . . . 40 lbs.
12 H. P. Four Cylinder . . . 100 lbs.
A strictly HIGH GRADE Motor that will give CONSTANT and EFFICIENT service. Especially adapted for CANOES and LIGHT BOATS. Aluminum base, copper water jacket, steel shaft, bronze bearings.

THE WATKINS MOTOR CO.
837-839 West Sixth Street CINCINNATI, OHIO

THE RIGHT MOTOR FOR YOUR BOAT

We manufacture Two and Four Cycle Engines from 1½ H. P. to 60 H. P., from \$31.50 to \$1500.00. Write us, tell us what you want—if we have it, we will give you all particulars and quote you a price that will meet with your heartiest approval—if we haven't got what you want, we will tell you so and advise you where to get it. Our catalog contains information of vital importance, information that YOU should have—GET IT!



THE STRELINGER

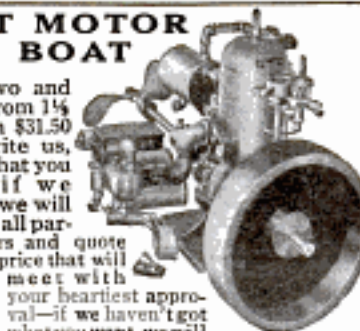

STRELINGER MARINE ENGINE CO.
171-175 Woodbridge W., Detroit, Mich.

Stop Paying for Marine Engine Experiments

Reputable agents wanted to handle popular-priced marine engine. Absolutely guaranteed for 5 years. Thirty days' trial by the purchaser. Your money promptly refunded, without question, if you are not fully satisfied.

A sure favorite and quick seller. Big returns assured. Simplicity the keynote of construction.

Just the engine you have been looking and waiting for. Combines the good features of the best, with all the bad ones eliminated.

Pool-proof. As near perfect as anything mechanical can be produced.

All sizes in stock from 2 to 50 h. p. Ready to ship on 24 hours' notice if necessary.

Details of the greatest selling plan and agents' money-making proposition ever offered.

Liberal discount, specified territory and absolute protection to accepted agents.

Some very productive territory still open.

Write today for Catalog

COLUMBIA ENGINE COMPANY
5 Mt. Elliott Avenue, DETROIT, MICH.

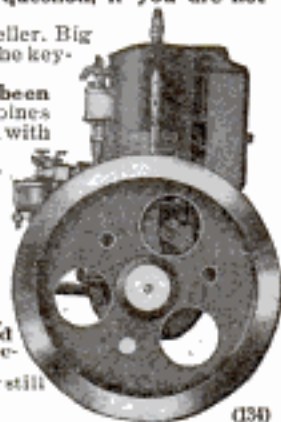

(134)

GRAY MOTORS FOR BOATS



Made in the Largest Plant in the World devoted to manufacturing 2-cycle marine gasoline engines.

3 H.P. with Complete Outfit ready to install \$55
ALSO 3½ TO 36 H.P.

Guaranteed by a big responsible concern. Write for big catalog—tells and shows you all about these high grade motors and how they are made.

GRAY MOTOR CO., 792 U. S. Motors Bldg., Detroit, Mich.

ORIGIN OF THE WORD "FOOLSCAP"—Various explanations are given of the odd name of foolscap paper. Some persons have thought that it came from the habit of teachers in school of rolling up a sheet of the big paper and setting it as a fool's cap on the head of some child who had not learned his lesson. But the historical facts about it appear to be quite otherwise.

The name was given by so dignified a body as an English parliament. It was the so-called Rump parliament.

Big Bargains in Launches



My low prices on launches have staggered the trade. I'll sell you a first-class launch with a simple, powerful engine ready to run, for less than half what you pay elsewhere. That's a strong statement, but a true one. As a naval architect I'm in a position to undersell all others.

Dozens of models in all sizes ready to ship. Every engine is a marvel of simplicity. Only three moving parts. No cranking necessary in this engine. Every outfit fully guaranteed. Send your name for special illustrated catalog, packed from cover to cover with money-saving boat and engine pointers. Address

B. A. LENHARD
1147 East Grand Boulevard, Detroit, Mich.

Buy From Naval Architect

As a special boat designer I can sell you a non-sinkable steel launch complete with engine for half what you pay elsewhere. Has air-tight compartments—can't sink, leak, break or rust. Engine a marvel of simplicity. Two-cycle reversible with speed controlling lever. Has only three moving parts starts without cranking. Every launch guaranteed. Built in 18, 20, 25 and 27-ft. sizes. My prices have every other boat builder wondering how I do it. Write me and I'll send you my big Free Catalog. It's brimful of boat information you ought to have. Write—right now! Address **ED. SWINK, 316 Fischer Avenue, DETROIT, MICHIGAN**



Complete With Engine—\$100

2H.P. Complete \$39

With all fittings, including propeller and shafting, stuffing box, wiring, etc., ready to install.

MARINE ENGINE

For all kinds of boats. Compact, silent, reliable, low running cost—a perfect two-cycle reversing engine. 5 years guarantee. So simple a child can run it. Used in Government Harbor Service, and Chicago Police Boats. 3, 4, 6 and 10 H.P. —proportionately low priced. Special prices to boat builders and agents. Big book free. Also STATIONARY ENGINES 2 to 12 h.p. NORTHWESTERN STEEL & IRON WORKS 746 Spring Street, Eau Claire, Wis.



Ready to Install

Engines at Half Price

I am a mechanical engineer and am in a position to sell you a good engine at a lower price than you can get one of the same quality elsewhere. My engines have only three moving parts—fewer than any marine engine on the market. Few parts mean few "lay-ups" for repairs. Simple enough for a child. Steady trollers—speedy racers. Every part a masterpiece of marine engine construction. Engines guaranteed five years. Send your name and I'll tell you why and how I can sell you a first-class marine engine at a rock-bottom price. Address

L. L. PLACE, 28 Wight Street, Detroit, Mich.

**Motor Boating Without Danger**

A Baldrige Reverse Gear will make your boat easy to control as an automobile. Send for FREE BOOK. THE BALDRIDGE GEAR CO. 682 W. Grand Blvd., Detroit, Mich.

ment of Cromwell's day, which decreed that the royal arms, formerly appearing as a water-mark on the best paper, should be replaced by a court jester's cap and bells in ridicule of the royal prerogative.

Those who secured the right to sell this best English paper had acquired large fortunes, and when the civil war came in England this monopoly was one to be abolished. From that day to this, paper of the particular size of this monopolistic manufacture has been called foolscap.—The Keystone.

FERRO MARINE ENGINES \$60 to \$500

The World's Standard Two-cycle Marine Motor. Ten sizes; one, two and three cylinders; 3 to 25 horse power. Exclusive 1912 improvements. 48-page Practical Treatise on Marine Engines free—a valuable reference book. THE FERRO MACHINE & FOUNDRY CO. 118 Hubbard Avenue, Cleveland Agents in principal Cities and Ports.

Get it now.

GIVES illustrations, complete specifications and prices of all our models, including Cruisers, Commercial Launches, Runabouts, Family Launches, Canoes, Rowboats, etc.

THE CLEVELAND AUTO BOAT MFG. CO. Dealers in all large cities. 1048 River Av., Cleveland

2 HORSE POWER

AMERICAN \$38

MARINE MOTORS COMPLETE OTHER SIZES 2 TO 20 HORSEPOWER PROPORTIONATELY LOW PRICES

GUARANTEED FOR LIFE. AGENTS WANTED.

Send for complete marine engine book FREE. AMERICAN ENGINE CO., 419 Boston St., Detroit, Mich.

**Expert Knowledge is the Best Tool**

for the man who drives an
**Automobile,
Aeroplane or
Motor Boat**

The American School's Complete Cyclopedia of Automobile Engineering
New 1912 Edition

1,700 pages, 7x10 inches in size, with 1,500 illustrations, full page plates, diagrams, etc. Substantially and handsomely bound in half morocco, printed on extra-grade paper, in large, clear type—chock-full of detailed information, facts and figures covering the entire field of Aeroplanes, Automobiles, Motorcycles, Motor Boats, etc.

This Complete Set Sent Free—Express Prepaid

—the full set of four volumes—without one cent of expense—without obligation on your part—just mail us the coupon. We let you keep the books seven days, while you thoroughly examine them. Then—if you do not want them—notify us, and back the goods come, at our expense. Or, if you wish to keep them, you can do so at the special low price of \$12.80 which we are just now offering them at (the regular price of the set is \$20.00). Simply send us \$2.00 when writing that you wish to keep the books—then pay \$2.00 per month until paid for.

A Few Things Which These Books Inform You On

Gasoline, Automobiles, Explosion Motors, Automobile Mechanisms, Electric Automobiles, Steam Automobiles, Types of Automobiles, Motorcycles, Commercial Vehicles, Automobile Garages, Home Repairs, Automobile Driving, Motor Boats, Types of Aeroplanes, Aeronautical Motors, Building and Flying an Aeroplane, Glossary of Automobile and Aeronautical Terms, Self Starters, Electric Lighting Systems, etc.

Free with every order received before August 1, 1912

With each set is included a year's Consulting Membership entitling you to the free advice of a staff of Automobile Engineering Experts. This will give you practical help in handling working problems which are too specific to be taken up in detail in the cyclopedias. There will be no limit to this service. A single problem solved for you might be worth more than first cost of the books.

FREE EXAMINATION COUPON**American School of Correspondence**
Chicago, U. S. A.

Please send set Cyclopedia of Automobile Engineering for 7 days' free examination. I will send \$2.00 within 7 days and \$2.00 a month until I have paid \$12.80, or notify you to send for the books. Title not to pass until fully paid. Pop. Mech. 7-12

NAME.....
ADDRESS.....
OCCUPATION.....
EMPLOYER.....

A Measured Mile in Three Minutes FLAT

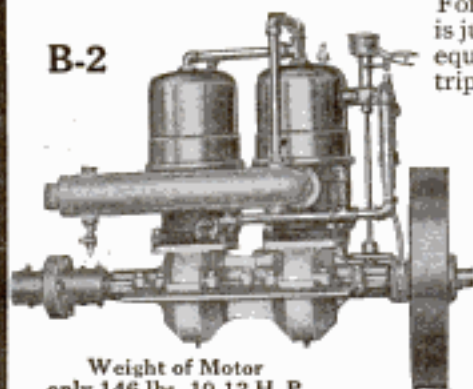
B-2

Weight of Motor
only 146 lbs., 10-12 H. P.

For small hydroplanes and Hand V bottom boats, a Waterman Motor is just the thing. One of our customers has just launched an 18-footer, equipped with our B-2 (only 10 to 12 horsepower) and on the trial trip went over a measured mile in three minutes flat.

There is a Waterman Marine Motor for every purpose—guaranteed for life. Light—strong—dependable—smooth-running.

The Porto—Two in One—

makes a motor boat of any boat in 5 minutes, and also makes good ashore, running any machine requiring two horsepower or less.

Waterman Speed Motors

are made with aluminum crank cases, copper waterjackets and all other high grade features. Don't fail to write for catalog today. Our concise, fully illustrated book of marine engine values will be mailed on request, FREE. Send for it NOW.

WATERMAN MARINE MOTOR CO., 1507 Fort St., West, DETROIT, MICH.



REO THE FIFTH Mr. Olds' finest creation—his FAREWELL CAR—with center Cane-Handle Control.
R. M. Owen & Co., General Sales Agent for
REO MOTOR CAR CO., LANSING, MICH.

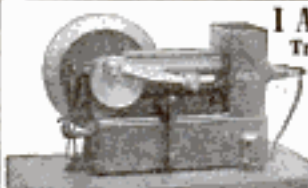

I Am Yours for \$1950
Try me for 10 days

This is our 1-2 horse power Gasoline Engine fully equipped. Batteries, Switch, Coil, Spark Plug, Gasoline Tank, Mixing Valve, all ready to run. Fully Guaranteed. Return if not satisfactory and money refunded. Will run Washing Machines, Cream Separators, Butter Churns, or any light machinery where small power is required. Includes 2¢ stamp for reply.

SIEVERKROPP ENGINE CO., 1224 18th St., Racine, Wis., U.S.A.

Write today
for Big
Illustrated
Engine
Book "S"

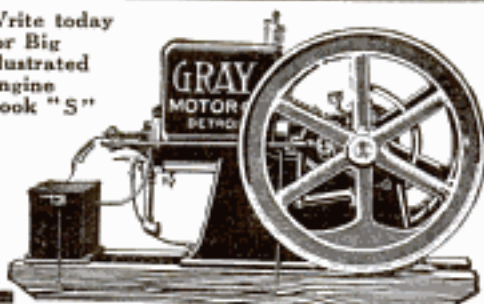

POWER FOR THE FARM, SHOP AND COUNTRY HOME

Complete ready to run—fuel tank in base—water cooled—wonderful economy, uses Kerosene or Gasoline—12 sizes, 1½ to 36 H. P. **30 DAYS TRIAL.**

GRAY MOTOR CO., 732 U. S. Motor Bldg., Detroit, Mich.

Get This Power Boat at Maker's Prices

BUY DIRECT FROM MANUFACTURER AND SAVE DEALERS' PROFITS

This Toppan Power Dory as illustrated above is made of best guaranteed materials and is the standard rough water boat of the world. Safe and reliable—used by U. S. Government in all departments. Send 4¢ in stamps for catalogue. Ask for prices and facts about Toppan Reversible Motors, built with 2, 3, 4 and 12 Horse Power—and if you want to build your own dory, saving exactly HALF, ask for "TOPPAN" BOAT MFG. CO. FREE KNOCK-DOWN BOAT QUOTATIONS. 5 Haverhill St., BOSTON, MASS.



BAY STATE MOTORS

"Perfect Simplicity" and "Simple Perfection" are the results, embodied in these Motors, of 15 years devoted to the developing of these essential characteristics, which enable us to put on the market a reliable and economical motor at a reasonable price. Write for catalog, stating size and type (2 or 4 cycle) of motor wanted. We also furnish castings for these motors.



BAY STATE MOTOR WORKS

Successors to
A. J. HOULE MOTOR WORKS
580 South East Street, HOLYOKE, MASS.

An English missionary has published a book about the natives of Africa in which he makes the startling statement that the compulsory wearing of clothes by people not accustomed to them is of doubtful good as it gives an excuse for the development of self consciousness and self importance.



Our original construction allows a person of ordinary intelligence but without knowledge of tools to build from our knock-downs in an incredible short time the fastest and most seaworthy type of boat yet designed, thereby saving more than 1/3 the cost of such a boat. Something new in construction, no steam bending, difficult fitting, or preliminary moulds. It will pay you to investigate. Send five cent catalogue P. M. stating whether you are interested in complete boat, knock-down, plans or pattern.

BATH MARINE CONSTRUCTION COMPANY, BATH, ME.
A. F. BOMER, 216 State St., Boston, New Eng. Sales Agt.

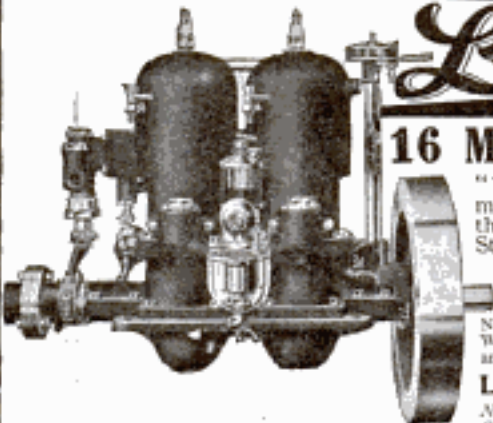

LA MARINE MOTORS

Built On Honor

16 MILES UP THE RAPIDS IN 3 HOURS

"With your 5 horsepower, 2-cylinder motor in my 16-foot boat, I made 16 miles up the worst rapids in the Mississippi River in three hours on about two-third speed."—F. M. Bacon, 2706 Teck St., Fort Madison, Iowa.

L. A. Marine Motors are Sold on 30 Days Trial—They Always Make Good

No outdoor sport can equal motor boating if you have a Lockwood Ash Motor. Write today for our beautiful 1912 catalog. Gives all details and specifications, and quotes prices that you cannot equal—quality considered—anywhere.

LOCKWOOD ASH MOTOR CO., 108 Horton St., Jackson, Mich.

Nothing is too much trouble for us if it means better satisfaction to one of our customers. Our SERVICE is as good as our engines. PROMPT SHIPMENTS GUARANTEED.



DIAMONDS - WATCHES ON CREDIT

LOFTIS
CREDIT SYSTEM

HOW EASILY
- YOU -
CAN WEAR
AND OWN A
DIAMOND
OR A WATCH

Send for These Two Books—They Are Absolutely FREE!

Write for our handsome free catalog. It contains over two thousand (2,000) beautiful illustrations of diamonds, watches, solid gold jewelry, silverware and novelties at bargain prices. Select any article desired, have it sent to your own home or express office—all charges prepaid. If it is entirely satisfactory, send one-fifth the purchase price and keep it; balance in eight equal monthly amounts. We are offering great bargains in ladies' and men's watches. Our Blue Book, which tells "How Easy You Can Wear a Diamond or Watch by the Loftis System," answers every question that a person could ask about our liberal credit plan or concerning the purchase of diamonds, watches and jewelry on credit. It is beautifully embossed in blue and gold and is worth its weight in gold to anyone interested in our line.

Both of these books will be sent to you absolutely free upon request. Order today.

LOFTIS BROS. & CO.

THE OLD RELIABLE, ORIGINAL Diamond and Watch Credit House
Dept. 8894 100 to 108 N. State Street, CHICAGO, ILL.
Branch Stores: Pittsburgh, Pa., and St. Louis, Mo.

LOFTIS BROS. & CO.
THE OLD RELIABLE
DIAMOND AND WATCH CREDIT HOUSE



\$50 A Week—EASY

Here's the easiest, quickest money you ever heard of. Just send name and address—we will ship—express prepaid—Sweetest Big Outfit of Samples and Color Plates, showing over 100 correct and latest styles in Men's Made-to-Measure Clothing; also special offer of a free suit to you. We back you to win, no money or experience necessary.

Best Tailoring On Earth

Appeals to every thinking man. Suits and Top Coats, \$9.50 up; Pants, \$2.50 up. Perfect work guaranteed or money back. Special confidential, inside wholesale prices and guarantee you can undersell all others. You coin money with our goods. We put you in big paying business and take all risk, show you how and give you exclusive territory. Most liberal attractive offer ever made, bar none! Your one best chance. Keep this private and write us today.

ELK TAILORING CO.
280 Jackson Blvd., Chicago



THIS SUIT
and Big Outfit FREE

Canoeing Fishing

The Baldwin Camp Lamp

Gives a white penetrating light. Burns acetylene gas. Can be fastened to cap or belt, carried in hand or stood upon table. Stays lighted in the strongest wind—absolutely safe. No oil, soot, dirt or grease. For Camping, Fishing, Canoeing, Boating, Hunting and Woodcraft.

3 1/2 inches high, weighs (charged) 5 ounces.

For sale at leading Sporting Goods and Hardware Dealers, or sent by mail prepaid upon receipt of price—Brass \$1.00; highly polished nickel plate with hinged handles \$1.50.

Write for free booklet stating name and address of your dealer.

JOHN SIMMONS CO.
34 Franklin Street
New York City
52 St. Nicholas Street
Montreal, Can.

Hunting Camping

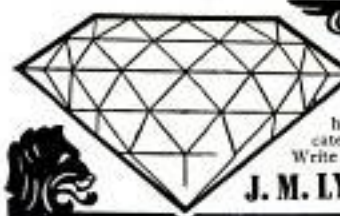

Diamonds on Credit

20% Down; 10% a Month

Every customer is protected by our written guarantee to refund his money if his dealer can duplicate our diamond at our price. Write for Illustrated Catalog No. 3.

J. M. LYON & CO., 71-73 Nassau St., New York City

SUCCEED IN LIFE

You cannot accomplish great things nor climb to the top of the ladder of success unless your muscular development is given proper attention because that is the only way the arteries, the nerves and the vital organs can keep the machinery of your body in wrecking harmony. Educate yourself in deep breathing and attain great strength and vitality by reading the wonderful book "Intelligence in Physical Culture" written by Lionel Strongfort, the world's strongest and most perfect athlete. The Strongfort system of physical culture is a revelation in health culture and body building. It explodes many of the weak points and the fallacies of other systems showing why they fail and making it easy for you to accomplish your dreams of fame and fortune through the vitality, strength, health, strong nerves and perfect poise that my method teaches. The Secret of Success. My original methods are effective and when you write me you will always have my personal attention. Send 4 cents for postage and secure this book; it will start you toward health and happiness today.

LIONEL STRONGFORT
Department P.S., Mohegan Lake, New York



LIONEL STRONGFORT

MOTORCYCLE SUPPLY CATALOGUE

LOWEST PRICES—LARGEST EVER ISSUED

1000 guaranteed articles for the motorcycle owner at rock bottom prices.

A hundred new imported articles you should know about.

For 4c postage, catalog will be mailed to you.

Write today.

MOTORCYCLE EQUIPMENT CO.
HAMMONDSPORT, N.Y.



Please Mention Popular Mechanics

Disfigured Walls made Beautiful



TRUS-CON STONETEX

A Liquid Cement Coating for
Stucco, Concrete and Brick

APPLIED WITH A BRUSH

Uniform in color results. Absolutely dampproof. Prevents mould and dampness reaching inside. Weather resisting. Does not chip off, crack or peel like paint. Becomes an inseparable part of the wall, sealing all pores and filling hair cracks, giving an artistic flat finish as hard as flint. Adds to external beauty and durability of buildings. Stone-Tex is furnished in various colors.



Free Stone-Tex Color Card and valuable suggestions if you write about your building.

Trussed Concrete Steel Co.

462 Trussed Concrete Bldg., Detroit, Mich.

Dampproofings, Waterproofings, Tackalac Paints

When you want anything and don't know where to find it—write Bureau of Information, Popular Mechanics, Chicago



**WE SELL YOU
AT WHOLESALE**

Agents' Price One

AMERICAN

Motorcycle or Bicycle

\$139⁸⁵

Honest hand-made machines at factory cost. Write now for catalog. Say whether interested in Motorcycle or Bicycle.

AMERICAN MOTOR CYCLE CO., 107 American Bldg., CHICAGO



\$18⁸⁵

Learn Electric Signalling



At Home—By Mail

A splendid profession. Great opportunity. Big demand by railroads for signal engineers. More men needed all the time to fill vacant positions. You can keep present position while learning.

\$1,800 TO \$4,500 PER YEAR

Rapid advancement from the first. Easy to learn. Taken out about time. Write today for free booklets. Do not put this off. Special offers to new students.

DEPARTMENT OF SIGNALLING, Dept. 1197, 491 Cass St., CHICAGO



ONLY \$4.50

For this beautiful, solid quarter-sawn oak table, paid only direct from factory. Genuine Brooks Master-Built construction. Will last a lifetime. Completed and finished in color desired—then shipped in sections. Easily assembled in a few minutes. Height 30 in., top 25 in. square. Suitable for sewing table, side table, or for magazine. Price Five Dollars. Illustrating 100 designs. Sent on request. Mail a postal for it today. Address

Brooks Table No. 309

Brooks Mfg. Co., 2807 East Ave., Saginaw, Mich.



OLD COINS

\$7.75 paid for RARE date 1853 quarters. \$20.00 for a \$15. We pay a CASH premium on hundreds of coins; keep all money dated before 1884 and send TEN cents at once for our New Illustrated Coin Value Book, size 4 x 7. It may mean your fortune. C. F. CLARKE & CO., Coin Dealers, Dept. P, LE ROY, N. Y.

PORTRAIT AGENTS

We make the best Portraits in Chicago, and we can prove it. Frames at wholesale prices. Samples Free. 30 days credit. Send for our 1912 Catalog. ILLINOIS ART CO., 6310 Westwark Ave., Dept. P, CHICAGO

Practical Applied Electricity

By DAVID PENN MORETON, B.S., E.E.

Associate Professor of Electrical Engineering at Armour Institute of Technology

A book that has long been needed. It is a practical man's talk to practical men, so simple, thorough and up-to-date that the untrained as well as the trained electrical worker or artisan can obtain a complete knowledge of the subjects treated. A book of handy form and convenient size, especially designed to be a practical working guide instead of mere theoretical discussions intended only for the student.

Practical Applied Electricity is the outgrowth of actual work combined with classroom experience. The author is Associate Professor of Electrical Engineering at the Armour Institute of Technology, an institution foremost of its kind in the world. Most of the students taking the electrical course attend the evening classes, being employed at electrical work through the day. The problems which confront these students are embodied in this book—one reason for its being so practical and up-to-date. To illustrate this valuable information, careful detailed line drawings have been made under the personal supervision of the Author. In plain words—this book contains the experience of a large number of ambitious electrical workers, gathered together by a recognized authority on the subject.

Regular Edition. Bound in black flexible leather. Price \$2.00 net. Postage extra 10 cents.

Engineers' Edition. Bound in black flexible leather with protecting flap and inside pocket; also including 16 pages of co-ordinate blank paper for memoranda. Price \$2.50 net. Postage extra 12 cents.

450 pages, 273 special illustrations, 50 half-tones, diagrams and descriptions—20 full pages of tables. Pocket size 4½ x 7¼ inches

POPULAR MECHANICS BOOK DEPT., 318 W. Washington St., CHICAGO



Prest-O-Lite

The only efficient lighting system for automobiles and motorcycles.

MAKERS OF
 Prest-O-Lite
 Prest-O-Starter
 Prest-O-Welder
 Prest-O-Liter
 Prest-O-Tire Tube
 Prest-O-Tire Tanks
 Prest-O-Carbon Remover



The Light Universe

Ask for Booklet on any or all of them

The Prest-O-Lite Co.
 265 East South Street
 INDIANAPOLIS, IND.

Thirty eminent European geographers have been invited by the American Geographical Association to help in its unique celebration of the 60th anniversary of the founding of the association. The celebration will take the form of a trip across the United States during the course of which the geographical, ethnological and geological data of each section will be studied.

Agents Wanted



HERE YOU ARE

Sharpen Your Own Razor or Safety Blades with Our

AUTOMATIC RAZOR SHARPENER

EASY, ACCURATE, GUARANTEED

AUBURN SUPPLY CO., Dept. D, 7746 Peoria St., CHICAGO

Postpaid
\$1.50



Helios Lighting Storage Battery

These storage batteries are suitable for all experimental work. They are made for any voltage, and are listed for the following uses: Automobile lighting, motor boat lighting, wireless experiments, signal circuits, and for all electrical experimental work. Send us 2 cents today for our booklet, showing how storage batteries are applied to the lighting of boats, automobiles and miniature plants.

HELIOS MANUFACTURING COMPANY, Bridesburg, Phila.



BE INDEPENDENT

Don't depend upon public service for your light and small power. Get one of our small engines; they are especially designed for household use, and are ridiculously inexpensive.

1-4 and 1 H. P. engines complete \$20 and \$27.50

Send stamp for catalogue

THE ELGIN WHEEL & ENGINE CO.
 112-114 Douglas Ave. ELGIN, ILL.

\$7⁵⁰

=

And You
Keep
This

Great Engine

We will ship you a Schmidt's Chilled Cylinder Gasoline Engine for you to use as if it were your own for 10 full days. Then, if you don't want it send it back at our expense. If you wish to keep it, pay as low as \$7.50 and you can pay rest in easiest monthly payments. Send coupon or a postal card for all particulars.

We Send This Engine FREE

We do this to prove that the Chilled Cylinder is the simplest and most economical engine ever built. We want you to see for yourself that it is better than any other engine that costs twice and three times as much. Schmidt engines are the only engines with the marvelous, powerful chilled cylinder. The engine with spark retarders. The new type gasoline engine that has revolutionized the gasoline engine industry. The only engine good enough to send out on actual free trial to sell itself. Your choice of many sizes. Catalog free.



SCHMIDT'S CHILLED CYLINDER GASOLINE ENGINE



Ten Days' Free Trial

This is the first genuine free trial ever offered on gasoline engines for farm and shop use. No other manufacturer has ever dared to make such a liberal offer. Do not put the paper down without sending the free coupon.

Take a Long Time to Pay

If you like the engine after trying it out for 10 whole days you can keep it and take a long time to pay for it on easy monthly payments. Schmidt's Chilled Cylinder Gasoline Engines are absolutely guaranteed five years in every part. The biggest bank in Iowa backs our \$500 challenge offer. Write to us promptly for particulars and we will send you our valuable book, "How to Use Power" free.

Schmidt Bros. Co.
Engine Works
 Department 119Y
 Davenport Iowa

FREE BOOK COUPON

Schmidt Bros. Co.
 Engine Works
 Dept. 119Y
 Davenport, Iowa

GENTLEMEN:—Please send me description of your wonderful Chilled Cylinder Gasoline Engine, also your book, "How to Use Power," also Schmidt Bros.' catalog and full particulars of your free trial and easy payment plan. All free and postpaid.

NAME.....

ADDRESS.....



Auto-Electric Refrigerating Plant Cuts Your Ice Bills in Half

This is a miniature refrigerating and ice-making plant and it can be attached to any ice box. Other sizes suitable for stores, meat shops, hotels, homes and hospitals, where pure, clean ice is required. It insures a dry cold ice box free from germs, with a refrigeration in 24 hours equal to that obtained by 200 lbs. of ice, and in larger sizes up to three tons. It maintains an even temperature automatically, never varying more than two degrees. Small plant requires no engineer. Makes from 10 to 50 lbs. of ice a day. Motor requires no special wiring for small machine, can be connected to any electric light socket. No unnecessary plumbing. Machines are made in all sizes, to fit any ice box.

Write today for full particulars.

Auto-Electric Refrigerating Company
Suite M 243, Railway Exchange CHICAGO, ILL.

\$1500⁰⁰ Made in One Month with a Long Popcorn Crispette Machine

"I made \$1500 first month in Louisiana with this same machine."—H. W. Eakins. Why shouldn't you do as well? Field is big—profits immense. Machine easy to operate Popcorn Crispettes are tasty—tempting, delicious. Everybody likes them—everybody buys. Almost four cents profit on every nickel. If you follow instructions you should make \$500 a month this summer at

**Fairs, Parks, Summer Resorts
Carnivals, on Street Corners, Stores, Etc.**

Think how freely pleasure seekers spend money. It rolls in like water. Get a good location and big income is assured. Start anywhere—makes no difference. I tell you how to succeed. New man in Michigan sold 10,000 crispettes first week. It's a great business. Great fortunes are made in nickel propositions. Crispettes sell for a nickel. Get my story. Write today. See what there is in this proposition for you.

W. Z. Long, 575 High St., Springfield, O.

Garages, Automobile Owners, Mechanics

The Deam Wash Gun is what you want. Economical, Durable Practical and Simple. No Repair Shop is Complete without One. Not only indispensable for use by automobile users, but for cleaning all kinds of machinery, typewriters or



Brush 25c extra Price of Wash Gun \$5⁰⁰ (F. O. B. Chicago)

printers' forms, as a fire extinguisher for automobile service. By adding a special spray nozzle so as to handle the spraying compound used on flowers and shrubbery, the gun becomes indispensable for florists and nursery use. An attractive proposition for live agents to make big money.

Deam & Co., Dep't P.M., 507 Great Northern Bldg., Chicago

TYPEWRITERS

LONG TIME PAYMENTS
Free Trial—Agent's Prices



Send for a copy of our sensational book "Typewriter Secrets." It will tell you how you can get a 5 dollar typewriter at about the price usually asked for so-called "rebuilt" and high-grade "second-hand." How you can arrange to pay in small monthly payments—protect yourself by trying the typewriter first. This Syndicate has a proposition for you that you will be glad to accept. Do not overlook this—send for the book today.

Typewriters Distributing Syndicate
166-P. O. No. Michigan Blvd., CHICAGO

THE JAPANESE NAVY—The Japanese navy at present comprises 62 vessels, with a total displacement of 450,500 tons. In addition 11 ships are in course of construction or contracted for, including the Kawachi and the Settsu, each of 20,800 tons, which are nearing completion. A third super-dreadnought of 30,000 tons will be built by 1915. Other projected naval construction includes four first-class cruisers of 27,500 tons, three third-class cruisers of 4,950 tons, a 700-ton gunboat, two 1,200-ton destroyers and one submarine.—Detroit Free Press.

BIG MONEY MADE



Operating Our Amusements

At Parks, Fairs, Carnivals, Etc.

Small Investment—Anyone can be successful

We build those Funny Mirror Shows, and have perfected a new kind of mirror, made of metal, that has reduced the cost of this popular attraction 75%. Fortunes have been made with the "Laughing Mirror"

Shows in the larger cities. Just as much chance to make money in the smaller places, and on a much smaller investment. We make the "African Dip" and the tick stairway that drops the negro in the tank of water.

We make a new style Moul Striking Machine; a Baseball Poker Game; Moving Water Fish Ponds, and other money-getters. Catalog Free.

J. M. Naughton Amusement Co., Mayer Bldg., Peoria, Ill.

Your Picture in a Postal Card IN ONE MINUTE



The pictures are developed, toned and finished in a single developing solution. No experience is necessary. Price of machines \$7.50 and \$25.00—catalogs describing our machines sent free. We are also headquarters for supplies for all minute picture machines.

AMERICAN MINUTE PHOTO COMPANY
Dept. Z 252, 2214 Ogden Ave., Chicago, Illinois
The largest manufacturers and distributors of minute picture machines and supplies in the world.

BUILDING CONTRACTORS Save \$6 a Day with the RAPID FLOOR SCRAPER

One man does more than three men by hand. Scrapes hard or soft wood and makes a finished job, 500 in use.



Free Trial
Pay Us When Satisfied
Catalog Free

MONARCH MFG. CO., 507 Shepard Bldg., GRAND RAPIDS, MICH.

Get Your Canadian Home From the Canadian Pacific



The
Home
Maker

THE richest virgin soil is waiting for you in Manitoba, Saskatchewan and Alberta. Go where you can prosper, earn a farm home in a few years—farmers have paid for their farms with one crop. First prize of \$1000.00 for best wheat in the world was awarded by American judges at the New York Land Show to a western Canadian farmer. Anyone can own land in Western Canada.

Land From \$10 to \$30 an Acre Ten Years in Which to Pay

The Canadian Pacific Railway offers you the finest irrigated and non-irrigated land along its lines. Land adapted to grain growing, to poultry raising, dairying, mixed farming, and cattle, hog, sheep and horse raising. Select your own land. Decide what kind of farming you want to follow, and let the Canadian Pacific Railway put you on the road to fortune.

To renters having sufficient farming experience and equipment the Canadian Pacific will loan money for a period of ten years at 6% for the purposes of erecting buildings and completing the improvements on their newly purchased Western Canadian farms.

Ask for our handsome illustrated books on Manitoba, Saskatchewan and Alberta—mention the one you wish. Also maps with full information free. Write today.

G. E. Thornton, Colonization Commissioner

Canadian Pacific Railway

Colonization Department 112 W. Adams St., Chicago

FOR SALE—Town Lots in all growing towns. Ask for information concerning industrial and business openings in all towns

WHEN YOU WANT ANYTHING AND DON'T KNOW
WHERE TO FIND IT—WRITE BUREAU OF
INFORMATION, POPULAR MECHANICS, CHICAGO

Printing Paper Stock for Sale

At a Bargain A considerable quantity of flat paper stock, fine quality Egg Shell, India tint, 38x50-140 suitable for catalogs, etc. This stock was specially made to order for use in one of our own publications. A radical change requires a different printing stock. This paper was purchased before the recent advance in paper and will be sold at less than cost, making a real bargain for any one who has use for an elegant stock in Egg Shell India.

ADDRESS

Popular Mechanics Magazine, Chicago

Boy Scouts! Get This Offer

\$4⁹⁵

Size 7x7 ft.
Genuine Full Weight
8 oz. Duck



Real Wall Tent

Complete with poles and pins.

Just the tent for "camping out." Large enough to accommodate 4 boys in great shape. If you are going on a camping trip you simply cannot afford to be without this remarkable tent. Only \$4.95. And you can set it up in your back yard and sleep in it during the summer months. *This is the greatest bargain ever made on a genuine 8 oz. Duck Wall Tent.* If you don't want to buy the tent alone, get two or three of your friends to go in with you. **BOY SCOUTS THINK IT'S GREAT!**

Army Shelter Tents

Commonly called "Dog Tents"—Made up in
2 Sections—Complete with poles and pins.

Special White Cloth

\$2

Special Khaki Cloth

\$3



These are used for temporary shelter for troops, each soldier carrying one section and one pole—poles are spliced. 5 ft. 3 in. long by 3 ft. 6 in. wide by 3 ft. 9 in. center height. Just the kind of a tent the U. S. soldiers use when they are out in active service. It can be put up or knocked down in a minute. Every Boy Scout—every boy—who loves outdoor life and adventure should own a shelter tent. Can be rolled up and strapped to the back.

"Camp Guide" FREE

Send Post Card Today We have a remarkable book—a "Camp Guide" which tells all about camp life; how to lay out a camp; what to take along; what to do when you get there. We will send this great book to you absolutely FREE. Just send a post-card. We will send you a copy FREE by return mail.

H. Channon Company
Dept. 119Y—Randolph and
Market Streets, Chicago, Ill.





Utility Wall Board is a tough fibre board put together with two insulations of Natural Water Proof Asphalt, rolled under tremendous pressure into one solid compact sheet and surfaced on both sides with special moisture proofing—

**It is the only Wall Board
Made Under This Scientific
Moisture Proof Process**

UTILITY WALL BOARD

takes the place of both lath and plaster—It is very tough and durable—It is easily cut with an ordinary saw and is nailed direct to the studding. It will not warp, or crack, or shrink—and may be decorated in any style desired.

It is used in building the new house—and in making over the old—Put it on right over old and cracked plaster if you wish—The cost is less than lath and plaster.

Write for a sample and the illustrated book.

THE HEPPEES COMPANY, 4516 Fillmore Street, Chicago, Ill.



ROBERTS MOTORS

THE MOTORS THAT NEVER BACKFIRE

FOR AEROPLANES



H. E. Wetzix flying at Roswell, New Mex., with his Roberts 4-X 53 H. P. Aviation Motor

If you are looking for a motor that will make flight safe and certain, you can make no mistake by placing your confidence in a Roberts. You can find only "Boosters" among Roberts Motor users. We shall be pleased to send you unsolicited letters of appreciation received from many prominent aviators.

Three sizes, 4 cyl. 50 H. P., 6 cyl. 75 H. P.
6 cyl. 125 H. P.

Our Aviation Motor Catalog
will be sent upon request

FOR BOATS



This boat is making 27½ miles per hour with a 30 H. P. Roberts which was built in 1908! In this, the fifth season of service, the motor is still on the job and in perfect working order.

You want your money's worth. You want a motor that will make boating a real pleasure and not a lot of trouble.

A Roberts will cost a little more at first but much less in the end.

Twelve sizes—twenty-one models—a motor for every craft

Our Marine Motor Catalog
will be sent upon request

THE ROBERTS MOTOR CO

1419 COLUMBUS AVE., SANDUSKY OHIO U.S.A.

Please Mention Popular Mechanics

Crease 'em with "Nu-Pantz"



Crease your trousers in five minutes with the "NU-PANTZ" Creaser. Also presses ties, creases coat sleeves, removes wrinkles, etc. Does the work just as your tailor does it, by heat and pressure. Self-heated any time, any place, in three minutes. Pressure exerted by spring tension, simple and easy to operate with perfect results.

Save Half the Expense of Being Well Dressed

One suit with the "NU-PANTZ" gives more real service than two without. Save two-thirds the usual pressing and always appear neat and well-kept. Soon repays its cost many times and adds hundreds of dollars to personal appearance.

Five Days Free Trial Complete aluminum outfit weighs but two pounds. Send \$3.50 for the "NU-PANTZ" Creaser, express paid. Use it five days, if you wish to part with it we will pay return express and immediately refund your money.

Write at once for complete description and approval offer.

RACINE CREASER CO., 5th St., Racine, Wis.



POCKET TOOL KIT



**47 PERFECT-PRACTICAL
SPLENDID TOOLS \$1.00**

Made of highly tempered steel, handsome nicked case, size ordinary pocket knife, for desk, home, pocket or shop. No toy. A 20th Century marvel, needed by every man, woman or boy every waking hour because of its manifold uses. Astonishes everybody. Made on honor. Sold on guarantee, postpaid. Remit \$1.00 TO-DAY. Makes an attractive and acceptable holiday present.

**L. E. B. SALES CO., 115 BROADWAY
NEW YORK**

Mullin's Steel Motor Boats



Have no equal. Can't sink or warp. Puncture-proof, noiseless. Lowest in price, too. Complete line of Row Boats, Hunting and Fishing Boats and Marine Engines. Write for finest Boat Book ever printed. Free, postpaid.

THE W. H. MULLINS CO., 151 Franklin Street, Salem, Ohio

5 H. P. 1912 Peerless Motorcycle



With Free Engine Idle and Back Magneto together with the best there is in motorcycle construction—Power, Silence, Endurance, and Heavy Wearing qualities so essential for low cost of maintenance.
5 MILES FOR ONE CENT
Agents Wanted—Liberal Discounts

PEERLESS MOTORCYCLE CO., 179 Marlboro Ave., BOSTON, MASS.

HALL'S AUTOMATIC WHISTLE For MOTORCYCLES and BICYCLES



Hall's Automatic Motorcycle and Bicycle whistle works easier, looks better, sounds clearer and is cheaper than a bell. Sent direct to your address, transportation charges paid, for \$1.00. This latest device in motorcycle signals is made of steel and brass, handsomely nickel-plated and polished. Full directions for attaching enclosed with each whistle. Guaranteed to be perfect in every respect or money refunded. Send us your order today.

**H. & H. SPECIALTY CO., Sole Manufacturers
No. 19 Camfield St., NEWARK, N. J.**

Ann Arbor "INSTANTO" LIGHTING SYSTEMS

Change from 150 C. P. to 2 C. P. in a jiffy. The most up-to-date and complete lighting system on the market. Just the thing for summer houses. Attractive high candle power, inverted arcs for stores, halls, etc. Best proposition for hunting agents. Write today for terms and territory. Catalog free.

SUPERIOR MFG. CO., 234 2nd St., ANN ARBOR, MICH.

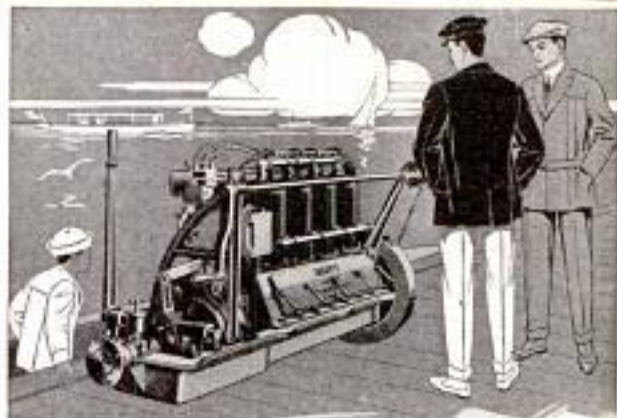

"YES SIR! That motor will do the business. The Scripps has the best stuff in it that can be bought. It will make you a compact, strong power plant—one upon which you can always rely. It's a complete, unit marine engine and gear—well designed, accurately constructed and thoroughly accessible. I know several men who are changing to Scripps equipment this year. They are wise."

Write for catalog describing our entire line of Complete Power Plants from one to six cylinders, 4 to 100 H. P.

**THE SCRIPPS
COMPLETE
MARINE POWER PLANT**

Scripps Motors are carried in stock in New York by **BOWLER, HOLMES & HECKER CO., 145 Liberty Street, New York City.**

The Scripps Complete Marine Power Plant.
"The motor that really did master Niagara"

SCRIPPS MOTOR CO., 650 Lincoln Ave., Detroit, Mich.

PUNCTURE TIRE INSURANCE $\frac{1}{3}$ ¢ Per Day

Pick up a nail?—just pull it out and ride ahead
If your tires have **SEALO TREATMENT**

Every motorist knows that the delays, expenses and discomforts of punctures are less serious than the ruin of engines resulting from riding soft or flat. No tire maker will make good his guarantee if you don't keep your tires pumped hard.

Write To-Day for **SEALO Tire Book (Free)**. Contains advice of many experts on how to get your money's worth out of your tires.



—seals punctures automatically while you ride. Apply it yourself! Keeps full pressure in tires.
MONEY BACK GUARANTEE in writing that SEALO will close all punctures and will retain its properties for the full life of the tire.
Splendid offer to dealers.

**SEALO TIRE CO.
Dept. 712B
1409 MICHIGAN AVE., CHICAGO, ILL.**

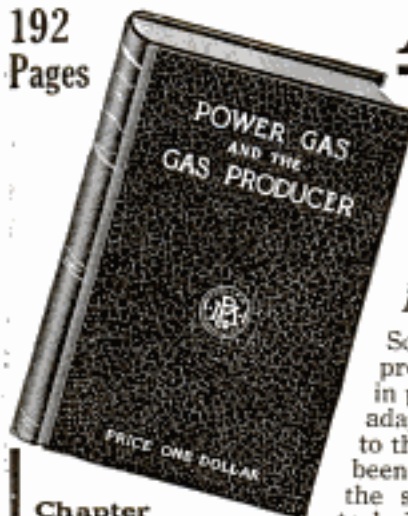
192
Pages

A NEW BOOK THAT IS NEEDED

Power Gas AND THE Gas Producer

By J. C. MILLER, M. E.

An Authentic Text Book and a Complete Reference Manual Covering Every Detail of Installation and Operation.

Price \$1.00

Sent Postpaid to Any Address

Scarcely twenty years have gone by since the Gas Producer was first proposed for power purposes, and in this short time its growth in use and in potentiality has proceeded by leaps and bounds. The new method of adapting the latent power in coal to man's best use is still a mystery even to the well informed, because nearly all the literature on the subject has been written under the assumption that the reader knows as much about the subject as the writer. A comprehensive treatise, clear of abstruse technicalities, in every way authentic, yet

Chapter Headings:

1. Producer Gas and the Gas Producer
 2. Classes of Gas Producers
 3. Industrial Gases
 4. Comparison of Heat Values
 5. Types of Producers
 6. Gas-Producer Fuels
 7. Gas Producer Operation
 8. Gas Power and Steam Compared
 9. Reliability of Gas Power
 10. Gas and Steam Power Costs
 11. Gas Producer Installation
- Alphabetical Index

"Written So You Can Understand It"

has therefore been needed for some time. Such is the book just published. The author is an authority on his subject, and he has covered it thoroughly.

FOR THE STEAM USER

This book will enable the Steam User to judge intelligently as to the economy and advisability of changing from Steam to Producer operation.

FOR THE STEAM ENGINEER

It will enable the Steam Engineer to understand thoroughly the working of the new system if the change is made, and to handle a plant competently and with confidence.

"POWER GAS AND THE GAS PRODUCER"

is published in one handsome volume of 192 pages, printed on the best quality of book paper, profusely illustrated with half-tones from photographs, diagrams, etc., and durably bound in extra cloth.

POPULAR MECHANICS BOOK DEPT., Publishers
318 W. Washington St., CHICAGO

A Valuable New Book on an Important Trade

PATTERN-MAKING

By G. H. WILLARD

With Additional Chapters on Core-Making and Molding

"WRITTEN SO YOU CAN UNDERSTAND IT"

A book for the man who does the work. Written by a practical pattern-maker of many years' experience. Gets right down to business in the first chapter and keeps it up throughout the book. Full of kinks and actual working information. Profusely illustrated.

Chapter Headings

I. Pattern-Making as a Trade. II. The Tools. III. Woods. IV. Joints. V. Turning. VI. Turning (Continued). VII. Turning (Continued). VIII. Turning (Concluded). IX. The Circular Saw. X. The Circular Saw (Continued). XI. Machine Tools. XII. Machine Tools (Continued). XIII. Simple Patterns. XIV. Simple Patterns (Continued). XV. Simple Patterns (Concluded). XVI. Crooked Patterns. XVII. Large Pattern Work. XVIII. Large Pattern Work (Continued). XIX. Crosshead Guide Patterns. XX. Sweep Work. XXI. Pipe Work. XXII. Stove Pattern Work. XXIII. Molding—Machine Work. XXIV. Molding Pattern Work.

Part II—Core-Making and Molding

Chapter I. Core-Making, Simple and Complex. II. Principles in Molding. III. Loam Patterns and Loam Molds.

Everyone following this trade, or intending to learn it, should have a copy of this valuable book. Price, \$1.00 Postpaid

Published by

POPULAR MECHANICS BOOK DEPT.
318 W. Washington Street, CHICAGO

Two Significant Opinions:

"I think the book is the best I ever saw for the price."
EDWIN SLUYTER, Construction Engineer, Burroughs Adding Machine Co., Detroit.

"I consider this is a valuable book and should be in the hands of all men engaged in this line of business."
E. W. CLARKE, Wilmington Malleable Iron Co., Wilmington, Delaware.

224 PAGES 312 ILLUSTRATIONS

CLOTH COVER

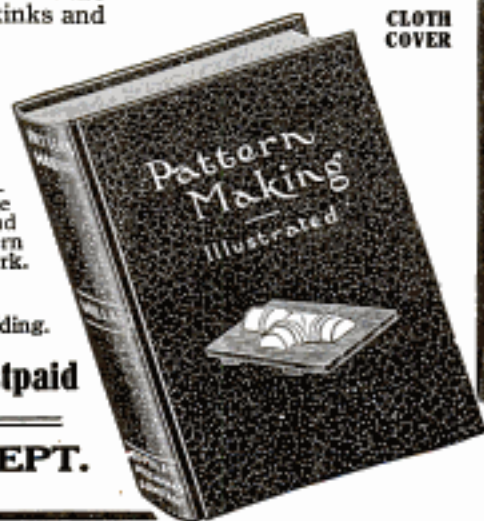

Reproductions of Five Great Paintings for 25c



This is a miniature of one of a series of FIVE Art Plates showing scenes of the West. The original plates are 11 x 20 inches, beautiful lithographic reproductions, in full color, of paintings by artists famous for depicting Western Life. The titles of the other four subjects are, "Attack on an Emigrant Train", "Westward Ho!", "The Relief Train" and "A Fight for the Overland Mail". The Plates are designed for framing for Den or Living Room and carry no display advertising. The complete set will be sent on receipt of 25c to any address in the U.S. or Canada.



Advert. Dept. C **ANHEUSER-BUSCH** St. Louis, Mo.
THE HOME OF BUDWEISER

RED OR BLACK VULCAN STYLOS Only Perfect Non-Leakable Ink Pencils at Moderate Price



\$1.00
POSTPAID

TWO SIZES, 4-1-4 AND 5-1-2 INCHES. AGENTS WANTED.

J. C. ULLRICH & CO., 27 Thames St., NEW YORK

I WILL START YOU
earning \$4 daily at home in spare time, silvering mirrors; no capital; send for free instructive booklet, giving plans of operation.
E. F. REDMOND, Des. 308-A, FOSTON, MASS.

FREE Instruction Book and Wood Finishing Samples

Here's the best book published on artistic wood-finishing, illustrated in 5 colors. If you are building tell us kinds of woods you will use, we'll mail you Free Panels of those woods artistically treated with Johnson's Finishes. Be sure to get this Free Instruction Book, Edition P. A. 7.

WRITE TODAY TO

S. C. JOHNSON & SON, Racine, Wis.

A SUPERB WING PIANO SHIPPED FREE

We will ship you for four weeks free trial, a genuine Wing Piano and WE PAY ALL FREIGHT. You are not out one cent—If you don't want the superb Wing after 4 weeks free trial in your own home, ship it back at our expense or keep it at dealer's price.

Wonderful Offer Our Piano Book sent free and prepaid—126 pages full of valuable information—also our Art catalog showing new styles of Wing Pianos and full particulars of our great free shipment offer. Don't fail to investigate this amazing offer. **WRITE AT ONCE.**



One of 40 Designs

WING & SON (Est. 1888) Dept. 1197, Wing Bldg., 9th Ave. & 13 St., NEW YORK CITY



ANTI-CRANK LACKA-MOTORS
THE WORLDS SIMPLEST Installed Operated by anyone. Complete Outfits ready for Rowboat or Schooner. **GUARANTEED TWELVE YEARS** building, perfecting, success with THE ONE TYPE. Write to Originators of VALVELESS for new "MARINE BOOK," a liberal Educator to all, free.
LACKAWANNA MFG. CO., Lackawanna Bldg., Greenwich & Liberty Sts., N.Y. City

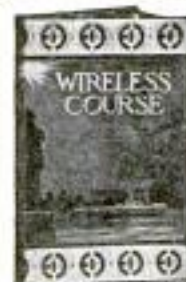

ABSOLUTELY FREE NO STRINGS

Complete Course of Wireless Instruction
In 20 Lessons 400 Illustrations

This course is not a gift—we owe it to you. It represents your discount for cash on future orders.

Send today 4c postage mentioning this adv. and we will forward full information, also copy of our 196 Page Electrical Cyclopaedia, No. 19 containing over 1,500 articles and 450 illustrations.

THE ELECTRO IMPORTING CO.
233a Fulton St., NEW YORK CITY

Illinois Standard Watches
Now sold at Wholesale prices

Buy direct from us; cut out all middlemen's profits and **SAVE 25 to 40% OR MORE. ILLINOIS**

WATCHES are known and used all over the world; standard in Railway service for over 40 years.

SEE THIS BIG BARGAIN

17 jewelled, Illinois movement, in fine Gold Filled case, warranted for 20 years, sold direct to you at our rock-bottom, wholesale price. **ONLY**

\$12.60 SENT FREE for full examination

BEFORE YOU PAY A CENT.

Many other models. All fully guaranteed. You take no risk. We are an old, established, reliable concern.

Reference: any Bank in our city, or ask your own banker.

Our Illustrated **CUT-RATE** Watch Catalog **FREE**, write

JOHN C. PIERIK & CO.

No. 10 Park Bldg.,

Springfield, Ill.



A Reproduction of a Great Ocean Liner

Actual Size Unfolded
14 x 23 inches

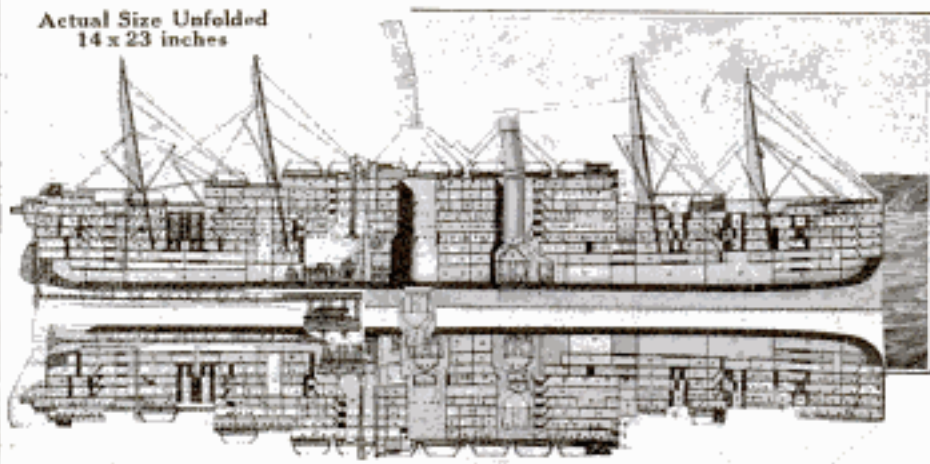

Showing and
Naming
Every Part

The accompanying illustration (actual photograph) conveys some idea of the vast amount of accurate detail of a big ship shown by our lithographic model. The different parts are shown by means of folds which may be opened, layer after layer, displaying everything in its proper position just as it would be found in the actual boat itself. The printing of the model in colors serves to bring out each part more distinctly and every one is numbered to correspond with the name found on the accompanying key. You can get more information regarding existing conditions by studying this model than in any other way as everything is pictured plainly before you.

Price Postpaid, 50c

Other models at the same price are:

Automobile	Locomotive	Steam Engine	Steam Turbine
Gas Engine	Dynamo	Wireless Telegraph	

POPULAR MECHANICS BOOK DEPT., Chicago

"The How and Why of the Automobile"

200 Pages. Bound in full cloth. 250 illustrations. Price \$1.00 Prepaid.

Did you ever talk to a man who came over on your side of the fence and talked WITH you and not AT you—who explained things in such a way that you laughed at yourself afterwards for not understanding the subject before—it was really so simple?

Do you remember the innumerable times you have said to yourself, "If I only had somebody here to explain things—someone who would go through this proposition with me until I understood it—someone who would use homely and familiar examples to explain things, instead of talking over my head by using technical terms?"

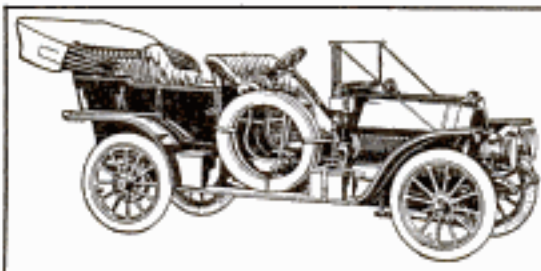

The author realized all these difficulties himself, because he has been through it all. Not only that, but his experience as an instructor of a large motor school taught him the way to explain the various parts of a motor vehicle in simple language, so that even the boy of fifteen could understand

and and appreciate them.

Would you like to see what's inside of an automobile engine—would you like to know the name of every part—be able to talk intelligently about it and be your own mechanic—tell your chauffeur what to do—know when he is bluffing you?

In a word, would you like to know all about a motor car—how it works—how to drive it and how to take care of it? Then send for a copy of this book by Fay L. Faurote, B.S., (M.E.), for five years closely associated with the Experimental Department of a pioneer automobile factory, for two years instructor in the Detroit Motor School.

Contents: Introduction—The Four-Stroke Cycle Motor—The Two-Stroke Cycle Motor—Motor Design—The Carburetor—Ignition—The Cooling System—The Transmission Gear—Motor Testing.

ADDRESS

POPULAR MECHANICS BOOK DEPT. 318 W. Washington Street
CHICAGO

ÆTNA-IZED?**WHY NOT BE ÆTNA-IZED WITH A
TEN DOLLAR BILL**

Ten Dollars will insure you for one year under the famous
ÆTNA TEN DOLLAR COMBINATION

In extent and variety of protection with-
out a rival. For \$10 this policy pays

\$2,250.00 for death from travel or burning building
accident

1,250.00 for death from ordinary accident

250.00 for death from natural causes. Paid at once
upon receipt of certified copy of official certificate of death.

It also pays liberally for loss of limb or sight, and pro-
vides weekly indemnity for accidental injury that results
in total or partial disability. The payments for accidental
loss of life, limb or sight increase each year without
additional cost, and make a possible payment of \$3,250.00.

\$3,250.00 Insurance for \$10.00

Send in the coupon to-day

Ætna Life Insurance Co. (Drawer 1341) Hartford, Conn.

Tear off

I am under 65 years of age and in good health. Tell me about ÆTNA Ten Dollar Combination.
My name, business address and occupation are written below.

Please Mention Popular Mechanics

BOOKS-THAT-TELL-HOW-TO-DO-THINGS

One man made and sold \$400.00 worth of one piece

Mission Furniture, How to Make It IN TWO VOLUMES

PART ONE—Plain directions with working drawings and illustrations for making 21 different designs. 96 pages. PART TWO—32 additional designs treated in the same manner. 128 pages.

Artistic. Inexpensive. Easily made in the home

Arts-Crafts Lamps, How to Make Them By J. D. ADAMS

Explicit instructions for making 16 different beautiful lamps out of paper, cardboard and wood. A working drawing and illustration accompany each design. 96 pages.

18 beautiful designs which the amateur can easily make

Lamps and Shades in Metal and Art Glass By JOHN D. ADAMS

Four different kinds of construction, built up—soldered—etched and sawn shades are treated. The designs range from ordinary reading lamps to pretentious chandeliers. 128 pages.

Covers every essential step in wood-working

Wood-Working for Amateur Craftsmen By IRA S. GRIFFITH, A. B.

Special chapters bring out every cut, joint and process, proper use and care of tools, working up of material, etc. 125 illustrations. 128 pages.

A complete handbook for art metal workers

Metal Work and Etching By J. D. ADAMS

Gives every detail for making a great variety of useful and ornamental objects such as book ends, desk sets, jewelry, hinges, drawer pulls, paper knives, letter openers, match boxes, tin and pipe racks, pad corners, etc. 50 illustrations. 96 pages.

The only book published on this interesting art

Metal Spinning By PROF. F. D. CRAWSHAW

A practical working manual for those who desire to spin metal as an art recreation or to follow this work as a trade. 33 illustrations. 80 pages.

Authorities proclaim it one of the best books on the subject

Electroplating By HENRY C. REETZ

A treatise which will not only enable the humblest beginner to make a start, but which gives pointers of value to even the most experienced electroplater. 62 illustrations. 112 pages.

Any boy can construct this at a trifling cost

How to Make a Wireless Set By ARTHUR MOORE

Explains in an understandable manner the construction of an outfit suitable for transmitting 4 or 5 miles. Fully illustrated. 96 pages.

A wonderful story

HEAT By PROF. J. G. OGDEN

An immensely interesting and instructive book pertaining to heat and its relation to modern mechanics. 50 illustrations. 128 pages.

One of the most remarkable non-technical books written

The Kingdom of Dust By PROF. J. G. OGDEN

The author deals with this vast kingdom as: A Boundless Domain, The Friend of the Housewife, The Foe of the Workman, The Skeleton in the Closet, The Right Hand of Death, Earth's Winding Sheet, Beginning and Ending of All Things Earthly. 40 illustrations. 128 pages.

A uniform series. Size 5 x 7 inches. Extra cloth covers.

PRICE EACH, 50 CENTS POSTPAID

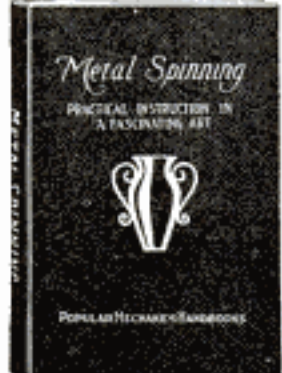
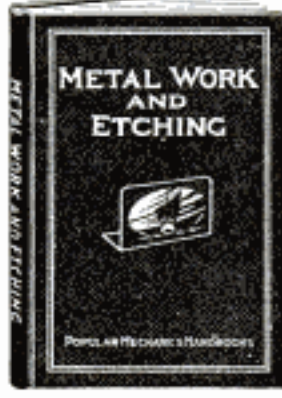
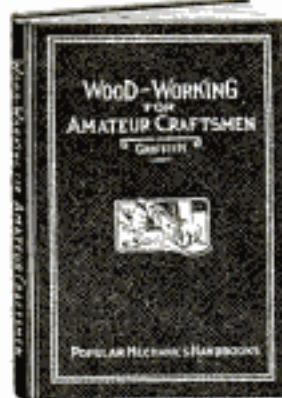

Popular Mechanics Book Department, 318 W. Washington St., Chicago



**12
Big
Books**

**Special
This
Month
\$24.80**

The Greatest Engineering Library At Less Than Half-Price

The American School's Cyclopedia of Modern Engineering Practice is the greatest ever published because it is the only one covering the entire field and every phase of up-to-date engineering practice. This library is the combined work of over 200 experts—every one a master of his subject—men who through study or practical experience, are able to give it to you in the most authoritative, and yet the most simple, practical and understandable form. This work contains 6,600 pages—5,000 illustrations—printed on special paper in large, clear type—bound in half red morocco, with gold titles and marble edges.

Partial Table of Contents

Boiler Testing; Construction of Boilers; Types of Boilers; Boiler Accessories; Gas and Oil Engines; Gas Producers; Steam Pumps; The Steam Turbine; Steam Engine Indicators; Valve Gears; Locomotive Boilers and Engines; Heat; Chemistry; Dynamo-Electric Machinery; Types of Dynamo-Electric Machinery; Management of Dynamo-Electric Machinery; Power Stations; Central Station Engineering; Alternating-Current Machinery; Power Transmission; Modern Central Station Design; Direct Current Motors; Storage Batteries; Elements of Electricity; The Electric Current; Electrical Measurements; Electric Bell Wiring; Electric Welding Development; Insulators for Transmission Lines; Machine Shop Work; Pattern Making; Foundry Work; Tool Making; Forging; The Air-Brake; Automobiles; Mechanical Drawing; Machine Design; Drafting-Room Organization; Heating and Ventilation; Steam and Hot-Water Fitting; Plumbing; Refrigeration; Metallurgy; Automatic Appliances for Handling Coal and Iron Ore; Electric Lighting; Shop Lighting; Hewitt Mercury-Vapor Converter; Electric Wiring; Motor-Driven Shops; Electric Railways; The Single-Phase Electric Railway; Telephony; Automatic Telephony; Wireless Telephony; Telephone Line Protection; Quality of Telephone Service; Automatic vs. Manual Exchanges; The Electric Telegraph; Wireless Telegraphy; The Telautograph.

The Complete Set Sent Absolutely Free—Express Prepaid

The complete twelve volumes, not a sample volume, will be sent, express prepaid, for seven days' free examination; returnable at our expense if the books do not contain the information you want. If you keep the books, pay \$2.00 seven days after receipt and then \$2.00 a month until you have paid the special price of \$24.80.

Another Great Free Offer

With each set is included a year's Consulting Membership entitling you to the free advice of a staff of Engineering Experts. This will give you practical help in handling working problems which are too specific to be taken up in detail in the Cyclopedia. A single problem solved for you might be worth more than the first cost of the books.

AMERICAN SCHOOL OF CORRESPONDENCE
CHICAGO, U. S. A.

NAME.....

ADDRESS.....

OCCUPATION.....

EMPLOYER.....

Pop.
Mech.
7-12
A. S. of C.

Please send Cyclopedia of Modern Engineering Practice for 7 days' free examination. I will send \$2.00 within seven days and \$2.00 a month until I have paid \$24.80, or notify you and hold the book's subject to your order. Title not to pass until fully paid.



CHIEF DRAFTSMAN

Will INSTRUCT PERSONALLY a limited number selected, ambitious men in

Practical Drafting, Detailing, Designing

Draftsmen Drawing \$125-\$150 Monthly

Are NOT MADE in Schoolrooms,
 Are NOT MADE by reading books,
 Are NOT MADE by making Copies,
 Are NOT MADE at home drawing pictures
 from printed book lesson.

LET ME TELL YOU:

It requires actual, practical, up-to-date
 DRAFTING-ROOM WORK to train YOU
 to gain the PRACTICAL EXPERIENCE
 that your employer will demand of you.



FREE

This \$13.85
 DRAWING
 OUTFIT

and Free Position.

As Chief Draftsman of Engineering firm I know exactly the Quality and Quantity of PRACTICAL training, knowledge and actual up-to-date experience (not school knowledge) you must have, in order to obtain a good position and advance to highest salary.

I give INSTRUCTION UNTIL COMPETENT and
 PLACED in POSITION at above Salary.

DON'T waste TIME and MONEY trying to learn from books or printed "STUFF" you can only learn on PRACTICAL WORK which I furnish you.

Address CHIEF DRAFTSMAN
 Div. 19, Eng's Equip't Co. (Inc.), Chicago

Please Mention Popular Mechanics

SAVES TOOLS, TIME, MONEY— MAKES WORK EASIER

**30 Days
Free Trial**



Prove, by 30 days free trial how this shop grinding outfit saves tools, time and money. Prove how this outfit makes tool sharpening so easy that tools are always in perfect edge, making all work so much easier, and enabling every workman to accomplish more work. Use this outfit 30 days free, then if you are willing to part with it, send it back at my expense.

Dimo-Grit—"the wheel for steel"—25 times faster than grindstone—10 times more efficient than emery—will not draw temper

Dimo-Grit the new artificial diamond abrasive, is a twin product of carborundum, but Dimo-Grit is especially suitable for steel, leaving the smoothest, keenest edge; cuts hardest steel as emery does soft copper. It peels steel away in tiny shavings instead of wearing it away like grindstones or emery wheels—never glazes, no heat developed—no need of water cooling—no danger of drawing temper. Genuine South African diamonds could cut steel no quicker—outwears any number of emery wheels and grindstones. Carborundum wheels furnished if wanted.



Mechanics' Outfit
14 Machines In One
Guaranteed 5 Years

No Money Needed

RETURN THIS COUPON TODAY

Luther Hummer Tool Grinder

Foot or engine power — runs by foot power as easy as sewing machine—built all of steel—shaft drive like automobile—dust-proof ball bearings—gravity lubrication—costs no more than cheap chain drive grinders—half a million Luther Grinders now in use—5 years guarantee—shop outfit provides for every sharpening, grinding, buffing and polishing need for mechanics, carpenters, and all other tool users. Extra attachments convert it into turning lathes, jig and circle saws, force feed drill, etc.—16 extra attachments—completely equips your work shop at low cost.

40 Page Free Book Tells the interesting story of artificial diamond abrasives as printed in McClure's Magazine—gives valuable pointers on tool grinding—fully describes all attachments and outfits. No red tape—no promises—no money needed to try this money-saving shop outfit free for 30 days. Return the coupon for full information and decide which outfit you want on 30 days free trial.

Luther Grinder Mfg. Co. 909 Michigan St. Milwaukee, Wis.

Return this coupon for Free Trial Offer

You put yourself under no obligation by returning this coupon — we will tell you all about our Free Trial Offer, and send you our 40 page book free. Don't delay — return this coupon today.

Dimo-Grit Sharpening Stones

Ask your dealer for Dimo-Grit sharpening stones—the fastest, smoothest stones for steel—look for the name "Dimo-Grit" on the stones.

COUPON
LUTHER GRINDER MFG. CO.
909 Michigan St. Milwaukee, Wis.

Please send me 30 Days Free Trial Offer and 40 page Free Book. It is understood that this coupon does not obligate me in any way.

NAME.....

ADDRESS.....

Coca-Cola

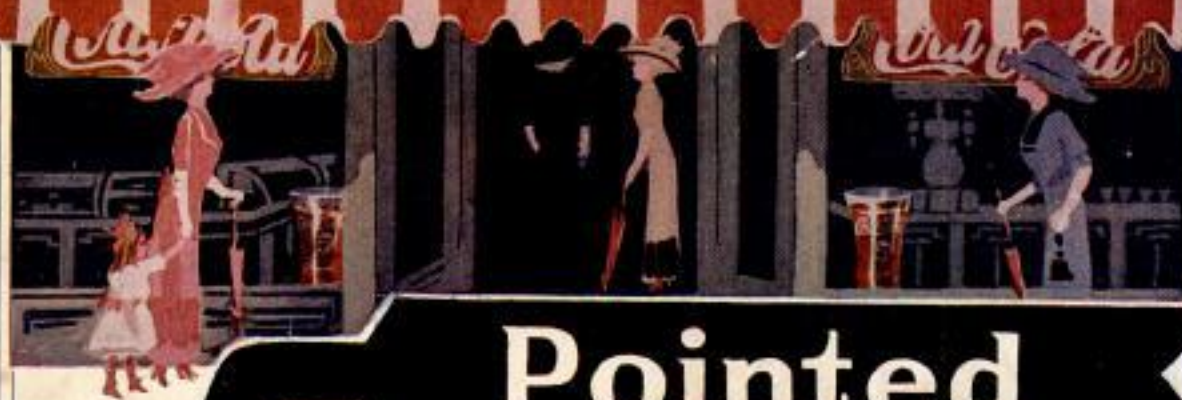

Pointed

No vagueness to *this* beverage—
there's point to it; like its arrow



Coca-Cola



has a tang—a bright liveliness—a thirst reaching deliciousness
that points the way directly to satisfaction and drink enjoyment.

Delicious—Refreshing—Thirst-Quenching

Demand the Genuine—Refuse Substitutes

THE COCA-COLA COMPANY
ATLANTA, GA.

Free Our new booklet, telling of Coca-Cola vindication at Chattanooga, for the asking.

Whenever you see an Arrow think of Coca-Cola.