

March

This Issue 300,000

15 Cents

# POPULAR MECHANICS

WRITTEN SO YOU CAN UNDERSTAND IT

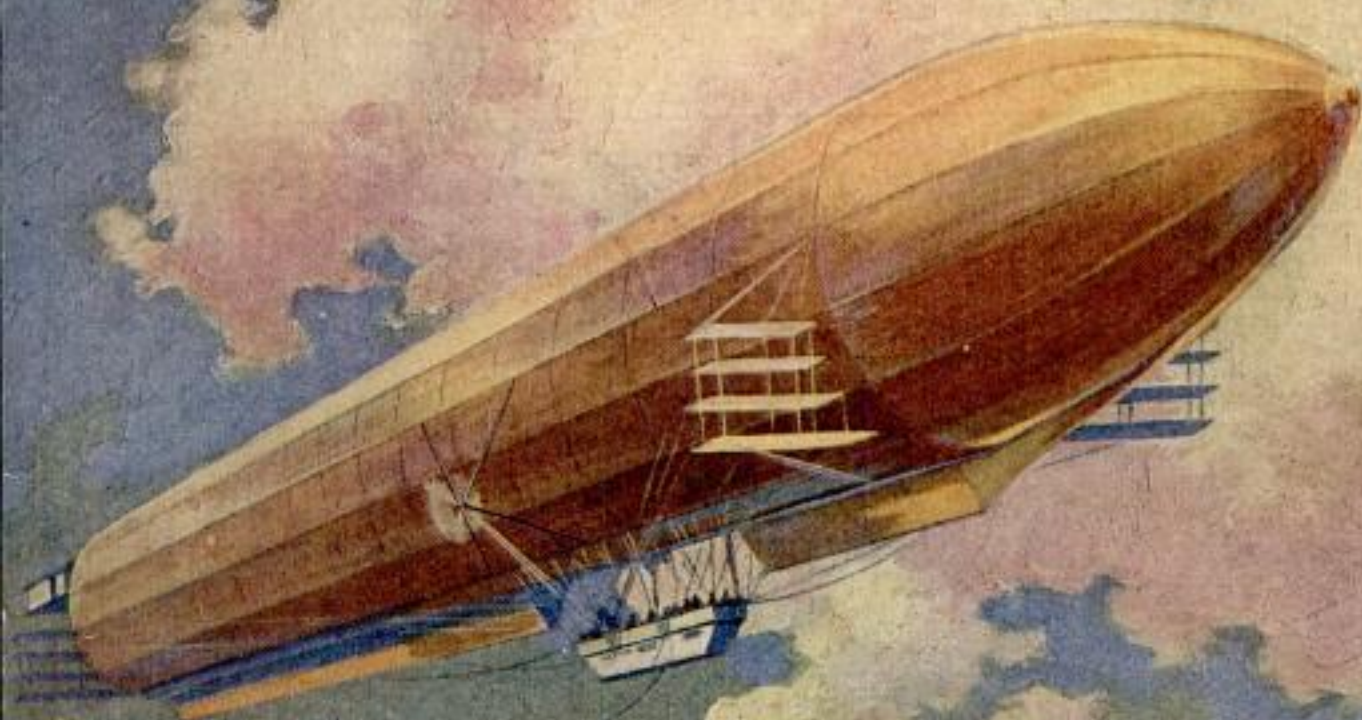

## The **Fallacy** of the **Dirigible**

By **VICTOR LOUGHEED**  
In This Issue



# Buy the Material NEEDED TO BUILD THIS HOME!

**Price Includes Blue Prints; Architect's Specifications; Full Details; Working Plans and Typewritten Material List  
OUR HOUSE DESIGN NO. 145**

Our Design No 145 is positively one of the very best, economical, up-to-date, sensible and practical houses ever offered. There are many points about this neat house that must be studied carefully to fully appreciate its value. Neat in appearance. Easy to build. Low cost of labor. Easy to maintain after built, meaning little or no repairs. An ideal city or country home. An investment proposition that will net big returns.

Seven good-sized rooms and bath, pantry, inside cellar entrance, handsome stairway. Entire interior, including floors, finished in clear Georgia Pine, of up-to-date style and finish. The material we furnish for construction is all BRAND NEW, selected with great care, excellent quality throughout, entirely suitable and in some localities almost too good for the purpose intended.

Our Guaranteed Building Proposition insures you ample quantities to complete the job strictly according to plans; prompt shipment, safe delivery and a personal follow-up letter from our President to find out whether our promises to you have been kept. Absolute satisfaction in the entire deal is what we offer.

## We Save You Big Money on Lumber and Building Material!

The Chicago House Wrecking Co. is the largest concern in the world devoted to the sale of Lumber, Plumbing, Heating Apparatus and Building Material direct to the consumer. No one else can make you an offer like the one shown above. We propose to furnish you everything needed for the construction of this building except Plumbing, Heating and Masonry material. Write for exact details of what we furnish. It will be in accordance with our specifications, which are so clear that there will be no possible misunderstanding.

### How We Operate

We purchase at Sheriffs' Sales, Receivers' Sales and Manufacturers' Sales, besides owning outright sawmills and lumber yards. Usually when you purchase your building material for the complete home shown above, elsewhere, it will cost you from 50 to 60 per cent more than we ask for it. By our "direct to you" methods we eliminate several middlemen's profits. We can prove this to you.

### What Our Stock Consists of

We have everything needed in Building Material for a building of any sort. Lumber, Sash, Doors, Millwork, Structural Iron, Pipes, Valves and Fittings, Steel and Prepared Roofing. Our stock includes Dry Goods, Clothing, Furniture, Rugs, Groceries, etc., Machinery, Hardware, Wire Fencing—in fact, anything required to build or equip. Everything for the Home, the Office, the Factory or the Field, besides everything to wear or to eat. Send us your carpenter's or contractor's bill for our low estimate. We will prove our ability to save you money. WRITE US TODAY, giving a complete list of everything you need.

### Free Book of Plans

We publish a handsome, illustrated book, containing designs of Houses, Cottages, Bungalows, Barns, etc. We can furnish the material complete for any of these designs. This book is mailed free to those who correctly fill in the coupon below. Even if you have no immediate intention of building, we advise that you obtain a copy of our FREE BOOK OF PLANS. It's a valuable book.

### Our Guarantee

This company has a capital stock and surplus of over \$1,000,000.00. Absolute satisfaction guaranteed in every detail. If you buy any material from us not as represented, we will take it back at our freight expense and return your money. We recognize the virtue of a satisfied customer. We will in every instance "Make Good." Thousands of satisfied customers prove this. We refer you to any bank or banker anywhere. Look us up in the Mercantile Agencies. Ask any Express Company. Write to the publisher of this publication. Our responsibility is unquestioned.

**\$2.00 Buys a Complete Set of Blue Prints** We send you a set of plans for the house described above, including the necessary specifications and complete list of material, transportation charges prepaid, for the low cost of \$2.00. This is only a deposit, a guarantee of good faith, and the proposition to you is that after receiving these blue prints, specifications and list of material, if you can place an order with us for complete bill of material, we will credit your account in full for the \$2.00 received, or we will allow you to return these plans, specifications, and list of materials to us and we will refund \$1.50, thereby making the total cost to you 50 cents.

### High Grade Bathroom Outfits!



The price of this Bathroom Outfit **\$37.50.**

Plumbing material direct to you at Bargain prices. We have everything needed in Plumbing Material. Our prices mean a saving to you of 30 to 60 per cent. Here is an illustration of a bathroom outfit we are selling at \$37.50. Your plumber would ask you about \$60.00 for this same outfit. It is only one of many other complete outfits that we are offering at prices ranging from \$25.00 to \$80.00.

Write for Our Free Plumbing Material Catalog No. 539.

### Hot Air Furnaces!

Don't let the contract for your hot air furnace until you get our figures. We will cut your local dealer's price in half. We can furnish you a complete equipment, including pipes, registers, furnace; everything required at a price not much more than what an ordinary heating stove would cost you. Complete hot air heating plants **\$48.00** up. Get our heating catalog at once. Tells you all about it. Write us today. We guarantee to save you money. We loan you tools. We make you plans. Every heating plant we sell is backed by our guarantee bond.

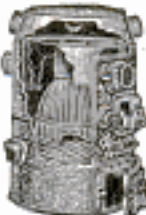

### Hot Water Heating Plants!

We guarantee to save you **50 to 75 per cent** on a modern hot water heating plant for your home. We make you complete plans and instructions and help you out every way we possibly can. We loan you tools. Every plant backed by our guarantee bond. We furnish the material you get the plant installed. Cut out the local dealer's profit and cut the cost in half. Thousands of our plants installed and working perfectly in every part of the country. Write today for our Special Heating Catalog. Tells all about our heating proposition. We can furnish Heating Apparatus for any building, no matter how large. Tell us your needs. Write for Free Special Heating Catalog No. 539.



**Water Supply Outfits!** Modern Air Pressure Water Supply Systems at prices ranging from **\$40.00 to \$200.00.** They are strictly new, first-class and complete in every detail. Even though you live in the country, you can enjoy every city comfort at little expense. Why not investigate this. We are ready to furnish you with all facts free of charge. All material fully guaranteed. We also have a complete stock of Pipe, Valves and Fittings at 40 to 50 per cent saving.

**1½ h. p. Gasoline Engines at \$24.75**

**CHICAGO HOUSE WRECKING CO.,** Thirty-Fifth and Iron Sts., **CHICAGO**

### Send Us This Coupon

Chicago House Wrecking Co.

I saw this ad in Popular Mechanics.

I am interested in.....

NAME.....

TOWN.....

CO.....STATE.....

# The Navy a Good Business Proposition

**N**OT many men know that as a *business proposition*, the U. S. Navy offers opportunities as good as those offered in civil life and in the cases of some men, opportunities that are distinctly *better*. For, in addition to steady regular pay, a man in the Navy is given systematic advancement, is given all his living expenses, his first outfit of clothing, free medical attendance if sick, and the chance and incentive to *save money*.

Of even greater value is the training, physical and mental, the healthy regular life, the companionship with ambitious, self-respecting helpful associates, and the chances to broaden by study and travel. These are things which in civil life are rarely combined with a business position.

There is great *variety* of work, too. A man may be employed as seaman, electrician, stenographer, machinist, bookkeeper, fireman, clerk, blacksmith, musician, shipfitter, steward, cook, plumber, carpenter, baker, coppersmith, or in the hospital corps.

The Navy Department never urges or influences any man to enlist. It does desire that these opportunities be brought to the attention of serious-minded men 17 to 35 years of age. Only the highest class men are wanted or accepted.

The officer in charge of the Navy Recruiting Station in your locality (address on request) will gladly explain all the Navy's requirements and opportunities. Call on him. You'll be glad you met him.

**"The Making of a Man-O'-Warsman" is a fascinating illustrated book telling in words and pictures all about the daily life in the U. S. Navy. Send for free copy today.**

ADDRESS DESK 69

## BUREAU OF NAVIGATION

NAVY DEPARTMENT, WASHINGTON, D. C.

This One



HARB-9N3-KJ6P

# Keen, True Blades

NO. K1  
PRICE \$3.50  
NO. K3  
GOLD-PLATED  
PRICE \$5.00



All Keen Kutter blades are true to their name. Not only does the fine steel of the cutting edges keep its sharpness through "thick and thin," but gives long service under the most exacting conditions.

Keen Kutter Safety Razors are the finest made. You take to them at once because they are made with a "hang" that just fits the natural shaving motion. Both the Keen Kutter Safety and its little brother, the Keen Kutter "Junior" Safety, give immense satisfaction.

Keen Kutter blades are made thick enough to hold their own against the stiffest beard. They are made of the finest Norwegian steel and ground with the greatest care and accuracy.

NO. K110N  
KEEN KUTTER  
JUNIOR WITH  
7 BLADES  
AND CASE  
PRICE \$1.00



## KEEN KUTTER



Pocket Knives have blades of finest English Crucible Steel, no matter what price you pay or style of handle you select. The quality is uniform.

The price differs according to number of blades, handle and finish, but every Keen Kutter Pocket Knife cuts equally well. All are fitted with strong, snappy springs that keep the blades open or keep them shut. With every piece of Keen Kutter cutlery goes the guarantee of your money back upon dissatisfaction.

"The Recollection of Quality  
Remains Long After the  
Price is Forgotten."  
—E. C. SIMMONS,  
Trade Mark  
Registered.

NO. K2443  
PRICE \$0.75

If not at your dealer's,  
write us.

**SIMMONS HARDWARE  
COMPANY, Inc.**

St. Louis  
and  
New York  
U. S. A.

NO. K3413  
PRICE \$2.25



NO. K 2613  
PRICE \$0.85

NO. K33498  
PRICE \$1.25



Please Mention Popular Mechanics

# Popular Mechanics Magazine

318 W. Washington Street, Chicago, U. S. A.

EDITED BY H. H. WINDSOR

ISSUED MONTHLY

SUBSCRIPTION:

SINGLE COPY, 15 CENTS

In United States, and its possessions, Cuba and Mexico, per year, postpaid	\$1.50
To Canada	1.75
To all other countries in the Postal Union	2.00
All subscriptions are discontinued at expiration. Please examine the date printed on your wrapper.	
Entered as Second Class Matter Sept. 15, 1903, at the Postoffice at Chicago, Illinois, under Act of March 3rd, 1879.	
Published monthly by POPULAR MECHANICS CO.	
Copyrighted 1912, by H. H. WINDSOR.	

The attention of prospective advertisers is called to the policy of this magazine in accordance with which the publisher waives all claim for payment of any advertisement appearing in any issue where the number of copies actually printed and circulated is less than the number printed on the front cover page.

## Contents for March, 1912

Steered His Ship with Packing Cases.....	309	Milk-Can Lock Used in England.....	361
Electricity Has Part in Cardinal's Welcome....	310	Fire Tools in the Forest.....	361
Mammoth Concrete Freight House.....	310	Combined Penknife and Six-Inch Rule.....	361
Power Saw Pulls Self through Forest.....	310	Interesting Test With Concrete Piles.....	362
Auto-Scooter Makes 80 Miles an Hour.....	311	Advertising on German Paper Money.....	363
Dancing Mascots for Motorists.....	312	Protection for Workers in Cotton Mills.....	363
Why the Continents Do Not Sink.....	312	World's Highest Dam to be Built in Idaho.....	364
Submarine Carries Disappearing Gun.....	313	By L. William Thavis	
A Fire Which Endangered Five Billions.....	315	Horse Draws Fuelless Locomotive.....	366
"Sub Rosa," or the Rose and the Thief.....	316	New Cuban Process of Sugar Extraction.....	366
Most Powerful Poison Known.....	316	Ultraviolet Ray Sterilizers for Army.....	366
"Trouble-Finder" Head Lamp for Motorists....	316	An Auto-Aeroplane Coaster.....	367
The Fallacy of the Dirigible.....	317	The Hudson River and Ocean Ships.....	367
Exceptionally Large Trestle Pill.....	328	A Solitaire Baseball Game on Mars.....	368
Joint Meeting of Clubs Seventy Miles Apart...	327	Daughter of Statesman to be Cabinetmaker...	368
Mooring Dolphins in Portsmouth Harbor.....	327	Submarine That Fires Its Bow at the Enemy...	368
Science and Mechanics Help Make Durbar		The Launching of the Drydock Gate.....	369
Spectacular.....	328	Seeing by Wire in Connection with Telephony...	372
Streamline Forms at Paris Aviation Exhibit....	330	Most Powerful Wireless Station.....	372
Captured Battle Flags May be Exhibited.....	332	Aeroplane Backs Down, Swinging to Earth....	373
First Aid-to-Injured Packages in Jars.....	334	Powerful American and European Engines....	374
"Pulmotor" Saves Seven Lives in Chicago....	335	Stranded Torpedo Boats Floated with a Hose..	375
Italians Make Bombs while Flying.....	335	Auto Mail Train Used in New Mexico.....	376
Motor Car Crosses Lake Erie on Ice.....	336	Lights in Floor Mark Seats in Theater.....	376
Key West Over-Sea Railway Opened.....	337	Love Letters Made into Walking Stick.....	376
Curtiss Patent Against Wright Monopoly....	337	The Largest Unit of Space in Use.....	377
Belgian Liners Now Fly American Flag.....	338	German Motor Road in Africa.....	377
Automobile Races Train on the Ice.....	338	Ferryboat Shipped in Sections by Rail.....	378
The Remarkable Weather of 1911.....	339	Sir Oliver Lodge Warns Electroculterists....	378
Navy Plans Extensive Wireless Field.....	342	Double-Gap Spark Plug.....	379
High-Voltage Transmission Line in Europe....	343	Lever Operated Motorcycle Stand.....	379
Aeroplane Seized as Contraband of War.....	344	Monument to Los Angeles Dynamite Victims...	379
Striking Mill Operatives Held Off by Hose...	345	The Remarkable Accident to the Torpedo-Boat	
No Gold Lace or Fine Feathers for the "Maine"		Destroyer "Warrington".....	381
Investigators.....	346	A Portable Electric Motor for General Farm	
San Francisco's Chinese Celebrate Republic...	348	Work.....	381
Comment and Review.....	347	Illuminated Car Washer for the Garage.....	382
By H. H. Windsor		Car Device to Announce Street Names.....	382
Low Temperatures Aid High Jumps.....	350	Locomotive Fire Extinguisher.....	383
Block-and-Tackle Outfit for Automobiles....	351	Electric Incubator Has 6,000-Egg Capacity....	383
Many Mechanical Tools Combined.....	352	Metal Work and Etching.....	384
Distillery Operated by United States.....	352	By John D. Adams	
World's Largest Block of Granite.....	352	Screw-Propelled Steamer Patented in 1803....	385
European Folding Typewriter.....	353	A Christmas Auto Train.....	386
Scorching Postcards on Lava Beds.....	354	Birthmarks May Show Knightly Descent....	386
United States' Production of Portland Cement...	354	Concrete House at Moderate Cost.....	387
Wall Built to Stop Evil Spirits.....	354	Gasoline Stations for Automobiles.....	388
Canary Birds in Mine Rescue Work.....	355	Subsurface Water for Irrigation.....	388
Treatment of Cancer by Fulguration.....	355	The German Submarines.....	389
Intake Gates of the Los Angeles Aqueduct....	356	Simple Device Measures Blood Pressure....	389
Army Truck Provided with a Capstan.....	357	Device for Testing Electric-Lamp Filaments...	390
"Streamline" Pipe for Motorists.....	357	Archaeologists Given a Prehistoric Banquet...	391
Rent Sword as Message of Peace.....	357	Motion Pictures of the Ocean Bottom.....	391
Interior of a Mortar Pit at Fort Totten.....	358	Australian Antarctic Expedition Starts...	391
A Giant Imitation Spider Web.....	360	Lobster-Cracking Implement.....	391
Illuminated Flowers as Hat Trimming.....	360	Electricity as an Aid in Trick Shooting....	392
A Glacier Tomb Gives Up Its Dead.....	360	Circulation of the Blood.....	392
Progress in Long-Distance Telephony.....	360	Electric Street-Cleaning Machines in Berlin...	392

[Continued on Page 6]

Popular Mechanics offers no premiums; does not join in "clubbing offers," and employs no solicitors to secure subscriptions. It is for sale by nearly every newsdealer in the United States and Canada.



# The Hands of the Expert

will recognize in PUMMO SOAP the skill and work of soap experts. The extraordinary cleaning qualities of PUMMO SOAP are not there just by chance, but are the result of years of experience and experiments by experts in the soap-making art.

PUMMO has not only all the cleansing qualities of the best toilet soaps, but it does more—it removes grease, grime, paint, oil, ink and other stains from the hands in a way which soap alone will not do.

The combination of finest Italian pumice with vegetable oils and glycerine gives to PUMMO SOAP extraordinary cleansing virtue, with a mildness no other pumice soap possesses.

PUMMO SOAP costs but 5 cents, but in its class you will find nothing better at any price.

If your dealer does not have it, let us send you a FREE sample. Fill out and mail the coupon underneath.

Made by  
THE N. K.  
FAIRBANK  
COMPANY  
Chicago



The N. K. Fairbank Company, Chicago  
Please send me Free Sample Soap Cake

Name \_\_\_\_\_  
Town \_\_\_\_\_  
State \_\_\_\_\_

Please Mention Popular Mechanics

THE DYKE  
SYSTEM IS  
A New Idea



## HERE'S A FREE BOOK ON MOTORING

Written by A. L. DYKE, the man who originated the first auto supply business and published the first practical book on automobiles.

This 32 page illustrated book is not only of interest to the auto owner and prospective owner, but of special interest to the young man who wants to establish himself in a permanent, paying and the fastest growing industry in the world today.

**Let Us Show You How We've Started Hundreds of Others without Capital**

This booklet will show you how hundreds of others started. This booklet will open your eyes as to the possibilities in this field:—it tells you about opportunities of the great motor industry, never before equalled in the history of the world.

—contains 32 pages, fully illustrated and very interesting and instructive.

—it is worth its weight in gold to you—don't miss it.

**Dyke's System is Something Different** It is a NEW IDEA system of teaching you by mail—with wonderful, real, actual metal, moving parts, WORKING MODELS of parts of the automobile and engine. In addition to the models there are 12 instruction books, with examinations (diploma when you finish) and 175 charts and a large 16 sheet (9x12) manikin. This manikin shows you how an auto is built, from the ground up—all parts are keyed. The Power Plant is also built up on this manikin in the same manner—this is another new idea—just out.

**Dyke's Working Model System (Pat. appl'd for)** is the only way to teach by mail successfully—Did you ever stop to think how the Patent Office, Inventors, Uncle Sam's Ship Builders, Architects and others first make a model?—they all know the value of working models.

**Actual Practice on My Models** These Models Actually Work—You can crank the engine, set the valves, time the ignition, work the clutch, operate the metal gears on the transmission model—in fact, all models actually work and all moving parts are made of metal—it's just like working on a real car—but every part is marked and much clearer than a real car itself.

**That's Why I Can Teach You** the principle and construction of Automobiles and Gasoline engines (engines for Aero and Launch work also) so thoroughly you can open a repair shop, overhaul cars and engines, drive, sell cars on commission—in fact, there are over a dozen branches in this field open and all are explained in this free book.

### Hundreds of Endorsements Like These

"I am now driving a 'Winton Six.' I do all my own repair work. I owe all to your course."—Edw. Sawyer, Montclair, N. J.  
 "Your Course enabled me to get a good position which has increased my income."—Geo. E. Davelar, Prosser, Wash.  
 "I was formerly farming, but am now in the auto repair business."—Geo. Milholke, Rheinbeck, Iowa.  
 "I have been driving a car now for a month, and I owe it all to your Course."—Rainsy Stewart, Jansen, Utah.  
 "I am now driving a Packard 30. Your Course helped me wonderfully."—Edw. Hauler, New Orleans, La.

The system is endorsed by Oldfield, Duryea, Splendor and other leading authorities. Let us show you what they say about this course.

**THE COURSE COMPLETE**—and all Models and Manikins, Charts, etc., are SENT ON TRIAL for you to see for yourself how easy it is to learn by this "New Idea" system. There is a special offer being made right now whereby you can get Course complete for only \$12. After you complete our Course we will help you get started—by giving you your first job.

We are starting others every day; we can do as much for you. My free book will show you how to start and how others made their start. May we have the pleasure of showing you?—then

**SEND FOR FREE BOOK**

It is instructive and interesting—does not cost you a cent and places you under no obligations whatever—you need it for your own sake, not mine. Don't wait—there's no profit in waiting—WRITE NOW.

**DYKE'S CORRESPONDENCE SCHOOL OF MOTORING**  
Box 88, Roe Building, ST. LOUIS, MO.

Please Mention Popular Mechanics

## Boston Garter

*Vitrol Grip*

Recommended by every wearer—it has made its way all over the world because of its superior quality, ease, and wear value. The preference of men who dress with care.

These two types sold everywhere by dealers,  
Lisle, 25 Cents. Silk, 50 Cents.  
Sample pair postpaid on receipt of price.

GEORGE FROST CO.,  
Makers, Boston.



## Every Boy His Own Toymaker

Greatest boys' book ever written, tells how to make a steam engine, telephone, magic lantern, boats, kites, balloons, electrical and mechanical toys, traps, fishing tackle, over 200 illustrations. Our big novelty catalog and extra 10c premium, all for 10c. AMERICAN SUPPLY CO., ST. PAUL, MINN.

The Best Book For Beginners

## A Practical Course in Mechanical Drawing

By Wm. F. Willard  
POPULAR MECHANICS BOOK DEPT.  
318 W. Washington Street, Chicago

Price 50c  
Postpaid

IF YOU HAVE lettering to do,  
send 55c for this book  
11,000 copies already sold



**CONTENTS:**  
**BLOCK LETTERS:**  
 Heavy, Outline,  
 Condensed, Ex-  
 panded, Fancy,  
 Shaded and Ital-  
 ics.  
**GOthic:**  
 Condensed, Ex-  
 panded, Italics.  
**ROMAN:**  
 Fancy, Italics.  
**SCRIPT: MODERN**  
**ARCHITECTURAL**

11th Edition Now Ready  
Contains 3 new alphabets

Well printed on fine paper and handsomely bound in cloth.

Spon & Chamberlain, 123 P. M. Liberty St.  
NEW YORK, U.S.A.



**India Paper Edition**  
**Webster's**  
**Universal**  
**Dictionary**

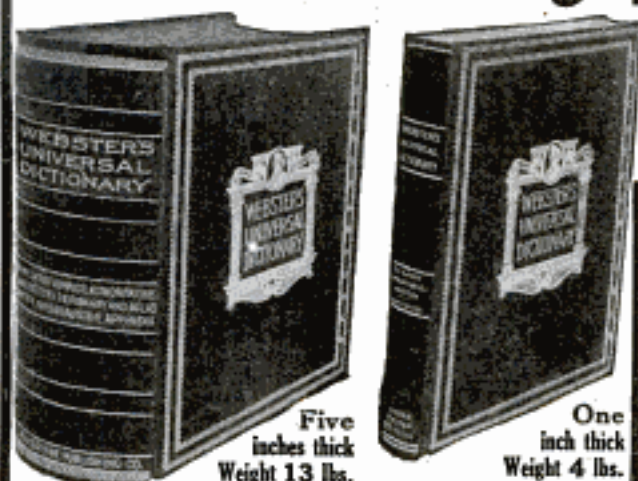

**Complete and Unabridged**

Printed on India paper is the greatest innovation in the history of book making. The exclamation of everyone is: "Why has it never been done before?" The complete Dictionary of 2,205 pages, bound in flexible morocco, makes a volume only **one inch thick**. It is set from new type. New plates. Thousands of new words. This dictionary is not published by the original publishers of Webster's dictionary, or by their successors, but is an entirely new work. This beautiful India paper edition is bound in **Full Flexible Morocco** and in such a manner as may enable the reader to fold it back to back and hold the complete dictionary in one hand as you would a magazine. The illustration shows the dictionary printed on regular book paper, full leather binding, and the same work with the same number of pages printed on India paper. **Take your choice.** In this advance offer by mail a very substantial saving may be had since no agent's commission or dealer's profit will be involved in the transaction.

**Before Publication Offer**

We will enter your order for this beautiful India paper Dictionary, bound in full flexible morocco, and ship for your examination, for a payment of \$1.00 on approval and \$2.00 per month thereafter for **seven months**, until our **Special Before Publication Price** of \$15.00 is paid. This is but little more than the price of one of the old editions of Webster's Dictionary printed on plain book paper, although the manufacturing cost is almost double. **This price is strictly limited to the small edition now being printed.** We fill orders in rotation, just as soon as the books are ready for shipment. **Mail coupon promptly.**

**INSPECTION COUPON**

THE RIVERSIDE PUBLISHING CO. Pop. Mech. 3-12  
 Marquette Building, Chicago

Please ship for my examination Webster's Universal Dictionary, India Paper Edition, patent thumb index, bound in full flexible leather. If after five days' examination I am entirely satisfied with the work, I will send you \$1.00 as first payment and \$2.00 per month thereafter for seven months until your **Special Before Publication Price** of \$15.00 is paid. If not satisfactory I will notify you within five days and return to you as soon as I receive shipping instructions.

Name \_\_\_\_\_

Address \_\_\_\_\_

If Old Style Edition is desired change India Paper Edition to read Old Style Edition, price \$15.00 to \$13.00, and seven months to six months.



**NAPOLEON A CAPTIVE**

**N**APOLEON a captive is gazing out across the solemn sea toward France, where he was once emperor. He realizes that his dream of Universal Empire is at an end, yet is unconscious of his banishment like an outcast a thousand miles from shore to the lonely and barren rocks of St. Helena. This picture illustrates but **one event** out of all the thousands which are fully described and illustrated in the world-famed publication.

**Ridpath's**  
**History of the World**

The publisher's failure placed in our hands the unsold edition of this monumental work, brand new, which we must sell immediately. We offer the remaining sets **LESS Than Even DAMAGED SETS Were Sold**

We will name our price only in direct letters to those sending us the **Coupon** below. Tear off the coupon, write name and address plainly, and mail to us now, before you forget it. Dr. Ridpath is dead, his work is done, but his widow derives her income from the sale of his History, and to print our low price broadcast would cause great injury to future sales.



**4000 pages**  
**2000 illustrations**

**THE REASON** for Dr. Ridpath's enviable position as an historian is his wonderfully beautiful style, a style no other historian has ever equaled. Reading this fascinating work widens your mental horizon, arouses your ambition, adds greatly to your fund of knowledge and increases your ability to succeed. Ridpath carries you with him down the long highway of time, through the rise and fall of empires, leaving mankind, today harnessing the powers of earth and air to be his servants, whispering messages across continents and oceans, crowning all with the glorious achievements of the nineteenth century. He covers **every race, every nation, every time**, and holds you spellbound by his wonderful eloquence. Nothing more interesting and inspiring was ever written.

Fold here, tear out, sign and mail

**Free Coupon-**

WESTERN NEWSPAPER ASSOCIATION

H. E. Sever, President

140 So. Dearborn St., Chicago, Ill.

3-12

Please mail, without cost to me, your 46-page sample booklet of Ridpath's History of the World containing photographs of Napoleon, Queen Elizabeth, Socrates, Caesar and Shakespeare, map of China and Japan, diagram of Panama Canal, etc., and write me full particulars of your special offer to Popular Mechanics readers.

Name \_\_\_\_\_

Address \_\_\_\_\_

Please Mention Popular Mechanics

# Our Trained Men Earn Big Money In Auto Business

**Demand for Chauffeurs, Truck and Taxicab Drivers, Demonstrators, Salesmen and Garage Managers Grows Larger Every Day.**

Steady, pleasant and profitable work all the time. Today no business offers the advantages that the automobile business holds in store for men with energy, ambition and a trained knowledge of motor cars. Money making opportunities are everywhere. It is the best business on earth today, has more opportunities and pays bigger than any other line of work.

**We Fit You in a Few Weeks.  
Real Practical Auto Training  
Day or Night School**

In A. E. I. Courses you learn thoroughly but quickly and easily all about automobiles, how to run and properly repair any car and fix any trouble—how to manage a garage and sell autos. You learn by actual practical work upon real autos of different makes in our completely equipped shops under expert mechanics as instructors and by plenty of driving on roads and city streets in our big touring cars.

**Send Coupon Below TODAY  
For FREE BOOKLET**

which explains fully everything you want to know about the A. E. I. courses in Real Practical Auto Training and the money making opportunities in the automobile business.



**Home of the A. E. I., Kansas City, U. S. A.**

The A. E. I. has recently moved into its new building which is the only building in the country built especially for an automobile school. It is fireproof throughout—of concrete and brick construction with a magnificent front of granite terra cotta stone. Large windows on every side make the interior as bright as out of doors. The building is electric lighted, heated by steam and a special system of ventilation has been installed making the building thoroughly sanitary, modern and up-to-date in every way.

### THE A. E. I. EQUIPMENT

We have the finest and most complete equipment used by an automobile school anywhere. We have our own electric light plant, electric driven lathes, drill press and other pieces of machinery, and in our blacksmith and forge department, oxy-acetylene welding and brazing departments, tire vulcanizing department, machine shop, garage and sales department everything is of the best—the best money can buy in the way of every known mechanism, appliance and sectional part of automobile construction and operation.

**Make Us Prove It**



**We Prove It Every Day**

1469 East 15th St.

KANSAS CITY, MO.

..... Clip off on dotted line, sign and return, NOW .....

The A. E. I.

1469 East 15th Street, Kansas City, Mo.

Please send me free of charge your booklet as advertised in Popular Mechanics.

Name..... Town.....

State..... R. F. D.....

# Stop Forgetting!

Now, What Was That Fellow's Name?  
I Can't Remember Those New Terms.  
I Know—But Can't Find Exact Word.  
What on Earth Did He Say About It?



## A Perfect Memory Is the Key to Success

The mind of the average person is filled with thousands of single unrelated ideas which waver and fluctuate with every emotion, like the billows of the sea.

The man with a Wandering Mind can never hope to Make Good—he will always be a drug on the market—he has too many competitors.

The great men of all ages are those who acquire the ability to concentrate and to memorize.

### You Can Be Trained to Remember Accurately

In the business battle—matching wits each hour of every day—the ability or inability to think on your feet, to remember instantly and accurately means gain or loss. To succeed you must be "forget-proof." Just as surely as a poorly organized business can be placed upon a basis of perfect systematization and thereby made thoroughly efficient—so can your mind be trained and made a classified indexed and cross indexed filing system of facts so that you can command, on the instant, any thought, fact or argument.

### The Dickson Method of Memory Training Will Do This for You

It will enable you to classify impressions, ideas, names, facts and arguments so as to have them ready at a moment's notice at any time. It will train you to think on your feet, to converse in a natural, interesting way, to overcome self-consciousness and bashfulness, to acquire easy, logical thinking. My course is not a theory, but is purely and absolutely scientific—the result of more than 20 years of close, intimate contact with students in schools and colleges and searching their developing minds for means of strengthening their memories.

### I Want to Send You My Book, "How to Remember," Absolutely FREE

Simply clip the coupon and mail it today. It will explain clearly the course that has raised thousands of men from failures to great successes. You can have this same training. My free book is the first step. Don't delay. Age, education, vocation or place of residence makes no difference. Send the coupon today.

### How to Get a Free Copy of This Valuable Book

De luxe edition handsomely illustrated, richly bound. Is exactly suited to meet the needs of the man or woman who desires to be a successful public speaker. The price of this 1911 de luxe edition is \$2.00. I will, however, present a copy absolutely free to every student who enrolls for my course of memory training within ten days after reading this offer.

Send the Coupon or Postal Today.

My method is highly recommended by ELBERT HUBBARD, PROF. DAVID SWING, and thousands of others. Ten minutes a day of your spare time will give you this training and not interfere with your work in any way.



Prof. Henry Dickson

America's foremost authority on Memory Training, Public Speaking, Self-Expression, and Principal of the Dickson Memory School, Auditorium Building, Chicago.

Prof. Henry Dickson  
Principal, Dickson School of Memory  
705 Auditorium Bldg., Chicago, Ill.

Send me free Booklet "How to Remember," also full particulars how to obtain a free copy of Dickson's "How to Speak in Public."

NAME.....

STREET.....

CITY.....STATE.....



Please Mention Popular Mechanics

# LITHOGRAPHIC MODELS



Automobile  
Gas Engine  
Dynamo  
Steamship  
(“Kaiserin Augusta Viktoria”)

Locomotive (Baldwin Atlantic Type)  
Steam Engine  
Wireless Telegraph  
Steam Turbine

Price **50c** Each  
Set of Eight **\$3.50**  
Postpaid

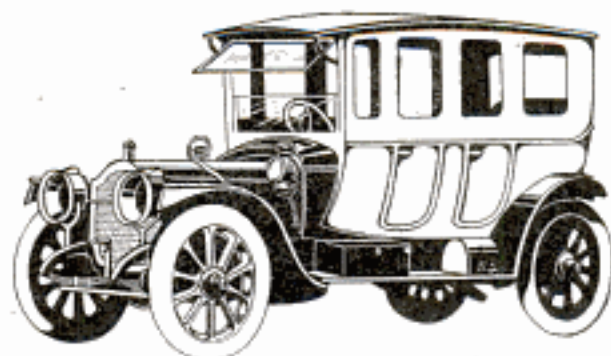
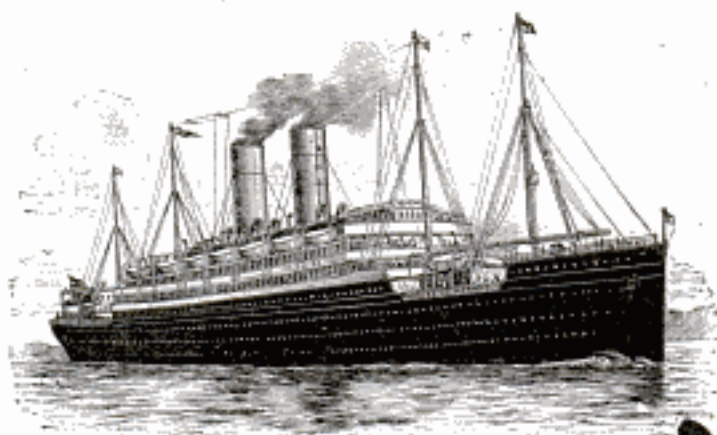

THESE models are of great value as a means of graphically showing all the interrelated parts of the above named mechanisms by virtue of their construction, which is similar to that of educational manikins of the human body and organs, with which nearly everyone is familiar. Beginning with the outermost or surface parts of the gas engine, for example, these are all differently colored and numbered to correspond to a printed key of names which comes with each model. By means of their hinge-like attachment, they may then be lifted, thereby disclosing to view the layer of parts next underneath, exactly as they would be in the engine itself, and so on until the innermost construction is shown.

THE use of these models is without a doubt the most practical method of familiarizing one's self with these wonderful machines. In fact, one can learn the construction and working principles better with the models than with the actual machines because with the former every inside part can be seen and studied—something impossible with the real thing itself unless it be taken entirely apart.

Reduced Prices on Quantities  
to Schools

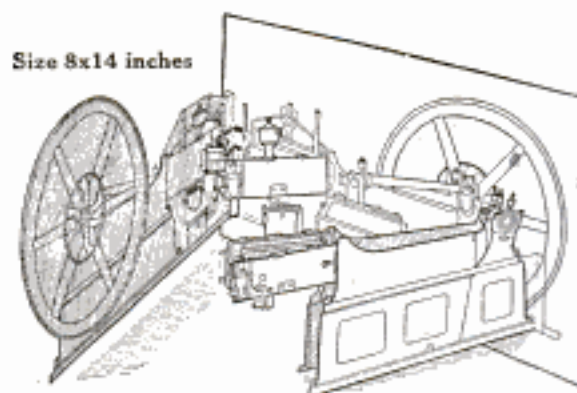

Illustration shows how parts separate

**POPULAR MECHANICS BOOK DEPARTMENT**

SOLE AGENTS

318 W. WASHINGTON STREET

CHICAGO

Please Mention Popular Mechanics

# HOW TO RUN AN AUTO IS SELF-TAUGHT IN AUDELS ANSWERS ON AUTOMOBILES

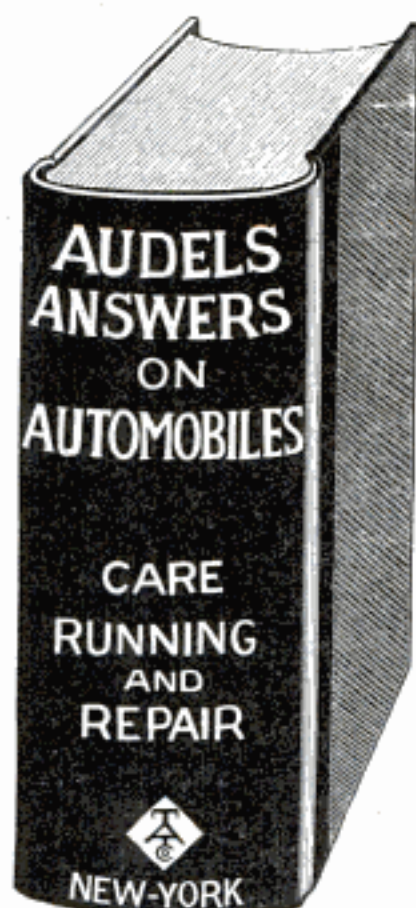

**A New Book from Cover to Cover  
LATEST — PRACTICAL — CONCISE — EXPLICIT — BEST**

**T**HE object of this book is to give, in the easiest understood form, the information necessary for the proper operation, care and maintenance of an automobile.

To adapt the book to many needs the subject matter is presented in the form of **questions and answers**. Technical terms are explained or made clear by the wording of the answer, which is always brief and direct.

Any one of the definite chapters on **Carburettors, Ignition, Gas Engine Operation, How to Run an Automobile, and Overhauling the Car, Battery Troubles**, are alone worth the price asked for the 28 complete chapters contained in this book of 512 pages, illustrated by **380 illustrations**.

The form and size are such that it is convenient to handle and study.

This book is a self-educator, hence: "he who runs may read" and improve his present knowledge of automobile engineering, and proficiency.

Handsomely bound in durable green cloth and full leather back.

**Audels Answers on Automobiles \$1.50**

## A BOOK WORTH HAVING

"Understand Your Car." Explained in the Following Chapters:

1. Ready Reference Index. 2. The Automobile. 3. The Gas Engine. 4. The Cycle of a Gas Engine. 5. Brief Outline of Gas Engine Principles. 6. Cooling Systems. 7. Fuels. 8. Carburettors. 9. Ignition. 10. Timing and Balancing. 11. Gas Engine Operation. 12. Clutches. 13. Transmissions. 14. The Drive. 15. The Differential. 16. The Running Gear. 17. Tires. 18. Brakes. 19. Ball and Roller Bearings. 20. Lubricants and Lubrication. 21. Motor Cycles. 22. Electrics. 23. Electricity. 24. Dynamos and Motors. 25. Storage Batteries. 26. Methods of Circuit Changing. 27. How to Run an Automobile. 28. Overhauling the Car.

## NONE OTHER JUST AS GOOD

### FREE EXAMINATION

We don't want you to take our word, or anyone else's for it. We are willing to send you the book without deposit. Use it seven days in connection with your car. Then send back the book or remit \$1.50. Could anything be fairer?

Cut out and fill in your name and address plainly at the bottom. Place it in an envelope and mail.

### **This Book Will Speak for Itself**

Theo. Audel & Co., 63 Fifth Ave., New York

Kindly mail me copy of **Audels Answers on Automobiles**, and, if found satisfactory, I will immediately remit you \$1.50, or return the book to you.

NAME.....

OCCUPATION.....

ADDRESS..... Mar. P. M.

# — THIS DIRECTORY OF — MECHANICAL INFORMATION

*Shows just where to find that particular help you  
are in need of on any of the following subjects:*

Aeronautics  
Air Brakes  
Amateur Mechanics  
Architecture  
Automobiles  
Boats  
Boilers  
Bricklaying  
Building  
Business  
Camping  
Carpentry  
Cement, Concrete, etc.  
Designing  
Dies  
Dyeing  
Electric Railways  
Electricity  
Electroplating  
Enameling  
Engineering  
Estimating  
Fishing  
Foundry Work  
Gas Engines  
Hand Forging  
Heating  
Hunting  
Industrial Progress  
Inventions  
Lathe Practice  
Lettering  
Locomotive Engineer's



**CATALOGUE  
OF THE LATEST AND BEST  
MECHANICAL  
BOOKS**

**A LIST OF  
500 TITLES ON  
100 SUBJECTS  
FREE for the ASKING**

Machine Shop Work  
Masonry  
Mechanics  
Mechanical Drawing  
Metal Working  
Millwrighting  
Mission Furniture  
Making  
Motorcycles  
Painting  
Pattern Making  
Plumbing  
Power  
Pumps  
Railroading  
Recipes  
Refrigeration  
Science  
Sheet Metal Work  
Shop Notes  
Sign Painting  
Slate Roofing  
Steam Engineering  
Steam Turbines  
Steel  
Telephones  
Tools  
Trapping  
Ventilation  
Welding  
Wireless  
Woodworking  
Wrought Iron  
Ornamental Work

**96 Pages—Vest Pocket Size—Indexed—Handy to Keep—Handy to Refer to**

This catalog is not a hit or miss collection of book titles, author's names and prices, but consists of intelligently prepared descriptions of good books. In many instances, complete lists of contents are given; the aim being to tell enough about a volume to enable anyone to determine whether or not it contains the information he is seeking.

SENT FREE UPON REQUEST BY

**Popular Mechanics Book Dept., 318 W. Washington St., Chicago**



# Let US Teach YOU a Trade Paying \$5.00 to \$8.00 Per Day

## Make Your Services More Valuable

and get a better job as Electrician, Plumber, Mechanical Draftsman, Painter and Decorator, Moving Picture Operator or Bricklayer. The demand for good men in these trades is greater than the supply. We assist our graduates to good jobs or we will start you in business for yourself.

Our school is the oldest, largest and best equipped trade school in the world. We occupy the entire large building illustrated above. Our instructors are all practical men—experts in their trades. We teach you quickly, practically and thoroughly by actual work. Tools instead of books.

Don't be satisfied with small pay.

The money you now earn won't satisfy you forever. You must increase your earnings. It costs more to live now than it used to. You need to get out of the small pay class. You can do it and we will help you. **Send us the coupon below.** You will be surprised how liberal an offer we make you.

## Here Are the Trades We Teach

**Electricity** offers the greatest field in the world today. Thousands more skilled electrical engineers and operators are needed. Wages are high and work steady, while the future offers the richest prizes in research work and new adaptation of electric power.

**Painting and Decorating** is of all trades the most varied and fascinating. It offers both outside and inside work and affords full scope for exercise of the artistic nature. Our special catalog tells how you can earn from \$200 to \$600 a month in the painting and decorating business.

**Moving Picture Operating** is practically a new business and good operators are so scarce that unusually high wages are enjoyed. You can soon earn a business for yourself.

School open all the year. You can enter any time. We have students 16 years of age to 60. Day and night sessions. Free Employment Department. Tuition and expenses very low. Easy payments if desired.

## Tools and Materials Furnished FREE

Drawing and estimating a part of each course. Delightful opportunities for general and social culture. Ten minutes walk to the heart of Chicago's business center. Send coupon now for FREE Book of the School.

Address, L. L. COOKE, Director

**Coyne National Trade Schools**

108 E. Illinois St., Chicago, Ill.

"The Oldest Practical Trade School in America."

**Plumbing** offers easy work, short hours, big pay and steady work. It's almost impossible now to learn the trade as an apprentice. Even then it will take years and perhaps you will never thoroughly master it. Plumbers are always in demand.

**Mechanical Drawing** There is always a big demand for good mechanical draughtsmen. Engineering firms, contractors, railroads, etc. are always on the lookout for good mechanical drawing experts.

**Bricklaying** A highly paid, fine, healthy, outdoor occupation. Builders are always on the watch for competent Bricklayers. You can develop into contracting work where there is no limit to your profits.

**FREE  
COUPON**

L. L. COOKE,  
Director  
Coyne National  
Trade Schools  
108 E. Illinois Street,  
Chicago, Ill.

GENTLEMEN: Without any obligations on me, please send me your school catalogue and full particulars of this special offer to men—  
all FREE.

NAME .....

ADDRESS .....

Please Mention Popular Mechanics



ARE YOU OUT OF

# WORK

Or Dissatisfied With Your Present Occupation?  
Learn the Automobile Business

A trade where you are in demand 12 months in the year. Work pleasant—big demand for trained men. 90% of the automobiles in daily use are not in proper adjustment on account of shortage of experienced automobile mechanics.



Everybody in the Automobile Business Today is Making Big Money

I want you to come to my school; I want you to see for yourself, how thoroughly and practically I teach all about the automobile. Six weeks after the day you enroll in my great practical Automobile School you will be prepared to properly repair any automobile made and drive any car or truck or open a garage and repair shop of your own. You can learn the automobile business thoroughly in my school because I have been years in working out for quick, thorough instruction, the

**"Sweeney System" of Practical Automobile Instruction**

It is today the most thorough, practical, comprehensive and interesting course of automobile instruction, and embraces every point worth knowing, including vulcanizing, brazing, oxy-acetylene welding, lathe work, machine shop practice, testing and road work, etc. You learn by doing the actual work on real cars with your own hands under the watchful eyes and ready suggestions of experienced instructors.

**No Books Used—Tools Furnished FREE** The tuition is low and, after you have paid that, you do not have another cent of expense in the school. You do not learn from books, but by practical work on real automobiles in everyday use.

**Free Coupon**

Emory J. Sweeney, Pres.  
Sweeney Automobile School  
1467 Woodland Ave., Kansas City, Mo.

Please send me free your catalog and place my name on your mailing list for your monthly school magazine which is also to be sent free.

NAME.....

STREET & NO.....

CITY..... STATE.....

**Send Coupon Today**

absolutely free. I want every man thinking of learning to become an Auto Expert to have my new, big, illustrated Catalog. This Catalog is just fresh from the printer. Contains articles by well known automobile men and tells all about the "Sweeney System" and the great opportunities in the automobile business—in fact, everything you want to know. Write for this great book. Send Coupon today—this very minute—NOW.

EMORY J. SWEENEY, Pres.  
**SWEENEY AUTOMOBILE SCHOOL**  
The School of Practical Experience  
1467 Woodland Ave. KANSAS CITY, MO.  
Experienced chauffeurs, repair men, truck drivers and demonstrators furnished

Please Mention Popular Mechanics



## Classified Advertisements

Advertisements in this section, 10 cents per word, each insertion, payable in advance. To insure ads being inserted under proper classified head in the April issue, copy must reach this office not later than March 1st.

December 30, 1911.

Popular Mechanics, Chicago, Ill.

Gentlemen: Enclosed we hand you check for \$13.70, for which please continue our "ads" in next issue. We have as yet done but little advertising as our article is a new one. We want to state, however, that though the "ads" have only been in one issue of Popular Mechanics, and that issue but 10 days old at this writing, we have sold more Suspender Belts through it so far than we have ever sold through advertising costing three times as much as we paid for the "ad" in Popular Mechanics.

Yours very truly,

KOKOMO BELT CO.,

Kokomo, Ind.

Geo. D. Jones, Secy.

### AUTOMOBILES

**A. C. C. A. PRICES TALK!** Great Opportunity for dealers to stock up! Hundreds of Runabouts, Roadsters, Touring Cars, Limousines Sacrificed! Here's some Bargains Offered! (50) Runabouts—Reo's, Oldsmobile's, Ford's, Cadillac's, Northern Long Distance \$50 up—(10) Light five-passenger touring cars—Buick's, Reo's, Cadillac's, Maxwell's, Autocar's, White Steamer's, Ramblers, Jackson's \$100—\$175. (20) three and four-passenger Roadsters and Speeders—Buick's, Ford's, Stoddard-Dayton's, Thomas', Pierce-Arrow's \$200 upward—(14) five and seven-passenger touring cars all leading Foreign makes \$500 upward. Landaulets and miscellaneous taxi-cabs at your own price. Guaranteed five years. We prepay Freight! Write today for our latest Illustrated Catalog, the largest and most complete price list of its kind ever published! The Automobile and Cycle Company of America, Dept. C, 1769-1787 Broadway, New York City.

**5,000 MILES OF WEAR WITHOUT PUNCTURE** is guaranteed for every 1912 "Durable" Auto Tire Tread sold by us. We give a written guarantee with every tread and ship subject to examination, paying express charges both ways if not exactly as represented. Write for our 1912 catalog which has just been issued and we will send copy of guarantee. Colorado Tire & Leather Co., 1020 Broadway, Denver, Colo.

**ONLY \$290.** NEARLY new White Steamer, just overhauled, perfect order, no worn parts, paint like new, Speedometer, five good tires, extra tubes. Runs beautifully. Photograph. Quick sale, discount. Columbia Poultry Yards, Toms River, N. J.

**AUTOMOBILE INSTRUCTIONS,** four weeks' course covering shop and road work—provision for out-of-town men. Send for booklet. P. M. West Side Y. M. C. A. Automobile School, 318 West 57th St., New York, N. Y.

**AUTOMOBILE RUNNING gear,** 30 inch wire wheel, tires and springs, for motorcycle. P. Aplan, 5806 Drexel Ave., Chicago.

**FORD 3 PASSENGER LIGHT ROADSTER,** Model "S," 4-cylinder. Expensively equipped, top, windshield, magneto, clock, five lamps, has everything. Like new. \$225. Shonnard, 114 Fifth Ave., New York City.

**WHITE STEAMER,** 30-hp. model G, luxurious, seven passenger touring. Elegantly and completely equipped. Cost \$4,700; sell \$400. Suite 337 Thoroughfare Building, 872 Eighth Ave., New York City.

**AUTOMOBILE OWNERS,** get an Elder Power-transmission; make your automobile run your machinery. Agents wanted. Elder Manufacturing Co., Indianapolis, Indiana.

**INCREASE YOUR POWER—**Reboring cylinders and regrinding crank-shafts a specialty. The Garvin Machine Co., 137 Varick Street, New York City.

**STREAM CAR OWNERS,** Myers Kerosene Burner, something new; write for circular, 387 Osceola Street, Denver, Colo.

**FORD SIX CYLINDER TOURING—**40 horsepower. Everything perfect. Cost nearly \$3,000. Finely equipped. Sell first offer. \$400. H. W. S., 17 Washington St., East Orange, New Jersey.

**FOR SALE—**Model 33 Overland two-passenger car, \$550. Pope Motorcycle \$120. Brooks saddle, \$6.50. A. Jordan, Athens, Ga.

**AUTOMOBILES,** Sacrifice sale on new and used cars. Box 275, Burlington, Wis.

**MAILING LISTS of Automobile Owners,** Any State. S. H. Carroll, Jr., Albany, N. Y.

**HUPMOBILE RUNABOUT,** perfect condition, equipped, \$350. Walter Tremper, Streator, Ill.

**ORIENT BUCKBOARD,** \$55. E. A. Snyder, New Philadelphia, Ohio.

**THE AUTOMOBILE DEALER & REPAIRER** is a handsomely illustrated monthly magazine of 100 pages which specializes the care and repair of the car, for the car owner, the dealer, the repairman, the garage man and the chauffeur. The "Trouble Department" with five pages of numbered questions from car owners and repairmen which are answered by experts on gasoline engine repairs, is worth many times the subscription price which is \$1 per year or 15 cents per copy. We have 2,215 subscribers in Illinois and 1,065 in Wisconsin. Charles D. Sherman, 212 Orchard Road, New Haven, Conn.

**AUTOMOBILES:** Save dealers' profits, buy your car direct from owners. I have all makes on my lists. A few specials for March Runabouts. Oldsmobiles, \$45. Reos, \$60. Cadillac's, \$75. Maxwell's, \$125. Ford's, \$150. Touring Cars, Cadillac's, \$300. Reo's, \$150. Buick's, \$175. Ford's, \$300. Ford six cylinder, \$375. Wintons \$275. Pope Toledo's, \$300. Send for my latest lists, it means dollars to you. I guarantee a saving to you of 5% on any car offered by any dealer. P. King (Automobile Broker), 217 W. 125th St., New York City.

**WINTON TOURING CAR,** \$235. Would make good truck. Walter Robb, Canal Dover, Ohio.

**POPE TRIBUNE—**5-passenger or runabout, convertible. Excellent condition. Quick sale, \$250. Write, Megargel, Mount Pocono, Pa.

**FREE CATALOGUE:** Automobile, Aeroplane, Motor Boat, Motorcycle instruction books. Nelson Book Co., Barton, Vt.

**WE WANT A MAN** in every town to sell automobile oils direct to automobile owners. Liberal proposition. Write us. The Independent Oil Co., Denton, Colo.

**FORD 1910 touring,** completely and elegantly equipped, good as new, must sell \$300. Kokesch 2537 Belmont Ave., Bronx, New York City.

**WANTED,** one ton truck. Will exchange 40 acre farm worth \$1,000. What have you, with price? Walter Shirley, Brownsburg, Ind.

**MITZ 1910 RUNABOUT,** splendid condition, cheap. King, 872 No. Prairie, Jacksonville, Ill.

**FORD 4 CYLINDER RUNABOUT** Top, Wind Shield, Three Oil, two gas lamps excellent condition, \$200. Wilson, 2230 7th Ave., New York City.

**14 H. P. DOUBLE CYL. ENGINE** complete, \$45, new. Used light automobile parts. B. E. Andre, Charleston, W. Va.

**AUTOMOBILES** cost too much; save \$50 to \$500 selling to yourself. Brand new, fully guaranteed 1912 cars, any model, any make, at liberal discounts; also all makes standard guaranteed tires. Referenced agents wanted every town. Union Motor Sales Co., C. P. A. Bldg., Dayton, Ohio.

**SEE WHAT WE SAY** under "Patent" heading. Swift, Attorney, Washington.

**"THE HOW AND WHY of the Automobile"**—A 200-page book of practical information for seekers after the fundamental facts regarding the gasoline engine and its application to the motor car. Interesting and instructive to both the beginner and the expert. Bound in full cloth—250 illustrations. Price \$1.00 postpaid. Popular Mechanics Book Dept., Chicago.

**AUTOMOBILE MODEL.** Every part shown and named. You can to all intents and purposes take off the wheels, raise the hood and remove the body; exposing to view the vital parts. The only practical method of studying the automobile. Price 50 cents postpaid. Popular Mechanics Book Dept., Chicago.

### AUTO SUPPLIES

**FORE-DOORS—**MAKE a fore-door model of your open front car by equipping with Universal Detachable Fore-Doors. Built of hardwood and metal and finished in conformity with the rest of your car. Ready to attach to standard models. Ask for Booklet G and special winter discount. Auto Specialty Manufacturing Company, 326 E. Market St., Indianapolis.

**TIRE BARGAINS!** A. C. C. A. prices talk! Diamond-Goodrich's and other standard makes—Guaranteed—Every size for every rim: 28x3 1/2, \$5.00; 32x3, \$8.00; 30x3, \$7.00; 34x3, \$9.00; 29x3 1/2, \$10. All other sizes and tubes proportionately low. Shipped on approval. Write today for price list. The Automobile and Cycle Company of America, Dept. B, 1769 to 1787 Broadway, New York City.

**FOR SALE—**One fine four cylinder 25-hp. air-cooled auto motor with carburetor, timer and fan, \$78. One brand new two cylinder opposed water cooled Beaver motor, 15-hp., and planetary transmission complete for \$85. Badger Motor Company, Milwaukee, Wis.

**HAVING JUST RECEIVED** a large consignment of best Standard make four ply tire retiners, will sell as follows: 28x3, \$1.80; 30x3, \$2; 32x3, \$2.20; 30x3 1/2, \$2.40; 32x3 1/2, \$2.50; 34x3 1/2, \$2.60. We have all sizes. Write quickly. Box 726, Trenton, N. J.

**THE POCKET AUTO-GUIDE:** full information; roads, hotels, garages, census, all states, transcontinental routes; satisfaction guaranteed, mail \$1. The Auto-Guide, Box 1508, Denver, Colo.

**FORD, BUICK, OVERLAND, E. M. F., Maxwell, Air-Friction** Carburetors, drive your cars three miles per hour on high. Much more speed; much less gas. Starts easy in cold weather. Satisfaction or refund money. Air-Friction Carburetor Co., Dayton, O.

**SPEEDOMETERS AT HALF PRICE.** New Stewarts. Never used. Complete with shaft, etc. Harry Fleishman, 54 S. Pearl St., Albany, N. Y.

**45 BUYS NEW DEVICE** that repairs a puncture in one minute. Adds to the life of your tire. Send for booklet. Kimball, 112 Adams St., Brockport, N. Y.

**FOR SALE—**Automobile engines and parts. John Murphy, 468 Broad St., Bridgeport, Conn.

**14 H. P. 2 Cylinder** auto engine, \$70. Good as new. E. G. Olmstead, New Philadelphia, Ohio.

**BEST MAKE RED RUBBER GOGGLES,** 35c, postpaid, Box 726, Trenton, N. J.

**AUTO RUNNING GEAR,** \$35. Make offer. Earl Budin, Dalton, Mass.

**TIRE SPECIALS.** Guaranteed Tires. 1912 fresh stock; just bought an entire surplus stock. Order today while they last: 28x3, \$8.90—\$2.52; 30x3, \$9.60—\$2.65; 30x3 1/2, \$14—\$3.60; 32x3 1/2, \$15—\$3.85; 34x4, \$24—\$4.95. Other sizes, prices in proportion. Write for complete list. We ship C. O. D. subject to examination upon receipt of express charges. Para Auto Tire Co., 1429 Michigan Ave., Chicago, Ill.

NEW 3½x4 4-CYLINDER Air Cooled Motor, \$90. Cadillac wheels, axles, springs, frame, steering gear, \$30. Planetary transmission, \$15; Engine, \$15. Butta, Oxford, New York.

AUTOMOBILE CYLINDERS REGROUND. New Pistons and Rings fitted. Broken cylinders welded. Cast Iron Brazing Co., Manchester, N. H.

MANY STYLES STOCK AUTOMOBILE BODIES, bargain prices, send chassis measurements with inquiry, Box 35, Industrial building, Indianapolis, Ind.

PELLET'S MAGNETO EXCHANGE, 1461 MICHIGAN AVE., Chicago. All makes bought, sold, exchanged, repaired and re-magnetized. Repairs guaranteed. Parts and coils in stock for all makes of magnetos. Agent for Eisenmann Magneto Co.

WE MAKE A BETTER unguaranteed Automobile Tire than most guaranteed tires. You get exactly what you pay for. Gums, Fabrics and Mechanical goods. National Company, 1409 Clybourn Place, Chicago, Ill.

TEN THOUSAND ¼" SAFETY VALVES, one dollar each postpaid. State pressure wanted. J. L. Lucas & Son, Bridgeport, Conn.

STEAM AUTO BOILERS Bought, Sold and Repaired. J. L. Lucas, No. 2 Fox St., Bridgeport, Conn.

FOR SALE—10 horse Automobile boiler (new) with automatic regulating burner, \$45. Wm. D. Gould, Albany, N. Y.

#### MOTORCYCLES

MOTORCYCLE BARGAINS—1 1911 Thor IV magneto, clutch, studded tires, \$140; 1 1911 Thor IV magneto, \$125; 1 1911 5-hp. Minneapolis magneto, 2 speed, fine shape, \$150; 1 1910 Wagner battery, very good condition; 1 1910 Thor 6-hp. twin, good condition, magneto, \$125; 1 1910 Yale battery, fine shape, \$85; 1 1910 Excelsior battery, fine condition, \$100; 1 1911 Thor IV, good condition, battery, \$100; 2 new Thor IV 1911, never used, \$170; 1 new Minneapolis, never used, \$240, and others. G. H. W., Rm. 18 McCurdy Bldg., Canton, Ohio.

MOTORCYCLES, EASY TERMS, every make, new and second hand, \$20 up. Some exceptional bargains. Every machine in perfect running order and guaranteed for 1 year. Shipments upon receipt of first payment. Free trial allowed. Write for price list of 150 machines. Agents wanted for unoccupied territory. Will trade. Boyd Motor Co., 225 Stanhope St., Boston, Mass.

1911 HARLEY, \$115; 1910 Greyhound, \$90; 1910 Sears, \$65. Also 1910 and 1911 Excelsiors and Indians. No old models or junk. Our prices always lowest. Every machine fully guaranteed. Get our list. Scribner, Ashtabula, Ohio.

MOTORCYCLE TIRE BARGAINS! A. C. C. A. prices talk; Diamond-Goodrich, G. & J., and other standard makes—Guaranteed—Griffon, Basket and Bailey Treads; 28x1¾, \$3.00; 28x2, \$4.95; 28x2½, \$5.70; 28x3¼, \$6.20; 26x2¼, \$5.45; 26x2½, \$6.20. Guaranteed. Tubes priced proportionately low. Shipped on approval. Don't buy until you receive our price list! The Automobile and Cycle Company of America, Dept. A, 1769 to 1787 Broadway, New York City.

CUSSINI! WHY? TANK DRY. NEXT—Rider green. Plenty gasoline. Why? Johnston gauge. Plain sight. Always right. Easily attached. Returnable sample, \$1.50. Circulars free. Don't miss. Get one. System, St. Joe, Ind.

FOR SALE, 1911 HARLEY DAVIDSON Mag. with tandem, speedometer and big lamp, in fine condition; speedy. Will sell for \$160. Otto Merker, 1921 S. Central Park Ave., Chicago, Ill.

LET ME SELL YOUR MOTORCYCLE. I will list them and sell them for 5 per cent. Write me what you have. B. A. Thomas, 1113 Willard St., Ann Arbor, Mich.

GREAT BARGAIN—Late 1911 twin Merkel with new belt and other extras, \$195. For particulars write Wm. Colegrove, Smethport, Pa.

MOTORCYCLES—A. C. C. A. PRICES TALK, Endless variety—Latest models—Every make—Indians, Merckels, Harleys, M. M.'s, hundreds others \$20 up. Every machine guaranteed five years. Freight prepaid! Largest and only Illustrated Catalog published, sent free. The Automobile and Cycle Company of America, Dept. D, 1769-1787 Broadway, New York City.

BARGAIN, 5 H. P. Twin Indian in fine condition. Horn, Cyclometer, pump and tools. Cheap at \$100. Leslie Hamersly, Washington, Ind.

FOR SALE—1908 YALE Motorcycle, \$45. Double flame Brazer ten gallon tank, with gauge, \$18. A. A. Jordan, Athens, Ga.

THOR MOTORCYCLE, late 1911 model, chain drive, free engine, run 300 mi., no puncture, \$155. John Bergstrom, May Day, Kansas.

MARSH METZ MOTORCYCLE with magneto, \$85. Anthony F. Fiorillo, 122 Asylum St., New Haven, Conn.

PIERCE SINGLE and Four-Cylinder Motorcycles, slightly shopworn, for sale at bargain prices. William B. Colburn, 18 Hanover St., Buffalo, N. Y.

1910 MAGNETO 4 Excelsior, fine condition, \$125. 1912 Excelsior 8 twin, run 300 miles, \$210. Wm. Stauffer, Chambersburg, Pa.

FOR SALE, TWIN CYLINDER 6 H. P. Thor motorcycle. Just been overhauled by Thor factory and repainted. Very cheap if taken at once. Price \$175. Must sell. H. Wenda, 514 S. 9th St., St. Joseph, Mo.

WAGNER 3½ H. P. Motorcycle, guaranteed perfect condition, \$125. B. C. Dillon, Taylor's Store, Va.

BOYS. Two good motorcycle engines and carburetors, \$10 each. R. Putnam, Corcoran, Calif.

WANTED—500 MOTORCYCLES immediately; any make, year, condition. We buy for cash! Let us make a cash offer for your motorcycle! A. C. C. A., 1769 Broadway, New York City.

FOR SALE—1911 M. M. Magneto Motorcycle, \$155. Richard Thompson, Bridgewater, Vt.

DON'T BUY A MOTORCYCLE until you have our latest catalogue of 300 machines, every one guaranteed. It's free. Indians, \$15. Wagners, \$20. B. S., \$18, others \$10 up. We carry the largest stock of motorcycles and accessories in the south and have satisfied customers, all parts of the world. (Can we make you one!) The Wolke Cycle Company, Louisville, Ky. Pioneer Dealers.

1910 HARLEY-DAVIDSON, \$150. Elegant order. Geo. E. Buss, New Philadelphia, Ohio.

INDIAN 2½ H. P. Excellent condition, \$75. Geo. E. Buss, New Philadelphia, Ohio.

GREAT BARGAINS! 1911, 5 and 7 Indian twins. Indian Motor Co., Tiffin, Ohio.

INDIAN FIVE TWIN 1910, \$100. W. W. Rupp, New Philadelphia, Ohio.

1911 HARLEY-DAVIDSON, \$140. Geo. E. Buss, New Philadelphia, Ohio.

1910 GREYHOUND, \$115. Geo. E. Buss, New Philadelphia, Ohio.

BIG BARGAINS in used motorcycles; \$25 and up. H. W. Shockey & Co., 1019 S. 16th St., Lincoln, Nebr.

1910 HARLEY-DAVIDSON. Overhauled and re-enameled like new. \$140 takes it. V. M. Gramman, Zanesville, Ohio.

SALE OR TRADE, 1908 Motorcycle, fine condition. Everhart, Ft. Scott, Kans.

MUST SELL: \$55 takes 1908 "Thor" Motorcycle. 2823 Colorado Ave., Chicago.

4 H. P. MOTORCYCLE. Bargain \$70. Write L. Darby, Belvidere, Ill.

28x2½ TIRE RELINERS, \$1.75 each. Box 726, Trenton, N. J.

CONSTRUCTION, MANAGEMENT AND CARE OF MOTORCYCLES, fourth Edition by E. W. Keller; 104 pages; practical information for every rider or beginner. Complete on all subjects. Postpaid for 25c silver or stamps. E. W. Keller, 356 Cedar Street, St. Paul, Minn.

MOTORCYCLE, LOWEST PRICES, largest stock. Save dealer's profits. Buy direct from the owners. I have all makes, Indians, \$20 up; Marshes, \$20 up. Don't purchase any Motorcycle until you get my prices. All guaranteed for one year. King, 213-217 West 125th St., New York City.

MOTORCYCLE TIRES, largest stock and lowest prices in the world. All makes, guaranteed, from \$4 up. Shipped C. O. D.—examination allowed. Write today for prices and be convinced. Guaranteed Tire Co., 213-217 West 125th St., N. Y. City.

MOTORCYCLES CHEAP—5" secondhand motorcycles that must be sold to make room for new Shaw Motorcycles. Send for special bargain list. Shaw Manufacturing Company, Dept. 20, Galesburg, Kansas.

SUPPLIES—The largest stock in America. Immediate shipment. Lowest prices. A hundred new ideas shown in our big free catalogue P. Keller's big book, Care and Repair of the Motorcycle, our price 15c. The Motorcyclist, a dollar magazine, trial quarter year, 25c. Motorcycle Equipment Co., Hammondsport, N. Y.

DON'T BUY A BICYCLE Motor Attachment until you get our catalog and prices. Shaw Mfg. Co., Dept. 27, Galesburg, Kansas.

WANTED—MOTORCYCLE; any make, year, or condition; must be cheap. Spillane, 211 West 125th St., New York City.

#### AERONAUTICS

\$500 WILL BUY a 40-50 H. P. Eldridge Featherweight Aero Motor, two propellers, radiators and tank. All in excellent condition. This equipment has made flights. Address M. A. Schmitt, 584 Eagle Street, Buffalo, N. Y.

"NURU" the new rubber strands for models, give 30 per cent more power and 25 per cent more turn than square rubber. Made flat like tape; used on English racing models. Price, 50 feet, 70c; 150 feet, \$1.80. Accessories list, 2c. A. Melcombe, 2102 Seventh, Seattle, Wash.

THIRTY PERFECT PHOTOGRAPHS, world-known aviators, machines, flights, etc., interesting, authentic, descriptions, \$1. Six photographs, 25c. Aero Specialty Co., Revere, Mass.

4,200 FEET is the amazing record of the "Mann" monoplane. Complete models, or sets of parts. A. Melcombe, Seattle, Wash.

SUPPLIES—Our line is the most complete, and of the highest quality. S-C Racer flies 1,500 ft. \$6.75. Cellulose Turbine Engine, ¼ H. P., \$2. Stamp for catalog. Shortt-Canniff Co., Marlboro, N. Y.

LEARN TO FLY in the only successful independent Aero school in the country. Students turned out last year are making good. Send for descriptive circular. Benoist School of Aviation, University City, St. Louis, Mo.

WORKING DRAWINGS AND DESCRIPTION of Santos-Dumont's monoplane or Wright's biplane. Fifteen cents each, but for twenty-five. Hilline, 708 W. Lafayette, Baltimore, Maryland.

PARKER MOTOR CO., of St. Paul, Minnesota, are now delivering their 1912 3-6 cylinder-magneto Parker Light Aero Motors, \$350-1000. Circular and data about real aeroplane motors complete for Red Stamp.

TURBOGNOME High Power Aeroplane Engine, price \$3.50. Cedar Valley Mfg. Co., Box 107, Waterloo, Iowa.

RIBS for model aeroplanes. Send stamp for prices. Model Rib Co., 4726 Kimbark Ave., Chicago, Ill.

FLIER-PLANE. Flies like a bird, 16c. Agents wanted everywhere. Richard Lavery, 150 Broadway, New York.

PATENTS SECURED on Aeronautical Inventions. C. L. Parker, 910 G. St., Washington, D. C.

FOR SALE—MODEL AEROPLANE, suitable for window display. Price \$25. Address J. F. Hillock, 2120 Millard Ave., Chicago.

**WE ARE THE LARGEST**, hence the best and cheapest. Everything for aircraft. For wheels, propellers, control pulleys, tanks, aluminum sockets, steering wheels, fittings or what you need. Turnbuckles—all kinds and sizes. Rust proof, Curtiss type, \$5.35 per hundred, 8 stamps for sample. Running gears, Farman, Wright or Curtiss complete with tires, \$48.50. Heath Aerial Vehicle Co., Chicago. 6 stamps for illustrated catalogue.

**WRIGHT MODEL**, 3 ft. biplane—complete plan drawn to scale with full instructions for building the only Wright model that positively flies, 25c. Drawing and directions for 3 ft. model Blériot monoplane, 15c. Our new 49-page catalog, 5c. None free. Ideal Aeroplane & Supply Co., 82½ West Broadway, New York.

**\$4 BUYS 5 FOOT FLYING MODEL ANTOINETTE** monoplane. Complete in every particular. Wheels, triple motors, 12" propeller, reinforced wings. Positively best flying model ever offered at any price. Express paid. Aero flyer Company, Medford, Mass.

**CHAMPION RACER OF "CECIL PEOLI"** Holds official record of 1,691 ft. Unofficial, 2,509 ft. Plan drawn to scale with instructions for building and flying, 25c. Ideal Aeroplane & Supply Co., 82½ West Broadway, New York.

**(RACING MONOPLANE) 30"x14"**. Flies 350 ft. Very durable; excellent prize winners. This wonderful racer \$1.25 postpaid. Robie Monoplane Co., Williamson, N. Y.

**"GRAPHIC AEROPLANING"** is a new booklet describing a trip through the air, and explaining the operations of starting, flying, and landing an aeroplane. Write now enclosing ten cents for this interesting booklet. H. M., 20 Commercial Wharf, Portland, Maine.

**BARGAINS FOR MARCH**—Rubber 2 feet for 1c. Ball bearing shafts, 20c. Send 2c for bargain catalogue. J. W. T. Aeroplane Co., 1038 Broadway, Brooklyn, N. Y.

**20 FT. BIPLANE GLIDER**. Blueprints and instructions for building and flying, \$1. No stamps. Stewart and Sherman, 631 West End Ave., New York.

**5 CENTS** brings our new, up-to-the-minute catalog, 40 pages, fully illustrated, includes rules for holding model contests. None free. Ideal Aeroplane & Supply Co., 82½ West Broadway, New York.

**WRIGHT TYPE GLIDER** blueprints and specifications, for a 4c stamp to cover postage. Central Aeronautical Supply Co., 1116 Princeton Ave., Chicago.

**I HAVE A SANTOS-DUMONT MONOPLANE I** will sell complete less engine. J. R. McDowell, Auburn, Ind.

**WRIGHT GLIDER** blueprints, 25c. Aviation Directory, Lawrence, Kansas.

**MODEL AEROPLANES**, two-foot Blériot, Antoinettes, 65c prepaid. Geo. Nero, Bottineau, N. Dak.

**FOR SALE**—Six cylinder, 50 h. p. "Kirkham" Aviation motor, perfect condition, guarantee 350 lbs. thrust. Bargain. Send for photos and price. Chas. Kirkham, Savona, N. Y.

**AVIATORS WANTED** by Aeroplane Factory, experienced and inexperienced. Aeroplane, 117 N. Dearborn St., Chicago.

**MODEL FLIERS**. Organize a club in your city. Particulars free. American Aviation Association, St. Louis.

**SEE WHAT WE SAY** under "Patent" heading. Swift, Attorney, Washington.

**MODEL AEROPLANES, HOW TO MAKE AND FLY THEM**. By W. Twining. Consisting of 5 sheets of scaled drawings, showing three different models, with descriptive booklet. By mail 55c. Popular Mechanics Book Dept., Chicago.

**"VEHICLES OF THE AIR"**, the newest and only up-to-date contribution to the literature of aeronautics, contains large working plans of all successful modern flying machines. This book of 500 pages, 140 half-tone photographs and 130 drawings is the only book published containing every known fact of this interesting subject. Size, 9x5½ inches. Price \$2.50 net, postage 25 cents extra. Popular Mechanics Book Dept., Chicago.

#### BOOKS AND PERIODICALS

**HITTING THE BULL'S-EYE** in reading. Don't buy a book till you know it is what you want. We loan you by mail books you may either buy or return. We plan you short reading courses free. Everybody gets personal attention. Self-help; business; health; recreation; house and home; agriculture; economics and social problems; religion; new thought; books for writers and speakers, etc. Standard books only. Ask for lists and Library Card. Oriental Koster's Library, 119 Washington, D. C.

**A CODE OF UNITED STATES LAWS**, Pierce's Federal Code, contains in one volume, the United States Constitution, etc., and all acts of Congress in force January, 1910, except court procedure. 2,700 pages, bound in buckram, \$6 prepaid. National Law Book Co., Seattle, Wash.

**ML. BOOK—"CEMENT—A LOST ART FOUND"**, contains full information about both ancient and modern concrete work, also directions for making wood-concrete lumber and building beautiful homes at small cost. Price, fifty cents, postpaid. Peter DeLinde, Zion City, Illinois.

**IMMORTALITY CERTAIN**. Edwin Markham says: "Swedenborg gives the spiritual calculus of the Unseen World." Swedenborg's great work on immortality, 400 pages, fifteen cents, postpaid. Pastor Landensberer, Windsor Place, St. Louis, Mo.

**AUTOGENEOUS WELDING**—Our book tells how to make your own machine for less than \$25, and all about operating it, etc. 50c postpaid. Welding Co., Aberdeen, S. Dak.

**FOX AND HOUND**—Monthly Magazine about Fox, Wolf, Coon, Possum, Mink and Rabbit Hounds; has Beagle Department; \$1 year. Sample free. Ask your newsdealer for a copy. Fox and Hound, Desk P, Decatur, Ill.

**STEEL TEMPERING BOOK** for mechanics, and Mechanical Digest one year, special offer, 25c. Mechanical Digest, Grand Rapids, Mich.

**HAVE YOU READ "HOW TO SUCCEED?"** It is the greatest satire ever written on the get-rich-quick mania. 15 cents postpaid. A. A. Hulman, Dept. 20, 289 Columbus Ave., New York.

**DON'T LET THE SUN GO DOWN** without sending for "The Money Maker." Popular Show Card Co., Desk B., 1235 Michigan Ave., Chicago.

**ANY BOOK IN PRINT**. Best prices. Send us your orders. Hill's Book Store, 108 St. Charles St., New Orleans, La.

**JUST OFF THE PRESS**. The Slide Rule Simplified, by Geo. W. Richardson, 29 full size engravings with explanation and examples. How to solve them. Paper cover, \$1. Cloth, \$1.50. Geo. W. Richardson, 4218-24th Place, Chicago. Book Dept.

**THE THEORETICAL AND PRACTICAL Boiler Maker**, 310 pages; 65 illustrations. By Samuel Nichols. Price \$2.50. Special offer \$1.50 postpaid. Circular free. J. S. Ogilvie Publishing Co., 577 Rose St., New York. Agents wanted.

**GREATEST OFFER EVER PUT IN PRINT**. \$2.50 book for only 10c. 142 red-hot secrets exposed. Satisfaction guaranteed. F. & S. Co-operative Association, Box 605, Columbus Grove, Ohio.

**HYDE'S TELEPHONE TROUBLES** and how to find them. Price, 25 cents. Hyde & Co., Telephone Bldg., 183 5th St., Milwaukee, Wis.

**BUILD YOURSELF A BOAT**. A Racing Cat or Speed Launch. Send for catalogue. Yacht and Boatbuilding Books, Buder Publishing Co., 3 Hudson St., New York, N. Y.

**ENGINEERS' questions and answers** for license, by Hobson, for twenty-five cents, postpaid. Send stamps. Reilly's Book Store, Philadelphia, Pa.

**"METAL SPINNING"** is the name of the only book published on this interesting art. A concise working manual both for those who desire to spin metal as an art recreation and to follow this work as a trade. 80 pages. 33 illustrations. Price, 50 cent postpaid. Popular Mechanics Book Dept., Chicago.

**GAS FOR POWER** is taking the place of steam for reasons of economy. Learn all about this great change, by reading our new non-technical book on this subject, written by a first class authority for the practical man. 192 pages, profusely illustrated, cloth binding. Price \$1.00 postpaid. Popular Mechanics Book Dept., Chicago.

**MECHANICAL BOOKS, ANY SUBJECT**. Catalogue for stamp. Crescent Book Store, B. 329, S. Halsted St., Chicago.

#### EDUCATIONAL AND INSTRUCTION

**IN CONNECTION WITH YOUR CLERICAL WORK** we show you how to earn \$10 to \$15 per week and hold your position besides. No canvassing. We, as manufacturers of patented specialties, have new easy mail order plans that can be carried on in your own home to keep the factories busy. Large profits. Small capital. If you are one-of-the-want-to-go-ahead kind write today for catalogue (copyrighted) plans and sworn statement. J. M. Pease Mfg. Co., 555 Pease Bldg., Michigan St., Buffalo, N. Y.

**RAPID CALCULATION MADE EASY**—Pupils puzzle professors. Teachers taken to task. Decimals, fractions and mixed numbers multiplied at a glance. Our modus operandi shows you how. Price, \$1. Examples and particulars, 19c. Aspen Sales Co., 4329 Aspen St., Philadelphia, Pa.

**LEARN SHOW CARD LETTERING** and designing from the best correspondence course of instruction in the world today. We teach practical work, a money maker. Prospectus free. Address, The Thompson School, Dept. M, Pontiac, Mich.

**A PRACTICING ACCOUNTANT** offers a special introductory course of double-entry bookkeeping, complete with books, on cash payments, \$12. Clarke D. Hunter, Accountant, Box 132, Sta. A, Boston.

**FAMOUS SPENCERIAN CHARTER SHORTHAND**. Used and endorsed by experts. Quickly learned by mail. Taught free to first applicant. For booklet, address, Brown's Correspondence School of Shorthand, 915 Realty Bldg., Charlotte, N. C.

**MECHANICAL DRAWING TAUGHT** by a practical draftsman. Students instructed until competent to take positions. Complete course \$20, including outfit. For particulars write W. Barton, Franklin St., Watertown, N. Y.

**BE YOUR OWN ADDING MACHINE**. You can master Severance's System of Rapid Methods in a few hours and be able to add, multiply, etc., mentally at sight. Book 192 pages, 5½x7½. Price \$1. Severance's School of Mathematics, Detroit, Mich.

**AMERICA'S FINEST PENMAN** teaches rapid, stressless business writing by mail. The position-securing, salary-raising \$2nd. Illustrated journal free. Francis B. Courtney, Cedar Rapids, Iowa.

**GO ON THE STAGE** and make from \$35 to \$75 weekly as an actor. Will tell you how! Write for descriptive circular. It is free! C. F. Andrews, Harvey, Ill. Box 144.

**CARD WRITING**—My alphabets, instructions, brushes, pens, inks, paints, complete, express prepaid, \$5.00. Long Sign Co., 1209 E. 45th St., Kansas City, Mo.

**FOR SALE**—A \$50 Correspondence Course in Salesmanship (new), at ½ price. E. W. Collins, 92 Davis St., Greenfield, Mass.

**BE PROSPEROUS**—Learn show card and sign writing. Easy method. Particulars free. Thurber, Box 516, Bar Harbor, Maine.

**DYNAMO RUNNING COURSE** in International Correspondence School. Cost \$50.00. Fully paid up. Two bound volumes, \$30.00 cash, or will consider any trade. L. A. Brown, Clay Center, Neb.

**SINGING LESSONS BY CORRESPONDENCE.** The Open Throat Method makes the voice powerful and beautiful. Send \$1 and I will send you 4 lessons by return mail. A. Francke, Voice Builder, 8405 N. Clark St., Room 3, Chicago, Ill.

**LEARN SYSTEM ACCOUNTING.** My Home-Study course produces capable bookkeepers in ten weeks. Costs \$17. First payment \$1. E. R. Zimmerman, Consulting Accountant, Chicago, Ill.

**LEARN WRITING MOTION PICTURE PLAYS.** Complete course of instructions, book form, 50c. Guaranteed. Rufus Satterfield, 2096 14th St. S. E., Washington, D. C.

**SHORTHAND IN 7 LESSONS.** Most rapid readable system. Quickly learned at home. Write today for free first lesson. Unigraph Co., Omaha, Neb.

**LEARN TO WRITE:** The Tamblyn System by correspondence will teach you. "Blue Book" and specimens free. F. W. Tamblyn, Meyer Building, Kansas City, Mo.

**LEARN SHOW CARD WRITING** by mail, complete course, \$5. Circulars free. I. S. C., Okin Bldg., Newark, N. J.

**CIVIL SERVICE COURSE.** International Correspondence Schools. One-third off. Box 49, Kenora, W. Va.

**\$66 I. C. S. advertising course, only \$33.** Write immediately. Lock Box 214, Amherst, Ohio.

**THE CHICAGO TRAFFIC ASS'N.** needs men to qualify as R. R. Claim Investigators and Traffic Managers.

**YOU CAN WRITE 100 WORDS** a minute without knowing shorthand. My new method, Abbreviated Longhand, simpler than the simplest shorthand, tried and approved by thousands. Your money back if not delighted. Sample lessons 20c. Full particulars free. Write today. A. B. Weaver, Court Reporter, Dept. C, Buffalo, N. Y.

**FREE TUITION BY MAIL:** Civil Service, Drawing, Engineering, Electric Wiring, Agricultural, Poultry, Normal, Academic, Book-keeping, Shorthand Courses. Matriculation, \$5. Tuition free to first applicants. Apply to Carnegie College, Rogers, Ohio.

**TELEPHONE PRACTICE.** Complete instruction by mail; qualifies men for quick advancement to high position. Write for particulars. The Sinclair School of Telephony, Cambridgeport, Mass.

**EDUCATION!** Learn typewriting. See what I say under "Typewriters." Atchison.

**ELECTROPLATING.** Learn this useful occupation from our 112-page treatise. It is "written so you can understand it" and will enable the humblest beginner to make a start. Price, 50c postpaid. Popular Mechanics Book Dept., Chicago.

**BEST SHORTHAND BOOK** for home study. Thousands of successful stenographers learned from it; so can you! Pitman system complete, cloth bound, handy size, finest engraving, specially arranged for self-instruction. Price, \$1. Every book contains coupon entitling the purchaser to receive one month's practical instruction by mail. Lessons given by the author, Eldon Moran, our best known American Shorthand Instructor. Students are introduced and correspond with each other. The time to begin is now. Young people succeed well. Book well worth \$1; besides, mail lesson worth \$2 will be received without extra cost. Book and lessons sent immediately upon receipt of order. Address Popular Mechanics Book Dept., Chicago.

**MOST WONDERFUL SHORTHAND** written. Trial lesson, 25c. Box 465, Puyallup, Wash.

#### TRADE SCHOOLS

**ARE YOU INTERESTED IN AUTOMOBILES** or thinking of taking up any branch of the business? Write for list trade secrets and valuable tips to beginners. Will save you money, time and costs nothing. Arthur E. Kelley, Manager Standard Automobile Co., Minneapolis, Minn.

**BE AN AUTO EXPERT.** Fine positions open for chauffeurs and salesmen now. Easy work, Big Pay. We teach you at home by charts, diagrams and model. Highest endorsements. Small payment to start. Write for new 1912 book—Free. Practical Auto School, 117 Pearl St., New York.

**LINOTYPE OPERATORS** earn \$1,200 per year, and are always in demand. This desirable trade can be mastered day or evening. Booklet "A" on request. Empire School, 419 First Ave., New York.

**ACADEMY OF AUTOMOBILE ENGINEERING.** 1420 Michigan Ave., Chicago. One of the best equipped auto schools in the United States where the construction, driving and repairing of automobiles is taught by practical up-to-date methods. Tuition for unlimited courses, \$35. Call or write for further information.

**AUTOMOBILE SCHOOL.** You learn with your hands under the superintendence of the best instructors obtainable at the Chicago School of Motoring. Write for particulars. F. E. Edwards, Inst., Dept. "B," 1619 Michigan Ave., Chicago, Ill.

#### DUPLICATORS AND DUPLICATING DEVICES

**HECTOGRAPH EASILY MADE.** Expense about 25c. Complete instructions (three different processes), 25c. Free bargain circulars. "Barstow," 514 23rd Street, Oakland, Calif.

**MAKE DUPLICATING MACHINE** for 25c, that will make 100 copies. Complete formula 25c. Novelty Works, 323 Eugene St., Chicago, Ill.

How to get a Hektograph that will make 150 copies in 10 minutes; letter size, \$2.00. Write for circular. Meyer Duplicator Co., 118 No. La Salle St., Chicago.

#### PICTURES AND POST CARDS

**POST CARD VIEWS,** Germany, Bavaria, Austria, colored, assorted, twenty for 25 cents with catalogue. American and foreign views. Price list for stamp. J. H. Gorham, Needham, Mass.

**JOIN OUR POST CARD CLUB:** Get hundreds of fine Post Cards free. Exchange cards and correspondence with thousands of members. We give away a collection of 40 elegant, assorted souvenir Post Cards and splendid large Album. Ten samples of very latest, most beautiful gold and embossed floral greetings and friendship cards if you join at once. Send name for membership today enclosing 10c to Capital Card Co., Desk P. M., Topeka, Kans.

**WILD BRONCO, INDIAN SQUAW** and eight other dandy photograph post cards of the Far West sent postpaid for 25c silver or stamps. Moore & Stone, Winnemucca, Nevada.

**POST CARDS** of the largest gold mine in the world. Underground and surface cards. 20c dozen. A. A. Lense, Lead, S. D.

**20 FINE GOLD** embossed Easter cards, 10c. 100 of these fine cards only 40c. German Am. Post Card Co., Dept. 211, Burlington, Iowa.

**12 LOVELY POSTALS:** Perfumed Silk Floral, Your Name Frosted; Easter, etc., 10c. American Art Co., West Haven, Conn.

**DOLLARS GIVEN** with every few packages containing 22 fine views of California and Exposition City, 15c. Frank Creed, 1315 Gough St., San Francisco, California.

**A TRIP THROUGH WASHINGTON CITY** via postal route. 10 post cards, views of Washington, 10c. DeLyte Distributing Co., Baltimore, Md.

**PHOTOS—Pretty girls** in "bewitching poses," 12 for 25c, 4 for 10c. Curtis Co., 148 West Seventy-third Street, Chicago.

**20 POST CARDS** and "The Money Maker," sent postpaid for 10 cents. Popular Show Card Co., Desk C, 1235 Michigan Ave., Chicago.

**EXCHANGE CARDS,** get acquainted, be somebody; membership, including 48-page magazine, 25c; literature free. Round World Postal Club, 19, Dayton, Ohio.

**FIFTEEN BEAUTIFUL VIEWS** of N. Y. and four valuable formulas for 12 cents. Ben Levy, 49 Malden Lane, N. Y.

**YOU'LL GET CARDS** from everywhere. Membership 10c. Idaho Card Exchange, Dept. K, Box 906, Boise, Idaho.

**JOIN HOOSIER CORRESPONDENCE CLUB.** Membership 10c. O. Pendergast, 2006 N. 9th St., Terre Haute, Ind.

**MAIL ORDER POST CARDS.** Samples and prices, 4c. Alvin Card Co., Connelville, Pa.

**22 BEAUTIFUL EASTER POST CARDS,** 10c. Claude Ross, Zanesville, Ohio.

**EXCHANGE POST-CARDS** with people from all parts of the country. Name inserted. List mailed you, one dime. Progressive Post Card Exchange, 336 C. 14th Street, Buffalo, N. Y.

**REAL PHOTOGRAPHS** from life, of Artist's Models, 3 for 25c. One 6x8 Fire Tone Free with 50c order. Royal Art Co., Dept. J, Grand Rapids, Mich.

**THE TRAVELLERS POST CARD EXCHANGE** has members in Holland, Wales, New Zealand, Egypt, France and everywhere. Membership 10c. 3508 Carroll Ave., Chicago, Ill.

**25 BEAUTIFUL** High Grade Souvenir Post Cards, 10c. Shepard Card Co., 1649 W. Adams St., Chicago, Ill.

**RECEIVE BEAUTIFUL VIEWS** from all parts of country. Membership 10 cents. International Post Card Exchange, Dept. G, Endicott, New York.

**FIVE BEAUTIFULLY EMBOSSED** Gold Post Cards free. Send 2c stamp. Willard Watch Co., Dept. P, Chicago.

**IF YOU REALLY WANT** to exchange post cards, try our splendid club. Lists circulate in many countries. Membership, 10c. Halyon Club, Box 133, Erie, Pa.

**25 BEAUTIFUL HIGH GRADE** Souvenir Post Cards, for only 10c. The Rehm Co., Weehawken, N. J.

**POST CARD COLLECTORS.** Get our Catalog of Lighthouse Post Cards. We have the largest assortment of these cards of any firm in the world. We can also supply cards of Irish scenery, etc. Lists for two-cent stamp, or send 25c for list and 12 sample cards. The Lighthouse, Dept. P. M., Linenhall Street, Belfast, Ireland.

#### DIAMONDS, WATCHES AND JEWELRY

**GENUINE, PERFECT CUT DIAMONDS** can now be purchased direct from the importer at 15 per cent less than wholesale, or about half the price of retail jewelers. Here are the lowest prices in the world:  $\frac{1}{4}$  karat, \$8.25;  $\frac{1}{2}$  karat, \$17.50;  $\frac{3}{4}$  karat, \$45; 1 karat, \$97.50. Hundreds of latest styles, all 14k solid gold mountings to choose from. Ladies' Engagement ring,  $\frac{1}{2}$  karat diamond, special price complete \$10. Gentlemen's ring, special with  $\frac{1}{4}$  karat diamond, complete \$12. A written contract to refund your money, with every diamond. We ship C. O. D., privilege of examination. Full information in our complete free Diamond Book. Established 33 years. L. Basch & Co., Dept. A-340 S. State St., Chicago, Ill.

**SEVEN-IN-ONE,** new novelty in jewelry scarf pin each day of week. Seven imported stones, match any color tie. Sells on sight. Agents wanted. Investigate. Weeks, 3344, Boston, Mass.

**GENTLEMEN'S \$15 FULL JEWELLED ELGIN** or Waltham 20 year watch. While they last, \$6.75. Sent on approval. Banghart Co., 16 State, Rochester, N. Y.

#### COLLECTIONS

**"FOLLOW THEM UP YOURSELF"** collection letters turn slow accounts into cash. Outfits for 6 accounts, with "follow-up" devices, 50 cents; 25, \$1.50; 100, with desk filing cabinet, \$6. Bankers' & Merchants' Commercial Agency, Dept. D, Independence, Iowa.

## CAMERAS, PHOTO SUPPLIES, ETC.

**KODAK FILMS DEVELOPED**, 10c per roll, any size. Prompt attention given mail orders. Prints  $2\frac{1}{4} \times 3\frac{1}{4}$  to  $3\frac{1}{4} \times 4\frac{1}{4}$ , 3c;  $4 \times 5$  to  $3\frac{1}{4} \times 5\frac{1}{4}$ , 4c. J. M. Manning, Box B, 1022 Third Ave., New York City.

**REAL BROMIDE ENLARGEMENTS**,  $8 \times 10$ , 45c (coin), post-paid, made from anything. Keystone Photo, 37 Morton Ave., Medford, Mass.

**LOOK—FILMS DEVELOPED**, 5c per roll, any size. Velox prints, 3c each. Prompt replies. Harold R. Parmelee, 108 Calhoun St., Springfield, Mass.

**THREE FINE NEW FORMULAS** for transferring photos to watch cases, chinaware, sofa pillows, etc., only 25c. Real Money Makers, P. Benson, Stewartville, Minn.

**$8 \times 10$  ENLARGEMENTS** made from any photograph, 35 cents. Forster's Art Studio, Calumet, Mich.

**POST CARDS PRINTED** from your negative, 5c each, 50c dozen. Prints up to  $4 \times 5$ , 3c each. J. H. McCurry, Texarkana, Texas.

**MAKE REAL CAMERA** for 4c. Actually takes photo post-cards. Anybody can make. Instructions and simplified blue prints 25c (coin). Sample photo free. Photographer, Fargo, Okla.

**PHOTO POST CARDS** made from your negatives, 4c each; 50c per dozen; \$1.50 per 100, postpaid. Edw. Lawson, Kane, Pa.

**FOR SALE—(4x5)** Camera, half price. Bargain. Write, Irving Peterson, Hawley, Minn.

**GOING TO BUY A CAMERA?** Postal brings catalog and full information. L. J. Peabody, 278 Devonshire St., Boston.

**LET FROSS HIMSELF DEVELOP YOUR FILMS.** A photographic expert of fifteen years' practical experience, his personal attention guaranteed. Fross Quality Developing and Printing. Rolls, 15c. Prints, 3c to 5c. Standard Photo Supply Co., Chicago.

**AZO PHOTO POST CARDS**, 100 of one subject \$1.50 (dozen 48c). Made from your negatives—all size films, 5x7 plates only. Sample made free. Best enlargements 30c. Films developed, 5c. Calkins Photo Works, Box 317K, Oneonta, N. Y.

**AMATEUR PHOTOGRAPHERS' FILMS DEVELOPED** 10 cents. I wish regular customers who desire the services of a careful, professional workman. Lewis Photo Studio, Atlantic, Iowa.

**MAKE MONEY WITH YOUR KODAK** or Camera, any size, working for us in your spare time. Send 25c for complete plans and working instructions. Standard Photo Supply Co., Dept. A, Chicago.

**FILMS DEVELOPED**, 10c per roll. All sizes. Prints:  $2\frac{1}{4} \times 3\frac{1}{4}$ , 2c;  $2\frac{1}{2} \times 3\frac{1}{2}$ ,  $3\frac{1}{4} \times 3\frac{1}{4}$ ,  $3\frac{1}{4} \times 4\frac{1}{4}$ , 4c;  $3\frac{1}{4} \times 5\frac{1}{4}$  and  $4 \times 5$ , 5c. On post cards, 5c. Prompt returns. Highest grade work. Send 2 negatives and will print free as sample. G. R. Hoke, 6206 Jefferson Ave., Chicago.

**SPECIALISTS IN SELLING, EXCHANGING**, second-hand cameras and lenses. Full line of Kodaks, Century, Premo and Graflex Cameras; supplies. Send 3c in stamps for catalogue and bargain list. "P." Gloeckner & Newby Co., 171 Broadway, New York City.

**FOR DEVELOPING AND PRINTING** you will save money by writing me for prices. Developing 10 cts. per roll. Prints, 3 cts. up. Send two films for free prints. H. A. Clark, 1 Plaza, Brooklyn, N. Y.

**WE BUY, SELL AND EXCHANGE.** Bargains in Microscopes, Telescopes, Field Glasses, Cameras, etc. Catalogue and Bargain List free. Kahn & Co., Established 1850, 26 John St., New York.

**FILMS DEVELOPED**, 9c a roll, any size prints  $2\frac{1}{4} \times 3\frac{1}{4}$ ;  $3\frac{1}{4} \times 4\frac{1}{4}$ ;  $4 \times 5$ , at 3c.  $8 \times 10$  enlargements, 25c each. King, 2239 7th Ave., N. Y. City.

## DOGS, POULTRY AND LIVE STOCK

**BARRED P. ROCKS** that are barred. Over one thousand cockerels that are now ready to ship. We breed all the paying varieties of Standard bred poultry. Address W. F. Holcomb, Manager, Nebraska Poultry Co., Clay Center, Neb.

**BARRED ROCK COCKERELS** from birds that won more prizes than all competitors together at Wis. State Fair, Green Bay, Fond du Lac and Milwaukee. Males, \$3 and \$5. I'll please you or return your money. Edward Meyer, Box M, Green Bay, Wis.

**AIRDALE PUPS FOR SALE**, Sire Wisslichon Chief, the best American Bred out this year, Dam Helgeley Floribel, these are the right kind, over distemper. E. F. Watson, 129 Mich. Ave., Detroit, Mich.

**BUFF WYANDOTTE COCKERELS**—Bred from winners at Boston and New York. Prices reasonable. "H. & M." Poultry Farms, Chagrin Falls, Ohio.

**BIRDS, DOGS, GOLDFISH**, pet stock and their supplies. Mail orders a specialty. Ill. catalogue for 2c stamp. Edwards Bird Store, Detroit, Mich.

**MY PERFECT POULTRY HOUSE.** How to build, complete plans and specifications. Address A. Sawyer, Forest Park, Ill.

**POULTRY JOURNAL**—Practical and reliable; monthly; special introductory offer, 6 months for 10c. The Poultry Record, Box M, Carey, Ohio.

**DARK CORNISH STOCK** for sale. Circular free. M. J. Van Eman, Box 1009, Elgin, Ohio.

**SHEPHERD PONIES FOR SALE** by E. L. Andrews' Sons, Bristol, Tenn. Send two-cent stamp. Illustration.

**FOR SALE**, S. C. White Leghorn Cocks and Cockerels. Write J. M. Case, Gilboa, N. Y.

**RHODE ISLAND RED EGGS**, \$3 per setting. Prize winning stock. Special prices in larger lots. Write or remit to Charles Rickhart, Route 5, Rosedale, Kansas.

**WANTED**—Men to care their own horses. Two cent stamp brings valuable prescription, free. Michigan Veterinary Co., 82 Julia St., Grand Rapids, Mich.

**SCOTCH COLLIE DOGS**. Send for list. W. R. Watson, Oakland, Iowa.

## BUSINESS OPPORTUNITIES

**BIG MONEY** to agents selling O-tak-a Tire Remover. The only tire remover in the market that will do what is advertised. Sells for \$5.00. 50 per cent profit to the agent. Many people ordering two and three at a time by mail. One sale makes four or five new customers. Write for proposition for exclusive territory. J. W. Grumiaux, sales agent, Le Roy, N. Y.

**BE INDEPENDENT**—Start a mail order business in your own home. We tell you how, and furnish everything needed wholesale. An honorable and profitable business for man or woman. Particulars free. Many make \$5,000 a year. Murphy Mfg. Co., Dept. 3, South Norwalk, Conn.

**MAKE MORE MONEY!** Start Mail Business; operate "Silent Salesman" system; spare time; possibilities unlimited. But don't invest any money in the mail business until you read "Booster," as "The Booster" starts you in business for yourself; puts you next to the best money making propositions on earth—ones that get you the money. Get away from wage slavery! Send 10c for two months' trial. Booster Magazine, 369 Northwestern Building, Chicago.

**EARN \$4 TO \$10 DAILY.** Replating table cutlery, watch cases, rings, chains, jewelry, etc., with gold, silver and nickel. No apparatus of any kind, no capital, simple instructions. Our guaranteed instructions cost you only one dollar. Address Silver Plating Co., Dept. 33, Preston, Ont., Can.

**MAKE \$20.00 DAILY** with our Diamond machine; takes pictures without negatives. Postals, buttons, all sizes, in one minute. Anybody can operate. Price \$7.50 up. Write for free circular. International Metal & Ferrotyping Co., Dept. BC, Chicago, Ill.

**FOR SALE TO CLOSE ESTATE**, foundry and wood shop on railroad siding main line M. C. R. R. Worth \$5,000, will sell for \$2,500. One-half cash, balance time to suit purchaser. Address Ray Beach, Millington, Mich.

**ELECTRIC LIGHT PLANT** for sale, 110 V., direct current, will run 150 16-c. p. carbon lamps. Switchboard complete. Engine 2-cyl. Westinghouse gas or gasoline motor, 6" x 8". The plant is in good condition and is now in use. Cost \$1,550.00 new. Will sell at a bargain, as it is too large for our use. Delavan Lake Boat & Engine Co., Delavan, Wis.

**GREAT SPRING AND SUMMER MONEY-MAKER?** Yonge's Improved Method for Polishing Marbles; Old Weather-Beaten Monuments made new; a winner. Price of process, \$2 complete. Have also Formulas—Condition Powders, Stock and Poultry Foods, Salt-Water-Taffy. Many others. Send for list. Address Henry J. Yonge, Box 716, Niagara Falls, N. Y.

**WE START YOU IN BUSINESS**, wholesale or retail, furnishing everything. Men and women, \$38.00 to \$200.00 weekly operating our Original "New System Specialty Candy Factories" home or small room anywhere. Opportunity lifetime; booklet free. W. Randsdale Co., East Orange, N. J.

**INCREASE YOUR BUSINESS.** Our Sales Letters will do it—that's our specialty. Send outline of your proposition; we'll write two snappy, result-producing letters meeting your particular requirements, for \$5. One only, \$3. Prompt service. Write us today. Sales Letter Service, 455 Fourth Ave., Newark, N. J.

**DID YOU EVER SAY THIS?** "Isn't there something new, original and dignified I can do in my city? Something different, something to demonstrate my independence and ability." Here is your chance. Live, wide-awake people having a fond desire to "make good" should write us immediately. Publicity System of Ohio, Bellefontaine, Ohio.

**IN THE U. S. MANUFACTURING PAYS BETTER** than anything when you have a good article and the field to yourself. From a money making standpoint my safety step-ladder patent is the greatest put through in years. U. S. and Canadian patents for sale. Eddie Bentley, Lincoln, Illinois.

**\$3.00 YEARLY** in your back yard! No poultry, trucking, ginseng, mushroom "dope!" New industry, you never heard of. "Short Cuts" magazine explains; editor starts subscribers. Two months' subscription, 10 cents. Bend. Burdick, Dept. 3, Oshkosh, Mich.

**ILL SHOW YOU HOW** to start a profitable collection business of your own. No capital required. Earn \$109 monthly. Collection Service, Box 15, Pierre, South Dakota.

**BE A DETECTIVE.** Splendid opportunities to travel and earn big money. Many of our graduates are operating agencies of their own. Write American School of Criminology, Dept. F, Detroit, Mich.

**YOU CAN START** a mail order business on \$1 capital. No outfit scheme. Strictly legitimate. Full details, 50c. C. W. Fenster, P. O. Box 129 P. Windsor, Mo.

**I MADE \$55,000** in five years with a small mail order business; began with \$5. Send for free booklet. Tells how. A. Weber, 4812 Calumet Ave., Chicago.

**BE YOUR OWN BOSS**—Start mail order business. We tell you how, 18 years in business. Everything furnished. "Starter" particulars free. Krueger Co., Dept. 2B, 164 W. Washington, Chicago.

**BIG PROFITS!** Open a dyeing and cleaning establishment, splendid field, little capital needed. We teach by mail. Write for booklet. Ben-Vende System, Dept. C, Charlotte, N. C.

**OPEN AUTO TIRE REPAIR** and Supply Shop. We furnish equipment, man to teach you, small investment, big income. John C. Gibson Company, Manufacturers, Akron, Ohio.

**THE UNDERSIGNED COMPANY** has a mail order business proposition of unusual character to offer—a protected, high-profit line, based on thorough business principles but requiring extremely little money. We furnish high-calibre advertising matter and back you with our own service and capital. Write for details. R. W. Bixby Publishing Co., Box 134 C, Buffalo, N. Y.

**A BIT SHY ON SALARY?** I pick up \$1,500 yearly additional from newspaper correspondence. My book tells what's news, how to get it, where to sell. Newspaper directory included. No correspondence school expense; only 50 cents. First sale returns investment. Morris White, Station 50, Detroit, Mich.

**I CAN POSITIVELY** secure the position you desire or start you up in well paying, sensible and dignified mail order business; with very little money. Investigation means independence. Invaluable details free. No advance payment whatsoever. Address: Bachmann Home Bank, Baltimore, Md.

**MANUFACTURE DRY BATTERIES**, get into this exclusive business. Our treatise, written by a practical battery man covering formulas, processes, description of machinery, will enable you to start in this profitable business. Ford Co., Ford Building, White Plains, N. Y.

**BE A HANDCUFF KING;** make big money on the stage; all vaudeville circuits pay from \$50 per week up. I teach everything in this line. For particulars address, Box 962, Springfield, Mass.

**DON'T SELL GOODS.** Stay home write letters. Earn dollars, not dimes, every evening. Nothing to buy or sell. Box writing paper whole outfit. Absolute truth. Particulars 10c, full plan \$1.00. Essex Assn., Box 2240, Glenridge, N. J.

**MAIL ORDER MEN** look here! For 25c I will send you a legitimate scheme that brought me 368 mail orders in one month. Try it. Address: C. A. Larson, 28 Sidney Place, P. I. Minneapolis, Minn.

**BIG MONEY MADE** operating the Base Ball Batting Device. Send for catalogue. Wm. Sullivan, 344 Ward St., Richmond Hill, N. Y.

**THE ROADMAN'S GUIDE** contains greatest collection of 109 trade secrets, plans and ways to make money easy and quick. \$1 book for 25c. M. O. Rester, Box 1228, Ft. Worth, Tex.

**ESCAPE FROM PACKING CASE**, Milk Can, and Cloth Bag. Three secrets for 25c. Magic Works, 323 Eugene St., Chicago, Ill.

**FOR SALE**—Elevator in live town in heart of Michigan's grain belt, cheap. Everything complete and in good shape. E. H. Morehouse, Lake Odessa, Mich.

**PUBLISHERS AND MAIL DEALERS.** We supply books, catalogs, etc., with your imprint. Also commission circulars that insure \$50 per thousand. Successful plan free. Popular Institute, 500 West 64th St., Chicago.

**I MADE \$20,000** in three years in the mail order business. Begin small. Send for free booklet, tells how. No "outfit" scheme. H. System, 910, Marion, Kentucky.

**HAVE YOU A MECHANICAL DEVICE**, toy, novelty, household or mail order article? If so, patent it and start in business with it. I show you how; Book free. Sanders, 35 Crilly Block, Chicago.

**MAKE MONEY**—Buy Oxacetylene Welders, Blowpipes, Accessories, Fluxes, Oxacetylene, 245 W. 24th, New York.

**I MAKE \$60 a week.** So could you. No mail order, or canvassing. Particulars for stamp, Gordon Mack, St. Stephens Church, Va.

**SEND 10c** (coin preferred) for "Key to Success in The Mail Order Business," contains valuable information where to buy supplies, etc. Theo. A. Hill, 3309 Quivas, Denver, Colo.

**GO IN BUSINESS FOR YOURSELF.** Small capital. Constant re-orders. Unlimited field. Particulars free. Winslow W. Chase, Dept. 12, Washington, D. C.

**START MAIL BUSINESS** in your spare time. Possibilities unlimited. Small outlay, big profits. Send stamp for select propositions. "A" Distributing Co., 923 Alder, Philadelphia.

**MONEY MADE DURING LEISURE HOURS** with my dollar getting secrets. Valuable samples free. G. Edward Harrison, Baltimore.

**WRITE TODAY** for plain talk on how to start mail order business; tells how to make \$50 a week. Washington Herman Co., A 58 & Spruce, Philadelphia, Pa.

**START MAIL ORDER BUSINESS** in your own home. Everything furnished. Full particulars and "The Money Maker" sent free. Write today. Popular Show Card Co., Desk X, 1235 Michigan Ave., Chicago.

**CONDUCT A "CANDY KITCHEN."** Clear \$20 daily. Small capital required. Send for particulars. Kennon and Co., 148 West Ontario St., Dept. A, Chicago.

**BE YOUR OWN MASTER.** Own a business of your own. This is no fake scheme, but a genuine, legitimate business. Address E. Daugherty, 1008 W. Monroe St., Chicago, Ill.

**I MADE \$50,000** in five years with a small mail order business; began with \$5. Send for free booklet. Tells how. Heacock, Lockport, N. Y.

**WE CAN TRADE OR SELL** for cash any good business or property; mining claims developed and marketed; companies incorporated; stock sold. Addison Company, Crilly Block, Chicago.

**\$1 CAPITAL STARTS** a good paying mail order business, strictly legitimate. Particulars free. Manager, 451 W. 40th St., New York.

**MAKE \$3.00 OR MORE DAILY.** No canvassing. No capital required. Home work. Free particulars. P. O. Box 224, Spokane, Wash.

**GOOD PAYING** mail order business can be started with \$50. Pals, 25 E. 14th Street, N. Y. City.

**CAPITAL WANTED** for developing patented speedboat, an entirely new idea. The same propeller lifting the boat out of water and giving it forward motion. Box 332, Dayton, Ohio.

**ENTIRELY NEW**—Profitable Mail Order Business for Young and Old. Address M. E. P., Box 104, Bucyrus, Ohio.

**START MAIL ORDER BUSINESS** for yourself: "Money-Making Tips," magazine shows you how; two months' trial 10c. Santa Publishing Co., Fort Madison, Iowa.

**PATENTS SECURED**—C. L. Parker, 910 G St., Washington, D. C.

**GOOD INVESTMENT** means independence. Dollar starts. L. Finley, Roscommon, Michigan.

**START A MAILING BUREAU.** "Key" tells how, 10c. E. Cable, Palestine, Ohio. Box 36.

**RESILVER MIRRORS**—Instructions 25 cents. Clair Gilson, East Lansing, Mich.

**GREAT BARGAIN**—Wish to dispose of an excellent business. Reasons and particulars. Box 142, Bucyrus, Ohio.

**INDEPENDENCE** and fortune quickly attained in the Manufacturing Mail Order Business. I furnish Formulas, Manufacturing Processes and Trade Secrets in all lines. Sold under positive guarantee; 18 years' practical experience. Revision and improvement of Formulas and Processes—reduction of manufacturing cost—utilization of waste materials, etc., a specialty. Booklet, Formula List, and Valuable Information Free. W. L. Cummings, Ph. D., 127 Standard St., Syracuse, N. Y.

**WE START YOU** in a permanent business with us and furnish everything. We have new easy selling plans and reasonable leaders in the Mail Order line to keep the factories busy. No canvassing. Small capital, large profits. Spare time only required. Personal assistance. Write today for (copyrighted) plans, positive proof and sworn statements. J. M. Pease Mfg. Co., 541 Pease Bldg., Michigan St., Buffalo, N. Y.

**FROM \$7 TO \$12 DAILY**, at home, in spare time, restoring faded colors in rugs and carpets. No capital. Free booklet tells how. Wm. A. Eldred, Dept. 75, Detroit, Mich.

**LEARN THE TRUTH** about Mail Order Business before buying "outfits." Important information and particulars sent free. Mail Order Library, P. M., Tompkinsville, New York.

**FORM A CORPORATION**—Congress Law for D. C. and all States; cheap. Raise money easily; advice free. U. S. Legal Corporation, Washington, D. C. Representing \$1,225,000,000.

**FREE SAMPLE** goes with first letter. Something new. Every firm wants it. Orders from \$1 to \$100. Nice, pleasant business. Big demand everywhere. Write at once for free sample and particulars. Metallic Sales Co., 406 N. Clark St., Chicago.

**HAVE YOU ANYTHING TO ADVERTISE?** Our Rate Book tells you all about advertising mediums, rates, circulation, closing dates, etc. Sent for 10c. Worth dollars. Folder free. Correspondence invited. Dearborn Advertising Agency, 455 Franklin Bldg., Chicago.

1,000—34x8 book paper circulars printed, sent prepaid. \$1. B. P. Newnham, Waukegan, Ill.

**I WILL START YOU** earning \$4 daily at home in spare time, silvering mirrors; no capital; send for free instructive booklet, giving plans of operation. G. F. Redmond, Dept. 306, Boston, Mass.

**BUILD A BUSINESS** of your own and escape salaried drudgery for life. Learn the Collection Business. Limitless field; little competition. Few opportunities so profitable. Send for "Pointers" today. American Collection Service, 101 State St., Detroit, Mich.

**SEE WHAT WE SAY** under "Patent" heading. Swift, Attorney, Washington.

**PATENTABLE IDEAS WANTED**—Send for 3 free books. Richard B. Owen, 39 Owen Bldg., Washington, D. C.

**POSITIVELY BEST RIBBONS**, three, \$1.10. See what I say under "Typewriters." Atchison.

**MAKE MIRRORS AT HOME.** Big profits with little outlay. One 18x26-in. mirror costs \$2 to \$5. You can silver a glass this size for 20c. Send \$1 in stamps or money order and we will send you explicit directions how to do it; also how to emboss, grind, toll, gold leaf, frost, chip and make imitation stained glass. How to transfer photos on glass, bore holes in glass and cut skylights. George L. Patterson & Co., Dept. 3, Brookville, Ky.

**BE INDEPENDENT.** Start Money Making Mail Order Business at Home, New Plans. Everything furnished. Only small capital required. Free Booklet & Particulars tell how. W. P. Miller Co., Box 254, Muskegon, Mich.

**668 WAYS** to make money, 2,716 formulas in Encyclopedia Business Opportunities, 3 volumes, price \$3, yours for \$1. Booklet free. B. P. Newnham, Waukegan, Ill.

**WE HELP RAISE CAPITAL** at once to start you in retail—manufacturing—patent—real estate—mail order or any legitimate business by means of "Our Practical Method." Particulars free. The Business Aid Co., K504, Detroit, Mich.

## CEMENT

**CONCRETE BUILDING BLOCK MACHINES** and molds, Free catalogue. 5 Market St., St. Louis, Mo.

**FOITY CENTS MAKES MACHINE**, making building stones. Directions and licenses fifty cents. William Barten, Gordon, Nebr.

**IF YOU WANT** the best information on cement and concrete construction, subscribe for Concrete, leading cement and concrete monthly. Sample copy, 10 cents. Yearly subscription, \$1.00. Concrete, 135 Newberry Bldg., Detroit, Mich.

## AGENTS WANTED

**GET THIS OFFER**—All the clothes you want. All the money you want. To learn how you can have one of our stunning well tailored suits absolutely free, not a penny of cost to you (we prepay the express); to learn how you can make \$5.00 to \$10.00 a day, every day of your life, to find out what beautiful tailoring really is, to offer styles that everybody goes wild about, to get all of your own clothes always free, do this today, now, this minute, write us a letter or postal and say, "Send me your New Wonderful Tailoring Offer," and receive by return mail, free, the most astonishing tailoring offer you ever heard of, a beautiful set of samples to pick from, styles that will get your county afire, an offer so surprising, so new, so liberal, so wonderful, you can hardly believe it. A. J. Polk, Tenn., writes: "I never had a suit as well. Made \$110.00 last month, besides my own suit." Ed Hill, Miss., says: "The men are wild about your styles. No trouble getting orders. My profits \$40.00 last week and all the tailoring I want." R. P. Gatewood, Pa., says: "My suit cost me nothing. Nice, easy business. Thanks for \$28 check." You don't need money or experience. No matter what you are doing, selling books, cutlery, groceries, soap, tailoring for others, or just working, be sure to get our offer, it's so much better than anything else. We want good agents everywhere. Your spare time only will do. Write at once and receive fine outfit and samples free. Everything explained. The greatest offer ever heard of. You will succeed sure, make big money and wear fine clothes. Write now or show this to a friend who may be glad of this great chance. Address Banner Tailoring Co., Dept. 448, Chicago.

**BIG PROFIT IN FIBERSILK KNITTED TIES.** Made by new process on patented machines in many rich, beautiful colors. Brilliant, silky lustrous—washable. Sell quickly at 35 and 50 cents each—can sell for 25 cents and still net you 100 per cent profit. Exceptional proposition for spare time and agents. Send 15c for sample tie (guaranteed). Neat sample display box to agents. Fisher Knitting Co., 40 Whitesboro St., Utica, N. Y.

**AGENTS!** Wild with excitement! Do you blame them? Everybody eager to buy our beautiful artistic air brush design show cards. Cards printed in colors, 11x14, 240 varieties. No talking—simply show the show cards to storekeepers—the cards speak for themselves. Big profits, something new. Tide just setting in. Can start mail order business. Beautiful two-color catalog furnished with your imprint. The show cards are great, you'll say so, you can't help it. Wake right up, no time to argue. Do it now, send this very minute a letter or postal for free catalog and sample, also the "Money Maker." Popular Show Card Co., Desk W, 1235 Michigan Ave., Chicago.

**BIG MONEY** to agents selling O-tak-a Tire Remover. The only tire remover in the market that will do what is advertised. Sells for \$5.00. 50% profit to the agent. Many people ordering two and three at a time by mail. One sale makes four or five new customers. Write for proposition for exclusive territory. J. W. Grumiaux, sales agent, Le Roy, N. Y.

**BIG MONEY IN SELLING USED AUTOMOBILES**—No business so easy to learn, so profitable, so congenial. On \$50 to \$200 investment our Agents make \$50 to \$100 per week. We furnish the cars and teach you how to drive, sell and repair them. Write today for particulars and territory. The Automobile and Cycle Company of America, Dept. One, 1769-1787 Broadway, New York City.

**AGENTS**—To sell the newest electric appliance on the market; sold everywhere there is electricity, in the home and office; liberal profit; sales-driving sample, weighs a pound, no experience or knowledge of electricity required; it shows how to use one light instead of two and get the same results; sells for \$3.50 and saves the purchaser an investment of \$25; write for particulars. The Handy Light Co., 711 East Eighth Avenue, Cincinnati, Ohio.

**HAVE YOU MONEY TO MAKE MONEY?** We want hustling agents and general agents, with from \$3 to \$50 capital. We give exclusive city or State agency and send samples to every telephone user. Just call and sale is made. Four cents, stamps, brings sample and particulars. Positively no postals answered. Helim P. Mfg. Co., 247 W. 125th St., New York.

**ATTENTION**—One pint of milk merged into one pound of butter, 4 cents pound. Looks the same, used the same, gets as hard and is sweet as fresh country butter. No chemicals used. Goodsend to every family. Wonderful machine. Family size, \$3. 100 per cent profit. County and State agents wanted on salary and commission. 30 sworn testimonials from home users of this great money saver. Illustrated circulars and agents' credit terms sent free. Family Butter Mergers Co., Indianapolis, Ind.

**SALESMEN**—Send your name and address to Raymond E. Wood, 990 East Eighth St., Cincinnati, Ohio. I am the manufacturer's Sales Manager for the best household and office electric specialty ever invented. Sells for \$3.50 and \$2.50. Guarantee for credit or deposit required. Capable men only need apply. I want only a few men; the work is permanent, profitable and high-grade. You will be given territory and expected to produce business.

**AGENTS, BOTH SEXES: LIFETIME OPPORTUNITY**—Our high-grade household specialties positively breaking all records; whirlwind sellers, repeat orders every house, no competition, immense profits—Immediate replies will secure free beautiful catalog and extraordinary proposition. Atlantic Supply Co., Montclair Ave., Montclair, N. J.

**AT LAST THE BEST SELLER** for agents has been found; we have it, a deaf and dumb agent could sell it; don't take our word for it; send for particulars that will prove it. The Rig-Stavay Supply Co., Dept. 16, Brigham City, Utah.

**MAKE \$20.00 daily** with our Diamond machine, takes pictures without negatives. Postals, buttons, all sizes, in one minute. Anybody can operate. Price \$7.50 up. Write for free circular. International Metal & Ferrotype Co., Dept. A. C., Chicago, Ill.

**AGENTS, MEN OR WOMEN,** make big money handling Grab's Famous Household Specialties. Fastest selling articles of the age. Easy, fascinating work. Spare time or permanent. Hurry. Write today. Victor M. Grab & Co., C16 Ashland Block, Chicago, Ill.

**NEW SUIT OFFER!** Just send us your name and you will promptly receive the most astonishing—yes, wonderful suit offer, together with Paragon Complete Outfit, packed with big assortment of Cloth Samples, Tape Measure, Fashion Figures, Order Blanks, etc.—all absolutely Free by Return Mail. Postpaid. This includes an offer on a fine suit for yourself so liberal it will startle you, and our Grand Offer to start you in a big money-making business for yourself. Our wide-open terms, conditions and privileges will astonish you. The low prices we will make you on men's high-class clothes will amaze you. And we pay all express charges. We go to the limit in liberality. We want you for our agent in your town, so that we can turn all our business over to you. We will start you in a big, established, money-making business. New agents make \$40 a week. Do you wonder that our agents make all kinds of money? We must have an agent in your town. Get our Grand Offer and the Special Paragon Outfit, which is already packed with big Assortment of Cloth Samples and complete equipment, ready to be sent you free, charges paid by us. "First Come, First Served." Rush your answer to us quick if you want a suit for yourself, before some one else gets the prize. Address Dept. 11, Paragon Tailoring Co., Chicago, Ill.

**WANTED—LIVE MEN AND WOMEN TO TAKE THE AGENCY** for Tate's dust absorbing dust cloths, mops, brushes, etc.; great demand; everybody buys; 100% profit. Apply to Department B4, Consumers' Direct Supply Co., Boston, Mass.

**TRAVELING SALESMEN, AGENTS, ORGANIZERS,** etc., may secure a highly profitable side line, paying \$25 to \$50 monthly and upwards. No samples to carry, no house-to-house canvassing. Will bring you in touch with the best people in every community. Full information sent. Address The Christian Herald, Sales Dept. O, Bible House, New York City.

**500% PROFIT** selling our wonderful sign letters for office windows, store fronts and glass signs; resembles finest gold leaf; easily applied; samples free. Metallic Letter Co., 406 N. Clark St., Chicago.

**FREE SAMPLE** goes with first letter. Something new. Every firm wants it. Orders from \$1 to \$100. Nice, pleasant business. Big demand everywhere. Write at once for free sample and particulars. Metallic Sales Co., 406 N. Clark St., Chicago.

**WANTED RELIABLE PERSON IN EVERY CITY.** Either sex to push the sale of new patent household articles; new ironing device; keyless door locks; umbrella clothes bars; combination skirt and trouser hanger; folding sleeve board; ideal roaster; sanitary water proof rugs, etc. \$5 to \$15 daily, easily made. Now is the time to get started. For particular address, Dexter Supply Co., 508 S. Dearborn, Chicago.

**10,000,000 U. S. HOMES NEED** The Aladdin Mantle Lamp because they burn kerosene. Using less oil than ordinary lamps, the Aladdin outshines gas or electricity. Sells itself on overnight trial. Ball sold \$59 on money-back guarantee. Not one returned. Sample lamp furnished. Write quick for agency proposition. Mantle Lamp Company, Dept. 118-O, Chicago.

**WANTED—AGENT.** Man or woman, in every town to sell "Egypto Triple Service Neckwear, Five Ties for \$1." The best advertised line of gents' neckwear in the United States sold direct to the consumer; goods sell on sight. Indianapolis Neckwear Co., Saks Bldg., Indianapolis, Ind.

**AGENTS**—Get six pairs guaranteed hose free. Write for unparalleled special offer. Big money selling Triplewear Hosiery. Beautiful line, guaranteed six months. First application secures agency. Triplewear Mills, Dept. D, 730 Girard Avenue, Philadelphia.

**AGENTS BIG PROFITS.** Brandt's Patented Automatic Razor Strop, automatically puts a perfect edge on any razor, old style or safety. Retail at \$2. Big seller. Every man wants one. Write quickly for terms, prices and territory. P. Brandt Cutlery Co., 84 West Broadway, New York City.

**AGENTS—LIVE AGENTS TO SELL** "The American Lady Fiber Broom," on one year's guarantee; dices away with corn brooms; exclusive territory; free samples; big, permanent business; one man in every county. F. L. Hurt, 2255 S. State St., Chicago.

**AGENTS WANTED** to sell the Comfort Feed Bags. Excellent invention for feeding horses while hitched. Humane, economical and convenient. Every horse owner wants them. Liberal commission. Send \$1.50 for sample outfit and mention territory desired. Expressage prepaid. Comfort Feed Bag Co., Manufacturers, 1031 Vine Street, Philadelphia, Pa.

**MALE AGENTS, ANY KIND.** This space is too small to tell how good our proposition is. Write. Ninety Sixty Three Company, 2561 Milwaukee Ave., Chicago.

**AGENTS, CATCH THIS!** Big money making permanent position; a high class household necessity just invented; investigate for your own interest. G. O. Beasley, B. 45, Wood, Cal.

**NEW FAST SELLING SPECIALTIES** for Mechanics, office-men and everyone. Something out of the ordinary. Demand already created, 400% profit. Samples 10c. La Rue Soap Co., 584 Niagara St., Buffalo, N. Y.

**WANTED:** 5,000 salesmen at once, \$10 daily, easily made. Something new; cheap, simple, strong, neat. Only up to date Home Fastener out. Every horseman wants it, greatest seller out; most liberal terms; apply at once. B. & B. Mfg. Co., Courtenay, N. Dak.

**STOP! SELL WATCHES!** Liberal commissions paid on standard makes. Easily sold in spare time. Stamp brings confidential prices, salary and premium offer. Winslow Cabot Co., Boston.

**\$2,940.00 IN ONE SEASON** made by one concern. McCullough made \$420.00 in one week selling our bustling outfit to saloons. You can make big money. Write for information. Simplex Mfg. Co., Dept. Keweenaw, Ill.

**AGENTS:** Give \$3.00 automatic stropper free with every sale of our goods. New selling plan. Sells in home or office, town or country. Write for terms and free outfit. Thomas Mfg. Co., 1762 Third St., Dayton, Ohio.

**GREAT SUIT OFFER!** Just write us and we will send you absolutely Free, by return mail, postpaid, a large outfit containing a big variety of cloth samples, fashion figures, tape measure, order blanks, etc. Everything Free, and we will start you in a paying business. A most liberal offer on a suit for yourself that will make you wonder. Terms, conditions and privileges that will astonish you. We will name you so much lower prices on men's fine clothing that it will surprise you. We want a live agent in your town. You can make \$1,000 to \$2,000 per year. If you will write us before we get an agent in your town you will get a wonderful offer. As soon as we get an agent in your town he will get profits on every dollar we sell in his territory. We turn all our business over to him. That's why our agents make so much money. If you want a suit for yourself answer quick before we get an agent in your town, you will then get all of our great inducements. Address Dept. 468, American Woolen Mills Co., Chicago, Ill.

**WE MANUFACTURE FOUR FASCINATING GAME BOARDS.** 100% profit. Orders repeat. Can be carried as side line where Candy, Pipes and Cigars are sold. Particulars free. Unique Novelty Co., Independence, Ia.

**AGENTS**—To handle remarkable money-getter; easy to sell; easy to handle; write today for particulars, illustrated catalogue, and confidential price-list. The F. A. Coyle Supply Company, DeKalb, Illinois.

**AGENTS—MAKE BIG MONEY,** selling Congo-Lac, New waterproof coating for autos, floors and furniture. Applied with cloth. Write for territory. The Congo-Lac Company, Indianapolis, Ind.

**AGENTS—CANVASSEES**—Our Expense Records and Household necessities sell rapidly. Profits large; easily handled; big repeat business. Some territory still open. Samples free. Enclose stamp. Armstrong, Box 405, Springfield, O.

**AGENTS**—Men and women make big money, 50 to 500 sales in every office building. Almost every user of desk telephone pays quarter on sight for Empire Cord Holder. Sample 12c. Send today. Empire Supply Co., Chicago.

**WE WANT ONE LIVE AGENT** in every town—Something new; big money-maker for purchaser as well as the agent; sells at sight; get particulars. Kern Mfg. Co., Libertyville, Ill.

**AGENTS,** a first class self-filling fountain pen, sells at sight, send 5c, we will send you sample pen and agents' terms. E. Gruber & Co., Stanwood, Iowa.

**AGENTS:** To sell Clutch tire repair kit for automobiles; big commission to hustlers; call or write today. Peyrot Novelty Co., 1029 Grand Ave., Chicago, Ill.

**AGENTS, WRITE TODAY** for discounts on Peerless Automatic Draft Regulator. Insures warm house when you arise. Every home with cellar heat should have one. Price \$5. O. K. Landis, 423 Charlotte St., Lancaster, Pa.

**AGENTS WANTED**—To sell the new 3 in 1 Scrub Brush, Floor Mop and Wringer combined. Also 8 other original styles. 25 profit 1/2 day's work. Send name on postal to Hilker Mop Co., 1181-A, Grand Ave., Chicago. Free catalogue and sample.

**AGENTS**—Four in one is the best of the latest; no more burnt fingers; not sold in stores; every housewife buys; 15c gets 25c sample and prices. Money back if not satisfied. Progress Mfg. Co., 423 Main St., Elmwood Place, Cincinnati, Ohio. "Patentees."

**AGENTS—JOBBER**—Help introduce three new household necessities. Samples, 25c silver. Bedsum Novelty Co., 316 East 55th St., N. Y.

**GERMAN SILVER POCKET KEY TAG,** marked with your name and address, with key ring, 15 cents. We want you to take orders, 100% profit. We sell blank tags, steel letters, key rings, etc. Pease, Die Maker, Winchester, N. H.

**LIVE AGENTS AND DEALERS,** High-Grade, to handle Tungsten lamps, highest merit, lowest price, sells large quantities, factories, stores, hotels, buildings, supply houses. Agent must carry small stock. Large profits. Union Light & Supply Co., 89 S. La Salle St., Chicago.

**24 MINIATURE PHOTOS** copies from any picture sent us, 12 cents. Original returned unopened. Reference, any Washington resident. Brooks Studio, 915 Pa. Ave., Washington, D. C.

**SALESMEN ACQUAINTED WITH AUTOMOBILE OWNERS.** Sell direct guaranteed cold weather auto starter. Easily installed; ready sale. Instantaneous Auto Starter Co., Cincinnati, Ohio.

**WANTED AGENTS** and Mail Dealers for new popular novelties with original money-making plans, working great everywhere. Columbia Novelty Mfg. Co., 1555 Wells, Chicago.

**I MADE \$20,000** in three years in the mail order business. Began small. Send for free booklet, tells how. No "outfit" scheme. H. System, 219, Marion, Kentucky.

**PORTRAIT AGENTS** find our plan beats all others. Prompt shipments—rejects credited, 30 days' credit. Catalogue of Portraits, Frames, Pillow Tops, Sheet Pictures and samples free. James C. Bailey & Co., Desk J, Chicago.

**ONE MILLION AGENTS WANTED.** Fast seller costs 6c, sells 50c. Every firm needs. Orders to \$50. Postal brings samples. Embossed Co., 2497 Milwaukee Ave., Chicago.

**AGENTS**—The best paying seller in America needed in every office, store and home, once tried always used, liberal commission, ten cents brings full size sample package and agents' terms. Lebau Mfg. Co., Ware, Mass.

**THE MONEY-MAKER** of the season. Make \$5.00 to \$15.00 daily. 100% profit. No little Tom foolery. Free particulars. Answer this ad in preference of others. Grove Mfg. Co., Duding-Moore Bldg., Desk "B," Greenfield, Ind.

**LAMP, 200 HOURS OF LIGHT** for 1 cent. Makes and burns its own gas from kerosene oil, which is vaporized by a glass bulb burner. Scientific wonder of the world. Lamps used where people have electric lights. Makes it possible to sell to every household. Lamp made entirely of brass. Riches awaiting you. Rush \$1.50, complete lamp will be sent, charges paid. We guarantee lamp as above stated, or your money returned. Town, county and state agents wanted. Lamp a whirlwind seller. Pat. U. S. A. and foreign countries. New Process Mfg. Co., Lamp Room 24, Salina, Kans.

**WE WANT** to start one good merchant or salesman in each town in the merchant tailoring business. We furnish a big complete sample outfit free, no cheap folder or catalogue but 500 large size samples, elaborate fashion portfolio and every accessory. No experience necessary, profits \$5. to \$15 a day. Unlimited possibilities. Write at once for exclusive selling agency. Dept. 87, McCall, Sales Manager, Lock Box 483, Chicago.

**AGENTS:** \$6.00 to \$10.00 DAILY. \$2.00 profit each sale. One man sold eight first day. You can do as well. Wonderful invention cuts butter bill in two and gives far superior product. Easy to operate. Every woman is interested in a household device that will actually save her money. Be the first in your territory and reap the harvest. Your letter brings testimonials, guarantee and special trial offer. Write today. American Supply Co., 35 N. Dearborn St., Chicago.

**SIGN LETTER AGENTS**—Painters. Something new and better. Attractive Gold or Silver Letters. Anyone can apply them. Big money lettering store windows—making glass signs. Write today for free sample and catalogue. Attracto Sign Co., 2655 N. Clark Street, Chicago.

**LIVE AGENTS WANTED—HUSTLERS** to handle our attractive 1912 combination packages of soap and toilet articles with valuable premiums. One Michigan agent made \$65 in 47 hrs.; another \$21 in 8 hrs.; another \$22.50 in 19 hrs. Write today. Davis Soap Works, 294 Davis Bldg., Chicago.

**AGENTS MAKE 500% profit** selling our gold window letters, novelty signs and changeable signs, 800 varieties in enormous demand. Catalogue free. Sullivan Co., 1238 Van Buren St., Chicago, Ill.

**AGENTS—\$30.00 WEEKLY;** great advertising campaign introducing business with premium coupons; easy for beginners; big money for hustlers. Family Portrait Co., Dept. P. M. Wayne, Ill.

**AGENTS, EVERY DEMONSTRATION** of our new Inverted Gas Burners or Kerosene Mantle Burners makes a sale with large profits. Positively fastest money makers on the market. Particulars free. Simplex Gaslight Co., 1 Park Row, New York.

**TAILORING SALESMEN WANTED** to take orders for our Guaranteed Made-To-Order Clothes. Suits—\$10 up. No capital required. Write today for territory and complete equipment. Address Warrington W. & W. Mills, 173 Adams St., Department 489, Chicago, Ill.

**THE MAIL ORDER MAN** (magazine) and big offer of how to add \$5 to \$50 weekly to your income through mail order business, all for 19c; none free. Brenner, 908 Chestnut, Philadelphia.

**EXCLUSIVE SALE** will be given of an unusual meritorious article which sells on sight. A permanent and lucrative business can be built up by any man who isn't positively lazy. Every home and office a possible customer. Act quickly or you lose it. Marrel Mfg. Co., Springfield, Mass.

**AGENTS WANTED EVERYWHERE.** Hustlers make large quick profits. New Automatic Strapper puts a perfect edge on any razor, safety or old style. Absolutely guaranteed. Every call a sale. Write today for territory (state or county). S. O. Kanner, 552 Broadway, New York.

**GREATEST SENSATION OF THE YEAR!** New invention. Every auto owner buys. Agents make 100% profit. Easy to demonstrate. Particulars free. Sample prepaid \$1.00. Buckeye Auto Accessories Sales Co., Toledo, Ohio.

**PERFECTION POCKET ADDING MACHINE.** Lightning seller. Agents wanted. Cincinnati Specialty Mfg. Co., Dept. R., Cincinnati, Ohio.

**AGENTS—MAIL ORDER DEALERS**—Make big money selling fountain pens, best seller out, profits enormous. Sample 25c. Doxan \$1.85. Post Supply Co., Waltham, Mass.

**PIGGY WANTS A PENNY.** Toy Banks. Sample 14 cents prepaid. Agents wanted. Devenstone Novelty Co., Akron, Ohio.

**"ALCA,"** the famous \$6.00 Vacuum Cleaner, seeks a few more selling agents to show its merits and promises prosperity and success in return. Write for gilt-edge proposition. Alca Co., 366 W. 56th St. (Dept. B), New York.

**AGENTS:** \$35 a week for 2 hours work a day selling wonderful new household necessity, new selling plan with free advertising done by Collette Mfg. Co., Box M. A., Amsterdam, N. Y.

**WANTED—AGENTS** to send 35c stamps for sample of my Daily Expense Record and terms to agents. Sells 50c. Big profits, big seller. A. J. Crago Specialty Co., Main St., Crago, Mich.

**PICTURE AGENTS.** \$60 week easy, 26x24 Framed Religious, Art, Negro Pictures, complete, 12c. Portraits, 25c. Catalogues, Samples Free. Berlin Art Association, Dept. 76, Chicago.

**SUCCESS IS YOURS** if you work our new mail order plan. Particulars free. Write today. Chromatoscope Co., Dept. B, Newark, Conn.

**EVERYBODY NEEDS RUBBER STAMPS.** Big money making them. Simple process. Vulcanizers, \$5 up. Circulars free. Central Stamp Works, Newcastile, Ind.

**QUICK SELLER.** See advertisement under "Printing." CH-Feed Press.

**SIGN LETTER AGENTS**—Painters: Our "classy" new window letters are money makers. Samples free. Attracto Sign Co., 2655 North Clark St., Chicago.



**AGENTS, INVESTMENT \$11 NETS \$20 Daily**, selling new flash light pavement signs, projectors; sells everywhere. Electric Co., Heed Bldg., Philadelphia.

**AGENTS, GET OUR CATALOGUE** and free sample. Unlimited opportunity and profits. Boston Sales Company, Box 2177, Boston, Mass.

**AGENTS, MAKE \$20 A DAY**. Every automobile owner buys the Cinch repair kit for punctures. 1456 West 11th St., River Side, Calif.

**AGENTS**, to sell 50 candle power smokeless, odorless lamp and lantern burners. Sample 50c. White Flame Co., Kansas City, Mo.

**\$100 MONTHLY** and expenses to trustworthy men and women to travel and distribute samples; big manufacturer. Steady work. S. Scheffer, Treas., G. W., Chicago.

**AGENTS, BUY DIRECT FROM FACTORY**, fastest selling article ever produced; large profits, permanent business. A post card will bring you full particulars. Edm Mfg. Co., Brooklyn, N. Y.

**AGENTS WANTED EVERYWHERE**—To sell high grade household necessity, \$18 to \$50 weekly. Large demand. Quick sales. Particulars free. Ross Specialty Co., Belvidere, N. Y.

**AGENTS**—Sell Penny Gift Gum. Outfit, 3 styles, 600 pieces, \$1.50. Write quick for territory. Austin Mfg. Co., Cranston, R. I.

**NEW DEVICE REPAIRS PUNCTURE** in one minute. Sells at sight. Agents average \$10 to \$25 daily. Write for booklet. Kimball, 112 Adams St., Brockport, N. Y.

**AGENTS WANTED**—Article sells at sight. Two to six in every home. 100 per cent profit. Barched Distributing Company, Box 57, Lima, Ohio.

**WANTED, AGENTS**—To sell Farmers' Account Book, Quick Seller, Big Paving Proposition. Act quick. Address, L. L. Sypers, Fort Wayne, Indiana.

**AGENTS WANTED**. Have splendid proposition for agents, easy seller, pays good fat profit; full particulars for the asking. Arthur C. Morey, Baniam, Ct.

**AGENTS**—Double your money with this attractive 50c kitchen utensil. Six articles in one. Absolutely new. Outfit, mailed, 40c. Proposition free. Malaney Company, Cleveland, Ohio.

**BOTTLES—CORKS—LABELS**—Boxes, Cartons and supplies for mail order business. State your needs. M. Bonsall Co., Baltimore, Md.

**"PREVENTO"** positively prevents steaming eyeglasses. Sample 25 cts. Samuels, Optician, Wilkes-Barre, Pa.

**AGENTS**. We have a money making proposition to offer you for selling our goods. Write. Guard Sales Co., Phoenixville, Pa.

**MAKE EASY MONEY** Recutting Old Files. Secret process. We teach you for \$1. Covert, 1900-8th Ave., Beaver Falls, Pa.

**CLAY COOKING SET**. Big profits. Pace Pottery Company, Roseville, Ohio.

**AGENTS**—Embossed Gold and Silver Sign Letters. Immensely profitable. Sample free. Johnston Co., Quincy, Ill.

**MAN WANTED**, to sell Baking Powder. Large commissions. Mail us 35c for \$1.00 outfit. Prudential Baking Powder Co., Hudson, Canal and Deshusses Sts., N. Y.

**AGENTS**: Sell our quick Tire Repair Kit to automobile owners. Staten and McDow, 407 Morgan, St. Louis, Mo.

**AGENTS, PORTRAITS 50c, FRAMES 15c, Pillow Tops 30c**. Best work and service. Catalogs free. Sheet Pictures Co., Central Portrait Co., 2609 Wilcox Ave., Chicago, Ill.

**DID YOU EVER** hear of anyone selling popular 25c sheet music at 5c? You can do it and make 300%. Four sample copies and proposition, 10c. People with pianos can't resist you. Best thing yet. Chicago Music Co., Hyde Park, Chicago.

**NOVELTY STORES**, send for a Whisler Broom Holder. Just out, sells at sight, 15 cents postpaid to anyone. Get agents' prices. John Whisler, Gilson, Iowa.

**AGENTS WANTED EVERYWHERE** for easy selling \$5 proposition. \$10 daily easily made. Particulars free. Ideal Mfg. & Supply Co., Holland, Mich.

**AGENTS**—Either sex, your opportunity—Earn \$5.00 daily, selling our line of Women's Specialties. William Bowman, 522½ North St., Richmond, Va.

**AGENTS**—Young Folks' Novelty, new invention, large profits, no competition; other staple articles, sells everywhere. Particulars free. Box 434-M, Crookston, Minn.

**SIGN PAINTING AGENTS**. 1,000% profit. Best and cheapest window letters made. Easiest mounted. Outfit free. Success positively guaranteed. Embossed Letter Co., 2563 Milwaukee Ave., Chicago.

**WE WANT LIVE AGENTS** to sell our high grade specialties. Write quick. Box 259, Greenwich, Conn.

**SELLS EVERYWHERE**. Agents write Trolter Manufacturing Company, 767 Beaubien, Detroit.

**AGENTS**—\$5 daily selling our Handy Tool, 12 articles in one. Lightning seller. Sample free. Thomas Mfg. Company, 462 Third St., Dayton, Ohio.

**AGENTS**, don't accept an agency. It will pay you to send stamp for booklet. G. Tibbets, Palmar, Conn.

**DRY GOODS REMNANTS** supplied to agents and storekeepers. Bargains only; all sellers. Remnant Store, 1301 Linn St., Cincinnati.

**SLIDE-EASY NECKTIE DEVICE**, just out. Agents' sample, 25c. Press Mfg. Co., Minneapolis, Minn.

**AGENTS**—Big money distributing free pkgs. Borax-co Soap Powder. D. Ward & Co., 170 Berman, Chicago.

**AGENTS WANTED**—Send 25 cents silver for Clear and Gas Lighter and one of our catalogues with Terms to Agents. A. S. Mankin & Co., Alexandria, Va.

**AGENTS TO SELL** high and low-priced cigars, box lots. Kremer Company, Heed Bldg., Philadelphia.

**AGENTS—SIGNISTS, IMMENSE PROFIT**. Beautiful window letters. Very low prices. Easy proposition. Business-getting guarantee cards, glass sample free. Bordeaux Co., 2561 Milwaukee Ave., Chicago.

**AGENTS, MALE AND FEMALE**, to sell novelty pencil. Supplies its own memorandum paper instantly. Catalogue, premium offer and sample, 20c. Henry H. Dines, Brattleboro, Vt.

**AGENTS—DON'T** accept an agency until you read our new book, "Piling Dollars;" It's Free. Darling Bros., Derry, N. H.

**BE A GUN MAN**. Sell our Cowboy Watch Fobs, Genuine Strap Leather Holster and Miniature Six Shooter. Immense profits. Send 25c for sample and quantity prices. Publishers' Clearing House, 35 So. Dearborn, Chicago.

**GUILFORD KEROSENE MANTLE LAMPS**—America's largest variety. None better. Burners fit ordinary lamps. Supplies for all mantle lamps. No city prices. Guilford Co., Seville, Ohio.

**AGENTS**—To sell Automobile Tire Removers; it will do the trick in one minute. The Barnes Mercantile Company, Webster, Massachusetts.

**FORMULA FOR SHAMPOO**, 10 cents; makes hair light and fluffy; 5 cents makes 16 shampoos. Mad Company, Washington, D. C.

**A WINNER**: Mail Box Supply Signal. Sells on sight. Mail man's delight. Send 15c for sample. Mail Box Supply Co., Perry, Mich. Box 217.

**AGENTS**. Big easy profits selling Gold Window Letters. Mounted sample free. P. M. Ward Co., Dept. 6, 2559 Milwaukee Ave., Chicago.

**ARTICLE SELLS ON SIGHT**, needed in every home, office and factory. 100% profit. Vangold Supply Co., Dept. 2, Alexandria, La.

**WILL SEND BIG SET** winning Mail Order Plans on approval; \$3.00 if accepted, otherwise return. Include 7c actual postage. Specialist, Box 1615, New York.

**BIG MONEY** for salesmen everywhere. Burlington Repair Works, Burlington, Kans.

**AGENTS WANTED**. Hustlers only. 100% profit. Particulars free. Rinehart Co., 2930 15th St., Washington, D. C.

**AGENTS**. Sell Advertising Novelties, 25% commission. 2 samples 10 cents. Joel Kenyon, Owego, N. Y.

**AGENTS WANTED** to sell State rights for Evaporative Cooler. J. H. Collett, Eddy, Texas.

**FORMULAS FOR ANYTHING**, 20c each, four for 50c. Hyman, 417 National Safety Vault Bldg., Denver, Colo.

**AGENTS**. Sell new household necessity. Samples free. J. Fenstermacher, Hamburg, Pa.

**AGENTS WANTED**—New Automobile Specialty. Box 217, Albany, N. Y.

**AGENTS, SELL BRIGHTERSHINE METAL POLISH**, one package makes half pint best liquid metal polish, sample 10c. Leroy Brown Co., 1210 E. Madison, Baltimore, Md.

**AGENTS wanted**. Fine line. Crosby Co., Box A, North Conway, N. H.

**EARN \$15 TO \$25 A WEEK** or more as our Mail Order Dealer. Right from your own home. Hold your position until entire time is required. We are manufacturers and owners of patented just-in-season specialties. If you are just starting a Mail Order Business or if already established, you can't afford not to handle our Patented Money Making Getters. We sell exclusively to our Mail Order Dealers. We protect them. We carry stock and furnish everything. No canvassing. Small capital. Experience unnecessary. Write today for Latest Patented Leader and Manufacturer's Easy Selling; Mail Order (copyrighted) plan backed up by "Whole Truth," Positive Proof and Sworn Statement. J. M. Pease Mfg. Co., 129 Pease Bldg., Michigan St., Buffalo, N. Y.

**EXCLUSIVE TERRITORY NOW BEING ALLOTTED** for Little Giant Lift and Force Pump. Only thing of its kind, it has free field wherever there's plumbing. Removes all stoppages in pipes, saves plumbers' bills, prevents noxious gases. Everyone wants it, everyone can afford it, everyone can operate it. As strong in business world as among homes. Selling at top speed. 50,000 already in use. I can grant you absolute monopoly and fix you for life, if you are the right man. Address at once, J. E. Kennedy, Dent, P., 41 Park Row, New York City.

**AGENTS—\$50 weekly**; we manufacture the best needle case made; a wonderful seller; 200 to 300 per cent profit; talking unnecessary; our copyrighted "Trust Scheme" Envelopes do the work; general agents can make over \$100 weekly; send 10c for a 25c sample containing 115 needles; particulars free; buy direct from the factory at wholesale. Patsy Needle Co., 102 Union Sq., Somerville, Mass.

**AMAZING INVENTION**—Entirely new lamp burner. Changes common kerosene light into large, brilliant, white flame. Burns gas or electricity. Odorless, smokeless. Not a mantle. Can't break. Wonderful, different. Irresistible selling proposition. Experience unnecessary. Show one; sale made. Sample outfit, 35c prepaid, will start you. Radiolite, 364 Colonnade, Toledo, O.

**THE NEW "SWIFTLIT" GAS LAMPS** light instantly with ¼ match like city gas; no alcohol used; radically different from any other; portable or systems, 100 to 1,000 candle power at will; burners cheap for old lamps; Agents making money; great novelty; wholesale price for introduction. Planet Mfg. Co., Dept. 4, St. Louis, (Established 1868.)

**MAIL ORDER ADS THAT PAY**. 20 different propositions fully explained. All bona fide, sure-fire Money-getters. Each one the foundation of a successful Mail Order business. Send 10c for full particulars and regular bulletins of new propositions. Mail Dealers Wholesale House, 450 Franklin Bldg., Chicago, Ill.

**LIVE AGENTS WANTED.** A permanent income selling Keeth Kombination Kit, 15 tools in one. Finest tool steel, guaranteed. Big profits. Wonderful seller. Exclusive territory. Send for free sample offer and terms. Currier-Keeth Mfg. Co., 52 West St., Coudersport, Pa.

**AGENTS—WE MANUFACTURE GLASS PAPER.** Plain glass windows made to look like real stain glass; something new; easily applied; big money maker; two sample sheets of paper, with catalogue in colors and discount sheet, for 19c. S. H. Parrish & Co., 202 S. Clark St., Chicago.

**AGENTS WANTED—SELL RICH LOOKING** Imported 36x68 rods, \$1 each. R. H. Carter, Milan, Tenn., sold 115 in four days; his profits, \$51. You can do as well. Write for sample offer and unique selling plan; exclusive territory. A. Condon, Rug Importer, Stonington, Maine.

**AGENTS OUTFIT FREE.** Quick profits. Best Handkerchiefs, Dress Goods and Fancy Goods on the market. Large Manufacturer. Particulars for stamp. Maricopa Mfg. Co., 93 Water St., Brooklyn, N. Y.

**AGENTS—MAKE \$2 EACH SELLING OUR WONDERFUL** luminous crucifixes; nothing to sell six a day; absolutely new; shine all night in darkest room. Pioneer Portrait Co., 5409 Halsted St., Chicago.

**SALESMEN—Can you talk to merchants?** Every retailer uses show cards and price tickets because they sell big goods. Show cards are easy to sell. Profits enormous. Opportunity to start in business for yourself. Chas. Maler, 1366 Broadway, New York.

**YOU CAN MAKE \$888** as our general or local agent. Household necessity; sales 80 per cent; permanent business; exclusive territory; salary or commission; free sample; credit. J. Pitkin, Newark, N. Y.

**WE PAY \$80 A MONTH SALARY** and furnish rig and all expenses to introduce our guaranteed stock and poultry powders; money back guarantee; outfit free; new plan; steady work. Address Bigler Co., X 368, Springfield, Illinois.

**AGENTS—PORTRAITS 35c, FRAMES 15c.** Sheet Pictures 1c. Stereoscopes 25c. Views 1c. 30 days' credit. Samples and catalogue free. Consolidated Portrait Co., Dept. 1191, 1027 W. Adams St., Chicago.

**MEDALLIONS SELL AT SIGHT.** 300 per cent to 500 per cent profit. Make up your own goods and be independent. "It's easy." Catalog free. Fred Reag Co., 1295 W. Randolph St., Chicago.

**I WILL START YOU** earning \$4 daily at home in spare time, silencing mirrors; no capital; send for free instructive booklet, giving plans of operations. G. F. Redmond, Dept. 306, Boston, Mass.

**AGENTS—HANDKERCHIEFS, DRESS GOODS.** Carleton made \$8.00 one afternoon; Mrs. Bosworth \$25.00 in two days. Free samples. Credit. Stamp brings particulars. Freeport Mfg. Company, 59 Main St., Brooklyn, N. Y.

**AGENTS make big money** selling our new gold letters for office windows, store fronts and glass signs. Any one can put them on. Write today for free sample and full particulars. Metallic Sign Letter Co., 400 N. Clark St., Chicago.

**WIDOWS, Ladies, Men.** New interesting, profitable, easy work. Spare time or permanent. Sell our useful specialties. Our original selling plan will double your sales. Particulars and \$2.00 premium offer free. Fair Mfg. Co., HF51, Racine, Wis.

**AEROPLANES, DYNAMOS, ELECTRIC FANS,** Picture Machines, Mechanical Toys, at half price. Catalogs, 300 illustrations with your name on. Samples and particulars free. Murphy Company, Norwalk, Conn.

**AGENTS—It costs me about \$2.00** to secure your name and slip sample machine, but it's a dead sure way of convincing you I've got best household invention on earth. Camrassers and crew managers make up to \$20.00 a day. Elmer E. Stevens, 1189 Adams Express Bldg., Chicago.

**BIG PROFITS—Exclusive territory, not in stores.** The Magic Cooker—outsells all other household specialties. Belden Supply Co., 17 E. Lake St., Chicago.

**LARGER PROFITS—MAKE YOUR OWN GOODS.** We furnish formulae, manufacturing process and trade secrets. All lines. Fourteen years experience. Instructive circulars Free. B. Mystic Company, Washington, D. C.

**400% PROFIT SELLING GORDON** Photo Pillow Tops. High grade work. Samples and catalogue free. Luther Gordon Co., 164 Washington St., Chicago.

**AGENTS MAKE \$30.00 WEEKLY** selling our 509 Handy Household Articles; catalogue free. Scheff Company, 1637 Wells Street, Chicago.

**ENVELOPE MOISTENER, NO-WHITTLE PENCIL!** Self-selling. Sample, terms, 10c coin. Apex Sales Company, 1224-1226 17th St., Denver, Colo.

**BOKARA DIAMONDS—Agents, everyone, wear and sell** our famous Bokara Diamonds; write for sample offer and catalogue free. Northwestern Jewelry Co., 52 Northwestern Bldg., Chicago.

**SELF-THREADING NEEDLES,** 10c a paper. Agents' samples and terms free. Ladies' Art Co., Dept. 44, St. Louis, Mo.

**SEE WHAT WE SAY** under "Patent" heading. Swift, Attorney, Washington.

### BLACKSMITHS

**GOOD BLACKSMITHS ARE SCARCE** and few learning the trade and the blacksmiths must make the tools for all—from surseon to the safe blower. Buy Toy's Modern Methods Forging and Welding different kinds of steel solid, and doing all hard jobs easy, also hardening and tempering to a standard by colored charts. Any smith can be an expert. That means good jobs and big money. All for one dollar. Send for valuable samples free. W. M. Toy, Sidney, Ohio.

### HELP WANTED

**ARE YOU THE MAN?** Here is your opportunity. No matter where you live—if you want to make big money and establish yourself in an independent business Requiring No Capital—we will teach you, by mail, all the secrets of the Real Estate Business, including thorough Commercial Law Course, list with you readily salable properties, co-operate with and assist you to permanent success. Our 64-Page Free Book fully explains our methods and tells what it means to be the local representative of oldest and largest Co-Operative Realty and Brokerage Corporation, 2334 Manhattan Building, Chicago, Ill.

**WANTED ONE GOOD MAN** in each town to take orders for men's tailoring; beautiful styles; very low prices; orders come easy; high class, permanent business; fine profits; \$10 a day and up; no money or experience needed. We ship on approval express prepaid, and guarantee perfect fit. Write for free sample outfit and inside price on suit for yourself. Banner Tailoring Co., Dept. 449, Chicago.

**BIG MONEY WRITING SONGS.** Thousands of dollars for anyone who can write successful words or music. Past experience unnecessary. Send us your song poems, with or without music, or write for free particulars. Acceptance Guaranteed if available. Washington only place to secure copyright. H. Kirkus Dugdale Co., Dept. 265, Washington, D. C.

**BIG MONEY to agents selling O-tak-a-Tire Remover.** The only tire remover in the market that will do what is advertised. Sells for \$5.00. 50% profit to the agent. Many people ordering two and three at a time by mail. One sale makes four or five new customers. Write for proposition for exclusive territory. J. W. Grumiaux, Sales Agent, Le Roy, N. Y.

**AGENTS: Live, hustling men** to canvass the homes and offices, selling my new electric device. Cuts electric bills in half. A demonstration sells it. Repeat order getter. You can make big money without previous experience. Complete outfit and selling instructions, \$5.45, and I guarantee money back if not satisfactory. Exclusive territory is going fast. Write me today for my proposition. Stanley B. Freiberg, 959 Eighth St., East, Cincinnati, Ohio.

**WANTED—RAILWAY MAIL CLERKS—Average \$90.00** month. Rapid advancement. Every second week off duty with full pay. Short hours. No "layoffs." Work very interesting, as you travel continually on free pass. Examinations everywhere, May 4th. 2,000 appointments coming. Common education sufficient. "Pull" unnecessary. Farmers stand excellent chance. Write for free sample questions and schedule showing examination places. We will prepare a limited number—free. Franklin Institute, Dept. T 21, Rochester, N. Y.

**MEN WANTED, age 18 to 35,** to prepare for firemen or brakemen on railroads in Chicago vicinity; \$80 to \$100 monthly. Experience unnecessary; no strike. Promotion—engineer or conductor, \$150 to \$200 monthly. Good life careers. State age; send stamp. Railway Association, Dept. 89, 227 Monroe Street, Brooklyn, N. Y.

**WANTED—Railway Mail Clerks.** Average \$90.00 month. Rapid advancement. Every second week off duty with full pay. Short hours—no "layoffs." Work very interesting, as you travel continually on free pass. Examinations everywhere May 4th. Common education sufficient. "Pull" unnecessary. Farmers stand excellent chance. Write for free sample questions and schedule showing examination places. Franklin Institute, Dept. T 21, Rochester, N. Y.

**WANTED—HUSTLING MAN IN EACH LOCALITY.** Join this Society. Sick, accident, death benefits. Introduce our Memberships. Spare time to start. \$50 to \$300 a month. Write, Box JF-293, Covington, Ky.

**WANTED—RAILWAY MAIL CLERKS.** Average \$90.00 month. Rapid advancement. Every second week off duty with full pay. Short hours—no "layoffs." Examinations everywhere, May 4th. Common education sufficient. "Pull" unnecessary. Farmers stand excellent chance. Write for free sample questions and schedule showing examination places. Franklin Institute, Dept. T 21, Rochester, N. Y.

**MEN AND BOYS** to learn automobile repairing, driving on up-to-date cars; electrical, civil engineering, surveying. Methods most practical. Room and board while learning. Positions secured; satisfaction guaranteed; catalog free. National School of Engineering, 2110 W. 7th, Los Angeles.

**WANTED—MEN** at Los Angeles. Can learn trade. Fair wages after second month. Automobiles, electricity, plumbing, brick-laying. Practical work on actual jobs. 1,200 students last five years. Only few months required. United Trade School, Los Angeles.

**\$100 WEEKLY PROFIT FOR YOU.** Wonderfully successful mail order plan. Your own boss. Your own business. Don't worry about capital. Experience unnecessary; success guaranteed. One man made half million. Write, at once, for Free Booklet telling how. Boyd H. Browne, 603 Brown Block, Omaha, Nebr.

**MEN WANTED** for Government positions. Influence unnecessary. Average salary, \$1,100. Annual vacations. Short hours. Steady work. Rapid promotion. Thousands of appointments coming soon. Send postal immediately for list of positions open. Common education sufficient. Franklin Institute, Dept. T 21, Rochester, N. Y.

**AUTO RACE DRIVERS** needed. Big field. Would you like to drive a big racing car? Send 25c for particulars quick. Drivers Exchange, Lock Box 278, Jackson, Mich.

**CONFIDENTIAL CLERK** wanted in every town—Big pay for a few minutes of your time—one employed preferred. No strings whereby you are asked to spend a cent. Sans Bois Land and Development Co., McCurtain, Okla.

**WANTED—YOUNG MEN** to learn automobile business; big pay; demand greater than supply; make you expert in ten weeks; automobile model free; interesting booklet free. Box 997, American Automobile Institute, Rochester, N. Y.

**MONEY MADE AT HOME**, by Men—Women—Boys and Girls. Work is easy and clean. We pay freight on work both ways. Send 10c coin for sample and particulars. Wheeler Engine Works, Bridgeport, Conn.

**AGENTS MAKE BIG MONEY** and become sales managers for our goods. Fast office sellers. Fine profits. Particulars and sample free. One Dip Pen Company, Dept. 2, Baltimore, Md.

**WANTED—RAILWAY MAIL CLERKS.** Average \$90.00 month. Every second week off with full pay. Examinations everywhere, May 4th. Write for free sample questions. Franklin Institute, Dept. T 21, Rochester, N. Y.

**MEN WANTED**—Learn to make name plates, house numbers, etc. Make \$15 a day. Send for free booklet. Sixty illustrations. E. E. Palmer, Wooster, Ohio.

**WANTED—RAILWAY MAIL CLERKS.** Average \$90.00 month. Examinations everywhere May 4th. Write for sample questions and schedule showing places. Franklin Institute, Dept. T 21, Rochester, N. Y.

**WANTED PICTURE PLAY WRITERS.** Big pay. We'll teach you how. United Picture Play Association, San Francisco.

**RAILWAY MAIL CLERKS WANTED**—Average \$90.00 month. Examinations everywhere May 4th. Write for sample questions. Franklin Institute, Dept. T 21, Rochester, N. Y.

**RAILWAY MAIL CLERKS WANTED**—Examinations everywhere May 4th. Preparation free. Franklin Institute, Dept. T 21, Rochester, N. Y.

**MAKE MONEY** writing short stories. Big pay. Free booklet tells how. United Press Syndicate, San Francisco.

**RAILWAY MAIL CLERKS WANTED**—Average \$90.00 month. Examinations everywhere May 4th. Preparation free. Franklin Institute, Dept. T 21, Rochester, N. Y.

**LINOTYPE INSTRUCTION**: write for Booklet "P." Empire School, 415 First Ave., New York.

**9,000 GOVERNMENT JOBS OPEN**—Write for list. Franklin Institute, Dept. T 21, Rochester, N. Y.

**LOCAL REPRESENTATIVE WANTED** in each town to sell our underwear, hosiery, neckties and sweaters direct to wearer on commission. Profitable opportunity with permanent future because every article is guaranteed satisfactory or money refunded. Write for Spring and Summer catalogue. Steadfast Mills, 27 Courtland St., Cohoes, N. Y.

**GOVERNMENT RAILWAY MAIL CLERKS WANTED.** Examinations everywhere soon. Get prepared by former United States Civil Service Examiner. Write Now for free booklet and schedule. Patterson Civil Service School, Box 826, Rochester, N. Y.

**COMMISSION SALESMAN WANTED**—Best proposition on earth. Clear field. Lansdale Placer Machinery Co., 2556 W. 27th Ave., Denver, Colo.

**DETECTIVES.** We teach by mail. Earn money while taking course. Send stamp for particulars. Western Detective School, Denver, Colorado.

**RAILWAY MAIL CLERKS.** Examinations everywhere soon. Common education enough. (M) Clerk Agency, Providence, R. I.

**WANTED DISTRIBUTORS**—of advertising matter everywhere. Oliver D. Barkley, Mount Pleasant, Pennsylvania.

**WANTED ONE THOUSAND CHAUFFEURS** and repair men. Our demand for automobile engineers exceeds the supply. Calls for men of intelligence and mechanical bent capable of commanding \$100.00 to \$150.00 per month upon graduation. Resident course \$20.00 to \$60.00. Home Correspondence course completed by practical road and shop work at this school, highly successful. Look this up. Auto Schools of America, Dept. T, 1600 Michigan Ave., Chicago.

**EARN \$10 TO \$15 a week** and hold your position besides. No canvassing. We, as manufacturers of patented just-in-season specialties, have new easy mail order plans to keep factories busy. We furnish everything. Large profits. Small capital. Experience unnecessary. If you are one of the want-to-go-ahead-kind, write for our most modern (copyrighted) plans. Sworn statement. J. M. Pease Mfg. Co., 540 Pease Bldg., Michigan St., Buffalo, N. Y.

**BE AN ELECTRICAL METERMAN**—Pays \$900 to \$1,800 a year. New field. Demand for competent metermen, created by rapid introduction of electricity, greater than supply. Our personal, practical instruction by mail quickly qualifies you for splendid position as meterman. Graduates assisted. Write for particulars. Fort Wayne Correspondence Schools, Dept. 29, Fort Wayne, Ind.

**WANTED, AGENTS, MACHINISTS, ATTENTION!** Increase salary, new revised Saunders' Hand Book of Practical Mechanics. Best ever ready reference. Thousands in use. Postpaid \$1.00 cloth; \$1.25, \$1.50 leather flap. Big profits. E. H. Saunders, 216 Purchase St., Boston, Mass.

**WANTED**—A man or woman to act as our information reporter. All or spare time. No experience necessary. \$50 to \$200 per month. Nothing to sell. Send stamp for particulars. Sales Association, 601 Association Bldg., Indianapolis, Ind.

**STOP HERE!** Let me start you in a home business that will bring you money every day. Experience unnecessary. Spare time. No canvassing. I furnish everything and guarantee success. Send for proofs. Voorhies, Desk C. R., Omaha, Neb.

**I WILL START YOU** earning \$4 daily at home in spare time, silvering mirrors; no capital; send for free instructive booklet, giving plans of operation. G. F. Redmond, Dept. 306, Boston, Mass.

**WANTED SALESMEN** to sell Gasoline Lighting Systems; no experience necessary; attractive proposition. Doud Lighting Co., 174 No. Sangamon St., Chicago, Ill.

**WANTED RELIABLE MEN** to learn Automobile Driving and Repairing in the largest and best equipped school teaching this trade. A most interesting, healthful and paying profession. Can be learned in a few weeks and at small cost. Competent men always in demand at salaries ranging from \$18 to \$35 a week. Our 32-page book "How to Drive" gives full particulars. Greer College of Motoring, 1457 Wabash Avenue, Chicago, Ill.

**SALESMAN AND BRANCH MANAGERS EVERYWHERE** to handle best selling proposition known. Experience unnecessary. Legitimate, permanent and commands instant attention. Big commissions. Exceptional opportunity. W. E. Bryan & Co., Cincinnati, Ohio.

**WE TRAIN DETECTIVES.** You can be one. Splendid opportunities. Travel. Earn \$100 to \$300 monthly. This fascinating profession taught practically and scientifically by mail at a nominal cost. American School of Criminology, Dept. F, Detroit, Mich.

## MACHINERY, TOOLS AND SUPPLIES

**WOOD-WORKING PLANT FOR SALE.** Entire plant of the Philadelphia Veneer & Lumber Co., Inc., consisting of land, buildings and machinery. Machinery consists of engines, boilers, pumps, heaters, bend mill, short-log mill, veneer slicers, dryers, veneer saw, planers, etc., complete outfit for the making of cigar-box lumber and shooks. Splendid location for a furniture, chair or woodworking plant. Right in the heart of the Appalachian forest region. Cheap lumber and labor. White help. Located on two trunk lines. For further particulars address, Philadelphia Veneer & Lumber Co., Inc., Knoxville, Tennessee.

**ONE 30 H. P. TWISS** Automatic Horizontal Steam Engine; 10 inch bore, 20 inch stroke; Corliss type of valves; recently repaired and in first class condition. Also one 30-hp. Marsh Steam Pump and one 50-hp. National Heater, both in first class condition. John W. Russell & Sons Co., Springfield, Mass.

**FOR SALE**—Machine shop; 16" lathe, 16" shaper, 24" drill, power hack saw, emery wheel, drills, taps and dies, pipe-cutting tools up to 3"; cheap rent; in a town 4,500; good place to work up auto repairing. A. O. K. Young, Vandalia, Ill.

**FOR SALE**—Reed Lathe, 10"x1". American Gas Case Hardening Furnace No. 2. Fitchburg Speed Lathe, 16"x6". Garvin small 3-Spindle Drill Press. Cleveland Automatic Screw Machine, 1/2". Durbrow & Hearne Mfg. Co., 12 Wooster Street, New York.

**MODEL STEAM TURBINES AND RECIPROCATING ENGINES.** Complete set of turbine castings (rough), and blueprint, \$1. Complete set of reciprocating engine castings (rough), \$2. Both sets for \$2.75. Midget Machine Co., Box 214, Elizabeth, N. J.

**BARGAINS IN TOOL CABINETS** for Toolmakers, Draftsmen, or Machinists, beautifully finished in Oak or Mahogany, concealed lock on drawers; ask for circulars and prices. The Ohio-National Manufacturing Co., Chillicothe, O.

**HARRISON KEY FILING JIG**, the greatest invention of the age. Enables anyone to make perfect duplicate Pin Tumbler Keys, no misfits, saves blanks; price within reach of everyone. Harrison & Co., 81 New St., N. Y.

**FOR SALE**—2 2-in. x 24-in. Jones & Lanson flat head turret lathes, with tools. The Challenge Machinery Co., Grand Haven, Michigan.

**FOR SALE AT BARGAIN** one new 16 in. 6 H. P. upright copper tube boiler. Kerosene burner, injector, pop-valve and automatic fuel regulator. The Electric Specialty Co., Cregea, Iowa.

**MECHANICS:** Build your own 2 h. p. water cooled gasoline engine. Castings, \$7.00. Send 10c in silver, for blue print, photo, and particulars. Vigneau Machine Co., 246 Biddle Bldg., Detroit, Mich.

**NEARLY NEW** six horse boiler \$55; fifteen horse \$110; ten light generator \$30; eight horse gasoline engine \$50. Hunter Dyar, Kentonworth, Ill.

**FOR SALE—THE LITTLE ELGIN** 1 H. P. 2 Cycle Air-cooled gasoline engines. Runs washing machines, vacuum cleaners, electric lighting outfits, etc. Price \$30. Henry Muntz Co., Elgin, Ill.

**FOR SALE**—One 8 H. P. portable, and one 5 H. P. stationary gasoline engine—fine condition, \$115 each. Ellison's Machine Shop, Marengo, Ill.

**FOR SALE—CASTING** for 1 H. P. 2 Cycle air cooled gasoline engines. Runs washing machines, vacuum cleaners, electric lighting plants, etc. Price \$7.50. Henry Muntz Co., Elgin, Ill.

**FOR SALE**—12 H. P. Otto gas engine, single cylinder, slide valve; complete with pipe and water tank, \$100. Blake Electric Mfg. Co., 1 Rowes Wharf, Boston, Mass.

**BRAINERD** 18 in. Automobile Gear Cutting Machine with countershaft, change wheels, chart, etc., \$150. Excellent condition. E. J. Flather Mfg. Co., Nashua, N. H.

**SAVE 1-3 OF ACTUAL COST.** Install your own welding plant. Plans and specifications only \$25. The National Vulcanizing Co., 215 8th St., Des Moines, Iowa.

**WANTED—ONE SECOND-HAND** Gasoline Engine 25 H. P. to run a Cotton Gin and Grist Mill. Address Lock Box 134, Carbon Hill, Ala.

**BARGAINS** in rebuilt Palmer Marine Gasoline Engines. Palmer Bros., 31 E. 21st St., New York.

**FOR SALE—SECOND-HAND** two cylinder six horse power vertical steam engine, good condition. Address Midget Machine Co., P. O. Box 214, Elizabeth, N. J.

**WANTED**—Small second hand lathe. F. E. Mason & Son, Batavia, N. Y.

**WE ARE OVERSTOCKED** in several sizes of gasoline hoists and have decided to let some of them go at cost. Our usual strong guarantee is back of every one. Write us today, giving us horse power wanted and we will quote you promptly. The Otto Gas Engine Works, 3420 Walnut St., Philadelphia, Pa.

**CASTINGS**—1 H. P. VERTICAL air cooled gas-gasoline engine \$9.50. Rotary Vacuum Pump, receiver, base castings for engine-motor connection, \$7.50. All steel truck parts, \$4.50. Drawings 25c per set. Elgin Gas Engine & Machine Co., Elgin, Ill.

**SIX HORSE POWER** Gray Marine Engine, fine condition, sixty dollars. John W. Newcomer, Box 57, Jacobs Creek, Pa.

**ONE 18 H. P. ROBINSON** traction engine, \$700 cash. Christ Hofstetter, R. R. 4, Box 7, Geneva, Ind.

**PULLEYS, GEARS, SPROCKETS, Shafting, Hangers;** see page 159. W. A. Jones Foundry & Machine Co., Chicago.

**OTTO 4 H. P. Stationary Gas Engine, \$85.** Also have pulleys, hangers, magnos. John J. Horn, New Haven, Conn.

**FOR SALE:** 2 cylinder opposed 4 1/2 x 6 air cooled engine, like new, with transmission, \$75, or will trade for lathe. Also 6 1/2 x 7 vertical 2 cycle marine engine, like new, \$50. Also 4 x 4 1/2 water cooled 4 cycle auto-engine, new, \$35. Also one 8-hp. on trucks, new, \$125. One 6 cylinder Ford car, good running order, \$375. Fully equipped. Split & Boettcher, Manitowoc, Wis.

**WE BUY AND SELL** all kinds Iron Woodworking, Turners' Machinery, Motors, etc. Mollitor, 215 So. Clinton St., Chicago.

**AUTOMOBILE AND MARINE MOTORS,** both light and heavy types. Highest quality and lowest prices. If you are in the market, write us. American Specialty Mfg. Co., Manitowoc, Wis.

**FOR SALE:** 4 millers, 4 shapers, 20 lathes and many other rebuilt and second hand tools. Face and angle plates. We manufacture new machinery and the simplest marine engine made. Hickmell, Janesville, Wis.

**FOR SALE:** One fine two cylinder opposed air-cooled motor, \$35. One fine four cylinder air cooled motor, \$78. Badger Motor Co., Milwaukee, Wis.

**NEW AND SECOND HAND AUTO** and marine engines, of various sizes, a few 5 and 10-hp. stationary. Will be sold at a bargain. Write us your wants. R. Heise, Box 248, Manitowoc, Wis.

**UNIQUE ENGINES** are small, powerful and compact. See our ad on page 157. Amateur Mechanics Supply Co.

**BUILD YOUR OWN ENGINES,** rough and machined castings for 5-10 and 20-hp. motors. Write for prices. See our ad page 158. Richards Engine Works, Manitowoc, Wis.

**SECOND-HAND** complete 5 h. p. Steam (125 lbs.) Woodrow outfit. Lyandot, Mahtowa, Minn.

**LATHE FOR SALE**—Screw cutting, foot power, cheap. Hayes, 2643 East Union, St. Louis, Mo.

**STANLEY STEAM ENGINE,** 10 h. p., perfect condition, \$25. B. Doherty, 312 Pawtucket Ave., Pawtucket, R. I.

**MARK YOUR TOOLS.** Send 25c and full name. Frank B. Hunt, Salda, Colorado.

**REBUILT MOTORS**—We have a number of second-hand marine engines of our own and other makes, completely rebuilt and guaranteed by us. As the builders of "Buffalos" are not in the second-hand engine business, we will sell them at less than factory cost to make room. This is a rare opportunity to get the highest grade of engines—2 to 100-hp.—cheap. Buffalo Gasoline Motor Co., 1284-86 Niagara St., Buffalo, N. Y.

**FOR SALE**—Rebuilt: Throttling, Automatic and Corliss Engines, Boilers, Pumps, Heaters, Machine Tools, Tanks, Saw Mills, and general machinery, at bargain prices. Let us know your wants. The Randle Machinery Co., 1761 Powers St., Cincinnati, Ohio.

**FOR SALE**—Engine lathe, swings 9 1/2 in., takes 25 in. between centers. Complete with full set change gears to cut all size threads, 3 to 40 in.; price only \$43.50. Address L. F. Grammes & Sons, Allentown, Pa.

**FOR SALE**—Gasoline Engines, automobiles, marine and stationary, also castings. Second hand ones taken in exchange and for sale. Apply with stamps. B. W. Richardson, R. No. 36, Peoria, Ill.

**IF YOU WANT** the best information on cement and concrete construction, subscribe for Concrete, leading cement and concrete monthly. Sample copy, 10 cents. Yearly subscription, \$1.00. Concrete, 135 Newberry Bldg., Detroit, Mich.

**ENGINE CASTINGS,** 1 1/2 horse vertical gasoline, air-cooled, \$7. Three horse marine water-cooled, \$9 cash; drawings included; catalogue for stamp. Norelty Manufacturing Co., 553 West 84th St., Cincinnati, Ohio.

**FOR SALE**—Two 10-HP. Gasoline Engines and two 18x7 ft. bed screw cutting lathes, Two 24" Band Saws. Geo. J. Adams, 39 South St., New York.

**THE PATTERSON TOOL & SUPPLY CO.,** Dayton, Ohio, are specialists in furnishing equipment for automobile repair shops. Tell them your wants.

**CASTINGS** for a 2 h. p. stationary gas or gasoline engine, suitable for experimental work, \$5. R. H. Bowersox, Hanover, Pa.

**STEAM BOILER OUTFITS** Complete; 1 1/2 Horse Power 20" diam., 51" high, \$40. Page Boiler Company, 815 Larrabee St., Chicago.

**VERTICAL STEAM ENGINES,** 2 to 25 hp. Send for circular, E. T. Frank & Son, 642 W. Pratt St., Baltimore, Md.

**FREE**—"How to Run and Install Gasoline Engines." Greatest little book ever published on this subject, sent free with year's subscription to Gas Energy. Learn how to solve all knotty Gas Engine problems in few moments. O. L. Stevens, Ind., writes, Gas Energy is best magazine published. Send 50c for year's subscription. Book free. Gas Energy, 28 Murray St., New York.

**LATHE FOR SALE**—For bargains in small lathes write South Bend Machine Tool Co., Dept. L., South Bend, Ind.

**OTTO GAS ENGINES!** Standard of the World! Otto Gas Engine Works, 218 Granite Bldg., St. Louis.

**PATTERN MAKERS!** A book devoted to the principles of pattern and core making and molding. Written by G. H. Willard, a practical pattern maker of years experience. This book, just published, treats the subject in a much more simple, direct and effective manner than most books along this line. 224 pages, 312 illustrations. Price \$1.00 postpaid. Popular Mechanics Book Dept., Chicago.

**SERIES OF 7 LITHOGRAPHIC MODELS**—Steamship, Automobile, Gas Engine, Steam Engine, Steam Turbine, Wireless Telegraph and Dynamo. Size 8x14 inches. All parts of these machines. Price each 50 cents postpaid or set of 7, \$3.00 postpaid. Prices are shown and numbered to correspond to printed keys of Popular Mechanics Book Dept., 318 W. Washington St., Chicago.

**FOR SALE.** Second hand 16" shaper; also motor driven small grinder. Sibley Machine Tool Co., South Bend, Ind.

#### FLOUR AND FEED MILLING MACHINERY

**SPECIAL BARGAINS IN SECOND HAND:** Attrition Mills, Burr Mills, Crushers, Corn Shellers, Bran Dusters, Dust Collectors, Purifiers, Reels, Double, Single, 2 and 3-pair High Roller Mills, Sieve Bolters, Receiving Separators, Securers, etc. Write for description and prices. Sprout, Waldron & Co., P. O. Box 429, Muncy, Pa.

#### MANUFACTURING MACHINERY

**WANTED**—Contract and jobbing work of all kinds, estimate given on machine, foundry, boiler, blacksmith, and all kinds of forging. Dunkirk Boiler and Machine Co., Dunkirk, N. Y.

**LIGHT MANUFACTURING, DIES,** small press work, metal patterns and experimental work. I build a 10 in. emery grinder. Prices given. H. A. Barr, 38 Market St., Auburn, N. Y.

**INVENTORS**—We are equipped to make models, patents and experimental work to advantage—fair prices. Frost Engine Co., Evansville, Wis.

**WE ARE EXPERTS** on Piston Rings for all makes of Engines. Let us make your rings. Wheeler Engine Works, Bridgeport, Conn.

**SAVE THAT HEAVY DUTY**—We manufacture sheet metal stampings, tools and dies. Send specifications. Herod Machine & Stamping Co., Brantford, Canada.

**WANTED**—Specialties or machines to manufacture. A. & E. Bess, Hamilton, Ohio.

**IRON, BRASS AND ALUMINUM CASTINGS,** Metal Specialties, Patterns, Models, Polishing, Planing and Japanning. North Chicago Tool Works, North Chicago, Ill.

#### BOATS, LAUNCHES AND STEAMBOAT MACHINERY

**"V" BOTTOM KNOCK-DOWN FRAMES** and boats; five models including 20' hydroplane. The M. I. Doyle Co., 30 Church St., New York.

**MOTOR BOATS,** Stock or built to order. Ask for folder C. Cayuga Lake Boat Yard, Kidder, N. Y.

**WANTED**—Second hand launch with or without engine. D. S. Roadhouse, Shelby, Mich.

**CHART OF A MODERN SUBMARINE BOAT** showing and naming over 200 parts. Size, 14x25 inches. Printed on Plate Paper. Shows clearly and distinctly all the interior. Mailed in a tube for 25c. Popular Mechanics Book Dept., 318 W. Washington St., Chicago.

**FOR SALE**—22 ft. x 3 ft. 8 in. Semi-speed boat; 10 H. P. 2-cylinder, 2-cycle engine, Ballbridge clutch, Atwater Kent ignition, rear starter, bronze shaft log and strut, self bailer, copper tank, B. & B. speed wheel. Rare bargain, \$215 F. O. B. Send for photo. B. M. Ikert, Elgin, Ill.

#### MECHANICAL ENGINEERS

**TOOLS, DIES,** light press work. Get our prices, then wonder what's the matter with other firms. C. A. Gooney Co., Weensocket, R. I.

#### WANTED

**WANTED TO PURCHASE**—Patent rights, small article suitable for mail order use. John F. Keller, P. O. Box 458, New Orleans, La.

**WANTED**—Second-hand gasoline ploughing outfit. George Svendsen, Curlew, Iowa.

**WANTED**—One first-class camera and telescope. C. Bass, Norwinger, Mo.

**MAIL ORDER DEALERS, Agents.** The French Egg Beater, cream whip and batter blender, sells. Patented, Mary E. French, Clyde, Ohio.

**WANTED**—Slide-rest for Hopkins Watch Lathe. Alfred O. Hicks, Long Branch, New Jersey.

**WANTED**—Agency work. Ernest Morse, Laverne, Minn.

**WANTED SAMPLE COPIES** and advertising rates of Mail Order publications. All publications carrying a classified section preferred. Johnson, 4250 N. Kimball Ave., Chicago.

**WE WANT SALABLE ARTICLES** in iron line to manufacture and market. Wish to hear from practical men. Will pay reasonable royalty whether patented or not. Crescent Mfg. Co., Erie, Pa.

**WANTED—BUZZ-SAW** and feed grinder, trade or cash. Want small gasoline engine power spray pump and Edison phonograph. S. W. Alter, Forest, Ohio.

**WANTED, TO LEASE** small machine repair shop. Can give satisfactory references as to character and workmanship. P. S., 6th floor, 318 W. Washington St., Chicago.

**WANTED: 1/2 or 3/4-hp. gasoline or steam engine outfit.** High speed engine preferred. Karl Johnston, 99 Hobson Ave., Ingram, Pa.

#### FOR SALE

**FLAMING ARC LAMPS**, French imported with clock work feeding and rheostat, never used, giving 4,000 C. P., sold regularly at \$40.00. Our bargain price to experimenters is \$1.80 each, complete without glass ware. The clock work alone is worth the price. Only 15 on hand. First come first served. Cosmos Elec. Co., 136 N. Liberty St., N. Y.

**LARGE STOCK OF COLLECTORS** and bankers leather cases and wallets with alphabetically arranged pockets and loose leaf binders of all sizes. If you can use one or more, write for special prices. The Records Company, Traer, Iowa.

**FOR SALE—One 7 h. p. Marine engine, 4 h. p. motorcycle, moving picture show.** All complete, in the best of condition. J. J. Conway, 129 E. 10 St., Covington, Ky.

**FOR SALE—EDISON PHONOGRAPH.** 29 German records and text books. Never used. Worth \$68. Take \$35. A. C. White, Porterville, Texas.

**FOR SALE—Large U. S. copper cents, dated before 1850, 10c; three for 25c.** W. H. Hines, jeweler, West Salem, Ohio.

**SLOT MACHINES**, Electric Planes, Penny Baseball, Operator's Bells, Detroit's, Deweys and Arcade Machines, McCusker, 210-12 N. 8th, Phila., Pa.

**BOTTLING WORKS**, Best Order and Location, at Great Sacrifice. Write, Max Fromhold, 512 Shukert Bldg., Kansas City, Mo.

**GOLD, SILVER AND COPPER** plating outfit for sale. A real bargain. Write A. Benson, Stewartville, Minn.

**FOR SALE—Buck Deer heads**, newly mounted, cheap. Saylor & Son, 497 S. Broadway, Dayton, Ohio.

**10,000 RECORDS, 15c, or exchanged; phonographs, 43; typewriters, \$9.** Knights, 212 12th St., Louis, Mo.

**FOR SALE—Guns, Typewriters, Printing Presses, Musical Instruments, etc.** List free. Guy Kendall, Dundee, N. Y.

**NEW GUARANTEED storage batteries**, portable type, 6 volt, 60 ampere hour, \$5. John Conley, Fort Washington, Maryland.

**PARKER mechanical shooting gallery.** Danville, 1701 Indiana Ave., Connersville, Indiana.

**VULCANIZING PLANT**, steam system, A1, used short time only. Cheap if sold quickly. Box 471, Paulding, Ohio.

**PIANO PLAYER, WATCH, Player, music, bench, \$63.** Hamilton watch, \$25. Bailey, New Salem, Mass.

**FOR SALE—Moving picture film** 1c foot. H. Davis, Watertown, Wis.

**FOR SALE: half interest in Blacksmith business** in live town in S. E. South Dak. Cheap if taken at once. J. W. Garlin, Box 381, Vermillion, S. D.

**FOR SALE: Small metal manufacturing business**, patented, mail order, price \$2,000. J. D. Roberts, Oakmont, Pa.

**PLANS FOR STEAM LAUNDRIES** and dry cleaning plants. Earl Bess, Hamilton, Ohio.

**STEAM BOILERS, \$15 and up.** H. W. Shockey & Co., 1019 S. 16th St., Lincoln, Neb.

**POWER VACUUM CLEANER**, run one season, in fine shape. Bargain at \$400. Gale Bros., Greensprings, Ohio.

**ENGINEERS**, Transits, telescope, compasses, good and cheap. Burnett, Ludlow, Ky.

**RUBBER STAMP MAKING OUTFIT.** Stamp Works, Newcastle, Ind.

**TO WHOLESALERS** and trade in general. We are introducing new patented articles on the market. Send for list of same and also for catalogue of Typewriters, Motorcycles, Engines, Musical Instruments, etc. Atlantic Supply Co., Long Branch, N. J.

**"TEXTIGUM" TYPEWRITER COVERS**, 6mc, 50c. See what I say under "Typewriters." Atchison.

#### SALE OR EXCHANGE

**SALE OR EXCHANGE—Pair Brunswick bowling alleys**, sectional, bargain, \$200. Two K-W magnets, one used, other new, \$10 and \$12; Indian motorcycle, \$50. Want light weight, high speed machine, 15 to 30; air cooled motor for ice boat about \$10; twin motorcycle. W. R. Brown, Granville, N. Y.

**FOR SALE—5x7 folding camera** and supplies, worth \$30 for \$20, or will exchange for running motorcycle. Carl Nelson, Balfour, N. Dak.

**FOR TRADE—Station Indicator** No. 927,405. A patent simple device. What have you? E. P. Kuhn, Dunlap, Ill.

**HAVE \$300 MAHOOGANY PIANO;** want large elevator or offers. Clarence Skinner, Topeka, Kansas.

**WILL EXCHANGE 8x10 camera** for anything. Ehlen, Seventy Peachtree, Atlanta.

**EXCHANGE LADY'S solid gold 18k jeweled watch** for auto, shotgun or gasoline engine. Geo. Dutelar, 542 N. Clark, Chicago.

**EXCHANGE 6 reels of films** for bench lathe or what? Chas. Wells, R. F. D. No. 2, Frankfort, Ky.

**GROUP FINE RESIDENCE LOTS** will exchange for 1911 Model Automobile, standard make in A1 condition. C. W. Morrison, Fort Benton, Mont.

#### PATENTS FOR SALE

**HALF INTEREST IN U. S. PATENT** and entire Canadian Patent For sale. Combination hot pan lifter, utensil scraper, nut cracker and tack puller. Grand agents' article. Manufactured for five cents; retails 35c and 50c. Geo. N. Bartlett, Medicine Hat, Alberta.

**FOR SALE—Outright or on royalty.** Patent No. 985,635, dated Feb. 28th, 1911, base ball score keeping novelty. A winner. Fans want it. Perpetual. Preservable record for each game. Cost little, carries postage. Model free if you mean business. L. A. Brown, Clay Center, Neb.

**EXTREMELY SIMPLE**, practically tested electrical device. Big demand. Requires little capital. Reasonable. L. C. Steele, Electrician, 151 Willis East, Detroit, Michigan.

**OVERSHOE RETAINER.** U. S. No. 993,212, a device that will appeal to any person accustomed to wearing overshoes in damp weather. Will sell cheap if paid cash at once. W. G. Wheeler, R. F. D. No. 1, Ashland, Ky.

**FOR SALE—UNITED STATES** and Canadian Patents on new, inexpensive, metal household article; daily necessity; unlimited field; large profits. J. D. Wall, 7229 South May St., Chicago, Ill.

**PATENT 1,009,927 AUTOMATIC GATE** for railway street crossings, both steam and suburban electric; also 919,827, lock for hats, coats and umbrellas. Wm. Noville, 8503 Quincy Ave., Cleveland, O.

**FOR SALE—Outright or royalty.** Patent No. 997,402, sanitary tooth brush holder; manufacture cheaply. Address J. A. McGrath, Hancock, Mich.

**FOR SALE—Valuable Patent** recently issued, detachable rim trolley wheel, nothing like on the market. W. C. Banton, Salamanca, N. Y.

**FOR SALE—U. S. A. and Canadian patent** No. 975,304. Handle Extractor for axes, hammers, picks, etc. James Veno, General Delivery, Vancouver, B. C., Canada.

**COLLAR BUTTON RETAINER.** Patent just allowed. Will consider manufacturer's rights or royalty basis soon as patent issues. No triflers answered. Henry Hofflander, Speed, Missouri.

**\$600 BUYS FIRST-CLASS SEASONABLE PATENT.** Manufacturers, investors, ask for particulars. Victor Cozine, Glorerville, N. Y.

**PATENT ON HIGHLY ENDORSED** logenic article, universal usefulness in bicycle, typewriter, novelty line; money-maker for competent manufacturers. For convincing circulars, address E. Blouch, Lebanon, Pa.

**PATENT FOR SALE—Measuring and billing machine** patent for sale. Measures and bills anything in cans or jars. R. J. Workman, 81A Woodward Ave., San Francisco, California.

**FOR SALE—Automobile sleighing attachment.** U. S. patent No. 1,806,265, just issued. If interested, address Martin Olson, Carlin Bay, Idaho.

**CIRCUIT TESTING screw driver.** Very useful. C. A. Hetherington, Lock Box 520 West, Des Moines, Iowa.

**PATENT FOR SALE—Something new, automobile automatic** drop brake. Box 93, West Enfield, Maine.

**PATENTS, DIRTY CHEAP,** money maker. Trap and cut off. Geo. Krieger, Wooster, Ohio.

**MONEY IN PATENTS.** See Eddie Bentley's advertisement under Business Opportunities.

**PATENT FOR SALE—No. 856,994.** New automatic clothes line prop. Emerson Sechrist, Girard, Ohio.

**U. S. PATENT FOR SALE—See-Saw and merry-go-round;** new device for the outdoor amusement for children; inexpensive and easily made; big improvement over anything now upon the market. P. O. Box 148, John Mueller, Elmhurst, Ill.

**WILL SELL HALF INTEREST** or on royalty door check, patent applied for No. 638,259, made of wood and corrugated rubber. Can be manufactured cheap and sold at a good profit. If interested write. P. O. Box 462, Trenton, N. J.

**BEST OFFER TAKES MY PATENT** No. 1,006,315, dated Oct. 17, 1911. Portable mirror sticks to any smooth surface where light is. makes home shaving comfortable. Excellent article for investors. Will manufacture cheaply. Karl Toth, Box 149, River Rouge, Mich.

**ELECTRIC LAMP CORD HOLDER**, used in every home and office. Best offer takes it. Mail order houses write quick. R. C. Bowden, Conway, Ark.

**FOR SALE, U. S. PATENT** No. 967,649, also Canadian Patent 128,247. Insulator protection cap. For particulars address G. R. Schidcock, 2225 S. Avera Ave., Chicago, Ill.

**FOR SALE, patented article, novelty, excellent for advertising** purposes. Clara H. Tupper, Daytona Beach, Fla.

**FOR SALE: Interest in useful inventions.** Unique opportunity for parties with capital. Cleveland Gunter, Box 45, Bremen, Ga.

**FOR SALE: Hog Holder** No. 959,422, sell cheap for cash. J. O. Bechdel, No. 5, Portland, Ind.

**TWO THOUSAND DOLLARS** buys patented Automatic Baseball Indicator. Ernest Heusser, Murray, Utah.

**NEW TELESCOPING SELF-FEEDER** and Band Cutter for threshers, hullers. Will sell valuable patent for \$7,000. J. Holmes Wilson, Carlisle, Pa.

**AUTOMOBILE TAG HOLDER**, No. 961,267, including patterns and stock. John J. Thompson, Lancaster, Pa.

**MITER GAUGES**, No. 1,006,948 issued Oct. 24, 1911. Submit bids to Box 231, Phoenix, Ariz.

**INTERESTED PARTIES.** Correspond with owner of Patents on Locking Whip Sockets. Severin Lillard, Jewell, Iowa.

**EYEGLASS CASE** containing glass cleaner No. 1,008,523. John J. Thompson, Lancaster, Pa.

**PATENT FOR SALE, No. 925,474;** address Herbert E. Hawes, 128 Young St., Manchester, N. H.

## PATENT ATTORNEYS

**PATENTS PROCURED AND POSITIVELY SOLD** if the idea has merit; all countries; satisfied clients my best references; a good invention properly protected by patent should prove very profitable to the inventor; protect your business against competition by patenting any new manufacture, process, formula, or article associated with it; capitalize your ideas; perfect, patent and market your new ideas; send sketch today; book free. H. Sanders, Crilly Building, Chicago, Ill.

**PATENTS OF VALUE.** Prompt and efficient service. No misleading inducements. Expert in Mechanics. Book of Advice and Patent Office Rules free. Clements & Clements, Patent Attorneys, 704 Colorado Bldg., Washington, D. C.

**I PROCURE BEST** protecting patents; moderate rates; easy payments; free information. Benjamin Roman, Park Row Building, New York.

**FIBRE, STEEL, IRON,** brass, copper, aluminum sheets, rods, plates, bars, die and tool steel, tools, machinery, hardware, etc. Models built, free information and advice. A. L. Parker, Schofield Building, Cleveland, Ohio.

**SAVE \$10.00** on your Patent. I have a \$15.00 credit check issued by a leading attorney, which I will sell for \$5.00. Jno. Woodworth, Care Gen. Delivery, Washington, D. C.

**IMPORTANT NOTICE**—Read my page ad on page 128, Advertising Section of this magazine, relative to patents, trade-marks, etc. Special offer contained in the ad. E. E. Vrooman, Patent Lawyer, Washington, D. C.

**C. L. PARKER,** Patent Attorney, 910 G St., Washington, D. C. Inventor's handbook "Protecting, Exploiting and Selling Inventions" sent free upon request.

**PATENTS OBTAINED** by competent and reliable attorney. Personal services. Advice free. Fees reasonable. A. W. Foose, Room 2008, 165 Bway, New York City.

**ONE DIME,** two months. The Inventors' Outlook, Educational. Dollar for year. Washington, D. C.

**PATENT BOOKS MAILED FREE**—showing 160 mechanical movements invaluable to inventors and mechanics—and telling what is patentable, how to obtain patent or partner, etc. Free on request. Chas. E. Brock, 761 Eighth St., Washington, D. C.

**"PROTECTIVE PATENTS"** and our other book "Letters of Patent Success," sent on request to inventors. Wide experience. Personal service. Trademarks registered. Write today. Beeler & Robb, Patent Specialists, 211 McGill Bldg., Washington, D. C.

**SEND SKETCH** or model for free advice on patentability. Book telling truth about "prizes." "No patent, no pay." Sent free. John J. Thompson, patent attorney, 1110 F St., Washington, D. C.

**IDEAS HAVE MADE FORTUNES.** On request I will send my "Inventor's Pocket Companion," telling how to use your idea to greatest advantage. Patent secured or Fee returned. Write today. Wm. N. Roach, Jr., 562 Metzger Bldg., Washington, D. C.

**PATENTS—HERBERT JENNER,** patent attorney and mechanical expert, 608 F St., Washington, D. C., established 1883. I make a free examination and report if a patent can be had and exactly what it will cost. Send for circular.

**PATENT WHAT YOU INVENT.**—It may be valuable. Write me. No attorney's fee until patent is allowed. Estab. 1882. "Inventor's Guide" Free. Franklin H. Hough, 522 Loan & Trust Bldg., Washington, D. C.

**"PATENTS AND PATENT POSSIBILITIES,"** a 72-page treatise sent free upon request; full of valuable and interesting information; tells what to invent and where to sell it. Write today. H. S. Hill, 905 McGill Building, Washington, D. C.

**PATENT BOOKS** on How to Obtain and Sell Patents, containing exhaustive information on these subjects, with 160 mechanical movements, mailed free on request. F. G. Dieterich & Company, 690 Ouray Bldg., Washington, D. C.

**PROTECT YOUR IDEAS.** Inventor's Primer free. Free search and contingent fees. Milo B. Stevens & Co., estab. 1864, 685 F St., Washington; 353 Monadnock Bldg., Chicago. Guaranteed by Bankers Register.

**PATENTS SECURED** or Fee Returned. Send sketch for Free Expert Search and Report as to patentability. Books on inventions and patents and reference book sent free. John S. Duffie & Co., Dept. 1, Washington, D. C.

**PATENTS THAT PROTECT** and pay. Advice and books free. Rates reasonable—Highest references; best results. Watson E. Coleman, Patent Lawyer, 622 F St., N. W., Washington, D. C.

**THE PATENTOME** tells all about patents and how to get them. Free on request. Established 1865. Anderson & Son, Patent Solicitors, 727 G Street, Washington, D. C.

**PATENTS.** Advice free. 30 years' experience. Send for book. Edgar Tate & Co., 245 Broadway, N. Y.

**NO ATTORNEY'S FEES** until patent allowed. Free search and books. Fuller & Fuller, Washington, D. C.

**PATENTABLE IDEAS WANTED**—Send for 3 free books. Richard B. Owen, 30 Owen Bldg., Washington, D. C.

**SEND FOR FREE BOOKLET,** All about patents and their cost. Shepherd & Campbell, 500A Victor Bldg., Washington, D. C.

**PATENTS SECURED.** Booklet and advice free. Maxwell Stevenson, Attorney, Washington, D. C., and Philadelphia, Penna.

## PATENTS

**PATENTS THAT PROTECT.** Careful, honest work in every case. Patent your ideas, they may bring you wealth. 64-page book free. Fitzgerald & Co., 804 F St., Washington, D. C. Established 1878.

**MONEY IN IDEAS—EDISON,** Greatest Inventor, tells "How to Invent" in booklet, sent free, by Henry N. Copp, Registered Patent Attorney, 51 Washington, D. C.

**"MONEY IN PATENTS"** tells the truth about the subject. It is free to inventors. Write today. Patent secured or fee returned. Herman A. Phillips, 1101 L & T Bldg., Washington, D. C.

**PATENTS SECURED**—Reports on patentability, validity and infringement. Patent suits conducted. C. L. Parker, 510 G St., Washington, D. C.

**I WISH TO BUY** outright or on royalty any good novelty or device. Send fullest particulars. R. Morgan, Newport, R. I.

**OVER 125 BIG MANUFACTURERS** and investors want your invention. Send \$1 for list. Victor Cozine, Gloversville, N. Y.

**ONE DIME,** two months. The Inventors' Outlook, Educational. Dollar for year. Washington, D. C.

**WE SELL PATENTS.** Established ten years. To buy or having one to sell write Charles A. Scott Co., 1098 Granite Bldg., Rochester, N. Y.

**FIND OUT FOR YOURSELF** what to invent and how to protect it. My book, "Inventors' Universal Educator," covers the matter from A to Z. Price, \$1. Postage free. Money returned if not more than satisfactory. F. G. Dieterich, 651 Ouray Bldg., Washington, D. C.

**PATENTS BUILD FORTUNES FOR YOU.** Our free booklets tell how, what to invent, and how to choose an attorney. Best bank and other references. All business strictly confidential. Write today. D. Swift & Co., 317 Seventh St., Washington, D. C.

**INVENTORS**—Send copy of your patent, etc., and we will send contracts outlining our special offer to market your invention. Atlantic Supply Co., Long Branch, N. J.

**SEND FOR FREE BOOKLET.** All about Patents and Their Cost. Shepherd & Campbell, 500A Victor Bldg., Washington, D. C.

**PATENTABLE IDEAS WANTED**—Send for 3 free books. Richard B. Owen, 30 Owen Bldg., Wash., D. C.

**PATENTS WITHOUT ADVANCE ATTORNEY'S FEES.** Send sketch for free report. Books free. Fuller & Fuller, Washington, D. C.

## REAL ESTATE AND FARM LANDS

**5 CENTS PER ACRE CASH.** Texas school land coming on the market, you can buy good land at \$2 per acre; pay 5 cents per acre cash, and no more for 40 years, but 5 per cent interest on the balance. Send 6 cents postage for further information. Investor Pub. Co., Dept. B, San Antonio, Tex.

**MONEY-MAKING FARMS** throughout 16 Eastern and Southern States, \$15 to \$50 an acre. Livestock and tools often included to settle estates quickly. Big illustrated catalogue free. We pay buyer's railroad fare. E. A. Strout Farm Agency, Station 3043, 47 West 34th St., New York City.

**FOR SALE**—In Colorado, fine country home, 12 mi. from Colo. Springs, 60 acres, modern new 8-room house. Price \$8,500. Send for description and photo. Address Box 125, Fountain, Colo.

**CHOICE CENTRAL SOUTH DAKOTA FARM LANDS.** Beautiful 800 acres improved farm, \$25 per acre; 160 improved, \$32 per acre. Tracts in any size; fine location. R. C. Greer, Blunt, S. D.

**FLORIDA LAND, ON GULF COAST,** high land, low prices. Liberal contracts. Join German Colony. Write for literature to Max Fromhold, 512 Shubert Bldg., Kansas City, Mo.

**BUY A VIRGIN FARM** in West Virginia. Rich, high, virgin soil; needs no fertilizer. Any size farm; good community. Ten dollars acre. Write Sectt Radeker, Parkersburg, W. Va.

**WAURIKA, OKLA.** Write us, many good things here. For instance: A bottling works with established trade; a stock of furniture; an A-1 lumber yard; several fine farms, cheap; easy payment plan. Johnston & Kenaga.

**DON'T FREEZE YOURSELF!** Come to Bertie County, North Carolina, and buy land. We have good values for little money. Leighton Realty Co., Aulander, N. C.

**FARM HOMES**—Best in United States, soil unequalled for poultry, fruit, truck; mild, healthful climate, pure water, good roads. Illustrated 1912 catalogue free. Frank Wanser, Vineland, N. J.

**FOR SALE**—2 Greenhouses, 6,000 ft. glass, 12 acres land, 7 room dwelling. For particulars write Willmar Greenhouse, Willmar, Minn.

**TO SELL YOUR PROPERTY** write Northwestern Business Agency, Minneapolis.

**BARGAIN,** 160 acres good land, good improvements. Ira Ashkin, Verona, Mo., Lawrence Co.

**FOR SALE**—One fifty-foot lot, Klinger Lake, Mich. Write for information. Box 142 Bucyrus, Ohio.

**CO-OPERATIVE COLONY** locating here. Co-operators invited. Edward Miller, Crystal Springs, Fla.

**SELL YOUR PROPERTY QUICKLY** for cash, no matter where located. Don't pay big commissions. Particulars free. Real Estate Salesman Co., Desk B, Lincoln, Neb.

**GOVERNMENT FARMS FREE**—Official 112-page book "Vacant Government Lands" describes every acre in every county in U. S. How secured free. 1911 diagrams and tables. All about irrigated farms. Price 25c postpaid. Webb Pub. Co., Dept. 285, St. Paul, Minn.

**FINE FARMING OPPORTUNITY** in Louisiana. 60 miles from New Orleans on I. C. R. R. Temperate climate, good markets, splendid stock country with natural forage. \$20 per acre. Terms reasonable. Address, C. H. McNie, Kentwood, La.

**WANTED—MEN TO BECOME INDEPENDENT FARMERS** in Eastern North Carolina. The "Nation's Garden Spot." Leads for large profits on small capital. Write for booklet. C. Van Leuven, 812 Southern Bldg., Wilmington, N. C.

#### FOR THE HOME

**EXCEPTIONALLY HIGH-GRADE** water power washing machines. Cedar or cypress tubs; gearless, brass motor operating on sixteen pounds pressure. Guaranteed two years. Regularly sold for \$18. Price \$11.75 each, complete. Armstrong Sales Company, Springfield, Ohio.

**SAVE 50c TO \$5.00** on your gas bill every month with our governor. A great invention. Send for free circular today. Specialty Supply Co., Box 18, Kewanee, Ill.

**ENGRAVING GLASS OR METALS**.—Inexpensive, simple, entertaining and instructive. Complete illustrated instructions and designs postpaid, 25 cts. C. M. Shigley, Distributor, 208 Brunson Bldg., Columbus, Ohio.

**YOUR OLD CARPETS** made into beautiful rugs. Circulars free. Formula for scouring carpets, 25c. Springfield Rug Co., Springfield, Ohio.

**MAKE YOUR OWN MISSION FURNITURE** at the minimum of expense. Our 2 books "Mission Furniture, How to Make It," Parts 1 and 2, tell in plain, simple language just how to make 50 different pieces. Full dimensioned working drawings and half tones of finished articles. Price 50 cents each or \$1.00 for the two volumes, postpaid. Popular Mechanics Book Dept., Chicago.

**METAL WORK AND ETCHING**—A 96-page handbook for art metal workers telling how to make a great variety of useful and ornamental objects such as desk sets, arts-crafts jewelry, etc. Price, 50c postpaid. Popular Mechanics Book Dept., Chicago.

**BEAUTIFUL ARTS-CRAFTS LAMPS**—Anyone can make them out of paper, cardboard and wood. 16 designs. Inexpensive yet artistic. Complete book of instructions. Price 50c postpaid. Popular Mechanics Book Dept., Chicago.

#### FOR MEN

**MARVEL PIPES** smoke in volume, no hot streams, stem remains clean. Guaranteed. 50 cts. prepaid; no stamps. Marvel Mfg. Co., 241 East 43rd St., New York.

**MARVELET SAFETY RAZOR SHARPENER** for Everybody, Gem Jr., and Gillette blades. Sharpens 5 blades in 5 minutes. Price prepaid, 50 cents. M. Meyler R. 10, Kalamazoo, Mich.

**MATCHLESS POCKET LIGHTER**. 25c. Indispensable for autoists and smokers. Richard Lavery, 194 Broadway, New York.

**FOR SALE**—40,000 pounds best leaf tobacco, mail stamps for samples. Anton Warrin, Franklin, Ky.

**\$1.00 SAFETY RAZOR**, 50c; blades, 50c doz. Lake Sales Co., Port Clinton, O.

**FREE**. Two Safety Razor Blades resharpened, enclose return postage. Blades, 25c. Detroit Cutlery Co., Detroit, Mich.

**THE BEST BARBERS' RAZOR**, pair of prepared barbers' strops all fully warranted and complete information how to keep them in shape and how to shave for only \$5.00. You will not part with them for any price. M. L. Kant, 2 Mahlen Lane, Torrington, Conn.

**WHY DARN SOCKS?** It really isn't necessary if you send direct to us for 6 pairs of "Superior Linenweave" socks for \$1.00, linen heels and toes, extra reinforced, special seamless process to make them fit, very dressy. Black, tan, navy, slate, wine, grey. State size and color. Money back if not satisfied. Windsor Specialty Co., 123 West Windsor St., Reading, Pa.

**KEYLESS LOCKS**, attached without tools. Nickel plated sample. 25c prepaid. Hoosier Novelty Co., Indianapolis, Indiana.

**SAFETY RAZOR BLADES** sterilized and sharpened better than new; 2 cents each. Five years' success. Send for blade box and circular. Electro Strapping Co., 134 Shelby St., Detroit, Mich.

#### GAMES AND ENTERTAINMENTS

**YOU CAN'T LOSE!** Mail 50 cents (stamps acceptable) and we will send postpaid, the delightfully absorbing new Card Game "I Win—You Lose," with complete instructions for playing. Entirely different from any other game. A most interesting game for home or social diversion. If you are not fully impressed with the beauty and class of "I Win—You Lose"—or should the game in any way not meet with your entire approval—just return it to us and the purchase price shall at once be refunded. United Games Concern, Inc., Beaver Falls, Pa.

**SOMETHING ENTIRELY NEW**, mystify your friends. The Mephisto vanishing coin, no strings, no elastic. Price 20 cents. Send 5c for illustrated catalogue of magical tricks, puzzles and jokers. Mephisto Mfg. Co., 151 7th Ave., Brooklyn, N. Y.

**PLAYS, VAUDEVILLE** Sketches, Monologues, Dialogues, Speakers, Minstrel Material, Jokes, Recitations, Tableaux, Ditties, Musical Pieces. Entertainments for all occasions. Make-up Goods. Large catalogue free. T. S. Denison & Co., Dept. 11, Chicago.

**CACHOO**—Sneeze powder. Sample 10c., dozen 80c., hundred \$5.00. Hundred page catalogue of wigs, makeups, puzzles, tricks, etc. Percy Ewing, Decatur, Ill.

**SEND 10c** for two Standard Puzzles, and receive Free, two Card, two Coin Tricks, two Joke Novelties, with apparatus; also Puzzle, Trick, Joke and Novelty Catalogue. Puzzle Works, 323 Eugenie St., Chicago, Ill.

**84 NEW CARD TRICKS**, 10c. Three illustrated catalogues of Magic Tricks, Books, Jokes, Puzzles, etc., Free. Magic Store, Minneapolis, Minn.

**INDIAN FINGER TRAP**—Hot Joke, 10c. Wm. Fisher Co. Harrisburg, Pa.

**153 TRICKS**, 10c. Wm. Schaffer Co., 218 Augusta St., Pittsburg, Pa.

**NEW AND NOVEL JOKES**—Great fun producers. So simple a child can operate them. 1. The Spilt Jam (Look what you've done to the table cloth!!!). 2. Red Hot Clinker (Drop it on the rug or floor in front of fireplace). 3. Damaged Finger (Deceptive blood-soaked bandage. Great sympathy is expressed by your friends). 4. Blot of Ink (The Bookkeeper goes mad. Mother is frantic). Price 10 cents each, postpaid. Address Popular Mechanics Book Dept., 318 W. Washington St., Chicago.

**STINK them out**—10c; better than sneeze powder. Lake Sales Co., Port Clinton, O.

**GOOD PUZZLES** provide great pleasure. Illustrated list free. Atwater, Sixth Street, Bridgeport, Conn.

**TRICKS, MAGICAL APPARATUS AND SUPPLIES**—Amateurs supplied as well as the Great Professionals. Easy, interesting and entertaining. Amuse and astonish your friends. Large illustrated catalogue of clever tricks for the pocket, parlor and stage, price ten cents. Buy from real Magic Dealers. Send now. Read & Covert, 821 East 43d St., Chicago, Ill.

**YOU CAN BE A MAGICIAN**; travel; give shows; make money. I tell how. Send stamp. Prof. Rapp, Box F-1115, Madison, Wis.

**FREE MAGIC CATALOG**, send 2c stamp. Wholesale Magic Supply, 270 West 39th St., New York.

**MAGIC-SKULL**, shines in dark, 10 cents. Klein, 1193 Broadway, New York.

**100 TRICKS**, with directions, fifteen cents. Bamberg, 1193 Broadway, New York.

**LEARN VENTRILOQUISM** at home. Particulars for stamp. M. Bailey, Box 253, St. Paul, Minn.

**MAGIC BOOK FREE**—600 Tricks, Puzzles, etc. Send address. Crest Trading Co., 10 Wiltmark Building, N. Y.

#### RARE COINS AND STAMPS

**GREENBACKS**—Pack of \$1,000 Stage Bills and present, 10c; 5 packs 25c. Send for a pack and show the boys what a wad you carry. A. Nichols, Box 92, Chill, N. Y.

**\$7.75 PAID FOR RARE DATE 1853 QUARTERS**, \$20.00 for a Half-Dollar. We pay a cash premium on hundreds of coins. Keep all money coined before 1880, and send 10 cents at once for our New Illustrated Coin Value Book; size 4x7. It may mean your fortune. C. F. Clarke Co., Coin Dealers, Dept. 14, Le Roy, N. Y.

**STAMPS FREE**—4 different Soudan (camel), 8 different Costa Rica, stamp lists, free offers, etc., for 2c postage. Fine 50c approvals. Stamps bought. W. C. Phillips & Co., Glastonbury, Conn.

**POST MARK COLLECTIONS!** The latest craze. Start a collection at once; be first in your neighborhood. We will send you 25 different, postpaid for only 10c. Penn Stamp Co., Box 267, Meads, Pa.

**FREE**—Good foreign pocket to all applying for our 50c approval sheets. Enclose 2c for postage. M. Teeling & Co., Box 3257, Boston, Mass.

**SEND FOR COLLECTOR'S CATALOGUE**, gives value of all stamps; only 15c postpaid. Robert Blakely, Prescott, Arkansas.

**100 DIFFERENT STAMPS**, album, hinges, gauge, list of unique "made-to-order" packets, 25 cents. Sooner Stamp Co., Norman, Okla.

**100 DIFFERENT FOREIGN** 10c—100 different United States 5c. Stimm, 2313 Douglas, Omaha, Nebraska.

**STAMPS**—Thibet on China. Nine different, \$1.50. Poole, Alhambra, California.

**300 DIFFERENT FOREIGN STAMPS**, 30c. W. L. Barrows, Box 12, Hartford, Conn.

**FREE**—100 foreign stamps. Popular Stamp Company, Box 840, Wallingford, Conn.

**OLD COINS BOUGHT AND SOLD**. Buying Catalogue 10 cents. New 55 page 1912 Selling Catalogue to collectors only free. William Hesslein, Malley Bldg., New Haven, Conn.

**OLD POSTAGE STAMPS**. Collections bought. Meyer, Old Hickory, New Orleans.

**COINS**—Selling list of rare gold, silver, copper coins, fractional currency, bills, etc., free for stamp. John A. Lewis, 253 No. Washenaw Ave., Chicago, Ill.

**COINS**—20 DIFFERENT FOREIGN, 25c. 5 different Confederate state bills, 15c. 150 page illustrated premium coin book, 25c. 1,000 U. S. stamps, 25c. F. L. Toupal Co., Chicago Heights, Ill.

**STAMPS**, 100, ALL DIFFERENT, FREE. Postage 2c. Mention paper. Quaker Stamp Co., Toledo, Ohio.

**24 VARIETIES CUBAN STAMPS** 10 cents. List of 6,000 low-priced stamps free. Chambers Stamp Co., 111 P. Nassau St., New York City.

**100 DIFFERENT GOOD UNITED STATES STAMPS**, 25c. Catalogue free. Collins, 285 Orleans, Detroit, Michigan.

**STAMPS**—100 China, etc., stamp dictionary and list, 2c. Bullard, 8th A., Boston.

## MUSIC

**LEARN TO PLAY THE PIANO** in four weeks. We teach you, by our new method. Send 25c as guarantee, we then send first lesson for examination. If satisfied send 75c additional and second lesson is sent. 5 lessons \$5. Satisfaction or money back. Chicago Music Co., Hyde Park, Chicago.

**ANY SHEET MUSIC YOU WANT**, no matter where published we will supply at 20c a copy postpaid, Willis Woodward & Co., 1101 Broadway, New York.

**IF YOU WANT** the latest sheet music and a better assortment for less money than elsewhere, write for our catalog. Semple's Music House, 204 West Ave., Norwalk, Conn.

**MUSIC**—Send \$1 and receive two folios containing the music to Silver Bell, On Mobile Bay, and fifty other late and popular pieces. Latest catalogue included with order. Geo. Chapman, 2227 Beach Ave., Chicago, Ill.

**SONG POEMS WANTED** for publication, with or without music. Eaton, Desk 44, 1370 R'dway, N. Y.

**SONG WRITERS**, send us your poems for our special 1912 publishing offer. Box 1207, New Orleans, La.

**RAIG-TIME PIANO PLAYING** taught by mail. Book free. Christensen, 81 Auditorium Bldg., Chicago.

## PIANOS AND MUSICAL INSTRUMENTS

**STRADIVARIUS VIOLIN** for sale cheap. Excellent sweet tone. Miss Bertha Mardes, Route 5, Rosedale, Kansas.

**BOHEM FLUTE** for sale cheap. Walsh, 26 Grant St., Newark, N. J.

**PIANOS PLAYERS**. Sell 350 each. Pianos, Angelos, Apollis, and other makes, in perfect order. Cost new \$250. Meriden Player Piano Co., 291 West 145th, New York.

## PRINTING

**THIS MONTH'S SNAP!** 100 XXX Envelopes and 100 20-lb. Bond Letterheads printed and mailed to you for \$1. Watch for next month's Snap. Eastern Printing Company, Baltimore, Md.

**PRINTING**—Just to introduce my High Grade Printing, I will print 1,000, 3x6 circulars for a dollar bill. Postpaid. P. Raymond Benson, Elgin, Ill.

**1,000 IMITATION TYPEWRITTEN LETTERS** \$2.25; circulars, letterheads, envelopes, folders, lowest prices. Elegant set samples free. Good's Printery, Harrisburg, Va.

**CAN YOU BEAT THIS** for good printing: 100 letterheads and 100 envelopes to match, good bond paper, and 100 business cards all for \$1 prepaid. Axtcraft Printing Co., Columbus, Ohio.

**PRINTING PRESS FREE**. Send names and addresses of six boys under 15 years of age and get a press free. Gage Mfg. Co., Dept. P-3, Elston Sta., Chicago, Ill.

**HOWARD'S GUMMED LABELS** and advertising stickers, any size, design or wording. Stamp brings samples. Howard Label Co., 726 Chestnut Street, New Castle, Pa.

**LABELS AND ADVERTISING STICKERS**—No line of business should be without them. Send for catalog. Seymour L. Sauer, 164 19th St., Oakland, Cal.

**125 FINE BOND** letter heads and 100 envelopes prepaid for \$1. People's Press, Preston, Minn.

**100 VISITING CARDS** printed in engraved style. 25c. Samples free. Letter Bros., Tippecanoo City, Ohio.

**BEST WHITE** envelopes printed, only 20c a 100. Harry Partridge, Hoboken, Mass.

**1,000 3x5 CIRCULARS** PRINTED on book paper, 80c. J. Hunt, Printer, Lambertville, N. J.

**"ENGRAVOTYPED" STATIONERY** is the latest form of stationery for particular people, being a perfect imitation of steel die stamping. Samples on request. Clifford D. Stone, 501 Snowflake Bldg., Toledo, O.

**TELEPHONE DIRECTORY**—Fits any telephone. Big field for agents. Reasonable prices. Sample, 5c. Clifford Press, 21 East 21st, New York.

**500 CARDS, LETTER HEADS, envelopes** for both, printed for \$1, cash with order. Room 22, 625 1st Ave., Seattle, Washington.

**IMITATION TYPEWRITTEN LETTERS** printed through silk. Samples and prices free. R. P. Burr, Altoona, Pa.

**1000 3 1/2 x 6 CIRCULARS**, book paper; postpaid, \$1. Smith Supply, Waukegan, Ill.

**PRINTING PRESSES, Type and Supplies**. Instruction book and catalogue free. L. M. Carroll & Co., 147 W. Washington St., Chicago.

**500 BUSINESS CARDS** PRINTED to your order. 75c, postpaid. Samples furnished. Geo. Hirt, 714-713 Russell Ave., Indianapolis.

**PRINTING**—100 NOTEHEADS, 100 Envelopes and 100 Cards neatly printed to your order; prepaid, \$1. Sample for stamp. Union Pub. Co., Dept. M, Uniondale, Ind.

## FORMULAS

**FUELO—A NEW FUEL**; takes the place of coal or wood. Easily made, low cost. Try it. You can save money. Send now for complete formula and instructions, 50 cents. The Banker Company, Fort Madison, Iowa.

**3,000 FORMULAS** and Digest publishing 100 formulas, etc., monthly, one year 40c Digest, Grand Rapids, Michigan.

**ENGINE MEN AND OTHER MECHANICS**—Four mechanical formulas. Each one gives you a living. No trash. Send 2 cent stamp for particulars. C. W. G., 32 So. Elm St., Lynn, Mass.

**200 FORMULAS** and Digest publishing 100 formulas, etc., monthly, one year 25c. Digest, Grand Rapids, Mich.

**PRACTICAL FORMULAS**, anything guaranteed, 25c. Address Expert Chemist, 103 Baldwin Ave., Detroit, Michigan.

**SILVERING MIRRORS**, 2 formulas, 25c silver, Teq, Box 122, Crowley, La.

**GASOLINE AGE**, Electric Dry Cell No. 6 Igniters. Peerless formula. Written demonstration and exclusive territory to manufacturers guaranteed, \$25. J. Dougan, 234 Smith St., Winnipeg, Canada.

**MARBLE AND GRANITE CAN BE IMITATED** and manufactured very cheaply with our formulas. Concrete workers, contractors and builders, get our literature. Gramman and Lawhead, Zanesville, Ohio.

**SILVERING MIRRORS FORMULA** and one year's subscription to Digest, 25c. Digest, Grand Rapids, Mich.

**200 PRACTICAL FORMULAS** for 10 cents. Jas. G. Sproul, Lima, Ohio.

**SEND 20 CTS.** in stamp or coin for formula and directions for putting a glass finish on table tops, that will not scratch. No varnish used. P. O. Box 462, Trenton, N. J.

**MANUFACTURE FLAVORING EXTRACTS** and Toilet Articles. Complete information and formulas, \$1. Chas. Barnes, Kirksville, Mo.

**SPECIAL**—\$1 gets my complete formula, for Non-Abrasion Developing Soda, worth \$50.00. Success Supply Co., Laceyville, Pa.

**500 FORMULAS**, Book Form, 25c. Other circulars free. Tielens Co., 117 Bloomfield St., Hoboken, N. J.

**FURNITURE POLISH FORMULA**, 25c. E. P. Moore, Upholsterer, Chester, N. H.

**SEND 25c STAMPS**—Morgan's book of over 500 valuable formulas, trade secrets, etc. The Morgan Press, 17 Harvard Place, Boston.

**10,000 RECEIPTS, FORMULAS, processes, etc.**, for every business, 800 pages, price \$3. Circular and scientific book catalog for stamp. R. P. Newlands, Waukegan, Ill.

**500 SECRET FORMULAS**, 25c. Globe Co., 1112 Leavenworth, Omaha, Neb.

**FORMULAS**—Six money makers, \$1. Warren Stewart, Hope, Indiana.

## TYPEWRITERS

**TYPEWRITER BARGAIN HUNTERS**—We can save you money on any typewriter you wish to buy. Greatly reduced prices on brand new latest model machines, any make, or excellent line guaranteed factory rebuilt typewriters, \$10 up. Investigate today. We prepay expressage. Write us. Southern Typewriter Sales Co., Tyler, Texas.

**GENUINE TYPEWRITER BARGAINS**, no matter what make, will quote you lowest prices and easiest terms. Write for big bargain list and catalogue 17. L. J. Peabody, 278 Devonshire St., Boston.

**SCARCELY USED** Smith and Underwood at sacrifice. P. Ablin, 1665 N. Humboldt St., Chicago, Ill.

**TYPEWRITERS—ALL MAKES**, all prices, a square deal assured you, ribbons for any make machine. E. F. Kuhn, Dunlap, Ill.

**FIFTY SECONDHAND TYPEWRITERS**, five hundred ribbons, ten thousand sheets carbon paper, Will sell separately; get list. Ayer, 254 Hennepin, Minneapolis.

**A BARGAIN—REMINGTON** No. 6 good as new. Will send and allow your inspection. \$19.50. E. F. Kuhn, Dunlap, Ill.

**OLIVER VISIBLE TYPEWRITER** cheap. Charles Bickhart, Route 5, Rosedale, Kansas.

**SPECIAL WHOLESALE PRICES**, five days free trial. Standard makes of typewriters, rebuilt. Remington, Oliver, Underwood, choice of 300 makes, \$19 to \$15. Send for catalogue No. 52. Dearborn Typewriter Exchange, Monadnock Bldg., Chicago.

**BARGAIN—SMITH PREMIER** No. 2, \$18.50. Will send on inspection. E. F. Kuhn, Dunlap, Ill.

**No. 4 UNDERWOODS** \$40, No. 5 Olivets \$38.50, No. 2 Smith Premiers \$22.50, No. 6 Remingtons \$22.50. Excellent factory rebuilt machines. Free trial. Augustus Perow, Treasurer, Bath, Maine.

**SAVE 40%!** Cash dealing does. Absolutely best values. Underwoods, Smiths, Remingtons, Olivets, \$15 to \$38. Sent on approval. (Established 30 years.) Consolidated Typewriter Exchange, 245 Broadway, N. Y.

**REMINGTON LATE MODEL**, sacrifice \$20. Cost \$100. Miss Wagner, Stenographer, 350 Elm, Arlington, N. J.

**ELEGANT REMINGTON** No. 6 and Smith Premier No. 2, \$15 each. F. Thelin, 2945 Prairie Ave., Chicago.

**REMINGTON TYPEWRITER**, \$12; Calligraphs, \$6; Hammonds, Yost, Denkmores, \$10; Smith Premiers and Jewetts, \$15; Olivets, Underwoods, L. C. Smith and Royals, \$25. Fifteen days' free trial and one year's guarantee; don't purchase until you get our prices. Harlem Typewriter Exchange, Dept. P. M., No. 217 West 125th St., New York.

**I WANT TO CORRESPOND** with persons who are about to buy a high-grade typewriter, and object to paying the high prices generally asked by manufacturers and dealers. Any make on approval. Catalogue, bargain list and valuable information sent free. A. E. Atchison, 4127 West 21st St., Chicago.



**TYPEWRITERS OF ALL MAKES**, low prices; satisfaction guaranteed. Edward Quimby, Dover, New Hampshire.

**TYPEWRITERS**—Every kind on the market, write today for best bargain you ever secured. Shipped anywhere on approval, \$10 up. Fletcher Typewriter Co., 297 N. 7th St., St. Louis, Mo.

**TYPEWRITER RIBBONS** for any make of machine, four for \$1. Carbon paper \$1 per hundred. Guaranteed. Peenick Ribbon Co., 217 West 125th St., N. Y. City.

**STENOGRAPHER** must sell her Remington typewriter, \$9. Miss King, 2230 7th Ave., N. Y. City.

**WHY PAY MORE ELSEWHERE** when you can get our typewriters from \$19.00 to \$15.00 less on any make. Write for wholesale price-list and free trial offer. All-Makes Typewriter Exchange, 162 No. Dearborn St., Atheneum Bldg., Chicago, Ill.

#### SHORTHAND TYPEWRITERS

**ANDERSON'S SHORTHAND TYPEWRITER** is faster than stenography! One stroke prints a word in plain English. 100 words a minute in six weeks. Anderson Shorthand Typewriter Co., 5714 Cedar Avenue, Philadelphia, Pa.

#### TELEGRAPHY

**TELEGRAPHY TAUGHT QUICKLY**—Wire and Wireless—Operators in demand—Position secured—Train Dispatchers Wire—Wireless Station—Station Agency. Catalog free. Eastern Telegraph School, Box 3, Lebanon, Pa. Established 1896.

**TELEGRAPHY—MORSE AND WIRELESS**—Railway Accounting (Station Agency) taught quickly. R. R. Dispatchers and Western Union Wires and complete Wireless Station in school. Splendid opportunities—graduates assisted. Living expenses low—may be earned. Largest and oldest school—established 37 years. Investment \$25,000.00. Correspondence courses also. Catalogue free. Dodge's Telegraph & Railway Institute, 15th St., Valparaiso, Ind.

**TELEGRAPHY TAUGHT** in the shortest possible time. The Omnigraph Automatic Transmitter combined with standard key and recorder. Sends you telegraph messages at any speed just as an expert operator would. Five styles. \$2 up; circular free. Omnigraph Mfg. Co., 41 G. Cortland St., New York.

**TELEGRAPHY—THE ONLY TRADE** that is not overdone. We are official instructors for the Western Union Telegraph Co. and Illinois Central Railroad Co. Main line wires. Station agents' course free. We can secure a position for young men where they can earn \$30 to \$35 per month while taking our course. State your age. Jones School of Telegraphy, R17, 312 So. Clark St., Chicago.

#### WIRELESS

**DOUBLE 2,000 OHM HEAD RECEIVERS**, complete with headband and cord, \$7.50; 3,000 ohm, \$8.50. Absolutely guaranteed. Loose coupler, best on the market, \$15. Variable condensers, \$3. Fine line of quality apparatus. Wm. J. Murdock Co., 10 Carter St., Chelsea, Mass.

**WIRELESS EXPERIMENTERS**: Send 2c stamp for large wireless catalogue. I. W. T. Wireless Co., 1042A Broadway, Brooklyn, N. Y.

**WIRELESS MFG. CO.**, 80 West 124th Street, New York. Surprising low prices. One inch induction coil guaranteed \$3.98. 1000 Ohm Double pole receiver \$1.20, 3c catalogue.

**WIRELESS SET**. How to Make—96-page book telling how to construct at small cost an outfit suitable for transmitting four or five miles. Price 50 cents, postpaid. Popular Mechanics Book Dept., Chicago.

#### ELECTRICAL

**DO YOU WISH TO LEARN** practical, everyday electricity by the most modern method of instruction. Write us; we will send you sample pages of the Branch method of teaching E. The Joseph G. Branch School of Engineering, 21 E. Van Buren St., Chicago.

**DON'T WASTE MONEY**—Renew your old dry batteries. Formula 25c. Very efficient. Stewart Laboratory, 631 West End Ave., New York.

**STORAGE BATTERIES**, new, guaranteed one year. 6-40 at \$5.75; 6-60 at \$7; 6-80 at \$10; 6-100 at \$13.50; 6-140 at \$20. Walter W. Hartman, Quincy, Ill.

**BATTERY TESTERS**, 50c each, while they last. The People's Supply House, Lock Box 11, Warren, R. I.

**READ MY ARTICLE**: "Behind the Scenes of a Show Shop," that captured "Popular Electricity's" cover page (March issue). Then send for my book: "How to Become a Stage Electrician." Sample lesson free for stamp. T. J. Newlin, Denver, Colo. Theatre "M"

**RENEW OLD DRY BATTERIES**; complete instructions, 25c; guaranteed. Clark, 2830 Arch, Philadelphia.

**SPARK COILS IN PARTS**—We repair coils, magnetos, etc. Send for circulars. Electrical Testing Co., Peoria, Ill.

#### MISCELLANEOUS

**DO YOU LOVE YOUR FAMILY** more than lawyers? Then save your belongings and keep a will among your papers. Typewritten form and full instructions that anyone can fill out, 25 cents. Oxford Co-operative Bureau, Falmouth, W. Va.

**SAMPLE COPIES** of 100 different magazines and lots of other samples and agents propositions. Postpaid 10c. Association, 1027 Walnut St., Milwaukee, Wis.

**EARN \$15 TO \$25 A WEEK** as our mail order dealers. Right from your own home. Hold your position until entire time is required. We are manufacturers and owners of patented just-in-season, repeat order specialties. If you are just starting a mail order business or if already established, you can't afford not to handle our Patented Money Making Getters. We sell and furnish everything. No canvassing. Small capital. Experience unnecessary. Write today for Latest Patented Leader and Manufacturers' Easy Selling (copyrighted) Mail Order Plan backed up by "Whole Truth" positive proof and sworn statement. J. M. Pease Mfg. Co., 552 Pease Bldg., Michigan St., Buffalo, N. Y.

**NUSHAM, THE IDEAL SHAMPOO**—Cleanses the hair and scalp, removes dandruff, allays itching, and irritation, making the hair soft, silky, and fluffy; enough for eight shampoos postpaid 25c. Nusham Chemical Co., 743 N. Gay St., Baltimore, Md.

**LILLY DEW**—Finest cosmetic made, for either sex. Creates a clear, beautiful complexion. This \$10 formula and 12 useful household articles sent postpaid for 50c. F. Ayes Co., Fairview, Mo.

**ANYBODY CAN MAKE GOOD CUTS** with my simple zinc etching process; price, \$1; specimens and particulars for stamp. T. M. Day, Box M, Windfall, Ind.

**!!!LOOK! MECHANICS!!!** Just off the press! Standard Solder Chart containing complete directions for making 21 kinds of solders. Postpaid! This month only 25 cents (silver). Standard Service System, Batavia, Ill.

**GET OUR CIRCULAR** on sheet bluing mending tissue. Perfume post cards, rubber stamps, etc. They are all good. Free. W. M. Stuart, Marshall, Mich.

**YOUR NAME AND ADDRESS** stamped on German silver key chain, 25c. Silver Key Chain free. L. D. Thompson Co., 3121 La Salle St., Chicago.

**ADD AND SUBTRACT FRACTIONS** faster than you can think. My simple, accurate, and convenient adder does it. Price 10c. E. Lawrence, Box 422, New Britain, Conn.

**COCKROACHES EXTERMINATED QUICKLY**, 15c per pkg., 2 for 25c. Agents wanted. The Only Roach Destroyer Co., 1128 N. High St., Columbus, O.

**NAME AND INITIAL** stamps for tools, 10 cts. per letter. Joseph Mangold, 76 W. Crosier St., Akron, Ohio.

**YOUR AD PLACED** in nearly fifty magazines, 3 months, 5 cts per word. A. S. Mankin & Co., Alexandria, Va.

**ALCOHOLISM—Soberup—quit drinking**. Hundreds of homes made happy. Yours next, \$1. (Three formulas.) Dr. Garmon, Elmhurst, California.

**SAFETY RAZOR PREPAID** for 25 boys' addresses and 25c charges. Capitol Mailing List, Attica, Indiana.

**OUR NEW Double Sight Spectacles** are guaranteed. Prices and particulars 2c. Frederick & Co., Toledo, Ohio.

**YOUR NAME, BUSINESS AND ADDRESS** on neat rubber stamp with inked pad, 30c. Catalog 2c. Pop Durham Co., Corry, Pa.

**MANUFACTURERS** desiring increased sales, make us your general agency proposition. Reicard Company, Bangor, Penna.

**TATTOOING**—Send 15c for 6 beautiful hand colored tattoo designs. Price list free. J. F. Barber, 1019 Vine St., Cincinnati, Ohio.

**W. H. SNYDER** Veneers, 1-30 in. to ¼ in. thick. \$38 Jefferson Avenue, Indianapolis, Indiana.

**LINOTYPE INSTRUCTION**, write for Booklet "P." Empire School, 419 First Ave., New York.

**MAKE YOUR OWN CUTS**. Instructions, material, 50c. Circular Press, 64 Fairview Ave., Newark, N. J.

**RAISE GINSENG**—\$1 per ft. of ground; ¼ acre, \$25,000. Write, Ginseng Gardens, Sheboygan, Wis.

**PATENTS SECURED**—C. L. Parker, 910 G St., Washington, D. C.

**GIVING AWAY fountain pens** free. Stout Dotterer & Co., Pottstown, Pa.

**TATTOOING SUPPLIES**—E. Brown, 895 E. Washington St., Springfield, Ill.

**WANTED SAMPLE COPIES** and advertising rates of mail order publications. All publications carrying a classified section preferred. Johnson, 4250 N. Kimball Ave., Chicago.

**ALUMINUM SOLDIER** for crank cases or aluminum ware. Guaranteed. Bankable references, no fraud. Send \$1.50 to W. F. Smith, Almsworth, Neter.

**FOR ONLY \$1** we will insert your 25 word advertisement 2 months in 40 magazines and send you our money making magazine for one year. H. Latz, Atlantic City, N. J.

**YOUR AD** in 100 magazines, 3 months, 5c a word. Ad-Age, Big Flats, N. Y.

**TOBACCO CURE**. One box cures. Guaranteed or money back. Established 1894. Write for special offer. Allen Distributing Co., 319 Altman Bldg., Kansas City, Mo.

**YOUR ADVERTISEMENT** inserted in 40 magazines for only 3c per word. H. Latz, Atlantic City, N. J.

**1,000 MISSOURI NAMES**, mostly farmers, \$1. L. Boyer, Gallatin, Mo.

**CANDY MAKING**, \$15. Course 50c. Circular free. Eagle Co., "L" Quincy, Mass.

**CARPENTERS**—Even unskilled, with The New Parkhill Pitch Gauge on a square, can mark roof-framing quicker than any expert can without it. Any pitch roof—of hundreds—inside 5 minutes. Unequaled as a stair gauge. Sent prepaid for \$1.50. Money returned promptly if gauge is. John Parkhill, Rochester, Minnesota.

**I WILL START YOU** earning \$4 daily at home in spare time, silvering mirrors; no capital; send for free instruction booklet, giving plans of operation. G. F. Redmond, Dept. 306, Boston, Mass.

**PYRMA ALUMINUM MATTING**—Best covering in the world for automobile running boards and floor boards, motor boat floors, etc. Send for samples and particulars. Metallic Automobile Matting Co., 390 Mill St., Rochester, N. Y.

**GINSENG**, \$35,000 per acre. Send 10c for my "Ginseng Culture," giving full information, price of roots and seeds for planting. W. N. Long, Florence, Ky.

**TRICKS, JOKERS, PUZZLES, ILLUSIONS, Novelties**—Magle Pocket Trick Free. Illustrated Catalog included. Send 6c stamps. Magle Dept., 10-270 West 39th St., New York.

**SEE WHAT WE SAY** under "Patent" heading. Swift, Attorney, Washington.

**METALIZED FLOWERS, Insects, etc.**, for jewelry. Pleasant, profitable employment. Send stamp for free sample and booklet. F. Benson, Stewartville, Minn.

**SAFETY GATES FOR ELEVATORS.** We furnish iron; you put them up. Elder Manufacturing Co., Indianapolis, Ind.

**YALE POCKET ADDING MACHINE.** 30 cents prepaid, no stamps. Yale Mfg. Co., Dept. C, Newark, N. J.

**BROTHER**—Accidentally discovered root will cure tobacco habit. Gladly send particulars. F. Stokes, Mohawk, Florida.

**"TEXTIGUM" TYPEWRITER COVERS**, fine, 50c. See what I say under "Typewriters." Atchison.

#### TOO LATE TO CLASSIFY

**WANTED**—One good man in each town to take orders for men's tailoring; beautiful styles; very low prices; orders come easy; high class; permanent business; fine profits; \$10 a day and up; no money or experience needed. We ship on approval express prepaid, and guarantee perfect fit. Write for free sample outfit and inside price on suit for yourself. Banner Tailoring Co., Dept. 456, Chicago.

**WRITE US FOR ANY KIND** of a sign, letters and figures. Enclose 4c in stamps for our (P. M.) Catalogue, etc. Altright Sign Co., Inc., Muncie, Ind.

**POSITIVELY BEST RIBBONS**, three, \$1.10. See what I say under "Typewriters." Atchison.

**VACUUM CLEANER**—11-hp. Complete, \$450. Box 354, Charleston, W. Va.

**VELVET—The Smoothest Tobacco—10c**

**Matchless Pocket Lighter**

**Durable and waterproof, with perfect ignition. Satisfaction guaranteed or money refunded. Sent post-paid, complete with pocket clip, 35c. 4 for \$1.00. Special proposition to agents and dealers.**

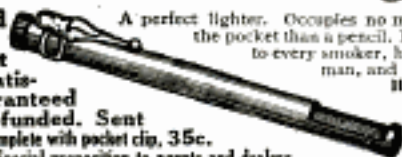

STAMPS ACCEPTED

**SCHILLER MFG. CO., Dept. M7, Schiller Building, Chicago**

**Don't Take 'Em Off**

Your trousers can be creased right on you (or off if you prefer) in five minutes with the "Nu-Pantz" creaser. Save \$10.00 to \$20.00 per year and add hundreds of dollars to your personal appearance by writing for the "Nu-Pantz" folder. Address **RACINE CREASER CO., 508 St., RACINE, WIS.**

**Reliable Selling Agents Wanted**  
Give references and present business

**ELECTRICIAN'S WATCH—NON-MAGNETIC**

Send now for my non-magnetic watch, only \$5.00 (delivered). This watch will positively withstand all magnetic attractions. Tested to 2000 volts, absolutely guaranteed to keep the most accurate time under all conditions. Approved by everybody in the Electrical Industry. Steam wind and set; dust proof; thin model. **E. KIRCHBERG, 132 No. State St. (Old No. 76) CHICAGO**

**WHEN YOU WANT ANYTHING AND DON'T KNOW WHERE TO FIND IT**  
**WRITE BUREAU OF INFORMATION,**  
**POPULAR MECHANICS CHICAGO**

**3,000 GUMMED LABELS**  
SIZE 1x2 INCHES, PRINTED TO ORDER AND POSTPAID. SEND FOR CATALOG. **\$1.00**  
**WILLIAM KOEHL CO. JAMESTOWN, N.Y.**

## BE YOUR OWN BOSS



Don't be an under-paid, overworked clerk. Get out of the wage earner's class and into the big field of business. Be somebody. **REALIZE** the best that is in you. Show the world what you can really do. It's easy, if you but know how to seize an opportunity when it presents itself. Here is your chance. The Mail order business is the greatest field today for the man of limited means to strike out for himself.

**Make \$35. to \$100. a Week**

We are manufacturers and market our Patented Specialties exclusively through our dealers. We furnish everything. Big profits. Small capital. No canvassing. No experience necessary. Begin at your own home. Spare time. Grasp YOUR opportunity. Write us right now for full particulars (copyrighted) plus, sworn statements and positive proof.

**J. M. PEASE MFG. CO., Dept. B, Pease Bldg., Michigan St., Buffalo, N.Y.**

## MONTHLY CASH PRIZES

Until further notice in this magazine the Editor of Popular Mechanics will pay two cash prizes each month for the best original contributions to its

### SHOP NOTES DEPARTMENT

**\$10 for the Best Contribution**  
**\$5 for the Second Best**

THIS IS IN ADDITION to our usual rates for such contributed articles.

Quality, not length counts. Checks will be sent on the last day of each month for the prize articles received during that month. Publication in the magazine will follow in about two months.

#### PRIZES AWARDED FOR JANUARY, 1912

First Prize—P. D. MERRILL, Chicago..... **\$10**  
"Sifting Ashes"

Second Prize—A. W. ABRAHAM, Los Angeles, Cal..... **\$5**  
"Removing Splinters from the Flesh"

#### EXTRA AWARD

On account of there being five contributions this month each of which deserved second prize, we have made an EXTRA AWARD of four additional second prizes, as follows:

JOS. C. WILSON, W. Lynn, Mass..... **\$5**  
"Forming a Lathe Tool"

J. J. O'BRIEN, Buffalo, N. Y..... **\$5**  
"Water Cooled Bearing Cap"

FRANCIS CHETLAIN, Chicago..... **\$5**  
"Door Key for a Round Hole"

CHAS. SCHAFFNER, Chicago..... **\$5**  
"Automatic Magnetic Lathe Dog"

All accepted contributions to our departments, "SHOP NOTES" and "AMATEUR MECHANIC," are paid for immediately; checks for prize awards are sent at the end of each month.

**Address, EDITOR POPULAR MECHANICS**  
**318 W. Washington St., Chicago**

**WHEN YOU WANT ANYTHING AND DON'T KNOW WHERE TO FIND IT**  
**WRITE BUREAU OF INFORMATION,**  
**POPULAR MECHANICS CHICAGO**

## Time and Its Measurement

By JAMES ARTHUR

Reprinted from Popular Mechanics. So far as known is entirely different from anything previously written on the subject. Mr. Arthur is a great authority along this line, having for years made an extensive study of clocks, watches and time-measuring devices.

**Contents:** Chapter 1—Historic Outline. 2—Japanese Clocks. 3—Modern Clocks. 4—Astronomical Foundation of Time.

**"Written So You Can Understand It"**

64 pages. Profusely illustrated. Size 7x10 in. Printed on coated paper with handsome blue cloth covers.

**Price \$1.50 Postpaid**

**Popular Mechanics Co., 318 W. Washington St., Chicago**

# The Swoboda Physiological Exercise Without Apparatus or Drugs

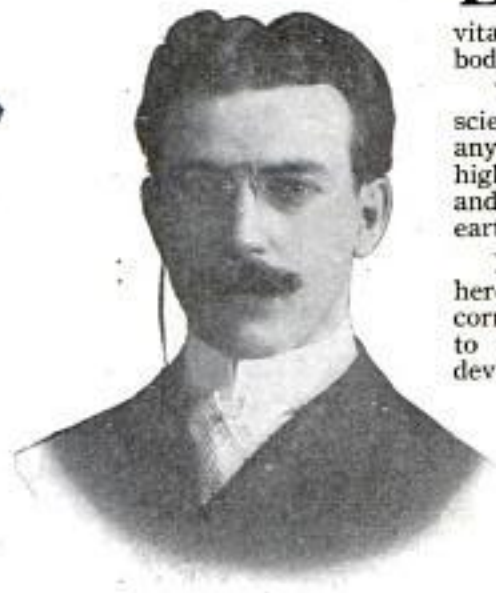

**B**UILDS vigorous brains, superb, energetic bodies, developing great nervous force, strong muscles, vigorous heart, creating a perfect circulation, overcoming general debility, lack of ambition, lack of vitality by revitalizing, regenerating, rebuilding, and developing the body, brain and nerves to their highest power.

When I say that I give something different, something new, more scientific, more rational and effective and immeasurably superior to anything ever before devised for the uplifting of the human body to a higher plane and restoring its health, I am only repeating what thousands of prominent men and women of every country on the face of the earth, who have profited by my treatment, are saying for me voluntarily.

**MY PHYSIOLOGICAL TREATMENT** is based upon definite laws, heretofore almost universally ignored. It is based upon absolutely correct scientific facts which when applied to the physical organism lead to the inevitable possession of a vigorous mind, strong and well developed body, high vitality, great endurance, *powerful nervous force and priceless regularity of all the functions.*

If you will follow my treatment for a few weeks, I will guarantee you such an immediate return to body and brain vigor as to convince you that no matter in what branch of industry you may be active, whether indoors or outdoors, ill or well, whether engaged in mental or physical labor, the **SWOBODA TREATMENT** solves the problem of disease resistance and full attainment of brain and body power and development.

## DRUGS OFTEN DECREASE THE CAPACITY OF THE BODY TO MAINTAIN ITSELF IN HEALTH AND STRENGTH

To be well and strong, you must have greater nervous force, more and better blood. No pupil of mine needs to digest his food with pepsin, or assist Nature with a dose of physic, nor take tonics to excite enfeebled and disorganized nerves, causing thereby deficient nervous force.

I will give you a vigorous appetite, and a healthy and capable digestive system to obey it, fill your arteries with rich blood, develop sound lungs to keep it rich, a strong heart to regulate your circulation and a liver that will work as Nature designed it should, and a healthy nervous system which will supply you with ideal physical and mental energy.

When the average person's health fails he invariably seeks at once for a magic cure in drugs. Temporary relief often deceives him into the belief that a cure is effected, but with each succeeding dose the effect of the drug is lessened until eventually it loses its effect entirely, and the body and nervous force have been considerably weakened.

**THE SWOBODA TREATMENT** strengthens the brain, nerves and all the internal organs of the body, therefore increasing the blood, as well as developing the nervous force. It increases the capacity for mental as well as physical labor, neutralizing the effect of excesses, improving the memory, gives clear and quicker perception and makes your daily work and life a pleasure instead of a drudgery.

## SWOBODA TREATMENT A PROVEN ONE

My treatment is no experiment. I have been giving it successfully to pupils all over the world for the past seventeen years. I have among my pupils hundreds of doctors, judges, senators, congressmen, members of cabinet, ambassadors, governors, thousands of business men, farmers, mechanics and laborers, and almost an equal number of women, ranging in age from 18 to 92 years.

## WHAT OTHERS HAVE TO SAY

"My banker said today he would not take \$1000 for benefit received 13 years ago from you."

"If you are doing for others what you are for me your work is truly wonderful."

"I cannot recommend your system too highly, and without flattery believe that its better propagation has been of great benefit to the health of the country."

"It has cured my constipation, bettered my digestion, improved assimilation and circulation, placed a rosier color in my cheeks, made me stouter, stronger, healthier and happier."

"Cannot describe the satisfaction I feel."

"Worth more than a thousand dollars to me in increased mental and physical capacity."

"Words cannot describe the new life it imparts both body and brain."

"For thirty years troubled with constipation. Your treatment has done for me what no medicine did."

"Constipated nervous wreck quickly restored."

"Did not expect such wonderful results."

"Stomach and bowels improve remarkably in 30 days."

"If anyone had told me that my chest measurement could be increased three inches in two months I should have laughed at him, but this is just what has happened to me. I thought that my health was all that could be desired, but I find now that I did not know what really good health was."

"Your treatment has done me a world of good. Feel 100 per cent better. I am working again, and that is more than medicine did for me. Everyone remarks how much better I seem to be."

"Before I started your course three weeks ago my chest measurement was 38 1/2 in. Today I measure 41 1/2 in. I sleep better and eat like a hungry man."



## THE FASCINATING STORY OF THE SWOBODA SYSTEM

How it came into existence through necessity, what it is doing for thousands, as well as what it can do for you, will be sent you, together with "The Dangers of Exercise" and "His Fight for Life," entirely FREE for the asking. I will also send you a full description of the principle of the System, showing how you can become strong, well developed, healthy and efficient, in every department of your organism. Write today.

**Alois P. Swoboda** 215 Victor Building  
Washington, D. C.

Please Mention Popular Mechanics

**Brief Outline of Contents**

Introductory—The Spirit of Decorating—Correct Principles in Designing—Equipment—How to Draw the Iron—Working at the Forge—Various Processes Described—Various Forms of Welding—Brazing—Twisting—Banding—Riveting—Scrollwork—Grilles—Welded Scrollwork—Box Forging—Embossing—Forms in Relief—Raised Forms—Special Designs—Drawer Pulls and Hinges, etc.—Door Plates—Iron Lamps.



Price  
**\$1.00**  
Postpaid

**A TIMELY BOOK—JUST ISSUED**

# Hand-Forging and Wrought-Iron Ornamental Work

By **THOS. F. GOOGERTY** Instructor of Forge Work at Stout Institute Summer School of Forging

208 pages. 122 illustrations. 12mo. Printed on a special grade of book paper and bound durably in extra cloth. Price \$1.00 postpaid. Special quotations to schools ordering in quantities.

**T**HE constantly increasing popularity of Art-Craft Ironwork together with the demand for an inexpensive handbook on the subject have prompted the publication of this volume.

Manual training instructors, students, professional workers and all others interested in this fascinating handicraft will surely welcome it, coming, as it does, from the pen of Mr. Googerty who is well known as a thorough authority.

While it deals largely with interior ironwork, it shows also the constructive side of ornamental hand-forging and points out the guiding principles and methods which underlie all forge work. It is written so that the amateur can readily understand all the points involved—is in no sense a theoretical treatise but a practical working handbook; the stimulation of original work being one aim of the author.

As for equipment for doing the work, the ordinary forge-shop and tools are all that are necessary. The manner in which the book is illustrated is especially helpful in explaining the text; the correct positions of holding the tools when working the materials being clearly shown. Scarcely a page is without one or more illustrations.

**POPULAR MECHANICS BOOK DEPT., Publishers**  
318 W. Washington St., CHICAGO

*One of the Most Remarkable  
Non-Technical Books Ever Written*



## The Kingdom of Dust

By **Prof. J. G. Ogden, Ph. D.**  
PROF. OF PHYSICS  
Fifth Ave. N. S., Pittsburg

128 Pages Cloth Cover  
40 Illustrations

Price 50 Cents  
Postpaid

*Did you ever  
think of this Vast  
Kingdom as*

*{ A Boundless Domain? ~  
The FRIEND of the Housewife?  
The Foe of the Workman?  
The Skeleton in the Closet?  
The Right Hand of Death?  
Earth's Winding Sheet?  
The Beginning and Ending of  
All Things Earthly? }*

These and scores of other interesting phases of this subject are treated at length in a most entertaining and instructive style by Prof. Ogden, making this book more fascinating than the best fiction ever penned, because it is true and "Written So You Can Understand It."

**POPULAR MECHANICS BOOK DEPT., Publishers**  
318 W. Washington St., CHICAGO

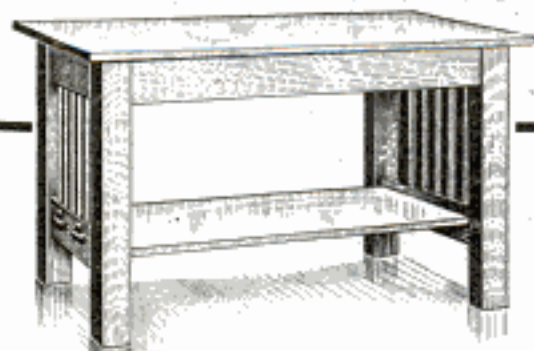

## Mission Furniture HOW TO MAKE IT 50 Designs for \$1.00

What one man accomplished  
with the aid of these books:

Popular Mechanics Co., Chicago, Ill. — Miss. —  
318 W. Washington St., Chicago.  
Sirs: Please send me Part Two, Mission Furniture: How to Make It, by mail postpaid. I have Part One, and have made and sold \$400.00 worth of one piece of furniture, and I am not a carpenter either, but with the instructions "Written so I can understand it," I have a business of my own.  
Yours truly,  
JOHN S. COLEMAN.

### TWO VOLUMES

**PART ONE** | **PART TWO**  
21 Designs. 96 Pages. | 32 Designs. 128 Pages.

Cloth Cover. Price 50c Each, Postpaid.  
**POPULAR MECHANICS BOOK DEPT.**  
318 W. Washington Street, CHICAGO

Please Mention Popular Mechanics

# "Just the Information We Need"

Every day in your talk and reading, on the street car, in the office, shop, and school some new question is sure to come up. You seek quick, accurate, encyclopedic, up-to-date information. A NEW CREATION

## WEBSTER'S NEW INTERNATIONAL DICTIONARY - THE MERRIAM WEBSTER

will answer *all* your questions with *final authority*.

**THIS NEW WORK** is used by the State Supreme Courts as *the standard*, which can be said of no other dictionary.

No matter what your occupation, trade or profession, the *New International* will tell you how the best authorities define all its terms. A steel expert confesses that its definition of vanadium steel gives him information long sought in vain.

A judge prefers its law definitions to those of his special law dictionaries. An architect, builder, clerk, machinist, merchant, banker, doctor, clergyman, each will find his department treated by a master. The man who *knows, wins success*.

Dr. C. H. PARKHURST writes: "*The New International is an indispensable feature of the library of every man who either reads or writes. There is no matter of land, sea, or sky that does not come within its purview and every topic is handled by a master.*"

It defines over **400,000 Words**; more than ever before appeared between two covers. **2700 Pages. 6000 Illustrations. Cost \$400,000.** It is the **only** dictionary with the new divided page. A "Stroke of Genius."

WRITE for specimen pages, illustrations, etc. Mention this publication and receive **FREE** a set of pocket maps.

**G. & C. MERRIAM COMPANY,  
SPRINGFIELD, MASS.**

Please send me sample  
Pages, etc. Include a set of  
FREE maps, as per advt. in Pop. Mech.

Name .....

Address .....



## LEARN to FLY



We need a few competent Aviators immediately ambitious to earn big money.

Earnings range from \$100 a week upward. Those who have a liking for mechanics preferred. We furnish you a standard-type Aeroplane practically without cost to you. Call or write for particulars at once.

Take a Special Home-Study Course for \$60. Do it to-day. It Will Pay You.

ADDRESS: DEPARTMENT 20

Milwaukee School & College of Aviation  
S. E. Cor. Grand Ave. and Fifth St., MILWAUKEE, WIS.



## WILL YOU BE THE DOCTOR

We Mean the  
**Doctor of Chiropractic**  
Whose Income is \$350.00  
to \$1,000.00 a month.

You can learn this new profession in a short time. We assure success even to those men and women who have only ordinary educations. The College offers every advantage to students, enabling them to comprehend the studies thoroughly and secure the Standard Diploma issued only by recognized colleges giving class instruction. Graduates never abandon the profession—the study and practice are that interesting and fascinating. Many physicians are studying Chiropractic because of its superior merits and exclusion of drugs. You will profit by investigating this exceptional opportunity. We'll see to it that you master the science.

The U. C. C.  
"THE SCHOOL OF QUALITY"  
Largest and Best  
Chiropractic College  
in the World.  
Capacity 1,000 Students

Write for our illustrated catalogue, **FREE**  
Universal Chiropractic College, Dept. M., Davenport, Ia.

Please Mention Popular Mechanics

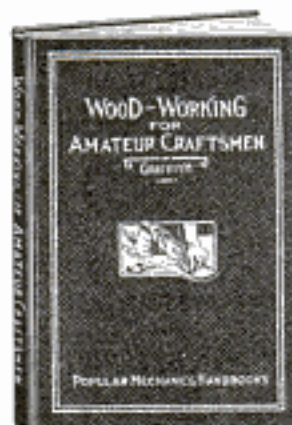
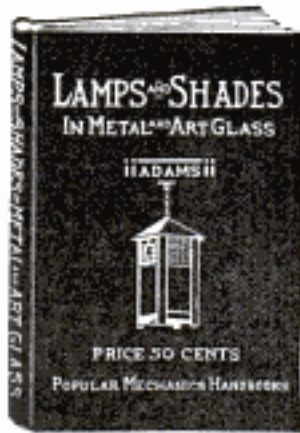
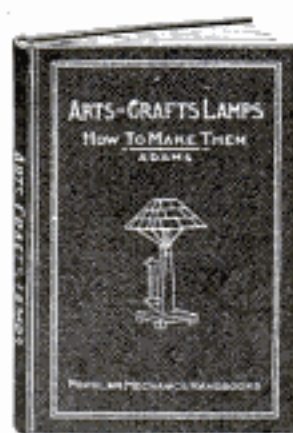

## USEFUL HANDBOOKS

MANY a man finds the home workshop a continual source of pleasure and profit, and there is no end to the designs in furniture, artistic lamps and metal work that may be reproduced at slight expense; to say nothing of the desirability of being able to do the countless little repair jobs continually arising about the house.

A great variety of designs and complete instructions for working them out will be found in our *Mission Furniture, How to Make It*, (2 vols.)—*Arts-Crafts Lamps—Lamps and Shades in Metal and Art Glass*, and *Metal Work and Etching*, while *Wood-Working for Amateur Craftsmen* gives every essential step required for learning this useful trade. *Electroplating* and *Metal Spinning* are practical working manuals which everyone engaged, or about to engage in these occupations should possess. The experimenter will delight in *How to Make a Wireless Set*, and the story of *Heat* written by Prof. Ogden is an immensely interesting and instructive book pertaining to heat and its relation to modern mechanics. In short

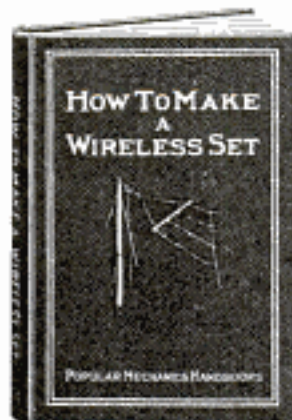
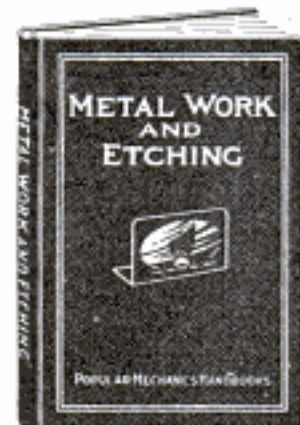

### Popular Mechanics Series of Industrial Handbooks

"WRITTEN SO YOU CAN UNDERSTAND IT"

Constitutes a useful, compact library of mechanical information that is unequalled.

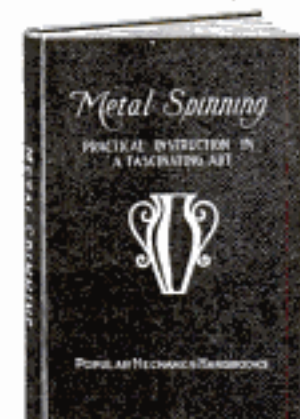

These books are written by practical experts who not only know the best practice, but know how to impart that knowledge to others. These titles now ready:

Mission Furniture, How to Make It—Part I, 21 designs,	96 pages
Mission Furniture, How to Make It—Part II, 32 designs,	128 pages
Wood-Working for Amateur Craftsmen	128 pages
Arts-Crafts Lamps, How to Make Them, 16 designs,	96 pages
Lamps and Shades in Metal and Art Glass, 18 designs,	128 pages
Metal Work and Etching,	96 pages
Electroplating,	112 pages
Metal Spinning,	80 pages
How to Make a Wireless Set	96 pages
Heat	128 pages

#### OTHERS TO FOLLOW

A uniform series printed on the best book paper and durably bound in extra cloth. Size 5 x 7 inches  
Artistic cover designs in gold and white.

**Price Each, 50 Cents Postpaid**

ORDER OF YOUR DEALER OR SEND DIRECT TO THE PUBLISHERS

**Popular Mechanics Book Department, 318 W. Washington St., Chicago**

# Cartoons

Published Monthly  
on the Fifth of the Month

**250 Cartoons**

**All the great  
Cartoonists  
Represented**

Cover Drawn for Cartoons by  
**JOHN T. McCUTCHEON**

**15 Cents a Copy  
\$1.50 Per Year**

**IT IS A HIT!**

## Current Events in Caricature

**Brightest Cartoons of All Countries  
Under One Cover**

The January number which initiated this newest of modern periodicals brought out flattering support from the leading cartoonists of the country and evidence that purchasers found it keen, timely and amusing.

Each number will have a full page portrait and an interesting sketch of some great cartoonist—McCutcheon of the *Chicago Tribune* in the February number. ¶ A supplement of 8 pages of fine half-tone cartoons is a new feature.

**FOR SALE BY NEWSDEALERS**

Published by  
**H. H. Windsor, 320 W. Washington St., Chicago**

## EVERYTHING YOU WANT TO KNOW YOU WILL FIND IN CASSELL'S CYCLOPEDIA OF PHOTOGRAPHY

We Will Ship You This **50c** Down  
Great Work for Only **\$1.00**  
per Month

For only 50 cents down we will forward you, all charges paid, this most valuable work. We know you will want it, but if you don't you may return to us and we will refund your money. You take absolutely no risk.

**SATISFACTION GUARANTEED**

Every contributor has written so plainly, that even the veriest beginner should find no trouble in understanding the most intricate branches of Photography. Whether you are amateur or expert, the knowledge these two books can give you will more than pay their cost in a few week's time. After you have learned some of the short cuts to successful and artistic work, you will join thousands of others in saying that

### Cassell's Cyclopedic of Photography Explains Things Plainly

(Edited by Twenty Experts Including the Leading Men in the Photographic World)

And that is what camera owners require—training that will enable them to take good pictures and overcome expensive and trying difficulties. Such a training saves time, temper and cash. Have CASSELL'S CYCLOPEDIA OF PHOTOGRAPHY on a shelf within easy reach. It will answer every question, solve every problem. The Cyclopedic consists of two large volumes of 572 double-column pages, handsomely bound in three-quarters morocco leather, with gilt top, printed on a high-grade paper in large sized, easily read type. The work is arranged in alphabetical form, making it easy for the student to find a given subject without searching an index. Text is illustrated by 454 practical working drawings, with numerous full-page plates in colors. Every photographic item is explained; every process and appliance described. Hundreds of experts declare it unquestionably the one leading authority on photography.

#### Special Offer to Readers of Popular Mechanics

Let us send you this great work on approval. We want you to examine it thoroughly before deciding. We want you to judge for yourself its great practical value TO YOU. The price is only \$7.50. Just send us 50 cents with the coupon opposite and you will receive the set carriage paid. If after five days you don't want it, notify us and hold subject to our order. We will then refund your money. If you keep it pay us the balance \$1.00 a month until paid. If you want to pay cash, deduct 5%.

**Cassell & Company** 43-45 East 19th St., New York City

(ESTABLISHED 1848)

**Cassell &  
Company,**  
(Established 1848)  
43-45 East 19th St., N. Y.

GENTLEMEN: I send you herewith 50c (stamps accepted). Send me, all charges paid, one complete set of Cassell's Cyclopedic of Photography, bound in 3/4 morocco. I may examine the work five days, and if I do not wish to keep it, I agree to notify you and hold subject to your order, and you will refund my money. If I keep it, I will pay you the balance of \$7.00 in monthly installments of \$1 until paid in full.

NAME.....  
ADDRESS..... & PREFERENCE.....

Please Mention Popular Mechanics



ACTUAL PHOTOGRAPH

## YOU Can Make Mission Furniture

Like this Shown in the Photograph

One of our readers, who is strictly an amateur with tools, experienced no difficulty in making and finishing every piece of furniture, with the exception of the piano, shown in the accompanying picture. His wife, at first skeptical, was highly pleased with the result and expressed the opinion that she was better satisfied by far than she would have been with articles they otherwise would have purchased.

The instructions were obtained exclusively from our two handbooks of which 50,000 copies have already been sold.

## Arts-Crafts Lamps

### HOW TO MAKE THEM

Cloth, 96 Pages

The results that the average person attempting this work can obtain are surprisingly good. Pleasure and satisfaction are derived, to say nothing of the money saving effected by having to invest only in raw material. The reading lamp shown on the table is one of 16 designs.

PRICE 50 CENTS EACH POSTPAID

## Mission Furniture

### HOW TO MAKE IT

Part 1—96 Pages, 21 Designs Part 2—128 Pages, 32 Designs  
Cloth, 2 Vols. Price 50c each.

These volumes comprise designs of extensive variety and usefulness; the instructions for making each consisting of explicit text directions accompanied by a stock list, detailed working drawing and half tone illustration of the finished article.

Popular Mechanics Book Dept., Publishers, 318 W. Washington St., Chicago

# 700 Things That a Boy Can Make

# 1000 Illustrations That Thoroughly Show How



**\$1** THE handsome set of four books—"Mechanics for Young America" and "Amateur Mechanics" (Nos. 1, 2 and 3)—each book bound separately in illuminated covers, and the whole set enclosed in a heavy Bristol Folding Case with extension clasp—will be sent prepaid to any address for **\$1.00.**

**\$1**

The Ideal Books for the Wide-Awake American Boy  
Thoroughly Practical and Instructive

Besides telling how to make scores of things useful about the house, full and complete directions are given on constructing the following and hundreds of others things which appeal to the heart of every boy.

Electric Appliances—Steam and Gas Engines—Motors—Wireless and Morse Telegraph—Self-Propelled Vehicles—Toboggans, Bobsleds, Ice-Boats—Motorboats—Paddle Boats, Canoes, Rowboats—Camping Outfits—Cabins—Tents—Fishing Tackle—Magic Lanterns—Searchlights—Cameras—Telescopes—Gliders and Aeroplanes—Kites and Balloons—Aquariums—Electric Furnaces—Electroplating Outfits—Lathes—Foundry Work at Home—Iron, Copper, Brass and Other Metal Work—Bookbinding—China and Pottery Kilns—Parlor Magic Tricks, etc.

Each book sold singly at 25c postpaid or the complete set for \$1.00



POPULAR MECHANICS BOOK DEPARTMENT

318 W. Washington Street, CHICAGO





Frederick Converse Beach, Ph. D.  
of the Scientific American  
Editor of Encyclopedia Americana



David Starr Jordan, Pres.  
Leland Stanford University



John H. Finley, Pres. College  
of the City of New York



John Hays Hammond  
International Mining  
Authority



Chas. F. Steinmetz  
Electrical Expert



Garrett P. Serviss  
Writer on Astronomical  
Topics

# INVESTIGATE

The 1912 India-paper Edition of the

# AMERICANA ENCYCLOPEDIA

Edited by Frederick Converse Beach, of the Scientific American, and embodying the combined educational effort of over 2,000 eminent authorities.

**SPECIAL INTRODUCTORY PRICE AND PREMIUM OFFER For One Month Only**

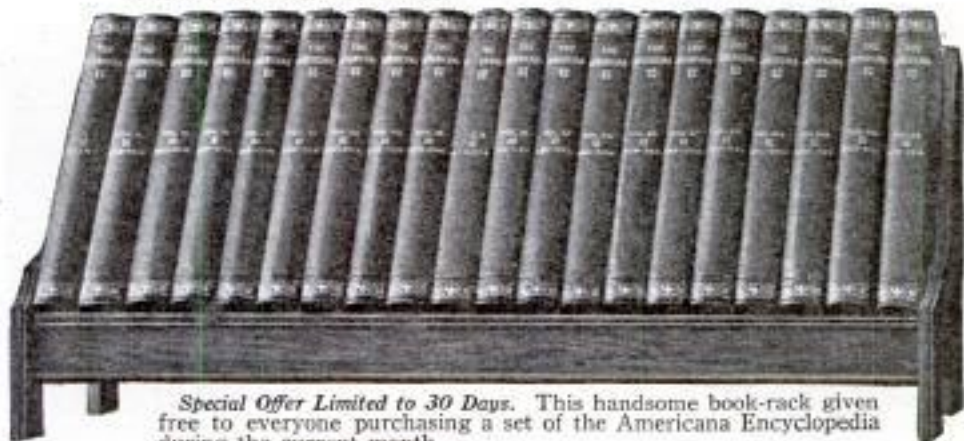

Special Offer Limited to 30 Days. This handsome book-rack given free to everyone purchasing a set of the Americana Encyclopedia during the current month.

## What "The Americana" Really Is

"THE AMERICANA" is a work edited from an American view-point and was originated in the thought that a comprehensive and reliable reference work was needed, and would find a welcome in every American home wherein they desired to know from those competent and of acknowledged authority in their own country, of the state and advance of the arts and science and literature of our land. The Americana has exactly fulfilled this condition. While the work has been edited from an American standpoint, and having in chief view American usage, it has secured amongst its contributors those also renowned in Europe for their scholarship and research, and the work contains as well the fruit of the European knowledge, without which no reference book would be of avail.

**22 Volumes**  
**2,387 Special Contributors**  
**2,540 Illustrations**

**65,287 Special Subjects**  
**126 Color Plates**  
**160 Maps**

### The 1912 India-paper Edition

The paper on which this edition is printed is opaque, yet so thin that each volume bulks only one inch as against the three-inch bulk of the old style reference volume. The entire set of twenty-two volumes takes up but twenty-two inches. It can be kept upon the office desk or library table for ready reference, and read as conveniently as a magazine.

### Valuable Booklet Mailed Free

The publishers have prepared a sample-page descriptive booklet of the Americana, which should be in the hands of everyone who has a library, large or small. This booklet will be mailed free upon request.



Note the difference between the *handy India-paper edition* and the *bulky regular volume*.

### Cash For Your Old Encyclopedia

If, in sending the attached coupon, you will advise us the name and date of publication of your old encyclopedia, we will make a liberal allowance in exchange for a set of Encyclopedia Americana.

SCIENTIFIC AMERICAN  
COMPILING DEPARTMENT  
225 FIFTH AVENUE  
NEW YORK

Send me full particulars about your distribution of the ENCYCLOPEDIA AMERICANA with explanatory pamphlet and actual pages from the work.

NAME.....

ADDRESS.....

Also state basis of exchange proposition:

I own the.....encyclopedia

published by.....Date.....

**INVESTIGATE TODAY**  
**SCIENTIFIC AMERICAN COMPILING DEPARTMENT**

Publishers of THE AMERICANA

225 FIFTH AVENUE

NEW YORK

Please Mention Popular Mechanics

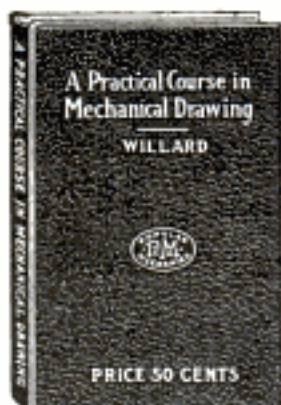

A NEW BOOK FOR WHICH THERE IS A REAL NEED

## A PRACTICAL COURSE IN MECHANICAL DRAWING

"Written So You Can Understand It"

By WM. F. WILLARD

(For several years instructor in Mechanical Drawing at Armour Institute of Technology, Chicago.)

134 Pages      Price 50 Cents      Cloth Cover  
131 Illustrations      POSTPAID      Size, 5x7 Inches

A book for individual study, shop classes, trade or high schools, and those who would like to know something of the DRAFTING PROFESSION.

### WHAT OTHERS SAY ABOUT IT:

"It is one of the best books on Practical Mechanical Drawing I have ever seen and I can recommend it to any one who desires to make an individual study of drawing."

E. S. Lusk, B.S., M.E., Prof. in Experimental Engineering, Armour Institute.

"This is a very useful little book, and every young fellow who is desirous of making himself more valuable to both himself and his employer will find it a great help in 'boosting' himself to a higher plane and 'bigger pay.'"

—THE NATIONAL BUILDER.

## POWER GAS AND THE GAS PRODUCER

"Written So You Can Understand It"

The only authentic reference manual covering every detail of installation and operation which has been written in a non-technical manner. This book was prepared especially for the inquirer in this field who would like to be able to judge intelligently as to the economy and advisability of changing from other forms to Producer operation. It will also appeal to the engineer who wishes to understand thoroughly the working of the new system and thus be prepared to handle a plant competently.

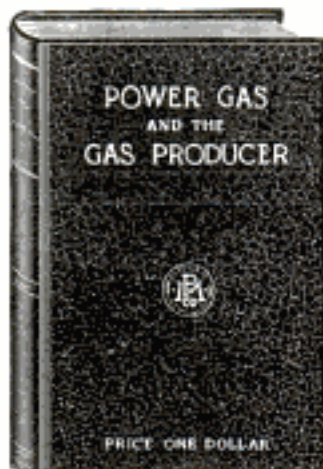

By J. C. MILLER, M. E.

One handsome, cloth bound volume of 192 pages, printed on the best quality of book paper and profusely illustrated.

Price Post-Paid \$1

The following list of chapter headings shows how thoroughly the author has covered his subject: Producer Gas and the Gas Producer—Classes of Gas Producers—Industrial Gases—Comparison of Heat Values—Types of Producers—Gas Producer Fuels—Gas Producer Operation—Gas Power and Steam Compared—Reliability of Gas Power—Gas and Steam Power Costs—Gas Producer Installation—Alphabetical Index.

## PATTERN-MAKING

By G. H. WILLARD

WITH ADDITIONAL CHAPTERS ON

## CORE-MAKING AND MOLDING

"Written So You Can Understand It"

A book for the man who has to do the work. Written by a practical pattern-maker of many years' experience. Gets right down to business in the first chapter and keeps it up throughout the book. Full of kinks and actual working information. Profusely illustrated. Every one following this trade, or intending to learn it, should have a copy of this valuable book.

224 Pages, 312 Illustrations, Cloth Cover

"Ten chapters are devoted to careful instruction for the making of specific patterns. The patterns chosen are of gradually increasing difficulty and cover practically all the points that come up in ordinary practice. Considering especially the low price of \$1.00, this book is remarkably practical and comprehensive. It is written in a style much more readable and effective than is usual with books on this subject."

—Engineering News.

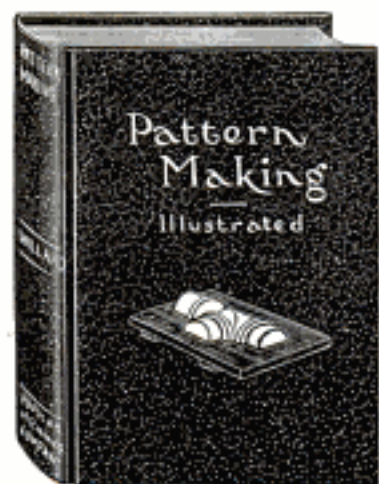

Price \$1 Postpaid

POPULAR MECHANICS BOOK DEPT., PUBLISHERS, CHICAGO

25  
Fascinating  
Volumes  
25

# The Library of Valuable Knowledge

"The Fairy Tales of Science"

1,000  
Unusual  
Illustrations  
1,000



**I**N this series of 25 volumes we have successfully met the great demand for a library that will reveal in an interesting and entertaining way the wonders of the universe and the history of man's accomplishment. Eminent scientists have sorted, sifted, and arranged the scientific knowledge of today, and have made some of the most interesting fact-stories that have ever been put into print. The men who prepared these volumes not only knew their subject, but they knew how to present it in a popular and pleasing way. It is just as if you were attending a course of public lectures where a group of eloquent experts were explaining for your benefit the wonderful truths they had learned, making all nature speak to you in a new language and mean something richer and deeper than ever it did before.

## Unique—Accurate—Down to Date

Heretofore it has been impossible to get this knowledge in a reliable and accurate shape except from text-books which repel the average busy man or woman. The idea back of **The Library of Valuable Knowledge** is a new and vital one. Becoming absorbed in these volumes, you will find that unconsciously your powers of observation have been quickened and your imagination has been stimulated.

If you will examine "The Story of Electricity," or "The Story of Rapid Transit," for example, you will find that the books have been brought down to date. At the same time, there is no "Sunday newspaper" science here—nothing that has not passed under the eye of an expert and received the stamp of his approval.

*"I have not time to go into detail, but suffice it to say that I am so pleased with them that I felt I would be doing you and some more of my thinking friends a great service to let them know about this set, which I think is the finest of its kind that I have ever seen. Those that love nature can scarcely lay one of these books down when once they have begun to read it."*

*From a letter to a personal friend of*

*E. S. CLEM, Instructor in Chemistry,  
Fairmont, Minn. High Schools.*

**Special Introductory Offer** In order to introduce this set of books among people interested in these matters and to promote its sale to them and their friends, we are offering to send the 25 volumes at our own expense for your examination and approval. If they are satisfactory, you may keep them and send us the special, low introductory price in small monthly payments. If they are not, notify us and we shall arrange for their return at no expense whatever to you. Read, fill out, and forward the coupon today, but send no money with it.

**THE UNIVERSITY SOCIETY** 44-60 E. 23d Street  
NEW YORK

## 25 PROFITABLE FACT-STORIES 25

1. The Story of the Stars
2. The Story of the Solar System
3. The Story of the Eclipses
4. The Story of the Earth
5. The Story of the Earth's Atmosphere
6. The Story of Germ Life
7. The Story of the Plants
8. The Story of Life in the Seas
9. The Story of Animal Life
10. The Story of the Living Machine
11. The Story of a Piece of Coal
12. The Story of a Grain of Wheat
13. The Story of the Cotton Plant
14. The Story of Primitive Man
15. The Story of Extinct Civilizations of the West
16. The Story of Extinct Civilizations of the East
17. The Story of the Alphabet
18. The Story of Geographical Discovery
19. The Story of the Art of Building
20. The Story of Music
21. The Story of Books
22. The Story of Photography
23. The Story of Electricity
24. The Story of Rapid Transit
25. The Story of the Mind

Bound in rich half-leather, dark blue leather backs and linen buckram sides, head-bands and gold backs. Every detail of manufacture will suit the most exacting. Each vol. (7½x5¼) has a complete index.

A mere glance at the authors named below will suffice to convince you of the wealth of learning at your service.

Geo. F. Chambers, F.R.A.S.; Prof. H. G. Seeley, F.R.S.; Douglas Archibald, F.R.M.S.; Prof. H. W. Conn; Grant Allen; Prof. S. J. Hickson; B. Lindsay; Edw. A. Martin, F.G.S.; Hon. W. C. Edgar; Frederick Wilkinson, F.G.S.; Edward Clodd, F.L.S.; Robert Anderson, M.A., F.A.S.; Jas. Jacobs; P. L. Waterhouse, R.I.B.A.; F. J. Crowest; G. B. Rawlings; A. T. Story; John Munro, C.E.; Beckles Wilson; Jas. M. Baldwin, P.L.D., I.L.D., Dr. Sc.

With introduction by William T. Harris, A.M., I.L.D., late U. S. Commissioner of Education, Washington, D. C.

### COUPON

**CUT THIS COUPON OFF AND MAIL TODAY**

The University Society  
44-60 E. 23d St., New York

Please send me on approval, charges prepaid, a set of THE LIBRARY OF VALUABLE KNOWLEDGE, twenty-five beautiful volumes bound in half-leather. If satisfactory, I agree to pay you \$1 promptly and \$2 a month thereafter for eleven months. If not satisfactory, I will notify you. P.M. 5-13

NAME.....

STREET.....

CITY AND STATE.....

# LAW

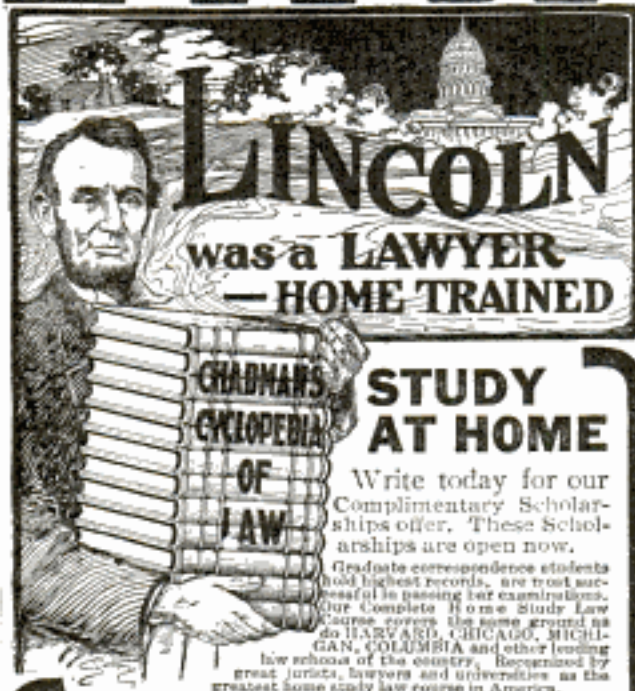

**LINCOLN**  
was a **LAWYER**  
— HOME TRAINED

**STUDY AT HOME**

Write today for our Complimentary Scholarships offer. These Scholarships are open now.

Graduate correspondence students hold highest records, are most successful in passing bar examinations. Our Complete Home Study Law Course covers the same ground as do HARVARD, CHICAGO, MICHIGAN, COLUMBIA and other leading law schools of the country. Recognized by great jurists, lawyers and universities as the greatest home study law course in America.

**We Guarantee** to coach **FREE** any graduate failing to pass bar examination. Our course covers both theory and practice—prepares for bar in **any state**. Abraham Lincoln, Henry Clay, John Marshall, Jas. A. Garfield, Edward H. Harriman, Wm. H. Ryan and thousands of our most noted men and lawyers **STUDIED LAW AT HOME**.

Decide **now** to study law at home. Make this great step toward a successful business or professional career.

## Special Business Law Course

PATRICK HENRY said that there is only one lamp to guide your footsteps, the lamp of experience; only one way to judge the future—by the past. Know just what to do. Avoid expensive lawsuits. We teach you a thorough knowledge of commercial law; we give you the fundamental foundation and principles of business.

## FREE Scholarships

Write today. **FREE** Scholarships open. Scholarship students pay only for text and postage. This is a very extraordinary opportunity. We want a large number of students quickly, and hence this chance we are giving to a very few. If you want this opportunity, be quick. Answer at once, for we reserve the right to withdraw the offer at any time.

## FREE COUPON Send Free Coupon

American Correspondence School of Law, Manhattan Bldg., Dept. 1193, Chicago.

Gentlemen: Without any obligations on me whatsoever, please send me your Catalog and full particulars of your Free Scholarship Offer.

Name..... Dept. 1193  
CHICAGO, ILL.

Address.....

Please Mention Popular Mechanics

## Learn Electric Signalling



At Home—By Mail

A splendid profession. Great opportunity. Big demand by railroads for signal engineers. More men needed all the time to fill vacant positions. You can keep present position while learning.

**\$1,800 TO \$4,500 PER YEAR**

Rapid advancement from the first. Easy to learn. Taken but short time. Write today for free booklets. Do not put this off. Special offers to new students.

DEPARTMENT OF SIGNALLING, 491 Cass St., Desk 1192, CHICAGO

# MODERN SUBMARINE CHART

Over 200 Parts Numbered and Named

Actual Size 14x28 Inches  
Printed on Plate Paper

A **CROSS-SECTION** view that shows clearly and distinctly all the interior of a Submarine of the latest type. You can get more information from this chart, about the construction and operation of a Submarine, than in any other way. No Details omitted—everything is accurate and to scale. It is absolutely correct in every detail, having been approved by Naval Engineers. One of the best Mechanical Illustrators in the Country worked on the drawing for months. This chart is really an encyclopedia of a Submarine. It is educational and worth many times its cost. **Mailed in a tube for 25c.**

ADDRESS

Popular Mechanics Book Department  
318 W. Washington St., CHICAGO

## THE INDEX

TO VOL. XVI

## Popular Mechanics Magazine

(July to December, 1911, inclusive.)  
is now ready and will be mailed to any address upon receipt of 10c in stamps.

**POPULAR MECHANICS CO.**

318 W. Washington Street, CHICAGO

## Mechanics For Young America

A book which tells how to make scores of articles which delight the heart of the average boy. Price 25 Cents Postpaid

**POPULAR MECHANICS BOOK DEPT.**  
318 W. Washington Street, CHICAGO



# I Am the Original Cliff Hogan

—The Man Best Fitted To Teach You  
To Run, Repair and Sell Automobiles

—and I base this claim upon the fact that I am a thoroughly experienced and capable automobile man from the ground up. I began as an orphan boy sweeping out a garage. I became a repair man, a demonstrator and finally an expert automobile mechanical engineer, in business for myself, doing a large repair and supply business. It is no idle boast to claim that I know every make of automobile in its every detail.

## The Demand for Expert Automobile Men Far Exceeds the Supply—and Always Will

The automobile business is still in its infancy and I know of no single line of business which is developing so rapidly—in which there is such a constant, insistent demand and so small a supply of competent, reliable, *trained, expert automobile mechanics, repairmen, chauffers, salesmen and demonstrators.*

### Get Into A Business With A Future To It

Many successful men of today started their careers by getting into a line of business when it was young. Your opportunity is in the Automobile business. In no other vocation can so large prospects for returns, both in immediate big money and in advancement, be had for so small an investment of time and money.

*Now is that time to begin*—this very winter—and be ready to earn from \$75 to \$500 a month after completing my course of training in a remarkably short time.

### Your Training Is Everything Be Careful Where You Get It

Look farther than mere printed assurances before deciding. There are many so-called Automobile Schools, their literature is alluring—but they are not controlled by expert automobile mechanics.

Secure your instruction from a school with an established reputation, presided over by a staff of recognized automobile experts. I want to prove to your complete satisfaction that the Kansas City Automobile School is just this kind of an institution. I, the presi-

dent and treasurer of this school, have a well-known reputation as an expert mechanic and I have surrounded myself with a corp of the best instructors and assistants obtainable, and maintain the

### Largest and Best Equipped Automobile School in America

Not only was my school the first of its kind west of the Mississippi, but it is today the largest and best equipped Automobile School in America, having more regular instructors, more demonstrating cars and more money invested than any other, and *one* of the only two schools owned and controlled by a competent mechanic.

### I Can Train You To Become A Competent Chauffeur In Six Weeks

When you tackle a job, you've got to know every little trick of the machine. You don't want "book training" but practical shop and road work with actual cars, and that's what you get when you come to me. Every student gets personal attention—what it took me years in time and ages in hard knocks to acquire, I can, with my able corp of assistants, teach you in from six to eight weeks in the

# KANSAS CITY AUTOMOBILE SCHOOL

**The Largest and Best Equipped School in the United States  
for Training Automobile Experts and the Oldest in the West**

### My Resident Course

By all means come here to Kansas City for your instruction, where you can not only receive my personal attention and instructions, but, where the steep grades and stiff climbs over our hilly sections will give you the very best road experience possible. When you are competent to handle a car here you will have no trouble anywhere.

### My Correspondence Course

If you cannot come to my school, then take my advice and do the next best thing. That is: ask me to send you the full particulars of my correspondence course of training which you can take at home in your spare time. Two or three evenings of honest study each week will fit you to take a good position in the spring.

### I Give Diplomas and Certificates of Efficiency

#### Mail Coupon Today For Free Information Book

It tells you of new and wonderful opportunities. Or write me personally and I will cheerfully, personally answer you.

CLIFF HOGAN, Pres., Kansas City Automobile School,  
2201 E. 15th St., Kansas City, Mo.

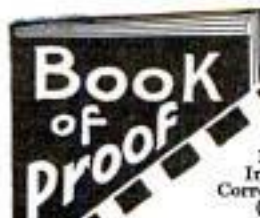

Mr. Cliff Hogan,  
Pres., Kansas City  
Automobile School,  
2201 E. 15th St., Kansas City, Mo.

Please send me your Free Book of  
Information regarding Resident-  
Correspondence Course.  
(Cross out one not wanted)

Name.....

Street.....R. F. D. ....

P. O.....State.....

Please Mention Popular Mechanics

## How You Can Get An Automobile FREE

We want honest, sober young men in every county to learn at home to repair, run, and to teach others, and then sell the COEY "FLYER," a 6 cylinder, 50 H. P., 5 passenger Automobile—"The World's Best Value." Write for full particulars how you can get one free—address:

**C. A. Coey's  
School of  
Motoring**  
Dept. 20  
1424-26 Michigan Ave.  
CHICAGO, ILL.



## Highland Park College

Des Moines, Iowa



One of the most completely equipped **ENGINEERING SCHOOLS** in the country

Students may enter any time they are ready to come

Enter  
Any  
Time

2000  
Students  
Annually

### COURSES OFFERED

**1. CIVIL, ELECTRICAL AND MECHANICAL ENGINEERING COURSES.** Standard courses are offered in Civil, Electrical and Mechanical Engineering. Special opportunity is offered for making up work or for taking a complete course preparatory to the standard Engineering Courses. Shop work from the beginning comes in preparatory courses. See our new Engineering Catalogue.

- 2. SHORT COURSES**
1. One Year Electrical Engineering Course
  2. One Year Telephone Engineering Course
  3. One Year Steam Engineering Course
  4. One Year Machinists' and Automobile Course
  5. One Year Course in Mechanical Drawing

Just a fair common school education is all that is required for entrance to these courses. These courses are very practical and are intended for those who have had limited education and do not see their way clear to take a complete Engineering Course. The Machinists' Course is especially practical. The new machine shops are the most complete to be found in connection with any Engineering School in the United States.

### SPECIAL COURSES

- 1. TRACTION ENGINEERING.** This is the most complete course in Traction Engineering offered by any Engineering School in the country. It may be completed in three months. Students are taught how to make all repairs on engines as well as to handle them. Four traction engines used for experimental purposes.
- 2. GASOLINE AND AUTOMOBILE COURSES.** These courses may be completed in three months. They are exceedingly practical. Complete Chauffeur practice. Just a fair common school education is all that is necessary to enter.
- 3. FARM BLACKSMITHING, FARM CARPENTRY.**

Mention course in which you are interested. Address,

**O. H. LONGWELL, Pres., Des Moines, Ia.**

Please Mention Popular Mechanics

## MEN WANTED!

**SOUND MEN**—21 to 40 years old, wanted at once for **Electric Railway Motormen and Conductors** in every State. Experience Unnecessary. Permanent employment, no strike. Write immediately for Application Blank. No colored men hired. Address **Manager Employment Department, Room 17, Dwight Bldg., Kansas City, Mo.**



## Do You Want a Good Position as a Traveling Salesman or Saleswoman

Where You Can Earn From \$1,000 to \$5,000 a Year and Your Expenses?

We will teach you to be an expert Salesman or Saleswoman by mail in six to eight weeks and our **Free Employment Bureau** will assist you to secure a good position where you can earn good wages while you learn. We cannot begin to supply the demand of leading business houses in all parts of America for our students. If you want to enter the best paid, most independent profession in the world, write today for our handsome free catalog, "A Knight of the Grip," also testimonial letters from hundreds of students we have recently placed in good positions; list of positions now open, and full particulars of the special offer we are now making new students. Address our nearest office.

**Dept. 124 National Salesmen's Training Association**  
Chicago New York Kansas City Seattle New Orleans Toronto

## BE AN ENGRAVER

**LEARN AT HOME—EARN \$25 to \$50 WEEKLY.** We give personal instructions and furnish necessary tools **FREE.** Terms reasonable. Complete particulars by mail.

Chicago Engraving School, Dept. 20, 110 W. Chicago Ave., Chicago

**STAMMER NO MORE** I can cure you. Reputation world-wide.

Established 16 years. Trial lesson explaining Home Instruction, with 200-page book, **FREE.** Answer at once.

George Andrew Lewis, 178 Adelaide Street, Detroit, Mich.

**WHEN YOU WANT ANYTHING AND DON'T KNOW  
WHERE TO FIND IT—WRITE BUREAU OF  
INFORMATION, POPULAR MECHANICS, CHICAGO**



## Learn This Profession

**We Teach You by Mail to Be a Doctor of Chiropractic** and equip you to earn \$5,000 a year.

Greatest demand for this treatment. Big practice from start assured. A profession that is not crowded. Easily and quickly learned at home with our lessons and charts. Write today for free book—"How to Learn Chiropractic," and full information as to special offer.

**NATIONAL SCHOOL OF CHIROPRACTIC**  
244 Wendell Bldg., 1233 W. Madison St., Chicago, Ill.

**THE PATHWAY**  **TO PLENTY**

**HELP WANTED**  
**AVERAGE \$90<sup>00</sup> MONTH**  
**by U.S. GOVERNMENT**  
**Railway Mail Clerks**

**Examinations everywhere May 4th**

Every second week off duty at full salary. Excellent opportunities for quick advancement to Higher Government Positions. If you want immediate appointment, send TODAY for sample questions and our schedule showing locations of the May 4th examinations in your section. Any delay means the loss of just so much time in preparing yourself for examination.

**We Prepare Candidates Free**

**FRANKLIN INSTITUTE**  
Dept. W 108, ROCHESTER, N. Y.

This coupon, filled out as directed, enables the sender to free sample questions; a free copy of our book, "Government Positions and How to Obtain Them," and to consideration for Free Coaching for the examination here checked.

**COUPON**

Bookkeeper (\$300 to \$1800)	Customs Positions (\$800 to \$1500)
Postoffice Clerk (\$900 to \$1200)	Internal Revenue (\$700 to \$1800)
Postoffice Carrier (\$600 to \$1000)	Stenographer (\$800 to \$1500)
Rural Mail Carrier (\$500 to \$900)	Clerk in the De- ( \$800 to \$1500)
Railway Mail Clerk (\$800 to \$1400)	partments at Washington

Name.....  
Address..... W 108

*Use this before you lose it. Write plainly.*

**CORNET FREE!** We guarantee to teach you give you a Beautiful Cornet or any Band Instrument absolutely FREE. You pay weekly as lessons are taken. Instrument is sent with first lesson. Write today for our booklet and wonderful tuition offer.

**INTERNATIONAL CORNET SCHOOL**  
810 Musical Hall, Boston, Mass.

**LEARN JEWELERS' ENGRAVING**  
A high salaried and easily learned trade, taught thoroughly by mail. We will teach the beginner better engraving than he can gain in years of paid apprenticeship. We will also improve the skill of any engraver. Send for our catalog. The Engraving School, 112 Page Bldg., Michigan Ave., Chicago, Ill.

**IF YOU STAMMER**  
Attend no stammering school till you get my large FREE book and special rate. Largest and best school in the world curing by natural method. Write today. See Wills Millard, Pres., North-Western School for Stammerers, Inc., 317 First St., Milwaukee, Wis.



**Band Instruments**

This is election year — a busy time for Brass Bands! Write today for our **Big New Catalog** which fully describes all band instruments, gives our unequalled low prices, and tells how to organize a Band. We sell standard makes, take old instruments in exchange, give liberal credit terms and ship on Six Days Trial. Instruction Book and Lessons free with every instrument. Special Free Offer to Bands buying entire sets. Satisfaction guaranteed. Second-hand instruments very cheap. Write for Price-List. Send us your name, address, and say what instrument you play or think of learning—the catalog comes to you by return mail.

**W. J. Dyer & Bro., Dept. 75, St. Paul, Minn.**

**LEARN TO WRITE EARN \$25 to \$100**  
**ADVERTISEMENTS A WEEK**

How to increase your salary. BOOK MAILED FREE. PAGE-DAVIS CO., 112 Page Building, Chicago, Ill., or 156 Nassau St., New York



**Brand New—Up to Date—Just Off the Press**  
The Theory and Practice of Every Phase of Electrical Communication is thoroughly covered  
**Modern American Telephony**

This book treats of present day telephony in all its branches in plain everyday understandable language. It will serve to make the rough places smooth and will solve problems to telephone workers in all departments.

Edited by ARTHUR BESSEY SMITH, E. E., assisted by a large corps of Telephone Experts whose reputation in their respective fields is international.

The very latest AUTOMATIC SYSTEMS, as well as WIRELESS TELEPHONY is fully described.

An elegant book of about 800 pages, it is beautifully bound in full dark blue seal leather, round corners, polished red edges, and has upward of 400 specially designed engravings and diagrams. Genuine gold leaf stampings, pocket size (postage paid to any address). PRICE ONLY **\$2.00**

The only way the practical merit of this book can be proven is by an examination of the book itself, which we will submit for examination, to be paid for or returned, after looking it over. Upon receipt of the following agreement, the book will be forwarded.

**Order Now On Approval**

**Positively down to the last minute. It has no rival**

**NO MONEY IN ADVANCE REQUIRED**  
**FREDERICK J. DRAKE & CO.,**  
1325 Michigan Ave., Chicago, Ill.

Kindly mail me a copy of Modern American Telephony. If found satisfactory, I will immediately remit you \$2.00 or return the book to you.

NAME.....  
OCCUPATION.....  
ADDRESS..... P. M.

**Lesson Number 1 FREE**

**YOUR Start in Life—FREE!**

Many a man, now a Doctor of Chiropractic, earning \$5,000, yes \$10,000, even \$15,000 a year traces his start in life direct to this book, Lesson No. 1—They all paid for it—**YOU get it FREE.**

95% of the people around you are sick. More and more of them every day are learning of the wonderful results of Chiropractic—the science of common sense. No drugs! No surgeon's knife! The world wants Doctors of Chiropractic and stands ready to pay them handsomely. We now have on file urgent demands for Chiropractors from more than 1000 cities where certain incomes of \$5,000 to \$15,000 await competent graduates.

J. V. Markwell, a Leesville, La. Chiropractor recently wrote us: "\$840.50 is the exact amount I have taken in since opening my office, just seventeen business days." Tell us; where is there another profession where the financial returns are so great or so sure? Now, are you going to let a two-cent stamp stand between you and this chance to get your start in life at our expense? Stop right now—write for this free lesson.

**PALMER SCHOOL OF CORRESPONDENCE**  
CHIROPRACTIC FOUNTAIN HEAD  
DEPT. P. M. DAVENPORT, IA. U. S. A.

**BE AN ELECTRIC METERMAN**

The rapid introduction of electricity is creating hundreds of new positions each year. Instruments and Meters are used wherever Electricity is used. Trained men must be had to maintain these Instruments and Meters.

**Metermen Earn \$900-\$1800 a Year**

Our course will qualify you for a position as Meterman. Practical—easy to learn—recommended by leading electrical men. Our Employment Bureau assists graduates. Tuition low. Terms easy.

Write to-day for FREE booklet—tells all about this new field and our instruction. Write me personally, C. S. Tumbleson, Secretary.

**Ft. Wayne Correspondence School**  
311 Trust Bldg., Ft. Wayne, Ind.  
—Oldest and Largest School of Its Kind—

**YOUNG MEN WANTED**

**You Can Easily Learn**

to be an automobile salesman, chauffeur, demonstrator or repairman. Our home-study course of 10 weeks is **simple, practical and interesting.** No mechanical experience required. Our graduates are everywhere, earning **\$25 to \$50 weekly** in positions we obtained for them. **Free model of automobile to every student.** Highly endorsed and reasonable.

**SEND FOR FREE LESSON AT ONCE**

A postal will bring it. Chauffeurs and competent men supplied owners and garages.

**Empire Auto Institute**  
888 Empire Bldg. Rochester, N. Y.  
The Original Automobile School

**IN AUTOMOBILE BUSINESS**  
**NICE WORK-BIG PAY-DANDY JOB**

**SEE THE WORLD BE AN AUTO EXPERT**

**EARN \$25 TO \$100 A WEEK.**

Course endorsed by Benj. Briscoe, Pres. United States Motor Co., J. D. Maxwell, Pres. Maxwell-Briscoe Motor Co., and J. I. Handley, Pres. American Motors Co.

We teach inflexible lessons the **WHOLE** subject. Course on Salesmanship **FREE.** Best and most practical system. Small payment starts you. **Free Model To Each Student.** Big demand for chauffeurs and salesmen. We assist you to get a position. Write for Free Book. It explains how to enter this new industry. (We supply owners with competent men.)

**THE PRACTICAL AUTO SCHOOL, 65 BEAVER STREET, NEW YORK.**

**Become An Expert Auto Driver**

Golden opportunities for bright young men in this newest most profitable vocation. Experts in great demand. Jobs numerous; work easy and very interesting; salaries

**\$35. TO \$60. A WEEK**

Our systematic course of training—clear, easy, complete—will positively make you an expert automobilist. Only few weeks home study necessary while holding present job. Personal attention given each student together with complete working model free. Read lessons. **SMALL PAYMENT STARTS YOU.** Write at once for particulars. We help you to a good position.

**BUFFALO AUTOMOBILE SCHOOL, 77A Edward St., Buffalo, N. Y.**

**WANTED Motion Picture PLAYS**

**YOU CAN WRITE THEM.** We teach you by mail. No experience needed. Big demand and good pay. Details free.

**ASS'D M. P. SCHOOLS, 601 Sheridan Rd., Chicago**

**LEARN WATCHMAKING**

refined, profitable labor—Competent men always in demand. We teach it thoroughly in as many months as it formerly took years. Does away with tedious apprenticeship. Money earned while studying. Positions secured. Send for catalog.

**St. Louis Watchmaking School, St. Louis, Mo.**

**ADVICE**

Information and counsel on any subject under the sun. No matter what you want to know, no matter what your present condition, our big organization can help you.

WRITE TODAY FOR BEAUTIFULLY ILLUSTRATED BOOK FREE

**NATIONAL BUREAU OF ADVICE AND EDUCATION, 527 Ashland Block, CHICAGO**

**LEARN WATCHMAKING**

Engraving and Jewelry repairing. Earn while learning. Our school endorsed by leading jewelers. Positions secured for graduates. Send for Free catalogue.

**CHICAGO SCHOOL OF WATCHMAKING**  
Dept. 20, Bush Temple CHICAGO



# Be An Expert Electrician

## LEARN IN SPARE TIME

THEY LIGHT THE WAY

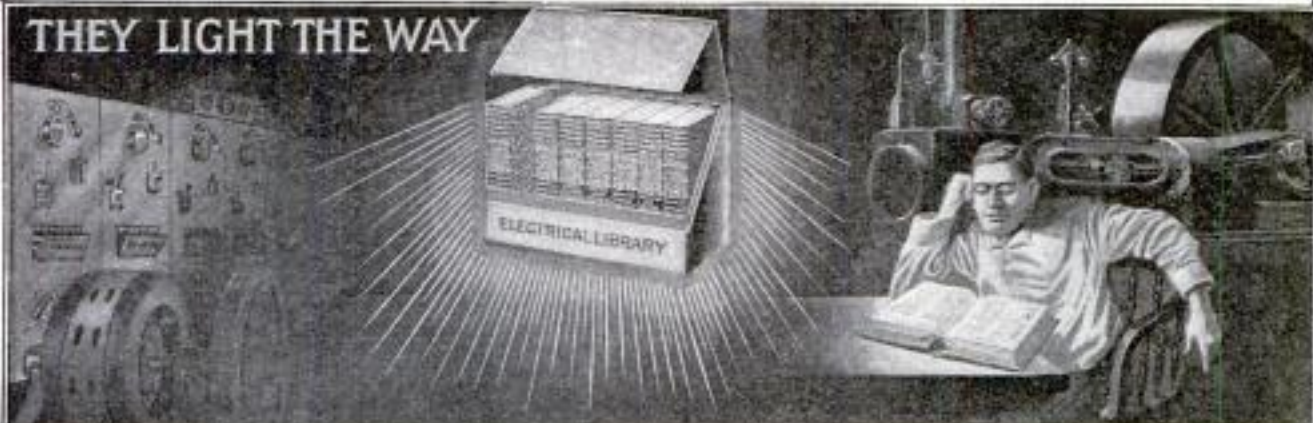

## Electrical Workers' Standard Library

A Vast Reservoir of Specialized Knowledge

**Practical  
Authoritative  
Comprehensive**

Here are text books that radiantly "light the way" for those who wish to easily and quickly master the Electrical profession. They contain a Complete Course of Easy Lessons for Beginners. The lessons are arranged in progressive order in the form of Questions and Answers. The language is plain everyday English—and when technical terms are used they are simply explained. Hundreds of

diagrams and drawings make everything so clear and plain that even a boy can understand.

This remarkable set of books is a vast reservoir of specialized knowledge embodying the research and life-time experiences of the foremost practical experts. All this knowledge has been carefully sifted, tested and proved, and gathered together and arranged in logical order.

There are eight volumes, pocket size, of about 380 pages each, profusely illustrated with diagrams, drawings and plates. One of the volumes has about 750 pages and covers very fully everything connected with up to date American Telephone practice. This volume alone has upward of four hundred engravings. Comprised in this set is a Complete Electrical Dictionary and also the Civil Service Examination Questions and Answers for Electricians.

The Expert CONSULTATION SERVICE of this Institute for a term of THREE YEARS is at the command of every student who purchases these text-books for self-instruction.

The library makes an elegant appearance, the books being bound in full leather, round corners, and red edges. Put up in a cloth covered case as shown above.

We want you to make a thorough examination of this most remarkable set of books, at your leisure time and in your own home, at our expense.

**COUPON**

National Institute of Practical Mechanics, P. M.

Without any obligation on my part to purchase, please send me particulars and prices of the Electrical Workers' Standard Library with the Consultation Service of your Institute.

Name.....

Address.....

Occupation.....

Employer.....

NATIONAL INSTITUTE OF PRACTICAL MECHANICS  
1326 Michigan Avenue CHICAGO, U. S. A.

**WINDOW TRIMMING**  
Advertising and Card Writing are the best paid professions in the world. Interesting prospectus FREE tells you all about it.  
KOESTER SCHOOL, 306 Jackson Boulevard, CHICAGO

**I TEACH BY MAIL**  
WRITE FOR MY FREE BOOK "How to Become a Good Penman" and beautiful specimens. Your name elegantly written on a card if you enclose stamp. Write today. Address F. W. TAMBLYN, 418 Meyer Bldg., Kansas City, Mo.

**STUDY LAW AT HOME**  
Young Man! Crystallize Ambition! Stop wishing—and act! Law is powerful, honorable and well-paid. And our College Law Course is complete, easily mastered and highly endorsed. Write for the catalogue and "evidence." Read the testimonies of our hundreds of graduates. Oldest and best. 21 years of biggest success. Write now!  
SPRAGUE CORRESPONDENCE SCHOOL OF LAW  
237 American Bldg., Detroit, Mich.

**COPY THIS SKETCH**  
and let me see what you can do with it. You can earn \$20.00 to \$125.00 or more per week, as illustrator or cartoonist. My practical system of personal individual lessons by mail will develop your talent. Fifteen years successful work for newspapers and magazines qualifies me to teach you. Send me your sketch of President Taft with 6c. in stamps and I will send you a test lesson plate, also collection of drawings showing possibilities for YOU.  
**THE LANDON SCHOOL OF ILLUSTRATING AND CARTOONING**  
1438 Scholfield Building, Cleveland, Ohio.

**You Can Be More Successful**  
Are you a business and social success or merely one of the submerged millions? You can be exactly what you WILL be! I have cashed the proof, why not you? Hundreds are applying Deductive Thought and my suggestions to their daily lives and are enjoying that buoyant health which makes costable thought and action NATURAL. It will cost you nothing to write and learn the truth. My new booklet, "Success Through Deductive Thought," sent absolutely FREE. Address:  
FRANK D. FOLLANSBEE, 7157 Yale Ave., CHICAGO

Please Mention Popular Mechanics



## This Man Marked the Coupon

—and now he is a specialist in his particular line of work. Knowledge is the directing power in every industrial field in the world.

Thousands of I. C. S. students are today specialists in the largest manufacturing, inventive, constructive, and business enterprises. And for 20 years it has been the business of the I. C. S. to prepare men for such positions. But today there are more businesses than ever, more opportunities than ever, and there must be more trained men than ever to fill the many positions.

Great employers indorse the method of I. C. S. training and readily accept I. C. S. students because trained men are scarce, and they know that I. C. S. training is REAL TRAINING.

If you want to know how you can benefit by this great system that is in successful operation all over the world, mark on the coupon the kind of work you desire to follow, and mail the coupon to the International Correspondence Schools. It is well worth your time and postage to get full information about the position in which you are most interested.

### Mark and Mail the Coupon TODAY

**International Correspondence Schools**  
Box 872, Scranton, Pa.

Please explain, without further obligation on my part, how I can qualify for a larger salary and advancement to the position, trade, or profession before which I have marked X.

Electrical Engineering  
Electric Lighting  
Electric Railways  
Electrician  
Electric Car Running  
Dynamo Foreman  
Dynamo Tender  
Wireman  
Mining Engineer  
Telephone Expert  
Civil Engineer  
Automobile Running

Mechanical Engineer  
Mechanical Draftsman  
R. R. Constructing  
Concrete Construction  
Architect  
Contracting and Build'g  
Architectural Draftsman  
Plumbing & Heating  
Chemist  
Bookkeeper  
Advertising Man  
Civil Service Exams.

Name \_\_\_\_\_

St. & No. \_\_\_\_\_

City \_\_\_\_\_

State \_\_\_\_\_

Present Occupation \_\_\_\_\_

## PIANO TUNING PAYS

You can learn at home by devoting your spare moments to the study of our correspondence system.

It is a profession that can be converted into money at any time or place in the civilized world at an hour's notice.



THE TUNE-A-PHONE IN USE

Our graduates earn \$5 to \$10 per day the year round. We supply free a Tune-a-Phone, also a working model of a full-sized, Modern, Upright Action, and the necessary tools for each pupil.

Our wonderful invention, the Tune-a-Phone, gives the exact number of beats that should occur in the test intervals. With it the student knows what the result should be. It eliminates guess-work.

Write today for free illustrated descriptive booklet. Address:

**NILES BRYANT SCHOOL of PIANO TUNING**  
14 Fine Arts Building BATTLE CREEK, MICH., U. S. A.

I TEACH  
*Penmanship*  
BY MAIL



I won the World's First Prize for best course in Penmanship. Under my guidance many are becoming expert penmen. Am placing many of my students as instructors in commercial colleges at high salaries. If you wish to become a better penman, write me. I will send you Free one of my favorite pens and a copy of the Kalamazoo Journal.

**C. W. Ransom, 324 Niner Bldg., Kansas City, Mo.**

## LEARN TELEGRAPHY BOOKKEEPING or SHORTHAND

By Mail. Splendid Positions Open

Great possibilities. Easy to learn in a few weeks by our unequalled methods. Small cost, easy payments. All books and materials FREE. Mention course and write to me today for particulars. E. P. SUMPTION, Pres.  
**MICHIGAN BUSINESS INSTITUTE**  
DEPT. D-60  
Kalamazoo, Mich.

BE AN ILLUSTRATOR

by mail how to draw for magazines and newspapers.

Send for Catalog

Learn to draw.

We will teach you  
School of Illustration  
112 Page Bldg.  
Chicago, Ill.

## MUSIC LESSONS FREE AT YOUR HOME

Write Today for our Booklet. It tells how to learn to play Piano, Organ, Violin, Mandolin, etc. Beginners or advanced pupils.  
**American School of Music, 50 Lakeside Bldg., Chicago, Ill.**

## LEARN DRAFTING

Qualify to fill high-paying positions. Full or partial courses. Conducted by active architects and engineers.  
Low rates. Send for free folder.

**CHICAGO TECHNICAL COLLEGE, 659 Athenaeum Bldg., CHICAGO**

## BE A DETECTIVE

Earn from \$150.00 to \$300.00 per month; travel over the world. Write  
**C. T. LUDWIG, 1600 Searritt Bldg., Kansas City, Mo.**

## LEARN PLUMBING

A trade that will make you independent for life. Hours Shorter — Pay Bigger — Demand Greater than most any trade. You need no previous experience. Our practical methods enable you in a few months to hold position as skilled plumber or conduct your own business. Catalog sent free.

**St. Louis Trades School**  
4430 Olive St. ST. LOUIS, MO.

**BIG  
PAY  
SHORT  
HOURS**

Please Mention Popular Mechanics

# Let Me Show You How to Earn \$3,000 to \$10,000 a Year in the Real Estate Business



J. H. JOYCE, President

## NO CAPITAL NECESSARY

If you are ambitious to better your condition—if you want to establish yourself in a splendid paying business requiring no capital—send me your name and address and I will mail you—*free*—a valuable 62-page prospectus explaining our system of money-making, without interfering with your present occupation. We have perfected a thoroughly practical scientific method of teaching by mail the

### Real Estate, Brokerage and Insurance Business

Under our plan, we teach these big money-making branches. When you are thoroughly qualified to make a success of the business, we appoint you

### Special Representative

This gives you a chance to identify yourself with the oldest and largest Co-operative Real Estate and Brokerage Company in America. By our system you can—if you will—be making money in a few weeks without conflicting in any way with your regular work. Our Co-operative Department will give you more choice, salable property to handle than any other concern in the world. So the sooner you investigate our plan, the sooner you will get your name on your own real estate signs and be ready for business.

### Valuable Commercial Law Course Free

To each of our representatives we also give a thorough course in commercial law without cost. The instruction is indispensable to any man who wants to make his way in the business world. We teach you, free, everything you need to know to successfully meet legal problems that may arise in any business transaction. And we also furnish you free legal advice whenever you require it.

### Send For This Book Now

Our Big 62-Page Free Prospectus will prove of great interest and real value to anyone, but it is of vital importance to office employees, salesmen, agents, clerks, solicitors and others who are ambitious to enter the realms of better things in business. This book is an inspiration to the indifferent, a spur to the laggard, and a stimulus to the ambitious. It deals with the great problems of business, and points the only sure way to the complete mastery of Real Estate, Brokerage and Insurance, three of the most profitable branches of modern business, which have made many millionaires and brought great prosperity to tens of thousands of active, energetic men all over the land.

### MAIL THE COUPON TODAY

Don't procrastinate. Act! Anything that is worth doing is worth doing promptly. Resolve to send for this big free prospectus, and send for it right now, while the matter is before you. "I'll do it tomorrow" has been the grave of countless good intentions. "I'll do it today" is the solid rock on which to build the only enduring success.

Just clip the coupon, fill it out, sign and send today. By return mail you will receive free the invaluable book, which to thousands of ambitious men has proved the key that opens the door of great achievements in business.

**INTERNATIONAL REALTY CORPORATION,**  
2336 Manhattan Building, Chicago



#### COUPON

The International Realty  
Corporation,  
2336 Manhattan Building, Chicago

Please send me, by return mail,  
your big 62-page Free Prospectus  
and oblige.

Name .....

Address .....

## The Demand For Competent Men

in the Telegraph and Railway and Wireless Fields far exceeds the supply. We are unable to keep pace with the demand for our graduates. Greatest possibilities.

### My Thorough Comprehensive Course of Instruction



Geo. M. Dodge, Pres.  
Dodge's Institute of Telegraphy  
Valparaiso, Ind.

enables my students to become proficient in a short time. I have the oldest, largest and best telegraph and railway instruction school in America. Established 1874. Thousands of my former students successfully employed everywhere. Railway and train dispatchers and Western Union Telegraph wires in classrooms. Complete high power wireless station, also an unexcelled course in railway accounting as applied to station agency work. ENROLL NOW.

*Steady Work—Good Wages—A Bright Future*

Expenses very low and may be earned while learning. Easy payments and many other big advantages. Large illustrated catalog tells all. FREE. Write for it now.

GEO. M. DODGE, Pres.

**DODGE'S INSTITUTE OF TELEGRAPHY**  
5th Street VALPARAISO, IND.



## DO YOU LIKE TO DRAW?

**That's all we want to know**  
Now we will not give you any grand prize—or a lot of free stuff if you answer this ad. Nor do we claim to make you rich in a week. But if you are anxious to develop your talent with a successful cartoonist, so you can **make money**, send a copy of this picture with 5c. in stamps for postage of cartoons and **sample lesson plate**, and let us explain.  
The W. L. Evans School of Cartooning  
321 Kingmoore Bldg., Cleveland, O.

## IF YOU STAMMER



I will send you my 93-page book "Advice to Stammerers" Free. It explains how I quickly and permanently cured myself. Profit by my experience and write for free book and advice. Do it now.  
BENJ. N. BOGUE, 1599 North Illinois St., Indiana, Ind.



## Learn a Paying Profession

that assures you a good income and position for life. For seventeen years we have successfully taught

## PHOTOGRAPHY

Photo-Engraving and Three-Color Work

Our graduates earn \$20 to \$30 a week. We assist them to secure these positions. Learn how you can become successful. Terms easy—living inexpensive. Write for catalogue—NOW!

ILLINOIS COLLEGE OF PHOTOGRAPHY, 999 Wabash Avenue, Effingham, Ill.

## SHORTHAND IN 30 DAYS

We absolutely guarantee to teach shorthand complete in only thirty days. You can learn in spare time in your own home, no matter where you live. No need to spend months as with old systems. Boyd's Syllabic System is easy to learn—easy to write—easy to read. Simple. Practical. Speedy. Sure. No ruled lines—no positions—no shading as in other systems. No long lists of word signs to confuse. Only nine characters to learn and you have the entire English language at your absolute command. The best system for stenographers, private secretaries, newspaper reporters and railroad men. Lawyers, ministers, teachers, physicians, literary folk and business men and women may now learn shorthand for their own use. Does not take continual daily practice as with other systems. Our graduates hold high grade positions everywhere. Send today for booklets, testimonials, etc.

**Chicago Correspondence Schools**  
969 Chicago Opera House Block, CHICAGO, ILL.



## EARN A SPLENDID SALARY

Let us train you in our splendidly equipped shops for a good position as automobile mechanic, salesman or chauffeur. Thousands of graduates are earning big salaries. Complete training in 4 weeks, including extensive practice in repairing and driving high powered cars. Tuition and board reasonable.

Send to-day for catalogue and list of graduates

CLEVELAND AUTOMOBILE SCHOOL, 2341 Euclid Ave., CLEVELAND, O.

## LEARN TO BE A WATCHMAKER

**BRADLEY POLYTECHNIC INSTITUTE**  
Horological Department, Peoria, Illinois



Largest and Best Watch School in America  
We teach Watch Work, Jewelry, Engraving, Clock Work, Optics. Tuition reasonable. Board and rooms near school at moderate rates. Send for catalog of information.  
BRADLEY, Dept. S., PEORIA, ILL.

## LEARN WATCH REPAIRING

Be a watchmaker—you can learn this profitable trade by correspondence in a few weeks in your own home by the DeSelms Chart System. After you complete the course you will know a watch from A to Z. You will know just what the matter is and how to repair one. When you graduate you will be a practical watchmaker and repairer and competent to fill any position. Positions for our graduates.

Ask for our Free Book. It explains our system and terms.

**THE DeSELMS WATCH SCHOOL**  
23 Perry Street ATTICA, INDIANA



## WANTED—MEN



Prepare as Firemen, Brakemen, Electric Motormen, Train Porters (colored). Hundreds put to work—\$65 to \$150 a month. No experience necessary. 500 More Wanted. Enclose stamp for Application Blank and Book. State position.  
I. RAILWAY C. I., No. 35, INDIANAPOLIS, IND.



## MUSIC TAUGHT BY MAIL

You can learn by mail in spare moments at your home to play the piano or organ.

**IN TWENTY EASY LESSONS**  
by our wonderful Simplex System. No previous knowledge of music necessary. Delighted students in every state. Write for Free Book today. State if you have piano or organ.  
**SIMPLEX SCHOOL OF MUSIC**  
Conservatory 747 KANSAS CITY MO.

**THIS FREE BOOK TELLS HOW**

**EARN \$100 TO \$200 A MONTH****Be a Railroad Man**

Hold the throttle of a monster Locomotive, travel 30,000 miles a year, see the country and earn big wages. Our

**Self Educational Complete Practical Railroad** teaches how to become a successful Locomotive Fireman and then an Engineer in quickest time at small expense. Learn in spare time.

FULL PARTICULARS SENT FREE  
National Institute of Practical Mechanics  
1325 Michigan Ave., CHICAGO, ILL.

**APPLIED ART PAYS**

E. S. PUSTROWSKI  
Founder and Art Director

Study Applied Art at home. Personal Correspondence System. Eminent Instructors. More than twelve years successful teaching. Practical results guaranteed. Our students in demand by leading employers of artists. Applied Art Courses in Commercial Drawing, Illustrating, Teachers Normal, Fashion, Lettering and Design, Cartooning, Photo Retouching, Architectural Perspective, Etc. Endorsed by high authorities.

Residence Finishing School for Advanced Students. Artists' outfits furnished enrolled students. Year Book free.  
SCHOOL OF APPLIED ART,  
55-4 Applied Art Bldg., Battle Creek, Mich.

**BE A BANKER**

Edgar G. Moore  
Author of Course

Learn a profession in a few months that will give you standing and independence the rest of your life. No matter where you live or what your occupation we will teach you by mail. No business or profession offers better opportunities. The work is pleasant, hours short, salary good. Endorsed by leading bankers. Very low cost, easy payments. Write today for catalog.

AMERICAN SCHOOL OF BANKING, 119 Nelson Bldg., Columbus, Ohio

**LEARN WATCHMAKING**

Watchmaking pays and you can earn while you learn. Write for FREE BOOK, "How to be a Watchmaker." Postal brings it.

Stens's School of Watchmaking  
912 Globe Bldg. St. Paul, Minn.

**I TEACH SIGN PAINTING**

SHOW CARD WRITING or LETTERING by mail and guarantee success. Only field not overcrowded. My instruction is unequalled because practical, personal and thorough. Easy terms. Write for large catalogue.

CHAS. J. STRONG, Founder

DETROIT SCHOOL OF LETTERING  
DEPARTMENT PM. DETROIT, MICH.  
"Oldest and Largest School of its Kind"

**STAMMER**

Write M. L. HATFIELD, 1918 Geve St., OAKLAND, CALIF.

**LEARN WATCHMAKING AT HOME**

You can learn by our modern and original system of instruction every part of the Watchmaker's Trade at home as good or better than at a shop. You can earn money while learning and secure a well paying position or start in business after completing our course of instruction. Good watchmakers are always in demand and earn from \$20 to \$35 per week. For particulars apply to the WISCONSIN SCHOOL OF WATCHMAKING, Stroh Bldg., MILWAUKEE, WIS.

**LAW****STUDY AT HOME**

Administration Building

**We Make Your Home a University**

Graduate correspondence students hold highest records and are most successful in passing bar examinations. Leading home study law course in America—recognized by bench, bar and noted educators. Our own modern texts—lately prepared by Deans and Professors from leading university law schools—Harvard, University of Chicago, Michigan, Wisconsin, Illinois, Iowa, Leland Stanford, and others. We guarantee to coach free any graduate failing to pass bar examination.

**Legally Trained Men Achieve Greatest Success**

in business and public life. Abraham Lincoln, Edward H. Hartman, Thomas F. Ryan, Robert S. Lovett, John Mitchell, Samuel Gompers, John F. Dillon, and thousands of our most noted men and lawyers have studied law without attending a resident college.

**President Taft Says:**

"Every man who expects to achieve substantial success in the business or professional world should be legally trained." DECIDE NOW to study law, and thus make the first step toward a great and successful business or professional career. Extremely low cost—easy monthly payments. Send free coupon for catalog.

**Our Great Offer**

Write at once and learn how to save over half the cost by enrolling now. Greatly reduced scholarships offered at this time to secure a large enrollment quickly. We reserve right to withdraw offer at any time; be quick, send in the coupon right away and secure full particulars of the most remarkable offer ever made by an institution of learning.

**Special Business Law Course**

for those desiring a knowledge of commercial law. Know your rights; keep out of lawsuits. Send coupon today. Don't wait until the offer is withdrawn and it is too late.

Send Free Coupon Cut out and mail this coupon today for free 112-page catalog and full particulars of our great offer to new students. Don't delay—send at once—right now.

FREE  
COUPON

LA SALLE EXTENSION  
UNIVERSITY

LA SALLE EXTENSION  
UNIVERSITY  
Box 1193, CHICAGO, ILL.

Box 1193  
CHICAGO  
ILL.

GENTLEMEN: Please send at once particulars and complete catalog FREE, regarding Special Advertising Scholarships offered in your Department of Law.

NAME.....

STREET & NO.....

CITY.....STATE.....

Please Mention Popular Mechanics

REVERSIBLE  
**"Linene"**  
 TRADE MARK

COLLARS  
 CUFFS AND BOSOMS

**LINENE COLLARS**

have a dull lustre and look just like linen, but are so cheap that they can be thrown away when soiled. They may be reversed and worn both sides

10 for 25 cents at the stores

By mail 30 cents in U. S. stamps. Sample free.  
 Give Size and Style.

**REVERSIBLE COLLAR CO.**  
 Department U BOSTON, MASS.

MAN SVICK  
 Sizes 12 to 18 Inches  
 Front 12 Inches Back 11 Inches

ANGELO  
 Sizes 12 to 20  
 Inches  
 Front 21 Inches  
 Back 1 Inch

RAPHAEL  
 Sizes 12 to 20 Inches  
 Front 21 Inches  
 Back 1 Inch

RUBENS  
 Sizes 12 to 20 Inches  
 Front 2 Inches Back 1 Inch

## SEBASTIAN 15-INCH LATHE

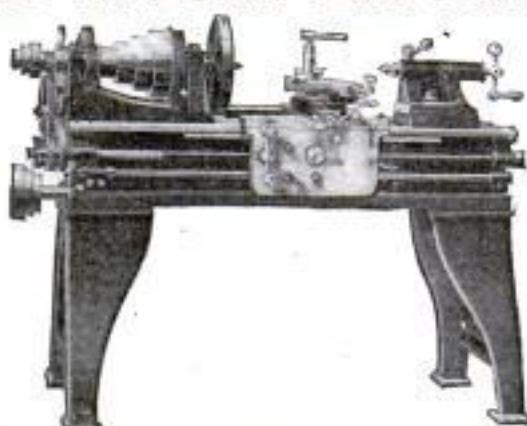

The Low Price, Perfect Quality lathe for the Garage, Automobile and General Repair Shop. If you are in the market for a lathe, be sure and investigate the merits of the Sebastian. We also build 9-inch and 10-inch foot power lathes.

Catalog mailed free on request

**THE SEBASTIAN LATHE CO.,** 107 Culvert Street  
 CINCINNATI, O.

**ELECTRICITY IN A NUTSHELL**

Laird & Lee's Vest Pocket Practical Compend of Electricity, by Jas. A. Benton, A. M. Magnetism and Electricity, Batteries, Accumulators, Wiring, Dynamos and Motors, Lighting, Plating, X-Rays, Wireless Telegraphy, Electricity Applied to Medicine and Surgery, Current-Carrying Capacity, etc., of Different Wires—Electric Railways, Naval and Military Uses of Electricity, Submarine Telegraphic Cables, Vocabulary of Technical Terms, etc. Cloth, 25c; Leather, 50c. Postpaid by

**LAIRD & LEE, Publishers,**  
 1732 Michigan Ave., Chicago, Illinois.

## ARITHMETIC SELF-TAUGHT

A plain, easily-understood volume for all who have not had the opportunity of learning this subject thoroughly, or who have forgotten what they once learned. 257 Pages. Requires no teacher. This great little book sent postpaid for 60 CENTS. Stamps accepted, leather binding \$1.

**GEO. A. ZELLER BOOK CO.**  
 Est. 1874, 442 W. Belle Place ST. LOUIS, MO.

SPANGENBERG'S  
 PRACTICAL  
 ARITHMETIC  
 Self-Taught



### HERE YOU ARE BOYS

A medalion pin of Foxy Grandpa. Everyone will notice it on the lapel of your coat and try to get a closer look at it. All you have to do is press the bulb.—Foxy Grandpa will finish the job by squirting a fine stream of water over the inquisitive one. Will squirt 20 feet. Greatest joke out. Order one today and fool your friends. Price 15c. Foxy Grandpa and Heoligan both for 25c. 5 for 50c or 1 doz. for \$1.00. A beautiful fountain pen free with every \$1.00 order.

**AMERICAN SUPPLY CO., ST. PAUL, MINN.**



### 127 KINDS Iron, Wood, Wire & Steel PUZZLES

Sample with Catalog 10 cents, or 3 leaders for 25 cents.  
**WESTERN PUZZLE WORKS**  
 St. Paul, Minn.



## VENTRILOQUISM

Send today 2c stamp for particulars and proof.  
**O. A. SMITH, Room D 40, 823 Bigelow St., PEORIA, ILL.**



### Every Boy His Own Toymaker

Greatest boys' book ever written. Tells how to make a Steam Engine, Telephone, Magic Lantern, Boats, Kites, balloons, electrical and mechanical toys, traps, fishing tackle, 200 illustrations; also catalog of 150 puzzles, set of Kollar's Trick Cards and "DOUBLE TUNOAY" warbler and bird call, all for only 10c. **WESTERN PUZZLE CO., ST. PAUL, MINN.**

When you want anything and don't know where to find it—write Bureau of Information, Popular Mechanics, Chicago



## A SCHOOL WITHIN ITSELF

There are XX chapters in all, XIX carrying you from the fundamental principles of electricity on through the various branches to a point where the careful student comprehends the complete designing, care and operation of a dynamo or motor, and one chapter on electric automobiles, outlining their construction, care and operation, and all about storage batteries and how to handle them. Each subject is carefully written and to the point. After a student studies a subject, he is questioned on that subject in such a manner as to bring clearly to his mind the points he needs to know regarding same. The book contains a dictionary defining 1500 Electrical Words, enabling the reader to ascertain the meaning of any electrical word, term or phrase used in this book, as well as hundreds of others in common use. All required tables necessary in the study are in it.

**\$2.00 PER COPY—SIXTH EDITION—30,000 COPIES SOLD.**

The offer we make of refunding money if book is not satisfactory upon examination is AN UNUSUAL ONE in connection with the sale of a book. But we have no fear of its return. Your decision will be what thousands of others have been. Money would not buy it if it could not be duplicated. We could print testimonials by the hundreds. It is best to order and be your own judge of its merits.

**CLEVELAND ARMATURE WORKS, 49 & St. Clair Ave., Cleveland, Ohio**

Armatures and Fields Wound—Caromutators Filled  
 AMERICA'S GREATEST REPAIR WORKS

# LEARN *by* DOING

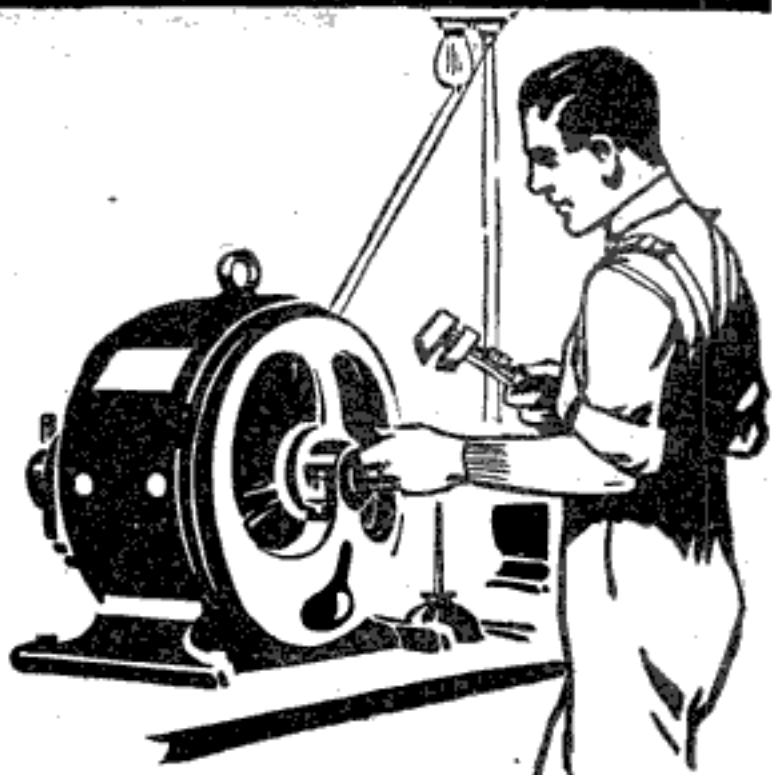

That's the  
Way Here

**Y**OU learn **ELECTRICITY** in all its modern applied forms by *doing*—not by theory from books. You are taught by “this-is-the-way-to-do-it” Teachers and then *you work it out* with your own **HANDS RIGHT IN THE SCHOOL.** And what you learn, you know “for keeps.”

No classes. You get **INDIVIDUAL INSTRUCTION** and go ahead without hindrance. **DAY AND NIGHT SESSIONS** the year 'round. Come in and talk it over. Anyway, write for free illustrated catalogue that tells you all about the practical, small cost, “learn-by-doing.”

---

**NEW YORK ELECTRICAL SCHOOL**

44 West 17th Street

Open from 9 A. M. to 9 P. M. This is **NOT** a Correspondence School



## "That coupon gave me my start"

"It's only a little while ago that I was just where you are now. My work was unpleasant; my pay was small. I had my mother to take care of, and it was tough sledding trying to make ends meet. I hadn't had much schooling. I didn't *know enough* to fill any better job than the one I had.

"One day I saw an advertisement of the American School. It told how other men got better positions and bigger salaries by taking their courses. I didn't see how a correspondence school could benefit me, but as long as it didn't *cost* anything to mark the coupon I thought it was worth investigating at least. I marked the coupon and sent it in on the next mail.

"That was two years ago, and *now I'm drawing more every week than I used to get in a month.*"

If you want a *better position*, if you want to get into *congenial work*, if you want a salary that's *worth while*—

**SIGN AND MAIL THE COUPON NOW**

**American School of Correspondence**  
Chicago, Ill., U. S. A.

## Opportunity Coupon

### American School of Correspondence CHICAGO, U. S. A.

Please send me your Bulletin and advise me how I can qualify for the position marked "X."

- |                                |                             |
|--------------------------------|-----------------------------|
| .....Automobile Operator       | .....Lawyer                 |
| .....Draftsman                 | .....Fire Insurance Eng'r   |
| .....Architect                 | .....Telephone Expert       |
| .....Building Contractor       | .....Moving Picture Op'r    |
| .....Structural Engineer       | .....Book-keeper            |
| .....Civil Engineer            | .....Stenographer           |
| .....Electrical Engineer       | .....Accountant             |
| .....Elec. Light & Power Supt. | .....Cost Accountant        |
| .....Master Mechanic           | .....Certified Public Acc't |
| .....Sanitary Engineer         | .....Auditor                |
| .....Steam Engineer            | .....Business Manager       |
| .....Reclamation Engineer      | .....College Preparatory    |

NAME \_\_\_\_\_

ADDRESS \_\_\_\_\_

OCCUPATION \_\_\_\_\_

Pop. Mech. 3-12

Please Mention Popular Mechanics



# Popular Mechanics Magazine

WRITTEN SO YOU CAN UNDERSTAND IT

Vol. 17

MARCH, 1912

No. 3

## Steered His Ship with Packing Cases



Alaska Skipper's Emergency Steering Gear

**T**HE ingenuity and resourcefulness of Captain Achton Jochimsen, master of the little power schooner "Duxbury," bound from Nome to Seattle with 14 passengers, saved the vessel and the ship's company recently when apparently all odds were against the craft.

The "Duxbury" sailed from Nome, November 6, and two days later left St. Michael, southbound. She ran her nose into heavy weather from the start. The fourth day out, in Bering Sea, during a terrific gale, the rudder was carried away by a huge



Schooner "Duxbury" at Her Dock in Seattle, after a Remarkable and Most Perilous Voyage from Nome

wave. For six days the "Duxbury" drifted helpless in the gale, driving down toward the Pribilof Islands. During those six days Captain Jochimsen was a busy man.

He ordered the main boom taken off the main mast and lashed cross-ships over the roof of the after house so that an end protruded some distance on either side of the vessel. He brought out two big wooden packing cases from the hold. From the forward rigging on either side of the bow he ran a stout line aft to the ends of the boom to steady it. Across the boom,

which ran cross-ships, he rigged a free-running tackle that was fastened at the outer end to the tops of the boxes and aboard ship took a turn about the drum of the steering wheel.

With this rig, when the wheel was turned to starboard the box on the starboard side was lowered into the sea and quickly brought the schooner's

nose about. A turn to port hauled her over on that course. The rig served to take the "Duxbury" to Dutch Harbor, Unalaska, where she arrived November 24. At Dutch Harbor a permanent rudder was rigged and the schooner reached Seattle on December 12, with all hands well and full of praise for the ingenious master.

## ELECTRICITY HAS PART IN CARDINAL'S WELCOME



St. Patrick's Cathedral in New York Illuminated in Honor of the Home-Coming of Cardinal Farley

Not the least impressive feature of the welcome extended Cardinal Farley on his recent return to New York was the illumination of St. Patrick's Cathedral, the seat of the archiepiscopal diocese of New York over which the new cardinal has for so many years presided and where he will continue his duties as archbishop, although now a cardinal. The cathedral is a structure of great dignity in architectural design. On the evening of the day the cardinal returned home its beautiful outlines were illuminated with 50,000 incandescent lights and formed a brilliant spectacle. The spires, crosses, buttresses and the lines of the Gothic decorations were illuminated with rows of lights.

## MAMMOTH CONCRETE FREIGHT HOUSE

One of the largest private freight houses in the world has been erected by a concern in Buffalo, and will be used exclusively for the receiving and shipping of freight. It is also one of the largest buildings ever constructed of reinforced concrete, having a height of 10 stories, a length of 588 ft., and a width of 109 ft.

## POWER SAW PULLS SELF THROUGH FOREST

A new gasoline-driven drag saw which pulls itself from tree to tree in the forest is being marketed by a Portland, Ore., concern. The machine,

which comprises a gasoline engine, the sawing mechanism and a cable drum, is mounted on a skid or sledge. By attaching the cable to a tree and

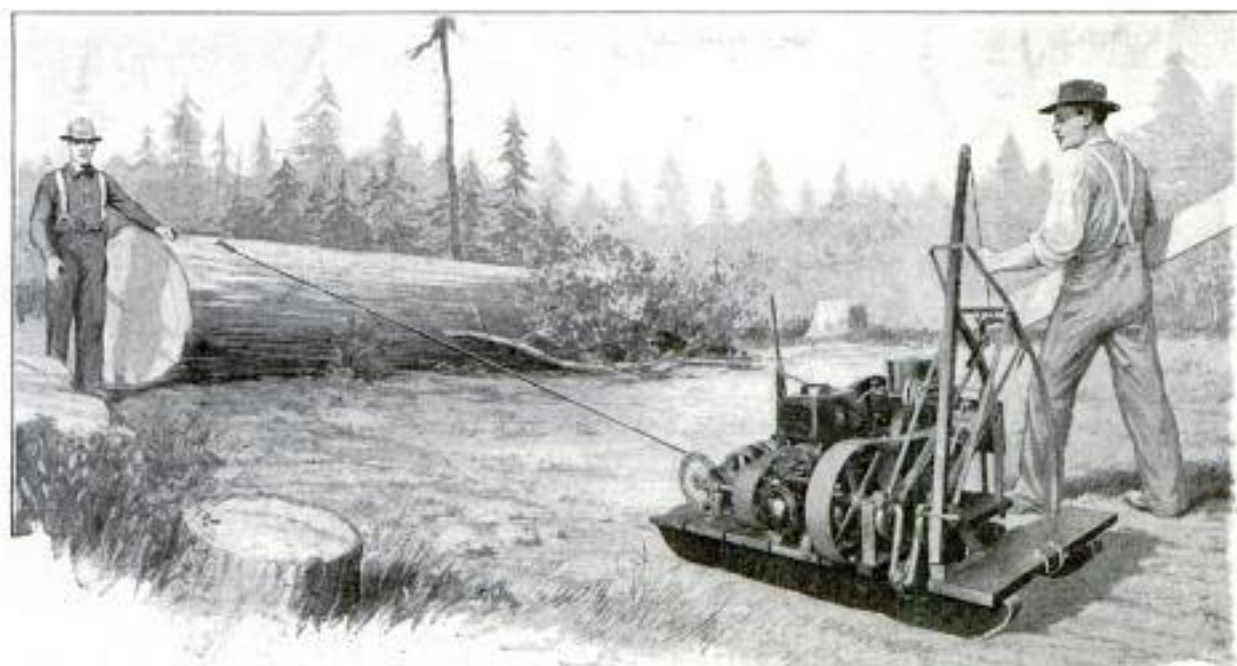

This Power Saw Drags Itself from Tree to Tree by Winding in a Cable Attached to the Fallen Trunk. It is to Cut Up

throwing the power to the drum, the outfit can be moved any distance desired, whether it be an inch, a foot or a mile.

Several interesting features are also claimed for the sawing mechanism proper. Two eccentrics give the saw a tilting motion similar to that of the hand-operated kind. The machine is said to have a record of sawing through a 5-ft. log in 5 min.

#### AUTO-SCOOTER MAKES 80 MILES AN HOUR

A small automobile of the runabout type, converted into an "auto-scooter" by means of runners and a cogged shoe on the tire of one of the wheels, has been causing much excitement on the

Shrewsbury River, New Jersey, because of its remarkable speed. It made its appearance during the annual ice-boat races, and succeeded in running circles around all the other types of craft represented. One of the fastest of the ice boats was selected to race the auto-scooter, and, although there was a brisk wind, appeared to be standing still when the latter started.



A Small Runabout, Converted into an "Auto-Scooter" by Attaching Runners to the Axles and Placing a Cogged Shoe on the Tire of One of the Wheels, Made a Speed of 80 Miles an Hour When Racing an Ice Boat on the Shrewsbury River, New Jersey

A speed of 80 miles an hour, it is claimed, was maintained by the auto-scooter for more than half an hour.

The remarkable machine is owned by a resident of Red Bank, N. J., who, in equipping it with runners, did so because the ice offered a better surface for traveling than the rough roads, and not with any idea that it would be remarkably speedy.

The four solid runners, fitted with steel shoes, and attached to the axles of the runabout, and the cogged shoe, placed on the tire of one of the wheels, were made by him.

### DANCING MASCOTS FOR MOTORISTS

Motoring mascots are still growing in popular favor in Europe, although they have not yet made a general appeal to the fancy of motorists in this country. One company in London has placed a new line of mascots on the market, which may be obtained in bronze, silver or goldplated metal. Two interesting models are shown in the accompanying illustrations, one being a Greek dancer and the other a conventional ballet dancer.



A Snail and Two Dancing Mascots

### WHY THE CONTINENTS DO NOT SINK

In a remarkable piece of work carried out recently by the U. S. Coast and Geodetic Survey, largely under the direction of Prof. John F. Hayford, it has been shown that the material of which the continents are made and that which lies under them is lighter than that which lies under the oceans. This explains why the continents do not sink though they are several miles higher than the ocean beds and exert enormous pressures on the material beneath.

The work of Hayford proves that the total amount of matter in a column of given size, reaching from the tablelands of the continent to 100 miles below the surface of the sea, is the same as that of a similar column reaching from the surface of the ocean to the same depth. This means that the continents are lighter than the ocean beds and that they are floating, as it were, upon the denser material of which most of the earth is made. The average density of a continent is about 2.75 times that of water, while the average density of the whole earth is 5.53 times that of water.

The balance of the continents is continually disturbed as they are washed down into the sea by the rivers. The Mississippi River, for example, carries into the Gulf of Mexico every year about a cubic mile of material brought down from the mountains and thousands of hills by the Missouri and its many other tributaries. The weight of the continent is decreased by this amount. Consequently, it has a tendency to float higher, just, as a ship rises when a part of its load has been thrown into the water. This process continuing for the hundreds of thousands of years of geological time leads to the elevation of new mountain chains and plateaus. Of course the process is, on the whole, very slow; but now and then the rocks break under the strains to which they are subject and slip by each other a little distance, and when they do, vibrations

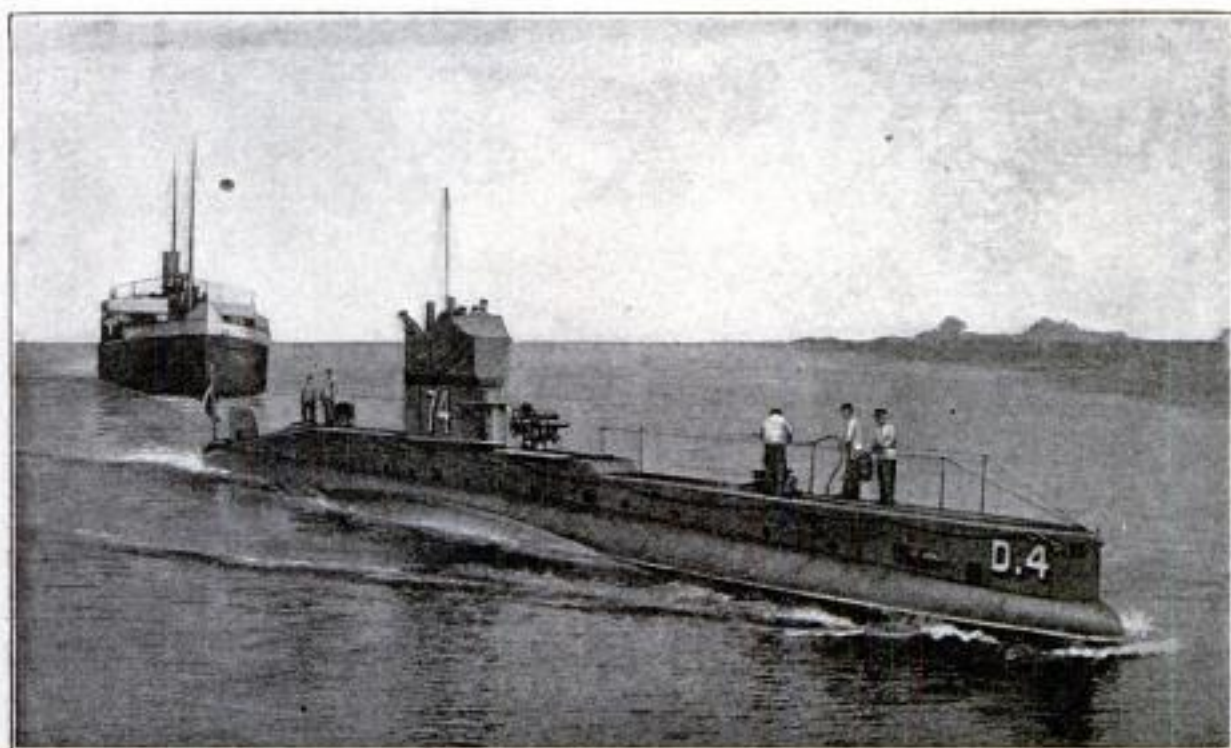

The Rapid-Firing Gun in Position for Action while the Submarine is Running on the Surface

are set up which are transmitted through the rocks and become what are called earthquakes. If the break is big enough and the change is sudden enough, the vibrations are so violent that they shake cities into ruins. The slip which caused the California earthquake in 1906 was one of about 10 ft.

#### SUBMARINE CARRIES DISAPPEARING GUN

The British submarine "74," claimed to be the most powerful submarine in the world, is the first ship of its kind to carry a gun other than a torpedo gun, and is also probably the first war vessel on which the disappearing-gun principle has been utilized. But while the reason for disappearing guns in coast defense is to mask them from the enemy, thus providing additional protection for both guns and crews, the idea is adopted on the submarine because the gun must be inclosed within the vessel when it is submerged.

Submarine "74" is exceptional in its length, being about as long as a torpedo-boat destroyer. Her surface

speed is about 17 miles an hour. The illustrations show the quick-firing gun being pushed upward through the deck, the hatch doors being swung back, and the gun in position for action.



The Disappearing Quick-Firing Gun of Great Britain's Most Powerful Submarine being Raised through the Deck

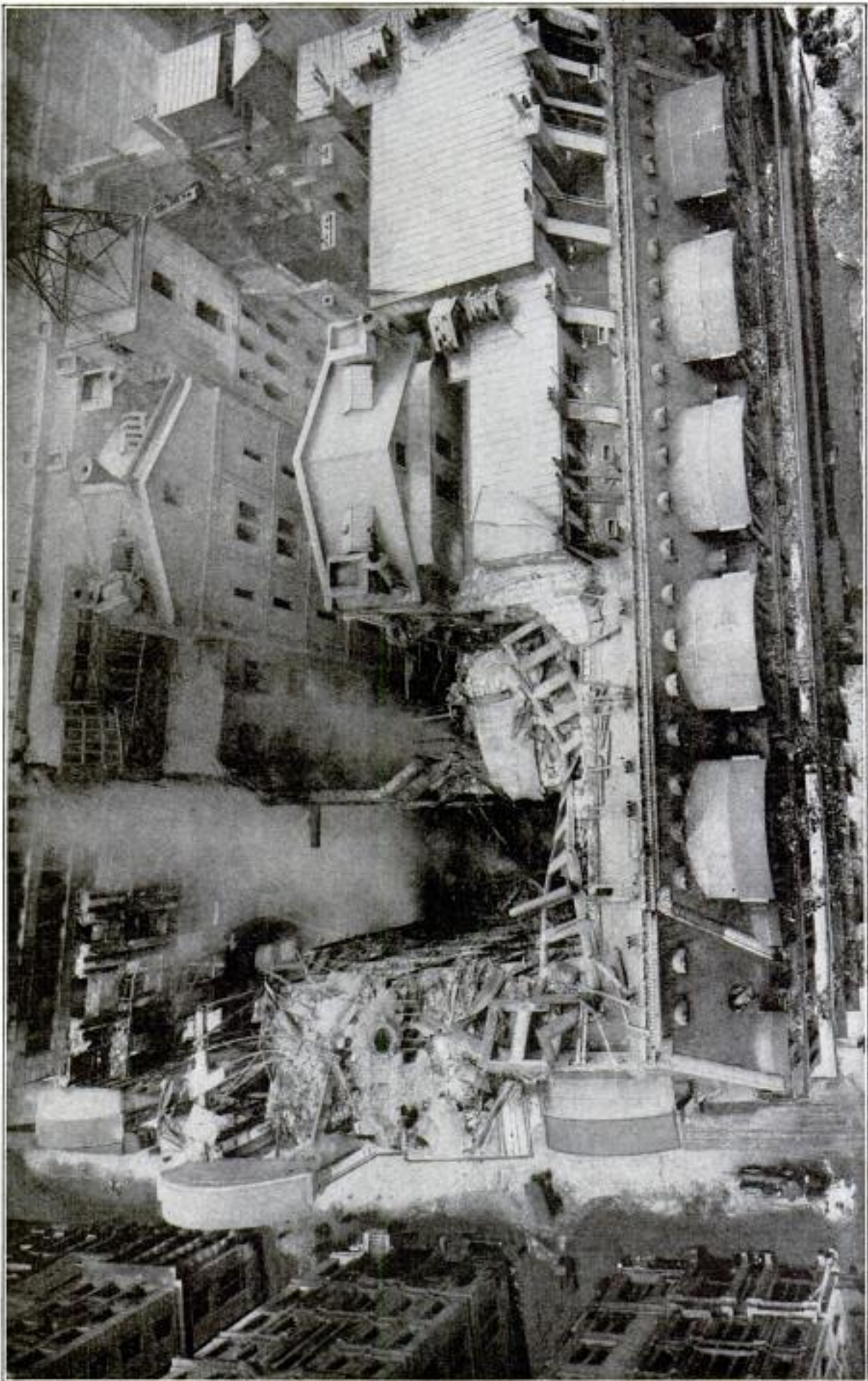
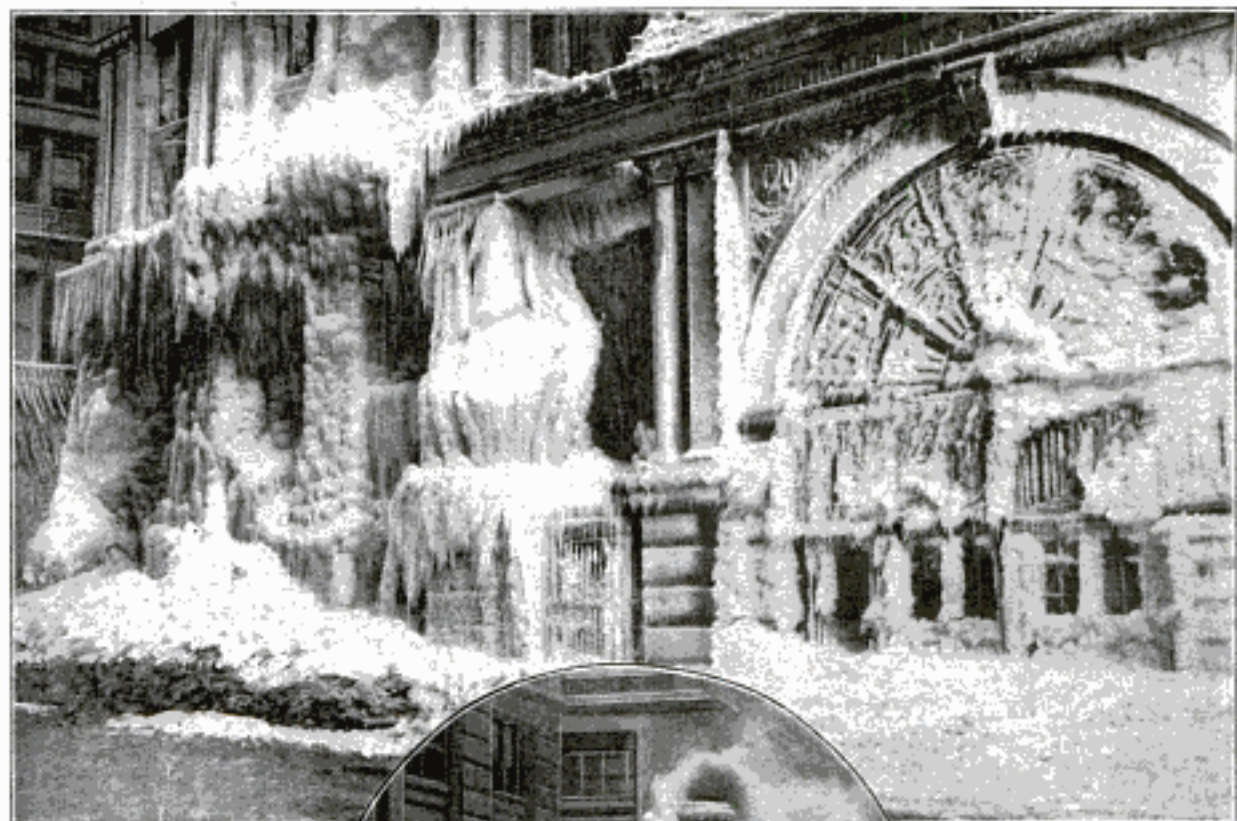

Photo by Fretornal News Co.

Remarkable Photograph of the Equitable Building Ruins, Taken from the Top of a Near-by Skyscraper

## A FIRE WHICH ENDANGERED FIVE BILLIONS



Copyright, American Press Association

The Front of the Building, Thickly Coated with Ice, Looked Like a Canadian Ice Palace

The Equitable Life Assurance Building fire, which occurred Jan. 9, killing six men and destroying property at first estimated to be worth from \$12,000,000 to \$15,000,000, but later conceded to be many millions below this figure, was one of the most spectacular ever occurring in New York's financial district.

The building, constructed of marble and granite, was a landmark of New York's earlier period of skyscrapers, located at 120 Broadway, in the very heart of the financial district. The fire, which started during the early hours of the morning, upset the financial machinery to such an extent that business was practically suspended throughout the day. The fire started in a café, located in the basement.

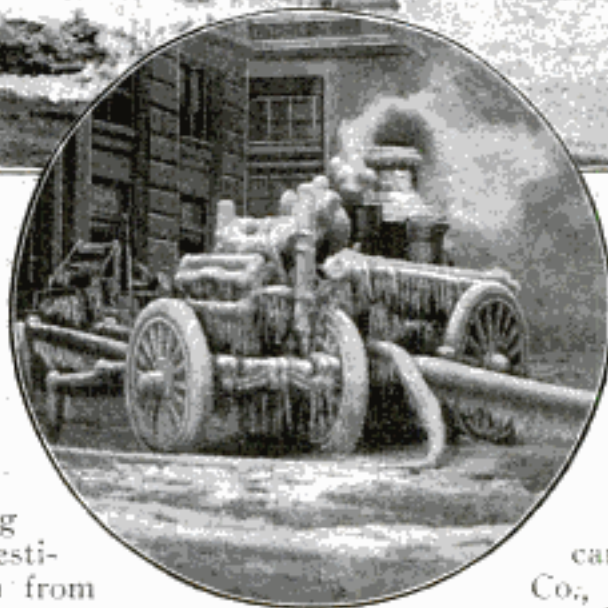

The Ice-Covered Fire Engine Indicates that the Firemen Had to Fight Ice as Well as Fire

Particular interest centered about the fire because of the vast wealth stored in the vaults of the Mercantile Safe Deposit Co., which were buried many feet deep under the ruins of the structure. According to an estimate made by W. B. Bröner, assistant treasurer of the Equitable Life Assurance Co., which controls the Mercantile concern, this wealth, consisting of securities, stocks and bonds, represents a probable value of \$5,000,000,000, which would, if converted into currency, be twice as much as is in circulation in the United States. It would pay the national debt and leave a balance greater than the combined fortunes of John D. Rockefeller, Andrew Carnegie and J. P. Morgan. No fear was felt for its safety.

### "SUB ROSA," OR THE ROSE AND THE THIEF

Every rose has its thorn and in this particular instance it consists of an ingenious hook which can be made to



The Rose as a Hiding Place for Stolen Rings

protrude from the center and drag such unconsidered trifles as diamond rings into the hollow depths veiled by the rose petals. The hook is operated through the stem of the imitation rose.

### MOST POWERFUL POISON KNOWN

The most powerful poison known is reported to have been extracted by a German chemist from the seeds of the ricinus, the familiar castor-oil plant, and has been attracting much attention on account of its remarkable properties. Its power is estimated to be so great that a gram—about a thirtieth of an ounce—would kill a million and a half guinea pigs. If administered so as to cause severe illness without death, it gives immunity against a larger quantity, and the dose can be gradually increased until more than a

thousand times as much can be endured as would kill an untreated animal. Though arsenic, morphine and other poisons can be taken in larger and larger quantity, nothing approaching this marvelous increase in dose can be borne. The ricinus poison has effects much like those of living germs, and in immunized animals an antitoxin is formed, so that injections of their blood serum may cure animals that are already in danger or have become ill from ricinus poisoning.

### "TROUBLE-FINDER" HEAD LAMP FOR MOTORISTS

This "trouble-finding" head lamp for motorists, recently placed on the market in France, has become very popular. In the center of the metallic mirror is attached a small electric lamp, and the combination is firmly held to the head or cap by means of an elastic band. The whole weighs about 2 oz., without the small dry cell supplying the current, which may be attached to the head band or be carried in a pocket. It is found very useful in searching out engine troubles and making temporary repairs on the road after dark, as it leaves both hands free to do the work.



Working on the Engine under Illumination from the Head Lamp Leaves Both Hands Free for the Task



# The Fallacy of the Dirigible



The finish of \$400,000 expended by the British Navy on its great dirigible, which was dubbed "Mayfly" but which didn't.

**T**HE lightest practical aeroplane capable of carrying a man weighs, with operator and enough fuel for flights of reasonable duration, about 1,000 lb. Such aircraft are sustained—as are the birds—by the complex but highly effective dynamic reactions of the air streams flowing under their wings.

The volume of 1,000 lb. of air is about 15,000 cu. ft.—the approximate contents of a sphere 30 ft. in diameter. By substituting for this volume of air something weighing less than 1,000 lb., the something weighing less will float statically in the air, just as anything weighing less than water, volume for volume, will float in water.

As a successful flying vehicle, the aeroplane is a development of no more than a very few years. Yet consistently since its advent it has evolved faster than any other device in the history of transportation. Its genuinely utilitarian applications are already considerable. Its applications to warfare are even now a proved success.

Yet the problem of the aeroplane is inherently complex.

The laws governing its action are exceedingly obscure. The limits of its efficiency are still unknown. Its best form is still undetermined. The difficulties of its equilibrium will still take much solving. And at every turn the aeroplane offers a field for investigation that seems as unlimited as it has

proved fertile. While its structures are simple and cheap to build, their design is so baffling and involved, so demanding of the finest abilities of the best engineers, as to rank the problem of dynamic flight as one of the most difficult that modern science has to face.

The balloon as a means of travel is still of negligible utility, despite the numerous and long-continued efforts to make use of it in many fields. Without counterpart in nature, it has proved without justification in fact.

Yet the problem of the balloon is inherently simple.

The laws of its action are obvious. The limit of its lifting capacity is the easily ascertained weight of the air. The problems of its propulsion, steering, and navigation are inescapably definite. Yet, in the 50 years the dirigible has existed, it has not undergone a single fundamental change or improvement. Its changes have been changes in detail. Its improvements have been improvements in degree. Although tremendously expensive to build, and almost impossible to keep built, the problems of floating a balloon structure in the air are so inherently simple as to be easily understood by, and thus appeal to, the veriest tyros in mechanical science.

Automobile and aviation motor developments have advanced the speed of the dirigible from 7 to a present

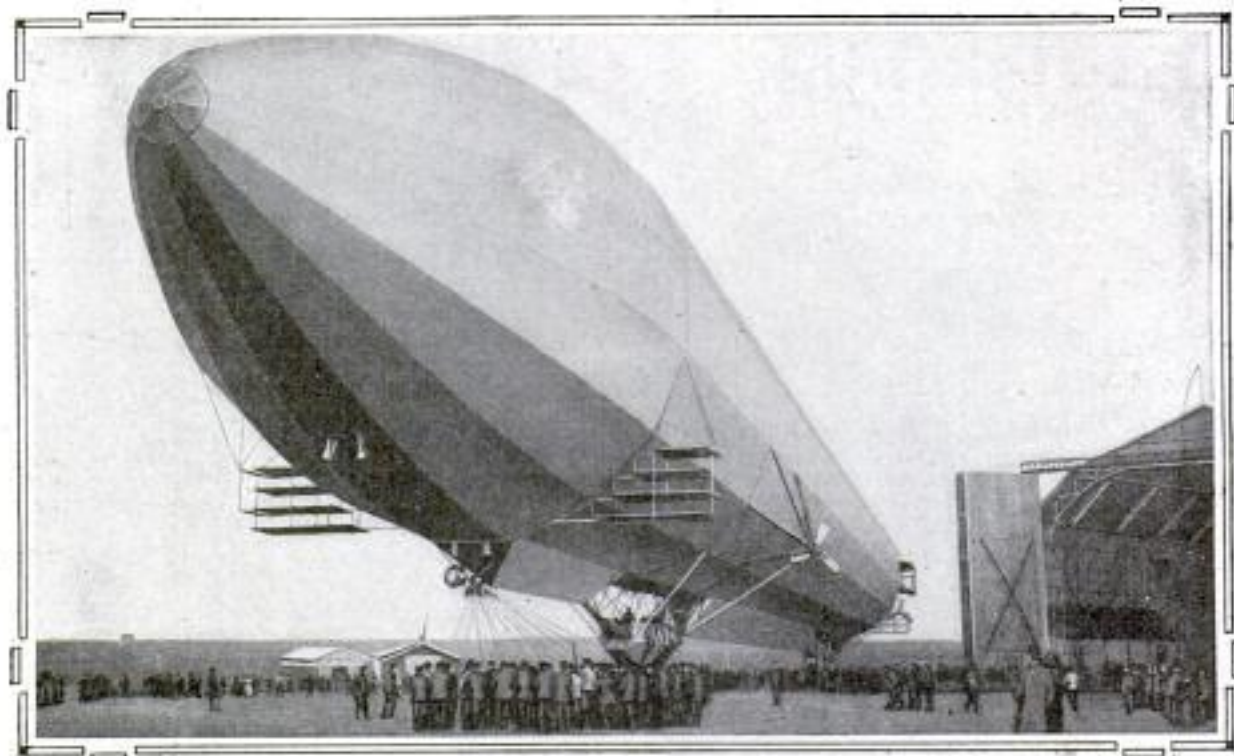

One of the most recent Zeppelin dirigibles. The size of these gigantic airships, which unquestionably are the best of their type, is well shown in this illustration and that on the opposite page. They average in cost not less than one-third of a million dollars each, and cost over \$1,000 for a single filling of hydrogen gas.

maximum of some 30 miles an hour—nowhere enough to make headway against an ordinary adverse wind. Improved fabrics have enabled the dirigible to stay in the air the present maximum of 36 hours, without descending for gas. Similar slight improvements are the most that even its advocates are able to prophesy for the dirigible.

Yet on this much-punctured bubble of fabric-enveloped gas, it is conservatively estimated that there has been expended within the past 60 years—most of this within the latter decade of this period—not less than \$50,000,000.

Never elsewhere in engineering history has so great an expenditure been made in a quest for practical results

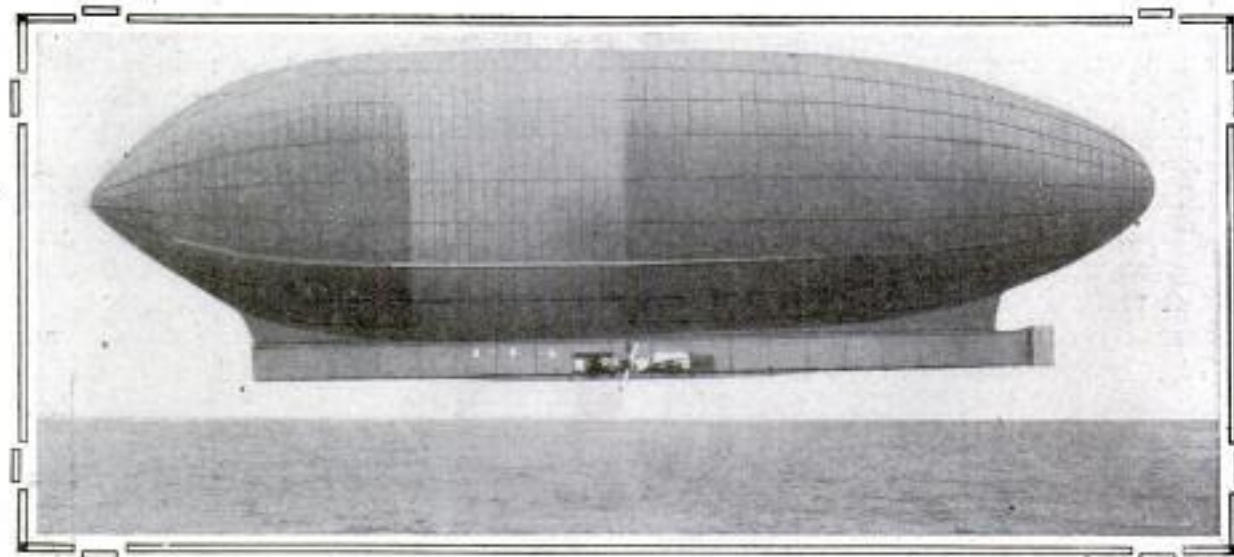

The Wellman dirigible which attempted to cross the Atlantic in 1910, as it appeared drifting off to oblivion, after the crew had been rescued. The attempt reflected little or no credit on this type. Before it was abandoned it "performed" a thousand-mile drift at the mercy of the wind.

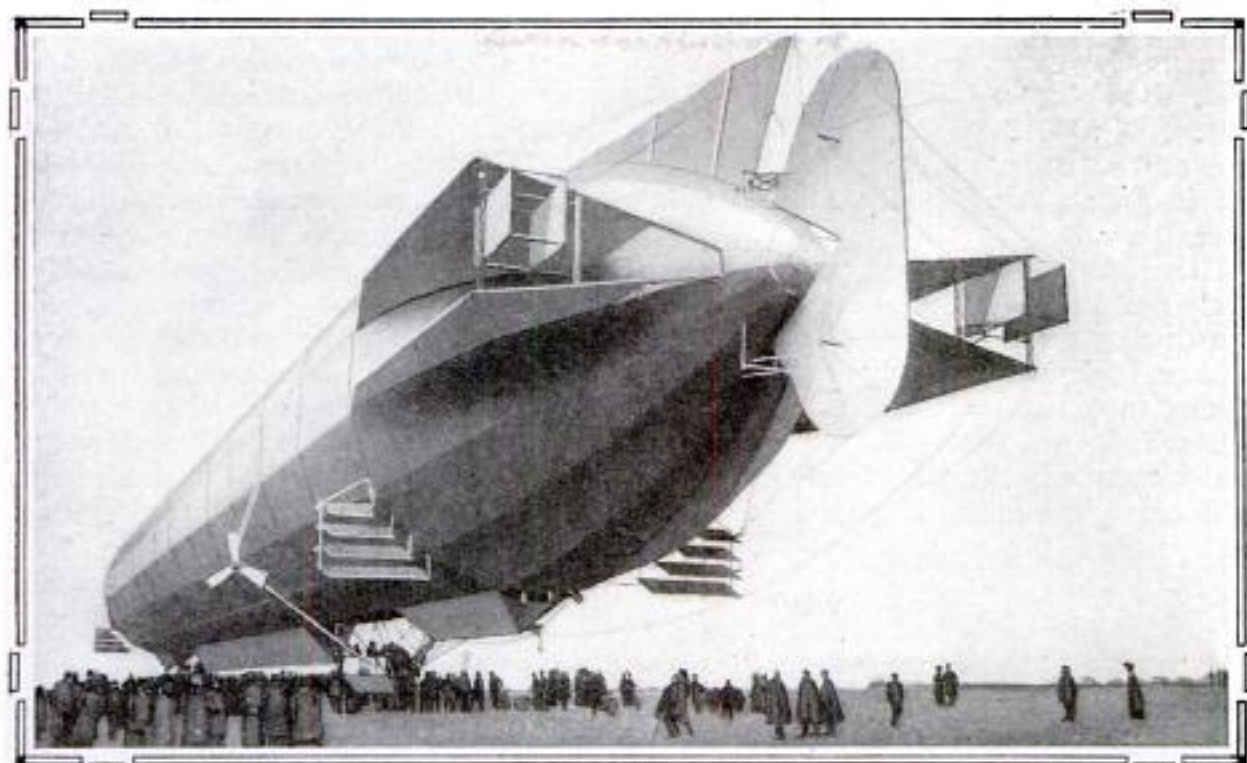

The Zeppelin dirigible has been developed at a total expenditure of not less than \$5,000,000. It has inspired the comment, by a famous French authority on aero-navigation, that Germany "has freely and frankly confessed her mistake in pinning her faith to the illusive gas bag . . . by voting the sum of \$7,500,000 for aeroplane manufacture."

that were in no measure realized. The pyramids may have cost the world more than the balloon, but a definitely practical result was not their object. Canals have been tremendous consumers of human labor, but canals serve their purpose. Immense sums have been spent in useless and unsuccessful invention, but it requires whole groups rather than single types of

worthless devices to total such expenditures as the balloon has achieved.

Naval and military devices—battleships, weapons, armor, equipment, etc.—are tremendously costly, but these serve the utilities they are designed to serve, however much these types of utilities may be disparaged by peace advocates.

Experiments with dirigible balloons

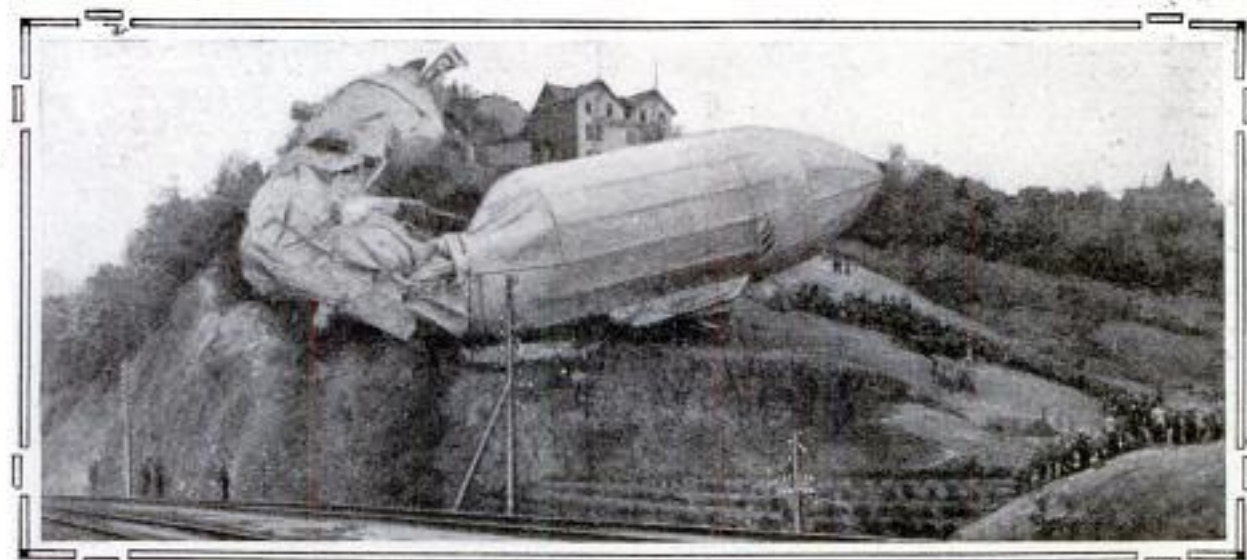

The \$250,000 Zeppelin dirigible, ruined beyond hope of salvage through being wrapped around a German hillside by a wind gust. Fortunately none of the passengers was seriously injured, but the slow speed of these clumsy and unwieldy giants renders them unable to drive into an opposing wind and thus escape such mishaps.

within comparatively recent years have cost, in Germany, \$6,300,000; in England, over \$2,000,000; in the United States, \$4,000,000; in France, \$5,000,000; and in other countries of Europe and in Japan not less than \$5,000,000 more.

These figures do not include the costly and long-continued experimentation during an earlier period of development, nor do they include the expenditures in non-dirigible ballooning, which has been made a costly hobby to which American and foreign millionaire sportsmen are even yet

Indeed, by no method of sound reasoning can the term flight be held to apply to mere uncontrolled sustentation in and movement through the air—a feat that is variously accomplished by projectiles, skyrockets, objects adjacent to exploded dynamite, etc.

Condemned by this analogy, the various phenomena of balloon ascension, drifting, and dirigibility, however interesting they may be, are by no proper process of logic entitled even to classification with the phenomena of true flight—such as the controlled flight of birds and aeroplanes, faster

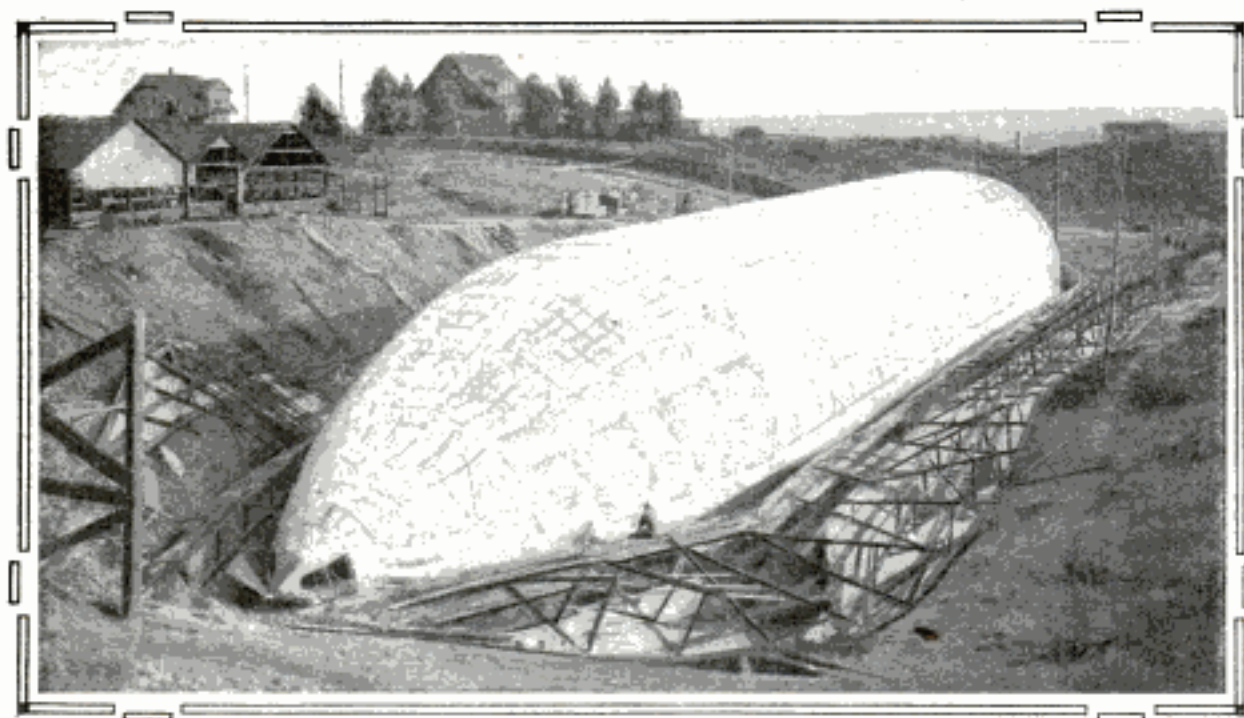

A recent fizzle in American dirigible building. This giant gas bag, which was built at San Diego, Cal., by a promotor with one previous failure of the same sort to his credit, proved not only unsuccessful in an engineering way, but also occasioned some curious legal complications, house dwellers in the neighborhood of the plant declaring the escaping gas to be a nuisance and a menace.

much addicted—apparently under the impression that they are furthering aeronautical research.

The problem of aerial navigation is fundamentally, as the term implies, a problem of *navigation*—of controlled and directed movement from place to place. Only in an incidental way is it a problem of sustentation, and to solve the problem of sustentation, difficult though it has proved, is not of itself a solution of the problem of navigating definite courses against adverse winds, at sufficient speeds to admit of practical and reasonably dependable travel.

than the average movement of the earth's atmosphere in the form of winds, such speed and control being absolutely essential prerequisites to any real navigation of the air.

Thus the balloon is an evasion rather than a solution of the real problems of aerial navigation. It floats in the air rather than navigates it, much as a soap bubble may float for a time, and, in reality, is no more a flying machine than a cork in the sea is an ocean liner.

As one authority, writing in a well-known flight magazine, said recently,

"We have been experimenting with dirigibles for years, and . . . the sum total of success achieved is not a tithe of that attained in the case of the heavier-than-air type in as many months." Another European expert says that Germany "has to thank her dirigibles for her backward position in aviation, but . . . she has freely and frankly confessed her mistake in pinning her faith to the illusive gas bag."

The fact that numerous flights, so-called, have been made with dirigible balloons, and that many of these flights have been widely heralded as being practical instead of merely spectacular, is completely discounted by the further fact that the successes have been, without exception, achieved in almost perfectly calm weather. In all other cases the result has been complete failure to travel in the intended direction.

The circuitous thousand-mile drift of the recent "transatlantic" Wellman dirigible, over the Atlantic Ocean, is a typical case in point, and instead of being in any way to the credit of the dirigible, as a trip of that distance, constitutes as conclusive proof as could be sought of the completeness with which these gas bags are at the mercy of every wind that blows.



The French army dirigible "Republique" in incipient collapse because of the deflation of the interior ballonets which maintain tautness of the envelope by having air pumped constantly into them.

In the course of similar "balloony," as these perennial trans-oceanic fiascos have been classed, there is a remote possibility that some fortuitous combination of a good gas bag with a bad chance, may at last result in one of these exploits being crowned by a sufficiently long drift in the right direction—a contingency, however, rather more likely to be realized with a good motorless spherical balloon, several of which have already drifted across country to distances substantially equal to the narrowest dimension of the Atlantic Ocean. Then the problem of aerial navigation will be solved—in the daily newspapers.

Similarly, in the case of the great dirigibles of Count Zeppelin—which unquestionably are far in advance of other constructions of the same general character, and thus constitute a fair measure of the maximum practicability of the dirigible—the much-exploited and sensational "passenger-carrying" trips of these great balloons, in Germany, have not only been conducted in calm weather, but in addition to this have been attended by most frequent accidents and disasters in landing. Fortunately, these have happened to be without loss of life in most cases, but the property loss in the way of destruction to the giant aircraft has been prodigious. One expert has estimated that there is an

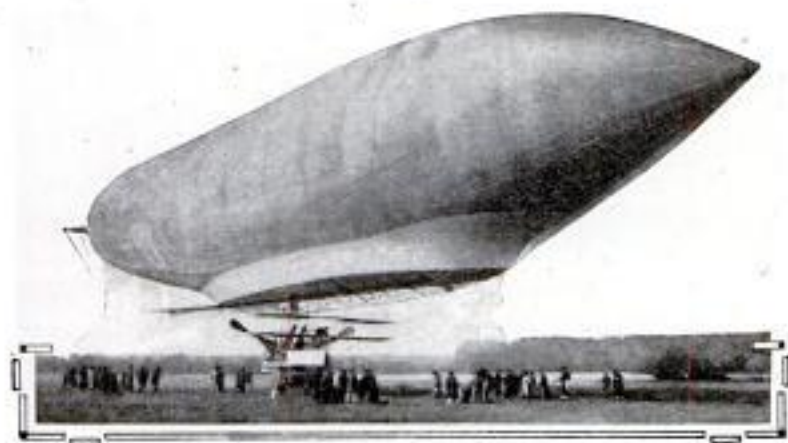

The ill-fated French military dirigible "Republique," which on September 25, 1909, was exploded at a height of 500 ft. by a broken propeller blade, with its consequent complete destruction and loss of the lives of the four French officers who were piloting it.

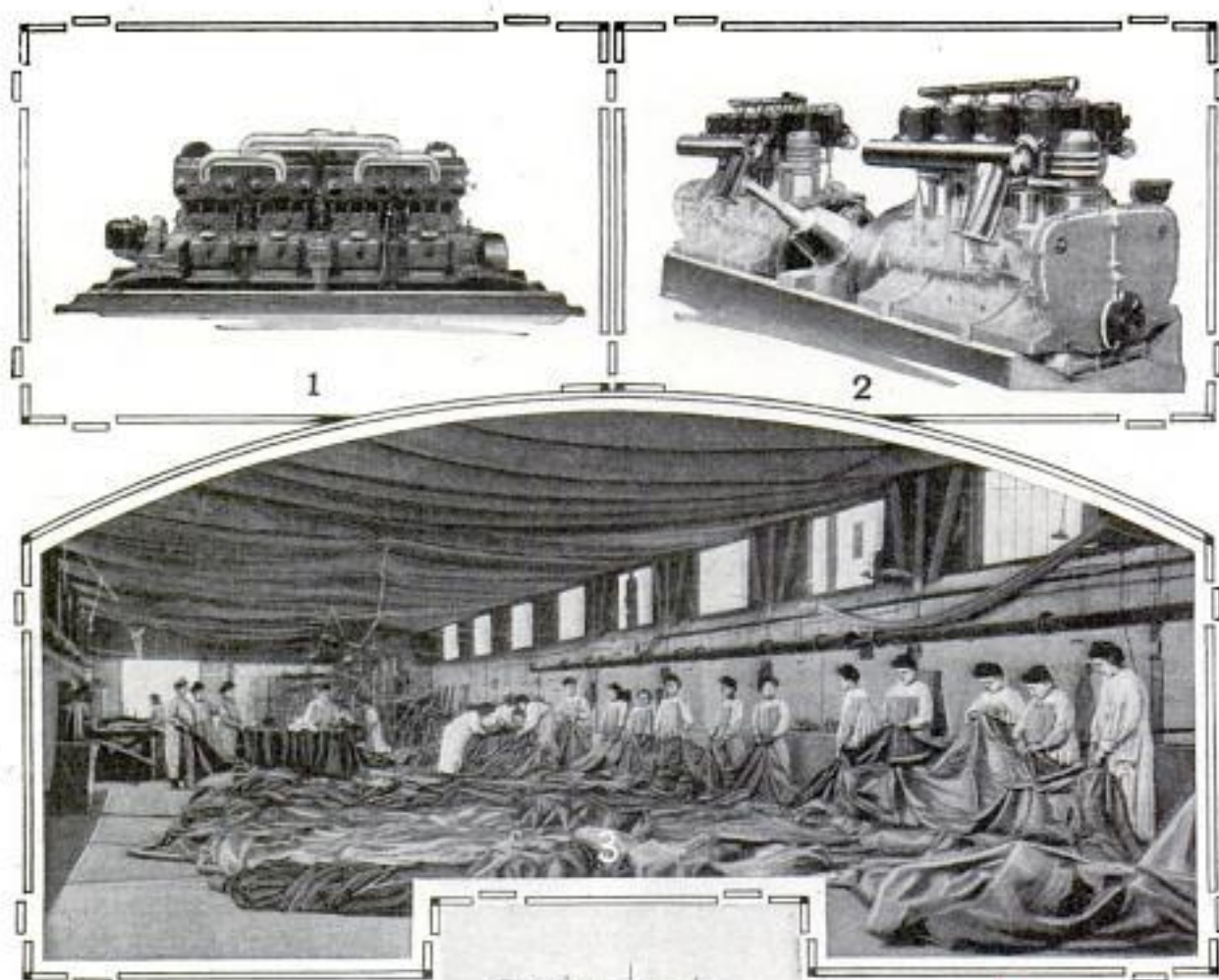

WHERE SOME OF

The two engines shown—1 and 2—one of 100 hp. and the other of 180 hp., are of expensively made, light-weight types that cost \$30,000 and \$40,000 apiece to build.

3. Working on the envelope of a French balloon. This picture well shows the vast size of the modern dirigible, and suggests the amount of labor expended on what, after all, is one of the most simple and least expensive elements in the whole apparatus.

THE MONEY GOES

4. Another source of expense. A characteristic example of the type of balloon shed necessary for housing an army dirigible. Some of these sheds are as large and cost as much as a great modern world's-fair building or convention hall, and vast sums are expended for the labor required to set them up and dismantle them in the course of the military maneuvers of the European armies.

average of \$10,000 of damage done to the Zeppelin balloons in each three out of every five of the landings they make.

The effect of size on balloon design is a subject that has been befuddled with much misunderstanding. The common assertion that doubling the dimensions of a balloon cubes its capacity, while only squaring the areas of the surfaces, is, of course, true. But it does not follow from this that the lifting capacity increases faster than the weight with increase in size, for to

maintain a proportionate strength it is necessary to increase the thickness of the surface material and the weight of the internal bracing, with each added increment of size.

Insurmountable objections to the balloon are its inescapably enormous volume and its consequent strict limitation in weight of structure. To ascend, a balloon must be lighter than the volume of air it displaces. And, the weight of a given volume of air being fixed, there is no possible discovery or invention that can open a way of es-

cape from this inexorable factor of the problem. The only substances that even approach air in lightness being also gases, the design of no conceivable lighter-than-air machine can escape the necessity for two essential elements—space occupied by a gas lighter than air, and a stout envelope of heavier-than-air material to contain the gas. To the weight of these primary essentials must be added the further weight of structure necessary to afford passenger or cargo accommodation.

Since a sphere of air 30 ft. in diameter weighs about 1,000 lb., while a similar sphere of hydrogen, the lightest known gas, weighs only 70 lb., it is evident that the unlikely discovery of a gas lighter than hydrogen can be of no great benefit, for even should it become feasible to encase a vacuum of the requisite size, as some enthusiasts have hoped, this could add to the sustentation only to the extent of the eliminated 70 lb. of hydrogen. From all of which it follows that the best of balloons must be hopelessly bulky and fearfully flimsy, and of only the very smallest lifting capacities in proportion to their sizes.

Provided with motors and propelling means, they not only oppose the resistance of enormous areas to rapid motion, but also prove of such fragility that their structure must inevitably collapse under the heavy stresses, should sufficient power ever become

available—as is not unlikely—to drive them greatly faster than their present maximums of 25 or 30 miles an hour.

In this connection, however, another comparison between the balloon and the aeroplane, relating to the matter of power, is most interesting. An average aeroplane, weighing 1,000 lb., will oppose not more than 25 sq. ft. of projected area to its movement through the air. A balloon of similar lifting capacity, if made spherical, will oppose over 700 sq. ft. to movement through the air—28 times as much area as the aeroplane of the same weight.

Even by compacting this necessary bulk into the most approved elongated dirigible form, the cross-sectional area cannot be reduced below a minimum that is still at least six or seven times as great as the area of the equivalent aeroplane. And, since it is area opposed to movement through the air that measures the quantity of horsepower required, it follows that to propel a dirigible against the minimum resistances of its cross section, must forever require much greater power than is required for both the sustentation

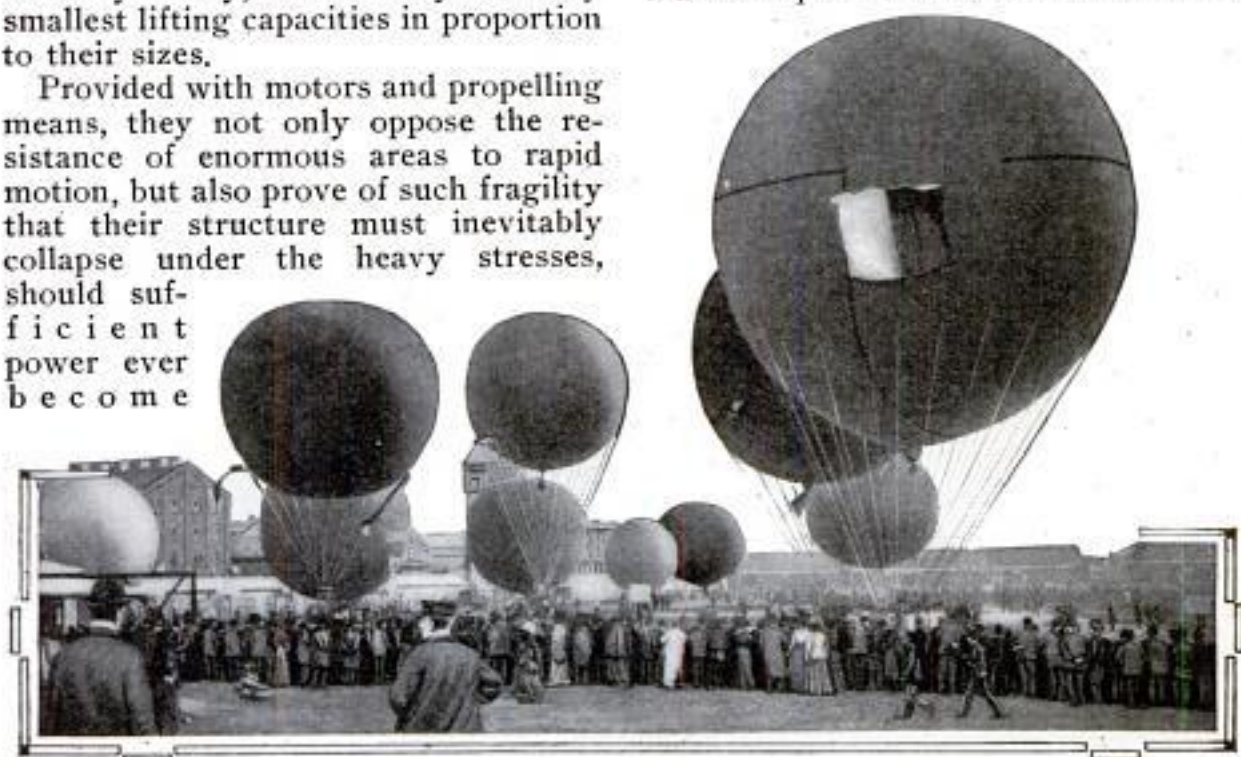

The fad aspect of ballooning. The start of a recent Gordon-Bennett balloon race. In this sport it has become quite the fashion for millionaires to engage, under the impression that they are furthering the cause of aviation, though, as a matter of fact, their expenditure of several thousand dollars each for spherical balloons, and subsequent cross-country drifting with whatever winds may blow, bears about as little relation to aero-navigation as drifting on a raft would to crossing the ocean in a modern liner.

and propulsion of an aeroplane of equivalent loading.

Incidentally, it is to be remarked that all changes from a spherical form, as in realizing or approximating the elongated form of the dirigible, involve special means for staying the structure, in addition to which they add greatly to the area of the envelope required for a given volume of gas enclosed. The problem of weight and structural security are thus greatly complicated.

The most elementary type of balloon is the spherical balloon, designed for mere ascension and flotation in the air, with no attempt at navigation in a lateral direction except as such movement may result from wind.

The invention of the spherical balloon, according to some authorities, is properly to be credited to the Chinese, who, according to the writings of a French missionary, sent up a balloon in celebration of the coronation of a Chinese emperor, in 1306 A. D.

The first European appreciation of the principle by which a balloon is made to ascend appears to have been due to a Jesuit, Francis Lana, who in 1670 proposed an airship sustained by four hollow copper vacuum balls, each 25 ft. in diameter. In 1776, Dr. Black, of Edinburgh, made a small balloon that proved to be too heavy for sustentation by the hydrogen it contained, but a few years later Tiberius Cavallo succeeded in inflating soap bubbles with

hydrogen, with the result that they floated upward until they burst.

The balloon that is commonly credited with being the first was invented by Stephen and Joseph Montgolfier, and sent up from Annonay, France, on June 5, 1783. This balloon was of paper, about 30 ft. in diameter, and was inflated with heated air, affording an ascensional force of probably 500 lb.



The original balloon. An exact copy, shown at a recent French exposition, of the original Montgolfier balloon, which was sent up from Annonay, France, without passengers, on June 5, 1783. Since 1784, in which year all of the essential details of the balloon were devised—coated-silk fabric, gas valve in the top, sand ballast, the rip cord, netting-supported basket, etc.—there has been no development of fundamental importance.

Soon after, on August 27, 1783, a hydrogen balloon was sent up from Paris. On September 19, 1783, the brothers Montgolfier sent up a balloon to which a small car was attached, in which were placed a sheep, a cock, and a duck, which thus had thrust upon them the distinction of being the first balloonists. The descent

occurred eight minutes after the start, and the sheep and duck were uninjured. The cock had not fared so well and his condition was gravely attributed by the scientists present to the

effects of the thin atmosphere of the upper regions. More recent diagnosis, however, has suggested that he was trampled upon by the sheep.

The first ascent of a man-carrying balloon was ventured by Pilatre de Rozier, who went up to a very moderate

height in a captive balloon, built by the Montgolfiers, on October 15, 1783. Following this, on November 21, 1783, de Rozier and the Marquis d'Arlandes made the first free-balloon ascension,



The first attempt at a dirigible. The car of the balloon used by Blanchard and Jeffries, in their crossing of the English Channel on January 7, 1785, in a favoring wind. It was attempted to propel this balloon by the use of large fan-like oars but this expedient naturally proved a complete failure, and the wind became the sole means of propulsion.



from Paris, accomplishing a safe descent in a field 5 miles away after about 20 minutes of drifting, at a height of 500 ft.

Since the foregoing, thousands of other balloon ascensions have been made all the world over. In the course of these, some utility has developed in the way of military and meteorological observations, but the early and unavailing attempts to navigate definite courses from one point to another, either in calm weather or independent of the direction of the wind, have not been materially improved upon by the most recent efforts, aided by every resource of modern engineering. Indeed, as one wag has put it, the sole result has been the division of balloons into two classes, "non-dirigibles and near-dirigibles."

The first obvious line of improvement in the quest for dirigibility was the reduction of the head resistances, as has been already explained. This is the ideal held in view in the many cylindrical, cigar-shaped, and other elongated and pointed gas bags with which the modern student of this subject is familiar.

Dirigible balloons have been developed in three principal types—the rigid, the semi-rigid, and the non-rigid. Of the first of these, the Zeppelin was the original and still remains the most conspicuous example. In it the whole device is given its form by a maze of internal structure, partitioned into compartments within which the gas is confined in a plurality of small fabric reservoirs.

The semi-rigid type of dirigible, of which the French army has been the chief sponsor, involves a

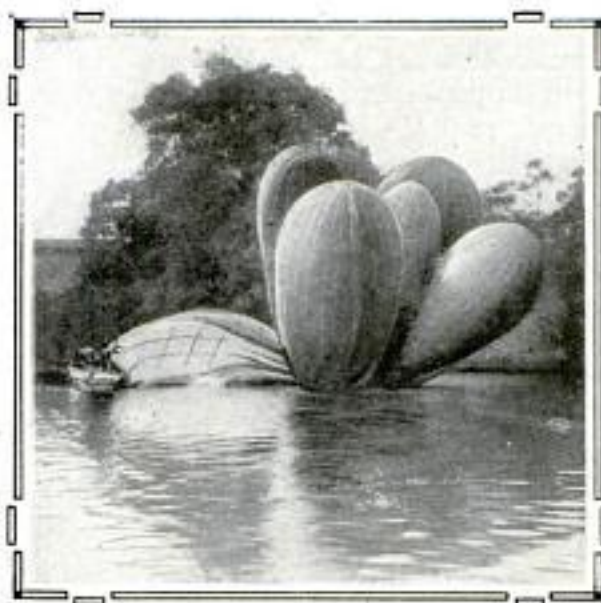

The wreckage in the Seine of the gigantic military dirigible recently built by the Clement-Bayard concern in France. This accident, like many other dirigible accidents, occurred without loss of life but with tremendous destruction of valuable property.

pointed gas bag, not internally braced, and kept in shape by being stayed by netting and numerous ropes to a long truss-like girder beneath it.

The non-rigid balloon is simply a bag kept in shape by its form and the pressure of the gas within it, so it is naturally subject to all sorts of failures to maintain its proper form.

A particular example of the sorry

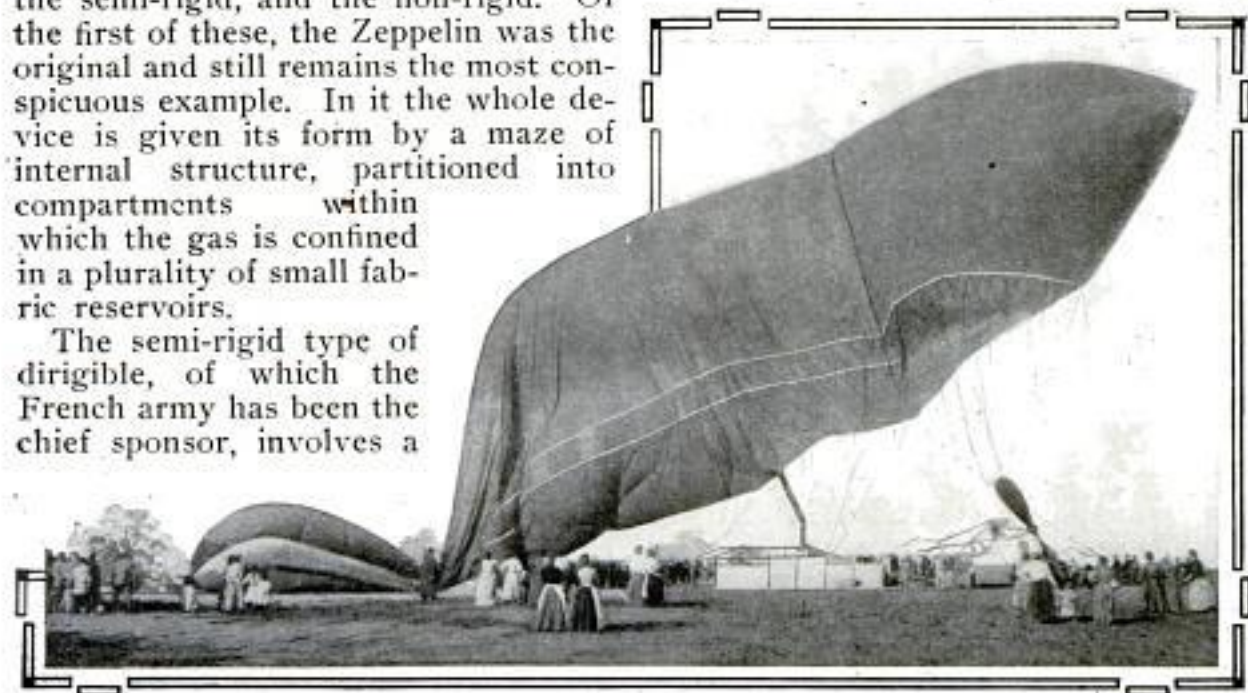

The dirigible "Espana," showing the destructive results of a modern landing. A dirigible of this type costs about \$100,000.

and expensive experiences various governments have had with the dirigible-balloon problem is the German government's recent dismissal of the Zeppelin proposition in favor of the aeroplane, for which an army appropriation of some \$5,000,000 has been made for the coming year.

Another case is that of the English navy dirigible, aptly dubbed "Mayfly," which recently broke in two and capsized at a total loss of \$400,000, the first time it was taken out of the floating shed that housed it.

Further condemnation of the dirigible is found in the fact that most of the ablest engineers who have given attention to its problems—Santos Dumont, Renard, and Ferber, for conspicuous examples—and who have expended vast sums upon its development, with resulting successes that will rank with any, have finally deserted the balloon as hopeless, and turned their attention to the aeroplane.

In the matter of propulsion, experiments commenced with the hand-manipulated cars and sails of early investigators and developed down to the engines and propellers of modern dirigibles. So far, however, all successes achieved with dirigible balloons have been more spectacular than practical, and despite the roseate imaginings of popular writers, there is little technical reason for expecting that results of more serious value are in any prospect of attainment.

Even admitting the possibility of an exceedingly limited and precarious utility for the dirigible in warfare, in the opinion of those best qualified to judge, it is most unlikely ever to assume the least importance as a means of travel, and can have no future be-

yond such as is too often founded upon the activities of ignorant inventors or unscrupulous promoters, or upon the thrills a great dirigible undoubtedly affords as a Gargantuan spectacle.

The cost of gas for each filling of a large balloon is alone enough to place it out of the question for performing commercial travel at reasonable cost. Not less than a thousand dollars worth of hydrogen on the basis of the most economical production possible, is required for each inflation of a Zeppelin balloon, which, though 450 ft. long and nearly 50 ft. in diameter, possesses a reserve carrying capacity of only three or four tons. Moreover, with a century of experimenting, no balloon builder as yet has been able to improve materially upon the first envelopes of varnished silk—which still remains the most impermeable material—and at the present time no dirigible balloon has ever succeeded in staying in the air for more than 36 hours.

The conclusion is inevitable, from any competent and unbiased consideration of both the shortcomings and the merits of the balloon, that it can never really compete with the aeroplane as a practical means of traveling in the air. Mere going up in the air is another matter, but for the uses that can be thus served the simpler and cheaper spherical balloon would appear to be in every way superior to the expensive and practically no more useful dirigible.

When it comes to real navigation of the air, to fast, certain, and absolutely controlled travel in any desired direction, nature's model, the bird, is proved by every test of logic and experience to be the only safe pattern for man to follow.

### EXCEPTIONALLY LARGE TRESTLE FILL

An exceptionally large undertaking in railroad-trestle filling is in progress at Sprague Gulch, near Lamont, Wash., on the Spokane, Portland & Seattle Railroad. The wooden trestle across this gulch, built in 1907, is 4,869 ft.

long, with a maximum height from base of rail to surface of water of 101 ft., and an average height of over 75 ft. In planning for the necessary reconstruction of this trestle, it was found that it could be filled at no

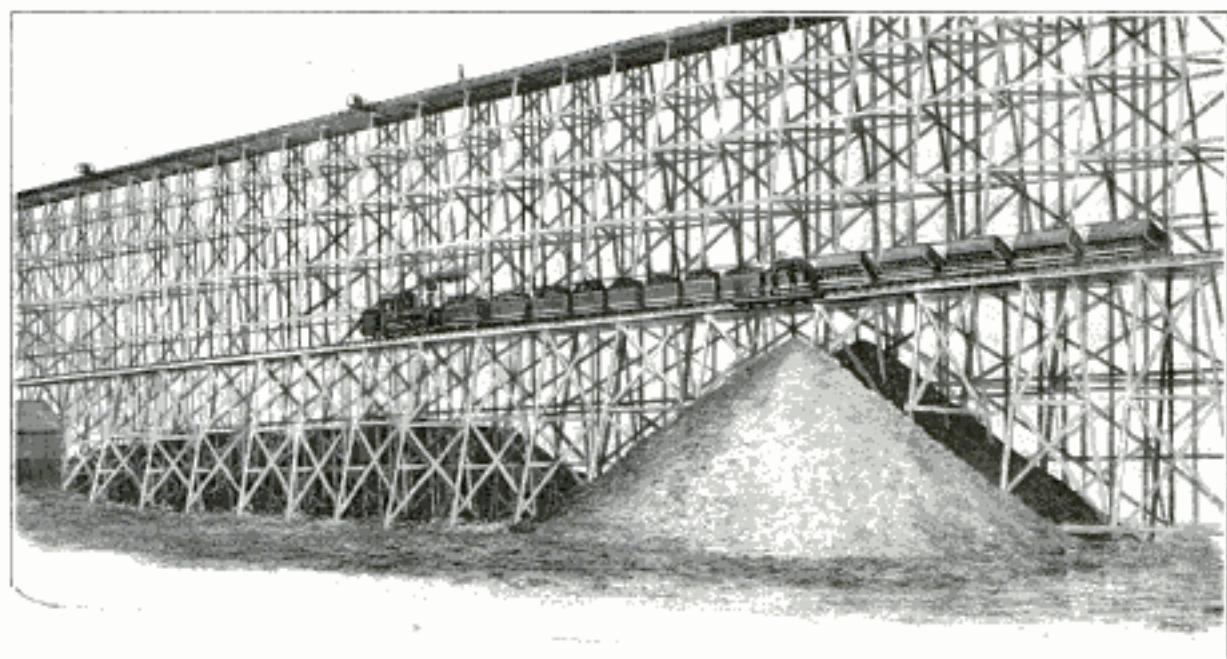

At Work on First Lift, in Filling the Railroad Trestle across Sprague Gulch, Wash.

greater cost than that of building a steel viaduct and the work was started in 1911.

The illustration shows a dirt train being dumped on the first lift, a working trestle being erected close to the main trestle. Working trestles were constructed for the first and second lifts, but in the third lift the contractor will change to standard-gauge equipment and unload from the main line, working under control of the regular railway train dispatcher. The total estimated amount of earth to be handled is 2,350,000 cu. yd.

#### JOINT MEETING OF CLUBS SEVENTY MILES APART

A feat that is said to be without a precedent, was the bringing together of two club meetings, 70 miles apart, so that members of each club could hear every word spoken at the other, recently accomplished by the Buffalo and Rochester (N. Y.) Advertising Men's Clubs.

Each club arranged a meeting to be held at its respective city the same afternoon, and as each guest sat down to luncheon he was equipped with a receiver, like those used by telephone operators, and by the aid of a large transmitter at the end of each room,

everything that was spoken in either club could be heard by the guests in both cities.

A feature of the affair was that the members of the Rochester Advertising Men's Club sang to the music of the orchestra in Buffalo.

#### MOORING DOLPHINS IN PORTSMOUTH HARBOR

The rapid increase in the number of warships that have to be berthed in Portsmouth Harbor, which is Great Britain's chief naval base, has compelled the Admiralty to construct new mooring means. Four concrete dolphins, to which warships and other vessels can be moored, have already been built.

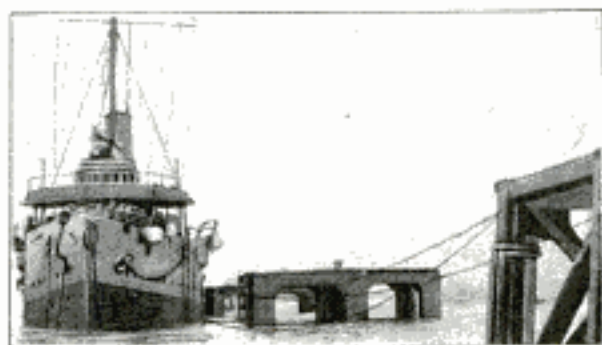

A British Warship Berthed by the Concrete Mooring Dolphins Recently Built in Portsmouth Harbor, Which is England's Chief Naval Base

## SCIENCE AND MECHANICS HELP MAKE DURBAR

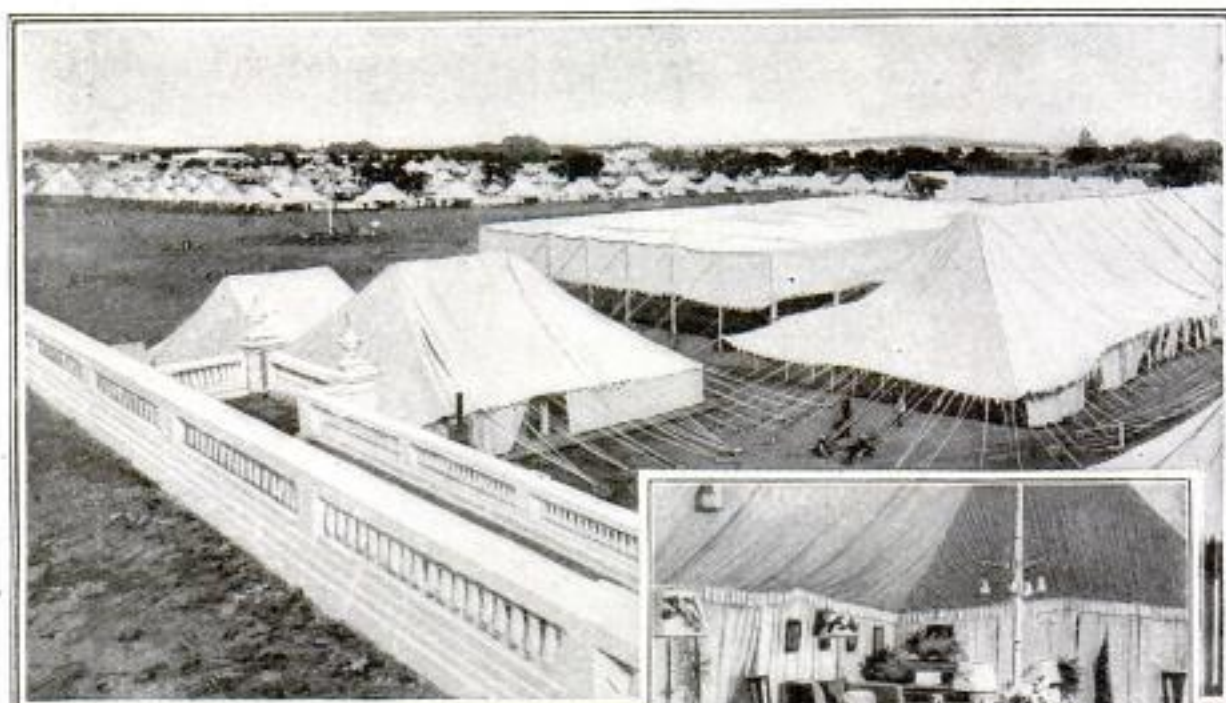

The Royal Palace of Great Britain for the Time Being. Tents Occupied by George V and His Suite at Delhi. The Tents were Lavishly Decorated and Divided into a Number of Large Apartments



The King-Emperor's Work Room in His Delhi Tent-Palace



Their Majesties Showing Themselves to Their Subjects

The most gorgeous spectacle in the history of the world is not a fulsome phrase when applied to a description of the Durbar at Delhi when George V personally received the homage of the people of his Indian empire. Though the ceremony was of an ancient character it was carried out with the aid of the most modern mechanical and scientific appliances, electricity being employed to produce all sorts of

## MOST SPECTACULAR OF MODERN CEREMONIALS

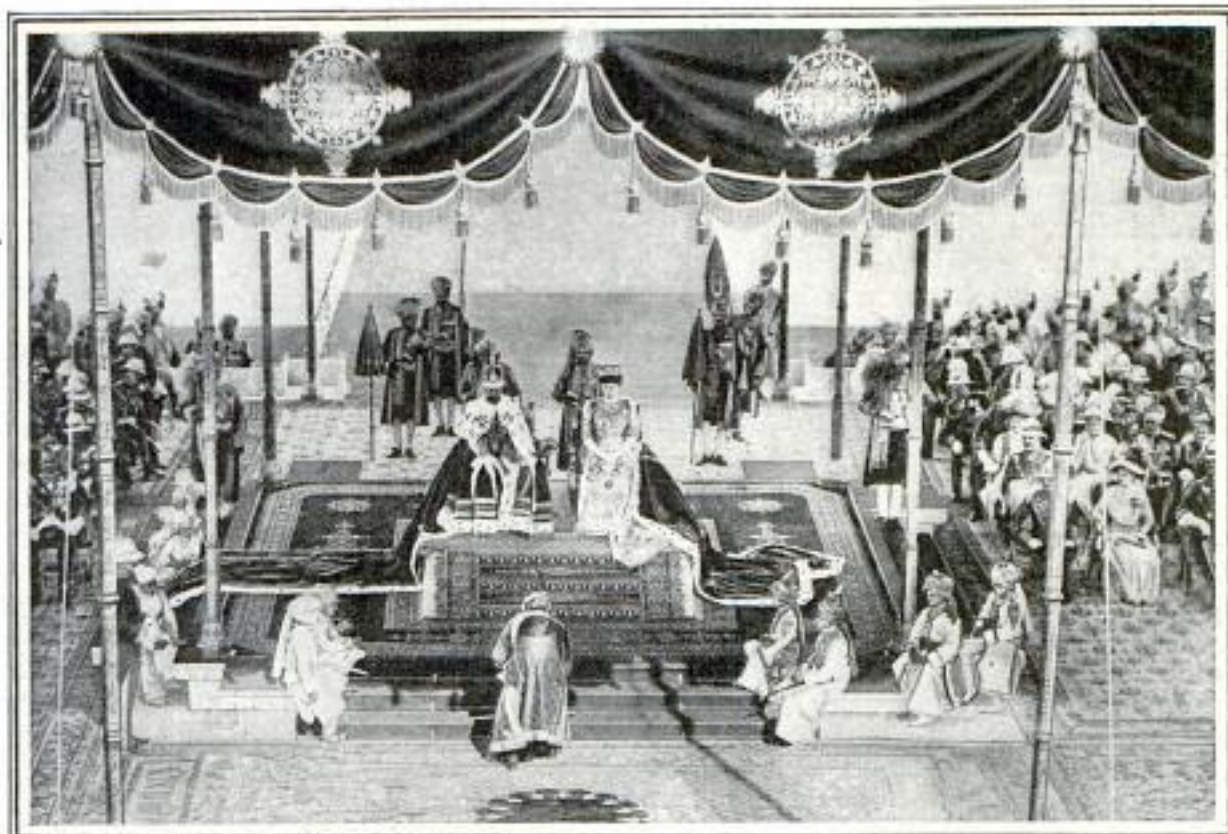

Princes and Potentates of the Indian States Paying Formal Homage to George V and His Queen during the Durbar Ceremonies

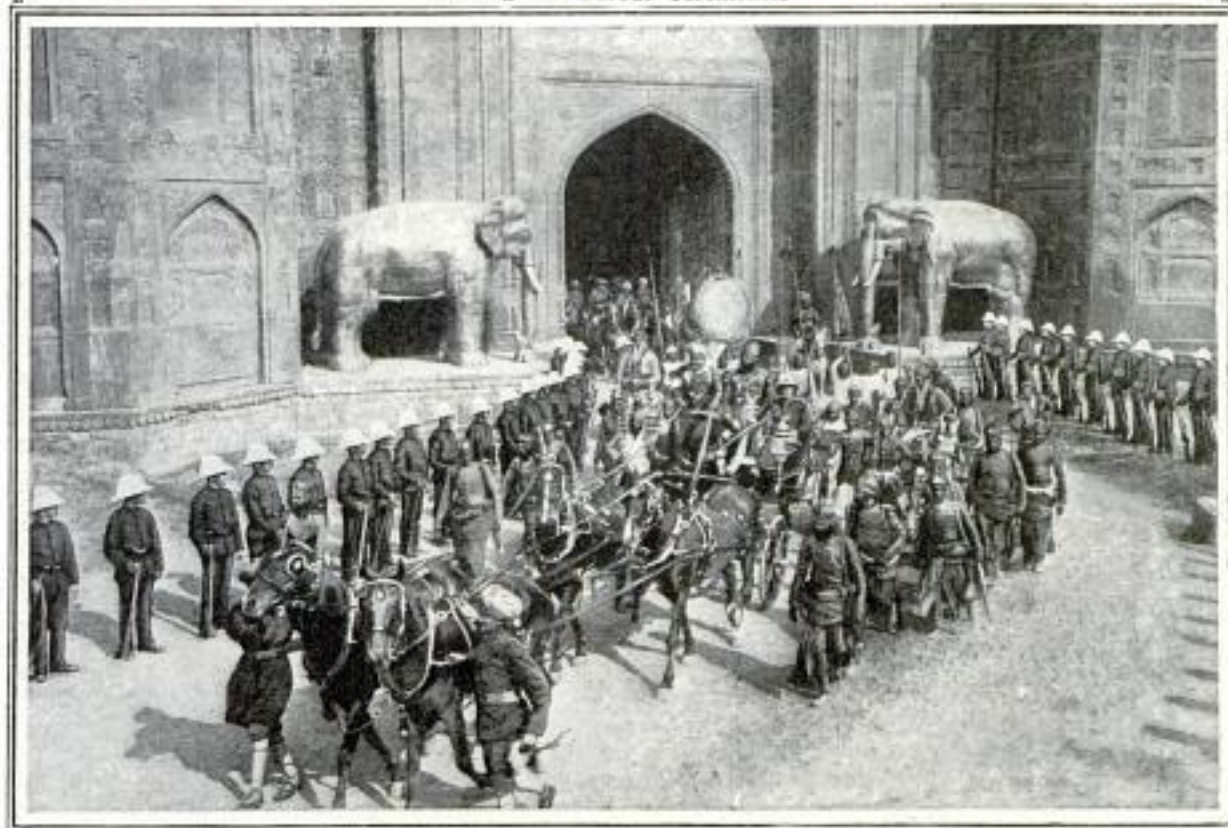

State Entry to Delhi through the Ancient King's Gate

brilliant lighting effects as well as to insure the comfort of their majesties in the tented city where they made their homes during their stay at Delhi. The permanent record of the festival to be filed in the government archives will include a complete set of moving pictures of the various ceremonies as well as a written narrative. The festivities cost the government millions of dollars.

## STREAMLINE FORMS APPEAR AT PARIS EXHIBIT

To the uniformed skeptics, who, because of their remoteness from the *locale* of the most important progress, still fail to realize that aviation has developed from a scientific investigation into a commercial fact, a glimpse into the recent great exhibition of the French aeroplane manufacturers, held in the largest exposition hall in Europe, the Grand Palais, in Paris, would have seemed like a translation into another world.

More overwhelming confusion for the doubter could scarce be imagined. Staged under the dome and in the wings of the great glass and steel edifice were ranged stand after stand of wonderful devices — of steel, wood, and wire, and fabric, fashioned by human ingenuity into cunning semblance of na-

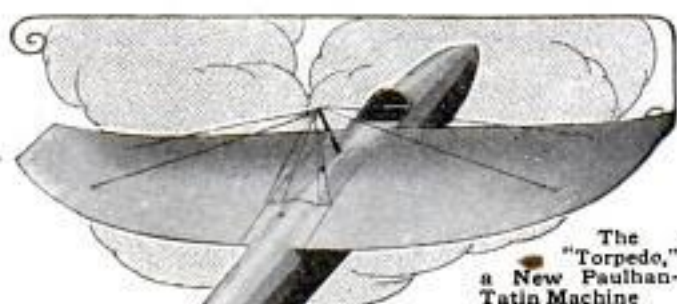

The "Torpedo," a New Paulhan-Tatin Machine

ture's transportation masterpiece, the bird.

With no machine yet as efficient as the bird, the aeroplanes shown were, of course, vastly heavier and much larger than any bird that has ever existed. And although none is yet made as safe and reliable as the bird, there were shown one or two that undoubtedly are faster than any bird.

But, more important than the details of the achievement is the fact of it. For almost all the machines shown were capable of flight, all represent distinct improvement toward some unknown future perfection, and most are even now capable of practical military and commercial use.

Probably the most conspicuous feature of

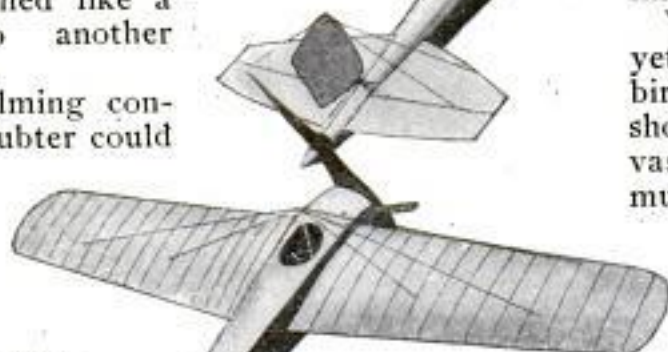

The Latest Nieuport

the bird, there were shown one or two



Farman Biplane

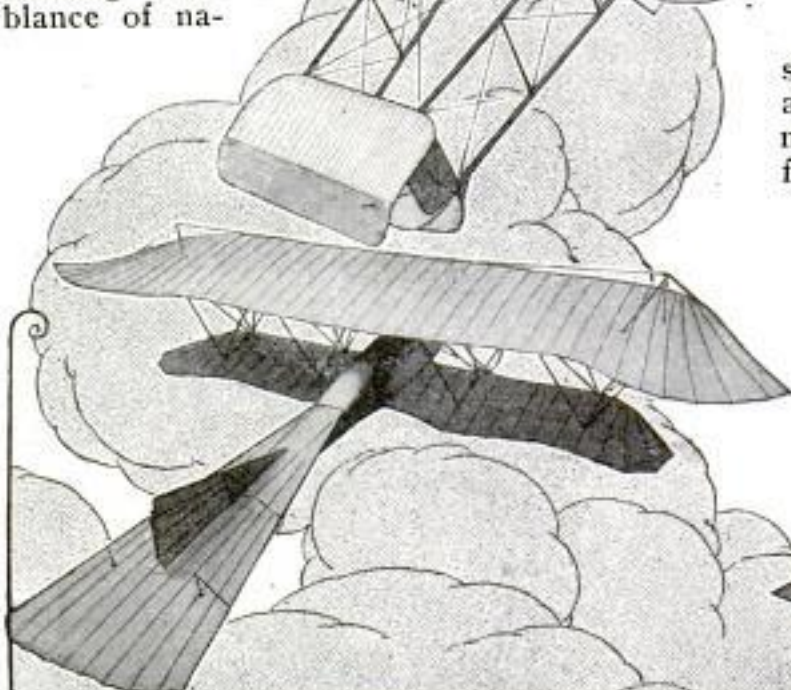

"Albatross," a New German Biplane, on Left, and Morane-Saulnier, Below



## UNIQUE VIEWS OF SOME ADVANCED TYPES SHOWN

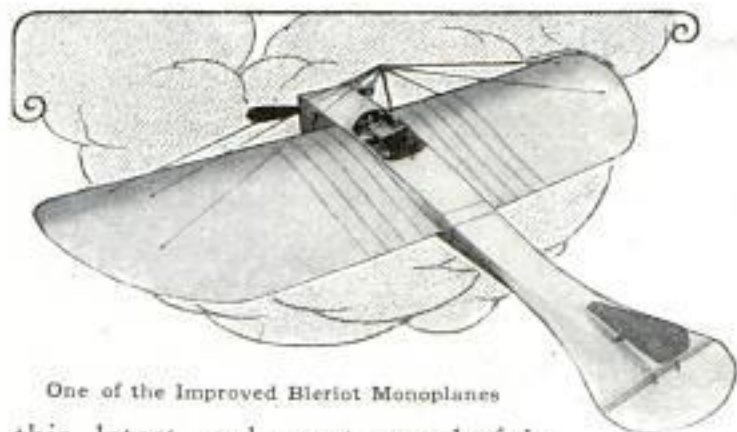

One of the Improved Bleriot Monoplanes

this latest and most wonderful aviation show is the complete disappearance of the freak and the almost total neglect of the dirigible. The helicopters and ornithopters of other years, and the gigantic gas bags were conspicuous by their absence.

In the place of these, there reigned supreme the proved flying machine of today and the developing device of tomorrow—the aeroplane—almost every model in the building being the creation of a far-seeing, technically able, and well-financed concern, seriously and successfully engaged in the commercial exploitation of a new field of engineering, in which great successes have been achieved and in which greater are coming.

Not only were most of the machines shown capable of flight; many of them had actually flown,

Zodiac Biplane on Right

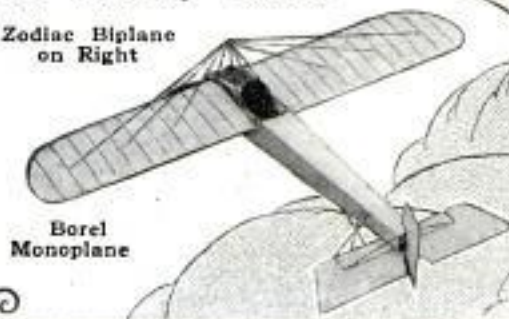

Borel Monoplane

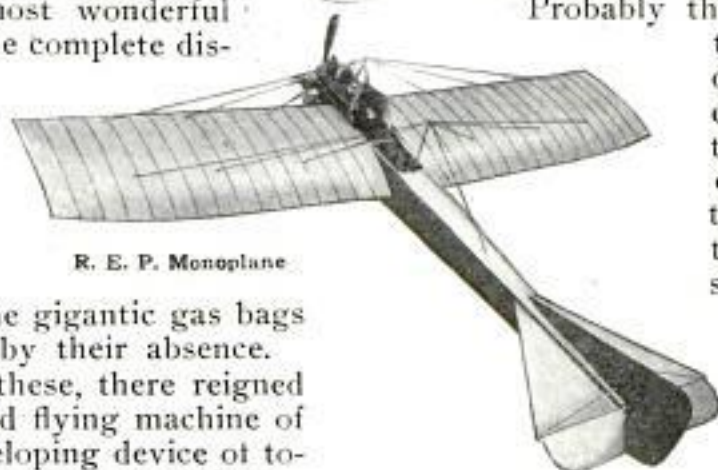

R. E. P. Monoplane

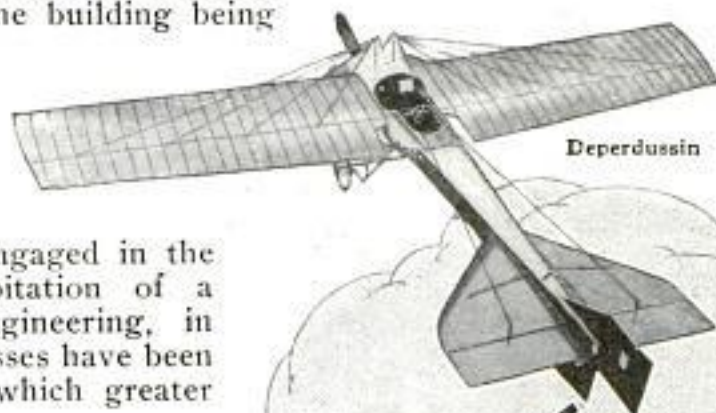

Deperdussin

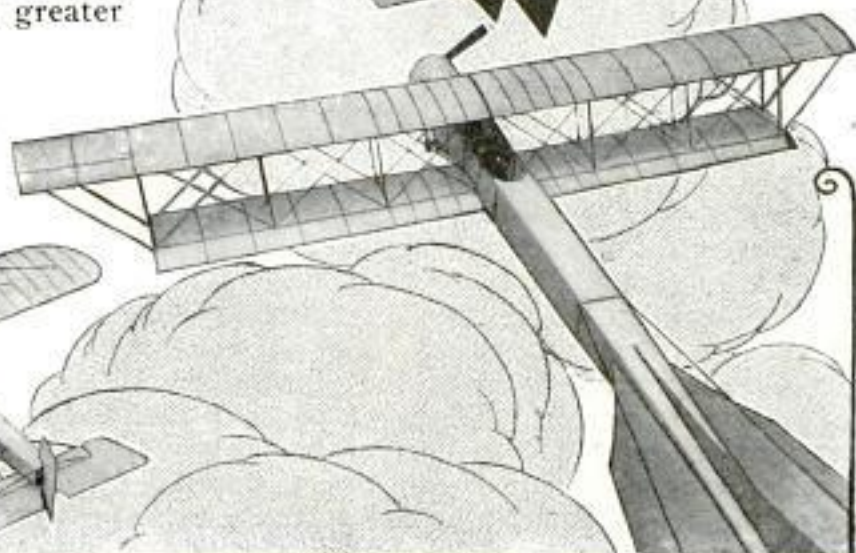

and unfailing centers of interest were the battered and weathered monoplanes and biplanes, which, in contrast with the surrounding newness of clean fabric, varnished wood, and bright metal, bore placards testifying to wonderful cross-country, altitude, and speed flights, performed in the course of various military and other European competitions.

Probably the most important technical development in evidence was the thoroughly emphasized trend toward the use of streamline

forms, as means of reducing the forward resistances of the aeroplane, and therefore the amount of power required for

its propulsion. As suggested in the articles in the December and January issues of Popular Mechanics Magazine, the inherent advantages of the streamline form are so astounding that, as they commence to be appreciated, it is not to be wondered at that there is a stampede towards their realization.

At the French show, however, it was to be noticed that the streamline form has been applied so far chiefly to bodies, despite the fact that its application to wings and other elements is of almost equal importance—in progressing towards the ultimate quality that will rank the man-bird with nature in the important respect of efficiency.

Another important development is the increasing use of metal in place of wood, steel tubing in the alighting gears of the monoplanes, and in the struts and wing bars of the biplane being very common. Less general, but more interesting, are the examples of steel construction applied to body designs and wing elements.

The question of biplane vs. monoplane still remains unsettled, but there is a definite tendency, particularly on the part of the most important manufacturers, to favor the single-surfaced craft. Emphasizing this tendency is a not uncommon disposition on the part of the biplane builders, to lengthen the upper surface very greatly, at the same time so reducing the lower surface that it constitutes little more than a sort of extended underbracing and under member of the fuselage, useful chiefly as a structural element between the alighting gear and the upper surface, and of only incidental use in its contribution to sustentation.

In the way of motors, there are several new revolving motors to compete with the well-known make of this design that has contributed so much to the development of aviation, but the generality of manufacturers seem inclined to pin their faith to the more conservative, heavier, and more conventional engines, adapted from automobile practice, and therefore reasonably capable of more sustained use without stopping or overhauling.

### CAPTURED BATTLE FLAGS MAY BE EXHIBITED

Students of American history, more especially those interested in the navy, are giving much attention to the disposition of the collection of captured battle flags and trophies now slowly decaying in iron chests in the chapel of the Naval Academy at Annapolis. It has been proposed to place these trophies on exhibition by hanging them in the chapel, after the manner of the display of such things in European cathedrals and battle abbeys. It will be necessary to make elaborate repairs of many of the flags, however, and to do this Congress has been asked to appropriate \$30,000 to bear the expense of the delicate operations necessary. The repairs will constitute a complete restoration of the flags, so far as texture is concerned, by reinforcing them with a fine and almost invisible linen mesh. It has been estimated that 1,200 yd. of this mesh will be needed for the work, as there are 150 ensigns and pennants in the collection. The material for the work will cost \$1,500 and the work itself will consist of a series of long, tedious and delicate operations which can only be performed by the most skilled needlewomen.

The trophies include a number of the most interesting relics of American naval warfare. To naval men the most important of them all is the flag of Commodore Perry, which, during the battle of Lake Erie, he carried from his sinking flagship, "Lawrence," to the "Niagara," on which he won the battle. This faded and tattered ensign bears the dying message of Captain Lawrence to his officers, a phrase which has become the motto of the American navy—"Don't Give Up The Ship." The immortal words were uttered during the engagement between the American ship "Chesapeake" and the British vessel "Shannon," June 1, 1813. Lawrence, the commander of the "Chesapeake," fell mortally wounded and with his last breath commanded his successor not to give up the ship. It was for this that Perry's flagship was



## TREASURED TROPHIES OF NAVAL PROWESS

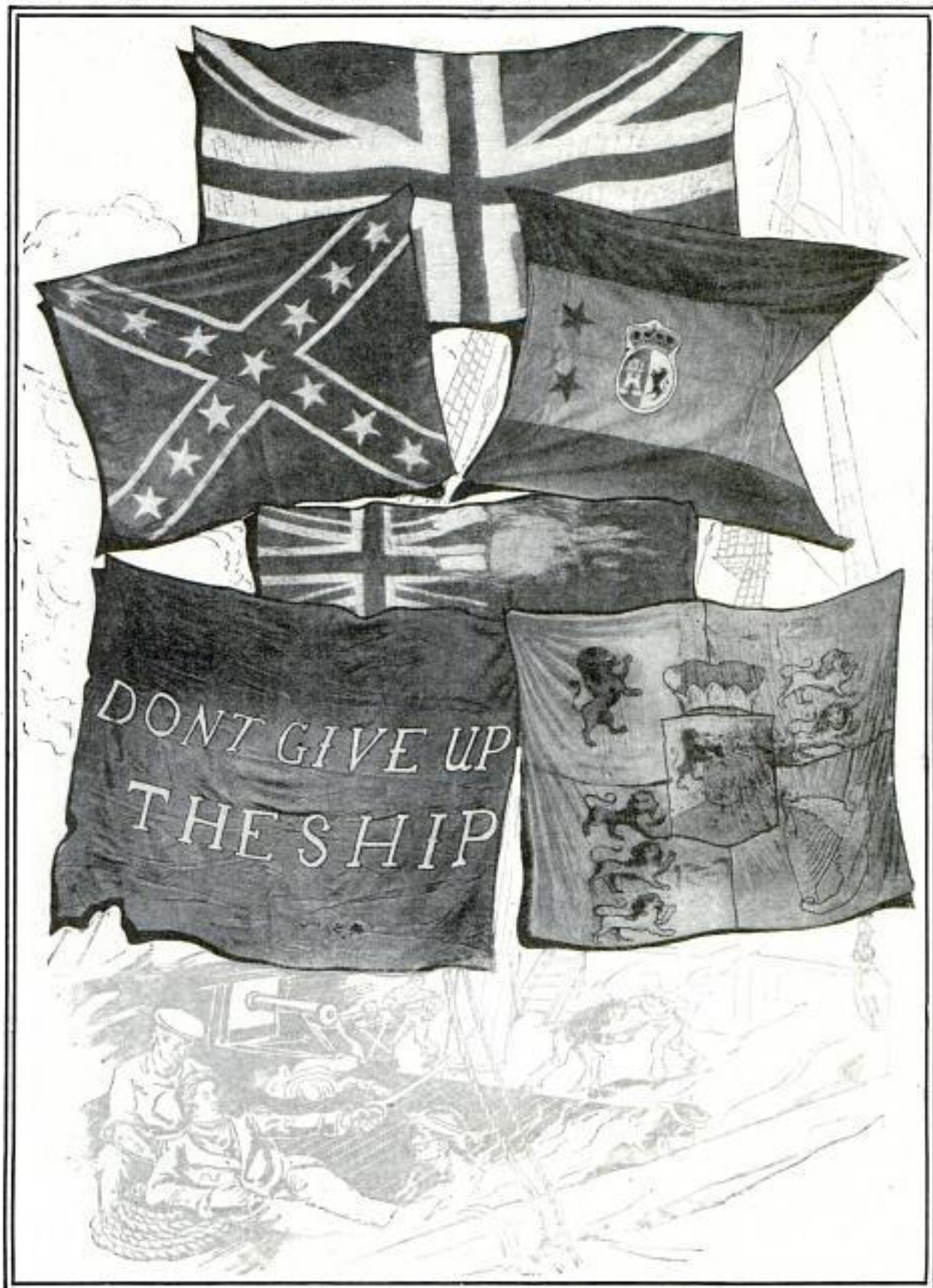

Jack of the British Ship "Guerriere," Captured by Commodore Isaac Hull, Commanding the "Constitution"  
 Ensign of the Confederate Ironclad "Albemarle," Captured by Lieut. W. B. Cushing, U. S. N., Oct. 27, 1864  
 Flag of British Ship "Macedonian" Captured by Commodore Decatur, Commanding "United States," Oct. 25, 1812  
 The Battle Flag of Perry at the Battle of Lake Erie Bearing Lawrence's Dying Words, Now the Motto of the American Navy—"Don't Give Up the Ship"  
 Personal Ensign of Admiral Cervera of the Spanish Navy, Captured July 3, 1898, at Santiago, Cuba  
 The Only British Royal Standard Ever Captured by any Nation. Taken by American Troops at the Capture of York (now Toronto), Canada, April 27, 1813

named the "Lawrence" and his battle flag was a large ensign bearing the never-to-be-forgotten words.

Another interesting relic is the only British royal standard ever captured in battle by any nation. This fell into the hands of the Americans at the capture of the Canadian city of York, April 27, 1813. York is the former name of the city now known as Toronto. Still another trophy is a relic of the battle between the "Constitution" and the "Guerriere," August 19, 1812, and is no less than the flag of the British ship which was captured by Commodore Hull, the American commander. The deeds of Commodore Stephen Decatur are commemorated in a dozen or more trophies of various kinds, one of the most interesting being the ensign of the British ship "Macedonian" captured by him, October 25, 1812, while in command of the frigate "United States."

The flag of the Confederate ship "Albemarle," captured by Lieut. W. B. Cushing, Oct. 27, 1864, which is in the collection, is of more than passing interest because it is not only a trophy captured during a most daring exploit, but also commemorates the first successful use of a torpedo boat. Cushing was the originator of the use of torpedoes fired from special craft, and in this instance he penetrated the enemy's lines in a small boat, to a boom on which was attached a torpedo. He ran his little craft alongside the "Albemarle," launched his boom-torpedo and exploded it, destroying the enemy's ship.

One of the newest and best preserved of all the flags is the personal pennant of Admiral Cervera of the Spanish navy, captured at the battle of Santiago. There are numerous other flags in the collection, each of which has an interesting history.

### FIRST-AID-TO-INJURED PACKAGES IN JARS

In a large factory at Worcester, Mass., having a well equipped medical department to care for injured or

unhealthy employes, the articles required for first aid are kept in air-tight glass jars. Each jar contains three bandages of different widths, one package of gauze pads, three finger splints, one rubber tourniquet, one measuring glass and a bottle of aromatic spirits of ammonia.

Labels containing general directions for use are pasted on the outside of each jar, and a card of first-aid instruction is posted



in each department. Every foreman in the factory is provided with a jar, and is given special instruction. Once a week all the foremen are called together and given a 30-minute lecture upon treatment of victims of accidents which occur most frequently. These lectures are illustrated by blackboard and practical demonstrations, such as putting on bandages, splints, etc.

### EAR-PHONES FOR THE DEAF

A device, designed to improve the hearing of the deaf, recently shown before the French Academy of Sciences, is of particular interest because of its diminutive size. It comprises a microphone transmitter and receiver joined by a tube, and is so small that the whole can be easily introduced into the auditory canal of the ear and be worn there without discomfort. Two sets are provided, one for each ear, and the necessary electric current is supplied by a dry cell, which may be carried in a vest pocket.

## "PULMOTOR" SAVES SEVEN LIVES IN CHICAGO

A German resuscitation machine, called the "pulmotor" because it is designed to induce pulmonary action shortly after breathing has been stopped by unnatural interference, was recently added to the emergency equipment of the Commonwealth Edison Company of Chicago. It was the first of these machines brought to Chicago, but it will not be the last, for in the month of January alone it was successfully used in resuscitating seven persons who were apparently dead from gas asphyxiation.

The first test given the machine was in the case of a retired lawyer, 65 years old, who was found apparently lifeless from asphyxiation in his home. In less than half an hour he was restored to consciousness.

The success of the first local test of the machine resulted in an offer of the Commonwealth Edison Company to allow the city the free use of the machine. This offer was accepted, and a few days later two women and a little girl, overcome by gas escaping from a gas range and apparently beyond hope of recovery, were all saved from death. A week later it was called into service again, and this time saved the lives of a man, woman, and child found unconscious by a policeman who was attracted to their home by the fumes of escaping gas.

The remarkable success of the "pulmotor" in Chicago, however, is not

the first demonstration in America of its efficiency. It has also been used successfully in the East, and a number of the machines were required last year by the government for use in connection with the mine-rescue service. Several months ago it was described in this magazine in connection with mine-rescue work, but its late successes warrant a further and more detailed description.



The "Pulmotor" in Operation, Causing Mechanical Respiration Which is a Perfect Imitation of Natural Breathing

The apparatus is carried in a case as easily handled as an ordinary dress-suit case. The tank, which is an iron cylinder, 21 in. long by 3½ in. in diameter, contains oxygen at a pressure of about 2,800 lb. when completely filled. This gas, which is life-sustaining when taken into the lungs, also fur-

nishes the energy required to reproduce the action of natural breathing. The oxygen flows first through a reducing valve, which maintains at the outlet a pressure of about 75 lb., and from there to the controlling valve. This controlling valve, which is connected to the metallic face cap by means of rubber tubes, provides, initially, a free passage to the lungs, but when the pressure of oxygen in the lungs reaches a certain value, about normal, a bellows, interconnected with the lung cavity through the rubber tubes, actuates the controlling valve in a manner that reverses the action. That is, the pressure of the oxygen

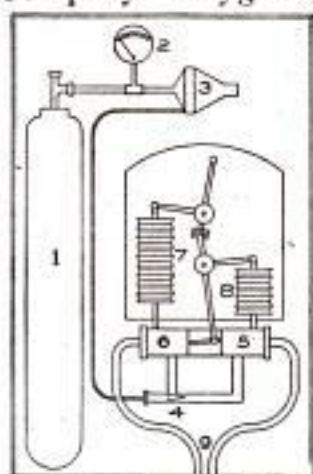

This Drawing Shows the Working of the Machine: 1, Oxygen Tank; 2, Pressure Gauge; 3, Reducing Valve; 4, Inspirator; 5 and 6, Inlet and Outlet Slides of Controlling Valve; 7, Operating Bellows; 8, Dashpot Bellows; 9, Flexible Tubing; 10, Face Cap

is now directed so as to create a suction, thereby causing exhalation of the oxygen previously forced into the lungs.

Then, when a certain vacuum is reached in the lungs and bellows, the outer atmosphere acts upon the latter, which in turn operates the controlling valve and again admits the oxygen to the lungs. The frequency of the inhalation and exhalation, which is thus mechanically made to imitate natural breathing, depends upon the size of the lung cavity, a large space requiring longer time, while with

small lung cavities the operation is correspondingly more frequent. The mechanical inhalation and exhalation is continued until the patient shows signs of the return of natural respiration, then the action of the apparatus is discontinued and the patient allowed to breathe the pure oxygen through another small face cap connected by a hose directly to the oxygen tank. The face cap used during the early stage of the operation is provided with a device by means of which the patient's tongue is kept from obstructing the pharynx.

### ITALIANS MAKE BOMBS WHILE FLYING

The airmen of the Italian military aeroplanes, which have been dropping bombs into the ranks of the Turks, do



Courtesy Illustrated London News

Dropping Bombs into the Ranks of the Turks from an Italian Military Aeroplane

not start flight with the bombs loaded, lest the machines should come to earth heavily and thus cause disaster. Instead, the officer whose duty it is to drop bombs while his companion op-

rates the aeroplane, fills each bomb as he requires it, holding the bomb case or shell between his knees and the screw-cap between his teeth, pouring the ingredients in as best he can. The bombs used are about the size of an orange.

### MOTOR CAR CROSSES LAKE ERIE ON ICE

The automobile has conquered Lake Erie, not very far from where Commodore Perry achieved his famous victory almost a century ago. In fact the track of the automobile across the lake undoubtedly intercepted the paths of the "Lawrence" or the "Niagara" during the great conflict. A party of venturesome motorists are responsible for the conquest of the lake by a motor-driven wheeled vehicle. They set out from Catawba Island to make a trip over the ice to Put-in-Bay, O. On arrival at their original destination they were tempted by the great stretch of comparatively smooth ice to continue their journey all the way across the lake to Canada. Despite a driving snowstorm, the party, consisting of five men, made the trip. At times they were in imminent peril through broken ice and huge cracks, and it is estimated that the journey to Leamington, Canada, where they finally struck the northern shore, and back to Catawba Island, was between 125 and 150 miles

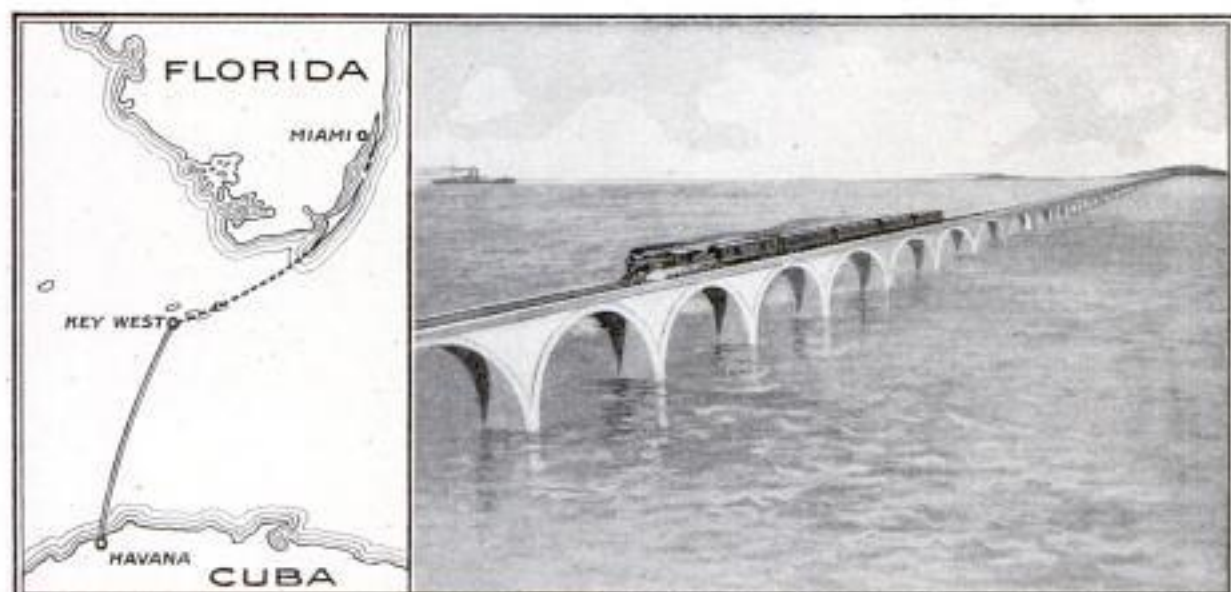

The Dotted Line Shows the Route of the Over-Sea Railroad to Key West, and the Lines Indicate the Route of the Car Ferries Which will Carry Through Trains to Cuba.—A Stretch of Concrete Viaduct over Open Water

long, although the lake at this point is just about 35 miles wide. The automobile was compelled to make wide detours to avoid ice hills and huge cracks. At one point where a fissure and a stretch of bad ice were encountered, boards were placed across the crack and the machine ran across on this improvised bridge. Part of the time the snow was so thick it was impossible to see 100 ft. ahead.

### KEY WEST OVER-SEA RAILWAY OPENED

The Key West or over-sea extension of the Florida East Coast R. R., of which considerable has been published in this magazine during the past four or five years, was formally opened on Jan. 22. Key West is built on the last of the low coral reefs which curve around the lower end of Florida, extending far out into the waters of the Gulf of Mexico. The distance from Miami, which is on the east coast of Florida, at the northern end of the string of keys, is 150 miles, and the nearest Florida mainland, not following the keys, but directly across the water, is Cape Sable, 60 miles distant.

The story of the building of this railroad over the sea is one of the most remarkable and interesting in the railroad history of the world, but much

has already been said of it. It is sufficient to restate that the line extends out, over the keys and the water between them, a distance of 128 miles from solid land. About 75 miles of the extension is over water.

### CURTISS PATENT AGAINST WRIGHT MONOPOLY

Seemingly very much of a slap at the Wright claims to a monopoly of the air in the United States was the recent granting of a United States patent to Glen H. Curtiss, very completely covering his "lateral balancing rudders"—the type of separated ailerons long used on the Curtiss machines.

Since the Wrights have strongly contended that such ailerons constitute "lateral marginal portions" within the meaning of their patent claims, and therefore constitute an infringement upon their construction, the fact that the Patent Office has seen fit to grant a patent on the Curtiss application is most significant, and apparently goes a long way to uphold the views of those who regard the Wright patent as of little value.

AN incombustible motion-picture film has been demonstrated before the Berlin Chemical Society and is reported to be a complete success.



Photograph by Edwin Levick, N. Y.  
Raising Stars and Stripes on S. S. "Finland"

### BELGIAN LINERS NOW FLY AMERICAN FLAG

Impressive ceremonies were held aboard the Red Star liners "Kroonland" and "Finland" recently, incident to the raising of the American flag on these vessels in token of their transfer from the Belgian to the United States shipping register. The crew of each of the vessels were assembled on the quarter deck and the band played the national anthem. A brief prayer was offered after the flag was raised. The photograph shows the crew of the "Finland," Capt. Thos. G. Barnum in the center, saluting the Stars and Stripes.

The United States armored cruiser "Colorado" was temporarily disabled by collision with the liner "Cleveland" in Honolulu Harbor, January 24. The accident was caused by the sudden death of the pilot of the liner while taking the vessel into the harbor.

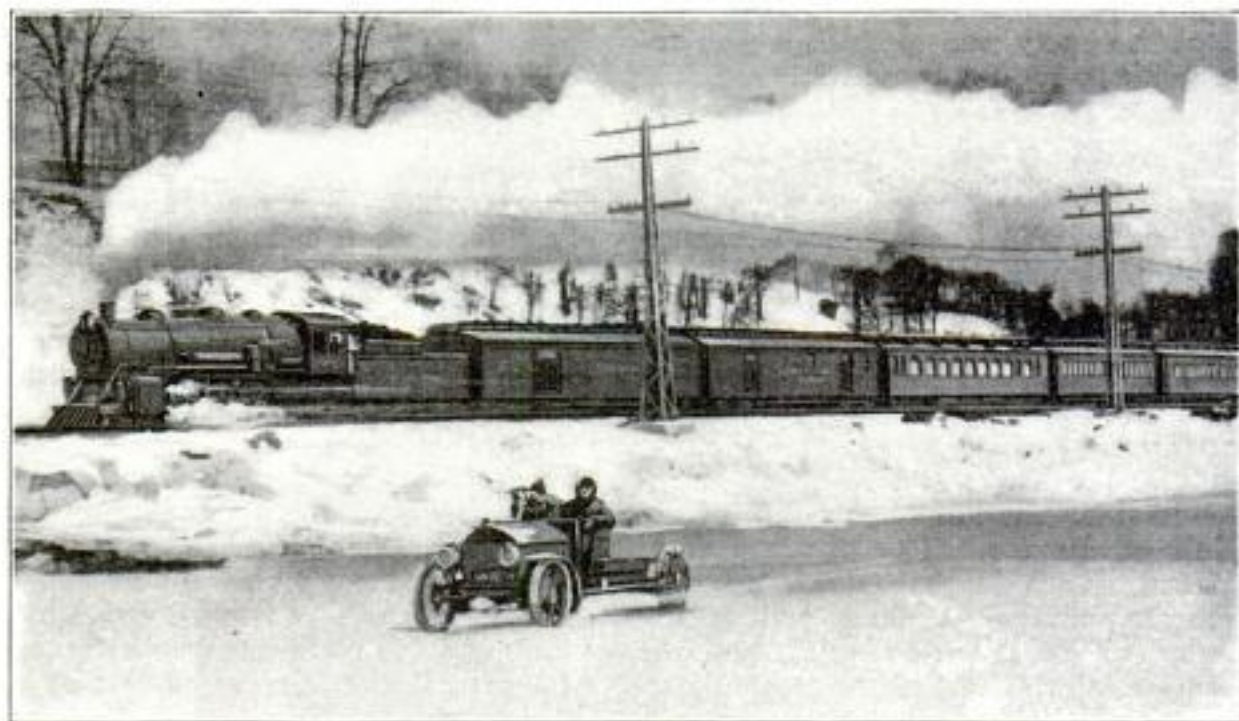

### AUTOMOBILE RACES TRAIN ON THE ICE

A real race between a fast express train and a racing automobile occurred recently on the ice-covered surface of the Hudson River at Tarrytown, N. Y., the course being a true parallel. The train was the Twentieth Century Limited and the automobile was a 60-hp. machine driven by Fred Koenig. The race was over a two-mile course, and during the first half neither the train nor the auto had the advantage. Then the automobile gradually drew away and at the finish had an open lead of more than 100 yd.



## REMARKABLE WEATHER OF 1911

The Effect of the Combustion  
of Coal on the Climate — What  
Scientists Predict for the Future

By FRANCIS MOLENA

THE year 1911 will long be remembered for the violence of its weather. The spring opened mild and delightful, but in June a torrid wave of unparalleled severity swept over the country. The cities baked and gasped for breath, while the burning sun and hot winds withered the corn and cost the farmers a million dollars a day. A little later England was scorched and France and Germany sweltered. The mercury went above 100 deg. in western Canada, and whalers brought back reports from the Arctic regions of open water where always before there had been solid ice. The reports from Mexico and Central America would well describe the lower regions, but it is said that the summer in Iceland was enjoyable.

In August the elements took a different turn and the flood-gates of the heavens were opened. Kentucky and the South Atlantic states were deluged, and the Philippines were more thoroughly drowned than they had been before since the time of Noah. Alberta was visited by a killing frost which ruined hundreds of pioneer farmers. A cyclone devastated Costa Rica and a violent gale swept the South Atlantic coast, destroying a great number of vessels. During the later fall, the North Atlantic was tormented by a series of more violent storms than were known to the oldest sea captains. In November the southern states were visited by a killing frost, while December was remarkable for its high temperatures.

Aside from the extreme heat, the frosts of the far North and the sunny South, and the violent storms at sea, the year 1911 was still exceptional.

The mean temperature of every month except November was above the average of that of the 40 years covered by the records of the United States Weather Bureau. The average daily excess was from four to six degrees.

With only one month out of twelve below normal, one may well ask if the climate is not changing and getting warmer. There is a general impression among older men that the good old-fashioned winters in which "the snow was fifteen feet deep and lasted six months" do not come any more. In spite of the fact that the year just past was above the average in temperature, there is no clear indication that there is any progressive change in the direction of a warmer climate. The average temperature of the year 1878 was as high as that of 1911. There seem to be moderate changes in a cycle of about 35 years, and it is suggested that this is related to the period of sun-spot activities, which is about one-third as long.

It has recently been found by archeologists from their studies in Asia Minor that, during the thousands of years these semiarid countries have been inhabited by civilized men, their populations have increased and decreased with a period of two or three hundred years. It is supposed that the epochs of greatest population were when there was more than the normal amount of rainfall, so that more people than ordinarily could be supported. When the oscillation in climate changed toward a dry period, so that food became scarce, the population necessarily decreased, though the changes might be ascribed in some instances to other causes. The cli-

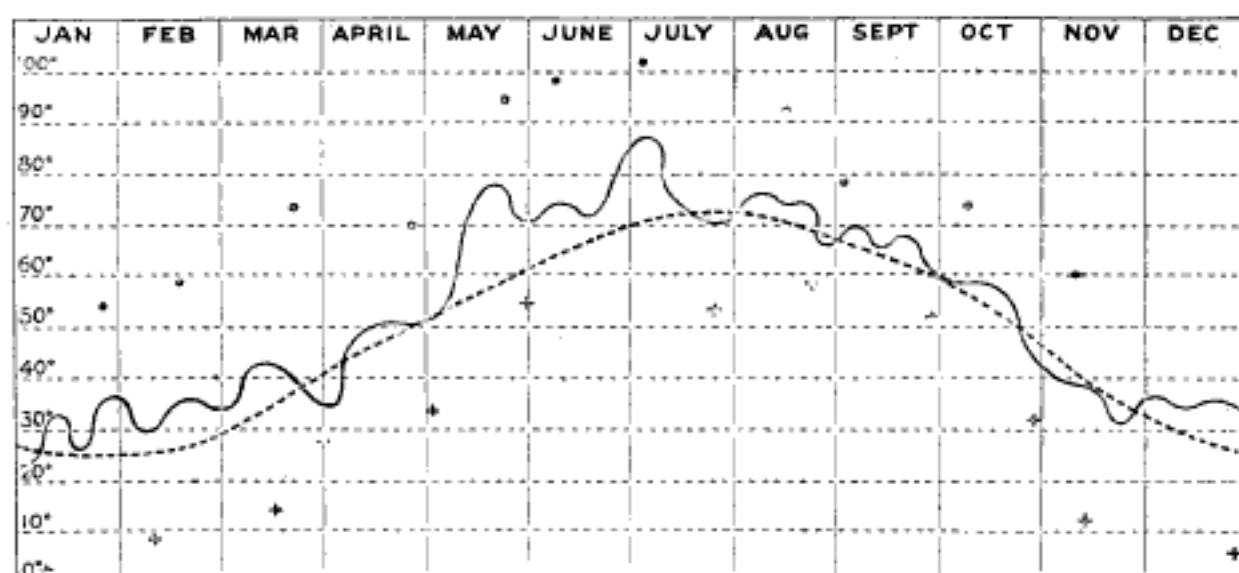

Temperature variations for 1911 as observed at Chicago by the U. S. Weather Station. The full curve shows the variations of mean temperatures based on weekly averages. The dotted curve is the mean for the 40 years covered by the observations of the Weather Bureau. The round dots give the highest temperatures for each month, and the crosses the lowest. In 1911 the average for each month except November was above normal.

matic explanation of these variations in population seems most reasonable.

But it is not necessary to refer to the history of mankind in order to prove that the earth has undergone much greater changes in climate than those we are now experiencing. The deposits of salt and gypsum which are found in New York and Michigan are the beds of ancient seas which dried up when these regions were deserts; on the other hand, arid Arizona was once watered with abundant rains, as is shown by the petrified remains of enormous trees which hundreds of thousands of years ago grew in that region. In frozen Greenland, the fossil remains of magnolias and other semitropical plants are found; while at the other end of the earth, near the south pole, there are beds of coal formed from vegetation which flourished when that region had a temperate climate.

On the other hand, time after time, great sheets of ice have pushed down from the table-lands of Canada through the valleys of the Great Lakes, over the prairies and across the hills, and have reached as far south as the Ohio and the Missouri Rivers. The records written on the hillsides by these slowly moving glaciers, and the heaps of soil and rounded boulders where they

have stopped and melted, prove that at least seven times this country has been buried beneath the snow and ice. At other times, still earlier in the history of the world, there have been glaciers at moderate altitudes on both sides of the equator, well within the tropical zone. It is difficult to determine with any high degree of accuracy how long it has been since the last glacial epoch, but fifty or a hundred thousand years have passed since the ice sheets covered this region.

If the earth has undergone such remarkable changes in temperature and has experienced such extremes of drought and moisture, it may be asked what the prospects are for the future. It may be answered immediately that these climatic variations are so slow and that these cycles are so vast, that there is no prospect of any material change in the lifetime of a single individual, or even of a nation. It is highly improbable that the mean temperature will change sensibly in a thousand years, and very probable that it will not be much different from what it is at present ten thousand years from now. But if we may judge the future from the past, we may conclude that extremes of cold and warmth will succeed each other in long cycles measured by tens of thousands or hun-



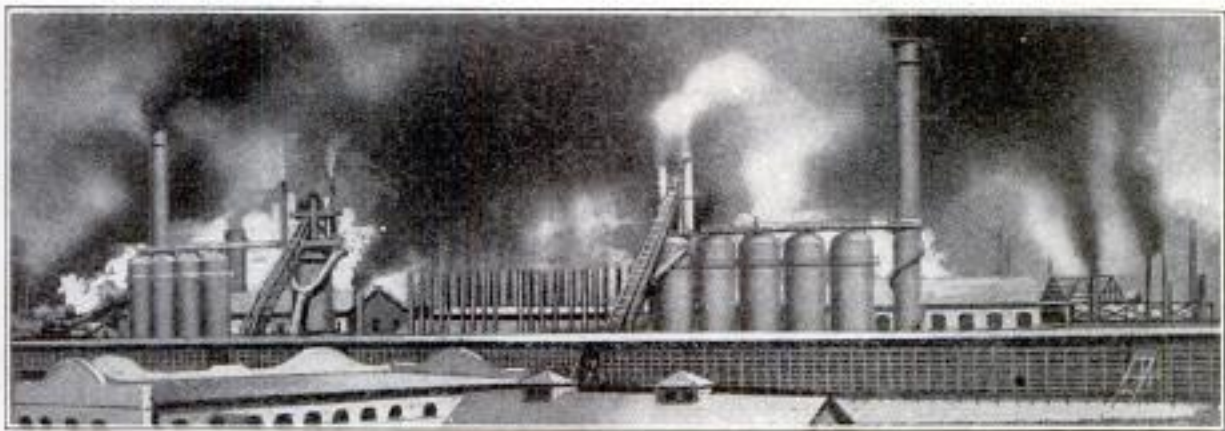

The furnaces of the world are now burning about 2,000,000,000 tons of coal a year. When this is burned, uniting with oxygen, it adds about 7,000,000,000 tons of carbon dioxide to the atmosphere yearly. This tends to make the air a more effective blanket for the earth and to raise its temperature. The effect may be considerable in a few centuries.

dreds of thousands of years; for there is no more reason now to suppose that conditions will henceforth be fixed or even steadily progressive in one direction than there would have been to have made the supposition at the corresponding stage in any previous cycle. There are indications that the maximum of the warm era in which we now live has not yet been reached and that, therefore, the climate will probably become slowly warmer for some thousands of years, this progression being broken by many small oscillations. After the maximum is past the climate will, on the whole, probably steadily become colder until another ice age follows.

The causes of the changes are about as interesting as the changes themselves, and if they are known it may be questioned whether we can not control the climate in the future. While the heat which warms the earth comes from the sun, the climate is fundamentally dependent upon the earth's atmosphere and upon its circulation. It screens off the heat somewhat in the daytime and holds it in at night. The winds carry vast quantities from the torrid equator to the higher latitudes, and freshen the equatorial zone with the cooler atmosphere from the polar regions. The absorption and screening properties of the atmosphere depend upon its constitution. It has been found that if the air contained more carbon dioxide, which is the prod-

uct of the combustion of coal or vegetable material, the temperature would be somewhat higher. In fact, a theory has been elaborated, primarily by the great Swedish scientist Arrhenius, that the earth has had a warm climate when the amount of carbon dioxide in the air was abundant, and a cold climate when it was scarce. It is believed that if the atmosphere contained two or three times its present amount, the climate would be considerably warmer, and that if it should lose half of that which it now has, the glaciers would again form in Canada. There are good reasons for believing that the quantity of this gas in the atmosphere may slowly undergo variations.

Since burning coal produces carbon dioxide it may be inquired whether the enormous use of that fuel in modern times may not be an important factor in filling the atmosphere with this substance, and consequently in indirectly raising the temperature of the earth. In the United States about 500,000,000 tons of coal were mined in 1911. Suppose four times this amount were mined and burned in the whole world. When this amount of coal is burned, 7,000,000,000 tons of carbon dioxide are put into the atmosphere. The question is, simply, whether this is an appreciable fraction of that which the atmosphere already holds, and whether there are any important ways in which it is being removed from the atmosphere.

The atmosphere contains altogether 1,500,000,000,000 tons of carbon dioxide. Consequently the combustion of coal at the present rate will double it in about 200 years, unless it is removed by some means in enormous quantities. Carbon dioxide is removed from the atmosphere by growing plants, and in fact the carbon in the coal came from the air through the vegetable matter from which it has



Outline map of North America at the time of most extensive ice cap. The glaciers radiated from three points, covered 4,000,000 square miles, and were probably two or three miles deep in some places. They disappeared probably 50,000 years ago. There have been several glacial epochs and there may be others in the future.

been formed. But when vegetable matter is burned, or decays, or is consumed by animals, the carbon dioxide is returned to the atmosphere. It does not seem that there will be in this way any great gain or loss in the next few centuries. A more important factor is the oceans which now hold enormous quantities of carbon dioxide and which, under suitable conditions, can absorb much more. In fact, they are the great regulators and have been involved essentially in all the variations of the past. But the action of the sea is very slow, and it may well

be that the enormous present-day combustion of coal is producing carbon dioxide so fast that it will have important climatic effects.

It is perhaps somewhat hazardous to make conjectures for centuries yet to come, but in the light of all that is known it is reasonable to conclude that not only has the brain of man contrived machines by means of which he can travel faster than the wind, navigate the ocean depths, fly above the clouds, and do the work of a hundred, but also that indirectly by these very things, which change the constitution of the atmosphere, have his activities reached beyond the near at hand and the immediate present and modified the cosmic processes themselves. It is largely the courageous, enterprising, and ingenious American whose brains are changing the world. Yet even the dull foreigner, who burrows in the earth by the faint gleam of his miner's lamp, not only supports his family and helps to feed the consuming furnaces of modern industry, but by his toil in the dirt and darkness adds to the carbon dioxide in the earth's atmosphere so that men in generations to come shall enjoy milder breezes and live under sunnier skies.

#### NAVY PLANS EXTENSIVE WIRELESS FIELD

The Navy Department has prepared plans for a chain of wireless stations which will bring the department into aerial communication with all its battleships wherever they may be, almost from the coast of West Africa to Chinese waters. Congress will be asked to appropriate \$1,000,000 to establish this system, which will be superior to anything of the kind now in existence in any part of the world.

The chain, as planned, will consist of seven stations. One is already under construction at Arlington, Va., across the Potomac from Washington. The others will be on the canal zone, at San Francisco, at Pearl Harbor, Hawaii, on the Island of Guam, on the Island of Luzon, in the northern



World-Wide Distribution of Wireless Impulses from Proposed Navy Stations. Messages will Fly Quickly from Parts of World on Which Sun Shines to Regions in Darkness of Night

Philippines, and on Tutuila Island, one of the American Samoan Islands.

The Washington station is expected to cover the entire Atlantic coast, with a sending radius of 3,000 miles. The station on the canal zone will cover the Caribbean Sea effectively, besides being in touch with both Washington and San Francisco. From the San Francisco station communication will be had with Pearl Harbor. The Pearl Harbor station will easily reach the Guam station, and the operator at Guam will be able to talk to the man at the Luzon station. From the Luzon station it is proposed to control all the naval vessels in Japanese or Chinese waters. The station in the Samoa Islands will cover the South Pacific. This station is especially desired, because there is now no cable at Tutuila Island.

Each of these stations will be equipped with 100-kilowatt generating apparatus. The design adopted for the Arlington station, now under construction, will be used; that is, three tall steel and concrete towers with the antennæ stretched between them. The Arlington station is to have one tower 600 ft. high and two towers 450 ft. in height. It is estimated that if \$1,000,000 only is appropriated, the other stations in contemplation will have only 450-ft. towers. Each of these stations will have a sending and

receiving radius of 3,000 miles. This is what the stations are expected to do regularly under fair conditions, both day and night. Day communication is more difficult than during the night, as sunlight absorbs the electric waves sent out from the stations. Another thing, communication over land is more difficult than over salt water.

#### HIGH-VOLTAGE TRANSMISSION LINE IN EUROPE

The first high-voltage system, exceeding 100,000 volts, in Europe is being installed at Lauchhammer, Germany. Long transmission lines are not numerous enough abroad to encourage the use of exceedingly high voltage. The length of this line is only 35 miles and its voltage well up to the American limit. In a short time, however, America will have a line carrying 140,000 volts, such an installation being under way in the state of Michigan.

The extraordinary voltage, which is 110,000 volts, used for so short a transmission is due first to the fact that the total energy to be transmitted will be something like 20,000 kw., and secondly, to the design of the apparatus. Any voltage in excess of 65,000 requires special transmission apparatus, and as for reasons of economy in transmission this limit was too low, the figure of 110,000 volts was decided upon.

## AEROPLANE SEIZED AS CONTRABAND OF WAR

The aeroplane threatened for a day or two to disrupt the peace of Europe and involve Italy and France in a quarrel when, about the middle of January, the Italian government seized a French ship and arrested an airman named Duval who was taking passage, with his machine, to join the Turkish forces in Tripoli. This is the first time that the aeroplane has figured in an international dispute and it is also the first time that an aircraft has been declared contraband of war. The difficulty was overcome and the airman released when France assured Italy that Duval would not be permitted to join the Turkish forces.

The French war department has decided to recommend to the Chamber of Deputies the appropriation of \$4,400,000 to be used for construction of aeroplanes during the next year. No definite plans for the expenditure of this sum were outlined in the brief dispatches received in the United States announcing the determination of the government officials.

The newspapers have contained several dispatches indicating that the variety of freak feats to be performed by the aeroplane has not yet been exhausted, either by actual performance or in the imagination of writers or airmen. From Los Angeles, where an annual aviation meeting opened Jan. 19, comes a story that while the airmen were gathering for the meeting, four of them were called upon by the sheriff to assist him in the capture of a couple of fugitives from justice who had eluded the posses organized to capture them. The airmen searched the country with field glasses from the vantage points of their machines, several hundred feet above the ground, but were unable to accomplish anything.

In Illinois a candidate for a state office announced his intention of engaging an airman to fly over the state and distribute circulars pleading for the suffrage of his fellow citizens.

James V. Martin and Harry N. Atwood are both quoted in press dispatches as having announced their intention of essaying a transatlantic flight. Martin proposes to fly from Newfoundland to Ireland in a heavy biplane capable of carrying three passengers and equipped with wireless, etc. Atwood is said to have asserted that there is nothing impossible in the scheme of Martin and declares if he is provided with the proper machine, equipped with two engines and 200 gal. of gasoline, he will make the trip from Newfoundland to the Irish coast, in 40 hours.

The announcement was made Jan. 28 at Los Angeles that Glenn Curtiss had been awarded the annual trophy of the Aero Club of America for 1911 for the greatest achievement in aviation, the perfection of the Curtiss hydro-aeroplane being cited as the basis of the award.

The annual prize known as the "Criterium de l'Aéro Club de France," given the aviator making the longest continuous flight during the calendar year, was awarded to M. Gobé of France, for 1911. Gobé flew 740 kilometers, (about 460 miles), in 8 hr. 16 min. with a Nieuport machine, Dec. 24.

M. Prevot, driving a monoplane, is credited with setting a new altitude record with two passengers at Rheims, France, Jan. 22, when he reached the height of 2,200 meters (about 7,200 ft.). On the same day a new world's duration record for flight with two passengers was established by G. L. Ulich at Berlin when he flew 2 hr. 2 min. 45 sec. Maurice Tabuteau is reported to have broken three world's records at Pau, France, Jan. 24. He is said to have covered 200 kilometers (about 124 miles) in 1 hr. 54 min. 21 sec.; 250 kilometers (about 155 miles) in 2 hr. 22 min. 57 sec., and 300 kilometers (about 186 miles) in 2 hr. 51 min.

Pierre Védrines, who claimed to have made great speed on his Paris-

Madrid flight, again demonstrated his capacity for fast flying at Pau, France, Jan. 13, when he attained a speed of 88.84 miles an hour in a racing Deperdussin monoplane. While this time was officially taken by officers of the aero club who were on hand to verify it, as it was made for a distance of less than 5 kilometers (about 3 miles), it will not stand as an official record.

Three deaths were reported during the month ending Jan. 30 as due to aeronautics. In the United States Rutherford Page, a graduate of Yale university, fell a distance of 150 ft. at Los Angeles, Jan. 24, and was killed. Page had just received his license as a pilot. In France, Lieutenant Boerner, of the military aviation corps, was fatally injured, Jan. 19, by a fall at

Senlis, France. The aeroplane caught fire after the fall and the airman was frightfully burned. He died Jan. 21. On Dec. 31 a German military balloon which had commenced a flight Dec. 26 was found in a lake 24 miles from Salzburg, the starting point, the aeronaut, Lieutenant Warner, having been drowned.

Emile Dubonnet, a French aeronaut, is credited with having broken the world's record for flight in a spherical balloon, the distance traveled having been 2,100 kilometers (about 1,300 miles). The start was made from Compiègne, France, at midnight, Jan. 7, in the balloon "Condor III," and a safe landing is reported to have been accomplished at a small village in the government of Kiev, Russia.



STRIKING MILL OPERATIVES HELD OFF BY HOSE

During the recent strike of the mill hands in the cotton and woolen mills at Lawrence, Mass., unique means were adopted to protect one of the establishments threatened by strikers. The crowds were prevented from advancing on the buildings by a continuous stream of water thrown at high pressure from a hose which was directed on a bridge, the only approach to the mill. The photograph reproduced above was taken during a snow storm.

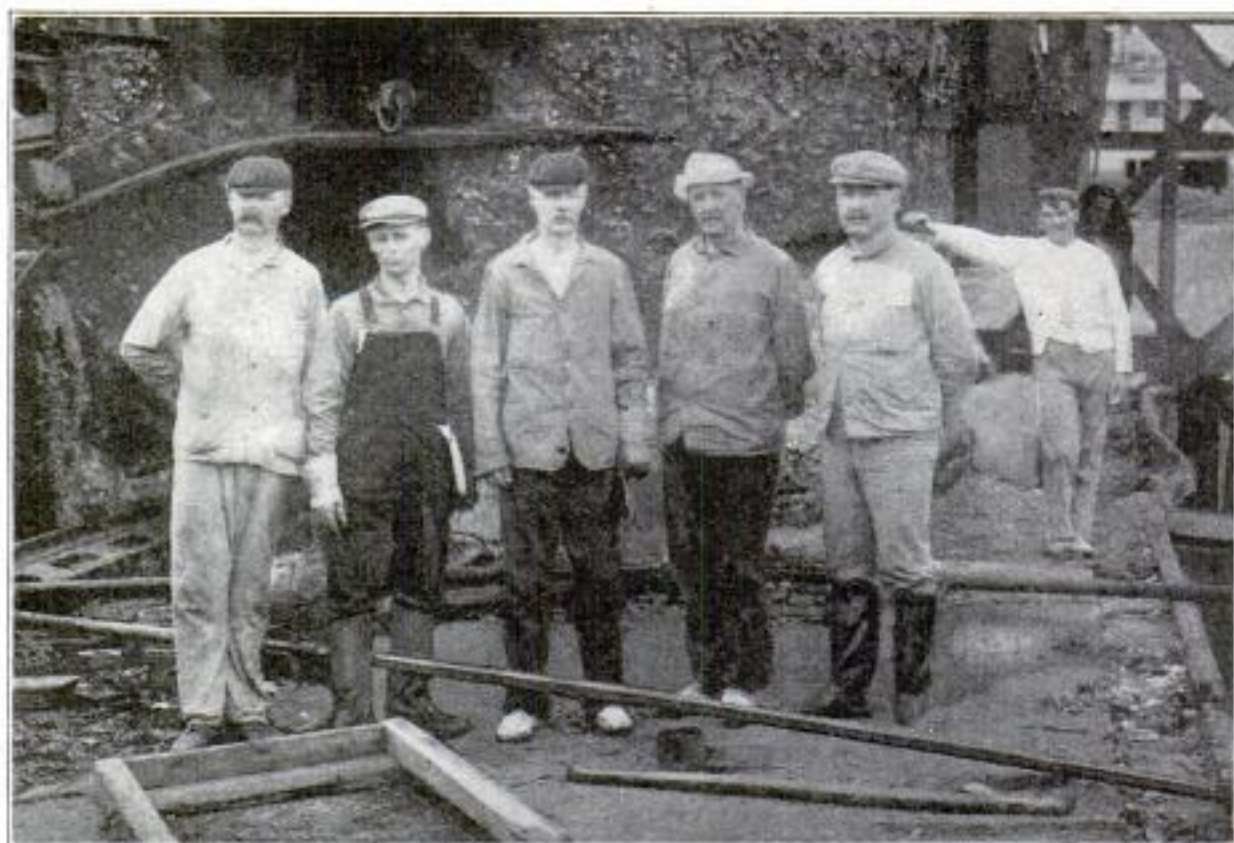

Courtesy Collier's Weekly

#### NO GOLD LACE OR FINE FEATHERS FOR THE "MAINE" INVESTIGATORS

Not a construction gang—but officers of the army and navy in their working clothes. From left to right: Commander C. F. Hughes, U. S. N.; Chief Constructor (Rear Admiral) Richard M. Watts, U. S. N.; Rear Admiral C. E. Vreeland, U. S. N., Colonel William M. Black, U. S. A., and Commander Joseph Strauss, U. S. N. This photograph was made on the wreck of the battleship "Maine" in Havana Harbor, while the board of officers appointed by the President was making the investigation which determined the cause of the disaster

### SAN FRANCISCO'S CHINESE CELEBRATE REPUBLIC



Striking the Chinese "Liberty Bell" in San Francisco's Chinatown

The birth of the Chinese republic was celebrated in San Francisco's Chinatown by many curious ceremonies and a monster parade in which the flag of the new republic was carried. In the accompanying illustration is shown a Chinaman beating a bowl-like bell, which, according to the placard, in both Chinese and English, placed beside it, is the Chinese "Liberty Bell."

ⒸThe census of the Dominion of Canada, recently completed, has caused some disappointment as the population is shown to be slightly in excess of 7,000,000 instead of more than 8,000,000 as had been estimated.

## COMMENT AND REVIEW

**T**HE young men from the country come to the city full of expectation for the future. With many of them expectation is greater than ambition, and such fall an easy mark to those lazy, indifferent, insipid fellows who tell the newcomers "There are no chances any more." In proof they point out this millionaire who had the good "luck" to land in the town without a dollar but when a day's work paid for an acre of land which today is worth thousands of dollars per front foot. Inasmuch as those particular conditions are not the conditions of today, therefore there are no opportunities. They do not realize that in those early days there were scores and hundreds of young men who talked then just as they do now, and who were equally blind to the paths to fortune.

### *Opportunities of Today*

A young man recently from the country who did not seem to be making the rapid advance he expected, was talking with the head of the concern for whom he worked and the latter said to the boy:

"What! no chance for a beginner? Young man, look out that window: See those skyscrapers on every hand? Well, those buildings are running over with opportunities of every kind—professional and commercial: They are filled with banks and big corporations. It takes men of brains and experience to conduct these enterprises, and such men command big salaries because they are scarce. It takes years of hard work and long hours to fit for the management or presidency of the enterprises over there, and only one young man out of hundreds seems to have the ambition and perseverance to make good. There are plenty of positions paying from \$5,000 to \$25,000 a year waiting for you; take your pick. You can have any one of them you really want, if you will only fit yourself for the job. The great trouble today in big concerns is to find competent men big enough to fill big places. You are now 22 years of age. If you will play the game fairly, according to the rules, which are honesty, perseverance, morality and your-mind-intensely-on-the-job all the time, when you are 45 and perhaps sooner, you will have landed in the place you can select this minute. Unusual natural ability combined with the qualities named may make a short cut to success, but fellows with less natural ability who earnestly fulfill the other requirements will win where the more brilliant man, neglecting them, fails."

Just then the lights began flaring from one office after another along the walls of towering buildings, like so many opening eyes. "Young man, your opportunities are already calling you: select your beacon and win it."



**H**ERE is a story of the success of two young men who went from the city to North Dakota. Each had about \$15,000 of which \$8,000 was put into machinery. This provided them with two powerful traction engines, and the necessary equipment of farming machinery. Operations were begun with breaking the raw land in March, 1911; by November of the same year the young city-farmers had marketed \$60,000 worth of flaxseed, which was hauled 40 miles to the nearest railroad station. The entire undertaking was managed on modern lines: A day's plowing with each engine was estimated at 25 acres, but when the crew by saving time turned 30 acres in one day, they were given a bonus of \$5.

### *The Modern Way*

Thereupon 30 acres per day became the usual thing. The same broad-gauge, liberal policy characterized the whole undertaking. The most competent men obtainable were hired and well paid; the aim being to do the largest amount of work that could be done well, in a day, and pay accordingly. Neither of these young men had ever raised any flax, but they went to the agricultural station and thoroughly posted themselves. This was a success which could not have been obtained with mere ability, willingness and a pair of hands; it required capital, yet it was brain and initiative which won; for not only was the crop itself highly profitable but the land advanced in value in that one season more than the entire expenditure for machinery.

In these days the really successful farmer must possess brains and machinery.



**WE** Americans are gradually coming to recognize a positive asset—a prosaic monetary profit—in an architecturally beautiful structure. Europe long ago learned this lesson; we have yet very much to learn. In all the large cities of the Continent one is not permitted to erect a building which will prove a disfigurement to surrounding structures, or to the symmetry of the street on which it fronts. Thirty years ago our commercial buildings were put up with a view chiefly to secure a certain amount of space protected from the weather. This was the period of flimsy construction, bare utilities, resulting in buildings that were dangerous fire traps, and which frequently tumbled down from overloading. The next step was toward more substantial structures, better light and sanitation. Yet when an owner planned, say, a \$100,000 factory, he regarded the architect's plea for an extra \$5,000 for interior and exterior decoration as absurd and impossible. He refused to entertain the idea. The building must cost the least possible amount compatible with the law. And yet the interest at 6 per cent on the amount represented by the difference between an actually hideous front and one permanently pleasing and ennobling was only \$300 a year.

*Beauty  
as an  
Asset*

Environment has so largely to do with results. Imagine, if you can, Shakespeare trying to write one of his plays at a desk in a modern department store! An extreme case, to be sure, yet it has been demonstrated time and again that in a factory the quality and quantity of the output is noticeably affected by the surroundings in which employes work. The same is true in an office. Appropriate fittings inspire a definite dignity and respect for the establishment, which have an actual commercial value. Picture a bank cashier talking across a counter like a butcher's block! An attractive exterior and interior of any business concern has a definite advertising value at a minimum of cost.

We have left too much to the engineer, and sought too little from the architect. Hundreds of bridges may be seen in our large cities which have been built with the one aim to sustain a certain number of tons at one time. A bridge should be a thing of beauty, yet how seldom do we see in this country a beautiful bridge. In Europe, for years past, the architects have built the bridges, beautiful bridges, as they did the cathedrals which Americans travel thousands of miles to see. An architect who can build a 20-story office building 150 by 100 ft., capable of safely carrying a load of 8,000 tons, surely can plan a bridge 150 ft. long to carry a load of 500 tons. No good architect would ever have been guilty of such a monstrosity as the elevated



railway loop in Chicago. It would have cost a few hundred thousand dollars more to have made a slight structure; but is not this much due the public whose streets the railroad uses as a free right of way?

In speaking of the city of Gary—the town built by the United States Steel Corporation—a leading Chicago architect said: "The company failed to provide the beautiful surroundings which they had the opportunity to do in building Gary. Having decided to build a manufacturing plant in such a way that the economies would be conserved without cross currents from the side of raw material to the side of finished product, millions were put in gas engines as an illustration of the saving between the gas engines and steam engines, thus bringing the efficiency of the plant up, theoretically, to 100 per cent, whereas the efficiency of the human beings is only about 70 per cent. The reason for it is that they have failed to provide the comfortable housing necessary for the workers, and parks and recreation grounds, in order to give the same consideration to the human beings in their employ as to the machinery part of the organization."



"**W**HY not a business man for President?" is the question of E. C. Simmonds, a successful manufacturer of St. Louis, in a notable article on government and business, printed in the Chicago Tribune.

*Government  
a  
Business  
Proposition*

Is it not about time a President were selected from the business interests of the country? Of our 26 presidents, 19 were lawyers, 2 statesmen, 2 soldiers, 1 public official, 1 planter and 1 a farmer. Nine were not college graduates. In the House of Representatives 70 per cent are lawyers. In these modern days the conduct of the government of a big country like this is certainly more one of good business management than of diplomacy. The State Department has to attend to diplomatic affairs anyway. While many congressmen are admittedly able men, of the great majority how many ever were or ever would be successful managers of any large business interest?

By good business management is not meant some star official of a big trust; quite the contrary. As Mr. Simmonds suggests, the type of business man contemplated is that of the late Marshall Field—a man of large affairs. Such men in congress and the White House would sweep away the cobwebs of red tape, put the departments on as economical a basis as compatible with good service; increase efficiency by team work and secure that same enthusiasm in departments that soldiers and sailors display toward their generals and admirals when something is doing. How long would a bank, factory, mine or store last in these days, if conducted on business principles which characterize a great deal of government management?

If ours were not a vast, rich country, it would go broke. What this country needs in its city, state and national officials is men of honor who already have demonstrated their natural ability and fitness by having made a pronounced business success. The day is not far distant when their duty to their fellow-citizens will impose the same obligation on these men to leave their desks and take office, to which they would respond if called upon to defend their country from a foreign foe.

H. H. WINDSOR

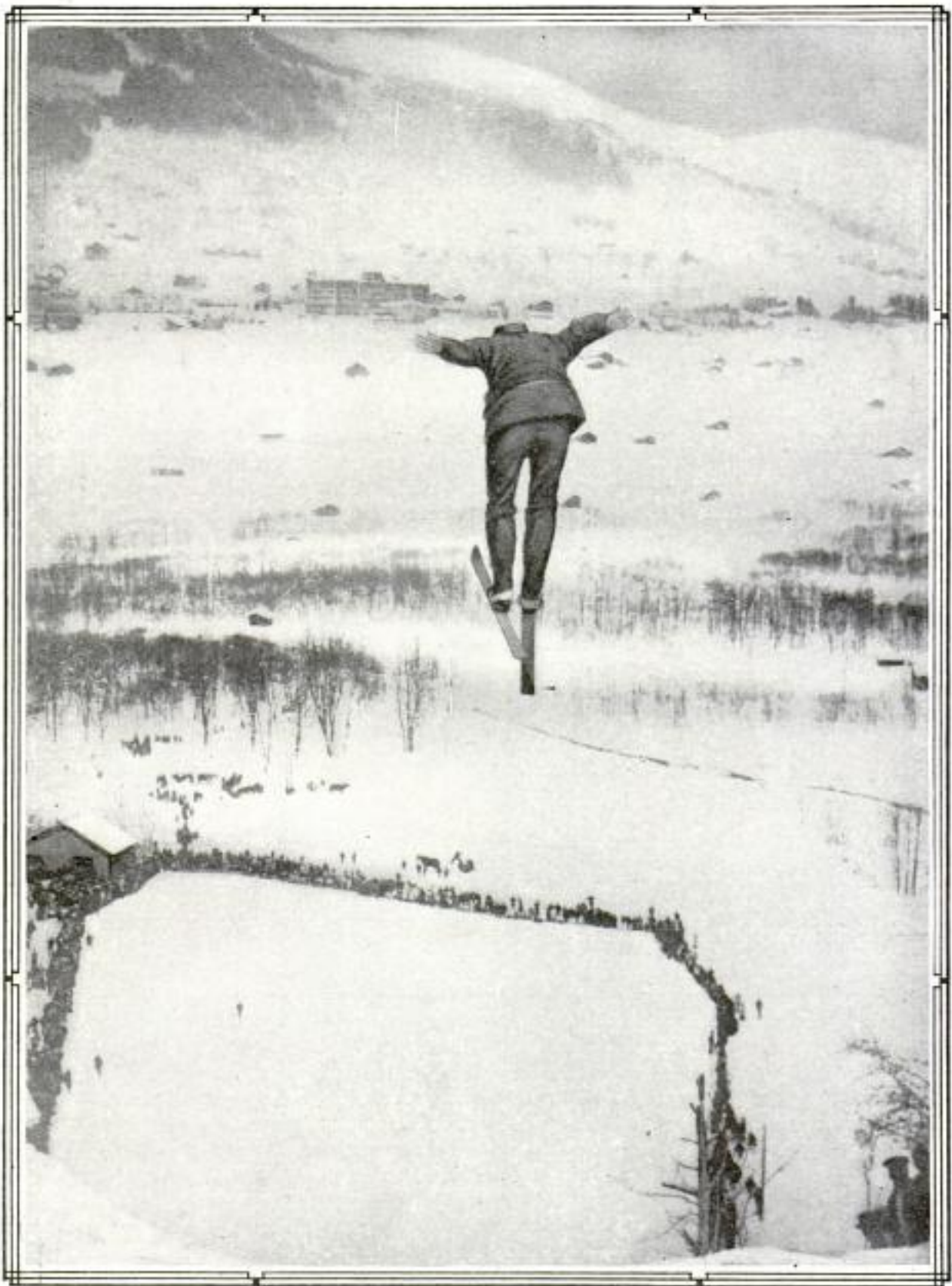

#### LOW TEMPERATURES AID HIGH JUMPS

The most wonderful jump in the history of skiing is credited to Harold Smith who is said to have leaped from the side of a mountain at Davos, Switzerland, and to have made a safe landing hundreds of feet below. The art of using skis is peculiar to people who live in the cold bracing weather of the northern latitudes, where low temperatures make possible plenty of hard-packed snow at all times. Its charm is said to lie particularly in the high jumps that can be made, jumps that begin in slides from high hills which send the skier into the air by means of an obstruction, natural or artificial, placed in his path, the impetus received from the preliminary slide sending him for a great distance before again touching the surface of the snow.

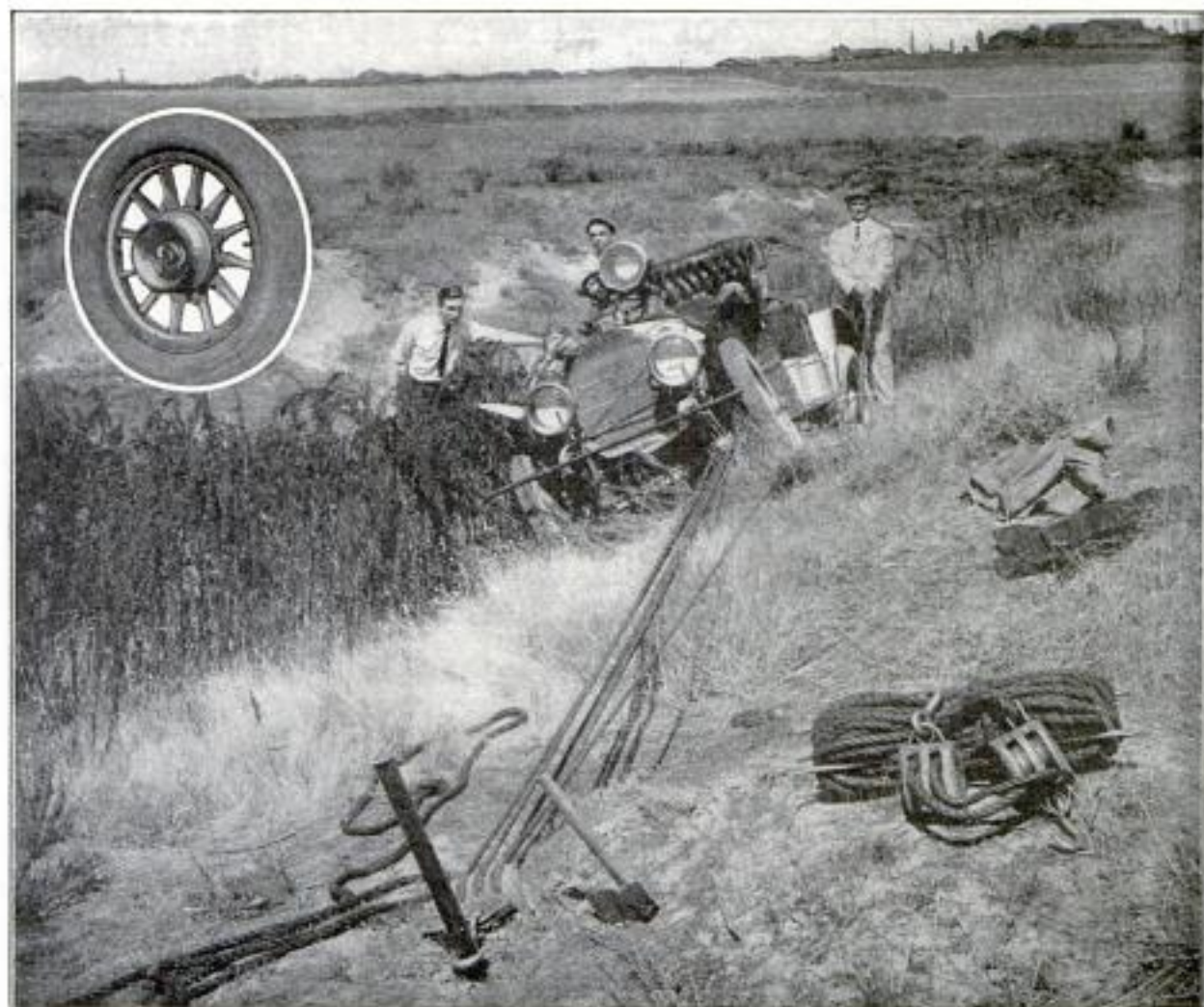

Pulling an Automobile Up the Steep Bank of a Washout with Block and Tackle. The Insert View in the Upper Left-Hand Corner Shows One of the Capstan Drums Attached to the Hub of One of the Rear Wheels

## BLOCK-AND-TACKLE OUTFIT FOR AUTOMOBILES

A Californian, whose business keeps him traveling by motor car over all kinds of roads and in every kind of weather, has equipped his car with a block-and-tackle outfit for emergency service. The accessories of the block and tackle are an iron stake, the necessary rope cable and two capstan drums, the latter being fitted to the hubs of the rear wheels. In case the car becomes bogged in a mud hole or sticks in the heavy sand of a washout, he is not at the mercy of a chance farmer with a team of mules, but simply drives the iron stake some distance ahead of the car, adjusts the block and tackle, takes a turn of his cable around one of the capstan drums, starts the engine and pulls himself out with ease.

An interesting feature of the outfit is the removal of the rear seat and the substitution of a box for the storage of the block and tackle, containing 500 ft. of rope, tools, and a camp outfit for use through unsettled districts.

¶The final award of the \$10,000 prize for the Statue-of-Liberty flight at Belmont Park, N. Y., in October, 1910, has been made to Claude Grahame-White by the International Aeronautic Federation. This race was actually won, in point of time, by the late John B. Moisant, but he was disqualified, and the question of the award has been before the Federation ever since, several decisions having been made and reversed.

### MANY MECHANICAL TOOLS COMBINED

An ingenious combining of mechanical tools, devised by a Frenchman, is here shown. It includes a forge, anvil,

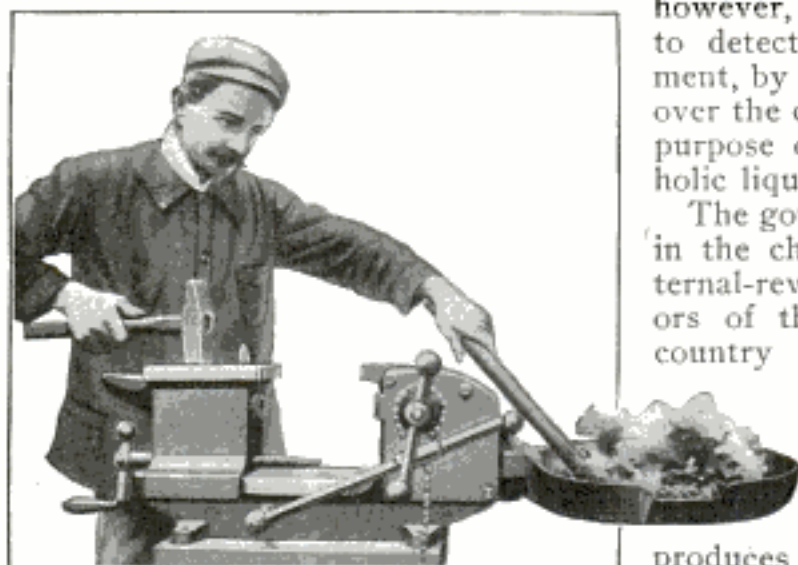

A Mechanical Tool Combination, Which Includes an Anvil, Boring Machine, Vise, Grindstone, Forge, Punch and Workbench

boring machine, vise, workbench, grindstone and punch, yet weighs only 132 lb. and occupies but little space. The steel anvil, which can be moved along its cast-iron base by the turning of a screw, forms one jaw of the vise, while the other jaw is a fixed steel block provided with a tool head and screw clamp for the attachment of drills and other tools. One end of the apparatus also carries a dustproof tool box and a grindstone. The forge is simply an iron pan connected with a blower, and can be removed when not needed. Power is furnished by a treadle, and the transmission is devised to give either low or high speed, as required.

### DISTILLERY OPERATED BY UNITED STATES

The United States Treasury Department is running an unlicensed distillery. The law is not being violated, however, as the plant is operated solely to detect fraud against the government, by exercising a scientific control over the commercial distilleries for the purpose of revenue taxation on alcoholic liquors.

The government apparatus is located in the chemical laboratory of the internal-revenue bureau. The inspectors of the bureau are scouring the country to secure the formulas of every distillery for the manufacture of their product. Using these formulas, the government in its own distillery reproduces these alcoholic liquors, ascertaining the exact amount of distilled spirits which should be yielded by any given quantity of grain according to any given formula.

These results are compared with the returns made by the distilleries for the purpose of taxation. In all cases where a marked discrepancy is displayed the distillery is placed under suspicion, and if the returns prove fraudulent, the plant becomes known as a "pirate distillery."

By this method the government also holds a tight check on the internal-revenue officers stationed at the distilleries to guard the revenue. If there is any collusion between these officials and dishonest distillers, the government distillery reveals the fact, and the official head of the employe falls.

### WORLD'S LARGEST BLOCK OF GRANITE

For two years granite quarriers have been working away cutting out the immense block from nature's storehouse, at Barre, Vt. Even now, it is not removed from its original resting place, nor have they gotten the exact dimensions of the monster. They

know, however, that in rough figures, the mighty block exceeds 230 ft. long, 65 ft. wide, and is at least 30 ft. in depth. Since clearing away the face, it has been found that the depth will exceed 30 ft. as no sign of the bottom bed is yet reached. Taking the above



Block of Granite being Quarried at Barre, Vt. Its Immensity may be Judged by the Relative Size of the Workman on the Corner of the Great Block

figures as criteria, the block weighs about 75,000,000 lb.

The drilling and cutting out of the monster block have involved a patience, persistence, nicety of calculation and judgment that would be almost unbelievable, except to those who know the difficulties of this undertaking.

☞ Luther Burbank is claimed to have discovered that the fiber of the spineless cactus is an excellent substitute for rubber in the manufacture of automobile tires, and that the plant can also be converted into paint. One leaf, it is said, will make 10 gal. of paint.

☞ The ever-present moving-picture maker has at last broken into the aviation field, a machine and an operator having accompanied Robert G. Fowler for a short distance across Texas, for the purpose of making a series of films.

### EUROPEAN FOLDING TYPEWRITER

This typewriter, which is of European manufacture, has a carriage which folds forward over the keyboard, forming a square body of small dimensions and weight, easily incased and carried when traveling. The machine is solidly built and modern in construction, the writing being visible and in a choice of two colors. The keyboard bears 90 characters.



A French Visible Typewriter, the Carriage of Which Folds Forward over the Keyboard for Carrying

### SCORCHING POSTCARDS ON LAVA BEDS

One way of securing unique souvenirs is shown in the reproduction of this photograph of tourists in



Tourists Scorching the Edges of Postcards in the  
Crevices of Lava Beds in Hawaii

Hawaii, who are engaged in scorching the edges of picture postcards in the cracks of a lava bed. This bed of lava is quite cool and hard on the surface, so there is no danger in the process, but in the cracks formed by the cooling of the crust there is sufficient heat

to brown the cards neatly at the edges, and in that condition they are mailed to distant friends. Hundreds of visitors from Honolulu visit this spot every year and go through this rite peculiar to the place.

### UNITED STATES' PRODUCTION OF PORTLAND CEMENT

The production of Portland cement in the United States reached the enormous total of 76,549,951 bbl. in 1910, according to figures just issued by the Geological Survey, the value of which is given as \$68,205,800. This is an increase over the production of 1909 of 11,558,520 bbl., or nearly 18 per cent, and an increase in value of \$15,347,446, or more than 29 per cent. This increase alone is greater than the total output in 1900, when the production first passed the 10,000,000-bbl. mark, and the production of 1900 was an increase of 2,600 per cent over the production of 1890. Measured by the capital invested, the cement industry is one of the world's three greatest extractive industries.

### WALL BUILT TO STOP EVIL SPIRITS

The Chinese believe that evil spirits are able to move only in straight lines, and that they cannot penetrate through solid matter, therefore, the problem of keeping them out of a dwelling or a garden seems to them a simple matter. On passing through the entrance of the ordinary middle-class home in China, it is necessary to turn to the right or left because of a fixed screen, the purpose of which is to keep evil spirits out. Likewise, just back of the entrance to a walled garden, may sometimes be found a wall of the type shown

in the illustration, erected for the same purpose.



A Wall Built Back of the Entrance of a Chinese Garden to Keep  
Evil Spirits from Entering

## CANARY BIRDS IN MINE-RESCUE WORK

That canary birds are destined to play an important part in mine-rescue work was proven for the first time to the United States government in its rescue work recently at the Cross Mountain mine explosion at Briceville, Tenn., in which 89 miners were killed.

It was the first chance for the government rescue workers to test the value of canary birds in connection with their work, and for the first time the rescue cars each had from one to three dozen birds on board as part of their equipment. It was known that the canary bird is very susceptible to impure atmosphere and this led the government experts to experiment with them in air of unknown quality in the depths of mines.

Government rescue men equipped with the new oxygen-making machines strapped to their backs, and protected with hoses leading into their mouths, entered the mine depths with these canary birds and a squad of unmasked volunteer rescuers. The birds were watched closely as the party moved further into the tunnels of the mine.

As long as the birds remained cheerful and hopped about in their cages it was known that all was well with the surrounding atmosphere, but suddenly when the birds began to droop and

gasp for breath it was realized that the traces of the deadly "afterdamp" were present and the unmasked volunteer rescuers with no oxygen equipment had reached the place for them to stop, for no one but the men with the oxygen machines could penetrate into the death-dealing atmosphere beyond.

The canary birds drew the line of safety. At no time were the rescuers exposed to the dangers of the afterdamp. It was the first time in mine-rescue work where rescuers were not brought forth overcome with gas and afterdamp.

## TREATMENT OF CANCER BY FULGURATION

The apparent increase in the number of cancer cases has led physicians to put forth the greatest efforts to find a cure for that dread disease. Many methods of treatment have been devised and much study has been given to determining the cause. No definite cause has been established, and the great number of methods of treatment employed shows that no absolutely successful one has yet been found.

Dr. De Keating-Hart, a noted cancer authority, of the Hospital Saint Luc, Paris, has originated a treatment which he believes is the most successful yet employed, and in New York recently he explained and demonstrated his electro-surgical method which he calls "fulguration." The word means flashing, lightning-



Mine-Rescue Worker, Equipped with New Oxygen-Making Machine and Canary Birds. About to Enter a Mine after Explosion

like, and the treatment consists in applying to the region of the cancer powerful electric sparkings of great frequency and high tension from a coil or a static machine, using special electrodes for applying the spark after first cooling it. This does not destroy either the cancer tumor nor the surrounding tissue but acts on the soil in which the cancer grows, cutting off its supply of nourishment and preventing a recurrence. The best results are secured by first removing all the cancer tissue possible by the knife and then applying fulguration, which prevents the growth of any remaining cancer tissue in the neighborhood.

Radium, the X-ray and the Finsen light or violet rays have also been used for this purpose, and with good results in many cases. Both Dr. Doyen and Dr. Nagelschmidt have tried to destroy cancer by the electric spark, but by their methods the tissues were burned in an objectionable way. Dr. De Keating-Hart's method avoids this, and is a valuable palliative and curative method in inoperable cancers. In 70 per cent of these hopeless cases it stops the growth, relieves pain, causes healing and the patient becomes stronger and lives longer. Cancers on the skin and mucous membranes of the mouth and elsewhere have been cured in 83 per cent of cases with no return in one to two years.

Cancers of the breast have also been cured, apparently with no return in three years in 40 per cent of cases. The method is being used at the New York Skin and Cancer Hospital.

### INTAKE GATES OF THE LOS ANGELES AQUEDUCT

The Los Angeles aqueduct, without doubt one of the greatest civic achievements of history, is now within one year of completion. By means of this water course, 240 miles in length, that skirts the Mojave Desert for 130 miles and tunnels a mountain range, the city of Los Angeles will ultimately take her domestic water supply from the Sierra.

The accompanying photograph is the first to be printed of the giant gates at the head of the aqueduct through which the Owens River will be diverted into the man-constructed channel that is to carry it so far southward.

The entire diversion works are of concrete masonry many feet in thickness and reinforced with steel. The gates which are four in number are approximately 10 ft. high and 10 ft. wide. They are of solid steel, semi-circular, and work on pivots, being so nicely adjusted and balanced that they are easily opened or closed by hand.

The photograph is taken from be-

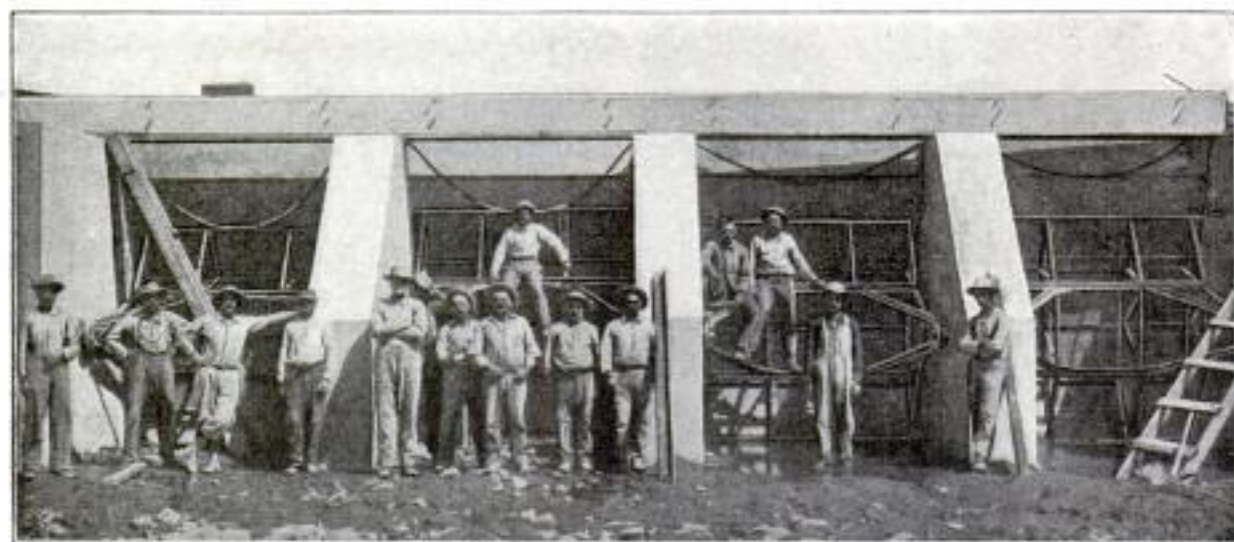

The Giant Intake Gates of the Aqueduct, by Means of Which Los Angeles will Bring Its Water Supply from a Distance of 240 Miles



low, the Owens River being shut off by a temporary earthwork embankment. The size of the gates and the dimensions of the concrete structure will be appreciated, if they are compared with the number and the height of the men seen in the foreground.

### ARMY TRUCK PROVIDED WITH A CAPSTAN

One of the motor-truck manufacturing concerns of Paris is equipping several of its army and commercial trucks with capstans, mounted at the rear end as shown in the illustration. The drive for the capstan is by means of a horizontal shaft operated by worm gearing from the jackshaft, and allowing of the use of the four gears normally used for driving the vehicle. Locating the capstan at the rear does not necessarily curtail the length of the body, for on the type of open or closed body,

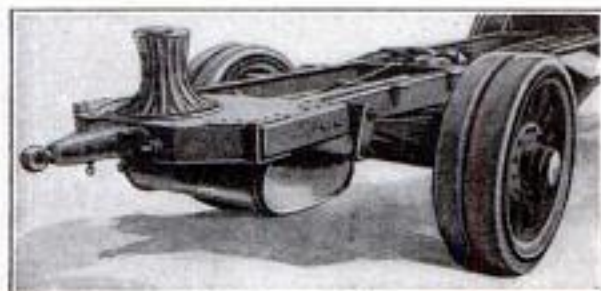

The Motor-Operated Capstan and Spring-Buffer Coupling for Trailers are Features of a New Military Motor Truck Built in Paris

built to fit the army regulations, the clearance between the top of the frame members and the bottom of the body is sufficient for housing the capstan.

Another feature of these trucks, also shown in the illustration, is a coupling provided for the use of a trailer. It is composed of a steel housing bolted to the transverse rear-frame member and containing a connecting link having spring buffers.

### "STREAMLINE" PIPE FOR MOTORISTS

Various shaped pipes have been designed for motorists who wish to enjoy tobacco without discomfort when traveling at high speeds, and the accompanying illustration shows one



A Pipe Designed for Motorists Who Wish to Smoke while Running at High Speeds

type of "high-speed" pipe in action. It is called a "streamline" pipe, because the shape of the bowl is in accordance with the streamline form, which is calculated to offer the least wind resistance.

### BENT SWORD AS MESSAGE OF PEACE

Following the capture of the village of Kebang by the British expedition in penetrating the Abor country of India to suppress the savage natives, the chiefs of Damroh, which is the chief village of the Pedam Abors, sent a letter or message begging for peace. This message consisted of a sword and a spear, both of which had been bent.

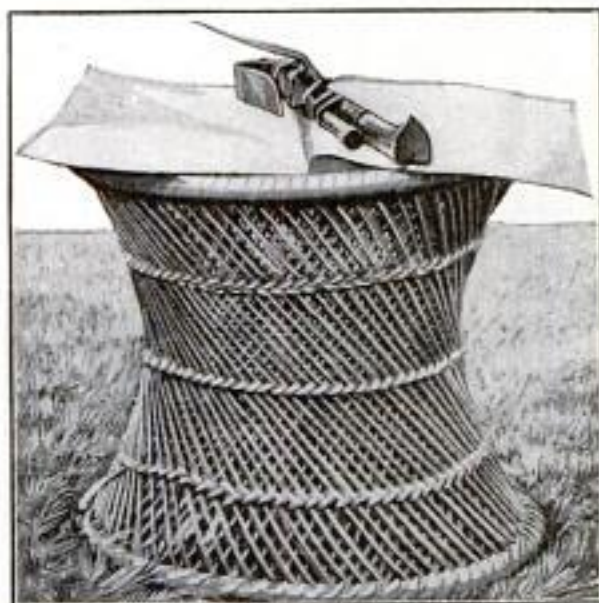

A Bent Sword and Spear Sent to a British Expedition in India as an Abor Token of Peace

## INTERIOR OF A MORTAR PIT AT FORT TOTTEN

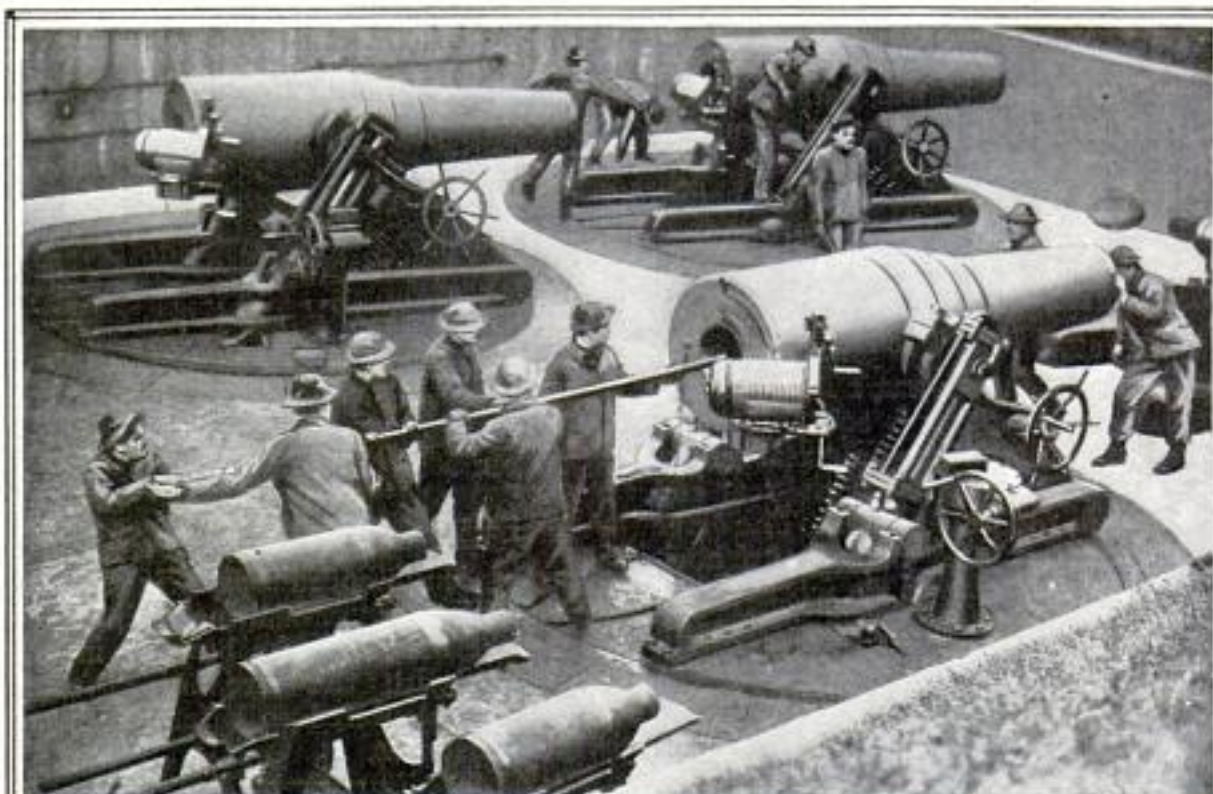

Loading a 12-In. Mortar. Three of the 1,000-Lb. Projectiles on Trucks in the Foreground

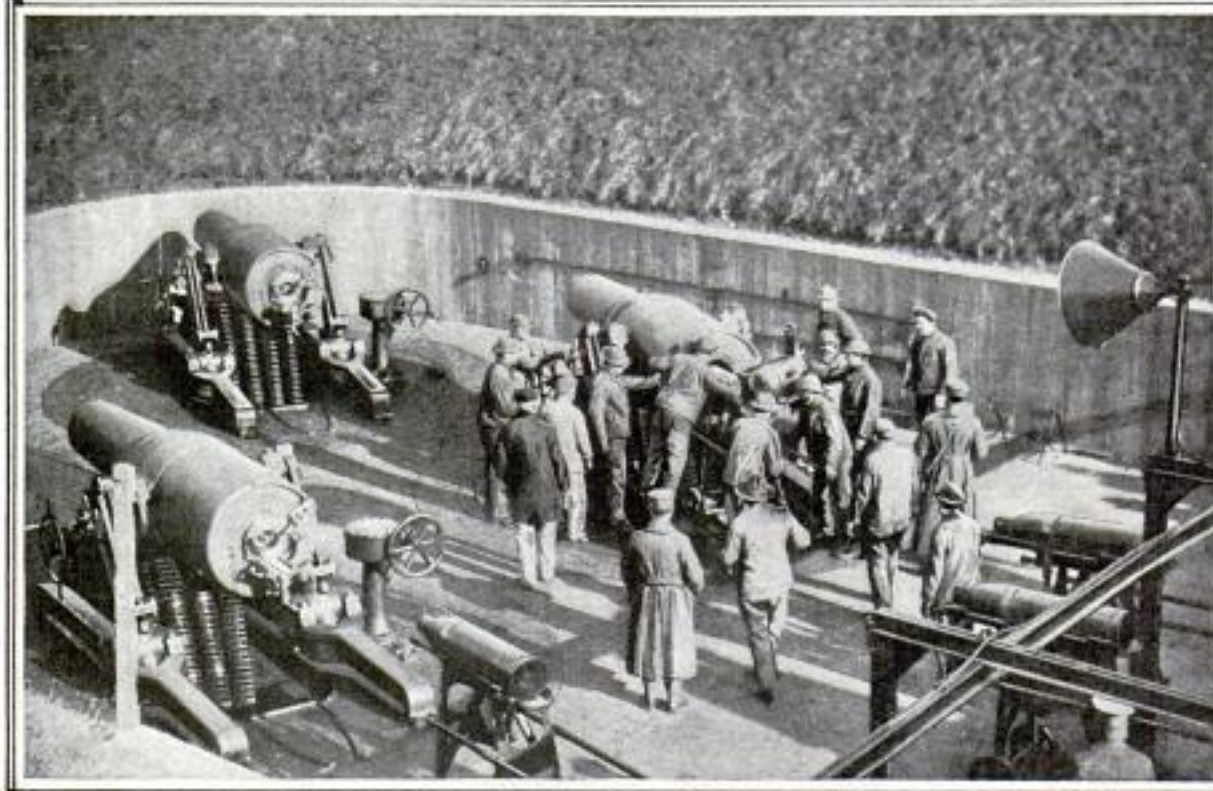

Artillerymen Preparing One Section of the Mortar Battery at Fort Totten for the Test

Artillery and ordnance officers at Fort Totten, New York Harbor, recently tested a set of gun carriages built for 12-in. mortars, a battery of eight of these guns being fired with full charges at various ranges and under varying conditions for the purpose of the test. The mortars are among the most deadly weapons of coast defense. They are mounted in groups in an emplacement known as a "pit," which is

## DURING RECENT TESTS OF IMPROVED MOUNTS



Photograph Made an Instant after Firing of a Mortar. Most of the Plates Used in Trying to Make Pictures on This Occasion were Broken by the Shock of the Explosion

Method of Transporting the 1,000-Lb. Projectile by Trolley from the Magazine to the Pit. As Much of This Work as Possible is Done by Machinery

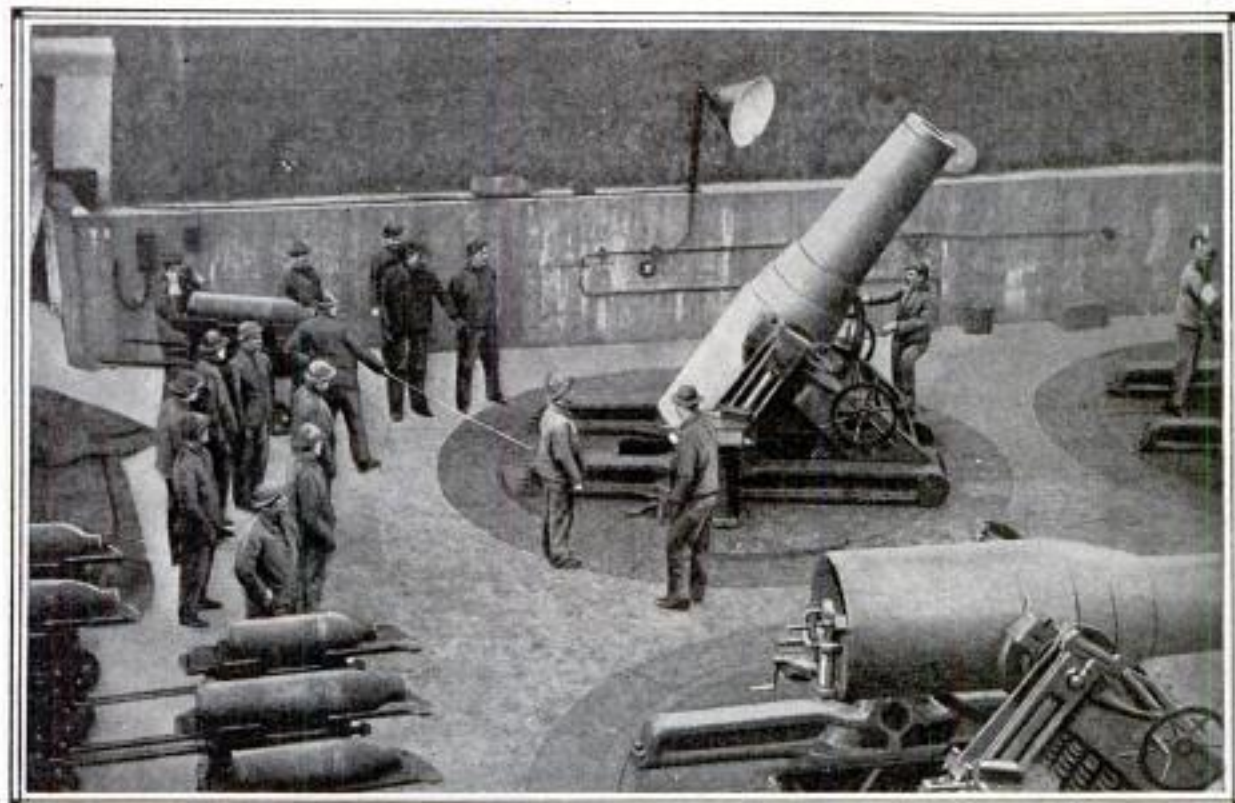

One of the Mortars Ready to be Fired. The Gunner is Seen with the Lanyard in His Hand, Ready to Discharge the Piece and Send a Shell 10 Miles Out to Sea

usually divided into two sections, four of the guns being in each section, eight constituting a battery. The guns are short, stubby pieces of artillery of an ominous, bulldog type, and their mission is to send a 1,000-lb. shell high in the air to drop finally on the deck of a ship. They are effective up to a range of 10 miles, and American gunners have attained a remarkable degree of accuracy with them.

### A GIANT IMITATION SPIDER WEB

This odd imitation spider web is found on the country estate of a Chicago man who was searching for unusual decorative effects. It is 60 ft.

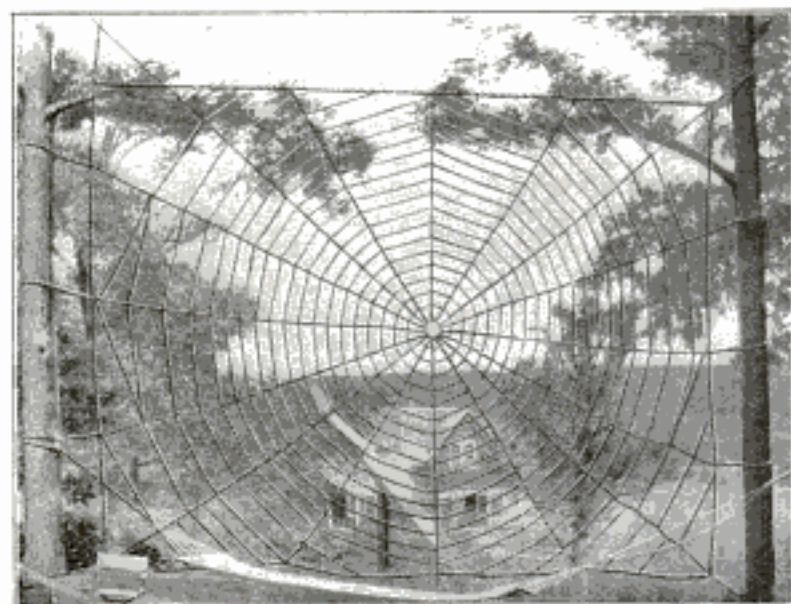

An Imitation Spider Web, 60 Ft. Wide by 40 Ft. High, Strung between Trees on the Country Estate of a Chicago Man

wide by 40 ft. high, strung between two large trees, and one may easily climb to the top of it. At a distance, the illusion of actual spider's work is said to be perfect. The web is made of rope.

### ILLUMINATED FLOWERS AS HAT TRIMMING

In a search for bizarre ideas in millinery designs, one milliner has displayed several evening hats or bonnets trimmed with illuminated flowers. Each flower contains a tiny electric bulb and the battery is carried in the crown of the hat. A hidden switch enables the wearer to throw the "headlights" on or off at will.



### A GLACIER TOMB GIVES UP ITS DEAD

Because of the excessive heat of the last summer in Europe, the glaciers of the Alps underwent exceptional changes, and one glacier tomb has given up one of its dead, while the bodies of other climbers lost several years ago may yet be found. The body found was that of a young electrician who was lost in the famous Loetschen glacier in 1899. Two Englishmen were lost in the same glacier in 1895, and the alpenstock of one of them has been found, which leads to the belief that the bodies might also be recovered.

It is of interest to note that the number of lives lost each year through accidents while climbing the Alps is fully twice that of the aviation death list. The greater number of deaths are due, of course, to inexperience on the part of tourists. After making trips with guides, they often start out alone on climbs which to them seem simple. They lose their footing, or slip through a crust of snow which is apparently safe, and are swallowed without hope of escape, or dashed to their death.

### PROGRESS IN LONG-DISTANCE TELEPHONY

Two long-distance telephone conversations carried out recently in experimental work, are of much interest, not because of any exceptional distance between the points, but because of the condition or nature of the territory lying between. One of these conversations occurred in Europe and the other in this country.

The European conversation was held between London and Basel, Switzerland, the distance being 620 miles. The experiment is one of the many being made to ascertain how far the

public telephone service between England and the continent may be extended through the medium of the new and improved cable across the English Channel. Conversation was maintained quite easily in this test.

In the other instance the conversation was between San Francisco and El Paso, Texas, a distance of 1,296 miles over mountain, valley and plain. This establishes a new record for long-distance telephone conversation in the west, and was made possible by the completion of new lines in New Mexico.

### MILK-CAN LOCK USED IN ENGLAND

The milk-can holder and lock shown in this illustration has been invented by an Englishman to prevent thieves

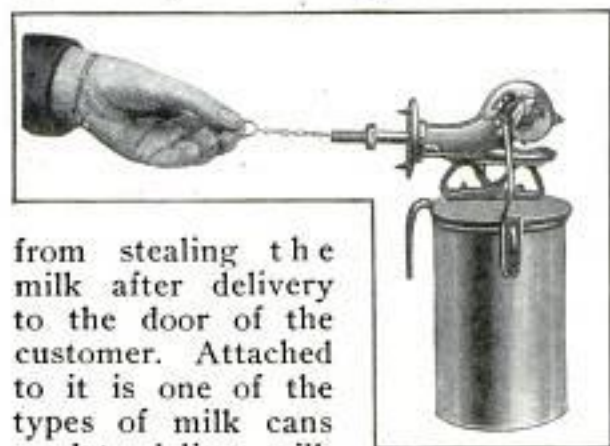

from stealing the milk after delivery to the door of the customer. Attached to it is one of the types of milk cans used to deliver milk in that country.

The milk-can holder is attached knocker-fashion to any door, the tube with which its base is provided protruding inside the door. The milkman, in delivering the milk, inserts the handle of the can in the circular teeth, which lock automatically. A chain, attached to the locking mechanism, passes through the tube and hangs down inside the door. The only way to release the catches of the lock is by pulling this chain.

Locking Device to Protect Milk Cans from Thieves

As the result of reports from engineers to the French ministry the project to build a ship canal from Paris to Rouen has been dropped.

### FIRE TOOLS IN THE FOREST

One means, newly adopted, by which provision is made for quick attack upon fires in the national forests, is

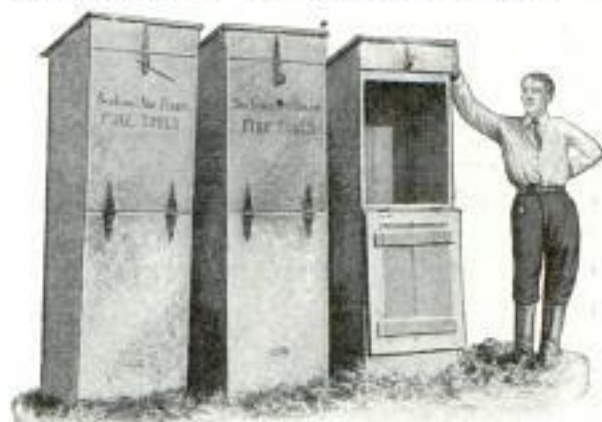

Boxes for Fire-Fighting Tools in the San Isabel National Forest

the keeping of fire-fighting tools at many different points, where they will be immediately accessible in case of emergency.

The tools for this purpose are housed in boxes such as those shown in the accompanying photograph, taken in the San Isabel national forest. Chief among them are spades, axes, and pick axes.

### COMBINED PENKNIFE AND SIX-INCH RULE

An interesting combination of pocket tools is shown in the accompanying illustration. It is a two-bladed penknife, one side of the handle of which, when extended, is a 6-in. rule,

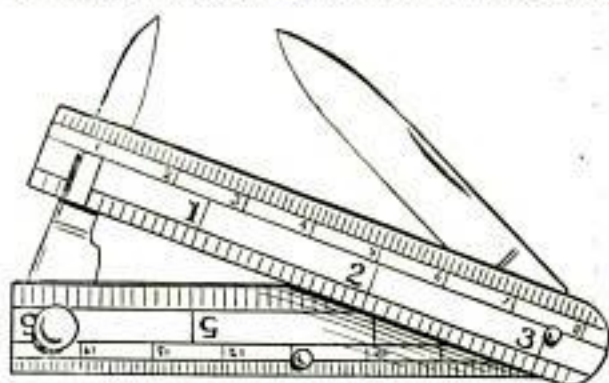

A Penknife, the Handle of Which is a Six-Inch Rule which gives both the standard and metric systems of measurement.

## INTERESTING TEST WITH CONCRETE PILES

A concrete pile, 16 in. in diameter and 60 ft. in length, said to be one of the longest concrete piles of that size ever constructed, was recently used in Washington when an experiment was made to devise a suitable foundation for the magnificent city post office which is soon to be erected adjoining the Union Station, and but a short distance from the National Capitol.

The site on which the post office is to be erected, besides being ground that was filled in at the time the station was built, is directly above the bed of a stream that flowed through that section of Washington many years ago. Test borings showed that the foundation would have to be an unusually deep one because of the peculiar nature of the ground.

Officials of the office of the supervising architect of the Treasury Department, which has charge of the erection of all government buildings, finally decided to experiment with concrete piles and accordingly two of them, 60 ft. in length, were made. These piles were reinforced with six 1-in. steel bars.

By means of a steam hammer, three 20-ft. sections of steel tubing, having an inside diameter of 17 in., were first driven into the ground. A cone-shaped point of iron was fitted to the end of the first section of the tubing. When

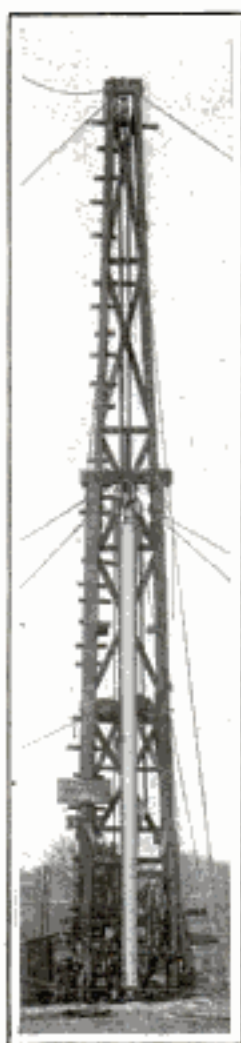

One of the Reinforced Concrete Piles Used in Government Test



Lowering the Concrete Pile into Steel Bore, a Critical Stage of the Experiment

this was driven into the ground the additional sections were connected to it by means of heavy drive-pipe couplings.

When the time came to lower the concrete pile into the tubing, the biggest task of the whole experiment was encountered, for the officials of the office of the supervising architect feared that the pile would be broken in half during the operation.

With the use of an 80-ft. derrick and skillful rigging, the pile was lowered into the tube, however, without a mishap. Clamps were then attached to the end of the tube which was soon withdrawn from the ground by means of hydraulic jacks.

A testing platform was then arranged so that the greatest weight rested on the end of the pile, which protruded several feet above the surface of the ground. The platform was then loaded with pig iron. Measurements that were taken from time to time showed that after about three weeks the pile had sunk to

such a degree that despite the extreme length of the concrete shaft, this type of foundation could not be used in that particular site. Had the experiment shown that no sinking resulted after the shaft had been subjected to a test, about 1,500 piles of this nature would have been used in the construction of the building's foundation.

It is understood that further experiments will be conducted for the purpose of determining the safest kind of foundation for the new post office.

### ADVERTISING ON GERMAN PAPER MONEY

The blank space on German 100-mark notes is being made use of for advertising purposes by a German motor-car company in a manner designated as bold and ingenious. On a number of them this concern has printed the design of an automobile and an announcement to the effect that "whoever drives these cars saves many of these notes." Many people regarded the notes as spurious at first, and considerable excitement was caused in official circles, but as there is no law that



German 100-Mark Note Bearing the Advertisement of a Motor-Car Concern

forbids such treatment of the notes, nothing could be done to restrain the company.

¶The "Flower Express," a train which runs every day in the year between Toulon and Paris, carries nothing but cut flowers in baskets and pasteboard boxes for the Paris market.

### PROTECTION FOR WORKERS IN COTTON MILLS

As dirt is damaging to spun yarn, giving the finished yarns and the cloth made from it an unclean appearance, naturally every means of eradicating it is employed in the great cotton-spinning mills, regardless of its being objectionable from a sanitary standpoint. But in cleaning the wires of the carding machines, which has to be done

three or four times during the working day by workmen known as "strippers," much dust and fine fibrous matter is nevertheless liberated, forming dense clouds about the breathing area of the strippers. This involves serious risk to the strippers, and it is a well-known fact that a large percentage of these men have been found to be



Courtesy Cassier's Magazine  
Simple Cotton Respirator Used for Many Years by Lancashire Cotton Workers

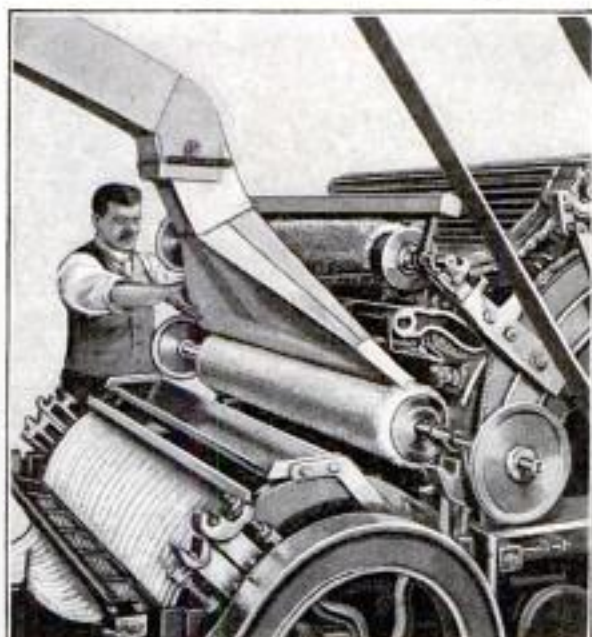

A Type of Dust Extractor Which may Solve the Dust Problem in Cotton Mills. Fan-Currents Draw the Dust into a Hopper and It is Carried Away by Pipes



A Scientific and More Effective Respirator is being Used to Some Extent

more or less affected with lung and throat complaints.

The strippers, naturally, seek relief in any way obtainable, and for many years have adopted the simple plan of wedging a plug of cotton between their lips in the manner shown in one of the illustrations, in the hope of mitigating, to some extent, the effects of dust inhalation. This simple respirator has been used by hundreds of strippers in the cotton mills of Lancashire, Eng., but the more scientific and effective respirator shown in another illustration is now being used in some of the mills.

Complete elimination of the dust clouds, however, is the aim of the mill operators, as well as the removal of

dirt and fibrous matter from the cards, not only as a protection to the workers, but as a means of obtaining still cleaner and finer yarns. To properly solve the problem, means must be adopted to catch the dust particles as near as possible to the point where the stripping brush impinges on the card cylinders, and in endeavoring to do this, a dust extractor of the type shown is being used. The dust is drawn into a hopper by means of fan-currents and is carried away through pipes. One hopper suffices for 20 or 30 cards, according to the length of the line of machines, the hopper being supported by a movable carriage running on rails attached to the dust trunk, which runs along the ceiling.

## WORLD'S HIGHEST DAM TO BE BUILT IN IDAHO

BY L. WILLIAM THAVIS

Building the highest dam in the world, owning and operating a railroad, and creating the biggest reservoir in existence are three of the present activities of Uncle Sam. The railroad was constructed by the Reclamation Service. It is of standard gauge, 22 miles long and runs between Arrowrock and Boise City, Idaho.

The necessity for it was the same that has caused Uncle Sam to do many unprecedented things in connection with the big irrigation projects in the West. Many of these are located in the desert, and it is necessary for the government to build roads, telegraph and telephone lines, run hotels and department stores and, in this last venture, to build a railroad to get men and material to the scene of work.

The big dam that is being put in on the Arrowrock project in Idaho will be 351 ft. high and will cover an acre of ground. It is in a narrow section of the Boise Cañon, about 20 miles above Boise City. The site was selected only after long search. There were several drillings and pit diggings before bedrock was struck, 90 ft. below the surface of the river.

Four or five years will be consumed in construction. The top will be 25 ft. wide and 1,000 ft. long, with a roadway which will be protected by a parapet on each side. The dam itself will back up a lake of water that will irrigate 250,000 acres. When the reservoir is full, the water will be drawn off through gates near the top. As the level of the water is lowered, lower gates will be opened, so that these outlets never will operate under an excessive head of water.

The one place where there will be a maximum head will be the penstock that will be put in to run the turbines at the foot of the dam. There will be need for much electric light and power in connection with the dam itself, and a generating electric plant will be constructed so that it can be enlarged as desired for this purpose, and for the manufacture of electric power for sale. This is a feature that produces a steady income for several of the big irrigation works.

When the dam is full and there are floods in the Boise River, the capacity of the work may be taxed, and as a result there is a safety valve in the





The Site of the Arrowrock-Boise Dam, to Be the Highest in the World. White Line Indicates Height of Dam, 351 Feet above the River



Looking Downstream from the Site of the Dam, the Camp and Railway Bridge in Middle-Foreground

shape of a spillway at one end, capable of carrying 40,000 cu. ft. of water a second. It is thought this will more than take care of any normal flood in

the river, but the dam is so built that, if necessary, water can waste over the top to a depth of from 2 to 4 ft. without injuring the structure itself.

### HORSE DRAWS FUELLESS LOCOMOTIVE

The Raquette Lake Railroad, which traverses a forest section of New York state, used oil-burning locomotives even before the state passed the law



Automobiles are Not the Only Vehicles That Have to be Towed by the Humble Horse

compelling such locomotives for forest stretches. In the accompanying illustration is shown a horse hauling one of the oil-burning locomotives of this road to an oil-supply tank. Its supply of fuel had been consumed while still a short distance from the station.

### NEW CUBAN PROCESS OF SUGAR EXTRACTION

A new process of sugar extraction, being tested by a sugar factory in Cuba, is said to waste only one per cent of the sugar content of the cane. In this process the cane is first reduced to a fibrous pulp, which is dried and then treated by diffusion.

It is also claimed that by this method the residual pulp is, without further treatment, ready for immediate utilization in the making of paper.

### ULTRAVIOLET-RAY STERILIZERS FOR ARMY

Uncle Sam proposes to safeguard the lives of his soldiers stationed at tropical posts against death by drinking impure surface water. This is to be done by sterilizing the water by electricity.

The statement is made by War Department officials that more American soldiers were killed in the Philippines by impure drinking water than by Filipino bullets. This is also true of the Spanish-American war. It has been found almost impossible to induce the soldiers to boil their drinking water and they have too often preferred to take chances of impurities of the surface

water in the Islands rather than drink the flat boiled liquid. At last the medical corps officers believe that they have solved this important problem by a system of sterilizing the water with ultraviolet electric rays.

Strange as it may seem, drinking water can be purified more cheaply by electricity than by the universal method of boiling. At the same time the "live" taste of drinking water will be retained. All the microbes and death-dealing animalculæ can be destroyed by a single flash of the rays from an electric bulb.

The work of producing ultraviolet rays will be a very simple one at the army posts, most of which have electrical plants. For troops in the field it is proposed to furnish a small gasoline engine to run a miniature electrical plant. It is not the heat from the electrical bulb that kills the germs, but the ultraviolet rays.

## AN AUTO-AEROPLANE COASTER



A Curious Swiss Coasting Sleigh Which Has Features Adopted Both from the Automobile and the Aeroplane

An ingenious coasting sleigh, which recently made its appearance at Davos, Switzerland, is described as combining the features of an automobile, a sleigh, and an aeroplane. It is designed for use on the long coasting slides in Switzerland, and the two sets of small wheels are so arranged that a lever raises them from the surface and drops the skids in position to carry the machine. When the coaster reaches the bottom of the slide and stops, the manipulation of the lever raises the skids and the machine returns up the grade on its wheels. The two planes or wings in front aid the pilot in steering during the trip downhill.

### THE HUDSON RIVER AND OCEAN SHIPS

A project to deepen the Hudson River so that ocean vessels may ascend to Albany and Troy, 150 miles from the sea, is receiving considerable attention, and several of the consulting engineers on the New York State Barge Canal work, seem to be in favor thereof. The Federal government has

already appropriated some \$5,000,000 to provide broader channels, with a minimum depth of 12 ft., to Albany and Troy. Mortimer G. Barnes, one of the consulting engineers, estimates that by increasing this appropriation to \$15,000,000, the channel could be deepened to 21 ft., with a width of 600 ft. to Staats Landing, and 400 ft. to North Albany; and that \$21,250,000 would provide for an increase of depth to 25 ft.

With the river deepened to 25 ft., an ocean vessel could deliver its cargo to Albany, making, it is claimed, nearly as much speed as on the open ocean. There is, however, according to an article in the *Engineering News*, a doubt as to whether the deepened river would be extensively used by ocean ships. So far as traffic over the New York Barge Canal is concerned, when that channel is completed, barges coming through from Buffalo on the west, or Lake Champlain on the north, can pass down the Hudson River and discharge their cargoes at New York more cheaply than ocean vessels could go to Albany to meet them.

## A SOLITAIRE BASEBALL GAME ON MARS

It would be possible for a man to play a game of baseball alone on one of the two little moons of Mars, provided he could live there as well as he can on the earth. The possibility of such a game depends upon the fact that these satellites are only a few miles in diameter and that they have no atmosphere. Of course, it follows from the latter fact that the baseball player would be continually out of breath, but this circumstance will be neglected. Such a wonderful baseball game was recently outlined by Prof. F. R. Moulton, of the department of astronomy of Chicago University, in a lecture.

When a baseball player on the earth throws what we call a "swift ball," it leaves his hand with a velocity of, roughly, 100 ft. per second. The resistance of the atmosphere diminishes the speed of the ball and the attraction of the earth curves it downward. On one of the satellites of Mars the speed of the ball would not be diminished until it struck the ground, because there would be no air to retard it, and the ball would curve downward very slowly, because the attraction of so small a body is very feeble. A body dropped at the surface of the earth falls a distance of 16 ft. in the first second, while on one of these satellites its fall would be only one-fifth of an inch. Otherwise stated, a body which weighs one pound on the earth would weigh only one-sixtieth of an ounce on the satellites of Mars.

The baseball would be very light, but its inertia would be no less than it is here, and therefore the same amount of energy would be required to throw it with the same velocity. Consequently it must be supposed that the baseball player, who would himself weigh only one-fifth of a pound, could not throw the ball any faster than he can on the earth. But since the curvature of the ball downward would be very much less than it is here, he could throw the ball much farther there. In fact, it is found

by computation that the curvature of the ball downward is less than that of the surface of the satellite, because so small a body has a strongly curved surface. This circumstance, together with the fact that the ball would not be retarded by an atmosphere, makes possible a solitaire baseball game.

The baseball player would start the game as a pitcher. After such preliminary motions as he might wish to make, he would throw the ball in a horizontal direction. There would be no use in giving it a spin, for there would be no atmosphere to make it curve. If he threw the ball anywhere near 100 ft. per second, it would go around the satellite, remaining continually at about the same distance from its surface, and would return directly over the point from which it was thrown.

In the meantime he would change himself into a batter and stand facing the direction from which the ball was coming; that is, opposite to that in which it was thrown. Unless his batting average were equal to that of Ty Cobb, the chances that he would miss it as it came speeding over the plate would be good. If he did miss it, it would go on around the satellite a second time with undiminished velocity, because it would not be retarded by an atmosphere, and he would get a second strike at it. If he took three strikes and missed each one, he would become a catcher while it was going around the fourth time. With a catcher's big mitt, he would catch himself out on its fourth return.

If he should succeed in hitting the ball, as baseball players sometimes do, and it were a grounder, it would go bouncing along the surface around the satellite; and during this time he would change himself into a second baseman or shortstop, picking it up on its return. This, of course, would not put the batter out, so he would throw the ball in a horizontal direction, when it would again go around the satellite and return to the first

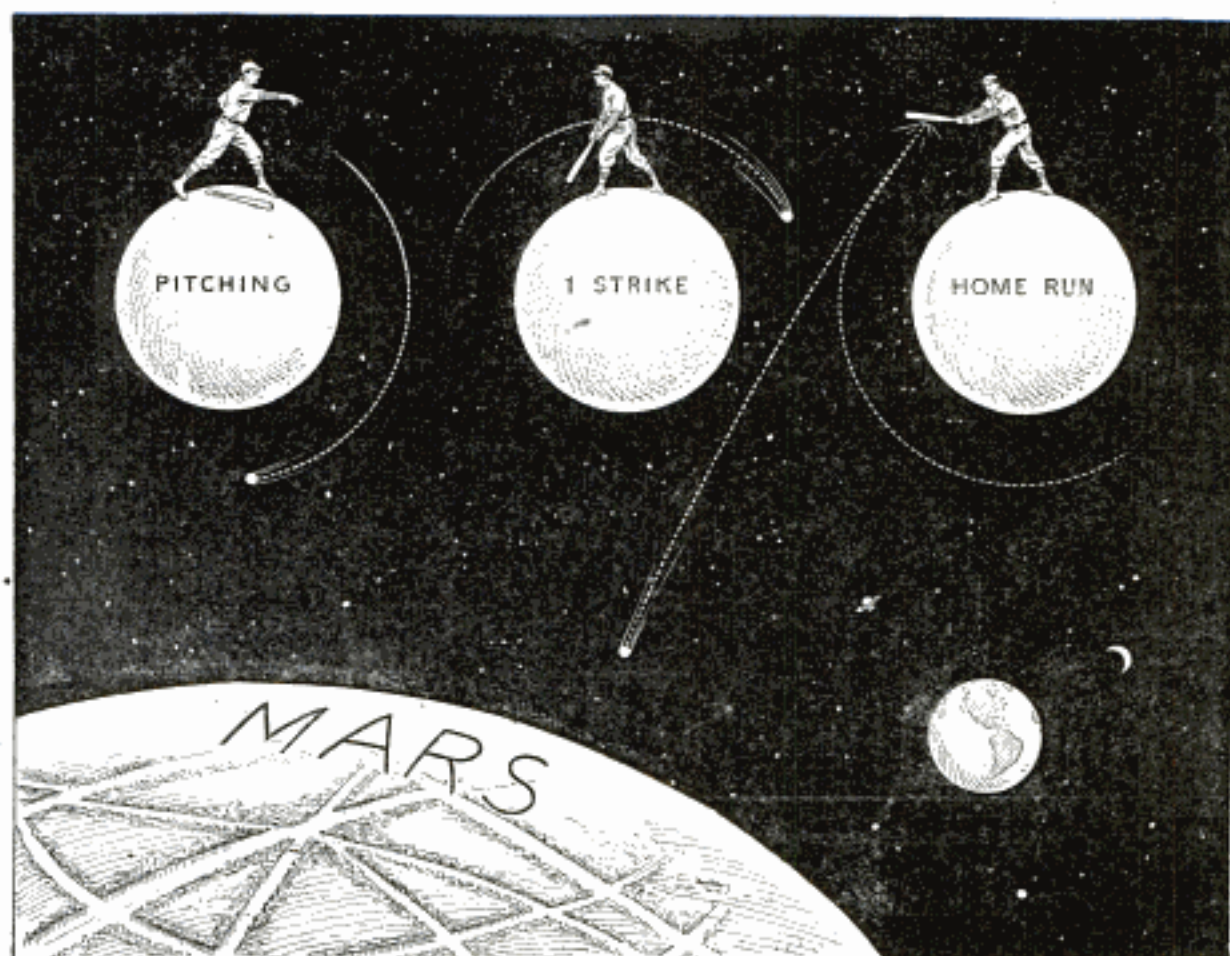

Professor Moulton's Remarkable Method of Illustrating Atmospheric and Other Conditions on the Moons of Mars, Assuming That a Man Could Exist There—Which He Cannot—He would be Enabled, Because of the Lack of Atmospheric Resistance and Gravity, to Play a Game of Solitaire Baseball

baseman, which he would have become while it was gone. If, on the other hand, he should knock a fly, it would go round the satellite in such a way as to be far from the surface on the side opposite from the place of the player; but it would return exactly to the point from which it had been hit. While it was doing this, he would change himself into a center fielder and catch himself out.

It seems from what has been said that the batter would necessarily get out every time he came to bat. Of course, the first baseman might miss a throw and the center fielder might drop the ball. But there is another result possible in which he would not only not be out, but would score a home run. If he should hit the ball very hard, that is, about as hard as is necessary to knock a home run on the earth, he could not catch himself out, for the ball would go with such speed

that the small attraction of the little satellite could not bring it back to its original place, and it would go down on the planet Mars. This would necessarily be regarded as a home run.

Every story, to be a good story, should have some point, and this story has a point. The atmospheres of the earth and other worlds are made up of little balls, called *molecules*, so small that it takes billions of them to make an ordinary baseball. These little balls are darting in every direction and continually hammering on everything which is in the atmosphere. Their continual bombardment makes the pressure of the air about 15 lb. to the square inch at the surface of the earth. Some of these little balls, or molecules, dart upward, but they are brought back again by the strong attraction of the earth. If one of the little satellites of Mars should have an atmosphere, molecules would dart upward

from its surface with such a velocity that they would escape from its feeble gravitative control, just as the baseball did when the batter made a home run. They would pass to the planet Mars, or perhaps to some other world,

and become a part of its atmosphere. This is the reason why small worlds, such as our moon and those which are still smaller, lacking in gravitative force, can not retain atmospheres and do not have any.



The Daughter of the Prime Minister of Denmark is Apprenticed to a Cabinetmaker

### DAUGHTER OF STATESMAN TO BE CABINETMAKER

The seventeen-year-old daughter of the Prime Minister of Denmark has given up social life to apprentice herself to a cabinetmaker. Until her apprenticeship is over she will live the life of a simple working woman, but hopes some day to manage her own workshop, devoting her life to the making of artistic furniture.

Of the 50,000 passenger cars in use on the steam railways of the United States, 11,017 are electrically lighted, according to the report of a committee of the Railway Electrical Engineers' Association.

### SUBMARINE THAT FIRES ITS BOW AT THE ENEMY

Construction is about to be commenced in San Francisco of a diminutive submarine having several ingenious features, invented by a retired major of the United States army. As shown by the plans, the little vessel, which is called an auto-submarine torpedo boat, is 45 ft. long, has a beam of but 43 in., and weighs only  $9\frac{1}{4}$  tons, so that it may easily be carried on the decks or suspended from the davits of a battleship. It is driven by gasoline engines of 225 hp., and will have a

speed of from 25 to 28 miles an hour on the surface.

In constructing such a small, one-man-operated submarine, the problem of carrying the torpedo was of particular importance. A torpedo that could be wholly carried within such a small boat would be too small to be effective, and the inventor therefore decided to use a standard-size torpedo, placed partially within and partially without the boat, making the longitudinal axis of the torpedo coincide with that of the

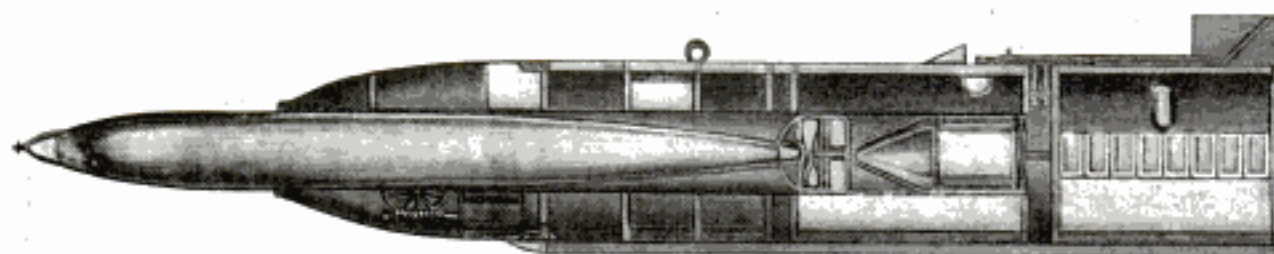

Showing the Size and Interior Mechanism of a Diminutive a Standard-Size Torpedo, at the Enemy; a Shoe, Engaging with

boat, and causing the forward third of the torpedo to perform the service of a bow until projected against a hostile warship. This is made possible by the use of a sort of shoe which the inventor calls a "sabot," and which is engaged by the tail of the torpedo. This sabot is operated by compressed air, and, when the air is released, is thrust forward, launching the torpedo and fixing itself in the bow of the boat as a plug, thereby forming a bow to take the place of the launched torpedo, and enabling the boat to be navigated back to its battleship.

The little submarine is designed to carry one man as crew. He sits in a conning tower which is hermetically sealed from all parts of the boat, and controls the vessel by means of operating mechanism in easy reach of his hands. The nose of the torpedo, of course, is not sensitized until it leaves the boat. The idea of the inventor is that such boats, to the number of five or ten, should be carried by each battleship, and that all should be discharged against a single target.

In making an attack, it is suggested that they run on the surface until within the sight-range of the enemy, then dip 5 ft. under the surface. At this depth they are still driven by the gasoline engines, but at lower depths storage batteries are to be used. The torpedo should be discharged when the boat is within 900 ft. of the enemy, according to the inventor, then the boat would dive to a depth of 15 ft., turn around and return to its battleship.

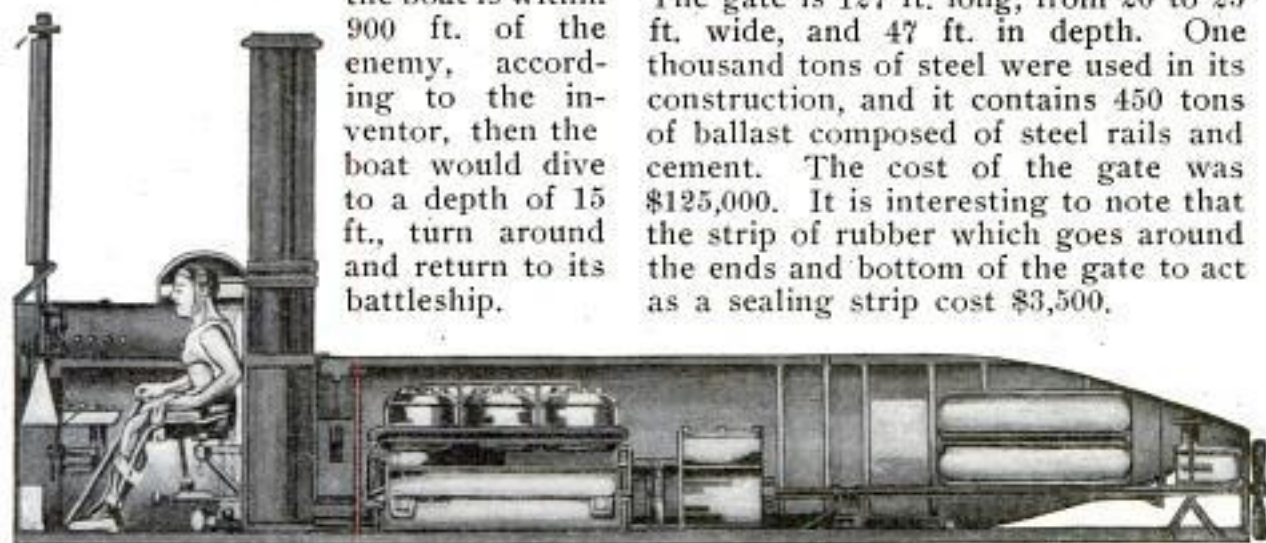

Submarine Designed to Discharge Its Bow, Which is Formed by the Tail of the Torpedo, Taking the Former's Place as a Bow

## THE LAUNCHING OF A DRY-DOCK GATE

The large gate for the new drydock at the Bremerton Navy Yard, across the Sound from Seattle, was launched



Launching of the 127-Ft. Gate for the New Drydock of the Bremerton Navy Yard

recently at Seattle, sliding down the ways in the same manner as a ship. The gate is 127 ft. long, from 20 to 25 ft. wide, and 47 ft. in depth. One thousand tons of steel were used in its construction, and it contains 450 tons of ballast composed of steel rails and cement. The cost of the gate was \$125,000. It is interesting to note that the strip of rubber which goes around the ends and bottom of the gate to act as a sealing strip cost \$3,500.



Though there are still many difficulties to be removed before seeing on the telephone ceases to be a problem, the realization by no means seems to be very far ahead.

Professor Rosing of the Technological Institute, St. Petersburg, taking advantage of the light-impressibility of a photoelectric element discovered by him, has invented what he calls a "phos-telephonic" system (from the Greek word "phos" meaning light), which is a remarkable approximation to the final achievement. Two other scientists, Drs. Elster and Geitel, have even gone a step further; for they have discovered an element which, apparently, is more susceptible to the impressions of light than Dr. Rosing's "phos-electric" element. Considering these facts, it is not unreasonable to expect the last and crowning success within a comparatively short time.

When a person stands before Professor Rosing's instrument and opens the circuit by taking the receiver off the hook, a small luminous pencil begins to draw his likeness on a dark screen, and in the twinkling of an eye the work is complete. His visible counterpart is there, and is rapidly transmitted to the sight of the person with whom he is speaking. So it is with the person at the other end: his image is traced on a screen and is transmitted to another small screen.

How is this done? Two systems of mirrors are moving in such a way as to cast the image upon the phos-electric element inside the transmitter. An ingeniously made vacuum tube sends out fine rays, not seen by the eye. These rays, falling on the screen, cause a certain part of it to appear very bright—that part where the image is—and an electric current transmits the image to the screen of the second person, wher-

ever that person may be. He sees the sudden brightness on the screen, and also the lifelike photograph—the miniature of the person to whom he is speaking.

The manner in which the mirrors move must be taken into account. By their movement they cause the light on the screen to accord exactly with the light rays reflected from the speaker's body. The image is thus transferred by the mirrors to the phos-electric element, in which is thereby excited an electric current that carries the image to the screen of the second person. All this is done instantaneously and being continuously repeated, causes the photograph to remain on the screen until the speaker withdraws, in the same way as moving pictures are possible through the cinematograph.

As the Rosing apparatus is yet in its infancy, only very small objects can be seen with it. But, considering the idea behind the invention, and in view of the favorable opinion of a celebrated expert, we may reasonably expect to have the final happy result at no distant date. To see a person while speaking to him on the telephone, will soon be a very familiar circumstance.

### MOST POWERFUL WIRELESS STATION

The wireless-telegraph station at Coltano, Italy, recently constructed by Marconi, is said to be the most powerful now in existence. It disposes of a transmitting power of 1,000 kilowatts (1,340 hp.) and its antenna contains about 3,300 ft. of wire. With this equipment it is expected that connection will be easily established with North and South America.



## AEROPLANE BACKS DOWN, SWINGING TO EARTH

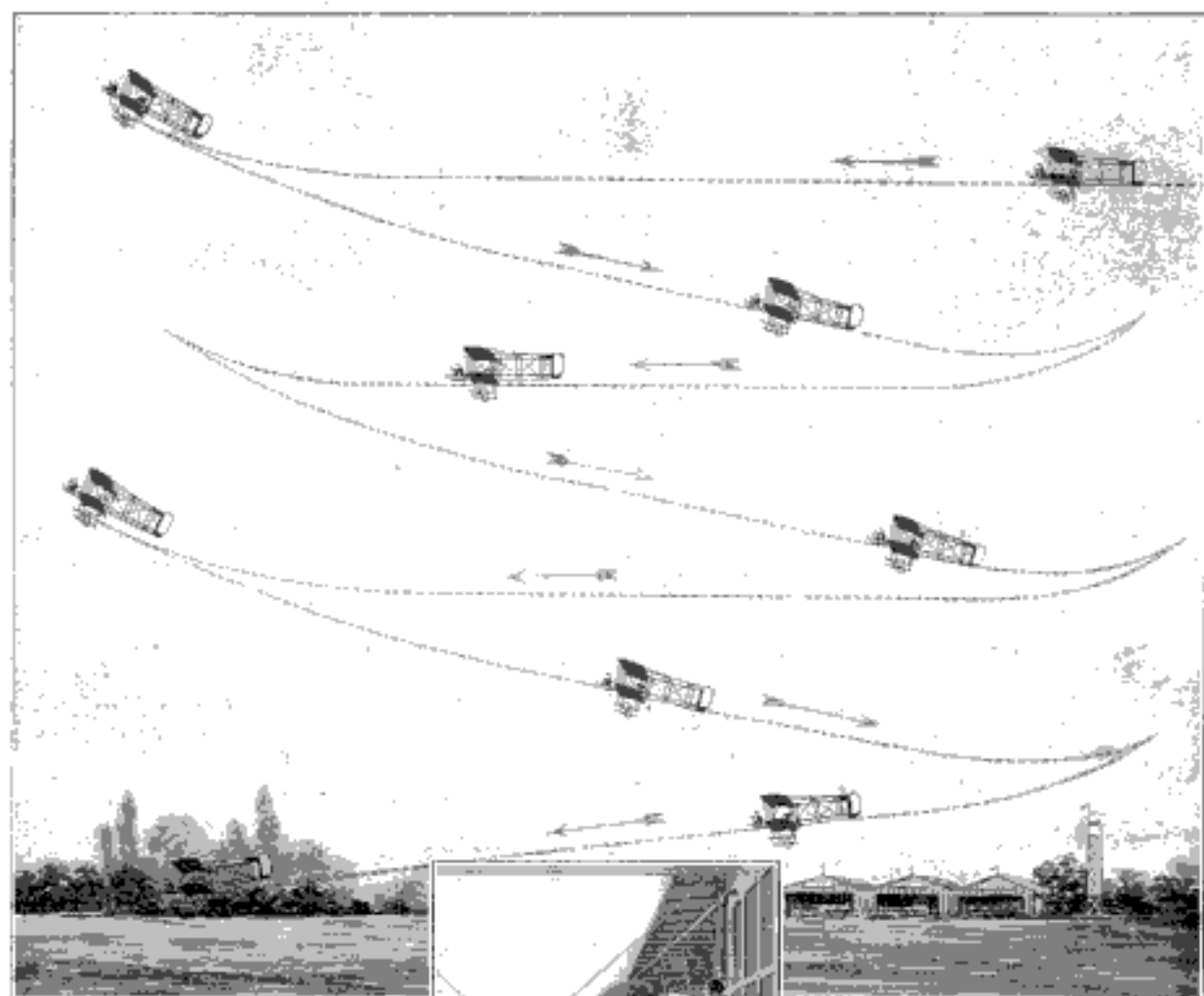

How Legagneux, the French Airmen, Executed His Latest Feat, Backing Down in Long Swings

The latest aviation stunt, news of which has just come from France, is the feat illustrated herewith, and in the performance of which it is stated that Legagneux, first famous as a bicycle rider and afterward known to two continents as an automobile racer, has attained great proficiency.

On the occasion of his most sensational execution of this new aerial maneuver, Legagneux is declared by various French army officers and other credible witnesses to have first ascended to a height of over 3,500 ft. Then, driving his machine on a horizontal course, he shut off the motor, steered momentarily upward, and as



Insert Shows This Pilot about to Start a Flight in the New Eleriet Aeroplane-Bus

soon as all momentum and forward movement were lost, permitted the machine to back down an incline in the air for a distance of several hundred feet. This accomplished, another movement of

the horizontal rudder tilted the machine into a position for diving forward, the motor was switched on, and travel in a normal direction, on a level course, resumed. A succession of these evolutions, with the machine swinging backward and forward, like the bob of a giant pendulum, and the ground was reached.

Interesting though such a flight may seem, as attesting the completeness of man's conquest of the air, it contributes

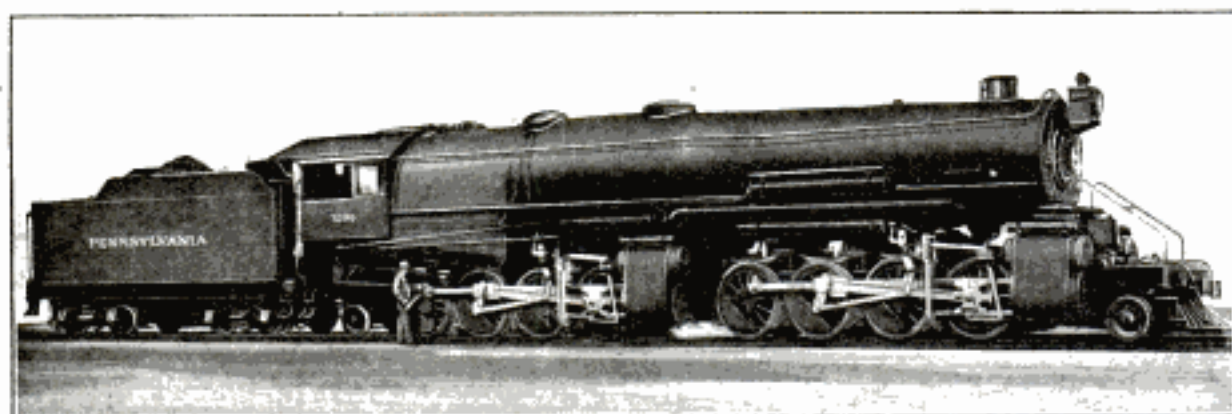

An American Locomotive, One of the Most Powerful Ever Built for an Eastern Railroad, Which is 98 Ft. Long, Including Tender, and, with the Loaded Tender, Has a Weight of 668,900 Lb.

little of value to engineering progress, because it can be accomplished only with the inefficient types of sustaining surfaces, so little specialized for ideal use that they will operate about equally well in either direction.

From the safety standpoint, such performances are even more to be condemned, since every fatality added to the present list in aviation does not affect merely the man foolish enough needlessly to risk his own life. There is in addition the injury to the future of a great industry, which at the present time is all too widely and vigorously denounced as a dangerous pursuit, with little consideration of the fact that many reckless but ignorant men, wholly incompetent except as mere aerial chauffeurs, are seeking large returns as aviation hippodrome artists by taking the most reckless and dangerous chances imaginable, chances that can have practically no bearing upon nor relation to saner flight.

### POWERFUL AMERICAN AND EUROPEAN ENGINES

One of the locomotives shown in the accompanying illustrations was built for the freight service of the Pennsylvania Railroad system, and while smaller and less powerful than the hugeallet type of one of the western railroad systems, is one of the most powerful used on eastern roads. Including the tender, it has a length of 98 ft., and, with the tender loaded, the total weight is 668,900 lb.

The other illustration shows the most powerful passenger-train locomotive in Europe. It is a 4-cylinder compound superheater locomotive used to draw the Nord Express, connecting Paris with Brussels. Drawing a train of 400 tons' coach load, this locomotive attains a speed of 75 miles per hour, developing about 2,000 hp. in the cylinders. The total weight, with tender loaded, is 317,000 lb.

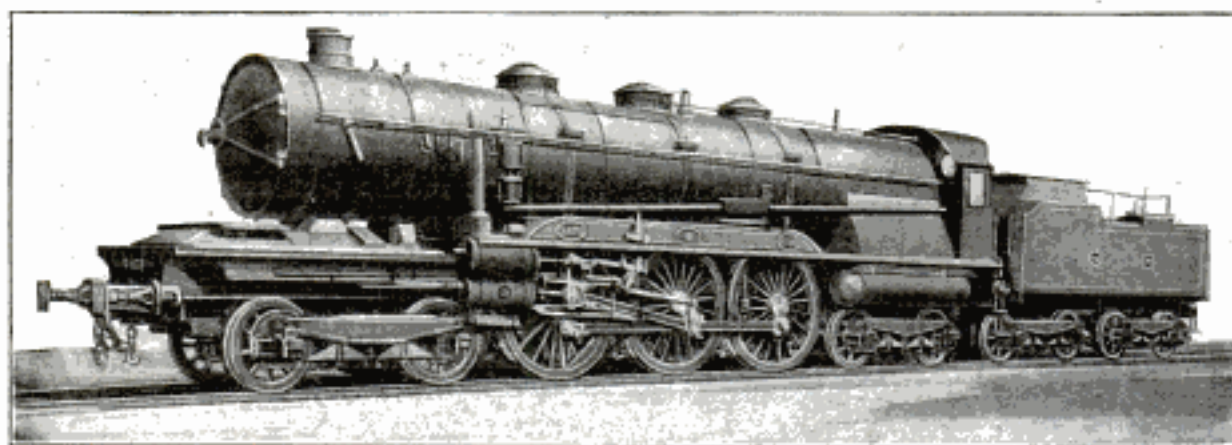

The Most Powerful Passenger Locomotive in Europe Weighs 317,000 Lb., Including Loaded Tender, and Draws the Nord Express at a Speed of 75 Miles per Hour

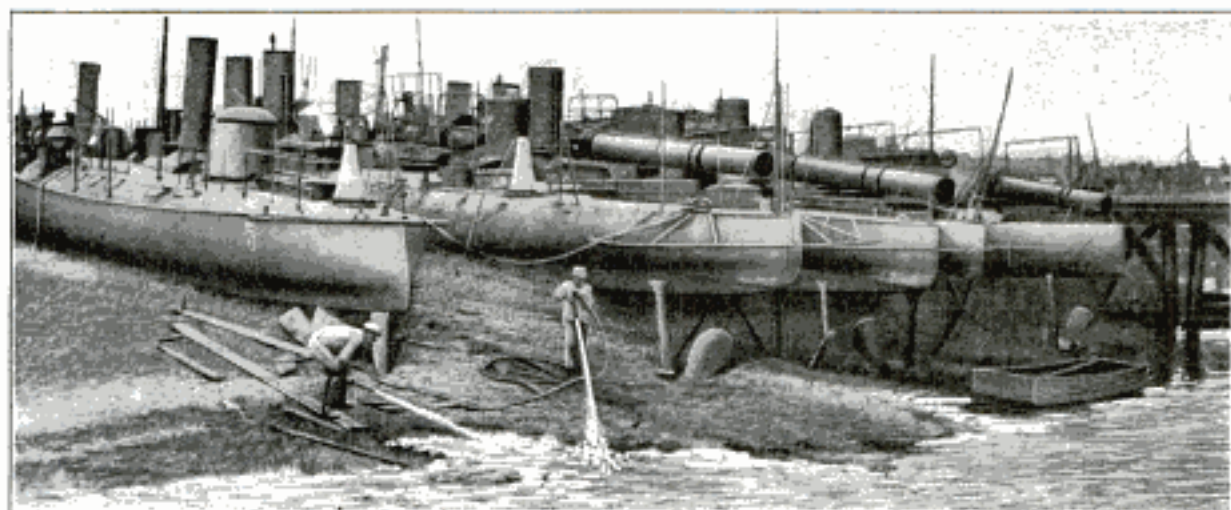

The Five Torpedo Boats "Hurricaned" into the Mud at Charleston, S. C.; at Work Flushing Channels for Them with a Hose

## STRANDED TORPEDO BOATS FLOATED WITH A HOSE

One of the most unique floating feats ever accomplished in the U. S. navy took place at Charleston, S. C., after five of the reserve torpedo division had been driven clear out of the water and stranded in the mud by a hurricane which struck that section of the country a few months ago.

The boats, which were the "Cushing," "Dahlgren," "Biddle," "Craven" and "Barney," were driven ashore in a parallel column, as shown in one of the



The "Dahlgren" being Drugged Back into the Water

illustrations. The mud in which they landed was covered with a coating of heavy marsh grass in which it was practically impossible to use a spade, so the expedient of using a high-pressure hose to float the vessels was adopted with success. Power was furnished by the "Worden," which had not suffered the fate of her companions, and, one at a time, a channel was excavated for each boat. Then cables were attached and the little fighters again dragged back into the

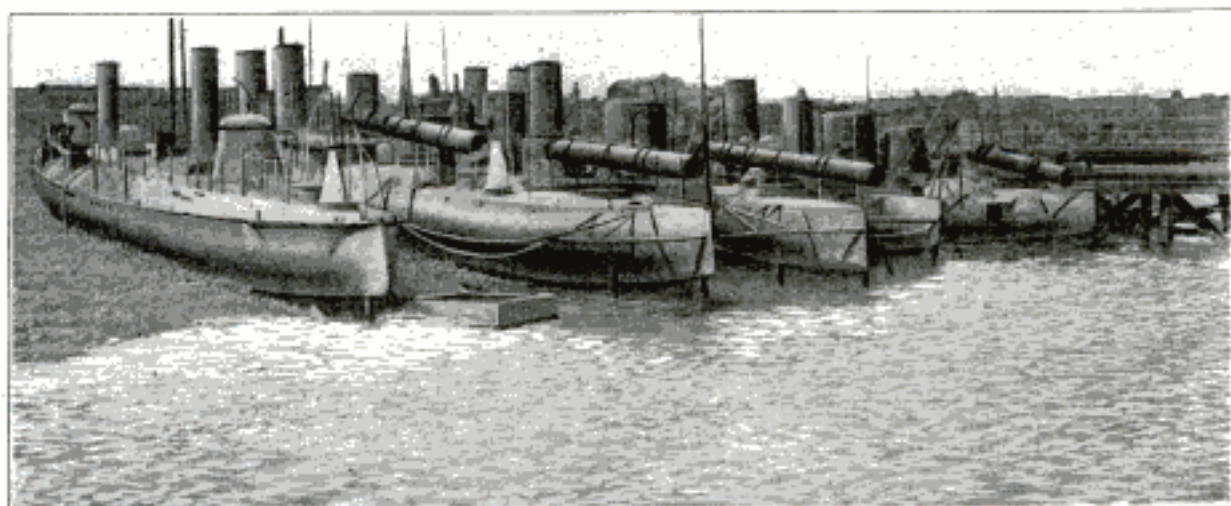

Courtesy The Fleet Review

The Little Sea Fighters High and Dry in the Mud as Viewed from the Water

water. It was necessary to drag each boat about 100 ft. before it became waterborne, and it required about 150 tons' pull to even budge them.

The refloating was accomplished

without the slightest damage to either the hulls or machinery, and with but one mishap. A tackle carried away once, injuring one man, but not seriously.

### AUTO MAIL TRAIN USED IN NEW MEXICO

The auto mail stage line, which has been in operation for six years in the Pecos Valley of New Mexico, has an

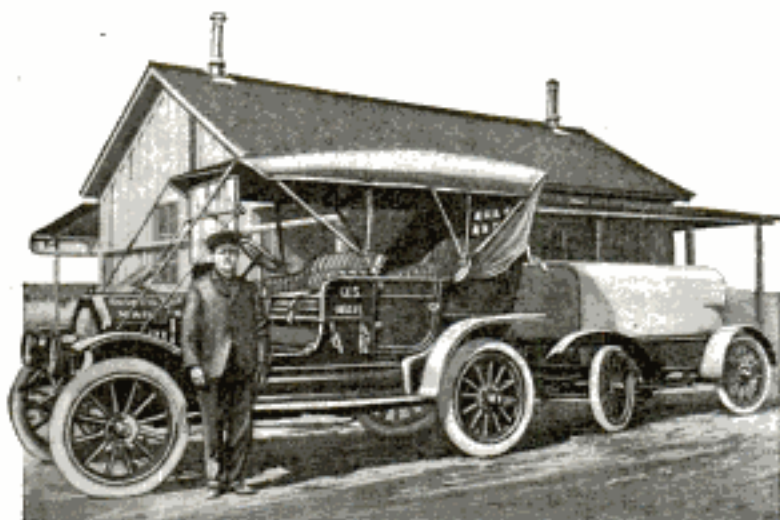

An Automobile Mail Train, Consisting of a Touring Car and Trailer Carries Passengers and Mail in New Mexico

interesting auto mail train running between Roswell and Vaughn, a distance of 110 miles. Attached to an automobile of the touring type is a special mail-carrying trailer which stands about 40 in. high, is 9 ft. long, and weighs 550 lb. Its capacity is 1,550 lb. of mail. A waterproof top protects the mail from damage by rain. The car drawing the trailer is reserved for passengers.

### LIGHTS IN FLOOR MARK SEATS IN THEATER

A motion-picture theater in Portland, Ore., has installed green lights in the floor, beside every row of seats, so that a person entering after the beginning of the show can find a seat without groping about in the dark. The device is merely a slot cut into the floor to hold the light, with a piece of thick glass over it.

### LOVE LETTERS MADE INTO WALKING STICK

A unique and ingenious way of disposing of love letters and yet have them always at hand, although in a form which makes reading impossible, was devised by a seaman of the British navy, who converted the letters written to him by the young lady who is now his wife into a "sentimental" cane.

The love letters made into a cane by this sailor numbered 1,000, about 150 of which were received after his marriage. In making the cane he first procured a  $\frac{1}{4}$ -in. steel rod and threaded it throughout its entire length to receive a nut. Then he cut the letters into portions an inch square, pierced a hole in each square, and thrust several of them at a time on the rod, in the manner of filing receipts. After putting a certain number on the rod he compressed them by screwing up the nut with a hand-spanner, and, when they were sufficiently compressed, removed the nut, placed more on the rod, and repeated the operation until the whole stick length was finished. He then cut off the rough edges with an old razor, chipped the paper into a tapering form with a chisel and hammer, and finally obtained a perfectly smooth surface with an ordinary plane. The final touches included the varnishing of the surface, and the placing of a metal tip on the small end and an ebony handle on the other.

One of the artistic features of the completed cane are the grey rings in it at intervals of about an inch. They represent the letters written on grey

paper by the seaman's wife during the year after their marriage. The cane is exceptionally strong and formidable, and looks very much like a Malacca stick.

### THE LARGEST UNIT OF SPACE IN USE

Scientists use a unit of space depending upon the magnitudes of the things with which they are dealing. If they are interested in very small things, they use the cubic centimeter or cubic inch. If they are engineers, engaged in making excavations such as the Panama Canal, they use the cubic yard. If they are geologists, considering the volume of the continents and oceans and how the continents are washed into the oceans, they use the cubic mile.

The largest unit in use by scientists is that which astronomers employ when they measure the celestial spaces. Their unit of volume is a sphere whose radius is 200,000 times 100,000,000 miles. The volume of this unit is approximately the radius cubed and multiplied by 4. The number of cubic miles in this unit is therefore represented approximately by 3 followed by 40 ciphers.

Obviously, the reason astronomers use such an enormous unit of space is that the volumes with which they deal are very great. But one might ask if this unit is not much larger than is necessary. Indeed, it is scarcely thinkable that it would not include the whole universe. If such a sphere were constructed with its center at the sun and its surface out in every direction to the distance of 200,000 times 100,000,000 miles, one might ask if it would not contain within its limits the North Star, the Pleiades, the Milky Way, and all the other stars that fill the sky. The

astonishing answer to this question is, however, that there would not be another star in it besides the sun. Most of them are hundreds of times as far away from us as the surface of this immense sphere would be. The appalling magnitude of the universe is indicated by the fact that there is, on the average, but one star in seven or eight of these enormous units of space, though through the great modern telescopes the stars seem literally to fill the sky.

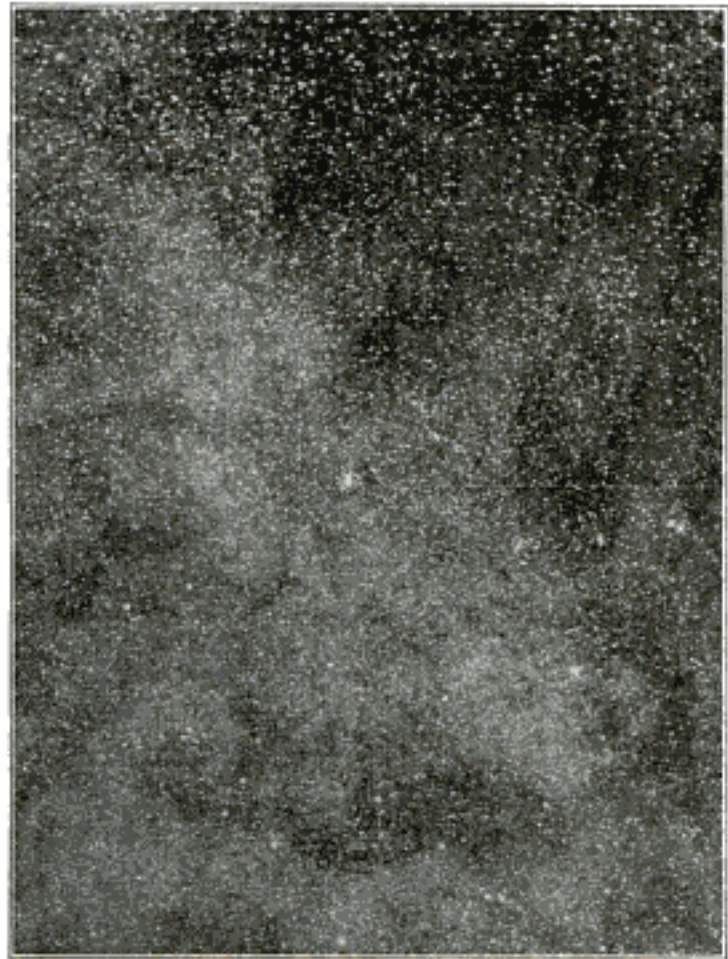

Great Star Cloud Photographed by Professor Barnard. Here Where the Stars Seem Crowded Together Like Flakes of Snow in a Drift, There is Only One to Seven or Eight Spheres Whose Diameters are 400,000 Times 100,000,000 Miles

### GERMAN MOTOR-ROAD IN AFRICA

Germany's new West African territory, obtained from France in the settlement of the Morocco dispute, is, according to reports, to be linked up with her East African colony by a service of motor cars across the continent,

passing through Belgian Congo. A corps of German engineers and military officers are already surveying the ground and studying the best route. New roads will have to be hewn out of mountains and through forests, and

many bridges will have to be constructed across rivers.

The idea of a motor-car service is the result of the success of this means of communication and transportation between districts in Belgian Congo.

### FERRYBOAT SHIPPED IN SECTIONS BY RAIL

A rather unusual transportation method was adopted recently by the New York Shipbuilding Co. in delivering a large ferryboat from Camden, N. J., to San Francisco. She was built

### SIR OLIVER LODGE WARNS ELECTROCULTURISTS

Many attempts have been made in the past, and are still being made, to supply electricity to a network of wires placed over a field by means of elevated spikes, arranged so as to absorb the electricity of the atmosphere with the end in view of thus stimulating plant growth.

Sir Oliver Lodge, the English scientist who was the first to make extensive tests to determine the practicability of electroculture, utters a word of warning in a letter to *Nature* with regard to attaching too much importance to negative results obtained by such supposed electrification of wire network over a field, unless there is reasonable guarantee that the network is really kept positively electrified during considerable periods. He says that singularly perfect insulation would be required to enable electricity slowly supplied in this way to accumulate until a fizzing point was reached, and that the attainment of such a potential over a large area is quite impracticable except when a thunder storm is passing overhead.

The same difficulty of adequate insulation has also militated against many attempts made in the past to supply electricity from artificial but old-fashioned high-potential sources, especially when the area to be supplied extended over many acres. According to Sir Oliver Lodge, any metallic network not really charged, but kept practically at zero po-

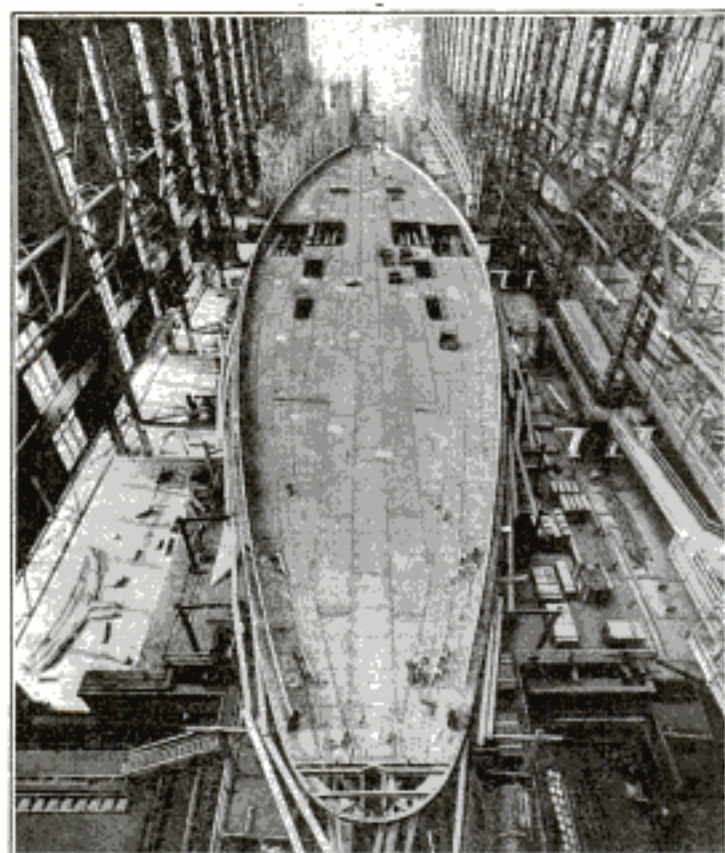

The "Knock-Down" Ferryboat, Built to be Transported by Rail, as She Looked on the Ways Fully Bolted Up and Ready to be Delivered

on the "knock-down" plan and shipped by rail, 35 cars being required for transporting her.

The extreme length of the boat, which is a side-wheeler, is 292 ft., and her beam, over guards, 75 ft. She contains 850 tons of steel. Her carrying capacity is 4,000 people, and she has a seating capacity of 2,000.

tential by leakage to earth, would be rather detrimental than otherwise to the growth of plants beneath it, as it would tend to screen them from inductive electrification by the electricity of the atmosphere, which is a natural process in plant life.

### DOUBLE-GAP SPARK PLUG

A spark plug, which has two gaps, thus producing two sparks, has been placed on the market by an English concern and is meeting with much favor. Simultaneous sparks are given at both gaps. Should one gap become sooted, sparking continues at the other, and the continued explosions tend to clean the dirty points automatically.

### LEVER-OPERATED MOTOR-CYCLE STAND

A motorcycle stand, raised and lowered by means of a hand lever, has been patented by an inventor of Chatham, Mass. It is shown attached to a high loop-frame old-style machine, the saddle of which has been brought low enough for the rider to stand over it, with his feet on the ground. After starting the engine, the rider presses forward on the hand lever, thus throwing the stand in its inoperative position, the revolving drivewheel comes in contact with the ground, and the machine starts under momentum. The brake-shoe attachment of the stand rests against the lower part of the front

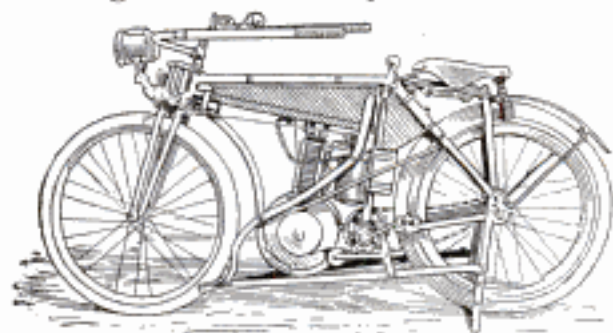

Lever-Operated Stand Applied to Old-Style High-Framed Motorcycle

tire when the stand is in operative position, and is designed to eliminate most of the jar incident to the use of the ordinary stand.

### MONUMENT TO LOS ANGELES DYNAMITE VICTIMS

The monument erected in Hollywood cemetery, near Los Angeles, to the memory of the 20 men killed in the



Monument Erected in Hollywood Cemetery, Los Angeles, to the Men Who Were Killed by the Dynamiting of the Los Angeles Times Building

dynamiting of the Los Angeles Times building is shown in the accompanying illustration. The base stone weighs approximately 22,000 lb., and the main die, upon which the larger of two beautifully inscribed bronze tablets appears, weighs 12,000 lb. Above this tablet die rises a rocky crag-like mass of granite, upon the high projecting end of which is perched a bronze eagle. An imposing figure, (not in place when the photograph was taken) stands upon a pedestal at the foot of the base, half facing the main tablet. This tablet tells the purpose of the monument, and bears a eulogy and the names of the men who lost their lives.

What is said to be one of the strongest searchlights in existence has recently been placed on the roof of the Bank of International Pensions, Montevideo: The candlepower is said to be 90,000,000, and the light can be seen 11 miles and illuminates every portion of the city.

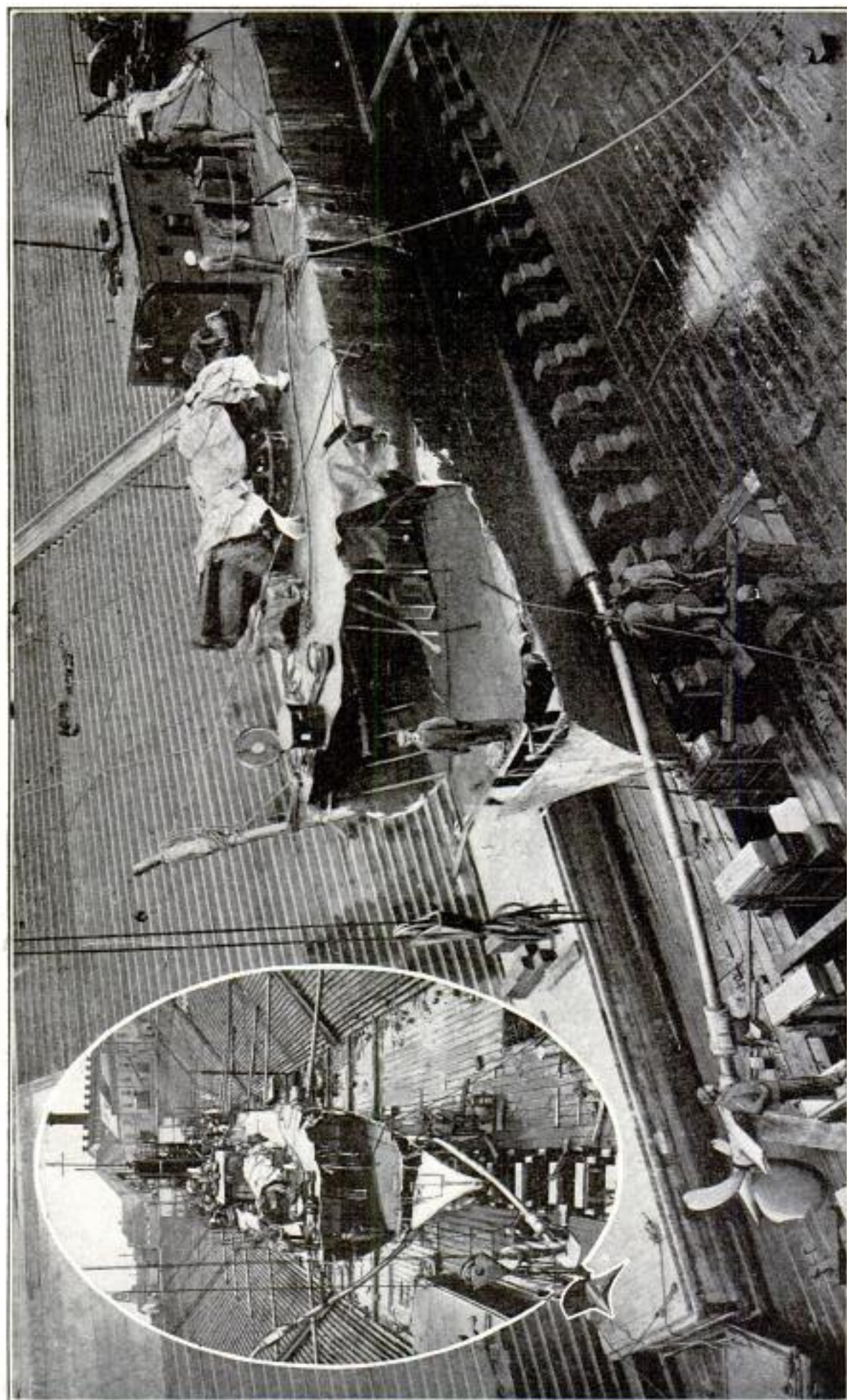

The Torpedo-Boat Destroyer "Warrington" in Drydock at Norfolk, Va., Showing How the Schooner Ripped Her Stern Away —  
The Smaller View Shows How the Propeller Shafts Were Twisted



## THE REMARKABLE ACCIDENT TO THE TORPEDO-BOAT DESTROYER "WARRINGTON"

"Nothing like it ever happened before to any ship in the world."

Such is the comment of Rear Admiral Hutch I. Cone, chief of the Bureau of Steam Engineering, of the Navy Department, on the remarkable accident which befell the U. S. torpedo-boat destroyer "Warrington," which was struck by an unidentified lumber schooner at one o'clock on the morning of Dec. 29, when on her way from Charleston to Norfolk.

As shown in the photographs reproduced on the opposite page, more than 25 ft. of the stern of the destroyer was sliced off in the collision, yet the little vessel survived, unaided, until the cruiser "Salem" came out from Norfolk and towed her to the drydock. The coolness and bravery of her crew saved the ship from sinking then and there. Watertight compartments were quickly closed, and the middle and forward portions of the vessel saved from being flooded with water.

Six men were sleeping in the compartment shown torn open in the pictures when the collision occurred. Thrown into a corner by the impact, upon this rude awakening, they saw the black waters rushing in upon them, and saw the sky above them where a moment before had been a steel deck. Two of the men clambered out over the rushing waters, upon the jagged steel side, and to the deck above. To this day they cannot remember how they accomplished this almost unbelievable feat.

The other four escaped into the next compartment, but were unable to close the watertight door. With the seamen in that compartment, they rushed into the next, and succeeded in closing the door, thus saving the lives of all on board, and the ship.

With propeller shafts hopelessly bent, the "Warrington" wallowed in the heavy seas while wireless calls for aid were sent out. The revenue cutter "Onandaga" was the first to respond, taking off the majority of the crew.

The rest, with the officers, stuck to the ship until it was brought to the Norfolk yard by the "Salem."

Preliminary estimates place the cost of repairing the damage at \$50,000. The stern will have to be entirely rebuilt, and new propellers and propeller shafts installed.

## A PORTABLE ELECTRIC MOTOR FOR GENERAL FARM WORK

The extreme convenience of electricity as motive power for the many small machines used in agricultural work has not, as yet, been fully recognized. The cost of installing and maintaining numerous small motors, each of which is in use only occasionally, is one of the chief hindrances, but one which would soon disappear if the custom of employing a single portable motor for all the miscellaneous work of the farm became more general.

A motor suitable for such work has been recently brought out by a foreign firm. The motor which is of the semi-enclosed type (of from 2 to 6 hp., according to the work to be done) is mounted on a light angle-iron frame supported on two wheels. Two long handles are provided at one end of this two-wheel truck to aid the operator in moving it. The breadth between wheel centers is only about 17 in., so that it can be drawn along the narrowest paths or passages. The weight is so distributed that only about 50 lb. fall on the handles. The motor is provided with ample pulleys and gearing, enabling belt speeds ranging from 102 to 1,950 ft. per minute.

A portable machine of this type is obviously readily applicable to work of the most varied kinds, including the driving of threshing machines, sifters, chaff-cutters, winnowing machines, crushers, sewage pumps, wine presses, mills, hoists, band saws, circular saws, and in fact, practically any of the machines met with on a farm.



Revolving-Arm Automobile Washer with Electric Light

### ILLUMINATED CAR WASHER FOR THE GARAGE

An ingenious means of specially illuminating an automobile while it is being washed, is shown in the accompanying illustration. The water-supply pipe enters the garage through the ceiling, and to it is attached a revolving arm, one end of which carries the hose. Mounted near the same end of the revolving arm as the hose is a powerful electric lamp which throws a stream of light downward on the part of the automobile being washed. As the arm can make a complete revolution, a short length of hose will suffice to reach all parts of the automobile with the spray of water.

### CAR DEVICE TO ANNOUNCE STREET NAMES

A Chicago street railway company has, for experimental purposes, equipped a number of its cars with a new device which is intended to do away with the opening and closing of the door by the conductor in order to announce the names of streets. This device is really a loud-speaking telephone and consists of a specially constructed telephone transmitter and what the makers call a "reproducer." The reproducer takes the place of a receiver in the ordinary telephone circuit, but its construction is quite different and it is many times as powerful. When used in street cars, the reproducer is mounted in combination with two horns, and the combination is then supported from the ceiling of the car, the horns pointing toward the forward and rear ends of the car. A number of these reproducers can be connected in multiple, and all be operated by the same transmitter.

The transmitter itself is of special

construction and it is mounted on a handle, the electrical connection being made through well insulated, flexible conductors bound into one cord.

When not in use, the transmitter is hung on a hook within easy reach of the conductor. The conductor removes the transmitter from the hook when he desires to announce the name of a street, and speaks directly into it, thus eliminating to a great extent the disturbances due to the vibration of



By Calling the Names of Streets through a Loud-Speaking Telephone Outfit, the Necessity of the Conductor Opening and Closing the Door as Each Street is Approached is Done Away With

the car that would occur if the transmitter were fastened rigidly to the car. The current used in operating the enunciator is taken from the trolley.

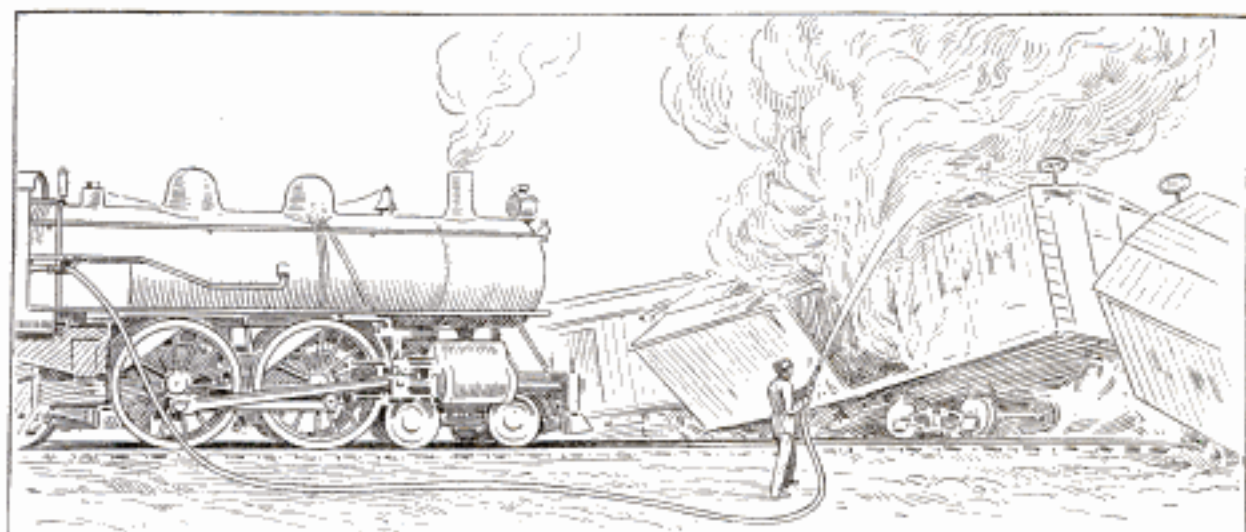

Fighting a Freight-Yard Fire with the Water Carried by a Locomotive. A Simple Three-Way Valve Placed in the Feed-Water Pipe between the Injector and the Boiler, and 50 Ft. of Regulation Steam Hose Convert the Locomotive into a Fire Fighter

### LOCOMOTIVE FIRE EXTINGUISHER

An ever ready and ingenious fire-fighting apparatus, which is applied to locomotives, has recently been tested out by the Missouri Pacific railway at the Ewing Avenue shops, St. Louis, Mo., to the satisfaction of the fire chiefs of that city and the officials of the road. It is simply a three-way valve placed in the feed-water pipe of the locomotive between the injector and the boiler. A regulation steam hose, about 50 ft. in length, is used for the fire hose and is kept on a reel under the running board of the engine.

It was found necessary to use the regulation steam hose, as an ordinary fire hose would soon be destroyed on account of the hot water coming from the injector. The water tanks of the ordinary yard engine hold about 6,000 gal. of water, and the idea is that when the engine reaches the scene of a fire in the yards, the switchman is to jerk the hose from the reel and attach it to the valve connection in the feed-water pipe and pull the hose to the fire. Meanwhile the engineer is to start his injector while the fireman gets on to the running board and opens the connection to the fire hose.

CA chair in aeronautics has been established at the Polytechnical College, Vienna, Austria.

### ELECTRIC INCUBATOR HAS 6,000-EGG CAPACITY

One of the largest electric incubators in use anywhere in the world was built for a poultry raiser in New Orleans. It is 40 ft. long by 5 ft. wide, and contains 40 compartments, each having a capacity of 150 eggs. Each compartment can be separately controlled, so that any one, or all of the compartments, can be operated, according to the number of eggs to be hatched. The controlling thermostats used do not completely break the

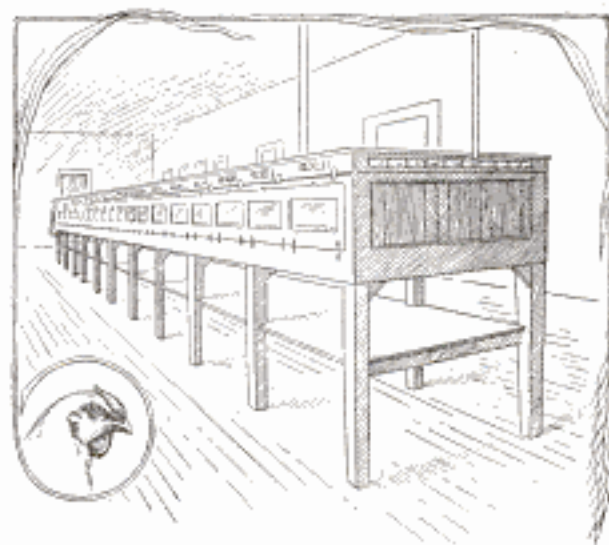

This Electric Incubator, Located at New Orleans, is 40 Ft. Long and Has a Capacity of 6,000 Eggs

heater circuit, but introduce the comparatively high resistance of a small electric lamp when open, thus avoiding sparking at the contacts.



## METAL WORK AND ETCHING

By JOHN D. ADAMS

### PART VI—Candle Sconce and Whisk-Broom Holder

**A**LTHOUGH the woodwork may seem to be the most conspicuous part of this candle sconce, it will, in reality, occupy but a small portion of our time.

There are four pieces of wood; viz., the back, the shelf and two brackets, all of which may be readily prepared by anyone who can make fair use of the saw and plane. A little care will be necessary to have the four edges beveled off to exactly the same extent. Nail the shelf in place and then the brackets, setting in all nails from behind and supplementing them with a little glue. Stain as desired, and then thoroughly rub with wax.

A suitable little brass or copper pan to catch the drippings can usually be picked up at the stores; if not, one must be hammered up from a disk of the metal duly softened. Gradually work the edge over, turning the disk slightly between each stroke of the hammer. To hold the candle, we must prepare two strips about  $\frac{3}{8}$  in. wide and 5 in. long, each of which is bent U-shape and riveted to the bottom

of the metal drip pan. By this means we provide four upward-projecting pieces, which may be adjusted by bending so as to firmly hold the candle.

The back plate or reflector should, of course, be of the same metal as the drip pan, and may be left plain or else have an elliptical strip etched around it as shown. This feature may be further varied by cutting the sheet in some other form than the rectangular. The etching in this case will prove a very simple matter, and whichever of the previously described coloring or oxidizing solutions is employed, be sure to have at least the central portion of the reflecting plate rubbed up bright and evenly lacquered.

If it is desired to make an electric-candle sconce, the drip tray should be dispensed with and an ordinary electric socket set up in place.

This should then be completely boxed in with thin pieces of wood, through which the operating key will project. The top of this small concealing box should not be less than

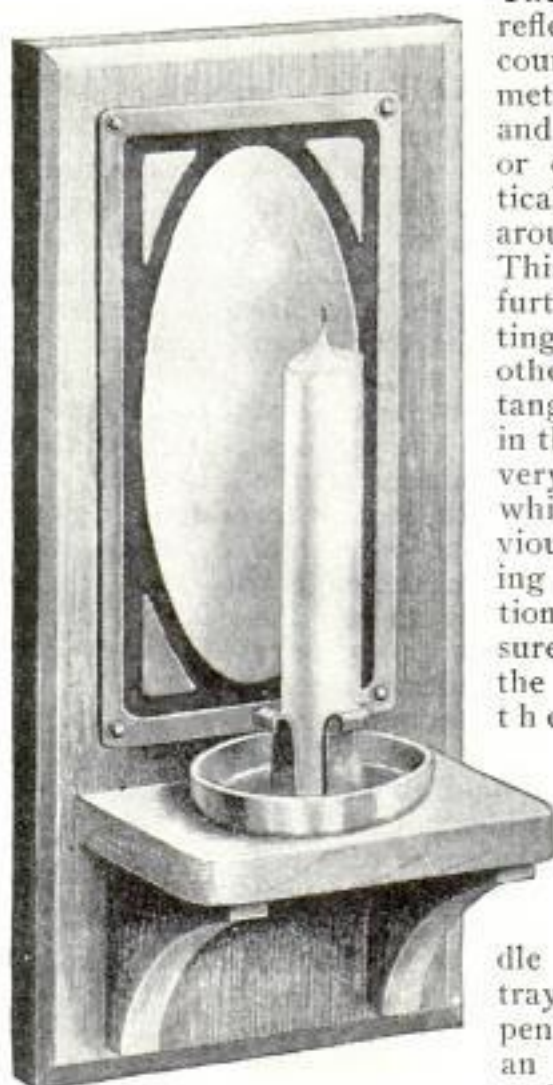

A Candle Sconce

$\frac{1}{4}$  in. thick, and project over the sides by a like amount. A central hole is also to be cut therein to allow the frosted electric candle to be screwed into the socket.

#### Whisk-Broom Holder

Another of the many attractive household articles that may be made at the cost of a few cents is the whisk-broom holder. In the design illustrated, the back board has beveled edges and bears a brass or copper plate etched with a simple design, under which is fastened a bent strip of the same metal to hold the broom. If desired, the



Whisk-Broom Holder

metal plate may be replaced with a match holder or even a small mirror, in which case the etching will be confined to the strip that holds the whisk broom.

A sufficient number of these household articles have been described and illustrated to put any amateur craftsman on the road to the artistic solution of many of the little problems in decoration and furnishing that come up from time to time. Any of the designs described for other articles may be used on these holders by adapting them in size and form.

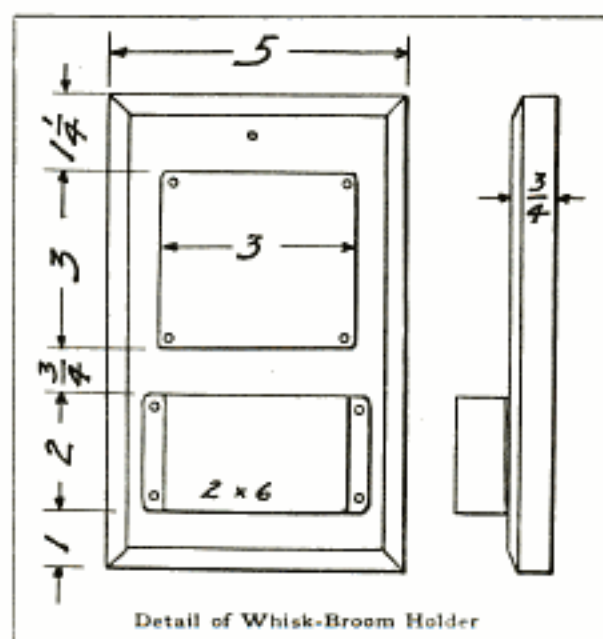
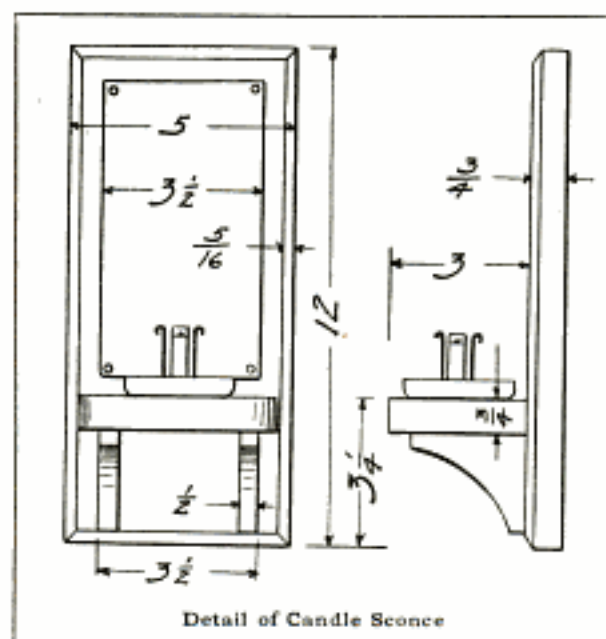

## SCREW-PROPELLED STEAMER PATENTED IN 1803

One of the curiosities found in the French patent office is the drawings and description of a screw-propelled steamer for which a patent was granted to Charles Dallery in 1803. Although the mechanism of the machinery is exceptionally crude, the

whole is remarkable in that the propellers are of the screw type, and that the boiler was of the vertical water-tube type, consisting of six units, each comprising 12 tubes, connected at the top to a common steam chamber from which the steam was to be carried to

the cylinders. Dallery is said to be the first to design a vertical water-tube boiler.

The arrangement of the screw propellers is also interesting, one being

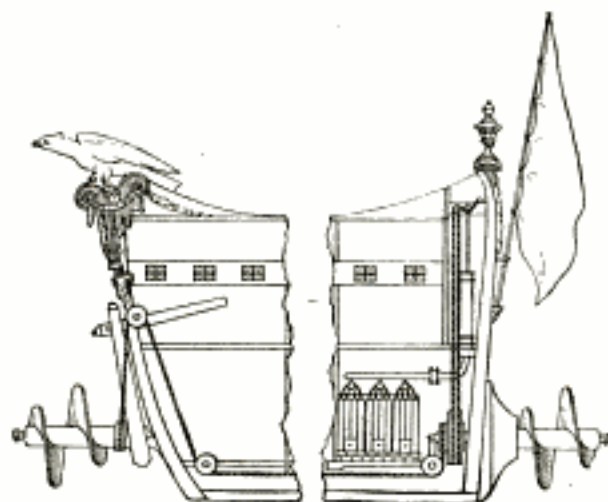

A Screw-Propelled Steamer, Fitted with Vertical Water-Tube Boilers, Patented in France in 1803

located at the stern and the other at the bow. The bow propeller was pivoted, as it was intended for steering the vessel.

At the time the patent was issued, Napoleon was contemplating an invasion of England. Dallery invested all his means in building his steam vessel and offered it to the government as a transport, but, receiving neither thanks nor encouragement, he, in despair, destroyed the vessel without even giving it a trial, and tore up his patents.

### A CHRISTMAS AUTO TRAIN

During the shopping rush just before Christmas, one of the largest department stores in Philadelphia found it necessary to attach a trailer to sev-

eral of its heavy motor delivery trucks to take care of the suburban delivery.

### BIRTHMARKS MAY SHOW KNIGHTLY DESCENT

According to Dr. P. Baroux, of Paris, writing in the *Revue Scientifique*, it is possible for the customs and habits of a social class, persisted in for generations, to leave their impress on far-distant descendants in the form of birthmarks, etc., long after the customs have ceased to be. He says he has found birthmarks in families not now in good social position which would indicate that they were of gentle descent, and investigation is said to have proved that the indications were correct.

The French physician attempts to show that the casque or headpiece worn by warriors in the age of chivalry would be likely to irritate the cheek and neck in precisely the regions where he has found the "birthmarks" which he believes to be hereditary marks of knighthood. Likewise, he believes that other peculiarities, such as what he calls "the martial hand," are also transmitted. This hand, while normally formed on the back, is much swelled on its under side by exaggeration of its flexing muscles. In its appearance it resembles that of masons or laborers who also, in handling trowel or pick, clench the fist and bend the fingers as in the exercise of arms.

A 250-mile pipe line, for the conveyance of petroleum, is being constructed in the Congo Free State, Africa, from Leopoldville to the coast.

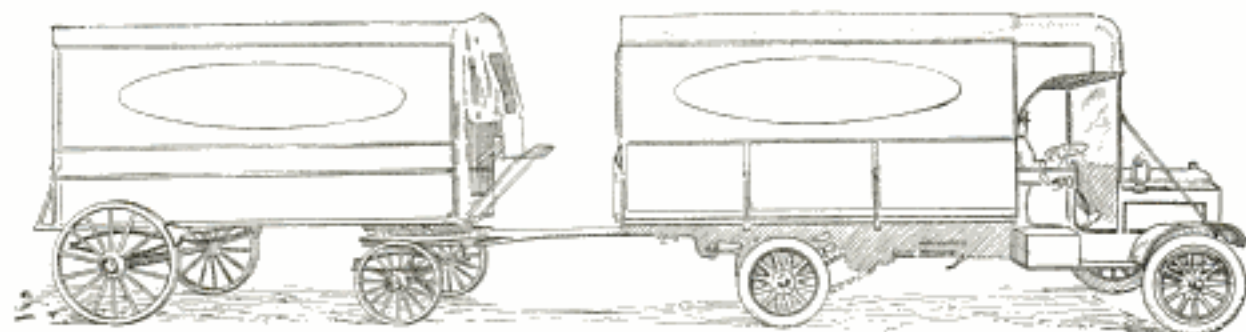

The First "Christmas Automobile Train." A Means Adopted by a Department Store in Philadelphia to Care for Its Suburban Deliveries Just before Christmas

## CONCRETE HOUSE AT MODERATE COST



Front Elevation of \$4,000 Concrete House

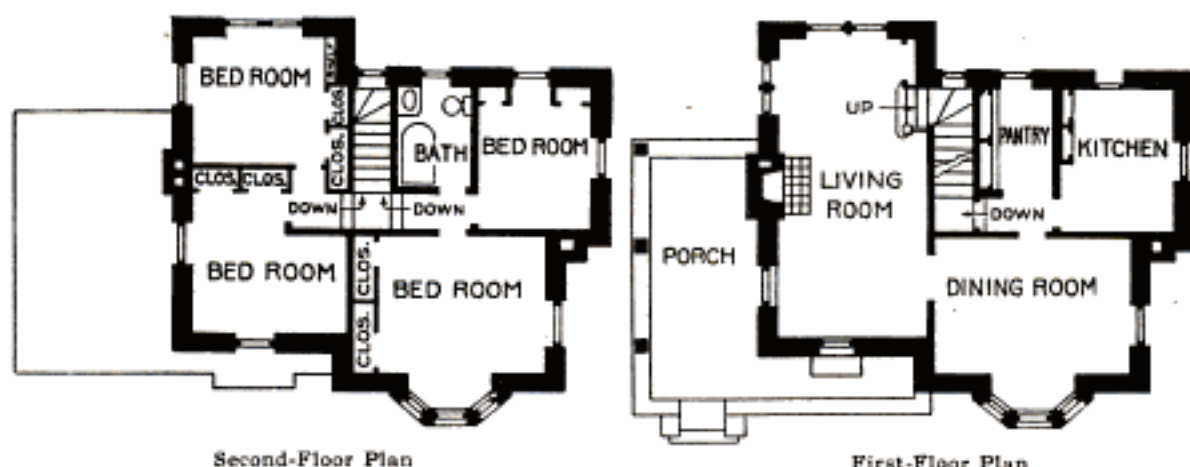

Rankin & Early, Architects, Philadelphia, Pa.

Every person of moderate means who designs a home for himself seeks to have something of his individuality reflected in his building, that it may be unlike the house of his neighbor. Architects are as keen to put the individual touch into their work as their clients, but the result is often such a compromise that the desire of neither is fully realized. The utmost skill is required of the architect to design a house that will fulfill all the require-

ments of the owner and come within the limit of his means. A set of plans for a distinctive \$4,000 house was drawn recently by a Philadelphia architect. This house is provided with four bedrooms, a living room, a dining room, kitchen, bathroom and pantry, all of ample size and grouped in such a way that the exterior of the building has graceful lines of such design that it would appear equally well in city, country or suburb. The prin-

cipal bedroom and the dining room are both provided with bow windows and there is a porch of excellent size. The

walls are reinforced concrete, and the interior finish of the lower floor is hard wood.

### GASOLINE STATIONS FOR AUTOMOBILES

When a motorist finds himself without gasoline in Indianapolis, he need not worry about finding a gar-

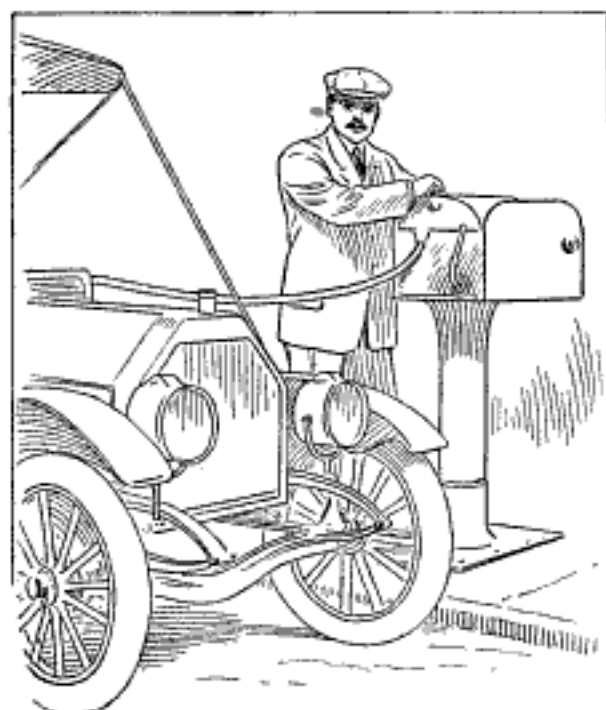

Obtaining Gasoline by Placing a Coin in the Slot of a Curb Gasoline Station

age. A company is installing gasoline supply stations on the street corners and by dropping a coin in the slot and connecting up his tank with the hose, the motorist can renew his fuel supply in a few minutes.

### SUBSURFACE WATER FOR IRRIGATION

Although the use of subsurface water for irrigation is not a new method in the western states, the installation adopted in a section of Colorado lying directly north of Denver is of particular interest because of its economic possibilities. In this particular region the subsurface water or "underflow" is found at a depth of 20 or 25 ft., and the method of locating the pumps and the kind of installation, as described

by an article in the *Electrical World*, is as follows:

Before the pumping plant is installed considerable work must be done to ascertain the location and quantity of the underflow. A special apparatus is built for drilling small, deep holes, and provision is made for taking out the core without disturbing the relative positions of the strata or the materials which make up the core. A hole is drilled and the test core taken out and analyzed, thus determining the depth of the water-bearing strata, and the thickness and porosity of the strata. The water content of the strata is then determined from direct measurement. After these determinations have been made, the operation is repeated on a number of holes put down in a 5-ft. radius, the first hole being taken as a center. All the determinations made upon the first are repeated in the later holes to check the accuracy of the first, then a standard chemical solution is introduced in the first hole and, by means of galvanometric measurements, the rate of flow from one hole to the other is determined.

By these tests are found not only the approximate rate of flow but its direction as well.

Holes are then put down at such a distance from the first hole that an hour's time will be consumed for the water to flow from the first to the last one. Where the conditions can be thus accurately measured, the amount of water that can be secured may be determined with much greater accuracy than can that of surface streams, as the waters found below the surface are subject to fewer factors of uncertainty.

A power company has its main transmission line running through the district in the form of a closed loop, inclosing an area of 940 square miles, and it is this power which is mainly used for pumping the irrigation wells.



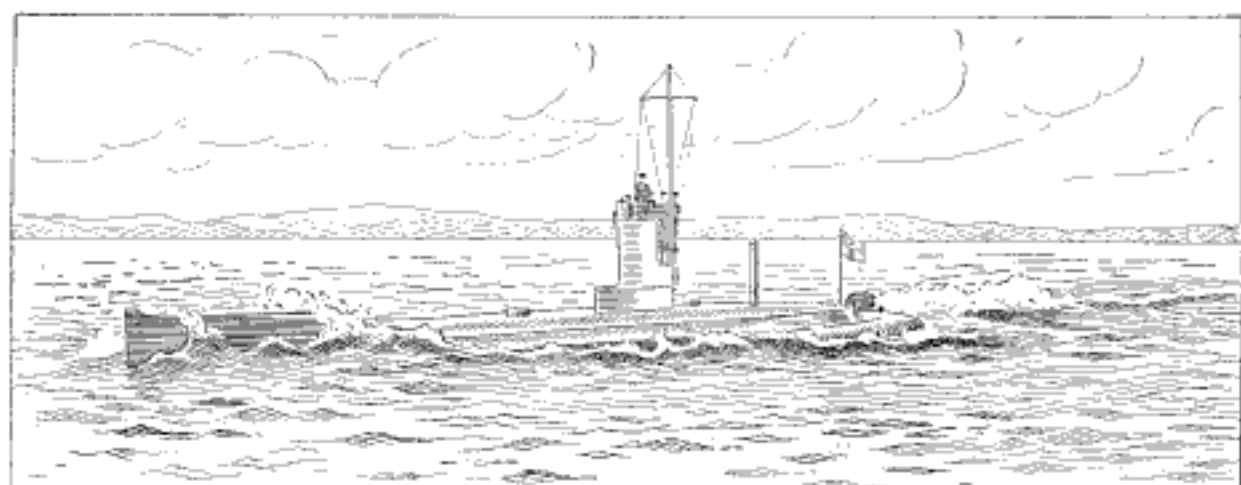

Courtesy The Engineer, London

A Powerful German Submarine of Which Not Much is Known

### THE GERMAN SUBMARINES

Although but little information leaks out concerning the submarines of the German navy, it is believed in England that they are more powerful and more numerous than is generally supposed. The submarines of the "U" class, of which one is shown in the accompanying illustration, are said to have a displacement of close to 190 tons, a length of 138 ft., a beam of 10 ft., and a submerged speed of about 11 miles an hour.

The submarine "U 8" is shown in the illustration. Its shape, particularly its bow, is somewhat different than those of either the American or British submarines.

### SIMPLE DEVICE MEASURES BLOOD PRESSURE

This little apparatus, recently placed on the market by a maker of scientific instruments, serves to measure both the pulse beats and the internal pressure of the blood. The instrument comprises a small tube provided with a slender spring carrying a small disk at its upper end. When the lower end of the spring is applied to the pulse, the small disk oscillates in accordance with the number of beats.

In using the instrument to measure blood pressure as well as pulse beats, a second tube and its spiral spring are slipped over the first tube, as shown in the illustrations. At the top of this

second tube is a graduated quadrant, the hand of which points to zero when the spring tube carries it in its extended position. After finding the position of the pulse and applying the bottom of the central spring to it, the outside tube is gradually pushed downward over the inner one, the spring carried by the former becoming more and more compressed, until the disk showing the pulse beats ceases to oscillate. At the moment the oscillation of the disk ceases the pressure ap-

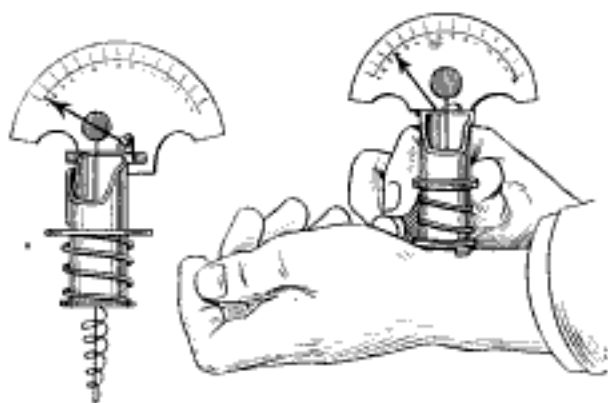

A Device Which, Pressed against the Pulse, Shows the Pulse Beats by the Oscillation of the Disk, and may Also be Made to Indicate the Blood Pressure on the Scale

plied in pushing the outer tube down over the inner equals the internal pressure of the blood, which is indicated by the hand on the quadrant.

Italy is experimenting with the aerial post, Dal Mistro, an Italian airman, having recently carried a sack of mail from Bologna to Venice, a distance of 101 miles, in 1 hr. 28 min.

## DEVICE FOR TESTING ELECTRIC-LAMP FILAMENTS

The device for testing metallic-filament lamps illustrated herewith, was devised by an engineer of the Western Railway of France. A description of the device appeared in a recent number of the *Railway Age Gazette*. The device is used to give the lamps that are being tested repeated shocks, so

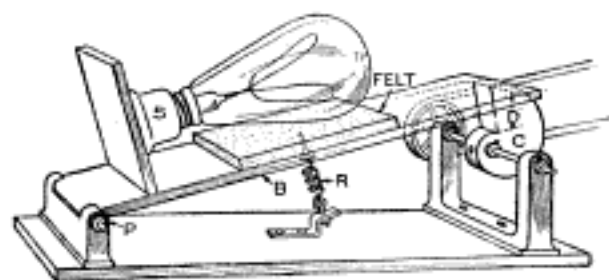

Fig. 1—Device for Testing Electric-Lamp Filaments

as to test the strength of the metallic filament under conditions corresponding, as nearly as possible, to those that would exist in practice. The lamp is placed in a socket, S, as shown in Fig. 1, which is mounted upon an upright piece attached to the board B, that is pivoted at the point P, and so arranged that it can be raised by the cam C, and allowed to fall through a distance, D. A piece of felt is mounted upon the board B, directly under the lamp, to

The lamps are tested both hot and cold; and the electrical connections of the motor driving the cam shaft are such that the motor stops as soon as the lamp filament is broken. The main motor circuit is controlled by a relay, whose winding is connected in series with the lamp. The connections of this relay are given in Figs. 2 and 3. Figure 2 shows the connections for testing the lamp while it is burning; Fig. 3 shows the connections for testing the lamp cold. In the first case, the lamp and relay winding are connected in series and directly across the line. If the lamp burns out, the relay is no longer energized, its armature drops and the motor stops; since the circuit through the motor is broken by the falling of the armature of the relay.

In the second case, the lamp being tested is in series with the relay only a very short time, it being connected to the small segment S, as shown in Fig. 3. So long as the lamp filament is not broken, there will be a continuous current through the winding of the relay, but if the filament breaks, the relay circuit will be open when the brush B is in contact with the segment S, and the relay armature will drop down, opening the motor circuit and

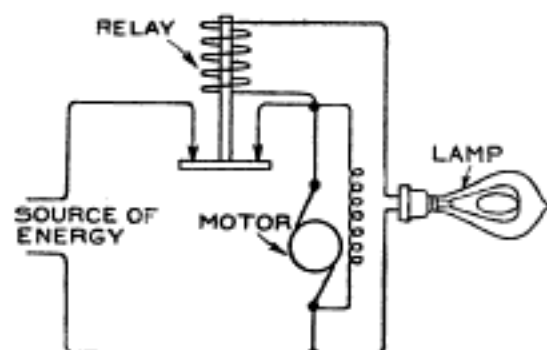

Fig. 2

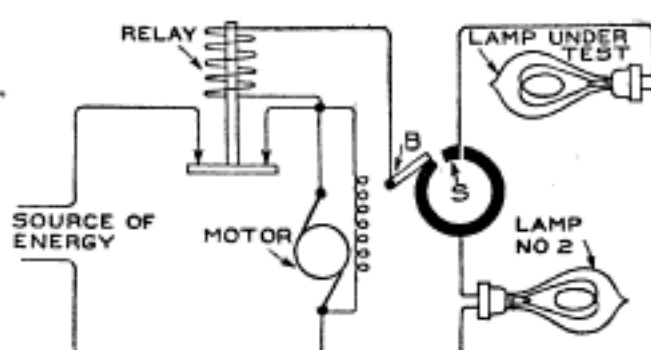

Fig. 3

Method of Testing Lamp Filaments Hot and Cold

deaden the fall; a spring, R, whose tension may be easily adjusted, is used to increase or decrease the force of the fall. The cam can be driven at any desired speed and the number of revolutions or shocks may be indicated on a revolution counter connected to the cam shaft.

stopping the cam. The time that the brush B is in contact with the segment S is so small that the lamp does not heat up to any extent. The second lamp is used to prevent an excessive current passing through the relay when the brush B is in contact with the main part of the commutator.

### ARCHAEOLOGISTS GIVEN A PREHISTORIC BANQUET

During an excursion in the valley of the Danube, the members of an anthropological society in congress at Heilbronn, Germany, were given a stone-age banquet by Edouard Hahn, an archaeologist of Berlin. A sand bank in the middle of the river served as the table, and all the utensils, dishes, etc., used, were of wood, especially made for the occasion, in exact imitation of those used in the stone age.

The menu consisted of cabbage soup, cooked in a wooden bowl by placing heated stones therein; boiled "leg of horse," roast pork with stewed maize, turnips roasted in the ashes, and a dessert of dried berries served with honey.

According to the guests at this unique banquet, the human race of the stone-age period could have had no reason to complain of such fare.

### MOTION PICTURES OF THE OCEAN BOTTOM

A remarkable film showing the submarine gardens of the Pacific at the Catalina Islands, which are just off the California coast near Los Angeles, has been made by one of the great American motion-picture film companies. The film, which is said to be the first successful one of its kind ever attempted, shows very clearly the seaweed and other forms of submarine vegetation, coral, sea urchins, and many varieties of fish. By rare good fortune the operators got an octopus into the picture.

The submarine pictures taken cover about 50 ft. of film. In making the pictures, the machine was installed in one of the glass-bottomed boats in which tourists view the wonders of the deep.

### AUSTRALIAN ANTARCTIC EXPEDITION STARTS

An Australian Antarctic expedition, headed by Dr. Mawson, sailed from Sidney recently in the "Aurora." One

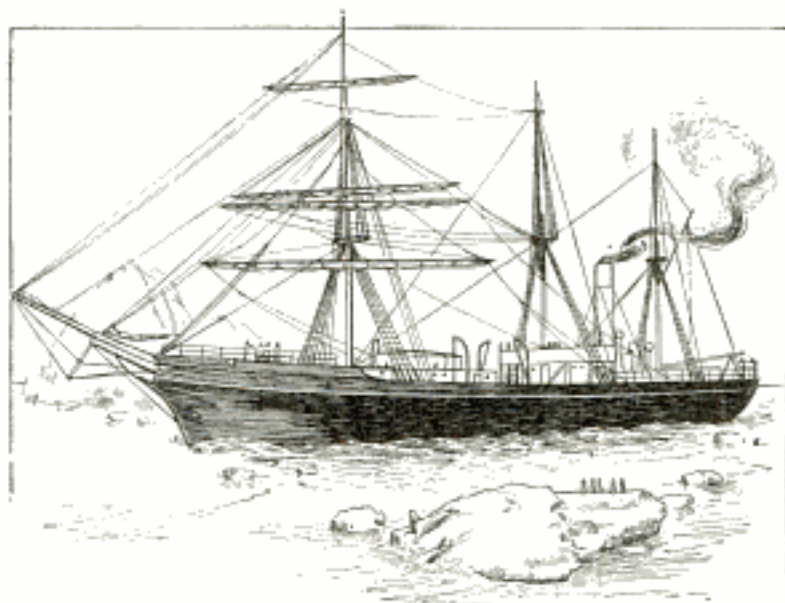

The "Aurora," in Which the Australian Antarctic Expedition is Penetrating the Far South

of the most important features of the work of this scientific expedition will be an investigation of Antarctic weather conditions with a view to discovering their effect on the coasts of Australia and New Zealand.

Among the contributions for financing the expedition was \$35,000 from the government of New South Wales. Other of the Australian states also contributed, and large sums were given by individuals.

### LOBSTER-CRACKING IMPLE- MENT

An implement somewhat similar to a nut-cracker, but designed especially



A Lobster-Cracker is the Latest Novelty Added to the Already Imposing Array of Tableware

for the cracking of the shells of lobster claws, is here shown. The long han-

dles of the implement give sufficient leverage to break the strongest shell, while the pointed nose serves to grasp and pull out the delicious meat.

### ELECTRICITY AS AN AID IN TRICK SHOOTING

Finding that the necessity of keeping the rifle trigger in reach of at least one finger of one hand or of one toe of one foot limits the number of



Trick Shooting in Which the Rifle Trigger is Operated by Pressing an Electric Button

spectacular firing positions assumed by trick marksmen, one of the professional shots often seen on the American stage is utilizing electricity as an aid. Balancing the rifle on a notched broomstick, which he in turn balances on his chin or on the sole of one foot held upright when he is reclining on his back, this professional pulls the trigger by simply pressing a button held in one hand. A pocket battery is connected by a flexible cord with a magnet, taken from an annunciator, fastened to the stock of the rifle in such position that its ends are near those of a piece of soft iron riveted to the trigger.

### CIRCULATION OF THE BLOOD

Among the many interesting features of the International Hygienic Exhibition at Dresden, Germany, the one which most interested the general public, was the "Temple of Man," in which a number of mechanical devices

were shown to demonstrate the different functions of the human mechanism. Perhaps the most ingenious of these was the representation of the circulation of the blood.

In this representation a full-sized skeleton was used, the heart, with its four chambers and valves, being shaped of rubber bladders. The arteries and veins, with the capillaries joining them, were formed of tubes of red and blue glass. The heart was made to beat 80 times a minute by an electrical device, and at each beat sent a colored fluid streaming first into the lungs, then back to the heart, and then through the whole body, thus presenting a true picture of the circulation.

### ELECTRIC STREET-CLEANING MACHINES IN BERLIN

Berlin, Germany, has somewhere in the neighborhood of 25 electric street-cleaning machines, all of which are rendering fine service. One of these machines will cover 20 to 25 miles per day, and although the speed is only 10 per cent greater than that of a similar horse-drawn vehicle, the work accom-



One of a Number of Electric Street Cleaners Used in Berlin

plished is much greater, as the electric machines carry more water, have greater flexibility of manipulation in crowded traffic, and are much speedier when empty.

The tanks of the electrical machines

hold 660 gal. of water. Forward of the front wheels are two shower pipes, operated by foot levers, which serve to loosen the dirt. The main shower pipes are directly under the tank, and the cleaning roller, equipped with a spiral of soft rubber, is situated behind the rear wheels, being driven by a gear connection with the rear wheels.

The battery is mounted in front of the driver and comprises 40 cells of 200 amp.-hour capacity at the 5-hour rate. A 4-hp. series motor is attached to each of the forward axles. The weight of the cleaner empty is about 8,000 lb.

### HOW TO MAKE A MAGAZINE RACK

The accompanying cut shows a magazine rack that will find favor with many amateur wood-workers on account of its simplicity in design and its rich, massive appearance when properly finished. It is so constructed that each piece may be polished, stained and finished before it is finally put together. Quarter-sawed oak is the best wood to use. Plain sawed oak looks well but it is more liable to warp than quarter-sawed and this is quite an element in pieces as wide as the ones here used. Following is a list of the material needed:

- 4 posts, 2 by 2 by 40 in., S-4-S.
- 5 shelves, 1 by 14 by 24 in., S-2-S.
- 20 F. H. screws, 2 in. long.

Considerable labor can be saved if the material be ordered from the mill ready cut to length, squared and sanded. The corner posts should be made first. The most convenient and accurate method of laying out the mortises is to square one end of each post and lay them on the bench flat, with the squared ends even with each other; then clamp them securely and lay out the mortises on one side across all four pieces at once; then loosen the clamp and project the marks to the other side with a try-square. Now saw along these marks, making each cut just deep enough to bring the mortises diagonally across the piece from one corner to the opposite corner

as shown in the detail sketch. Be careful not to get the mortises wider than the shelves are thick. Bevel the tops of the posts as shown.

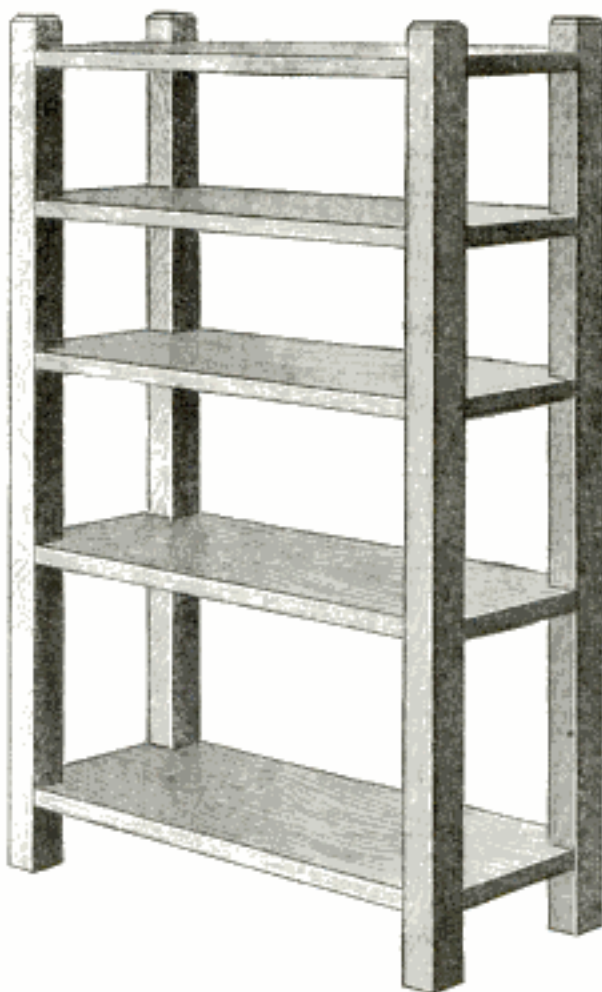

Magazine Rack Easily Made by the Home Craftsman

See that the ends of the shelves are square and smooth, then set a scratch gauge so that the scribe is just 2 in. from the face of the block and mark this distance off each way from the corner of the shelves. Saw these corners diagonally across as shown, being careful not to saw off too much.

The parts can now be assembled. Place all the parts in position, then pass a rope around each end and twist it up tightly with a small stick. If this is properly done you can now pick up the rack and handle it in any way you wish. The screws can now be put in the corners. You can use flat-head screws and plug the holes, or you can use round-head blue screws and let the heads project. After the screws are all in, dress off all unevenness where the

shelves are mortised into the posts, then mark each shelf and post so that you can put it together again after the parts are finished. Take the rack apart and transfer the marks to some part of the mortises and shelves that will not be covered with the finish you intend to put on. Apply the finish you wish to

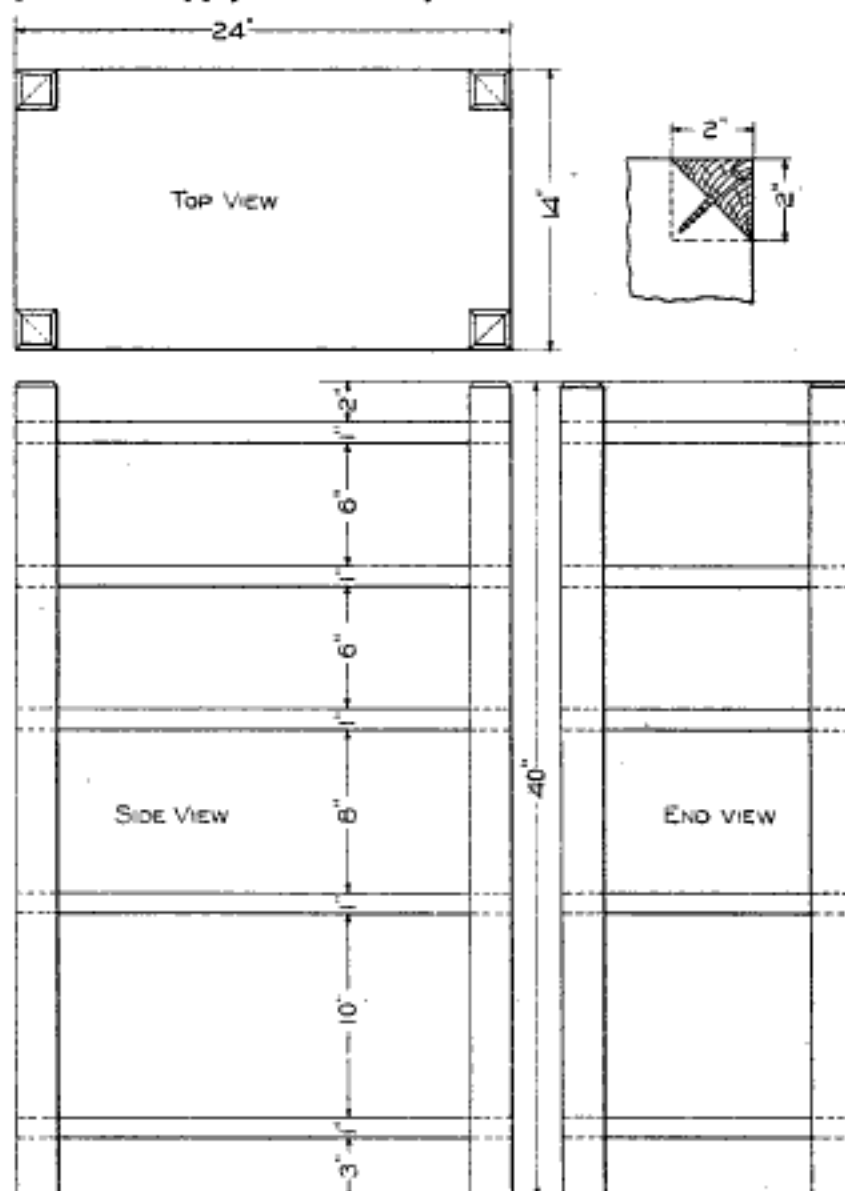

Detail of the Magazine Rack

use and when the parts are thoroughly dry they can be reassembled and your rack will be complete.

CA New York authority on spelling has discovered 13 ways of representing the sound of long "o"—so, boat, roe, oh, door, soul, though, low, owe, yeoman, sew, hautboy and beau.

## FALSE TEETH WERE USED BY ANCIENT ROMANS

Among the million patents the United States government has issued to protect the devices of men who believe they have found something "new under the sun," despite the old philosopher's screed to the contrary, there are a number that deal with various forms of dental surgery and especially what is known as bridge work. The Journal of the American Medical Association in an editorial recently set forth a number of newly acquired bits of information that would seem to refute the proposition that modern dentistry is modern, by recounting the achievements of unknown dentists of ancient Egypt and Rome.

Just who the dentists were, the historians do not always relate, but the results of their work have proven beyond a doubt that bridge work of the most skillful kind was done as long ago as six or seven centuries before Christ.

In the tomb of Sidon were found four incisors and two canine teeth in the jaw of a woman that were held together by gold wire,

two of the former being transplanted teeth—what might be called crowns in this day—fastened in by gold wire. In the museum at Corneto, the ancient capital of the Etruscan federation, are to be seen several specimens of bridge work done by riveted bands of metal. One of these bands supports three artificial teeth, and another, two artificial teeth, the latter being made from a

single ox tooth grooved to imitate the teeth of a human being. These were made in the sixth or seventh century before Christ.

Under the laws of the twelve tables, written in Rome, 450 B. C., while it was expressly forbidden to bury gold ornaments with the dead, a special exception was made for gold with which teeth may be held together. Martial, one of the satiric poets of Rome, once referred to the teeth of one woman as dark and another as white and explained the difference with the statement that one of them bought her teeth while the other had her own. The transplantation of teeth from the mouths of slaves into those of their mistresses is said to have been a common practice in the early days of the Roman empire.

### THREE-COLOR AIR BRUSH

While not materially different in construction from the ordinary air brush, this brush, now being marketed in France, is different in that it has three color cups, the outlets from which, it is claimed, are so constructed that there is no possibility of the colors becoming mixed when one color is turned off and another on.

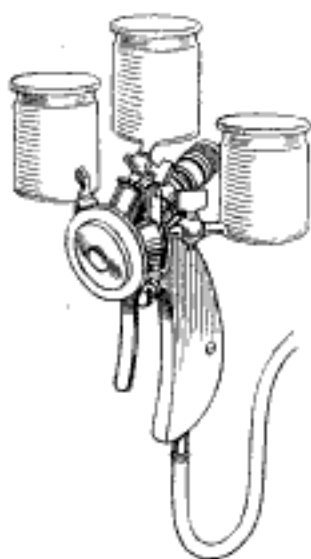

ⒸThe remarkable increase in the demand for motor-driven commercial vehicles is shown by the fact that at the New York motor-truck show space was reserved for the products of 31 manufacturers of such conveyances.

ⒸThe number of men engaged in the mines and quarries of the world is considerably over 6,000,000, of whom about 700,000 are in the United States.

### ADJUSTABLE SUNSHADE FOR MOTOR RIDES

An adjustable sunshade, designed especially for use when riding in automobiles, is being marketed in England. The shade can be adjusted to any angle on the handle and is useful as a protection from the sun when fine weather makes it advisable to push back the automobile hood.



### EXTENT OF MOTOR INDUSTRY

The United States leads the world in the number of automobiles in service and the annual output by large figures, far outrivaling the United Kingdom, France, Germany and Italy combined, in both consumption and production. The number of automobiles in service in the United States, according to figures compiled by Motor, is 500,000, while the output for the year 1911 is estimated as 190,000. The number of cars in service in the United Kingdom (England, Scotland, Ireland and Wales) is given as 150,000, the annual output as 25,000; France has 85,000 in service, and an annual output of 40,000; Germany, 50,000 in service, and an annual output of 15,000; Italy, 15,000 in service, and an annual output of 5,000.

The valuation of the total output of cars in the United States in 1911 is given as \$215,650,000.

### "MESMERIZING" LOBSTERS

The last report of the Sea Fisheries Committee of Northumberland, Eng., gives considerable space to the "mesmerizing" of lobsters. The usual method, states the report in all seriousness, is to hold the lobster's head down, with the claws arranged so as to form a support with the rostrum, and to rapidly stroke the part of the shell covering the head and tho-

rax with the tips of the fingers. In about a minute the lobster succumbs and will remain without movement for a variable period. In order to see whether the holding of the head down, so that the blood will rush to it, is essential, a lobster was treated with the head up, and so successfully that it remained without movement for three hours. Placed in sea water the lobster will immediately recover from the "mesmerizing" treatment.

### GLASS PROTECTOR FOR FOUNTAIN FAUCETS

The glasses used for serving beverages at soda-water fountains are often broken by striking against the metal faucets, and to prevent this a rubber company is placing a protector on the market. It is a corrugated rubber sleeve that fits

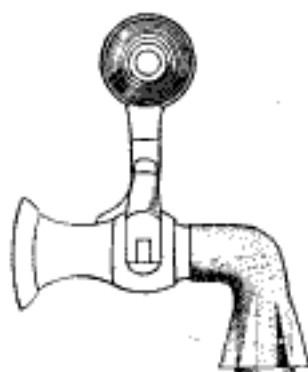

over the faucet and acts as a cushion for the glasses.

### DEVICE FOR MEASURING THE FEET

A recently patented device for measuring the feet in fitting shoes is shown in the accompanying drawing. By its use, the width and length of the foot and the height of the arch can be reg-

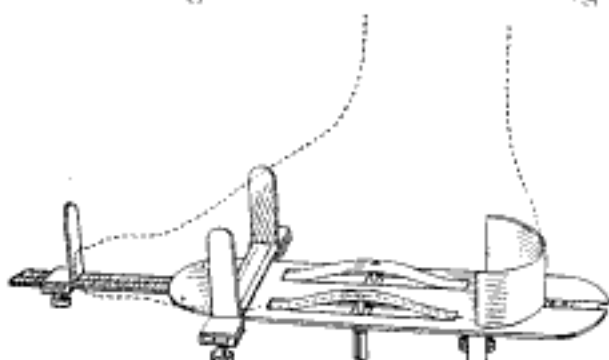

A Device for Measuring the Feet in Fitting Shoes  
istered in degrees of  $\frac{1}{16}$  in. The arch of the foot is placed on the bowed or arched steel pieces in the center.

### FLATFISH COPY PATTERN OF SEA-BOTTOM

In experiments made at the United States fisheries laboratory at Woods Hole, Mass., Francis B. Sumner has drawn attention to the remarkable ability of the flatfish to not only change its hue to conform to the color of the background on which it happens to lie, but to copy the geometrical pattern of the background as well.

The phenomenon of changing the hue has been known for a long time, and for a time biologists supposed the adaptation was effected by action of light upon the skin. A quarter of a century ago a biologist proved that it was brought about through the functioning of the eye. He found that blinded fish do not change their color adaptively.

The astounding behavior of the flatfish in adapting its own geometrical skin patterns to copy the geometrical pattern of the sea-bottom upon which it rests, however, was given no serious attention until Mr. Sumner made his discoveries last year. "In observing a turbot," says Mr. Sumner, "I was impressed by the detailed resemblance which obtained between the markings of the skin and the appearance of the gravel on which the fish rested. . . . The query at once suggested itself: Is it a mere coincidence, or does the fish have the power of controlling the color pattern as well as the general color tone of the body?"

This question was answered by preparing a number of backgrounds, some reproducing various types of natural sea-bottom, and some being highly unnatural geometrical patterns, such as checkerboard, polka dot, stripes, screen, etc. Placed in a tank having one of these patterns the flatfish began to copy the pattern on its back. The time taken ranged from several seconds to several days, according to the nature of the pattern. A change involving the almost complete withdrawal from view of the skin pigments in a dark specimen probably required the longest period. The fact that prac-



tice or habituation to these changes greatly reduced the time required was also shown, as certain specimens, after several changes of background, were found to adapt themselves, in almost full measure, to one of these within a fraction of a minute.

The discoveries of greatest interest, however, are that the imitation or change is accomplished through the flatfish's eyes, and that only part of the fish's visual field is involved in the process, the imitation not being of everything it sees, but of the bottom immediately under or around the fish. Sumner demonstrated that the imitation is accomplished through the eyes by cauterizing the flatfish's eyes with silver nitrate, blindfolding them, or blinding them completely. So treated, the fish ceased altogether to imitate the background pattern, and its hue reverted to an even dark shade.

The discovery that the imitation is practically only of bottom immediately around the fish was made by a series of experiments in which the walls of the tank were variously colored and patterned. The influence of the vertical walls proved to be subordinate, even in cases where the fish was so large that it covered a considerable fraction of the bottom and was obliged to lie constantly with its eyes close to one side or the other of the tank. Although the flatfish notices objects directly overhead, following such with its eyes and moving toward or away from them, the very same pattern which sets up the pigment reactions when it is underneath the fish has absolutely no effect when above it. The change of color and pattern is also only on the back, and the belly is not sensitive to change.

#### AEROPLANE LAMP FOR AERO CLUBS

Believing that the lighting fixtures of aeronautic clubs and other organizations interested in aerial navigation should be distinctive, a South Berkeley, Cal., inventor has designed an aeroplane lamp, which may be placed

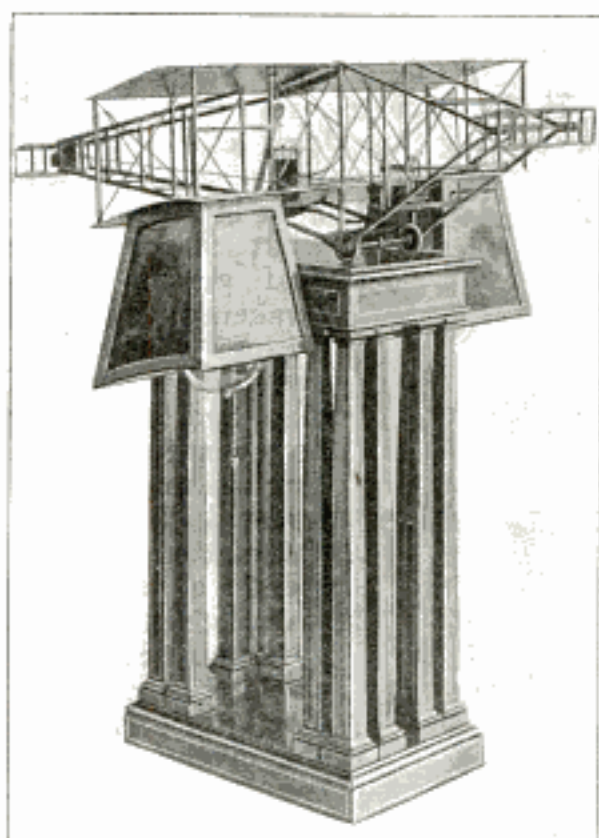

A Clever Lighting Fixture Designed for Aeronautic Clubs

on a pedestal as shown, or be slightly altered for use as a hanging fixture. The electric lamps are contained in art-glass shades hanging from the lower plane of a biplane on both sides.

#### REVOLVING NUTMEG GRATER

In the French nutmeg grater shown in the accompanying drawing the cylindrical indented surface of the ordinary grater is replaced by a disk revolved by means of a crank. The nutmeg is inserted in the tube shown at the top and is held against the disk by means of a spring.

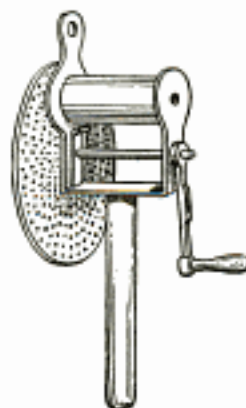

Massachusetts has the largest percentage of motor-driven vehicles, according to a state report just issued, more than 30 per cent of all the vehicles in the state being self-propelled.

### AN ALARM CLOCK MADE TO WAKE THE DEAF

If the ordinary person has trouble in hearing an alarm clock when it

rings at an early hour in the morning, what chance has a deaf person to be awakened by such means? The answer is that the deaf man had absolutely no chance until an English inventor interested himself in the matter and provided a form of alarm clock that is guaranteed to awaken the deaf. The clock part of the invention is incased in a wooden box that is placed at the top of a standard of which it forms a part. A long arm is hinged to the bottom of the box. The clock is placed beside the bed of the person wishing to be awakened. The long arm is connected with a trigger which is released at the

time set, and falls, striking the body of the sleeper a light quick blow which is said to awaken him from the deepest slumber.

### GOVERNMENT WORK ON LAND AND WATER

Recent extensions of the government work being done under the direction of the Department of Agriculture, include the preparation for publication by the Weather Bureau of meteorological charts of the North and South Atlantic, the North and South Pacific and the Indian Oceans, and of the Great Lakes. Besides, the Weather Bureau and Forest Service

combined are making an exhaustive study of the entire question of forest effects upon climate and streamflow.

In collecting the data utilized in the preparation of the meteorological charts, of which the first are now being distributed, the services of 2,416 marine observers have been enlisted, and 10,669 books of weather reports have been issued for their use. The wireless-telegraph service and the vessel-reporting service, the first conducted through coöperation with various wireless-telegraph stations and the latter at the seacoast stations of the Atlantic and Pacific coasts, have been particularly serviceable to marine interests.

In the work of studying the forest effects on climate and streamflow, the experiment station at Wagon Wheel Gap, Colo., established for the purpose of this investigation, is now on a firm basis, and a complete series of observations has been made during the past year. Coöperative stations are also maintained in the Coconino National Forest in Arizona and in the Fremont National Forest in Colorado, and experimental areas may be secured and plants installed in both the Allegheny and White Mountain regions.

### ADJUSTABLE SOLDERING IRON

A soldering iron which can be adjusted at various angles on the handle is being marketed in France. It is shown in the two extreme positions in the drawings, but can be adjusted to any intermediate angle by simply operating the screw which holds it to the handle. It is an iron adapted for difficult positions.

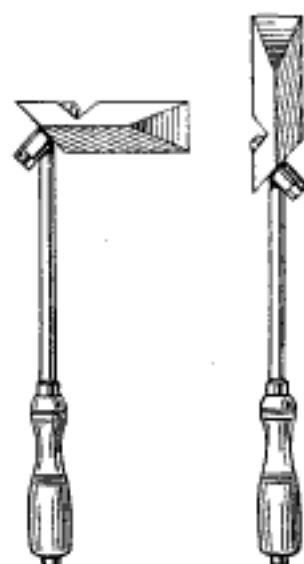



# The Wonders of Light

By J. GORDON OGDEN, Ph. D.

## I—The Nature of Light and How Light Travels

This is the first of a series of articles by the author of "Heat" and "The Kingdom of Dust," which have appeared in this Magazine. Dr. Ogden is professor of physics in the Fifth Avenue High School, Pittsburg, Pa.

**W**HAT is light? Whether it be the dim fox-fire produced by decaying wood, the mystical gleam of a firefly or a glow worm in the shadowy forest, the "Will o' the Wisp" that flits hither and thither over a marsh, the flash from a meteor flying swiftly across the sky, the tremulous quiver from out the vast abyss of the star depths, the emblazoned pathway of a bolt of lightning, or whether it be the illumination produced by a pine knot, a candle, a gas jet, an incandescent mantle or filament, light is one of nature's mysteries—a problem set for man to solve.

And man has learned in the ages that have elapsed since he was created, that by far the greatest part of the mystery lies with himself. The perception of light, heat, sound, and possibly of other forms of energy to which he cannot as yet give even a name, depends almost entirely upon the chemical and physical changes that take place within his own body—especially in the brain and its faithful

outposts in the nervous system. In our consideration of the wonderful properties of light we shall not dwell at length upon the psychological phases of the subject, but shall attempt to make clear some of the simpler physical phenomena with which everyone is more or less familiar, but which are nevertheless not generally understood. We shall regard light as a form of energy, a definite thing—the thing that enables us to see, the thing that gives us the power to distinguish green

from red, the thing that hammers away at the emulsion on a photographic plate causing the chemicals therein contained to deposit a thin film of metallic silver, which we may utilize in making a picture of a landscape, a comet, or the face of some dear friend.

Up until the last century or so, throughout the thousands of years that man has been a thinking and reasoning being, little was learned concerning light. From its association with heat, some philosophers, including the brilliant Lavoisier, reasoned



Light is One of Nature's Mysteries

that light is an element on a parity with iron and oxygen. This belief is a survival of the teachings of Aristotle, who claimed that there are only four elemental substances in nature—earth, air, water, and fire.

One of the first experimenters to tell us something definite and something true about light was a young Danish astronomer, Olaus Roemer, who determined the velocity of light in 1675. Many years before the time of Roemer, an Italian scientist, Galileo, had satisfied himself that light did not require any time to travel from one place to another; in other words, that it could cover any distance instantaneously. He based this belief on the outcome of a very crude experiment. In the neighborhood of his home were two hills separated by a valley about a mile wide. On one hill he stationed an assistant with a lantern. Galileo, on the other hill, displayed a light. At the precise instant both lights were extinguished. Galileo thought that a perceptible time would elapse between the snuffing out of the lights, and the perception of the same from either hill, just as some seconds of time must intervene between the flash and report of a gun under similar conditions. Galileo could not notice any interval, although he performed the experiment many times, and lamely concluded that there was none.

These experiments and the conclusion therefrom, were generally accepted, until Roemer made his wonderful, though simple deductions from his observations of Jupiter's nearest satellite. From his station in the observatory at Paris, Roemer noticed a peculiar variation in the time of the appearance of one of Jupiter's moons. It was well known to him that the moons of Jupiter disappeared at certain intervals behind that planet, and then, after a certain period of hiding, known among astronomers as an eclipse, reappeared on the other side. This, of course, was very simple, but one peculiar fact puzzled him: Sometimes these eclipses were unaccount-

ably delayed, although he knew that the nearest moon always moved with practically the same velocity. Why, then, did it not always remain hidden for exactly the same interval of time?

Finally the explanation came to him. He noted that the greatest discrepancy in the time of occultation occurred once in each year when the earth was farthest from Jupiter. It became clear to him that the satellite really appeared on schedule time from behind Jupiter and sent its light speeding on its way to the earth. Now if the earth were nearest to Jupiter on the first of January, it would be farthest away on the first of July. Therefore when the light from Jupiter's moon arrived at the earth's orbit on July first, the earth was not there to receive it. The light then traveled on until it met the earth on the other side of its orbit. Obviously this would take time. Roemer knew the diameter of the big ellipse in which the earth moves. He divided this enormous number of miles by the number of seconds it took the light to cross this distance, and presto! the velocity of light was known! The velocity as determined by Roemer was upward of 186,000 miles per second.

This same problem has been worked out by other experimenters since the time of Roemer, and by other methods, more accurate and more refined. Roemer's determination remains practically unchanged. The latest determination, that of Professor Michelson, gives the velocity of light in a vacuum as 299,860,000 meters per second, the equivalent of 186,330 miles. No wonder Galileo had drawn a wrong conclusion from his experiment, as the interval between the snuffing out of the light on one hill and its perception on the other hill, was only the 1-186,000 of a second. No matter how accurately he might perform the experiment with the crude means at his disposal, it was manifestly impossible to detect such a slight interval of time.

How does light travel? There are only two ways in which energy of any kind may be transferred. Matter



Galileo Attempting to Ascertain the Speed of Light

must be actually projected from one place to another, as illustrated by the flowing of a river, or else there must be a series of waves or pulses set up in some more or less stationary medium that will carry the disturbance, as illustrated by the sweeping of great tidal waves across the ocean, twice in every 24 hours, through the attractive influence of the moon. Which of these two forms of transfer is used by light? Does the sun, 93,000,000 miles from the earth, project small particles of matter across that immense space, or does its energy reach us in the form of waves?

The pioneers of science in the seventeenth and eighteenth centuries debated these questions with great brilliancy. Sir Isaac Newton taught that light and heat are material things each associated with the other in some mysterious way. He believed that a luminous body sends forth billions of incandescent particles, infinitely small in size; that these particles, or "corpuscles" as they were termed, enter the eye and stimulate the sense of sight into activity. Robert Hooke, an eccentric English mathematician and natural philosopher, denied the reasonableness of the corpuscular theory of light, and proposed what is now known as the undulatory or wave theory. As Hooke's theory was largely guesswork, his arguments were weak and easily answered by Newton.

Over in Holland, Christian Huygens, a natural philosopher of renown, studied with eager zeal the merits of the different theories. He entered the debate and advanced such additional

arguments in favor of the wave theory that he is commonly considered to be the originator of the general doctrine of the propagation of light by means of waves. Newton accepted the gage of battle thrown down by this new adversary and the scientific publications of the day are full of the details of this celebrated discussion. For three quarters of a century after the death of Newton, this bloodless battle was waged. In the absence of scientific proofs or actual demonstrations, however, the arguments on both sides were simply matters of opinion.

Now it is a well-known fact that a concentrated solution of certain chemical substances will rapidly crystallize when a small crystal of the substance is thrown into the liquid. The controversy concerning the nature of light needed but the addition of a small crystal of scientific truth to simplify

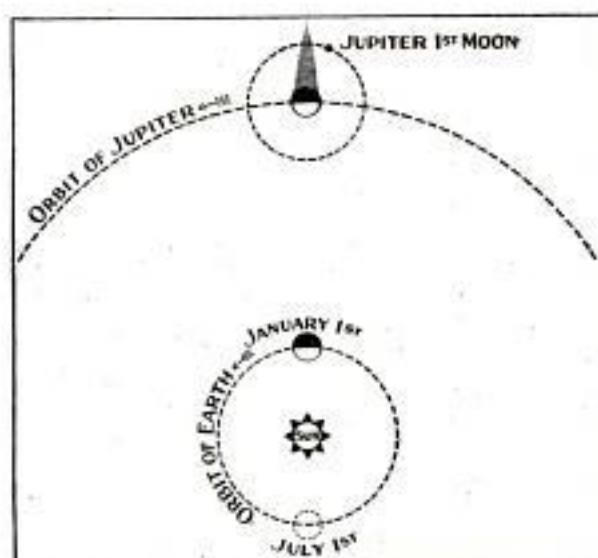

How Roemer Found That Light Travels Upward of 186,000 Miles a Second



Sir Isaac Newton

He Believed That a Luminous Body Sent Forth Billions of Incandescent Particles

and clear up the whole matter. And the crystal of truth—the result of an experiment that anyone could perform—was supplied by the celebrated Dr. Thomas Young.

Let us stop a moment and learn something of the personality of this wonderful man before we learn more about his epoch-making experiment. Born in England in 1773, even in his childhood he gave evidence of unusual intellectual powers. While an infant in arms he could read fluently. At the age of four, he had read the Bible through twice. At 14, he could read and write 14 languages, including such



The Simplest Demonstration of Wave Motion

difficult tongues as Persian, Arabian, and Ethiopian. As he developed into the full vigor of manhood, his intellectuality became even more pronounced. As one writer said of him: "He seems to have entered every available field of thought—mathematics, physics, botany, literature, music, painting, languages, philosophy, archaeology, and so on, to tiresome lengths—and once he had entered any field he seldom turned aside until he had reached the confines of the subject as then known, and added something new from the recesses of his own genius. He was as versatile as Priestley, as profound as Newton himself."

Doctor Young became interested in the debate concerning the nature of light, and, like Huygens so many years before, weighed the evidence on both sides. His wonderful perceptive powers enabled him to grasp the subject in its entirety, and his equally wonderful reasoning powers soon gave him the argument that finally overthrew the followers of Newton. On Nov. 21, 1801, he delivered a lecture before the Royal Society, on "The Theory of Light and Colors." This lecture marked the beginning of a new epoch in physical science.

Although Young had already pointed out the extreme improbability that particles of matter could travel at the enormous speed of 186,000 miles per second, one argument was advanced by him that was quite convincing.

The reader will be interested in learning just what Young had discovered, but before we enter into an explanation of it, let us recall what happens when a stone is dropped into a pond of still water. A number of tiny waves start out in every direction from the point of disturbance. If a second stone is dropped at the same time in another part of the pond, a second series of waves, similar to the first will start on its way. When these two sets of waves meet, they must do one of two things: they must either combine to form waves higher and deeper, or else they must destroy each

other wholly or partially, and cause the surface of the water to lose its wrinkled appearance and become smooth again. In other words, the waves will either "reinforce" each other or else "interfere."

This word "interference" is a very important one in the explanation of how light travels, as it was the demonstration that light added to light might produce darkness or increased brightness, that enabled Young to prove the reasonableness of the theory that light travels in waves. Young's experiment was quite simple. He admitted a beam of sunlight into a darkened room through a narrow opening in the window shutter. He placed a screen containing two minute holes quite close together, in the path of this beam. The two holes permitted twin beams of light to pass to a second screen of white cardboard, where they met and overlapped. The overlap, instead of being uniformly brighter, was made up of a series of bands, alternately dark and rainbow colored. When either of the two holes was covered, the bands disappeared. Here were phenomena unexplainable by any theory other than that light is a wave motion. Two sounds added may produce silence, two water waves added may neutralize each other, and Young had succeeded in demonstrating that precisely the same thing is true of light.

A curious fact had been pointed out by Robert Boyle over a hundred years before Young was born. This phenomenon, afterwards known as "Newton's rings," a series of colored rings produced when two films of glass are pressed tightly together, could not be explained by any twistings or turnings of the corpuscular theory. Young boldly announced that the rings as well as the beautiful, mysterious colors of soap bubbles, were the direct result of the interference of light waves. Ordinary white light, as will be shown in a later chapter, is made up of a multitude of wave lengths, each wave length being a color. When white light strikes the curved surface



Thomas Young

One of the Most Brilliant Men in History. He Proved That Light Travels in Waves

of a soap bubble, some of the colors are reflected from the outer surface of the film; others penetrate to the under side of the same film and are there reflected, following the first train of waves, and separated from them only by the tiny distance of the thickness of the film. Since the brotherhood of colors known as white light is thus broken up by the two reflections, the brilliant colors of the bubble are accounted for, and likewise, those of the "rings."

Only one point remained to be cleared up. Newton's chief objection

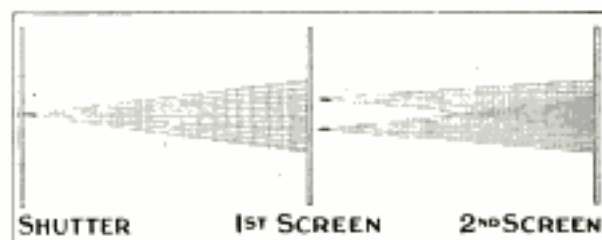

Young's Experiment Which Demonstrated the Wave Theory of Light

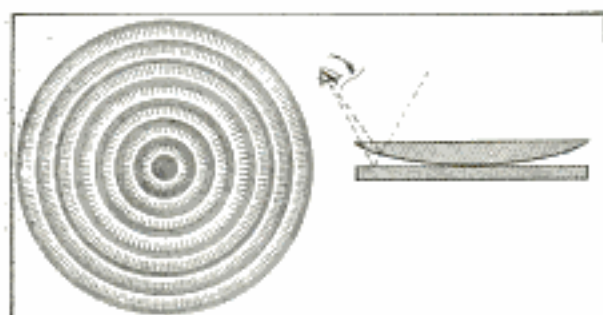

Newton's Rings. Young Utilized These Rings to Prove His Theory

to the wave hypothesis was based on his belief that the so-called light waves could not go around corners, like sound waves or water waves, and that therefore light could not be a wave system. Grimaldi, nearly a century

and a half before, had noticed and described the "light and dark fringes at the edges of shadows of small opaque bodies placed in the path of sunlight admitted through a small hole." This phenomenon was termed "diffraction." It can readily be observed in looking through a feather at a strong light. In 1815, Fresnel, a brilliant young French scientist, demonstrated beyond doubt that diffraction is really a bending of the light waves, produced by interference. The last objection to the undulatory theory of light had been answered, and since then it has taken its place as an accredited tenet of science.

### AERIAL EXPRESS PICKING UP THE MAIL

An artist of the London Sphere, looking into the future with largely imaginative eyes, sees an aeroplane mail express picking up the mails from a high tower in somewhat the same



An Aeroplane, Rushing through the Night, Picks Up the Mail from a High Tower without Stopping

manner as in practice on railroads. At the top of the tower is a swinging contrivance consisting of a horizontally mounted revolving shaft controlled by hydraulic buffers. The mail bags are suspended from the shaft by rings, and the aeroplane is fitted with a projection, which, in coming in contact with the bags, sweeps them from the shaft and drops them into a net placed suitably to receive them.

The article accompanying the illustration says, that, granting that aeroplanes will in the not remote future be much larger and heavier and able to steer with much greater precision, the prediction is quite a feasible one.

### BALTIMORE HAS MONSTER STORAGE BATTERY

The monster storage battery recently installed in Baltimore, Maryland, as insurance against interruption in the city's electric light and power service, is said to be the largest ever placed in one plant in the world.

The installation of the battery cost about \$400,000, which includes the cost of the special building erected for it. The battery weighs 616½ tons, and required 14 tons of copper to make the necessary connections. When



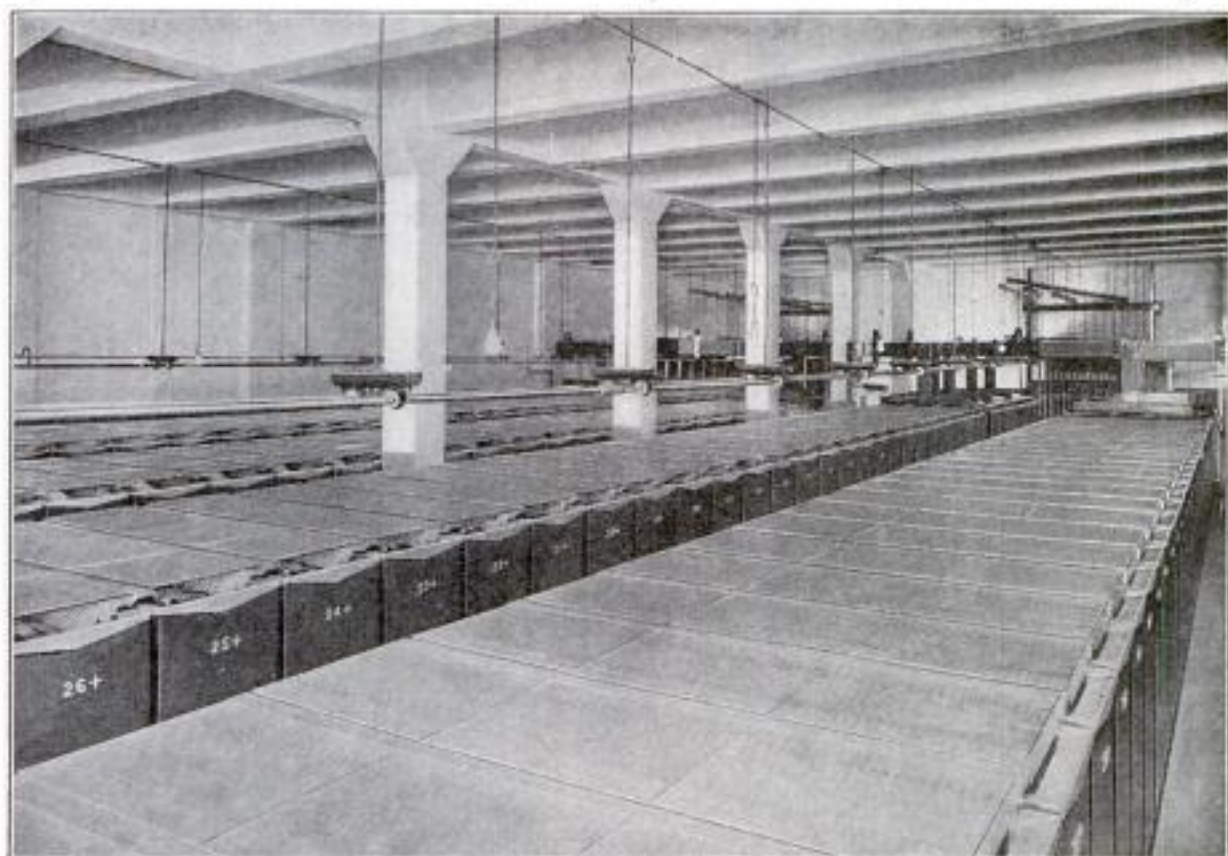

Huge Baltimore Storage Battery, Weighing 616½ Tons, and Requiring 14 Tons of Copper to Make the Connections, in the Special Building Erected to Contain It

accidents occur which necessitate the shutting down of one of the stations for short periods, the battery will automatically supply current, with no break in the service.

### POTASH FROM SEaweEDS

In a recent report of Secretary Wilson, of the Department of Agriculture, the statement is made that the kelp beds that border the coasts of California, Washington and Oregon are capable of supplying 1,000,000 tons of chloride of potash annually, worth at least \$35,000,000. That is about three times the value of the potash salts now imported each year from Germany, for the use of American fertilizer manufacturers. It appears, therefore, that the hitherto neglected harvest of the sea constitutes a national resource of very great monetary value, capable of relieving American farmers from the necessity of further dependence upon foreign sources of

supply for a necessary constituent of all commercial fertilizers.

Secretary Wilson's report is based upon investigations made by scientists of the Bureau of Soils, who operated with a special appropriation of \$12,500 granted by congress a year ago. These have mapped and studied kelp groves, extending from Puget Sound to Point Loma, with a total area of about 100



Kelp Cast Ashore after a Storm on the California Coast—Government Scientists Declare That Potash can be Secured from It, Thus Freeing Us of Dependence on the German Sources

square miles. However, they state that they have mapped and examined but a portion of the kelp beds off the Pacific coast, so that the annual supply of potash salts available from the

of the kelp beds, or whether this new resource will be safeguarded by restrictions, to prevent the possible destruction of the forests of the ocean, is an interesting question.

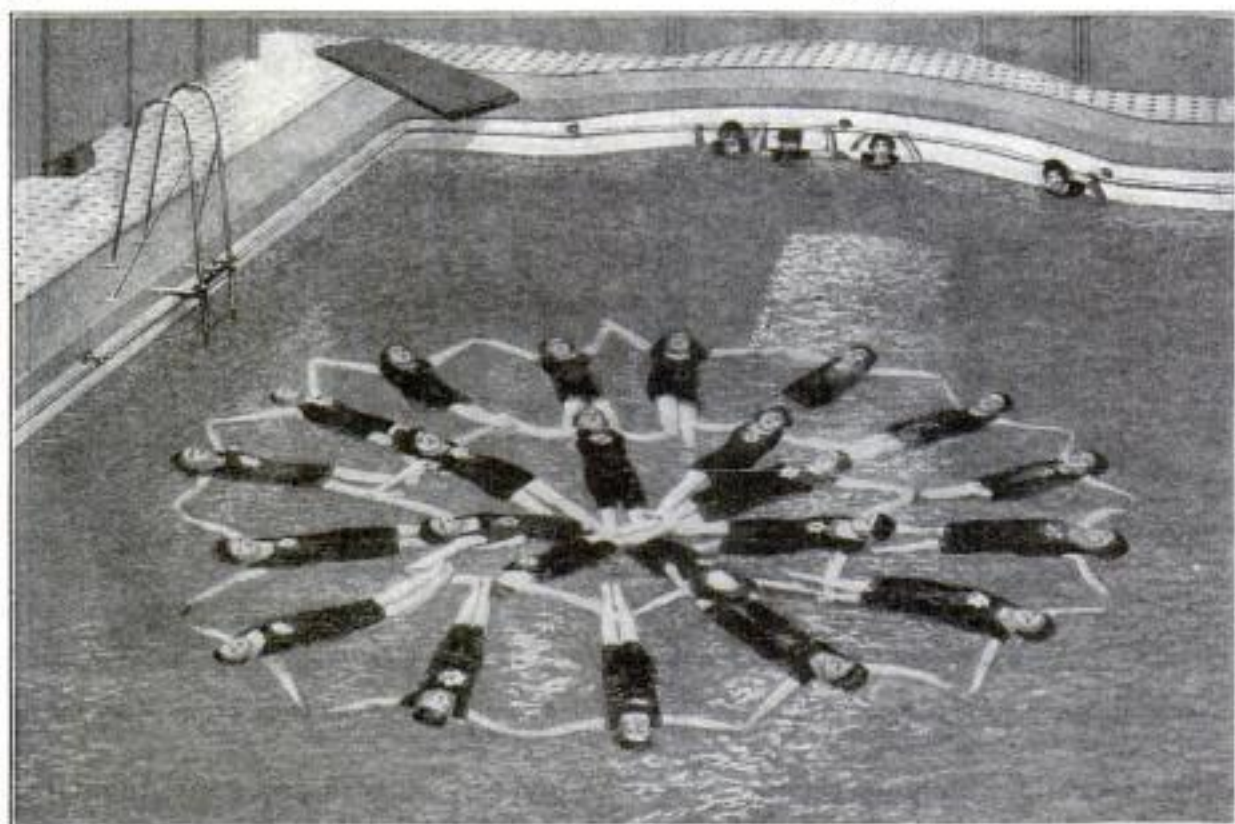

Twenty-Three Women in a German Swimming Tank Floating in a Star Formation

seaweed harvest is much greater than stated. The kelp beds so far examined vary in extent from less than an acre up to stretches five miles in length and two miles or more in width. The investigations made by the Bureau of Soils constitute the first serious attempt that has ever been made to ascertain their extent, character and possible uses. Heretofore they have been considered devoid of economic value, except as they supplied food to the fishes of the Pacific.

One company has been organized at Coronado, Cal., for the extraction of potash salts from seaweeds. A boat has been built, with specially designed machinery for the harvesting of the kelp. However, the plans of the company have been kept secret, and little is known of the methods it will employ. Whether the government will permit the indiscriminate harvesting

### STAR FORMED BY WOMEN SWIMMERS

A woman's swimming club at Augsburg, Germany, frequently gives swimming exhibitions in which novel and interesting feats are accomplished. In the accompanying illustration 23 women are shown floating on the surface in a star formation.

### DISEASED TISSUES TREATED WITH RADIUM SALVE

The application of radium in treating diseased tissues is difficult in a great many cases because of the location or seat of the disease and the necessity of repeated treatments, but in order to provide for such cases, a New York radium specialist has devised a radium gelatine. This is a sterilized solution of a gelatine which

contains a small quantity of radium and which will coagulate when it becomes cold. Before becoming cold, however, it is charged with as large a quantity of emanations as possible. The coagulated solution is heated several times, thereby liquefying it, and each time it is again charged with emanations, so that there is finally obtained a radioactive product which contains primary as well as secondary radioactivity.

The radium gelatine or salve is injected into the diseased parts in liquid form or is applied by means of tampons, etc. Tests are said to show that it is readily absorbed by the surrounding diseased tissues.

### THE ONLY BLIND WIRELESS OPERATOR

John Ellis, of Providence, Rhode Island, is said to be the only sightless wireless operator, and his success is believed to open a new field for the blind. The operation of a wireless outfit depends on hearing alone, and the idea held by some people that the wording of a message is read by the sparks is erroneous. The operator sits with telephone receivers at his ears and hears the ticking of the message.

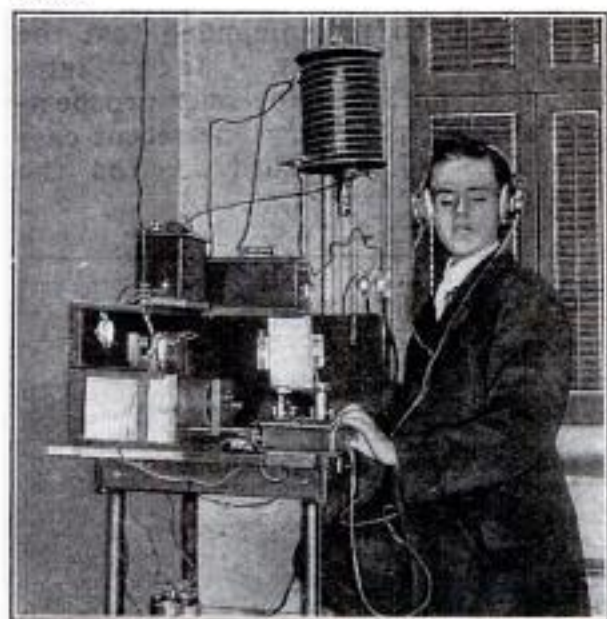

A Sightless Wireless Operator, Claimed to be the Only Blind Man So Employed, Receiving and Transmitting Messages

### SIGN SPACE RENTS FOR \$60,000 A YEAR

In this illustration is shown a six-story building at the northwest corner



The Sign Privileges of This Building are Valued at \$60,000 a Year, Which is \$20,000 a Year More than the Building is Leased For

of Broadway and 34th Street, New York, which receives \$20,000 a year more for the signs it carries than for its store and office rentals. The building is leased for \$40,000, and the sign privilege yields a rental of \$60,000 a year.

The frontage of the property is but 31.10 ft., and the area covered is not more than half of a full city lot, yet it was recently sold for \$1,000,000, which is about \$866.55 a square foot, making it one of the most valuable pieces of land in the world.

President Madero of Mexico made a four-minute flight in an aeroplane recently at Mexico City as a passenger with George M. Dyott. This is the first time that the actual head of a nation has ever gone into the air on an aeroplane.

## OIL PROSPECTORS FILE ON RESIDENTIAL PROPERTY

When a man buys a house and lot in a city of more than 300,000 population, he naturally feels that he is safe from such attacks on his property as are usual in new mining districts; having mining claims filed upon his ground, and prospectors attempting to dig for minerals in his front lawn.

A case has just come up in Los Angeles, however, which points that ancient **moral** that a real estate purchaser should make sure of his title from the beginning of all records. It seems that a wealthy widow, who owns a tract of improved land in one of the most fashionable residential districts of Los Angeles, woke up one morning to find a gang of laborers erecting an oil derrick on her property, not far from her home. On asking for an explanation, she was told that the quarter section of land which comprised her tract had been filed upon by eight prospectors, that notices had been duly posted, according to law, and that they were prepared to resist any attempt to expel them.

The derrick was hastily erected, to the disfigurement of the neighborhood, and the dismay of lot owners, who saw their property jeopardized, or at least depre-

ciated in value by the proximity of an oil field. Legal advice was sought, and the status of the case was declared to be as follows: The land had been originally granted to the Southern Pacific Railroad in 1879, but like the other railroad grants, this one exempted mineral lands from the patent. At that time the land was not known to contain oil, and as far back as 1884 it was sold to an innocent purchaser. From him it passed to his widow. Now the mining men hold that inasmuch as mineral land is not included in the grant, the quarter section is still government land, and as such, open to prospectors.

There is some doubt as to whether the city has an ordinance against drilling wells in the city, but even so, the federal law would stand against any city regulation. While litigation is expected, the matter may be compromised out of court.

Not more than a mile from the land in question is an extensive oil field which is being operated right beside some of the city's finest homes. This is not only a nuisance, but a direct menace, for there is always great danger from fire about the derricks and storage tanks.

It has been recommended that the mining laws of the United States should be amended to cover prospecting in municipalities. One recent case shows to what absurd lengths the

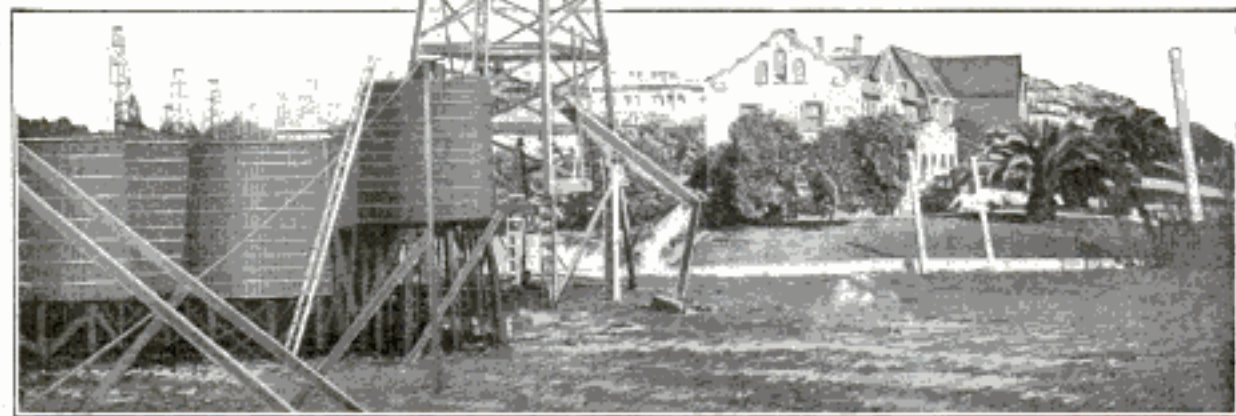

Oil Claim Made on Residential Property in Fashionable District of Los Angeles

present law can be stretched by literal interpretation. A party who claimed to have found gold near the surface, tried to stake out a placer mining location on the site of the Arcade Railway station, the most important depot in Los Angeles.

### OLD CUP DEFENDER GIVEN CONCRETE REINFORCING

One of the old defenders of the American Cup, the "Pilgrim," has been converted into an auxiliary schooner by its owner, John A. Royall, and will be used in research and experimental work on the southern coasts, gathering data for the development of the southern fisheries.

The reconstruction of the sloop was unique, the thin steel plates of her hull being reinforced with concrete. The concrete at the keel is 6 in. thick at the stem, 14 in. thick amidships, and 8 in. thick at the stern, graduating upward into wings between steel frames, and tapering to 2½ in. in thickness at the water line. The dimensions of the "Pilgrim" are, length over all, 128 ft.; beam, 26 ft.; draft, 6½ ft. She has no topmasts and all sails are inboard. Her auxiliary power consists of two 4-cylinder, 35-hp. heavy-duty engines.

### LIVE-FLOWER FANS

The latest fad in Paris is a fan that can be covered or decorated with all sorts of real flowers. When folded, it appears to be a simple bouquet. The manner of attaching the flowers and

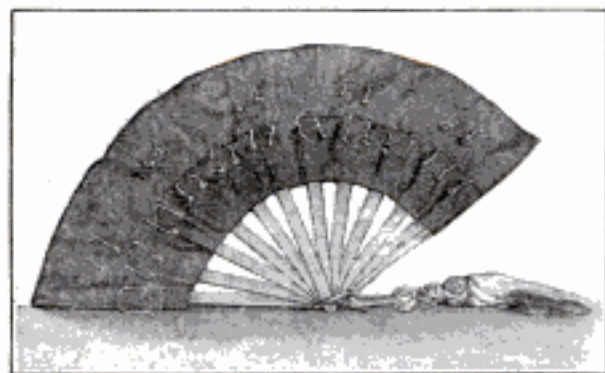

The Real-Flower Fan Ready to be Covered with Flowers



The Fan as It Appears When Covered

leaves, by means of flexible covered wires, is shown in one of the illustrations, while the other shows the effect when covered. New flowers are, of course, attached to the fan each time it is used.

### AUTOMATIC DEVICE CHECKS RAVAGES OF SHIPWORM

An inventor of Long Beach, Cal., has designed an automatic device for the protection of partially immersed wooden piles from the ravages of parasites. The contrivance consists of a floating collar and connected rings encircling the pile which by waves and tide are given horizontal and vertical variations of position in such a manner as to result in a continuous friction against the wood. This is supposed to prove fatal to all animal life attached.

Ordinarily the life of a pile set into the salt water of the Southern California coast varies from three to six years. The inventor claims that his device will prolong this period of usefulness from 50 to 100 years, depending upon other conditions.

The most destructive pest of the Pacific is the teredo or shipworm, a mollusk which attacks timbers in the water between high and low-tide lines and bores its way into the wood. In 1731 and 1732, the same sort of teredo now playing havoc here created national alarm in Holland by boring into the piles constituting part of that country's defense against the inroads of the sea.

### RESULT OF A DOUBLE EXPOSURE

In his photographic enthusiasm, the father of the baby shown in the accompanying illustration made two



This is Not Twins, but the Same Baby Appears Twice Because of a Double Exposure

exposures without changing the plate, and as a result the baby appears twice, once in a natural position for babies of its age and once floating in the air just outside the railing of the porch.

### ROAD BUILT ACROSS A COUNTY IN A DAY

A remarkable demonstration of what may be accomplished in road-building by the right kind of coöperation has been given by the residents of Lincoln county, Oklahoma, who constructed a road 33 miles long, from the east to the west boundaries of the county, in one day. Several weeks had, of course, been devoted by the leaders to making arrangements, but the actual

road-building was accomplished in eight working hours, 3,000 men and 2,000 teams being utilized. Half or one side of the road is constructed of hard surface and the other half or side of dirt, thus furnishing a base for motor cars on one side, and for the unshod horses of the farmers on the other.

The road-making day was in the nature of a holiday in the entire county. All business in Chandler, the county seat, was suspended, and merchants, bankers, professional men and artisans reported for work. All stores, factories and schools in the other towns were also closed by proclamation. At noon the women of the county served a vast dinner, and, as hot food was served along the entire line of the road, it is no exaggeration to say that the dining table or roadside used as such was 33 miles long. Boiling pots of coffee were available every sixteenth of a mile. The greater number of the men were unfamiliar with the handling of teams, scrapers, shovels and dynamite, but capable bosses were in charge of all sections of the road, and the construction was carried out without a hitch.

### PORTLY LOBSTER GENTLEMAN IN SHOP WINDOW

This curious representation of a portly gentleman is made entirely from a lobster, even to the pipe and walking-stick. It is exhibited in a London shop window, where it provokes much amusement.



A process has been recently discovered by means of which banana stocks can be subjected to a process which squeezes out the juice and shreds the fiber, the result being a substitute for cotton waste.



United States Cotton-Standard Laboratory at the Department of Agriculture; Experts on Balcony can Detect Slightest Difference in Color at This Elevation

## GOVERNMENT EXPERTS FIX COTTON STANDARD

A system for the standardization of cotton which eliminates the inaccuracy connected with the usual methods of grading is a recent achievement of the Bureau of Plant Industry of the Department of Agriculture. By determining the average length of fiber of the cotton to be graded, the government experts in Washington have hit upon a scheme which they believe will revolutionize the present methods of buying and selling and benefit both the grower and spinner.

Heretofore the grading of cotton was purely a matter of guesswork. The accuracy of the work depended upon the judgment of cotton experts. If an expert wished to favor the buyer by cheapening the grade of the cotton to be examined, it was only necessary for him to jerk it apart, thereby snapping the fibers and causing them to appear short.

Standardization, according to the

new method of the bureau of plant industry, is accurately accomplished by smoothing out 50 or 100 cotton fibers in the usual manner and then separating them under a microscope. The individual fibers are then placed between two pieces of clear glass, thus forming a lantern slide. By placing this slide in a solar camera fitted with a powerful electric light each fiber is magnified about 20 times and reproduced on a large glass screen directly in front of the projecting apparatus. The operator making the standardization then takes a rotary map measure and measures the length of each fiber. These lengths are then tabulated on an adding machine until the lengths of from 100 to 200 fibers have been determined. The total length is then found and an average computed. Upon this average length the standardization is based. The government experts say that this system of grading



Measuring Cotton Fibers. Projection Lantern in Rear of Screen



Glass Blower at Work Placing Samples of Standard Cotton in Vacuum Tubes

can be accomplished at a cost of about \$2 for each sample.

Previous to two years ago, when the government experts first took up the matter, it was almost impossible to preserve the standard samples of cotton. Storing them away in a dark room prevented color changes as the result of the action of the light, but oxygen and other gases in the air caused a change in appearance which made all accuracy impossible.

After a series of experiments, it was found, however, that if the samples were kept in a vacuum, no changes in their appearance would take place, no matter how long they were stored away. The most convenient way in which to keep the samples in a high vacuum was to seal them in glass tubes. The standard grades are now being put in these tubes daily, to be broken open from time to time so as to insure the consistency of the official grades of this country.

### AEROPLANE AUCTIONS IN FRANCE

Several aeroplane auctions, both voluntary and forced by creditors, have taken place in France in the past several months, and the prices obtained for complete machines and for accessories have been remarkably small.

In one instance a propeller of first-class make brought less than one dollar, and a monoplane, without motor, was sold for \$35. A complete machine, motor and all, in good order, brought only \$60.

The life of an aeroplane, even though it meets with no serious accidents, is short. French papers speak of a Farman biplane, which has been in service only a year, as a veteran of its type.

### LONGEST-STROKE AUTO ENGINE

The engine used in an automobile of English make in a recent hill-climbing test, which the car won, is said to have one of the longest, and in all probability the longest, strokes ever employed in a motor car. The bore is 3.35 in. and the stroke 10.64 in., which makes the ratio of stroke to bore approximately 3:1. The top of the engine bonnet is shoulder-high to an average man.

"It is safe to state," says Motor, "that for any practical purpose, not excepting that of racing, the bounds of stroke length have been passed in this engine. It is hard to see what purpose is served by such an engine, unless it be an experiment to establish by a cut-and-dry method the limit beyond which one cannot go."



## WAYS MISSING SHIPS MAY HAVE BEEN LOST



By Foundering after a Storm



By Tidal Wave



By Waterspout



By Capsizing

An interesting series of pictures, depicting the probable manner in which ships posted as missing at Lloyd's were wrecked, was published recently in the Illustrated London News. Four pictures of the series are here reproduced, showing ships foundering after a gale, caught by a tidal wave, overwhelmed by a waterspout, and capsized by some convulsion or other.

During the first three months of last year 144 steam and sailing vessels were lost at sea, and of these, 13 were posted at Lloyd's as missing, their fate being conjectural.

### GOGGLES AS PROTECTION FROM FLYING METAL

The use of goggles by workmen employed at tasks in which there is a possibility of the eyesight being de-



Showing the Protection Afforded by Goggles, One Side of Which is Completely Covered with Babbitt Metal Which would have Destroyed the Eyes had the Goggles Not been Worn

stroyed by flying metal, is one of the protections provided in modern steel plants, the importance of which, strange to say, it is difficult to impress upon the men. Every morning in one plant, for instance, the foremen of certain departments make sure that each man has a perfect pair of goggles, and call his attention to the necessity of wearing them. Most of the men do wear them, according to Robert J. Young, safety inspector of the Illinois Steel Company, but on their hats.

An example of the protection afforded is shown in the illustration, one side of the goggles being completely covered with babbitt metal. The metal exploded while the wearer of the goggles was pouring it, but he received merely a slight burn about the face. His eyesight would probably have been destroyed if he had not been wearing the goggles.

### BERLIN'S NEW POLICE TELEPHONE SYSTEM

A new and very interesting telephone system has been installed by the police department of Berlin to facilitate the calling of branch stations and headquarters. All the members of the department, uniformed and secret service, are provided with pocket telephone sets so compact as to be easily carried in the pocket or in a small

leather holder attached to a strap. Contact stations are scattered over the city, on fence posts, on the walls of buildings, and on trees in the parks. The connection is established by merely plugging the contact station.

### A TRAIN-ILLUMINATION INSTRUCTION CAR

To the list of special instruction cars usually maintained by railroads for the benefit of their employes, the Pennsylvania system has added a train-lighting car. This railroad system utilizes no less than eight distinct axle-device systems, in addition to a large number of straight storage equipments, and an instruction car was deemed necessary in order to furnish uniform instructions to yard electricians. The car will be sent to the different points at which electrical forces are maintained, and the men at such points will be given lectures and demonstrations on the operation and maintenance of the various systems.

### A COLUMBARIUM MONUMENT

The monument shown in the accompanying illustration is similar in size and design to those usually placed in the center of a family burial lot, but it serves as a columbarium as well as a monument. The ashes of the cremated dead are placed in urns, which are kept in a receptacle back of the metal grating.



CA large electric motion sign, 65 ft. wide and 50 ft. high, using more than 3,000 5-watt lamps, advertising electric vehicles, has been erected at Broad and Market Streets, Newark, N. J.

## VOLCANIC ERUPTIONS ON THE STAGE

The sequence of phenomena characterizing a volcanic eruption is usually subterranean grumblings followed by smoke, which at first seems to hesitate at the edge of the crater and then rises in the air. The smoke is succeeded by streams of lava, the projection of rocks and ashes, and often vast outpourings of flame.

To reproduce such a scene on the stage of a theater would seem a rather difficult, complicated, and dangerous undertaking, but it has been accomplished in a particularly vivid manner in a French theater with the simple apparatus shown in one of the illustrations. Concealed behind the scenery representing the crater of the volcano is a stand, from the center of which rises a funnel of wire screen, about 13 ft. in diameter, connected with a compressed-air supply by three tubes. Below the funnel is a circular metal tube provided for about half of its circumference with a steam ejector, which rises above the wire-screen funnel. Attached to the circular tube is a hose or tube connecting it with a source of steam supply behind the scenes.

The portion of the crater seen from



The Ingenious Apparatus by Means of Which the Effect is Produced. Sponges and Paper are Blown from the Funnel to Imitate Rocks and Ashes, Steam Rises from an Ejector, Fire Flames from the Fire-Pans, and Flowing Lava is Imitated by Turning a Scenic Belt

the body of the theater is formed of transparent material, and behind this an endless belt is set in motion, lighted from behind by a cluster of 24 red



A Volcano Reproduced on the Stage of a French Theater

lamps. This belt, which is shown at the right of the illustration, is also transparent, and is so decorated that, as it is revolved above the red lights, it imitates the flow of lava. Sponges, painted red or gray, to represent glowing or dark rocks, and pieces of paper, to represent ashes, are thrown into the funnel-like receptacle by men concealed in the scenery, and are then thrown as high as 18 or 20 ft. by the compressed air. Bengal fires lighted in pans on each side of the crater serve to give the effect of leaping flames, smoke-producing tablets, placed just back of the funnel serve to add smoke to the steam; subterranean thunder is supplied by men beating drums and the operation of other noise-producing apparatus, and illumination is thrown down into the crater from reflectors arranged above the stage.

CALL Isthmian records of excessive rainfall for short periods were broken at Porto Bello recently by a fall of 2.46 in. in three minutes. The highest previous record was 0.75 of an inch in five minutes at Rio Grande in July, 1908.

### GERMAN MOTOR-CAR HAS HAMMOCK SEATS

A German maker of automobiles is equipping several cars with suspended seats, the frames of which consist of



Hammock Seats for Automobiles, Constructed by a German Concern

strong metal springs. The seats are mounted on a kind of metal sled, on which they may be slid from place to place in the car body. Two, three, four or five seats may be used, to suit

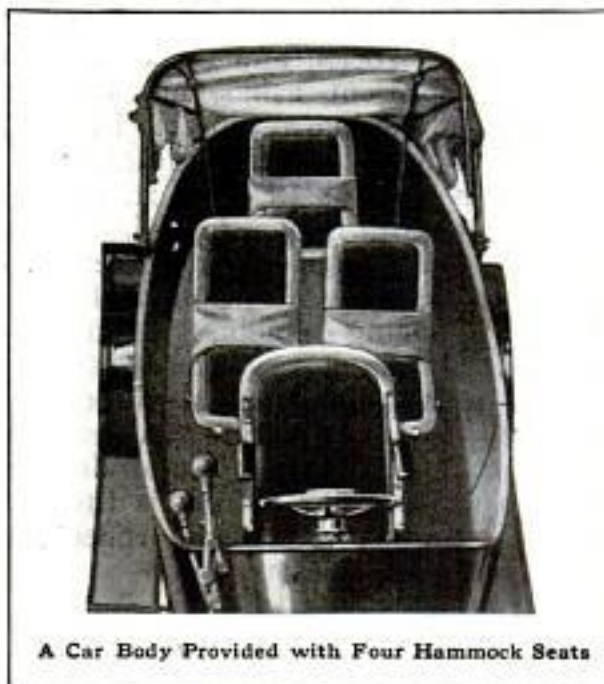

A Car Body Provided with Four Hammock Seats

the convenience of the owner of the car. In one of the illustrations four seats are shown.

It is claimed that a passenger rests

in one of these seats as in a hammock, the body having no fixed position, but changing when the speed is suddenly slackened or sharp curves are turned.

### INGENIOUS MACHINE FOR CUTTING ASPHALT

A motor-driven trenching machine, capable of cutting out in one day from 900 to 1,200 linear feet of asphalt and concrete pavement preparatory to the sinking of ditches for sewer and water pipes or electric conduits, was recently demonstrated in the streets of Washington, D. C. It is claimed that the machine, which can be operated at the cost of about \$15 per day, can accomplish more cutting in that time than can 45 to 60 laborers armed with picks and crowbars.

This trenching machine is constructed almost entirely of steel and resembles a huge road roller. It is operated by a 40-hp. gasoline motor. By means of a series of gears the power from this motor, besides being conveyed to the tractor wheels, is also conveyed to an apparatus resembling a pile driver which is fitted to the rear end of the machine.

This apparatus consists of two board lifts fitted with heavy cutting knives which are so arranged that the distance between them can be varied from 1 to 3 ft. according to the desired width of the trench to be dug. The cutting knives are operated alongside of two heavy shoes which are pressed down against the pavement with great force, thus preventing any crumbling of the edge of the asphalt outside of the trench, and insuring a clean cut. The knives can be operated in unison or alternately, and the force with which they hit the asphalt can be varied from 350 to 2,500 lb. Three blows in the same spot are usually required to cut the asphalt. The peculiar construction of the knives causes the asphalt to be swaged up in the center and entirely loosened from the concrete base.

The cutting of the pavement is done in two operations. The machine first

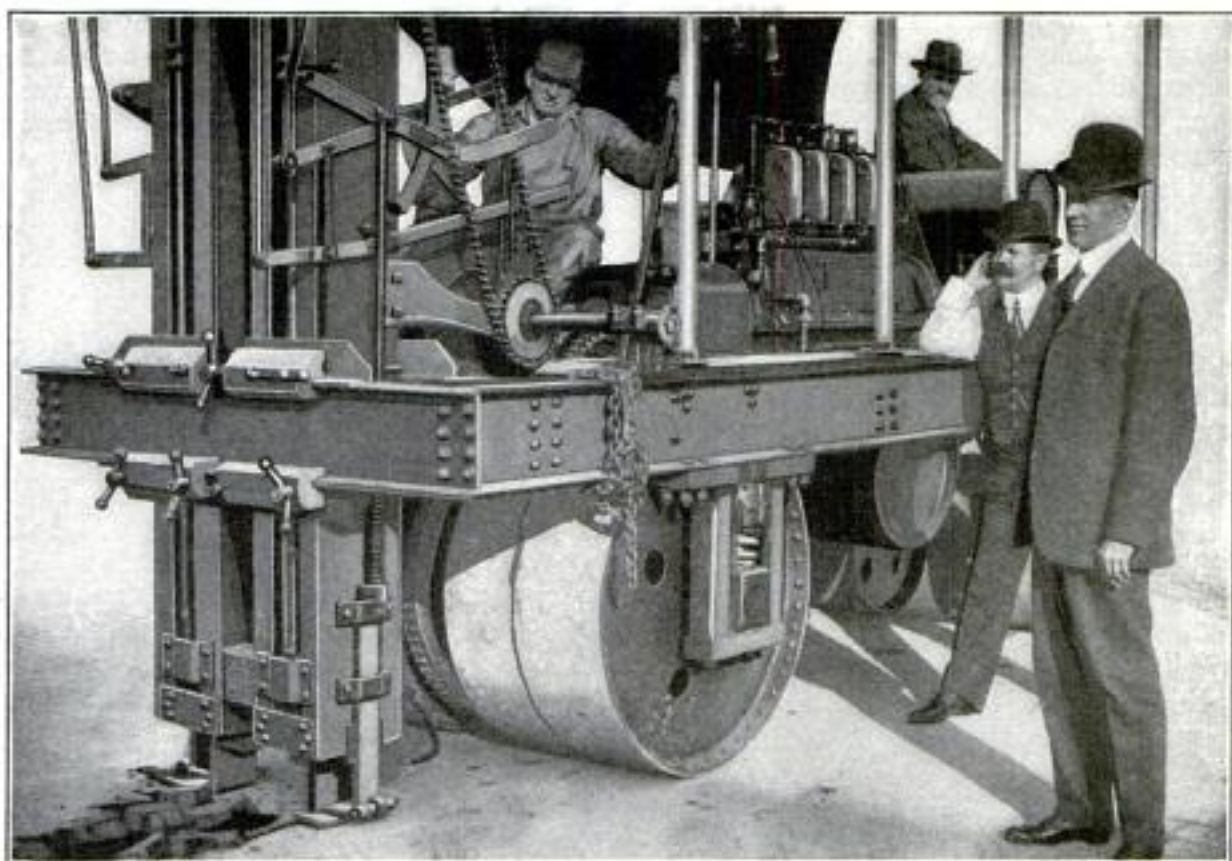

A Motor-Driven Machine Which Cuts Asphalt and Concrete Pavement, Doing the Work of 45 to 60 Laborers Armed with Picks and Crowbars

cuts away the asphalt surface. This is accomplished at the rate of from 5 to 7 ft. per minute. After the broken asphalt has been removed the machine then passes over the ground a second time and cuts away the concrete foundation or base.

During this second operation a heavy hammer is brought into play which crushes the concrete into rubble so that it can be used again when the trench is resurfaced. The cutting of the concrete is a slower operation, yet 3 to 5 ft. can be cut per minute.

### HYDRAULIC DREDGE SAVES IMPERIAL VALLEY CROPS

The irrigation troubles in the Imperial Valley, lower California, due to the silt carried in the Colorado River water, which was continually obstructing the flow of water in the Imperial Canal, have been finally solved, and, it is believed, successfully, by the operation of a suction dredge.

The lack of available water in 1910, due to the deposits of silt, was so threatening to the entire crop of the valley, that appeal was made to the War Department for permission to construct a diversion weir in the Colorado River below the canal intake, as the only means to save the valley. President Taft was appealed to, to use his influence with the War Department in this emergency, and permission was obtained for such a

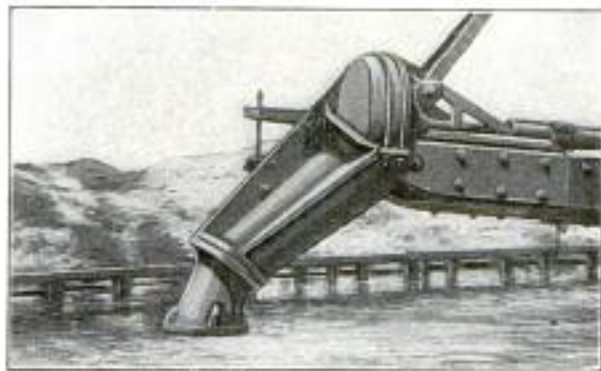

Courtesy Engineering News

The Suction Nozzle of the Dredge Acquired at a Cost of \$63,589 to Remove the Silt from the Imperial Valley Irrigation System

weir on condition that it be only temporary. Work was rushed and upon September 1, 1910, the water level was thus artificially raised, but by that time more than \$1,000,000 of damage had resulted to the crops because of the lack of water. The success of the temporary weir gave rise, for a time, to the idea that the removal of such a weir before high water, and re-installation thereafter each year, was the only remedy for the Imperial Valley, but the cost was shown to be too high, and the use of a hydraulic dredge having a 15-in. pump was finally decided upon.

The dredge was built during the winter of 1910-11, at a total cost of \$63,589. Its operation last year is said to have proved entirely successful, solving the silt problem, and saving the 1911 crops of the valley, which were worth several million dollars.

#### RIVER BOATS DRIVEN BY AERIAL PROPELLERS

Aeroplane motors and propellers built by one of the big monoplane-manufacturing concerns of France are being tested on shallow-draft river

boats intended for navigation in the French colonies. The shallowness of the colonial inland rivers and the vast amount of vegetation in the water make the ordinary submerged propeller impracticable.

#### COLOR AND THE FISHES

The scientist, C. Hess, in making a study of the color vision of fishes at the zoological station at Naples, Italy, finds that for certain fish, both of salt-water and fresh-water varieties, the brightest point of the spectrum lies between yellowish green and green. The yellowish red and red rays of the spectrum had only a small value of brightness for the fishes experimented with.

In several experiments one-half of the basin was illuminated by red and the other half by blue light, and, although the red would appear distinctly brighter than the blue to human eyes, the fish gathered in the blue. It is said that the relative brightness in which the examined fish see the various parts of the spectrum coincides with that in which the totally color-blind man sees them.



Shallow-Draft River Boat Driven by Aeroplane Propeller in Tests being Made in France

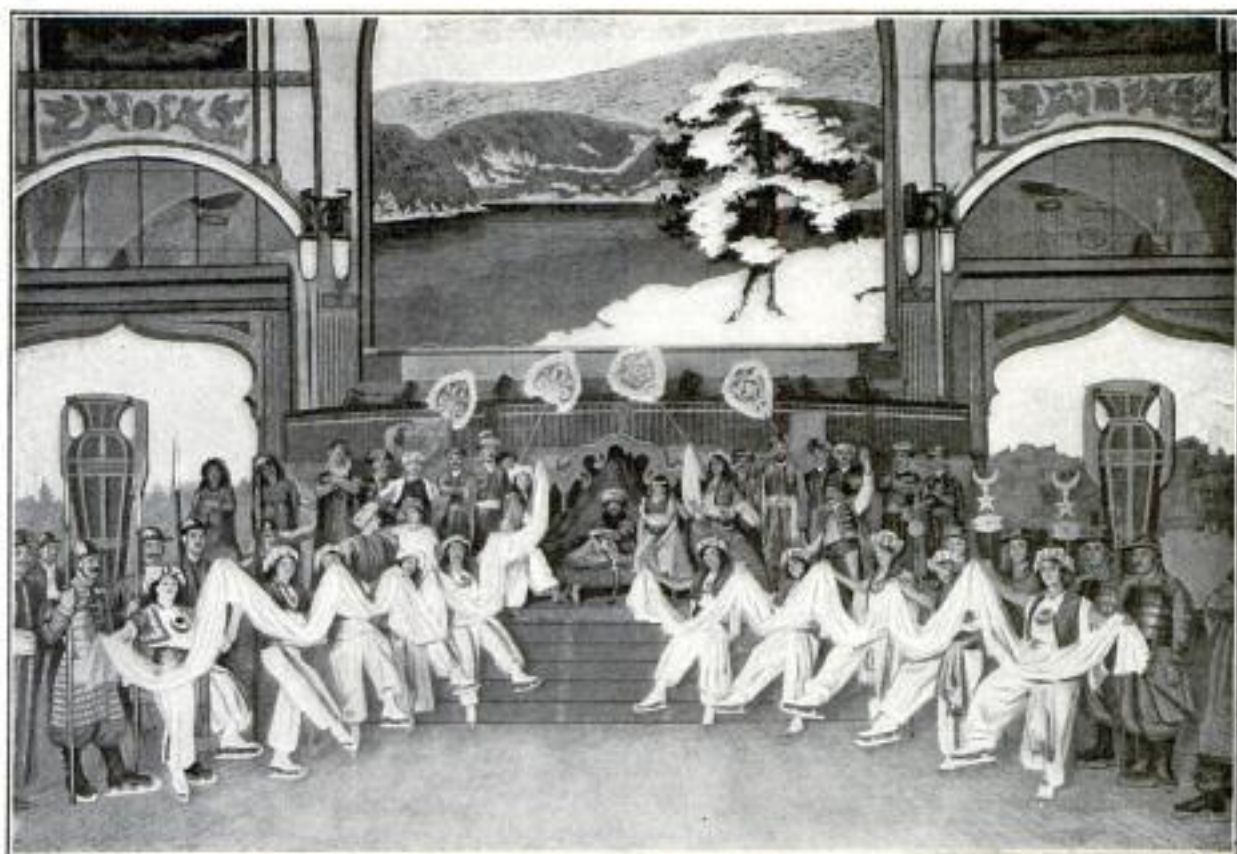

A Theatrical Production on Skates at the Ice Palace in Berlin

### A BALLET ON SKATES

Berlin has a huge ice palace in which, aside from the ordinary skating of the general public, are produced many unique-feature entertainments. One of the most unusual of these was the staging of a theatrical production called "The Harem Feast," everything

being carried out as it would be in an ordinary theater, excepting that the participants were on skates. The illustration shows the scene in which the "veil dance" was given on an iced section corresponding to the stage of an ordinary theater.

### INVERTIBLE ELECTRIC FRYING-PAN

The electric-cooking utensil here shown is not only a complete frying-pan, capable of cooking anything that can be fried in the ordinary manner, but also becomes a disk stove, suitable for all kinds of light cooking, toasting, etc., by simply inverting it. The pan is made of sheet steel, and the heating element is located in the bottom, hermetically sealed between steel walls so that it is completely protected from oxidation. It can be operated at three temperatures, high, medium, and low, the desired temperature being obtained by means of an indicating push-button switch.



Electric Frying-Pan Used as Such



Inverted for Use as an Electric Disk Stove



The Aero Club of France recently instigated a competition among sculptors for a design of a projected monument in glorification of the achievements of the French in aviation. The prize was awarded to Ernest Dagonet for the group shown in the accompanying illustration.

### REINFORCED-CONCRETE PAVEMENT

A reinforced-concrete pavement constructed in Plymouth, Wis., about 18 months ago has passed through one winter and more than half of another without showing the sign of a crack or a flaw, even along the street car tracks. The three interesting features of construction in the laying of this concrete pavement were the use of cypress for expansion joints, a new form of rough surface, and a reinforcement of woven wire mesh. In place of the usual asphaltum or tar expansion joints, 1 by 8-in. cypress boards were used along each gutter and every 4 ft. across the street. The surface finish coat consisted of crushed granite chips ranging in size from  $\frac{1}{4}$  to  $\frac{3}{4}$  in. in diameter, granite screenings from  $\frac{1}{4}$  in. down to dust, and Portland cement mixed in a proportion that would give the densest mixture. The wire-mesh reinforcing was placed directly on the base concrete, so as to lie between the surface and the base.

### MOTOR ILLUMINATION CAR FOR SWISS RAILWAY

A self-contained illumination car, intended for service at night or in tun-

Swiss railways. It is a converted old-style passenger car equipped with a gasoline engine, which drives a dynamo furnishing current for motive power and illumination.

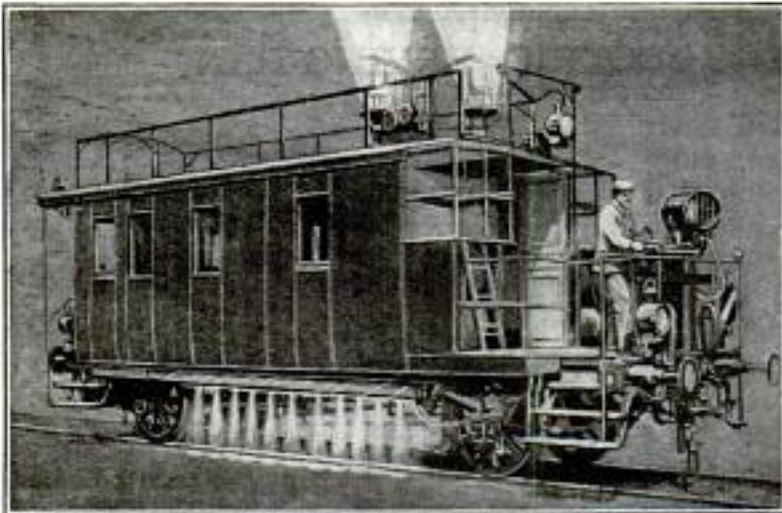

Self-Contained Motor-Driven Illumination Car Used in Construction and Inspection of Tunnels or for Night Work on a Swiss Railway

nels, for construction and inspection work, has been installed by one of the

In addition to the searchlight, the car is equipped with six arc lamps and two rows of incandescent lamps. The searchlight is mounted in front on a fixed pedestal, or on a movable pedestal which may be placed at either side of the platform or on the roof. The two arc lamps on the roof are attached to a revolving support and are provided with reflectors below to facilitate inspection of the roofs of tunnels,



while the four other arc lights may be disposed in different positions. The two rows of incandescent lamps are stretched along under the car, one

row on a side, and above each row is a long reflector designed to throw the light downward for the inspection of the rails and roadbed.

## FALCONRY BY AUTOMOBILE

A European huntsman, who still enjoys the ancient sport of falconry, which is the sport of capturing wild fowl or game by means of falcons or hawks, takes his falcons to the vicinity of the hunt in an automobile having a specially constructed body for their accommodation. Until the moment the falcon is released for its flight to capture some other bird, its head is inclosed in a hood. Three hooded falcons are shown in the automobile.

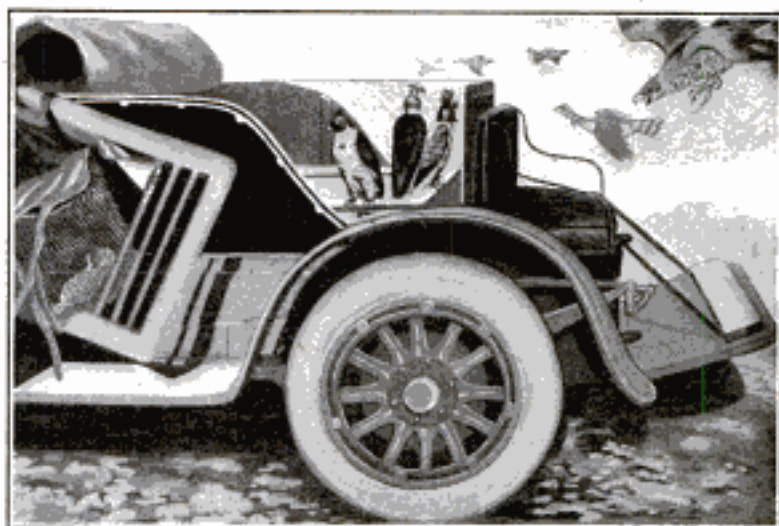

Falcons Taken to the Scene of the Hunt in a Specially Constructed Automobile

## BAYONET PRACTICE ON DRESSED BEEF

Punched steaks, perforated steaks, and punctured stews will be the fare of Uncle Sam's soldiers henceforth, if the recommendations of two army officers who have been revising the manual of bayonet practice are accepted.

In a recent report, Gen. Leonard Wood, chief of staff, stated that the present bayonet drill in the army was nothing less than a farce and recommended that henceforth the soldiers be put through a drill that has some actual value. Accordingly there have been many suggestions regarding bayonet drills, but the recommendation of the two officers who are revising the manual is the most novel. There has been much speculation regarding the probability of its adoption.

These officers declare that there is too little realism in the life of a soldier to make him a good fighting man, and therefore recommend that they use

dressed beef as a target in practicing thrusts with the bayonet. Not until the soldier has actually felt his bayonet plunge into raw meat and learned to withdraw it from real flesh, in readiness for another deadly jab, will he be ready to carve up the enemy on a field of battle, these officers declare.

There would be no additional expense attached to this practice, it is said, because the sides of beef used for bayonet practice could be borrowed from the company kitchen, and returned after the bayoneteers had finished with them. Clean bayonets, it is added, will be sufficient protection of the stomachs of the men who are to eat the beef.

Thus far the suggestion of these two officers has not met with any markedly enthusiastic reception.

☞The United States government has purchased 200,000 lb. of chewing and smoking varieties of tobacco for its seamen in all quarters of the globe. This is the largest purchase of the weed ever made by the government.

### LONG-ARMED TRACTION CRANE FOR YARDS

A long-armed electrically propelled crane of light construction for use in factory yards, where it may be run

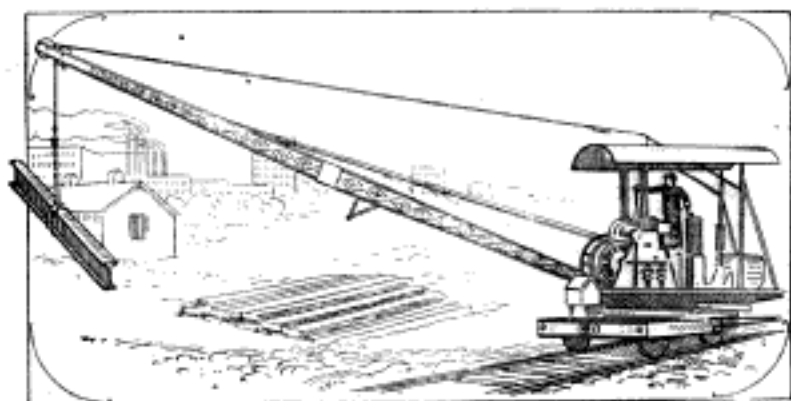

A Long-Armed, Self-Propelled Electric Yard Crane

from point to point, is being placed on the market. It is operated by one man, has a maximum lifting capacity of 15 tons at a 10-ft. radius, and 2.5 tons at the 40-ft. radius, and the drawbar pull is about 7,600 lb., which enables it to handle six or seven cars on a level track.

### EFFECT OF SWITCHING ON METAL FILAMENTS

Prof. E. W. Marchant of Liverpool (Eng.) University, and Prof. W. Parry have proven by experiment that there is practically no change in the useful life of metal-filament lamps due to the effect of switching. Although it was found that 72,000 switchings reduced the life of the lamps about 33 per cent, and that the effects of the switchings, as indicated by the results of the experiment, seemed to be accumulative and directly proportional to their number, nevertheless the number of switchings that would occur in ordinary use would produce only a very small effect. For if the useful life of the lamp be taken as 1,000 hours, and it be assumed that they are switched once every hour, then the effect of switching them on and off 1,000 times will be equal to  $1,000 \div 72,000$  parts of 33, or .46 per cent.

### THE GAEKWAR OF BARODA'S VAST WEALTH

The Gaekwar of Baroda, who is one of India's most potent princes, ruling over a state 8,099 square miles in extent and having a population of 2,000,000, possesses vast wealth, having an income claimed to be more than \$10,000,000. His jewels are among the most wonderful in the world, and include a necklace composed of 200 diamonds, valued at \$10,000,000, and a carpet, 4 yd. wide, made of rubies, diamonds and pearls, woven into a pattern, said to be worth \$4,000,000. Although the four cannon which defend his castle have steel cores, the outer parts of two of them are composed of gold, and the other two of silver.

### BUILD MODERN TIMBER RAILROAD BRIDGE

To build a large heavy-traffic railroad bridge of timber in this day of structural steel may seem unusual, yet such a bridge, comprising nine 150-ft. Howe trusses, one 240-ft. swing draw span, and nearly 1,000 ft. of timber trestle in approaches, has just been constructed across the Columbia River by the Oregon-Washington Railroad Co. The piers are of concrete. The spans have an aggregate length of 1,639 ft., and the remaining distance between abutments is covered by timber-trestle approaches, the one upon the west side being 503 ft. long, and the east approach, 447 ft.

All timbers used in the construction were of Washington fir, and the life of the approaches and truss spans is estimated at 8 to 10 years. All joints and framed portions of the trusses were treated with a liberal coating of red mineral paint mixed with linseed oil, and the entire timber portions were given one thorough coat of this preservative. Much attention was

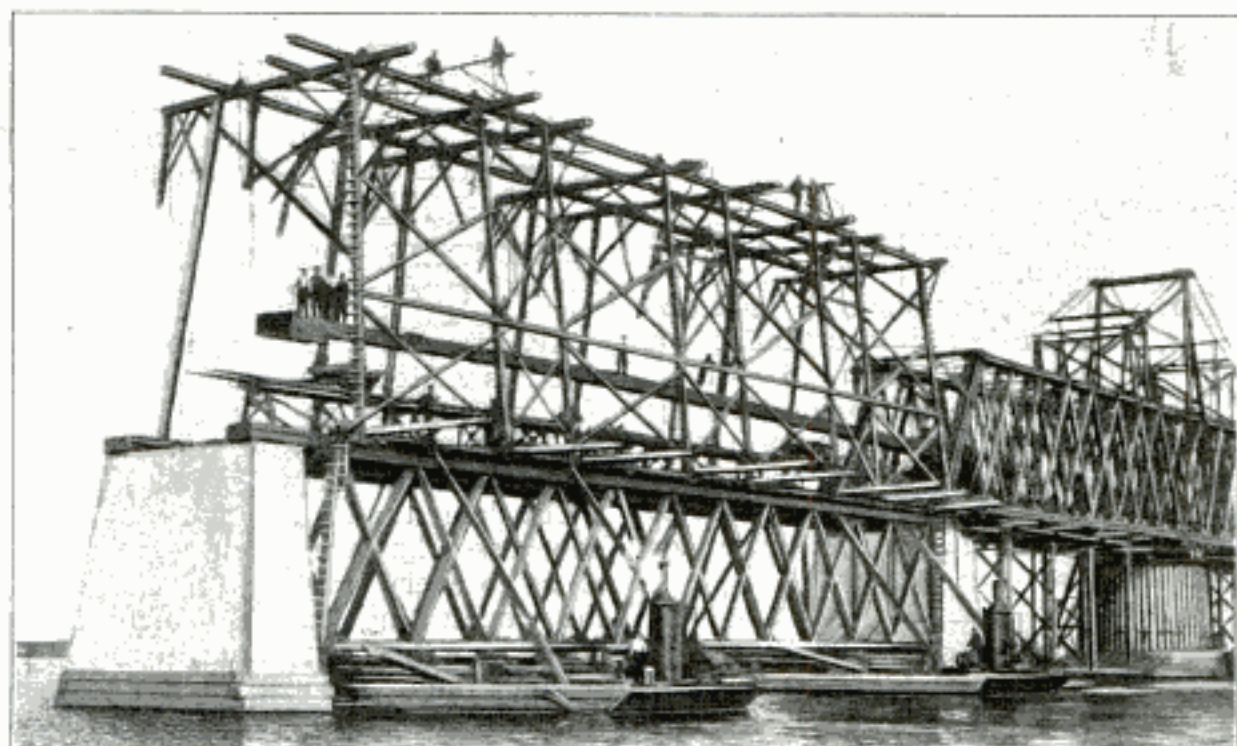

Erecting the Timber Spans of a 1,639-Ft. Railroad Bridge Constructed across the Columbia River. The Erecting Framework is Carried by a Pair of Timber-Deck Trusses Supported on Two Scows

paid to the design of joints, and in every point of contact of timber on timber an iron plate or casting has been introduced to minimize rotting.

### A MACHINE THAT DIGS A MILE OF DITCH PER DAY

What would an ancient Egyptian irrigation engineer say if he were to reappear on earth and be given the information that the modern builder of irrigation works uses a machine that is capable of daily excavating a mile of ditch 6 ft. deep and 12 ft. wide? Undoubtedly he would immediately elect his informer to full membership in the Ananias Club and call him by a short and ugly word into the bargain.

This machine is said to be the largest excavator of its kind ever built. It is employed in the construction of canals and laterals comprising an irrigation system to water the 16,000 acres which compose the Cudahy ranch, situated in the Imperial

Valley of Mexico, just across the international boundary from California. The conditions are identical with those of the valley of the Nile, for this ranch is of silt lands built up by the ages of overflow of the Colorado River.

The huge machine weighs 100,000 lb. and covers an area of 25 by 60 ft. It is entirely of steel construction and is propelled by two 30-hp. gas engines. The fore part of the machine carries the engines which drive a shaft wheel, which, in turn, by a series of cogs and chains, propels the machine over the ground and at the same time operates

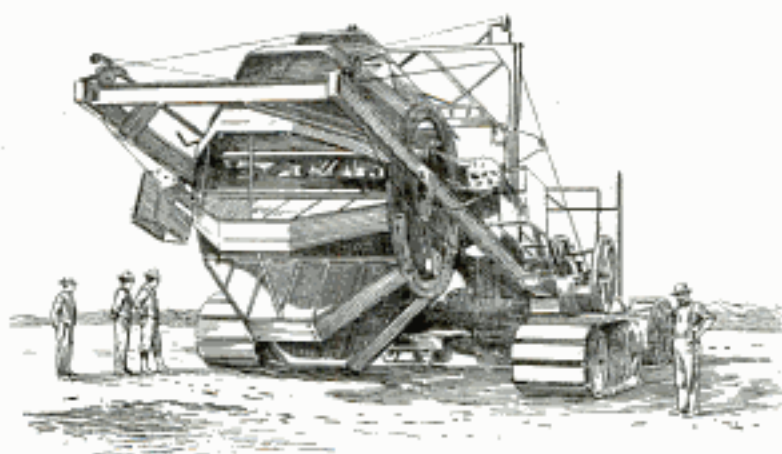

One of the Largest Ditch Excavators Ever Built

the immense circular digger carried at the rear. This digger is equipped with scoops bearing sharpened blades of steel. It first picks up the dirt and revolving upward, drops its burden onto conveyors which carry it to both sides, depositing it upon the banks of the excavation.

The machine, cumbersome as it appears, is so nicely adjusted that it can dig a ditch from 2 in. up to 8 ft. in depth and from 4 to 12 ft. wide, shaping and finishing the excavation as it proceeds. With this machine, seven men do the work of 50 scraper shovels hauled by 100 mules, with a driver for each team.

### THE WHITE SPECTER

The odd contour of the rocks that form the mouth of a cave at La Jolla, California, forms a fanciful resemblance to a woman's figure, as the photograph indicates. She wears a head-dress somewhat like the "liberty cap," holds her arms slightly akimbo, and the folds of her skirt at the hem are suggested by the waves that break upon the beach outside. In securing



The Opening of a Cave at La Jolla, Cal. The Photograph Here Reproduced was Made by a Photographer Located in the Cave

this picture, the artist explored the cave and carefully selected a point for his camera where all the lines of the rocky entrance would conform to this general idea of "the white specter."

### ELECTRIFICATION OF THE GOTTHARD LINE

Almost every American traveler who has visited Italy and Germany has also traveled through Switzerland over the Gotthard railway which unites Italy and Switzerland by rail.

The long tunnel through which the line passes has ever been a great nuisance to every traveler, on account of the penetrating smoke which could never be entirely shut out of the cars. It takes the express 20 minutes to pass through the largest tunnel, and there are about 12 shorter tunnels on this line. The smoke emanating from the two large locomotives is very offensive, and it has been adequately proven that the cars of this line deteriorate more rapidly than on any other part of the various railways. The sulphur, which is free in the smoke, destroys the best of paints and varnishes and attacks the wood of the cars.

Considering all these disadvantages, the Swiss Railway Federation, has, after much discussion, voted for the electrification of the Gotthard line. The work will be started in a short time, but it will probably be several years before it is entirely completed.

### COMBINED PLAYER VIOLIN AND PIANO

The new combination mechanical-player violin and piano being placed on the market by a Leipzig, Germany, firm, is arousing much interest, not only because it combines the violin and piano, either of which can be played alone, but because of the wonderful quality of the violin tones.

In the violin part of this machine a circular bow is rotated around three violins by electric power, and the violins are shifted with increasing or decreasing pressure against this bow by

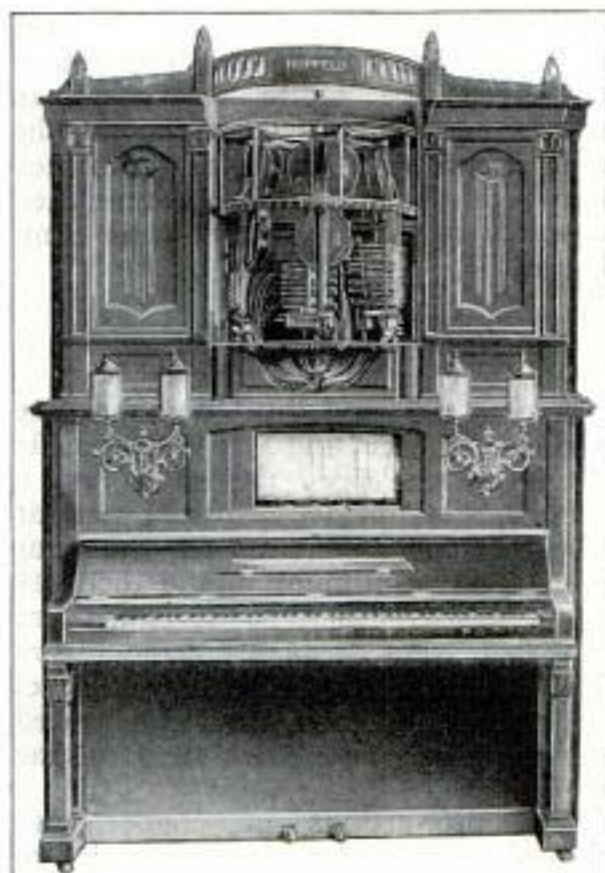

New German Mechanically Played Violin and Piano

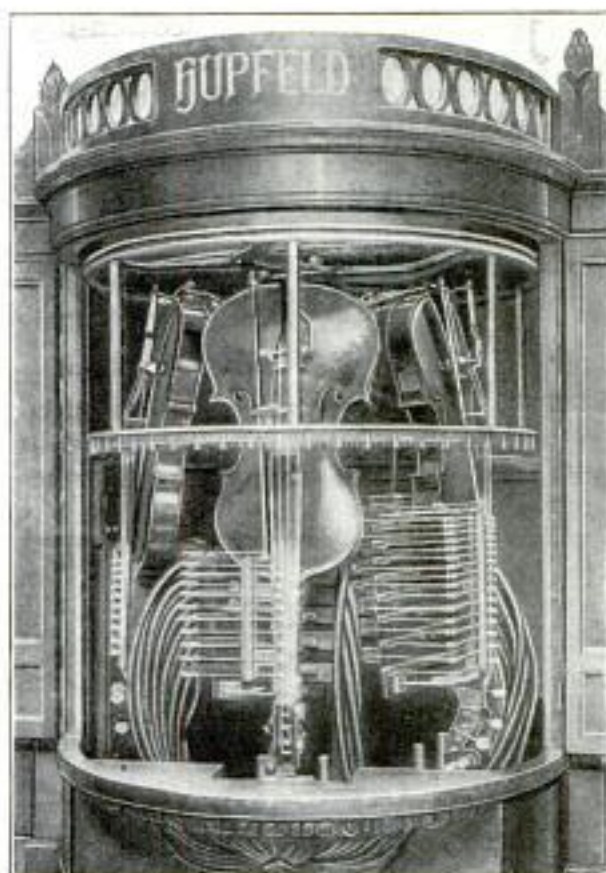

A Close View of the Violin Mechanism

means of pneumatic force, and thus the gradual, soft sound is obtained as if by human hand. A series of levers, taking the place of the human fingers, press against the lower end of the various strings.

By shutting off the electric current,

the piano, which is provided with the perforated records required for mechanical playing, may be played as an ordinary instrument. The perforated music roll for the violins is inserted in the upper part of the cabinet in a vertical position.

### AN EXPLOSION CAUSED BY STATIC ELECTRICITY

An explosion that occurred recently at the works of the Cotton Powder Co., Ltd., near Faversham, Eng., which unfortunately resulted in the death of one of the workmen, has been accounted for after a thorough investigation, as being due to static electricity, according to the *Electrical Review*.

The man who was killed, was engaged in spreading a highly explosive mixture—consisting of fulminate of mercury, chlorate of potash and guncotton—upon a rubber cloth for the purpose of drying it. The weather, for a period previous to the explosion,

had been exceedingly dry and warm, and, no doubt, the mixture was quite a bit drier than the workman supposed. In view of the fact that the man wore rubber shoes, which insulated him from the surface upon which he stood, there was supposed to be a sufficient accumulation of static electricity, due to the friction between his fingers and the rubber cloth, upon which he was placing the mixture, to produce a spark which ignited the mixture and caused it to explode.

During the investigation of the cause of this explosion a number of experiments were made, and it was found that under the above conditions sparks could be produced of sufficient size to ignite guncotton and fulminate

mixtures. The trays in guncotton-drying stoves are often fitted with strips of copper to prevent the accumulation of static electricity. After an earlier explosion, of acetone vapor, at another factory, due to the discharge of static electricity from a workman's finger, the workmen were all protected by

having copper rivets placed in the soles of their overshoes. The rivets permitted the static electricity to readily pass from their bodies, and the danger due to a spark being formed by the discharge of an accumulated quantity of electricity was thus eliminated.

### A SUMMER HOUSE OF BOX

While box hedges are often trimmed into fantastic shapes, it is seldom that one finds such an attractive and use-



A Cool and Attractive Summer House of Box Hedge

ful specimen as that shown in this photograph. The circular hedge has been converted into a summer house with a door and windows and the tops of the trees meet in a cone-shaped roof. The interior is furnished with seats, making a delightful, shady retreat for a hot day.

**C**An electric cigar lighter, attached to the batteries by a flexible cord and kept in a polished metal casing attached to the dashboard, is suggested as a practical smoker's device for automobiles,

### NEW COPPER ALLOY

A new copper alloy which has the hardness of steel and has great tensile strength has been invented by a French metallurgist. Eleven pounds of chromium are melted for one hour with 11 lb. of aluminum, and then 242 lb. of copper are added. The entire charge is kept at fusing temperature for half an hour. Then 55 lb. of nickel are added and the mixture is heated another hour, upon which 44 lb. of zinc are added.

The proportions of copper and chromium can be varied according to the use to which the alloy is to be put, according to La Fonderie Moderne, but the order in which the metals are brought to melting temperature, as also the addition of aluminum, must not be changed.

### NEW METAL CALLED "CANADIUM"

"Canadium" is the name given a new metal discovered by A. G. French, metallurgical chemist of Nelson, British Columbia, when investigating a large gold mine in that province. While examining a deposit of platinum metals, he discovered, sometimes isolated and sometimes in combination, another metal which was quite different from other members of the group. It has since been found in many other igneous dikes in the vicinity of Nelson.

Canadium is a beautiful white metal, but little softer than gold or silver and melting at a somewhat lower temperature. It is not tarnished by damp atmosphere nor blackened or affected

by sulphureted hydrogen, alkaline sulphides or tincture of iodine, which blacken both silver and palladium. When burnished, it is much more brilliant than either silver or palladium.

### CUBE MIXER PROVIDED WITH HEATER

A new combination in mixing apparatus, consisting of a cube concrete or asphalt mixer having an ordinary charging elevator, boiler and engine, but provided with a material-heating attachment, is being placed on the market by a Chicago concern. Just beneath the charging hopper is a small steel box, lined with fire brick, forming a combustion chamber. Crude oil, contained in a tank carried on the platform of the machine, is carried by compressed air to an oil burner or atomizer, which projects directly into the combustion chamber. The heat thus generated in the combustion chamber is driven under air pressure into the mixing cube, where an intensely high temperature is generated.

It is claimed that in one test only three minutes were required to thoroughly heat a mixture of crushed rock and liquid asphalt, but the stone was thoroughly dry before being turned into the mixer. Very wet stone re-

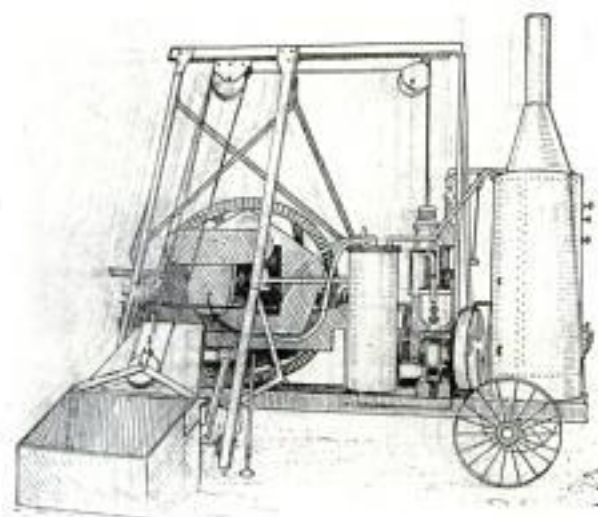

This Cube Mixer Provided with a Heating Attachment is a New Combination in Mixing Apparatus

quires about 5 min. for complete heating, and is then too hot to be handled with the hands.

### PLAYING CRICKET ON SHIPBOARD

Now that golf and cricket have been played at sea, it would not be surprising to hear of a baseball or football



English Cricket Players Keeping in Practice en Route to Australia

game played on one of the big passenger steamships. During a recent voyage to Australia, where the team was to play Australian champions, an English cricket organization kept in practice by playing on the deck of the "Orvieto." The photograph illustrates the manner in which the deck about the players was completely netted in to retain the balls and prevent the injury of other passengers.

According to The London Mirror the International Aeronautical Federation is considering the proposal of establishing a board of inspection to examine and mark aeroplanes with a distinctive symbol as ships are marked by Lloyds, with a view of making flying safer.

### PRIMITIVE WORKING OF OIL WELLS IN RUSSIA

Although the Chatma oil field of Russia is very rich and oil is being extracted by modern machinery in the



A Primitive Method of Extracting Oil Still in Use in Russia

greater part of the district, the Russian peasant who first utilized the richness of the field is still using primitive apparatus. He has at present about 30 wells, each about 15 in. in diameter at the top and 8 in. at the bottom, and varying in depth from 40 to 60 ft. These wells, according to a writer in the *Petroleum World*, are simply holes in the ground, having no casing of any kind, and are worked by two men with the aid of a primitive windlass, hauling a baler. When the oil gathered at the bottom of one well becomes exhausted, the men carry the windlass to the next well, and so on, returning to each well when sufficient time has elapsed for oil to gather again at the bottom. With this primitive apparatus, and selling the oil only locally, the proprietor makes a net profit of about \$7,000 a year.



### EXECUTION OF ARABS IN TRIPOLI AS OBJECT LESSON

Among the recent executions of Arabs at Tripoli is included the hanging of 14 who were found guilty of having resumed arms and killed Italian soldiers after having surrendered. Being hung by the neck instead of shot was decided upon as providing more of an object lesson to the natives. They were strung up side by side on a long gibbet in the bread market before the troops and a stolidly indifferent crowd.





## Safety Stop to Prevent Gasoline-Engine Cylinders Overheating

In the accompanying illustration are shown two ways of inserting a safety switch in the circuit of electric wires on the ignition system of a gasoline engine to prevent overheating, should the water for any reason fail to reach the cylinder.

On the thermo-siphon system of cooling, it is easily made, as it requires only an extra switch, a block of wood for a float, some wire and an L-shaped piece of metal. The first sketch shows how it makes a break in the circuit when the water falls below the required amount.

For engines using forced-feed circulation from a low water supply the safety switch can be installed as shown in the second sketch. This requires an extra switch, an old curtain-pole spring with the wooden rod in it, a sheet-metal clamp to hold the spring, and a small pail. A larger pail to receive the overflow from the small pail is connected to the return water pipe as shown. In the bottom of the small pail there is a hole, A, one-quarter the diameter of the outlet on the pipe. As long as there is plenty of water the small pail will overflow and hold the pail down, but when the water fails to run, the small hole will drain the pail, the spring will draw it up, and the small rod inside of the spring will make the break at the switch. A small nail driven in over the clamp will keep the pail from stopping the flow of water through the pipe below.

When adjusting the small pail upon installation, it should be filled with water and the hole in the bottom

plugged until the right adjustment is reached. When starting the engine, pull the plunger rod in the spring to

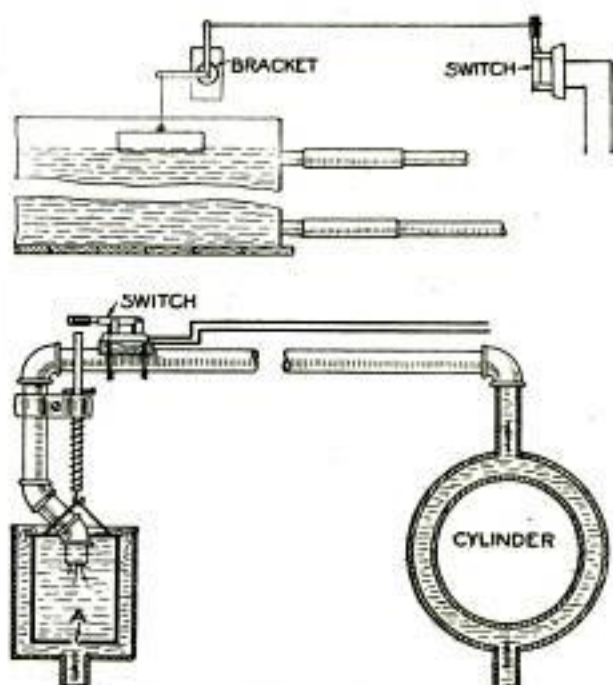

Wiring and Switch Connections

one side of the switch. The flexibility of the clamp will allow this to be done. —Contributed by J. P. Simons, Herrick, So. Dak.

## Homemade Chair Bottoms

Chair bottoms can be made at home by anyone who can drive a nail straight. The following method was used by a suburbanite who could not take advantage of city conveniences or afford the prices. This chair bottom can be easily duplicated by persons similarly situated. The cost is small and the labor so slight that 15 min-

utes will be sufficient to complete the job.

Scraps of the paper that was left from the roofing of his bungalow were utilized. These pieces were a very good grade of paper, which can be procured from a first-class dealer in lumber. The paper has the appearance of leather, is about the same thickness, and wears well. The paper can be bought by the roll or square foot, and a single square yard should be sufficient to make bottoms for several small chairs.

The paper is fastened with carpet tacks or brass-head upholstering tacks, the latter making a better appearance. Place the material under the bottom of the chair and mark with a pencil the size of the opening. Cut out the bottom with scissors or a sharp knife, 1 in. outside of the pencil line and tack it on the top of the chair frame.—Contributed by Della Yoe, Knoxville, Tenn.

#### A Wheelbarrow Brake

Pushing or rather holding a loaded wheelbarrow in going down an incline is very tiresome, and I made a brake as shown in the sketch that works exceedingly well. The brake consists of two pieces of channel iron, A, run between the handles of the wheelbarrow frame down to a trifle below the level of the supports on the handles. On the top of these channel irons I fastened a block of wood, B, by means of a single bolt. Another block, C, is placed at the bottom.

To prevent the brake from sliding on the ground when the handles were

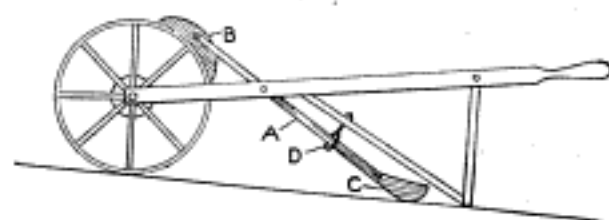

Brake Attached to Frame

lifted, an eyebolt, D, was placed in the brace to hold the channel-iron arm. When going down an incline with a load, it was only necessary to slightly

lower the handles and the pressure on the block C would cause the brake block B to be held tightly against the wheel.—Contributed by J. N. Bagley, Superior, Neb.

#### Use for an Old Shade Roller

Many shed and storm doors are hung where it is almost impossible to attach a weight in the ordinary way without interfering with other doors or with people passing in or out. By using an old shade roller, as shown in the drawing, the weight can be put on the door itself, taking up no room, the roller keeping the weight in place.

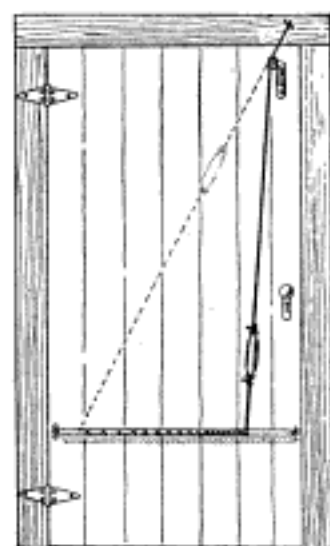

Take an old shade roller and break off the stops or checks, leaving the roller, when the spring is wound up, to run its limit without stopping. Take the holders of the same roller and place them on the door about 1 ft. 6 in. from the bottom in a similar manner as when they were on the window. Then place the roller in the holders and drive a nail over the side with a slot in, to keep the roller from slipping out. Then take the end of the line (heavy twine will do) and tack it in the roller on the side nearest the hinges, and wind the line around the roller. In that way, when you pull the string, you wind up the spring, just as a curtain is wound around a roller, and when you release the string it winds up. After this is successfully tried, turn the spring around about ten times so that it is always strong, and tie the other end of the line to the weight.

The rest is simple. Put a small hook in the frame over the door; fasten the end of the string to this, pass the line

through the pulley, which is on the upper corner, down, and attach it to the other end of the weight.—Contributed by J. L. Brown, Jersey City, New Jersey.

### Care of Blowtorches

When extinguishing the flame of a gasoline blowtorch or fire pot, the valve should never be allowed to remain tightly closed. If it is closed tightly and left so, the hot valve body will contract as it cools on the needle, and this will cause the needle to slightly enlarge the hole through which the vapor issues, and the torch will fail to work so well.

To shut off the flame, the valve should either be nearly closed and the flame blown out, or else entirely closed and then slightly opened.—Contributed by Van Allen Lyman, Paynes Creek, Cal.

### Wedge for a Hammer Handle

A common wedge in a hammer handle usually comes loose in time and causes considerable trouble to keep the hammer tightly on the handle. If the wedge can be kept in place, the hammer will not loosen on its handle. A simple wedge that will not come out is shown at A in the sketch. It is made

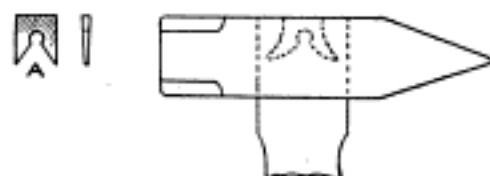

Shape of the Wedge

of soft steel. When driven into the hammer handle, the wood spreads the two prongs so that it is impossible to pull the wedge out.—Contributed by F. G. Marbach, Cleveland, O.

### How to Stiffen the Backs of Saws

When cutting hard wood with a carpenter's saw I have had much trouble with the sudden bending of the saw, which would cause it to break or get out of line. Where there is no heavy

work to be cut requiring the saw to pass entirely through it, the device described as follows will be found helpful.



Metal on Saw Back

Secure a piece of stiff sheet metal, about 18 in. long and 1½ in. wide. Bend it to a narrow U-shape so it will fit over the back of the saw, as shown in the sketch. This will prevent the saw from bending, and the metal may be easily removed when desired.—Contributed by Wm. Grotzinger, Baltimore, Md.

### Cutting Terra-Cotta Tile with a Pipe Wrench

An ordinary large pipe wrench makes a much better tool for cutting terra-cotta sewer tile than a chisel and

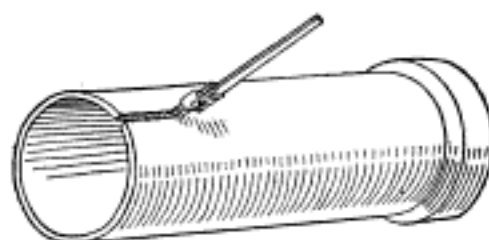

Wrench in a Cut

hammer. The wrench is less apt to break the tile where it is not wanted.

The manner of using the wrench is very similar to that of breaking glass away from a cut with a pair of pliers. The jaws are set to the thickness of the tile wall and short bits are broken away by leverage as the course of the cut is followed.—Contributed by L. H. Atwell, Atlanta, Ga.

☞ Two mill files placed crosswise in a vise so as to form a V, make a good knife sharpener. The knife edge is drawn through the V-notch.

☞ Cement work, consisting of 1 part cement and 3 parts sand, can be made waterproof after the work has set by applying as much kerosene oil to the surfaces as they will absorb.

## Homemade Drill Press

The elevation of the drill is shown in Fig. 1. The two uprights, A, are of  $1\frac{1}{2}$  by  $\frac{3}{8}$ -in. iron, as are also the hori-

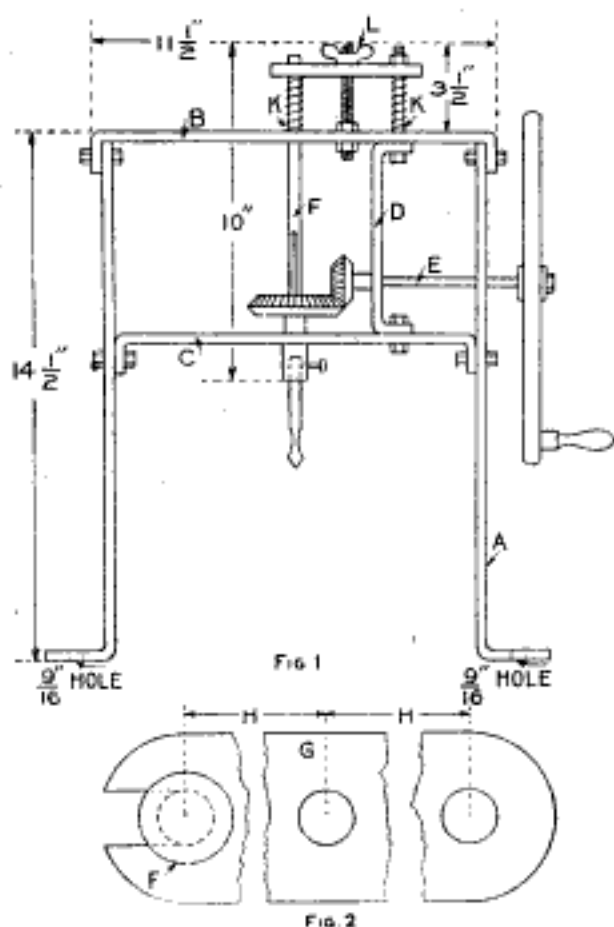

Details of the Drill Press

zontals B and C, and the intermediate upright D. The main shaft, F, is of  $\frac{5}{8}$ -in. round steel, as also handwheel shaft E. Cut a  $\frac{3}{16}$ -in. keyway in the shaft F. Obtain a pair of bevel gear wheels. Fix the small wheel on the shaft tightly with a pin, but allow wheel on the vertical shaft to slide with a flat key. The feed is controlled by the wing nut L. Two coil springs, K K, keep the pressure plate against the thumbnut.

The dimensions H H, Fig. 2, must be determined by the size of the wheels procured. The top of the shaft F must be turned to form a notch to slip into a slot cut in the plate G, which is  $1\frac{1}{4}$  by  $\frac{3}{8}$  in. All bolts and studs are  $\frac{3}{8}$  in.—Contributed by J. W. Verner, Roxbury, Mass.

## Removing Fence Posts

A laborer was sent to remove a number of fence posts from an old fence. The job would have taken a half day of ordinary work, but two hours later we found him asleep in the shade, and the posts all removed. We let him sleep till noon as we thought he had earned his rest. His method of removing the posts was very simple, as he used an ordinary gravel pick, drove the sharp point into the post close to the ground, put a hardwood block under the pick and pulled on the handle. This operation was repeated as the post was drawn out of the ground.—Contributed by J. C. Auman, Saskatoon, Can.

## Wetting Attachment for a Grindstone

A grindstone will quickly absorb any water in which it rests, thereby causing it to become worn unevenly and run out of true. The sketch shows how to attach a trough which is raised when the crank is turned, thus bringing the water in contact with the face of the stone as long as the grinding goes on. Two braces, A, are bolted loosely to the legs of the stand and fastened on the sides of the trough B, which normally rests on the support C. A small rope is fastened to the trough and wound around the shaft to give it the necessary friction. A small weight is added to raise the trough to

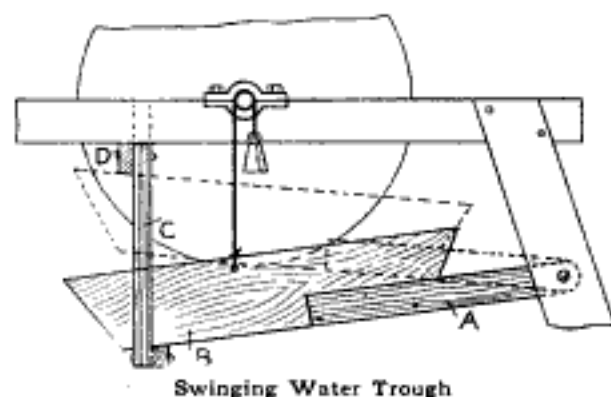

the stop D. When through grinding, raise the weight, and the trough will lower itself.—Contributed by John V. Loeffler, Evansville, Ind.

## The Art of Stencil Making

By HOMER H. KNODLE

### PART IV—Centerpiece and Panel Designs

A design that will fill the need of a dark effect where it is necessary to balance the scheme of treatment is shown in Fig. 30. It may be used for a panel by surrounding it with a border, either fancy or straight-line. If a line is used, it should be heavy enough to harmonize with the main part of the design. The torch should have the binders across to relieve the monotony of the heavy outline. It should not be made much larger than 2 ft., nor smaller than 1 ft., as the massiveness of the design necessitates large treatment. This design is susceptible of a variety of changes without altering the general outline. A slight change may be made by leaving narrow binders throughout the length of each bar crossing the darts.

A heavy effect, for a centerpiece, is shown in Fig. 31. The central oval may be attached to the balance of the design, if so desired, or it can be kept separate. In the former case, the oval should have a lighter treatment. The scrolls can be ornamented in any manner in harmony with the general style of the design, and the outer border

cut out as the stencil can be reversed to finish the other half. It should not be made smaller than 30 in.

Another panel design that can be treated in various ways is shown in Fig. 32. It may be used as shown, or inclosed in a border of proper proportions, or it may serve for a combination border and panel by using the top portion as a border, inclosing it in a neat border, and the bottom part as a panel design, inclosing it also, but stenciling the bottom design only under every other motif of the top. This will give about the proper proportion and will be found to look very well. It will prove doubly effective if it is stenciled in a lighter tint of the body color, and trimmed with a contrasting color. This design also may be variously altered to produce original patterns.

A heavy centerpiece design that will be found especially adapted to use in conjunction with other designs in the decoration of Gothic buildings, is shown in Fig. 33. The leaves of the design are laid out on radial lines drawn with the aid of the 30 and 60-

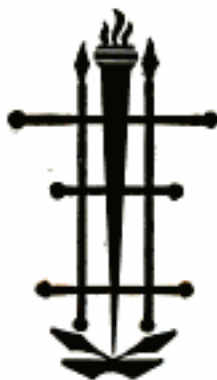

Fig. 30

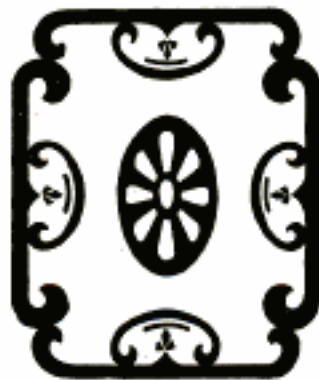

Fig. 31



Fig. 32

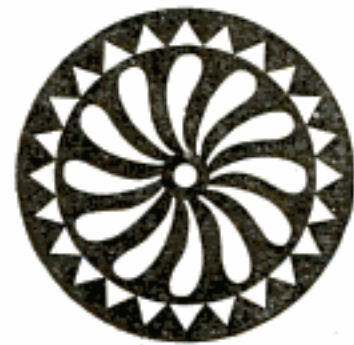

Fig. 33

Centerpiece and Panel Designs

may be varied in several ways. A large portion of the design should be left white so as to relieve the heavy outlines and give the desired contrast. This design can be made in almost any size, and only one-half need be

deg. triangles, used separately and together. The outside border may be given a variety of treatments and permits some delicate work.

The various panel designs can be changed by using different borders,

which, however, must harmonize with the design to produce the proper effect. Four such designs are shown in Figs. 34, 35, 36 and 37. That shown in Fig. 34 should be made from 1 to



Fig. 38



Fig. 39

Panel and Centerpiece

2 in. high, or may be made as high as 4 in. and be used alone as a border. The one shown in Fig. 35 is very similar, but is not adapted to be used alone. It must not be cut larger than 2 in. Figure 36 shows a purely geometrical design which will stencil in conjunction with other designs along the same line. It should not be made much larger than 3 in. It is designed by crossing a perfect square with another perfect square at an angle of 45



Fig. 34



Fig. 35



Fig. 36



Fig. 37

Borders for Panels

deg. and using the perimeter thus formed for the outline. The design in Fig. 37 is useful only for its contrast. The diamonds are shaped with the 30 by 60-deg. triangle, and the squares drawn in to suit the designer. Diamond shapes may be substituted for the squares.

Another torch design adapted to a panel is shown in Fig. 38. A smaller design of a torch can be used with equally good results, and the design will look well also without the outside border.

A centerpiece, intended for light treatment or in small sizes in medium-heavy

treatment, is shown in Fig. 39. This design can be made in any size needed, and is one of the most flexible motifs known. The center can be completely changed and the symmetry of the design still be maintained. The design is laid out mechanically and necessitates no free-hand work.

Throughout the work great care should be taken to preserve sufficient binders. The design should first be drawn full size, completely ignoring the binders, and first when this work is completed, the binders should be laid in and colored as previously described, starting at the center of the design and working outward. If a design contains 12 repetitions and one or more binders each, one of the binders in each design connecting like pieces are cut one after the other. This will prevent the maker cutting or forgetting a binder. The binders need not be any wider than  $\frac{1}{4}$  in. Only one principle need be observed: to place the binders where they will be as short as possible.

☪ Oiling nails with common machine oil makes it easy to drive them into hard wood.

### Ash for Cleaning Cooking Utensils

A good ash for this purpose can be made by burning rags coated with the following solution: Dissolve 2 lb. of coarse salt in 1 gal. of water and soak the rags in this solution. After drying the rags they are burned in the open air and the ash saved. To use, moisten a rag in water and sprinkle a little ash over it and scrub the utensil.

This ash with a little vinegar added also removes flyspecks from gas-lamp globes and all glass articles. It does not injure either the hands or the articles to be cleaned.—Contributed by Loren Ward, Des Moines, Iowa.

### A Door Holder

A door that is closed with a spring can be held open at any point with a stop as shown in the illustration.

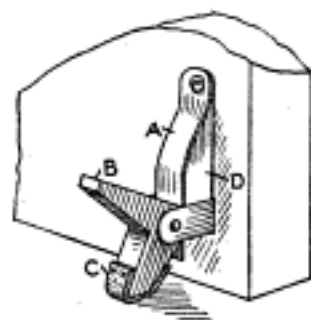

The stop can be thrown in or out of action with the foot. The base D is a piece of sheet metal cut and bent to form a bearing for the L-shaped block of wood B. The spring A holds the block either up or down as it is set. A piece of rubber, C, is put on the wood for contact with the floor.—Contributed by C. R. Poole, Los Angeles, Cal.

### A Draftsman's Substitute Horn Center

Take an ordinary solid-head thumb tack and make a small depression exactly in the center of the head with a center punch. File the tack part until it



is about 1-32 in. in diameter. This will prove valuable to the draftsman where a lot of circles are to be drawn from one center. It will not dull the compass points.—Contributed by Theo A. Oberhellman, St. Louis, Mo.

### Removing a Threaded Stud

A threaded stud screwed solidly into metal is hard to remove without injuring the threads. Such a stud was

in a flywheel of an automobile engine and I wanted to remove it without twisting the metal off or mashing the threads. The threaded stud A

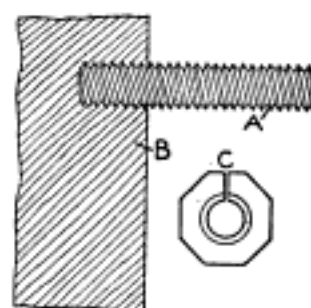

was very solid in the metal B. I used a split nut, C, clamped like the jaws of a vise over the threads, in turning the pin. The stud was thus easily removed and without injury to the threads.—Herbert A. Bartlett, Brockton, Mass.

### A Belt Stick

The illustration shows a very handy device for placing belts on pulleys.

The device is made of 1/2-in. iron in any suitable length. If it is to be used for very heavy belts, make it of 3/4-in. iron, and the length will depend on the height of the pulley from the floor. Belts can be easily put on pulleys from 16 to 18 ft. from the floor.—Contributed by Lewis F. Enyeart, Marion, Ind.

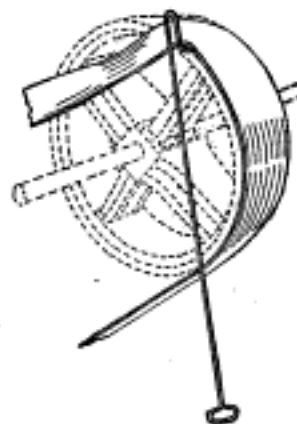

### Coloring Iron or Steel Silver-White

Dissolve about 1 qt. of white-ash bark ashes in the cooling water, which must be soft. Heat the iron or steel to a good red and then plunge it into the solution to cool. The metal will be silver-white when removed.—Contributed by Irl R. Hicks, Hallsville, Mo.

### Paint-Pot Hanger

The ordinary method of hanging a paint pot on the rung of a ladder makes

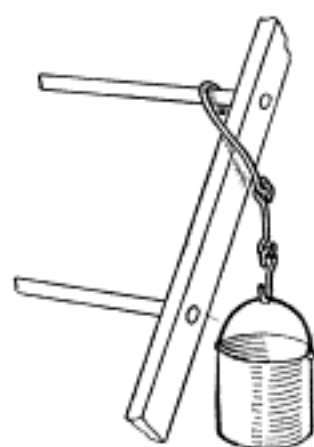

it necessary to pass the brush between the rungs to reach the paint. A very handy way to hang a pot is to use a hook made up in sections, as shown in the sketch, and hang the pot over the side of the ladder.

This will prevent dropping of paint on the rungs of the ladder, and also makes it accessible for the painter.—Contributed by Fred L. King, Islip, N. Y.

### Emergency Belt for a Motorcycle

A little distance from home I broke the V-belt which drives my motorcycle. A new belt could not be secured and the old one was beyond repair. I tried a number of ideas, but to no avail. Finally I decided to take the clinch from an old automobile tire and use it as a belt. This belt carried me about 500 miles, and when I removed it to put on a new belt, it was in fine condition.—Contributed by J. N. Bagley, Superior, Neb.

### Increasing the Killing Power of a Small Rifle

A 22-caliber cartridge may be made to equal that of a larger-bore rifle in killing power by the following method. A long cartridge should be used. Split



the lead from the point of the bullet almost to the edge of the shell. Flare the split slightly and place a small shot in the split as shown in the sketch. Use a shot about B-size. Close the lead over the shot with a pair of pliers so that it is held tightly. The shot should project a

little beyond the point of the bullet. In striking an object the shot is driven into the bullet by the impact, thus spreading the lead still more and increasing the killing power. Trim off the bullet after cutting it open and fastening the shot, so that it will fit the bore of the gun.—Contributed by John L. Waite, Cambridge, Mass.

### Long-Handle Electric-Globe Remover

A discarded automobile-horn bulb makes an efficient receptacle for replacing or removing electric-light globes in places too high to reach. The bulb is cut off on the line marked A in the sketch and the lower

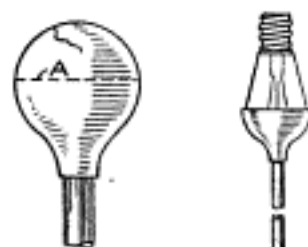

end is fastened to a long pole. The rubber will have sufficient hold to the glass bulb to allow it to be unscrewed from the socket. The use of the device is obvious.—Contributed by Morgan Hand, Jr., Ocean City, N. J.

### Increasing the Size of a Lathe Chuck

The attachment shown in the sketch is in use in a shop for the purpose of

increasing the radius of an ordinary lathe chuck of small dimensions. The auxiliary jaws A slip over the regular jaws and are held in place by set screws.

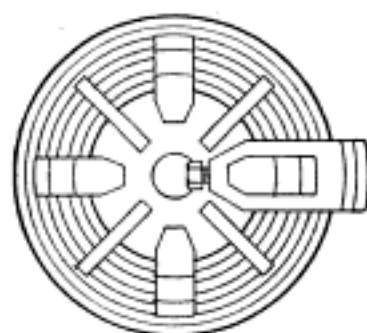

The one shown is intended for holding piston rings or other hollow work that may be held from the inside. It is evident, however, that a modification of the same arrangement, having an over-



hang, may be applied, by which larger diameters may be chucked than would be possible with the regular chuck.

### Making Hooks for Trolley Ropes

In making hooks for use in holding trolley ropes, instead of heating the wire and bending it over the horn of an anvil, a handy device used by a correspondent of *Electric Traction Weekly* makes the work easy and saves much time. This is shown in the sketch. It consists of two slightly grooved disks, respectively  $1\frac{3}{4}$  in. and 1 in. in diameter, fixed to the base. Around the pins by which the disks are

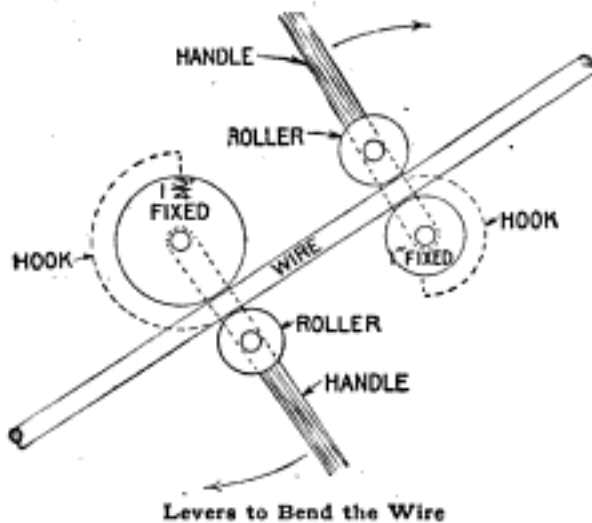

fastened to the base rotate two handles, to each of which, in the same plane as the disks, is attached a roller. The wire used, which is  $\frac{1}{8}$ -in. mild steel, cut to the proper length, is run between the fixed disks and the rollers, and by working the handles in the directions indicated in the illustration, the wire is bent into the desired shape.

### Cutting the Ends of Round Stock

The base of the cutting tool is forged the same as a swage and capped with steel. An offset is formed to provide a cutting edge and a soft base for the chisel edge to strike when it cuts through the metal. The semicircle in the chisel edge should have a long slope filed so that it will extend upward on the sloping side of the chisel. The

steel cap is rounded out to fit the round stock. A tool of this kind can be made to cut any size round stock. The

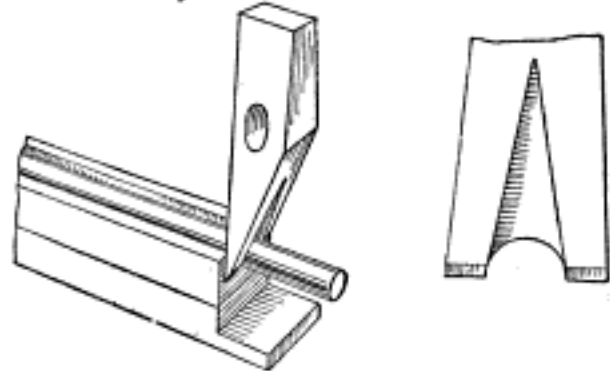

larger sizes should be cut hot. Both tools should be tempered, in the same manner as chisels.—Contributed by D. O. Wilkins, Hempstead, Tex.

### Filling in the Place of a Knot

Sometimes, in using second-grade lumber for sluices, troughs and laundry tubs, a board will be sound except for a large loose knot that may happen to be on the edge. To cut the board at that point would be a waste of lumber, and to leave the knot in would present a bad appearance. The knot may be successfully removed as shown in the sketch. At A is shown a knot, and at B how the board will appear after the knot is cut out and a block put in its place.

The first thing to do is to mark around the knot, squaring a portion a little larger than the knot, then sawing on both end lines and carefully cutting the bottom out with a chisel. The chiseling can be better accom-

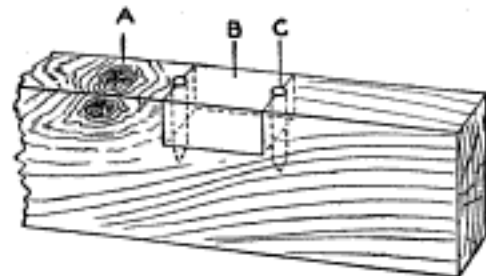

plished if several saw cuts are made through the knot. Fit a straight-grained block of the same material

tightly in the opening so that it will need driving in place. Bore a hole, deeper than the notch cut, at each end of the block and drive a pin, C, into each hole. Dress the surfaces with a plane. A knot in the center of a board can be fixed in the same manner with the exception that no pins are used.—Contributed by W. A. Lane, El Paso, Texas.

### Method of Laying Out Angles in Degrees and Minutes

The following method for obtaining odd angles will be found very useful by patternmakers, machinists and those engaged in laying out bends for pipe lines, which are usually given in degrees and minutes.

Any angle can be obtained by the use of a trammel and pair of dividers, without any calculation, as follows: If an arc be drawn having a radius of 57.29 in., then 1 in. of the arc will subtend an angle of 1 deg., or in other words, if two points 1 in. apart be located on the circumference and a line be drawn from each point to the center, the angle between these lines will be 1 deg. It should be noted here that while this distance, to be absolutely correct, should be measured on the arc, for practical purposes the chord and arc for a distance of 1 in. may be

that 1/60 in. on the circumference represents 1 min., and where a scale is not available having divisions in multiples of 60, a scale with 64ths can be used, if the number of minutes is small. When taking 1/64 in. to represent 1 min., it will be seen that the error is 1 min. in 15. If, however, the arc be drawn with a radius of 53.71 in., 1 min. on the circumference will be subtended by 1/64 in., or in other words, every 1/64 in. of the circumference will represent an angle of exactly 1 min., and 1 in. will represent 1 deg. 4 min.

It may be of interest to know how the radius 57.29 in. is obtained, which is as follows: If we assume that 1 in. on the circumference is to represent 1 deg., then the whole circumference which contains 360 deg. will be 360 in. long. If we divide this by 3.1416; we obtain 114.58 in., which is the diameter of the circle, and one-half of this is 57.29 in., or the radius.

It is evident that the method outlined is not intended for laying out directly a very wide angle, but rather for finding the odd degrees and minutes after the approximate number of degrees has been found in some other way.

For example, suppose it is desired to lay out an angle of 32 deg. 10 min. First scribe the arc with a radius of

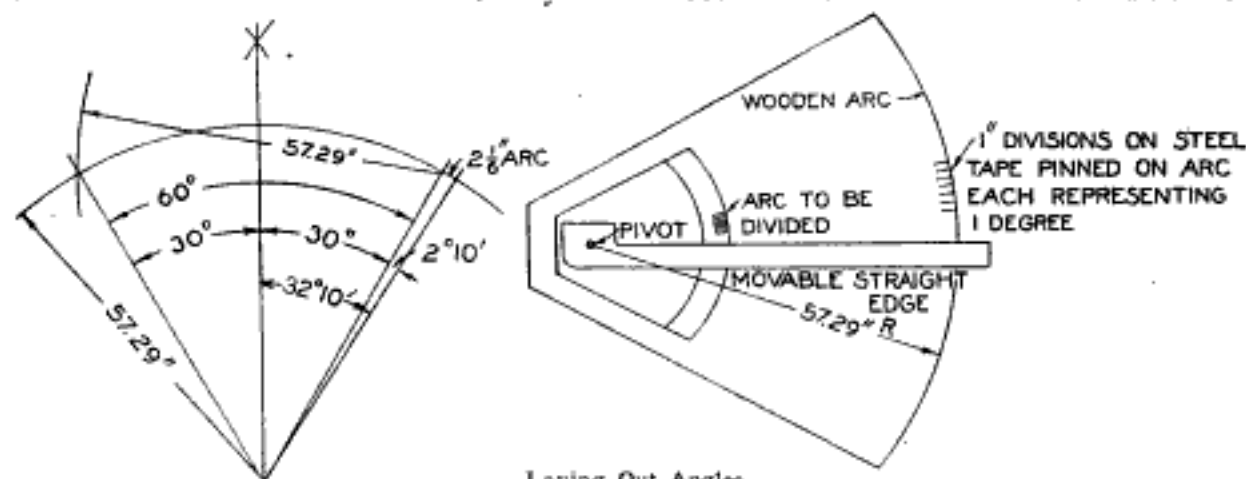

Laying Out Angles

considered equal. From the above it will be seen that an angle of 30 min. would have an arc  $\frac{1}{2}$  in. long; 15 min.,  $\frac{1}{4}$  in. long;  $7\frac{1}{2}$  min.,  $\frac{1}{8}$  in. long, and 5 min.,  $\frac{1}{16}$  in. long. It will be seen also

57.29 in., then with the same radius lay off a chord on the arc which will give 60 deg. Bisect this arc and each half will be 30 deg. From one end of the 30-deg. arc lay off a distance of

2 1/6 in., which added to 30 deg. will make the desired angle. This operation is shown in the first sketch.

If the angle is not required to be laid out very accurately, a radius of 28.64 in. can be used for the arc, then 1/2 in. of the circumference will represent 1 deg.; or with a radius of 14.32 in., 1 deg. will be subtended by 1/4 in. on the circumference.

This method may be used for graduating arcs in degrees and fractions by sawing out an arc of the desired radius and pinning a steel tape on it as a scale. The arc to be graduated is fastened so that its center coincides with the center of the large arc. By means of a straightedge, pivoted at the center of the arcs, a very accurate division can be made. If a radius of 57.29 in. be used for the large arc, then with an ordinary steel tape the 1-in. divisions will represent degrees; the 1/2-in., 30 min., and the 1/4-in. divisions, 15 min. The method of doing this is shown in the second sketch.—Contributed by C. A. Jackson, New York.

### A Neckyoke Safety Hook

The purpose of the hook is to prevent the neckyoke from accidentally slipping off the tongue. It is made of a piece of round iron bar, about 12 in. long and bent into the shape shown in Fig. 1. The hook is fastened into the end of the iron on the tongue, as shown in Fig. 2. If, from any cause, the neckyoke should slip toward the

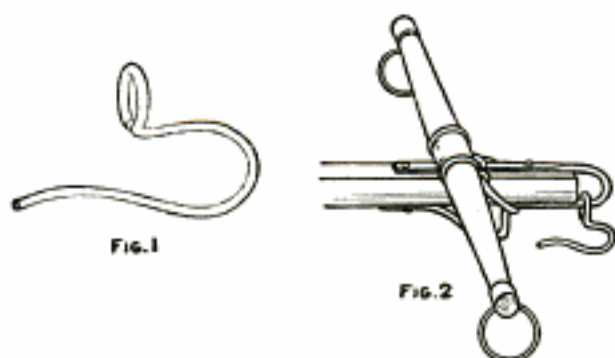

Hook on Tongue End

end of the tongue, the ring will catch in the hook and prevent the tongue from dropping down.

### To Make a Check and Bill File

Take two cypress boards, 4 ft. long and 6 in. wide, one board, 4 ft. long and 10 in. wide, and two pieces, 11 by

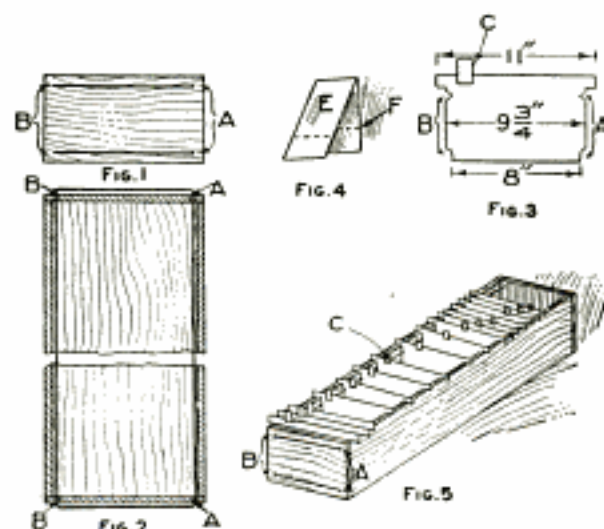

Check and Bill File

6 in., all 1/2 in. thick. Out of these make an oblong box, and at each end bore four holes, about 3/4 in. from the bottom and sides, as indicated at A and B in Fig. 1. Run picture wire through from one end to the other, A A, Fig. 2, then across the end and back from one end to the other, B B, and fasten the ends at the starting point. Cut 26 pieces of pasteboard, as in Fig. 3, with notches as shown at A and B. Cut some heavy paper into 3-in. strips about 1/2 in. wide and fold as in Fig. 4. Paste at dotted line F to board, and letter cards. Then insert cards in box in alphabetical order. The notches and wire will keep the boards upright and thus prevent loss and mixing of checks and papers.—Contributed by Maurice Baudier, New Orleans, La.

### Removing Old Paint or Varnish

The average person, when wanting to revarnish or paint some article, removes the old coating with sandpaper. This is a waste of time and labor, as old paint or varnish can be washed off much easier in the following manner:

Dissolve one-half cupful of washing

soda in a pint of warm water. Wet the article with this solution, then scrub it with a stiff brush. Rinse with clear water and let it dry thoroughly before recoating. This method will easily remove varnish or paint from crevices.—Contributed by Katharine D. Morse, Syracuse, N. Y.

### Wood Pulley with Internal Setscrew

The drawings show how I built a wood pulley which gave good satisfaction and cost but a trifle for materials.

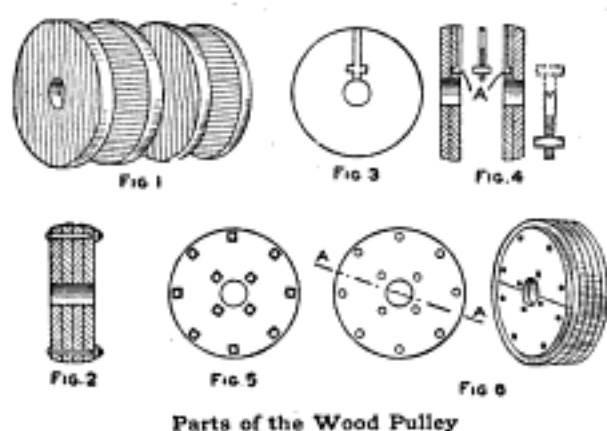

Parts of the Wood Pulley

Cottonwood was selected because with it there is less danger of cracking. Four circular pieces were cut and placed together, with the grain of each piece at right angles to its neighbor so as to prevent warping. See Fig. 1.

Placing these in a vise I fastened them with two carriage bolts, and then bored the hole for the shaft (Fig. 2). The shaft hole was bored so as to secure a snug fit. A  $\frac{3}{8}$ -in. hole for the setscrew was then bored between the two central sections until it met the shaft hole (Fig. 3). Withdrawing the bolts, I cut a square pocket, A, Fig. 4, across the setscrew channel in each of the central sections. The pockets were cut a short distance from the edge of the shaft opening. Cutting the head off a  $\frac{3}{8}$ -in. bolt I filed a screwdriver slot in it. This bolt when finished should be a trifle shorter than the channel so that it will not project beyond the face of the pulley.

The square pockets mentioned above should be cut just large enough to allow the square nut to fit in them without any play.

After placing the nut and bolt in the channel and pockets, I smeared the sections with white lead, inserted the two carriage bolts and added the remaining bolts as shown in Fig. 5.

As it was not advisable to screw the nuts and washers so tightly as to force them into the wood, I cut another piece of wood a trifle less in diameter than the other sections, Fig. 6, and bored holes in it to correspond with the bolts in the pulley. This piece was screwed to the pulley face to conceal the nuts and prevent them from tearing the belt, should it slip off on that side. This shield could be cut in half on the line AA, so that it could be removed without disturbing the pulley.

After filing a seat in the shaft for the setscrew, I placed the pulley in position and tightened the setscrew. I found that it held quite as well, if not better than a wedged pulley. If one setscrew is not deemed sufficient, more can be added in the same way.—Contributed by James M. Kane, Doylestown, Pa.

### Draft Shield for a Bed

A screen for preventing drafts blowing across a sleeper's head, when a window is left open for fresh air, is shown in the sketch. The screen is attached to the bed post on hinges, so that it may swing in any position. This permits it to swing out of the way either when getting into bed or in case the sleeper gets up suddenly in the dark, in which case he might break

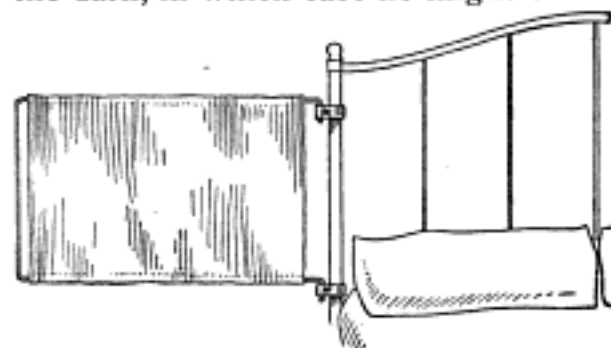

Shield on the Bed Post

an ordinary stationary screen or injure himself, if it were permanently attached.—Contributed by W. E. Morey, Chicago.

## Tracing Down Telephone Troubles

By GEORGE M. PETERSON

## PART II—TESTING

When a case of cable failure is reported, the galvanometer man is immediately called and he at once connects his voltmeter and battery on the cable and pairs which are in trouble, the connection being made as shown in the sketch, and care being taken to connect like poles together.

The first operation consists of connecting the voltmeter lead to a good ground, usually the cable armor, and touching each wire in the cable with the battery lead. This is the test for "grounds" and will show up grounded wires having anywhere from 2 volts to a "solid," or full voltage of the battery ground. A grounded wire with less than a 6-volt ground is fit to use, but is apt to be a bit noisy. If the voltmeter shows up several

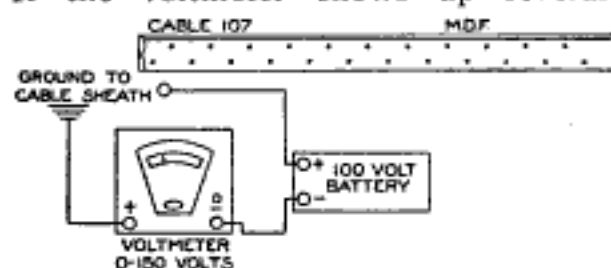

Voltmeter Test for Grounds

heavily grounded pairs, the trouble may be taken for a "ground" and a Wheatstone bridge or any of the various faultfinders is brought into action to obtain the exact location.

If the trouble happens to be "shorts" instead of grounds, the voltmeter is connected as shown and the leads touched to each side of a pair, taking the pairs straight through the cable and recording the voltage of each pair. If the full voltage of the battery is recorded, it shows a "dead" or "solid" short, and again the bridge is used to determine the actual location.

Crosses are also located with the voltmeter and battery by attaching one lead to the crossed wire until the wire with which it is crossed is picked up by the other voltmeter lead. If

the battery has an E. M. F. of 100 volts and the crossed pair should register up to 140 volts, it shows that

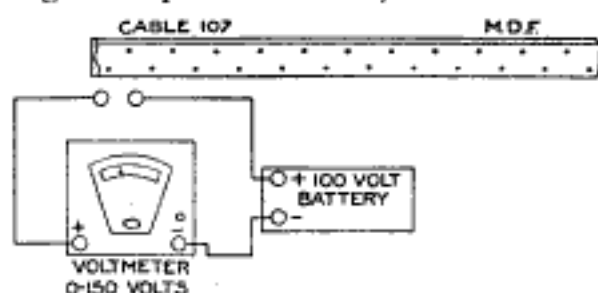

Voltmeter Test for Shorts

it is crossed with "battery," as the "common battery" system carries a voltage of 40. Often the voltage of a cross will be so high that the voltmeter needle leaves the dial completely. Then look out, as the cross may be with a high-potential circuit and great care must be exercised, not only to protect the instrument, but life as well.

The buzzer test set can also be used for testing out open crosses, shorts, etc. When testing for "grounds" with the outfit described in Part I, the circuit is arranged as shown for grounds. A heavy ground closes the relay through the receiver, but a light ground causes a faint click in the receiver alone.

By putting a "ground" on certain wires at the farthest terminal box, one after another, and connecting test set as shown, the wires may be tested

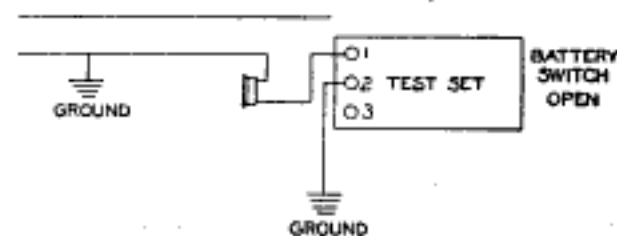

Buzzer Test for Grounds

for continuity or "opens." A sharp click of the relay shows the wire to be continuous or closed, but the lack of any click in the receiver shows the wire to be open.

A "short-circuited" pair can be tested by arranging the set as shown for "shorts." The short circuit will cause the relay to close through the

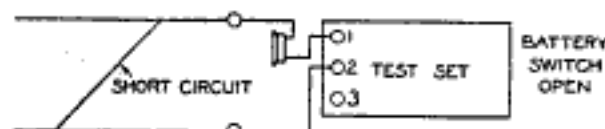

Buzzer Test for Shorts

receiver. If the relay remains open, the pair is all right unless it is open.

In testing for crossed pairs in a working cable, the set must be con-

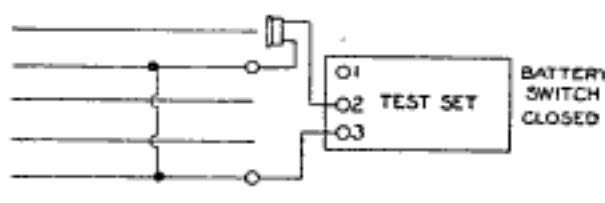

Buzzer Test for Crosses

nected as shown for "crosses," and test must be made from terminal. The

(To be continued)

cross will also make itself known by closing the relay through the receiver.

In an underground case, where tests show several heavy shorts and grounds, together with numerous crosses and opens, an experienced man would know that most likely the cause of the trouble was the cutting, or the breaking in two, of the cable. A solid ground on several pairs usually indicates that water has entered the cable through some poorly wiped sleeve, that electrolysis has eaten away the armor allowing the water to enter, or that some similar accident has happened.

In aerial cables the troubles are many and varied, the main trouble being from "burn outs" caused either from high-potential crosses with the cable itself, or from lightning. Then there are the mechanical damages caused by bullets, knife cuts, spur holes, etc.

## Heating a Shop with Engine-Jacket Water

In a small shop operated by a gas or gasoline engine considerable expense can be saved in winter by utilizing the cooling water from the engine for heating purposes, says a correspondent of Power. The method employed is shown in Fig. 1, where A is

connecting the engine with the regular cooling tank, and B and C, Fig. 2, are the heating coils. Valves are provided to control the flow in all of the pipes.

To secure the most efficient operation of the system, the coils and piping should be arranged as shown in Fig.

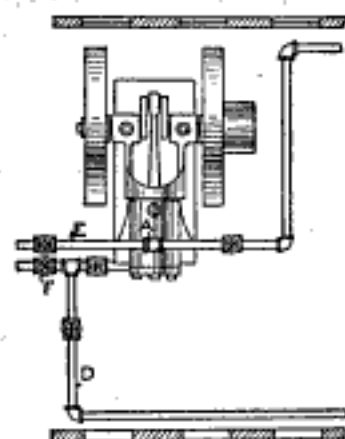
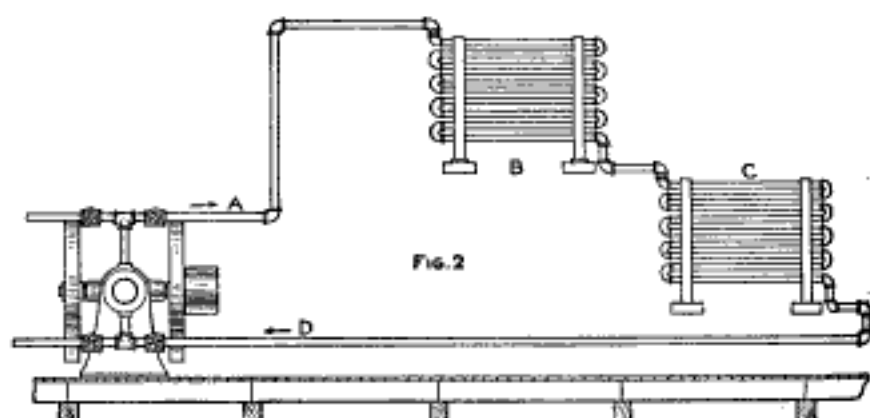

Fig. 1



Plan and Elevation of Piping System

the jacket-water outlet pipe, and D the cooling-water return pipe. The pipes E and F are the circulating pipes

2, as this arrangement gives better circulation than when the coils are placed on the same level.

If the volume of water passing through the heating coils be regulated by the valves in the supply and return pipes, the temperature of the room being heated may be varied to suit the weather conditions. It must be remembered, however, that when these valves are partially closed, the valves in the pipes E and F must be opened an equal amount to allow the engine to receive the required volume of cooling water.

The amount of space that the system will heat depends, of course, upon the amount of cooling water passed through the engine jacket, and the power and efficiency of the engine. Under ordinary conditions, the quantity of heat carried away per hour by the cooling water is from 2,000 to 4,000 B. T. U. per brake horsepower. A fair average is 3,000 B. T. U. per brake horsepower and about one-half of this is available for heating. Multiplying this quantity (1,500) by the brake horsepower and dividing by the number of B. T. U. required per hour to heat 1 cu. ft. of free air from 20 to 75 deg. F. for ordinary climates (or from -25 to 75 deg. for cold climates) gives the number of cubic feet which the system will heat.

The number of B. T. U. required to heat 1 cu. ft. of air through the required number of degrees of temperature can be obtained from any standard book on heating and ventilation, and will vary somewhat with the construction and exposure of the building.

The heating coils should not be built haphazardly, but should be figured out beforehand by the use of some of the simple formulas found in books and catalogs on heating and plumbing.

#### Grooving Short Pieces on the Saw

The sketch shows how short blocks of wood may be grooved on the saw without danger of kicking back, thereby preventing accidents. The drawing will be understood at a glance by any woodworking mechanic, and the rigging can be made in 15 minutes. This method not only eliminates the

possibility of injury to the operator's hands, but also makes it possible to do more work in the same time than by

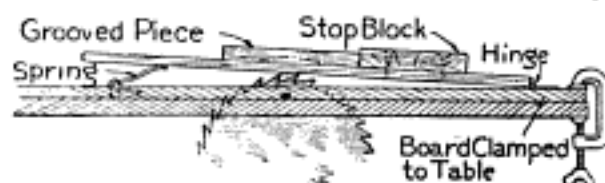

How to Groove Short Blocks

the old way of dropping the pieces on the saw.—Contributed by Henry Zahn, Chicago.

#### A String Cutter

The accompanying sketch shows a handy little string cutter for fastening to the edge of the counter. It is made of a thin piece of steel and the cutting edge A tempered and sharpened. The shape of the cutter forms a guard over the cutting edge and prevents anyone from being cut. It also allows the string to reach the cutting edge easily.—Contributed by Abner B. Shaw, N. Dartmouth, Mass.

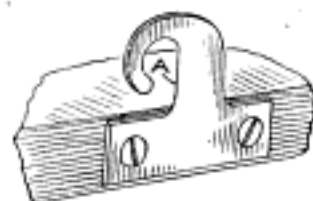

#### Pipe Puller

A puller the right size to pull a 4-in. pipe must have the dimensions shown in the sketch. The main body is made of soft steel and the catches of tool steel tempered. The two catches are pivoted in notches milled in opposite sides of the main body in such a way that when the puller is lowered in the pipe, they will slip through, but, upon drawing the puller, the catches will

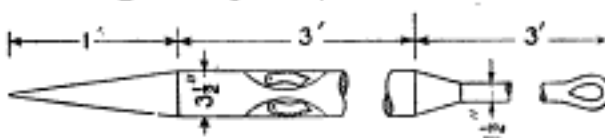

Puller for 4-In. Pipe

take hold on the pipe and pull it out. As many catches as are desired can be fastened to the puller.—Contributed by J. C. Talley, Rock Hill, S. C.

### Mending Moving-Picture Films

A little device which gives the best results in repairing films, says a correspondent of the Moving Picture World, is made of steel,  $\frac{1}{4}$  in. thick by  $\frac{5}{8}$  in.

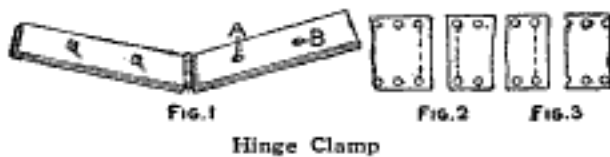

Hinge Clamp

wide. Two pieces are hinged together as shown in Fig. 1. Small pins, the same shape as those on the sprocket of a moving-picture machine, are set in one half of the hinge, spaced the same distance apart as the two rows of perforations in the edges of the film. Two holes, A and B, are drilled in the

other half hinge to receive the pins. This makes an effective press for the patch.

The ends of the film are prepared in the usual manner. The mend is made as shown in Fig. 2. This will not split the sprocket holes. If it is desired to split the holes, as in Fig. 3, then use more than one set of pins in the mending hinge.

☞ A tool for cutting brass should have no top rake, but for cast iron it should have at least 5 deg. and for steel at least 15 deg. rake.

☞ Small jugs, 1-qt. size, covered with crocheted wool make excellent hot-water bottles.

### Connecting a Radiator to a Range Boiler

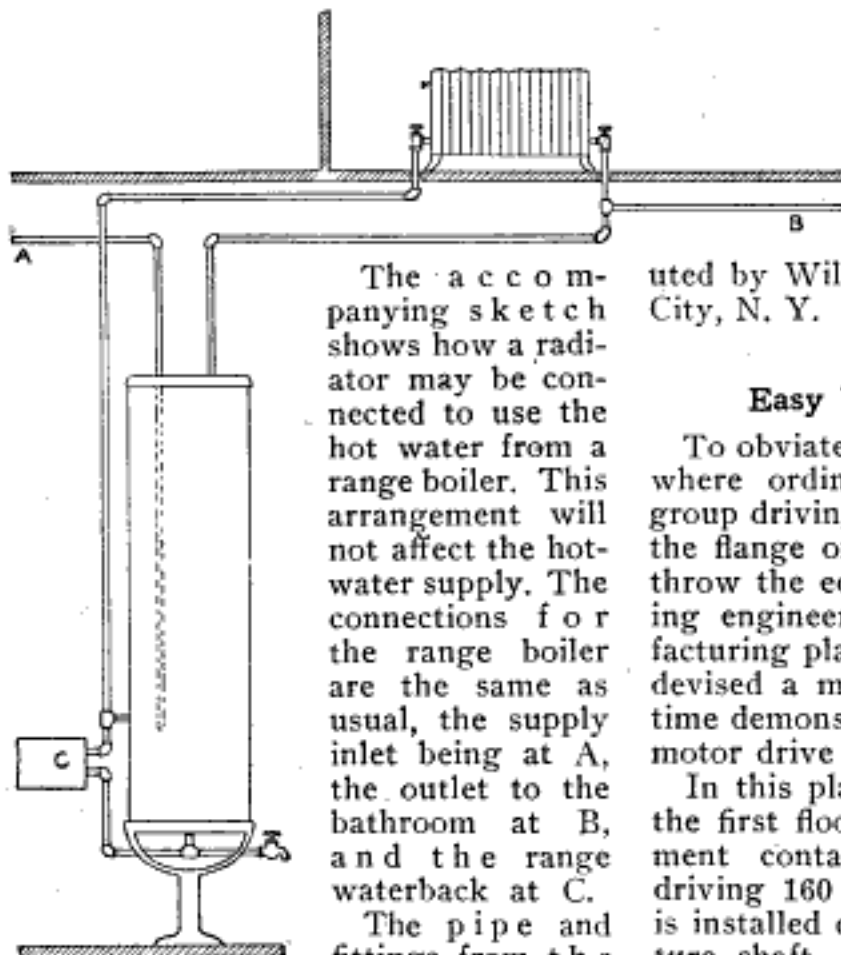

Connections from Waterback to Boiler and Radiator

The accompanying sketch shows how a radiator may be connected to use the hot water from a range boiler. This arrangement will not affect the hot-water supply. The connections for the range boiler are the same as usual, the supply inlet being at A, the outlet to the bathroom at B, and the range waterback at C.

The pipe and fittings from the boiler to the radiator and the waterback and return should be 1 or  $1\frac{1}{4}$

in. The inlet pipe and the pipe supplying the bathroom can be the regular size for the boiler. The radiator will heat a good-sized room nicely.—Contributed by William Carroll, Long Island City, N. Y.

### Easy Way to Shift Belts

To obviate the tendency of the belts, where ordinary pulleys are used in group driving of machines, to slip over the flange of double pulleys and thus throw the equipment idle, the designing engineers of a big cotton-manufacturing plant at East Boston, Mass., devised a method which at the same time demonstrates the flexibility of the motor drive in special cases.

In this plant, according to Factory, the first floor of the spinning department contains forty 20-hp. motors driving 160 frames. A double pulley is installed on each end of each armature shaft, four frames being driven per motor, but instead of the usual flange on the double pulleys to separate the belts, the crowning on each



section is made  $\frac{1}{4}$  in. off center, away from the middle of the pulley. By this means the belts are kept apart without any danger of their climbing the flange and being thrown off, and in addition, by centering these tight and loose pulleys on the frames with the highest point of the crown on the driving pulley, the belt can be shifted without throwing it off the motor pulley.

### Broom Holder Made of Rubber Hose

A piece of rubber hose, 6 or 8 in. long, cut as shown in the sketch, and nailed or screwed to a wall, makes a handy broom holder. The hose should be tacked to the wall about 2 or 3 ft. from the floor, so that the broom handle can be pushed through from the top and rest on the floor. This holder is easily made and will give satisfaction.—Contributed by

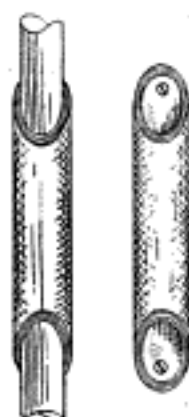

Irl R. Hicks, Hallsville, Mo.

### Tamper Made of Pipe and Fittings

A very satisfactory tamper for earth can be made of a 1-in. pipe, fitted with a bushing and caps, as shown. The pipe should be about 5 ft. long. The



Tamper of Pipe and Fittings

bushing is used to secure a large tamping head.—Contributed by Earnest Boyce, Winterset, Iowa.

### Boring-Tool Sounder

When boring on a lathe it is quite hard to determine whether or not the tool is cutting properly. The instrument shown in the sketch will tell with a remarkable degree of accuracy. The instrument is made of a piece of  $\frac{1}{8}$ -in. drill rod, about 13 in. long, set in an elliptical piece of wood,  $1\frac{1}{8}$  in. long and  $\frac{3}{8}$  in. in diameter in the largest

part. A small fork is formed on the end, as shown in the sketch.

In using the fork, place it on the bor-



Sounder

ing tool and place the wood knob close against the ear. If the tool is cutting a trifle out of the way, the vibrations will show it instantly.—Contributed by F. W. Shrier, New Haven, Conn.

### A Safety Lathe Dog

The construction of this lathe dog is apparent from the illustration, from which it will be seen that the setscrew is so protected as to avoid the familiar accident due to the lack of such protection. The setscrew can be adjusted by the ordinary type of wrench, and should it become burred or damaged, can be readily renewed by the use of a socket wrench inserted through the hole in the protection frame.



### A Gauge for Setting Centers in Taper Turning

It is not always necessary to know the amount to set over a tailstock on a lathe in turning tapers. A very easy

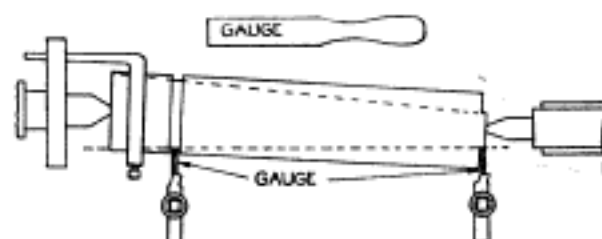

Gauge Used in Setting Taper Stock

way to set the work in the centers to turn a taper is to use a gauge as shown in the sketch. The first requirements

are to turn a piece to the right diameter at each end of the part to be tapered, then loosen the tailstock so that it can be easily moved. Set the gauge between the surface of the turned part and the cutting edge of the tool first at one end and then the other, without changing the crossfeed, but moving the carriage back and forth until the tailstock is set right to make it gauge the same in the cut at both ends. Set the clamp bolt on the tailstock and cut the taper.—Contributed by C. Gatter, Bridesburg, Pa.

### Cutting Off Hollow Bored Cores

Cylindrical hollow steel bodies with bottoms can be made from the solid bar by boring out a core down to the inside of the bottom and using an undercutting tool to cut down to where the core may be broken off, as shown in Fig. 1. This method is applicable to all kinds of steel, says the American Machinist. It is especially advantageous, where valuable material is used, in saving the stock in the core, and,

borings is shown in Fig. 2. Its construction is special. The body of the tool, A, is made of steel. A steel bolt is screwed into a milled eye and on this bolt a tool-holder, B, is pivoted, curved in conformity with the bore. The cutter C, of high-speed steel, is dovetailed into the holder. In the end of the holder there is a hole in which there are fastened two cords of very high-grade steel wire, with loose ends. The cords are led out through opposite eyelets in the tool body, parallel to its axis. The cord that is entirely visible in Fig. 2 serves to feed the cutter under. The smaller cord may be used to pull the cutter out of the undercut. The body of the tool is centered in the bore that has been made by four hardwood blocks, D, dovetailed into the periphery of the body.

The cutting off of the core is performed on the same machine that is used for the boring, Fig. 3. The cutting-off tool is attached in the same manner as the hollow boring tool, by means of threads on the hollow boring bar. The cord F, Fig. 3, used to feed

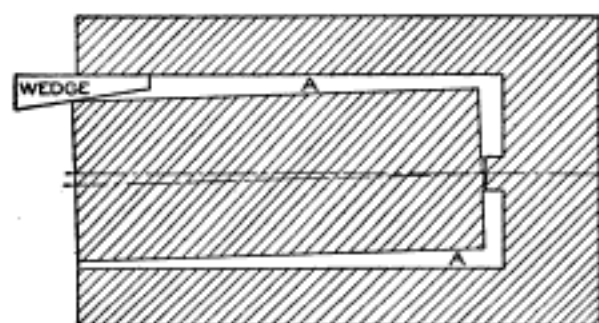

Fig. 1

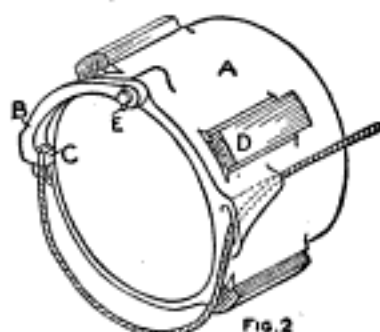

Fig. 2

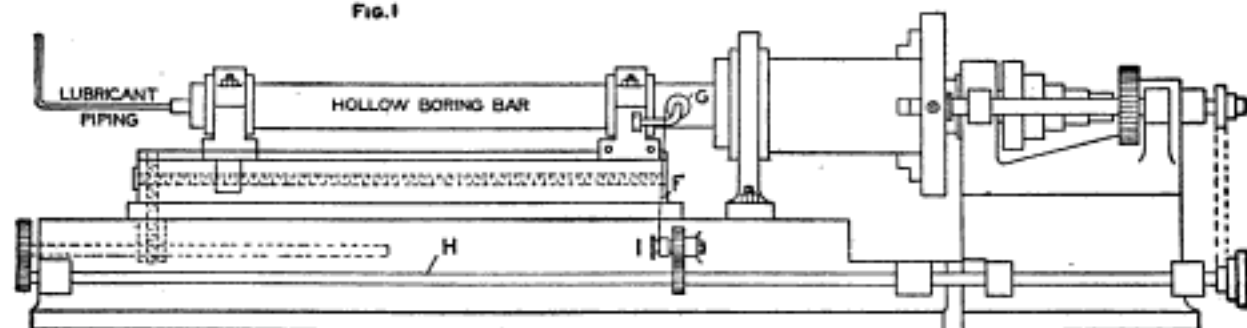

Fig. 3

Cutting-Off Tool and Its Position on a Lathe

where the interior pressure is to be high, in simplifying the construction and reducing the cost.

The cutting-off tool for hollow core

in the cutting-off tool, is led over the pulley G, and wound on the drum I, which is driven by the feed rod H. For undercutting the core, the axial feed

of the hollow boring bar must, of course, be disconnected.

The cutting lubricant, composed of a mixture of water with a cutting oil soluble in water, is forced, under high pressure, through the boring bar, to wash away chips. It is of great importance to grind the cutter so that the chips do not roll off as long shavings, but break into small pieces.

### Chip Magnet for Drill Holes

When drilling holes in parts that cannot be turned over, the little tool shown in the sketch cannot be excelled for removing the metal chips from the



Small Rod Magnet

bottom of the holes. It is made of a piece of  $\frac{1}{8}$ -in., or larger, drill rod. The rod has a slot cut in it, as shown; then the steel is magnetized by placing on an electric generator, or, by wrapping a coil of insulated wire around the head end and passing an electric current from a battery through the wire.—Contributed by J. F. Tholl, Ypsilanti, Mich.

### Mounting Emery Wheels

A way to lessen the chances of an emery wheel breaking is to use two

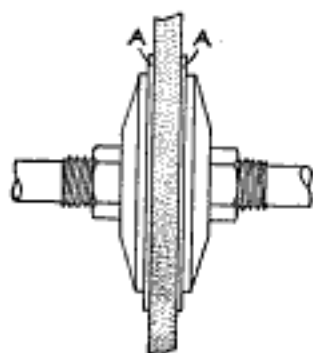

rubber washers, AA, between the sides of the wheel and the nuts. In case the wheel should break, the greater part of the fragments are prevented from flying. I have tried this

only on wheels up to 6 in. in diameter.—Contributed by Chas. Hattenberger, Buffalo, N. Y.

Window sash can be made to run smooth in the grooves by applying a solution of paraffin in turpentine.

### An Emergency Tire-Lacing Needle

A needle for lacing the casing of a double-tube tire can be easily made of a piece of medium-weight wire



Needle of Twisted Wire

twisted as shown in the illustration. Such a needle is better than the ordinary steel needle as it can be bent to pass through the holes, and not being sharp, it is not so liable to puncture the inner tube.—Contributed by Paul H. Burkhart, Blue Island, Ill.

### Wire-Cutting Notch in Shears

A small pair of pocket shears can be fixed to cut small wires by forming a notch in each blade, as shown at A in



Notch in Blades

the sketch. The notch does not interfere with the ordinary use of the shears.—Contributed by C. Irving Fisher, New York City.

### A Whitewash Mixture

Walls may be given a bright, clear, white coating with a whitewash made up as follows: 1 teacupful of salt, 1 teacupful of brown sugar and 2 oz. of powdered blue vitriol are separately dissolved in hot water and then added to 1 pailful of water-slaked lime. Stir the parts together thoroughly. This will make a whitewash that will not rub or peel off.

The vitriol gives a bright, clear color. If a yellow tint is desired, use green vitriol instead of blue. The mixture will have a green tint, but when it dries on the wall it will be a nice yellow.—Contributed by Frank J. Lilja, Indian Orchard, Mass.

### A Gasoline Torch

An old discarded gas generator used on a motorcycle served the purpose well in making a gasoline torch, says a

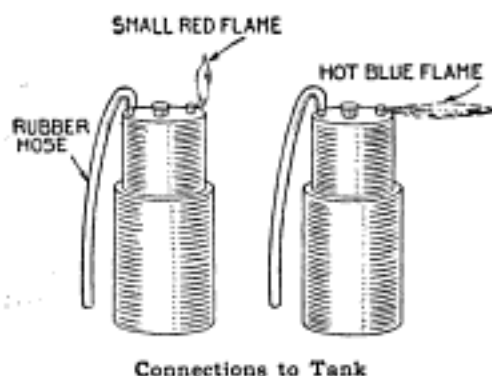

correspondent of Motor Cycling. I put a hose, 6 or 7 in. long, over the water pipe on top of the generator, and then lit the gas that escaped from the opening in the top. It burned with a small red flame. When blowing through the tube, it was changed into an intensely hot blue flame. This is a handy torch for a multitude of things where the ordinary gasoline blowtorch is generally used.

### Stand for Lathe Tools

Lathe tools often become scattered, and even when they are laid in order, it is sometimes difficult to pick out the right one. To overcome this difficulty, the stand shown in the sketch was

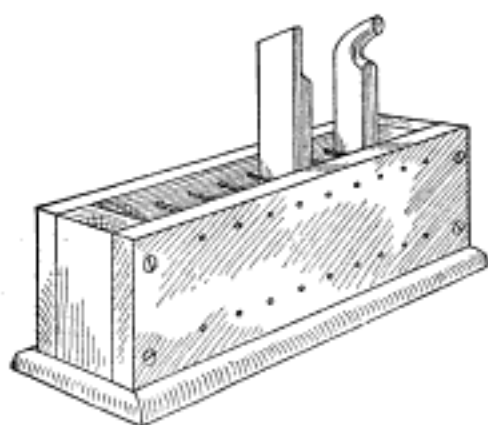

Tools in Stand

made, in which the tools are kept upright and the points in plain sight. In addition to this, all the tools may be moved easily. No dimensions are

given, as each stand will have to be made for each particular set and size of lathe tools. The stand will be of more use for small lathe tools.

The stand is made by clamping two sides together and laying out the holes, which are spaced so that the distance between them will be about  $\frac{1}{8}$  in. larger than the thickness of the lathe tools. The lines of the holes are about as far from the edge of the side pieces as the pieces are thick. Each hole in the bottom line is directly under the corresponding hole on the top line, so that when the tool is placed in the stand it will be held upright. The holes for the crosspieces, which are wire finishing nails, are drilled through one side but not quite through the other, and must be a shade smaller than the nails, or else the nails will work loose and fall out. If the nails fit too tightly, the wood will split when they are driven in.

The end pieces are cut  $\frac{1}{8}$  in. wider than the largest tool and as long as the sides are wide. Small round-head screws are used to hold the sides to the ends. The base is  $\frac{1}{4}$  or  $\frac{3}{8}$  in. larger all around than the main body and is rounded or chamfered on the four top edges. It is fastened to the body by countersinking a screw through it into each end piece.—Contributed by Donald A. Price, Wilmington, Del.

### Drilling Holes in Metal

Starting a hole with a center-punch mark and drilling until the depression is gone, then using the punch again, is slow work on large holes and, besides, is not very accurate. I tried using a small drill and following with a larger one. Holes  $\frac{1}{2}$  in. in diameter can be drilled through very heavy plate in this manner without any particular effort. Start the hole with a  $\frac{1}{8}$ -in. drill and follow with a  $\frac{1}{4}$ -in. drill. Holes can thus be drilled both quickly and accurately either by hand or on a makeshift drill press.—Contributed by C. W. Goddard, Bellaire, Mich.



## Timing Photo Printing

Having hundreds of postals of a single subject to print, I made a perfect timing apparatus for exposing the prints from an old metronome and an old gong magnet. A disk, B, 20 in. in diameter, was made of heavy tin with two apertures, C C, each cut 7 in. in diameter, on a line with the center of the disk, and 2 in. from the edge. A large spool, F, was used to serve as a hub and also as a reel on which strong twine was wound, with a weight, E, attached to the free end.

The disk was bolted to the partition P of the darkroom, the partition having a hole, G, to coincide with the holes in the disk as it revolved. Four catch pins were fastened on the rim of the disk to engage a catch pin on the armature of the magnet. The gong and commutator were removed and the magnet placed in the position shown in the sketch. A strip of wood was fastened across the face of the metronome H, about 1 in. above the pendulum shaft or axle. On the inside of the center of the strip a small piece of wood was projected, with copper wire on one side only, to form a contact with a piece of flexible copper on the pendulum. Wiring was made as shown in the sketch and a switch used to stop the disk from revolving.

An ordinary postal-card printing frame, D, with a hinged back was used and placed on the shelf A, as shown. A hinge was made from heavy elastic bands to allow for two dozen cards in the frame at one time. As each card was printed it was taken out and dropped into the developer. The reel and metronome should be wound

up after printing two dozen cards. The stops can be varied for any length of

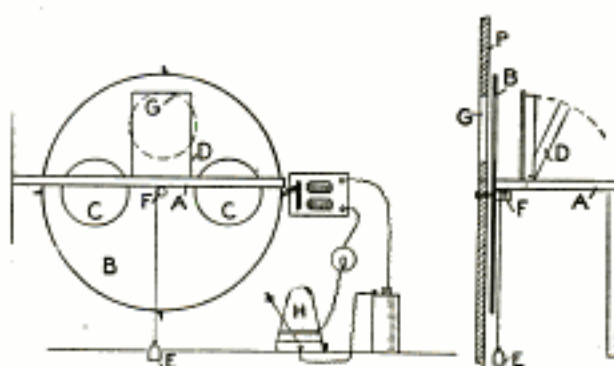

Details of Timing Apparatus

time by regulating the weight on the metronome. The disk and all woodwork must be painted a dull black. The circuit is completed on the return stroke of the pendulum, causing the magnet to attract the armature, which releases the catch, allowing a quarter turn of the disk.—Contributed by Frank W. Preston, Paterson, N. J.

## Pail Hook for a Pitcher Pump

When pumping water from the ordinary pitcher pump, the bucket must either be held to the spout or placed on the ground. The accompanying sketch shows how I arranged a hook, fastened over the collar of the pump, to take the bail of the bucket. The hook is made of  $\frac{1}{4}$ -in. round iron.—Contributed by Laurence B. Robbins, Harwich, Mass.



### A Use for Discarded Wafer Razor Blades

A paper trimmer and mat cutter can be made from a wafer razor blade. As a paper trimmer, place the blade C over

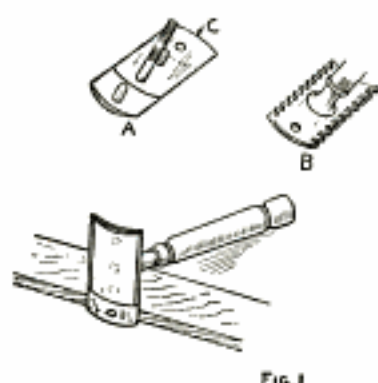

FIG. 1

the part A of the razor, as shown, with only two of the holes engaging in one post and the center screw. Then place the part B in position and clamp with the handle. This will allow about  $\frac{1}{2}$  in. of the blade to project at one end. If a part of the extending blade is cut or broken off, it will be more easily handled. The cutter is guided along the straightedge as shown in Fig. 1.

If it is desired to make a more permanent form of instrument, or if no holder is at hand and only a castoff wafer blade, a handle, C, may be cut from a piece of wood and fitted with

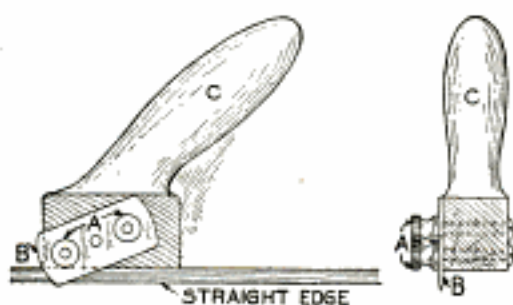

FIG. 2

Blade Attached to Handle

two or three binding-posts, A, taken from an old battery, to hold the blade B in place, as shown in Fig. 2.

### Armatures for Small Motors

Without the proper tools and material, the amateur electrician will find it quite difficult to construct a small armature for a battery motor that will run true, without vibration and have a neat appearance. Ordinary cast-iron

gears or pinions, as shown in Fig. 1, make excellent cores for armatures on small motors. A gear of any number of teeth can be used for an armature with a smaller number of coils by cutting out a certain number of teeth. For example, a gear with 12 teeth will take 12 coils, but if every other tooth is cut out, it will take only 6 coils, etc. The teeth can be easily chipped out with a cold chisel.

Larger armatures can be made from gears with spokes, the spokes being cut out, if a ring armature is desired. The gear, when wound, can be mounted on a hub made of empty thread spools. The spool can be turned at one end to insert it in the armature, and if too long, one end will serve for the core of the commutator, as shown in Fig. 2.



FIG. 1

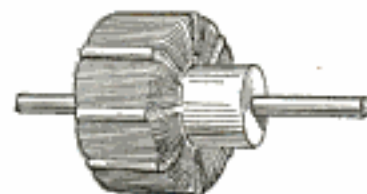

FIG. 2

Gear Used as a Core

This combination will make a neat, efficient little armature, which will run quite free from vibration. Only simple tools, such as a hammer, cold chisel, file, jackknife and a vise, are required.—Contributed by R. J. Nault, Hartford, Conn.

### Ice Creeper for Shoe Heels

Many persons, young and old, have falls every winter on the ice or snow which can be avoided if their shoes are fitted with ice creepers. A very efficient device of this kind, which any boy can make at home in a short time, is shown in the sketch. These ice creepers need not be removed from the shoes or boots until the winter is past, for they may be worn indoors without injuring the finest floor.

The two plates A may be made from either iron or steel—preferably the latter. An all-steel scraper, or a piece of a saw blade, makes good

creepers. Draw the temper by heating the steel to a cherry red and then letting it cool slowly. It may then be sawn with a hacksaw, cut with a cold chisel, or filed into plates of the proper shape, as shown. The teeth are filed to points. The two L-shaped slots are made by drilling  $\frac{3}{8}$ -in. holes through the plates, and then sawing, filing or chiseling out the metal between the holes. The projections at the ends are then bent out at right angles with heavy pliers or the claws of a hammer, and finally the plates bent to fit the curve of the heel.



Creeper Attached to Heel

The creepers are attached by means of round-head wood screws turned into the leather. In this operation place the teeth of the plates just below the bottom of the heel and turn the screws into the ends of the upright slots until the heads just bind. The plate as set when indoors or else not needed is shown at B. To place the plate so it will grip the ice, slide it to the right, which will bring the screws into the horizontal slots, as shown at C.—Contributed by Chelsea C. Fraser, Saginaw, Mich.

### Opening Screw-Top Fruit Jars

Screw-top fruit jars may be easily opened in the following manner:



Secure a strap with a buckle and place it around the top as if it were to be buckled, but instead draw the loose end back and hold it with the thumb as shown. Turn cover and strap while held in this position and it will easily turn from the jar.—Contributed by Chas. A. Bickert, Clinton, Iowa.

### Lamp-Chimney Cleaner

Lamp chimneys of various makes are very difficult to clean quickly and thoroughly. The simple device shown

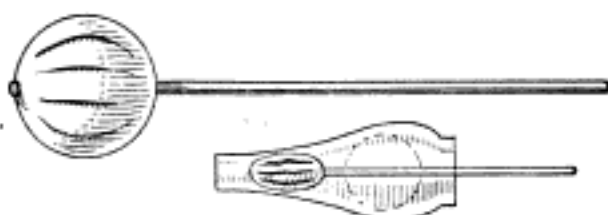

Rubber Ball on Stick

in the sketch makes the cleaning process a simple matter. The cleaner is made of a round rubber ball with slits cut in it as shown and then fastened to the end of a stick. When a cloth is placed over the ball it presses evenly against the curved surfaces of the glass. There is no danger of breaking a chimney with this cleaner.

### A Pop-Corn Popper

The accompanying sketch shows the construction of a pop-corn popper for thoroughly flavoring the corn with the

hot butter or lard, and at the same time mixing it with the necessary amount of salt. Procure a metal bucket that just fits the bottom of the frying pan. The stirring device is made of heavy wire bent as shown and provided with an empty spool for a handle. A brace is made of tin bent in the shape shown and riveted to the bottom of the bucket.—Contributed by F. A. Wirth, Farwell, Texas.

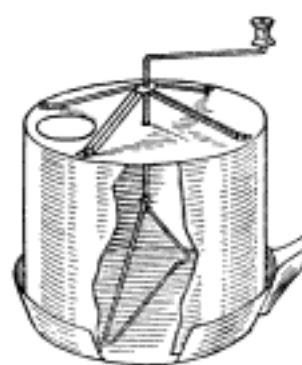

### A Homemade Floor Polisher

An efficient and cheap floor polisher may be readily constructed in the following manner: Make a box about 4 by 6 by 12 in., or the exact size may be determined by building it around

the household flatirons as these are used to give weight and pressure. The handle, which is attached as shown, should be at least  $2\frac{1}{2}$  in. wide

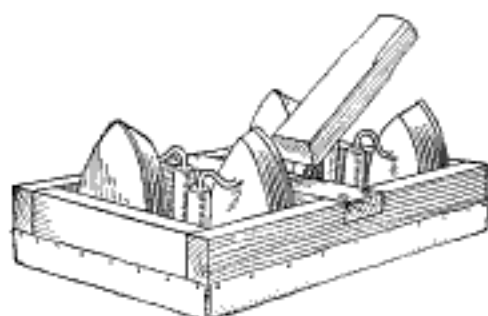

Flatirons in the Box

at the hinged end and should be sand-papered where it is grasped by the hands. A half-strap hinge is preferable, with the strap part fastened to the handle. The bottom of the polisher is covered with a piece of Brussels carpet.

In use, it is well to set the polisher on a soft piece of cotton or flannel cloth, which may be readily renewed when badly soiled.

A more slightly polisher may be made by filling the box with pieces of old iron or lead, tightly packed with paper to prevent rattling, and attaching a cover over the top. The handle may be hinged directly to this cover by means of a full-strap hinge.—Contributed by B. O. Longyear, Ft. Collins, Colo.

#### Simple Way to Mark Poison Bottles

A way to prevent any possible mistake of taking bottles containing poisons is to mark them as shown in the sketch. This method provides a way to designate a poison bottle in the dark.



The marker is made of a circle of heavy cardboard with a hole in the center so as to fit tightly over the neck of the bottle. No matter how dark it may be or how much of a hurry a person may be in, one cannot fail to note the char-

acter of the contents of the bottle as soon as the hand touches the cardboard marker.—Contributed by Katharine D. Morse, Syracuse, N. Y.

#### Removing Varnish

A good and easy way to remove varnish from old furniture is to wash the surface thoroughly with 95-percent alcohol. This dissolves the varnish and the wood can then be cleaned with a strong solution of soap, or weak lye. If lye is used, it should be washed off quickly and the wood dried with flannel cloth. When the wood is thoroughly dry it will take a fine finish.—Contributed by Loren Ward, Des Moines, Iowa.

#### Curling-Iron Heater

The curling-iron holder shown in the sketch can be made of metal tubing

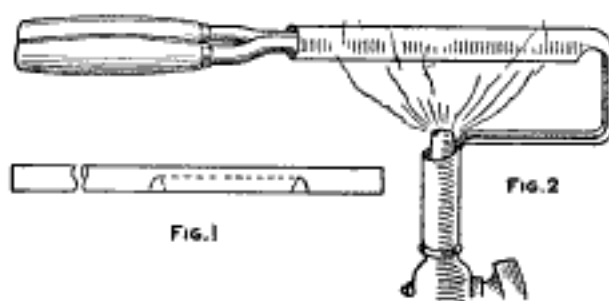

Heater on Gas Jet

having the size to fit both iron and gas jet. One-half of the tubing for a portion of its length is removed, as shown in Fig. 1. The remaining part is bent as in Fig. 2 and set on the burner of the gas jet.

The tube prevents the curling iron from becoming black with soot. The position on the jet may be changed. The tube can be placed on the jet and removed with the curling iron.—Contributed by W. A. Jaquythe, Richmond, Cal.

ⒸA whisk broom is the best cleaner for a gas stove. It will clean dirt from nickel parts as well as from the burner, grates, ovens and sheet-metal bottoms.



### An Electrical Walking Stick

A cane that will produce an electric shock when shaking hands is one supplied with the electrical apparatus shown in the sketch. An ordinary cane, 1 in. in diameter at the top and having a metal band A, is bored about 8 in. deep, to receive the battery B and induction coil C. One of the electrical connections is through the metal tip D to the earth, the other is through the

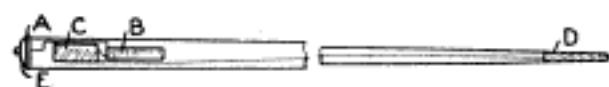

Battery and Coil in Cane

metal band A when the push button E is pressed.

The one using the cane merely holds the metal end D in contact with the earth and while shaking hands with a friend he pushes the button and starts the coil in operation.—Contributed by Stanley Radcliffe, Laurel, Md.

### Convenient Shelf Arrangement

A convenient device for crowded shelves and cupboards is shown in the accompanying sketch.

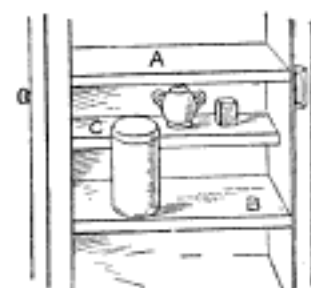

Halfway between shelves A and B is installed a second shelf C which is only half as wide as the other shelves. This

provides a convenient place for small articles and utensils, while in a china closet it furnishes a splendid space for cups, sauce dishes or other small pieces. It also adds a neat and pleasing appearance.—Contributed by E. M. Williams, Oberlin, Ohio.

### A Shoe Scraper

On steps of public buildings, shops and dwellings is usually found some sort of a mud scraper for the shoes. These remove the mud from the sole of the shoe and leave it on the edge

and sides. The scraper shown in the sketch is of simple construction, and removes the mud from the soles and

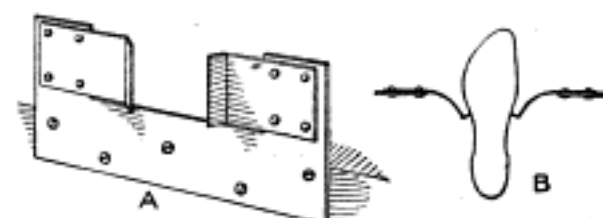

Scraper of Thin Steel

sides of any size shoe in one operation. The scrapers spread and bring pressure to bear on all sizes. The side scrapers must be made of metal that will spring. The standard is of heavy sheet metal with the thinner strips riveted to the projecting uprights at the ends.

### Fastening a Shade to a Roller

Tack the shade A in the usual manner and roll it as far back as possible and while in this position apply an ample quantity of glue near the tacks, as shown at B. A shade attached in this manner will not come loose from the roller.



### Vegetable Slicer

The slicer is made of a knife blade, screw and pin handle. The screw is soldered into the end of the knife blade. As the screw feeds into the vegetable

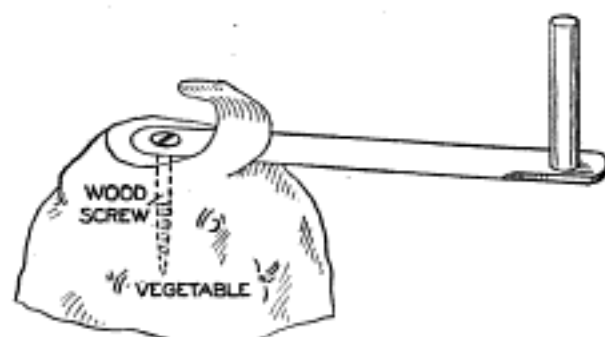

Slicer in Vegetable

or fruit, the blade will slice it in a curl of even thickness.—Contributed by H. C. Roufeldt, Toledo, O.

## POPULAR MECHANICS

### Arts-Crafts Leather Work

By MARY C. SCOVEL

#### PART I



Coin Purse—Back

and secondly, because any ordinary article can be made by simply following the directions carefully, although each of the various kinds of leather demands a different process.

The equipment necessary is simple, consisting of two special tools costing 50 cents each, one with a narrow edge for lining patterns, and one with broad ends for tooling; and a piece of tin, plate glass, or very smooth hard wood, which should not be smaller than 9 by 12 in. A soft sponge, a triangle, a rule, tracing paper and a hard pencil are also needed.

The first attempt should be made on a piece of Russian calfskin. This may be purchased at any leather store or craft shop and costs about 50 cents a square foot, if cut to measure. Whole skins contain from 8 to 12 sq. ft. and cost about 35 cents a square foot. Calfskin may be had in almost any color.

The coin purse will be the first article described. The size, pattern and design must first be determined. It consists of three parts, the front, back and flap, as shown in the sketch. This purse will require a piece of leather 4 by 8 in., in order to allow an extra

Leather work is one of the most interesting of the crafts, first, because the material is so pliable that any-

one can work it,

$\frac{1}{4}$  in. outside of the pattern to pin the leather on the board while transferring the design. The upper flap C folds over the front of the purse D. The design must be divided, the part belonging to C placed on the flap, and the part belonging to the front D, on the lower part of the front.

Take a piece of paper and fold it in accordance with the desired proportions of the purse, taking care that the design for the front D is on the same side of the paper as that of the flap C.

The space F under the flap is without any design. The design for the front D is on the lower part of the upper division of the pattern. Fold the part F behind H, and then the part C behind H and F. Turn the pattern over for the proper position of the purse. Draw the entire design on tracing or tough tissue paper. Wet the leather on the wrong

or unfinished side with a soft sponge. Pat the leather and endeavor to moisten, but not soak it, with water. On some leather the water, if it comes through, leaves a stain. When the leather is too wet it is very hard to tool, as the tool sticks and makes an uneven background.

Pin the design firmly down against the leather and fasten the leather with thumb tacks on the outer margin.



Coin Purse—Front



A Mat

With a hard pencil go over every line of the design with a firm, even pressure. If the leather is properly moistened, this will leave a clear outline of the design when the tracing paper is removed. Then with a lining tool—the tool with the narrow edge—go over the lines on the leather with a strong, firm stroke. Should a line design only be desired, this operation finishes the decoration.

Two other methods may be used: tooling or stamping. The design shown does not go to the edge of the pattern. A margin of at least  $\frac{1}{8}$  in. between the edge of the pattern and design must be left for tooling and stamping. For tooling, after lining the pattern, use the broad end of the tool and make even, long strokes to press down the background. If the background is not easily pressed down, the leather is too dry. Take it off the board and moisten the back again, move the tool back and forth and around until the background is comparatively smooth. Keep the edges very sharp between parts pressed down and those that remain raised. The depth of pressing down the background is a matter of taste, but it should be tooled down enough to make the design stand out plainly. Fold the parts together and line with silk to match the leather and then stitch up the front and back parts of the purse close to the edge. This

can be done on any sewing machine, or by a shoemaker. The circle M in the pattern is the catch or button which can be furnished and put on by a shoemaker, or at a trunk store.

Any ordinary article of leather can be stitched on a sewing machine in the home. To do this successfully the stitch must be long and the needle of a large rather than a small size. Try the stitch on a scrap of leather before sewing the article. If the foot or feed of the machine mars the leather, place tissue paper or a

plain piece of paper over the leather and stitch through both. After making the stitch the paper can be pulled away. Use as heavy a silk as the needle will take. The card case, coin

purse, stamp case and bags can all be stitched on an ordinary machine, if the above directions are followed. In stitching any soft leather, such as ooze cow or ooze calf, if paper is not put between the leather and the machine, the stitching will stretch the leather. In making bags, instead of stitching on a machine one can punch holes close together with a small punch, and then with strips of leather sew the sides together over and over, or in any manner desired. If no machine is at hand, nor a shoe-

maker's shop nearby, a large pin or awl may be used to prick holes in the leather, and then the parts sewed together with needle and silk. Use a

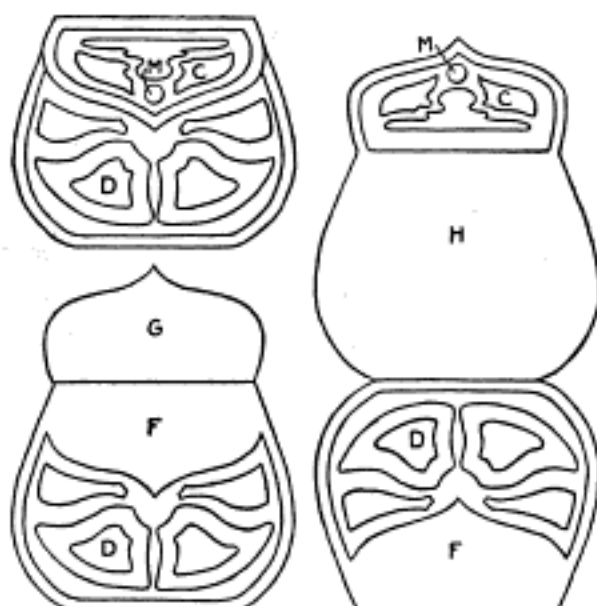

Pattern for Purse

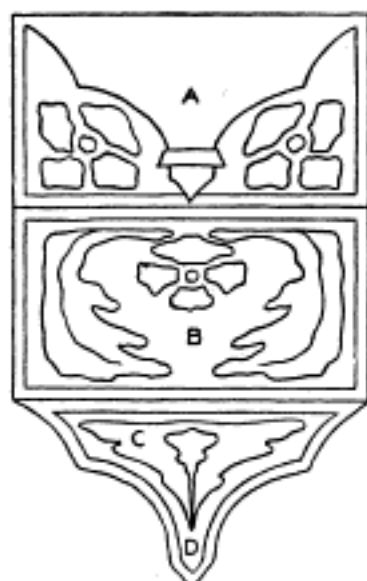

Stamp-Case Pattern

running or over-and-over stitch. An over-and-over stitch from one end of the seam to the other and back to the beginning of the seam, makes an X-shaped stitch which gives a very good finish.

The second method after tooling is stamping. Line the pattern as described. Purchase a common carpenter's nail set, with the head not too large. The smaller sets fit the patterns better and make smaller circles. Moisten the leather as described. Use a wooden mallet to strike the tool in stamping the background. This may be done either along circular lines or in a more irregular manner, but avoid striking the tool too hard, as too much pressure cuts through the leather. Other stamping tools of good patterns may be purchased at hardware stores or crafts shops.

A needle book or stamp case is another handy article to make in leather. The sketch shows the design. A piece of Russian calf,  $6\frac{1}{4}$  by  $3\frac{3}{4}$  in., is necessary. This allows  $\frac{1}{4}$  in. on each side and end for pinning down the pattern. Fold a piece of paper into three parts as A, B and C, the front

being A; the back, B, which is folded underneath the part A. The flap C folds up with B and then over A toward the front. When the pattern is open, the design for all parts must be on the same side of the paper. The design for the back B is put on the leather upside down. When the pattern is folded this makes the design upright. The parts A, B and C are equal in length and width. The part C may be cut in any shape desired, but keep the tongue D long and narrow. Make two horizontal cuts in the front A about  $\frac{3}{8}$  in. apart.

These cuts must be at the same distance from the bottom of the front as the narrowest part of the tongue is from the end. The tongue will then fit the cuts. Make the horizontal cuts a little wider than the tongue. The design is put on the leather in the same manner. It can be worked out in line, tooling or stamping. The parts A and B are sewed together.

The mat illustrated is another useful article and easy to make. Any size may be used, and the method of lining or tooling the design, or both, gives a very beautiful effect.

(To be continued)

### How to Make a Wood Lathe

A strong, substantial lathe in which wood and light metal articles may be turned can be made by carefully following the description below and the detailed drawings of the parts.

The bed is made of two pieces of straight-grained, smooth, 2 by 4-in. hard wood, 5 ft. long. They are held apart at each end by blocks of wood 2 in. wide. The bed can, of course, be made longer or shorter if desired, but the above dimensions are very satisfactory. The frame of the headstock, Figs. 1 and 2, is made of hard wood. The two end pieces have the dimensions and shape shown. These are fastened with screws to the base.

The base has a slider, a strip of wood 1 in. thick and 10 in. long, wide enough to slide smoothly between the bed pieces, nailed to its bottom, 2 in.

from the rear end. Two  $\frac{1}{2}$ -in. holes are bored through the baseboard and slide. Two  $\frac{1}{2}$ -in. bolts are run through these holes and through another slide and board which runs on the under side of the bed.

When the nuts on these bolts are tightened, the headstock is firmly clamped to the bed. A half-round, wedge-shaped piece is fastened with screws in the frame against the front end, to serve as a brace against any strain, and will also add to its appearance. The spindle is of tool steel or steel tubing,  $\frac{3}{4}$  in. in diameter and 14 in. long. Threads are cut on one end.

A hardened steel collar,  $\frac{1}{4}$  by  $1\frac{1}{2}$  in., is riveted on the spindle so it may turn against another collar of the same size on the headstock. Another collar is fastened with screws to the rear end

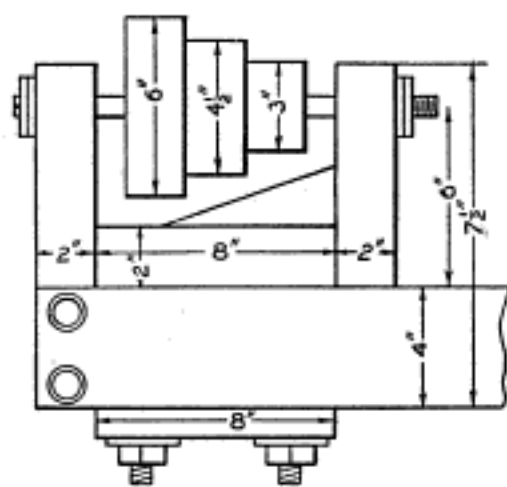

FIG. 1

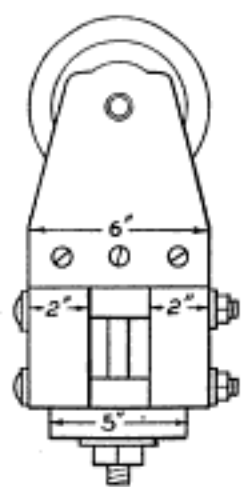

FIG. 2

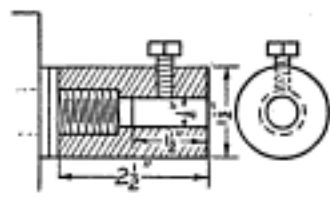

FIG. 3

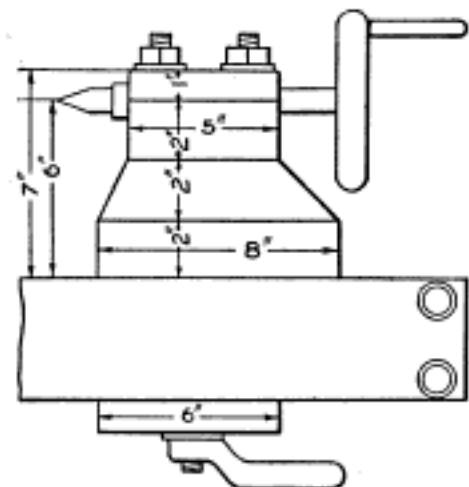
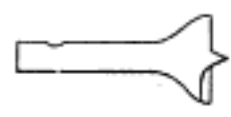

FIG. 4

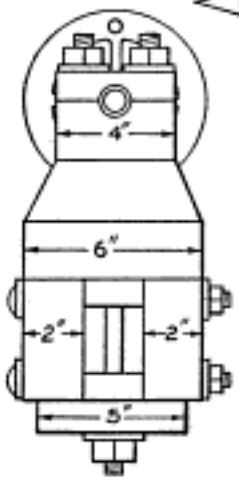
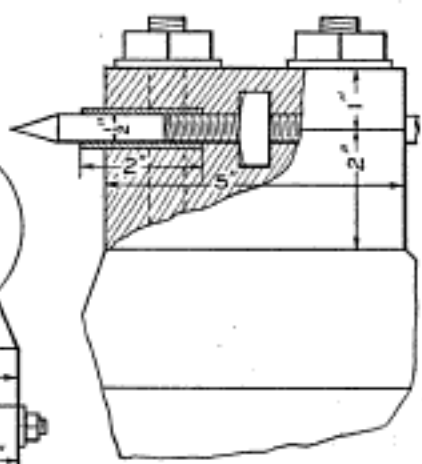

FIG. 5



SECTION THROUGH FIG. 4

FIG. 6

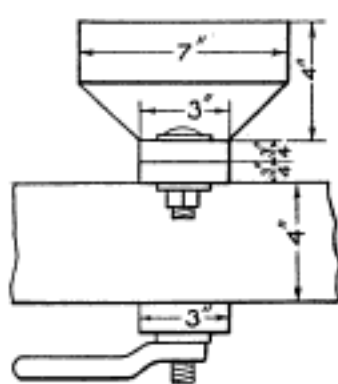

FIG. 7

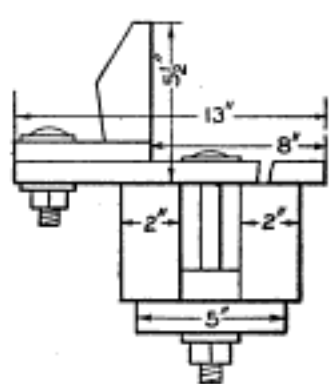

FIG. 8

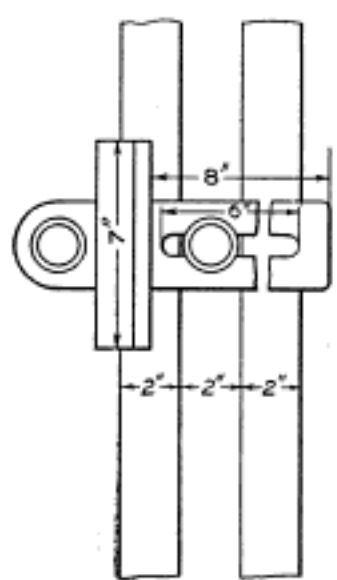

FIG. 9

Detail of Wood Lathe

piece, and a collar with a removable pin is fixed on the spindle. These should be fitted so as to revolve easily against each other and yet have no end play. The bearings are of brass tubing drilled for a spindle. These are inserted and wedged in the headstock, 6 in. from the bed.

Care should be taken to see that they are in line. Small holes are drilled from the top for oil. The pulleys are 2 in. wide with the diameters given in the drawing. They are fastened to the spindle with a removable pin.

A good chuck for this lathe is made, as shown in Fig. 3, of a piece of shafting  $1\frac{1}{2}$  in. in diameter and  $2\frac{1}{2}$  in. long. A  $\frac{1}{2}$ -in. hole is drilled through its center and one end reamed out and threaded to fit the threads on the end of the spindle. A setscrew is fitted over the  $\frac{1}{2}$ -in. hole. A center for turning wood is also shown. Many centers, drills, etc., can be made of  $\frac{1}{2}$ -in. tool steel.

The tailstock, Figs. 4 and 5, is built up of three pieces of hard wood, 2 in. thick, and one piece, 1 in. thick, shaped as shown. These are held together with four bolts,  $7\frac{1}{2}$  in. long. It has sliders and is clamped to the bed in the same manner as the headstock, but only one bolt is used. A

handle is welded to the nut. This will make the clamping easy.

A piece of tubing, 2 in. long, is drilled for a  $\frac{1}{2}$ -in. dead center and inserted for  $1\frac{1}{2}$  in. between the two upper pieces, as shown in Fig. 6. A hole for a  $\frac{1}{2}$ -in. bolt is bored through the sections so as to allow the bolt to slide freely in the tubing. The top section is taken off and a place chiseled out just back of the tube for a  $\frac{1}{2}$ -in. nut. A bolt, 7 in. long and threaded for 2 in. of its length, is turned into the nut and tubing. A handle or wheel is riveted on the end of the bolt. The center is made of tool steel,  $\frac{1}{2}$  in. in diameter, with a tapering point. Other centers can be made of  $\frac{1}{2}$ -in. tool steel.

The tool rest, Figs. 7, 8 and 9, has a slide,  $\frac{3}{4}$  by 3 by 13 in., with a slot  $\frac{1}{2}$  by 6 in. The base of the rest is bolted on this slide so it can be adjusted. The rest is fastened on this base with screws. The height of the rest can be varied. It can be raised or lowered by inserting wedges between the slide and the rest base. The tool rest is clamped to the base the same as the tailstock.

The power for this lathe can be supplied by means of a countershaft, although a foot-power arrangement may be attached.—Contributed by E. E. Hulgan, Marion, Ind.

### To Reduce the Gasoline Consumption of an Automobile

Quite recently I tried out a method of reducing the consumption of gasoline in my automobile, and, as a result, have higher efficiency without resorting to any of the numerous and exceedingly costly devices on the market.

I procured a piece of wire screen, cut it in the shape of the gasket between the carburetor and the intake manifold, but leaving it blind, that is, with the screen across the inlet. I put this between two gaskets and fastened the whole back in place. The result was an increase of 3 miles per gallon of fuel.—Contributed by W. J. Weber, New York City.

### Cutting a Tin Ball from a Child's Finger

A three-year-old child found a globe of tin with a hole cut through the center, and—it is hardly necessary to state—immediately thrust his finger into the hole. But he could not get it out again, and the mother, accompanied by several other small children, brought the screaming child to my office. I found the hole had been punched, which caused three harpoon-like fragments to be carried into the center of the globe.

The mother in her attempt to remove it had caused the sharp points to enter the flesh of the finger in two or three places. Any attempt to pull

the ball off, drove the points of the harpoons deeper into the finger, and it was therefore a question of cutting the tin or the finger. But what kind of an instrument could I use on this tin globe?

I had nothing in my case that would cut it. My 35 years of medical experience gave me no help. The tin was as hard and smooth as a glass marble. Yet, it would have been ridiculous to be thus conquered by a tin whistle, so after some meditation I called to mind that I had a pair of heavy tinner's snips in the basement. By using the utmost care I succeeded in cutting a small incision in the round ball, and then with the points of the shears I cut the metal away from the finger.

Such an accident may come under the observation of any parent, and if so, he can use the same method to relieve the child where medical assistance is not near at hand.—Contributed by R. W. Battles, M. D., Erie, Pa.

#### Child's Seat for Theaters

As children must hold tickets for theaters the same as adults, but the ordinary chair is too low to permit a child to see the performance, an auxiliary seat such as shown in the sketch

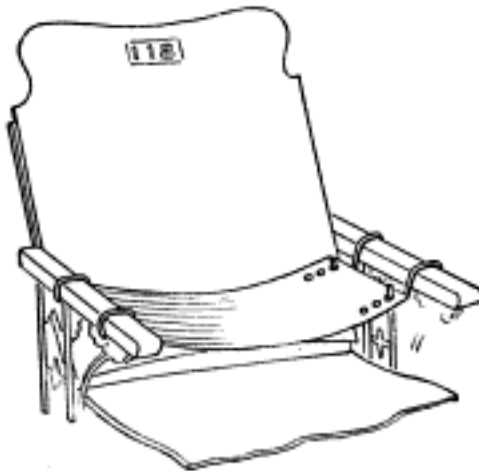

Seat in a Theater Chair

would sometimes be desirable as it elevates the child so its head will be on a level with those of other spectators. The seat is made of a strip of canvas with eyelets for wire hooks that fit over the arms of the ordinary theater

chair. It is necessary to have extra eyelets at one end of the canvas to adjust it to varying widths of seats.—Contributed by W. A. Jaquythe, Richmond, Cal.

#### Holding Spoon on a Hot Dish

After repeatedly burning my fingers in the attempt to prevent the spoon from sliding into the hot dish, I de-

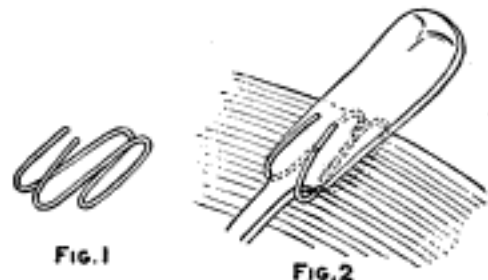

FIG. 1

FIG. 2

Spoon Holder on a Dish

ecided to do a little inventing on my own hook. Taking a clean, straight hairpin I bent it to the shape shown in Fig. 1, and after hooking it over the edge of the dish, I placed the spoon in it as shown in Fig. 2, and my troubles were at an end.—Contributed by Miss Genevieve Warner, Kalamazoo, Mich.

#### Locating Gas and Electric Fixtures in the Dark

A gas or electric fixture in the center of a room is quite hard to locate in the dark; more so if it is a single-light pendant. The location may be easily found if the fixture is marked as follows: Coat small pieces of cardboard on both sides with phosphorus and suspend them from the fixtures with small wires. No matter how dark the room may be, the phosphorus on the cardboard can be readily seen. The phosphorus is the same as used on matches and can be obtained from any druggist. The phosphorus, being poisonous, should be handled as little as possible, and, after using, should be returned to the water-filled jar in which it was received when bought. If left in the open, it may cause fire.—Contributed by Katharine D. Morse, Syracuse, N. Y.

## INTERESTING PATENTS,

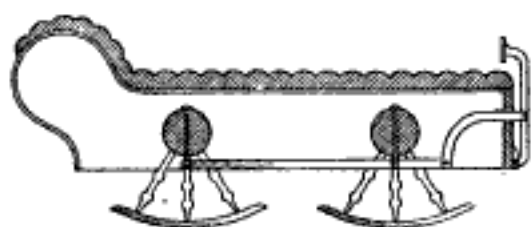

Fig. 1

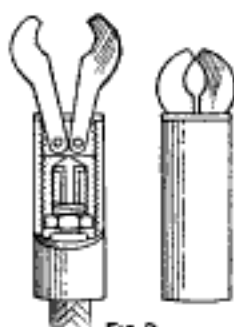

Fig. 2

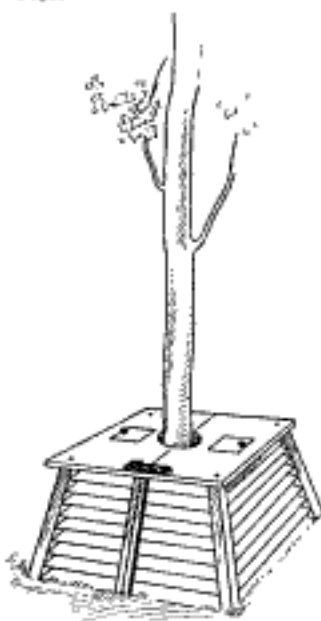

Fig. 3

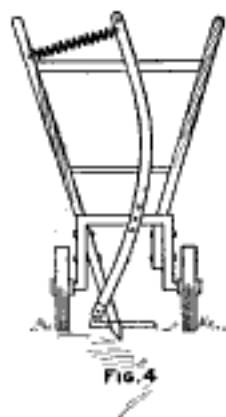

Fig. 4



Fig. 5

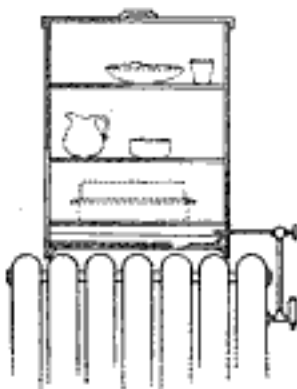

Fig. 7

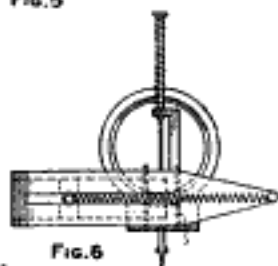

Fig. 6

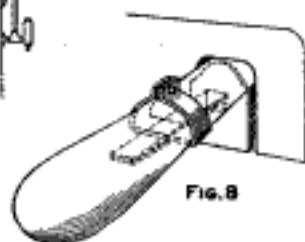

Fig. 8

**A ROCKER-COUCH**—An article of furniture thought worthy of a patent by an inventor of Asheville, N. C., is shown in Fig. 1. It is a rocker-couch, the body of which is supported by two sets of rockers. By means of foot pressure exerted against the lever at the lower end, the person reclining on the couch gives it a continuous rocking motion.

**UNIVERSAL TERMINAL CLIPS FOR SPARK PLUGS**—The opening in the brass jaws of this universal terminal (Fig. 2), is elliptic in form, giving secure hold on the thread of the plug in event of the top nut being lost. When the jaws are fully extended, the terminal will give a secure contact on a plug through the top cap in the event of the threaded post being broken off accidentally.

**FRUIT-TREE VENTILATOR**—Figure 3 shows a fruit-tree ventilator designed to circle the trunk of a tree at its base as shown. It is made in two sections, hinged at the back, and doors are carried in the top of each section to allow of access to the interior.

**CHOPPER AND THINNER FOR PLANTS**—One of the handles of this plant thinner (Fig. 4) terminates in a digger, and through a hole just above the digging point passes a blade, which is attached to a shift lever. The blade is arranged to actuate within the hole, a spring, extending between the upper end of the lever and one of the handles, keeping the blade-carrying end of the lever adjacent to the digging point. The machine is pushed along between the rows of plants in the same manner as an ordinary cultivator.

**PNEUMATIC TREAD FOR SHOES**—A low shoe, somewhat similar to an Indian moccasin in appearance, provided with an air cushion half-sole and heel, is shown in Fig. 5.

**MAGAZINE-NEEDLE FEEDER FOR DISK PHONOGRAPHS**—Figure 6 illustrates a device which facilitates the handling of the needles or points used with disk phonographs. The magazine, attached to an ordinary sound box or reproducer, holds 25 needles. After playing a record, all that has to be done is to push down the plunger and a needle is carried into the stylus or needle holder.

**RADIATOR COOKER**—A cooker for use with a steam radiator having an outlet passage provided with a relief valve for the escape of air or gas is shown in Fig. 7. The cooker comprises a main body or casing for holding articles to be heated or cooked, and pipe connections for conveying steam from the radiator to the cooker. The pipe contains a valve to control the passage of the steam.

**FOR PREVENTING MICE FROM ENTERING PIANOS**—The only unguarded openings through which mice can find an entrance into a piano are the pedal slots, and Fig. 8 shows a device designed to prevent this. Attached to the under side of the pedal by means of a band is an angle bar carrying at its inner end a plate, which normally closes the pedal opening in the foot board.

**A DIRIGIBLE OF UNUSUAL DESIGN**—Among the types of aerial craft being continually put forward by their respective inventors are many that are interesting simply because of some unusual idea of construction. Figure 9 shows such a dirigible, its unique point of interest being the house, windows and all, provided for the housing of the operating mechanism and for passengers. The inventor is depending upon two gas reservoirs and planes or wings for the lifting and control of his quaint craft. The upper chamber or attic of the house is open at both ends, and the current of air passing through this is expected to aid in sustaining the craft. The wings are attached to the corners of the house.

**COIL-COOLED SMOKING PIPE**—The inventor of this pipe (Fig. 10) believes he has solved the problem of a cool smoke. The distance between the bowl



## PRACTICAL OR UNIQUE

and the mouthpiece is materially lengthened without lengthening the pipe stem, this being accomplished by utilizing a spiral tube as the smoke passage. The tube is connected with the pipe bowl through the base of the bowl and is twisted around a solid pipe stem.

◆◆◆

**AUTOMATIC HORSE-FEEDING MACHINE**—

Figure 11 shows an automatic device for feeding grain to horses, which is operated and controlled by the lips of the animal in obtaining a mouthful. It prevents the animal from obtaining too large a mouthful and thus gulping or wasting its feed. The feed, kept in a supply box placed preferably on the second floor of the stable, is fed to the feeding machine by means of a chute, the flow being controlled by a suitable valve. The bottom of the feeding machine terminates in a circular feeding trough, which is pushed around by the lips of the horse as he eats. This trough is formed with crosswise or radial webs at its bottom so that, when the horse inserts its nose in the trough, the movement of his lower jaw or lip in the act of obtaining a mouthful of feed rotates it, thus causing more feed to be automatically discharged into it. The feeder may be attached to a post or wall by means of its bracket.

◆◆◆

**WEIGHING SCALE**—A weighing scale, made in both the postal and suspension types, but each having weights as a medium of balance, is shown in both types in Fig. 12. In the postal scale the standard is a combination of two telescopic members, and the telescoping of these members under the weight of the object placed upon the weighing table operates the weighted levers. In the suspension scale the same type of weight levers are used, but not the telescopic members. The supporting plate is held direct from the lever drums.

◆◆◆

**COMBINATION POLICEMAN'S CLUB AND EXTENSION REVOLVER BARREL**—A policeman's club which will likewise serve as an extension revolver barrel is shown in Fig. 13. A long pistol barrel passes through the center of the club and has suitable means of engagement with the revolver barrel at its inner end.

◆◆◆

**GRAVITY-FEED EMERGENCY DEVICE FOR AUTOMOBILES**—An emergency gravity-feed system for automobiles is shown in Fig. 14. An auxiliary supply tank is mounted near to and above the plane of the carburetor. A branch pipe extends from the main supply pipe to the auxiliary tank for refilling the same, and a check valve is located in the main supply pipe to prevent the return of the gasoline.

◆◆◆

**GLOVES PROVIDED WITH FINGER NAILS**

—Figure 15 shows a glove provided at the outer ends of the finger tips with separate rigid plates in imitation of finger nails. They are designed to provide extra protection to the ends of the fingers.

◆◆◆

**PROPELLER-GUARD**—A guard designed to protect the propellers of small boats from objects which might break the blades or become entangled with them is shown in Fig. 16. It consists of a number of horizontal rods spaced as shown.

◆◆◆

**POWER-TRANSMITTING DEVICE FOR AUTOMOBILES**—Figure 17 shows a means of power transmission for automobiles and other power-propelled vehicles, and particularly for motor plows. A motor-driven shaft runs longitudinally of the vehicle and is geared to both the front and the rear axles. The gear connection between the shaft and the rear axle includes a worm meshing with worm wheel keyed to the rear axle, while the gear connection with the front axle, which is the steering axle, consists of a worm on the shaft, which meshes with a worm wheel having a loose or swiveled connection with the front axle, whereby the front axle may swing or oscillate independently of the worm wheel. This flexible connection may also be applied to the rear axle if desired.

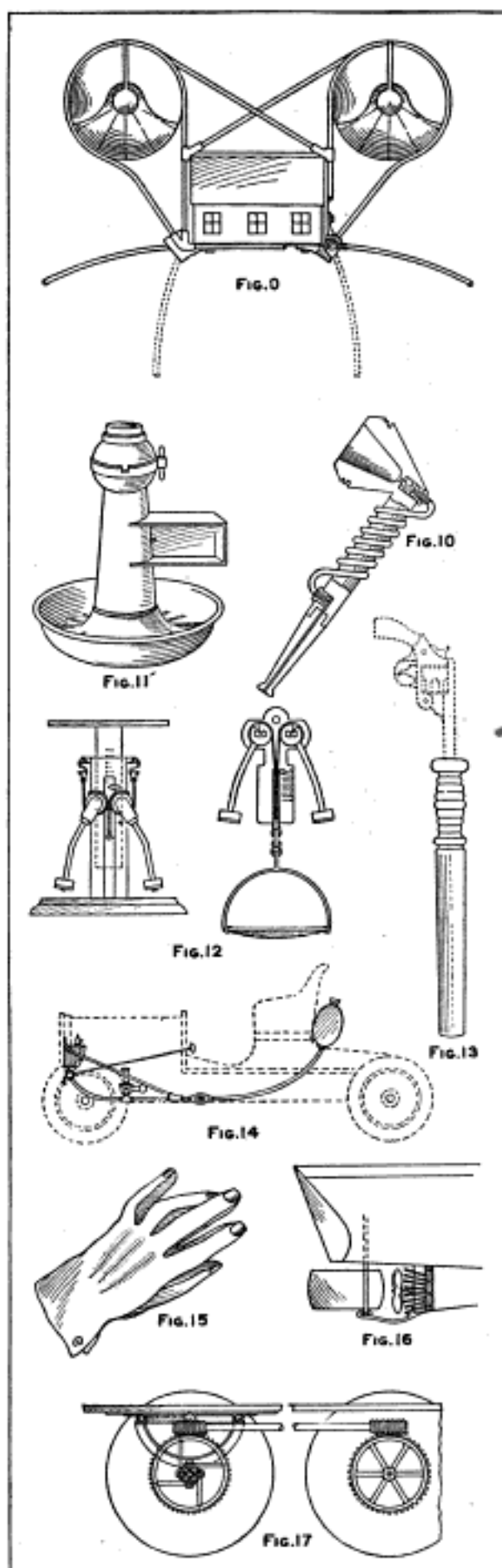

A BALTIMORE school teacher had encountered such a degree of ignorance on the part of one of her boys in relation to the recorded acts of the Father of his Country, that she grew sarcastic.

"I wonder," she began, "if you could tell me whether George Washington was a sailor or a soldier?"

The boy grinned. "He was a soldier, all right," he said.

"How do you know?" the teacher challenged.

"Because I saw a picture of him crossing the Delaware. Any sailor would know enough not to stand up in the boat."

So, you have two offers of marriage? Whom are you going to accept?

Oh, well, I guess I will marry the aviator first.—L'Aero.

Bill Sprague kept a general store at Croydon Four Corners. One day he set off for York to buy a lot of goods. The goods were shipped immediately, and as Bill had lingered in York sight-seeing, they reached Croydon Four Corners before him.

The goods, in an enormous packing case, were driven to the general store by the local teamster. Mrs. Sprague came out to see what had arrived and with a shriek tottered and nearly fell.

"Oh, what's the matter, Ma'am?" cried the hired girl.

Mrs. Sprague, her eyes blinded with tears, pointed to the packing case, whereon was stenciled in large black letters:

"Bill inside!"—Boston Traveler.

The Salesman:—Here is a machine exactly suited to a man of your corpulence. You will never have to get under it to make any repairs.

Buyer:—Is that possible?

The Salesman:—Yes, sir. If the least thing gets out of order in the machinery, the auto turns over of itself.

Lady—What! Thirty-eight cents a dozen for eggs! Why, that's more than three cents for one egg!

Grocer—Well, mum, you must remember that one egg is a whole day's work for one hen.—Ideal Farmer.

A colored preacher was vehemently denouncing the sins of his congregation. "Bred'ern an' sistern, Ah warns yo' against de heinous sin o' shootin craps! Ah charges yo' against de brack rascality o' liften pullets! But, above all else, breddern and sistern, Ah demonishes yo' at dis hyer season aginst de crime o' melon stealin'!" A brother in a back seat made an odd sound with his lips, rose and snapped his fingers. Then he sat down again with an abashed look. "Whuffo, mah frien'," said the preacher sternly, "does yo' r'ar up an' snap yo' fingahs when Ah speaks o' melon stealin'?" "Yo' jes reminds me, pahson," the man in the back seat answered meekly, "wha' Ah lef' mah knife."—San Francisco Argonaut.

"Why," writes one of those propounders of unanswerable questions, "does a girl always shut her eyes when a man kisses her?"

Send us your photograph and perhaps we can tell you the reason.—Toledo Blade.

Lunatics often assume a superiority of intellect to others which is quite amusing. A gentleman, while walking along a road, not far from the side of which there ran a railway, encountered a number of insane people out for exercise. With a nod towards the railway lines, he said to one of the lunatics:

"Where does this railway go to?"

The lunatic looked at him scornfully for a moment, and then replied:

"It don't go anywhere. We keep it here to run trains on."—Domestic Engineering.

"When I order poultry from you again," said the man who quarrels with his provision dealer, "I don't want you to send me any of those aeroplane chickens."

"What kind do you mean?"

"The sort that are all wings and machinery and no meat."

"What's that you call your mule?"

"I call him 'Corporation,'" answered the old colored man.

"How did you come to give him such a name?"

"F'm studyin' de animal and readin' de papahs. Dat mule gets mo' blame an' abuse dan anything else in de township, an' goes ahead havin' his own way jes' de same."—Express Gazette.

## NEW BOOKS

**NEW YORK AIR BRAKE SYSTEM**—374 pages; and **WESTINGHOUSE AIR BRAKE SYSTEM**—472 pages, form together a complete and up-to-date treatise on the two systems generally in vogue in America, with detailed descriptions of their various parts and a catechism of instruction in their construction, care and operation. The list of authorities consulted in the compilation of these two works offers a substantial guarantee of the correctness and thoroughness of the information and data given, and either or both should prove a welcome help to the prospective locomotive engineer. The books are uniform in size and appearance, 5½ x 8, cloth, and fully illustrated and indexed. Price \$2.00 each. Frederick J. Drake & Co., Chicago.

**THE UNITED STATES NAVY**—By Henry Williams, Naval Constructor, U. S. N. A little book, primarily intended as a source of information for relatives and friends of young men contemplating to enter the naval service, but of interest also to others who would learn something about the organization, personnel and equipment of this branch of our national defense, and of its routine and functions in peace and war. 220 pages, 5 x 7½, cloth, illustrated and indexed. \$1.50. Henry Holt and Company, New York.

**WOOD-TURNING. WOOD-WORKING MACHINES AND PATTERN MAKING**—By George H. Resides and Hugo Diemer, M. E., of the Pennsylvania State College. A textbook for university, college and technical high school shops, and for apprentice courses. 117 pages, 10¼ x 7½, cloth. With half-tone illustrations and working drawings. \$1.50 net. McGraw-Hill Book Company, New York.

**PHOTOGRAPHY: Its Principles and Applications**—By Alfred Watkins, F. R. P. S. A comprehensive treatise on this fascinating art from ordinary photography to color photography, including a brief outline of the underlying optical principles, and a chapter on the camera as combined with the microscope, telescope and X-ray machine. 333 pages, 5½ x 8, cloth, 98 illustrations, including a frontispiece in colors from an autochrome by the author; numerous formulas and an alphabetical index. \$2.00 net. D. Van Nostrand Company, New York.

**MODERN AMERICAN TELEPHONY**—By Arthur Bessey Smith, E. E. After a brief historical outline of the subject and an exposé of the underlying scientific principles, the author gives a complete treatment of modern telephone practice, installation, operation and maintenance, line construction, etc. The final chapters treat of automatic and wireless telephony. The whole is written in plain, easily understood language and is made still further intelligible by no less than 470 illustrations and diagrams. 700 pages, 4¼ x 7, leather, indexed. \$2.00. Frederick J. Drake & Co., Chicago.

**BEARINGS AND THEIR LUBRICATION**—By L. P. Alford, M. E., Editor American Machinist. Deals exhaustively with the difficult subject of friction and how it is overcome constructionally and by the use of lubricants. The treatment is not so much theoretical, as practical, for the book gives the actual results obtained from tests with various materials and lubricants under varying conditions of application and usage, thus presenting the facts on which modern practice in the design of bearings is founded. 235 pages, 6 x 9, cloth. With index, numerous illustrations, diagrams and tables. \$1.50 net. McGraw-Hill Book Company, New York.

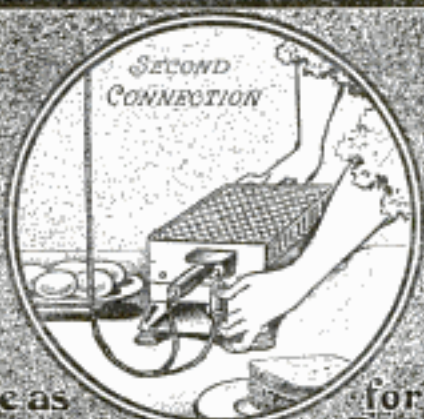

Safe as  
**ELECTRIC  
LIGHT**

for the  
**DINING  
TABLE**

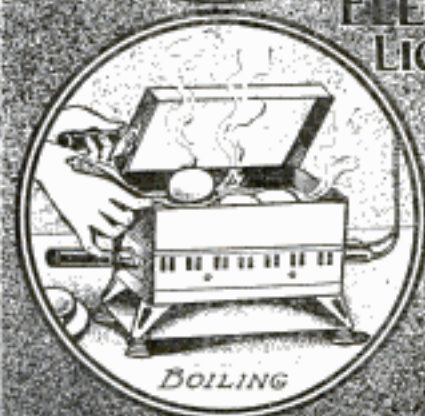

*A Few of Many Uses*

## The G-E Radiant Electric Grill

This new Electric Grill is really a miniature range that grills as well as fries, toasts, boils and bakes pancakes. Other small electric devices, boil, fry or toast but the G-E Radiant Grill is the first practical device that grills also.

Chops, steaks and fish are grilled *underneath* visible coils of wire that grow red hot the minute the current is turned on.

As shown above, the coil section can be lifted with one hand while the chop is turned or tested with the other. This Grill takes its electricity from *any* lamp socket, hence it is always ready for use. For the busy hostess, college girl, bachelor maid or bachelor, this Grill has a greater range of uses than any other electric convenience of its size.

*The Heat Produced by "Calorite"*

**\$8.50**

Of all the substances that change electricity into heat "Calorite" is the standard. "Calorite" is used *only* in G-E heating and cooking appliances—for example, in the half million G-E Flatirons in use everywhere. The "Calorite" heating coils in the G-E Radiant Grill insure its permanent superiority over all similar devices.

Handsomely finished in nickel and supplied with frying pan, stew pan, and all necessary attaching plugs, etc., the G-E Radiant Grill sells for only \$8.50. If your nearest lighting company or electrical supply dealer cannot show it to you, write us. Be sure to state the voltage of your lighting circuit.

*"Electric Heating and Cooking," a 64-page book illustrated in colors, will be sent to any adult mentioning this advertisement.*

## General Electric Company

Dept. 66-H, Schenectady, N. Y.

*The Guarantee of Excellence on Goods Electrical is the monogram trade mark of the General Electric Company*

3397

*Please Mention Popular Mechanics*

Copyrighted material

# No-Rim-Cut Tires

## Proved Average Oversize, 16.7%

Goodyear No-Rim-Cut tires are advertised as "10 per cent oversize."

We claim that this oversize adds 25 per cent to the tire mileage.

The actual oversize, over five leading makes, was lately **found to average 16.7 per cent.**

Note the table below.

Oversize is not measured by calipers. It is measured by air capacity. Air carries the load.

Note that only three tires in these 20 comparisons came within 10 per cent of our size.

That's because No-Rim-Cut tires have the hookless base. Your removable rim flanges, with these tires, turn **outward** instead of **inward**. Thus the tire has an extra flare.

Each one per cent oversize means one per cent extra carrying capacity.

Oversize means to save blow-outs—to increase tire mileage—to cut down tire expense.

Yet these oversize tires which can't rim-cut now cost no more than other standard tires.

### Last Year

The sale of Goodyear tires exceeded the previous **12 years put together.**

We sold enough last year to **completely equip 102,000 cars.**

No-Rim-Cut tires now far outsell any other type of tire.

Just because these two features—No-Rim-Cut and oversize—cut tire bills right in two. And tens of thousands of users have proved it.

### Comparison of Sizes Between Six Leading Makes of Tires

Rated Size	Make	Cubic Cap'ty	No-Rim-Cut O'ersize	Rated Size	Make	Cubic Cap'ty	No-Rim-Cut O'ersize
30x3	1—No-Rim-Cut	489	in.	34x4	1—No-Rim-Cut	858	in.
"	2—	402	"	"	2—	762	"
"	3—	381	"	"	3—	760	"
"	4—	371	"	"	4—	733	"
"	5—	383	"	"	5—	822	"
"	6—	365	"	"	6—	794	"
32x3½	1—No-Rim-Cut	637	"	36x4½	1—No-Rim-Cut	1190	"
"	2—	603	"	"	2—	966	"
"	3—	577	"	"	3—	1064	"
"	4—	536	"	"	4—	1025	"
"	5—	577	"	"	5—	1055	"
"	6—	546	"	"	6—	1080	"

Average No-Rim-Cut Oversize, 16.7%

# No-Rim-Cut Tires

## 127 Leading Makers Adopt Them

For the year 1910, 44 leading motor car makers contracted for Goodyear tires.

For the year 1911, 64 makers came to them.

For this year we have contracts from the makers of **127 leading cars.**

That shows how car makers—the shrewdest of experts—have come to the Goodyear tires.

As for users, the demand in the past two years has multiplied six times over.

Tens of thousands of users have told tens of thousands of others how their tire bills were cut in two.

Now more motor car owners buy these patented tires than any other tires in existence.

Tires can never be made, in our estimation, better than Goodyear tires of today.

Then No-Rim-Cut tires make rim-cutting impossible.

With old-type tires—clinchers—23 per cent of all ruined tires are rim-cut.

All that ruin is saved—all that worry avoided—by the use of No-Rim-Cut tires.

Even 10 per cent oversize, under average conditions, adds 25 per cent to the tire mileage. And our oversize, as shown by the table, averages 16.7 per cent.

These two features together—No-Rim-Cut and oversize—under average conditions cut tire bills in two.

### The Saving

No-Rim-Cut tires are the final result of 13 years spent in tire making.

Year after year we have been constantly learning by wearing out tires on tire-testing machines.

We have compared in this way hundreds of fabrics and formulas, methods and processes, until we knew what was best.

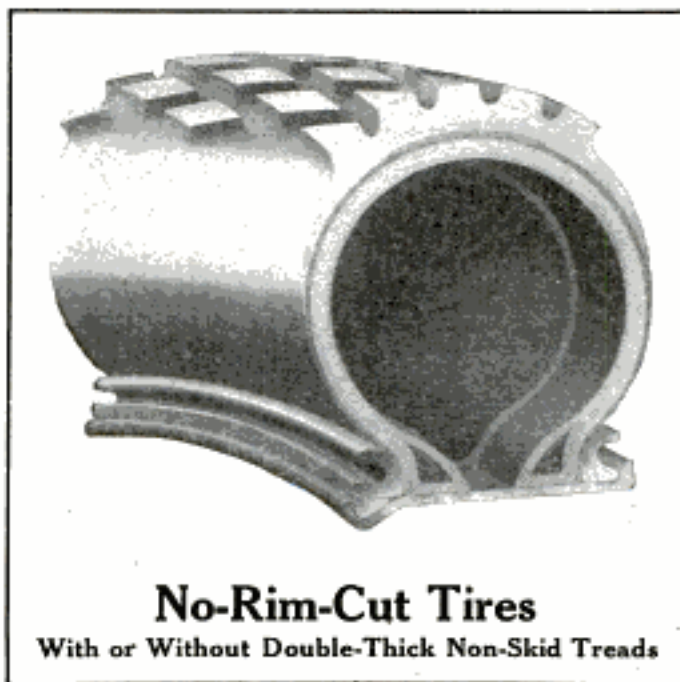

### No-Rim-Cut Tires

With or Without Double-Thick Non-Skid Treads

### No Extra Cost

No-Rim-Cut tires, when first brought out, cost one-fifth more than other standard tires. Now they cost but an equal price.

So the saving they make is entirely clear.

That's why every tire user who knows the facts insists on No-Rim-Cut tires.

Our Tire Book, based on 13 years of tire making, is filled with facts you should know. Ask us to mail it to you.

**THE GOODYEAR TIRE & RUBBER COMPANY, AKRON, OHIO**

Branches and Agencies in 103 Principal Cities

We Make All Kinds of Rubber Tires, Tire Accessories and Repair Outfits

Main Canadian Office, Toronto, Ont.

Canadian Factory, Bowmanville, Ont.

(462)

# More Than A Million Miles

**F**OR four years, individual owners have been putting their Winton Six cars through an exhaustive test. These owners have sent us monthly reports of miles traveled and repair expense incurred, and have sworn to the accuracy of their reports.

The result is a record of direct interest to men who own motor cars and pay repair bills.

For this record shows that, when you own a car as good as the Winton Six, you are practically free from repair expenses and from the annoyance and the humiliation that repair expenses carry with them.

## World's Record Cars

Our complete records cover 170 cars, standard Winton Sixes, manufactured in 1907, 1908, 1909, 1910, and 1911.

Fifty of these cars made the world's lowest repair expense record of 22.8 cents per 1000 miles. We have already advertised these figures.

The natural thought is that the other cars "didn't do as well." But let's see.

## Ran Without Expense

Sworn records show that 46 other cars (cars not included among the world's record cars) traveled 400,000 miles, averaging 8750 miles

each, without incurring a single cent of repair expense.

These cars were not placed by the judges among the world's record cars because the world's record cars averaged a greater distance (14,800 miles each), and with so little expense that it was practically nothing at all.

## Poorest Performances

Now consider the worst performances of all.

There were 27 cars whose repair expenses were high—\$65.87 per car on total mileage of 300,000 miles, or 11,000 miles each.

Nothing much to be proud of in that record—because the other Winton Six records are so much better.

## Still Other Cars

There were still other cars—47 of them—among the 170. These 47 cars, not otherwise classified, traveled more than 425,000 miles, or 9000 miles each, at a total repair expense of \$300, averaging \$6.39 per car, or 70 cents per 1000 miles. A fine performance.

## More Than a Million Miles

How exhaustive this four-year test has been is shown by the mileage.

**Complete Record of All Cars Traveling 5000 Miles or More Each in the Four Annual Winton Six Upkeep Tests of 1908, 1909, 1910, and 1911**

CLASSIFICATION	Number of Cars	MILEAGE		REPAIR EXPENSE		
		Total Miles	Average per Car	Total	Average per Car	Average per 1000 Miles
Cars making the world's lowest repair expense record . . . . .	50	744,426.2	14,888.5	\$ 170.27	\$ 3.41	\$0.228
Cars making the poorest records . . . . .	27	299,896.1	11,107.2	1,778.42	65.87	5.93
*Cars running without repair expense . . . . .	46	402,801	8,756.5	.....	.....	.....
Cars not otherwise classified . . . . .	47	426,668.5	9,078	300.53	6.39	.70
Totals for four years . . . . .	170	1,873,791.8	11,022.3	\$2,249.22	\$13.23	\$1.20

\*Not included in any other classification.

All these cars ran in the individual service of their owners, who made sworn reports of mileage and repair expense.

The Winton Co. guarantees every statement made in

## WINTON SIX

advertising to be true without qualification.

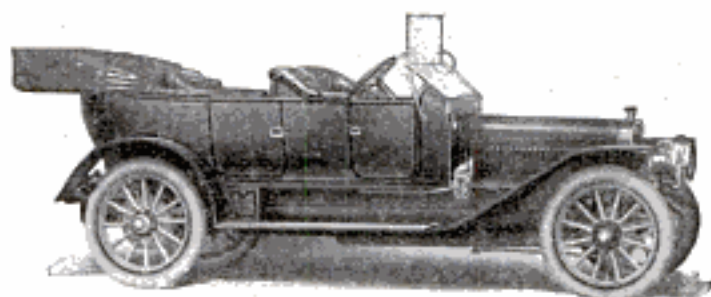

These 170 cars averaged 11,000 miles each (more than three times the distance across the American continent), and traveled a total distance of 1,873,791.8 miles.

That's a distance almost beyond comprehension.

It is 580 times the distance from New York to Paris.

Or, almost 75 times the distance around the earth at the equator.

And nearly eight times the distance from here to the moon.

### Wonderful Expense Figures

Sworn reports of the owners of these 170 cars place the total repair expense for this marvelous mileage at \$2249.22, which is less than the purchase price of one Winton Six.

The average repair expense for each car was \$13.23 for 11,000 miles, or—

Just \$1.20 per car per 1000 miles.

And that's less than one-eighth of a cent per mile.

### Expense is the Acid Test

Repair expense is the acid test of a car's merit.

As every owner knows.

For the merit that enables a car to keep down repair expense is in the *car itself*.

This test of more than a million miles, participated in by 170 Winton Six cars and 170 Winton Six owners, shows the merit of the Winton Six.

You would be happy if your car were a Winton Six.

### Same Model: Fifth Year

We are the pioneer makers of sixes exclusively.

Our present model is the same car we have made for four years *without a single radical change*. Now in its fifth season.

It is the original self-cranking car: has been a self-cranking car since June, 1907. Our self-cranking motor is no experiment.

This car represents all the quality a motor car can have, and because we do business on bed-rock business principles we can sell it profitably at \$3000.

If you want to know its worth, compare the \$3000 48 H. P. Winton Six with cars priced as high as \$5000 and \$6000.

And remember that the Winton Six is the only car in the world whose repair cost is definitely known through the sworn statements of individual owners.

We shall be glad to send you our Upkeep Book that gives the million-mile facts and figures in detail, together with our thoroughly descriptive catalog.

## THE WINTON MOTOR CAR. CO.

The World's First Makers of Sixes Exclusively

24 Berea Road, Cleveland—Sixth City

NEW YORK	Broadway at 70th St.
CHICAGO	Michigan Ave. at 13th St.
BOSTON	674 Commonwealth Ave.
PHILADELPHIA	246-248 N. Broad St.
BALTIMORE	Mt. Royal at North Ave.
PITTSBURGH	Baum at Beatty St.
CLEVELAND	1228 Huron Road
DETROIT	998 Woodward Ave.
MINNEAPOLIS	16-22 Eighth St., N.
KANSAS CITY	3324-3326 Main St.
SAN FRANCISCO	300 Van Ness Ave.
SEATTLE	1000-1006 Pike St.

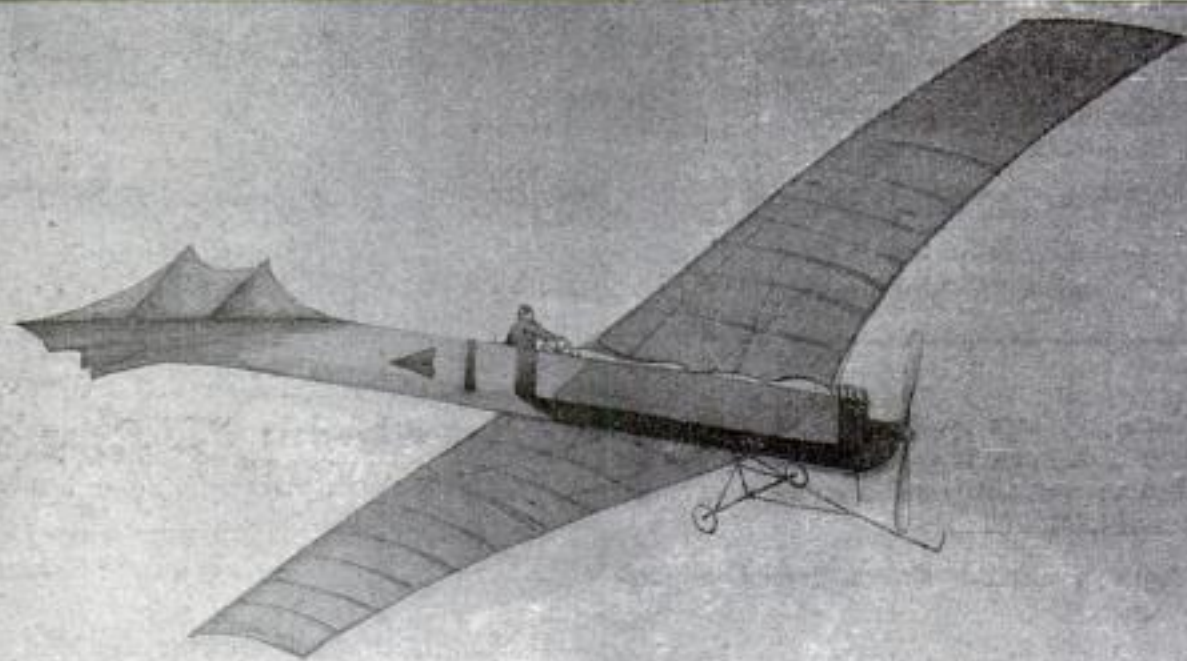

# Nothing is Impossible

Nothing is impossible to the man with ambition! It does not make any difference what you want to do, there is a way to do it.

You may think it impossible to have your earning power doubled, tripled or quadrupled, but the realization of such an ambition is no more impossible than flying from New York to Los Angeles—telephoning from New York to Denver—or telegraphing without wires from San Francisco to Japan, all of which has been done within the last year.

Ambition knows no obstacles.

Ambition will find a way.

First say, "I *can* do it," then say, "I *will* do it."

When your *will* begins to work, nothing can stop you.

But your *will* must be directed by your mind. Train your mind along the lines of your chosen work. *Learn* more—and you will pass by all those who are satisfied with what they have.

**To see how easy it is to do this, read the next page**



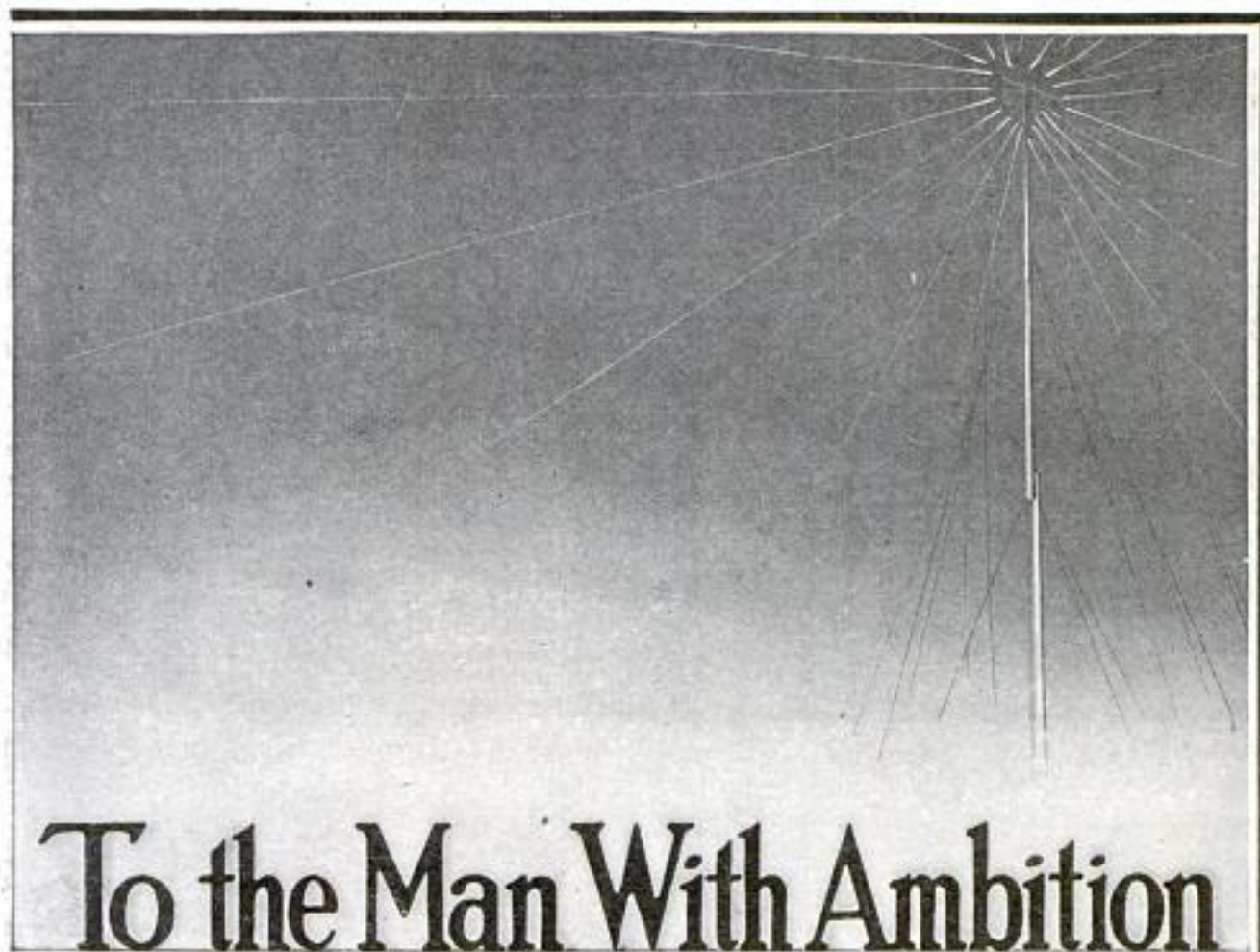

# To the Man With Ambition

The International Correspondence Schools offer to men with ambition, the opportunity to make their dreams come true. Thousands of ambitious men are now taking this short cut to better positions—to greater home comforts—to a higher standing as citizens.

An hour of your spare time each day is surely a small payment for special training that will put you at the top of your business or profession.

Now if you have said, "I CAN DO IT"—say, "I WILL DO IT," and the I. C. S. will help you to succeed. Just mark the coupon, for that is the first step.

This step will bring you, without any obligation on your part, all particulars as to how the I. C. S. trains you for success and the realization of your ambition.

Now is the time to start.

If you wait until tomorrow you have wasted a whole day.

## INTERNATIONAL CORRESPONDENCE SCHOOLS

Box 872, SCRANTON, PA.

Explain, without further obligation on my part, how I can qualify for the position before which I mark X.

Automobile Running	Civil Service
Mine Superintendent	Architect
Mine Foreman	Chemist
Plumbing, Steam Fitting	Languages
Concrete Construction	Commercial English
Civil Engineer	Building Contractor
Textile Manufacturing	Architectural Draftsman
Stationary Engineer	Industrial Designing
Telephone Expert	Commercial Illustrating
Mechan. Engineer	Window Trimming
Mechanical Draftsman	Show Card Writing
Electrical Engineer	Advertising Man
Elec. Lighting Supt.	Stenographer
Agriculture	Bookkeeper
Electric Railways	Cotton Manufacturing
Structural Engineer	Woolen Manufacturing
H. R. Construction	Toolmaking
Metal Mining	Foundry Work
English Branches	Pattern Making
Gas Engineer	Blacksmithing
Foreman Plumber	Surveyor
	Poultry Farming

Name \_\_\_\_\_

Present Occupation \_\_\_\_\_

Street and No. \_\_\_\_\_

City \_\_\_\_\_ State \_\_\_\_\_



PRICE COMPLETE  
AS ILLUSTRATED  
**\$98<sup>00</sup>**

INVESTIGATION  
UNDER THE  
**SPOTLIGHT**

PROVES  
THE VALUE OF  
OUR

**LATHES**

MORE  
FOR YOUR  
MONEY  
THAN CAN  
BE HAD  
ANY-  
WHERE  
ELSE

**WE  
SAVE  
YOU**

**\$25<sup>00</sup> TO \$75<sup>00</sup>**

ON A LATHE  
ACCORDING TO SIZE

**OUR LATHES ARE MADE TO  
SATISFY EXPERT MECHANICS**

**THEY ARE GUARANTEED ACCURATE  
STRONG AND UNEXCELLED IN WORKMANSHIP**

WRITE FOR OUR **Machinery Catalog "E"** MAILED FREE ON REQUEST

IT TELLS YOU WHERE TO BUY THE BEST MACHINERY  
AT THE LOWEST POSSIBLE PRICES

We Can Furnish Either Foot or Engine Power Lathes

**ADDRESS SEARS, ROEBUCK AND CO., CHICAGO, ILL.**

# \$50. will tip the Scales

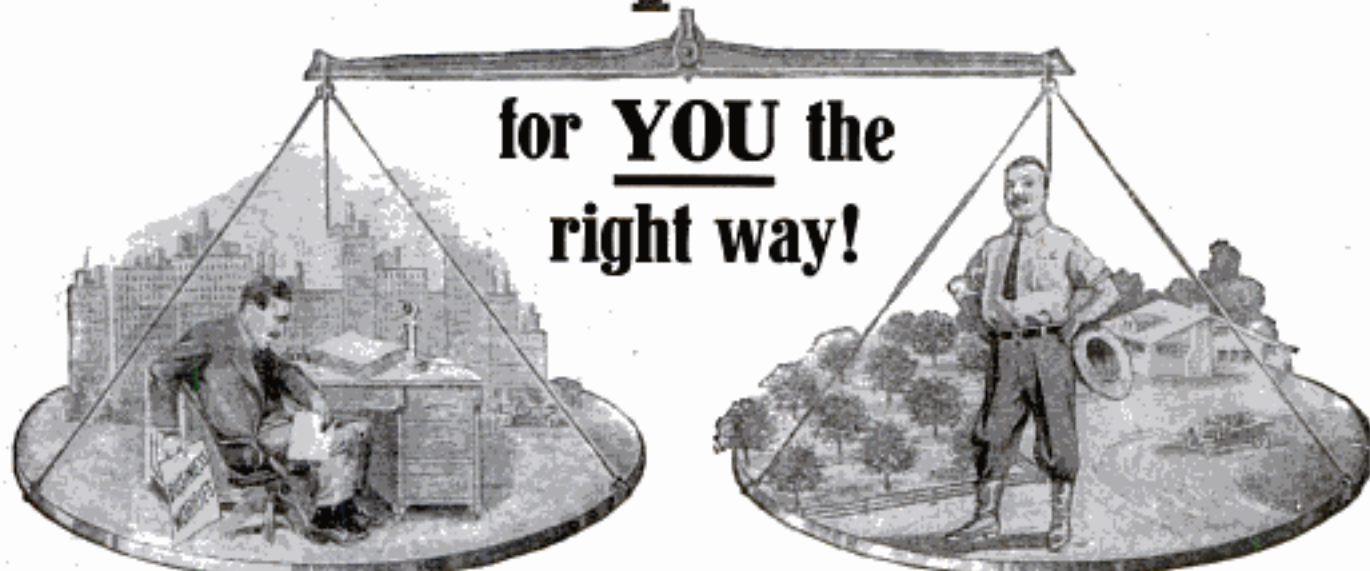

## \$5,000 a Year Income—Six Months Vacation

**I**F YOU are tired of the nerve racking grind of the city: If you see no future before you: If you crave the outdoor life where you can work under cloudless skies, breathe fresh air and enjoy the balmy sunshine, we can interest you. We know we can for our proposition offers all that you have been longing for and very much more for it offers the way to secure a yearly income of \$5,000 for life. It's a good business that permits six months of fishing, hunting or traveling with your family and provides plenty of funds to enjoy it, but that's what a full bearing apple orchard in the Bitter Root Valley will do. \$50 and a present fair income will start you on the way. Are you ready?

### Our plan of selling

#### Improved Orchard Tracts

practically amounts to loaning you \$2,500 to \$5,000 with which to buy and cultivate a 5 to 10 acre orchard on improved, well irrigated land, in the most famous apple growing region in the world!

The Sunnyside Bench Lands on which our tracts are located, are the very garden spot of the Bitter Root Valley!

They are the best situated as to city advantages, schools, universities, churches and amusements. Big game abounds in the adjacent mountains, fine fishing is found in the waters of the valley.

You must get our printed literature, and read to appreciate the full details of the ideal soil and climatic conditions which make this region the finest apple growing region in the world; together with statistics of undeniable facts of production, all endorsed and supported by the highest authorities in the world, including government reports, horticultural experts and practical orchardists.

#### Everything Conducive to Perfect Fruit

Our tracts are abundantly irrigated from a great irrigation system costing nearly \$4,000,000. The drainage is perfect. The apples grown there are hardy and perfect—as one government official observed, "not one worm in a hundred thousand boxes," big, bright, sound, toothsome fruit, ideal for export as well as domestic markets.

There are no destructive frosts; wormy fruit and crop failures are unknown. Transportation facilities splendid, social atmosphere and living conditions ideal, climate perfect, cool nights and long, sunshiny days. Everything that tends to health, happiness and prosperity.

#### \$5,000 Yearly for Life from 10 Acres

A Bitter Root apple orchard bears commercially in its fifth year. Ten acres, fully developed, will return you during early maturity, strictly net, a profit of from \$2,000 to \$5,000 yearly. Beginning with the tenth year from planting, judged by experience of others, 10 acres will net you

an income of \$5,000 yearly and employ only half your time.

If you have a fair-sized income now and are willing to improve your condition, you do not need capital to possess one of these big-paying orchards.

#### Our Proposition and Plan

briefly stated, is this: We will sell you a choice 10 acre Orchard Home Tract, already planted (spring of 1911) to best standard varieties (all apples, or apples and cherries)—with the company's definite, written contract to care for and develop your orchard under expert horticultural supervision for 5 years from date of planting, including all land taxes and irrigation charges—for \$500 an acre.

The land will easily be worth, conservatively stated, in fair comparison with other improved lands, \$1,000 an acre. There's a clean profit to you of 100% on a 5 year investment, at the outset. Only a \$50 cash payment required now to secure your orchard tract—balance in easy payments divided over a ten-year period. Your payments for the next few months are practically all the cash outlay you will have, as your orchard tract will pay for itself during the buying period and yield you a handsome profit besides!

Fractional orchard tracts of 5 acres and over at proportionate prices and easy terms—(\$25 monthly for 5 acres.)

Our orchard contracts contain the fairest and most liberal features ever offered you.

#### Responsibility of Our Company

We are the largest orchard planters and growers in the Northwest.

Our guarantees and contracts are as good as bonds for we have assets of over \$5,000,000; our lands are paid for; we are not hampered with debts, encumbrances or other "promotive" needs. We have plenty of money to finance both ourselves and our buyers. Buying these Bitter Root Valley Orchard Home Tracts is like buying government bonds on easy payments—except that the returns are infinitely larger, and you are at the same time making a future ideal home for yourself and family!

Here is the chance of a lifetime you have been looking for—it demands your consideration. We invite your fullest investigation. START TODAY by writing for our FREE ILLUSTRATED BOOK and get the whole interesting story.

## BITTER ROOT VALLEY IRRIGATION COMPANY

R. S. LEMON, General Sales Manager

838 to 846 First National Bank Building, Chicago, U. S. A.

Please Mention Popular Mechanics

# The Open Doors



## On the Bell Highway

The Bell system opens more than six million telephone doors, so that each subscriber can talk with any other subscriber.

It provides a highway of universal communication to open and connect all these doors.

It also furnishes the vehicle for use on this highway, to carry speech from door to door throughout the land.

The Bell highway is used daily by more than twenty million people—all telephone neighbors—by means of universal service.

AMERICAN TELEPHONE AND TELEGRAPH COMPANY  
AND ASSOCIATED COMPANIES

**One Policy**

**One System**

**Universal Service**

*Please Mention Popular Mechanics*

# My Famous Anti-Nicotine Pipes at Forty Cents Each, Three for a Dollar

**Or Two Pipes and My  
Fifty Cent Lighter for \$1.00**

Handsome  
Models!

*I want thousands to know how a smoke  
can be improved by the construction of  
a pipe and by the materials put into it.*

**S** MOKERS talk about the flavor, aroma and smoothness of tobacco. I know tobacco—so listen to me. A lot of that flavor, a lot of that aroma and a lot of that smoothness is *made or killed* by the pipe you smoke. Everybody knows it. I know men who have spent years trying to find a pipe they could smoke—and who today consider my scientifically-made Anti-Nicotine Pipes simply wonders! Some of them have actually given up other forms of smoking.

## My Pipes Kill the Poison as Well as Improve the Smoke

Here's my original Anti-Nicotine Pipe at the top of this advertisement, and my new Anti-Nicotine Calabash Pipe at the bottom of this advertisement. In both these pipes I put the famous bowl that does the work—that makes the nicotine disappear. This bowl is made of a material as old as the

Babylonians, a material that is like clay, a special composition first discovered by the ancients. This material is as hard as any clay, but it has a peculiar porous quality—just like the finest meerschaum—which *absorbs* the nicotine, keeps it out of your system and uses it to give the pipe a beautiful meerschaum coloring. I know that this special low price cannot blind you to the *quality* in these pipes. I know that the value to the health and enjoyment of my customers of these perfectly-made pipes, will get me twenty more customers every place that I send one now.

## ANY THREE FOR A DOLLAR

Above is my popular claw design—the kind you see at the rich men's clubs. And below I show my new Calabash, modeled after the original African Calabash Gourd, graceful and highly finished, trimmed in German Silver. The claw design colors like the finest Meerschaum; the Calabash colors and looks *exactly* like the genuine African article which sells anywhere from \$3.00 up. With them there is no burning the tongue—no charred wood fumes—no disgusting odor—and you do not have to "break them in." Any three for a dollar. Choose two of one design and one of the other, or all three of the same—just as you desire. I will sell these pipes to you at 40 cents each or three for a dollar. Order now—know that if you are not entirely satisfied, your money will be returned cheerfully. This offer holds good for this time only. Send the Coupon now.

My handsome illustrated 1912  
Smokers' Book sent FREE  
with every order.

**H. MENGES**  
The Smoker's Friend  
650 Menges Bldg.  
ST. LOUIS  
MO.

## THIS HANDY POCKET LIGHTER



50 cts.  
Alone  
With  
Two  
Pipes  
\$1.00

Claw is Design  
A, Calabash is  
Design B

**H. MENGES**  
650 Menges Bldg.  
St. Louis, Mo.

Enclosed find 40 cents for one, \$1.00 for three of your Anti-Nicotine pipes or two pipes and pocket lighter. Please send Design A.....Design B..... (State how many of each design wanted.) It is understood that if I do not like the pipe or pipes I am to return the goods and receive my money back in full. For the Lighter alone send 50 cents.

NAME.....  
ADDRESS.....  
TOWN.....  
STATE.....

CUT  
OUT  
AND  
MAIL  
TODAY



Next to your choice of a car, your choice of a lubricant is the most important thing. Poor lubrication will ruin the best car in the world.

**POLARINE** is the oil on which you can always depend for efficient service.

"We'll be all right now; I've got some **POLARINE**."

**CARBON  
PROOF.**

# Polarine

**FROST  
PROOF**

Polarine meets every fair demand that can be made on it, no matter how severe. It never thins out and loses its body.

It makes your motor deliver every possible ounce of power, with lessened friction and wear.

It puts an end to your troubles with carbon deposits on cylinders, valves and spark-plugs.

What Polarine Oil is to the motor, Polarine Transmission Lubricants and Polarine Greases are to the other wearing surfaces of your car.

**FULL EFFICIENCY. ABSOLUTE UNIFORMITY.  
PERFECT LUBRICATION.**

*Send for the Polarine Booklet to the nearest agency of the*

**Standard Oil Company**

(Incorporated)



# "You're the man I want"



**PRESIDENT:** "You're the man I want! And I want you to know why I chose you from among the 40 men who were after the job."

**YOUNG MAN:** "I would like to know, sir."

**PRESIDENT:** "There were several men with records just as good as yours, but—you are the cleanest cut man of the bunch. I want to have men like you around me, and I'm not ashamed to have your kind represent the house. My rule is, *clear the way for the man with the clear record and the clean look.* Remember that, young man, remember that, if you want to get ahead."

There you have it! Promotion to the "clean cut" man; the man with the clear skin. Is your skin clearer, cleaner and more wholesome than the average? Don't be content with soap-and-water cleanliness. Be "Pompeian clean." Discover for yourself how Pompeian Massage Cream makes a healthy, attractive skin because of its marvelous powers to cleanse the pores and exercise the facial muscles.

## POMPEIAN MASSAGE CREAM

Here is the test that has made millions of enthusiastic users of Pompeian. Get your face just as clean as old-time methods will permit. Then apply a pinch of Pompeian to your face. Rub it gently, but firmly. It disappears into

the pores. Massage a moment longer. Out comes the Pompeian, and with it comes the hidden pore-dirt. The darkened, dirt-laden cream astonishes you. That was the dirt which soap and water couldn't reach.



All dealers 50c, 75c, \$1

Make the test. If it doesn't convince you of the merit of Pompeian and its necessity as a complete cleanser of the face pores, then we have nothing more to say. A skin which is "Pompeian clean" means a clear, clean, fresh complexion. "Clear the way for the man with the clear record and the clean look. Remember that, young man. Use Pompeian." All dealers.

### TRIAL JAR

Sent for 6c (stamps or coin). Find out for yourself, now, why Pompeian is used and prized in a million homes where the value of a clear, fresh, youthful skin is appreciated. Clip coupon now.

*Cut along this line, fill in and mail today*

The Pompeian Mfg. Co., 149 Prospect St., Cleveland, O.

Gentlemen:—Enclosed find 6c (stamps or coin) for a trial jar of Pompeian Massage Cream. (M)

Name .....

Address .....

City..... State.....

Please Mention Popular Mechanics



NEW YORK OFFICE, 359 BROADWAY

**F**OR SIXTY-FIVE YEARS the firm of MUNN & CO. has conducted the largest patent practice in the country. We file thousands of applications for patents every year. Our system is so perfected that every case receives the best of attention and is prepared by experts who have had special training in handling every class of invention.

¶ **SEND SKETCH.** If you will send us a sketch, no matter how crude, we will give you a fair and candid opinion as to whether it is probable a patent can be obtained. All matters of this kind are strictly confidential and the description and sketches will be dated and placed in our secret archives for future reference. This service and our Hand Book on Patents are free if you will write us at once.

¶ **QUALITY.** The quality of our work has given us an unrivalled reputation among Patent attorneys and we are the recognized American attorneys for many leading Foreign Patent Solicitors. Our staff consists largely of Examiners from the United States Patent Office, who are therefore familiar with the latest procedure and the best practice. Our draftsmen are all expert mechanical constructors who are able to show the invention in operative form.

¶ **FREE NOTICE.** All patents secured through our house receive a free notice in the **SCIENTIFIC AMERICAN**. No better or more economical method of introducing your invention to the attention of the public could be devised.

¶ **OUR OFFICES.** Our Washington office is located in our own building, near the Patent Office. This permits of our attorneys making special oral arguments with the Patent Office Examiners—an advantage not enjoyed by local attorneys.

¶ We are prepared to conduct Interference Proceedings, Infringement Suits, give Validity Opinions, draw up contracts and attend to all branches of legal work connected with Patents, Trade Marks, etc.

¶ We do not offer prizes or other specious inducements, but rely upon our recognized reputation of over half a century. Our fees are as low as is consistent with good work.

**WASHINGTON OFFICE**  
625 F Street, N. W.  
Washington, D. C.

**MUNN & CO., Attorneys**  
359 Broadway, New York, N. Y.



WASHINGTON OFFICE

Please Mention Popular Mechanics



# You Can Have this Chair for 3 Cents a Day!

**This is addressed to you regardless of your position**

It is as important to the family whose income is \$6 a week as to those whose income is \$6,000 a year.

It makes no difference where you live, or how you are employed, we want you to know the best way—the new way—of buying home furnishings.

We have over a million customers. Our customers increase as more people learn our way of doing business, because they find ours the most profitable, dignified way of shopping by mail. Our million customers furnish their homes from our catalog—buy what they want—when they want it—pay as convenient.

**For 3 Cents a Day** you may have the splendid rocker shown at the top of this advertisement. It will prove one of the best investments you ever made. The smooth running guides assure perfect and easy action, and the heavy construction makes it extremely durable. Your local dealer would have to ask about double this price.

**For 8 Cents a Day** you can have all the articles illustrated. This includes the splendid rocker—the bed outfit—and the kitchen cabinet. All are best workmanship and we guarantee our price will save you up to 50%.

## We Sell Everything on Charge Account

Our business is conducted on an original "charge account" plan. We now have charge accounts with satisfied people in all walks of life, including:

Plumbers  
Lawyers  
Seamstresses  
Railroad Men

Telegraphers  
Draymen  
Mill Hands  
Teamsters

Laborers  
Merchants  
Firemen  
Housewives

Mechanics  
Brick Layers  
Carpenters  
Etc., Etc., Etc.

So you see this business is "a business for the people." We sell to all classes and everyone is welcome to an open charge account for whatever they require or desire.

### A Year to Pay

Our customers take an average of twelve months to pay for what they buy. Some take longer—some less—depending upon the amount of their purchases. There is no interest to pay, no notes to sign—no contract or mortgage, no extra charge of any kind—"charge account" prices the same as for cash.

### The World's Greatest Home Furnishers

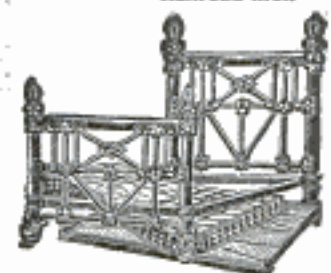

**2½¢ a Day** buys this high grade iron bed, with fine cotton top mattress and woven wire springs. Can be furnished in any solid color.

There is no village so small—no spot so remote—that has not had our Home Lovers Bargain Book. We do not employ salesmen—investigators or collectors. Our business is handled entirely by mail—direct with our customers—and in the strictest of confidence. This policy has built this the largest business of its kind in the world.

### CATALOG FREE!

We want you to refer to our catalog whenever you think of home furnishings. It tells all about our plan of selling on charge account—it explains our thirty day free trial—about our wonderful organization—how we undersell retailers and all others. It shows pictures of high grade furniture and home furnishings—remarkable bargains that you will be interested in. Write for it—now—before you forge it. The book will be sent free. Your copy is waiting your request. Unless you write for it now—while you are reading this advertisement you may forget. (Better read that last sentence again.)

**Spiegel, May, Stern Co.,** 1755 W. 35th St., CHICAGO - ILL.

Please Mention Popular Mechanics



**3 CENTS A DAY**

for this leather seat rocker, beautifully grained, panel top, heavy front posts, quarter-sawed oak, genuine Leather Seat.

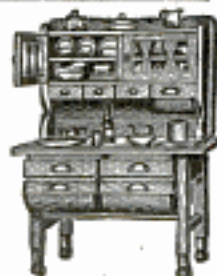

**Kitchen Cabinet For 2½¢ a Day**

Hard wood, oak front, nicely finished, 69 inches high, 42 inches long, latticed glass doors.

### Do Not Buy From Pictures

Our customers see the goods themselves—in their homes, if pleased they keep them—if not they return them and we pay freight both ways. Perhaps you'd like to see the bed—the kitchen cabinet—chair, or a rug—a pair of lace curtains—or a diamond—a watch—necklace—or a bracelet—no difference what you want—or where you live. We take all risk of pleasing you.

MAIL THE COUPON TODAY

Spiegel, May, Stern Company  
1755 W. 35th St., Chicago, Ill.

Gentlemen:—Send me copy of our new Home Lovers Bargain Catalog of home furnishings explaining our "charge account" plan. I understand you'll send this free and postpaid, and it is sent to me without any obligation on my part to buy.

Name.....

City.....State.....

Address (Street, R.F.D. or Box No.).....

A POSTAL CARD WILL DO if you do not want to cut your magazine.

Go to the nearest hardware store and ask to see this P. S. & W. Guaranteed Samson Brace. Take it in your hands and feel the well-balanced weight, note the fine finish of the steel sweep and coco-bolo center, and the graceful appearance.



Then test out the tremendous gripping power of the big chuck. It fits the hand comfortably, releases and tightens with a twist of the wrist—but holds any round, square or taper drill shank in its alligator jaw tighter than you can get it with a vise in an ordinary brace.

Then turn the head on its noiseless bearings (steel balls, not shot) and note how the lignum vitæ head is protected from splitting by a steel cap (not cast-iron plate) surrounding it to a height of 5-16 of an inch.

This fine tool is but one item in a large line of guaranteed P. S. & W. Hand-tools for Carpenters, including braces, chisels, gouges, squares, calipers, etc.,—all made by us and branded with

## The MARK of the MAKER

Write today for our "Mechanics' Handy List" a 170-page combination of valuable shop reference tables and information with a catalog of over 200 of the best hand-tools for Carpenters, Electricians, Machinists and Tanners.

**The  
Peck, Stow & Wilcox  
Company**

**MFRS.** of the Largest Line of Mechanics' Hand Tools offered by any maker

Address Correspondence to  
20 Murray St., NEW YORK CITY

Established 1819

Five Large Factories



*The Samson  
Ball-bearing Chuck.*

*The Steel-clad  
Ball-bearing Head*

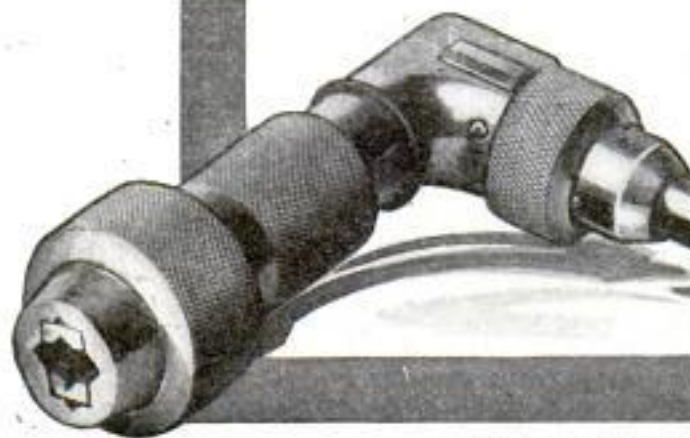

Please Mention Popular Mechanics



## \$1.25 Handbooks for 50c.

No books in existence contain in so small space as much information about the trades and professions of which they treat as do these Handbooks. They are little giant encyclopedias of practical knowledge giving data and information that is hard to find in ordinary books. These Handbooks have been prepared by the well-known textbook writers of the International Correspondence Schools whose textbooks are recognized the world over as the most practical treatises on applied sciences ever published. These Handbooks are consulting experts of the highest rank, and are the most powerful force in the world for the promotion of ambitious men. They are an indispensable help to quicker and better work that will command advancement. They are printed on a high-grade book paper in clear type, and durably and handsomely bound in cloth with gilt titles; contain on an average of 364 pages and 175 illustrations and are regularly sold for \$1.25 each.

**SPECIAL OFFER.**—We are selling these Handbooks, durably bound in cloth with gilt titles, at a special price for each Handbook of 50 cents.

**Mechanics'**—Tables; formulas; measurements; belting; mechanical powers; hydro-mechanics; strength of materials; shafting; boiler design; care of boilers; power of boilers; chimneys; exhaust heating; machine design; machine tools; slide valve; pulleys; cylinders and steam chests; pistons; gearing; transit surveying; triangulation; curves; radii and deflections; earth work; track work; electricity; etc.

**Advertiser's**—How to plan and write an advertisement; type and type measurements; points on printing style; display; preparation of manuscript; proof reading; engraving and printing methods; electrotypes; matrices; advertisement illustrations; magazines; newspapers; retail, department-store, general, trade-paper, and mail-order advertising; trade marks; circulars; advertising agencies; etc.

**Stenographer's & Correspondent's**—Advice to beginners; shorthand speed; letters of application; punctuation; correct and faulty diction; business correspondence; type-writing; abbreviations; addressing; mailing; rates of postage; duplicating work; etc.

**Telephone and Telegraph**—Useful tables; mechanics; electricity; magnetism; primary batteries; storage batteries; electrical measurements; telephony; tests with magneto-generator and bell; telegraphy; Morse telegraph systems; multiplex telegraphy; etc.

**Electrical Engineer's**—Mechanics; electricity; electrical units; symbols and quantities; physical and electrical properties of metals and alloys; wire gauges; magnetism; dynamos and motors; electric batteries; alternating current apparatus; alternators; transformers; wattmeters; electric transmission; electric lamps; wiring; electric heating and welding; electromagnets; controllers; car wiring; etc.

**Business Man's**—Arithmetic; tables; business forms; card systems; measures of extension; weight and capacity; time; value of foreign coins; duties on imports; bookkeeping; stenography; correspondence; postal information; financial terms; money and the money market; brokers and brokerage; patents; copyright and trade marks; corporations; business law; publicity; etc.

**Plumbers and Fitters'**—Arithmetic; involution and evolution; powers, roots, and reciprocals; circles; decimals; geometrical drawing; weights and measures; formulas; mensuration; mechanics; hydro-mechanics; building construction; heating and ventilation; gas-fitting; plumbing; etc.

**Mariners'**—Logarithms; trigonometry; navigation; terrestrial navigation; celestial navigation; organization of a man of war; naval ordnance; explosives; torpedoes; ship building; speed, tonnage, and fuel consumption; ropes; wind and weather; signals; nautical memoranda; etc.

**Building Trades**—Loads and structures; strength of materials; properties of sections; strength of rivets and pins; materials of construction; footings and foundations; masonry construction; woods used in building; qualities of timbers; joinery; framing; estimating; elements of architectural design; drainage systems; plumbing fixtures; plumbers' tables; heating and ventilation; gas and gas-fitting; etc.

**Bookkeeper's**—Arithmetic; formulas; tables; money; percentage; interest; equation of accounts; money and the money market; business law; financial terms; banks and banking; postal information; distances and time between various places; bookkeeping; business forms; card systems; modern office methods; cost accounting; bank bookkeeping; clearing house methods; etc.

### International Textbook Co.

Box 872, SCRANTON, PA.

I enclose \$\_\_\_\_\_ for which please send me the books BEFORE which I have marked X.

- |                        |                         |
|------------------------|-------------------------|
| —Mechanics' Handbook   | —Advertiser's Handbook  |
| —Elect. Eng. Handbook  | —Business Handbook      |
| —Bldg. Trades Handbook | —Bookkeeper's Handbook  |
| —Plum. & Fit. Handbook | —Sten. & Corr. Handbook |
| —Tel. & Tel. Handbook  | —Mariners' Handbook     |

Name \_\_\_\_\_

St. and No. \_\_\_\_\_

City \_\_\_\_\_ State \_\_\_\_\_

Please Mention Popular Mechanics



## Cover its Claws

When somebody drags a chair across your floor you can't wish away the unsightly scratches.

But you can make your chairs scratchless with little pads made fast to each of the legs with

# LEPAGE'S GLUE

It makes furniture noiseless, too. LEPAGE'S holds felt, leather, cloth, rubber, wood, glass or metal with the same grim grip. It never lets go!

## Get Two 10c Bottles Today

One for your home—one for your office

In air-tight cap bottles, it is always ready for use and can't dry out so long as you keep the cover on. To the last drop every drop is good, and with our new metal spreader not a drop is wasted.

Write for "Glueism" and see what this wonderful little innovation can do to save you money in your home and in your business.

### RUSSIA CEMENT CO.

We manufacture Glues (hard or liquid) in bulk for all industrial purposes.

88 Essex Av., Gloucester, Mass.

From a pin-sealing tube you may apply the glue direct—ideal for desk and office use.

Library Slips with every Bottle and Tube



Please Mention Popular Mechanics

## Lost—An Interview

What was it worth in card cost? It might have paid the slight difference in cost between the best card and any other for the rest of your natural life. If a card helps to get an interview, then the best card is the best help. What kind of help do you want?

### Peerless Patent Book Form Cards

are the best cards the modern business world has come in contact with. That means much. The man is measured by his card. What is your measure? What salesman would write across his card: "I am an inferior salesman with inferior goods?" Would you do that? But what does an inferior card indicate? It is inferior goods. He has used an inferior article to seek an interview. Surely the best men selling the best goods would not use such an article. That is natural, logical, psychological. Peerless Patent Book Form Cards are carried in books and the cards are detached one by one as used. All edges are perfectly smooth; all are flat, perfect, clean, elegant, impressive, and there is no waste. Send today for sample book and satisfy yourself. Fit your measure.

Our Smart Card In Case



**The John B. Wiggins Company**  
Engravers Plate Printers Die Embossers  
Established 1868  
62-64 East Adams Street, Chicago

The Swiss watch industry passed through varying vicissitudes in recent years. The period of greatest activity was attained in 1906, when the export values reached the record figure of \$29,027,495.—Brooklyn Eagle.

## Erickson Leg

Does not chafe, overheat or draw end of stump.

SOLD ON EASY TERMS  
The largest limb factory in the world.  
E. H. ERICKSON ARTIFICIAL LIMB CO.  
17 Washington Ave., N., MINNEAPOLIS, MINN.



## A Postal Brings Grand Free Millwork Catalog

5,000 Bargains in Building Material!

Send at once for the great Catalog of 5,000 Bargains in the highest grade Guaranteed Millwork and Lumber. Issued by the Largest Building Material Plant in America. Buy Doors, Windows, Mouldings, Stair and Porch Work—everything you need to build, remodel or repair—at 50 per cent saving! Quality, Safe Delivery and Satisfaction Guaranteed. (38)

GORDON-VAN TINE CO., 2755 Case Street, DAVENPORT, IOWA

### GREAT FREE BOOK

"How to Learn to Mount Birds and Animals"

## Mount Birds and Animals.

SPORTSMEN! Fishermen!

Hunters! Naturalists!

The wonderful profession of Taxidermy, so long kept secret, can now be easily learned right in your own home.

We Teach by Mail how to mount

Birds, Animals, Game Heads, tax skins, make rugs, and preserve all trophies. A delightful and fascinating art for men and women. Easily and quickly learned during spare time. Decorate home and den with fine trophies, or command big income selling mounted specimens and mounting for others. Skilled Taxidermists in great demand. Success guaranteed or no tuition fee. Endorsed by thousands of satisfied graduates. Write today for our Great Free Book "How to Learn to Mount Birds and Animals." Also our beautiful Taxidermy Magazine. BOTH FREE. Write today—do it now.

The N. W. SCHOOL OF TAXIDERMISTRY, Inc.

1183 Elwood Bldg., Omaha, Neb.

# We've Doubled the Durability of The OLIVER!

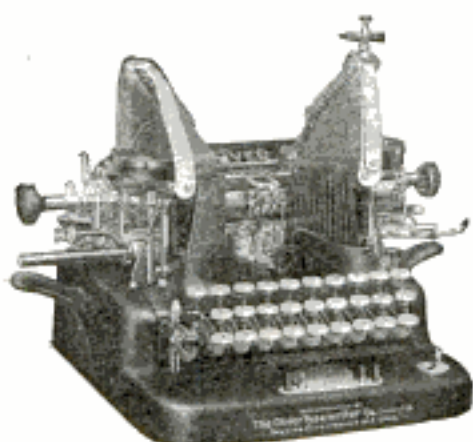

## Model 5, With Its Steel Coat-of-Mail, Gives Utmost Limit of Service

Built into the new Model 5 Oliver Typewriter are many exclusive devices for saving time and effort. We have even improved the type itself—and all the world now knows PRINTYPE.

Each of the refinements and added conveniences is a link in the "endless chain" of *completeness*. But equal in importance to these *combined* advantages is one that has scarcely been mentioned in print.

—An improvement that actually adds years to the life of the machine.

To deliver to the purchaser not only the highest *working-efficiency* but to *hold* that efficiency at the highest point—for a long term of years—is the problem worked out in Model 5.

The Vertical and Horizontal Line-ruling Device, the Tabulator, the Back Spacer, the Interchangeable Carriage, etc., widen the scope of its uses to the utmost practical limit.

### Versatility Plus "Printype"

PRINTYPE, the beautiful new type face originated for The Oliver Typewriter, was designed exclusively for Model 5. The shaded letters of PRINTYPE give distinction and character to typewritten correspondence. PRINTYPE makes a typewritten letter as readable as the best printed magazine or book. Its attention value adds to the effectiveness of selling letters. It aids and rests the eyes.

## Printype — OLIVER Typewriter

### The Standard Visible Writer

This masterpiece model is made with a steel coat-of-mail, which protects the important working parts from dust, dirt and damage from accident.

The mechanism works freely in a framework of solid steel, without the vibration and "rattle" so characteristic of typewriters.

This wonderful *stability* makes for *precision* and practically eliminates *wear*.

It gives to The Oliver Typewriter that marvelous *staying power* for which it is justly famed.

### Endurance Plus Speed

The speed possibilities of Model 5 keep pace with the most exacting demands. The light touch and easy action tempt the fingers to move swiftly. The smooth precision of the machine gives speed without conscious effort.

### Speed Plus Versatility

Model 5 is as notable for its *versatility* as it is for speed and endurance. Its various devices, for special uses, are simple, responsive and *practical*.

### To Purchasing Agents of Corporations

When placing your next order for typewriters, we suggest that you give special consideration to these important advantages of Model 5:

—Unlimited durability—No appreciable cost of maintenance—Unparalleled speed—Wide range of uses—Beautiful and novel PRINTYPE TYPE—Simplicity (several hundred less parts than other standard typewriters).

The same qualities that have won for The Oliver Typewriter the favor of the world's greatest firms and corporations, appeal with equal force to the one who buys a machine for personal use. Model 5 is an investment that pays handsome dividends in service and satisfaction, year after year.

### Art Catalog and Special Demonstration for the Asking

On request, we will forward a copy of the new catalog and a specimen letter written in PRINTYPE. A personal demonstration of the machine itself will place you under no obligation to purchase. Details of our 17-Cents-a-Day Purchase Plan gladly given. A \$5 cash payment brings this \$100 machine—you can pay the balance in pennies!

**THE OLIVER TYPEWRITER COMPANY**  
841 Oliver Typewriter Bldg., Chicago (160)

# 2c a Week Pays Wash Bill!

Write for  
FREE Book

Electricity or Water-Power Does the Work

## Just a "Twist of the Wrist" Starts or Stops the Machine!

The 1900 Motor Washers are now at work in thousands of homes. They are doing the work formerly done by women, at a cost of 2c a week for power! Saving thousands upon thousands of dollars in wash bills. Saving worlds of wash-day troubles. Leaving the women free to do other work while the machines are doing the washing.

## The 1900 Motor Washer

Washes a Tubful in Six Minutes!

1900 Water Motor Washer  
Can be connected with  
any water tap instantly



Handles Heavy Blankets or Dainty Laces

The outfit consists of the famous 1900 Washer with either Electric Motor or Water Motor. You turn on the power as easily as you turn on the light, and back and forth goes the tub, washing the clothes for dear life. Then, turn a lever, and the washer does the wringing. All so simple and easy that it is mere child's play.

### A Self-Working Wringer Free With Every Washer!

The motor runs Washer and Wringer. We guarantee the perfect working of both. No extra charge for Wringer, which is one of the finest made. Write for FREE BOOK and 30 Days' FREE TRIAL OFFER! Don't doubt! Don't say it can't be done. The free book proves that it can. But we do not ask you to take our word for it. We offer to send a 1900 Motor Washer on absolute Free Trial for an entire month to any responsible person. Not a cent of security—nor a promise to buy. Just your word that you will give it a test. We even agree to pay the freight, and will take it back if it fails to do all we claim for it. A postal card with your name and address sent to us today will bring you the book free by return mail. All correspondence should be addressed to 1900 WASHER CO., 5049 Court St., Binghamton, N. Y. Or, if you live in Canada, write to the Canadian Washer Co., 355 Yonge St., Toronto, Canada. (23)



Doing the wringing with  
1900 Electric Motor Washer

## HESS Sent on Approval FURNACE



No. 45  
"Leader" Hess  
Steel Furnace  
Price \$49

Delivered Here of Course and  
Back of this Issue  
Open and Inspect Extra

We will deliver a complete heating equipment at your station at factory prices and wait for our pay while you test it during 60 days of winter weather.

The entire outfit must satisfy you or you pay nothing. Isn't this worth looking into? Could we offer such liberal terms if we didn't know that the Hess Furnace excels in service, simplicity, efficiency, economy?

We are makers—not dealers—and will save you all middlemen's profits. No room for more details here. Write today for free 48-page booklet which tells all about it.

Your name and address on a post card is sufficient.

HESS, 910 Tacoma Bldg., Chicago

HUMANITY'S DEBT TO SCIENCE—Humanity's debt to delicate scientific instruments is well illustrated by three things used by the scientist—the microscope, the telescope, and the spectroscope, none of which were invented by an American, but all of which have been used by Americans to make some wonderful discovery in the realm of science. With the microscope man has been able to invade the regions of the infinitesimal; while the telescope has carried him into the realms of the infinite. The marvels of modern surgery came from knowledge gained with the microscope, and the whole germ tribe was discovered.—Southern Machinery.

### BUY PLUMBING SUPPLIES AT WHOLESALE

Will Save You 30%



Don't pay retail prices. Full stock on hand for prompt shipment. Send for free catalog. R. P. KAHOL, 268 to 322 West Harrison St., Chicago

## A Kalamazoo And Gas Stoves Too Direct to You

Cash or Credit  
Freight Prepaid

### Will You Write a Postal To Save \$5 to \$40?

That will bring the Kalamazoo Stove Book FREE with full particulars of the \$5 to \$40 saving, the \$100,000 bank bond guarantee, 400 stoves priced and described.

30 Days' Free Trial

300 Days' Approval Test. Prompt shipment, 170,000 customers testify this is the greatest stove offer and the Kalamazoo the finest stove made. Ask for Catalog No. 471.

Kalamazoo Stove Company, Mfrs.  
Kalamazoo, Michigan



Big Free Book

## Test an "IMPERIAL" 30 Days In Your Own Home at OUR RISK



Housewives Investigate THE RANGE WITH EXCLUSIVE FEATURES such as: Odor Hood, Ash Sifter, Stone Oven Bottom. These wonderful fuel savers are fully described in our catalog. Direct from our Factory to your Home at Wholesale Price. Freight Prepaid.

365 Days Guarantee.

Easy Credit Terms If Wanted

WRITE TODAY for Free Catalog and Special Prices

THE IMPERIAL STEEL RANGE COMPANY  
769 State Street, Cleveland, Ohio



Send a postal or write a letter today, giving just your name and address, so we can send you by return mail, postpaid, this new, big, splendid catalogue of 5,000 money saving bargains. This new book gives complete descriptions, illustrations and prices, and explains our easy payment plan, with 30 days' Free Examination Guarantee. Write today.

# FREE

(POSTPAID)

## Save 15% to 50% On House Furnishings

This is the largest, oldest and best known home furnishing concern in the world—57 years of success—22 Great Stores—1,000,000 regular customers. Could greater proof of honest, fair and square

### Easiest, Fairest, Credit Plan Ever Offered

No interest—no extra charges—no red tape—nothing but a square, honest plan of allowing you rock-bottom, cash prices, with privilege of arranging payments to suit your individual convenience. Our multi-million dollar resources, buying power and trusting power enable us to offer you terms no ordinary concern could even dare to think of. Learn about this fair, square, honest method. Investigate it now.

dealing be desired? Our customers are friends. We've proved ourselves to 1,000,000—can prove ourselves to you. Through our tremendous buying power—taking entire factory outputs—at low prices and discounts—we can save you money on the best quality in the world. Send for our big, new 5,000 Bargain Catalogue today. It gives you facts and figures with a guarantee of 15% to 50% saving on any article of furniture or house furnishings. Don't neglect—write postal card today.

### 30 Days' Free Examination Guarantee

Honesty has built our tremendous business. Every customer must be satisfied—and more than satisfied. You can get absolutely anything you want from our immense stock on 30 days, free examination in your own home—your money back in full to the last penny without a word or question if you are not positively and thoroughly pleased. You are the judge—our guarantee is legally binding and absolute.

## Here Are Six Regular Catalogue Bargains



**B4517 Kitchen Cabinet**

Madam: Stop kitchen drudgery—it wears one's life away. This Kitchen Cabinet makes kitchen work a pleasure and can be yours on the simplest credit terms. Made of hardwood, oak finish, is 62 inches high, 42 inches long, 26 inches wide, has 30 drawers, 42-inch long, 60-inch capacity floor bins. **\$7.60**  
Terms, 50c Cash—50c Monthly



**No. B4018 Dining Table**

Solid Oak, Claw Foot, Dining Round Extension Table. Has 42-inch round top, broad rim, massive pedestal base, extends to 6 feet by easy running slides and is fitted with three extra leaves to match top. **\$9.75**  
Worth fully 60 per cent more than our price.  
Terms, \$1.00 Cash—75c Monthly



**B6001 Genuine Coin Gold 100-Pc. Dinner Set**

A most magnificent 100-piece Set of Dishes, made of finest pure white under-glazed porcelain china, polished to a brilliant lustre and richly decorated with real coin gold. The Empire design is entirely new and fascinating. Sold in retail stores at 50 per cent more than we sell. Price, **\$9.95**  
Terms, \$1.00 Cash—75c Monthly



**No. B036 "Chesterfield" 9x12-ft. SEAMLESS BRUSSELS RUG**

A most magnificent, no-seam, Oriental design, richly colored real Tapestry Brussels Rug with heavy fine, all-wool facing, guaranteed by us and recommended by thousands who love its loom. A better value than ever before offered. Shipped to you on 30 days trial with money-back guarantee. Price **\$12.75**  
Terms, \$1.00 Cash—\$1.00 Monthly



**B1038 Rocker Bargain**

All the points which give perfect satisfaction are embodied in this elegant Rocker. It has a high, broad back, large, comfortable seat and is upholstered in famous "Imperial" leather (genuinely like genuine leather). Seat contains "Monarch" steel spring construction frame is of highly finished American quartered oak and is uniquely carved. Price, **\$3.95**  
Terms, 50c Cash—50c Monthly



**Bed Springs and Mattress B3013**

Just as shown in illustration, in glossed gold bronze or any color enamel, any width, continuous posts, 1 1/8 inch in diameter. Mattress has real 100 lbs. durable ticking, best woven wire springs with special springs acc. **\$8.50**  
Complete, only **\$8.50**  
Terms, \$1.00 Cash—75c Monthly

# HARTMAN

Established 1855—57 Years of Success

**FURNITURE & CARPET CO.**  
3945 WENTWORTH AVE., CHICAGO

22 Great Stores—1,000,000 Customers

Largest, oldest and best known home furnishing concern in the world.

Please Mention Popular Mechanics

**THEY'RE MADE TO MEASURE**



The  
World's  
Standard

# Putman Boots.

Go on like a glove and fit all over.

We have made boots for Sportsmen, Prospectors, Civil and Mining Engineers, &c., longer than any other boot makers and KNOW HOW. Putman boots sell all over the world and have justly earned the slogan "The World's Standard". We ship the Genuine Putman Boots direct to you and guarantee a fit. Catalogue of over 100 styles of Water Proof Boots and Shoes, Oiled Tanned and Mooschide Moccasins at all prices, and self-measurement blanks sent upon request. Our goods are all made to measure, and delivered in the United States, Canada or Mexico.

**H. J. PUTMAN & CO.** 122 FIFTH ST. N. E. MINNEAPOLIS, MINN.

## \$8,000 to \$10,000 YEARLY



**HERSCHELL-SPILLMAN CO.**  
MADE IN MANHATTAN, N. Y. U. S. A.  
CARUSSEL OPERATED BY STEAM OR ELECTRICITY.

### Make Money Out of Others' Fun

Pleasing the Public Pays Big Profits and owners of our famous attractions frequently make from \$8,000 to \$10,000 every year. We make everything in the Riding Gallery line from a hand-power Merry-Go-Round to the highest grade Carouselles. Bring in hundreds of dollars daily. It is a delightful, attractive, big-paying, healthful business. Just the thing for the man who can't stand indoor work, or is not fit for heavy work.

Just the business for the man who has some money and wants to invest it to the best advantage. Our goods are the finest appearing, easiest running, and most attractive line manufactured. They are simple in construction and require no special knowledge to operate. If you want to get into a money-making business write to-day for catalogue and particulars.

**HERSCHELL-SPILLMAN CO.**  
Park Amusement Outfitters  
232 Broadway Street, N. Tonawanda, N. Y., U. S. A.

## Complete Scholarship IN ART FREE

### SPECIAL LIMITED OFFER



We mean just what we say. We are determined to prove to the public generally, the wonderful success of our exclusive methods. If you love the beautiful, we guarantee to teach you Art. You learn right at home, by mail and in your spare time. Great artists your instructors. Same methods employed as are used in the great ateliers of Paris. WRITE at once for beautifully illustrated Prospectus and full explanation of our Free Scholarship Offer. Remember, this offer is limited to a few in each locality who answer at once. So write today.

**FINE ARTS INSTITUTE, Studio 1193 OMAHA, NEB.**

**THE AIRMAN'S HEART**—M. Dastre, one of the professors in the Faculty of Sciences in Paris, recently read a paper before the Academy, the subject dealt with having the "air-sickness." The trouble of aviators is said to be very much like mountain sickness, only it comes on much more rapidly. The sensation is experienced at a height of about 4000 ft. and again in the descent.

One thing M. Dastre endeavored to impress upon his hearers was that a sound heart was before all things necessary for those ascending to great heights. Another point of advice was that anyone who had experienced ill effects from an ascent should not allow the matter to rest when the sensations had passed away. He should make a point of consulting his doctor at the earliest opportunity.—London Globe.



### 3 YEARS TO PAY

**Meister Piano** 30 days free trial  
in your own home  
**\$1 A WEEK or Price \$175.00**  
**\$5 A MONTH**

No cash payment down. No interest—no extras. Piano stool and scarf free.  
**ROTHSCHILD & COMPANY**  
Dept. 16 N CHICAGO, ILL.

# CONGRESS CARDS

*For Social Play - Art Backs - Exquisite Colors - High Quality.  
New Designs - Club Indexes - Ideal for Bridge.  
Gold Edges - Air-Cushion or Ivory Finish.*

**OFFICIAL RULES OF CARD GAMES - HOYLE UP-TO-DATE**  
ISSUED YEARLY - SENT FOR 15 CENTS IN STAMPS  
THE U. S. PLAYING CARD CO., CINCINNATI, U. S. A.

# BICYCLE CARDS

*In Use Throughout the World for General Play  
The Most Durable 25 Cent Card Made.  
Club Indexes - Air-Cushion or Ivory Finish.*



50¢ per Pack



25¢ per Pack



Vibration  
is great  
after  
shaving



# POWER for YOU!

Power from within! Strength that is **more** than mere muscular strength—the strength of perfect health, abundant nerve force—the strength of the **perfect man** now within

your reach through **Vibration!** Nine people out of every ten are only **half alive**. They exist—they do not really live. How about yourself. Listen—

## All the Benefits of LIFE—STRENGTH—YOUTH

may be returned to you through **Vibration**. For **Vibration is Life itself**. It will chase away the years like magic. Every nerve, every fibre in your whole body will fairly tingle with the force of your own **awakened power!** Stagnation simply cannot exist. You are made over—new—from head to foot. Your blood is sent humming along through every vein, artery and tiny capillary. Poisonous matters in your system are **washed away**. Your self-confidence—**your self-respect**—are increased a hundred fold. Yes, **Vibration** will do all this and more, **much more**. And it is within your reach. You can enjoy its wonder-working powers right at home, right in the privacy of your own room. You can give yourself the same identical treatments that you would receive in the offices of the world's most famous specialists—all without extra charge.

You may give yourself Swedish Movement, Vibrating Chair Treatments, Electric Baths, Faradic or Galvanic Electric Treatments—just such treatments as you would have to pay from \$2.00 to \$3.00 for—yours without charge through the White Cross Electric Vibrator.



**The White Cross Electric Vibrator**

is the result of years of work and experiment. It is absolutely perfect. If you have your house wired for electricity, you can connect it up as easily as an electric lamp; if not, it will run perfectly on its own batteries.

### Special Offer for a Limited Time

For a short time only we are making a remarkable Special Introductory Offer on the White Cross Electric Vibrator, in order to place at least one of these splendid instruments in every city, town and village in the country—an amazing offer to those who write at once—amazing discounts—actual rock bottom prices direct if you act at once.

**FREE BOOK** Sign coupon and mail it today. Get our splendid big **FREE** book telling you all about the marvels of **Vibration**. Read what great scientists say. Post yourself on what it will do for you. Learn all about the **White Cross Electric Vibrator** and our limited offer. No obligations at all—send coupon, post card or letter **today**.

**Lindstrom, Smith Co.**

Dept. 1193, 218 So. Wabash Ave., Chicago, Ill.

Send for  
This Book

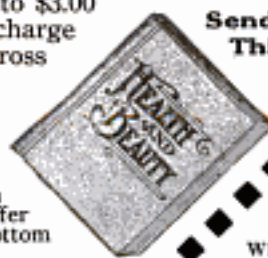

**FREE  
BOOK COUPON**

**LINDSTROM,  
SMITH CO.**

Dept. 1193

218 So. Wabash Ave.

Chicago, Ill.

Without any obligation at all, please send me, free and prepaid, your free book on **Vibration**, full particulars of the White Cross Vibrator and your Special 60 Day Offer.

NAME.....

ADDRESS.....

Cut this out and mail it today

# GUNN SECTIONAL BOOK CASES

## Write for Our "Book of Designs"

beautifully illustrated in colors, showing our Sanitary Clawfoot Mission and Standard bookcases and how you will save money by placing them in your home.

The handsome designs, the rich finish, the removable, non-binding doors, the absence of disfiguring iron bands, make them far better than the old fashioned kind.

## Our prices are lower than others

and high quality is guaranteed. Sold by dealers or direct. Address Dept. P.M. Gunn Furniture Company 55 Victoria Street, Grand Rapids, Mich.

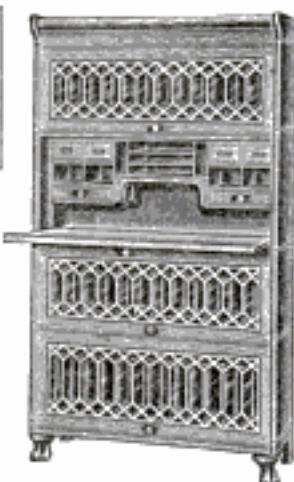

## ASTRONOMICAL TELESCOPE

Length 36 3/4 inches. 2 inch object glass



Complete with Case, Sun Shade, Sun Glass and Extra Eye Piece for Night Observation. **\$18**

One of these superb instruments will give material enjoyment. It will enable you to pick out the smallest Boats on the Horizon, tell the time by a clock many miles distant, and view the country

for fifty miles around. This telescope is made for Astronomical Work. With its aid the Mountains in the Moon, Jupiter's Moons and Saturn's Rings are clearly discernible.

Prof. Hicks, of Word and Works Almanac, says it is far superior to others he has examined at twice the price.

CATALOGUES SENT FREE ON APPLICATION

A. S. ALOE CO., 515 Olive St., ST. LOUIS, MO.

## LET US GIVE YOU THIS TRANSPARENT CELLULOID TRIANGLE

It is 4 inch size, 30°+60° angles. Lowest retail price, 25 cents. Absolutely essential to everyone who draws. We make this offer to introduce our new catalogue showing

## SPAULDING'S NEW CARRYING CASES AND COMPLETE OUTFITS

for designers, architects, engineers and students—compact, durable and convenient. Spaulding's Carrying Cases are made light and strong. They provide well arranged compartments, including space for drawing board and T square. Handled like a suit case; unique, practical, inexpensive. Outfits include all necessary equipment. If you draw, send us five 2-cent stamps to-day to pay postage and get the free triangle and the catalogue.

SPAULDING PRINT PAPER CO.

44 Federal St. BOSTON

## KEITH'S 20 WONDER HOUSES



A New Book of 20 Plans showing photo views as actually built and large floor plans for 20 selected types of Keith's best ideas in Bungalows, Cottages and Houses, costing \$2,000 up. They are Wonder Houses for practical, inexpensive homes. Send silver or stamps **10c**

M. L. KEITH, 456 McKnight Bldg., Minneapolis, Minn.

## BE PROSPEROUS

Grow Mushrooms at home all winter in cellars, stables, sheds, boxes, etc. Large demand. \$20.00 a week easily made. Only small space necessary. We are large growers, make best spawn, and insure your success. Write for big booklet and learn how.

NAT'L SPAWN CO., Dept. 12, HYDE PARK, MASS.



## Special Factory Price

on 10,000

## Rapid Fireless Cookers

Great offer—inside price—the famous, reliable RAPID. Fastest, most saving, best selling cooker made. 30 Days' Free Trial. Saves 1/4 your Meat and Grocery Bills. Free Recipe Book tells how. Write

WM. CAMPBELL CO., Dept. 64, Detroit, Mich.



## TYPEWRITERS ALL MAKES

All the Standard Machines SOLD or RENTED ANYWHERE at 1/2 to 1/3 MFR'S PRICES, allowing RENTAL TO APPLY ON PRICE. Shipped with privilege of examination. \$20 Write for Illustrated Catalog L. TYPEWRITER EMPORIUM, 92-94 Lake St., CHICAGO

## Independent Safety Fountain Pen

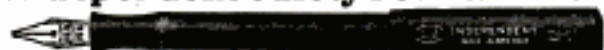

Can be safely carried in any position. New idea cap locks pen when not in use. All pure rubber and 14 kt. pens. With No. 2 gold pen, \$1.50. With No. 4 gold pen, \$2.00

FREE CATALOGUE—AGENTS WANTED

J. C. ULLRICH & CO., 607 Thames Bldg., 27 Thames St., NEW YORK

## LEARN DRAWING WITH AN ISOGRAPH

You can begin making pictures at once, with ever increasing skill. Indispensable to inventors and designers. Universally endorsed by draftsmen. Instrument with amply illustrated instructions postpaid 50c. Stamps accepted. Send today.



THE ISOGRAPH CO.  
145 E. 23d St.,  
NEW YORK CITY



# ILLINOIS - the Best Watch on Earth - Now Sold on CREDIT

For the first time in history the great genuine Illinois Watch is now sold by mail on the easy payment plan. No man or woman need be, nor should be, without a famous Illinois Watch.

This is the greatest public triumph of a decade—a believed impossibility made possible. It will revolutionize the watch business. Just think of owning the world-renowned Illinois, and paying for it as you please! For over 40 years the Illinois has been acknowledged the standard—the one great conspicuous watch value—the one watch chosen and worn by the great men and women of our nation.

## A Guarantee that Means Something

Part for part—in accuracy, in wear, finish, beauty, quality of material and workmanship, and every other feature, the Illinois is superior to any other watch at any price. Both the makers and we stand back of this remarkable time-piece with an ironclad, legal, broad guarantee—a guarantee that means something—that protects you in every respect—that assures you of the best watch on earth.

## Largest Watch Distributors In The World

We are one of the largest direct, easy-payment, dependable watch houses in the world. For over 35 years we have sold all kinds of watches, and honestly can say that we have never seen a watch—at any price—equal in quality to the marvelous Illinois.

## How We Save You Money

This famous Illinois will cost you less than inferior makes, so why not get the best for your money? This is indeed a profit sharing plan. Nowhere else can

you buy a genuine Illinois on credit—we are the exclusive credit distributors. If you buy from a jeweler, you'll have to pay cash. If you buy from us, you'll get it on approval—you take no risk—you have our guarantee and the maker's and you can pay as you please.

No dealer anywhere can under-sell us even for all cash on delivery.

## Free Book

Our free, beautiful, profit-sharing book, describing this great Illinois watch—reproducing many handsome styles. It's worth owning. Get it at once and learn the truth about watches—learn why an Illinois should be in your possession—learn how

you can own one on your own credit terms. Send your address. The American Watch Company of St. Louis Dept. 200 St. Louis, Mo.

Take Your Own Time To Pay



**200 EGG \$3.** Incubator; Actual hen heats, ventilates, controls. No lamp, no oil. Catalog Free.  
RAT. BEN INC., Sta. H., Dept. 27, Los Angeles, Cal.

**Greider's Fine Poultry**  
Book and calendar for 1912 contains 200 pages, 72 varieties pure bred, 62 colored plates. Many other illustrations, descriptions, incubators and brooders. Low prices on all stock eggs. How to raise and make hens lay. Get my plans. They all say it's great—this book—only 15 cents.  
B. H. GREIDER, Box 2, Rheems, Pa.

**Squab Book FREE**  
Make money breeding squabs. Read in our 1912 free book how Etwinsons Farms (Wt.) sells them for \$6 doz. Started with 25 pairs of our Extra P. R. Homers two years ago, multiplied now to 800 pairs. John Ludwig (Cal.) 75 years old, making \$25 week. Oscar Maczke (Wis.) \$4000 yearly shipping squabs to Chicago. Big western demand. 5000 squabs wanted nearly by only one N. Y. firm. See what they say in National Squab Magazine (monthly) specimen copy from us. Two Cents, one yr. \$1. All about pigeons and squabs; tenderness, largest, unique, original, practical.  
PLYMOUTH ROCK SQUAB CO., 229 Howard St., Melrose, Mass.

**FREE—244-Page Poultry Book**  
Get it—and learn how to succeed with poultry. Explains how "Cyphers Company Service" stands back of every customer for **CYPHERS INCUBATORS and BROODERS**  
Original, non-moisture machines; self-regulating, self-ventilating, fire-proof, insurable; the world's standard. You want the best! Write for Free 244-page 1912 Guide now—today!  
CYPHERS INCUBATOR CO., Dept. 961, BUFFALO, N. Y.

**HENS LAY AND PAY BY THE PHILO SYSTEM**  
**FREE** Booklet by E. W. Philo, entitled "A Little Poultry and a Living" or New 96-page book, "Making Poultry Pay," 10c. Both books and the new enlarged edition of the Philo System text-book, \$1.00, or all three books with our monthly magazine, Poultry Review, 1 year \$1.50.  
E. R. PHILO, 8 Lake St., Elmira, N. Y.



# STOP!

Just a Minute, Please

This little ad tells you how to get the big incubator bargain.

Write me a postal for "HATCHING FACTS" and ample proof of superiority of my famous

**WORLD'S CHAMPION BELLE CITY 140-EGG INCUBATOR**

Has double walls and door and dead air space all over, copper tank, hot water heat, self-regulator, "Tycos" thermometer, egg tester, safety lamp, nursery, high legs.

I am going to sell all my machines out on 1, 2, or 3 months' Home Test this year. Don't you want to be one of the lucky testers? If so, write today. I will surprise you with the proofs of the wonderful hatches of this machine. Why pay more for a machine that can't compete with mine in the championship class? My machine makes you money from the start at small outlay. When shipped together, I sell my Incubator (price \$7.55) and 140-chick double-walled hot water top heated Brooder (price \$4.85) for \$11.50 and pay freight. Send for "Hatching Facts" today, or if in a hurry you may send price direct from this ad—same home test—same guarantee. Money back if not satisfactory. Thousands buy this way.

Address, JIM ROHAN, Pres. Belle City Incubator Company, Box 164, Racine, Wis.



**\$7.55**  
FREIGHT PAID

East of Rockies



Please Mention Popular Mechanics



Private Office Victor J. Evans with View of Patent Office Through Window



Drafting Department, Victor J. Evans & Co.



Specification Department Showing Specialists at Work, Victor J. Evans & Co.

# Reasons

## Advantages of Applying for Patent Through Us

You should carefully consider the following statements of fact, which furnish the best of reasons for placing your patent business in our hands:

### FIRST.—Largest Patent Firm in the World.

We are the largest patent firm in the world, having the greatest facilities, more employees, and file more patent cases in the United States Patent Office than any other firm of patent attorneys. We are thus enabled to give your case IMMEDIATE attention. This is a great advantage to clients who are in haste to file their cases in the U. S. Patent Office.

### SECOND.—Our Specialists.

The field of invention is so vast that it is impossible for any one man to become an expert in all classes of invention. Only those skilled in the class to which the invention relates can render efficient service. For this reason this firm employs a number of patent experts who have been selected for their knowledge, experience and ability in certain lines of invention. This enables us to place each case in the hands of a specialist skilled in the class to which the invention relates, thus securing the best possible results.

### THIRD.—Our Office Building.

We have the finest and most perfectly equipped office building in the world devoted exclusively to patent business. This building was specially erected by us for our own use; is fire-proof, thus insuring safety, and is equipped with all modern appliances, which greatly facilitates and expedites our service to our clients.

### FOURTH.—Security.

We are bonded by the Columbia Bonding Co., of Washington, D. C., in the sum of \$10,000 to carry out our contract to return our fee if we fail to secure a patent. Our clients are thus doubly protected and insured against financial loss.

**VICTOR J. EVANS & CO.**  
(Formerly Evans, Wilkens & Co.) Victor Building, 724-726 9th St., N. W.

# Patents

## Trade Marks and Copyrights Secured or Fee Returned

### Special Offer — Free Search of Patent Office Records

Send us a model, photograph or sketch and description of your invention, and we will make a *Free Search of the Patent Office Records* to ascertain if it is patentable. If we report the invention patentable, we will guarantee to obtain a patent or return our fee, and furnish a certificate of patentability backed by a bonded contract to that effect.

**This Certificate of Patentability will protect the inventor and serve as proof of the invention until the case can be filed in the U. S. Patent Office.**

#### Obtaining Assistance for Inventors

Our certificate is of great assistance to inventors who require financial aid to obtain patents. It is useless to attempt to interest capital unless evidence is furnished that the invention is patentable. Our certificate gives this necessary assurance.

#### Our Four Books Mailed Free

to any address. Send for these books—the finest publications ever issued for free distribution.

#### How to Obtain a Patent

Our illustrated eighty-page Guide Book is an invaluable book of reference for inventors, and contains 100 mechanical movements illustrated and described.

#### Fortunes in Patents

Tells how to invent for profit, and gives history of successful inventions.

#### What to Invent

Contains a valuable **LIST OF INVENTIONS WANTED** and suggestions concerning profitable fields of invention; also information regarding prizes offered for inventions, among which is

#### Prize of One Million Dollars

offered for one invention, and \$10,000 for others.

#### Patents That Pay

Contains fac-similes of unsolicited letters from our clients who have built up profitable enterprises founded upon patents procured by us; also endorsements from prominent inventors, manufacturers, Senators, Congressmen, Governors, etc.

#### List of Patent Buyers

Containing personal requests and letters from Manufacturers and Patent Promoters for patents secured by us, and suggestions as to improvements desired and new ideas they wish to purchase.

#### We Advertise Our Clients' Inventions Free

In a list of Sunday newspapers with two million circulation, in manufacturers' journals and in the *World's Progress*. Sample Copy Free. We not only save you time and money in securing patents, but obtain patents which **PROTECT** the invention and **PAY**. After the patent is granted we assist you **TO SELL YOUR PATENT**.

#### Foreign Patents

**WE HAVE DIRECT AGENCIES IN ALL THE PRINCIPAL FOREIGN COUNTRIES** and can secure **FOREIGN PATENTS** in the shortest possible **TIME** and at the **LOWEST COST**. We **GUARANTEE TO SECURE THE FOREIGN PATENTS OR RETURN OUR FEES**. Write for our Illustrated Guide Book on Foreign Patents, sent free to any address.



**VICTOR BUILDING**  
Our new \$150,000 building opposite U. S. Patent Office  
SPECIALLY ERECTED by us for OUR own use

#### REFERENCES

Second National Bank, Washington, D. C.  
C. K. Lassiter, Mechanical Engineer, Schenectady, N. Y.  
Pitner Gasoline Lighting Co., Chicago, Ill.  
Sprout, Warden & Co., Mfrs. of the Monarch Feed Governor, Muncy, Pa.  
The L. B. Dozier Co., Mfrs. of Plumbing, Heating and Machinery Supplies, Columbia, S. C.  
B. B. Earnshaw and Bro., Mfrs. "Cream Blend" Flour, Washington, D. C.  
R. G. Dun & Co., Washington, D. C.  
National Savings and Trust Co., Washington, D. C.  
Smethport Glass Co., Smethport, Pa.  
Lawrence Mills, Mfrs. Bed Spreads, 51 Brooke Ave., Englewood, N. J.  
The Melvin Gauge and Signal Inst. Co., Scranton, Pa.  
Damon Mfg. Co., Mfrs. "Missing Link" Flour Mill Disintegrators, Bowling Green, Ky.  
Modern Canner Co., Mfrs. Canning Machinery and Canners' Supplies, Bridgeport, Ala.  
M. Winter Lumber Co., Sheboygan, Wis.

# PATENT ATTORNEYS

Opposite United States Patent Office

WASHINGTON, D. C.

→ **Protect Your Idea!** ←

# PATENTS THAT PAY

\$378,140.00 Made by Clients

"My Trade-Mark"

\$378,140.00 Made by Clients

Proof back of it—write for my FREE literature—it will pay!

## Special Offer:

Mr. Inventor: I invite you to come to see me, and bring, (or send by registered mail), sketches or photograph or model and description of your idea or invention for FREE examination of U. S. PATENT OFFICE Records and report as to patentability of the same;—to find out as to whether in my opinion you are entitled to a patent will not cost anything;—then, if your invention is new, upon receiving instructions, I will prepare ALL necessary (application) papers.

DO THIS AND SAVE TIME AND MONEY!

## WRITE NOW!

### Highest References:

"Over ninety (90) manufacturers intrust ALL their patent work to me."—E. E. V.

Lincoln National Bank,  
Washington, D. C.

NOTE: When writing these clients send two-cent stamp for reply.

Little Giant Hay Press Co.,  
Alma, Mich., and  
Dallas, Texas.

American Railway  
Appliance Co.,  
Oil City, Pa.

Farmers' Mfg. Co.,  
Norfolk, Va.

Anderson Mfg. Co.,  
Tulsa, Okla.

Griffin Mfg. Co.,  
New York, N. Y.

Warsaw Paper Box Co.,  
Warsaw, N. Y.

Sanford Mfg. Co.,  
Sanford, N. C.

Butler Engineering Co.,  
Akron, Ohio

Thompson Drug Co.,  
Sioux City, Iowa

Garl Electric Co.,  
Akron, Ohio

Gray Lithograph Co.,  
New York, N. Y.

Iowa Mfg. Co.,  
Oskaloosa, Iowa

New Era Mfg. Co.,  
Fairfield, Iowa.

Bernhard Furst,  
Vienna I,  
Austria-Hungary

A. J. Corsi,  
Irish Town,  
Gibraltar

Otto von Kottenburg,  
Schwindstrasse 20,  
Frankfort A. M.,  
Germany

H. A. Fonseca,  
Rios Dos Ourives 20,  
Sobrado, Rio de Janeiro,  
Brazil

Electro Importing Co.,  
New York, N. Y.

Rex Electric Co.,  
St. Louis, Mo.

Sam'l Allen & Son Mfg. Co.,  
Danville, N. Y.

Edward H. Smith,  
Lents, Oregon

Camp Conduit Company,  
Cleveland, Ohio

## INFRINGEMENT, VALIDITY AND INTERFERENCE WORK SOLICITED

I am admitted to practice before the United States Supreme Court and others

"I want to thank you for the most excellent services you have rendered me in this suit [B. Williams vs. Central Drug Co., U. S. C. C., Northern District of Illinois—E. Dis.], and assure you that I appreciate it very much, and if at any time I can secure some business for you, I will be only too glad to do so."  
(Signed) J. THOMPSON, Mgr. Central Drug Co., Sioux City, Iowa.

### Other Important Suits Successfully Settled

Instructive 112-page Guide Book for Inventors mailed to any address upon request

#### Foreign Patents a Specialty

If you have a U. S. application write me for excellent literature and terms for promoting your Foreign Patents. Liberal discounts.

#### I Advertise My Clients' Patents Free

in a publication having over 2,000,000 circulation. Write for Special Offer. Successful clients in every section of the U. S.



My Office and the Patent Office  
(I give you proof of my location)

Across the street from the U. S. Patent Office

Expert—Prompt Services

**E. E. VROOMAN, Patent Lawyer Wash., D. C.**

Old-established branches throughout the world.

**\$378,140.00 \$**  
MADE BY MY CLIENTS

Proof-circular mailed FREE

**YOU Should Have My FREE GUIDE BOOK**

Containing hundreds of testimonials, showing the kind of services rendered my clients.

"Your book is certainly a remarkable display of enterprise and shows business tact very much out of the ordinary, while the design, workmanship and general preparation displayed is exceptional and must bring to your office largely increased business, which is our heartiest wish."

AMERICAN RAILWAY APPLIANCE CO.,

(Signed) FRED A. STUCK, Pres., Oil City, Pa.

To E. E. VROOMAN, Esq., Washington, D. C.

High-Class Work—Excellent Testimonials

871 F Street, N. W.

Registered Patent Attorney. Patent Litigation

**Wash., D. C.**

# WANTED-IDEAS

Manufacturers are constantly writing me for patents procured through me. The demand for good ideas

## Protected by Owen Patents

is greater than ever before. Send for my free books and read the letters from the greatest manufacturers in this country. Read their requests for Owen Patents and see for yourself what ideas they want. You can help supply the unceasing demand for good inventions.

My clients are provided with free manufacturing facilities, and I aid them in **many ways, without charge**, to sell their patents. **Applications** filed through me advertised free.

You will get a strong patent or I will get no compensation. Your interests are my interests.

# FREE!

A simple request will bring you the following three finest patent books published **absolutely free**—you will incur no obligation by writing me.

**"SUCCESSFUL PATENTS"**—a new 72 page guide book; tells how to proceed to be successful; describes my advantageous business methods.

**"STEPPING STONES"**—gives list of over 200 inventions wanted; gives forecasts by Edison and many other authorities; tells the plain truth about prizes of millions of dollars for inventions.

**"PATENT PROMOTION"**—tells you how to promote your invention; why some inventors fail; the value of your rights, etc.



**Write for these books to-day—NOW! Advice costs nothing**

### VERY HIGHEST REFERENCES

Columbia National Bank,  
Washington, D. C.

American Loktile Co.,  
Alexandria, Va.

National Metal Tile Co.,  
Washington, D. C.

National Supply Co.,  
Berlin, N. H.

Louden Machinery Co.,  
Fairfield, Iowa.

Antholene Mfg. Co.,  
Hutchinson, Kans.

Whitehead Hosiery Mills,  
Burlington, N. C.

Dickinson Mfg. Co.,  
Des Moines, Iowa.

### SPECIAL!

Send me a sketch or model of your invention and I will make a search of the U. S. Patent Office Records **FREE OF CHARGE** and report to you concerning patentability, practicability, etc.

And an immense number of others whose letters are printed in my booklets.

Your work will receive my **PERSONAL** attention —but my fees are no higher than others.

**RICHARD B. OWEN** 9-303 OWEN BLDG.,  
WASHINGTON, D. C.

Inventors submitting their inventions to me are protected in a tangible manner until their applications are filed.

# PATENT YOUR IDEAS



*—There is a Constant Demand  
for Good Inventions*

Thousands of the biggest money-making inventions have been the "little" things that have made people wonder why they were never thought of before.

## "WHAT TO INVENT" and "HOW TO OBTAIN A PATENT" *These Books Sent Free*

If you have an invention send us a sketch, photograph or model of it. We will give you a report as to its patentability absolutely free. If you have no invention send for our book, "What to Invent." It contains hundreds of valuable suggestions. We are recognized authorities on patent matters and have helped hundreds to find a ready and profitable market for their ideas. We can prove it. If you wish to sell your patent we will advertise it in manufacturers' journals at our expense.

***Don't Wait—Find Out NOW!***

Your idea will never do you any good if some one else patents it ahead of you. Act quick! Let the other fellow say "he thought of it a long time ago." You reap the profit. Let the others wish they had.

***Advice Free—All Matters Confidential***

We have secured patents for thousands of inventors and have many letters proving the value of our services. Write us. Send rough drawing or model of your invention for our opinion. We will guard it carefully and report quickly. You are under no obligations to proceed further. Our plan is simply a square deal to all. Our books, "What to Invent" and "How to Obtain a Patent" are the best publications written for the man who has an idea to patent, or who is of an inventive turn of mind. They show just how to proceed with your idea and tell of hundreds of things to invent. We gladly send these books free. The sooner you write for them the sooner you will know all about patents and the many different lines in which new inventions or improvements may be made.

*If you have an invention send us a sketch of it for report and ask for the books at the same time.*

**CHANDLEE & CHANDLEE, 984 F Street, Washington, D. C.**

REGISTERED ATTORNEYS

(Combined with H. Ellis Chandlee & Co.)





**Patent Your Ideas—It Pays**  
**"WE GUIDE YOU TO SUCCESS"**  
 25 years' experience as Attorney and U. S. Patent Examiner. Send sketch of invention for **Free** report and Illustrated Guide Book. **No Patent—No Charge.** We succeed where others fail.  
**BUNYEA PATENTS CO.**  
 Room 27 WASHINGTON, D. C.

**PATENTS** C. L. PARKER  
 Ex-Examiner U. S. Patent Office  
**PATENT LAWYER**  
 210 MCGILL BLDG.  
 WASHINGTON, D. C.

Patents, Trade Marks, Copyrights, Patent Litigation  
 Handbook for Inventors. "Protecting, Exploiting and Selling Inventions" sent free upon request.

**LANGDON MOORE**  
 Counselor-at-Law and Patent Attorney  
**Patents, Trade-Marks  
 Designs and Copyrights**  
 9th and F Streets, WASHINGTON, D. C.  
 Formerly Examiner U. S. Patent Office  
 SEND FOR BOOKLET

**AN EXPENSIVE TREE**—We do not think much of trees in the United States, and let several million acres of them burn without getting excited, but in England small forests, and even individual trees, are maintained at great expense. If there is not actually an outlay of money, the trees occupy land that could otherwise be profitably employed.

Probably the most noteworthy tree in the world, so far as expensiveness is concerned, is a plain tree which grows in Wood Street, in the city of London. This

**OUR IMMENSE  
 FACTORY  
 CAN SAVE YOU  
 MONEY ON  
 STAMPINGS  
 PORCELAIN  
 ENAMELING**

*We Specialize  
 in Drawing,  
 Stamping and  
 Spinning—*

Aluminum,  
 Brass,  
 Copper,  
 Tin-Plate,  
 Monel Sheet  
 Steel and  
 Cupror

Japanning in All  
 Colors

**PORCELAIN  
 ENAMELING**

Tinning and Hot  
 Galvanizing  
**JOB WORK**

Any special sheet metal goods or parts that it would not pay you to make in your own plant, we can make to your order. Our facilities and experience enable us to make them just as you specify and at a price that will pay you to have us make them.

**Right Prices—  
 Quick Delivery**

are insured by a modern up-to-date plant with a floor space of 12 acres filled with time and labor saving equipment and machines and manned by an experienced and skilled organization that is keenly alive to your interests and wants. Let us figure with you and point out a saving.

**Geuder, Paeschke & Frey Co.**  
 Contract Dept. Milwaukee, Wis.  
 Incorporated 1881



**A Talk to the Inventor**  
**LEARN HOW A PATENT MAY BE MADE VALUABLE**  
 If there is any basis for an application in your idea, I can find it. But I will explain it to you before filing your application.  
 Copies of Nearest Patents, and Report, in Every Case I have patented inventions reported unpatentable elsewhere

Send for **FREE BOOK** {  
 What You Should Know  
 What to Invent  
 What NOT to Invent  
 How to Sell Your Patent

**H. L. WOODWARD,** 9th and G Sts., Opposite Patent Office, WASHINGTON, D. C.

**PATENTS** How to GET Every Dollar Your Invention is Worth. Send 8 cents stamps for new 128 page book of Vital Interest to Inventors.  
 R. S. & A. B. LACEY, Dept. 45, Washington, D. C.

**PATENTS** **BUILD FORTUNES FOR YOU**  
 Our free booklets tell how, what to invent, How To CHOOSE AN ATTORNEY, and save you money.  
 Prosperous clients in all states. Best bank and other references. **WRITE TODAY**  
**D. SWIFT & CO.,** 317 SEVENTH ST., WASHINGTON D. C.

**PATENTS THAT PROTECT and PAY**  
 Advice free. Terms reasonable. Highest references. Best results.  
 Send sketch or model for **FREE** examination and opinion.  
 Recommended Patent Lawyer in the Bankers' Register and special list of selected lawyers. Also in Martindale's Law Directory, Sharp and Alleman's Directory of Lawyers, The Gast-Paul Directory of Lawyers, and Kime's International Law Directory.  
**ALL BUSINESS GIVEN PROMPT AND PROPER ATTENTION**  
 A large list of strong recommendations furnished free  
**WATSON E. COLEMAN, Patent Lawyer, 622 F St., N.W., Washington, D.C.**

## LET THE RED DEVIL WATER MOTOR DO YOUR WORK

### 6-inch Motor

Improved construction, absolutely perfect, runs your washing machine and a hundred other things. Power for small tools.  $\frac{1}{4}$  horse power on  $\frac{1}{2}$ -inch pipe, 80 pounds pressure; 1 horse power on 2-inch pipe, 60 pounds pressure. New net price, \$5.00 cash with order.

No. 1492 4-inch Motors for grinding, polishing and buffing. Runs sewing machines, fans, bottle washers, etc. Price with emery buffing wheel, silver polish and pulley, \$3.00. No. 1493 Motor and pulley only \$2.50.  $\frac{1}{2}$  horse power on 80 pounds pressure. Improved construction. Speeds, 3,000 to 5,000 revolutions per minute. Only scientifically and mechanically perfect small water motor manufactured. Patented construction makes it possible. Tremendous output warrants the price. Money back for any reason.

**CATALOGUE AND LARGE SHEET FREE**

### DIVINE WATER MOTOR CO.

Dept. T UTICA, NEW YORK, U.S.A.

For the name of your local hardware or tool dealer, we will send you free booklet on "Theory and Design of Water Motors."

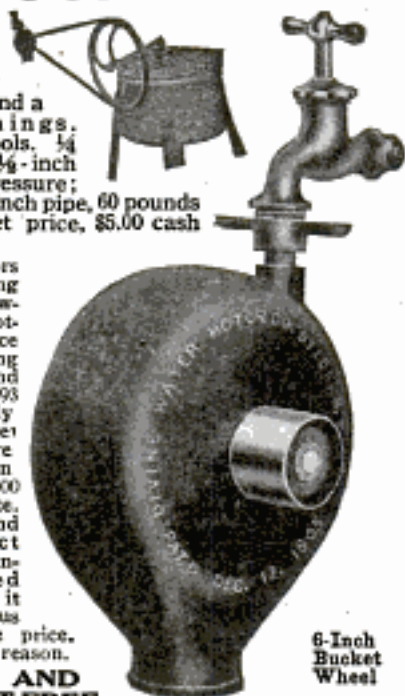

6-Inch Bucket Wheel

## GEARS SPROCKETS, CHAINS, ETC.



All kinds in stock and made to order up to 10 inches diameter. Send for Catalog A.

Write for prices on any goods in this line.

WOBURN GEAR WORKS, Woburn, Mass.

Active Powers of Inventive Genius



### INVENTORS Our Brain Belongs to You. Our Ideas Are Free of Charge.

All we want in return is to build your model, special machinery, dies, tools and jigs to manufacture sheet metal goods, etc. We are expert mechanics, over thirty years experience and have one of the best equipped shops in the country. Ask for Booklet No. 17. Consultation free. Experimental work strictly confidential.

A. NACKE & SON  
236-242 S. 9th St. Philadelphia, Pa.

### DON'T DISCARD BROKEN PARTS



Have them welded together by the Oxy-Acetylene Process. Steel, Cast Iron, Bronze, Copper, Aluminum and all other metals can be welded. Manufacturing quoted on. Welding equipments for repair shops or large plants supplied.

DAVIS BOURNONVILLE CO.  
105 West St., NEW YORK; 505 So. LaSalle St., CHICAGO

tree occupies a lot which would bring in ground rent to the amount of \$1,200 per annum. It says much for the nature-loving qualities, and, incidentally, for the fortune, of the owner of that lot that the ancient tree flourishes safely year after year.—Illustrated Sunday Magazine.

**Rife Automatic Hydraulic Ram** Pumps water by water power. No attention; no expense; 2 feet fall elevates water 50 feet, etc. Guaranteed. Catalogue free. RIFE RAM COMPANY 2131 Trinity Building, NEW YORK CITY

### BUILDING OF MODELS IS EXPENSIVE

Know you are right before spending your money on experimental work; have us lay out and develop your ideas. Expert opinion as to cost and practicability furnished free. All work strictly confidential. HERBERT J. SAUVAGE, Consulting Engineer  
728 First National Bank Bldg. CHICAGO



MECHANICAL SUPPLIES AND MATERIAL of all kinds.

EXPERIMENTAL AND LIGHT MACHINE WORK to order.

132 MILK STREET, BOSTON

### Let Us Do Your Manufacturing

Buying material in large quantities and having a modern factory equipped with the latest machinery enable us to make almost anything in metal or wood at a very low price. Estimates free. We have a complete model and pattern department.

TINLEY PARK MFG. CO., 222 N. State Street, CHICAGO

DIES, FINE TOOLS METAL SPECIALTIES  
MOORE & CO., 341 W. Indiana Street CHICAGO

SPECIAL MACHINERY. INVENTIONS PERFECTED.



## LATHES

FOOT POWER for WOOD TURNING

12 inch swing, 51 inches long.

C. CHRISTIANSEN  
2219 Grand Ave., CHICAGO, ILL.

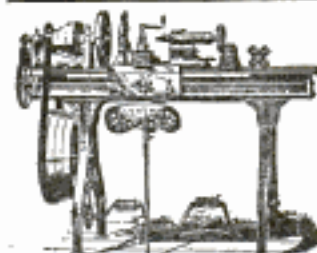

## LATHES

9 to 13-inch Swing

List price \$75 and up according to size. When ready to buy send for Lathe Catalog and prices.

W. F. & John Barnes Co.  
100 Ruby Street, ROCKFORD, ILL.

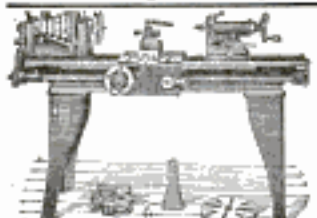

## LATHES

\$75 Screw Cutting Foot or Power

9 to 13 inch

CATALOG FREE

SOUTH BEND MACHINE TOOL CO., 423 Madison St., South Bend, Ind.



## "JARVIS"

New Model Pump has them all stopped. No more "Waterlogged" Pressure Tanks. Pumps both air and water.

Send for List No. 7. We also make Tanks.

JARVIS ENGINE AND MACHINE WORKS LANSING, MICH.

## "Norton" Water Motors Lead Them All

"Model B," for grinding, polishing, \$3.50

running fans, etc. "Norton Improved" with Patented combination shift gear, for flat or round belt, \$6.50

Very powerful. Catalogue sent upon request

NORTON WATER MOTOR CO., Roslindale, Mass.



J. B. Norton

# IDEAL

## Lawn Mower Grinder

Grinds all makes of mowers perfectly in 15 minutes, without removing wheels, ratchets or reel-knife. Operated by either hand or power. Ball-bearing Aluminum Grinding Wheel and Main Shaft. New 1912 Model will grind straight-blade without removing from mower. Has Skate Sharpener Attachment for sharpening skates.

Write Today for full information of this great labor-saver and money maker. Will do the work so much better, quicker and easier, you cannot afford to do without it.

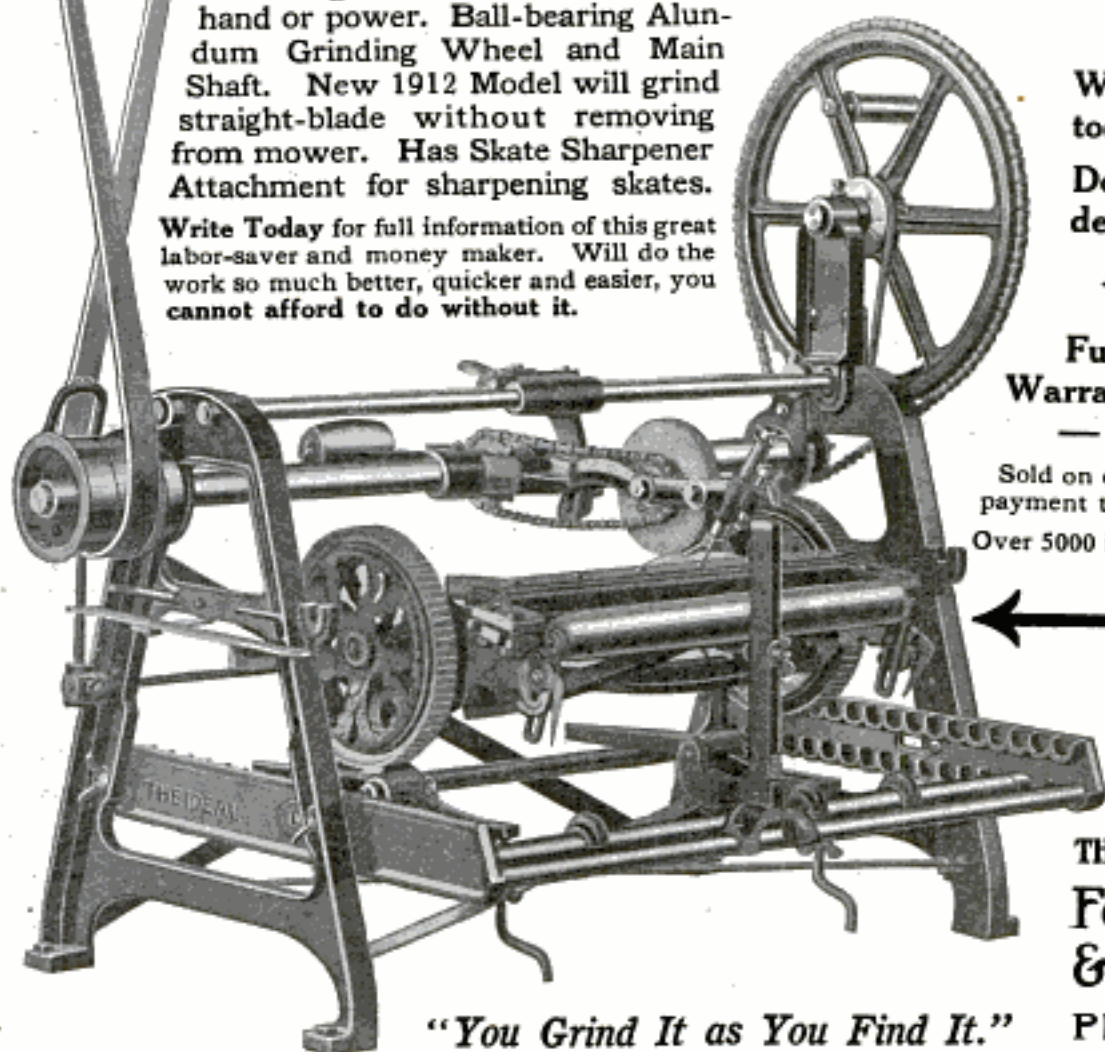

Write today  
Don't delay.

Fully  
Warranted

Sold on easy  
payment terms.  
Over 5000 in use.

*"You Grind It as You Find It."*

THE HEATH  
FOUNDRY  
& MFG. CO.  
PLYMOUTH  
OHIO

### You May Crowd a Crescent Jointer



to the limit of capacity and the machine will do work just as smoothly as though you had not crowded it at all. Built in six sizes. Send for catalog telling all about them and describing our line of Band Saws, Saw Tables, Planers, Planers and Matchers, Shapers, Swing Saws, Borers, Disk Grinders, Variety Wood Workers.

THE CRESCENT MACHINE CO., 93 Columbia St., Leetonia, O.

### VACUUM PUMPS

For Powerful Portable and Stationary Vacuum Cleaning Plants. They take up their own wear. Powerful; Noiseless; can't get out of order.

GET CATALOG No. 23



LEIMAN BROS., 62P John St., NEW YORK

### Bull-Dog Die Stock



for threading from  $\frac{1}{4}$  to  $1\frac{1}{4}$ " pipe.

Cuts from the smallest to the largest threads used on most repair jobs.

The Quick-Opening Die is a Big Feature.

It has a self locking pipe centering device.

Send for complete list and prices

Price \$8.50

THE OSTER MANUFACTURING CO.  
2100 East 61st Street CLEVELAND, OHIO

Please Mention Popular Mechanics



## In the Shop—About the House In the Manual Training School

A Carborundum Sharpening Stone means sharp, perfectly conditioned tools—and sharp tools mean better work. Ask your hardware dealer—if he hasn't them send direct.

No. 107H—Round combination stone for carpenters . . . \$1.00  
 No. 108H—Oblong combination stone . . . . . 1.25  
 No. 108H—Oblong combination stone in aluminum box . . 2.75  
 No. 191H—Scythe and grass hook stone . . . . . .25

No. 114H—Sportsman's pocket stone in soft leather case . . . . . .75  
 No. 149H—Pocket stone in card-board case . . . . . .15

**THE CARBORUNDUM COMPANY**  
 NIAGARA FALLS, N. Y.



### AGENTS

Make \$30 Per Wk.

This AWL sews a lock stitch like a machine. Best thing ever made for repairing Harness, Shoes, etc. A dozen exclusive features. Demand is immense. Sales astounding. Roy Sage writes "Rec'd Awl today sold 5 in 15 min." L. Perrine says "Sold 9 on way home with sample." Lowest price, biggest profit, greatest value, quick sales. Drop everything and write for sample and instructions.

ANCHOR MFG. CO., Dept. 940, DAYTON, O.



**CELLULOID**—Hundreds of useful articles are made out of celluloid, which is a substitute for coral, rubber, bone and ivory. All know of its explosive nature, being close of kin to nitroglycerine chemically, though all do not know that the Germans have learned how to eliminate this dangerous quality. In their hands it is as harmless as burning wood when ignited and this fact must make its use more popular and general.

Celluloid is a compound of a vegetable fibrine, called cellulose, reduced by acids to gun cotton. This fibrine



### Portable Cases

FOR TOOL MAKERS  
AND MACHINISTS

Twelve styles, felt lined drawers, solid brass trimmings, best of material, beautiful finish, low prices, satisfaction guaranteed. Ask for booklet of cases built for service.

The Pilliod Lumber Co.  
SWANTON, OHIO

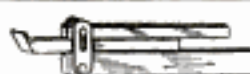

### The Handiest Tool Holder Made

Constructed of hardened steel; accurately machined; and will hold securely, round, flat, square, hexagon, and shaped tools in the tool post, from the largest sized tool down to a No. 60 drill. Write for full particulars, and prices. Satisfaction guaranteed.

**B. MORGAN**, Manufacturer of SPECIALTIES  
Bellevue St., Newport, Rhode Island



No. 501.

### "OHIO" CHISELS

are made from high grade and specially selected tool steel, and the care, skill and experience of our 89 years in the Edge Tool business is put into every tool bearing our "Ohio" Trade Mark shown here. The result is a high grade and very satisfying tool, with a keen, tough and lasting cutting edge.

### "OHIO" PLANES

are fitted with our special Extra Heavy Cutter, which prevents Chattering or Trembling when used in hard or knotty timber. High grade cutters, accurate adjustments and true faces are only a few of the points in which our planes excel and make it well worth your while to insist on having them from your dealer.

Write for our free Catalogue of High Grade  
Tools and Benches

**OHIO TOOL CO.** (Dept. 3)  
COLUMBUS, OHIO



Please Mention Popular Mechanics

# STANLEY ANGLE DIVIDERS

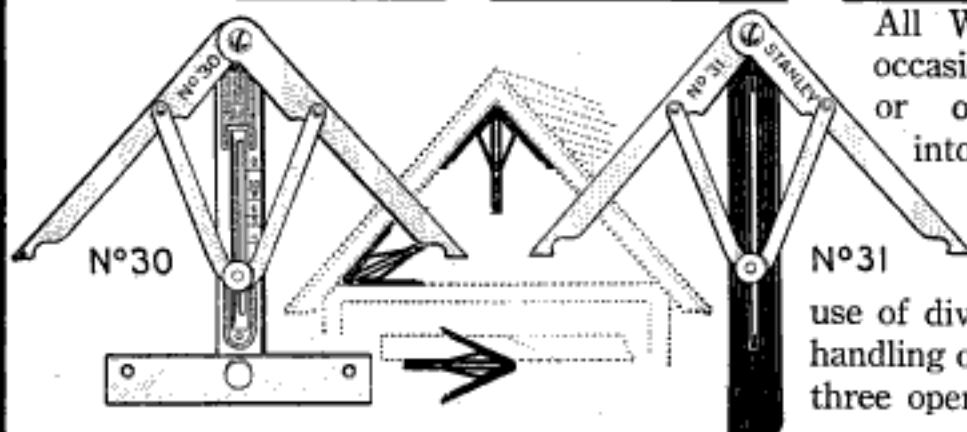

All Wood-workers have occasion to fit mouldings, or other wood work, into odd angles. To lay out the cut with an ordinary bevel necessitates the use of dividers and a second handling of the bevel, making three operations.

**The Stanley Angle Divider** is designed for performing this work at one setting and is practically a double bevel. The two blades each fit one side of an angle and the handle gives the center line.

**No. 30**—Is entirely of metal, nickel plated, has graduated handle for laying out 4, 6 or 8-sided work and a "T" head for use as a "T" Square. List Each . . . . . **\$1.50**

**No. 31**—Has Rosewood handle, is not graduated and has no "T" head. List Each . . . . . **1.00**

Manufactured  
by

**Stanley Rule & Level Co.**  
NEW BRITAIN, CONN. U.S.A.

For Sale by  
All Hardware  
Dealers

is found in all vegetable life, especially in all young plants. It is a substance like starch. The fiber of cotton is mainly cellulose.

When the cotton fiber is submerged in acids it quickly becomes a thick paste, which is semitransparent. Then camphor is added to further thicken the mass and the desired coloring matter mixed in, which may be of any hue whatsoever. At this stage the celluloid is molded by heat and pressed like wax into various shapes, such as combs, paper cutters, collars, and the like.—Louisville Courier-Journal.

**Make \$25 to \$50 Weekly**

Selling the Automatic Combination Tool in your home county. A Fence Builder's Tool, Post Puller, Lifting Jack, Vice, Wrench, etc. Used by Farmers, Teamsters, in Factories, Mills, Mines, etc. Weight 24 lbs. Capacity 3 tons. No experience necessary. Free instruction. Write for special offer to live agents. Send no money. Name county where you live.

**AUTOMATIC JACK COMPANY**  
Box 224 Bloomfield, Ind.

**LUFKIN**

**Measuring Tapes**

Standards of efficiency for the Amateur and the Expert. The big improvement in markings, **instantaneous readings**, saves time and avoids error. Send for sample piece of tape and our complete catalogue.

**THE LUFKIN RULE CO.**  
SAGINAW, MICH.  
New York London, Eng. Windsor, Can.

## Files That Stand the Test

Many an ordinary file becomes useless in a very little while. After being used several times the teeth have lost their sharpness—the cutting edge is gone—the file is worthless. Now the safe way to buy a file is to ask your dealer for

# Gold ★ Medal Files and Rasps

Then you are sure of getting the finest file manufactured. Every one is made of a superior grade of crucible steel, cut on the latest improved machinery by expert workmen and tempered by our secret chemical process that produces the finest temper known. The result is what every mechanic knows as

**"The File that Files"**

Remember the name—Liveright—and look for the star. If not at your dealer's, write us direct.

**LIVERIGHT BROTHERS (Not in the Trust) Philadelphia, Pa.**

## A Handy Little Tool for Every Mechanic

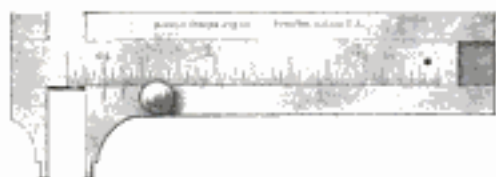

### B. & S. Pocket Slide Caliper Rule

For measuring washers or nuts, selecting stock, and taking other external and internal measurements. One side is an ordinary 3" rule; Slide reads to 64ths.

### FURNISHED ALSO AS A BUTTON GAUGE

Write for folder "Up-to-Date  
Tools for Up-to-Date Men."

**Brown & Sharpe Mfg. Co.**  
Providence, R. I., U. S. A.



### Hand Drill No. 3

is a perfect tool of its kind. Extreme length over all is 11 inches and diameter of drive gear 3 3/8 inches. Has hollow handle to hold Points, which is unique and convenient. For sale by all dealers. Write for catalog and instructive booklet, "Tool Practice."

**MILLERS FALLS COMPANY**  
28 Warren Street New York

## GET THIS!



Time and strength are worth money. With the Double Claw Hammer you save both. It pays for itself many times over. It pulls the nail up instead of rolling it out. You drive the same nail right in again. You never smash your fingers in high nailing, and your left hand is free to hold the board to be nailed. The carpenter who got this up knew his job and saved himself a lot of trouble.

Free delivery to your address on receipt of \$1.50

The Double Claw Hammer will pay for itself many times over in the time and strength it saves the user. It is indeed a pleasure to work with it. If you are not satisfied with this hammer send it back at our expense and we will refund your money. Not one returned yet. Remember—it costs three times as much to make this hammer.

SEND FOR IT NOW

**DOUBLE CLAW HAMMER CO.**  
453 Broadway BROOKLYN, N. Y.

## Steam Fitters and all Pipe Line Workers

Here is a tool that grips large size iron and steel tubing with the power of a giant—a fast and easy worker on any threaded pipe. Seven sizes: No. 10, 11, 12, 13, 13 1/2, 14 and 15. Smaller takes 1/8 in. to 3/8 in. pipe—largest, 2 in. to 12 in. This wrench has several distinct advantages. Jaws are interchangeable and so perfectly fitted against shoulder, which is forged on handle, that "pull" of the chain is not on the jaws or on a bolt, but on the collar forged with the handle. The chain of the

## BONNER

"Victor"

### Chain Pipe Wrench

is hand made and swings from an eye forged in the end of handle, thus making the wrench instantly reversible.

Like every other Bonner tool, this wrench is of highest quality. Tempering is done by an expert, and jaws can be sharpened only by filing. This is guaranteed as the most efficient and powerful chain pipe wrench made. If your local hardware store cannot supply you, send us dealer's name.

C. E. BONNER MFG. CO., Champaign, Illinois.

Makers of Bonner Pry  
Bars, Auto Kits, Farm-  
er Kits and other  
special purpose tools.

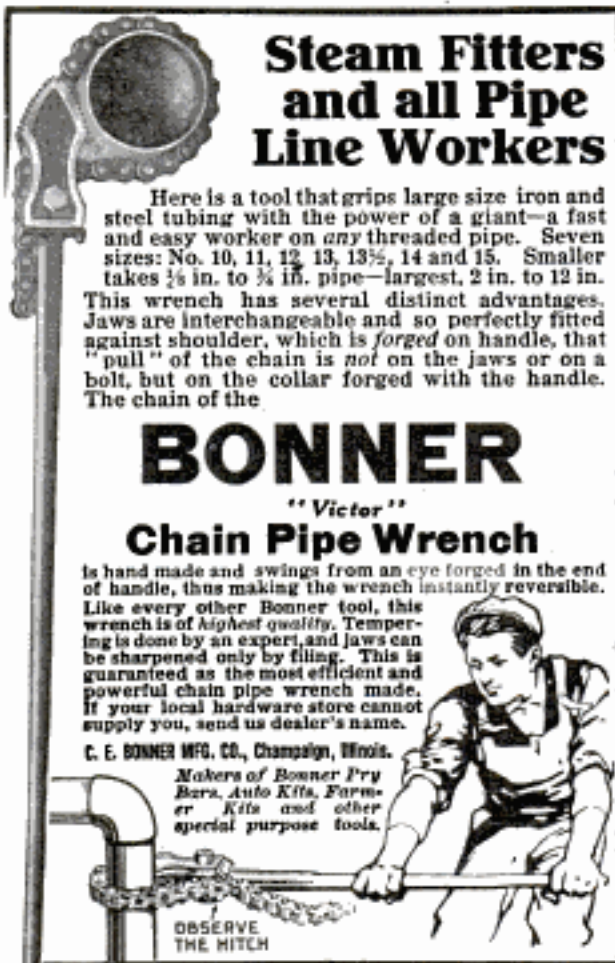

OBSERVE  
THE HITCH

**AN 80-POUND DOLLAR**—There have been many kinds of dollars in the United States—silver dollars, gold dollars and multifarious paper dollars of sometimes dubious value; and in other countries, iron, platinum, brass, bone, ivory, and even wheat and cotton goods have done duty as money. But the oddest "dollar" ever seen thus far, perhaps, is that coined, or rather quarried, by the chiefs of the island of Yap, one of the group of Caroline Islands in the South Pacific. These Yap coins are even more cumbersome to carry

## FOR MENDING HARNESS

shoes, tents, awnings, pulley belts, carpets, saddles, suit cases, buggy tops, dash boards, or any heavy material. Stewart's Automatic Awl is the only perfect Sewing Awl.

It takes a wax thread, feeds from spool and does the work of any harness maker machine. It is indispensable for taggers. Agents wanted. Sent prepaid for \$1.25. Send at once for catalog.

**STEWART-SKINNER CO.**  
26 Hermon Street  
Worcester, Mass.



USE ONLY  
ONE HAND  
FOR HIGH  
NAILING



# "YANKEE" TOOLS *Make Better Mechanics*

## This "YANKEE" Ratchet Breast Drill

can be worked in places and under conditions where it is impossible to operate any other drill or boring machine. The "YANKEE" improvements enable the user to instantly adapt the tool to the working requirements of any drilling or boring job.

### Five Adjustments

Right, Left and Double Ratchet movements; Plain Drill; and gears locked.

Breast Plate can be turned to right angle of position illustrated.

Two Speeds. Changed at a touch of this little lever, at any point in revolution, without removing drill from work.

### This Shifter Controls the Adjustments

First notch—Plain Drill; Second notch—Left-hand Ratchet; Third notch—Right-hand Ratchet; Fourth notch—DOUBLE RATCHET; Fifth notch—gears locked. Changes made at a finger touch.

The DOUBLE RATCHET is a big time-saver and convenience when work is in close quarters: Every movement of the crank, forward and back, causes the drill to *cut continuously*. Twice the work is done, compared with a single ratchet. The drill is advanced as speedily as with a full revolution of the crank.

"YANKEE" Ratchet Breast Drill No. 555 Length, 17 inches. Weight, 6½ pounds. Double speed. Two-jaw chuck; capacity, ½ inch. Price, \$5.25. Your dealer can supply you. Write for "YANKEE" Tool Book illustrating and describing the various styles of "YANKEE" Ratchet, Breast and Hand Drills and other "YANKEE" Tools

**NORTH BROS. MFG. CO., PHILADELPHIA**



### Two-Jaw Chuck

of new design, for round or square shanks. Jaws are accurate; securely hold drills, bits and other tools—centered absolutely. The hexagon permits use of a wrench for tightening large drills. "YANKEE" Breast and Hand Drills are made also with three-jaw chucks (for round shank tools only).

This Handle is made with a bit for use as a screw-driver for the tool.

AUTOMOBILISTS—Write for "YANKEE" Tools in the Garage."

about than the great silver "daddy dollar" of our own land—vastly more cumbersome, indeed, since they weigh 80 lb. apiece, and are over 2 ft. in diameter. A defaulting cashier would certainly have difficulty in absconding with many of them.

Two of these strange pieces of money form part of a collection of coins in this country. They are circular discs of coralline rock, dull white in color, yet apparently crystalline, 2½ in. in diameter, and from 3 to 4 in. thick. At the center of each there is a round hole



**Toolmakers and Machinists.** Here's a Portable Tool Case with a convenient arrangement of different sized drawers, all felt lined, with a place for every tool. No need of throwing one on top of the other. This Case will pay for itself in saving tools, time and drayage expense. You need one of the many styles shown in our catalogue which we will mail free. No mechanic is up-to-date without a Gerstner's Case.

**Gerstner & Sons**

Mfrs. of Mechanics' High Grade Tool Cases  
818 Germantown Street, DAYTON, OHIO

One sample to one person only, \$1.  
Ask about our 3,000 R. D. Tools

## "Red Devil"

SPECIAL

### Heavy "Klein" Pattern Electricians' No. 1950 Side Cutting Plier, 8"

**SMITH & HEMENWAY CO.**  
150 Chambers Street, New York City, N.Y., U. S. A.

## DON'T ABUSE YOUR HANDS

with an old fashioned screw driver

Get a Benjamin Friction Drive Screw Driver with the revolving cap.

No more blisters  
Insulated handle



### Introductory Prices

Length 3-16 in. Dia. 5/8 in. Dia.	
3" Blade	.30 .35
4" "	.35 .40
5" "	.40 .45
6" "	.45 .50

3-16 in. dia. with straight blade for countersunk work if ordered

Sent postpaid to any address on receipt of price.

Better than Ratchet Driver, as the Friction Grip works in either direction —Without Adjustment. If your dealer does not carry, write direct to us.

**BENJAMIN-SELLAR MFG. CO., 557 W. Quincy St., CHICAGO, ILL.**

Please Mention Popular Mechanics

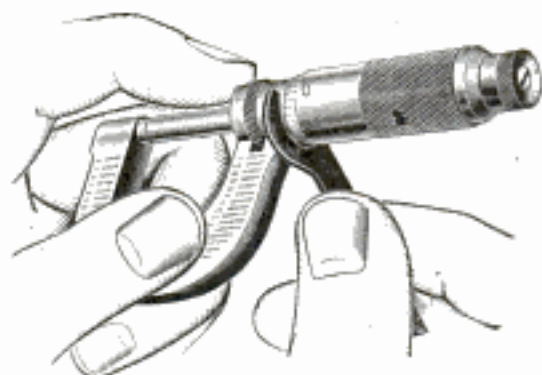

## The Simple Adjustment

of the Starrett Micrometers is a feature that enthruses all mechanics. It takes up any wear quickly and accurately — not by the trial, hit-and-miss way of the movable anvil. This is obtained by placing over the barrel a thin, graduated sleeve, which carries the base or zero line, instead of having it marked on the barrel itself.

If at any time on account of excessive wear, the zero line is not correct, a small turn of this sleeve with a small spanner wrench will remedy the error. A wrench is sent with each Micrometer.

When you see any Starrett Tools you will notice some little difference which makes it better—which makes the Starrett Tools known and trusted wherever accurate work is done.

Catalog 19AP is free. It tells of and illustrates all the fine Starrett Tools.

**The L. S. Starrett Company**  
Athol, Mass.



## BAR BENDERS

For Concrete Reinforcements

WRITE FOR OUR BENDING TOOL CATALOGUE.

Wallace Supply Co. 124 No. Jefferson St., Chicago  
26 Cortlandt St., New York City

## For Sewing Leather



**\$1.00** A perfect stitcher. Sews or mends anything. Whole repair shop. Original perfect lock stitch. Diamond point grooved needle protects thread. Always ready. Sample prepaid. Agents get busy. Sells on sight. C. A. MYERS CO., 6339 Lexington Ave., Chicago, Ill., U. S. A.

## YOU CAN DIG 40 FOOT WELLS

quickly through any Earth with our Guaranteed **Well-Boring Outfit**. Nothing else like it. Cheapest and Best method known. Price \$10.00 Delivered. **Our Big Circular for 2-cent Stamp. Write to-day.**  
**STANDARD EARTH AUGER CO.**  
1128-45 Newport Ave. CHICAGO, U.S.A.

## THE EXCELSIOR BRAD SET. PRICE 25 CENTS

Takes No. 18 and No. 20 Brads from 1/4 to 3/4 in. long



The tool illustrated above will be indispensable to the Pattern Maker, Cabinet Maker, or Picture Framer who purchases it. It will set brads in places that would be inaccessible without it, and dispenses with the brad awl and nail set. If, after a fair trial, you are not satisfied that you have received your quarter's worth, your money will be promptly returned to you on receipt of tool. **Standard Tool Supply Co., 42 W. 15th St., New York City**

## POCKET KIT

47 PERFECT-PRACTICAL  
SPLENDID TOOLS \$1.00

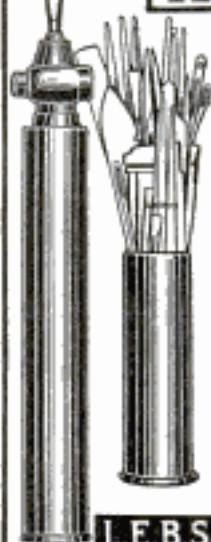

In handsome nickled case, pocket size, for pocket, desk, home, automobile or shop. All of fine steel. A 20th Century marvel.

### Some of the 47 Tools

Hammer, Screw Driver, Chisel, Corn Knife, Dividers, Tweezers, Compass, Saw, Protractor, File, Round File, Rule, Bevel, Universal Chuck, Tool Handle, T Square, Tri Square, Scratch Gauge, Depth Gauge, Rule Gauge, Slide Callipers, Reamer, Countersink, Brad Awl, Harness Awl, Scratch Awl, Straight Edge, Ink Eraser, Tack Claw, Nail Set, Center Punch, Bag Needle, Sail Needle, Button Hook, Spatula, Scraper, Stillite, and ten others.

Made on honor. Sold on guarantee, postpaid. Money back if not satisfied. Remit \$1 TO-DAY.

L. E. B. SALES CO., 115 BROADWAY, NEW YORK

## A Fortune in this Exclusive Agency

For the L. E. B. Shock Absorber for Typewriters

Which doubles the life of the typewriter, and accomplishes so much besides that it passes belief. Write us for terms and particulars. Also about our other self selling and fortune making Office Specialties, together with the above L. E. B. Pocket Tool Kit.

L. E. B. SALES CO., 115 Broadway, NEW YORK, N. Y.

2 1/2 in. in diameter.

The Yap chief enjoys a monopoly in this singular sort of coinage. When in want of money he has but to send his slaves to the quarry to fashion as many flat "dollars" as he needs. His treasury is a number of long poles set on supports in front of the royal hut. The dollars are strung on the poles like beads on a necklace.—Harper's Weekly.

An electric flatiron with an automatic cut-off, so that the current is used only when the iron is in operation, has been patented by two Californians.—Los Angeles Times.

## GASOLINE SOLDERING IRON BLOW TORCH

You have used all the rest — now try the best.

EMMELMANN BROS. MFG. CO., INDIANAPOLIS, IND., U.S.A.

## AGENTS 100% PROFIT



Just out. Patented. New Useful Combination. Low priced. Agents aroused. Sales easy. Every home needs tools. Here are 15 tools in one. Essex Co., N. Y. agent sold 100 first few days. Mechanic in shop sold 50 to fellow workmen. Big snap to hustlers. Just write a postal—say: Give me special confidential terms. Ten-inch sample free if you mean business. THOMAS MFG. CO., 2848 Wayne Street, DAYTON, OHIO





**Only \$14.50**  
**For this Home Bench**

Besides its convenience and usefulness, you will save its price in a year by doing repair work and "fixing things" that you now pay a carpenter or repair man to do. Thousands of homes have home benches we have furnished—why not you?

Top is 50 in. long, 20 in. wide, with a 13-inch glazed-up portion of thick maple

**Grand Rapids Hand Screw Co.**  
 620 N. Front St. GRAND RAPIDS, MICH.

**MECHANICS' COMPOUND Lever Snip**

A size larger than our "Vest Pocket," eight inches long, strong, powerful, durable. Forged from a solid bar finest crucible tool steel.

By mail Prepaid **\$1.50**



**DETROIT SHEAR COMPANY**  
 902 Greenwood Ave., DETROIT, MICH.

It is estimated that Texas has 120,000,000 acres of land suitable for growing cotton. At present there are 10,088,000 acres in cotton.—Louisville Courier Journal.

## AGENTS 100% Profit

Hundreds are coining money selling Novelty Knives. Many styles and sizes. Transparent handles, decorated with secret society emblems, photos, address, etc. Hundreds of designs to choose from. Easy sellers. Big profits. D. Wilson, one of our hustlers reports:

### ONE MONTH'S PROFIT, \$260

C. E. Warner, another live one, made \$80.00 in 8 days, working in the noon hour only. We want more like them. Why not you? No experience needed. We teach you how. Exclusive territory. Free samples to successful agents. Catalog and terms on request. Don't wait—write quick—today.

**NOVELTY CUTLERY CO., 267 Bar St., Canton, Ohio**

## WIDE YOUR FEET



Mud, snow, dust and dirt will not be tracked over your floors if you use

**Grab's Foot Scraper**

outside your door. The only device made which cleans bottoms and sides of shoe in one operation. Has ten parallel plates for scraping soles and two stiff bristle brushes which clean sides of shoe.

**AUTOMATICALLY ADJUSTS ITSELF**

to any size shoe. Handsomely enameled. Looks neat. Can be rotated and swept under. Fastens to doorstep or any handy place. Get one and save useless work. Price \$1.00. If your dealer will not supply you, don't take substitute, but send your order direct to us. Illustrated folder FREE. AGENTS WANTED.

**VICTOR M. GRAB & CO., 872 Ashland Block, CHICAGO, ILL.**



**THE NEW**  
**CYCLOPAEDIA OF**  
**ENGINEERING**

**At Half Price**

Every Engineer must read if he would progress—the biggest men in the field can't go around telling what they know—but they can write it. And you can read it—in our New Cyclopaedia of Engineering—the most valuable set of books on this subject ever offered to Engineers. This Cyclopaedia has just been revised—it's right up to the minute.

These books cover every subject you are likely to meet in practical engineering. They are interestingly written by well-known authorities and are not only valuable for studying, but also as permanent reference books.

The seven books contain 3,300 pages, size 7x10 inches, and over 2,500 illustrations, full page plates, diagrams, etc. The regular price of these books is \$36.00, but as a special introductory offer we have put the price at \$19.80.

### \$1.80 Down \$2.00 a Month

Sent express prepaid. You can examine the books before paying a cent. Just fill in and mail the coupon.

This price and these terms make it easy for any engineer to secure the valuable set of books. Read the brief description below and see what you will get when you mail the coupon.

#### OUR PROTECTIVE GUARANTEE.

Send for the Cyclopaedia of Engineering, examine it carefully and if, at the end of seven days, you see that you need it, send us \$1.80 and \$2.00 each month thereafter until the total, \$19.80, has been paid. If the books are not satisfactory—don't send us a cent—we will pay all charges. Use this coupon. We absolutely protect you against loss. Signing the coupon does not obligate you in any way.

#### —READ THIS SYNOPSIS—

Construction of Boilers—Boiler Accessories—Fuel Economizers—Mechanical Stokers—Steam Pumps—Steam Engines—Indicators—Valve Gears—Steam Turbines—Gas and Oil Engines—Fuels—Automobiles—Carbureters—Locomotive Boilers and Engines—The Air Brake—Single-Phase Electric Railway—Elevators—Marine Boilers—Marine Engines—Heating and Ventilating—Compressed Air—Transmission—Absorption and Compression Refrigeration—Ammonia Machines—Direct Current Dynamos and Motors—Management of Dynamos and Motors—Electric Wiring—Electric Lighting, etc.

**ANOTHER GREAT OFFER** With each set is included a year's Consulting Membership entitling you to the advice of our business and engineering experts free. This will give you practical help in handling working problems which are too specific to be taken up in detail in the cyclopaedia. A single problem solved for you might be worth more than the first cost of the books.

#### FREE EXAMINATION COUPON

**American School of Correspondence**  
 CHICAGO, U. S. A.

Please send set Cyclopaedia of Engineering for 7 days' free examination. I will send \$1.80 within 7 days and \$2.00 a month until I have paid \$19.80; or notify you to send for the books. Title not to pass until fully paid.

Pop. Mech. 3-12

NAME.....  
 ADDRESS.....  
 OCCUPATION.....  
 EMPLOYER.....

## DEAM WASH GUN

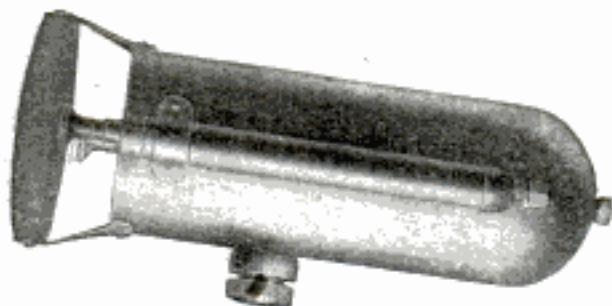

For Garages, Automobile Owners, Mechanics, etc. Economical, durable, practical and simple. An indispensable necessity. Will wash all inaccessible parts of motor and will economize gasoline to a minimum. No grease cup or oil cup should be removed or opened and filled until it is first cleaned off with this wash gun. Price of Wash Gun (F. O. B. Chicago) **\$5.00** Brush 25c Extra

We fully guarantee the gun to give complete satisfaction barring carelessness and abuse.

### NO REPAIR SHOP IS COMPLETE WITHOUT ONE

The use of the Wash Gun is not confined to the automobile, by any means—it is indispensable for cleaning all kinds of machinery, typewriters or printer's forms, as the force of the gasoline jet will cut gummed dirt, etc., out of type and can be used to advantage in many other places too numerous to mention.

Also if carried filled with a fire extinguishing fluid, when not in use as a wash gun, you have a ready fire extinguisher at hand equal to or superior to any fire extinguisher on the market for automobile service.

By adding a special spray nozzle so as to handle the spraying compound used on flowers and shrubbery, the gun becomes indispensable for florists and nursery use.

An attractive proposition for live agents to make big money. Write for particulars to

**Deam & Co., Dept. P.M., 507 Great Northern Bldg., Chicago**

## "BALLITE" Spark Plugs

Boston Made New England Quality

A magneto as well as a battery plug. Construction simple and thoroughly mechanical in every detail. Insulated with finest grade of porcelain of special pattern, securely packed, which prevents spring through.

WILL NOT LEAK  
WILL NOT SPOOT

A Live Wire  
Proposition  
to Dealers!

ALL PLUG  
VALUE—  
NO FRILLS!

**75¢**

If you wish to satisfy your customers, then you would do well to connect with our proposition. "Ballite" spark plugs sell quickly. Not only that, but they bring repeat orders.

Although we sell these plugs at the low price of 75c, we have sacrificed nothing in the making. Only the best mechanics make these plugs, using reliable and durable material.

Try  
a Set  
On Your Car!

Send Prepaid Anywhere

We will guarantee your satisfaction and twice the wear of any other plug made—used under normal conditions.

**G. A. WALKER MACHINE CO.**  
51 Chardon St. Estb. 1860 BOSTON, MASS.

WESTERN TRADE SUPPLIED BY  
MARSHALL OIL CO., MARSHALLTOWN, IOWA

**BIRDS DESTROYING THE FISH**—Fish-eating birds, seals and porpoises are making such inroads on edible fishes along certain portions of the coast of England that fishermen are appealing to the British government for relief. In Wales the cormorant has become a fearful pest, it would seem. A correspondent writing to the London "Fishing Gazette" says he and some friends spending a vacation on the north shore of the Broadwater and banks of the River Dysynni, near Towyn, Merionethshire, were much concerned at the

## \$3000.00 IN ONE YEAR



One man invested his SAVINGS in an Auto Tire Repair Plant and made \$3000.00 the first year and was worth \$10,000.00 at the end of the second year.

You can make money repairing tires and tubes as evening employment. As an independent occupation, you can turn out thousands of dollars gross business per year. We furnish complete instructions. Investment small. Write for information.

**Haywood Tire & Equipment Co.**  
529 N. Capitol Ave., Indianapolis, Ind.



## \$40 Motorcycle

We have the largest line of new and used Motorcycles in the country at the lowest prices. We also have a thoroughly equipped repair department and are in position to furnish repairs for any machine. Send us your machine to be overhauled. We pay cash for second hand motorcycles. *Send for Catalog.*  
**HARRY R. GEER CO., 888 McLaran Ave., ST. LOUIS, MO.**

## WANTED—RIDER AGENTS IN EACH TOWN

Model "Ranger" bicycle furnished by us. Our agents everywhere are making money fast. *Write at once for full particulars and special offer.* NO MONEY REQUIRED until you receive and approve of your bicycle. We ship to anyone, anywhere in the U. S. without a cent deposit in advance, *prepay freight*, and allow **TEN DAYS' FREE TRIAL** during which time you may ride the bicycle and put it to any test you wish. If you are then not perfectly satisfied or do not wish to keep the bicycle you may ship it back to us at our expense and *you will not be out one cent.*

**LOW FACTORY PRICES** We furnish the highest grade bicycles it is possible to make at one small profit above the actual factory cost. You save \$10 to \$25 middlemen's profits by buying direct of us and have the manufacturer's guarantee behind your bicycle. **DO NOT BUY a bicycle or a pair of tires from anyone at any price until you receive our catalogues and learn our unheard of factory prices and remarkable special offer.**

**YOU WILL BE ASTONISHED** when you receive our beautiful catalogue and study our superb models at the wonderful low prices we can make you. We sell the highest grade bicycles at lower prices than any other factory. We are satisfied with \$1.00 profit above factory cost. **BICYCLE DEALERS**, you can sell our bicycles under your own name plate at double our prices. Orders filled the day received.

**SECOND HAND BICYCLES**—a limited number taken in trade by our Chicago retail stores will be closed out at once, at \$3 to \$8 each. Descriptive bargain list mailed free.

**TIRES, COASTER BRAKE** rear wheels, inner tubes, lamps, cyclometers, parts, repairs and everything in the bicycle line at half usual prices. **DO NOT WAIT**—but write today for our Large Catalogue beautifully illustrated and containing a great fund of interesting matter and useful information. It only costs a postal to get everything. Write it now.

**MEAD CYCLE CO. Dept. G 108, CHICAGO, ILL.**



# We Will Sell You One American Motorcycle At Wholesale Agent's Price

## \$139.65

In every locality where we are not now fully represented by Advertising Agents—men to advertise our machines by riding either one of our Motorcycles or Bicycles for regular business or pleasure use—we will sell you your machine at our Wholesale Price.

Here is the only Motorcycle made entirely by hand—and I guarantee it for three years. All other motorcycles are machine-made—and because machinery can not make a flawless motorcycle, no other manufacturer can give such a guarantee. I alone make motorcycles by the same methods used in making bicycles ten and fifteen years ago—every part an exclusively hand-made product. Those bicycles of the old days were worth your money. But competition lead manufacturers of bicycles and motorcycles to "cheapen" their output in order to lower their prices and yet clear the profit required in retail and mail-order selling. I alone have stuck to the old methods of manufacture and adopted new methods of selling. I introduce my American Motorcycles and Bicycles by selling one man in every locality his machine at wholesale price. As a result, my Company today is the largest Motorcycle and Bicycle manufacturing and distributing concern in the world. So grasp this opportunity now to secure for yourself at Wholesale Price this absolutely best Motorcycle or Bicycle on the market. Take

**This One Big Value—\$139.65—Illustrates the Value of All American Motorcycles**

our 4 to 5 H.P. Motorcycles, Model No. 12; spring frame of genuine cold drawn steel seamless tubing; flat belt and idler; free engine; ball bearing motor; and full high-grade equipment in every particular—only \$139.65. Complete description with illustrations sent free on request—Model No. 12.

**Write Today for 1912 Catalog and Special Wholesale Price Offer.** This Free Catalog contains illustrations of all American Motorcycle Models, also photographic illustrations of the various parts, and complete, detailed description of construction. Write immediately to get advantage of our wholesale price to one man in your locality. Just by riding your American Motorcycle you will attract other purchasers—and all orders secured through you will pay you a liberal commission. Here is your opportunity to get your American Motorcycle at a big reduction and make extra money out of your pleasure. Write today. Tomorrow this opportunity may be gone in your locality.

## \$18.85



big value to you. Nowhere else can you get such a bicycle these days. Only my American Bicycles now are made by hand—all others are made by automatic machinery to "cheapen" the cost of production, and the consequence is a "cheap" product. I want an American Bicycle Advertising Agent in each city or town, and to such will sell one American Bicycle, any model you select, at wholesale factory agent's price. No work to do. Just ride your American Bicycle. Get a liberal commission on every purchaser you refer to us—besides securing your own bicycle at actual factory price. Write today for 1912 American Bicycle Catalog—and Special Advertising Wholesale Price Offer. When writing state whether you are interested in Motorcycle or Bicycle.

## AMERICAN MOTORCYCLES AND BICYCLES

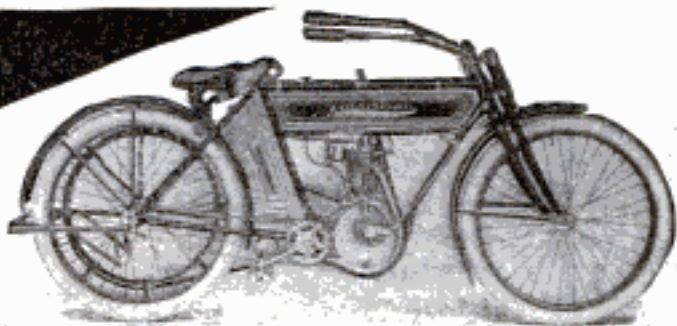

I alone make motorcycles by the same methods used in making bicycles. Those bicycles of the old days were worth your money. But competition lead manufacturers of bicycles and motorcycles to "cheapen" their output in order to lower their prices and yet clear the profit required in retail and mail-order selling. I alone have stuck to the old methods of manufacture and adopted new methods of selling. I introduce my American Motorcycles and Bicycles by selling one man in every locality his machine at wholesale price. As a result, my Company today is the largest Motorcycle and Bicycle manufacturing and distributing concern in the world. So grasp this opportunity now to secure for yourself at Wholesale Price this absolutely best Motorcycle or Bicycle on the market. Take

our 4 to 5 H.P. Motorcycles, Model No. 12; spring frame of genuine cold drawn steel seamless tubing; flat belt and idler; free engine; ball bearing motor; and full high-grade equipment in every particular—only \$139.65. Complete description with illustrations sent free on request—Model No. 12.

**Write Today for 1912 Catalog and Special Wholesale Price Offer.** This Free Catalog contains illustrations of all American Motorcycle Models, also photographic illustrations of the various parts, and complete, detailed description of construction. Write immediately to get advantage of our wholesale price to one man in your locality. Just by riding your American Motorcycle you will attract other purchasers—and all orders secured through you will pay you a liberal commission. Here is your opportunity to get your American Motorcycle at a big reduction and make extra money out of your pleasure. Write today. Tomorrow this opportunity may be gone in your locality.

**Bicycles Guaranteed for Life** My price means a big saving to you—my guarantee means a big value to you. Nowhere else can you get such a bicycle these days. Only my American Bicycles now are made by hand—all others are made by automatic machinery to "cheapen" the cost of production, and the consequence is a "cheap" product. I want an American Bicycle Advertising Agent in each city or town, and to such will sell one American Bicycle, any model you select, at wholesale factory agent's price. No work to do. Just ride your American Bicycle. Get a liberal commission on every purchaser you refer to us—besides securing your own bicycle at actual factory price. Write today for 1912 American Bicycle Catalog—and Special Advertising Wholesale Price Offer. When writing state whether you are interested in Motorcycle or Bicycle.

*A. J. Musselman*  
Pres. American Motor Cycle Co.,  
103 American Building, Chicago.

scarcity of fish this year. He referred to the manner in which the cormorants are preying on the fish and adds that the birds become so bold that on the upper reaches they come within a few yards of the fishermen. "One daring bird could not be moved, although we made the most frantic efforts to frighten him, and we assumed he was wounded by a gunshot, although he dived repeatedly. We counted flocks of as many as 20 flying at night to their haunt, the Bird Rock; and I have no hesitation in saying there must be hundreds regularly feeding in the river daily."

### MAKE A MOTORCYCLE OF YOUR BIKE



at small cost, by using our attachable outfit. It fits any bicycle. Motorcycles, all makes, new and second hand \$35.00 up. Send stamp for catalogue and bargain list. Keller's new 104-page booklet, "Construction, Management and Care of Motorcycles" is now ready. Price, postpaid, 25c.

SHAW MFG. CO., Dept. B, Galesburg, Kansas

### Columbian Portable Garages



Are built of double walls of galvanized steel which have a lining of asbestos between, thus making them impervious to heat or cold—cool in summer—warm in winter. This essential feature cannot be obtained in single wall construction. A handsome, substantial building which is ABSOLUTELY FIRE-PROOF and is

#### Guaranteed Ten Years

Can be set up or taken down in a short time. Our Illustrated Catalog shows pictures and quotes prices on many different sizes. Hunting lodges, boat-houses, cottages and all kinds of steel buildings made to SUIT YOU. We also manufacture the most up-to-date underground gasoline storage systems for private and public garages. Write for one or both catalogs today. We send them Free.

COLUMBIAN STEEL TANK CO., Dept. 11, KANSAS CITY, MO.

### \$15.00 Per Month Buys this Motorcycle

A GENUINE \$200  
4 1/2 HP MOTORCYCLE

WITH FREE ENGINE AND  
ALL 1912 IMPROVEMENTS

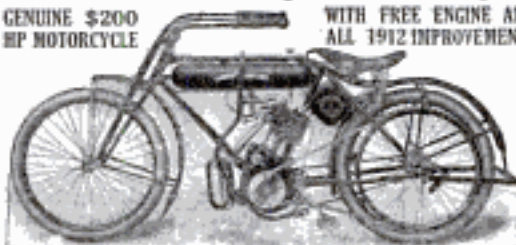

Rider Agents Wanted to ride the Peerless Jr. while paying at the rate of \$15.00 per month.

Special Introductory Price Now \$149. Only \$19 down. \$13.00 per month for only six months. Write quick for catalog and full details of this big special Peerless Jr. Motorcycle offer.

PEERLESS MOTORCYCLE CO., 174 Columbus Ave., Boston, Mass.

### THE MOTOR-BOB

A BOY'S SIZE  
AUTO



Made so you can build and run it. We supply motors and all parts.

Also finished machines. The MOTOR-BOB is practical, educational and supplies unlimited fun for boys from 10 to 18 years old. Get this ad and read today with 25 cents for our booklet, "How to Build a Motor-bob," which contains drawings, blue prints, diagrams, dandy pictures and complete instructions for building and operating, full information and list of parts.

MOTOR-BOB MFG. CO., Dept. (14) Main & Amherst Sts., BUFFALO, N. Y.

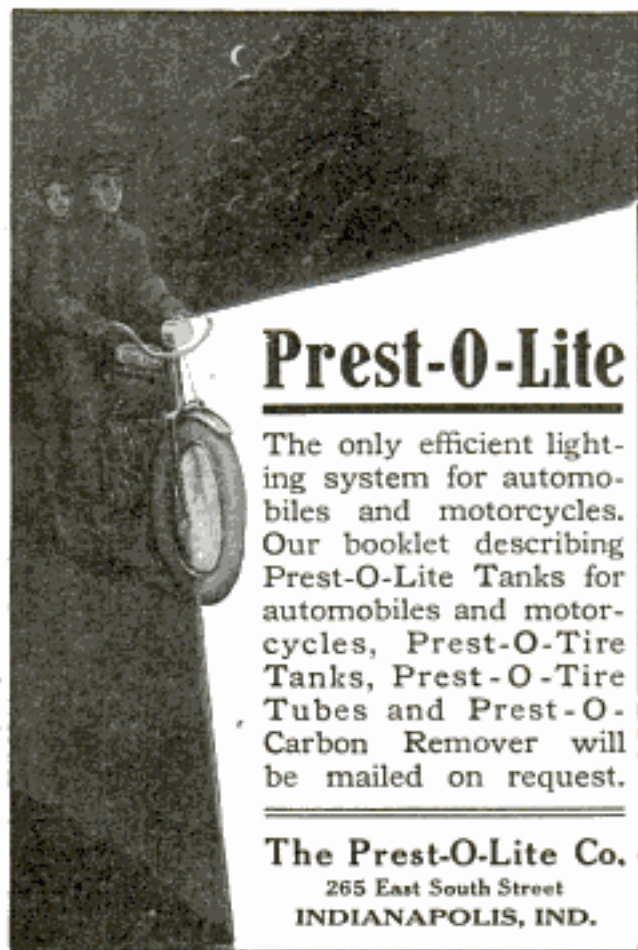

## Prest-O-Lite

The only efficient lighting system for automobiles and motorcycles. Our booklet describing Prest-O-Lite Tanks for automobiles and motorcycles, Prest-O-Tire Tanks, Prest-O-Tire Tubes and Prest-O-Carbon Remover will be mailed on request.

**The Prest-O-Lite Co.**  
265 East South Street  
INDIANAPOLIS, IND.



## UNIVERSAL TERMINAL

The Mac-Kae Universal Terminal fits any type of plug, either foreign or domestic.

Turn the threaded fibre sleeve and the jaws are firmly closed and simply cannot work loose.

By fully extending the jaws, this terminal will give secure contact on a plug through the top cap, if by accident the threaded post should be broken off.

You can remove the Mac-Kae Universal Terminal while the motor is running.

25c each at all dealers, or direct from us.

**MAC-KAE MFG. CO.**  
BOSTON, MASS.

Mac-Kae Spark Plugs are best. \$1 each.

## For Genuine Motorcycle Comfort, Ride

### THE FLYING MERKEL

Its distinctive Spring Frame and Spring Fork mean "automobile comfort on two wheels,"—no bumping, shaking or engine vibration. The most powerful ball-bearing motor of its size made. Free Engine Clutch on all models—enables rider to start without pedaling, or on a hill. Send today for our free illustrated Motorcycle Book.

**The MIAMI CYCLE & MFG. CO.**  
350-370 HANOVER ST.  
MIDDLETOWN, O.



**BRIGHTON'S FAMOUS AQUARIUM**—Few aquariums in the world have earned so wide a fame as that at Brighton. First opened in 1872, when the British Association visited Brighton, the early years of its career were filled with triumphs. Great scientists praised it, royalty patronized it, and the general public visited it in record numbers.

Since then other improvements have been added. In 1901 the building became the property of the city, and

## JOY RIDING

on a Good Motorcycle is some sport

**M·M** Line most complete in country—  
4 to 8 H. P. \$140 to \$240.

All latest improvements. Free engine clutch, etc. Agents wanted in open territory. Mail postal for handsome new catalogue today.

**M. M. MFG. CO. BROCKTON, MASS.**

## 50% Off on World-Famed Bicycle

Write today—before a Retail Dealer takes on the America line in your community. We will let you have your wheel at same price as dealer has to pay for the "America" by the wholesale. Just as soon as we close with a dealer, this offer will positively be withdrawn. Now you can save half. Later, everybody must pay full retail price.

### The "America" Truss Frame and Coaster Brake Diamond

represent 20 years of leadership in highest grade bicycle success in United States. Double-strength Truss Frame (our exclusive construction), Hevienda Spring Fork (we have exclusive rights to use this fork for whole United States). Ten-year guaranty. Others guarantee only five years. Protection against thieves. Protection against accidents. Write today for Big FREE Catalog and our Money-Saving Proposition in FULL. Address (4)  
**AMERICA CYCLE MFG. CO., Dept. 1066, 1108 S. Michigan Blvd., CHICAGO**

# Phelps

Book Ready

BE SURE to write a postal to Phelps for his big show room book of 1912 buggies—all made-to-order and over 125 to choose from. The biggest selection in America.



## SPLIT HICKORY VEHICLES

ON 30 DAYS' FREE ROAD TEST

Phelps sells only direct from factory. All latest styles, brand new stock. His book tells you more about styles and values than 25 dealers' stores could show you in 10 big towns. It's Free.

If you decide after trial to buy Phelps Saves You an Average of \$25 or up. Write today.

H. C. Phelps, Pres.  
THE OHIO CARRIAGE  
MFG. CO.

Sta. 57, Columbus, O.  
Largest Factory in the  
World Selling Vehicles  
Direct



2 YEARS' GUARANTEE

they have had a winter garden constructed, and arrangements have been made for the fine municipal orchestra to give concerts here, while the collection of piscatorial specimens has been most carefully gathered.—Philadelphia Inquirer.



## Convert Your Bicycle into a Motor-Cycle

using our Attachable Outfit, Fits any wheel. Also Marine and Stationary Motors and Finished Castings. Stamp for catalog. STEFFEY MFG. CO., Girard Ave. and 20th St., PHILADELPHIA, PA.

## UNITED STATES TIRES

Continental  
G & J

Hartford  
Morgan & Wright

AMERICA'S PREDOMINANT TIRES

## PLAY THE VIOLIN 30 DAYS' TRIAL

We send direct from our Chicago and European shops. Your choice from the finest collection of stringed instruments in America. Everything the violinist needs. Violins from \$5 to \$100 and up.

Time Payments arranged if desired. 30 DAYS' TRIAL before you decide to purchase. Write Today for our valuable Violinist's Catalog. Sent to you FREE.

WM. C. LEWIS & SON, Makers and Importers  
(Est. 1869) 220 Wabash Ave., Chicago, Ill.

Our Specialties: Imported wood, varnishes and tools for violin makers.



## Amazing Profits In Mushrooms

Anybody can add \$8 to \$40 per week to their income, in spare time, enter your growing mushrooms in cellars, sheds, barns, boxes, etc. I tell you where to sell, at highest prices.

Free Illustrated Instruction Booklet

HIRAM BARTON

Desk 2, 329 W. 48th St., New York

# FANCY APPLES

bring

# FANCY PRICES

AT ALL TIMES—  
IN ALL PLACES—  
THE WORLD OVER

☞The growing of Fancy Apples is both an Art and a Science.

☞The marketing of fancy apples is a—Business.

☞Skill is required; years of training and experience based upon Technical Knowledge—the ability to secure the proper blending of soil and climate; a familiarity with Horticultural Chemistry and Bacteriology, and a hundred and one know-what-to-do-on-the-instant characteristics—these are the requisites for SUCCESS in this business.

☞The demand for High Grade Apples, Men and Things in General is always in excess of the supply. This explains WHY the Apple Business is becoming centralized and the "manufacturing" of Premium Priced Apples is rapidly gravitating into the hands of a few Highly Specialized Experts, whom experience and learning have taught—HOW TO ACCOMPLISH RESULTS.

☞THE AMERICAN APPLE COMPANY is a corporation—an ORGANIZATION—comprised of men from widely separated sections of the country who are thoroughly versed in the Art, Science and Business of Fancy Apple Culture—experts in this one line of business.

☞In order to extend this trade to meet the growing demands for its products, The American Apple Company is Offering an Investment Opportunity which enables ANYONE who can save so small an amount as Five Dollars a Month to join this enterprise upon the same basis of Security and Profit as the Capitalist who can invest into the thousands.

☞Immediate interest return at the rate of six per cent is paid upon all sums invested for the first five years—after this period a Certified Public Accountant determines net profits, the larger proportion of which, under the fixed terms of the contract, accrues to the investor.

☞The American Apple Company not only has at its head highly trained, technical Pomologists, but the Company is endorsed and financially backed by some of the Nation's leading Business and Public Men.

☞Correspondence solicited with sincere inquirers, whose object is no mere curiosity. Ask for Booklet "G."

SPLENDID OPENINGS FOR HIGH CLASS  
INVESTMENT SALESMEN—WRITE

The American Apple Co.  
Washington, D.C.

DIVISION SUPT. \$3000 A YEAR  
 MASTER MECHANIC \$3500 A YEAR  
 CIVIL ENGINEER \$2000 A YEAR  
 ASST. SUPERINTENDENT \$2500 A YEAR

**Would You Pay \$2 a Month for a Better Salary Every Day?**  
 —for a chance to show what you're REALLY WORTH. Would you pay \$2 a month for the difference between failure and real achievement, between a common job and a BIG SUCCESS?

**Some Important Subjects Covered**

Handling Men Figuring Costs Strength of Floors Strength of Walls Strength of Beams Roof Trusses Roof Coverings Ventilation Steel Construction Masonry Plane Surveying Mechanical Drawing Railroad Engineering Building Roadbeds Tunnel Construction Railroad Finance Bridge Building River and Harbor Improvements Wind Pressure and Snow Loads House Drainage and Sanitation Cement and Concrete Building Water Power and Water Supply Irrigation Engineering Hauling Power of Locomotives Highway Construction

American School of Correspondence, Chicago, U. S. A.

**Then Sign the Coupon and Let Us Send You the New Cyclopedia of Civil Engineering**

a work that every railroad employee, every man in the engineering and construction departments of every industrial enterprise, every foreman and superintendent in mill and factory, should have as a quick and ready reference.

This great practical Cyclopedia is not a dictionary of disjointed facts, not a dry and technical work, but a clear and simple exposition of every phase of civil engineering—a history of the tried and tested experiences of the greatest railroad and industrial engineers. For these eight volumes teach the handling of men as well as the strength of stone and steel; they describe modern tests of irrigation as well as the building of mills and factories; the latest triumphs of cement and concrete construction as well as the laying of tracks of steel over mountains and plain. These eight meaty volumes are handsomely bound in half Morocco and contain 3500 pages, with over 3000 illustrations, folding maps, diagrams, etc.

**Shipped Free — Express Prepaid**

We want you to at least see these books. We want you to judge their worth. We want to send them to you at our risk, express prepaid, for you to examine at your leisure, and then if you don't believe them to be actually worth twice the price we ask, if you don't believe them to be worth to you twelve times \$2.00 a month, then simply send them back at our expense. The fact that you can return these books if not satisfactory in our absolute guarantee that they are all we claim them to be.

**Another Great Offer**

With each set is included a year's Consulting Membership entitling you to the advice of our business and engineering experts free. This will give you practical help in handling working problems which are too specific to be taken up in detail in the cyclopedias. There will be no limit to this service. A single problem solved for you might be worth more than the first cost of the books. Order the books now.

**FREE OFFER COUPON**

AMERICAN SCHOOL OF CORRESPONDENCE: Pop. Mech. 3-12  
 Please send set of Cyclopedia of Civil Engineering for 7 days' FREE examination. I will send \$2.95 within 7 days and \$2 a month until I have paid \$24.80; otherwise I will notify you and hold the books subject to your order. Title not to pass until fully paid.

NAME.....  
 ADDRESS.....  
 EMPLOYER.....  
 OCCUPATION.....

Please Mention Popular Mechanics

**Wonderful Handy Lamp**

Gasoline Lighting System. Equal to a Private Gas Plant

Entirely under your control; so simple any one can operate it.

**Saves You Half**

your lighting expense. Just push the lever and down comes a flood of 800 candle power shadowless light. Push it back and down goes the light to a mere glimmer which can be instantly turned up. Better light than gas, kerosene or electricity, at half the cost. For Home, Store, Church, Factory, etc. Write for P.O.P. Catalog. It's free. We have 5 other lines.



**Brilliant Gas Lamp Co.**

Dept. 1, N182 No. State St., Chicago, Ill.

**SUNSHINE LAMP FREE!**



to try in your home 15 days, incandescent 300 Candle Power. Gives better light than gas, electricity, acetylene or 15 ordinary lamps at one-tenth the cost. Unequaled for fine sewing or reading. Burns common gasoline. Absolutely safe. **COSTS 1 CENT PER NIGHT** Guaranteed 5 years. No wick. No chimney. No mantle trouble. No dirt. No smoke. No odor. A perfect light for every purpose. Take advantage of our 15 day FREE TRIAL. **FACTORY PRICE.** **SUNSHINE LAMP CO.,** 70 Factory Bldg., Kansas City, Mo.



**LOW COST LIGHT FOR YOU**

No smoke, no dirt, no smell, no deadly carbide, no tearing up of walls or floors. Complete gas plants that you can install in an hour's time. 500 styles to select from. Costs 1/2 cent an hour for 400 candle-power. Write for catalogue. **AGENTS WANTED**

**American Gas Machine Co., 183 Clark St., Albert Lea, Minn.**

There is a Welsh colony in Patagonia, established 46 years ago, that has developed a fertile region in what was a waste before. It is the Chubut valley and among its enterprises are more than 200 miles of irrigating canals.—Brooklyn Eagle.



**Nulite Portable Parlor Lamp**

The cheapest, best and most beautiful light obtainable for town or country. Makes and burns its own gas; 300 C. P. 5 hours for 1 cent. Can be used anywhere with amazing results. Low in price. Thoroughly reliable. Many new and exclusive features. Best proposition of the year for agents.

WRITE TODAY FOR FULL DETAILS  
**National Stamping & Electric Works**  
 422 S. Clinton Str., Chicago

**NEW—WONDERFUL Standard-Gillett SAFETY LAMP**

Portable—can be placed anywhere. Brightest light known. Twice as bright as electricity. Costs one-fifth of a cent per hour. Beautiful, soft, mellow light; particularly desirable for reading. Base of lamp made of nickle-plated brass. Shades in all colors to suit any taste. Write for illustrated circular No. 295. **Standard-Gillett Light Co., 4-9 Michigan St., Chicago, U. S. A.**

**WHITE VALLEY GEMS** IMPORTED from FRANCE

SEE THEM BEFORE PAYING!  
 These gems are chemical white sapphires—LOOK like Diamonds. Stand acid and fire diamond tests. So hard they easily scratch a file and will cut glass. Brilliance guaranteed 25 years. All mounted in 14K solid gold diamond mountings. Will send you any style ring, pin or stud for examination—all charges prepaid—no money in advance. Write today for free illustrated booklet, special prices and ring measure. **WHITE VALLEY GEM CO., 901Q Sals Bldg., Indianapolis, Ind.**

# THE WIZARD LIGHT



**THE INSTANTANEOUS SYSTEM**  
REQUIRES NO GENERATION  
WHEN YOU WANT LIGHT  
JUST PULL THE CHAIN

**WIZARD**  
FOUR MANTLE ARC

**THE "QUICKLIT"**  
No. 30  
LIGHTS WITH A MATCH  
AS CONVENIENT AS CITY GAS

**THESE** latest inventions represent the acme of perfection in artificial lighting. After once installed the instantaneous system requires no generation and can be operated as conveniently as electricity at one-tenth the cost.

The Quicklit Systems are operated as conveniently as city gas, as lamps are lit with an ordinary match.

All our lighting systems represent the highest standard of quality and are fully guaranteed. They are so simple that any one can operate same.

For further particulars and exclusive agency address  
**THE NAGEL-CHASE MFG. CO., 153 West Ohio St., Chicago, Ill.**

TABLE LAMP

**WEDDING PRESENTS FOR HIRE**—Did you ever hear of hired wedding presents? Some curious information about them is given by the Paris Excelsior, which declares that wedding presents may now be hired for the occasion. The mother who is anxious to make a brave show of presents at her daughter's wedding has only to go to one of the large stores in the Opera quarter. There a complete set of presents may be hired. The goods remain under the care of a shopman disguised as a guest.

Honor is thus saved, but the journal adds that it is as well when paying a first visit to the young couple not to ask to be shown some of the charming gifts of jewelry exhibited on the wedding day.—Detroit Free Press.

## BEACON LAMP FREE BURNER FREE



100,000 satisfied users  
Incandescent, 100 Candle Power. Burns common coal oil. Gives better light than gas, electricity or six ordinary lamps at one-sixth to one-tenth the cost. Fits your old lamp. Unequaled for fine sewing or reading.

**COSTS ONLY ONE CENT FOR SIX HOURS**  
We want one person in each locality to whom we can refer new customers. Take advantage of our Special Offer to secure a Beacon Burner FREE. Write today. Agents Wanted.  
HOME SUPPLY CO., 248 Home Building, Kansas City, Mo.

## LIGHT AS DAY

Better light from your old kerosene (coal oil) lamp and lantern than from electricity or gas. Our great **WHITE FLAME BURNER** fits any lamp, gasifies the oil and develops a brilliant, white, 50 candle power light from a one inch wick, and never smokes. **NO MANTLE TO BREAK.** Nothing to get out of order. Safe and reliable.



**AGENTS WANTED** RED HOT Seller. Sample, 35 CENTS, postpaid. **MONEY BACK IF NOT SATISFACTORY.** "G-C" LIGHT CO.,  
500 Baldwin Block Indianapolis, Ind.

## AGENTS AMAZING INVENTION!

An entirely new Lamp Burner. Changes ordinary kerosene illumination into beautiful large white light. Rivals gas or electricity. Scientifically made. Beats the old style lamp. Not a mantle. Can't break. **BIG PROFITS** Easy to show; quick to sell. \$8 to \$10 daily for you. Experience unnecessary. Sample outfit 35c prepaid. Particulars FREE.  
THE RADIOLITE CO., Dept. 1, TOLEDO, OHIO



# LIGHT UP!

You can transform any kerosene (coal oil) lamp or lantern into dazzling brilliancy with our wonderful **Bright Light Burner**. 50 candle power invisible and **unbreakable Steel Mantle**. Brighter than electricity, better than gas or gasoline, and **perfectly safe**. No generating—simply light like any kerosene lamp. Nothing to get out of order. Positively will not smoke or flicker.

**AGENTS WANTED EVERYWHERE.** Sells like wildfire. An opportunity of a life time, work all or spare time. Experience unnecessary. Make big money—be independent. Write today. Act quick—territory going fast. Complete sample, postpaid, 30c, 4 for \$1.00. **Money back if not satisfactory**  
**BRIGHT LIGHT CO., Dept. 414, GRAND RAPIDS, MICH.**





## QUEEN QUALITY TOBACCO

Just spend five minutes  
with "Queen Quality"

and you'll never be without it.  
Choice *granulated tobacco*;  
cured right and made especially  
for the chap who likes to roll  
his own cigarettes; and put up  
in the Big Blue Bag, which gives  
you Sixty Satisfying Cigarettes  
or Twenty Plentiful Pipefuls!

Now, let's light up!

First puff: "Fine!"

Second puff: "Great!!!"

Third puff: "Gosh, that goes  
to the spot!!!"

Fourth puff: "Isn't this a  
good old world!!!!"

More puffs: !!!!!

Last puff: "Where's that Big Blue  
Bag? I'm going to roll another!"

Well, old fellow, the way to com-  
mence is to begin! Just hand a nickel  
to your dealer and say "Mister, I want  
to marry that Queen Quality,  
and here's the price of a  
license."

Hurry, Hurry, Hurry!

5c for the  
Big Blue Bag

F. R. PENN TOBACCO CO.  
The American Tobacco Co. Successor



## Snappy, Stylish Suit To Your \$12.00 Measure



A suit that your tailor would ask \$25 or \$30 for. We deal direct with the consumer—no middlemen's profit to pay. You can wear tailor-made garments at less than ready-made prices. We make you a stylish, perfect fitting, better wearing suit than you can possibly buy from your local tailor or dealer, and save you money.

We make suits and overcoats to order for \$12 to \$24 and prepay express.

We Send You Our  
Style Book and Samples Free

Make your selection from our Style Book, which contains cloth samples of the latest weaves and designs, most carefully selected, also fashion plates showing the swiftest, classiest, snappiest styles ever created. It is absolutely free. Send for it today.

There is positively no chance for a mistake with our simple, yet perfect, system of home measurement.

Remember, we aim to please every customer. We have been making honest tailored clothes at rock-bottom prices for the last 15 years. The Fort Dearborn National Bank, of Chicago, will tell you that we are responsible. We want local agents in your territory.

**Madison Tailors,** 261 Central Union Block,  
CHICAGO, ILL.

## Scotch Style Calabash Pipes

Price 50c each, or  
3 for \$1, postpaid

Why kill yourself by smoking a strong pipe? You can get a Scotch Calabash that absorbs all nicotine and poisons and ensures a cool, sweet smoke. Money back if you are not satisfied.

THE ROYAL PIPE CO.,  
243 Broadway, Nashville, Tenn.



Stamps  
Taken

**LARGEST EGG IN THE WORLD**—Naturalists are searching the world over all the time for information regarding everything that is of interest and which will help to enlighten man as to the wonderful work of nature on the globe which we call our home. It is wonderful the variety of interesting matter they produce. One of the more recent finds, and one that is attract-

## HERE'S A GOOD ONE



The most successful picture machine on the market to-day makes 6 pictures in one minute. Our combination automatic and sleeve Wonderful Ferrotypes Machines have a double lens and one cup. Button plates are worked **Automatically**, and square plates  $1\frac{1}{2} \times 2\frac{1}{4}$  and  $2\frac{1}{4} \times 3\frac{1}{4}$  are fed by hand. It is also reversible for taking groups and is considered the best for general professional work.

A full line of street tintype supplies at moderate prices. Write to-day for our free circular and price list.

**UNITED FERROTYPES CO.**  
78 Delancey St., Dept. 64 NEW YORK CITY, N. Y.

## BENJAMIN AIR RIFLE FOR MEN AND OLDER BOYS

An air gun that will shoot through one-half inch pine easily. Many times more powerful than spring guns. Uses compressed air, same as air brakes, rock drills, etc. 15c pays for 1,000 shots, (delivered 30 cents). Practical for small game. 37 inches long. Walnut stock. Nickel barrel. Takes down. Fully Guaranteed. Sold by dealers everywhere. If your dealer does not carry it, write us. Sent prepaid east of Rocky Mountains on receipt of \$2.50. Pacific Coast and Parcel Post Countries \$3.00. Circular free. **BENJAMIN AIR RIFLE & MFG. CO., 2022 France Bldg., ST. LOUIS, MO.**

## BE YOUR OWN BOSS

**Make Money Easy**  
AGENTS wanted in every county to sell the popular Golden Rule Knives with name, address, photo, lodge emblems, etc., on handle. Agents earn \$75 to \$200 a month selling our shears, transparent handled pocket knives and razors. Big profits, quick sales. Exclusive territory. Experience unnecessary. **WE TEACH YOU NOW.**

Write today for terms and become one of our successful salesmen.



**GOLDEN RULE CUTLERY CO., 362 Wendell St., Dept. 157, CHICAGO**





# HANSEN'S GLOVES

**"Built Like a Hand"—For All Kinds and Conditions of Service**

**D**O you treat your hands well? They are *your fortune*; neglect of them is bad business, for men at work or play. For trade, profession or sport, Hansen's Gloves give the only *perfect protection* with full *liberty* of fingers and fist.

Hansen's Gloves are made of horsehide or pigskin leather, tanned by a special process, warranted not to shrink nor shrivel, harden, crack nor peel. Washing in gasoline leaves them soft, pliable and shapely as new.

**MADE IN HUNDREDS OF STYLES** and all sizes in various colors for automobilist and cyclist, hunter, farmer, miner, ironworker—you cannot name a field of play or work for which there is not a Hansen Glove practically *made to order* but ready to wear.

They are "built like a hand" and built exactly to suit all lines of labor. They are economical, too. They cost no more and outlast the ordinary kind.

**FREE BOOK:** Fill out attached coupon, mail to us and receive free book describing and illustrating all styles. Or, write us a postal if more convenient.

**O. C. HANSEN MFG. CO.**  
291 Milwaukee Ave. Milwaukee, Wis.

**O. C. HANSEN MFG. CO.**

291 Milwaukee Ave. Milwaukee, Wis.

Please send me your Free Book illustrating and describing your styles of gloves and mittens. I am most interested in the styles you make for the following purpose:



Hansen "Glad Hand" One of a hundred styles.

Name.....

Address.....

Town..... State.....

ing world-wide attention, is a monster egg, said to be the largest in the world, which was found in the sands of one of the streams of Madagascar.

The egg is supposed to be that of the huge fowl known as the epyornis, which is claimed to have been a wingless monster that stood over 12 ft. in height and which, owing to its strong limbs, could outdistance any other living creature in a flight, or rather run, across the island.

The egg is on exhibition in the Museum of Natural Science in New York city, and it is large enough to



## CLASS PINS AND BADGES

For College, School, Society or Lodge.

Descriptive catalog with attractive prices mailed free upon request. Either style of

pins here illustrated with any three letters and figures, one or two colors of enamel. **STERLING SILVER, 25¢ each; \$2.50 doz.; SILVER PLATE, 10¢ each; \$1.00 doz.**

**BASTIAN BROS. CO., Dept. 672 ROCHESTER, N. Y.**

**Elegant Thin Model 20 Year Watch \$3.75**  
Hunting case beautifully engraved, gold finished throughout, stem wind and stem set, fitted with 7 jeweled American lever movement, guaranteed 20 years, with long, gold finished chain for Ladies, vest chain or fob for Gents. **IF YOU SEE IT YOU WILL BUY IT.** Let us send it to you nearest express office, and if you think it a bargain and equal in appearance to any \$15.00 gold finished watch pay the express agent our special sales price **\$3.75.** Mention if you want Ladies', Men's or Boys' size.



**DIAMOND JEWELRY CO., A 9, 219 S. Dearborn St., CHICAGO, ILL.**



## Geisha Diamonds

THE LATEST SCIENTIFIC DISCOVERY

Bright, sparkling, beautiful. For brilliancy they equal the genuine, standing all test and puzzle experts. One twentieth the expense. Sent free with privilege of examination. For particulars, prices, etc., address

**THE R. GREGG MFG. & IMPT. CO.**

Dept. 11, 517 Jackson Blvd., Chicago, Ill.

# Rémoh Gems

NOT IMITATIONS  
LOOKS LIKE A DIAMOND  
WEARS LIKE A DIAMOND

## A Marvelous Synthetic Gem

The greatest triumph of the Oxy-Hydrogen Furnace. Will cut glass. Stands filing, fire and acid tests like a diamond—guaranteed to contain no glass. Rémoh Gems have no paste, foil or artificial backing—their brilliancy is guaranteed forever. One thirtieth the cost of diamonds. Set only in 14-karat, Solid Gold Mountings. Sent on approval—your money cheerfully refunded if not satisfactory.

**Book in Colors Free**  
Write for our De-Luxe Jewel Book, handsomest ever published.  
**Remoh Jewelry Co.,**  
429 N. Broadway St. Louis, Mo.



## Do You Judge a Cigar by Pennies or Satisfaction?

Too many smokers think of cigars as "five cent" cigars or "ten cent" cigars or "six for a dollar" cigars. A few men speak of "domestic" cigars—"Key West" cigars—"seed tobacco" cigars—"Clear Havana" cigars, etc. These men come nearer to knowing what they are talking about. They base their judgment of a cigar on what it is made of—not what it costs.

The fact that my Shivers' Panatela can be sold by my plan at \$5.00 per hundred does not deter thousands of wealthy business men from smoking it. Able, if they wished, to smoke cigars that cost a dollar apiece, they buy their cigars by mail, direct from my clean Philadelphia factory, because they have found my cigars greatly to their liking.

On the other hand, there are scores of men who buy my cigars because their knowledge of selling conditions convinces them that my plan enables me to sell the 10c cigar of the trade for five cents. I have eliminated all the selling expense that distributing through usual channels entails, and every business man knows what a saving this is when applied to a cigar.

**MY OFFER IS:** I will, upon request, send fifty Shivers' Panatela Cigars to a reader of *Popular Mechanics*, express prepaid. He may smoke ten of these cigars and return the remaining forty at my expense if he is not pleased with them; if he is pleased with them and keeps them, he agrees to remit the price, \$2.50, within ten days.

Should you accept this offer, be pleased with the cigars and pay for them, my real profit on the sale would be nothing. I absolutely depend on the quality of my cigars to induce a repeat order, and in most cases it succeeds. Repeat orders are the back-bone of my business. You, of course, are not under the slightest moral obligation to re-order from me at all unless you want to. I leave all that to the capacity of my cigars to please you. In ordering please state whether you prefer mild, medium or strong cigars, and use business stationery or give reference.

**HERBERT D. SHIVERS**

913 Filbert Street

Philadelphia, Pa.



Shivers' Panatela  
EXACT SIZE  
AND SHAPE

**Your Picture in a Postal Card  
IN ONE MINUTE**

The pictures are developed, toned and finished in a single developing solution. No experience is necessary. Price of machines \$7.50 and \$15.00—circulars describing our machines sent free. We are also headquarters for supplies for all minute picture machines.

**AMERICAN MINUTE PHOTO COMPANY**  
Dept. U, 726-728 W. 12th St., Chicago, Illinois  
The largest manufacturers and distributors of minute picture machines and supplies in the world.

**A SENSATIONAL MONEY-MAKER**

The Automat machine makes a picture in less than 20 seconds. Automatically. It is the latest invention for street photography. No sleeve, no electricity, no magnetism, plain, simple and practical. It is very easy to operate, and full instructions accompany each machine. No experience is necessary. Our Wonderful Ferrotypesleeve Machines, best for professional use, \$13.00 and up. Regular Plates 1 1/2 x 2 1/4, 75c per 100. Mounts, 20c per 100. Postcards, 30c per 100. Button Plates for all button machines, 75c per 100. Brooches, 65c per Gross and up. Developer, 15c per set. All of our plates are Guaranteed. A deposit is required with every order.

**NEW YORK FERROTYPE CO. (Inc.), Dept. 72**  
168 1/2 Delancey St. New York City, N. Y.

### GO INTO THE Moving Picture Business

FROM \$45 to \$60 STARTS YOU AND YOU WILL EARN AS MUCH IN 1 OR 2 NIGHTS

The small payment required to get our machine will make more money than thousands of dollars invested in any other enterprise.

**\$25** and more per night can be made exhibiting with our machine in halls, schools, churches, theaters, etc., in your own and surrounding towns. We furnish everything—rent films, too.

Write for particulars about our Moving Picture Machines and our 6-months-to-pay plan.

**P. & W. SALES CO., 339 Temple Court Bldg., CHICAGO**

contain 2 gal. or about as much as would be contained in 150 ordinary eggs. It is 2 ft. 8 in. round the egg the long way, and 2 ft. 2 in. round the shell halfway between the ends. The shell is over 1/4 in. in thickness and is very hard.

The bird is extinct, and the eggs that have been found were preserved by being deposited in the sands of the Madagascar streams.

It is asserted that the epyornis was much more active than the moa of New Zealand, but many declare the latter was the larger of the two extinct creatures.—Los Angeles Times.

**AGENTS \$50. A WEEK** selling our wonderful sign letters for office windows, store fronts and glass signs. Resembles finest gold leaf. Easily applied. Every firm wants them. Samples free. **METALLIC SIGN CO., 406 N. Clark, CHICAGO**

**AGENTS BIG PROFITS**

**Noburn Aluminum Kettle Bottom** makes it impossible to burn meats, fruits and vegetables. Made of pure aluminum. Fits inside any kettle. Raised buttons prevent contents touching bottom. Saves its price every day. This is the best household article you can handle. Every woman buys two or four. Samples (2 sizes) prepaid for 25c. Particulars FREE. Act on this.

**THE GIER & DAIL MFG. CO.**  
Dept. "G", Lansing, Mich.

**CIGAR CLERK MAKES BIG MONEY**

Start Box Ball Alleys! Cigar Clerks—Barbers—Street Car Employees now making \$100 to \$500 a month profit. One man with 4 alleys made clear \$680.00 in 30 days. No expense except rent.

**OUR GUARANTEE**—If you are not satisfied after 30 days we take back the alley and refund what you paid us minus what you took in. Write for our proposition at once.

**AMERICAN BOX BALL COMPANY** Box 344  
INDIANAPOLIS, IND.

**Brainy Diet**

"Fat, oil, butter, cream and eggs certainly caused my catarrh and deafness, but your diet of lean meats, green vegetables, fruits, etc., cured me in a few weeks. My brain power and complexion improved tremendously, and I succeeded financially." . . . Different classes of foods cause different diseases, but correct combinations cure. Foods which cause expectoration, catarrh, fevers, rheumatism, constipation, etc., are specified in 4 very instructive booklets—sent for ten cents.

**G. H. Brinkler, Food Expert, Dept. 16, Washington, D. C.**



# \$50 a Week

New business. 500 per cent profit. No canvassing. No experience necessary. Work all or spare time—traveling or at home. **"MANDEL" Post Card Machine Makes Photos on Post Cards Without Using Plates or Films.**

Everybody buys. Tremendous new opportunity everywhere. Smithsonian, N. M., writes: "Clear \$10 every afternoon." Powell, N. C., says: "Just received machine. Made \$16.00 first day." Hundreds of such letters tell the story of quick, big profits. At fairs, picnics,

on the streets, in the country, everywhere. Machine weighs only 6 lbs.—carry it around from house to house. Always ready for business. Makes post cards two sizes (3x4 1-2 and 2x3 inches) at rate of three a minute, right in daylight. No dark room. No experience. Complete instructions with outfit.

With a total investment of but \$25 you can build a business worth \$2000 to \$5000 all your own. First sales from post cards shipped with outfit practically returns all money invested. Don't delay. Write today for FREE BOOK, LET and learn all about this wonderful 6-lb. "portable post card gallery."  
**CHICAGO FERRTYPE CO., Dept. 110, Chicago, Ill.**



## IRON WITHOUT A FIRE

Now, easy, pleasant way. Mrs. Larkins, Mich. writes, "Have ironed 6 years with perfect satisfaction." Mrs. Timm, O. says, "Couldn't think of ironing without it."

**Improved Monitor Sad Iron**  
Self-Heating. Not Sold in Stores.

Strong, light, handsome—durable. Easy to operate; heat regulated instantly; no dirt—no odor.

**WANTED—AGENTS, SALESMEN, MANAGERS.**

\$10. to \$20.00 a day. No experience required. Sells almost on sight, Martin, Tenn., cleared over \$5,000 in 1 yr. Trimmer, Ill., writes, "Sold 12 in 10 hours."

Mrs. Nixon, Vt., made \$14.00 in half day. Send for big, colored circular, full size and interior view of iron. Exclusive selling rights—no charge for territory.

Monitor Sad Iron Co.

44 Wayne St. Big Prairie, O.



**THE COSTLIEST KITCHEN**—Who keeps the costliest kitchen in the world? Not, as one might imagine, the American millionaire, but the Shah of Persia. The utensils, fittings and furnishings of the Shah are said to be worth \$26,500,000. Every saucepan is gilded inside, and the dishes appearing on his table are of solid gold, as well as the spoons, knives and forks, the handles of which are, besides, ornamented with precious stones. Moreover, the chef, in preparing dishes for the Shah's table, must use none but silver spoons and forks, and

# TOBACCO HABIT BANISHED

**DR. ELDERS' TOBACCO BOON BANISHES** all forms of Tobacco Habit in 72 to 120 hours. A positive, quick and permanent relief. Easy to take. No craving for Tobacco after the first dose. One to three boxes for all ordinary cases. We guarantee results in every case or refund money. Send for our free booklet giving full information.

Elders' Sanitarium, Dept. 144, St. Joseph, Mo.

# NO MORE BALD HEADS



When our **VACUUM CAP** is used a few minutes daily. We accept no pay until you have tried the Cap 60 days and are satisfied. The Vacuum Cap is an appliance that draws the blood to the Hair Roots and starts a new healthy crop of hair. It stops Dandruff, stops the hair from falling out. Bought by Doctors and men who

know that it is the only reasonable **HAIR GROWER** known to science. No Drugs Used. Write for application blank, testimonials, and booklet on "HAIR," sent sealed in plain envelope, FREE.

**THE MODERN VACUUM CAP CO.**  
F. 559 BARCLAY, DENVER, COLO.



## Seven Big Volumes of Electrical Knowledge

This is the greatest electrical reference library, for the expert and student. These books are published especially for the ambitious man who is training himself for advancement—for the wide-awake man who is likely to be called upon for work outside of his regular line—for the man who needs at his elbow, for ready reference, an accurate down-to-date work on Electricity. Seven volumes, 3,200 pages with over 2,600 full-page illustrations, diagrams, formulas, etc., printed in large, clear type on special quality paper.

### Sent Absolutely Free—Express Prepaid

The complete seven volumes, not a sample volume, will be sent, express prepaid, for seven days' free examination; returnable at our expense if the books do not contain the information you want. If you keep the books, pay \$1.80 seven days after receipt and then \$2.00 a month until you have paid the special introductory price of \$19.80. The Table of Contents below will give you some idea of the tremendous scope of this work—but only an examination of the books will reveal their full value to you.

Just fill in and mail the coupon. It won't cost you a cent to examine the books. We know they'll be worth many times their cost to you. Mail the coupon now before the busy season begins and you will receive your books promptly.

#### What You Can Learn From These Great Books

Theory—Calculation, Design and Construction of Generators and Motors—  
Electrical Measurements—Electrical Wiring—Electric Welding—Types of  
Generators and Motors—Management of Generators and Motors—  
Storage Batteries—Electric Lighting—Alternating-Current Machinery—  
Station Appliances—Power Stations—Power Transmission—Central  
Station Engineering—Electric Railways, including Single-Phase—The  
Electric Telegraph—Telephone Equipment, Systems and Operation—  
Wireless Telegraph and Telephone—Teleautograph, Telephonograph, etc.

### Free with every order received before April 1st, 1912

With every set is included a year's Consulting Membership entitling you to the advice of our business and engineering experts free. This will give you practical help in handling working problems which are too specific to be taken up in detail in the cyclopedia. There will be no limit to this service. A single problem solved for you might be worth more than the first cost of the books.

**American School of Correspondence**  
Chicago, U. S. A.

**7 Day Examination Coupon**

NAME.....

ADDRESS.....

OCCUPATION.....

EMPLOYER.....

Please Mention Popular Mechanics

Pop. Mech. 8-12  
A. S. of C.

Please send me Cyclopedia of Applied Electricity for seven days' free examination. I will send \$1.80 within seven days and \$2 a month until I have paid \$19.80; otherwise I will notify you and hold the books subject to your order. Title not to pass until fully paid.

# THE ONLY SERVICE HE LEAST EXPENSIVE SERVICE

## JONES SERVICE PULLEYS GEARS CLUTCHES



### POWER USERS

Have you tried JONES Service? If not why not?

Save money and time and buy your equipment from the manufacturer. For anything in the line of appliances for transmitting power—"Jones Service" and goods are unparalleled. No order too small for attention. No order too large to execute. Our catalog A-18 shows our complete line. "Jones Service" is Prompt Shipments, Reliable Goods, Right Prices.

### JONES SERVICE IS UNEQUALED

In Power Transmitting Machinery. If you are not getting it—order direct from our factory. We are extensive manufacturers of Machine Moulded Pulleys, Gears, Hangers, Shafting, Bearings, Belting, Friction Clutches, Sprocket Wheels and Chain Belt.

### W. A. JONES FOUNDRY & MACHINE CO.

Mail Order Department

1400 North Avenue CHICAGO, U. S. A.

## STOP! STOP! STOP!

### THIRTY DAYS TRIAL of

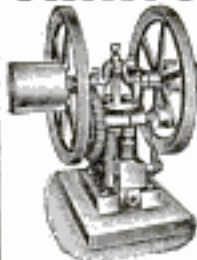

2 to 50 H. P. Wonderful New Pumping Engine  
Send postal today for Illustrated Catalog.

### United States Bonded Engine.

Burns gas, gasoline, kerosene, distillate. Consider these

### 12-ADVANTAGES-12

- 1st, Pays for itself in fuel saving in short time.
- 2nd, No violent vibration.
- 3rd, Greatly reduced bulk.
- 4th, Easily portable; mounted anywhere.
- 5th, Every engine part and horse power guaranteed.
- 6th, Absolutely frost proof.
- 7th, Positively most economical running engine made.
- 8th, Only engine with pulley on both sides.
- 9th, Small pulley on cam shaft, for very slow machines.
- 10th, Perfect Lubrication, cooling and ignition.
- 11th, Lowest cost engine in the world.
- 12th, Made by reputable firm, 60 years in business.

United States Engine Works  
1536 Canal St. CHICAGO, ILL.

When you want anything and don't know where to find it—write Bureau of Information, Popular Mechanics, Chicago

## Cheaper for Every Purpose Power

The WATERLOO BOY GASOLINE ENGINE will run all day without attention, furnish exactly the power you need, maintain a uniform speed and save you money every hour it works. Uses either Kerosene or Gasoline for fuel—equipped for both at no extra charge

The recent award of Gold Medal at Budapest, Hungary, in open competition with the best engines of all countries is clinching proof that the Waterloo Boy leads the World in Construction, Power, Service and Durability.

Has many important exclusive features—Speed Lever works like throttle on a locomotive; old reliable fly ball governor, automatic feed regulation, open jacket, starts easy in Winter, interchangeable parts, etc.

Lowest in price because made in largest quantities, at low manufacturing cost. Guaranteed 5 Years. Book free. Write today. Waterloo Gasoline Engine Co.



Awarded Gold Medal First Prize at the International Gasoline & Oil Engine Show Budapest, Hungary

1021 W. 3rd Ave. Waterloo, Iowa.

any dish on which he puts cold viands to keep them must also be of silver, gilded inside. The Spanish royal kitchen is also an expensive establishment. The saucepans in which the food for the royal table is prepared are said to be worth \$60,000, while the value of the cooking utensils used for the royal children is put at \$40,000, every saucepan being inlaid with gold, on the ground of this being necessary for the children's health.—Tit-Bits.

## WITTE ENGINES

GAS—GASOLINE—DISTILLATE—NAPHTHA

Do the work at average cost of One Cent per horse power hour. Immense saving by our method of "pre-heating" the fuel. Built so perfectly that repairs cost less than \$1 per year average. Every valve is vertical and will not wear on the stem or slip inside. Freezing cannot injure bed as cylinder and base are separate. Hammered steel cranks, cut gears, etc.

### GUARANTEED FIVE YEARS

We are experts in engine building; have done nothing else for twenty-six years. Our reference is thousands of satisfied customers. Our prices are right. All sizes, 2 to 40 H. P. Special inducements to introduce in new localities.

Write for free catalog stating size wanted.



WITTE IRON WORKS CO.

1654 Oakland Avenue, Kansas City, Mo.

## Try the Wonderful Columbia Kerosene Engine at our Risk

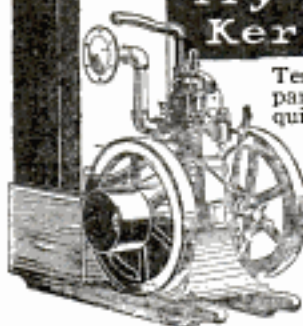

Test it out on your own place for fifteen days. Give it the hardest engine test you can think of. Compare it with any other engine. If the Columbia doesn't develop more power at less cost, send it back quick. No conditions. We are willing to let you be the judge and jury. Kerosene (common lamp oil) is by far the cheapest fuel today. The price of gasoline is climbing all the time, while kerosene remains the same, and in the right engine it lasts longer and produces more power per gallon than gasoline. You get ALL the power when you use a Columbia, because it is the right engine. It is the one really simple and perfect kerosene engine. It never bucks when you need it most. It is always on the job.

### Write for Particulars of Our Big Special Offer

We are going to double our output for next year. We can do it easily. It is just a matter of getting engine users to test the Columbia for themselves. So we are making a great special money saving offer on Columbia Kerosene Engines. This offer is liable to be withdrawn at any time, so write today for full particulars, for it is a money saver you would hate to miss. Free Book No. 17 full of engine facts you need to know, sent free.

Sizes 2 to 16 H.P.

COLUMBIA ENGINE CO., 17 Fuller St.

DETROIT, MICH., U. S. A.

Please Mention Popular Mechanics

## 1½ Horse Power For 1½ Hours For 1½ Cents

We know this Caille Perfection Special to be absolutely the greatest engine value on the market. Built by automobile men with automobile machinery—runs economically on kerosene or gasoline—your two hands the only tools you'll need. The simplest construction of any power plant—your 14-year old boy can take care of it. Made of the finest material, every moving part works as smooth and sweet as a watch. Our free book tells how we make a better engine at a lower price than our competitors. Write for free book and 15-day free trial offer.

CAILLE PERFECTION MOTOR CO.  
1207 Second Street Detroit, Mich.

### \$48

Complete and  
Ready to Run

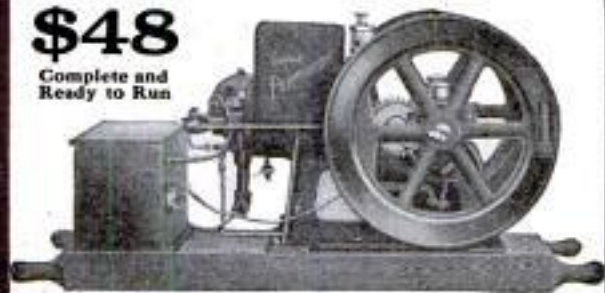

**CHOWDER SUGGESTED FISH GLUE**—Benjamin Robinson, of Gloucester, Mass., 82 years old, spry as a man of 30, the discoverer of fish glue, told a writer for the Boston Globe recently that some fish chowder sticking to his fingers made him think glue could be made from fish. That very day he bought a codfish head and went to work. Here's what he did:

"I had a large bread pan with a cover and I took the cover to the plumber's and had a ¾-inch hole made in

### Factories, Mechanics, Shop, Laboratory or Home



ALL—Everybody ought to know and have this GAS ENGINE.

**The Plunket Jr.** The engine that makes good always. The best 1-2 horse power high grade Gas or Gasoline Engine on the market today. IT IS SIMPLE, EFFICIENT AND DURABLE (equal to two extra men about the place); is perfectly governed by throttling governor and a wide range of speeds is always at operator's command. Write now.

Today. Send for circular and prices. Free for the asking.

J. E. PLUNKET, 1342 W. Lake Street, CHICAGO

## \$50 to \$300 SAVED

We are manufacturers, not merchants. Save dealers', jobbers' and catalog house profit. I'll save you from \$50 to \$300 on my High Grade Standard Gasoline Engines from 2 to 22 h.p. — Price direct to you lower than dealers or jobbers have to pay for similar engines in carload lots for spot cash.

### GALLOWAY

Price and quality speak for themselves and you are to be the sole judge. Sell your poorest horse and buy a

**5-H.-P. only \$119.50**



Direct From My Factory on 30 Days' Free Trial.

Satisfaction or money back. Write for special proposition. All you pay me is for raw material, labor and one small profit. Send for my big **BOOK FREE.**

WM. GALLOWAY, Pres.  
**WM. GALLOWAY CO.**  
1965 Galloway Station  
WATERLOO, IOWA

You Can Make From \$5 to \$10 a Day

# \$7<sup>50</sup>

And You  
Keep  
This



## Great Engine

We will ship you Schmidt's Chilled Cylinder Gasoline Engine on your simple request without an order or any promise from you. You use the engine 10 entire days—use it all you please. Then, if you don't want it, send it back at our expense. If you wish to keep it, pay us only \$7.50 and you can pay the rest in the easiest monthly payments. Send coupon or a postal card for all particulars.

### We Send This Engine Free

We do this to prove that the chilled cylinder is the simplest and most economical engine ever built. We want you to see for yourself that it is better than any other engine that costs twice and three times as much. It is the only engine with the marvelous, powerful chilled cylinder. The engine with a spark retarder. The new type gasoline engine that has revolutionized the gasoline engine industry. The only engine good enough to send out on actual free trial to sell itself. Write for free catalogs.

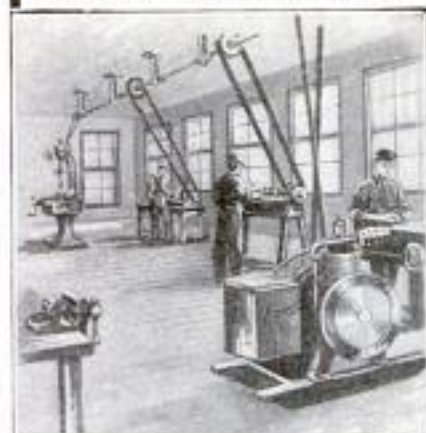

### Ten Days Free Trial

This is the first genuine free trial ever offered on a gasoline engine for farm and shop use. We want you to see that women and children can run this engine. Use the engine to run your pumps and any machinery you have.

### Take a Long Time to Pay

If you like this engine after trying it out for 10 whole days you can keep it and take a long time to pay for it on easy monthly payments. Schmidt's Chilled Cylinder Gasoline Engine is absolutely guaranteed five years in every part. The biggest bank in Iowa backs our \$1000 challenge offer on our engines. Write to us promptly for particulars and we will send you our valuable book, "How to Use Power" free.

### Schmidt Bros. Co. Engine Works

Department 1193

Davenport Iowa

### FREE BOOK COUPON

Schmidt Bros. Co. Engine Works Dept. 1193 Davenport, Iowa

GENTLEMEN:—Please send me description of the wonderful Chilled Cylinder Gasoline Engine, also your book, "How to Use Power," also Schmidt Bros.' catalogs and full particulars of your free trial and easy payment plan. All free and postpaid.

NAME.....

ADDRESS.....

Please Mention Popular Mechanics

# BISSELL Bargains

## In New or Used Electrical Machinery

The ONLY House in the World Giving a REAL Guarantee on Used Electrical Machinery—just the same as we and others give on new goods.

This unusual guarantee is made possible only because every piece of used machinery we sell has been put in first-class condition in our own unequalled repair shop, under our own supervision—when it leaves us we know its condition and can guarantee its service. If you want to save 25 to 75 per cent on any needed electrical machinery or supplies—first consult our Bargain Bulletin No. 25. It shows hundreds of attractive bargains in guaranteed new and used Motors, Dynamos, etc., etc.

We will buy for cash, or trade for other machinery or supplies, any used electrical machinery you wish to sell. Write full particulars and if possible, send photos of two sides.

**Our Repair Dept.**—has a national reputation for its efficiency in high-grade rush work. A trial will enable you to appreciate its facilities. No matter where you are located or what your needs—we can supply them to your complete satisfaction.

Write for Bargain Bulletin No. 21 We do not deal in Toys or Novelties

The F. Bissell Company, 226-230 Huron St., Toledo, O. "The House with the Stocks"



**We Buy As Well As Sell**

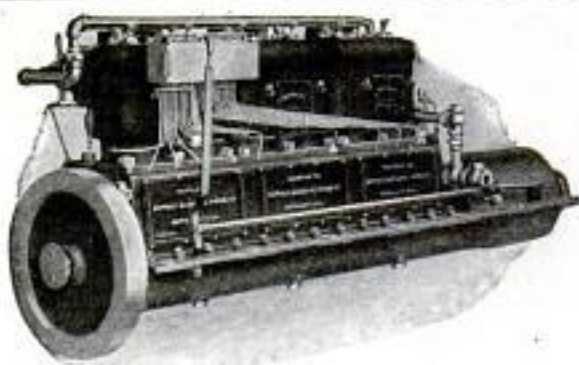

## BUFFALO MARINE ENGINES

combine endurance, speed and simplicity of operation. They are built in 20 sizes—3 to 125 h. p.—for launches, speed boats, cruisers and work boats. They operate on gasoline, kerosene or distillate.

*The Engine of Constant Service.*

ASK FOR OUR NEW CATALOGUE  
BUFFALO GASOLINE MOTOR CO.  
1284-1296 Niagara St., Buffalo, N. Y.

## KEROSENE ENGINES

Give most power with least expense for fuel. Run on common coal oil, gasoline, distillate or alcohol.

### Middleditch Engines

are simplest—safest—most durable—easiest to start—smoothest running. (Our free catalogue explains why.) We will send you one on 30 days

#### Genuine Free Trial

Most liberal trial proposition ever made. If you are not perfectly satisfied, you pay nothing. Our new 1912 model now ready for delivery. Write for introductory prices. They will surprise you.

MIDDLEDITCH ENGINE CO. 105 Melburn Ave., DETROIT, MICH.



## BEST FOR SHOP OR FARM

it and a tin pipe of the same size to fit into the hole. I then took it home and put one end of the pipe into the nose of an old-fashioned water kettle. The other end I put through the cover into the fish and then I steamed the fish head for two hours. I then took it off the stove and strained it through a piece of muslin into some old tin plates and put it on the roof of the hencoop to cool. "I then went down to my business of making fish oil from fish livers. When I returned in the evening I



**\$69.00** for a 1000 gallon Tank with Conical Roof, and a 20 foot Four Post Steel Tower. Tower with a substantial steel ladder from base to top of Tank. Guaranteed for five years. The "NOWETO" 2 H. P. water cooled Gasoline Engine for \$49.00. Pumps and any other equipment for Water Works.

Write for our circular "DC" showing the different types of Water Works Equipment

THE BALTIMORE COMPANY, BALTIMORE, MD.



# 34c

## Runs this 6 H.P. Engine for a 10 hour day on KEROSENE.

By means of the patent throttle you can run it as a 4 H. P. engine for 23 cents a day, or as a 2 H. P. for 12c a day. Many other strong points; force-feed lubrication; uniform speed; sight-feed fuel supply; automobile muffler; no cranking; runs either way; uses any fuel oil satisfactorily. And it's **Guaranteed for 10 Years.** Write for catalogue and 30 days' free trial.

WE PAY THE FREIGHT

ELLIS ENGINE CO., 65 Mullett St., Detroit, Mich.

3 to 12 H. P.

## Here is the Engine that will Save You Money Fairbanks-Morse Oil Engines

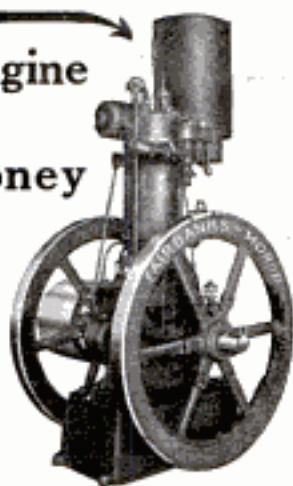

operate on low grade oils costing about 2c or 3c per gallon at the refinery. Compare this with the cost of gasoline and you will see why a reliable oil engine like the Fairbanks-Morse furnishes the cheapest power obtainable. The saving on fuel in many cases amounts to as much as 70 per cent.

If low grade oil is not now available in your locality the engine may be operated on kerosene or gasoline and later when available, operated on the cheaper fuels.

Fairbanks-Morse Oil Engines are built of the highest grade materials by expert workmen in a factory with every modern facility for economical production. You get the very best engine at a reasonable cost.

Engines are simple, automatic in operation and do not require a licensed engineer or skilled attendant to operate. Fully described in Catalog No. 449 NC.

Horizontal and Vertical Engines, 1 H. P. to 500 H. P.  
Complete Power Plants, up to 2,000 H. P.

**Fairbanks, Morse & Co.**  
900 So. Wabash Ave. Chicago, Ill.

found the glue in good condition."

Mr. Robinson took his sample of glue to Boston, found a manufacturer who used glue in large quantities and made a deal to furnish all he could make for \$1.25 a gallon. His sons still carry on what has come to be a great business.—Fishing Gazette.



The manufacture of wood-pulp paper involves twenty-eight separate operations from cutting down the trees to selling the product.

## I WILL make your dull SAFETY RAZOR

BLADES keener than new. Double edge blades 5c. each. Single blades 2½c. each. Write for mailing wrapper.  
P. MacNEILL, 167 Congress Street, Boston, Mass.

The ONLY ENGINE that gives you \$65  
4 H.P. and complete equipment for



## KEROGAS

Comes to you ready to run. No extras to buy. Equipped with Retarded Spark, Fuel Injector, Governor, Truck Skids. Four full horsepower and a \$15 Friction Clutch Pulley absolutely FREE. Positively the best buy in the entire engine market. Runs on Gasoline, Kerosene, Fuel Oil, Distillate, Alcohol. 8 and 16 H.P. models also. Air and water cooled.

WRITE TODAY FOR COMPLETE DESCRIPTION.

**KEROGAS ENGINE CO.,** 102 Fort Street, West, DETROIT, MICH.

## The Wall Beautiful

Because Bishopric Wall Board costs so much less than other walls, it must not be supposed that it is not a handsome Wall. It is the most artistic wall ever made. Air tight—moisture-proof—rot-proof—and fire-resisting. It is used in the largest mansions where cost-saving is no object. It can be painted with oil or water colors—used in its natural gray tint and decorated with panels. It can be papered, or covered with burlap.

## BISHOPRIC WALL BOARD

Bishopric Wall Board is used in the finest Residences—Cottages—Bungalows—Apartment Buildings—Offices—Stores—Banks—Hotels—Restaurants—Gymnasiums—Rooms for Bowling Alleys and Box Ball—Lodge Rooms—Schools—Churches—Hospitals—Public Buildings—Bed Rooms—Toilet Rooms—Libraries—Opera Houses—Moving Picture Houses—Pool and Billiard Rooms—Pleasure and Health Resort Buildings—Factories—Warehouses—Portable Houses—Garages—Boat Houses—Pantries—Kitchens—Doctors' Offices—Workshops.

This is the only wall board made with laths. Laths are positively necessary to hold Wall Board flat and rigid and to prevent warping and swelling. Bishopric Wall Board is guaranteed for the life of the building.

Make a room anywhere. Comes to you in sheets 4x4 feet, all ready to nail on the studs. Any man who can drive nails can put it on.

Price \$2.50 per 100 square feet; \$6.40 PER CRATE of 16 sheets, 256 square feet. F. O. B. Cincinnati.



Applying Wall Board to Studding

Write for our Book of House and Room Plans Showing Bishopric Wall Board construction. With the book we will send you FREE sample of Wall Board. Address

**The Mastic Wall Board and Roofing Mfg. Co.**  
394 Este Ave., Cincinnati, Ohio

## \$150—KERMATH—\$150

4 cylinder, 4 cycle, 3½" x 4", 10-12 H. P.

"The engine you have hoped for." (Made by Kermath Mfg. Co., Detroit, Mich.) A sturdy, conservatively designed motor, of standard type, built for marine and general use. High-grade from pig-iron to paint, and sold at a decent price. Reliable, durable, economical, flexible.

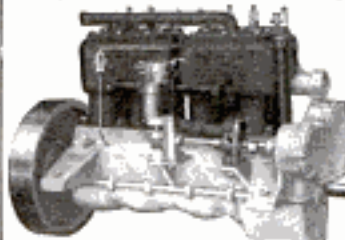

Sole Distributors:

**Morton Motor Co.**  
Dept. P, Detroit, Mich.

## POWER AT LOW COST Kerosene as Fuel 15 Days FREE Trial

HERE is Power for you that can always be relied upon. The Colton Modern Kerosene Engine is the most economical, simplest and most reliable Power Plant yet invented. Its many new improved patented features are most valuable and are not found on any other engine. Power is constant, speed regulated without stopping engine—adjusts itself instantly to any overload—no cranking to start it. Every Colton is sold under a positive, unqualified guarantee to give satisfactory service or money refunded. Our company has been established 27 years. Get it on trial and compare its simple, compact construction, superior quality materials and high grade workmanship. You will see it operate with less attention and furnish more power per rating than any engine you ever saw. Send for Free Engine Book at once.

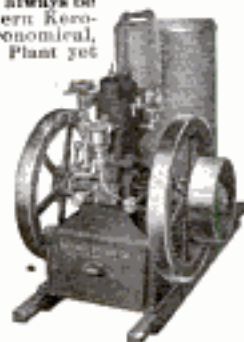

**Arthur Colton Co.,** 182 Brush St. Detroit, Mich.

## DON'T BUY A GASOLINE ENGINE

until you investigate "The Master Workman," a two-cylinder gasoline, kerosene or alcohol engine, superior to any one-cylinder engine; revolutionizing power. Its weight and bulk are half that of single cylinder engines, with greater durability. Costs Less to Buy—Less to Run. Quickly, easily started vibration practically overcome. Cheaply mounted on any wagon. It is a combination portable, stationary or traction engine. SEND FOR CATALOGUE! THIS IS OUR FIFTY-NINTH YEAR.

**THE TEMPLE PUMP CO., Mfrs., 442 West 15th St., CHICAGO**

# ROBERTS MOTORS

THE MOTORS THAT NEVER BACKFIRE

## AEROPLANE

MOTORS THAT INSURE SUCCESS

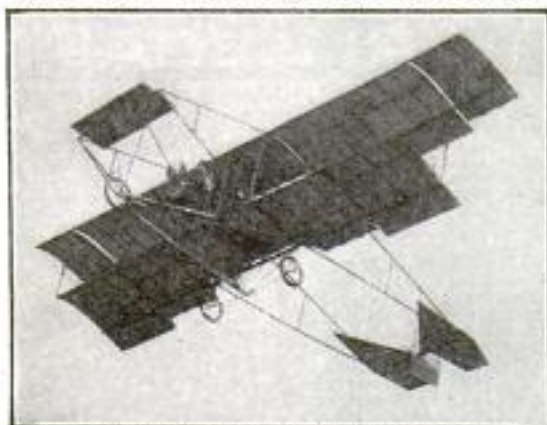

C. O. HADLEY, FLYING WITH HIS ROBERTS 4X-50 H. P. AVIATION MOTOR, AT MINEOLA, N. Y.

Over fifty motors in actual flight

Two sizes—4 cylinder 50 H.P., 6 cylinder 75 H.P.

Ask for our Aero Motor Catalog

## MARINE

MOTORS THAT GIVE REAL SERVICE



PIRATE II 40 H. P. ROBERTS

The power plant of Pirate II is a ROBERTS 4P-40 H. P. motor which was built in 1908. Four seasons of constant racing service have proven the real worth of ROBERTS quality.

Built in ten sizes. 3 to 125 H. P. 1 to 6 cylinders  
Our Marine Motor Catalog will be mailed upon request

THE ROBERTS MOTOR CO., 1419 Columbus Ave., Sandusky, Ohio

## Two Wonderful Boats

### The Famous VIPER III Type Hydroplane

The fastest and least expensive hull for low powers ever devised. 8 h. p., 14 miles. 30 h. p., 25 miles. Shipped to any part of the world; complete, or taken down and crated, ready to set up and screw together. Export knockdown, \$40.



### VIPER IV Type, with Surface Propellers HICKMAN PATENTS

The first shoal-draft speed boat. Entirely weedless. Through the heaviest weed-growths in 14 inches of water at 20 miles an hour or above. No stern wheel. No tunnel stern. No shaft under water. No strut. No projecting rudder.

Write for free Viper treatise and illustrated circular describing surface propeller boats.

THE VIPER CO. PICTOU, NOVA SCOTIA, CANADA

**EXPERIMENTS IN SOUND-PROOFING**—Professor Nussbaum, a German scientist, has been studying the problem of the suppression of noise in dwelling houses. One point he has ascertained is that the more solid, tough and strong the building material is, the more quickly and loudly it conveys sound. Experiments with partition walls showed that those of tile and cement transmit sound most and those of solid clay least. Between the two comes the wall of ordinary brick, and the more the brick is burned the more noise it trans-

**PALMER MOTORS AND LAUNCHES**  
2 AND 4 CYCLE

Catalogue M Free of Motors  
Catalogue B Free of Boats

ENGINES FROM 2 TO 40 H.P. PALMER BROS.,  
IN STOCK COS COB, CONN.

## MULLINS CEDAR CANOES CAN'T SINK

Famous Yale and Harvard models—highest grade materials—finest finish—the strongest canoe built. In each end is a Mullins Buoyancy Pad, which has sufficient buoyancy to float a capsized, water-filled canoe and keep two people afloat. No other canoe on the market has this essential feature.

We also manufacture steel launches, row boats, etc.

Write for magnificent catalogue, illustrated in colors—free—postpaid.

THE W. H. MULLINS CO. 302 Franklin Street  
SALEM, OHIO



Please Mention Popular Mechanics





**Build Your Own Boat**  
—It is Interesting,  
Economical and Healthful

Our Advanced Bulletin, which illustrates twelve new designs, tells you how from start to finish. The "FAULTLESS SYSTEM" relieves you of all the drudgery of boat building.

We do all the hard work by machinery—your part is easy and simple.

Don't spend your time and money trying to make parts of a boat that can be turned by machinery easier and better.

It is cheaper to let us furnish them.

With the "FAULTLESS ERECTED FRAMES" your work is easy and simple.

You can start planking two or three hours after you have uncrated your frame.

We can furnish plans, parts, erected frames or completed hulls for all kinds of boats—speed boats, launches, cruisers, passenger and tug boats, also gasoline motors.

Our boats are all designed by a well known Naval Architect and built by experienced men who know how.

Send for our Advanced Bulletin and two interesting books, entitled, "The Boat That Jack Built" and "The Building of The Idle Case." Mailed free.

**VALLEY BOAT and ENGINE COMPANY**  
1202 Hess St. SAGINAW, MICH.

mits. A quickly hardening lime mortar is to be preferred to a clay mortar. It was found that when a floor was covered with sand and cork mats spread over it, hardly any noise penetrated to the room below, but when the cork mats were joined together by any material underneath, noise at once became perceptible below. To exclude the sounds of musical instruments from neighboring apartments, the scientist recommends that the ceilings or walls be lined with a layer of zinc or lead.—The Furniture Journal.

**FERRO MARINE ENGINES**  
\$60 to \$500 The Engine that Mastered Niagara

The World's Standard Two-cycle Marine Motor. Ten sizes; one, two and three cylinders; 3 to 25 horse power. Exclusive 1912 improvements.

48-page Practical Treatise on Marine Engines free—a valuable reference book.

**THE FERRO MACHINE & FOUNDRY CO.**  
118 Hubbard Avenue, Cleveland  
Agents in principal Cities and Ports.



## Control your Boat Like an Automobile

You will never know half the delights of motor boating until you install a **Baldrige Reverse Gear**. Makes you master of your boat, for by simply moving a single lever, you can stop, go ahead, or reverse your boat's motion almost instantly. **Engine does not stop—full power always available.** Quickly pays for itself by preventing collisions in docking, and in emergencies. Praised in highest terms by nearly 12,000 users. Don't use or buy a boat without a "Baldrige."

If not at your dealer's, send for **FREE BOOK**—every page of interest if you want to get the most out of your boat.

**THE BALDRIGE GEAR CO.,**  
682 W. Grand Blvd., Detroit, Mich.



Billiards and Pool are fine, clean, interesting games—games that fascinate with their close, exciting, constantly changing situations—games that test the skill of hand, eye and brain, and arouse the keenest sort of friendly rivalry—games that the whole family will enjoy. Billiards and Pool are expensive if played in a public poolroom, but almost anyone can afford to have at home a

## BURROWES Billiard and Pool Table

You can play on it while you are paying for it. The prices are \$6, \$15, \$25, \$35, \$45, \$55, \$75, etc., on easy terms of \$1 or more down (depending on size and style selected), and a small amount each month. Sizes range up to 4½x9 feet (standard). Complete playing equipment of balls, cues, etc., free.

No special room is needed. The Burrowes Table can be set on your dining-room or library table, or mounted on its own legs or folding stand, and quickly set aside when not in use. Burrowes Tables are

### Used by Experts

for home practice. The most delicate shots, calling for skill of the highest type, can be executed with the utmost accuracy.

### FREE TRIAL—NO RED TAPE

On receipt of first installment we will ship Table. Play on it one week. If unsatisfactory return it, and on its receipt we will refund your deposit. This ensures you a free trial. Write today for illustrated catalog, giving prices, terms, etc.

**THE E. T. BURROWES CO.**

166 Spring St.

PORTLAND, ME.

## Change Your Boat Into a Motor Boat

AT VERY SMALL COST



If you have any kind of a boat, you might just as well have a motor boat. Simply take your rowboat, skiff, dinghy, punt or sailboat and install one of our Motorgo Engines.

Just as easy as it sounds. We will sell you one of these wonderful Motorgo Engines direct from our factory, and you can install it in your boat in a few hours' time. No need at all of a mechanic. You can do the installing yourself. We guarantee that positively.

Furthermore, we absolutely guarantee that when you install a Motorgo Engine you will own the safest, speediest, simplest and most reliable marine engine ever manufactured, the ideal engine for pleasure boats, speed boats, for transporting supplies, fishing and hunting. And you can actually buy this engine at

### One-Half the Price of Others

Because you buy direct from the factory, and for that reason you get the dealer's price. Notice these prices:

**2½-Horse Power, complete, \$ 44.35**  
**8 -Horse Power, complete, 125.65**

Remember, other size engines at just as startling low prices.

**Sears, Roebuck and Co., Chicago**

*Marine Engine Book No. 80P78 Free.*

Now get our Free Book on Marine Engines at once. It tells you just how to equip your boat, and all about the bargain prices. Write now. Ask for Book No. 80P78.

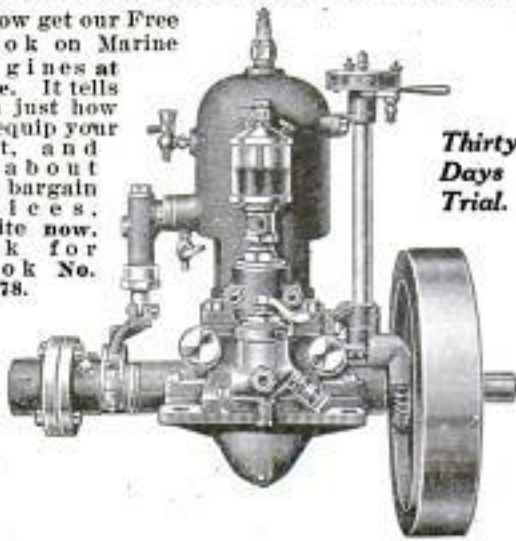

**Thirty  
Days  
Trial.**

## PERFECTION MARINE ENGINE 100% RIGHT

The big 1912 line of Caille Perfection Marine Engines from 2 to 30 H. P. give dollar for dollar more real service than most engines costing double their price — Perfection service is 100% right

### Without a Rival

For yachts, cruisers and ferry boats, a Perfection power plant is without a rival and simply thrives on hard, tough work. It works equally well in fresh or salt water, tidewater or stream, calm or storm. It embodies more refinements than any other engine on the market. The Igniter Equipment with the 6 H. P. and 8 H. P. insures a water-proof ignition and does away with batteries, coils, magneto and timer.

### Free Book of Engines

Our new 1912 Engine Prompt Book is free for the asking — refer to it any time for the true and correct meaning of Standard Construction; write today while you have the subject in mind — get book and refer to it, no matter what motor you buy. If your engine does not tally with this book, then you know you are not getting a Standard motor.

**The Perfection owner could  
not buy a better engine**



**Sizes 2 to 30 H. P.**

**Full Rating Guaranteed**

**CAILLE PERFECTION MOTOR CO.**  
**1207 Caille Street DETROIT, MICH.**

### THE POCKET HANDKERCHIEF'S HISTORY—

Everybody knows that a penknife is no longer a penknife. In the days of the squeaky quill pen, before the introduction of steel pens, the penknife was used for the purpose of trimming the quill and keeping it in good writing order. It was made with a folding blade, so that it could be carried around in the pocket where it would be easily found whenever needed.

The words "pocket handkerchief" have a curious history. The syllable "ker" is short for the French

## Stop Paying for Marine Engine Experiments

Reputable agents wanted to handle popular-priced marine engine. Absolutely guaranteed for 5 years.

Thirty days' trial by the purchaser. Your money promptly refunded, without question, if you are not fully satisfied.

A sure favorite and quick seller. Big returns assured. Simplicity the keynote of construction.

Just the engine you have been looking and waiting for. Combines the good features of the best with all the bad ones eliminated.

Fool-proof. As near perfect as anything mechanical can be produced.

All sizes in stock from 2 to 50 h. p. Ready to ship on 24 hours notice if necessary.

Details of the greatest selling plan and agents money-making proposition ever offered.

Liberal discount specified territory and absolute protection to accepted agents.

Some very productive territory still open.

Write today for Catalog

**COLUMBIA ENGINE COMPANY**  
**5 Mt. Elliott Avenue, DETROIT, MICH.**



(134)

Please Mention Popular Mechanics

## Fairbanks-Morse Marine Engines Easy Starting No Cranking

Engines that anyone can start and handle; for any kind of boat; any power you want from 3½ up to 40 horse power. Reliable, economical, durable. Thoroughly up-to-date in design, attractively finished, remarkable in workmanship.

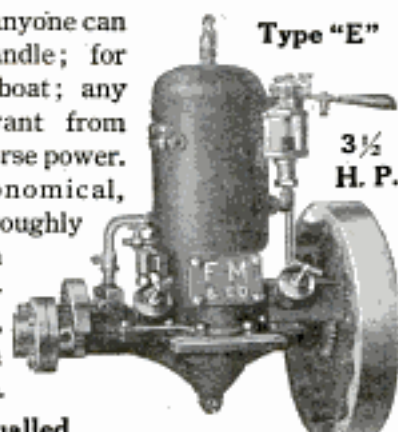

Type "E"

3½  
H. P.

Quality Unequaled

Absolutely Guaranteed The Price is Right

Write for Catalog No. 449TG stating type and size of your boat.

Two Cycle High Speed, 3½ to 24 H. P.

Two Cycle Slow Speed, 7½ and 15 H. P.

Four Cycle Engines, 4½ to 40 H. P.

Fairbanks, Morse &amp; Co.

900 So. Wabash Ave.

Chicago, Ill.

The Canadian Fairbanks-Morse Co., Limited, Montreal, Sole Agents for Canada

Best Proposition for Agents and Boat Builders

"couvrir," to cover, and "chief" is nothing else but "chef," the head. Kerchiefs were used also for the neck, and that made them neckerchiefs. Finally, when they became what they now are, and were carried in the hand, they expanded into handkerchiefs. Then when pockets were invented and worn, in the time of Queen Elizabeth, the term pocket handkerchief came into use. The word "pocket" is nothing but a form of the old Saxon word "poke," a bag or pouch, combined with the diminutive "et."—New York World.

### UNIQUE ENGINES

SMALLEST and Most Powerful on the market. UNSURPASSED for Laboratory, Experimental work and running Light Machinery. Light Weight. Specially Designed for Small Individual Electric Light Plants. Water Cooled, ¼ and ½ h. p. 2-cycle, Gas, Gasoline and Alcohol. Write for circular. Attractive prices on these sizes for a short time only. Catalog of Steam Engines, boilers, pumps, electrical goods, etc., 15c. (coin preferred) Refunded on First Order.

AMATEUR MECHANICS SUPPLY CO.  
518 G, 219 S. Dearborn Street, CHICAGO.

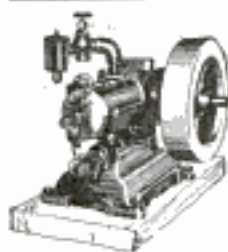

## 2 H. P. Complete \$39

With all fittings, including propeller and shafting, stuffing box, wiring, etc., ready to install.

### MARINE ENGINE

For all kinds of boats. Compact, silent, reliable, low running cost—a perfect two-cycle reversing engine. 5 years guarantee. So simple a child can run it. Used in Government Harbor Service and Chicago Police Boats. 3, 4, 6 and 10 H. P.—proportionately low priced. Special prices to boat builders and agents.

Big book free. Also STATIONARY ENGINES 2 to 12 h. p.

NORTHWESTERN STEEL & IRON WORKS  
746 Spring St., Eau Claire, Wis.

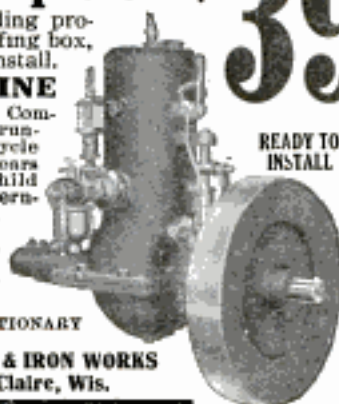
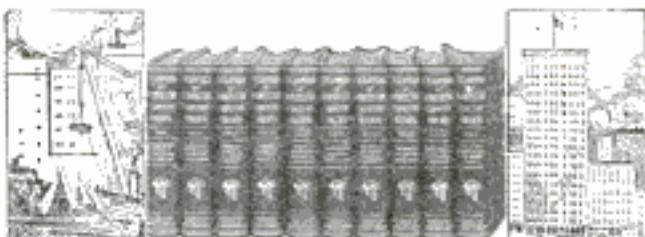
READY TO  
INSTALL

## FROM FOUNDATION TO FLAGSTAFF

Don't stick along at an **under** job through all the best years of your life. Don't let the humdrum drudgery of every-day routine CRUSH your ambition. Don't be satisfied with merely pushing a saw and driving nails. Learn to PLAN as well as to work—to use your BRAIN with the **same skill** that you use your hands. Learn to fill a **BIG SALARIED** job—the kind of a job that hundreds of other men, with no more natural ability than you, are filling with ease and success.

### How You Can Learn More and Earn More

You can MASTER EVERY DETAIL of your line of work. EVERY BRANCH of building construction, EVERY ANGLE of architecture and carpentry—can do it in your spare moments and at almost no expense at all. You can have the knowledge and experience of over **FOUR SCORE EXPERTS** at your command ready for instant use whenever you want it—can fit yourself to fill any **first-class position above you that you desire**—simply by allowing us to place in your hands, this great ten-volume set, **without your sending us one cent in advance.**

### THIS CYCLOPEDIA OF

## Architecture, Carpentry and Building

is the most exhaustive, comprehensive and practical work on the building trades that has ever been published. It covers every detail of building construction from foundation to flagstaff, from common carpenter work to reinforced concrete and steel, from masonry to heating and ventilation; from specifications and estimates to building laws and superintendence. It covers all the **PRACTICAL** things that you **WANT TO** know, all the things that you've **GOT TO** know if you're going to be a success. It contains over 4,000 drawings, full page plates, diagrams, etc., has 4,760 pages, is bound in handsome half morocco and printed on special paper in large clear type. No **CARPENTER, CONTRACTOR** or **BUILDING OWNER** can afford to be without it a single day.

### Get these books FREE and see for yourself

Just what they are before you send us a single cent. Look them over carefully at your leisure, keep them for seven days before you decide whether you want them or not, and then if you don't believe that each volume is actually worth more to you than the price of the entire set, send them back at our expense and the transaction won't cost you one penny. If you do decide to keep them, our charge will only be \$24.80, spread out this in easy payments of only \$3.00 a month. We don't ask you to buy these books on our description of them. We don't ask you to trust our judgment. We simply ask you to get the books and see for yourself.

### Free with every order received before April 1, 1912

With each set is included a year's Consulting Membership entitling you to the advice of our business and engineering experts free. This will give you practical help in handling working problems which are too specific to be taken up in detail in the cyclopedias. There will be no limit to this service. A single problem solved for you might be worth more than first cost of the books. Order the books now.

American School of Correspondence, Chicago, U. S. A.

### FREE EXAMINATION COUPON

American School of Correspondence, Chicago, U. S. A.

Please send set Cyclopedias of Architecture, Carpentry and Building for seven days' free examination. I will send \$2.80 within seven days and \$2.00 a month until I have paid \$24.80 or notify you and hold the books subject to your order. Title not to pass until fully paid.

Pop.Mech. 3-12

NAME .....

ADDRESS .....

OCCUPATION .....

EMPLOYER .....

Please Mention Popular Mechanics

# FORTY FIVE DOLLARS



3 HP Gile Marine Motor with equipment as shown has **warranted** spark coil, ground cylinders, pistons, rings and crank shafts, large long bearings. Entirely reversed and controlled by one lever. Float feed automobile carburetor. Neat in design. Absolutely reliable. **Warranted** as represented. If not found to be so, will refund money. **No quibbling.** Have other sizes equally as reasonable. Same equipment. In order to avoid the spring rush we will give every purchaser who gets his order in with a small deposit **before** the first of April a 5 per cent. discount. **NOW IS YOUR CHANCE!**

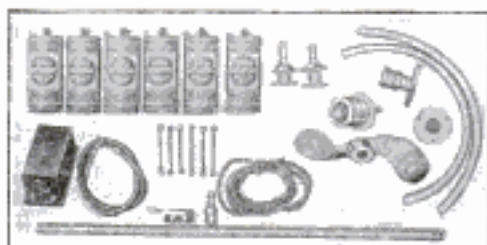

We also have a full line of boats from 16 ft. to 20 ft. including our new **CONCAVE STERN** at most astonishing prices ever heard of. Free catalogue of boats and engines sent on application. Send **NOW.**

**GILE BOAT & ENGINE COMPANY, 402 Filer Street, LUDINGTON, MICHIGAN**

**10 H. P. MANITOU \$104.00**  
**MOTOR**  
America's greatest two cycle engine

3 H. P. one cylinder complete.....	\$ 54.00
5 H. P. one cylinder complete.....	62.00
10 H. P. two cylinder complete.....	104.00
20 H. P. four cylinder complete.....	180.00

Including Planhard carburetor, and complete electrical outfit, fully guaranteed.

**Richards Engine Works, Manitowoc, Wis.**

**12<sup>H</sup> TOLEDO \$164.00**  
**MARINE MOTOR**

Including Schebler carburetor, complete electrical and propeller outfit. Other sizes from 3 to 18 H. P. at proportionately low prices. Fully guaranteed. Simple and reliable, 2 cycle 2 port.  $3\frac{1}{2} \times 3\frac{1}{2}$  and  $4\frac{1}{2} \times 4\frac{1}{2}$ .

Send for Marine Motor Catalog "C" at once.

**THE UNIVERSAL MACHINE CO., Pike Ave., Bowling Green, O.**

## On or Off in Five Minutes—"Porto"

**Makes a Motor Boat of ANY Boat AND also  
"makes good" on shore.**



Here is the famous original Portable marine motor, now adapted for also running a hundred different small machines ashore. Simple—light—strong—**SOLD ON THIRTY DAYS FREE TRIAL. MONEY BACK IF YOU ARE NOT SATISFIED.**

**"PORTO" the Marine and Stationary Engine  
Combined—TWO IN ONE**

A reliable 2 h.p. motor that will drive an 18 ft. rowboat 7 miles per hour for 4 hours on a gallon of gasoline, or in five minutes can be mounted for use in shop, laundry, barn, or any other place desired.

Write Quick for new "Two-in-one" catalog, mailed free. Orders filled in order of receipt. Don't delay.

**WATERMAN MARINE MOTOR CO. 1507 Fort St., W., DETROIT, MICH.**



**BAY STATE MOTORS**

"Perfect Simplicity" and "Simple Perfection" are the results, embodied in these Motors, of 15 years devoted to the developing of these essential characteristics, which enable us to put on the market a reliable and economical motor at a reasonable price. Write for catalog, stating size and type (2 or 4 cycle) of motor wanted. We also furnish casings for these motors.

**BAY STATE MOTOR WORKS**  
Successor to  
**A. J. HOULE MOTOR WORKS**  
580 South East Street, HOLYOKE, MASS.

**QUEEN OF PIPES**—The queen of pipes belongs to the Shah of Persia. Why is the great chieftain of pipes a queen? Probably because a pipe is a feminine noun in French. The little Shah's pipe was smoked by his father before him, and by his uncle and by his grandfather, and how many more of the rulers of Darius's kingdom Tip knows not. The pipe is adorned with all the precious stones, and is said to be worth \$50,000. It is constantly guarded by a high court functionary, for once upon a time a grand vizier was caught trying



## MULLINS STEEL BOATS CAN'T SINK

The reason is this: They are built like Government Torpedo Boats, of tough, puncture-proof steel plates, pressed to rigid form and so securely joined together that a leak is impossible. The Mullins Steel Boats are **guaranteed** against puncture—leaking—waterlogging—warping—drying out—opening seams—and **NEVER REQUIRE CALKING.**

**MOTORS:** The Loew-Victor 4-Cycle and Ferro 2-Cycle. Light—powerful—simple—can be operated by the beginner—start like automobile motors—one man control—never stall at any speed—exhaust silently under water.

We also manufacture a complete line of steel hunting and fishing boats—row boats—cedar canvas-covered canoes.

Our beautiful book, illustrated in colors, is free.

**THE W. H. MULLINS CO.,**

151 Franklin St., Salem, Ohio Famous Yale and Harvard Model Canoes



## The Whispering Telephone Mouthpiece

Makes All Phones Private

Stop shouting over the phone so that everyone in the office can hear you. Insist on your phone being equipped with

### The Whispering Telephone Mouthpiece

Made of aluminum—hence sanitary. Properly insulated



Price 75c  
Worth \$75

Especially adapted for long distance conversation. Guaranteed as represented or your money refunded. In ordering, please state what make phone you are using.

**The S. & M. Electric Co.**  
MANUFACTURERS  
470 Monadnock Bldg. Chicago

which enables you to talk as low as a whisper and still be plainly heard by the party to whom you are talking. Thousands in use. Endorsed by telephone companies everywhere.

to pry out a stone from the pipe with his poniard. He was immediately beheaded, and the brave soldier who had prevented the theft was made guardian of the pipe, with a pension for life.—New York Press.

**FAMOUS MICHIGAN SPEED WHEELS - REVERSE GEARS & MARINE HARDWARE**

**MOTOR BOAT MEN** Send for our large catalog of valuable information on speed wheels, reverse gears and marine hardware. Everything new and up-to-date.

Prices Right. Satisfaction Guaranteed

We carry an immense stock and can make you prompt shipments and save you money. Send for our free catalog today

**MICHIGAN WHEEL COMPANY**  
365 Canal Street, GRAND RAPIDS, MICHIGAN

## Water Can Never Rust Sides or Edges



### Edwards "REO" Steel Shingles "Tightcote" Galvanized

Last forever because all four edges as well as sides are galvanized by Edwards "Tightcote" process. Each shingle dipped in molten zinc after the sheets are resquared. Every particle of shingle thus protected by heavy galvanizing. Styles for all purposes. Ask about Edwards Metal Spanish Tile Roofing for homes. Looks like Moorish Tile—lasts forever.

### We Have a Special Cash Money Making Proposition for One Man in Your Community

If any of your buildings need roofing, you are the man. Send dimensions of your buildings and we will quote you cost of an Edwards roof, freight prepaid. You get your roof at agent's price.

Edwards Shingles come ready to put on. Hammer and nails all that is required. Anyone can do it. Can be applied over wood shingles or on sheathing 12 inches apart.

### \$10,000 Ironclad Bond Lightning Insurance

We refund amount paid in every case where roof covered with Edwards Interlocking "Reo" Steel Shingles is destroyed by lightning. Guaranty backed by our \$10,000 Ironclad Bond.

Ask for Free Roofing Catalog No. 350

**THE EDWARDS MANUFACTURING COMPANY**  
300-350 Culvert St. (69) CINCINNATI, OHIO  
Largest Manufacturers of Steel Roofing Material in the World

**WATKINS' SPECIAL MOTORS**

3 H. P. Single Cylinder . . . 30 lbs.  
6 H. P. Double Cylinder . . . 60 lbs.  
12 H. P. Four Cylinder . . . 100 lbs.

A strictly HIGH GRADE Motor that will give CONSTANT and EFFICIENT service. Especially adapted for CANOES and LIGHT BOATS. Aluminum base, copper water jacket, steel shaft, bronze bearings.

**THE WATKINS MOTOR CO.**  
837-839 West Sixth Street CINCINNATI, OHIO

### Get This Power Boat at Maker's Prices

BUY DIRECT FROM MANUFACTURER AND SAVE DEALERS' PROFITS

This Toppan Power Dory as illustrated above is made of best guaranteed materials and is the standard rough water boat of the world. Safe and reliable—used by U. S. Government in all departments. Send 4c in stamps for catalogue. Ask for prices and facts about Toppan Reversible Motors, built with 2, 3, 5, 8 and 12 Horse-Power—and if you want to build your own dory, saving exactly HALF, ask for **TOPPAN BOAT MFG. CO. FREE KNOCK-DOWN BOAT QUOTATIONS.** 3 Haverhill St. BOSTON, MASS.

**LA MARINE MOTORS**  
Built On Honor

**FOR FAITHFUL SERVICE**

you can depend on a Lockwood Ash Motor every time. Built on honor—sold on honor—made RIGHT from design to the finished details. Schebler Carburetters—Columbia Multiple cell batteries—Never-miss ignition system throughout. Three horse-power to thirty.

**A Square Deal—A 30 Day Trial**

Our handsome new 1912 catalog tells of our liberal test offer and 12 months Guarantee—of the service we give all customers. Send TODAY for this—it is mailed free.

**LOCKWOOD ASH MOTOR CO., 108 Horton St., Jackson, Mich.**



NORTH ISLAND IN SAN DIEGO HARBOR

**SEASON 1911-12**

Opened October 20, 1911

Under the direct supervision of Glenn H. Curtiss, assisted by Lieut. J. W. McClaskey and staff of aviators. Among the prominent aviators trained at these grounds are:

Lieut. T. G. Ellyson, U. S. N.  
 Capt. Paul W. Beck, U. S. A.  
 C. C. Witmer,  
 Hugh Robinson,  
 R. C. St. Henry.

**TUITION** applies on purchase price of aeroplane. All classes filling rapidly. Get our proposition and booklet "TRAINING" to-day.

Sales Agents and Foreign Representatives — THE CURTISS EXHIBITION CO., 1737 Broadway, New York City

**WINTER TRAINING GROUNDS****Curtiss Aviation School**

SAN DIEGO, CALIFORNIA

1000 acres of level sand without a tree or building to interfere with flying. Undoubtedly the best ground for aeroplane flying in America, if not in the world. Delightful and Perfect Climatic Conditions.

Leased exclusively for **THE CURTISS AVIATION SCHOOL** and Experimental Grounds

**THE CURTISS AEROPLANE CO.**

HAMMONDSPOORT, NEW YORK

**BARODA** Flash Like Genuine  
**DIAMONDS.**  
 ANY STYLE at 1/40 the cost—IN SOLID GOLD RINGS  
 Stand acid test and expert examination. We guarantee them. See them first—then pay.  
 Special Offer — 14k Tiffany ring 1 ct. \$5.98.  
 Gents ring 1 ct. \$4.98, 14k Stud 1 ct. \$4.98. Sent C. O. D. for inspection. Catalog FREE, shows full line. Patent ring gauge included, 10c. The Baroda Co., Dept. A. S. Leiland & Dever Sts., Chicago

**UNCLE SAM'S MOVING-PICTURE SHOW**—Uncle Sam has gone into the moving-picture business. At the cost of \$125,000 a theater has been built. It will be known to the film world as Hitchcock Hall, named after Ethan Allen Hitchcock, Secretary of the Interior. The theater will be devoted to amusing the inmates of St. Elizabeth Insane Asylum in Washington. Men who have given years of study to the question of insanity have reached the conclusion that moving pictures are a great aid in restoring and curing disordered minds.—Memphis Commercial Appeal.

**Don't Calculate—Let the Slide Rule Do It! Does It Better at 1/2 The Price! 1/2 The Time!**

There seems to be a misunderstanding about what the Slide Rule will accomplish, many think it an instrument, the use of which is applicable only to Engineers and Technical men. So frequently have I heard this remark that I have completely re-written and enlarged my instruction book, which shows the actual setting of the rule by 70 full size engravings, each engraving and example is explained and written so you can understand it. In fact any person who has never seen a Slide Rule, and not a technical person, could not help but learn its use. The examples selected and shown by illustrations are those which frequently come up for solution by the Banker, Broker, Auditor, Inventory Man, Cost Estimator, Printer, Paper Mfg. Contractor, Salesman, Time-Keeper, Bookkeeper, Lumber, Land, and other merchants too numerous to mention.

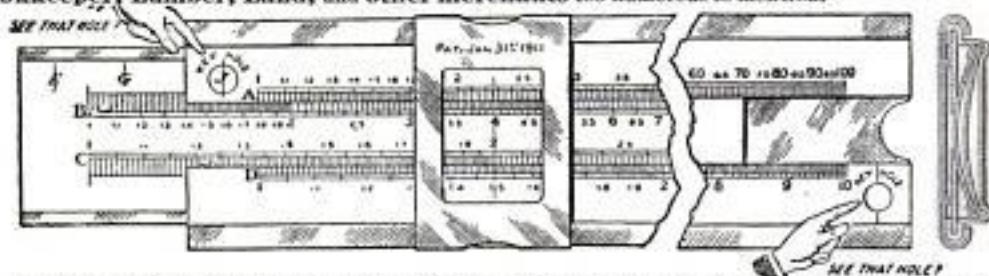

This Slide Rule will multiply, divide, solve proportion, extract the square and cube roots, find the decimal equivalent of vulgar fractions or "vice versa," calculate interest, percentage. Also the mensuration of superficies, and the rule of three. For Engineers, Electricians, Draftsmen, Superintendents, Master Mechanics, etc., the rule is indispensable in their work. It is one of the most valuable instruments ever offered to mankind. For Electricians it is a complete wire table in itself, calculates the size of a motor to run a pump, shows percentage a customer's recording meter is either "slow or fast." The Richardson Direct Reading Slide Rule is specially designed for those who wish to learn its use. Its operation being very simple. You simply place the key to the problem wanted in the keyhole (the key is printed in red on slide, see cut) and answer is given direct; such as the Horse Power of Engines, Pumps, Boilers, Belts, Water Falls; size of duct for ventilating; radiation and size grate, and steam main required; change gear and pulley problems; areas, circumference and diameter of circles. This Rule is my 1912 type now being placed on the market for the first time. No other like it. Aluminum stock 11x11/2 with runner, scales white celluloid printed from engine divided plates, in two colors, polished and washable. Scales of Slide mounted on non-corrodible nickel steel. Price, \$2.50 in cardboard case. If ordered at once I give you free a 70 illustration instruction book. Special cloth covered case with end flap and button fastening, 25c extra. Five-5-inch Rule, 1 1/2 x 5 1/2, vest pocket size, in leather case. If ordered at once I give you free a 70 illustration instruction book, stock and slide made entirely of non-corrodible nickel steel with scales same as above. Price \$2.00. 70 illustration instruction book, paper \$1.00. Cloth cover \$1.50, but free with each rule if ordered now.

**GEO. W. RICHARDSON, Consulting Engineer, Ex-Chief Electrician U.S. Navy, 4318 34th Pl., Chicago, U.S.A.**

THE SLIDE RULE  
SIMPLIFIED

1912

by  
Geo. W. Richardson

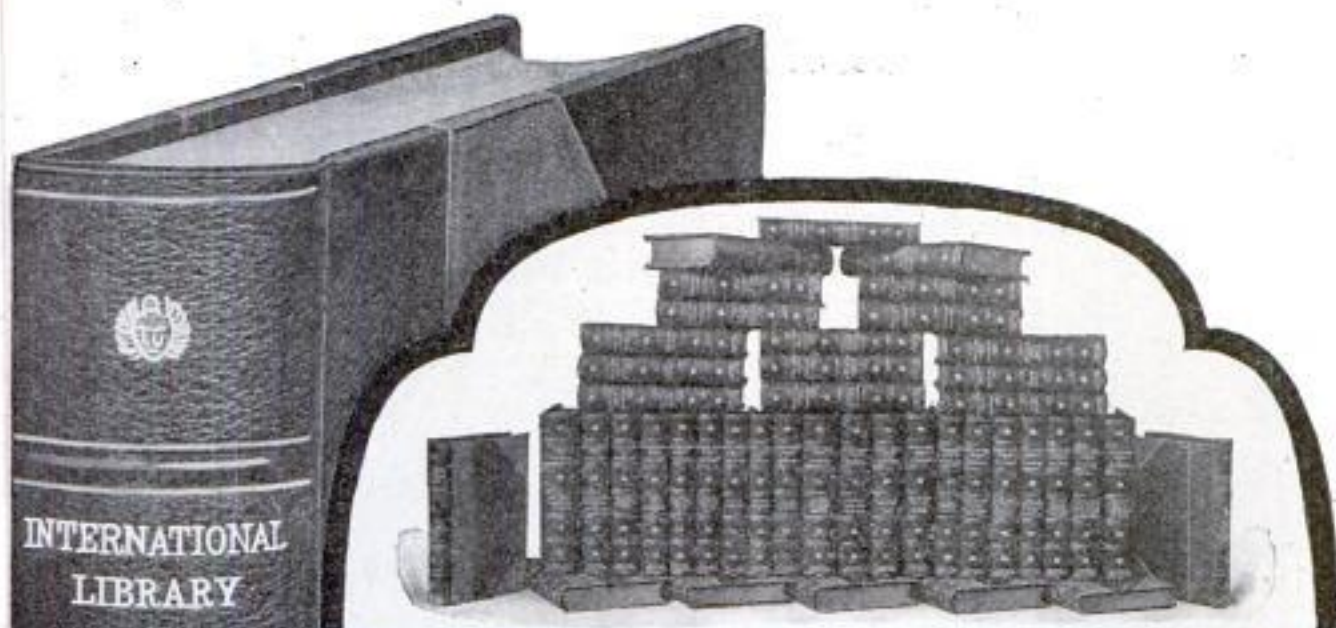

## The Greatest Technical Library in the World

At an original cost of over one million dollars there has been prepared 99 Volumes of the International Library of Technology. This Library contains the knowledge obtained through years of experience by the greatest business, manufacturing, and engineering concerns in the world. The matter has been written by the best technical experts obtainable and illustrated by a special staff of artists and draftsmen. In these books are found the best modern methods of American engineering, shop, field, mine, and laboratory practice. It is the only practical technical library in existence that can be readily understood and practically applied by those having no knowledge of higher mathematics.

Edwin S. Cramp, vice-president of the William Cramp & Sons Ship and Engine Building Company, of Philadelphia, states:

"I have examined the International Library of Technology and have no hesitancy in saying that it is the most complete set of technical books that I have ever had the pleasure of placing in my book case. The thoroughness with which you go into the various subjects is marvelous."

The Library contains over 42,000 pages and 20,000 illustrations; 99 Volumes durably and handsomely bound in three-fourths red morocco, stamped and numbered in gold. The type is large and easy to read and is printed on a high-grade book paper. Each volume is 6 by 9 inches in size. The Library is sold in sets of 5 or more Volumes.

This storehouse of the world's best technical brains awaits to help you advance, to broaden and better yourself. Send us this coupon NOW.

INTERNATIONAL TEXTBOOK COMPANY  
872, Scranton, Pa.

Please send, without further obligation to me, full description and particulars regarding the International Library of Technology.

Name \_\_\_\_\_

St. and No. \_\_\_\_\_

City \_\_\_\_\_ State \_\_\_\_\_

38B

Please Mention Popular Mechanics

# \$3 AND YOU KEEP ELGIN THIS 17 JEWEL ELGIN GUARANTEED 25 YEARS



**STEVE HARRIS, Pres.**

**Says:**—Before you buy any Watch I want you to see this Thin-Model 17-Jewel Elgin. It's the latest and finest product of the Elgin Factory.

**We want to Send You this Magnificent 16 size, Thin Model 17-Jewel Elgin, fully Adjusted to Temperature, Isochronism and Three Positions, Complete with fine Double Strata Gold Case, Guaranteed 25 Years on**

## 30 Days Free Trial

And if you don't say this is the biggest Elgin Watch bargain you ever saw, send it back at our expense. If you wish to keep it, the way is easy. Pay us only \$3.00, and the rest in similar amounts each month. No interest—no security—just common honesty among men. We want you to see for yourself that this fine Elgin is better than other Watches costing twice or three times as much.

**Send for Our Free Catalog** Write today for particulars and we will send you

OUR NEW FREE WATCH AND DIAMOND BOOK, also our book called "Facts vs. Bunc" or all about the watch business, both at home and abroad. **HARRIS-GOAR CO. Dept. 384, KANSAS CITY, MO.**

The House That Sells More Elgin Watches Than Any Other Firm in the World.

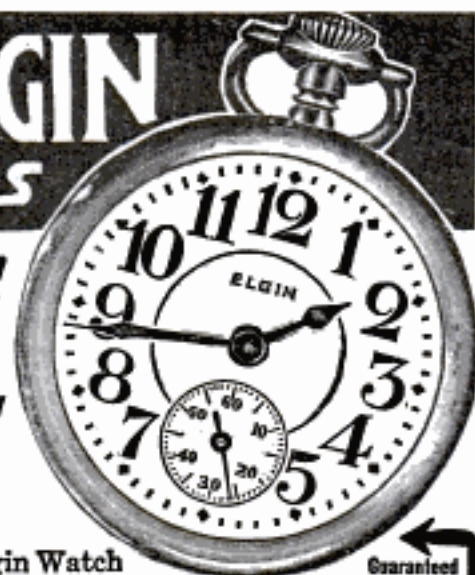

Guaranteed For 25 YEARS

## MAKES A PHONOGRAPH SOUND LIFE-LIKE

**The Morse Clarifier** a remarkable little device that fits in tube between reproducer and horn of any make of machine. It renders the sound loud, clear, lifelike and eliminates that unpleasant metallic effect. It fills a long-felt want. Can be inserted

in a minute and is everlasting.

**\$1.00 MAILED PREPAID** PAT. JAN. 16, 1912

Send dollar bill, 2c stamps or check at our risk. Guaranteed absolutely satisfactory or money refunded

State whether for Victor, Victor Victrola, Edison with rubber or metal connection, Columbia disc or cylinder.

Information and circular matter free.

**MORSE BROTHERS, Manufacturers and Distributors**  
450 Lumber Exchange, Minneapolis, Minn.



## PRINT YOUR OWN

Cards, circulars, books, newspaper. Press, \$5. Larger \$18. Rotary \$60. Save money. Big profit printing for others. All easy rules sent. Write factory for press catalog, TYPE, cards, paper, &c. **THE PRESS CO., Meriden, Connecticut**



**A CORONER'S INQUEST OVER COINS**—A short time ago 150 gold coins, dating from the period of the Roman occupation of Britain, were found in a bronze jar about one foot below the surface of the ground

## Caementium Sales Co.

offers you a new and improved liquid cement—

# QUIXO



The adhesive that sticks permanently materials not alike, such as wood and metal. Sets like rock—mends to stay, no odor to it. Easy to use. Does not stick to the fingers. Mends metal, wood, marble, china, glass—everything except celluloid, rubber and black lead. Air tight bottle, with screw cover easily opened.

**QUIXO will save you many a dollar**

25c. at all stores. If you can't get it, send 25c. for full sized bottle to **WALTER JANVIER, 454 Canal St., NEW YORK, Sole Agent for U.S.A.**

## MAKE MONEY HERE

# AGENTS! DROP DEAD ONES. AWAKE! GRAB THIS NEW INVENTION! THE 20th CENTURY WONDER

## LEARN the NEW WAY

Get started in an honest, clean, reliable, money-making business. Sold on a money-back guarantee

World's magical gift realized by this new invention. The **BLACKSTONE WATER POWER VACUUM MASSAGE MACHINE** for the home. No cost to operate. Lasts life-time. Price within reach of all. No competition. New field. New business. That's why it's easy. Removes blackheads, wrinkles, rounds out any part of the face or body and brings back Nature's beauty. Endorsed by leading doctors and masseurs. Listen: Parker, Okla., says, "8 orders first day." Margwarth, Pa., writes, "I am making \$19.00 per day." Shes, "First order 12, second 20, third 72. Sebermerhorn, Ia., orders eight dozen machines first month. Shaffer, Va., "selling 4 out of 5 demonstrations." Vaughn, Wash., orders one dozen. Four days later wires "Ship 6 dozen by first express." Spain, Tenn., started with sample. Orders one dozen, then 2 dozen, next 3 dozen. Lewis, Ind., sells 3 machines first hour. Says "Best article he ever saw for merit and money-making." No experience necessary. Territory with protection given free to active workers. Nothing in the world like it. Best agent's article ever invented.

We own all U. S. and foreign patents. Big book entitled, "The Power and the Love of Beauty and Health" Free. Investigate now, today. A Postal will do. A big surprise awaits you. Address **BLACKSTONE MFG. CO. 344 Meredith Bldg. TOLEDO, O.**





## Want New Suit?

It will cost you nothing, it is positively yours if you act at once. Everybody needs clothes, your friend, neighbor or acquaintance will buy of you. The easiest thing in the world. Show our up-to-date line of woolen samples—our extremely low prices—beautiful fashion plates and the profit on two orders will pay for your suit. Hundreds have started in a good paying business—why not you?

**Big Outfit Free!** We give you a much larger selection, a bigger and better line of samples, make our prices lower than any other house in the U. S. Our system insures a better fit, better workmanship and quicker service. We guarantee a perfect fit, take all risk and ship on approval. **We want Live Men** to represent us. Our agents make as high as **\$15.00 a day**. Take up the clothing business as a side line. You need no money or experience. We furnish everything to start.

**FREE!** Complete sample outfit, including big assortment of cloth samples, latest fashions, tape measure and special offers that will surprise you. This is a wonderful opportunity to make some money.

**Write today**  
**Capitol Tailors** 248 Capitol Bldg., Chicago



**THIS GENUINE DIAMOND \$4.50**

GUARANTEED  
Full 1-4kt Diamond,  
fine cut and color, set in (14 kt.)  
Solid Gold Ring, Band or Pearl Pin; cannot be  
duplicated anywhere else for twice the money—  
ELGIN movement in Duster or Wadsworth case, jewel,  
warranted 20 year case, \$7.75 retail jewelers get \$15  
or more for this watch. Send immediately for our catalog con-  
taining 1000 similar jewels. Send us your old gold or silver,  
diamonds, watches or jewelry, new or broken, any quantity. We send  
you highest cash value and hold subject to your approval. Money back  
guaranteed. Bank References.

LIBERTY REFINING CO., 240 Pittsburgh Life Bldg., PITTSBURGH, PA.

three miles from Hexham, England, on the site of the ancient Roman city of Corstopitum.

A coroner's inquest has been held to determine their ownership. The jury, however, was unable to agree as

**MAKE \$20.00 A DAY** Price \$7.50 up

With our "Diamond" Machine. Takes pictures without negatives. Postals and Buttons all sizes in one minute. Anybody can operate. Price \$7.50 up. Write for FREE Circular.

International Metal & Ferrottype Co.  
Dept. B, Chicago, Ill.



**AGENTS \$45. TO \$90. A WEEK**

I want a good man in every territory in the United States—as local agent for one county, or as General Agent for a number of counties. This is a new proposition and offers you an opportunity to make from \$45.00 to \$90.00 a week, and on up to \$3,000 or \$10,000 a year. No experience is necessary; but I want men—young or old—who will treat me square, who will follow instructions, and who will do their level best.

THE NEVER FAIL CO., 1048 Colton Building, TOLEDO, O.

**390,000**

## Happy, Deaf People

If 390,000 people have come back from the deaf-world—now hearing through the help of our device—is there not great probability that you, too, will do so through its help? May that not be so?

The Wilson Ear Drum is one of the simplest things in the world. Yet one of the most wonderful. It fits in the ear out of sight. You never feel it, even when lying down. But you hear. This 390,000 are made up of people just like you—who thought they couldn't ever hear, but who do hear.

You who let prejudice stand in your way may be missing your sole opportunity. Our book can convince you. It costs not a penny. Think what it may mean. A post card to WILSON EAR DRUM CO., 144 Todd Building, Louisville, Ky., gets it. Get it now.



Write for  
Free  
Catalog

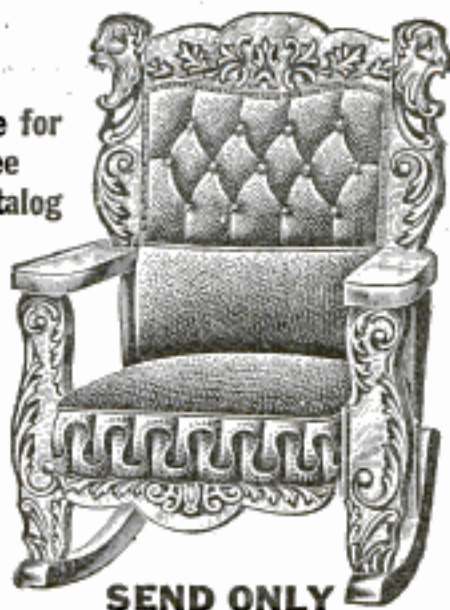

SEND ONLY

**50c** and We Ship You This Superb Rocker!

Yes, only 50c and we ship you this magnificent Rocker. Only 50c down and then 50c per month—\$3.95 in all for this handsome piece of furniture. **Positively the greatest bargain ever offered here or at any other place.** Write for free catalog and bargain list today. We defy any house in America to equal our stupendous offers. You can see for yourself what an elegant rocker this is. It is made in American Quarter-sawed oak finish. Large with high back. Handsomely upholstered. Profusely carved back, front posts and under-seat. Upholstering throughout in best grade Boston Leather, beautifully diamond tufted. Steel spring seat with ruffled edge. Shipped from factory. No. A1264. This rocker is only one of the special bargains we are now giving. Send for this bargain list today.

## Easy Payments

The great house of Straus and Schram, with a proud quarter century record, endorsed by the greatest bank, will trust you and allow you to buy any article on easiest monthly payments. If you want anything in rockers, chairs, bedsteads, carpets, rugs, curtains, washing machines, crockery, silverware, baby carriages, go-carts, Men's, Women's and Children's apparel, stoves, ranges or any other article of housefurnishings, don't fail to get our sensational easy terms.

## FREE Special Bargain List and Catalogs

Don't wait a minute before sending for our great bargain catalog and special monthly bargain list.

Bargains which are positively astounding; bargains which simply cannot be met by our competitors because of our stupendous buying and manufacturing facilities.

**Write Today, Don't Wait**

Send the free coupon, a postal or letter—but send right now. Take advantage of these special offers while they last. **This month only.**

So hurry. Just your name and address on postal or letter and we will mail, free and postpaid, our catalog and bargain list.

**STRAUS AND SCHRAM (Inc.)**  
Dept. 9193  
35th St.,  
CHICAGO

My name is.....

My address is.....

If you would like to have the rocker shipped at once send only 50 cents.

### FREE COUPON

STRAUS & SCHRAM (Inc.)

Dept. 9193 35th St., Chicago, Ill.

Gentlemen: Please send me free and prepaid your big bargain lists—also the catalogs I have marked with No obligations on me whatsoever.

General House Furnishings  
 Ladies' Clothing  
 Stoves & Ranges  
 Men's Clothing

Please Mention Popular Mechanics

**AGENTS - SALESMEN - MANAGERS -** All Men Out of work—those who want better positions—Stop right here—get free information on the Greatest Household Invention ever known—**A SELF WRINGING MOP.**

AN OPPORTUNITY TO MAKE EASY MONEY—AT HOME OR TRAVELING



**LISTEN:** One man's orders \$2600 one month—profit \$1650. Mere boy in Pa. made \$9.00 in 25¢ hrs. A. E. Martin, Mich., says: "Sold 131 in 2 days." H. Randal, Minn., "Canvassed 11 families, took 11 orders." John D. McLeod sold 6 after supper in less than an hour. Don't need experience, sells itself. That's the way it goes. You can't fail. You are bound to win. You can sell 100 mops a week, working only half time. "I don't see how a better seller could be manufactured," says Parker J. Townsend, Minn. "Took 16 orders first morning." N. H. Torrence, New York. "Took six doz. orders in four days," says W. R. Hill, Ill.

Two turns of crank wrings out every drop of water. Simple, practical, reliable, durable, never wears out. Every home buys. No talking necessary. Show it, take the order. Get started now, don't wait. We will help you. We want Agents, Salesmen, Managers in every county to fill orders, appoint, supply, control sub-agents. 150 percent profit. No investment required. Sample free with first order. New catalog, instructions, sweep-to-evidence, all Free.

U. S. MOP CO., 1516 Dorr St., TOLEDO, OHIO

**WORK FOR US.**  
Get Your Share of this Easy Money Selling EASY WRINGER Mops.  
**150% PROFIT.**

MAKE  
**\$50 TO**  
**\$75**

EVERY  
WEEK  
Start  
NOW

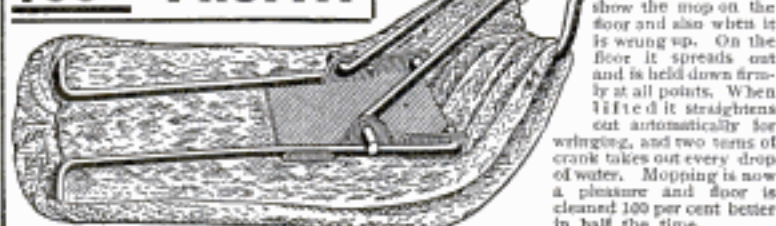

These illustrations show the mop on the floor and also when it is wrung up. On the floor it spreads out and is held down firmly at all points. When lifted it straightens out automatically for wringing, and two turns of crank takes out every drop of water. Mopping is now a pleasure and floor is cleaned 100 per cent better in half the time.



**How to Entertain** Book with 250 Jokes and Riddles, 73 Toasts, 67 Parlor Tricks, 8 Fortune-Telling Secrets, 52 Money-Making Secrets, 22 Funny Readings. All 10c Postpaid.

J. C. DORN, 709 So. Dearborn St., Dept. 17, CHICAGO, ILL.

**Relief Model PANAMA CANAL**  
of the completed

Showing Fortifications, New Panama R. R., Etc.

THIS model has been carefully constructed from surveys and plans of the U. S. Canal Commission, finished in five colors, size 9 1/4 x 13 3/4 accompanied by Profile of Canal, Historical and Descriptive matter, Simple, Comprehensive and a thorough education on the subject. Copies have been supplied to Geographical Soc., Public and Private Schools, Colleges etc. Mailed on receipt of price.

ONE DOLLAR THE COPY  
**CENTRAL NOVELTY CO.** 110 NASSAU ST. NEW YORK

to whether the coins were treasure trove or not, the contention of the owner of the land being that the coins had been left on an ancient highway and abandoned during a raid by the Caledonians against the Romans. The coroner therefore agreed to keep the coins for a week to see if some arrangement could be made with the treasury as to their disposal.—Christian Science Monitor.

**CACHOO!** Make the whole family and all your friends "just sneeze their heads off" without knowing why, with CACHOO, the new long distance harmless snuff. Sent anywhere for 10c. 3 for 25c. 90c a dozen. Catalog included FREE.

P. T. & N. CO., Department B, Chicago, Ill.



**"BABBITT-HOLD"**

**NEW DISCOVERY:**—To hold Babbitt in bearings when pouring. Will not melt, cake, crack or crumble. Easy to apply. Easy to remove. Brushes off and leaves the work as "Clean-as-a-Whistle." Sticks like glue when pouring; never budge! Easy-to-make, inexpensive. Send one dollar to David Welsh, 639 North 22nd St., Philadelphia, Pa., and get by return mail, the formula for "BABBITT-HOLD." Results guaranteed, or money refunded immediately. "BABBITT-HOLD" has clay or putty "Skun-a-mile."

**Pay No Money**  
and we send you a fine Diamond.

**GENUINE PERFECT CUT LEGALLY GUARANTEED DIAMONDS \$97.50 PER CARAT**  
The Wonderful Basch Plan

of buying your diamond makes it unnecessary to send any money or references. No delays. Just select any fine diamond and it will be sent immediately.

**\$97.50 per carat** is the world's lowest price for genuine brilliant perfect cut diamonds. \$97.50 per carat is the importer's price direct to you (15 per cent less than wholesale), saving you nearly half the price of your retail jeweler. Note these remarkable prices:

1/2 carat, \$48.25; 3/4 carat, \$17.50; 1 carat, \$45.00; 1 carat, \$97.50.

Read in our Free Diamond Book how we have cut out the diamond broker, jobber, wholesale and retail jeweler, with all their salesmen, expenses and profits.

The Basch Legal "Money-Back" Guarantee. "We'll be a passing surprise to read about this written contract to refund your money any time you wish! Read in our Free Diamond Book, too, how we guarantee the carat weight, quality and value of every diamond. Won't you be glad to buy a fine diamond when you can secure your money back at any time!"



Established 33 years

We mail your FREE copy of the complete Basch Diamond Book immediately on receipt of your name. Contains full explanation of our low prices and guarantees. Illustrates hundreds of the latest styles in men's and women's rings, scarf pins, earrings, shirt studs, brooches, cuff links, lockets, watches and other diamond jewelry.



Send for this big Free Diamond Book TODAY.

L. BASCH & CO., Dept. M. 347, S. State St., CHICAGO, ILL.

# Make It Yourself

Put Sentiment Into Your Furniture  
and Money in Your Pocket

You can save the dealer's profit and much of the manufacturer's cost on any piece of Home Craft Furniture by our new approved selling plan. We send you thoroughly seasoned, quarter-sawn white oak, smoothly dressed, accurately cut, ready to put together, with all materials and complete instructions for simple finishing required. We ship



## HOME CRAFT FURNITURE

right from our factory direct to you, freight prepaid. The work of putting it together and furnishing is mere fun. Anyone can do it.

Our new and enlarged catalog containing illustrations and descriptions of beautiful, artistic, refined and money saving Home Craft Furniture will be sent you upon request. Remember, you save at least 50% on Home Craft Furniture.

WRITE TODAY FOR CATALOG

### THE HOME CRAFT COMPANY

"Originators of Home Constructed Furniture"

3314 North Ave. MILWAUKEE, WIS.

**THE U. S. VOLUNTEER LIFE-SAVING SERVICE**—Since the U. S. Volunteer Life-Saving Corps was organized about 17 years ago, the life savers connected with it, and who serve only on Saturday afternoons, Sundays, and holidays, have saved 6,000 lives. There

## \$50 A Week—EASY

Here's the easiest, quickest money you ever heard of. Just send name and address—we will ship—express prepaid—Sweetest Big Outfit of Samples and Color Plates, showing over 100 correct and latest styles in Men's Made-to-Measure Clothing; also special offer of a free suit to you. We back you to win, no money or experience necessary.

### Best Tailoring On Earth

Appeals to every thinking man. Suits and Top Coats, \$3.50 up; Pants, \$2.50 up. Perfect work guaranteed or money back. Special confidential, inside wholesale prices and guarantee you can undersell all others. You coin money with our goods. We put you in big paying business and take all risk, show you how and give you exclusive territory. Most liberal attractive offer ever made, *bar none!* Your one best chance. Keep this private and write us today. ELK TAILORING CO. 180 Jackson Blvd., Chicago



**THIS SUIT FREE**  
and Big Outfit

## "Ten Tests of an Automobile"

By Herman Amel. These tests tell just how to investigate an automobile for its weak points and prove in advance its merits as a practical and economical car. The book shows you what a car should and should not have, and warns in plain, readable English the car not to buy, and why. Mailed to you for 10c. Worth hundred times the price asked. Get your copy today and learn all about automobiles. Address

HERMAN AMEL, 837, 76 W. Monroe St., Chicago

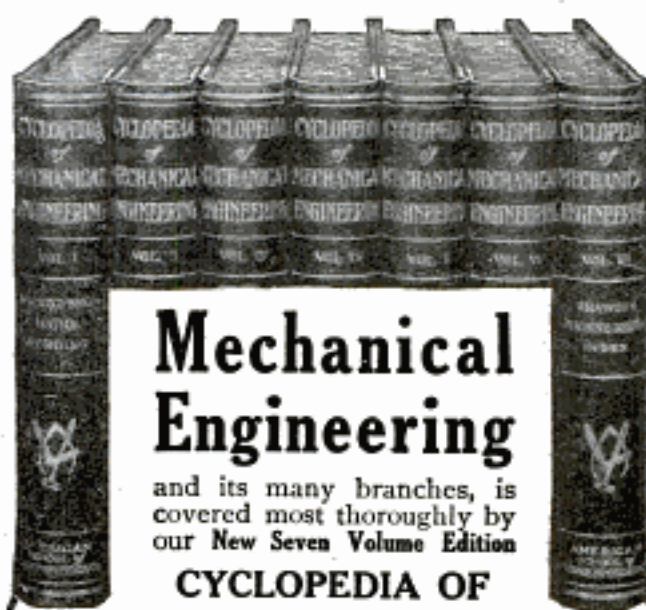

## Mechanical Engineering

and its many branches, is covered most thoroughly by our New Seven Volume Edition

### CYCLOPEDIA OF Mechanical Engineering Gas Engine Operation and Modern Shop Practice

In this wonderful work will be found instruction in Gas Engine Operation and Manufacture; Machine Shop Work; Assembling of Machinery; Tool Making and Shop Management in such simple and comprehensive form that the student cannot fail to benefit by it. Every detail of mechanical engineering is thoroughly analyzed and treated, rendering the books of unusual value to the experienced mechanic and shop manager, as you will note by reading "Subjects Thoroughly Covered."

The Cyclopedia contains 3,992 pages and is supplemented with a series of practical test questions, including over 2,327 full-page plates, illustrations, tables, formulas and "shop kinks."

#### Subjects Thoroughly Covered

Machine Shop Work—Vertical Milling Machine—Motor-Driven Shops—Shop Lighting—Forging—Electric Welding—Tool Making—Metallurgy—Manufacture of Iron and Steel—High-Speed Steel—Flaws in Castings—Electric Lifting Magnets—Magnetic Clutches—Making a Machinist—The Ideal Foreman—Pattern Making—Foundry Work—Automatic Coal and Ore Handling Appliances—Machine Parts—Construction of Boilers—Types of Boilers—Boiler Accessories—Steam Pumps—Air Compressors—The Steam Engine—The Steam Turbine—Indicators—Valve Gears—Refrigeration—Gas Producers—Gas Engines—Automobiles—Elevators—Sheet Metal Work—Practical Problems in Mensuration—Mechanical Drawing—Drafting Room Organization—Machine Design.

### WE'LL PROVE THEIR VALUE TO YOU

by sending you the complete Cyclopedia absolutely free for examination—just mail the coupon. Keep the books seven days—test every formula. You will agree that they are all we state, and more. Send \$1.80 after examination and \$2.00 a month until you have paid the special price of \$19.80. The regular list price is \$36.00. If the books do not meet with your requirements, advise us and we will remove them at our expense.

**ANOTHER GREAT OFFER** With each set is included a year's Consulting Membership entitling you to the advice of our business and engineering experts free. This will give you practical help in handling working problems which are too specific to be taken up in detail in the Cyclopedia. A single problem solved for you might be worth more than the first cost of the books.

#### Free Examination Coupon

American School of Correspondence  
Chicago, U. S. A.

Please send set Cyclopedia of Mechanical Engineering for 7 days' free examination. I will send \$1.80 within 7 days and \$2.00 a month until I have paid \$19.80, or notify you and hold the books subject to your order. Title not to pass until fully paid. Pop. Mech. 3-12

NAME .....

ADDRESS .....

OCCUPATION .....

EMPLOYER .....

Please Mention Popular Mechanics

## We Mean Business

**E**NTHUSIASTIC workers—men and women with ambition—who will work for us can earn \$3,000 to \$5,000 easily this year. We are increasing our sales force so as to cover the entire country. We need representatives. Need them quickly. What we want are men and women with hearts and souls. Those who are honest. Those who will be on the level with us. To such we offer an opportunity that comes to few people in a lifetime.

## Can You Fill the Bill?

If so, here's your chance to become independent—to get out of the rut—to make money and plenty of it. No selling experience is necessary. The tremendous merit of our proposition makes sales come easy and fast.

Our agents are meeting with tremendous success everywhere. Some started working part time. Now everything is laid aside for the sale of Kwicksharp Automatic Knife Grinders.

### \$375,000

will be divided amongst our sales force this year. Whatever your capacity for work is, in that measure will you receive your proportion of this sum of money. The first thing to do is to secure an appointment. Then your future is assured.

# Men and Women! Will \$5,000 A Year Satisfy Your Appetite For Money?

## Agents Make 100% Profit

No long study or tedious preparation is necessary. Anyone can start and earn \$6.00 to \$10.00 a day right now. It's simply a case of demonstrating what Kwicksharp will do and how easily it does it. The housewife does not live who would not like a Kwicksharp Knife Grinder in her home. Restaurant, hotel, cafe and lunch room proprietors have long felt the need of an article like ours. The demand is existing everywhere where knives are used and must be kept sharp—and we want men and women to take care of it.

## Respond Quickly

—If you want to join our army of representatives. There are thousands of dollars in it for you. All the facts cannot be told in small space. Write us and we'll lay the plan before you. No effort has been made to arouse false hopes. This is not a "get-rich-quick" scheme. We are organizing our selling force right now; employing agents and appointing managers to secure sub-agents. It costs nothing to investigate. Just ask yourself whether you can afford to hold back. You couldn't dream of a proposition so good as this one. If you meet our requirements, you cease to be a wage slave and can earn \$3,000 to \$5,000 a year at least. Write your name on a postal. We'll send you full facts and hold territory for you, awaiting your decision in the matter. Address

**SPENGLER SPECIALTIES CO.**

213 Olsen Bldg., 37-39 East 28th Street, New York City

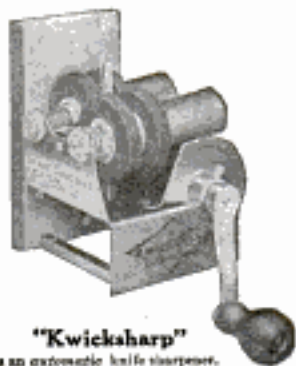

"Kwicksharp"

It is an automatic knife sharpener. A child can operate it and get perfect results—puts the keenest edge on the dulled blade in a moment or two. It is the only device made that silver plated blades can be re-sharpened on without injuring the silver plating. Kwicksharp quickly saves its cost and lasts a lifetime. It is guaranteed to be mechanically perfect and to do what we claim for it or money refunded. An attachment is now furnished free with Kwicksharp that makes easier grinding just as simple an operation as knife sharpening. This attachment increases its usefulness and selling possibilities. Every housewife wants it.

## MONARCH CONCRETE MIXER \$218



complete with high grade gasoline engine, all on truck. Capacity 40-50 yards in ten hours with two men. Low feed. Saves cost in 60 days. Concrete Machinery of all kinds. **Mixers from \$35.00 up.**

CATALOG FREE  
**MONARCH MANUFACTURING CO.**  
803 Shepard Bldg., Grand Rapids, Mich.

## BIG MONEY MADE



## Operating Our Amusements

At Parks, Fairs, Carnivals, Etc. Small Investment—Anyone can be successful. We build those Fanny Mirror Shows, and have perfected a new kind of mirror that has reduced the cost of this popular attraction 75% and made it a success for traveling. We make a new style Nail Striking Machine—A Baseball Battering Machine—Moving Water Fish Ponds—African "Dips," and other moneygetters.

CATALOG FREE  
**J. M. NAUGHTON AMUSEMENT CO.,** Mayer Bldg., Peoria, Ill.



## The Temco Electric Breast Drill

### A 20th Century Wonder

Runs on A. C. or D. C. Current, Either Forward or Backward. A Very Rapid Machine for Tapping. Carry Your Drill To Your Work. More Convenient in Shape than a Common Breast Drill. Especially Designed for Manufacturers and Repairmen. An Investment with Guaranteed Profits. A Postal will bring you Descriptive Booklet.

**THE TEMCO ELECTRIC MOTOR CO.**

Drill Dept.  
77 Sugar St. LEIPSIK, OHIO, U. S. A.

are about 40 life-saving stations connected with this service, each of which is manned by from 8 to 16 men and equipped with a 16-ft. dory, from 4 to 6 life rings, and a small medical kit. The stations are distributed from Point Lookout, Long Beach, Long Island, to Orchard Beach, Long Island Sound. The members of this organization serve without compensation, and the \$11,000 which this city contributes annually goes toward the building and maintenance of the stations.

One of the principal duties of these volunteer workers is the endeavor to convince people of the great impor-



## Their Secret Out!

The Old Masters guarded their Violin-making methods closely, but modern practice has found them out. Full instructions and patterns. Write for particulars.  
**C. C. FRASER, SAGINAW, MICH.**



## CHEAPER THAN EVER!

Every Kind of Woven Wire Fence, also Wrought Iron Ficket Fences, Gates, Etc. Write for free Catalog  
**Enterprise Foundry & Fence Co.,**  
1151 E. 24th St., Indianapolis, Ind.

## Model Aeroplanes and Accessories

We manufacture the highest grade of aeroplane models on the market. Every part is well made from the best of materials and in exact accordance with the designs submitted to us. We have on hand at all times stock models of all well-known machines. We carry a complete stock of accessories of all descriptions—miniature pneumatic wheels, ball-bearing shafts, turnbuckles, eyebolts, light model wood, Para rubber, wire, etc. Our simple and compound elastic motors are the most durable sold. Our prices are very reasonable. Send at once for catalogue C, which fully describes and illustrates all models and parts.

**Aero Mfg. & Accessories Co.**

18 Dunham Pl.

BROOKLYN, N. Y.

## SOLDER IT YOURSELF

No skill needed. Perfect work first time by using

### TINOL

the modern combined solder and flux. Paste and hollow wire forms. Use a candle, gas jet, or the Tinol Alcohol Torch. No acid or resin. Largely used in telephone and industrial work. Send us your hardware dealer's name and \$1.20 for Tinol Torch and can of Tinol Paste. Literature free.

**HESS & SON, Dept. F, 1215 Filbert St., Philadelphia, Pa.**

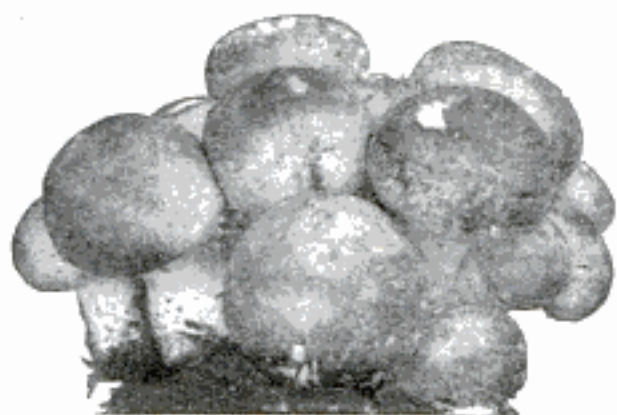

## Grow Mushrooms

For Big and Quick Profits  
Small Capital to Start A Safe Business

I am the largest grower in America. Ten years experience enables me to give practical instruction in the business worth many dollars to you.

No matter what your occupation is or where you are located, here is an opportunity to acquire a thorough knowledge of this paying business.

Send for Free Book giving particulars and information, how to start, cost, etc. Address  
**JACKSON MUSHROOM FARM**  
3990 N. Western Avenue CHICAGO, ILL.

tance of teaching children to swim, and it is the ambition of the organization to equip each of its life-saving stations with an expert swimming instructor. To do this an increase of the annual appropriation is needed. At present a paid swimming instructor is employed on each of the principal beaches in the summer, but some of these teachers have to cover three beaches a week because of lack of funds to employ the necessary number.—Marine Journal.

### JUMP SPARK \$20 Let "Baby" Do It M. & B. SPARK \$16



"BABY" is a 1/2 H. P., 2 cycle, air cooled, gas or gasoline engine. It weighs 24 pounds and for running light machinery or a small dynamo it can't be beat.

The engine is complete with coil, switch, plug, wire, mixing valve, tank, pipe, crank, and muffler at these prices. Can you beat it?

Get one for the washing machine, the home workshop, or the boy's experimental work. At least, send for our free circular.

**THE ELGIN WHEEL & ENGINE CO.**  
112-114 Douglas Ave. ELGIN, ILL.

## LIFE THRU HEAT

By Taking Turkish Bath at Home—Only 2c



Exhaustion and many other ills means that waste matter has over-accumulated in your body. Drugs do not drive them out. Exhausted men and women have been made strong at home, in a few moments' time, by the use of

### ROBINSON'S TURKISH BATH CABINET

Prominent physicians have abandoned drugs for this new treatment. If your mind or body is tired, open your pores and feel the rapid change in your condition, at home, for only 2c a bath. The Robinson Bath Cabinet is the only scientifically constructed bath cabinet ever made, a model of ingenuity. Valuable Book Sent FREE—"The Philosophy of Health and Beauty"—represents lifetimes of thought of well known scientists and is written plainly so that anyone can understand every word. Write in time—today.

Agents Wanted in Unoccupied Territory.

**ROBINSON MFG. CO., 172 Robinson Building, Toledo, O.**

19 Jewels  
Adjusted to the  
Second

Thin Model  
A Perfect Time  
Keeper



## Superb

Watch with Monogram  
Great Special Offer

The superb Burlington Special at the anti-trust rock-bottom price the same price that even the wholesale jeweler must pay. You may secure one of these superb time-pieces—a watch of the very latest model, the popular new thin design, adjusted to the second—19 jewels—the most perfect product of the most expert watch manufacturers in the world, at the rock-bottom price, direct from us—the identical price that even wholesale jewelers must pay.

Your Choice of Cases Open face or hunting cases, lady's or gentleman's size. These can be had in the newest designs;

Block Monograms Lodge Designs  
Ribbon Monograms French Art Designs  
Diamond Set Dragon Designs

**\$2.50 a Month at the Rock-Bottom Price**

\$2.50 a month for the world's most superb timepiece! The easiest payments at the rock-bottom price. To assure us that everybody will quickly accept this introductory direct offer, we allow cash or easy payments, as you prefer.

Sent on Approval We ship the watch on approval, prepaid. You risk absolutely nothing—you pay nothing—not one cent unless you want the great offer after seeing and thoroughly inspecting the watch.

Write for Free Catalog

Send for free book. It will tell you the inside facts about watch prices, and explains the many superior points of the Burlington over double priced products. Just send free coupon or a letter or postal, now!

**Burlington Watch Co.**  
19th St. & Marshall  
Bld. Chicago  
Dept.  
1193

**Burlington Watch Co.**  
Dept. 1193 19th St. & Marshall Bld.  
Chicago, Ill.

Please send me (without obligations and prepaid) your free book on watches and a copy of your \$1,000 challenge, with full explanations of your cash or \$2.50 a month offer on the Burlington Watch.

NAME.....

ADDRESS.....716

# NEW CATALOGUE No. P 26 READY MARCH 5th

This catalogue will be ready for distribution about March 5th. You cannot afford to be without it. It means money saved to you to have one with our prices. In order that you may be among the first to get a copy, we urge you not to delay, but



## SEND FOR IT NOW

The catalogue will contain about 200 pages illustrating and describing clearly and concisely the various material manufactured by us, which includes—**Wireless Apparatus; Telegraph and Telephone Material; Ignition Supplies; Electrically Heated Goods; Medical Batteries; Electric Vibrators; Bells; Batteries; Burglar Alarm Contrivances; Automobile and Motor Boat Electric Appliances, etc.** Be up to date and have one. It costs you nothing.

**MANHATTAN ELECTRICAL SUPPLY CO. NEW YORK, 17 Park Place CHICAGO, 118 S. 5th Ave.**

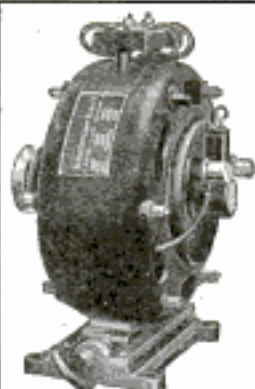

**The Holtzer-Cabot**  
ANTI-TRUST  
ANTI-RUST  
ANTI-"CUSS"

**A. C. Motors**  
Single Phase, Induction Type  
From 1-20 to 5 H. P.

Will drive anything from a delicate diamond drilling outfit to a large printing press.

Write us for Bulletin 330 P.

**The Holtzer-Cabot Electric Co.**  
BOSTON, MASS. and CHICAGO, ILL.

**ELECTRIC** House Lighting Plants, Telephones, Dynamos, Fans, Lamps, Engines, Motors, Meters, Batteries, Belts, Bells, Books, Catalog 3c. **Ohio Electric Works, CLEVELAND, OHIO.**



The most wonderful and fascinating study of the age. Everybody should have a copy of the new

**"VOLTAMP ELECTRICAL PRODUCTS"**  
our 112-Page Catalog, now ready. The most complete and interesting book ever issued. Full of illustrations and descriptions of **VOLTAMP** Novelties—Motors, Dynamos, Telegraph and "Wireless" Instruments, Spark Coils, Lamps, Flashlights, Transformers, etc. Everything Electric for the experimenter. The greatest line of **MINIATURE ELECTRIC RAILWAYS** ever shown. Catalog with valuable coupon sent only for 6 cents in stamps or coin. (No postals answered.)  
**VOLTAMP ELECTRIC MFG. CO., Veltz Block, BALTIMORE, MD.**

**MODERN ELECTRICS** "The Electrical Magazine for Everybody"

The brightest and most interesting electrical monthly magazine published, with a new department on aeronautics. **The AUTHORITY ON WIRELESS.** The magazine to read if you want to keep up to date on wireless and progress in electricity.



**This Bleriot Model**  
**Aeroplane guaranteed**  
**to fly 1000 feet**

OR



**This Double Magnetic Reversible**  
**Engine with Speed Contact Lever**  
1000 to 2500 revolutions per minute. Two heavy cast iron fly wheels. Wiring entirely concealed. Either of the above machines **FREE** with one year's subscription to **Modern Electrics** for \$1.00. (Canada, \$1.25.) (Foreign, \$1.50.)

**MODERN ELECTRICS, 231 Fulton Street, NEW YORK**

## The Electro Audion

is the latest word in Wireless. It is the most sensitive Detector constructed today, being even more sensitive than the Electrolytic and many hundred times more sensitive than Silicon and Carborundum.

Now used by nearly every government.

Send today four cents postage for our marvelous 196 page encyclopedia No. 10 with 425 illustrations on experimental, electrical apparatus and instruments.



Price of this marvelous instrument **\$4.00**

**THE ELECTRO IMPORTING CO., 233a Fulton St., NEW YORK CITY**  
"EVERYTHING FOR THE EXPERIMENTER"

## WIRELESS SUPPLIES ELECTRICAL NOVELTIES

We are Western Agents for The Electro Importing Co. Same Catalogue—Same Prices. We also carry a complete stock of electrical supplies, trains, toys and pocket cigar lighters. Send 4 cents in stamps for Catalogue.

**ANDERSON LIGHT & SPECIALTY CO.**  
KNOWN AS LASALLE LIGHT STORE  
140 No. LaSalle St. Dept. A. CHICAGO, ILL.

## BIG 250-p ELECTRICAL and Wireless Catalog Mailed for 6c Stamp

75 pp. **WIRELESS** Instruments for Commercial and experimental use; 20 pp. Telegraph Instruments; 30 pp. Motors and Dynamos; 10 pp. Microscopes; 15 pp. Flash-lights and Miniature Lamps at very attractive prices; 25 pp. Miniature Railways; 75 pp. General Electrical Supplies.

**J. J. DUCK, 424-426 St. Clair Street, Toledo, Ohio**

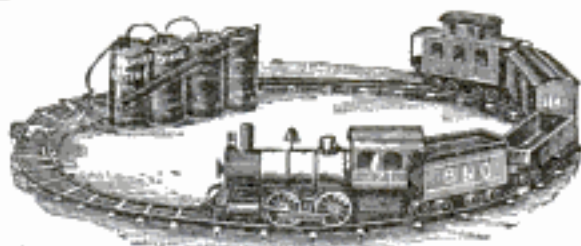

Electrical railways, tracks, switches, trolley cars, dynamos, motors, dynamo castings, gas engine castings, everything for the young electrician. Send for our complete catalog "B."

**The Carlisle & Finch Co.**  
262 E. Clifton Ave. Cincinnati, Ohio

Please Mention Popular Mechanics



## A Strange Catastrophe

**T**HIS tree had stood in City Hall Park, New York for nearly a hundred years. It showed no signs of decay. One day while the park was crowded with persons hurrying to their homes all unconscious of danger, with no apparent cause and without warning it fell and injured a score of persons—three seriously.

Just as sudden and unexpected are most of the accidents which occur daily. No mind can foresee them. No amount of caution can prevent them.

Amid such unseen dangers the only sensible thing is to carry a policy of accident insurance. Such a policy provides for the cost of injury by loss of time and in case of death takes care of the family. You have escaped the accidents of yesterday. To-morrow is yet to come. To-day is the time to act.

We paid last year 15,719 personal accident claims with benefits amounting to \$1,713,046.

**MORAL: Insure in the TRAVELERS**



## The Travelers Insurance Company

HARTFORD, CONN.

Please send me particulars regarding ACCIDENT INSURANCE.

Occupation \_\_\_\_\_ Name \_\_\_\_\_

Age \_\_\_\_\_ Business Address \_\_\_\_\_

Pop. Mech. \_\_\_\_\_ City \_\_\_\_\_ State \_\_\_\_\_



**READY**

## Shop Notes Year Book for 1912

224 Pages—612 Articles—510 Illustrations  
Vol. VIII of the Series — Price 50c Postpaid

The tradesman in any line who desires to save himself the trouble of puzzling out the "kinks" and "short-cuts" of his occupation will find the Shop Notes Series of Year Books a veritable encyclopedia of

## EASY WAYS TO DO HARD THINGS

They represent the valuable experience of expert engineers, firemen, carpenters, machinists, plumbers, painters, iron and wood workers, electricians, masons and other tradesmen.

200 Pages	Vol. I,	"Shop Notes for 1905"	385 Illustrations
228 Pages	Vol. II,	"Shop Notes for 1906"	555 Illustrations
228 Pages	Vol. III,	"Shop Notes for 1907"	580 Illustrations
212 Pages	Vol. IV,	"Shop Notes for 1908"	536 Illustrations
224 Pages	Vol. V,	"Shop Notes for 1909"	461 Illustrations
224 Pages	Vol. VI,	"Shop Notes for 1910"	451 Illustrations
224 Pages	Vol. VII,	"Shop Notes for 1911"	468 Illustrations
224 Pages	Vol. VIII,	"Shop Notes for 1912"	510 Illustrations

The low price of 50 cents a volume or \$4.00 for the 8 books in a handsome case, prepaid, places them within the reach of all as the set may be acquired gradually, one volume at a time, if desired.

**Popular Mechanics Book Dept., 318 W. Washington St., Chicago**

## "The How and Why of the Automobile"

**200 Pages. Bound in full cloth. 250 illustrations. Price \$1.00 Prepaid.**

Did you ever talk to a man who came over on your side of the fence and talked WITH you and not AT you—who explained things in such a way that you laughed at yourself afterwards for not understanding the subject before—it was really so simple?

Do you remember the innumerable times you have said to yourself, "If I only had somebody here to explain things—someone who would go through this proposition with me until I understood it—someone who would use homely and familiar examples to explain things, instead of talking over my head by using technical terms?"

In a word, would you like to know all about a motor car—how it works—how to drive it and how to take care of it? Then send for a copy of this book by Fay L. Faurote, B.S., (M.E.), for five years closely associated with the Experimental Department of a pioneer automobile factory, for two years instructor in the Detroit Motor School.

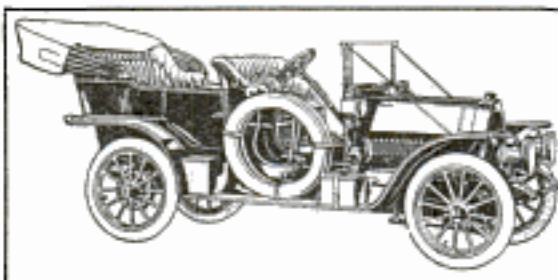

The author realized all these difficulties himself, because he has been through it all. Not only that, but his experience as an instructor of a large motor school taught him the way to explain the various parts of a motor vehicle in simple language, so that even the boy of fifteen could understand

and and appreciate them.

Would you like to see what's inside of an automobile engine—would you like to know the name of every part—be able to talk intelligently about it and be your own mechanic—tell your chauffeur what to do—know when he is bluffing you?

**Contents:** Introduction—The Four-Stroke Cycle Motor—The Two-Stroke Cycle Motor—Motor Design—The Carburetor—Ignition—The Cooling System—The Transmission Gear—Motor Testing.

— ADDRESS —

**POPULAR MECHANICS BOOK DEPT. 318 W. Washington Street CHICAGO**



## Take Robinson Electric Light Baths In Your Own Home!

### HEALTH, VIGOR, LIFE THRU LIGHT

Only 2c to 4c for a life-pulsing, invigorating, vitality-strengthening Electric Light Bath in your own home—taken just as conveniently with this Robinson Electric Light Bath Cabinet as you would step into and out of a tub. Enter the cabinet—turn the switch—and the myriad rays of light infuse your whole system with a new, lasting feeling of real life.

### Makes a New Being of You

Gives you all the benefits of the Turkish bath with the tonic effect of electric light rays in addition—a natural health preserver, for Light is Life. Cleanses and keeps the skin clear, the body full of vigor, the brain quick and active.

A Free Book, handsomely illustrated, giving complete information about Life Thru Light, and describing in detail this wonderful Cabinet, is ready to be sent to you. Be sure you write for it—a postal card will do—today.

Robinson Electric Mfg. Co.,  
401 Robinson Bldg., TOLEDO, O.

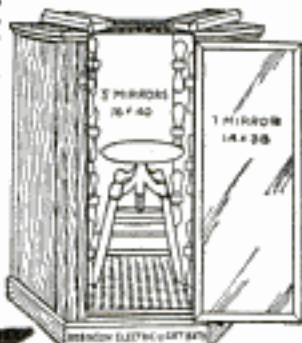

30 Days' Free Trial  
365 Days' Test  
3 Years To Pay

We Save You \$128 to \$222  
Take Your Own Time to Pay

No Interest—  
No Collectors

**Send No Money**

Let us send this artistic piano to you at our expense. We pay the freight. You pay nothing down. Try it for 30 days. If we cannot satisfy you with the piano, we will pay the freight for its return. Take 3 years time to pay if satisfied.

**Reed & Sons PIANOS**

At the World's Columbian Exposition they won the highest award medal. We offer you direct-from-factory-to-home wholesale prices on Reed & Sons Pianos, giving you the highest artistic quality at a price much lower than your dealer would charge you for a cheap, inferior instrument.

**BIG BOOK FREE**  
Clip coupon below. It will secure for you our Special Proposition and Prices; all in handsomely colored illustrated catalog sent free. A 2c stamp will save you dealer's profit.

**REED & SONS PIANO BOOK**

REED & SONS PIANO MFG. CO.  
Dept. F. 17, Cor. Jackson Blvd. and Wabash Ave., CHICAGO, ILL.

Fill in Coupon Today

Send me Your Big Free Book and Piano Offers.

Name .....

Street..... R.F.D.....

Town.....County.....State.....

Capital and Resources \$1,750,000

**WHERE THE CUSTOMS GAINED**—The German custom houses have the right to draw a liter of wine from each shipment that enters the country from France, and for the appraisement twenty marks is charged to the consignee. Recently a German dealer had twenty bottles of French wine, each of a different kind, sent to him, so that he might examine the samples and select his stock. The custom house regarded it as its duty to sample every variety, and did the logical thing by keeping the entire shipment. They then sent a bill to the consignee, charging him the customary appraisement fee of twenty marks for each bottle!—New York World.

## "CECIL PEOLI" CHAMPION RACER

(Controlled by Ideal Aeroplane and Supply Co.)



Plans and directions for building this famous model..... 25c

Plan for building Wright Bi-plane, 3-ft. Flying model..... 25c

Bleriot Monoplane 3-ft. Flying model-plan..... 15c

COMPLETE STOCK OF GUARANTEED MATERIALS AND PARTS.

Our new up-to-the-minute Catalog contains EVERYTHING.

Also has Official Rules for contests. 5 cents brings it.

IDEAL AEROPLANE & SUPPLY CO., 52-58 West Broadway, New York City

## LEARN to FLY



We need a few competent Aviators immediately ambitious to earn big money.

Earnings range from \$100 a week upward. Those who have a liking for mechanics preferred. We furnish you a standard-type Aeroplane practically without cost to you. Call or write for particulars at once.

Take a Special Home-Study Course for \$60. Do it to-day. It Will Pay You.

ADDRESS: DEPARTMENT 20

Milwaukee School & College of Aviation  
E. E. Cor. Grand Ave. and Fifth St., MILWAUKEE, WIS.

**BE AN EXPERT MOVING PICTURE OPERATOR**  
MAKE FROM \$22 TO \$30 PER WEEK

Big pay and short hours in this paying profession. The demand for expert motion picture operators is increasing daily.

The American School of Correspondence will teach you to be an expert operator in a few weeks, without loss of time. Even if you have a good job now it will pay you to learn motion picture operating. Many operators are making "a little extra" in their spare time.

Fill in the coupon and we'll send you our booklet "The Motion Picture." It explains our motion picture course fully—gives some valuable information about operating.

Also ask for information about our "Cyclopedia of Motion Picture Work." Just off the press—the only complete work on this subject ever published. Special introductory price on first thousand—ask about it today. Fill in the coupon, specifying whether you want books or course.

**American School of Correspondence, Chicago, U. S. A.**

**The American School of Correspondence**  
Chicago, U. S. A.

Please send me further information about your

{ } Motion Picture Course.  
{ } Motion Picture Cyclopedia.

NAME .....

ADDRESS .....

Pop. Mech. 3-12

## CYCLISTS AND MOTORCYCLISTS:



the best way to ensure safety is to have your machine fitted with a

## Corbin Coaster Brake

It means Confidence, Reliability and Control—especially in traffic and when coasting.

If you are riding a bicycle, or intend to purchase one, insist on the Corbin Brake.

Any bicycle repair shop can fit it to the hub of your machine. For sale by bicycle and hardware dealers everywhere.

Send for free catalog describing all models  
**THE CORBIN SCREW CORPORATION**  
 Division of The American Hardware Corporation  
 Licensed Coaster Brake Manufacturers  
 204 High Street New Britain, Conn.

## THE Racycle

rides  $\frac{1}{4}$  easier than other wheels. Think how much further you can ride on a "Racycle!"

Think how much easier hill climbing becomes! A patented crank hanger construction that reduces bearing friction and chain strain gives "The Racycle" its easy-riding qualities, and makes it the largest-selling, high-grade bicycle made. Send today for "Racycle" Book, containing much interesting bicycle information. Copy mailed free on request, together with "3 Reasons Why" pamphlet.

THE MIAMI CYCLE & MFG. CO.  
 53 Grand Ave. Middletown, Ohio.



## Four Car Owners in Five Use the Reliable Stewart Speedometer

An absolute necessity. Tells you how fast you go—saves you from arrest and accidents; keeps track of your season mileage; helps you follow guide book mileage when touring; saves you money on tire adjustments; checks your gasoline and oil supplies; helps you get maximum efficiency out of your car.



Speedometers, \$15 to \$30  
 Clock Combinations, \$45 to \$70

Stewart Speedometers have 100,000-mile season odometer; 100-mile trip register; can be reset to any tenth of a mile.

Beautifully made; absolutely accurate; open dial; easily read; jewel bearings; positive odometer; unbreakable flexible shaft; drop forged swivel joint that will outwear the car.

Speedometer Guaranteed for Five Years.

Send for new 1912 descriptive catalog; tells you why in our big factory we can make the best speedometer at the lowest price.

WRITE TODAY

**STEWART & CLARK MFG. CO.**  
 1906 Diversey Blvd., Chicago

Detroit, Chicago San Francisco, New York, Boston, Cleveland, Philadelphia, Kansas City, Los Angeles, Minneapolis, Indianapolis, London, Paris

New York City surface car lines still carry more passengers than either the subway or the elevated roads. For the year ending June 30 the figures are (for Manhattan): Surface roads, 386,952,020; elevated roads, 301,449,292; subway, 276,704,796.—The Outlook.

## GRAY MOTORS FOR BOATS



Made in the Largest Plant in the World devoted to manufacturing 2-cycle marine gasoline engines.

3 H.P. with Complete Outfit ready to install \$55  
 ALSO 3 1/2 TO 35 H.P.

Guaranteed by a big responsible concern. Write for big catalog—tells and shows you all about these high grade motors and how they are made.

GRAY MOTOR CO., 392 U. S. Motors Bldg., Detroit, Mich.

## INITIAL GUN FOB

Niftiest, catchiest, most serviceable watch fob in the world. Makes a hit anywhere; attracts attention, because it carries an air of Western romance. Made within gun-shot of the famous "Alamo," Cradle of Texas Liberty. Miniature of the cowboys' equipment. Reminiscent of the woolly days of the Great Southwest. Holster of good leather, metal gun, slipped inside ready to be pulled. Holster branded with your own initial, which adds an air of individuality.

### A NOVELTY

Appreciated by young and old of both sexes. Send 25 cents today and receive one of these unique fobs by return mail. One dollar will bring 5 fobs.



**ALAMO LEATHER & NOVELTY CO.,** Desk P.H. San Antonio, Tex.

**“Count the  
Indians on  
the Road”**



The  
**Indian**  
Motorcycle

Ride a motorcycle. It's the most fascinating of modern vehicles. It makes you wholly independent and self-reliant—gives you the means to go anywhere, any time, at a moment's notice. For regular trips or just running about as the mood suggests, the motorcycle is the vehicle you need.

## The Indian 1912 Models

4 H. P. Single Cylinder, \$200

7 H. P. Twin Cylinder, \$250

are the same in principle and construction as the Indians which finished *First, Second* and *Third* in the International Tourist Trophy Endurance Contest in England. Distance, 187½ miles; 57 starters, including the world's leading motorcycles and riders.

The peculiar readiness and reliability of the Indian make it a wise and profitable investment. Maintained at small expense. Official record shows that the Indian has run nearly 32 miles on 1 pint of gasoline. Any speed from 3 to 50 miles an hour.

Free Engine Clutch enables you to slow down and get off without stopping the engine and to start again without pedaling or running alongside. You simply move a lever.

**14 important improvements in 1912 models.** New Indian armored type magneto is entirely enclosed. Protected from oil, dust and moisture. Perfect ignition assured. This feature and the Free Engine Clutch are supplied free of extra charge with all 1912 Indians.

1,200 agents throughout the country sell the Indian. So that no matter where you may ride, you're always in Indian territory.

*Learn more about this wonderfully useful machine. Write today for new 1912 catalogue. Mailed free to any address.*

### THE HENDEE MANUFACTURING COMPANY

(Largest Manufacturers of Motorcycles in the World)

871 State Street : : Springfield, Mass.

Chicago  
1251 Michigan Ave.

Denver  
138 16th St.

San Francisco  
235 Van Ness Ave.

London  
184 Gt. Portland St.

Please Mention Popular Mechanics

# BUILD A BOAT

This Spring  
and Double Next Summer's Sport!

You'll never know the full joy of boating until it is **your** boat, your creation, that leaps and dips and skims along in your command. And your pleasure begins the day you get our plans and materials. Everyone who has built a Brooks Boat wants to build another for the **sport of building**. Also for the satisfaction and confidence given by knowing what's under you—that every part is staunch and true. And you cut the cost to a fraction of regular price.

## The Brooks System Makes It Easy To Build a Motor Boat, Sail Boat, Row Boat or Canoe



Only \$25

Model 234 shown above—23 feet long. Knocked down Frame with full sized pattern to finish by. Fine Free Book Shows 100 other designs at proportionately low prices.

Not only easy to construct but easy to pay for. We send all parts of frame complete, ready to put together. Plans and instructions so clear and simple anyone without the least experience is sure of success. Every piece, every bolt and rivet fits to place. Satisfaction guaranteed or money refunded.

You can build any style boat you want from our full sized patterns, costing from \$2.00 to \$12.00 according to design selected.

**Brooks Boat Book Free.** Learn how easy it is to make a boat, how inexpensive. You will find this book mighty interesting. Puts you under no obligation. Write for it now. Address

**BROOKS MFG. CO.,** 8003 East Ave., SAGINAW, MICHIGAN

You Can Now Buy  
A New Typewriter  
For \$18 <sup>IN</sup> U.S.A.



—And It's Portable

Wherever you care to work, at business, home, on trips, in hotels, you can have this efficient typewriter at your elbow.—It weighs but 7½ ounces, takes space but 2x5x11 in. and is easily carried in overcoat pocket or grip. Yet it

**Does Work of \$100 Machine**

Has standard keyboard of 84 characters, ribbon. Is up-to-date in every respect. The Bennett Portable Typewriter was perfected by a mechanical wizard. Only 250 parts. Others have 1700 to 3700. Hence our \$18 price. Made in famous Elliott-Fisher Billing Machine Factory. Sold on rigid money-back-unless-satisfied-guaranty. Send for catalog today. Save that \$82.

Over 24,000 Bennett Typewriters now in use. We have splendid proposition for a few more agents.

**P-P BENNETT TYPEWRITER CO.**  
366 Broadway NEW YORK

## SAVE YOUR BRAIN

Goldman's Handiest, Fastest, Cheapest  
**ARITHSTYLE ARITH-MACHINE**  
Carries automatically! Resets instantly!  
Adds, Subtracts, Multiplies, Divides!  
Portable, Durable, Reliable!  
Shortcut Methods! Checking Systems!  
Agents Wanted, Request Booklet.  
Arithstyle Co., Suite 24, 118 E. 28th St. N.Y.



THIS MACHINE  
MADE ME  
**RICH**

It enabled me to build a big confectionery business in my home town. This machine makes Popcorn Crispettes, a new—delicious—delightful confection. I earned my money making and selling Crispettes. If you will write me today I'll tell you how I did it and tell you how to start. If you follow instructions you should make more money this winter and next summer than you ever dreamed of.

**Every Time You Take in a Nickle  
You Make Almost Four Cents Profit**

Somewhere in your town is a small store—a half-store—a store window—or a nook where you can set up your machine and make money. Or I stand ready to help you make good. You can start at home—establish jobbing connections—sell to retailers and make a fat profit. Making money isn't half as hard as it seems. At least investigate my proposition. Write today, if only a card.

**W. Z. LONG**

469 High Street, Springfield, Ohio.

Please Mention Popular Mechanics

# 4 Musical Instruments FREE



One of Forty Designs

1. Superb Harp
2. Tyrolean Zither
3. Concert Guitar
4. Artist Banjo

## ALL FREE

## With Every Wing Piano or Player Piano

A great special offer that we are making for a limited time only. Write at once to learn of our offer whereby we ship you your choice of any of our 40 designs—either piano or player piano—and the four attachments for a Free Trial lasting four weeks. By the mere pressure of a pedal on the Wing instrument, the piano is changed to a delicate harp with its beautiful notes—to the mellow tone of a guitar—furnishes the rollicking music that only a banjo can produce—or if you choose, it can be transformed into a Tyrolean zither, beloved by musicians. And you can play any or all with the skill of the specialized artist. All these attachments are free to those who will write at once.

## Our Great Offer

Now remember—our offer is to send to you absolutely free for four weeks either a genuine Wing piano or Wing player piano, with or without the four instrumental attachments. Each piano guaranteed for forty years. We pay the freight both ways if it is necessary—you pay nothing, even though you decide not to keep the Wing. Send this coupon now for a free copy of the valuable "Book of Complete Information About Pianos" and the Wing Art Catalog.

**WING & SON** Wing Bldg. 9th Ave. and 13th St.  
Dept. 1193, NEW YORK CITY

**WING & SON** WING BUILDING  
9th Ave. & 13th St.  
DEPARTMENT 1193 NEW YORK CITY

GENTLEMEN:—With the understanding that I am not buying or paying for anything, you may send to me free and postpaid the "Book of Complete Information About Pianos" and your Art Catalog of Wing Pianos. Also full particulars of your special Free Instrumental Attachment Offer.

Name.....

Address.....

**WHERE AUTOS MUST HAVE HORSES**—The small city of Odder, Denmark, a place of some 4,000 inhabitants, still refuses to allow the motor car to use its roads. Motorists passing through the town have to procure a horse to draw their cars through the streets and those guilty of contraventions of this regulation are heavily fined.—Philadelphia Inquirer.

**ORGANIZE A GUN CLUB**  
Address Dept. 248 for "Gun Club Organization"  
Let Us Help You Get Started  
E. L. & PONT DE NEMOURS POWDER CO. WILMINGTON, DEL.

## Folding BATH TUB



Costs little, no plumbing, requires little water. Weight 15 pounds, and folds into small roll. Full length baths, far better than tin tubs. Lasts for years. Write for special agents offer and full description. ROBINSON MFG. CO., 2005 Adams Street, TOLEDO, OHIO. Manufacturers Turkish Bath Cabinets.

**BUILDING CONTRACTORS** Save \$6 a Day with the  
**RAPID FLOOR SCRAPER**

One man does more than three men by hand. Scrapes hard or soft wood and makes a finished job. 500 lb. use.



Free Trial  
Pay Us When Satisfied  
Catalog Free

MONARCH MFG. CO., 503 Shepard Bldg., GRAND RAPIDS, MICH.



## Solar Motorcycle Lamps

are the neatest looking, strongest and most efficient lamps made. The product of light specialists, makers of 90% of the automobile lamps used on the high grade cars of America. Catalog shows many styles—gas, oil and electric. Write for it today.

**BADGER BRASS MFG. CO.**  
Kenosha, Wis. New York City, N. Y.

## THE McWADE SYSTEM OF SELLING GOODS BY MAIL



has sextupled the sales of merchants and manufacturers by opening the way for them to sell BY MAIL, a thousand customers in the time it would take to sell one by personal solicitation.

I want you to send for my Free Literature describing this marvelous method of selling. I will show you how to sell anything from a needle to a threshing machine and sell it wherever the mails reach and never step out of your office to do it. I have a proposition which will interest every man who wants to better himself, or increase his business, or open a Mail Order department or start a Mail Order business. Send for this literature NOW before you forget it. You will be intensely interested in knowing what other men are doing in this business.

**FRANK L. McWADE, PRES.**  
301 COPELAND BLDG., ROCHESTER, N. Y., U. S. A.

## FREE BOOKLET

Every man should know how to use a Saw—"Saw Points" is an illustrated booklet, telling many interesting methods of using and caring for your Saw.

## MORRILL'S SAW SET

Your Saw must be properly set and sharpened to give the best results—Morrill's Saw Set is fully described in our Booklet No. 8 "Saw Points"—Free to you.

**CHAS. MORRILL** 281 Broadway  
NEW YORK

Two 4-ply  
Collars  
with  
every  
Signal  
Shirt



## Open All the Way Down

Here's the only work shirt that's built like a coat—open all the way down—so you slip in easy when you're in a hurry, and out easy when you're hot, sweaty and tired. Besides this is the only work shirt suitable for semi-dress wear and which comes in many neat colored patterns.

This big advantage alone would make the Signal Coat Shirt the most comfortable shirt on the market, but in addition it has many other equally desirable improvements over the ordinary shirt.

Extra button at bottom of breast plait—rip-proof sleeve-slit placed in side, so it can't gap. Extra full skirts, cut for utmost comfort—not to save cloth.

## The Signal Coat Shirt

Two 4-ply Collars. Two Handy Pockets

Also made with soft collar attached, if this style garment should be desired. Material is fast indigo percale. Like all Signal clothes they give perpetual comfort. Painstaking methods and the experience of years make the Signal Coat Shirt unbeatable.

If your dealer hasn't the Signal Coat Shirt, tell us his name and your size and we will send you a couple by express for your examination.

Send for a Couple.

Price \$1.00



West of Missouri River, \$1.25

If pleased, pay Express Company. If not entirely satisfied, return at our expense.

**Hilker Wiechers Mfg. Co.**

Makers of Famous SIGNAL Work Clothes

1256 Mound Ave.

Racine, Wis. Union

Made



### HOW TO GET BETTER LIGHT

From **KEROSENE (Coal Oil)**

Recent test by Prof. Rogers, Lewis Institute, Chicago, and Prof. McKergow, McGill University, Montreal, on leading oil-burning lamps show the Aladdin Mantle Lamp is the most economical and gives over twice as much light as any of the other lamps tested. It is odorless, safe, clean, noiseless. Better light than gas or electric. Every Aladdin Lamp fully guaranteed and protected by patents in nearly every country on earth. Our burners fit your old lamps.

To introduce the Aladdin, we will give

**ONE LAMP or BURNER FREE**

in each neighborhood. Send postal with name and address, ask for catalogue M. **AGENTS** Ball sold over 1000 on money back guarantee; not one returned. Bruner sold \$800 in 15 days. Ask for liberal agency proposition. Sample lamp furnished. **MANTLE LAMP COMPANY, 112 Aladdin Building, Chicago, Ill.**

## A SURE—BIG MONEY MAKER



Eighth season—thousands used—in every case has paid back original investment many times over during first year used. Pound of sugar makes 35 five cent packages candy—Takes like wildfire—Empire

### Candy Floss Machine

making sure, big profits everywhere. Get catalog of Pop-Corn and Peanut Roaster—Ice Cream Cone machines—

Home Ice Plant. Auto owners everywhere buy our Tire Valve—Pocket Lighter—and Full Line automobile accessories. Books Free. Agents Proposition Extraordinary.

**STEVENS MFG. & SUPPLY CO., Dept. A, 1225 Wabash Ave., Chicago**

The raising of deer on plots of waste land is attracting attention in various parts of the country. One New Jersey farmer who began with 10 deer ten years ago now has 400, and a Pennsylvania organization which started with 90 eight years ago has a herd of 3,000.

### LEARN a Profitable Profession

\$3,000 to \$5,000 a year. We teach you by mail. In a few months you can begin practicing Mechano-Therapy—an elevating and highly paid profession for men and women. Simpler than Osteopathy. Endorsed by physicians. Easy to learn. We guarantee success in the study. Only ordinary education required. Authorized diplomas to graduates. Work very interesting. Vast opportunities for social and financial betterment. Special terms now. Write today for ill. prospectus, free.

**AMERICAN COLLEGE OF MECHANO-THERAPY, 81 W. Randolph St., CHICAGO, ILL.**

### \$5.00 to \$10.00 A Day Made Easy



The "American" No. 3 Patented

Hones razors, sharpens all kinds of safety razor blades, clippers, scissors, etc. No make-believe, but the real thing. Complete outfits furnished with instructions how to do the work. No previous experience required. Address, Mgr. Dept. 308, Illinois Cutlery Company, 184 Washington St., Chicago

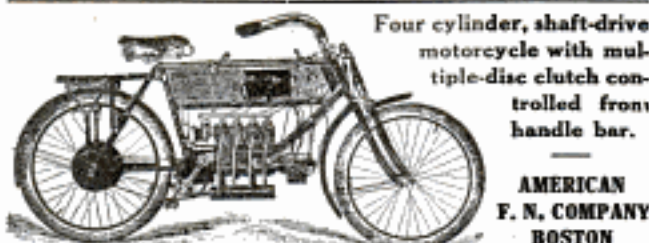

Four cylinder, shaft-drive motorcycle with multiple-disc clutch controlled from handle bar.

**AMERICAN F. N. COMPANY BOSTON**

### REINHOLD "NOFLUX" ALUMINUM SOLDER A Real ALUMINUM SOLDER Found at Last

Let Us Send You a Trial Bar Enclose 35 cents, coin or stamps, and we will send you a good sized bar of this wonderful Aluminum Solder; contains no mercury or lead—does not corrode—is not affected by electric current passing through it. Aside from many commercial uses, it may be used with great success to repair kitchen utensils as it is impervious to heat. Address your order or inquiry to **REINHOLD NOFLUX ALUMINUM SOLDER COMPANY, 53 Demarest Street, NEWARK, N. J.**

# PIERCE

## Motorcycles

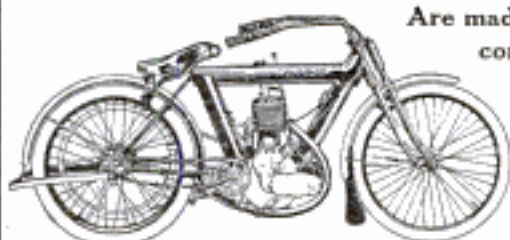

Are made not to compete in price, but to surpass in quality

### THE SINGLE CYLINDER MODEL

Is simpler in design and construction than any other motorcycle. In efficiency, strength, speed and hill-climbing it is superior to other singles, comparing favorably with twins. The engine, unlike most others, is of the slow speed type and will not shake to pieces when put in service. The strong large tubing frame made of 3 1/2 in. diameter seamless steel tubing positively will not break or buckle and eliminates unsightly separate tanks.

**Distinctive Features** Large tubing frame, no separate tanks, 5 H. P. engine, roller bearings, spring forks, mechanical valves, magneto ignition, automatic carburetor and free engine.

We also manufacture the celebrated Pierce Four Cylinder which is the world's finest motorcycle, a de luxe product for discriminating users. Read the whole story in catalog "O." Free on request.

**THE PIERCE CYCLE COMPANY, Buffalo, N. Y.**

Manufacturers of Pierce Bicycles, Standard for 20 years

Pacific Coast Branch, OAKLAND, CAL.

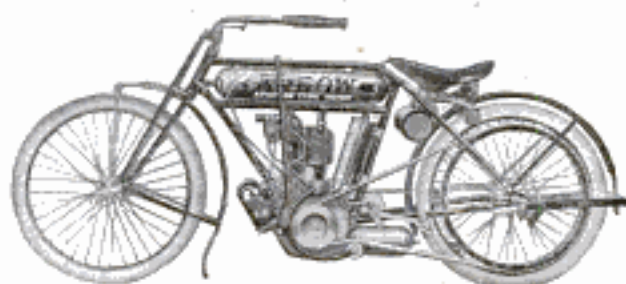

## \$12.50 Per Month

### BUYS THIS MOTOR CYCLE

**T**HE genuine and famous Arrow, four and one-half horse power, 1912 model, with the great Aviation Type motor. The motor that has made this machine 25 per cent faster with 50 per cent less strain and gasoline consumption. **Agents terms on this big Introductory Offer.** Same credit

#### Dealers' Credit to You if You Write Quick

This offer is to quickly place Arrows in every locality. We give the same liberal terms we allow to dealers, requiring only a part payment with plenty of time to pay remainder. Send for free catalog today—Now—Don't wait.

dealers get. We want good riders every place **AT ONCE.** Ride the **ARROW** while paying at the rate of only \$12.50 per month. Only \$100 down and \$12.50 per month for 10 months—\$225 in all for the absolutely perfect Arrow.

**Send the coupon today for our Big offer.**

### THE 1912 MODEL ARROW

With the new Aviation Type Motor—speed, 60 miles per hour. Latest style Messenger compound spring saddle—seamless tubing frame—grip control—double truss fork—Bosch high tension magneto with special control—positive force feed—triple expansion exhaust chamber—mineral tanned flat belt—free engine—most splendid finish—a superb motorcycle—and at only \$12.50 per month.

### Send the Free Coupon

Just your name and address on the free coupon and mail it to us today. We will send you at once full details of this big Arrow Motor Cycle offer. Remember, we want good riders everywhere and for a limited time we allow the dealers' credit and easy terms to all buyers of the Arrow. Send Coupon *at once.*

#### Arrow Motor Co.

California Ave. and 19th Street

Dept. 1193

CHICAGO ILL.

**FREE COUPON**

ARROW MOTOR CO.  
California Ave. and 19th St.  
Dept. 1193  
CHICAGO, ILLINOIS

You may send me your free Arrow Catalog. I am under no obligations.

NAME.....

ADDRESS.....

Please Mention Popular Mechanics

**TESTING A TROUT'S MEMORY**—An exhibition given to show that trout have the sense of memory is related by the New York Herald. The fish was a specimen in a hatchery, and on one occasion an attache tried out a baseless hook on it. Before the trout, which had seized the hook, could be released, its upper jaw had been badly lacerated. Ever afterwards when a rod and line was brought to the tank the trout would dart away and conceal itself behind some rocks in the tank, but would not move when a walking stick or cane was held near it.

#### WEAR

Trade Mark Registered **B.V.D.** U.S. Patent Office and Foreign Countries

#### UNDERWEAR

Remington Arms—Union Metallic Cartridge Co.

### Arms and Ammunition

299 Broadway, New York

### Learn to Fly

Be an Aviator  
Each from  
\$50 to \$200

per week. The biggest opportunity ever offered—the demand today is greater than ever. Our school is endorsed by leading men in the business. Easy Home Study Course to start with. Now is the best time to start studying, to secure positions for spring business. We make flyers. Positions secured competent graduates. Send 10 cents today for Aviation lesson and detail blueprint drawings of air currents.

STANDARD AVIATION CO., 1306 Manhattan Bldg., CHICAGO, ILL.



#### AEROPLANE MODELS

First Edition 1912 Catalog of the highest grade Supplies, Fittings and Accessories.

sent free on application. Listing an entirely new and complete stock of Models. Knocked Down and Complete, ready to Fly. 1000 foot "WHITE RACER," The Original "3 fosters"—Eliot, Antoinette. 321 Adams Street Wright and Nieuport. The White Aeroplane Company, BROOKLYN, N. Y.



**This  
"Old Town Canoe"  
Beat a Motor Boat**

and the fellows in it got three times the ordinary fun, exercise and benefit of being out of doors and on the water. The

**"Old Town Canoe"**

leads in every important test. It is built for service and reliability. It is light, swift, staunch, safe. It leads in satisfaction, whether in racing, cruising, or just lazy paddling for the fun of being on the water. Canoeing is magnificent for developing the physique. Every

minute spent in an "Old Town Canoe" realizes the possibilities of canoe enjoyment and canoe seamanship. Our models embrace canoes for all purposes. Write for illustrated, descriptive catalogue. Agents everywhere. 2000 canoes in our storehouses insure prompt deliveries.

**OLD TOWN CANOE CO., 1663 Middle Street, OLD TOWN, MAINE, U. S. A.**

**Looking for  
Mechanical  
Information** ?

500 Titles  
on 100  
Different  
Subjects

OUR NEW REVISED

## BOOK CATALOG

Shows just where to find that particular help you are in need of. SENT FREE on request.

Popular Mechanics Book Dept.  
318 W. Washington Street, CHICAGO

*The Best Book for Beginners*

**A Practical Course in** Price 50c  
By Willard **Mechanical Drawing** Postpaid

**POPULAR MECHANICS BOOK DEPT.**  
318 W. Washington St., Chicago

Three Excellent Books for Those Who  
Like to Make Things

**Amateur Mechanics Nos. 1, 2 & 3**  
PRICE 25 CENTS EACH POSTPAID

Popular Mechanics Book Department 318 W. Washington St.  
CHICAGO

## A MODERN SUBMARINE CHART OVER 200 PARTS NUMBERED AND NAMED

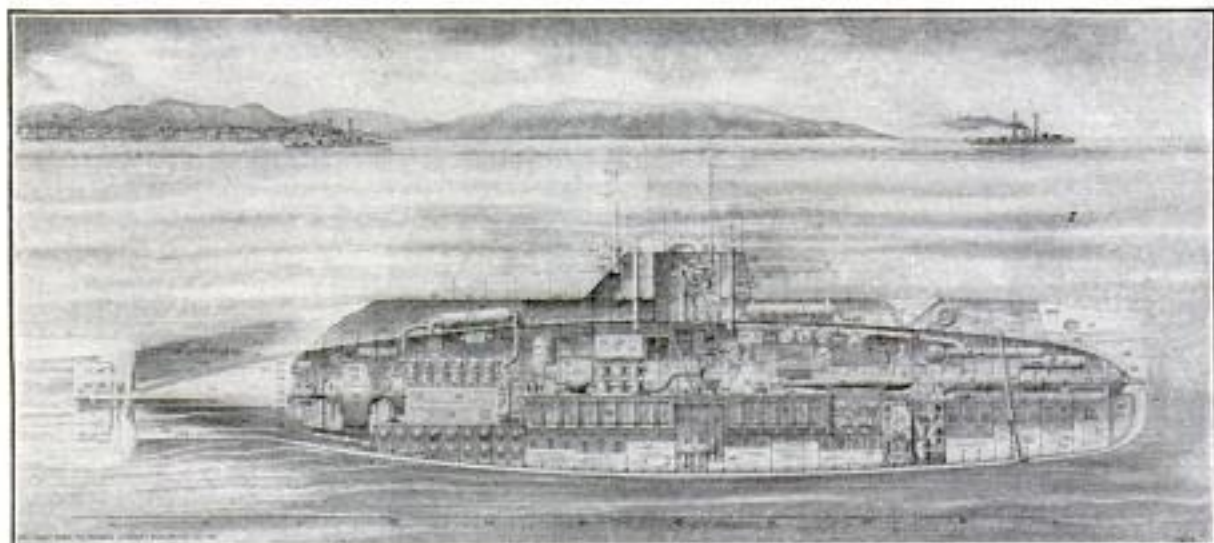

Actual Size 14x28 inches—Printed on Plate Paper

**T**HIS cross-section view shows clearly and distinctly all the interior of a Submarine of the latest type. You can get more information from this chart, about the construction and operation of a Submarine, than in any other way. No Details omitted—everything is accurate and to scale. It is absolutely correct in every detail, having been approved by Naval Engineers. One of the best Mechanical Illustrators in the Country worked on the drawing for months. This chart is really an encyclopedia of a Submarine. It is educational and worth many times its cost.

Mailed in a tube for 25c. Address—

Popular Mechanics Book Department, 318 W. Washington St., Chicago



# DIAMONDS-WATCHES ON CREDIT



**Our Great Special**  
LOFTIS "PERFECTION" RING  
Finest pure white diamond

**\$48 TERMS**  
**\$4.80 A MONTH**

Other sizes and styles at \$25, \$35, \$100, \$125. See our Catalog. Sent Free.

No. 363

**THIS ELGIN WATCH, 17 JEWELS, ADJUSTED,**  
Men's 16 Size, (also Ladies' O Size) Thin Model, New Marginal Minute Dial, in Gold Filled Case, Guaranteed for 25 Years, plain polished or handsomely engraved, sent prepaid on

**30 DAYS FREE TRIAL**  
Then **\$2.50 a Month**

Our cut price of \$25.50 for this magnificent Elgin Watch, that will pass Railroad Inspection, is the greatest bargain ever heard of. **NO MONEY DOWN**—\$2.50 a Month after examination by you. Whether you are a railroad man or not, this is the Watch you want. No matter where you live, we will trust you. Send us your order today. Write for our free Catalog, containing over 2,000 illustrations of Diamonds, Watches, Jewelry, Silverware, etc. It tells all about our easy credit plan. Write today, before you forget it.

**LOFTIS BROS. & CO.**  
THE OLD RELIABLE, ORIGINAL DIAMOND AND WATCH CREDIT HOUSE  
DEPT L804, 100 to 108 N. State St., CHICAGO, ILL.  
Branch Stores: Pittsburg, Pa., and St. Louis, Mo.



No. 364

GUARANTEED 25 YEARS

## Ann Arbor "INSTANTO"



**GASOLINE LIGHTING SYSTEMS**

Change from a 150 candlepower light to 2 candlepower in a jiffy. This latest and most perfect development of the gasoline lamp found only in Ann Arbor Lighting Systems. It gives the country home a lighting system as perfect, handsome and modern as city gas. Ann Arbor Lighting Systems are brighter than gas, steadier and clearer than electric light, and cost about one-tenth as much to operate. Each lamp gives 250 to 500 candlepower for less than 1/2 cent per hour. Fuel is gasoline; perfectly safe.

We make Complete Lighting Systems for Homes, Churches, Stores, Etc. Price, \$10 up, according to number of lamps desired.

We Want Agents who will push our line. A splendid opportunity right now for handling agents in large cities to sell to owners of summer cottages, country homes and resorts. No other light can equal it in brilliancy, beauty of fixtures and economy. Sells on sight. Catalog and prices on request.

SUPERIOR MANUFACTURING COMPANY, 294 Second St., ANN ARBOR, MICH.



I will send as long as they last my 25 Cent Book

## STRONG ARMS

For 10c in stamps or coin

Illustrated with 20 full page halftone cuts, showing exercises that will quickly develop, beautify, and gain great strength in your shoulders, arms, and hands, without any apparatus.

**PROF. ANTHONY BARKER**  
641 Barker Bldg., 10 W. 42d Street, New York

**WHEN SALT GETS DAMP**—Very few persons know that when the salt gets damp it is either because it is too near the sea or because it is going to rain. It is very hard to keep the salt cellar dry at the seashore, as there is so much moisture in the air all the time; but in other places it is usually a sign of rain when the salt gets damp.

Things that help themselves to the water in the air are called "deliquescent," and salt is one of them. When water is in the air in the form of gas it some-

### STEEL AND BRASS ENGRAVING

Dies, Tools, Metal Stamping of all kinds

**STEEL STAMPS OUR SPECIALTY**

**RELIANCE WRENCH MFG. CO.** 1023 Douglas Ave. RACINE, WIS.



### 3 BEAUTY POSES 25c.

Decorate your "Den" with "Art Gems"

Exquisite portrayals of female loveliness. 3 bewitching poses 25c; 6 for 50c. One 6 1/2 x 8 1/2 photograph free with every order for six.

**Our Dollar Special:** Two 6 1/2 x 8 1/2 photographs, 6 cabinet size and 32 small photos, all for \$1.

Our pictures are all real photographs. No reproductions of paintings or other cheap trash. Money back if not pleased.

ART PHOTO CO., 2003 P.M., Grand Rapids, Mich.

## WEAR AND SHOW THE SWELLEST CLOTHES

**\$5**

**EASY \$5 a Day—\$10 if You Try—all or Part Time**

**\$10**



Entirely new plan—our swell clothes on you will sell your friends—orders roll in—we back you—our Agents make the big style hit and \$30 to \$60 a week.

**Complete Outfit FREE**  
We supply everything—handsome Art Fashion Plates in Colors—Samples of Fabrics—Wonderful Advertising Novelties—Full Directions, etc.

**Big Easy Profits for You**  
Our Suits, Pants, Vests, do the talking—wear them and take the orders. Fit, style, workmanship, guaranteed. Express prepaid.

**Send Us No Money**  
Just your name and address brings everything—Free—including our Greatest Free Suit Offer ever made. Don't pass this—be first in your town to grasp it! The very first time you appear on the street in your swell new suit, orders will come your way.

**WE SUPPLY EVERYTHING**

Do Not Delay! Act Now Today

**Mail Coupon—We Do The Rest**  
Progress Tailoring Co. 116 Harrison St, Chicago  
Send me Complete Free Outfit.

NAME.....  
ADDRESS.....

## Only \$36.00 The Wonderful ILLUSTRATOR LANTERN

With our improved famous ALCO RADIANT LIGHT.

This new 1913 Model has many improvements and double brilliancy. Write for illustrated circular of this and Lanterns of all styles and lights at bottom prices.

**IF YOU OWN A LANTERN** we should have your name to mail to you our regular announcements of new slides and lecture sets. 75,000 Lantern Slides to rent.

**POST CARD MAGIC LANTERN** reflects image of postcard or any other picture or object. Prices, \$2.75, \$12.50, \$25.00, \$60.00, express paid.

**WILLIAMS, BROWN & EARLE, Inc., 918 Chestnut St., Philadelphia, Pa., Lantern Dept. 20**  
Engineering, Microscope, Optical, Scientific, Photo Lantern Slide Supplies



# HY-RIB LOW COST BUILDINGS

**Hy-Rib** is a steel sheathing with deep, stiffening ribs, a combined unit of reinforcement, centering, studs and lath, used in concrete and plaster work. **Hy-Rib** does away with wood forms in roofs and floors, with steel studs and centering in sidings and partitions. Builds at one half the cost of brick. Any contractor can handle it without expensive equipment. **Hy-Rib** makes a monolithic construction that never rots, rusts nor crumbles—a minimum of dead weight with a maximum of strength. **Hy-Rib Concrete Construction** safeguards contents and cuts insurance costs to lowest rate. If you are interested in building—from a garage to a factory or hotel—write at once for our valuable catalog of details and specifications. It is **free**.

**TRUSSED CONCRETE STEEL CO., 662 Trussed Concrete Bldg., Detroit, Mich.**

## This Lathe Costs You

Complete with lathe tools and scroll saw attachment as shown in cut. An ideal outfit for home work or small shops. Well built and highly finished, polished parts nickel plated. Swing of lathe 5 in. Length of bed 24 in. Distance between centers, 13 1/4 in. Write for full information. If you are interested in scroll saw work, send 10c for Bowman & Russell catalogue of patterns. We also sell scroll saw wood—all kinds.

**\$12**



**ORR & LOCKETT HARDWARE CO.**  
Lathe Dept., 14-16 W. Randolph St., CHICAGO

times becomes too plentiful for the air to hold, and then we get what is called "precipitation," or rain. But long before the water vapor in the air is heavy enough to fall in rain there is enough of it to spare to make salt damp.—New York Sun.

## Expansive Breathing



A book that fully explains how to vitalize the Blood through proper breathing. Correct breathing (both sexes) described by diagrams, etc. Book contains 64 pages of important information on Chest Expansion, Lung Development and Internal Exercise; includes Special Breathing Exercises. Endorsed by Physicians—Accepted by the National Medical Library.

Send on receipt of 10c—coin or stamps

**P. Von Boeckmann, R. S.**  
1711 Terminal Bldg.,  
103 Park Avenue, New York City

2317  
\$25



# DIAMONDS ON CREDIT

20% DOWN—10% PER MONTH

Why wait for your Diamond until you have saved the price? Pay for it by the Lyon Method. Lyon's Diamonds are guaranteed perfect blue-white. A written guarantee accompanies each Diamond. All goods sent prepaid for inspection. 10% discount for cash. Send now for catalogue No. 3

**J. M. LYON & CO., 71-73 Nassau St., N. Y.**

3291  
\$50



2132  
\$60



2113  
\$50

2315  
\$35



2157  
\$25

2110  
\$35

\$35  
6252

\$35  
3312

2159  
\$35

2385  
\$40

2156 \$20

Please Mention Popular Mechanics

**\$8!**  
**a Day, and Nobby  
 Merchant Tailored Suit**



**It's a Cinch!** You are a live young man, and I want you to get these stylish clothes free and \$8 a day besides. A man nowadays is surely judged by his appearance. You know this. **This is a wonderful opportunity.** You owe it to yourself to learn every detail. No experience necessary. Not a cent of money.

**Thousands of Our Agents  
 Are Making Big Money!**

We make no extravagant promises, but we guarantee every one of our agents our full support and assistance in every way. We furnish advertising matter, names, samples, materials, blanks—everything necessary or desired by our agent, **without a cent of money from you.** We help you make money, for it is easier to sell our goods than those of any other house—not only because we help you, but by giving you a suit of our merchant tailored clothes we give you the best advertising in the world.

**No Other Clothes Fit Like Ours  
 No Other Clothes As Low Priced**

We sell our clothes cheaper than any other tailoring house in America—we give you the same suit at less money or a better suit at the same money than any other house. We guarantee this. Suits, \$8 up.

We operate our own tailor shops—other firms have their work done for them—that increases cost. We buy enormous quantities of woolsens—get wholesale prices; other concerns buy by the piece and pay 20 per cent more for material alone. **Every garment must please you and your customer.** If it falls short in any way—if not the biggest value at lowest price—send it right straight back to us.

**What We Give You FREE**

We give you the finest, most complete outfit possible (only a firm of our size could furnish it)—handsome portfolio of actual samples of fine woolsens, one you can be proud to show—fashion plates showing models of latest styles to be worn in New York and London—tape measure, charts, and improved, accurate, exact measuring blanks, list of confidential costs and discounts, stationery, order blanks, complete and all **FREE, Express prepaid.**

Sit down now and write for details of how you can make all this money—no matter what else you are doing you owe it to yourself to investigate this wonderful money-making proposition. A postal will do.

Knickerbocker Tailoring Co., 1982 S. Halsted St., Chicago

**WHEN YOU WANT ANYTHING AND DON'T KNOW  
 WHERE TO FIND IT—WRITE BUREAU OF  
 INFORMATION, POPULAR MECHANICS, CHICAGO**

**FOR SALE—A Limited Number of  
 Complete Files**

**Popular Mechanics Magazine  
 For 1911**

consisting of the 12 issues of the magazine  
 with a complete index suitable for binding.

**Price \$1.50 Postpaid**

**POPULAR MECHANICS CO.  
 318 W. Washington St. CHICAGO**

## Why Not Post Yourself on Wood Finishing By Getting this Valuable Book Free?



You won't obligate yourself in the least by sending for the latest edition of our handsome book—"The Proper Treatment for Floors, Woodwork and Furniture"—written by famous experts on Wood Finishing. With the book we want to send you two sample bottles of Johnson's Wood Dye, and one of our Prepared Wax. We want you to know all about

## Johnson's Wood Dye

in 15 shades as follows:

No. 126 Light Oak	No. 130 Weathered Oak
No. 123 Dark Oak	No. 131 Brown Weather'd
No. 125 Mission Oak	No. 132 Green Weathered
No. 140 Early English or Manila Oak	No. 121 Moss Green
No. 110 Bog Oak	No. 122 Forest Green
No. 128 Light Mahogany	No. 172 Flemish Oak
No. 129 Dark Mahogany	No. 178 Brown Flemish
	No. 120 Fumed Oak

Half Gallons \$1.50

This is a DYE, not a "stain." There's a great difference. Ordinary stains just cover the wood and quickly fade. Johnson's Wood Dye sinks deep into the pores of the wood; brings out all the beauty and high lights of the grain.

## Johnson's Prepared Wax

a complete finish and polish for all wood-floors, woodwork and furniture, including pianos. Johnson's Prepared Wax should be applied with a cloth and rubbed to a polish with a dry cloth. It imparts a velvety, protecting finish of great beauty. It can be used successfully over all finishes. *Send for Booklet Edition P. A. 3.*

**S. C. Johnson & Son, Racine, Wis.**  
*The Wood Finishing Authorities*

# Engine Buying Simplified!

## Look for the I H C Trade-Mark



You can't go wrong when you buy an engine with the I H C trade-mark. We can't afford to sell engines that disappoint. You can't afford to take a chance. It is as much to our interest as yours that you be completely satisfied with your machine. All



## I H C Gasoline Engines

regardless of size or price, can be relied on for years of service and satisfaction. You are sure of correct design, honest materials and workmanship. You get the benefit of expert knowledge and experience gathered from the working tests of thousands of engines.

I H C engines are made in all styles and sizes, from 1 to 50-HP; built to operate on gas, gasoline, kerosene, or distillate; tractors from 12 to 45-HP. We shall be pleased to send catalogues of these high grade engines and tractors and any special information you desire. Address

**International Harvester Company of America**  
(Incorporated)  
16 Harvester Building Chicago U S A

*Scripps Reliability*



## This Book Will Help Engine Buyers

who want to know, by actual fact, what is the most reliable motor they can buy.

## Scripps Motors

make no special claims for low price, yet no purchaser of a Scripps Motor has ever expressed anything but satisfaction with his engine.

The reliable service the Scripps Motor will give you, backed by the service of the Scripps factory, makes the Scripps the most economical engine you can buy.

All Scripps Motors are four-cycle in type, ranging in size from one to six cylinders, and from 4 to 100 H. P.

*Write for the booklet today. It is entertaining as well as useful.*

**SCRIPPS MOTOR COMPANY**

650  
Lincoln  
Ave.



Detroit,  
Michigan

Agricultural colleges throughout the country are nothing if not up to date. One of them in the Middle West has recently instituted a course for farmers in which moving pictures of growing crops form an important part, and another is building a modern mill for the purpose of teaching its students scientific methods of grinding flour.

## Model Aeroplanes

Send \$3.00 for complete set of parts for Bleriot or Nieuport 3 foot model with finished ribs. Price list on request.  
LAWRENCE L. BUTLER, 219 So. Dearborn St., CHICAGO, ILLS.

## Accept This Swell \$25 Suit

One of Many Styles



Yes, FREE. We start our swell-dressed sales representatives out looking right—we send our outfit free, at once, biggest and best sample books, attractive fabrics, handsomest color plates, with our new, remarkable, easy money-making offer, your extra sample suit offer as well. Swell-dressed, and backed by us, you can make big money showing our superior line of men's suit and overcoat samples—orders come thick, fast and easy. Spare time or all of it. No money or experience necessary. No references or red tape. We trust you absolutely.

**YOU CAN MAKE**  
**\$5 Per Day Easy or**  
**\$30 to \$50 a Week**

**SAMPLE SUIT**  
Everything in Just for you.  
**FREE To You**  
**OUTFIT**

live territory and special inside wholesale price so you can undersell all competition and make big profit. When your friends see your suit they will gladly order these swellest, hand-tailored made-to-measure garments. They will save \$3 to \$5. Suits, \$8 up. Fit, workmanship, material guaranteed by bond. Finest for style, looks and wear. We back one man this way in each locality. Chance of your lifetime to get swell clothes and make most money. Get in quick. No risk. Everything sent express paid. Hurry up postal today.

**Great Central Tailoring Co.** 710A-Jackson Blvd., CHICAGO, ILL.

Please Mention Popular Mechanics

# BUY DIRECT

## Read How YOU Can Have the Furniture Dealer's 25% to 75% Profit on Superb Quartered Oak Furniture

Notice the prices and descriptions on this page—then write for the Brooks Furniture Book, the Brooks Plan, Brooks prices.

Buy from the furniture factory direct. Leave the dealer out. You can have his profits—25% to 75% and higher. You'll pay  $\frac{1}{2}$  and less than  $\frac{1}{2}$  dealers' prices and secure the very finest Arts and Crafts furniture human skill can produce.

The Brooks Direct Sale Plan from furniture factory to consumer has fitted thousands of homes, lodges, fraternity and clubhouses, barracks and state institutions. It has proved its worth under the careless handling and abuse of college students and soldiers. With ordinary household use Brooks furniture will last a lifetime.

Built by skilled cabinet workers of choicest quarter-sawed oak. Fitted and finished with the utmost care, and shipped in sections. Anybody can set up a chair, davenport or table in just a few minutes.

## Write for 64-Page Furniture Book

Filled from cover to cover with beautiful photographic reproductions of all kinds of furniture showing the very grain of the wood, and giving you a true idea of the beauty of these Brooks masterpieces. Write today for this book—mailed Free—also full particulars of the Brooks sales method that cuts the dealer's price in half. Address

### Brooks Manufacturing Co.

5803 Rust Avenue  
Saginaw, Mich.

This roomy settee is one piece of the set to which the No. 11 chair shown on this page belongs. However its admirable design is one that seems to fit into its surroundings no matter what their style. Height, 37 $\frac{1}{2}$  inches. Length, 67 inches. Depth, 21 inches. Material, quarter-sawed oak. Price includes cushion covered with marokene leather.



Brooks Chair  
No. 11

Handsome and comfortable quarter-sawed oak chair for living room or den. Possesses all the dignity of the Arts and Crafts style relieved by curved and diagonal lines under the arms and in the back. Height, 37 $\frac{1}{2}$  inches. Width, 31 inches. Depth, 21 inches. Price includes cushion covered with marokene leather.

Dealer's Price . . . \$14.00  
Brooks Factory Price . . . 6.75



Brooks  
Breakfast  
Table No. 312

A simple design of remarkable beauty and all 'round utility. Planned as a breakfast table, it may be used as a round top center or card table. Designed with unusual care. Height, 30 inches. Solid top, 42 in. Quarter-sawed oak of exquisite marking used as material.

Dealer's Price . . . \$20.00  
Brook's Factory Price . . . 9.00



Brooks Settee No. 12

Dealer's Price . . . \$25.00  
Brooks Factory Price . . . 11.75

Please Mention Popular Mechanics



*"The World is mine—  
I own a KODAK"*

Take a Kodak with you, and picture, from your own viewpoint, not merely the places that interest you but also the companions who help to make your trip enjoyable.

Anybody can take good pictures with a Kodak. Catalogue free at the dealers or by mail.

*If it isn't an Eastman, it isn't a Kodak.*

**EASTMAN KODAK CO.,**

ROCHESTER, N. Y., *The Kodak City.*

**SAVE \$100 to \$250**  
on a modern heating plant

Steam or hotwater Heating Systems. Best type of boilers and radiators. Special working plans with every plant make installation easy. Get our prices and save money.

**\$38.95** Buys this Complete Bathroom Outfit

Strictly high grade outfit, guaranteed to give satisfaction or I refund money instantly. Beautiful white porcelain enameled bathtub, 5 ft. long. Latest design golden oak closet.

One-piece sanitary porcelain enameled lavatory. Full instructions for installing free.

Write today for my big plumbing catalog, giving full descriptions on bathroom outfits, heating plants, pneumatic water systems for running water (\$42.00 up), gasoline engines, hydraulic rams, pumps, pipes, valves, lighting plants and fixtures. Save 30 to 50 per cent. Write today for large catalog—FREE.



**M. J. GIBBONS** DEPT. A  
DAYTON, O.

**THE WAY TO OIL A CLOCK**—When a clock does not run continuously, or stops frequently, the cause is often due to a lack of oil. This may be remedied by saturating a piece of absorbent cotton with kerosene oil and placing it inside the clock below the pendulum. When the cotton is removed a month or so later it is found to be very dirty. This shows that the fumes of the kerosene oil have not only oiled the clock, but have also cleaned it.—Pictorial Review.

**"A SQUARE DEAL" in the Patent Business**

**OSCAR E. PERRIGO, M. E.**  
EXPERT PATENT ATTORNEY

6 Beacon St. BOSTON, MASS.

FREE Preliminary Examination as to Commercial Value and Patentability. Handbook for Inventors FREE on request.

Long Experience—Expert Work—Moderate Charges

**THE BEST LIGHT**



A complete lighting plant in itself. Makes and burns its own gas. Cheaper than kerosene and more brilliant than electricity or acetylene. For homes, stores, factories, churches, etc. Made in over 200 styles. Every lamp warranted. Used in every civilized country on earth. Agents wanted. Write for catalogue and prices.

**THE BEST LIGHT CO.**  
324 E. 5th Street, Canton, O.

# Hoarding Up Happiness

By FRANKLIN O. KING

The Miser Hoards for Greed of Gain—The Wise Man Saves 'gainst Days of Rain. The World hates a Miser, but loves a Provider. By *Cancelling* a few Habits, You will be able to *Divide* more Comforts with Your Family, and Happiness will *Multiply* for All of You. Happiness after all is a mere question of *Arithmetic*. "For unto Every One that Hath shall be Given, and He shall have Abundance; but from Him that Hath Not, shall be Taken Away even that which he Hath." The Man who Lays by Something each day for his Loved Ones is *Hoarding up Happiness*, because he is providing for them an Independent Future. "You may sin at Times, but the Worst of All Crimes is to Find Yourself Short of a Dollar or Two."

How much Better off are You than Last Year, or the Year before That? How Much have You Actually Got that You could call Your Own? A little Furniture? A Piano, perhaps? A Few Dollars in the Bank? And how many Weary Years has it taken You to get Together that little Mite? Don't You see how Hopeless It is? You come Home each Night a little more Tired, and Your good Wife can see the gray coming into Your Hair—if It isn't already There. Chances for Promotion grow Less and Less, as each Year is added, but Ever and Always Your Expenses seem to Grow.

The Systematic Saver Accumulates slowly, unless His Savings are Put to Work where They can Earn Something Worth While. Fifteen Hundred Dollars put into the Savings Bank will, in One Year, at 3 per cent earn You less than Fifty Dollars. Half of Fifteen Hundred Dollars invested in One of our Ten-Acre Danbury Colony Farms, in convenient Monthly Payments (Protected by Sickness and Insurance Clauses) will Earn Freedom from Care, and that Comfort which comes from the Ability to Sit under One's "Own Vine and Fig Tree," with a certain Income Insured.

*The Best Incentive to Persistent and Systematic Saving is the Desire to Get a Home.* The Best Place I Know of to Get a Home is in the Rain Belt of Gulf Coast Texas, where You can Grow Three Big Money-Making Crops a Year, on the Same Soil, and where Irrigation and Fertilization do not Eat up the Profits Your Hands Create.

If every Man who reads this Article would Take the Time to THINK, and the Trouble to INVES-

TIGATE, every Acre of our Danbury Colony Land Would be Sold Within the Next Three Months. If Every Woman who glances through this Advertisement but Knew the Plain Truth about our Part of Texas, You couldn't Keep Her away from There with a Shot-Gun, because the Woman is Primarily a Home-Seeker and a Home-Maker, and the Future of Her Children is the Great Proposition that is Uppermost in Her Mind and Heart.

Do You Know that Growers of Figs, Strawberries and Early Vegetables clear a Net Profit of \$300 to \$500 an Acre in Gulf Coast Texas? Do You Know men have realized more than \$1,000 an acre Growing Oranges in Our Country? If You Do Not know these things, you should read up on the subject, and you must not fail to get our Free Book, which contains nearly 100 photographs of growing Crops, etc.

What would You think of a little Town of about 1,200 People situated near our Lands, where they ship on an average of \$400,000 worth of Fruit, Vegetables, Poultry, Eggs, etc., a year? During

1910 this Community shipped nearly \$100,000 worth of Strawberries alone.

We are situated within convenient shipping distance of Three Good Railroads, and in addition to this have the inestimable Advantages of Water Transportation through the Splendid Harbors of Galveston and Velasco, so that our Freight Rates are Cut Practically in Half. The Climate is Extremely Healthful and Superior to that of California or Florida—Winter and Summer—owing to the Constant Gulf Breeze.

Our Contract Embodies Life and Accident Insurance, and should You die, or become totally

disabled, Your Family, or anyone else You name, will get the Farm without the Payment of another Penny. If You should be Dissatisfied, we will Absolutely Refund Your Money, as per the Terms of our Guarantee.

Write for our Free Book. Fill Out the Blank Space below with Your Name and Address, plainly written, and mail it to the Texas-Gulf Realty Company, 1316 Peoples Gas Building, Chicago, Illinois. Read It carefully, then use Your Own Good Judgment.

Please send me your book, "Independence With Ten Acres."

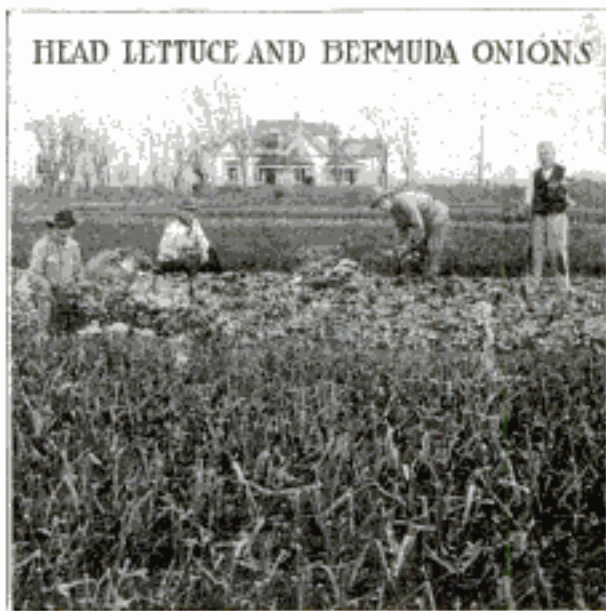

A Winter Vegetable Garden near Danbury.

# "I Shall Never Paint Those Roofs!"

"I shall simply leave them alone. It will not be necessary to spend a cent on them." They are covered with

## Amatite ROOFING

**A** MATITE has a real mineral surface and therefore needs no painting.

There have been other ready roofings in the past which had a mineral surface, but they were not practical.

Amatite, however, is successful because the mineral matter is embedded in *pitch*. Pitch is very tough and

has great adhesive power. Year after year those roofs will give faultless service without

anybody giving a thought to them. This is the kind of roofing to have!

The day of these smooth coated roofings that require a heavy coat of paint every year or two is past. They cost too much to maintain.

You can spend more money on the paint alone during the ten years than a new Amatite roof would cost.

A free sample of Amatite Roofing and a booklet can be obtained on request by addressing the nearest office.

## Everjet Elastic Paint

A very low-priced black paint—very tough and durable. Stands heat so well that it can be used on boilers. For wood or metal, ready roofings, fences, iron work, farm implements, tanks, etc.

### BARRETT MANUFACTURING CO.

New York	New Orleans	Minneapolis
Boston	Chicago	Seattle
Pittsburgh	St. Louis	Philadelphia
Kansas City	Cincinnati	Cleveland

Canadian Offices: — Montreal, Toronto, Winnipeg, Vancouver, St. John, N. B., Halifax, N. S.

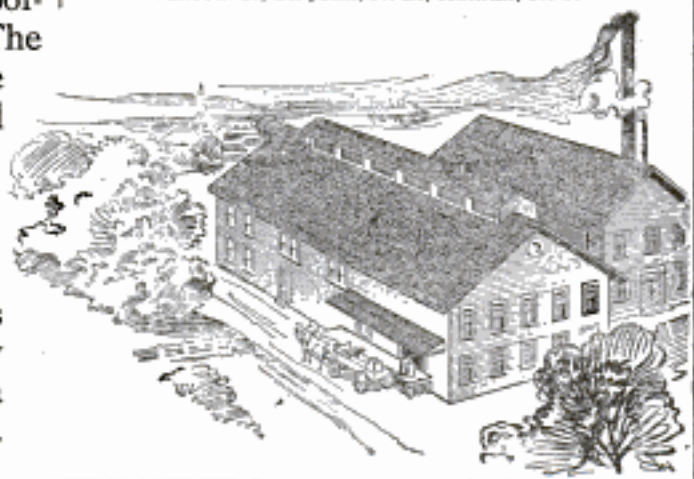

Please Mention Popular Mechanics



"I Want It In Puritan Serge"



## Know Your Style Pick Your Cloth

For clothes that will "stand up" against the wear and tear of busy days —

Get a suit made of our **PURITAN SERGE**. 'Twill be a suit you'll hate to part with, even after it has served its time.

Ready-to-wear or custom-made — the choice is up to you. But if you'd be sure of its looks and its wear — specify **PURITAN SERGE** in any case.

Resists wrinkles — "comes back" after every pressing — does you credit every time you put it on.

**PURITAN SERGE** is a strictly pure all wool cloth of fourteen-ounce weight for spring and summer wear; a distinctive blue, noticeably rich in tone; width, 58-60 inches — London shrunk.

Specify at your tailor's or clothier's — "**PURITAN SERGE**." If they cannot supply you, send their names to us, together with your money order or check for the desired quantity of **PURITAN SERGE** at \$3.00 the yard (3½ yards to the suit), and we will see that you are supplied through regular channels as we do not sell at retail.

Remember to "Order the Cloth as well as the Clothes," when you buy. **PURITAN SERGE** is extensively used by makers of high-grade, ready-to-wear clothing for men.

Reg. Name Stamped on the Cloth

**PURITAN SERGE**  
1620

A Thoroughbred Serge  
For the Man who Cares

# American Woolen Company

Wm. M. Wood, President.

Selling Agency  
AMERICAN WOOLEN CO. OF NEW YORK  
American Woolen Building  
18th-19th Streets on 4th Avenue  
New York

Please Mention Popular Mechanics

Copyrighted material



# CHIEF DRAFTSMAN

Will INSTRUCT PERSONALLY a limited number selected, ambitious men in

## Practical Drafting, Detailing, Designing

### Draftsmen Drawing \$125-\$150 Monthly

Are NOT MADE in Schoolrooms,  
 Are NOT MADE by reading books,  
 Are NOT MADE by making Copies,  
 Are NOT MADE at home drawing pictures  
 from printed book lesson.

### LET ME TELL YOU:

It requires actual, practical, up-to-date  
 DRAFTING-ROOM WORK to train YOU  
 to gain the PRACTICAL EXPERIENCE  
 that your employer will demand of you.



# FREE

This \$13.85  
**DRAWING  
 OUTFIT**

and **Free Position.**

As Chief Draftsman of Engineering firm I know exactly the Quality and Quantity of PRACTICAL training, knowledge and actual up-to-date experience (not school knowledge) you must have, in order to obtain a good position and advance to highest salary.

I give **INSTRUCTION UNTIL COMPETENT** and  
**PLACED in POSITION** at above Salary.

DON'T waste TIME and MONEY trying to learn from books or printed "STUFF" you can only learn on PRACTICAL WORK which I furnish you.

Address **CHIEF DRAFTSMAN**  
**Div. 19, Eng's Equip't Co. (Inc.), Chicago**

*Please Mention Popular Mechanics*

# SAVES TOOLS, TIME, MONEY— MAKES WORK EASIER

**30 Days  
Free Trial**



**Mechanics  
Outfit—14  
Machines  
IN ONE  
Guaranteed  
5 Years**

Prove, by 30 days free trial how this shop grinding outfit saves tools, time and money. Prove how this outfit makes tools sharpening so easy that tools are always in perfect edge, making all work so much easier, and enabling every workman to accomplish more work. Use this outfit 30 days free, then if you are willing to part with it, send it back at my expense.

**Dimo-Grit—"the wheel for steel"—25 times faster than grindstone—10 times more efficient than emery—will not draw temper**

Dimo-Grit the new artificial diamond abrasive, is a twin product of carborundum, but Dimo-Grit is especially suitable for steel, leaving the smoothest, keenest edge; cuts hardest steel as emery does soft copper. It peels steel away in tiny shavings instead of wearing it away like grindstones or emery wheels—never glazes, no heat developed—no need of water cooling—no danger of drawing temper. Genuine South African diamonds could cut steel no quicker—outwears any number of emery wheels and grindstones. Carborundum wheels furnished if wanted.

**No Money Needed**

**RETURN  
THIS  
COUPON  
TODAY**

## **Luther Hummer Tool Grinder**

Foot or engine power—runs by foot power as easy as sewing machine—built all of steel—shaft drive like automobile—dust-proof ball bearings—gravity lubrication—costs no more than cheap chain drive grinders—half a million Luther Grinders now in use—5 years guarantee—shop outfit provides for every sharpening, grinding, buffing and polishing need for mechanics, carpenters, and all other tool users. Extra attachments convert it into turning lathes, jig and circle saws, force feed drill, etc.—16 extra attachments—completely equips your work shop at low cost.

**40 Page Free Book** Tells the interesting story of artificial diamond abrasives as printed in McClure's Magazine—gives valuable pointers on tool grinding—fully describes all attachments and outfits. No red tape—no promises—no money needed to try this money-saving shop outfit free for 30 days. Return the coupon for full information and decide which outfit you want on 30 days free trial.

**Luther Grinder Mfg. Co. 509 Michigan St. Milwaukee, Wis.**

### **Return This Coupon for Free Trial Offer**

You put yourself under no obligation by returning this coupon—we will tell you all about our Free Trial Offer, and send you our 40 page book free. Don't delay—return this coupon today.

### **Dimo-Grit Sharp- ening Stones**

Ask your dealer for Dimo-Grit sharpening stones—the fastest, smoothest stones for steel—look for the name "Dimo-Grit" on the stones.

### **Coupon**

**LUTHER  
GRINDER  
MFG. CO.  
509 Michigan St.  
Milwaukee, Wis.**

Please send me 30 Days Free Trial Offer and 40 page Free Book. It is understood that this coupon does not obligate me in any way.

NAME.....

ADDRESS.....

# Tough, sharp crystals that just EAT steel

It's fun to see the way a Pike India Stone puts a dandy, keen edge on a tool. No other stone that cuts so fast wears down so slowly. It holds its shape almost indefinitely. Besides, if properly oiled, Pike India Stones never glaze.

They are made of Alundum and so tough that even dropping won't break them! Pike India is the most widely useful of all the



## PIKE SHARPENING STONES

The only line that includes every sharpening substance—natural or artificial—each the best for some sharpening need.

No one abrasive substance is best for all kinds of edges. It is because the Pike line includes every substance that you are certain to get the best stone for your purpose if you insist on the famous Pike trade mark.

**Guarantee**—Pike Stones are sold by hardware and cutlery dealers the world over—and every one of these dealers is authorized to replace any Pike Stone that proves defective.

### "How to Sharpen" Sent Free

A little book that gives expert advice on how to select and use sharpening stones to get the very best results. If you use any edged tools—anything from a razor to an axe—you will find some valuable information in this book. It's free—send for your copy today.

### FREE—Pike India Vest Pocket Stone

To introduce Pike Sharpening Stones, we will send a Pike India Vest Pocket Stone free to every one who will send us his dealer's name and 4 cents in stamps to pay postage. This stone is just the thing for penknives and most small tools.

PIKE MANUFACTURING CO., 1 Main St., Pike, N. H.

#### Pike India Reversible Oil Stone

Two stones in one— one side coarse, the other fine, mounted in handsome, patent hinged box that permits instant use of either side. (See illustration.) . . . . . \$2.00  
Pike India Combination Bench Stone, Size 7x2x1 inches. \$1.00  
Mounted in hardwood box. \$1.25

#### Pike India Kantbreak Knife Sharpener

Best device ever offered for quickly sharpening carving knives and many other household tools. Better, easier and quicker than a steel. Anyone can use it. Lasts for years. Heavy rubber mountings make it practically indestructible. 35c

#### Pike India Sportsman's Pocket Stone

No sportsman's kit is complete without it. One side coarse for sharpening knives, axes, fish-hooks, etc.; other side fine for finishing. In durable leather case that fits the pocket. . . 50c

#### Pike Peerless Junior Grinder

Every home, shop, hotel, farm should have one. Cuts very fast, is dust-proof, noiseless and thoroughly practical. Patent tool rest holds the tool and makes it easy to get just the right angle for any edge. Fitted with a fast, cool-cutting wheel, 5x1 in. . . . . \$5.00  
Other sizes from \$3.00 to \$7.00

In addition to Pike India, the Pike line includes the famous Pike Arkansas, Pike Washita, Pike Crystolon Stones and others.

Sold by dealers everywhere,  
or sent direct