

POPULAR MECHANICS

WRITTEN SO YOU CAN UNDERSTAND IT

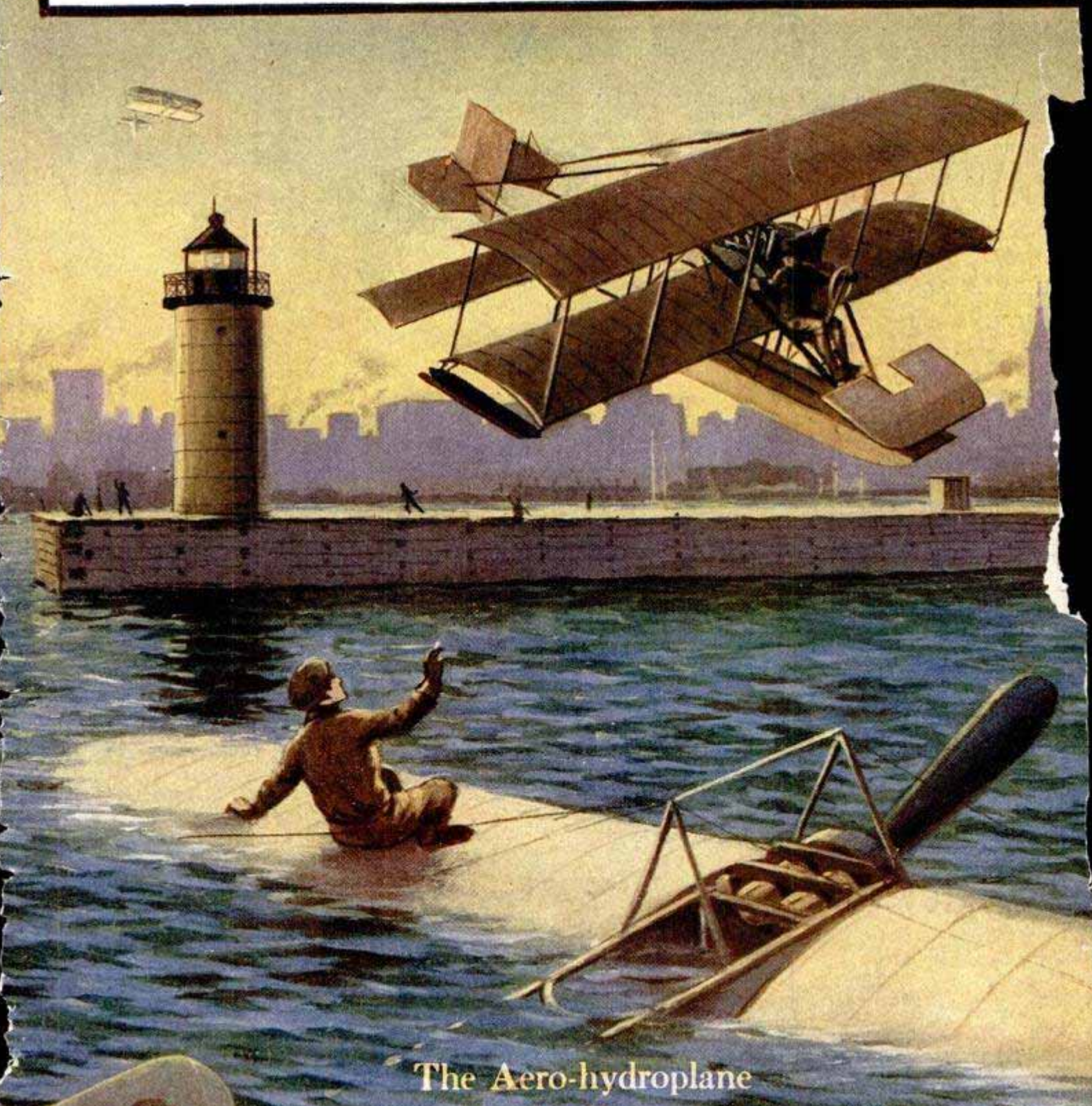

The Aero-hydroplane

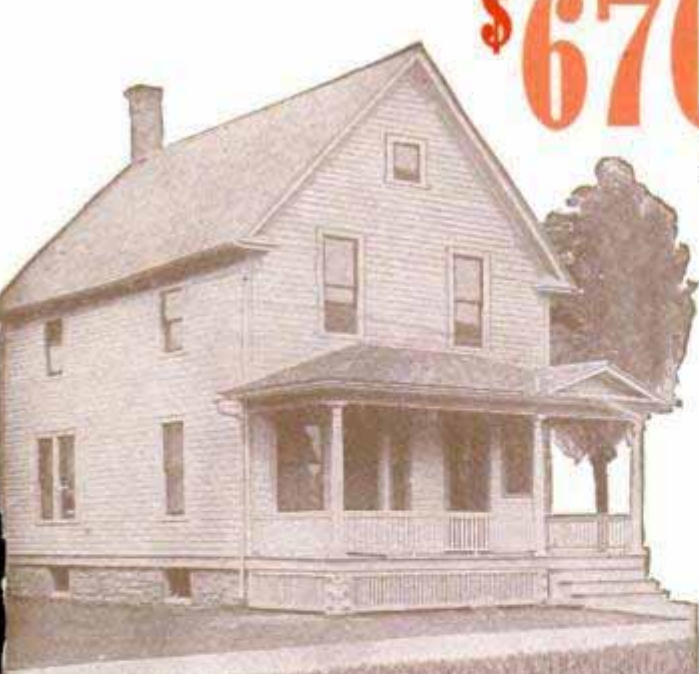

Buy the Material NEEDED TO BUILD THIS HOME!

Price includes Blue Prints; Architect's Specifications; Full Details; Working Plans and Typewritten Material List
OUR HOUSE DESIGN NO. 145

Our Design No. 145 is positively one of the very best, economical, up-to-date, sensible and practical houses ever offered. There are many points about this neat house that must be studied carefully to fully appreciate its value. Neat in appearance. Easy to build. Low cost of labor. Easy to maintain after built, meaning little or no repairs. An ideal city or country home. An investment proposition that will net big returns.

Seven good-sized rooms and bath, pantry, inside cellar entrance, handsome stairway. Entire interior, including floors, finished in clear Georgia Pine, of up-to-date style and finish. The material we furnish for construction is all BRAND NEW, selected with great care, excellent quality throughout, entirely suitable and in some localities almost too good for the purpose intended.

Our Guaranteed Building Proposition insures you ample quantities to complete the job strictly according to plans; prompt shipment, safe delivery and a personal follow-up letter from our President to find out whether our promises to you have been kept. Absolute satisfaction in the entire deal is what we offer.

We Save You Big Money on Lumber and Building Material!

The Chicago House Wrecking Co. is the largest concern in the world devoted to the sale of Lumber, Plumbing, Heating Apparatus and Building Material direct to the consumer. No one else can make you an offer like the one shown above. We propose to furnish you everything needed for the construction of this building except Plumbing, Heating and Masonry material. Write for exact details of what we furnish. It will be in accordance with our specifications, which are so clear that there will be no possible misunderstanding.

How We Operate

We purchase at Sheriffs' Sales, Receivers' Sales and Manufacturers' Sales, besides owning outright sawmills and lumber yards. Usually when you purchase your building material for the complete home shown above, elsewhere, it will cost you from 40 to 60 per cent more than we ask for it. By our "direct to you" methods we eliminate several middlemen's profits. We can prove this to you.

What Our Stock Consists of

We have everything needed in Building Material for a building of any sort. Lumber, Sash, Doors, Millwork, Structural Iron, Pipes, Valves and Fittings, Steel and Prepared Roofing. Our stock includes Dry Goods, Clothing, Furniture, Rugs, Groceries, etc., Machinery, Hardware, Wire Fencing—in fact, anything required to build or equip. Everything for the Home, the Office, the Factory or the Field, besides everything to wear or to eat. We will prove our ability to save you money. WRITE US TODAY, giving a complete list of everything you need.

Free Book of Plans

We publish a handsome, illustrated book, containing designs of Houses, Cottages, Bungalows, Barns, etc. We can furnish the material complete for any of these designs. This book is mailed free to those who correctly fill in the coupon below. Even if you have no immediate intention of building, we advise that you obtain a copy of our FREE BOOK OF PLANS. It's a valuable book.

Our Guarantee

This company has a capital stock and surplus of over \$1,000,000.00. Absolute satisfaction guaranteed in every detail. If you buy any material from us not as represented, we will take it back at our freight expense and return your money. We recognize the virtue of a satisfied customer. We will in every instance "Make Good." Thousands of satisfied customers prove this. We refer you to any bank or banker anywhere. Look us up in the Mercantile Agencies. Ask any Express Company. Write to the publisher of this publication. Our responsibility is unquestioned.

\$2.00 Buys a Complete Set of Blue Prints

material, transportation charges prepaid, for the low cost of \$2.00. This is only a deposit, a guarantee of good faith, and the proposition to you is that after receiving these blue prints, specifications and list of material, if you can place an order with us for complete bill of material, we will credit your account in full for the \$2.00 received, or we will allow you to return these plans, specifications, and list of materials to us and we will refund \$1.50, thereby making the total cost to you 50 cents.

We send you a set of plans for the house described above, including the necessary specifications and complete list of

High Grade Bathroom Outfits!



The price of this Bathroom Outfit **\$37.50.**

Plumbing material direct to you at Bargain prices.

We have everything needed in Plumbing Material. Our prices mean a saving to you of 30 to 60 per cent.

Here is an illustration of a bathroom outfit we are selling at \$37.50. Your plumber would ask you about \$60.00 for this same outfit. It is only one of many other complete outfits that we are offering at prices ranging from \$25.00 to \$50.00.

Write for Our Free Plumbing Material Catalog No. 539.

Hot Air Furnaces!

Don't let the contract for your hot air furnace until you get our figures.

We will cut your local dealer's price in half. We can furnish you a complete equipment, including pipes, registers, furnace; everything required at a price not much more than what an ordinary heating stove would cost you. Complete hot air heating plants \$48.00 up.

Get our heating catalog at once.

Tells you all about it. Write us today. We guarantee to save you money. We loan you tools. We make you plans. Every heating plant we sell is backed by our guarantee bond.



Hot Water Heating Plants!

We guarantee to save you 50 to 75 per cent on a modern hot water heating plant for your home. We make you complete plans and instructions and help you out every way we possibly can. We loan you tools. Every plant backed by our guarantee bond. We furnish the material; you get the plant installed. Cut out the local dealer's profit and cut the cost in half. Thousands of our plants installed and working perfectly in every part of the country. Write today for our Special Heating Catalog. Tells all about our heating proposition. We can furnish Heating Apparatus for any building, no matter how large. Tell us your needs. Write for Free Special Heating Catalog No. 539.



Water Supply Outfits

Modern Air Pressure Water Supply Systems at prices ranging from \$48 to \$200. They are strictly new, first-class and complete in every detail. Even though you live in the country, you can enjoy every city comfort at little expense. Why not investigate this. We are ready to furnish you with all facts free of charge. All material fully guaranteed. We also have a complete stock of Pipe, Valves and Fittings at 40 to 50 per cent saving.

Gasoline engines at low prices.

Acetylene Lighting Outfits

Write today for our circular describing our modern house and barn lighting outfits; economical, simple and better than any other isolated system; no odor, smoke or soot.

Price for complete outfit for an 8 room house, including Generator, Piping, Tools and necessary Gas Fixtures **\$150.00**
Other outfits at proportionate prices. Suitable for homes, stores, hotels or for any place where light is needed.

Send Us This Coupon

Chicago House Wrecking Co. (539)

I saw this ad in Popular Mechanics.

I am interested in.....

NAME.....

TOWN.....

WHY YOUNG MEN JOIN THE NAVY

YOUNG MEN enter the Navy nowadays in order to better themselves; to learn a useful trade; to earn good wages; to have a job where they are sure of getting advancement as they deserve it; and to have steady work. A great number of men join too, because the Navy has been recommended to them by friends or relatives already in the service.

*These facts are shown by statistics
collected by the Navy Department.*

Besides the prospect of earning a good living, the Navy offers many other attractions: A chance to travel and visit foreign ports; indulge in the different Naval sports and athletics; and to associate with healthy and ambitious young men.

Navy life is healthy, the hours of work are regular and not burdensome, the food is excellent, and to the man who renders faithful service there is *always* promotion.

If you are over 17 and want to better yourself, write for illustrated booklet telling all about the Naval Service. **It is free.**

ADDRESS

BUREAU OF NAVIGATION

Desk 69, Navy Department

WASHINGTON, D. C.

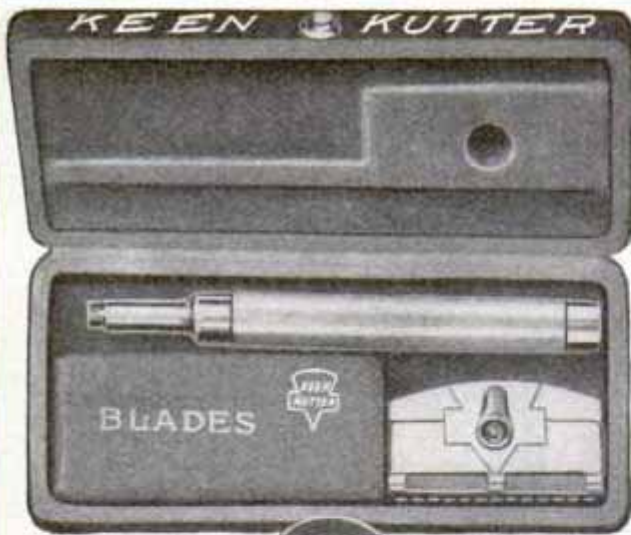

**Knockdown
Pattern**

No. K-5, Silver-Plated, \$3.50
No. K-6, Gold-Plated, \$5.00
No. KJ-10N, Keen Kutter Junior, \$1.00



**No. K-10
Price \$3.00**



**No. K-153
Price \$1.75**



**No. K-3555
Price \$1.50**



**The Temper's
the Thing**

When you buy a pocket knife—a razor or a safety razor—any cutlery, in fact, how can you tell whether it is going to give satisfactory service? You can always examine their external points, such as handles, linings, rivets, springs and finish, but the *temper* is the important thing, and in ordinary cases you can tell nothing about the temper until actual use shows it to be good or bad.

**KEEN KUTTER
Tools and Cutlery**

have been the standard of America for over 40 years as a complete line—every article of the highest quality—every article guaranteed.

Especial attention is directed to the Keen Kutter Safety Razor. Aside from its perfect quality and temper, as proven by the trademark which it bears—the angle of the blade makes it the easiest safety razor to use. This angle is just right for the cutting stroke. It is not a "hoe" to scrape your face, nor is it so flat that it skips.

You can rest assured when you see the name Keen Kutter on anything, every detail has been studied and perfected.

**"The Recollection of Quality
Remains Long After the Price is
Forgotten."**—E. C. SIMMONS.
Trademark Registered.

If not at your dealer's, write us
SIMMONS HARDWARE CO., Inc.
 St. Louis and New York, U. S. A.



**No. K-5558
Price \$2.00**



**No. K-1
Price \$3.50**
**No. K-3
Gold-Plated
Price \$5.00**

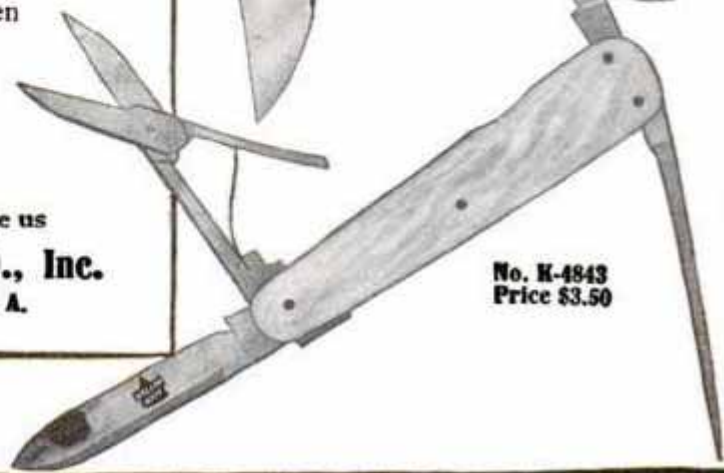

**No. K-4843
Price \$3.50**

Popular Mechanics Magazine

318 W. Washington Street, Chicago, U. S. A.

EDITED BY H. H. WINDSOR

ISSUED MONTHLY

SUBSCRIPTION:

SINGLE COPY, 15 CENTS

In United States, and its possessions, Cuba and Mexico, per year, postpaid - - - \$1.50

To Canada - - - - - 1.75

To all other countries in the Postal Union - - - - - 2.00

All subscriptions are discontinued at expiration. Please examine the date printed on your wrapper.

Entered as Second Class Matter Sept. 15, 1903, at the Postoffice at Chicago, Illinois, under Act of March 3rd, 1879.

Published monthly by POPULAR MECHANICS CO. Copyrighted 1911, by H. H. WINDSOR.

The attention of prospective advertisers is called to the policy of this magazine in accordance with which the publisher waives all claim for payment of any advertisement appearing in any issue where the number of copies actually printed and circulated is less than the number printed on the front cover page.

Contents for October, 1911

Schoolhouse with Direct Exits from Every Room	463	Train of Melons More Than Mile Long	510
An Electric Death Trap for the Fly	464	An Immense Carburetor	510
Blow Out the Gas Now Without Danger	464	Grease Paint and Pen Give Way to Hammer and Saw	511
Automobiles to Carry Telephone Sets	465	Combined Kitchen Table and Ironing Board	512
Newest Style for Women Like Knight's Armor	466	Explosion Engines at One Pound per Horsepower	512
Valuable Discovery in Propeller Design	466	Portable Machine Makes Railroad Ties	512
Life-Savers Hold their First Convention	466	"Dixie IX" Makes Fifty-Six Miles an Hour	513
Runs Factory by Power of Engines under Tests	468	A Curious Electrical (?) Phenomenon	514
Vollmoller's Aeroplane	469	English Laborer's Bungalow	515
Building Expenditure of Three Eastern Cities	469	Train of Self-Propelled Motor Trucks	515
Hat Provided with Electric Fan	469	Giant Fire-Fighting Water Tower	516
Swimmers Photographed in the Water	470	Blasting Rock with Water Pressure	516
Abnormal Feet and a Peg-Leg	470	New Electric Switching Locomotive	517
Possum Farms Started in Australia	471	Illustrated Songs in the Home	518
Internal-Combustion Riveting Machine	471	Steam Boilers Heated by Electricity	518
Dual-Control Biplane Made by Curtiss	471	Completely Inclosed Auto Body	519
Cast-Steel Plates of Extreme Hardness	471	A School of Photography	519
Are We Really a Wasteful People	473	Testing Ballast for Railroad Tracks	520
By Oscar P. Austin		Steamship "Aquitania" Will Exceed 900 Feet	520
Panama to Have Largest Docks in the World	481	Swiss Village Guard	521
Submerged Electric Lights to Stop Eel Migration	481	Motoring in 1961	521
Horse Has Gold Tooth	482	Log-Cabin "Mansion" of an Artist	523
Convertible Car for Electric Roads	482	By Francis Buzzell	
A Rotary-Sleeve-Valve Automobile Motor	482	U. S. S. "Kansas" Has a Diving Dog	527
Three-Wheeled Summer Toboggans	483	Gas Holder of 6,000,000 Cu. Ft. Capacity	527
Long-Distance Hearing Apparatus	483	New Seaport Contemplated for Rome	527
Giant Stone Arrow to Guide Flyers	484	Children's Drawings on a Mummy Wrapping	528
Hardtack Loses Place in Soldiers' Diet	484	Silica for Standards of Length	528
Anti-Rolling Tank of 12,600-Ton Liner	485	Rotary Motor on the "Demoiselle"	529
Wireless Lighthouses	485	Discussion of Channel Tunnel is Revived	529
Lincoln Monument in Scotland	486	Crude Elevator a Money-Making Attraction	530
A Simple Speed Gauge for Aeroplanes	486	Fire Apparatus Drawn by Motor or Horses	531
A Huge Falsework Structure	487	"Ice Stove." Professor Alexander Graham Bell's Latest Invention	532
A Chemical Rhapsody	487	An Aerial Propeller Testing Station	534
Duck-Shooting Gunboat	488	"Pumping" Taximeters	535
First Moving Picture	489	Emergency Door Lock	535
Four Drill Holes Bored in Rescue of Miner	489	High Price of Platinum Due to Monopoly	535
New Aviation Records and Deaths	490	Interesting Fancy of Air Ownership	536
Vaniman's Attempt to Cross the Atlantic	491	Indestructible Labels for Nurserymen	536
By J. Q. Roberts		Billboard Advertising Device on Wheels	536
The Millionth Patent	494	Cottage Designed on Colonial Lines	537
Hydro-Aeroplane Progress	496	An Expanding Anchor	538
British Sailors Practice with Dummy Aeroplane	498	Weighs Three Materials at One Time	538
England Menaced by Famine	498	Automobile Wireless for Army Use	538
Two Round-the-World Records	499	The Motorette of a Japanese Noble	538
The Reapers of Forty Centuries	500	A Safety Mining Cap	539
Washington Has World's Champion Fly Swatter	502	Slanting Desk Saves the Eyes	539
Automatic Aeroplane Stabilizer	503	Motorette Engine with Two Flywheels	539
Transporting Horses by Auto Trucks	504	Do We Really Live in Three Dimensions	540
A Real Revolution in Automobile-Engine Design	505	By Harry English	
By Anton Camille		Aeroplane Rangers for Forest Reserves	541
Teeth of Man of Half Million Years Ago	507	Typhoid Death Rate of America and Europe	541
Wicket Dams to Make the Ohio River Navigable	508	French Road-Menders Live on the Road	542
Women Unload Ship During Strike	509	Balloon-Shaped Sunshades	542
Photographs Mounted on the Finger Nails	509		
Emergency Folding Oars	510		

[Continued on Page 6]

Popular Mechanics offers no premiums; does not join in "clubbing offers," and employs no solicitors to secure subscriptions. It is for sale by nearly every newsdealer in the United States and Canada.

Contents—Continued

Some Unusual Railroad Water-Storage Tanks.....	542
Metal Work and Etching—Part I, Book Ends.....	543
Cellular Feeder for Bees.....	545
Polynesian Idols.....	546
Great Field for Slag in Concrete Making.....	546
Lifting Fire Hose by Building-Elevators.....	546
Geared Ratchet Lifting Jack for Autos.....	547
Adjustable Wrench Set.....	547
Cleverly Constructed Card Table.....	547
Bellows Vacuum Cleaner.....	548
Hailstorm Protection in France.....	548
A Prince Edward Island Tunnel.....	548
Auto Designed to Minimize Air Resistance.....	549
Bodily Recuperation and Physical Law.....	549
Simple Cylinder-Bore Measuring Device.....	549
How to Make a Lamp Stand.....	550
England's One Monopoly is China Clay.....	550
Combined Cane and Camp Stool.....	551
New Turbo-Locomotive with Novel Features.....	551
Portable Shower and Friction Bath.....	552
New Uses for Road Drags.....	552
Testing Materials with a Sandblast.....	552
The Kingdom of Dust.....	553

By J. Gordon Ogden

Kerosene Gas-Producer for Gasoline Engine.....	557
Peruvian Sail Boat Made of Reeds.....	558
The Manufacture of Artificial Eyes.....	558
Arrow Points Direction Motor Car Will Take.....	559
Hideous Masks Placate Tibetan Gods.....	559
British Warship Uses Awnings as Sails.....	559
Electric Motorcycle.....	560
Distillation of Orange Flowers in France.....	560
A Portable Hat-Stand.....	560
A Comprehensive Fire-Alarm System.....	561
The Salvation Navy.....	561
A Twentieth-Century Scribe.....	562

By Roy O. Randall

The Aeroplane and the Submarine.....	565
Radical Innovations in Street-Car Design.....	566
Most Primitive Weapons Now Hospital Aid.....	567
An Exposure Indicator for Film Cameras.....	567
Locomotive Banked by Men Who Built Her.....	568
Cookstove of Cobblestones and Cement.....	568
Powerful Italian Auto with 300-Hp. Motor.....	569
Largest Two-Cycle Motor Ever Built.....	570
The Versatile Buffalo in Darkest China.....	570
A Computing Oil Pump.....	570
Automatic Loose-Pulley Oil Cup.....	571
Recovering Silver from Sweepings.....	571
Most Sensitive Method of Chemical Analysis.....	572
Pollenizing Carnations with a Brush.....	573
Worm-Gear Drive for Automobiles.....	574
Snowfall and Evaporation Study.....	574

By L. William Thavis

Oil-Burning Articulated Locomotives.....	576
Radioactive Snow.....	577
Concrete House Has a "Keyhole" Entrance.....	577
Freight Elevator on Apartment House.....	577
Live Tigers Used as Models.....	578
Ingenious Fire-Escape Key Arrangement.....	578
Birds in Cages Pets on British Battleship.....	579
Overheat Whistle for Automobiles.....	579
A Canopy-Top Aeroplane.....	580
A "Headless Horse" Photograph.....	580
The Omniscient Engineer.....	580
How to Make a Pedestal.....	581
New Color-Perception Lantern.....	581
Cheap Construction for Tall Concrete Walls.....	582

SHOP NOTES

A Water Heater.....	583
Lighting Interior of Refrigerator.....	583
Painting the Inside of a Rain Pipe.....	584
Emery Cloth Used in a Hacksaw Frame.....	584
Lace Curtains Drawn Back with the Shade.....	584
Marking Divisions on Circumferences of Shafts.....	585
Curtain Ventilator for a Van.....	585
How to Cut a Cone-Shaped Kettle Cover.....	585
Removing Obstruction in a Well Casing.....	586
Producing Marble Effects with Paint.....	586
Clothesline Holder.....	586
Substitute for an Expansion Bolt.....	586
Removing a Stuck Ax.....	587
Sink-Drain Strainer.....	587
Stretcher for Covers.....	587
Splicing Rope Drives.....	588
Grinding a Twist Drill.....	588
Protecting a Wood Partition Around a Stovepipe.....	590
Pressure-Gauge Tester.....	590
Ink Well for a Lettering Pen.....	591

Drain Board for a Sink.....	591
Ladder Props.....	591
Stand for Holding Coiled Wire.....	592
How to Prevent Motorcycle Belts from Slipping.....	592
Test of Humidity in Living Rooms.....	592
An Adjustable Garden Marker.....	592
Lathe Parallels.....	593
Keeping Vermin Out of Beehives.....	593
Cellar-Door Support.....	593
Hinge Stop on a Gate.....	593
Fireproof Chimney for Frame Houses.....	594
Testing Lubricating Oils.....	594
Furniture Polish.....	594
Fastening Hammer Handles.....	594
Electric Welding of Metal Saws.....	594
Adjustable Mirror.....	595
Cementing Brass to Glass.....	595
Vise for a Drill Press.....	595
Revolving Drawing Board.....	595
Chisel for Cutting Mortises in Cabinet Drawers.....	596
Making Brass Letters in Steel.....	596
Automobile Cooling Alcohol Mixtures Kept at Proper Strength.....	596
Removing a Milling-Machine Arbor.....	597
How to Bend Tubing or Pipe.....	597
Scale on a Monkey Wrench.....	597
A Sprinkler Bottle Stopper.....	597
A Pipe-Ripping Tool.....	598
Overhead Clothes Rack.....	598
Fumigating School Books.....	598
Door Lock for Travelers.....	599
Planer Work in a Lathe.....	599
Removing a Pin from Cast Iron.....	600
Coloring Concrete.....	600
Glass-Cleaning Solution.....	600
Kettle-Cover Holder.....	600
Steady-Rest Jaws with Babbitt Ends.....	601
Spark Gap for Testing.....	601
Holder for Starting Screws.....	601
Fastening Stovepipe Joints.....	601
Catch for a Small Door.....	601
Holding Work on the Center of a Lathe.....	602
Coloring Brick.....	602
Sharpening a Nail Set.....	602
Reflector for an Automobile-Trouble Lamp.....	602
Increasing Efficiency of a Coil Door-Spring.....	602
Operating Air Pumps.....	602

AMATEUR MECHANICS

A Homemade Steam Turbine.....	603
Homemade Telegraph Key.....	604
Keeping Food Cool in Camps.....	604
How to Make a Flint Arrowhead.....	605
An Opening Handle for a Stamp Pad.....	605
Concrete Kennel.....	605
Nutshell Photograph Novelty.....	606
Spoonholder on a Kettle.....	606
Repairing Cracked Gramophone Records.....	606
New Use for a Vacuum Cleaner.....	607
Filtering with a Small Funnel.....	607
A Postcard Rack.....	607
Substitute Shoe Horn.....	607
Building a Small Photographic Dark Room.....	608
The Versatile Queri.....	610
An Emergency Soldering Tool.....	610
Smoothing Paper after Erasing.....	611
Base for Round-End Bottles.....	611
A Cherry Seeder.....	611
A Dovetail Joint.....	611
Homemade Work Basket.....	612
A Window Display.....	612
The Construction of a Simple Wireless Telephone Set.....	613

INTERESTING PATENTS, PRACTICAL OR UNIQUE

Device Aids in Hemming.....	615
Dispensing Vessel for Several Beverages.....	615
Clincher Gaff for Fishermen.....	615
"Flytrap" Aeroplane.....	615
Adjustable Cake Pan.....	615
Miner's Breathing Mask.....	615
Folding Decoy Duck.....	615
Individual Lemon or Orange Squeezer.....	615
Sprayer.....	615

Jokes.....	616
------------	-----

Louisiana Delta Raises Richest Crops

Stay Where You Are, Own Your Farm, Make 3 Certain Profits on Our Guaranteed Income Plan

THIS is the only guaranteed income and land ownership plan offered today—through 6% Ownership Certificates. Be absolutely protected on each dollar you invest—on easiest payments drawing 6% interest guaranteed from the start—also draw one-half share cash profits each year from rich crops which we raise for you—and also own for your future the fast increasing cash market value of your farm.

6% Interest to You on Your Easy Payments
One-half Share of Cash Profits on Rich Crops
All the Fast Increasing Value of Your Farm

We do all the work. Our expert Holland farmers operate the farm you buy on one-half crop-share basis, if you do not wish to go there now or in the future. You can begin now by taking one \$100 ownership certificate, or more, at only \$10 down and \$5 per month.

Winter Garden Farms

CHICAGO TITLE AND TRUST CO., Trustee

Each Ownership Certificate represents 1 acre in Winter Garden Farms. Five of these Certificates may be exchanged by you at any time for a deed to 5 acres, 10 for 10 acres and up, in multiples of five. Each dollar you pay draws guaranteed 6% interest continuously until you want to live on or operate your farm. Less than 300 farms of 10 acres each are now offered. This is the richest land in America, raising winter vegetables and fruits for northern markets.

You get clear title deed from the largest and strongest title and trust company in the world, with which we have placed this land in trust.

By investigation—from expert engineering reports—from U. S. Government Agricultural reports—maps—photographs—actual cash crop figures, descriptions and testimonials from prominent northern business men, as well as leading New Orleans and southern business men, you will find that the officers of this Company, our plan, and *this 3-crop-a-year land itself* offer the most profitable opportunity for safe investment in farms anywhere today.

Men and Women on Salary and Keen Business Men are Investing Here

We want all to be absolutely satisfied by most careful investigation before investing a dollar. Write for our books explaining all—or call. There are less than 3000 acres now offered in Winter Garden Farms and it is the best and last big tract on water front, with all water transportation, within 10 miles of New Orleans' market and rail and water shipping docks. To avoid disappointment, we advise you not to delay investigation. If not satisfied by our proof it will cost you nothing. Write today to reserve your share, or to get all facts and books free and investigate fully.

NEW ORLEANS NETHERLANDS COMPANY

References: Chicago Title and Trust Co., Trustee,

We can refer you to the oldest and strongest National Bank in Chicago as to our responsibility.

1321 First National Bank Bldg., Chicago, Ill.

Name.....

Address.....

Remember to Write for Free Books, etc.

Write For
FREE BOOKS

EXPLAINS
YOUR
3 PROFITS

PHOTOS OF
OPERATIONS

EXPERT
REPORTS

6%
LAND
OWNERSHIP
CERTIFICATES



Black Space on Map Shows Our Location. Only 10 Miles from New Orleans—600 Miles Nearer the New Panama Canal Than Any Other U.S. Port.

FREE Town Lot

First buyers of 5 acres or more get first choice of Winter Garden town lots in New Orleans' new suburb, on the shore of beautiful Lake Cataouatche—only 100 town lots free. Share in this special offer. First inquiry buyers get first choice.

Only 10 Miles from New Orleans, La.

This One



A Library of the World's Greatest Business Letters

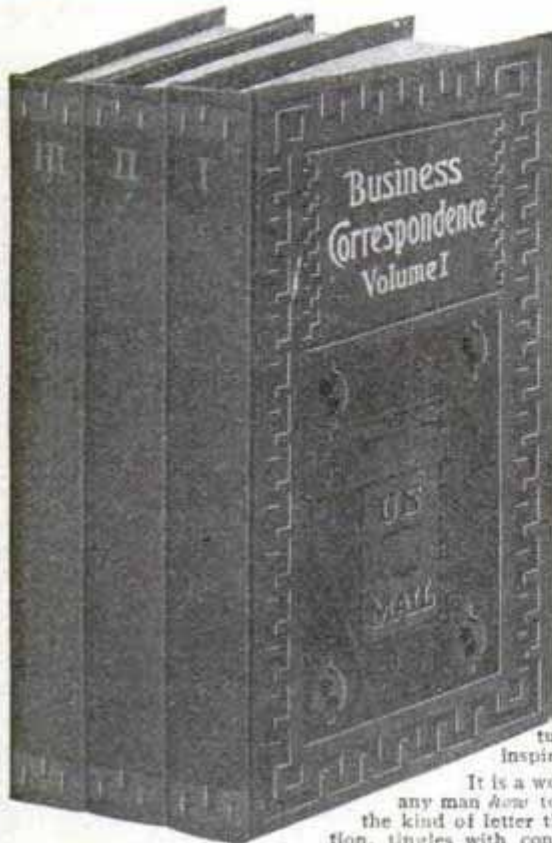

The letters that have sold the *most* goods, collected the *most* money, settled the *hardest* complaints, won the *best* jobs, had the *strongest* influence—analyzed and dissected for *you* to learn from, to adapt to your needs, or to develop an original style of your own—with the best examples actually reproduced as they were used and graphically explained point by point.

Here in these three volumes—672 pages—are packed the success-secrets back of the letters that are actually winning the biggest results today, that are bringing orders from you and me, and making other men's fortunes.

Two years of investigation by a staff of experts employed by SYSTEM, the Magazine of Business, were spent collecting the letters of firms and individuals; investigating the actual results; analyzing the comparisons of costs and profits; studying the difference in results obtained by differences in arrangement, wording, enclosures, etc.

Every striking idea found in use by mail order house, wholesaler, manufacturer, retailer, real estate or insurance man, bank, collector, individual salesman or complaint clerk was followed out and its returns studied. This mass of information, this wealth of ideas, this gold mine of absolute facts was then *charted* and *diagrammed*—and developed into one complete, yet concise library so clear and simple that from it any busy man can pick out any sort of proposition, an idea or sug-

gestion that he can know in advance to be successful; or can turn to for original inspiration.

It is a work that will show any man *how* to write or dictate the kind of letter that arouses attention, tingles with convincing strength, and carries its point; how to conduct a follow-up campaign, how to key results, how to compile and index names, how to fit schemes and plans to any proposition.

low-up campaign, how to key results, how to compile and index names, how to fit schemes and plans to any proposition.

Special Forced Edition—\$ **1**

DOWN

SYSTEM, the Magazine of Business, conducted this investigation for its subscribers. It was not to be given to the general public until 1912. But the subscribers' edition has caused a public knowledge of the contents, and an extra advance edition has been made imperative. 2640 special sets have been hastily printed.

\$1 with this coupon brings to you the complete "Business Correspondence Library"—3 volumes—672 pages, transportation prepaid. \$2 per month for 4 months thereafter—less than 7 cents a day—pays for them complete and in addition brings you SYSTEM, the Magazine of Business, every month for two full years—24 numbers of this remarkable business magazine, including a copy of

The Big September SYSTEM

—the number that contains not only many pages of business plans and ideas and schemes, but also the biggest and most interesting advertising section of any magazine in the world. SYSTEM stands pre-eminent the Monthly Magazine of Business—260 to 356 pages in every issue and you cannot afford to miss a single one of them. SYSTEM shows you how to conduct or how to start a business, how to win trade, minimize wastes, keep down expenses, manage men. With this coupon you receive SYSTEM every month for two years and receive at once the complete new 3 Volume Business Correspondence Library. Send only \$1 with the coupon.

Here at last is the clear, complete, specific method by which the business manager can make his firm's letters crackle and snap with business strength—the salesman make his letters as keen and terse as his selling talk—the young man develop himself into a power with his employers—by which banker, real estate agent, insurance man, credit man, can dictate into a letter with scientific certainty the style and character that commands. Do not risk losing *your* chance at this advance edition—act today.

I enclose \$1. Send me at once, transportation charges fully prepaid, the complete 3 volume "Business Correspondence Library"—672 pages—bound in Maroon vellum, and enter my name for a full 2 years' subscription to SYSTEM, the Magazine of Business, to include the big Sept. number. I promise to remit \$2 each month for the 4 following months, making \$9 in all.

Name..... P. M.—10

Address.....

City and State.....

Wabash and Madison
CHICAGO

SYSTEM
THE MAGAZINE OF BUSINESS

44-60 E. 23rd St.
NEW YORK

NOTE:—In Canada price complete is \$10. Price in foreign countries \$11—\$5 down, \$2 per month. Communications from European countries should be addressed to A. W. Shaw Company, Ltd., 34, Norfolk, Strand, London.

Would You Like to See Actual Examples of How Other Successful Men Have Written—

- Letters to Follow-Up Inquiries—see Vol. I, pp. 138, 139; Vol. III, pp. 75, 84.
- Nine Main Angles for Follow-Up Letters—see Vol. III, pp. 63, 64, 78.
- Letters to Accompany Catalog—see Vol. II, p. 35.
- Opening Paragraphs to Get Attention—see Vol. I, pp. 34, 35, 36, 37, 38, 39, 84, 85.
- Interest-Holding Paragraphs—see Vol. III, pp. 149, 150.
- Arguments to Clinch the Sale—see Vol. I, p. 47; Vol. II, pp. 47, 136.
- Schemes to Get New Customers—see Vol. II, pp. 169, 214, 224, 225, 227; Vol. III, pp. 29, 31, 137.
- Money-Getting Collection Letters—see Vol. I, p. 135.
- Clever Answers to Complaints—see Vol. III, pp. 189, 198.
- Arguments to Advance Prices—see Vol. III, pp. 159, 161, 174.
- Paragraphs to Prompt Action—see Vol. II, pp. 16, 17, 71, 72, 73, 74, 75, 76, 77, 78, 79; Vol. III, pp. 92, 93.
- Letters to Dealers' Clerks—see Vol. III, p. 32.
- Educational Letters to Dealers' Customers—see Vol. III, pp. 8, 9, 12, 13, 138.
- Sales Letters to Dealers' Customers—see Vol. III, pp. 18, 19, 21, 22.
- Letters to Follow-Up Real Estate Sales—see Vol. III, pp. 77, 86, 87, 88.
- Letters to Illustrate Demonstration Offers—see Vol. III, p. 157.
- Effective Descriptions in Letters—see Vol. I, pp. 44, 45.
- Salesmen's Letters to Dealers—see Vol. III, pp. 41, 42, 43, 44.
- Unusual Sales Letters—see Vol. II, p. 12.
- Letters to Answer Specific Inquiries—see Vol. II, pp. 37, 38.
- Clever Schemes to Get Replies—see Vol. II, pp. 22, 26, 27, 28; Vol. III, pp. 167, 168.
- Paragraphs to Increase Effectiveness of Enclosures—see Vol. III, p. 148.
- Business-Getting Postals—see Vol. II, p. 63.
- Schemes to Get Line on Prospects Needs—see Vol. III, p. 136.
- Plans for Offering Premiums—see Vol. III, pp. 100, 175.
- Effective Summaries—see Vol. I, p. 46.
- Their Best-Pulling Letters—see Vol. II, pp. 108, 109.
- Letters Emphasizing the "You" Element—see Vol. II, pp. 133, 134.
- Letters Backed With Proof—see Vol. II, p. 15.
- Special Inducements to Retailers—see Vol. II, pp. 128, 129, 141, 178.
- Letters Emphasizing Special Prices—see Vol. I, p. 149; Vol. III, p. 158.
- Dealer's Trade-Getting Letters—see Vol. II, pp. 186, 187, 188, 189, 190, 191, 197, 198, 205, 206, 207, 208, 211, 214, 217, 218, 219, 220, 221, 222, 226, 228; Vol. III, p. 25.
- Trade-Getting Letters to Consumers—see Vol. II, p. 147.
- Letters Asking Credit Information—see Vol. I, pp. 185, 186, 187.
- Letters to Poor Credit Risks—see Vol. I, p. 185.
- Letters Taking Reader Into Confidence—see Vol. III, p. 181.
- "Last Resort" Collection Letters—see Vol. I, pp. 160, 164.
- "True Note" Collection Letters—see Vol. I, pp. 190, 193, 194.
- Retailers' Collection Letters—see Vol. I, pp. 147, 148.
- Installment Collection Letters—see Vol. I, pp. 154, 155.
- Collection Letters Offering Inducement—see Vol. I, pp. 156, 157.
- Tactical Collection Letters—see Vol. I, pp. 140, 161, 162, 3—4.
- Collection Letters Quoting from Delinquent's Letter—see Vol. I, p. 176.
- Letters to Bring Cash With Order—see Vol. I, pp. 189, 191.
- Collection Letters Containing Salesmanship—see Vol. I, p. 188.
- Letters for Collection Agencies—see Vol. I, pp. 158, 159.
- Letters Based on Current Events—see Vol. I, pp. 91, 92, 147, 173.
- Letters Illustrating "Man-to-Man" Attitude—see Vol. I, pp. 86, 89, 90.
- Letters Backed With Inducement—see Vol. I, p. 47; Vol. II, pp. 49, 136.
- Letters Appealing to Women—see Vol. II, pp. 87, 89, 91, 92, 93, 95, 96, 97.
- Letters Appealing to Merchants—see Vol. I, p. 149.
- Letters to Revive Old Customers—see Vol. III, p. 182.
- Letters Offering Investments—see Vol. II, pp. 102, 107, 110, 111.
- Letters Appealing to Farmers—see Vol. II, pp. 118, 119, 120.
- Letters With Appeals That Get Attention—see Vol. II, p. 26.
- Letters With Effective and Clever Appeal—see Vol. I, pp. 101, 103, 104; Vol. II, pp. 101, 102, 103; Vol. III, pp. 172, 178, 179.

CASSELL'S CYCLOPÆDIA OF MECHANICS

6,500 ILLUSTRATIONS 30,000 INDEXED ARTICLES

Edited by
PAUL N. HASLUCK

If You Want to Make Anything
Consult These Volumes

Assisted by
100 Practical Experts



For the Mechanical and
Electrical Engineer



For the Handy Man
About the House



For the Boy Who
Likes to Make Things

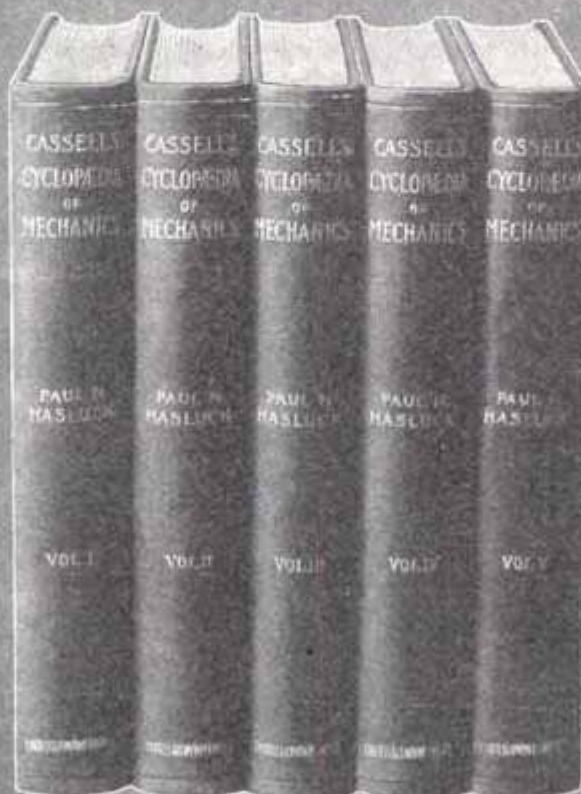

For the Practical
Shop Mechanic



For the Searcher
After Scientific Knowledge



For Every Man
with a Hobby

EVERY Mechanic, Engineer, Scientist, Farmer, Handyman and Man with a Hobby should own a set of these books. The work is not only of priceless value to Mechanics, Electricians and Scientists, but contains thousands of articles written for the Handyman about the house, farm and shop; for anyone who likes to make things, from a match-holder to a suite of furniture—from a wheelbarrow to a carriage or motor body. The boy who is learning how to use his brains and hands will find these volumes a never ending inspiration. Read the description below when let us send you the set for examination before you purchase.

This Famous Mechanical Library Sent You for Examination on Receipt of \$1.00

Sign your name to the coupon below and let us send you this complete five volume work at once on approval. If you don't keep the books, the set is returnable AT OUR EXPENSE, and we will refund your \$1.00, plus any expenses.

Cassell's Cyclopaedia of Mechanics is an authoritative work, well printed and handsomely bound in five volumes. Written by a staff of skilful and talented mechanical and technical writers, under the direct editorship of Paul N. Hasluck, the foremost living writer on mechanical subjects, every item the paid contribution of an expert. The complete work contains over 6500 illustrations and 30,000 separately indexed articles; over 2,500,000 words. The five volumes number 1760 pages in all; each volume measuring 7 1/2 x 10 1/2 inches; strongly bound in stout extra durable cloth binding, with lettering in gold. We know you will be amazed by the scope and completeness of this work. A leisurely examination is the only method of sale that will do it justice. That is why we make you this out-and-out offer to place the five volumes in your home at our expense, without obligation to keep them unless you are satisfied.

For the Practical Mechanic The practical mechanic will find in this work thousands of articles such as: Spindle molder for treadle power; cramps used in drilling holes; chucks for holding small tools in lathe; electric motor connections; boiler covering compound; forging swivels; reducing high pressure of electric circuit; tail vice for wood-worker's bench; truing emery wheels; regulating speed of electric motors; tool for cutting round holes in sheet metal; tube ignition for small oil engine; oxy-acetylene blow pipe or torch for welding and cutting metals; rustless coating for iron patterns; uses of shunt coils; spacing dynamo brushes; heat gauge for use in hardening steel; fitting electro ignition to gas engine; grinding and polishing metals for a high finish; calculating weight of rolled metal, etc., etc.

Some General Subject-Headings which indicate the exceptional range and comprehensiveness of the work include: Acetylene—Acids—Alabaster—Alloys—Barometers—Boat Building—Bookbinding—Building—Cements—Chemicals and Chemistry—Cleaning and Renovating—Coal—building—Concrete—Cycles—Drawing Instruments—Dyeing—Electricity—Embossing—Enameling—Engineering—Engraving—Entomology—Etching—Explosives—Filters and Filtering—Fireproofing—Floors—Furnaces—Gas—Gauges—Gilding—Glass—Granite—Guns and Firearms—Heating Apparatus—Illuminating—Inlaying—Ivory—Jewelers' Work—Lamps—Lantern Slides—Leather Working—Lenses—Lithography—Lulri—cutting—Machinery—Marble—Metal Working—Metals and Metallurgy—Modelling—Motors—Moulding—Machines—Paints—Paper—Paving—Photography—Pipes—Plaster—Plumbing—Pottery—Poultry Appliances—Presses—Printing—Pumps—Refining—Refrigeration—Roofing—Ropes—Sand—Sanitation—Saws—Screws—Surveying—Sign Writing—Soaps—Soldier—Staircasing—Stone—Stoves—Tanning—Taxidermy—Terracotta—Tiling—Timber—Tools—Upholstery—Valves—Veneering—Water—Wireworking—Woodworking.

Examine This Great Set of Books at OUR Expense We want you to see this famous five volume work, for we know that you will be pleased with its binding, paper and printing, and the wonderful fund of information it contains. We want you to examine it thoroughly, for we know you will be quickly impressed with its practical value. The price of this complete work in five volumes as above described, is \$18.00. Just mail us the coupon opposite with \$1.00 and you will receive the set, carriage paid. Examine it five days. If at the end of that time you do not want it, notify us and hold subject to our order, and we agree to return the dollar you have sent us. If you keep the books, pay us \$1.00 within five days, and the balance \$2.00 a month until paid.

CASSELL & COMPANY (Established 1848)
43-45 East 19th Street NEW YORK

P.M.
10-11
CASSELL & COMPANY,
43-45 E. 19th St.,
NEW YORK

GENTLEMEN:—I enclose herewith \$1.00 for which kindly send me carriage prepaid, for free examination, one complete set of Cassell's Cyclopaedia of Mechanics, in five volumes. It is understood that I may examine the work five days, and if I do not wish to keep it, I agree to notify you and hold subject to your order. If I keep it, I agree to pay you \$1.00 within five days and the balance of \$16.00 in instalments of \$2.00 per month until paid. It is further understood that you will refund the dollar paid, if I decide not to keep the books.

NAME.....
ADDRESS.....
OCCUPATION OR EMPLOYER.....
Send this coupon or copy of it



Send for Sample

We will send you by mail, postage paid, 10 collars for 30 cents, or a sample for 6 cents in U. S. Stamps. Cost at the stores 25 cents for box of ten. *State size and style.*

These collars look just like linen and are more comfortable, but cost so little that they may be thrown away when soiled. They may be reversed and worn both sides.

REVERSIBLE COLLAR COMPANY
Department U, BOSTON, MASS.



Engineers, Draftsmen

and all others who have lettering to do need this system of *easy lettering*.
10,000 Copies Sold

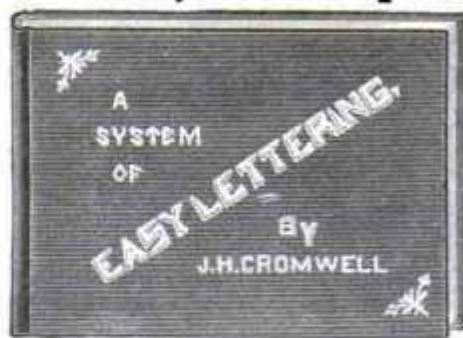

CONTENTS:
BLOCK LETTERS:
Heavy, Outline, Condensed, Expanded, Fancy, Shaded and Italics.
GOTHIC:
Condensed, Expanded, Italics.
ROMAN:
Fancy, Italics.
SCRIPT: MODERN
ARCHITECTURAL

11th Edition Now Ready
Contains 3 new alphabets

Well printed on good paper and handsomely bound in cloth.
Sent postpaid on receipt of 55 cents.

Spon & Chamberlain, 123 P. M. Liberty St. NEW YORK, U.S.A.



127 KINDS Iron, Wood, Wire & Steel **PUZZLES**
Sample with Catalog 10 cents, or 3 leaders for 25 cents.
WESTERN PUZZLE WORKS
St. Paul, Minn.

Mechanics For Young America

A book which tells how to make scores of articles which delight the heart of the average boy. **Price 25 Cents Postpaid**

POPULAR MECHANICS BOOK DEPT.
318 W. Washington Street, CHICAGO

Three Months—25 Cents

Let us send you a trial subscription to our finely illustrated magazine, **Electrician and Mechanic**. Practical directions for all kinds of electrical and mechanical work. Aviation, Wireless Telegraphy.

Sampson Publishing Co., 514 Pope Building, Boston, Mass.

Have You a Camera?

Send us 25 cents for 3 numbers of **American Photography**, full of practical suggestions, formulas and directions for making better pictures. Monthly prizes. Prints criticized. Questions answered. \$1.50 a year. **American Photography**, 514 Pope Bldg., Boston, Mass.

Every Boy His Own Toymaker

Greatest boys' book ever written. Tells how to make a Steam Engine, Microscope, an Electric Telegraph, Telephone, Magic Lantern, Bots, kites, balloons, electrical and mechanical toys, traps, fishing tackle, 200 illustrations. Price only 10c postpaid, 3 for 25c. **Electric Fun Makers**, Dept. 6, Kewanee, Ill.



50 SMOKES FOR 99 CENTS



Send me 99 cents by mail Now and I will send you this box of 50 Menges Havana Seed Stogies post prepaid. You'll find them stogies only in shape; in quality superior to many 10-cent cigars. My tobacco is grown in this country from **pure Havana seed** and is rich, aromatic, flavory. Get this box, try one—if not satisfactory send the rest back and get **all** your money back.

H. MENGES, Smoker's Friend
512 Menges Bldg. ST. LOUIS, MO.

A CHANGE

Under a new plan effective April 1, 1911, our street number is changed to

318 W. Washington St.

The change in address is caused by a re-numbering of the streets and is not a change of location. Please address our mail to the **new number**.

Popular Mechanics Magazine

A SCHOOL WITHIN ITSELF

There are XX chapters in all, XIX carrying you from the fundamental principles of electricity on through the various branches to a point where the careful student comprehends the complete designing, care and operation of a dynamo or motor, and one chapter on electric automobiles, outlining their construction, care and operation, and all about storage batteries and how to handle them. Each subject is carefully written and to the point. After a student studies a subject, he is questioned on that subject in such a manner as to bring clearly to his mind the points he needs to know regarding same. The book contains a dictionary defining 1500 Electrical Words, enabling the reader to ascertain the meaning of any electrical word, term or phrase used in this book, as well as hundreds of others in common use. All required tables necessary in the study are in it.

\$2.00 PER COPY—SIXTH EDITION—30,000 COPIES SOLD.

The offer we make of re-funding money if book is not satisfactory upon examination is AN UNUSUAL ONE in connection with the sale of a book. But we have no fear of its return. Your decision will be what thousands of others have been. Money would not buy it if it could not be duplicated. We could print testimonials by the hundreds. It is best to order and be your own judge of its merits.

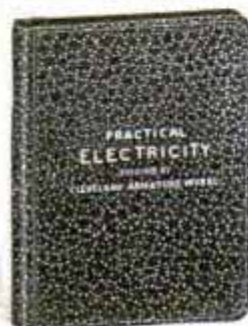

CLEVELAND ARMATURE WORKS, Cleveland, Ohio. Arrangements and Fields Wound—Commutators Filled



The NEW ENCYCLOPÆDIA AMERICANA

2,387 Special Writers (American and Foreign)
 65,287 Subjects 160 Maps
 2,114 Half-tone Illustrations
 400 Special Engravings and Drawings
 126 Beautiful Color Plates. The whole representing
10 Years' Co-Operative Work
 Assembled at a cost of
OVER A MILLION DOLLARS

IN 20 VOLUMES

**An American Encyclopaedia
 of World-wide Scope and
 Undoubted Authority**

BRENTANO'S to Distribute the New (1911) India-Paper Edition

For more than a generation, Brentano's with stores in New York, Washington and Paris, has been a leading book-emporium, our list of correspondents numbers more than forty thousand names.

These correspondents frequently ask our advice and opinion, not only about fine sets of standard authors, rare editions and volumes but also regarding *subscription* books (histories, dictionaries, encyclopaedias) and our experts have naturally kept well posted with respect to these—especially encyclopaedias.

We have endeavored to deserve the confidence of those who thus write; we believe they trust us and we have therefore long felt that the distribution by us of a high-grade, general encyclopaedia that we *knew* and could *vouch for* would prove a welcome offering to our friends throughout the country, as well as to the general public everywhere in the United States and in foreign countries.

Finally there came an opportunity quite to our liking, namely, the revision and enlargement of the celebrated ENCYCLOPÆDIA AMERICANA, published by the *Scientific American* Compiling Department in collaboration with Frederick Converse Beach, managing editor, and more than 2,000 editorial writers.

We knew the AMERICANA to be a work of exceptional worth, of which many thousand sets were owned and prized; we knew that its twenty volumes covered every field of the world's essential knowledge, *old and new*; that it was a vast repository of *fixed* knowledge—the kind that does not change as years go by; that it revealed what may be called *experimental* knowledge—the kind that has been the necessary outgrowth of recent inventions and discoveries as well as modern methods and processes in so many departments of to-day's endeavor.

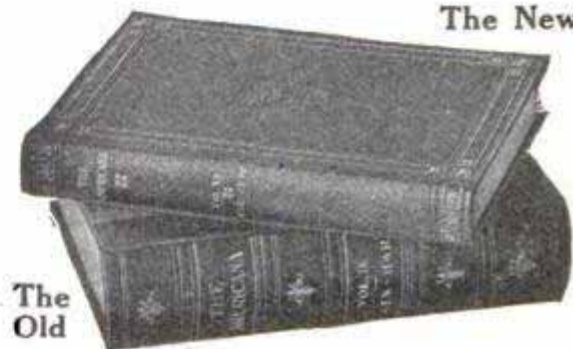

We knew all this and we were also strongly attracted by the purpose of the publishers to print the work on India paper, to bind it according to Brentano specifications and to give us the exclusive distribution of the entire edition.

This means that the Brentano edition of the AMERICANA will bear the hall-mark of quality and that those who secure it will not alone enjoy a feeling of satisfaction when they *consult* it, but when they even *glance* at it in the place of honor it is certain to hold on desk or reading-table.

For the Brentano India-paper AMERICANA is a set of books, which though in twenty volumes of more than eighteen thousand pages, can easily be kept at your elbow on even a *small* desk or reading-table, making frequent reference easy, especially for the young folks.

THE OLD AND THE NEW

The two volumes shown in cut, so unlike in size, contain *exactly* the same subject matter and illustrations. The old is on ordinary paper, the new on India paper. The old is 2½ inches thick, the new 1 inch thick; the old weighs 6½ pounds, the new 2½ pounds; the old (full set) weighs 104 pounds, the new (full set) weighs 50 pounds; the old (full set) requires 3 feet and 8 inches of shelf room, the new only 20 inches of shelf room.

*"Ring out the old!
Ring in the new!"*

In a word, it is an ideal work for home, office or study, and it will be well worth your while to learn more about it than can be here said; also about the easy way to make it yours.

Just say: "*Send full particulars about the AMERICANA as mentioned in Popular Mechanics for October*" Address

BRENTANO'S [Cyclopedia] Dept.
 Fifth Avenue corner of Twenty-seventh Street

GRADUATED PAYMENT PLAN

A privilege of this distribution is a graduated system of easy payments to those who so desire, or a liberal discount for cash on delivery, all of which will be fully explained to those who write.

Examine **FREE** the
Indispensable **NEW** **PARSONS**

The foremost of money savers in telling one what **NOT** to do
The Famous Legal Standard Parsons'

LAWS OF BUSINESS

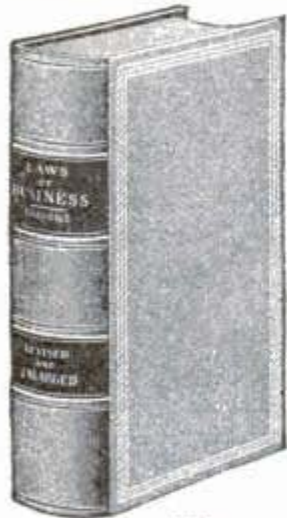

The invaluable companion of every one in business, every one who *does* business, every one needing knowledge *about* business; every one who holds property or wishes to hold it; that is, all the world.

Over 220,000 sold of former editions. Whether or not you have one, you cannot afford not to own **The New, Greatly Enriched 1911 Edition.**

With up-to-date chapters on Employers' Liability; Powers and Liabilities of Stockholders, Officers and Directors of Corporations; Food and Drug Law; New Trade-Mark Law; New Copyright Law, Bailment, etc. Also a Full Glossary of Law Terms.

It treats also of rights and duties under Contracts, Sales, Notes, Agency, Agreement, Consideration, Limitations, Leases, Partnership, Executors, Interest, Insurance, Collections, Bonds, Receipts, Patents, Deeds, Mortgages, Liens, Assignments, Minors, Married Women, Arbitration,

9x6¼ in. 909 pp.
Splendidly bound in
Low Canvas

Guardians, Wills, and very much besides.

Up-to-Date 1911—The book contains also abstracts of **All State Laws** relating to collection of Debts, Interest, Usury, Deeds, Holidays, Days of Grace, Limitations, Liens, etc. Likewise nearly **300 Approved Forms** for Contracts of all kinds, Assignments, Guaranty, Powers of Attorney, Wills, etc.

Please Use Your Business Letter-Head When Writing
Sent by prepaid express, on examination for ten days. If what we claim, remit \$3.50 in payment; if not wanted, we will send stamps for return.

S. S. SCRANTON CO. 25 Case-Lockwood Block
HARTFORD, CONN.

ATTENTION:

GARAGES, AUTOMOBILE and GENERAL REPAIR SHOPS

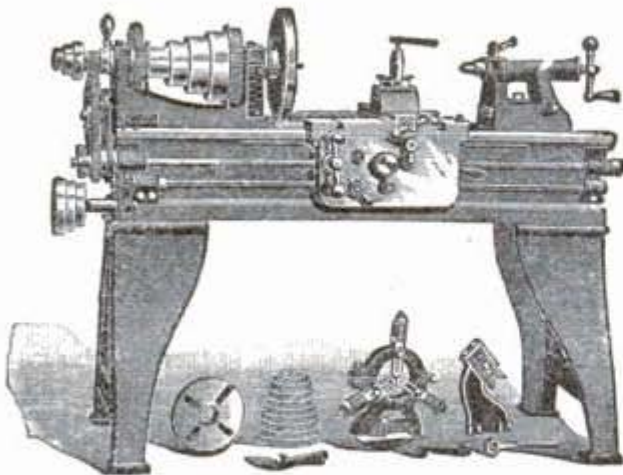

Are you in the market for a Lathe?

If so, before placing your order elsewhere, be sure and investigate the merits of our 15-inch lathe, as it is the ideal lathe for your work. The quality is there and the prices are low. A copy of our catalog will be mailed free on request.

THE SEBASTIAN LATHE CO., 107 Culvert Street
CINCINNATI, O.

*The Largest Periodical in the
World Devoted Exclusively to
Mechanics and Practical Science*

Shop Notes Quarterly

The Great Magazine of the
Mechanic Arts

Every number contains, besides about fifty special articles and hundreds of original contributions from practical men, a careful Digest of the World's Best Technical Literature—all written and illustrated "so you can understand it."

**25 CENTS A COPY
\$1.00 A YEAR**

Ask your newsdealer
to save you
a copy of each issue.

Or can you find a more profitable investment for One Dollar than a year's subscription?

Popular Mechanics Company

318 W. Washington Street, CHICAGO

Stop Forgetting!



Now, What Was That Fellow's Name?
I Can't Remember Those New Terms.
I Know—But Can't Find Exact Word.
What on Earth Did He Say About It?

A Perfect Memory Is the Key to Success

The mind of the average person is filled with thousands of single unrelated ideas which waver and fluctuate with every emotion, like the billows of the sea.

The man with a Wandering Mind can never hope to Make Good—he will always be a drug on the market—he has too many competitors.

The great men of all ages are those who acquire the ability to concentrate and to memorize.

My method is highly recommended by **ELBERT HUBBARD, PROF. DAVID SWING**, and thousands of others. Ten minutes a day of your spare time will give you this training and not interfere with your work in any way.

You Can Be Trained to Remember Accurately

In the business battle — matching wits each hour of every day — the ability or inability to think on your feet, to remember instantly and accurately means gain or loss. To succeed you must be "forget-proof." Just as surely as a poorly organized business can be placed upon a basis of perfect systematization and thereby made thoroughly efficient — so can your mind be trained and made a classified indexed and cross indexed filing system of facts so that you can command, on the instant, any thought, fact or argument.

The Dickson Method of Memory Training Will Do This for You

It will enable you to classify impressions, ideas, names, facts and arguments so as to have them ready at a moment's notice at any time. It will train you to think on your feet, to converse in a natural, interesting way, to overcome self-consciousness and bashfulness, to acquire easy, logical thinking. My course is not a theory, but is purely and absolutely scientific—the result of more than 20 years of close, intimate contact with students in schools and colleges and searching their developing minds for means of strengthening their memories.

I Want to Send You My Book, "How to Remember," Absolutely FREE

Simply clip the coupon and mail it today. It will explain clearly the course that has raised thousands of men from failures to great successes. You can have this same training. My free book is the first step. Don't delay. Age, education, vocation or place of residence makes no difference. Send the coupon today.

How to Get a Free Copy of This Valuable Book

De luxe edition handsomely illustrated, richly bound. Is exactly suited to meet the needs of the man or woman who desires to be a successful public speaker. The price of this 1911 de luxe edition is \$2.00. I will, however, present a copy absolutely free to every student who enrolls for my course of memory training within ten days after reading this offer.



Prof. Henry Dickson

America's foremost authority on Memory Training, Public Speaking, Self Expression, and Principal of the Dickson Memory School, Auditorium Building, Chicago.

Prof. Henry Dickson
Principal, Dickson School of Memory
705 Auditorium Bldg., Chicago, Ill.

Send me free Booklet "How to Remember," also full particulars how to obtain a free copy of Dickson's "How to Speak in Public."

NAME

STREET

CITY.....STATE.....

Send the Coupon Today

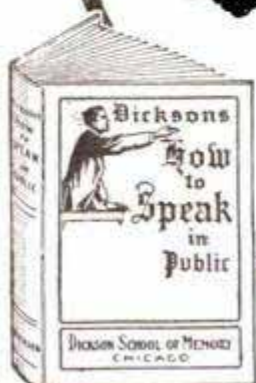

A NEW BOOK FOR WHICH THERE IS A REAL NEED

A PRACTICAL COURSE IN MECHANICAL DRAWING

"Written So You Can Understand It"

By WM. F. WILLARD

(For several years instructor in Mechanical Drawing at Armour Institute of Technology, Chicago.)

134 Pages
131 Illustrations

Price 50 Cents
POSTPAID

Cloth Cover
Size, 5x7 Inches

A book for individual study, shop classes, trade or high schools, and those who would like to know something of the DRAFTING PROFESSION.

WHAT OTHERS SAY ABOUT IT:

"It is one of the best books on Practical Mechanical Drawing I have ever seen and I can recommend it to any one who desires to make an individual study of drawing."

E. S. LIBBY, B.S., M.E., Prof. in Experimental Engineering, Armour Institute.

"This is a very useful little book, and every young fellow who is desirous of making himself more valuable to both himself and his employer will find it a great help in 'boosting' himself to a higher plane and 'bigger pay.'"

—THE NATIONAL BUILDER.

POWER GAS AND THE GAS PRODUCER

"Written So You Can Understand It"

The only authentic reference manual covering every detail of installation and operation which has been written in a non-technical manner. This book was prepared especially for the inquirer in this field who would like to be able to judge intelligently as to the economy and advisability of changing from other forms to Producer operation. It will also appeal to the engineer who wishes to understand thoroughly the working of the new system and thus be prepared to handle a plant competently.

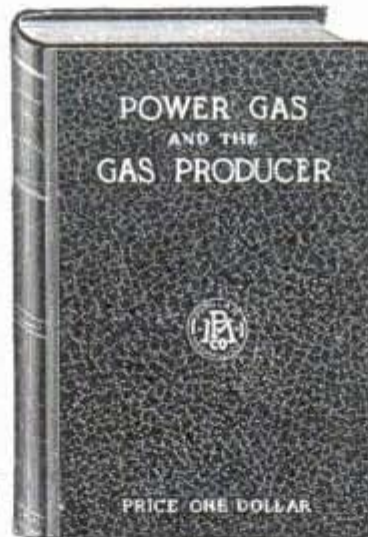

By J. C. MILLER, M. E.

One handsome, cloth bound volume of 192 pages, printed on the best quality of book paper and profusely illustrated.

Price Post-Paid \$1

The following list of chapter headings shows how thoroughly the author has covered his subject: Producer Gas and the Gas Producer—Classes of Gas Producers—Industrial Gases—Comparison of Heat Values—Types of Producers—Gas Producer Fuels—Gas Producer Operation—Gas Power and Steam Compared—Reliability of Gas Power—Gas and Steam Power Costs—Gas Producer Installation—Alphabetical Index.

PATTERN-MAKING

By G. H. WILLARD

WITH ADDITIONAL CHAPTERS ON

CORE-MAKING AND MOLDING

"Written So You Can Understand It"

A book for the man who has to do the work. Written by a practical pattern-maker of many years' experience. Gets right down to business in the first chapter and keeps it up throughout the book. Full of kinks and actual working information. Profusely illustrated. Every one following this trade, or intending to learn it, should have a copy of this valuable book.

224 Pages, 312 Illustrations, Cloth Cover

"Ten chapters are devoted to careful instruction for the making of specific patterns. The patterns chosen are of gradually increasing difficulty and cover practically all the points that come up in ordinary practice. Considering especially the low price of \$1.00, this book is remarkably practical and comprehensive. It is written in a style much more readable and effective than is usual with books on this subject."

—Engineering News.

Price \$1 Postpaid

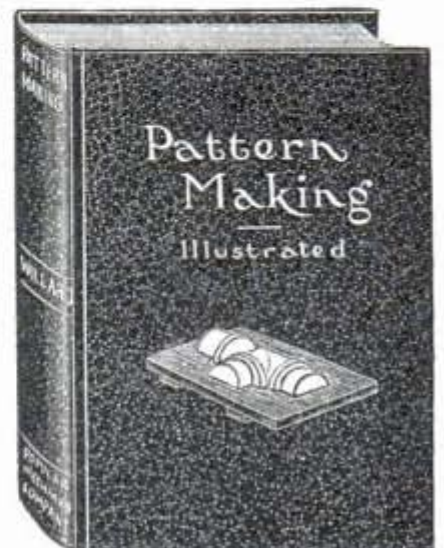

POPULAR MECHANICS BOOK DEPT., PUBLISHERS, CHICAGO

HOW TO RUN AN AUTO

Every Owner, Operator, Repairman and Intending Purchaser Should Have a Copy

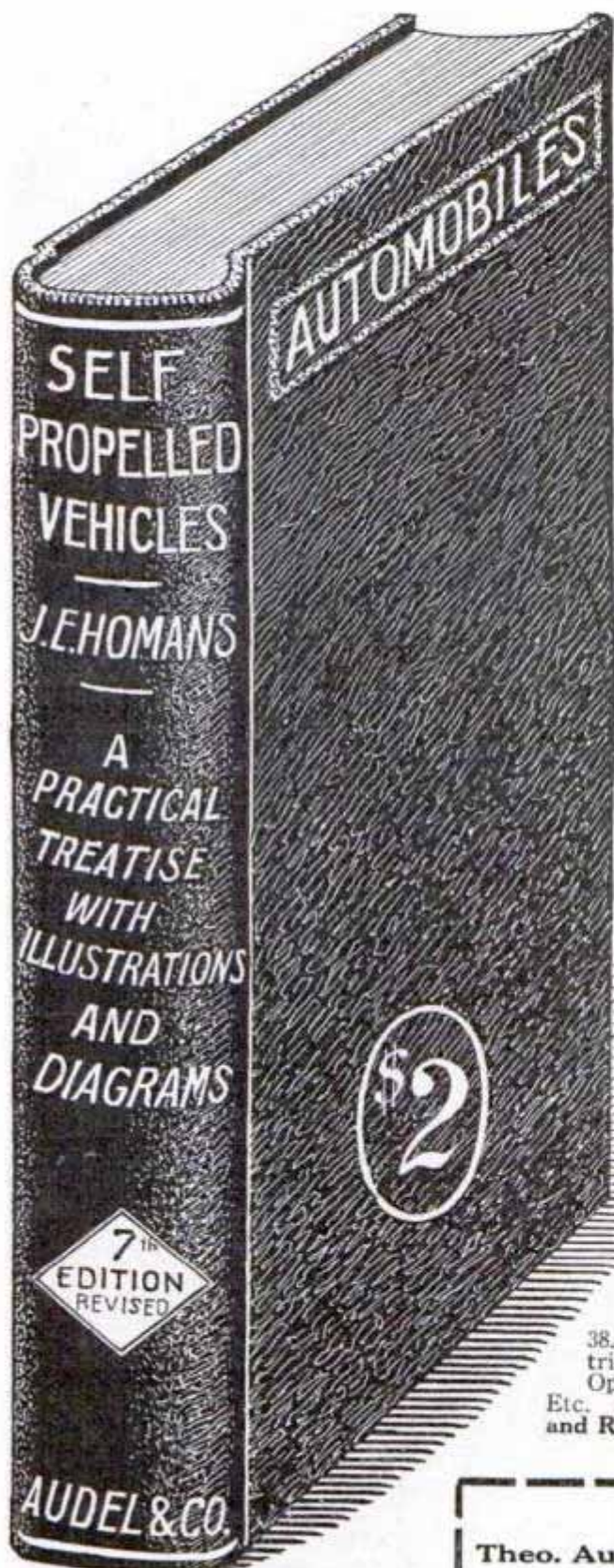

THIS up-to-date Edition tells in plain words how to keep your car in good running condition.

It is a good investment, highly approved by manufacturers and operators everywhere.

By its use you will learn how to set magnetos, time the valves, adjust the carburetters, etc., also how to make your own repairs.

It contains many "Shop Kinks" and "pointers" relating to one, two, four and six cylinder cars. It describes in detail the various types of ignition and wiring systems. It tells how to get the mileage out of your tires.

The book is a useful cyclopedia of automobile operation in one handsome volume of 675 pages, 400 illustrations, with ready reference Index. Price \$2.00 postpaid to any address.

Table of Contents

1. Brief History of Self-Propelled Vehicles.
2. Make-up of a Motor Carriage.
3. Compensation and Compensating Devices.
4. The Driving Gear, Methods of Power, Transmissions.
5. Steering a Motor Vehicle.
6. Combined Steering and Driving.
7. Motor Vehicle Supports.
8. Motor Carriage Wheels, Requirements, Types.
9. Solid Rubber Tires: Theory and Construction.
10. Pneumatic Tires: Advantages, Construction and Types.
11. Tire Troubles.
12. Tires: Care and Repair.
13. Types and Merits of Automobiles.
14. Theory of Gas Engines.
15. Parts of a Gas Engine.
16. Four Cycle Gas Engine.
17. Two Cycle Gas Engine.
18. Compression and Expansion.
19. Gas Engine Operation and Efficiency, Combustion.
20. Exhaust of a Gas Engine.
21. Water-Cooling System.
22. Air-Cooling System.
23. Power Elements of a Gas Engine.
24. All About Carburetters.
25. All About Ignition: High and Low Tension Systems, Wiring, Etc.
26. Balancing Gasoline Engines.
27. Governing and Control, Various Methods.
28. Clutches and Transmissions.
29. Transmissions: Principles and Construction.
30. Operation of Brakes.
31. Ball and Roller Bearing: Theory and Use.
32. Oils, Lubricants and Lubricators.
33. Practical Operation of Engines.
34. How to Operate Motor Cycles.
35. Operation of Steam Engines for Automobiles.
36. Boilers and Flash Generators.
37. Burners and Regulators.
38. Automatic Regulating Devices.
39. All About Steam Cars.
40. Electric Vehicles.
41. Principles of Electricity.
42. Dynamos and Motors: Operation and Construction.
43. All About Storage Batteries, Charging, Etc.
44. Methods of Circuit Changing.
45. Automobile Running, Care and Repair, with Words of Caution.

ORDER NOW ON APPROVAL

The only way the practical merit of this Manual can be given is by an examination of the book itself, which we will submit for examination, to be paid for or returned, after looking it over. Upon receipt of the following agreement the book will be forwarded.

NO MONEY IN ADVANCE REQUIRED

Theo. Audel & Co., 63 Fifth Ave., New York

Kindly mail me copy of Homans' Automobiles, and if found satisfactory I will immediately remit you \$2.00, or return the book to you.

NAME.....

OCCUPATION.....

ADDRESS..... (Oct. P. M.)

Classified Advertisements

Advertisements in this section, 10 cents per word, each insertion payable in advance. To insure ads being inserted under proper classified head in the November issue, copy must reach this office not later than October 1st.

Madison, Ill. August 24, 1911.

Popular Mechanics Magazine,

318 W. Washington St. Chicago, Ill.

Gentlemen: In response to your letter dated the 31st inst. will say that the "Patent For Sale" advertisement we placed in your valuable magazine, POPULAR MECHANICS, has brought more replies than we could answer, it can't be beat. Wishing you the success you deserve, we remain

Yours very truly,

F. H. FERAUD.

AUTOMOBILES

FOR SALE—Brush runabout fitted with box on rear. Has not been run more than 300 miles. Good as new. Just the thing for butcher, grocer or suburban home. Jno. R. Gammeter, Akron, O.

AUTOMOBILE INSTRUCTIONS, four weeks' course covering shop and road work—provision for out-of-town men. Send for booklet P. M. West Side Y. M. C. A. Automobile School, 318 West 57th St., New York, N. Y.

FOR SALE—"N" Ford, \$150; 10 Buick, \$250; Cadillac, \$150; five-passenger 40-hp. Wayne, \$350; 20 H. steam engine, \$100; 1/4 to 2 in. power-pipe threading machine, \$25. F. J. Rettig, Wabash, Ind.

FORD MODEL "T" four-cylinder, five-passenger touring car, fully equipped. First \$395.00 takes it. King, 2230 7th Ave., N. Y. City.

1910 MITCHELL 5-passenger touring car; fine condition; top, windshield, Presto-tank, extra tire, tubes, etc.; right price to quick buyer. F. N. Slingerland, 442 Hudson Ave., Albany, N. Y.

FORD FOUR-CYLINDER RUNABOUT, is as good as new. Full equipment, \$200.00. C. Kokesch, 2537 Belmont Ave., Bronx, N. Y. C.

50 NEW, 6-leaf, full elliptic, automobile springs, 1 1/2 x 38, \$1 each. F. E. Alford, Goshen, Ind.

1911 BRUSH ROADSTER nearly new. Fully equipped. H. E. Burlingame, Box 1435, Providence, R. I.

50 SINGLE CYLINDER Runabouts, Reos, Cadillacs and Oldsmobiles, \$60.00 each. King, 217 West 125th St., N. Y. City.

BUICK MODEL 10, five-passenger roadster, elegantly equipped, \$400.00. Spillane, 248 East 119th St., N. Y. City.

CADILLAC five-passenger touring car, \$110.00, perfect condition. McDonough, 147 Morningside Avenue, N. Y. City.

AUTOMOBILES—Hundreds of Runabouts, Roadsters, Touring Cars. Latest models. Guaranteed. Shipped freight prepaid. Write today for latest illustrated catalogue. The Automobile and Cycle Company—PM, 213-215-217 West 125th St., New York City.

TIRES—Another Big Sale On! 10,000 Goodrichs, Michelins, Diamonds, etc., at unheard of reductions. Every size for every rim. Guaranteed. Shipped on approval. Also 5,000 Motor-cycle tires sacrificed. The Automobile and Cycle Company—PM, 213-215-217 West 125th St., New York City.

FORD 1910 TOURING—four cylinder—twenty-two horse power—completely and elegantly equipped. Positively like new. Must sell, \$400.00. Photograph supplied. The "Theresa," Suite 18, 117 West 129th St., N. Y. City.

CADILLAC—5 passenger touring cars—only four, \$125.00 each! Nicely equipped. Guaranteed perfect running order. Chance of a lifetime! The Automobile and Cycle Company—PM, 213-215-217 West 125th St., New York City.

OLDSMOBILES SACRIFICED! A Hundred Perfect running Oldsmobile runabouts \$75.00 each! Great chance for dealers! The Automobile and Cycle Company—PM, 213-215-217 West 125th St., New York City.

FORD, 4 cylinder Runabout, runs and looks like new—\$200.00—photo. Shonnard, 114 Fifth Ave., New York City.

REO—FIVE PASSENGER touring—good as new—\$250. Particulars, photograph. Office 457 Thoroughfare Building, 972 Eighth Ave., New York City.

HOW TO EXAMINE and test secondhand automobile before buying. Written by one who knows. 15c. Mechanic Supply Co., Woburn, Mass.

WHITE STEAMER—30 hp, seven passenger, richly equipped, cost \$4,700.00, need \$500.00 quickly, picture furnished. H. W. S., 17 Washington St., East Orange, N. J.

CLEVELAND automobile, \$125. Aug. Bayard, Green Bay, Wis.

ON ALL 1912 AUTOS, lamps, horns and metal parts have gun metal finish. Make your car up to date. Apply "New Era Elastic Black Enamel" on all metal parts. Use brush—one coat only. Dries without heat. Waterproof. Always ready for use. Makes polishing unnecessary. Send 50 cents for can. Dealers wanted. New Era Lustre Co., 93 Water St., New Haven, Conn.

STEAM CAR OWNERS. Myers Kerosene Burner, something new; write for circular, 729 West Colfax Ave., Denver, Colo.

FORD TIMER ATTACHMENT. Changes timer to position where it can be cared for. Installed in 30 minutes. Write for circular. Spengler Optical Co., Geneva, N. Y.

FORD "1910" TOURING CAR, five-passenger full equipment, as good as new, first \$450 takes it. Write for full particulars. King, 2230 7th Ave., N. Y. C.

GET OUR LIST of used Automobile Bargains. Box 275, Burlington, Wis.

STEAM CAR Correspondence School. Particulars, 520 Fourteenth St., Denver, Colo.

AUTOMOBILE MODEL. Every part shown and named. You can to all intents and purposes take off the wheels, raise the hood and remove the body; exposing to view the vital parts. The only practical method of studying the automobile. Price 50 cents postpaid. Popular Mechanics Book Dept., Chicago.

"THE HOW AND WHY of the Automobile."—A 200-page book of practical information for seekers after the fundamental facts regarding the gasoline engine and its application to the motor car. Interesting and instructive to both the beginner and the expert. Bound in full cloth—250 illustrations. Price \$1.00 postpaid. Popular Mechanics Book Dept., Chicago.

FORD 1910 five passenger touring 22 horse power, perfect condition, full equipment, must sell, \$400.00. O'Brien, 2145—5th Ave., New York City.

AUTO SUPPLIES

FOR SALE—1 new 20-in. locomotive boiler and burner, \$60; 1 secondhand 18-in. boiler and burner, \$45; several 4 1/2-hp. steam engines, \$15; steering columns with wheel complete, \$6 to \$10; 1 1908 single cylinder Cadillac engine, 10-hp. complete with transmission, \$40; 1 2-cylinder Pope Hartford engine, 16-hp., complete with sliding gear transmission, a bargain at \$50. R. Roth, 1423 North Ave., Bridgeport, Conn.

12-HORSE OPPOSED AUTO ENGINE, 6-horse auto engine, 4-horse stationary mounted, \$35.00. Auto less tires and motor, \$30.00; front axle complete, \$10.00; steering gear, \$10.00; light running gear, \$15.00; runabout body with top, pumps, etc. Chamberlain, Bartley, N. J.

FOR SALE—One Bosch low tension magneto. Good as new. Suitable for marine or stationary engine for operating make-and-break, \$25.00. One 1 1/4-in. F. Schebler carburetor, \$5.00. One double coil, \$5.00. All in A-1 condition. Jno. R. Gammeter, Akron, O.

AUTO ACCESSORIES—WHOLESALE. 28x3 tires (all firsts), \$10.21. Other sizes, 25% off standard lists. Guaranteed spark plugs, 50c. 10% with order. Balance C. O. D., privilege examination. Geo. W. Bolton Co., Detroit, Mich.

DISTRIBUTORS, to sell famous Lady Elgin electrical horn. Retail \$15. Sent for \$7.50. Sample horn expressed paid to your city. J. Frank Kramer, Elgin, Ill.

LOOK! 1 1/4-in. Stromberg, \$6; 1 1/4-in. Holley, \$4; 1 1/2-in. Holley, \$5; double spark coil, \$5; all guaranteed. 463 Fourth Ave., Newark, N. J.

AUTOMOBILE OWNERS: HURRAH! Don't worry over a puncture. Permanent minute repair done with my kit. Guarantee. Booklet free. Joseph Campion Specialty Co., Benton Harbor, Mich.

GENUINE GUN METAL FINISH for automobile lamps; write for sample, Gun Metal Finish Co., Decatur, Ill.

4 CYLINDER FRANKLIN motor transmission, Carburetor, timer, coil, muffler, \$60; running gear, \$25. H. Kaskel, Spencerville, Ohio.

3 1/2 x 4 FOUR CYLINDER air cooled motor, carburetor, timer, coil, \$85.00. Butts, Oxford, N. Y.

AUTO CASES AND TUBES. Guaranteed—28x3, \$9.50; tube, \$3.03; 30x3, \$10. tube, \$3.10. 30x3 1/2, \$14.25; tube, \$3.75; 32x3 1/2, \$14.75; tube, \$4.25. Prices are for tubes by mail. Send for complete list. I ship, allow examination on receipt of 10% of order. The largest tire dealer in the central states. Try them. Many have reordered. Vanderpool, Springfield, O.

SAVE THE PIECES—Broken cylinders, crank cases, shafts, gears and housings promptly repaired just like new at one-third the cost and guaranteed. Address Welding Dept., Bertschy Motor Co., Council Bluffs, Iowa.

STEAM AUTO BOILERS Bought, Sold and Repaired. J. L. Lucas, No. 2 Fox St., Bridgeport, Conn.

SOMETHING NEW—"Auto heel rest" Aluminum. 75 cents postpaid. Lucas & Son, Bridgeport, Conn.

AUTO BODY POLISH—Used in Garage two years—sixty cents gallon to make. Formula, fifty cents. W. W. Snow, Spirit Lake, Iowa.

MOTORCYCLES

BUY MOTORCYCLES NOW—1911 Magneto Excelsior, New, \$190; 1911 Magneto Harley, new, \$190; 1911 Magneto Excelsior, nearly new, \$140; 1911 Battery Harley, perfect condition, \$120; 1910 Excelsior, \$100; 1910 Greyhound, \$100; 1910 Sears, \$90. We sell cheaper than anybody. Scrivens, Ashtabula, Ohio.

1911 FIVE-H.P. PIERCE, excellent condition, equipped with 8-in. lamp, prest-o-lite tank, luggage carrier, No. 5 Calvery saddle and full set tools. \$200.00 if taken at once. The Kahler Company, New Albany, Ind.

FEW MOTORCYCLES LEFT to be sold reasonably, devoting our entire time to aeroplane business. Chance to get bargains. List for three cents stamps. Rubel Co., Louisville, Ky.

MOTORCYCLES, \$50 UP. Indians, Royals, Thors, Harley Davidsons, Excelsiors, Wagners, etc.; every one guaranteed; send for bargain list and large motorcycle supply catalogue, repairs, etc. F. B. Widmayer Co., 2312 Broadway, New York City.

WE HAVE 15 N. S. U. Machines, Singles and Twins, all Magneto Models that we sell at actual cost. \$75.00 up. N. S. U. Motor Co., 206 W. 76th Street, New York City

YOUR MONEY BACK if you do not find Keller's Booklet, "Construction, Management & Care of Motorcycles" worth many times the price. Sent postpaid for 25c stamps or silver. Address E. W. Keller, St. Paul, Minnesota.

FOR SALE—ROYAL PIONEER motorcycle magneto ignition; used 500 miles; cost \$265. Sell \$100. Guaranteed. R. L. Barth, Lamar, Mo.

WANTED, old Model Motorcycle, condition immaterial, must be cheap. Spillane, 213 West 125th St., N. Y. City.

NEW 1911 HAVERFORD motorcycle. Run less than 200 miles. Magneto \$125.00. 2817 N. Bailey St., Philadelphia, Pa.

INDIAN TWIN cylinder motorcycle, fine condition, \$85.00. J. B. Parks, Lawton, Okla., P. O. Box 387.

NEW STANDARD SPEEDOMETER, perfect condition, with adapter for Indian motorcycle; run less than 1,000 miles, \$14.50; cost \$20.00. A. V. Benson, Loveland, Colo.

FOR SALE—1910 Indian Motorcycle; new tires; good condition, \$165. John Pearson, Box 596, Weatherford, Tex.

WILL SACRIFICE latest model twin motorcycle and cameras. P. O. Box 979, Schenectady, N. Y.

ROTARY BICYCLE SIRENS, \$2; motorcycle sizes, \$5 and \$6 Chain repair tools, \$1. Battery or magneto cut-out switches, 75c. Magneto covers, 75c. Coaster brake bicycles, \$25 up. Send for catalogue. F. Widmayer, 2312 Broadway, New York City.

TRADE 1909 motorcycle for moving picture machine film. C. Giles, So. Cumberland, Md.

1910 FIVE TWIN Indian Free Engine attachment, \$190.00. Taylor Bros., 8 So. Hudson, Okla. City, Okla.

WANTED—Good, serviceable motorcycle. Must be cheap. Blanchard Mill & Ele. Co., Blanchard, Iowa.

2% "THOR" factory overhauled, \$85.00. G. E. Kurk, Lawton, Okla.

1909 INDIAN motorcycle, \$100.00. Photo upon request. Chas. L. Barkley, Salisbury, N. C.

WANTED—MOTORCYCLES, any make, year or condition. King, 2230 7th Ave., N. Y. City.

FOR SALE—1911 Indian 7. Bargain. Wm. Leffler, Tiffin, Ohio.

CASH for used motorcycles. Rubel Co., Louisville, Ky.

MOTORCYCLES—Enormous variety of American and Imported makes—Indians, Marsh's, \$25.00. Hundreds of other bargains! Shipped freight prepaid. Write today. Large illustrated catalogue free. The Automobile and Cycle Company—PM, 213-215-217 West 125th St., New York City.

FOR SALE—Pierce Arrow four cylinder, run only 300 miles. Has Bosch Magneto, Schebler carbureter, luggage carrier and box. Prest-Lite and \$6.00 lamp; extra inner tube; tires new; cash \$150.00; absolutely in good running condition. O. R. Carlson, 124 West 9th St., Rochester, Ind.

TIRES—Another Big Sale of 5,000 motorcycle tires—Goodrichs, Diamonds, Michellins, at unheard of reductions—Every size for Every Rim. Guaranteed. Shipped on approval. Also 10,000 Automobile tires sacrificed. The Automobile and Cycle Company—PM, 213-215-217 West 125th St., New York City.

WANTED USED MOTORCYCLES—One or a car load! The Automobile and Cycle Company, 213-215-217 West 125th St., New York City.

INDIANS \$30, Wagners \$60, R. S. Twin \$95; other bargains. Get the largest motorcycle catalogue ever issued for 5 stamps. Wolke Cycle Co., Louisville, Ky.

MOTORCYCLES CHEAP—50 secondhand motorcycles that must be sold to make room for new Shaw Motorcycles. Send for special bargain list. Shaw Manufacturing Company, Dept. 30, Galesburg, Kansas.

TORPEDO MOTORCYCLE: Ready to ride, \$50. Photograph sent. "Motorcycle," 202 Sloan Ave., Syracuse, N. Y.

LECTRIC Motorcycle horns, \$2.50 prepaid, guaranteed, money back. Leslie Buzzell, Malden, Mass.

MOTORCYCLE CASES AND TUBES—28x2, corrugated, \$5. Bailey, \$5.50; tube, \$2.40. 28x2½, corrugated, \$5.75. Bailey, \$6.25; tube, \$2.65. 28x2¾, corrugated, \$6.25. Bailey, \$7. Nobby, \$7.75; tube, \$2.66. Single or double clinch. Guaranteed cases and tubes. Bailey type, single clinch, 28x2¾, \$7.75; tube, \$2.65. 28x2½, \$8.30; tube, \$2.82. Price of tubes is by mail including postage. Send postoffice order for tubes and 25% on cases and I ship, allow examination. Wm. Vanderpool, Springfield, Ohio.

DON'T BUY A BICYCLE Motor Attachment until you get our catalog and prices. Shaw Mfg. Co., Dept. 27, Galesburg, Kansas.

SUPPLIES—The largest stock in America. Immediate shipment. Lowest prices. A hundred new ideas shown in our big free catalogue P. Motorcycle Equipment Co., Hammondsport, N. Y.

INDIAN MOTORCYCLE, cheap for cash. Frank Paine, Route 5, Rosedale, Kansas.

PIERCE FOUR-CYLINDER MOTORCYCLES scarcely used and in first-class condition; for sale at very low prices. Wm. B.

RUBEL COMPANY AT LOUISVILLE, KY., can give you anything needed in the aeronautical line. Get their big catalogue of motors, propellers and supplies. A visit to their factory would convince you that they have the largest Aero Supply House in America. Enclose ten cents in stamps.

FOR SALE—A perfect Santos Dumont monoplane, thirty horsepower, fitted with pontoons for water and wheels for land. Guaranteed to fly. Just the thing for an amateur. Will demonstrate to purchaser or send photo while in flight. Reason for selling, buying two passenger machine. Price at Akron, O., \$800.00. Jno. R. Gammeter, Akron, O.

MODEL SUPPLIES, DRAWINGS that the smallest boy can understand, 3-ft. Bleriot or Antoinette with building instructions, postpaid, 15c. 40-in. Curtiss as used by Lincoln Beachey, price 25c. Ballbearing Shafts, 30c; 2½-in. rubber tired wheels, 30c. Send stamp for catalogue. Brooklyn Aeroplane Supply Co., 151 7th Ave., Brooklyn, N. Y.

WORKING DRAWINGS AND DESCRIPTION of Santos-Dumont's monoplane or Wright's biplane. Fifteen cents each, both for twenty-five. Hibline, 708 W. Lafayette, Baltimore, Maryland.

RACING MODEL, guaranteed flight 1,000 feet; everything ready for putting together; drawings and instructions \$2 postpaid. Large catalogue 5c. A. Melcombe, Castle Rd., Bedford, England.

INTERESTING CATALOGUE PRINTED IN COLORS of "Expanding Pitch" aeroplane propellers mailed on receipt of three cents in stamps. "Expanding Pitch" Propellers are the most efficient blades in this country. Rubel Co., Louisville, Ky.

USED AEROPLANE MOTORS, \$125.00 up. Rubel Co., Louisville, Ky.

FOR SALE—One Curtiss type aeroplane without power, one with power, and one 50-hp. aeromotor, all have made flights. Write for particulars. Longo Balloon and Bi-Plane Co., Danville, Ky.

HOW HIGH? HOW FAR? Why guess at the distance? Obtain it accurately with a Metroscope Cane; sent on receipt of \$1.00. The Metroscope Mfg. Co., 723 W. Mulberry St., Springfield, Ohio.

SEVEN AVIATORS with Gray Eagle Aero Motors are flying Curtiss type bi-planes. They cost but \$485.00 complete and fully equipped. Write for illustrated booklet of proof. Immediate deliveries. Rubel Co., Louisville, Ky.

AIR-SHIP FOR SALE, complete with silk bag, motor and tent, \$300 f.o.b. Seattle. H. P. Vidal & Co., New Westminster, B. C.

AEROPLANES in stock, immediate delivery. Rubel Co., Louisville, Ky.

COMPLETE PLAN drawn to scale with full instructions for building the only Wright 3 ft. Bi-plane Model that positively flies. 25c postpaid. Drawing and directions for three-foot model Bleriot Monoplane, 15c. Stamp brings most complete, interesting and instructive catalog published. Ideal Aeroplane & Supply Co., 82 W. Broadway, New York, N. Y.

ROTARY GAS UNIMOTORS. Air or water cooled. 32 explosions every revolution. Reliable as steam. Guaranteed, 100 hp., 200 pounds. Popular prices. E. R. Holmes, 620 N State St., Chicago.

LET US SUPPLY your wants. Everything for aircraft. 6 stamps for large illustrated catalogue Heath Aerial Vehicle Co., 3403 Southport, Chicago.

1 NEW 15-HP. Air-cooled Curtiss Motor, 4-cycle, 4-cylinder, with accessories, \$225.00. O. A. Loveless, Watersmeet, Mich.

ANZANI MOTOR, two cylinder, twelve horse, air cooled, weight sixty pounds. Perfect condition. \$150 with Longuemere and coil. Mack, 571-45th St., Brooklyn, N. Y.

RACING MONOPLANES: 30-in. x 40-in., flies 950 feet, very durable; excellent prize winners, \$1.25 postpaid; very speedy 3-ft. racer flies 1,000 ft., \$2.25. Robie Monoplane Co., Williams, N. Y.

OLDEST, MOST RELIABLE MODEL DEALERS in the U. S. Biggest line guaranteed models ready to fly 50c upwards. Special, guaranteed flyer prepaid \$1.00. Send stamp for catalogue. Aero flyer Company, Medford, Mass.

BENTON'S CHICAGO AERO WORKS, 164 North Wabash Ave. Aeroplane accessories, also models, wood, rubber, propellers. Stamp for catalogue.

AEROPLANE MODEL, won first prize St. Louis Aero Show; record flight 175 feet. 50c. Globe Sales Co., Box 542, Pontiac, Michigan.

WORKING DRAWINGS OF THE "DEMOISELLE." Santos-Dumont's remarkable monoplane, offered to the public for the first time. The set comprises seven large blue prints, showing every detail of construction, accompanied by a description of how to build. The machine is unencumbered by patent rights, the famous aviator placing his invention at the disposal of the world. Price \$2.00 postpaid. Popular Mechanics Book Dept., Chicago.

"VEHICLES OF THE AIR," the newest and only up-to-date contribution to the literature of aeronautics, contains large working plans of all successful modern flying machines. This book of 500 pages, 140 half-tone photographs and 130 drawings is the only book published containing every known fact of this interesting subject. Size, 9x5½ inches. Price \$2.50 net, postage 25 cents extra. Popular Mechanics Book Dept., Chicago.

MODEL AEROPLANES HOW TO MAKE AND FLY THEM. By W. Twining. Consisting of 5 sheets of scaled drawings, showing three different models, with descriptive booklet. By mail 55c. Popular Mechanics Book Dept., Chicago.

PATENTS SECURED on Aeronautical Inventions. C. L. Parker, ex-examiner Patent Office, 910 G. St., Washington, D. C.

BAMBOO SPECIAL GRADES for Aeronautic Work. Reed, Rattan, Split Bamboo for models. J. Deltour, Inc., 49-6th

ENGINEERS' questions and answers for license, by Hobson, for twenty-five cents, postpaid. Send stamps. Reilly's Book Store, Philadelphia, Pa.

GASOLINE STERN WHEEL BOATS: Their design and equipment; 15 illustrations; data from 50 boats, 10c. The Gas Engine, Cincinnati, O.

FOR SALE: BOOKS: Many scarce items. List free. W. W. Yarey, 521 Crittenden, Owensboro, Ky.

WE ADVISE YOU FREE, and Loan By Mail the very best standard books on Success, Business, Recreation, Health, Home, Social and Political Problems, Religion, New Thought, etc. Prompt service. No security or tiresome rules. Full lists and weekly bulletin for postal with your name and address. Oriental Esoteric Society, 119, Washington, D. C.

BOOKS, ANY KIND you want. Catalogs free. Reese Publishing House, Mt. Pleasant, Pennsylvania.

WIZARD'S MANUAL explains Ventriloquism, Mind-reading and Magic Tricks. Price, 25c. Crescent Co., Box 111, Aurora, Nebr.

READ "The Mail Order Merchant," a monthly money making magazine. Special six months only 15c. H. Latz, Atlantic City, N. J.

FOR SALE: A very little used pocket Kent, \$3. F. H. Tiltonson, 4167 Lake Ave., Chicago.

THE ROADMAN'S GUIDE or Money Maker's Manual is the best selling one dollar mail order book ever published. Circulars furnished. Write for sample circular and prices or send 10 cents postage for sample copy of the book. Address J. C. Burrow, Publisher, 533 Fourth Avenue, Louisville, Ky.

INTERESTED IN GASOLINE ENGINES? Send 50c for booklet, "How to Run and Install Gasoline Engines," and a year's subscription to Gas Energy, 28 Murray St., New York.

GOOD RESULTS, greatest mail order magazine published, three months 10c. Good Results, 2014 A West 25th St., Chicago.

3,000 MONEY-MAKING FORMULAS, 368-page cloth bound book 25c prepaid. Scientific book catalogue free. Clarence Hardage, Syracuse, N. Y.

YACHT AND BOAT BUILDING BOOKS, ship pictures, etc. Send for 80-page illustrated catalogue. The Rudder Publishing Co., 3 Hudson St., New York City.

GAS FOR POWER is taking the place of steam for reasons of economy. Learn all about this great change by reading our new non-technical book on this subject, written by a first class authority for the practical man. 192 pages, profusely illustrated, cloth binding. Price \$1.00 postpaid. Popular Mechanics Book Dept., Chicago.

"METAL SPINNING" is the name of the only book published on this interesting art. A concise working manual both for those who desire to spin metal as an art recreation and to follow this work as a trade. 80 pages. 33 illustrations. Price, 50 cents postpaid. Popular Mechanics Book Dept., Chicago.

"KEEN KNOWLEDGE" subscription 25c. Advertising 2c per word, \$1 per inch, three times. Palmland, Floral Park, N. Y.

EDUCATIONAL AND INSTRUCTION

SUPERINTENDENCE OF BUILDING CONSTRUCTION—instruction given by specialists in all branches, who are actually engaged on high class New York City work; you learn from the start; terms low. Address, giving present occupation, P. O. Box 41, Mount Vernon, New York.

AMERICA'S FINEST PENMAN teaches rapid, tireless writing by mail. Small cost. Wire, write or telephone. Francis B. Courtney, Cedar Rapids, Iowa.

STENOGRAPHERS—Our tested system increases speed 50 to 100 per cent. No pay unless salary is increased. School Speed Stenography, 1215 Harvard, Washington, D. C.

FREE TUITION BY MAIL: Civil service, drawing, engineering, electric wiring, agricultural, poultry, normal, academic, book-keeping, shorthand courses. Matriculation, \$5. Tuition free to first applicant. Apply to Carnegie College, Rogers, Ohio.

CLASSES IN DRAWING and mathematics, Sundays from 9-12 at 822 North Clark St. H. Hanstien & Son.

SHORTHAND IN SEVEN LESSONS. Quickly learned at home. Most rapid readable system. Most rapid numbers. Send 10c now, and 25c in 3 days, or return book. Unigraph Co., Omaha, Nebr.

YOUR OPPORTUNITY to secure six illustrated lessons with instructions, from a celebrated teacher in penmanship for 50c; write today. Luther System, 5234 W. 25th Place, Cicero, Ill.

YOU CAN WRITE 100 WORDS a minute without knowing Shorthand. My new method, Abbreviated Loughand, simpler than the simplest shorthand, tried and approved by thousands. Your money back if not delighted. Sample lesson 20c. Full particulars free. Write today. A. B. Weaver, Court Reporter, Dept. C, Buffalo, N. Y.

\$200 TO \$600 MONTHLY easily made fitting eyeglasses. Short, easy mail course. Diploma. Special reduced tuition fee. Big demand for opticians. Best and easiest money-making business. Quick sales. Tremendous profits. We assist you to start. Write today for free "Booklet 4." Tells how. National Optical College, St. Louis, Mo.

LEARN TO PAINT BEAUTIFUL art glass pictures. Inexpensive. Easily learned. Big profits. Particulars for dime. La Bowers, Bluefield, W. Va.

HOME-EDUCATIONAL SCHOOLS (established 1891), thorough courses, practical in all subjects, made and tested by years of experience. Address Home-Educational Schools, Dept. 8, 17 E. Third St., Dayton, Ohio.

TELEPHONE PRACTICE. Complete instructions by mail; qualifies men for quick advancement to high position. Write for particulars. The Sinclair School of Telephony, Cambridgeport, Mass.

ELECTROPLATING. Learn this useful occupation from our 112-page treatise. It is "written so you can understand it" and will enable the humblest beginner to make a start. Price, 50c postpaid. Popular Mechanics Book Dept., Chicago.

BEST SHORTHAND BOOK for home study. Thousands of successful stenographers learned from it; so can you! Pitman system complete, cloth bound, handy size, finest engraving; specially arranged for self-instruction. Price \$1. Every book contains coupon entitling the purchaser to receive one month's practical instruction by mail. Lessons given by the author, Eldon Moran, our best known American Shorthand Instructor. Students are introduced and correspond with each other. The time to begin is Now. Young people succeed well. Book well worth \$1; besides, mail lessons worth \$2 will be received without extra cost. Book and lessons sent immediately upon receipt of order. Address Popular Mechanics Book Dept., Chicago.

PICTURES AND POSTCARDS

GET THE LATEST SET of screamingly funny high-grade comic post cards in ten different designs, entitled "How Can You Do It." Forwarded to any address upon receipt of only 12c. Green's Supply Company, Dept. P, 82 Times Square Station, New York.

IF YOU REALLY WANT to exchange post cards, try our splendid club. Lists circulate in many countries. Membership, 10c. Halcyon Club, Box 133, Erie, Pa.

POST CARD FOLDER, containing 22 beautiful colored scenes along the Columbia River, in a fine imitation burnt leather cover. Send 10c. Orders filled promptly. N. B. Pearson, 214-214 1/2 Fourth St., Portland, Ore.

YOU'LL GET CARDS from everywhere. Membership 10c. Idaho Card Exchange, Dept. K, Box 906, Boise, Idaho.

ABSOLUTELY FREE! Receive postals from everywhere between Gotham Town and Frisco, by joining our club. Offer expires Nov. 1, 1911. O. Pendergast, 2006 North 9th St., Terre Haute, Indiana.

RED HOT SELLERS. Photographic Post Cards of Chicago aviation meet, August, 1911. 50 subjects. Aviators, machines, wrecks and races; 6 for 25c. 100, \$2.50. Hornby & Freiberg, 153 No. LaSalle St., Chicago.

JOIN HUB POST CARD EXCHANGE, 3 months 10c. One year 25c. Ross Charles, Roxbury, Mass.

ART LOVERS: Send for beautiful landscape water color pictures. All original. No two alike. Only \$1.50. Dealers charge \$4.00. Save \$2.50 buying direct from artist. If you are not satisfied, return picture and I will refund your money. Yours for art, J. Gorman Strasler, 15 Central St., Elkins, West Va.

FINE POSTCARDS; 12c stamps brings 20 highest grade. Robt. G. King, 117 Garland Ave., Youngstown, Ohio.

MOVING PICTURE Post Cards, sample dime. Ferguson's Mutoscope Co., Springfield, Missouri.

POST CARDS—50 high grade samples, 25c. P. M. Fitzgerald, 110 Fulton, Brooklyn, N. Y.

YOUR OWN PHOTO, or any picture, on twelve handsome photo post cards, three hand painted natural, lifelike colors and beautifully embossed, 70 cents. Send best picture. It will be returned unharmed. Samples for stamp. Photo-Art Gallery, Fargo, Okla.

TRIP AROUND THE WORLD. Tour of American Continent. 25 post cards each set. Beautiful colors from actual photographs. 20c set postpaid. Roth 35c. Eastern Sales Co., 90 Pearl St., Hartford, Conn.

BARGAINS: Post Cards; Dandies, \$1.00 per thousand. Sample hundred, prepaid, 25c. Write for bargain list. Publishers Clearing House, 35 So. Dearborn, Chicago.

POST CARD EXCHANGERS' 20 artistic post cards free with large list of new members, 10c. Maple Valley Card Ex., Box 1183, Pittsfield, Mass.

TRADE SCHOOLS

WANTED—Men. Apprenticeship plan reversed; the student does the work instead of watching the journeyman. Men learn in a few months trades of electricity, automobiles, plumbing, bricklaying. Pay or board at the start. Actual contract jobs. United Contracting Co., 658 P. E. Bldg., Los Angeles, Cal.

AUTOMOBILE SCHOOL. You learn with your hands under the superintendence of the best instructors obtainable at the Chicago School of Motoring. Write for particulars. F. E. Edwards, Inst., Dept. "B," 1619 Michigan Ave., Chicago, Ill.

ELECTRICITY, PLUMBING, BRICKLAYING, PAINTING and Decorating and Mechanical Drafting, taught quickly by expert workmen. Actual work takes place of books. Tools and materials furnished Free. Splendid positions always open. Oldest, largest and best equipped trade school. Write for catalog. Coyne National Trade Schools, 85 E. Illinois St., Chicago.

CAMERAS, PHOTO SUPPLIES, ETC.

SPECIALISTS IN SELLING, EXCHANGING, second-hand cameras and lenses. Full line of kodaks, Century, Premo and Graflex Cameras; supplies. Send 3c in stamps for catalogue and bargain list, "P." Glockner & Newby Co., 171 Broadway, New York City.

FILMS DEVELOPED, 10c per roll. All sizes. Prints: 2 1/4 x 3 1/4, 3c; 2 1/2 x 4 1/4, 3 1/2 x 3 1/2, 3 3/4 x 4 1/4, 4c; 3 1/2 x 5 1/2 and 4x5, 5c. On post cards, 5c. Prompt returns. Highest grade work. Send 2 negatives and will print free as sample. G. R. Hoke, 6206 Jefferson Ave., Chicago.

FILMS, PLATES DEVELOPED FREE. Prints, all sizes to 5x7, 40c per dozen. Post cards same price. 20 years' experience. Mail orders. Capacity 500 rolls per day. Always busy. Why? Davidson. McVickers Theatre, Chicago.

HOW TO MAKE a smokeless flashlight outfit, simple and cheap. Complete instructions mailed for 25c. Photographer, 31 Maple St., Corona, Long Island, N. Y.

ENLARGEMENTS MADE to any size from plate or film negatives, pictures or photographs. Cameras and supplies. New catalog and price-list for the asking. Write to-day for your copy. Address T. Harold Knight, Dept. C, Racine, Wis.

BOYS' "IMPERIAL" GUARANTEED CAMERAS, finishes pictures complete two minutes, sample prepaid 50 cents. Enormous seller. Imperial Camera Co., 807 Valley Street, Dayton, Ohio.

ARE YOU INTERESTED in new original color photography? Send for free circular of advice. R. Isenmann, 385 Bergen St., Newark, N. J.

GOING TO BUY A CAMERA? Postal brings catalog and full information. L. J. Peabody, 278 Devonshire St., Boston.

KODAK FILMS DEVELOPED, 10c per roll, any size. Prompt attention given mail orders. Prints 2 1/4 x 3 1/4 to 3 1/4 x 4 1/4, 3c; 4x5 to 3 1/4 x 5 1/2, 4c. J. M. Manning, 1062 Third Ave., New York City.

WE BUY, SELL AND EXCHANGE. Bargains in Microscopes, Telescopes, Field Glasses, Cameras, etc. Catalogue and Bargain List free. Kahn & Co., Established 1850, 26 John St., New York.

BUSINESS OPPORTUNITIES

MAKE BIG MONEY operating a Daydark Post Card Machine. Photo postal cards made and delivered on the spot in ten minutes in the open street. No dark room necessary—it does not require an experienced photographer to make first-class pictures. Pays a gross profit of 500%. Write to-day for free sample and catalogue. Daydark Specialty Co., Dept. K, St. Louis, Mo.

LET ME START YOU manufacturing name plates, numbers, glass, checkerboards, etc. Make \$25 a day. I sold 40,000 plates in ten years. Write for free booklet. Sixty illustrations. E. E. Palmer, Wooster, Ohio.

WANTED—ONE GOOD MAN in each town to take orders for made-to-measure clothes. Up-to-date styles, very low prices; orders come easy. High-class permanent business; splendid profits, \$5.00 a day and up. No money or experience needed. We ship on approval, express prepaid, and guarantee perfect fit. Write for territory, terms and free samples. Banner Tailoring Co., Dept. 187, Chicago.

POTATO MACHINERY FACTORY having a fine line of machines, wishes to sell factory and equipment, including controlling interest to a live party or firm. The factory is well situated in the central west, has first class planter, digger, sorter, sprayer and cutter, all established with first class jobbers and selling by car loads. Can be had for much less than actual value. An unequalled opportunity. Address, B. H., 6th floor, 318 W. Washington St., Chicago.

MAKE MIRRORS AT HOME. Big profits with little outlay. One 18x36-in. mirror costs \$2 to \$5. You can silver a glass this size for 20c. Send \$1 in stamps or money order and we will send you explicit directions how to do it; also how to emboss, grind, foil, gold leaf, frost, chip and make imitation stained glass. How to transfer photos on glass, bore holes in glass and cut sky lights. George L. Patterson & Co., Dept. 3, Brooksville, Ky.

MAKE MORE MONEY! Start a mail order business; operate a "silent salesman" system; spare time; possibilities unlimited. The best money making propositions are in "Booster." Get away from wage slavery! "Booster" starts you in business for yourself with small investment. Send 10c for two months' trial. Booster Magazine, 360 Northwestern Bldg., Chicago.

WANTED—PARTNER OR CAPITALIST, to finance the marketing of my improved Rotary Expansion Engine, with patented Rotary valve. No special machinery required. Durable, simple, compact. Compares favorably with reciprocating engines and requires but 2/3 the space. Other patents pending. Principals only. (Address) Robt. W. Riordan, 399 Rugby Road, Brooklyn, N. Y.

FOR SALE OR TRADE—Brick and tile factory, good location, sheds, machinery, kilns, on two railroads, best reason for selling, will bear investigation. If you want a bargain write Zales S. McGinnis, Aledo, Illinois.

FOR SALE—To close up an estate, bicycle and general repair shop, with a sporting goods and cutlery store, and novelties, \$3,500.00 for \$2,500.00; a snap; established 20 years. M. N. Wertz, Adm., Thomsville, Ga.

BICYCLE AND MOTORCYCLE STORE, established for years, doing more business than ever, price less than \$1,000; owner has other business. 732 Madison, Covington, Ky.

WRITE MOVING PICTURE PLAYS. Big demand; anyone, anywhere, can do this work. Complete instruction, list of those who buy them, \$1. La Favorite, 62 Franklin St., Jersey City, N. J.

LEARN THE TRUTH about Mail Order Business before buying "outfits." Important information and particulars for starting free. Mail Order Library, P. M. Tompkinsville, New York City.

EARN \$10 A MONTH on \$10 investment. Use all your time or spare time. No lottery. No gambling. Strictly legitimate proposition. Nothing to sell but plan. Get booklet and full particulars. Thos. A. Hill, 3300 Quivas, Denver, Colo.

WRITE PICTURE PLAYS. Big demand. Good pay. Easy to learn. We'll teach you. Particulars free. Address today United

MAKE \$2.50 TO \$5.00 spare time cleaning and glazing ladies' furs; all profit; complete instructions 50c. Satisfaction guaranteed. Morehouse, Furrier, 822 Fifth, Des Moines, Ia.

YOUNG MEN (gentlemen) who are looking for a real business opportunity and who would appreciate same are invited to correspond with the undersigned. William Mullally, 8 So. 12th St., Newark, N. J.

5,000 FORMULAS AND TRADE SECRETS for the home, farm, laboratory, workshop and every department of human endeavor. The entire collection, postpaid, \$1. Process Company, 415 Ft. Dearborn Bldg., Chicago.

BIG PROFITS: Open a dyeing and cleaning establishment, very little capital needed. We teach a successful method by mail. Write for booklet. Ben-Vonde System, Dept. C, Charlotte, N. C.

I MADE \$50,000 in five years with a small mail order business; began with \$5. Send for free booklet. Tells how. Heacock, Lockport, N. Y.

\$2.00 STARTS MAIL ORDER BUSINESS, new original plan, sample free. Ha. Reynolds, 622 Leavitt St., Chicago, Ill.

START HOME BUSINESS. Sell your ideas, plans, formulas and knowledge by mail. Some make \$1,000 monthly. Instructive booklet for stamp. Information System, 258, Marietta, Ohio.

YOUR OPPORTUNITY: Start mail order or local business, or add to your present line. Write Maryland Sales Co., Baltimore.

DON'T SLAVE. Learn to re-silver mirrors, new method. Metallize flowers, transfer photos to watch dials. 10c each, three for 25c, no stamps. The Mills Co., Box 744, Dallas, Texas.

I HAVE AN OPENING for a few more intelligent, ambitious young men to join me in a legitimate, money making business. Wilmont C. Pearse, Grand Rapids, Michigan.

INCREASE YOUR INCOME! Be a Sales Reporter and earn \$50 to \$150 monthly. Nothing to sell. Great sideline. Particulars for stamp. Sales Reporter, Caywood, N. Y.

MAIL DEALERS: You can make 95c profit on every \$1.00 order. Write quick for Leader Propositions. Van Buren Supply Co., 350 Crane Bldg., Racine, Wis.

BEST 10c Mail Order Book out. Explains business fully. Barstow Co., 514 23d St., Oakland, Calif.

WANTED—To trade good incoming Waterloo property for clean stock hardware. J. B. Green, 808 Walnut St., Waterloo, Ia.

A SPLENDID CHANCE to make money. No experience necessary; success certain. For particulars address Hixson & Co., 2796 E. 68th St., Cleveland, O.

FREE YOURSELF FROM WAGE DRUDGERY! Send stamp at once for 12 Valuable Dollar Getting Trade Secrets; start a profitable business of your own and become independent. "Be Money Back Store," Baltimore.

MEN WANTED FOR GOVERNMENT POSITIONS—October examinations everywhere. Influence unnecessary. Average salary \$1,100.00. Annual vacations. Send immediately for list of positions open. Common education sufficient. Franklin Institute, Dept. N 82, Rochester, N. Y.

MANUFACTURERS—We want a good agency. Send full proposition. United Agencies Co., Newark, N. J.

MAKE MONEY WRITING SHORT STORIES. Big pay. Free booklet. Tells how. United Press Syndicate, San Francisco.

LEARN THE ART of silvering mirrors at home, complete instructions, 25c. H. Clark, 2019 N. Carlisle, Philadelphia.

FORMULAS for anything, 25c each. Mystic Company, Washington, D. C.

INDEPENDENCE and fortune quickly attained in the Manufacturing Mail Order Business. I furnish formulas, manufacturing processes and trade secrets in all lines. Sold under a positive guarantee; 18 years' practical experience. Revision and improvement of formulas and processes; reduction of manufacturing cost; utilization of waste materials, etc., a specialty. Booklet, formula list and valuable information free. W. L. Cummings, Ph. D., 127 Standart St., Syracuse, N. Y.

INCORPORATE your patents and business under Arizona Laws. Cost very small. No annual or franchise tax. Members exempt from corporate debts. No public statements required. No restrictions. Hold meetings and do business anywhere. Charters cannot be repealed by subsequent laws. Particulars, laws and forms free. Southwestern Securities & Investment Co., Box L188, Phoenix, Arizona.

NOW LISTEN:—Our Mail Order Encyclopedia (3 volumes) tells how to build up profitable mail business without capital; our co-operative plan helps you do it. Write today. Herman Co., Spruce & 58, Philadelphia, Pa.

MONEYMAKING MAIL ORDER PLANS by which anyone can increase their income with small capital. Send for free booklet. The Stoddard Company, Room 505, 47 Orange St., New Haven, Conn.

START A MAIL ORDER BUSINESS at home. You can make a success from the start. We furnish catalogs, circulars and merchandise at wholesale. Send for our proposition at once. It's free. Peerless Trick & Novelty Co., 3146 & 3148 State St., Chicago, Ill.

ENCYCLOPEDIA BUSINESS OPPORTUNITIES and Trade Secrets, 2 volumes, containing 2,716 rare formulas, 365 valuable schemes, etc. Price \$3.00. Yours for \$1.00; further information

I'LL SHOW YOU how to start a profitable Mail Order business of your own, quickly, inexpensively and sensibly without any advance payment, if honest. Expert, P. O. Box 1615, N. Y.

BE A CHEWING GUM Manufacturer at your home. No machinery necessary. 500 per cent profit. Complete formula \$1.00. Particulars free. A. J. St. Germain, 72 Canal St., Lewiston, Maine.

SEND US 25 CENTS and we will send you complete instructions for silvering and re-silvering mirrors. Box 283, Scranton, Pa.

WHEN YOU ARE SICK you call a doctor. When your business is not doing well, do the same. We are business doctors. Write for our free plans on making your business a big business. Better Business, San Diego, Calif.

YOU CAN START IN BUSINESS for yourself at home. Particulars free. M. Haynes & Company, 37 Bible House, New York.

MAIL ORDER BUSINESS—Priceless information free. Peter Cobbs, Hoboken, N. J.

MAIL ORDER BUSINESS FOR SALE: Retail value, \$250. Snap for \$35. Carden Mfg. Co., 821 Market St., San Francisco.

AGENCIES AND DEALERS, get prices and territory for sale of Victor Furnace Tender. Universal, Automatic, sells \$7.50. V. E. Cozine, Gloversville, N. Y.

I WILL START YOU earning \$4 daily at home in spare time, silvering mirrors; no capital; send for free instructive booklet, giving plans of operation. G. F. Redmond, Dept. 306, Boston, Mass.

BUILD A BUSINESS of your own and escape salaried drudgery for life. Learn the Collection Business. Limitless field; little competition. Few opportunities so profitable. Send for "Pointers" today. American Collection Service, 101 State St., Detroit, Mich.

HAVE YOU ANYTHING TO ADVERTISE? Our Rate Book tells you all about advertising mediums, rates, circulation, closing dates, etc. Sent for 10c. Worth dollars. Folder free. Correspondence invited. Dearborn Advertising Agency, 455 Franklin Bldg., Chicago.

RAISE GINSENG—\$1 per square foot of ground. \$25,000 on 1/2 acre. Grows anywhere: 1/2 city lot a bonanza. 10c brings booklet. Sheboygan Ginseng Gardens, Sheboygan, Wis.

WE START YOU in a Permanent Business with us and furnish everything. We have new easy selling plans and seasonal leaders in the mail order line to keep factories busy. No canvassing. Small capital. Large profits. Spare time only required. Personal assistance. Write today for plans, positive proof and sworn statements. J. M. Pease Mfg. Company, 181 Pease Bldg., Michigan St., Buffalo, N. Y.

BE INDEPENDENT. Start Money Making Mail Order Business at Home. New plans. Everything furnished. Only small capital required. Free booklet and particulars tell how. W. P. Miller Co., Box 254, Muskegon, Mich.

PATENTS SECURED—C. L. Parker, ex-examiner Patent Office, 910 G St., Washington, D. C.

METALIZE FLOWERS, Insects, etc., for jewelry. Pleasant, profitable employment. Send stamp for free sample and booklet. P. Benson, Stewartville, Minn.

I MADE \$18,000 in three years in mail order business. Dollar booklet free, tells how. H. System, 125, Marlon, Ky.

FORM A CORPORATION—Congress Law for D. C. and all States; cheap. Raise money easily; advice free. U. S. Legal Corporation, Washington, D. C. Representing \$1,225,000,000.

CEMENT

MAKE YOUR OWN DOWN-FACE MACHINE for \$1.00. Any style face-plate for three cents each. Simple. Speedy. Blocks rest on face plates until hard. Directions and drawings \$1.00. Money back if not as represented. Concrete, Box P 183, Clinton, Ontario.

IF YOU WANT the best information on cement and concrete construction, subscribe for Concrete, leading cement and concrete monthly. Sample copy, 10 cents. Yearly subscription, \$1.00. Concrete, 135 Newberry Bldg., Detroit, Mich.

BLACKSMITHS

BLACKSMITHS' CALIPERS AND DIVIDERS, the latest pattern, made of special steel by expert workmen. Write for catalogue. Address Gallagher Bros., Uhrichsville, O., Dept. A.

GOOD BLACKSMITHS ARE SCARCE and few learning the trade and the blacksmiths must make the tools for all—from surgeon to the safe blower. Buy Toy's Modern Methods Forging and Welding different kinds of steel solid, and doing all hard jobs easy, also hardening and tempering to a standard by colored charts. Any smith can be an expert that means good jobs and big money. All for one dollar. Send for valuable samples free. W. M. Toy, Sidney, Ohio.

DUPLICATORS AND DUPLICATING DEVICES

How to get a Hektograph that will make 150 copies in 10 minutes; letter size, \$2.00. Write for circular. Heyer Duplicator Co., 118 No. La Salle St., Chicago.

COLLECTIONS

ACCOUNTS collected anywhere; legal opinions. Charles Fitzgerald, Roanoke Building, Chicago.

ACCOUNTS COLLECTED ANYWHERE. Fidelity Credit Co., Richmond, Va. Collections. Law.

DOGS, POULTRY, AND LIVE STOCK

SHEPHERD BONES for sale by E. J. Andrews, Soap, Bristol.

AGENTS WANTED

NEW SUIT OFFER! Just send us your name and you will promptly receive the most astonishing—yes, wonderful suit offer, together with Paragon Complete Outfit, packed with big assortment of Cloth Samples, Tape Measure, Fashion Figures, Order Blanks, etc.—all absolutely Free by Return Mail, Postpaid. This includes an offer on a fine suit for yourself so liberal it will startle you, and our Grand Offer to start you in a big money-making business for yourself. Our wide-open terms, conditions and privileges will astonish you. The low prices we will make you on men's high-quality clothes will amaze you. And we pay all express charges. We go to the limit in liberality. We want you for our agent in your town, so that we can turn all our business over to you. We will start you in a big, established, money-making business. New agents make \$40 a week. Do you wonder that our agents make all kinds of money? We must have an agent in your town. Get our Grand Offer and the Special Paragon Outfit, which is already packed with big Assortment of Cloth Samples and complete equipment, ready to be sent you free, charges paid by us. "First Come, First Served." Rush your answer to us quick if you want a suit for yourself, before some one else gets the prize. Address Dept. 11, Paragon Tailoring Co., Chicago, Ill.

SALESMEN WANTED to sell our celebrated "Never Rust" to manufacturing establishments, machinists' tool and supply houses, sporting goods houses, hardware, house furnishing and department stores, also office buildings and residence trade. "Never Rust" is used everywhere for rustproofing all metals. We protect our representatives and assists them in building up a legitimate, profitable and permanent business of a substantial and dignified character. Write for particulars. Bancroft & Company, Harrison Building, Philadelphia.

SELL XMAS GOODS in Oct., Nov. and Dec., no matter what you do the other 9 months of the year. You can't fail to make big money taking orders in home town. No experience necessary. Outfit furnished. Work all or part time. Our 1912 catalog beautifully illustrates 5,000 quick sellers all sold on money-back-if-not-satisfied plan. Signed guarantee for every customer. Extra valuable premiums besides liberal cash commissions. \$1,000.00 prize contest begins Oct. 1st. Express on goods prepaid everywhere. Write today for territory and the most magnificent, expensive and complete agents' catalog ever made—it's free. A. W. Holmes & Co., Dept. F-3, Providence, R. I.

AGENTS: To sell the newest electric appliance on the market; sold everywhere there is electricity, in the home and office; liberal profit; sales driving sample, weighs a pound, no experience or knowledge of electricity required; it shows how to use one light instead of two and get the same results; sells for \$3.50 and saves the purchaser an investment of \$25; write for particulars. The Handy Light Co., 211 Opera Place, Cincinnati, Ohio.

Simply show it and sell it. Make \$5.00 to \$20.00 a day. Stevens Standup Scrubber—only one that scrubs with a brush (as it should be done), mops with a cloth, wrings cloth between rollers, without twisting or tearing, cleans baseboards, windows, walls. No stooping, no wet hands, 130% profit to agents. Credit given. Get it now, but act quickly, for territory is going fast. Elmer E. Stevens, 1189 Curtiss St., Downers Grove, Ill.

EARN A HANDSOME SUIT. Our agents' wholesale Price List is wonderful for its low prices. Fine tailor-made Suits, \$8.75 to \$24.00; pants, \$2.75 to \$7.50. Finest clothes in America. Free samples go with first letter. If you want to make this your regular work, you can earn about \$8.00 a day or \$50.00 a week taking orders. It's easy. No experience required. Our good clothes make friends. The business keeps growing. Order a suit for yourself. Let your friends see a sample of our high class tailoring. Everybody will be delighted. We guarantee absolute satisfaction. Send us your name. We want only one agent in your town. Don't let anyone get ahead of you. Chicago Tailors' Association, 416 Market Street, Chicago.

THE NEW "SWIFTLIT" Lamps light instantly with 1/8 match; like city gas; no alcohol used; radically different from any other; portable or systems, 100 to 1,000 candle power at will; burners cheap for old lamps; agents making money; great novelty; wholesale price for introduction. Planet Mfg. Co., Dept. 4, St. Louis. (Established 1868.)

MY! HOW THEY FALL for our "Lucky Seven" toilet combination (\$3.20 value). You sell for \$1.00. Other fellows making \$6, \$12, \$15, \$20 and \$25 daily. Will put you on Easy Street. Great crew managers' proposition—good for \$100 profit weekly. This is only one pipkin in our "27 varieties" we manufacture—you save middleman's profit. Our new colored circular is like seeing the real goods. Free to workers. Get aboard. Act today. Davis Soap Works, 264 Davis Bldg., 1429 Carroll Ave., Chicago, Illinois.

ANYONE, ANYWHERE, CAN START a mail order business of their own. Make \$10 to \$50 a week during spare time; experience unnecessary; we, as manufacturers, start you and furnish everything. Patented great repeat order getters; sold exclusively to our co-workers; big profits; small capital; get in now on our new leaders and new plan; get in touch with full particulars, "Whole Truth" and sworn statement. Write today. J. M. Pease Mfg. Co., 193 Pease Bldg., Michigan St., Buffalo, N. Y.

LARUES PINE TAR PASTE, and Velvety Paste are high grade, down to date, cleaning specialties which competition has not touched. No live agent or dealer can afford to be without them. Samples 1c prepaid. F. C. LaRue Soap Co., Department 8, 584 Niagara St., Buffalo, N. Y.

HIGH GRADE SALESMAN or city representative for most remarkable instantaneous calculator ever devised. New idea. Faster than expensive machines. Will revolutionize all present methods. Fractions easy as whole numbers. Sells for \$5.00. Handsome

GREAT SUIT OFFER! Just write us and we will send you absolutely Free, by return mail, postpaid, a large outfit containing a big variety of cloth samples, fashion figures, tape measure, order blanks, etc. Everything Free, and we will start you in a paying business. A most liberal offer on a suit for yourself that will make you wonder. Terms, conditions and privileges that will astonish you. We will name you so much lower prices on men's fine clothing that it will surprise you. We want a live agent in your town. You can make \$1,000 to \$2,000 per year. If you will write us before we get an agent in your town you will get a wonderful offer. As soon as we get an agent in your town he will get profits on every dollar we sell in his territory. We turn all our business over to him. That's why our agents make so much money. If you want a suit for yourself, Answer Quick, before we get an agent in your town, you will then get all of our great inducements. Address Dept. 468, American Woolen Mills Co., Chicago, Ill.

BRUSHES—We are leaders in the brush business. We make 50 different kinds—one for every use. Houses, hotels and schools have to use these brushes. Over 100% profit. Write for catalogue and prices. Torrington Brush Works, Torrington, Conn.

MAIL ORDER ADS THAT PAY. 20 different propositions fully explained. All bona fide, sure-fire Money-getters. Each one the foundation of a successful Mail Order business. Send 10c for full particulars and regular bulletin of new propositions. Mail Dealers Wholesale House, 450 Franklin Bldg., Chicago, Ill.

LATEST PATENT DRINKING CUP. Nothing like it ever invented. Clear as ghost, light as a feather. Strong as canvas; use on train, hunting, fishing. Fits vets pocket; 25c by mail. Agents wanted; sells on sight. Hygienic Collapsible Cup Co., 218 Adams Ave., Scranton, Pa.

AGENTS WANTED everywhere to sell the celebrated Capitol Sanitary Brushes. Excellent inducements. Large profits. Easiest selling line in America. Write at once for our new catalogue and eight reasons. Address Managers Office, Capitol Brush Co., Hartford, Conn.

EITHER SEX TO SELL Gartside's Iron Rust Soap. Removes iron rust, ink and all unwashable stains. Guaranteed. Write today. Big margins. H. M. Gartside, 312 Edmond St., Pittsburg, Pa.

MEN AND WOMEN WANTED to control exclusive agencies, rapid selling, low priced specialty. Universal demand, plenty repeat orders; good profit to hustlers. Write for free sample and terms to-day. The G. V. Sales Co., Room 1325, 150 Nassau St., New York City.

LIVE AGENTS WANTED; make big money selling our "Auto-Vehicle Washer." Washes a vehicle clean in a few minutes. Sales come easy. Write for particulars. Cataract Auto-Vehicle Washer Co., Topeka, Kans.

AGENTS WANTED—SELL RICH LOOKING imported 35x68 rugs, \$1 each. R. H. Carter, Milan, Tenn., sold 115 in four days; his profits \$51. You can do as well. Write for sample offer and unique selling plan; exclusive territory. A. Condon, Rug Importer, Stonington, Maine.

EVERY HOME MUST HAVE our Leader; large profits, quick sales; \$6 a day to be made; samples and catalogue free. Johnston Supply Co., 218½ Post St., Spokane, Wash., Dept. E.

AGENTS MAKE \$30.00 WEEKLY selling our 500 Handy Household Articles; catalogue free. Scheff Company, 1637 Wells Street, Chicago.

AGENTS WANTED—Send 15 cents for smallest Bible in the world and one of each of our catalogues, with agents' prices. A. S. Mankin & Co., Alexandria, Va.

AGENTS—PORTRAITS 35c, FRAMES 15c, Sheet Pictures 1c, Stereoscopes 25c, Views 1c, 30 Days' Credit. Samples and catalogue free. Consolidated Portrait, Dept. 1197, 1027 W. Adams St., Chicago.

I WILL START YOU earning \$4 daily at home in spare time, silvering mirrors; no capital; send for free instructive booklet, giving plans of operations. G. F. Redmond, Dept. 306, Boston, Mass.

AGENTS' specialties that sell. Big profits. No chance proposition. Success absolutely certain. Circulars furnished. Three samples for dime. Free particulars. Poulson Company, 213 East Tenth Street, N. Y.

OPPORTUNITY TO ESTABLISH PROFITABLE AGENCY. Representatives wanted for moderate priced office specialty of great merit; extensively advertised. Exclusive territory and assistance in making sales. Scofield Company, Manufacturers, 1950-1955 American Tract Society Building, New York.

WE PAY YOU WELL—Whole or part time to sell the Pratt Automatic Blind Latch. New. Demand everywhere. Showing sells it. Chance to make good money. Write today for particulars. Send 25c for sample. Lamford Sales, 203 Broadway, New York.

FREE GOLD SAMPLE goes with first letter. Something entirely new. Every firm wants it. Orders \$1.00 to \$100.00. Nice pleasant business. Write today. Metallic Sales Co., 460 N. Clark, Chicago.

AGENTS WANTED EVERYWHERE to sell our New Automatic Stripper. Puts a perfect edge on any razor, safety or old style. Quick sales; large profits. See our display ad on page 152 this issue. S. C. Kanner, 556 Broadway, New York.

HANDY TOOL HOLDERS save labor, time, money. Mechanics delighted. Fastest selling household device ever invented. Nickel plated pocket outfit, 5c. Big profits. Manager, 158 Lawrence St., Brooklyn, N. Y.

AGENTS—HANDKERCHIEFS, DRESS GOODS. Carleton made \$8.00 one afternoon; Mrs. Bosworth \$25.00 in two days. Free samples. Credit. Stamp brings particulars. Freeport Mfg. Company, 59 Main St., Brooklyn, N. Y.

\$5 TO \$10 A DAY for reliable men and women agents; easiest, fastest, best sellers, ever offered; nine sales to each ten calls, by our special plan; big profits for you. Full details free. Address Household Co., Agency Division, No. 63, Topeka, Kansas.

"TOUR AMERICAN CONTINENT," "Trip Around World." 50 water color post cards in attractive boxes. Both sets 25c. Big profits. Secor Company, 502 West 122d Street, New York.

MANUFACTURER WANTS AGENTS to sell Aurora Black Beauty Kitchen Set. Splendid opportunity. Handsome premium every customer. Aurora Mfg. Co., 335 Broadway, N. Y.

IF YOU ARE TIRED of working for other people; if your income is too small, or if you are looking for something to do during your spare time, write me for my big money making propositions. It will put you right. C. Palmer, Box 155, Weyburn, Sask., Canada.

SMALLEST ALARM CLOCK, bible and telescope, 10c each prepaid. W. H. Garner, A-119 South Lafayette St., Evansville, Indiana.

AGENTS HAVE STEADY INCOME selling our Novelty Changeable Signs, gold and silver letters; in demand everywhere; catalogue; Climax Novelty Co., 452 Gay Bldg., St. Louis.

AGENTS WANTED in every county to sell Transparent Handle Pocket Knives. Big commission paid. From \$75.00 to \$300.00 a month can be made. Write quick for terms. Novelty Cutlery Co., 57 Bar St., Canton, Ohio.

WANTED—DISTRIBUTING AGENTS—Each county, for Paroxo, the peroxide of Hydrogen washing process. Something different, permanent, exclusive. Either sex. 2c stamp for sample. Thoreau Mfg. Co., 1153 W. Superior St., Chicago, Ill.

GERMAN SILVER KEY CHECKS—over 35 styles. Steel alphabets for stamping names and addresses on checks, key rings, etc. Agents wanted. Price list free. Pease, Die Maker, Winchester, N. H.

NEW: 25c ALUMINUM MUCILAGE SPREADER; marvelous seller at 25c. Agent's sample filled with several months' supply 15c prepaid. Morrison Co., Halsted & Melrose Sts., Chicago.

AGENTS: Portraits 25c, Frames 15c, Pillow Tops 35c, Sheet Pictures 5c. Best terms and prices. Oak Park Portrait Co., Oak Park, Illinois.

OLD ESTABLISHED CONCERN desires to establish agencies in all important centers for the sale of the National Water Filter. Write for particulars. Federal Filter Co., 548 West Jackson Blvd., Chicago.

HOME BUSINESS. Collect names, information, etc., for business concerns. Steady income. Instructive booklet for stamp. Information System, 259, Marietta, Ohio.

AGENTS make big money selling our new gold letters for office windows, store fronts and glass signs. Any one can put them on. Write today for free sample and full particulars. Metallic Sign Letter Co., 466 N. Clark St., Chicago.

WANTED—Sales agents for the Maxon Pat. Lever and Ratchet Screw Jacks. The best jack on the market. Kinsey & Norton Mfg. Co., Cincinnati, O.

AGENTS WANTED—New and indispensable specialty for automobile owners; quick seller; big profits; illustrated booklets; write today. R. M. Herold, Elgin, Ill.

AGENTS—GET BUSY; write today for our proposition; every housewife buys. Middle-West Supply Co., Dept. D, Ft. Scott, Kansas.

THE INSTANTANEOUS FRACTION COMPUTER; computes fractions mechanically without mental calculation. Postpaid 50c. Agents wanted. Numerometer Mfgs., 3635 Archer Ave., Chicago, Ill.

A LIVE AGENT in every town, to sell goods used in every household; write to-day. W. W. Sprague Supply Co., 100 North Cambridge, Mass.

BEST SIDE LINE ON EARTH; clean cut proposition; pocket samples; prompt commissions; consigned goods; Dyer Manufacturing Co., 1420 S. Michigan Ave., Chicago, Ill.

\$100 MONTHLY and expenses to trustworthy men and women to travel and distribute samples; big manufacturer. Steady work. S. Scheffer, Treas., MU, Chicago.

FREE AUTOMOBILE to agents. Address Franklin Mercantile Co., Franklin, Indiana.

\$1 INK PENCIL; as good as \$2 and \$2.50 makes. Practical; guaranteed. Agents' sample, 25c prepaid, coin, stamps; 10c clip free. Morrison Co., Halsted & Melrose Sts., Chicago.

AGENTS WANTED to sell our beautiful scripture wall mottoes. Frank Shilling Co., Navarre, Ohio.

DISTRIBUTE SAMPLES, \$25 weekly. Investigate. Mystic Company, Washington, D. C.

WANTED experienced agent to sell state rights. Big money. Box 908, Spokane, Wash.

AGENTS—Investigate our 50c household necessity, enormous sales, fat profits. Jersey Supply House, Washington, N. J.

NEW ERA Combination Kettles sell at sight. Other specialties. United Supply House, Lyons, Iowa.

WANTED—Agents to sell teas and coffees. Burns & Reed, 209 Hudson St., New York.

WOULD YOU LIKE WEEKLY INTERESTS? Taking orders from samples. That's the lowest weekly commissions paid any one of our representatives since April (Some earned \$85). Our goods are so beautiful and reasonable, your order is practically taken when samples are shown. If you want a fast selling line, with a chance for a Permanent General Agency and mean business, we will send you samples worth \$2.00 for \$1.00 prepaid. (Refunded if samples are unsatisfactory.) Our method (square dealings) Royal Mfg. Co., Rutledge, Penna.

GENERAL AND LOCAL AGENTS: Here is your opportunity. Energetic men can make \$2,500 yearly and up. The Improved Canchester Kerosene Mantle Lamp revolutionizes old methods. Far superior to electricity, gas, acetylene or gasoline at 1/10 the cost. Burner fits all lamps. Safe; clean; odorless. Burns with or without mantle. Tested and pronounced by State of Pennsylvania "Most efficient light found." Greatest seller known. We want a few more live men in open territory. Canchester Light Company, Dept. P. M., 204 N. State St., Chicago.

AGENTS. Men, women, everywhere, new invention just out. New Automatic Filter for cistern. Nothing like it on the market. Every home needs. Used by all classes. Women delighted. Big demand. Price insignificant. Fascinating, dignified exciting work. Everything right for enormous business. Success sure. Big profits. Write today. Automatic Filter Co., Toledo, O.

A NECESSARY ARTICLE in every home where stoves are used. Patented detachable appliance to hold the stove pipe in perfect position, preventing danger of fire and suffocation from gas. This article is very reasonable in price and sells at sight. Agents can make handsome wages. No experience required. Write for particulars. National Stove Pipe Holder Company, Ottawa, Ohio.

A BIG WINNER FOR AGENTS: 7-in-1 Nickel Plated Combination Tool Key Ring; screw driver; bottle cap opener, envelope opener, pipe cleaner, cigar cutter, nail cleaner. Most useful pocket novelty invented. Sells itself. Sample 10 cents. Joseph Mathieu, 203 Court St., Brockton, Mass.

10,000,000 U. S. HOMES NEED The Aladdin Mantle Lamp because they burn kerosene. Using less oil than ordinary lamps, the Aladdin outshines gas or electricity. Sells itself on overnight trial. Ball sold \$50 on money-back guarantee. Not one returned. Sample lamp furnished. Write quick for agency proposition. Mantle Lamp Company, Dept. 118-J, Chicago.

SIGN LETTER AGENTS—PAINTERS. Something new and better. Attracto Gold or Silver Letters. Anyone can apply them. Big money lettering store windows—making glass signs. Write today for free sample. Attracto Sign Co., Kemper and Orchard, Chicago.

AGENTS—The Novelty Fish Pond and The County Fair are two of the most fascinating game boards ever invented. 100% profit. Orders bound to repeat. Nothing like them on the market. Slot machines beat. Both games and two other crackerjacks and full particulars on receipt of \$1.50. Money refunded after orders amount to \$10.00. Unique Novelty Co., Independence, Iowa.

COMFORT DRAWERS SUPPORTERS. Samples, ten cents. Sip Manufacturing Co., Jersey City, N. J.

WANTED—AGENTS and managers to handle new special tool. Particulars free. Gordon & Wilder, Norwood, Mass.

\$25 WEEKLY and expenses to men and women to collect names, distribute samples and advertise. Steady work. C. H. Emery, MP, Chicago, Ill.

AGENTS MANUFACTURE your own goods. Send dime for successful plan. Cherry, Myra, Penn.

O, YOU MONEY! \$25.00 daily can be made. You be the one to get the thousands of dollars. Just send postal asking for terms and free sample proposition. A revolution in Vacuum Cleaners that will be snapped up. Get in quick. Aero Vacuum Co., X12, Cincinnati, O.

LIVE AGENTS WANTED. A permanent income selling Koeth Combination Kit, 15 tools in one. Finest tool steel, guaranteed. Big profits. Wonderful seller. Exclusive territory. Send for free sample offer and terms. Currier-Koeth Mfg. Co., 52 West St., Coudersport, Pa.

(CELLULOSIA) DOOR PLATES, new, lettering pure gold. Send for sample case. Nothing invested. 100% profit. sell to every house. Public demand them. La Fontaine, Inventor and Mfr., Sherburne, N. Y.

AGENTS—SELF-WRINGING MOPS; six styles for all purposes. New inexperienced men make \$9.00 per day. No investment. Send for exclusive territory proposition that will make you independent. Edward Hilker Mop Co., 1195-A Grand Ave., Chicago, Illinois.

EVERYBODY CAN SHINE THEIR SHOES with ease, convenience and economy by using the Kroll Patent Shoe Polisher. In tremendous demand. Agents making piles of money. Write today for exclusive territory. Adam J. Kroll, 600 Blue Island Ave., Chicago.

AGENTS—LIVE ONES, either sex, can make big money selling our three specials in furs, sell for \$10.00 per set. Write for particulars. Merchants Fur Co., 186 N. La Salle St., Chicago, Ill.

SEND 10c FOR HANDSOME SAMPLE German silver key check, your name and address stamped thereon. Big commission for taking orders. We also supply blank stock and stamping outfits. Hart Manufacturing Co., 200 Eckford St., Brooklyn, N. Y.

WANTED! ENERGETIC MAN OR WOMAN, in every city,* to advertise, deliver and collect. \$4.00 daily easily made. Experience not necessary. Steady employment to right party. Write us at once for particulars. Dexter Supply Co., 508 S. Dearborn St., Chicago.

EARN \$25 TO \$50 A WEEK, spare time. Selling braided and embroidered, lawn and lace shirtwaist patterns, Mexican drawn work, petticoats, etc. Catalogue and samples free. F. B. Smith Co., 1425 Exchange Bldg., Paterson, N. J.

AGENTS WANTED. Sure repeat. Hundred per cent profit. For particulars address: Lincoln Contractors Supply Co., First National Bank, Lincoln, Nebraska.

A NEW NOVELTY as a leader. Start with us. Samples and catalogue free. \$5.00 a day easily made. J. C. Dodge Co., Barrington, Ill.

SALESMEN MAKING SMALL TOWNS, just what you want for pocket side-line. Something new, snappy and catchy. Quick shipments and prompt commissions. Write for order book today. State territory covered. R. Dahne, Sales Mgr., 208 Sigel St., Chicago, Ill.

AGENTS—100% PROFIT—Genuine Leather Combination Purse, Billfold, Memorandum Book, Pencil, Identification Card. Sells at sight. Agents' sample 45c postpaid. LeRoy Specialty Co., 76 Park Place, Room 52, New York.

AGENTS—Our new 1911 model Incandescent Kerosene Burner 100 candlepower light—burns with or without mantle. Prices defy competition. Particulars free. Simplex Gaslight Co., New York.

SALESMAN—Traveling, to carry Garvey Fountain Stencil Brush as side line; thousands sold. American Diagraph Co., 13 N. 2d St., St. Louis, Mo.

SALESMEN, AGENTS, REPRESENTATIVES. Write White Vending Co., 1335 Van Buren, Chicago. Big commissions paid monthly, for selling our Vending Machines.

WANTED—AGENTS, 7 cents profit each 10 cent sale; best little article ever offered; sample for 3 cents in stamps. Rawlings, Box 945, St. Louis, Mo.

EXPERIENCED AGENTS. Male or female. Repeat orders. 100%. Write us. Shaver Specialty Co., Dept. L-1, Somerset, Pa.

UNLIMITED OPPORTUNITY FOR AGENTS selling automobile tire repair kit. Florence Novelty Co., Box 1, 4505, Philadelphia.

VALUABLE INFORMATION for agents, mail order dealers and beginners. Descriptive literature free. Andrew Brems, Corona, N. Y.

AMAZING INVENTION—Entirely new lamp burner. Changes ordinary kerosene illumination into beautiful large white gas light. Guaranteed Smokeless. Odorless. Not a mantle. Can't break. Unlike others. Brings you quick sales, large profits. Show ten, sell nine. Only 35c retail. This territory just opened. Act now. "Radolite," 364 Colonnade, Toledo, O.

AGENTS—\$50 weekly; we manufacture the best needle case made; a wonderful seller; 200 to 500 per cent profit; talking unnecessary; our copyrighted "Trust Scheme" Envelopes do the work; general agents can make over \$100 weekly; send 10c for a 25c sample containing 115 needles; particulars free; buy direct from the factory at wholesale. Paty Needle Co., 102 Union Sq., Somerville, Mass.

"AGENTS, 100% PROFIT." New Patented Automatic Razor Strapper, automatically puts a perfect edge on any razor, old style or safety. Retail at \$2. Big seller. Every man wants one. Write quickly for terms, prices and territory. P. Brandt Cutlery Co., 84 W. Broadway, N. Y. City.

AGENT'S OUTFIT FREE. Quick profits. Best Handkerchiefs, Dress Goods and Fancy Goods on the market. Large Manufacturer. Particulars for stamp. Maricopa Mfg. Co., 93 Water St., Brooklyn, N. Y.

HONEST MAN OR WOMAN WANTED in every town to represent well-known wholesale firm. Experience unnecessary. Must furnish good references. Easy, pleasant work. Fair salary to start. McLean, Black & Co., 351 Medford St., Boston, Mass.

BECOME A MILL AGENT. We manufacture Triplewear Hosiery—outwears 3 ordinary kind, replaced free when hole appears. Large profits. 1st reply obtains agency your town. Write today. Triplewear Mills, Dept. D, 724 Girard Ave., Philadelphia.

YOU CAN MAKE \$\$\$\$ as our general or local agent. Household necessity; saves 80 per cent; permanent business; exclusive territory; salary or commission; free sample; credit. J. Pitkin, Newark, N. Y.

MEDALLIONS SELL AT SIGHT. 300 per cent to 500 per cent profit. Make up your own goods and be independent. "It's easy." Catalog free. Fred Resag Co., 1205 W. Randolph St., Chicago.

ONE MILLION AGENTS WANTED; fast seller costing 5c, selling 50c. Every firm needs. Orders to \$50. Postal brings samples. Embossed Co., 2497 Milwaukee Ave., Chicago.

AGENTS—WE MANUFACTURE GLASS PAPER. Plain glass windows made to look like real stain glass; something new; easily applied; big money maker; two sample sheets of paper, with catalogue in colors and discount sheet, for 10c. S. H. Parrish & Co., 202 S. Clark St., Chicago.

WIDOWS, Ladies, Men, New Interesting. Profitable, easy work. Spare time or permanent. Sell our useful specialties. Our original selling plan will double your sales. Particulars and \$2.00 premium offer free. Fair Mfg. Co., HF51, Racine, Wis.

AGENTS TO COVER EXCLUSIVE TERRITORY and sell physicians. Established line, liberal commission, weekly advance. Address Rebman Company, 1123 Broadway, New York.

MATCH VENDING MACHINES Sell Easily Everywhere. Agents paid liberal commissions. Geo. A. Bayle, Second and Elm Sts., St. Louis Mo.

I MADE \$18,000 in three years in mail order business. Leaflet booklet free, tells how. H. System, 125, Marion, Ky.

AGENTS TO SELL new Automatic device. Big profits. Unworked field. Write today for our profitable offer. Superior Wrench Co., Box 900, Marshalltown, Iowa.

AGENTS—\$5 daily selling our Handy Tool, 12 articles in one. Lightning seller. Sample free. Thomas Mfg. Company, 462 Third St., Dayton, Ohio.

SIGN PAINTING AGENTS. 1000% profit. Best and cheapest Window Letter made. Easiest mounted. Outfit free. Success positively guaranteed. Embossed Letter Co., 2563 Milwaukee Ave., Chicago.

AGENTS—BOTH SEXES—We manufacture and control the fastest selling household specialty ever invented. P. M. Conolly, 123, Liberty, New York.

PERFECTION POCKET ADDING MACHINE. Lightning seller. Agents wanted. Cincinnati Specialty Mfg. Co., Dept. R., Cincinnati, Ohio.

SELF-THREADING NEEDLES. 10c a paper. Agent's samples and terms free. Ladies' Art Co., Dept. 41, St. Louis, Mo.

AGENTS! If you are after \$\$\$, better write us. Formosa Mfg. Co., Thibodaux, La.

HANDY RAT TRAP. Great agents' seller. Terms free. Zerbe, Sacramento, Pa.

HELP WANTED

WE START YOU IN a permanent business with us and furnish everything. We have new easy selling plans and seasonable leaders in the Mail Order line to keep our factories busy. No canvassing. Small capital. You pay us out of the business; large profits. Spare time only required. Personal assistance. Write today for plans, positive proof and sworn statements. J. M. Pease Mfg. Co., 191 Pease Bldg., Michigan St., Buffalo, N. Y.

\$3,000 TO \$10,000 YEARLY in the real estate business, without capital; we will teach you the business by mail, appoint you special representative in your locality, of leading real estate company, list with you readily salable properties, co-operate with and assist you to permanent success; a thorough commercial law course free to representatives. If you are honest and ambitious, our free 62-page book will surely interest you. Address International Realty Corp., Dept. 1834, Chicago, Ill.

WANTED ONE THOUSAND CHAUFFEURS and repair men. Our demand for automobile engineers exceeds the supply. Calls for men of intelligence and mechanical bent capable of commanding \$100.00 to \$150.00 per month upon graduation. Resident course \$20.00 to \$60.00. Home Correspondence course completed by practical road and shop work at this school, highly successful. Look this up. Auto Schools of America, Dept. T, 1600 Michigan Ave., Chicago.

WHY NOT PREPARE for Civil Service Examination? Teaching? Stenographer? Bookkeeper? Stationary Engineer? Electric Wiring? Electrical Engineer? Mechanical Engineer? Mechanical Draftsman? Electric Wiring? Matriculation, \$5. Tuition free. Mail course. Address Carnegie College, Rogers, Ohio.

MEN WANTED FOR GOVERNMENT POSITIONS—Influence unnecessary. Average salary, \$1,100. Annual vacations. Short hours. Steady work. Rapid promotions. Thousands of appointments coming soon. Send postal immediately for list of positions open. Common education sufficient. Franklin Institute, Dept. N-21, Rochester, N. Y.

IDEAS HAVE MADE FORTUNES. On request I will send my "Inventor's Pocket Companion," telling how to use Your idea to greatest advantage. Patent Secured or Fee Returned. Write today. Wm. N. Roach, Jr., 502 Metzger Bldg., Washington, D. C.

MEN WANTED FOR GOVERNMENT POSITIONS—October examinations everywhere. Influence unnecessary. \$90.00 a month. Annual vacations. Write for list of positions open. Franklin Institute, Dept. N-21, Rochester, N. Y.

WANTED DISTRIBUTERS of advertising matter everywhere. Oliver D. Barkley, Mount Pleasant, Pennsylvania.

MEN WANTED FOR GOVERNMENT POSITIONS—October examinations everywhere. Influence unnecessary. Average salary, \$1,100. Annual vacations. Send immediately for list of positions open. Common education sufficient. Franklin Institute, Dept. N-21, Rochester, N. Y.

WANT—ACTIVE MAN OR WOMAN, each locality. To join this society, and introduce our memberships. Sick. Accident. Death Benefits. All or spare time. \$50 to \$500 a month. Every member secured gives steady monthly income. Box GA-293, Cornington, Ky.

SALARY OR COMMISSION. lubricating oils, auto oils, greases, house, barn and roof paints, hundred other specialties, all winners. Big inducements. Address Desk A, Inland Oil Works Co., Cleveland, Ohio.

YOU ARE WANTED for Government position. Salary \$1,100. Send postal for list of positions open. Franklin Institute, Dept. N-21, Rochester, N. Y.

BOILER ROOM SPECIALTY. Leading manufacturer wants an exceptionally high grade salesman, capable of selling \$100 specialty to large power plants. Minimum com. on each sale, \$25. Ladd, 885 Niagara St., Buffalo, N. Y.

GOVERNMENT WANTS EMPLOYEES. Write for list of positions open. Franklin Institute, Dept. N-21, Rochester, N. Y.

DANDY HOME BUSINESS. Collect names, information, etc., for business concerns. Steady income. Fascinating work. Instructive booklet for stamp. Information System, 260, Marietta, Ohio.

WANTED—CLERKS, by U. S. Government, October examinations everywhere. Preparation free. Write immediately. Franklin Institute, Dept. N-21, Rochester, N. Y.

7,000 GOVERNMENT POSITIONS OPEN. Write for list. Franklin Institute, Dept. N-21, Rochester, N. Y.

GOVERNMENT POSITIONS offer steady, pleasant employment, big pay. Influence unnecessary. Get your preparation from former U. S. Civil Service Examiner. Write for big, free, descriptive booklet. Patterson Civil Service School Box 836, Rochester, N. Y.

WANTED SALESMEN to sell Gasoline Lighting Systems; no experience necessary; attractive proposition. Doud Lighting Co., 174 No. Sangamon St., Chicago, Ill.

WE TRAIN DETECTIVES. You can be one. Splendid opportunities. Travel. Earn \$100 to \$300 monthly. This fascinating profession taught practically and scientifically by mail at a nominal cost. American School of Criminology, Dept. F, Detroit, Mich.

WANTED MAN IN EVERY SHOP to do special work for us. Good pay. Will not interfere with regular work. P. Seewagen, Dunkirk, N. Y.

WANTED, AGENTS, MACHINISTS, ATTENTION! Increase salary, new revised Saunders' Hand Book of Practical Mechanics. Best ever ready reference. Thousands in use. Postpaid \$1.00 cloth; \$1.25, \$1.50 leather flap. Big profits. E. H. Saunders, 216 Purchase St., Boston, Mass.

STOP HERE! Let me start you in a home business that will bring you money every day. Experience unnecessary. Spare time. No canvassing. I furnish everything and guarantee success. Send for proofs. Voorhies, Desk C. R., Omaha, Neb.

I WILL START YOU earning \$4 daily at home in spare time, silvering mirrors; no capital; send for free instructive booklet, giving plans of operation. G. F. Redmond, Dept. 306, Boston, Mass.

WANTED—A man or woman to act as our information reporter. All or spare time. No experience necessary. \$50 to \$300 per month. Nothing to sell. Send stamp for particulars. Sales Association, 601 Association Bldg., Indianapolis, Ind.

I MADE \$18,000 in three years in mail order business. Dollar booklet free, tells how. H. System, 125, Marion, Ky.

MACHINERY AND TOOLS FOR SALE

HAVING CHANGED OUR FACTORY to individual motor power we have some snaps in second-hand equipments. 1 20-hp. Fairbanks-Morse gas engine run less than one year, \$225.00; 1 11x16 slide valve Atlas steam engine, \$80.00; 1 Williams, White & Co. bull dozer, cost \$350.00, will take \$150.00; 1 planer, good condition, \$50.00; 1 28-in. diam. 2 11/16-in. bore friction clutch, never been uncrated, \$15.00. Two large iron pulleys, one 60-in. diam., 24-in. face, 3 7/16-in. bore, the other 84-in. diam., 12-in. face, 3 7/16-in. bore, also 13 ft. of 3 7/16-in. shafting with 2 ring roller bearings; make a bid. Lot of wood split pulleys ranging in size from 24-in. diam., 8-in. face, to 44-in. diam. 17-in. face, will sell any or all cheap. Several 10-hp. air cooled automobile engines good as new, \$30.00 each. New steering gears at \$10.00 and used ones at \$6.00, also 5 new automobile seats at \$5.00 each. All F. O. B. here. M. M. Johnson Co., Clay Center, Nebr.

FOR SALE by The Patterson Tool & Supply Co., Dayton, O. One Goodell Pratt Bench Lathe, with slide rest and chuck fitted; 1/2-hp. Sterling DC 110-volt motor, all mounted on neat work bench; fine condition. \$60.00.

REBUILT MOTORS—We have a number of second-hand marine engines of our own and other makes, completely rebuilt and guaranteed by us. As the builders of "Buffalos" are not in the second-hand engine business, we will sell them at less than factory cost to make room. This is a rare opportunity to get the highest grade of engines—2 to 100-hp.—cheap. Buffalo Gasoline Motor Co., 1284-96 Niagara St., Buffalo, N. Y.

ONE 3-HP. VERTICAL 4-cycle stationary gasoline engine, also one 3-hp. horizontal engine; both water cooled. Price \$50 each. Also one 12-hp. horizontal on trucks, never was used. Price \$200. Splitt & Boettcher, Manitowoc, Wis.

FOR SALE—Two water-tube boilers, 100-hp. each, Heine type; three tubular boilers, 66x18; perfect condition and cheap. Address Armstrong Mfg. Co., Springfield, O.

FOR SALE by The Patterson Tool & Supply Company, Dayton, Ohio, 50 16-in. Cast Iron Pulleys, 1 7/16-in. bore, for 2-in. belt, turned, faced, balanced, and set screwed.

FOR SALE—1-hp. Gasoline Engine, No. 4 Barnes Lathe, Speed Lathe, Power Hack Saw, Sheep Shearing Machine, Forge, Blacksmith Tools, etc. A. W. English, Wycocena, Wis.

FOR SALE by The Patterson Tool & Supply Co., Dayton, O., a new 12-hp. Alamo Gasoline Engine, \$350.00; one 8-hp. Dayton Upright Gasoline Engine, good order, \$60.00. One practically new 40-hp. Callahan Gas or Gasoline Engine, \$900.00.

\$26.00 TAKES 3-HP. four-cycle marine engine with accessories; \$78.00 takes 20-hp. two-cyl. water cooled auto motor with accessories. Badger Motor Co., Milwaukee, Wis.

WALLACE HERMAN, 112 Alberta Ave., Dayton, Ohio, has a dandy 7-in. swing, wood-turning lathe for \$4.50. Send stamp for photo.

FOR SALE—\$1,930 Coffin Hardware Machine, used 3 months, take cash \$750. E. Stallings, Euclid, N. C.

FOR SALE—4-cylinder 24-hp. engine, 4-speed planetary transmission, very near new, make offer. 200 West 5th, Newton, Kan.

FOR SALE—Five-hp. Gasoline Engine, in good running order, also one chest patternmakers' tools. O. A. Wenberg, Batavia, Ill.

12 5-HP. STEAM ENGINES \$12.00 each. Lucas & Son, Bridgeport, Conn.

FOR SALE—1 24x27 7-ft. iron planer. W. J. Ferrell, Barber-ton, O.

ELECTRIC MOTORS—1/15 to 1/2-hp. Cheap, for sale. Cosmos Electric Co., 134 Liberty St., New York.

FREE, on ten days' trial, three horse power gasoline engine, no money down, 5 years guarantee. Welding of any broken parts of machinery. Particulars, Welding Co., 8 N. 1st St.

FOR SALE

FOR SALE by W. B. Patterson, Dayton, Ohio, Bausch & Lomb microscope No. 12067, with one-inch objective, in hardwood case, \$15.00.

FOR SALE—Set of castings for 2-hp. gasoline engine suitable for experimental work, \$5.00. R. H. Bowersox, Hanover, Pa.

SECOND-HAND BELTING, bought, sold, repaired. The front entrance to market for leather belting, new or old. Wm. P. Stanton & Bros., 4 India Square, Boston, Mass.

BARGAINS, contents of an electrical experimental shop for sale. Write for list. W. A. Schablowsky, 136 Dean St., Brooklyn, N. Y.

FOR SALE—Stevens Rifle, Colts Revolver, Smith & Wesson Revolver and Pistol; all 22-calibre, and practically new. Charles Taylor, Norwalk, Conn.

\$13.00 DRAFTING OUTFIT (new), \$8.00. Blazer, Box 122, Allentown, Pa.

FOR SALE—Moving picture film, 1c foot; machines, \$40. H. Davis, Watertown, Wis.

RAMEY'S ALUMINUM SOLDER for soldering aluminum. Ramey's U. S. Vacuum Cleaners, standard everywhere. Ramey Mfg. Co., Newark, Ohio.

TYPEWRITERS \$10, Phonographs \$10, Records 10c, Motorcycles \$40, buy yours. Knight's, 279, 12th St. Louis, Mo.

ONE LUBIN Moving Picture Machine for sale, \$50. James G. Lake, Danville, Pa.

SALE OR EXCHANGE

FOR SALE—MOVING PICTURE MACHINE. Want Precision Lathe. Robinson, 396 Broadway, Albany, N. Y.

FOR SALE or will exchange. Writerpress or Planotype, little used, full equipment. Only need one machine. Jos. B. Weiler, Olney, Ill.

AUTOMOBILE RUNABOUT and motorboat, good condition, for iron working machinery. What have you? Rubel Co., Louisville, Ky.

WINCHESTER PUMP GUN, No. 12, like new. For good Thor or Hedstrom motor and carburetor. Box 381, Herington, Kas.

PARKER MECHANICAL shooting gallery, good order. Kemper, 1701 Indiana Ave., Connersville, Ind.

SALE OR EXCHANGE, 8x10 view, 5x7 camera and outfit, 8 volumes of Practical Photography, for motorcycle. Chas. M. Wimmer, Perkaskie, Pa.

GLIDER for motorcycle. Ed. Moyemont, Secor, Ill.

PATENTS

PATENT YOUR IDEAS, no unnecessary delay. Reasonable. Best references. Send for free book. Williamson & Williamson, 1325 Arch St., Philadelphia, Pa.

WE SELL PATENTS. Established ten years. To buy or having one to sell write Charles A. Scott Co., 1696 Granite Bldg., Rochester, N. Y.

INVENTORS WISHING to sell outright or royalty, communicate. Engineer, Boulevard & 26th Street, Bayonne, N. J.

PATENTS SECURED—Reports on patentability, validity and infringement. Patent suits conducted. C. L. Parker, ex-examiner Patent Office, 910 G St., Washington, D. C.

PATENTS—Our advanced methods save you 80% of your money. "How to succeed as an inventor" sent free. Inventors and Investors Corporation, Philadelphia, Pa.

MODELS made for inventors. Low prices. Howard Merryman, Towson, Md.

PATENTS FOR SALE

FOR SALE—CANADIAN PATENT No. 131,947, United States No. 991,957 and Mexican No. 11,350 on a device to prevent a trolley pole from coming off of wire. For particulars address Frank H. Crane, 2355 W. 38th Street, Cleveland, Ohio.

FOR SALE—U. S. patent No. 994,475, on an automatic photographic printing machine for use with artificial light printing papers. A compact scientific apparatus. A. McCurdy, 1920 W. Venango St., Philadelphia, Pa.

BED RAIL ATTACHMENT; repair for iron bed rails; gives perfect satisfaction. On the market now. U. S. Pat. Mar. 28, 1910. F. W. Merriweather, 128 "C" St., Rosedale, Kans.

WANTED TO CORRESPOND with men in position to manufacture article of merit, successfully used by hundreds of farmers, or will sell patent outright; investigate. W. C. Reynolds, Pole, Ill.

PATENT No. 694,445 Swinging and Folding Desk Shelf. First \$65 takes it. E. J. Timmons, Frankfort, Ohio.

FOR SALE, PATENT No. 991,921, an automatic faucet; particulars address Bertram Whitehurst, Trenton, N. J.

SAWSET; all saws. Mrs. Wm. Boynton, North Western Sanitarium, Port Townsend, Wash.

AM PATENTING my invention here. Make offer for foreign rights. E. D. Howe, Centralia, Illinois.

VALUABLE PATENT oil squirt can, just issued, for good late model auto. J. T. Smallwood, 304 Houston St., Chattanooga, Tenn.

\$10,000 BUYS U. S. PATENT on safety stepladders outright; \$8,000 buys Canadian Patent outright; royalty propositions considered; Ladders are now in service. Eddy Bentley, Lincoln, Ill.

PATENT; dirt cheap. Money maker. Write. Geo. Krieger, Worcester, Ohio.

HARRISON KEY FILING JIG (Improved). The most practical tool on the market; saves blanks, no misfits, no experience necessary; anyone can make a duplicate key with this tool, and price within reach of everybody. Factories, office buildings cannot afford to be without one. Harrison & Co., 81 New St., N. Y.

INTERESTED IN GASOLINE ENGINES? Send 50c for booklet, "How to Run and Install Gasoline Engines," and a year's subscription to Gas Energy, 28 Murray St., New York.

BARGAIN: Steam boiler, engine separator, churns, vats, butterworker. H. Smith, Ravanna, Missouri.

PULLEYS, GEARS, SPROCKETS, shafting Hangers; see page 150. W. A. Jones Foundry & Machine Co., Chicago.

FOR SALE—Rebuilt; Throttling, Automatic and Corliss Engines, Boilers, Pumps, Heaters, Machine Tools, Tanks, Saw Mills, and general machinery, at bargain prices. Let us know your wants. The Randle Machinery Co., 1761 Powers St., Cincinnati, Ohio.

VERTICAL STEAM ENGINES, 2 to 25 hp. Send for circular. E. T. Frank & Son, 642 W. Pratt St., Baltimore, Md.

ENGINE CASTINGS, 1½ horse vertical gasoline, air-cooled, \$7. Three horse marine water-cooled, \$9 cash; drawings included; catalogue for stamp. Novelty Manufacturing Co., 853 West Sixth St., Cincinnati, Ohio.

STEAM BOILER OUTFITS Complete; 1½ Horse Power 20" diam., 51" high, \$40.00. Page Boiler Company, 815 Larrabee St., Chicago.

FOR SALE—Gasoline Engines, automobiles, marine and stationary, also castings. Second hand ones taken in exchange and for sale. Apply with stamps. B. W. Richardson, R. No. 36, Peoria, Ill.

FOR SALE—Engine lathe, swings 9½ in., takes 25 in. between centers. Complete with full set change gears to cut all size threads, 3 to 40 in.; price only \$43.50. Address L. F. Grammes & Sons, Allentown, Pa.

4 CYCLE GASOLINE ENGINE, 2½ HP. Complete or Castings. B. W. Livingston & Sons, Lestershire, N. Y.

LATHES—Send for free circular showing bargains on small Screw Cutting Engine Lathes. S. B. Machine Tool Co., Dept. J, South Bend, Ind.

PATTERN-MAKERS! A book devoted to the principles of pattern and core making and molding. Written by G. H. Willard, a practical pattern maker of years experience. This book, just published, treats the subject in a much more simple, direct and effective manner than most books along this line. 224 pages, 312 illustrations. Price \$1.00 postpaid. Popular Mechanics Book Dept., Chicago.

SERIES OF 7 LITHOGRAPHIC MODELS—Steamship, Automobile, Gas Engine, Steam Engine, Steam Turbine, Wireless Telegraph and Dynamo. Size 8x14 inches. All parts of these machines are shown and numbered to correspond to printed keys of names. Price each 50 cents postpaid or set of 7, \$3.00 postpaid. Popular Mechanics Book Dept., 318 W. Washington St., Chicago.

MANUFACTURING MACHINERY

WE MAKE MODELS, experimental die tool work and light manufacturing reasonable and quick; our 30-years' experience is at your service. Palmer Machine Works, 418 West 27th street, New York.

INVENTIONS PERFECTED AND MANUFACTURED, best plant in South for same. Russell Machine Co., Dallas, Tex.

INVENTORS—WE BUILD MODELS, do experimental work, light manufacturing, dies and tools. Geo. Schwartz & Co., 123 Liberty St., New York.

METAL SPECIALTIES, INVENTIONS PERFECTED. Tools, dies and special machinery. Emil Poeppel Novelty Works, 3433 N. Leavitt St., Chicago.

WATER MOTORS, WATER FANS, Tapping Machines, Magnet Winders. Inventions developed. Special articles to order. Cleveland Specialty & Manufacturing Co., Cleveland, Ohio.

IRON, BRASS AND ALUMINUM CASTINGS. Metal Specialties. Patterns, Models, Polishing, Plating and Japanning. North Chicago Tool Works, North Chicago, Ill.

MECHANICAL ENGINEERS

DEVELOPING INVENTIONS to a practical and commercial basis, is my specialty for the last ten years. Estimates furnished for building machines, models, tools and stampings. Patents secured, working drawings, blue-prints, etc., made at low prices. Benj. Brownstein, Mechanical Engineer and Expert Designer, Ellwood City, Pa.

I WILL INVENT what you want or perfect what you have; make working drawings, blue prints, etc., reasonable and quick. W. A. DeHart, 418 West 27th Street, New York.

FLOUR AND MILLING MACHINERY

Special Bargains in second hand: Attrition Mills, Burr Mills, Crushers, Corn Shellers, Bran Dusters, Dust Collectors, Purifiers, Reels, Double, Single 2 and 3-pair High Roller Mills, Sieve Bolters, Receiving Separators, Scourers, etc. Write for description and prices. Sprout, Waldron & Co., P. O. Box 429, Muncy, Pa.

WANTED

WANTED—Agency for novelties in hardware special machinery, tools, wrenches, etc. Success Novelty Co., Inc., Richmond, Va.

WANTED, small automobile engine, cash. Clyde Orr, Kempton, Indiana.

PATENTS SECURED OR OUR FEE RETURNED. Free expert search and report as to patentability. Our three beautiful books on inventions and patents, sent free. Best references. John S. Duffie & Co., Dept. 2, Washington, D. C.

CLEMENTS & CLEMENTS, Patent Lawyers, Colorado Building, Washington, D. C. Expert associate in mechanics. Free information to inventors. Fees reasonable. Best references.

PATENTS; gas engine, motor vehicle and aeronautical work a specialty. John O. Seifert, Solicitor of American and foreign patents, designs and trademarks, 500 Fifth Ave., New York City.

IMPORTANT NOTICE—Read my page ad on page 120 Advertising Section of this magazine, relative to patents, trademarks, etc. Special offer contained in the ad. E. E. Vrooman, Patent Lawyer, Washington, D. C.

"PATENTS AND PATENT POSSIBILITIES," a 72-page treatise sent free upon request; tells what to invent and where to sell it. Write today. H. S. Hill, 905 McGill Building, Washington, D. C.

PATENTS—Books How to Obtain and Sell Patents, with 100 mechanical movements; mailed free. F. Dieterich & Co., Lawyers, Washington, D. C.

MAKE MONEY IN IDLE HOURS. Send for "Good Things to Invent." Edgartate & Co., 245 Broadway, New York.

PATENTS WITHOUT ADVANCE ATTORNEYS' FEES, payable when patent allowed. Send sketch for free report. Books free. Fuller & Fuller, Washington, D. C.

PATENTS OBTAINED by competent and reliable attorney. Personal attention given to each client. Communications strictly confidential. Fees very reasonable. A. W. Foose, Room 2008, 165 Broadway, New York City.

PATENTS PROCURED and positively sold if the idea has merit; all countries; satisfied clients my best references; send sketch; book free. H. Sanders, Crilly Bldg., Chicago.

PATENTS—HERBERT JENNER, patent attorney and mechanical expert, 608 F. St., Washington, D. C., established 1883. I make a free examination and report if a patent can be had and exactly what it will cost. Send for circular.

PATENTS PROMPTLY OBTAINED. Our free booklet will help you to fortune. Read pages 11 and 12 before applying for patent. Free searches. Write today. D. Swift & Co., 317 7th St., Washington, D. C.

C. L. PARKER, Patent Attorney, Ex-examiner U. S. Patent Office, 910 G. St., Washington, D. C. Inventor's handbook "Protecting, Exploiting and Selling Inventions" sent free upon request.

PATENTS THAT PROTECT and pay. Advice and books free. Rates reasonable—Highest references; best results. Watson E. Coleman, Patent Lawyer, 622 F. St., N. W., Washington, D. C.

REAL ESTATE AND FARM LANDS

ADVANTAGES OF OREGON, 100 page book gives amount of government land open to homestead in each county in Oregon, Washington and California; description of same gives homestead, desert, timber, stone, coal and mineral laws, two maps of Oregon in colors, 21x28, showing railroads in operation, and one showing railroads under construction and proposed, including eastern and central Oregon. Book 25c, maps 20c each, or the three 50c. Nimmo Ruy & Co., Hamilton Bldg., Portland, Oregon.

FARM FOR PROFIT in Eastern North Carolina. The "Nation's Garden Spot." Leads other localities for vegetables, fruits and staple farming on small capital. Homeseekers and investors write Carolina Trucking Development Co., 812 Southern Bldg., Wilmington, N. C.

WE ARE HEADQUARTERS for large and small tracts of colonization, cut-over, phosphate, coal, mineral and extensive timber properties, located throughout the Southern States, Pacific Northwest, Canada and Mexico. Associate offices in several of the important cities. Address Parker Land & Timber Agency, Charlotte, N. C.

NO DROUGHTS OR CROP FAILURES in Central Minnesota. Write for list of exceptional land bargains to Fred Mohl, Capital Bank Bldg., St. Paul, Minn.

MINNESOTA FARM LAND SNAPS, \$12 per acre. Remarkable opportunity. Adler Land Co., St. Paul, Minnesota.

LET US TELL YOU about big crops and cheap lands. Short & Shannon, Mountain Grove, Mo.

FOR SALE, Poultry Farm, \$3,500.00; good established trade. Peter N. Jersild, Oak, Ala.

OKLAHOMA FARM BARGAINS, corn, oats, and wheat lands. 80 acres, \$2,500; 160 a. fine, \$6,500. Our list free. O. K. Realty Co., Newkirk, Okla.

IOWA FARM BARGAINS in Howard Co., \$50 to \$90 per acre. Large list on request. Luers Land Co., Cresco, Iowa.

TO SELL YOUR property, write Northwestern Business Agency, Minneapolis.

GAMES AND ENTERTAINMENTS

LEARN TO THROW YOUR VOICE! Be a ventriloquist in a few hours. Clean, highclass, intensely interesting amusement. Anyone may learn. Small cost. New natural method never explained before. Protected by copyright. Send stamp for interesting booklet. W. M. Bailey, Lock Box 212, St. Paul, Minn.

TRICKS, MAGICAL APPARATUS AND SUPPLIES—Amateurs supplied as well as the Great Professionals. Easy, interesting and entertaining. Amuse and astonish your friends. 4c stamps brings our three catalogues: Magical Apparatus, Latest Supplement, Marvelous Card Tricks. Buy from real Magic Dealers. Send now. Read & Covert, 817C East 43d St., Chicago, Ill.

Speakers, minstrel material, Jokes, Recitations, Tableaux, Drills, Musical Pieces, Entertainments for all occasions. Make-up Goods. Large catalog free. T. S. Denison & Co., Dept. 11, Chicago

578 JOKES, Riddles, etc., 10c. 250 Magic Tricks, 10c. Queen Supply Co., Dept. 2, Chicago.

BEAUTIFUL MAGIC FLOWERS FREE, with big catalogue, new tricks, puzzles, funny novelties. Ten cents. Crest Trading Co., 6 Witmark Building, New York.

CACHOO (the genuine sneeze powder) sample 10c; dozen 80c; hundred \$5.00. Catalogue Theatrical Wigs, Makeups, etc., 5c. Percy Ewing, Decatur, Ill.

GO ON THE STAGE—We teach you how! Write for descriptive circular. It's free! H. I. Mead & Co., New Ross, Ind.

GO ON THE STAGE—Will tell you how; descriptive circular free. Western Supply Co., Dept. Z, Parker, S. D.

YOU CAN BE A MAGICIAN; travel; give shows; make money. I tell how. Send stamp. Prof. Rapp, Box F-1115, Madison, Wis.

1400 CONUNDRUMS and Riddles 10c. A great collection. Edman & Co., Dept. 16, Chicago.

GO ON THE STAGE! Will tell you how! Write for descriptive circular. It's free. Cutter Publishing Company, Atlanta, Ga.

MAGIC SKULL, shines in dark, 10 cents. Klein, 1193 Broadway, New York.

100 TRICKS, with directions, fifteen cents. Bamberg, 1193 Broadway, New York.

NEW AND NOVEL JOKES—Great fun producers. So simple a child can operate them. 1. The Spilt Jam (Look what you've done to the table cloth!!!). 2. Red Hot Cinder (Drop it on the rug or floor in front of fireplace). 3. Damaged Finger (Deceptive blood-soaked bandage. Great sympathy is expressed by your friends). 4. Blot of Ink (The Bookkeeper goes mad. Mother is frantic). 5. Luminous Pencil (a friend asks for a light, when you instantly hand him this pencil. Upon his assertion that it was a light he requested, not a pencil, you withdraw the protector from end of pencil and hand him a lighted match). Price 10 cents each, postpaid. Address Popular Mechanics Book Dept., 318 W. Washington St., Chicago.

RARE COINS AND STAMPS

FREE STAMPS—3 different Soudan (Camel), or 5 different Costa Rica, or 5 different Tunis, stamp lists, lists of free premium stamps, etc. for 2c postage. Fine 50% approvals. W. C. Phillips & Co., Glastonbury, Conn.

\$7.75 PAID FOR RARE DATE 1853 Quarters, \$20.00 for a Half-Dollar. We pay a cash premium on hundreds of coins. Keep all money coined before 1880, and send 10 cents at once for our New Illustrated Coin Value Book; size 4x7. It may mean your fortune. C. F. Clarke Co., Coin Dealers, Dept. 14, Le Roy, N. Y.

1,000 MIXED OLD UNITED STATES, 25c, 100 foreign 5c. Herman Kleinman, 3641 Marshall, Philadelphia, Pa.

FREE sample copy Stamp and Coin Collector. A. Kraus, 439 Chestnut St., Milwaukee, Wis.

STAMPS 100 ALL DIFFERENT, FREE. Postage 2c. Mention paper. Quaker Stamp Co., Toledo, Ohio.

20 DIFFERENT FOREIGN COINS 25c, 500 old U. S. or foreign stamps 15c. F. L. Toupal, Chicago Heights, Ill.

MY NEW 50 PAGE coin selling catalogue just out, free. Buying coin catalogue sent on receipt of 15c in stamps. William Hesslein, Malley Bldg., New Haven, Conn.

FINEST STAMPS, Approvals, references, 100 different United States 25c; 150 different United States 75c; catalogue free. Collins, 285 Orleans, Detroit, Mich.

STAMPS—105 China, etc., stamp dictionary and list, 2c. Bullard, Sta. A., Boston.

FOR THE HOME

MAKE A MISSION MORRIS CHAIR, Arm Chair, Dining Chair, Library Table, Round Table, Sewing Table, Shaving Stand, Couch or Bookcase for yourself. Complete blueprints, 15 cents each. Mertens, 522 W. 136th, N. Y.

DARN YOUR SOCKS AND STOCKINGS with our New Star Darning Machine. Mends anything from underwear to lace curtains. Only 25c by mail, postpaid, with full instructions. Green's Supply Company, Dept. P, 82 Times Square Station, New York.

PEERLESS AUTOMATIC DRAFT REGULATION, puts on draft while you sleep, insures warm house when you arise. Price \$5.00. Write for circular B. Liberal discount to agents. O. K. Landis, 423 Charlotte St., Lancaster, Pa.

68 DESIGNS in knitting and lace making 10c. Catalog free. Edman & Co., Dept. 14, Chicago.

BEAUTIFUL ARTS-CRAFTS LAMPS—Anyone can make them out of paper, cardboard and wood. 16 designs. Inexpensive yet artistic. Complete book of instructions. Price 50c postpaid. Popular Mechanics Book Dept., Chicago.

MAKE YOUR OWN MISSION FURNITURE at the minimum of expense. Our 2 books "Mission Furniture, How to Make It," Parts 1 and 2, tell in plain, simple language just how to make 50 different pieces. Full dimensioned working drawings and half tones of finished articles. Price 50 cents each or \$1.00 for the two volumes, postpaid. Popular Mechanics Book Dept., Chicago.

METAL WORK AND ETCHING—A 96-page handbook for art metal workers telling how to make a great variety of useful and ornamental objects such as desk sets, arts-crafts jewelry, etc. Price, 50c postpaid. Popular Mechanics Book Dept., Chicago.

FOR MEN

ATTENTION—COMBINATION SET. Correct Style, Silk Socks, Silk Tie, Silk Handkerchief. All match. Special price, \$1.25. Worth \$2.50. Splendid Christmas present. All colors. Morse Bros., 6308 Justine St., Chicago.

FOR MEN; discard your suspenders and wear the natural fitting, nonslipping, invisible L. & N. belt. Satisfactory the year round, \$1 postpaid. Send for circular. Live agents wanted. L. & N. Belt Co., 1257 N. Clark, Chicago, Ill.

FREE, SAFETY RAZOR USERS, send one dull blade, returned sharp, free. Chas. E. Jewell, 17 James St., Auburn, N. Y.

KEEP YOUR RAZOR in first class condition without honing—10 cents. Progress Spec. Co., 2 Stuyvesant St., New York.

GILLETTE AND OTHER SAFETY Razor blades resharpened 2½c each. Our machine grinds, hones and stropps. Try us. Detroit Cutlery Co., 29-31 Monroe, Detroit, Mich.

SAFETY RAZOR BLADES sterilized and sharpened better than new; 2 cents each. Five years' success. Send for blade box and circular. Electro Stropping Co., 134 Shelby St., Detroit, Mich.

DIAMONDS, WATCHES AND JEWELRY

HALF OFF ON WATCHES and silverware. Let us show you how to make the dealers 50 per cent discount either by buying for yourself or selling to others. Write for watch book; it's free. E. B. Bonnell & Co., Harrison County, Tippencanoe, Ohio.

WATCHES—RARE OPPORTUNITY for individuals. Bargains till stock exhausts. Request particulars. The M. Elwin Company, No. Attleboro, Mass.

MUSIC

ANY SHEET MUSIC you want, no matter where published, we will supply at 15c per copy postpaid. Willis Woodward & Co., 1193 Broadway, New York.

IF YOU WANT the latest music and a better assortment for less money than elsewhere, write today for catalog. Sample's Music House, 204 West Ave., Norwalk, Conn.

"ASK PAPA," Entrancing Waltz Song with piano accompaniment, and 50 other latest songs, only 25c, stamps. Sullivan & Co., 24 Rose, Battle Creek, Mich.

PIANOS AND MUSICAL INSTRUMENTS

STRADIVARIUS VIOLIN for sale cheap. Excellent sweet tone. Miss Bertha Mardes, Route 5, Rosedale, Kansas.

FOR SALE—Grand Roller Organ with 85 rolls. Charles Taylor, Norwalk, Conn.

PRINTING

PRINTING—Just to introduce my high grade Printing, I will print 1,000 3x6 circulars for a dollar bill. Postpaid. F. Raymond Benson, Elgin, Ill.

GUMMED LABELS; 3,000, \$1.00. Printed two colors. Catalogue free. Advertising specialties. Mac Taggart, Station J, Philadelphia, Pa.

JOB PRINTING OUTFIT for sale. For particulars write Warren Vosburgh, Voorheesville, N. Y.

50 PRINTING PRESSES, 1,000 fonts type; outfits, \$12.00 up. Popular Bargains, Richland, Pa.

FOR \$2.90 WILL PRINT to your order 500 Envelopes and 500 Letter Heads. Material and work first-class. Samples free. Pearl Printing House, Palestine, Ill.

WE PRINT ANYTHING at Rock Bottom Prices. Stamp brings samples and price list. Eastern Printing Company, 1506 Eastern Avenue, Baltimore, Md.

PRINTING—100 NOTEHEADS, 100 Envelopes and 100 Cards neatly printed to your order prepaid \$1.00. Samples free. Union Pub. Co., Dept. M, Joliet, Ill.

100 ENGRAVED STYLE Visiting Cards, 25c. 100 Neat Business Cards or Envelopes, 40c. Retter, Box 142-P, Tippencanoe City, Ohio.

PRINTING PRESSES, Type and Supplies. Instruction book and catalogue free. L. M. Carroll & Co., 167 W. Washington St., Chicago.

TYPEWRITERS

WE DON'T WANT YOUR ORDER or any money until we prove by Five Days Free Trial that our typewriters are the biggest bargains ever offered. Get our proposition at once. Typewriter Sales Co., 165A No. Dearborn St., Chicago.

I WANT TO CORRESPOND with persons who are about to buy a high-grade typewriter, and object to paying the high prices generally asked by manufacturers and dealers. Any make on approval. Catalogue, bargain list and valuable information sent free. A. E. Atchison, 4127 West 21st St., Chicago.

STENOGRAPHER must sell her Remington typewriter, \$9.00. Miss King, 2230 7th Ave., N. Y. City.

STOCK OF TYPEWRITERS at bankrupt sale. Write for list. Ayers Investment Co. Sykes Block, Minneapolis, Minn.

GENUINE TYPEWRITER BARGAINS, no matter what make, will quote you lowest prices and easiest terms. Write for big

STENOGRAPHER sacrifices new Remington, \$25. Miss Wagner, 350 Elm St., Arlington, N. J.

CASH SAVES: Why pay installment houses 40% more? We sell high grade rebuilt Remingtons, Smiths, \$17; Underwoods, Oliviers, \$33—others cheap; sent on approval; sold under guarantee. Old Reliable. Consolidated Typewriter Exchange, 245 B'way, N. Y.

REMINGTON TYPEWRITERS \$12.00, Caligraphs \$8.00, Hammonds, Yost, Densmores, \$10.00, Smith Premiers and Jewetts \$15.00, Oliviers, Underwoods, L. C. Smiths and Royals \$25.00. Fifteen days free trial, and one year's guarantee, don't purchase until you get our prices. Harlem Typewriter Exchange, Dept. P.M., No. 217 West 125th St., New York City.

TYPEWRITERS—Every kind on the market, write today for best bargain you ever secured. Shipped anywhere on approval, \$10.00 up. Fletcher Typewriter Co., 207 N. 7th St., St. Louis, Mo.

OLIVER VISIBLE TYPEWRITER cheap. Charles Rickhart, Route 5, Rosedale, Kansas.

TYPEWRITER RIBBONS for any make of machine, four for \$1.00. Carbon paper \$1.00 per hundred. Guaranteed Peerless Ribbon Co., 217 West 125th St., N. Y. C.

TELEGRAPHY

TELEGRAPHY—MORSE AND WIRELESS—Railway Accounting (Station Agency) taught quickly. R. B. Dispatchers and Western Union Wires and complete Wireless Station in school. Splendid opportunities—graduates assisted. Living expenses low—may be earned. Largest and oldest school—established 37 years. Investment \$25,000.00. Correspondence courses also. Catalogue free. Lodge's Telegraph & Railway Institute, 15th St., Valparaiso, Ind.

TELEGRAPHY TAUGHT in the shortest possible time. The Omnigraph Automatic Transmitter combined with standard key and sounder. Sends you telegraph messages at any speed just as an expert operator would. Five styles. \$2 up; circular free. Omnigraph Mfg. Co., 41 G. Cortlandt St., New York.

WIRELESS

IS YOUR RECEIVER A WIRELESS RECEIVER? A wireless receiver should be at least 1000 ohms, and must be wound with copper wire. Our receivers are guaranteed to be wound to 1000 ohms with copper wire, and made especially for wireless work. Send stamp for pamphlet giving hints on wireless receivers. C. Brandes, 109-113 Broadway, New York.

NEW VARIABLE CONDENSER: best yet offered, \$3; moulded sending condenser, new, \$2 per section; new receivers, \$5 up. Wm. J. Murdock Co., 10 Carter St., Chelsea, Mass.

WIRELESS SET, How to Make—96-page book telling how to construct at small cost an outfit suitable for transmitting four or five miles. Price 50 cents, postpaid. Popular Mechanics Book Dept., Chicago.

MISCELLANEOUS

ADD AND SUBTRACT FRACTIONS faster than you can think and with absolute accuracy. You can do it with my extremely simple and convenient fraction adder. Price 10 cents. E. J. Lawrence, Box 422, New Britain, Conn.

THE GEOGRAPHICAL TIME and Distance Indicator. A mathematical apparatus, adaptable for schools, homes and libraries, practical and convincing, showing longitude, time and distance together. For descriptive circular and booklet write C. A. Iffert, Monroe, Wis.

FOR YOUR OFFICE, DEN or dining room, nicely mounted game heads, open-mouth fur rugs, extra pairs of horns, etc., at reasonable prices, write us your wants. R. H. Chaney, Taxidermist, Fort Stockton, Texas.

PAINT FOR 10 CENTS a gallon: A fine chemical paint that can be made of any color, by anyone. Materials purchased anywhere. Full working formula and directions sent for a dollar. Address, American Supply Co., Lebanon, Mo., Desk 4.

GINSENG, \$35,000 per acre. Send 10c for my "Ginseng Culture," giving full information, prices of roots and seeds for planting. W. N. Long, Florence, Ky.

HANDCUFFS, LEGIRONS, NIPPERS, etc., repairs, keys, handcuffs, \$2.50 pair up. Frank Widmayer, 2312 Broadway, New York City.

CAST IRON brazing formula \$1.00, won't break where brazed. Edmundson, 3027 N. Lawrence St., Phila., Pa.

WHO WANTS A DEMONSTRATING AGENT for county fairs, convincing talker, Fifteen Dollars per week commissions and found. Klinker, 1112 Park Avenue, New York.

FORMULAS OF ANY KIND, 20 cents per formula, or 4 for 50 cents. Address Formula, Box 85, Newark, N. J.

ROADMAN'S GUIDE.—Contains over 50 plans and schemes, also tells where to get supplies. 25c silver. Claude O. Hamilton, Greenfield, Ohio.

ALUMINUM SOLDER FORMULAS (3), and dry battery formula, all (4) for 50c, postpaid. Address Box 195, Roaring Spring, Pa.

101 NEW MONEY-Making formulas. 25c silver. Willard Eddy, 1109 Sycamore St., Waterloo, Iowa.

BUILD YOUR OWN WELL DRILL. I sell drawings and irons. Chas. E. Wyman, 425-427 Watt St., Jeffersonville, Ind.

DESKS—Direct from factory to user. Write for our new catalogue. Monarch Desk Co., Columbus, Ohio.

GOLD FILLED SOLITAIRE SCARF PINS. Diamond cut brilliant set. Guaranteed. Fifty Cents postpaid. R. Oldham, Mogadore, Ohio.

ELECTRO PLATING. Gold, silver, nickel, copper oxidizing, cold galvanizing. Send 50c for formulas and instructions. R. Moore, 205 Harrison Ave., Jersey City, N. J.

BASEBALL Curver. Ten cents. Carlton, Silver Bay, N. Y.

MAKE AND SELL Decoration Wreaths. Big Profit. Instructions 10c. Andy Mills, Weir, Miss.

WHAT DO YOU WANT TO BUY? We have unlimited facilities for purchasing. If the article you want is to be had, in any market in the world we can buy it for you. Tell us your requirements. International Purchasing Bureau, 1241 Giel Ave., Cleveland, Ohio.

IF YOU ARE THINKING OF BUILDING, send me your rough sketch for criticism and suggestions. Sketches developed. Scale drawings, tracings, blueprints made to order. Prices reasonable. L. P. Guion, Colorado Springs, Colorado.

CURIOS, GUNS, musical instruments, real Indian goods, secondhand. Write for circular. The Original, 528-15 St., Denver, Colo. L. A. Roebel. Fine fall dress suits rented.

TRICKS, JOKERS, PUZZLES, ILLUSIONS, Novelties—Magic Pocket Trick Free. Illustrated Catalog included. Send 6c stamps. Magic Dept., 10-270 West 39th St., New York.

WE MAKE BIG MONEY monthly mailing circulars. Our plan can be operated by anyone, anywhere. Particulars free. Mail Order Bureau, Box 283, Scranton, Pa.

100 MONEY Making Formulas, etc., published monthly. Worth dollars. 6 months, 10c. Sample copy 2c. Digest, Grand Rapids, Mich.

INTERESTED IN GASOLINE ENGINES? Send 50c for booklet, "How to Run and Install Gasoline Engines," and a year's subscription to Gas Energy, 28 Murray St., New York.

FOR THE SUCCESSFUL BRAZING of cast-iron use Mul-tum-tin-parvo. Particulars for stamps. R. Britt, Louisville, Ky.

MECHANICS! Get my Aluminum Solder formulas and book, "How to Solder Aluminum Successfully." For 30c in coin. G. Grundstrom, 5722 Aberdeen St., Chicago, Ill.

OLTS adjustable Duck Call; unequalled, \$1. Phillip Ott, Pekin, Ill.

1,000 MONEY MAKING FORMULAS, postpaid 25c. A. H. Smith, 414 Ft. Dearborn Bldg., Chicago.

5 SLICK-WINNER Formulas 4c. Jack Hellwig, 49 Clinton St., Albany, N. Y.

TOBACCO CURE, one box cures. Guaranteed or money back. Established 1894. Write for special offer. Allen Distributing Co., 319 Altman Bldg., Kansas City, Mo.

SAMPLE OF PERFUME 10c. Catalogue of Post Cards and Rubber Stamps free. W. M. Stuart, Marshall, Mich.

SPIRAL WIRE TAILED Vibration animal cards. Cannot keep them quiet. Sample 10c. Agents wanted everywhere. Richard Lavery, 194 Broadway, N. Y.

YOUR NAME AND ADDRESS on an air-cushion rubber stamp, 20c. Including pad, 30c. Smith Supply, Waukegan, Ill.

TATTOOING MACHINES—J. F. Barber, 1019 Vine St., Cincinnati, Ohio. (7)

PYRMA ALUMINUM MATTING—Best covering in the world for automobile running boards and floor boards, motor boat floors, etc. Send for samples and particulars. Metallic Automobile Matting Co., 300 Mill St., Rochester, N. Y.

MOTION PICTURE MACHINES, Film Views, Magic Lanterns, Slides and similar Wonders For Sale. Catalogue Free. We also Buy Magic Machines, Films, Slides, etc. Harbach & Co., 809 Filbert St., Philadelphia, Pa.

TRANSFER PHOTOS TO WATCH CASES, chinaware, sofa pillows, etc. New process. Very profitable. 25c brings full instructions. P. Benson, Stewartville, Minn.

I WILL START YOU earning \$4 daily at home in spare time, silvering mirrors; no capital; send for free instruction booklet, giving plans of operation. G. F. Redmond, Dept. 306, Boston, Mass.

ANYBODY CAN MAKE GOOD CUTS with my simple zinc etching process; price, \$1; specimens and particulars for stamp. T. M. Day, Box M, Windfall, Ind.

PATENTS SECURED—C. L. Parker, ex-examiner Patent Office 910 G St., Washington, D. C.

BROTHER—Accidentally discovered root will cure tobacco habit. Gladly send particulars. F. Stokes, Mohawk, Florida.

BOYS NOTICE—16 C. P. lamp will light on 5 dry cells; complete with shade, \$2.60. Mounts Electric Co., Krum, Tex.

Take Your Pick



So Easy To Do It

Show our samples to three of your friends, take two orders easy and make profit enough to get a swell, stunning tailored suit free. Trimmed with big pearl buttons, many other swell styles. No trouble, simply show our new, up-to-date samples. Everybody is surprised, prices so low, styles so beautiful, orders come easy. We take all the risk, ship on approval and guarantee perfect fit or no sale. We pay the express.

\$5 a Day Our new agents are making and wearing the swellest clothes besides; old agents after one season make twice as much. Banner agents have a snap. We want a few more hustling agents, willing to dress swell and make \$5.00 a day and up. No money or experience needed. Write quick before we fill your territory, and we will send you free a complete outfit to start at once—beautiful samples, latest styles in colors, everything you need to take orders, all fully explained. We will make you even one beautiful suit at a special inside wholesale price as a sample. It's a wonderful opportunity, so write at once or tell some friend who would be happy to get this grand easy money-making chance. Write us this minute.



Hurry and Get Yours

Banner Tailoring Co., Dept. 186, Chicago, Ill.

Matchless Pocket Lighter

Durable and waterproof, with perfect ignition. Satisfaction guaranteed or money refunded. Sent post-paid, complete with pocket clip, 35c. Special proposition to agents and dealers.



A perfect lighter. Occupies no more space in the pocket than a pencil. Indispensable to every smoker, hunter, fisherman, and automobilist.

Heavily nickel plated and made of finest material.

SCHILLER MFG. CO., Dept. M2, Schiller Building, Chicago

CAMERA AND COMPLETE OUTFIT



25c Takes pictures 1 1/2" x 1 1/4"; a "little gem." Leatherette covered Camera and complete outfit of plates, paper, chemicals, etc.

together with full instructions so simple that a boy or girl can take photos of landscapes, buildings, etc. All mailed for only 25c (silver or M. O.) or 3 for 60c.

ELECTRIC FUN MAKERS Keenan, Ill. Dept. 1

AGENTS

Our new Tampico Brooms with two other needed articles all retail \$1.00. Will deliver prepaid Complete Outfit for 75 cents.

6 other winners for Men and Ladies. Write—**FAIR MFG. CO., 6 Wisconsin Street, RACINE, WIS.**



ELECTRICIAN'S WATCH—NON-MAGNETIC

Send now for my non-magnetic watch, only \$5.00 (delivered) This watch will positively withstand all magnetic attractions. Tested to 2000 volts, absolutely guaranteed to keep the most accurate time under all conditions. Approved by everybody in the Electrical Industry. Stem wind and set; dust proof; thin model.

E. KIRCHBERG, 132 No. State St. (Old No. 76) CHICAGO

AUTOMATIC PISTOLS

BAYARDS, best in the world, \$14.00 and up. Revolvers, \$1.75 and up. Ask your dealer or send for particulars. FRED BIFFAR & CO., 180 N. Dearborn St., Chicago, Dept. 25

WHEN YOU WANT ANYTHING AND DON'T KNOW WHERE TO FIND IT WRITE BUREAU OF INFORMATION, POPULAR MECHANICS CHICAGO

FREE UPON REQUEST

OUR

Valuable 96-Page Catalogue

OF THE

Best Mechanical Books

It is well worth having and keeping for reference.

Popular Mechanics Book Dept.

318 W. Washington Street, Chicago

Continued on
Page 148
Advertising Section

Are You The Man?

Are you ambitious to better your condition—do you want to earn more money—to establish yourself in an independent business requiring no capital? We want to train such a man—you, if we can—a man who is unquestionably honest, whose capacity for intelligent work is unlimited, and who has unbounded faith in his own ability to succeed.

If you are such a man, we will give you a thorough, scientific and practical training that, with your willingness to study—work—and learn, you can be the owner of a growing, congenial business, with no question of your chance of success.

We Teach You All the Secrets of Real Estate, Brokerage and Insurance Business

We Instruct You In

- Salesmanship.
- Advertising.
- Office System.
- Real Estate Titles.
- Conveyancing.
- How to List Properties.
- How to Judge Values.
- How to Option Properties.
- How to Find Prospective Customers.
- How to Close Deals.
- How to Secure Loans.
- How to Get Insurance Business.
- How to Organize and Finance Corporations.

In fact, all the essential secrets known to and practiced by the successful broker and promoter.

We also give you a thorough *Commercial Law Course*, enabling you to meet for yourself and overcome difficulties that may arise. In short, we start you on the road to success.

Mr. Gates says:

"I started into this business without capital and have built up one of the most successful agencies in Vermont."

Mr. Dunbar, of Kansas, says:

"I have cleared up for myself during the year (his first year) over \$9,000."

Mr. Reynaud, of Texas, says:

"I have done remarkably well for a beginner, having made over \$6,500 in commissions since I started, nine months ago."

Mr. Knapp, of Los Angeles, writes:

"Three years ago \$900 per annum. Net income for 1910, \$8,000. They don't let up, but keep right on sending me business."

Mr. Taylor, of Montreal, Can., says:

"\$17,000 profits for 1910—Thanks to you, and your concern." Thousands have been helped to better their positions in life through our instruction!

Location No Bar To Success

The book we want to send you FREE tells how we start by giving you a thorough, practical and scientific training in the Real Estate, Brokerage and Insurance business; how we teach you to appraise values, approach customers, and close sales. It gives you, in detail, the outline of the complete training in Commercial Law which you will receive, enabling you to meet all legal problems as they arise—instantly. Explains our methods thoroughly and what it means to YOU to be the local representative of the oldest and largest Co-Operative Realty & Brokerage Company in America.

This 64-page book—yours for the asking. Simply clip the Coupon—mail it today.

International Realty Corporation
1836 Manhattan Building,
Chicago, Ill.

Mail This Success Coupon Today!



International Realty Corp.,
1836 Manhattan Bldg., Chicago, Ill.
Please send me at once your big 64-page Free Prospectus and oblige.

Name.....

Address.....



ASP THE LAW AT HOME—AS LINCOLN DID BE A LAWYER

Learn in spare time. Legal training ensures success in business. Modern methods create demand for men with knowledge of Law. Lawyers are leaders of men. The calling one of great dignity and profit.

Our Course of Instruction endorsed by Bench and Bar prepares for admission in any State. 12,000 Students now enrolled

Special limited low-cost offer now open. Terms to suit your own circumstances and convenience. Particulars and Catalogue Free. Write Now—Today—It may be the turning point in your career. Address:

AMERICAN CORRESPONDENCE SCHOOL OF LAW
Largest Law School in Text Book Instruction for Home Study in the World
Established 1886 1327 Michigan Boulevard, CHICAGO, ILL.

Traveling Salesmen and Saleswomen Wanted

Earn While You Learn. We now have on file letters from thousands of Wholesale and Manufacturing firms who are anxious to employ Salesmen and Saleswomen capable of earning from \$1,000.00 to \$10,000.00 a year and expenses. No former experience needed to get one of these good positions. We will teach you to be a high grade Salesman or Saleswoman in eight weeks by mail and our **Free Employment Bureau** will assist you to secure a position where you can earn good wages while you are learning Practical Salesmanship. Write today for full particulars, list of good openings and testimonials from over a thousand persons we have recently placed in good positions.

Address, Nearest Office, Dept. 124

National Salesmen's Training Association
Chicago New York Kansas City New Orleans Seattle U.S.A.

LEARN WATCHMAKING AT HOME



You can learn by our modern and original system of instruction every part of the Watchmaker's Trade at home as good or better than at a shop. You can earn money while learning and secure a well paying position or start in business after completing our course of instruction. Good watchmakers are always in demand and earn from \$20 to \$35 per week. For particulars apply to the WISCONSIN SCHOOL OF WATCHMAKING, Enterprise Bldg., MILWAUKEE, WIS.

MONTHLY CASH PRIZES

Until further notice in this magazine the Editor of Popular Mechanics will pay two cash prizes each month for the best original contributions to its

SHOP NOTES DEPARTMENT

\$10 for the Best Contribution
\$5 for the Second Best

THIS IS IN ADDITION to our usual rates for such contributed articles.

Quality, not length counts. Checks will be sent on the last day of each month for the prize articles received during that month. Publication in the magazine will follow in about two months.

PRIZES AWARDED FOR AUGUST, 1911

- First Prize—W. A. LANE, El Paso, Tex. \$10
"Lemon Squeezer"
- Second Prize—JOHN MASON, Armstrong, Okla. \$5
"Thawing a Frozen Pipe"

EXTRA AWARD

On account of there being five contributions this month, each of which deserved second prize, we have made an EXTRA AWARD of four additional second prizes, as follows:

- WILFRED E. BERTRAND, Philadelphia, Pa. \$5
"Removing Rust Pits in Rifle Barrels"
- JOSEPH OLESON, Milwaukee, Wis. \$5
"Substitute for a Small Lifting Magnet"
- D. J. McKENNA, New Britain, Conn. \$5
"Wheels on a Shop Stepladder"
- HARRY L. BERRY, Philadelphia, Pa. \$5
"A Belt Stick"

All accepted contributions to our departments, "SHOP NOTES" and "AMATEUR MECHANICS," are paid for immediately; checks for prize awards are sent at the end of each month.

Address, EDITOR POPULAR MECHANICS

This Superb World's History Shipped Free

15
Volumes

5000
Pages



700 Illustrations
Splendid De Luxe Edition

Library of Universal History

Yes, shipped free—just as we announce. Unquestionably the world's most reliable and trustworthy History. Used in 250,000 homes. Adopted by Educators, Schools and Colleges. Send the free coupon for free map of Panama and sample pages. This handsome Edition is bound in Genuine Maroon English Crash Buckram, all printed from large new type, one hundred double-page maps and plans.

Publisher Fails—Write Today for Great Sacrifice Price

Do not fail to send the coupon below for the most sensational price on history that ever has been made. We, as underwriters, obtained a limited number of these books upon the failure of the Publishers. We will quote the price only in direct letters for we are not allowed to injure future sales by printing sensationally low prices here. This is a chance of a life time to secure the greatest history of the world ever published at a price you never dreamed of—a price which you would not believe possible.

You must read some history. Why not read the best? History fixes ambition. It broadens the mind. It inspires the unworthy to worthiness. The late Ex-President Cleveland said of the work: "I am sure this history will find an important place among the publications intended to give wider familiarity with historical literature." Dr. Frank W. Gunsaulus, Pres. of Armour Institute of Technology says: "It is a work of rare genius. Its thought is clear and vigorous—its English pure and elegant."

Big CANAL MAP Free

FREE COUPON

Write Now. Send This Free Coupon If you will send the coupon at once we will mail you free and postpaid a full, complete and comprehensive map and profile of the Panama Canal showing dams, locks and cuts, a handsome art picture of Pres. Taft, and a genuine colored territorial map of the United States— together with sample book of history.

American Underwriters Corporation Dept. 1197 171 N. State St., Chicago

With the understanding that I am not buying anything you may send me free, map and profile of Panama Canal, etc., also free sample history book and quote me the special underwriters' price on the Library of Universal History.

AM. UND. CORP.
171 N. State St.
Dept. 1197
CHICAGO

NAME

ADDRESS

MARVELOUS NEW SYSTEM OF SHORTHAND

LEARN AT HOME—BY MAIL—IN ONE MONTH

We positively guarantee to make you a finished shorthand writer in thirty days through our new perfected system. All the disadvantages of the old-fashioned systems eliminated—no complications—so simple a child can learn—only 9 characters—no "positions"—no "shading." The only rational system of shorthand in the world. Not simply a modification of the old-fashioned methods, but absolutely new and perfect. Thousands of successful students prove the value of our methods. FREE! Write for our new book, "Shorthand in 30 Days." Get posted. Find out how you may learn the most interesting, profitable profession in the world in just your spare time. Send a postal today.

CHICAGO CORRESPONDENCE SCHOOLS [15]
966 Chicago Opera House Block - Chicago

ADVICE

Information and counsel on any subject under the sun. No matter what you want to know, no matter what your present condition, our big organization can help you.

WRITE TODAY FOR BEAUTIFULLY ILLUSTRATED BOOK FREE
NATIONAL BUREAU OF ADVICE AND EDUCATION, 527 Ashland Block, CHICAGO



STAMMER

My book "How to Stop Stammering"—a treatise on "Scientific Talking"—direct to the point.

Write M. L. HATFIELD, 1462 Grove St., OAKLAND, CALIF.



LOTS OF FUN !! DOUBLE THROAT. Fits roof of mouth. Invisible when in use. Astonish and mystify your friends. Whine like a puppy, sing like a canary, and imitate other birds and beasts of field and forest. **LOTS OF FUN.** Thousands sold. Price, 10c each; 4 for 25c or 12 for 59c.
ELECTRIC FUN MAKERS, Dept. C. Kewanee, Ill.

WHEN YOU WANT ANYTHING AND DON'T KNOW WHERE TO FIND IT
WRITE BUREAU OF INFORMATION,
POPULAR MECHANICS CHICAGO

Mission Furniture

50c How to Make It 50c
PART I

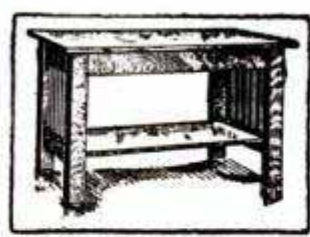

One of Popular Mechanics Series of INDUSTRIAL HANDBOOKS. "Written so you can understand it." Tells very

plainly how to make 21 different articles of mission furniture; the instructions being accompanied by working drawings and half tones of the finished articles.

96 pages. Cloth cover.
Price 50 cents, postpaid.

Order from your newsdealer or direct from the publisher.

POPULAR MECHANICS CO.
CHICAGO

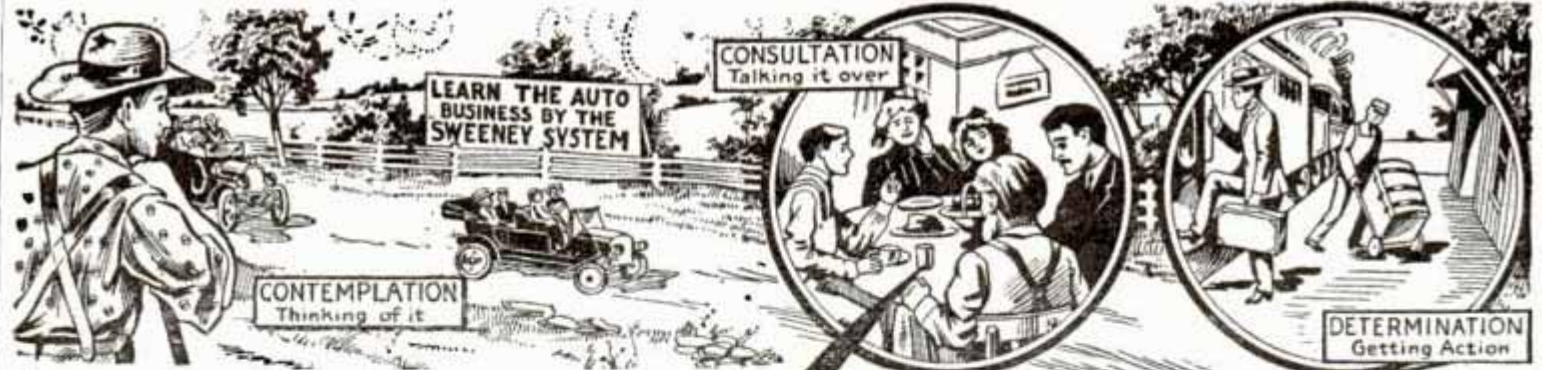

I'll Double Your Earning Ability in Six Weeks

Try My Course in Automobile Training ONE WEEK FREE

—Emory J. Sweeney

car or truck or open a garage and repair shop of your own. You can stay until you have learned. You can learn the automobile business thoroughly in my school because I have been years in working out for quick, thorough instruction, the

I want you to come to my school one week; I want you to see for yourself, absolutely without expense to you, how thoroughly and practically I teach all about the automobile. Six weeks after the day you enroll in my great practical Automobile School you will be prepared to properly repair any automobile made and drive any car or truck. I guarantee to teach you and if you don't learn in 6 weeks you can learn the automobile business thoroughly in my school because I have been years in working out for quick, thorough instruction, the

"Sweeney System" of Practical Instruction

It is today the most thorough, practical, comprehensive and interesting course of automobile instruction, and embraces every point worth knowing, including cleaning, greasing, brazing, oxy-acetylene welding, lathe work, machine shop practice, testing and road work, etc. You learn by doing the actual work on real cars with your own hands under the watchful eyes and ready suggestions of experienced instructors.

No Books Used—Tools Given FREE The tuition is low and, after you have paid that, you do not have another expense in the school. You do not learn from books, but by practical work on real automobiles in everyday use. A complete set of tools is given free to students who take Course C.

Send Today for FREE Catalog and One Week's FREE Tuition Enrollment Blank I want every man thinking of learning to become an Auto Expert to have my new, big, Illustrated Catalog. This Catalog is just fresh from the printer. Contains articles by well known automobile men and is all about the "Sweeney System" and the great opportunities in the automobile business—in fact, everything you want to know. Write for this great book and free enrollment blank. Write today—this very minute—NOW

EMORY J. SWEENEY, Pres.

SWEENEY AUTOMOBILE SCHOOL

1462 Woodland Ave. Where You Learn by the "Sweeney System" KANSAS CITY, MO.
Experienced chauffeurs, repair men, truck drivers and demonstrators furnished.





DO YOU LIKE TO DRAW?
That's all we want to know
Now we will not give you any grand prize—or a lot of free stuff if you answer this ad. Nor do we claim to make you rich in a week. But if you are anxious to develop your talent with a successful cartoonist, so you can make money, send a copy of this picture with 6c. in stamps for portfolio of cartoons and sample lesson plate, and let us explain.
The W. L. Evans School of Cartooning
321 Kingmoore Bldg., Cleveland, O.

STUDY LAW High-Grade Instruction by Correspondence
Prepares for the bar. Three Courses; College, Post-Graduate and Business Law. Nineteenth year. Classes begin each month. Send for catalog giving rules for admission to the bar of the several states.
CHICAGO CORRESPONDENCE SCHOOL OF LAW
558 Reaper Block, CHICAGO





In the Old Days It Often Meant Trickery
Now auctioneering exemplifies the highest type of salesmanship. For seven years we have trained capable, competent, successful auctioneers. Send for catalogue.
JONES NATIONAL SCHOOL OF AUCTIONEERING,
2868 Washington Blvd., CHICAGO.



LEARN WATCHMAKING
Watchmaking pays and you can earn while you learn. Write for FREE BOOK, "How to be a Watchmaker." Postal brings it.
Stone's School of Watchmaking
912 Globe Bldg. St. Paul, Minn.

Learn to Write
I TEACH BY MAIL
WRITE FOR MY FREE BOOK
"How to Become a Good Penman"
and beautiful specimens. Your name elegantly written on a card if you enclose stamp. Write today. Address F. W. TAMBLYN, 418 Meyer Bldg., Kansas City, Mo.

IF YOU STAMMER
I will send you my 83-page book "Advice to Stammerers" Free. It explains how I quickly and permanently cured myself. Profit by my experience and write for free book and advice.
BENJ. N. BOGUE
1509 North Illinois St., INDIANAPOLIS, IND.

I TEACH SIGN PAINTING
SHOW CARD WRITING or LETTERING by mail and guarantee success. Only field not overcrowded. My instruction is unequalled because practical, personal and thorough. Easy terms. Write for large catalogue.
CHAS. J. STRONG, Founder
DETROIT SCHOOL OF LETTERING
DEPARTMENT PM. DETROIT, MICH.
"Oldest and Largest School of its Kind"

ANYBODY CAN LEARN
to paint portraits by my practical system of personal instruction by mail. You can earn \$25 to \$50 a week as portrait artist. Write for free test lesson plate and booklet.
L. T. KUNDE, Dept. A, Cawker Bldg., MILWAUKEE, WIS.



LEARN WATCHMAKING
Watchmaking, Engraving and Jewelry repairing taught in all its branches. Personal instruction by practical specialists. By our profit sharing plan students can earn while learning. Positions secured for graduates. Our school is endorsed by leading jewelers. Send for free catalog.



LEARNED BY ANY MAN OR BOY AT HOME SMALL COST
VENTRILOQUISM
Send today 2c stamp for particulars and proof.



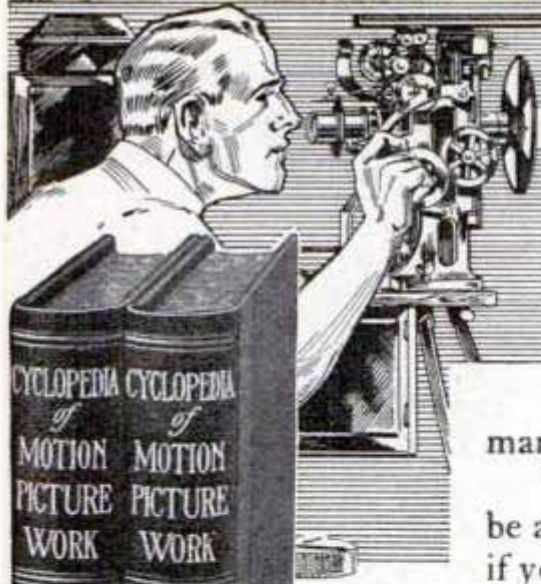

BE AN EXPERT MOVING PICTURE OPERATOR MAKE FROM \$22 TO \$30 PER WEEK

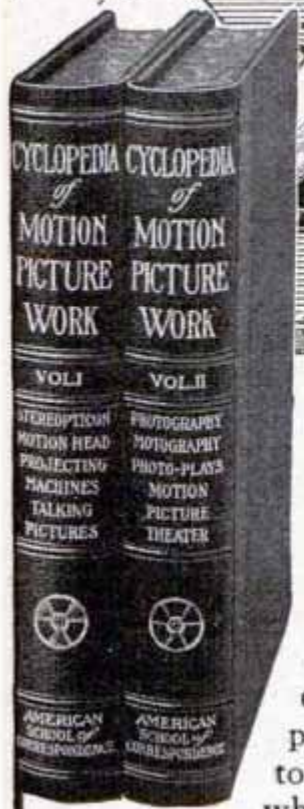

Big pay and short hours in this paying profession. The demand for expert motion picture operators is increasing daily. The American School of Correspondence will teach you to be an expert operator in a few weeks, without loss of time. Even if you have a good job now it will pay you to learn motion picture operating. Many operators are making "a little extra" in their spare time. Fill in the coupon and we'll send you our booklet "The Motion Picture." It explains our motion picture course fully—gives some valuable information about operating.

Also ask for information about our "Cyclopedia of Motion Picture Work." Just off the press—the only complete work on this subject ever published. Special introductory price on first thousand—ask about it today. Fill in the coupon, specifying whether you want books or course.

AMERICAN SCHOOL OF CORRESPONDENCE, CHICAGO, U. S. A.

The American School of Correspondence
Chicago, U. S. A.

Please send me further information about your

- () Motion Picture Course.
- () Cyclopedia of Motion Picture Work.

NAME

ADDRESS

Pop. Mech. 10-11



LEARN THE AUTO BUSINESS

EARN A SPLENDID SALARY

Automobile mechanics, salesmen and chauffeurs are in demand at big salaries. A course in our splendidly equipped resident school prepares for the best positions. Hundreds of successful graduates. Course includes actual practice repairing and driving high powered cars. Complete training in 4 weeks.

SEND TODAY FOR BOOKLET F.

CLEVELAND AUTOMOBILE SCHOOL, 2167 E. 9th St., Cleveland, O.

EARN \$100 TO \$200 A MONTH



Be a Railroad Man

Hold the throttle of a monster Locomotive, travel 30,000 miles a year, see the country and earn big wages. Our

Self Educational

Complete Practical Railroading teaches how to become a successful Locomotive Fireman and then an Engineer in quickest time at small expense. Learn in spare time.

FULL PARTICULARS SENT FREE

National Institute of Practical Mechanics
1325 Michigan Ave. CHICAGO, ILL.



"HELP WANTED" -Uncle Sam.

Mail Clerks - Clerks
in the Offices at Wash-
ington, D. C.—City Carriers
—Stenographers—Typewriters
Fall Examinations Everywhere
**\$800⁰⁰ to \$1800⁰⁰ a Year
for LIFE**

No "layoffs" without pay, because of strikes, financial flurries or the whims of some petty boss. Excellent opportunities for quick advancement to Higher Government Positions. If you want immediate appointment, send TODAY for our schedule showing locations and dates of the Fall examinations. Any delay means the loss of just so much time in preparing yourself for examination.

We Prepare
Candidates
Free

SEND
COUPON
BELOW

FRANKLIN INSTITUTE
Dept. O 108, ROCHESTER, N. Y.

The coupon, filled out as directed, entitles the sender to a free copy of our book, "Government Positions and How to Obtain Them," and to consideration for Free Coaching for the examination here checked.

COUPON

- | | |
|--|---|
| Railway Mail Clerk (\$800 to \$1400) | Customs Positions (\$800 to \$1500) |
| Postoffice Clerk (\$800 to \$1200) | Internal Revenue (\$800 to \$1800) |
| Postoffice Carrier (\$800 to \$1200) | Stenographer (\$800 to \$1500) |
| Rural Mail Carrier (\$500 to \$ 900) | Clerk in the Depart-
ments at Washington (\$800 to \$1500) |
| Bookkeeper (\$900 to \$1800) | |

Name

Address

Use this before you lose it. Write plainly.

O 108



A New Creation

The Most Remarkable Set of Books Ever Published

Electrical Workers Standard Library

FOR REFERENCE AND HOME STUDY

Practical — Authoritative — Comprehensive and Up-to-date

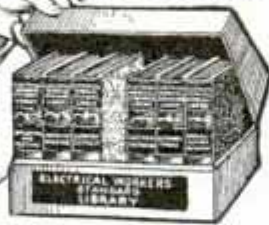

Real Pocket Size Volumes. Arm yourself against emergencies. Carry them on the job. Apply the practical problems to your everyday work. Ensure the Electrical Inspector's "O. K." Provides a complete treatise on Electrical Construction Work for the Beginner or Working Electrician. A Reliable, Practical Guide.

SEVEN handy pocket size volumes, size 4 1/2 x 7, bound in full American Morocco, stamped in genuine gold leaf, 2500 pages, 1500 illustrations, including full page plates, working diagrams, etc. Hundreds of tables and formulas. Fully indexed for quick and easy reference. For Electrical Engineers, Electricians, Railway Power Station Engineers, Linemen, Telephone or Telegraph Engineers, or for anyone engaged in electrical work.

WILL YOU EXAMINE THESE BOOKS FREE OF CHARGE?

If interested in Electricity, these books are just what you want. To convince you, we will send a complete set by pre-paid express; keep them five days; examine them thoroughly and carefully; test them; apply the knowledge to your everyday work. If you keep them, send us \$2.00 after five days and \$2.00 a month until you have paid the special price of \$21.00. The regular list price is \$28.00. Just fill in the coupon below and mail it. The books will be sent you at once.

FREE EXAMINATION COUPON

National Institute of Practical Mechanics: P. M.
Please send Electrical Worker's Standard Library for FREE examination. I will send \$2.00 within five days and \$2.00 a month until I have paid \$21.00; or notify you and hold the books subject to your order. Title not to pass until fully paid.

NAME
ADDRESS
OCCUPATION
EMPLOYER

Sold only by subscription. For further information address

NATIONAL INSTITUTE OF PRACTICAL MECHANICS
1325 Michigan Ave. CHICAGO, U. S. A.

LEARN TO REPAIR AND RUN AUTOMOBILES



EARN BIG MONEY IN AUTOMOBILE BUSINESS

as a chauffeur, repairman, salesman. Work pleasant. Big demand for trained men. Fine chances for starting automobile livery, agencies, taxicab and repair companies. Learn the automobile—every part, and its mechanical operation thoroughly and practically in a few weeks. Write today for our interesting free book and learn about the tremendous opportunities everywhere in this new business and our excellent course of training.

KANSAS CITY AUTOMOBILE SCHOOL

(Conducted by CLIFF HOGAN)
(Largest and Best Equipped Automobile School in America)
2139 E. 15th Street, Kansas City, Mo.

Join the Better Paid Class!

Young men, learn a profession that is clean, fascinating and profitable. Here is your opportunity to forge ahead of the mediocre class. We offer a practical and complete course in Architectural, Structural and Mechanical



DRAFTING

BY MAIL

You study from blue-prints of buildings and machinery actually being erected. Your lessons are approved by Chicago's best known architects and engineers. Full or partial courses to fit your need. No text-books to buy. We assist you to a position when qualified. Reasonable tuition, easy payments. Mention course and write for folder today.

CHICAGO TECHNICAL COLLEGE
660 Athenaeum Building, Chicago, Illinois.
Short resident courses in the same studies at our school in Chicago. Low tuition. Day and evening classes. Send for catalog B

BE A DETECTIVE

Earn from \$150.00 to \$300.00 per month; travel over the world. Write C. T. LUDWIG, 1600 Scarritt Bldg., Kansas City, Mo.

BE AN ENGRAVER

LEARN AT HOME—EARN \$25 to \$50 WEEKLY. We give personal instructions and furnish necessary tools FREE. Terms reasonable. Complete particulars by mail. Chicago Engraving School, Dept. 20, 110 W. Chicago Ave., Chicago



YOUNG MEN WANTED

You Can Easily Learn

to be an automobile salesman, chauffeur, demonstrator or repairman. Our home-study course of 10 weeks is simple, practical and interesting. No mechanical experience required. Our graduates are everywhere, earning \$25 to \$50 weekly in positions we obtained for them. Free model of automobile to every student. Highly endorsed and reasonable.

SEND FOR FREE LESSON AT ONCE

A postal will bring it. Chauffeurs and competent men supplied owners and garages.

Empire Auto Institute

702 Empire Bldg. Rochester, N. Y.

The Original Auto School

IN AUTOMOBILE BUSINESS
NICE WORK-BIG PAY-DANDY JOB

6 ROADS to SUCCESS

These
Practical
Trades Pay



5 to 8
Dollars
a Day

Electricity

Our Main Building

Plumbing



offers the greatest field in the world today. Thousands more skilled Electrical Engineers and Operators are needed. Wages are high and work steady, while the future offers the richest prizes in research work and new adaptation of electric power. Elec-

trical science is only in its beginning, says Thomas Edison. The future holds possibilities undreamed of.

We teach thoroughly and practically every branch of electrical work. Our graduates are filling the highest positions everywhere.

offers easy work, short hours, big pay and steady work. It's almost impossible now to learn the trade as an apprentice. Even then it will take years and perhaps you will never thoroughly master it.

At this school in a few months you are graduated as a master workman, able to hold a job anywhere in the world. Not books but tools and actual working materials under actual working conditions used here. Plumbing offers splendid chances to start a business of your own.



Mechanical Drawing



is a most useful and attractive profession. Good Draftsmen command their own hours and conditions of work with highest salaries.

We teach every detail of the work from ordinary plan drawing to most elaborate and intricate me-

chanical designing. Enroll at once. Positions assured all graduates.

Painting and Decorating

is of all trades the most varied and fascinating. It offers both outside and inside work and affords full scope for exercise of the artistic nature. We teach it all thoroughly, from painting and paper-hanging to finest color harmonies and mural decoration, including the almost lost art of glazing (or marbling?) Send for Special Catalog on Painting and Decorating.



Bricklaying



A highly paid, fine, healthy, outdoor occupation. Builders are always on the watch for competent Bricklayers.

We teach Bricklaying by actual work on building operations—every branch of it, including the fancy finishing and cornice work

which few workmen understand. Come now. You'll be a competent mechanic in a short time earning your \$5 to \$8 a day.

Moving Picture Operating

is practically a new business and good operators are so scarce that unusually high wages are enjoyed. It's a fascinating work, and offers splendid fields for advancement to responsible and very high salaried positions. In our school the entire science and practical operation, care and maintenance of the kinematograph is thoroughly and quickly mastered. Join the class now.



School open all the year. Enter any time. Day and night sessions. Free Employment Department. Tuition and expenses very low. Easy payments if desired. Largest and best equipped school buildings in America. Delightful opportunities for general and social culture. Ten minutes walk to the heart of Chicago's business center. Send for Book of the School. It's FREE. Send Now.

Address, L. L. COOKE, Director

COYNE NATIONAL TRADE SCHOOLS, 50 E. Illinois St., CHICAGO, ILL.

"Learn a trade and start in business for yourself"

#10 COVERS ALL AUTOMOBILES LEARN TO RUN AND REPAIR



Why don't you learn this profession and double your salary? If you master this profession you are independent. Repairmen and Chauffeurs are needed in every town and city of the country.

My system is positively the only system in the world that can be successfully taught by mail.

My system of teaching by mail is a New Idea—it's different from others. I will so thoroughly train you that you will not only be able to drive a car, but you can repair motors, overhaul cars, repair tires, repair launch engines, repair stationary gasoline engines—you could go into the repair business—and also sell cars and engines.

SEE THIS WORKING MODEL

There are other models; one of a Magneto, Engine and Carburetor; also a Manikin of an automobile. The Manikin can be taken apart and the models actually work. All moving parts on the models made of real metal.

The Course consists of 29 Instructions, 3 Models, and a Manikin, and examinations, diploma, etc. Special price right now is but \$10.00. If you paid \$1,000.00 you couldn't get a better course—nor as good a course—because it is the only one of its kind.

Let me show you what others say whom we have started and who have doubled their income. Let me show you what Barney Oldfield, Chas. Duryea and other motor authorities say.

SEND FREE BOOK
How to Get into the Auto Business and Its Opportunities.

DYKE'S CORRESPONDENCE SCHOOL OF MOTORING

Box 1, Roe Building, ST. LOUIS, MO.

(A. L. Dyke is the originator of the first Auto Supply Co. in America)

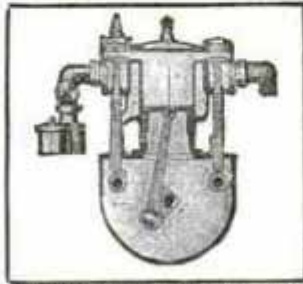

ONE OF THE WORKING MODELS

With this engine model you learn the principle of a gasoline engine and you can actually set the valves, time the ignition, etc.



LEARN PIANO TUNING AT HOME by the aid of the TUNE-A-PHONE. A Profession that can be converted into money at any time or place in the civilized world at an hour's notice. Earn \$5.00 to \$15.00 per day. Valuable illustrated book FREE. Write NILES BRYANT SCHOOL OF PIANO TUNING, 31 Music Hall, Battle Creek, Mich.

LAW STUDY at HOME

Graduate correspondence students most successful at bar examination. Write now for proof and free 112-page catalog. We make your home a university. Leading home-study law course in America. Our own modern text—prepared by deans and professors from big law colleges—Harvard, Chicago, Wis., Ill., Mich., Iowa, Stanford and others. Very low cost and easy terms. Also business law.

LA SALLE EXTENSION UNIVERSITY, BOX 1197, CHICAGO, ILL.

We teach you to Earn big money

There are numberless chances for young men to make fortunes in aviation and in the automobile business. We give you the necessary instruction in both branches. We give not only technical instruction by mail, but practical experience right here in Washington with real machines, in the factory. And we put you in a profitable business right from the start with no investment necessary. We appoint you agent for the cars manufactured at factory where our students are trained and pay you \$175.00 on each sale you make. We help you start in the garage business from which profits of from \$10.00 to \$15.00 a day are made. If you want to get ahead in the world and be somebody, send for our Plan No. F and handsome catalogue. It shows you just how to get started.



AutoCollege of Washington, Inc., Washington, D.C.

Highland Park College

Des Moines, Iowa



Enter Any Time

2000 Students Annually

Special terms open October 16, November 28, January 2.

Students, however, may enter any time they are ready to come

One of the most completely equipped **ENGINEERING SCHOOLS** in the country

COURSES OFFERED

1. CIVIL, ELECTRICAL AND MECHANICAL ENGINEERING COURSES. Standard courses are offered in Civil, Electrical and Mechanical Engineering. Special opportunity is offered for making up work or for taking a complete course preparatory to the standard Engineering Courses. Shop work from the beginning comes in preparatory courses. See our new Engineering Catalogue.

- 2. SHORT COURSES**
- 1. One Year Electrical Engineering Course
 - 2. One Year Telephone Engineering Course
 - 3. One Year Steam Engineering Course
 - 4. One Year Machinists' and Automobile Course
 - 5. One Year Course in Mechanical Drawing

Just a fair common school education is all that is required for entrance to these courses. These courses are very practical and are intended for those who have but limited education and do not see their way clear to take a complete Engineering Course. The Machinists' Course is especially practical. The new machine shops are the most complete to be found in connection with any Engineering School in the United States.

SPECIAL COURSES

- 1. TRACTION ENGINEERING.** This is the most complete course in Traction Engineering offered by any Engineering School in the country. It may be completed in three months. Students are taught how to make all repairs on engines as well as to handle them. Four traction engines used for experimental purposes.
- 2. GASOLINE AND AUTOMOBILE COURSES.** These courses may be completed in three months. They are exceedingly practical. Complete Chauffeur practice. Just a fair common school education is all that is necessary to enter.
- 3. FARM BLACKSMITHING, FARM CARPENTRY.**

Mention course in which you are interested. Address,

O. H. LONGWELL, Pres., Des Moines, Ia.

\$25 TO \$100 A WEEK

Big Salaries paid to our graduate chauffeurs and auto experts. We teach you at home in 10 simple lessons to earn big money and assist you to secure a position. Over 100 diagrams in course. Write for prospectus, sample pages, testimonials from students and endorsements of 19 leading auto makers. Small payment starts you. Free model of an auto to each student.

PRACTICAL AUTO SCHOOL
68 Beaver Street New York



WANTED Motion Picture Plays

Demand rapidly increasing; larger prices being paid. You can write them; we teach you in 10 easy lessons. Ours is the original and only thorough course; graduates selling their plays. Write now for full details. Address **ASS'D M. P. SCHOOLS, 701 Chicago Opera House Block, Chicago**

LEARN WATCHMAKING

refined, profitable labor—Competent men always in demand. We teach it thoroughly in as many months as it formerly took years. Does away with tedious apprenticeship. Money earned while studying. Positions secured. Send for catalog. **St. Louis Watchmaking School, St. Louis, Mo.**

BE AN ILLUSTRATOR. Learn to draw. We will teach you by mail how to draw for magazines and newspapers. 112 Page Bldg. Chicago, Ill. Send for Catalog

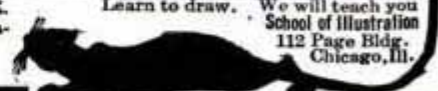

ARITHMETIC SELF-TAUGHT

A plain, easily-understood volume for all who have not had the opportunity of learning this subject thoroughly, or who have forgotten what they once learned. **257 Pages. Requires no teacher.** This great little book sent postpaid for **60 CENTS.** Stamps accepted, leather binding \$1.

SPANGENBERG'S PRACTICAL ARITHMETIC Self-Taught

THE
MECHANICS
HANDBOOK

ELECTRICAL
ENGINEERS'
HANDBOOK

BUILDING
TRADES
HANDBOOK

ADVERTISERS'
HANDBOOK

BUSINESS
MAN'S
HANDBOOK

BOOKKEEPERS'
HANDBOOK

STENOGRAPHER
AND
CORRESPONDENTS'
HANDBOOK

PLUMBERS
AND
FITTERS'
HANDBOOK

TELEPHONE
AND
TELEGRAPH
ENGINEERS'
HANDBOOK

MARINERS'
HANDBOOK

\$1.25 Handbooks for 50c.

No books in existence contain in so small space as much information about the trades and professions of which they treat as do these Handbooks. They are little giant encyclopedias of practical knowledge giving data and information that is hard to find in ordinary books. These Handbooks have been prepared by the well-known textbook writers of the International Correspondence Schools whose textbooks are recognized the world over as the most practical treatises on applied sciences ever published. These Handbooks are consulting experts of the highest rank, and are the most powerful force in the world for the promotion of ambitious men. They are an indispensable help to quicker and better work that will command advancement. They are printed on a high-grade book paper in clear type, and durably and handsomely bound in cloth with gilt titles; contain on an average of 364 pages and 175 illustrations and are regularly sold for \$1.25 each.

SPECIAL OFFER.—We are selling these Handbooks, durably bound in cloth with gilt titles, at a special price for each Handbook of 50 cents.

Mechanics'—Tables; formulas; measurements; belting; mechanical powers; hydro-mechanics; strength of materials; shafting; boiler design; care of boilers; power of boilers; chimneys; exhaust heating; machine design; machine tools; slide valve; pulleys; cylinders and steam chests; pistons; gearing; transit surveying; triangulation; curves; radii and deflections; earth work; track work; electricity; etc.

Electrical Engineer's—Mechanics; electricity; electrical units; symbols and quantities; physical and electrical properties of metals and alloys; wire gauges; magnetism; dynamos and motors; electric batteries; alternating current apparatus; alternators; transformers; wattmeters; electric transmission; electric lamps; wiring; electric heating and welding; electromagnets; controllers; car wiring; etc.

Building Trades—Loads and structures; strength of materials; properties of sections; strength of rivets and pins; materials of construction; footings and foundations; masonry construction; woods used in building; qualities of timbers; joinery; framing; estimating; elements of architectural design; drainage systems; plumbing fixtures; plumbers' tables; heating and ventilation; gas and gas-fitting; etc.

Advertiser's—How to plan and write an advertisement; type and type measurements; points on printing style; display; preparation of manuscript; proof reading; engraving and printing methods; electrotypes; matrices; advertisement illustrations; magazines; newspapers; retail, department-store, general, trade-paper, and mail-order advertising; trade marks; circulars; advertising agencies; etc.

Business Man's—Arithmetic; tables; business forms; card systems; measures of extension; weight and capacity; time; value of foreign coins; duties on imports; bookkeeping; stenography; correspondence; postal information; financial terms; money and the money market; brokers and brokerage; patents; copyright and trade marks; corporations; business law; publicity; etc.

Bookkeeper's—Arithmetic; formulas; tables; money; percentage; interest; equation of accounts; money and the money market; business law; financial terms; banks and banking; postal information; distances and time between various places; bookkeeping; business forms; card systems; modern office methods; cost accounting; bank bookkeeping; clearing house methods; etc.

Stenographer's & Correspondent's—Advice to beginners; shorthand speed; letters of application; punctuation; correct and faulty diction; business correspondence; type-writing; abbreviations; addressing; mailing; rates of postage; duplicating work; etc.

Plumbers and Fitters'—Arithmetic; involution and evolution; powers, roots, and reciprocals; circles; decimals; geometrical drawing; weights and measures; formulas; mensuration; mechanics; hydro-mechanics; building construction; heating and ventilation; gas-fitting; plumbing; etc.

Telephone and Telegraph—Useful tables; mechanics; electricity; magnetism; primary batteries; storage batteries; electrical measurements; telephony; tests with magneto-generator and bell; telegraphy; Morse telegraph systems; multiplex telegraphy; etc.

Mariners'—Logarithms; trigonometry; navigation; terrestrial navigation; celestial navigation; organization of a man of war; naval ordnance; explosives; torpedoes; ship building; speed, tonnage, and fuel consumption; ropes; wind and weather; signals; nautical memoranda; etc.

International Textbook Co.

Box 872, SCRANTON, PA.

I enclose \$_____ for which please send me the books BEFORE which I have marked X.

- **Mechanics' Handbook** **Advertiser's Handbook**
- **Elect. Eng. Handbook** **Business Handbook**
- **Bldg. Trades Handbook** **Bookkeeper's Handbook**
- **Plum. & Fit. Handbook** **Sten. & Corr. Handbook**
- **Tel. & Tel. Handbook** **Mariners' Handbook**

Name _____

St. and No. _____

City _____ State _____

I Can Make You a Convincing Speaker

says Grenville Kleiser formerly of Yale Faculty). He rids you of timidity—gives you confidence in yourself—develops your power and personality. Just give him fifteen minutes of your time daily—at home—and he will speedily teach you how to

Sell Goods—Make Political Speeches—Address Board Meetings—Deliver After Dinner Speeches—Propose Toasts—Converse and Tell Stories Entertainingly.

If you can't talk to the point, you can't carry conviction—you can't win! Don't you want to be a winner? Then write to-day. Let us tell you all about this helpful Course and prove its value.

FUNK & WAGNALLS COMPANY, Dept. 241, NEW YORK

WANTED—MEN

BRAKEMEN, FIREMEN, ELECTRIC MOTORMEN, CONDUCTORS, TRAIN PORTERS

Hundreds put to work. \$65 to \$150 per month. 500 more wanted. Experience unnecessary. Application blank and map of new lines free. Give age and position wanted. Enclose stamp.

I. Railway C. I., No. 35, Indianapolis, Ind.

COPY THIS SKETCH

and let me see what you can do with it. You can earn \$20.00 to \$125.00 or more per week, as illustrator or cartoonist. My practical system of personal individual lessons by mail will develop your talent. Fifteen years successful work for newspapers and magazines qualifies me to teach you. Send me your sketch of President Taft with 6c. in stamps and I will send you a test lesson plate, also collection of drawings showing possibilities for YOU.

THE LANDON SCHOOL OF ILLUSTRATING and CARTOONING
1438 Schofield Building, Cleveland, Ohio.



New York Electrical School

Offers a theoretical and practical course in applied electricity without limit as to time.

Instruction individual, day and night school, equipment complete and up-to-date. Student learns by doing, and by practical application is fitted to enter all fields of electrical industry fully qualified. School open all year. Write for free prospectus.

44 West Seventeenth St., NEW YORK



Learn a Paying Profession

that assures you a good income and position for life. For seventeen years we have successfully taught

PHOTOGRAPHY

Photo-Engraving and Three-Color Work

Our graduates earn \$20 to \$50 a week. We assist them to secure these positions. Learn how you can become successful. Terms easy—living inexpensive. Write for catalogue—NOW!

ILLINOIS COLLEGE OF PHOTOGRAPHY, 999 Wabash Avenue, Effingham, Ill.



IF YOU STAMMER

attend no school till you hear from me. Largest school in the world, employing the advanced natural method for the cure of stammering, stuttering, etc. No sing-songing or time-beating. If let run, stammering will wreck your life's happiness and handicap your endeavors. I cured myself and thousands of others by my method and can cure you. Beautiful 188 page book and Special Rate sent FREE.

Loe Welles Millard, Pres., North-Western School for Stammerers, Inc., 917 First St., Milwaukee, Wis.

THE UNIVERSITY OF CHICAGO

Correspondence-Study Dept.

HOME STUDY

offers 350 class-room courses to non-resident students. One may thus do part work for a Bachelor's degree. Elementary courses in many subjects, others for Teachers, Writers, Accountants, Bankers, Business Men, Ministers, Social Workers, Etc. Begin any time.

19th Year

U. of C. (Div. 20) Chicago, Ill.

Learn Telegraphy

MORSE and WIRELESS

At My Practical School. Splendid demand for operators and agents. We also teach Station Agency Work. Graduates assisted. We occupy our own 2 large modern buildings equipped with R. R. Dispatchers and Western Union Wires and Wireless Stations. Endorsed by Railroad, Wireless and Western Union Officials. Exclusive Methods. Teachers are practical experts. Living expenses earned. Easy payments. Catalogs Free. Correspondence course if desired. GEORGE M. DODGE, Pres., Dodge's Institute, 8th St., Estab. 1874, Valparaiso, Ind.

Bliss Electrical School

Complete ONE-YEAR Course Sound, scientific, practical—without frills. Every branch of electricity taught in detail. For young men of energy and character. 19th year. Opens September 20.

WRITE FOR NEW CATALOGUE
15 Tacoma Avenue, WASHINGTON, D. C.

LEARN WATCH REPAIRING

Be a watchmaker—you can learn this profitable trade by correspondence in a few weeks in your own home by the DeSelms Chart System. After you complete the course you will know a watch from A to Z. You will know just what the matter is and how to repair one. When you graduate you will be a practical watchmaker and repairer and competent to fill any position. Positions for our graduates.

Ask for our Free Book. It explains our system and terms.
THE DeSELMS WATCH SCHOOL
23 Perry Street ATTICA, INDIANA



LEARN JEWELERS' ENGRAVING

A high salaried and easily learned trade, taught thoroughly by mail. We will teach the beginner better engraving than he can gain in years of rigid apprenticeship. We will also improve the skill of any engraver. Send for our catalog. The Engraving School, 112 Page Bldg., Michigan Ave., Chicago, Ill.

LEARN PLUMBING

A trade that will make you independent for life. Hours Shorter—Pay Bigger—Demand Greater than most any trade. You need no previous experience. Our practical methods enable you in a few months to hold position as skilled plumber or conduct your own business. Catalog sent free.

St. Louis Trades School
4430 Olive St. ST. LOUIS, MO.

BIG PAY SHORT HOURS

Earn

\$25⁰⁰ to \$75⁰⁰ Weekly

Repairing Watches

We Teach you how.

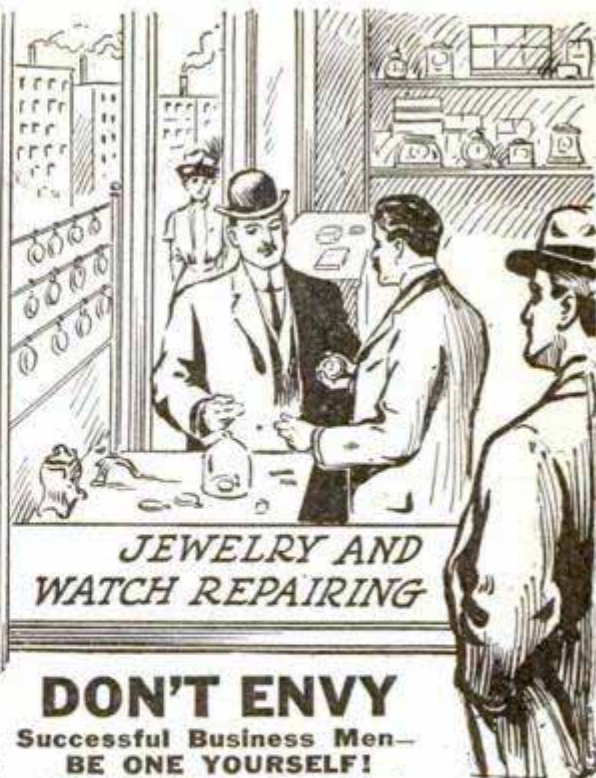

**JEWELRY AND
WATCH REPAIRING**

DON'T ENVY

**Successful Business Men—
BE ONE YOURSELF!**

If you are not the owner of an independent business—it's your own fault. Don't wait until you have saved up money—you will need only a few dollars for tools. Let us start you now and you can make what money you need repairing watches—then you can soon have an independent business of your own. If you want us to show you—we will give you the names of men we have helped start in business. Send us your name and address on a post card and we will send a full, illustrated explanation of our plan by return mail quick. "To-morrow" means never—send the card now!

CHAS. F. ELMORE, Principal of Watchmaking College
Rogers, Thurman & Co. 101-103 N. Wabash Ave., Chicago

We Will Help You START IN BUSINESS

Remember that this is not a correspondence school! It is a big watch repairing and jewelry concern that stands ready to teach you the business that has made it the largest and most successful concern of its kind in the World. While learning you can stay at home—you can continue your present occupation while learning. You can begin making money at once.

WE WILL TEACH YOU the business absolutely Free, because we want you to represent us.

We mean just what we say—this is a straightforward business proposition to you. We will furnish you, free of cost, all text-books; clear, simple lessons; illustrated chart and photo prints showing you just exactly how to prepare each job. You will be surprised to see how simple and easy it is. Our repair department will do the difficult jobs for you until you learn how—you take the profit.

IF YOU MEAN BUSINESS WE WILL STAND BACK OF YOU. If you are the right kind of a man we will back you to the limit. You won't have to make any experiments—we have made them—we will start you right. You will have the benefit of our advice, instruction and experience. We will supply you with materials, jewelry, etc., at rock-bottom prices. You can beat any competition because you will have the backing of the most successful watch repairing and jewelry establishment in existence.

LEARN TO WRITE ADVERTISEMENTS EARN \$25 to \$100 A WEEK

We can positively show you by mail How to increase your salary. BOOK MAILED FREE. PAGE-DAVIS CO., 112 Page Building, Chicago, Ill., or 150 Nassau St., New York



LEARN CHIROPRACTIC

The new method of drugless healing
EARN \$50 TO \$100 PER WEEK

Our free book tells how you can learn to detect disease and remove the cause by Howard's method of Spinal Adjustment. Positively the most simple, direct, advanced and scientific method of drugless healing. Based on unerring natural laws Anyone can understand it; learned in spare time. Improve your social prominence and financial standing. Start now on the road to honor and success. Write for free book and special scholarship offer.

NATIONAL SCHOOL OF CHIROPRACTIC
806 Wendell Building CHICAGO, ILL.

WANTED
DOCTORS OF
CHIROPRACTIC

\$5000
to
\$15,000
yearly await
our graduates

Osteopathy **FREE**

Our Valuable 100 Page Book on Drugless Healing

FREE

This free book explains the Theory and Practice of the latest and best method of Drugless Healing and shows a correct way to master disease without the use of injurious or habit-forming drugs.

We give you this interesting book absolutely free in order to tell you all about Mechano-Therapy—the Recognized System of Drugless Healing which pays

\$3,000 to \$5,000 Yearly

In a few months by our system you can begin practicing Mechano-Therapy—an elevating and highly paid profession for men and women. Simpler and more comprehensive than Osteopathy. Endorsed by physicians. A fascinating study, easy to learn. We teach you in your own home by mail or in class and guarantee success—an ordinary education and our course of instruction fits you for a professional life. Authorized diplomas to graduates. Work absorbingly interesting. Vast opportunities for social and financial betterment. Special terms now. Write today for our 100-page book on Osteopathy, 84-page ill. prospectus sent free. American College of Mechano-Therapy, Dept. 466, 120-122 Randolph St., Chicago.

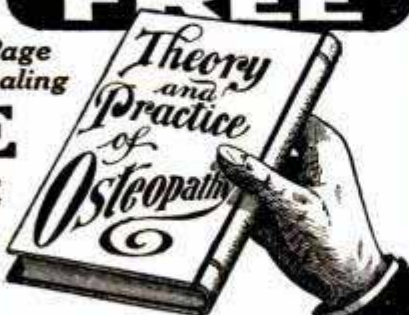

There is a World-Wide Demand for Doctors of Chiropractic From all over the world come demands on the chiropractic Fountain Head for chiropractors. Large as the yearly graduating classes are, there are still thousands of excellent locations unsupplied.

Learn Chiropractic at Home

Send Today for our Free Book, "The P. S. C. Way to Health for Wealth."

It tells how we teach by mail the new science, "Chiropractic," which removes the causes of sickness by adjusting the vertebra of the spine to their normal positions, allowing health-giving mental forces to flow unhindered through spinal cord and nerves to all parts of the body.

Why not be a doctor of Chiropractic with immense fields of certain success open to you? Earn an income; NOT MERELY WAGES! Write today.

PALMER SCHOOL OF CORRESPONDENCE

Chiropractic Fountain Head

Dept. P. M.

DAVENPORT, IOWA

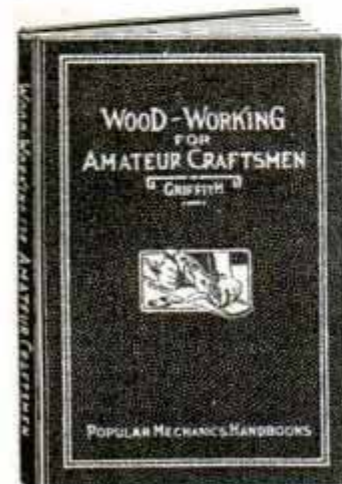
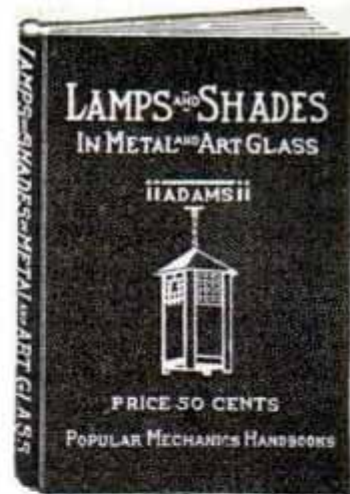
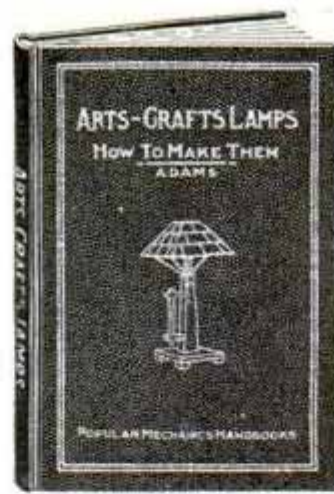

Learn a Useful Craft

MANY a man finds the home workshop a continual source of pleasure and profit, and there is no end to the designs in furniture, artistic lamps and metal work that may be reproduced at slight expense; to say nothing of the desirability of being able to do the countless little repair jobs continually arising about the house.

A great variety of designs and complete instructions for working them out will be found in our *Mission Furniture, How to Make It*, (2 vols.)—*Arts-Crafts Lamps—Lamps and Shades in Metal and Art Glass*, and *Metal Work and Etching*, while *Wood-Working for Amateur Craftsmen* gives every essential step required for learning this useful trade. *Electroplating* and *Metal Spinning* are practical working manuals which everyone engaged, or about to engage in these occupations should possess. The experimenter will delight in *How to Make a Wireless Set*, and the story of *Heat* written by Prof. Ogden is an immensely interesting and instructive book pertaining to heat and its relation to modern mechanics. In short

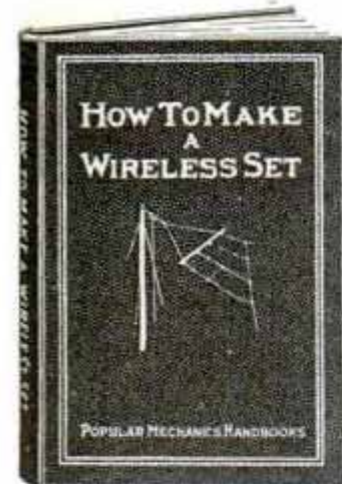
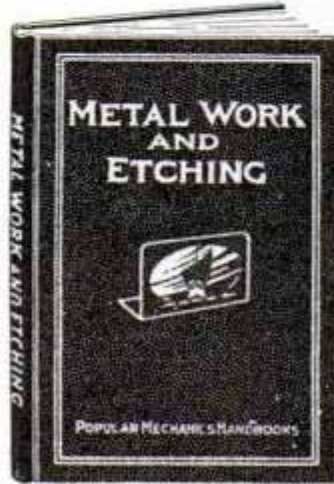

Popular Mechanics Series of Industrial Handbooks
 "WRITTEN SO YOU CAN UNDERSTAND IT"
 Constitutes a useful, compact library of mechanical information that is unequaled.

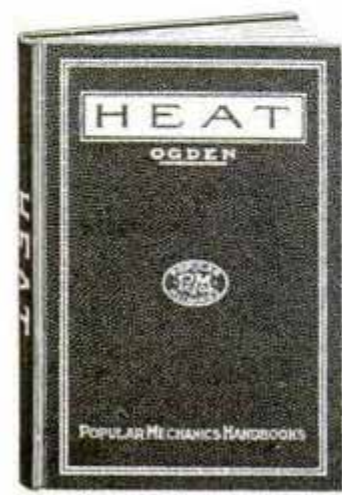
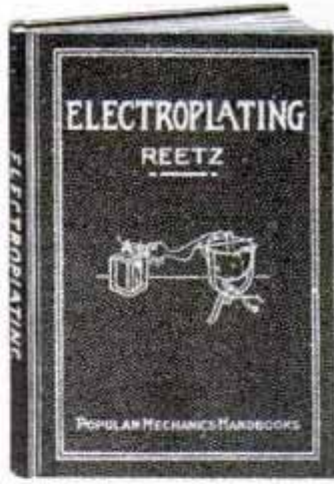

These books are written by practical experts who not only know the best practice, but know how to impart that knowledge to others. These titles now ready:

Mission Furniture, How to Make It—Part I, 21 designs,	96 pages
Mission Furniture, How to Make It—Part II, 32 designs,	128 pages
Wood-Working for Amateur Craftsmen	128 pages
Arts-Crafts Lamps, How to Make Them, 16 designs,	96 pages
Lamps and Shades in Metal and Art Glass, 18 designs,	128 pages
Metal Work and Etching,	96 pages
Electroplating,	112 pages
Metal Spinning,	80 pages
How to Make a Wireless Set	96 pages
Heat	128 pages

OTHERS TO FOLLOW

A uniform series printed on the best book paper and durably bound in extra cloth. Size 5 x 7 inches. Artistic cover designs in gold and white.

Price Each, 50 Cents Postpaid

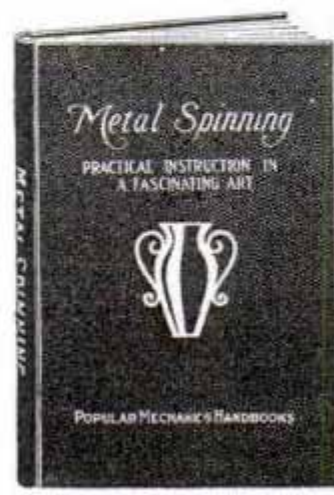

ORDER OF YOUR DEALER OR SEND DIRECT TO THE PUBLISHERS

Popular Mechanics Book Department, 318 W. Washington St., Chicago

A Present-Day Story of Reclamation
 A New Novel by Harold Bell Wright, Author of
 "That Printer of Udell's" "The Shepherd of the Hills"
 and "The Calling of Dan Matthews."

THE WINNING OF BARBARA WORTH

SECOND EDITION
 250th THOUSAND

The Illustrations, secured at great cost, made on the scenes of the story by Mr. F. Graham Coates, are Six in number with the addition of Jacket in Colors

→ Cloth, 12mo, 512 Pages, \$1.30 Net ←

¶ The Winning of Barbara Worth is different from any novel the author has heretofore done, but it is somewhat after the style of *The Shepherd of the Hills*. The three elements of strength—"motive power," "story power," and "thought power"—that each of his other three novels in turn so distinctively possess, are combined in this latest story.

Other Novels by Mr. Wright
 Bound in uniform style with above

Illustrated, 12mo, Cloth
 Each \$1.50

That Printer of Udell's
The Shepherd of the Hills
The Calling of Dan Matthews



¶ The Winning of Barbara Worth is another star in the author's crown of success and the brightest of them all.

¶ As clean a story as man ever wrote—a story with big incidents, strong people, high ideals and the Spirit of the West.

¶ A story of desert life and the national reclamation work with a sane, wholesome message as broad as humanity itself—*The Ministry of Capital*.

Philadelphia Dispatch—"The secret of his power is the same God-given secret that inspired Shakespeare and upheld Dickens."

Oregon Journal, Portland—"It is this almost clairvoyant power of reading the human soul that has made Mr. Wright's books among the most remarkable works of the present age."

¶ Mouth to Mouth Advertising has made Harold Bell Wright the most popular living author because his books "make good." By special arrangement 250,000 copies of "The Calling of Dan Matthews," the most widely discussed book in the world, have been published in the Popular Edition. Harold Bell Wright's Ozark "Life Stories," *That Printer of Udell's*, *The Shepherd of the Hills* and *The Calling of Dan Matthews* are all now published in the Popular Edition and are For Sale Wherever Books Are Sold.

¶ The Winning of Barbara Worth for wholesomeness, plot, clear analysis, vitality to our national life, love story and literature combined, is the biggest novel ever issued from any American press and is published in one edition only. The Winning of Barbara Worth **Will Not** be published in the popular edition.

The An Allegory (not a novel) Uncrowned King

New York Tribune—"It embodies the aspiration, civic and moral, of the present day."
Grand Rapids Herald—"It is the greatest story since Bunyan's 'Pilgrim's Progress.'"
Omaha World-Herald—"It is a classic in nature and spirit and rendering."
Buffalo Evening News—"It represents dreams of artistic magnificence."

Frontispiece and Ten Illustrations in Color by John Rea Neill. Over 100 pages. 16mo (4¾x7). Bound in Red and Gold—Cloth, 75 Cents Net. Full Leather, Gilt Top. Boxed, \$1.25 Net

Mr. Wright's Books Are For Sale Wherever Books Are Sold

Or Send Your Order to the Publishers—The Book Supply Company

Our mammoth catalog, size 8½x5½ inches, advertises books of all the publishers at big savings. Bibles, Periodicals, etc. Write us for it today. Bargains on every page. Books on all subjects. **BOOK CATALOG FREE** Hundreds of Fine Sets and Fine Bindings for your library. Every book carried in stock. Orders filled promptly. Great reductions. Big savings. Catalog sent postage prepaid, free on request. A quarter million buyers testify to the advantages we offer. Every purchaser a satisfied customer. We want your orders. Our prices are convincing. Unequaled service for handling Public, Private and School Library orders.

THE BOOK SUPPLY COMPANY, Publishers and Booksellers

ESTABLISHED 1895

E. W. REYNOLDS, President

231-233 West Monroe St., CHICAGO

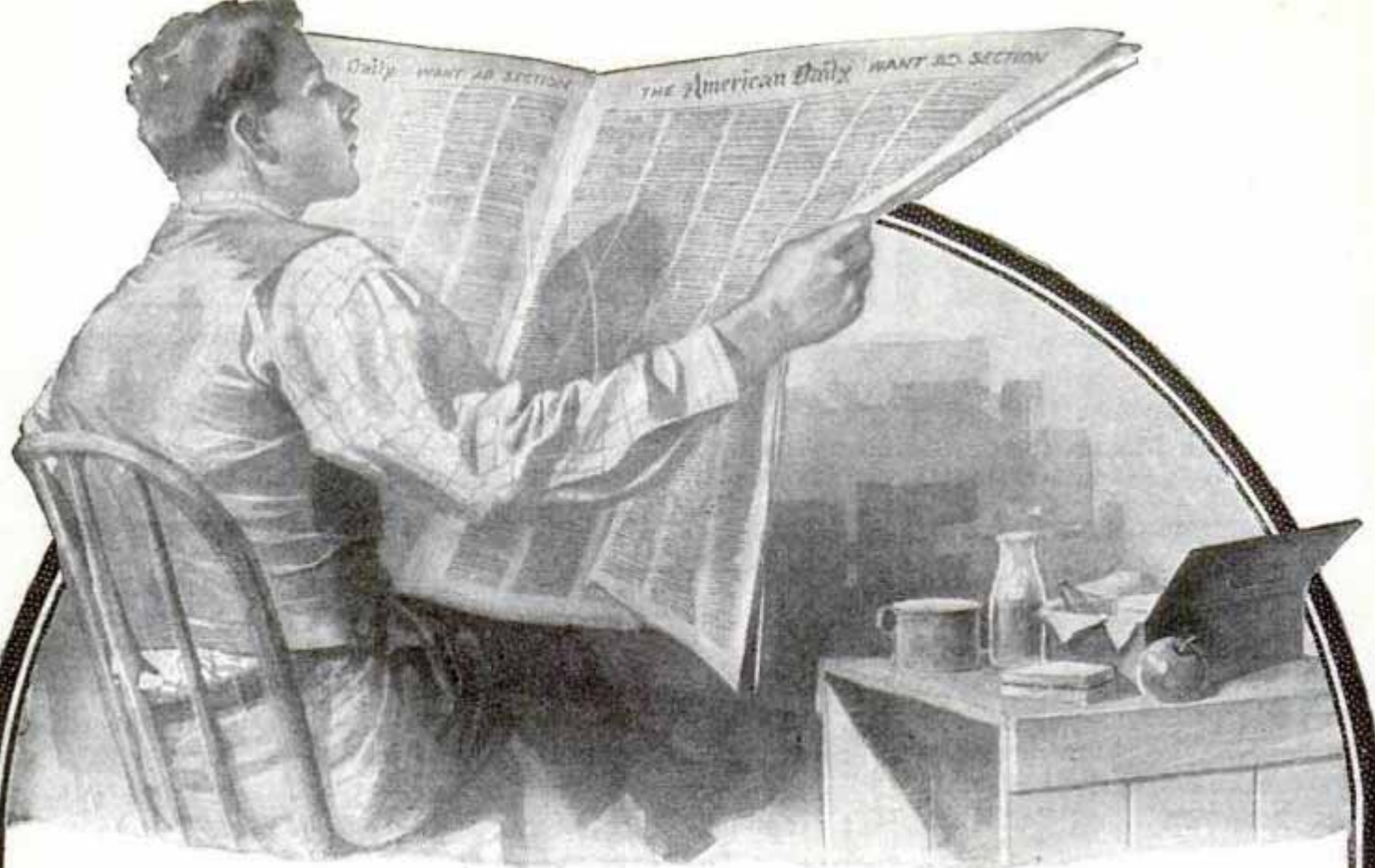

Trained Men Wanted

Every year thousands of **good jobs** are seeking **trained men** through the daily press. You won't have to look for a good job if you have the necessary training to fill one—**the job will look for you**—the "Help Wanted" columns in every daily paper prove this.

The American School of Correspondence offers every ambitious man a chance to make more money and get a better job.

Every man has "got it in him" to make good. Lack of time is no excuse. An hour a day spent now will be worth ten hours a little later on. A better job, a better man, a pleasanter home, and a future full of prosperity—all these and more will be yours for a few hours a week and a few cents a day spent now—before you're too old and your ambition is gone.

Check the coupon and send it to us now. Tell us what you want to be—what your ambitions are, then tell us what you are doing now. We'll be glad to advise and help you. There is no obligation attached to this. We'll tell you frankly just what we can do, the rest is "up to you."

The American School is an educational institution. No agents, representatives or collectors are employed. If you send us the coupon, we'll not bother you by sending an agent. All of our business will be carried on privately by correspondence.

American School of Correspondence
CHICAGO, U. S. A.

OPPORTUNITY COUPON

American School of Correspondence, Chicago, U. S. A.
Please send me your Bulletin and advise me how I can qualify for the position marked "X."
Pop. Mech. 10-11

- | | |
|--------------------------------|--------------------------|
|Draftsman |Fire Ins. Engineer |
|Architect |Telephone Expert |
|Building Contractor |Moving Picture Op'r |
|Structural Engineer |Bookkeeper |
|Civil Engineer |Stenographer |
|Electrical Engineer |Accountant |
|Elec. Light & Power Supt. |Cost Accountant |
|Master Mechanic |Cert'd Public Acc't |
|Steam Engineer |Auditor |
|Sanitary Engineer |Business Manager |
|Reclamation Engineer |College Preparatory |

NAME

ADDRESS

OCCUPATION

Popular Mechanics Magazine

WRITTEN SO YOU CAN UNDERSTAND IT

Vol. 16

OCTOBER, 1911

No. 4

Schoolhouse With Direct Exits From Every Room

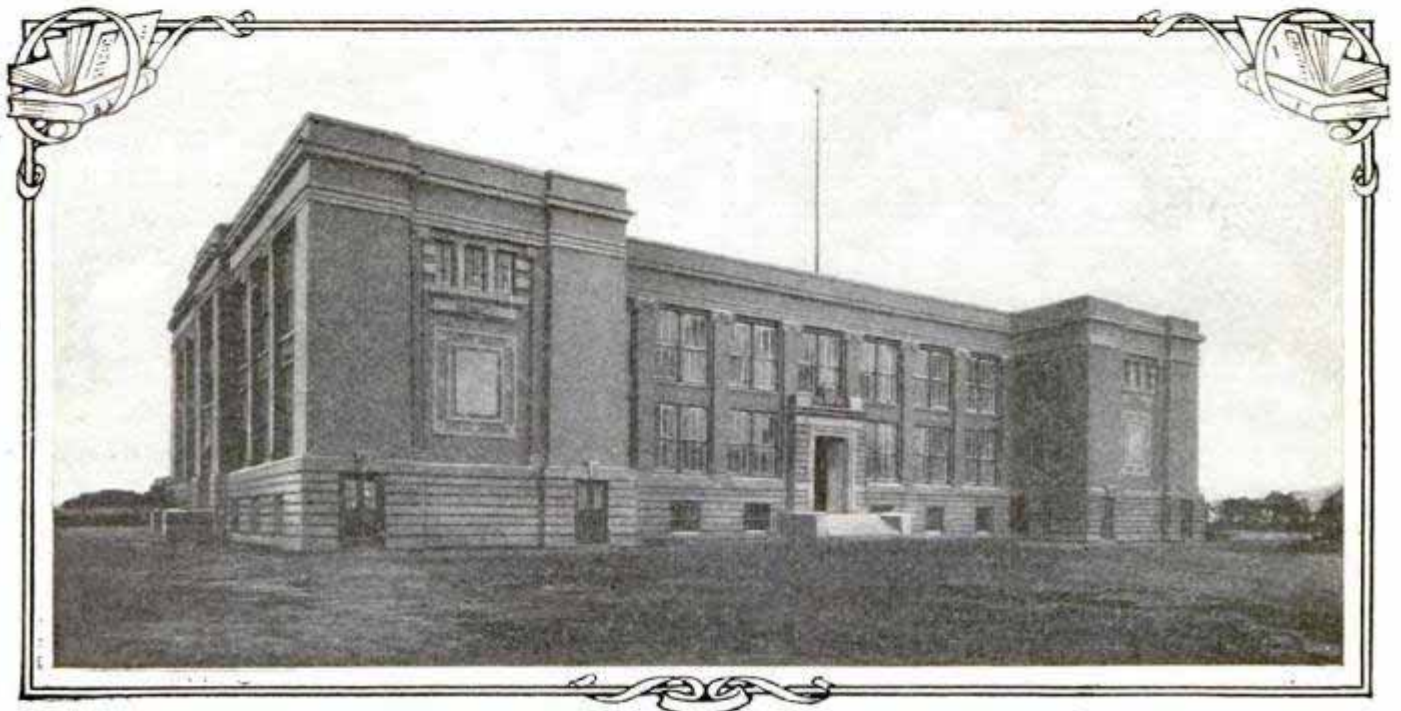

New Fireproof Building Erected Beside the Site of the Collinwood, O., School in Which 175 Children Were Burned to Death. It Has Many Novel Features

A SCHOOL building in which every room has a direct connection with the ground, without first entering the main hall, has been built just beside the site of the famous Collinwood, O., school in which 175 children perished by fire in 1908. It represents many unique features of construction and is said to be as fireproof and panic-proof as it is possible for a school building to be.

There are 12 large class rooms and a spacious auditorium in the new building. Between each two rooms a cement stairway extends straight down to the ground, making it possible to empty the entire building in two minutes without using the main halls,

and with never more than two classes coming in contact with each other. The stairways from the rooms on the first floor are directly under the stairways from the second floor. Doors at the ground exits open on the slightest pressure.

Steel doors are used at the main entrances and steel doors also separate the class rooms from the halls. Door and window casings are of steel. The floors are laid on concrete and the roof is concrete. The corridors and cloak rooms have cement-finished floors.

Each room is ventilated without the necessity of opening a window. An electrically operated fan, 12 ft. in diameter, provides the ventilation. Heat

is furnished from a separate building and passes beneath the floor in brick ducts. An even temperature is preserved by automatic devices.

The auditorium of this building is circular in form, is directly on the ground, and has no balcony. There is a glass dome in the center for light. Seven exits lead from this room.

The building cost about \$85,000. It is 155 ft. wide and extends back 180 ft., is two stories high, and above the stone foundation is built of brick and terra cotta. On the adjoining ground and directly on the site of the great fire, a memorial park, 140 by 500 ft., is for flower gardens, shrubbery, decorative trees and lawn.

AN ELECTRIC DEATH TRAP FOR THE FLY

The latest effort in the "swat-the-fly" campaign is an electric death trap which although clever in conception and design seems too expensive ever to

BLOW OUT THE GAS NOW WITHOUT DANGER

In these days of electrically lighted hotels, one does not hear so much of the foolish person who blows out the gas to the imminent danger of losing his own life by asphyxiation or of blowing up the building. But any danger that now exists with gas installations, in spite of more widespread information on the subject and the familiar printed warning "Don't Blow Out the Gas," can now be avoided by the use of a foolproof, self-closing gas valve, which automatically turns off the gas when it is blown out.

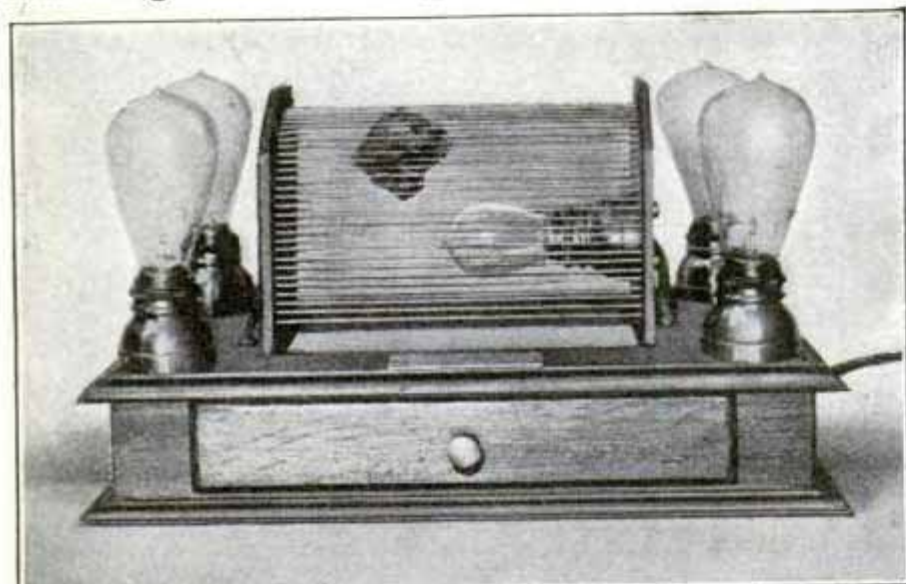

The Flies are Supposed to be Attracted by Bait within the Cage and be Electrocuted When They Attempt to Get at It

come into more than very limited use. The idea was originated by two young Denver men. The apparatus stands on a 10 by 15-in. base and comprises an arrangement of wires $\frac{1}{16}$ in. in diameter and $\frac{1}{8}$ in. apart. Electric current of 450 volts—which ordinarily would require some auxiliary apparatus to obtain—is turned on through these wires, and the flies are attracted within the cage by a piece of meat or other suitable bait. The lamp inside serves also to draw the flies, the external lamps being employed to prevent damage from short-circuiting of the current when the flies are electrocuted.

The new burner is simple and automatic. A hinged valve is opened by pressing down a spring-controlled plunger after the main gas cock is opened. When the gas jet is lit, the steady pressure of the gas serves to keep this valve open, but when the gas is blown out, the sudden rush of gas out of the burner unbalances the pressure on the automatic valve which promptly closes and remains shut under its own weight and the pressure of the gas behind it.

ⒸThe ties used on the Panama railroad are all hardwood and most of them are lignum-vitæ. This wood is so hard that it has to be bored for the spikes that fasten the rails, a special form of screw spike being used.

AUTOMOBILES TO CARRY TELEPHONE SETS

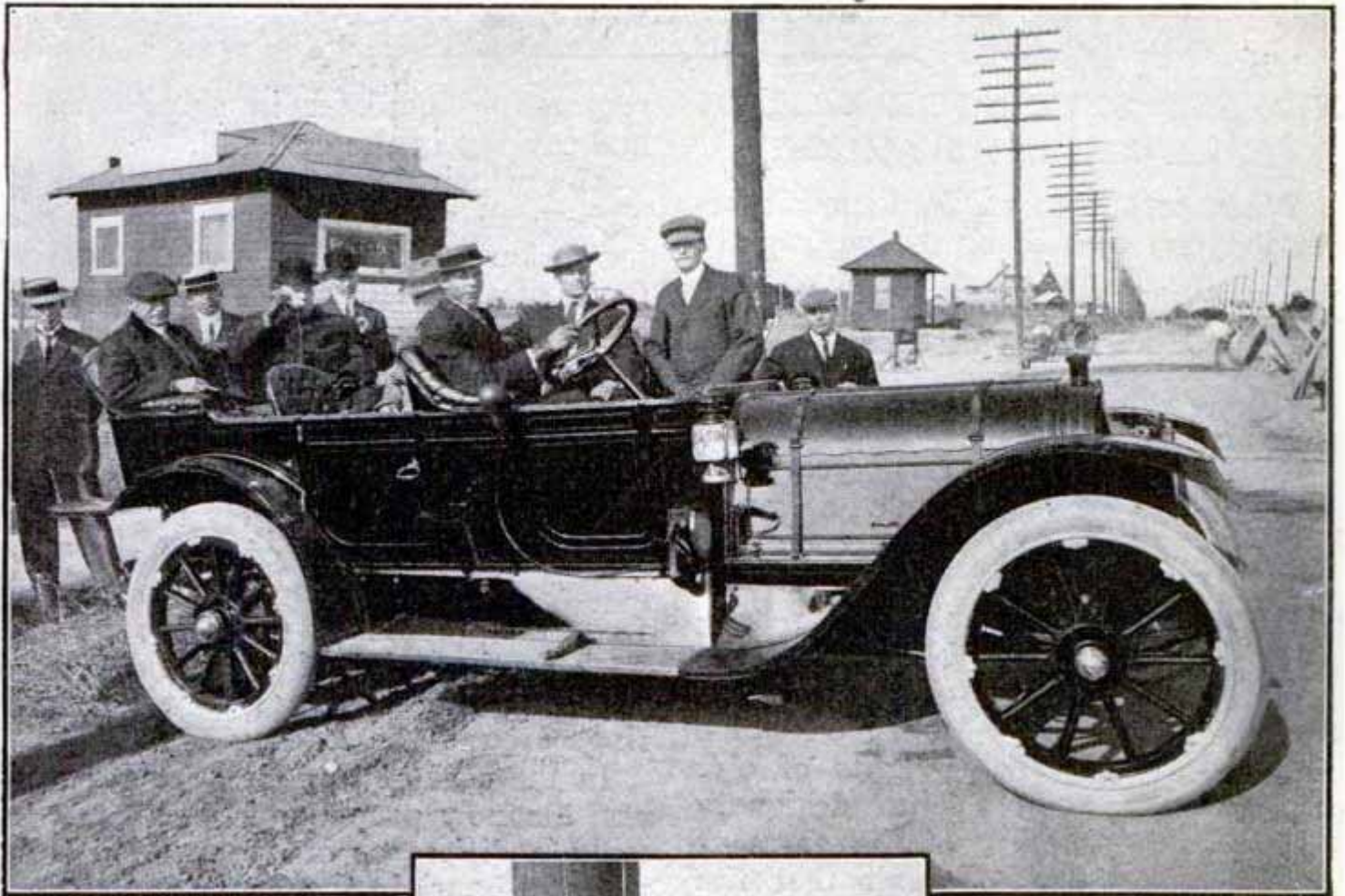

The Telephone Box is on the Pole 25 Feet in Rear

If the efforts of a new western company prove successful, the automobilist will no longer dread a breakdown in an isolated part of the country miles away from the nearest town or settlement, for he will be able to walk to the nearest road-telephone station, plug in his portable instrument and call up the nearest telephone exchange for assistance, or even make a long-distance call should that be necessary.

The instrument that will make such a desirable consummation possible is called the "autophone." It



One of the Roadside Telephones

Man in Automobile is Using Instrument Attached to It

consists of two parts, the hand set that comprises the transmitter and receiver, and a ringer box containing the buzzer, magnets, condenser, battery, induction coil, and jack (terminal or junction piece). The box weighs but 5 lb., and this miniature set will enable one to talk over all kinds of lines, by simply plugging in at a small box mounted on a telephone pole on the road. It is proposed to establish these boxes on the poles at intervals not exceeding two miles, on the road, and every five or six blocks in the cities. Sub.

scribers will be charged a flat monthly rate for such service.

It is intended to install boxes on all

the main traveled roads and mountain passes in the west, and eventually to extend the system all over the country.

NEWEST STYLE FOR WOMEN LIKE KNIGHT'S ARMOR

Whether due to an awakened interest in Joan of Arc or the suffragette movement, Paris fashion molders have



not as yet announced, but their ultra fashionable models this year include a gown for women that bears unmistakable resemblance to the chain-mail armor of the knights of old. The designers of the garment admit that the chain-mail idea is the one they wish especially to emphasize. The dress is for evening wear and is an ex-

ample of simplicity in the extreme. It is the bodice or waist that carries the central idea of the designers. The skirt is perfectly plain and built on absolutely straight lines with a short train.

VALUABLE DISCOVERY IN PROPELLER DESIGN

Experiments in the Washington experimental ship-model tank, by Naval Constructor W. D. Taylor of the United States navy, have led to an important discovery which upsets previously accepted theories on the behavior of high-speed ships' propellers and paves the way to the designing of high-speed propellers of greatly increased power and efficiency, with cor-

responding increases in ships' speeds and savings in the coal bill.

The principal cause of inefficiency in high-speed propellers and fans is the formation of a partial vacuum on the faces of the blades, this phenomenon being known as "cavitation." The cavitation which occurs on the backs of the blades was found not to have any injurious effect. Mr. Taylor discovered that cavitation on the driving faces of the blades could be largely reduced by serrating the leading edge of the propeller and introducing ribs extending from the middle of the blade at the back to the point of each tooth, thus confining the face cavities to narrow rings around the leading edge.

In the case of torpedo-boat destroyers, the new propeller is estimated to make a difference of one knot (1.1515 miles an hour) in the speed, or a saving in power of 10 per cent.

LIFE-SAVERS HOLD THEIR FIRST CONVENTION

The life-savers of the country, whose business of yanking drowning persons from a watery grave has ordinarily been regarded as a matter of course at summer resorts throughout the country, formed an organization at a national convention held on the Atlantic Coast during the summer. The convention was the first of the kind that was ever held in this country and during its course many thrilling exhibitions were given. The women life-savers attracted more attention than the men during the various contests held in connection with the meeting. Difficult rescues, throwing life lines and life buoys, and many other feats of skill the members of the corps are supposed to perform in their daily work, were reproduced, and prizes awarded the most skillful. Before the close of the meeting steps were taken to form a permanent organization.

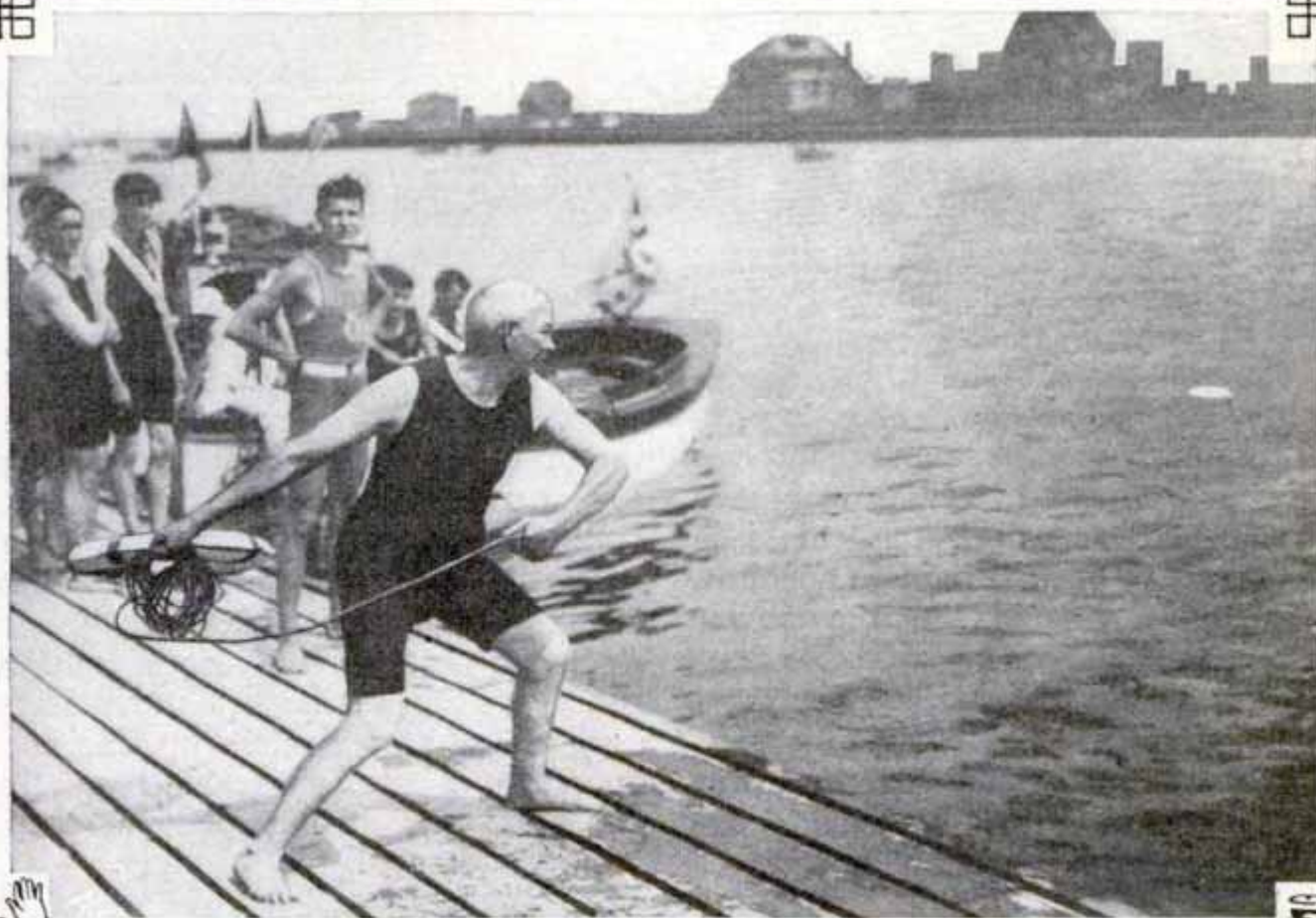

A Feature of the Life-Savers' Convention was the Life-Buoy-Throwing Contest



Life-Savers Competing for Prizes in Bringing "Unconscious" Bathers Ashore

RUNS FACTORY BY POWER OF ENGINES UNDER TEST

An ingenious method of economizing on the power bill has been adopted by an engineering firm in an Iowa city by using the power of the engines under test to generate electricity for light and power purposes in the factory. Naturally the engines made by this concern have to be tested to determine whether they come up to requirements, and in most factories the power generated by such machines under test is wasted. But in this case the energy has been turned to account, with material savings in the power department.

The firm in question makes farm tractors of from 20 to 80 hp. for general farming operations and turns out from 30 to 40 machines each day. Before being shipped, each tractor is

belted to a dynamo and given a run of several consecutive hours, test cards being made of the output of each tractor and filed for reference. Through switchboards the current generated during the tests is turned into the mains, thus furnishing both light and power to the factory. As the testing room provides for the testing of 14 tractors at the same time and the output from the factory keeps the testing room full all the time, it may be seen that the electrical output always amounts to several hundred electrical horsepower. Each tractor is run into the testing room under its own power and blocked up, the entire operation of taking a tested tractor out and putting in an untested one seldom taking more than ten minutes.

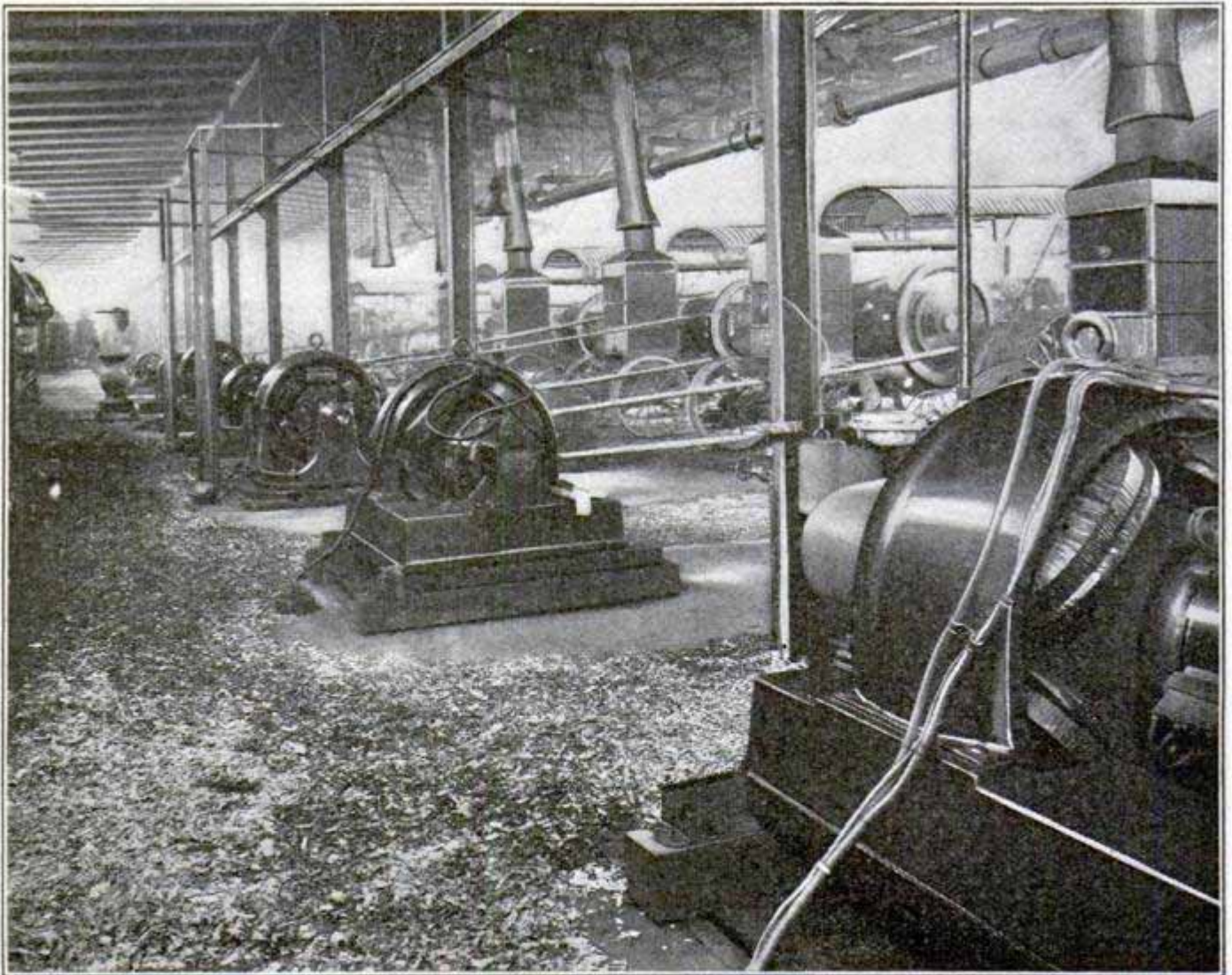

These Motors, Being Used for Furnishing Power, are Also Undergoing Test to Determine Whether They Come Up to Requirements. They are Changed Every Day

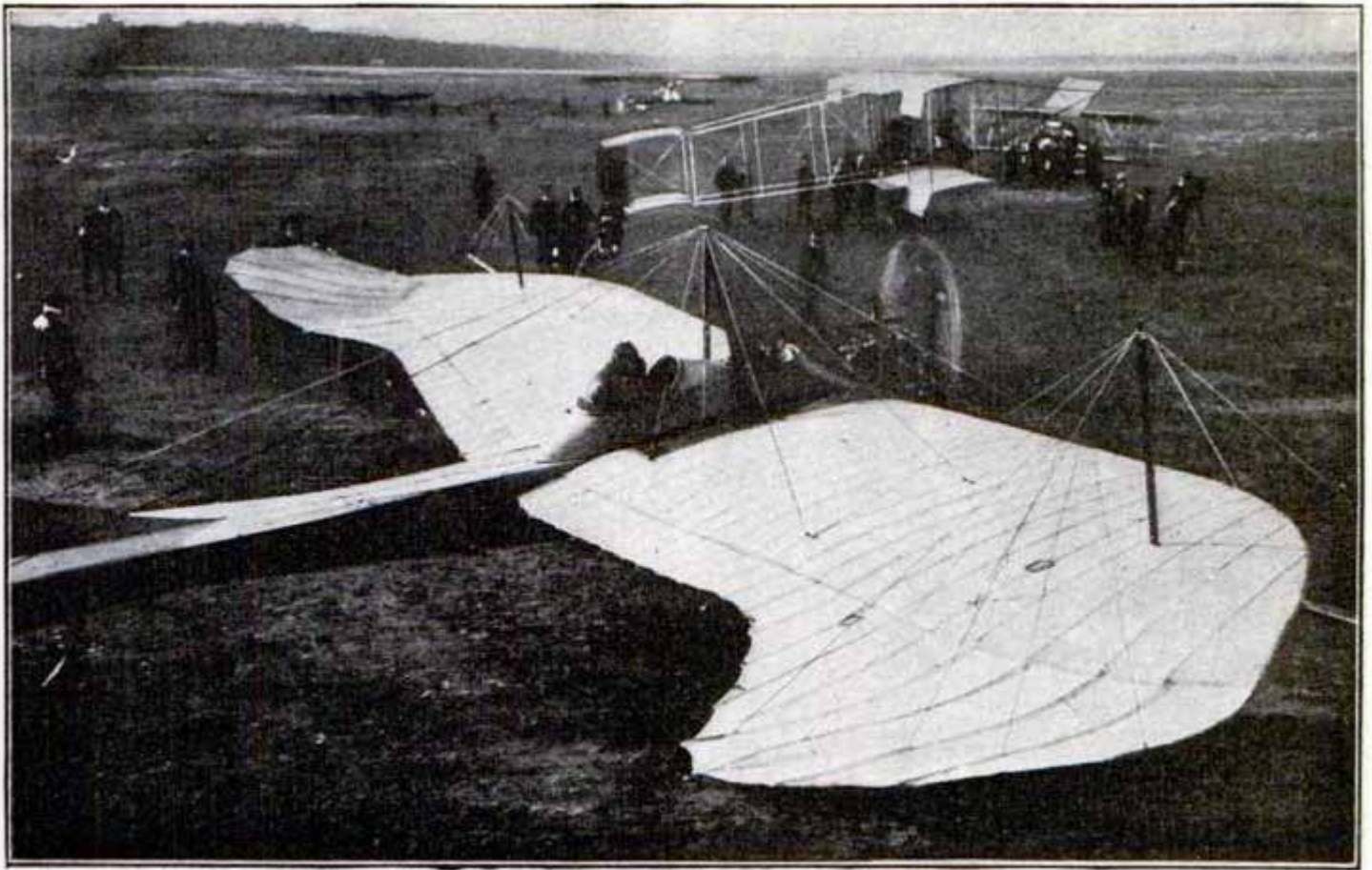

Vollmöller, the German Airman, in His Aeroplane, "Taube," Which Translated Means "Pigeon," So Called Because of Its Appearance. With This Machine He Won Second Prize in the Recent German Circuit

BUILDING EXPENDITURE OF THREE EASTERN CITIES

The extent to which building operations have been conducted in New York, Boston, and Philadelphia in the past five years is here given, the figure for New York being stupendous. The records of the New York building department show that in this period \$20,000,000 of new capital was expended in theaters, \$15,000,000 in hotels, and \$97,000,000 in office buildings, making a total of \$132,000,000.

Boston invested \$1,500,000 in theaters, \$2,000,000 in hotels, and \$15,000,000 in office buildings, making a total of \$18,500,000, while Philadelphia invested \$8,000,000 in the same class of construction.

☞The French government has honored Airmen Alfred Leblanc and Hubert Latham with the Cross of the Legion d'Honneur, for services rendered in the advancement of aviation.

HAT PROVIDED WITH ELECTRIC FAN

An electric fan installation for use in top hats during the warm summer months has been invented. The battery will last for several days, and a renewal only costs 15 cents. The fan is regulated by a switch on the brim. Fan, motor, and battery are mounted

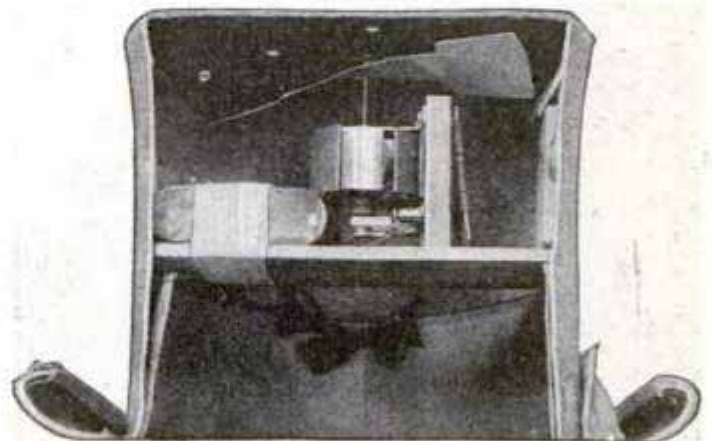

Electric Fan Mounted in Top Hat Keeps Head Cool in Hot Weather

on a board which is supported in the crown of the hat just above the space occupied by the head.



SWIMMERS PHOTOGRAPHED IN THE WATER

What seem like curious contortions of the human body are the result of attempting to take photographs of the aquatic performers from a position almost directly above them

ABNORMAL FEET AND A PEG-LEG



This Mule Has Six Hoofs, No Two of Which are Alike, and Walks with a Wooden Leg

This peg-legged mule is normal in every way except as to its feet. It has six hoofs, no two of which are alike, and is compelled to walk with the aid of a wooden leg because of the exceptional malformation of its left fore foot. This foot tapers to a point, there being a hoof or toe 6 in. long at the end. Growing at right angles from the left fore leg is another leg, at the end of which is another slender hoof 8 in. long. The right fore foot has a double hoof, the right hind hoof is cloven like that of a cow, and the left hind hoof is an imperfect mule hoof. The mule is two years old.

¶The dean of the College of Chemistry of the University of Minnesota announces a method of utilizing waste wood and sawdust by means of which the United States may produce 100 times more pulp wood than was believed possible.

POSSUM FARMS STARTED IN AUSTRALIA

The possum is no longer the humble little animal he used to be. First came presidential recognition and now more honors have fallen upon him. Australia has recognized his commercial value, and numbers of possum farms have been started in that country. One farm exclusively for them has been started in the eucalyptus bush land of Victoria, and in Western Australia a company has been formed for the breeding of the possum on a stretch of eucalyptus country comprising about 200,000 acres of land.

INTERNAL-COMBUSTION RIVETING MACHINE

An ingenious type of riveting machine just developed in Europe operates on the principle of the internal-combustion engine, an explosive mixture of air and gasoline vapor being forced into the working cylinder of the riveter by means of a small electrically driven pump.

The operation of closing the rivet is simple, the first action being the throwing of the switch which causes the motor-driven pump to force the explosive mixture into the working cylinder. This pressure drives the die forward until it touches the rivet, then the pressure accumulates in the cylinder until it rises to a fixed value, when a small plunger actuates the motor switch. This stops the mixture pump and causes an ignition device to spark, an explosion occurs, and the pressure closes the rivet.

It is claimed that the cost of operating the machine is about one-twentieth that of a pneumatic riveter.

DUAL CONTROL BIPLANE MADE BY CURTISS

One of the recent products of the Curtiss experimental workshops at Hammondsport, New York, is a dual control biplane in which the controls

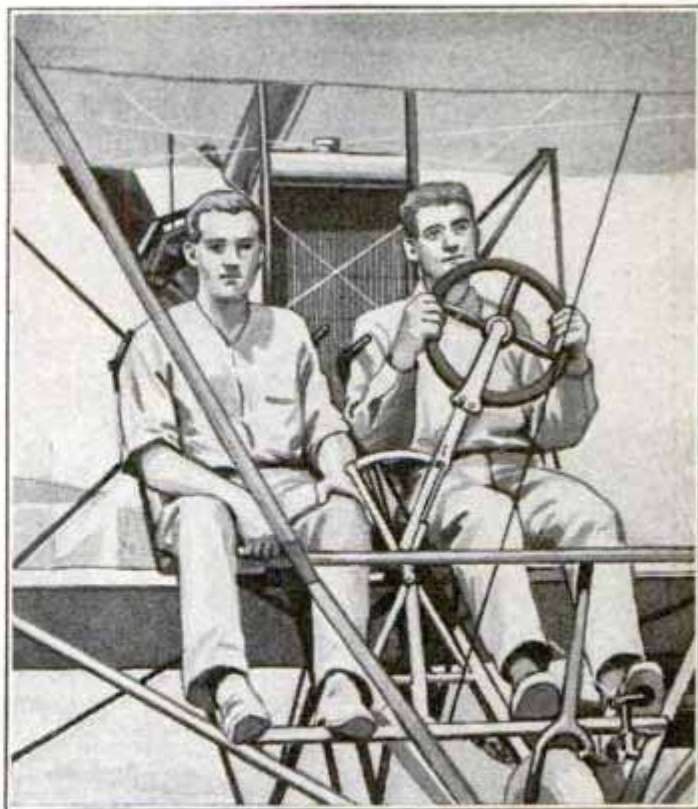

Signal-Corps Officers in Dual Control Curtiss

can be shifted back and forth between two operators sitting side by side. This is especially useful for teaching purposes. One of these machines has been delivered to the army and is now at College Park, Md., where the signal-corps officers are receiving instruction in aviation with a view to the use of aeroplanes in warfare. As is shown in the illustration, the control column is mounted on a pivot.

CAST-STEEL PLATES OF EXTREME HARDNESS

The Krupp works at Essen, Germany, has recently turned out cast-steel plates for safes and vaults of such extraordinary hardness as to be absolutely proof against drilling, and nearly so against the oxy-acetylene blowpipe. Tests show that to make a hole of 3.15-in. diameter through a plate of half that thickness by means of the oxy-acetylene method would require 8 to 14 hours of hard work, and the consumption of from two to three 154-lb. tanks of compressed oxygen, and a somewhat smaller quantity of acetylene gas. This would seem to be enough to discourage a safe-blower, no matter how devoted to his calling.

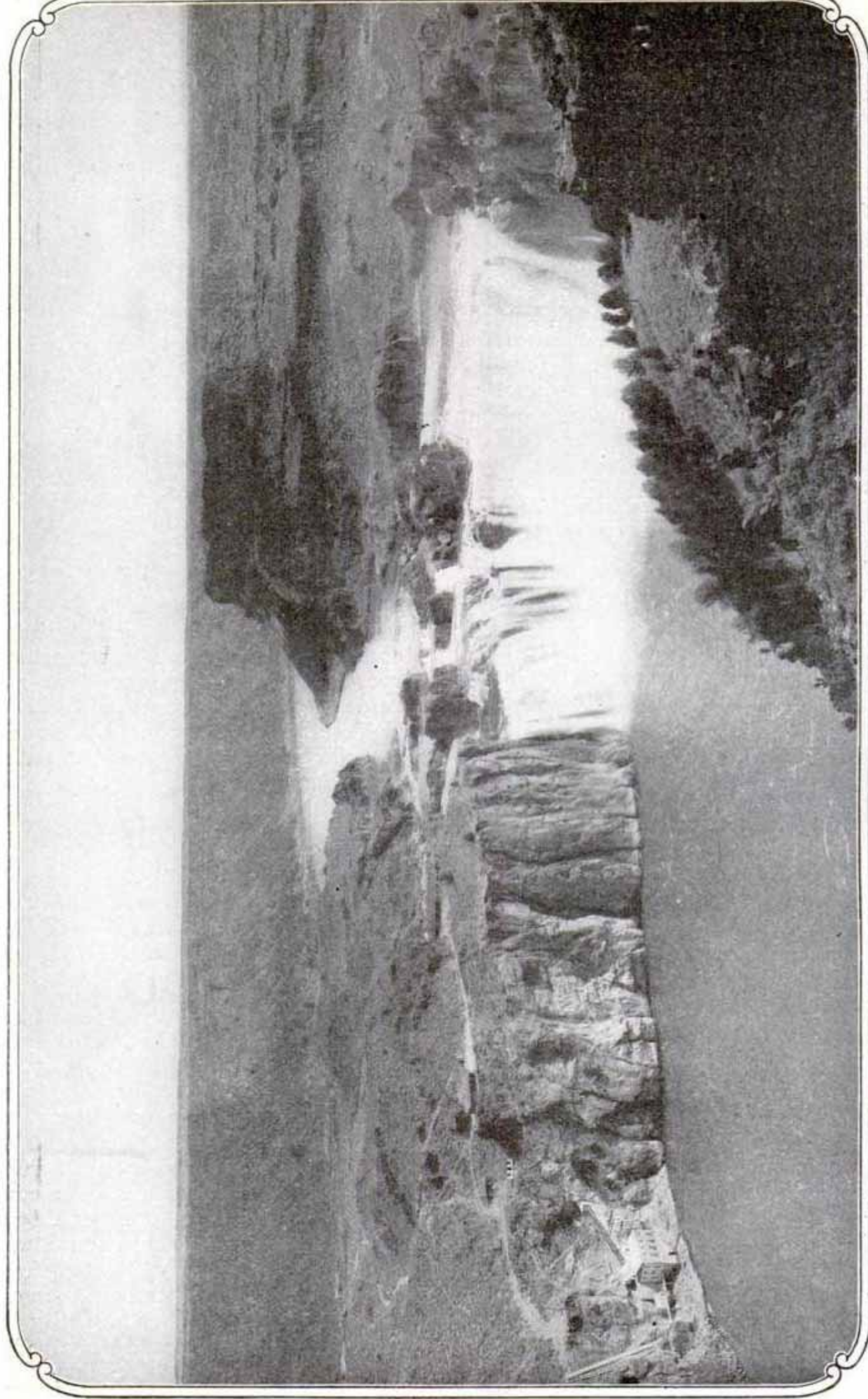

THE SHOSHONE FALLS, IDAHO

"The Percentage of Free Power Existing in Waterfalls and Streams . . . Which is Now Being Utilized is Yet Very Small; But Why Scold About It When We are Making More Progress in This Line in a Single Decade Than was Formerly Made in a Century?"

Are We Really a Wasteful People?

By OSCAR P. AUSTIN

Chief of United States Bureau of Statistics



IS wastefulness distinctively an American habit? The writer does not belong to the class of persons who believe that whatever is wrong. The habit of "knocking" everybody and everything, of asserting that all the things which are happening are wrong, of bewailing conditions of today as worse than those of yesterday and worse among our own people than those of some other country or community, is too prevalent. The tendency toward the "yellow" in every discussion of conditions in our own country, of searching up and down the land to find some means of leading Americans to think ill of their own people and their own country, is unfortunate. It is worse than that, it is positively bad. It destroys respect for our own people and their institutions, it destroys pride of country, it is destructive of patriotism. And much of it, much of the criticism of things American, of the things of today as compared with those of yesterday, is based upon misconception, inaccurate inferences, inaccurate statements.

I have been asked to discuss for Popular Mechanics Magazine the subject of "Wastes," and in considering the statements upon this subject upon which this country has been fed, I find myself unable to fall in line and join in the cry that everything is wrong and that everybody in America is lacking in the qualities of common sense and good business judgment.

Of course there is waste. So there is everywhere. But is it not a law of nature that certain of its products go back to the original elements and would not the energy devoted to preventing much of this waste be of itself a greater waste? For instance, I find the statement that one gentleman who is an inventor of waste-preventing devices is of the opinion that among the greatest wastes in America are corn cobs, corn stalks, broken glass, and waste leather strops. But is this true? If the corn cobs are worth preserving and utilizing as fuel and the stalks for paper-making, why does not capital set itself about the preservation of them? Millions, yes, hundreds of millions of American capital are seeking investment in any line which will guarantee a return of from three and a half to five per cent per annum; and the American inventor is the most resourceful and energetic in all the world. Yet this combination of invention and waiting capital has failed to produce a method by which these elements can be made useful, except by creating a "waste" of money still greater in value than their return to enrich the soil upon which they grew. In other words, with all the thought which the restless American inventors and the American investors, by thousands, have given to this form of "waste" which is constantly before their eyes, no plan has been devised by which these articles can be profitably utilized. Is it, then, a "waste" to let them decay and go to enrich the earth which produces the next crop, or would it be any less a "waste" to spend two dollars of accumulated capital in producing one dollar's worth of material from them?

Another favorite theory with those who complain of the "waste" of everyday life is that we are permitting countless millions of horsepower to waste in our streams and waterfalls every year. True, but are not conditions being greatly and rapidly improved in this particular? Are we not doing

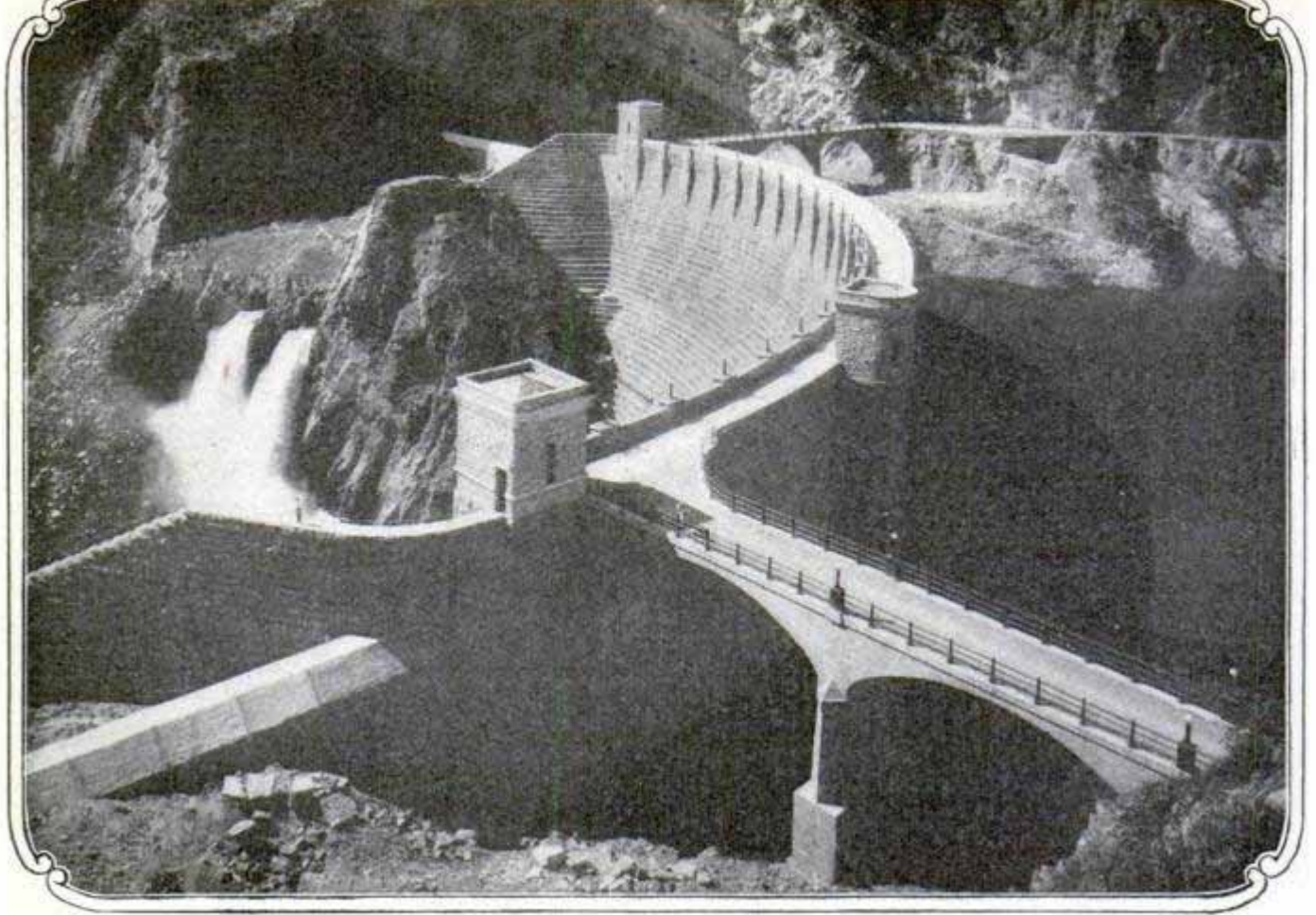

THE GREAT ROOSEVELT DAM

"Millions of Dollars Worth of Waterpower are Now Being Utilized Because Man Has Just Learned How to Harness That Power"

wonderful things in transferring our natural power, that of the waterfalls and rivers, into electricity with which to operate our railways, light our cities and homes, and perhaps also heat them? Millions of dollars worth of waterpower, wasted through centuries of time and countless generations, are now being utilized because man has just learned how to harness that power and carry it to the place where it can be utilized. To be sure, the percentage of the free power existing in waterfalls and streams and tides and air currents which is now being utilized is yet very small; but why scold about it when

we are making more progress in this line in a single decade than was formerly made in a century?

And why is it that so much of this free power is still being permitted to go to waste? Simply because those who are seeking investments for their capital, who are carefully studying the subject with the aid of the best scientific men of the country and of the world find that a more rapid development of the process of transforming this "waste" power into usable condition would produce another waste, still

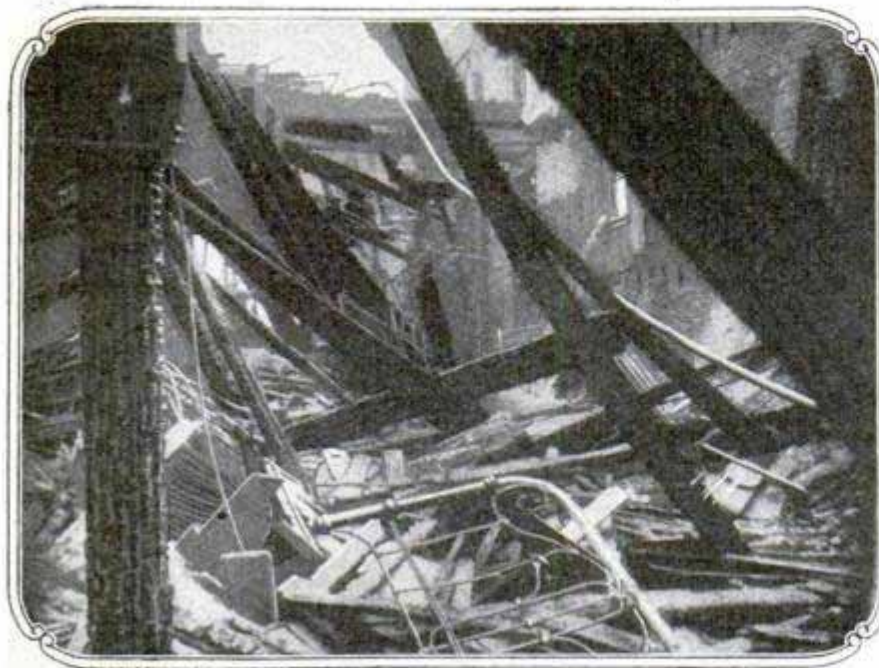

"It is a Well Known Fact That the Fire Losses are Being Steadily Reduced as the Quantity of Wood Used is Decreased"

Another set of professional "knockers" bewail the "waste" which is being devoted year by year to the construction of great navies. "Millions of money," they cry, "are being absolutely wasted in the building of battleships and cruisers and all the equipments of naval warfare." Is not the construction of warships chiefly for the purpose of preventing the destruction of property and perhaps the lives of the people who are paying for them? The purpose of the great battleship, of the



"The United States Still Has More Forests . . . Than Any Other Country in the World Except Russia"

navy of today, is to prevent war rather than make it, and the few million dollars put into the battleship may prevent a waste of perhaps ten, perhaps a hundred times as much in wars, which are averted by the existence of the battleship, to say nothing of the prevention of the waste of human life which would come from war.

We are told that we are wasting our coal by the neglectful methods of mining, by using too much of it to get certain results; that only a small per-

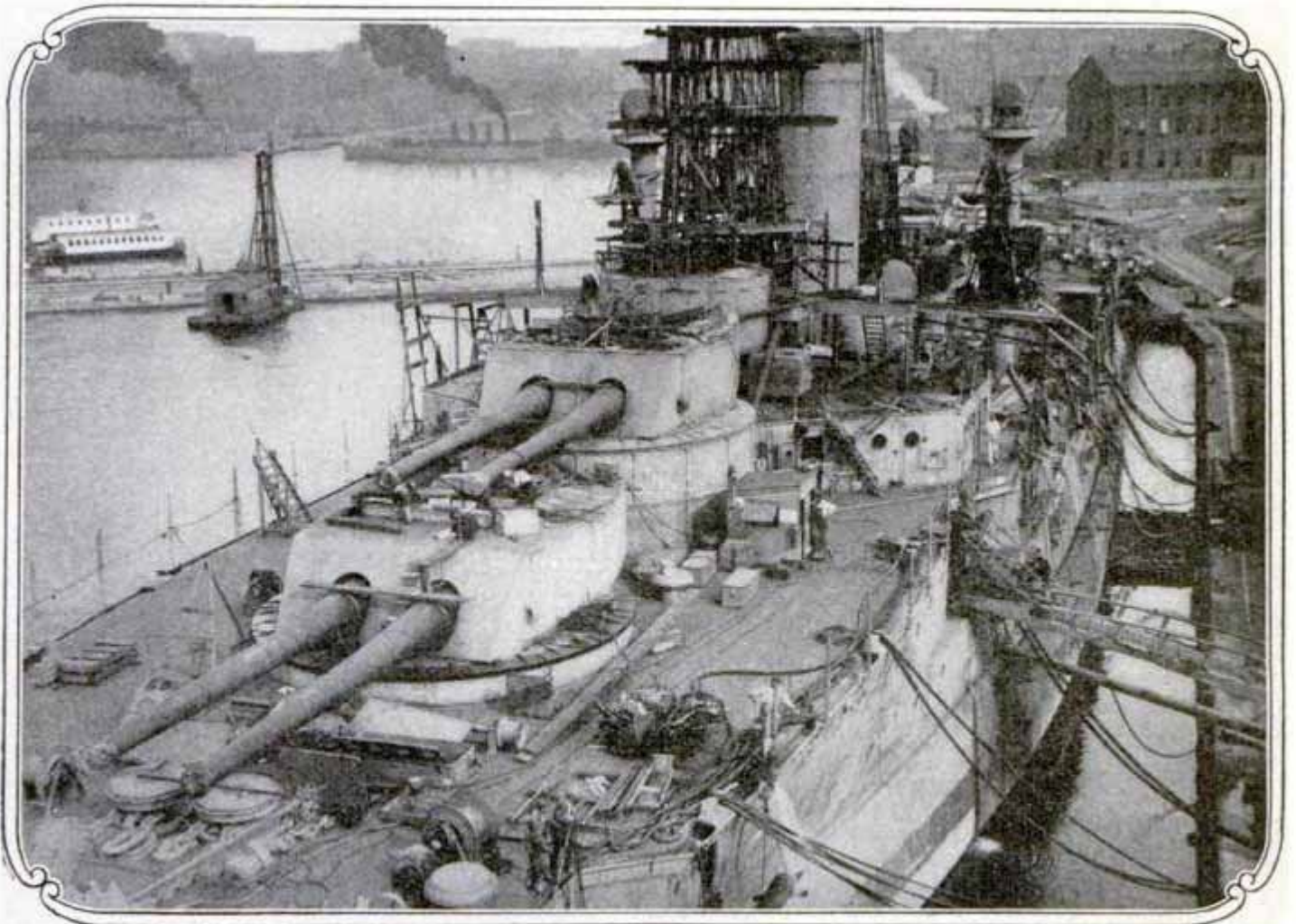

COMPLETING THE NEW BATTLESHIP "FLORIDA"

"The Purpose of the Great Battleship of Today is to Prevent War Rather Than Make It"

centage of its "energy" is utilized in turning it into steam or heat or light. Undoubtedly a large percentage of the coal is left in the mine, another large percentage is so mixed with rock or dirt that it is not utilized, and another large percentage of its energy is lost before it is transformed into the service of man. Yet the greatest scientists of the world have thus far been unable to devise methods by which it can be more fully utilized without a greater waste of that other form of energy, capital.

We hear frequently much about the fact that our losses by fire in the cities of the United States are much greater than in Europe, and the professional fault-finders see in this another opportunity to scold the people of the United States for their "wastefulness" as compared with other countries of the world. But do they not realize that the buildings in American cities are to a much greater extent constructed of wood than in the European countries in which the supply of this inflammable material was long ago so greatly reduced that wooden houses in their cities are much less frequent than in the United States? And is it not a fact that the proportion of the structures now being built in which wood is the chief factor is very much less at present than a decade or several decades ago? It is a well known fact that the fire losses in the United States, while much greater, proportionately, than in European cities, are being steadily reduced, and as the quantity of wood used in buildings in the cities is proportionately decreased we are proportionately approaching the low rate of fire losses existing in European countries.

A few months ago we were told by a well known "business organizer" that the railways of the country are wasting hundreds of millions of dollars every year by bad business methods, and that the prices at which they are carrying people and merchandise might be readily reduced if they would only adopt his plans of management. Probably he may be right, but where in all the world can be found a more able, intelligent, thoughtful, and energetic class of men,—who go to the bottom of every business proposition, who realize more fully the importance of economies in small things as well as greater things,—than those employed by the railways of the country, of the world, in fact?

No thoughtful man who watches the progress of events in our own country or abroad can fail to observe that the advance in prices has been much less, proportionately, in manufactures than in foodstuffs, or raw material, or labor. This steadying of the price of the finished article during the very period in which the raw material and the labor through which it is produced are rapidly advancing is the result of economies of production and distribution, of a reduction of the "waste" formerly practiced in such production; and yet the public complains that these economies are driving the small tradesman out of business, not realizing, apparently, that the prevention of this waste of former years has, at the same time, precluded the necessity of advancing the price of the finished article in the same proportion as that of the raw material, the labor employed, or the food consumed by those engaged in its production.

The newspapers and other reformers located in the bituminous coal regions indulge in periodical outbursts about the waste resulting from smoking chimneys, and declare that it could be averted by the use of smoke-consumers. Perhaps; but where are the practical smoke-consumers, the application of which will reduce the waste now in progress in this line? We have been hearing of them for more than a quarter of a century, but meantime capital has been vainly searching for them, for if there is anything that the shrewd capitalist most desires it is to keep down his expenses, and he is willing to



"We Hear Frequently Much About the Fact That Our Losses by Fire . . . are Much Greater Than in Europe"



"But . . . the Buildings in American Cities are to a Much Greater Extent Constructed of Wood"

pay large sums to those who will help him to do it through a reduction in any waste now in progress. But if the waste of money in adopting waste-preventing devices is greater than the waste of retaining them, he is likely to retain them.

The farmers of the country come in for a hard "jolt" when the question of waste is under consideration. They are described as an outrageously wasteful lot, with no thought for their business future, working the poor land to a state of absolute depletion and then abandoning the farm and moving off to a place where they can find more new land to wear out. The people who make this assertion do not seem to realize that the farmers of the country are utilizing enormous quantities of soil food each year at a cost of approximately \$100,000,000 per annum and actually increasing their production per acre instead of further reducing it. The statistics of the Department of Agriculture show a larger average yield of wheat per acre the country over in 1909 than in any year since the sixties, the yield of oats per acre in 1908 larger than in any year since the sixties, and the average yield per acre of corn during the past five years much greater than the average of any preceding five years during the period covered by detailed statistical records.

A distinguished railroad magnate amuses himself by periodical outbursts about the depletion of the farms and farm production of the United States and predicts that the United States is soon to become an importer of food. Do the people who thus criticize the farmer for his wastefulness realize that the wheat and corn crops of 1909 were the largest (with a single exception) ever known in the United States, that the oat and barley crops of that year exceeded by far those of any earlier year? Do they know that these "wasteful" American farmers have, according to the Secretary of Agriculture, increased their wealth production from \$4,250,000,000 in 1897 to \$8,750,000,000 in 1909? Do they know that the population of this "wasteful" country of ours increased its wealth from \$30,000,000,000 dollars in 1870 and \$44,000,000,000 in 1880, to \$107,000,000,000 in 1904? Does this really look like "wastefulness?"

We hear many complaints about the destruction of our forests, and while there is, of course, too much truth in them, we must remember that the United States still has more of forests and lumber-producing area than any other country of the world except Russia; and when we hear complaints about the destructiveness of forest fires we must remember that forest fires occur in other parts of the world, perhaps with less frequency, but that the Forestry service of the government is exercising the greatest activity possible under existing appropriations and conditions to reduce destruction of the forests by fires.

And is there really the danger of a timber famine which so many people suppose? A member of the present congress, sitting at my desk a few weeks ago, said to me:

"This talk about the destruction of our timber and lumber materials is, it seems to me, based upon lack of understanding of conditions, existing and possible. I went into western Pennsylvania forty years ago as a very young man and established a sawmill. The prediction was then made that the timber supply for lumber purposes in that section would not last over ten years. The work of turning out lumber in that section has gone on uninterruptedly and yet the quantity now being turned out and the quantity of timber now available for lumber purposes is as great as forty years ago."

Of course we do not want to see our forests depleted for mere temporary

gain, but is it not worth considering that after using all we require for our own people, the people of other parts of the world have sent us during the last twenty-five years more than a \$1,000,000,000 worth of money for such surplus as we may choose to spare from our forest supply, the greatest of any country in the world except Russia?

Another subject of complaint frequently discussed, and one in which common humanity justifies a most careful consideration, is the waste of human life by accidents in coal mines, on railways and steamers and other public transportation facilities. True, the losses of life in this way are very great. But does not every firm or company or corporation engaged in mining or transportation realize that for every life lost through its own negligence toward its employes it must pay thousands of dollars in damages to the families of the deceased, and does it not seem probable, therefore, that a large percentage of the loss of life is due to carelessness on the part of others than the employers or to absolutely unforeseen accidents? True, the number of lives lost per 1,000 of people employed in our coal mines is much greater than in the mines of Europe, but it must be remembered that the European mines have been operated under different conditions and for a much greater length of time, and that there is already apparent a marked reduction in our own case as compared with a few years ago in the loss of life in our coal mines in proportion to the number of persons employed.

Still another subject of complaint is the waste of water—the fact that countless millions of gallons of water which falls from the clouds upon the soil in the interior of the continent are permitted to flow past certain comparatively arid areas straightway down to portions where it is not needed, instead of being impounded in those arid or semi-arid sections and used to irrigate the land and increase production. All this is true. But is not the United States already doing more and better and more intelligent work in this line—of increasing the producing power of its lands through irrigation—than any other country of the world? The sums expended on irrigation and reclamation during the last decade by the federal government amount to \$60,000,000 and by private individuals fully twice that amount, and will probably greatly exceed those sums during the next decade, a record which cannot be approached by that of any other country. Writers complain loudly about soil erosion, especially in the United States, due to the cutting away of the forests. But do they not know that the area formerly covered with forests became through their removal the garden spot of the world and so remains, and that the grain produced upon the area formerly occupied by forests has made this the richest country of the world and its people more prosperous than those of any country upon which the sun shines?

It is so easy to complain about other people's management. I know of no easier or more delightful occupation than that of managing other people's business at long distance and without responsibility for the results. But the people who have built up that business, who are responsible to themselves and their families and their stockholders and their stockholders' families, and to the public under the laws which govern and directly control their work, are much better able to judge whether this or that line of conduct or this or that failure to utilize a natural product is really a "waste," or whether the elimination of that waste by the necessary outlay therefor would or would not produce an equal or greater waste of the capital already accumulated, and for the conservation of which they are responsible.

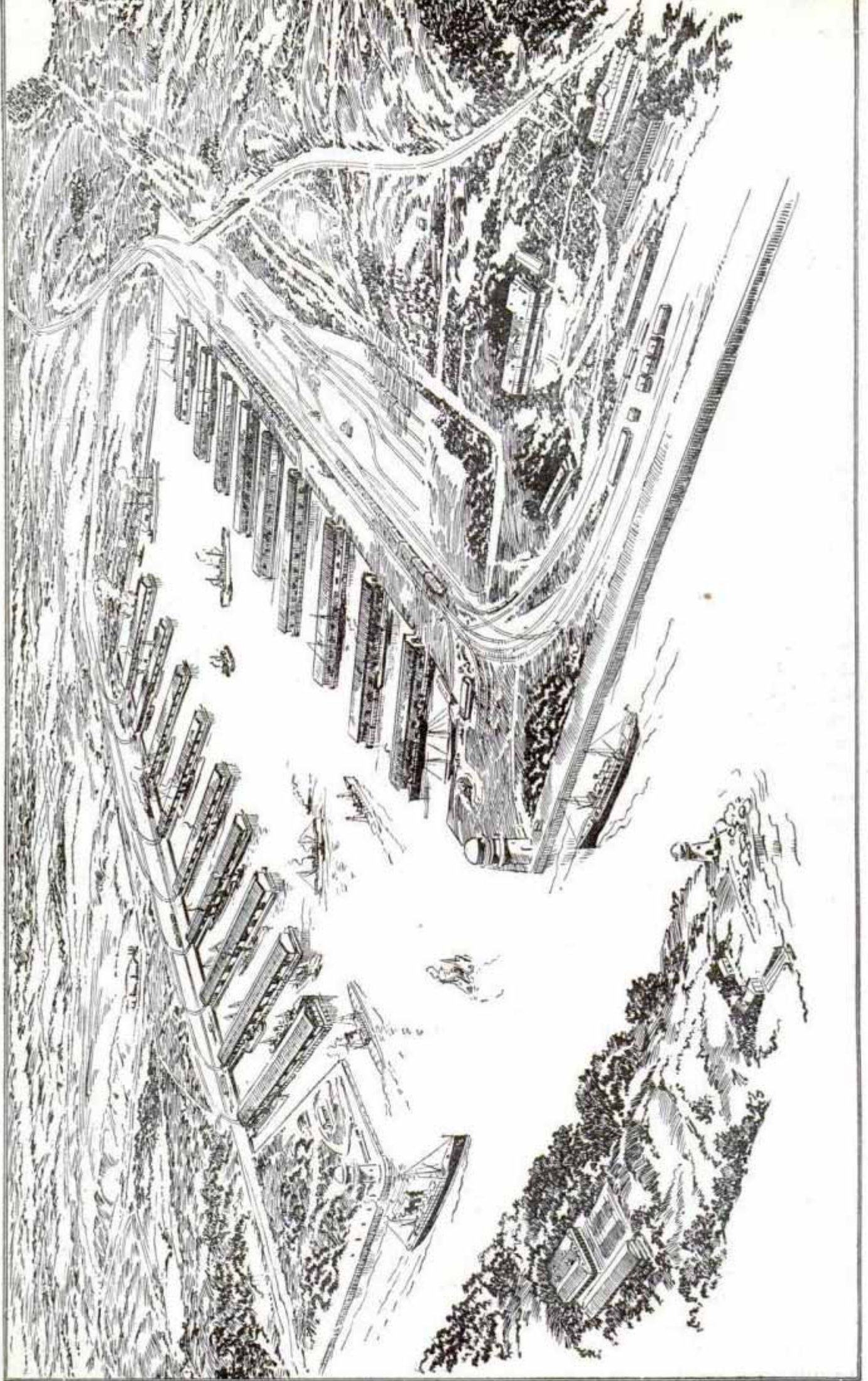

SKETCH OF DOCKS AND HARBOR AT PANAMA, TO BE THE LARGEST IN THE WORLD. CANAL PROPER IN THE FOREGROUND

PANAMA TO HAVE LARGEST DOCKS IN THE WORLD

In contemplating the great engineering problem being solved in the construction of the Panama Canal, the people of the United States have almost forgotten that the plans for the big "ditch" also provide for the largest and most completely equipped harbor and dock system in the world, to be located at the Pacific end of the canal. A strip of land along the water front two miles in length has been reserved for the docks, and while but two-thirds of this will be immediately improved, the improvements thus provided for embrace construction work that will give the turning basin alone an area of 271 acres. There will be a series of piers on either side of the canal entrance, each of which will be 1,000 ft. long. The width of the canal between the pier ends will be 3,000 ft.

When it is remembered that the new Tilbury docks in London have a water area of only 70 acres, that the Hudson River at Hoboken is but 2,500 ft. wide, and that the longest docks in New York had to be lengthened, under temporary permit, to allow for the docking of the "Olympic," which is 860 ft. long, some idea of the immensity of the Panama dock plans may be gained.

The entire construction work is to be steel and concrete with foundations resting on bed rock, the material dredged from the harbor to be placed behind the docks and form an immense freight-transfer yard for the Panama railroad, which forms an integral part of the harbor plans. These yards will extend the full length of the docks and a spur of track will run out on each pier. The piers will be 1,000 ft. long and the slips between them will be 300 ft. wide. The length of the piers permit the docking at any one of them of two vessels 400 ft. long or three vessels 300 ft. long on either side or both sides at once. The width of the slips between the piers will permit a vessel to lie in the slip with steam barges on either side for the transshipment of freight.

Each of the piers will be fitted with the most approved appliances for loading and unloading, all the machinery to be operated by electricity. Huge electric overhead cranes, built so that they can command the top hatches of any vessel that can be accommodated—and this means the largest ships afloat,—and a system of escalators, or automatic loaders of the endless conveyor or chain type, will be installed for handling the cargoes. There will be enough of the cranes and the other appliances to serve every hatch of any ship that draws alongside the dock. It is believed by the engineers and steamship men who have planned the docks that their existence means a vast increase in the business of the canal. It now requires 21 days to carry a carload of freight across the continent by rail from the shipper in California to his agent in New York. With the use of 16-knot steamers from San Francisco to Panama and transshipping at Panama for New York, the freight schedule between the two cities can be reduced to 14 days. Similar reductions will be made in the freight service between North American and South American cities. Work was begun on the docks last November and it is the intention of the commission to have about one-half the work completed in time for the opening of the canal.

SUBMERGED ELECTRIC LIGHTS TO STOP EEL MIGRATION

The Danish government has undertaken to prevent the migration of eels from a portion of the Baltic Sea into the outer ocean, by means of a barrier of electric light. Fifty electric lamps are to be placed along a submerged cable between the island of Fanö and the coast of Fyen. The eels migrate only during the dark hours, and it is believed this wall of light will keep them from passing.

HORSE HAS GOLD TOOTH

"Black Bess," the British horse who plays the leading part in the production



The Tooth Broken by This Horse was Replaced by a Gold Crown

of "Dick Turpin's ride to York," recently broke a tooth. A dentist was called in from his office on the Strand and built a gold crown to replace the broken tooth.

CONVERTIBLE CAR FOR ELECTRIC ROADS

A type of electric car that can be used either for freight or passengers has been put into service by the Hummelstown & Campbelltown Electric



An Electric Car Which may be Used for Either Freight or Passengers, the Seats Folding against the Walls When It is to be Used for Freight

Railway, Pennsylvania. Used as a passenger car, the seating capacity is 48, the seating accommodation consisting of continuous folding benches along both sides. Even the space in front of the sliding freight doors can be utilized for seating passengers, folding seats being hinged to the doors. These, when folded, slide with the doors into the door pockets. When the car is used for freight, the other benches fold against the walls.

A ROTARY-SLEEVE-VALVE AUTOMOBILE MOTOR

There has recently been placed on the market in France a new "valveless," single-cylinder, automobile motor which possesses features similar to those of the Knight engine and of the so-called "cylinder-valve" (rotary-cylinder) motor that attracted attention a few months ago. This engine has a continuously rotating sleeve, with ports or openings (for inlet and exhaust) located approximately at 90 deg. one from the other, in place of the more usual lift or poppet valves. The sleeve fits between the piston and the cylinder walls and is fitted with a deep compression ring to allow for expansion or contraction due to changes of temperature and so prevent leakage of the gases. It is driven at half the engine speed by helical or inclined-tooth gearing through a small countershaft which is rotated by a silent chain drive from the engine crankshaft. The motor is said to be admirably suited for small cars, and the automobile which has been especially designed for it has many new and interesting features.

When King George V goes to India for the Durbar he will live in a tent. Thousands of the visitors to India to attend the pageant will also live in tents, the British government taking this means to counteract the exorbitant charges that are being already made for houses in the vicinity of Delhi during December.



Coasting down a Curved Incline in Germany on Three-Wheeled Summer Toboggans

THREE-WHEELED SUMMER TOBOGGANS

A three-wheeled coaster, called a summer toboggan, is coming into general use in Germany for coasting down inclines. The seat is arranged above the single rear wheel, and steering is

done by means of both the hands and feet. The little coaster is quite light, and at the end of a descent can be collapsed and slung over the back for the return trip up hill.

LONG-DISTANCE HEARING APPARATUS

Differing from the various kinds of earphones which are used to aid persons of defective hearing, a new long-distance hearing apparatus has recently been invented to assist the hearing of normal persons in much the same way that a telescope does the eye; that is, it enables one to distinguish sounds through a greater distance, besides amplifying those which would ordinarily be detected by the unaided ears. For this reason it has been facetiously called the "ear telescope."

Really, it is a sound-concentrating device, and gives a person the same advantage as if he had ears larger than those of a donkey. A reflector catches

a greater volume of sound waves than would be intercepted by the ear. These waves are concentrated to a

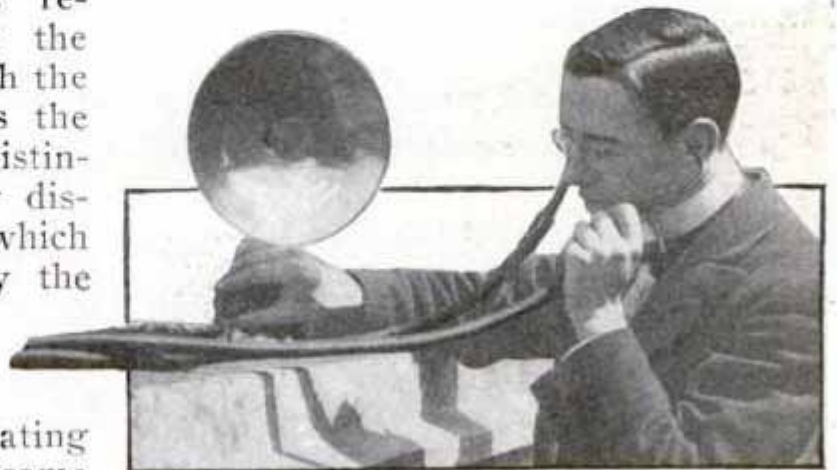

The "Ear Telescope" Which Enables the Ear to Detect Otherwise Inaudible Sounds Proceeding from Great Distances

focus, and then directed through flexible tubes to earpieces. Thus a person is enabled to obtain about 12 times the volume of sound at his ear drums that he would with his own ears unaided by the apparatus.

The reflector or sound receiver is mounted on a swiveling contrivance by which it can be turned in any desired direction. Naturally the sound heard by the operator will be greatest when the reflector is directed toward the source of the sound. And this fact has suggested as one of its principal uses the location of ships in fogs, for the direction from which the sound of a fog horn or fog bell is proceeding would immediately be made apparent by means of the "ear telescope."

GIANT STONE ARROW TO GUIDE FLYERS

A giant white stone arrow has been constructed on the cliffs above Dover as a guide to airmen flying by day from England to France. It points

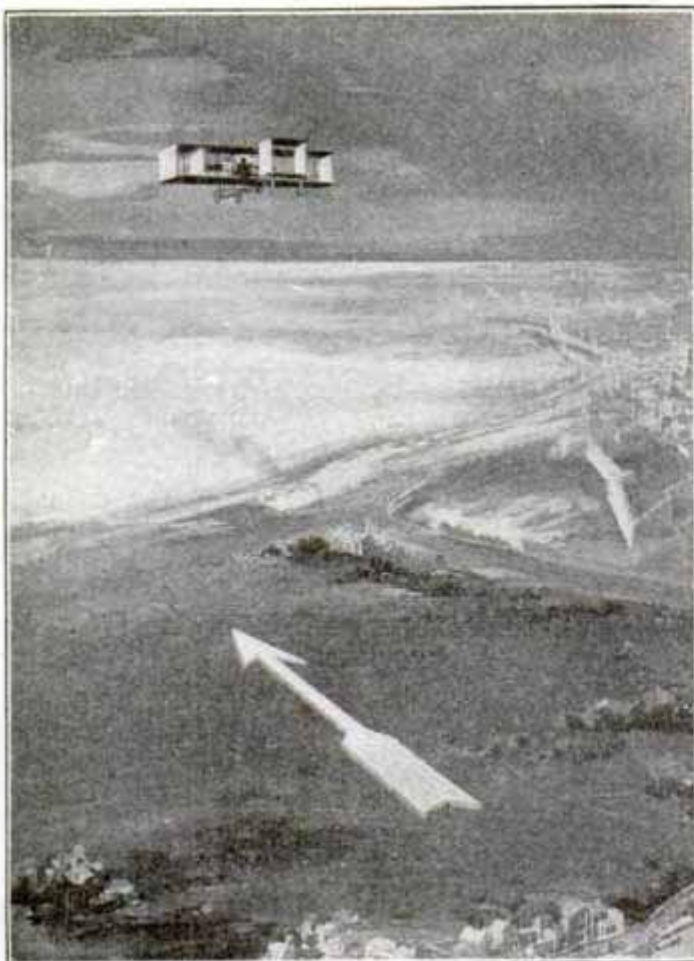

Giant Arrow of White Stone Constructed on the Cliffs above Dover, Eng., to Guide Airmen

the exact direction they should take to reach Calais. It is proposed to construct a number of similar arrows at different points along the coast.

HARDTACK LOSES PLACE IN SOLDIERS' DIET

The American warrior of the future will not be able to build romances or excite the sympathy of the home folks with his tales of hardtack. Hardtack is about to pass into the great beyond with the other things that have been forgotten by a progressive people. Field bread will take its place except as an emergency ration. Quietly, but none the less diligently, at the big Texas maneuver camp, scores of new things have been tested, numberless theories have been tried out and conclusions reached that may work a revolution in the conduct of military affairs. In the subsistence department there have been numberless innovations resulting from the experience gained by the commissary officers. The development of a new form of bread to take the place of hardtack in the field under all but extraordinary circumstances, has been but one of these.

Field bread is like the fresh bread that has always been made for the troops except that it is of a finer, porous structure and is covered with a thicker crust. Exhaustive tests have shown that it keeps fresh for a week or ten days. Some of the troops to whom it has been issued prefer it to fresh bread and it has been conclusively demonstrated that it can be served to troops in the field under practically all conditions to be found during a war. Hardtack will still have a place as a part of the ration, but it will not have so extended a field of usefulness as heretofore.

☞The aluminum radiator constructed in Dresden for the 300-hp. engine of an airship, is claimed to be the largest in the world. The weight is 145 lb. empty, and 209 lb. when filled with water.

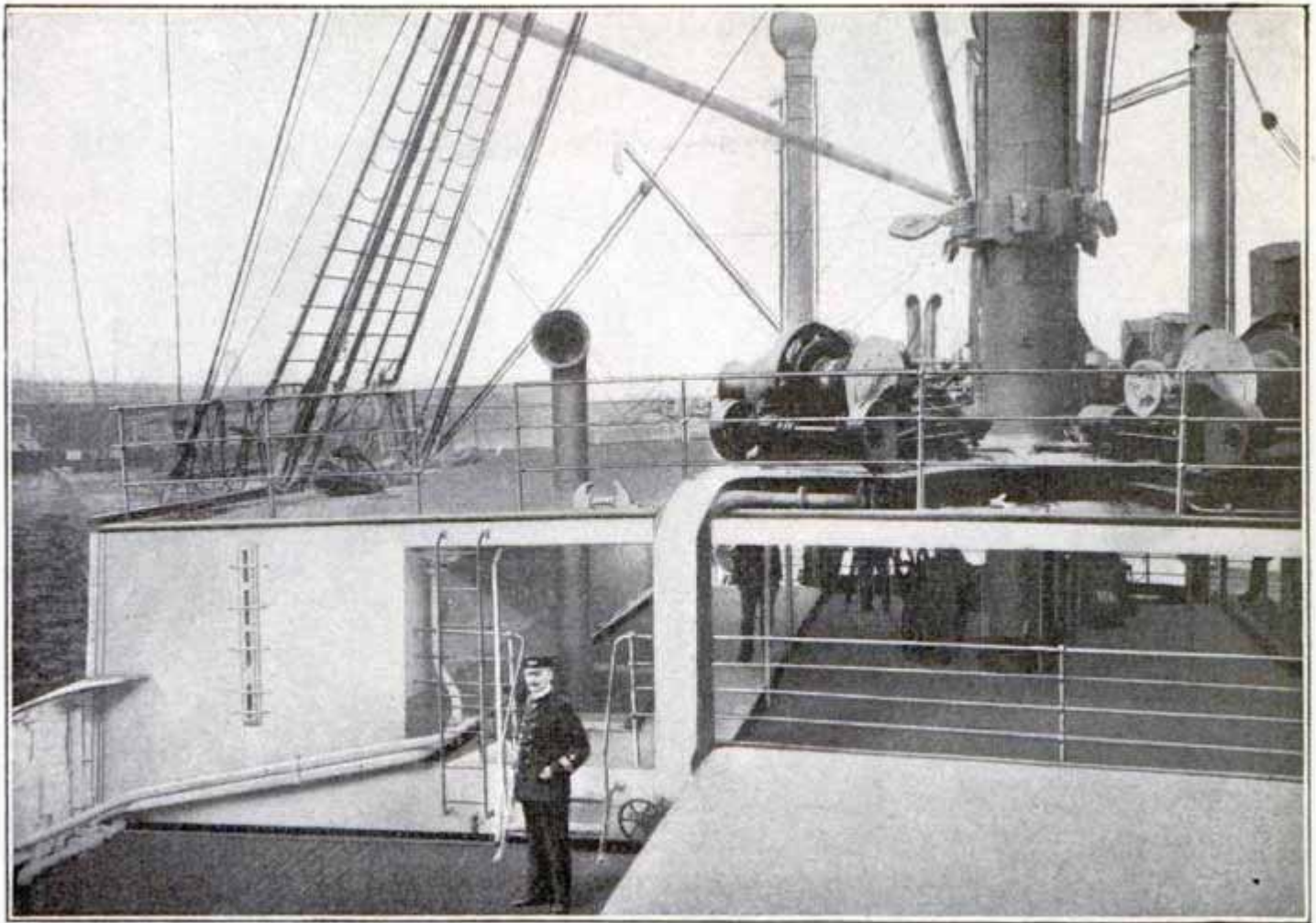

On the Left Is One of the Anti-Rolling Tanks of the "Ypiranga" Which Converted an Unsteady Vessel into One of the Steadiest Ships Afloat. Height of Water in Tank Can Be Seen by Gauge

ANTI-ROLLING TANK OF 12,600-TON LINER

The illustration shows one of the anti-rolling tanks of the Hamburg-American liner "Ypiranga," a 12,600-ton boat which, in spite of her bilge keels, was formerly notorious for her unsteadiness at sea. There are two of these tanks, placed respectively near the fore and the after masts on the upper deck, and connected by a flying bridge. The tanks are replenished by the deck-washing pump, and the action of the water in the tanks, when the ship is rolling, may be controlled by regulating the movement of the air in the side branches by means of an air lock situated between the upper ends of the side branches.

Since the installation of these tanks the "Ypiranga" has become one of the steadiest ships afloat, the pendulous action of the water in the tanks seeming to compensate the wave action which causes rolling. A sister vessel, the "Corcovada," has been similarly

fitted, and the same construction has been or will be applied to many other big ships, in passenger vessels to prevent seasickness and in warships to steady them for gun fire.

"WIRELESS" LIGHTHOUSES

The French government has decided to install wireless sending apparatus on two lighthouses near Cape Finisterre and on a lightboat, stationed near the mouth of the Seine River, for the protection of vessels during fogs. These "wireless lighthouses" will each emit a characteristic signal, conveying no special meaning, but calculated to be easily "heard" and intended only to enable vessels to locate, by means of the Bellini-Tosi radio-compass, the direction of these lighthouses relative to the ship, and to set their course accordingly.

LINCOLN MONUMENT IN SCOTLAND

The first statue of Abraham Lincoln erected in Europe is in the Calton cemetery at Edinburgh, Scotland. It was raised to perpetuate the memory of the Scottish-American soldiers who were



Lincoln Monument at Edinburgh, Erected in Memory of the Scottish-American Soldiers of the Civil War

killed in the Civil war. The statue of Lincoln, mounted on the top of the pedestal, is a life-size bronze cast, and the figure on one of the ledges of the pedestal is a freed slave poised as if to greet his liberator.

A SIMPLE SPEED GAUGE FOR AEROPLANES

It is important for an airman to know the speed at which his machine is traveling through the air, and although any device for measuring speed which depends on the forward pressure of planes against air may be extremely deceptive owing to the varying head resistance of winds, such an instrument is of great value when

gliding down from a great height where a mistake in estimating the speed may result in disaster.

Ogilvie, the English airman, used a simple speedometer on his baby Wright biplane during the recent Gordon Bennett race. It was constructed from a design originally made by Sir Hiram S. Maxim. The gauge is simple and yet all the parts are in balance.

The part marked A in the illustrations represents a spar on the aeroplane, which by means of a bracket B, supports a horizontally arranged bar C. The scale D is inserted in a slot in C, and two pairs of levers, E and F, both pivoted to the bar C, are kept in their normal positions by two springs G, one on either side of the bar C. The lower ends of the levers E and F support a horizontal stick H, which carries a semi-spherical cup J at its front end. This cup is made of celluloid; in fact, it was made from one-half of a baby's rattle.

It will be readily seen that when the aeroplane travels forward the open side of the cup J receives the force of the wind, and pushes back the stick H, thus turning the levers E and F on their fulcrums, and extending the springs G, and as the springs are attached to portions of the levers E and F, which move in opposite directions and increase in angular movement with the continued movement of the stick H, the resistance to the move-

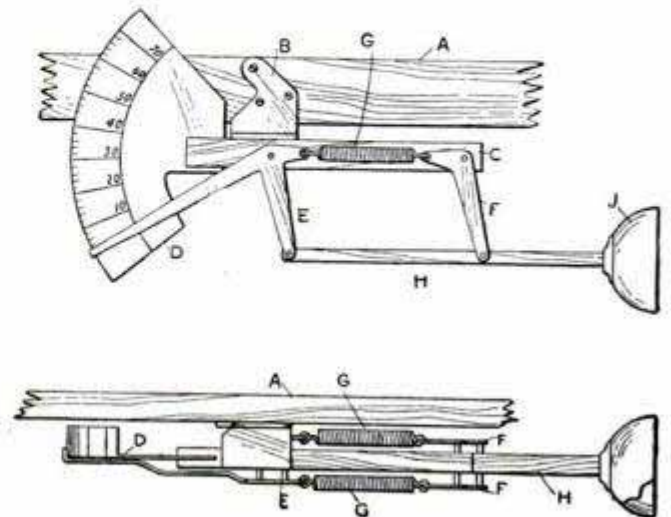

Side and Top View of Simple Speed Gauge, Made by an English Airman

ment of the lever E is proportionately increased, so as to enable the indicating finger to travel over the scale with a movement approximately proportional to the speed of the machine through the air.

A HUGE FALSEWORK STRUCTURE

The picture below shows the timber falsework for what is to be the widest concrete span in the world, although

it lacks 12 ft. of breaking the world's record for length. The bridge will connect Larimer avenue, Pittsburg, Pa., and it takes the place of the antiquated trestle which formerly occupied the site.

The structure will cost the city about \$150,000, and its design is considered an artistic as well as an engineering triumph. It has a total length of 650 ft. It will support a roadway 50 ft. in width and will be ready for foot traffic by December. The concrete work is of the reinforced type.

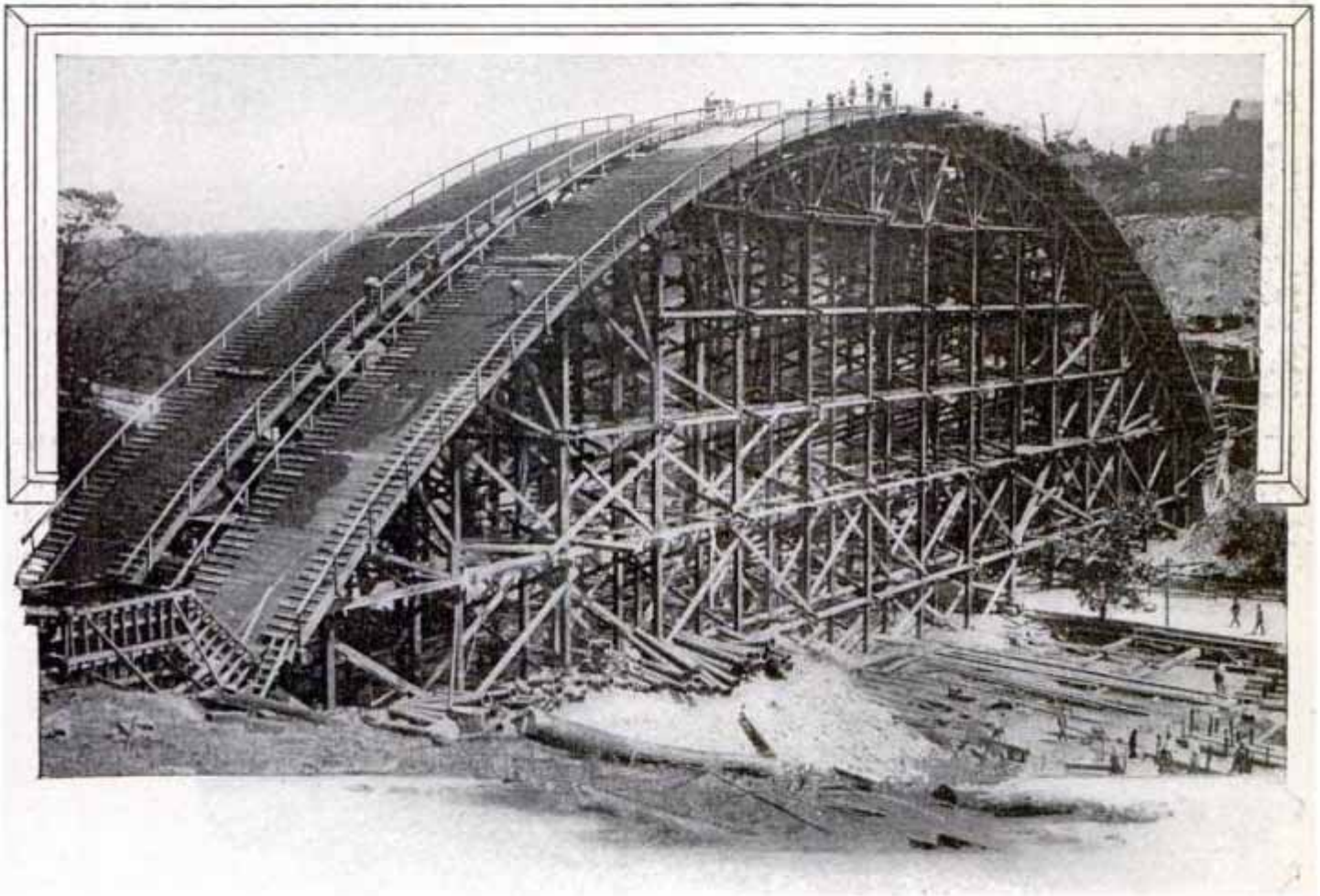

Remarkable Falsework in Construction of Pittsburg Concrete Arch Bridge

A CHEMICAL RHAPSODY

O come where the cyanides silently
flow,
Where the carbonates droop o'er the
oxides below,
Where the rays of potassium lie white
on the hill
And the song of the silicate never is
still.
Come, O come, tum titti tum,
Peroxide of soda and uranium.

While alcohol's liquid at thirty de-
grees
And no chemical change can affect
manganese,
While alkalis flourish and acids are
free
My heart shall be constant, sweet Sci-
ence, to thee.
Yes, to thee, fiddle-de-dee.
Sulphate of iron and H O plus C.

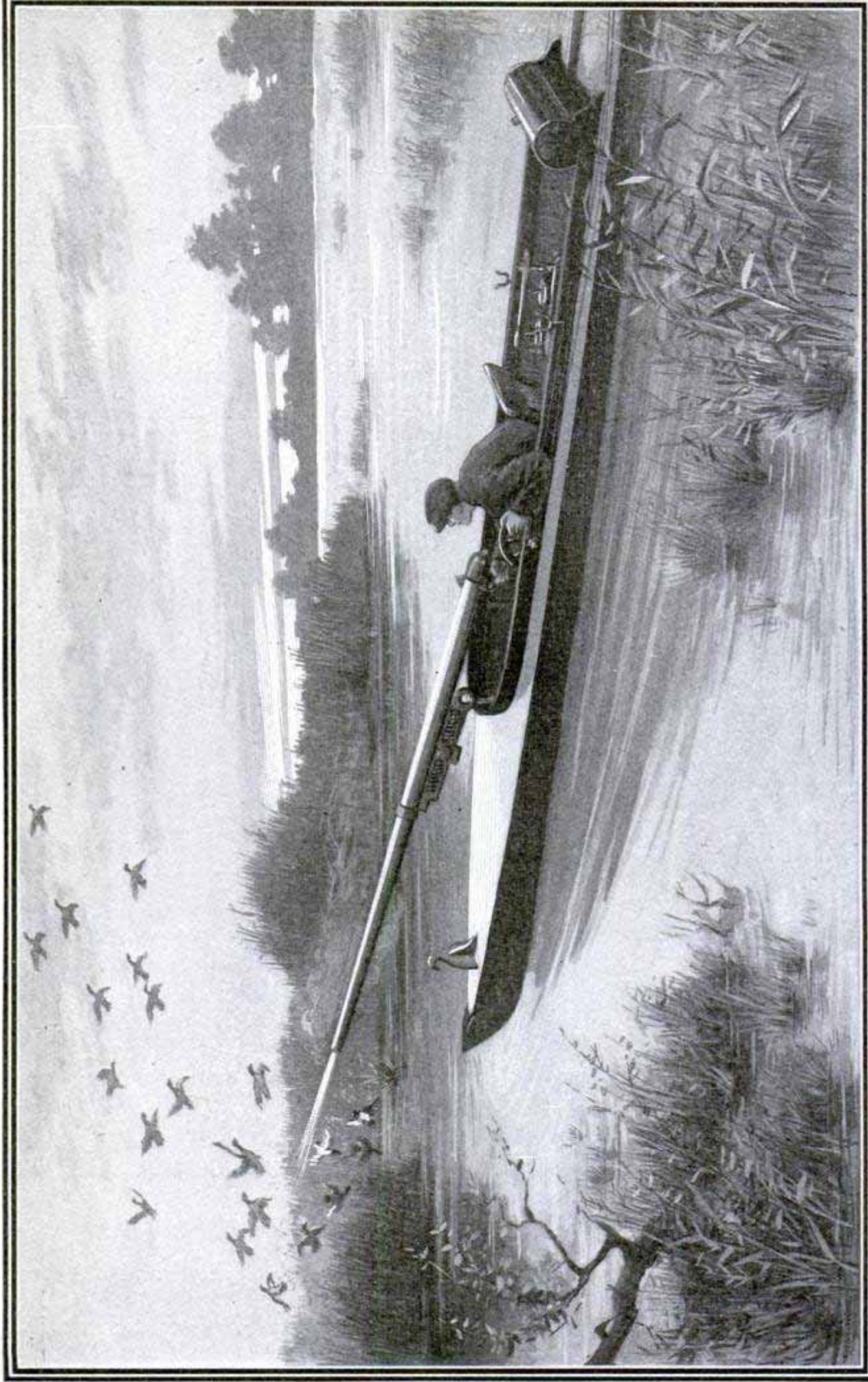

DUCK-SHOOTING GUNBOAT

If the combination shown in the accompanying illustration were designed for the shooting of human beings instead of ducks, it would come under the head of warships. It is a duck-shooting motorboat of shallow draft, provided with a long gun, which swings to any angle on its

FIRST MOVING PICTURE

Probably the man that can claim the greatest credit for moving pictures is Edward Muybridge of Oakland, Cal., who, at the instigation of Governor Leland Stanford of California, made countless pictures of the governor's celebrated trotter Occident, the first horse to trot a mile in 2 min. 20 sec. west of the Rocky Mountains. Occident was the pride of the governor's heart and he engaged Muybridge to photograph him in every conceivable size and shape. In making a series of snapshots of the horse's action, Muybridge was enabled to show the exact motion. In order to satisfy the governor, he thought of a novel scheme of placing a number of cameras covering at least one-tenth of a mile. From these cameras, he stretched silk threads across the track at about the height of the trotter's knee. These threads being broken, each camera made a separate, distinct picture of the horse, and by putting them together and riffling from the thumb, the horse could be seen as in actual motion. In 1885 Muybridge sailed for England, and there, in connection with six or seven others, evolved the first moving-picture camera. In about 1886 some of these cameras reached America. In 1887 the patent offices at Washington commenced to receive a shower of applications for moving-picture apparatus both for taking and projecting purposes.

FOUR DRILL HOLES BORED IN RESCUE OF MINER

Four 6-in. drill holes had to be bored before the workers attempting to rescue Joseph Clary, a miner, from his entombment in the White Oaks mine, Joplin, Mo., succeeded in establishing communication with him. Imprisoned 78 ft. below the surface by a cave-in, he faced several forms of death, including death by starvation, and death by drowning in the slowly rising water. When the rescuers had at last reached

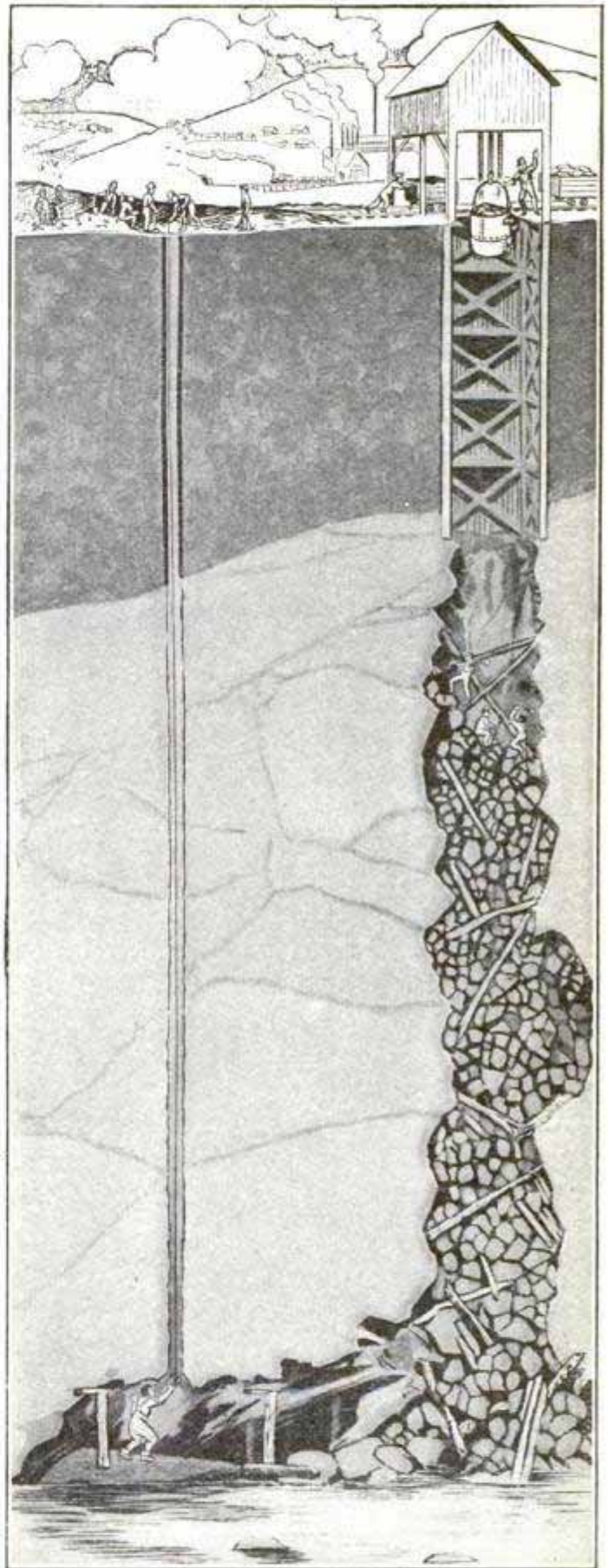

Diagrammatic Drawing Showing How Miner was Saved by Drilling a Hole through Which Food was Lowered to Him

him he had retreated to the highest point in the drift and the water was above his waist in many parts.

Communication and a food supply was established long before the rescue

shaft penetrated the drift. The first food sent to him through the 6-in. drill hole which opened communication with him was in liquid form. This was followed a few hours later with a light lunch, and the cold chicken he had been demanding was promised for several hours later. He was entombed 72 hours.

NEW AVIATION RECORDS AND DEATHS

Three new marks set and four lives lost are recorded in the history of aviation in the past few weeks. The new records made have all been along the line of practical development. Harry N. Atwood flew from St. Louis, Mo. to New York, a distance of 1,265 miles in 28 hours and 31 min. of actual flying time, making 20 separate flights. The total distance covered was 1,365 miles. Atwood started from St. Louis, August 14, at 8 o'clock in the morning and flew to Chicago on the first day, a distance of 286 miles. An international aviation meet was in progress at Chicago and the transcontinental airman's arrival and departure for the east the next day were made features of the meet program. After various vicissitudes Atwood arrived in New York and alighted on Governor's Island, August 24,

beating the former world's record held by Herr Koenig, a German, by 101 miles.

The Chicago air meet extended over ten days, and was notable for two world's records and two lives lost. G. W. Beatty remained in the air 3 hr. 22 min. with a passenger. The day before he had broken another record by remaining in the air 1 hr. 18 min. 22 sec. with two passengers. William R. Badger and St. Croix Johnstone were the airmen who lost their lives, their deaths following one another on the afternoon of August 15. Badger fell 50 ft. from a Baldwin biplane at the end of a vol plane. Johnstone's Moisant-Bleriot monoplane fell into Lake Michigan from a height of 600 ft.

The other deaths occurred in Europe and both victims were military officers. Lieutenant T. J. Ridge of the British army fell at Aldershot, Eng., August 18, while trying out for the first time a new type of military machine. On August 29, Lieutenant Zelotnehin of the Russian army fell at St. Petersburg and was killed.

According to a report from Coalinga, Cal., two men recently made descents to a depth of 185 ft. in a hole only 18 in. in diameter to recover drill tools which had been lost.



Route Followed by Atwood, Showing His Flight from St. Louis to New York

VANIMAN'S ATTEMPT TO CROSS THE ATLANTIC

By J. Q. ROBERTS

STILL strong in his faith in the dirigible balloon and the possibility of crossing the Atlantic in a properly constructed lighter-than-air craft, Melvin Vaniman, chief engineer of the "America," which made a brave attempt to accomplish the feat a year ago, is now assembling a larger airship at Atlantic City, expecting to start for Europe by the air route some time in October. He believes that by applying the knowledge gained from the experiences of the "America," and a new means of compensating for the added lifting power of the gas when exposed to the heat of the sun, he will be able to make his way through the storms of the Atlantic and the uncertainties of the air lanes.

Just what this new means of compensating consists of has not been made public. The famous "equilibrator" of last year's airship will be missing. Two methods have been discussed by Vaniman and his assistants and advisers, but these may be discarded at the last moment and another method adopted. One was to pump water into tanks in the airship by means of a long hose; the other to pull up water in a string of buckets something like the plan adopted by Brucker, the German-American who planned to attempt to cross the Atlantic in the "Suchard," a large dirigible. Up to September 1st, however, the plans of the builders in this connection were withheld. At that time Vaniman stated:

"I am not at liberty to disclose this method. There will be no equilibrator, however. This phase of the airship is being kept secret as it now seems to be the only problem which has not been solved. There are no water buckets and no special tanks for water in the airship."

As a result of the experience last year, when the absence of a flywheel on the after engine put it out of commission and deprived the aeronauts of

the lifting thrust of the after propellers, close attention has been paid to this feature of the "Akron," as the new craft will be christened. There will be four engines, two of 100 hp. each, one of 80 hp., and one of 18 hp., the first three for the three sets of propellers, and the latter for lifting purposes and for running the dynamo which will furnish electricity for the wireless apparatus. Two of these engines will be of American manufacture and two of foreign make. At least one pair of propellers will be mounted so that the thrust can be secured in any direction.

In almost every detail of the "Akron" there will be improvements suggested by the experiences of the Wellman expedition. One of the most important changes will be in the manner of suspending the motor lifeboat under the inclosed frame. Last year the boat was almost swamped when it was launched, owing to the fact that the airship, in descending to the water, came down with a side movement, launching the little boat broadside. This was due to the method of suspending the lifeboat by the ends. This year it will be suspended by a single fall and tackle, enabling the crew to launch the boat bow on in spite of any broadside movement of the balloon.

The position of the vertical rudder will be the same. The principal horizontal rudders, governing the ascent and descent, will consist of a pair of triplanes attached to the frame well toward the bow. There will be three auxiliary horizontal rudders at the rear.

Filled with hydrogen gas, the balloon will have a gross lifting power of 26,000 lb. The bag is built of a strong fabric composed of layers of cotton and rubber cemented together. The upper two-thirds of the envelope is made of four layers of rubber and three of cotton. This fabric has a tensile strength of 175 lb. per sq. in. As the



The Enormous Box in Which the Balloon Fabric was Shipped to Atlantic City—Section of Building Wall was Removed to Get the Box Out

under side of the bag will have only the strain of the internal pressure to withstand, this part will consist of only two layers of cotton and three of rubber. The frame, which is built of steel tubing, will be attached to the envelope by loops sewed onto the side of the bag. Long, light rods will be run

through them, and the framework suspended from these rods. The balloon fabric is bright yellow to prevent deterioration by the ultraviolet rays of the sun.

One of the features of the "Akron" will be two balonets, located in the lower part of the gas bag. To com-

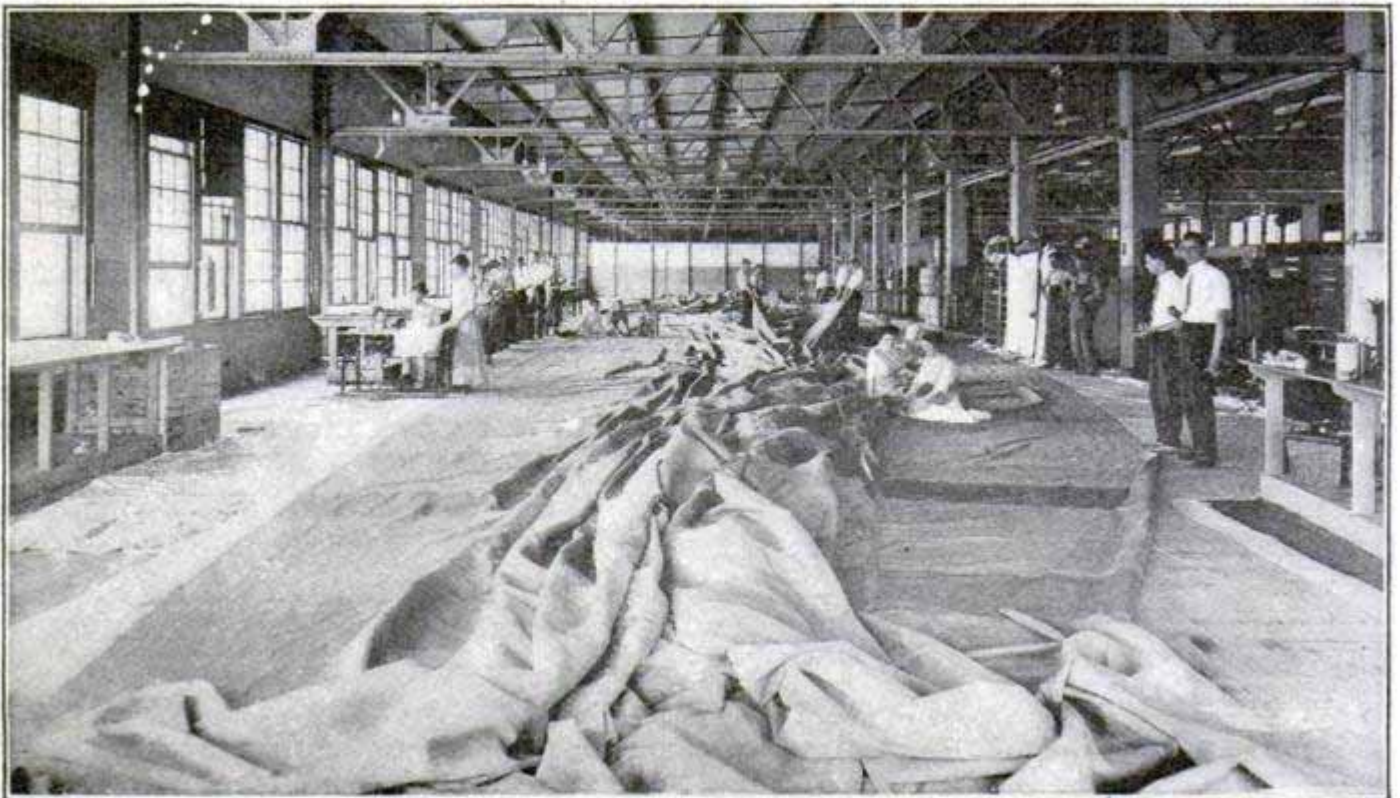

The Balloon Fabric, the Largest Ever Made in the United States, Stretched Out on Floor of Factory

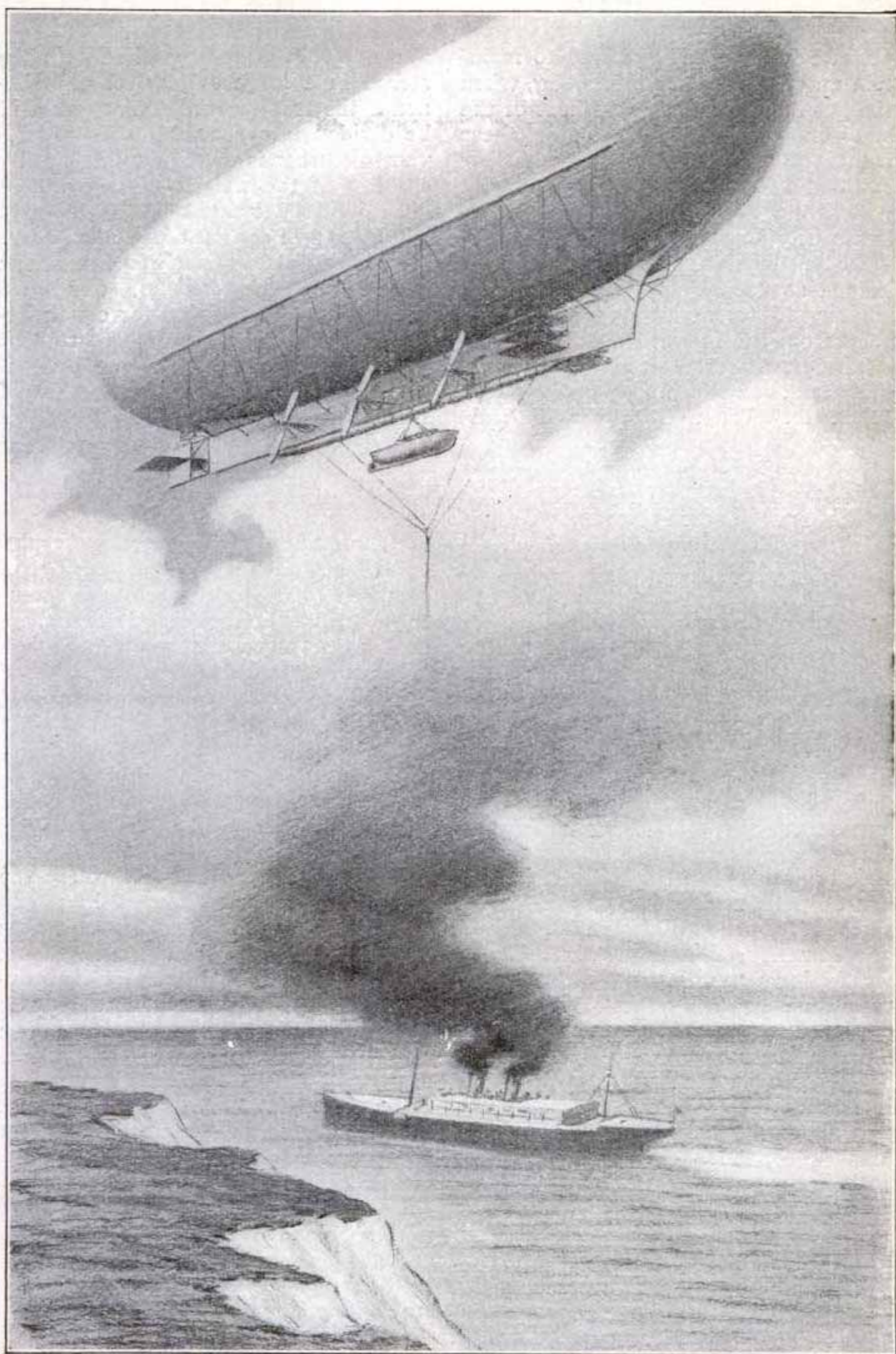

THE "AKRON," DIRIGIBLE DESIGNED BY MELVIN VANIMAN, WHICH WILL ATTEMPT TO CROSS THE ATLANTIC

pensate for any leakage, and to maintain an even pressure in the bag, when the gas is expanded by the heat of the sun or contracted by cold, these balonets can be filled with air or emptied at will. The hydrogen with which the bag will be filled at Atlantic City must carry it on its entire journey. The envelope will be cigar-shaped as usual, with the extreme diameter, 45 ft., about one-fourth way back from the forward end.

The framework, with the engines, fuel tank and cabin, weighs about 14,000 lb. When the start is made,

about 8,000 lb. of gasoline will be stored in a large cylindrical tank beneath the framework. This tank will be divided into compartments to prevent disturbance of the equilibrium by shifting of the weight. The wireless outfit will be located in the lifeboat. The crew will consist of six men. Five have been chosen; one Frenchman, one Dane, one Englishman, and two Americans. The capital for constructing the dirigible, which will cost about \$150,000, was furnished by F. A. Seiberling, a rubber manufacturer of Akron, O.

THE MILLIONTH PATENT

The millionth patent has been issued!

It seems difficult to realize that in 121 years the government of the United States has given its protection to the devices of inventors more than a million inventions have been recorded as practicable, and their fortunate owners permitted to enjoy the exclusive right to make or sell them, or say how they should be made or sold. The millionth patent marks an epoch in the history of invention, although it is not strictly accurate in recording the number of patents that have been issued since 1790, when this branch of the government started business. There was a long time when business was very dull, and but one clerk, working only part of his time on this particular part of his duties, was able to handle every application made. There had been 9,957 patents issued before the present system of numbering was inaugurated.

It therefore appears that some 1,009,957 patents have really been issued in 121 years—an average of about 8,349 per year or 22 a day. These figures, too, are misleading, because the fact is that during the early years of the republic's history only 9,957 patents were issued. Then the numbering of them commenced. In 1891, when

the hundredth anniversary of the patent office was celebrated, there had been 450,000 patents issued since 1836. So that in the last 20 years there have been more patents issued than in the entire century preceeding them. That is to say, that of the 1,000,000 patents issued some 550,000 have been granted in 20 years. It would be interesting to know just how many of them have brought their inventors the riches they dreamed of getting. Some of the wealthiest men in the country have gained their wealth through the medium of a patent owned by them, and some of the biggest monopolies in the world owe their security from competition to the protection the government has given them. But this is not always the result. Inventors are usually pictured as poor men who have a difficult time placing the creatures of their brain and hands on the market. It is a fact that while many feel called to revolutionize the industries or arts of the country, few are chosen to enjoy the fruits of their work.

It so happens that the process protected by the first patent ever granted by the government has never been improved. This patent was issued to Samuel Hopkins of Vermont, July 31, 1790, and protected a method of making pearlsh, or potash, when vege-

The Completed Model of Machine



Reducing the Idea to Form



Consulting a Patent Attorney



Through the Patent Office



Receives Letters Patent

Birth of the Inventive Idea



Attempting to Organize Company



FAILURE — His Patent Has No Place in the World

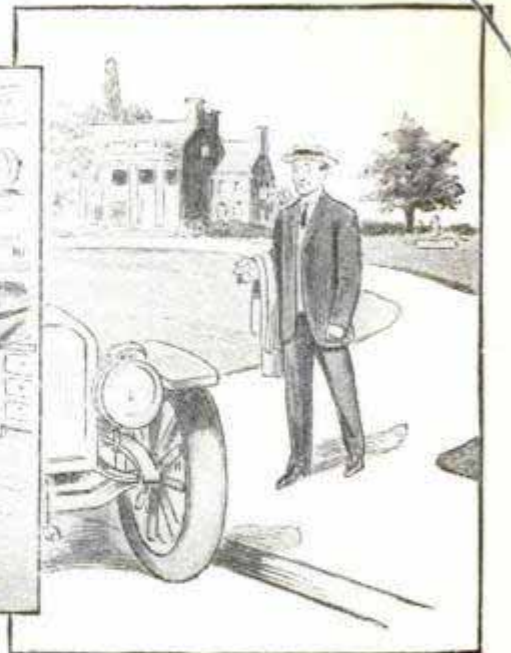

SUCCESS — His Found a Market and Wealth

THE COURSE THROUGH WHICH A MILLION PATENTS HAVE PASSED — FAILURE OR SUCCESS AWAITS THE INVENTOR

table matter is refined in a crucible. The patent bearing No. 1 on the files of the patent office covered a steam engine designed to run on an inclined plane, and was issued to John Ruggles,

July 28, 1836. The "millionth patent" was issued August 8, 1911, to Francis H. Holt of Akron, Ohio, and covered an invention for a puncture-proof pneumatic tire.

HYDRO-AEROPLANE PROGRESS

Commencing rather more than a year ago, the first successful experiments with aeroplanes designed to start from

headquarters in the city of Marseilles. In its final form, Fabre's design evolved to a monoplane with a front elevator, borne upon three hydroplane floats, closely resembling the hydroplane hulls that are so recent and novel a feature of high-speed motorboat development. One of the floats was placed beneath the elevator and the other two toward the extremities of the main planes, so that the arrangement afforded a three-point support of the whole machine upon the water. Handicapped by the use of an aeroplane that had not been previously developed as a flyer, frequent minor mishaps attended the trials, but ultimately numerous flights were made at good speed, starting from and alighting upon the water with the utmost ease and without accidents.

Following the Fabre experiments, Glenn Curtiss commenced in the United States his work of improving the hydro-aeroplane or aero-hydroplane, with which he has been highly successful. Especial credit is due to Curtiss for his combination of the hydroplane with land-alighting gear,



The Machine Built for the English Government

and alight upon water surfaces, were carried out by the French engineer Fabre, of the famous steamship-line firm of the same name, which has its

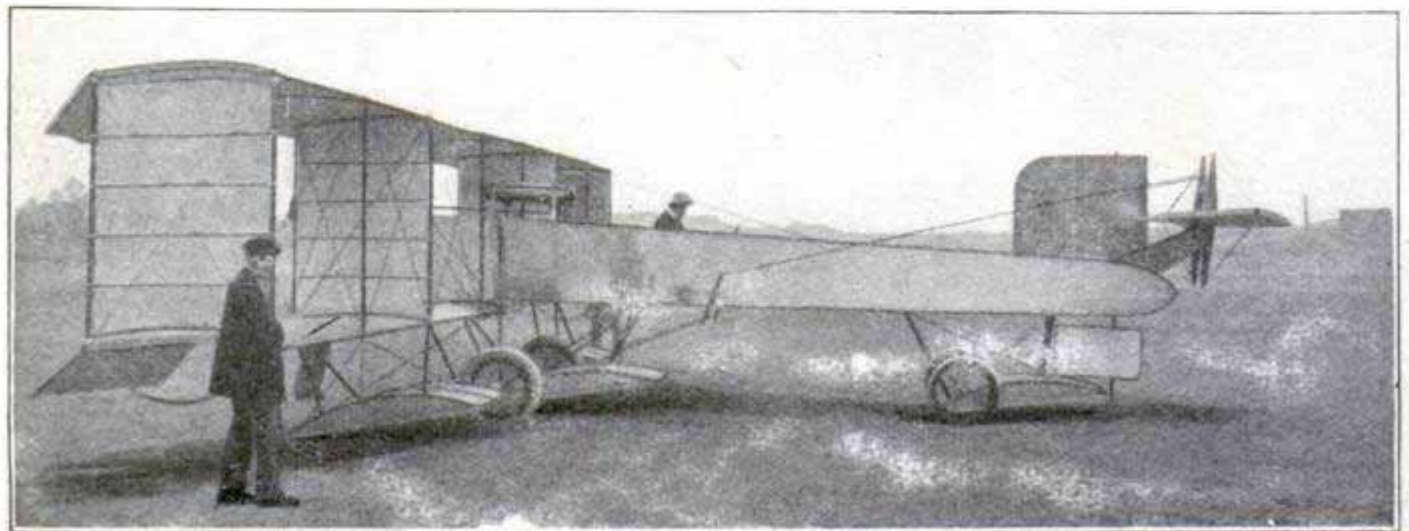

Voisin's New "Canard" ("Duck")—Note Small Vertical Water Rudder over Float in Front



One of Glenn Curtiss' New Hydro-Aeroplanes on Lake near
Hammondsport, N. Y.

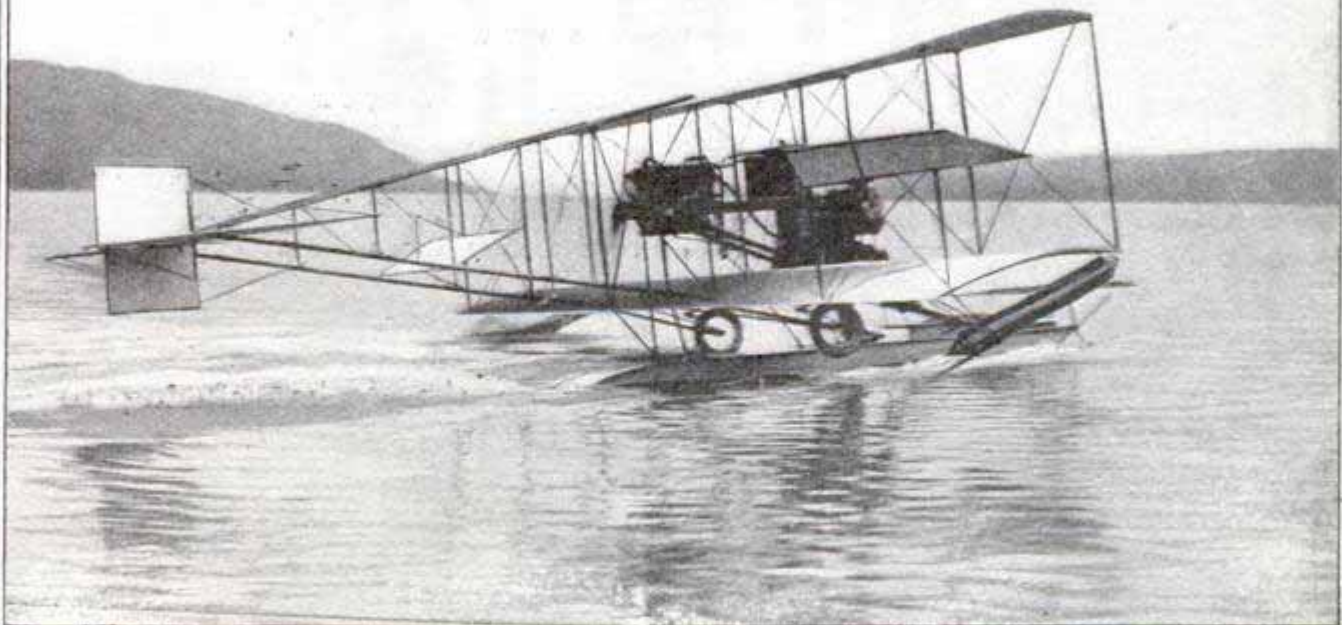

It Moves with Great Speed on the Water, Outstripping Fast Motorboats

The Possibilities of this Machine as a Life-Saver were Demonstrated during the Recent Chicago Meet when It Offered Assistance to Airman who Fell into Water, but Preferred to Remain with His Floating Aeroplane, as Depicted on the Front Cover of This Issue

so that his machines can be brought down upon or started from either land or water.

The Curtiss system now involves only one pontoon-like float at the center of the machine, provided with a characteristic hydroplane underform. Cylindrical floats at the wing tips prevent their submersion if the machine tilts on the water, but perform no normal function in landing or starting. A small "splash plate" is placed just above the water in front of the main float, to give the initial elevation for starting by striking the bow wave pushed along by the float.

Other experimenters at work upon the hydro-aeroplane problem are the Voisins, in France, and A. V. Roe, in England. One of the Voisin "Canard" machines with four floats has thus been flown from the Seine very successfully by the well-known airman, Colliex. This machine has a water rudder attached to the forward float. The Roe experiments have been for the British navy, and the machine is a new Roe biplane with twin floats under the main planes. Indifferent success has been attained so far, due apparently to lack of proper balance rather than to any more inherent difficulty.

BRITISH SAILORS PRACTICE WITH DUMMY AEROPLANE

The man-o'-war's men stationed at Barrow to man the British navy's airship are as interested in the heavier-

is a skeleton framework representing an aeroplane and is balanced on a pivot. A fresh breeze sets it rocking and swinging, the motion being counteracted by the planes. The bluejackets learn by practice to keep the machine fairly steady in spite of the wind.



Courtesy Illus. London News

British Bluejackets Practicing Aeroplaning with a Specially Constructed Stationary Machine

than-air type of flying machines as in the dirigibles. Several of the bluejackets recently purchased for themselves a machine specially designed for the instruction of airmen. It

ENGLAND MENACED BY FAMINE

England's last great sensation, coming on the heels of the coronation and the stripping of the veto power from the House of Lords, was the threatened paralyzation of the business of the empire resulting from a general strike that for a short time portended most serious results and created a grave situation.

The strike started with the men who work on the docks refusing to load and unload ships. When means were used to employ outside help the carters promptly refused to haul goods thus unloaded from the ships and their refusal was quickly followed by the walking out of the railroad employes. The result of this series of walk-outs was that so far as the haulage of goods was concerned, practically all lines of transportation were tied up,

trains and ships being run only as make-shift crews and stevedores could be obtained. The schedules of some of the big liners were suspended altogether. There being practically no freight hauled by the various shipping interests and practically no carting in the cities, the supplies of the shops were quickly exhausted and a food shortage occurred.

While the strike was accompanied by more or less disorder and troops and police were frequently called into action, there was comparatively little violence, practically none of which was blamed on the strikers themselves. The question of wages was the main issue with the dockmen and carters, but this was not the case with the railway men.

The strikers have all returned to work and a commission has been appointed to inquire into the causes and consider a means of preventing such outbreaks in the future.

One of the features of the situation was the discussion among scientists of the effect of the extreme hot weather on the labor situation. Medical men insist that the spirit of unrest and revolt was largely due to the extended period of heat and sunshine which prevailed in England to an unusual extent for several weeks. Analogy was made to the effect on the white man



Courtesy "The Graphic"

Luxurious Touring Cars Used for Hauling Meat through London during the Progress of the Strike

of the tropical sun in Africa under weather conditions to which he was not accustomed. It was a common remark in London that a good sousing by a three days' rain would settle the whole thing.

TWO 'ROUND-THE-WORLD RECORDS

André Jaeger-Schmidt, a French journalist, completed a record-breaking trip around the world on Aug. 26, his time being 39 days 19 hours 43 min. 37 sec. A telegraphic dispatch sent, as a commercial message, around the world by a New York newspaper, made the circuit in 16 minutes and 30 seconds. No arrangements for this message were made in advance.

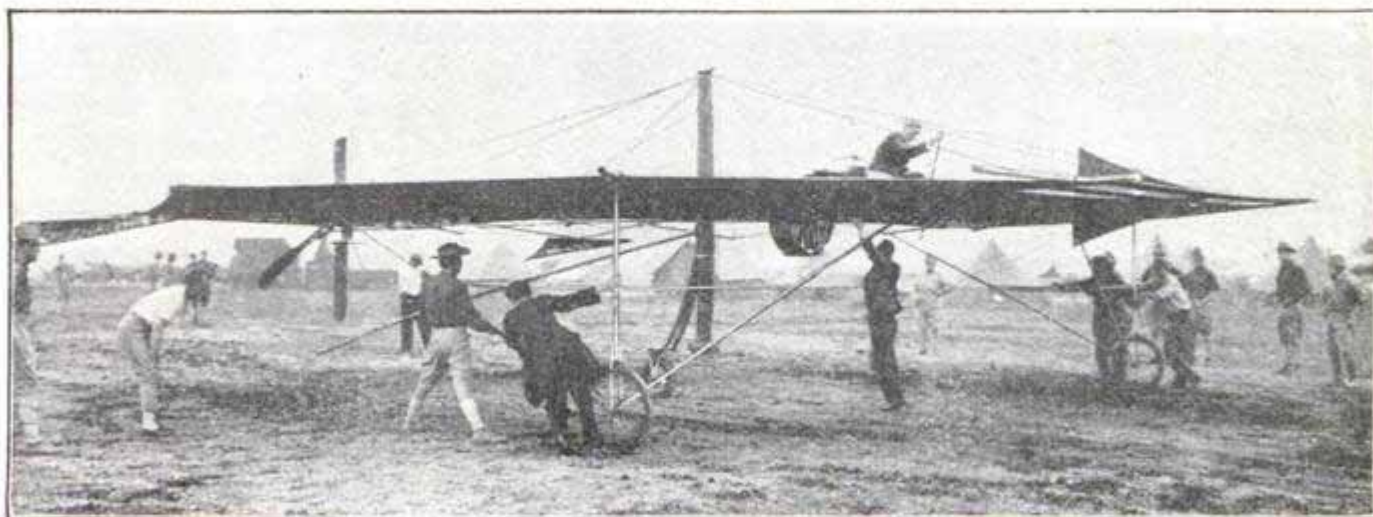

A curious type of air craft, known as the Rommé-McCormick aeroplane, a circular monoplane with a bamboo structure, resembling a giant Japanese umbrella. It has been undergoing tests at the army camp at San Antonio, Texas. It is 40 ft. in diameter and is equipped with a Gnome rotary motor

THE REAPERS OF

OF



The Reaper Hook or Knife, Most Primitive of Harvester Implements



The Flail, the Original Thresher for Beating Grain from the Straw



The Scythe with a Cradle. The First Real Improvement over the Reaper Hook



The First Horse-Drawn Reaper, Which Simply Cut the Grain

THE WONDERFUL PROGRESS OF HARVESTING IMPLEMENTS DEMON

FORTY CENTURIES

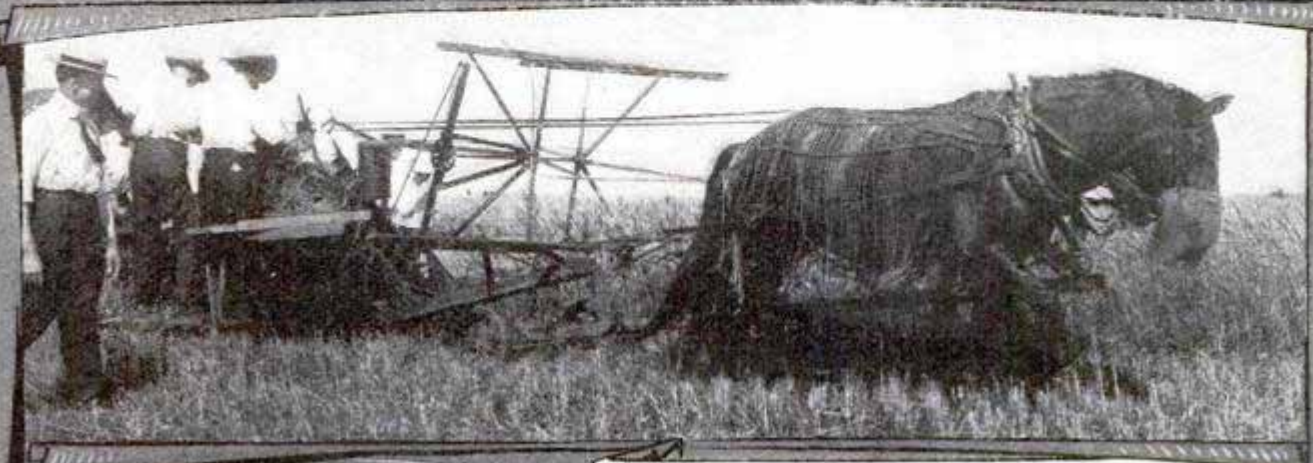
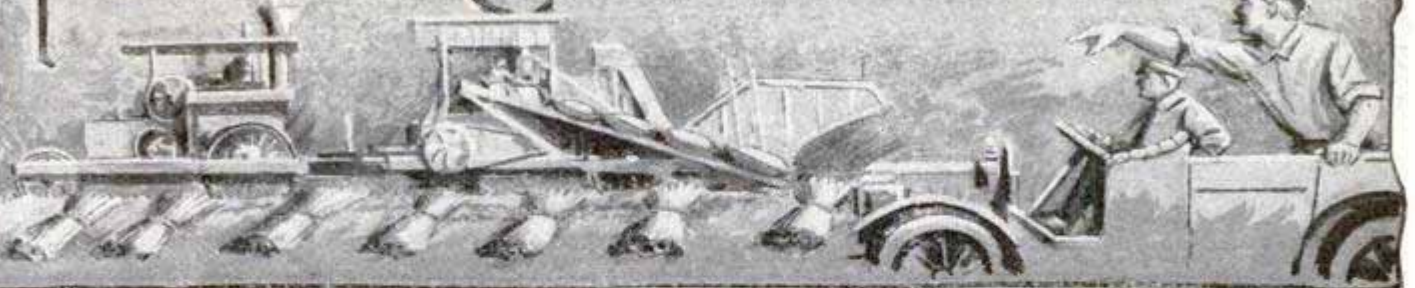

The Original Binder Which Required Two Men to Tie the Bundles of Grain



A Battery of Modern Machines that Both Reap and Bind Drawn by a Traction Engine



The Highest Development of Agricultural Machinery—the Traction Reaper-Threshing Machine Which Takes the Grain from the Ground and Threshes It, Getting Both Locomotion and Power from a Gasoline Engine

WASHINGTON HAS WORLD'S CHAMPION FLY SWATTER

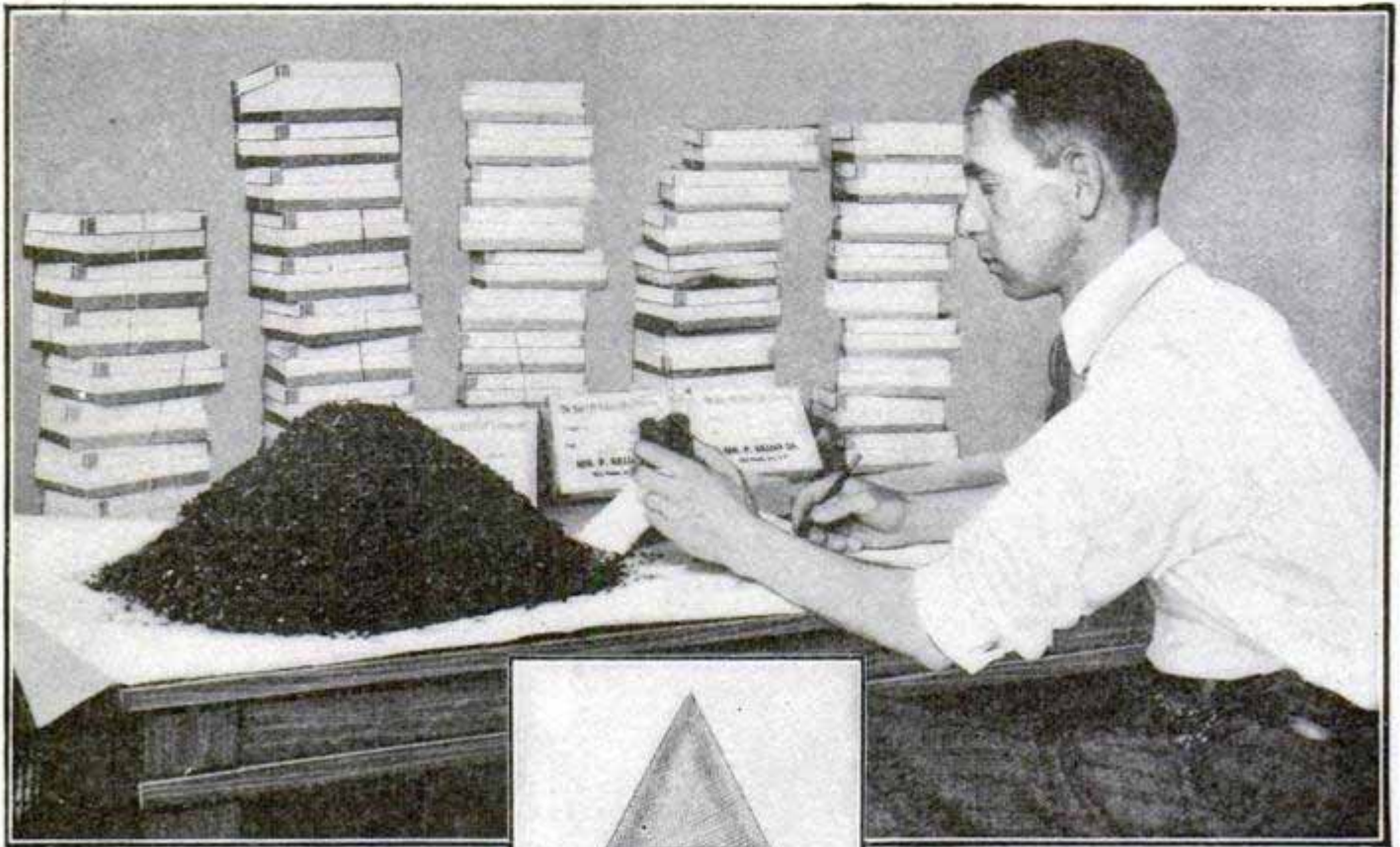

Counting One Day's "Catch" in

Seven million flies killed in less than two weeks is the record made by the children of Washington, D. C., in a remarkable campaign conducted there under the auspices of the health department.

Spurred on by the hope of winning cash prizes offered by a newspaper, the keenest rivalry developed among the hundreds of young campaigners. When the battle ended, the leader, a 13-year-old boy had 383,400 dead flies to his credit.

The health department and the newspaper which gave the prizes have had dozens of inquiries about the campaign from cities all over the country. A public spirited citizen furnished, free of charge, boxes in which the "catches" of the contestants were delivered to the officials who measured and counted them, the Associated Charities received the dead flies daily at their stations in various parts of the city, and a transfer company collected the boxes

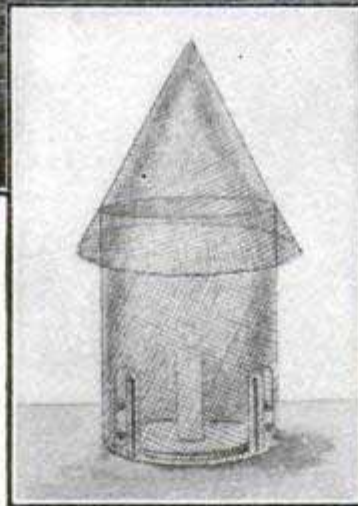

Fly Trap That Proved Its Efficiency

Washington Fly-Swattling Contest

and delivered them to the health department.

It was ascertained that so many flies of average size made a gill and the score was kept on this basis. The officials were provided with graduated gill measures made of glass, and each day's catches of flies were measured. The daily record of each contestant was kept on a card together with his name and address and the section of the city where he caught the flies. This information has been carefully preserved by the department and will be used in a systematic and tireless effort to eradicate the breeding places of the disease carriers, many of which had escaped the attention of the inspectors.

Layton Burdette, the winner of the first prize, set out to distance his competitors by organizing his friends into a fly-swatting brigade. These boys divided their section of the city into beats and enlisted the aid of store-

keepers and marketmen in their neighborhood. Burdette made his own traps but his main dependence was on the ordinary swatter made of wire. His traps were constructed of screen wire, cylindrical in shape with a dome which was detachable. The bait was placed at the bottom, which had several small openings, a dark cloth drawn around the lower portion of the

trap, and the dome left uncovered. After feeding, the flies sought the lighted dome and this was removed at intervals and the flies killed by sulphur fumes. Health Officer Woodward is of the opinion that the value of the flyless-city campaign cannot be overestimated. He sees no excuse for the fly and says it can be driven out of existence by determination and patience.

AUTOMATIC AEROPLANE STABILIZER

One of the first serious attempts to place into practical use an automatic stabilizing device for aeroplanes, is in progress under the auspices of French army officials.

The new device is the Doutré "stabilizer," and is intended to effect automatic control of only the longitudinal equilibrium of the machine. Its essential elements comprise a movable pressure plate interconnected with a

compressed-air device for manipulating the elevator surface. Various delicately balanced details are involved, so that if the speed becomes excessive, as in too abrupt a descent, the elevator is set to ascend. Conversely, if the machine slows to a point rendering the sustentation insecure, the elevator is manipulated to steer down. Rather clever utilizations of the forces of momentum and inertia, applied through

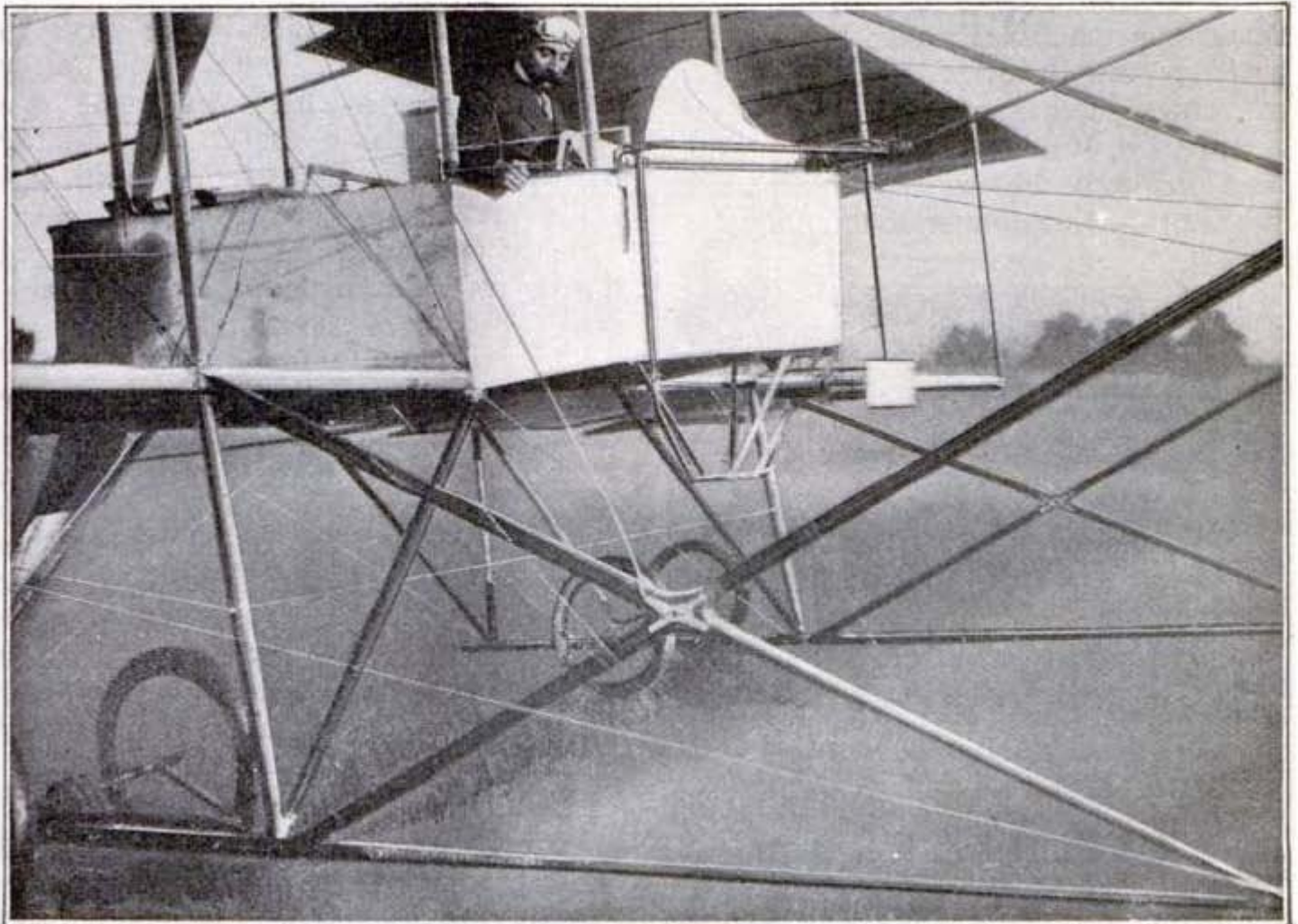

The Doutré Stabilizer Installed on a Maurice Farman Biplane

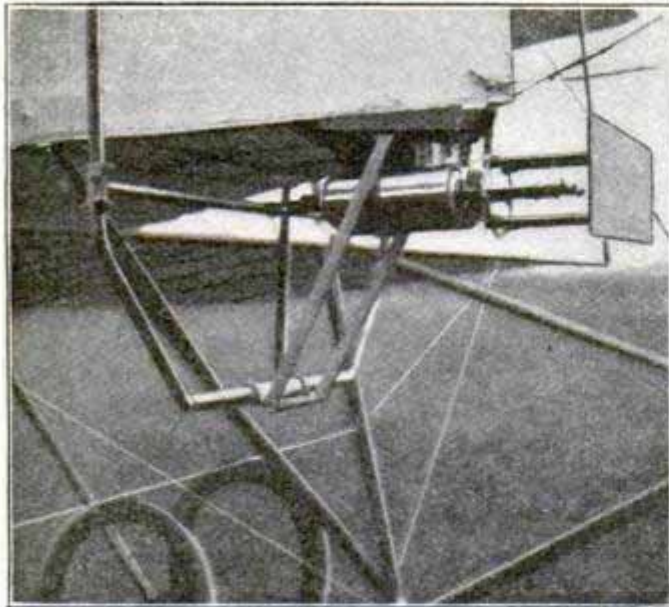

How the Stabilizing Device is Attached to the Front of the Machine

the means of sliding weights, are claimed to make the action of the device in exact quantitative proportion to the upsetting moments on the machine, but engineers who have had experience with aeroplanes in the air are tending to grow more and more skeptical of all automatic devices of this character, and to rely more and more upon the undoubted feasibility of so designing machines that they are inherently stable by virtue of the arrangement and interaction of their sustaining, fin, and rudder surfaces, rather than through the, at best, precarious juggling of automatic balancing devices.

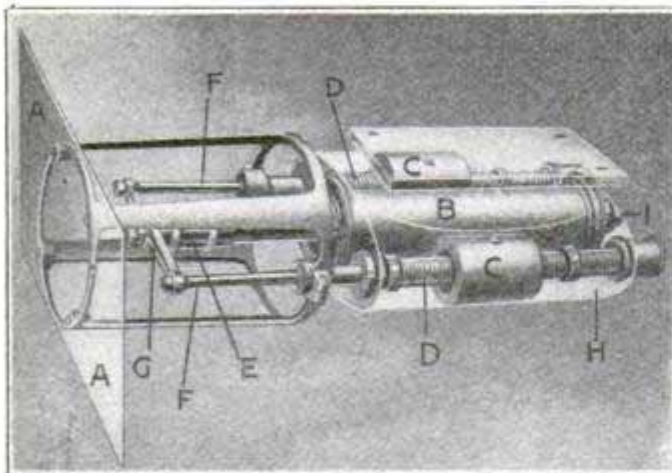

Phantom View of the Stabilizer—A, Windplate; B, Compressed Air Cylinder; C, Movable Weights; D, Springs Controlling Movable Weights; E, Piston Rod into Compressed-Air Chamber; F, Fixed Sliding Rods; G, Cross-Arm Connecting Them; H, Spring Controlling the Windplate; I, Point of Attachment to System of Levers.

Aeroplane models and full-size machines can be and have been built, that

will, without action on the part of the operator, turn right-side up, even when dropped upside-down. Development of the principles that determine such action is, in the opinion of those best qualified to judge, the road to the highest possible safety in the air, and is one it will best pay experimenters to travel.

TRANSPORTING HORSES BY AUTO TRUCKS

A curious and interesting demonstration of the superiority of auto trucks over horse-drawn trucks is a matter of every-day occurrence in the operation of a large express company in Chicago. This company is operating about equal numbers of auto trucks and horse trucks. An important part of their business is the delivery of freight at a point about 25 miles out.

The following procedure has been found most efficient and economical: A three-horse truck, loaded, is started out on the long trip early every morning. At noon a loaded motor truck is started on the same run. The latter ordinarily carries three times the tonnage of the horse truck. The motor truck makes the trip in $1\frac{3}{4}$ hours, unloads and waits for the horse truck. This is unloaded on arrival and the horses are unhitched and led up a plank into the body of the motor van.

The wagon is fastened to the rear of the motor truck and at 6 o'clock or even earlier the whole outfit is back at the stable ready for a trip the next day. The horses apparently suffer no ill effects from the rough ride in the auto and, in fact, are thought to enjoy it. As will be seen, this device actually doubles the tonnage hauled by the horse truck without in any way cutting down the tonnage of the motor truck.

Recent investigation has developed the fact that 67 out of every 100 taxicab drivers in London were formerly drivers of horse-drawn public vehicles.

A REAL REVOLUTION IN AUTOMOBILE-ENGINE DESIGN

By ANTON CAMILLE

VERY much of a sensation has been created in American automobile manufacturing circles by the announcement that three or four prominent firms in this country, after exhaustive examination and tests, have decided to discard the long-established poppet-valve type of gasoline motor in favor of the Knight sleeve-valve construction. And to add force to the innovation, several foreign licensees of the highest prestige—makers of the Panhard, Daimler, Mercedes, and other famous cars—have entered upon vigorous advertising campaigns to sell in this country their newest models, equipped with the same motor.

The history of the Knight motor is so interesting that a few words concerning it are almost essential to an understanding of the present situation. Designed by a Chicago engineer, Charles Y. Knight, the motor was built in a small way for several years. But that prophets are without honor in their own country was never more notoriously emphasized than in the reception encountered by the new engine. It was not until after a long period of indifferent business and financial struggle that the new motor loomed suddenly into prominence in England, as a result of its remarkable performance in very successfully passing some exceedingly severe tests imposed by the engineers of a British automobile club. Almost immediate adoption

by several big manufacturers abroad was succeeded by nearly two years of extending use and uninterrupted success, before the present awakening on this side of the Atlantic to the fact that here was really distinct and important improvement, and not mere difference, in automobile motor design.

Now that the tide has turned, however, it seems to have turned hard, and for the student of mechanical progress the United States Patent Office presents interesting evidence of a scramble on the part of designers to get in line with all sorts of both doubtful and promising variants from previously patented schemes of sleeve, piston, rocker, and other valves that dodge the shortcomings of the poppet-valve construction. Zest is lent to the competition by the rumor that Knight's European contracts interdict the licensing of more than four American concerns.

To describe it briefly, the Knight motor is one of conventional enough four-cycle design, except for the fact that the admission of the charge and the exit of the exhaust are controlled by two sliding sleeves to each cylinder, instead of by cam-actuated poppet valves. The sleeves are two to each cylinder, about $\frac{5}{8}$ in. thick in an ordinary motor, and are ground outside and in. The outer sleeve slides within the cylinder, the inner sleeve within the outer, and the piston

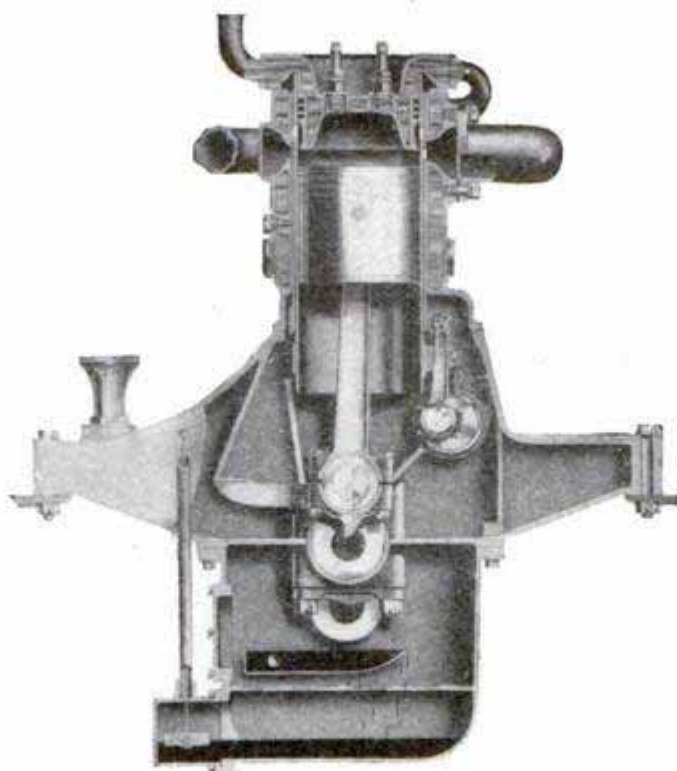

Vertical Section of One Cylinder of the Knight Motor, Showing the Connecting Rods for Actuating the Sleeves, the Two Spark Plugs in the Cylinder Head, the Sleeve and Cylinder Ports, etc.

within the inner sleeve. Both sleeves are positively reciprocated by small cranks, and ports or openings cut in their sides register with cylinder ports at the proper moments of the cycle. With reasonably close fitting, no troubles are experienced from leakage, heating, breakage, etc., while the advantages are numerous.

The positive action of the cranks actuating the sleeve valves is a vast improvement over the nonpositive cam movements of poppet-valve mechanisms; the very large port openings reduce wiredrawing of the incoming charges and free the exit of the exhaust; no noise is made by the valve mechanism; the combustion chamber is made to approximate the spherical form known to conduce to highest efficiency; wear of a character to impair the operation or require frequent readjustment is almost eliminated; and lubrication and complete inclosure of all working parts are facilitated. Several of these conditions are, of course, well understood to make for higher power and efficiency than are com-

mon, so it is no more than might be expected that in addition to an altogether exceptional reliability and durability the new motor is low in its fuel consumption and very powerful for a given cylinder capacity.

The exact relation of the positive-acting valve motor to the future of automobile-engine practice presents a number of puzzling features to those who attempt to prophesy beyond an immediate future, during which it is safe to predict that the poppet valve may tend to disuse.

But a good many engineers believe that some day, sooner or later, air cooling must supplant the present water works and plumbing with which automobile construction is complicated, and which besides being a considerable source of cost in the factory is a prolific source of unreliability and trouble on the road, particularly in winter climates. And as none but poppet-valve motors lend themselves in the least to air cooling, it is more than probable that the last word is not yet said against this type.

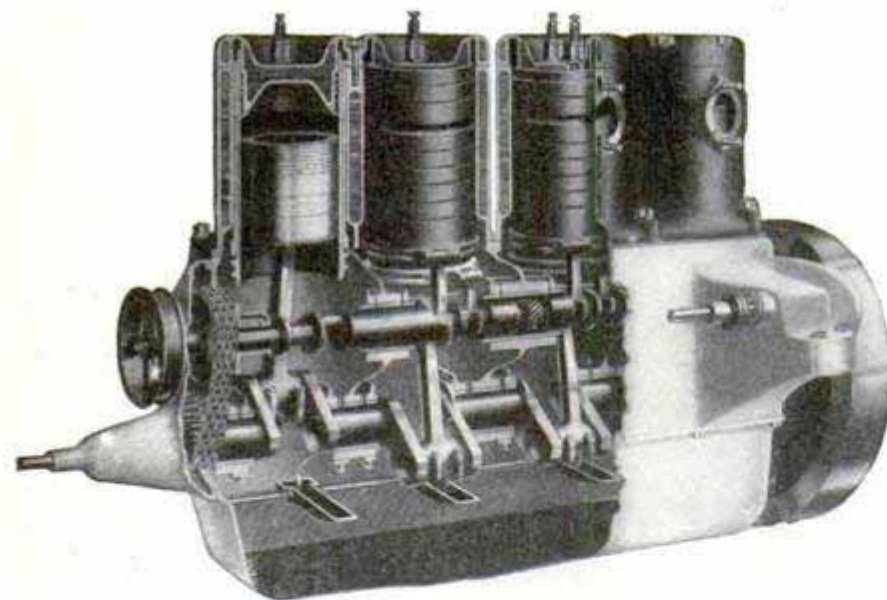

View of the Knight Sleeve-Valve Motor, Given Partly in Section to Show Main Working Parts

The valve-actuating shaft, shown above the engine crankshaft, is driven from the latter by the silent chain seen to the extreme left. The speed reduction is two to one. The two small cranks that reciprocate the sleeve valves for the first cylinder are clearly shown just to the right of the chain. The sleeves of this cylinder are shown in section. The front half of the casing of the second cylinder is entirely removed to show the outer of the two sleeves, in the upper part of which is seen one of the port openings. The small connecting-rods for reciprocating the sleeves are shown under the second and third cylinders. A good idea of the water-jacket construction may be obtained in the third cylinder. The small troughs in the lower part of the crankcase form part of the lubrication system, which is partly force feed and partly splash. The troughs are automatically raised and lowered with the opening and closing of the throttle, thus economizing oil on the lower speeds.

Indeed, if there be taken the view of men who have served in consulting capacities for automobile-company engineering departments, rather than the opinions of conservative business interests that in the United States have been disposed to copy tried constructions in preference to the development of new ones, it seems probable that ultimate victory will rest with poppet-valve designs that have been long suggested but little exploited. Fuel injection, internal scavenging, and eccentric or crank operation of the valve mechanism, in conjunction with the rapidly progressing European scheme of multiple valves, seem to offer the most promising possibili-

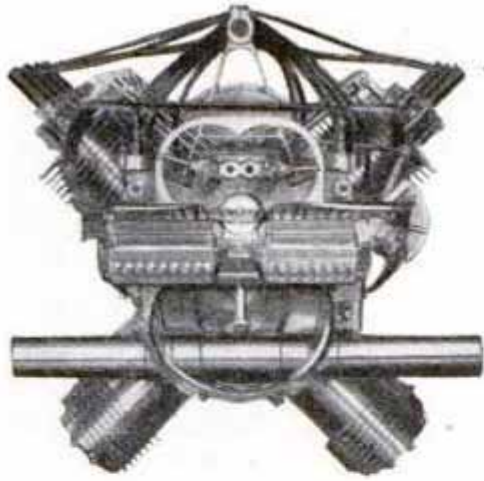

Rear View.

Loughheed eight-cylinder, V-shaped aviation motor, a recent American invention. Weighing less than 100 lb. and of a fuel and lubricant economy that is very high, it nevertheless is claimed to

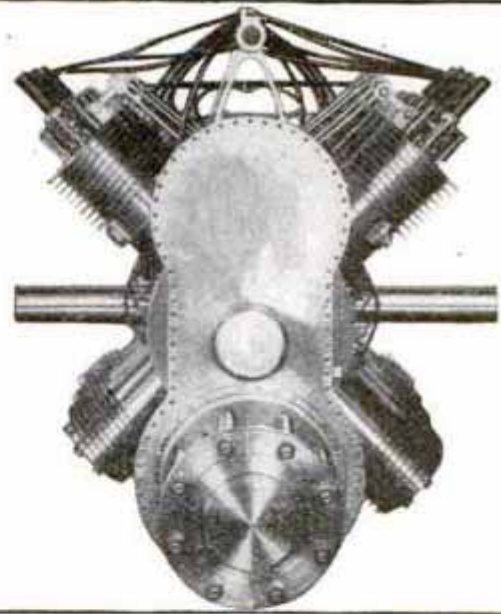

Front View

be capable of standing up to the steady delivery of over 60hp. The motor is built almost entirely of chrome nickel steel. Fuel injection is employed, eliminating the carburetor.

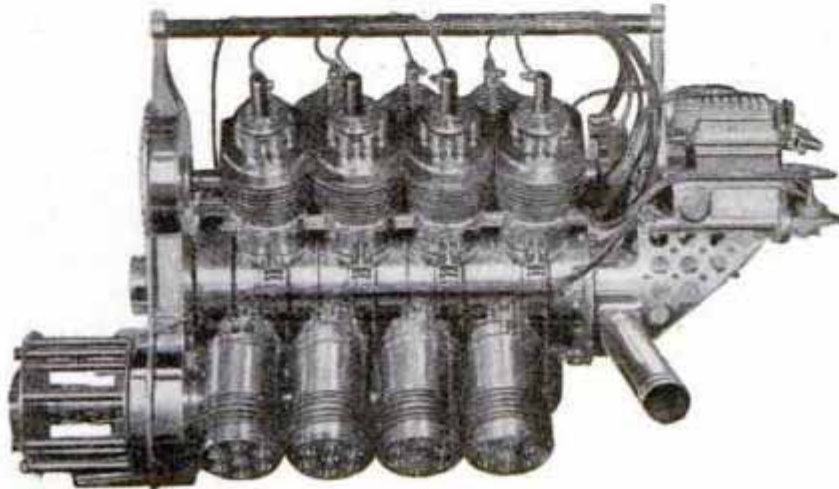

ties, especially as they have already proved the road to some quite remarkable, though not yet widely published

results, in the design of certain aeronautical motors experimented with in a quiet way in this country.

TEETH OF MAN OF HALF MILLION YEARS AGO

A primitive cave dwelling, believed by scientists to have been a human abode as far back as half a million

years ago, was recently found in the cliffs at La Cotte, in St. Brelade's Bay, Jersey, Eng. After about three weeks'

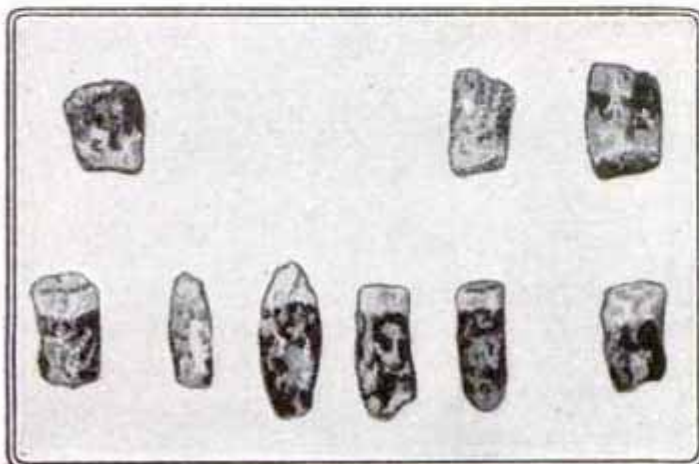

The Teeth of a Man Who is Believed to Have Lived 500,000 Years Ago



The Corresponding Teeth of an Adult Male of Today

work, the floor of the cave was laid bare, and a hearth was found containing a quantity of wood ashes. In one corner was a mass of bones and teeth, among which were found the nine teeth shown in one of the accompanying illustrations. These teeth are said to be those of one of the dwellers of the cave, who lived 500,000 years ago, and is the earliest known type of man.

They are remarkable for their massive roots, indicating great muscular strength. The three in the top row,

reading from left to right, are the first right molar, the second left premolar, and the second left molar from the upper jaw. Those in the lower row, from the lower jaw, are the second right molar, second right incisor, left canine, first left premolar, second left premolar, and second left molar. They are reproduced in actual size. The other illustration shows the corresponding teeth of the adult male of today, and are arranged in exactly the same order for comparison.

WICKET DAMS TO MAKE THE OHIO RIVER NAVIGABLE

After nearly six years of hard work, Uncle Sam's latest and greatest engineering feat, the Fernbank dam, in the Ohio River, is completed.

The big dam, known officially to the government as No. 37, swung open its big lock gates for business when the largest river steamer on the Ohio passed through there on July 25. But Uncle Sam went about his business there as if it were an everyday occurrence, there was no celebration then, but for one week early in September the people of the Ohio Valley came

to Cincinnati and there was more than \$30,000 worth of fun just because the big dam marked another step toward making the Ohio River navigable the year round.

This new engineering feat is the largest movable wicket dam in the world, and furthermore it is the only one built entirely of reinforced concrete. It cost the government \$1,500,000, but it is a beauty, and Uncle Sam is so well pleased with it that he is going to build more like it in the Ohio River until the entire stream is pooled

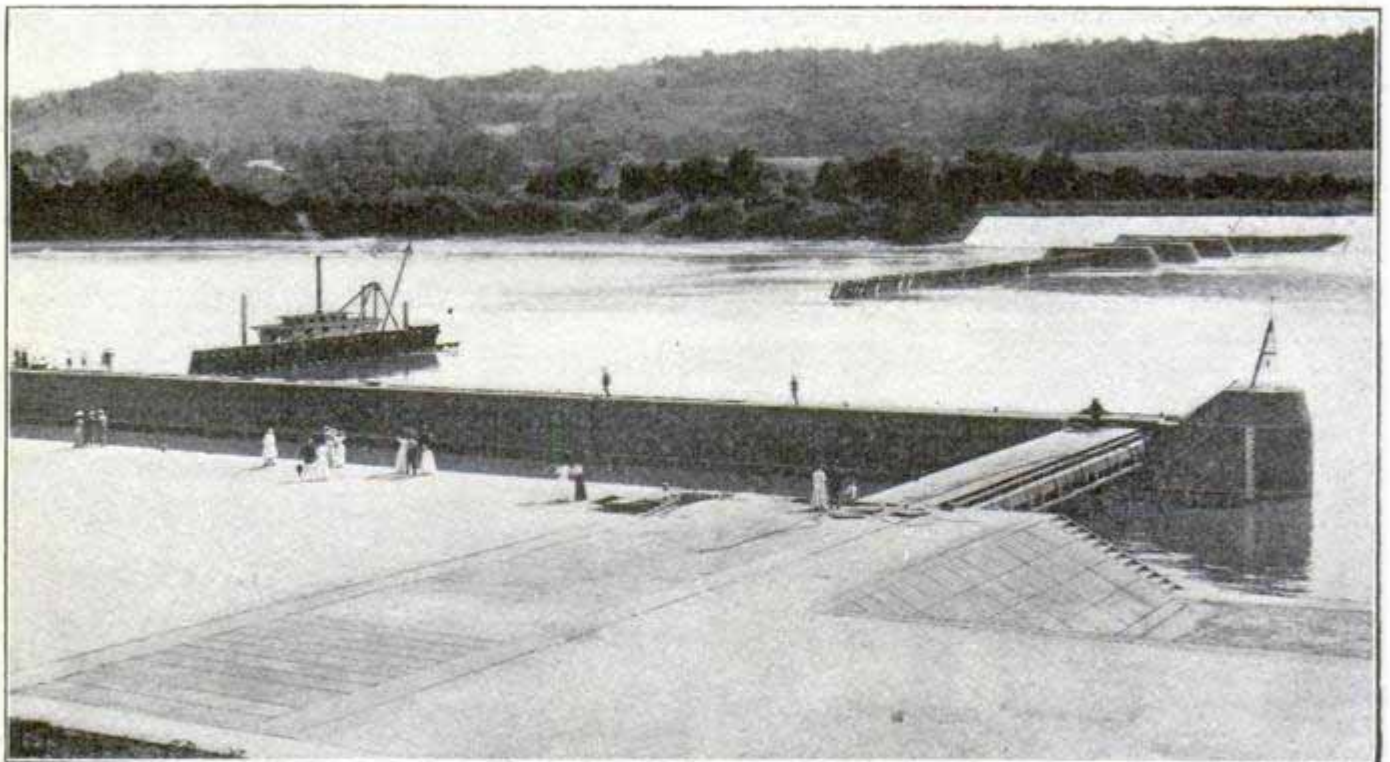

The Fernbank Dam from the Ohio Shore. Showing the Placing of the Movable Wickets Forming the Dam across the River, and Also Showing the Lock or Canal along the Ohio Shore through Which All Boats Must Pass

from Pittsburg to Cairo, a distance of more than 1,000 miles.

The Fernbank dam gives Cincinnati a permanent harbor of not less than 9 ft. of water, and navigation can be carried on for a distance of 12 miles upstream and for 12 miles downstream from Cincinnati to the location of the dam. It takes a small army of men to care for this big dam and there are neat little government houses for some of these men to live in. A new little village has suddenly sprung into existence, under strict government control.

WOMEN UNLOAD SHIP DURING STRIKE

At the commencement of the shipping strike at Hull, Eng., the steamship "Titania" was left without men to unload its cargo of butter. A number of stewardesses and other women employes of the company took the places of the men on strike, and, under police protection, unloaded the ship until the hostility of the strikers compelled them to cease work.

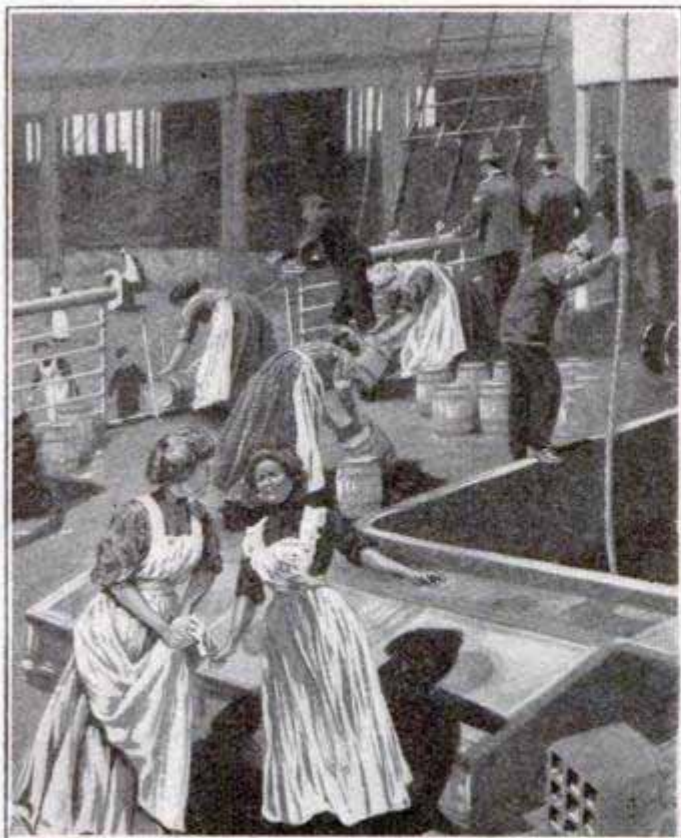

Women Unloading Butter from a Ship during the Shipping Strike in England

PHOTOGRAPHS MOUNTED ON THE FINGER NAILS

One of the latest fads in Germany is the mounting of photographs on the fin-

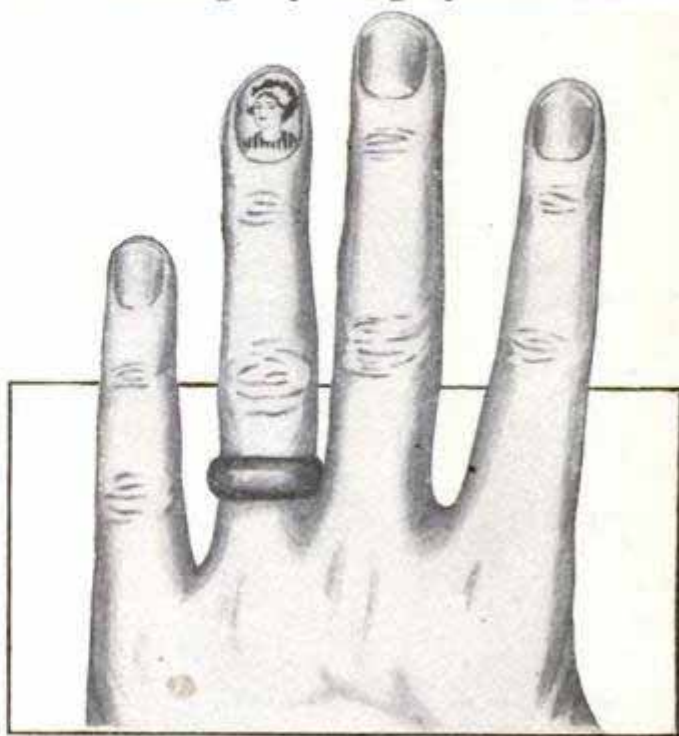

The Latest Fad in Germany is the Waterproof Mounting of Photographs on Finger Nails

ger nails, the idea growing out of the whim of a cousin of the Kaiser, who had an enameled portrait of her fiancé worked on the nail of her little finger. This portrait was a work of art and cost \$90, but now the fashionable manicures of Berlin have taken up the idea in the photograph form.

The feature of this work by manicures is rendering the photograph waterproof, which is done by coating it over with a shellac-like substance burned upon the nail. It is said that, with careful handling, a photograph so mounted will last about four months without renewal.

Something of the romantic and picturesque which clings to the prospecting and discovering of gold appears in the name of the newest camp in Nevada—"Awakening"—in the Slumbering hills, says the Mining and Engineering World. It is said to have been named by a woman, and gives proof that feminine fancy can not be subdued by the hardships and rough surroundings of a mining camp.

EMERGENCY FOLDING OARS

The possibility of the engine stopping at inopportune times makes at least one pair of oars a necessity on

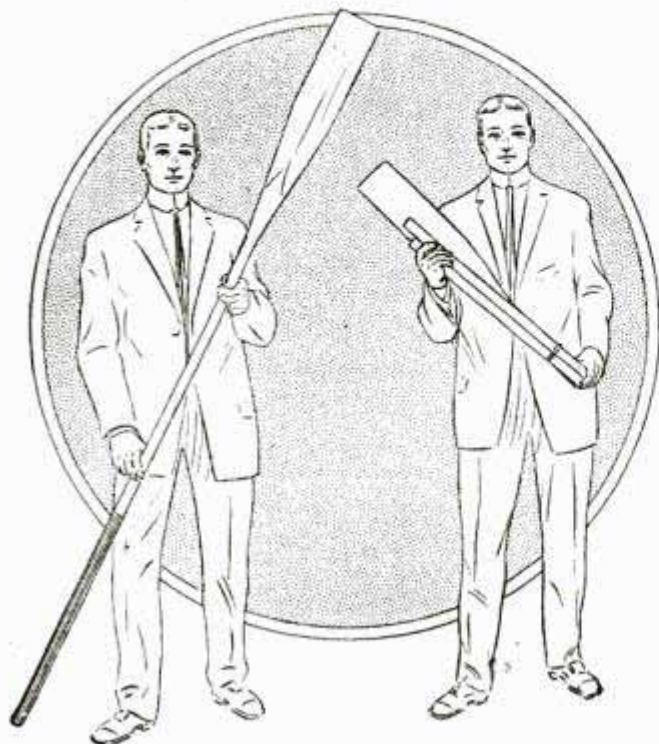

Emergency Folding Oar for Motorboats in an Extended and Folded Position

board a motorboat. The storage of oars on a small boat, however, unless it is provided with a stationary top, is so difficult that one boating company has brought out a folding oar. Each oar weighs only 6 lb. and can be stowed in a locker in a space of 2 ft. 9 in.

TRAIN OF MELONS MORE THAN MILE LONG

The transportation of melons from the Imperial Valley during the past season is considered one of the most remarkable crop movements in the history of the Southern Pacific Railroad. The total number of cars shipped was 2,700, which is about 900 more than in any other season. The biggest day's packing was June 11, when 133 carloads of cantaloupe were harvested and transported from Brawley, the shipping center, to Imperial Junction, in one train, the length of which was 6,175 ft. There were 324 crates in each car and 45 melons to the crate, which

makes a total of 14,580 melons to each car, and 1,939,140 melons on the train. The amount of ice required in the field and at Yuma, Arizona, to take care of the Imperial Valley shipments was 56,000,000 lb.

AN IMMENSE CARBURETOR

What are claimed to be the largest carburetors ever made were recently constructed for use on a number of gasoline-electric interurban cars built to the order of an American railway company. The gasoline vaporizer and mixing device illustrated herewith is one of these. It stands nearly five feet high, and is designed to serve an eight-cylinder, V-shaped gasoline motor which delivers 167 hp. (125 kw.) at a speed of about 600 revolutions a minute.

Most people are more or less familiar with the carburetors used on automobiles. The man in the picture is shown holding one of these in his hands, in order to furnish a contrast with the mammoth carburetor made for the interurban cars.

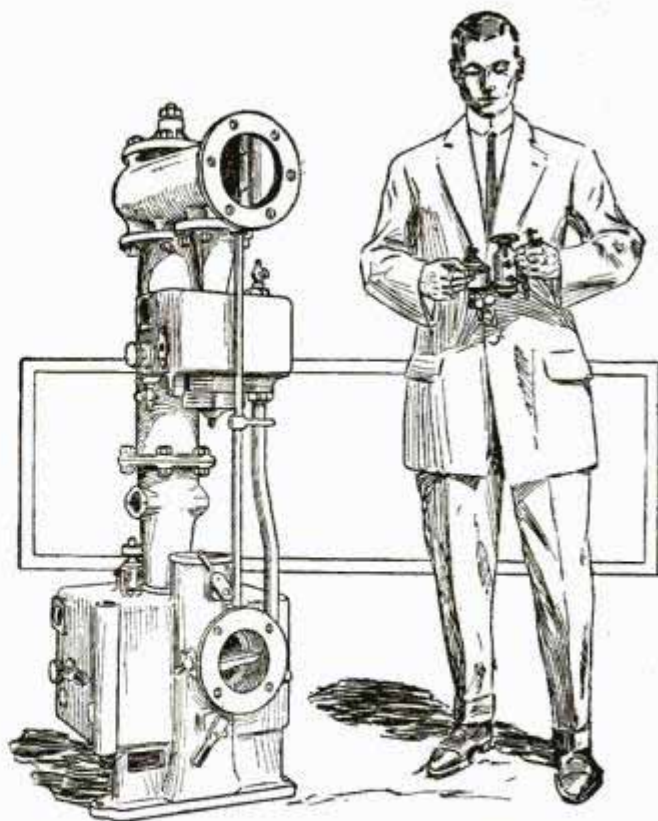

The Largest Carburetor Ever Made for Use on a Gasoline Motor Contrasted with an Automobile Carburetor Which the Man Holds in His Hands



Holbrook Blinn, star of "The Boss," receiving a 2-by-4 beam from Edgar Selwyn, author of "The Country Boy." Mrs. Blinn assisting, while Mrs. Selwyn (Margaret Mayo, author of "Baby Mine") sits on a saw horse and bosses the job of building the Blinn barn at Croton on the Hudson



Holbrook Blinn is an Honest-to-Goodness Carpenter. Look at His Overalls



Mrs Edgar Selwyn (Margaret Mayo) Doing a Little Job of House Painting

COMBINED KITCHEN TABLE AND IRONING BOARD

Among the new furniture offerings for the kitchen is a combination kitchen table and ironing board. The



A Kitchen Table with Disappearing Ironing Board

front half of the table top is held in place by means of dowel pins, and is easily lifted and laid back over the rear portion of the top when the table is to be used for ironing. The ironing board, which is contained in the space under the removable portion of the top, is then raised and locked in place at just the right height for ironing.

EXPLOSION ENGINES AT ONE POUND PER HORSEPOWER

This is not an account of some wonderful invention that is going to revolutionize the art of flying, but merely the rattling of an old skeleton in the mind closet of an engine designer, who, in the light of modern progress in the construction of internal-combustion engines, proposes—we do not know how seriously—to construct engines capable of developing power at the rate of 1 hp. for each 1 lb. of weight of prime mover.

The proposition is set forth in a recent issue of the French journal *Cosmos*. The idea itself is older than the successful internal-combustion engine. It is a resurrection of the old gun-

powder engine, in which an early inventor proposed to use the explosive force of gunpowder to generate power. The writer considers one of the latest forms of machine guns used in the French army, and shows by the aid of figures that a 100-lb. gun, during the time it is in action, develops 100 hp. in power and delivers it to the projectiles fired by the gun. From such a gun to an industrial engine using nitroglycerin seems but a plausible step in the mind of the writer, but to the lay mind an airman using such an engine in his aeroplane would seem to be taking more liberties with death than even the exigences of progress and science would seem to demand, while the spectacle of a fleet of nitroglycerin-propelled airships fighting a battle in the air would indeed be terrifying.

PORTABLE MACHINE MAKES RAILROAD TIES

Instead of hauling the lumber to the sawmill, the owner of this machine, which is propelled and operated by draft animals, may take it out into the woods or wherever the lumber may be, and make his ties on the spot, at an estimated saving of 50 per cent for



Portable Railroad-Tie Cutting Machine

hewn ties. This machine is the recent invention of a Kentucky man and has a capacity, it is said, of 250 ties a day.

The four knife blades are mounted

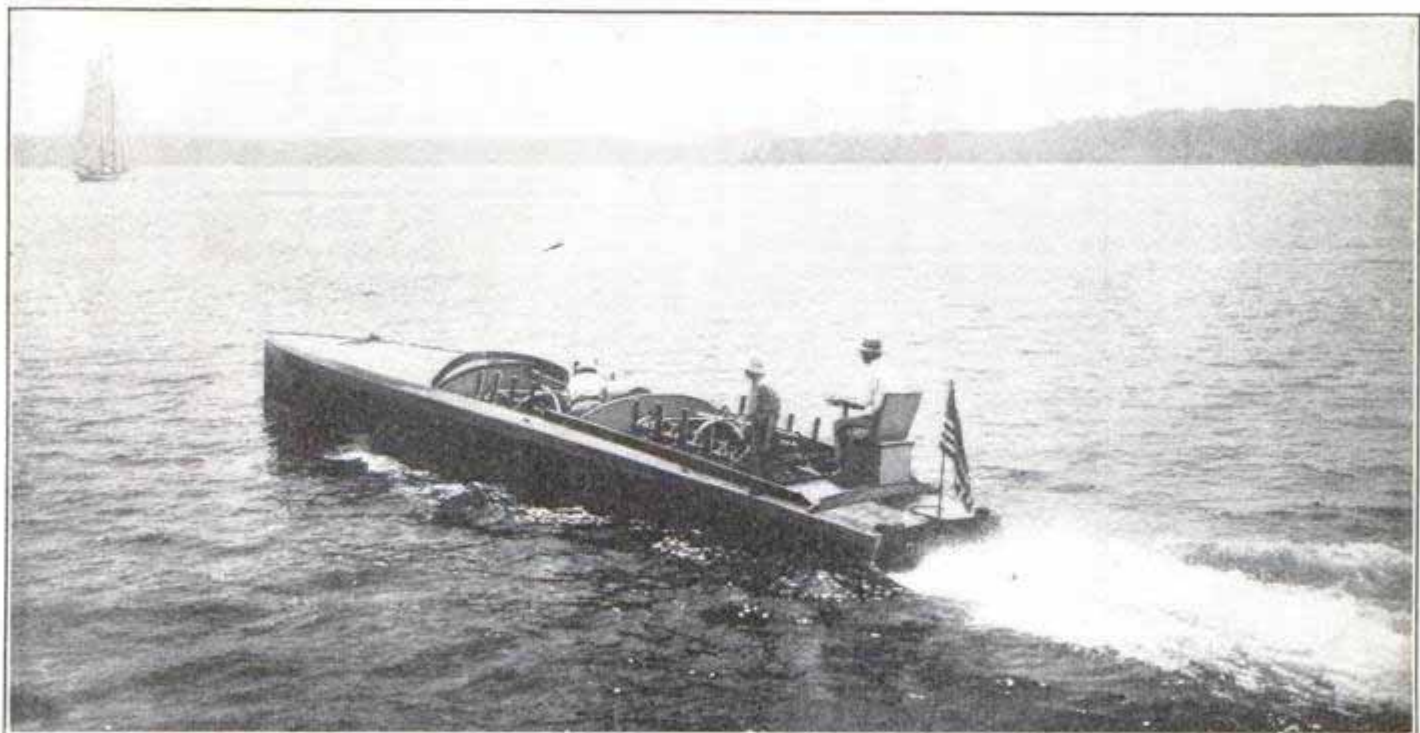

The International Cup Defender Lying Low at Slow Speed

on a vertically movable carriage, the width adjustment being made by a handwheel. Two sides of a tie are faced at one operation, and the other two sides may be faced by simply turning over the tie for the next downward cut. The power is transmitted to the carriage by means of a sweep and screw, and counterweights are used to elevate the carriage after the cut.

☐ In military maneuvers with aeroplanes in France it has been discovered that airmen flying at an altitude of 600 ft. can locate submarines 30 ft. below the surface.

"DIXIE IV" MAKES FIFTY-SIX MILES AN HOUR

"Dixie IV," built to defend the British international trophy against the English challenger, is said to have made 56 miles an hour in one of her trials over the international cup course at Huntington. The illustrations show the "Dixie IV" at low speed, and raising her hull out of the water at a speed of 45 miles an hour. One of the interesting features of this boat is the raised seat on the stern, which elevates the steersman above the water and clouds of spray thrown by the boat at high speeds.

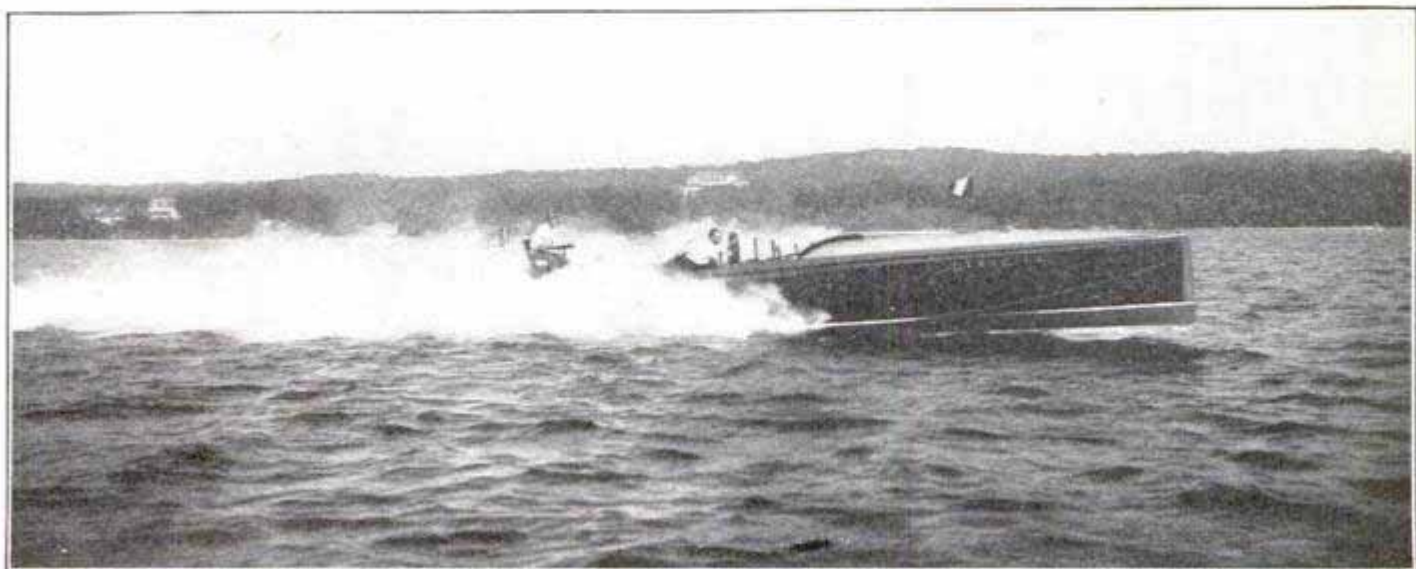

Making 45 Miles an Hour, and Illustrating the Necessity of the Raised Steersman's Seat

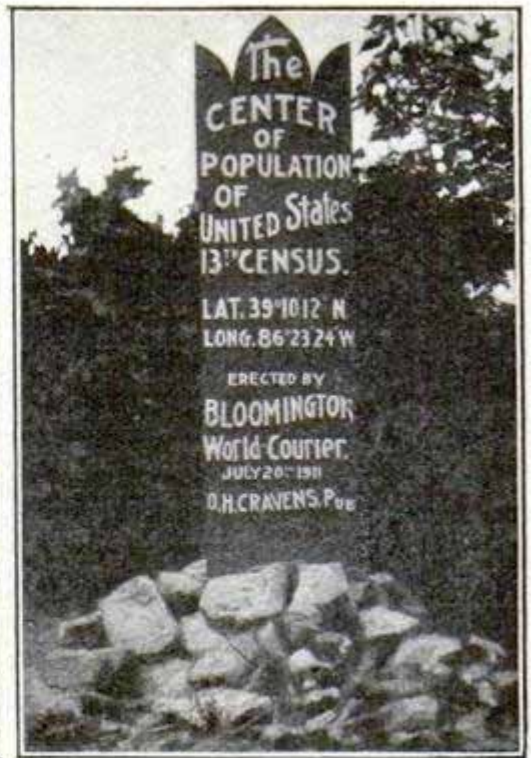

The Mosier Farmhouse Near Bloomington, Ind., Back of Which Center of Population is Located

Pile of Rock and Monument Marking the New Center

THE CENTER OF POPULATION OF THE UNITED STATES AS DETERMINED BY THE RECENT CENSUS. IT HAS MOVED STEADILY WESTWARD SINCE THE FIRST CENSUS

A CURIOUS ELECTRICAL (?) PHENOMENON

A phenomenon described as absolutely unique and suggested by a well known technical authority as being due

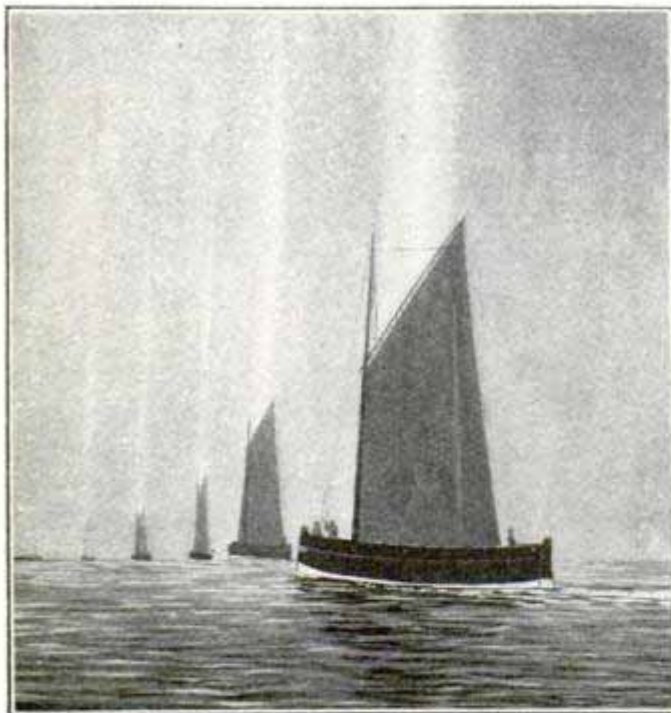

The Flare above the Sail of the Fishing Vessels in This Picture May Have Been Due to Atmospheric Electricity, and is Similar to the "St. Elmo's Fire" Sometimes Observed as a Luminous Electrical Discharge from the Masts and Spars of a Ship at Sea

to an electrical cause, is recorded by the Electrical Review, of London, England. The illustration herewith is a reproduction of one of several photographs of fishing boats taken by a Newcastle man while on a yachting cruise in Scotch waters. All of the pictures showed a peculiar white glare extending skywards from the masts and yards of the boats, and a close examination of the photographs discredited the belief that this effect might be due to a defect of the camera or to some kind of halation. A reference to an electrical expert elicited the suggestion of electricity as the cause, especially as there had been thunderstorms during the previous two days and the neighborhood was probably not yet cleared of the effects of the electrical disturbances in the upper atmosphere.

CHavre and other French cities are using a new method to allay the dust nuisance. Roadways are sprinkled with common salt and then watered freely.

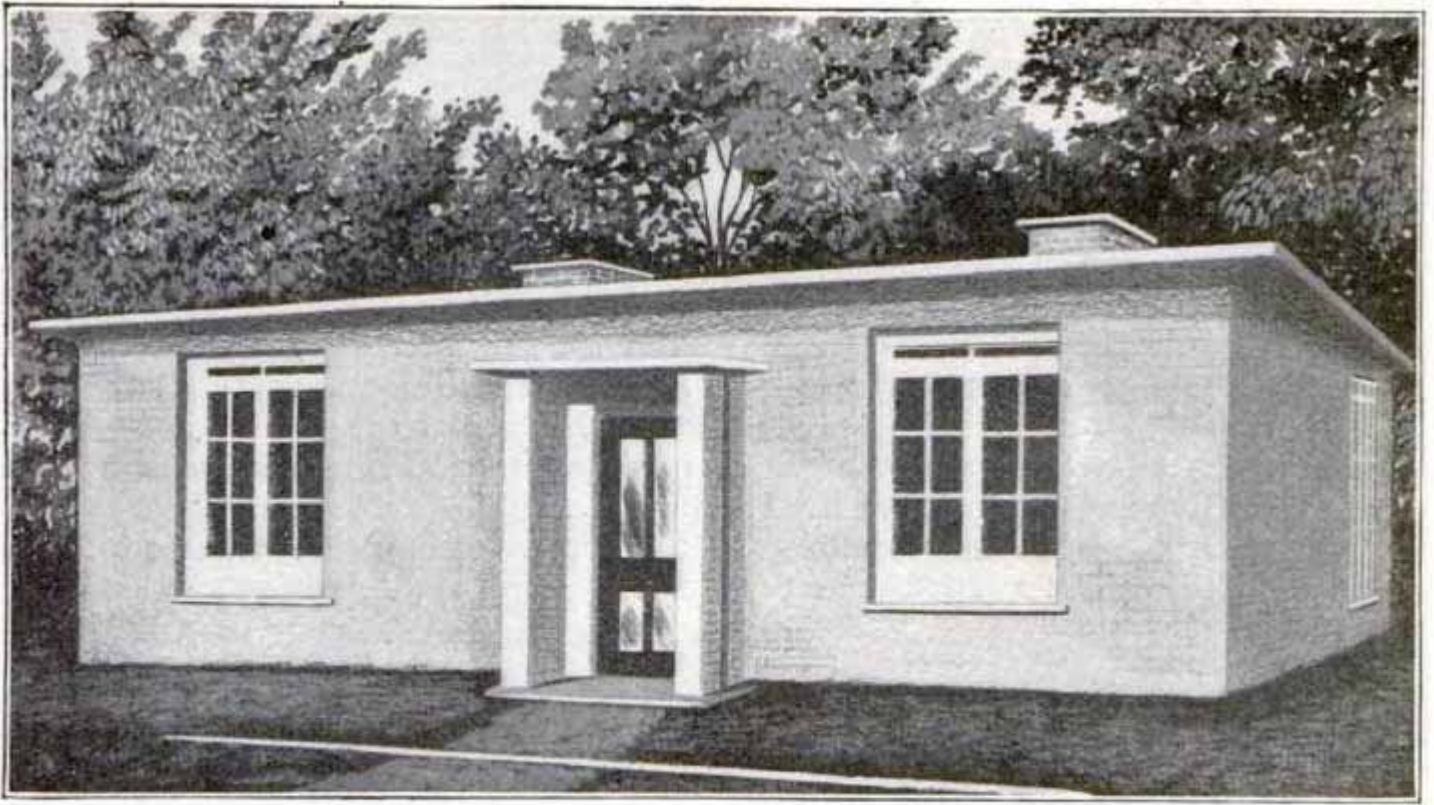

Type of Bungalow Built for English Laborer

ENGLISH LABORER'S BUNGALOW

Comfortable, sanitary, and inexpensive cottages for agricultural laborers are being built in many parts of England under the supervision of county associations organized for the purpose. Such a cottage, built in Herefordshire, is here shown. The walls are of brick, coated with cement concrete, and the roof is of concrete, $4\frac{1}{2}$ in. thick. The sills and the window and door heads, are also of concrete. The cottage has a combined sitting room and kitchen, 19 ft. by 14 ft., and

three bedrooms. There is a wash-house at the back. The cost of the cottage, including foundation work, was about \$800.

TRAIN OF SELF-PROPELLED MOTOR TRUCKS

A motor-truck train, the engine car of which is simply a traveling electric central station, supplying current to each of the self-contained motor trucks following it, is being used with considerable success in Germany. Each wheel axle of the motor trucks has its own motor and driving gear, and suffi-

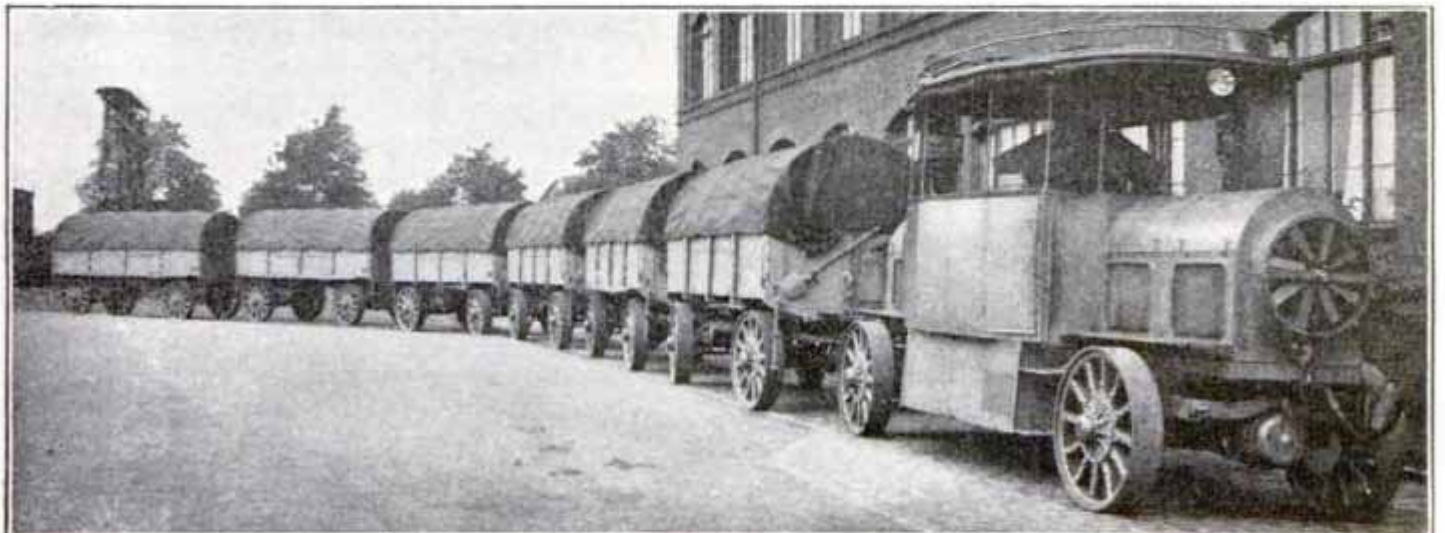

Train of Self-Propelled Motor Trucks Provided with a Traveling Power Station in the Form of an Engine Car

cient power is provided by the engine car to allow 10 trucks being coupled up in a single train.

The engine car carries a gasoline engine at each end, and each drives a dynamo. These two generating sets are operated singly or together, according to the length of the train and the condition of the roads. The cable distributing the current to the motor of each driving axle can be coupled and uncoupled between the trucks. Besides the cable coupling, each trailer is provided with mechanical clutches, which serve to automatically steer

them on the path taken by the engine car as well as serving to connect them together.

The road train illustrated, consisting of a traveling power station, and six self-propelled motor trucks, can transport a net load of 33 tons at a maximum speed of eight miles an hour. The starting of the train is effected by means of the dynamo regulators as smoothly and steadily as when gradually opening the steam valve of a locomotive. The electrical brake acts uniformly on all the wheels of the train.

GIANT FIRE-FIGHTING WATER TOWER

The new collapsible water towers of the Berlin fire department are interesting because of the great height

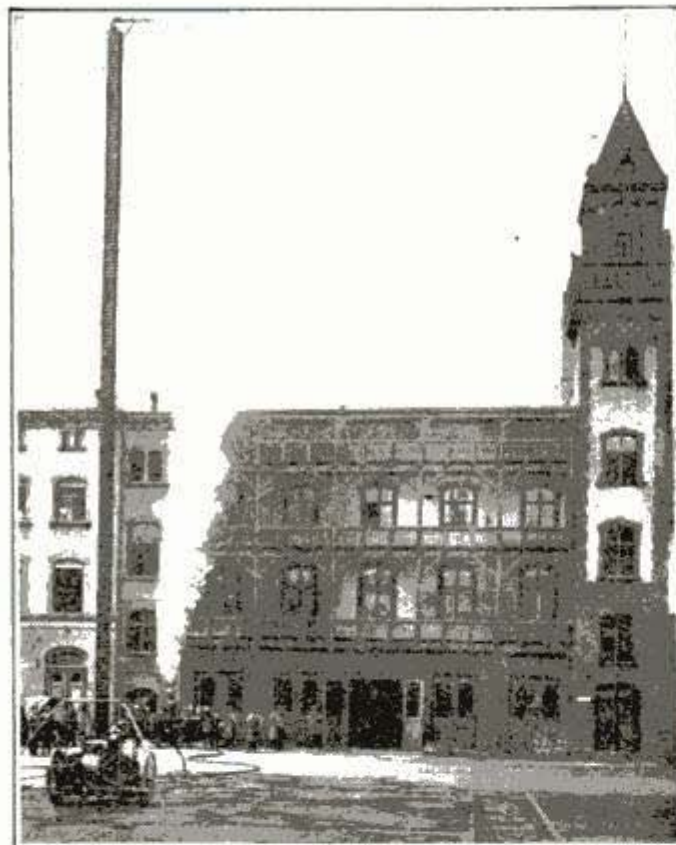

A German Fire-Fighting Water Tower That will Discharge a Stream of Water Straight into the Eighth Story of a Building

to which they can be extended and the little space they occupy when collapsed. When collapsed the tower has a height of less than 5 ft., and can be transported on an ordinary wagon instead of requiring a long truck that

is difficult to steer through the streets. The tower can be extended to a height that will enable a stream of water to be discharged straight through the windows of the eighth story of a building.

BLASTING ROCK WITH WATER PRESSURE

A process of rock blasting by which water pressure is substituted for powder has, according to the Mining and Engineering World, been invented by a German engineer. The method consists of suddenly increasing the water pressure in an apparatus placed in the bore hole. There have been many water-pressure processes of rock blasting proposed, but in the majority of them the pressure has been exerted gradually and as a result the stone to be broken has been crushed at the ends of the expansible sleeve. This crushed material is forced forward in the form of powder toward the bearing point of the sleeve, thus causing it to expand too soon and leak. It is claimed that in the German system the sudden pressure acts in such manner that crushing cannot take place. Instead, the force first applied tightens the plunger and the expanding sleeve, filling the bore at comparatively low pressure. Then by one or two sudden strokes of the plunger the pressure is suddenly increased and the mass of rock broken.

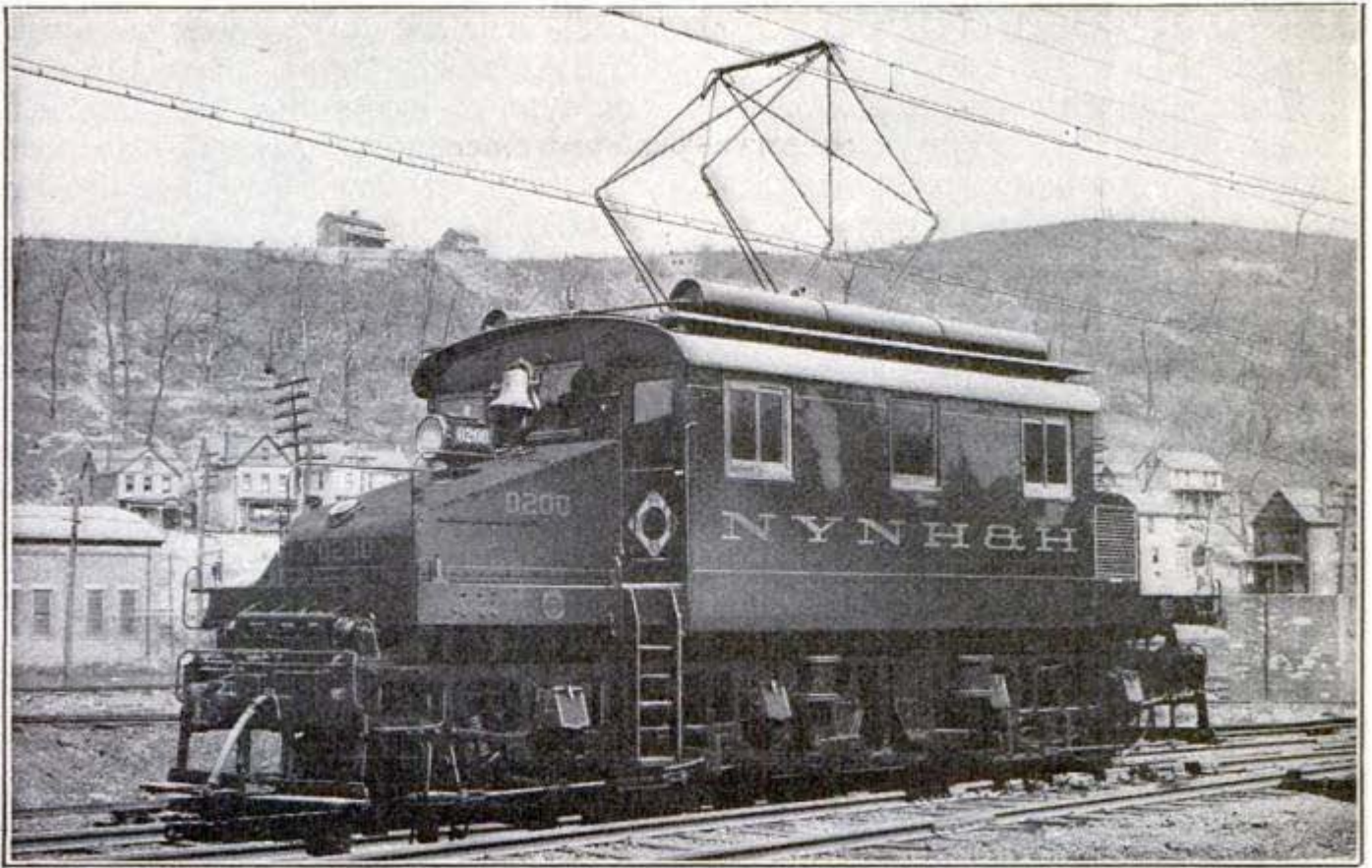

Electric Switching Locomotive of the New Articulated-Truck Type

NEW ELECTRIC SWITCHING LOCOMOTIVE

The first articulated-truck electric locomotive of large capacity built in this country for switching purposes in the freight yard of a trunk line has recently been constructed and delivered to an eastern railroad company.

The new locomotive is a 79-ton machine with a central steeple-type cab and four double-g geared motors. The pulling force of the motors is transmitted through the truck frames, which are located outside the wheels and joined by bolsters (crossbeams forming bearing pieces) at the middle of each truck, hence the designation "articulated" which means jointed.

The driving wheels are massive affairs, 63 in. in diameter, and are driven by gears through a system of springs. These gears are mounted on hollow shafts inclosing the axles. These hollow shafts, or "quills," as they are technically termed, are supported by bearings on the motor frames. The motors operate on alternating current at 190 volts, and are designed to produce

about 230 hp. each for one hour, or 165 hp. on a long continuous run. They are kept cool by forced air ventilation through their working parts, and are provided with spring suspension. The air blowers are electrically operated.

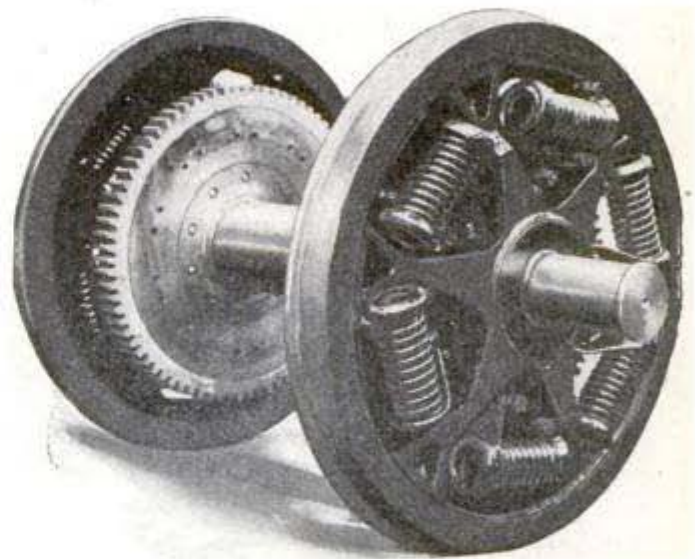

Driving Wheels of Electric Switching Locomotive

The adoption of electric switching locomotives in railroad yards not only

increases the speed of handling cars but also reduces the cost of operating, besides enabling the use of much lower engine powers. It has been conservatively estimated that a steam switching locomotive burns three times the coal

that is required at the power station to furnish current for operating the electric type of locomotive, and this in a measure accounts for the displacement of steam by electricity in switching service.

ILLUSTRATED SONGS IN THE HOME

A new attachment for the phonograph is a device which illustrates the text of songs as they are sung, by pro-

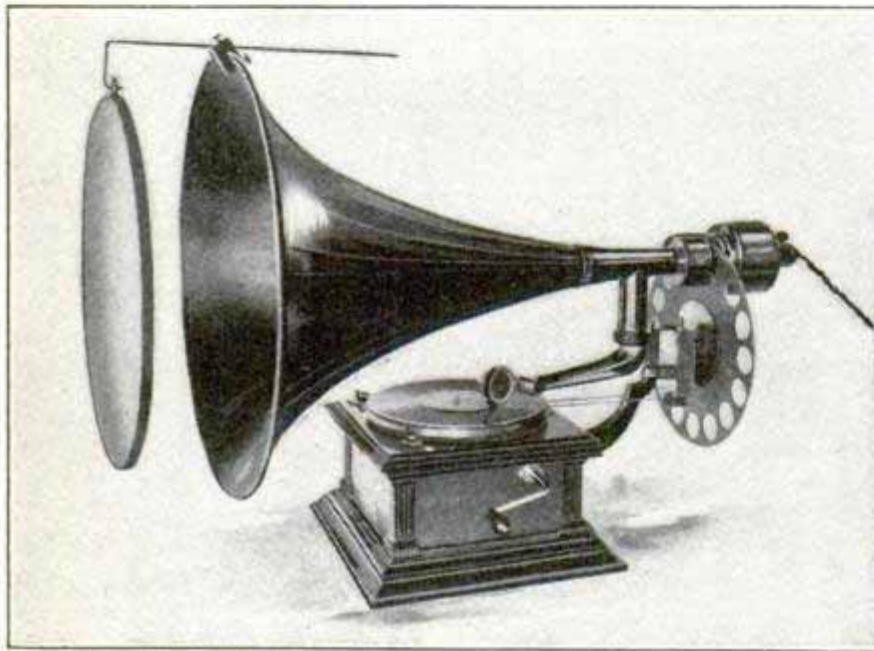

While Music is Playing, Pictures on Circular Disk are Projected from Small Light Chamber on Right, through the Horn of the Phonograph, onto the Circular Screen in Front

jecting lantern-slide views upon a screen in front of the horn. A small electric-light chamber is attached to the small end of the horn, and a disc containing the slides is placed in front of it, and moved at regular intervals by the motor of the phonograph. Thus a popular feature of the low-priced theaters can be made a part of the home entertainment. Of course, the song record and the picture disc are designed to be sold in pairs, so that words and illustrations will harmonize. This device does not interfere with the use of non-illustrated records.

Ⓒ A St. Louis gas company is now covering its wrought-iron piping with layers of pitch and paper as a protection against electrolysis.

STEAM BOILERS HEATED BY ELECTRICITY

At the rate at which electricity is retailed for ordinary consumption, it would be nothing short of financial suicide to attempt to heat water by electricity on anything but the smallest scale, where utility and dispatch are of more consequence than cost. But there are some cases in which an electrically heated boiler may prove an actual economy. Such an instance is furnished in railroading, in the case of trains running over sections of track on which electric locomotives are used, as on one of the big railroads entering New York City from the north.

An electrically heated steam generator is now being made by a New York concern to meet this requirement in railroading. It is an adaptation of the usual vertical type of steam boiler, but instead of the fire tubes being heated by the products of combustion of a fire they are made to inclose electric heaters of special design. The resistance wire, which is heated by the electric current, is wound on soapstone spools which are threaded on a metal rod alternately with porcelain insulators of larger diameter, the whole being inclosed by a thin brass tube. The interstices between the spools and the tube are filled with fine sand. A boiler 4 ft. 6 in. long and 3 ft. 10 in. in diameter, with one hundred and forty-eight 2-in. tubes, and electric heating elements of the type described, is able to

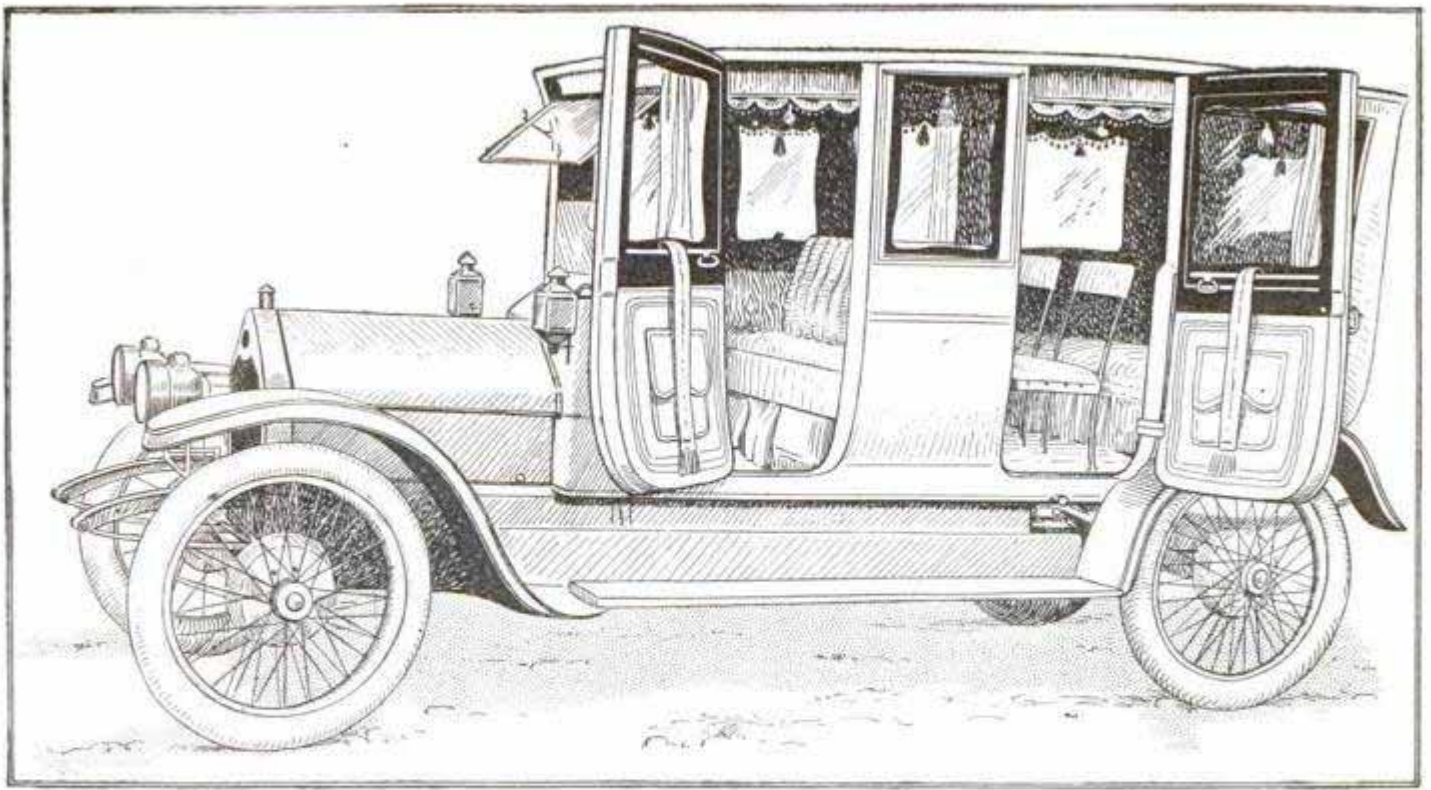

An Automobile Which Has the Driver's Seat Inclosed in the Same Manner as the Rear Seat

produce 850 lb. of steam an hour at 110 lb. pressure. The efficiency is over 90 per cent.

COMPLETELY INCLOSED AUTO BODY

This 20-hp. English automobile has a Pullman auto body of new design, the front or driver's seat, as well as

the rear portion of the body, being completely inclosed. Access to the front and back seats is given through separate doors. Ordinarily the driver's seat is shut off from the rest of the car by a glass partition, but this may be dropped when desired, which is an excellent idea when the owner is operating it himself. The interior furnishing of this car is luxurious.

A SCHOOL OF PHOTOGRAPHY

Photography is considered so much more of an art in Europe than in the

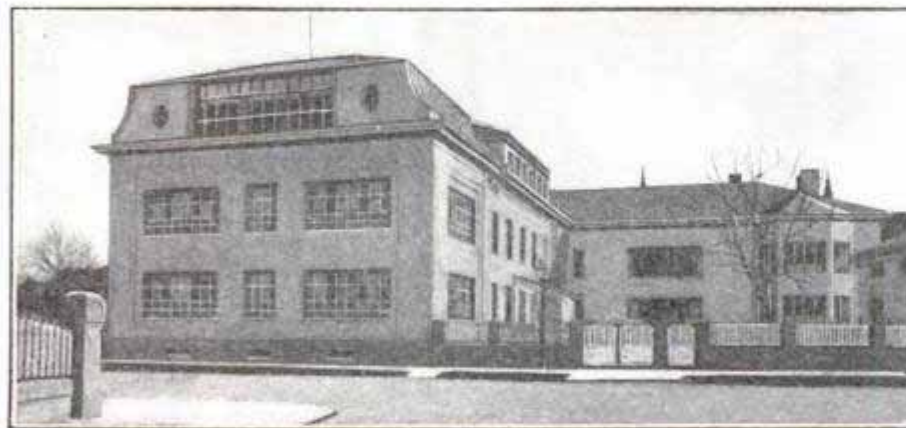

The Munich School of Photography

United States that schools of a considerable size, and having a large staff of instructors, are devoted to its teach-

ing alone. One of the finest of these schools is the Teaching and Experimental Institute for Photography, at Munich. The contributions to this school from the government, the city of Munich, and private citizens, make a total of \$8,000 a year.

The school has no less than 90 rooms, among them being included two skylight studios, four modern drawing-room studios, one reform studio, seven darkrooms, several laboratories for enlargement and reproduction,

the departments for copper etching and autotype, and of photography for criminal investigation, rooms for

testing materials, photochemical laboratory, Roentgen department, draftsmen's and printers' rooms, library, etc.

TESTING BALLAST FOR RAILROAD TRACKS

The testing of materials of construction is one of the most important branches of engineering science, for it is often cheaper to devise a special

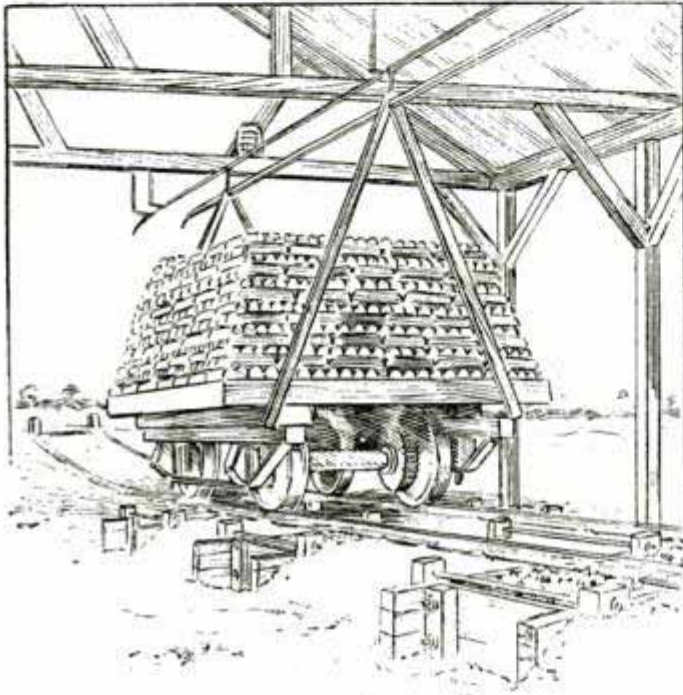

The Testing Car Loaded with Pig Iron

test, even at the expenditure of many thousands of dollars, than to trust to the haphazard and expensive scheme of trial and error in the school of experience.

One of the most unique tests of this kind was the one recently carried out by a great American railroad company, to determine the necessary depth of stone ballast for railroad tracks under stated conditions. A series of experiments extending over a period of nearly two years was undertaken with the apparatus shown in the accompanying illustration. This consisted of a piece of track over which was run continuously back and forth, at the rate of five miles an hour, a two-axle truck of 9-ft. wheelbase and loaded with pig iron so that the gross weight amounted to 150,000 lb., or 75,000 lb. per axle. The ballast to be tested was placed under the track in

three boxes, open at both ends, and after the settlements in the boxes amounted to about 1 in., the car was stopped and the track raised to its original elevation by tamping the ballast with picks according to the usual service methods. After each of the five prolonged tests which were made, the ballast was cut into sections for examination.

The boxes were covered by a roof to protect them from the weather, and water was poured on the ballast at certain times during the test to approximate to the effect of a predetermined rainfall. In this way, even the exact weather conditions were made known in determining the effects of the test. The car was operated by an electric motor which automatically reversed at the ends of the track. A speed counter on the car registered the number of trips, which amounted in the aggregate to some hundreds of thousands.

The net results of all of the tests was that the committee in charge of the experiments recommended the use of 24 in. of stone ballast underneath the ties for existing conditions of railroad work, and under this a layer of engine cinder, gravel or an equivalent, to act as an absorbent mat to dispose of the water falling on the track and so prevent softening of the roadbed material.

STEAMSHIP "AQUITANIA" WILL EXCEED 900 FEET

The plans of the "Aquitania," now being built for the Cunard line, have been slightly modified to make this ship the largest in the world. She will be more than 900 ft. long, probably 910 or 915 ft., which will make her about 25 ft. longer than the vessel being built in Germany to eclipse the "Olympic" and her sister ship. The speed specifications have also been raised, and she will have a speed of 26½ miles an hour (23 knots), which will make her, next to the "Mauretania" and "Lusitania," the fastest transatlantic liner.



Swiss Village Guard Dressed for a Gala Occasion

SWISS VILLAGE GUARD

During the annual fairs in the Swiss villages, the local guard of each turns out in quaint costumes that have come down through the generations. So

garbed, the officers of the law are admired by the entire population, although they make anything but a martial impression.

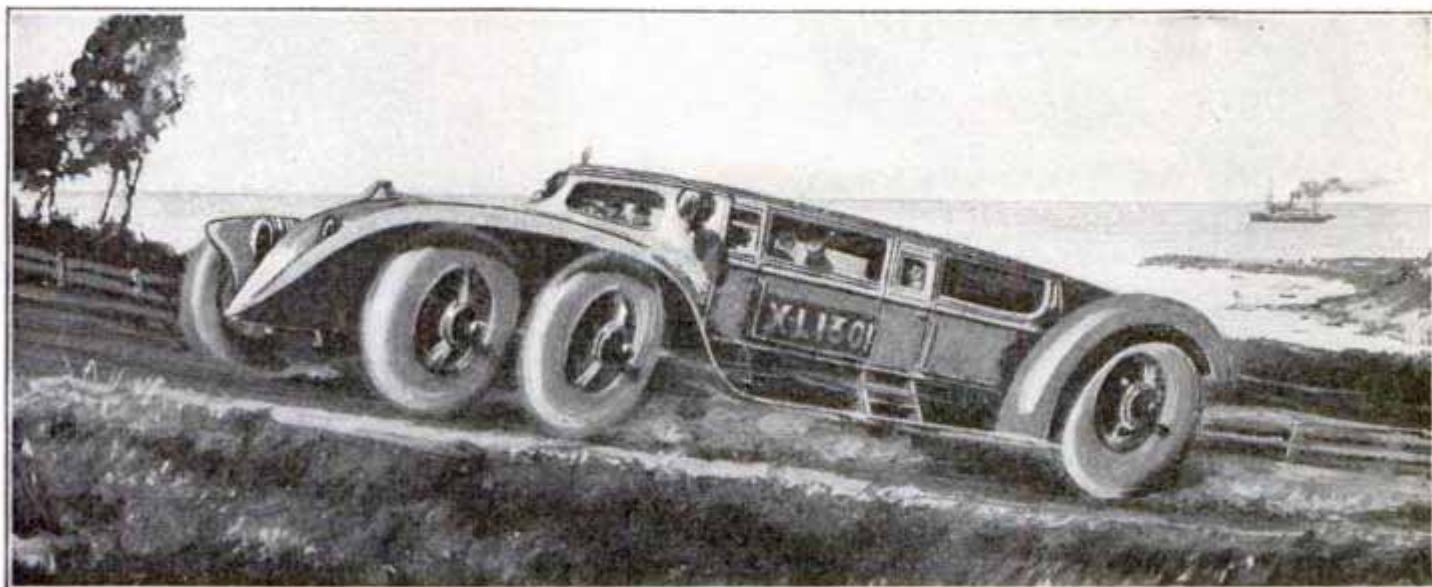

Courtesy The Car

How We May Motor in 1961, Fifty Years Hence, as Seen by an English Artist

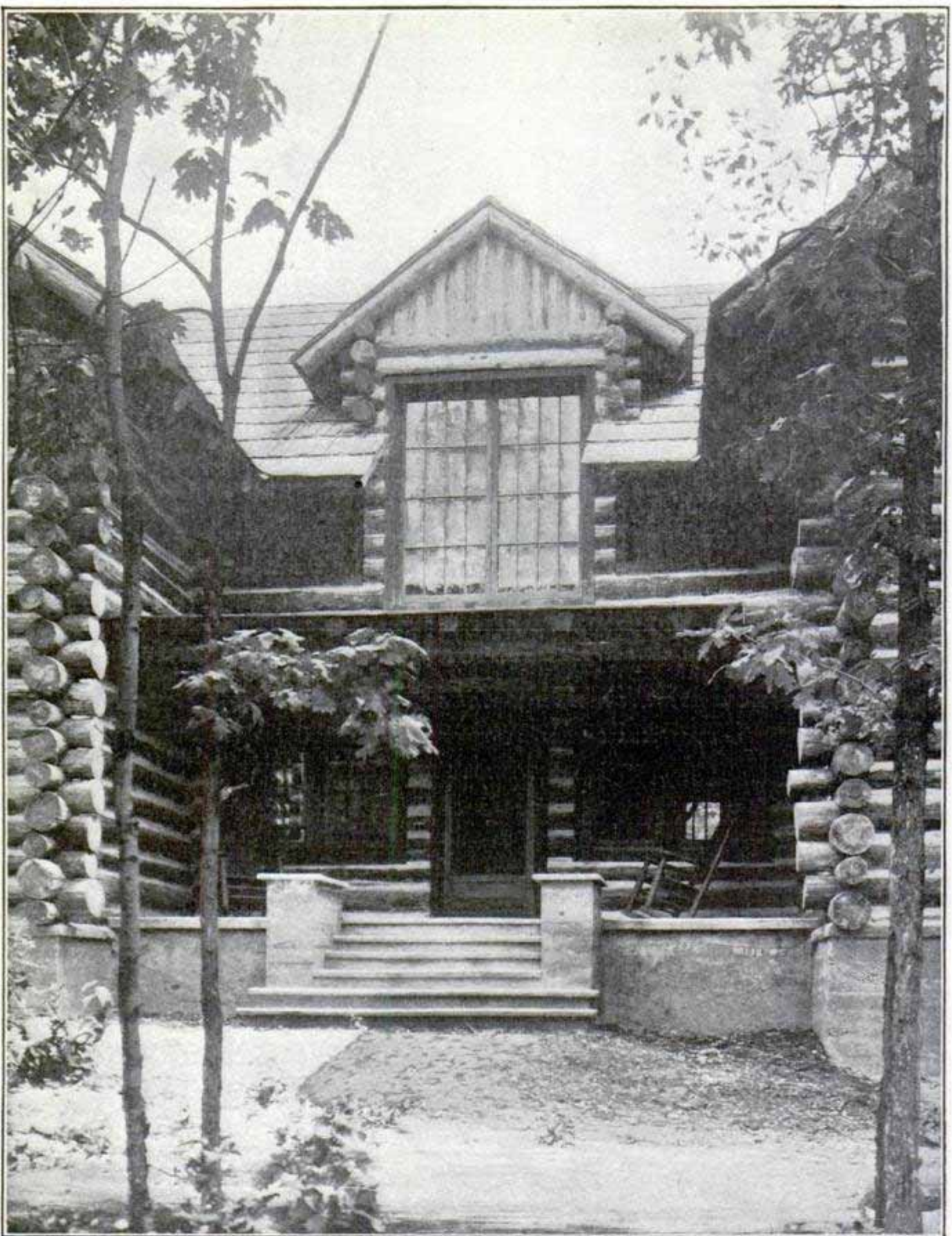

Entrance of the Log-Cabin "Mansion" with Large Sleeping Room Above—Sun Parlor is at the Back of this Section

Log-Cabin "Mansion" of an Artist

By FRANCIS BUZZELL

ABOUT 30 minutes from the center of Chicago by suburban railroad service, among the trees of an oak forest which makes the suburb of Hubbard Woods one of the most ideal of the many stretching along Lake Michigan's shore, is a log-cabin dwelling the like of which would have been difficult to duplicate in the pioneer days.

For a log cabin, it is vast, being a two-story structure, 84 ft. long by 48 ft. wide, and having such conveniences as a sun parlor and sleeping porch, the arrangement of which is so ingeniously handled as to fit in perfectly with log construction. The whole is erected upon a concrete foundation, which, were the dwelling a modern conventional structure, would accommodate a 22-room house.

But we will leave the structural details of the place for the present and make the acquaintance of the man who wanted a big log cabin for a home and overcame the difficulties that stood in the way of his obtaining it. For a vacant house is a poor soulless thing, and such a house as this, whether vacant or occupied, would lose more than half its interest and charm, were the individuality of the man who built it to live in left out of the story.

One day during the summer of last year Adam Emory Albright, an artist who has made an international reputation as a painter of country children, visited the suburb of Hubbard Woods and found therein the ideal spot he had long dreamed of acquiring. Being the manner of man who experiences quick enthusiasms, he made up his mind in five minutes, purchased a 200-ft. frontage on a country road thickly populated on both sides with trees of the oak forest, and decided then and there that the home should be of logs. Then he told his friends. All of them liked his idea of a house, but the practical

ones shook their heads over the difficulties and insisted such a big log cabin was impossible. But he kept on telling his friends of the idea and one day a couple of weeks later one came along who owned a tract of timber in northern Wisconsin.

"Why, I've got just the logs you want," said his friend, and he had. They were straight Oregon pine logs 60 ft. long, ranging in diameter from 12 to 14 in., and practically the same size at both ends. Mr. Albright made up his mind about these logs in less time than he had required to decide upon the land. The order specified 170 logs 60 ft. long, and they arrived late in the autumn on a train of six flat cars. In the meantime the artist-builder had definitely decided upon the general shape his house should assume and solved the architect problem by drawing his own plans. No architect could have done the thing satisfactorily to him for several reasons, the most important of which was the fact that he was at no time in the early stages quite sure what his general idea would develop into. Minor changes were made from time to time, and the whole structure, with the exception of the concrete foundation, was built without blueprints. The only working plans were charcoal drawings made by the artist as the work progressed. The practical-minded man would laugh at this method of house planning, but Mr. Albright, being an artist, was not practical as a builder. Yet, as you will see as the story progresses, the result would please the most practical as well as the most artistic building constructor.

The foundation being in readiness and the logs arrived at the station, the next problem was the means of transporting them the half mile from the station to the building site. Mr.

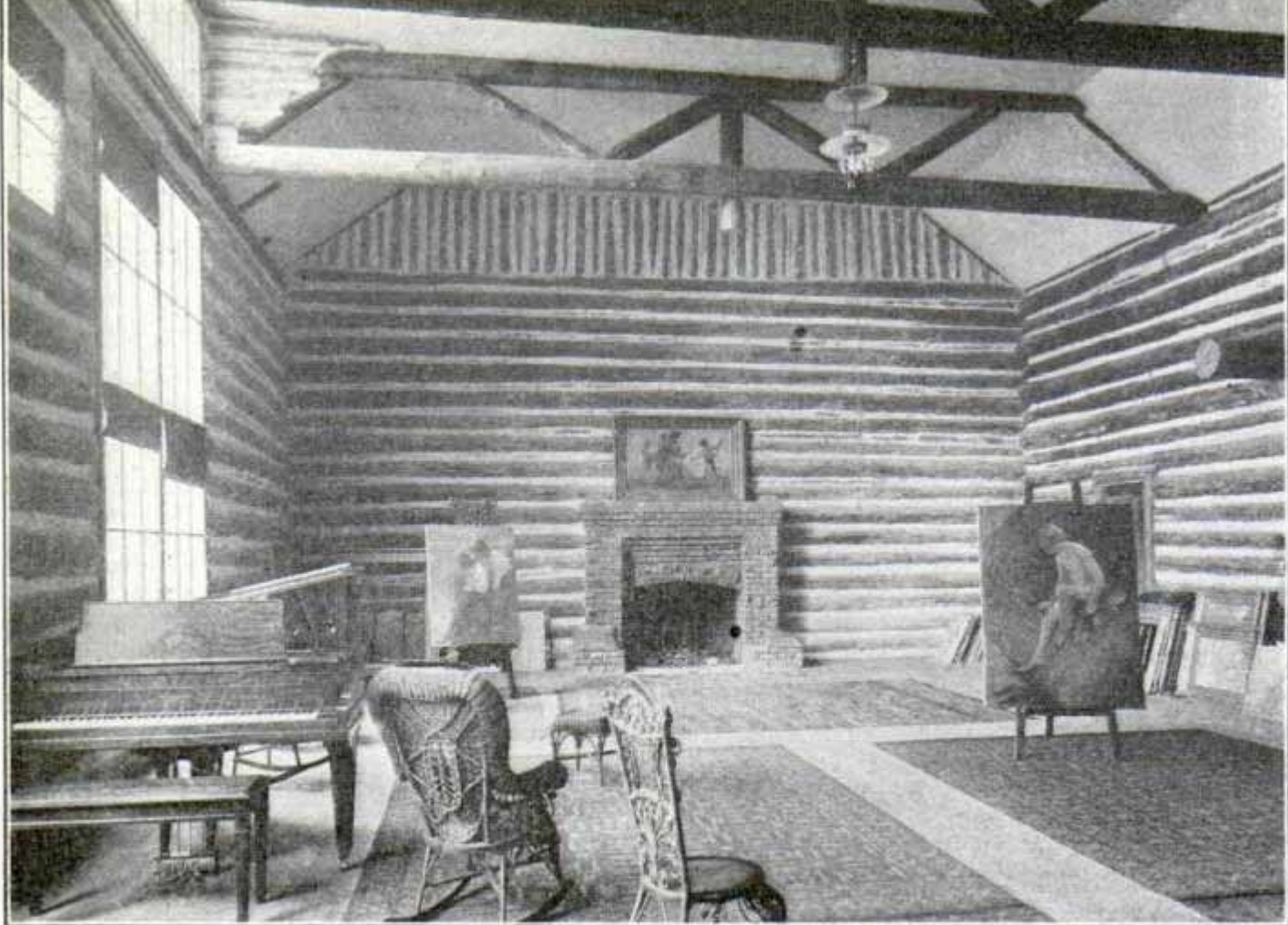

Interior of the 32 by 48-Ft. Studio, Showing Size of the Logs and the Method of Interior Treatment. Over the Heavy Oak Doors Leading from the Reception Hall into this Great Room will be a Carved Oak Balcony, Entered from the Second-Story Hall

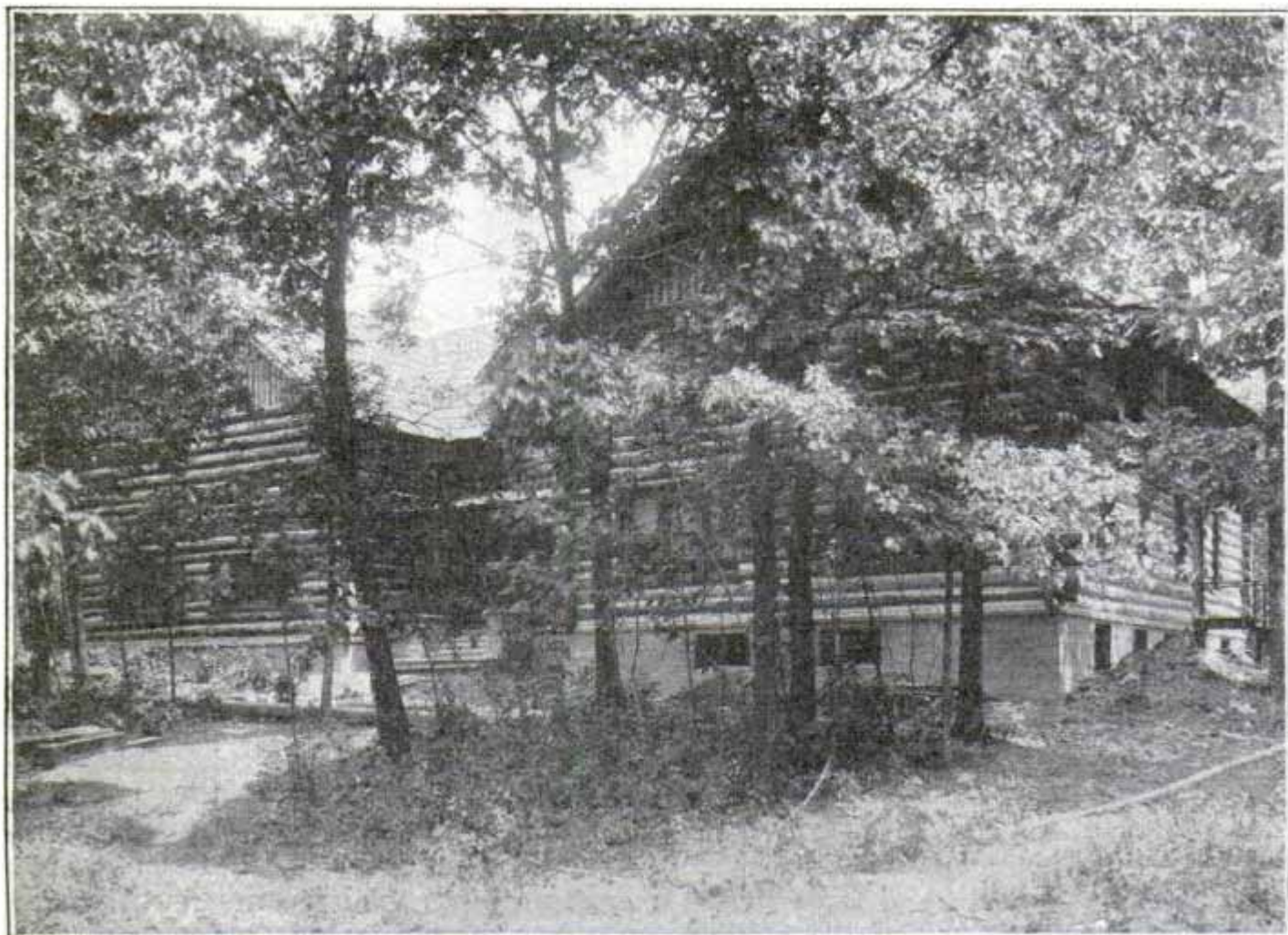

General View of the Front of the Log-Cabin Dwelling, Showing the Rough and Wooded Nature of the Surroundings. The Section at the Left is the Studio, the Living Section is at the Right

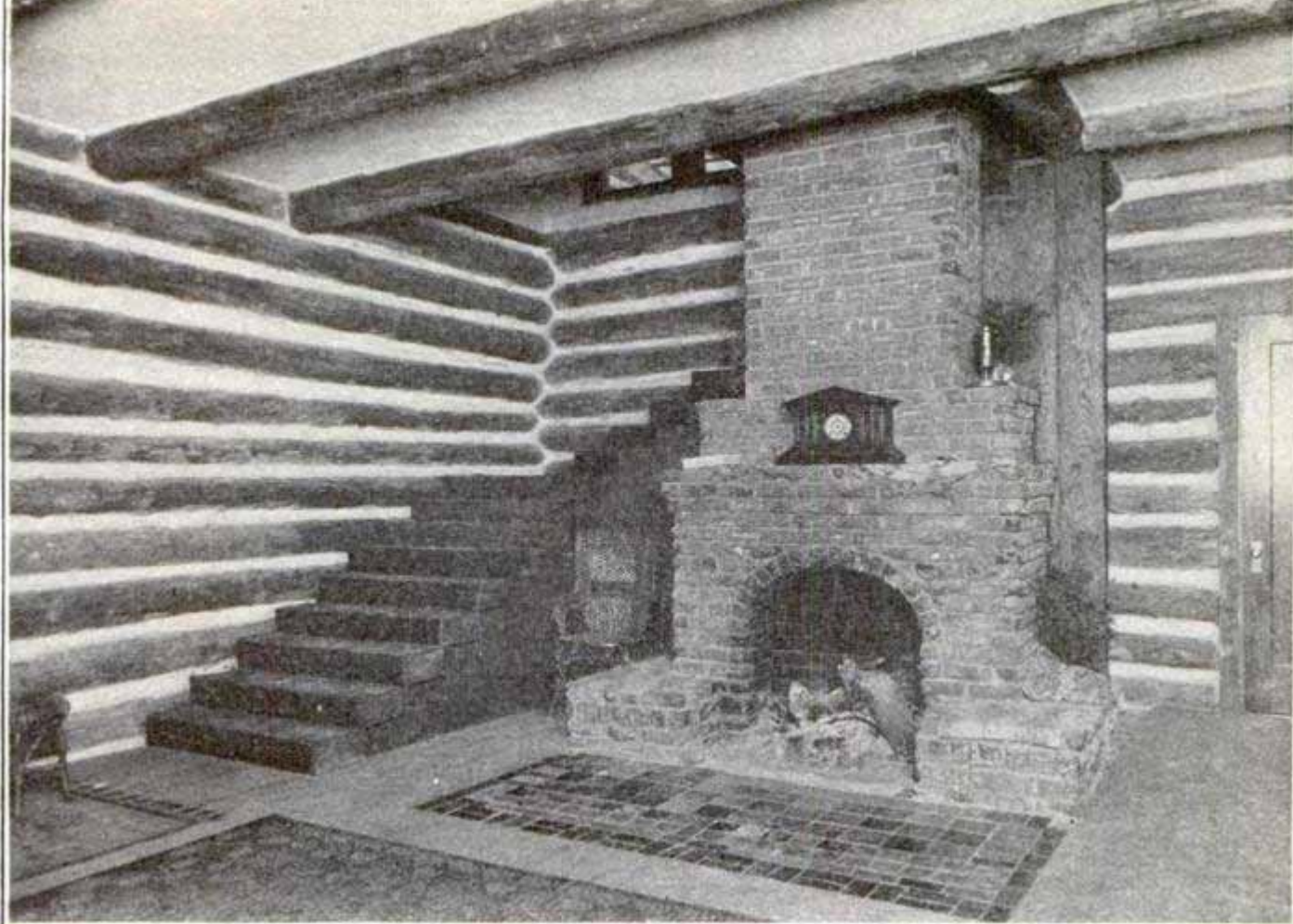

Entrance Hall, 20 by 24 Ft. The Stairway Consists of Solid Oak Slabs 4 Ft. Long, 12 In. Deep and 6 In. Thick. The Fire Place is Made of Clinker Brick. The Door Just Showing at the Right Leads Out onto the Sun Parlor

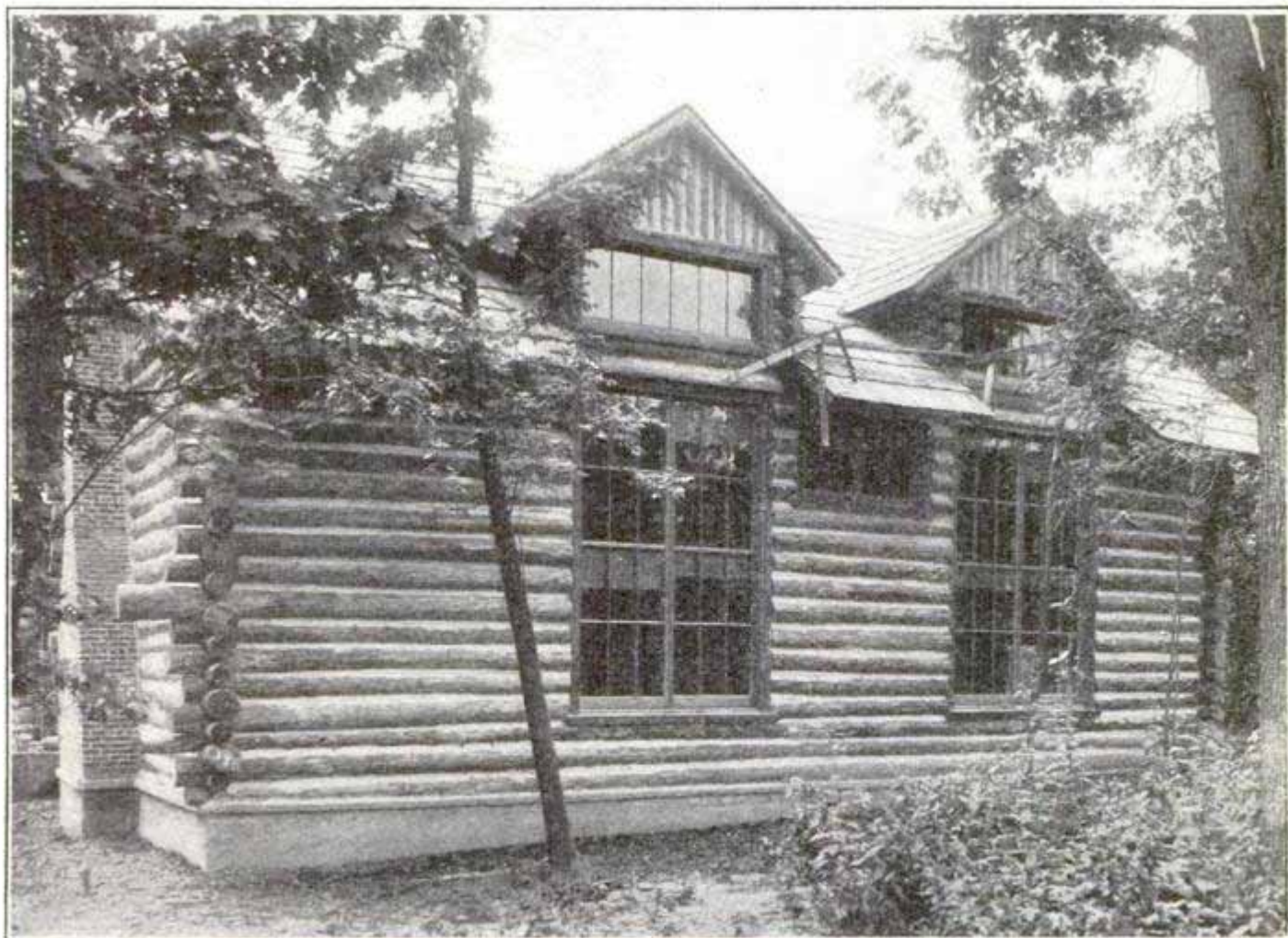

View of North Wall of the Studio Section, Showing Large Windows which Give the Artist a North Light. The Two Dormers are an Interesting Feature, and One Unusual for Log Construction

Albright didn't know how, nor did the teamsters. Therefore, he started out after information and got it in the form of a former woodsman whom he found in Chicago. The logs were transported by two teams of horses, two logs at a time, or 85 hauls, and this cost just \$118.

Next of the many problems which required solving was the hiring of men familiar with such work. A representative of the carpenters' organization had already arrived on the ground and insisted that the house would have to be built by members of the association if it were to be built at all. "All right," said Mr. Albright, "send along your men. All I want is to get the house built." The men came, did at least \$100 damage to the logs the first afternoon, and then gave up in despair. Subsequently, the association held a meeting, but of all the carpenters in and about Chicago could not find one who could build a log house. The result was another visit from the representative, who admitted that the association was "up against it" and gave Mr. Albright the privilege of hiring any men he wished as long as he hired two carpenters to do the nailing and sawing. He laughingly promised to do this and after a few days search rounded up six woodsmen who were more than delighted to tackle the job. The two carpenters arrived, thus completing the construction force, and it was not long before the representative of the carpenters' association understood the reason for the Albright laugh.

So far, the foundation is down, the logs are on the ground, the carpenters' association has been disposed of to the satisfaction of both sides, the woodsmen are ready, ax in hand, and there are one or two rough charcoal drawings which no one but Mr. Albright understands. The next problem, therefore, and the last for some time, is the tackle for raising the logs. Under the supervision of a civil engineer this is evolved in the form of a derrick 58 ft. high, with a boom the same length.

The rope required was 1½ in. in diameter and 1,000 ft. long.

The first log was put in place Jan. 2, and the last the latter part of March. Mr. Albright plumbed every log as it was put in place, and all his workers insisted that they had never had a more pleasant task or ever worked quite so hard. Even the carpenters came in on this, especially the "never having worked so hard." Their work, as specified by the association representative, consisted of doing the sawing and nailing. There was considerable sawing, and of a rather heavy variety, but the part of the specification which made Mr. Albright laugh was concerning the nailing. It is sufficient to state that every log, as well as the heavy oak window framing, was fastened in place by means of spikes half an inch square and 10 in. long.

By the time the logs were up, the oak-slab shingles, specially cut for the purpose in southern Indiana, had arrived. The shingling did not take long and presented no difficulties. Then Mr. Albright started out to find a material for filling up the chinks. Blue clay was recommended and a whole carload was procured from a construction company sinking a tunnel under the Chicago river. Two days' work sufficed to put the clay in place, but on the fourth day it all came down again. Blue clay, no matter how compactly pressed when wet, shrinks one-eighth in drying. This caused it to fall away from the logs or to crack badly when it stuck. Had it been mixed with two parts sand, the blue clay would have been ideal for the purpose, but Mr. Albright did not know this at the time. He substituted cement plaster, which proved perfectly satisfactory. The clay experiment cost him just \$100.

The easiest way to explain the shape of the structure is to say that it consists practically of two gable-roof log houses, 48 ft. deep by 32 ft. wide, placed side by side 20 ft. apart and connected by an intervening section. This intervening section is the main entrance and reception hall, one of the log

houses is the artist's studio, 48 ft. long by 32 ft. wide, and two stories high, and the other contains the actual living quarters. The living section has its inner walls plastered in the conventional way, and consists, on the ground floor, of a 16 by 24-ft. living room, a dining room the same size, a 12 by 18-ft. library, and a kitchen. The second story has five large bedrooms, one of which is above the entrance hall. The sun parlor is back of the reception hall and between the two gable-roof sections, and the sleeping porch is just above it.

Eventually the house is to be fur-

nished with heavy oak, carved furniture of Mr. Albright's own design. He intends employing an old wood carver in the basement for at least two years doing this work.

Mr. Albright says he could not tell for the life of him just how much his venture has cost, as he kept no accounts and paid no attention to the little sums continually going out. The only part of the work done by contract was the foundation, so he knows that this cost \$1,600. He does know, however, that the result is just what he wanted, and that the woods and children he loves are all about him.

U. S. S. "KANSAS" HAS A DIVING DOG

Among the many accomplishments accredited to the dog mascot of the U. S. S. "Kansas" is its ability as a diver. The greater number of dogs



Dog Mascot of the U. S. S. "Kansas" Diving into the Sea

taught to enter the water from piers and boats take a springing leap outward and upward, the hindquarters entering the water first. This dog dives head and forefeet first.

GAS HOLDER OF 6,000,000 CU. FT. CAPACITY

The largest gas holder in the world for the storage of natural gas will be erected in Pittsburg at a cost of \$500,000. It will be 208 ft. high, have a diameter of 226 ft., will weigh about 5,000 tons, and will have a capacity of 6,000,000 cu. ft. The steel plates for its construction are $1\frac{7}{8}$ in. thick, and more than 1,500,000 rivets, each 2 in. in diameter, will be used in putting them together.

NEW SEAPORT CONTEMPORATED FOR ROME

Negotiations are on foot in Rome for the construction of a new seaport for that city, and it is probable that a French syndicate will build it. The place likely to be chosen is Palidoro, which is situated about 12 miles to the northwest of the city. The banks of the river at this point are more steep than at other points, which makes it easier to obtain the desired harbor depth of 30 ft. A short railroad will connect Palidoro with the railroad running between Civita Vecchia and Rome. Civita Vecchia strongly opposes the scheme because it will oust it from its present position as Rome's most important seaport.

CHILDREN'S DRAWINGS ON A MUMMY WRAPPING

That children of 2,000 or more years ago had many characteristics akin to those evinced by children of today is illustrated by this mummy wrapping



Drawings Made by Children of 2,000 Years Ago on the Wrapping of a Mummy

which bears several crude drawings accredited by archæologists to childish hands.

Mummies, according to Prof. Flinders Petrie, of the British School of Archæology in Egypt, probably stood about the dwellings for one or two generations. Then, when the foot-cases had been kicked in, when little boys at their lessons had scribbled caricatures on the toes, they were carted off to the cemetery to make room for later deaths in the family. No funeral monument or cenotaph was put over them, because they were not buried so long as there was interest in them.

Under authority of the Australian statute which corresponds to the American pure food and drug law, orders have recently been issued that methylated spirits henceforth must contain 0.5 per cent of coal-tar naphtha, which does not affect the value of the spirits but makes them unpalatable for drinking purposes, and will thus check the sale of such liquids as substitutes for ordinary alcoholic drinks.

SILICA FOR STANDARDS OF LENGTH

Instead of using gold or platinum bars on which to mark the official standards of length, as of the yard or meter, a British scientist proposes to use silica, which is practically the same as ordinary sand.

Metals have usually the property of expanding or contracting with changes in temperature, and gold and platinum are no exception to the general rule. There is a metal called "invar," a nickel-steel alloy containing 36 per cent of nickel, which preserves nearly invariable dimensions under ordinary temperature changes—hence its name.

But invar has other physical properties which render it unsuitable for standard measures.

A silica length standard was recently constructed in England, and showed to advantage under temperature tests, as its expansion per degree Centigrade rise of temperature proved to be but one-twentieth that of platinum-iridium alloy which has hitherto been considered to be the best material to use for length standards.

The present model, which is the first of its kind, consists of a silica tube into the ends of which are fused plane parallel slabs of transparent silica. The under sides of these slabs are covered with a platinum deposit which is cut through with a ruling diamond at the transverse lines defining the standard meter. These lines, which are beautifully clean-edged, are viewed through the slabs from above, and are thus seen to advantage.

The Russian military authorities have announced their intention of buying 2,000 motor trucks of a capacity of from 1½ to 3 tons, for use in the army.

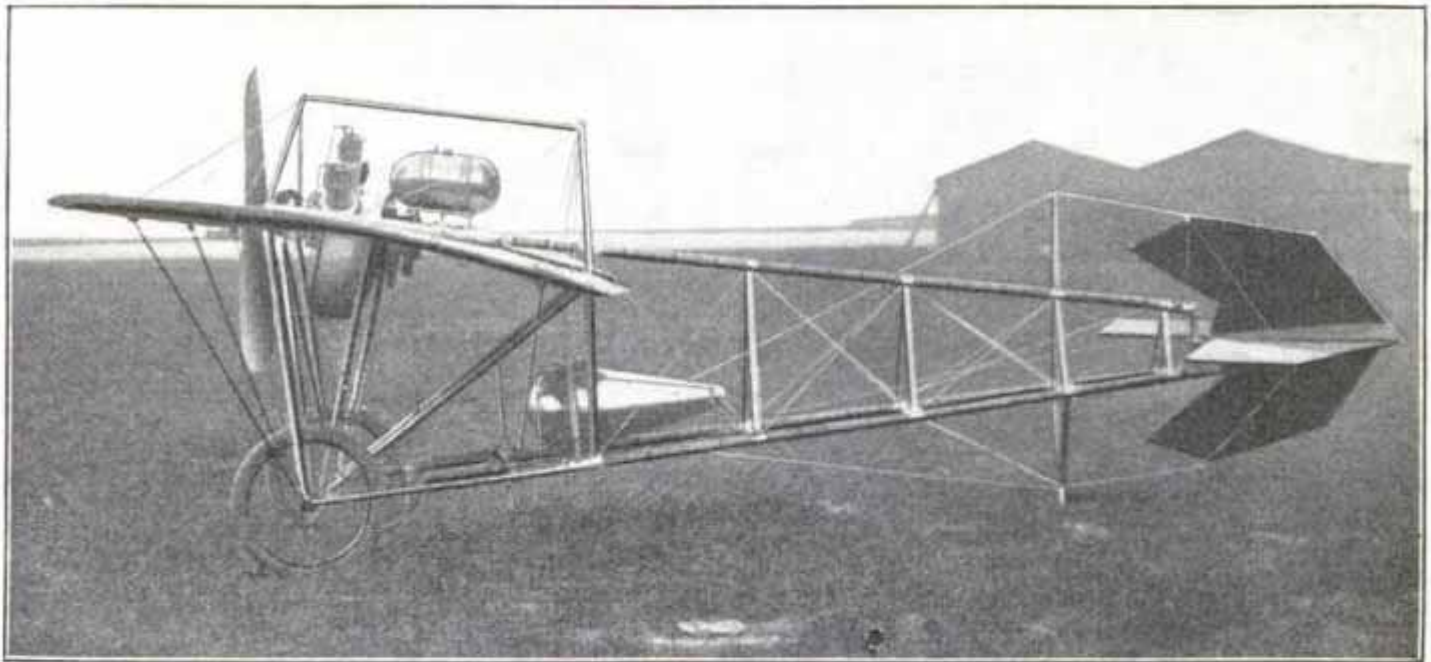

The "Demoiselle," Santos-Dumont's Tiny Aeroplane, Equipped with Rotary Motor

ROTARY MOTOR ON THE "DEMOISELLE"

After a year of experimenting, the "Demoiselle," which since its invention by Santos-Dumont has retained the distinction of being the smallest and lightest of aeroplanes, has been successfully fitted with a Gnome rotary motor, and Messrs. Audemars and

Garros, the French airmen who have made many flights with the tiny flyer, declare it is a big improvement over the two-cylinder, horizontal opposed motor with which it has been equipped. The extreme lightness of the bamboo framework for a time made it seem impossible to use the rotary type of motor, but by strengthening the upper parts, it has been accomplished.



The Gnome Motor Fitted on "Demoiselle" for First Time, Replacing Horizontal Opposed Motor

DISCUSSION OF CHANNEL TUNNEL IS REVIVED

Considerable attention has been given lately in engineering publications to the long discussed question of tunneling the English channel. The election of Lord Kitchener to the directorate of one of the English railways revived the matter although the famous British soldier has never given public expression of his ideas in the premises. It is regarded as highly probable that the matter will be seriously considered within the course of the next few years, however, especially in view of the fact that such opposition as has hitherto existed, based upon the military menace to Great Britain such a tunnel would hold, has been entirely dissipated through the arguments of those in favor of the tunnel to the effect that an invading force could easily be stopped and engulfed by the use of a few sticks of dynamite.



Preparing to Descend through Ledge in Unique Elevator

CRUDE ELEVATOR A MONEY-MAKING ATTRACTION

As an example of primitive mechanics the crude elevator at Chain Mill Falls, near Hanover, Ind., and high up in the "knobs" on the north side of the Ohio river, is unique. As shown in



At the Bottom of the Shaft under the Ledge

the two pictures the elevator drops through the ledge of rock, over which the water falls, and is intended to carry sightseers down into the cavern behind the waterfall.

Fifty years ago a pioneer established a flour mill on the site of the upper picture. He bored a hole through 80 ft. of rock and swung a chain with buckets through it. He persuaded the six or ten cubic feet of water per minute which flows there to drop into these buckets and turn his mill wheels, thus giving the falls their name.

Long ago the dam washed out and the mill and its chain gear disappeared and until this year there was nothing there except a big hole through the rock which was gradually growing over with vines. The scenery at the point is wild and picturesque, and a new tenant on the farm conceived the idea of establishing a small amusement park with the improvised elevator as the principal attraction. College students from Hanover are the chief patrons.

The crude elevator is balanced by weights. In order that it may be sent down without a load, the inventor has provided it with a large water tank. A portion of the stream is diverted into the tank and down goes the car to the bottom, without a brake or any stoppage. The college students or others who have been beneath the falls may then get up by pulling out the plug in the tank and waiting until the tank on the weights is full enough to bring them up. The only braking device used is a stick which is applied to the pulley. Two is a good load for the car.

Surplus water runs into the barrel shown at the bottom of the rock ledge under the falls. If it becomes necessary to fill the tank on the weights a siphon from the barrel is used.

Hydraulic engineers who visited the spot recently found that by means of a dam and a pipe line a total "head" of 200 ft. could be obtained. This would be sufficient to operate a small generator which would not only run the ele-

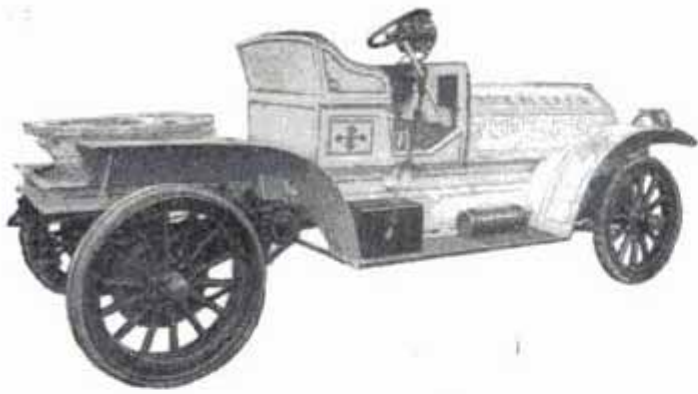

Motor Car Designed for the Conversion of Horse-Drawn Fire Apparatus into Motor-Propelled Apparatus



Ordinary Automobile Used in Converting Horse-Drawn Fire Engine into Motor-Driven Machine

vator with less danger to life and limb, but would also light the farmer's house and his amusement park. But the present tenant is perfectly satisfied with the homemade elevator, probably because it is such an unusual piece of mechanical engineering that it draws many visitors, all of whom are charged for the privilege of riding on it, if they have the courage to tackle it.

FIRE APPARATUS DRAWN BY MOTOR OR HORSES

The hesitancy of many cities when the question of motor-propelled fire apparatus is raised is due in part to the cost of installing completely new apparatus. One motor company, at least, has attempted to overcome this objection in the ingenious manner shown in the accompanying illustrations. Instead of the city buying a complete motor-driven hook-and-ladder truck, service truck, or fire engine, it may purchase from this company a motor car built along the lines of the ordinary touring car, but especially constructed and equipped to be quickly

substituted for the forward truck of the ordinary horse-drawn vehicle. Thus the horse-drawn apparatus may be changed over for motor propulsion without taking it out of service, the cost is much less than that of a complete new vehicle, and should the necessity arise the change back to a horse-drawn vehicle can be quickly made.

That an ordinary automobile may be used in the same manner is shown in the illustration of a converted fire engine. The front wheels and the tongue of this fire engine were removed, and it was mounted on the chassis of a 40-hp. car. A hanger bar with a ball joint was used as a mounting for the engine on the automobile chassis, and springs serve as cushions to break the impact, on the same principle as is worked out on railroad trains. The arrangement is a temporary one of the Bridgeport, Conn., fire department, and was utilized because there was no place for the horses while repairs were being made to the stables of one of the fire houses. The equipment has a speed of 35 miles an hour.

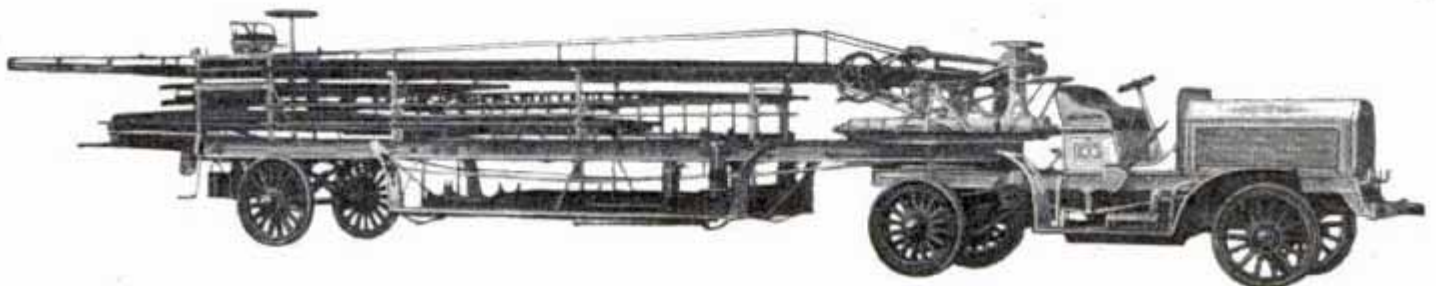

The Substitution of the Specially Designed Motor Car for the Ordinary Forward Truck of This Aerial Converts It into a Six-Wheeled Motor-Propelled Vehicle



The "Ice Stove"

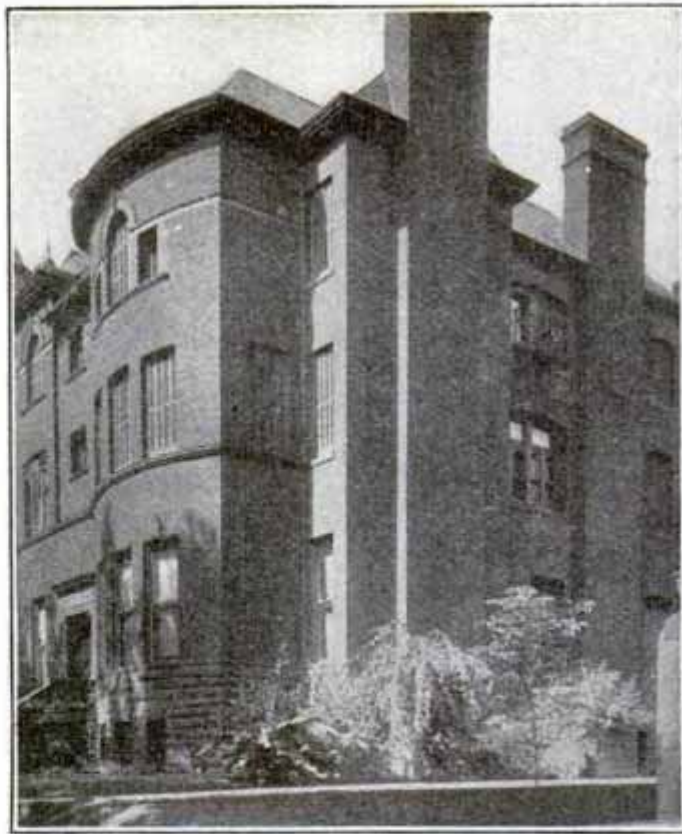

Professor Bell's Residence

"ICE STOVE," PROFESSOR ALEXANDER GRAHAM BELL'S LATEST INVENTION

Prof. Alexander Graham Bell, inventor of the telephone and scientist of world-wide fame, has recently invented and constructed an apparatus for cooling dwelling houses in summer at small cost and with simple operation, which has been used with much success in the inventor's home in Washington, D. C., during the hot spells of the summer.

While other dwellers on aristocratic Connecticut avenue in that city sweltered and wilted under the torrid temperature that, even within doors of the mansions of that wealthy locality, rose daily to 90 deg., Professor Bell sat comfortably at work in his study. On his desk the thermometer, throughout the whole summer, has never registered higher than 61 deg.

While there are numberless appliances for cooling buildings, they are, for the most part, adapted only to large structures and are of a costly and complicated nature, dependent upon involved mechanism and many-syllabled chemicals, requiring an expert to op-

erate. Professor Bell's latest invention avoids all these objections.

He first became interested in the subject during a recent tour of the world, being much impressed in India and other tropical countries with the total absence in the dwelling houses, even of the wealthy classes, of all means of tempering the fierce heat. When he returned to the United States he at once addressed his talents to devising an apparatus that, while avoiding the objections of high cost and complex operation, would yet achieve satisfac-

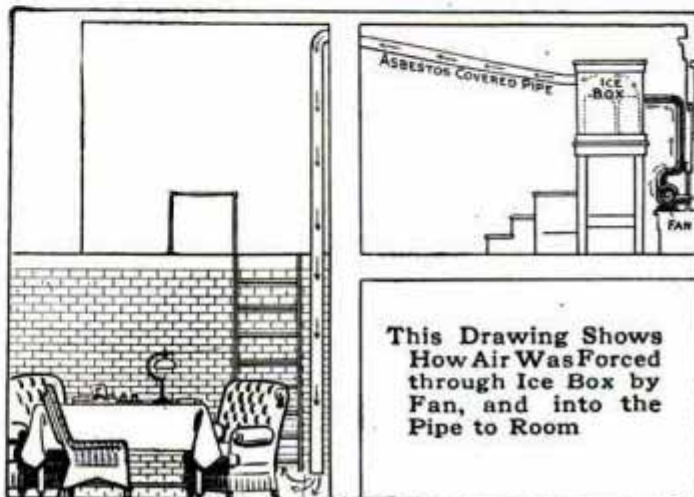

This Drawing Shows How Air Was Forced through Ice Box by Fan, and into the Pipe to Room

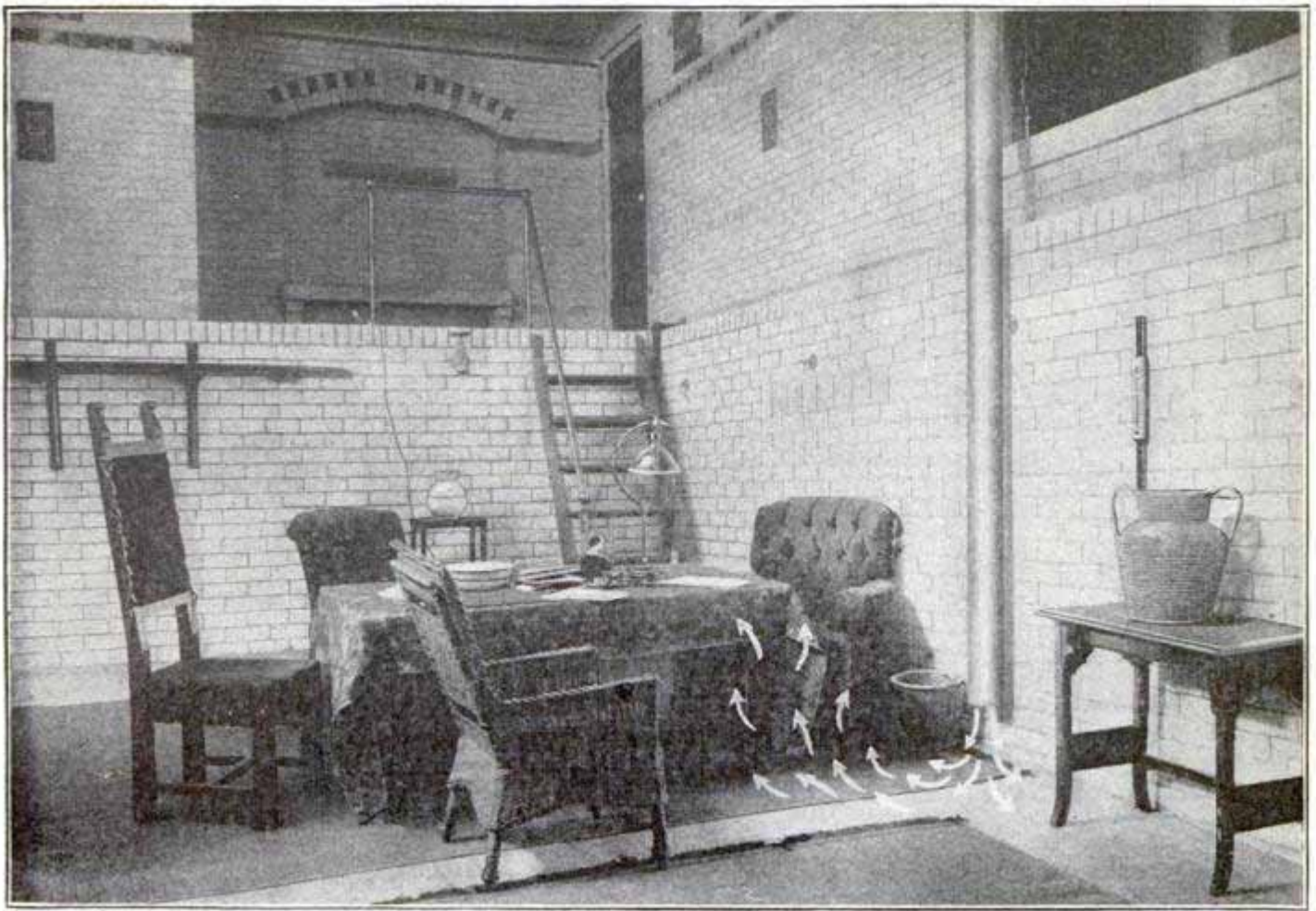

Study, Formerly a Swimming Tank, in Professor Bell's Washington Home in Which Thermometer Never Went Above 61 Degrees During the Summer. Cold-Air Pipe, Ending Near Floor, is Shown on Right

tory results in the cooling of private dwellings. With characteristic energy he soon conceived and constructed an appliance which, he thought, would fill the requirements. Nature aided him, for hardly had he installed this latest creation of his genius when a series of blistering hot spells put it to a crucial test.

This is the method of constructing the "ice stove," as it is now installed in Professor Bell's home in Washington:

On the window ledge is set a small fan, about 6 in. in diameter. It is operated by a small electric motor attached by a wire to an electric-light socket. The fan is inclosed in a casing. Under the lower sash of the window is set a board in which is a 2½-in. hole. A short pipe connects this hole with the encased fan, thus supplying pure air from outdoors. Another pipe runs from the fan casing to a large wooden box, which formerly served as a pantry ice box, about 3 ft. high and broad, and about 4 ft. long. In this box are cakes of ice. The lid fits with

air-tight snugness. From the opposite side of the box at which the pipe from the fan enters, another pipe leads off to the apartments to be cooled in just the same manner that hot-air pipes lead from a heating furnace. This pipe is heavily encased in asbestos. When this service pipe comes through the wall into the room to be cooled, it runs down to within about 3 in. of the floor, the end being open for the discharge of the cold air.

All that is necessary to cool the room is to turn on the electric current and start the fan. This draws the air in through the window pipe and drives it through the connecting pipe into the ice box. Here the pressure of the air from behind, due to the driving power of the fan, forces it across the ice, thereby cooling it, and thence on into and through the service pipe, whence it is discharged into the room.

While Professor Bell uses electricity as the most convenient method for operating his fan, any other motive power would be equally good.

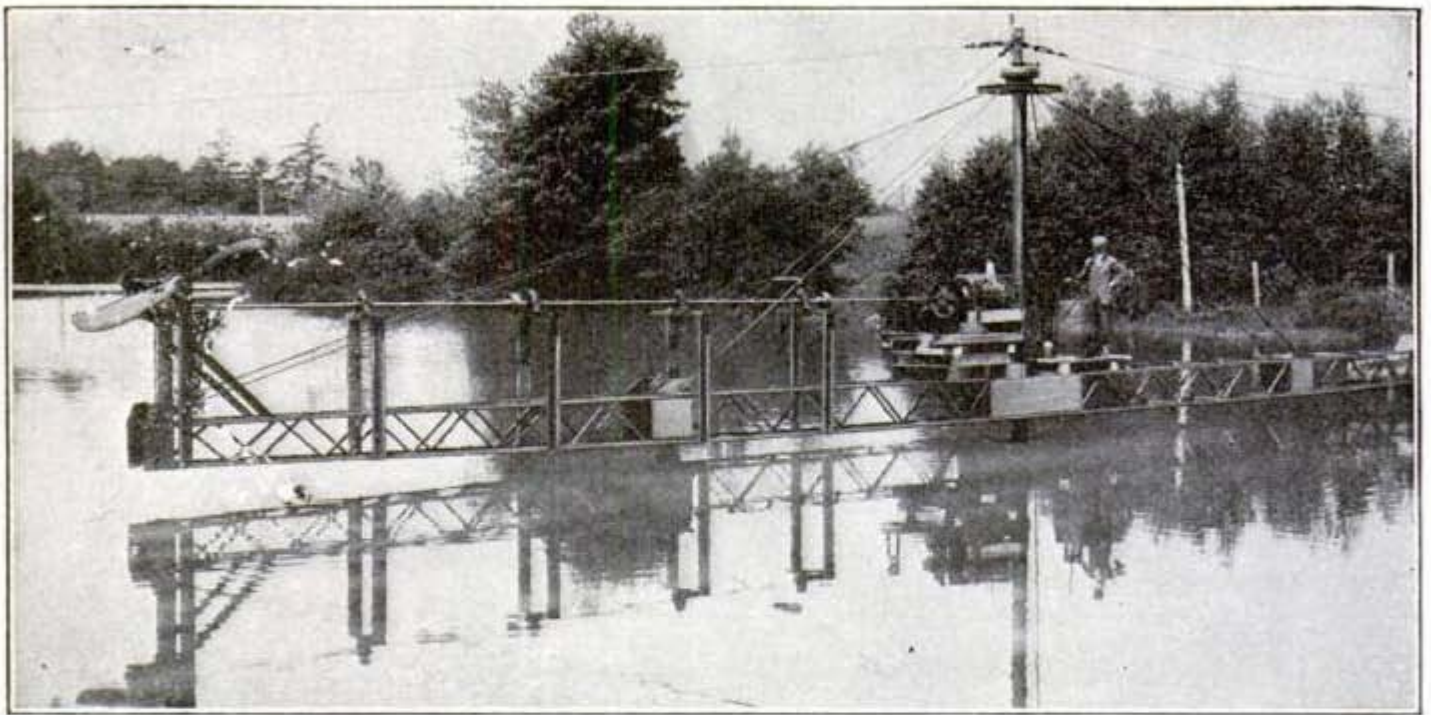

Whirling Table of the Worcester Polytechnic Institute for Testing Aeroplane Propellers

AN AERIAL PROPELLER TESTING STATION

An experimental station for carrying out a long series of tests of aeroplane propellers has been established at the Worcester Polytechnic Institute, Worcester, Mass. The apparatus was designed by David L. Gallup, assistant professor of gas engineering, and some results of real scientific value are being secured with it.

As a basis Professor Gallup took an apparatus which has been used in testing current meters. A large shaft is imbedded in a boulder in the bottom of the lake which supplies water to the hydraulic plant. At the top of this shaft is a heavy boom, 84 ft. in length, which swings in a circle of 42 ft. radius, making a circumference of nearly 264 ft.

The propeller is mounted on one end of this boom, its axis being tangent to the circumference at that point, and is driven by a 75-hp. variable-speed motor located at the center of the boom. At the present time the boom is turned on its axis by the action of the thrust exerted by the propeller, but later a supplementary motor will be installed which will drive the boom at a speed up to at least 60 miles per hour at the tip. The tip

speed of the boom or the velocity of the propeller through the air is measured by means of a delicate electrical arrangement and is checked by a speedometer which shows the speed in miles per hour.

Tests are to be run on various makes of propellers, determining the relation between "standing" thrust and "moving" thrust. That is to say, the propeller is to be anchored and the thrusts obtained for various speeds of rotation of the propeller. Then the propeller is to be operated at a definite number of revolutions per minute, say 1,500, and various drags placed on the boom so that the speed of the propeller through the air will vary from 10 to 60 miles per hour. The propeller will next be run at 1,400 revolutions per minute and a sufficient drag placed on the boom to allow the propeller to go through the air at various rates of speed, and similarly for 1,300, 1,200, 1,100 revolutions per minute, etc. Of course this performance will be varied in detail on account of varying pitches and diameters of the propellers which are undergoing test, but the instance cited serves as an illustration of the work.

"PUMPING" TAXIMETERS

One of the tricks of the taxi-drivers' trade was described before one of the Paris police courts recently when three chauffeurs were accused of attempting to defraud. It appears that by gently hitting the meter with the hand or manipulating the metal flag, it is possible to make the "prix à payer" mount up without the extra sum thus registered showing on the day's receipts.

A few days ago, three drivers, while waiting outside a church for the passengers they had brought there, "pumped" the meters. Before the people came out one of the meters had registered 146 francs. The drivers seeing that they had gone too far endeavored, by hitting and shaking the meter, to reduce the amounts. They only succeeded in breaking the machines entirely.

EMERGENCY DOOR LOCK

A lock that can be carried in the pocket and may be applied to any door, enabling the user to secure the door against all other persons by a lock controlled exclusively by himself, has been especially designed for travelers.

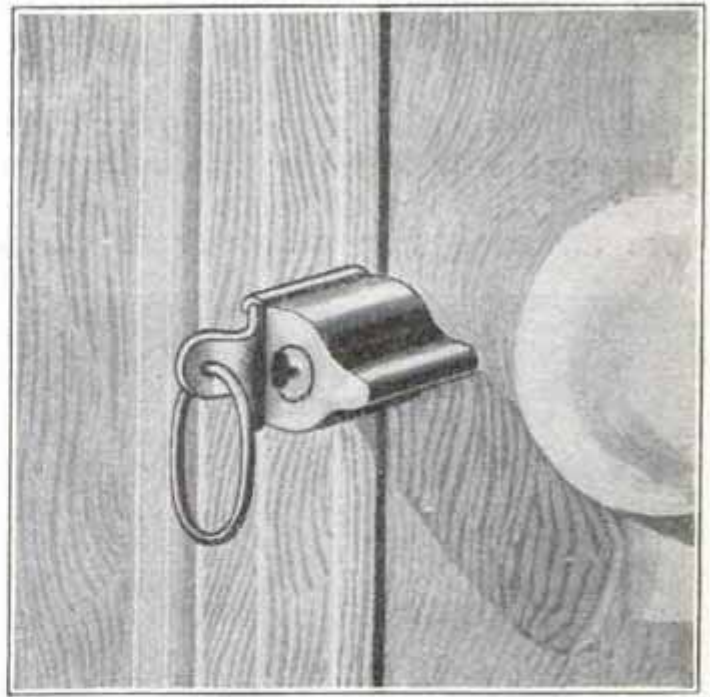

Door Closed, Showing Lock Applied to Slide, in Which Position it Prevents Opening of Door

The device consists of a slide which hooks into the strike or keeper on the door jamb, and a cylinder lock which engages with the slide and prevents the door from opening when in place.

A person provided with such a lock may secure any room, closet, or wardrobe against sneak thieves and against persons having duplicate keys. It is particularly desirable where doors are fitted with insecure locks or when keys are lost.

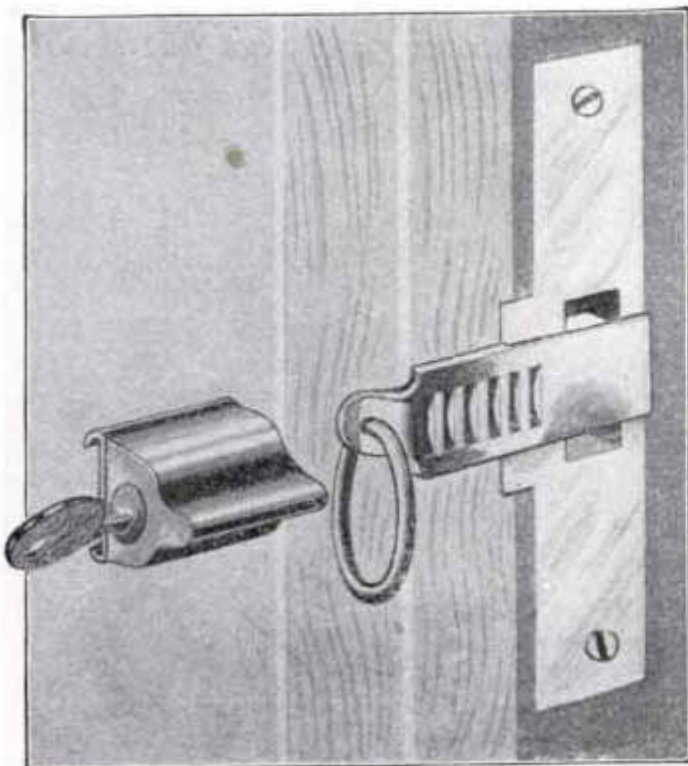

Door Open, Showing Slide and Bolt in Position

HIGH PRICE OF PLATINUM DUE TO MONOPOLY

The high price of platinum, which has risen from about \$100 a pound to nearly \$730 per pound at the present time, is not altogether due to its scarcity, but also to the fact that almost the whole world's supply comes from the deposits in the Ural mountains and that this supply is completely controlled by two men. These men are Prince Demidoff and Count Schuwaloff, who fix the price to suit themselves.

Three British submarine boats recently completed a voyage of 9,000 miles from Portsmouth, England, to Hongkong, China.

INTERESTING FANCY OF AIR OWNERSHIP

The problem of ownership of the air, which will have to be faced by the lawmakers of the different nations before air navigation grows much older,

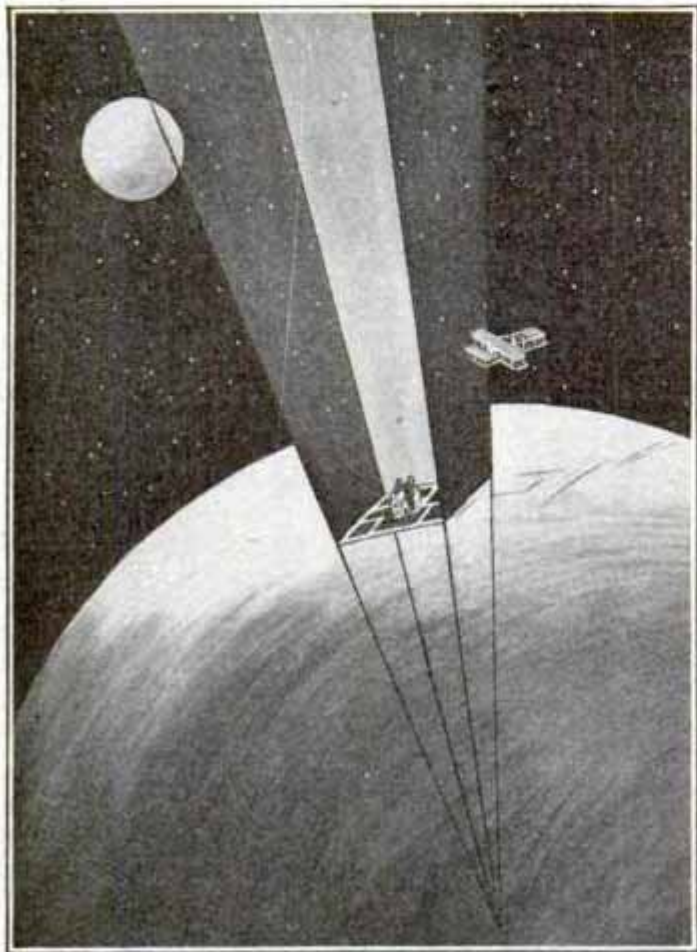

A Piece of Land Includes the Earth Below to Its Center and the Air Above

brings up the question of how much air space each land owner might be able to lay claim upon. According to the London Sphere, it is evident that fences, walls, and so forth, are all built to lines diverging, and plumb to the earth's center. Theoretically, therefore, it may be said, in passing, a house is wider at the top than at the bottom. Thus a piece of landed estate is in the form of an immense inverted pyramid, having its apex at the earth's center and its base anywhere from the earth's surface to any given distance above. The higher the distance, the larger in extent is the air space allotted to a given space on the earth's surface until, if the idea be carried far enough upward, the moon and other heavenly bodies become trespassers.

INDESTRUCTIBLE LABELS FOR NURSERYMEN

An indestructible label, said by the French scientific magazine "La Nature," to be the simplest and most practical device of the kind on the market for nurserymen, is now being sold by a Paris firm. The label consists of a very thin malleable sheet of a bronze alloy, perforated at one end for the insertion of a wire with which to attach it to the plant. Laid on a folded newspaper or other similar soft surface, the name of the plant and other data can be easily inscribed upon the metal by means of a nail or even a hard lead pencil.

BILLBOARD ADVERTISING DEVICE ON WHEELS

A familiar sight in the streets of Geneva, Switzerland, is the traveling billboard which contains theatrical and other forms of advertisement. The billboard is really a cylinder about 10 ft. high and 3 ft. in diameter, mounted on a low four-wheel truck. The cylinder revolves slowly as the truck is pulled through the streets by hand. Usually it is topped with a pyramid painted with stars to resemble the heavens, and over this is set a grotesque head.



Traveling Billboard Used in Geneva, Switzerland

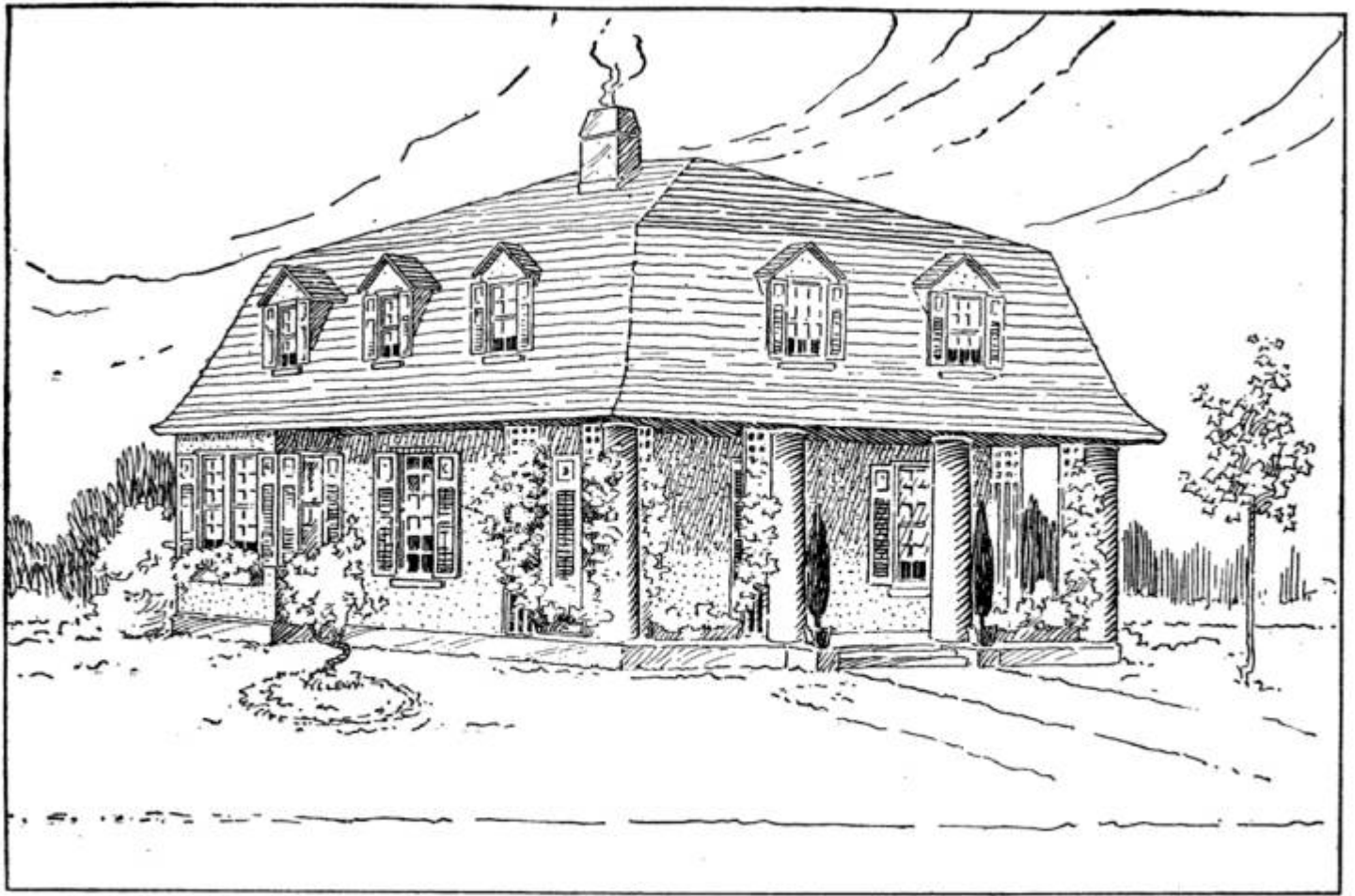

William F. Leppin, Architect

Front Elevation of the \$4,500 Concrete and Shingle Cottage

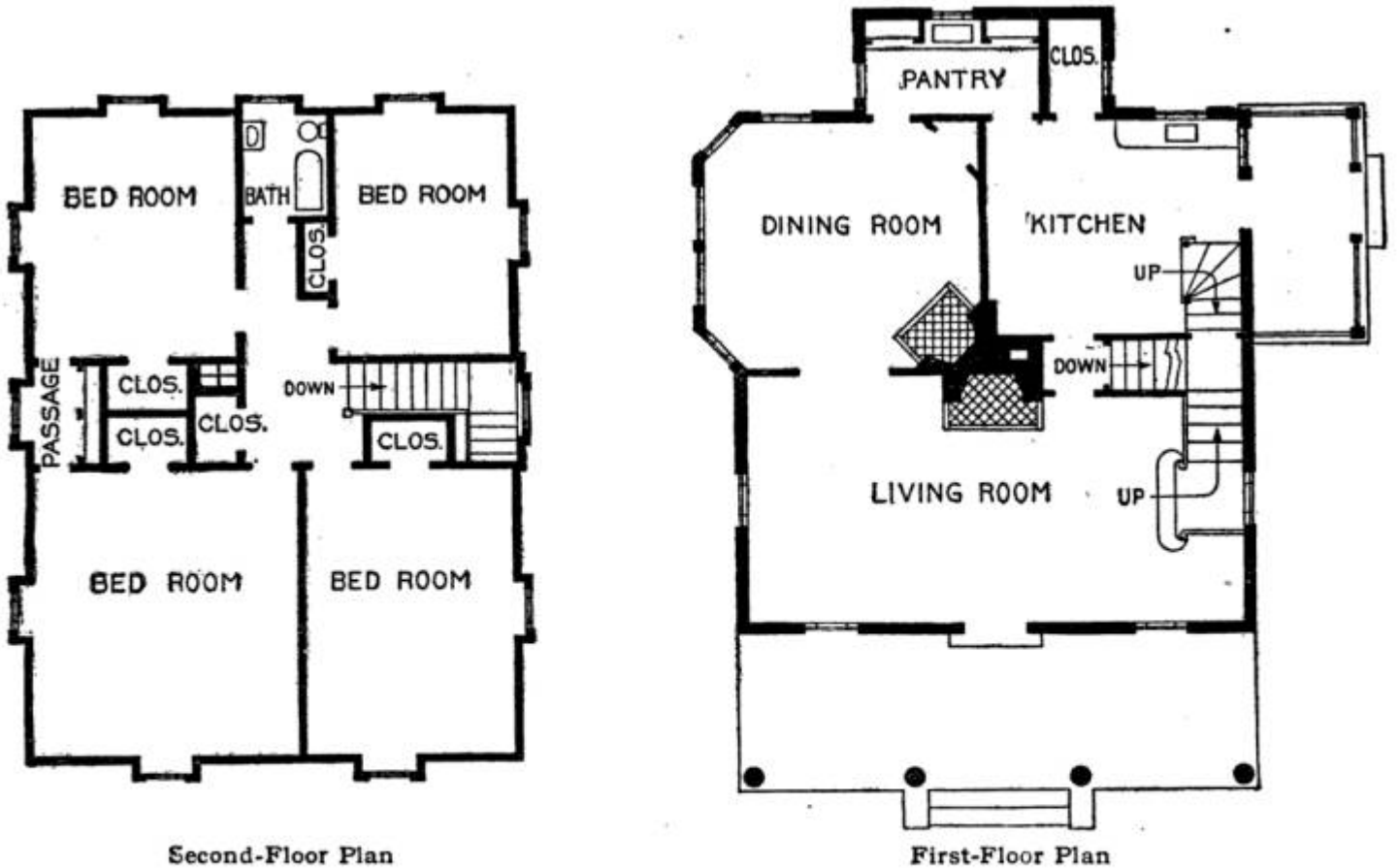

Second-Floor Plan

First-Floor Plan

A solid and substantial building, suggestive of the farm and field, though designed for a suburban home, is represented in the accompanying \$4,500 house plan. Seven rooms are provided for in the architect's sketches. The design of the house is a modification of the colonial type, built of concrete and shingle or slate. There are four bedrooms on the second floor, and the living room and dining room are not only large, but provision has been made for exceptional lighting. The entire plan is regarded as unusually interesting because of its ready adaptability to a variety of locations. The house plan published in Popular Mechanics Magazine for August was drawn by James W. O'Connor of New York and was one of the prize-winning designs in the Building Employers' Association competition.

AN EXPANDING ANCHOR

A ground anchor of the expanding type and so strong in its grip that it is said its solid steel rod will break

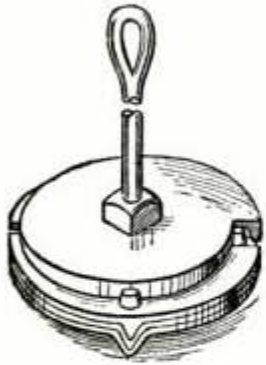

The Expanding Anchor Closed

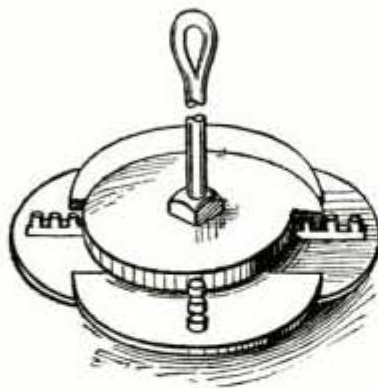

The Anchor Fully Expanded

before the anchor will pull up, has recently been devised and put on the market. The hole for the anchor is bored in the round by a tool known as a "deflector," which makes an aperture which increases with the depth. The closed anchor is dropped into this hole and expanded by a special kind of wrench which turns the square nut at the bottom of the anchor shank.

WEIGHS THREE MATERIALS AT ONE TIME

A novelty in weighing machines is known as a "triplet," as it weighs three different materials at one time, automatically. This simultaneous weighing, which is correct to within 1 per cent, is of especial use in the proportioning of materials for mixing, such as cement, sand and gravel for concrete.

The material is fed to the different buckets by means of small traveling conveyors, and as each bucket is filled to the amount required for a balance, its conveyor is automatically stopped and the supply of material cut off. Then, when all three buckets are filled, they are

simultaneously dumped, and the process is repeated. From two to three discharges of the buckets can be made per minute, according to the materials handled. A counting device can be attached to the machine so as to register the total number of weighings in a given period.

AUTOMOBILE WIRELESS FOR ARMY USE

A self-propelled wireless outfit, in which the gasoline engine of the carrying automobile may be used to drive the vehicle or to operate the electric generator for running the wireless telegraph apparatus, has recently been constructed for the military railway and telegraph corps of the Austrian army. The car is a special 28-32 hp. chain-driven machine, and has a roof designed to carry the 98-ft. telescopic mast of the wireless apparatus. It has a speed of 25 miles per hour and accommodations for six persons and a chauffeur.

THE MOTORETTE OF A JAPANESE NOBLE

One of the most curious motor vehicles in Japan is the three-seated motorette of Count Yanagisawa. It

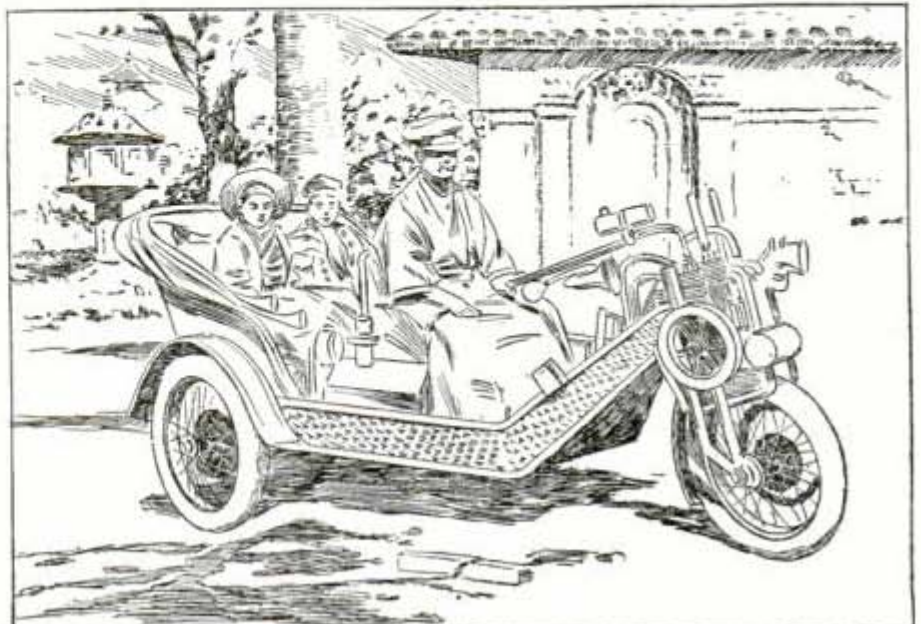

Motor Vehicle Owned by a Japanese Nobleman

has a set of wheels at the back and a single wheel in front, and the complete power plant, gasoline tank and all, is mounted over the front wheel, which is the drive wheel as well as the steering wheel.

A SAFETY MINING CAP

Misfires in mine blasting are said to be impossible with this mining cap, which is of simple construction and designed to prevent any moisture whatever from getting into the fulminate which explodes the blasting charge when it is detonated by the heat of the burning fuse.

The fulminate is contained in the lower part of the cap, which fits tightly

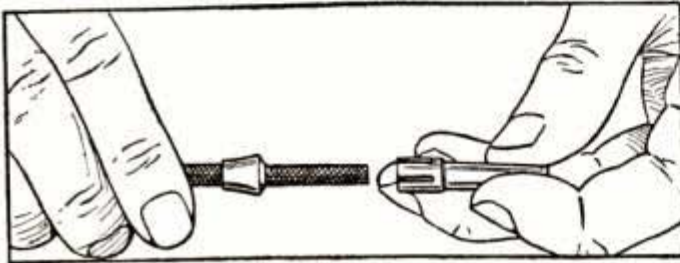

Placing the Safety Mining Cap on a Piece of Fuse

over the fuse. The upper end has an expanded portion which fits over this, and ingress of moisture is prevented by a rubber sleeve and a special waterproof preparation. Longitudinal slits in the expanded end permit of the necessary expansion of the upper part of the device when it is forced over the lower part. The illustration shows the simplicity of the device in use.

SLANTING DESK SAVES THE EYES

How a desk should be slanted in relation to a source of light so that the glare from the surface of the printed page or the paper on which a student is writing will not strike the eyes is shown in the accompanying illustration, along with an improperly arranged desk. The man at work at the flat-topped part of the desk will suffer eye-strain because of the glare which enters his eye directly, while the young woman

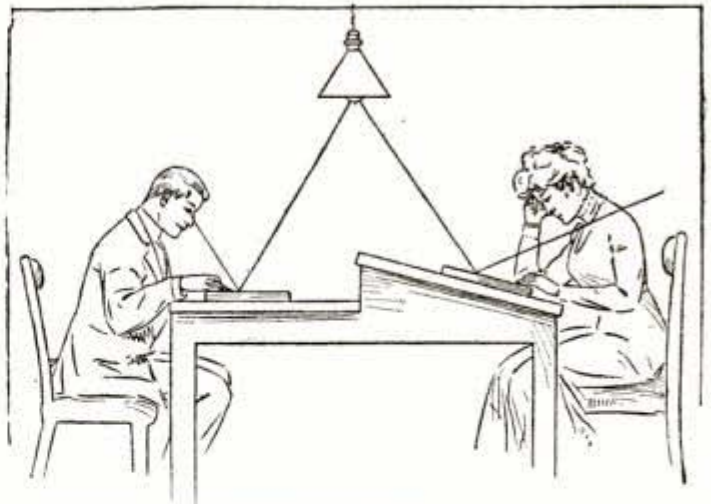

Courtesy Optical Journal and Review

The Flat-Top Desk Causes Glare to Strike the Eye, while the Inclined Desk Prevents Direct Glare

will escape this trouble, the course of the light ray, after striking the book, being considerably below the eye.

MOTORETTE ENGINE WITH TWO FLYWHEELS

The little 6-hp. engine of a new British motorette, the name given the three-wheeled type of machine which is a cross between a motor runabout and a motorcycle, has two external flywheels with two frictionally driven fans attached. One of these machines made a run of 330 miles in 20 hours after just being assembled, which would be considered in the nature of a remarkable performance for any kind of machine.

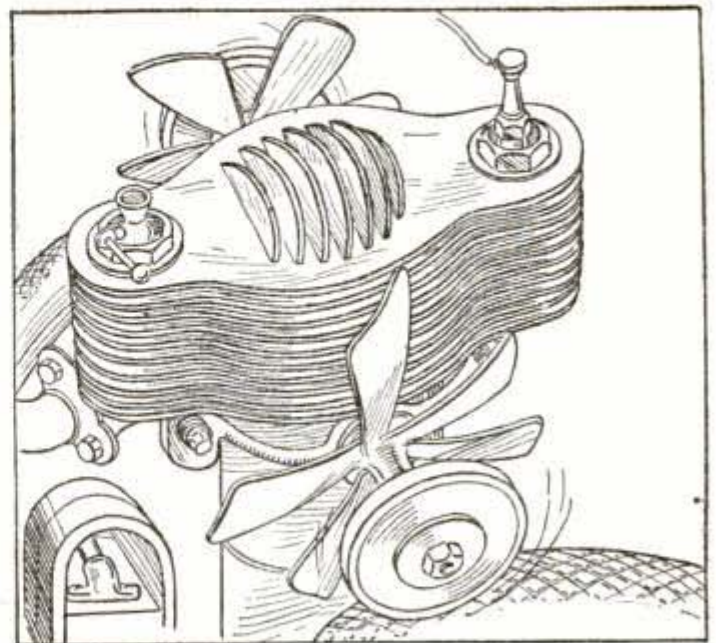

Frictionally Driven Fans and the Two External Flywheels of a 6-Hp., Air-Cooled Motorette Engine

DO WE REALLY LIVE IN THREE DIMENSIONS?

By HARRY ENGLISH

Do material things, as we know them in this world, really have length, breadth and thickness, or do we only think they do?

The question is a fairly old one. Geometers and psychologists have argued it over with all the skill possible for finite minds dealing with the works of an Infinite Being, but up to quite recently they have only had theories and comparisons upon which to work. We are all conscious, more or less, of certain emotions, and in lieu of any positive information to the contrary, we have been content to refer these to the "five senses" — sight, hearing, smell, taste, and touch.

What is claimed to be a real "sixth sense" — real in so far that it has been demonstrated by actual experiments—is the "sense of space and time" which has just been announced by E. de Cyon, a celebrated Russian physiologist, after nearly 40 years of painstaking research. This "sense" gives us our conception of time and space, and limits our perceptions so that, willy nilly, we are bound to regard space as having three dimensions, those of length, breadth and thickness.

The location or the cause of this sense is in the internal ear, or particularly the so-called semicircular canals of that anatomical organ. There are three of these canals, arranged in three directions approximately at right angles to each other. They are called the anterior vertical, the posterior vertical, and the horizontal canal, respectively, and each of them receives sensations corresponding to a particular

one of the three dimensions of space, that is, of length, breadth or thickness, as the case may be. Upon the intensity of these sensations depends the intensity of the resulting nerve-reactions which convey the corresponding impressions to the brain, which thereupon promotes a certain train of thought, of reflection and abstraction, giving us the perception of length, breadth and thickness. The semicircular canals of the internal ear thus classify the three principal directions of space as sensations are transmitted from the auditory canal.

The investigations which led up to these important discoveries included experiments on animals and observations of certain malformations occurring in nature. When one,

two, or all three of the semicircular canals in the internal ear of an animal had been removed, it was observed that the movements of the animal were disorganized in consequence and in a way that corresponded to the direction function of the missing part. Thus a frog which had its horizontal canal taken away, lost its sense of equilibrium, and gyrated around on its longitudinal axis while it swam in the water, or went around in circles. When the anterior vertical canal of a frog was removed, the amphibian swam straight forward without turning, and indulged in convulsive jumps. A frog from which the posterior vertical canal was separated, assumed a vertical position in the water and began to spin around on its longitudinal axis. Similar results were obtained with pigeons and rabbits.

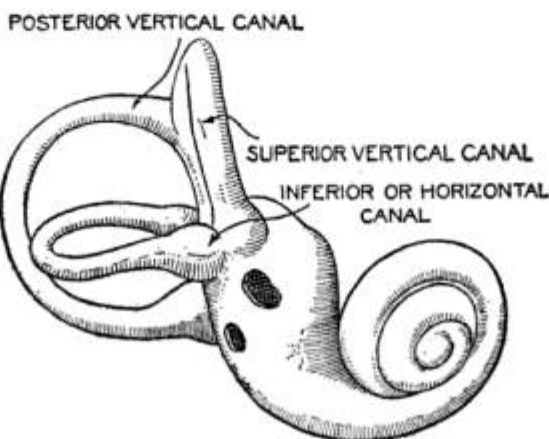

Structure of the Internal Ear Showing Relative Position of the Semicircular Canals



Sectional View Showing the Relation of the Internal Ear to the External Ear

A confirmation of these experimental results was obtained by observations of certain animals which nature has provided with only one or two canals. The lamprey and the so-called "dancing mouse," a Japanese rodent, are examples. This mouse has only one fully developed canal, the others being rudimentary. It behaves as if it did not possess all of the space conceptions of the normal animal. Thus it seems to be incapable of walking straight ahead, moving diagonally instead, or in curved paths. Its most peculiar characteristic is that of spinning around and around as if dancing, frequently for hours at a time.

While these researches do not prove that we do not live in three-dimensional space, they show that our conceptions of space as possessing three fundamental directions are due to these so-called canals in the internal ear, and that if these organs are modified the sense of directional, areal and volumetric space is changed accordingly. Possibly some future experiments may yet indicate the existence of a fourth or higher dimension of space, such as has already been conceived theoretically by men of science.

AEROPLANE RANGERS FOR FOREST RESERVES

The supervisor of the Selway forest, consisting of 1,600,000 acres which was formerly part of the Nez Perces reserve in Idaho, predicts that aeroplanes and wireless telegraphy will be important factors in forest-fire prevention before a far distant date. He believes that a man in an aeroplane could do more accurate and extensive survey work in the forests of the Pacific slope country in a few hours when forest fires are raging than is usually accomplished by 20 rangers in a week. With wireless stations installed on peaks in the chief danger zones, he believes it would be a comparatively easy task to assemble men and apparatus to check and extinguish the flames and prevent spreading.

TYPHOID DEATH RATE OF AMERICA AND EUROPE

The typhoid death rate per 100,000 population of the cities of the United States, according to the accompanying

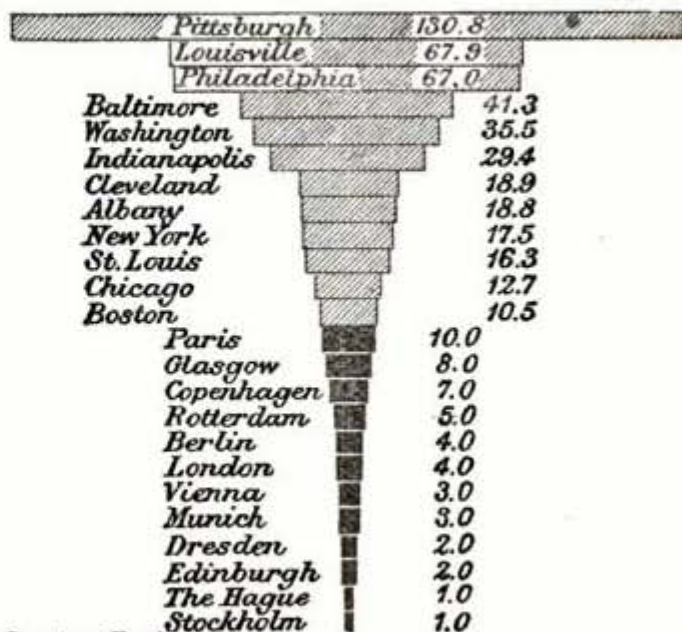

Courtesy Engineering

Twelve American Cities Head This Table of Typhoid Death Rates

table compiled by H. de B. Parsons, for an English publication, is far in advance of that of European cities, even though the water supply of the European cities is considered bad from a European standpoint. Pittsburg, for instance, according to this table, has the enormous typhoid death rate of 130 per 100,000 of its population, as against four in London, two in Edinburgh, and one in Stockholm.

"See Naples and die" is an adage which may be applied to many American cities with as much reason as to the Italian city whose beauty and unhealthiness are alike proverbial. No matter how risky water drinking may be on the Continent, it seems to be much more dangerous in many cities of the United States, the 12 cities heading those listed in the typhoid death-rate table being all American. Dangers to health and life are accepted far more readily than they are in the older countries, and small variations in the death rate attract but little attention. Then, too, in the Latin countries of Europe, a light inexpensive wine is used by even the poorer classes in place of water, which may have something to do with low typhoid death rates.

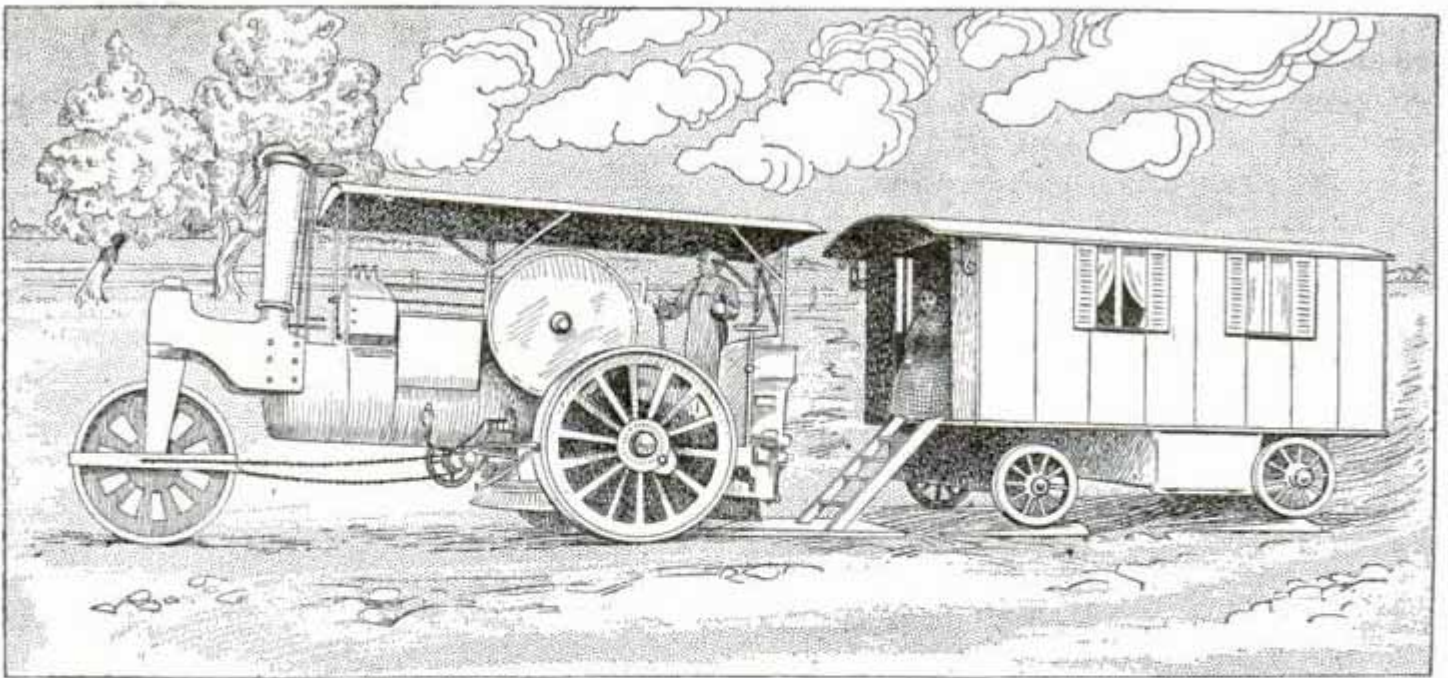

A French Road-Mender's Outfit and the Wheeled House in Which He Moves His Family About with Him

FRENCH ROAD-MENDERS LIVE ON THE ROAD

Many of the French road-makers and repairers live on the road during the six or seven months of the year they are at work. The driver of this road roller carries his family along in the caravan shown. When one road has been repaired, he moves along to the next, dragging his wheeled house behind.

BALLOON-SHAPED SUNSHADES

The new sunshades now coming into use in Paris and London when small hats are worn are called "balloon sunshades," because they resemble the



One of the Balloon Sunshades Designed to be Used When Small Hats are Worn

top of a balloon the bottom half of which has been cut away. They are being made in all colors and shades, and have four more ribs than the ordinary sunshade.

SOME UNUSUAL RAILROAD WATER-STORAGE TANKS

In the construction of a water-storage tank recently by the San Pedro, Los Angeles and Salt Lake Railway, the company took advantage of the topography of the country in a somewhat unusual way. About 400 ft. above the track level was a mass of conglomerate (closely packed gravel or shingle in a matrix of sand). A reservoir of 150,000 gal. capacity was excavated in this rock, lined with rich concrete to prevent leakage, and roofed over. A small drift was driven upward to the bottom of the tank, and a pipe laid in it to supply a standpipe alongside the track. The cost was about one-half of that for a standard steel water tank of the same capacity.

The same railroad recently built an emergency tank of 300,000 gal. capacity at another point, by excavating a reservoir in dolomite rock in the hills about two miles from the track, and cementing and roofing it over as in the other case. This tank was fitted with automatic control.

PART I—BOOK ENDS

There is practically no end to the number of useful and decorative articles that can be made of brass and copper, finished with a variety of designs and effects. It is an ideal pastime, which can be made a source of profit, training the hands in skillful work as well as developing originality and producing beautiful objects. Succeeding articles will describe how to make desk sets, blotting-pad corners, paper knives and letter openers, stationery rack, rocking blotter, desk calendars, match boxes, tie and pipe racks, whisk broom holder, candle sconce, arts and crafts jewelry, brooches, hatpins, tie pins and cuff buttons, desk clocks, hinges and drawer pulls.

IT is the intent of this and several succeeding articles to point out a few of the many artistic possibilities of brass etching that render this gentle art one of the most fascinating and least expensive of hobbies. It is fascinating because the field is almost without limit. Book ends, on which are etched attractive designs or favorite quotations; desk sets, comprising the blotter corners, stationery rack, calendar and paper knife, all etched with the same motif; arts-and-crafts jewelry, such as hatpins and watch fobs; pipe and tie racks and match holders, not to mention the many plain hammered brass and copper pieces that may be

purchased and etched in all manner of pretty designs, are among the many practical and attractive possibilities.

This art is fascinating because it affords the worker every opportunity for the display of original talent in working out new designs, and those to be illustrated in this series have been selected not so much on account of any particular artistic merit, but because they are suitable for the amateur, and serve to clearly set forth the method involved. And unless we may hope to so instruct the reader that he or she will be able to apply these methods to the carrying out of new ideas and designs, our efforts, we feel,

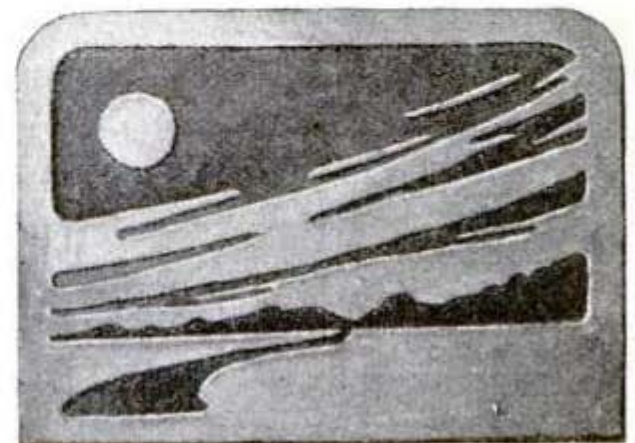
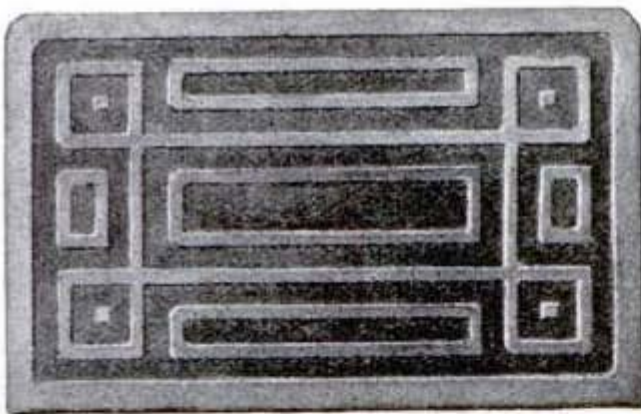

Conventional Designs for Book Ends — The Lower Design Requires Considerable Hammer Work, as the Outer Edge is Bent Over and Hammered Down Around the Top and Sides, and the Center Portion is Beaten Out

Designs for Book Ends Which Give an Idea of the Possibilities for Originality of Treatment, Adding Fascination to the Work of Making Useful and Ornamental Articles for the Home

will have been in vain. For a great many, there is undoubtedly much pleasure in working with the hands; but, when the thing made is the product of one's own originality, this pleasure is doubled.

Not only is our subject truly interesting, but the work inexpensive to carry on and does not require much space. Any convenient nook or corner where may be kept a few jars or trays of glass or crockery, a bottle of nitric acid, a small can of asphaltum paint and two or three brushes, is about all that is necessary in the way of a workshop to initiate the beginner. As the work proceeds, the results will become more perfect and therefore more interesting, so that the reader will not hesitate to invest in such few tools as the constantly increasing scope of the work may make necessary. Remember, however, that the fascination of any of the crafts lies largely in the doing of original work, so that it is better to have made some simple thing of an original design than to make a mere copy of something more elaborate. If one is on the lookout, a suggestion for a design is apt to turn up almost any place, and among the advertisements of the current magazines or in labels and fancy wrappers, one may find an idea that will serve as the starting point for several original designs.

This series has nothing in common with that department-store, brass-covered woodenware upon which the design or pattern is already clearly stamped, thus leaving nothing more to be done except the punching of this pattern full of holes. That fixed operation permits of no originality, requires no talent, very little time and a like amount of intelligence.

Book Ends

Let us suppose that the following supplies have been purchased: About a half-pound bottle of nitric acid; a like amount of turpentine or kerosene; a few cents' worth of black asphaltum paint or varnish; a small and a large water-color brush; ten cents' worth of lacquer; a sheet of carbon paper, and a piece of 16 or 18-gauge brass, measuring 6 by 7 $\frac{1}{4}$ in. A flat file and a pair of tin snips will be required sooner or later and may as well be purchased at once.



Effective Book-End Design

Square up the sheet of brass to the proper dimensions, and then round off the corners rather liberally. About three of the seven inches must now be bent to a right angle to form the base portion. This operation should be done over the sharp edge of a table or between two pieces of wood held in the vise, so that the bend may be uniform along its entire length. Upon a sheet of paper make a full-size and accurate drawing of the design to be etched, and, after thoroughly cleaning the surface of the brass, transfer the design thereto by means of the carbon transfer paper, taking due care to keep the surface clean and free from grease.

Now take the small brush and see that the asphaltum paint is of such a consistency as may be readily and accurately applied. If too thick, thin with turpentine, and then paint out all that portion of the design that is not to be etched. The larger brush will now be useful in expediting the application of the paint to the remaining portion of the face and to the entire back. That is, nothing but the darker portions shown in the illustrations should be left uncovered.

After the paint has thoroughly dried,

which may take from eight to twelve hours, the piece should be immersed in a solution composed of one part nitric acid to two parts water. In making this solution, be sure to pour in the acid last, or painful burns and damage to clothing may result. In the present instance, a glass tray, such as photographers use, will be found convenient. If after five or ten minutes the solution should bubble rather actively and throw off heavy greenish-yellow fumes, a little water should be added. The duration of the etching process will vary from one to four hours, depending on the strength of the solution and the composition of the metal. Until a little experience has been gained, it will be well to lift the brass from the solution every now and then to see how the etching is progressing.

As soon as the required depth has been obtained, remove the piece, rinse it off, and then remove the asphaltum by means of a rag after a good soaking

in kerosene. Finally, wash with soap and water, and dry. In order that the design may show up, the contrast be-

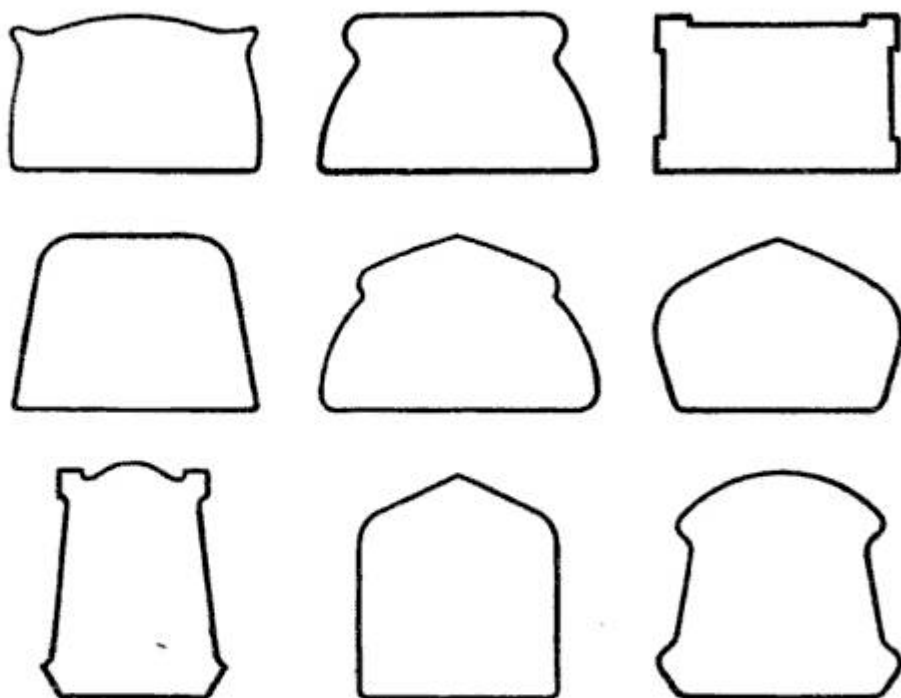

Outline Suggestions for Book Ends

tween the etched and unetched portions must be developed by means of some oxidizing agent such as a strong solution of butter of antimony, which soon darkens the clean surface of the metal. The high lights are then rubbed up with pumice or a piece of old emery cloth, after which a uniform coat of lacquer should be put on.

CELLULAR FEEDER FOR BEES

An ingeniously constructed cellular feeder for use during the early spring and fall, when nature does not provide sufficient nourishment for bees, has been designed by a French inventor. The feeder consists of a metallic box divided into five compartments. The middle one is the entrance, the end compartments contain the food supply, and the remaining two compartments are each provided with 250 feeding cells, which are perfect counterfeits of the cells of a bee comb. The food, which consists of syrup made of sugar, is poured into the end compartments and flows into the feed cells through notches in the bottoms of the

partition walls. The syrup only moistens the lower part of the cells, and the bees, each one selecting a cell, feed upon it undisturbed by neighboring

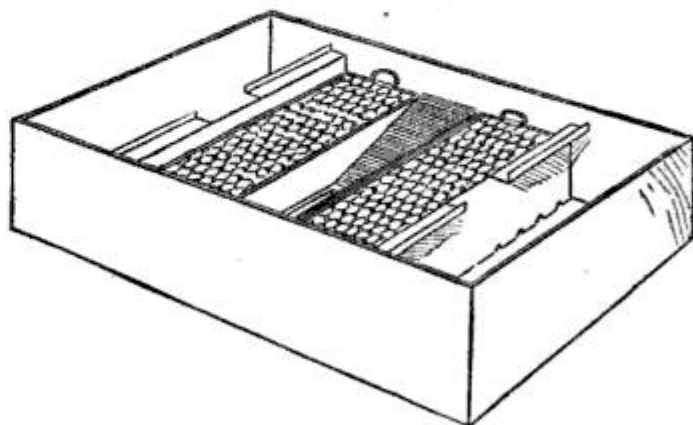

An Individual Feeding Cell for Each Bee

bees. Two inclined runways lead from the entrance compartment to the cell compartments.

POLYNESIAN IDOLS

Although the greater number of the Polynesian idols are in the image of man, some of those found in the Her-

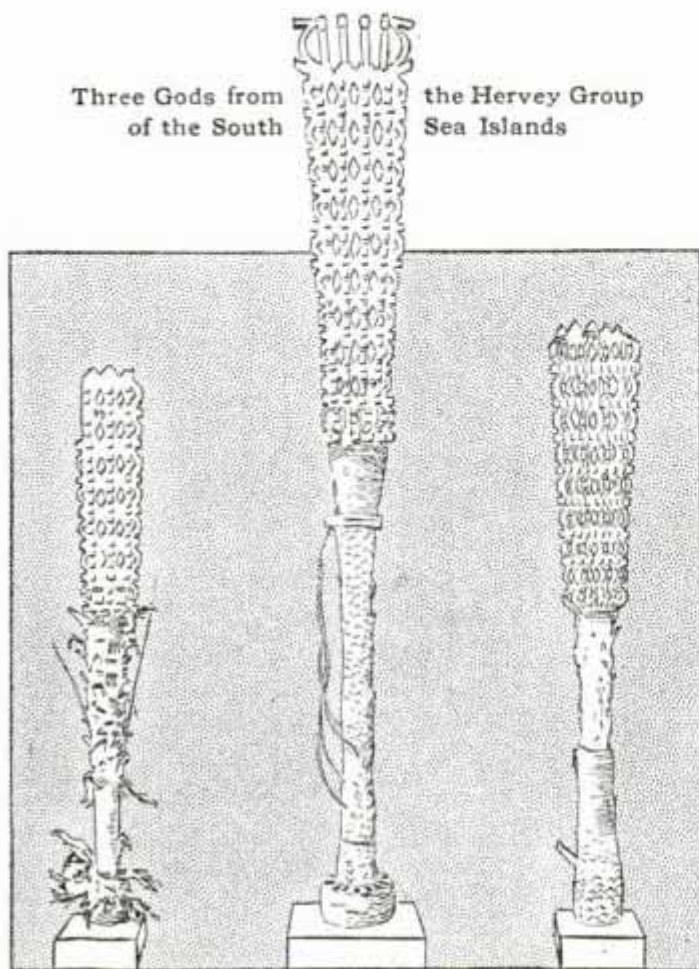

Three Gods from
of the South

the Hervey Group
Sea Islands

vey group of the South Sea Islands are simply shafts, 4 or 5 ft. high, elaborately carved, with the stems bound round with cord. These are described as "district gods."

GREAT FIELD FOR SLAG IN CONCRETE MAKING

In the modern striving toward the conservation of our natural resources, the steel industry has played a not unimportant part. For many years the slag produced from the blast furnaces, amounting in this country to over 10,000,000 tons a year, has been practically a waste by-product, although within recent times it has been and is being used with some success to make paving bricks, as a base in the manufacture of Portland cement, for railroad ballast, and macadam in road building, etc. But these industries

account for only a small percentage of the total yearly product.

Recently a big steel company of Pennsylvania made a series of tests on the use of slag in concrete making, and as a result it has announced that a mixture of 1 part cement, 3 parts sand, and 6 parts slag forms a fine quality of concrete, if the slag is treated in a special way and the mixture is properly made. These tests would seem to indicate a great field for blast-furnace slag in the concrete industry.

LIFTING FIRE HOSE BY BUILDING ELEVATORS

The latest idea for raising water for fire-extinguishing purposes to the uppermost floors of tall buildings is to lift the hose by means of the passenger or freight elevators. A simple attachment is provided for affixing the hose to the floor of the elevator, the pipe being coiled up in the bottom of the shaft so as to be easily raised.

In a recent demonstration at Memphis, Tenn., it was said that the water arrived at the sixth floor of a building practically as soon as the floor was reached by the elevator, and the fire

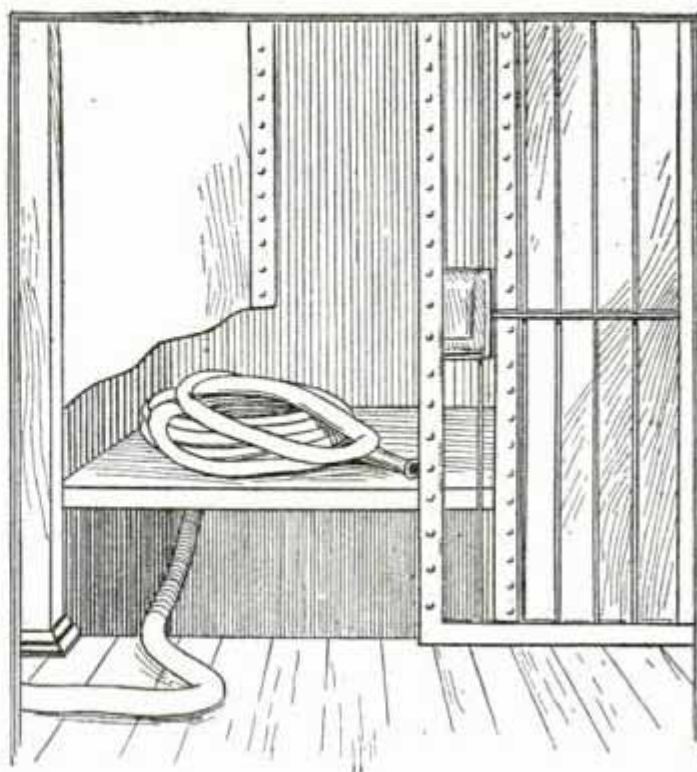

The Elevator Hose Conveyor

chief of that city recommended the compulsory adoption of the device by all buildings provided with elevators. The hose is inserted in the attachment about two sections behind the discharge nozzle, these sections being coiled on the elevator floor.

GEARED RATCHET LIFTING JACK FOR AUTOS

This geared ratchet automobile jack embodies several interesting features, among which are the lifting arms or antlers. The working mechanism is simple and easy to operate. A pinion meshes with the large gear wheel, the motion being imparted from the gear-wheel shaft to a pinion engaging a rack on the tube which slides up and down in the frame. The tube is

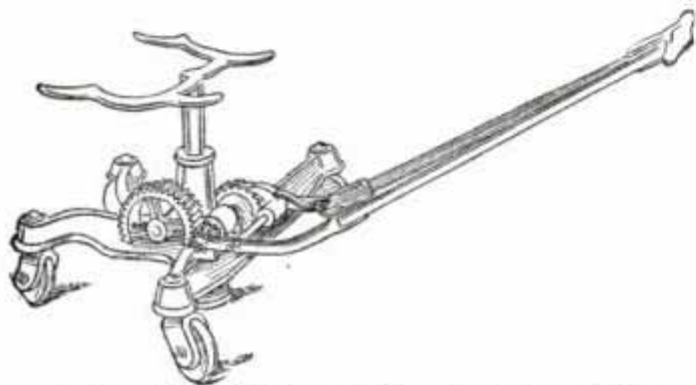

A New Geared Ratchet Lifting Jack Especially Designed for Automobile Garages

threaded on the inside, and into it screws the arms, which are called antlers because of their peculiar shape. The antler form was adopted as one which would fit the rear axle of any make of automobile. The short horns are for lifting front axles, but the others may also be used for this purpose.

The jack is mounted on four rubber-tired casters, with both ball and roller bearings.

ADJUSTABLE WRENCH SET

A wrench, whose heads or sockets can be adjusted to any position, enabling the user to get at nuts and bolts in difficult positions or in close corners, is here shown. The set consists of a telescopic extension reversible ratchet handle and 12 wrench heads. The dif-

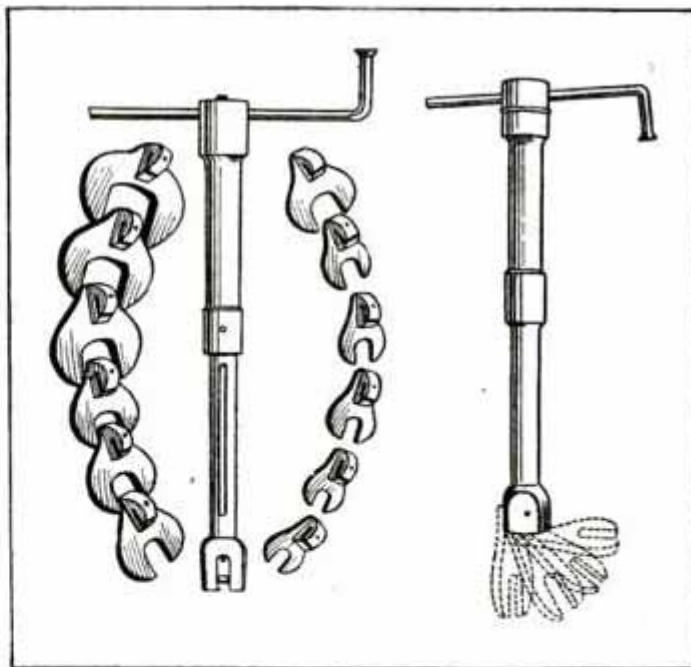

The Handle and 12 Wrench Heads

Showing Different Positions of Heads

ferent positions in which any one of the wrench heads in the set may be fixed for use is shown in one of the drawings.

CLEVERLY CONSTRUCTED CARD TABLE

A cleverly constructed card table, provided with sliding boxes in a circular running groove for each player's chips, cigars, ashes, etc., is here shown. It is adjustable to any number of players up to seven or eight, depending upon the size of the table, and can be reduced to accommodate a smaller



Card Table Provided with Sliding Boxes, in a Circular Running Groove

number of players by removing the sliding boxes. The table is provided with a removable top, so that it may be used as a center table, as for a library or dining room.

BELLOWS VACUUM CLEANER

In this hand-operated vacuum cleaner, which has been recently placed on the market, a bellows, strapped to



A Vacuum Cleaner Operated by Means of a Bellows Attached to the Back

the back and around the waist, provides the suction. A lever, worked to and fro by the left hand, operates the bellows, and the right hand directs the suction nozzle. The dust is drawn into the bellows, where it is confined by means of porous felt. The apparatus weighs only $5\frac{1}{2}$ lb.

☞ A German fish dealer has had a special car built for transporting live fish through long distances, the fish being kept in water which is constantly aerated by a motor-driven pump.

HAILSTORM PROTECTION IN FRANCE

Working on the theory that hailstorms are closely associated with the electrical conditions of the upper atmosphere, a French inventor has constructed a line of lightning conductors of special design and $6\frac{1}{4}$ miles long, which it is proposed to extend right across France from east to west, with a view not only to protect against lightning discharges but to prevent the occurrence of hailstorms which often do great damage to the crops.

The lightning conductors, which their originator calls "electric Niagaras," comprise large sheets of electrically deposited copper provided on top with a special system of points and connected electrically with a water-bearing stratum in the earth below. Large surfaces, rather than great weights, are essential to carry off lightning discharges, which, on account of their oscillatory nature, are disposed to travel on the outside of electrical conductors instead of throughout their whole substance, as is the case with direct-current electrical discharges.

A PRINCE EDWARD ISLAND TUNNEL

One of the quaintest islands of the North American continent which, on account of its being cut off from the mainland by ice from about December to April, is living according to the ideas of at least half a century ago, will shortly have the chance to catch up with modern American progress, if present plans are approved. This new-world island with old-world customs is Prince Edward Island, in the Gulf of St. Lawrence. It is proposed to connect the island with the mainland of Canada by building a tunnel between Cape Traverse and Cape Tormentine, at an estimated cost of \$15,000,000.

There are practically no manufactures on the island, which depends for its livelihood on its agriculture and fishing and a few occasional tourists. Labor is cheap and abundant.

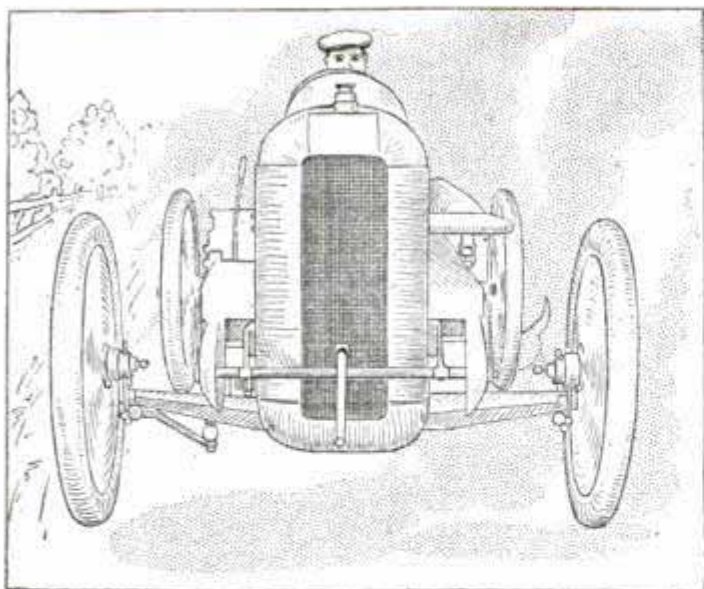

Showing Radiator and Front Carriage of Racing Automobile

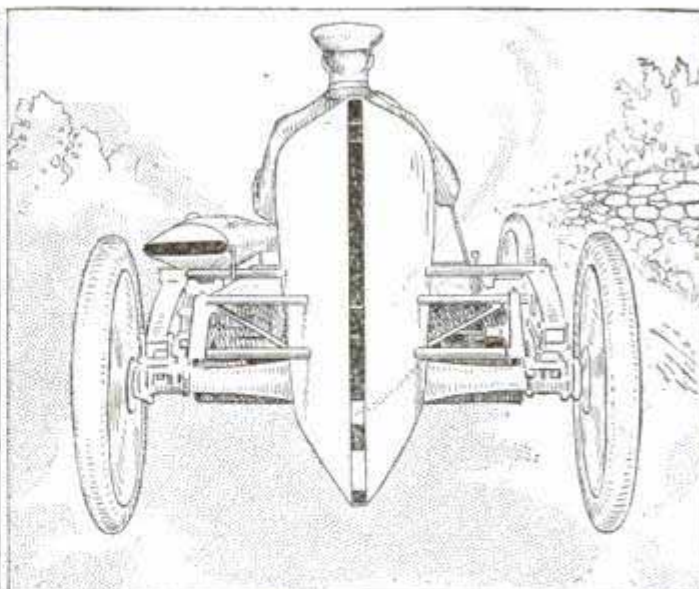

A Curious Rear View Showing Ventilation Slot in Body

AUTO DESIGNED TO MINIMIZE AIR RESISTANCE

Front and rear views of a new English racing automobile are shown in the accompanying illustrations. The car presents a curious effect when viewed either from the front or the rear. The slot down the center of the rear end is for ventilation purposes.

BODILY RECUPERATION AND PHYSICAL LAW

That the human body recuperates from fatigue according to the same law by which a heated substance becomes cooled, is the latest discovery of a French scientist, and this seems to be borne out by experience. Thus a short period of rest suffices to prepare a person for new exertion after heavy but not protracted work, while a longer rest is necessary after continuous work of a lighter nature.

This new theory should be of interest to those who are developing the modern science of "scientific management" which aims to produce the maximum amount of work per day from a worker by carefully regulating the amount and duration of his periods of labor and intervening rests.

¶ There are 100 firms and individuals engaged in the manufacture of aeroplanes and aeroplane motors in the German empire.

SIMPLE CYLINDER-BORE MEASURING DEVICE

A simple but remarkably effective device for measuring the bore of an engine cylinder without disassembling any

of the principal parts has recently been invented. The instrument comprises two legs or feelers which are introduced through the compression or relief-cock hole and expanded until their ends touch the cylinder walls, the dimension being registered on the dial. These legs

or feelers are moved by a tiny cam which is actuated by pressing down a slide with the thumb. The instrument is carried in a small morocco case.

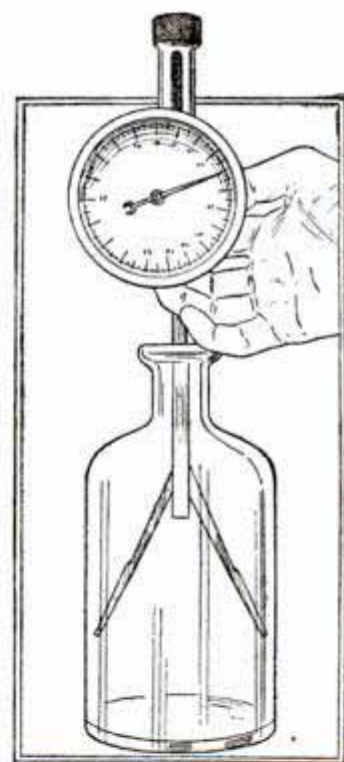

¶ Japan has recently been given a child-labor law that prohibits the employment of any person under 12 years of age, or the employment of any women or children under 15 years of age for more than 12 hours daily.

HOW TO MAKE A LAMP STAND

A mission table lamp stand for those who use electric lights is shown in the accompanying illustration. It is suitable for either the office or the home and is very simple in design and construction. The stock should be quarter-sawed oak and it can be ordered from the mill ready cut to length, squared

the detail sketch. A mortise, 1 in. square, is cut in the center of the blocks for the center post. Lead weights, covered with felt, should be attached to the bottom, as shown. The post has a tenon cut on one end to fit the base, and a mortise cut in the other for the arm. Holes are bored in the arm from

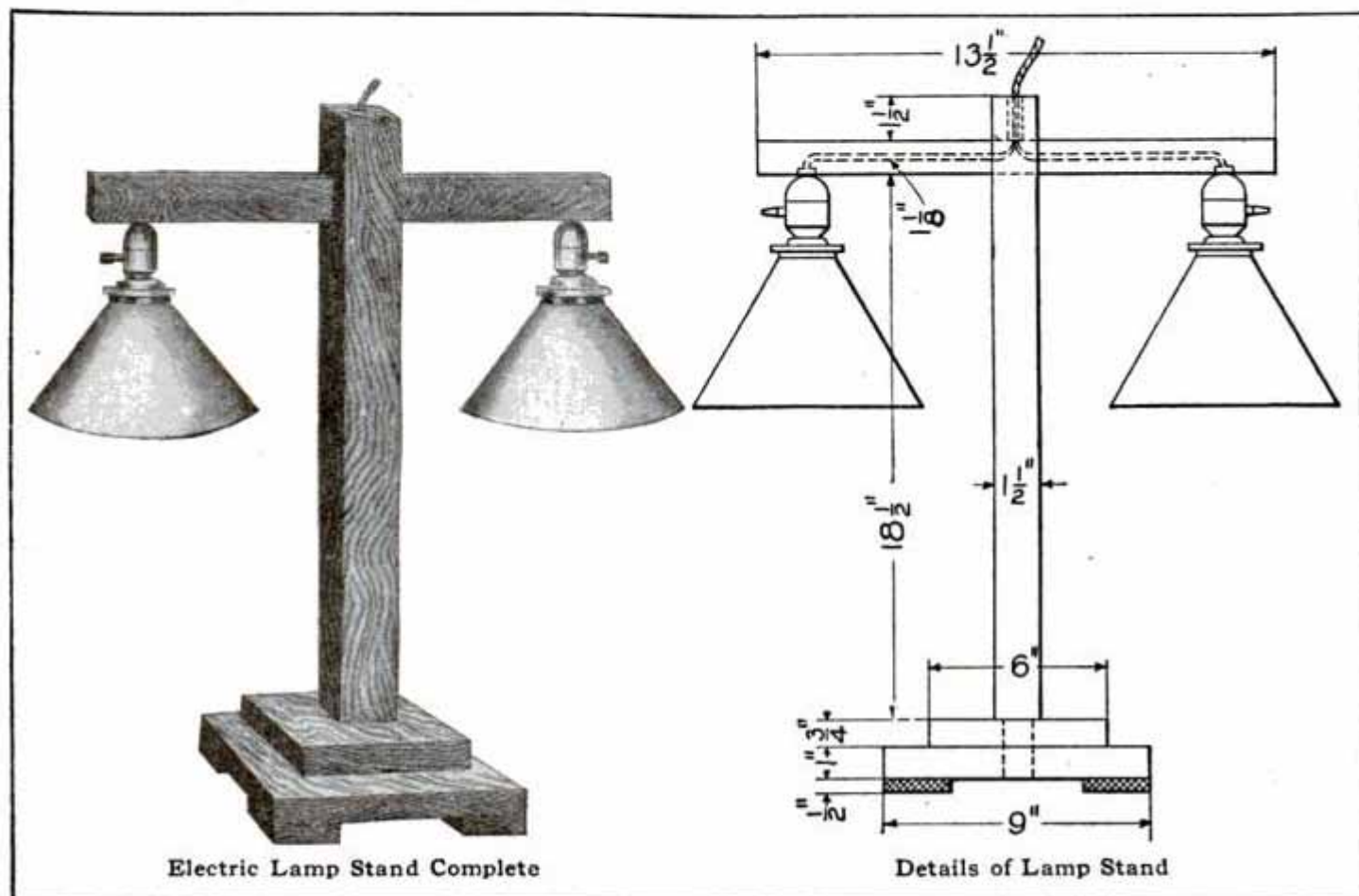

Electric Lamp Stand Complete

Details of Lamp Stand

and sanded. The following pieces will be needed:

- 1 post, 1 1/2 in. sq. by 23 in.
- 1 arm, 1 1/8 by 3/4 by 13 1/2 in.
- 1 block, 3/4 in. thick by 6 in. square.
- 1 block, 1 in. thick by 9 in. square.

Square up the base blocks and fasten them together with screws as shown in

the ends for the wires. They can be plugged after the wires are in place. A hole is also bored in the top of the center post to connect with the holes in the arm for the lead wire. It is best to glue the joints together. Sandpaper the parts thoroughly, and stain.

ENGLAND'S ONE MONOPOLY IS CHINA CLAY

The only industry which the British are believed to have exclusively in their own hands is the production of China clay, used for the manufacture of highly finished paper, in the ceramic arts and the textile trade. The greater part, if not all of the product now comes from Devonshire and Cornwall, the latter producing by far the greater portion. The production is estimated

at 2,076,682 tons, annually, for the two sections, the value being set at 761,521 pounds sterling, or \$3,700,992. China clay is believed to be decomposed granite although scientists differ as to its exact origin. It is obtained in a simple manner which requires no great technical skill. It is usually found in beds shaped like a bowl or basin, between granite hills and is covered by

what is termed an "overburden" which varies in thickness from 6 ft. to 40 ft. A pit is formed by removing the overburden and a shaft is sunk outside the bed on more solid ground conveniently near. A passage called an "adit level," being almost horizontal but sloped enough for drainage, is driven from the shaft into the bed of clay. A stream of water is turned into the top of the pit and runs down over the face of the clay. Workmen stamp about in the pit to dislodge the clay, which then flows in liquid form into a hole in the bottom of the pit through the adit level to the bottom of the shaft, from whence it is pumped to the surface. Sand, mica and other impurities in the clay are separated in what is known as a "mica drag," a tank or basin so arranged that the mica and other particles fall from the clay proper by force of gravity. The clay is then passed into settling tanks and from these the water is drawn off and the deposit of clay removed to the kiln where it is dried in blocks. In this form it is shipped to the potteries or other factories using it. There are several grades of the clay and the supply of none of them is quite equal to the demand. In the United States a clay that has some of the characteristics of the China clay is found in the South and is called "edible" clay from the fact that many people eat it and the further fact that pottery clays are often tested by being chewed, that which remains in a gummy state after chewing being regarded as of good grade.

COMBINED CANE AND CAMP STOOL

This new French novelty cane is made of light but very strong steel tubing and can be taken apart and set up as a stool in about 30 seconds without the use of any part not contained in the cane. The unscrewing and drawing out of one end of the handle brings to light three holes, into which are inserted the three lower sections of the cane tubing, thus forming the seat. In-

side the cane tubing are the three legs forming the tripod. These are joined to a head which screws into the top section of the cane tubing.

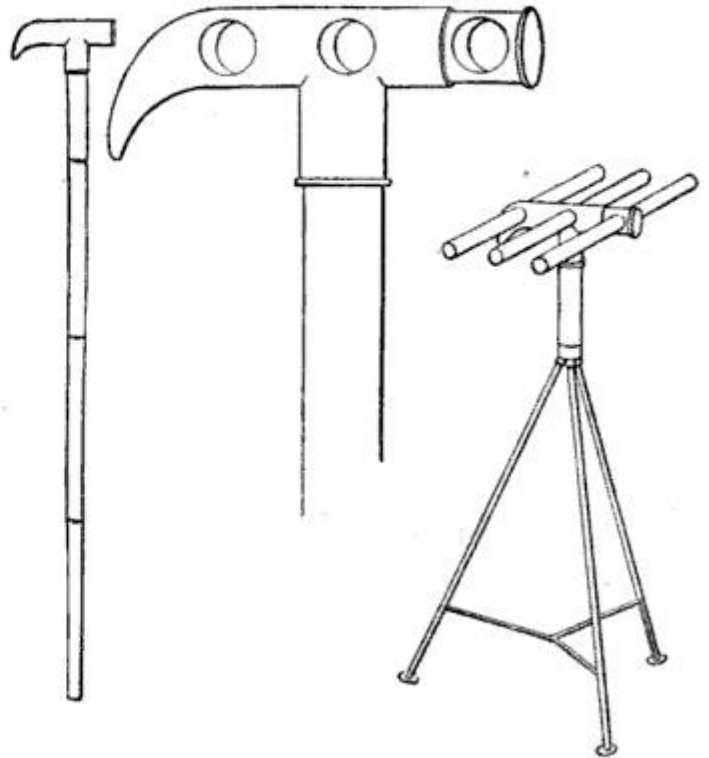

A Cane That can be Changed into a Stool in 30 Seconds

The seat thus formed is the average height of the ordinary stool and will support a weight of two or three hundred pounds. The device is designed especially for sportsmen, tourists and painters.

NEW TURBO-LOCOMOTIVE WITH NOVEL FEATURES

A small turbo-locomotive with a turbine designed on entirely new principles is reported to have given favorable results in its recent try-out at Milan, Italy.

The turbine has four sets of movable blades, operated in series, and at high speed the steam strikes the first set of blades only, while at intermediate speeds two or three sets are utilized. The reversing mechanism is unique. On the rotating elements there are two sets of blades curved in opposite directions. When running in one direction, the steam passes over the blades at the outer circumference from left to right; when running in the reverse direction, the steam passes over the other set of blades from right

to left. The energy loss due to the blowing action of the additional set of blades is very small, amounting to from 2 to 3 per cent of the total. The steam consumption on test did not exceed 38 lb. per horsepower per hour.

PORTABLE SHOWER AND FRICTION BATH

This novel portable bath outfit is being introduced in Australia. It comprises a metallic container, a rubber

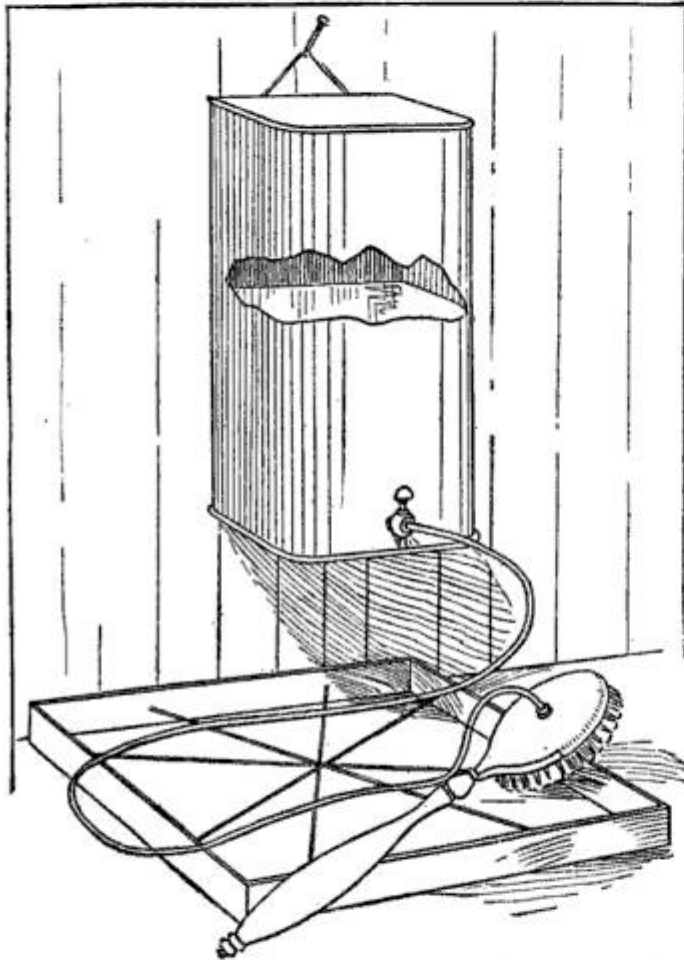

Shower or Friction Bath with Portable Bath Outfit

hose, a shower brush, and a light tray to receive the spent water. The container, filled with a gallon or two of water, hot or cold, is hung on a hook or placed on a raised shelf. The bath combines cleansing, friction, massage and shower, through the proper manipulation of the brush.

NEW USES FOR ROAD DRAGS

The road drag was an invention of a resident of Missouri. It has remained for other Missourians to find new uses for it, says Engineering and Contracting. For example, a farmer living near

Columbia, Mo., has used his road drag for carrying produce to town, thus improving the road and at the same time saving the wear on his wagon. Another farmer has gone a step further and combined business with pleasure. His wife wished to visit a neighbor living about a mile away. As he was using his team to haul a road drag, he made a seat on the drag and hauled his wife to the neighbor's and later brought her home in the same way. A still further use for the road drag has been suggested. This is the requiring of all joy-riding motor cars to tow road drags, thus improving the roads and at the same time reducing the speed of the cars. It might also be suggested that road overseers who neglect the roads in their charge, should be required to ride on the road drags attached to the joy-riding cars. This would add the ballast necessary to make the road drag hit the ground occasionally.

TESTING MATERIALS WITH A SAND BLAST

The sand blast—a spray of sand blown by compressed air—has long been used for cutting and abrading materials, but it has remained for a German scientist to apply it for testing building materials. A blast of fine quartz sand under an air pressure of two atmospheres was used to test the resisting qualities of granite, pine, linoleum, and other substances, in some recent experiments at the Gross-Lichterfelde Institute, Germany, and furnished a good means of comparing the wearing qualities of these materials in external and internal building construction. The time of each test was two minutes.

CA French aeroplane manufacturer recently offered five of his monoplanes for sale on the installment or "easy-payment" plan to licensed aviators, the only condition being that the machines and the purchasing airmen take part in the aviation meets of the year in France.

The Kingdom of Dust

By J. Gordon Ogden, Ph. D.

THIS is the eighth of a series of articles by Dr. Ogden, who is professor of physics at the Fifth Avenue High School, Pittsburg, Pa. In every home, in every office, in every shop or factory, the fight against Dust is never-ending. Dr. Ogden illuminates this subject in a manner which brings a realization of its infinite importance.

VIII—The Right Hand of Death

MOST of us are familiar with the beautiful and artistic conception of French, wherein a young sculptor who is plying his magic chisel upon a block of stone, and summoning from the snowy depths of the marble the dream face of his soul's ideal, is gently touched by the wistful-eyed Angel of Death, and the skillful arm forever stayed. The whole creation is marvelously beautiful and the world is better for its birth. Nevertheless it is allegorical and misleading.

The real Angel of Death in the case of the thin-faced sculptor was not a sad-visaged maiden of classical profile. In all probability it was a minute, rod-like organism floating amid motes of dust and known to scientists as the "bacillus tuberculosis." The writer does not want to be a shatterer of ideals, but the sooner such poetic notions of death are done away with, and the mass of the people educated in a commonsense way to the dangers of dust and bacteria, the better it will be for humanity in general.

Death is likewise represented as a

scythe. A truer representation of the king of terrors would be a round-cheeked housemaid wielding a broom and dust-cloth, or a cloud of dust stirred up by the passage of an automobile along a crowded dirty street.

Bacteria are tiny little plants, so small that 50,000 of some varieties may be placed in single file along a line one inch in length. They are barely visible under the highest power of the microscope, and there is no doubt that there are untold myriads of bacteria that are absolutely beyond the limits of definition of any microscope as yet known to science.

Although these bacteria are so minute, they make up in numbers what they lack in size, and if the animal life of the globe from the elephant down to the flea were to be aggregated into one mass, this mass would probably be far less than the aggregate of all the microscopic forms of life, animal and vegetable.

Bacteria are divided into three great classes—the spherical, known as cocci; the rod-shaped, known as bacilli and bacteria, and the spiral. It was orig-



"THE ANGEL OF DEATH"
Conception of Death of Young Artist by French, the
Famous Sculptor

inally thought that bacteria were animals, as some of them, such as the bacilli, have the power of moving from place to place. It is a well known fact, however, that many plants possess the power of locomotion, and it is now admitted that bacteria are plants.

This power of locomotion, possessed by many bacteria, is due to locomotor organs known as "flagellæ." The flagellæ are tiny hairs that whip and lash the fluid in which the bacteria flourish, and thus cause motion. The simplest of all the bacteria types is the coccus. The cocci consist of tiny spheres, without the slightest evidence of any internal structure. Sometimes they form long threads or chains, while others of the same general species form irregular masses, resembling cannon balls piled into the form of a cube. The rod-shaped bacteria are, as the name would indicate, tiny rods that lengthen and break up into smaller rods, which in turn repeat the process indefinitely, as in this manner they are reproduced.

A bacillus is one of the rod-shaped bacteria that have flagellæ, and is, consequently, capable of motion; while a bacterium proper is rod-shaped, but has no flagellæ. The spiral bacteria are less often met with, and like all other kinds of bacteria, may or may not have flagellæ.

In a preceding article it was pointed out that yeasts and bacteria are fungi. A yeast, however, is known as a budding fungus, as the new individuals

appear as buds on the older cells. Bacteria, on the other hand, reproduce almost entirely by "fission," or the splitting of the parent cells. We say "almost entirely,"

because it sometimes happens that bacteria reproduce by means of spores that germinate into individual bacteria. So far as human life and disease are concerned, the formation of these spores is especially important in that they are much harder to kill than the bac-

teria themselves. For example, they can be dried perfectly, whirled along in a cloud of dust, and be ready for active work as soon as they reach the proper medium. They will withstand greater extremes of temperature, likewise, and are therefore exceedingly persistent.

Some bacteria have the power of reproducing themselves every half hour. Let the reader sit down quietly with pencil and paper and figure out what the progeny of such a micro-organism would be at the end of 24 hours. In other words, multiply the number two by itself 47 times. One can hardly realize the

frightful rapidity with which bacteria multiply unless some such calculation is made. Of course, they do not all live. Hence we live, and have some chance to remain alive.

As has been stated, the number of bacteria is legion. Fortunately for us, the greater part are harmless, and some are beneficial to man; but there are enough of the deadly kinds to more

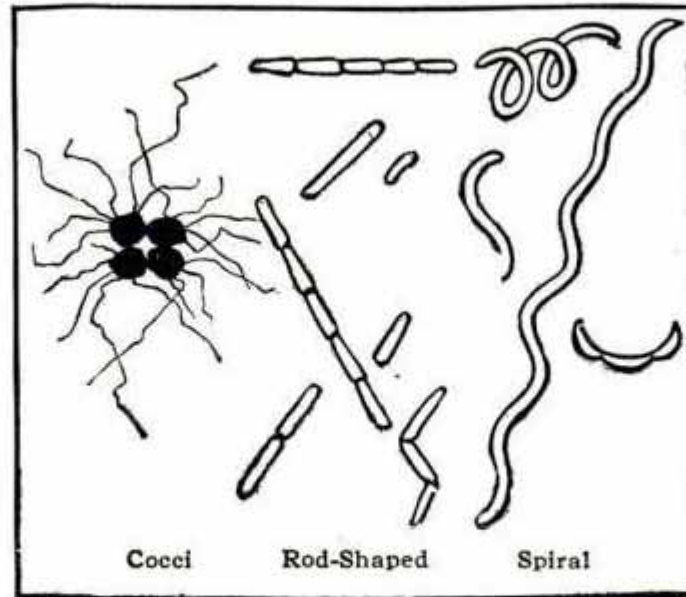

Three Types of Bacteria Which Cause Disease



Fig. 1—Petri Plate Exposed in Lecture Hall of Fifth Avenue High School, 8 a. m., before the Arrival of Pupils



Fig. 2—Similar Plate Exposed in Same Place at Noon Recess, Showing Mold and Colonies of Bacteria Collected

than offset the good done by the benignant types.

As regards the distribution of bacteria, they are practically everywhere on the globe. In crowded cities, in purling brooks, on lofty mountain tops, in shaded vales, in Arctic wastes, and in tropical forests; frozen by winter's icy blasts, or baked by the withering simoon of the desert, they live and move and have their being. They are found in the ice in our refrigerators, the bread in the oven, the cream in the pitcher, the vegetables in the garden, and the meat on the butcher's stall. The human mouth contains as many as 27 different varieties of these children of the dust.

Even under the most unfavorable conditions, they thrive to a certain extent. For example, in the Boston City Hospital, where the most rigid sanitary conditions prevail, the number of living bacteria to every cubic foot of air was found to be 1,350, and of

molds, 675. In Central Park, New York, 1,500 bacteria were found in every cubic foot of the presumably pure air of that favored resort.

The number of bacteria in a given quantity of air or other container, is ascertained by what is known as the "culture" method. A thin bouillon or soup is made from gelatine, peptone, and Liebig's extract of beef, or from agar-agar (a preparation derived from Iceland moss).

This medium is first rendered sterile by dry steam. It is then placed in a small glass dish known as a Petri plate, about $3\frac{3}{4}$ in. in diameter, and allowed to harden, after having been securely covered with a glass plate. These plates are then exposed for a few minutes to the air, and the dust particles settle on them. They are then closed and kept at a temperature of about 70 deg. Fahr. for two or three days, when a number of colonies appear, made up of molds of bacteria. Figures 1 and 2



Possibly Our City Fathers may Learn, Some Day, that the Hose and not the Sweeper should be Used on the Public Highways

show the result of such exposures in the lecture room of the Fifth Avenue High School, Pittsburg. Those in Fig. 1 were exposed for a few minutes at 8 a. m. while the room was practically free from bacteria, as the pupils had not arrived, and there was comparatively little dust. Figure 2 shows the result of a two-minute exposure at noon, immediately after the passage of a large class through the room. The larger form in the center of the plate is a mold while the small dots around it are colonies of bacteria.

A five-minute exposure of Petri plates on a public street where the sweepers have just passed in their unsanitary, death-dealing march, revealed the presence of 5,810 living germs in the small space of less than four inches. Possibly our city fathers may learn, some day, that the hose and not the sweeper should be used in the public highways.

Bacteria cause three classes of diseases. In the first class, of which pneumonia is the type, the bacteria enter the general blood circulation of the body and reproduce enormous numbers of the tiny plants that feed on the tissues of the organs infected, or else produce loss of function of the organ by clogging the cells. Bacteria of this class produce what are commonly known as septic diseases.

In the second class, of which diphtheria and lockjaw are the types, the bacteria, like those of the first class, settle in some part of the body, but in addition, they produce poisons known as toxins, that are carried throughout the body. These toxins are concentrated poisons that cause cell death. The blood carries the toxin to all parts of the body, while the bacteria that produce the toxins do not leave the part of the body originally infested. It is generally conceded that a cell, once infected, must die, and the only possible hope in cases of diseases of this class, is the formation of an antidote, or "antitoxin," as it is termed. This the body can do, and very often does. Sometimes, however, it takes too long

for the body to do this, and the toxins, untrammled, poison enough of the cells to produce death. The knowledge that toxins are formed in the body has proved to be of enormous value, as antitoxins, which neutralize the poisons, have been artificially prepared. The antitoxin of diphtheria, for example, has cut down the mortality from this erstwhile plague of childhood, from 90 per cent to practically zero, as it is an infallible cure when administered in time.

The third class of bacteria-caused diseases is represented by typhoid fever. In this class not only do the bacteria enter into the circulation, but their toxins likewise move freely throughout the system.

To which of these classes belongs the great white plague, the right hand of death, is not known. Curiously enough although so much study has been given to this dread disease, tenfold more than to any other ailment of the human race, we do not know whether Koch's famous bacillus kills by multiplying in the tissues, or by producing poisons that destroy the cells.

It would be useless for the writer to attempt to convince any of his readers of the frightful mortality due to "consumption," the older and better name for tuberculosis. Every one is already convinced. More than half of all the deaths in the world, from the equator to the poles, is due to this destroyer.

And the pity of it is that it is avoidable! If the excreta from consumptive and typhoid patients were to be destroyed, instead of being sent into the Kingdom of Dust, in a single year both diseases would disappear from this planet. Consumption is dust-borne. Typhoid fever is water-borne, or milk-borne. In accordance with the germ theory of diseases, so generally accepted, if we would destroy the germs, there would be an end of the disease.

Unfortunately, the chosen places of the earth, climatically speaking, such as Denver and Asheville, where the natural conditions are most favorable

for patients suffering from tuberculosis, have become hot-beds for the growth and dissemination of this disease. By every train, sufferers come to these places, and congregate in a comparatively narrow area. Every swirl of dust in these centers of infection carries more germs than are to be found anywhere else, and it is almost a miracle when any one recovers in these nurseries of germs, the conditions, other than climatic, being so adverse.

What shall we say of the careless men and women, who deliberately eject into the public streets, highways, and conveyances, sputum that may contain billions of germs, which, when they are dried, shall join the Kingdom of Dust, as the right hand of death? Were a man to run amuck through the crowded streets of our cities, stabbing and shooting, right and left, what would be done with him? In self-defense, one would shoot him down as though he were a beast of prey. And yet, he

would be comparatively harmless, as he could wound or kill only a few people before he were stopped. Yet we permit the well dressed gentleman or lady, educated and apparently refined, to expectorate upon the streets, although we know, absolutely know, that their sputa might and probably will, cause hundreds of thousands of deaths. Such unfortunates are infinitely more dangerous to the welfare of mankind than the poor madman who runs amuck, and is shot down as a beast.

If we are to fight the great white plague, it must be through the means given to us by science. We know the cause. We know how to stamp it out. Stringent laws concerning expectoration and the disposal of excreta should be passed by every law-making body in the world, and the people made to save themselves from the terrible, frightful punishment inflicted upon them by the bacillus tuberculosis, the grewsome right hand of death.

KEROSENE GAS-PRODUCER FOR GASOLINE ENGINE

Gasoline-engine experts and operators will be interested in a new device which, if the claims for it are substantiated in practice—and the manufacturers are said to guarantee them—will enable any two-cycle or four-cycle gasoline engine of standard make to be run with kerosene as a fuel, with perfect combustion, no increase in fuel consumption, and no decrease in power.

This device is known as a hydrocarbon-gas producer. It is quite a simple affair, cylindrical in shape, about 14 in. long and 6 in. in diameter. It has no moving parts, and, when once attached to the engine, becomes a permanent fixture and requires no attention whatever. When it is installed on an engine, the fuel is drawn in through an atomizer and induced by the suction of the engine to go through passages heated by the exhaust, so that the action is entirely

automatic and the fuel supply is in proportion to the demands of the engine under all conditions of speed and load.

The producer is said to be applicable both to stationary and automobile engines, to produce perfect combustion of the fuel, and thus absolutely insure a smokeless exhaust and clean cylinders.

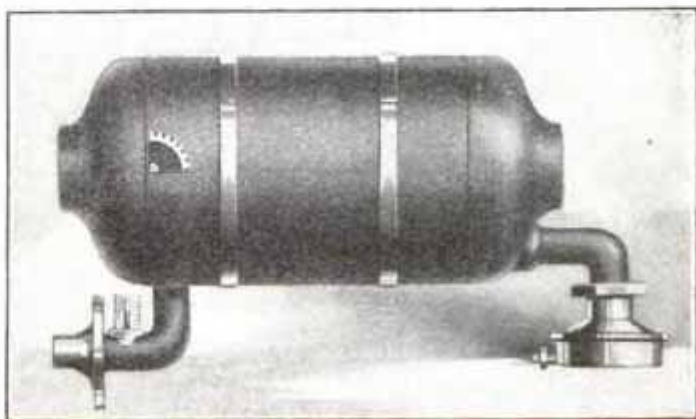

A Simple Device That Enables Any Standard Make of Internal-Combustion Engine to Run on Kerosene as a Fuel

PERUVIAN SAIL BOAT MADE OF REEDS

Among the most curious of the South American native boats is the "balsa" of Peru. This boat is made entirely of

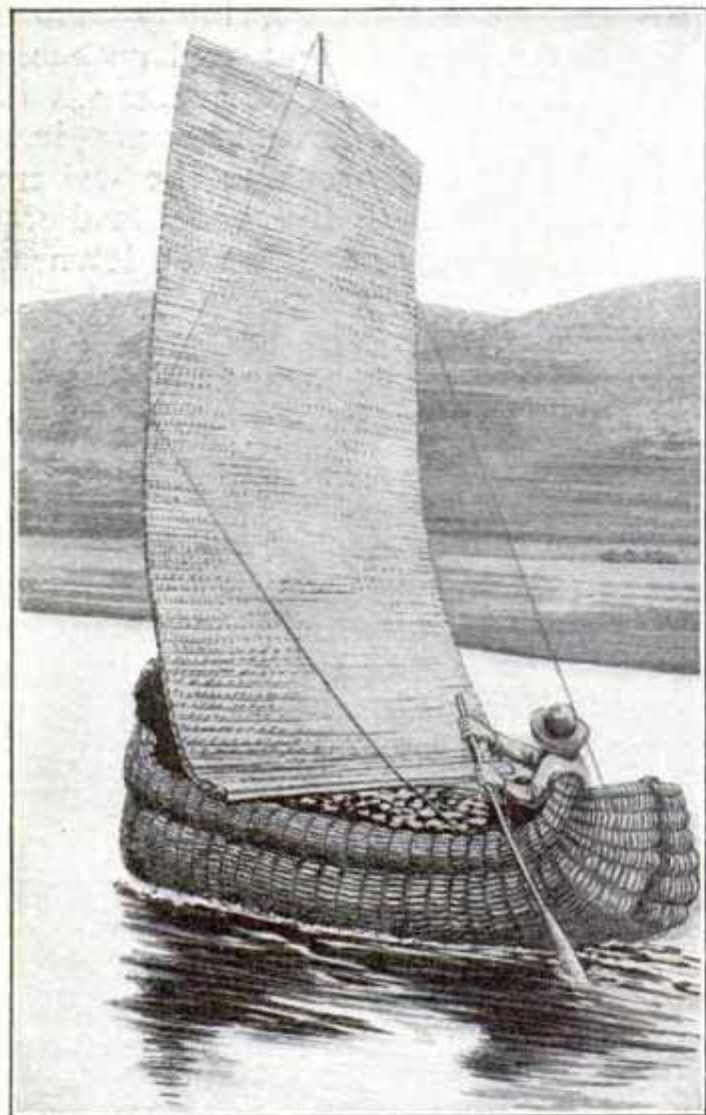

Peruvian Sailboat Made Entirely of Reeds and Straw reeds and straw, and has a curiously shaped bow and stern. The sail is of straw, and a long pole is used to steer and to help push the boat along.

THE MANUFACTURE OF ARTIFICIAL EYES

Unauthenticated accounts seem to show that man utilized artificial eyes in early times, but the first reliable report was given by the French surgeon Ambroise Paré in 1560. Two kinds of artificial eyes were known to him, the "ekblepharos" and the "hypoblepharos," the first consisting of painting the eye and all the surrounding parts as far as the brows on a plate, which was placed in front of the eye socket and held in

position by a string tied over the head. The second was used in a manner similar to that of today, being put behind the eyelid, in the eye socket itself, and was composed of a copper, silver or gold shell, covered with enamel and glass fusions.

It was not until the close of the 18th century that it was found possible to do away with the metal shell altogether and employ only enamel and glass, the material then coming into use being a soft lead glass, easily shaped, but also easily destructible. As late as 1880 all artificial eyes, no matter where made, showed a pronounced boundary line between the iris and the outer covering of the eye. These parts touched each other sharply, while in the human organ the outer covering turns into a transparent coat called the cornea and is lined with a highly pigmented membrane called the choroid, which changes according to the state of health of the eye. Attempts to imitate this peculiarity of nature were finally successful, so that now this choroid can be produced to suit every case.

With the above discovery, the last link in the chain for producing a successful imitation of the iris was found, but the shaping of the eye still required improvement. The latest result is called the "reform eye." It must be made to fit the eye socket exactly, and in most cases can be worn even at night.

The artificial-eye industry of Germany centers about Lauscha, which is near Coburg. It is a house industry, the eyes usually being made by one member of the family, who hands the art down to the next generation. A gas flame is used for melting the glass, and the manufacture is as follows: A small drop of white glass is put on the white blown ball from which the sclerotic or outer covering of the eye is to be made, and is then blown so as to make a circle about 0.315 in. in diameter. On this circle the structure of the iris is built by means of thin, variously colored glass rods. A drop of black glass makes the pupil, crystal glass is melted over the finished iris in order to

imitate the cornea, and by means of a thin, pointed red rod, the blood vessels to be seen on the hard coat of the human eye are melted in.

ARROW POINTS DIRECTION MOTOR CAR WILL TAKE

One of the simplest and most easily understood mechanisms for indicating to traffic in the rear the direction a motor car is about to take, is shown in the accompanying illustration. It is a large arrow, attached to the rear of the car just to one side of the license number, and actuated by a simple hand lever. When the car is running straight ahead, the arrow points vertically; but when a turn to right is con-

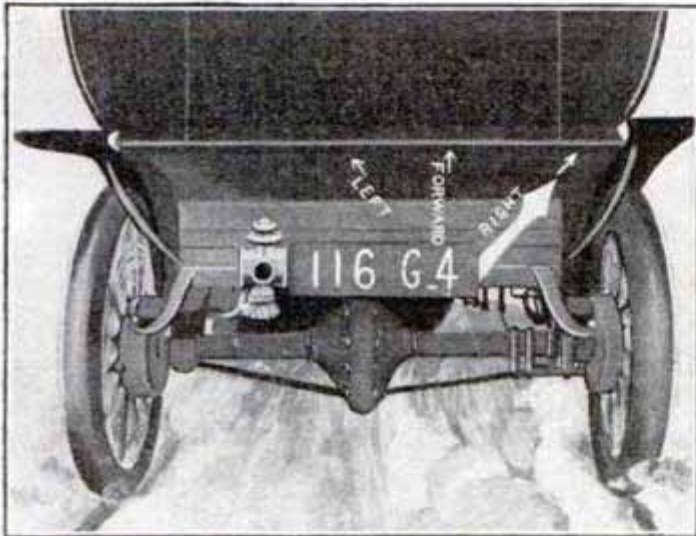

Simple and Practical Indicator of Direction an Automobile is About to Take Prevents Collisions from Behind

templated, a turn of the lever swings the arrow in that direction, a turn to the left being indicated by swinging the arrow in the opposite direction.

HIDEOUS MASKS PLACATE THIBETAN GODS

Among the most grotesque forms of religious ceremony students give a prominent place to the festivals of the Lamaist church of Thibet during the course of which hideous masks are worn by the participants and the most fantastic dances are staged. Lamaism is a corrupt form of Buddhism, states Dr. Sven Hedin, who made exten-



Some of the Grotesque Masks Used in Religious Ceremonies in Thibet

sive investigations and explorations in Thibet. The object of these ceremonies is usually to propitiate the powerful demons that reign everywhere and whose only function the religious fanatics believe is to plague, torture, and persecute the people of the earth.

BRITISH WARSHIP USES AWNINGS AS SAILS

The British warship "Proserpine" of the East Indies squadron ran short of coal about 300 miles from Colombo, Ceylon, and was compelled to resort to sails. Not being equipped with this necessary adjunct of wind propulsion, sails were made of all the awnings, and other large pieces of canvas available. Her speed so rigged was $2\frac{1}{3}$ miles an hour.

British Warship Sailing $2\frac{1}{3}$ Miles an Hour with Sails Made of Awnings

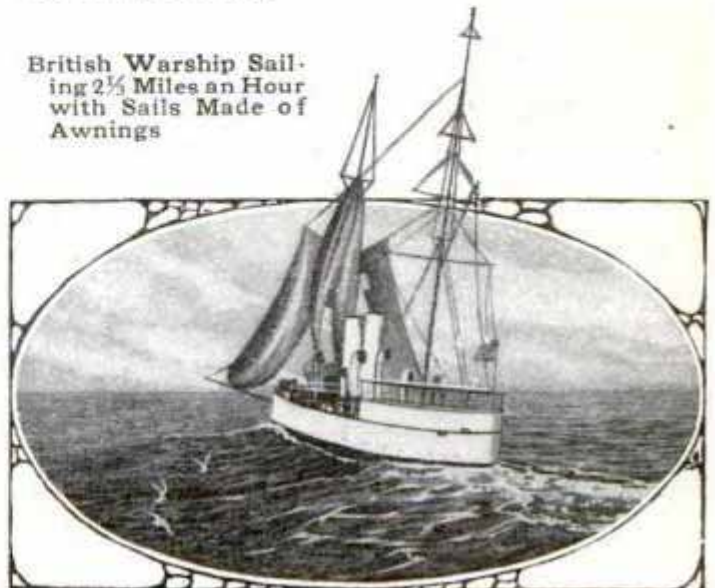

ELECTRIC MOTORCYCLE

Motorcyclists who object to the trouble of starting the gasoline-driven cycle, or to its gatling-gun-like exhaust, will welcome a new type of electric motorcycle which is being introduced, and which, it is claimed, will

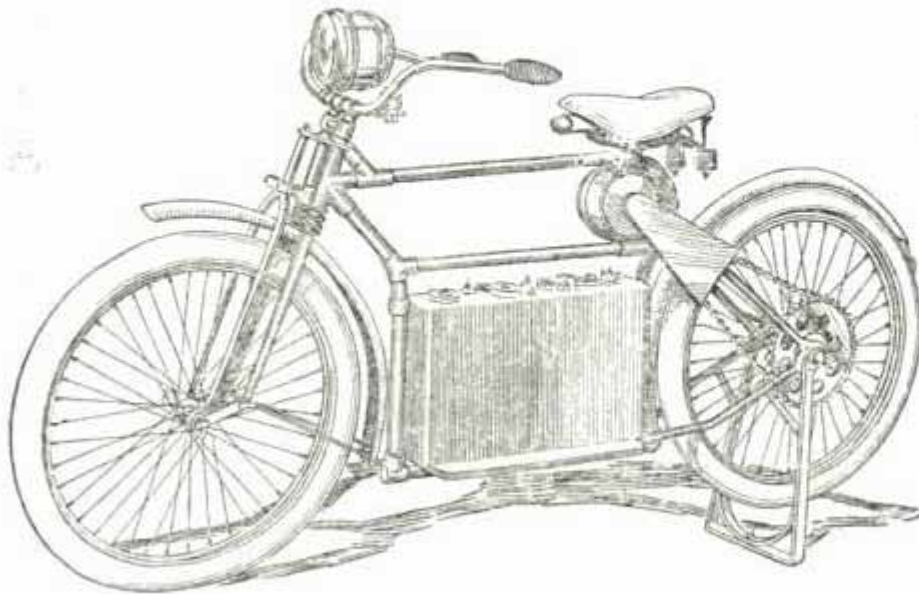

Simplicity, Ease of Starting and Noiselessness in Operation are the Features of This Electric Motorcycle

run from 75 to 100 miles on a single battery charge, start instantly on the turn of a switch, and run absolutely without noise.

The motor, which is located under the seat, drives the rear wheel by means of a chain and sprocket wheels, and is connected to the three-speed controller which provides for speeds of 4, 15 and 35 miles an hour. The 6-cell, 12-volt battery is suspended in the lower part of the frame, and any of the standard types may be used. The motorcycle has a 51-in. wheelbase, and weighs complete about 200 lb.

DISTILLATION OF ORANGE FLOWERS IN FRANCE

It will be news to most people that the distillation of orange flowers is one of the most important industries of the French Riviera. No less than 3000 tons of these flowers—enough to deck innumerable brides—are produced annually for the purpose of making essential oils used in the manufacture of perfumes, an industry in which the French are unexcelled. The leaves

and even the young fruit of the orange are used, as well as the flowers, for this purpose.

There are several varieties of orange tree used in this unique branch of trade, but the best quality of oil, called "néroli," is obtained from the flowers of a wild bitter-orange tree, locally termed "bigaradier." The flowers are gathered in the month of May.

The preferred form of still used in the distillation process is smaller at the bottom than the spirit still, and somewhat higher. The flowers rest on a grating so as not to be scorched by the direct heat of the fire. From a still containing about 90 lb. of flowers and about 12 gal. of water, from 6 to 8 gal. of distillate are obtained. The essential

oil is collected from the top of the distillate and is worth, in the best qualities, from \$45 to \$90 a pound. The remaining perfumed water—orange-flower water it is called—brings about 5 cents a quart on the market. About 500 lb. of orange flowers are required to produce 1 lb. of essential oil.

A PORTABLE HAT-STAND

To prevent madame's latest creation in the way of headgear from being damaged by lack of suitable supporting facilities while my lady is on her

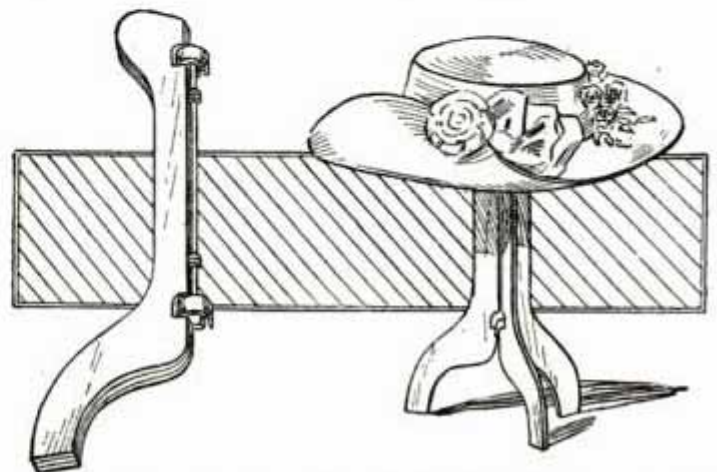

The Folding Hat-Stand Ready for the Suitcase and in Position Supporting a Lady's Hat

travels, a Parisian firm has introduced a folding hat-stand which can be easily carried in a suitcase and quickly adjusted to accommodate the most fragile of feminine hats without fear of disfigurement.

The hat-stand is simplicity itself. It consists of three legs which fold together as shown in the sketch. When the legs are unfolded like those of a three-legged table, two catches drop and hold them in place, and the device is ready for use. An inversion of the stand releases the catches and permits the apparatus to be folded together again for packing in the suitcase or grip.

A COMPREHENSIVE FIRE-ALARM SYSTEM

What is probably the most perfect fire-alarm system in the world has recently been installed at Krefeld, Rhenish Prussia. Alarm boxes are distributed throughout the city, and when an alarm is turned in at any one of them, the receiving apparatus at the fire station automatically registers the number of the box and the time, alarm bells are sounded in various parts of the station, the number of the alarm box is displayed at each of various boxes conspicuously placed about the station, and the location of the alarm box is luminously indicated on a plan of the city.



Indicates that Fire-Alarm Box No. 378 Has Been Rung in the City

The illuminated number boxes, one of which is shown herewith, contain a number of small lamps which are combined into numerals by an electric selecting device. Another apparatus takes care of alarms that may be turned in simultaneously.

THE SALVATION NAVY

The branch of the New York Salvation Army which works the waterways of that city is now being spoken of as the Salvation Navy. The flagship is the launch "Jerry McAuley," presented to the Salvation Army by Bradford Lee Gilbert. Religious services are held on board twice a day, and the boat runs from point to point in search of converts.



The Flagship of New York's Salvation Navy

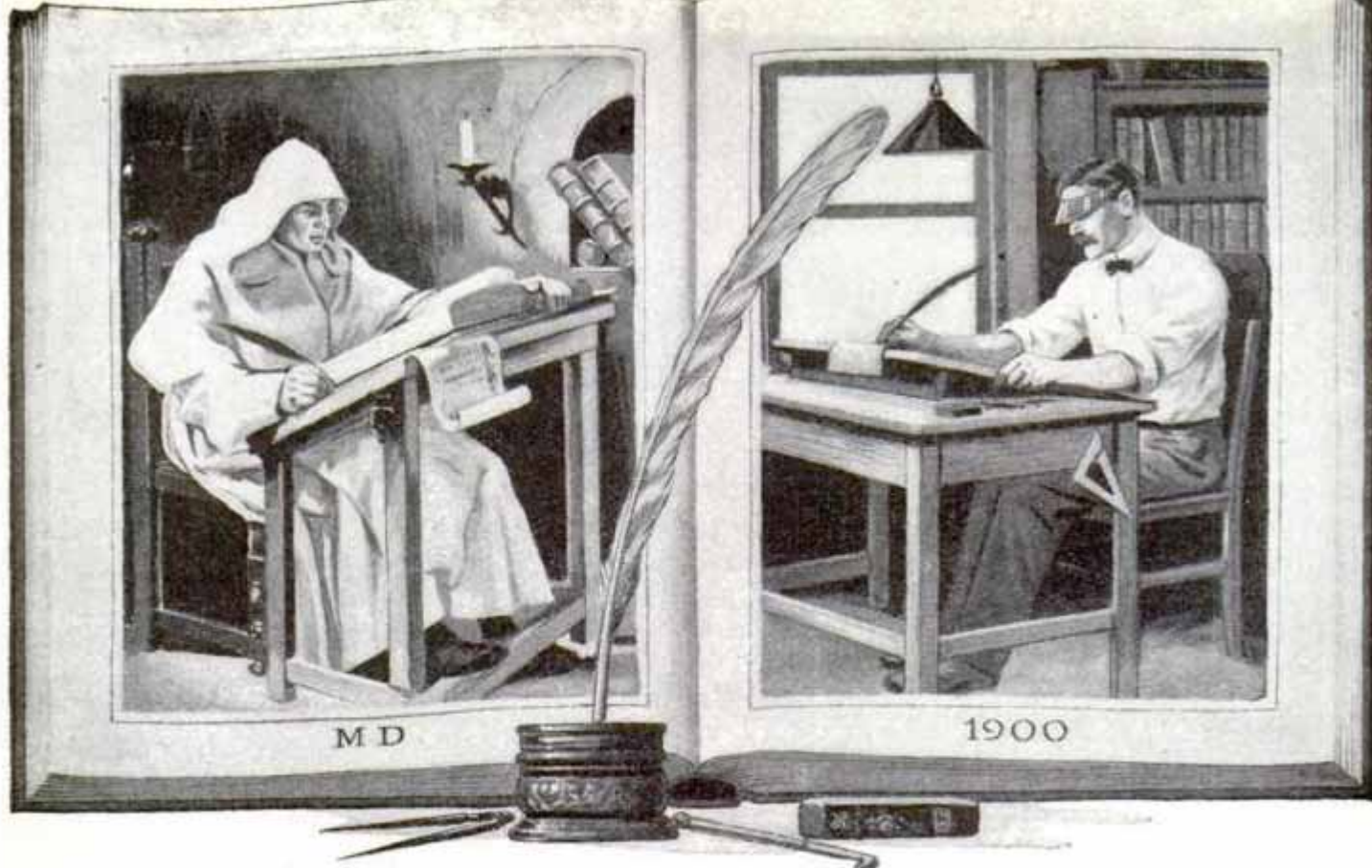

A TWENTIETH-CENTURY SCRIBE

By ROY O. RANDALL

FOUR hundred and sixty-one years ago a hooded monk sat at his accustomed desk close to the window of a monastery in the suburbs of Milan, Italy. He was finishing the text and illumination of a manuscript on vellum, a rare and beautiful work of art. Finally it lay before him complete and perfect, save for the signature and date. These he placed with marvelous skill and accuracy within a perfect circle of black and red: "Guinifortis de Vicomerchata, Milan, 1450." He then sprinkled sand from a bronze vessel with perforated top over the page still wet with ink. A few moments passed and he shook the sand from the page into a shallow tray. Then he picked up the completed book and turned its pages, one by one, with the pride of the artist who sees before him a masterpiece from his own hands.

Today that manuscript, with its wonderfully preserved colors, reposes in a mahogany case in a modern "scriptorium" located in the heart of Chicago where, with scores of other fine examples of ancient and medieval writ-

ing, it serves as an inspiration and guide to scribes of the twentieth century. For, notwithstanding the development of printing, the art of the scribe and illuminator still survives. Unlike the printer, however, the scribe does not advertise, as that would conflict with the ethics of his artistic profession. He, therefore, remains comparatively unknown.

The scriptorium of the world's newest great city, Chicago, is a place of infinite interest to the bibliophile. Here is a museum of the writing art valued at many thousands of dollars and here also the ancient craft of quill and compass is perpetuated and made adaptable to modern use. In executing the commissions received from the patrons of the modern scribe no clumsy, puerile imitations of the excellent work done by the craftsmen of the middle ages is permitted, but rather their best efforts are reproduced with astonishing fidelity. The head of this scriptorium has spent 30 years in learning, developing and teaching the art, and nearly every year he spends several

months in the libraries and monasteries of Europe examining and copying their most famous manuscripts. His collection of old books, and photographs and copies of ancient manuscripts is a magnificent one, representing the growth of the art in all sections of the British Isles and the Continent. On one of his tours he asked permission to photograph a famous work done in gold leaf. This was refused; whereupon he begged leave to copy it. The incredulous monks, declaring that an impossibility, reluctantly granted permission. They marveled greatly when the visitor from America produced a copy that for exactness of line and beauty of detail equaled the original. In other cases photographs have been made and filled in with the colors of the old manuscripts.

In his researches this modern scribe has established the theory, which may prove surprising to many, that the work of the scribe did not languish immediately upon the introduction of printing but, on the contrary, he says, there is indubitable evidence that the art reached its zenith after Gutenberg's invention had become a commonplace throughout Europe. Competition, then, as now, proved the stimulus to a perfected product. Eventually it had to succumb save for the isolated instances that may be found in all civilized countries, of which the Chicago scriptorium is one.

It is his belief that the illumination of vellum as a distinctive art originated with the monks of Ireland as early as the eighth or ninth century. The

simple scribe, of course, is an institution older than history, coincident with the dawn of human intelligence, when a scratch on a stone told a story. From the ancient symbolism or "picture writing" of man in his most primitive state, the art of expression by written forms has progressed from the hieroglyphics and papyrus rolls of Egypt to present-day multiple presses and linotype machines. Vellum took the place of papyrus at an early period, the oldest vellum manuscript extant being a fragment of Demosthenes' philosophy. Vying with it in venerable age are the codices of the Bible and a Latin manuscript of Virgil of the fourth century.

Marked changes have taken place in the development of penmanship. The Lombardic was one of the earliest of the so-called "national hands"—letter forms that assumed gradually an individuality according to the

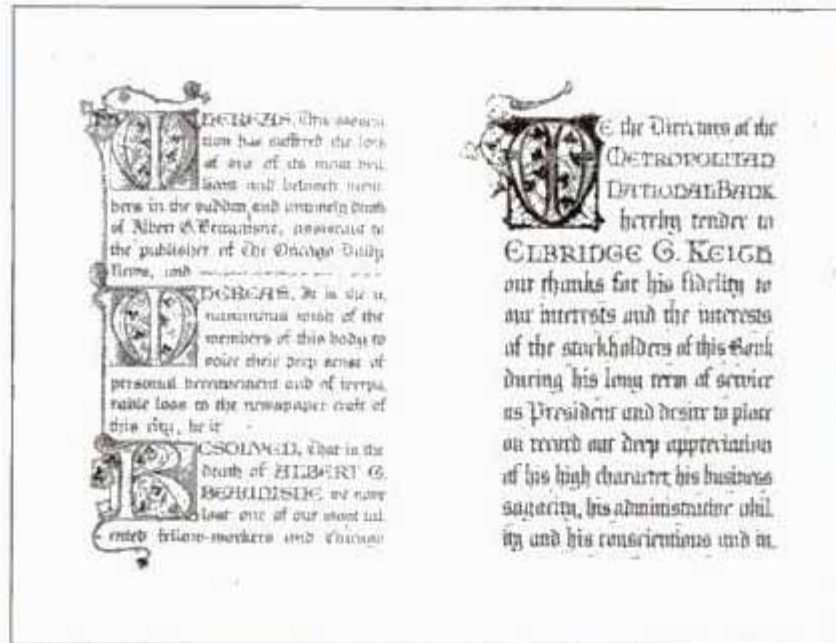

Examples of Work of the Modern Scribes

locality in which they held sway. The Lombardic had its origin in Italy and developed from the style of penmanship which was practiced, from the ninth to the thirteenth century, in the monasteries of Monte Cassino and La Cava. What eventually became the Irish and Anglo-Saxon style was brought to Ireland by missionaries from southern Europe in the sixth century. The famous Book of Kells, produced in Ireland in the seventh century, is a work notable for its beauty of ornamentation. The Irish hand found its way into the northern part of Britain and thus the English hand is traced to the Roman.

A decree of Charlemagne in 789 A. D. for the revision of church books resulted in a reform of writing in France. This new and distinctive hand had its origin in the monasteries of Tours where, in the Abbey of St. Martin, under direction of Aleuin (or Alcuin) of York, much attention was given to writing.

Individual forms of script developed in various nations of Europe in the eleventh century. In the twelfth century the so-called Gothic writing appeared. There was a gradual decline of the art in the fourteenth century save for the renaissance in Italy where was developed a regular and beautiful style—the “humanistic” hand of the fifteenth century which had great influence on the later type forms.

Up through all history the scribe has proved an important factor in human activity, but to the Irish monk should be given the credit of bringing the work of the writer up to the standard of a fine and high accomplishment. He it was who established monasteries in many remote corners of Europe and carried with him his art of beautiful scripts, teaching it in widely scattered communities.

Not only is a peculiar skill required in the work, but immeasurable patience as well and mathematical exactitude. Its ancient perfection is proof of the dictum, realized keenly in those somnolent centuries, that “art is long.” Ten thousand strokes of the quill, years and decades of labor, were counted as naught; the end of art justified the time expended and the toil.

In the collection of the Chicago scriptorium are splendid examples of the writing art extending from the eleventh century to the present. It is indeed a veritable museum of writing, including, besides the manuscripts, an assemblage of working materials that is the delight and despair of antiquarians abroad, though little known here. Lying beside a bit of dimly ruled vellum, 600 years old, is the ruler that traced the lines—a dull-pointed bit of iron found in Florence, discarded by

the monks centuries ago. Here are Greek and Roman styli, used for blocking vellum in squares, one marked with the sign of the early Christians and carved as delicately as if turned from a wheel. There is an inkhorn of 1350, probably the oldest in existence, with compartments for ink, sand (used in lieu of blotting paper) and pens; and in the case is a quill of the fourteenth century, wrinkled and useless. The foregoing are shown in the accompanying photograph with a Venetian inkpot of the fourteenth century, and other tools of the craft.

Among the precious relics is an ancient bloodstone-tipped implement used for burnishing gold leaf. This is about 600 or 700 years old and is one of the gems of the peculiar collection. Other burnishers are fitted with wood, brass and agate tips. A writing case from Arabia is of brass, beautifully decorated in repoussé work; on a shelf below is a copybook on vellum done by Ulrich Hoffman, at Nuremburg, in 1660. Each page written by this great quill artist is a master work.

A compass of 1425, a fifteenth-century Florentine master-printer's seal, a sand sprinkler and tray of Siena, 1400, quill sharpeners 200 years old, and miscellaneous antiquities having no relation to the art of writing, all claim the attention of the visitor to the scriptorium. He is assured, too, of the genuineness of each object by the veteran scribe and illuminator whose third of a century of research has fitted him to detect the clever imitations foisted on the unsophisticated in all markets of the antique. According to this expert, there are in Europe today 226 manufacturers of fake antiquities.

Much of the work of the present day is done with the same implements and materials that were used hundreds of years ago. Quill pens are fashioned by old time steel cutters made for that purpose; the strange inks are mixed, the gold leaf is burnished; civilization, with all its progress in invention, apparently cannot improve upon the essentials of the art as employed when

the monasteries were in their prime. India ink, as an instance, is a staple of the artist in black and white today as it was to the monk of centuries ago. Many and vain have been the attempts to wrest from the Chinese the secret of its manufacture, but its ingredients have been jealously guarded by the impassive, reticent celestial. Even his wily neighbor, the Japanese, failed in his effort to duplicate it. This much only is known about the composition of India ink—its base is cuttle-fish bone. Gray is produced by the combination of Chinese white with India ink; reds, greens, blues and other primary colors are imported from France. The gold used is of English preparation.

Most interesting of all the museum's treasures are the musty old tomes, the age-hallowed books that tell of the genius, the labor of love, the instinct for beauty that thrived in the dim light of monasteries. What pictures of medieval glory, pageantry and chivalry they conjure! And here at these

modern desks are men practicing the ancient profession.

One may ask, "Who are the patrons of the modern scribe?" They do not come from the philistines nor from those without much worldly goods. Rather they are of the rich who chance to be of esthetic temperament; those who revel in the beauty of antique things and who richly reward the modern scribe. Illuminated testimonials to those who have accomplished something of note, memorials to those who have left behind a record of work well done; engrossed resolutions, diplomas of schools and colleges, limited editions de luxe, significant texts and mottoes—these are only a few of the orders that the scribe and illuminator of today is called upon to execute on vellum or parchment in the manner of his illustrious predecessors. It is only just to say that he performs his work in a way to merit the approbation of the quiet craftsman of the middle ages whose manuscripts today are the delight of artist and antiquarian alike.



From a drawing by W. Dohrk, in *The Sphere*, London

The Modern Twins of Destruction—the Aeroplane and the Submarine

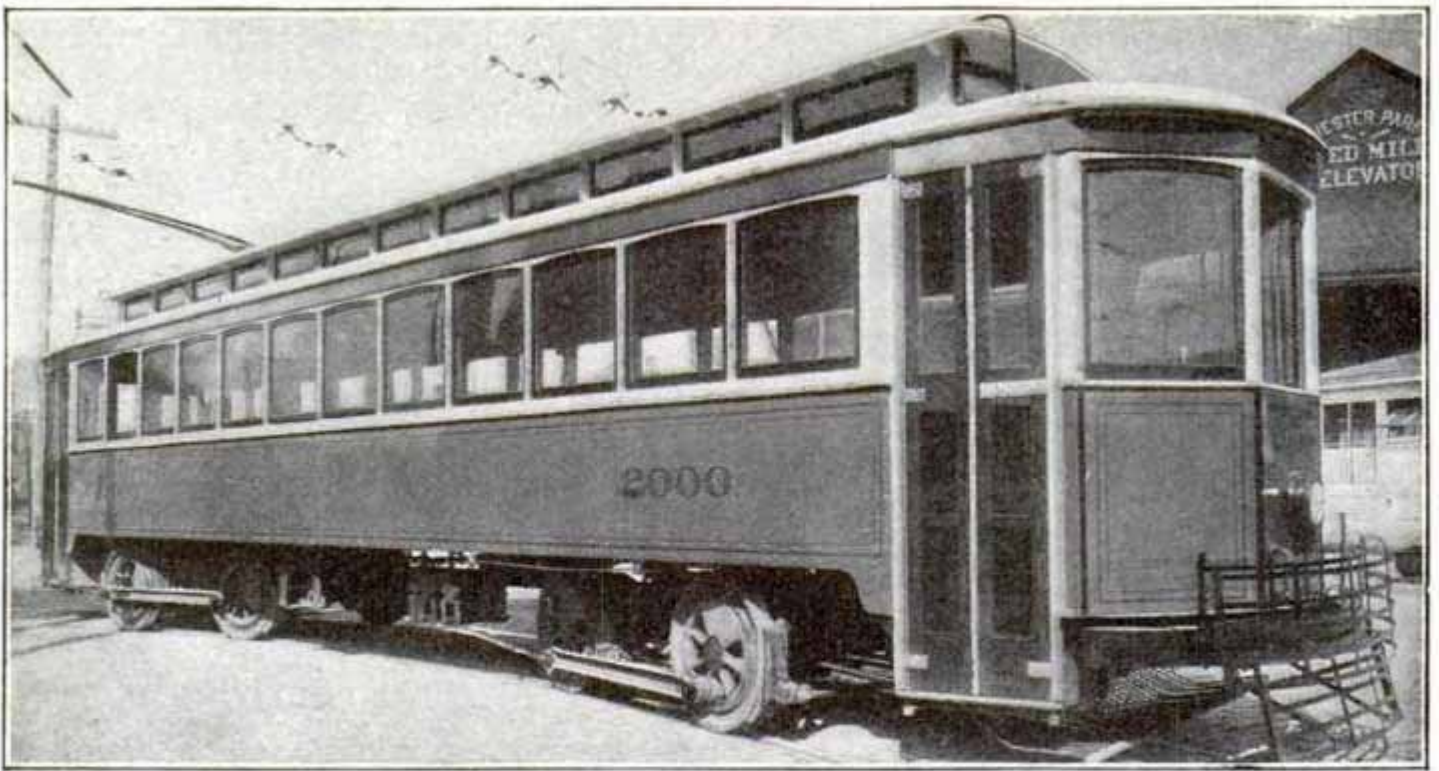

Driving-Rod Connection on Wheels Saves Extra Motor on Each Truck

RADICAL INNOVATIONS IN STREET-CAR DESIGN

A new type of street car, with wheels in each double truck connected with driving rods, much like a locomotive, is the latest innovation in street-car construction, just turned out by a well known American manufacturer. This new type of car is being tried out on Cincinnati streets and, so far, has been satisfactory in operation.

The idea of connecting the wheels by driving rods saves the necessity of using an extra motor in each truck. One motor to each truck now does the work of two as formerly used. The connection of the wheels tends to prevent them from spinning when the rails are slippery.

There are no sliding doors separating the platforms from the rest of the car. It is all interior after mounting the steps. The conductor, by means of a lever, opens the step doors for a passenger to enter and then closes them again, collecting the fare. Exit is from the front and rear ends. Seats for 25 persons are on each side while 50 more can find straps to hang to and another 50 can be packed in between.

The new type of car is said to be the solution of the problem of carrying the greatest number of passengers in one vehicle.

“They are brutes for driving their horses so recklessly,” is the burden of a charge by women of New Haven, Conn., who are trying to get the Humane Society of that city to cut down the speed of horse-drawn apparatus in answering fire alarms.

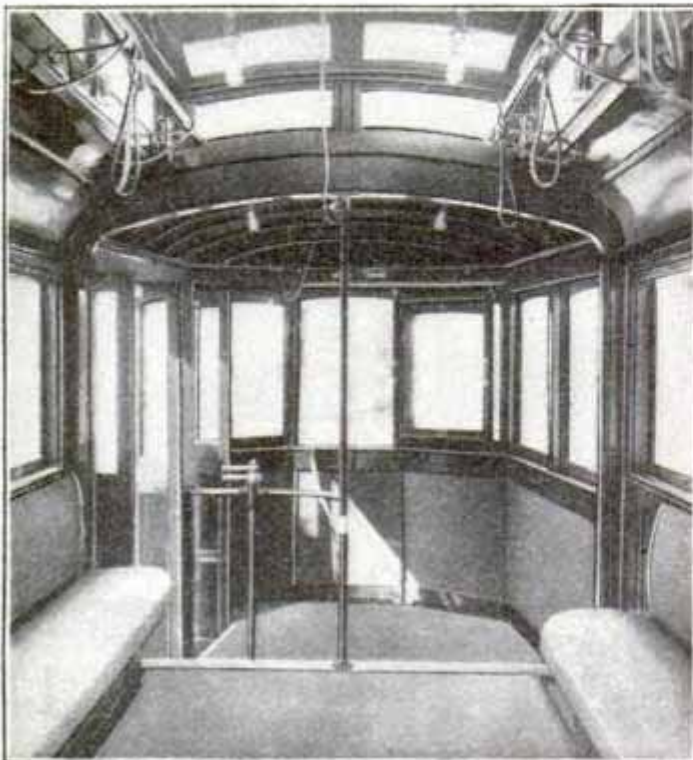

End View of Street Car Put in Service in Cincinnati

MOST PRIMITIVE WEAPONS NOW HOSPITAL AID

The old wife's advice that the hair of the dog was good for the bite thereof is about to have further exemplification in the retirement of a certain form of lance as a weapon of offense in the French army that it may be introduced as a part of the hospital-corps equipment for removing wounded from the field. The most primitive of warlike implements is thereby consigned to the lowly task of supporting the litters on which the fallen are carried to the hospitals. The armies of continental Europe have held to the lance as a weapon for a portion of their troops since very early times. The modern regiments of lancers carry them more as ornaments than anything else. It is now proposed to cut off the heads of the lances used by the French army in Morocco and issue them to the litter bearers of the medical corps. Each litter will be equipped to receive four lances at the four corners, so that the bearers can rest on their way from the field to the hospital, the lances being placed upright on the ground and the litter held on top of them. It is often as much as half or three quarters of a mile from the field of action to the nearest dressing station or hospital in Morocco and the carrying of a wounded man across the desert under a tropical sun is a severe task. The litter bearers, four in number, find it necessary to rest at frequent intervals and to prevent any chance of injuring the wounded man by lowering him from their shoulders, they are to be encouraged



Using Lances as Rests for French Hospital-Corps Litters

to rest the litter on made-over lances. When not in use, the lances will be carried by the litter bearers.

AN EXPOSURE INDICATOR FOR FILM CAMERAS

Probably all users of roll-film cameras have had the experience of finding, upon developing the film, some much coveted view sharing its section of the film with some alien scene. A recent invention which will prevent double exposures has been patented by a Connecticut man. This is an attachment which will, upon operating the shutter, cause the word "exposed" to appear in an opening in the top of the camera. This word remains in sight until the film-winding mechanism is operated to bring a new section of the film into position behind the lens, when it disappears, thus indicating that the field is clear for another exposure. The device is entirely automatic, and requires no thought or attention on the part of the operator. It is applicable to either folding or box cameras.



Method of Carrying Lances When Not in Use

Recent investigations of hygienic conditions of the air in the interior of a modern battleship, have proven that the air, even in the crowded sleeping quarters during the night, is much purer than in barracks and modern houses.

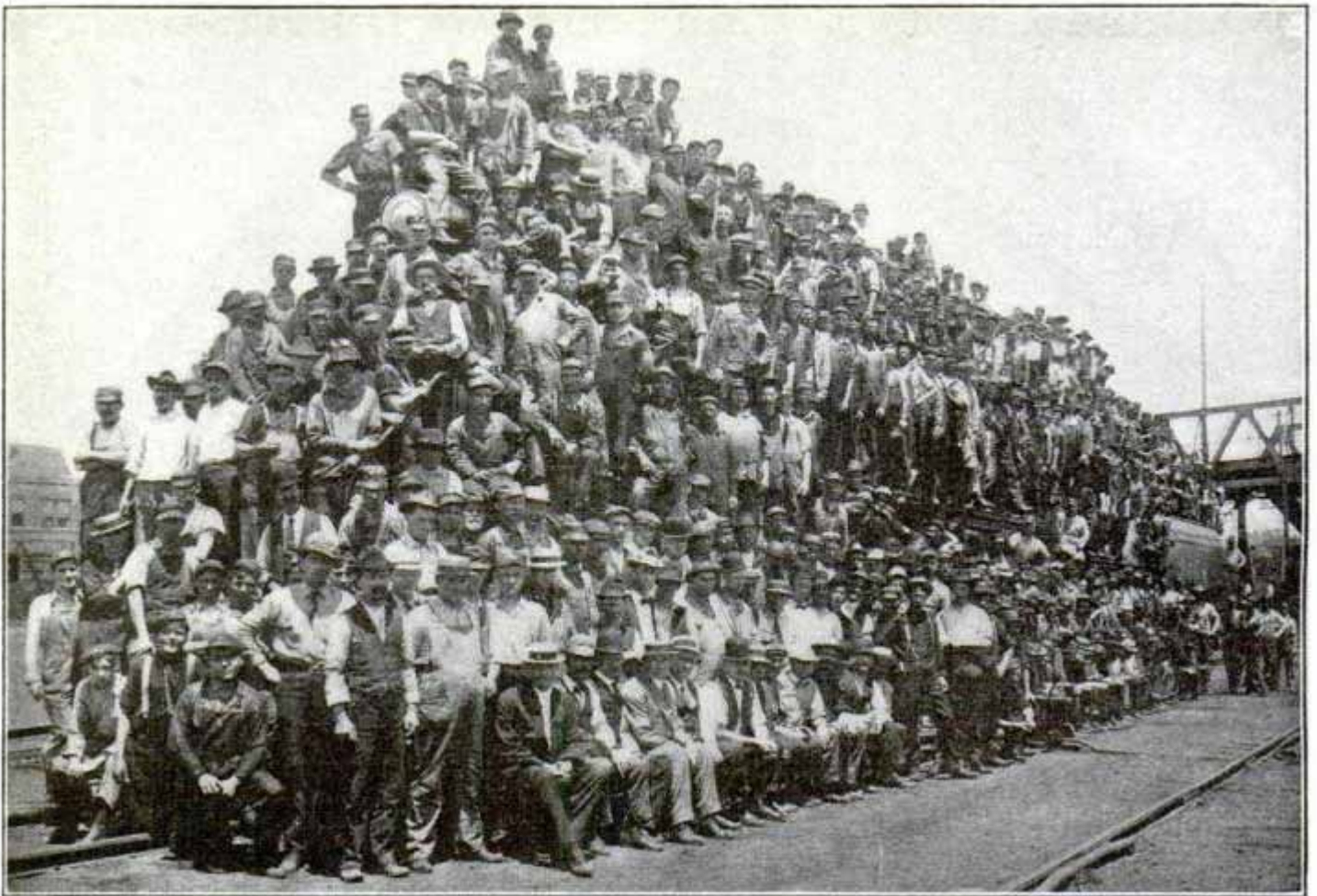

Courtesy Santa Fe Employees' Magazine

LOCOMOTIVE BANKED BY MEN WHO BUILT HER

The accompanying illustration shows the largest locomotive in the world banked by the men who built her in the Topeka shops of the Santa Fe Railroad. The men in the picture number 610, all of whom are machinists or machinist apprentices.

COOKSTOVE OF COBBLESTONES AND CEMENT

In order to give the picnickers in the parks a chance to make coffee and heat food and obviate the danger of

unextinguished camp-fires, the city of Los Angeles, Cal., has provided rustic cookstoves which are useful and ornamental. They are formed of the cobblestones which are very plentiful there, and with the addition of a little cement a durable and artistic little heating device is ready for outing parties. A sheet-iron top, large enough to accommodate the coffee pots of several companies of picnickers is provided. Fuel is plentiful, as the twigs and branches from trimmed trees are placed near by, and all rubbish, such as lunch boxes and papers is readily consumed, helping to keep the parks neat.



Cobblestone Cookstove at Picnic Grove

German winegrowers are being encouraged to scatter nesting material and erect houses for birds that the insects which are making great inroads on the grape crop, may be eventually destroyed.

POWERFUL ITALIAN AUTO WITH 300-HP. MOTOR

English motordom was considerably stirred by the appearance of a 300-hp. Italian car in the race meet recently held on the Yorkshire coast. This car was the most powerful that has been seen in England and under adverse conditions reeled off a mile at the rate of 116 miles per hour. The car made 125 miles per hour in an unofficial trial a day or two previous

it is impossible to start the engine by hand, so that it is necessary to have another car tow the monster a short distance, throw in the clutch until the engine is started by the revolution of the gears, and as soon as it is running well, throw out the clutch and bring the car to a standstill, thus leaving the engine running free. The motorist must be careful from then on not to

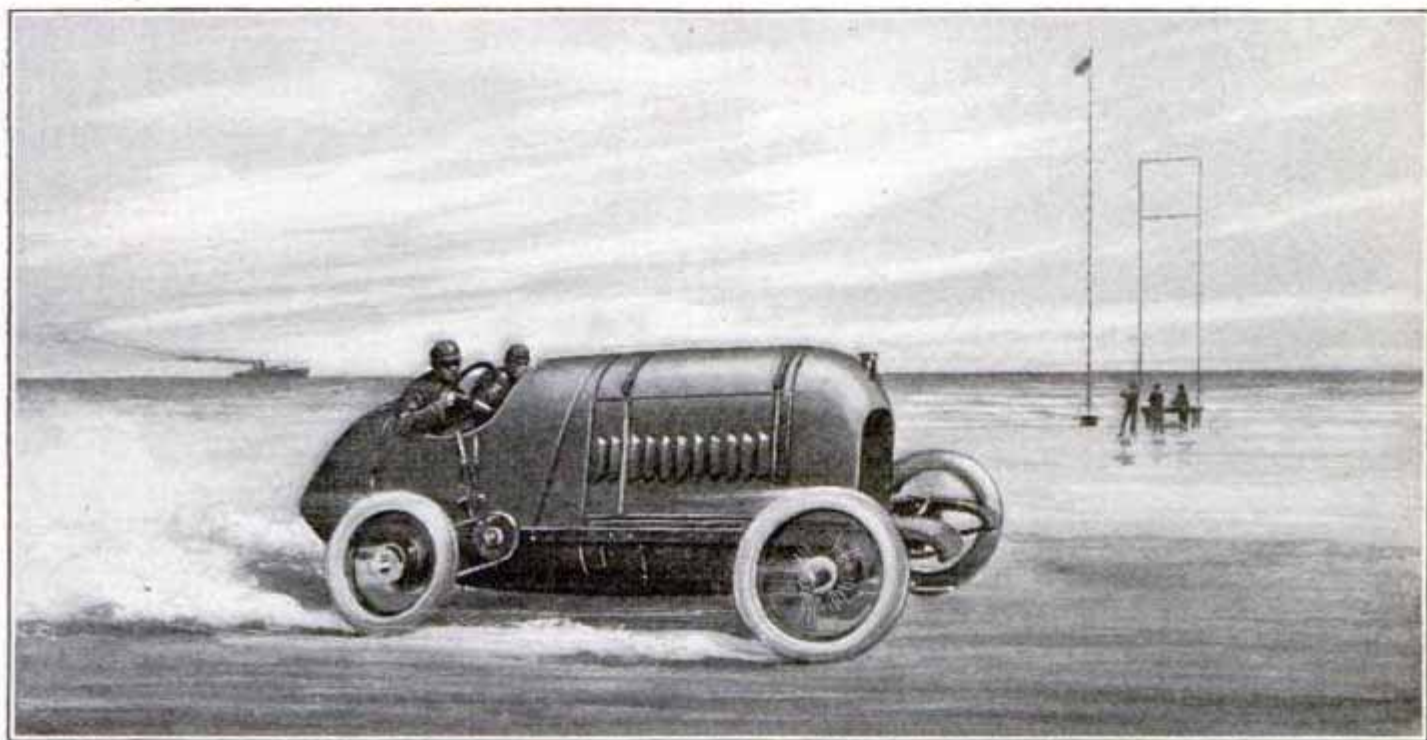

The 300-Hp Italian Racer on Yorkshire Beach, England. Negotiations were Being Made to Secure This Car for Lewis Strang, the American Racing Driver, Who was Killed in July

to its official performance. Because of its peculiar appearance, the car was dubbed the "Fire Engine" and was the source of considerable anxiety on the part of the managers of the meeting. The racing was held on the seashore, and on the way from Brooklands to the place of the meeting the powerful automobile became stuck in the sands and required the services of a seven-horse team to pull it out.

The car presents a peculiar appearance because of the great height of its bonnet, the top of which is 6 ft. from the ground. The exhaust ports are very large and when the engine is running at full speed, the exhaust is a sheet of flame flaring out frequently as much as 2 yd. square. The compression of the engine is so great that

permit his engine to go "dead" or he will have the towing process to go through with again. When the great car was making its attempt to lower the mile record, everyone near the course on the ocean sands fled to the surrounding cliffs as fear was expressed as to just what might happen when the powerful engines were properly tuned up. The fears were groundless, however, and the car is expected to make a big showing as soon as the drivers become familiar with its work.

☉ Preparations are being made at Lyons, France, for an elaborate celebration of the 150th anniversary of the establishment of the first veterinary school in the world.

LARGEST TWO-CYCLE MOTOR EVER BUILT

The largest two-cycle, internal-combustion engine ever built, and probably the largest single-cylinder motor

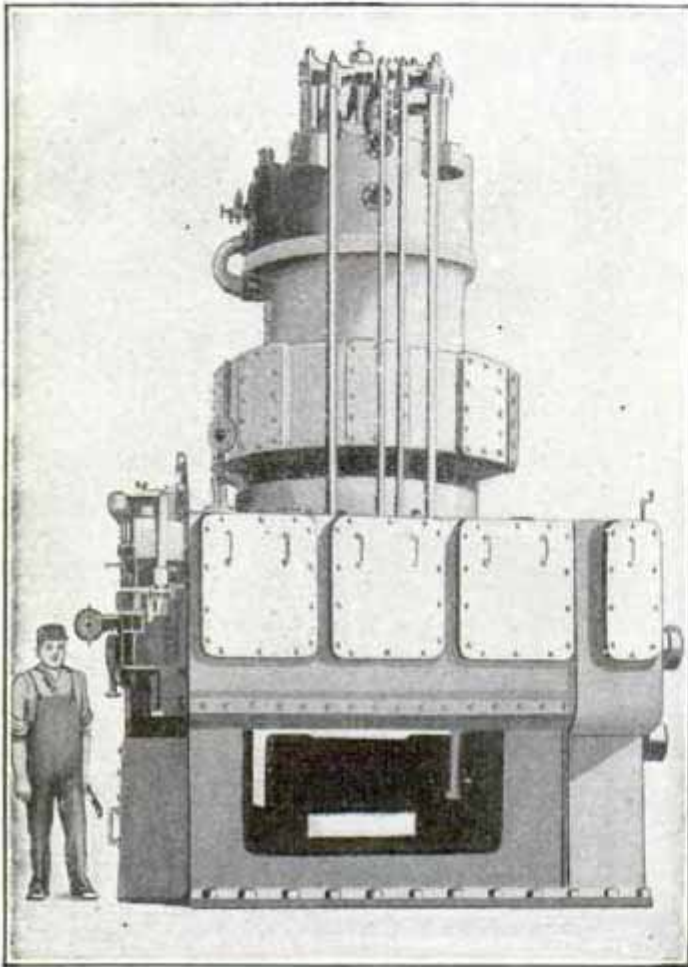

The Kind of Motor that Will Shortly Be Used in British Naval Vessels. It is the Largest of Its Kind in the World

in the world, is shown in the illustration. This powerful machine is rated at 1,200 hp., and such is its size that the crankpin is more than 2 ft. in diameter. This engine has been constructed by an English concern merely for experimental purposes, and is the prototype of many others that are under order for the British navy. The man in the photograph is 6 ft. tall.

THE VERSATILE BUFFALO IN DARKEST CHINA

Compared with the horse that Shakespeare's Richard III called for with an earnestness that has resounded through the ages, the water buffalo is a heaven and earth combined to the primitive agriculturist of backward China. This patient, long-suffering

bovine is both horse and cow to the local farm, for besides supplying the family with milk the buffalo grinds the rice into flour, pulls the plow, hauls the loads, and even raises the water to irrigate the fields.

The way in which this irrigation is carried out is interesting. The water-raising machines are primitive affairs of wood, and comprise long chains of paddles running from the water to a wooden shaft fitted with wooden gears and turned by the buffalo. The animal plods around and around in slow, monotonous circles, being blindfolded to prevent dizziness. On the poorest farms, the buffalo is superseded by hand labor, which is very cheap, two men lifting the water by means of closely woven scoops of bamboo. It is said that two men, working ten minutes at a time with intervening rests of five minutes, can elevate 1,500 gal. of water an hour.

A COMPUTING OIL PUMP

An oil pump, especially designed to prevent waste through leakage, and fitted with an automatic computer, is being marketed by an Indiana manufacturer. The illustration shows the



This Oil Pump, Designed for Retailers, is Provided with an Automatic Computer

transfer of oil from barrel to tank, the pump registering the exact amount taken from the barrel. By disconnecting the hose and closing the valve, the pump is made ready to draw the oil from the tank as wanted. The automatic computer arrangement measures the exact amount of oil pumped.

thrown by centrifugal action to the inclosed outer end of the cup, and fills the feeding tube. The cup can be removed, filled and replaced with the pulley in any position. One filling lasts from one to three weeks, according to the work imposed on the lubricator.

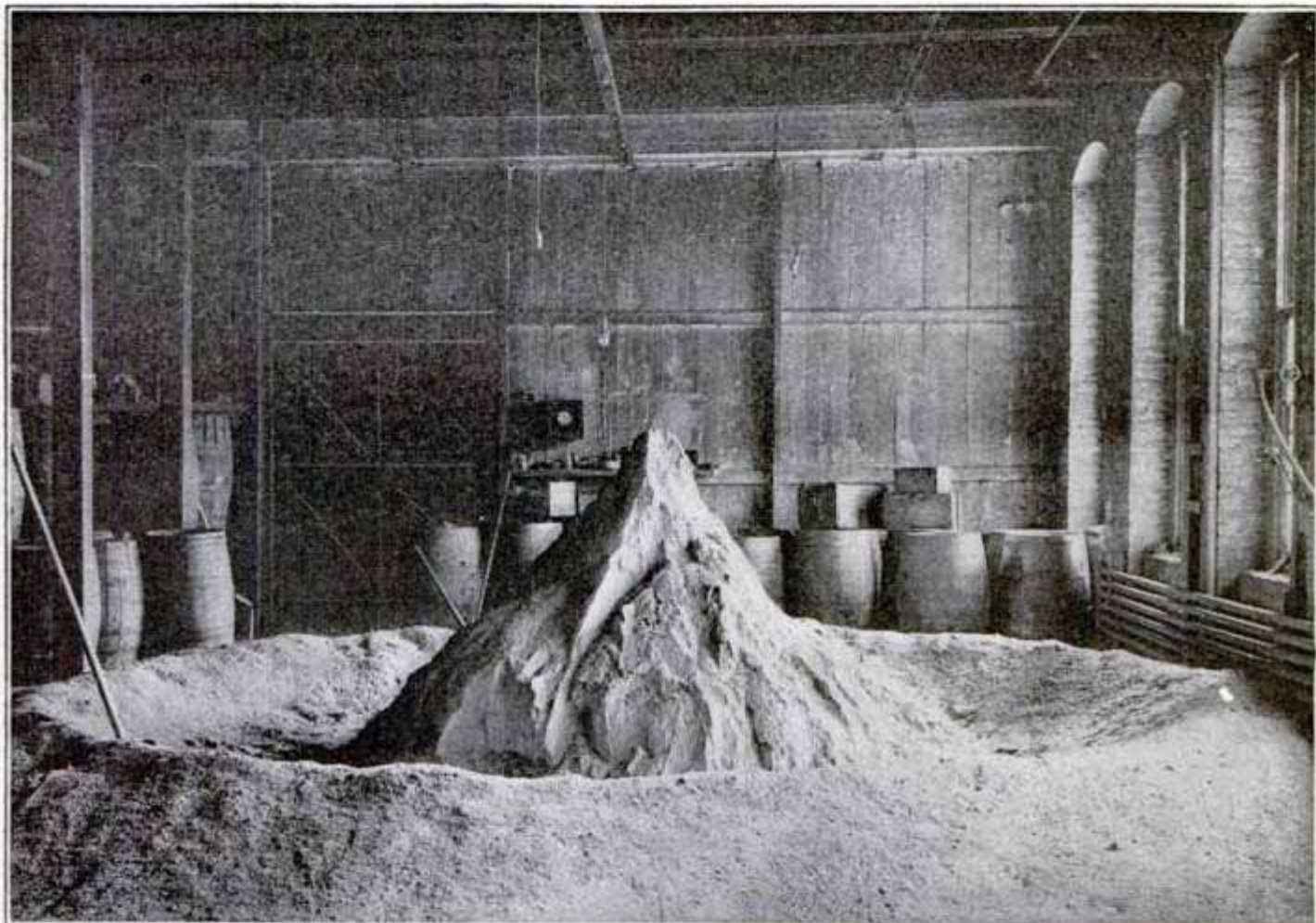

A Pile of Finely Ground Silver Sweeps in the Process of Mixing

A customer, for instance, wishes 15 cents' worth of oil selling at 19 cents per gallon. No matter what the price of oil per gallon may be, the computer will indicate exactly when to stop pumping to deliver the required amount.

AUTOMATIC LOOSE-PULLEY OIL CUP

An automatic loose-pulley oil cup, which feeds oil only when the pulley is in operation, has lately appeared on the market. The oil cup consists of two main parts, an inclosed outer cup and a feeding tube leading from its outermost end to the shaft journal. When the pulley is rotating, the oil is

RECOVERING SILVER FROM SWEEPINGS

In the manufacture of silver wares the loss of silver in floor sweepings would be great were it not for the methods of recovery. The smelting of sweeps requires a special plant which but few concerns can afford to have, therefore most of them prepare this material so that it can be sold. The most satisfactory method is to grind the sweeps to a fine powder so that a fair sample can be obtained for assay. One assay of the material may then be made by the purchaser and another by the seller. Unless the sweeps are ground very

fine, however, and then mixed thoroughly, there is but little chance of agreement between the two assays,

as coarse material is filled with fine shot silver which, when samples are made, is not evenly distributed.

MOST SENSITIVE METHOD OF CHEMICAL ANALYSIS

When Kirchhoff and Bunsen, away back in 1859, found that from the appearance of the peculiar bands of color produced in the spectroscope by light-giving sources they were able to detect and identify the chemical elements in the sun and other far-off bodies, it was supposed that the limits of possibility had about been reached in this branch of physical and chemical research. But recently there has been discovered a still more sensitive method, which reveals the presence of almost infinitely small quantities of gaseous or radiant matter that would be impossible to detect, much less identify, by the most refined processes of spectroscopic analysis. In fact, it is supposed that eventually the new method will lead to an explanation of the processes involved in the disintegration of one elementary substance into another, such as occurs in the case of radium and its various emanations, as well as affording the chemist an actually visible insight into the mysterious processes of chemical action.

This new analysis is the discovery of Prof. Sir J. J. Thomson, the famous English physicist, and was evolved in the course of his researches on electrical discharges in tubes containing highly rarefied gases. The phenomenon discovered by Thomson, which led to the new analysis, is one which

accompanies the production of the so-called cathode rays under certain conditions. These cathode rays are the negatively electrified particles which are thrown off from the cathode or negative terminal in a highly exhausted or vacuum tube when an electric discharge is passed through it between electric terminals. Under ordinary conditions they move in straight lines, but may be deflected from a straight path by the influence of a magnetic or electric field. When they are caused to strike against solid substances they generate Roentgen or X-rays.

Thomson found that when the cathode or negative terminal in an exhausted tube (through which an electric charge is passed) is pierced with holes, there appears another group of electric rays which are given off by the positive terminal or anode, as it is called, and that these consist of positively electrified particles which are much larger and which move more slowly than the so-called electrons or ions which constitute the cathode rays. These also move in straight paths and are capable of deflection by electric or magnetic fields, and Thomson found that when they are so deflected and made to fall on a sensitized plate, they will register photographically their point or points of impact, accord-

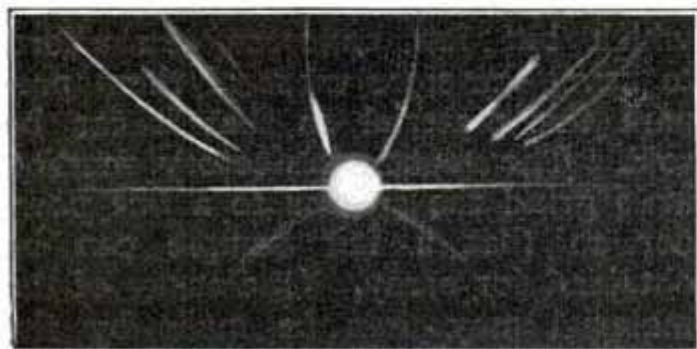

1 Parabolic Spectrum of Nitrogen Mixed with Argon

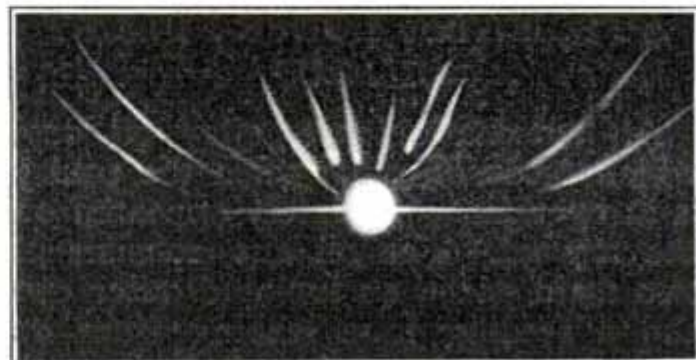

Parabolic Spectrum of Carbonic Acid Gas



Florist Witterstetter at Work with His Brush Artificially Pollenizing a Carnation Bloom

ing as the rate of movement of the particles is constant or varying. It is this phenomenon that Thomson has turned to account as a means of detecting and identifying chemical elements, whether they occur singly as atoms or grouped as molecules. For the amount of deviation of the photographic record is an infallible and invariable measure of a certain chemical property—the atomic or the molecular weight, as the case may be—of each constituent particle.

The new analysis has been called the "parabolic spectrum" method, from the form of the photographic records and its similarity to spectroscopic analysis. By means of this method, Thomson has been able to detect and identify as small a quantity as the one 700-millionth part of a grain of a substance when the spectroscope absolutely failed to reveal its presence.

POLLENIZING CARNATIONS WITH A BRUSH

Assisting nature with a little paint brush and creating new flowers mechanically is what a florist is doing in Cincinnati.

Where a small pink once bloomed

the little camel's-hair paint brush has made a mammoth carnation bloom. Single blooming varieties are transformed into double ones with a little patience by this magic brush. Even colors are changed.

This wonderful work is going on under glass and wire screening, for should a busy little bee or other honey-seeking insect ever invade this private sanctum, the fairy work of the little brush would come to naught.

For years R. Witterstetter, a florist, has been experimenting in the control of flower pollenization, and, by doing the work himself with the aid of his fine little camel's-hair paint brush and a small, powerful magnifying glass, he has succeeded in growing a new double pink carnation that blooms as large as a big rose. Another group of plants has a delicate salmon pink color, but this unusual color, he says, is not "fixed" as yet, and the blooms have a tendency to revert to the colors from which the salmon pink was derived.

¶ There are still 1,714 sailing vessels, aggregating 1,121,814 tons register, engaged in foreign trade under the American flag.

WORM-GEAR DRIVE FOR AUTOMOBILES

During the past year or so, European automobile manufacturers have been regarding with increasing favor the worm-gear drive for their cars,

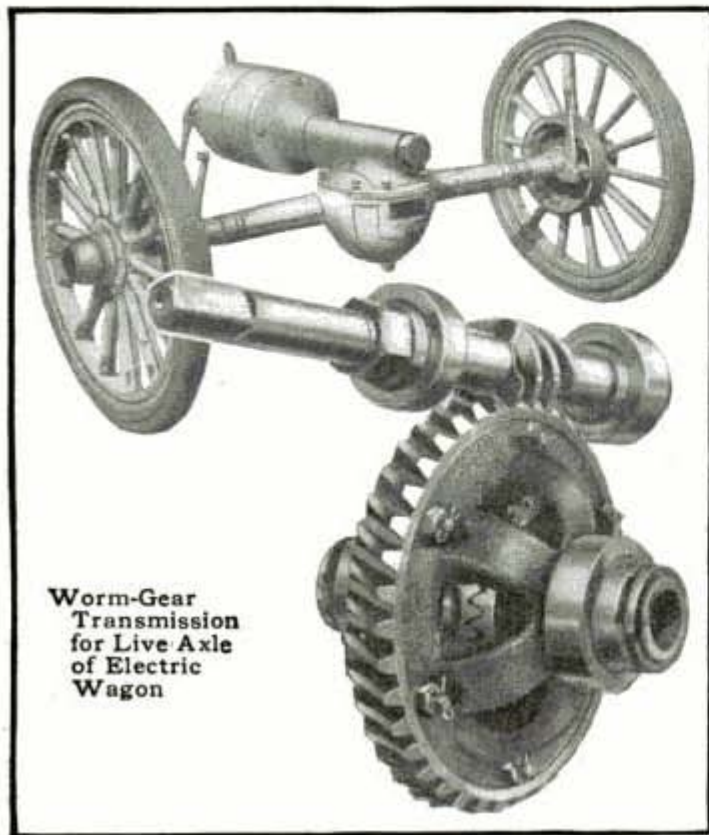

with the result that many of the leading firms have adopted this form of transmission as standard. American concerns are now watching closely this recent development, and already

one prominent manufacturer of electric wagons has devised a form of worm-gear drive that is giving splendid results in practice.

In a paper by E. R. Whitney read before a recent meeting of the Society of Automobile Engineers, at Dayton, Ohio, it was claimed that contrary to a widespread opinion which exists even among engineers, the worm gear is superior to other forms of drive for motor-driven vehicles, within the scope of its legitimate field, on the score of efficiency, durability and simplicity. A series of experiments carried out by Wilfred Lewis, a well known American authority on gears, showed the maximum efficiency of a worm gear like that here illustrated to be 93 per cent, which corresponds to an extremely small friction between the worm and the worm wheel. The thread of the worm had four turns, the average angle of the thread being 28 deg. The worm was of the variety known as Hindley's screw, that is, it was shaped like an hourglass to fit the curvature of the worm wheel. Such a construction is of course expensive. The "life" of such a gear was estimated at about 60,000 miles.

SNOWFALL AND EVAPORATION STUDY

By L. WILLIAM THAVIS

The United States Weather Bureau is engaged in conducting an important investigation of a practical kind in two directions. One is with an apparatus for catching and conserving the snowfall in remote mountainous sections for the determination of the season's snowfall in the form of its water equivalent. The second is an investigation of the laws of evaporation over lakes and storage reservoirs wherein the snow water from the mountain peaks is held for distribution by irrigation during the summer. These two problems have assumed unusual significance in recent years in connection with the devel-

opment of the great irrigation projects in the Rocky Mountain and Pacific states, and the power plants in the mining districts.

The amount of snow in the high mountains varies greatly from year to year in consequence of the great currents of moisture-bearing winds, which deposit more or less snow and rain. If there is much snow in the mountains, the rivers, reservoirs and ditches will be abundantly supplied; if there is comparatively little snow in the high levels, then the irrigation engineers must economize all along the line. If a contract is made to supply so many

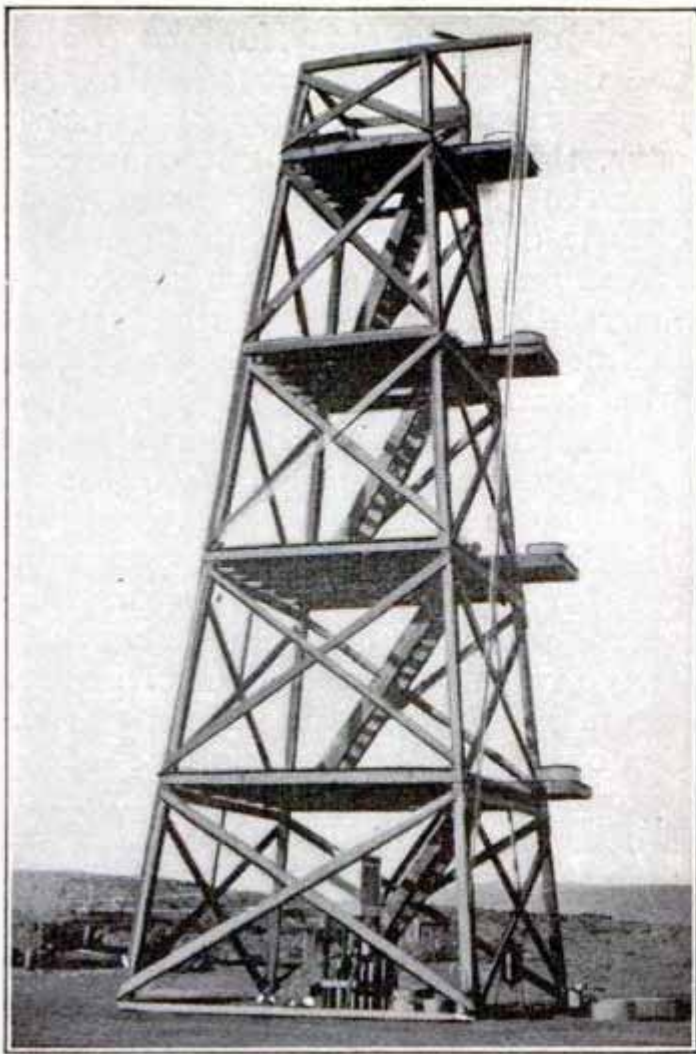

Tower for Studying Evaporation in Mountainous Regions

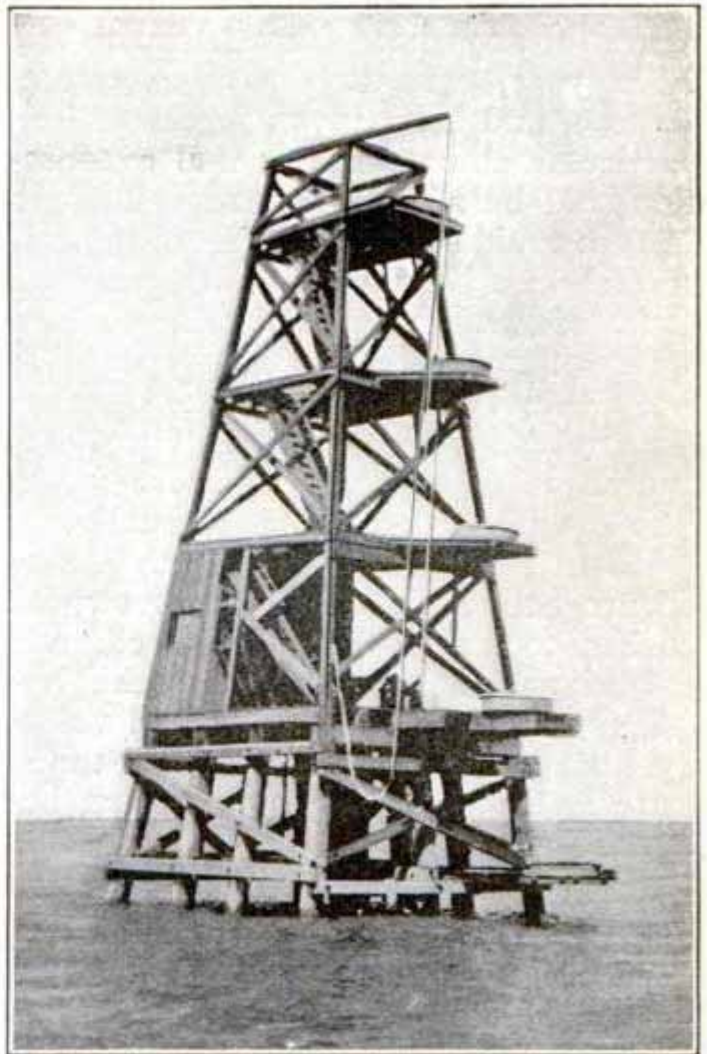

Observation Tower Used on Ocean for Studying Moisture

acre-feet of water to a given district and water is not available on account of the causes in the great atmospheric circulation beyond man's control, it is important for the engineer to have his figures of probable water supply be-

fore signing the contract. This water once spread out in a great storage reservoir loses a large mass by atmospheric absorption, especially in the arid regions of the West.

Water may evaporate from a pan at

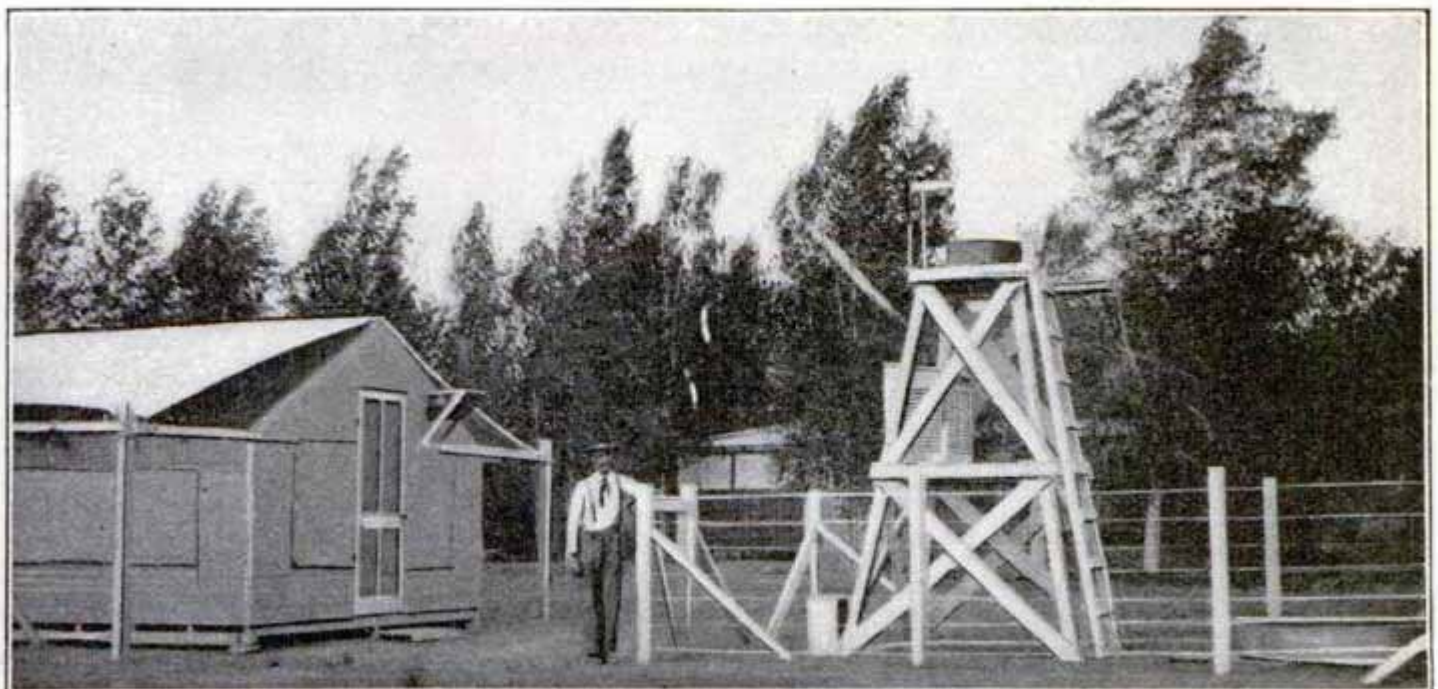

Observation Station and Tower for Inland Studies of Evaporation

a rate of anywhere from 10 in. to 200 in. a year, according to the circumstances, and for a given reservoir in a particular climate the annual evaporation will be a certain number of feet. In the humid states of the East, the reservoirs lose by evaporation from 2 to 4 ft. of water; in the arid western states, similar reservoirs would lose from 4 to 7 ft. of water; the open irrigated land would lose from 6 to 10 ft., and some small elevated areas might lose even 15 ft. of water annually.

When an engineer goes into a new country to construct a reservoir, he wishes to know the general climatic conditions, the temperature, the humidity, and the prevailing wind velocity, that he may determine how much water will be lost by evaporation before he begins to build the dam. If the dam is too high and spreads out the water over too great an area, there will be too much loss by evaporation; if the dam is too low, its storage power will not be great enough for practical purposes.

The engineer needs such information

in planning the dam for the project and the network of dependent distributing canals. Similarly, for power sites, there is an economic connection between mountain snow supply and electric or waterfall distribution. The forestry service has much interest in the relation of the growth of trees on the mountains to the moisture-bearing winds; and the bureau of plant industry has a strong reason for studying soil evaporation and plant transpiration. Hence it is easily perceived how wide a field of scientific research is open to the government bureaus connected with this co-operative work.

At present this vast field of investigation is occupying the serious attention of five great bureaus of the federal government, and practical information is being furnished the people to insure against unwise expenditures and improvident projects.

Apparatus for making these scientific studies are mounted on towers, ranging from 10 to 50 ft. in height, and at least 200 observation stations are maintained both inland and at sea.

OIL-BURNING ARTICULATED LOCOMOTIVES

The articulated or Mallet type of locomotive, which combines flexibility with great size and strength by having two separate sets of engines and driving wheels on separate trucks, has up to recently been made only with coal-fired boilers, but the latest engine of this class, of which twelve have just been built for a western railroad, has been equipped with oil-burning boilers.

In opposition to the usual run of locomotive design, this monstrous engine runs firebox end first, a feature which enables the crew to have an unobstructed view of the track ahead. Among other modifications from previous practice, the new Mallet has two steam domes, a supply of dry steam being insured by locating the throttle valve in the front dome and by draw-

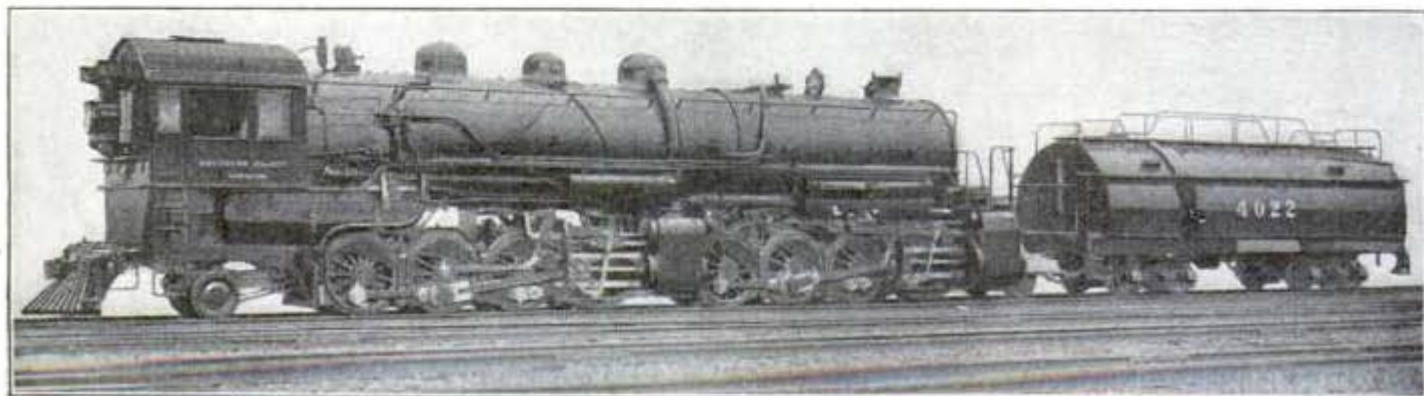

New Oil-Burning Articulated Locomotive with Tender for Oil and Water

ing the steam for the cylinders from the rear dome through two internal pipes each 6 in. in diameter.

The tender comprises two semi-cylindrical tanks, the forward one carrying 3,200 gal. of oil and the rear one 10,000 gal. of water. The steam pressure is 200 lb. per square inch, and there is a reheater in the smoke box. The locomotive weighs 432,600 lb. alone, and the combined weight of engine and tender is 612,600 lb., or over 306 tons.

RADIOACTIVE SNOW

In the course of a recent investigation in France on the radioactivity of snow, it was discovered that freshly fallen snow is highly radioactive but that it loses its radium-like properties after about two hours. Snow that fell on soil seemed to retain its radioactivity longer than when it fell on roofs.

CONCRETE HOUSE HAS A "KEYHOLE" ENTRANCE

This oddly designed concrete plaster house, located in Los Angeles, attracts considerable attention. The entrance, which is the only aperture in the first-story front wall, is shaped like a keyhole, and because of this the structure is called "the keyhole house."

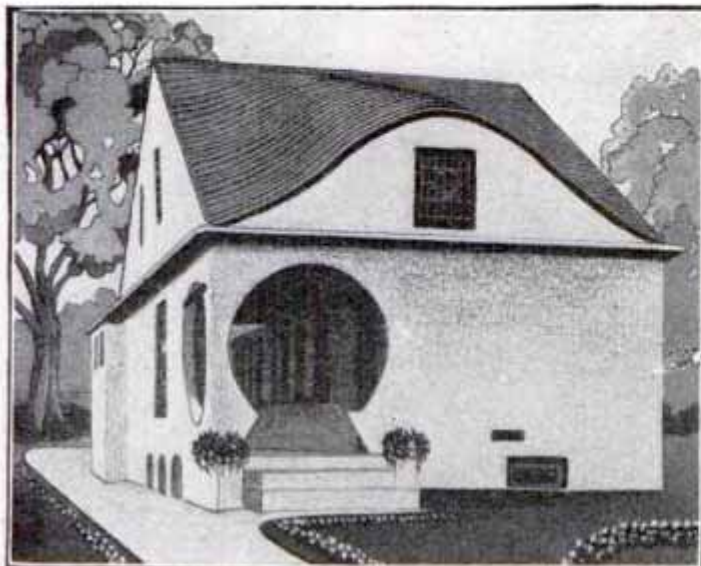

Courtesy Cement World
Called "The Keyhole House" Because of the Odd Shape of Its Front Entrance

FREIGHT ELEVATOR ON APARTMENT HOUSE

Several of the large modern apartment houses in Berlin are equipped with external freight elevators, usually



Exterior Freight Elevator on an Apartment House in Berlin

located in the court yards with which German apartment houses are provided. These outside elevators are used by the tradesmen in delivering goods, and for the removal of garbage.

It is interesting to draw attention to the artistic qualities of the wall facing on this interior court as compared to the interior courts of the majority of American apartment houses.

George Prentice, in Northboro, was recently married to Miss Mary De Witt, in Blanchard, by the Rev. H. B. Minton, in Coin, Ia., by means of the telephone, the bride and bridegroom, each holding a phone, answering the customary questions of the minister and hearing him pronounce them man and wife.

LIVE TIGERS USED AS MODELS

Four bronze tigers, perfect counterparts of the king of the jungle, only larger, have recently been placed in



One of Four Bronze Tigers

position on the parapets of the Sixteenth Street bridge in Washington, at a cost of \$10,000.

The sculptor, A. Phimister Proctor, of New York, spent 18 months in fashioning the tigers, drawing his model from a former terror of the wilds, the property of a circus. The sculptor chose the circus tiger because it appeared to him the most perfect specimen obtainable. For two months he traveled with the circus, devoting his entire time to the tiger. Many sketches of the animal were made in various poses, followed by a rough clay model, then a quarter model in bronze, and eventually the finished model.

The tigers are hollow, and even at that weigh 1,550 lb. each.

Sixteenth Street bridge, on which the bronze tigers have been placed, spans a ravine 75 ft. deep, and is part of a magnificent boulevard, nearly five miles in length, extending from the White House to the border of the District.

INGENIOUS FIRE-ESCAPE KEY ARRANGEMENT

Although the fire-escape doors in the Irish Lace Depot at Dublin are kept locked while not in use, they may be

Cut in the wainscoting by the side of each fire-escape exit is a small door opening into a deep hollow in the wainscoting. In this is a pulley, and the key is attached to a weighted chain which runs in the hollow woodwork. This chain is just sufficiently long to allow the escape door to be opened to its fullest width with the key in the lock, and immediately the key is removed the weight at the end of the chain draws it back into the box again.

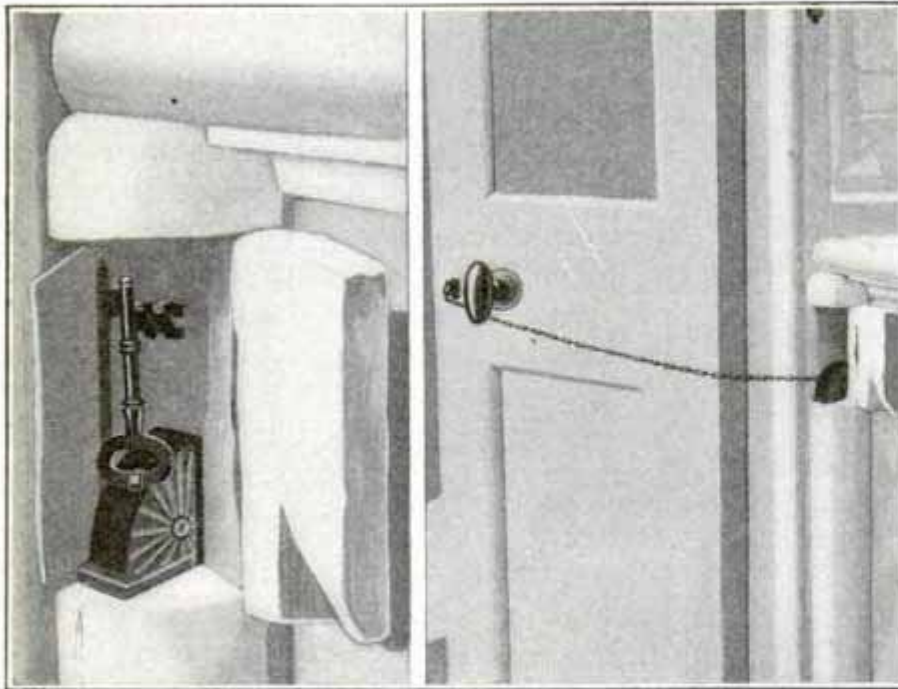

Fire-Escape Key Always Available because Chained to Opening Door and Kept in Wainscoting

always opened at a second's notice because of the ingenious method of assuring the presence of the keys.

Owing to the fact that fire-escape doors are rarely used, there is always the danger that the keys may become misplaced, and many firms adopt the system of enclosing them in glass fronted cases. This system is not applicable, however, for factories where the fire-escape

doors are occasionally used for other purposes, as is the case in the lace depot, where the landings are used for drying purposes and for photographic printing.

on the market by a New York concern. It is threaded into the cylinder head and is used in place of the ordinary petcock for priming-cup purposes as well as for an alarm. When

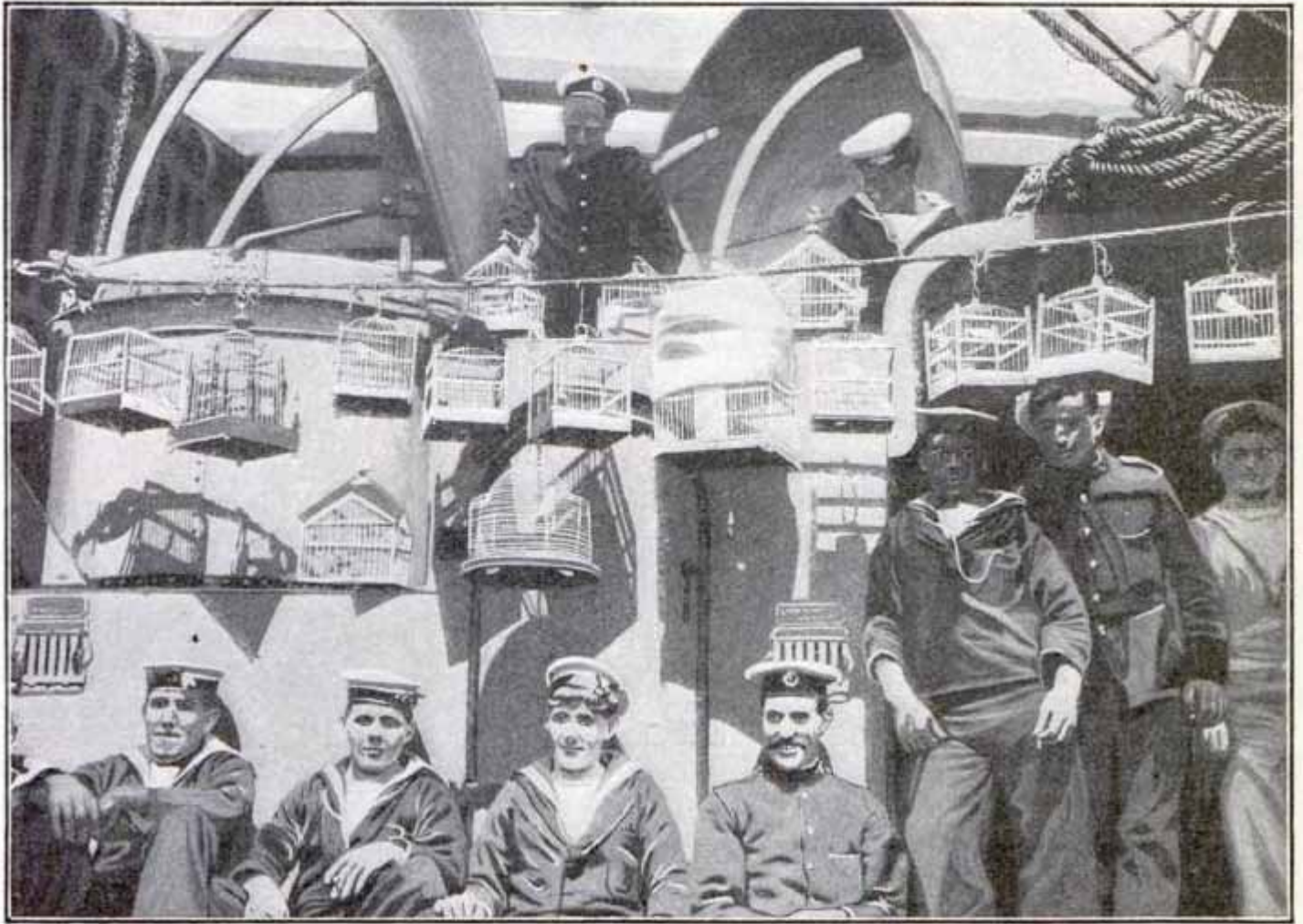

Bird Pets on a British Naval Vessel Brought on Deck for an Airing

BIRDS IN CAGES PETS ON BRITISH BATTLESHIP

British sailors have pets of all sorts, but on at least one ship birds are kept instead of dogs, goats or monkeys. These birds are carefully tended by the members of the crew and their existence is officially recognized by the officers in charge through the allotting of special time for the airing of the birds and the cleaning of the cages.

OVERHEAT WHISTLE FOR AUTOMOBILES

A device which resembles an ordinary petcock, but which whistles when an automobile motor becomes overheated, thus drawing the attention of the driver to the fact, is being placed

a motor heats up beyond a safe running temperature, the brass valve spindle of the mechanism expands and elongates at a quicker rate than the steel pin that passes through it. Although the brass valve remains closed, this difference in expansion provides a passage for the hot gases to the whistle, causing it to give mild blasts, which can be easily heard by the driver of the car.

⌋The largest cantilever crane in the world, recently made by a British firm for a Japanese dockyard, is capable of dealing with a load of 200 tons at a radius of 95 ft. A still larger one is now being built for the Japanese navy, to have a load capacity of 200 tons at 105 ft. radius.

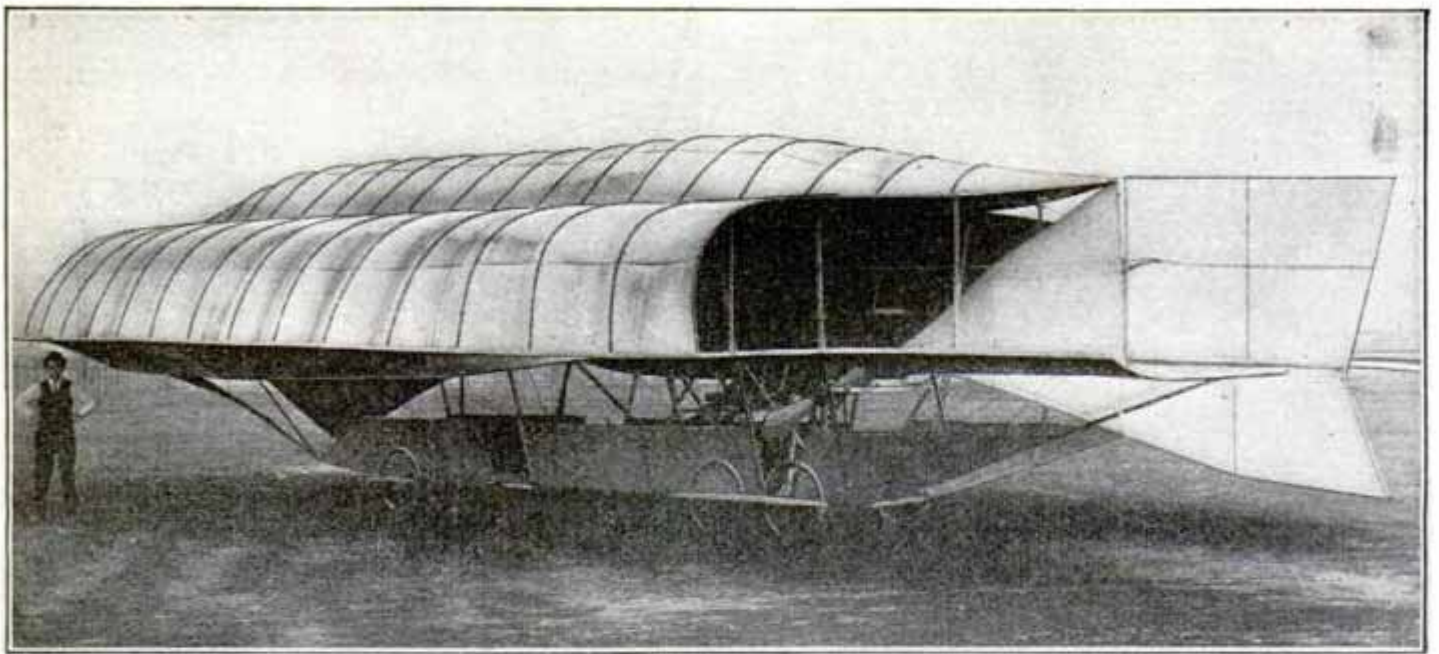

An Aeroplane of Unique Design Constructed by a Florist of Hackensack, N. J.

A CANOPY-TOP AEROPLANE

This curious aeroplane was designed and built by a Hackensack, N. J., florist who believes he has struck the right idea in aeroplane construction. The most unusual feature is the can-

opy top, extending the whole length of the machine, and intended to act as a parachute in case it falls. The machine is 50 ft. long, has an engine of 75 hp., and weighs 1,200 lb.

A "HEADLESS HORSE" PHOTOGRAPH

This horse really has a head, but a moment before the camera was snapped he swung it around to dislodge a fly or investigate some other source of irritation. The amateur photographer who took the picture did not give this movement of the horse

any thought at the time, and consequently was much surprised on developing the plate to find the animal headless.

THE OMNISCIENT ENGINEER

In Jules Verne's story, "The Mysterious Island," which enchanted the boys of a generation ago, the hero was an American engineer who was a walking encyclopedia of technical knowledge relating to every art and industry. He had a correct answer for every question, and promptly found ways of escape for himself and his comrades from every difficulty.

Unfortunately, such engineers live only in fiction, says the Engineering News, but there still persists in the minds of many people a lingering idea that a great engineer necessarily ought to know everything on every sort of technical matter. It is often humiliating for an engineer to run against this idea, particularly when one finds it in one's own family! A man whose



This Horse Swung His Head around a Moment before the Camera was Snapped

engineering reputation extends across the continent, for example, may be informed at the breakfast table some morning that the hot water drawn into the laundry tubs is so red and muddy with iron rust that the week's washing cannot be done. It is humiliating for the great engineer under such circumstances to have to weakly confess that he neither knows why the hot-water supply so misbehaves nor what to do to remedy it. He has an uneasy conscience that those of his own family who ought to most respect him have their faith in his greatness sadly shaken!

HOW TO MAKE A PEDESTAL

The pedestal shown in the accompanying illustration is another piece of furniture that can be made in the mission style. It is very simple in design and construction, and can be made by anyone who has a few simple tools and a slight knowledge of their use. It is best to make it of quarter-sawed oak as this is the most easily procured wood and also looks the best when finished. If you order the material from the mill ready cut to length, squared and sanded, much hard labor will be saved. Following is a list of the material needed:

- 1 top, $\frac{3}{4}$ by 12 by 12 in., S-1-S.
- 1 bottom, $\frac{3}{4}$ by 12 by 12 in., S-1-S.
- 8 pieces, $\frac{3}{4}$ by 2 by 11 in.
- 2 sides, $\frac{3}{4}$ by 5 by 26 in., S-1-S.
- 2 sides, $\frac{3}{4}$ by $3\frac{1}{2}$ by 26 in.
- 1 piece, $\frac{3}{4}$ by 6 by 6 in.
- 4 blocks, 1 in. square.

Having the boards for the post cut to the proper length and square, nail

them together as shown in the detail drawing. Use finishing nails, then set the heads and fill the holes with putty. Next, nail the $\frac{3}{4}$ by 6-in. piece on one end of the post leaving the edges projecting even on all sides. Pick out the best board for the top. On the under side and $\frac{1}{2}$ in. in from the edges, nail four of the $\frac{3}{4}$ by 2 by 11-in. pieces which have been previously mitered as shown in the plan view. Now fasten this top to the post by nailing through the projecting edge of the top piece into the top board. Be careful to get this top on square with the post and exactly in center.

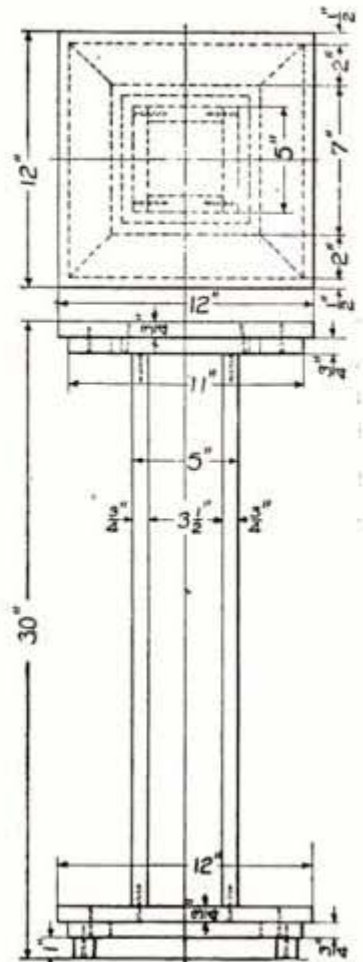

The bottom board is made in the same manner as the top board and is nailed to the lower end of the post as shown. Four 1-in. square blocks should be fastened to the bottom for the pedestal to rest on.

When complete sandpaper smooth and apply any one of the many mission stains that are supplied by the trade for this purpose.

NEW COLOR-PERCEPTION LANTERN

Really scientific color tests are made possible by the use of this new British color-perception lantern. By an exceedingly ingenious arrangement, a wide range of colors, scientifically true to the spectrum, can be produced as they would appear to the engineer at distances varying from 3,000 ft. to a comparatively close range. The effect of distance is made possible by means

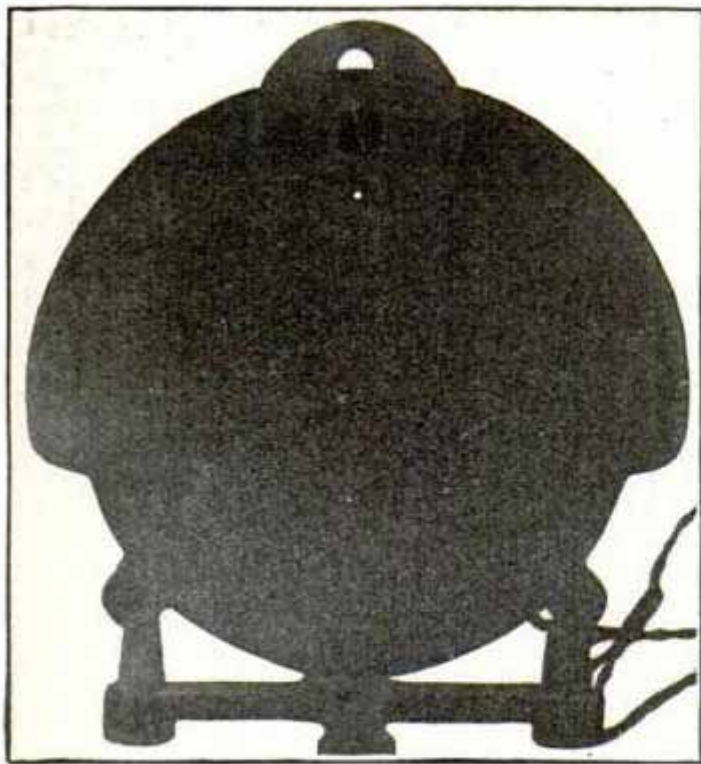

The Light Reduced to Represent Distance of 3,000 Ft.

of modifying glasses set before the source of light and by reducing the size of the light by turning a disc provided with different-sized holes. Lights as seen in rain and fog are produced by means of ribbed glass for the former and ground glass for the latter.

Around the edge of the small revolving disc mounted near the top of the dark board of the lantern are five holes, ranging in size from the large hole used to produce the effect of a light comparatively close at hand to a hole which

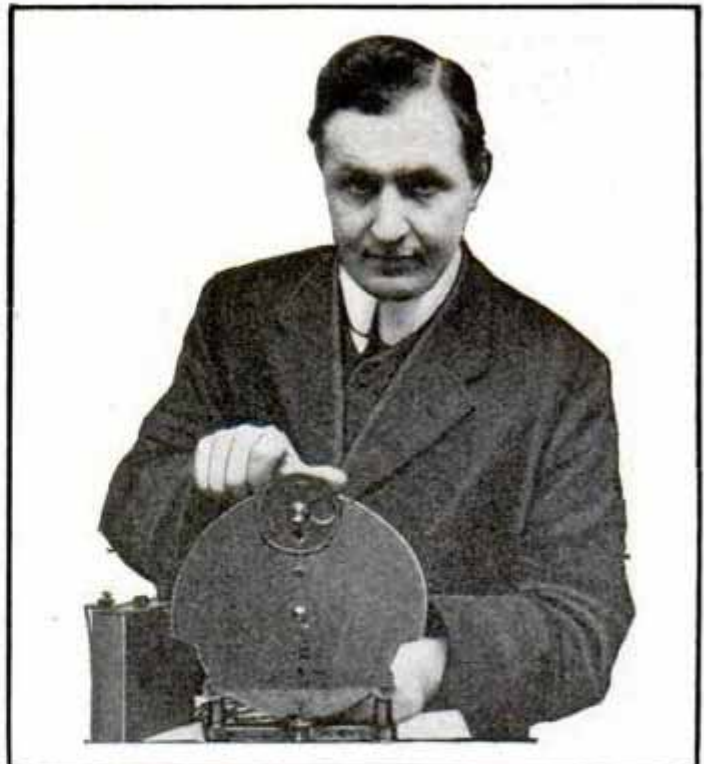

Photos Clarke & Hyde

Operating Lantern; Second Largest Hole in Position

produces the same light the size it would be seen by the engineer at a distance of 3,000 ft. The two largest holes are for close range, the third in diminishing size produces the effect of a distance of 1,800 ft., and the fourth gives the effect at 2,400 ft. The person whose color vision is being tested stands about 20 ft. from the lantern.

This new device is being used for the British admiralty tests, and has also been adopted by several railroad companies.

CHEAP CONSTRUCTION FOR TALL CONCRETE WALLS

The cost of building tall concrete walls has been greatly lessened by a new form of construction, recently adopted in erecting a building for a Chicago brewery company, in which the forms are made so as to slide up the wall continuously as the concrete is being poured. It has been calculated by an authority on concrete construction that the new method is materially cheaper than other systems for walls above 18 ft. in height, so that it is especially applicable for elevators,

silos, storage bins and warehouses having high straight walls.

The forms are raised by jacks which straddle the wall and support the forms against it. The forms, which are about 4 ft. high, are bolted or spiked to the legs of the jacks, and are lifted by screws working against pipes placed in the poured wall. On straight walls, without window openings or floor recesses, about 3 ft. of wall can be poured in a working day of 8 hours. One laborer can attend to from 9 to 11 jacks, and the entire force is organized as a unit so that all the jacks will be raised equally.



Shop Notes

A Water Heater

In places where the bath room adjoins the kitchen, and the gas stove and tub are in close proximity a simple and cheap bath-water heater may be arranged as shown in Fig. 1.

Make a cone-shaped coil similar to an old-fashioned beehive of $\frac{1}{2}$ -in. copper pipe. The base should be 8 in. in diameter to fit detachably over the stove burner. At the ends insert a garden-hose connection and solder in tightly. Connect the coil to the sink faucet with a piece of garden hose of the right length having the usual connections at each end. Use a similar piece of hose to connect the top of the coil with the bath tub. An efficient and continuous flow of hot bath water may be secured with this coil.

A piece of galvanized iron is shaped as shown in Fig. 2 and set over the coil to utilize all the heat and confine the gas flame within the coil. Slip hose connections would answer as well as metal connections, if a close fit is

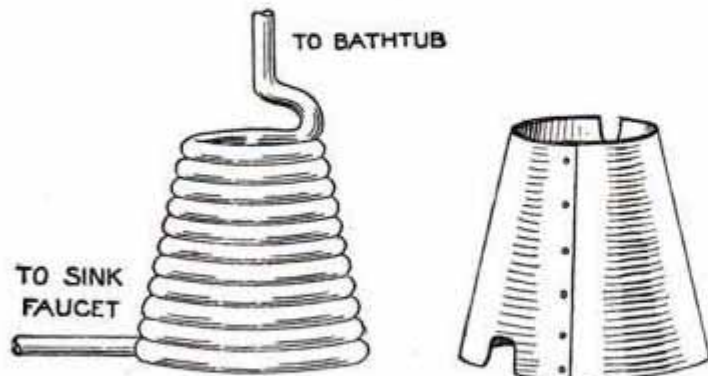
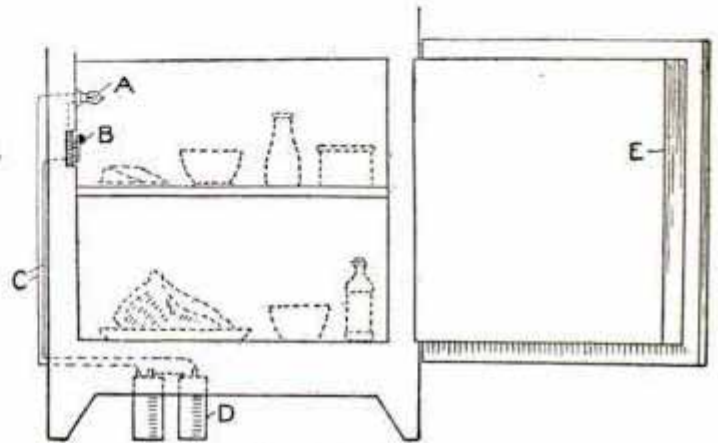

FIG. 1
FIG. 2
Copper Coil and Iron Cover

secured. The water should be turned on before lighting the burner. A decreased flow will give hotter water.—Contributed by Victor Labadie, Dallas, Texas.

Lighting Interior of Refrigerator

The place for the refrigerator in my home does not permit enough light to enter when the door is opened to



Location of Lamp

plainly see the articles within. This made it necessary to have a light of some kind, and I rigged up a very practical little device to light the interior when the door is opened. The lamp is a miniature, flashlight-type globe set in a miniature socket, fastened with screws on the wall inside of the refrigerator, where it will not be in the way.

The switch is an ordinary one-pole type, which is fastened to the refrigerator just inside the door with the handle projecting so that it will be pushed open by the shoulder on the door when this is closed. This prevents leaving the lamp burning thoughtlessly. The wires are carried through the wall or floor and connected to a battery of two dry cells beneath the refrigerator.—Contributed by Clarence G. Myers, Waterloo, Iowa.

☞ Filing babbitt is made easy by using a rod having a standard thread, newly cut. This will not fill up like an ordinary file.

Painting the Inside of a Rain Pipe

While painting the rain pipes on a house I thought of a way to paint the inside of the pipes. I procured a sponge large enough to fit the inside of the pipe and fastened a weighted cord to it. I then dropped the weight through the pipe and forced the sponge

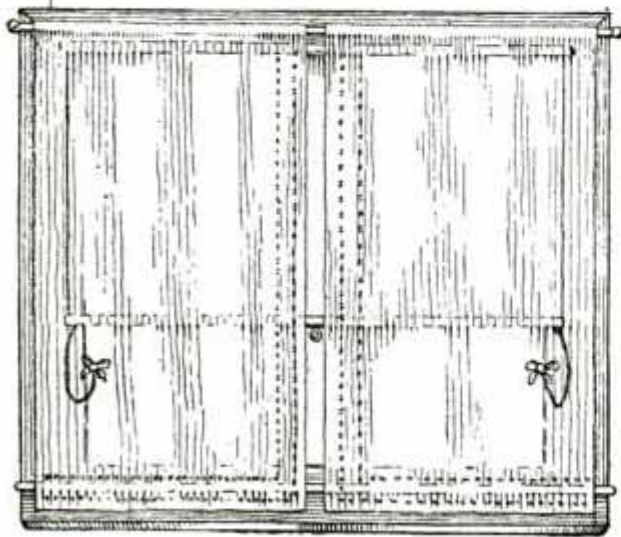

FIG 1

Curtains Tied to the End of the Shade

them in the holes. The cloth is shown at A in the sketch and one of the eyelets at B. The cloth is kept taut by the thumbscrew in the same way as drawing up the hacksaw blade. Strips of emery cloth in the various grades can be prepared and kept ready for use in the frame.—Contributed by Oscar Carlson, Tacoma, Wash.

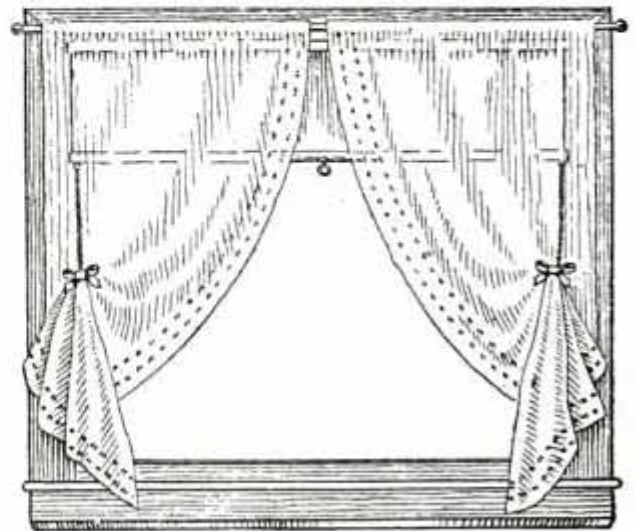
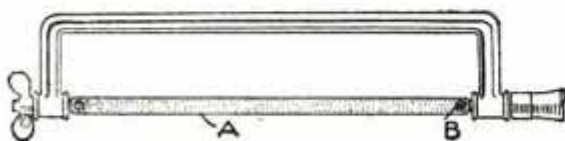

FIG.2

a few inches into the pipe, making a cavity large enough to hold paint. Fill the cavity with paint and pull the sponge by the cord slowly through the pipe. Place an old pail at the bottom to catch the surplus paint. This method will apply a coat of paint to the inside of the pipe that will preserve the metal as well as if painted with a brush.—Contributed by Ed. Borchik, Cleveland, O.

Emery Cloth Used in a Hacksaw Frame

The illustration shows an emery-cloth holder for polishing small places or round edges. It consists of a hack-



Emery Cloth in Frame

saw frame and emery cloth. The cloth is cut $\frac{1}{2}$ in. wide and the length of the saw blade. Punch a hole in the cloth $\frac{1}{2}$ in. from each end. Procure some eyelets from a shoe store and rivet

Lace Curtains Drawn Back with the Shad

An easy and convenient way of drawing back lace curtains is to attach them to the window shade as shown in the sketch. On bright days sufficient light will enter the room for reading when the shade is within 18 in. of being closed as shown in Fig. 1. On dark days, even with the shade to the top of the sash, I find the light insufficient, unless the lace curtains are drawn back, also. I accomplish the whole process by just raising the shade.

Attach a small screw-eye to the end of the bottom slat. Connect it with some part of the lace curtain with a cord in such a way that it will allow the shade to be closed entirely, and when raising the shade higher than shown in Fig. 1 it will draw the curtains back as though they were draped, as shown in Fig. 2. A bow of ribbon, artificial flowers or any other suitable ornament, may be placed where the cord is attached to the curtain.—Contributed by M. O. Henning, Swissvale, Pa.

Marking Divisions on Circumferences of Shafts

A method of finding certain equal divisions on the circumferences of shafts, body bands of gas and electric fixtures or on any cylindrical surface where dividers are not at hand or cannot easily be used, is shown in the sketch.

Cut a piece of paper about 1/2 in. in width, or smaller if necessary, and a little longer than the length of surface to be divided. Put the paper around the cylinder and cut it so that the ends just meet when the paper is pulled snugly to the surface, then fold and cut for the various divisions as follows:

To find the point diametrically opposite, fold as in Fig. 1 and cut notches

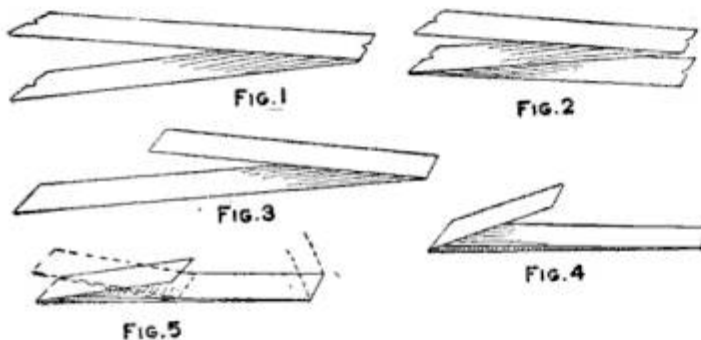

Strips of Paper Folded

out at the ends, then place the paper on the cylinder and mark the division in line with the fold or break on the surface through the holes. For three divisions fold the paper as shown in Fig. 2, and for four divisions, fold as shown in Fig. 1 and then double. For five divisions, fold as shown in Fig. 3 by lapping the end over two-thirds the way, then folding the single end back over the double part, Fig. 4, then doubling in the center, Fig. 5. With a little practice one can make these papers quite perfect with almost any number of divisions.—Contributed by G. T. Nelson, St. Paul, Minn.

Curtain Ventilator for a Van

When passing a large van one day I saw it was fitted with a clever curtain ventilator, evidently homemade, that could be raised and lowered at

usual curtain on the back end extended to within 6 or 8 in. of the top. Above this was hung a small independent

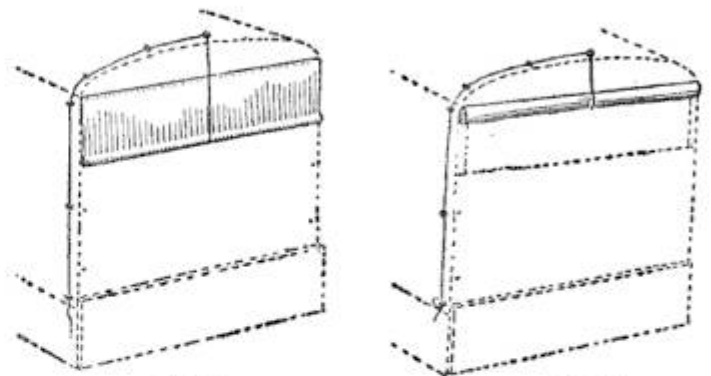
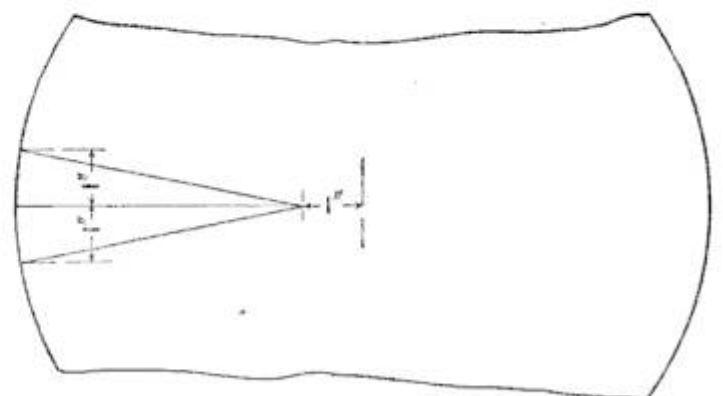

Fig. 1 Ventilator on Van Fig. 2

curtain having an iron rod fitted in the hem so as to cause it to hang without flapping, and also to make it drop when the elevating cord is released. The cord is run through screweyes turned into the side of the van, as shown in Fig. 1. The curtain is shown drawn up in Fig. 2.—Contributed by Jas. M. Kane, Doylestown, Pa.

How to Cut a Cone-Shaped Kettle Cover

Cut the metal 1 in. larger in diameter than the hoop after the edge is turned. Mark a line starting 1 in. from the center and extend it to the edge. Mark two other lines starting from the same point and extending each to a point 1 in. on each side of the center line as shown in the sketch. Cut out the gore and turn the edge tapering from



Size of Gore to be Cut

the circumference to the center on a hatchet stake. No edges are to be allowed.—Contributed by S. C. Ship-

Removing Obstruction in a Well Casing

When putting down or driving the ordinary tubular wells it often happens that the pipe must pass through a stratum of soft sticky soil or clay.

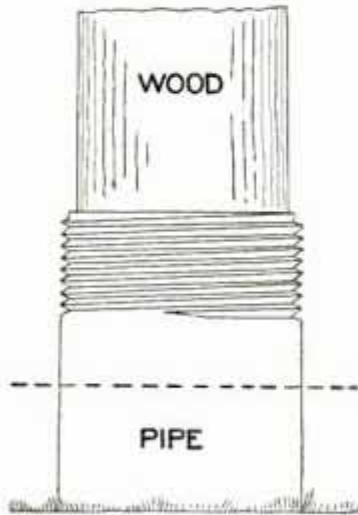

The strainer or point on the bottom end of the pipe will become completely sealed up, thereby preventing the entrance of the water into the pipe, which naturally prevents the pump from raising the water.

Ordinarily it is the custom to pull out the pipe and clean the strainer to remedy the trouble, but having had trouble of this kind recently, it occurred to me that the obstruction might be removed without withdrawing the pipe.

When I found that the point was sealed, I procured a round piece of wood that would fit the inside of the pipe snugly, the wood being about 1 ft. in length. The pipe was filled with water to the point shown by the dotted line in the sketch, then the wood plunger was placed on top of the water and struck a sharp blow with a hammer. The obstruction was completely removed. The wood must be held or else the suction of the water will draw it into the pipe.—Contributed by E. S. Sheperd, Wichita, Kans.

Producing Marble Effects with Paint

Prepare the colors to be shown in the marble, using varnish for the vehicle and japan colors, reduced in turpentine, making glaze colors or varnish stains. Put in the ground color with lead and turpentine and allow it to dry, then apply different glaze colors so as

No care need to be taken for this part of the work, as the crudest efforts give the best results.

Dissolve a lump of potash the size of a pea in 1 oz. of kerosene, and while the glaze coat is fresh, dash small drops of this on the painted surface. This will separate the colors and blend them into very pretty marble effects.

By the exercise of a little taste and ingenuity surprising effects can be obtained. If spar varnish is used, it can be rubbed down and a coat of clear spar put on as a protector.

I have in my yard a pair of large garden urns made of plaster-of-paris marbled to a malachite green, and these have stood the weather for four years.—Contributed by Wm. G. Browning, Los Angeles, Cal.

Clothesline Holder

The holder consists of a stationary piece, C, fastened to the post, on which the piece A is pivoted on the screw D, the piece A having a block B fastened to its edge as shown.

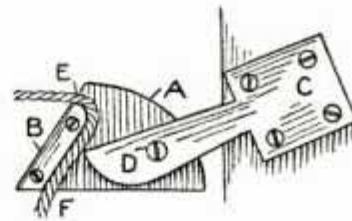

The clothesline E is passed over the block B and drawn as taut as necessary, then it is gripped between the block B and the pointed end of C.—Contributed by H. Frisch, St. Louis, Mo.

Substitute for an Expansion Bolt

A very effective, simple and cheap method of fastening anything on brick walls where expansion bolts are not at hand is as follows: Take a common nut, $\frac{3}{8}$ in. square, and cut it almost through with a hacksaw as shown at A.

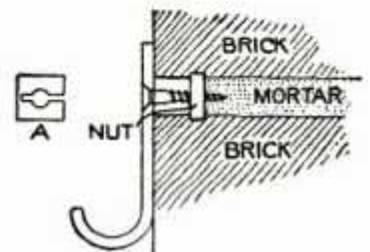

The size of the nut is governed by the

bricks or the size of the hole made in the wall. The size of the hole in the nut should be about the same diameter as the wood screw at a point about $\frac{1}{4}$ in. from the end.

After making a hole in the mortar between the bricks, the prepared nut is inserted and the screw driven into it. The screw will spread the parts of the nut and firmly hold it between the bricks. Be sure to have the cut in the nut parallel with the two bricks between which it is wedged.—Contributed by Gilbert A. Wehr, Baltimore, Maryland.

Removing a Stuck Ax

An easy way to remove an ax stuck in a log is to use the method shown in the sketch. A small chip is placed under the cutting edge of the ax on the handle end and a pressure on the

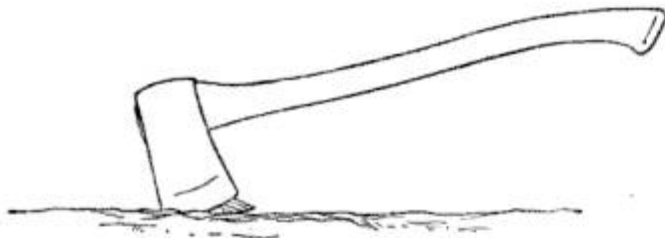

Ax in the Wood

handle will easily withdraw the blade. When the ax is stuck so that the entire edge is in the wood, raise the handle until a part of the edge is out above the surface.—Contributed by Fremont Leland, Chester, Conn.

Sink-Drain Strainer

Bath, sink and other drain pipes clog easily where the opening is left entirely open. A little device can be made at home to keep the drain pipes clean, and its cost will be practically nothing.

The illustration A shows a piece cut from tin having four projections B and an opening C. Another piece is cut as shown at D with projections F and an opening E the same size as the one at C. A small piece of screen is placed over the opening E and the projections B bent over the edge as in G.

shape shown in the last sketch. The diameter of A and D should be a trifle less than the inside diameter of the drain opening.

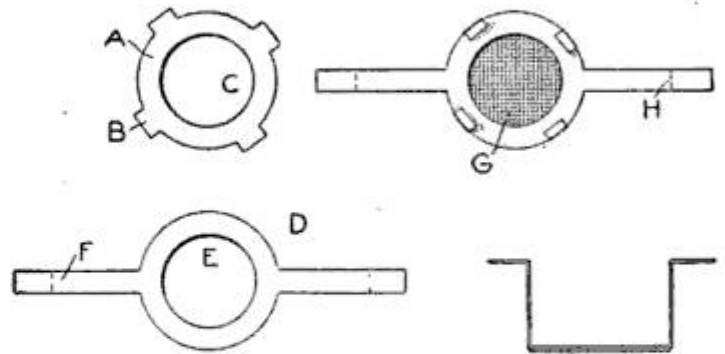

Parts of Strainer

Set the strainer in the opening of the drain and it will keep out all dirt that is apt to stop in the pipe. The wire screen can be easily replaced if it becomes worn.—Contributed by Maurice Baudier, New Orleans, La.

Stretcher for Covers

The ordinary way of stretching a piece of leather, canvas or other like covering is to pull the edges with the fingers. This will make an uneven surface, as the material cannot be drawn very tightly or at every part of the edge. The tool described herewith will be found quite useful for the home or shop. It is made of a pair of long-nosed pliers provided with a pair of notched clamps which are fastened with machine screws. In using the tool the edge of the cover is gripped between the clamps and then tightly

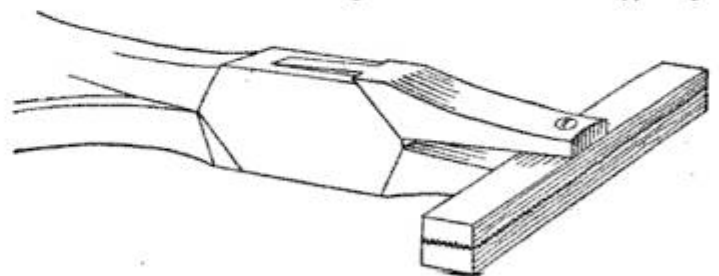

Notched Clamps in Pliers

drawn and held while tacking the cover.—Contributed by Wm. Grotzinger, Baltimore, Md.

Ⓒ Approximately every 2 ft. of elevation is equal to 1 lb. pressure per

Splicing Rope Drives

By W. B. HOSFORD

Many interesting experiments in rope splicing have been made in an effort to obtain a splice that will fill the bill in every particular in connection with the American system of rope driving. A long rope splice that has so far given the best of results is shown in the sketches. These show each successive operation in splicing a 1½-in. four-strand rope.

After the rope has been tied and unraveled, measure back from the end of the rope the necessary distance, about 7 ft. for 1½-in. rope, and tie securely with a piece of twine, as shown in Fig. 1. A good rule for all sizes of rope is to measure back 60 diameters of the rope to be spliced and tie it, then unlay the strands of each end back to the twine tie. Cut the core close to the end of the solid rope and place the ends together and join each pair of strands as shown in Fig. 2.

Take one pair of strands and unlay one and lay in the other until the length is in place, allowing sufficient end to do the tucking as shown in Fig. 3. Treat the other pairs in the same manner, so as to leave the three spaces between strands the same distance apart, as shown in Fig. 4. Each pair of strands are unlaid two full turns back from the point of meeting, as shown by the half strands 3 and 4 in Fig. 5. Each strand is now divided equally, one-half of each strand is laid forward to the center of the space between the two dropped half strands and tied in a simple knot, so as to have the threads running in the same direction as they are running in the rope. These are shown at A in Fig. 6, after the tie is made. The rope is now held and opened with a marlin spike as shown in Fig. 8.

Take strand 3 (Fig. 7) and lay it around until it meets half strand 4. Untwist the threads in the loop as shown and draw them in until the threads run in the same direction as

peat the same operation in the opposite direction using half strand 4 to meet half strand 3. The end is ready to tuck at this point. Treat all strands where they meet, in the same manner.

The operation of tucking is shown in Figs. 8, 9 and 10. Cut half strand 3, Fig. 8, for convenience, and take out one thread, and one thread out of strand 4, or the tucking strand, insert the marlin spike so as to open the strand, holding the rope as shown. Pull the remaining threads of half strand 3 out from under strand, making room for 4. Draw half strand 4 over and under, taking the twist out of the threads, as shown in Fig. 9, pull down firmly in the direction the strands run in the main body of the rope. Continue to repeat this operation, dropping a thread out of each half strand until all the threads are dropped. Treat all strands alike and the rope will have the appearance shown in Fig. 10. Cut the threads off close to the body of the rope and it will have the appearance shown in Fig. 11.

In splicing a three-strand rope, the operation of measuring back, tying, unraveling and butting together is the same as in a four-strand rope. There is one pair of strands less and one pair of strands is laid out in each direction, leaving a tucking end and one pair of strands remain in the center. Every other operation is the same as for a four-strand rope.

Grinding a Twist Drill

When drilling, either grind the cutting edge of the drill to the center of the supporting rib, or first use another drill which is not less in size than the center rib, as on a 1-in. drill there is about 1/8 in. of stock in the center without any cutting edge. If the cutting edge is not carried to the center of the rib or no small drill used in advance, there is a great waste of power and

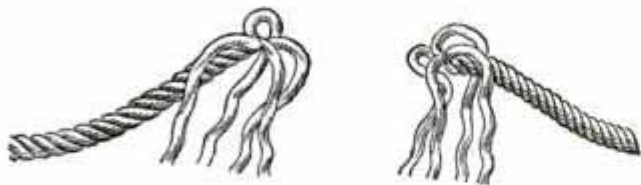

FIG. 1



FIG. 2

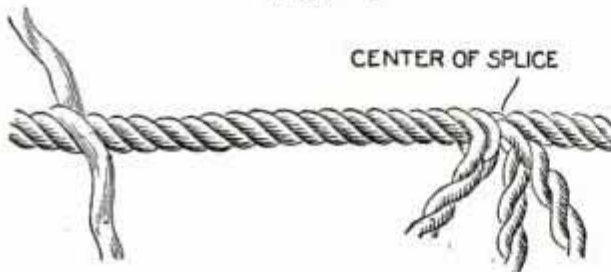

FIG. 3

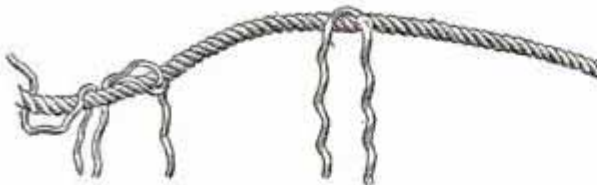

FIG. 4

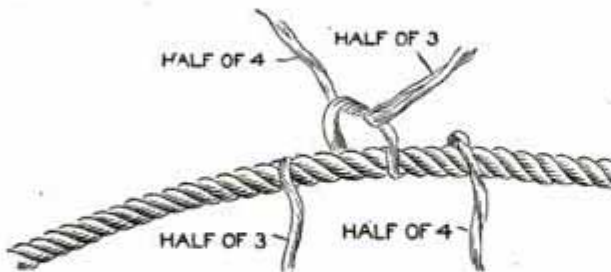

FIG. 5



FIG. 6

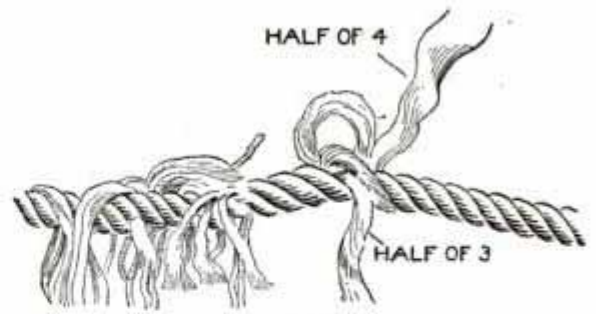

FIG. 7

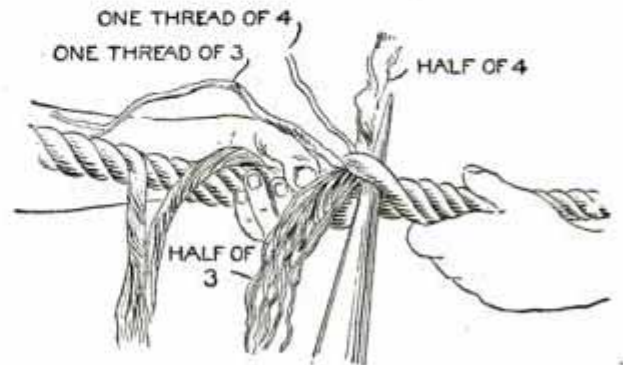

FIG. 8



FIG. 9



FIG. 10



FIG. 11

Protecting a Wood Partition Around a Stovepipe

The sketch shows a very satisfactory method of protecting a thin board partition through which a stovepipe is passed. A square, 14 in. each way, is

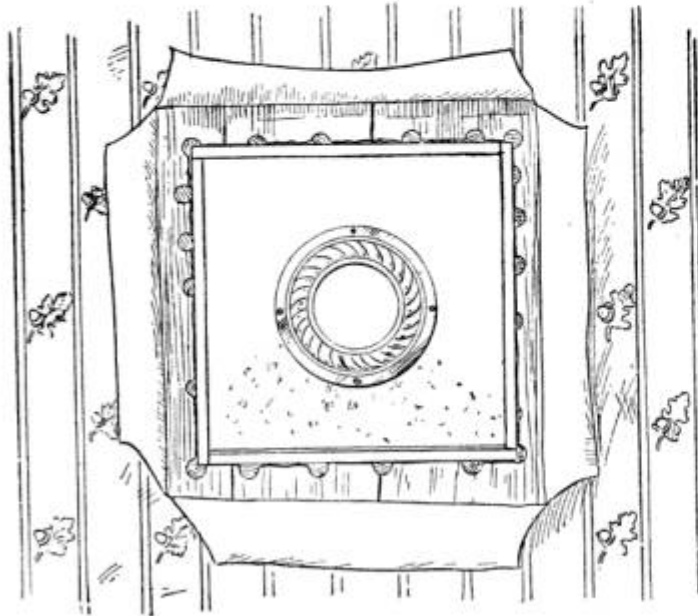

Asbestos Filling

marked on the wall where the pipe is to pass through and the wallpaper cut with a sharp knife in such a way that it will turn back and expose the boards. Bore sufficient holes on the lines of the square to enable one to cut it out with a keyhole saw or ordinary handsaw.

Place a piece of asbestos board that is about $\frac{1}{8}$ in. thick in the space where the boards were removed. The asbestos can be obtained at any hardware store. Fasten the board on all sides with eight small pine strips, each about $\frac{3}{8}$ in. thick and of a length to make a neat double frame which can be held secure by a few nails or screws. Turn the wallpaper back and paste in place, or put on new paper around the frame, if the old paper has been damaged. Cut a round hole, a little larger than the stovepipe, in the asbestos before fastening it in the partition.

Procure a couple of tin stovepipe collars and lay them down together evenly and punch four or more small holes in their rims. Fasten the collars, one on each side of the asbestos board, over the hole with roundhead stove bolts. The stovepipe joint is run

through the collars. This will make an arrangement that will be a safe one, and, if well done, a neat appearing job in a situation where it would be impossible to use a chimney ring.—Contributed by J. G. Allshouse, Avonmore, Pa.

Pressure-Gauge Tester

Every engineer, stationary or marine, can easily make the pressure-gauge tester shown in the sketch. The cost for the material will be small, and, although not so elaborate as the factory-made article, it will give first-class results.

The main body A is a piece of brass tubing, 12 in. long and $1\frac{1}{2}$ in. in diameter. Two holes are drilled on one side, one at each end, and fitted with two $\frac{1}{4}$ -in. pipe couplings, DD, which are soldered in place. Another brass tube B, 12 in. long and 1 in. in diameter, having a hole in it at C, is fastened with the tube A on a solid disk, I. A $1\frac{1}{2}$ -in. washer, F, with a hole the same size as the inside tube is soldered on the other end of the tubes. The hole in the washer is threaded to receive the bushing G, which has a bolt with a long thread to fit its internal threads. An iron washer and a good cup leather is attached to the end of the rod at E.

Fill the tubes with water and place a test gauge on one of the openings D and a gauge to be tested on the

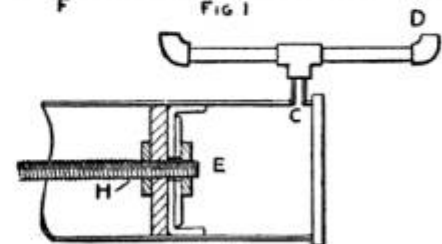
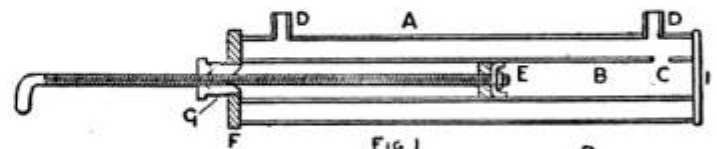

FIG. 2
Details of the Tester

other opening D. Before filling with water, the piston E should be at the washer end F. Turn the rod to make a pressure on the water. The number

of pounds pressure can be raised as desired.

In Fig. 2 is shown a single tube tester which is very simple. Its construction can be understood by the sketch. As high as 300 lb. pressure can be obtained with a few turns of the rod.—Contributed by Jas. E. Noble, Toronto, Can.

Ink Well for a Lettering Pen

The sketch shows an ordinary drawing-ink bottle filled with cement up to the neck, leaving a very small space at the top for ink. The advantage of

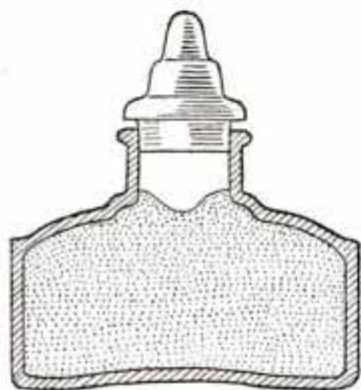

this well, which is for use with the lettering pen, is that the pen need be only dipped in the ink a short distance, avoiding the smearing of ink on the pen holder, as is usually the case. The ce-

ment filling makes a heavy paper weight of the bottle, which will not easily tip over. The stopper should be cut as short as practicable so that it will not limit the ink space. While the capacity is small, it is sufficient for ordinary work, as the lettering does not require much ink.—Contributed by J. J. O'Brien, Buffalo, N. Y.

Drain Board for a Sink

The simple drain board shown in the sketch is a great kitchen help. It consists of two frames of pine strips each 1 ft. wide and just long enough to fit across the sink. Nail the cross strips far enough apart to allow a plate to stand upright. Reverse the frames so that the strips in one frame will be at right angles to those in the other. Make four uprights about 2 in. high to support the corners and keep the two frames apart. In washing dishes place them on this drainer and pour

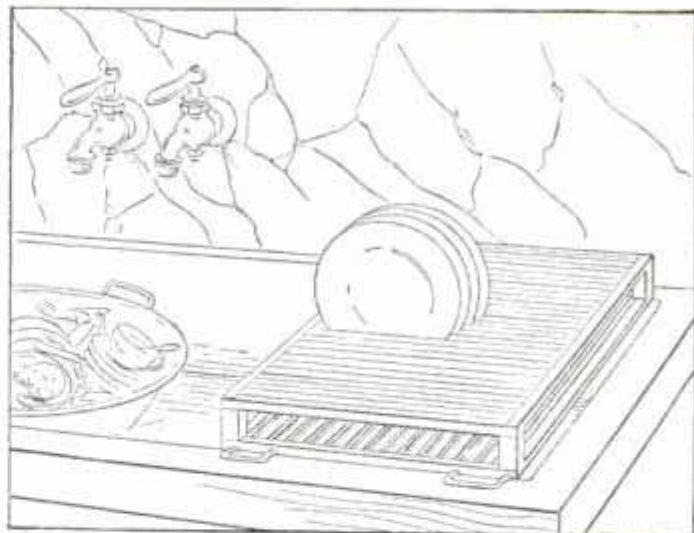

Plates between Slats

drying is necessary. The end of the board nearest the wall may be hinged and when not in use it is hooked up out of the way.

Ladder Props

It is often necessary for the owner of a house or garden to do some work that requires a ladder. Most ladders are heavy and hard to handle. The illustration shows a light ladder that can be placed anywhere alone or against uneven surfaces. The two props, which extend to the ground, are detachable and can be set up at any angle. The hooks are easily made by any blacksmith and riveted to the poles. They are set under any rung and, when climbing the ladder, it will stay where it is placed. The climber need not fear falling headlong, even though he may stand on the top rung. When

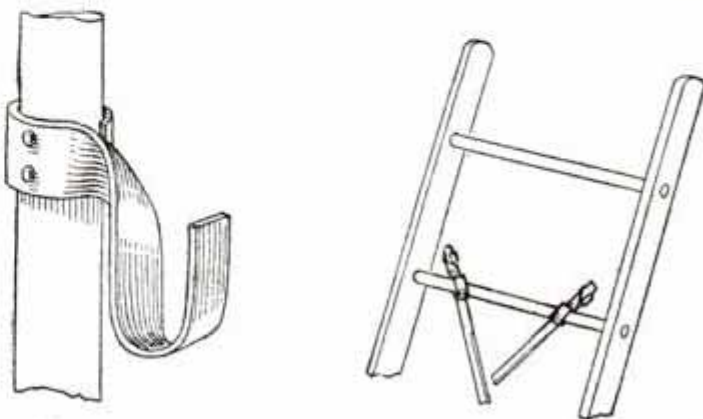

Props on the Ladder

gathering fruit, this ladder can be set against any limb without danger of breaking the branches.—Contributed

Stand for Holding Coiled Wire

A stand for holding coiled wire in various sizes is shown in the sketch. The stand is suitable for the shop or

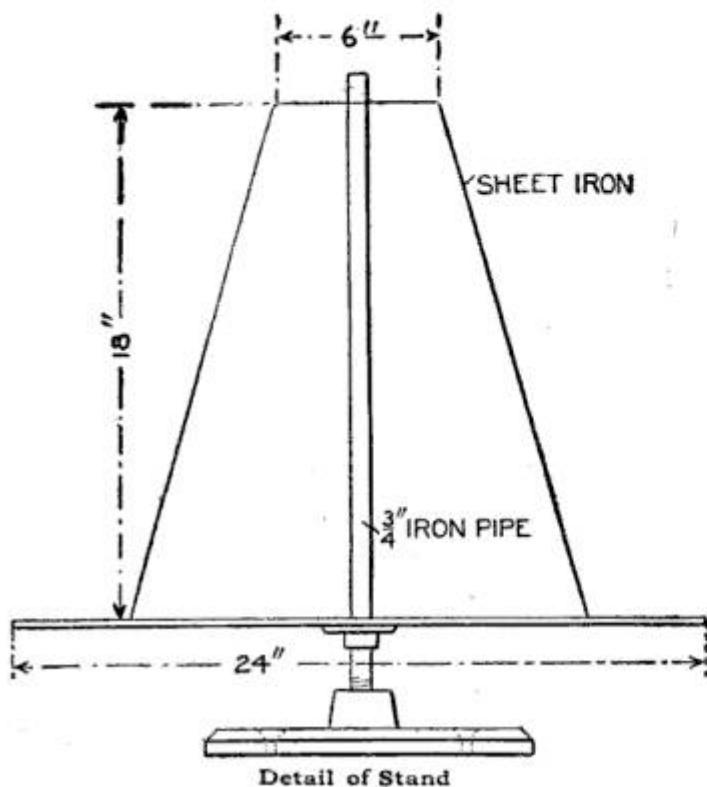

salesroom. Such a stand will hold a coil of wire and keep it from becoming tangled as the wire is used or sold.—Contributed by Peter J. Theisen, Denver, Colo.

How to Prevent Motorcycle Belts from Slipping

Having had considerable trouble with flat belts slipping on motorcycle engine pulleys owing to dust and dry surfaces, and after trying various kinds of dressing and building up the metal surface with friction tape, leather, rubber, etc., to increase the friction, I used the following method with better results: A strip of canvas was cut to fit in between the flanges of the driving pulley, thoroughly soaked in good glue, and wound tightly on the pulley surface until it consisted of six layers. After this dried, it gave excellent results. The band wears well and increases the friction between the surfaces, and it also allows the driving belt to run with less tension.—Contributed by Geo. Forest, Crystal Lake,

Test of Humidity in Living Rooms

The French Journal de la Sant (Sanitation or Health Journal) gives the following simple test for determining whether or not the humidity of a building unfits it for habitation. Place a known quantity, say 2 or 3 lb., of newly slaked lime in the suspected apartment, closing the doors and windows hermetically as in disinfecting it, and after 24 hours weigh the lime again. If it has increased in weight one per cent or more, the apartment should be pronounced insanitary.

An Adjustable Garden Marker

The adjustable marker is made on the same principle as the ordinary garden rake or marker with the exception of the teeth, which can be set at any distance apart (Fig. 1). The part holding the teeth consists of two strips of wood, 3 ft. long, 1½ in. wide, and 5/8 in. thick, fastened at the ends so that they will have a space between them for bolts. The teeth or markers are fastened with 3/8-in. bolts having washers and thumbnuts. These are shown in Fig. 2. The opposite side of the strips with the bolt heads is shown in Fig. 3. The teeth can be set from ¼ in. to 3 ft. apart. The teeth are shown set 4½ in. apart at A and 2¼

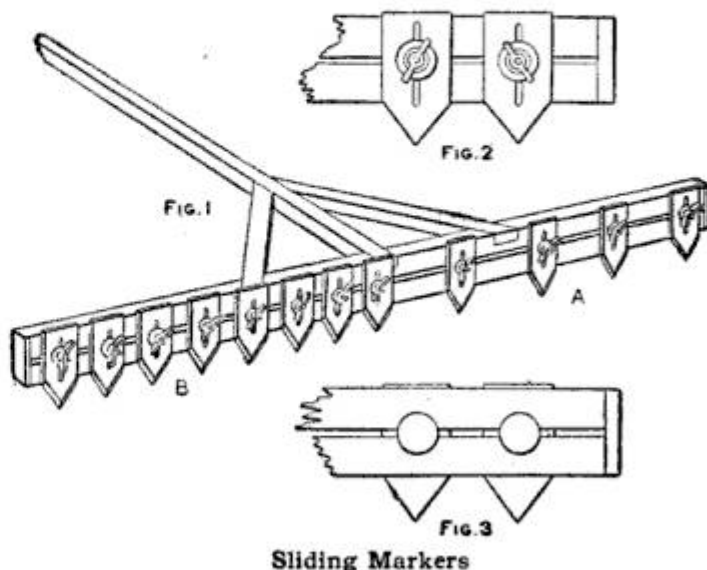

in. at B. The markers not in use can be raised up so the points will be on a level with the lower edges of the bottom strip.—Contributed by E. R.

Lathe Parallels

For boring, facing and special lathe work, a pair of parallels such as shown in the sketch is quite useful. Reference to the sketch shows that the parallels are provided at each end with a foot through which bolts are passed to secure them to the lathe carriage. A T-slot is cut in the top to provide a way for clamping the work to the parallels quickly and securely. If both parallel castings are planed up alike, work set on them which must be bored parallel to a given face is directly in line with the cut of a lathe.

When a large number of pieces of the same kind are to be machined, it will pay to make a special plate to fit them and bolt it to the lathe parallels. Cylinders, bearings and work too large to

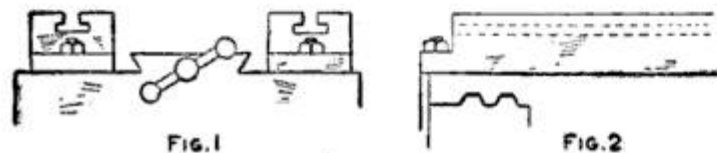

FIG. 1

FIG. 2

Parallels on Lathe Carriage

swing on a faceplate may be bored and faced with this aid.—Contributed by Donald A. Hampson, Middletown, New York.

Keeping Vermin out of Beehives

Mice and ants can be kept from entering beehives by setting the hives on the bottoms of inverted quart bottles whose necks are set in the ground. Be sure to keep the grass or weeds cut close to the ground about each hive.—Contributed by Paul Woodward, Rodney, Iowa.

Cellar-Door Support

The illustration shows a self-opening and self-closing support for a cellar door. One-half of the door is shown opened and resting on the support A. The other one-half shows the support fastened in place. It is very simple to make and attach.

Use a strip of wood for the support, $\frac{7}{8}$ by 2 in., with the required length

wanted when open. Fasten two blocks with screws, one on each door as shown, and attach a support to each

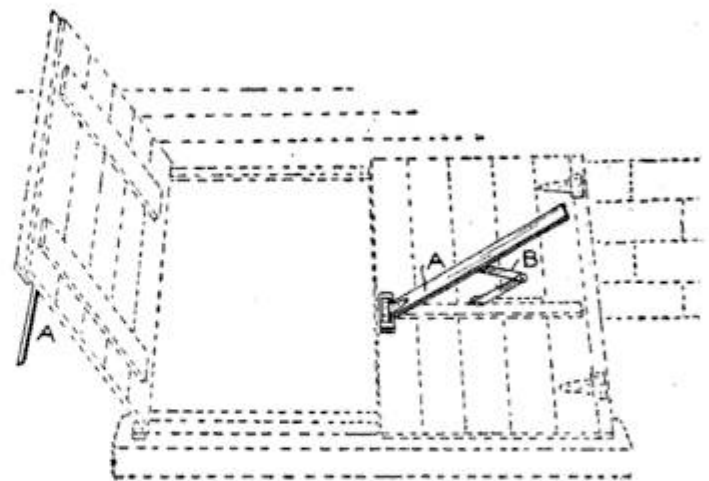

Folding Support

block with a tee hinge. The folding bracket B is easily made of a piece of hoop iron. The support will lay flat on the door when it is closed but will open up to the right position for a support as soon as the door is opened.—Contributed by W. A. Proctor, Clef-tondale, Mass.

Hinge Stop on a Gate

An ordinary gate or barndoor can be kept partly open or held in any position against a wind or draft by the use of a stop as shown in the sketch. The stop is made from an ordinary hinge which has only one wing fastened to the lower part of the door or gate. The loose wing catches on the floor, ground

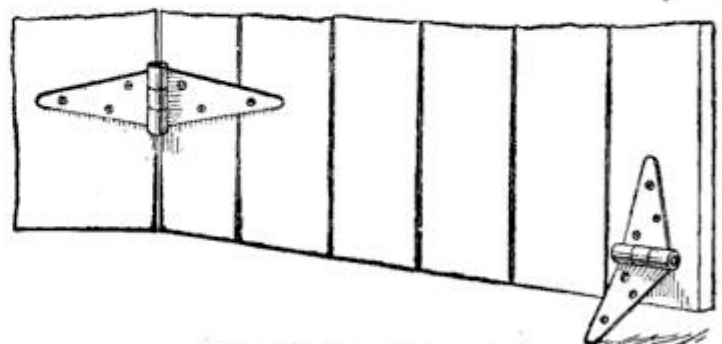

Hinge Fastened to a Gate

or cement walk. When not in use it is turned up against the gate.—Contributed by W. E. Cleveland, Chicago.

ⒸAfter cutting a taper on a lathe, do

Fireproof Chimney for Frame Houses

In a mining camp where many fires were caused by defective chimneys the one described herewith was adopted as

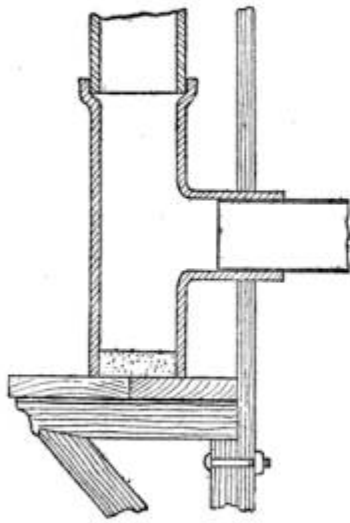

the best and safest kind for a frame house. It finally became compulsory to have every frame house equipped with this chimney. This style of chimney is inexpensive and the parts can be purchased in

almost any little country place.

A bracket is made and fastened to the outside of the wall on which a tee joint of terra-cotta sewer pipe is set and a bottom of cement put in on the boards. The tee opening extends through the wall and is used for the stovepipe opening. The chimney is then built up as high as desired with sewer pipe, the joints being well cemented.—Contributed by W. A. Lane, El Paso, Texas.

Testing Lubricating Oils

Place one drop of each oil to be tested on a piece of glass so that the drops will be in a line at one end. The glass should be about 30 in. long with a width sufficient to hold the number of drops without their mixing. Raise the end on which the drops were placed, about 6 or 8 in., to form an inclined plane. The oil will run down this plane. An oil having a light body runs and dries quickly, but an oil that has both a body and a free flow will be readily detected by this test. An oil may have a good body and yet may have a tendency to gum badly, which quality will also be detected on the glass. The oils should be protected from dust while these tests are being made.

Furniture Polish

The following formula makes an excellent creamy furniture polish:

Animal oil soap.....	1 oz.
Solution of potassium hydroxide.....	5 oz.
Beeswax	1 lb.
Oil of turpentine	3 pt.
Water enough to make.....	5 pt.

Dissolve the soap in the lye with the aid of heat; add this solution all at once to the warm solution of wax in the oil, says the Druggists' Circular. Beat the mixture until a smooth cream is formed, and gradually beat in the water until the whole is completely emulsified.

Fastening Hammer Handles

The illustration shows a method used by a correspondent of American Black-

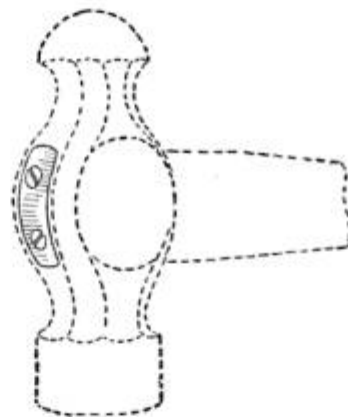

smith to keep hammers from coming loose on handles. The hammer is first set on the handle and then it is wedged as tightly as possible. Two $\frac{1}{16}$ -in. holes are drilled in the end of the wood and two large wood screws driven into the holes. The screws never come out and the hammer head does not come loose.

Electric Welding of Metal Saws

The installation of a cold-metal saw in a factory called for an operator, and the man selected was unskilled in the use of the machine. The saws used were $\frac{1}{4}$ in. thick and 3 ft. in diameter. Three of the saws were broken by the workman. One of the saws had a crack $4\frac{1}{2}$ in. in length from the cir-



cumference. This was placed on an electric welding machine and a piece about the size of a silver quarter broken from a $\frac{1}{16}$ -in. thick metal saw placed on each side of the crack. These welds were made about 1 in. apart. The current was used on the fourth power. The surplus metal was chipped off and the surface ground.

Another saw had six cracks all running toward the center from the outside. They were all treated in the same manner. This method was used after an unsuccessful attempt to join the break by brazing.—Contributed by John B. Roberts, Pittsburg, Pa.

Adjustable Mirror

A flat piece of iron, A, Fig. 1, 6 ft. long, $\frac{1}{2}$ in. thick and 1 in. wide, is attached to the wall or window casing with a screw. The mirror B is attached

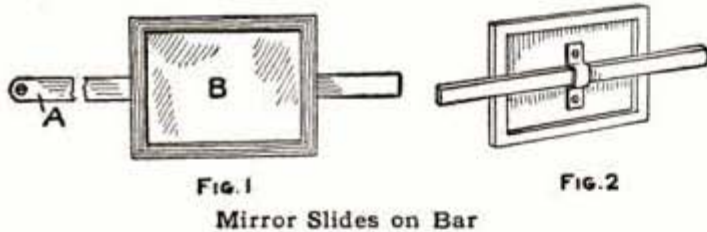

FIG. 1
Mirror Slides on Bar

to the iron bar by a clasp on the back as shown in Fig. 2. The object of such a device is to adjust the mirror to accommodate different heights. This device will be found quite convenient where there are small children.—Contributed by Milton O. Freeman, Ghent, O.

Cementing Brass to Glass

An elastic cement for holding brass to glass can be made by mixing together with a gentle heat 5 oz. of rosin and 1 oz. of beeswax, then stirring in 1 oz. of dry Venetian red slowly, after which take from the fire and let cool. This is used as a cement.

☞ Stains on gold and silver can be removed by immersing in a solution of cyanide of potassium, $\frac{1}{2}$ oz., rain water, 1 pt., and brushing off with prepared chalk.

Vise for a Drill Press

When a number of bars of a uniform size are to be drilled, the vise shown in the sketch is a great time saver, as

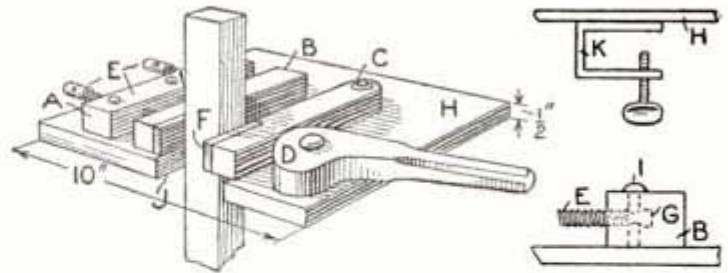

Quick Acting Vise

one movement of the lever D tightens or releases instantly after setting the jaws B and C to the right size by the screws E which turn in the piece A. The pieces A, B and C should be 8 in. long and $1\frac{1}{2}$ in. square. The pieces B and C are fitted with steel jaws F. The piece A is riveted to the base plate H. The ends of the screws E have grooves turned in them to admit a part of the rivet I so that the jaw B may be moved either way with the screw. The clamp K is attached to H so that the whole device can be quickly fastened to the drill table.—Contributed by J. W. Vener, Boston, Mass.

Revolving Drawing Board

In lettering certain kinds of work on an ordinary drawing board the draftsman must move around the board to do credit to his work. He either walks around the board or moves it to get at the work. If the drawing board is attached to a revolving stool, as shown in the sketch, the board can be turned

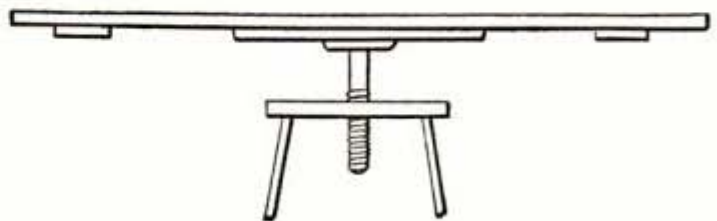

Drawing Board on Revolving Stool

to any angle desired, and also elevated or lowered to a convenient height.—Contributed by F. E. Robertson, College Station, Texas.

Chisel for Cutting Mortises in Cabinet Drawers

When fitting locks in drawers on cabinet work, it is necessary to cut a mortise in the rail above the drawer

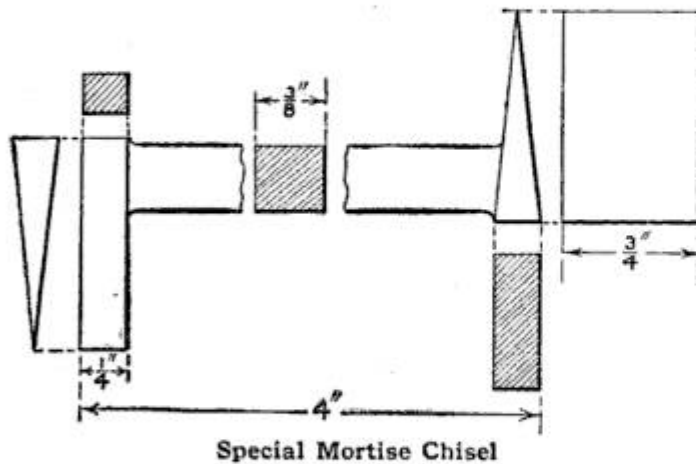

Special Mortise Chisel

end to receive the bolt of the lock. If the drawer is not a very deep one, the work becomes difficult, as the space between the rails is too small to work an ordinary wood chisel. The sketch shows the dimensions and shape of a tool that will do the work. It is made of tool steel and sharpened like a chisel.—Contributed by F. O. Andersen, San Francisco, Cal.

Making Brass Letters in Steel

The letters, name or numbers are cut in the steel surface with acid or steel letter punches and the indentation filled with brass. This is accomplished by heating the prepared steel red-hot in a brazing furnace, forge or kitchen range, and flowing spelter in the indentations. Use borax as a flux and a piece of brass wire for the spelter. The wire can be handled much easier than the regular brazing spelter. Be sure to braze a good thick coat of brass on the lettered surface. After cooling, the surplus brass is filed away from the top of the article and the steel surface polished. The indentations will be filled with brass.

Tools may be marked in this manner. If used for paper weights, the steel surfaces must be lacquered after polishing to keep them from tarnishing.—Contributed by D. O. C. Kersten, Detroit, Mich.

Automobile Cooling Alcohol Mixtures Kept at Proper Strength

According to law, denatured alcohol is the "grain alcohol of commerce rendered unfit for beverages." The freezing point of this alcohol is about 160 deg. F., says the Automobile. When added to water in various proportions, it lowers the freezing point of the water. An approximation of the freezing points of various proportions of water and denatured alcohol is given in the following table:

Proportion of water in gallons	Proportion of denatured alcohol in quarts	Freezing point in deg. Fahr.
1	1	10
1	1.5	5
1	2.5	-20
1	4	-35

In order to maintain the solution at proper strength, it may be necessary from time to time to add one or other of the constituents to keep the proper proportions. If it is safe to employ a mixture holding 2.5 quarts of denatured alcohol to the gallon of water, it is advisable to maintain this proportion.

A very simple way of observing the relation of alcohol to water is to mix, say, 2½ qt. of denatured alcohol with one gallon of water and then by means of a weighted float with a stem on it find out how low the float sinks in the solution and mark this point on the stem as shown at C. With a good-sized cork, B, a long slender stick of wood and a washer, A, it would be possible to make a measuring instrument in five minutes that will serve every purpose. Calibrate the instrument by finding

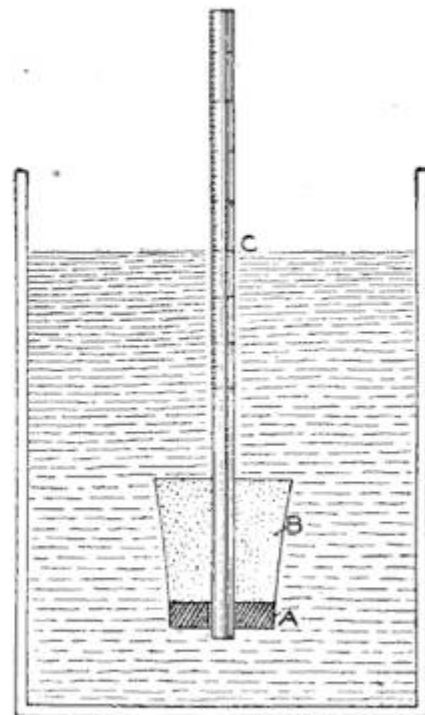

out how low it will sink into the solution, and mark the place. After this, all that has to be done is to draw off some of the solution from the radiator in a bucket and drop the instrument into the liquid, noting how low it will sink. If it does not sink down to the mark, add alcohol until it will; if it sinks below the mark, add water to float it up to the same.

Removing a Milling-Machine Arbor

The arbor of a small milling machine had become so firmly lodged in the taper hole that it was impossible to drive out with a hammer from the back, so I had to use some other method to loosen the shank. I stripped the arbor of all its bushings and put on a cutter,

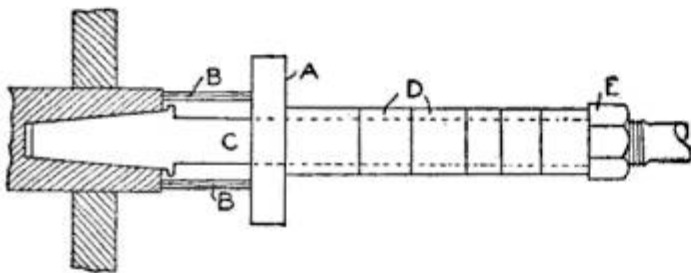

Drawing Arbor with a Nut

A, then placed two pieces of steel, B, of equal length, between the cutter and the end of the spindle, one on each side of the arbor C. The pieces of steel were long enough to hold the cutter some distance from the shoulder of the arbor. The arbor was filled to the end with bushings, D, and the nut, E, screwed on them. The pressure removed the arbor with ease. Be careful to use a cutter heavy enough to stand the pressure.—Contributed by C. H. Rauschenberg, Greenville, Pa.

How to Bend Tubing or Pipe

Heat the piece where the bend is to be made to a good red heat, then put it in a vise or other convenient place and bend while a stream of water is turned on the inside of the bend. Pipe can be bent in almost any angle in this manner without kinking or breaking.—Contributed by Irl R. Hicks, Hallsville, Mo.

Scale on a Monkey Wrench

A scale stamped on the side of a wrench provides a means for setting the jaws so they will slip on a square

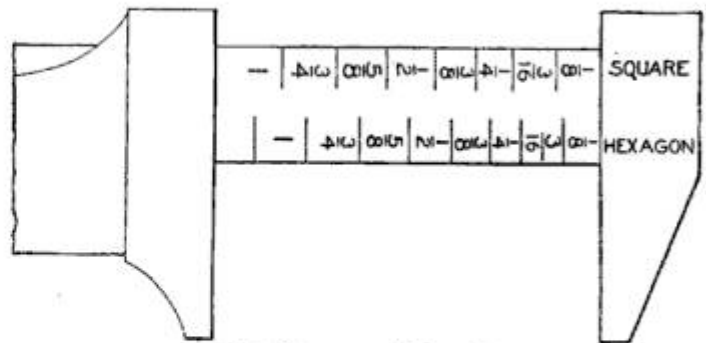

Nut Sizes on Wrench

or hexagon nut without fitting it to the facets. This makes it quite handy for turning nuts in dark and unhandy places. The scale may be marked after setting the jaws on standard square and hexagon nuts of the different sizes. The fractions designate the size of the bolt in fractional parts of an inch.—Contributed by Cecil Richards, Wheeling, W. Va.

A Sprinkler Bottle Stopper

A sprinkling stopper to fit any size bottle can be made by cutting four long notches in a cork as shown in the sketch. Force this notched cork well down in the neck of the bottle after first turning in a small corkscrew so that it can be easily withdrawn when the bottle is to be refilled. Cut a notch

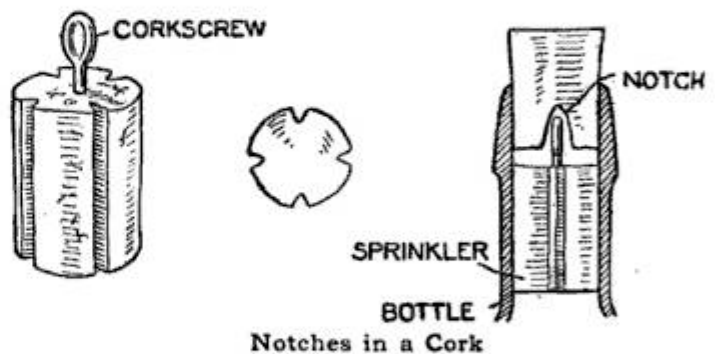

in another cork so as to allow it to fit over the corkscrew. This last cork is to close the bottle when it is not in use.

Do not flood the bearings of a magnet with oil, a few drops once a month is sufficient.

A Pipe-Ripping Tool

The sketch herewith illustrates a very handy tool for ripping wrought-iron pipe. It can be made by any blacksmith at very little cost.

This tool was originally intended for

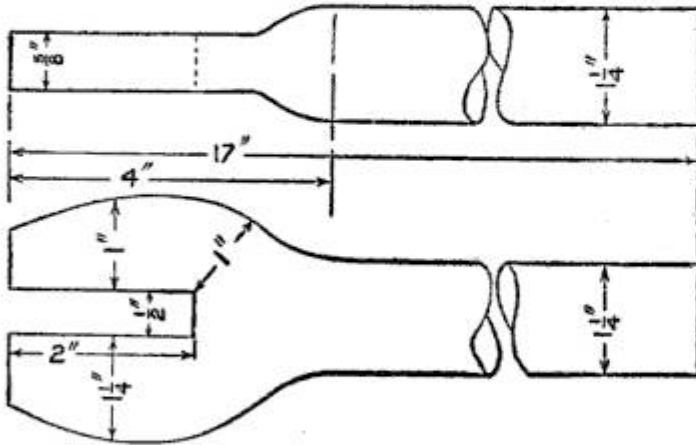

Details of Ripping Tool

breaking 3-in. wrought-iron pipe which contained a cable. The old method of removing the cable was to saw a piece off the side of the pipe and slip the cable out. The ripping tool is held against the open end of the pipe, which enters the opening in the jaws freely. A hard pull upward on the handle will tear a large piece free. One man can rip more pipe in a half hour with this simple tool than he could saw in a day. Such a tool is also of value to plumbers, steam fitters and electricians.—Contributed by G. M. Peterson, Buffalo, New York.

Overhead Clothes Rack

The accompanying illustration shows an overhead rack that is designed to lift up out of the way articles placed

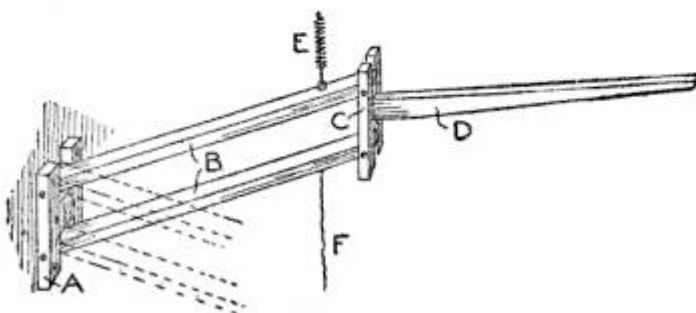

Rack above One's Head

upon it to dry, thus economizing room and using wasted space. The rack can be placed over the range in a kitchen

to receive the tea towels and dishcloths and as they are directly above the heat that rises from the stove, they will dry in a few minutes.

The base A is 1 in. thick, 3 in. wide and 8 in. long, mortised $1\frac{1}{2}$ in. deep by $\frac{9}{16}$ in. wide on each end. The piece C is $1\frac{1}{2}$ in. thick, 2 in. wide and 8 in. long, mortised in the same manner as the base, with the addition of a central mortise, 3 in. long, $\frac{1}{2}$ in. wide and $1\frac{1}{2}$ in. deep, to accommodate the end piece D. The two pieces B are $\frac{1}{2}$ in. thick, 1 in. wide and 30 in. long with a $\frac{7}{8}$ -in. hole bored 1 in. from each end. The piece D is $\frac{1}{2}$ in. thick by 3 in. wide at one end and $1\frac{1}{2}$ in. at the other, and 36 in. long.

To assemble and hang this rack, first screw the base to the wall at the desired place and about $6\frac{1}{2}$ or 7 ft. from the floor. Fasten the pieces B into the mortises in A with a $\frac{3}{16}$ -in. by $3\frac{1}{4}$ -in. bolt in each. Insert the piece D into the central mortise of the piece C and nail on each side and back with small nails. Fasten the loose ends of the pieces B into the mortises in C with $\frac{3}{16}$ -in. by $1\frac{3}{4}$ -in. bolts and fasten a screweye in each of the pieces B, as shown in the sketch. One end of a spring taken from an old shade roller is attached to the upper screweye and the other end is fastened to a screweye turned into the ceiling, after first drawing the spring up with sufficient tension to hold the rack at the desired place. A cord is attached to the lower screweye so that the rack may be pulled down to place the clothes on it for drying.

If it is desired to hang the rack over the center of a stove or table, simply hinge the piece A to the wall with a small pair of butts, then as the rack is pulled down it can be swung around to the side of the stove or table and brought within easy reach.—Contributed by H. J. Tinsley, Lancaster, Ky.

Automobile tires should be inspected after every long run and the cuts attended to immediately.

Fumigating School Books

Many times children are found in school who are suffering from some contagious disease and who are not sick enough to stay at home. They are a source of danger as well as the books and other articles which have been used by them. I devised a way to fumigate these articles whereby they can be disinfected at once and at very little cost.

The device consists of a can—an empty carbide can is very good for this purpose—with a screw top and a place for a candle in the bottom. A carbide can is about 2½ ft. high and 15 in. in diameter. The top of one of these cans can be screwed down tightly to keep in the gas. Formaldehyde candles are used for fumigating. The candles are set in a small tin about 1½ in. in diameter and ½ in. in height. These can be obtained at a slight cost and each one is sufficient to fumigate 1,000 cu. ft.

A hole is cut in the bottom of the large can so that it will admit the upper part of the candle. The books are then placed in the can, which is raised off the floor enough to permit the lower part of the candle to touch the bottom of the fumigator. The top of the can is not put on until the gas begins to issue forth and it is then screwed down firmly. The candle is allowed to burn about one minute, or until the can is well filled with gas. The gas is allowed to act on the books and other articles for about 7 hours. This insures perfect and complete fumigation. The odor of formaldehyde is sometimes unpleasant, but this can be overcome by sprinkling household ammonia over the articles after they are removed.—Contributed by George Thomas Palmer, M. D., Springfield, Ill.

☞ A thick, soft painter's brush is better than waste for removing dust from an automobile engine.

☞ Calipering the front end of a hole does not show that it is bored straight.

Door Lock for Travelers

A very simple and effective lock for the inside of doors can be made of two pieces of sheet steel or galvanized iron cut in the shape shown in the sketch.

The teeth are about ⅛ in. long, and the metal is bent at right angles on the dotted line. The oval hole is made large enough to admit an ordinary lead pencil. The lock is applied by pushing the teeth of one piece into the door casing and the other directly opposite in the door. Close the door and put a pencil or nail through the holes and it will be impossible to open the door from the outside.—Contributed by A. Lester Shipton, Watertown, Mass.

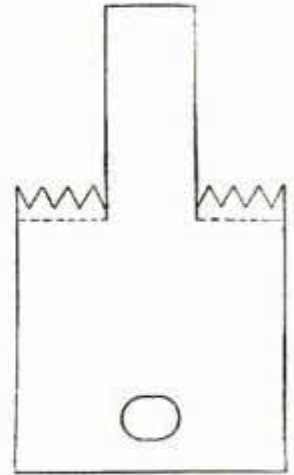

Planer Work in a Lathe

Quite a variety of small machines were made in a shop equipped with a lathe, drill press and grindstone. The lathe, naturally, did most all the work including some planer work.

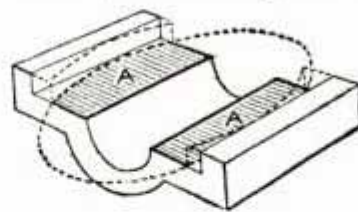

The sketch shows a box having cast edges to guide the cap. These were made in quantities. The portion marked A is the seat for the cap, which had to be machined flat. They were put in a four-jawed chuck in the lathe and faced out as far as the dotted line. This cut out more than three-quarters of the face and a boy chipped out the corners.

Keyways, both internal and external, may be cut by mounting the work and hand-feeding the carriage. Fairly good flat surfaces can be produced by clamping the work to the faceplate and hand-feeding the carriage, using the coarse feed screw each time to take a deeper cut.

Removing a Pin from Cast Iron

My foreman told me more as a joke than otherwise to pull out a 1/2-in. cold-

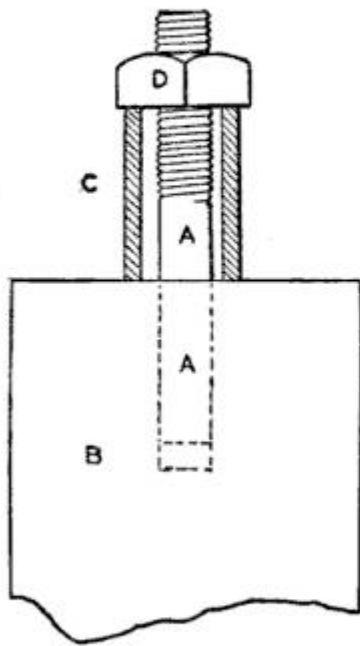

rolled steel pin, A, which had been driven 1 in. without lubrication into cast iron, B. Thinking I must do it, I tried to turn it with a pipe wrench and only succeeded in roughing the pin in the hole. I then used a method as follows that removed the pin without much work. I cut a thread on the pin with a 1/2-in. die and then put a collar, C, on it and ran a nut, D, on the threads. A hard pull of a 12-in. wrench on the nut removed the pin.—Contributed by Roy E. Coram, No. Chelmsford, Mass.

Coloring Concrete

The latest report of the National Association of Cement Users recommended only certain mineral pigments that should be used for obtaining tinted mortars for concrete or stucco surfaces. These pigments are given in the following list:

Grey	Lampblack, manganese dioxide
Slate	Lampblack, manganese dioxide
Red	Red iron oxide
Bright Red	English red oxide
Brown	Brown roasted iron oxide, brown ocher
Yellow	Ocher
Blue	Ultramarine
Green	Chromium oxide, ultramarine green
Violet	Violet oxide of iron

The amount used should be small, owing to the danger of impairing the strength of the resulting mortar. The limit should be 5 per cent by weight to that of the cement. Even this amount of certain colors which differ little from that of cement, such as yellows and reds, does not produce a

ment. Lampblack is best for darkening, and to lighten the color, use lime. The coloring constituents can be used dry or in a paste, but it is most convenient for mixing to use the dry form, which should be thoroughly mixed with the dry mortar before adding water.

Glass-Cleaning Solution

Glass tumblers, tubing and fancy bottles are hard to clean by washing them in the ordinary way as the parts are hard to reach with the fingers or a brush. The following solution makes an excellent cleaner that will remove dirt and grease from crevices and sharp corners. To 9 parts of water add 1 part of strong sulphuric acid. The acid should be added to the water slowly and not the water to the acid. Add as much bichromate of potash as the solution will dissolve. More bichromate of potash should be added as the precipitate is used in cleaning.

The chemicals can be purchased cheaply from a local drug store, and made up and kept in large bottles. The solution can be used over and over again. If a large jar is filled with the solution, articles of glass can be dipped in it for a few minutes and then washed in clear water.—Contributed by Loren Ward, Des Moines, Iowa.

Kettle Cover Holder

A cover if not hinged to the kettle will fall off when the kettle is tilted for pouring, and this is not only a source of annoyance every time any of the contents of the kettle is poured out, but often results in a bad scald or burned fingers. This annoyance can be prevented by making and attaching to the kettle top the little device shown in the sketch. It is made of

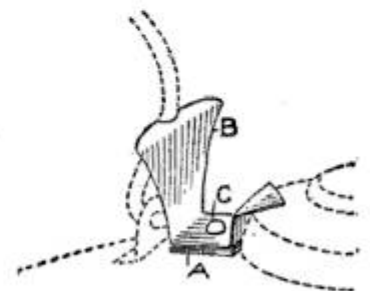

two strips of metal, one soldered to the kettle top and the other riveted to it. When the handle of the kettle is raised it forces the clip over the cover.

Steady-Rest Jaws with Babbitt Ends

In using the steady rest on lathe work, I have always had a lot of trouble with the jaws cutting into and marring the work, especially brass work, says a correspondent of American Machinist. I tried fiber, rawhide and other materials with little or no success, as they all wear away in a very short time; so,

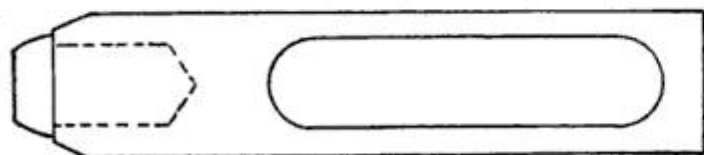

Babbitt in End of Jaw

finally, I tried drilling out the ends of the jaws and filling the hole with babbitt, as shown in the sketch. This method works to perfection.

Spark Gap for Testing

An adjustable spark gap to be used in testing and timing automobile engines can be made as follows: Take a piece of fiber, $\frac{1}{8}$ in. thick, $\frac{1}{2}$ in. wide and $1\frac{3}{4}$ in. long. Bore a $\frac{3}{16}$ -in. hole near each end and fit with a bolt or connection taken from an old dry cell. Put the nuts on a piece of 18-gauge copper wire, about 1 in. long, and fasten them down. Attach a large ter-



Adjustable Spark Gap

minal on one end to slip on the spark plug, and fasten cable to the other end. The spark gap is adjusted by bending the ends of the wires closer or farther apart.—Contributed by C. R. Poole, Los Angeles, Cal.

While automobiling give the engine a rest by advancing the spark and nearly closing the throttle. It is not good practice to run on full throttle for long periods.

Holder for Starting Screws

The tool shown in the sketch is for holding screws when starting them in tapped holes. It consists of a wood



Screw in Holder

handle having two pieces of clock-spring, $\frac{1}{8}$ in. wide, bent at the points, as shown, to spring into the slot of a screw. The manner of using the tool is obvious.—Contributed by Henry Hertiner, Amarillo, Texas.

Fastening Stovepipe Joints

While putting up a stovepipe recently I found that I did not have any place to fasten the guy wires. In their stead I used a 1-in. iron pipe, which I placed in the stovepipe, and fastened each joint with a rivet. A small piece of wire, wrapped a couple of turns around the iron pipe and run through holes in the stovepipe, will hold the

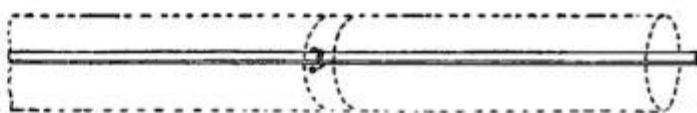

Iron Pipe in Stovepipe

parts together as well as the rivets.—Contributed by Victor Maene, Bustleton, Pa.

Catch for a Small Door

An easily made and very effective catch to hold any small door, as in a washstand, sideboard, etc., is shown in the sketch. It is simply a small screw-eye and an upholstering staple attached as shown at A. The manner in which

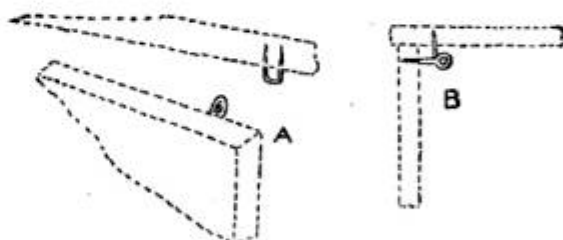

Catch on Door

they hold the door is shown at B.—Contributed by Jos. L. Schreick, Portsmouth, O.

Holding Work on the Center of a Lathe

All that is necessary to use is two fillister head screws, A A, with two coiled springs of even tension. File a

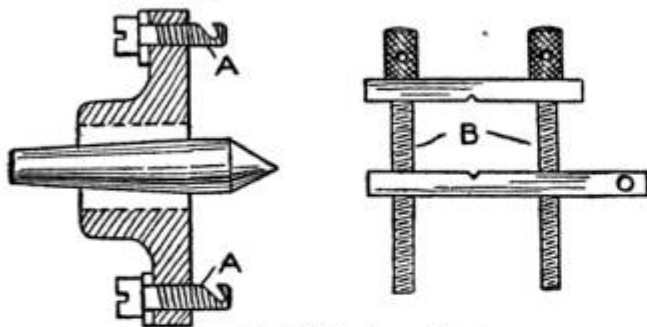

Springs Hold Work on Center

groove in each screw, as shown in the sketch, put one spring on each screw B of the small lathe dog, and when in position it can be readily hooked on the screws in the driving plate, thus holding the work back securely.—Contributed by Arthur W. Andrews, Brooklyn, N. Y.

Coloring Brick

Brick owes its color to the presence of iron in the clay from which it is formed. Usually 5 or 6 per cent of oxide of iron (ferric oxide) will give a deep red color to brick, a higher percentage giving a deeper color. The presence of carbonates of lime and of magnesium will modify the color.

Sharpening a Nail Set

A nail set will become worn in time so that the face will be flat as shown at A. This will allow it to slide off the head of the nail when it is struck with a hammer. If the edge is hammered down, it will form a concave



End of Punch Hammered Over

as shown at B. When hardened, it will work as well as a new one.—Contributed by Albert Hahn, Chicago.

☞An ordinary curling iron makes a very good finger stretcher for kid gloves.

Reflector for an Automobile-Trouble Lamp

A handy reflector for a trouble lamp for automobiles can be made by taking a funnel and putting it over a light bulb and fastening it with insulation tape to prevent a short circuit. We have used this reflector in the shop, and find it cheaper to go to the hardware store and buy a funnel than to buy a reflector at an automobile-supply house.—Contributed by Thos. J. Becker, Kansas City, Mo.

Increasing Efficiency of a Coil Door-Spring

The efficiency of an old-fashioned coil door-spring can be increased by applying two blocks of wood as shown in the sketch. The blocks are cut triangular-shaped. One is fastened to the door and the other to the casing. The spring is applied as shown. This will curve the spring backward a little when the door is closed, and cause the spring to exert constant pressure against drafts on the door.

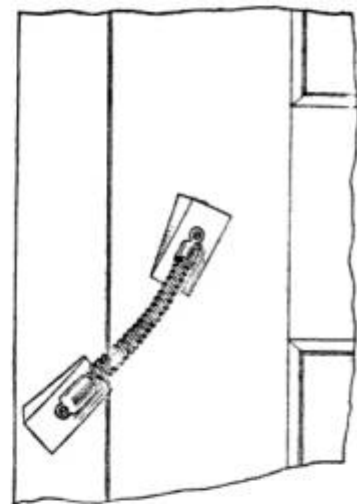

The manner of holding the spring does not increase the tension, but applies the pressure when the door is closed.—Contributed by Victor Labadie, Dallas, Texas.

Operating Air Pumps

Many engineers start the pump, set it at its normal speed and let it run regardless of the load. The result is that the air pump does a great deal of unnecessary work, and, at times, it is pumping steam to a greater extent than air. This often can be quickly checked by slowing down the air pump materially without any appreciable effect upon the vacuum.

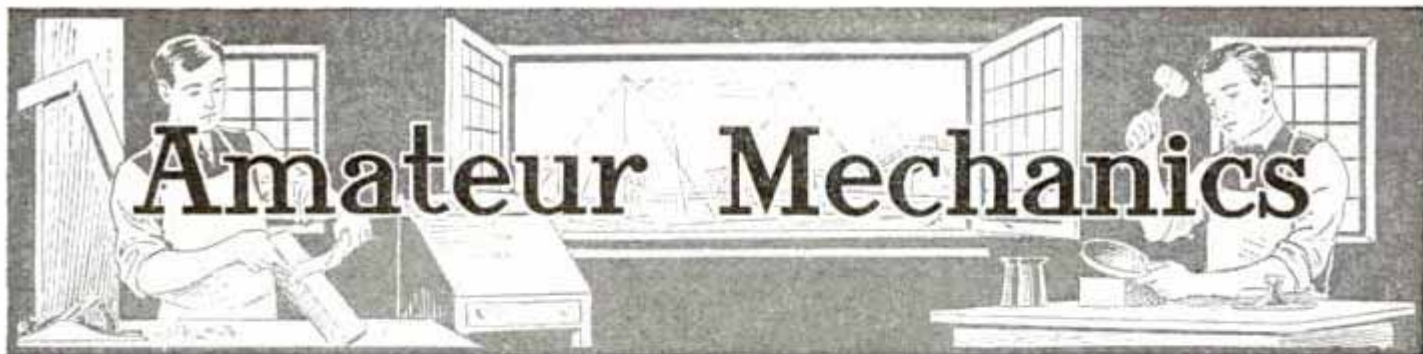

A Homemade Steam Turbine

By WILLIAM H. WARNECKE

Lay out on a piece of $\frac{3}{16}$ -in. brass the disk of the turbine and also the line indicating the depth to which the slots are to be cut. Mark the point where a hole is to be drilled for the shaft; also locate the drill holes as shown at A, Fig. 1. After the shaft hole and the holes A are drilled in the disk, it can be used as a template for drilling the side plates C.

The rim of the disk is divided into 53 equal parts and radial lines drawn from rim to line B indicating the depth

around the shaft hole between the disk and the side plates. The side plates are secured by $\frac{1}{8}$ -in. machine screws with nuts. Two nuts are placed on each screw. The nuts should be on the side opposite the inlet valves. It is cheaper to file the shaft hole square, insert a square shaft, and file the ends round for the bearings.

The casing for the disk is made of two enameled iron saucers, Fig. 2, bolted together with a thin piece of asbestos between them to make a tight

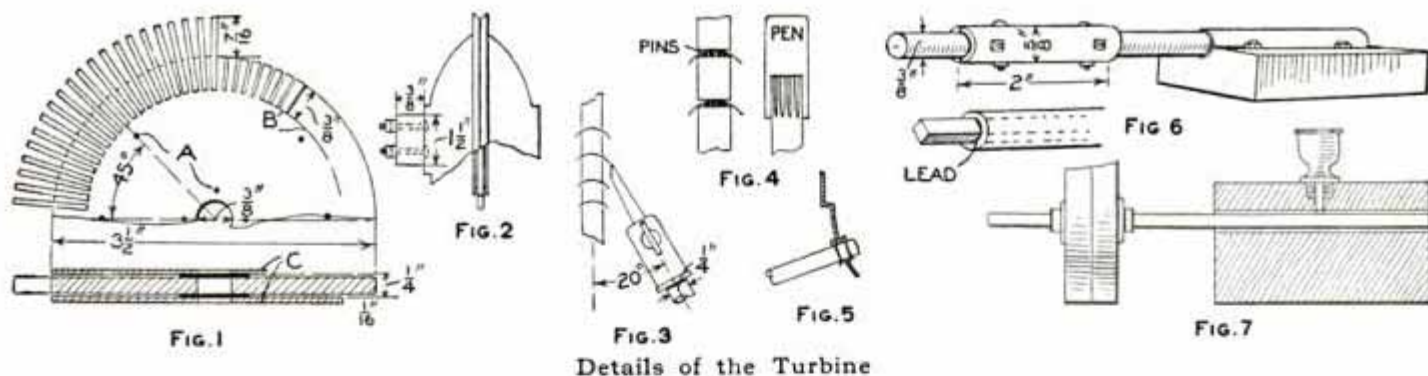

Details of the Turbine

of the slots. Slots are cut in the disk with a hacksaw on the radial lines. A small vise is convenient for holding the disk while cutting the slots.

When cutting the disk out of the rough brass, sufficient margin should be left for filing to the true line. The slots should be left in their rough state as they have a better hold on the pens which are used for the blades. The pens are inserted in the slots and made quite secure by forcing ordinary pins on the inside of the pens and breaking them off at the rim as shown in Fig. 4.

After this operation, the side plates are fastened as shown in Fig. 1, C, with the $\frac{3}{32}$ -in. filling pieces first placed

joint. A $\frac{3}{4}$ -in. hole is cut near the edge of one of the saucers for the exhaust. If it is desired to carry the exhaust beyond the casing, a thin pipe can be inserted $\frac{1}{4}$ in. into the hole. Holes are drilled through the pipe on both inside and outside of the casing and pins inserted as shown in Fig. 5. Solder is run around the outside pin to keep the steam from escaping. At the lowest point of the saucer or casing a $\frac{1}{8}$ -in. hole is drilled to run off the water. A wood plug will answer for a stopcock.

Nozzles are made of two stopcocks having a $\frac{1}{8}$ -in. hole. These are connected to a $\frac{3}{8}$ -in. supply pipe. The

nozzles should be set at an angle of 20 deg. with the face of the disk. The nozzle or stopcock will give better results if the discharge end is filed parallel to the face of the disk when at an angle of 20 deg. There should be a space of $\frac{1}{16}$ in. between the nozzle and the blades to allow for sufficient play, Fig. 3.

The bearings are made of $\frac{1}{4}$ -in. brass and bolted to the casing, as shown, with $\frac{1}{8}$ -in. machine screws and nuts. Two nuts should be placed on each screw. The pulley is made by sliding a piece of steel pipe on the engine shaft and fastening it with machine screws

and nuts as shown in Fig. 6. If the shaft is square, lead should be run into the segments.

The driven shaft should have a long bearing. The pulley on this shaft is made of pieces of wood nailed together, and its circumference cut out with a scroll saw. Flanges are screwed to the pulley and fastened to the shaft as shown in Fig. 7.

The bearings are made of oak blocks lined with heavy tin or sheet iron for the running surface. Motion is transmitted from the engine to the large pulley by a thin but very good leather belt.

Homemade Telegraph Key

A simple and easily constructed telegraph key may be made in the following manner: Procure a piece of sheet brass, about $\frac{3}{16}$ in. thick, and cut out a strip $3\frac{1}{2}$ in. long by $\frac{3}{4}$ in. wide. Bend as shown in Fig. 1 and drill a hole for the knob in one end and a hole for a screw in the other. Procure a small wood knob and fasten it in place with a small screw. Cut a strip of the same brass $2\frac{3}{4}$ in. long and $\frac{5}{16}$ in. wide and bend as shown in Fig. 2. Drill two holes in the feet for screws to fasten it to the base, and one hole in the top part for a machine screw, and solder a small nut on the under side of the metal over the hole.

Mount both pieces on a base $4\frac{1}{4}$ by $2\frac{3}{4}$ by $\frac{1}{4}$ in., as in Fig. 3, and where

Fasten the parts down with small brass wood-screws and solder the connections beneath the base. Binding-posts from an old battery cell are used on the end of the base. The screw on top of the arch is used to adjust the key for a long or short stroke.—Contributed by S. V. Cooke, Hamilton, Canada.

Keeping Food Cool in Camps

Camps and suburban homes located where ice is hard to get can be provided with a cooling arrangement herein described that will make a good substitute for the icebox. A barrel is sunk in the ground in a shady place, allowing plenty of space about the outside to fill in with gravel. A quantity of small stones and sand is first put in wet. A box is placed in the hole over the top of the barrel and filled in with clay or earth well tamped. The porous condition of the gravel drains the surplus water after a rain.

The end of the barrel is fitted with a light cover and a heavy door hinged to the box. A small portion of damp sand is sprinkled on the bottom of the barrel. The covers should be left open occasionally to prevent mold and to remove any bad air that may have collected from the contents.—Contributed by F. Smith, La Salle, Ill.

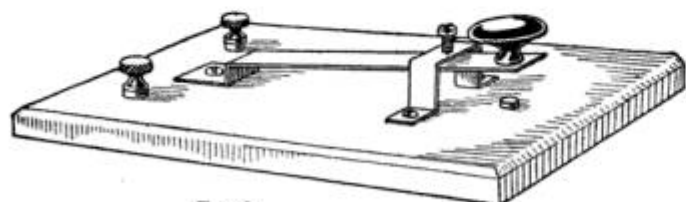

FIG. 3
Brass Key on a Wood Base

the screw of the knob strikes the base when pressed down, put in a screw or brass-headed tack for a contact.

How to Make a Flint Arrowhead

If you live where flints abound, possess the requisite patience and the knack of making things, you can, with the crudest of tools and a little practice, chip out as good arrowheads as any painted savage that ever drew a bow.

Select a piece of straight-grained flint as near the desired shape as possible. It may be both longer and wider than the finished arrow but it should not be any thicker. The side, edge and end views of a suitable fragment are shown in Fig. 1. Hold the piece with one edge or end resting on a block of wood and strike the upper edge lightly with a hammer, a small boulder or anything that comes handy until the piece assumes the shape shown in Fig. 2.

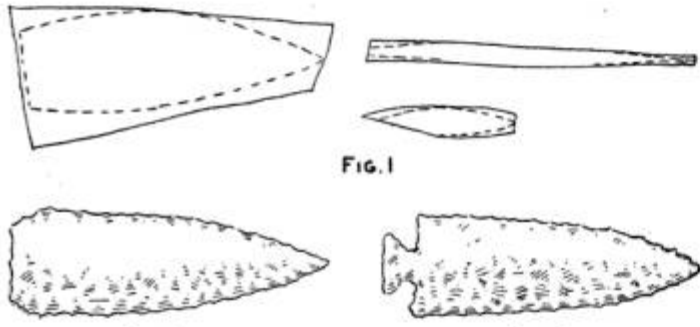

FIG. 2 The Stone Chipped into Shape

FIG. 3

The characteristic notches shown in the completed arrow, Fig. 3, are chipped out by striking the piece lightly at the required points with the edge of an old hatchet or a heavy flint held at right angles to the edge of the arrow. These heads can be made so that they cannot be distinguished from the real Indian arrowheads.—Contributed by B. Orlando Taylor, Cross Timbers, Mo.

An Opening Handle for a Stamp Pad

A stamp pad is a desk necessity and the cleanliness of one depends on keeping it closed when it is not in use. The opening and closing of a pad requires both hands and consequently the closing of a pad is often neglected in order to avoid soiling the fingers. This trouble can be avoided if the pad is

fitted with a small handle as shown in the sketch. Take the ordinary pad and work the hinge until it opens freely.

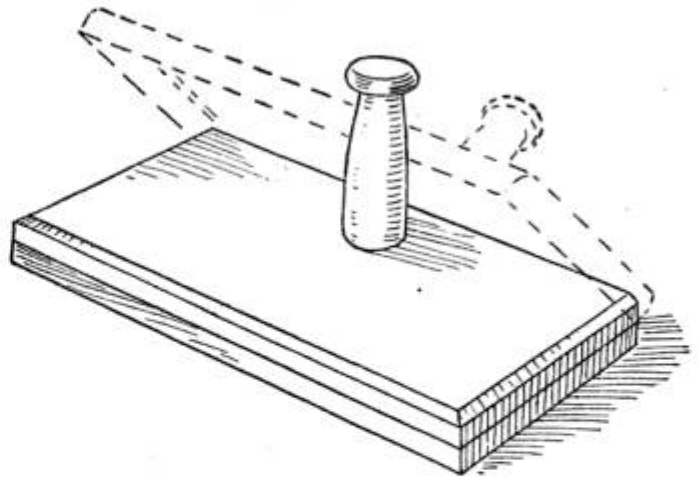

Handle on Cover

If necessary apply a little oil and spread the flanges of the cover slightly.

Saw off the top of a common wood clothespin just above the slot, saving all the solid part. Fasten this to the cover near the back side in an upright position with a screw. A tap on the front side of the pin will turn it over backward until the head rests on the desk thus bringing the cover up in the upright position. When through using the pad, a slight tap on the back side of the cover will turn it down in place—Contributed by H. L. Crockett, Gloversville, N. Y.

Concrete Kennel

The kennel shown in the illustration is large enough for the usual size of dog. It is cleanly, healthful and more ornamental than the average ken-

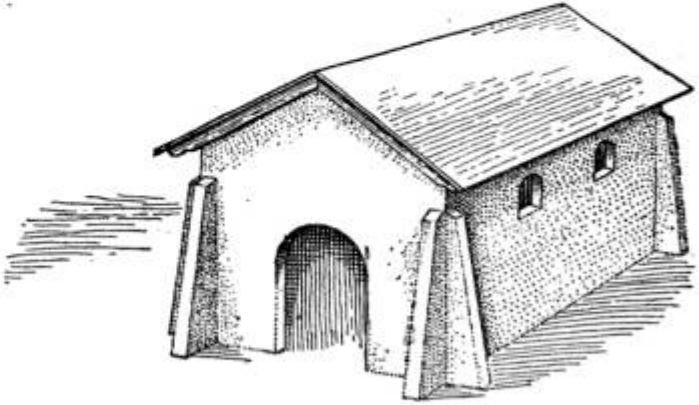

Finished Kennel

nel. This mission style would be in keeping with the now popular mission and semi-mission style home, and, with

slight modifications, it could be made to conform with the ever beautiful colonial home. It is not difficult to

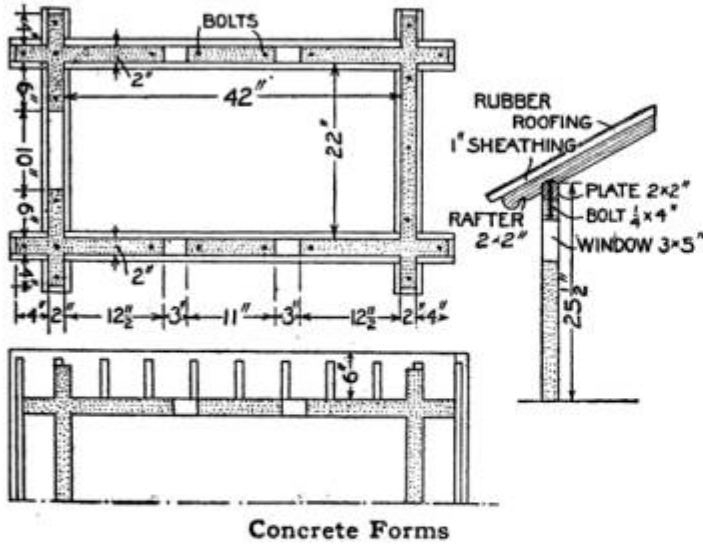

Concrete Forms

build and will keep in good shape for many years.

The dimensions and the manner of making the forms for the concrete, and the location for the bolts to hold the plate and rafters, are shown in the diagram.—Contributed by Edith E. Lane, El Paso, Texas.

Nutshell Photograph Novelty

Split an English walnut in the center, remove the contents, and scrape out the rough parts. Make an oval



Photograph in the Shell

opening by filing or grinding. If a file is used, it should be new and sharp.

After this is done, take a small half-round file and smooth the edges into shape and good form.

The photograph print should be quite small—less than $\frac{1}{2}$ in. across the face. Trim the print to a size a little larger than the opening in the shell, and secure it in place with glue or paste. It may be well to fill the shell with cotton. Mount the shell on a small card with glue, or if desired, a mount of different shape can be made of burnt woodwork.—Contributed by C. S. Bourne, Lowell, Mass.

Spoonholder on a Kettle

In making marmalade and jellies the ingredients must be stirred from time to time as the cooking proceeds. After

stirring, some of the mixture always remains on the spoon. Cooks often lay the spoon on a plate or stand it

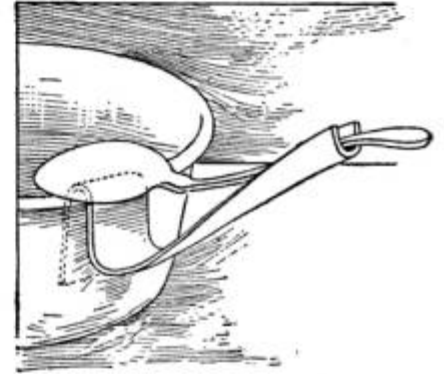

against the cooking utensil with the handle down. Both of these methods are wasteful. The accompanying illustration shows a device made of sheet copper to hold the spoon so that the drippings will return to the cooking utensil. The copper is not hard to bend and it can be shaped so that the device can be used on any pot or kettle.—Contributed by Edwin Marshall, Oak Park, Ill.

Repairing Cracked Gramophone Records

Some time ago I received two gramophone records that were cracked in shipment but the parts were held together with the paper label. As these were single-faced disk records, I used the following method to stick them together: I covered the back of one with shellac and laid the two back to back centering the holes with the crack in one running at right angles

to the crack in the other. These were placed on a flat surface and a weight set on them. After several hours' drying, I cleaned the surplus shellac out of the holes and played them.

As the needle passed over the cracks the noise was hardly audible. These records have been played for a year and they sound almost as good as new.—Contributed by Marion P. Wheeler, Greenleaf, Oregon.

New Use for a Vacuum Cleaner

An amateur mechanic who had been much annoyed by the insects which were attracted to his electric lights found a solution in the pneumatic moth-trap described in a recent issue of Popular Mechanics. He fixed a funnel to the end of the intake tube of a vacuum cleaner and hung it under a globe. The insects came to the light, circled over the funnel and disappeared. He captured several pounds in a few hours.—Contributed by Geo. F. Turl, Canton, Ill.

Filtering with a Small Funnel

In filtering a large amount of solution one usually desires some means other than a large funnel and something to make the watching of the process unnecessary. If a considerable quantity of a solution be placed in a large bottle or flask, and a cork with a small hole in it inserted in the mouth, and the apparatus suspended in an inverted position over a small funnel so that the opening of the cork is just below the water level in the funnel, the filtering process goes on continuously with no overflow of the funnel.

As soon as the solution in the funnel is below the cork, air is let into the flask and a small quantity of new solution is let down into the funnel. The process works well and needs no watching, and instead of the filtrate being in a large filter paper, it is on one small piece and can be handled with ease.—Contributed by Loren Ward, Des Moines, Iowa.

A Postcard Rack

The illustration shows a neat rack for postcards. Those having homes

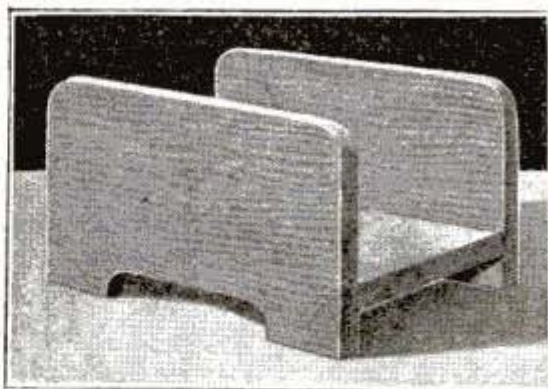

Finished Rack

with mission-style furniture can make such a rack of the same material as the desk, table or room furnishings and finish it in the same manner.

The dimensions are given in the detail sketch. The two ends are cut from $\frac{1}{4}$ -in. material, the bottom being $\frac{3}{8}$ in. thick. Only three pieces are required, and as they are simple in design, anyone can cut them out with a

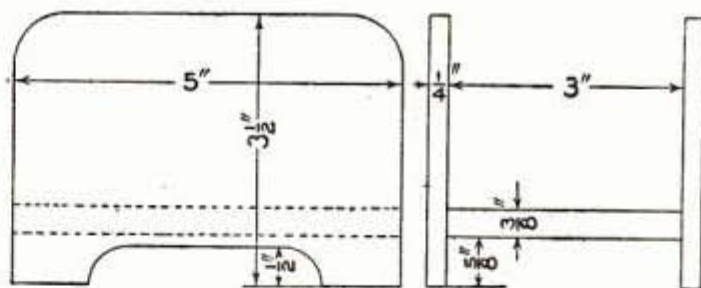

Details of the Rack

saw, plane and pocket knife.—Contributed by Wm. Rosenberg, Worcester, Mass.

Substitute Shoe Horn

A good substitute for a shoe horn is a handkerchief or any piece of cloth used in the following way: Allow part of the handkerchief or cloth to enter the shoe, place the toe of the foot in the shoe so as to hold down the cloth, and by pulling up on the cloth so as to keep it taut around the heel the foot will slide into the shoe just as easily as if a shoe horn were used.—Contributed by Thomas E. Dobbins, Glenbrook, Conn.

Building a Small Photographic Dark Room

In building a photographic dark room, it is necessary to make it perfectly light-tight, the best material to use being matched boards. These boards are tongued and grooved and when put together effectually prevent the entrance of light.

The next important thing to be considered is to make it weather-tight, and as far as the sides are concerned the matched boards will do this also, but it is necessary to cover the roof with felt or water-proof paper.

The best thickness for the boards is 1 in., but for cheapness $\frac{3}{4}$ in. will do as well, yet the saving is so little that the 1-in. boards are preferable.

The dark room shown in the accompanying sketch measures 3 ft. 6 in. by 2 ft. 6 in., the height to the eaves being 6 ft. Form the two sides shown in Fig. 1, fixing the crosspieces which hold the boards together in such positions that the bottom one will act as a bearer for the floor, and the second one for the developing bench. Both sides can be put together in this way, and both exactly alike. Keep the ends of the crosspieces back from the edges of the boards far enough to allow the end boards to fit in against them.

One of the narrow sides can be formed in the same way, fixing the crosspieces on to correspond, and then these three pieces can be fastened together by screwing the two wide sides on the narrow one.

Lay the floor next, screwing or nailing the boards to the crosspieces, and making the last board come even with the ends of the crosspieces, not even with the boards themselves. The single boards can then be fixed, one on each side of what will be the doorway, by screwing to the floor, and to the outside board of the sides. At the top of the doorway, fix a narrow piece between the side boards, thus leaving a rectangular opening for the door.

The roof boards may next be put on, nailing the to each other at the ridge, and to the sides of the room at the

outsides and eaves. They should overhang at the sides and eaves about 2 in., as shown in Figs. 3 and 4.

One of the sides with the crosspieces in place will be as shown in Fig. 2 in section, all the crosspieces and bearers intersecting around the room.

The door is made of the same kind of boards held together with crosspieces, one of which is fastened so as to fit closely to the floor when the door is hinged, and act as a trap for the light. The top crosspiece is also fastened within 1 in. of the top of the door for the same reason.

Light traps are necessary at the sides and top of the door. That at the hinged side can be as shown at A, Fig. 5, the closing side as at B, and the top as at C in the same drawing. These are all in section and are self-explanatory. In hinging the door, three butt hinges should be used so as to keep the joint close.

The fittings of the room are as shown sectionally in Fig. 6, but before fixing these it is best to line the room with heavy, brown wrapping paper, as an additional safeguard against the entrance of light.

The developing bench is 18 in. wide, and in the middle an opening, 9 by 11 in., is cut, below which is fixed the sink. It is shown in detail in Fig. 7, and should be zinc lined.

The zinc should not be cut but folded as shown in Fig. 8, so that it will fit inside the sink. The bench at each side of the sink should be fluted (Fig. 9), so that the water will drain off into the sink. A strip should be fixed along the back of the bench as shown in Figs. 6 and 9, and an arrangement of slats (Fig. 10), hinged to it, so as to drop on the sink as in Fig. 6, and shown to a larger scale in Fig. 11.

A shelf for bottles and another for plates, etc., can be fixed above the developing bench as at D and E (Fig. 6) and another as F in the same drawing. This latter forms the bottom of the tray rack, which is fixed on as shown

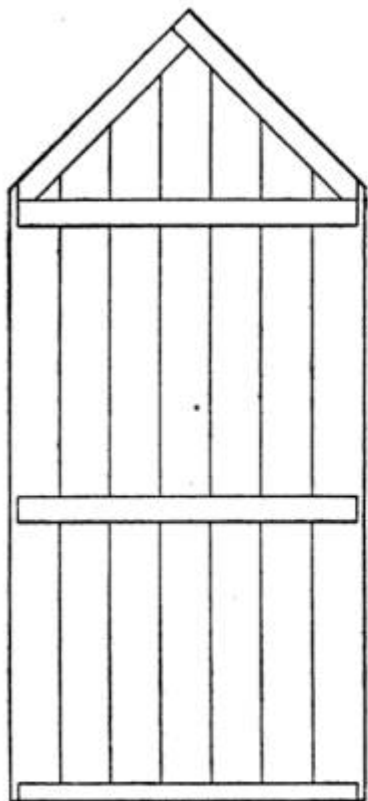

FIG. 1



FIG. 2

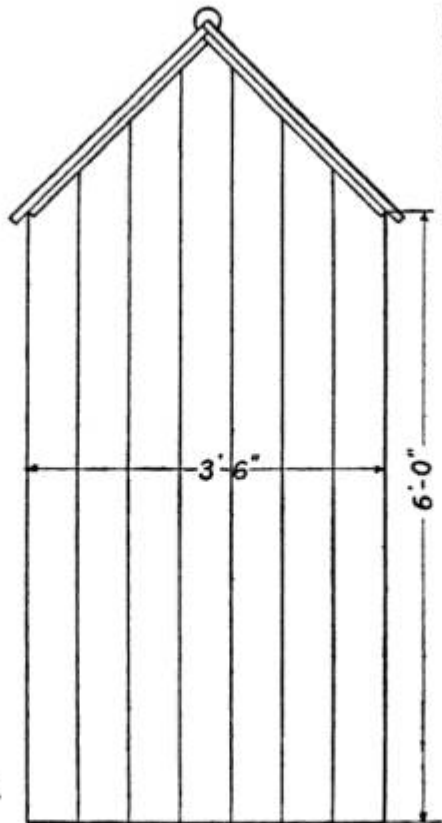

FIG. 3

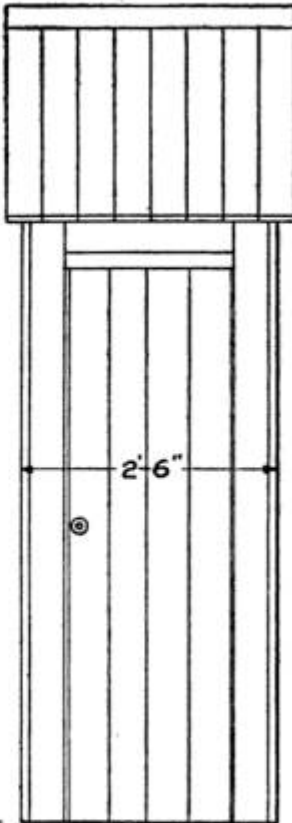

FIG. 4

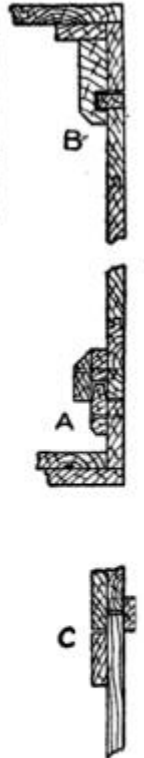

FIG. 5

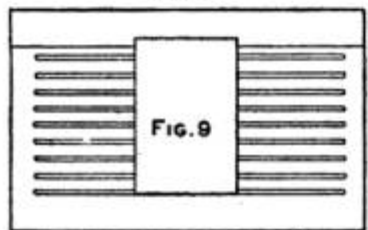

FIG. 9

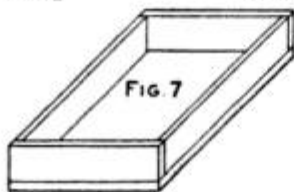

FIG. 7

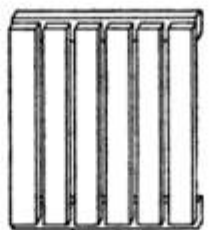

FIG. 10

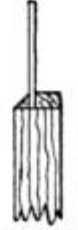

FIG. 15



FIG. 20

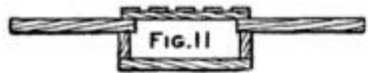

FIG. 11

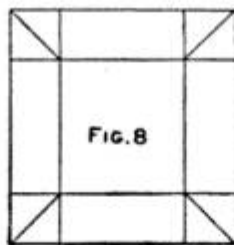

FIG. 8

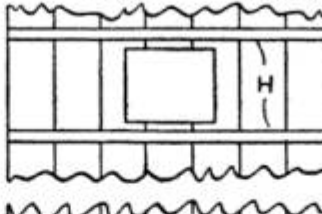

FIG. 16



FIG. 19



FIG. 18



FIG. 17

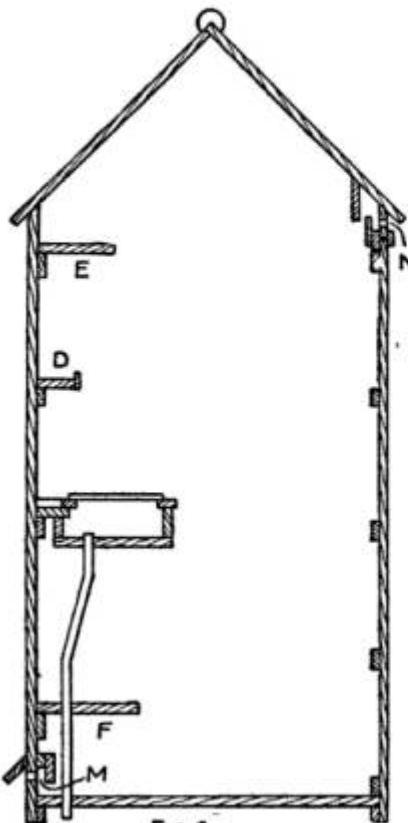

FIG. 6

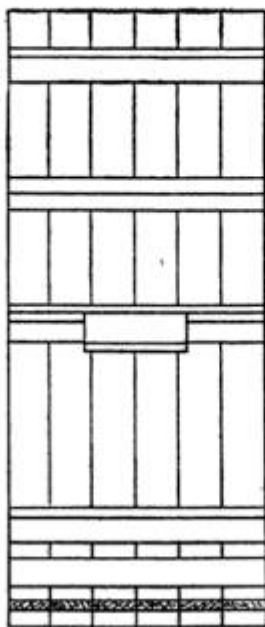

FIG. 12

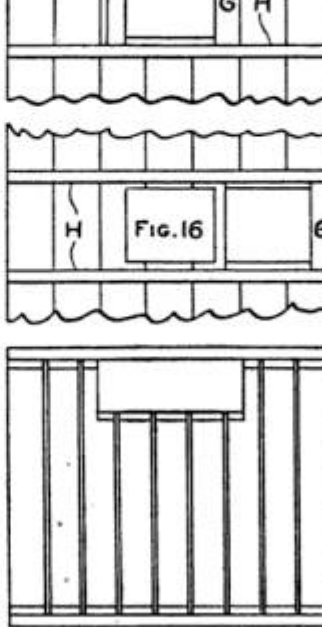

FIG. 13

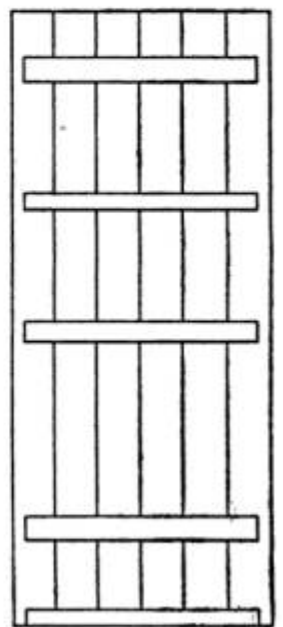

FIG. 14

Details of the Dark Room

in Fig. 13. The divisions of the tray rack are best fitted loosely in grooves formed by fixing strips to the shelves and under the bench and sink as in Fig. 13.

Extra bearing pieces will be wanted for the shelves mentioned above, these being shown in Fig. 14. The window is formed by cutting an opening in the side opposite the door, and fixing in it a square of white glass with strips of wood on the inside and putty on the outside, as in Fig. 15. A ruby glass is framed as shown at G, Fig. 16, and arranged to slide to and fro in the grooved runners H, which makes it possible to have white light, as at I, or red light as at K, Fig. 16. The white glass with runners in position is shown at L in the same drawing, but not the red glass and frame. Ventilation is arranged for by boring a series of holes near the floor, as at M, Fig. 6, and near the roof as at N in the same drawing, and trapping the light without stopping the passage of air, as shown in the sections, Fig. 17.

The finish of the roof at the gables is

shown in Fig. 18, the strip under the boards holding the felt in position when folded under, and the same is true of the roll at the top of the roof in Fig. 19.

The house will be much strengthened if strips, as shown in Fig. 20, are fastened in the corners inside, after lining with brown paper, screwing them each way into the boards.

The door may have a latch or lock with a knob, but should in addition have two buttons on the inside, fixed so as to pull it shut tightly at top and bottom. A waste pipe should be attached to the sink and arranged to discharge through the floor. A cistern with pipe and tap can be fastened in the top of the dark room, if desired, or the room may be made with a flat roof, and a tank stand on it, though this is hardly advisable.

It is absolutely necessary that the room be well painted, four coats at first is not too many, and one coat twice a year will keep it in good condition.

A brick foundation should be laid so that no part of the room touches the ground.

The Versatile Querl

"Querl" is the German name for a kitchen utensil which may be used as an egg-beater, potato-masher or a lemon-squeezer. For beating up an egg in a glass, mixing flour and water, or stirring cocoa or chocolate, it is better than anything on the market.

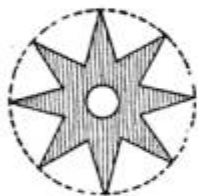

FIG 1

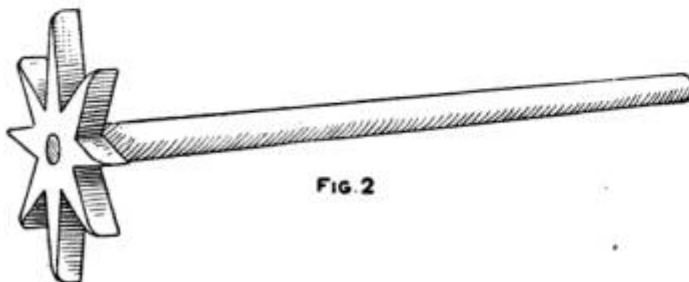

FIG 2

Querl Made of Wood

This utensil is made of hardwood, preferably maple or ash. A circular

piece about 2 in. in diameter is cut from $\frac{1}{2}$ -in. stock and shaped like a star as shown in Fig. 1, and a $\frac{3}{8}$ -in. hole bored in the center for a handle. The handle should be at least 12 in. in length and fastened in the star as shown in Fig. 2.

In use, the star is placed in the dish containing the material to be beaten or mixed and the handle is rapidly rolled between the palms of the hands.—Contributed by W. Karl Hilbrich, Erie, Pennsylvania.

An Emergency Soldering Tool

Occasionally one finds a piece of soldering to do which is impossible to reach with even the smallest of the ordinary soldering irons or coppers. If a length of copper wire, as large as the job will permit and sufficiently long to admit being bent at one end to form a rough handle, and filed or dressed to a point on the other, is heated and tinned exactly as a regular

copper should be, the work will cause no trouble on account of inaccessibility.—Contributed by E. G. Smith, Eureka Springs, Ark.

Smoothing Paper after Erasing

When an ink line is erased the roughened surface of the paper should be smoothed or polished so as to prevent the succeeding lines of ink from spreading. A convenient desk accessory for this purpose can be made of a short

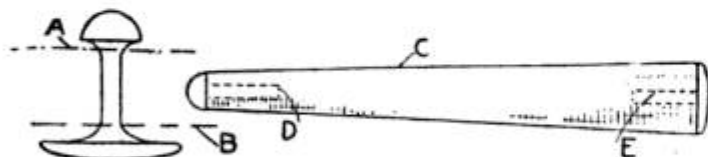

Collar Button Ends in Wood Stick

piece of hardwood and two bone collar buttons.

File off the head of one button at A and the base from another at B. Bore a small hole D and E in each end of the wood handle C and fasten the button parts in the holes with glue or sealing wax. The handle can be left the shape shown or tapered as desired. The small end is used for smoothing small erasures and the other end for larger surfaces.

A Cherry Seeder

An ordinary hairpin is driven part way into a small round piece of wood, about $\frac{3}{8}$ in. in diameter and 2 or $2\frac{1}{2}$ in. long, for a handle, as shown in the sketch. The hairpin should be a very



Hairpin in Stick

small size. To operate, simply insert the wire loop into the cherry where the stem has been pulled off and lift out the seed.—Contributed by L. L. Schweiger, Kansas City, Mo.

A Dovetail Joint

The illustration shows an unusual dovetail joint, which, when put together properly is a puzzle. The tenon or tongue of the joint is sloping on

three surfaces and the mortise is cut sloping to match. The bottom surface of the mortise is the same width at

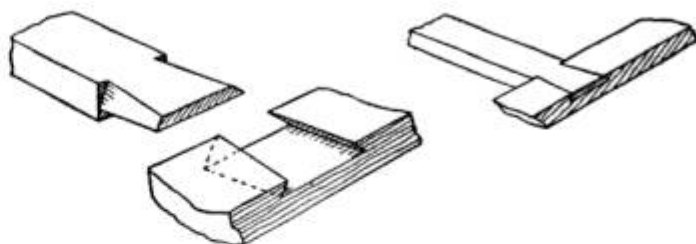

Shape of Tenon and Mortise

both ends, the top being tapering toward the base of the tongue.—Contributed by Wm. D. Mitchell, Yonkers, New York.

Base for Round-End Bottles

The many forms of round-bottomed glass bottles used in chemical laboratories require some special kind of support on which they can be safely placed from time to time when the chemist



FIG. 1

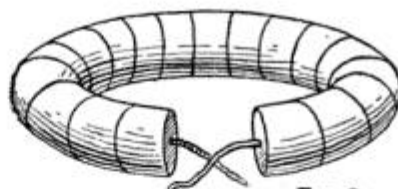

FIG. 2

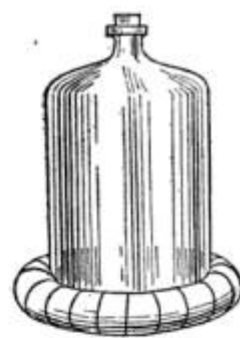

FIG. 3

Base Made of Corks

does not, for the moment, need them. These supports should not be made of any hard material nor should they be good conductors of heat, as such qualities would result in frequent breakage.

A French magazine suggests making the supports from the large corks of glass jars in which crystal chemicals are usually supplied from the dealers. The manner of making them is clearly shown in the sketch. Each cork is cut as in Fig. 1 and placed on a wire ring (Fig. 2) whose ends are twisted together and the last section of cork is cut through from the inner side to the center and thus fitted over the wire covering the twisted ends, which binds them together. The corks in use are shown in Fig. 3.

Homemade Work Basket

Secure a cheese box about 12 in. high and 15 in. or more in diameter. It will pay you to be careful in selecting this box. Be sure to have the cover. Score the wood deeply with a carpenter's gauge inside and out $3\frac{1}{2}$ in. from the top of the box. With repeated scoring the wood will be almost cut through or in shape to finish the cut with a knife. Now you will have the box in two pieces. The lower part, $8\frac{1}{2}$ in. deep over all, we will call the basket, and the smaller part will be known as the tray.

Remove the band from the cover and cut the boards to fit in the tray flush

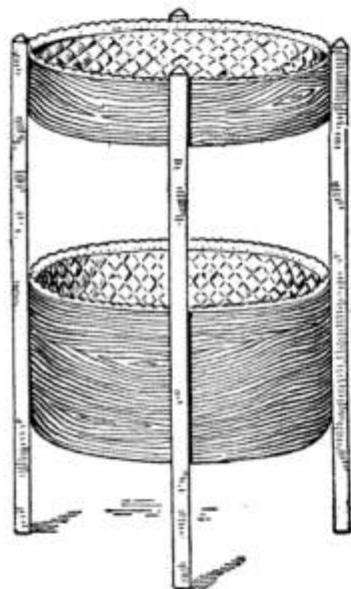

with the lower edge, to make the bottom. Fasten with $\frac{3}{4}$ -in brads. The kind of wood used in making these boxes cracks easily and leaves a rough surface which should be well sandpapered.

The four legs are each $\frac{3}{4}$ in. square and $30\frac{1}{2}$ in. long. The tops should be beveled to keep them from splintering at the edges. With a string or tape measure, find the circumference of the tray or basket and divide this into four equal parts, arranging the lap seam on both to come midway between two of the marks. When assembling, make these seams come between the two back legs.

The tray is placed $1\frac{1}{4}$ in. from the top end and the basket $6\frac{3}{4}$ in. from the bottom end of the legs. Notch the legs at the lower point about $\frac{1}{8}$ in. deep and $1\frac{1}{4}$ in. wide to receive the band at the lower end of the basket. Fasten with $\frac{3}{4}$ -in. screws, using four to each leg, three of which are in the basket. Insert the screws from the inside of the box into the legs.

Stain the wood before putting in the

lining. If all the parts are well sandpapered, the wood will take the stain nicely. Three yards of cretonne will make a very attractive lining. Cut two sheets of cardboard to fit in the bottom of the tray and basket. Cover them with the cretonne, sewing on the back side. Cut four strips for the sides from the width of the goods $5\frac{1}{2}$ in. wide and four strips 10 in. wide. Sew them end to end and turn down one edge to a depth of 1 in. and gather it at that point,—also the lower edge when necessary. Sew on to the covered cardboards. Fasten them to the sides of the tray and basket with the smallest upholsterers' tacks. The product of your labor will be a very neat and useful piece of furniture.—Contributed by Stanley H. Packard, Boston, Mass.

A Window Display

A novel and attractive aeroplane window display can be easily made in the following manner: Each aeroplane is cut from folded paper, as shown in the sketch, and the wings bent out on the dotted lines. The folded part in the center is pasted together. Each aeroplane is fastened with a small thread from the point A as shown. A figure of an airman can be pasted to each aeroplane. One or more of the aeroplanes can be fastened in the blast of an electric fan and kept in flight the same as a kite. The fan can be concealed to make the display more real. When making the display, have the background of such

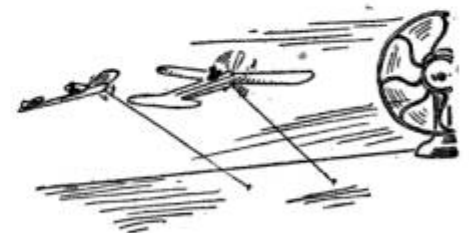
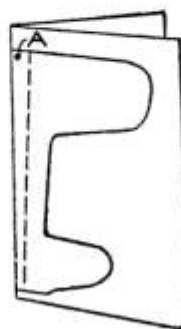

Paper Aeroplanes in Draft

a color as to conceal the small threads holding the aeroplanes.—Contributed by Frederick Hennighausen, Baltimore, Md.

The Construction of a Simple Wireless Telephone Set

By A. E. ANDREWS

In Two Parts—Part II

If two coils of wire be placed parallel to each other as shown in Fig. 6, and a current be passed through the winding of one of them, say A, a part of the magnetic lines of force created by this current will pass through the other coil B. These lines of magnetic force must cut across the turns of wire of the coil in which there is no current as the magnetic field is being created, and as a result there will be an electrical pressure produced in the winding of the coil carrying no current. When the current in coil A is discontinued, the magnetic field created by this current is destroyed or it contracts to zero, and the magnetic lines again cut the various turns composing the winding of coil B. The direction in which the magnetic lines of force and the winding of coil B move with respect to each other is just the reverse, when the current in the winding of coil A is increasing, to what it is when the current in the winding of the coil A is decreasing. Any change in the value of the current in the winding of coil A will result in a change in the number of magnetic lines of force linked with the winding of the coil B, and as a result of this change in the number of lines linked with the winding of coil B there will be an induced electrical pressure set up in coil B. The direction of this induced electrical pressure will depend upon whether the current in the winding of coil A is increasing or decreasing in value. When the current in the winding of coil A is increasing in value, the electrical pressure induced in the winding of coil B will be in such a direction that the current produced by this induced electrical pressure will pass around the winding of coil B in the opposite direction to that in which the current passes around the winding of coil A. Or the current produced by the induced electrical pressure tends to produce a magnetic field opposite in

direction to the one created by the current in the winding of coil A. When the current in the winding of A is decreasing in value, the induced pressure in the winding of the coil B is just the reverse of what it was in the previous case and the current produced by this induced pressure passes around the winding of the coil B in the same direction as the current passes around the winding of coil A. The current produced by the induced electrical pressure aids the current in the winding of coil A in producing a magnetic field. In general the current resulting from the induced pressure always passes around the circuit in such a direction as to produce a magnetic effect which will oppose a change in the value of the magnetic field causing the induced electrical pressure.

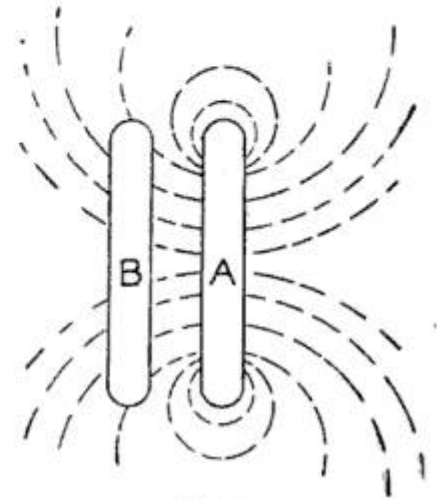

Fig. 6

There will be an induced pressure in the winding of coil B, due to a change in the value of the current in the winding of coil A, as long as the coil B remains in the magnetic field of the coil A and its plane is not parallel to magnetic lines; or, in other words, coil B must always be in such a position that some of the magnetic lines created by the current in coil A will pass through the winding of coil B.

If a telephone transmitter and a battery be connected in series with the winding of coil A, a fluctuating or varying current can be made to pass through the winding by causing the dia-

phragm of the transmitter to vibrate by speaking into the mouthpiece of the transmitter. This varying current will set up a varying magnetic field and there will be an induced electrical pres-

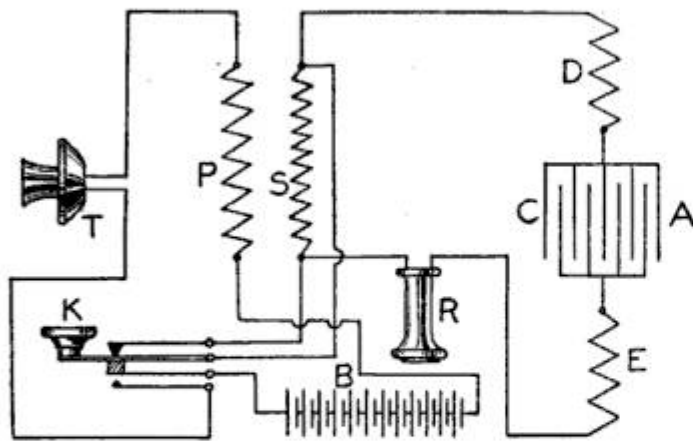

Fig. 7—Sending and Receiving Equipment

sure set up in coil B, if it be properly placed with respect to coil A. A receiver connected in series with the winding of coil B will be subjected to the action of a varying current due to the induced electrical pressure in the winding of coil B and as a result, the diaphragm of the receiver will vibrate in unison with that of the transmitter, and speech can thus be transmitted. The connection just described should be somewhat modified and a little more equipment used in order to give the best results.

Figure 7 shows the complete sending and receiving equipment, a complete outfit of this kind being required for each station. The transmitter T and the receiver R may be an ordinary local battery transmitter and receiver, although a high-resistance receiver will give better results. The induction coil with the windings, marked P and S, may be any commercial type of induction coil as used in a magneto telephone instrument, but a coil with a high-wound secondary will give better results. The push button K is to be used in closing the transmitter circuit when the set is being used for transmitting, the key being depressed, and for shorting out the high resistance secondary winding when the set is used in receiving, the key being

in the normal position. Ten dry cells should be connected in series and used to supply current to the transmitter circuit, as shown by B in the figure. The receiver R, secondary winding of the induction coil S, and the winding of coil A used in transmitting and receiving the magnetic effects, are all connected in series. The winding of the coil A consists of two parts, D and E, as shown in the figure, with two of their ends connected together by means of a condenser, C, having a capacity of about 2 micro-farads. Each of these parts should consist of about 200 turns of No. 22 gauge silk-covered copper wire, wound on an ordinary bicycle rim. The inside end of one winding should be connected to the outside of the other by means of the condenser, the two coils being wound in the same direction. The condenser C can be procured at a small cost from almost any telephone company.

To talk, two of the instruments are placed 25 or 30 ft. apart, and they may be placed in different rooms as walls and other ordinary obstructions that do not interfere with the production of the magnetic field about the transmitting coil, have no effect upon the operation. Pressing the button K at the transmitting station, closes the transmitter circuit and removes the shunt from about the secondary winding of the induction. Any vibration of the transmitter will cause a varying current to pass through the primary winding P, which in turn induces an electrical pressure in the secondary winding S, and this pressure causes a varying current to pass through the coil A. The varying current in the winding of the coil A produces a varying magnetic field which acts upon the receiving coil, inducing an electrical pressure in it and producing a current through the receiver at the receiving station.

A filing coherer, adapted to close a local relay circuit and ring an ordinary bell, may be used with the sets just described for signaling between stations.

INTERESTING PATENTS, PRACTICAL OR UNIQUE

DEVICE AIDS IN HEMMING—A Salt Lake City inventor has recently been granted a patent on a cloth holder which he calls a hemmer. This device, shown in Fig. 1, facilitates the hemming of linen by hand and enables the whip stitch to be taken without danger of sticking the finger with the needle. It also holds the cloth firmly in position and presents a straight edge for hemming. The linen to be hemmed is folded in the usual way, and then the hemmer is placed over the fold as shown in the first drawing. The stitch is whipped along the tight straight edge of cloth which shows above the hemmer.

DISPENSING VESSEL FOR SEVERAL BEVERAGES—A dispensing vessel in which three different beverages may be carried and discharged separately through the one spout is shown in Fig. 2. Vertical partitions form three compartments, through all of which the spout extends. Spring-seated valves, operated by flexible connections passing over pulleys to the back of the receptacle just above the handle, close or open the passages between each compartment and the spout.

CLINCHER GAFF FOR FISHERMEN—A clincher gaff controlled by one hand and designed to take the place of a landing net is shown in Fig. 3. It will grip and hold any fish from $\frac{1}{2}$ to 20 lb., and it is claimed that its grip leaves no ugly holes or tears on the fish. A spring holds the jaws open, but when the fish is touched the user closes his hand, thus causing the jaws to shut and grip the fish like a vise.

"FLYTRAP" AEROPLANE—This curiously shaped aeroplane (Fig. 4), which resembles an old-fashioned flytrap inverted, or the lower half of a Chinese lantern, is the idea of a Columbus, Ohio, inventor, who believes sufficiently in its merits to have it patented. The lifting surface of the machine consists of a series of annular planes of progressively increasing diameters arranged one above the other.

ADJUSTABLE CAKE PAN—Figure 5 is an adjustable cake pan comprising a bottom, and a body portion capable of being adjusted to varying diameters. The body portion is held securely at the diameter to which it is adjusted by means of tongues engaging with notches. The diameter of the pan may be readjusted at any time during the baking process.

MINER'S BREATHING MASK—An ingenious means of assembling and carrying the different parts necessary in the use of a respirator for operation in gas-filled mines, or under other like conditions, is shown in Fig. 6. The different parts are assembled in a waistcoat, having an inflatable reservoir in the back portion, and three pockets on the front, of which the upper holds a receptacle for the absorbent, and the two others, gas-containers. Tubes connect the face mask with the former and the inflatable reservoir, and the reservoir with the gas-containers.

FOLDING DECOY DUCK—Figure 7 shows an ingenious folding decoy duck both folded and extended. This decoy is made of canvas, has no levers or cranks, and does not require air pressure for opening. This is done by means of two wire-spring supports, one for the head and one for the tail, the only other parts of the decoy being a wooden float, the head block, and the canvas cover. It automatically expands when the anchor is unwound, and will come right side up in the water no matter how carelessly tossed out.

INDIVIDUAL LEMON OR ORANGE SQUEEZER—A handy device for afternoon teas and other like functions is shown in Fig. 8. It consists of a device for squeezing the juice out of the small slices into which lemons are cut when lemon juice is used instead of cream in tea. It may also be used for squeezing juice from orange carpeles.

SPRAYER—Figure 9 is a spraying apparatus which may be wheeled along a row of plants or small trees as shown. The top of the tank is adapted to serve as a platform. The delivery pipe has a pair of downwardly projecting arms, each of which is provided with four nozzles. The delivery pipe may be swung to either side of the tank.

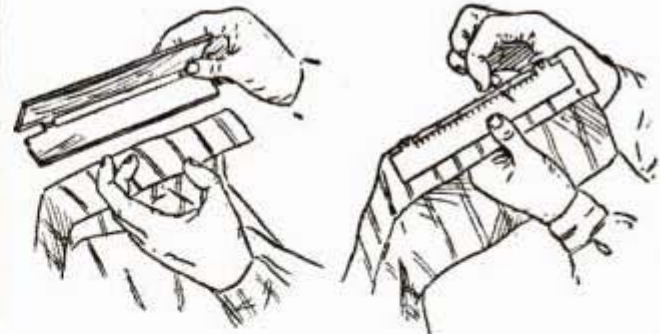

FIG. 1

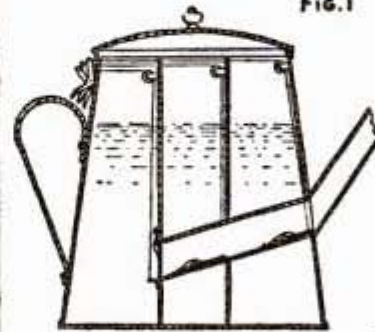

FIG. 2

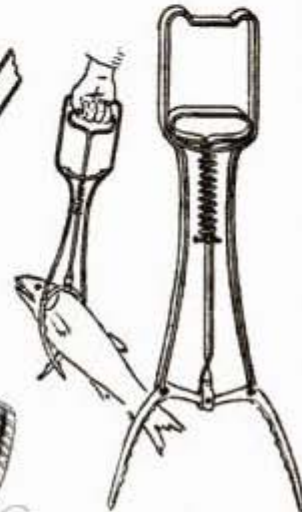

FIG. 3

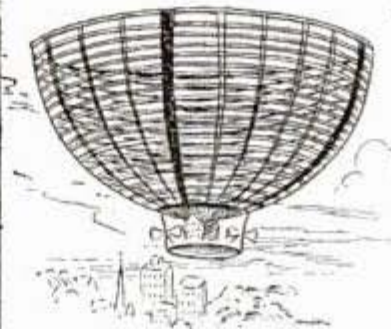

FIG. 4

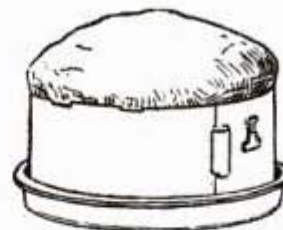

FIG. 5



FIG. 6

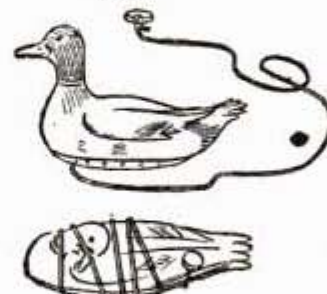

FIG. 7



FIG. 8

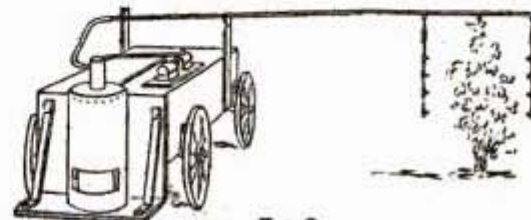

FIG. 9

TWO of the more impressive sights of a railroad grading camp are the marvelous alacrity of the men in responding to the call for dinner and their unparalleled quickness in wrapping themselves around their grub. During construction of the new lines of the Louisville & Nashville in Kentucky, an old farmer furnished one of the grading camps with vegetables. He often arrived at the camp at meal time and was always greatly impressed with the voracity of the men. The work was hard and when the call for dinner was given every man made a rush for the table and the food disappeared in quick time. One day a workman on his way to the table tripped on the root of a tree and fell. He lay all sprawled out making no attempt to rise. The farmer in great concern rushed to him. "Are you hurt, are you hurt?" he asked anxiously. "No," answered the man. "Well, why don't you get up and go to your dinner?" "No use," returned the other, sadly, "It's too late now."—Engineering & Contracting.

"How does your husband keep occupied during his vacation?"

"Oh, he's chauffeur of an electric fan."—Louisville Courier-Journal.

Robert Underwood Johnson, the well-known poet and editor, declared at the University of New York's commencement that New York as a literary center was ridiculous—that nowhere in this county was poetry more appreciated than in Boston, and nowhere less than in New York.

"In fact," said Mr. Johnson, afterward, "New York's love of poetry is about equal to the Earlham College boy's love of languages."

"In my sophomore year at Earlham this lad was visited by his mother.

"Well, my dear," she said to him, "what languages have you decided to take up here?"

"I have decided to take up Pictish," he replied.

"Pictish?" said his puzzled mother. "Why Pictish?"

"Only five words of it remain," said he."—Los Angeles Times.

Wigg—Henpekke has bought a motorboat and named it after his wife.

Wagg—Can't manage it, eh?—Philadelphia Record.

"It is said that impetuous people have black eyes."

"Yes, and if they don't have them, they are apt to get them."—New York Mail.

"What did you do with the steam gauge?" asked the superintendent of the lumber mill. "Oh!" replied the darky engineer. "Do you mean that thar ole clock? I taked it off an' throwed it away. It won't keep time, nohow."—Power.

Olaf Larson, working in a warehouse, backed into an elevator shaft and fell down five stories with a load of boxes. Horror-stricken, the other employes rushed down the stairs, only to find him picking himself unharmed out of the rubbish.

"Ess de boss mad?" he whispered cautiously. "Tal 'em Ay had to come down for nails anyway."—Success Magazine.

The teacher had been reading to the class about the great forests of America.

"And now, boys," she announced, "which one of you can tell me the pine that has the longest and sharpest needles?"

Up went a hand in the front row.

"Well, Tommy?"

"The porcupine?"—London Tit-Bits.

Hercules had been driven in a taxicab to the Augean stables and told to get busy.

"What's the use," he bitterly muttered, "just as soon as I get 'em cleaned up they'll be turned into a garage."

Nevertheless he fell to work.—Cleveland Plain Dealer.

A St. Louis traveling man, making his first trip through North Dakota, woke up one May morning to find the ground white with snow.

"For heaven's sake," he asked the hotel clerk disgustedly, "when do you have summer out in this God-forsaken country?"

"I don't know," replied the clerk. "I have only been here eleven months."—Success.

Possibly there are no more interesting mechanical plants to visit anywhere than the big watch factories, and so constant are the applications from visitors that a force of guides is kept in readiness to pilot parties through the shops and explain the work of the almost human machines which form the bits of metal into perfect watch parts. One of the factories, noted for its attractive female operatives, might as well advertise at wholesale for more guides, as they will surely be needed when it becomes known that the following notice was recently posted in the shops: "Please Leave All Wearing Apparel in the Cloakroom."—Manufacturing Jeweler.

"I wouldn't miss the pyramids for worlds."

"I am glad to see somebody interested in research."

"It isn't that. I want to have my photograph taken standing in front of the main dump."—Washington Herald.

"Tell me," said the customs inspector, "have you anything dutiable concealed about your person?"

"Well," came in a weak voice from the pale passenger; "if I swallowed anything of that sort I can assure you that I haven't."—Yonkers Statesman.

Apropos of the numerous accidents that befall foreign submarines, Lewis Nixon, the eminent ship-builder, said at the Union club in New York.

"Two French government officials were once discussing naval affairs.

"To what account," said the first, "had our new submarines, the "X," and "XI," best be charged?"

"To the sinking fund, of course," was the reply."—Detroit Free Press.

"There's a fool-proof aeroplane on the market."

"Good. What's its main characteristic?"

"It won't fly."—Cleveland Plain Dealer.

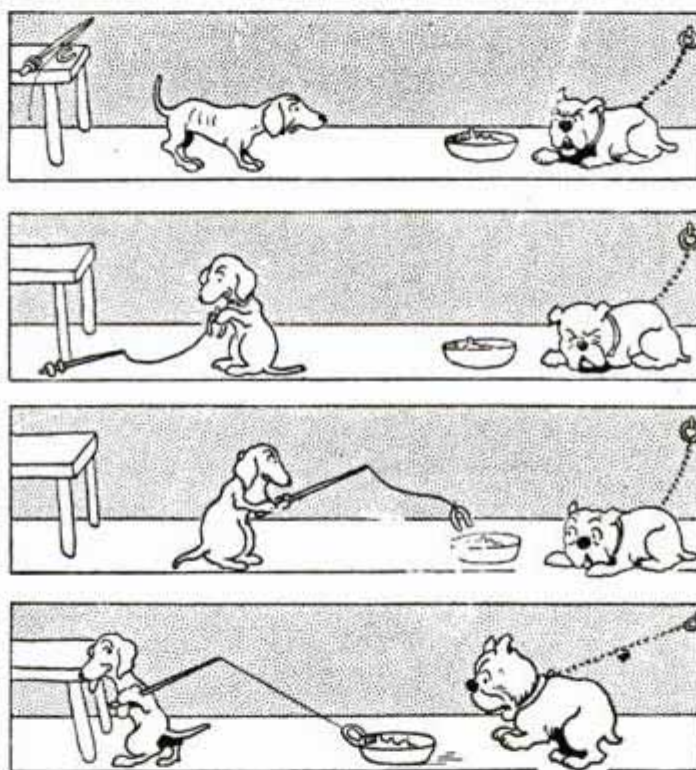

—Pele Mele

A Wise Pup and a Magnet

Help for HOME-BUILDERS!

Full Particulars and Valuable Books—FREE

We have revolutionized the building material business by our system of selling Millwork and Lumber **direct to the actual user**, who saves all the middle dealers' profits and secures a guarantee of quality that means satisfaction or money back.

With our vastly enlarged and improved facilities we have doubled our stock of materials and can ship to any point in the United States within 48 hours after receipt of orders.

We saved our customers over a million dollars last year. Three great banks endorse us.

Lumber and Millwork for this House—**\$698**
Plan Book 10c



Lumber and Millwork for this 8-Room Stucco House, \$1,634

5,000 Building Material Bargains Including Doors, Windows, Mouldings, Stairs, Porches, Flooring, Finish and LUMBER

Get our prices on everything you need to build a new house or modernize an old one. Our Grand Free Building Material Catalog offers 5,000 Bargains—the very latest designs in Millwork, approved by best architects.



Head Blocks, 4c

We Save You About 50 Per Cent

We offer the lowest prices ever known on everything needed to build complete and beautiful homes of the most modern types—even to the mantels and hardware. No local lumber yard or planing mill can begin to offer such a wonderful variety. Everything up to official grades of Sash and Door Manufacturers' Association.

Quality, Safe Delivery and Satisfaction Guaranteed

We ship everywhere under an absolute guarantee of quality, safe delivery and satisfaction. Money refunded and freight paid both ways if goods are not as represented.

Send Coupon or Postal

for Free Books and let us help you build at a big saving.

Gordon-Van Tine Co.

2681 Case Street

Davenport, Iowa

(142)



Lumber and Millwork for this 7-Room House, \$1,057

Plan Book FREE

Over 50 complete designs for beautiful, practical, economical homes. The only Plan Book that keeps cost within estimates. Enclose 10c for postage and mailing.



Flight of Stairs, Complete and ready to put together. **\$23.93**

We offer a splendid variety of Stair Material in Oak and Yellow Pine. Our designs admit of many variations. Our prices save you from \$60 to \$125 on a complete flight of stairs. See Catalog for latest stair designs.

Estimates FREE
FREE BOOKS

Gordon-Van Tine Co.
2681 Case St.
Davenport, Iowa

Please send the FREE BOOKS checked below to

Name

Address

Occupation

Millwork Lumber
Roofing Plan Book

If you wish the PLAN BOOK, enclose 10c for postage and mailing.



ong Door, 77c



Lumber and Millwork for this 5-Room Bungalow, \$946

Own the Time Clock—

Why not own the time clock instead of "ringing up" all your life? There is no reason why you can't do it if you have enough ambition.

The first step is training—that leads to promotion and more and more money. Once a man acquires training and begins to go up, there is no such thing as calculating where he will stop. There are many students of the International Correspondence Schools who are now owners and directors of great enterprises, who were merely laborers before they received the help of the I. C. S.

How is it done? Read the next page!



Don't Be a "Ringer"

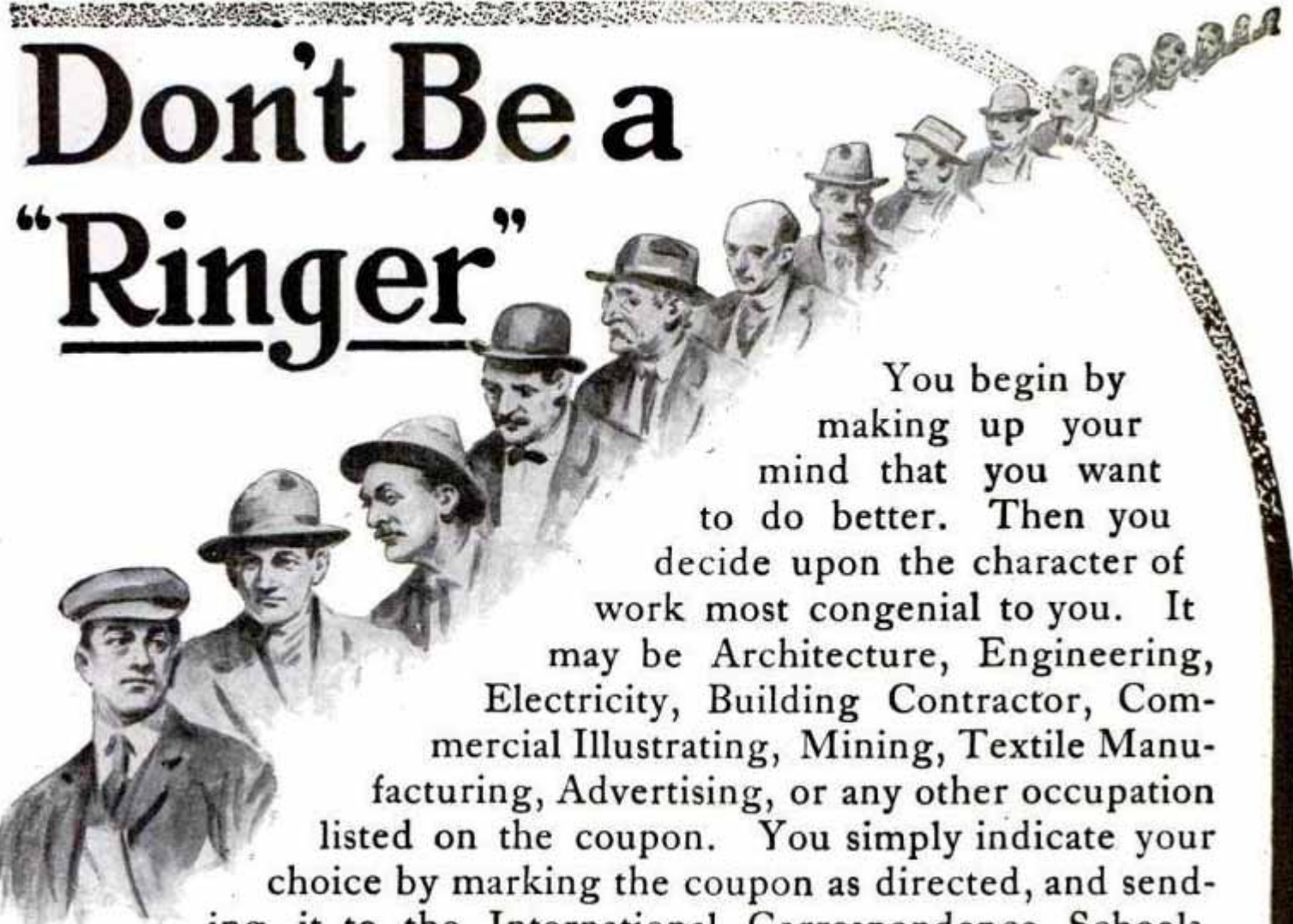

You begin by making up your mind that you want to do better. Then you decide upon the character of work most congenial to you. It may be Architecture, Engineering, Electricity, Building Contractor, Commercial Illustrating, Mining, Textile Manufacturing, Advertising, or any other occupation listed on the coupon. You simply indicate your choice by marking the coupon as directed, and sending it to the International Correspondence Schools.

By return mail, you will receive without charge a wealth of illustrated literature, containing invaluable information on the trade or profession in which you wish to perfect yourself.

The I. C. S. will show you how to start at the very beginning, or it will enable you to advance from the point where you are today. There is neither lost ground, nor lost time with I. C. S. instruction. It is designed to put money in a man's pocket right away—not years hence.

Remember you don't leave home, lose time, nor tie yourself up with any embarrassing obligation. Mark the coupon today and take the first step towards being boss of the time clock, instead of having the time clock boss you.

Do it today!

INTERNATIONAL CORRESPONDENCE SCHOOLS
Box 872 SCRANTON, PA.

Explain, without further obligation on my part, how I can qualify for the position before which I mark X.

Automobile Running	Civil Service	} Spanish
Mine Superintendent	Architect	
Mine Foreman	Chemist	} German
Plumbing, Steam Fitting	Languages	} Italian
Concrete Construction	Commercial English	} Building Contractor
Civil Engineer	Building Contractor	} Industrial Designing
Textile Manufacturing	Industrial Designing	} Commercial Illustrating
Stationary Engineer	Commercial Illustrating	} Window Trimming
Telephone Expert	Window Trimming	} Show Card Writing
Mechan. Engineer	Show Card Writing	} Advertising Man
Mechanical Draftsman	Advertising Man	} Stenographer
Architectural Draftsman	Stenographer	} Bookkeeper
Electrical Engineer	Bookkeeper	} Poultry Farming
Elec. Lighting Supt.	Poultry Farming	

Name _____

Present Occupation _____

Street and No. _____

City _____ State _____



There's a
DU PONT
Smokeless Powder
For Every
Hunting Requirement



BALLISTITE
A PERFECT
DENSE SMOKELESS POWDER

Both Infallible and Ballistite are dense smokeless powders.

Absolutely waterproof—Not affected by extremes of heat or cold—Impervious to moisture.

Moderate recoil, shoot clean, no unburned grains to "blow back." Will not deteriorate with age.

Characteristics invaluable to the game shooter.

The correct 12-gauge loads for field shooting are from 22 to 28 grains of powder and from $1\frac{1}{8}$ to $1\frac{1}{4}$ ounces of shot, depending on the game hunted.

Other popular Du Pont brands are Dupont, Schultze, "E. C." and Empire Bulk Smokeless Powders, and Dupont, Laflin & Rand and Hazard Black Sporting Powders.

Perfection in Sporting Powders is only obtained by the employment of the most skillful workmen, the operation of the most improved machinery and the exercise of the most scrupulous care in the selection and preparation of raw material.

Du Pont Sporting Powders are fully guaranteed by the Pioneer Powder Makers of America.

Write for Booklet No. 248, stating which powder interests you.

Specify Du Pont loads when buying ammunition.

Sold by all first-class dealers.

E. I. DU PONT DE NEMOURS POWDER COMPANY

Established 1802

WILMINGTON, DEL.

The P. S. & W.
Solid Handle
Wrench

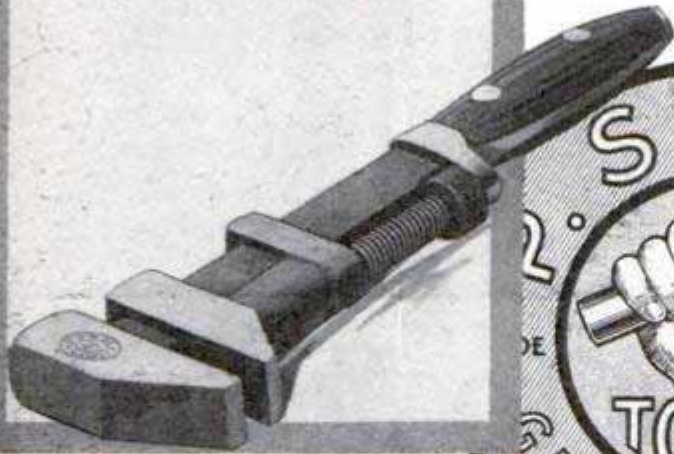

The P. S. & W.
Samson
Brace

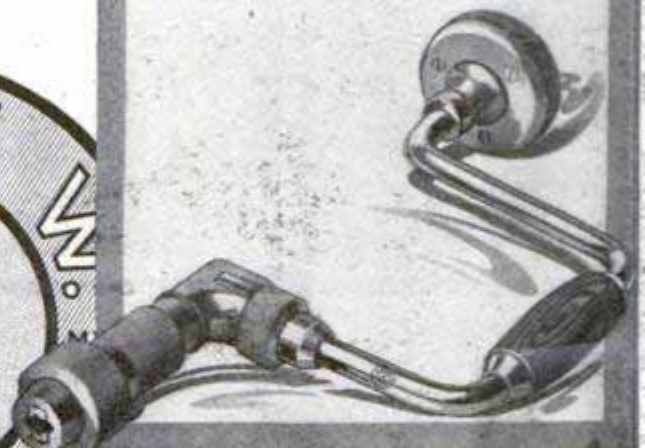

Four Top-notchers in
Four Large Lines of
Mechanics' Hand Tools



Guaranteed Tools for
Carpenters, Machinists,
Electricians, Tinsmiths, etc.

Branded with The MARK of the MAKER

EVERY P. S. & W. Guaranteed Hand Tool carries our registered hand-tool Trade-Mark, which stamps it as the highest product of nearly a century of able, experienced, and progressive tool-making. It is the guarantee mark of quality and excellence, for we put it only on tools that satisfy the most exacting requirements of critical users.

The P. S. & W. Samson Brace

The only brace made with the Ball-bearing Chuck. It has bored ten-penny nails through solid oak, but tightens and releases so easily that a child could do it. No other brace like it.

The P. S. & W. Solid-handle Wrench

Head, bar, ferrule and handle-frame are one solid piece of drop-forged steel. The sliding jaw, screw, and wood facing of handle are the only other parts. The strongest general purpose wrench made.

The P. S. & W. No. 30 Box-joint Plier

The adjustment of the handles gives greatest possible leverage. The cutting edges meet with absolute accuracy. It has no equal for strength, cutting-power and long life—a perfect tool for expert users.

The P. S. & W. 1819 Original Snip

Made of the best Norway iron, laid with special high-grade tool-steel. No other snip has ever rivalled it in quality or in the favor of expert tinsmiths everywhere.

The Peck, Stow & Wilcox Co., MANUFERS. of the Largest Line of Mechanics' Hand-tools Offered by Any Maker

Address Correspondence to
20 Murray Street, NEW YORK CITY

Established 1819
Five Large Factories

The No 30
P. S. & W.
Box Joint
Plier



A Handy Book for Tool-Users

Our 165-p. "Mechanics' Handy List" shown above contains 35 pages of valuable shop information and a catalog of over 200 tools. Sent free at your request.

The 1819
Original
P.S. & W.
Snips



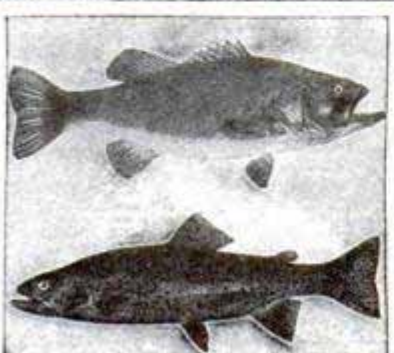

Learn to Mount Specimens Like These

This advertisement is for every *sportsman* and *nature lover*, everywhere. *Write to-day. Send the coupon* for our *free books*. They contain something of great value to hunters, trappers and all people who love the out-of-doors. *You should have this book. Write for it today.*

Do You Shoot or Fish?

If so, you should be able to save your beautiful and valuable trophies. *We can teach you how.* We have taught over 35,000 of the best sportsmen of the country, and they are now doing their own taxidermy work with wonderful success. They save taxidermists' bills and enjoy their spare time as never before. Taxidermy is the most fascinating of all professions. *We can teach you to mount all kinds of game specimens* absolutely true to life, by the latest and best methods. Easily, quickly and perfectly learned, in your own home *during your spare time.* No need of leaving your present employment. You can decorate your home with Nature's best art; you can double your interest in sportsmanship. Let your gun and rod pay for your vacation.

BIG PROFITS You can easily make from \$25 to \$50 a month during your *spare time*, practicing Taxidermy, or if you go into the work as a profession you can make \$5,000 or more per year. You can sell your own mounted specimens for big profit. You can make big money doing mounting for others. You should investigate this remarkable offer.

This Taxidermy Book FREE

We will send you this book on taxidermy absolutely free. It tells you all about our school and the most fascinating profession of Taxidermy. It will tell you how you can learn to become an expert taxidermist in a few months—*by mail—in your own home*—during your spare time. You need this book and it *costs you absolutely nothing.* Merely send in the *free coupon.* Write for it today—it is free—we will also send you the famous *Taxidermy Magazine* and hundreds of letters from our delighted graduates. Write today—*now—immediately—before you lay aside the paper.*

NORTHWESTERN SCHOOL OF TAXIDERMY
1197 Elwood Building
OMAHA, NEB.

"A school for sportsmen
by sportsmen."



FREE COUPON

Northwestern School
of Taxidermy
1197 Elwood Bldg.
Omaha, Neb.

Gentlemen—Please send me your Book on Taxidermy and the Taxidermy Magazine; also full particulars of the wonderful Free Trial of your course of instruction. All are to be sent to me free and prepaid—no obligations on me whatsoever.

Name.....

Address.....

ÆTNA-IZED?

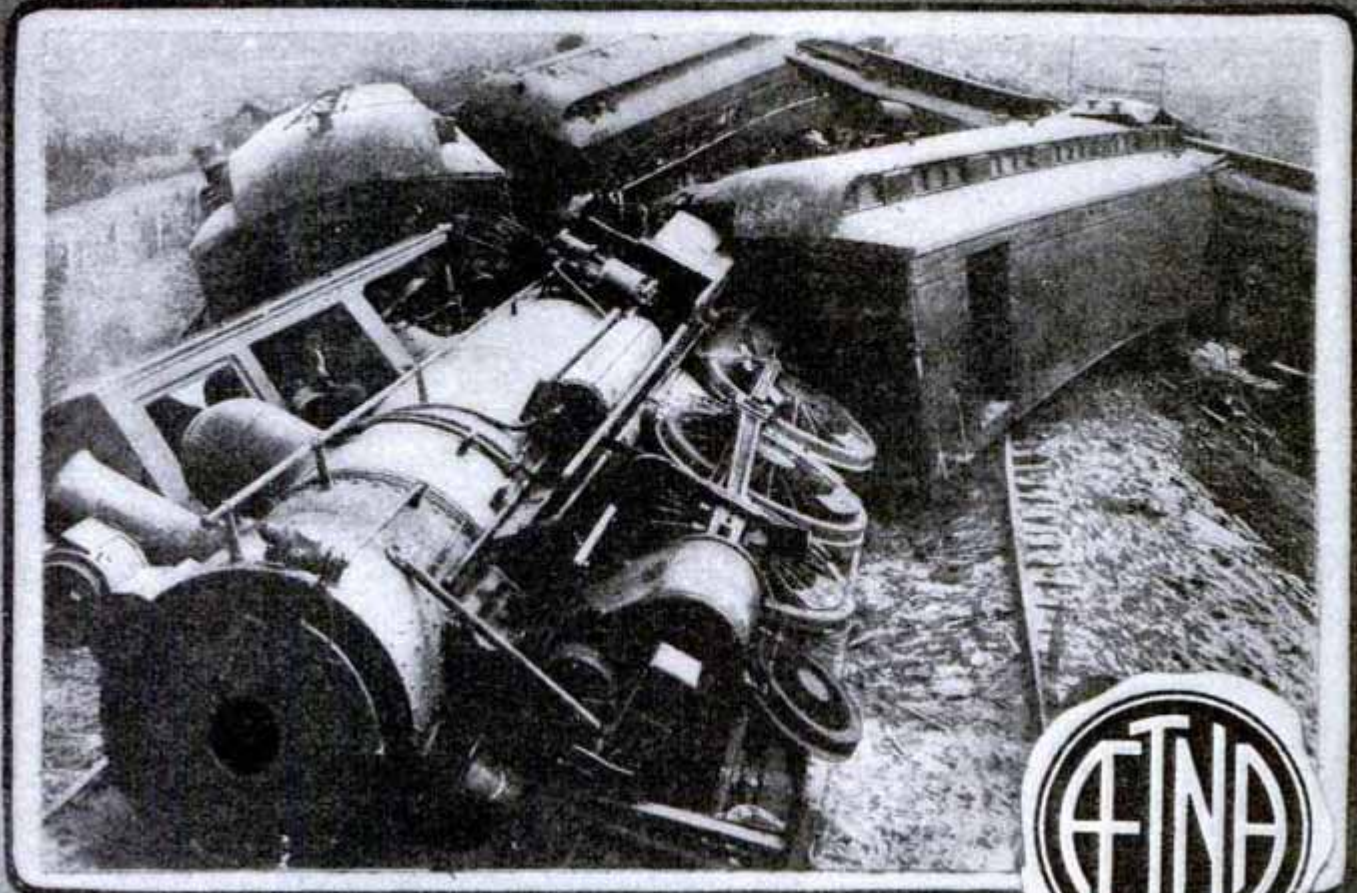

TO be **ÆTNA-IZED** is to be protected against accident by a policy in the **ÆTNA LIFE INSURANCE CO.** This famous and strong company writes life, accident, health and liability insurance in all forms, but it calls special attention to what it considers the most attractive insurance proposition on the market

The **ÆTNA** Ten Dollar Combination

In the extent and variety of protection this policy gives, it is without a rival. For \$10 a year this policy pays
\$2,250.00 for death from travel or burning building accident
1,250.00 for death from ordinary accident
250.00 for natural death

It also pays liberally for loss of limb or sight, and provides weekly indemnity for accidental injury that results in total or partial disability

The payments for accidental loss of life, limb or sight increase each year without additional cost

YOU CAN BE **ÆTNA-IZED** FOR A TEN DOLLAR BILL.

ÆTNA LIFE INSURANCE CO.

ACCIDENT AND LIABILITY DEPARTMENT

HARTFORD, CONN.

Send me information about your \$10 COMBINATION POLICY

Name _____

Address _____

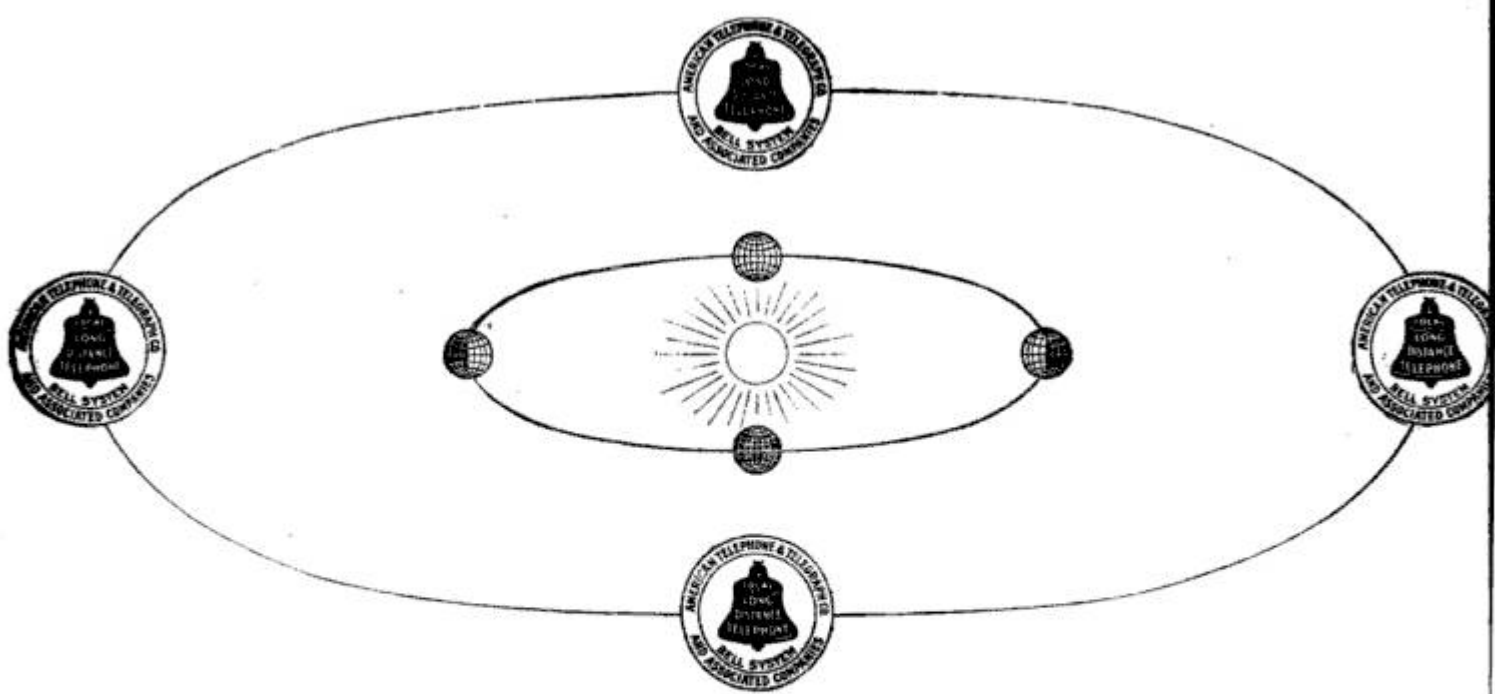

Comparison of the Distance Traveled by Earth and Bell Telephone Messages

The Orbit of Universal Service

In one year the earth on its orbit around the sun travels 584,000,000 miles; in the same time telephone messages travel 23,600,000,000 miles over the pathways provided by the Bell system. That means that the 7,175,000,000 Bell conversations cover a distance forty times that traveled by the earth.

When it is considered that each telephone connection includes replies as well as messages, the mileage of talk becomes even greater.

These aggregate distances, which exceed in their total the limits of the Solar system, are actually confined within the boundaries of the United States. They show the progress that has been made towards universal service and the intensive intercommunication between 90,000,000 people.

No such mileage of talk could be possible in such a limited area were it not that each telephone is the center of our universal system.

**AMERICAN TELEPHONE AND TELEGRAPH COMPANY
AND ASSOCIATED COMPANIES**

One Policy

One System

Universal Service

11 Tools in One



Save tools—save time—do all work easier, faster by having your tools always keen. Luther's Mechanics' Special Outfit supplies every sharpening, burnishing and polishing need, makes it the work of only a minute to do the toughest job of sharpening. The outfit consists of the Luther Mechanics' Special Carborundum Grinder with 11 accessories. This is the most complete sharpening, buffing and polishing outfit ever offered, and the most remarkable value.

6 Months' Free Trial

We offer you a whole half year's free trial of this full outfit to prove in your own shop, on your own tools, how this grinder saves and makes money for you—more than pays for itself in the time you use it free. If after a half year's use you do not firmly believe it is one of the greatest time-saving and work-saving outfits you have ever seen—if you do not believe it is a real money-maker for you, return it to us. No hard feelings on our part, and the six months' use will have cost you nothing. Return the coupon for our six months' free trial offer.

Carborundum wheels peel steel away in tiny shavings—no danger of drawing temper—no need of hard pressing—no need of cooling with water. The sharp Carborundum crystals cut toughest steel as emery does copper. Luther Grinders save and make money for any tool user—save money by saving time and tools, make money by making all work easier and faster because of keen, bright tools.

Luther Tool Grinders

are built like high grade lathes—steel and malleable construction, machine cut spur gears, bronze bearings in oil bath, etc. The machine lasts a life-time, and the wheels are guaranteed for 5 years and outlast any number of emery wheels in severest service. This outfit is a great economy for any tool user and we want you to prove it—FREE.

RETURN THIS COUPON

Return this coupon for our extraordinary half year's free trial offer on this entire Mechanic's Special Outfit, and for free booklet reprinting from McClure's Magazine the story of the discovery of the wonderful artificial diamond abrasive. Cut out the coupon now.

LUTHER GRINDER MFG. CO.

1909 Madison St., Milwaukee, Wis.

LUTHER GRINDER MFG. CO.,
1909 Madison Street, Milwaukee, Wis.

Please send me free and prepaid your free carborundum booklets and your six months' free trial offer on the Luther Mechanics' Special Diamond Tool Grinder.

NAME

ADDRESS

DEALER'S NAME

DEALER'S ADDRESS



Garage Men, Blacksmiths and Manufacturers

DON'T LET AN



STOP YOU

We know that "IF" you could see our lathes you would not hesitate in ordering from us, for they are practical in design, unexcelled in workmanship and, size for size, considerably heavier than other makes that will compare with ours in general design.

WHY HESITATE ANYWAY? Every lathe we sell is sent out with **our guarantee:** Your money back, including all freight charges, if you are not thoroughly satisfied. **If the lathe is not what we claim it is, we want you to send it back.** We have sold hundreds of lathes and not one has yet been returned. Every lathe sold adds one more satisfied customer to our list. We can satisfy you. **PRICES RANGE FROM \$60.00 UP.**

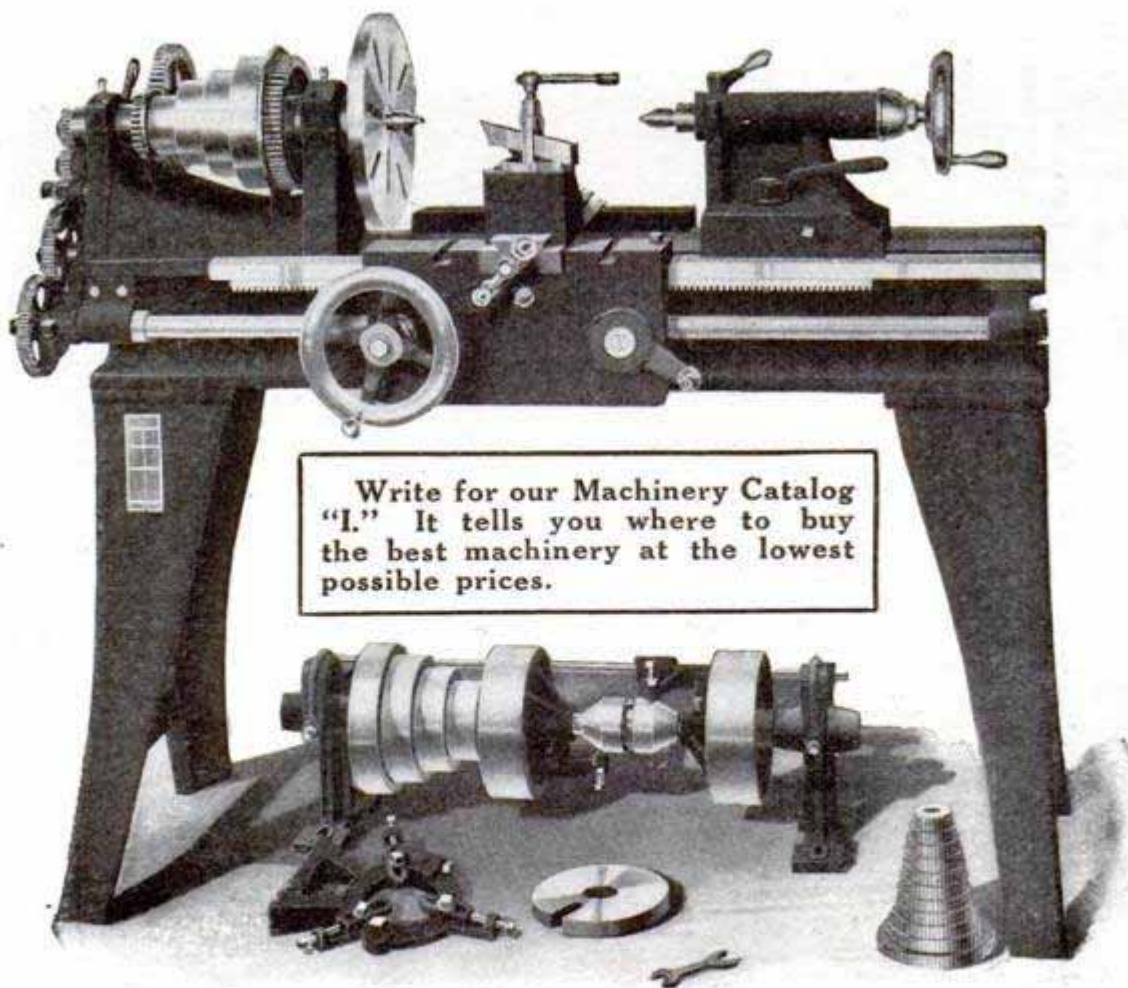

Write for our Machinery Catalog "I." It tells you where to buy the best machinery at the lowest possible prices.

Address, SEARS, ROEBUCK AND CO., Chicago

Pay 17 Cents a Day and Own The Printype Oliver Typewriter

IMPORTANT: The introduction of the Printype Model came as the climax to our great advertising campaign in which we offered The Oliver Typewriter No. 5 on the 17-Cents-a-Day Purchase Plan. For months past we have devoted all our advertising announcements to the new Printype Oliver Typewriter, with its revolutionary improvement in typewriting type.

The impression has gained ground that the 17-Cents-a-Day Purchase Plan does not apply to the Printype Model. In some instances the idea prevails that we can even charge extra for The Oliver Typewriter equipped with Printype.

We desire to state with all possible emphasis that The Printype Oliver Typewriter can be purchased on the "17-Cents-a-Day" Plan at the regular price of \$100.

The Machine That "Typewrites Print!"

America rings with praise for The Printype Oliver Typewriter—the first writing machine that successfully TYPEWRITES PRINT!

This remarkable machine combines all the operative conveniences, all the practical improvements of the most highly perfected typewriter, with the type that from time immemorial has been used for magazines and books!

It is infinitely superior to the old style, thin outline Pica typewriter type—a fact which none will deny. It ranks in importance with *visible writing*, which the Oliver introduced.

The preference of typewriter buyers is so overwhelmingly in favor of Printype that *already over 70 per cent of our total output are "Printypes."*

The advantages of Printype are *self-evident*. The story is told at a *glance*.

Its beauty, its symmetry, its clearness and character, lend a new distinction to typewritten correspondence.

Printype Increases Speed

Not only does Printype enhance the artistic appearance of typewritten matter, but it enables the operator to attain greater *speed*, as the type is

so easy on the eyes. It relieves the tension on the nerves and thus gives wings to the fingers.

Printype —
OLIVER
Typewriter

The Standard Visible Writer

With all its commanding advantages from a purely mechanical standpoint, and its new *artistic triumph*, its supremacy is unquestioned. Its simplicity, versatility and extreme durability all revolve around the great basic feature—the *Oliver Double Type-Bar*.

Without this Double Type-Bar the successful use of Printype would be absolutely impossible.

"17-Cents-a-Day" Plan

This machine—*The Printype Oliver Typewriter*—offered on the famous "17-Cents-a-Day" Plan—has all the improvements, all the exclusive features which our experts have developed. It has the Vertical and Horizontal Line-Ruling Device, the Disappearing Indicator, the Back Spacer, the Tabulator, the Adjustable Paper Feed, the Double Release, the Automatic Spacer, the Locomotive Base and many other innovations which contribute to *high efficiency*. It operates with the lightest touch and, of course, *writes in sight*.

Why Don't You Write Us Today?

How can you resist the attractions of "Printype" and the appeal of the "Penny Plan?"

Here is the world's greatest writing machine—*The Printype Oliver Typewriter*—the standard visible writer—the regular \$100 machine—*actually offered for pennies!*

A small first payment brings The Printype Oliver Typewriter. Then you save 17 cents a day and pay monthly.

Your request will bring the special Printype Catalog, the details of the Penny Plan and a letter *written in Printype*. Whether you are "Commander-in-chief" of a business or a private in the ranks, you will be greatly interested in the literature we will send you. (128)

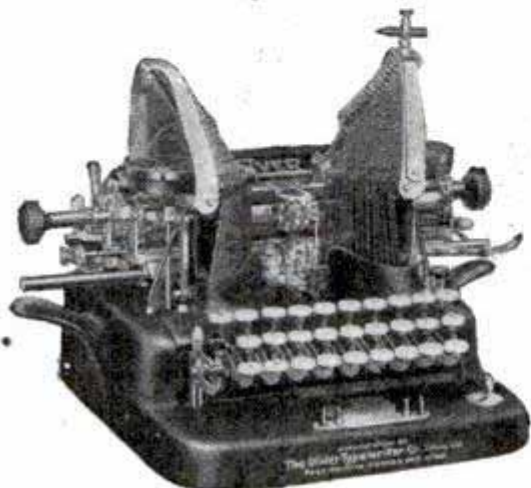

The Oliver Typewriter Company
794 Oliver Typewriter Bldg., CHICAGO
Agencies Everywhere

2c a Week Pays Wash Bill!

Write for
FREE Book

Electricity or Water-Power Does the Work

Just a "Twist of the Wrist" Starts or Stops the Machine!

The 1900 Motor Washers are now at work in thousands of homes. They are doing the work formerly done by women, at a cost of 2c a week for power! Saving thousands upon thousands of dollars in wash bills. Saving worlds of wash-day troubles. Leaving the women free to do other work while the machines are doing the washing.

The 1900 Motor Washer

Washes a Tubful in Six Minutes!

1900 Water Motor Washer
Can be connected with
any water tap instantly



Handles Heavy Blankets or Dainty Laces

The outfit consists of the famous 1900 Washer with either Electric Motor or Water Motor. You turn on the power as easily as you turn on the light, and back and forth goes the tub, washing the clothes for dear life. Then, turn a lever, and the washer does the wringing. All so simple and easy that it is mere child's play.

A Self-Working Wringer Free With Every Washer!

The motor runs Washer and Wringer. We guarantee the perfect working of both. No extra charge for Wringer, which is one of the finest made. Write for FREE BOOK and 30 Days' FREE TRIAL OFFER! Don't doubt! Don't say it can't be done. The free book proves that it can. But we do not ask you to take our word for it. We offer to send a 1900 Motor Washer on absolute Free Trial for an entire month to any responsible person. Not a cent of security—nor a promise to buy. Just your word that you will give it a test. We even agree to pay the freight, and will take it back if it fails to do all we claim for it. A postal card with your name and address sent to us today will bring you the book free by return mail. All correspondence should be addressed to 1900 WASHER CO., 5024 Court St., Binghamton, N. Y. Or, if you live in Canada, Write to the Canadian Washer Co., 355 Yonge St., Toronto, Canada. (23)



Doing the wringing with
1900 Electric Motor Washer



By All Odds the most satisfactory lighting systems made are the
Yale "Arcolight" Pipe System
and the
"Yale Special" Hollow Wire System

Easy to install, easy to operate and approved by all insurance underwriters. Lights instantly. For stores, churches, homes. Gives a soft, brilliant light. 10 times that of electricity at 1/4 the cost. Sold strictly on Merit and shipped complete ready to set up. Guaranteed 2 Years.

Write for catalog. Agents wanted.

YALE MFG. CO., 28 S. Clinton St., Chicago

TRIUMPH STAND LAMP

A 300 Candle Power Lamp for Home, Store, Shop, work bench, library, desk, or wherever a steady and powerful light is wanted or stand lamp can be used. Can be turned up and down like gas, and carried around with more safety than a kerosene lamp, and gives 10 times the light at less than 1/4 the cost to operate, which a child can do. Better than gas or electric lamps because there is no hose or drop wire to prevent their being moved or used anywhere. Holds 2 quarts of gasoline, always ice cool, and one gallon lasts 40 to 50 hours. It has no competitor.

We have five other distinct lines of gasoline lamps, Hollow Wire Systems, and individual gravity lamps, unequaled by any other house. Every one a success and winner. Our POP Catalog tells all about them. Get it now and decide which line you want.

BRILLIANT GAS LAMP CO.

Dept. 1, No. 182 N. State Street, Chicago, Ill.



SOLID OAK EXTENSION DINING TABLE AND CHAIRS \$20.50

48 inch, Round Top, Pedestal Dining Table, extends to 72 inches, \$13.50. 4 Dining Chairs, \$7. 6 Dining Chairs, \$10

This sensational price is made possible by our original exclusive method of manufacturing in sections and shipping in a compact package which may be unpacked and the furniture made ready for use in thirty minutes.

Don't confuse this furniture with cheap furniture. We manufacture quality furniture only.

The oldest and largest firm
of its kind in the world



You do not risk one cent. Use the furniture for thirty days in your home. Prove our claim that you cannot duplicate it for double our price—then if you are not satisfied notify us and we will return all the money you have paid.

Free catalog full of similar bargains, giving full details, and a postal will bring it to you. Send for it today.

BROOKS MANUFACTURING COMPANY, 710 Rust Ave., Saginaw, Mich.

Catalog of 3862 Bargains FREE

Everything For the Home—On Credit

3862 bargains in home-furnishings are illustrated in our big fall catalog, hundreds of carpets and draperies in their natural colors. And this great book is free. We have a copy for you, send for it. Every housekeeper should have this wonderful book. Better send NOW for your copy.

Factory Prices

This catalog shows an endless variety of things that make the home more cheerful and comfortable. The largest city store does not show so many home conveniences—and on every article we guarantee an absolute saving of 15 to 50%. No other house—cash or credit—sells house furnishings at any where near our prices. We Ship Our Goods on 30 Days Approval, so you can return them if you find we have not made good on our claims. Our whole business is built upon special lots bought for spot cash from makers who are hard pressed, or from factories whose outputs we control. And we buy in enormous quantities. Factories compete with each other to sell us, thus we buy very close to actual cost.

Sent for \$1.25

No. AK387

Our Belle Oak Heater Burns any kind of fuel. Is splendidly nickeled trimmed, 43 inches high and has 10 inch fire pot. Made of heavy gauged sheet steel and highly ornamented cast. One of the 112 stove bargains in our stove catalogue, and a guaranteed heater and fuel saver. Total price \$6.95.

Only 75 Cents Monthly

Sent for \$1.75

This beautifully finished Solid oak 42 inch top pedestal table finished in rich flaky grain of golden. Has hand carved legs. One of the specials of our bargain catalog. Only a limited lot to close out at this special saving price of \$10.95.

Only \$1.00 Monthly

No. AK4942

Sent for \$2.50

This elegant reversible Brussels Rug, woven of extra heavy, all-wool worsted yarns, is another example of the 3862 bargains in our big catalog. Comes in colors, green, red and tan, size 9x12 feet. \$18.00 value, our price only \$16.50.

Only \$1.25 Monthly

Guaranteed Savings on

Furniture	Pianos	Washing Machines
Stoves Rugs	Draperies	Musical Instruments
Carpets	Go-Carts	Refrigerators
Men's Clothing	Silverware	China ware
Women's Clothing	Lamps & Clocks	Sewing Machines

Easy to Pay Terms

While You Are Using the Goods

On \$10.00 Purchase	On \$25.00 Purchase	On \$50.00 Purchase
Pay \$1.00 Cash 75c Monthly	Pay \$3.75 Cash \$2 Monthly	Pay \$7.50 Cash \$4 Monthly

Over a Year to Pay

And no matter where you live or how much you earn, you can buy your home-furnishings here—on credit—without publicity—without red tape. We have trusted the great working class for over 27 years, and we know they are honest. Several hundred thousand people all over the country have open accounts with us. We give them over a year to pay for anything they buy while they use and enjoy the goods. You too, can have the same easy-to-pay terms on any of the 3862 things in our catalog.

30 Days Free Trial

Anything you select from our bargain catalog will be sent you for 30 days approval. You may use the goods a whole month before you decide to buy them. If they are not more than satisfactory—if we have not actually saved you 15 to 50% on your purchase—return the goods at our expense. We'll refund your small first payment—and even pay the freight charges both ways. Back of this offer is the endorsement of the First National Bank of Chicago.

4 Catalogs Free

Our New Fall General Catalog of 3862 bargains in home-furnishings should be in every home. Every housewife will appreciate its thousands of magnificent comforts.

Our 1911-1912 Stove Catalog shows 112 styles of Supreme stoves and ranges from 95c up. And any stove you select will pay for itself in the saving of fuel long before you have paid for it.

Our Women's Apparel Catalog contains illustrations of all the newest women's and children's clothing, right from the fashion centers.

Our Men's Clothing Catalog shows all the clever designs in men's suits and overcoats—cloth samples of all wool fabrics in the newest weaves and patterns.

Send for These Catalogs—They are All Free

CUT OUT THIS COUPON

STRAUS & SCHRAM, Inc., Dept. 1028, 35th St., Chicago, Illinois

Gentlemen:—Please send me the catalog checked "X."

General House Furnishings Stoves & Ranges Ladies' Clothing Men's Clothing

Name.....

Postoffice.....

Address..... State.....

15 to 50% Savings

Everything we sell is bought for spot cash at staggering reductions and sold at factory wholesale cash prices, on credit. When makers are caught with over-productions and surplus stocks—when they need ready cash, they come to us. We have more customers and buy in larger quantities than any other concern. So these makers cut their prices, to clear their factories—often selling practically at cost. Our entire Fall Catalog is made up of these phenomenal purchases. We Scoured the World's Markets to Get the 3862 Bargains This Wonderful Book Contains. And as no middlemen share in our prices we can absolutely guarantee a saving of 15 to 50% under any other prices. We invite you to make comparisons at our own expense.

Sent for \$1.00

Richly hand carved rocker finished in American Quarter Sawn Oak—upholstered in chase leather—offered here at a guaranteed saving of 25%. Total price \$5.25.



Only 50¢ Monthly

No. A525

No. AK100

Sent for \$2.00



A magnificent solid oak book case finished in high gloss golden oak color. Has four adjustable shelves, bent glass door convenient desk compartment and drawers for storing papers, etc. One of our catalog features at this price \$11.70.

Only \$1.00 Monthly



No. A1165

Sent for \$2.00

This complete outfit consisting of bessemer angle steel bed in any color—spring support steel spring and cotton top mattress—bought from a factory whose output we control. A topnotch value at \$11.65.

Only \$1.00 Monthly

STRAUS & SCHRAM, Inc., Dept. 1028, 35th St., CHICAGO

Please Mention Popular Mechanics

ELGIN WATCHES ON CREDIT

Special This Month!

17-JEWEL GENUINE ELGIN \$16.50

IN A 20-YEAR GOLD FILLED CASE, only
Sent Prepaid on Free Trial at our Rock-Bottom Wholesale Price



P. STEPHEN HARRIS, Pres.

I want to send you a free copy of my latest book "Facts vs Bunc" or all about the Watch Business, both at home and abroad.

Let Us send you this beautiful Genuine 17-Jewel Elgin Watch, Complete in 20-year Gold Filled Case, Biggest Bargain Ever Offered!

No Money Down—\$2.00 A MONTH

\$2.50 AFTER EXAMINATION.

You Assume No Risk Whatever in Dealing With Us

because, before you buy or pay one cent we place the watch right in your own hands and let it do its own talking. We ask NO SECURITY and NO INTEREST—just plain honesty among men. Our Elgin Watches are so well known and our CREDIT PLAN so easy, that no matter where you live or how small your wages, WE WILL TRUST YOU, so that you and every honest man and woman can own a DIAMOND or High-Grade Elgin Watch in a beautiful Guaranteed 25-year Gold Filled Case and wear it while paying for it in such small payments that you never miss the money. Write Today for Our Big Free Watch and Jewelry Catalog.

It tells all about our easy credit plan and how we send Elgin 19-Jewel

B. W. Raymond and 21 and 23-Jewel Elgin Veritas everywhere on Free Trial, without security or one cent deposit, positively Guaranteed to Pass Any Railroad Inspection.

HARRIS-GOAR CO., Dept. 218, KANSAS CITY, MO.

The House That Sells More Elgin Watches Than Any Other Firm in the World.

WATCH AND DIAMOND Book FREE Write For It.

Scotch Calabash Pipes

Price 50c each, or 3 for \$1, postpaid

Why kill yourself by smoking a strong pipe? You can get a Scotch Calabash that absorbs all nicotine and poisons and ensures a cool, sweet smoke. Money back if you are not satisfied.

THE ROYAL PIPE CO.
243 Broadway, Nashville, Tenn.



Stamps Taken

The value of salt meadows was not realized until aviators found them the most suitable portions of the earth's crust to fall upon. They are Nature's springs and hair mattresses for weary bird men.—Brooklyn Eagle.

ELECTRIC GOODS FOR EVERYBODY.

World's headquarters for Dynamos, Motors, Fans, Toys, Railways, Batteries, Belts, Bells, Pocket Lamps, Telephones, House Lighting Plants, Books. If it's electric we have it. Undersell all. Fortune for agents. Big Catalogue 4 cents.

OHIO ELECTRIC WORKS, CLEVELAND, OHIO

WONDER LAMP

The United Factories of 617 Wyandotte St., Kansas City, Mo., is making an offer to send a \$6 lamp free, FREE express prepaid, to one person in each locality in the U. S. who will show and recommend this marvelous incandescent 100 candle power oil lamp. Simply send name and address for their offer.

MAKE \$10.00 A DAY WITH THIS \$5.50 TAKE QUICK MACHINE

which takes and finishes in one minute a square or button picture in a Postal Card or Brooch which costs you less than one cent and sells from 10 to 15 cents each. No dark room. No Experience Necessary. The best money getter wherever crowds assemble. Fairs, Carnivals, Conventions, etc. Be your own boss, a small investment starts you in business. Write for FREE catalog describing our Machines.

INTERNATIONAL METAL & FERROTYPE CO. INCORPORATED ESTABLISHED 1891
Dept. B, 1262-64 Blue Island Ave., CHICAGO, ILL.



Compare the Prices on COME-PACKT SECTIONAL FURNITURE See the Big Saving!

Put the prices of Come-Packt Sectional Furniture side by side with the lowest cash figures of the best stores. You will find you save over half buying from our factory. We make and guarantee every piece absolutely. Quarter Sawn White Oak used throughout. Shipped completely stained and finished, in sections. Your choice of eight finishes.

\$90.75 Dining Room Suite for \$42.50

No.	Dealers' Price	Come-Packt Price
413, Buffet (Copper Trimmings)	\$40.00	\$17.75
337, Extension Dining Table (3 Leaves)	34.75	14.75
104, Four Dining Chairs	16.00	10.00

Which price do you pay, \$90.75 or \$42.50?

Any of the above sold separately at these figures.

Big Six Catalog Mailed Free. Six money saving departments—Mission and Bungalow furniture (200 pieces) new Willo-Weave Furniture, Mission Lamps, Cluny Lace Curtains, etc. Write Today.

COME-PACKT FURNITURE CO., 1001 Edwin Street, Ann Arbor, Mich.



Where Fortune Seekers Win

100 New Towns and Cities in Western Canada are Clamoring for Men Like You

Write for Big Free Book, "A Chain of Opportunities in Grand Trunk Pacific Towns"

In 1913, the last spike will be driven on the Grand Trunk Pacific, Canada's ocean-to-ocean transcontinental railway that has opened new worlds of opportunity for men of push and pluck.

The main line from Winnipeg to the Rocky Mountains is already completed, with a network of branch lines tapping vast areas of the finest wheat land in the world. The provinces of Manitoba, Saskatchewan and Alberta, which for the past few years have been the scene of the most marvelous colonization movement in all history, have filled up so rapidly with farmers that the present era of town-building is to meet existing demand for market facilities. On the Grand Trunk Pacific main and branch lines are more than a hundred new towns, in various stages of development, with more than



10,000 Business Openings

in a multitude of different lines. These hundred rapidly growing towns are calling for men. They offer splendid rewards for labor of hand or brain. Fortunes are being won in advancing values of real estate, in profits on business enterprises. Artisans, laborers—all who are willing to work—command the highest wages. Everybody has money. Prosperity is in the air. Opportunity is everywhere. The sound of the saw and hammer echoes throughout the land. The tremendous activity in town-building typifies the spirit of Western Canada—the spirit of Achievement, shown in the resistless sweep of civilization, conquering the Last Best West.

A New Empire in the Making

Here is a vast new country, fabulously rich in resources, teeming with opportunities, where every man can generously share in the fruits of Empire-building.

Such chances will never come again. Such chances will not wait. Even now, as you read this announcement, thousands are on the way and thousands are ready to start. This very hour you should decide to answer this, the Last Call of the Last West.

How \$2,000 Grew to \$235,000 in 6 Years

John W. Phillips arrived in Western Canada in 1903 with \$2,000. Today he pays taxes on \$235,000 worth of real estate holdings. He simply seized opportunities, Canada did the rest. One man makes \$18,000 to \$32,000 a year from a general store. Incomes of \$5,000 to \$10,000 and \$15,000 a year are common.

Mirror—the Magic City

The town of Mirror, named in honor of the famous newspaper, the London Daily Mirror, is a typical example of town-building in Western Canada. No more striking illustration of the condition of this great section can be given than the following fact: One day in the month of July at a sale of lots in Mirror, all records were broken, 577 lots being sold in 660 minutes, bringing the enormous sum of \$251,648. That's nearly a lot a minute! \$2,075.00 was paid for one corner lot. Canada's keenest business men were among the buyers.

The town of Mirror already has two banks, two stores, two lumber yards, hotel, restaurant and a newspaper.

Mirror is located on the Edmonton and Calgary line of the Grand Trunk Pacific Railway and is surrounded by one of the richest agricultural sections of Alberta. Towns of today are cities of tomorrow.

Send for the Great Book

"A Chain of Opportunities in Grand Trunk Pacific Towns," FREE

It will quicken your pulse beat to read the astounding fact-stories of success which men in your own circumstances have achieved in Western Canada. Send a postal or letter at once. *Get in early!* Let the Coupon be the Hand of Fortune that will lead you to the great opportunity land.

Grand Trunk Pacific Railway Co.

G. U. RYLEY, Land Commissioner
Room 304, Union Station, Winnipeg, Canada
Or, TRANSCONTINENTAL TOWNSITE CO., Ltd., Agents
Room 304, 268 Portage Ave., Winnipeg, Canada (3)

The Secret of Sudden Wealth

Individuals are swept along to fortune by the marvelously rapid growth of Western Canada towns. The rate of growth seems incredible, yet here are the absolute facts:

- 10 Western Canada Towns Grew 500 per cent in 1910
- 17 Western Canada Towns Grew 400 per cent in 1910
- 22 Western Canada Towns Grew 300 per cent in 1910

This phenomenal, unprecedented rate of growth of towns explains the startling rapidity and ease with which men make fortunes in Western Canada towns. Such progress is impossible in towns that grow at a snail's pace.

Workers in Every Line Needed Now!

These hundred busy, thriving towns are clamoring for men in all trades and professions. Right now they offer big opportunities to school teachers, lawyers, physicians, clerks, bookkeepers. They need armies of carpenters, bricklayers, stone masons, plumbers, electricians, machinists, laborers—skilled or unskilled.

They offer great inducements for more general stores, drug stores, hardware stores, grocery stores, meat markets, shoe stores, barber shops, laundries, furniture stores, millinery stores, repair and blacksmith shops, lumber yards, amusement enterprises, etc., etc. The trade of thriving communities is there—waiting!

Grasp the Hand of Fortune!

If you are ambitious to get ahead; if this brief outline of the boundless opportunities of Western Canada stirs your blood, act quickly, decisively. There is no time to lose. These towns are going right ahead, whether you come or not. *Why not go ahead with them?*

SEND COUPON TODAY

FREE Fortune-Seeker's Coupon!

G. U. RYLEY, Commissioner Grand Trunk Pacific Railway
Room 304, Union Station, Winnipeg, Canada

Dear Sir: I am greatly interested in the opportunities offered by 100 new towns in Western Canada.

I am giving you some information about myself, so that you can tell me what is the best opportunity for me.

Business.....
(Give name of profession, business or trade.)

Age..... Married or single (cross out one or the other).

Number of Children.....

Do you wish to invest any money?.....

Name.....

Street No. or Rural Route.....

Town..... State.....

The Oil that adds Life and Power to your Car.

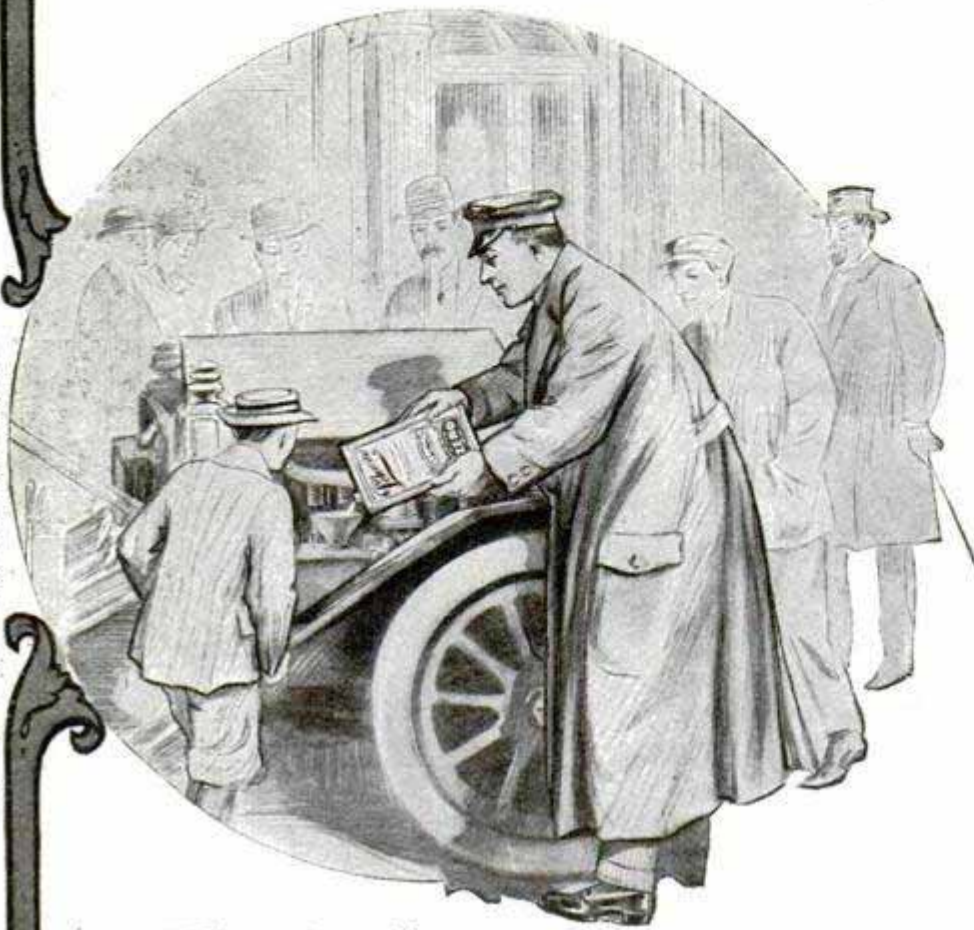

POLARINE OIL
is the final product
of the most skilful
tests in the labora-
tory, supplement-
ed by exhaustive
trials in all makes
of cars on the road.

It has won rec-
ognition as the
most efficient
automobile oil on
the market strictly
on its merits.

"What's that stuff,
Mister? It looks like
syrup."

"Better than any
syrup for my business,
sonnie. It's POLAR-
INE—the best automo-
bile oil on the market."

Polarine

The Carbon-proof, Frost-proof Oil

Polarine forms a lasting film on the wearing surfaces that makes them *wear well*.

Polarine keeps its body under extreme heat, yet feeds properly even in the coldest weather.

No carbon deposits where Polarine is used—no carbon troubles with valves or spark-plugs.

What Polarine Oil is to the motor, Polarine Transmission Lubricants and Polarine Greases are to the other wearing surfaces of your car—efficient, uniform, perfect lubrication.

Send for the Polarine Booklet to the nearest agency of the

Standard Oil Company

(Incorporated)



\$500.00 for

This Simple Invention

Perhaps some reader of Popular Mechanics Magazine can help us to solve this problem:

We control 92% of the oyster beds from which genuine Blue Point oysters come.

Because no one has ever trademarked oysters, substitution and fraud are easily possible.

How can we mark the shells of our Blue Point oysters so that the consumer can be sure that he is getting the genuine and not the substitute?

The marking must be accomplished without hurting the oyster, or detracting from its flavor or attractiveness.

It must be of a nature that will

show on both upper and lower shells and that will withstand the water incident to handling the oyster.

It must be so distinctive that we can prosecute frauds—those who advertise and offer Blue Points without this mark.

The whole cost of trade-marking oysters must be less than 25c a barrel—which contain from 800 to 1800 oysters.

We have thought of dipping the point of the oyster in blue plaster of Paris, and of sand-blasting two lines across both shells—but we have never worked either of these methods out.

To the inventor who devises a method which we can adopt we will pay \$500 in gold.

To the inventor who furnishes us with an idea, not complete in itself, but which enables us to perfect a method, we will make a suitable reward.

You can easily get oyster shells to experiment with. Send your solution to

Sealshipt Oyster System, 42 Central Street, Boston, Mass.



MR. H. ELLIS CHANDLEE

PATENT WHAT YOU INVENT! PATENT

YOUR IDEAS MAY BRING YOU A FORTUNE

There is A Constant Demand For Good Inventions.

One of our clients recently made \$85,000; another \$7,000; another \$5,000; another \$3,400; two others \$1,000 each, and two others \$500.

WRITE FOR

“OPPORTUNITY”

A List of Needed Inventions

Also, “U. S. LETTERS PATENT,” telling how to obtain a patent.
“THOUGHTS THAT HAVE PAID,” a history of successful inventions.
“TESTIMONY,” giving our testimonial letters from manufacturers and inventors.

Mailed free to any interested person

IF YOU HAVE AN INVENTION send us a rough sketch and description, model or photograph of it, and we will give you our opinion as to its patentability **WITHOUT CHARGE**. If our opinion is favorable, we will issue a contract binding us to **refund every cent of our fee if we fail to obtain a patent**.

This assures you that we will not make application unless the chances of success are good, and that **every effort** will be made to obtain an allowance. We advertise the patents of Our Clients for sale in prominent dailies free of charge.

“Prompt and Proper Service”

H. Ellis Chandlee & Co.

Suite 55, Bornot Building, WASHINGTON, D. C.

PATENTS TRADEMARKS AND COPYRIGHTS SECURED OR FEE RETURNED

SPECIAL OFFER — FREE SEARCH OF PATENT OFFICE RECORDS

Send us a model, photograph or sketch and description of your invention, and we will make a *Free Search of the Patent Office Records* to ascertain if it is patentable. If we report the invention patentable, we will guarantee to obtain a patent or return our fee, and furnish a certificate of patentability backed by a bonded contract to that effect.

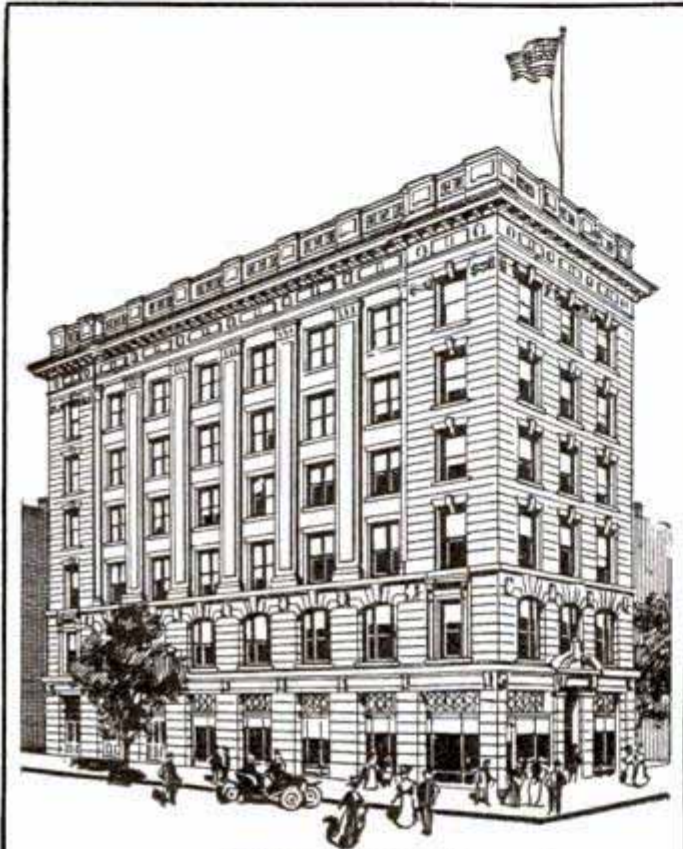

VICTOR BUILDING

Our new \$150,000 building, opposite the U. S. Patent Office, specially erected by us for our own use, designed and equipped with all modern appliances for our patent business.

This Certificate of Patentability will protect the inventor and serve as proof of the invention until the case can be filed in the U. S. Patent Office.

OBTAINING ASSISTANCE FOR INVENTORS

Our certificate is of great assistance to inventors who require financial aid to obtain patents. It is useless to attempt to interest capital unless evidence is furnished that the invention is patentable. Our certificate gives this necessary assurance.

OUR FOUR BOOKS MAILED FREE

to any address. Send for these books—the finest publications ever issued for free distribution.

HOW TO OBTAIN A PATENT

Our illustrated eighty-page Guide Book is an invaluable book of reference for inventors, and contains 100 mechanical movements illustrated and described.

FORTUNES IN PATENTS

Tells how to invent for profit, and gives history of successful inventions.

WHAT TO INVENT

Contains a valuable LIST OF INVENTIONS WANTED and suggestions concerning profitable fields of invention; also information regarding prizes offered for inventions, among which is

PRIZE OF ONE MILLION DOLLARS

offered for one invention, and \$10,000 for others.

PATENTS THAT PAY

Contains fac-similes of unsolicited letters from our clients who have built up profitable enterprises founded upon patents procured by us; also indorsements from prominent inventors, manufacturers, Senators, Congressmen, Governors, etc.

WE ADVERTISE OUR CLIENTS' INVENTIONS FREE

in a list of Sunday newspapers with two million circulation, in manufacturers' journals and in the *World's Progress*. Sample Copy Free. We also send a LIST OF PATENT BUYERS. We not only save you time and money in securing patents, but obtain patents which PROTECT the invention and PAY. After the patent is granted we assist you TO SELL YOUR PATENT.

FOREIGN PATENTS

WE HAVE DIRECT AGENCIES IN ALL THE PRINCIPAL FOREIGN COUNTRIES and can secure FOREIGN PATENTS in the shortest possible TIME and at the LOWEST COST. We GUARANTEE TO SECURE THE FOREIGN PATENTS OR RETURN OUR FEES. Write for our Illustrated Guide Book on Foreign Patents, sent free to any address.

REFERENCES:

Second National Bank, Washington, D. C.
R. G. Dun & Co., Washington, D. C.
National Savings and Trust Co., Washington, D. C.
Smethport Glass Co., Smethport, Pa.
Schrade Cutlery Co., Walden, N. Y.
Clum & Atkinson, Brass Founders, Rochester, N. Y.
Rochester Rotary Pump Co., Rochester, N. Y.
Lawrence Mills, Mfrs. Bed Spreads, 51 Brooke Ave., Englewood, N. J.
The Melvin Gauge and Signal Inst. Co., Scranton, Pa.
Damon Mfg. Co., Mfrs. "Missing Link" Flour Mill Disintegrators, Bowling Green, Ky.
Modern Canner Co., Mfrs. Canning Machinery and Canners' Supplies, Bridgeport, Ala.
M. Winter Lumber Co., Sheboygan, Wis.

C. K. Lassiter, Mechanical Engineer, Schenectady, N. Y.
Pitner Gasoline Lighting Co., Chicago, Ill.
Sprout, Wardon & Co., Mfrs. of the Monarch Feed Governor, Muncy, Pa.
The L. B. Dozier Co., Mfrs. of Plumbing, Heating and Machinery Supplies, Columbia, S. C.
B. B. Earnshaw & Bro., Mfrs. "Cream Blend" Flour, Washington, D. C.
A. L. Schultz, Consulting Engineer, Pittsburgh, Pa.
Arthur H. Swan & Co., Mfrs. of Peel-Blade Tips, 279 Warren St., Roxbury, Pa.
The H. W. Moore Piano Truck Co., Anderson, Ind.
The Culver Novelty Co., Mfrs. of Carbureters and Mixers, Culver, Ind.

VICTOR J. EVANS & CO., VICTOR BUILDING
(Formerly EVANS, WILKENS & CO.) 724-726 9th St., N. W.

Opposite United States Patent Office

WASHINGTON, D. C.

Protect Your Idea!

PATENTS THAT PAY

"My Trade-Mark"

Special Offer:

Mr. Inventor: I invite you to come to see me, and bring, (or send by registered mail), sketches or photograph or model and description of your idea or invention for FREE examination of U. S. PATENT OFFICE Records and report as to patentability of the same;—to find out as to whether you are entitled to a patent will not cost anything;—then, if your invention is new, upon receiving instructions, I will prepare ALL necessary (application) papers.

DO THIS AND SAVE TIME AND MONEY!

WRITE NOW!

Highest References:

Lincoln National Bank,
Washington, D. C.

NOTE: When writing these clients send two-cent stamp for reply.

Little Giant Hay Press Co.,
Alma, Mich., and
Dallas, Texas.

American Railway
Appliance Co.,
Oil City, Pa.

Farmers' Mfg. Co.,
Norfolk, Va.

Anderson Mfg. Co.,
Tulsa, Okla.

Griffin Mfg. Co.,
New York, N. Y.

Warsaw Paper Box Co.,
Warsaw, N. Y.

Sanford Mfg. Co.,
Sanford, N. C.

Butler Engineering Co.,
Akron, Ohio

Thompson Drug Co.,
Sioux City, Iowa

Garl Electric Co.,
Akron, Ohio

Gray Lithograph Co.,
New York, N. Y.

Iowa Mfg. Co.,
Oskaloosa, Iowa

New Era Mfg. Co.,
Fairfield, Iowa.

Bernhard Furst,
Vienna I,
Austria-Hungary

A. J. Corsi,
Irish Town,
Gibraltar

Otto von Kottenburg,
Schwindstrasse 20,
Frankfort A. M.,
Germany

H. A. Fonseca,
Riea Dos Ourives 20,
Sobrado, Rio de Janeiro,
Brazil

Electro Importing Co.,
New York, N. Y.

Rex Electric Co.,
St. Louis, Mo.

Sam'l Allen & Son Mfg. Co.,
Danville, N. Y.

Smith-Evenson
Electrical Co.,
Seattle, Wash.

Camp Conduit Company,
Cleveland, Ohio

INFRINGEMENT, VALIDITY AND INTERFERENCE WORK SOLICITED

I am admitted to practice before the United States Supreme Court and others

"I want to thank you for the most excellent services you have rendered me in this suit [B. Williams vs. Central Drug Co., U. S. C. C., Northern District of Illinois—E. Div.], and assure you that I appreciate it very much, and if at any time I can secure some business for you, I will be only too glad to do so."

(Signed) J. THOMPSON, Mgr. Central Drug Co., Sioux City, Iowa.

Other Important Suits Successfully Settled

FREE: Two Books—61-page "Inventor's Guide" and 64-page "Proof of Fortunes in Patents—What and How to Invent"

Foreign Patents a Specialty

If you have a U. S. application write me for excellent literature and terms for promoting your Foreign Patents. Liberal discounts.

I Advertise My Clients' Patents Free

in a publication having over 2,000,000 circulation. Write for Special Offer. Successful clients in every section of the U. S.



My Office and the Patent Office
(I give you proof of my location)

Across the street from the U. S. Patent Office

Expert—Prompt Services

E. E. VROOMAN, Patent Lawyer Wash., D.C.

Registered Patent Attorney. Patent Litigation

High-Class Work—Excellent Testimonials

\$287,540.00 \$

MADE BY MY CLIENTS \$

YOU Should Have My FREE BOOK

Telling HOW OTHERS will do the same IN THE FUTURE. "WHAT and HOW to INVENT" BOOK FREE!

"I received ONE HUNDRED DOLLARS (\$100.00) down (in re my Can Righting Machine inventions) and in thirty days NINE HUNDRED DOLLARS (\$900.00), and when my patents are issued ONE THOUSAND DOLLARS (\$1000.00) more. I can conscientiously state to my fellow inventor that he will do the right thing by placing his patent business in Mr. Vrooman's hands for the best iron-clad patents."

(Signed) WILLIAM C. BRIDGES, Wapello, Iowa.

871 F Street, N. W.

PATENTS THAT PROTECT and PAY

Advice free. Terms reasonable. Highest references. Best results.

Send sketch or model for FREE examination and opinion.

Recommended Patent Lawyer in the Bankers' Register and special list of selected lawyers. Also in Martindale's Law Directory, Sharp and Alleman's Directory of Lawyers, The Gast-Paul Directory of Lawyers, and Kime's International Law Directory.

ALL BUSINESS GIVEN PROMPT AND PROPER ATTENTION

A large list of strong recommendations furnished free

WATSON E. COLEMAN, Patent Lawyer, 622 F St., N.W., Washington, D.C.

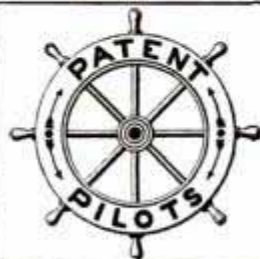

Patent Your Ideas—It Pays

"WE GUIDE YOU TO SUCCESS"

25 years' experience as Attorney and U. S. Patent Examiner. Send sketch of invention for **Free** report and Illustrated Guide Book. **No Patent—No Charge.** We succeed where others fail.

BUNYEA PATENTS CO.
Room 27 WASHINGTON, D. C.

PATENTS UNDER THE LAW

must be granted for any novel invention, but are worthless, unless carefully protected. If others cannot safeguard your invention, I can. **HONEST** advice free. Send for it.

HIGHEST REFERENCES IN U. S.

HERMAN A. PHILLIPS, 800 H. St., Washington, D. C.

One Inventor gets rich; another gets nothing. New 128 p. book of Vital Advice, Great Value and Intense Interest to Inventors, tells **Patent Fortune** how to make money, About Prizes, Rewards, Etc. Fortune Making Inventions Past and Future. Mailed for 20 cents postage. Publishers Patent Sense, Dept. 45, Barrister Bldg., Washington, D. C.



PATENT YOUR IDEAS

\$100,000 for one invention; another \$8,500. Book "How to Obtain a Patent" and "What to Invent" sent free. Send rough sketch for free report as to patentability. We advertise your patent for sale at our expense. **PATENT OBTAINED OR FEE RETURNED.**

CHANDLEE & CHANDLEE, Patent Atty's

1044 F. Street WASHINGTON, D. C.

LANGDON MOORE

Counselor-at-Law and Patent Attorney
**Patents, Trade-Marks
Designs and Copyrights**

9th and F Streets, WASHINGTON, D. C.

Formerly Examiner U. S. Patent Office
SEND FOR BOOKLET

WANTED-IDEAS

The demand for good, patentable ideas is greater than ever before. Am constantly in receipt of letters from parties desiring to buy patents procured through me. Electrical devices, tools of all kinds, advertising novelties, agents' supplies, mail order articles, and many other inventions are sought after. Protect your idea! Write for "Stepping Stones" (containing over 200 new inventions wanted) and new guide book "Successful Patents."

Clients' patents sold free. My personal services. Highest references.

RICHARD B. OWEN

9 Owen Bldg. WASHINGTON, D. C.

CAPITALIZE YOUR BRAINS

A Patent of Quality

is the only kind that will protect your invention and make it salable. You need my free advisory information. Send for it.

GEO. R. HAMLIN, Patent Lawyer

801-8th Street, N. W. WASHINGTON, D. C.

PATENT YOUR INVENTION

The only way to protect it. Let us send you our free search and contingent fee proposition. **FREE BOOKLET.**

MILO B. STEVENS & CO., Attys.

ESTABLISHED 1864

685 F St., Washington; 353 Monadnock Blk., Chicago

Guaranteed by Bankers' Register and highest rating by Martindale's Law Directory.

PATENTS

C. L. PARKER
Ex-Examiner U. S. Patent Office
PATENT LAWYER
210 MCGILL BLDG.
WASHINGTON, D. C.

Patents, Trade Marks, Copyrights, Patent Litigation

Handbook for Inventors, "Protecting, Exploiting and Selling Inventions" sent free upon request.



A Talk to the Inventor

LEARN HOW A PATENT MAY BE MADE VALUABLE

If there is any basis for an application in your idea, I can find it. But I will explain it to you before filing your application. Copies of Nearest Patents, and Report, in Every Case I have patented inventions reported unpatentable elsewhere

Send for
**FREE
BOOK**

**What You Should Know
What to Invent
What NOT to Invent
How to Sell Your Patent**

H. L. WOODWARD,

9th and G Sts., Opposite Patent Office,

WASHINGTON, D. C.

DIAMONDS GENUINE PERFECT CUT \$97.50 PER CARAT



\$97.50 per carat

—world's lowest price, from **Importer Direct to You.** Jewelers ask \$150 to \$175 per carat. Note our prices: 1/8 carat, \$8.25; 1/4 carat, \$17.50; 1/2 carat, \$45. 1 carat, \$97.50.



Your unlimited choice from latest styles in fine artistic diamond jewelry for men and women.

The Basch Plan is a convenient and safe method of selecting your diamond by mail. Besides saving 40% to 60% in price, we are sure of pleasing you, because we ship any diamond you select, for your thorough examination, without obligating you; entirely at our expense. **No deposit required.**

We Legally Guarantee the carat weight, quality and value of every diamond. Also allow full purchase price on an exchange. Also contract to **refund 90% in cash**, any time, for any reason. Where else can you get equal safety, at any price?



OUR DIAMOND BOOK (FREE) the handsomest, most authoritative diamond guide ever produced. It represents the experience of 33 years of successful diamond selling. Illustrated in colors, cover by famous painter Spielberger. **You cannot buy a diamond intelligently without the information it contains**

Cut out this ad NOW for reminder. — **WRITE TODAY FOR YOUR COPY.**
L. BASCH & CO., Dept. B, 347 S. State St., Chicago, Ill.

Do You Need A Gear



of any description for any purpose? We carry practically all the standard sizes in stock ready for immediate shipment.

We make gears of any style, size or material to order—promptly.

Our new free catalogue contains tables and rules for figuring both spur and bevel gears.

Grant's "Treatise on GEARS"—Price \$1.00 is a valuable reference book for the student and designer.

Philadelphia GEAR Works, Inc.
 1120 Vine Street GEO. B. GRANT, PRES. Philadelphia, Pa.

DON'T DISCARD BROKEN PARTS



Have them welded together by the **Oxy-Acetylene Process.** Steel, Cast Iron, Bronze, Copper, Aluminum and all other metals can be welded. Manufacturing quoted on. Welding equipments for repair shops or large plants supplied.

DAVIS BOURNONVILLE CO.
 105 West Street NEW YORK, N. Y.

INVENTORS Our Brain Belongs to You. Our Ideas Are Free of Charge.

Active Powers of Inventive Genius



All we want in return is to build your model, special machinery, dies, tools and jigs to manufacture sheet metal goods, etc. We are expert mechanics, over thirty years experience and have one of the best equipped shops in the country. Ask for Booklet No. 17. Consultation free. Experimental work strictly confidential.

A. NACKE & SON
 236-242 S. 9th St., Philadelphia, Pa.

FISH PICKS STRAWBERRIES—Fred Vosen, fishing in the Lee reservoir, heard on shore a noise that he at first supposed was made by a muskrat, but on investigation it proved to be a big carp.

He watched the fish for some minutes, and says that along the shore strawberries hung over the water, a distance from 4 to 10 in. from the surface, and he was surprised to see the big fish bobbing its head out of the water and grabbing the berries. He watched the carp repeat the operation half a dozen times. He then tried his bait and succeeded in hooking the fish, but had to shoot it before he could land it. The carp weighed 32 lb.—Philadelphia Record.



MECHANICAL SUPPLIES AND MATERIAL of all kinds. EXPERIMENTAL AND LIGHT MACHINE WORK to order.
 132 MILK STREET, BOSTON

Let Us Do Your Manufacturing

Buying material in large quantities and having a modern factory equipped with the latest machinery enable us to make almost anything in metal or wood at a very low price. Estimates free. We have a complete model and pattern department.

TINLEY PARK MFG. CO., 222 N. State Street, CHICAGO

DIES, FINE TOOLS METAL SPECIALTIES
MOORE & CO., 301 W. Indiana Street CHICAGO

SPECIAL MACHINERY. INVENTIONS PERFECTED.

HONEST MAN OR WOMAN WANTED

in every town to represent well-known wholesale firm. Experience unnecessary. Must furnish good references. Easy, pleasant work. Fair salary to start.
McLEAN, BLACK & CO., 701 Doty Building, Boston, Mass.

BIG MONEY FOR YOU

Selling our metallic letters for office windows, store fronts, and glass signs. Any one can put them on. Nice, pleasant business. Write today for free sample and full particulars.
METALLIC SIGN LETTER CO., 406 No. Clark St., Chicago



Every Boy His Own Toymaker

Greatest boys' book ever written. Tells how to make a Steam Engine, Microscope, an Electric Telegraph, Telephone, Magic Lantern, Boats, kites, balloons, electrical and mechanical toys, traps, fishing tackle. 200 illustrations. Price only 10c postpaid, 3 for 25c. **Western Puzzle Co., St. Paul, Minn.**

PATENTS INVENTORS OF WIDE EXPERIENCE

employ my method in securing patents. So will you eventually. Why wait? Just send for my book. *Every client secured becomes a client for life.*

WM. T. JONES, 803 G St., Washington, D. C.

CIGARS from maker to smoker, by mail, at wholesale price. Send for catalog. La Reclama Cuban Factory, 414A, E. 32d St., N. Y. C.



ARE YOU A SUCCESS?

Are you content with your present condition? Or have you ambitions? Do you wish to climb the ladder of success until you get to the top? To accomplish something that may bring you fame and fortune? If so, you must attend to your physical development, because the arteries and nerve cells are the feeding machines of the brain, and unless the machinery is kept in running order it will not perform its proper function. Proper Physical Culture is playing a prominent part in the general development and success of the human race, and the best known method is **The Strongfort System of Physical Culture**, as taught by **Lionel Strongfort (Max Unger)** the World's Strongest and Most Perfect Athlete. Read his book, "Intelligence in Physical Culture." **A Wonderful Book by a Wonderful Man.** This book tells you how perfect health may be gained and maintained. A revelation in health culture and body building. Explodes many fallacies and fads. Tells why systems fail; teaches new truths. An education on deep breathing, great strength, vitality and **The Secret of Success.** You cannot afford to miss this book. Perhaps, you, too, can accomplish something impossible if you have the strength of mind and body to realize your ambitions. **The Strongfort System** will give you vitality, strength, health, and strong nerves, which will set you on the road that leads to fame. My methods are original, intelligent and effective, and you have my personal attention. **SEND FOR MY BOOK NOW!** "Every time I feel blue I get out your booklet, and can almost recite many of its pages," says one. "The only sane Physical Culture Booklet," says another. See what you will say. Enclose 4 cents for postage.

LIONEL STRONGFORT
 Dept. "P.S.," Castle Strongfort, Mohegan Lake, N. Y.
 Gentlemen's Training Quarters and Hygienic Institute.



**LEIMAN BROS.
BLOWERS
VACUUM
PUMPS**

for all Gas and Oil Appliances, Sand Blasts, Boat Whistles, Calliopes, Gas Producers, Gas Boosting, Testing

VACUUM CLEANING
Take up own wear. Small Piston. Big Air Space. No Springs. Powerful. Noiseless. Can't get out of order.

Blower Catalog No. 22
Vacuum Catalog No. 23

LEIMAN BROS. 62 P John St., NEW YORK



LATHES

\$75 Screw Cutting
Foot or Power
9 to 13 inch

—CATALOG FREE—

SOUTH BEND MACHINE TOOL CO., 423 Madison St., South Bend, Ind.



LATHES

9 to 13-inch Swing

List price \$75 and up according to size. When ready to buy send for Lathe Catalog and prices.

W. F. & John Barnes Co.
100 Ruby Street, ROCKFORD, ILL.

MUST RESPECT DEAD ROYALTY—A Vienna court has sentenced a woman, Leopoldina Futschel, to three months' imprisonment for abusing Empress Maria Theresa, who died in 1780. Frau Futschel, who had

Rife Automatic Hydraulic Ram Pumps water by water power. No attention; no expense; 2 feet fall elevates water 50 feet, etc. Guaranteed. Catalogue free.

RIFE RAM COMPANY 2131 Trinity Building, NEW YORK CITY

AIR GAS! LATEST INVENTION

Standard Vacuum Gas Machine makes gas automatically! Uses 97% ordinary air! Cheapest, safest, most hygienic for lighting, heating and cooking! All conveniences of city gas! Non-poisonous, non-asphyxiating, inexpensive and odorless! Machine always ready! Gas can be made for 15c per 1000 cu. ft. 25 times cheaper than acetylene! Cheaper than kerosene lamps, electricity or city gas! Saving will pay for the machine in a few months! Agents wanted everywhere in the United States and abroad! Machine of 25 light capacity, \$125.

Standard-Gillette Light Co., 10B Michigan St., Chicago, U.S.A.



PUMPS

For Well or Cistern Water
USE ANY KIND OF POWER

Automatic or Hand Controlled
We furnish Tanks, Fixtures, etc.

"JARVIS" 900 River Street
LANSING, MICH.

You May Crowd a Crescent Jointer



to the limit of capacity and the machine will do work just as smoothly as though you had not crowded it at all. Built in six sizes. Send for catalog telling all about them and describing our line of Band Saws, Saw Tables, Planers, Planers and Matchers, Shapers, Swing Saws, Borers, Disk Grinders, Variety Wood Workers.

THE CRESCENT MACHINE CO., 93 Columbia St., Leetonia, O.

LET THE RED DEVIL WATER MOTOR DO YOUR WORK

6-inch Motor
Improved construction, absolutely perfect, runs your washing machine and a hundred other things. Power for small tools. 1/4 horse power on 1/2-inch pipe. 80 pounds pressure; 1 horse power on 2-inch pipe, 60 pounds pressure. New net price, \$5.00 cash with order.

No. 1492 4-inch Motors for grinding, polishing and buffing. Runs sewing machines, fans, bottle washers, etc. Price with emery, buffing wheel, silver polish and pulley, \$3.00. No. 1493 Motor and pulley only, \$2.50. 1/2 horse power on 80 pounds pressure. Improved construction. Speeds, 3,000 to 5,000 revolutions per minute. Only scientifically and mechanically perfect small water motor manufactured. Patented construction makes it possible. Tremendous output warrants the price. Money back for any reason.

CATALOGUE AND LARGE SHEET FREE

DIVINE WATER MOTOR CO.
Dept. T UTICA, NEW YORK, U.S.A.

For the name of your local hardware or tool dealer, we will send you free booklet on "Theory and Design of Water Motors."



6-Inch Bucket Wheel

"Norton" Water Motors
Lead Them All

"Model B," for grinding, polishing, running fans, etc. \$3.50
"Norton Improved" with Patented combination shift gear, for flat or round belt \$6.50

Very powerful. Catalogue sent upon request

NORTON WATER MOTOR CO., Roslindale, Mass.



Pat. March 23, 1911
J. B. Norton

LET THE "MULTIMOTOR" RUN YOUR SHOP!

Every Mechanic, Carpenter, Contractor, Repairman, Blacksmith, Home Owner needs this midget engine. Runs hand-power or tread-power machines perfectly. Speed 500 to 600 revolutions per minute—adjustable. Weight 250 lbs. Self-governing.

Runs for Less than One Cent an Hour
Saves time, money, muscle. **BOOK FREE!** Send today. Also Farm Pump Engines and high-powered engines. Dealer's name on request. Address

FULLER & JOHNSON MFG. CO., 10 Partridge Street, Madison, Wis. Est. 1840



Have Running Water On Your Place Whenever you like—Bath, Laundry, Toilet, Kitchen, Upstairs and down, Barns, Lawn. Force enough for fire protection. Air pressure guaranteed at all times by our patent pump. So simple anyone can install. Every detail worked out for your individual needs by expert engineers without charge. Complete specifications furnished.

Burton Water Works
received only medal ever awarded a water supply system—proof of its superiority. Best constructed tank on market. Sold on 30 Days' Free Trial. Correspondence with Villages, Towns, Public Institutions as well as farms, ranches, country houses solicited. Write for testimony of satisfied users near you and booklet, "An Interesting Tale Simply Told."

\$50.00 Up. Lasts a Lifetime.

C. A. Burton Water Supply Co., 26 West 7th St., Kansas City, Mo.



30 Days FREE

Write for Book

B & S Steel Rules



We make all varieties of steel rules, both Metric and English measure. So accurate are these rules that they are considered as standards in all parts of the world. They can be obtained with almost any series of graduations from 8ths to 1000ths parts of an inch.

SEND FOR A CATALOGUE



BROWN & SHARPE MFG. CO.
PROVIDENCE, R. I., U. S. A.

“SAW POINTS”

A FREE BOOKLET

We have just issued a booklet called “Saw Points,” that will show you the proper way to care for your Saw.

Every user of a Saw should know how to care for it as a Saw won't saw unless it is properly set.

A Saw will render poor service if not kept in good condition and a Saw to obtain the best results with the least possible effort must be properly set and sharpened.

Send a postal for our booklet No. 8 “Saw Points.” It will tell the correct method of using the Morrill Saw-Set

CHAS. MORRILL

277 Broadway

NEW YORK

Will drill Iron, Steel or Rock with Bit Brace

“Red Devil”

Self-Feeding Chain Drill

Send this to us with \$1.50 and we will deliver to your nearest express office. Ask about our 3,000 R. D. Tools.

SMITH & HEMENWAY CO.
148 Chambers Street, New York City, N.Y., U. S. A.

LUFKIN

Measuring Tapes

Now made with **Instantaneous Readings**, the big improvement in markings. Saves time and eliminates errors. Send for sample piece of tape and our complete catalog.

THE LUFKIN RULE CO.
SAGINAW, MICH.

New York London, Eng. Windsor, Can.

been ordered by the police court to be expelled from Vienna for some offense, heard from a fellow prisoner in her cell that the law providing for expulsion from a town was passed, in Maria Theresa's reign. “She then relieved her feelings,” says a London Standard correspondent, “by violent abuse of the great empress, not knowing or not caring that under the Austrian law the ancestors of the emperor are protected from unduly unfavorable criticism, written or spoken, for two hundred years back.”

WE SHIP ON APPROVAL

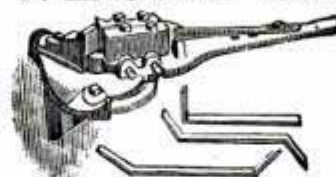

Our Hand Power Angle Benders are so indispensable for bending rods, squares, and flat pieces into all sorts of angles that we do not hesitate to ship tools for 10 days free trial. Made in 3 sizes to cover a wide range of work. We also make hand power tools for bending eyes, hooks, “U” shapes, hinges, rings, etc. Write for complete descriptive catalogue

WALLACE SUPPLY CO., 124 No. Jefferson St., Chicago; 26 Cortlandt St., New York City

Another New “YANKEE” PUSH BRACE, No. 75

Drives Wood Augers up to 5-8 in. easier and quicker than a Bit Brace. Drives or Draws Screws, and takes all the small tools used in a bit brace. A fine tool for crowded corners.

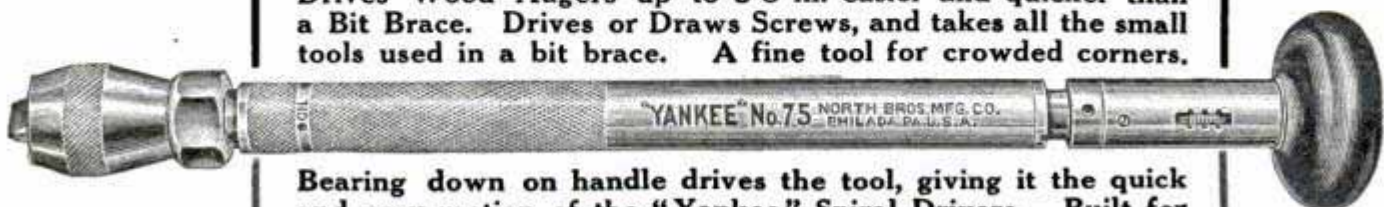

Bearing down on handle drives the tool, giving it the quick and easy motion of the “Yankee” Spiral Drivers. Built for good service—it's a “Yankee.” Let Your dealer show you one.

SEND FOR BOOK OF LABOR SAVERS

NORTH BROS. MFG. CO., Station Q, PHILADELPHIA, PA.

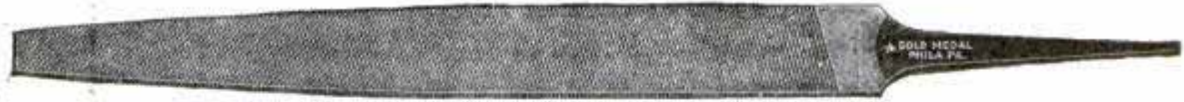

Files That Stand the Test

Many an ordinary file becomes useless in a very little while. After being used several times the teeth have lost their sharpness—the cutting edge is gone—the file is worthless. Now the safe way to buy a file is to ask your dealer for

Gold ★ Medal Files and Rasps

Then you are sure of getting the finest file manufactured. Every one is made of a superior grade of crucible steel, cut on the latest improved machinery by expert workmen and tempered by our secret chemical process that produces the finest temper known. The result is what every mechanic knows as

"The File that Files"

Remember the name—Liveright—and look for the star. If not at your dealer's, write us direct.

LIVERIGHT BROTHERS (Not in the Trust) **Philadelphia, Pa.**



The Handiest Tool Holder Made

Constructed of hardened steel; accurately machined; and will hold securely, round, flat, square, hexagon, and shaped tools in the tool post, from the largest sized tool down to a No. 60 drill. Write for full particulars, and prices. Satisfaction guaranteed.

B. MORGAN, Manufacturer of SPECIALTIES
Tews Court, Newport, Rhode Island

GASOLINE SOLDERING IRON BLOW TORCH

This tool spells satisfaction. Get Booklet today.



EMMELMANN BROS. MFG. CO., INDIANAPOLIS, IND., U.S.A.

Mechanics' Grand Bench \$16.00

is just the bench that every Mechanic ought to have. This illustration shows correct construction. The bench is 48" long, 23" wide and 38" high, and is fitted with a first-class Machinist's Vise, of which jaw is 2 1/2" wide and opens 3 1/2". This bench has three drawers, all of same size, being 23"x19"x8". It also has one cupboard 30"x20"x10 1/2". The drawers are fitted with good locks, and the whole bench is made of hard maple and has a good shellac finish. Send cash with order direct to manufacturer.



C. CHRISTIANSEN
2219 Grand Avenue, Chicago, Ill.

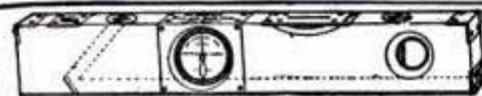

The American Combined Level and Grade Finder Most Practical, Durable and Convenient Instrument Made

At one glance you can get the true slant on any line or grade either in degrees, inches or percentage, or all at the same time, and will at once give the exact distance needed to plumb up to a true level. The longitudinal recess shown in cut is well worth the low price of the instrument. Write AT ONCE for circular and Testimonials. Special Introductory Price given to First Applicants with privilege of taking Agency. Address **EDWARD HELB, Mfr., Box 75, RAILROAD, PENNA.**

A KEEPERLESS LIGHTHOUSE—"What do you think of a perpetual lighthouse, needing no keeper and yet as regular in its flashes of light as one maintained by the government?" asked Albert D. Van Wyck.

"This natural light never fails, and that means much for navigation. It is a volcano on the island of San Salvador. This volcanic lighthouse is about eight miles inland from the port of Acajutla. It is a veritable pillar of cloud by day and the flash of its light by night has

The "Sure" Center Finder

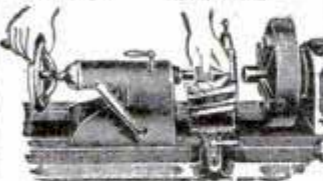

The "Sure" Center Finder has a socket that fits on the 60 degree angle taper of Center in tail stock of lathe. When fed up to work held and revolving in lathe chuck it immediately locates, drills and countersinks a center in the work. Four sizes, Drill Diameters 1-8, 5-64, 1-16 and 3-64 inches.

Price 65 cents postpaid

W. A. PECK, 145 Brewery St., NEW HAVEN, CONN.

For Sewing Leather



\$1.00 A perfect stitcher. Sews or mends anything. Whole repair shop. Original perfect lock stitch. Diamond point grooved needle protects thread. Always ready. Sample prepaid. Agents get busy. Sells on sight. **C. A. MYERS CO., 6339 Lexington Ave., Chicago, Ill., U. S. A.**



Toolmakers and Machinists. Here's a Portable Tool Case with a convenient arrangement of different sized drawers, all felt lined, with a place for every tool. No need of throwing one on top of the other. This Case will pay for itself in saving tools, time and drayage expense. You need one of the many styles shown in our catalogue which we will mail free. No mechanic is up-to-date without a "Gerstner" Case.

A. Gerstner & Sons

Mfrs. of Mechanics' High Grade Tool Cases:
818 Germantown Street, DAYTON, OHIO

BISHOPRIC WALL BOARD AND SHEATHING

SAVE MONEY, TIME, AND LABOR IN BUILDING

BISHOPRIC WALL BOARD is cheaper and better than lath and plaster. Made of kiln-dried, dressed laths imbedded in Asphalt Mastic. Laths are necessary in Wall Board to prevent warping and to insure solid, rigid, stiff, substantial



Walls and Ceilings

It's the only Wall Board with laths; the only one with a water-proof body. Clean, odorless and sanitary. Guaranteed not to shrink, warp or crack; also proof against dampness, heat, cold, sound and vermin. Sold under our money-back guarantee. Easily nailed to studs. Applied dry it is ready at once for paint, paper or burlap—inexpensive or artistic decoration. Used for finishing new buildings of every description; also for partitions, attics, cellars,

porches, laundries, garages. It is the original Wall Board, construction patented. **BISHOPRIC SHEATHING** is made of same materials as Wall Board, but is nailed smooth side to studs with laths and asphalt exposed.

SAVES 75 PER CENT

in material and labor. Does away with building paper. Makes smooth, solid job. Proof against heat, cold, dampness and vermin. Used under weather boards, flooring and ready roofing or cement; also as lining for barns, poultry houses and other out-door buildings. Houses finished with Bishopric Wall Board and Sheathing are ready for immediate occupancy. Write today for prices and

FREE Booklet and SAMPLE of Bishopric Wall Board, Bishopric Sheathing, Bishopric Ready Roofing

Dealers Write for Attractive Proposition
60 E. Third Street, Cincinnati, O.

ROBERTS MOTORS

THE MOTORS THAT NEVER BACKFIRE

AEROPLANE

MOTORS THAT MAKE GOOD



INTERNATIONAL AEROPLANE WITH MODEL 4-X ROBERTS MOTOR

NIGHT LETTER

THE WESTERN UNION TELEGRAPH COMPANY

Chicago, Ill., Aug. 20th, 1911

The Roberts Motor Company,
Sandusky, Ohio

Smashed local duration record yesterday and beat our own record to-day with one of our bi-planes equipped with Roberts 4-X motor. Van Ludvik up 30 minutes yesterday, Semeniouk up 35 minutes to-day. Capacity of fuel tank our only limit. Motor perfect. International Aeroplane Mfg. Co.

Our new Aero Motor Catalog will be mailed upon request
You will find it worthy of your careful consideration

MARINE

MOTORS THAT MAKE RECORDS



PRONTO III AT 28.07 M. P. H. WITH HER 6 CYL. 60 H. P. ROBERTS

WORLD'S CHAMPIONSHIP HELD BY

Pronto III, for 20 ft. boats of the displacement type, owned by Geo. E. Smith, Peoria, Ill., and is equipped with a 6 cyl. 60 H.P.

ROBERTS MOTOR

This record was made at Peoria, Ill., on Decoration Day against hulls equipped with two and three times this amount of power.

Before selecting a power plant for your hull, send for a Roberts marine motor catalog. It is yours for the asking.

THE ROBERTS MOTOR CO., 1419 Columbus Ave., Sandusky, Ohio

Everything For Model Aero Making



We can furnish you with all supplies for model aeroplane making. Quality and workmanship perfect—stock complete and up-to-date. Our new Wright 3 ft. Bi-plane Model is positively guaranteed to fly. Send 25 cents for plan and directions for building. Plan of 3 ft. Blériot Monoplane, 15 cents.

Stamp brings interesting, illustrated Catalogue

IDEAL AEROPLANE AND SUPPLY CO.

82-88 West Broadway

NEW YORK CITY

been valuable to mariners for years. It can be seen far out at sea, and a burst of flame has gone upward every seven minutes without the variation of a second for many years.

"A lighthouse fee is collected of all vessels that put in at the harbor nearest the volcano and no skipper objects. He knows that the volcano is more reliable than the lighthouses kept by human beings on other coasts and the novelty of the light is worth the price charged by the government."—Washington Post.



Aeroplane Models

Racing Flyers
Altitude Flyers

Complete new line of supplies. Light pneumatic tired wheels. Turnbuckles, lightest fittings. Aluminum sheet and tubing, all sizes. Finest selected wood and Rubber Strands. Send for Catalogue S.

THE WHITE AEROPLANE CO.

Office and Salesrooms:

337 Adams Street., BROOKLYN, N. Y.

Study Art At Home By Mail

Earn \$25-\$50 a week

Learn to draw or paint in Water-Colors, Oil and Decorate China.

BE AN ARTIST, Illustrator, Designer or Cartoonist. Enroll in our Home Study Art Courses. No previous experience necessary. Cost exceedingly small. Competent artists are in great demand. YOU CAN EARN \$2,000 to \$3,000 A YEAR and even more. We employ the same methods as those used in the famous Ateliers of Paris, and guarantee to teach you with complete success by mail or make no charge for tuition. Eminent teachers, graduates of leading European Art Academies.

Write for our beautifully illustrated "PROSPECTUS." Tells "How to Learn Art at Home" and describes our methods. Sent FREE. Postage prepaid. Gives just the information

you want. Write for it NOW. Do not delay. Address: THE FINE ARTS INSTITUTE, Studio 1197 Omaha, Neb.

12 Art Panels 50c

Beautiful Duo Tint Reproductions of Famous Paintings—Panel Size 7x10

These pictures are real gems—the most exquisite portrayals of

"WOMAN BEAUTIFUL"

ever shown in one collection. We send a full set of 12 in handsome Art Portfolio, packed flat and safe delivery guaranteed, together with lifelike miniatures of 70 other beautiful and catchy den pictures, for only 50c. coin, money order or U. S. stamps. Send at once. Money back if not satisfied. Or send \$1.25 for same set hand-colored.

Florentine Art Company
Dept. U. 10, 2209 Prairie Ave., Chicago, Ill.

FREE Order panels at once and we will include Free a beautiful den picture in colors.





Prest-O-Lite

The only efficient and economical lighting system for automobiles and motorcycles.

FREE Our Handy Ruler and Gasoline Gauge

Light, flexible, folding foot rule. Half of it is specially made for gauging depth of gasoline in tank. Inches and centimeters. Measures tires, etc. Handy in a hundred ways. Sent free on request. Give name and address.

The Prest-O-Lite Co.
265 East South Street
INDIANAPOLIS, IND.



Protected against the Weather in 30 seconds time--- without leaving your seat

The Limousine Buggy

In pleasant weather your Cozy Cab is a smart, light-running buggy, open to the breeze on all sides.

In stormy weather it is a wind-tight, rain-proof Cozy Cab as shown above.

Just three, simple, one-hand movements release the swinging front window and close the roller door side curtains. You don't need to leave your seat, or even drop the lines.

You have completely shut out the weather, without in the least cutting off your view of the road.

There is plenty of room with a system of ventilation which provides fresh air without draft.

Sent anywhere for 30 days' free trial, and fully guaranteed.

Write today for our handsomely illustrated catalogue and details.

Fouts & Hunter Carriage Mfg. Co.
Dept. PM-2 Terre Haute, Ind.

FREE Murray Style Book

Save \$30



Before you buy, it will pay you to get this money-saving book; 178 pages and 251 illustrations of genuine Vehicle and Harness bargains of every kind and for every purpose. Vehicles built to order, direct from our factory; 4 weeks' road trial, 2 years' guarantee. Send for Big Free Book, best ever published.

THE W. H. MURRAY MFG. CO., 366 E. 5th Street, CINCINNATI, O.

From Factory To Horse

BOYS



MOTOR BOB

2 H. P. AIR COOLED 4-CYCLE GASOLINE MOTOR

A PRACTICAL MINIATURE AUTO propelled by a small gasoline motor. The greatest instructive, mechanical device ever invented. Boys all over the world now building Motor Bobs. Any boy of 12 years and up can build and operate the Motor Bob. Send 25 cents (coin preferred) for our complete instruction booklet, "HOW TO BUILD A MOTOR-BOB," which contains simple drawings, diagrams, pictures, instructions for building and operating, and list of parts.

Motor-Bob Mfg. Co., Dept. H, Main and Amherst Sts., Buffalo, N. Y.

5 H. P. 1912 Peerless Motorcycle

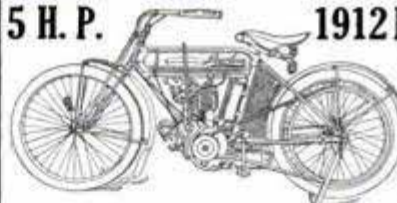

With Free Engine Idler and Bosch Magneto together with the best there is in motorcycle construction--Power, Silence, Endurance, and those Wearing Qualities so essential for low cost of maintenance.

5 MILES FOR ONE CENT

Agents Wanted--Liberal Discounts

PEERLESS MOTORCYCLE CO., 179 Huntington Ave., BOSTON, MASS.



SCHACHT

3 Cars in 1--\$850.00

The Schacht is the greatest under \$1000 car ever put on the market for it not only is a remarkably staunch and speedy roadster, but the addition of a rear seat makes of it a big, roomy family car; or the addition of a box, an up-to-date delivery car.

SEND FOR CATALOG

THE SCHACHT MOTOR CAR CO.
2802 Spring Grove Ave., CINCINNATI, OHIO

THE FLYING MERKEL

Is "The World's Most Comfortable Motorcycle," because

it is the only one with a Spring Frame and Spring Fork, a device that eliminates the usual jolting, bumping and engine vibration, and makes motorcycling under all kinds of road conditions a real pleasure.



The ball-bearing motor of "The Flying Merkel" is distinctive for its remarkable power and unusual reliability—it's a motor that not only gets you there, but can be depended upon to bring you home.

THE MIAMI CYCLE & MFG. CO.

350-370 Hanover St.
MIDDLETOWN, OHIO

Send today for free book describing and illustrating "The Flying Merkel" models.

We Ship on Approval

without a cent deposit, prepay the freight and allow 10 DAYS FREE TRIAL on every bicycle. IT ONLY COSTS one cent to learn our unheard of prices and marvelous offers on highest grade 1912 models.

FACTORY PRICES Do not buy a bicycle or a pair of tires from anyone at any price until you write for our new large Art Catalog and learn our wonderful proposition on the first sample bicycle going to your town.

RIDER AGENTS everywhere are making big money exhibiting and selling our bicycles. We sell cheaper than any other factory.

TIRES, Coaster-Brake rear wheels, lamps, repairs and sundries at half usual prices. Do Not Wait; write today for our latest special offer on "Ranger" bicycle.

MEAD CYCLE CO. Dept. T 108, CHICAGO



\$40 Motorcycle

We have the largest line of new and used Motorcycles in the country at the lowest prices. We also have a thoroughly equipped repair department and are in position to furnish repairs for any machine. Send us your machine to be overhauled.

Send for Catalog.

HARRY R. GEER CO., 888 McLaran Ave., ST. LOUIS, MO.

We Sell You At Wholesale



Agents' Price One
AMERICAN
Motorcycle or Bicycle



We give 30 Days' Free Trial and Prepay the Freight. Write for our introducing offer and catalog and say whether you want Motorcycle or Bicycle. Do it now.

AMERICAN MOTOR CYCLE CO., 1010 American Bldg., Chicago

Cut down your tire expense by doing your autumn motorcycling on

United States Motorcycle Tires

G & J
Morgan & Wright

The fellow who rides on United States Tires rolls up a big tire mileage without rolling up a big tire bill.

They are the only motorcycle tires made that combine all the toughness and resiliency of two world-famous makes, G & J and Morgan & Wright.

You will get from them the greatest possible amount of mileage with the smallest tire expense, because they are unquestionably

The Strongest Motorcycle Tires in the World

UNITED STATES TIRE CO.

Broadway at 58th St.
NEW YORK



THE WORLD'S HORSE SUPPLY—It has been estimated that of the 100,000,000 horses in the world about 80,000,000, or four-fifths of the whole number, exist in the temperate zones, and that nearly all of these are to be found in Occidental countries.

The remaining 20 millions, scattered throughout the tropics, are said to be but poor representatives of the animal as it is known to the peoples of America and Europe.

The horse's carrying capacity ranges from 150 to 200 lb. The llama can carry from 50 to 200 lb.; the donkey from 100 to 200 lb.; the ox from 150 to 200 lb., the camel from 350 to 500 lb., and the elephant from 1,800 to 2,500 lb.—Toronto Globe.



Convert Your Bicycle into a Motor-Cycle using our Attachable Outfit. Fits any wheel. Also Marine and Stationary Motors and Finished Castings. Stamp for catalog. **STEFFEY MFG. CO.,** Girard Ave. and 30th St., PHILADELPHIA, PA.

MAKE A MOTORCYCLE OF YOUR BIKE



at small cost, by using our attachable outfit. It fits any bicycle. Motorcycles, all makes, new and second hand \$35.00 up. Send stamp for catalogue and bargain list. Keller's new 104-page booklet, "Construction, Management and Care of Motorcycles" is now ready. Price, postpaid, 25c.

SHAW MFG. CO., Dept. B, Galesburg, Kansas

NSU

WHY TAKE CHANCES on a Second-hand Motorcycle if you can buy a High class "N. S. U. at \$185.00" Covered by a Year's Guarantee? **ACT QUICKLY!**
N. S. U. MOTOR CO.
206 W. 76th St., New York City

**The Wing
Piano Shipped FREE**

Read Below



**The Wing
Piano Shipped FREE**

Read Below

ONE OF OUR 40 DESIGNS

Greatest Piano Offer—Read, read below !!

Here is indeed the greatest, the most stupendous, the most amazing offer ever made in the history of the piano; a simply sweeping, paralyzing offer. Yes, the most gigantic of ultra-liberal offers!

We Will Ship You Free

an upright piano, a grand piano or a wonderful new style upright with our *Inside Player*.

A WONDERFUL NEW INVENTION

Learn in five minutes to play all the most difficult, dashing operas, dances, marches, that only the great pianists have been able to play. Yes, you can—you can learn to play it yourself **right away**—Wing's new inside piano player may prove a revelation to you; **the piano that plays** all the tunes, operas, marches, etc., by machinery exactly like the greatest artist—**everybody** can play this wonderful piano player after five minutes' practice and play it well. **Everything** the world's greatest pianist can play you can learn to play at once if you get the player with the piano. We'll ship it free, if you say so, with the piano on a month's loan. That's besides having a regular piano used in the regular way. **Free also, a complete course in musical education** for all actual purchasers of Wing Pianos; free also, that remarkable invention for students, the Noteaccord. French Damask Brocatel or China silk scarf, fine stool, etc., all free with every Wing.

Think of It!—Shipped FREE!

The genuine Wing shipped free direct from our factory—absolutely not one cent to pay. Shipment all free and everything prepaid.

Put the genuine Wing piano right up in your parlor. (Notice the exquisite up-to-date beauty of the cabinet, the superior grain of the wood, the elegance of finish.) Play on the piano, use it freely, take music lessons on it, if you wish. (Note the sweet singing tone quality at which the experts marvel, regard carefully the even action, the timbre, the sonorous bass and the bell-like treble—and ask yourself if any of your neighbors ever had such a wonderfully fine musical instrument in their homes.) Use the Wing piano just like your own for four full weeks on this free loan. Then you may return it at our expense and no harm done. No obligations. But if you want to keep the Wing, if you want to be the proud owner of the very latest style finest piano in the entire neighborhood, then keep it at our wholesale price—yes, we mean it, the genuine Wing at wholesale price, exactly to the cent the same price that any dealer must pay. Just choose your own terms of cash or easy monthly payments while saving these tremendous profits (running into hundreds of dollars) which Mr. Dealer is accustomed to making on the sale of every piano.

The Wing is the only piano sold direct from an exclusive piano factory. That explains why Wing & Son are able to ship such a superior quality, such a magnificent instrument at a price that paralyzes the competition both of the largest and of the smaller mail order houses who ALL have to buy from a piano factory.

Important!—Valuable Pointers FREE!

An invaluable book for all who expect to buy a piano—the book of ten tests, entitled, "The Book of Complete Information," telling the public **how** to judge values and prices of pianos. **Get Posted!** This remarkable book of 156 pages tells about material, how to judge the kinds of wood used in the piano, the action, sound board, case—in fact, this book gives you the **TEN TESTS for judging the value of any piano.** The *New York World* says, "A book of educational interest everybody should own." Don't think of buying a piano anywhere until you have read and studied the ten tests in this book.

If you are thinking, if you are in any way considering the purchase, some time or other, of a new piano, then here is your opportunity right **NOW**. At any rate, investigate **NOW**. Even if you don't want to buy at once, or have practically decided what other piano you think you prefer, get posted anyway right **NOW** on the greatest and most stupendous of all piano offers.

With this free book we send colored pictures of Wing pianos showing the very latest beautiful designs in cases and we quote **amazingly low** wholesale dealers' prices on these **quality** instruments. Now **write for the book of ten tests** and the Wing prices today. Drop postal or just send the coupon—but do it **NOW!**

WING & SON Department 1197
Wing Bldg., 9th Avenue and 13th Street
NEW YORK CITY

Est. 1868

What Price Do You Want for Your Old Organ or Old Piano?
We'll Allow You FULL VALUE in Exchange for a WING.

**FREE
COUPON
To Wing &
Son**

(Est. 1868)
Dept. 1197

Wing Bldg.

9th Ave. & 13th St.
New York City.

Gentlemen:—Without the slightest obligation to accept anything or to pay for anything, I would like to get free full information about your wonderful free shipment offer on the new style highest grade Wing Piano. Please explain. Also send free the 156 page book giving the ten tests for judging the value of a piano and other important information for people who may want to buy a piano.

My name is

My address is.....

No letter necessary; coupon will do; no obligation in getting the 156 page book, etc., all free.

SEND for our free Booklet and see how an Aldine Fireplace is suited to your needs.

You can get as much heat with one Aldine Fireplace and save 60% of your fuel bill as from four common grates.

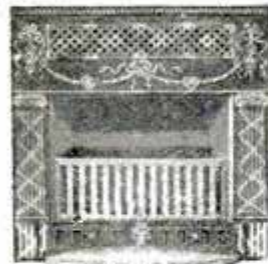

Mission Design

This is because it is really a return draft stove in fireplace form. 85% of the heat is thrown out into the room instead of

85% being wasted as in common grates. It can be set in any chimney opening at half the cost of a common grate, no special chimney construction is necessary, no pipe to connect, extra large fire pot; made in seven patterns, at prices no higher than any good common grate. 50,000 now in use

Satisfaction guaranteed or your money back.



RATHBONE FIREPLACE MFG. CO., 7310 Clyde Park Ave., GRAND RAPIDS, MICH.

DON'T PAY TWO PRICES

Save \$18.00 to \$22.00 on

HOOSIER RANGES AND HEATERS



Hoosier Steel

Why not buy the best when you can buy them at such low, unheard-of Factory Prices? **THIRTY DAYS' FREE TRIAL BEFORE YOU BUY.** Our new improvements absolutely surpass anything ever produced. **SEND POSTAL TODAY FOR OUR FREE CATALOG AND PRICES.**

HOOSIER STOVE FACTORY, 249 State St., Marion, Ind.

Test an **"IMPERIAL" 30** Days In Your Own Home at **OUR RISK**



Thousands now in use! Demand growing amazingly! Housewives delighted! The result surprises even themselves!

Has exclusive features, such as: **Odor Hood**—Carries all steam and cooking odors to chimney. **Ash Sifter**—Permits sifting ashes right in range. **Oven Thermometer**—Stone **Oven Bottom**—Absorbs and

holds heat in oven; a fuel saver. Direct from factory to you at Wholesale Price, Freight Prepaid. Easy Credit Terms if wanted. **365 Days' Guarantee!**

Write Today for Free Catalog and Special Prices

THE IMPERIAL STEEL RANGE COMPANY 269 State Street, Cleveland, Ohio

Kalamazoo Stove Book FREE

Write for the stove book with the astounding inside facts about stove making and stove selling—how you can save \$5.00 to \$40.00 by buying stoves direct from the factory. Built by experts—prices \$6.50 and up, east of the Mississippi. Stove Book yours for the asking with description of 400 sizes and styles of stoves—richly illustrated.



Stove or Range Shipped Freight Prepaid 30 Days' Trial



You don't decide finally until you've used the stove or range 30 days and then it comes back to us—at our expense—if you're not satisfied. 170,000 people have tried Kalamazoo and bought. 360 Day's Approval Test. Cash or credit terms, shipment within 24 hours. Repairs at cost or less if ever needed. Your interest demands that you get our proposition first. Now send for the Stove Book and Catalog No. 473 at once.

KALAMAZOO STOVE COMPANY MFRS. KALAMAZOO, MICHIGAN

"A Kalamazoo Direct To You" And Gas Stoves Too

SWIMMING TAUGHT WITHOUT WATER—The school children of Germany are taught to swim without the use of water. It is claimed that the proper stroke and motions of the arms and legs are more readily acquired in this manner than in the water, as is the more general way of teaching swimming. The student is suspended by a wide belt from an overhead rail, while the feet are attached to a pair of ropes running over pulleys

AGENTS - \$45.00 A WEEK **MENDETS**

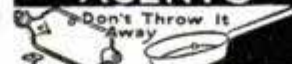

Mend all leaks instantly in graniteware, hot water bags, tin, copper, cooking utensils, etc. No heat, solder, cement or rivet. Any one can use them. Fit any surface. Smooth. Sample box, 10c. Complete box, assorted sizes, 25c, postpaid. Wonderful opportunity for live agents. Write today. Collette Mfg. Co., Box 1118, Amsterdam, N.Y.

BUY PLUMBING SUPPLIES AT WHOLESALE



Will Save You 30% Don't pay retail prices. Full stock on hand for prompt shipment. Send for free catalog. B. P. KAROL, 768 to 772 West Harrison St., Chicago



NULITE Gasoline Table Lamp

A beautiful lamp for homes, hotels, offices, stores, banks, cafes. Portable, safe; can be turned upside down or rolled on the floor without danger or affecting the light. 300 c.p. of soft, brilliant light, 1/2c per hour. Also 200 different styles of lamps and systems.

AGENTS—We want town, county and traveling salesmen. Best proposition ever offered. Sells everywhere. WRITE FOR SPECIAL OFFER.

NATIONAL STAMPING & ELECTRIC WORKS 422 So. Clinton St. CHICAGO



Geisha Diamonds

THE LATEST SCIENTIFIC DISCOVERY

Bright, sparkling, beautiful. For brilliancy they equal the genuine, standing all test and puzzle experts. One twentieth the expense. Sent free with privilege of examination. For particulars, prices, etc., address

THE R. GREGG MFG. & IMPT. CO. Dept. 11, 517 Jackson Blvd., Chicago, Ill.

\$1.50
Takes This
4-PIECE
Mission
SET

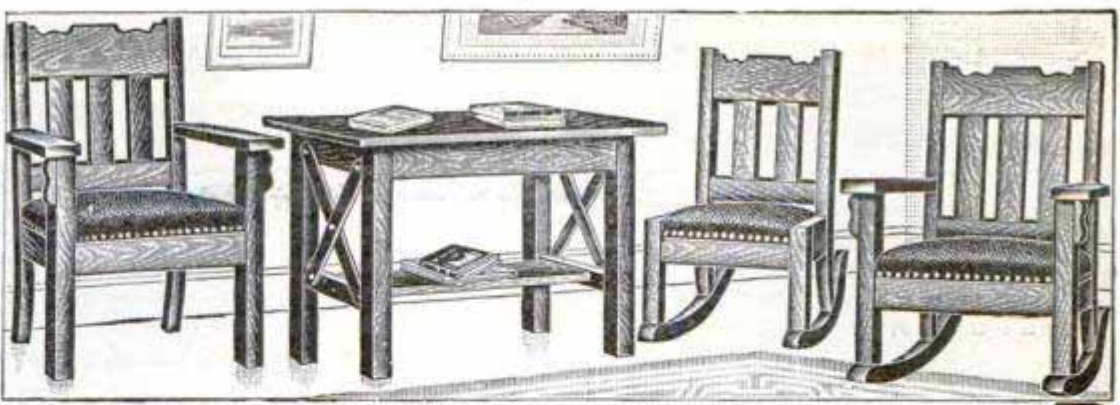

\$1.50 brings you this entire mission set—the rich, massive library table, the two elegant comfort rockers and the big, handsome arm chair. These elegant pieces are all made of best selected solid oak in the popular weathered oak finish. Seats of rockers and chair are heavily padded and upholstered in high-grade Imperial leather. A beautiful set that you will be proud to show.

50c PER MONTH Just let us put this 4-piece set in your home for a 30-day trial. Show it to your friends. Test it thoroughly—then if at the end of the 30 days you are not satisfied with it in every way, notify us and we'll send for the goods and refund every cent paid. If you're perfectly satisfied at the end of 30 days and wish to keep the set, send us only 50c per month until you have paid our special, low, direct-from-factory price of..... **\$9.75**

FREE CREDIT to ALL—MONEY-BACK GUARANTEE

We charge no interest and make absolutely no extra charges whatever for our credit service. And our terms are the most liberal in existence. All deals are kept strictly confidential, so that no one need know you are buying on credit. Our credit prices are actually 15 to 50% lower than cash prices elsewhere, because our 22 im-

mense retail stores and over a million customers make it possible for us to buy our goods in far bigger quantities and at much lower prices than any other similar concern, on earth. Our strong guarantee—backed by our enormous capital and multi-million dollar resources protects you on every purchase.



CATALOG FREE "A Message of Joy" will be sent you free on request. It's the finest and most elaborate catalog ever printed by a home-furnishing concern. Costs us \$1.25 to print and mail each copy. It pictures in actual colors over 5000 different articles, such as stoves, ranges, rugs, curtains and furniture of all kinds, as well as silverware, glassware, chinaware, crockery, etc. It contains 330 pages showing everything for the home at unduplicated prices—330 pages that give you your choice of the world's best bargains and plenty of time to pay for them. Post card sent today will bring you the book right away.

HARTMAN FURNITURE & CARPET CO.
 3945 N. Wentworth Avenue, Chicago, Ill.
 — Largest, oldest and best known home-furnishing concern in the world — (56)
 Established 1855—56 years of success. 22 Great stores—1,000,000 Customers.

and adjusted to various requirements. The pupils thus suspended are then taught how to perform movements of the breast stroke until the action becomes almost instinctive. The advantage in teaching these movements in such a way is that the pupil is not distracted by the fear of a ducking.—Detroit Free Press.

The "BEST" LIGHT

Used in every civilized country on earth. Best and cheapest light for homes, stores, factories and public buildings. Makes you independent of lighting companies. Over 200 styles. Every lamp warranted. Makes and burns its own gas. 100 to 2,000 candle-power. Agents wanted. Write to-day for catalogue and prices.

2¢ a week

THE BEST LIGHT CO.
 324 East 5th Street, Canton, O.

No Dirt
 No Grease
 No Odor

400 Plans for \$1.00
 (and 25c for postage)

Are you going to build? Send for our latest designs of cottages, bungalows, single and double houses, flats, etc., from \$300 to \$12,000. Don't build until you have seen them.

J. H. DAVERMAN & SON, Architects
 5101 Murray Block GRAND RAPIDS, MICH.

A BIG \$2 OFFER—KEITH'S

72 page monthly magazine for a year with your choice of any one of Keith's famous

\$1.00 PLAN BOOKS FREE

Keith's Magazine is the recognized authority on building and decorating artistic homes.

No. 1065. Cost \$2200. One of the 215
 Each issue contains 8 to 10 plans by leading architects. Subscription \$2.
GET KEITH'S BIG PLAN BOOKS WITH A REPUTATION
 215 Bungalows and Cottages, \$1 | 175 Plans costing \$5000 to \$6000, \$1
 200 Plans costing \$2000 to \$4000, \$1 | 125 " " " " 6000 and up, \$1
 175 " " " " 4000 to 5000, \$1 | 100 " " Cement and Brick, \$1
 Any one of these \$1.00 Plan Books FREE with a year's subscription \$2.00
 M. L. KEITH, 705 Lumber Exch., Minneapolis, Minn.

HESS MEDICINE SANITARY LOCKER
 CABINET

The Only Modern, Sanitary STEEL Medicine Cabinet

or locker finished in snow-white, baked everlasting enamel, inside and out. Beautiful beveled mirror door. Nickel plate brass trimmings. Steel or glass shelves.

Costs Less Than Wood
 Never warps, shrinks, nor swells. Dust and vermin proof, easily cleaned.

Should Be In Every Bath Room
 Four styles—four sizes. To recess in wall or to hang outside. Send for illustrated circular.

HESS, 910 L Tacoma Bldg., Chicago
 Makers of Steel Furnaces. Free Booklet.

AGENTS! A REVELATION NEW BUSINESS

REMARKABLE OFFER—READ EVERY WORD

Investigate this phenomenal opportunity to make money. Sells on sight. Actual experience not necessary. **100% PROFIT.** Everybody enthusiastic. Irresistible selling proposition. I want live agents, general agents and managers at once everywhere. No charge for territory.

This Is Your Opportunity

—your chance to make good. Jump into the big income class. No reason on earth why you shouldn't get there, simply follow my instructions, make an earnest effort—success is yours. **Anyone can sell this marvelous machine.** Half a minute demonstration does the trick. Everybody amazed at the wonderful accuracy of this device. **You pocket 100% profit every sale.** Opportunities like this come only once in a life time. You've been looking for opportunity—felt you were built for better things. Catch hold. **Success is ambition, plus a plan.** Listen to the words of success. Young men, old men, farmers, teachers, carpenters, students, bank clerks—everybody makes money. **One man (H. C. Wingo) sold 720 sharpeners in six weeks; profit, \$1080.** Stauffer, Penn., sent third order for 300 machines. Krantz, N. D., says: "Had a good day and stoppers selling fine. Took 27 orders." Corey, Me., "Went out at bed time and took 5 orders in one hour. **People want it.**" Applewhite, La., "Took 6 orders in thirty minutes." Crafts, New York, "Sold 3 in fifteen minutes." Harmon, Texas, says: "The man who can't sell the Never Fail Stropper better go back to chopping cotton, for he couldn't sell \$10.00 gold pieces for \$1.00 each." Strong talk, but true. **\$1000.00 Reward** to any one proving that any testimonial given is not genuine and unsolicited.

\$45 TO \$90 A WEEK

time. **This is a new proposition.** A positive Automatic Razor Sharpener—absolutely guaranteed. The thing all men had dreamed of. Perfect in every detail, under every test. With it you can sharpen to a keen, smooth, velvety edge any razor—safety or old style—all the same. Handles any and every blade automatically. Just a few seconds with the NEVER FAIL puts a razor in a better shape to give a soothing, cooling, satisfying shave than can an expert operator, no matter how careful he works. Men are excited over this little wonder machine—over its marvelous accuracy and perfection. They are eager to buy. Women buy for presents to men. Agents and salesmen coin money. Field untouched. Get territory at once. Write for full facts concerning this high grade offer. Sworn-to proofs of success never before equaled. Don't envy the other fellows. Make big money yourself. **Don't pass this opportunity by. Act prompt. Investigate.**

THE NEVER FAIL CO. 1154 Colton Building TOLEDO, O.

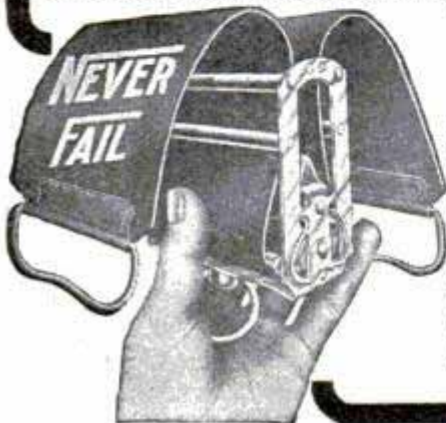

can easily be made as sales agent for the NEVER FAIL at home or traveling, all or spare razor sharpener—absolutely guaranteed. Perfect in every detail, under every test. With it you can sharpen to a keen, smooth, velvety edge any razor—safety or old style—all the same. Handles any and every blade automatically. Just a few seconds with the NEVER FAIL puts a razor in a better shape to give a soothing, cooling, satisfying shave than can an expert operator, no matter how careful he works. Men are excited over this little wonder machine—over its marvelous accuracy and perfection. They are eager to buy. Women buy for presents to men. Agents and salesmen coin money. Field untouched. Get territory at once. Write for full facts concerning this high grade offer. Sworn-to proofs of success never before equaled. Don't envy the other fellows. Make big money yourself. **Don't pass this opportunity by. Act prompt. Investigate.**

IMPERIAL CLOCK

"runs itself"

You can't expect reliability of a *spring wound* clock that is *dependent* on someone's *memory*. Get an *Imperial*—the clock that *never needs winding* and *can't run down* for months. Operated by dry cell batteries. The "works" has just four parts—no spring, no mechanism to get out of order, or to wear out.

"Imperials" run a year without attention

and tell the *correct* time *always*. Handsome as they are *efficient*. The cases are splendidly designed, finely finished. The faces are extra large and open—the figures are big, easy to read—the whole clock would ornament *any* place. **Guaranteed 20 years** in every way. Your money back if not pleased. Prices \$10 to \$60. If your dealer cannot supply you, write us. There's an Imperial model for every office or home—write today for complete free illustrated catalogue.

IMPERIAL CLOCK CO.

114 N. 4th St., St. Louis, U.S.A.

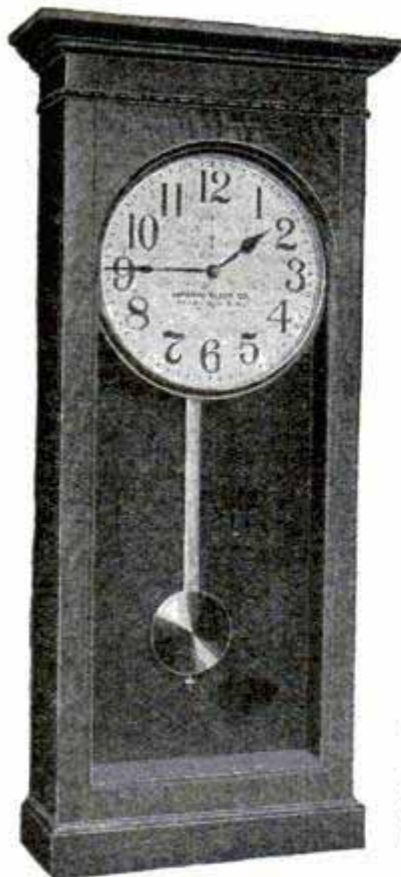

No. 18—Price \$24.00

Length 43 inches, width 17 inches

Dial 12 inches

Golden Oak or Birch—Mahogany Finish
An ornament for any wall

OUR FOOLISH SILVER DOLLAR—After July 1 the New Orleans mint was closed but 22,000,000 silver dollars are yet stored there to keep it from feeling that it is entirely useless. The silver dollar is the bulky coin of which we are so fond that hundreds of millions are stocked around the country, while the people eagerly take paper representations of it on the government's pledge that it will keep them on a par with gold.—Pittsburg Dispatch.

AGENTS! BIG PROFITS



Makes Every Man an Expert
No Experience Necessary
Guaranteed for Life

New patented Automatic Razor Stropper. Automatically puts a perfect edge on any razor, old style or safety. Big seller. Every man wants one. Write quick for terms, prices and territory. P. BRANDT CUTLERY CO., 84 W. Broadway, N.Y.



GUARANTEED GAS MANTLES

We guarantee the Harris Wood Fibre Mantle to outlast three ordinary mantles; to be superior to any other mantle at any price; to give one-third more light, to be jar-proof and free from shrinkage; and to increase in candle power while burning. We will refund your money if the Harris Mantle is not as represented.

Harris Wood Fibre Mantles are made for natural or artificial gas, or for gasoline vapor, high or low pressure. No kerosene. They give a beautiful white light. To introduce them we will send you six mantles, prepaid, for \$1.00. Specify loop or cap, upright or inverted. Soft mantles for pressure gasoline, \$1.00 per dozen, prepaid. Mention wire or tube system.

We want dealers and Manufacturers' Agents Everywhere. Write for Money Making Proposition.

THE HARRIS WOOD FIBRE MANTLE CO.
407 Harris Building CLEVELAND, OHIO

GROW MUSHROOMS

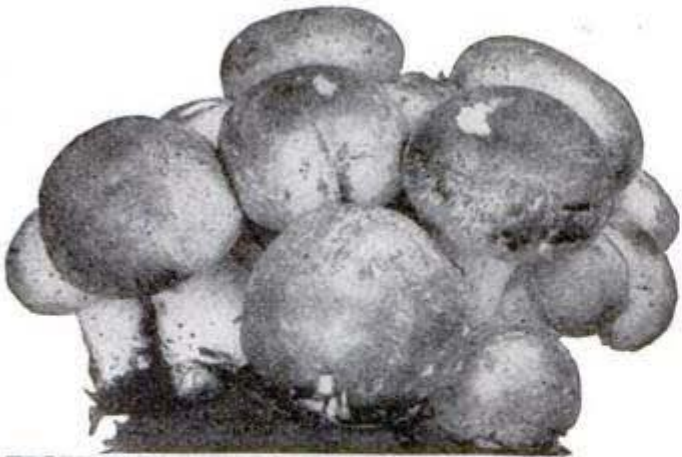

It's as Easy as A-B-C to Add \$5 to \$60 a Week to Your Income

This is just the opportunity you have been looking for. I have shown hundreds of readers of Popular Mechanics how to increase their income. **Here are the facts** that should appeal to you.

- 1 You can grow mushrooms anywhere. In your barn, shed, or any outbuilding. One of the best places in the world is your basement.
- 2 Mushroom growing does not take any time from your present occupation, as they require almost no care at all.
- 3 Success is certain with my method and the demand will always be far in excess of the supply.
- 4 Almost no "capital" is required. Many successful growers have started with \$2 worth of spawn.
- 5 My instructions are so plain and easy to follow that anyone who can read English is sure of success.

Women succeed in mushroom business as well as men. Mrs. Mary Bonar, Ohio, writes: "I know a woman can raise mushrooms successfully, for I have tried it and succeeded." Mrs. Guillaume, Wis., says: "Can sell all I have at 80 cents per pound." Boys find a sure enough "gold mine" in mushrooms. Herbert Fickenworth, 12 years old, Chicago, writes: "I am picking and selling mushrooms every day." Webster Jones, aged 14 years, Little Rock, Ark., says: "Any boy who is willing to follow directions can learn to grow mushrooms." "Growing mushrooms is just the kind of work a boy likes, and I know I can make more money out of it than anything else."

How Some Bank Accounts are Growing

Just read these extracts from letters such as I am receiving every day:

I have a customer in California who started a few years ago with a few small beds, and this year is putting \$10,000 in the business.

Another customer in Massachusetts also started in a very small way and this year is putting in \$60,000. (Names upon request.)

My youngest grower is 10 years old and he is meeting with splendid success. I have any number of letters from people who started with an investment of \$2 and find that they can easily net from \$50 to \$60 on the one spawn.

Every State Agricultural School in the United States has my book of instructions as a reference book. One of the biggest crops that I ever heard of has been grown at one of the Experimental Stations by my method of growing and with my spawn.

Two of my customers in Arlington Heights, Ill., in the basements of their homes last year, invested \$75 in the mushroom business and raised \$680 worth of mushrooms, leaving a clear profit of \$605 on an investment of \$75.

I Will Tell You the Facts About This Business

The fact that you have read these statements and have learned a few facts concerning the money making possibilities of mushroom growing, will never benefit you one penny's worth if you don't take advantage of the chance it affords you, and GET POSTED.

I am the largest grower in America and have had 14 years' experience. I have put the facts about this great business into a book which I call, "How to Make Money in Mushrooms." Now the first thing for you to do is to either write, or send the coupon for this book. IT IS FREE. And when I send the book I will also give you very complete information as to the best way for you to start, the cost, etc., etc. Then you can think it over and make up your mind. But send for the book anyhow. DO THAT MUCH TODAY.

Please mail me your book "HOW TO MAKE MONEY IN MUSHROOMS," and also give me full information as to the best way to start, cost, etc. All this to be entirely without cost or obligation on my part.

P.M.

A. V.
Jackson,

Jackson Mushroom
Farm

6248 N. Western Ave.
Chicago, Ill.

Address _____

Jackson Mushroom Farm

6248 N. Western Ave., CHICAGO, ILL.

NAME.....

ADDRESS.....

TOWN.....

STATE.....

TEAR OFF THIS COUPON AND MAIL TO-DAY

Make Your Own Terms

**YOURS
ON
APPROVAL**

**NO
MONEY
DOWN**



Take this
King Sewing Machine
into your home and try it
30 DAYS FREE

If you don't want to buy it, simply send it back at our expense. You will owe us nothing and will not be out a cent, as we pay the freight both ways. But if you want to keep it, you may make your own terms—you can have it for about one-third the price agents ask for this very machine, and you can take 2½ years to pay if you want to.

Ours is the only factory in the world selling a high-grade sewing machine direct to the family at factory cost without profits to middlemen. The King won the gold medal, first prize, highest award at the Alaska-Yukon Exposition. The judges officially declared it to be "The World's Best Sewing Machine."

Our 20-Year Guarantee

means if the machine proves defective in material or workmanship during 20 years of service we will replace it or refund your money. Our half-million dollar factory stands back of this guarantee.

Gold Medal Winner!

Strictly ball bearing; has the newest drop head automatic lift; is easy running and sews a perfect lock-stitch. Among the operations it performs are Adjustable Hemming, Hemming and Sewing on Lace, the French Seam, Frilling, Tucking, Binding, the French Fold, Braiding, Darning, Quilting, Ruffling, Plaiting, Ruffling between two bands, Edge Stitching and Piping and Shirring. We positively guarantee that this marvelous variety and perfection of work cannot be duplicated by the attachments of any other family sewing machine in the world. The machine is complete and includes all the attachments. Try it 30 days FREE. Then if you wish to keep it make your own terms. Write to-day for our free 64-page illustrated catalogue and full particulars of the most liberal sewing machine offer ever made.

King Sewing Machine Co., 2024 Rano St., Buffalo, N. Y.

Please Mention Popular Mechanics

TURKISH ROCKER

Covered in high grade soft, pliable Royal Leather. Deep, roomy—just as comfortable as a chair can be made.



Handsome side wings form an ideal head rest. Deeply diamond tufted back. Deep ruffles on front, back and sides. Rounded arms—just the right height for comfort. Superior seat base formed of highly oil tempered steel springs under thick layers of upholstered padding. The most handsome, durable and restful chair that can be made.

No. 950

Shipped to Your Home

FREE

Yes, positively, absolutely Free. Not a cent down or in advance. No deposit—no guarantee. Just let us send you this magnificent rocker

entirely at our own risk. When you get the chair, take off the wrappings—set it in your own parlor or living room and use it for ten days just as though it were your own. Let every member of your family try it—let them see how wonderfully comfortable it is—see, too, how it adds to the appearance of your home. Get the opinion of your friends, too. Then, after ten days, if you decide that you do not want to keep the chair for your own, simply send it right back to us at our expense.

If you decide after the ten days' trial that you do not want to part with the chair, simply tell us so and send us only 85c—then just \$1 a month for 9 months and the chair is yours. Only \$9.85 for this great bargain. You get the rock bottom, cash price, and on the easiest kind of payments.

Why We Make You This Offer

We realize that this is an unusual offer, but we want every home in the country to become thoroughly familiar with the superb quality of Fish's merchandise and our remarkably liberal plan. So we have decided to make a special offer for a short time only which you simply cannot afford to refuse. And remember—you are the sole judge; we accept your decision cheerfully and without a quibble.

HOMEMAKER'S BOOK FREE Just your name and address on a postal or letter brings you a copy of our handsome, big, 96-page Homemaker's Book absolutely free. Tells you how you can furnish your home in the most beautiful way—just like you have always wanted to—and besides explains fully how you may do all this on the most remarkably liberal plan you ever heard of. Don't wait a minute—send for the Homemaker's Book right now.



Dept. 22

CHICAGO, ILL.

SPECIAL TO DEALERS: We are conducting a nation-wide campaign for the benefit of dealers handling Fish's Stamps. If we have no representative concern in your city, write us at once for full particulars of the most unusual and profitable merchandising plan of its kind ever presented.

(10)

Get the genuine

Bush & Gerts

(ONE NAME--ONE TRADE-MARK)

Piano



Put right in your home on

One Full Year's Trial

This offer is strictly limited and will be withdrawn as soon as a certain number of acceptances are received. So act now if you want the benefit

America's standard of highest grade piano manufacture—the genuine Bush & Gerts—now offered to you on a **whole year's** trial. Think of it! We will let you have one of these exquisite instruments right in your home for a full year. Test it in every way. Compare it with any piano in the world, no matter what the price, **then decide.**

Don't try any piano any other way. Don't be deceived by any of the "30-day trials" offered by dealers in unknown "masked" or "stenciled" brands. **Any** piano will retain its tone for a month, **but a year will tell.** Remember, every Bush & Gerts Piano is made in **our own model factory** under the **personal** supervision of both members of its firm. We honestly believe it to be the highest grade piano produced in America at the price. **OUR LIFETIME GUARANTEE** protects you absolutely. It is the most liberal guarantee on a really high grade instrument in the whole history of the piano industry. **A Guarantee that *does* guarantee.**

Conservatory Term of Music Without Charge

SPECIAL—For a limited time we offer to every purchaser of a Bush & Gerts piano, a standard conservatory term of instruction in the famous Bush Temple Conservatory, under some of the best known instructors in the country, **absolutely without any charge.** Send for full particulars of this great opportunity **right away.**

About Monthly Payments: We believe that we have succeeded in arranging the fairest and most liberal plan of Deferred Payments that it is possible to offer. Our **extremely** liberal terms place the ownership of a genuine Bush & Gerts within the reach of practically every reader of this magazine.

Bush Temple Conservatory of Music and Dramatic Art

is one of the very highest class institutions of its kind in the country. The faculty is composed of eminent masters, many of whom have international reputations. We offer you a Conservatory Term in this institution **WITHOUT CHARGE,** in connection with this great offer.

Home of the Bush & Gerts Piano



Send the COUPON

for our Piano Books and our Great Offer. No obligations whatever. Get real truth—the inside facts about the piano business. Learn how you can select a piano as well as an expert. Learn the details of our unusual offer—the most remarkable offer ever made on a really high grade piano. Remember, this offer is limited—so send name and address today.

BUSH & GERTS
Dept. 7
Bush Temple, Chicago

Free Music Term and Book Coupon

**BUSH & GERTS, Dept. 7
Bush Temple, Chicago, Ill.**

Without any obligations whatever, please send me a copy of your Piano Book and full particulars of your Year's Trial Offer. Also tell me how I can get a term in music without cost.

Name.....

Address.....

Perfect Team Work of
Perfect Units—that is
what Wins the Type-
writer Game. The

L. C. Smith & Bros. Typewriter

(Ball-Bearing, Long-Wearing)



is a rare and unusual combination
of mechanical features of superior
excellence, each of which is designed,

First—To do its individual work better than it could
be done in any other way.

And,

Second—To work so smoothly and accurately, in con-
junction with all others, that the completed result is
just as perfect as the work of any individual part.

That is what makes a good-working typewriter—it is what justi-
fies the overwhelming verdict of 150,000 users in approval of the
L. C. Smith & Bros. Typewriter—it is why this typewriter does
all kinds of work superlatively well *without attachments* and
gives no disappointing results.

Send for free descriptive matter today.

Branches in all large cities **L. C. SMITH & BROS. TYPEWRITER CO.** Head Office for Domestic and Foreign Business, Syracuse, N. Y., U. S. A.



GUNN SECTIONAL BOOK CASES

You will save money by putting
these bookcases in your home.

The handsome designs, the rich finish, the remov-
able non-binding doors, the absence of disfiguring
iron bands make them far better than the old fashioned kind.

Our prices are lower than others

and high quality is guaranteed. Write for our artistic catalogue PM with
colored illustrations showing Sanitary Clawfoot, Mission and Standard
Styles. Sold by dealers or direct.

GUNN FURNITURE CO., 55 Victoria Street, GRAND RAPIDS, MICH.

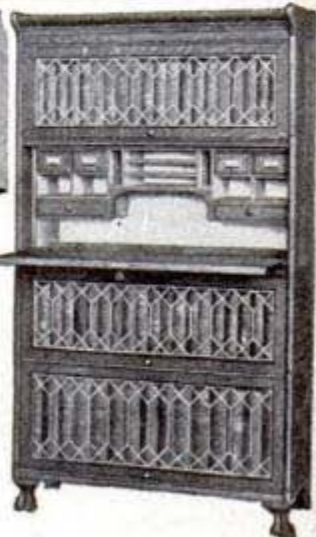

Please Mention Popular Mechanics

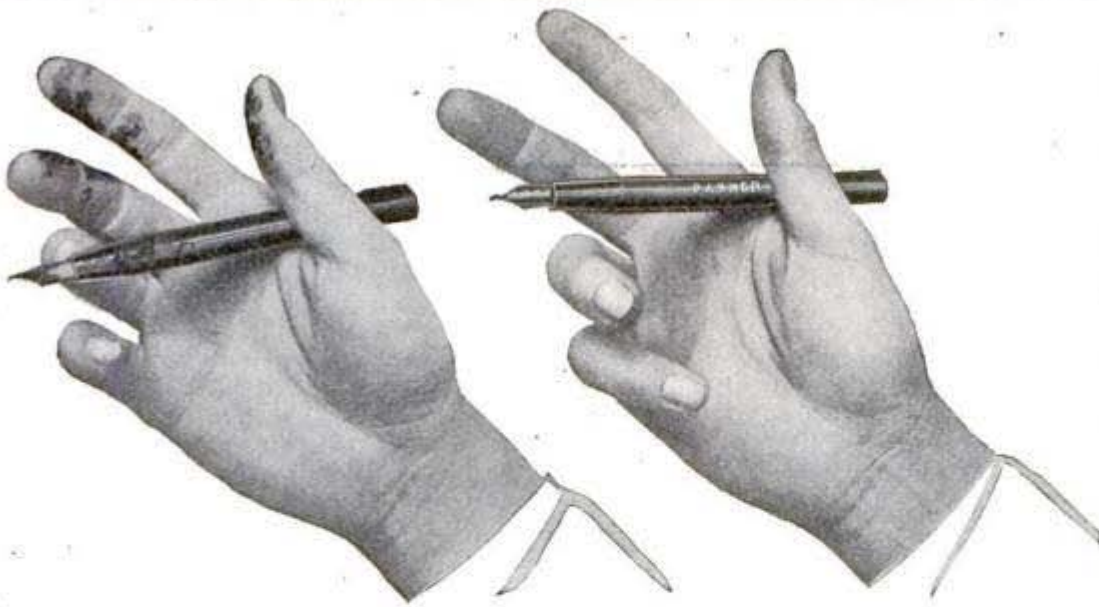

Finger Smearing Abolished by this New Invention

WHEN you put an ordinary fountain pen in your pocket, you think all the ink settles in the bottom. Most of it does, but some ink still stays at the top in the straight tube which feeds the pen point.

The space between the bottom ink and the top ink is full of air.

When this air gets warm from the heat of your body, it begins to expand. Like expanding steam this air pushes out where it can. So it pushes out through the feed tube and pushes the ink out ahead of it, smearing ink over the writing end of the pen.

Until George S. Parker, of Janesville, Wisconsin, invented the "Lucky Curve," no fountain pen manufacturer was able to abolish finger smearing.

Mr. Parker simply curved the back end of the feed tube over against the wall of the fountain pen barrel. The touching of the end of the curved tube against the wall causes a quick and powerful suction which draws all the ink out of the feed tube down into the reservoir below, every time you place your Parker in your pocket. Thus the expanding air finds no ink to push out.

The "Lucky Curve" suction is created by capillary attraction, that wonderful trait of nature which causes a flower stem to suck water, or a lamp wick to draw oil.

There's never a hitch or skip in flow of ink from a Parker Pen. Made plain, or with gold or silver mounting. Standard style Parker Lucky Curve Pens, \$1.50 to \$250.00, according to size, style and ornamentation. Self-Filling and Safety styles, \$2.50 and upwards. The only pocket clip that recedes out of the way, when you slip cap off to write.

Get a Parker Fountain Pen today before you forget it. If it isn't satisfactory, return it and get your money refunded. Don't hesitate to return it. We protect dealer by contract.

If dealer doesn't keep them, send us his name, and we'll send you our artistically printed catalogue and fill your order direct.

The Parker Pen Co., 100 Mill Street, Janesville, Wis.

New York Retail Store, 11 Park Row, opposite the Post Office

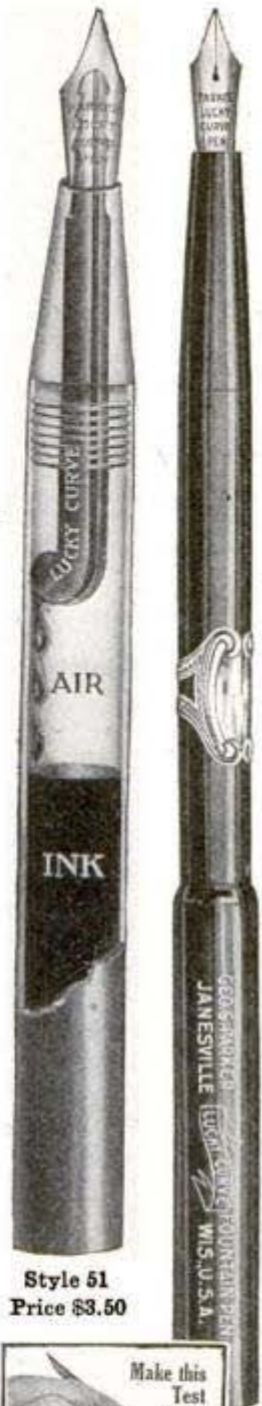

Style 51
Price \$3.50



Make this
Test
Your-
self

Fill Parker feed tube with ink; touch curved end to barrel wall, as in test picture. Watch the ink scoot down, proving thereby that the Parker Pen will not leak.

PARKER LUCKY CURVE FOUNTAIN PEN

50c
EACH

Lithographic Models

50c
EACH

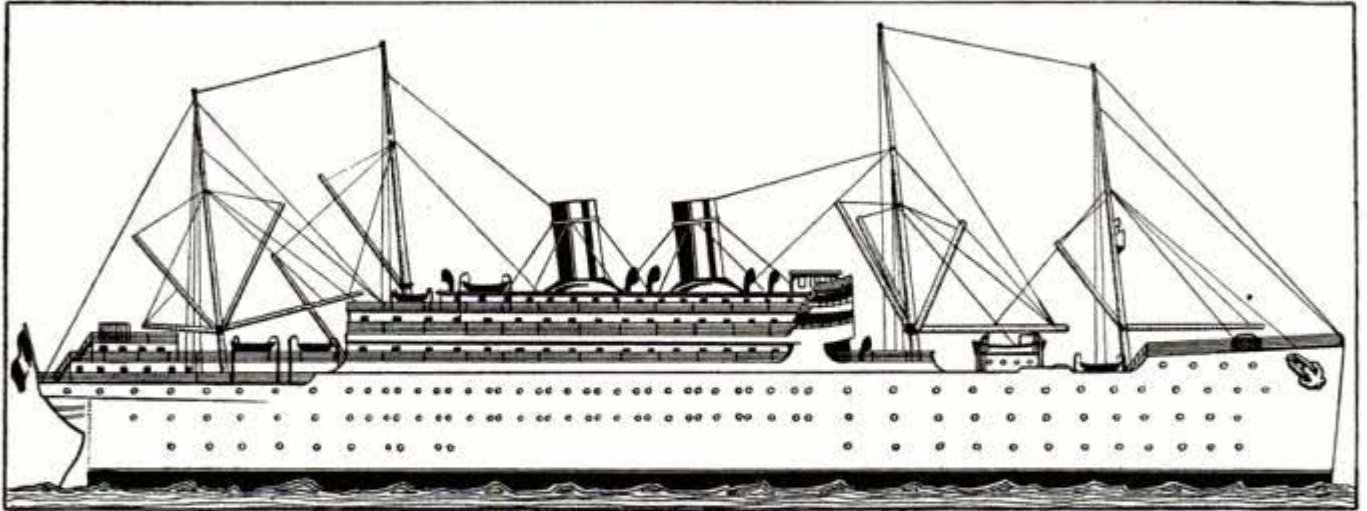

Steamship

("KAISERIN AUGUSTA VIKTORIA")

**Automobile
Gas Engine
Dynamo**

Price **50c** Each
Set of seven, \$3.00
postpaid

**Steam Engine
Wireless Telegraph
Steam Turbine**

THESE models are of great value as a means of graphically showing all the interrelated parts of the above named mechanisms by virtue of their construction, which is similar to that of educational manikins of the human body and organs, with which nearly everyone is familiar. Beginning with the outermost or surface parts of the gas engine, for example, these are all differently colored and numbered to correspond to a printed key of names which comes with each model. By means of their hinge-like attachment, they may then be lifted, thereby disclosing to view the layer of parts next underneath, exactly as they would be in the engine itself, and so on until the innermost construction is shown.

Size 8x14 inches

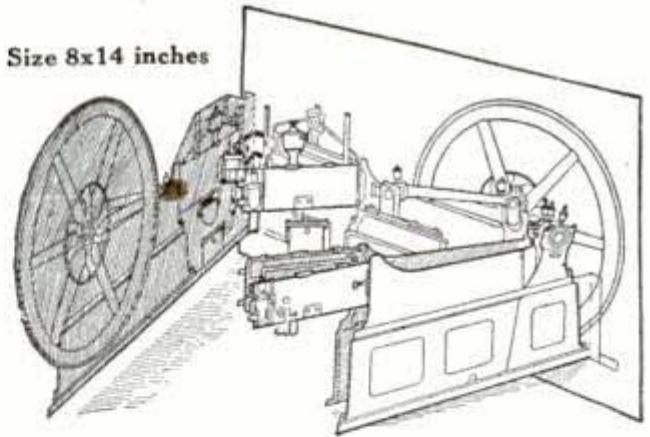
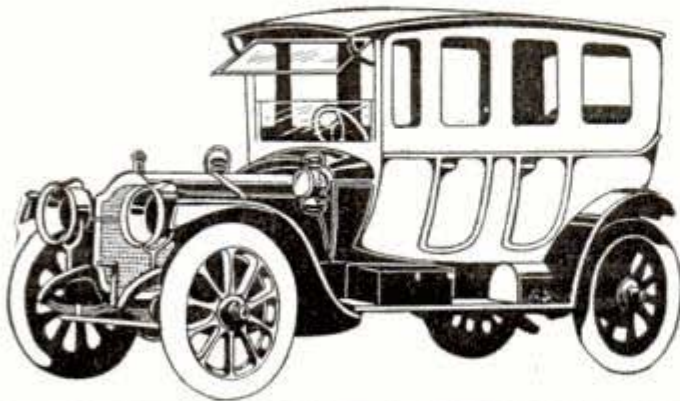

Illustration shows how parts separate



THE use of these models is without a doubt the most practical method of familiarizing one's self with these wonderful machines. In fact, one can learn the construction and working principles better with the models than with the actual machines because with the former every inside part can be seen and studied—something impossible with the real thing itself unless it be taken entirely apart.

**Reduced Prices on Quantities
to Schools**

POPULAR MECHANICS BOOK DEPARTMENT

SOLE AGENTS

318 W. WASHINGTON STREET

CHICAGO



For Any \$5.00 Article

Pay 1½ Cents Per Day

You have no idea what beautiful things a little money can buy until you get our new Bargain Book.

There are over 3,000 new-style things for the home pictured in this one book. We bought them from hard-up makers. They are overstocks which someone had to sell. We got them at auction prices. We sell them by mail for as low as half what the same things cost in stores. In this book there are:

Chairs as low as 63c.

Stoves as low as 89c.

Tables for \$1.45 and up.

Lace Curtains at 69c per pair.

So on with 3,000 beautiful things. Every price that we quote will amaze you.

Pay With Pennies

Ask us to mail this book. If you see something you want in it, have it sent on approval. Keep it a month before deciding to buy. If you wish to return it, we'll pay freight both ways.

Any furnishings you keep will be charged to your

account. You can pay as convenient—a little each month. On a \$5 article pay 1½ cents per day. On the average purchase we allow a year to pay.

We ask for no mortgage, no form of security. There is no interest, no publicity, no red tape. There is no extra price. We simply ship the goods on an open account. We have done this for 46 years. We have accounts now with over one million people. If you want such an account you have simply to ask it. We gladly trust people who buy things for their homes.

New Bargain Book

Our greatest Bargain Book has just come from the presses. It shows the thousands of things which we picked up in midsummer—in the dullest summer known in years. It will show you what sacrifices factories made to get rid of surplus stocks. Every page shows beautiful things at the lowest prices ever quoted.

You should see this book, for there is nothing else like it. The book is entirely free. Simply cut out this coupon, fill it out and mail it to us today. The mammoth book will then be mailed at once. Act now, else you may forget it. (153)

3,029 Bargains On Credit

Furniture
Carpets
Rugs
Draperies
Stoves
Lamps

Silverware
Chinaware
Washing Machines
Sewing Machines
Kitchen Cabinets
Baby Cabs, etc.

Our Bargain Book is enormous—pages 11x17 inches. The pictures are big, and many are in actual colors. The pictures shown here are simply small reproductions.

SPIEGEL, MAY, STERN CO.

1647 35th St., Chicago

Mail me new Bargain Book.

Mail me Offers on Stoves.

Name _____

Street _____

Town _____

State _____

Spiegel, May, Stern Co., 1647 35th St., Chicago

Railroad Men Wanted Quick \$80 to \$185 a Month



Write for our legal binding bond to place graduates in position sure if 20 to 35 years of age and mentally and physically O. K. We can quickly fit you for a big paying position no matter where you live, in your spare time at home. Learn from practical Railroad men. This is the school endorsed by R. R. Managers. Write now.

OFFICIAL RY. SCHOOL, Gen. Office 500, Freeport, Ill.

\$18 to \$30 a Week Sure

Farmers "Ever Ready" Tool Kit does it

Agents going wild over results M. Snyder made \$46 in 2 hours Joseph Pine took 65 orders in 2 days. M. D. Finch sold 42 in 9 hours. Had no experience. You can do it. To show it means a sale. FREE SAMPLE to workers.

FOOTE MANUFACTURING CO., Dept. 260, Dayton, O.





The smoothest thing in life
is "Velvet."



"Velvet"—one splendid pipe tobacco, so-called because of its unusual smoothness. It's Burley leaf—"special selection"—that's some! Two years of aging—hanging while time mellowed it—and the harshness, the bite, disappeared—goodness was left—Velvet. Velvet can be smoked all day and won't disagree—good taste—fine fragrance. Make a special trip to the ship—Velvet. 10c at all dealers.

Velvet should be on every dealer's shelf—IF OUT, send us 10c. for the regular tin—sent only in United States.

SPAULDING & MERRICK
Chicago, Ill.



Use KEROSENE Engine FREE!

Amazing "DETROIT" Kerosene Engine shipped on 15 days' FREE Trial, proves kerosene cheapest, safest, most powerful fuel. If satisfied, pay lowest price ever given on reliable farm engine; if not, pay nothing.

Gasoline Going Up!

Automobile owners are burning up so much gasoline that the world's supply is running short. Gasoline is 9c to 15c higher than coal oil. Still going up. Two pints of coal oil do work of three pints gasoline. No waste, no evaporation, no explosion from coal oil.

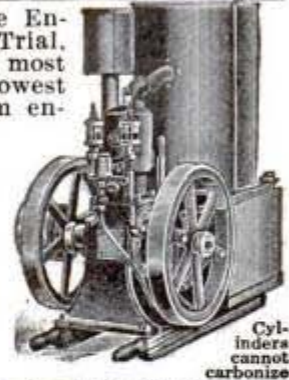

Amazing "DETROIT"

The "DETROIT" is the only engine that handles coal oil successfully; uses alcohol, gasoline and benzine, too. Starts without cranking. Basic patent—only three moving parts—no cams—no sprockets—no gears—no valves—the utmost in simplicity, power and strength. Mounted on skids. All sizes, 2 to 20 h.p., in stock ready to ship. Complete engine tested just before crating. Comes all ready to run. Pumps, saws, threshes, churns, separates milk, grinds feed, shells corn, runs home electric-lighting plant. Prices (stripped), \$29.50 up.

Sent any place on 15 days' Free Trial. Don't buy an engine till you investigate amazing, money-saving, power-saving "DETROIT." Thousands in use. Costs only postal to find out. If you are first in your neighborhood to write, we will allow you Special Extra-Low Introductory price. Write!

DETROIT ENGINE WORKS, 213 Bellevue Ave., DETROIT, MICH.

1 1/2 H.P. Kerosene or Gasoline Engine \$49.50

4 and 6 h. p. sizes at proportionate prices. Runs farm machinery, pumps, separators, saws, water systems, electric light outfits, etc. Very simple. A woman or boy can operate it. Uses little fuel. Absolutely guaranteed. Write for catalog and 30 day trial offer.

GRAY MOTOR CO.

1032 U. S. Motors Bldg., Detroit, Mich.



GOFF'S Prize Winning Model Aeroplanes

Best and Go Farthest

Our RED WING model is the speediest Flyer made. One customer writes: "Your RED WING model 'B' is a remarkable Flyer, its maneuvering in a wind being wonderful." Our machines are not mere toys, but are built on scientific lines of the finest material and workmanship. Large, powerful motor and propeller, made to stand rough usage. Size of machine 16 in. wide by 18 in. long, no parts to put together, every machine guaranteed to fly 125 feet. (Simple directions sent with each outfit as well as a blue print 18 1-2" x 26 1-2" of Blériot Monoplane FREE.) Sent by prepaid express on receipt of \$1.00.

WRITE FOR CATALOG

Goff Aeroplane Co., 219 S. Dearborn St., Chicago

Ann Arbor "INSTANTO"



Change from a 150 candlepower light to 2 candlepower in a jiffy. This latest and most perfect development of the gasoline lamp found only in Ann Arbor Lighting Systems. It gives the country home a lighting system as perfect, handsome and modern as city gas. Ann Arbor Lighting Systems are brighter than gas, steadier and clearer than electric light, and cost about one-tenth as much to operate. Each lamp gives 150 to 500 candlepower for less than 1/2 cent per hour. Fuel is gasoline; perfectly safe.

We make Complete Lighting Systems for Homes, Churches, Stores, Etc.

Price, \$10 up, according to number of lamps desired.

We Want Agents who will push our line. A splendid opportunity right now for hustling agents in large cities to sell to owners of summer cottages, country homes and resorts. No other light can equal it in brilliancy, beauty of fixtures and economy. Sells on sight. Catalog and prices on request.

SUPERIOR MANUFACTURING COMPANY, 294 Second St., ANN ARBOR, MICH.

THE WIZARD LIGHT



**THE INSTANTANEOUS SYSTEM
REQUIRES NO GENERATION
WHEN YOU WANT LIGHT
JUST PULL THE CHAIN**

**WIZARD
FOUR MANTLE ARC**

**THE "QUICKLIT"
No 30
LIGHTS WITH A MATCH
AS CONVENIENT AS CITY GAS**

THESE latest inventions represent the acme of perfection in artificial lighting. After once installed the instantaneous system requires no generation and can be operated as conveniently as electricity at one-tenth the cost.

The Quicklit Systems are operated as conveniently as city gas, as lamps are lit with an ordinary match.

All our lighting systems represent the highest standard of quality and are fully guaranteed. They are so simple that any one can operate same.

For further particulars and exclusive agency address
THE NAGEL-CHASE MFG. CO., 153 West Ohio St., Chicago, Ill.

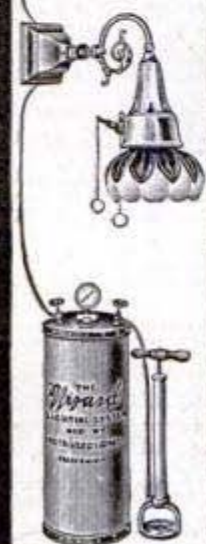

TABLE LAMP

I H C Gasoline Engines

Small Power at Small Cost



The I H C line is complete—a style and size for every need. 1 to 50-horse power; stationary or portable; horizontal or vertical; air or water-cooled; also gasoline traction engine 12 to 45-H. P.

Write at once for catalogue

This famous one-horse power, hopper-cooled I H C gasoline engine when belted to a pump jack will supply all the water needed on an ordinary suburban country home, or farm. It will also operate the cream separator, grindstone, bone cutter, saw, washing machine, etc. And in the shop, it operates the lathe,

drill, presses, emery wheels, grinders, and other small machines. This little worker is surprisingly powerful for its size and operates at very small cost. Equipped with governor, etc., same as our large engine. Wait till you get all the facts about I H C gasoline engines before you decide. Address

International Harvester Company of America

(Incorporated)

16 Harvester Building

Chicago U S A

\$10⁰⁰ AND UP

FLOOR your new home or re-floor your old one with hardwood at \$10 and up per room, by the Colonial Method and save from \$15 to \$20 per room.

Colonial HARD WOOD Floors

are of best, standard quality Oak and Satin Walnut, steam kiln dried to prevent shrinking and accurately milled. Used over old floors or in new buildings, they add tone to any property and dollars to its selling or renting value. Simple, sanitary and ornamental. Colonial Hardwood Floors represent the least cost of re-furnishing rooms, and beautiful rugs cannot be properly displayed without them.

Simple and Economical

Installation simple and maintenance economical. Old floors or other woodwork need not be removed. An ordinary carpenter or anyone handy with tools can do the work. Suitable designs for irregularly shaped rooms furnished free.

Materials sold FREIGHT PREPAID; safe delivery guaranteed; money refunded if not satisfactory.

Write today for free samples of material and descriptive booklet, all sent prepaid.

THE COLONIAL HARDWOOD FLOOR CO.
42 Park Place, Cincinnati, O.

Snappy, Stylish Suit

To Your \$12.⁰⁰ Measure



A suit that your tailor would ask \$25 or \$30 for. We deal direct with the consumer—no middlemen's profit to pay. You can wear tailor-made garments at less than ready-made prices. We make you a stylish, perfect fitting, better wearing suit than you can possibly buy from your local tailor or dealer, **and save you money.**

We make suits and overcoats to order for \$12 to \$24 and prepay express.

We Send You Our Style Book and Samples Free

Make your selection from our Style Book, which contains cloth samples of the latest weaves and designs for fall and winter wear, also fashion plates showing the swellest, classiest, snappiest styles ever created. It is absolutely free. Send for it today.

There is positively **no chance for a mistake** with our simple, yet perfect, system of home measurement.

Remember, we aim to please every customer. We have been making honest tailored clothes at rock-bottom prices for the **last 15 years.** The Illinois Trust and Savings Bank of Chicago will tell you that we are responsible.

MADISON TAILORS
250 Central Union Block - Chicago, Ill.

FOR SALE One each—one, two, and four cylinder 4 1/2 x 5

SHEFFIELD MARINE FOUR CYCLE ENGINES

Never been used. At a sacrifice for immediate sale.

FULL DESCRIPTION ON REQUEST

E. H. ALLEN, 3620 Michigan Ave., Chicago, Ill.



Front View

ARE YOU ROUND SHOULDERED?

"Nulife" straightens and squares your shoulders instantly. It compels you to stand, sit and walk correctly. Makes you breathe properly at all times. Expands your chest from one to three inches. Reduces your abdomen to the proper proportions. Fills out the hollows around the neck, strengthens the back and supports the spine; gives the person who wears it a commanding appearance. "Nulife" is worn by men, women and children. It is sold throughout the United States and Canada at \$3.00. For a limited time I will send "Nulife" to the readers of POPULAR MECHANICS MAGAZINE for \$2.00 postpaid. When ordering send your proper height, weight and chest measurement. Illustrated booklet on "Nulife" sent free upon request.

PROF. ANTHONY BARKER, 649 Barker Bldg., 110 W. 42nd St., New York, N. Y.



Back View

AGENTS

BEACON LAMP BURNER FREE

Incandescence. 100 Candle Power. Burns common coal oil. Gives better light than gas, electricity or six ordinary lamps at one-sixth to one-tenth the cost. Fits your old lamp Unequaled for fine sewing or reading.

COSTS ONLY ONE CENT FOR SIX HOURS

We want one person in each locality to whom we can refer new customers. Take advantage of our special offer to secure a Beacon Burner FREE. Write today. Agents Wanted. **HOME SUPPLY CO.**
248 E. C. Life Bldg., Kansas City, Mo.

WANTED



Health

"Fat, oil, butter, cream and eggs certainly caused my catarrh and deafness, but your diet of lean meats, green vegetables, fruits, etc. cured me in a few weeks. My brain power and complexion improved tremendously, and I succeeded financially." . . . Different classes of foods cause different diseases, but correct combinations cure.

Send ten cents for instructive booklets: (1) The Brainy Diet Cure, (2) Diet vs. Drugs, (3) Effects of Foods, (4) Key to Longevity.
G. H. Brinkler, Food Expert, Dept. 16, Washington, D. C.



Bernarr Macfadden's Physical Culture Course — FREE

In order to quickly secure new subscribers to the Physical Culture Magazine

We're going to give away a complete course in physical culture, personally prepared by Mr. Macfadden, to every person sending us \$1.00 for an eight months' subscription.

If we were to market this course for profit we could not offer it at a cent less than \$15.00

We feel certain you'll become a regular subscriber when you have read PHYSICAL CULTURE for eight months. It's the most needed periodical in the field of literature because it teaches you how to be well. It will save you many dollars in doctor bills if you heed the advice it contains. Not alone the most valuable magazine published but one of the most interesting.

Just enclose \$1.00 and say, "Send me that free course and enter my name for an eight months' subscription to PHYSICAL CULTURE." Your money back any time you're not satisfied.

PHYSICAL CULTURE PUBLISHING CO., 410 Flatiron Bldg., New York

MAKES A PHONOGRAPH SOUND LIFE-LIKE

THE Morse Clarifier is a remarkable little device made to fit in tube between reproducer and horn of phonographs. It renders the sound loud, clear and life-like and eliminates that unpleasant metallic effect which is more or less common to all phonographs, regardless of price. Can be attached in a minute by anyone and lasts as long as the machine. Thoroughly tested and proven successful. **PAT. APPLIED FOR**

Mailed Prepaid upon Receipt of Price, \$1.00. Guaranteed Absolutely Satisfactory or Money Refunded.

In ordering please state whether for Victor, Victor-Victrola, Edison with rubber or metal connection, Columbia Disc or Columbia Cylinder.

Information and circular matter free.

MORSE BROTHERS, Manufacturers and Distributors
450 Lumber Exchange, Minneapolis, Minn.



FAMOUS MICHIGAN SPEED WHEELS REVERSE GEARS & MARINE HARDWARE



MOTOR

BOAT MEN

Send for our large catalog of valuable information on speed wheels, reverse gears and marine hardware. Everything new and up-to-date.

Prices Right, Satisfaction Guaranteed
We carry an immense stock and can make you prompt shipments and save you money. Send for our free catalog today
MICHIGAN WHEEL COMPANY
565 Canal Street, GRAND RAPIDS, MICHIGAN



Solar Motorcycle Lamps

are the neatest looking, strongest and most efficient lamps made. The product of light specialists, makers of 90% of the automobile lamps used on the high grade cars of America. Catalog shows many styles — gas, oil and electric. Write for it today.

BADGER BRASS MFG. CO.

Kenosha, Wis. New York City, N. Y.

WINDOW TRIMMING

Advertising and Card Writing are the best paid professions in the world. Interesting prospectus FREE tells you all about it.
KOESTER SCHOOL, 306 Jackson Boulevard, CHICAGO

BE AN ELECTRIC METERMAN

Hundreds of new positions created yearly. Instruments and Meters are used wherever Electricity is used. Trained men must maintain them.

Metermen Earn \$900-\$1800 a Year

Our Course will fit you for a position. Practical—easy to learn—recommended by leading electrical men. Write to-day for free booklet—learn how we assist our graduates.

FORT WAYNE CORRESPONDENCE SCHOOL
911 Shoaff Bldg Fort Wayne, Ind.

DIAMONDS ON CREDIT

This Diamond Ring is our great special. Only the finest quality pure white diamonds, perfect in cut and full of fiery brilliancy are used. Each diamond is skillfully mounted in our famous Loftis "Perfection" 6-prong ring mounting, which possesses every line of delicate grace and beauty.

L-1220—Specially selected fine brilliant white Diamond **\$25** \$5 down, \$2.50 a month

"PERFECTION" DIAMOND RINGS

L-1221—Specially selected brilliant white Diamond **\$50** \$10 down, \$5 a month.

L-1223—Specially selected brilliant white Diamond **\$100** \$20 down, \$10 a month.

The three rings here shown are the most popular, although we show all sizes in our large, handsome Catalog. Each ring is solid 14 karat gold, and is cased in a dark blue velvet ring box with white satin lining.

An Ideal Gift

Ask us to send you a Ring on approval. It will be sent at once, all charges prepaid. If you are not perfectly satisfied, return it at our expense.

Write for our Free Catalog containing over 2,000 illustrations of Diamonds, Watches, Jewelry, Silverware, etc. It tells all about our easy credit plan. Write today.

LOFTIS BROS. & CO., Diamond Cutters,
Dept. E 894, 100 to 108 N. State St., CHICAGO, ILL.
Branch Stores: Pittsburg, Pa., and St. Louis, Mo.

ALL-METAL SELF-CLEANSING

Electric Washer

And WRINGER Complete for

\$65

Positive Drive—No Springs to break. Will wash any washable fabric clean, quickly at trifling cost. Will save its cost in 8 months in wear and tear of clothes alone, to say nothing of time, money and hard work. We will ship to you direct anywhere in the United States. A year's guarantee goes with every Washer sold.



Send for folder
Domestic Equipment Co., Dept. P. M., 30 W. Lake St., Chicago

Earn \$60 to \$100 a Month



OUR BOOK FREE

Fill in the coupon, cut it out and send it at once for our Free Book, "Great Opportunities in Electric Railway Work."

NATIONAL RAILWAY TRAINING ASSOCIATION
Suite 7, Dwight Building Kansas City, Mo.

Men 20 to 40 Years Old Wanted at Once for Electric Railway Motormen and Conductors

Our mail course will prepare you for Motorman or Conductor in four to six weeks, and we will immediately assist you to a good paying position. You will be independent; your services will be in demand; good Motormen and Conductors are needed everywhere. We place men on city and interurban lines in all parts of the country, and want men in every state.

RIGHT NOW IS YOUR OPPORTUNITY!

Name _____ P.O. _____ State _____ Age _____

WIN THIS \$1200!

Thousands Already Won—Going on Daily

TEN PEOPLE GET \$40,000

They Tell You How to Win

LISTEN! Stoneman (Nebr., photographer) actually received \$1200 one month, \$51.50 in 15 minutes, \$800 in 11 days; Korstad (Minn., solicitor) \$2212 in 2 weeks; Sevegne (N. Y., telegrapher) \$100 daily. Not a fairy tale, fake or humbug, but proven absolutely true by sworn statements, Government patronage, statesmen, judges, bankers, world's famed institutions, local references. Costs nothing to investigate. This gigantic money-making contest no longer controlled by a few—now open to any honest industrious man or woman. Big money made by mechanics, clerks, farmers, teachers, doctors, lawyers, people from all walks of life. Experience, capital, business training unnecessary. You can own, operate and control same private enterprise that brought Wilson (banker) \$3,000 in 30 days; Rasp (agent) \$1685 in 73 days; Oviatt (minister) \$4,000; Rogers (surveyor) \$2800; Juell (clerk) \$6800; Hoard (doctor) \$2200; Hart (farmer) \$5000; Schleicher (minister) \$195 first 12 hours. Hundreds sharing similar prosperity—banking money, buying homes, automobiles. Don't wonder. Same appointment should mean same money for you—same power, prominence, dignity, respect, influence. Rise to big earnings, wage freedom, ownership, and private monopoly. Knowing the reason dispels all doubt. Wonderful, but true. Strange invention gives every home a bath room for only \$6.50; excels



M. Stoneman



M. Juell

others costing \$200. Abolishes tubs, bowls, buckets, wash rags, sponges. Turns any room into a bath room with hot or cold running water. Think of it! So energizes water, one gallon ample; cleanses almost automatically; no plumbing; no water-works; self-heating. Gives cleansing, friction, massage and shower baths. So simple child can operate. Truly marvelous. A modern home-bathing without drudgery, inconvenience, muss of lugging water, filling tubs, emptying, cleaning, putting away. Could anything be more popular? Think of millions who want bathrooms! At sight people exclaim: "There, there, that's what I've been longing for." Little wonder Wilson sold 102 in 14 days; Hart, 16 in 3 hours. Think what you could do. Come—fall in line—make a fortune. Don't let another get there first. Your chance now to secure exclusive sale. Devote all or spare time. Means phenomenal earnings; no competition; fascinating, high-grade business.



"SEE IT ENERGIZE"



Credit given active distributors. Send no money—investigate first. Send to-day for remarkable offer—it's valuable but free. Address

ALLEN MFG. CO., 3382 Allen Building, TOLEDO, OHIO

Best Turkish Bath At Home 2c



Just flush out the three million pores in your body with the "Robinson" Thermal Bath. It takes only 15 minutes. Costs only two cents. Relieves La Grippe, Bad Colds, Rheumatism, Dyspepsia, Skin Diseases. Our Big #2 Book Free for a few days only.

Robinson Mfg. Co., 172 Snowflake Bldg., Toledo, O.

4 Inch Hand Machine

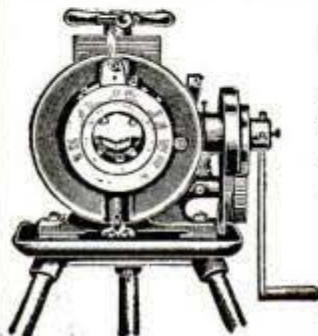

Combined Cutting and Threading Pipe Machine complete with Vise and Stand.

Get Price and Catalog

THE OSTER MFG. CO.

2100 East 61st St., CLEVELAND, OHIO

Sandow \$37⁵⁰ 2½ H. P. Stationary Engine—Complete

Gives ample power for all farm uses. Only three moving parts—no cams, no gears, no valves—can't get out of order. Perfect governor—ideal cooling system. Uses kerosene (coal oil), gasoline, alcohol, distillate or gas. Sold on 15 days' trial. **YOUR MONEY BACK IF YOU ARE NOT SATISFIED.**

5 year ironclad guarantee. Sizes 2½ to 20 H. P., at proportionate prices, in stock, ready to ship. Postal brings full particulars free. Write for proposition on first engine in your locality. (116)

DETROIT MOTOR CAR SUPPLY CO., 2 Canton Av.,



Only \$14.50

For this Home Bench

Besides its convenience and usefulness, you will save its price in a year

by doing repair work and "fixing things" that you now pay a carpenter or repair man to do. Thousands of homes have home benches we have furnished—why not you?

Top is 50 in. long, 20 in. wide, with a 13-inch glued-up portion of thick maple

Grand Rapids Hand Screw Co.
620 N. Front St. GRAND RAPIDS, MICH.

FOR MENDING HARNESS



shoes, tents, awnings, pulley belts, carpets, saddles, suit cases, buggy tops, dash boards, or any heavy material. **Stewart's Automatic Awl** is the only perfect Sewing Awl.

It takes a wax thread, feeds from spool and does the work of any harness maker machine. It is indispensable for farmers. Agents wanted. Sent prepaid for \$1.25. Send at once for catalog.

STEWART-SKINNER CO.
26 Hermon Street
Worcester, Mass.

3 BEAUTY POSES 25c.

Decorate your "Den" with "Art Gems"

Exquisite portrayals of female loveliness. 3 bewitching poses 25c; 6 for 50c. One 6½x8½ photograph free with every order for six.

Our Dollar Special: Two 6½x8½ photographs, 6 cabinet size and 32 small photos, all for \$1.

Our pictures are all real photographs. No reproductions of paintings or other cheap trash. Money back if not pleased.

ART PHOTO CO., 2010 P. M., Grand Rapids, Mich.



NO MORE BALD HEADS



When our VACUUM CAP is used a few minutes daily. We accept no pay until you have tried the Cap 60 days and are satisfied. The Vacuum Cap is an appliance that draws the blood to the Hair Roots and starts a new healthy crop of hair. It stops Dandruff, stops the hair from falling out. Bought by Doctors and men who

know that it is the only reasonable HAIR GROWER known to science. No Drugs Used. Write for application blank, testimonials, and booklet on "HAIR," sent sealed in plain envelope, FREE.

THE MODERN VACUUM CAP CO.

A. 559 BARCLAY, DENVER, COLO.

CONGRESS CARDS

For Social Play - Art Backs - Exquisite Colors - High Quality.
New Designs - Club Indexes - Ideal for Bridge.
Gold Edges - Air-Cushion or Ivory Finish.

OFFICIAL RULES OF CARD GAMES - HOYLE UP-TO-DATE

ISSUED YEARLY - SENT FOR 15 CENTS IN STAMPS.
THE U. S. PLAYING CARD CO., CINCINNATI, U. S. A.



BICYCLE CARDS

In Use Throughout the World for General Play
The Most Durable 25 Cent Card Made.
Club Indexes - Air-Cushion or Ivory Finish.



The Little Friend of the Deaf



Actual Size

This ad is to deaf people who have about given up—who are failing in hope and in courage—people who think their cases unlike other cases which have been relieved. We don't want any money. Just send for a book that tells about "Wireless Telephones for the Ears"—little devices that 390,000 deaf people are using today because they HEAR with them. Think of it, men and women; these tiny wonders are so small that they fit in the ears out of sight and so soft that you never feel them, even when lying down! *Yet you hear whispers!* Is your case beyond such simplicity? Not a bit of it. One of the officers of this company is a deaf man. He became desperate, and in desperation developed this marvelous ear drum. It is one of the inventions of Mother Necessity—an *inspiration*. Talk to him today. You'd never even suspect his affliction. He's been improving this tiny "phone" for 20 years. There is nothing else to compare with it—anywhere. Don't you want the book he has written about it—a book by a man who understands deaf people because he is one of them? You do, if you want to improve your hearing. Just say, "Send the book," on a post card, and mail it to WILSON EAR DRUM CO., 144 Todd Bldg., Louisville, Ky. (17)

Fairbanks-Morse Eclipse Pumper

This shows The Eclipse Pumper attached to an ordinary windmill pump. (The pump is not included with the engine)



A high grade Pumping Engine at the **\$50.00** Low Price of

Plus the freight from factory, Beloit, Wis. Buy One Now

It is a Four Cycle Water Cooled Gasoline Engine and Pump Jack ready to attach to any pump.

A reliable engine, so simple a child can start it.

Will pump 200 to 2000 gallons per hour depending on size and type of pump and lift.

Engine has two belt pulleys at different speeds for driving cream separator, churn, grind stone, etc.

Catalog shows how to attach to other pumps and farm machines.

Send for Free Catalog No. MZ 449.

Fairbanks, Morse & Co.
Wabash Ave. and Eldredge Place Chicago

Let the Slide Rule Do Your Work—Do Your Work

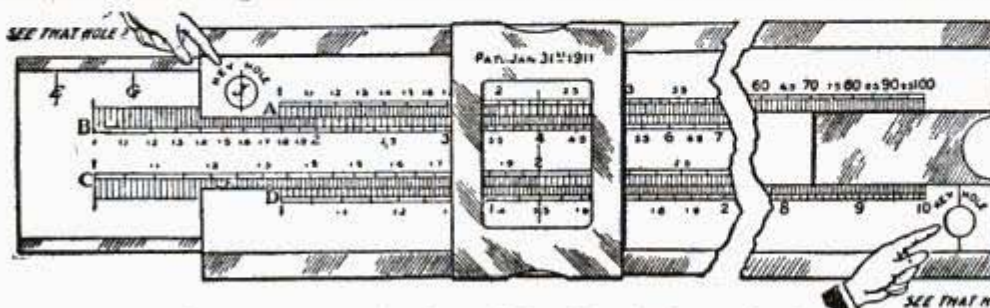

Engineers, Electricians, Draftsmen, Superintendents, Managers, Master Mechanics, Estimators and Business Men:

Your Time is too valuable to waste in solving problems or checking over the work of others the old way. The Richardson Slide Rule will do it mechanically. One of the most valuable instruments ever offered to mankind is the Slide Rule. Not until the above rule was designed did it become possible for a person of a limited education to learn to operate it.

Besides, the usual price has been reduced one-half, and the free instruction book is "written so you can understand it." This Slide Rule will multiply, divide, solve proportion, extract the square and cube roots, find the decimal equivalent of vulgar fractions or "vice versa," calculate interest, percentage. In addition to above the rule is direct reading for forty-four other problems, such as the Horse Power of Engines, Pumps, Boilers, Belts, Water Falls; size of motor to run a pump; size of duct for ventilating; percentage a recording wattmeter is "Slow" or "Fast"; radiation and size grate, and steam main required; chain gear and pulley problems; areas, circumference and diameter of circles. You simply place the key to the problem in the key hole (the key is printed in red) and answer is given direct. This rule is my latest improved type now being placed upon the market for the first time. "See sectional cut" curved slide bound with aluminum. No other like it. Good value. Price \$2.50 with substantial pocket case and instruction book. Stock aluminum 11x1 5-8 inches with runner. Scales celluloid printed and polished in two colors and washable. A limited number of new, but older pattern rules at \$1.00 each.

GEO. W. RICHARDSON, Mechanical and Electrical Engineer, Ex. Chief Electrician, U. S. Navy, 4218-24th Place, CHICAGO, ILL.

Amateur Mechanics ^{No. 3}

PRICE 25¢



A BOOK FOR THOSE WHO LIKE TO MAKE THINGS

THE LATEST of our books for those who like to make things

Amateur Mechanics No. 3

“Written So You Can Understand It”

A thorough, practical book containing 200 articles which tell how to make scores of appliances of daily use about the house; various amusement devices; simple electrical apparatus; novelties; tricks; magic; puzzles, etc. The following are typical articles:

Driving a Washing Machine with Motorcycle Power—Campers' Appliances—Workbench for the Amateur—Home-Made Vise—Revolving Christmas Tree—How to Cane Chairs—Home-Made Electric Clock—Outdoor Gymnasium—Bent Iron Work.

128 Pages PRICE 25c POSTPAID 194 Illustrations

THE OTHERS IN THIS SERIES ARE:

- Amateur Mechanics No. 1** — 174 Articles
165 Illustrations
- Amateur Mechanics No. 2** — 193 Articles
196 Illustrations
- Mechanics for Young America** — 150 Articles
196 Illustrations

Each of these books contain different matter, yet all are along the same interesting, practical lines. They should be in every American home. **Price 25 Cents Each, Postpaid**

AMATEUR MECHANICS

A BOOK for OLD and YOUNG who like to make things

WRITTEN SO YOU CAN UNDERSTAND IT

Reprinted from POPULAR MECHANICS

No. 1

CHICAGO POPULAR MECHANICS COPYRIGHTED

AMATEUR MECHANICS

A BOOK for OLD and YOUNG who like to make things

WRITTEN SO YOU CAN UNDERSTAND IT

Reprinted from POPULAR MECHANICS

No. 2

CHICAGO POPULAR MECHANICS COPYRIGHTED

Mechanics for Young America

A Book for Boys

How to Build

BOATS, WATER MOTORS, WIND MILLS, SEARCHLIGHT, ELECTRIC BURGLAR ALARM, ICE BOAT, WATER BICYCLE, CABINS, CAMPS, CLOCKS, FISHING TACKLE, KITES, IMITATION STREET CAR LINE, ETC.

The Directions are Plain and Complete

COPYRIGHT POPULAR MECHANICS CHICAGO

PRICE 25 CENTS

FOR SALE BY ALL NEWSDEALERS, OR

POPULAR MECHANICS BOOK DEPT., Publishers, CHICAGO



This is the only boat powered by a

Scripps Motor

entered in the recent Scripps Reliability Cruise

The Sea Wolf with her 60 H. P. six-cylinder Scripps Motor, was one of the four boats that came through the exacting test with a perfect score, after eight days of strenuous running through all kinds of weather.

The Motor of the Sea Wolf had two seasons of hard, continuous service before entering this contest. No repairs were made, and as the Sea Wolf was not entered until the day before the start of the cruise, no opportunity was afforded to even overhaul the engine.

There is something significant to the man who is looking for a motor that combines power with reliability, in the consistent way in which the Scripps motor acquits itself so well in the many events in which it is entered.

Write for catalog today, also a copy of our latest book, "THE STORY OF THE SCRIPPS CRUISE"

SCRIPPS MOTOR COMPANY

650
Lincoln
Ave.

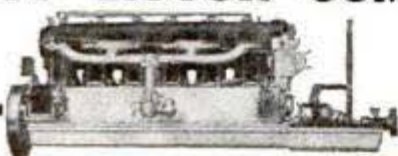

Detroit,
Michigan



Amazing Profits In Mushrooms

Anybody can add \$8 to \$40 per week to their income, in spare time, entire year growing mushrooms in cellars, sheds, barns, boxes, etc. I tell you where to sell, at highest prices.

Free Illustrated Instruction Booklet

HIRAM BARTON

Desk 2, 329 W. 48th St., New York

It is Made
From
Nickel

NICKELITE

It
Nickel
Plates

The new synthetic substance for nickel plating metals by hand. By merely rubbing NICKELITE on the metallic surface to be plated, with a wet rag, a durable coat of nickel is quickly deposited on the metal. The process is Electrolytic, but no apparatus of any kind is required.

Price, 25 cents per box

Supplied by your dealer or will be sent postpaid direct from manufacturer upon receipt of price.

GORMAN MANUFACTURING COMPANY, HAZLETON, PA.



REGISTERED

"Ohio" Tools

Insist on them—it will pay you.

Carefully made from specially selected steel—fully warranted.

Write for complete catalog of



"Ohio" Planes,
Chisels, Drawing
Knives, Auger Bits,
Screw Drivers, etc.

**OHIO TOOL CO., DEPARTMENT 3
COLUMBUS, O.**



This Edison

Fireside Model
Phonograph

Shipped FREE!

Read This Great
NEW Offer



Thomas A Edison

Shipped FREE!

The latest and greatest offer on the Genuine Edison. This offer is for every one who has not yet heard our Edison in his own home—for you to hear concerts and entertainments by the world-famous musicians—just such entertainments as the metropolitan theaters are producing.

MY OFFER

I will send you this Genuine Edison Fireside Outfit (newest model) complete with 1 dozen Edison Gold Moulded and Amberol Records, for an absolutely Free Loan. I don't ask any money down or in advance. There are no C. O. D. shipments; no leases or mortgages—absolutely nothing but a plain out-and-out offer to ship you this phonograph together with a dozen records of your own selection on a free trial so that you can hear it and play it in your own home.

Why I Want to Lend You This Phonograph

I know that there are thousands of people who have never heard the Genuine Edison Phonograph. Now, there's only one way to convince people that the Edison is superior, and that is to let them actually see and hear this remarkable instrument for themselves. **That is why I am making this offer.** The only way to make you actually realize the value of yourself is to loan you a Genuine Edison Phonograph free and let you try it.

All You Need Do

All I ask you to do is to invite as many as possible of your friends to hear this wonderful Fireside Edison. I feel absolutely certain that out of the number of your friends who will hear your machine there will be at least one and probably more who will want an Edison of his own. If there isn't (and this sometimes happens) I won't blame you in the least. You won't be asked to act as our agent or even assist in the sale of a single instrument.

If You Want to Keep the Phonograph

that is if you wish to make the phonograph your own, you may do so. Either remit us the price in full, or if you prefer, we will allow you to pay for it on the easiest kind of payments.

Our Easy Payment Plan

Two dollars a month pays for an outfit. There is absolutely no lease or mortgage of any kind, no guarantee from a third party, no going before a notary, no publicity of any kind, and the payments are so very small, and our terms so liberal you never notice the payments.

FREE

Just sign this coupon now and mail it to us. I will send you our Edison Phonograph Catalog, the very latest list of Edison Gold Moulded and Amberol Records (1500 of them) and our Free Trial Certificate entitling you to this grand offer. Sign this coupon or send postal or letter now. No obligations—get catalog.

**F. K. BABSON
EDISON
PHONOGRAPH
DISTRIBUTERS
Dept. 1197**

**F. K. Babson,
EDISON PHONOGRAPH
DISTRIBUTERS**

Edison Block, Chicago, Ill.

**Edison Block, Dept.
1197 Chicago, Ill.**

Western Office: 65 Post
Street, San Francis-
co, California. Can-
adian Office: 355
Portage Ave.,
Winnipeg,
Canada.

Please send me, without any obligations, your New Edison Phonograph Catalog, list of Edison Gold Moulded and Amberol Records and Free Trial Certificate entitling me to your grand offer, all free.

Name

Address

Please Mention Popular Mechanics

TOO LATE TO CLASSIFY

WRITE US FOR ANY KIND of a sign, letters and figures. Wood, glass, metal and foil. Ask for (P. M.) printed matter. Albright Sign Co., Inc., Muncie, Ind.

SEND 25c for our latest bungalow book showing score of beautiful California homes with plans as we build them—direct from bungalow land. Home Seekers' Bldg. Corp., 703-705 Higgins Bldg., Los Angeles, Calif.

VALUABLE TRADE SECRETS: Get the information you've been searching for, in this vast collection of an experienced chemist's high-grade formulas. Many now made public for first time, as Cuban Cherry Phosphate, "Arc" Metal Polish, "Swiss" Maple Flavor, Junket and Orange ade powder, Chinese Universal Cement, Perfect Paint Remover, Massage Cream, Chewing Gums, Dusting Cloths (New Dustless), Hayes Famous Asthma Cure, Rag Gas Mantles, Butter Color, Bismuth Harmless Hair Dye, "Carbons" Dry Cleaner, and advertised specialties as Flexible Mirrors, Butter Merger, Cachoo Sneez Powder, Artificial Rubber, Etching Ink for marking steel and 3,217 other valuable recipes complete in two books and supplementary sheets, \$1.00. Liscomb Miller, Evak Chemical Company, Marietta, Georgia.

OUR SENSATIONAL BOOK "TYPEWRITER SECRETS" has stirred the typewriter world to a frenzy. It tells about the high prices on typewriters, the so called rebuilds and the value of second hands. Tells you how you can get a good standard Visible typewriter at a price never heard of before, how you can pay a little each month, how you can have it on trial without deposit. Just write "Send the Book;" it's free. It is wonderfully interesting even if you are not in the market. Typewriters Distributing Syndicate, 159 DD N. State St., Chicago.

LEARN FASHION ILLUSTRATING—"The Art That Pays." Personal instruction by Art Superintendent of large exclusive fashion house—Practical up-to-date training.—We show results in less than three months. Finished Fashion Artists earn from \$25.00 to \$125.00 per week. Write for particulars. The Fashion School of Illustrating, 231 N. Fifth Ave., Chicago, Ill.

TYPEWRITER BARGAINS: Practically new, very latest model back-spacer L C Smith Visible, half price. Fine Olivets, \$24. Chicago Visible, \$10. Get catalogue and bargain list. Minnesota Typewriter Exchange, Minneapolis, Minn.

8x10 PHOTOGRAPHIC ENLARGEMENTS 25c EACH, made from any size negative or film. All size 6 exposure Kodak films developed, 5c roll, 12 exposures, 10c roll. Send for price list and sample print. Scarlett Studios, 45-47 N. 13th St., Philadelphia, Pa.

PRACTICAL BUSINESS MEN are buying our co-operative mail order proposition. The price is \$450.00 and it will stand all the investigation you may wish to give it. A limited number can connect with us. Address, Providence Starch Company, Providence, R. I.

INCREASE YOUR BUSINESS AND DECREASE your expense by using the "Born Iceless Refrigerating system," for markets, creameries, hotels, etc.; better refrigeration, less cost; sales agents wanted. H. A. Born Co., Chicago, Ill.

BARGAIN GARAGE CLEANOUT SALE: Combination delivery and touring car, 20 H. P., \$375.00; High Wheel running gear and body with tires new, \$100.00; Double Cyl. Water cooled 20 H. P. Engine, \$60.00; Planetary Transmission, \$10.00; Double Coil, \$6.00; Schebler Carburetor, new, \$6.00; Pair front and rear axles with wheels and 5 good tires 3 in. by 28 in., \$75.00; Runabout, 20 H. P., \$175.00. O. L. Schaefer Auto Co., Milwaukee, Wis.

AMATEURS. CONGRESS MEETS REGULAR SESSION, December. Efforts control Wireless by new laws sure. Colleges and Clubs and individuals urged co-operate secure passage Roberts resolution. New movement. Amateurs only. No import company. Geo. Hiram Mann, 274 14th St., Portland, Oregon. After October 15th address 60 Wall St., New York.

FREE sample; free instructions for putting our new beauty gold sign letters on windows; big quick money. Eastern Specialty Co., 63 Barclay St., New York.

AGENTS WANTED to handle our lefthanded corkscrew. Turns the wrong way. Ask the man to open a bottle and give him the laugh. Sample 10c. 75c per dozen. Esandbee, 109 Broad St., N. Y.

AGENTS WANTED for our 25c darning machine; just out; weaves new heel or toe in sock in 5 minutes; no sewing machine required; works by hand; send 15c for sample or \$1.25 for dozen. R. W. Hutton Co., Dept. 2, Philadelphia, Pa.

AGENTS—Over 500% profit. Gold sign letters; sell everywhere; sample free. Johnston Co., Quincy, Ill.

400% PROFIT SELLING GORDON Photo Pillow Tops. High grade work. Samples and catalogue free. Luther Gordon Co., 164 Washington St., Chicago.

\$5 TO \$10 DAILY Selling Gem Camera Outfits. Picture complete in 2 minutes, \$1.00. Also other Novelties. Send 10c for our 25c "One Dip" Parisian Ivory Penholder and Reservoir, lasts a life time. Gem Supply Co., 200 Fifth Ave., N. Y.

HUSTLERS WANTED EVERYWHERE; \$25 to \$100 made weekly; particulars free; Curiosity Seekers don't write. Leonard Supply Co., Dept. A., Warren, Pa.

MAKE \$300 MONTHLY as Sales Agent for large Ohio manufacturer. No experience needed. Get the agency at once. W. E. Bryan & Co., Cincinnati, O.

EMBOSS YOUR STATIONERY with your initial, monogram or name and address. My Nickered steel-die embosser does it perfectly. High class useful irresistible novelty, nothing like it for the price. Initial 25c. Monogram 50c. Specimen sheets free. Harry L. Miller, Embosser, Marietta, Georgia.

BUILD YOUR OWN GASOLINE ENGINE from our castings and blue prints: 2 H. P. water cooled; 3 H. P. air cooled. 4 blue prints 12 in. by 18 in.—50c. A photo of either engine 10c, both 15c; prices or particulars free. If you make a purchase, will credit you. Vigneau Machine & Mfg. Co., Box 9, 236 E. Jefferson Ave., Detroit, Mich.

CASTINGS OR FINISHED PARTS for Commercial Motors 1-12 to 1-2 h.p. Dynamos 2 to 10 lights. Complete finished machines at low prices. Armature discs 2 to 6 in. diameter. Commutators 7-8 to 3 in. diameter, 12 to 48 bars. Two cent stamp for circular. F. E. Averill, 365 7th St., Buffalo, N. Y.

MID SEASON SALE of Auto and Marine Gasoline Engines at cut prices. Write us your wants. Richards Iron Works, Manitowoc, Wis.

AUTO ENGINE, 4 cylinder, 4 cycle, suited for automobile, truck, farm traction or boat. Never used. Bargain. Can furnish radiator. Photographs to interested persons. Detroit Motor Car Supply Company, Dept. 26, Detroit, Michigan.

2 H. P. EDDY ELECTRIC MOTOR, 22 volt direct current, perfect condition, \$47.00. Waldorf Motor & Machine Co., Bridgeport, Conn.

TWO CYCLE, TWO CYLINDER, 4x3 1/2 in. Marine and Automobile Gasoline Engines, at \$94.00 complete. Castings and drawings of same for sale. Richards Iron Works, Manitowoc, Wis.

FOR SALE—Alamo gasoline engine, 20 horse, fine condition, \$450. Stanley H. Abbot, Wilton, N. H.

ONE 1911 NEW ERA MOTORCYCLE, used very little, \$190. Parlor City Electric Co., 152 Court St., Binghamton, N. Y.

TOURING CAR, 7 passenger, 40 H. P., Continental motor magneto, bargain, \$400. E. Casey, Far Rockaway, N. Y.

BARGAINS IN AERO ENGINES of different sizes and types. Special light weight, 35-40 H. P. at \$128.00. Write us for list. American Specialty Mfg. Co., Manitowoc, Wis.

PARTNER WANTED to help construct Curtiss aeroplane and share in exhibition profits. Arthur Nichols, Chill, N. Y.

WE CAN FURNISH repair parts for Liberty Bicycles, all Models. Waldorf Motor & Machine Co., Bridgeport, Conn.

CURTISS AEROPLANE, \$250. Motor and lot supplies cheap. Box 105, Chill, N. Y.

100 LADIES' LIBERTY BICYCLES, fully equipped \$22.00. 50 Liberty Tandem Bicycles, \$38.00. Waldorf Motor & Machine Co., Bridgeport, Conn.

FOR SALE—Half or whole interest in valuable patent. For particulars, address Carl F. Kindahl, 24 Marlboro St., Belmont, Mass.

FOR SALE—Steel Athletic Apparatus. Fortune for Manufacturer with Capital. R. C. Bowden, Conway, Ark.

MONEY-MAKING FARMS throughout 15 states; great variety, size and price. Stock and tools included with many to settle estate quickly. Mammoth illustrated catalogue No. 34, free. E. A. Strout, Station 3043, 47 West 34th St., New York City.

A NUMBER of choice properties in California. Write for particulars to J. H. Behrens, Box 1304, Fresno, California.

3,200 ACRES, 800 in cultivation, balance Boisdarc timber, best in northeast Texas. Box 62, Annona, Texas.

FIFTY DIFFERENT YELLOWSTONE Park Postals, beautifully colored, fifty-five cents postpaid. Evans Curio Store, Livingston, Montana.

RUBBER GOODS, Imported Comic Novelties. Sample and price list 10c. Bayer, Folio Block, Burrows Ave., Winnipeg.

"RULES FOR YOUNG MUSICIANS," A little booklet sent postpaid for 12 cents. Address Francis Publishing Co., Revere, Mass., Dept. C.

ELLIS USE KEROSENE

Gasoline, Distillate—Any Fuel Oil
QUALITY FIRST
 Smooth running, steady, powerful, quiet. Ten exclusive features. Fine appearance. Finished seven coats of engine enamel. Greatest value in the engine world for the price. Number of 1912 exhibition engines ready now. Get one. Special price while they last.

FREE TRIAL
 No obligations till satisfied. 10-year guarantee. "Engine Facts" free; write for it NOW.

ELLIS ENGINE CO.
 39 Mullett Street, DETROIT, MICH.

WE PAY THE FREIGHT

3-12^h.

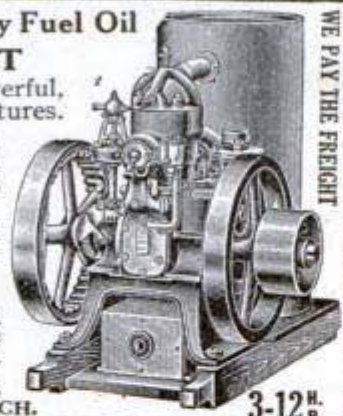

THE RAPID FLOOR SCRAPER

scrapes more hard or soft wood floor with one man than 3 men do by hand.

Send for Catalogs and **FREE TRIAL offer**

Monarch Mixers Concrete Machinery Coal Chutes are low priced.

MONARCH MFG. CO.
 5010 Shepard Bld.
 GRAND RAPIDS, MICH.



Get This Power Boat at Maker's Prices

BUY DIRECT FROM MANUFACTURER AND SAVE DEALERS' PROFITS

This Toppan Power Dory as illustrated above is made of best guaranteed materials and is the standard rough water boat of the world. Safe and reliable—used by U. S. Government in all departments. Send 4c in stamps for catalogue. Ask for prices and facts about Toppan Reversible Motors, built with 2, 3, 5, 8 and 12 Horse Power—and if you want to build your own dory, saving exactly HALF, ask for **TOPPAN BOAT MFG. CO. FREE KNOCK-DOWN BOAT QUOTATIONS.** 3 Haverhill St. BOSTON, MASS.



AGENTS

Make \$30 Per Wk.
 This AWL sews a lock stitch like a machine. Best thing ever made for repairing Harness, Shoes, etc. A dozen exclusive features. Demand is immense. Sales astounding. Roy Sage writes "Rec'd Awl today sold 5 in 15 min." L. Perrine says "Sold 9 on way home with sample." Lowest price, biggest profit, greatest value, quick sales. Drop everything and write for sample and instructions.

ANCHOR MFG. CO., Dept. 940, DAYTON, O.



MAKE MONEY HERE

Learn this new way to make money this year. Send name and address today.

I Want

AGENTS—Men and Women

New invention—low-priced, water power massage machine. \$2.50 profit on every sale. Hoyle sold 30 first week. Landom took 8 orders first four hours. Mrs. Howell sold 12 first two days—52 for first delivery.

Absolutely new. Nothing else like it. Women delighted—enraptured—buy on sight. A sale at every home in every town and city. We mail circulars to advertise ahead for you in your own field. We help you build the business.

No experience is necessary. Start right and make money first day. Agents—men and women—general agents—wanted quick.

Exclusive territory. No competition. Secure high-class position. Write today for complete particulars free. Address

The Blackstone Mfg. Co., 262 Meredith Bldg., Toledo, O.

BE YOUR OWN BOSS

Make Money Easy
 AGENTS wanted in every county to sell the popular Golden Rule Knives with name, address, photo, lodge emblems, etc., on handle. Agents earn \$75 to \$200 a month selling our shears, transparent handled pocket knives and razors. Big profits, quick sales. Exclusive territory. Experience unnecessary. WE TEACH YOU HOW.

Write today for terms and become one of our successful salesmen.

GOLDEN RULE CUTLERY CO., 362 Wendell St., Dept. 140, CHICAGO

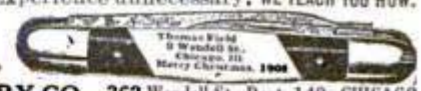

THE EXCELSIOR BRAD SET. PRICE 25 CENTS

Takes No. 18 and No. 20 Brads from 1/4 to 3/4 in. long

THIS END IS MAGNETIZED

The tool illustrated above will be indispensable to the Pattern Maker, Cabinet Maker, or Picture Framer who purchases it. It will set brads in places that would be inaccessible without it, and dispenses with the bradawl and nail set. If, after a fair trial, you are not satisfied that you have received your quarter's worth, your money will be promptly returned to you on receipt of tool.

STANDARD TOOL AND SUPPLY CO., TORRINGTON, CONN.



Buy Direct—Save Money—We Pay Freight

Our monthly installment plan of selling direct saves you the dealer's profit and his excessive charges for installation and repairs. You can save at least 1/3 the cost of your furnace. We have been building Jahant Furnaces for over 30 years and guarantee satisfaction

JAHANT DOWN DRAFT FURNACE

THE BEST HEATING SYSTEM MADE for residences, schools, hotels, churches, etc. It is the most economical furnace too and saves 1/3 to 1/2 the cost of fuel because the patented "Down-Draft System" burns wood, hard or soft coal, and burns it ALL without clinders, clinkers or any waste. Needs less attention, yet heats much better than any other furnace, hot air, steam or hot water heating system. Our plan of monthly payments

ONLY \$10 DOWN and \$10 A MONTH

makes it easy for any one to have the best heating system made. Every Jahant Furnace is sold with a strong "Guaranty Bond" that allows you 365 DAYS TRIAL. You don't run any risk buying from us. We send complete outfit, furnace, pipes, registers, etc., together with special plans, full directions and all tools for installing. If you can drive a nail you can install a Jahant Furnace without the aid of a tinner.

Write To-Day for Catalog which explains the Jahant Down-Draft System and tells why it gives more heat at less cost.

THE JAHANT HEATING CO., 3 Mill Street, Akron, O.





DIAMONDS ON CREDIT

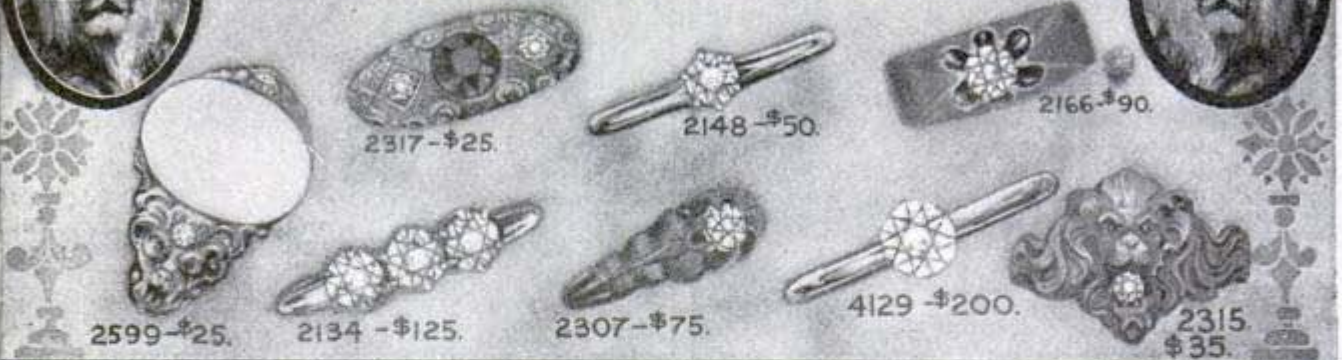

20% Down, 10% A Month.

Quality and price, the two vital considerations in diamond buying, are always satisfactory to the buyer of Lyon Diamonds. Our 64-year reputation for reliability is your guarantee of quality. It is to our interest as much as to yours that every sale we make should strengthen that reputation.

As for prices, we are the lowest in the market, because we eliminate every avoidable expense. Importing diamonds in the rough, we save the enormous duties imposed upon polished stones. We import, cut, polish and sell direct to you. This saves you middlemen's profits.

Every customer is protected by our written guarantee to take back the diamond we sell him, and refund his money, if his dealer can duplicate our stone at our price. We agree to exchange any diamond, any time, at full value.

Diamond solitaire rings from \$20 to \$1,000 are included in our regular selling plan. Goods sent prepaid for examination. Write for illustrated Catalogue No. 3.

J. M. LYON & CO.

ESTABLISHED
1843

71-73 Nassau Street
New York City.

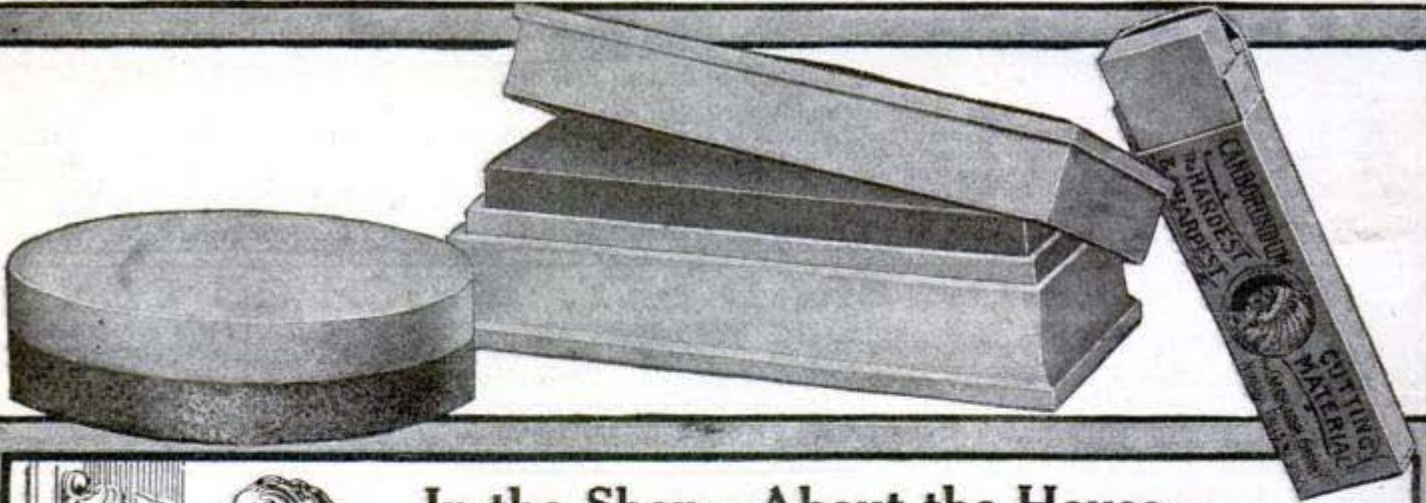

In the Shop—About the House— In the Manual Training School

A Carborundum Sharpening Stone means sharp, perfectly conditioned tools. And sharp tools mean better work. Ask your hardware dealer. If he hasn't them send direct.

- | | | | |
|---|--------|--|--------|
| No. 107-H. Round Combination Stone for Carpenters | \$1.00 | No. 191-H. Scythe and Grass Hook Stone | \$.25 |
| No. 108-H. Oblong Combination Stone | 1.25 | No. 114-H. Sportsman's Pocket Stone in soft leather case | .75 |
| No. 108-H. Oblong Combination Stone in aluminum box | 2.75 | No. 149-H. Pocket Stone in cardboard case | .15 |

THE CARBORUNDUM COMPANY

NIAGARA FALLS, N. Y.



This Engine Saves 3 Men's Pay 15-Day Free Trial to Prove It

PUT the wonderful **Perfection** portable kerosene engine in your shop—the difference in your pay-roll will soon cover its cost. Never gets sick, discontented or restless—just plugs away day in and day out doing the work of three men with never a complaint. Does a hundred things about the place quicker and better than manual labor could do them.

Perfection Portable Kerosene Engine

is the simplest, most compact engine made. That's because it's built by skilled automobile men, with years of engine experience. And the principle is *right*. The kerosene is drawn in a light film through the carburetor, vaporized and having the same energy as gasoline. And kerosene is from 6 to 16 cents cheaper than gasoline. The **Perfection** works equally well with gasoline, distillate or naphtha. **Call on your nearest dealer today—let him explain our great 15-day trial offer or write us direct for our big free engine book.** Sizes and types to suit every purpose.

FREE Advice on Power Problems

If you're in doubt about the quantity of power you can use profitably, or the kind of engine to buy, write your questions on a post-card and mail it to our Chief Consulting Engineer. He will give you, absolutely without charge or obligation to you, unprejudiced advice about your problems that may mean a big saving to you. Learn how easy it is to make a cheap transmission layout that will help you to run several machines at once with a single engine. Write today to

Chief Consulting Engineer,
Caille Perfection Motor Company
205 Second Avenue, Detroit, Mich.

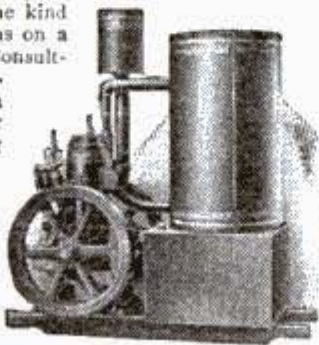

VARIETIES OF ANIMALS—In 1830 Gunther made a list of all the known animal species. In 1881 another list was made and the two lists were compared. In 1830 there were about 78,588 species; in 1881 the number had increased to 311,653. And as the minimum yearly increase since then has been 12,000, about 600,000 are known at the present time. This is a large figure, but it is probable that it is insignificant compared with the figures of the species as yet undiscovered.

The world of the lower animals is teeming. In 1905 the naturalist Sharper listed a quarter of a million insects, and expressed the belief that a quarter of a million was only a tenth part of the number of insects on earth.—Harper's Weekly.

FREE THIS ALADDIN LAMP FREE

BURNS KEROSENE (COAL OIL)



Outshines city gas or electricity. *Simple, noiseless, odorless, clean, safe, money-saving. Guaranteed. Write nearest office for catalogue **M** and learn how to get an Aladdin Mantle Lamp **FREE**.

AGENTS T. H. BALL SOLD 850 on money back guarantee, not one returned. Stacey sold 12 in one hour. Newsom sold 12 in 10 calls. Gibson sold 48 in 5 days. Sells itself. Needed in every home. Our Sunbeam Burner fits other lamps. Complete line for homes, stores, etc. Ask for our liberal agency proposition.

MANTLE LAMP CO. OF AMERICA, Dept. 36-J
Offices at—Chicago, Ill., Portland, Ore., Waterbury, Conn., Dallas, Tex., Winnipeg, Montreal, Canada

Real Gas Light at



One-Half Cost of Kerosene

In your own home, no matter where you live, you can have all the warmth, light, comfort and convenience of city gas. You can do away with smelly, smoky kerosene lamps and save the dirty work of caring for them. You can do away with danger from fire or explosion, have more and better light—six times as much light—all for half your present expense for kerosene. That is what we offer you in the

B & W Gas Light Plant sold on easy payments

From \$50 upward you can get a complete 4-room lighting plant—fixtures and everything (installed at our expense). You can extend it to other rooms, to the front porch, barn or cellar at slight additional cost. You can cook with it or heat any room with it. If you are a responsible person you can pay for it on easy monthly payments if desired. Write us a postal now for our illustrated free book telling all about this new gas light. Without expense or obligation on your part we will submit contract price for equipping your home.

Write Now—Agents Wanted

BOLTÉ & WEYER CO.
Lighting Engineers
131 S. Center Avenue, CHICAGO

Your Friends Wear Clothes

Take Their Orders!



Think that over! Show them **KNICKERBOCKER TAILORING** samples and styles. Two orders make you enough profit to get snappy suit for yourself **FREE**. Simple and easy. Just a little spare time. You need no money. We send complete outfit—all free—and show plainly just what to do.

Make Up to \$10 a Suit!

Some of our suits make **\$10 commission** for you. Almost no effort. Astonishing how quick you get business. Every suit shipped on approval, **EXPRESS PREPAID**. Money back if not satisfactory. We are the Largest Wholesale Tailoring House in the World. **30 years in business**. Reliable, successful, make best clothes. Men like you, without experience, now making **\$10 a day** just showing samples! Get our outfit. Compare with others. Make our profit. Ask about big **FREE PREMIUM PLAN. HUNDREDS OF BEAUTIFUL AND USEFUL THINGS FREE**. Our proposition best! Prove it. Write **NOW!**

KNICKERBOCKER TAILORING CO., 1933 Halsted St., Chicago, Ill.

When you want anything and don't know where to find it—write Bureau of Information, Popular Mechanics, Chicago

START A NEW INDEPENDENT BUSINESS MAKE \$5.00 TO \$10.00 A DAY

The "American" machine is doing it for others and will do the same for you. We teach you to hone razors, sharpen all kinds safety razor blades, scissors, clippers, etc. No previous experience required. **At \$20—This is the only machine of its kind on the market that sharpens; Hones and strops. No MAKE BELIEVE, but the REAL THING**

—FOR PARTICULARS, ADDRESS MANAGER—

ILLINOIS CUTLERY CO., Dept. 1008, 184 W. Washington St., CHICAGO

NOTE—We sharpen all kinds of safety razor blades. Razors Honed, 15c.

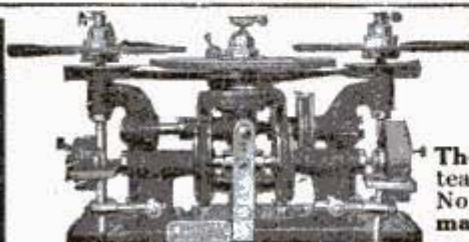

"American" No. 3, Patented

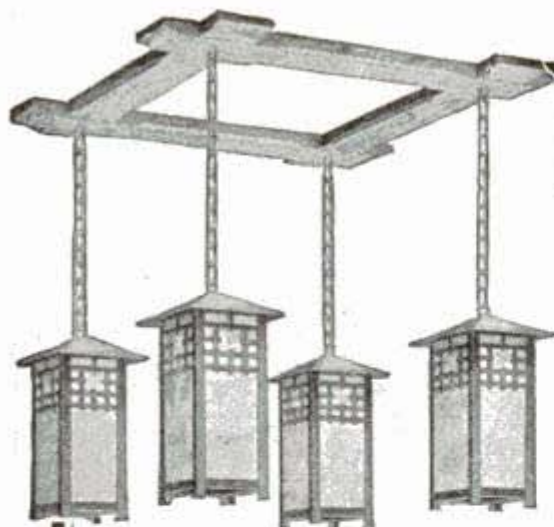

Price
Post-
paid **50c**

JUST OUT

Price
Post-
paid **50c**

Lamps and Shades IN METAL AND ART GLASS

By JOHN D. ADAMS

AUTHOR OF 'ARTS-CRAFTS LAMPS, HOW TO MAKE THEM'

*The latest of Popular Mechanics Series of Industrial Handbooks.
18 Complete Designs. 128 pages. Cloth. Size 5x7 in.*

Amateur Craftsmen will find in this book complete instructions for making a variety of beautiful electric lamps and shades in metal and art glass at a small outlay of time and money. The subject of lamps is important for four reasons: the necessity of a good and conveniently arranged light; the pleasing decorative effects possible; the variety and number of lamps that may be used to advantage in the home; and the small cost of equipment and necessary materials. Four different kinds of construction are treated:

Built-up Shades, Soldered Shades, Etched Shades and Sawn Shades. The designs include Drop-lights, Reading Lamps, Dining-Room Domes, Mission Chandeliers, Desk Lights and Library Lamps.

ORDER OF YOUR DEALER OR SEND DIRECT TO THE PUBLISHERS

Popular Mechanics Book Department, 318 W. Washington St., Chicago



Shop Notes for 1911

Vol. VII of the Series—Just Published—Price 50c Postpaid

THE Series of Shop Notes Year Books now comprises seven volumes and constitutes a *Mechanics Encyclopedia* of unequalled value. The low price of 50 cents a volume or \$3.50 for the complete set places them within the reach of all and no one who uses tools should do without them. The investment of but \$3.50 places at the disposal of every tradesman over

4000 Easy Ways To Do Hard Things

some of which daily confront him. These books are "Written So You Can Understand Them," and cover every department of mechanics. They represent the "boiled down" experience of expert engineers, firemen, carpenters, machinists, plumbers, painters, iron and wood workers, electricians, masons and other tradesmen.

The addition of a new volume each year affords the purchaser of a set an opportunity of keeping abreast with the newest and best developments, as each volume contains matter entirely different from the others and of a strictly up-to-date nature.

200 Pages	Vol. I,	"Shop Notes for 1905"	385 Illustrations
228 Pages	Vol. II,	"Shop Notes for 1906"	555 Illustrations
228 Pages	Vol. III,	"Shop Notes for 1907"	580 Illustrations
212 Pages	Vol. IV,	"Shop Notes for 1908"	536 Illustrations
224 Pages	Vol. V,	"Shop Notes for 1909"	461 Illustrations
224 Pages	Vol. VI,	"Shop Notes for 1910"	451 Illustrations
224 Pages	Vol. VII,	"Shop Notes for 1911"	468 Illustrations

Sold singly at 50 cents a volume postpaid, or the complete set of seven volumes may be had in a handsome case at \$3.50 prepaid.

Popular Mechanics Co., Publishers
318 W. Washington Street
CHICAGO, ILLINOIS



MEMINDEX SAVES TIME, WORRY, STRENGTH and CASH

Keeps you in touch with your affairs. Automatically reminds you of the right thing at the right time. No more worry about forgetting. Helps you to plan your work and work your plan. Used eight years by thousands of the best business and professional men. They speak of it like this:
 "There is no limit to its usefulness." "Nothing on the market can approach it."
 "I would not be without it for \$25 a year." "It has paid for itself a hundred times over." "The handiest possible thing in the line of note book and tickler."

NO OTHER DEVICE ANSWERS ITS PURPOSE

Has made good in 100 kinds of business. A fresh dated card comes to the front each day in the handy leather pocket-case, showing reminders for the day and space for more jottings; also for following days. Dated cards for the year in cabinet make an ideal desk system. Money back if not satisfied. Write for new booklet and name of dealer nearest you.

Express prepaid on receipt of price.
 Genuine Morocco case, quartered oak tray and cards..... Small \$3.50 Large \$4.25
 Genuine Seal-skin case, solid mahogany tray and cards..... 5.00 6.00
 Other styles from \$2.00 up. Sunday cards extra..... .35 .50
 Prices in Canada 20% more, duty paid.

Your Memindex shipped the same day we get your check
WILSON MEMINDEX CO., 105 Dey St., ROCHESTER, N. Y.



Only Live Matter Carried

THE LIMOUSINE

Life doesn't seem the same to us
 Since father bought a limousine.
 Our thoughts, our dreams, our talk—yes, all—
 Are flavored now with gasoline.
 We realize what we in years
 Of limousineless life have lost,
 What joy to see the neighbors stare
 And know they're wondering what it cost!

On cushioned air we glide along—
 The tires haven't busted yet—
 With not a single thing to show
 How deeply father is in debt.
 We look as rich as Carnegie,
 And ma's especially elate,
 Although, of course, she had to sign
 The mortgage on pa's real estate.

We go out riding every day,
 And you can bet we cut a dash,
 Although we must admit we are
 Extremely short of ready cash.
 What though the sordid tradesmen wear
 A look that's not at all serene?
 Our life is so much broader now,
 Since father bought a limousine!

—Somerville Journal.

LANGDON ACME MITRE BOX

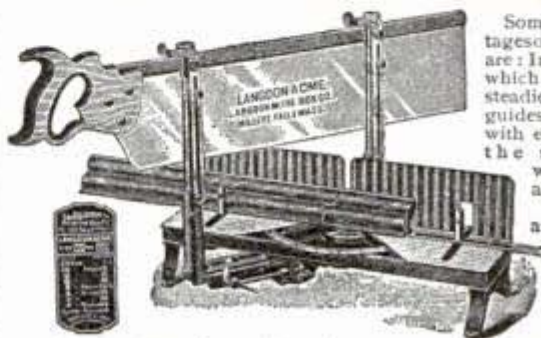

Some of the advantages over other models are: In longer guides, which hold the saw steadier, and these guides are provided with elevators to hold the saw stationary, when desired, above the work. In a graduated arc showing the various angles commonly used. In supporting guides, to hold the work in place.

In an appliance for quicker adjustment of extension lever. In a length gauge for duplicate lengths. These boxes are made in three sizes and put up with varying sizes of saws, ranging from 22"x4" to 30"x5". Send for the FREE Book "Tool Practice."
MILLERS FALLS CO., 28 Warren St., New York

\$20 to \$75 PER WEEK EASY to EARN

AGENTS

Sell Scientifically Tempered Knives, Razors, etc. Handles decorated with name, address, photos, Lodge Emblems, etc. Individual guarantees of quality. Sell on sight. Big profits. Write quick for money making plan. We teach you.

CANTON CUTLERY CO. Dept. C-59 CANTON, O.

Beauty and Health Bath for 2 Cents

Same principle used by old Romans. Cleans and refreshes—revivifies body scientifically. Purifying steam opens millions of pores. Dirt, germs, waste matter and incipient disease flow out with perspiration. The pink complexion—buoyancy—vigor of youth and health returns.

Buckeye Vapor Bath Cabinet

Nature's Cure for Human Ills
 Better—safer—cheaper than medicine or turkish baths. Germ breeding cloths or brushes unnecessary. Marvelously relieves colds, grippe, fever, rheumatism, kidney and liver trouble, etc. Wonderful for children—keeps them healthy and robust.

Can be used anywhere—at home or traveling. Over 600,000 sold. Write today for free copy of Health and Beauty Book, illustrated. Local and traveling agents wanted. Sales easy—profits big. Write today for territory offer.

Price \$5.00

McCREERY MFG. CO., 57 Lawrence Ave., Toledo, O.

Time and Its Measurement

By **JAMES ARTHUR**

Reprinted from Popular Mechanics. So far as known is entirely different from anything previously written on the subject. Mr. Arthur is a great authority along this line, having for years made an extensive study of clocks, watches and time-measuring devices.

Contents: Chapter 1—Historic Outline. 2—Japanese Clocks. 3—Modern Clocks. 4—Astronomical Foundation of Time

"Written So You Can Understand It." 64 pages. Profusely illustrated. Size 7x10 inches. Printed on coated paper with handsome blue cloth covers. Price \$1.50 Postpaid.

POPULAR MECHANICS BOOK DEPARTMENT, CHICAGO

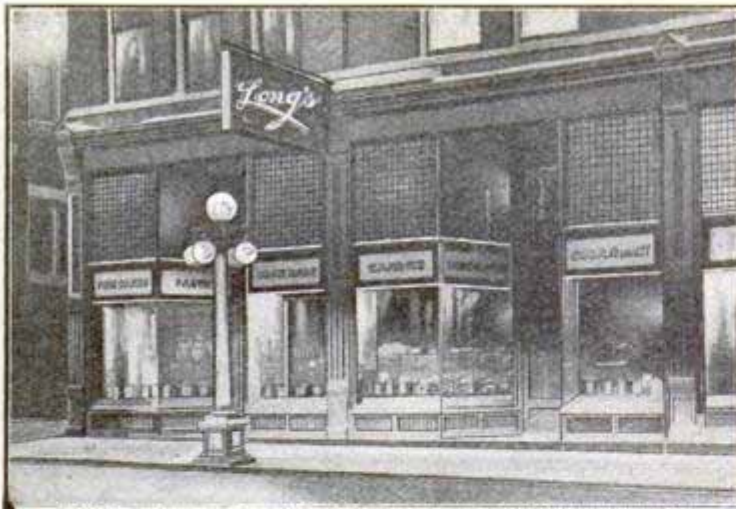

This is a picture of my big confectionery store in Springfield, Ohio

The money I earned, selling Popcorn Crispettes—a new, delicious confection—enabled me to do it. My Popcorn Crispette Machine made me a rich man. Any other man who goes at it as I did can make a lot of money. I am just a common, everyday sort of a fellow. No reason why I should do any better than you. Write me today. I'll tell you how I built my big business. I'll tell you just how I went about it—how you can do the same.

If you follow instructions you should make more money this fall and winter than you ever dreamed of. Somewhere in your town there is a small store—a half-store or a little nook, or even a store window—where you can set up your machine and make money. You can start at home if you wish.

Every Time You Take in a Nickel You Make Almost Four Cents Profit

You'll have a good thing all to yourself. I furnish a secret formula for making Crispettes; it's different from anything else. So you escape competition. People buy and buy and buy Popcorn Crispettes because of the taste. They're so different—so tasty and tempting, folks want more and more of them. In my literature I tell you all about them; about men who have made big money with the machine, and the men tell you how they did it. It's very interesting reading. Making money isn't nearly as hard as it seems. Half of success is in making the start—the other half is nerve, judgment and a good proposition. I've got the proposition—you've got the nerve and judgment. Put the three together now and make money, as I did. At least investigate. Look into the proposition. Get my story, and the story of other men who are making money with a Long Popcorn Crispette Machine. Write today.

W. Z. LONG, 387 High St., Springfield, Ohio

Popcorn Crispettes Built This Big Business — For Me —

I stand ready to help
other men to make
good; men who have
business hopes;
who are anxious
to make lots
of money.

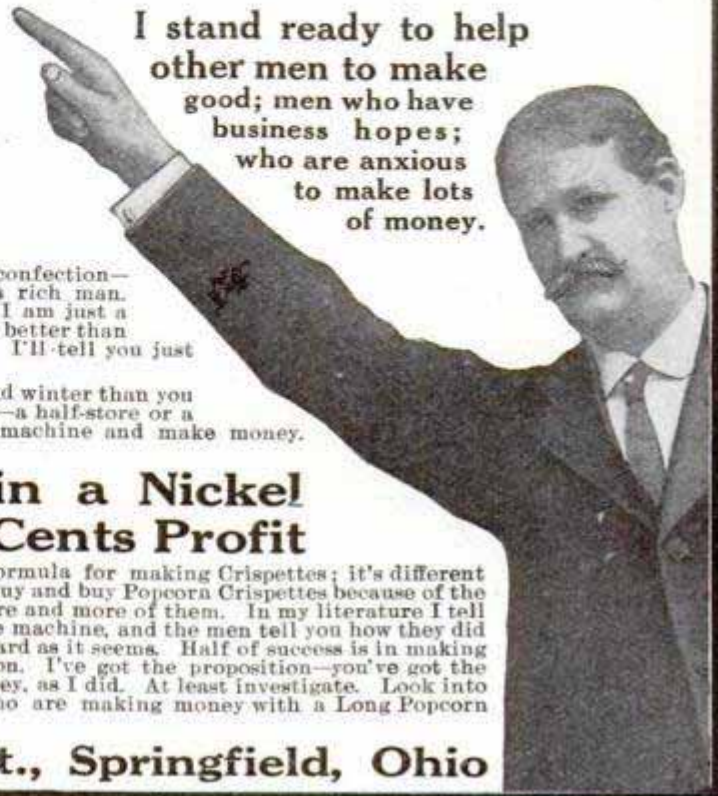

The New Plymouth 5-6 H.P.

Built on a new principle, this new 2-cycle engine will produce its full rated power on less fuel than any gas engine sold today. It combines the simplicity of the 2-cycle motor, with the smoothness and quietness of the 4-cycle engine. Built as well as a high-grade automobile engine.

Open crankcase, reversible, starts without cranking. Gives all the power you want for shop, farm, dairy, house and mill work. Engine shipped complete ready to run, freight paid and guaranteed to please you, or return at our expense. Price lower than other engines not so modern in design, or built so well.

Send for complete description today
PLYMOUTH MOTOR COMPANY
32 MILL STREET PLYMOUTH, MICH.



HOT WATER AND STEAM HEATING PLANTS

We are manufacturers and can save you money. Write for our catalogue and prices. We make complete plans and help you in every way possible.

CONCORD MANUFACTURING CO.
429 E. Third St. DAYTON, O.



Folding BATH TUB

Costs but little and will last for years. Weight only 15 pounds. Requires but little water, and no plumbing necessary. Folds into small roll and no more trouble to carry than a valise. Enjoy the delights of a full length bath in your private room. Far superior to a tin tub. Write for description and special offer to agents. **ROBINSON MFG. CO., 654 Jefferson Ave., Toledo, Ohio.** Mrs Turkish Bath Cabinets.



Thor Free Engine Clutch and the Motor Goes on Just the Same

No need to stop the motor, even though you do stop the machine. The Thor Free Engine Multiple Disc Clutch running in oil is now equipped on all Thor Chain Drive models at no extra charge. It is perfect in action and principle of construction. It enables you to bring your machine to a standstill while the motor runs smoothly and silently on.

Thor Motorcycles — Champions of all Endurance Contests

Won every important endurance contest last season as well as this season. Endurance is the real test of a motorcycle—because you do want absolute dependability. For 1911 we submit five very handsome models—Four (4) horse power single cylinder and one (1) seven horse power double cylinder, all described in our big booklet sent anywhere on request. "A Guide to Motorcycles."

Agents—there are a few more openings in good territory; this is a big business opportunity. Act quickly if you want to get in on the ground floor.

AURORA AUTOMATIC MACHINERY COMPANY, Dept. 11, 1307 Michigan Ave., Chicago, Ill.



Flexible Fingers and a Free Fist

With every protection from heat and steam; strong and soft but with no binding seams nor rivets to scratch—this is the fine combination you get in Hansen's Gloves. Water will not hurt them; a thorough soaking leaves them good as new—soft and shapely. And speaking of *shape*—

Hansen's Gloves

"Built Like a Hand"

are so constructed as to fit every man according to his task. Strong—they are made of best horse-hide leather, tanned by special process and guaranteed never to shrink nor shrivel, harden, crack nor peel.

For the railroad man, the engineer, fireman, brakeman, etc., there is the famous "Peccary Gauntlet," of stoutest pigskin; the "Protector," deep and re-enforced; the "Glad Hand," with long cuff, in or out-seam. Linemen, lumbermen, doctors and hunters—all professions, trades and sports—each finds in the Hansen line the glove that precisely suits his own specific needs. For the autoist and motorcycleist there is the "Six-Cylinder" Gauntlet, and a wide list of styles.

Free Book Fill out attached coupon, mail to us and receive free book describing and illustrating all styles. Or write us a postal if more convenient.

O. C. Hansen Manufacturing Co.
291 Milwaukee Ave., Milwaukee, Wis.

O. C.
Hansen
Mfg. Co.

291 Milwaukee Ave.,
Milwaukee, Wis.

Please send me your Free Book illustrating and describing your styles of gloves and mittens; I am most interested in your style for the following purpose:

Hansen's Special Lineman's Gauntlet
Heavily reinforced cuff for climbing poles and handling wires. Just one of hundreds of Hansen styles.

Name.....
Address.....
Town.....
State.....

The city of New York last year consumed \$60,000,000 worth of potatoes, for which the farmers who produced them received only \$8,000,000.—Louisville Courier-Journal.

Baltimore scientists have discovered how to grow flesh in a test tube, which is exactly the way the young ladies nowadays look as if they had been grown.—Washington Post.

RIFLES and SHOT GUNS On Credit

This Accurate, Strong-Shooting, Hammerless Shot Gun



\$4⁵⁰ DOWN

PRICE \$17.50

This high grade shot gun is fitted with Rummel's No. 14 Armory Steel barrels, full tapered choke, bored for either black or smokeless powder—12 or 16 gauge, 28 or 30 inch lengths, 7 1/4 to 8 pounds. Top lever action—hammers cock and throw safety automatically. Sent for \$4.50 Down and \$2.00 a month—no interest—no extras and you have 7 months in which to complete payment on this gun that will compare favorably with any \$40 or \$60 gun made. Every man wants a good gun, but not every man can afford to pay the full amount cash down—therefore, we have just lately decided to sell high grade fire arms on

CONFIDENTIAL CREDIT

If you want a guaranteed shot gun or rifle why not open a credit account. We have been selling high grade guns for thirty-five years. Write us for Complete Information and Catalog.

A. J. Rummel Arms Co., 127 St. Clair St., Toledo, Ohio

A Wonderful Typewriter



The Fox is indeed "A Wonderful Typewriter" because it will do all—and more—than any other typewriter, and do it easier and better. The Fox has a lighter touch and action than any other typewriter built and is full automatic. It is easy to make advertising claims of superiority, but we will prove our claims by sending to anyone, anywhere, one of our typewriters on ten days' free trial—express prepaid—the typewriter to be returned at our expense if it does not prove satisfactory.

Send today for a catalog with prices. Select from this the model wanted, width of carriage, style of type, etc., and a typewriter, put up just as you want it, will be sent you for trial. After trial if the typewriter is perfectly satisfactory you can pay us a little down and the balance monthly, or in all cash, as you prefer.

Date.....
FOX TYPEWRITER CO.,
3810-4010 Front St.,
Grand Rapids, Mich.

DEAR SIRS:
Please send catalog and prices.
Name.....
Address.....
Business.....



Write today—
use the
coupon.

Oh-You Fox!

"The How and Why of the Automobile"

By **FAY L. FAUROTE**

200 Pages. Bound in full cloth. 250 illustrations. Price \$1.00 Prepaid.

DID you ever read a book which gave you just the information you wanted without being compelled to go through page after page of introduction and history?

Did you ever talk to a man who came over on your side of the fence and talked WITH you and not

AT you—who explained things in such a way that you laughed at yourself afterwards for not understanding the subject before—it was really so simple?

Do you remember when you used to study by outlines—how difficult problems unfolded themselves—how the logical sequence of facts seemed to make what you expected to find hard, readily understandable?

Do you remember the innumerable times you have said to yourself, "If I only had somebody here to explain things—someone who would go through this proposition with me until I understood it—someone who would use homely and familiar examples to explain things, instead of talking over my head by using technical terms?"

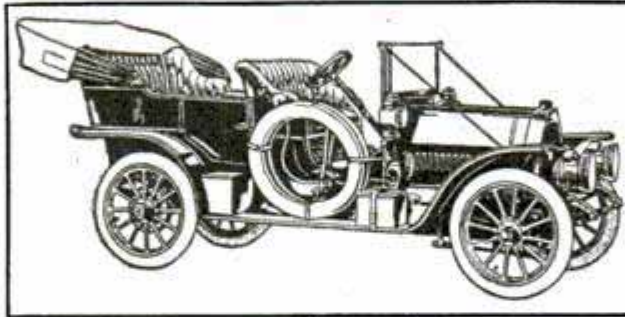

The author realized all these difficulties himself, because he has been through it all. Not only that, but his experience as an instructor of a large motor school taught him the way to explain the various parts of a motor vehicle in simple language, so that even the boy of

fifteen could understand and appreciate them.

For instance, did you ever think that the physician uses a form of carburetor whenever he gives chloroform or ether—do you realize that a shotgun is a form of gas engine whose action is almost identical with that of an automobile motor?

Do you want to know what a sliding gear transmission is—explained in such simple language that anyone can understand it?

Would you like to see what's inside of an automobile engine—would you like to know the name of every part—be able to talk intelligently about it and be your own mechanic—tell your chauffeur what to do—know when he is bluffing you?

In a word, would you like to know all about a motor car—how it works—how to drive it and how to take care of it? Then subscribe for a copy of

"The How and Why of the Automobile"

A book of practical information for seekers after the fundamental facts regarding the gasoline engine and its application to the motor car. Interesting and instructive to both the beginner and the expert—the former for information, the latter for reference. Written by Fay L. Faurote, B.S., (M.E.), for five years closely associated with the Experimental Department of a pioneer automobile factory, for two years instructor in the Detroit Motor School. The book, which is handsomely bound in full cloth, printed on high-grade enameled paper, contains over 200 pages and 250 illustrations and covers the following subjects:

CONTENTS:

GENERAL THEORY OF GAS ENGINES. Simple explanation of cycle—The four-stroke cycle—The two-stroke cycle—Advantages and disadvantages of each.

MOTOR DESIGN. Cylinder, what it is and its use. Valves, mechanical and automatic—Forms of valves—Valve timing and its influence on the motor—Valve grinding, how to do it—Valve nomenclature. Crank Case—The construction. Bearings—Accessibility—Working parts—Uses. A crank case oiling system. Crank Shafts—What they are—One, two, four and six-cylinder crank shafts—Crank case diagram, showing instantly conditions in all cylinders—Diagram showing firing points and sequence of same. Connecting Rods, construction and material—Bearings and lubrication. Pistons—Piston rings—Piston Pins.

THE TRANSMISSION. Reason for and use of transmission. Simple Explanation of Action—Individual clutch type—The sliding gear—The three speed progressive—The three speed selective—The four speed selective—Planetary gear—Friction drive.

METHODS OF DRIVING. Single chain drive—Double chain drive—Bevel gear drive.

THE CARBURETOR. A very simple explanation of carburetion—The mixing valve—A few of the first types—Some of the modern carburetors—Foreign carburetors.

IGNITION. The make and break system—A simple explanation of the apparatus used. The Jump Spark System—Electrical units. Sources of Electricity—The dry cell—The storage cell—Dynamos and magnetos—The spark-coil—Commutators and timing devices—Spark plugs—Wiring diagrams.

COOLING SYSTEM. Air Cooling. Water Cooling—Direction of circulation—Radiators—Water pumps—Fans—Anti-freezing solutions.

RUNNING GEAR. Front Axle—Construction of—Steering Gear. Rear Axle—Differential gear—The live axle—The dead axle—Wheel construction—Bearings.

HORSE POWER DETERMINATIONS. Engine testing—Indicated horse power—Brake horse power—Mechanical and heat efficiency—Road testing.

Send in your order at once—don't delay. The price is \$1.00 postage prepaid, and the address is

**POPULAR MECHANICS BOOK DEPARTMENT
CHICAGO**

You Want Power

Speed, reliability, perfect control. No engine at the price can compete in those vital essentials with



T&M MARINE ENGINES

A size and type for every craft up to 65 feet—light, medium and heavy duty, 1, 2, 3 and 4 cylinders.

WRITE FOR NAME OF NEAREST DEALER

TERMAAT & MONAHAN CO., Dept. A, OSHKOSH, WIS.

Agencies in all principal cities

Make a Motor Boat of Any Boat in Five Minutes



You can do it with the Waterman Out Board Motor, which you can quickly attach (and detach) to the stern of any skiff, rowboat, dinghy, punt, sail boat, and have a good motor boat. It is not a toy, but a reliable 2 H. P. Marine Motor that will drive an 18-ft. rowboat 7 miles an hour, 4 hours on one gallon of gasoline. Simplest motor made. Weight 40 lbs. Six years successful results behind it. Canoe and larger motors—light weight models K and B

—LIFE GUARANTEE.

WATERMAN MARINE MOTOR CO.
1507 Fort St., West, DETROIT, MICH., U. S. A.

NEW CIRCULATING LIBRARY SCHEME—The following scheme is about to be set on foot in Brussels for the diffusion of enlightening literature. A central library, consisting at the outset of 10,000 choice volumes, is to be created there, and any inhabitant of any part of Belgium owning a savings bank book will be entitled to borrow from it and receive by post any book for a period of a fortnight on checking a penny off his savings bank book at the postoffice, his money at the bank serv-

TOLEDO MOTORS

HIGH QUALITY, LOW PRICE!

- 3 H. P., complete . . . \$ 65.00
- 6 H. P., 2 cyl., complete . . . 125.00
- 6 H. P., 1 cyl., complete . . . 84.00
- 12 H. P., 2 cyl., complete . . . 160.00
- 18 H. P., 3 cyl., complete . . . 250.00



FULLY GUARANTEED, ORDER NOW.

3½ x 3½ and 4½ x 4½—2 cycle 2 port

Send for Cat. "C" Schebler Carburetors

UNIVERSAL MACHINE CO., Palmwood Ave., TOLEDO, OHIO

BAY STATE MOTORS

"Perfect Simplicity" and "Simple Perfection" are the results, embodied in these Motors, of 15 years devoted to the developing of these essential characteristics, which enable us to put on the market a reliable and economical motor at a reasonable price. Write for catalog, stating size and type (2 or 4 cycle) of motor wanted. We also furnish castings for these motors.

BAY STATE MOTOR WORKS

Successor to

A. J. HOULE MOTOR WORKS

580 South East Street, HOLYOKE, MASS.



WATKINS' SPECIAL MOTORS

- 3 H. P. Single Cylinder . . . 30 lbs.
- 6 H. P. Double Cylinder . . . 60 lbs.
- 12 H. P. Four Cylinder . . . 100 lbs.

A strictly HIGH GRADE Motor that will give CONSTANT and EFFICIENT service. Especially adapted for CANOES and LIGHT BOATS. Aluminum base, copper water jacket, steel shaft, bronze bearings.

THE WATKINS MOTOR CO.

837-839 West Sixth Street CINCINNATI, OHIO



The World Famous

MEISTER PIANO

Sent to any home in America on
30 Days Free Trial

The Freight Prepaid

Eight artistic styles to choose from ranging in price from

\$175 to \$350

Sold direct from the factory to you, and not sold to dealers or commission men under any circumstances.

If you like the instrument and desire to keep it after the month's free trial, these are the terms of sale:

SMALL WEEKLY or MONTHLY PAYMENTS

NO CASH PAYMENT DOWN

NO INTEREST ON PAYMENTS

NO EXTRAS OF ANY KIND

PIANO STOOL AND SCARF FREE

Sold under Rothschild & Company's Guarantee Bond, which is as good as a Government Bond.

Rothschild & Company's resources are in excess of \$4,000,000, and every promise they make is absolute. Ask any banker in America for Rothschild & Company's commercial rating.

Send for our beautifully illustrated catalog showing Meister pianos in the natural wood colors. The book also contains hundreds of testimonial letters from delighted customers. A post card will bring it.

The Meister Piano Co.

(Rothschild & Company, Sole Owners)

Dept. 16 H

CHICAGO, ILL.

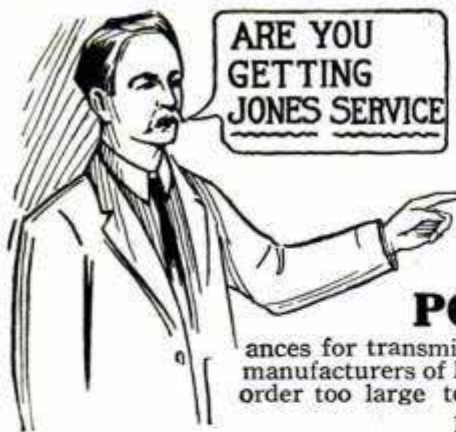

ARE YOU
GETTING
JONES SERVICE

JONES SERVICE

In Power Transmitting Machinery is unequalled. If you are not getting it—order direct from our factory. We are extensive manufacturers of **Machine Moulded Pulleys**, gears, hangers, shafting, bearings, belting, friction clutches, sprocket wheels and chain belt.

POWER USERS Save money and time and buy your equipment from the manufacturer. For anything in the line of appliances for transmitting power—"Jones Service" and goods are unparalleled. We are the largest manufacturers of **Machine Moulded Pulleys** in the United States. No order too small for attention. No order too large to execute. Our Catalogue A-18 shows our complete line. "Jones Service" is

PROMPT SHIPMENTS, RELIABLE GOODS, RIGHT PRICES.

W. A. JONES FOUNDRY & MACHINE CO., MAIL ORDER DEPARTMENT 1400 North Ave., CHICAGO, U. S. A.

Use a Kerosene Engine

Kerosene Power—is cheaper and safer than any power yet discovered. Kerosene costs half as much as gasoline and produces more power.

It can be bought anywhere or kept on hand in quantities without danger, and without affecting insurance. The effectiveness, economy and safety of Kerosene depend largely, however, on the engine in which it is used—whether it is a real Kerosene Engine or a gasoline engine with a makeshift Kerosene attachment.

The COLUMBIA Kerosene Engine is Built for KEROSENE



It gets the very greatest power out of the Kerosene it uses and does it without any complicated attachments whatever. It is the most simple engine that it is possible to build—Has only three moving parts.

And it is absolutely safe, because it uses **Cold Kerosene**. Has no vaporizer or heater to catch fire or explode.

Every Columbia Engine is sold on fifteen days' absolutely free trial

And is guaranteed for five years by a guarantee that is "Backed by a Million." It is a safe engine to buy.

SEND FOR FREE CATALOG NO. 17

Columbia Engine Company
DETROIT, MICH.

"Caldwell Special"

60 Days
Trial FREE

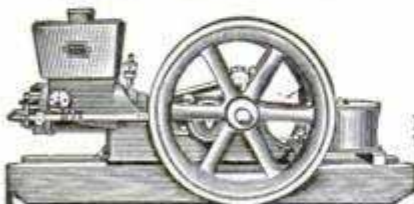

Prove it on your own premises that it saves time, saves labor and makes money.

The "Caldwell Special" is as clean cut as a race horse. Built right—works

right. Simply built—always gives full H. P. Costs little to run—big profit producer to pump water, run cream separator, shred or grind corn and a dozen other things.

Write any or all the 8 Banks of Waterloo as to our responsibility. Sixty day Trial Free. We prove it to you on your own premises at our expense that you cannot afford to do without a "Caldwell Special."

CALDWELL-HOLLOWELL MFG. Co.
514 Commerce Street, WATERLOO, IOWA.

WITTE ENGINES

GAS—GASOLINE—DISTILLATE—NAPHTHA

Do the work at average cost of **One Cent** per horse power hour. Immense saving by our method of "pre-heating" the fuel. Built so perfectly that repairs cost less than **\$1** per year average. Every valve is **vertical** and will not wear on the stem or slip inside. Freezing cannot injure bed as **cylinder and base are separate**. Hammered steel cranks, cut gears, etc.

GUARANTEED FIVE YEARS

We are experts in engine building; have done nothing else for twenty-six years. Our reference is thousands of satisfied customers. Our prices are right. All sizes, 2 to 40 H. P. Special inducements to introduce in new localities.

Write for free catalog stating size wanted.



WITTE IRON WORKS CO.
1654 Oakland Avenue, Kansas City, Mo.

ing as a guarantee for payment for books not returned. As there are about 1500 postoffices in Belgium, this will amount to the creation of a circulating library with 1500 branches whose risks will be more than covered by the deposits in the savings banks.—London Evening Standard.

Every Mechanic and Experimenter

young or old, should get our large, illustrated catalog. Most complete line of Mechanical and Electrical novelties published. Gas, Gasoline and Steam ENGINES (1-32 H. P. up), Motors, Dynamos, Storage Batteries, Telegraph and WIRELESS Instruments, Printing Presses, Postcard Projectors, Ikonographs, Saws, Lathes, complete Miniature Railway Equipment. Send 15c stamps or coin. Refunded on first order.



AMATEUR MECHANICS SUPPLY CO., 518G, 219 S. Dearborn St., CHICAGO

\$50 to \$300 SAVED

We are manufacturers, not merchants. Save dealers', jobbers' and catalog house profit. I'll save you from \$50 to \$300 on my High Grade Standard Gasoline Engines from 2 to 22 h.p. — Price direct to you lower than dealers or jobbers have to pay for similar engines in carload lots for spot cash.

GALLOWAY

Price and quality speak for themselves and you are to be the sole judge. Sell your poorest horse and buy a

5-H.-P. only \$119.50



Direct From My Factory on 30 Days' Free Trial

Satisfaction or money back. Write for special proposition. All you pay me is for raw material labor and one small profit. Send for my big **BOOK FREE.**

WM. GALLOWAY, Pres.
WM. GALLOWAY CO.
1965 Galloway Station
WATERLOO, IOWA

HERE'S CHEAP POWER FOR YOU

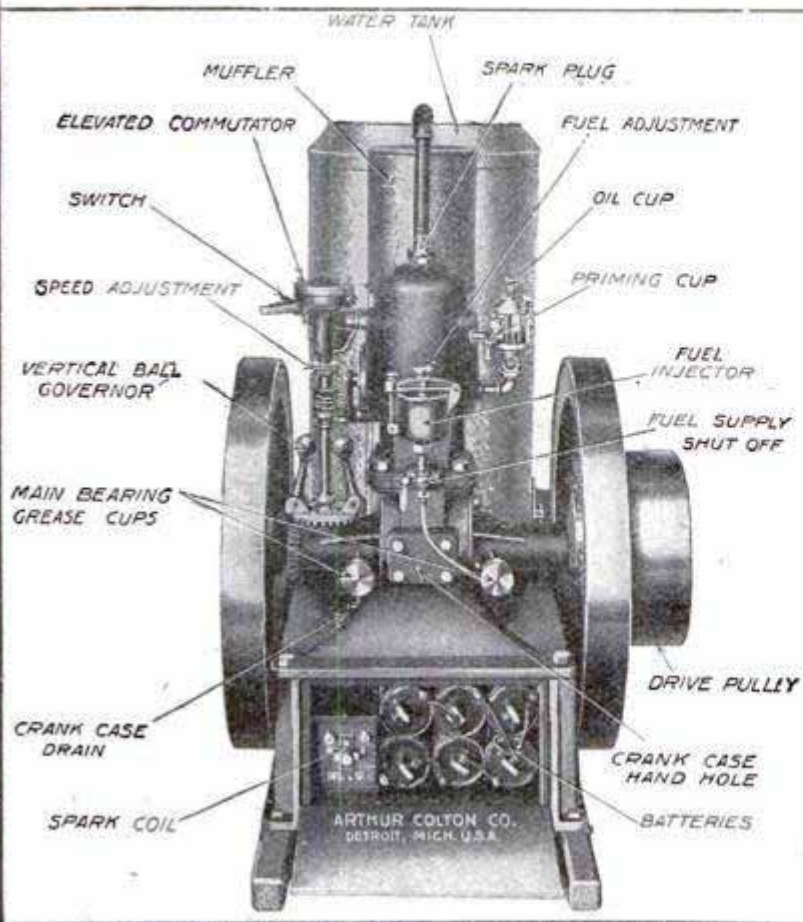

The Colton Modern Kerosene Engine does the work at the lowest possible cost, because it develops power more economically than any other power plant that has ever been invented. If you want power for any purpose—the most power you can get for the lowest cost—power for lighting the home, for water supply systems, for operating shop or farm machinery of any kind, investigate this wonderful engine. It is guaranteed to operate perfectly on kerosene oil as well as gasoline.

The Colton Modern Engine is the product of an organization twenty-seven years old, that has an enviable reputation for building high grade machinery. No other engine is so simple in operation, compactly built or so durable, reliable and economical. It gives an engine service unequalled by any engine heretofore on the market. You have the opportunity to prove this by trying the engine 15 days free. Every Colton is guaranteed positively and absolutely.

The Colton Modern Kerosene Engine Many New Patented Improved Features

Any engineer or mechanic who knows gasoline engines grows enthusiastic when he examines the Colton and watches it work and sees its simple mechanism—its great power, easy handling and its many improved and convenient features. This engine is scientifically built, eliminating the many chances for trouble, which exist with other engines. The careful workmanship and high grade material employed in the Colton, also appeal to the man who knows. Every engine is subjected to the most rigid tests and inspection before it leaves our factory. Sold on a positive guarantee. If you say the engine is not satisfactory—money refunded.

Learn Full Particulars

Send for our Engine book and learn of the many special features which make this engine the most economical power plant in the world.

ARTHUR COLTON COMPANY
182 Brush St., DETROIT, MICH.

A MOVING LAND—One of the broad slopes of Mont Gringuez, France, is reported to have become detached from its foundations, and to have moved over a distance of nearly a quarter of a mile, carrying with it the soil, meadows and woods, and covering up in its passage roads and bridges that stood in the way. A chestnut grove has traveled 500 ft. without suffering any apparent damage but many small lakes have been formed by the damming of the waters.

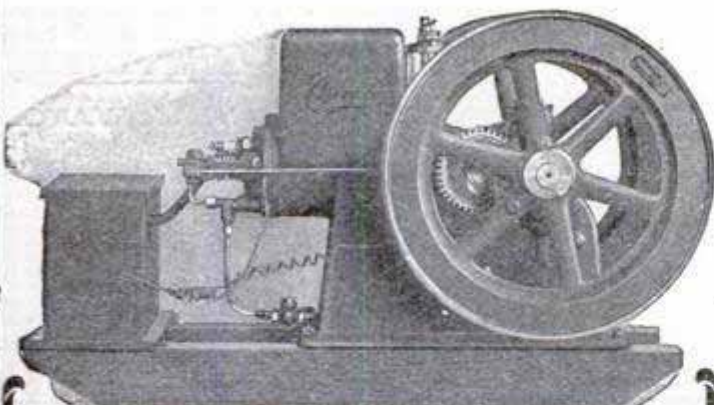

Get Our Price First Don't buy until you get our prices and catalog describing our line of high grade **CHICAGO GASOLINE ENGINES**

You want the best at the lowest cost—investigate the construction simplicity, reliability of the "Chicago"—none better. Save 1/3 usual cost. Sold on Free Trial. Five year guarantee. Sizes 1 to 14 h. p. Write to-day.

COLBORNE MFG. CO., 410 W. Indiana St., CHICAGO, ILL.

5 YEAR GUARANTEE

Price WATERLOO BOY THE PRICE MAKER No other gasoline engine reduced the price of gasoline engines like the **WATERLOO BOY**

Has fewer parts than any other engine. It costs less to make few parts than many parts. Waterloo Boy is made in large quantities. It costs less per engine to make 100 engines a day than 10. That's why we make the under-selling price

Service
Waterloo Boy is Dependable

Always ready to go. No fuss. No backing. Starts easy in winter. Igniter simple as a pair of scissors. Automatic feed regulation. No bother or expense of a pump. Speed lever works like a throttle on a locomotive. Nearly all parts are interchangeable. If you want satisfaction all the year round buy the Waterloo Boy. Waterloo Boy Lasts.

Built of best material by men that know how

Waterloo Gasoline Engine Co.
1021 W. 3rd Ave.,
Waterloo, Iowa.

Durability

WE DO AS WE ADVERTISE

WHEN YOU WANT ANYTHING AND DON'T KNOW WHERE TO FIND IT WRITE BUREAU OF INFORMATION, POPULAR MECHANICS CHICAGO

DON'T BUY A GASOLINE ENGINE

until you investigate "The Master Workman," a two-cylinder gasoline, kerosene or alcohol engine, superior to any one-cylinder engine; revolutionizing power. Its weight and bulk are half that of single cylinder engines, with greater durability. Costs Less to Buy—Less to Run. Quickly, easily started. Vibration practically overcome. Cheaply mounted on any wagon. It is a combination portable, stationary or traction engine. SEND FOR CATALOGUE THIS IS OUR FIFTY-NINTH YEAR.

THE TEMPLE PUMP CO., Mfrs., 442 West 15th St., CHICAGO

Please Mention Popular Mechanics

Send For Our Free Vibrator Book



If you send your name and address we will send you **Free** our Vibrator Book describing the White Cross Electric Vibrator shown here.

Merely send a Postal Card and our FREE Vibrator Book will be mailed to you.

This Vibrator is a rubbing machine which draws the blood to any aching part of the body to do its work. This machine rubs much better and much faster than the hands.

While the hands are able to give a few dozen rubs per minute the machine gives several thousand rubs. It rubs hard or gently, just as the operator chooses. The machine can be operated by anyone in his own home.

Send today for the
FREE VIBRATOR BOOK

Lindstrom-Smith Co.
218 S. Wabash Ave., Dept. 1197
CHICAGO

MAXIMOTOR
Flying now in over half states of Union. 4 cycle; 4 and 6 cylinder; 30-75 h. p.
MAXIMOTOR MACHINES
DETROIT
ASK FOR BOOKLET 67 CRANE AVENUE

WHITE VALLEY GEMS IMPORTED from FRANCE
SEE THEM BEFORE PAYING!
These gems are chemical white sapphires—LOOK like Diamonds. Stand acid and fire diamond tests. So hard they easily scratch a file and will cut glass. Brilliancy guaranteed 25 years. All mounted in 14K solid gold diamond mountings. Will send you any style ring, pin or stud for examination—all charges prepaid—no money in advance. Write today for free illustrated booklet, special prices and ring measure.
WHITE VALLEY GEM CO., 901 L Saks Bldg., Indianapolis, Ind.

\$2.00
KANNERS STERLING STROPPER
AGENTS WANTED EVERYWHERE
To sell our new Automatic Stropper. Puts a perfect edge on any razor, or any safety razor. Absolutely guaranteed. A boon to every man who shaves. Every call a sale; every sale a good profit. Write to-day for territory. Become a general or a local agent. No experience necessary. Canvassers, Salesmen, Clerks, Artisans, Students, are making big money, and so can you. Clean-cut hustlers are doing wonders. A golden opportunity. Write to-day and reserve your territory.
S. C. KANNER, 556 Broadway, NEW YORK

DISTANCE COVERED IN A WALTZ—Every one has observed that the lady or the beau who objects strenuously to taking any sort of exercise and pleads incapacity to endure strain will dance through a full and exhaustive program, being in this fashion seduced into a most vigorous, and under proper conditions beneficial, exercise.

It seems that in a normal little dance the parties travel something like 11½ miles, and do it in much more strenuous fashion than they would if they calmly set out to walk the same distance. An average waltz takes you over something like three-quarters of a mile,

ELEGANT THIN MODEL 20-YEAR WATCH
Hunting case, beautifully engraved, gold finished throughout, stem wind and stem set, fitted with 7 ruby jeweled American lever movement. Guaranteed 20 years; with long, gold plated chain for Ladies or vest chain for Gents. IF YOU SEE IT YOU WILL BUY IT! Let us send it without expense to you C. O. D., express charges paid by us, for examination at your nearest express office and if you think it a bargain and equal in appearance to any \$15.00 gold finished watch pay the express agent \$3.95 and it is yours. Mention if you want LADIES', MEN'S or BOYS' size. Address **M. C. FARRER C13, 219 S. Dearborn Street, Chicago, Ill.**

\$3.95

TYLER'S RAW FOOD BOOK AND HEALTH GUIDE
(Copyrighted)
PRICE 25 CENTS including constipation, rheumatism, appendicitis and even consumption.
A week's trial will convince the most skeptical, therefore, if you are depressed, feeling badly, about half sick—buy the book, adopt the new food idea and learn the art of **GAINING AND RETAINING HEALTH** by the sanest, most successful and economical method known to science simply by living wholly (or at least in part) on natural or uncooked foods. This book is a revelation and a source of inspiration to every ailing person. Order it today and commence the new life at once.
Byron Tyler, Food Specialist 82 Syndicate Bldg. KANSAS CITY, MO.

Let Us Give You this Book

On Loose Leaf Bookkeeping

We offer to send without charge, this practical instruction book, covering the entire subject of Loose Leaf Bookkeeping, to any business or professional man who will mail us the coupon together with his business letter-head.

The book is full of valuable information. It shows short cuts in office work that save time and money, and how you can greatly increase the efficiency of your office force. It tells how to install and use the famous

MOORE'S MODERN METHODS

in any business—large or small. The book contains 160 pages; and illustrates and describes 40 different Loose Leaf Record Forms.

Cut out the Coupon—Mail to-day

JOHN C. MOORE CORPORATION

696 STONE STREET, ROCHESTER, N. Y.

Agencies in Principal Cities and Towns

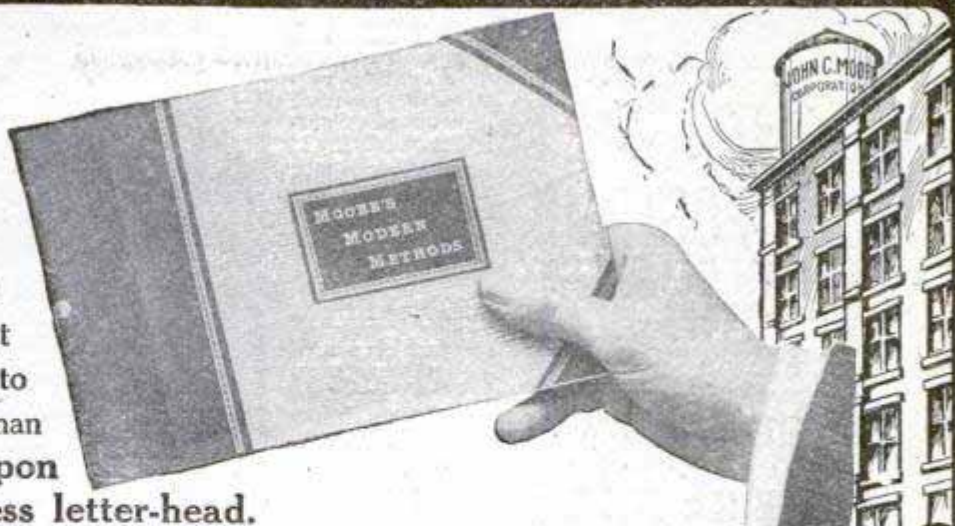

Send your Free Book

Name

Business

Address

and the various old-fashioned square dances are at least half a mile long.

To make dancing beneficial the room should be thoroughly ventilated so that a constant supply of fresh oxygen is available for the overworked heart.—Chicago Tribune.

CACHOO! Make the whole family and all your friends "just sneeze their heads off" without knowing why, with CACHOO, the new long distance harmless snuff. Sent anywhere for 10c. 3 for 25c. 90c a dozen. Catalog included FREE.
P. T. & N. CO., Department B, Chicago, Ill.



GINSENG RAISING is the surest way to make Big Money on Little Capital. One acre produces 5,000 lbs. Sells at \$6 lb. Requires your spare time only. Grows anywhere. I will buy all you raise. Write today.
T. H. SUTTON, 1000 Sherwood Ave., Louisville, Ky.

The New Schwarzlose AUTOMATIC PISTOL



"The Faultless," 8 Shots, repeating. Imitates no other. New and superior features. Most compact, lightest, most accurate. Shoots 32 Cal. Automatic Cartridge, obtainable everywhere. Krupp Steel Barrel, made by A. W. Schwarzlose, whose Automatic Arms are used by European armies. Marvellous invention! Moderate in price.

Ask dealers for it. Take no other. Send for illustrated description, expert opinions, etc.
KIRTLAND BROS. & CO., 90 Chambers Street, New York



CLASS PINS AND BADGES

For College, School, Society or Lodge.

Descriptive catalog with attractive prices mailed free upon request. Either style of pins here illustrated with any three letters and figures, one or two colors of enamel. STERLING SILVER, 25c each; \$2.50 doz.; SILVER PLATE, 10c each; \$1.00 doz.



BASTIAN BROS. CO. Dept. 672 ROCHESTER, N. Y.

HEAD FOREMEN WANTED

Machine Shop—Wood Shop

Two first class head foremen. Prefer men that have been assistants to high-grade superintendents in large works and understand modern shop practice. State age, experience, reference and salary expected. Address—

BLUMENSTOCK BROS., ADVERTISING AGENCY,
1612 Chemical Building, St. Louis, Mo.

(ESTABLISHED 1842)

Reed & Sons Pianos

Highest Award World's Columbian Exposition

Now Sold Direct to You from Factory

30 DAYS' FREE TRIAL IN YOUR HOME. Take your own time to pay. No payment in advance required. For free book address

REED & SONS PIANO MFG. CO.

Dept. A 17 Cor. Jackson Blvd and Wabash Ave. CHICAGO

THE HAT WITH THE MOST FRIENDS!

The Hat That Don't Blow Off



3 Felt Hats IN ONE

Sent Postpaid To You For Only \$1

The nobbiest and most comfortable hat you can buy at any price for dress, business, travel, motoring, and all sports. It is made of genuine English felt, has flexible leather sweat band, and will wear like iron. Can be rolled up and into several shapes without damaging. All sizes in black, blue, brown, and gray. If not exactly as represented—drop ME a line and I will refund your dollar by return mail—AND YOU MAY KEEP THE HAT. You can't lose—send me a dollar TODAY. Two for \$1.80. Write for booklet of "Working Clothes for Workmen."
GEO. F. BUNGAY, 28 S. William St., N. Y.

The "APOLLO" Safety Razor



Sold direct to you with a positive guarantee of satisfaction. It is very simple and unbreakable. Will last a life time.

Made of best metal with nickel finish.

Six blades of best tempered steel with each set. Each blade has two keen edges giving at least six shaves. With the "APOLLO" you cannot cut yourself. It is impossible.

SAVE the Middleman's PROFIT for yourself and buy direct at a saving of at least 150%. Razor and blades come in plush lined box and with a guarantee that if same is not as represented or not entirely satisfactory, money will be refunded.

SEND \$1 TODAY

and receive The "APOLLO" and be one of the thousands that write "I NOW SHAVE WITH COMFORT."

EXTRA BLADES 50c. BY THE DOZEN.

American Sales Co.
San Fernando Bldg. LOS ANGELES, CAL.

Models Built by Boys!

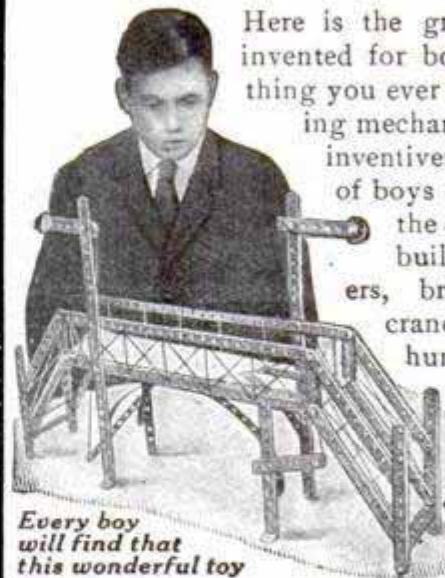

Here is the greatest toy ever invented for boys. Beats anything you ever saw for developing mechanical genius and inventiveness. Thousands of boys are experiencing the delightful fun of building signal towers, bridges, traveling cranes, trucks and hundreds of other things that are actual working models, built on the same principles that the real ones are.

Every boy will find that this wonderful toy

"MECCANO"

offers the widest field for the serious study of mechanics because it is a simplified system of modern mechanical construction. It comprises the main parts used in machines—beams, wheels, axles, levers, pulleys, bolts, etc. All made of nickel steel and brass—can be used indefinitely. Every father should see that his son has this instructive toy.

Sold by leading toy and sporting goods dealers.

Write for illustrated catalogue P.

THE EMBOSING COMPANY, Albany, N. Y.
Manufacturers of "Toys That Teach."

Remoh Gems

Not Imitations

A marvelously reconstructed gem—the greatest triumph of the electric furnace. Looks like a diamond—wears like a diamond—will cut glass—stands filing, fire and acid tests like a diamond—guaranteed to contain no glass. Remoh Gems have no paste, foil or artificial backing—their brilliancy is guaranteed forever. One-thirtieth the cost of a diamond. These remarkable gems are set only in 14 Karat Solid Gold Mountings. Sent on approval—your money cheerfully refunded if not perfectly satisfactory. It will be well worth your while to get our De-Luxe Jewel Book—yours for the asking. Cut out and mail the coupon below—or write a postal. Address

Remoh Jewelry Co.
429 N. Broadway, St. Louis, Mo.

Remoh Jewelry Co.,
429 N. Broadway, St. Louis, Mo.
Send your De-Luxe Jewel Book.

Name.....
Address.....
City.....
State.....

**Sign
And
Mail This
Coupon Today**

BIRDS AS BALLOONS—Not many people are aware of the fact that all birds utilize the principle of the hot-air balloon in their flight. It will be remembered that the Montgolfier brothers, who first went up in a balloon during the eighteenth century, built a fire under a silk bag open at the bottom, thus allowing the air to become heated. Of course the air expanded, and part of it flowed out, while what was left, although perfectly filling the balloon, was very much lighter than ordinary air, and would consequently be lifted by it. Now, all

\$10 A DAY And This Suit

YOU can easily make big money with our new cooperative plan, showing our wool samples and snappy fashions to your friends. It's new. They'll buy on sight, for you save them from \$4 to \$8, give them the latest striking city fashions and the finest tailoring in the world.

Your Own Suit For Nothing

by making enough on the first two or three orders to pay for it. Why not dress swell, get your clothes at a confidential inside figure, and easily make from \$5.00 to \$10.00 a day? No money or experience needed. Agent's complete outfit sent FREE—60 rich woolen samples—perfect measuring system—full instructions—everything necessary to start you successfully in a big paying business all your own. All clothes made to measure. Remember

We Pay Express Charges

and take all the risk. Everything sent subject to examination and approval before payment is made. Clothes must fit and satisfy or your money back. Send no money—we furnish everything FREE. Just mail a postal today and the dollars will soon be flowing your way. We appoint only one agent in a town, so write quick and be the lucky man to get in on the big money.

RELIABLE TAILORING COMPANY,
908 W. Jackson Blvd., Chicago, Ill.



\$42 will put running water in your home

This system will supply running water for the laundry, kitchen, bathroom, garden and stables.

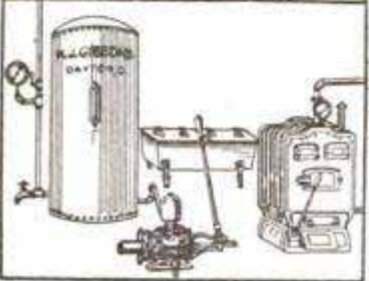
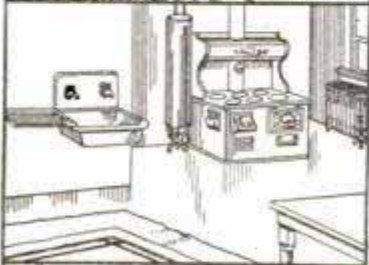

Made in all sizes, from \$42 up, and operated by hand power, electric motors or gasoline engines.

\$38.95 buys this complete bathroom outfit

The luxuries of modern plumbing at half the ordinary cost.

Save \$100 to \$250 on your steam and hot water heating plants.

Do away with the danger and trouble of oil and coal stoves. Enjoy the comforts of steam and hot water heating.

A Few of Our Specialties

Complete Electric Lighting Plant, \$300. Gasoline Engines for general utility farm use. Hydraulic rams, Pumps, Pipe, Valves, Fittings, at lowest prices. Farmers' Tanks, Gas and Electric Fixtures. All high-grade strictly guaranteed goods. Plans free. Get our prices. We will save you money.

BIG CATALOG FREE!

M. J. GIBBONS
Dept. A DAYTON, O.

birds have hollow bones, the hollows being connected with the lungs by means of natural and very ingenious and wonderful passages, and consequently with the outside air. On account of this the bones are always full of air. The heat of the bird's body makes this air very much lighter than the outside air, and thus we have a perfect analogy to the hot-air balloon.—Harper's Weekly.

Your Tired Feet



are speaking to you; do you hear them? They want you to make them comfortable and happy by wearing our

ANTI-TENDER-FOOT-SHOES

and such of our other specialties as they may need. Give us a call soon, personal or by mail—your feet will thank you.

Peterson's, Shoe Specialists
23 South Fifth Ave., CHICAGO



IN THE AVERAGE SHOE

IN THE PETERSON SHOE

FINEST VIOLINS on 30 DAYS' TRIAL

We sell direct from our Chicago and European shops. Your choice from the finest collection of stringed instruments in America. Everything the violinist needs. Violins from \$5 to \$100 and up.

Time Payments arranged if desired. **30 DAYS' TRIAL** before you decide to purchase. Write **Today** for our valuable Violinist's Catalog. Sent to you **FREE**.

Wm. C. Lewis & Son, Makers and Importers
(Est. 1869) 225 S. Wabash Ave., Chicago, Ill.

Our Specialties: Imported wood, varnishes and tools for violin makers.

BARODA DIAMONDS

Flash Like Genuine

ANY STYLE

at 1/40 the cost--IN SOLID GOLD RINGS

Stand acid test and expert examination. We guarantee them. See them first—then pay. **Special Offer**—14k Tiffany ring 1 ct. \$5.95. Gents ring 1 ct. \$6.95. 14k Stud 1 ct. \$4.85. Sent C. O. D. for inspection. **Catalog FREE**, shows full line. Patent ring gauge included, 10c. The Baroda Co., Dept. A5, Leland & Dover Sts., Chicago

STARTLING Watch Offer

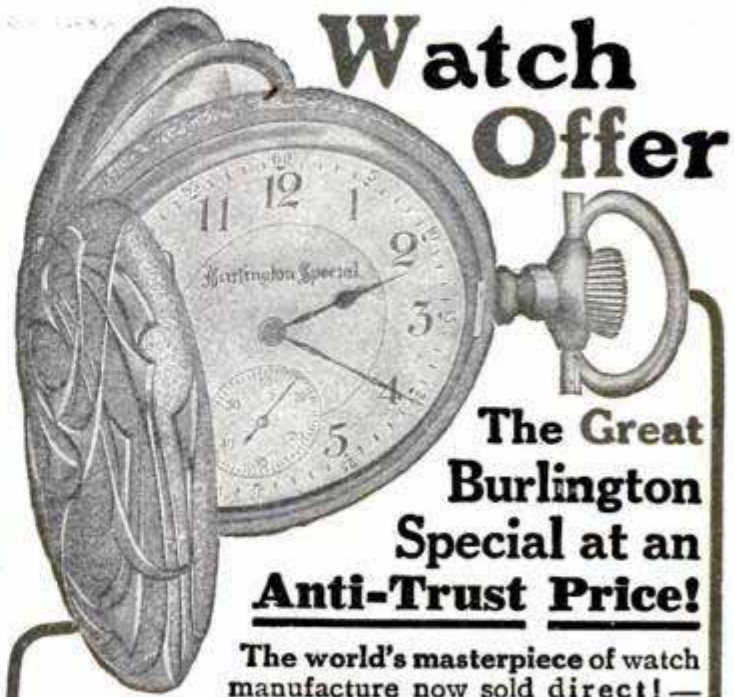

The Great Burlington Special at an Anti-Trust Price!

The world's masterpiece of watch manufacture now sold direct!—

The most amazing offer ever made in the whole history of the watch industry — an offer which has absolutely PARALYZED competition — the offer of the genuine Burlington Special direct to the public at the rock-bottom ANTI-TRUST PRICE, without middlemen's profits.

The Fight is On!

We will not be bound by any system of price-boosting contracts with dealers. We will not submit to any "high profit" selling scheme. We will not be dictated to by ANY Trust.

NO MATTER WHAT IT COSTS, we are determined to push our independent line even if we should have to fight a combination of all the Watch Manufacturers of the country!

And so we are making this offer—the most sweeping, astounding offer ever made on a high-grade watch. The famous BURLINGTON direct and at the same price WHOLESALE Jewelers must pay.

And in order to make the proposition doubly easy for the public we will even allow this rock-bottom price, if desired, on terms of **\$2.50 a Month**. Don't miss this wonderfully liberal offer. Sign and mail coupon now. Rock-bottom, anti-trust price, whether you buy for cash or time.

POST YOURSELF!

Be sure to get posted on watches and watch values, trust-method prices and anti-trust prices before you buy a watch. Learn to judge watch values!

Get the Burlington Watch Company's

FREE WATCH BOOK

Read our startling exposure of the amazing conditions which exist in the watch trade today. Read about the anti-trust fight. Read about our great \$1,000.00 Challenge. Learn how you can judge watch values.

Send your name and address for this valuable **FREE BOOK** now — TODAY. Sign & mail coupon.

BURLINGTON WATCH CO.
Dept. 1
19th & Marshall Blvd.,
Chicago, Ill.

Please send me without obligation and prepaid, your free book on watches and copy of your \$1,000.00 challenge, with full explanations of your cash or easy a month offer on the superb ANTI-TRUST Burlington Watch.

Name.....
Address.....
No letter necessary will be

New Sensation

THE BIGGEST SURPRISE OF THE AGE

Photos Direct on POST CARDS NO NEGATIVES



Hustlers and wide-awake men—the photo post card business offers unlimited opportunities.

Small investment—**500% Profit.** No experience needed. Be independent—here is your chance to start your own business. Big money made at fairs, carnivals, amusement parks, etc., etc., with the

Mandel Combination No.3 Camera

This Camera makes two styles photo post cards (size 3x4 1/4 and 2x3) on the cards direct—no negatives. A complete, "portable photo gallery." Camera weighs 9 pounds. Pictures made in broad daylight and finished on the spot in one minute. Price of Camera \$17.50.

COMPLETE OUTFIT ONLY \$26

Outfit includes everything needed to start making money right away; also 100 large and 100 small post cards. Send \$5 with order, bal. C. O. D. Write today for Free Circular.

CHICAGO FERROTYPE CO.

Dept. B102, Congress and Laflin Sts., CHICAGO

Your Picture in a Postal Card IN ONE MINUTE



The pictures are developed, toned and finished in a single developing solution. No experience is necessary. Price of machines \$7.50 and \$15.00—circulars describing our machines sent free. We are also headquarters for supplies for all minute picture machines.

AMERICAN MINUTE PHOTO COMPANY
Dept. U, 720-728 W. 12th St., Chicago, Illinois
The largest manufacturers and distributors of minute picture machines and supplies in the world.

OVER \$400 Made in One Day Operating the



CIRCLING-WAVE AMUSEMENT DEVICE *Read this*

Armitage & Guinn: At Eagerton, Ind., away back from no place we got in \$350.90 in six hours' run. At Crawfordville, Ind., we had a \$402 day.

BOOHER BROS.

IF BOOHER BROS. DID THIS, WHY CAN'T YOU?

Let us tell you all about this marvelous CIRCLING WAVE, and its wonderful money-making power. Address,

ARMITAGE & GUINN, 34 Mill St., Springville, Erie Co., N.Y., U.S.A.

Corner the Fun Market!

Box Ball has taken fun lovers by storm—is cleaning up from \$100.00 to \$600.00 a month clear profit for Managers everywhere. One man with four alleys made clear

\$680.00 in 30 Days

Be a Manager. All you need is energy, and on a small investment you can make the same profits, if not greater ones, right in your own locality. Box Ball is a clean, moral game—an exercise that fascinates the best class of men and women everywhere. New improved alley—noiseless, fast, irresistible. Big, regular shaped ten-pins set automatically by the players—you just take in the cash. No help needed to operate—no expenses of any kind except rent.

Our Guarantee—you can set yourself up in a permanent, big-paying business on an investment as low as \$120 to \$300. If you are not satisfied after 30 days we take back the alley and refund what you paid us minus what you took in. Write for our proposition at once.

AMERICAN BOX BALL CO., Box 364, Indianapolis, Ind.

\$15. to \$35. PER DAY IN MINUTE PHOTOGRAPHY

WE CAN PROVE IT. Our No. 4 Ferrottype machine takes three sizes of pictures, on plates 2 1/2 x 3 1/4—1 3/4 x 2 1/2 and buttons. It is also reversible. Send for Our Descriptive Catalog. It tells all about it. Don't delay. It means your future.

NEW YORK FERROTYPE CO., Dept. 72
168 1/2 Delancey St., NEW YORK, U. S. A.



You can make \$10.00 to \$20.00 per day

by operating our No. 6 wonderful Ferrottype Machine which takes three sizes of pictures, on plate 2 1/2 x 3 1/4, 1 3/4 x 2 1/2 and button sizes. It is also reversible for taking groups.

Send for our free 1911 Catalogue. Don't delay; it means your future.

JAMESTOWN FERROTYPE CO.

Dept. A., M. Brody, Gen. Mgr.
No. 1113 S. Halsted Street, Chicago, Ill.



The antemortem statement of a man killed by stabbing in St. Paul was taken in a phonograph and ground out, in the voice of the dead, to the coroner's jury. It acquitted the accused. This is novel, but it is easy to see, on the first trial of the phonograph in such a way, how easily the use of the machine could be abused to defeat the ends of justice.—St. Louis Globe Democrat.

PRINT FOR YOURSELF



Cards, circulars, book, newspaper. Press \$5, Larger \$18, Rotary \$60. Save money. Print for others, big profit. All easy, rules sent. Write factory for press catalog. TYPE, cards, paper.

THE PRESS CO., Meriden, Connecticut

GO INTO THE Moving Picture Business

FROM \$45 to \$60 STARTS YOU AND YOU WILL EARN AS MUCH IN 1 OR 2 NIGHTS

The small payment required to get our machine will make more money than thousands of dollars invested in any other enterprise.

\$25 and more per night can be made exhibiting with our machine in halls, schools, churches, theaters, etc., in your own and surrounding towns. We furnish everything—rent films, too.



Write for particulars about our Moving Picture Machines and our 6-months-to-pay plan.

P. & W. SALES CO., 839 Temple Court Bldg., CHICAGO

Magic Lanterns with the Alco-Radiant Light



The Alco-Radiant is the only practical, intense light for Lanterns if electric is not to be had. It burns alcohol, costs little to use and a trifle to buy; weighs 3 lbs.; adaptable to any Lantern. New Lantern slides for Lenten season, plain or colored, for sale or rent. Lecture sets of slides with readings, such as Judas, Herod, The Multitude, Way of Grief, Seven Words from the Cross, Passion Play of 1910, etc. Ask About Post Card Projectors. They show on a screen the image reflected from a post card or any other picture or flat object. Prices, \$4.50, \$13.50, \$25.00, \$60.00.

WILLIAMS, BROWN & EARLE, Dept. 20, 918 Chestnut Street, Philadelphia, Pa.

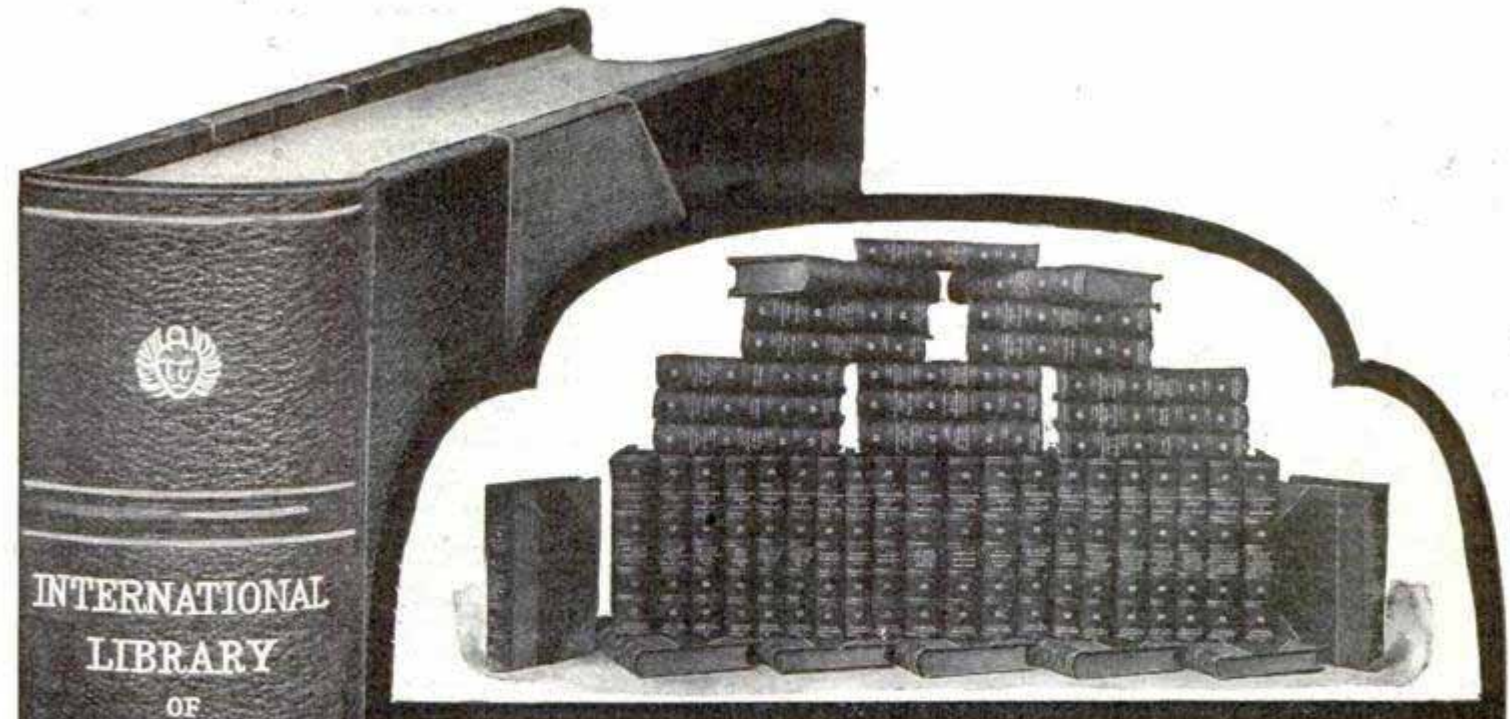

INTERNATIONAL
LIBRARY
OF
TECHNOLOGY

HOISTING
HAULAGE
MINE DRAINAGE

INTERNATIONAL
TEXTBOOK COMPANY
38B

The Greatest Technical Library in the World

At an original cost of over one million dollars there has been prepared 99 Volumes of the International Library of Technology. This Library contains the knowledge obtained through years of experience by the greatest business, manufacturing, and engineering concerns in the world. The matter has been written by the best technical experts obtainable and illustrated by a special staff of artists and draftsmen. In these books are found the best modern methods of American engineering, shop, field, mine, and laboratory practice. It is the only practical technical library in existence that can be readily understood and practically applied by those having no knowledge of higher mathematics.

Edwin S. Cramp, vice-president of the William Cramp & Sons Ship and Engine Building Company, of Philadelphia, states:

"I have examined the International Library of Technology and have no hesitancy in saying that it is the most complete set of technical books that I have ever had the pleasure of placing in my book case. The thoroughness with which you go into the various subjects is marvelous."

The Library contains over 42,000 pages and 20,000 illustrations; 99 Volumes durably and handsomely bound in three-fourths red morocco, stamped and numbered in gold. The type is large and easy to read and is printed on a high-grade book paper. Each volume is 6 by 9 inches in size. The Library is sold in sets of 5 or more Volumes.

This storehouse of the world's best technical brains awaits to help you advance, to broaden and better yourself. Send us this coupon NOW.

INTERNATIONAL TEXTBOOK COMPANY
872, Scranton, Pa.

Please send, without further obligation to me, full description and particulars regarding the International Library of Technology.

Name _____
St. and No. _____
City _____ State _____

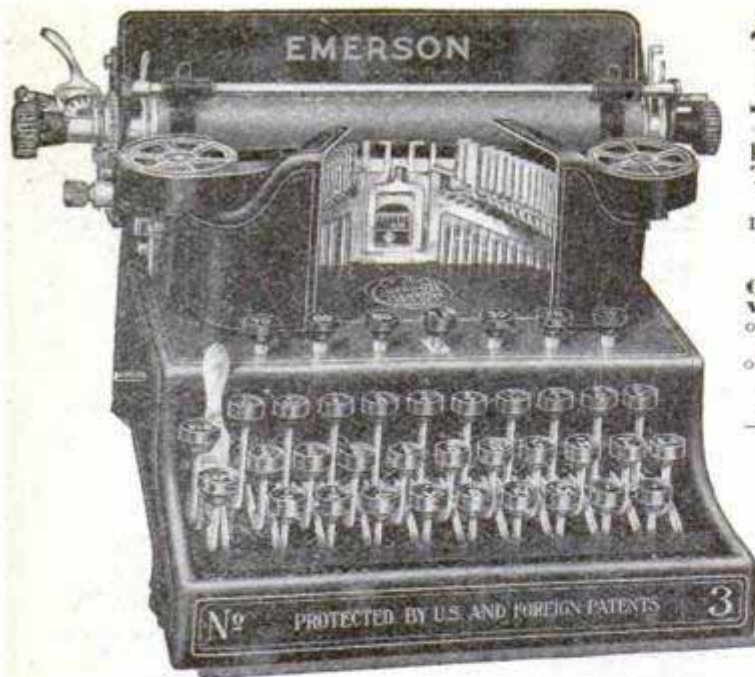

10 CENTS A DAY

buys the New Improved Wholly Visible Wonderful Emerson Typewriter.

Two-Color Ribbon, Tabulator, Back Spacer, Every improvement. One of the best typewriters made.

UNHEARD-OF LOW PRICE

One Emerson Typewriter FREE to any person, man or woman, boy or girl who will do us a slight service, no selling, no canvassing, only a few moments of your spare time required.

Don't pay even \$20 for any typewriter made until you first write for our FREE offer.

Our Customers Write Like This:

Received a piano and typewriter free for not more than five hours of my time.—EVERETT WALKER, Tunnelton, W. Va.

Earned an Upright Grand Piano and EMERSON Typewriter in five hours. Since getting the "EMERSON" I have set my \$100 machine aside.—R. W. SUTTON, Hillsdale, Ind.

Received a piano and typewriter free. It comes nearer to getting something for nothing than I ever thought possible. There is no \$100 typewriter that excels the "EMERSON."—W. C. BENTLEY, Las Animas, Colo.

The EMERSON Typewriter excels all others. I wasn't six hours earning an Upright Grand Piano and Typewriter. People writing for your Free Offer will be greatly surprised and delighted, for they will find they can earn a piano and typewriter free in a very few hours easily.—B. J. MILLER, Benson, Ill.

Consider the "EMERSON" the best machine made. I earned mine in just a few hours.—I. N. CLACK, Lampasas, Texas.

The "EMERSON" is beyond anything on the market in the shape of a typewriter. I earned a typewriter and piano in one day.—K. S. VAN ZANDT, Whitt, Texas.

We Could Fill This Paper With Similar Letters

Earned an EMERSON Typewriter in just a few minutes.—F. W. HORN, Burlington, Iowa.

Earned an EMERSON Typewriter for less than two hours work. The EMERSON is better than any \$100 typewriter on the market.—JOS. M. PHELPS, Centralia, Mo.

FOR OUR GREAT FREE OFFER and to learn of our easy terms, and full particulars regarding this Great Offer, for copies of letters from the many who are using Emerson Typewriters which they received FREE for only a few hours of their time. For everything we and others can tell you about the Emerson Typewriter on a Postal Card or in a letter to us, simply say "Mail Me Your FREE Offers."

THE EMERSON TYPEWRITER COMPANY, Box 169, WOODSTOCK, ILL.

LET US GIVE YOU THIS TRANSPARENT CELLULOID TRIANGLE

It is 4 inch size, 30°+60° angles. Lowest retail price, 25 cents. Absolutely essential to everyone who draws. We make this offer to introduce our new catalogue showing

SPAULDING'S NEW CARRYING CASES AND COMPLETE OUTFITS

for designers, architects, engineers and students—compact, durable and convenient. Spaulding's Carrying Cases are made light and strong. They provide well arranged compartments, including space for drawing board and T square. Handled like a suit case; unique, practical, inexpensive. Outfits include all necessary equipment. If you draw, send us five 2-cent stamps to-day to pay postage and get the free triangle and the catalogue.

SPAULDING PRINT PAPER CO.
44 Federal St. BOSTON

LEARN ISOMETRIC DRAWING

Easy to produce quickly read working plans. The Isograph makes an expert of a novice. Invaluable to inventors and designers. Handy for any draftsman. Celluloid 6x6 inches. Postpaid 50c with amply illustrated instructions. 2c stamps accepted. Send today.

THE ISOGRAPH CO.
145 E. 23d St. NEW YORK CITY

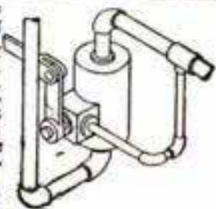

"Aviation," says a surly exchange, "is a disease." Wright's disease?—Chicago Tribune.

RED or BLACK VULCAN STYLOS

Moderate priced, easy writing pens that give satisfaction; unequaled for rapid writing and ruling.



\$1.00 Postpaid. Two Sizes, 4 1/4 and 5 1/4 Inches
AGENTS WANTED. Extra size, 8 inches (BLACK ONLY) \$1.25
J. C. ULLRICH & CO., 27 Thames St., NEW YORK
Manufacturers of Stylo and Fountain Pens

\$18
in U.S.A.

Bennett
MADE IN U.S.A.

20,000—\$18 BENNETT In Use

It does work equal to any \$100 machine

That's what you get in this unique, wonderful little typewriter, so small it can be carried in pocket or grip, with every modern improvement. LET US PROVE THIS Standard keyboard 84 characters. Get out letters, orders, records, etc., on train, in office, at home, everywhere—see the neat, rapid work the Bennett does—saves you time, stenographers' charges, prevents errors. Write for catalog and special offer.

We have a splendid chance for agents. Foreign Address: 75 Cannon St., London, E. C.
P. K. BENNETT TYPEWRITER CO. - 366 Broadway, New York



TYPEWRITERS ALL MAKES

All the Standard Machines SOLD or RENTED ANYWHERE at 1/4 to 1/2 MFR'S PRICES, allowing RENTAL TO APPLY ON PRICE. Shipped with privilege of examination. Write for Illustrated Catalog L.
TYPEWRITER EMPORIUM, 92-94 Lake St., CHICAGO

Wireless

We publish the best 25c wireless books in the country. Your money refunded if these books are not the greatest value for the money you run across. "How to Make Wireless Instruments" by 20 wireless experts. 96 pages, 75 illustrations. "Wireless Telephone." by H. Gernsbaek, 80 pages, 57 illustrations. "Construction of Induction Coils and Transformers" by H. W. Secor, 100 pages, 72 illustrations. "Wireless Hoo-kups" 100 pages, 161 illustrations. Each book mailed for 25c, or the four for \$1.
MODERN PUBLISHING CO., 231 Fulton Street, NEW YORK CITY

ALOE'S

Our Renowned Double Combination TELESCOPE

Size 2 in. Object Glass, Length 63 in. Prof. Hicks, of Word and Works Almanac, says they are far superior to others he has examined at twice the price.

CATALOGUES ON APPLICATION



ASTRONOMICAL TELESCOPES

Complete with Case, Sun Shade, Sun Glass and Extra Eye Piece for Night Observation \$18⁰⁰

One of these superb instruments will give material enjoyment. It will enable you to pick out the smallest Boats on the Horizon, tell the time by a clock at many miles distant, and view the country for fifty miles around. "This Telescope" for Astronomical Work is simply unequalled, with its aid the Mountains in the Moon, Jupiter's Moons and Saturn's Rings are clearly discernible.

A. S. ALOE COMPANY, 515 Olive S., St. Louis, Mo.

Fixed Receiving Condenser



The above cut illustrates our new fixed receiving condenser. Enclosed in polished brass case. Has capacity sufficient for any station and a greater capacity than any other at the same price or less.

Price 75 Cents

Our Manual of Wireless Telegraphy and Catalog No. 1P will be sent on request

Manhattan Electrical Supply Co.

NEW YORK

CHICAGO

17 Park Place

112-114 So. Fifth Ave.

SECONDARY "UNITS" FOR WIRELESS
INDUCTION COILS AND TRANSFORMERS. THESE UNITS COST BUT LITTLE MORE THAN WIRE ALONE. SEND 2 CENT STAMP FOR WIRELESS CATALOGUE.

Dawson & Winger Electric Co., 429 Dearborn Street, Chicago



Ideal Christmas Gifts The most wonderful and fascinating study of the age. Everybody should have a copy of the new "VOLTAMP ELECTRICAL PRODUCTS" our 112-Page Catalog, now ready. The most complete and interesting book ever issued. Full of illustrations and descriptions of VOLTAMP Novelties—Motors, Dynamos, Telegraph and "Wireless" Instruments, Spark Coils, Lamps, Flashlights, Transformers, etc. Everything Electrical for the experimenter. The greatest line of MINATURE ELECTRIC RAILWAYS ever shown. Catalog with valuable coupon sent only for 6 cents in stamps or coin. (No postals answered.)
VOLTAMP ELECTRIC MFG. CO., Voltamp Block, BALTIMORE, MD.

Wireless Supplies

We are Western Representatives for The Electro Importing Co., carrying a complete stock. Same catalog. Same prices. Mail orders promptly attended to. Send 4c stamp for catalog

ANDERSON LIGHT AND SPECIALTY CO.
140 No. La Salle St. (Opposite New City Hall) CHICAGO, ILLINOIS

EXPERIMENTERS

We carry the largest line of experimental supplies in the U. S. Complete RAW MATERIAL STOCK as Brass Sheeting, Tubing, Rod; Copper Sheeting, Tubing, Rod; Aluminum Sheeting, Tubing, Rod; Iron Sheeting, Tubing, Rod; Silver Sheeting; German Silver Sheeting; Lead Sheeting; Nickel Sheeting; Phosphor Bronze; Hard Rubber Sheeting, Tubing, Rod; Fibre Sheeting, Tubing, Rod; Carbon Plates; Empire Paper and Cloth; Tin Foils; Paraffine Paper; Brass, Copper, Aluminum, Piano, Platinum Wires. Full line of Gears; Platinum Contact Points; Armature Discs; Pulleys; Switch Points and Levers; Numeral Tacks; Switch Handles; Brass Balls, Glass Tubing, Rods and the most complete line of low priced tools in the world. We furthermore, have the greatest assortment of Electrical Experimental Goods that you can conceive. WIRELESS GOODS FOR THE EXPERIMENTER our greatest specialty. Send today 4 cents postage for our great 196 page Electrical Cyclopedic. The greatest information book in print. No postals answered. **THE ELECTRO IMPORTING CO., 233a Fulton St., New York.** "Everything for the Experimenter."

BARGAIN PRICES on New and Used Electrical Machinery

You can sell, buy, rent or trade Electrical Machinery by dealing with us. We'll do business your way. Our stocks are large and our prices are low. Tell us your needs; we can help you. No other house can match our bargains on new or used apparatus. Remember you can turn in to us at a good price (Cash or Trade) any apparatus you own and do not want to keep.

Repair Dept. We are equipped with a highly efficient repair department that can handle any repairs. This coupled with unsurpassed shipping facilities assure you quick work and prompt delivery.

The Only House in the World With a **REAL Guarantee on Used Machinery**—Same as We and Others Give on New

We do give such a guarantee because we have the highest confidence in our used machinery. We thoroughly overhaul it ourselves, and back it up as we do the new.

"Bargain Bulletin No. 20"

Gives hundreds of attractive bargains in new and used Motors, Dynamos, and other Electrical Machinery. How does \$6.75 down to \$5, for quantities, look to you on new 1-20 H. P. Motors? And \$15 on new 1-6 H. P.? Low speeds. All sizes between at corresponding prices. All new and in their original shipping crates. These are a few of the many bargains in this Bulletin. You should have a copy. Write today. It's FREE.

We Do Not Handle Novelties or Toys

The F. Bissell Co.

"The House with the Stocks"

226-230 Huron St., TOLEDO, OHIO



BIG 250-p. Catalog Just Out Electrical and Wireless Goods

Mailed for 6c Stamps or Coin, which may be deducted from first order of \$1.00. Largest and most artistic Electrical Catalog published. 85 pages WIRELESS Instruments for commercial and experimental use. 30 pages Motors and Dynamos of all sizes. 35 pages Miniature Trains. 20 pages Telegraph Instruments. 30 pages Electrical Novelties, etc. 50 pages general Electrical Supplies.
J. J. DUCK, 424-6 St. Clair St., TOLEDO, OHIO

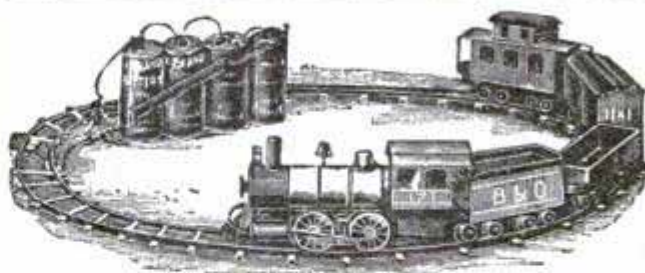

Electrical railways, tracks, switches, trolley cars, dynamos, motors, dynamo castings, gas engine castings, everything for the young electrician. Send for our complete catalog "B."

The Carlisle & Finch Co.

262 E. Clifton Ave.

Cincinnati, Ohio

Don't Let a Few Cents a Week the Books You



Cyclopaedia of

Architecture, Carpentry and Building

Ten large volumes, bound in half morocco, gold stamped titles; 4,760 pages, 7x10 inches; 4,000 illustrations. A practical, up-to-date reference work and home study course for the Student, Concrete Constructor Engineer, Builder, Carpenter, Draftsman, etc.

Special Price, \$24.80—Regular Price, \$50.00.

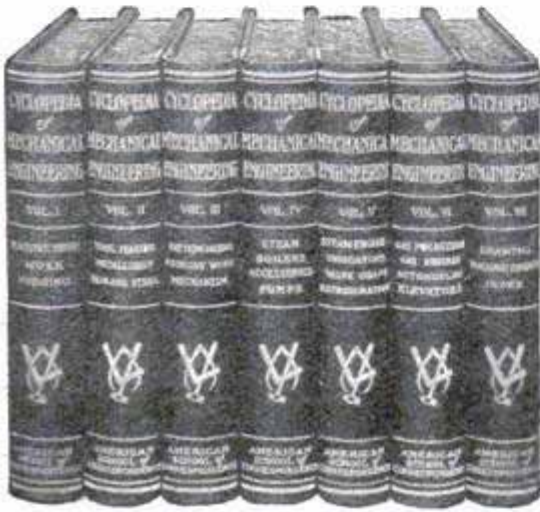

Cyclopaedia of Mechanical Engineering

Seven large volumes, bound in half morocco, gold stamped titles; 3,992 pages, 7x10 inches, 2,327 illustrations. A practical, up-to-date reference work and home study course on Modern Shop Practice and Mechanical Engineering.

Special Price, \$19.80—Regular Price, \$36.00.



Cyclopaedia of Applied Electricity

Seven large volumes, bound in half morocco, gold stamped titles; 3,200 pages, 7x10 inches, 2,600 illustrations. A practical, up-to-date reference work and home study instructor covering Electricity from Electric Wiring to Design and Construction of Electric Machinery and Power Stations, including a new volume on Alternating Current Machinery.

Special Price, \$19.80—Regular Price, \$36.00.

the Books You

Pick out the cyclopedia you want, fill in and mail the coupon. We'll send you the complete set free of charge. You can keep the books a week and examine them at your leisure.

What these Cyclopedias are: These great cyclopedias are not collections of theories, but complete reviews of the actual, tried and tested experiences of the greatest engineers of the world. The books are not dictionaries of disjointed facts—not dry technical works, but clear and simple explanations of every phase and every branch of practical engineering. They are books you will need every day—books that will raise your salary by increasing your knowledge of your work.

Reference value guaranteed by the fact that the books are compiled from the text-books used in the correspondence courses of the American School of Correspondence. These practical lessons are arranged for quick reference, and the new cross index enables you to turn to any subject in an instant.

We prove their value to you by sending the set you select on approval. If the books are not all we claim them to be—and more—do you think we could afford to take this chance?

No chance for you to lose—no deposit required—no transportation to advance—nothing to pay unless the books are just what you want. Isn't this a fair proposition?

AMERICAN SCHOOL

CHICAGO.

Stand Between You and Need Every Day

Another great offer that goes
with every Cyclopedia

With each set we include a Consulting Certificate entitling you to the advice of our business and engineering experts free. This will give you practical help in handling working problems which are too specific to be taken up in detail in the cyclopedia. There will be no limit to this service. A single problem solved for you might be worth more than the first cost of the books. Order the books you need now.

Remember—It costs you nothing to examine the books—you will save money by owning them. Mail the coupon—make your final decision with the books before you.

Other Cyclopedias

Cyclopedia of Motion Picture Work	4 vols.	\$ 9.80
Cyclopedia of Drawing	4 vols.	9.80
Cyclopedia of Heating and Plumbing	4 vols.	12.80
Cyclopedia of Telephony and Telegraphy	4 vols.	12.80
Cyclopedia of Automobile Engineering	4 vols.	12.80
Cyclopedia of Fire Insurance	4 vols.	15.80
Cyclopedia of Textile Work	7 vols.	19.80
Cyclopedia of Business	10 vols.	24.80

We mean just what we say. We will ship the set you select, absolutely free of charge, just to prove to you the superiority of our engineering cyclopedias over all others. Keep the books a week—examine them thoroughly, critically—subject every formula and problem to the severest test you know. Then, if you are satisfied the books are just what you want, send us the first payment of \$2.80 and \$2.00 each month until you have paid the special price.

When filling in coupon be sure and mention cyclopedia wanted.

of CORRESPONDENCE

U. S. A.



Cyclopedia of Civil Engineering

Eight large volumes, bound in half morocco, gold stamped titles; 3,908 pages, 7x10 inches; 3,000 illustrations. A practical, thorough, up-to-date reference work and home study course covering every branch of Civil Engineering.

Special Price, \$24.80—Regular Price, \$48.00.



Cyclopedia of Engineering

Seven large volumes, bound in half morocco, gold stamped titles; 3,300 pages, 7x10 inches, 2,500 illustrations. A practical, up-to-date reference work and home study work on Steam Boilers; Steam, Gas and Oil Engines; Automobiles; Marine and Locomotive Work; Heating and Ventilation; Refrigeration; Dynamos; Elevators; etc.

Special Price, \$19.80—Regular Price, \$36.00.

FREE EXAMINATION COUPON

American School of Correspondence, Chicago, U. S. A.

Please send me set of Cyclopedia of.....

.....
for 7 DAYS' FREE examination. I will examine the books thoroughly and if satisfied, will send \$2.80 within 7 days and \$2 00 each month until I have paid

the special price of \$.....
If I decide to not keep the books, I will notify you at once and hold the books subject to your order. Title not to pass to me until the books are fully paid for.

NAME

ADDRESS

EMPLOYER

REFERENCES..... Pop.Mech.10-11

Better Than Nails

After fitting the corners of a picture frame or the joints of other light work, have you ever ruined the whole thing by splitting it with a nail? Then you've had need for

LEPAGE'S GLUE

For, of course, glue won't split the weakest wood. Yet a square inch of glue makes as strong a joint as three six-penny nails do.

And is just as handy as nails or string. Put up in air-tight bottles, it positively can not dry out. The last bit you scrape from the bottle with the metal spreader is as good as the first.

With the metal spreader you can use glue in places where you couldn't use a brush, and without muss or waste.

Get a bottle today and put it with the hammer and saw. Send, too, for our booklet—"Glueism" Gives 101 uses for glue in our new bottle and patent collapsible pin sealing tube.

RUSSIA CEMENT COMPANY

We manufacture Glues (hard or liquid) in bulk for all industrial purposes.

53 Essex Avenue,
Gloucester, Mass.

Library Slips with every Bottle and Tube

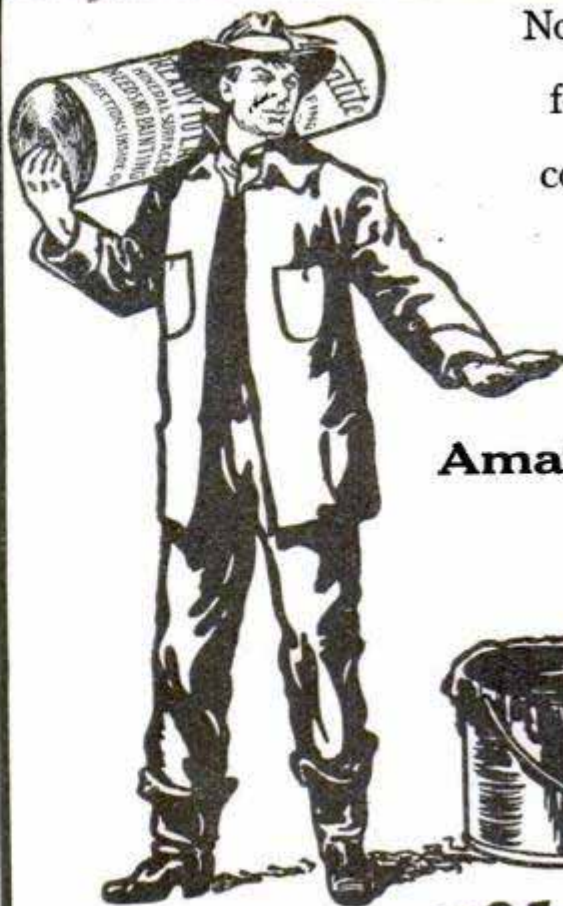

No more paint for me! I've covered every roof on my place with

Amatite

Amatite ROOFING

TO buy a roofing that requires painting is inviting trouble.

Painted roofings are as out of date as the harvester machinery of thirty years ago.

The roofing of to-day needs no painting. That's one of its great features.

If you are still using the "old rubber kind," the kind that requires painting every year or two to keep it tight, we want to tell you about Amatite; why it *needs no painting*; why it *wears longer* than the "smooth surfaced" roofings, and why it *costs less*.

We want to send you a sample so that you can see what a solid, substantial waterproof roofing Amatite really is. Write to-day. Address nearest office.

BARRETT MANUFACTURING CO.

New York
Philadelphia
Cincinnati
Cleveland
Pittsburg
Kansas City

Chicago
Boston
Minneapolis
St. Louis
New Orleans
London, Eng.



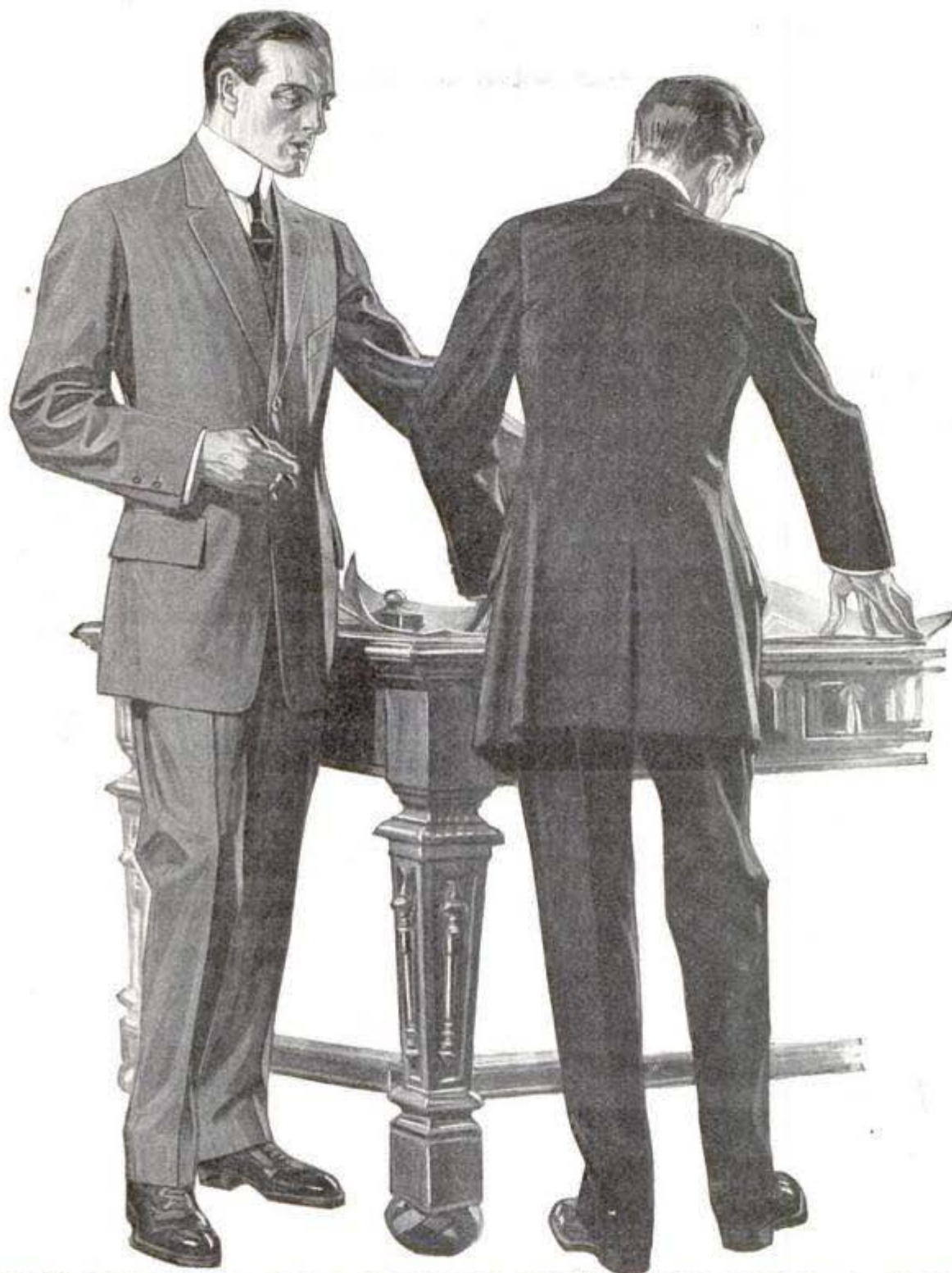

THIS MATTER OF LOOKING WELL—IT ISN'T A LITTLE thing! It's of far reaching importance.

Kuppenheimer clothes accord the man who wears them full measure of social and business standing, and the self reliance and poise that comes with the assurance that he is correctly dressed.

At the better clothiers in your town. Send for booklet "Styles for Men."

The House of Kuppenheimer

Chicago

New York

Boston

Copyright, The House of Kuppenheimer, Chicago.

CHIEF DRAFTSMAN

Will INSTRUCT PERSONALLY a limited number selected, ambitious men in

Practical Drafting, Detailing, Designing

Draftsmen Drawing \$125-\$150 Monthly

Are NOT MADE in Schoolrooms,
 Are NOT MADE by reading books,
 Are NOT MADE by making Copies,
 Are NOT MADE at home drawing pictures
 from printed book lesson.

LET ME TELL YOU:

It requires actual, practical, up-to-date
 DRAFTING-ROOM WORK to train YOU
 to gain the PRACTICAL EXPERIENCE
 that your employer will demand of you.



FREE

This \$13.85
**DRAWING
 OUTFIT**

and **Free Position.**

As Chief Draftsman of Engineering firm I know exactly the Quality and Quantity of PRACTICAL training, knowledge and actual up-to-date experience (not school knowledge) you must have, in order to obtain a good position and advance to highest salary.

I give **INSTRUCTION UNTIL COMPETENT** and
PLACED in POSITION at above Salary.

DON'T waste TIME and MONEY trying to learn from books or printed "STUFF" you can only learn on PRACTICAL WORK which I furnish you.

Address **CHIEF DRAFTSMAN**
Div. 19, Eng's Equip't Co. (Inc.), Chicago

IT is the manner in which your woodwork is finished more than the quality of the wood itself that gives you artistic interiors. Old woodwork and very inexpensive woodwork is made refined and beautiful by



Johnson's Wood Dye

Architects, contractors and practical craftsmen everywhere will tell you how superior it is in soft color, deep-staining qualities and permanent richness.

Would you like to try it yourself on some piece of woodwork or furniture?

**You Can Be Supplied
With Samples FREE**

Paint dealers will furnish trial packages of whatever color you wish, without charge. If you fail to secure samples, write us, giving your dealer's name. We

will see that you are supplied. We would also like to provide you with a little book which pictures fully and describes the best means of finishing all woodwork, floors and furniture. Ask for Book PA-10, mailed postpaid on request.

S. C. Johnson & Son, Racine, Wis.

"The Wood Finishing Authorities"



\$7.50

And You Keep This Great Engine

Yes, sir, that's right—you keep this engine for \$7.50, a wonderful gasoline engine offer, an offer without a parallel. We ship you Schmidt's Chilled Cylinder Gasoline Engine on your simple request without an order or any promise from you. You use the engine 10 entire days, use it all you want to. Then, if you don't want it, send it back at our expense. If you do wish to keep it, pay us only \$7.50 and the rest in the easiest monthly payments. We send you the engine free, to prove that it is the greatest air cooled 3 horse power engine on earth.

TEN DAYS TRIAL FREE

This is the first genuine free trial ever offered on gasoline engines for farm and shop use. We want you to see that women and children can run this engine. Use the engine to run any machinery you have—the pump—separator—washing machine—corn sheller—grinder—anything, and remember, the engine is ready to run when you get it—complete and ready to run. Your daughter, wife or son can run this engine as easily as winding a clock. Send the free coupon and we will send you prepaid our sensational offer and our very useful book, "How to Use Power," free.

EASY PAYMENTS

If you like this engine after trying it out for 10 whole days you can keep it and pay for it on easy monthly payments. If you decide that the Schmidt Chilled Cylinder Engine is the greatest Engine on earth all you need send us is \$7.50 after the free trial. If you don't want to keep the engine, for any reason whatever after using it free for ten days, just send it back at our expense. Now put your name and address on the coupon and mail it to us or drop us a card, and we will send you all particulars of this stupendous offer free. Don't forget that when you send us your name you get the book "How to Use Power," also free.

5 YEARS GUARANTEE

Schmidt's Chilled Cylinder Gasoline Engine is absolutely guaranteed for 5 years in every piece and part. The biggest bank in Iowa backs our \$1,000 challenge offer on our Engines.

FREE COUPON

SCHMIDT BROS. ENGINE WORKS, Dept. 1197, Davenport, Iowa.

GENTLEMEN: Please send me absolutely free, postpaid, your engine catalogs, wholesale price on easy payments, all information about your free trial offer on Schmidt's Chilled Cylinder Gasoline Engine, also a copy of your free book, "How to Use Power on the Farm or in the Shop," all free and postpaid.

SEND COUPON

Get all particulars of this amazing offer before you think of buying any engine from anybody. Learn all about this wonderful new type economy engine, so easy to handle. Get our catalogs before you obligate yourself to anybody or make any decision. Learn about the wonderful Chilled Cylinder; learn how useful the Engine will be to you and to the women folks on the farm. Learn how many things you can do with a chilled cylinder engine and how to save all dealers' profits for yourself. Send your name today. Fill out the coupon or drop us a postal card. Act quickly. Write now.

FREE COUPON

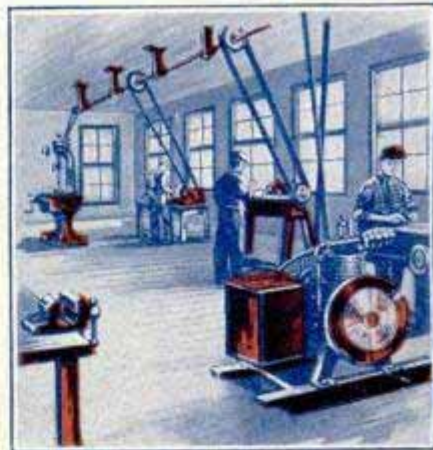

Greatest Farm Engine

It is the only engine with the marvelous, powerful chilled cylinder. The only engine for farm use with a spark retarder. The only engine good enough to send out on actual free trial without a cent down in any way and then sold to you on easy payments if you want it. Write for catalogs and wholesale price.

Schmidt Bros. Co. Engine Works

Dept. 1197

Davenport, Iowa

NAME

ADDRESS