

# Everyman's Car

*The Brush  
Runabout*

**\$450**

**T**HE contractor needs a reliable means of getting from place to place to oversee his work.

The Brush appeals to him because it is quick, dependable and particularly suited to getting through crowded city streets with the least loss of time. It earns its cost easily.



**D**OESN'T the Brush fit your needs as well as it does the contractor's—if you must go quickly from place to place?

To any one who loses valuable time in a business day by the slowness of ordinary means of city traffic—the Brush will pay for itself in no time.

It means more business calls—more business done—relief from the frets of city crowds—better health, better temper—better results—more money.

Whether contractor, architect, or artisan—whether salesman, solicitor or collector—whether merchant or manufacturer—it will save you time and earn its keep as an aide in your business.

**B**UT the Brush isn't only a business man's car. It is useful to others—the physician, the farmer—in business, or as a family car.

Here its dependability, its simplicity, its durability, its adaptability, commend it. To many, they are more important than its low first cost and economy in operation.

Dependability has been repeatedly proven in public contests—in letters from enthusiastic owners. The famous 9-year-old Louis Abernathy proved its simplicity when he drove it from New York all the way to Oklahoma. Its business record proves its durability. Its use by young and old in the families of owners proves its adaptability for both business and pleasure.

*Let us send you detailed data on Everyman's Car.*

**BRUSH RUNABOUT COMPANY**

786 Rhode Island Ave.  
DETROIT, MICH.

*Division of the United States Motor Company*



# LEARN TO RUN AND REPAIR AUTOMOBILES FOR

# \$10

**BARNEY  
OLDFIELD  
SAYS:  
IT IS THE BEST  
SYSTEM FOR TEACHING  
BY MAIL.  
IF OTHERS CAN  
LEARN AND EARN  
\$20 TO \$50 WEEK  
YOU CAN**



Why don't you learn this profession and double your salary? If you master this profession you are independent. Repairmen and Chauffeurs are needed in every town and city of the country.

My system is positively the only system in the world that can be successfully taught by mail.



My system of teaching by mail is a **New Idea**—it's different from others. I will so thoroughly train you that you will not only be able to drive a car, but you can repair motors, overhaul cars, repair tires, repair launch engines, repair stationary gasoline engines—you could go into the repair business—and also sell cars and engines.



## Read These Testimonials —You Can Do as Well

"I have been driving a car now for a month, and I owe it all to your Course."  
—Ramsey Stewart, Jansen, Utah.

"I am working in a repair shop. Have increased my income \$20 more per month so far and expect to get as high as \$50 more per month."  
—Jno. C. DeKoster, Lynden, Wash.

"I am now working in the American Auto Co., was formerly in the jewelry business."  
—James Tronto, Providence, R. I.

"I am now driving a Packard 30. Your Course helped me wonderfully."  
—Edw. Hauler, New Orleans, La.



"I am driving a 'Winton Six.' I do all my own repair work."  
—Edw. Sawyer, Montclair, N. J.

"Your Course enabled me to get a good position which has increased my income."  
—Geo. E. Davelarr, Prosser, Wash.

"I was formerly farming, but am now in the auto repair business."  
—Geo. Milholke, Rheinbeck, Iowa.

## SEE THIS WORKING MODEL

There are other models: one of a Magneto, Engine and Carbureter; also a Manikin of an automobile. The Manikin can be taken apart and the models actually work. All moving parts on the models made of real metal.

The Course consists of 29 Instructions, 3 Models, and a Manikin, and examinations, diploma, etc. Special price right now is but \$10.00. If you paid \$1,000.00 you couldn't get a better course—nor as good a course—because it is the only one of its kind.

### WARNING

We have patents applied for and pending covering the system of teaching with working models.

**Send To-day for  
My Free 24-Page Book**

Will tell you how to get into the Auto business—we will also show you testimonial letters from students everywhere who are now driving cars, working in Auto Repair Shops, who have gone into the Auto Repair Business, and who are making money.

### WE WILL DO MORE

We will show you actual reproduced letters from Barney Oldfield, Chas. Duryea, (the man who built the first Auto in America) and other leading Motor authorities—who endorse this system. Surely this system must be something wonderful—and it is—let me tell you all about it.

You are safe in dealing with me. I allow you two days trial examination. If you are not satisfied, return the course and your money will be refunded promptly. **Why Don't You Make Your Start—NOW?**

**DYKE'S CORRESPONDENCE SCHOOL OF MOTORING**  
Box 88, Roe Building, ST. LOUIS, MO.

(A. L. Dyke is the originator of the first Auto Supply Co. in America)

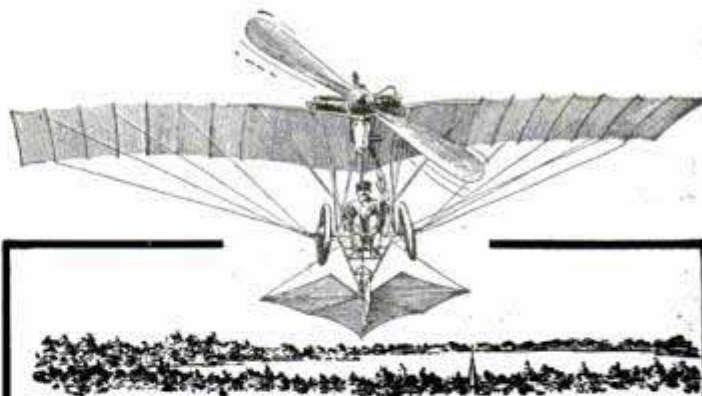

## Working Drawings of Santos-Dumont's Remarkable Aeroplane The "Demoiselle"

PRICE POSTPAID \$2.00

Complete plans for the construction of the wonderful monoplane offered to the public now for the first time.

### The Smallest Flyer Ever Built--One of the Most Successful

The machine is unencumbered by patent rights, the famous aviator preferring to place his invention at the disposal of the world in the interest of the art to which he has devoted his life. These plans were published in two parts in the June and July, 1910, numbers of Popular Mechanics Magazine, but the restrictions of space made them much smaller. They were secured by representatives of Popular Mechanics from Santos-Dumont, and are the result of consultations with his engineers and observations made at his workshops.

The set comprises seven large blue prints, showing every detail of construction, accompanied by a description of how to build.

Address

**Popular Mechanics Book Department**  
CHICAGO

## Practical Instruction In the Fascinating Art of METAL SPINNING

By PROF. F. D. CRAWSHAW  
College of Engineering, University of Illinois

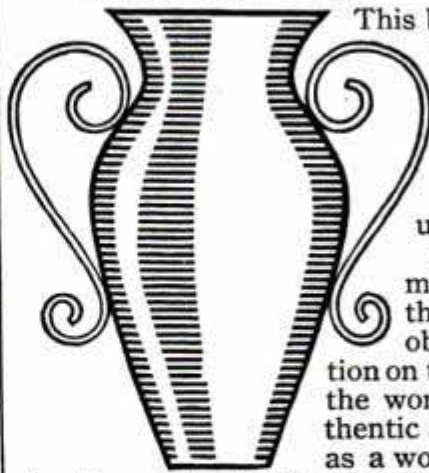

This book, the only one published on this interesting art, is one of the series of Industrial Handbooks being published by Popular Mechanics Co.

It is written by a man who has made a thorough study of all obtainable information on the subject, making the work absolutely authentic and adapted to use as a working manual both

for those who desire to spin metal as an art recreation and to follow this work as a trade.

80 Pages. 33 illustrations. Cloth cover.

**Price 50 Cents, Postpaid**

Can be ordered through your newsdealer or direct from the publisher  
**Popular Mechanics Book Dept., Chicago**

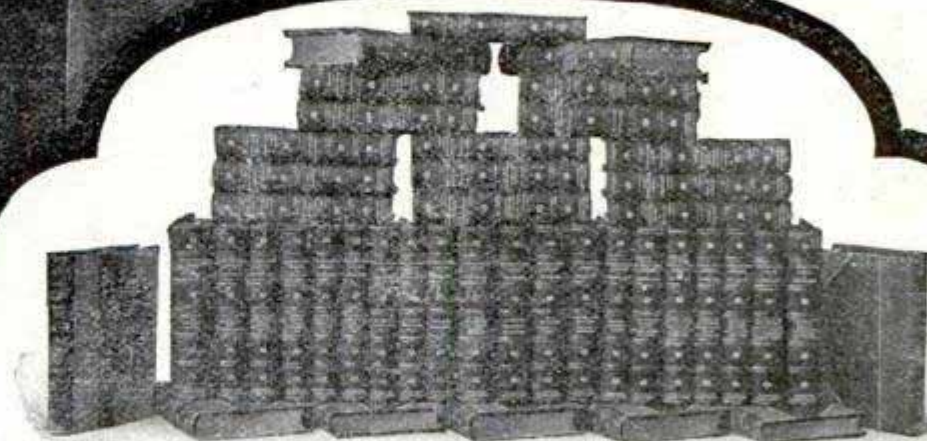
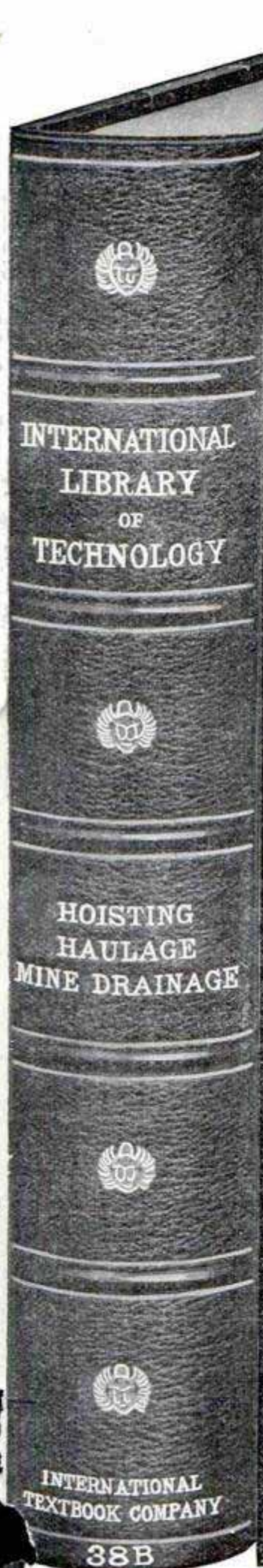

## The Greatest Technical Library in the World

At an original cost of over one million dollars there has been prepared 99 Volumes of the International Library of Technology. This Library contains the knowledge obtained through years of experience by the greatest business, manufacturing, and engineering concerns in the world. The matter has been written by the best technical experts obtainable and illustrated by a special staff of artists and draftsmen. In these books are found the best modern methods of American engineering, shop, field, mine, and laboratory practice. It is the only practical technical library in existence that can be readily understood and practically applied by those having no knowledge of higher mathematics.

Edwin S. Cramp, vice-president of the William Cramp & Sons Ship and Engine Building Company, of Philadelphia, states:

"I have examined the International Library of Technology and have no hesitancy in saying that it is the most complete set of technical books that I have ever had the pleasure of placing in my book case. The thoroughness with which you go into the various subjects is marvelous."

The Library contains over 42,000 pages and 20,000 illustrations; 99 Volumes durably and handsomely bound in three-fourths red morocco, stamped and numbered in gold. The type is large and easy to read and is printed on a high-grade book paper. Each volume is 6 by 9 inches in size. The Library is sold in sets of 5 or more Volumes.

This storehouse of the world's best technical brains awaits to help you advance, to broaden and better yourself. Send us this coupon NOW.

INTERNATIONAL TEXTBOOK COMPANY  
Box 872, Scranton, Pa.

Please send, without further obligation to me, full description and particulars regarding the International Library of Technology.

Name \_\_\_\_\_

This One



ETLO-A92-TZY2

**50c**  
Each

**ENTIRELY NEW**  
**IN THIS COUNTRY**

**50c**  
Each

# Separable-Parts Models

of Steam Engine, Wireless Telegraph, Motor Car, Gas Engine, Dynamo, Steam Turbine

Size 8x14 inches

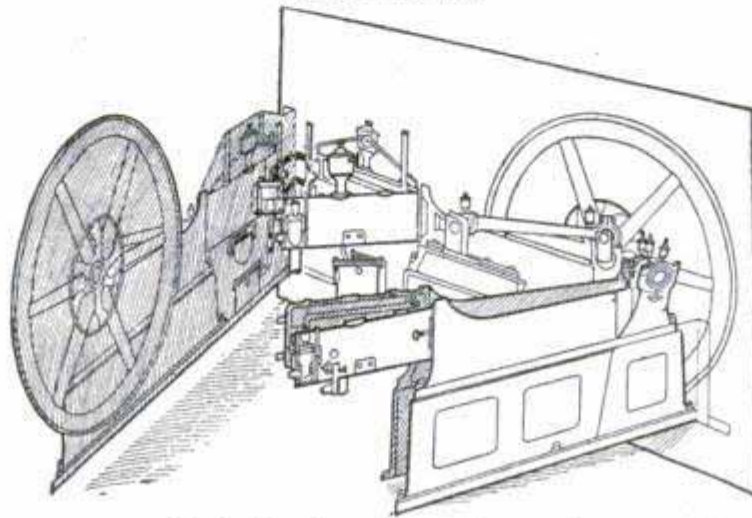

Illustration shows how parts separate

Price  
50c  
Each  
Postpaid

Complete Set  
of  
6 Models  
\$2.50  
Postpaid

**T**HESE models are of great value as a means of graphically showing *all* the interrelated parts of the above named mechanisms by virtue of their construction, which is similar to that of educational manikins of the human body and organs, with which nearly everyone is familiar. Beginning with the outermost or surface parts of the gas engine, for example, these are all differently colored and numbered to correspond to a printed key of names which comes with each model. By means of their hinge-like attachment, they may then be lifted, thereby disclosing to view the layer of parts next underneath, exactly as they would be in the engine itself, and so on until the innermost construction is shown.

The models are carefully made by hand in Bavaria, and this is the first time they have been offered in this country. We are the sole representatives in the United States.

As their value to engineers, students and, in fact, everyone having occasion to refer to the construction and working of the different mechanisms mentioned, was at once apparent to us, we felt that they would be highly appreciated here. They are substantially made of heavy paper, and with ordinary care will last indefinitely.

**Supply Limited — Order Now**

ADDRESS

**Popular Mechanics Book Dept., CHICAGO**

318 W. WASHINGTON STREET

# Vehicles of the Air

By VICTOR LOUGHEED

Member of the Aeronautic Society

Founder Member Society of Automobile Engineers

## A Popular Exposition of Modern Aeronautics with Working Drawings

550 pages. Bound in cloth,  
handsomely stamped in  
gold. Size 9x5 $\frac{3}{4}$  in. Sent  
on receipt of price, \$2.50  
net. Postage 25c extra.

**This book positively presents every known fact concerning  
aerial navigation and air vehicles—with working drawings.**

Authentic—complete—up-to-the-minute—500 subject headings—200 aeronautical terms defined—270 illustrations, including working drawings of machines and parts—140 halftone views—history of 1000 flights, with tabular comparisons of successful flying machines.

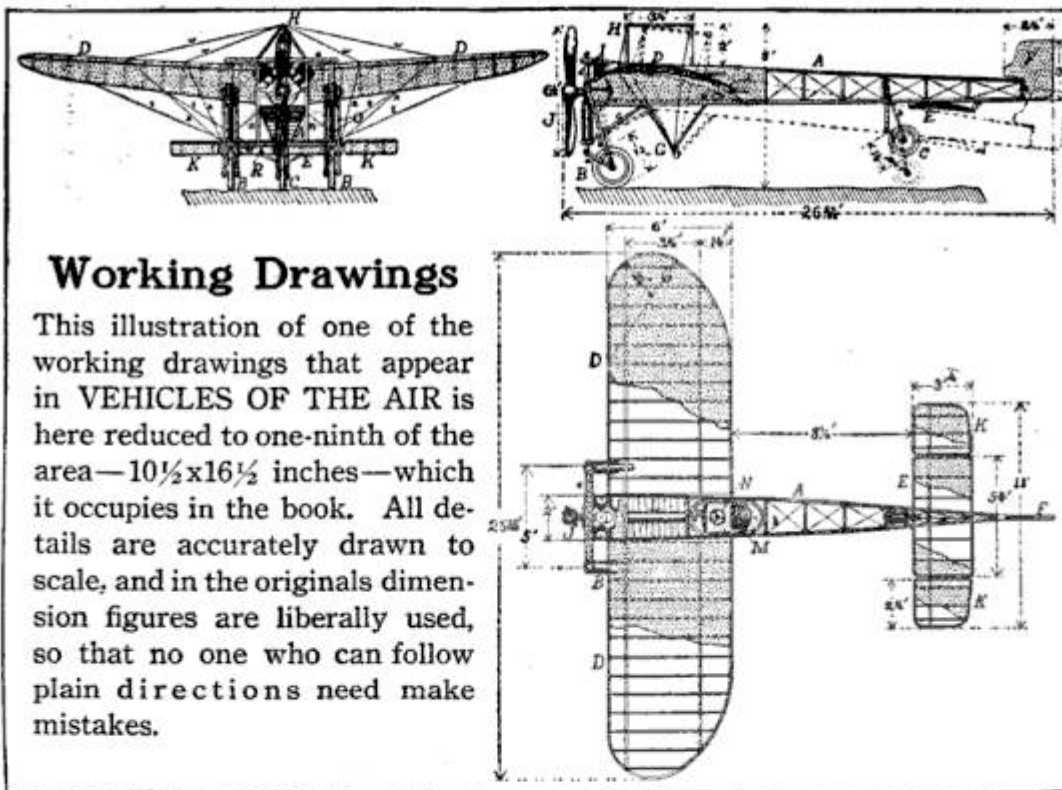

Figure 197—Scale Drawings of Bleriot Monoplane Number XI

### Working Drawings

This illustration of one of the working drawings that appear in VEHICLES OF THE AIR is here reduced to one-ninth of the area—10 $\frac{1}{2}$ x16 $\frac{1}{2}$  inches—which it occupies in the book. All details are accurately drawn to scale, and in the originals dimension figures are liberally used, so that no one who can follow plain directions need make mistakes.

### Make Your Own Flying Machine

The author fully treats all phases of aerial navigation—with particular attention to modern types of successful aeroplanes. With the information afforded by this book any one of ordinary mechanical abilities, and with very little money, can build and operate machines of known flying capabilities.

FOR SALE BY

POPULAR MECHANICS BOOK DEPT., 318 W. Washington Street, CHICAGO

# "The How and Why of the Automobile"

By **FAY L. FAUROTE**

**200 Pages. Bound in full cloth. 250 illustrations. Price \$1.00 Prepaid.**

**D**ID you ever read a book which gave you just the information you wanted without being compelled to go through page after page of introduction and history?

Did you ever talk to a man who came over on your side of the fence and talked WITH you and not AT you—who explained things in such a way that you laughed at yourself afterwards for not understanding the subject before—it was really so simple?

Do you remember when you used to study by outlines—how difficult problems unfolded themselves—how the logical sequence of facts seemed to make what you expected to find hard, readily understandable?

Do you remember the innumerable times you have said to yourself, "If I only had somebody here to explain things—someone who would go through this proposition with me until I understood it—someone who would use homely and familiar examples to explain things, instead of talking over my head by using technical terms?"

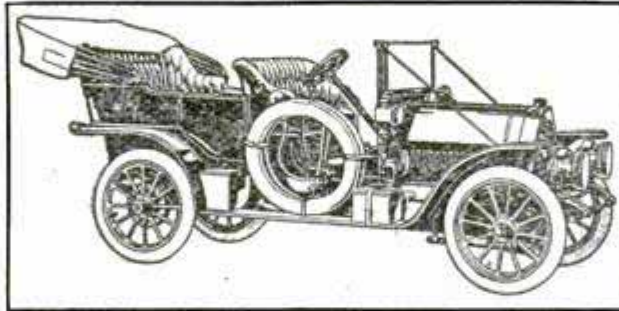

The author realized all these difficulties himself, because he has been through it all. Not only that, but his experience as an instructor of a large motor school taught him the way to explain the various parts of a motor vehicle in simple language, so that even the boy of

fifteen could understand and appreciate them.

For instance, did you ever think that the physician uses a form of carburetor whenever he gives chloroform or ether—do you realize that a shotgun is a form of gas engine whose action is almost identical with that of an automobile motor?

Do you want to know what a sliding gear transmission is—explained in such simple language that anyone can understand it?

Would you like to see what's inside of an automobile engine—would you like to know the name of every part—be able to talk intelligently about it and be your own mechanic—tell your chauffeur what to do—know when he is bluffing you?

In a word, would you like to know all about a motor car—how it works—how to drive it and how to take care of it? Then subscribe for a copy of

## "The How and Why of the Automobile"

A book of practical information for seekers after the fundamental facts regarding the gasoline engine and its application to the motor car. Interesting and instructive to both the beginner and the expert—the former for information, the latter for reference. Written by Fay L. Faurote, B.S., (M.E.), for five years closely associated with the Experimental Department of a pioneer automobile factory, for two years instructor in the Detroit Motor School. The book, which is handsomely bound in full cloth, printed on high-grade enameled paper, contains over 200 pages and 250 illustrations and covers the following subjects:

### CONTENTS:

**GENERAL THEORY OF GAS ENGINES.** Simple explanation of cycle—The four-stroke cycle—The two-stroke cycle—Advantages and disadvantages of each.

**MOTOR DESIGN.** Cylinder, what it is and its use. Valves, mechanical and automatic—Forms of valves—Valve timing and its influence on the motor—Valve grinding, how to do it—Valve nomenclature. Crank Case—The construction. Bearings—Accessibility—Working parts—Uses. A crank case oiling system. Crank Shafts—What they are—One, two, four and six-cylinder crank shafts—Crank case diagram, showing instantly conditions in all cylinders—Diagram showing firing points and sequence of same. Connecting Rods, construction and material—Bearings and lubrication. Pistons—Piston rings—Piston Pins.

**THE TRANSMISSION.** Reason for and use of transmission. Simple Explanation of Action—Individual clutch type—The sliding gear—The three speed progressive—The three speed selective—The four speed selective—Planetary gear—Friction drive.

**METHODS OF DRIVING.** Single chain drive—Double chain drive—Bevel gear drive.

**THE CARBURETOR.** A very simple explanation of carburetion—The mixing valve—A few of the first types—Some of the modern carburetors—Foreign carburetors.

**IGNITION.** The make and break system—A simple explanation of the apparatus used. The Jump Spark System—Electrical units. Sources of Electricity—The dry cell—The storage cell—Dynamos and magnetos—The spark-coil—Commutators and timing devices—Spark plugs—Wiring diagrams.

**COOLING SYSTEM.** Air Cooling. Water Cooling—Direction of circulation—Radiators—Water pumps—Fans—Anti-freezing solutions.

**RUNNING GEAR.** Front Axle—Construction of—Steering Gear. Rear Axle—Differential gear—The live axle—The dead axle—Wheel construction—Bearings.

**HORSE POWER DETERMINATIONS.** Engine testing—Indicated horse power—Brake horse power—Mechanical and heat efficiency—Road testing.

Send in your order at once—don't delay. The price is \$1.00 postage prepaid, and the address is

**POPULAR MECHANICS BOOK DEPARTMENT  
CHICAGO**

**READY JULY 1**

# Shop Notes Quarterly

for the third quarter of 1911 covers an almost endless variety of topics. Among the subjects of leading articles are:

The Inventor of the Electric Motor—Oxy-Acetylene Welding and Cutting—Air Navigation in Europe—The Atom of Electricity: Has the Final Indivisible Charge Really Been Found?—The Fiction of the Lost Arts—Adapting the Turbine for Slow Speed—Making Farms Fertile—Automobile Lighting Batteries—Slow-Burning Mill Construction—Straight Tips About Steam Boilers—Clay Modeling and Plaster Casting—Architectural Drawings Made Plain—How to Lay Out Stairs—New Ideas in Interior Decoration—Slide-Rule Errors—The Factory Laboratory—Gasoline Engine Troubles—Producer Gas for Heating—Plumbing and Sanitation—Handling Concrete in Hot Weather—A New System of Refrigeration—Welding Aluminum—Electric Commercial Vehicles—Motor Applications in the Textile Industry—Wireless Telegraphy: Principles and Operation.

The installment of "Hand and Machine Tools" in this issue takes up the subject of Hammers and Percussion Tools. A new series on "Tool and Jig Designing" also begins in this number—all elaborately illustrated. The regular departments devoted to shop kinks, drafting notes, etc., are better and more varied than ever.

**This number contains about four times as much reading-matter as the ordinary 15-cent magazine.** An alphabetical index makes all the contents available for ready reference. **Shop Notes Quarterly** is the largest publication in the world devoted exclusively to Mechanics, Science, and Practical Knowledge.

**\$1.00 a Year—Ask the Newsdealer—25c a Copy**

*One Dollar for One Year's Subscription is a Wise Investment for Those Who Want Up-to-Date Information on Modern Methods in All the Mechanic Arts.*

**POPULAR MECHANICS CO., 318 W. Washington St., CHICAGO**

# Amateur <sup>No. 3</sup> Mechanics

PRICE  
25¢



A BOOK FOR THOSE  
WHO LIKE TO MAKE THINGS

## THE LATEST

of our books for those  
who like to make things

# Amateur Mechanics No. 3

“Written So You Can Understand It”

A thorough, practical book containing 200 articles which tell how to make scores of appliances of daily use about the house; various amusement devices; simple electrical apparatus; novelties; tricks; magic; puzzles, etc. The following are typical articles:

Driving a Washing Machine with Motorcycle Power—Campers' Appliances—Workbench for the Amateur—Home-Made Vise—Revolving Christmas Tree—How to Cane Chairs—Home-Made Electric Clock—Outdoor Gymnasium—Bent Iron Work.

**128 Pages PRICE 25c POSTPAID 194 Illustrations**

THE OTHERS IN THIS SERIES ARE:

**Amateur Mechanics No. 1** — 174 Articles  
165 Illustrations

**Amateur Mechanics No. 2** — 193 Articles  
196 Illustrations

**Mechanics for Young America** — 150 Articles  
196 Illustrations

Each of these books contain different matter, yet all are along the same interesting, practical lines. They should be in every American home. **Price 25 Cents Each, Postpaid**

**AMATEUR MECHANICS**

A BOOK for OLD and YOUNG who like to make things

WRITTEN SO YOU CAN UNDERSTAND IT

Reprinted from POPULAR MECHANICS

**No. 1**

CHICAGO POPULAR MECHANICS COPYRIGHTED

**AMATEUR MECHANICS**

A BOOK for OLD and YOUNG who like to make things

WRITTEN SO YOU CAN UNDERSTAND IT

Reprinted from POPULAR MECHANICS

**No. 2**

CHICAGO POPULAR MECHANICS COPYRIGHTED

**Mechanics for Young America**

A Book for Boys

How to Build

BOATS, WATER MOTORS, WIND MILLS, SEARCHLIGHT, ELECTRIC BURGALAR ALARM, ICE BOAT, WATER BICYCLE, CABINS, CAMPS, CLOCKS, FISHING TACKLE, KITES, IMITATION STREET CAR LINE, ETC.

The Directions are Plain and Complete

CHICAGO POPULAR MECHANICS COPYRIGHTED

**PRICE 25 CENTS**

FOR SALE BY ALL NEWSDEALERS, OR

**POPULAR MECHANICS BOOK DEPT., Publishers, CHICAGO**



## SPON'S WORKSHOP RECEIPTS

New Edition Revised to Date—JUST OUT  
An Encyclopaedia of Manufactures, Receipts and Processes that will prove invaluable for everyday use. Contain 2144 pages, 1053 illustrations and make a

complete technical reference library for manufacturers, inventors, mechanics, electricians and others.

### CONTENTS

- Vol. I. Acetylene Lighting to Drying.  
Vol. II. Dyes and Dyeing to Japans and Japanning.  
Vol. III. Jointing Pipes to Pumps and Syphons.  
Vol. IV. Rainwater Separators to Wire Rope Splicing.

## SPONS' WORKSHOP RECEIPTS



The 4 volumes, 12mo., cloth, will be sent to any part of the world, prepaid, on receipt of **\$6.00**

Send your order NOW for prompt and early delivery.

## SPON & CHAMBERLAIN

Publishers of Technical Books  
123 P. M. Liberty Street, New York



**STOCK & WORKING DETAILS FOR THIS TABLE 575**  
ALL THE DIFFERENCE BETWEEN THIS & ANY K.D. FURNITURE IS THE BORING OF DOWEL HOLES, SANDPAPERING THE WOOD SMOOTH. ALL THE STOCK IS OF THE BEST GRADE OF OAK, KILNDRIED & DRESSED SMOOTH. THE TOP IS IN ONE PIECE. THE END PIECES ARE BANDSAWED TO SHAPE. WE WILL FURNISH MATERIAL & WORKING DETAILS FOR ANY PIECE OF MISSION OR FLANDERS FURNITURE AT PROPORTIONATE PRICES  
**FURNITURE-STOCK-CO.**  
217-CHAMBER-COMMERCE-BLDG, CHICAGO.



## Mission Furniture

How to Make It

PART I

One of Popular Mechanics Series of INDUSTRIAL HANDBOOKS. "Written so you can understand it." Tells very plainly how to make 21 different articles of mission furniture; the instructions being accompanied by working drawings and half tones of the finished articles.

96 pages. Cloth Cover. Price 50 cents, postpaid

Order from your newsdealer or direct from the publisher

POPULAR MECHANICS CO., CHICAGO

The Best Book For Beginners

## A Practical Course in Mechanical Drawing

By Wm. F. Willard

Price 50c Postpaid

POPULAR MECHANICS BOOK DEPT.

318 W. Washington Street, Chicago



## Mechanical Engineering

and its many branches, is covered most thoroughly by our New Seven Volume Edition

CYCLOPEDIA OF

## Mechanical Engineering and Modern Shop Practice

These seven great volumes contain 2,992 seven by ten inch pages of information which is of vital interest to every progressive mechanic.

In this wonderful work will be found instruction in Machine Shop Work; Assembling of Machinery; Tool Making and Shop Management in such simple and comprehensive form that the student cannot fail to benefit by it. Every detail of mechanical engineering is thoroughly analyzed and treated, rendering the books of unusual value to the experienced mechanic and shop manager, as you will note by reading "Subjects Thoroughly Covered."

The Cyclopaedia is supplemented with a series of practical test questions and includes over 2,000 full-page plates, illustrations, tables, formulas and "shop kinks."

### TO PROVE THEIR VALUE TO YOU

we will send you the complete Cyclopaedia absolutely free for examination—just mail the coupon. Keep the books five days—apply the principles to your work—test every formula. You will agree that they are all we state, and more. Send \$2.00 after examination and \$2.00 a month until you have paid the special price of \$18.80. The regular list price is \$36.00. If the books do not meet with your requirements, advise us and we will remove them at our expense.

### Subjects Thoroughly Covered

Machine Shop Work—Vertical Milling Machine—Motor-driven Shops—Shop Lighting—Forging—Electric Welding—Tool Making—Metallurgy—Manufacture of Iron and Steel—High-Speed Steel—Flaws in Castings—Electric Lifting Magnets—Magnetic Clutches—Making a Machinist—The Ideal Foreman—Pattern Making—Foundry Work—Automatic Coal and Ore Handling Appliances—Machine Parts—Construction of Boilers—Types of Boilers—Boiler Accessories—Steam Pumps—Air Compressors—The Steam Engine—The Steam Turbine—Indicators—Valve Gears—Refrigeration—Gas Producers—Gas Engines—Automobiles—Elevators—Sheet Metal Work—Practical Problems in Mensuration—Mechanical Drawing—Drafting Room Organization—Machine Design.

**SPECIAL OFFER IF YOU MAIL COUPON PROMPTLY** For a short time we will include, as a monthly supplement, for one year, the TECHNICAL WORLD MAGAZINE. This is a regular \$1.60 monthly, full of Twentieth Century Scientific Facts, written in popular form. Also contains the latest discussions on timely topics in invention, discovery, industry, etc.

### Free Examination Coupon

American School of Correspondence, CHICAGO, U. S. A.

Please send set Cyclopaedia of Mechanical Engineering for 5 days' free examination. Also Technical World for 1 year. I will send \$2 within 5 days and \$2 a month until I have paid \$18.80, for books and magazine; or notify you and hold the books subject to your order. Title not to pass until fully paid.

NAME.....

ADDRESS.....

OCCUPATION.....

EMPLOYER.....

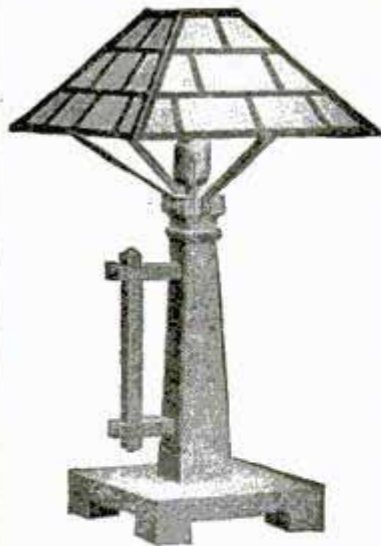

Portable Reading Lamp

¶ This book contains plain explicit instructions with detail drawings and illustrations for making 16 designs of extensive variety as follows:

Two Light Portable—Portable Reading—Four Light Chandelier—Reading Lamp—Dining Room Dome—Porch or Den Lantern—Four Light Chain Hung Chandelier—One Light Portable—Lantern—Drop Light—One Light Bracket—Piano Lamp—Wall Lamp—Electric Candle Sconce—Newel Post Lamp—Chain Hung One Light Bracket.

## ARTISTIC—INEXPENSIVE

# Arts-Crafts Lamps

## How To Make Them

“Written So You Can Understand It”

By JOHN D. ADAMS

Beautiful lamps that are usually made from expensive leaded glass can be made at home out of paper, cardboard and wood at an almost negligible expenditure by anyone possessed of a fair amount of patience. A great variety of lamps may thus be produced which will, nine times out of ten, be mistaken for the product of a professional rather than of an amateur.

### Price 50 Cents Postpaid

A handy little working manual of 96 pages, printed on the best quality of book paper and handsomely bound in cloth. Supplied by your newsdealer or may be ordered direct from the publisher

**POPULAR MECHANICS BOOK DEPARTMENT, CHICAGO**

## Save Money—Beautify the Home and Enjoy Making Your Own Mission Furniture

Plain directions are given in our two books

### *Mission Furniture—How to Make It*

#### PART I

21 Designs, 96 Pages  
Cloth Cover

Price Each **50c** Postpaid

#### PART II

32 Designs, 128 Pages  
Cloth Cover

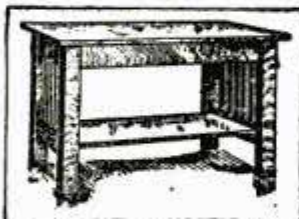

These handy manuals contain explicit instructions for making over 50 different handsome pieces of this popular style furniture; the directions being accompanied by complete dimensioned working drawings and half-tone illustrations of the finished articles.

**The Designs are the Newest and Most Approved and comprise the following:**

Book Shelf—Porch Chair—Library Table—Lamp Stand and Shade—Roman Chair—Mission Chair—Book Rack—Tabouret—Another Mission Chair—Roll Top Desk—Lawn Swing—Candlestick—Magazine Stand—Blackening Case—Shaving Stand—Piano Bench—Two China Closets—Two Arm Chairs—Rocker—Side Chair—Mantel Clock—Lamp Stand—Two Foot Stools—Bookcase—Magazine Table—Smoking Stand—Wall Case—Waste Paper Basket—Music Stand—Hall Clock—Cedar Chest—Child's Dresser—Couch—Oil Lamp—Grill—Two Writing Desks—Library Set—Buffet—Bedstead—Dining Table—Medicine Cabinet—Telephone Stand—Plate Rack—Dining Room Shade.

Order of your Newsdealer or direct from the Publishers

**POPULAR MECHANICS BOOK DEPARTMENT, CHICAGO**



# Classified Advertisements

Advertisements in this section, 10 cents per word, each insertion payable in advance. To insure ads being inserted under proper classified head in the August issue, copy must reach this office not later than July 1st.

Ashtabula, O., March 29, 1911.

Popular Mechanics Magazine,

318 W. Washington St., Chicago, Ill.

Dear Sirs: In the March number of your magazine we inserted a small classified advertisement of a four-cylinder engine and we received over fifty replies. The engine was sold three weeks ago and we could have sold two or three more if we had had them. The answers to this advertisement which are still coming in, come from coast to coast and from North Dakota to Texas, demonstrating that your circulation covers the entire country and that it is of the quality that brings results. We consider your magazine to have the best pulling power as an advertising medium of any that we have ever tried.

Yours very truly,

THE C. L. SCRIVENS MOTOR CAR CO.

## AUTOMOBILES

**FOR SALE**—1,000-lb. Motor Truck, double opposed 18-hp. motor, water-cooled platform type with removable sideboards and engage. Equipped with solid tires somewhat worn, otherwise the machine is in first-class shape. Write for photo and bargain price. Robt. Holmes & Bros., Danville, Ill.

**MOTOR BARGAINS.** We offer six 1910 cars—four have never turned a wheel; two have been rebuilt—at prices from \$1,350 to \$1,400. Cars new, 1910, cost \$1,850. 1911 models practically unchanged, \$2,150. J. I. Case Plow Works, Racine, Wis.

**AUTOMOBILE INSTRUCTIONS,** four weeks' course covering shop and road work—provision for out-of-town men. Send for booklet P. M. West Side Y. M. C. A. Automobile School, 318 West 57th St., New York, N. Y.

**FOR SALE; A BARGAIN.** 1910 light delivery Auto, guaranteed first-class condition except rear tires. \$200 cash. Harry Christensen, Clifton, Ill.

**CARTERCAR, FIVE PASSENGER,** good as new, one-third price. Scrivens, Ashtabula, Ohio.

**FORD "1910" TOURING CAR,** five-passenger full equipment, as good as new, first \$450 takes it. Write for full particulars. King, 2230 7th Ave., N. Y. C.

**METZ**—1911 model, regular equipment, run about 500 miles. \$300 cash. L. W. Deitz, Gilbertsville, N. Y.

**FORD 1910 five passenger touring** 22 horse power, perfect condition, full equipment, must sell, \$400.00. O'Brien, 2145—5th Ave., New York City.

**TWO HOLSMAN RUNABOUTS** in A1 condition, cheap. H. P. Finks, Ft. Smith, Ark.

**OLDS RUNABOUT,** overhauled and repainted, first-class condition, \$95. H. Emrick, 908 Waite St., Middletown, Ohio.

**1—4 C. P. TAIL,** 2—4 or 8 c. p. Side Tungsten Electric Lamps, multiple dry batteries. Total \$5.50. Robt. Ross Jones & Bro., Harrisburg, Pa.

**VULCANIZING, AUTOMOBILE,** Motor Cycle tires explained. Free circular. Acme Vulcanizer, Patterson St., Pittsburg, Pa.

**GET OUR LIST** of used Automobile Bargains. Box 275, Burlington, Wis.

**FOR SALE**—1911 Metz Runabout with top, windshield, gas lamps and generator. Used two months, \$400. Box 572, Payne, Ohio.

**ELMORE 4 PASSENGER** \$120.00 Black Crow run 300 mi. 1911 model, full equipped \$1,000. 15 light Acetylene generator \$50. Write, J. H. Bihl, Fremont, Ohio.

**MOTOR BUGGY,** good as new; cost \$500; sell for \$150. A. Booth, Stanley, N. Y.

**BE SURE TO READ** "Standardization in the Automobile Industry" in the next number of Shop Notes Quarterly, ready July 1.

**AUTOMOBILE CYLINDERS REBORED** and accurately ground, including new piston and rings, fifteen dollars. Cast Iron Brazing Co., Manchester, N. H.

**AUTOMOBILE TURNTABLES,** write for particulars. Sterling Elliott Co., Newton, Mass.

**FORD, 4 CYLINDER, RUNABOUT,** runs and looks like new, \$225.00. Shonnard, 114 Fifth Ave., New York City.

**REO, 5 PASSENGER TOURING CAR,** good as new, \$300.00. Apartment No. 18, 115 West 129th St., New York City.

**CADILLAC, 5 PASSENGER** touring, excellent running order, first \$175.00. Room No. 73, 217 West 125th St., New York City.

**FORD OWNERS.** Drop us a postal for our catalogue. It will save you money. Auto Parts Co., Providence, R. I.

"THE HOW AND WHY of the Automobile."—A 200 page book of practical information for seekers after the fundamental facts regarding the gasoline engine and its application to the motor car. Interesting and instructive to both the beginner and the expert. Bound in full cloth—250 illustrations. Price \$1.00 postpaid. Popular Mechanics Book Dept., Chicago.

**AUTOMOBILES**—Over Four Hundred Bargains \$95.00 upward. All guaranteed. Freight prepaid. Write now for Latest Illustrated Bulletin. Motor Car Exchange, Dept. C-215, West 125th St., New York City.

**AUTOMOBILE MODEL.** Every part shown and named. You can to all intents and purposes take off the wheels, raise the hood and remove the body; exposing to view the vital parts. The only practical method of studying the automobile. Price 50 cents postpaid. Popular Mechanics Book Dept., Chicago.

## AUTO SUPPLIES

**AUTO CASES AND TUBES,** 1st quality, guaranteed. 28x3 \$10.30, tube \$2.75; 30x3 \$11.30, tube \$2.85; 30x3½ \$15.45, tube \$3.75; 32x3½ \$18.70, tube \$4.25; 34x4 \$27.45, tube \$5.75. Send for list of all sizes. I ship, allow tires to be examined before payment is made on receipt of 10% amount of order. The largest tire dealer in the central states. W. Vanderpool, Springfield, O.

**STEAM AUTOMOBILE ENGINES, BOILERS;** parts of Prescotts, Locomobiles, Mobiles, Stantons, or other steamers; for sale at reasonable prices. Send for list. State wants. E. L. Marshall, 34 Vernon Ave., Lake View, N. J.

**EXCEPTIONAL CHANCE FOR DEALERS**—To close out far below cost a number of electric horns, imported spark plugs, goggles, one magneto, Duro battery. Write for complete list. T. H. G., 24 E. 17th St., Room 818, New York City.

**AUTOMOBILISTS** by thousands enthusiastically endorse our one minute, everlasting, tire repair kit. Be your own agent, sell two, yours free. Postal. Willett Manufacturing Company, Willow Grove, Pa.

**FOR SALE—BODIES**—\$60.00 each to close out. Six new toy-tonneau metal bodies 34x84, fully upholstered and ready for color. The Barndt & Johnston Auto Supply Co., Columbus, Ohio.

**CUT YOUR TIRE EXPENSE** in two. Spencer Inner Tires will do it. Ask us how. Good live agents wanted. Spencer Tire & Rubber Company, Cleveland, Ohio.

**12 HP. 4 CYL. aircooled engine,** 110 lbs., with accessories. Write for terms. M. A. Newton, 9 Pine St., Potsdam, N. Y.

**200—1¼" pitch roller chains,** \$1.50 each. "Mail Order" Garage, Bridgeport, Conn.

**5 HORSE STATIONARY ENGINE** mounted. 12 Horse Auto opposed motor. Chassis for commercial delivery. Set of solid tires 28x3. Chamberlain, Bartley, N. J.

**REPAIR A PUNCTURE** in a minute, without using cement. "The Clinch Tire Repair Kit," compact, simple, effective in all kinds of weather. Economical. Repaired to stay. Can't leak. Write, Adolph Bushek, Riverside, Iowa.

**BRASS POLISH,** effective but harmless; two formulas for 25c. M. S. Ryan, Laredo, Texas.

**BARGAIN IN SECONDARY** and primary windings for experimental work. Timers, carburetors, switches, coils and 2 cylinder seven hp. Ferro marine engine, etc. The R. E. Hardy Co., 1134 Austin Ave., Chicago.

**GOING TO BUILD AN AUTO?** Steam or gasoline? If so, send for list telling us what you need. J. L. Lucas & Son, 3 Fox St., Bridgeport, Conn.

**STEAM AUTO BOILERS** Bought, Sold and Repaired. J. L. Lucas, No. 2 Fox St., Bridgeport, Conn.

## MOTORCYCLES

**NEW \$225 GREYHOUND \$175;** new \$215 Emblem \$175; 1910 Reliance \$115; 1909 Indian \$95. Second hand machines taken toward 1911 models. Get our prices. Scrivens, Ashtabula, O.

**MOTORCYCLES ALL MAKES.** Prices low, oldest Motorcycle dealer in the south. Established 1896. Send stamps for Catalog. R. L. Davis, the Motorcycle Man, 911 West Broadway, Louisville, Ky.

**TWO 1910 THOR MOTORCYCLES,** rebuilt and thoroughly overhauled. Guaranteed in first class condition, for \$150. Will ship on one day's trial. Arnold Motor Co., Logansport, Ind.

'07 THOR \$45, '09 Thor \$85, '09 Magneto 7 hp. M. M. \$115, '07 Indian \$60, '08 Indian \$70, '08 Twin Indian \$95, '09 Indian Loop \$95, '09 Indian Magneto Twin \$125. Postal brings bargain sheet and catalogue. Howard A. French, Baltimore, Md.

**ROTARY BICYCLE SIRENS,** \$2; motorcycle sizes \$5 and \$6; chain repair tools, \$1. Battery or magneto cut-out switches, 75c. Magneto covers, 75c. Coaster brake bicycles, \$25 up. Send for catalogue. F. Widmayer, 2312 Broadway, New York City.

**90 USED MOTORCYCLES** for your selection. Illustrated catalogue for 3 cents in stamps. Rubel Co., Louisville, Ky.

**FOR SALE OR WILL TRADE** for runabout or roadster. Single magneto 1910 Excelsior, full equipment. Price \$200.00. Ralph E. Busse, Porter, Ind.

**INDIAN, 1910,** twin magneto, five hp., in good condition, used only three months; sacrifice on account of European trip; \$50. George Bourne, Bay Shore, N. Y.

**WANTED**—Good motorcycle in exchange for 1 K. W. Wireless set. Send photos. D. E. McKissen, 2157 Glenwood Ave., Toledo, Ohio.

**MOTORCYCLES AND TRICARS,** 50 of them. All kinds of prices. Send stamp for list. New York Motorcycle Co., 318 West 48th St., N. Y.

**MOTORCYCLES, \$50 UP.** Indians, Royals, Thors, Harley Davids, Excelsiors, Wagners, etc.; every one guaranteed; send for bargain list and large motorcycle supply catalogue, repairs, etc. F. B. Widmayer Co., 2312 Broadway, New York City.

**CASH** for used motorcycles. Rubel Co., Louisville, Ky.

**FOR SALE**—Orient motorcycle engine in good condition, \$20.00. 1021 W. Madison, Chicago.

**MOTORCYCLE RIDERS** can make good money on the side just through their association with other riders by acting as our local representative for Tire-Doh. Tire-Doh repairs every injury that can happen to a tube or casing easier and quicker and better than vulcanizing, and at one-tenth its cost. Special motorcycle outfit sells for 75 cents. Money back to any purchaser who asks it. Send us 75c, stamps or money order today; try Tire-Doh yourself at our risk, and we will make you a proposition to be our agent on a profitable basis. Atlas Auto Supply Co., 49 East Adams St., Chicago.

1911 EMBLEM 5H, MAGNETO, \$175.00. 1910 Excelsior 4h. magneto, \$160.00. 1910 Emblem 4h. battery \$125.00. Guaranteed. Rullman Bros., Louisville, Ky.

**PIERCE FOUR CYLINDER MOTORCYCLES** scarcely used and in first class condition; for sale at very low prices. Wm. B. Colburn, 18 Hanover St., Buffalo, N. Y.

**READING STANDARD Motorcycle** 3 hp. \$75. E. J. Reid, Arkansas City, Kans.

1910 INDIAN Twin Motorcycle, cheap. E. K. Rutherford, Girard, Ill.

**SALE OR TRADE**—3 hp. "Greyhound" motorcycle, \$65.00. F. W. Steffen, Spencer, Iowa.

**SUPPLIES**—The largest stock in America. Immediate shipment. Lowest prices. A hundred new ideas shown in our big free catalogue P. Motorcycle Equipment Co., Hammondsport, N. Y.

**MOTORCYCLE CASES AND TUBES**, fresh stock, 28x2, corrugated \$5.00, Bailey \$5.50, tube \$2.40; 28x2½, corrugated \$5.25, Bailey \$6.25, tube \$2.65; 28x2¾, corrugated \$5.50, Bailey \$7.00, Nobby \$7.75, tube \$2.66. Price on tubes is by mail including postage. Send post office order for tubes and 25% on cases and ship, allow examination. Wm. Vanderpool, Springfield, Ohio.

**KELLER'S LATEST BOOKLET**, "Construction, Management and Care of Motorcycles," most complete instruction book on motorcycles ever published. Sent postpaid for 25c stamps or silver. Keller & Risque Motor Co., St. Paul, Minn.

**MOTOR CYCLES**—Enormous variety of American and Imported makes—Indians, Marsh's, \$35.00. Hundreds of other bargains. Shipped freight prepaid. Write now. Large illustrated bulletin free. Motorcycle Exchange, 215 West 125th St., New York City.

**ACCOUNT OVER STOCK**, we now offer until sold new Dow Coils for single cylinder, \$3.50; double, \$4.00. Hundreds of other bargains in our catalogue. Write to-day. Motorcycle Equipment Co., Hammondsport, N. Y.

**WANTED**—Motorcycles of any make. Several Wagners wanted. Give description and lowest price for yours. Shaw Mfg. Co., Dept. 28, Galesburg, Kans.

**DON'T BUY A BICYCLE Motor Attachment** until you get our catalog and prices. Shaw Mfg. Co., Dept. 27, Galesburg, Kans.

**MOTORCYCLES \$35 UP**. All makes. Send today for bargain list. Shaw Mfg. Co., Dept. 30, Galesburg, Kansas.

**AERONAUTICS**

**RACING MODEL**—The Fairey Monplane Champion flyer, England 1910, 34x22, silk planes, twin propellers. Record flight over half mile. Price \$8.50 postpaid. The "Speedy" model flown 900 feet, \$1.00 postpaid. Large catalogue, model accessories, 5 cents. Model Gasoline Engine for \$6.00. Complete set of castings, nuts, bolts, etc., for 1/3 hp. engine, air cooled. Price, finished engine, \$20. Weight 4 lbs.; 1 hp. finished engine \$40 (weight, 8 lbs.). A. Melcombe, Castle Rd., Bedford, England.

**LARGE ILLUSTRATED CATALOGUE OF AEROPLANES** and supplies just published, mailed on receipt of ten cents in stamps. We offer \$1,500.00 in prizes to aviators purchasing motors of us. Rubel Co., Louisville, Ky.

**LEARN AVIATION** by taking up a Correspondence Course in The American School of Aviation. A thorough grounding in the principles of Aeronautics without troublesome formulae and calculations. Especially suited for the mechanic. Send for particulars to M. K. Kasmar, Secretary, 1952 North Ave., Chicago.

**COMPLETE PLAN**, drawn to scale, for building a Three Foot Flying Bleriot Monoplane Model with full instructions. 15c postpaid. Complete material for same with plan \$3.00. Everything for model making. Stamp brings list. Ideal Aeroplane & Supply Co., 1200 Bedford Ave., Brooklyn, N. Y.

**READ THIS!** Send stamp for catalogue of 25 styles model aeroplanes, 50c to \$7.50. Biggest line of guaranteed models ready to fly. Our special flyer sent prepaid for \$1.00. Aero-flyer Company, Medford, Mass.

**FREE TO EXPERIMENTERS**. Model monoplane plans, aeroplane dictionary, 16-page model catalogue, advice, valuable information, record sheets, circulars, catalogues, fabric; 10c postage. H., 817 36th St., Oakland, Cal.

**30-40 HORSE POWER**, 4 cylinder "Gray Eagle" Aero Motor \$485.00 complete with magneto, carburetor and offer fully guaranteed. Immediate deliveries. Circular for a stamp. Rubel Co., Louisville, Ky.

**PROPELLERS FOR MODELS**; from 4 in. up, wood, also M. A. P. Monoplanes with an automatic lateral stability. M. A. P. Monoplane Mfg. Co., P. O. Box 66, Station D, New York, N. Y.

**MODEL FLYING MACHINES** for boys. Interesting study, great amusement. Catalogue. American Flying Machine Company, Aero Grounds, Racine, Wis.

**POWER PLANT COMPLETE** with propeller, 20-25 hp. \$250. Fully guaranteed. Wood and metal parts for improved Curtiss \$90. Wolverine Aeronautic Co., Albion, Mich.

**WANTED**—Mechanics for aeroplane factory, work in metal and wood; also aviators, wireless operator, electricians, pattern makers, draftsmen, motor experts and others wishing to learn. Address to Eagle Aeroplane Company, Brunswick, Ga.

**WORKING DRAWINGS AND DESCRIPTION** of Santos-Dumont's monoplane or Wright's biplane. Fifteen cents each, both for twenty-five. Hibline, 708 W. Lafayette, Baltimore, Maryland.

**PROPELLERS FOR MODELS**, guaranteed satisfactory or money refunded. Send for circular. Pollock Propeller Co., Longwood Chicago, Ill.

**AEROPLANE MODEL**, won first prize St. Louis Aero Show record flight 175 feet. 50c. Globe Sales Co., Box 542, Pontiac Michigan.

**EVERYTHING FOR AIRCRAFT**. Heath Aerial Vehicle Co., 3403 Southport, Chicago. Send 6 stamps for catalogue.

**AVIATION DICTIONARY FREE**—Send \$3 for year's subscription to Aero, America's Aviation Weekly, and receive free. Dictionary of 4,276 Definitions, just published; complete airman's vocabulary (publisher's price \$1.40). Aero, 21 South Broadway, St. Louis.

**RENTON'S CHICAGO AERO WORKS**, 164 North Wabash Ave. Aeroplanes, accessories, wheels, motors, also models, wood, rubber, propellers. Stamp for catalogue.

**BLERIOT FLYING MODELS**, rattan construction, aluminum joints, steel wire wing braces. Guaranteed flyers. Price 25c, prepaid. Balritt Importing Company, 158 Lawrence St., Brooklyn, New York.

**DETROIT AERO**, 1911, including propeller, carburetor, ignition; 200 lbs. minimum thrust, 150 lbs. maximum weight. Detroit Aeroplane Co., Detroit, Mich.

**PATENTS SECURED** on Aeronautical Inventions. C. L. Parker, ex-examiner Patent Office, 910 G. St., Washington, D. C.

**MODEL AEROPLANES HOW TO MAKE AND FLY THEM** By W. Twining. Consisting of 5 sheets of scaled drawings showing three different models, with descriptive booklet. By mail 55c. Popular Mechanics Book Dept., Chicago.

"VEHICLES OF THE AIR," the newest and only up-to-date contribution to the literature of aeronautics, contains large working plans of all successful modern flying machines. This book of 500 pages, 140 half-tone photographs and 130 drawings is the only book published containing every known fact of this interesting subject. Size, 9x5½ inches. Price \$2.50 net, postage 25 cent. extra. Popular Mechanics Book Dept., Chicago.

**WORKING DRAWINGS OF THE "DEMOISELLE,"** Santos-Dumont's remarkable monoplane, offered to the public for the first time. The set comprises seven large blue prints, showing every detail of construction, accompanied by a description of how to build. The machine is unencumbered by patent rights, the famous aviator placing his invention at the disposal of the world. Price \$2.00 postpaid. Popular Mechanics Book Dept., Chicago.

**BOOKS AND PERIODICALS**

**FREE**—A safety razor and three blades with a subscription to "The Mail Order Merchant," at 60c. H. Latz, Atlantic City, New Jersey.

**FREE**—"How to Run and Install Gasoline Engines." Greatest little book ever published on this subject sent free with year's subscription to Gas Energy. Learn how to solve all knotty gas engine problems in few moments. O. L. Stevens, Ind., writes. Gas Energy is best magazine published. Send 50c for year's subscription. Book free. Gas Energy, 28 Murray St., New York City.

"THE BOY GARDENS"—A handsome booklet, illustrated in colors, describing the work and methods of money-making juvenile enterprise which can be duplicated in any community—15c. The Boys' Garden Co., Dayton, Ohio.

**TEN books**, 10c. H. Caskey, 941 East 53rd St., Chicago.

"BOY AVIATORS," "BOY SCOUTS," "Dreadnought Boys," "Bungalow Boys," "Motor Rangers," "Border Boys." Six new series of Boys' Books. Get Vol. 1 of any series immediately. 50c postpaid. Sold everywhere or from Hurst & Co., 395 Broadway, New York. Catalogue free.

**SHOP NOTES QUARTERLY** is not written above the heads of the amateur or beginner, and yet it contains many exclusive articles of value to technical men. Only \$1 a year. Ask your newsdealer.

"METAL SPINNING" is the name of the only book published on this interesting art. A concise working manual both for those who desire to spin metal as an art recreation and to follow this work as a trade. 80 pages, 33 illustrations. Price, 50 cents postpaid. Popular Mechanics Book Dept., Chicago.

**YACHT AND BOAT BUILDING BOOKS**, ship pictures, etc. Send for 80-page illustrated catalogue. The Rudder Publishing Co., 3 Hudson St., New York City.

**WONDERFUL BOOK ON HYPNOTISM**, Personal Magnetism, and other Occult sciences sent free to anyone. Send your address today. M. D. Betts, Sta. 65, Jackson, Mich.

**ENGINEERS'** questions and answers for license, by Hobson, for twenty-five cents, postpaid. Send stamps. Reilly's Book Store, Philadelphia, Pa.

**GAS FOR POWER** is taking the place of steam for reasons of economy. Learn all about this great change by reading our new non-technical book on this subject, written by a first class authority for the practical man. 192 pages, profusely illustrated, cloth binding. Price \$1.00 postpaid. Popular Mechanics Book Dept., Chicago.

## EDUCATIONAL AND INSTRUCTION

**LEARN SOMETHING WORTH WHILE.** We teach photo retouching and mechanical wash drawing by a system of individual instruction. This course covers every department of mechanical illustration and is so simple, the lessons being so gradual, that any intelligent person cannot fail to make a success of it. We furnish a full equipment to each scholar including the latest type of airbrush and compressor. This is the best paid branch of art and is strictly commercial, not being "Art for Art's Sake," but "Art for Money." Special talent or originality not necessary. Send for full particulars and proofs. Mechanical Art Studio, 112 Wisconsin St., Milwaukee, Wis.

**FREE TUITION BY MAIL—Civil Service, Mechanical Drawing, Stationary Engineering, Electrical Engineering, Electric Wiring, Agriculture, Poultry, Normal, Bookkeeping, Shorthand and Typewriting Courses.** For Free Tuition apply Carnegie College, Rogers, Ohio.

**NAUTICAL SCHOOL—Ocean and Lake navigation, marine engineering.** Makes a specialty of preparing young men for original or raise of papers. Students taught at school or by correspondence. Commence at any time. Chicago Nautical School, Masonic Temple, Chicago, Ill.

**FOR SALE—100 DRAWINGS and Instructions illustrating Sheet Metal Pattern Cutting.** Samples free. E. R. Probert & Co., Box 476, Cincinnati, Ohio.

**MOTION PICTURE PLAYS WANTED.** You can write them. We teach you by mail. No experience needed. Big demand and good pay. Book free. Associated Motion Picture Schools, Room 944, Chicago Opera House Block, Chicago.

**PHYSICAL CULTURE for men and women; no apparatus required.** Complete course illustrated sent on receipt of two dollars. S. E. Galbraith, 79 Perry St., Pontiac, Mich.

**SHORTHAND IN SEVEN LESSONS.** Most rapid readable system. Self-teaching method. Text book, 25c. Money returned if not satisfied. Agents wanted. Unigraph Co., Omaha, Neb.

**DETECTIVES—If you wish to become a successful Detective,** write for our free booklet, it tells how. Western Detective School, Denver, Colo.

**GET A PRACTICAL ELECTRICAL EDUCATION.** Write for free illustrated book today, 1021 Winnebago St., Milwaukee, Wisconsin.

**SHOP NOTES QUARTERLY,** a most valuable supplement to any course of instruction for those who want up-to-date information or modern methods in all the mechanic arts. Only one dollar a year. 25 cents a copy.

**LEARN BOOKKEEPING: FIRST LESSON FREE.** Course of 26 lessons \$6.50, you pay 25c for each, you're not compelled to take entire course. Work corrected free. Send 2 cent stamp for first lesson and particulars. Cox & Beck, Accountants, Office 43, Warburton Bldg., Yonkers, N. Y.

**WITHOUT KNOWING SHORTHAND** you can write 100 words a minute and increase your income—treble your dispatch of business—save your time. Let me explain to you fully how with my new method. Abbreviated Longhand, any longhand writer can easily become the equal of the average professional stenographer—in a few short evenings—at merely nominal cost. Sample Lesson 20c, and full particulars free. Write to-day. A. B. Weaver, Court Reporter, Dept. C, Buffalo, N. Y.

**\$200 TO \$600 MONTHLY** easily made fitting eyeglasses. Short, easy mail course. Diploma. Special reduced tuition fee. Big demand for opticians. Best and easiest money-making business. Quick sales. Tremendous profits. We assist you to start. Write today for free "Booklet 4." Tells how. National Optical College, St. Louis, Mo.

**BEST SHORTHAND BOOK** for home study. Thousands of successful stenographers learned from it; so can you! Pitman system complete, cloth bound, handy size, finest engraving; specially arranged for self-instruction. Price \$1. Every book contains coupon entitling the purchaser to receive one month's practical instructions by mail. Lessons given by the author, Eldon Moran, our best known American Shorthand Instructor. Students are introduced and correspond with each other. The time to begin is Now. Young pupils succeed well. Book well worth \$1; besides, mail lessons worth \$2 will be received without extra cost. Book and lessons sent immediately upon receipt of order. Address Popular Mechanics Book Dept., Chicago.

**ELECTROPLATING.** Learn this useful occupation from our 112-page treatise. It is "written so you can understand it" and will enable the humblest beginner to make a start. Price, 50c postpaid. Popular Mechanics Book Dept., Chicago.

**EDUCATION?** Learn typewriting. See what I say under "Typewriters." Atchison.

## PICTURES AND POST CARDS

**"TOUR UNITED STATES"—"Trip Around World"—50 water color post cards in attractive boxes.** Both sets 25c. Agents wanted. Big profits. Secor Company, 502 West 122 St., New York.

**CALIFORNIA SCENERY.** San Francisco Earthquake postals (regular two for 5c), one cent each. "Barstow," 514-23d St., Oakland, Cal.

**43 COMIC POST CARDS,** 10c. Magnus Hess, 837 Ashland Boul., Chicago.

**ART PICTURES AT BARGAIN PRICES.** Reproductions of celebrated pen and ink sketches, produced in colors. Suitable for framing. These pictures are worth 25c; 11x17 inches in size; ready for framing. In order to get your name we will send you three different pictures for 10c. Allen & Co., 818 E. 47th Place, Chicago, Ill.

**YOU'LL GET CARDS** from everywhere. Membership, 10c. Idaho Card Exchange, Dept. K, Box 906, Boise, Idaho.

**IF YOU REALLY WANT** to exchange postcards, try our splendid club. Lists circulate in many countries. Membership, 10c. Halcyon Club, Box 153, Erie, Pa.

**MODEL OF PANAMA CANAL** in relief, \$1. Greenback or M. O., payable Cristobal, Canal Zone. Panama Souvenir Co., box 165, Colon, R. F.

## CAMERAS, PHOTO SUPPLIES, ETC.

**FILMS DEVELOPED,** 10c per roll. All sizes. Prints: 2¼x3¼, 3c; 2½x4¼, 3½x3½, 3¼x4¼, 4c; 3¼x5½ and 4x5, 5c. On post cards, 5c. Prompt returns. Highest grade work. Send 2 negatives and will print free as sample. G. R. Hoke, 6206 Jefferson Ave., Chicago.

**DEVELOPING—PRINTING.** Brownies 10c per roll. Prints, 3c. Enlarging, copying, finishing. Best results. Kanawha Photo Company, Point Pleasant, W. Va.

**SOUTHERN CALIFORNIA** produces the clearest, most brilliant kodak pictures known. Send 10c. stamps or silver, and two negatives for sample prints. Homer Howry Co., Estb. 1907, Los Angeles, Cal.

**FOR SALE—DAYDARK CAMERA,** Model B, style 2 with 12 lens attachment; cost \$45, want \$30. C. Steiner, 816 Highpoint Ave., West Hoboken, N. Y.

**WE BUY, SELL AND EXCHANGE.** Bargains in Microscopes, Telescopes, Field Glasses, Cameras, etc. Catalogue and Bargain List free. Kahn & Co., Established 1850. 26 John St., New York.

**MAKE PHOTOS CHEAP!** Get our catalog—Cameras, Supplies, Developing, Enlarging. Valuable exposure meter included, 10c. Rex Bromide Co., A., Lincoln Park Station, Chicago.

**PHOTOS AND SNAP-SHOTS** tinted reasonably. Promptly finished. Write for particulars. Miss Ethel Halsey, 1 Lucas St., Charleston, S. C.

**EVERY WORKER IN PHOTOGRAPHY** should read The Camera, \$1.00 a year. Send 25 cents for three months' trial subscription. The Camera, Philadelphia, Pa.

**66 2-3% DISCOUNT.** The \$1 popular book entitled, "The Selection of a Photographic Outfit," sacrificed at 33c; 10c extra for mailing. Order now before supply is exhausted. Willoughby, 814 Broadway, New York City.

**KODAK FILMS DEVELOPED,** 10c per roll, any size. Prompt attention given mail orders. Prints 2¼ x 3¼ to 3¼ x 4¼, 3c; 4 x 5 to 3¼ x 5½, 4c. J. M. Manning, 1062 Third Ave., New York City.

## TRADE SCHOOLS

**WANTED—Men** by large Contracting Co. \$20,000.00 contract work going. Can learn automobiles, electricity, plumbing, brick-laying trade in few months. No apprentices or helpers work and no expense. Catalogue free. United Trade School Contracting Co., Los Angeles.

**SHOP NOTES QUARTERLY** (25 cents a copy) contains about four times as much reading matter as the ordinary 15-cent magazine. It's contents are all of the kind that is worth money to the reader. Ask your newsdealer to show you a copy.

**LEARN PLUMBING, EARN \$5.00 A DAY.** We qualify you in four to six months by actual experience on new buildings, which feature of instruction cannot be obtained in other schools in the country. Tools furnished Free. Tuition reduced. For particulars address Master Plumbers Trade School, 3657 Finney Ave., St. Louis, Mo.

**A COMPLETE COURSE** in Practical Automobile Engineering, under experienced instructors, with all modern equipment and appliances. Our four-story building offers special accommodation to out-of-town students. Call or write for our liberal proposition on Resident or Home Courses. Automobile School of Chicago, 1339 Michigan Ave., Dept. P. M.

**AUTOMOBILE SCHOOL.** You learn with your hands under the superintendence of the best instructors obtainable at the Chicago School of Motoring. Write for particulars. F. E. Edwards, Inst., Dept. "B," 1619 Michigan Ave., Chicago, Ill.

**PLUMBING, ELECTRICITY, BRICKLAYING** or Mechanical Drafting, taught by expert workmen. Short time and small cost. Positions always open. Catalogue free. Write today. Coyne National Trade Schools, 80 E. Illinois St., Chicago.

## DIAMONDS, WATCHES AND JEWELRY

**HIGH GRADE WATCHES** sold on easy terms to anyone anywhere without references or security. George Winstel, 1624 Pleasant St., Cincinnati, Ohio.

## MECHANICAL ENGINEERS

**HAVE YOU** any intricate mechanical problems to solve? If you have, let me solve them for you at a saving of money, time and trouble. Developing inventions to a practical and commercial basis my specialty. Benjamin Brownstein, Mechanical Engineer and Expert Designer, Ellwood City, Pa.

**THE LARGEST PERIODICAL** in the world devoted exclusively to mechanics and the practical arts is Shop Notes Quarterly. Ask your newsdealer.

## DOGS, POULTRY AND LIVE STOCK

**FOR SALE—Fine bird dogs,** registered Rip Rap pointer puppies, Comanche Frank stock. Pedigree on application. Chas. T. Keller, Anadarko, Okla.

**AMERICAN Hen Magazine,** Chicago. 35 cents a year. Agents wanted.

## BUSINESS OPPORTUNITIES

**WANT A FINE TAILORMADE SUIT?** Show our samples to three friends, take two orders easy and make enough to get your suit free. Novelty styles, very low prices, your profits \$5.00 to \$10.00 a day. We ship on approval, express prepaid and guarantee perfect fit. We want good agents everywhere; no money or experience needed. Write for free sample outfit and great offer. Banner Tailoring Co., Dept. 37, Chicago.

**MUSHROOMS—NEW PURE TISSUE** culture summer spawn. Now is the time, plant this new spawn; produces big crop white mushrooms all summer. Four other varieties winter planting; modern plan forcing plants, mushrooms, early quick crop. Book free. Fresh sample brick, 35c postpaid. We are originators and manufacturers of pure tissue culture mushroom spawn. Order direct from laboratory. Challenge Farm, 6961 Gravois Ave., St. Louis, Mo.

**MAKE MIRRORS AT HOME.** Big profits with little outlay. One 18x36-in. mirror costs \$2 to \$5. You can silver a glass this size for 20c. Send \$1 in stamps or money order and we will send you explicit directions how to do it; also how to emboss, grid, foil, gold leaf, frost, chip and make imitation stained glass. How to transfer photos on glass, bore holes in glass and cut skylights. George L. Patterson & Co., Dept. 3, Brooksville, Ky.

**BE INDEPENDENT.** Start Money Making Mail Order Business at Home. New plans. Everything furnished. Only small capital required. Free booklet and particulars tell how. W. P. Miller Co., Box 254, Muskegon, Mich.

**FOR SALE—A well equipped foundry** with 900 feet of Big Four track, three and a half acres of land, city of six thousand people, other connecting lines of railroad in reach. Can be had at a bargain. Address Neal & Company, Lebanon, Ind.

**UNITED STATES PRODUCES BILLIONS** in minerals annually—perhaps valuable deposits near you. Send 25c for ten ore specimens—gold, silver, copper, iron, lead, tin, etc. Also booklet. McLaughlin, Sharpsville, Pa.

**WE START YOU** in a Permanent Business with us and furnish everything. We have new easy selling plans and seasonal leaders in the mail order line to keep factories busy. No canvassing. Small capital. Large profits. Spare time only required. Personal assistance. Write today for plans, positive proof and sworn statements. J. M. Pease Mfg. Company, 181 Pease Bldg., Michigan St., Buffalo, N. Y.

**CHICAGO FIRM WANTS RELIABLE MAN** as State Representative. Responsible man with few hundred dollars can positively clear \$150.00 monthly. We manufacture 350 varieties Highgrade Air Brush Design Show Cards. Peoples Show Card Concern, 752 W. Madison St., Chicago.

**CASH YOUR IDEAS!** If patentable and practical you can sell them or start a business on them; my clients make money on their patents, send sketch for free opinion of merit and patentability; reliable dependable service. Book free. H. Sanders, Crilly Bldg., Chicago.

**START A MIRROR FACTORY** in your town!! We teach and trust you. \$10 to \$25 daily guaranteed. 10c brings sample lesson! Booklet! Proof! Hullingers (2), Francesville, Ind.

**MAIL ORDER ADS THAT PAY.** 20 different propositions fully explained. All bona-fide, sure-fire Money-getters. Each one the foundation of a successful Mail Order business. Send 10c for full particulars and regular bulletin of new propositions. Mail Dealers Wholesale House, 450 Franklin Bldg., Chicago, Ill.

**BIG PROFITS—Open** a dyeing and cleaning establishment, very little capital needed. We tell you how. Write for booklet. Ben-Vonde System, Dept. C, Staunton, Va.

**MANUFACTURERS OF QUICK SELLING ARTICLES,** of proven merit, requested to communicate. Have both men and money requisite quickly market. Globe Office Supply and Specialty Co., 40 Vine St., Cincinnati, Ohio.

**YOU ARE WANTED FOR GOVERNMENT Positions.** \$80.00 month. Annual vacations. Short hours. No "layoffs." Common education sufficient. Over 12,000 appointments coming this year. Influence unnecessary. Send postal immediately for list of positions open. Franklin Institute, Dept. K-83, Rochester, N. Y.

**IF YOU ARE INTERESTED** in the Mail Order Business send us twelve cents for a dollar booklet containing over 20 Mail Order and other schemes. E. Rebreth Co., Box 131, Memphis, Tennessee.

**MAKE MORE MONEY!** Start a mail business; operate a "Silent Salesman" system; evenings; possibilities unlimited. The best money making plans are in "Booster." Get away from wage slavery! "Booster" starts you in business for yourself with small investment. Send 10c for two months' trial. Booster Magazine, W. 208 N. Fifth, Chicago.

**AGENTS—College students** earn big vacation money selling our instantaneous automobile tire repairs; one agt. sold 160 one week. Free booklet. Chas. Kinsey Co., Willow Grove, Pa.

**WANTED—SALESMAN,** who calls on Machine Shops, to sell widely advertised patented specialty. Liberal commissions. Vest pocket sample. American Specialty Company, Chicago.

**PARTNER WANTED** with capital to put forward improved reinforced concrete rail tie with fasteners. Address F. W. Simons, Box 321, Santa Maria, Cal.

**WE START YOU** manufacturing article which brings 1,000% profit. No competition. Sample and particulars, 25c. Tallala Mfg. Co., Talladega, Ala.

**I MADE \$50,000** in five years with a small mail order business; began with \$5. Send for free booklet. Tells how. Heacock, Lockport, N. Y.

**START A MAIL ORDER** book business in your own home, big profits, particulars free. Address Arthur Beers, Bradley Beach, N. J.

**48 BUSINESS SECRETS** to become rich. Write for my circular. Geo. S. Ross Co., New Orleans, La.

**MAKE MONEY WRITING SHORT STORIES.** Big pay. Free booklet. Tells how. United Press Syndicate, San Francisco.

**FREE YOURSELF** from wage drudgery. 12 ways, 10 cents. "Be. Money Back Store," Baltimore.

**"LEND ME NICKEL" GAME.** Great joke. Makes everybody laugh. Price 10c. Goldman, Phillipsburg Bldg., Yonkers, N. Y.

**H. L. EVANS,** Clay Center, Kan., wants capital develop New Fiber.

**\$ MAKE \$ MORE \$ MONEY.** 53 business secrets telling how, 25c. B. Newnham, Waukegan, Ill.

**CHANCE OF YOUR LIFETIME—Explicit** directions and formula for silvering mirrors, fifty cents. Quickest and easiest method. Limited time only. Randall & Co., Box 45, Clay Center, Kan.

**GO INTO THE MOVING PICTURE** business you can get an entire outfit for a small capital on the installment plan. Write for catalogue. Dearborn Novelty Co., R. 1001, 538 Dearborn St. Chicago.

**WANTED—YOUNG MAN** commanding about \$5,000—purchase half interest, established automobile and wagon rim bending business; attend to books and finances. Frank Willett, Willow Grove, Pa.

**LEARN HOW TO MAKE MIRRORS.** Send \$2.00 and we will send complete instructions how to make mirrors at home. Chemical Silvering Co., Ft. Wayne, Ind., P. O. Box 21.

**FOR SALE OR EXCHANGE—Photo Novelty Manufacturing** Business, Denver, Colorado, old established; a money maker, value \$8,000. Clear exclusive business. A man or woman can learn the business in ten days; owner too old. Wants clear income property equal value anywhere. Western Button Company, Denver, Colo.

**START A HOME BUSINESS.** Sell your ideas, formulas and knowledge by mail. Some make \$1,000 monthly. Instructive booklet for stamp. Information System, 249, Marietta, Ohio.

**INCORPORATE** your patents and business under Arizona Law. Cost very small. No annual or franchise tax. Members exempt from corporate debts. No public statements required. No restrictions. Hold meetings and do business anywhere. Charters cannot be repealed by subsequent laws. Particulars, laws and forms free. Southwestern Securities & Investment Co., Box L488, Phoenix, Arizona.

**CONDUCT A "CANDY KITCHEN."** Clear \$20 daily. Small capital required. Send for particulars. Kennon & Co., 148 West Ontario St., Dept. A, Chicago.

**MANUFACTURERS AGENTS AND SIDE LINE** men wanted to represent us in every country on earth. Money making proposition responsible parties of established reputation answer. Lustre Bak., Holden, Mo., U. S. A.

**FOR SALE—Good** mail order business instructing sewing machine repairing by mail. Address Leroy Brown, 1216 Madison St., Baltimore, Md.

**OUR FORMULAS AND NEW PROCESS** in Silver plating brings the \$\$\$ to you. Circulars free. Daniel's & Sons, Jersey City, New Jersey.

**SEND 25c FOR BOOK** of lectures, 5x8 inches, on Halley's Comet and astronomy that every one can understand. U. S. Spark Arrester Co., Wilton, N. Dak.

**SUCCESSFUL MAIL ORDER PLAN** for beginners and others free. Popular Club, 7114 Eggleston Ave., Chicago.

**SALES AGENCIES,** get exclusive contract now for distribution of Victor Furnace Tender in your state. V. E. Cozine, Gloversville, N. Y.

**HOW TO SUCCESSFULLY CONDUCT** a Mail Order Business. 95 page book of Real Secrets and Facts for 25c postpaid. Stark Co., Whiting, Ind.

**START A MAIL ORDER BUSINESS** of your own. Be your own boss. I made \$25,000 in two years with small capital to start. My booklet "Money Making Opportunities in the Mail Order Business," sent free. Address, McKean, Dept. 375, No. 2232 Eighth Ave., New York.

**PATENTS SECURED—C. L. Parker,** ex-examiner Patent Office, 910 G St., Washington, D. C.

**BUILD A BUSINESS** of your own and escape salaried drudgery for life. Learn the Collection Business. Limitless field, little competition. Few opportunities so profitable. Send for "Pointers" today. American Collection Service, 101 State St., Detroit, Mich.

**I WILL START YOU** earning \$4 daily at home in spare time, silvering mirrors; no capital; send for free instructive booklet, giving plans of operation. G. F. Redmond, Dept. 306, Boston, Mass.

**LEARN THE TRUTH** about Mail Order Business before buying "outfits." Important information and particulars for starting free. Mail Order Library, P. M. Tompkinsville, New York City.

**HAVE YOU ANYTHING TO ADVERTISE?** Our Rate Book tells you all about advertising mediums, rates, circulation, closing dates, etc. Sent for 10c. Worth dollars. Folder free. Correspondence invited. Dearborn Advertising Agency, 455 Franklin Bldg., Chicago.

**FORM A CORPORATION—Congress** Law for D. C. and all States; cheap. Raise money easily; advice free. U. S. Legal Corporation, Washington, D. C. Representing \$1,225,000.000.

**POSITIVELY BEST RIBBONS,** three, \$1.10. See what I say under "Typewriters." Atchison.

## AGENTS WANTED

**WEAR A STYLISH SUIT!** Clothes make the man. The man who is admired is the swell-dressed man whose clothes are fashionable, and are 1911 styles. You will be that man in your neighborhood! 1911 styles are just in. Get this suit—the swellest, classiest, snappiest style we ever created, and better your appearance! This is our idea: We want one man as our representative in your neighborhood. You've got a lot of friends. They wear clothes. It is the easiest thing in the world to get them to order their clothes from you. Prices, \$7.50 and up. These orders mean a big business that more than doubles your salary, and the work is the easiest, cleanest, nicest occupation in the world. New representatives make \$5 to \$10 a day. You simply take the order and measurements and mail them to us. We make the clothes, ship them on approval to your friend and hand you the profit money. A Regular Cinch! That's the beauty of being in business for yourself. Sit right down now; write us a postal or a letter for the free outfit to representatives. And you get the swellest suit of fashionable, tailor-made, all-wool, 1911 clothes ever worn in your neighborhood. If your personal appearance and a big business is worth a postal or a 2-cent stamp to you, then act now—write us today. Address, American Woolen Mills Co., Dept. 468, Chicago.

**I DON'T TALK** to Prospective agents in the language of the circus spieler. Don't want kind of agents that nonsense appeals to. But I do say, if you're a good, square man, making less than \$7.50 a day, you're cheating yourself. You can do better than that selling Stevens' Standup Scrubber, greatest household invention since the sewing machine. Scrubs, mops, dries the cloth, cleans the baseboard, dusts the walls. No stooping, no wet hands. Don't confuse it with so-called "wringing mops." Nothing else on market like it. Territory going fast. Elmer E. Stevens, 1142 Adams Express Bldg., Chicago.

**MAD RACE FOR AGENCY;** you may be chosen; means \$75 every week. J. Hodson, New York, sold 22 in two days (profit \$38.50); M. Clark, Montana, 43 first week (profit \$84). Home comfort scrubbing machine; powerful vibration; scrubs, cleans, dries floors, linoleums, etc.; no stooping, wetting hands; abolishes old style brushes, hands disfiguring mops; self-feeding, self-emptying, self sudsing; child operates easily. Price \$3.50. Women all buy; weighs 7 pounds; easily carried; new, irresistible; free sample; credit; hurry postal. Sanitary Supply Co., Box 328, Station F, Toledo, Ohio.

**AGENTS. DON'T BOTHER** with cheap trashy jewelry and tableware—it injures your reputation. Sell at low prices dependable sterling and plated silverware, jewelry, leather goods, razors, toiletware, fountain pens and novelties. Watches and diamonds at cut prices. We prepay all express and mail charges—our line of 3,000 absolutely reliable and fully guaranteed quick-selling articles is the largest and best offered by any agency company in the world. Write today for free catalog of 750 pictures and particulars about agents' free sample outfit. A. W. Holmes & Co., Dept. B-10, Providence, R. I.

**AGENTS—MEN, WOMEN, BOYS AND GIRLS.** Make \$15 to \$35 every week. New selling plan. We give a \$2.50 kitchen set free to your customers to advertise our goods. Big snap for agents. Over 2,000 guaranteed fast-selling articles. Work pleasant and easy. No experience needed. Earle White (age 21) made \$32.96 first week he worked. Samples furnished workers. Liberal credit terms. A handsome 1911 Maxwell five-passenger \$1,000 automobile; a \$400 piano, and 298 other prizes given absolutely free to the agents who sell the most goods. In case of tie, equal prizes given. Write this very minute. McLean, Black & Co., 350 Medford St., Boston, Mass.

**YOUNG AND ACTIVE AGENTS** wanted for the Sanitary Crown Pipe; it's kept clean simply by removing bit and shaking out aluminum chamber, where all nicotine and saliva is caught and held; elegant French Briar pipe; nothing to get out of order; the only practical thing of its kind; it's making new pipe smokers every day; big sales everywhere. Address Crown Pipe Co., 258 Broadway, New York City.

**"LIVE WIRE" AGENTS WANTED.**—One in each city and town to sell a household necessity; no "has beens" or "I guess I can" people desired; to right ones who produce results we will submit a money-making proposition; don't use a postal, write a live letter. Hamilton Sales Agency, 92 State St., Boston, Mass.

**AGENTS—Wild, rip-roaring excitement; \$100.00 weekly.** Strange invention startles world. Men money-mad; getting rich. Hurrah! Zimmerman grabbed \$3,853.00 in 38 days; Korstad, \$2,212.00 in 2 weeks—selling Allen's wonderful Bath Apparatus. Gives any house a bathroom with hot and cold running water facilities for \$6.50; abolishes plumbing, water-works. Field unworked; free sample; credit; millions eager to buy. Just show—money yours; 75 per cent profit. Just a postal brings amazing proposition. Allen Mfg. Co., 3370 Allen Bldg., Toledo, Ohio.

**AGENTS—To sell the newest electric appliance on the market;** sold everywhere there is electricity, in the home and office; liberal profit; sales driving sample, weighs a pound, no experience or knowledge of electricity required; it shows how to use one light instead of two and get the same results; sells for \$3.50 and saves the purchaser an investment of \$25; write for particulars. The Handy Light Co., 211 Opera Place, Cincinnati, Ohio.

**AGENTS, TEACHERS, STUDENTS,** here's your opportunity. Sanitary dustless rugs. Gem ironing shoes. Many new household specialties that sell in every house. \$5.00 daily easily made. Now is the time to start and get in on the ground floor. For samples and particulars address Dexter Supply Co., 508 S. Dearborn, Chicago.

**WANTED AGENTS EVERYWHERE** for Duplexo Vacuum Cleaner. Only perfect hand machine. Double Suction, weighs 6 lbs., cleans carpets, floors, curtains, furniture. A wonder. Can't get out of order. A child can use it. Demonstration means a sale. Big profits. High class permanent business. Write for particulars to the Duplexo Co., Dept. F, 95 So. 5th St., Brooklyn, New York.

**BUILD UP A PERMANENT BUSINESS** of your own. Represent us exclusively in your territory. No canvassing. Repeat orders. We, as manufacturers of patented specialties, want "live men on our original selling system. Everything complete for you to start at once. Field unlimited. If you mean business write today. J. M. Pease Mfg. Co., 182 Pease Bldg., Michigan St., Buffalo, N. Y.

**AGENTS** wanted for the most rapid selling household specialty on earth; every woman will buy one on sight; no talking; the goods will sell themselves; free samples and catalogue. The Boraten Novelty Co., McKeesport, Pa. Box 116 O.

**AGENTS—Biggest money-maker known.** The new Canchester Incandescent Kerosene Lamp revolutionizes old lighting methods. Burns air, not money. Six times brighter than electricity, gas or acetylene at 1-10th cost. Burns with or without mantle. Burns fits any lamp. Saves 75% oil. No trimming wicks. Showing means selling. Territory going fast. Write today. Handsome outfit furnished. Canchester Light Co., Dept. P. M. 7, 204 No. State St., Chicago.

**"MODERN" SELF-HEATING IRONS** and stands sell on sight. Exclusive proposition and every "Modern" Iron is guaranteed perfect. 100% profit for live hustling representatives. We advertise. Our specialties get the money. 10c brings Burglar Lock. Reserve territory at once and get outfit by writing for summer catalogue "P." Modern Specialties Mfg. Co., Milwaukee, Wis. (Patentees.)

**\$ DOLLAR \$ ADDER; POCKET ADDING MACHINE;** adds and subtracts quick; capacity \$999,999.99. \$1.00 prepaid. "Pen Cap" Check Protector, safeguard to checks, 35c prepaid. "Common Sense" Pencil Sharpener; best, pocket size, pencil sharpener made. 25c prepaid. Order now—today. Circulars free. Agents wanted. Ellis Sales Co., 1711 Leavenworth, Omaha, Neb.

**AGENTS, WOODWORKERS OR HANDY MEN** why not start a business of your own, easily manufactured—biggest seller out. Every family a customer. The "Folding Climax ironing stand," best ever invented. Full instructions and patterns only one dollar; wake up and get busy; send for circular. N. Scholl, Chillicothe, Ohio.

**AGENTS FOR KEEPEM BRIGHT Tarnish Preventative.** One application keeps automobile, store signs, and other brasses always like new. Wonderful seller. 100% profit. Regular can and agents contract \$2. Auburn Chemical Company, Auburn, Indiana.

**AGENTS—NEW INVENTION;** just out. Necessity in every home. Quick seller. 100% net profit. Territory open. Write today. Domestic Mfg. Co., Dept. P, Toledo, Ohio.

**LATEST INVENTION—DRY INK** for Fountain Pens. Best seller on market. 10 samples, big proposition. Price 10c. Secor Company, 502 W. 122 St., New York.

**\$20 WEEKLY SELLING HANDKERCHIEFS.** Agents wanted. Premium list and sample, 10c. The Northern Handkerchief Co., Lock Box 433, Barton, Vt.

**LIVE AGENTS WANTED—HUSTLERS** to handle our attractive 1911 combination packages of soap and toilet articles with valuable premiums. One Michigan agent made \$65 in 47 hrs., another \$21 in 8 hrs.; another \$22.50 in 16 hrs. Write today. Davis Soap Works, 264 Davis Bldg., 1429 Carroll Ave., Chicago.

**WE ARE MANUFACTURERS** of New Highgrade Original Air Brush Design Show Cards. Every storekeeper buys. 400% profit. Catalog containing 350 varieties free. Samples 10c. Peoples Show Card Concern, 750 W. Madison St., Chicago, Ill.

**AGENTS—Stamp names and addresses on key checks, name plates, watch fobs, etc.** We supply blank stock and stamping outfits; sample free. Hart Manufacturing Co., 200 Eckford St., Brooklyn, N. Y.

**GOOD PUZZLES** sell on sight, six different, white iron, 10c leaders with wholesale catalog, 25c. Western Puzzle Works, St. Paul, Minn.

**WANTED—BOYS** with mechanical ability to sell and put on our no-slam outfits for screen doors. One outfit and particular to agents, 15c. Satisfaction Guaranteed. King Mfg. Co., Chicago.

**\$100 MONTHLY** and expenses to trustworthy men and women to travel and distribute samples; big manufacturer. Steady work. S. Scheffer, Treas., M. R., Chicago.

**AGENTS, MEN AND WOMEN,** average \$10 per day, no capital, no experience required, easy work among friends. Write now for particulars. Gary Sales Company, Gary, Ind.

**KLENENE** will make your stained garments look like new agents wanted. 149 So. Broadway, Denver, Colo.

**AGENTS—\$25 per day** easily made selling our automobile tire repair kit. In demand by all automobile owners. Write today. E. C. Wolf Co., Sidney, Ohio., Dept. H.

**"A YARD OF KIDS."** The cutest picture ever! Beautiful happy, bouncing "kids" in different poses. 25c for one, 50c for three. Big reduction to agents and dealers; no free samples. Miller Co., 30 W. 126th St., N. Y.

**AGENTS—The Tufts Utility Co., Pittsfield, Mass.,** offer new and attractive high grade specialties that sell readily and profitably. Send today for illustrated catalogue E.

**MAKE PHOTO PILLOW TOPS** and Post Cards yourself. Easy secret process; no darkroom, no toning; big profits; learned by anyone at once; send today for free particulars. G. S. Vallan Co., Elkhart, Ind.

**WONDER OIL LAMP—Revolutionizes lighting—needed everywhere—60,000 already sold; agents enthusiastic; big profits; exclusive territory. Write quick. Free sample to active agent. United Factories, Dept. 6, Kansas City, Mo.**

**IF YOU ARE EMPLOYED** in a factory, foundry or any work shop you can make money with the Vaco bottle and Vaco Lunch Case. Write The Caloris Company, 2116 Allegheny Ave., Philadelphia, Pennsylvania.



**EARN A SUIT IN ONE HOUR!** Your profit for an hour or two as the representative of our great tailoring house pays for a special made-to-measure suit for you—the handsomest, the most stylish and the most durable ever made. Just show two or three of your friends the samples of our fine wool suitings, take two or three orders and you have earned the suit. You can't fail to get orders. Our 60 beautiful samples create a sensation wherever shown. No one ever saw such materials at the price before. You take no risk. Everything is shipped on approval, subject to 24 hours' examination. Customers try goods on and must be satisfied with style, fit and quality before paying. We pay express on everything. You can undersell everybody. Get clothes for your friends at less cost than they pay anywhere else and make wholesaler's, jobber's and retail dealer's profits. That means the swellest, cleanest and nicest business in America! A Big Business that more than doubles your earnings. We want you to represent us now. Don't wait until somebody else takes this great business. No experience necessary. We furnish you our portfolio with 60 samples of the latest weaves, fabrics and colors, absolutely free. Do you want this swell made-to-order suit and this remarkably easy money-making business that will make you rich? A postal or letter mailed to us at once gives you swell clothes and a big business. Write us now. A postal card will do. Or tell your friends about it. Paragon Tailoring Company, Dept. 11, Chicago, Ill.

**AGENTS—Cadox Clinches Quarters;** over 200% profit; fast easy seller, toilet necessity; leader or side line for either sex; write now. Cadox Company, Jacksonville, Florida.

**SMALLEST ALARM CLOCK,** bible and telescope, 10c each prepaid. W. H. Garner, A-119 South Lafayette St., Evansville, Indiana.

**SELF-THREADING NEEDLES,** 10c a paper. Agent's samples and terms free. Ladies' Art Co., Dept. 41, St. Louis, Mo.

**AGENTS SELL CHAUFFEUR'S BLUE BOOK,** how to drive, adjust and maintain automobiles and pass examinations; sample and prices 20c. Chas. Milward, 1546 N. 60th, Phila., Pa.

**THE NEW MATCHLESS CIGAR LIGHTER.** Agents—Just out—the new pocket lighter. Shaped like a fountain pen. Territory going fast. Write today for sample offer. Schiller Mfg. Co., Dept. R, Schiller Bldg., Chicago.

**HUSTLERS WANTED** everywhere to introduce new auto specialty—\$25-\$100 made weekly; big demand; free booklet. Taylor-Sayers & Co., A193 Lafayette Blvd., Detroit, Mich.

**AGENTS WANTED—**Combination laboratory filter stand and photographers graduated gas light printing outfit. Sells at sight. J. C. Barrett Co., Hartford, Conn.

**BEST SIDE LINE** on earth; clean cut proposition; pocket samples; prompt commissions; consigned goods. Dyer Mfg. Co., 1420 S. Michigan Ave., Chicago, Ill.

**AN OUTLAY OF 25c** that brings you 50c—100%—is good profit. Send dime for sample. Sell everybody that writes. J. C. Jennings, Winnsboro, Texas.

**AGENTS MAKE BIG MONEY** selling Dumanis Hand Cleaner and Household Necessity. Send for particulars. Dumanis Mfg. Co., 2232 Seventh Ave., New York.

**BOY AND GIRL AGENTS—**Sell 20 packages of bluing at 10c each. Send us \$1.00 and keep one dollar. Godward Adv. Service, Akron, Ohio.

**AGENTS WANTED** to sell our beautiful scripture wall mottoes. Frank Shilling Co., Navarre, Ohio.

**AGENTS—**Over 500% profit. Gold sign letters; sell everywhere; sample free. Johnston Co., Quincy, Ill.

**DON'T PEDDLE!** Make your dollars easy. Emery Furrer, Easton, Ill.

**AGENTS—**Improved specialty for automobile owners; quick seller; big profits; illustrated booklets; write today. E. L. Ellis, Nezaunee, Mich.

**AGENTS—**Portraits 35c, Frames 15c, Sheet Pictures 1c, Stereoscopes 25c, Views 1c. 30 days' credit. Samples and Catalog free. Consolidated Portrait, Dept. 119Y, 1027 W. Adams St., Chicago.

**\$25 WEEKLY** and expenses to men and women to collect names, distribute samples and advertise. Steady work. C. H. Emery, M. M., Chicago, Ill.

**DOLLARS ROLL IN** selling the greatest household article on earth. Specialty Co., 563, Stroudsburg, Pa.

**AVOID MICROBES, USE ALUMINUM** sanitary vest pocket drinking cup, agent's sample 15c. Every one buys. Dept. E, Texas Aluminum Co., Box 532, Chicago, Ill.

**AGENTS WANTED—**Rubber stamps and novelties. Send 4c for full particulars. A. S. Mankin & Co., Alexandria, Va.

**STERLING IGNITERS:** Write at once. N. Sterling Co., Box 166, Trenton, N. J.

**EVERYBODY CAN SHINE THEIR SHOES** with ease, convenience and economy by using the Kroll Patent Shoe Polisher. In tremendous demand. Agents making piles of money. Write today for exclusive territory. Adam J. Kroll, 600 Blue Island Ave., Chicago.

**AGENTS, OPERATORS, SALESMEN;** big money operating and selling fifty-six box match machine, stores, restaurants, merchants, territory given; liberal inducements. Write, Lion Machine Co., Detroit.

**AGENTS, YOU CAN MAKE \$3 to \$10** a day selling our goods; all winners; write at once enclosing 20c stamps or two dimes for latest catalog and an article worth 10c with outfit. Big money for you. The Nance Sales System, 804 Cass St., Chicago, Ill.

**AGENTS—**Quit peddling! Do it by mail! Your spare time worth \$25 weekly; investigate our unique mail business; amazing profits for shrewd people; write for details. Fredericks & Co 776 Unity Bldg., Chicago.

**COLLECT NAMES,** information, for business concerns. Steady profitable home business. Instructive booklet for stamp. Information System, 250, Marietta, Ohio.

**GOOD MAIL ORDER BUSINESS,** one dollar; express pre paid; sharpen safety razor blades by mail. We furnish complete outfit. Write Goldsmith Whiting Co., 63 Goebel Bldg., Detroit.

**NEW ARTICLES FOR HOUSEHOLD** and Mechanics. Quick sales, good profits. North Chicago Tool Works, North Chicago, Ill., 35 Broadway.

**SELLS LIKE HOT CAKES,** big profits, new ironing wax perfumes clothes with lasting violet perfume. Nothing like it Easy to handle. Exclusive territory. M. B. R. Mfg. Co., 16 Water St., New York.

**WANTED—AGENTS—**7 cents profit each 10c sale; best little article ever offered; sample for 3c in stamps. Rawlings, Box 945, St. Louis.

**AGENTS—WE MANUFACTURE GLASS PAPER.** Plain glass windows made to look like real stain glass; something new; easily applied; big money maker; two sample sheets of paper, with catalogue in colors and discount sheet, for 10c. S. H. Parrish & Co., 202 S. Clark St., Chicago.

**PERFECTION POCKET ADDING MACHINE.** Lightning seller Agents wanted. Cincinnati Specialty Mfg. Co., Dept. R., Cincinnati, Ohio.

**ANY LIVE AGENT CAN** make 100% profit working for us New article, sells for 25c, universal demand, exclusive territory quick sales. Send now for free sample and terms. The G. V. Sales Co., 150 Nassau St., New York, Room 1325.

**AGENTS EARN BIG MONEY** selling latest styles beautiful braided and embroidered waist patterns, dresses, Mexican drawn work linens, renaisance, petticoats, etc. Catalogue free. National Importing Co., Desk 27, 699 Broadway, New York.

**LIVE WIRE SALESMEN,** sell our own make brushes for every household use. Write for particulars, territory and the eight advantages of our propositions. 125% profit. Capitol Brush Co. Hartford, Conn.

**GERMAN SILVER KEV CHECKS—**Steel letters for marking same, key rings, etc.; over 30 styles. Agents wanted. Sample marked with your name and address, and key ring. 15c. Pease Die Maker, Winchester, N. H.

**AGENTS WANTED—**\$25 to \$100 per week easily made selling high-grade Automobile Specialty. Agents Supply Co., Box 98, Muscatine, Iowa.

**WE HAVE** an ideal side line. Nets big returns, \$6.00 to \$10.00 a day easily made. Getting orders for our Safety Matches bearing Dealer's special advertisement. Something new. Sells itself If you have a few spare moments on your route, this is your opportunity. Pocket sample case. For particulars, address Dept. P, Importers, 2282 East 55th St., Cleveland, Ohio.

**SELL SOMETHING ALREADY IN DEMAND.** Energetic specialty salesmen make \$2,000 up on our remarkable, original advertising proposition. Unlimited earning opportunity. Reliable advertising specialty salesmen wanted—state selling experience Agency Dept. Taylor Brothers Company, Rochester, N. Y. Established 58 years.

**AGENTS—**\$50 weekly; we manufacture the best needle case made; a wonderful seller; 200 to 500 per cent profit; talking unnecessary; our copyrighted "Trust Scheme" Envelopes do the work; general agents can make over \$100 weekly; send 10c for a 25c sample containing 115 needles; particulars free; buy direct from the factory at wholesale. Paty Needle Co., 102 Union Sq., Somerville, Mass.

**BECOME A MANUFACTURER'S AGENT.** We manufacture hosiery which outwears 3 of the ordinary kind, replaced free when hole appears. Easy sales; large profits. First reply obtains agency your city. Triplewear Mills, Dept. D, 724 Girard Ave., Philadelphia, Pa.

**MEDALLIONS SELL AT SIGHT.** 300 per cent to 500 per cent profit. Make up your own goods and be independent. "It's easy." Catalog free. Fred Resag Co., 1205 W. Randolph St., Chicago.

**AGENTS—**\$5 daily selling our Handy Tool, 12 articles in one. Lightning seller. Sample free. Thomas Mfg. Company, 462 Third St., Dayton, Ohio.

**THE NOEL KEROSENE MANTLE LAMP** beats electricity, gas or gasoline. The most economical light to burn. A whirlwind seller. Customers delighted. Agents write for territory. John B. Noel Co., 10th St., Grand Rapids, Mich.

**AGENTS: \$30.00 WEEKLY** easily made selling our Yankee Self-Wringing Mop and Duster; 500 other fast sellers; samples free. Scheff Co., 1637 Wells Street, Chicago.

**WIDOWS, Ladies, Men, New, Interesting.** Profitable, easy work. Spare time or permanent. Sell our useful specialties. Our original selling plan will double your sales. Particulars and \$2.00 premium offer free. Fair Mfg. Co., HF51, Racine, Wis.

**YOU CAN MAKE \$\$\$\$** as our general or local agent. Household necessity; saves 80 per cent; permanent business; exclusive territory; salary or commission; free sample; credit. J. Pitkin, Newark, N. Y.

I WILL START YOU earning \$4 daily at home in spare time, silvering mirrors; no capital; send for free instructive booklet, giving plans of operation. G. F. Redmond, Dept. 306, Boston, Mass.

AGENTS make big money selling our new gold letters for office windows, store fronts and glass signs. Any one can put them on. Write today for free sample and full particulars. Metallic Sign Letter Co., 406 N. Clark St., Chicago.

ONE-MILLION AGENTS WANTED; fast seller costing 5c, selling 50c. Every firm needs. Orders to \$50. Postal brings samples. Embossed Co., 2497 Milwaukee Ave., Chicago.

FREE GOLD SAMPLE goes with first letter. Something entirely new. Every firm wants it. Orders \$1.00 to \$100.00. Nice pleasant business. Write today. Metallic Mfg. Co., 406 N. Clark, Chicago.

AGENTS—Sell the Pinless Clothes Line. A labor-saving invention; sells on sight; write quick; exclusive territory; \$25 to \$75 weekly; freight prepaid; sample 25c. Pinless Clothes Line Co., 558 Lumber Exchange, Portland, Oregon.

AGENTS WANTED—25c novelty, housekeepers buy at sight; tea kettle attachment prevents scalding. William Cram, Box 8704, Haverhill, Mass.

### HELP WANTED

\$3,000 TO \$10,000 YEARLY in the real estate business, without capital; we will teach you the business by mail, appoint you special representative in your locality, of leading real estate company, list with you readily salable properties, co-operate with and assist you to permanent success—a thorough commercial law course free to representatives. If you are honest and ambitious, our free 62-page book will surely interest you. Address International Realty Corp., Dept. 1634, Chicago, Ill.

WANTED—RAILWAY MAIL CLERKS. Average salary \$1100.00. Alternate weeks off with full pay. Common education sufficient. Preparation free for examinations everywhere soon. Write immediately. Franklin Institute, Dept. K-21, Rochester, N. Y.

RAILWAY MAIL CLERK, Post Office Clerk, and Carrier Civil Service Examinations are held in the Fall. Commence preparation now under the personal supervision of a former Member and Secretary of the Board of U. S. Civil Service Examiners. 7 years experience in conducting Civil Service Examinations has shown us exactly the kind of preparation that an applicant requires. We can prepare you right. Write today for our big free descriptive booklet. Patterson Civil Service School, Box 826, Rochester, N. Y.

EARN \$10 TO \$15 a week and hold your position besides. No canvassing. We, as manufacturers of patented just in season specialties, have new easy mail order plans to keep factories busy. We furnish everything. Large profits. Small capital. Experience unnecessary. If you are one of the want-to-go-ahead kind write for our most modern plans. Sworn statement. J. M. Pease Mfg. Co., 183 Pease Bldg., Michigan St., Buffalo, N. Y.

WANTED—RAILWAY MAIL CLERKS; City Carriers; Post-office Clerks. Government Clerks at Washington, D. C. Thousands of appointments coming. Average salary about \$1100.00. No "Layoffs." Short hours. Annual vacations. Common education sufficient. Political influence not needed. Send postal immediately for list of all positions open. Franklin Institute, Dept. K-21, Rochester, N. Y.

WANTED—One representative in every important center to have exclusive sale of our line of drop-forged tools, hammers, cold chisels, pinchers, punches, etc.; responsible men only. Write at once to Sales Mgr., Van Doren Mfg. Co., Chicago Heights, Ill.

STOP HERE! Let me start you in a home business that will bring you money every day. Experience unnecessary. Spare time. No canvassing. I furnish everything and guarantee success. Send for proofs. Voorhies, Desk C. R., Omaha, Neb.

YOU ARE WANTED FOR GOVERNMENT Positions, \$80.00 month. Annual vacations. Short hours. No "layoffs." Common education sufficient. Over 12,000 appointments coming this year. Influence unnecessary. Send postal immediately for list of positions open. Franklin Institute, Dept. K-21, Rochester, New York.

BIG MONEY WRITING SONGS. Thousands of dollars for anyone who can write successful words or music. Past experience unnecessary. Send us your song poems, with or without music, or write for free particulars. Acceptance guaranteed if available. Washington only place to secure copyright. H. Kirkus Dugdale Co., Dept. 265, Washington, D. C.

RAILWAY MAIL CLERKS WANTED—Average salary \$1100. Write immediately. Franklin Institute, Dept. K-21, Rochester, New York.

BOOKS LOANED FREE—BY MAIL—On many subjects; others rented and sold. Occultism, success, business, health, new thought, etc. For conditions, lists, Weekly Bulletin, full information and impartial advice, address Librarian Oriental Esoteric Society, 119, Washington, D. C.

GOVERNMENT WANTS RAILWAY MAIL CLERKS; Carriers; Postoffice Clerks. Thousands of appointments coming. Write for list. Franklin Institute, Dept. K-21, Rochester, N. Y.

GOVERNMENT WANTS RAILWAY MAIL CLERKS; Carriers; Postoffice Clerks. Common education sufficient. Thousands of appointments coming. Write for list. Franklin Institute, Dept. K-21, Rochester, N. Y.

WANTED—A few specialty salesmen of unusual ability to cover eastern territory and to whom we will give an unusual contract. Guaranteed state rights to right man. Must be able to furnish fidelity bond and should have some knowledge of mechanics. Oxy-Acetylene Welding Machine Co., 213 S. W. Blvd., Kansas City, Mo.

GOVERNMENT WANTS HELP—Write immediately for list of coming examinations in your vicinity. Franklin Institute, Dept. K-21, Rochester, N. Y.

WANTED DISTRIBUTERS of Advertising Matter Everywhere. Oliver D. Barkley, Mount Pleasant, Pa.

SOBER MEN TO REPRESENT US in every locality to have charge of our Amusement Devices at profitable commission. No expense. Pleasant outside employment. Reference required. Universal Amusement Co., 725 Essex Bldg., Newark, N. J.

COLLECT INFORMATION, names, etc., for business concerns. Steady, profitable home business. Instructive booklet for stamp-Information System, 251, Marietta, Ohio.

WANTED ONE THOUSAND CHAUFFEURS and repair men. Our demand for automobile engineers exceeds the supply. Calls for men of intelligence and mechanical bent capable of commanding \$100.00 to \$150.00 per month upon graduation. Resident course \$20.00 to \$60.00. Home Correspondence course completed by practical road and shop work at this school, highly successful. Look this up. Auto Schools of America, Dept. T, 1600 Michigan Ave., Chicago.

WANTED, AGENTS, MACHINISTS, ATTENTION! Increase salary, new revised Saunders' Hand Book of Practical Mechanics. Best ever ready reference. Thousands in use. Postpaid \$1.00 cloth; \$1.25, \$1.50 leather flap. Big profits. E. H. Saunders, 216 Purchase St., Boston, Mass.

PLUMBING, ELECTRICITY, BRICKLAYING or Mechanical Draughting, taught by expert workmen. Short time and small cost. Positions always open. Catalogue free. Write today. Coyne National Trade Schools, 80 E. Illinois St., Chicago.

EXPERIENCED OR SUCCESSFUL SALESMEN to sell gasoline lighting system suitable for any place or purpose; attractive proposition. Write for catalogue. Doud Lighting Co., 174 N. Sangamon St., Chicago, Ill.

WANTED—A man or woman to act as our information reporter. All or spare time. No experience necessary. \$50 to \$300 per month. Nothing to sell. Send stamp for particulars. Sales Association, 601 Association Bldg., Indianapolis, Ind.

\$100 TO \$150 A MONTH paid to chauffeurs, demonstrators and truck drivers; no experience necessary. Write for free tuition certificate. Sweeney's Automobile School, 1436 Woodland Ave., Kansas City, Mo.

I WILL START YOU earning \$4 daily at home in spare time, silvering mirrors; no capital; send for free instructive booklet, giving plans of operation. G. F. Redmond, Dept. 306, Boston, Mass.

### MACHINERY AND TOOLS FOR SALE

FOR SALE CHEAP as we are going out of business. One No. 2 Foote Continuous Mixer, Hoist and 2 Cage Material Elevators; Kelly Taneyhill well drilling machine with tools complete; 4 hp. Fairbanks Morse Gasoline Engine; all in good condition. Address Martin & Kahler, Mauteno, Ill.

BIG BARGAINS in Air Compressors, Locomotives, Cranes, Hoisting Engines, Electrical Apparatus, Pumps, Crushers, Boilers, Engines, etc. Let me figure with you. Thos. P. Conard, 2 So. 15th St., Philadelphia.

A SOURCE OF POWER is necessary for operating small dynamos, display or experimental machines. We make small engines for just such purposes that embody startling new features, and are remarkably powerful and efficient. Let us send you our booklet; it explains them and their peculiar construction. The Elgin Wheel & Engine Co., Elgin, Ill.

MACHINERY—SECOND HAND. Iron working machinery, wood working machinery, gas and gasoline engines, steam engines, electrical machinery. Write us for what you want in machinery. We can furnish it. Cincinnati Machinery Co., Cincinnati, Ohio.

FOR SALE—One 3 ton Frick Ice Machine, \$300.00; one 8 ton Birmingham \$450.00; one 6 ton Remington \$500.00. Geo. J. Adams, 39 South St., New York.

FOR SALE—Rare bargains in new and slightly used stationary, marine and automobile engines. We have what you need. State your requirements. Get our prices and our guarantee. The Badger Motor Co., 916 Third St., Milwaukee, Wis.

ENGINE CASTINGS, 1½ horse vertical gasoline, air-cooled, \$7. Three horse marine water-cooled, \$9 cash; drawings included; catalogue for stamp. Novelty Manufacturing Co., 853 West Sixth St., Cincinnati, Ohio.

TWO-CYCLE, TWO-CYLINDER 4 in. by 3½ in. marine and automobile gasoline engines 16 hp., at \$94 complete. Castings and drawings of same for sale. Richards Iron Works, Manitowoc, Wis.

FOR SALE—DRAWINGS, PATTERNS, castings, finished engine, 5 horse, 2 cycle governed stationary gasoline engine. Cheap. P. O. Box 532, New Castle, Pa.

8 H. P. GAS ENGINE with two water tanks and connections also electric spark \$100. Kollenberg Co., Richmond, Ind.

WATERMAN OUTBOARD MOTOR, complete, \$25.00. Fine condition. Maffet, Lawrence, Kansas.

FOR SALE—Second-hand Saw Mill in first class condition. Write A. L. Crissinger, R. D. 5, Greensburg, Pa.

FOR SALE—MACHINE SHOP, TOOLS, motors, dynamos, castings for motors, dynamos and gasoline engines, volt-meters, ammeters, wire, everything in the electric line cheap. T. L. Thorsen, Menomonee, Wis.

FOR SALE—4" Forbes-Curtis hand or power Pipe Machine Good condition, \$85.00. Western Machinery Co., Cincinnati, O.

100 MARINE ENGINES \$25.00 to \$250.00. Lucas & Son Bridgeport, Conn.

PULLEYS, GEARS, SPROCKETS, Shafting Hangers; see page 144. W. A. Jones Foundry & Machine Co., Chicago.

FOR SALE—STORAGE BATTERIES, new and second-hand Cheap. T. L. Thorsen, Menomonee, Wis.

INTERESTED IN GASOLINE ENGINES? Send 50c for booklet, "How to Run and Install Gasoline Engines," and a year's subscription to Gas Energy, 28 Murray St., New York.

CASE HIGH SPEED ENGINE \$75; vertical boiler with fittings \$50. 15 Myrtle St., Meriden, Conn.

FOR SALE—A and R 1½ Horse Power Gasoline Engines for \$37.50. Write for catalog. Arnold & Ruopp, Manufacturing Company, Marshalltown, Iowa.

FINE TOOLS for sale. Wm. Quimbach, Black River Falls, Wisconsin.

EVEN IF YOU ARE an experienced tool maker you will find much information of value in the series of articles on "Tool and Jig Designing" which commences in the July issue of Shop Notes Quarterly.

TWO CYCLE 3¼x3¾ inch Marine Engine, \$30; complete casting for same for sale, \$9.00. Box 83, Harrison, Ark.

STEAM BOILER OUTFITS Complete; 1½ Horse Power 20" diam., 51" high, \$40.00. Page Boiler Company, 815 Larrabee St., Chicago.

FOR SALE—Rebuilt; Throttling, Automatic and Corliss Engines, Boilers, Pumps, Heaters, Machine Tools, Tanks, Saw Mills, and general machinery, at bargain prices. Let us know your wants. The Randle Machinery Co., 1761 Powers St., Cincinnati, Ohio.

FOR SALE—Gasoline Engines, automobiles, marine and stationary, also castings. Second hand ones taken in exchange and for sale. Apply with stamps, B. W. Richardson, R. No. 36, Peoria, Ill.

FOR SALE—Engine lathe, swings 9½ in., takes 25 in. between centers. Complete with full set change gears to cut all size threads, 3 to 49 in.; price only \$43.50. Address L. F. Grammes & Sons, Allentown, Pa.

LATHES—Send for free circular showing bargains on small Screw Cutting Engine Lathes. S. B. Machine Tool Co., Dept. L, South Bend, Ind.

LITHOGRAPHIC MODELS—Series of 6 subjects—Wireless Telegraph—Motor Car—Dynamo—Steam Engine—Steam Turbine—Gas Engine—Size 8x14 inches—All the parts of those mechanisms are shown and numbered to correspond to printed keys of names. Price per set of 6—\$2.50 or 50c each postpaid. Popular Mechanics Book Dept., Chicago.

PATTERN-MAKERS! A book devoted to the principles of pattern and core making and molding. Written by G. H. Willard, a practical pattern maker of years experience. This book, just published, treats the subject in a much more simple, direct and effective manner than most books along this line. 224 pages, 312 illustrations. Price \$1.00 postpaid. Popular Mechanics Book Dept., Chicago.

### MANUFACTURING MACHINERY

THE PIERCE MODEL WORKS. We make Models of any description. Experience and our modern equipped shop enables us to give you the best results at the lowest cost. We will improve your invention, make samples for exhibition, and sales agents. We also make the necessary tools and dies to manufacture same on contract. Write for catalogue of model supplies. The Pierce Model Works, 117 N. 5th Ave., Chicago, Ill.

INVENTORS—WE BUILD MODELS, do experimental work, light manufacturing, dies and tools. Geo. Schwarz & Co., 123 Liberty St., New York.

THE WELL INFORMED MACHINIST cannot afford to miss the two series of original tool articles now running in Shop Notes Quarterly. These are "Tool and Jig Designing" and "Hand and Machine Tools," and together comprise the most up-to-date and latest information on the subject.

DO YOU WISH TO SAVE valuable castings and parts which on account of minor defects or breakages would have to be thrown on the scrap heap? If so, read the article on "Oxy-Acetylene Welding and Cutting" in the July issue of Shop Notes Quarterly.

IRON, BRASS AND ALUMINUM CASTINGS. Metal Specialties. Patterns, Models, Polishing, Plating and Japanning. North Chicago Tool Works, North Chicago, Ill.

PATTERNS AND CASTINGS MADE. Send sketch for estimates. "Mail Order" Garage, No. 3 Fox Street, Bridgeport, Conn.

### BOATS, LAUNCHES AND STEAMBOAT MACHINERY

MODELS—CASTINGS, FITTINGS, DRAWINGS and instructions. Build a model steam or gasoline engine, dynamo, motor, motor boat, etc., outfit, in your spare moments. We furnish the material and instructions, you contribute a few hours pleasantly spent. Finished models carried in stock. Enclose five cents for illustrated booklet. The B. A. B. Model & Mfg. Co., Room 536B, Singer Bldg., 149 Broadway, New York.

### WANTED

WANTED—SMALL MARINE ENGINE, Waterman preferred. Must be in first class shape. H. D. Hutcheson, Atoka, Okla.

WANTED—Good legitimate business proposition that requires small capital to start. Box 575, Lents, Oregon.

WANTED—Small printing press, suitable for printing circulars. John Whisler, Gibson Iowa.

GIRL, TIRED OF OFFICE WORK, wants home with family on modern western farm. Address K. W. 6th floor, 318 W. Washington St., Chicago.

WANTED TOURING, Delivery cars, specialties. G. H. Geisel, Wheeling, W. Va.

### FOR SALE

FOR SALE—WATER POWER and Electric Lighting Plant, located at Heuvelton, St. Lawrence County, New York, on N. Y. C. & H. R. R. R. Can develop 1000 to 1800 hp. Write for particulars to Alonzo Thornton, Heuvelton, N. Y.

COLUMBIA DISC and cylinder Graphophones and records, 40 per cent discount. Box 965, Ashtabula, Ohio.

FOR SALE—A rebuilt No. 4 Optigraph, with steel intermittent motion, and automatic drop shutter double stereopticon, and complete outfits for gas and electric lights, 3500 ft. films, 3 lecture sets, screen, advertising, etc. Address Jos. G. Jones, Gaylord, Mich.

BLUE PRINT SHOWING HOW to make 1¼x1½" cylinder steam engine also boiler to run the same. Both 50 cents. L. A. Knutsen, Box 481, Tacoma, Wash.

NEARLY NEW \$750 WURLITZER Automatic Harp, coin operated, \$200. Will pay for itself in few months. Box 965, Ashtabula, Ohio.

DESKS—Direct from factory to user. Write for our new catalogue. Monarch Desk Co., Columbus, Ohio.

GINSENG for sale, seed and plants. George Hartz, Canal Fulton, Ohio.

RIFLES, REVOLVERS, AUTOMATIC PISTOLS, repeating shot-guns, \$3 up. Khaki Army hats, \$1.65 prepaid. O'Grady, Sisseton, S. Dak.

\$146.00 PRACTICALLY NEW watchmaker's outfit at half price, cash. E. P. Batchelder, Siskiyou, Oreg.

MOVING PICTURE OUTFIT, \$25.00. Outfits wanted. Fred L. Smith, Amsterdam, New York.

"TEXTIGUM" TYPEWRITER COVERS, fine, 50c. See what I say under "Typewriters." Atchison.

REAL BARGAINS, MOTOR CYCLES, BICYCLES, marine and stationary engines, furniture, musical instruments, pianos, typewriters, sewing machines, etc. Agents wanted. Make a whole lot of money getting orders for us. Write for booklet, Atlantic Supply Co., Long Branch, N. J.

### SALE OR EXCHANGE

24 INCH UNIVERSAL three jawed lathe chuck, want tool-post grinder, power hack saw, cold saw or other machinist tools. R. C. Lynn, Graham, Tex.

TWO GASOLINE LAUNCH ENGINES and new diamond ring will exchange for good second-hand motorcycle. E. S. Emerson, Webster, Mass.

FOR EXCHANGE FOR MOTORCYCLE, automobile or gasoline engine, patent No. 718,699 on an improved and safety pipe connection. Jos. Book, Hazel Dell, Pa.

COLLIES FOR SALE or will exchange for typewriter, gun or camera. H. Engelking, Sheboygan, Wis.

BUFFET BARTONE Saxophone for motorcycle or typewriter. J. H. Atkins, Hico, Texas.

PHOTOGRAPHER'S OUTFIT, including enlarging apparatus with lenses and powerful light. Cost \$300. Sale or trade for good motorcycle. R. R. Loving, Center, Texas.

\$145 STOCKS for good motorcycle. Elmer Maker, North Swansea, Mass.

### CEMENT

EACH NUMBER OF SHOP NOTES QUARTERLY contains many valuable articles on the use of cement and the working of concrete. 25 cents a copy; \$1 a year. A magazine for all practical men who wish to be well informed.

IF YOU WANT the best information on cement and concrete construction, subscribe for Concrete, leading cement and concrete monthly. Sample copy, 10 cents. Yearly subscription, \$1.00. Concrete, 135 Newberry Bldg., Detroit, Mich.

### BLACKSMITHS

GOOD BLACKSMITHS ARE SCARCE and few learning the trade and the blacksmiths must make the tools for all—from surgeon to the safe blower. Buy Toy's Modern Methods Forgings and Welding different kinds of steel solid, and doing all hard jobs easy, also hardening and tempering to a standard by colored charts. Any smith can be an expert that means good jobs and big money. All for one dollar. Send for valuable samples free. W. M. Toy, Sidney, Ohio.

### DUPLICATORS AND DUPLICATING DEVICES

How to get a Hektograph that will make 150 copies in 10 minutes; letter size, \$2.00. Write for circular. Heyer Duplicator Co., 118 No. La Salle St., Chicago.

### COLLECTIONS

LAW AND COLLECTIONS in all states. Reasonable fee. Charles Fitzgerald, Lawyer, Roanoke Bldg., Chicago.

OUR REGULAR \$10.00 COLLECTION COURSE, 50c. For collection agencies and merchants. Money back if not satisfied. National Law Institute, Youngsville, Pa.

ACCOUNTS COLLECTED ANYWHERE. Fidelity Credit Co., Richmond, Va. Collections. L.W.

### PATENTS

MODELS MADE FOR INVENTORS—Inventions and ideas, developed and manufactured. Special machinery designed and built at startlingly low rates. It pays to investigate. B. A. B. Model & Mfg. Co., Room 536B, Singer Bldg., New York.

INVENTOR WILL PERFECT ideas or design simplest effective mechanism to accomplish any desired purpose. Specialty, solving difficult mechanical and electrical problems for manufacturing concerns. Patents secured and articles manufactured. References. Terms reasonable. W. J. Spiro, 37 West 116th St., New York City.

TEN "TALKS" TO INVENTORS, 25c. Free with "First Aid Outfit," \$1. Sample for stamp. Catalog. Engineer Searching Co., Washington, D. C.

WE SELL PATENTS. Established ten years. To buy or having one to sell write Charles A. Scott Co., 1096 Granite Bldg., Rochester, N. Y.

PATENTS SECURED—Reports on patentability, validity and infringement. Patent suits conducted. C. L. Parker, ex-examiner Patent Office, 910 G St., Washington, D. C.

PATENTS—Our advanced methods save you 80% of your money. "How to succeed as an Inventor" sent free. Inventors and Investors Corporation, Philadelphia, Pa.

INVENTORS—Let us sell your patent. We are manufacturers' agents. Write for plan. Atlantic Supply Co., Long Branch, N. J.

### PATENTS FOR SALE

FOR SALE OR ROYALTY the most complete self loading Hay Rack invented. Patented March 14, 1911, No. 986,468. For information and circulars write to the inventor. Andrew Kirsch, Carroll, Iowa.

MY CANADIAN PATENT FOR SALE, now successfully manufactured in U. S. by a \$75,000.00 corporation. A good thing for some who want to go to Canada and exploit same. Best offer takes it. F. Ferard, Madison, Ill.

FOR SALE OR ROYALTY Automatic Pocket Match Box and Lighter. Pat. allowed Nov. 2, 1910. Other Pat. pending May, 1911. A money maker. Vincent Slezak, 1161 W. 18th St., Chicago.

FOR SALE—PATENT No. 972,589, Fountain Shower Bath Arrangement. Address Geo. Winters, 115 S. Sag St., Flint, Michigan.

FOR SALE—U. S. Patent No. 950,088, Salt Shaker. Carl Artner, 74 Locust St., Milwaukee, Wis.

### PATENT ATTORNEYS

PATENTS PROCURED and positively sold if the idea has merit; all countries; satisfied clients my best references; send sketch; book free. H. Sanders, Crilly Bldg., Chicago.

IMPORTANT NOTICE—Read my page ad on page 116 Advertising Section, of this magazine, relative to patents, trademarks, etc. Special offers contained in the ad. E. E. Vrooman, Patent Lawyer, Washington, D. C.

"PATENTS AND PATENT POSSIBILITIES," a 72-page treatise sent free upon request; tells what to invent and where to sell it. Write today. H. S. Hill, 905 McGill Bldg., Washington, D. C.

PATENTS—Books, 100 mechanical movements, perpetual motions, 50 illustrations. Mailed free. F. Dietrich & Co., Patent Lawyers, Washington, D. C.

PATENTS PROMPTLY OBTAINED. Our free booklet will help you to fortune. Read pages 11 and 12 before applying for patent. Free searches. Write today. D. Swift & Co., 317 7th St., Washington, D. C.

PATENTS—HERBERT JENNER, patent attorney and mechanical expert, 608 F. St., Washington, D. C., established 1883. I make a free examination and report if a patent can be had and exactly what it will cost. Send for circular.

SEND FOR FREE BOOKLET. All about Patents and their Cost. Shepherd & Campbell, 500A Victor Bldg., Washington, D. C.

PATENTS THAT PROTECT and pay. Advice and books free. Rates reasonable—Highest references; Best results. Watson E. Coleman, Patent Lawyer, 622 F. St., N. W., Washington, D. C.

C. L. PARKER, Patent Attorney, Ex-examiner U. S. Patent Office, 910 G. St., Washington, D. C. Inventor's handbook "Protecting, Exploiting and Selling Inventions" sent free upon request.

### PRINTING

2500 GUMMED LABELS, 1x2 inches, \$1. Interleaved with waxed paper. Postpaid on receipt of price. Can't stick together. Greenwood Press, Millville, N. J.

1000 IMITATION TYPEWRITER CIRCULAR LETTERS, \$2.50; 6x9 circulars, \$1.50. All other printing lowest prices. Elegant set samples free. Good's Printery, Harrisonburg, Va.

PRINTING for everybody. 100 each of noteheads, envelopes and cards, neatly printed to your order, prepaid \$1.00. Union Pub. Co., Dept. M, Uniondale, Ind.

PRINTING PRESSES, Type and Supplies. Instruction book and catalogue free. L. M. Carroll & Co., 167 W. Washington St., Chicago.

PRINTING PRESS and outfit, new. Dirt cheap. Write quick. Edgar Hamlin, Crockett, Texas.

PRINTED ENVELOPES—Good quality No. 6 white, 1,000 for \$1.20; 100 postpaid for 28c. Quick service. J. M. Hunt, Lambertville, N. J.

PRINTING OUTFITS \$12.00 to \$25.00. Presses, type; big list, one cent. Bargains, Richland, Pa.

PRINTING PRESS, Gordon, 7x11". Cheap. S. A. Heath, North East, Pa.

### REAL ESTATE AND FARM LANDS

HOUSTON, TEXAS—Lots \$25.00 in Rosslyn, suburban addition to Houston, the great Seaport city and metropolis of the Southwest. Every lot good; only \$2.50 down, balance monthly. Write for particulars. C. R. Kitchell & Co., Dept. 8, Houston, Texas.

OWING TO FINANCIAL REVERSES some of our first customers who bought land at Largo, America's Golden Grapefruit Garden, are unable to complete their contracts; hence we have for resale 86 choice ten acre tracts adapted to oranges, grapefruit, vegetables and general farming, which can be purchased for a short time at the original prices on terms of \$1.00 an acre per month. Our own land has been entirely sold out and this is your final opportunity to secure a home at Largo, on the Pinellas Peninsula, which is practically a large island, naturally protected from cold by the surrounding warm waters of the Gulf of Mexico, with probably the finest climate in America. Send today for the big Largo book, free. Pinellas Groves, Inc. 1129 Steger Bldg., Chicago.

MONEY-MAKING FARMS throughout 15 states; great variety, size and price. Stock and tools included with many to settle estate quickly. Mammoth illustrated catalogue No. 34 free. E. A. Strout, Station 3043, 47 West 34th St., New York City.

NORTH WIS. LANDS, near home market, no farther from Chicago than Des Moines or Quincy, worth now only \$10.00 per acre, will eventually be worth a hundred dollars. Address for maps and folders, C. P. Crosby, Rhinelander, Wis.

CALLAN, THE NEW FRISCO TOWN, Menard County, Texas. Great opportunities for investment and location. In heart of best farming country in West Central Texas. Full information furnished. Richey-DeFreest Land Co., Wheat Bldg., Forth Worth, Texas.

RIO GRAND VALLEY, MONTE CRISTO, orange orchards; low prices; liberal terms; guaranteed tillable; send for booklet; good agents wanted. George Kellogg, Audubon, Iowa.

FOR SALE near Medford, Wisconsin, Dairy farms from \$1,200 and up. Write for list and map. Oscar Nystrum, Medford, Wis.

FOR SALE—Cheap, 490 acres, Southern Georgia; 1 mile to town; \$1,500. R. J. Nelson, 3755 Cottage Grove Ave., Chicago.

WRITE ATLANTIC STATES FARM LAND Company, Barnwell, South Carolina, any kind of farm lands, hardwood, timber, and turpentine. Subject to full investigation. Terms, easy. References exchanged.

TO SELL YOUR PROPERTY write Northwestern Business Agency, Minneapolis.

8% NET TO YOU. First mortgage loans on irrigated farms and orchards in the rich Pecos Valley of New Mexico. 40% valuation. Collection of principal and interest guaranteed. Best security on earth. National Bank references. Fletcher & Peet, Roswell, New Mexico.

RICH ARKANSAS LANDS on railroad, cheap; no rocks. Robert Sessions, Winthrop, Ark.

CALIFORNIA OIL LAND—But 3½c per acre per day. Here opportunity knocks. Ten acre tracts. No interest, no taxes. Easy monthly payments. Write now. Frank Thorne, P. O. Box 1968, Los Angeles, Calif.

### GAMES AND ENTERTAINMENTS

TRICKS, MAGICAL APPARATUS AND SUPPLIES—Amateurs supplied as well as the Great Professionals. Easy, interesting and entertaining. Amuse and astonish your friends. 4c stamps brings our three catalogues; Magical Apparatus, Latest Supplement, Marvelous Card Tricks. Buy from real Magic Dealers. Send now. Read & Covert, 817C East 43d St., Chicago, Ill.

LEARN VENTRILOQUISM QUICK! I want representatives everywhere. Big money! Great fun! Success assured. Free interesting booklet tells how. Send stamp. Instructor Bailey, 857 Marshall Ave., St. Paul, Minn.

578 JOKES, TOASTS, RIDDLES, Magic Tricks, etc., 10c. Queen Supply Co., Chicago.

GO ON THE STAGE! Will tell you how! Write for descriptive matter. It is free! Percy Ewing, Decatur, Ill.

100 TRICKS, with directions, fifteen cents. Bamberg, 1193 Broadway, New York.

MAGIC-SKULL, shines in dark, 10 cents. Klein, 1193 Broadway, New York.

### RARE COINS AND STAMPS

TEN DIFFERENT RARE COINS 25c; 20 different 50c; five different old bills 25c; 10 different 50c; five different foreign notes 40c; 10 different 75c. Burgess Coin Company, 1018 Huron, Toledo, Ohio.

COINS. WE PAY CASH premiums on thousands rare coins, stamps, paper money. Send Ten Cents for large Coin Value Book. You may have Coins we want. National Coin Exch., Gunnison, Colo.

WANTED—OLD COINS, highest cash price for rare coins, paper money, etc. Send 25c for up-to-date illustrated price list and guide. O. L. Smith, 204 3rd St., Evansville, Ind.

STAMPS 100 ALL DIFFERENT, FREE. Postage 2c. Mention paper. Quaker Stamp Co., Toledo, Ohio.

### FOR THE HOME

REFRIGERATORS—THE LEONARD CLEANABLE. Best in the world. Lined with real porcelain enamel on sheet steel. All one piece. Easily cleaned as a china dish. You can't break, scratch or mar it. Fifty styles and sizes. Polished oak or satin walnut cases. Prices \$18.90 to \$75. We sell direct where we have no agent. Freight paid to Mississippi river. Write for catalog and free sample of the porcelain lining. Address Grand Rapids Refrigerator Co., 157 Clyde Park Ave., Grand Rapids, Michigan.

FRESH EGGS, KEEP 8 MONTHS. 10 years experience dipping in hot solution. Costs cent a doz. Prepaid package, 50c. Directions easy. Galvomed Dip, Clarinda, Iowa.

**SAVE BIG MONEY.** Buy at wholesale. Plumbing material. Heating plants. Waterworks. Pumps and tools. Send plans or list, for free estimate. Save 30 to 50%. Monarch Sales Co., 204 West Third, Cincinnati.

**LADIES SEND** 10c for one quart of better bluing than you ever used; once used, always used. F. E. Walker, 211 Main St., Toledo, Ohio.

**MAKE YOUR OWN MISSION FURNITURE** at the minimum of expense. Our 2 books "Mission Furniture, How to Make It." Parts 1 and 2, tell in plain, simple language just how to make 50 different pieces. Full dimensioned working drawings and half dozen of finished articles. Price 50 cents each or \$1.00 for the two volumes, postpaid. Popular Mechanics Book Dept., Chicago.

**BEAUTIFUL ARTS-CRAFTS LAMPS**—Anyone can make them out of paper, cardboard and wood. 16 designs. Inexpensive yet artistic. Complete book of instructions. Price 50c postpaid. Popular Mechanics Book Dept., Chicago.

**METAL WORK AND ETCHING**—A 96-page handbook for art metal workers telling how to make a great variety of useful and ornamental objects such as desk sets, arts-crafts jewelry, etc. Price, 50c postpaid. Popular Mechanics Book Dept., Chicago.

### FOR MEN

**FOR MEN**—Keep your trousers up just where you want them with the invisible, non-slipping, hip-fitting "L. & N." Belt. Guaranteed for one year. For boys, 50c; for men, 50c, 75c and \$1.00 postpaid. Send waist measure with order. Send for circular. "L. & N." Belt Co., 1257 N. Clark St., Chicago, Ill.

**MEN'S SUPERIOR "LINENWEAVE" HOSE**, fine texture heels and toes reinforced, 6 pairs for \$1.00 postpaid (retail \$1.50). Black, tan, navy and gray; state size. Satisfaction or your money back. Windsor Specialty Co., 123 West Windsor St., Reading, Pa.

**MEN, IF YOU WILL** send us \$1, we will send you a Wade & Butcher, finest quality steel, full hollow ground \$2 razor. Fully guaranteed. Money refunded if not satisfactory. We make this offer because we want your name on our mailing list. Dept. D, Technical Book Publishing Co., 304 Tribune Building, N. Y. City.

**GILLETTE AND OTHER SAFETY RAZOR Blades** resharpened 2½c each. Our new patented power machine grinds off nicks, hones and strops. Perfect work guaranteed, trial order solicited. Detroit Cutlery Co., 29-31 Monroe, Detroit, Mich.

**50c POSTPAID. GLOBE SAFETY RAZOR**, with six blades, handsomely boxed. Guaranteed to shave any beard. Heavily nicked. Audubon Specialty Company, 3525 Broadway, N. Y. C.

**FOR SALE**—30,000 pounds best leaf tobacco, mail stamps for samples. Anton Wavrin, Franklin, Ky.

**SAFETY RAZOR BLADES** sterilized and sharpened better than new; 2 cents each. Five years' success. Send for blade box and circular. Electro Stropping Co., 134 Shelby St., Detroit, Mich.

### MUSIC

**ANY SHEET MUSIC** you want, no matter where published, we will supply at 15c per copy postpaid. Willis Woodward & Co., 1193 Broadway, New York.

**JUST OUT**—Loma Waltz. A brilliant piano solo. Sent postpaid 25c. Albert W. Coe, Mason City, Iowa.

**IF YOU WANT** the latest music and a better assortment for less money than elsewhere, write today for catalog. Semple's Music House, 204 West Ave., Norwalk, Conn.

**SACRED SONG Success.** Bend Thou My Will to Thine. 25c prepaid. Roberts, 5615 Hazel Ave., Phila., Pa.

**COMPOSERS**—Get your song, march, waltz or two-step published. Send for particulars. George F. Briegel and Co., 1367 Broadway, New York.

### PIANOS AND MUSICAL INSTRUMENTS

**LYON & HEALY, ADAMS STREET, CHICAGO**, will mail, free, their newly enlarged catalog of Band Instruments, Uniforms and Equipments. Hundreds of fine illustrations describing every article required by bands or drum corps, including Uniforms, Trimmings, etc. Contains instructions for Amateur Bands, Exercises and Scales, Drum Major's Tactics, By-Laws, Selected List of Band Music.

**STARTLING DISCOVERY**—Guaranteed; pressureless violin tail-piece; makes remarkable improvement, \$1. Violincraft, Osakis, Minn.

### TYPEWRITERS

**BEST TYPEWRITER BARGAINS** and easiest terms for any make of machine. For illustrated catalogue and list of our prices, write L. J. Peabody, 264 Minot Bldg., Boston, Mass.

**TYPEWRITER RIBBONS** for any make of machine, four for \$1.00. Carbon paper \$1.00 per hundred. Guaranteed. Peerless Ribbon Co., 217 West 125th St., N. Y. C.

**STENOGRAPHER WILL SELL** her brand new Remington typewriter, does splendid work. \$30.00. Miss King, 2228 7th Ave., New York City.

**\$100.00 TYPEWRITERS** \$10.00; visibles \$15.00, \$20.00 all makes; rent applies; payments; lists. Agents. Knights, 273 Twelfth, St. Louis, Mo.

**TYPEWRITERS**—Every kind on the market, write today for best bargain you ever secured. Shipped anywhere on approval. \$10.00 up. Fletcher Typewriter Co., 207 N. 7th St., St. Louis, Mo.

**I WANT TO CORRESPOND** with persons who are about to buy a high-grade typewriter, and object to paying the high prices generally asked by manufacturers and dealers. Any make on approval. Catalogue, bargain list and valuable information sent free. A. E. Atchison, 4127 West 21st St., Chicago.

**CASH SAVES:** Why pay installment houses 40% more? We sell highgrade rebuilt Remingtons, Smiths, \$17; Underwoods, Oliviers, \$33—others cheap; sent on approval; sold under guarantee. Old Reliable, Consolidated Typewriter Exchange, 245 B'way, N. Y.

**REMINGTON TYPEWRITERS** \$12.00, Caligraphs \$6.00, Hammonds, Yost, Densmores, \$10.00, Smith Premiers and Jewetts \$15.00, Oliviers, Underwoods, L. C. Smiths and Royals \$25.00. Fifteen days free trial, and one year's guarantee, don't purchase until you get our prices. Harlem Typewriter Exchange, Dept. P.M., No. 217 West 125th St., New York City.

### TELEGRAPHY

**TELEGRAPHY**, both Morse and Wireless, taught quickly. Also Station Agency Work, R. R. Dispatcher's and Western Union wires, and complete wireless station and school. Big demand for operators. Living expenses earned. Correspondence courses if desired. Catalogues free. Dodge's Institute, 15th St., Valparaiso, Ind. Est. 1874.

**TELEGRAPHY TAUGHT** in the shortest possible time. The Omnigraph Automatic Transmitter combined with standard key and sounder. Sends you telegraph messages at any speed just as an expert operator would. Five styles. \$2 up; circular free. Omnigraph Mfg. Co., 41 G. Cortlandt St., New York.

### WIRELESS

**FULL LINE OF QUALITY INSTRUMENTS** for amateur and professional use, shown in Catalog 8. Beginner's receiving set, complete with receivers, \$15.00. Wm. J. Murdock Co., 10 Carter St., Chelsea, Mass.

**SHOP NOTES QUARTERLY** in its third issue for 1911, ready July 1, will contain a fine article on wireless telegraphy. Get it from your newsdealer.

**WIRELESS SET**, How to Make—96 page book telling how to construct at small cost an outfit suitable for transmitting four or five miles. Price 50 cents, postpaid. Popular Mechanics Book Dept., Chicago.

### MISCELLANEOUS

**WHAT DO YOU WANT** to buy? We have unlimited facilities for purchasing. If the article you want is to be had, in any market in the world we can buy it for you. Tell us your requirements. International Purchasing Bureau, 1241 Giel Ave., Cleveland, Ohio.

**ENCYCLOPEDIA BUSINESS OPPORTUNITIES** and Trade Secrets. 2 vol., 127,250 words, 2,716 chapters of formulas, schemes, etc. Regular price \$3.00, now \$1.00. Ben. E. Newnham, Waukegan, Ill.

**MACHINISTS', CARPENTERS', Miners', Farmers', Poultrymen's**, strong corduroy pants made to measure \$2.50 to \$3.00. Delivered at your door. Vernfield Clothing Co., Vernfield, Pa.

**"THE HOME COURSE** of Physical Culture." Get health and strength in your own home. Drop a postal and let one who has had fourteen years' experience in Y. M. C. A.'s and private clubs, tell you how. Jamieson E. Provan, Eddystone, Pa.

**MOTION PICTURE MACHINES**, Film Views, Magic Lanterns, Slides and similar Wonders For Sale. Catalogue Free. We also Buy Magic Machines, Films, Slides, etc. Harbach & Co., 809 Filbert St., Philadelphia, Pa.

**PLAYED OUT** dry cell batterie perfectly renewed; half cent each; directions easily followed; 25c coin. L. M. Burgess, Moundamin, Iowa.

**MOSKEETOPUNK** is guaranteed to free your home or camp from all Mosquitoes. Try one box, 25c; five, \$1.00. Moskeetopunk Co., Pekin, Ill.

**SEND US 25c coin** for miniature rubber Automobile Tire; or 35c coin for Automobile Tire Watch Fob. Everybody wants one, or both. Order early. Oakland Advertising Co., Dept. B, Akron, Ohio.

**RENEW DRY BATTERIES**, Metalize Flowers, Transfer Photos to Watch Dials. Formulas 10 cents each, 3 for 25 cents. Mail Order Bureau, Box 283, Scranton, Pa.

**FIREWORKS**, complete assortment, \$1.62 up. Fire Cracker assortments, \$1.95 up. "Kat-a-log" for 2c stamp. Marryatt, The Fireworks Man, 32 Park Place, New York.

**MONEY-MAKERS MANUAL**—Seventy pages. Worth its weight in gold. Twenty-five cents postpaid. National Supply Co., Gunnison, Colo.

**GINSENG** at \$5.50 to \$7.25 lb. One of most profitable crops. My "Ginseng Culture" 10c explains how grown. W. N. Long, Florence, Ky.

**WIRE FISH BASKETS FOR SALE**—Price \$1.50 with order; send for circular. W. A. Jester, Griffin, Ga.

**YOUR AD** in over fifty magazines 3 months, 5 cents per word. A. S. Mankin & Co., Alexandria, Va.

**ADVERTISERS**—Your ad in 100 magazines 5c word, list free. Harvard Co., Frankestown, N. H.

**ANY TWO FORMULAS** 25c. Photoelectric Shop, Rock Island, Illinois.

**CORRECT FORMULAS**, 20c each. Malalane Company, 1411 Longfellow Ave., New York.

**TELESCOPE Watch Charms** 10c. Eagle Co., Quincy, Mass.

**FREE! FOR A SHORT TIME.** Five Money Coining Formulas. Worth dollars but they are free. Send 2 cents. M. W. Rand, Box 224, Spokane, Wash.

**TEN DANDY FORMULAS** for 5 names and addresses and 4c. P. Benson, Stewartville, Minn.

**100 MONEY** Making formulas, etc., 2c. Digest, Grand Rapids, Mich.

**IGNITERS, 10c POSTPAID;** lights gas, gasoline, acetylene. 5,000 sparks. Dealers supplied. Jobber, 3525 Broadway, N. Y.

**50c BRINGS 5 FORMULAS** and full instructions for metalizing, mounting and coloring flowers, insects, etc., for jewelry. Easy home work. Big profits. P. Benson, Stewartville, Minn.

**THE WORKMAN WHO CAN** design and originate tools and jigs to cut down the cost of production in the machine shop is the one who draws the big pay envelope and who eventually attains to be a foreman or superintendent. The articles on "Tool and Jig Designing" which commence in the July issue of Shop Notes Quarterly will help you to do this.

**3300 GUARANTEED FORMULAS** and Trade Secrets. 50c postpaid. Process Company, 816 Oakwood Blvd., Chicago.

**PANAMA CANAL**—Matatoro Teeth; excavated on the Isthmus; interesting souvenir; limited number available; if we cannot supply you, money refunded, one tooth to a customer; order at once; send 25c silver to Panama Research Co., Box 36, Colon, Republic Panama.

**TRANSFER PHOTOS TO WATCH CASES,** chinaware, sofa pillows, etc. New process. Very profitable. 25c brings full instructions. P. Benson, Stewartville, Minn.

**GINSENG**—Roots and seed for sale. Send for price list. Plymouth Ginseng Gardens, Plymouth, Wis.

**SEND TWO CENTS** for Digest, containing 100 formulas, etc. 6 months for 10c. Worth dollars. Digest, Grand Rapids, Mich.

**FORMULAS—500 SELECT FORMULAS** for everything. Book form, 25c. Globe N. Co., 1745 Leavenworth, Omaha, Neb.

**PATENTS SECURED**—C. L. Parker, ex-examiner Patent Office, 910 G St., Washington, D. C.

**CATALOGUE OF RUBBER STAMPS** and sample of Stuart's printer pencils free. W. M. Stuart, Marshall, Mich.

**ANYBODY CAN MAKE GOOD CUTS** with my simple zinc etching process; price, \$1; write for specimens and particulars. T. M. Day, Box M, Windfall, Ind.

**I WILL START YOU** earning \$4 daily at home in spare time, silvering mirrors; no capital; send for free instruction booklet, giving plans of operation. G. F. Redmond, Dept. 306, Boston, Mass.

**TRICKS, JOKERS, PUZZLES, ILLUSIONS,** Novelties—Magic Pocket Trick Free. Illustrated Catalog included. Send 6c stamps. Magic Dept., 10-270 West 39th St., New York.

**TOBACCO CAUSES CHRONIC IRRITATION** of brain and nerve cells. Ni-Ko heals this irritation. You don't want tobacco any more. You will feel so good. Write today. King Ni-Ko, 7, Wichita, Kans.

**BROTHER**—Accidentally discovered root will cure tobacco habit. Gladly send particulars. F. Stokes, Mohawk, Florida.

**"TEXTIGUM" TYPEWRITER COVERS,** fine, 50c. See what I say under "Typewriters." Atchison.

#### TOO LATE TO CLASSIFY

**WRITE US FOR ANY KIND** of a sign, letters and figures. Wood, glass, metal and foil. Ask for (P. M.) printed matter. Albright Sign Co., Inc., Muncie, Ind.

**ENGINEER'S TRANSIT** for sale, good condition, \$110.00. W. F. Sprengnether, 205 Ozark Bldg., St. Louis, Mo.

**90% PROFIT: FINEST POLISH** for chandeliers, spoons, etc.; materials purchased anywhere. Recipe 10 cts. Earl Smith, 99 Good St., Akron, Ohio.

**CASH PAID** for old time pistols. A. Gruhlke, Waterloo, Ind.

**POSITIVELY BEST RIBBONS,** three, \$1.10. See what I say under "Typewriters." Atchison.

**REPRINTS OF VALUABLE TRADE SECRETS** of old Southern Chemist. Large collection of hard-to-secure formulas: as Dustless Dust Cloths (new), Chinese Cement, Lemonade and Buttermilk Powders, "Swiss" Maple Flavor, Quick Paint Remover, Artificial Rubber, Unburnable Benzine, "Silic" Egg Preserver, Aluminium Solder and other rare formulas not found in books, but trade secrets of certain manufacturers, and 2500 other shop formulas, working processes, valuable to no matter what your occupation. Entire collection postpaid \$1.00. Only a few hundred sets for sale. Liscom Miller, Evak Chemical Company, Marietta, Ga.

**2c SAFETY RAZOR BLADES SHARPENED** 2c. Gillette and all other thin blades sharpened to hair clipping edge by patented process 2c each. Your own blades tested, sterilized, and returned guaranteed sharper than when new. Star blades and regular razors honed, 15c. Regular razors ground and honed, 40c. Try us. De Vigney Sharpening Co., 48 N. 13th St., Room 5, Philadelphia, Pa.

**CRACKED AUTO CYLINDERS,** crank cases or any casting made of any metal welded and made like new by acetylene welding process; welding plant for sale account being too small, write us. Automobile parts bought and sold. Enterprise Garage and Machine Co., Aberdeen, S. D.

**EMBOSS YOUR STATIONERY** with your initial or Monogram. My nicked steel-die embosser does it perfectly. A high-class useful, irresistible novelty, nothing like it ever offered for the price. Initial, 25c; Monogram, 50c. Send stamp for specimen sheets. Show one and sell ten. Get yours free. Harry L. Miller, Importer, Marietta, Ga.

**WE TRAIN DETECTIVES.** You can be one. Splendid opportunities. Travel. Earn \$100 to \$300 monthly. This fascinating profession taught practically and scientifically by mail at a nominal cost. American School of Criminology, Dept. F, Detroit, Mich.

**AGENTS**—Both sexes; we manufacture and control the fastest selling household specialty ever invented. Connolly Co., 123 Liberty, New York.

**WANTED—OLD MOTOR-CYCLE,** any make any price. Write full particulars to King, 2228 7th Ave., New York City.

**FIRST INSERTION**—Good salesmen only. Western states only. To sell my signs only. Entirely new. Fraser Sign Works, Beach, N. Dak.

**INDIVIDUAL DRINKING CUPS.** Seasonable sellers to automobilists, travelers, excursions and advertising purposes, just out. Samples, 5 cents. Order today. Frank Creed, 1926 Broadway, New York.

**VACUUM CLEANER** cost \$2,500; sell for \$500. B. E. Andre, Charleston, W. Va.

**BIG MONEY SELLING** our \$2.00 31-piece, six color decorated china set. DeGraff of Okla. sold 21 set one day his profit \$30.03. Address, Royal Mfg. Co., Eaton, Colorado.

**40 POST CARDS** assorted, comics, etc., with illustrated catalogue. 10 cents. U. S. Card Works, Clintonville, Conn.

**"PATENTABLE IDEAS"** FOR SALE or exchange. Or will invent anything to your order. John Murphy, Hunter, Kans.

**OK AGENTS** sell our new Tampico Brooms. Different from any brush or broom ever sold. Sells on sight. Retail \$1.00, outlasts 4 brooms, will deliver Sample for 75 cents. Write **FAIR MFG. CO., 833 Wis. St., Racine, Wis.**



**"BRIGHTENSALL"**  
(POLISHING CLOTH)  
MAKES ALL METALS LOOK LIKE NEW

"Brightensall" the newly discovered MOIST POLISHING CLOTH. Always ready. DOES NOT DRY UP—instantly polishes all metals, silverware and jewelry. WILL NOT scratch. Leaves no "white dust" around edges; superior to pastes, powders or liquid polishes. For household use, and for polishing automobiles, motor boats, bicycles, brass signs cannot be equalled. Package (two pieces) sent postpaid for 25c. 3 packages for 50c. Use "Brightensall" to save time, temper, and extra work. Agents (either sex) and dealers wanted.  
**LITHOLIA PM. MFG. CO., West 125th Street, NEW YORK**

## The Inventor's Educator

140 PAGES

### ALL ABOUT PATENTS

How to Apply Therefor Costs—How Payable

600

MECHANICAL MOVEMENTS

50

Perpetual Motions and Flying Machines

PRICE \$1—ONE DOLLAR—BY MAIL

ADDRESS

F. C. DIETERICH, Ouray Building, WASHINGTON, D. C.

## Strikes Fire Without Matches!!

McLaughlin's "Imperator" Pocket Lighter

makes an instantaneous flame of fire every time you press the button. It operates with one hand and takes the place of matches in the vest pocket. It is smaller than a match safe and makes 1000 lights with 60 drops of benzine. Lasts for years and operates without winding or scratching—just push the button. Take this adv. to your Druggist or Cigar Dealer and get one if stamped "McLaughlin's Imperator." If not stamped "McLaughlin's" we will send you one by insured mail upon receipt of \$1 to

**McLAUGHLIN SALES COMPANY**  
Office 622-705 Olive Street ST. LOUIS, MO

Exclusive Licensed Manufacturers for America



# Amateur Mechanics No. 1

## A VALUABLE BOOK

Of Exceeding Interest to the Practical Mind

For both Old and Young  
Price 25c, postpaid

Contains 174 Articles, 165 Illustrations

"Amateur Mechanics" is a thorough, practical book for old and young; tells how to make hundreds of different articles of daily use; is of exceeding interest. This book should be in every American home.

**"Written So You Can Understand It"**

For sale by all newsdealers or can be ordered direct from the Publishers

### Popular Mechanics Book Dept.

318 W. Washington St.

CHICAGO

# Amateur Mechanics No. 2

Price 25 cents, postpaid

Bigger and better than No. 1. Contains entirely different matter, yet along the same interesting, practical lines. Tells how to make hundreds more different articles of daily use, among which are: Workbench; Pilot Balloon; Freak Photographs; Wireless Telegraph; Boats of Various Kinds; Induction Motor; Lantern Slides; Arc Lamp; Thermo-Electric Battery; Motorcycle; Battery Voltmeter; Geissler Tube; Devices for Winter Sports; Electric Locomotive; Glider; Flash Lamp; Static Machine; Concrete Swimming Pool; Copper Work; Post Card Projector; Tricks of All Kinds and Illusions, etc.

Interesting to the Practical Mind, both Old and Young, and "Written So You Can Understand It"

128 Pages 193 Articles  
196 Illustrations

For sale by all newsdealers or can be ordered direct from publishers

### Popular Mechanics Book Dept.

318 W. Washington St., CHICAGO

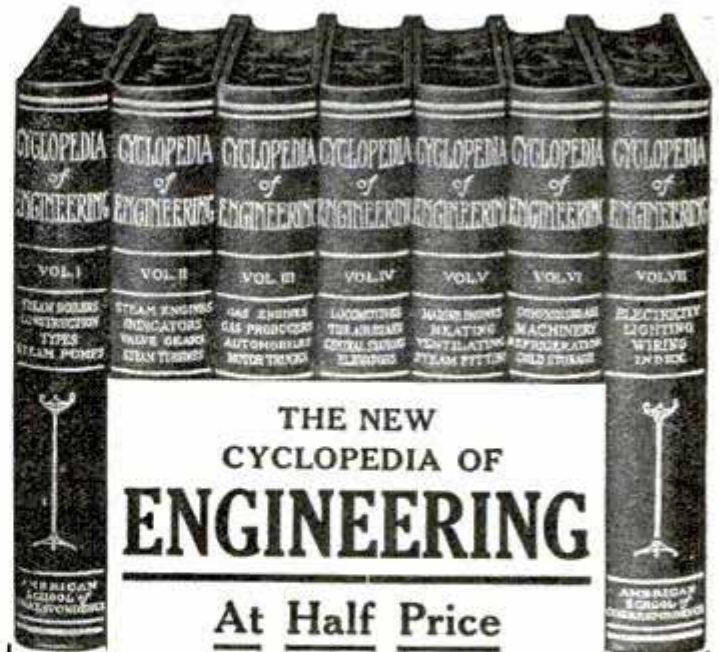

## THE NEW CYCLOPEDIA OF ENGINEERING

At Half Price

Every Engineer must read if he would progress—the biggest men in the field can't go around telling what they know—but they can write it. And you can read it—in our New Cyclopedia of Engineering—the most valuable set of books on this subject ever offered to Engineers. This Cyclopedia has just been revised—it's right up to the minute.

These books cover every subject you are likely to meet in practical engineering. They are interestingly written by well-known authorities and are not only valuable for studying, but also as permanent reference books.

The seven books contain 3,200 pages, size 7x10 inches, and over 2,500 illustrations, full page plates, diagrams, etc. The regular price of these books is \$36.00, but as a special introductory offer we have put the price at \$18.80.

### \$2.00 Down \$2.00 a Month

Shipped express prepaid so you can examine them before paying a cent

This price and these terms make it easy for any engineer to secure the valuable set of books. Read the brief description below and see what you will get when you mail the coupon.

### Our Protective Guarantee

Send for the Cyclopedia of Engineering, examine it carefully and if, at the end of five days, you see that you need it, send us your first \$2.00 and \$2.00 each month thereafter until the total, \$18.80, has been paid. If the books are not satisfactory—don't send us a cent—we will pay all charges. Use this coupon. We absolutely protect you against loss. Signing the coupon does not obligate you in any way.

#### READ THIS SYNOPSIS

Construction of Boilers—Boiler Accessories—Fuel Economisers—Mechanical Stokers—Steam Pumps—Steam Engines—Indicators—Valve Gears—Steam Turbines—Gas and Oil Engines—Fuels—Automobiles—Carbureters—Locomotive Boilers and Engines—The Air Brake—Single-Phase Electric Railway—Elevators—Marine Boilers—Marine Engines—Heating and Ventilating—Compressed Air—Transmission—Absorption and Compression Refrigeration—Ammonia Machines—Direct Current Dynamos and Motors—Management of Dynamos and Motors—Electric Wiring—Electric Lighting, etc.

For a short time we will include, as a monthly supplement, for one year, the TECHNICAL WORLD MAGAZINE. This is a regular \$1.50 monthly, full of Twentieth Century Scientific facts, written in popular form.

### FREE EXAMINATION COUPON

### American School of Correspondence

CHICAGO, U. S. A.

Please send set Cyclopedia of Engineering for 5 days' free examination. Also Technical World for 1 year. I will send \$2.00 within 5 days and \$2.00 a month until I have paid \$18.80 for books and magazine; or notify you to send for the books. Title not to pass until fully paid. POP. MECH. 7-'11

NAME .....  
ADDRESS .....  
OCCUPATION .....  
EMPLOYER .....

Please Mention Popular Mechanics

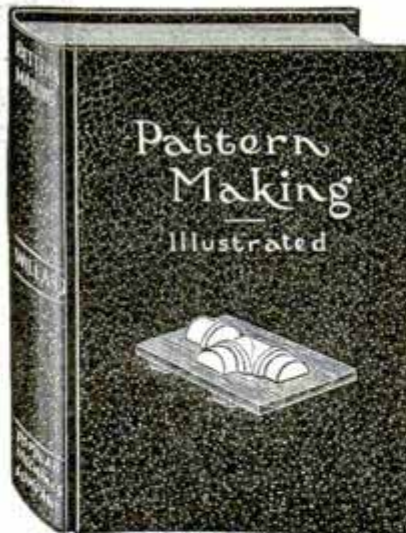

## A HELPFUL BOOK

# PATTERN-MAKING

WITH ADDITIONAL CHAPTERS ON

## CORE-MAKING and MOLDING

By G. H. WILLARD

### READ THESE OPINIONS:

"I find that the book contains a great many suggestions which will be of substantial benefit to me."

THEO. JOHNSON, Supt. of Pattern Shop,  
Chicago Flexible Shaft Co.

"We are much pleased with the simple style of the book and the amount of information it conveys."

THE OSBORN MFG. Co., Cleveland, O.  
R. H. Griswold.

"I think the book is the best I ever saw for the price."

EDWIN SLUYTER, Construction Engineer,  
Burroughs Adding Machine Co., Detroit.

"I consider this is a valuable book and should be in the hands of all men engaged in this line of business."

E. W. CLARKE,  
Wilmington Malleable Iron Co., Wilmington, Delaware.

"Written So You Can Understand It"

224 Pages  
312 Illustrations  
Cloth Cover

Price \$1 Postpaid

PUBLISHED BY

POPULAR MECHANICS BOOK DEPARTMENT, Chicago

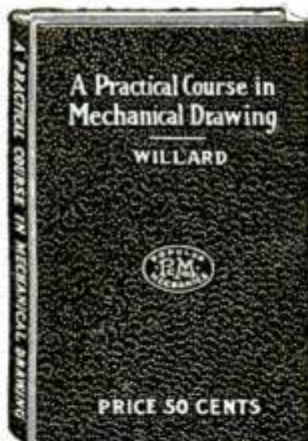

## A NEW BOOK FOR WHICH THERE IS A REAL NEED

# A PRACTICAL COURSE IN MECHANICAL DRAWING

By WM. F. WILLARD

(For several years instructor in Mechanical Drawing at Armour Institute of Technology, Chicago.)

134 Pages  
131 Illustrations

Price 50 Cents

Cloth Cover  
Size, 5x7 Inches

A book for individual study, shop classes, trade or high schools, and those who would like to know something of the DRAFTING PROFESSION.

### WHAT OTHERS SAY ABOUT IT:

"It is one of the best books on Practical Mechanical Drawing I have ever seen and I can recommend it to any one who desires to make an individual study of drawing."

E. S. LIBBY, B.S., M.E., Prof. in Experimental Engineering, Armour Institute.

"I am much pleased with your book, A Practical Course in Mechanical Drawing, and believe that it should produce good results when used as intended for individual study and for classes in trade or high schools or in the shop."

GEO. J. HOOD, Prof. of Mechanical Engineering, University of Kansas.

"I believe it especially attractive as compared with other texts on mechanical drawing in two particulars, principally; the very excellent drawings and the concise and yet explicit text."

PROF. F. D. CRAWSHAW, University of Wisconsin.

"The book contains a large number of neat drawings carefully lettered."

A. C. NEWELL, Director Manual Training, Illinois State Normal University.

"This is a very useful little book, and every young fellow who is desirous of making himself more valuable to both himself and his employer will find it a great help in 'boosting' himself to a higher plane and 'bigger pay.'"—THE NATIONAL BUILDER.

ORDER OF YOUR NEWSDEALER OR DIRECT FROM THE PUBLISHERS

POPULAR MECHANICS BOOK DEPT., CHICAGO



# MONTHLY CASH PRIZES

Until further notice in this magazine the Editor of Popular Mechanics will pay two cash prizes each month for the best original contributions to its

## SHOP NOTES DEPARTMENT

\$10 for the Best Contribution  
\$5 for the Second Best

THIS IS IN ADDITION to our usual rates for such contributed articles.

Quality, not length counts. Checks will be sent on the last day of each month for the prize articles received during that month. Publication in the magazine will follow in about two months.

### PRIZES AWARDED FOR MAY, 1911

- First Prize—C. R. POOLE, Los Angeles, Cal. .... \$10  
"Wetting a Grindstone"  
Second Prize—EARL R. HASTINGS, Corinth, Vt. .... \$5  
"Improving Acetylene Gas for Automobile Headlights"

### EXTRA AWARD

On account of there being four contributions this month, each of which deserved second prize, we have made an EXTRA AWARD of four additional second prizes, as follows:

- GILBERT A. WEHR, Baltimore, Md. .... \$5  
"Laying Terra Cotta Sewer Pipe"  
J. W. BANHOLSTER, Gresham, Oregon. .... \$5  
"How to Spread Fertilizer"  
JOSEPH H. NOYES, Murfreesboro, Tenn. .... \$5  
"A Potato Baker"  
H. W. HANKIN, Troy, N. Y. .... \$5  
"Friction Hold for Drilling"

All accepted contributions to our departments, "SHOP NOTES" and "AMATEUR MECHANICS," are paid for immediately; checks for prize awards are sent at the end of each month.

Address, EDITOR POPULAR MECHANICS  
318 W. Washington St., Chicago

WHEN YOU WANT ANYTHING AND DON'T KNOW WHERE TO FIND IT  
WRITE BUREAU OF INFORMATION,  
POPULAR MECHANICS CHICAGO

## COMPLETE FILES OF Popular Mechanics Magazine FOR 1910

Consisting of the twelve issues of the magazine and a very complete index. Suitable for binding. Supply limited.

May be had while they last at the price of \$1.50 postpaid.

Popular Mechanics Co. 318 W. Washington Street  
CHICAGO

## The Index to Vol. XIII

January to June, inclusive, 1910

# POPULAR MECHANICS

is now ready and will be mailed to any address on receipt of 10c in stamps.

POPULAR MECHANICS CO.

318 W. Washington Street, CHICAGO



# "HELP WANTED"

-Uncle Sam.

Railway Mail Clerks  
Clerks in the Departments at  
Washington, D. C.  
City Carriers — Postoffice Clerks  
Examinations Announced Everywhere July 15th  
Over 15,000 positions will be filled  
during 1911.

**\$800<sup>00</sup> to \$1800<sup>00</sup> a Year  
for LIFE**

No "layoffs" without pay, because of strikes, financial fluctuations or the whims of some petty boss. Excellent opportunities for quick advancement to Higher Government Positions. If you want immediate appointment, send TODAY for our schedule showing locations of the coming examinations. Any delay means the loss of just so much time in preparing yourself for examination.

We Prepare  
Candidates  
Free

SEND  
COUPON  
BELOW

FRANKLIN INSTITUTE

Dept. L 109, ROCHESTER, N. Y.

The coupon, filled out as directed, entitles the sender to a free copy of our book, "Government Positions and How to Obtain Them," and to consideration for Free Coaching for the examination here checked.

### COUPON

- |  |  |
|--|--|
| ... Railway Mail Clerk (\$800 to \$1400) | ... Customs Positions (\$800 to \$1500)                      |
| ... Postoffice Clerk (\$800 to \$1200)   | ... Internal Revenue (\$700 to \$1800)                       |
| ... Postoffice Carrier (\$800 to \$1200) | ... Stenographer (\$800 to \$1500)                           |
| ... Rural Mail Carrier (\$500 to \$ 900) | ... Clerk in the Departments at Washington (\$800 to \$1500) |
| ... Bookkeeper (\$900 to \$1800)         |  |

Name .....

Address ..... L 109

Use this before you lose it. Write plainly.

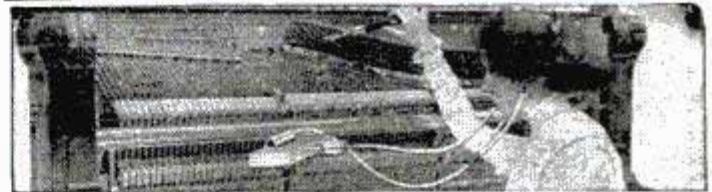

LEARN PIANO TUNING AT HOME by the aid of the TUNE-A-PHONE. A Profession that can be converted into money at any time or place in the civilized world at an hour's notice. Earn \$5.00 to \$15.00 per day. Valuable illustrated book FREE. Write NILES BRYANT SCHOOL OF PIANO TUNING, 31 Music Hall, Battle Creek, Mich.

## LEARN WATCHMAKING

refined, profitable labor—Competent men always in demand. We teach it thoroughly in as many months as it formerly took years. Does away with tedious apprenticeship. Money earned while studying. Positions secured. Send for catalog. St. Louis Watchmaking School, St. Louis, Mo.



## LOTS OF FUN!! DOUBLE THROAT.

Invisible when in use. Astonish and mystify your friends. Whine like a puppy, sing like a canary, and imitate other birds and beasts of field and forest. LOTS OF FUN. Thousands sold. Price, 10c each; 4 for 25c or 12 for 59c.

ELECTRIC FUN MAKERS, Dept. C, Kewanee, Ill.

WHEN YOU WANT ANYTHING AND DON'T KNOW WHERE TO FIND IT—WRITE BUREAU OF INFORMATION, POPULAR MECHANICS, CHICAGO

## Mechanics For Young America

A book which tells how to make scores of articles which delight the heart of the average boy. Price 25 Cents Postpaid

POPULAR MECHANICS BOOK DEPT.  
318 W. Washington Street, CHICAGO

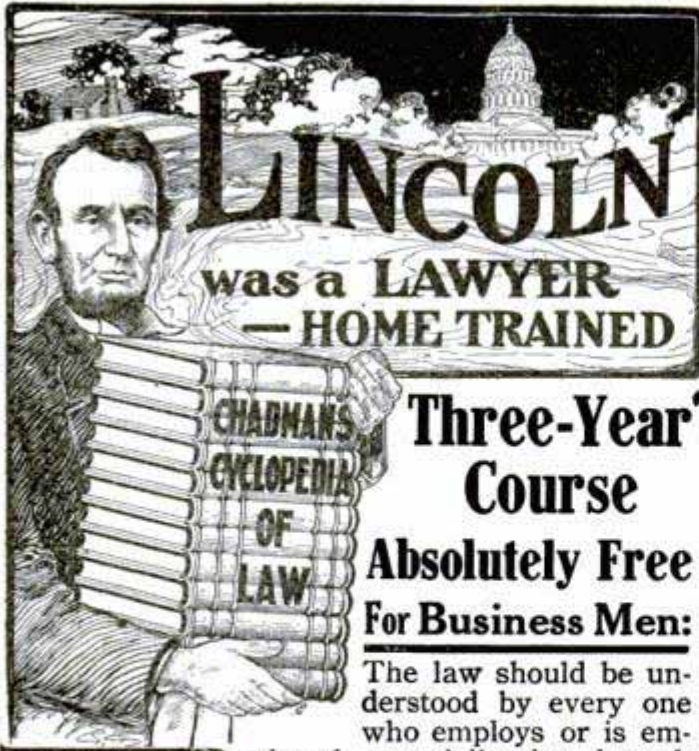

**LINCOLN**  
was a **LAWYER**  
— HOME TRAINED

**Three-Year Course**  
**Absolutely Free**  
**For Business Men:**

The law should be understood by every one who employs or is employed, especially that branch which pertains to a particular trade or profession. A correct understanding of the law will prove to be worth thousands of dollars to every business man during the course of his career. Can't you, as a business man, see where you have lost opportunities to protect yourself, or to make money, had you possessed a knowledge of law at the time? By our method of instruction, you can acquire a knowledge of the law without interfering with your business in any way.

**To the Law Student:** Law offers greater opportunities to the young man than any other profession. Nineteen of the twenty-six presidents of the United States were lawyers, and a large number of the members of the Senate and House of Representatives, at Washington, are lawyers. There is no profession so profitable, none so honorable. We assist the law student; we direct his study; we tell him what to read, how to read, how to absorb the contents of the different books, and pave the way and make the road to a legal education easy to travel.

Don't you want a knowledge of the law? Our course is absolutely free to a few. Don't you want to be one of the few? Judge Chadman, a graduate of the University of Michigan, after years of study, has just completed and perfected a plan whereby every business man or law student can obtain a legal education at home without interrupting his regular work. To introduce this plan, Judge Chadman has authorized us to give away, absolutely free, a limited number of complete three-year scholarships in this school. The course suggests text-books, supplies examination questions, lectures on law subjects written by eminent jurists, and a three-year Consulting Certificate. Upon satisfactorily completing course, the school issues a final credit Diploma.

If you are interested in securing one of these free scholarships, sign the attached coupon and mail it to us at once.

**AMERICAN CORRESPONDENCE SCHOOL OF LAW**  
1325 Michigan Boulevard, CHICAGO, ILLINOIS

GENTLEMEN:

Without obligation to me, please send at once full information regarding free scholarship in your School of Law.

NAME.....

STREET.....

OCCUPATION.....

CITY.....STATE.....

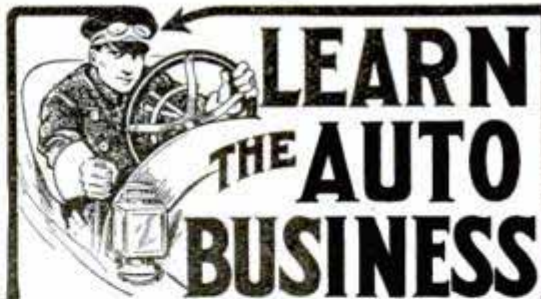

**EARN A SPLENDID SALARY**

Chauffeurs, Auto Salesmen, Repairmen, Testers, Assemblers and Inspectors are in demand at big salaries. We have trained hundreds for good positions. Our home study course covers mechanism, operation and repairing and prepares for the best positions. Let us train you in your spare time and put you in line for a good auto job. Results guaranteed or no pay. Send today for free catalogue and names of successful graduates. **CLEVELAND AUTOMOBILE SCHOOL, 2167 East 9th St., Cleveland, Ohio** "THE SCHOOL THAT MAKES GOOD."

**Salesmen Wanted**

Trained Salesmen earn from \$1,200.00 to \$10,000.00 a year and expenses. Hundreds of good positions now open. No experience needed to get one of them. We will assist you to secure a position where you can get Practical Experience as a Salesman and earn a good salary while you are learning. Write today for full particulars, list of good positions now open, and testimonials from hundreds of men recently placed in good positions.

Address Nearest Office, Dept. 124  
**National Salesmen's Training Association**  
Chicago New York Kansas City Seattle New Orleans



**LECTURE ILLUSTRATING COURSE**

Would you like to make money in Vaudeville or give illustrated lectures for churches, lodges, or amuse your friends? Our Chalk-Talk course will teach you how. No great amount of art ability is necessary. Ten lessons and two bound vols. for \$15. Let us tell you about it. Address

The Lockwood Art School, Dept. 127, Kalamazoo, Mich.



**WINDOW TRIMMING**

Advertising and Card Writing are the best paid professions in the world. Interesting prospectus FREE tells you all about it. **KOESTER SCHOOL, 306 Jackson Boulevard, CHICAGO.**



**I TEACH BY MAIL**

WRITE FOR MY FREE BOOK "How to Become a Good Penman" and beautiful specimens. Your name elegantly written on a card if you enclose stamp. Write today. Address **F. W. TAMBLYN, 418 Meyer Bldg., Kansas City, Mo.**



**LEARN CHIROPRACTIC**

The new method of drugless healing **EARN \$50 TO \$100 PER WEEK**  
Our free book tells how you can learn to detect disease and remove the cause by Howard's method of Spinal Adjustment. Positively the most simple, direct, advanced and scientific method of drugless healing. Based on unerring natural laws. Anyone can understand it; learned in spare time. Improve your social prominence and financial standing. Start now on the road to honor and success. Write for free book and special scholarship offer. **NATIONAL SCHOOL OF CHIROPRACTIC** 800 Wendell Building CHICAGO, ILL.



**VENTRILOQUISM**

LEARNED BY ANY MAN OR BOY AT HOME SMALL COST

Send today 2c stamp for particulars and proof. **O. A. SMITH, Room D 7, 823 Bigelow St., PEORIA, ILL.**

**BECOME AN ELECTRICIAN**  
of ELECTRICAL ENGINEER  
GET A PRACTICAL ELECTRICAL EDUCATION DAY AND NIGHT CLASSES ENTER ANY TIME ILLUSTRATED CATALOGUE '6' FREE  
**SCHOOL OF ENGINEERING**  
1021-27 WINNEBAGO ST. MILWAUKEE WIS.

Not a Correspondence School



Working on Dynamo

# STOP!! Looking for WORK

Come to the **COYNE NATIONAL TRADE SCHOOLS**, quickly learn to be an **Electrician, Plumber Bricklayer Painter and Decorator** or start a Business of your own and you will always have **WORK LOOKING FOR YOU**



Home of the Schools

**FREE** — Large Illustrated Book of the School. Write Today.

**COYNE NATIONAL TRADE SCHOOLS**  
57 East Illinois Street, CHICAGO, ILL.

Trades that pay \$5 to \$8 a day the year 'round. Anybody can learn in the right school. Come here. Most thorough, practical trade school in the world. No books, but tools instead. Individual teaching. Low expense. Success assured. Graduates never out of work.

## LEARN AUTOMOBILE BUSINESS IN THE FACTORY.

After 4 years of successful operation we have consolidated our school with an automobile factory. We teach the theory by mail and finish each student right in the factory. This is the best way to learn the automobile business. We employ all students. For photos of our factory and full information, write for Plan F.

Automobile College of Washington, Washington, D. C.



## LEARN JEWELERS' ENGRAVING

A high-salaried and easily learned trade, taught thoroughly by mail. We will teach the beginner better engraving than he can gain in years of rigid apprenticeship. We will also improve the skill of any engraver. Send for our catalog. The Engraving School, Dept. 112, Page Building, Chicago Ill.



## STAMMER

My book "How to Stop Stammering" — a treatise on "Scientific Talking" — direct to the point.

Write M. L. HATFIELD, 1462 Grove St., OAKLAND, CALIF.



## \$3,000 to \$10,000 Per Year For You

I can make you prosperous. If you want to earn more money—if you want to establish yourself in an independent business requiring no capital—send me your name and address on coupon below, (or a postal will do) and I will mail you, free, our **Big 62-Page Book**, fully explaining just how you can fit yourself to earn big money in the **Real Estate, Brokerage and Insurance Business**. Our thoroughly tested successful system not only equips you fully on every point of Real Estate, Brokerage and Insurance, we also give you, free, a valuable course in Commercial Law. Our Free Book is of great interest to anyone, but is of vital importance to Clerks, Book Keepers, Salesmen, Agents, Solicitors and others who are ambitious to be in a good paying business of their own.

**International Realty Corp., 1636 Manhattan Bldg., Chicago**  
Successors to The Cross Co. and H. W. Cross & Co.

**This Book Shows You How to Succeed in Real Estate, Brokerage and Insurance**



Send no money, but merely your name and address on a postal or on the Coupon below.

NAME .....

ADDRESS .....



## COPY THIS SKETCH

and let me see what you can do with it. You can earn \$20.00 to \$125.00 or more per week, as illustrator or cartoonist. My practical system of personal individual lessons by mail will develop your talent. Fifteen years successful work for newspapers and magazines qualifies me to teach you. Send me your sketch of President Taft with 6c. in stamps and I will send you a test lesson plate, also collection of drawings showing possibilities for YOU.

**THE LANDON SCHOOL** OF ILLUSTRATING and CARTOONING  
1438 Schollfield Building, Cleveland, Ohio.



## DO YOU LIKE TO DRAW?

**That's all we want to know**—Now we will not give you any grand prize—or a lot of free stuff if you answer this ad. Nor do we claim to make you rich in a week. But if you are anxious to develop your talent with a successful cartoonist, so you can make money, send a copy of this picture with 6c. in stamps for portfolio of cartoons and sample lesson plate, and let us explain. The W. L. Evans School of Cartooning  
321 Kingmoore Bldg., Cleveland, O.



## YOUNG MEN WANTED

## You Can Easily Learn

to be an automobile salesman, chauffeur, demonstrator or repairman. Our home-study course of 10 weeks is **simple, practical and interesting**. No mechanical experience required. Our graduates are everywhere, earning **\$25 to \$50 weekly** in positions we obtained for them. Free model of automobile to every student. Highly endorsed and reasonable.

**SEND FOR FREE LESSON AT ONCE**

A postal will bring it. Chauffeurs and competent men supplied owners and garages.

**Empire Auto Institute**  
643 Empire Bldg. Rochester, N. Y.  
The Original Auto School

**IN AUTOMOBILE BUSINESS  
NICE WORK-BIGPAY-DANDYJOB**

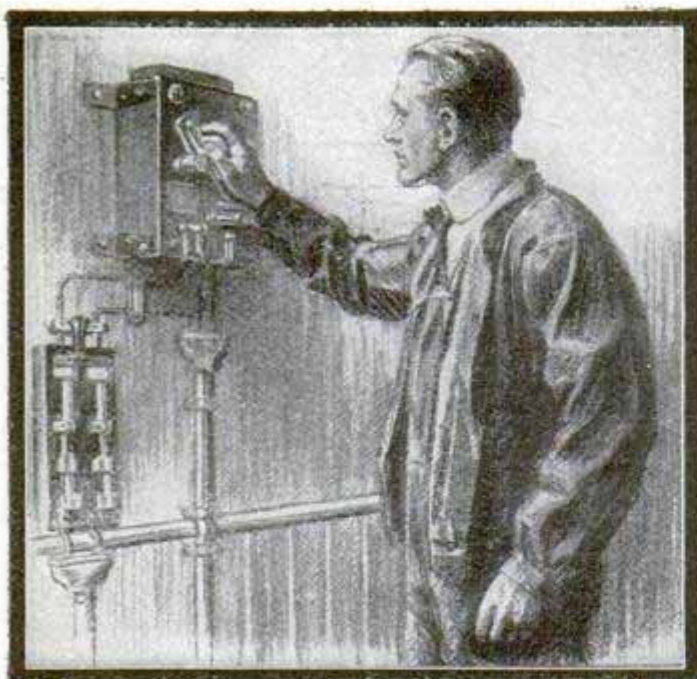

## Become An Expert Electrician In Spare Time

Never has there been such a demand for technically trained electrical men as at present. The great expansion of the electrical field in all its branches is responsible for this. The trained electrical man is always sure of a good position at a good salary.

The International Correspondence Schools have made the mastery of any electrical course easy. Any ambitious man can learn in spare time to become an expert electrician. You can.

Courses cover Electrical Engineering, Lighting and Railways, Interior Wiring, Dynamo Running, Electric Car Running, Heavy Electric Traction, Telephone Engineering and Telegraph Engineering. Everything made clear and simple. Courses conducted by experts. No hurry or delay. The I. C. S. stands by you until you are through.

It costs you nothing and puts you under no obligation to learn how the I. C. S. can help you. Simply fill in and mail the attached coupon to-day. Do it now.

**International Correspondence Schools**  
Box 872, Scranton, Pa.

Please explain, without further obligation on my part, how I can qualify for a good position in the line of electrical work indicated in the attached coupon:

Position.....  
Name.....  
Street and No.....  
City..... State.....

Please Mention Popular Mechanics

### Increase Your Earnings!



Train yourself for a responsible position, educate yourself to increase your earning capacity and fit yourself for a professional life by studying

## DRAFTING

Our courses are the most practical ever planned and cover all branches. Hundreds of plans of buildings and machinery in course of construction are at the disposal of students, who can also inspect actual work of construction. Short, practical courses, full or sectional courses, as needed; day and evening classes. Students assisted to obtain positions while attending school. Entrance can be made at any time—no examinations required. Start at once your step towards a lucrative career—call, or write for catalogue. Do it today.

Correspondence Courses in Architectural, Mechanical and Structural Drafting and Design, Plan Reading, Estimating, etc. If interested in correspondence courses, write for Folder No. 2.

CHICAGO TECHNICAL COLLEGE, 603 Athenaeum Bldg., CHICAGO

### Young Men Wanted



Big salaries paid to our graduate chauffeurs and auto experts. We teach you at home in 10 simple lessons to earn big money and assist you to secure a position. Over 100 diagrams in course. Write for prospectus, sample pages, testimonials from students and endorsements of 10 leading auto makers—Free Model of an auto to each student.

**PRACTICAL AUTO SCHOOL**  
68 Beaver Street, New York



### QUICK, THOROUGH ELECTRICAL INSTRUCTION

A complete college course in two years. Time and money saved. Taught by graduate engineers—Practice on apparatus and machines—construction, operation and repair. Every branch of generation, transmission and application. Graduates in leading electric companies. New classes September 25th.

WRITE FOR DETAILS

**BRYANT & STRATTON COLLEGE**  
No. 111, College Bldg., Buffalo, N. Y.

### LEARN WATCHMAKING AT HOME



You can learn by our modern and original system of instruction every part of the Watchmaker's Trade at home as good or better than at a shop. You can earn money while learning and secure a well paying position or start in business after completing our course of instruction. Good watchmakers are always in demand and earn from \$20 to \$35 per week. For particulars apply to the WISCONSIN SCHOOL OF WATCHMAKING, Enterprise Bldg., MILWAUKEE, WIS.

### STUDY LAW at Home

Become a Lawyer

# LAW

Legal Diploma

We make your home a university. Leading Correspondence Law Course in America—recognized by resident colleges. New text, specially prepared by 20 Deans and Univ. law school teachers. We guarantee to coach free any graduate failing to pass bar examination. Special Business Law Course. "Legally-trained men always succeed." Over 10,000 students enrolled. Begin now. Easy terms. Catalog and Particulars Free. LA SALLE EXTENSION UNIVERSITY, Box 119Y, CHICAGO, ILL.

## HYPNOTISM

Learned at home; small cost; 2c stamp for particulars. O. A. SMITH, Room B 61, 823 Bigelow St., Peoria, Ill.



### LEARN ABOUT OUR FREE COURSE IN SHOW CARD AND SIGN WRITING

To introduce "Litholia" Ready-to-use colors for show-card writing and artists' use, we are offering for a limited time only a complete course in show-card and sign writing to those purchasing a small assortment of these colors. This is a great opportunity for ambitious men and women to increase their earning capacity. Good show-card writers earn from \$25 to \$100 per week. Complete information for stamps, no postals. Litholia Pm. Color Co., 247 W. 125th St., N. Y.

# Earn \$25<sup>00</sup> to \$75<sup>00</sup> Weekly

## Repairing Watches

*We Teach you how.*



**JEWELRY AND WATCH REPAIRING**

### We Will Help You START IN BUSINESS

Remember that this is **not** a correspondence school! It is a big watch repairing and jewelry concern that stands ready to teach you the business that has made it the largest and most successful concern of its kind in the World. While learning you can stay at home—you can continue your present occupation while learning. You can begin making money at once.

### WE WILL TEACH YOU the business absolutely Free, because we want you to represent us.

We mean just what we say—this is a straightforward business proposition to you. We will furnish you, free of cost, all text-books; clear, simple lessons; illustrated chart and photo prints showing you just exactly how to prepare each job. You will be surprised to see how simple and easy it is. Our repair department will do the difficult jobs for you until you learn how—you take the profit.

### IF YOU MEAN BUSINESS WE WILL STAND BACK OF YOU.

If you are the right kind of a man we will back you to the limit. You won't have to make any experiments—we have made them—we will start you right. You will have the benefit of our advice, instruction and experience. We will supply you with materials, jewelry, etc., at rock-bottom prices. You can beat any competition because you will have the backing of the most successful watch repairing and jewelry establishment in existence.

### DON'T ENVY

### Successful Business Men—BE ONE YOURSELF!

If you are not the owner of an independent business—it's your own fault. Don't wait until you have saved up money—you will need only a few dollars for tools. Let us start you now and you can make what money you need repairing watches—then you can soon have an independent business of your own. If you want us to show you—we will give you the names of men we have helped start in business. Send us your name and address on a post card and we will send a full, illustrated explanation of our plan by return mail quick. "To-morrow" means never—send the card now!

CHAS. F. ELMORE, Principal of Watchmaking College  
Rogers, Thurman & Co. 101-103 N. Wabash Ave., Chicago



## IF YOU STAMMER

attend no school till you hear from me. Largest school in the world, employing the advanced natural method for the cure of stammering, stuttering, etc. No sing-songing or time-beating. If let run, stammering will wreck your life's happiness and handicap your endeavors. I cured myself and thousands of others by my method and can cure you. Beautiful 188 page book and Special Rate sent FREE.

Lee Wells Millard, Pres., North-Western School for Stammerers, Inc., 917 First St., Milwaukee, Wis.



## Learn Telegraphy

### MORSE and WIRELESS

At My Practical School. Splendid demand for operators and agents. We also teach Station Agency Work. Graduates assisted. We occupy our own 2 large modern buildings equipped with R. R. Dispatchers and Western Union Wires and Wireless Station. Endorsed by Railroad, Wireless and Western Union Officials. Exclusive Methods. Teachers are practical experts. Living expenses earned. Easy payments. Catalogs Free. Correspondence course if desired. GEORGE M. DODGE, Pres., Dodge's Institute, 8th St., Estab. 1874, Valparaiso, Ind.



## Learn Photography, Photo-Engraving or 3-Color Work

Photographers and Engravers Earn \$20 to \$50 Per Week Only College in the world where these paying professions are taught successfully. Established 17 years. Endorsed by International Association of Photo-Engravers and Photographers' Association of Illinois. Terms easy; living inexpensive. Graduates assisted in securing good positions. Write for catalog, and specify course in which you are interested. Illinois College of Photography or 999 Wabash Av., Bissell College of Photo-Engraving Effingham, Ill. L. H. BISSELL, Pres.



Enter Any Time  
2000 Students Annually  
One of the most completely equipped ENGINEERING SCHOOLS in the country  
Students may enter any time, and their term is 12 weeks from the day they enter.  
Mention course in which you are interested. Address,  
**O. E. LONGWELL, President, Des Moines, Ia.**

## COURSES OFFERED

1. CIVIL, ELECTRICAL AND MECHANICAL ENGINEERING COURSES. Standard courses are offered in Civil, Electrical and Mechanical Engineering. Special opportunity is offered for making up work or for taking a complete course preparatory to the standard Engineering Courses. Shop work from the beginning comes in preparatory courses. See our new Engineering Catalogue.
  2. SHORT COURSES
    - 1. One Year Electrical Engineering Course
    - 2. One Year Telephone Engineering Course
    - 3. One Year Steam Engineering Course
    - 4. One Year Machinists' and Automobile Course
    - 5. One Year Course in Mechanical Drawing
- Just a fair common school education is all that is required for entrance to these courses. These courses are very practical and are intended for those who have but limited education and do not see their way clear to take a complete Engineering Course. The Machinists' Course is especially practical. The machine shop is the most complete to be found in connection with any Engineering School in the United States.

## SPECIAL COURSES

1. TRACTION ENGINEERING. This is the most complete course in Traction Engineering offered by any Engineering School in the country. It may be completed in three months. Students are taught how to make all repairs on engines as well as to handle them. Four traction engines used for experimental purposes.
2. GASOLINE AND AUTOMOBILE COURSES. These courses may be completed in three months. They are exceedingly practical. Complete Chauffeur practice. Just a fair common school education is all that is necessary to enter.
3. FARM BLACKSMITHING, FARM CARPENTRY.



# RAISED

**Raised** tells the story of what the International Correspondence Schools are doing for ambitious men and women everywhere who have confidence in themselves, but have neither training nor opportunity. **RAISED** tells how the I. C. S. can increase *your* salary—no matter where you live, what you do, or what you earn—so long as you can read and write.

For just twenty years the I. C. S. has been successfully showing the poorly paid and often the well paid how to increase their earning power by specialized training. To celebrate its Twentieth Anniversary this institution has planned unusual inducements for those who seek its help during June. To secure free information and advice about your own case and how you can benefit by the anniversary offer,

**Mark and Mail this Coupon TO-DAY**

INTERNATIONAL CORRESPONDENCE SCHOOLS,  
Box 872 SCRANTON, PA.

Please explain, without further obligation on my part, how I can qualify for the position, trade or profession before which I have marked X

Automobile Running  
Mine Superintendent  
Mine Foreman  
Plumbing, Steam Fitting  
Concrete Construction  
Civil Engineer  
Textile Manufacturing  
Stationary Engineer  
Telephone Expert  
Mechanical Engineer  
Mechanical Draftsman  
Electrical Engineer  
Electric Lighting Supt.  
Electric Wireman

Civil Service  
Architect  
Chemist  
Gas Engines  
Banking  
Building Contractor  
Architectural Draftsman  
Industrial Designing  
Commercial Illustrating  
Window Trimming  
Show Card Writing  
Advertising Man  
Stenographer  
Book keeper

Spanish  
French  
German  
Italian

Name \_\_\_\_\_  
Present Occupation \_\_\_\_\_  
Street and No. \_\_\_\_\_  
City \_\_\_\_\_ State \_\_\_\_\_

Please Mention Popular Mechanics

## New York Electrical School

Offers a theoretical and practical course in applied electricity without limit as to time.

Instruction individual, day and night school, equipment complete and up-to-date. Student learns by doing, and by practical application is fitted to enter all fields of electrical industry fully qualified. School open all year. Write for free prospectus.

44 West Seventeenth St., NEW YORK

## Mackay School of Mines

University of Nevada

Best equipped mining school in the country—all buildings of special construction. Faculty composed of prominent engineers and every department is in charge of experienced instructors. Located close to great mining district—students can make money and gain practical experience during vacations. Splendid climate—every opportunity for outdoor life amidst beautiful surroundings. Summer school of Mine Survey and Geology begins May 18th. (Eight weeks' course.) Regular term opens Aug. 14th. Endowed by Clarence H. Mackay, 253 Broadway, New York. For detailed information address

JOSEPH E. STUBBS, President, Dept. 14, Reno, Nevada

## Learn Watch Repairing

Be a watchmaker—you can learn this profitable trade by correspondence in a few weeks in your own home by the DeSelms Chart System. After you complete the course you will know a watch from A to Z. You will know just what the matter is and how to repair one. When you graduate you will be a practical watchmaker and repairer and competent to fill any position. Positions for our graduates.

Ask for our Free Book. It explains our system and terms.

THE DeSELMS WATCH SCHOOL  
23 Perry St. ATTICA, INDIANA



## LEARN PLUMBING

A trade that will make you independent for life. Hours Shorter—Pay Bigger—Demand Greater than most any trade. You need no previous experience. Our practical methods enable you in a few months to hold position as skilled plumber or conduct your own business. Catalog sent free.

St. Louis Trades School  
4430 Olive St. ST. LOUIS, MO.

BIG  
PAY  
SHORT  
HOURS

## MUSIC LESSONS FREE AT YOUR HOME

Write Today for our Booklet. It tells how to learn to play Piano, Organ, Violin, Mandolin, etc. Beginners or advanced pupils. American School of Music, 50 Lakeside Bldg., Chicago, Ill.



## LEARN WATCHMAKING

Watchmaking pays and you can earn while you learn. Write for FREE BOOK, "How to be a Watchmaker." Postal brings it.

Stone's School of Watchmaking  
912 Globe Bldg. St. Paul, Minn.

## ARITHMETIC SELF-TAUGHT

A plain, easily-understood volume for all who have not had the opportunity of learning this subject thoroughly, or who have forgotten what they once learned. 257 Pages. Requires no teacher. This great little book sent postpaid for 60 CENTS. Stamps accepted, leather binding \$1.

GEO. A. ZELLER BOOK CO.  
Est. 1870, 4462 W. Belle Place, ST. LOUIS, MO.

SPANGENBERG'S  
PRACTICAL  
ARITHMETIC  
Self-Taught

# LEARN TO REPAIR AND RUN AUTOMOBILES



## EARN BIG MONEY IN AUTOMOBILE BUSINESS

as a chauffeur, repairman, salesman. Work pleasant. Big demand for trained men. Fine chances for starting automobile livery, agencies, taxicab and repair companies. Learn the automobile—every part, and its mechanical operation thoroughly and practically in a few weeks. Write today for our interesting free book and learn about the tremendous opportunities everywhere in

this new business and our excellent course of training.  
**KANSAS CITY AUTOMOBILE SCHOOL**  
 (Conducted by CLIFF HOGAN)  
 (Largest and Best Equipped Automobile School in America)  
 2139 E. 15th Street, Kansas City, Mo.

# ELECTRICITY



## Complete in One Year

SCIENTIFIC ELECTRICITY  
 IN ALL ITS BRANCHES

### Bliss Electrical School

Studies restricted to theoretical and practical electricity, mechanical drawing and

necessary engineering work. Teaches simplicity, concentration, hard work. For young men of energy and character. 18 years of greatest success. Graduates hold first-class positions. Opens Sept. 20. Write for new catalog.

15 Takoma Ave., WASHINGTON, D. C.

## I TEACH SIGN PAINTING

SHOW CARD WRITING or LETTERING by mail and guarantee success. Only field not overcrowded. My instruction is unequalled because practical, personal and thorough. Easy terms. Write for large catalogue.

CHAS. J. STRONG, Founder

**DETROIT SCHOOL OF LETTERING**  
 DEPARTMENT PM. DETROIT, MICH.

"Oldest and Largest School of its Kind"

# LEARN WATCHMAKING

Engraving and Jewelry Repairing. Practical specialists in charge of all instruction. Students trained for the best paying positions. Earn while learning. Our school is endorsed and recommended by leading jewelers. A few months will make you an expert. Positions secured for graduates. Demand for watchmakers greater than the supply. Write for free catalogue.

**CHICAGO SCHOOL OF WATCHMAKING**  
 Dept. 20, Bush Temple, CHICAGO

## LEARN TO WRITE ADVERTISEMENTS IF YOU ARE EARNING LESS THAN \$25 a WEEK

We can positively show you by mail how to increase your salary. Send for beautiful prospectus, mailed FREE.

PAGE-DAVIS SCHOOL, Dept. 112, CHICAGO, ILL.

# SHORTHAND IN 30 DAYS

Boyd Syllabic System—written with only nine characters. No "positions"—no "ruled line"—no "shading"—no "word-signs"—no "cold notes." Speedy, practical system that can be learned in 30 days of home study, utilizing spare time. For full descriptive matter, free, address

CHICAGO CORRESPONDENCE SCHOOLS  
 969 Chicago Opera House Block CHICAGO, ILL.

# Boston Garter

*Velvet Grip*

is made to suit all tastes, both as to type and style. Its materials are highest grade. The webbings are of the best quality, and will retain their strength and elasticity, giving maximum service. Metal parts are of brass, rust proof, and heavily nicked.



## THESE THREE TYPES

cover any man's needs for all seasons or occasions. The "Cord" is the original staple "Boston Garter"; "Needraw" for summer wear (no metal next the skin); "Pad," a recent type excelling in comfort and growing in favor.

The trade marks "Velvet Grip" and "Boston Garter" stamped on the loops.

For sale everywhere. Sample Pair, postpaid, Cotton, 25 cents, Silk, 50 cents.

GEORGE FROST CO. - - BOSTON, U.S.A.

# How to Run an Auto



"Homans' Self Propelled Vehicles" gives full details on successful care, handling and how to locate trouble.

Beginning at the first principles necessary to be known, and then forward to the principles used in every part of a Motor Car.

It is a thorough 1910 course in the science of Automobiles, highly approved by manufacturers, owners, operators and repairmen. Contains over 400 illustrations and diagrams, making every detail clear, written in plain language. Handsomely bound.

Price \$2.00 postpaid, or sent **Free on Approval**

The only way the practical merit of this MANUAL can be given is by an examination of the book itself, which we will submit for examination, to be paid for or returned after looking it over.

Upon receipt of the following agreement, the book will be forwarded:

No money in advance required, sign and return

THEO. AUDEL & CO., 63 Fifth Ave., NEW YORK, N. Y.

Kindly mail me copy of Homans' Automobiles, and, if found satisfactory, I will immediately remit you \$2, or return the book to you

NAME.....

OCCUPATION.....

ADDRESS..... (July Pop. Mech.)



# Popular Mechanics Series of Industrial Handbooks

**"WRITTEN SO YOU CAN UNDERSTAND IT"**

THESE books furnish reliable information on mechanical subjects at a price within the reach of all. They are convenient and uniform in size (5 by 7 in.) and neat and attractive in appearance; being bound in a good grade of durable cloth with artistic cover designs, printed in clear readable type on good book paper and fully illustrated.

A useful, compact library of mechanical books unequaled anywhere at the price **EACH 50c POSTPAID**

THESE ARE READY

## Mission Furniture

How to Make It, Part I.

A handy little manual containing plain directions for making 21 designs, with working drawings and illustrations.

96 Pages

## Mission Furniture

How to Make It, Part II.

A companion volume to Part I containing 32 additional designs.

128 Pages

## Arts-Crafts Lamps

How to Make Them

By J. D. ADAMS

Plain instructions for making 16 beautiful designs from paper, cardboard and wood. Good results can be obtained by anyone possessed of a fair amount of patience.

96 Pages

## How to Make a Wireless Set

By ARTHUR MOORE

Explains in an understandable manner the construction of an outfit for transmitting 4 or 5 miles. This set can be easily constructed at a small cost by any boy of ordinary ability.

96 Pages

## Metal Spinning

By PROF. F. D. CRAWSHAW,

UNIVERSITY OF WISCONSIN

The only book published on this interesting art. A practical working manual for those who desire to spin metal as an art recreation or to follow this work as a trade.

80 Pages

## Electroplating

By HENRY C. REETZ

A treatise which will not only enable the humblest beginner to make a start, but which gives pointers of value to even the most experienced electroplater.

112 Pages

## Heat

By PROF. J. GORDON OGDEN,  
Ph. D., Professor of Physics,  
Fifth Avenue H. S., Pittsburg

An immensely interesting and instructive story pertaining to heat and its relation to modern mechanics.

128 Pages

## Metal Work and Etching

By J. D. ADAMS

A complete handbook for art metal workers giving every detail for making a great variety of useful and ornamental objects such as book ends, desk sets, arts and crafts jewelry, hinges, drawer pulls, paper knives, letter openers, match boxes, tie and pipe racks, pad corners, etc. Fully illustrated.

96 Pages

## Wood-Working for Amateur Craftsmen

By IRA S. GRIFFITH, A. B.

This book was especially designed to cover every essential step from the A B C to the X Y Z of woodworking. The chapters dealing with making special articles bring out every cut, joint and process used in this important trade, and the proper use and care of tools, working up of materials, etc., are treated thoroughly and plainly.

128 Pages

**OTHER EQUALLY GOOD OR BETTER TITLES TO FOLLOW**

Obtainable at News-stands, bookstores or direct from the publishers

**Popular Mechanics Book Dept., CHICAGO**



**Attention: GARAGES, AUTOMOBILE and GENERAL REPAIR SHOPS**

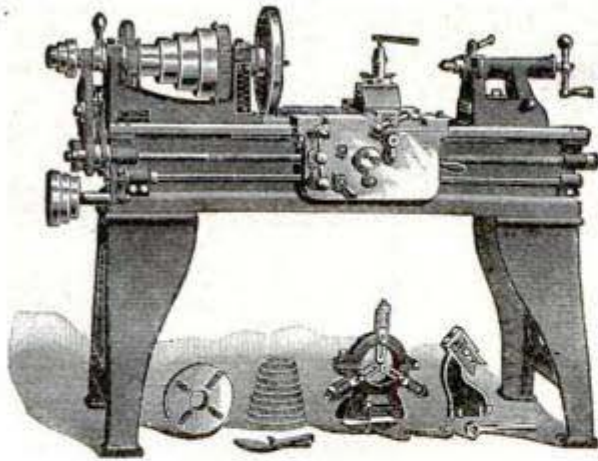

**Are you in the market for a Lathe?**

If so, before placing your order elsewhere, be sure and investigate the merits of our 15-inch lathe, as it is the ideal lathe for your work. The quality is there and the prices are low. A copy of our catalog will be mailed free on request.

**THE SEBASTIAN LATHE CO., 107 Culvert Street CINCINNATI, O.**

**Genuine Meerschaum Pipe**



No imitation or "chip" but guaranteed genuine imported block meerschaum, same as used in expensive pipes. Imported weichsel stem. Smokes and colors equal to any \$25 meerschaum. Cool, sweet and pleasant. Attractive shape, guaranteed. A gem of a pipe. Order 3 or more today.

**50c**  
three for  
**\$1.25**  
Sent Prepaid  
Anywhere

Your  
Money Back  
if not satis-  
factory and  
entirely as  
represented

**H. MENGES**  
The Smokers' Friend  
802 Menges Bldg., St. Louis, Mo.

**A CHANGE**

Under a new plan effective April 1, 1911, our street number is changed to **318 W. Washington St.**

The change in address is caused by a re-numbering of the streets and is not a change of location. Please address our mail to the new number.

**Popular Mechanics Magazine**

REVERSIBLE  
**"Linene"**  
TRADE MARK

**Made for Comfort**

Modeled to exact shape, but perfectly flexible. Finished in dull lustre. The ideal collar for traveling.

Price at the stores, 25 cents per box of 10, or by mail 30 cents in U. S. stamps. Sample by mail for 6 cents.

**State Size and Style**

**REVERSIBLE COLLAR CO.**  
Department U BOSTON, MASS.



**COLLARS**  
CUPS AND BOSOMS

**VAN DYCK**  
Sizes 12 to 18 Inches  
Front 1 1/2 Inches - Back 1 1/2 Inches



**ANGELO**  
Sizes 12 to 20 Inches  
Front 2 1/2 Inches  
Back 1 Inch



**RAPHAEL**  
Sizes 12 to 20 Inches  
Front 2 1/2 Inches  
Back 1 Inch



**RUBENS**  
Sizes 12 to 20 Inches  
Front 2 Inches - Back 1 Inch



**127 KINDS Iron, Wood, Wire & Steel PUZZLES**  
Sample with Catalog 10 cents, or 3 leaders for 25 cents.  
**WESTERN PUZZLE WORKS**  
St. Paul, Minn.

**9,059-Word Business Book Free**

Simply send us a postal and ask for our free illustrated 9,059-word Business Booklet, which tells how priceless Business Experience, squeezed from the lives of 112 big, broad, brainy business men, may be made yours — yours to boost your salary, to increase your profits. This free booklet deals with

- How to manage a business
- How to sell goods
- How to get money by mail
- How to buy at rock-bottom
- How to collect money
- How to stop cost leaks
- How to train and handle men
- How to get and hold a position
- How to advertise a business
- How to devise office methods

Sending for this free book binds you to nothing, involves you in no obligation; yet it may be the means of starting you on a broader career. Surely you will not deny yourself this privilege, when it involves only the risk of a postal—a penny! Simply say, "Send on your 9,059-word Booklet." Send to **SYSTEM, Dept. 81-7, 151-153 Wabash Avenue, Chicago**

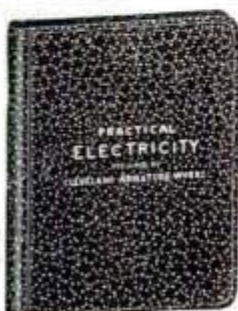

**A SCHOOL WITHIN ITSELF**

There are XX chapters in all, XIX carrying you from the fundamental principles of electricity on through the various branches to a point where the careful student comprehends the complete designing, care and operation of a dynamo or motor, and one chapter on electric automobiles, outlining their construction, care and operation, and all about storage batteries and how to handle them. Each subject is carefully written and to the point. After a student studies a subject, he is questioned on that subject in such a manner as to bring clearly to his mind the points he needs to know regarding same. The book contains a dictionary defining 1500 Electrical Words, enabling the reader to ascertain the meaning of any electrical word, term or phrase used in this book, as well as hundreds of others in common use. All required tables necessary in the study are in it.

**\$2.00 PER COPY—SIXTH EDITION—30,000 COPIES SOLD.**

The offer we make of refunding money if book is not satisfactory upon examination is AN UNUSUAL ONE in connection with the sale of a book. But we have no fear of its return. Your decision will be what thousands of others have been. Money would not buy it if it could not be duplicated. We could print testimonials by the hundreds. It is best to order and be your own judge of its merits.

**CLEVELAND ARMATURE WORKS, Cleveland, Ohio**

Armatures and Fields Wound—Commutators Filled  
**AMERICA'S GREATEST REPAIR WORKS**



*The only  
Solution:*

# Get a better job

Are you "trying to make both ends meet" on a small, unsatisfactory salary? Are you one of the thousands of energetic, capable men whose days are spent in work not suited to their natural talents?

**Then read this wonderful offer. We mean it and there is a fine chance for you if you improve it.**

If you lack the time and the means to stop work and take a course of training, the American School will **lend you the cost of the training** you need and let you make your own terms for repaying us.

**This is the greatest offer ever made to men who have "got it in them to rise," and we are prepared to help everyone who comes to us in earnest.**

Check the coupon, mail it to us, and we will explain fully our "Deferred Tuition" plan, how we will lend you the cost of the tuition, and allow you to pay us back when the increase in your yearly income equals the amount of the loan.

**No Promotion — No Pay** — that's what our "Deferred Tuition" Scholarship means. Send the coupon today and prepare for a **better job**.

**AMERICAN SCHOOL OF CORRESPONDENCE**  
CHICAGO, U. S. A.

## Opportunity Coupon

**American School of Correspondence, Chicago, U. S. A.**

Please send me your Bulletin and advise me how I can qualify for the position marked "X." Pop. Mech. 7-'11

.....Book-keeper	.....Draftsman
.....Stenographer	.....Architect
.....Accountant	.....Civil Engineer
.....Cost Accountant	.....Automobile Operator
.....Systematizer	.....Electrical Engineer
.....Certified Public Acc't	.....Mechanical Engineer
.....Auditor	.....Moving Picture Op'r
.....Business Manager	.....Steam Engineer
.....Commercial Law	.....Fire Insurance Eng'r
.....Reclamation Engineer	.....College Preparatory

NAME .....

ADDRESS .....

# Popular Mechanics Magazine

WRITTEN SO YOU CAN UNDERSTAND IT

Vol. 16

JULY, 1911

NO. 1

## The Eyes of the Battleship

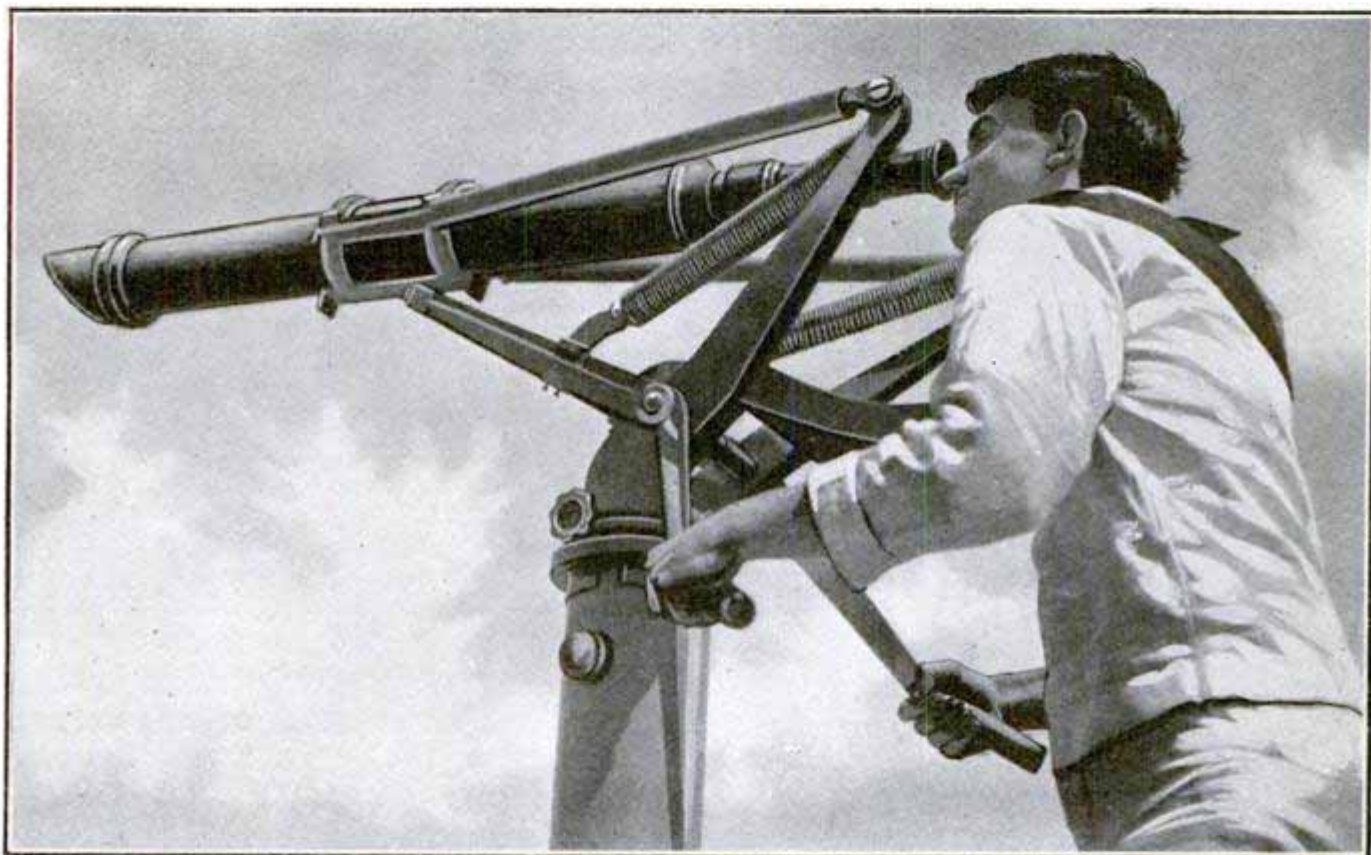

AS IMPORTANT AS THE TWELVE-INCH GUNS

One of the Powerful Telescopes Made Recently for the New American Fighting Ships—First Sight of an Enemy Gives a Great Advantage

**I**N the design and equipment of Uncle Sam's newer battleships, no feature is more noticeable than the facilities afforded for observation by the officers and men stationed on the bridge,—observations of the beacons and other aids to navigation, but more especially observations of the movements of a supposed enemy. On the bridge and on the "fire-control" tower overhead are to be found artificial aids for the "eyes of the battleship," ranging all the way from the old-fashioned glasses to the powerful telescopes and kindred annihilators of distance that

are too large to be supported at arm's length and manipulated after the fashion of the spy-glasses of the ancient mariner.

Upon the observations made by means of these inventions that extend vision, the officers on the bridge of the battleship or in the conning tower must depend not only for their most accurate knowledge of the movements of hostile craft, but also for much of the data essential to range-finding, and for reports as to the effect of the shots fired from the turret guns or the secondary battery.

## GIANT SKULL IN U. S. ARMY MEDICAL MUSEUM

The giant skull shown in the accompanying illustration is the property of the U. S. government, and has just been added to the collection in the medical

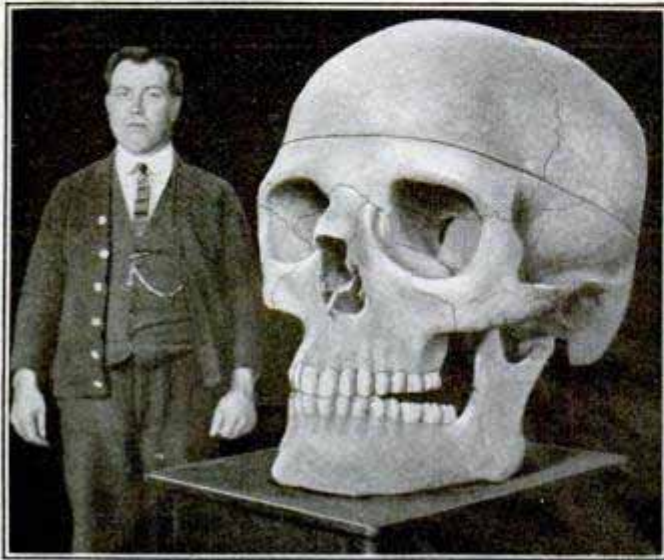

Papier-Mâché Skull in the U. S. Army Medical Museum

museum of the army. It is not, of course, a real skull, but simply a fine enlarged reproduction of a skull of average size. It is made of papier-mâché, and is very accurate in its details.

## A RAILROAD CAR WITH A CAPACITY OF 300,000 LB.

The railroad car constructed by the Bethlehem Steel Co. for special shipments is claimed to be the longest and highest capacity load-bearing vehicle in use on any railroad in the world. Its total length is 103 ft., its weight 196,000 lb., and its rated capacity 300,000 lb., or 150 tons.

Each of the four trucks has eight wheels, making 32 wheels in all. The length of the car between center plates is 64 ft., and the main bridge comprises two plate girders.

## ELECTRIC LIGHTS ON THE CHURCH CROSS

The gilded cross, 12 ft. high by 9 ft. wide, on the great steeple of St. Mel's Church, Chicago, has its north and south faces outlined with 70 electric incandescent lamps, for illumination during church festivals. The effect is very striking, even at great distances. The Louisville Roman Catholic Cathedral and other churches will probably follow suit, as the innovation is giving rise to favorable comment among church people.

## A PRIVATE PHONE SYSTEM FOR THIS FAMILY

Probably the most unique idea for binding together the scattered units of an interrelated family has recently been put into effect at Cullman, Ala. In that town there are a large number of people by the name of Holmes, all residing within a radius of seven miles of each other. The family feeling of the Holmes clan is evidently very strong, as it was suggested to connect the various branches by a private telephone system, on which no outsider could "butt in" to disturb the family confidences exchanged over the wire. Accordingly, a central exchange was installed in the house of John H.

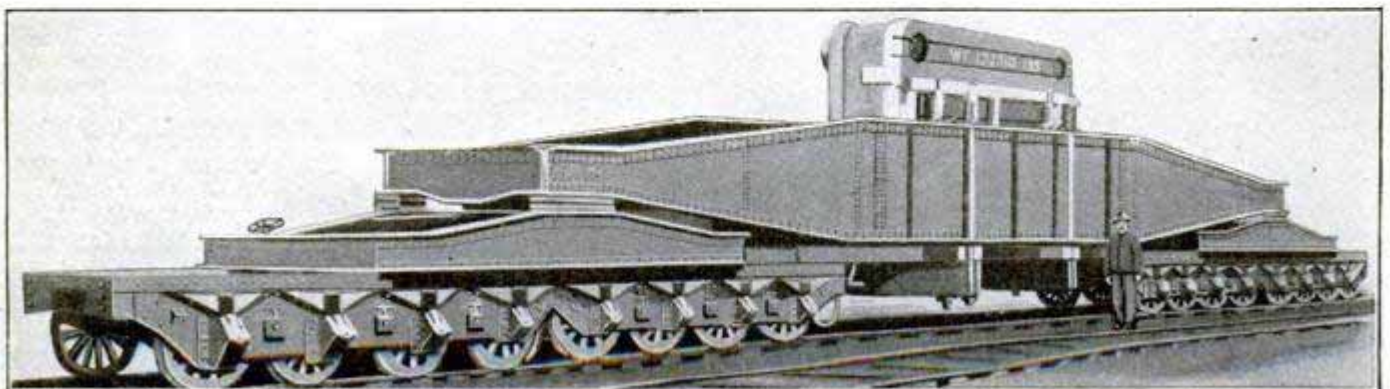

A Railroad Car Constructed to Carry Weights Up to 300,000 Lb.

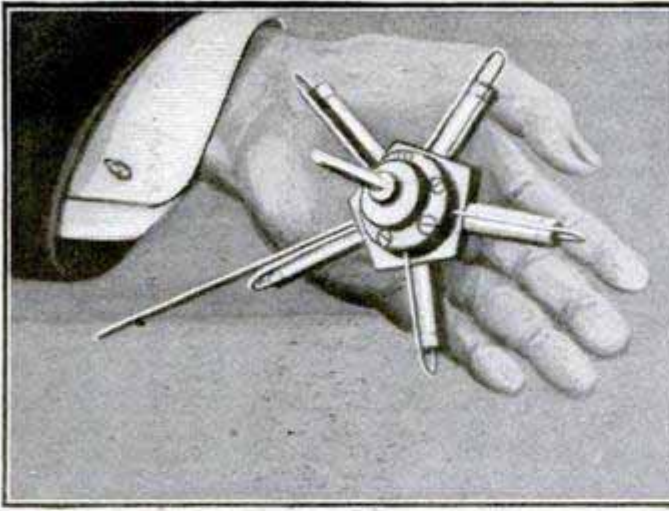

Tiny 5-Cylinder Gnome-Type Motor as Compared to Size of Human Hand

of the Holmes ilk, and 50 private wires were run from it to the homes of the various members of the Holmes family.

### BLIND PEOPLE RIDE FREE IN GLASGOW

Blind people are now permitted to ride free on the street cars of Glasgow, Scotland. The local town council has distributed a supply of brass tokens among the various institutions for aiding the blind, and an ordinary car ticket is given in exchange when a token is presented by a blind person desiring a free ride.

### MINIATURE AEROPLANE MOTORS

Miniature or model aeroplanes, with actual motors not much larger than the palm of the hand and capable of driving the toy machines at a high speed, are receiving much attention in Europe.

One of the miniature aeroplanes having a length of 7 ft., a wing span of 8 ft., and weighing but  $7\frac{1}{2}$  lb. complete, including motor and gasoline, is driven by a gasoline engine, the overall dimensions of which are 6 in. by 4 in. by 2 in. This engine has four horizontally opposed cylinders which are bored from one piece of solid steel. The cylinder heads are of magnalium and are screwed onto the cylinders, the valves and valve seats are of steel,

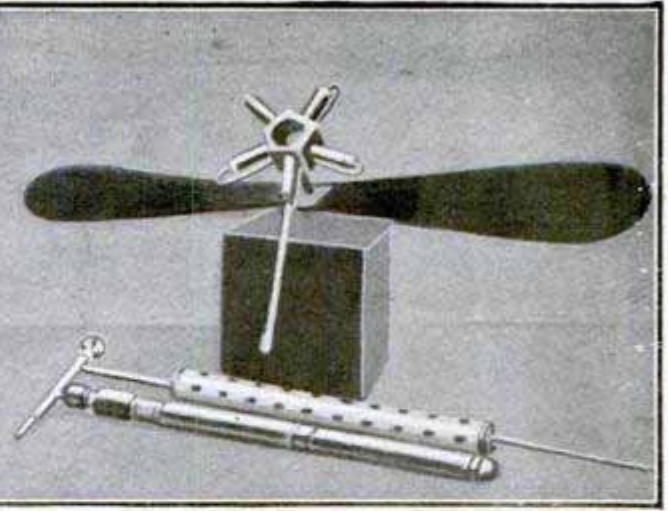

The 5-Cylinder Miniature "Gnome" with Propeller, Carbonic-Acid Tank and Heater

and one connecting rod serves for two opposite pistons. The exhaust valves are operated in the usual manner by overhead tappers and rockers. Ignition is by trembler coil for starting only, the firing being automatic in flight. The gasoline tank has a capacity of a gill.

The other motor illustrated is a 5-cylinder Gnome type, the size of which may be clearly seen as compared to that of the human hand. It is driven by carbonic-acid gas. The fluid carbonic acid in the tank is heated to overcome the extreme cold produced by its evaporation. The construction of this motor is remarkably simple. The gas, entering one of the cylinders after passing through an intermediate distributor, imparts to the piston a rectilinear motion which is then transformed into rotary motion in the ordinary way. This causes an angular displacement, which admits the gas into the next cylinder, and the rotation becomes continuous.

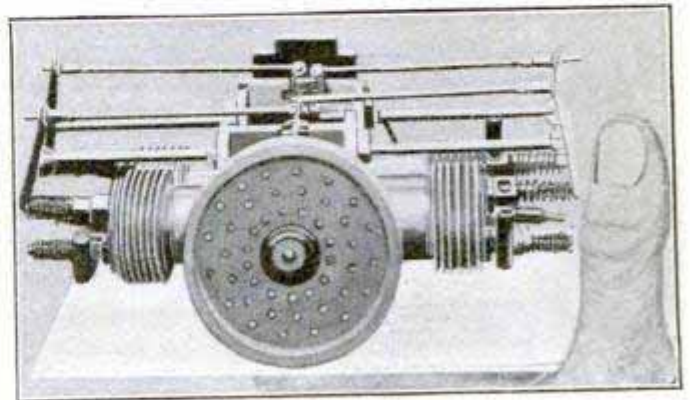

Miniature Gasoline Motor, the Overall Dimensions of Which are 6 In. by 4 In. by 2 In.



Home-Made Individual Grandstands

### "GRANDSTAND" TO ATTACH TO HIGH FENCES

They certainly do some things better in London, as is evidenced by this method of relegating the ticket-taker to the discard. Secure a section of bed-slat and cut two or three yards from the clothesline; connect as indicated in the picture; and then go and see whether the manager of your local ball-park will not give you a season ticket in exchange for the device and your sworn agreement not to make another.

### KRUPPS' AERIAL TORPEDO LIKE A SKYROCKET

An aerial weapon that launches a self-propelled torpedo is the latest development of ordnance experts for use in aeroplanes and dirigibles in time of war. According to a newspaper dispatch the scientists in the employ of the Krupps have succeeded in devel-

oping such a weapon after a series of experiments extending over a period of two years. The need for a weapon that could be mounted on an aeroplane or a dirigible, and discharge a shot that would be effective and at the same time not require the expenditure of such force, the recoil from which would wreck the flying machine, spurred the experimenters on. The device that has been presented as answering all the requirements with none of the objections urged against previous inventions, is a torpedo that can carry 6 lb. of explosive to an extreme range of 5,000 yd. The torpedo is launched by a light powder discharge or by electricity. It consists of two parts, an explosive head and a rear chamber which is filled with a slow-burning powder, the gases generated by which form the means of propelling it through the air on the principle of the skyrocket. The gas tubes are placed at angles and give the torpedo a spinning movement like that of a rifle bullet in flight.

# NEW YORK'S MAGNIFICENT NEW PUBLIC LIBRARY

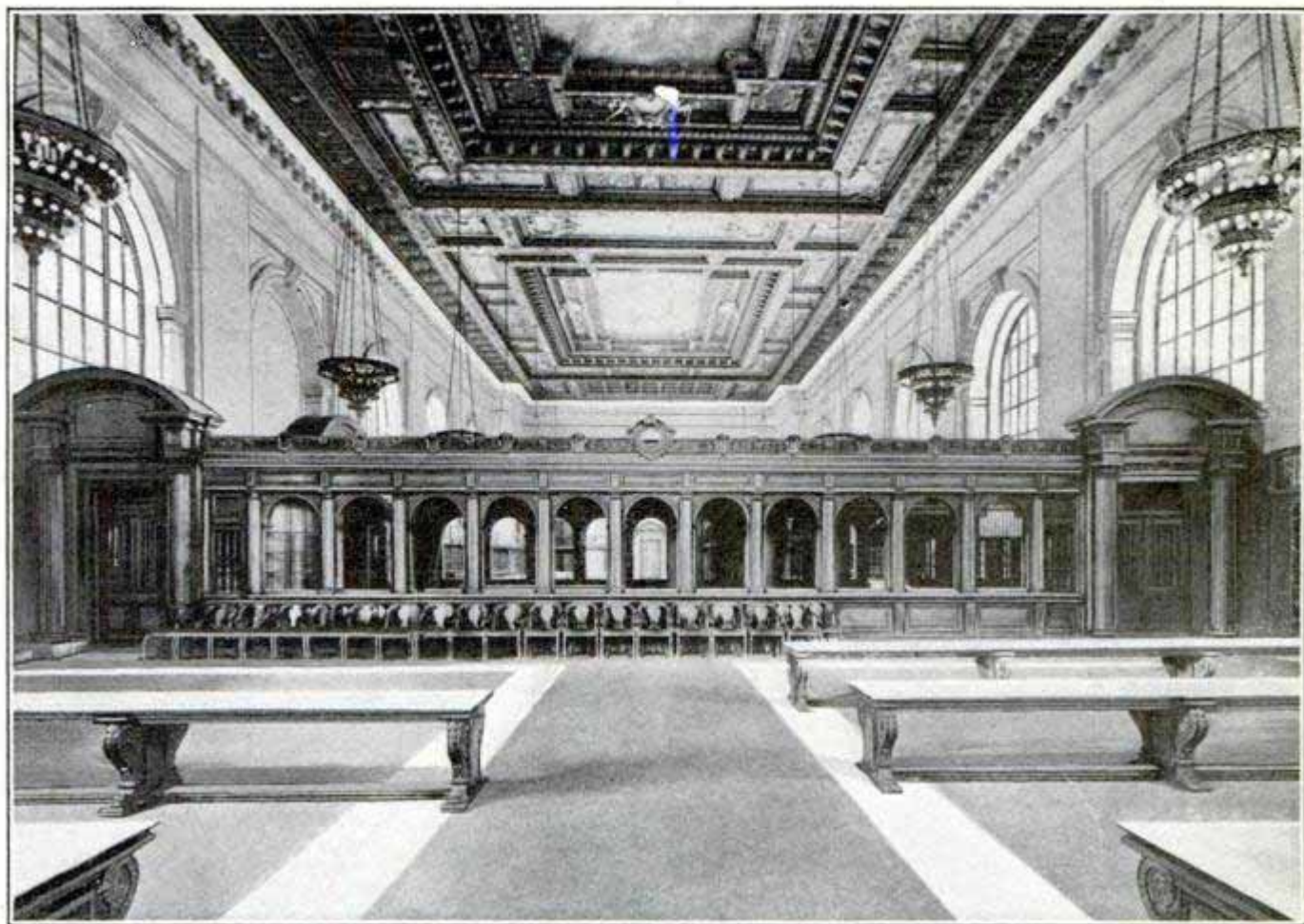

## THE MAIN READING ROOM

In point of light, facilities, and decorative effect, this room is said to be without a peer in the world

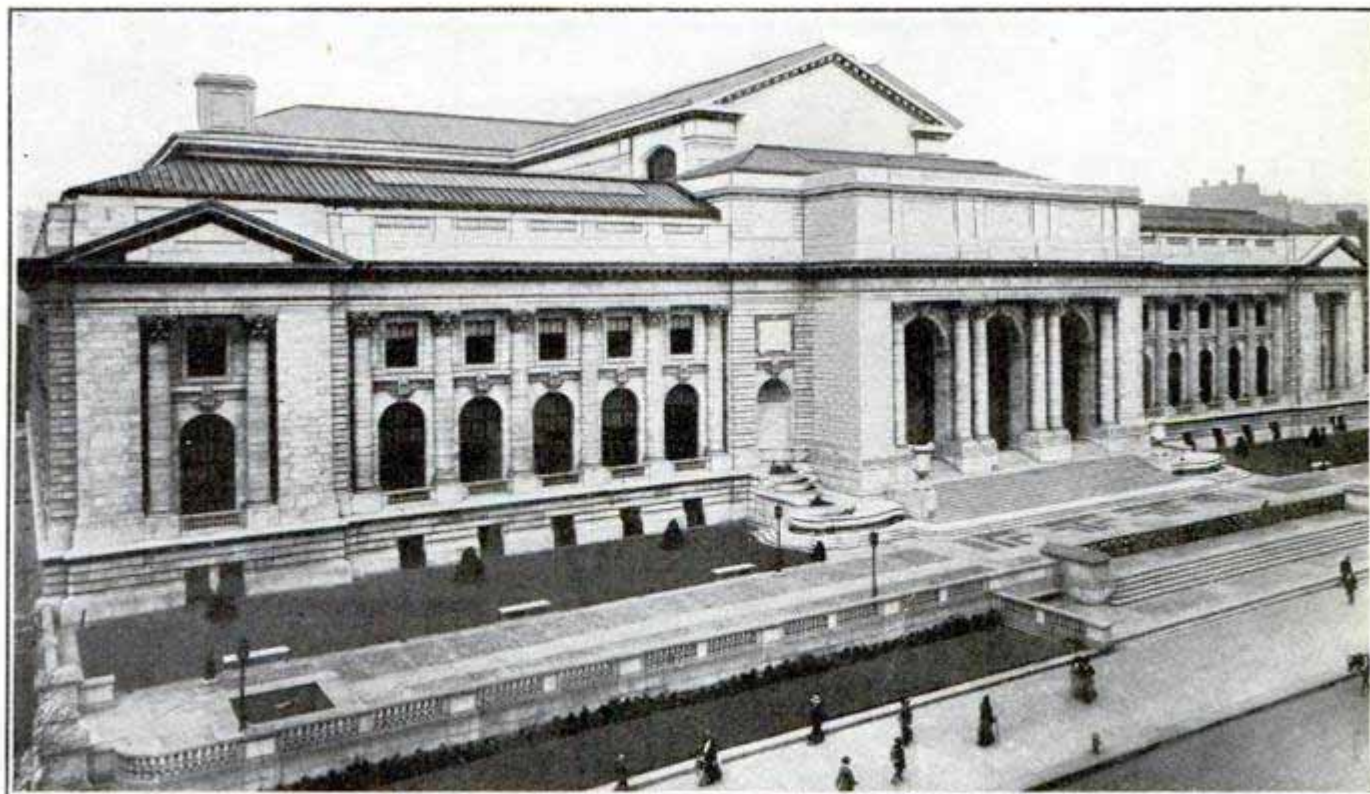

Copyright by Underwood & Underwood

## NEW YORK'S IMPRESSIVE PALACE OF BOOKS

The library contains the accumulated collections of the Astor, Lenox, and Tilden libraries. The building fronts on Fifth Avenue and extends from 40th to 42nd Streets

**"LADY SWITCHMEN"**

During a strike of railroad operators in California, it was found necessary to move a freight car from a sid-



Women Switching Cars in an Emergency

ing on the property of a big cannery. No railroad men would handle the car, of course, and the men employed about the cannery were rather shy of doing anything that might class them as "strike-breakers," so the women were called upon to make up a crew. There was no difficulty in securing volunteers and as the photograph

shows, seven members of the fair sex used muscles and crowbars and brakes to good effect.

### HUGE TELEPHONE SERVICE FOR NEW YORK HOTEL

A greater telephone service than is afforded by most cities and towns, and provided by what will be the largest private telephone exchange in the world, has been contracted for a hotel which will shortly be erected at the corner of Broadway and 34th street, New York City. No less than 100 trunk lines will enter the hotel which will contain 1,800 stations and four switchboards. The contract gives a service of 500,000 local messages a year at a cost of \$28,334. Besides the regular telephone service there will be 16 telautograph instruments which are covered by a separate contract calling for a further expenditure of \$2,250 a year.

### PROTECTING SAND LEVEES BY OIL APPLICATION

In California, it is necessary to protect some of the low river valleys with levees, to prevent flooding from spring thaws in the mountains. A large part of the subsoil is sand, of which the levees are made. The wind blows this sand and the water washes it, and the erosion is very rapid. As a matter of



Oiling Dikes on the Sacramento River



fact, one of the engineering problems of the age is the control of sand. France has partially controlled large fields of sand by gradually developing plant life, but the process is costly.

In California, the problem has been cheaply solved by sprinkling them with an oil made by a concern in San Francisco. It is applied in the form of a jet, under a pressure of 200 lb. per square inch. The oil penetrates the sand and forms an armor coat 6 in. thick, protecting the sand from the elements.

The picture shows the method of application and the appearance afterward. The system is widely used, and cheap to apply.

### A BINOCULAR MICROSCOPE

A microscope, having two separate oculars with one common objective, was shown and demonstrated before the French Academy of Sciences recently. The oculars are individually adjustable and placed such a distance apart that two persons can observe the same object simultaneously. The microscope is especially intended for educational institutions, where lessons and examinations would be greatly facilitated by its use, but is equally serviceable for many other purposes.

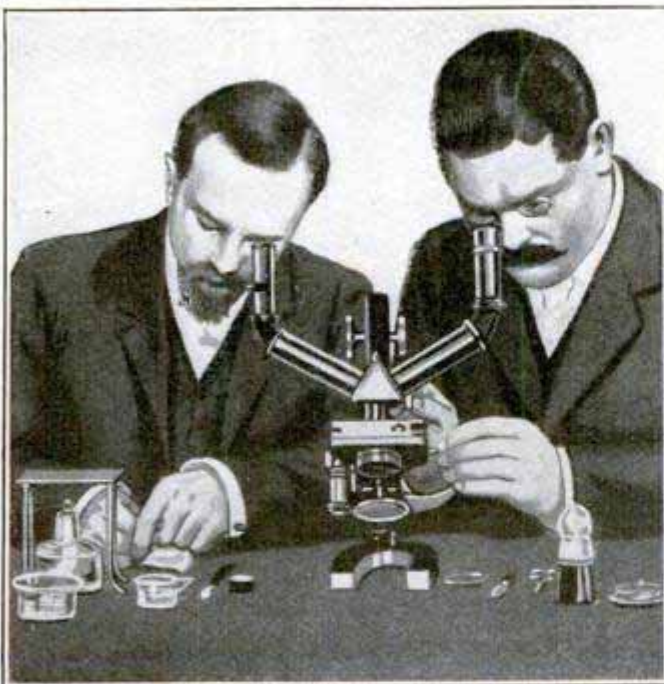

Two Persons Viewing a Single Object with Double Microscope

### PORTABLE WIRELESS SET IN USE IN THE U. S. NAVY

The public has heard much of the recent progress of the United States

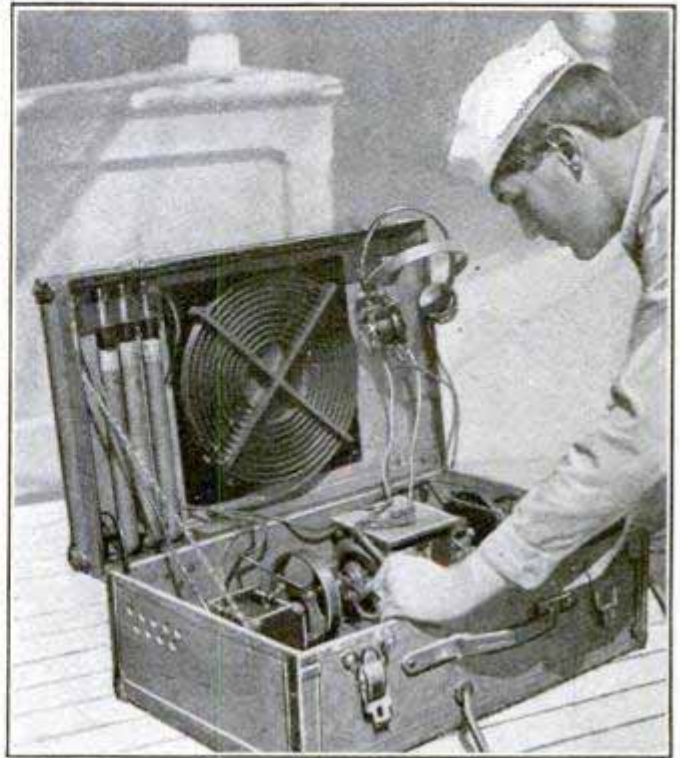

Portable Wireless Set Used in Navy

navy in its development of long-distance wireless telegraphy, but little has been said regarding other recent advances in this field which are almost as important though less spectacular. One of the latter embraces "emergency work" involving wireless communications between a warship and a landing party of seamen or marines sent ashore at short notice in territory where there are no wireless stations in existence, or if they do exist, are in the hands of hostile interests. To enable the establishment of such a wireless link between a landing party and its base of supplies, each of our battleships and armored cruisers now carries a newly designed "portable wireless set" which occupies a case no larger than an ordinary dress suit case and can be readily carried by one man. This lightweight apparatus, which is, of course, entirely dependent upon storage batteries, has a radius of 10 to 20 miles, which is considered ample for the character of work which it is likely to be called upon to perform.

## A 40-STORY SKYSCRAPER TO THE GREAT PYRAMID

**G**RAND old junk by the River Nile,  
Built in a dynasty no one knows,  
What d' you think of my modern style  
With my head 'way up where the star-dust  
blows?

You were assembled, heaven knows how,  
Wet with tears and the blood of man;  
But I'm a Temple of Up-to-Now,  
Contract-built on a union plan.

The Gods of Egypt blessed your shrine  
As slowly your cumbersome walls up riz;  
But mightier deities smiled on mine—  
For I am the home of the Gods of Biz.  
My priests are the wizards who span the zones,  
Drivers of dragons across the seas—  
What could your priesthood do, Old Bones,  
But mumble prayers on their poor, weak knees?

As an office building you're useless quite;  
You have size, perhaps, and an air of wealth,  
But your window space is so short on light  
That you ought to be closed by the Board of  
Health.

I've ventilation and light to burn  
And a vacuum plant for cleaning, too—  
Say, the dust would fly if they'd ever turn  
A vacuum-cleaning plant on you!

You stand in pomp by the sacred sand  
Where the jackals lurk and the mummies sleep.  
You like your location? It ain't so grand!  
Pooh! building lots on the Nile are cheap;  
You're far from the subway and surface car,  
By the Stock Exchange you were never put.  
Why, the land I'm built on is up to par—  
Ten thousand dollars for each front foot.

So back to the scarabs, you hoary wreck,  
Poor old Has Been of other times,  
Sight for the tourist rubberneck  
While the Arab courier grafts for dimes,  
Dream, if you must, of your past renown,  
But don't get chesty—what's that you say?  
*You'll still be standing when I'm torn down?*  
Well, of all the Egyptian nerve! Good day!

—WALLACE IRWIN.

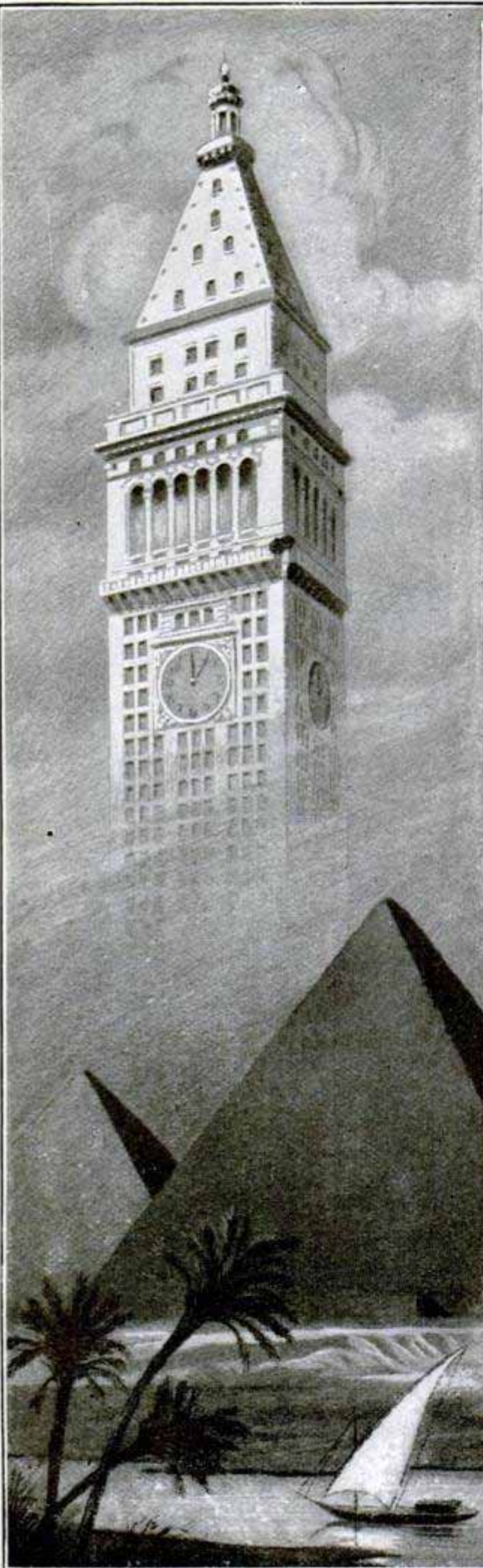

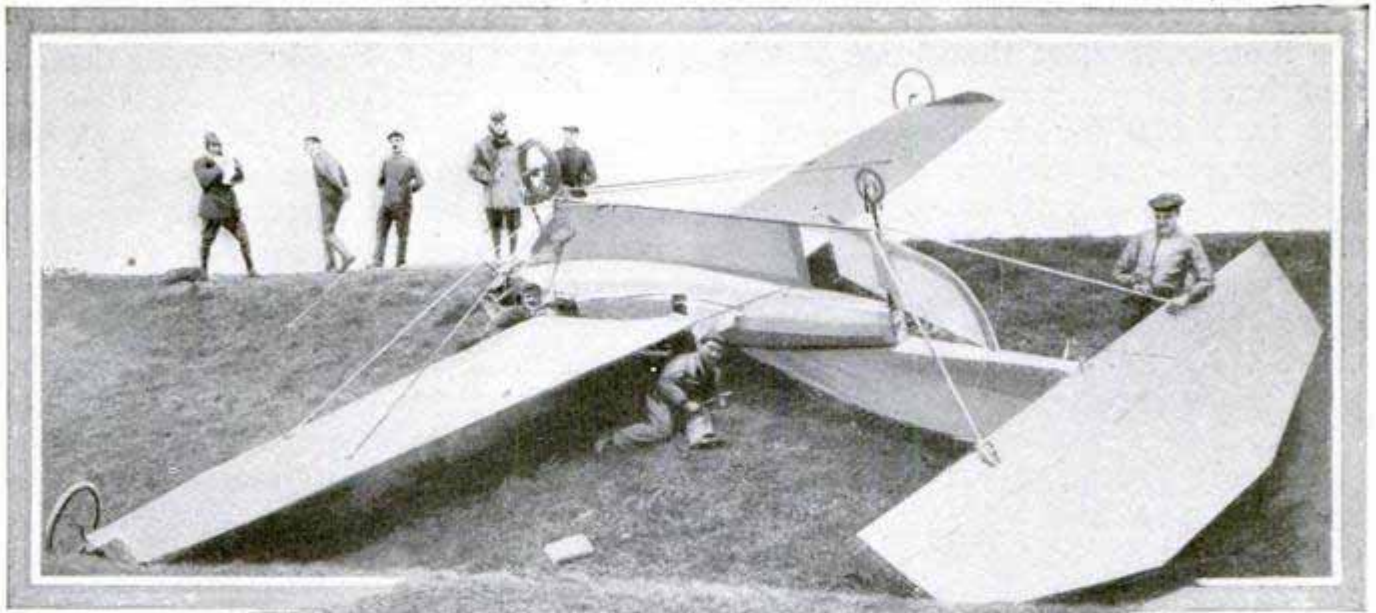

An R. E. P. Monoplane  
That Landed Upside  
Down while Traveling

at High Speed, the  
Operator Being Saved  
by Protection of Frame

## THE FATALITIES OF FLIGHT

By VICTOR LOUGHEED

If a novice in the operation of a high-powered automobile took his machine out on a stormy day and raced the car over rough, mud-covered roads and met disaster, the public would not blame the automobile. Yet men soar into the air in machines of such fragile construction that a conscientious mechanic would be ashamed of them; venture up when there are high winds, and come to grief in attempting reckless exhibition feats beside which "The Loop of Death" of the three-ringed circus is as safe as a Sunday afternoon promenade on Main Street. And in this case, the blame is placed on the whole art and practice of aviation. Mr. Lougheed, in this article, which will be concluded in the August issue of *Popular Mechanics Magazine*, shows that much of the responsibility for aeroplane fatalities is misplaced.—The Editor.

**O**F technical matters with which he has only the slightest acquaintance the man in the street inevitably takes a most superficial view. In nothing is this better illustrated than in the popular attitude toward the fatalities of aeronautics.

At the outset came the thrills inspired by man's first real conquest of the air—by machines capable of real dynamic flight—controlled, fairly stable, and of fast-improving safety. Then promptly followed in the popular imagination and its unfailing mirror, the yellow press, a frenzied exploitation of the horror stories that writers more clever than accurate could spin about the occasional fatalities, which naturally enough have attended the latest development in

engineering and transportation. As a matter of course in this sensational exploitation little account has been taken of such ordinary human frailties as recklessness and carelessness—usually considered only in their relations to the commonplace activities and mishaps of life. Instead, every aviation accident has been regarded as a catastrophe utterly unavoidable, absolutely inescapable—inherent in the very fact of human flight itself.

As a result many otherwise well-informed persons have come to view aeronautical progress as the development of a most desperate and dangerous folly, and to see in every aviator a money-mad participant in a carnival of death, and in every flying ground a shambles.

How different are the facts! In all the thousands upon thousands of miles that have been flown since men first got into the air with power-driven aeroplanes—the prototype of nature's mechanism, the bird, and the only type of flying machine that has really flown—there have been, according to the most reliable statistics obtainable, no more than forty-seven fatal accidents with such machines!\*

This is fewer fatalities than inconspicuously result from the caisson work in building one East-River bridge or one Hudson-River tunnel, or in an altogether commonplace railway or steamship accident. It is a mortality smaller by far than that of the most unimportant wars, which similarly demand sacrifice of valuable lives, but rarely, if ever, in so good a cause—one so definitely in the interests of human progress.

Men are prone to appraise casualty by its horror rather than by its statistics, and the thought of one individual tumbling from the skies grips harder on the popular imagination than the slaughter of a few scores in a factory fire, or a million deaths from tuberculosis. Yet the statistical measure is obviously the only fair one. This is unwittingly conceded by even the most uncompromising of critics, whose invariable retort to the suggestion that men occasionally meet violent death otherwise than by aeroplane accidents is triumphant citation of the fact that there are more of the other things—incompetently piloted automobiles, fenderless street cars, disre-

garded danger signals, or what not—in use. So be it. For it happens that the chief reason aeroplane accidents are becoming more frequent and will continue to become more frequent, in spite of the definitely improving safety of aeroplane travel, is the fact that more aeroplanes are in use.

The law of probabilities is no matter of uncertainty. The most timid thing in the world—money—is safely invested to the extent of hundreds of millions, solely upon the insurance actuary's unfailing ability to calculate correctly, to a minute fraction of one per cent, just how many of us, say 25 years old, will die next year from typhoid fever.

To the city editor whose first business is sensation-seeking, and to his following, the millions of more thoughtless newspaper readers, it may be news that John Smith falls with his aeroplane and merely breaks his neck, or "great news" if, perchance, John Smith fortuitously so contrives it that he is further

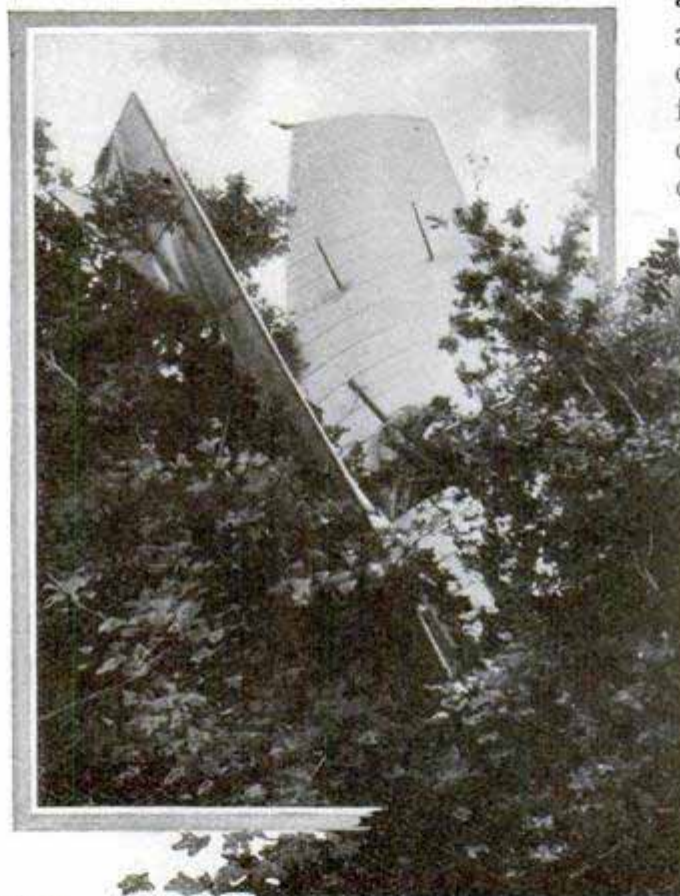

The Artificial Bird Is Not Yet Adapted for Alighting in Trees, though in This Case the Feat Was Accomplished without Injury to the Pilot

translated into the semblance of an exploded weinerwurst. But for John Smith and his family it is probably about as bad, perhaps even worse, if he dies from typhoid in bed or from contributory negligence in the course of his ordinary duties—in either of which cases his taking off can be depended upon not to start a propaganda for the abolishment of beds, or for the abandonment of the ordinary duties.

A little more than two years ago—on September 7, 1908—there occurred the first fatal accident with a power-

\*The deaths number 51 up to May 26, two men having been killed in each of four of the accidents.



Bleriot Monoplane of Chavez Which Fell 30 Feet after Successfully Crossing the Alps



The Wreck of the Bleriot Monoplane in Which Blanchard Was Killed



Smashed Voisin Biplane, Showing Considerable Protection Afforded Operator by Wings



Accident to Antoinette, Showing How Extended Wings Partially Protect Operator

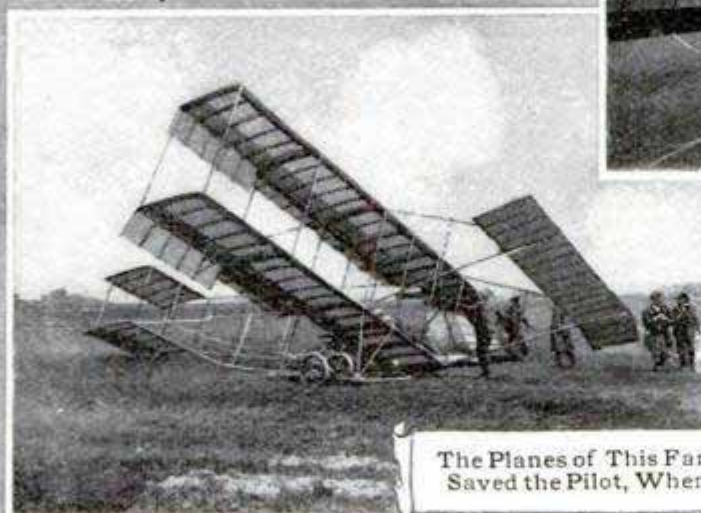

The Planes of This Farman Biplane Saved the Pilot, When It Capsized

driven aeroplane. At that time probably not ten persons in the world had been off the ground in an aeroplane; there were only four aeroplanes known that would really fly; none would go faster than 40 miles an hour; no aviator dared go aloft in a breath of wind; no aviator had been 200 ft. high; and it is doubtful if the total distance rather precariously flown up to that time exceeded a few hundred miles.

Up to the present writing, one man has flown continuously for over 8 hours, another has flown 500 miles in 6 hr. 50 min., several men have flown continuously for over 5 hours, 6 over 4 hours, 28 over 3 hours, and 76 over 2 hours, while one-hour flights have become so numerous as to cease to be chronicled even in the aviation magazines. The English Channel has been crossed and recrossed several times; oversea flights of a hundred miles, more and less, have been made; an aeroplane has flown from London to Paris in four hours, without a landing; the Alps have been surmounted; the altitude record stands at over two miles; repeated cross-country journeys, up to 500 miles in length, have been made at average speeds ranging up to 90 miles an hour and better, and many flights have been accomplished

in strong winds. At least three European aeroplane builders have sold over 300 machines each, and nearly a thousand aeroplane pilots have made a total of much more than 300,000 miles in the course of the qualifying flights necessary to secure the "certificate" of the Aero Club of France. Something like a million miles is the aggregate of all aeroplane flying to date, while it is conservatively estimated that present mileage totals about 55,000 a week for the whole world. Not less than 6,000 persons have made passenger flights that are matters of definite record, and fully thirty million dollars is invested in the industry in Europe alone.

Martyrs to all this progress—just as there are martyrs to all other progress—42 men have paid with their lives for what has been accomplished. As nearly as can be calculated, this figures about one death to each 60,000 miles of flight, which—statistically, and therefore unprejudicedly considered—proves human flight to be only about one-sixtieth as dangerous as it was two years ago.

From the standpoint of the supposed inherent dangers in aviation, an even better showing might be made by a careful analysis of the thirty-nine fatal accidents that have occurred. In-

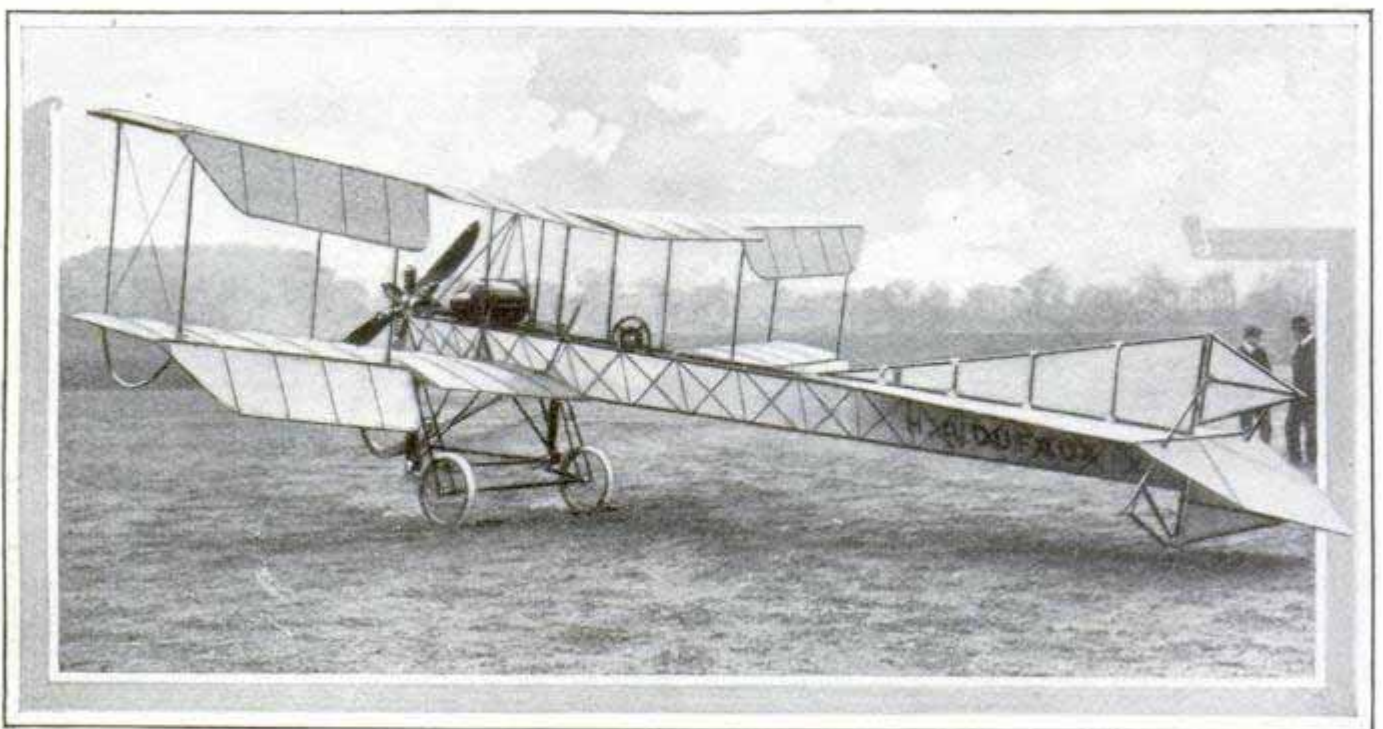

Dufaux Biplane with Monoplane Body, in Which the Operator is Well Protected by Structure Extending in Every Direction, with the Motor in Front Where It Cannot Very Well Fall on Operator

deed, the accomplishment of flight has become almost too easy—with the regrettable result that men wholly unequipped for its performance in this experimental period of its development have essayed it, and have thereupon needlessly contributed to the accident list by perfectly avoidable lack of engineering knowledge, by carelessness and by recklessness. As a matter of fact, so far from being inherently dangerous, flight possesses practically none but extraneous dangers.

Let a thoroughly competent engineer who has proved his ability in aeroplane construction design the machine, and let it be flown in a dead calm, over an unbroken and unencumbered land or water area, by a thoroughly competent pilot who has learned to drive during passenger trips with some other competent driver—and what is there to cause an accident?

It is to be granted that flight cannot forever be confined to such favorable conditions, but the point is that ventures from these conditions would be materially less prolific of mishap if more carefully and more competently conducted—or in any case would place the dangers squarely at the risk of the reckless and over-venturesome.

*(Concluded in August Issue)*

## HAIR TAKES PLACE OF SKIN IN SKIN-GRAFTING

Chopped hair has been successfully substituted for skin in skin-grafting by the French surgeon, P. Carnot, who has applied his method in many cases. It is based on the fact that the cells of the hair and its roots are epidermic outgrowths and can be easily transformed into skin cells. The use of hair not only does away with the necessity of taking skin from other persons, which is a painful operation, but it is said to be an improvement as well, as it is strong and hardy, and, being injured to a minimum of nutrition, is able to thrive under unfavorable conditions, such as prevail where grafting is necessary.

The manner of performing the operation is simple, a few hairs being pulled from the head of the patient or of a relative, and, with the bulbous root removed, the freshest or newest parts are cut into small pieces, so as to form a coarse powder. This powder is then strewn over the surface of the wound and a proper bandage applied. Within a week white spots appear on the surface, rapidly increasing in size. The spots extend and thicken, and finally form a perfect new skin.

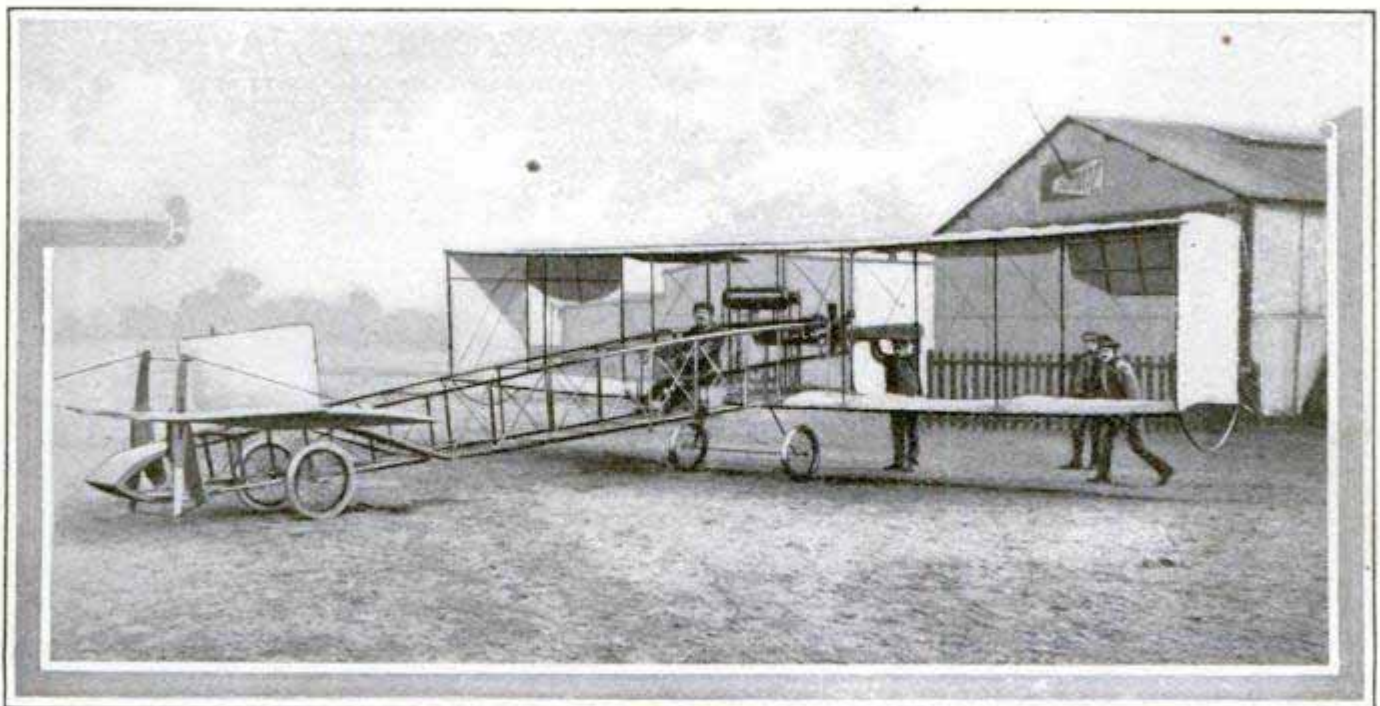

The New Tailless Voisin Biplane, in Which Most of the Frame is in Front of the Operator—Its Weak Point is That the Motor Might Crush the Operator, If the Machine Fell

### MOTORCAR TOP OPERATED BY CRANK

An ingenious patent top for automobile bodies is shown in the accompanying illustrations. The hood is ex-

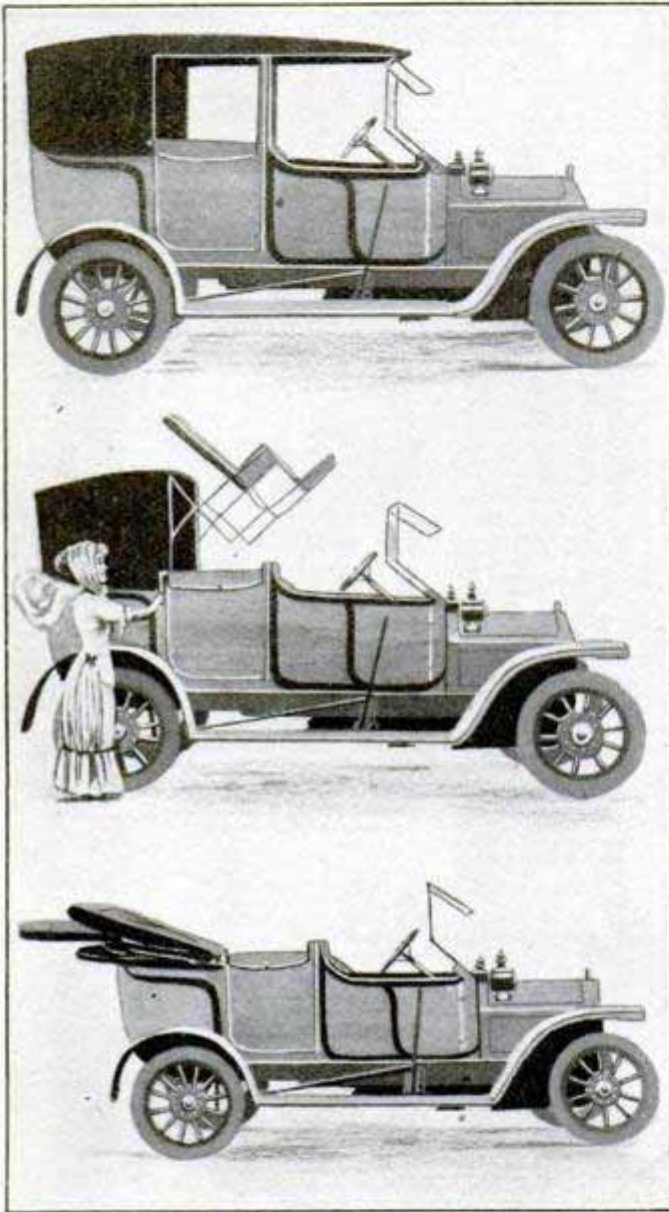

Top Completely Extended—The Extension Part Being Drawn Back—The Whole Turned Back Out of Use

tended into place or withdrawn by means of a winch handle inserted in a socket. A socket is provided on each side so that the hood can be operated from either side in a moment. The back part of the hood folds back in the ordinary way, but the extension frame of the forward part works on the lazy-tong principle.

Electrically made ice is cheaper than natural ice, in most large cities, when the cost of electric power does not exceed 5 cents per kilowatt-hour.

### ELECTRIC SHOCKS DUE TO STEAM FROM TRAIN

That exhaust steam from passing trains has the power of producing forcible electric charges on telegraph wires was conclusively proved in South Africa recently when some linemen were unpleasantly shocked by the wires during the laying of a new telegraph line on a stretch of railroad between Natal and the Transvaal. There was no current on the wires at the time, and at first the source of the electricity was wholly inexplicable. Later, it was noticed that the shocks were most powerful when a train was passing, and the linemen naturally suspended work while a train was in the vicinity. After a series of careful observations, which left no room for doubt, it was discovered that the steam exhausted by the engines had the power of producing an electrification of the air and earth in the immediate neighborhood, and that the telegraph wires served to conduct the electric charges to anyone touching them at the time. The only wonder was that the phenomenon had not been noticed before, the probable reason being that the local conditions were especially favorable for its occurrence in this particular instance.

### NEW YORK TO HAVE HUGE TELEPHONE BUILDING

The plans for the new exchange of the New York Telephone Co. call for an immediate structure of 16 stories, on foundations adequate for a 25-story building, which will be its ultimate height. It will cover a plot of about 22,000 sq. ft. between Church Street and West Broadway. All the switchboards, of which the main long-distance switchboard will be the largest, are to be ventilated by three large blower fans.

It is said that the structure will be the largest telephone exchange building in the world, and that the main long-distance switchboard will be the largest in the country.



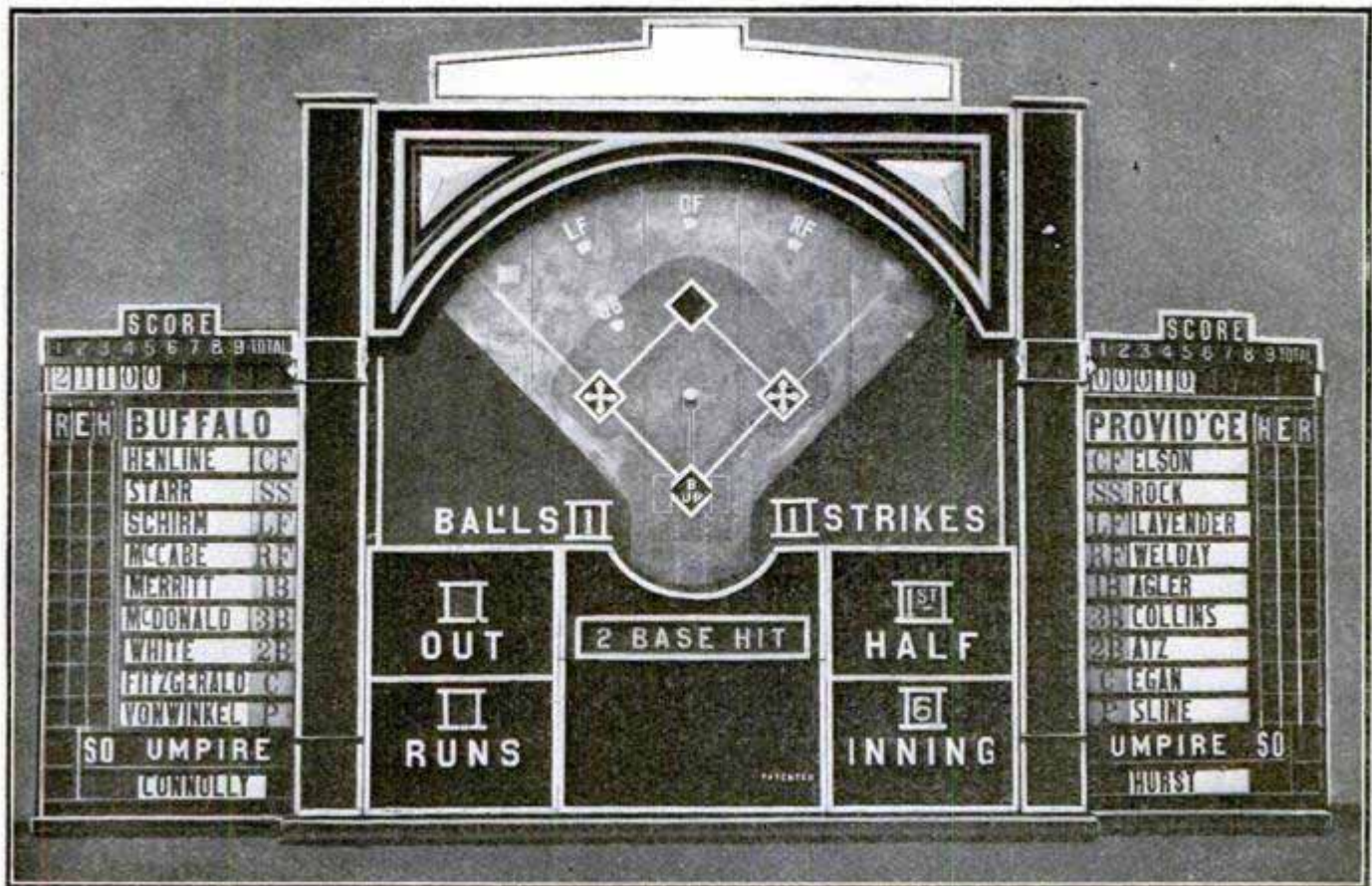

With this New Scoreboard the Fan Who is Unable to Attend the Game Can Follow Every Movement of the Ball and the Players

## A NEW SCOREBOARD FOR THE BASEBALL FANS

By GEORGE A. OBENAUER

A new form of baseball scoreboard, on which a baseball moves about the diamond, reproducing exactly the movements of the ball on a baseball field which may be a thousand miles away, has been introduced in an Eastern city. It is really a baseball game played on a field 17 ft. long and 35 ft. wide. The eager fans, unable to follow their home team about the country, are thus enabled to watch the sphere as it flies about the field. The device depicts the flights of the ball, introduces the players, and shows all the hits, catches, throws, pickups, and errors.

When the game is started in some other city, the telegraph operator who has charge of the telegraph instrument which is situated behind the board, gives word to the four men who operate the board. He is told, over the wire, just where the ball is thrown, or hit, whether in practice or in the game, and the ball on the board moves

about from one position to another, just as on the field. The line-up of each team is shown, opposite which are located three columns for runs, hits and errors.

Before the game is started, the ball is pulled around the board from one player to another, just as is done in practice on the field. This is done by means of strings, invisible to the spectators, which are attached to the ball and may be reversed in any direction.

Six seconds after the game is called, a bell is rung on the board and by means of a lever, a little card, on which is printed "B UP," is dropped over the home plate to signify that the batter is up. If the first ball thrown is a strike or ball, the ball passes from the pitcher to the catcher, and the umpire's decision is shown on the board by figures, which are operated the same as the "B UP" over the home plate. If the batter should hit the first ball pitched, it would go from the

pitcher's box to the home plate only, and then direct to the very spot to which the ball is hit on the field. If it be a ground hit to one of the infielders other than the first baseman, the ball passes to the player making the stop and then to the first baseman. If the runner is safe at first base, a cross is dropped over the base, as shown in the picture, and if caught out, an "O" is shown over that base at which the out is made. Foul hits, either in back of the catcher or in the field are also shown.

When a fly is made, the ball is moved to whoever makes the out, and the "O" is shown at the home plate. A feature of the board is that when the ball is hit to a fielder, it moves slowly so as to take up as much time as on the field, and the spectators know not whether it is a hit or an out until the ball reaches its destination and the sign "Flew Out" is shown where the words "Two Base Hit" are shown in the accompanying illustration. The same goes with a hit. The ball moves slowly into the outfield and the cross

shows up as the man passes each base and remains only at the bag at which the runner stops.

When a man reaches his base safely on an infield drive, an arrow, the ends of which are shown opposite the score on the picture, is lowered to show whether the runner was entitled to a hit or the fielder an error. If it be an error, an arrow with the word upon it will drop opposite the fielder's name, and the "hit" arrow opposite the batter, if it be a hit. Another arrow is kept lowered to show which man is at bat. The sign also shows the word "Fumbled" when an error is made.

The inning, and the outs and runs for that half inning, are shown by figures operated mechanically, and the total score is shown above the line-up.

After each half inning, the boards showing the runs, hits and errors are changed and cards inserted, showing the number of hits, runs or errors each player has to his credit as the game goes along. During the entire game not an operator is seen. All is worked by levers and strings behind the board.

### CURIOUS FOUR-WHEELED MOTORCYCLE

A passenger motorcycle of a design not at all ordinary is shown in the accompanying illustration. The passenger body, the use of which converts the machine into a 4-wheeler, can be

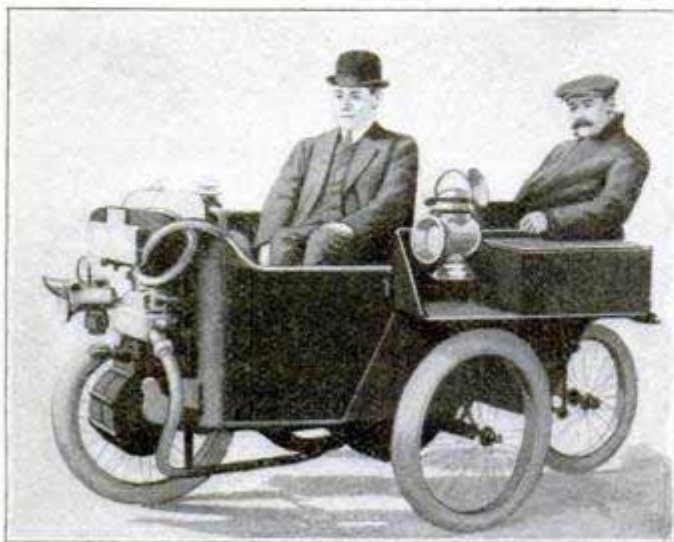

Novel 4-Wheeled Motorcycle Which has Established a Good Record

detached in five minutes. With passenger body attached, this machine has run 2,000 miles very satisfactorily. The motive power is a  $2\frac{1}{2}$ -hp. water-cooled engine, and the drive is by a 2-in. flat belt.

### CHAVEZ AEROPLANE IN PERUVIAN MUSEUM

Felipe Chavez, brother of George Chavez, has given the aeroplane used by the latter in his fatal flight over the Alps to the Peruvian government. The ceremony of placing it in the National Historical Museum was held recently. With the exception of the two wings, one of which is in a museum at Paris, the remains of the machine, badly broken and twisted, are all together.

During the year 1910 there were 550 boiler explosions in this country, resulting in death to 277 persons and injury to 506.

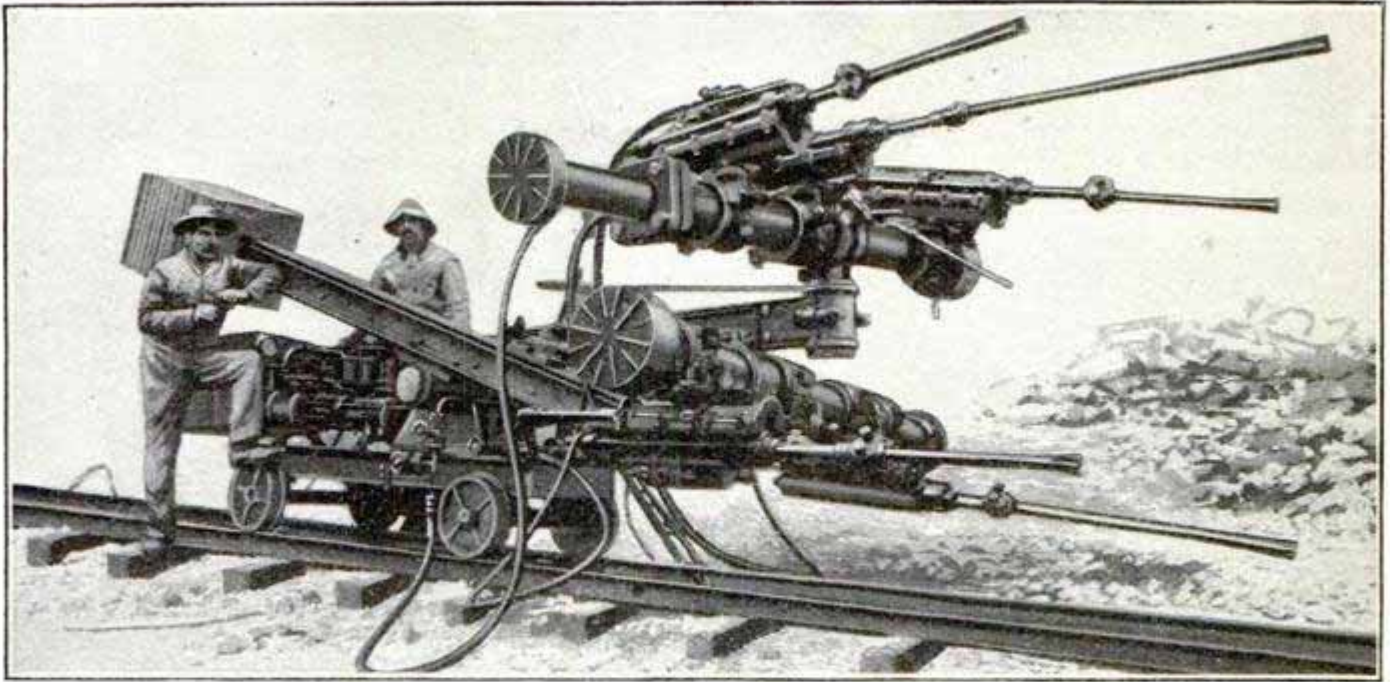

One of the Drills Used in Piercing the Alpine Tunnel

## BORE OF NEW ALPINE TUNNEL COMPLETED

The bore of the Loetschberg tunnel, which is nearly  $9\frac{1}{2}$  miles long, and the third longest of the great tunnels of Europe, was completed the early part of April, the meeting of the two working divisions occurring in the heart of the mountain on March 31. The blast which opened a breach was followed by wild enthusiasm, the engineers and miners of both sides repeatedly embracing each other. Engineer Rothpletz, in charge of the northern division, handed a bunch of Alpine flowers to Chief-Engineer Moreau, in direct charge of the southern division, then the chief engineer passed through the opening, followed by the workers.

The tunnel, which takes its name

from the pass under which it runs, is a little to the east of the Balmhorn, a 12,000-ft. peak. It is  $3\frac{1}{4}$  miles shorter than the Simplon tunnel, and  $\frac{1}{4}$  mile shorter than the St. Gothard. Unlike other Alpine tunnels, it is curved, its course having been diverted owing to a disaster in 1908, when the Kander River was tapped by accident, the water killing 25 men in the workings. When the tunnel is officially opened in 1913, the time between London and Genoa will be shortened three hours.

CA floating dock, large enough to accommodate ships up to 27,000 tons' displacement, is being built at Montreal, Canada.



The Meeting of the Two Divisions in the Heart of the Mountain



Electric Locomotive Used in Connection with the Work

## ANTI-ROLLING TANKS FOR SHIPS

The illustrations are diagrams of anti-rolling tanks for ships, made from rough sketches of Sir Phillip Watts',

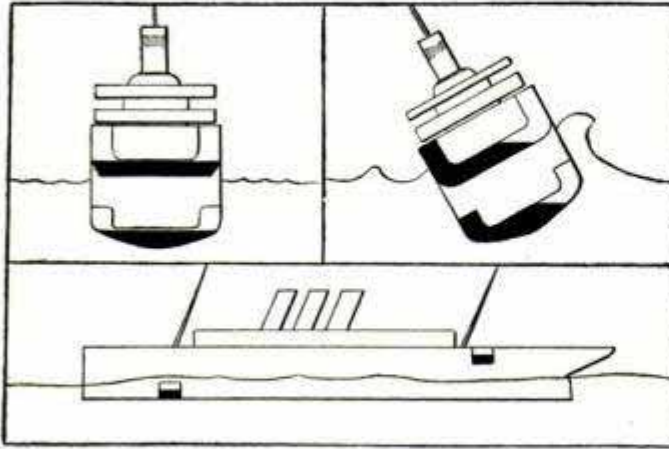

Courtesy Daily Mirror, London

Water in Tanks When Ship is Steady      Position of Water When Ship Rolls  
Location of the Fore and Aft Tanks

director of naval construction of the British navy, who had such tanks installed in the old ironclad "Inflexible."

The idea, according to Sir Phillip Watts, results in a "ship that carries her own waves." A ship at sea synchronizes in her rolling with the waves. She does not hurry or delay in her swing, but moves just as the waves force her to. But when, fitted with anti-rolling tanks, she goes over to starboard, some 90 tons of water in her tanks also goes to starboard, and the weight of this delays her from coming back on the rhythm of the waves, really acting as a wave working in the opposite direction. Consequently, the regular swing of the waves is broken, and the ship, by virtue of her own self-carried waves, is

able to resist to a large extent the rolling power of the sea.

Such tanks are being used on the 14,000-ton liners "Ypiranga" and "Corcovado" with considerable success. These ships, although new and of excellent construction, were bad rollers before the anti-rolling tanks were installed.

### VERTICAL FLUTE MAY BE USED IN NEW OPERA

A flutist in the orchestra at the Scala opera house at Milan, Italy, Signor Abelardo Albisi, has invented a new instrument of great compass in the lower notes, which he has christened the "Albisiphon." By means of a special attachment, or air chamber below the mouthpiece, it can be played like a clarinet, but the inventor claims it to be a genuine flute. Richard Strauss is said to be interested in this new instrument and may include it in the orchestration of his new opera.

### WHALES STRANDED ON THE SAND

Following a recent upheaval on the coast of Perkins Island, northwest Tasmania, 37 sperm whales were found stranded on the sand. The illustration shows just a few of them lying like huge water-worn rocks on the beach. An excellent idea of their size may be gained by comparing them with the human figure shown in the picture.



A Few of the 37 Huge Sperm Whales Stranded on Perkins Island, Northwest Tasmania

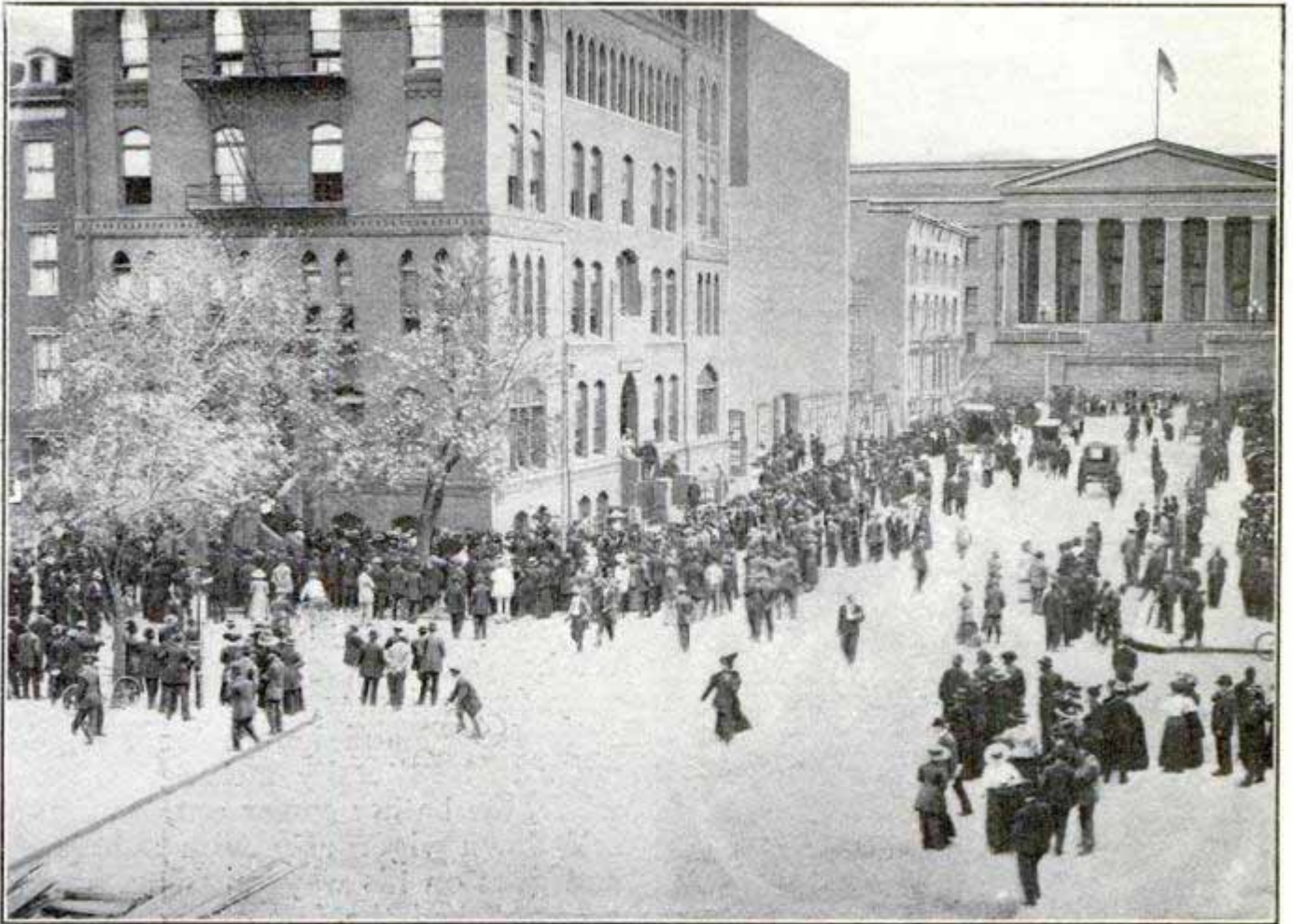

2,500 Government-Job Seekers Waiting for Civil-Service Office to Open

## A STRANGE VIGIL AT THE NATIONAL CAPITAL

The sun rose the other day in Washington on 2,500 patriotic men and women of all ages, surrounding a government building, anxious, for a consideration, to serve their country. The building is occupied by the Civil Service Commission and on two sides of it was a line of tired humanity, three abreast, stretching one block to the west and one to the south. Most of the patriots had been there since midnight with the full knowledge that it would be nine o'clock in the morning before the doors would swing open and admittance granted, one at a time.

And the cause of all this foregathering? No big positions to be handed out; no rewards for faithful service; nothing but a concerted rush to get an application blank which, when properly filled out and duly endorsed by two disinterested citizens, gives the holder the right to take at some future day an examination, the successful

passing of which means a place on a long list of "availables" for government jobs.

The size of the crowd and the eagerness with which the men and women in line watched the building naturally suggested the appointment of hundreds of them to lucrative positions, but in reality they were all there for a chance to qualify as unskilled laborers and char-women with the highest salary \$800 a year. The blank applications for these places are handed out once a year only, on one day and in limited number. Hundreds were turned away after the last folded white paper and book of instructions had been passed over the counter.

The watchmen at the building tell some interesting stories of the scenes on the narrow street during the long hours of the night; of young girls stupid with fatigue seeking rest by leaning against trees; of meager lunches

secretively relieved of their newspaper wrappings and as furtively eaten; of the curious shifting of the line after it had formed and the tired waiting throug stood on one foot and then on the other. It was a curious scene for the nation's capital.

### TUBULAR MICROMETERS OF LARGE SIZE

These tubular micrometer calipers, designed for measuring the diameter of shafts, wheels, piping, etc., are of in-

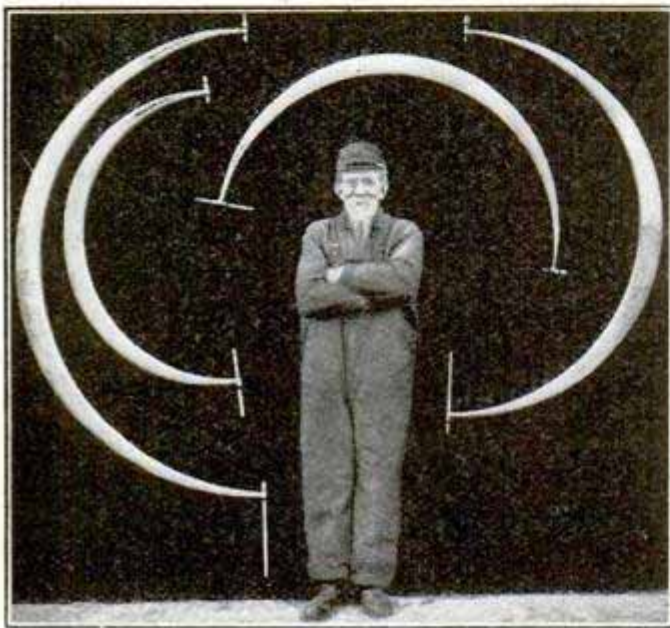

Bow Micrometers of Large Size

terest because of their unusual size, which is clearly shown as compared to the height of a man. They are made in sizes up to 72 in.

### NAVAJO "SWEAT HOUSE"

On the Navajo Indian reservation, comprising 20,000 square miles in northern Arizona and New Mexico, such a thing as a bathtub is unknown. Nevertheless, it must not be assumed from this that the Navajos, of whom there are about 28,000, never take a bath. Much of the reservation is desert in character, with water a scarce and precious commodity. Perhaps this explains why it is that they have invented a method of taking a bath without the application of a drop of water.

Near every "hogan" may be seen a "sweat house." This is a small oven-like structure usually built of adobe clay, but sometimes consisting simply of a wooden frame covered with skins and blankets. The person desirous of taking a bath builds a fire close to the sweat house, and places in the fire a number of good-sized stones. When the stones have been heated red hot, they are piled up against the wall in the interior of the sweat house. Then the bather divests himself of all clothing and crawls into the sweat house, allowing only the head to protrude, and closing the entrance by means of heavy blankets, held tightly around the neck, so that the air heated by the red-hot stones cannot escape. In a very few minutes, he begins to perspire freely, and before long, he appears to be literally melting. After a while, the bather comes out, rubs himself down vigorously with a blanket, and goes on his way rejoicing, having accomplished the feat of taking a waterless bath. The sweat bath is really equivalent to a Turkish bath with the cold plunge omitted. It accomplishes every purpose of the bath quite as efficiently as if an enameled tub, with nickelplated trimmings, and gallons of both hot and cold water were used. Thus perishes the common opinion that the redskin is never known to take a bath.



An Indian "Sweat House"

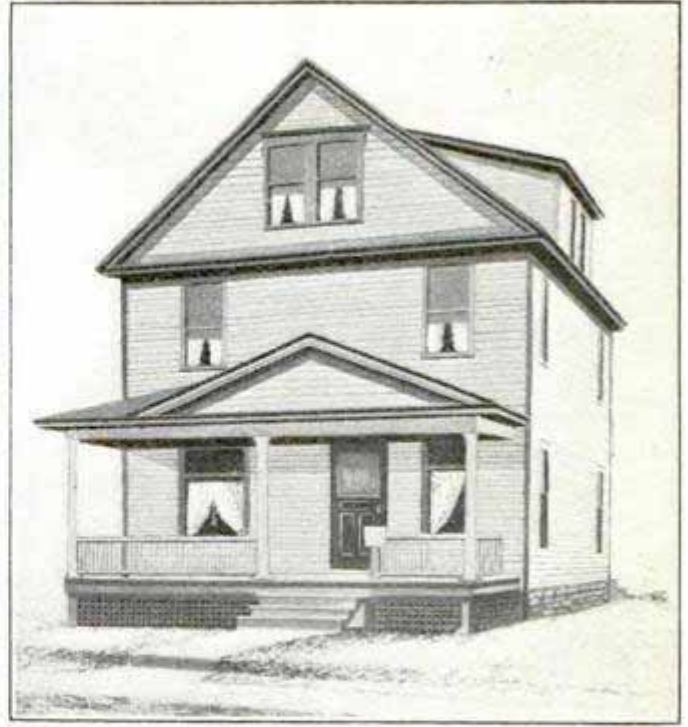

A Concrete House and a Wooden House, Practically Identical as to Size and Design, the Concrete House Costing \$194.60 Less Than the Wooden One

## CONCRETE HOUSE CHEAPER THAN WOODEN HOUSE

That it is possible to build a concrete house for less than a like house of wood, is demonstrated by these houses, which are to all practical purposes identical as to size and design. The wooden house is 26 ft. wide by 30 ft. deep, and

the concrete house, 27 ft. wide by 31 ft. deep. The inside dimensions are alike in both houses. The walls of the concrete house were constructed with a hollow wall machine, by means of which two separate and distinct walls are erected simultaneously, with an air space between. The wooden house cost \$194.60 more than the concrete.

## SIMPLE COURSE DIRECTOR FOR AIRMEN

A simple apparatus that enables an airman to hold to his direction of flight in any kind of weather, and even to detect lateral deviation from a given course when the landscape is not obscured by fog or cloud, has recently been patented by a French inventor.

It consists essentially of a camera, a mirror, and a compass needle having above it a long pointer which can be set to a desired course and fixed so as to move with the needle. The camera has its lens pointed downward so as to project upward a view of the landscape on a horizontal piece of ground glass. Marked legibly on this glass, and just under the long end of the compass pointer, there is a black line coinciding with the longitudinal

axis of the aeroplane, that is, with the line of flight on a straightaway course. The airman can see a vertical image of the pointer and the ground glass (with its landscape picture on it) in the mirror which is situated just

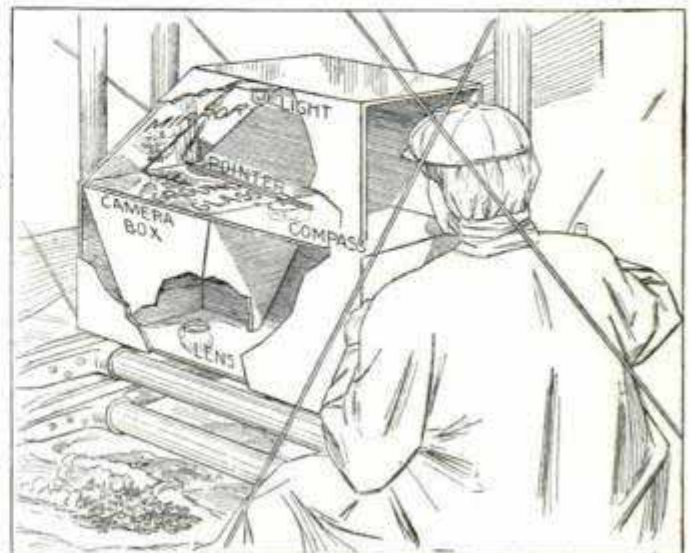

Navigating Device for Airmen

above them and inclined to the glass at an angle of 45 deg. Angular deviation of the aeroplane from the desired line of flight is made apparent by an angular difference between the pointer and the black line, and lateral drifting can be detected by the apparent movement of prominent objects in the landscape, as seen in the mirror, toward or away from the black line.

The apparatus is suspended so as to remain horizontal at all times and is situated so that the mirror is in the direct line of sight of the airman. It may be used alone or in conjunction with a map having the desired course marked upon it.

### A NEW ELECTRIC CELL

A radically new kind of electric cell is announced from Italy. The cell contains a horizontal amalgamated zinc plate, near the bottom, and a plate of lead peroxide, also horizontal in the middle. The space between the

plates contains sulphuric-acid solution, and that above the lead is filled with compressed oxygen gas which replenishes the cell by reoxidizing the lead as fast as it is reduced from peroxide to metal by the generation of electricity in the cell. When the cell is discharged, it may be recharged like a storage battery, only very much faster, it is claimed. It is said to be both light and economical.

### NEW SEARCHLIGHT TOWER AND CRANE

One of the distinct novelties in design in the new battleships of the dreadnought class in the United States navy is found in the presence on deck of steel structures designed to serve the dual purpose of searchlight towers and revolving derricks or cranes for lifting heavy weights aboard ship,—notably the steam launches which act as tenders to the battleship when she is in port, but which must be hoisted into position on deck ere the ship sails

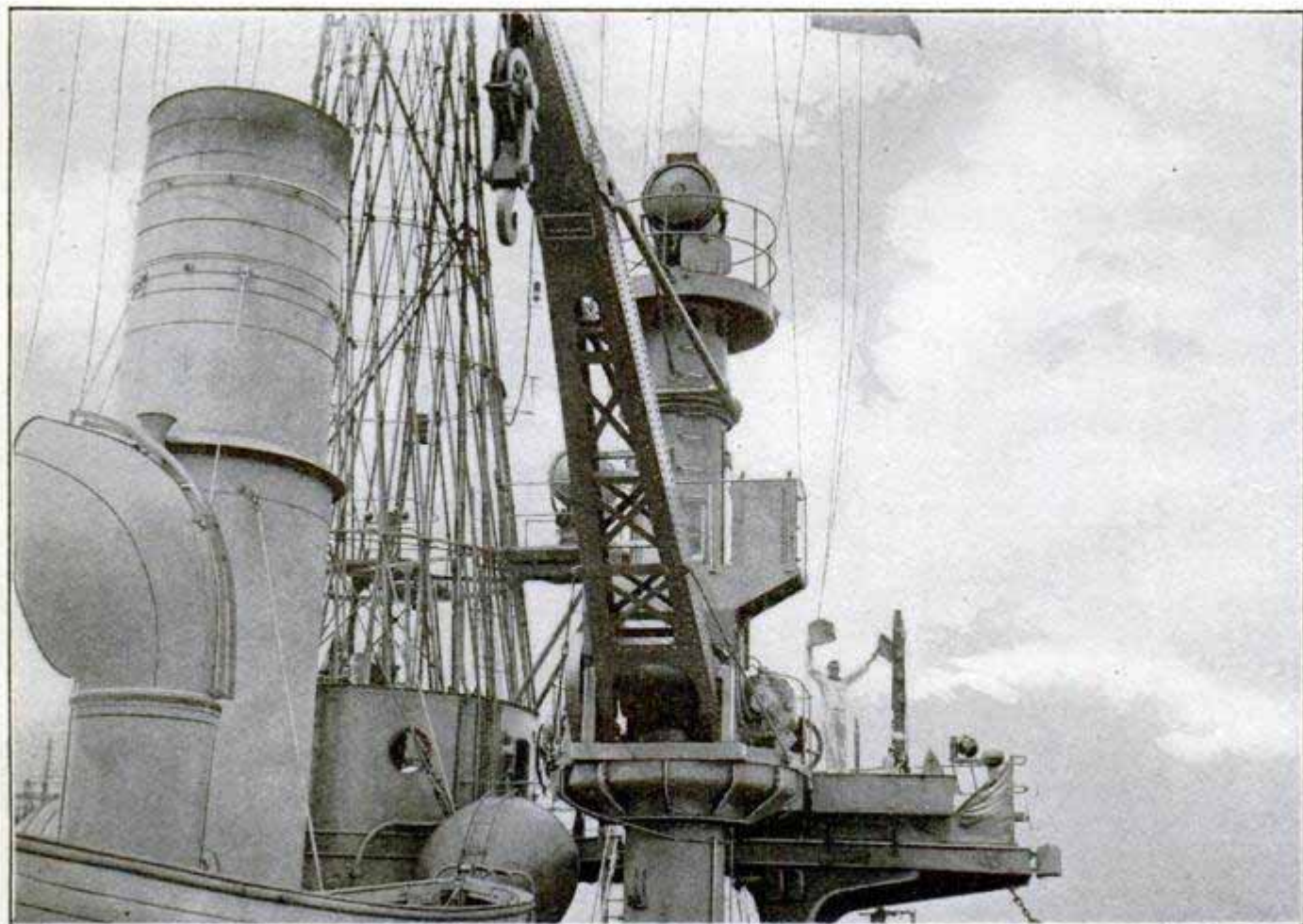

The New Tower on Latest Battleship Which Serves for Crane and for Searchlight



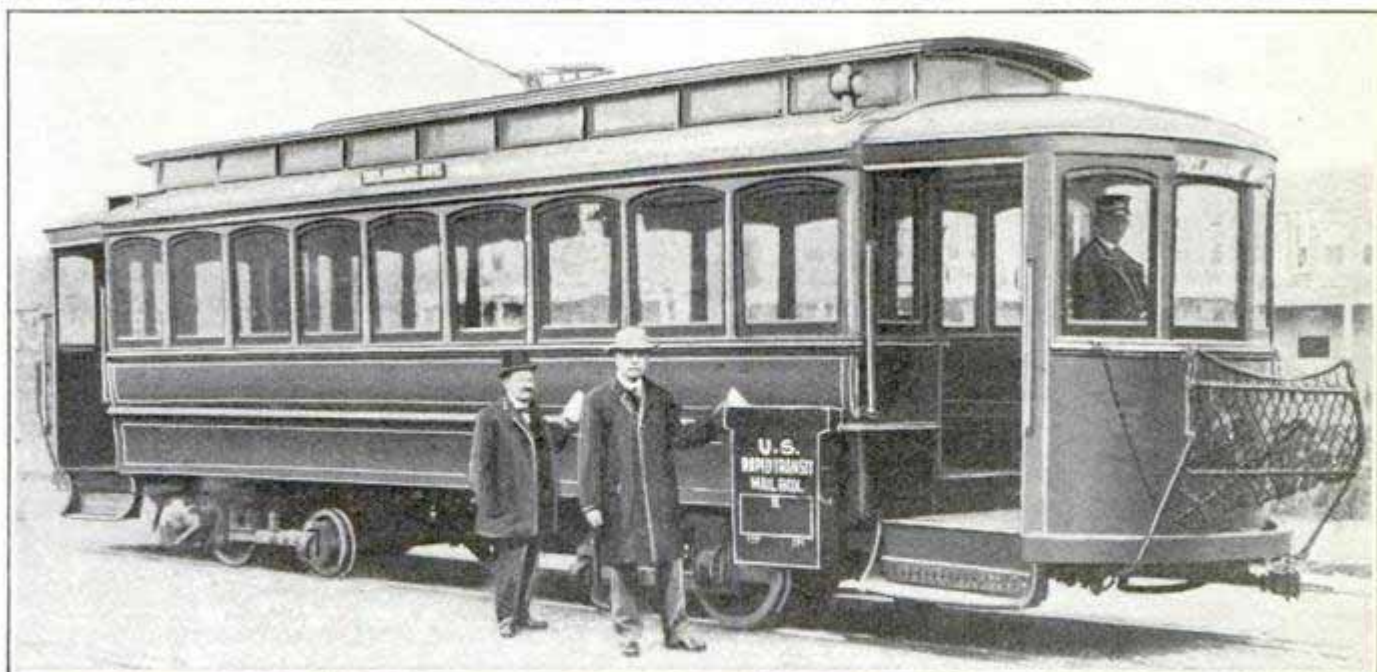

Street Car Equipped with Mail Box

on a cruise. The new structure is somewhat suggestive in outline of the old-style military mast, cut off short, and affords an elevated platform for an electric searchlight of the largest size, in addition to its primary function as a crane of 40 to 50 tons' capacity.

### MAIL BOXES FOR STREET CARS

The Postoffice Department is making experiments with the installation of street-car mail boxes of such character that letters may be deposited while the car is in motion. Experiments at Wilmington, Del., were not successful, several persons narrowly escaping injury in attempting to deposit letters while the cars were moving. At Des Moines, Iowa, however, the system has been put into effect with most satisfactory results.

The mail box is said to be capable of receiving mail while the cars are moving at a rapid rate of speed. This device is soon to be tested in Washington. It provides for the reception of letters from both the outside and the inside of the car. If the experiment in Washington demonstrates the popularity of the convenience, its extension will be made to other large cities.

When the street-car mail box is installed, there will be no excuse for street-car travelers who bring home at

night the letters which they were commissioned by their trusting wives to mail in the morning. When one of these forgetful persons takes his seat in a car to ride to work, he will find staring him in the face a large United States mail receptacle, which is his cue to approach and perform the duty which he took solemn oath to carry out.

Congress voted \$10,000 to carry on the street-car mail-box experiments.

### MOTORCYCLE LINEMEN TO CUT WIRES AT FIRES

The danger to firemen from falling "live" wires at fires is such as to suggest that the electric companies provide competent linemen with especially equipped motorcycles and send them to all fires.

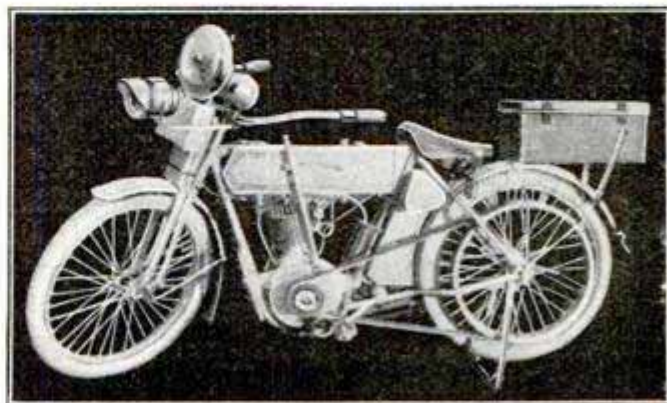

Motorcycle Used by a Lineman Who is Sent to All Fires to Cut Dangerous "Live" Wires

Such a motorcycle is shown in the illustration. It is equipped with a large electric alarm gong, and a galvanized iron box, in which are climbers, rubber gloves, pliers and the batteries energizing the electric gong.

## WOMEN "INSURGENTS" IN THE FARMING BUSINESS

Whatever may be surmised at first glance, the lady of the exaggerated jupe-culotte is not a member of the Mexican insurrectionist artillery pre-



Adjusting the Sundial which Sets Off the Cannon Automatically at Noon

paring to defend her pretty little private fort against the forces of the tyrant Diaz. The insurrection, however, is all there and all directed against the tyrant Man. In fine, she of the honest workingman's jeans is one of the suffragette farmerettes now being turned out by Mrs. Belmont's Long Island colony—to the general end that they may run the earth in absolute independence of the legitimate occupants of similar jeans. The cannon is a sort of emancipated dinner-bell, and the thing that looks like one end of a stereoscope is a lens rigged to the sundial which forms the cannon's bed. As the sun works around to noon, the solar rays are focused on the fuse, and with the blast, liberated woman knows that dinner is served. And, if one pause to ponder, this is a refined and soothing way to fire a cannon. Having set the mechanism, even an average walker can put ten miles of quiet open country between herself and the chance of shattered ear-drums or lacerated nerves.

¶ There are at least 60 amateur wireless telegraph stations in the vicinity of San José, California, constructed and operated by boys. Messages are sent for comparatively long distances, and have been received from as far away as Honolulu and Alaska.

## A MILLION-PIECE THEATER CURTAIN

When building an \$8,000,000 theater of white marble, as the temple of the nation's dramatic art, the one wholly impossible quality is mediocrity. So felt Señor Boari, the distinguished Mexican architect, when seeking a proper curtain for the new national theater in Mexico City. Beauty and security against fire were equally necessary, and funds were not limited. The net result was the exquisite mosaic glass curtain which was recently completed at the Tiffany furnaces.

All told, nearly one million separate pieces of Favre glass were used in the composition of the curtain's great picture, which is executed in the spirit of a romantic Mexican legend connected with the snow-capped volcanoes depicted (Ixtaccihuatl and Popocatepetl). Attempts had been made with paints and with Bohemian and Venetian glass, but without success. The pieces of glass were inlaid one by one, into a concrete composition, impervious alike to heat and moisture. The task occupied 20 expert work-

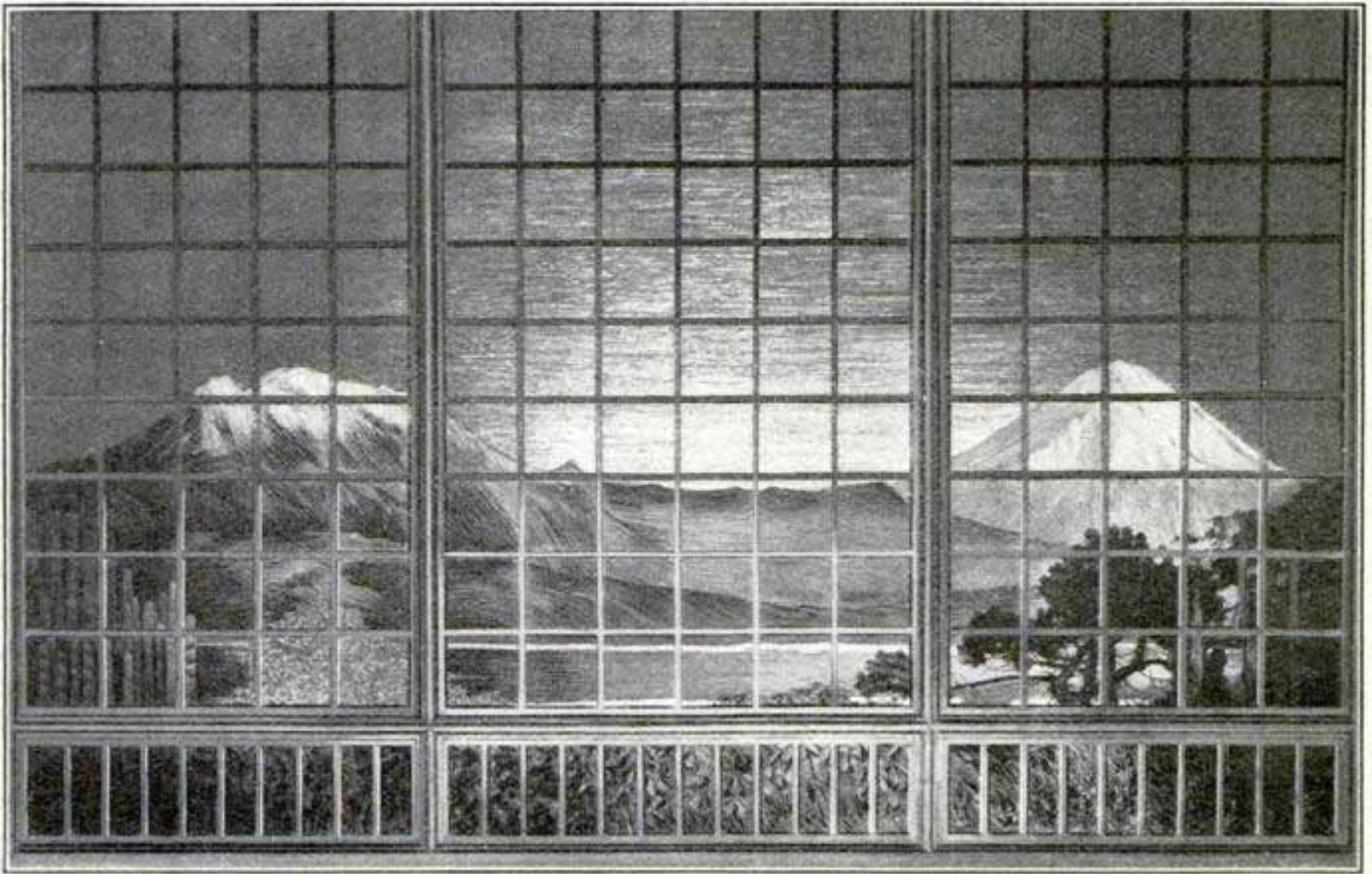

The Wonderful Curtain, Made of a Million Pieces of Glass in Beautiful Coloring

men for something more than 15 months, and when completed covered 2,500 sq. ft. and weighed 27 tons. For safety in transportation, the curtain was divided into some 200 panels about

3 ft. square. When finally in place, it will be raised and lowered by hydraulic pressure, and the time required for either operation will be only about seven seconds.

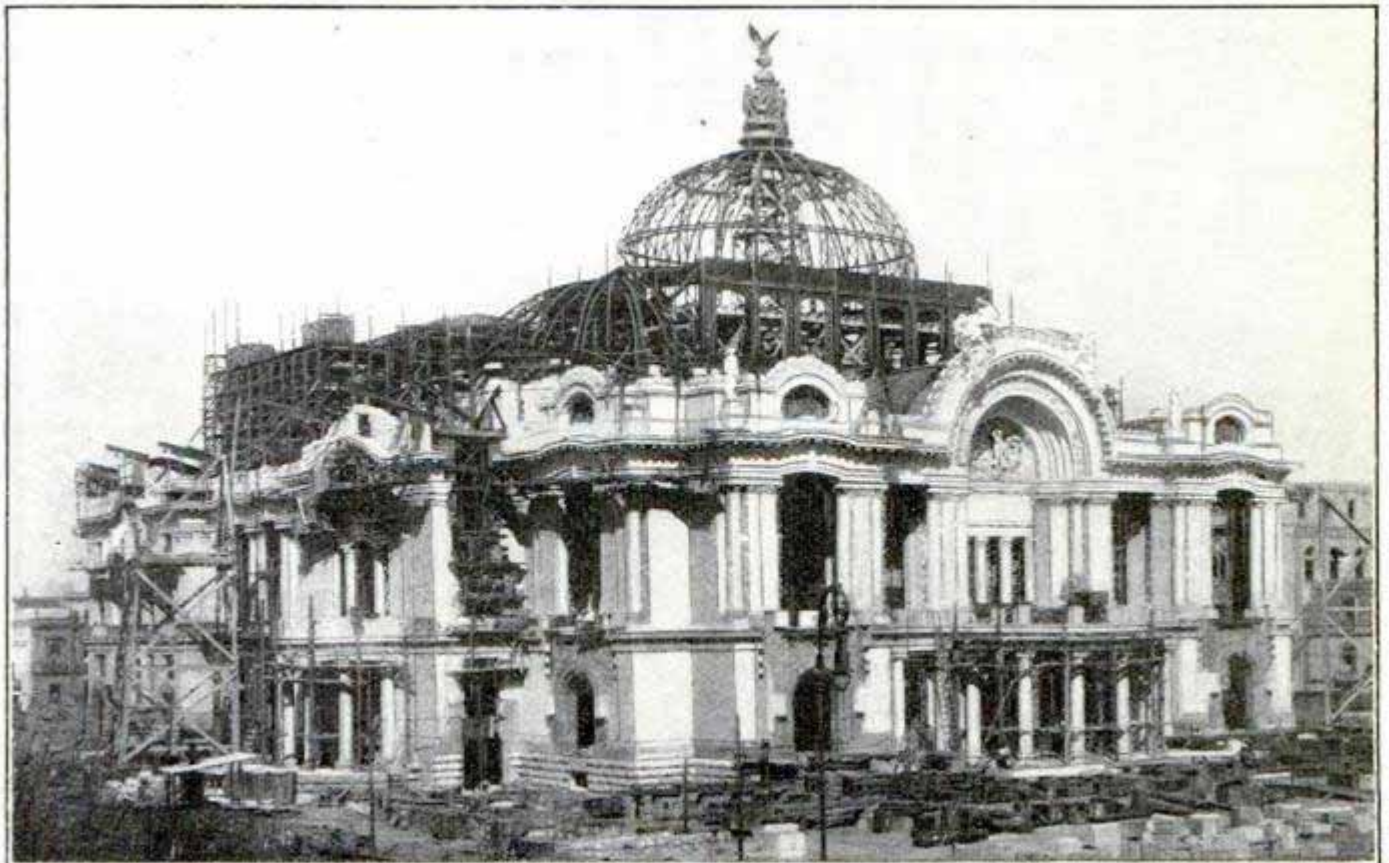

The New National Theater of Mexico in Course of Construction

## WIND-DRIVEN ICE CARRIER

That cheap but somewhat uncertain natural source of power, the wind, is nevertheless sufficiently reliable down

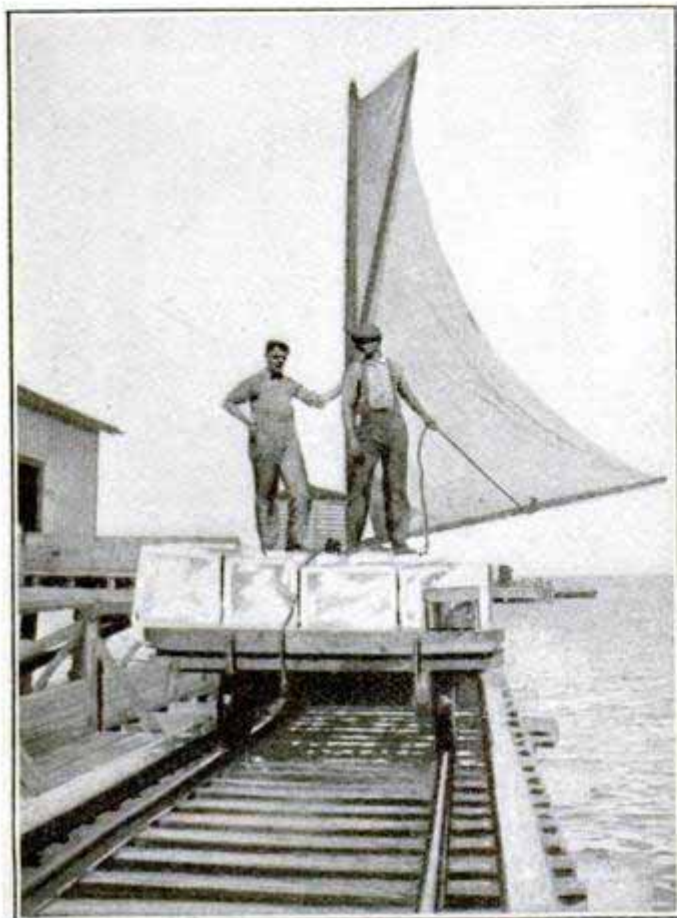

Carrying Ice on Sail Car in Florida

in Florida to have solved a knotty transportation problem in the town of St. Petersburg. In this place there is a warehouse where fish is received in large quantities from the surrounding fishing camps. A railroad track runs along a dock to the building, and as the ice house is situated about three-quarters of a mile away and the dock is not provided with a flooring or pavement, the ice has to be hauled to the warehouse on a handcar.

The car holds 70 cakes of ice, each weighing 200 lb., or a total of 14,000 lb., which is too great to propel by hand. Therefore the expedient of using a sail was tried, which has proved quite successful. There is usually enough wind blowing at any time to push the car, which, with an ordinary wind, makes the trip in three minutes. The car has no brakes, so the speed is checked by manipulating the sail.

About seven trips a day are made, enough fish being transported to ship out one carload of fish daily.

## ELECTRICIANS PERFORM FEATS ON TRAIN

Several distinctly novel stunts were performed on a special train which was recently engaged to carry a delegation from Chicago to an electrical jobbers' convention at Monterey, Cal.

The chief feature was the publication on the train of a daily newspaper—"The Daily Shock"—which, besides personal and trade notes, contained a serial story and a series of cartoons. Three editions were distributed, one each at Kansas City, Albuquerque and Grand Canyon, on successive days.

Another novelty was the demonstration of an instrument on the mandolin order, in which the first, second and third strings were made from genuine drawn tungsten wires such as are used for filaments in the latest designs of tungsten lamps. On the usual type of mandolin these strings are made of steel wire.

This was not the only unbelievable feat performed with the latest thing in tungsten filaments, the earlier varieties of which were so fragile that they would almost break by being looked at, much less touched. Some of the electricians actually lifted chairs with the hair-like filaments, which did not break under the extraordinary test. It may be of interest to note that the drawn tungsten wire is from three to five times as strong as the finest kind of steel wire, and shows a tensile strength of 500,000 lb. to the square inch.

According to the annual report of the Secretary of the French Aero Club, there were built in France, during 1910, no less than 1,300 aeroplanes with a combined motive power of 60,000 hp., and the distance covered in flights at aerodromes reached a total of over 500,000 kilometres (310,685 miles).

## RACING MOTOR CAR LITERALLY FLIES THROUGH AIR

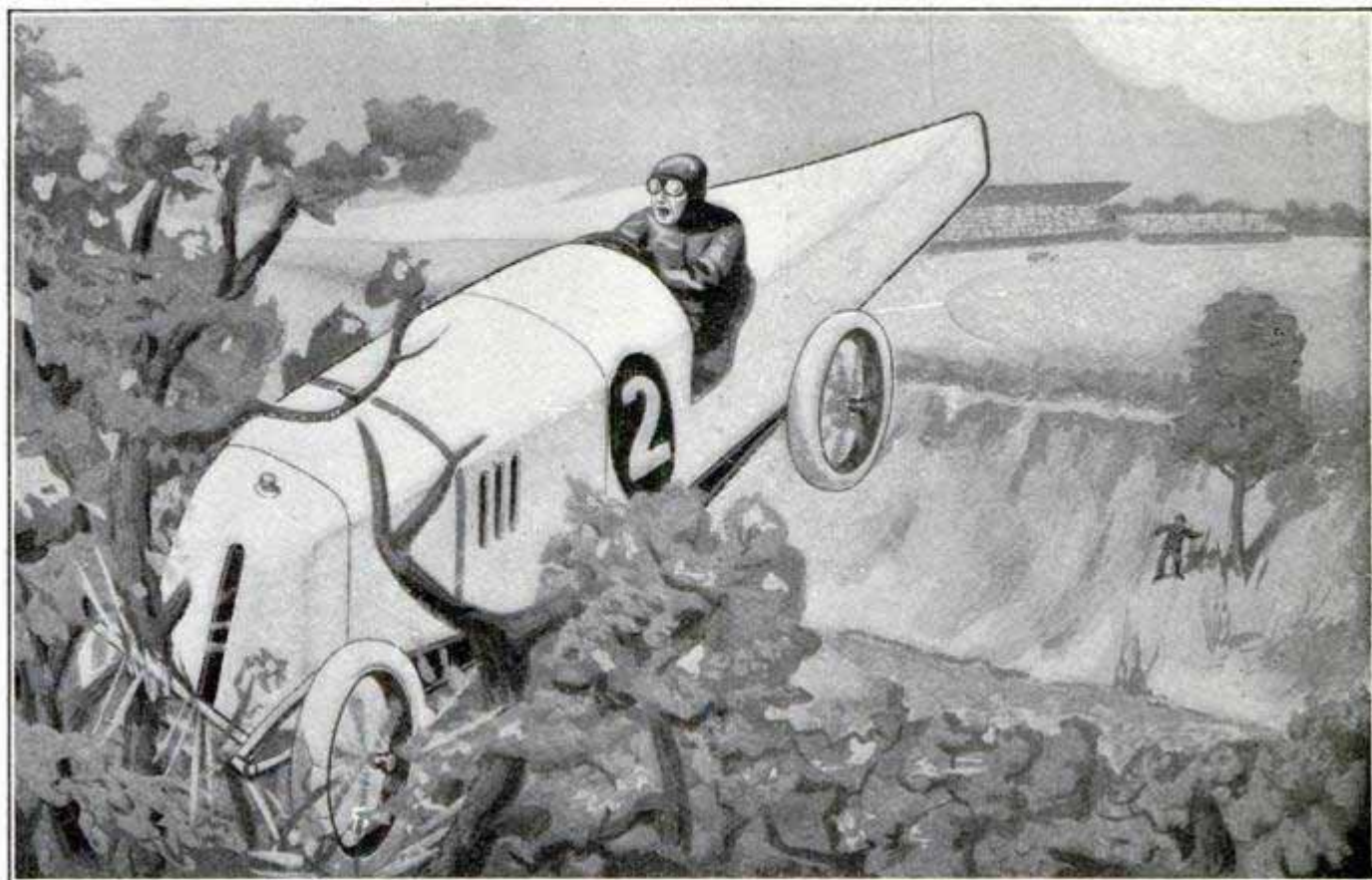

Speeding at 90 miles per hour, a racing automobile at Brooklands, England, cleared the top of the dish-shaped motor track and, according to spectators, flew 40 ft. through the air at a height of 30 ft. from the ground. G. Wilkinson, the driver, was brushed from his seat by the branches of the trees through which his machine passed, and was badly injured. The automobile was smashed, though the engine was not seriously damaged.

### WHY THE AMOUNT OF REAL MOCHA COFFEE IS SMALL

According to a recent inquiry as to why the amount of coffee exported from Arabia is small compared with what it might be, it was discovered that although the whole of the Yemen province is adapted to the cultivation of the berry, only a few scattered districts were devoted to coffee raising, on account of the fact that the Arabs need the land for growing food. This is in spite of the fact that the coffee would yield a greater monetary return than food products, the explanation being that even money cannot at present buy food in that part of the world, and therefore it must be grown locally. Another reason is that the coffee shrub takes four years to arrive at a bearing stage, whereas 16 crops of "dhurra," a plant resembling Indian corn but pro-

ducing a grain like millet, can be grown in the same time.

Contrary to commonly accepted opinions, the Yemen Arab never uses coffee himself, but cultivates it almost entirely for export. He prefers a beverage called "kishar," brewed from the dried hulls of the berries.

CA Chicago amusement-resort promoter has given costly recognition to the limitations of the hobble skirt by rebuilding all the stairways on his grounds, making the steps with a height of six inches instead of one foot, to prevent accidents among the women patrons of the park who wear the tight skirts.

CThe battleship "Wyoming" was launched at the Cramp shipyard in Philadelphia, May 25.

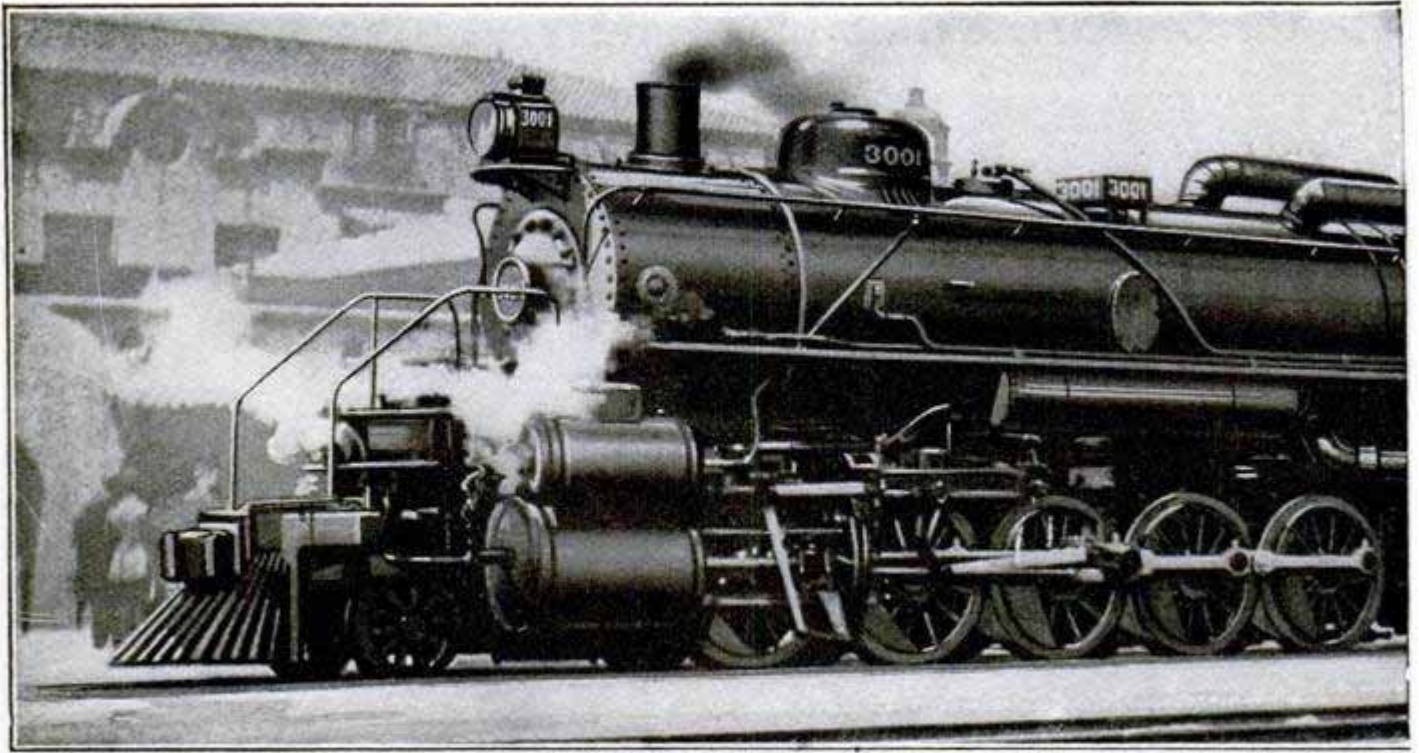

Side View of 300-Ton Locomotive of the Atchison, Topeka & Santa Fe Ry. She is Designed

## THE WORLD'S LOCOMOTIVE MONSTER

The largest locomotive yet built is the monster Mallet engine of the 2-10-10-2 class, which has just been placed in service on the Atchison, Topeka & Santa Fe Railroad in hauling 2,000-ton freight trains on long and severe grades. Made by combining two locomotives, huge in themselves, she has a weight of about 616,000 lb., while her tender, mounted on two 6-wheeled trucks, has, including a full load of water and oil fuel, a weight of 234,000 lb., which brings the total up to 850,000 lb.

The boiler of the monster locomotive is in two sections, united by a rigid separable joint. Beyond the

smokebox is a tubular section 9 ft. long forming the feed-water heater, and between this and the barrel proper is another tubular section forming the superheater. The latter is divided into

two compartments, one for superheating the live steam, and the other for reheating the high-pressure exhaust on its way to the low-pressure cylinders.

The locomotive has 20 drive wheels, 4 ft. 9 in. in diameter, and four truck wheels, 2 ft. 5 $\frac{1}{4}$  in. in diameter. The total length over engine and tender is 121 ft. 7 in., and the weight on driving wheels is 550,000 lb., or 55,000 lb. per axle.

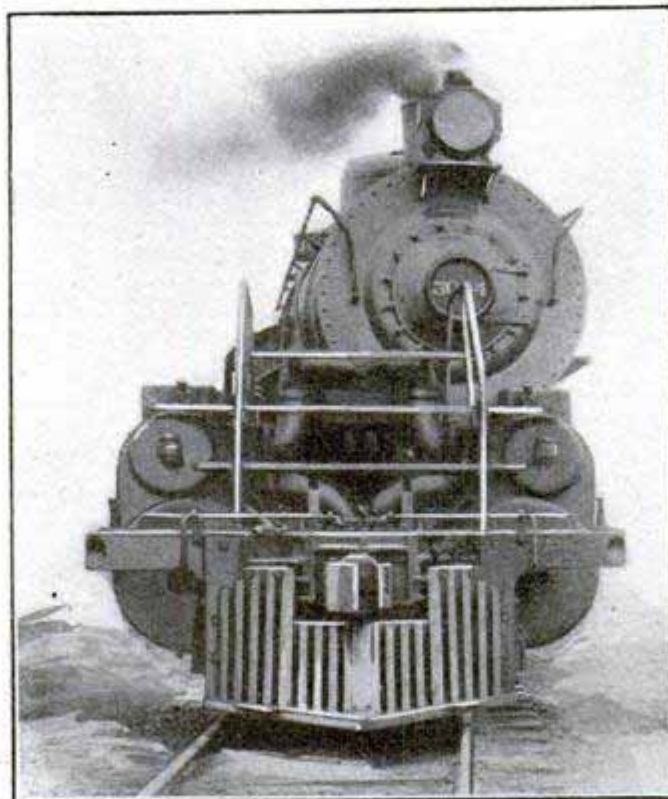

Front End of Monster Locomotive Seen Rounding a Curve

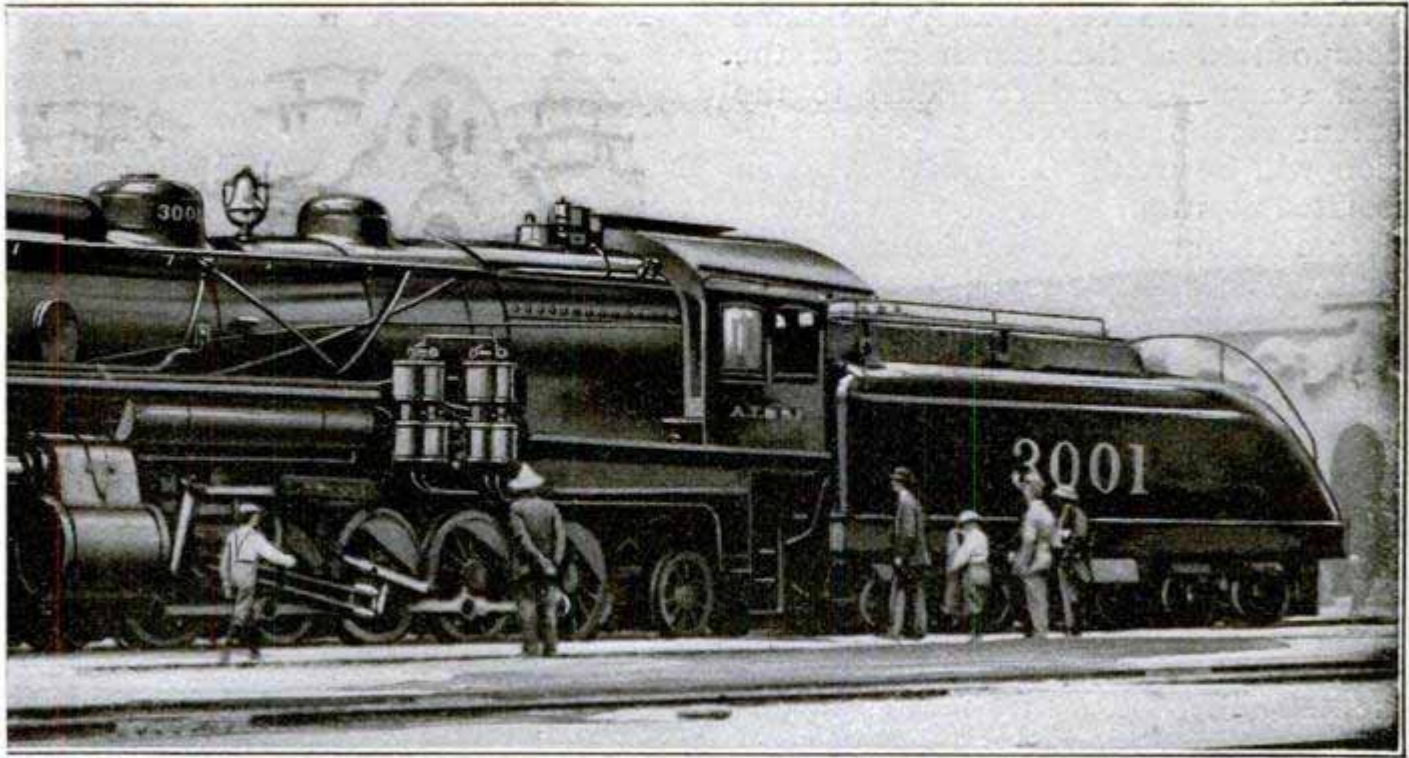

to Handle 2,000-Ton Freight Trains on Severe Grades, and is 121½ Ft. Long, Including Tender

## COAL MINE FOR TESTING EXPLOSIVES

The United States Bureau of Mines has established, near Bruceton, Pa., an experimental mine where actual mine explosions are to be carried on under scientific auspices. At the Pittsburg plant of the Bureau of Mines an explosive gallery has been maintained for several years, where explosive tests have been conducted

and some important facts developed with reference to mine safety. The mine is driven into the Pittsburg coal seam in some of the mines of which great explosions have occurred in the past.

Various explosions will be conducted in the experimental mine with coal dust, fire damp and natural gas,



Entrance to Experimental Mine of Bureau of Mines at Bruceton, Pa.

which last has very nearly the same composition as the marsh gas of the coal seams. Ground coal dust to the extent of about 4 tons for each explosion will be used. The mine is in an isolated position, though comparatively near Pittsburg, with no houses adjacent. The mine tunnel is from 60 to 160 ft. underground.

There will be at least two galleries when the mine is completed and, as it is anticipated that enormous explosive force will be developed at the mouth of the mine gallery, the latter will be given a heavy lining and arching of reinforced concrete. This will prevent great falls at the mouth of the mine.

A secondary purpose of the experimental mine, but by no means an unimportant one, is the study of coal-mining explosives which have been placed on the government "permissible list" for use in gaseous and dusty mines. Different types of coal-mining machinery will also be tested.

The various tests and explosions will be conducted as they would occur in an actual commercial coal mine, but they will of course be done deliberately and their causes and results scientifically studied.

## NEW YORK-SAN FRANCISCO TELEPHONE PREDICTED

Now that it is possible for a man in New York to talk over the long-distance telephone with a party in Denver, prominent electrical engineers freely predict that within a couple of years a through transcontinental telephone service will be established between New York and San Francisco. The recent completion of the New York to Denver line has been characterized as one of the greatest engineering accomplishments of the present age.

It is stated that when the projected circuit between Chicago and Omaha is completed, it will be possible, by using the two separate circuits between New York and Denver, to employ multiplex telephony and telegraphy, and to send over the same wires at the same time four telegraph and three telephone messages, without interference, by methods which are already in successful commercial use. And this is not taking into consideration the duplex and multiplex systems of telegraphy announced a few months ago, of which no commercial use seems yet to have been made.



Part of the Envelope, Rising Like a Funeral Pall Over the Shattered Framework of the War Airship

## BRITISH WAR AIRSHIP MEETS DISASTER

Great Britain's largest war airship, an immense craft 512 ft. long, was wrecked recently at Farnborough, Barrow-in-Furness, while being launched. The cause of the wreck was the breaking away of one of the 18 balloons with which the envelope was filled. Following the escape of 40,000 cu. ft. of hydrogen from this balloon, the craft swung into the trees, the envelope being badly torn, a considerable part of the framework of the car smashed, and the engines and one of the propellers badly damaged.

The wrecking of the airship from such a slight cause indicates how enormous are the difficulties of handling an air craft of such huge size.



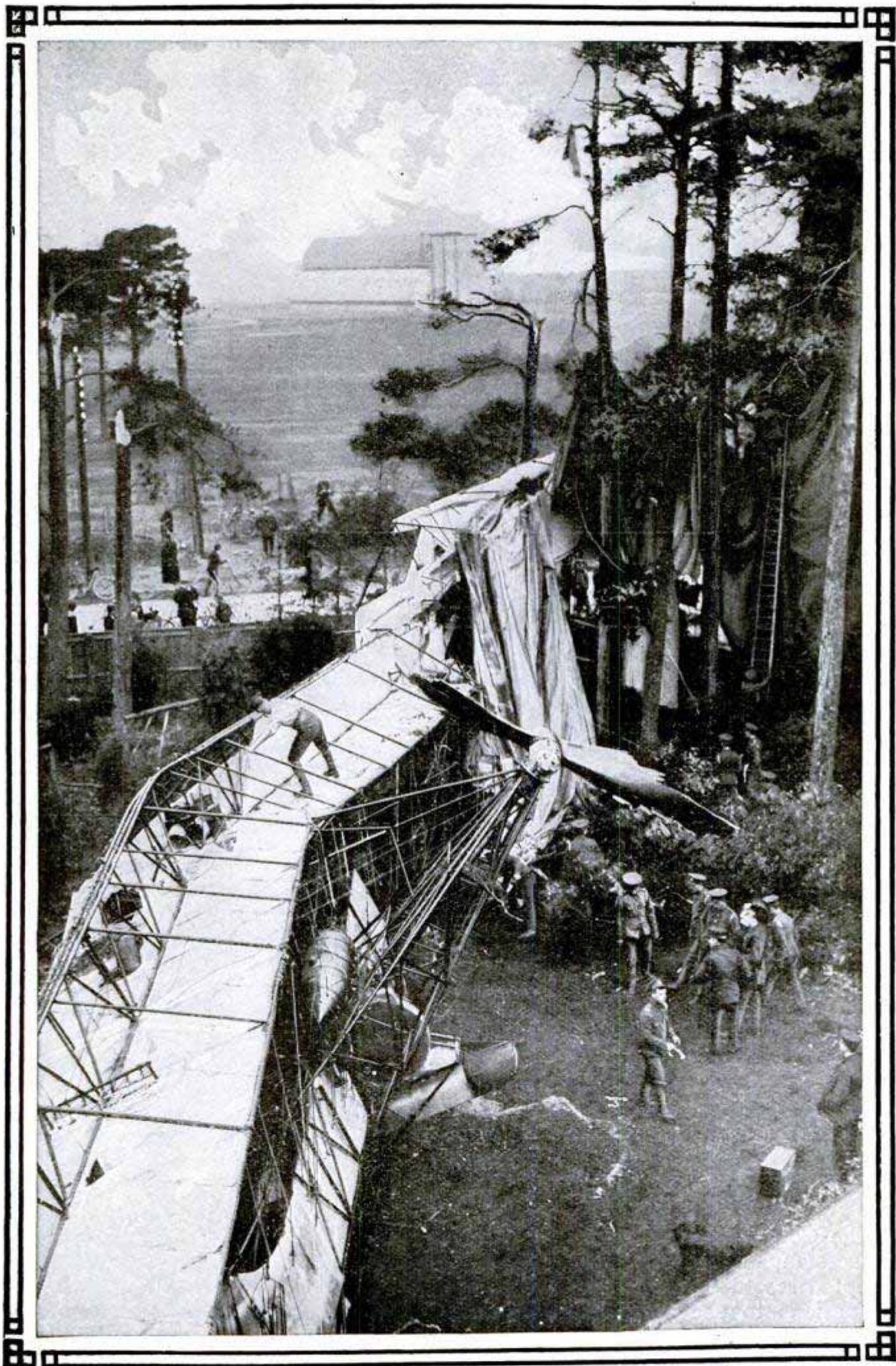

The Wreck of the British Airship in the Trees at Farnborough

### THE HAREM BATHING SUIT

Close on the heels of the harem skirt and similar costumes for aerial navigation, comes the harem bathing suit,



A Harem Creation for Women Swimmers

advertised as a "ravishing" creation that gives freedom of movement in swimming. The "harem" part of the costume is made of blue and white striped silk, the collar is of the same material, and the sweater is of blue knitted wool.

☐The legislature of the state of New York has under consideration a law to appoint an aeroplane commission for the state, the duties of which will be to license pilots and pass upon the qualifications of all airmen. A fee of \$10 is named in the law.

☐The Congress on International Law in session at Madrid, Spain, recently adopted resolutions affirming the right of nations to use aerial craft in war provided such use was not accompanied by greater danger to noncombatants than warfare on earth or sea.

### FLIES OVER 100 MILES AN HOUR

A well-authenticated report that this magazine has just received from Paris, is to the effect that Lieutenant Fequant, of the aviation corps of the French army, recently flew from Mourmelon to Reims, a distance of about 17 miles, in a fraction over ten minutes. The machine used was one of the latest Nieuport monoplanes, which have recently captured most of the official speed records, and it was propelled by a 60-horsepower, seven-cylinder, R. E. P. motor—an innovation in engine equipment for this machine. Despite the fact that a passenger was carried, the speed works out at the rate of 100.6 miles an hour. Shortly before Fequant's flight, Weyman, the hero of the first attempt to capture the Michelin prize for the Paris-Puy de Dôme flight, accomplished the same distance at the rate of an even hundred miles an hour, a favoring wind of about twenty miles an hour blowing in the direction traveled.



Lieutenant Fequant, of French Army, Who Flew at over 100 Miles an Hour

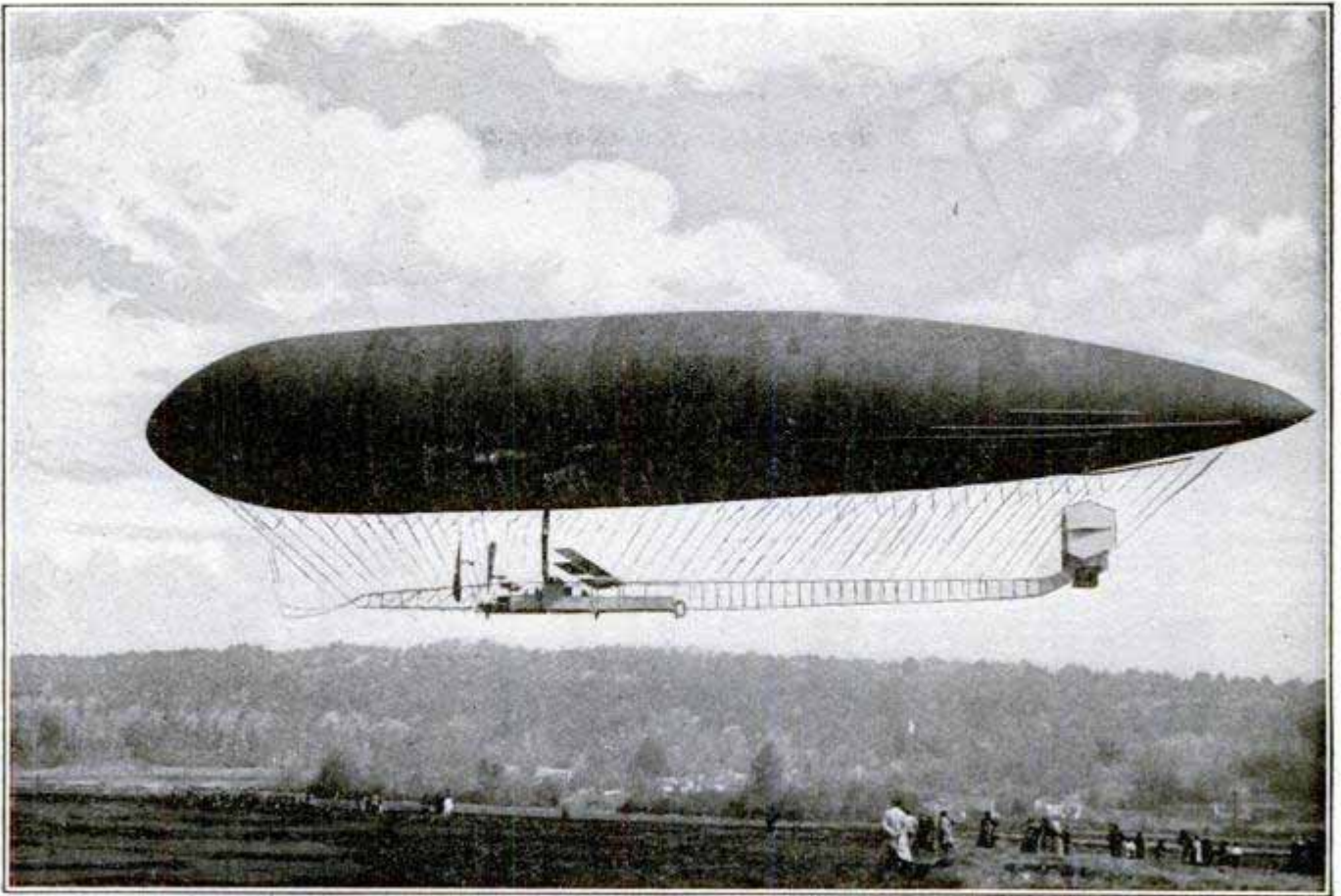

#### THE LATEST FRENCH DIRIGIBLE

The "Adjutant Vincenot," the new Clement-Bayard, in flight. It is about 320 ft. long, has a volume of over 300,000 cu. ft., and has two propellers, each operated by a 130-hp. engine. Its weight-lifting capacity is 7,700 lb.

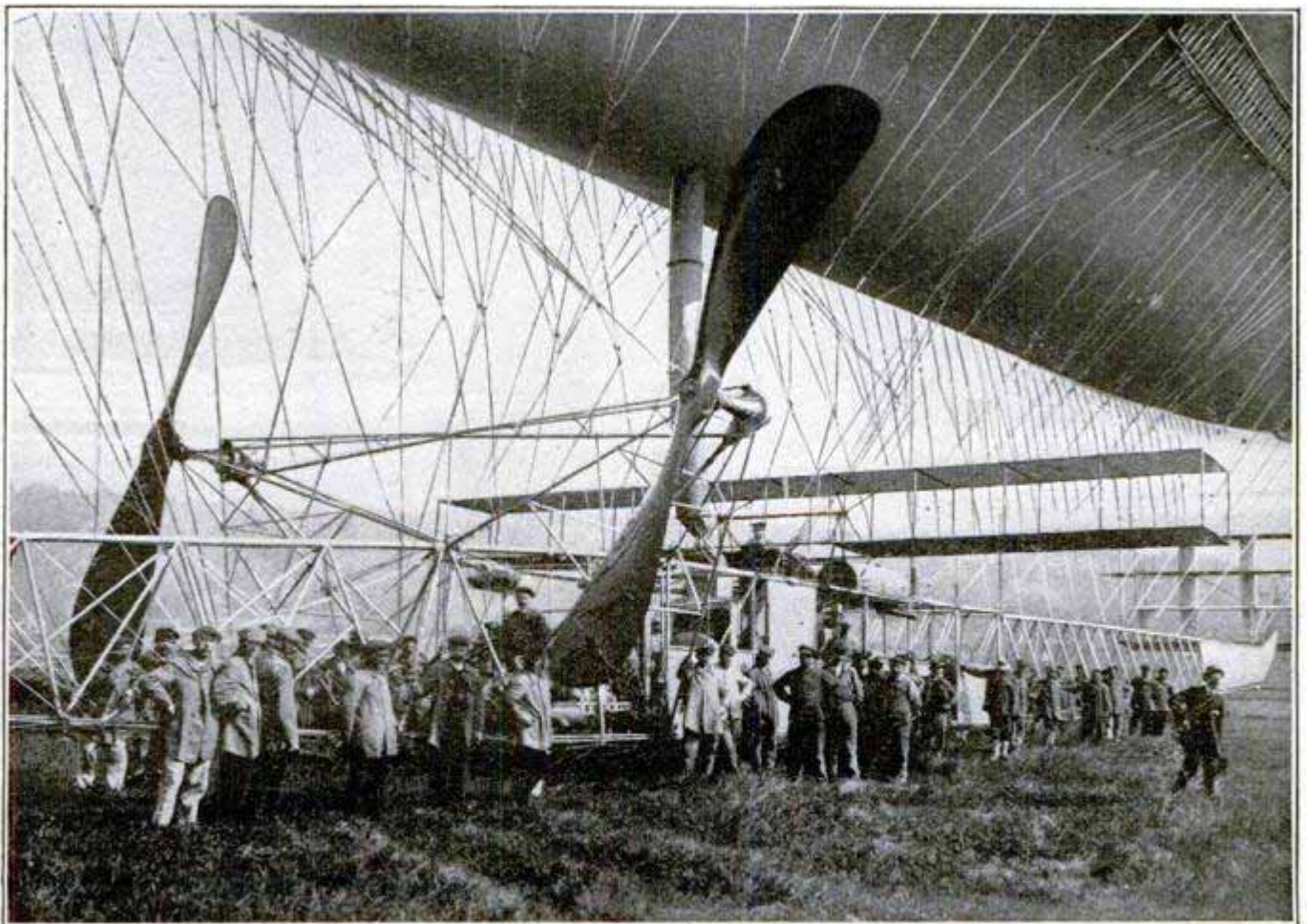

#### THE CHASSIS OF THE NEW DIRIGIBLE

The photograph was taken at Lamotte-Breuil, just before the preliminary trials. This airship is the largest so far constructed for the French army

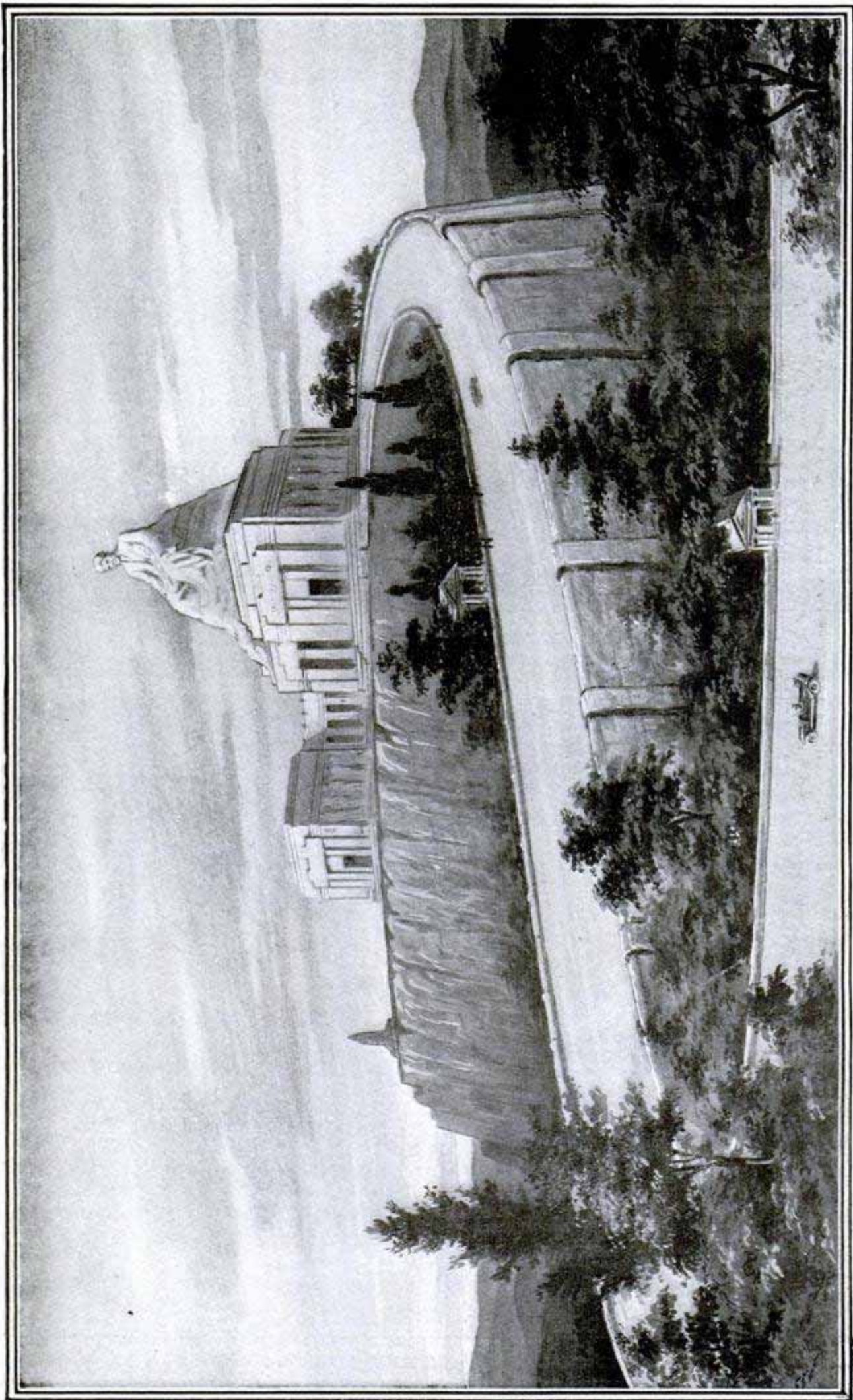

THE ' TEMPLE OF PEACE AND LINCOLN MEMORIAL THAT IS PLANNED TO RISE AMONG THE HILLS OF THE INDIANA STONE BELT: REDRAWN FROM THE ARCHITECT'S DESIGN

## GREAT LINCOLN PEACE MEMORIAL PROPOSED

By FRANK MAYNARD

A great Lincoln memorial and "Temple of Peace," beautiful in conception, with a ruggedness and strength of outline in keeping with its idealistic personification of peace and the unification of the Nation, will tower above the rugged stone hills somewhere between Bedford and Bloomington, Ind., if the present plans are carried out.

The idea, more vast than anything of the kind hitherto seriously contemplated in America, was evolved by Charles J. Mulligan, C. M. Dodd, and Tallmudge & Watson, sculptors and architects of Chicago. The conception is unique as well as beautiful, and no precedent whatsoever, in either the architectural or sculptural features, has been followed. It is to be built entirely of Indiana oolitic limestone, more commonly known as Bedford stone. It is, in fact, to symbolize stone as a great industry, but this is simply a minor phase, and, although of much importance in its erection, is dimmed by the great idealistic purpose of its being.

The "Temple of Peace," above which will rise the statue of Lincoln, is to be semicircular in form, about 35 ft. in height, and 200 ft. across from end to end. It will face the westward sun from a vast ledge of stone, probably near the edge of an old quarry, one of the dominant hills which abound in the midst of the rugged and wild scenery of the quarry district. How much of this ledge will be rough hewn in the face of the stone hill or will have to be built up in the form of huge stone blocks will be determined when the actual site is selected, but whether hewn out or built up, this base, and the broad winding road leading to its top, will be a great undertaking in itself.

The "Temple of Peace" has a central portion and two wings, each wing being connected to the central portion by a peristyle. The north wing or

temple will represent the North, and the south wing the South, while the central temple will represent the Na-

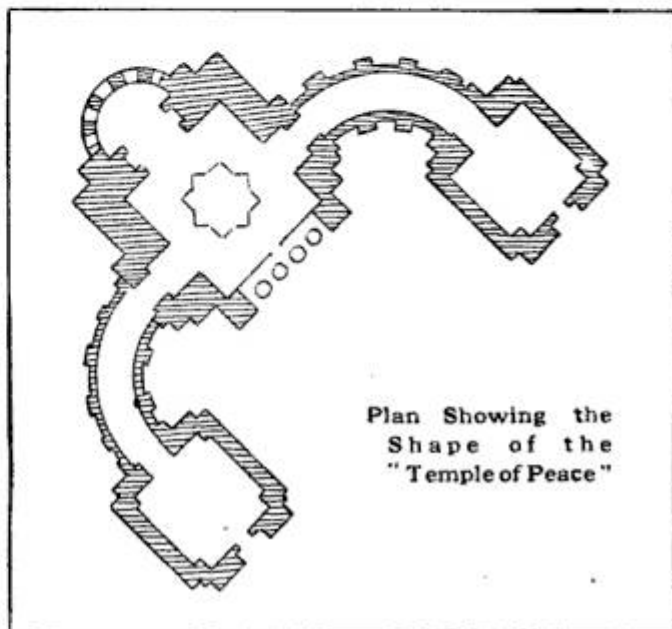

Plan Showing the Shape of the "Temple of Peace"

tion and form the pedestal of the statue of Lincoln seated, which will be 35 ft. in height. Thus the temple and statue will rise 70 ft. upon a base, which, from the lowest point seen in the road to its top, will be about 130 ft. high, making the height from this point in the road to the top of the statue about 200 ft. Around the walls of the "Temple of Peace" will be carved a procession of symbolical figures 18 ft. high, in bas-relief. Several stone rest houses will be built along the winding road for the people making a pilgrimage to the top on foot.

The plan of erection is to have every quarry owner in the Indiana stone belt furnish a quota of sawed stone blocks, and for every mill operator to furnish his share of labor for cutting and carving the stone required. Thus, although national in its character as a peace memorial, it is, if the plans are carried out, to be erected by the stone industry of Indiana.

The illustration shown is drawn from the design of Tallmudge & Watson, with slight additions. The statue of

Lincoln, not yet having been modeled, although the work is now being done at the Chicago Art Institute, was shown only in vague outline in the architectural design.

In speaking of the idealism and sentiment which inspired the designers of the peace memorial, Charles J. Mulligan points to the great idealistic monuments of the past: "Hark back to the epoch-making periods in the history of great nations and you will find that sentiment and ideals were at their height. Egypt is best known through her sphinx and pyramids, huge tombs of stone for her dead rulers, intended to preserve their fame in memory for

ages to come. The Parthenon on the highest platform of the Acropolis at Athens, the ruins of which today but faintly indicate the beauty and grandeur, is a temple erected to the virgin goddess Athene. Sentiment was shown by the people of Switzerland when they erected the colossal lion of Lucerne, designed to commemorate the men of the Swiss guard who fell in the defense of the Tuileries in Paris in 1792. This statue is unique, being hewn out of the solid rock in the mountain side. Other nations have followed these examples (notably Germany), making or creating symbols to personify both sentiment and idealism."

### LARGE MOTORBOAT FOR GREAT LAKES

The "La Belle," built at Camden, N. J., for Alexander Winton, of Cleveland, Ohio, is claimed to be the largest motor yacht in the world. She has a 140-ft. length over all, her water line is 118 ft., beam 19 ft., and draft 7½ ft. Power is supplied by three special 6-cylinder motors, capable of developing 175 hp. each, which gives the boat a total of 525 hp. The motors are said to weigh 17,000 lb. each. The gasoline tanks have a capacity of 3,500 gal. The contract speed is 16 miles an hour.

### RAPID SKYSCRAPER CONSTRUCTION

The record for quickest erection and inclosing of an 18-story building is claimed by the contractors of the Underwood building, at Vesey and Church street, New York. The structure is an office building, 52 ft. by 76 ft., and about 220 ft. high. The steel superstructure was erected and inclosed with stone and brick in 69 days, chiefly in December and January, under unfavorable conditions of weather and daylight, snow storms and extreme cold making work impossible some days.



A 140-Ft. Motorboat Built for Cruising on the Great Lakes

the film. An indicator shows the air pressure, and below there is another which gives the number of pictures per second (usually 15). The speed can be adjusted by a lever and the apparatus is started by a half turn of a button. The gyroscope axis is connected by a metal band with a pulley loosely mounted on the axis of the shutter.

The apparatus, which can be started or stopped almost instantly, is said to have given very satisfactory results on preliminary tests.

## TWO SIDES OF THE OIL FUEL QUESTION

The discrepancies between practice and theory are well illustrated in the following reports. The first is from the Steamship, and states that the French destroyer "Cavalier," on a voyage from Cherbourg to Oran at an average speed of 11 knots (12.67 miles an hour), and from Oran to Toulon at an average

speed of 20 knots (23.03 miles an hour), consumed 201 tons (presumably long tons) of oil fuel at a cost of about \$6,000. If the "Cavalier" had been burning coal on the same trip, says the Steamship, she would have used 100 tons, costing about \$700.

So much for the real figures. Now for the theoretical claims. The Mining World reports that Lewis E. Ambury, state mineralogist of California, has sent a strong memorial to the secretary of the navy, in which he "shows that the use of fuel oil instead of coal on the Pacific Ocean alone in the fiscal year 1910 would have resulted in a saving of \$1,027,556.10, and there is not counted into this large saving the less expense entailed in the handling of oil as compared with coal."

The price for the "Cavalier's" oil works out to a fraction under 10 cents a gallon, so the figures are not far wrong. Evidently there must be something wrong with somebody's calculations.

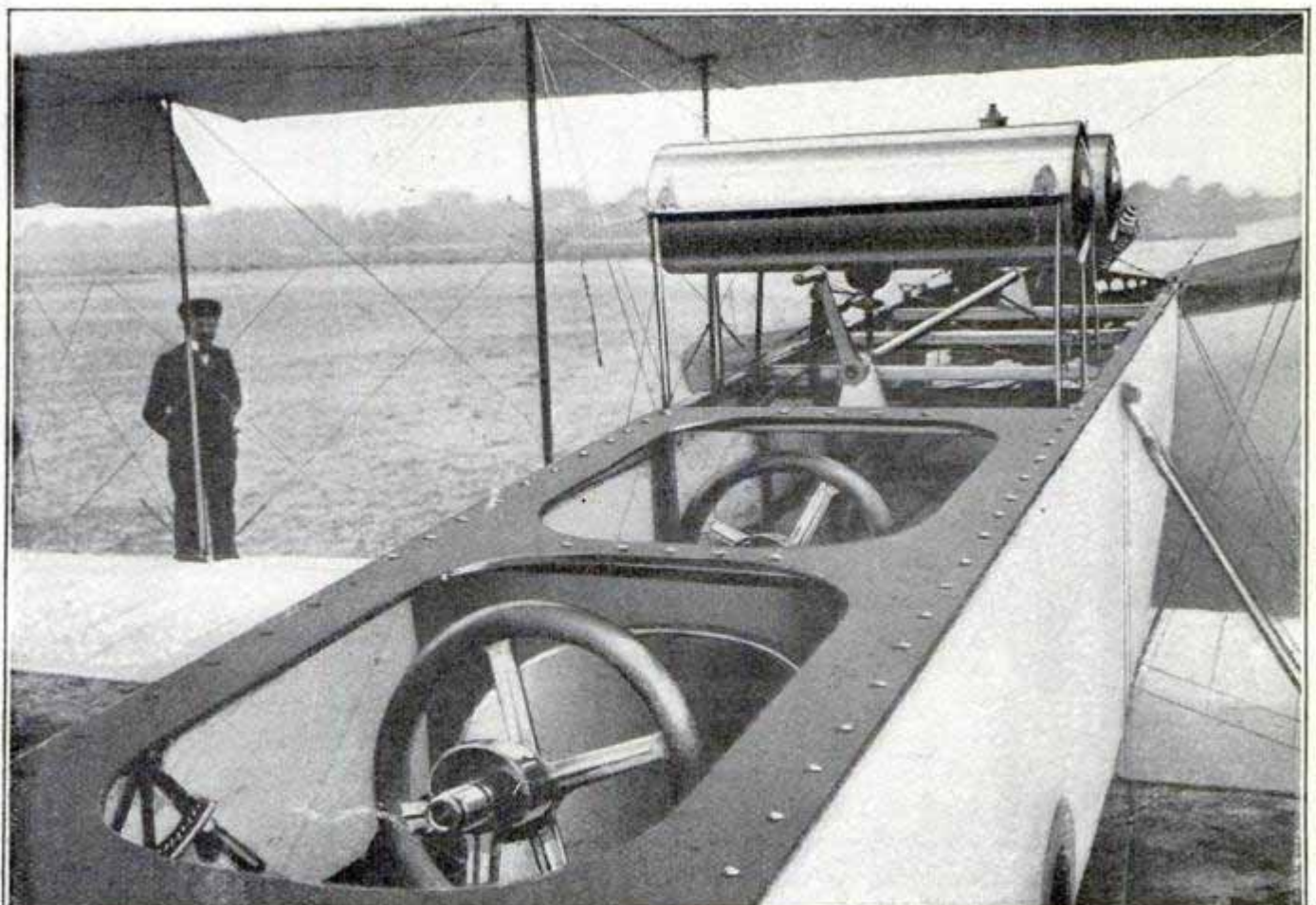

View of Body of Latest Voisin Aeroplane with Double Set of Controls and Crank to Start Engine from the Seat

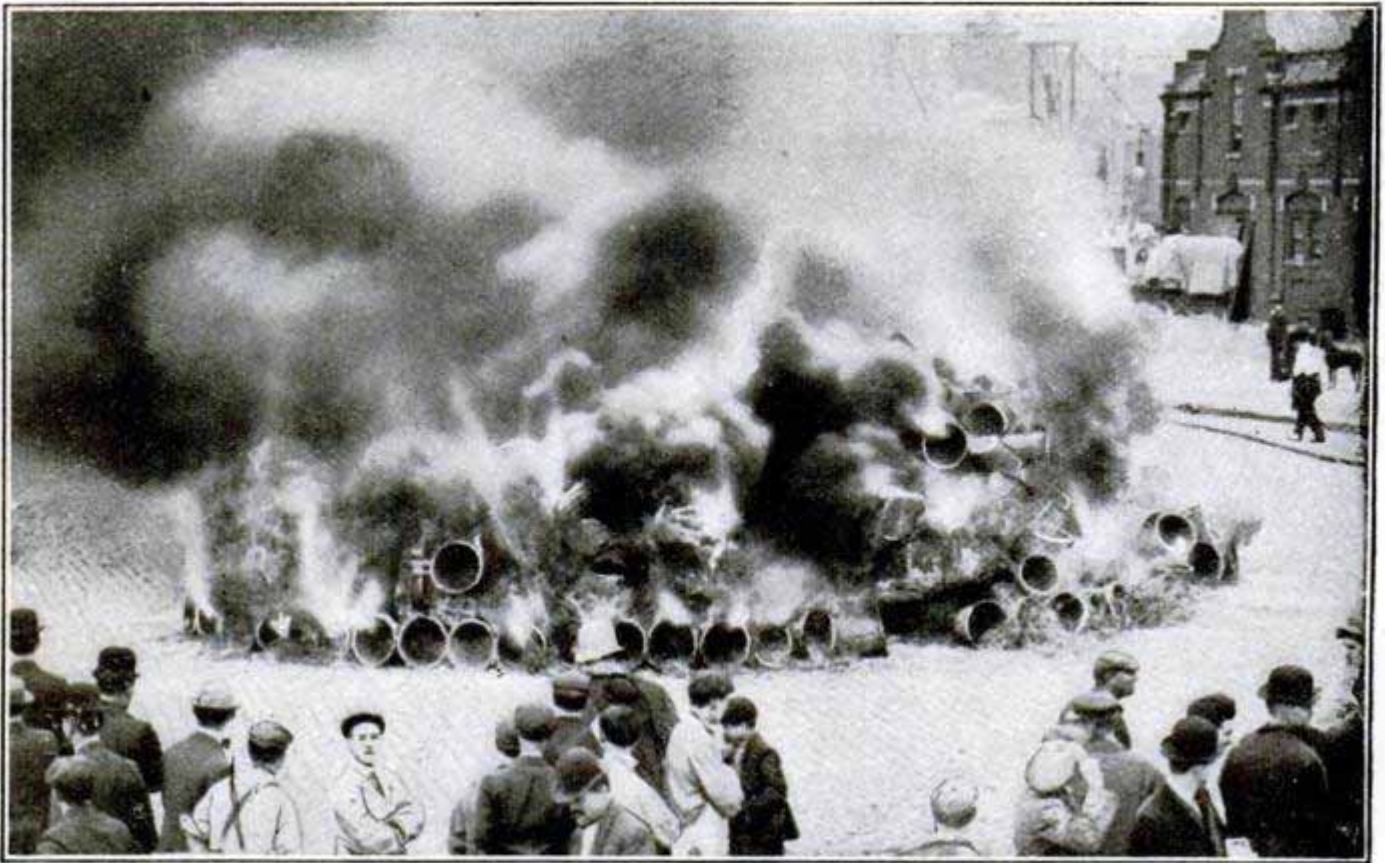

Copyright, Underwood & Underwood. New York, 1911.

Burning Short-Measure Baskets in Public as an Object Lesson

## DESTROYING SHORT-MEASURE MARKET BASKETS

The cremation of over 3,000 short-measure market baskets took place recently at the Wallabout Market, Brooklyn, following the seizure from the farmers and truck gardeners who wend their way daily to the Wallabout and Gansevoort Markets. For several

weeks the inspectors of the Weights and Measures Department waylaid the wagons, and nearly all of them were found to contain "bushel" baskets that were from 4 to 14 qt. short. Then the baskets were publicly burned on the market place as an object lesson.



## TO THE MEMORY OF DEAD AIRMEN

The "monument to airmen," executed by the sculptor, Roger Bloche, is grimly realistic and impressive. It was designed for the French government as a state monument to the memory of airmen who have given up their lives in advancing aerial flight.

CA blazing pot of tar, accidentally kicked into his face by a companion, emptied its contents over the body of an 11-year-old New York boy and caused his death, the tar burning him severely and then hardening in the pores of the skin as it became cool.

To the Memory of Airmen Who have Given Their Lives for the Advancement of Aerial Flight



# COMMENT AND REVIEW

**O**UR neighbor on the north is rapidly attracting the wistful eyes of over-populated Europe, to whom free homesteads and cheap farms offer possibilities impossible in the homeland. While the volume of immigration coming into Canada is much less than that coming to this country, it is very much larger in proportion to the resident population of the two countries. During the past two years the Canadian government gave away land to homesteaders in size equal to the State of Illinois, and the present year 200,000 homesteads are available, equivalent to the State of Ohio. Canada expects to receive half a million additional population this year, of whom 150,000 will enter from the United States. This, with the construction of 1,600 miles of railroad into new country, will make busy times across the border.

## *Canada's Rapid Development*

Until the past few years immigration to Canada was comparatively small, and the country, notwithstanding its vast area and natural resources, has been handicapped and held back for lack of population. This construction of her lines to the Pacific, and the inducements afforded settlers, with the excellent facilities and inviting opportunities, have directed attention to the Canadian Northwest, and the tide now flowing is but the vanguard of millions yet to come.



**S**CIENTISTS of many nations have toiled for years to unearth relics of past civilizations in almost every country. In response Egypt has yielded up the bodies of monarchs dead 4000 years; Aztec ruins have beckoned from Peru; the curtain of ashes has been lifted from Pompeii; mammoths that lived in tropic Siberia ages since have emerged from their tombs of ice; men of the stone age, the cave dwellers, and our own cliff dwellers, have each contributed their history: Yet all of these combined are as an incident compared to the sensation which would have followed the discovery that Bacon wrote Shakespeare. Dr. Owen, the Detroit physician who has evolved so many mysterious messages from the words of Shakespeare, has met with disappointment, and at least temporary failure in his explorations in the bed of the River Wye at Chepstow. He confidently expected to find buried there the positive and complete vindication of his Baconian theory, together with the head of Shakespeare himself. However, the end is not yet, for, as the Chicago Tribune says: "When a Baconian dies they have to put his optimism in a foundling's home. It never gives up the ghost."

## *The Shakespeare Enigma*

It is in keeping with tradition that not an Englishman, but the native of some land across the seas should make this exploration; and whatever our personal belief as to which really was the author, one cannot but wish, if history is to be corrected, the honor may come to an American. Meanwhile, as Owen plans to try again in a nearby spot, scores of the leading literary men of England and Europe are raising a scholarly memorial to William Shakespeare in his native town.

THE announcement by Dr. Flexner of the Rockefeller Institute, that they have at last discovered the germ, or rather its presence—for the strongest microscope fails to reveal it—which is responsible for infantile paralysis, will bring widespread hope and joy.

*Important  
Medical  
Discovery*

Starting in Sweden and Norway 25 years ago, this insidious and easily infectious disease has traveled to many countries. Neither preventive nor remedy has thus far been found; and while not always fatal, the after effects of crippled muscles or weakened mind have frequently made recovery more to be regretted than death.

The action of the germ is to attack the marrow of the spine and the brain. Infection is imparted through nasal discharges which often last for several weeks, and after recovery is well advanced. The infection may be carried by those in good health, who, not taking the disease themselves, may carry it to others. Now that the cause is definitely located, we are assured it will be less difficult to find the remedy.



WHAT seemed to many three years ago an impossible thing is already practically an accomplished fact. The Sane Fourth idea has not only spread rapidly, but wherever adopted, the improved conditions from every standpoint have abundantly demonstrated its wisdom. Other

*Sane  
Fourth  
a Success*

amusements than dangerous explosives have been found for young and old, and the only real sufferers are the fireworks makers, the largest of which has recently gone into bankruptcy. Night fireworks will continue to be used, but under the direction of police or fire departments in a way to render the display safe to spectators and to minimize the danger to those in charge. The indications are from all parts of the country that the day this year will be made the occasion for

beautiful and instructive historical parades, and that the new custom now so successfully inaugurated will become permanent. One stirring historical float will do more to nurture real patriotism than a carload of cannon crackers.



THE telephone in London is an exasperation not only to Americans who travel there, but to its own citizens as well. The service is conducted by the government as is the telegraph system. Ten to fifteen minutes are

*Telephones  
in  
London*

consumed in getting a connection and even then the transmission is quite imperfect; altogether a condition which would drive an American business man insane. There need be little surprise, therefore, that so comparatively few subscribers are found there. A telephone in a private residence, even of the well to do, is uncommon, and only recently have telephones been installed in the banks. In Chicago there is one telephone for each nine inhabitants; in England, one telephone for each 100 inhabitants.

It is only within the past few years that the royal palaces had either electric light, steam heat or elevators. On the other hand, every residence has trees, shrubs and flowers in front and back yards, housemaids and cooks can be had for \$2.50 per week, and a delivery of mail is made in residence districts at 10:30 p. m.

H. H. WINDSOR



Complete Suburban Home Exhibit of New York's Real Estate Show

### SUBURBAN HOME IN CITY BUILDING

One of the most interesting exhibits at the recent real estate show in New York was a miniature bungalow standing in its own grounds. The lawn was actual growing grass, and there were a growing hedge, flower beds, and a truck patch. Also a miniature poultry house and wire-inclosed chicken run, with live chickens.

### MOTOR CATAMARAN ACTS AS AEROPLANE LAUNCHER

A curious motor catamaran, called the "Pelican Nurse," has been built by Capt. H. L. Willoughby as a high-speed tender and a launching arrangement for his aeroplane, the "Pelican," during his flights at Sewall's Point, Florida. The hulls of the catamaran are 30 ft. long, having the appearance of two narrow racing motorboats, kept parallel to each other at a distance of

10 ft. by means of a system of bracing. In the center is hung a 30-hp. automobile engine, hooded over with wood and metal. The speed of the catamaran, unincumbered with the aeroplane, is 20 miles an hour. With the aerial machine resting upon it the speed is, of course, considerably less, although sufficient for launching purposes. When the desired speed is reached, the aeroplane takes to the air.

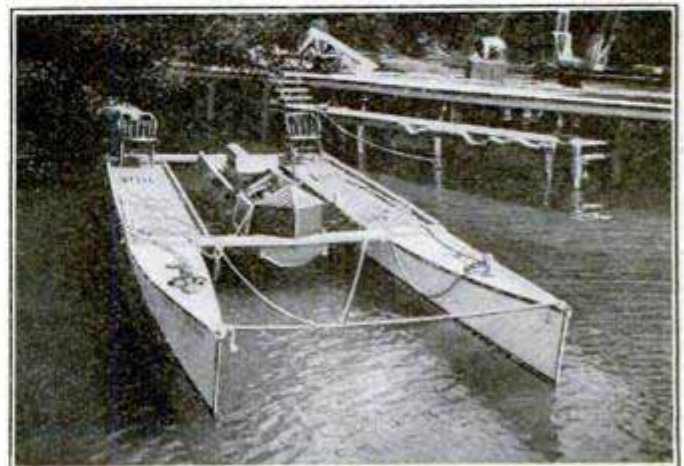

A Motor Catamaran which Acts as a Tender and Launcher for an Aeroplane

### FRUIT TURNED INTO METAL

By means of a secret process, Prof. L. G. Delamothe, a European scientist, is said to convert flowers, fruit and even

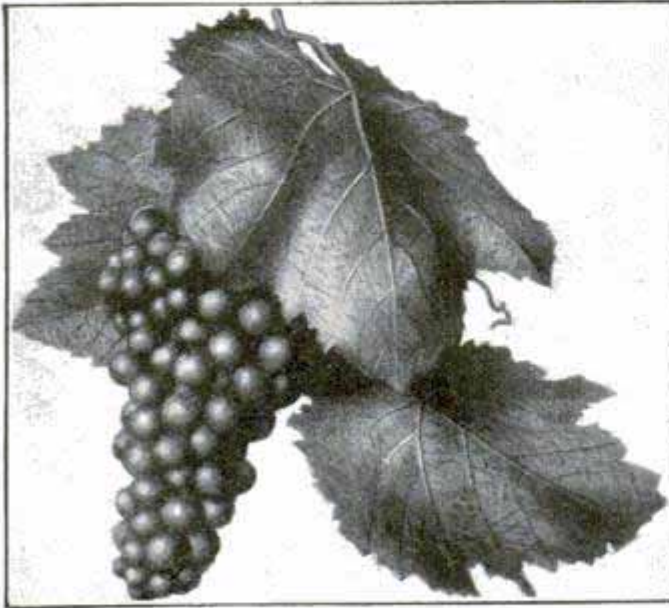

Bunch of Black Grapes Changed into Metal by Secret Process

animal tissue into metal. He does not deposit a thin layer of metal upon the surface, as in electroplating, but is said actually to transmute the life-grown material into dead metal.

The bunch of grapes shown in the illustration was so converted, the grapes and leaves having all their natural tints in the metal. The treatment is accomplished by an electrical agency.

### SOLVING THE MYSTERY OF THE SPHINX

Prof. George A. Reisner of Harvard University, after several years of tireless research has announced that the figure on the Sphinx is that of a lion equipped with the head of Chephren, a Pharaoh of Egypt of the fourth dynasty, who ruled in about the year 2850 B. C. This is the king who built the second pyramid which is known to archaeologists as "Wer-Khafa," meaning "Great is Chephren." Chephren was the son of Cheops and he was succeeded, in turn, by Mycerinus, who built the third pyramid.

The investigations which disclosed the identity of the sphinx began in

1903 and were finally terminated only a short time ago. Their progress forms an interesting story of international research, three noted archaeologists representing three big nations being the leading actors. They were each given permission to delve for hidden treasures beneath the desert sand and settled by drawing lots as to how they should divide the ground chosen for the purpose. To Prof. Reisner fell the investigation of the third pyramid and his discoveries were of unusual importance.

### HYDROGEN-GAS MOTOR FOR SUBMARINES

Hydrogen gas mixed with oxygen gas in the proportion of two volumes to one will be used as the mixture for an explosion engine which is designed to operate a submarine boat now being constructed by a French engineer. Supplementary power may be obtained by using the motor exhaust (consisting simply of steam), to run a steam turbine. The hydrogen and oxygen gases will be stored in separate cylinders under high pressure.

Such a combination has many points in its favor, if it can be proved to be practical. Considered as a fuel, hydrogen will produce about three times as much power, weight for weight, as gasoline, and it seems probable that the efficiency of the hydrogen-engine and steam-turbine combination will be very much greater than that of a simple gasoline engine. The weight of the storage cylinders for the gases would, no doubt, more than offset the gain from reduced engine weight and increased power efficiency, and the cost of the gases would be very much greater than that of gasoline. On the other hand, the coldness of the expanding gases released from the storage cylinders would probably solve the jacket-cooling question for the motor, and, chief of all, the operation of the power plant would not tend to vitiate the atmosphere of the submarine when immersed.

## PROGRESS OF WORK OF RAISING OF THE "MAINE"



**T**HE work of driving the interlocking steel piles of the 20 caissons forming the inclosing wall of the huge cofferdam surrounding the wreck of the "Maine" in Havana Harbor, has been completed,

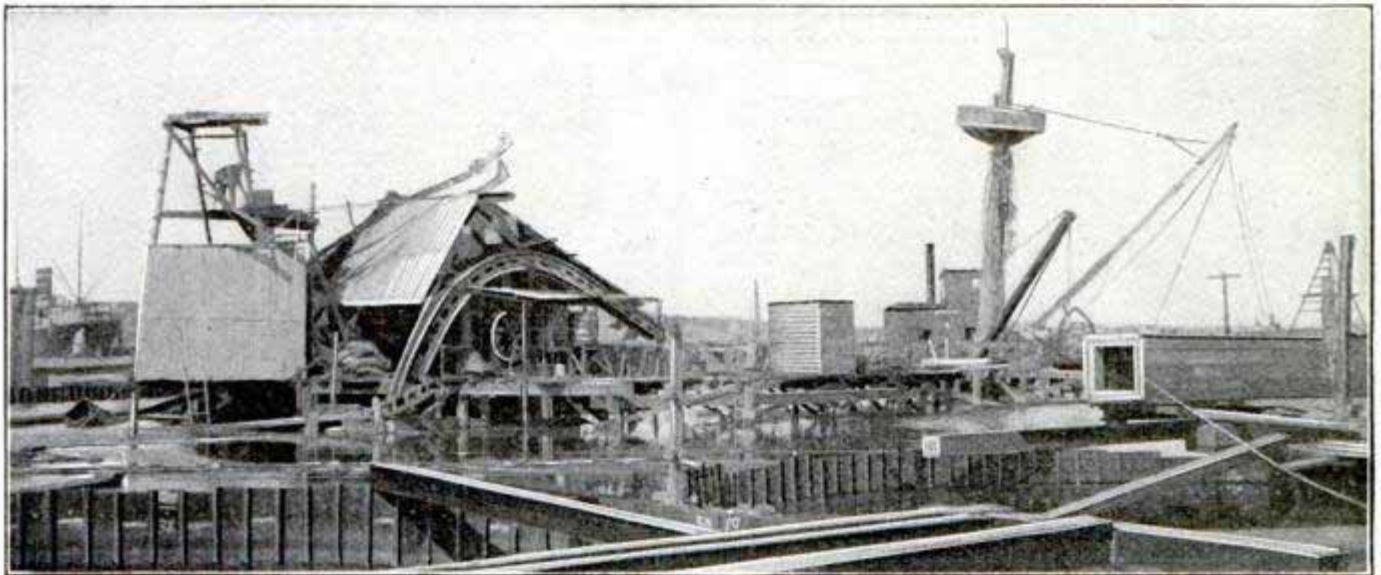

this part of the difficult task of removing the remains of the battleship having been accomplished without a single mishap. The second stage of this unique engineering feat, that of filling the caissons

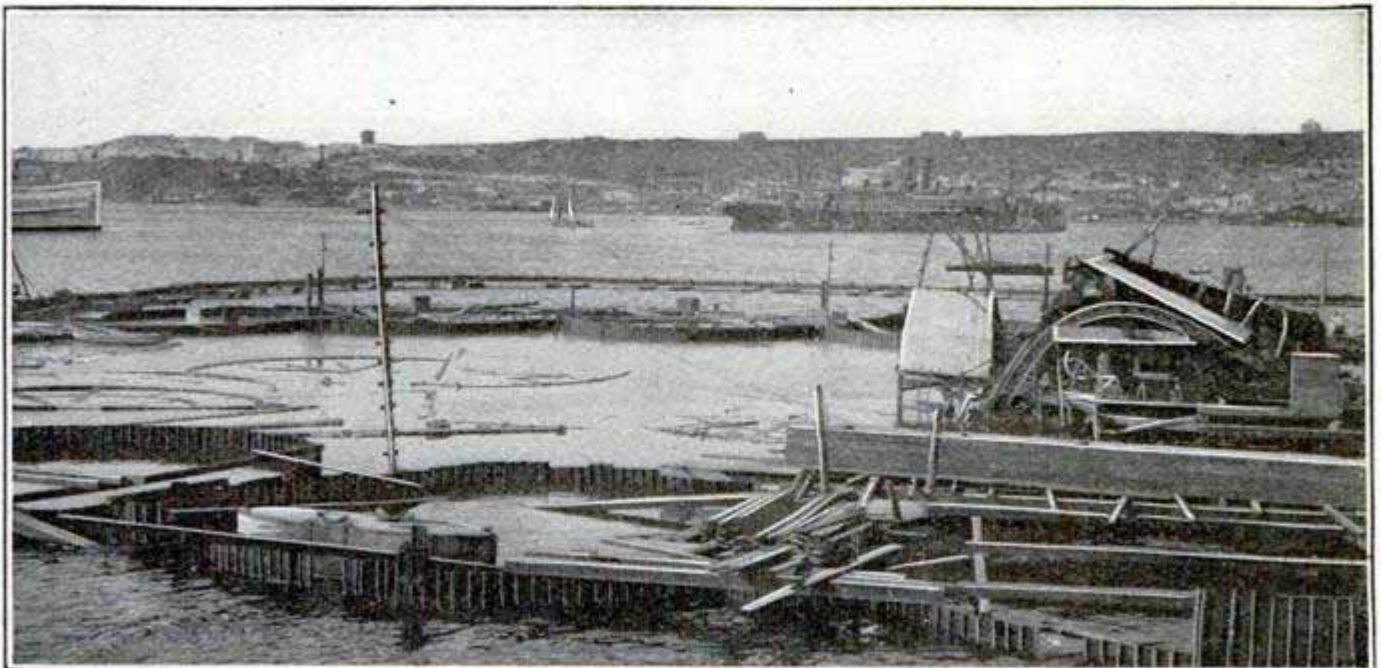

with mud, clay, and rock, dredged from the harbor bottom, is now under way. Then will come the pumping out of the inclosed basin and uncovering of the hull.

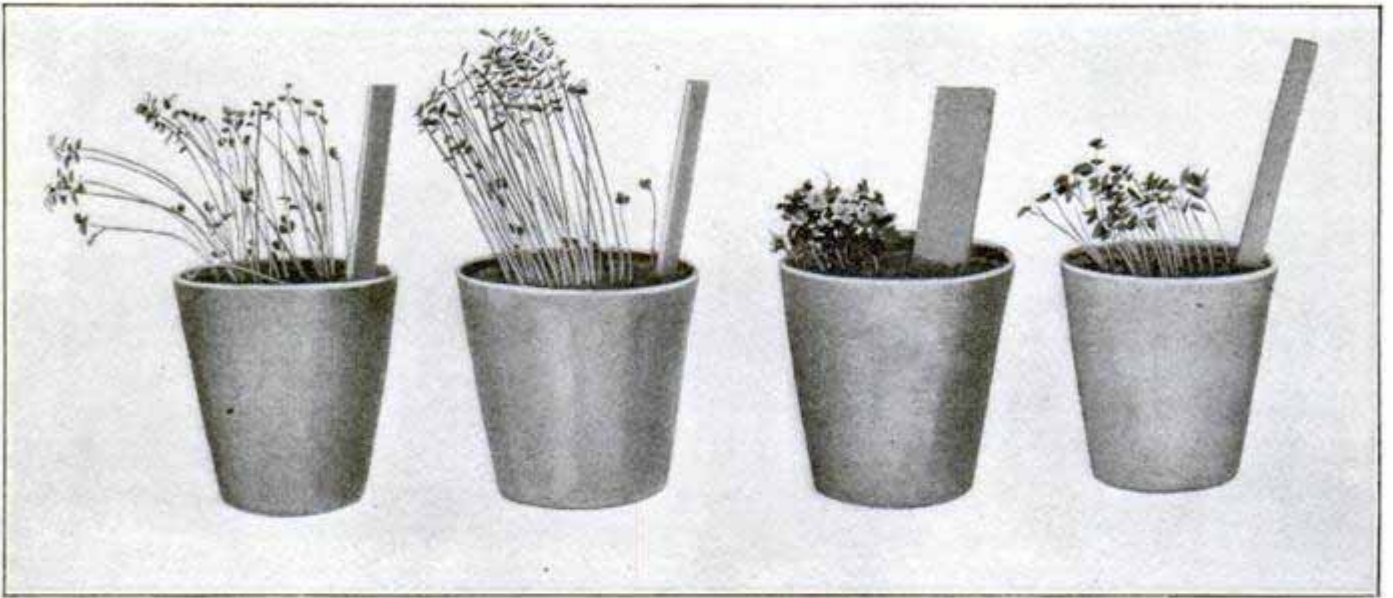

Mustard Plants Bending over toward the Electric Light

## EFFECTS OF ELECTRICITY ON GROWING PLANTS

Working plants overtime by the aid of artificial light is not a new idea, but has hitherto proved too expensive for the results attained. It has remained for a Scotch horticulturist, and a woman at that, to discover an efficient method of using electricity for this purpose. In her greenhouse at Dumfries, Scotland, Miss E. C. Dudgeon has placed up among the rafters a mercury-vapor lamp whose weird blue light has been the means of causing several varieties of seed to germinate in one half of the usual time, or less, and to increase the growth of the plants in an extraordinary manner, besides producing a greater depth of

color in the vegetation. One curious result was the tendency of the plants to lean over in the direction of the light, but, more wonderful still, the plants quite near to the lamp had not a single hair on them, while those further away developed hairs only on the side away from the light.

□ Investigation of interruptions on a party telephone line in Manitoba, Canada, brought to light the fact that one of the women on the line was in the habit of taking the receiver off the telephone and using it for a darning egg in mending socks.

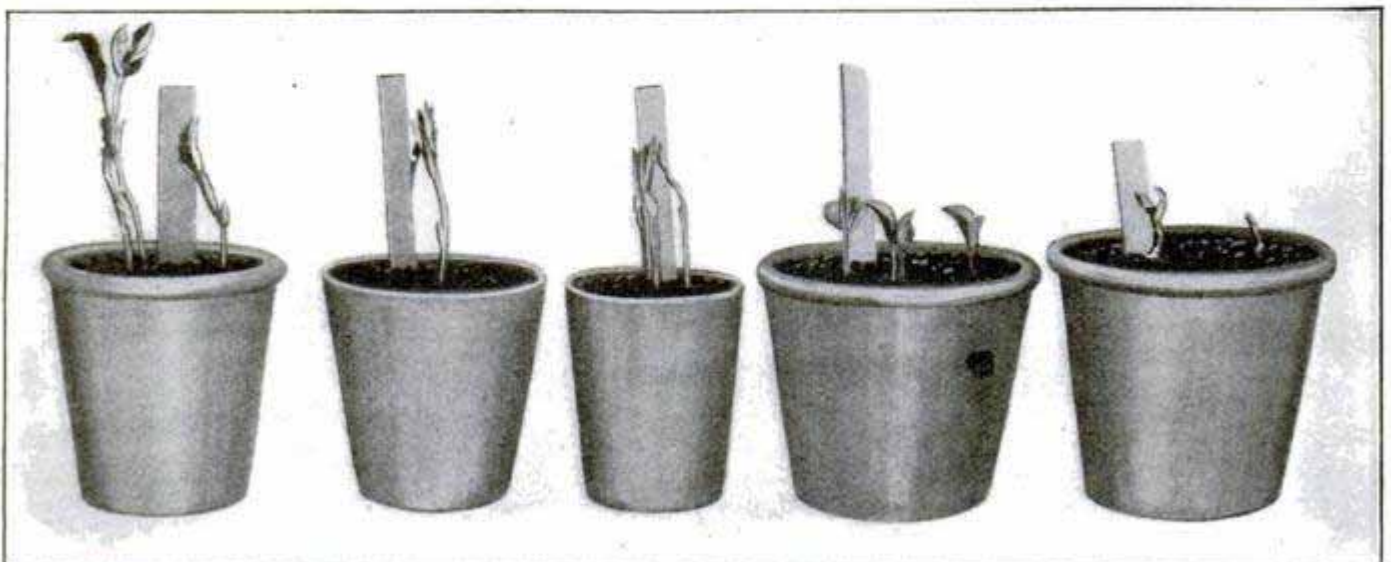

The Beans in the Three Pots on the Left Were Forced by Electric Light, Those to the Right being Grown Naturally in the Same Time

## THE WORLD'S LARGEST MAGNET

In the accompanying illustration is shown one of the most interesting feats performed by a remarkable electromagnet,—the most powerful in the world,—recently constructed specially for the United States government and installed for experimental work and tests at the bureau of standards at

with an electric current of 125 amperes. This is accomplished by the substitution of copper tape for the ordinary insulated wires. This copper tape is surrounded by insulating oil. Through the oil there are run coils of copper tubing about  $\frac{1}{2}$  in. in diameter, through which cold water is circu-

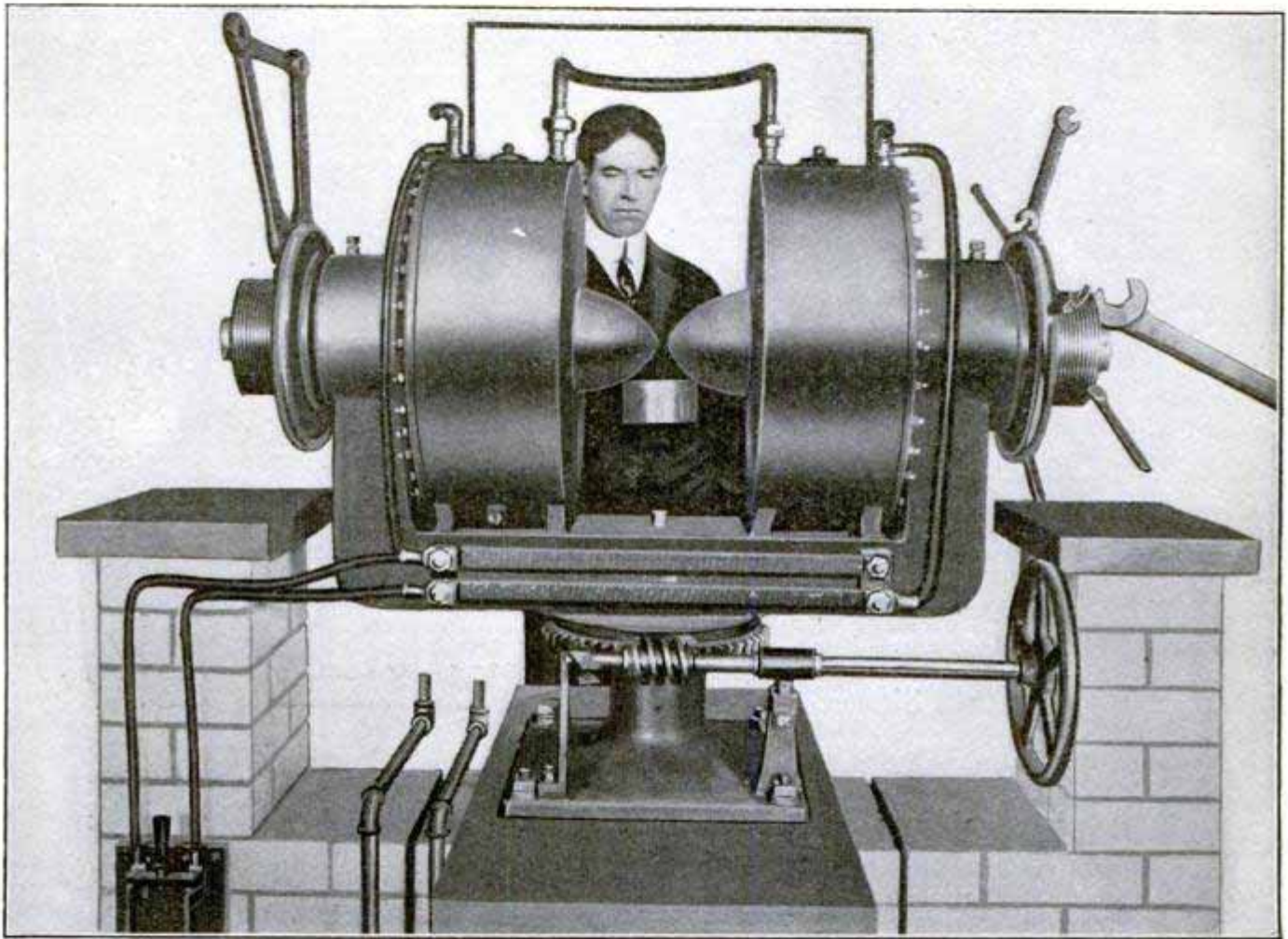

Electromagnet at Government Bureau of Standards, Showing Bowl Suspended from Pole-Pieces, and Wrenches Adhering to Ends

Washington, D. C. In the picture there is seen suspended from the pole-pieces of the magnet, in inverted position, a heavy glass bowl or dish of slightly larger size than the ordinary finger bowl and this glass receptacle is held in this position by means of the attraction exerted by the magnet (through the glass) upon a small piece of iron placed inside the dish.

The new magnet, which was made in Switzerland to the specifications of the United States government at a cost of \$1,200, is capable of continuous use

lated to carry off the enormous heat developed. The windings and cooling apparatus are inclosed in large brass cases, 2 ft. in diameter. In order to obtain magnetic fields of any desired intensity, the current in the coils is controlled by means of a massive, specially designed resistance, or rheostat, which permits such control ranging from  $\frac{1}{2}$  to 125 amperes. The distance between the pole-pieces of the magnet can be varied accurately and readily by the turning of a handwheel on the end of the magnet.

## GREAT BRITAIN'S LATEST DREADNOUGHT

The gun and lifeboat arrangement of Great Britain's latest dreadnought, the "Monarch," launched in April, is



Courtesy Illustrated London News

Deck View of H. M. S. "Monarch" as She Will Appear in Action

clearly shown in this illustration. The main battery consists of ten 13.5-in. guns, arranged on the center line in such manner that all may be fired on either broadside, as is also the arrange-

ment of the latest U. S. battleships. The 13.5-in. guns fire a projectile weighing 1,250 lb.

The "Monarch" has only one mast and the superstructure generally is pruned down as far as possible, with the end in view that wreckage caused by a projectile striking either may be easily cleared away and interfere as little as possible with the handling of her guns. The lifeboats are housed in shelter-screens, not only as a protection against the fire of an enemy, but because otherwise the blast of the ship's own huge guns would shatter them.

The length of the "Monarch" is 545 ft.; her beam, 88.5 ft.; displacement, 22,500 tons, and her horsepower, 27,000.

## TOMATO SEED OIL

Tomato seeds, once a waste product of the canneries of Italy, are now made to produce an oil, the rapid-drying quality of which is said to be excellent. The oil is used in the making of varnishes. Italy has many large tomato canneries, and in that country it is customary to carefully remove the seeds before canning the fruit. The canneries in the province of Parma alone can 54,000 tons of tomatoes annually, and now have an output of 600 tons of the seed oil.

## NUMEROUS TASKS FOR AUTOMOBILES

Three demonstrations of the utility of automobiles for tasks other than those for which they are designed are pictured in the accompanying illustrations. A Los Angeles business man, in moving from old quarters into new, towed his office safe slowly and steadily along several blocks of asphalt pavement, the only difficulty met with being at two lines of car tracks at street intersections. The safe weighs 1,500 lb.

The other demonstrations shown are on farms, one in California, and the

other near Worthington, Minn. The California land owner uses his runabout to furnish power for a corn-shelling machine, utilizing a belt attached to the left rear wheel as a means of transmission. The Minnesota farmer uses his machine for numerous farm tasks, among which is the operation of an old-fashioned washing machine. It is noticeable, however, that the automobile only runs the washing machine, and that the owner of the car is himself being utilized to turn the wringer.



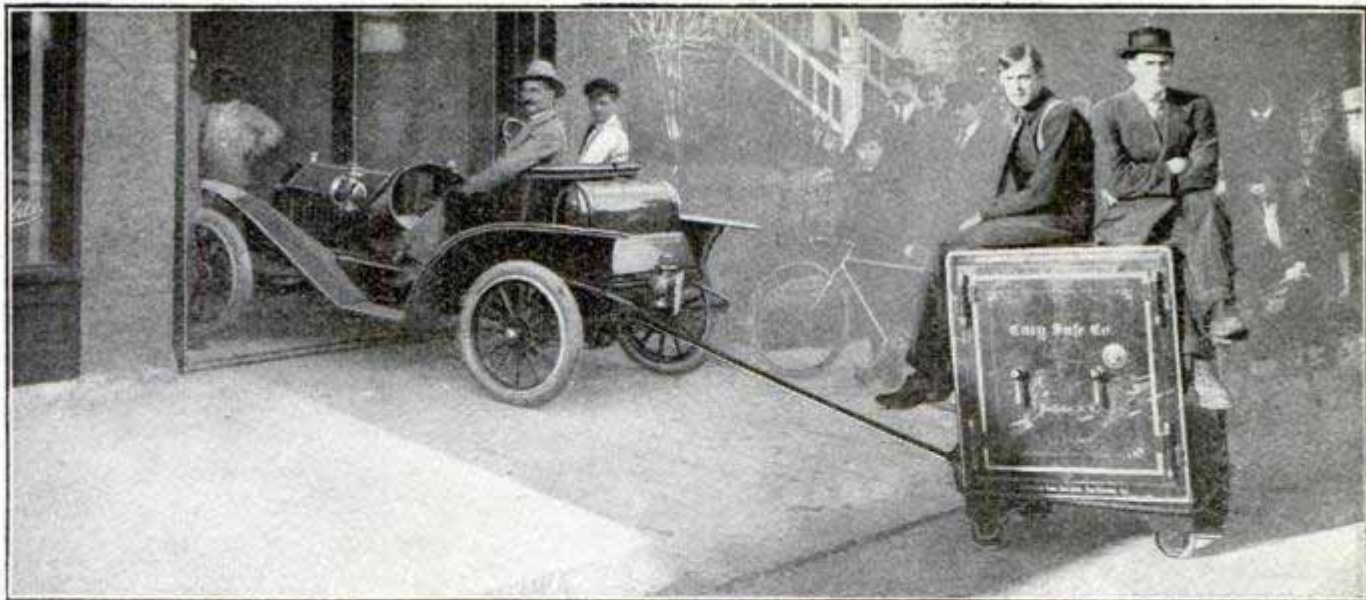

Towing a 1,500-Lb. Safe through the Streets behind a Light Runabout. The Only Trouble Experienced Was in Crossing Car Tracks

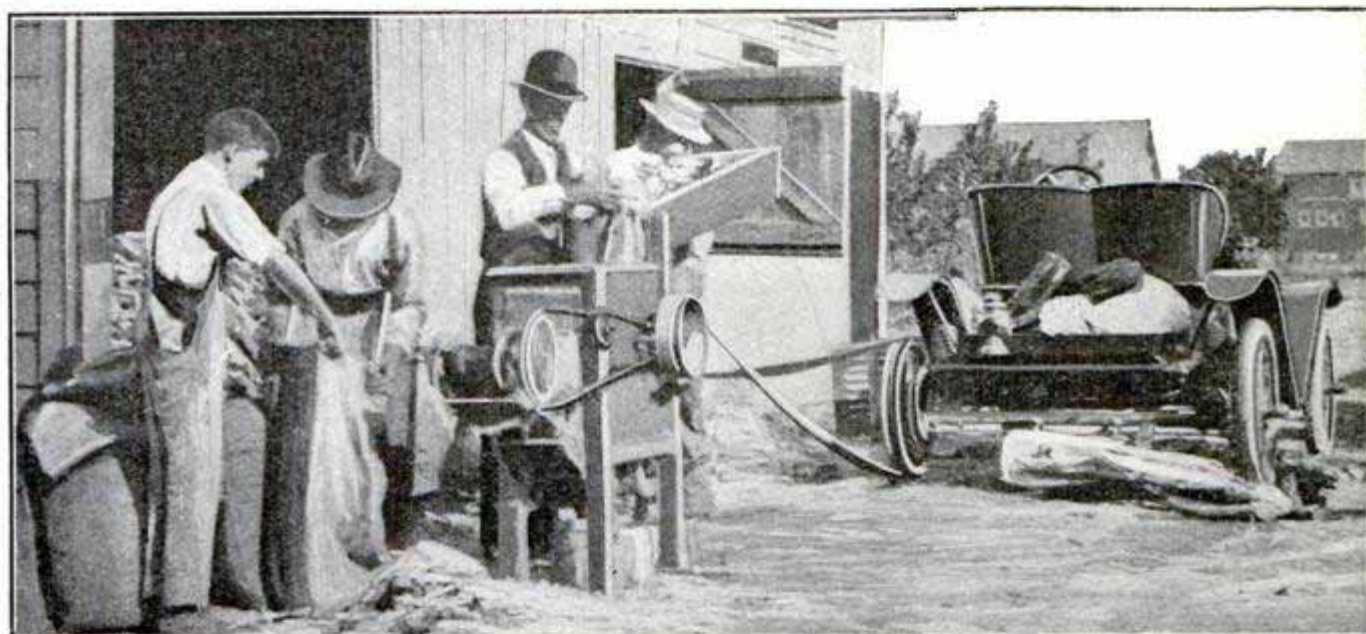

Driving a Corn Grinder on a California Ranch by Automobile Power. The Rear of the Machine is Raised by Placing It on a Log

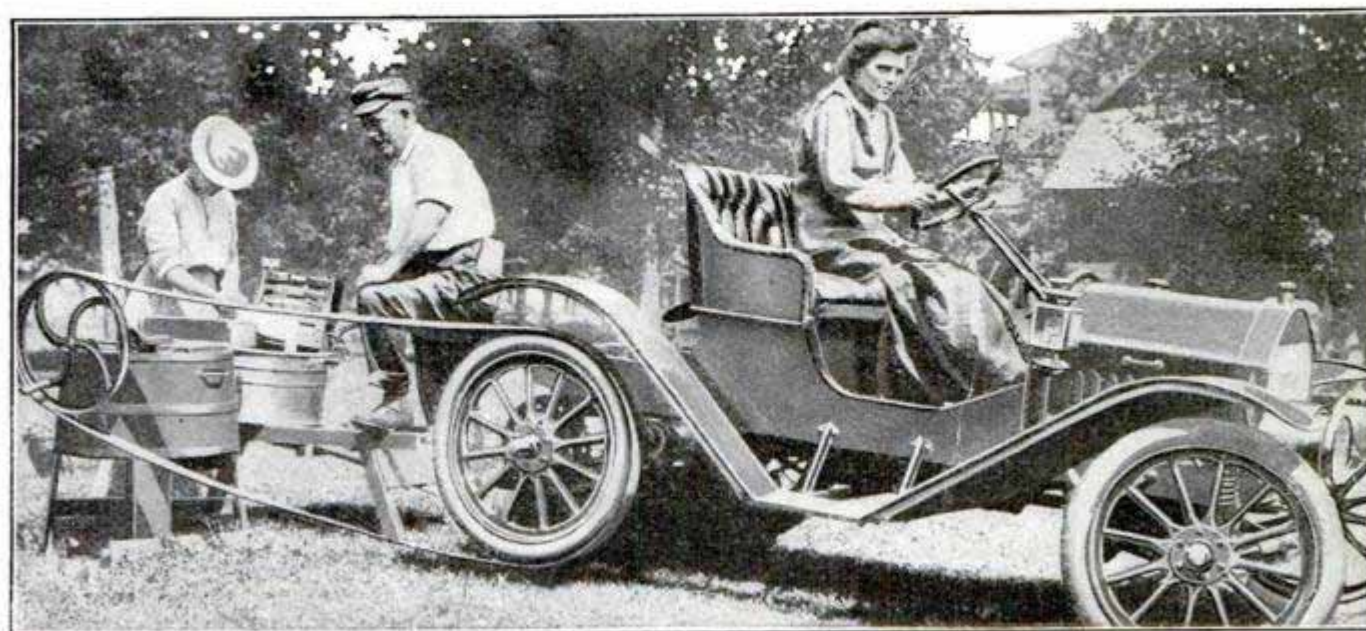

A Runabout Serving as Power for an Old-Fashioned Washing Machine. The Owner of the Car, However, Has to Operate the Wringer

## REGISTERING FARE BOX FOR PAY-ENTRANCE CARS

A registering fare box for use on the pay-as-you-enter type of street car

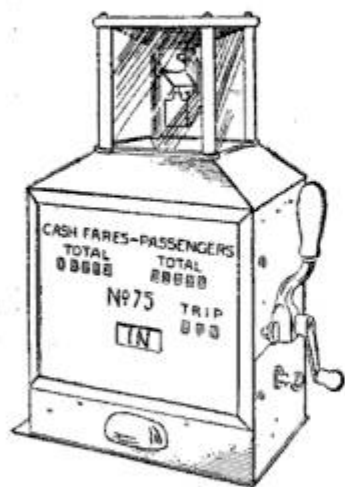

has been placed on the market by the inventor who designed the coin-counting machines used in the United States treasury and sub-treasuries. The important feature of the box is that it gives an absolute register of both the passengers and the

money they deposit, then passes the money on to the conductor for change purposes.

Conductors do not handle fares before registration, simply pulling a lever when the fare is deposited. This announces the fare on the gong, and dumps the coins on the examination plate into the box. Then continued operation of the lever carries the coins through the box, automatically counting, registering, separating, and depositing them in their respective places in the cash drawer for the conductor's use in making change.

CA recent type of electrical measuring instrument records the power consumption correct to within one per cent, regardless of temperature and current changes.

## A FLOATING LOBSTER HATCHERY

By C. B. EDWARDS

The Rhode Island Fish Commission has established at Wickford, Rhode Island, the most remarkable hatchery in the world. Unlike the ordinary state and government institutions for keeping the waters supplied with fish, the hatchery at Wickford is not even built on the ground. It is simply a large houseboat floating on an inlet of Narragansett Bay and surrounded by an extensive raftlike structure supporting innumerable boxes or cars for the hatching of lobsters. In the main houseboat section are two gasoline engines of 3 hp. each. These engines are coupled up independently to a system of small shafting and gears which run over the floats and extend to each rearing-box that the young lobsters are hatched in. Attached to the terminus of the geared shafting in each hatching-box is a two-bladed fan having blades which impose an angle of resistance against the water and when set in rotation cause a current in the water inside the box, in much the same manner that a boat propeller does.

Upon this principle alone, has hinged the success of the work of the Rhode Island Commission, for by the use of this artificial mode of inducing circulation, lobsters are raised to the fourth and fifth stages of development by the thousand. Other attempts to rear lobsters from the egg beyond the first larval stage have failed chiefly because when lobsters in the first larval stage are put together in any considerable quantities, the stronger individuals will consume the weaker, for food.

This cannibalistic tendency of the larvæ has been the insurmountable stumbling-block in lobster rearing up to this time, and only after years of study and experimentation has it been possible to overcome this tendency. The using of a fan to keep the water in motion prevents larvæ from eating one another by keeping them separate to a great extent and allowing only momentary contact at the most. Few of the shellfish have as delicate larvæ as the lobster, and it is due to this fact that great care has to be used in hand-



Feeding the Lobster Fry by Hand

ling and rearing. The first-stage lobsters, as liberated by the ordinary hatcheries, rarely reach maturity, eminent authorities estimating that not one lobster liberated out of a thousand ever reaches maturity. In the case of the Wickford station a high percentage of success has been secured both in point of cost and the actual results from the transplanting of lobsters in the beds of the State.

Great economy has been secured by the Rhode Island hatchery, fourth-stage lobsters being produced throughout the breeding season at an average cost of one-fifth of a cent, this including every expense, even interest on the

investment. It is not unusual to hatch as many as 7,400 egg lobsters from the eggs of a single female and carry more than 70 per cent of them to the fourth stage for planting. During the last season over half a million fourth-stage lobsters were reared and planted, besides 28,000 of the fifth stage. The success attained is considered as an important step in the direction of commercial lobster-raising on a large scale, and this is the ultimate goal of the Wickford authorities, who say that they hope by the new method of rearing to bring lobsters to maturity at a cost of  $2\frac{1}{2}$  cents apiece, allowing a fair margin of profit.

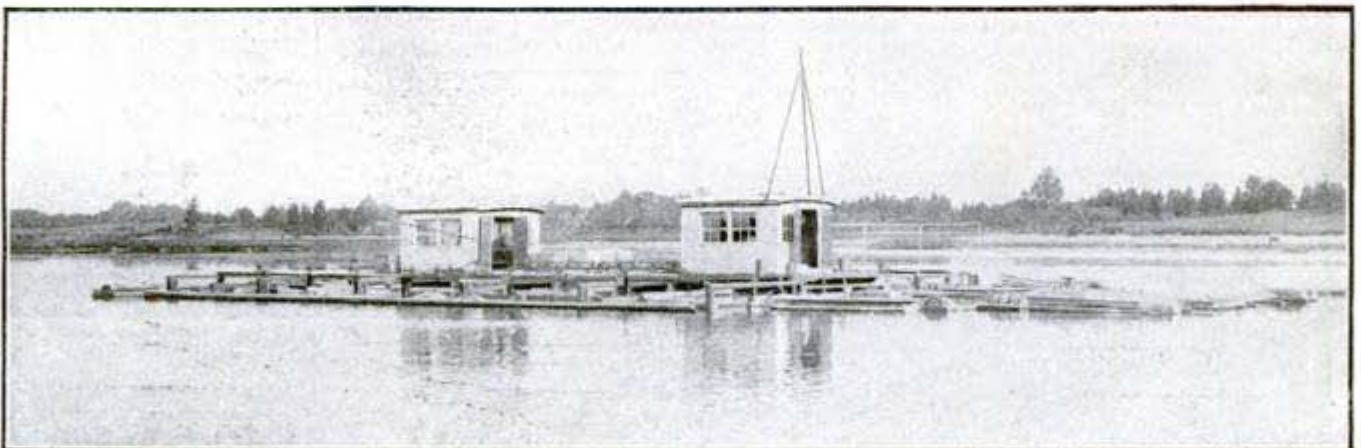

General View of the Floating Lobster Hatchery at Wickford, R. I.

## THE HAREM-AIR'EM SKIRT

The "jupe-culotte" or harem skirt, which has recently been evolved from the hobble and sheath skirt, with con-



Pauline Chase, the Actress, in  
'Plane Clothes

siderable success in Europe and less success in this country, is much more adapted for aerial flight than an ordinary costume. Miss Pauline Chase, the English actress who was formerly engaged to Claude Grahame-White, one of the foremost of the English airmen, is here shown in her harem flying costume, which is described by British writers as 'plane clothes.

## ALUMINUM FOIL

Aluminum can be rolled out into sheets no thicker than 0.00005 of an inch, which have all the strength and pliability of tinfoil. This latter, on the other hand, is not useful if rolled thinner than 0.0004 of an inch. Thus it comes about that out of one pound of aluminum can be produced 1757.75 sq. ft. of commercially usable foil, while one pound of tin yields only 73.25 sq. ft. Of course, to properly understand this comparison it should be borne in mind that tin is about three times as heavy as aluminum, and that, therefore, one pound of aluminum has three times the volume of one pound of tin. A factory in Belgium makes a specialty of turning out this aluminum foil, which finds its use in European countries, mainly as wrapping material for chocolates.

## DESIGN ACCEPTED FOR QUEBEC BRIDGE

The contract for the construction of the superstructure of the Quebec bridge has finally been awarded to a Canadian concern, whose design was approved by the majority of the board, as well as by additional experts appointed by the government. The contract price for the superstructure is about \$8,650,000, which, with the contract price for the substructure, makes a total of about \$12,000,000.

The accepted design has the K-web system in the cantilever and anchor arms, and the suspended span is a modified Pratt. The total length will be about 3,240 ft.; the suspended span being about 640 ft. long; the cantilever arms, 580 ft. long, and the anchor arms,

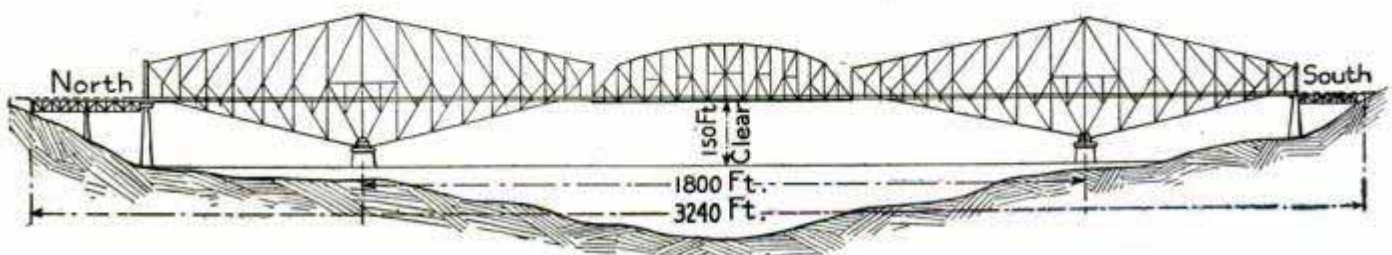

Design Finally Accepted for the Quebec Bridge

280 ft. long. The clear headroom above extreme high water will be 150 ft. The cantilever arms and suspended span will be of nickel steel, and all members in the anchor arms and those immediately over the main pier will be of carbon steel.

as the pressure was too great for effective work. Later, with additional equipment, the water was lowered to within 46 ft. of the big pump, and in ten days the divers repacked the pump, tightened the glands, smoothed the corroded parts and got it to working.

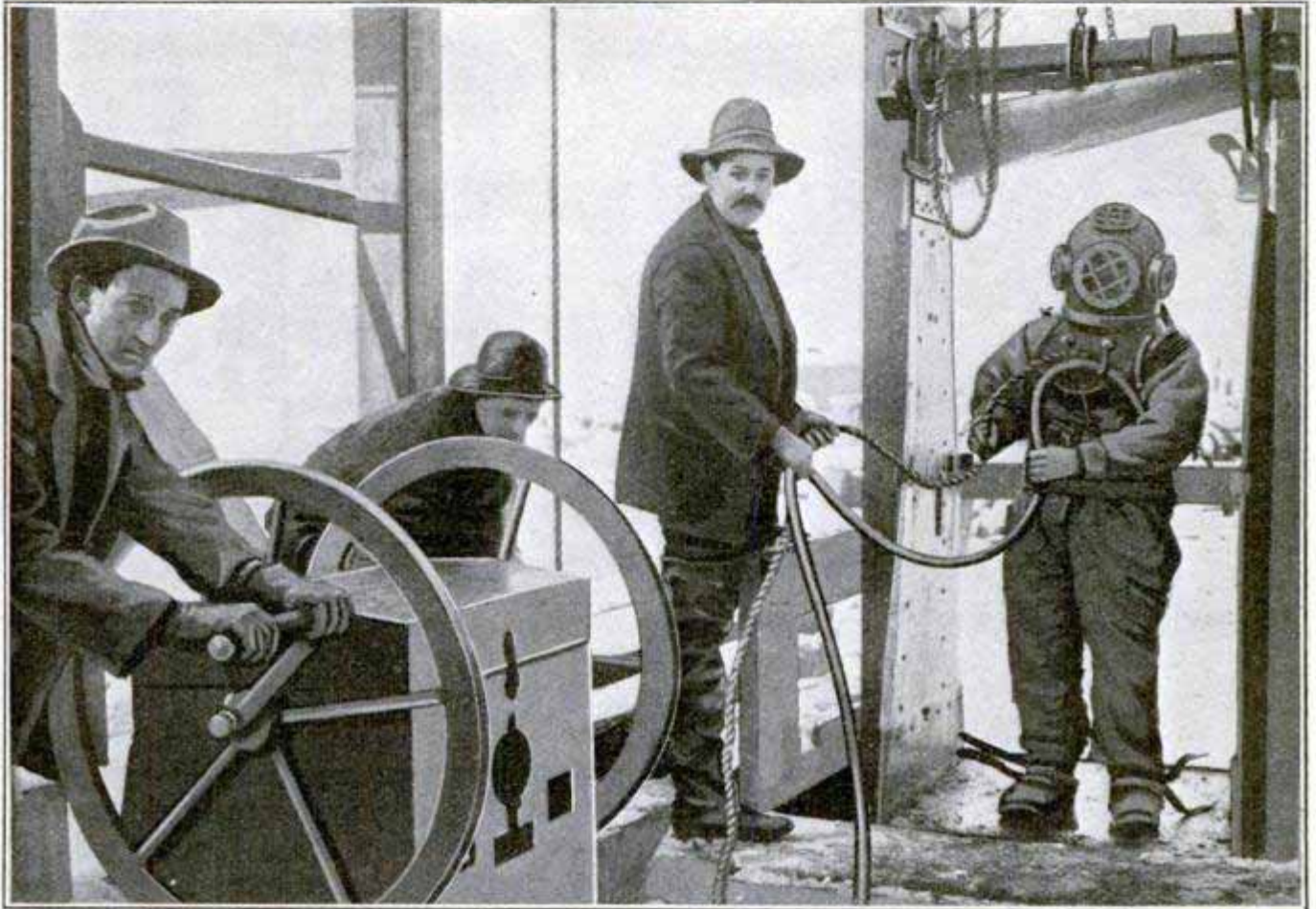

Diver about to be Lowered into Submerged Mine

### DEEP-SEA DIVERS IN MINING CAMP

In the heart of the Rocky Mountains profitable employment was found recently for deep-sea divers. At the bottom of the Free Silver shaft at Aspen, 1,200 ft. below the surface, a large duplex plunger Jeanesville pump had been submerged for 14 years. In June, 1910, the unwatering of the shaft was undertaken. Pumping equipment to take out 90,000,000 gal. a month, in addition to a normal inflow of 1,800 gal. a minute, was provided; and the water level was lowered to within 116 ft. of the pump. Two deep-sea divers were then employed to repair the submerged pump, and get it into shape to finish the unwatering of the mine. Their first attempts were unsuccessful

Twice afterward they were pressed into service, once to replace a broken flange and once to clean out the debris that had been precipitated into the sump by the breaking of a retaining screen. Finally, however, the draining of the shaft was successfully completed, and the capacity of the pumping plant has been made ample to meet any emergency. The net result of the undertaking will be the draining of 20 mines included in an area three miles square; and the production already begun from the deep ore bodies will place Aspen again among the great silver producing camps of the world.

Chicago is said to have more houses wired for electricity than any other city in the country.

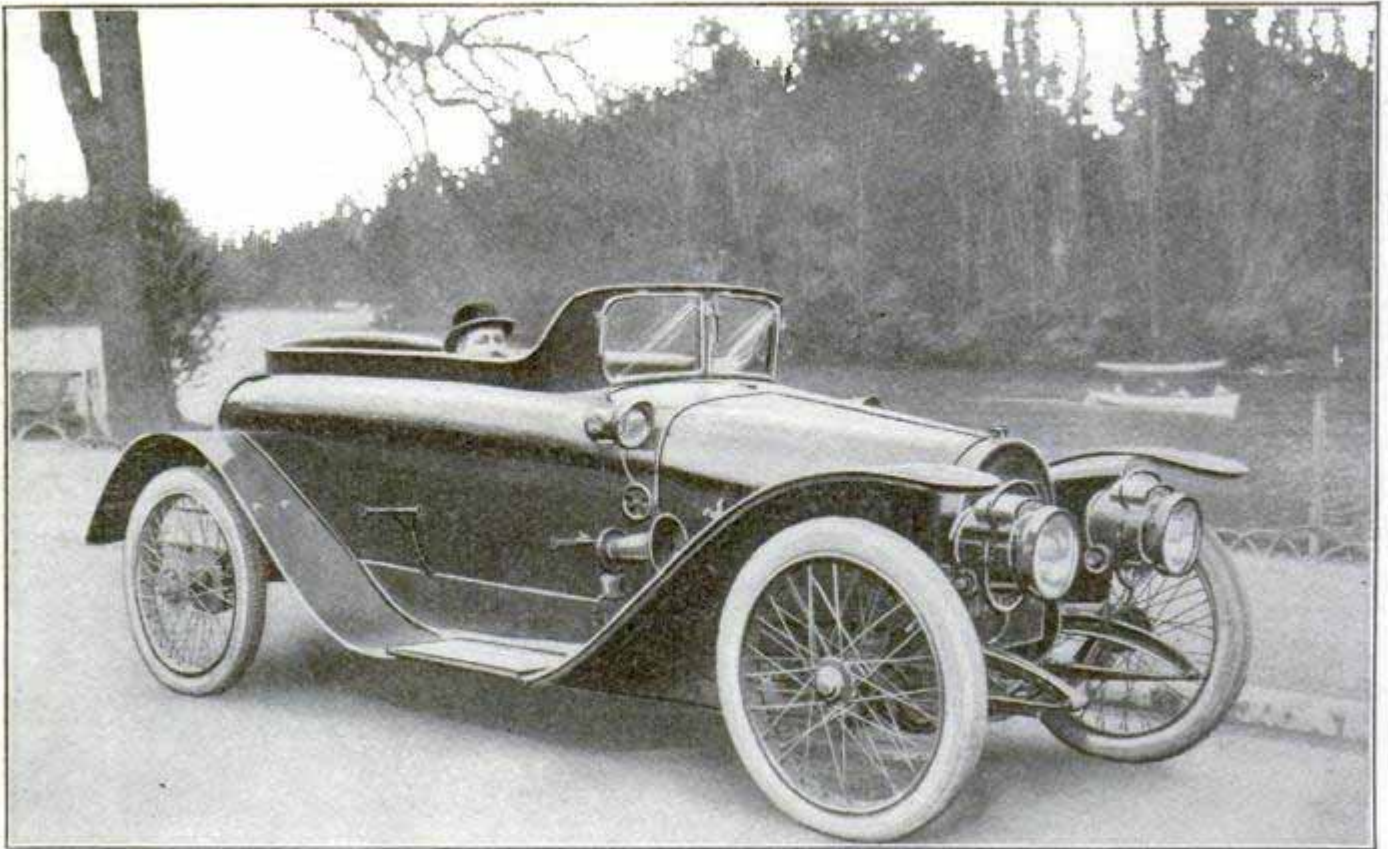

EXTREME TYPE OF "SUBMARINE" AUTOMOBILE

This new style of automobile body has met with favor in Europe, and many manufacturers are adopting it

### THE STRAW HOUSE

A summer house of straw has been built by a Californian, who utilized for that purpose the coverings of wine and beer flasks, which are placed around them to prevent breakage. A light wooden trellis was built on a circular foundation, and upon this the straw

sheaths were tacked like shingles, overlapping so as to shed the rain. The roof is covered with the same unusual building material. A round table and benches furnish the interior, and as it is electrically lighted, it is a pleasant resting place in the evening as well as by day.



An Easily Made Summer House of Straw

### ELECTROLYTIC IRON

Iron is now being produced electrolytically by a method devised by a German scientist and tried out at a large electrochemical plant at Leipzig. The iron obtained is said to be exceptionally pure, and is formed in a bright, very solid and easily worked sheet on the electrode. By selecting electrodes of suitable shapes, tubing and even very complicated forms of sheet iron may be readily made.

The electrolytic iron is said to be magnetized and demagnetized much more rapidly than ordinary soft iron, which, it is believed, will give it a wide field of usefulness in the construction of electromagnets.

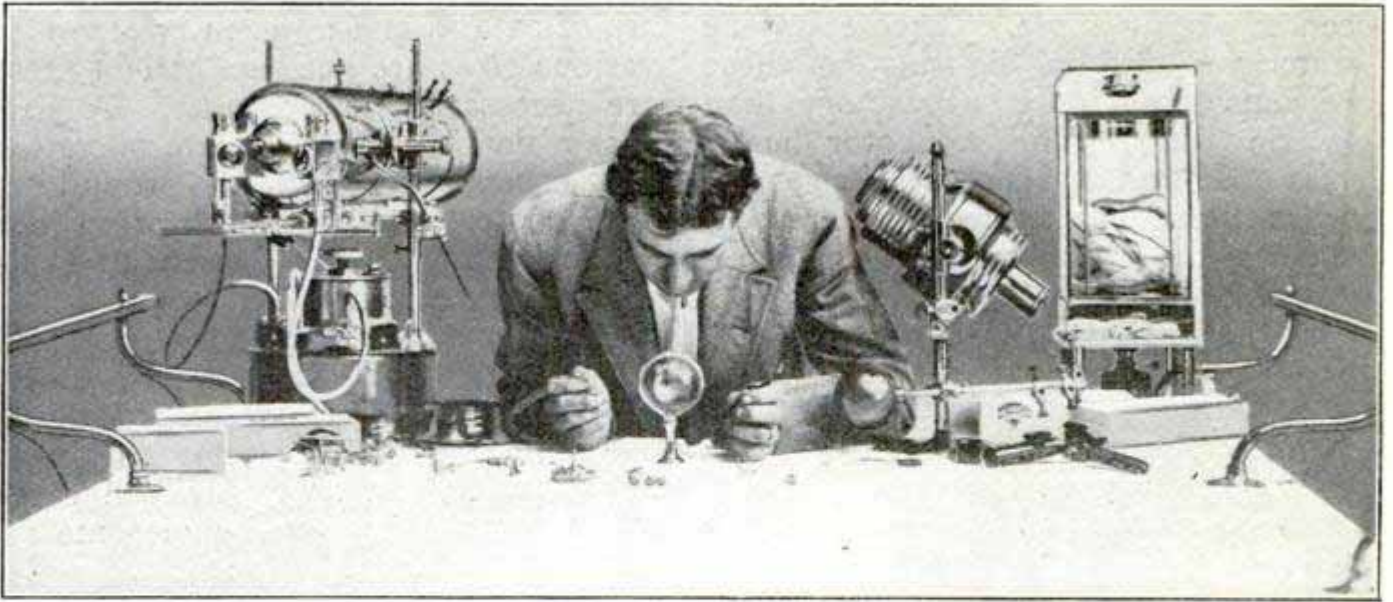

### BREAKING A PERFORMING FLEA OF THE JUMPING HABIT

The flea is confined within a glass globe until it is taught the futility of hopping, and learns to crawl. On the left of the picture is shown the large microscope. The incubator may be seen on the right, and the tiny circus paraphernalia in foreground

## PERFORMING FLEAS SHOWN IN MOVING PICTURES

A distinct novelty and somewhat of an achievement in motion-picture photography is the production of a film showing on the screen a greatly magnified picture of the tricks performed by a circus of trained fleas. These pictures were taken, considerably enlarged, directly on the film, instead of being made from enlargements of photographs taken in the ordinary way. The film makes the spectacle of the performing fleas accessible to as large a crowd as a theater will accommodate, whereas formerly only one person at a time could view the "circus," and then only with the aid of a microscope.

The reel, which is said to be unique of its kind, is 1,000 ft. long, and takes 21 minutes to run through the machine.

The fleas, under the skillful and

patient training of an expert, were taught to walk the slack wire, turn somersaults, pull tiny vehicles, etc.; and the spectator, watching the reproduction of these tricks on the screen, is apt to forget entirely any previous acquaintance—possibly of a disagreeable nature—he may have had with the performers or others of their kind, in contemplation of their truly wonderful feats. When it is remembered that the flea is less than  $\frac{1}{8}$  in. in length and that it appears from  $1\frac{1}{2}$  to several inches long on the screen, some idea of the magnification can be obtained.

The microscope used in making the pictures is about 3 ft. long with a field of vision of 18 in. It rests on a ball-bearing turret so that a view may be

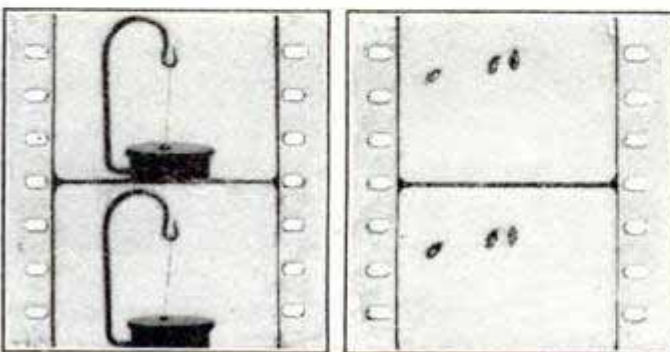

Sections of Films, Showing How a Refractory Trained Flea is Punished and Size of Performers on Films

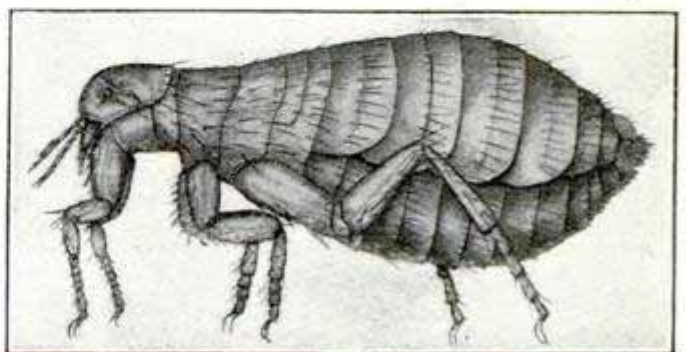

Flea Enlarged Hundreds of Times Original Size. This is the Size They Appear on Motion-Picture Screen

secured at any angle. Three acetylene lamps are used for lighting, as these are considered more satisfactory than electric bulbs. The incubator has a glass body and is raised on legs several inches high. The temperature is maintained by a water tank, at the base, heated by an alcohol lamp. The correct degree in heat is guaranteed by a thermostat at the top. There is also a water gauge and other minor details.

All the paraphernalia used in the circus acts, such as chariots, cannon, merry-go-round, and wire harness, are made of gold. The slack-wife props

are of catgut, and a dozen tweezers of various sizes are needed. All of these are necessarily very minute. To harness a flea is a very delicate operation and consists in securing around its neck a wire one-thousandth of an inch in diameter which is attached to the vehicle to be drawn.

In comparison with the size and weight of the objects he can move, the flea has wonderful strength and endurance, and after seeing the moving pictures, the spectator will carry away a probably more wholesome regard for the clever little insect.

### COLLAPSIBLE BICYCLE

John Robinson, one of the members of the famous Sheffield, Eng., choir, which is now singing in the United States during its world's tour, brought with him a collapsible bicycle, which he uses as a means of sight-seeing at all the stopping places of the choir.

The bicycle, which was invented by Robinson, is made mostly of aluminum, and can be taken apart and stored away in a leather case, as easily carried as a suitcase. Only five minutes are required to completely dis-

mantle or set up the unique machine. All he has to do is to loosen or tighten the collars that fit over the various parts of the framework.

As shown in the illustration, the bicycle is only partly folded.

### WRECKING A BRIDGE BY ELECTRICITY

Cutting the separate spans by means of electrically heated wires so as not to damage the old masonry piers and abutments which were required for the new bridge, was the unique method recently adopted to demolish an old wooden bridge which had to be removed in a hurry under a time-limit agreement. Dynamite and fire were both suggested, but were rejected as being liable to damage the masonry. Then the electrical method was tried and proved successful.

Each bridge span comprised nine chords of three timbers, and the method adopted was to cut the 27 sills simultaneously so that the span would drop into the river between the piers. Two loops of wire, heated to a cherry red by the electric current, were used for each sill, and 1 hr. 40 min. elapsed from the turning on of the current until the span fell into the river. The whole operation of wrecking the bridge took from 5 a. m. to 2 p. m., the work thus being finished in less than one day.



A Bicycle that Can be Folded Up and Carried in a Leather Case



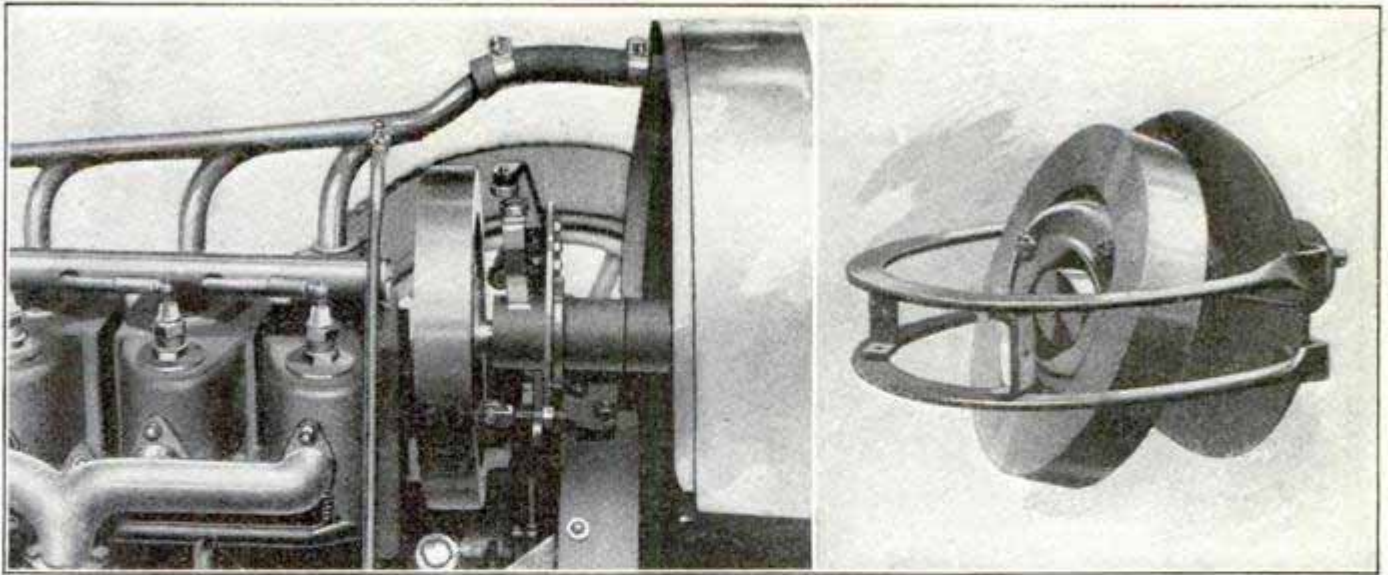

The Gyroscope Nonskid Fitted to a Motor

One of the Gyroscope Nonskids in Process of Making

## GYROSCOPE PREVENTS AUTOS FROM SKIDDING

It is claimed that with the application of the gyroscope to motors all danger of skidding and side-slipping can be obviated, that a car so fitted may take risky turns and run over slippery roads at a fair speed with absolute safety, and that the sudden setting of the brake will not cause it to deviate from its track.

## PROTECTING WAR VESSELS AGAINST TORPEDOES

The Navy Department has before it from time to time recommendations from officers afloat that our navy adopt nets for protecting war vessels against torpedo attacks. However, the judgment of our experts, in the matter of defense against torpedoes, continues to be in favor of more protection structurally, such as additional bulkheads below decks, so as to localize the injury

if a torpedo should happen to strike. The latest designs of our battleships contemplate an increase in area and thickness of the submerged armor, and there is a proposition so to extend this form of protection that it will cover every part of the hull which is likely to afford a vulnerable spot for a torpedo.

The latest information which comes from officers who have opportunity to observe the conditions in European navies quotes the English experts, for example, as disapproving of the torpedo net as being too cumbersome and heavy, and of doubtful efficiency against torpedoes, which, when nets are likely to be encountered, are fitted with net-cutting appliances. The French, on the other hand, seem to favor the net as a means of reducing the risk of damage by torpedoes. A torpedo net is mainly of use when a ship is at rest, and a material impediment to speed when a vessel is in motion.

## ELECTRIC ADHESION RAILWAY IN THE ALPS

Regardless of the fact that the Berninabahn, an electric Alpine railway, rises nearly 6,000 ft. between Tirano and Bernina-Hospiz, with exceptionally heavy grades, the trains do not run over rack rails, but on tracks like those of an ordinary electric street railway.

This is made possible by the adhesion of electromagnetic track brakes which are provided in addition to other emergency brakes.

The Berninabahn railway operates between Tirano and St. Moritz, a distance of about 36 miles. The 300-hp.

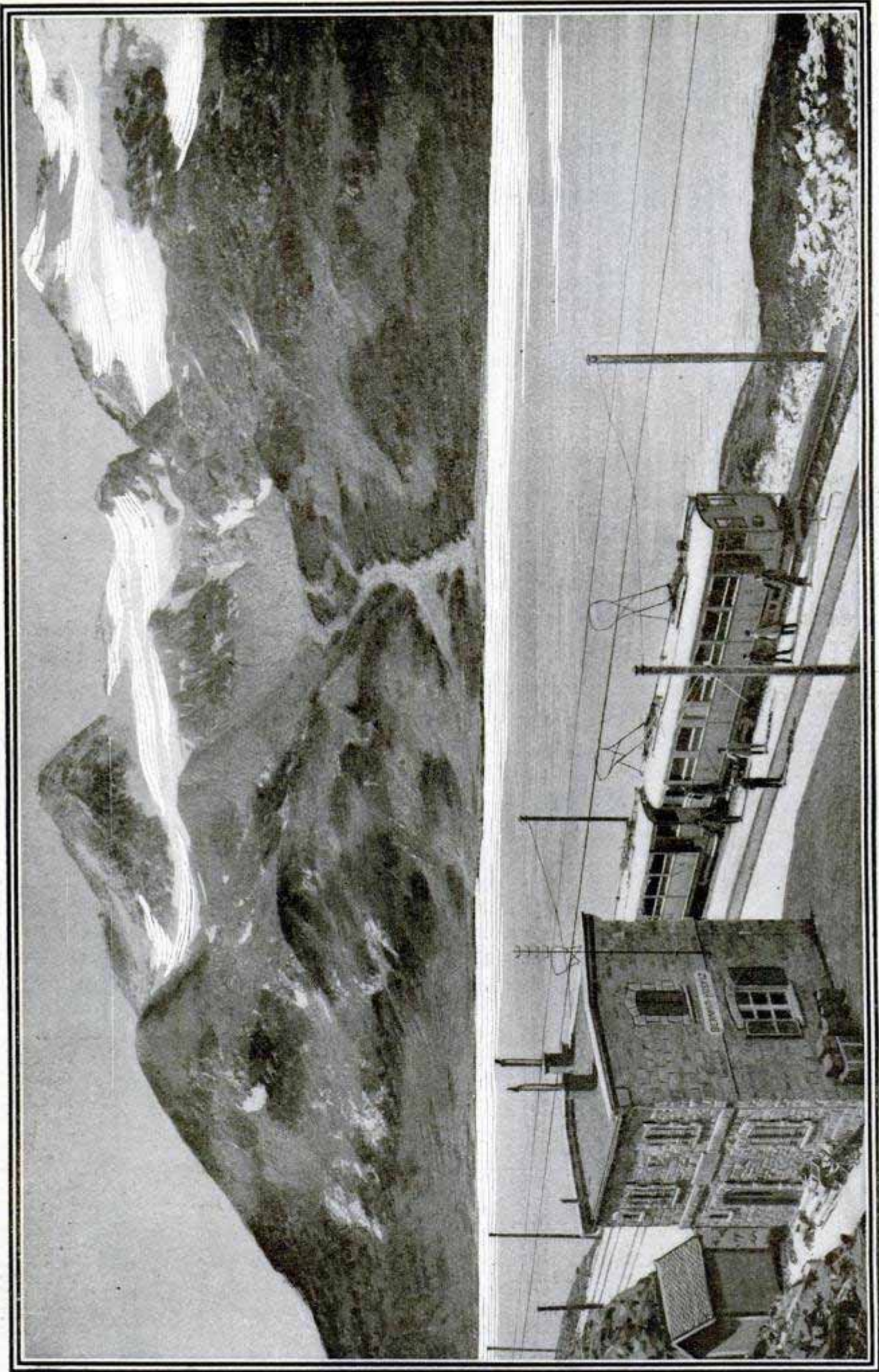

The Bernina-Hospiz Station of the Bernina Railway

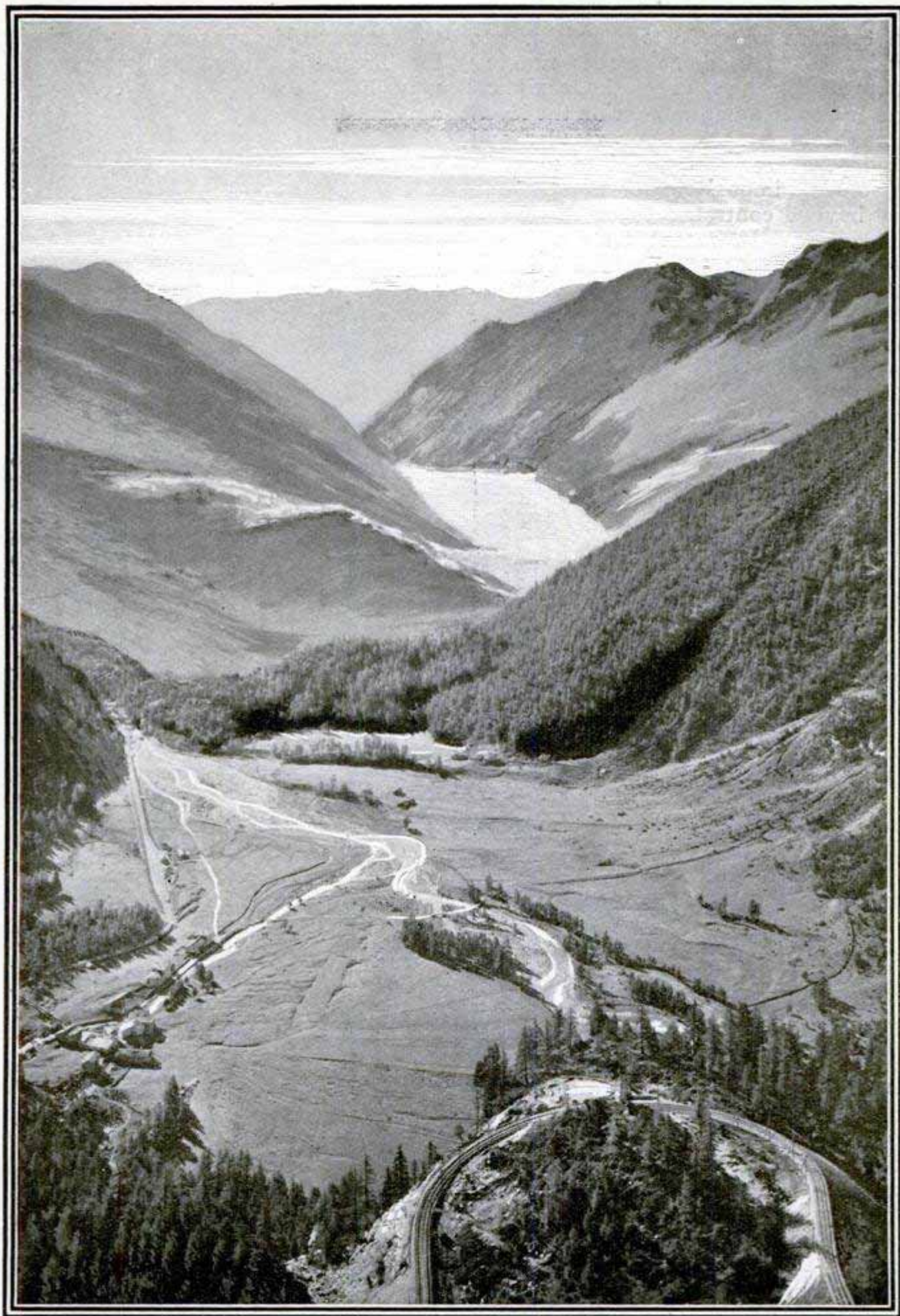

Swiss-Italian Alps, Showing Horseshoe Curve of Mountain Electric Railway

motor cars weigh 28 tons and operate trains of 45 tons, at speeds ranging from 10 miles an hour, on the maximum grades, to 35 miles an hour on the level. The braking system for regular and emergency service is said to make it absolutely impossible for the train to get beyond control, even on the heaviest grade. In recent tests on such grades, a 45-ton train was stopped in 10 seconds and within a distance of 115 ft. by using both the ordinary and the electromagnetic brake.

to want an old one, so they pile up in the Treasury vaults. Quite a saving may be effected if their coinage is abolished.

## NEW YORK HAS 1,490,000 WORKERS

The actual bread earners of America's metropolis, according to figures published by the New York Herald, number 1,490,000, of which the workers in factories lead all the rest with a

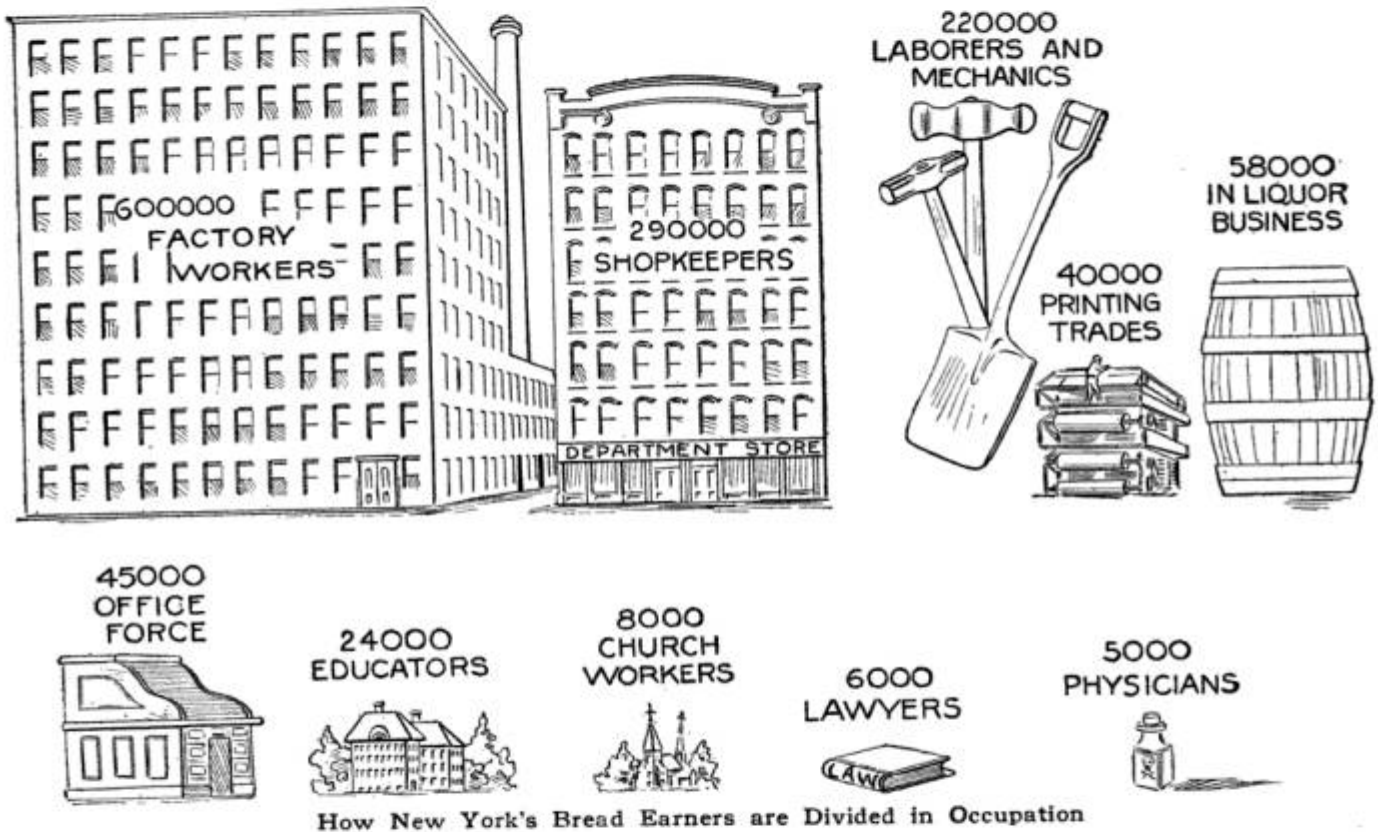

## U. S. MAY STOP COINING \$2.50 GOLD PIECES

The \$2.50 gold piece, which has long been a favored coin for watch charms and Christmas gifts, but not for circulation, may soon become obsolete if Secretary MacVeagh decides to ask Congress for authority to stop its coinage.

Even in California, where gold circulates almost to the exclusion of paper money, there is a public disposition to shun the little coin which is so easily confused with dimes and pennies, to the loss of the owner. Each year the mints have been coining new ones for the Christmas demand, but no one seems

total of 600,000. The store clerks are next in line with 290,000. There are 220,000 laborers and mechanics, 58,000 men in the liquor business, 45,000 office workers, 40,000 in the printing trades, 24,000 educators, 8,000 church workers, 6,000 lawyers, and 5,000 physicians.

## MOTORBOAT WITH AEROPLANE MOTOR

A motorboat equipped with an aeroplane motor made mostly of aluminum is making a wonderful record for speed on the Ohio River at Cincinnati. This new boat, known as the "Br'er Fox III," is able to maintain a speed



A Light Aeroplane Motor Pushing Motorboat through Water at Rate of 30 Miles an Hour

of 31 miles per hour for more than eight hours, and on a recent trip from Cincinnati down the Ohio River, a speed of 32 miles was attained for several hours, when the craft became entangled in some floating driftwood and her propeller broken.

The remarkable speed is more wonderful when it is known that the tests were made in fresh water, which is known to be a great hindrance for fast time. Nearly all the records of motorboats are made in salt water.

The case of the "Br'er Fox III" is a new departure in the use of the aeroplane motor, the light construction giving it a decided advantage. The new boat will take part in some of the big races of the summer. The photograph shows the boat when traveling about 30 miles per hour.

electric incubators are called—placed in their bedrooms. A setting of eggs of the Chinese ringneck, or other fancy breed of pheasant, is then placed in the electrobator, which, by connecting it with the ordinary electric light circuit, is supplied with all the heat necessary. The electrobaters are made in mahogany, ebony and other fancy woods, so as to harmonize with the most luxuriously furnished apartment; and the

## HATCHING PHEASANTS IN THE HOME

Pheasant breeding in the home has become something of a fad in Denver, probably owing to the presence of the privately owned pheasantries, which are reputed to be the largest in the world. Many of Denver's society ladies have had "electrobaters"—as the



"Electrobator" for Hatching Pheasants in Denver Home

owner may enjoy the novelty of watching the little pheasant chicks hatch under her own eyes.

Of course, after the pheasants have been hatched, they must be removed to the lawn, where inclosures of fancy iron fencing have been prepared for their reception. There the beautifully plumaged birds never fail to attract the attention and admiration of passers-by. In the end, however, they will be sacrificed to make a banquet for particularly favored guests.

### AN AUTOMOBILE SEE-SAW

One of the many obstacles placed in the path of the automobiles in a recent

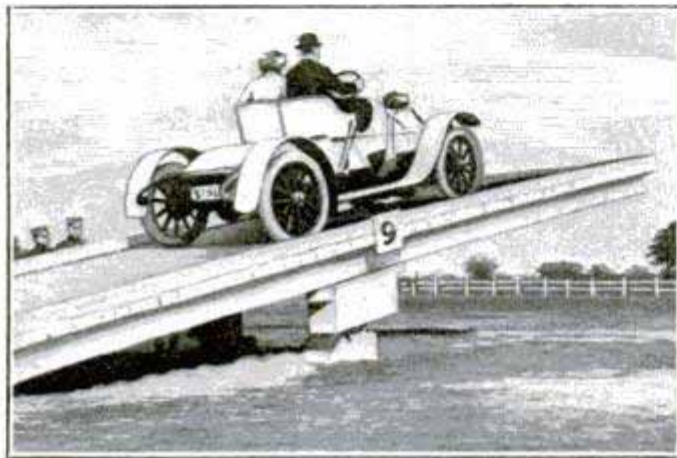

One of the "Stunts" of an Obstacle Race

obstacle race at Seville, Spain, was a huge see-saw. The run over it had to

be made with excessive care, as too much speed would drop the car off before its weight had brought the raised end of the see-saw down to the ground.

### PATTER OF RAIN HEARD BY WIRELESS

In a report to the hydrographic office of the United States Navy Department, the officers of the French steamship "Niagara" declare that the wireless operator of the ship is able, by wireless, to hear rain falling upon the sea at a great distance. The sound is like the patter of rain on a zinc-covered deck, and its increasing or decreasing intensity tells whether the squall is approaching or receding. The following explanation is given by E. Courteville, second officer of the ship:

"The night being clear and dry, we have an isolated cumulo-nimbus cloud loaded with electricity, positive for example, and the sea underneath is charged with negative electricity. At a certain instant, when the distance between the rain drop and the sea is small enough, a minute spark originates, giving a very small Hertzian wave. It is the superposition of these numerous rudimentary undulations that gives the pattering effect in the wireless receiver."

### CORONATION TIARAS IN THE MAKING

For many months before the coronation of King George V, the London jewelers were kept busy designing and constructing coronation tiaras, many of which are composed of more than 500 minute pieces of metal and are set with five or six hundred diamonds. Such a tiara will keep several workmen busy three months.

In making a tiara, the design is first created, and then reproduced in wax, all the stones being set in, so that the purchaser can see the exact effect of the ornament when completed. A zinc model is also made, with the design painted upon it, so that the exact effect

can be seen when tried on the head of the purchaser, and this is used to fit the tiara to the head destined to wear it.

After the various metal parts of the tiara are made, they are grouped together on a shaped frame covered with wax, then, when the desired effect is obtained, the pieces are cast in plaster, removed from the frame and united together. Drilling holes in the platinum to receive the stones is one of the many difficult tasks in tiara manufacture. Many tiaras have more than 600 holes, and it takes an expert workman a week to drill them. Then every hole has to be separately polished by hand, a task



**Fitting a Tiara to the Head. The Manufacturer Always Makes a Zinc Model and the Design is Painted on It**

which would take one polisher a month to accomplish, but the parts, of course, are given out to several. If a single workman should set all the stones, it would take him seven weeks to complete the task.

Although the makers of a tiara take the greatest care, at least \$50 worth of



**Making Up the Design of a Tiara in Wax. All the Stones are Placed in It, so That the Effect may be Viewed**

precious metal disappears in the process, even though the filings and washings recovered average as high as \$350 or \$400. The water used by the workers in gold and platinum for washing their hands is always filtered off to recover the precious part of the dirt it contains.



**Setting One of the Large Stones in a Coronation Tiara. If a Single Workman were to Set All the Stones in a Good Tiara, It Would Take Him Seven Weeks to Complete One**



CONEY ISLAND IN THE MONKEYSHINE SEASON





**A**GES ago the unwitting simian, all unwarned, built for himself a doubtful reputation as man's true ancestor. Latterly, we see fit to blame the defenseless ape for much. Yet is it anywhere on record that, some dear prehistoric summer, a merry little monkey ever passed his choicest cocoanut to a busy little monkey who owned a slanting rock, and thereafter, having folded about him his prehensile tail, slid gaily to the bottom and went his way feeling that his cocoanut's-worth had been gained? Has it ever been proven that the same merry little monkey, going forth in quest of diversion, tripped head over heels on a deftly concealed vine and, rolling thereafter in a hysteria of mirth, knew himself satiated? In fine, can the modern monkeyshine be blamed upon the ancient monkey? Science is silent.

What is the point of all this? Perhaps there is no point; but—here lies the gate of the summer amusement park. Let us enter.

Warm, is it not? A breeze would be grateful, and there are alleged to be plenty of them hereabouts. Who has stolen the breeze? Cast your indifferent, supercilious glance of inquiry at the wide, black-mouthed funnel yawning beside you. The polite uniformed attendant seems to be turning it in your own personal direction; why? Ah! A gust of compressed air—approximately 9,000,000 lb. pressure to the square inch—has emerged from the funnel and struck the back of your neck! Your hat has blown off and for an instant you fancied that the hair had gone with it; and now the multitude howls its merriment as you claw the air and choke down your deep emotion and strive to render your countenance like unto a wooden mask. Do you accomplish this last? You do not; but you have located a section, at least, of the breeze.

Well, it was all for the general fun. Now, if you choose, you may stand and watch other hats blow off until you drop for sheer weariness. But come this way; come and—what? Why the maniacal shriek and the accompanying dance? No, that top step did not crumble under your weight; it merely sank half an inch or so, to convey the impression that some malicious person had removed the floor entire. Now it is up in place again, ready for the next seeker after new sensations; and if there be a few raw spots on your fancied dignity, you have only yourself to blame. No one asked you to wave your arms and yell like that, you know. Come along.

Do you yearn to mount a fine, large wooden horse and career gaily up and down tracks for a space? No? Then observe this bowl—this splendid large wooden bowl, four or five feet deep, sunk in the floor and polished like glass

inside. What is the idea of the thing? Pshaw! Somebody pushed you in, did they? Well, at all events, you grasp the idea now; the idea is to get out. How? Oh, many, many ways suggest themselves. If a traveling crane were rolled up to the edge, you could grasp the hook firmly, signal for them to start the engine and thus be hoisted back to the level. Or a husky fireman might lie flat on the edge and extend you the courtesies of his scaling ladder; or you could manage it with a set of climbing irons; or even an Alpen

But, none of these see how Nature, ever path to freedom. Just as all these people are run like blazes and keep around and around; and track, will conduct you spiral which, by the land you at the level top

Well, it was a job, but no particular need of all Other people, not less enjoy that trick thornot be here. There is as there is in this human prefer to watch, eh? Martian if you choose The people, as you revolving disc of wood solely to see if they can of centrifugal motion the people naturally roll gracefully; but there is nothing like trying. In fact, it is fun to try.

What became of that small man, who seemed to pop into thin air? Why, he went through the trapdoor and down the vanishing slide, a new feature this year. You wouldn't like to vanish down a slide? Possibly the small man did not do it wholly from choice, you know.

And you don't care to venture into the trick house and have a new hair-raising sensation every three seconds; and you prefer to keep out of that delightful maze of wire-fenced passages which will tangle your sense of location until you are unable to walk down a sunlit street without a compass? Well, you own a strange mental make-up; possibly this particular park is not attuned to you. Let us pass into the next.

The broad, high, shiny incline, with the many ridges and rises and lumps upon its surface and the mattresses at the bottom, is the bump-the-bumps. One climbs to the top and then, sitting informally upon the smoothness, glides to the bottom once more. As a game it is in a class with golf; the object

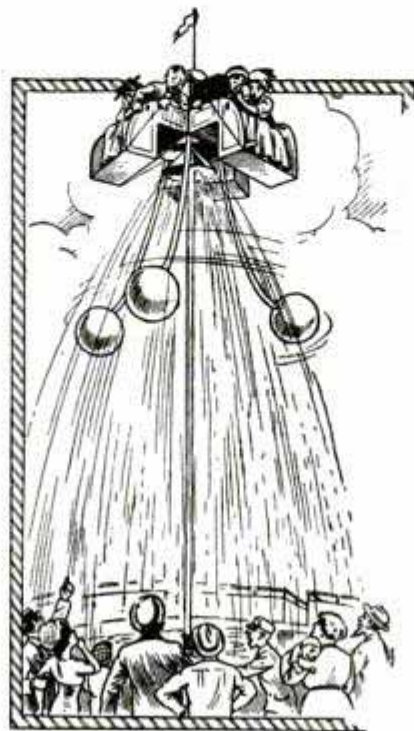

The Real Daring Ones Make an Ascension on a Stream of Water

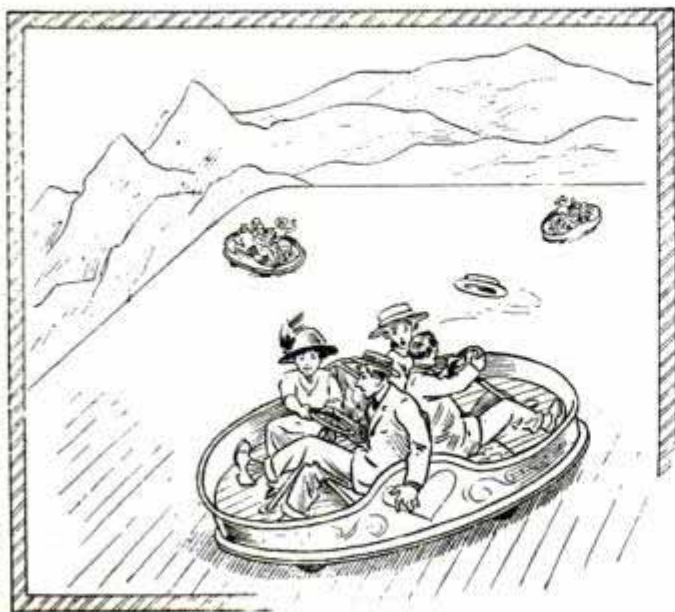

Like Two People Trying to Steer One Crazy Automobile at Both Ends

is to come to the end of the course striking as few times as possible. Few of the merry-makers are expert, though. They—well, you can see what I mean right there! See the pretty little lady lying on her side and rolling down at about 300 revolutions per minute? She raised her hands, you know, and lost her balance, and—what? Yes, as an exercise, that is supposed to keep down superfluous flesh and preserve the lines of the figure, if you choose to look at nothing but the serious side. Perhaps that is why the pretty lady is doing it, but her figure does not seem to need attention.

Somehow, I'm afraid spirit of that vivacious of this arrangement—the the steps ever moving wise like the sad sea mal flight; now two switched to the same the one side and down course, is to walk to the and come down the ground once more intact, course it can be done! before your eyes. And I see them falling over other; everyone sees merriment after that last

Well, well, well; if at this! This is the only skelter. All parties skeltered climb the long,—accept a grass mat if—and, in any case, seat

the long, deep curved flume of polished rattan, pointed groundward at a sharp angle. After that, it is all over in six seconds and half a dozen shrieks. There is something inexorable about that helter-skelter; there is no turning back after that first downward move.

Just see that anatomical jumble wave and surge and slide! It is like a flesh and blood jigsaw puzzle being emptied down a coal-chute, is it not?

See that shower of puffs and hairpins and other little odds and ends!

See that man crawling away with his collar behind his ears, while the stout lady who slid just behind him waves his necktie and screeches pointlessly!

Yes, and see that other lady, with hair trailing to her waist! How she clutches the impalpable atmosphere and staggers and gasps!

Isn't it simply great? Isn't it the greatest—*what?*

Are these sane people, presumably normal? Most emphatically they are, you chump—perfectly sane, normal, hard-working folk. And do they while away the long winter evenings at home banging each other with baseball bats and jumping out of windows? Do they descend their own stairs by standing



The Object is to Reach the End Striking as Few Times as Possible

you do not catch the slide. See what you think staircase over here with up and down and side-waves. Now it is a nor-steps have suddenly level, and so on, all up the other. The trick, of platform at the top, turn other side and reach the and it can be done—of Men are doing it right the women? Of course themselves and each them, as the gale of crash testified.

that doesn't appeal, look and inimitable helter-desiring to be helter-hot stairway to the right they are really fastidious themselves at the top of

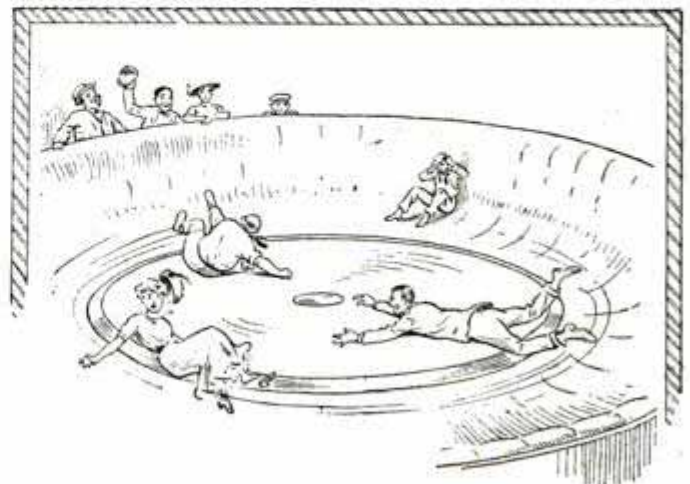

Get on That Revolving Disc and See if You Can Stay On

on their heads at the top and allowing a hydraulic ram to lend them the impetus necessary for the rest of the trip? Do their floors wave up and down and are their mirrors curved and are their knives and forks put before them white-hot?

Oh, you are impossible—utterly impossible! You are as far out of place here as an electric fan on the polar ice-pack. You miss absolutely the whole idea of this pure-fun scheme. Certainly, the people pay their money to do these things; just as certainly, they work for the money—yes; and if you are not one of them, that is your loss, not theirs.

You want to inspect the newer inventions—the strictly 1911 stuff? Look about you then.

“Rides” everywhere, are there not? Rides up hill, down hill, through lighted spaces and through black spaces, around corners and through magnificent sheet-iron canyons, hand-painted. Little coasts and bounces that merely raise your hair and others that cause your heart to stop short. See this one, the newest and the pride of Coney Island. Here the bored amusement seeker may ascend for his little trip, and before he has finished, much of the bored feeling is gone, for here you may make at least one drop of 90 ft.—the height, approximately, of a six-story building.

These, though, are long rides. There are plenty of shorter ones. Consider the blithesome egg-nogg. The little car is built egg-shaped and rolls about with the characteristic facility of the true hen product. You and your little car are turned loose at the top of the inclined plane, and you get your fun out of trying to steer a straight path to the bottom.

Here is another, too, rather more ornate—the tumbler. This, you will note, is a sort of flat, heavy, oval car, with the seats in the center and back to back, and a regulation automobile steering wheel for each of them. And incidentally, of course, there are a pair of wheels at each end to be steered. The passengers aboard, the car is hauled to the top of the incline and, like the egg-nogg, turned loose. And considering that two people are trying to steer independently; that whenever the wheel is twisted to the left, the car goes to the right, and vice versa; and that nothing under the sun can stop the general downward progress of the whole affair, even your analytical mind will fail in the search for any mathematical process of predicting the course of any given tumbler.

And the human sausage machine, too? Who would not pay to know the sensations of the supposititious canine taking the pure-food law course? Step right into the machine and walk ahead. You have no choice, once in, to be sure, for you are in a constantly traveling spiral cylinder and cannot turn back. Hark to the sounds alleged to be part and parcel of the making of the frankfurter! Ah! You’ve been ground out through the other end and you’re blinking in the sunshine again, presumably ready for cooking.

View the pneumatic tower, too—a western idea. The mighty glass cylinder rises some 200 ft. toward the sky. The tight-fitting, circular platform at the bottom is waiting for its hundred or so of passengers. They will arrive presently and the cylinder will be closed. After that, they will let in compressed air beneath the platform, and it will rise slowly but surely to the top of the tower. Once there an electric motor will turn platform, passengers and all through one complete revolution, so that all may view the landscape. And then, slowly but surely, the platform will sink down the shaft to the bottom once more, as the pressure is released. Nothing startling or nerve-racking about that, is there?

Nor is there about this floating geyser, another new idea on something the same principle, using water instead of air as the elevating medium. Three couples may sit in the three seats fastened to that big steel cone. When they

are quite ready, the water-pressure will be turned on, and a tiny stream—something like three-quarters of an inch in diameter—will be squirted up into the point of the cone. The pressure will be increased and increased again, until cone and passengers are 25 ft. in the air, balanced on a rod of pure water—to sink slowly to earth again as the force behind the stream is relaxed.

The round building over there? Well that is where they have the new automobile race. No, it does not seem large enough for a motion-picture show; but all the same they are racing over there on a banked track just 87 ft. in diameter. The tilt of the track is 50 deg. and there are more than 20 laps to the mile—and if you want to catch the real sense of this, just tilt your chair to an angle of 50 deg. and try to sit in it, the while reflecting that nobody, hitherto, has cared to race on a track furnishing a mile in only ten laps!

You have an idea of your own? Very well, I am listening. You will call it "the sleeper" and as people pass through the door a padded section of lead pipe, actuated by a powerful automatic spring, will present each medulla oblongata with a guaranteed impact of three thousand foot-pounds? And you feel sure that it would make a hit, do you?

Well, we'll run along home now. We'll go home and pore over some nice, snappy Egyptology or vivisect somebody's essay about the effect of capital on the trade winds or something else that you really can appreciate.

And that about the monkey? Feed him poisoned peanuts or drop him into boiling oil, but purge him of blame for any of these antics? Well—perhaps you are right. Consider the monkey vindicated.



"Step Right Up, Ladies and Gentlemen—One Dime—It Won't Make You nor Break You"

## POSTCARD PHOTOGRAPHS WITHOUT NEGATIVES

A very compact photographing machine embodying several interesting and ingenious features is being placed

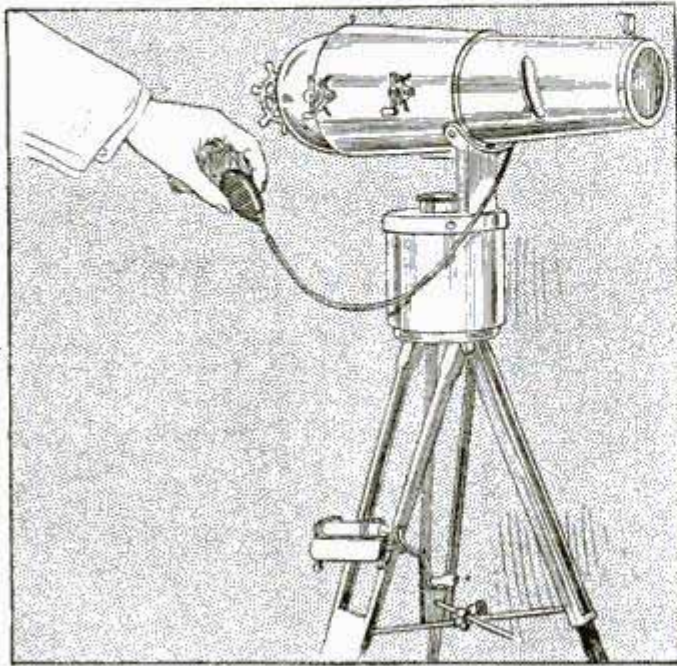

A Photographing Machine Which Makes the Photographs Directly on Postcards and Will Turn Out Three a Minute

on the market by a Chicago concern. It is an automatic machine, in the shape of a cannon, consisting mainly of a magazine (containing a charge of 100 sensitized positive postcards), a camera and a developing chamber. The photographs are made in a few seconds, without negative, directly on the postcards.

The operation is simple, a turn of one of the levers on the outside of the camera sufficing to unwind one of the sensitized postcards from the reel in the magazine and depositing it upon a carrier. A movement of the second lever brings this postcard into an upright position directly behind the lens in the proper focus for making the exposure, a pressure of the bulb makes the exposure, and another turn of the second lever releases the postcard from behind the lens and allows it to drop into the developing jar, which is directly underneath. This jar or chamber contains four developing cups, so that the operator may take four photographs in rapid succession, depositing each in a separate cup. The proc-

ess of developing is so rapid that, by the time the operator has made the fourth picture, the first is thoroughly developed and ready to be delivered. The postcards, sensitized by a secret process, do not require separate solutions of developer and fixer, the cards being developed and fixed simultaneously in the single solution. It is also claimed that the photographs cannot be overdeveloped, no matter how long they are left in the solution.

## SOAP SUBSTITUTE WASHES FINEST FABRICS

A new soap substitute which does not include any fats or oils in its composition has recently been produced and is said to be much better than any of the ordinary soaps, as regards ease, safety and satisfaction, for washing even the finest silks, laces or colored fabrics.

This soap is a combination of silica, alumina and alkali, mixed in certain proportions under proper conditions of temperature. In one formula that may be used, 180 lb. of commercial sodium silicate are mixed with 135 lb. of liquid caustic soda, or lye, of density 42 deg. on the Baumé scale, and boiled and mixed in an ordinary soap digester. After boiling for a short time, 34 lb. of commercial alumina (aluminum hydrate) are added and the boiling and mixing continued for three or four hours. The resulting liquid, which is now thick and creamy, is poured into the cooling apparatus, and after it is congealed it can be broken up into small pieces, or pulverized.

This product can either be used by itself or as an admixture to improve the quality of ordinary soaps.

⌈The hull of the British cruiser "Champion," which lay in the River Medway for seven years, was found completely covered with an immense accumulation of barnacles and weeds, among which were at least 40 tons of mussels.

## TESTING THE STRENGTH OF MONOPLANE WING

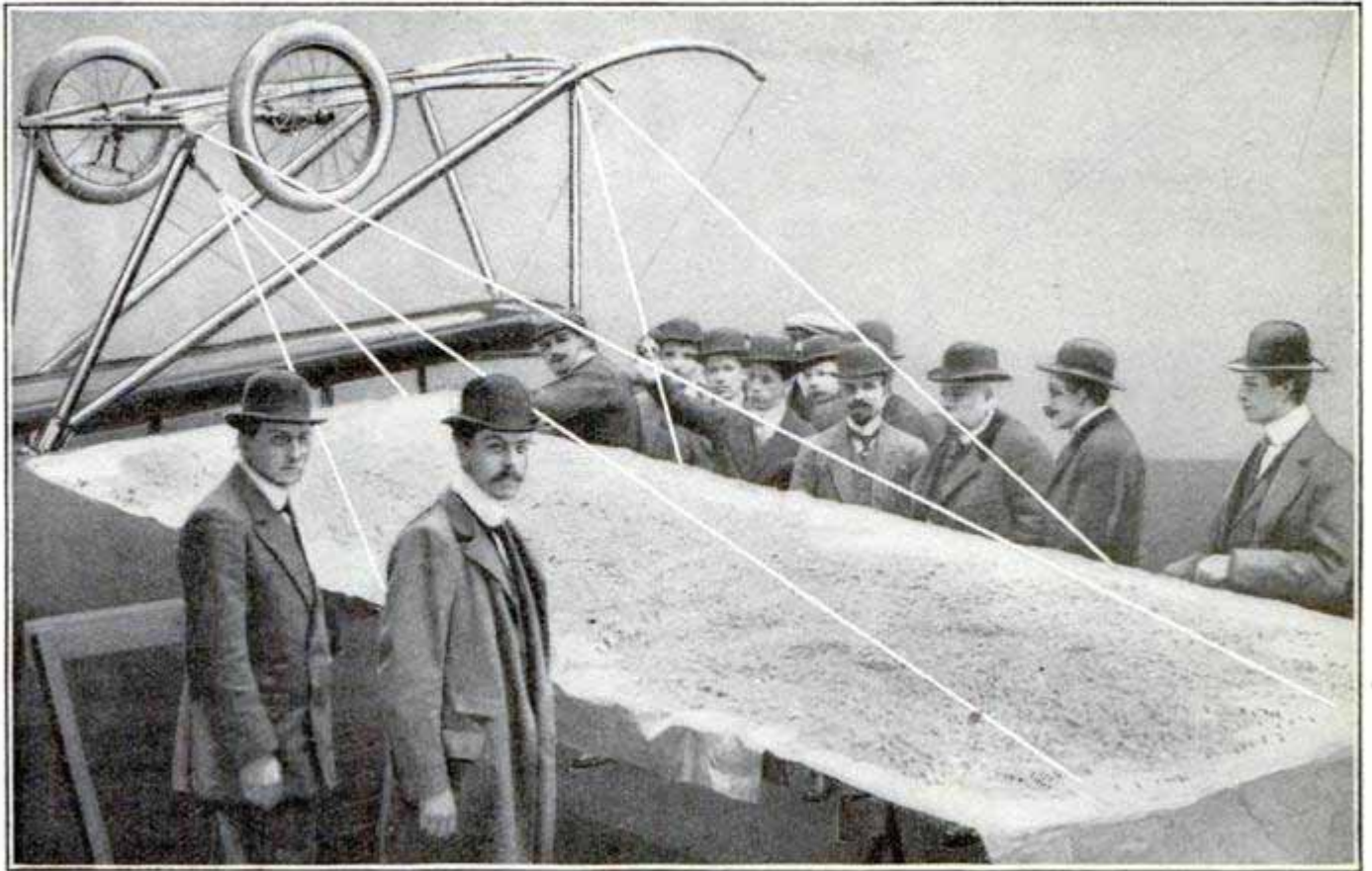

A novel method of testing planes is used at the Deperdussin aeroplane factory in France. The machine is inverted and the planes are gradually loaded down with sand, evenly distributed, until a weight exceeding the pressure which the wings must withstand in service is reached.

## DERRICK PICKS UP SHIP BODILY TO LAUNCH HER

An up-to-date parallel to the methods of the ancient philosopher and inventor, Archimedes, who is said to have devised a crane that picked up the galleys of the Roman invaders and dashed them on the rocks to save his city of Syracuse, was furnished in the recent launching of a 20-ton ship at Buffalo, N. Y.

The "Erie," the boat in question, is 45 ft. long, and was erected in a yard so far above the level of the water that it would have been difficult to launch her on the usual slides. It was therefore decided to lift up the ship bodily and swing her over into the river. A lofty derrick was erected on the river bank for this purpose, and rigged with steel cables which were bound tightly around the vessel. The lifting, swing-

ing and lowering were safely accomplished, and the method proved so satisfactory that it is probable the same

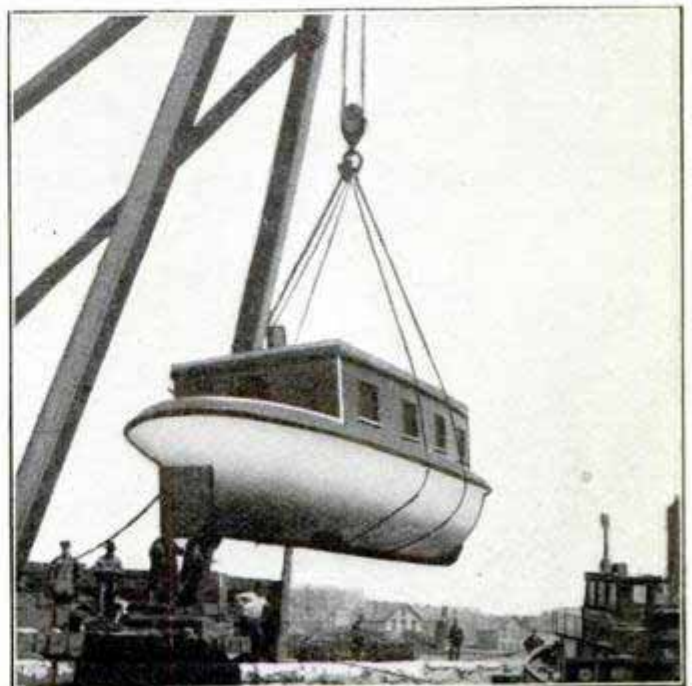

Launching Motorboat by Means of a Derrick

system will be used in the launching of other and larger craft within the weight capacity of the hoisting machinery available.

### PROJECTING SHADOW SIGNS ON SIDEWALKS

Flaming-arc lamps are being used in Germany to project shadow signs onto sidewalks in the manner shown, the

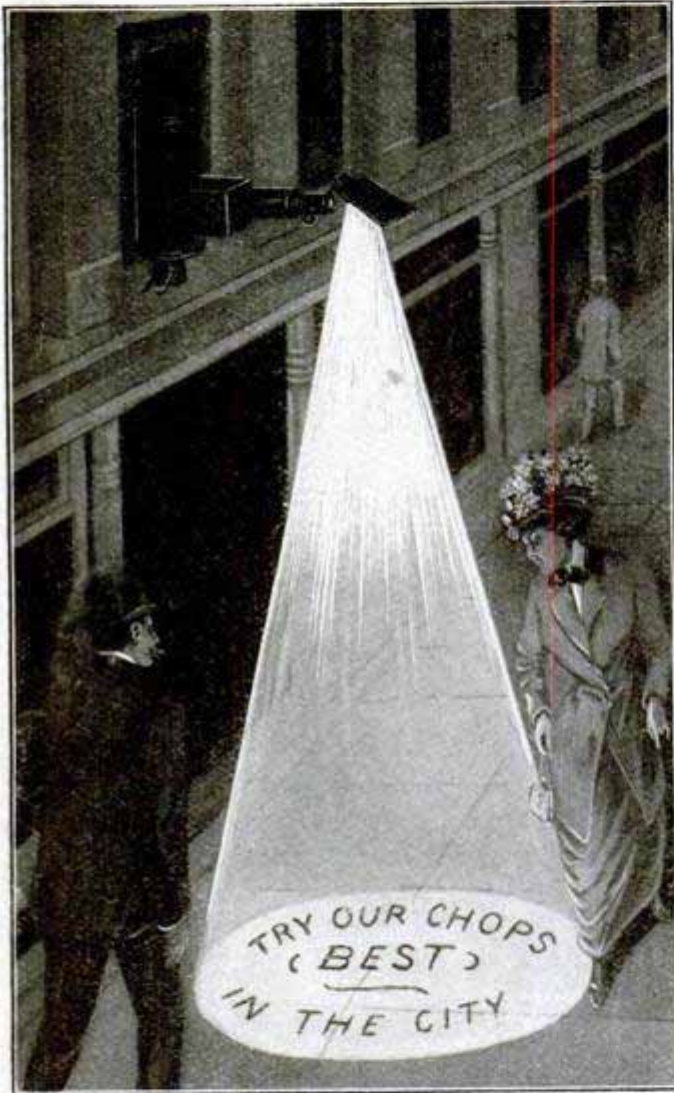

Using the Sidewalk as a Shadow-Sign Screen

intensity of the illumination being sufficient to make the display stand out strongly. The arc lamp is inside the vertical cylinder, and its rays are sent out through the horizontal projection, then deflected downward by the oblique mirror.

ⒸAn electric transmission line in Mexico has a single span 1,650 ft. in length where it crosses the Bavispe River.

### FRENCH MILITARY AIRMEN GET POOR PAY

France put a low value on the lives and service of the aviation enthusiasts of its army when the preparation of the extra pay table for airmen was in progress, as it provides the same compensation for a flight in an aeroplane in fair weather over an aerodrome as would be given for a difficult air feat such as the flight of Captain Bellanger from Pau to Paris. The basis of the pay table and its increases is time and not the character of the service. According to this table, a pilot who is an officer receives 5 francs (\$1) for a flight of 5 kilometers (3.1 miles), while a private is given but 3 francs (60 cents). Under 5 kilometers nothing is given the airmen. Distance ceases to be a factor with the first figure in the table. Time then enters into the equation. A balloon ascent of from one to two hours' duration gives an officer 60 cents; if the stay in the air amount to six hours, the pilot gets \$1, and for a longer period than that, \$5. For dirigible voyages in the same periods of time, the officer receives \$1, \$2 and \$4 respectively, while the aeroplane driver is given \$1, \$3 and \$5.

The aeronautic journals and the airmen generally are fighting the system on the ground that it is inadequate and absurd, as the conditions that govern flight are of the most diverse character, and while nothing but the most elementary knowledge may be required for a flight of several hours, on one occasion, on another it would require the skill of an expert to keep his craft in the air for a few minutes.

### PORTABLE DEVICE FOR TIMING AUTO RACES

The electric instrument which has been used for the past year or two at the famous Brooklands track in England has been accepted by the International Federation of Automobile Clubs as the official device for the timing of automobile races. The installa-



tion at Brooklands was, of course, permanent, but from it has been developed a portable instrument, the principles of which are the same, although the arrangement of the pens and magnets have been altered.

The batteries, clock, and recording mechanisms are packed in a box 28 in. long by 11 in. wide and 17 in. in depth, and a folding table, 36 in. long by 21 in. wide, is provided with the outfit. The operation of the instrument is simple. Across the track at the point where the measurement of speed must commence and finish is laid a pneumatic strip, so fastened down that it cannot be knocked out of place. This strip is merely a rubber tube, blown out under air pressure, and inside it at the top and bottom are metal strips, normally held apart by the inflation of the tube. When the wheels of the car pass over the strip, the two metal surfaces touch, and this closes an electric circuit, which causes one of the recording pens of the instrument to make a mark on the paper tape fed through the chronograph.

Experiments made to ascertain how fast a car would have to travel over the strip in order that the metallic contact should be so short and quick that the pen of the instrument would not be moved, proved that a speed of 460 miles an hour would have to be made before the capability of the machine could be questioned. These tests, of course, were made by other means.

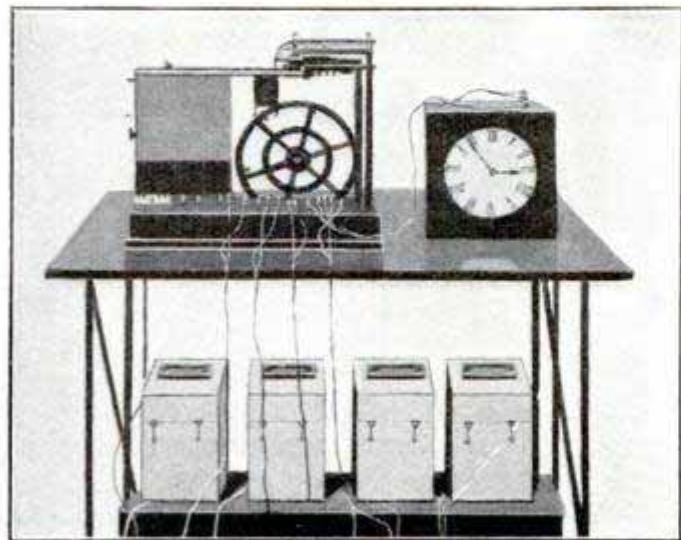

The Portable Electric Timing Machine Adopted by the International Federation of Automobile Clubs

## GUARDING THE TREASURES OF A GREAT CATHEDRAL

The treasure chest of a great cathedral rivals that of a royal treasury in the magnificence of the jew-

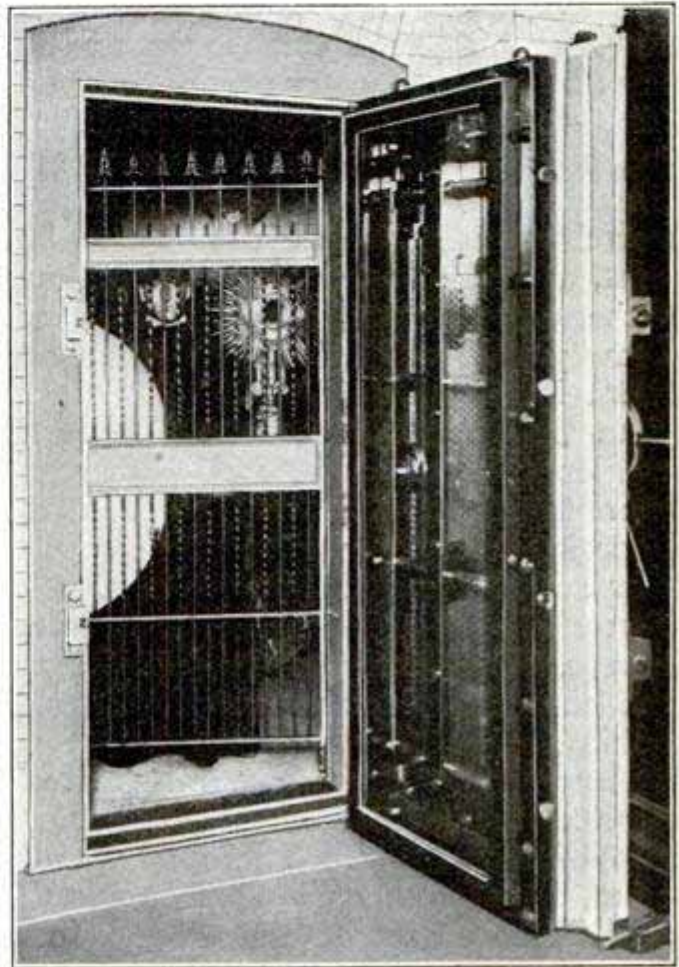

Door of Vault at St. Patrick's Cathedral, New York, Showing the Sacristan Holding the Ostensorium

els it incloses. These are set, not in crowns or necklaces, but in altar utensils and in symbols, or sewn upon the priceless vestments which are used only upon special occasions. Like the crown jewels of a nation, these often have a sentimental value as great as their monetary worth, and they must be carefully guarded.

The treasures of Saint Patrick's, the largest Roman Catholic Cathedral in New York City, are kept in a crypt back of and beneath the altar. Few people know of the location of this chamber. From a room behind the altar a broad marble stairway with velvet handrails leads downward. A long room used for the cleansing of altar vessels and donning of vestments is the first stage of the descent. From

a door in one end of this room a narrow flight of stone steps leads into the silent concrete regions below. They twist and turn steeply into a narrow, low-ceiled passageway, which leads to the heavy door of the subcrypt.

The sacristan opens this door, and turns on a blaze of electric light which is reflected from every part of the room. The shelves about the four sides are laden with bright-colored vestments. Some of these are of old rose and gold, permitted only to the use of a cathedral, and upon very special occasions. Others are of red velvet, and all are heavily embroidered. A single garment is valued at \$6,000.

In the corner, locked and bolted, is the door of the safe, and thither the sacristan leads the way. When the door is finally opened the whole interior seems a mass of jewels and gold. But there is a second door of steel bars, and not until this is unlocked are the contents, placed at a safe distance behind it, to be inspected.

Among the altar furnishings are a chalice, the gift of Pope Leo XIII, a cup of solid gold. There is a ciborium, a coffer or case which holds the Host, also a gift of the Pope. In a long leather box is an archbishop's episcopal cross of gold and silver,

which with its pedestal stands 8 ft. high.

But by far the most valuable article is the ostensorium or monstrance, a box in which the Host is exposed to receive the veneration of the faithful. In order that this might have a sentimental as well as a real value, a former director of the Sacred Heart called upon the congregation to put into the contribution box some article of jewelry which they valued for its associations. When the boxes were passed the women put in their rings and their earrings. This mass of jewels was imbedded in the outside of the case with great harmony of design. But so great is their number that an expert appraiser of jewels declared that he would require 24 hours to estimate their value, which is somewhere between \$50,000 and \$100,000.

Besides their intrinsic value, all of these articles are heavily chased and carved, or set with enamel to represent different scenes. In order that they may be safe, the door leading from the vestment room to the crypt is guarded day and night. None may pass there without the sacristan in attendance. And not even the archbishop himself knows the combination of the great safe.

### WASHING THE HANDS WITHOUT WATER

The only soap which can be used to wash the hands without requiring water for either the initial proceeding

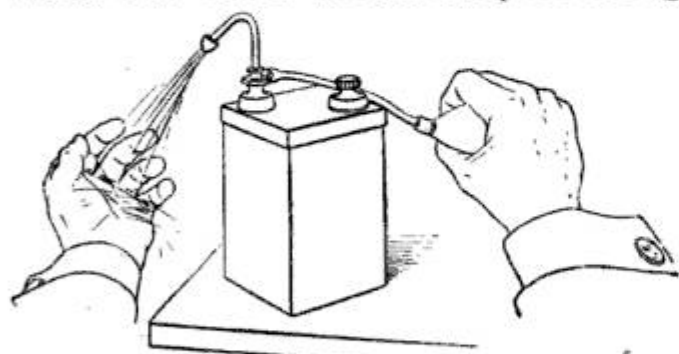

Using a Soap that Requires No Water

or the rinsing is claimed to be a soap foam made in France. It is a liquid soap of vegetable extracts mixed with

tetraborate of sodium, the latter giving off oxygen and thus making the soap antiseptic as well as foamy.

For family use the soap is put up in a small atomizer, as shown in the illustration, but where large quantities are used, as in hospitals, hotels and offices, it is contained in a large atomizer operated by a foot lever. After using, the soap is allowed to dry on the hands and is then wiped or rubbed off.

Chinamen or Lascars are said to be preferred by some captains to Britishers or Americans for sailors, not because they will work for lower wages, but because they do not forcibly resent physical ill-treatment.

## GUN PRACTICE ACCUSED OF WETTING ENGLAND

The question as to whether or not violent detonations of explosives cause rainfall has been raised in England through an appeal made to the First Lord of the Admiralty by Viscount Dalrymple in the House of Commons. The appeal embodied a request that the gun practice of the navy be held at some time other than the warm, fair season, when heavy rains might cause great damage to crops.

Admiral McKenna replied that there existed no proof that explosions caused rain, and that Shoeburyness, where practice with big guns is most frequent, and, in fact, the whole coast of Essex, has an average yearly rainfall far below the average of the British Isles. From this he concludes that it might as well be said that gun practice prevents rainfall as that it aggravates it.

## NEVER-USED RAILWAY CAR CHAPEL OF A POPE

In 1858 Emperor Napoleon III gave Pope Pius IX a train composed of three cars, one of which was the

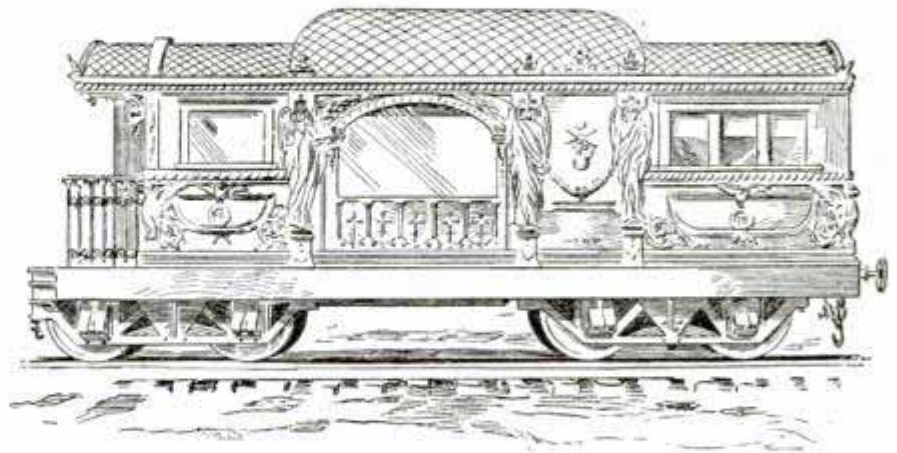

Oratory of a Train Given to Pope Pius IX by Napoleon III

chapel here shown. The other cars contained a saloon, with a balcony, and a dining and bedroom. The train was taken from Paris to Rome by water, but the pope never used it, and it remained almost neglected at Florence. It has now been restored for the exhibition in the castle of Saint-Angelo at Rome.

## ASSERTING PUBLIC RIGHT TO A FOOTPATH

Custom is almost a law unto itself in England, and common usage, in the eyes of the general public at least, generally decides the right or wrong

of a contention. For many years a footpath, winding its way over private land to a wood near High Wycombe, Bucks, England, was used as a short



Marching over Private Ground to Re-Establish a Footpath and Assert the Public Right to Use It

cut, but the path and the adjoining land was recently plowed up in an effort to close it. Consequently, 3,000 persons assembled to assert public right to the path, and, forming a double line, marched over the plowed land to re-establish right to it.

Another recent instance of public right has to do with the purchase of an old estate. The new owner attempted to close off a section of the land on which the public had long been allowed to picnic. The result was a lawsuit, the contention of the public being that, as the public had used this land for a hundred or more years, its right to it was solidly established.

### ARTISTIC CLOCK STAND

Recent furniture novelties include this artistic clock stand. Both the clock casing and stand are mahogany, the long legs and the saddle of the latter being inlaid.

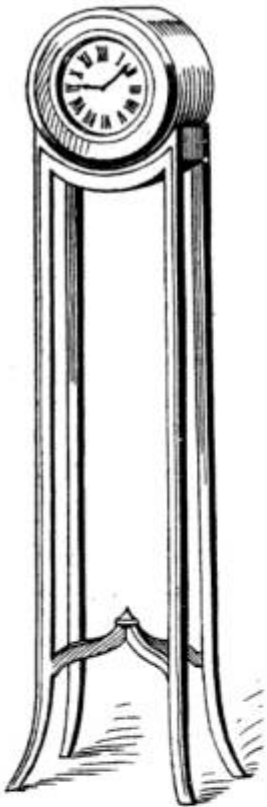

### A LARGE ELECTRIC SIGN

What might aptly be called an electric billboard has recently been constructed in Federal Park, Louisville, Ky., to advertise various local industries and the city itself. The sign is 100 ft. long and 60 ft. high, and is divided into six rectangular display spaces, each 30

by 20 ft. There are about 6,000 electric lamps of various colors, many of them operated by flashers to give motion effects, and at each end is a 40-ft. Corinthian pillar surmounted by a 4-ft. globe of wrought iron and glass. The sign includes many novelties, both of an electric and advertising nature, and is said to be the largest of its kind in the world.

### PERFECT HEARING REQUIRED BY AIRMEN

The perfect physical condition the man of the air requires if he expects to be successful is drawn attention to in a recently published work on the "Physiology of Aviators," written by Professor Nieuwe-Semidei, an Italian scientist. That the organs of respiration and circulation, as well as the nerve centers, should function properly, and the vision be perfect, is clearly understood, but that the condition of the organs of hearing has a no less important bearing on the question will, no doubt, seem less natural.

It is, however, according to the Italian scientist, absolutely indispensable that the labyrinth of the internal ear, and especially the three semicircular canals, be perfectly sound and send their message instantly and with unflinching correctness to the brain center they serve, which is the seat of the sense of equilibrium and orientation.

An actual demonstration of how ear trouble may bar men from flight was recently provided by a pupil of one of the French airmen. This pupil manifested errors in judgment of direction in all of his trial flights, and very nearly met with serious disaster. Upon examination, he was found to be suffering from an inflammation of the ear, which impaired the hearing and caused functional troubles in the semicircular canals. Asked to walk in a straight line with his eyes closed, he deviated from the course, always to the right, and this deviation was still more marked when he was requested to walk in a circle. When the path he attempted to walk was convex toward the right, he traced a widening spiral, and vice versa, all of which, it is claimed, was due to the troubles in the semicircular canals.

☞The recovery of tin from scrap heaps in the United States last year, including old tin cans, tin pipe, etc., amounted to 2,423 tons as tin, and 3,092 tons in the form of alloys.



Front Elevation Showing Entrance Porch at the Side



FIRST FLOOR PLAN

Norman Baird Baker, Architect



SECOND FLOOR PLAN

## SMALL HOUSE DESIGN THAT WON A PRIZE

One of the prize-winning designs for a \$2,500 house in the Building Trades Employers' Association of New York, that attracted particular attention, provided for a four-room and bath concrete and terra cotta block dwelling, the distinctive feature of which was a side entrance. The central chimney idea is also carried out in this plan which gives a big ornamental fireplace for the living room. The architect plans to make this room, which is also

to be used as the dining room, the main feature of the interior of the house, the space allotted to it being half the area of the ground floor, giving an apartment 13 ft. by 19 ft. The exterior walls from the first-floor level are to be built of terra cotta block, finished on the outside with stucco plaster. The interior trim of the first floor is to be chestnut with stained cypress door and window frames for the exterior. On the second floor, painted white pine is to be used.

## LATEST RAILROAD PILE DRIVER

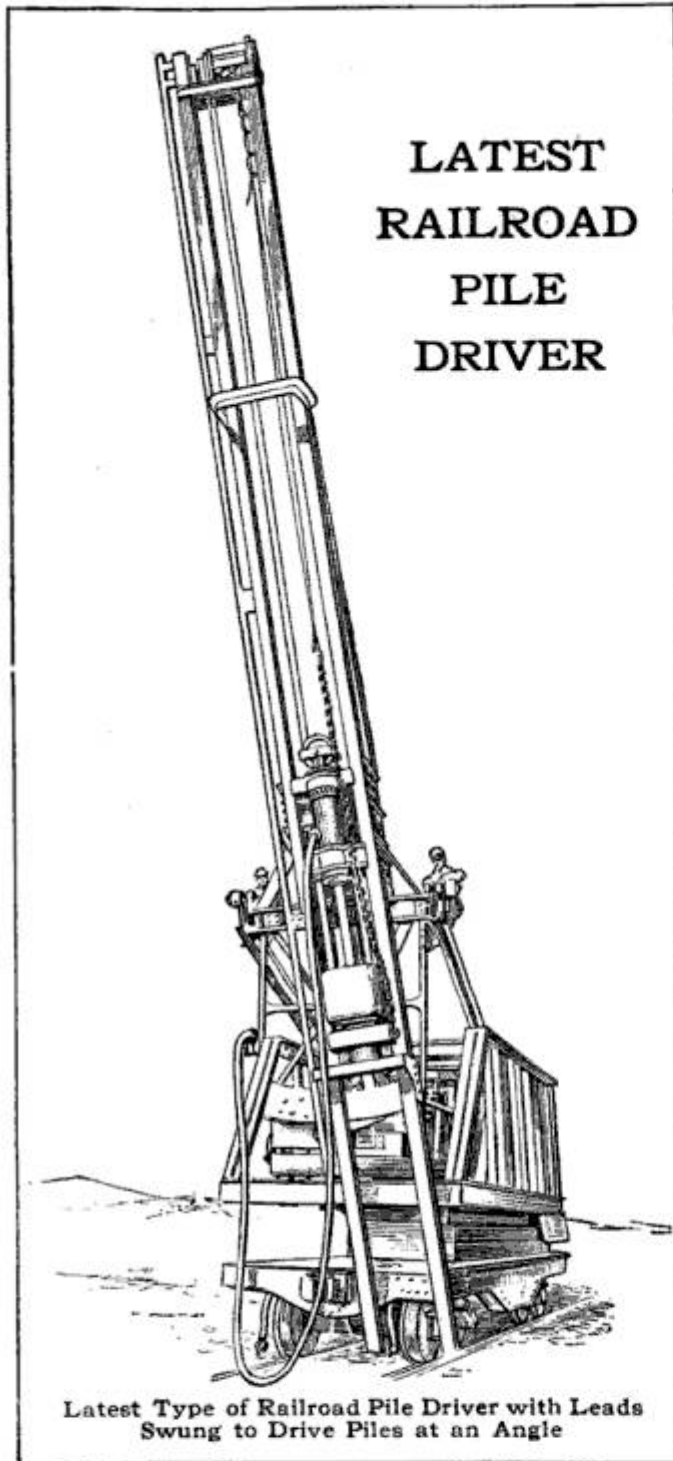

Latest Type of Railroad Pile Driver with Leads Swung to Drive Piles at an Angle

A new railroad or locomotive pile driver has been brought out by a Cleveland engineering company to meet the requirements of modern railroad work. To do this it must pick up and quickly place the pile in position, should be capable of moving quickly from point to point as a self-contained whole, and should be able to drive piles at various angles, either ahead or on the sides.

The new pile driver is a self-propelled car, carrying upon itself a self-propelled truck, which, in turn, supports a self-rotating structure for driving piles at various angles and in

any position. The whole is so designed that all the ways and equipment can be lowered quickly to within standard railroad clearance for traveling.

## ANESTHETICS USED BY ANCIENTS

Several scientists claim that the use of anesthetics in surgical operations can be traced back to the most remote antiquity, declares a writer in *Cosmos*. Thus, according to them, the Chinese used a plant, called Ma-yo, related to the hop, for the purpose, long before the Christian era. The ancient Greeks knew the sleep-producing qualities of several plants, as, for instance, the nepenthe mentioned by Homer; and, in the Middle Ages and the Renaissance, some surgeons had recourse to the soothing and pain-stilling properties of certain poisonous plants, of which the nightshade is the type. But these instances seem to have been rather isolated, and surgical anesthesia, properly so called, was not commonly practiced until the latter part of the 19th century.

Horace Wells, a dentist of Hartford, Conn., is said to have been the first, who, in 1844, used nitrous oxide, commonly known as laughing gas, as an anesthetic in a surgical operation.

Another American dentist, William Thomas Green-Morton, of Boston, was the first to use ether in extracting a tooth, and later in the same year, 1846, John Warren, at the Massachusetts general hospital, used it in a more important operation.

Chloroform as an anesthetic came into use in 1847, when, on the recommendation of the French physiologist, Flourens, operations were successfully performed in Paris hospitals on patients under its influence. Cocaine as a means of producing local anesthesia was first used in 1884.

On the comparative value of ether and chloroform the medical world has been much divided. Statistics show one death in 14,987 cases of anesthesia by means of ether, while one death in 3,258 cases, where chloroform is used,

is ascribed to the anesthetic. But the question is by no means settled, for even in the rare cases where death has occurred, it is difficult to say definitely whether it was caused directly by the anesthetic or by what the surgeons call syncope, sudden cessation or failure of the heart's action from nervous shock, or heart-failure. Medical history records many peculiar cases of this kind, as of a patient who died when the surgeon pointed out with his finger the spot where he was going to make an incision; another who expired, before an amputation, at the very moment a compress, containing no anesthetic or other substance, was placed before his nose; and several others who died at the first touch of the surgeon's knife. Such deaths have occurred also in vivisection of animals, some suddenly dying at the moment they were tied to the operation table.

### FIRST AMERICAN ELECTRIC AUTOMOBILE

This curious tricycle, propelled by a two-pole electric motor at a speed of six miles an hour on the level, is believed to be the first successful electric automobile made in America. In 1889, just 22 years ago, it created a mild sensation when it appeared on the new concrete paving of a Boston street for

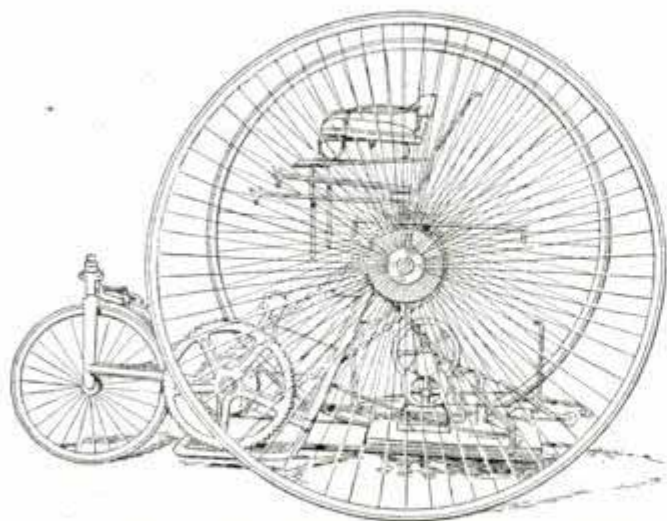

The First American Electric Automobile. It was Successfully Operated in Boston in 1889

its first tests. The machine was operated by a six-cell storage battery, and weighed complete about 300 lb.

### WEIGHING RACING MOTORBOATS

Many of the most interesting motorboat races of Europe are held on Lake Constance, Switzerland. The illustra-

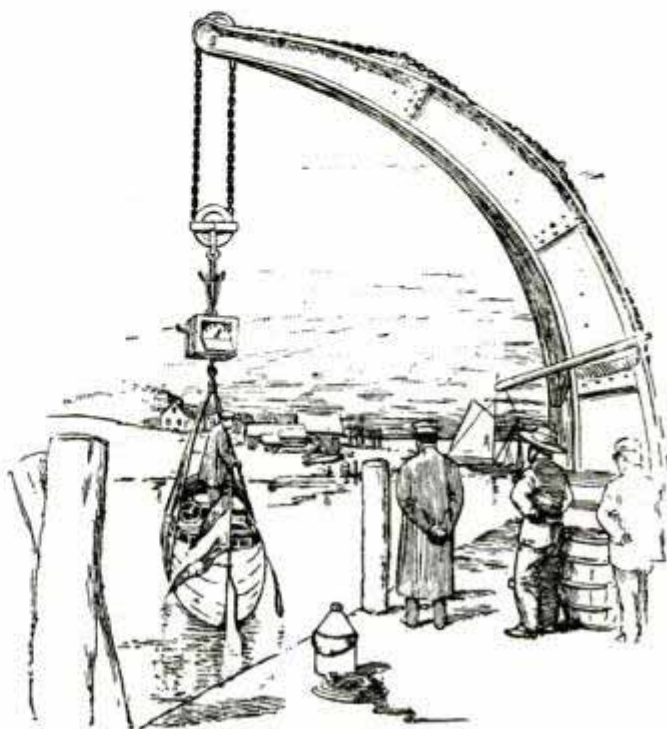

Weighing a Motorboat before a Race on Lake Constance

tion shows a racing motorboat being weighed preparatory to the start of a race. The boats are lifted out of the water by a crane to which the weighing mechanism is attached.

### THE AIRWOMEN OF FRANCE

The annual meeting of the Woman's Aviation Club of Paris has drawn attention to the activity of French women in aerial flight. The reading of the secretary's report shows that members of the club took part in 80 aeroplane flights and balloon ascents in 1910, and that numerous prizes were awarded for distance, speed, and duration. Among the prizes mentioned in the report were three "perfectly lovely" La Valliere pendants, of which one has yet to be won.

Three or four steel towers, 450 ft. high, are to be erected at Fort Myer, as the land base of the government wireless system.

## HIDING A FOUR-INCH BAR IN THE NOSE

A remarkable "black-art" trick, which, it is said, has never been described in any book or circular on

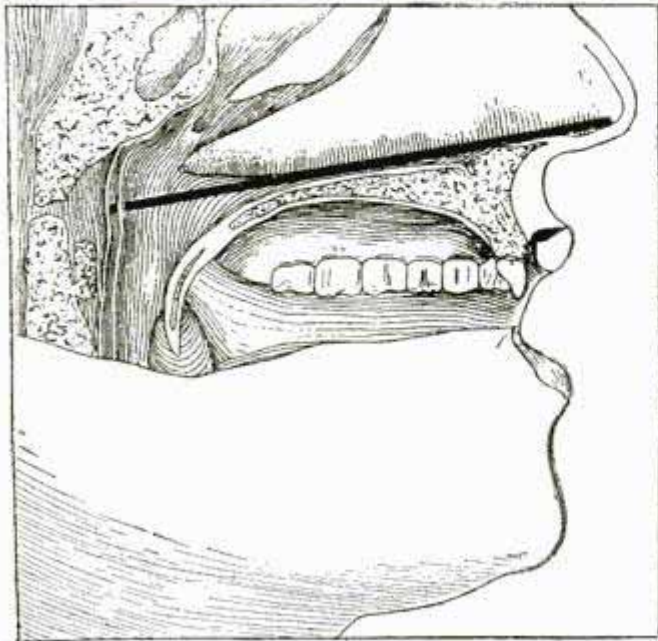

Position of the Disappearing 4-In. Bar

magic, yet has been worked from time to time by conjurers of different nationalities, is shown in the accompanying drawing.

The trick requires much nerve, and is one that should not be tried by the novice, as it might easily result in serious injury. It is done with two bars of stub steel, between 4 in. and 5 in. long and  $\frac{3}{16}$  in. in diameter, with the ends rounded, highly polished, and nickel plated. One bar is used for the trick, and the other for production from the back of the neck.

The trick is usually done at close range, the bigger the crowd the better. One of the steel bars is shown for critical examination, and then placed alongside the nose to show how far it would really go if pushed into the nose. It would apparently go to the brain, and the watchers become confident that, no matter how the bar disappears, it does not go into the nasal organ. But that is just where it does go, and in the following manner: The conjurer places his left hand over the nose, and then pushes the steel bar into his hand and up into the right

nostril until the right passage is found. Then it is pushed downward into this passage until the inner end reaches the spinal column, and the outer end is pushed up out of sight. When the hand is removed from the nose the bar is nowhere to be seen, and even the best posted watchers believe the bar has disappeared through sleight-of-hand. Then the bar is taken from the back of the neck, it having apparently passed through the head.

## DEVICE PREVENTS OVERLOADING OF CURRENT

This device prevents the use of more than a specified amount of electric current on a circuit, by causing the light to flicker as soon as any excess load is turned on. It consists of a small horizontal vacuum tube containing two mercury cups on the lower side, with leading-in wires sealed into the glass and making contact to a globule of mercury in each cup. A soft iron bar or needle rests on the globules of mercury and normally completes the electrical circuit between the two leading-in wires, and above one end of the needle is a small electro-magnet in series with one mercury cup.

The apparatus is placed in one leg of the circuit, the current passing, first

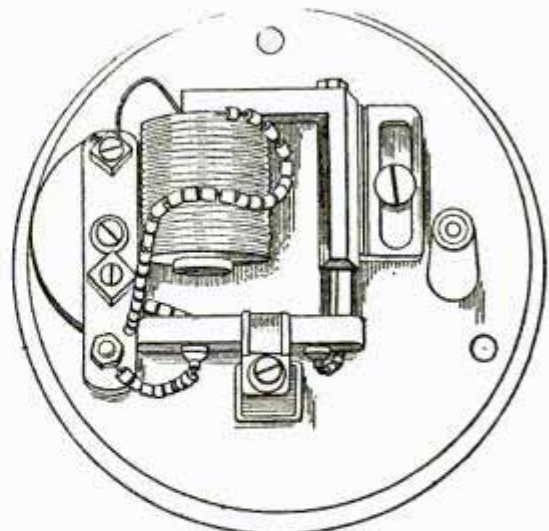

A Device for Limiting the Amount of Current Used

through the magnet, then to the left-hand mercury cup, through the needle to the right-hand cup, and thence to the load. When the load exceeds the



predetermined limit, the magnet lifts the needle away from the mercury cup and breaks the circuit. This interrupts the current in the magnet, the needle drops back in the cup and the cycle is repeated, producing a continuous flickering of the lights as long as the excess load is maintained.

### POCKET BANK CHECK PERFORATOR

A simple and ingenious little device, designed to prevent checks from being tampered with, is shown in the accompanying illustration.

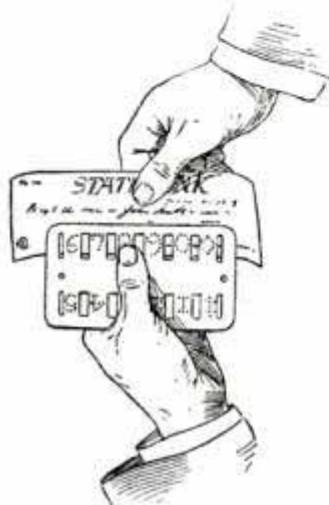

It is made of aluminum, weighs but half an ounce, and does not take up more space in the vest pocket than would a postcard. Unlike the majority of check protectors, it not

only perforates the paper beyond the figures so that the number cannot be extended, but also perforates the figures. One side of the device contains the dollar-sign perforator and the figures 1, 2, 3, 4, and 5, and the opposite side contains the perforators making the figures 6, 7, 8, 9, 0, and a star. In perforating the check with the dollar sign and the amount it calls for, all that is required is to slip the check between the plates and to press the figures desired, one at a time, between the thumb and forefinger.

### TO PROTECT MEN WORKING IN BOILERS

The Industrial Safety Association suggests the device here illustrated as a safeguard for men working in boilers. Live steam has more than once been turned by mistake into a dead boiler where men were working, and with fatal results. When a number of boil-

ers deliver steam to a common main there is always a shut-off or throttle valve to cut each boiler out of service

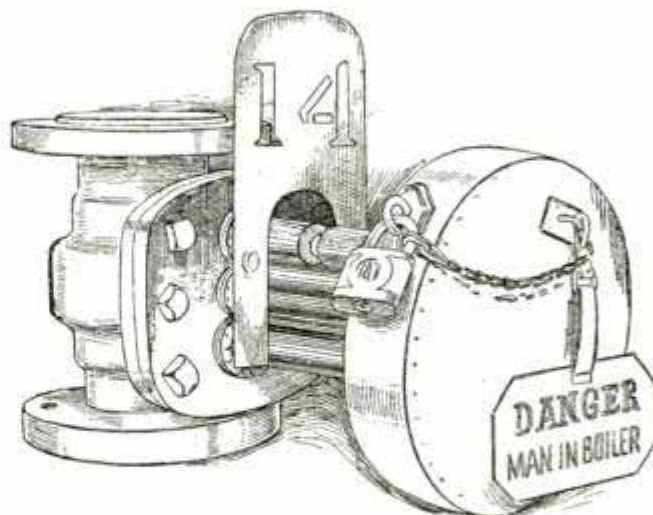

The Safety Locking Device in Place, Warning that Workman is in Boiler

and isolate it from the steam line, and it is for such a valve as this that the safeguarding device is designed. It consists of a split and hinged steel cylinder, which may be slipped over the hand wheel of the stop valve and locked in place by means of a padlock. The key is given to the man who enters the boiler, and as long as the cylinder is on the stop valve, it is impossible for anyone to turn on the steam.

### FINGER SIGNALS FOR MOTORCYCLISTS

The finger signals shown in the accompanying drawings are the idea of a motorcyclist who believes that his fellow enthusiasts would welcome a system of signs by which they could signal each other or convey informa-

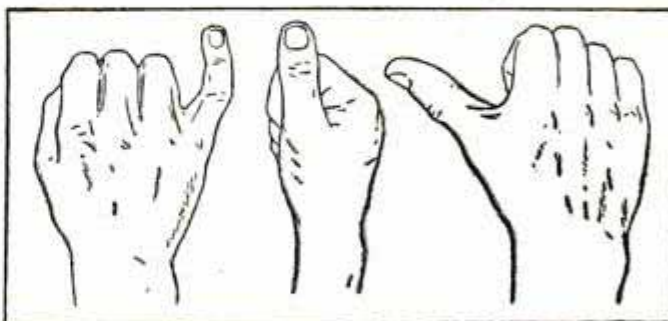

Courtesy Motorcycling, London  
 "Please Stop" "All Right" "Proceed Cautiously"  
 Finger Signals for Motorists

tion without dismounting. It is often difficult for riders to ask a question or make a request when approaching each

other because of the noise of the engines. The holding up of the little finger of the right hand might be adopted as a signal requesting an approaching rider to stop, the bending outward of the thumb as a warning to proceed cautiously, and the displaying of the thumb straight up as an "all right" answering signal.

### ELECTRIC VALVE-GRINDING TOOL

A line of electric valve-grinding tools, for grinding valves of the lift or poppet type, as in automobile en-

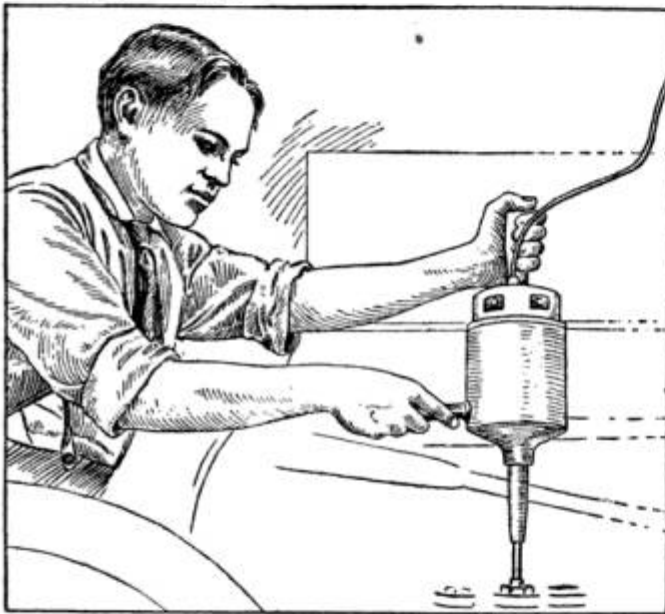

Portable Electric Valve-Grinding Tool being Applied to the Valves of an Automobile Motor

gines, compressors, etc., or any form of globe valve, or air or gas cock, has been placed on the market by an American tool company. These tools take the place of hand labor in grinding valves which require to be reseated periodically.

☞ Fifty public school children in Philadelphia gained an average of 4 lb. each during a period of one month, on the nourishment obtained from a three-cent lunch prepared as an experiment by the managers of the Sage Foundation, the lunch being served hot and usually consisting of Hamburg steak or Irish stew with rice and brown gravy. Bean soup, rice pudding, prunes, and bread and butter were also served.

### UTILIZING RESISTANCE OF AIR

A French inventor, M. Constantin, proposes to enlist the enormous resistance of air against rapidly moving vehicles as a force to add to the motive power of racing automobiles instead of allowing it to exist as an opposing force. His idea is to mount a turbine wheel at the front of the automobile, where the air pressure will cause it to revolve and consequently impart to it a certain energy. This energy he proposes to utilize as an auxiliary power, by means of a simple mechanical transmission. The front of the automobile will, of course, be struck by the air current after it has passed through the turbine wheel, but its force will be largely spent, and the inventor insists that the gain realized will be very considerable.

The inventor has not yet made tests of his idea on an actual automobile, but appears to be perfectly satisfied with the results as demonstrated by a model apparatus. This consists of a small aluminum car, weighing about  $2\frac{2}{3}$  lb., without motive power, but provided at the front with a turbine. Opposed by the current from an ordinary ventilating fan, the car is not driven back, but rushes toward it with surprising energy.

Representatives of the French scientific magazine "La Nature," who attended the experiments, say that the little car not only attained great speed, but actually climbed grades of 6 in

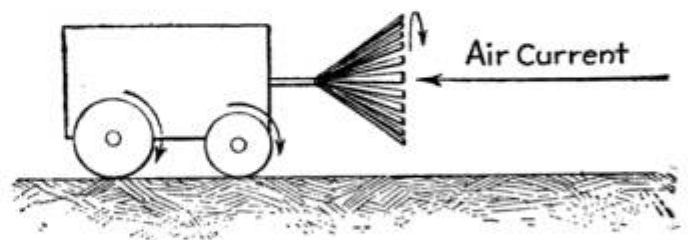

This Model Car Overcomes and is Propelled by the Resistance of Air Against a Turbine Wheel, which Transmits the Energy to the Drive Wheels

100. Opposed by a current from a more powerful fan, it moved into the teeth of the opposing air with a load of 24 lb.

## HOW TO MAKE A MISSION ARM CHAIR

A mission arm chair of simple design and construction is shown in the accompanying illustration. This chair is suitable for any room of the house and can be made of wood to match other furniture. Quarter-sawed oak is the wood most generally used, and it is also very easy to obtain. The stock can be ordered from the mill, cut to length, squared and sanded. Following is a list of the material that will be needed:

- 2 front legs, 2 by 2 by 26 $\frac{3}{4}$  in.
- 2 back legs, 2 by 4 by 43 in.
- 2 arm rests, 1 by 4 by 26 in.
- 5 rails,  $\frac{3}{4}$  by 4 by 21 $\frac{1}{2}$  in.
- 5 rails,  $\frac{3}{4}$  by 2 by 21 $\frac{1}{2}$  in.
- 2 back pieces,  $\frac{3}{4}$  by 2 by 16 $\frac{1}{2}$  in.
- 1 piece leather, 31 in. square.
- 1 piece burlap, 28 in. square.
- 2 pieces leather, 13 by 18 in.
- 2 pieces burlap, 13 by 18 in.
- 1 box 8 oz. tacks.
- 5 $\frac{1}{2}$  doz. ornamental nails.

Start with the front legs. Cut a tenon 1 $\frac{1}{4}$ -in. square and  $\frac{3}{4}$ -in. long on one end to fit the arm rests. The mortises for the side rails are cut  $\frac{1}{2}$  in. wide and  $\frac{7}{8}$  in. deep. The tenons on

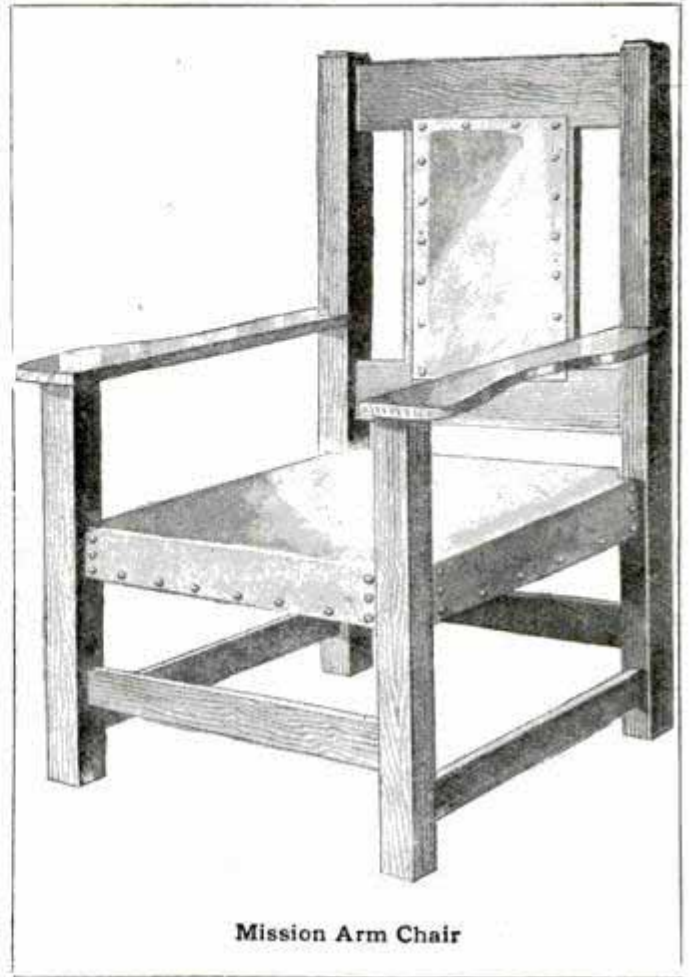

Mission Arm Chair

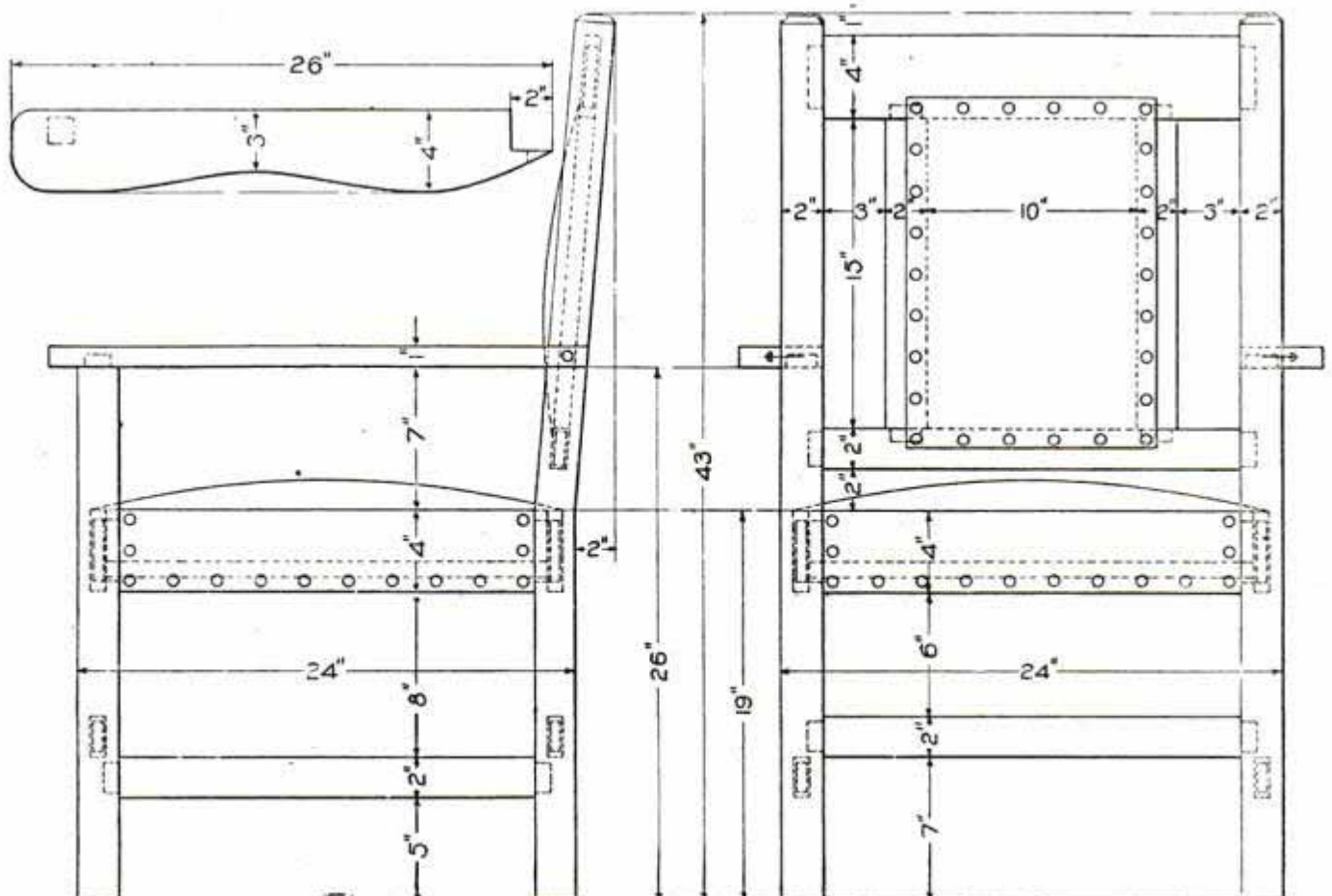

Details of Arm Chair Construction

the rails are cut to fit these mortises, care being taken to get them all the same length between shoulders. The back legs are cut with an offset of 2 in. as shown in the detail drawing and also have mortises cut in them for the back crosspieces. The upright pieces in the back are fastened into the crosspieces by means of tenons and mortises, and should be in place when the crosspieces are fastened to the legs.

The arms are cut from the 1 by 4 by 26-in. pieces. Be careful to get them so they will pair. The outside edge can be either curved or straight as desired. The front ends of the arms are held in place by mortises which fit over the tenons on the ends of the front legs, while the back ends are held in place by round-headed screws as shown.

The chair is now ready to be glued. Be sure to get the parts together perfectly square, and when dry scrape off all surplus glue around the joints, for

stain will not adhere to glue and a white spot will be the result of failing to remove it. Go over the parts carefully with fine sandpaper and remove all rough marks. Then apply the stain you wish to use.

To make the seat, first fit boards in the bottom and nail them to the side rails as shown. Fill the space with hair or elastic cotton felt to about 3 in. above the edge of the rails. Bind this down tightly with a piece of burlap and tack the edges to the rails. Cut out the corners of the burlap so that it will fit about the posts. Put the leather on over this and tack the edges to the bottoms of the rails. Then finish with the ornamental nails as shown.

To finish the back, first tack a piece of burlap over the opening, then place a layer of hair or cotton felt on this about 1 in. thick. Stretch the leather over this and fasten with ornamental nails. The back side is finished in the same manner, except that the hair is omitted.

## AUTOMATIC FRENCH BREAD- MAKING MACHINE

This machine, invented and used in France, automatically makes loaves of

The dough first passes between cylindrical rollers and is formed into a broad ribbon, which is carried on an endless sheet to the knife. The knife cuts it into the desired lengths, it passes to another set of cylinders which roll it into the desired thickness, and then another endless sheet carries it to a third roller, rotating against the motion of the sheet. When the dough has undergone this final shaping, the roller rotating against the motion of the sheet stops automatically and allows the loaf to pass under it and then under a board which presses it into the desired length. When this operation is completed, the loaf falls onto the pan on which it is to be baked

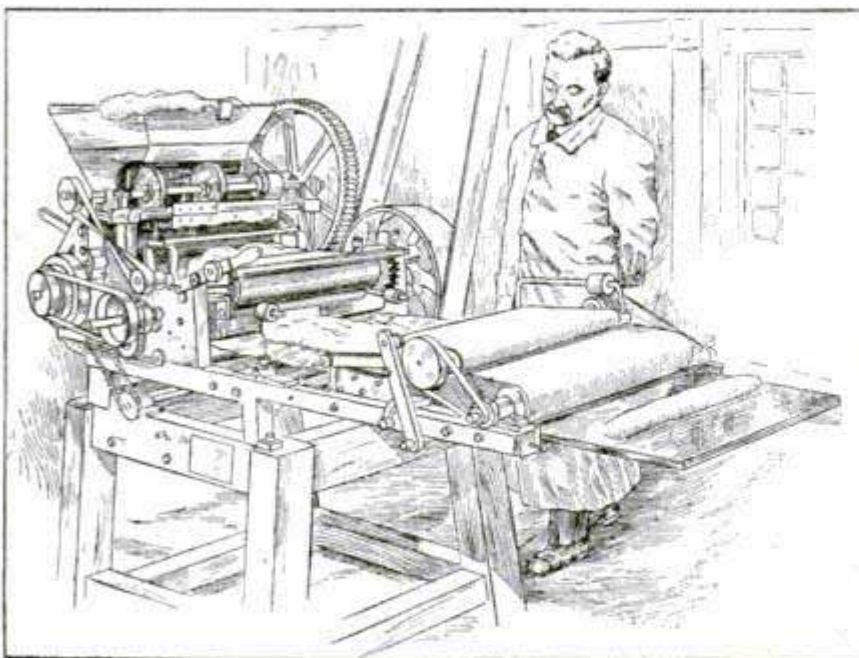

An Automatic Bread-Making Machine which Turns Out 1,200 Loaves an Hour

bread of any weight and size wanted, while the shape, also, can be varied.

in the oven.

The machine runs on 1/3 hp., and

only one man is required for its operation. It is claimed that as many as 1,200 loaves can be turned out in an hour.

### RADIOACTIVE ELEMENTS IN THORIUM

A German scientist who has made a special study of thorium, the metal which is used in large quantities in the manufacture of incandescent mantles, is said to have discovered several radioactive elements in the residuum after the thorium has been separated. He estimates that Germany alone could in

three stories high, with two towers rising 130 ft. above the street level. These towers will contain water tanks of 20,000-gal. capacity, to be used for fire and storage purposes. The main waiting room is 70 by 128 ft., with nothing above it but the roof, 60 ft. high, and will be finished in Italian marble. In addition to the large waiting room, small waiting rooms, cafés, etc., there is a large concourse, 50 by 200 ft.

The building's exterior is of the Spanish renaissance style, and is constructed of American terra cotta. Considerable color is introduced to conform with the tropical climate and the



The New Union Terminal Station of the Railways Entering Havana

one year extract enough of these elements as a by-product of its thorium industries to correspond in radioactive strength to a trifle over one-third of an ounce of pure bromide of radium. This is said to be more than the whole world's store of this wonderful substance at the present time.

### HAVANA'S NEW PASSENGER STATION

The new passenger station in Havana, which will be used as a union terminal by the Cuban lines, will be one of the finest structures in Cuba. The station building is 240 ft. by 70 ft.,

Cuban wealth of color. An interesting feature will be the absence of glass, the windows being provided with shutters. Double sets of shutters will be used for all the windows, the light, exterior set to be used when an ordinary rain storm occurs, and the inner shutters, which are provided with reinforcing bars and extra heavy bolts, as a protection against the Cuban hurricanes.

⌈The first whaling steamers to be equipped with wireless are the "Tyee, Jr.," "Fearless" and "Resolute," owned by the Tyee Company of Seattle, Wash.

## A DIVIDABLE WINDSHIELD FOR AUTOMOBILES

By using one half of this vertically dividable windshield, the motorist taking a spin by himself can materially

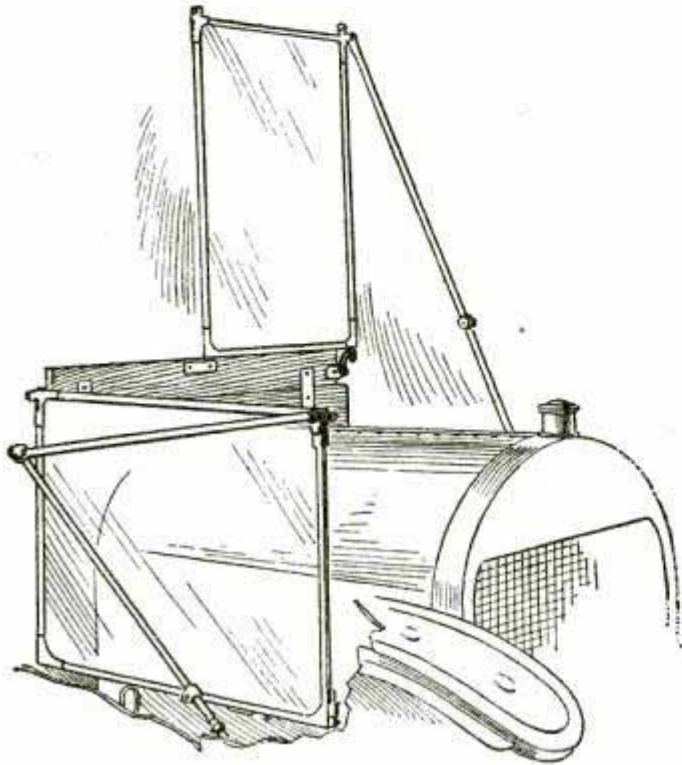

Cutting Down Wind Resistance by Use of Divided Windshield

cut down the wind resistance and still be well protected from the elements. When not in use, the shield, or either half of it, can be swung down parallel to the hood without interfering with the opening of the latter.

## REPAIR CLAMPS FOR AEROPLANE FRAMES

In the past, the airman whose aeroplane sustained a slight breakage of the framework has been obliged to abandon his flight and send the ma-

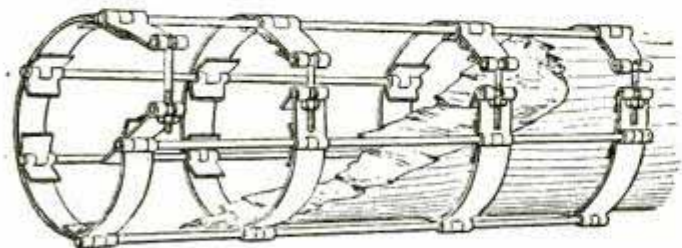

A Clamp by which Breaks in the Frame of an Aeroplane may be Quickly Repaired by the Airman

chine to the repair shop at great expense and loss of time. Now, however, there is a clamp on the market with

which he can mend the damage himself, unless it be exceptionally serious, and at least fly back to his hangar, if it be not advisable to continue the flight.

The clamp, recently patented by a French firm of machinists, is made in several different shapes, which have become standard in flying-machine construction in that country, but it is sufficiently flexible to fit slightly deviating shapes of framework. The nature of the clamp is clearly shown in the illustration. The flexible steel bands forming the collars are bent back on the inside at the hinges in order to form a spring catch which effectually prevents the joined parts from slipping.

## BELLS RING WHEN BALLOON SINKS OR RISES

Ingenious, yet simple, this curious alarm warns the aeronaut of the vertical movements of his balloon or airship without the necessity of his keeping an eye on an indicator, which might be difficult at critical moments.

The device, which may properly be called an aerial alarm clock, has two bells of extremely different tone, arranged in a cylinder open at both ends. A fan, disposed horizontally between the two bells, is revolved by the rush of air entering the cylinder, whirling in one direction when the balloon is descending and the air rushing up through the cylinder, and in the other direction when the balloon is ascending and the air rushing down. Mechanism geared to the fan actuates one bell when the machine is falling and the other when it is ris-

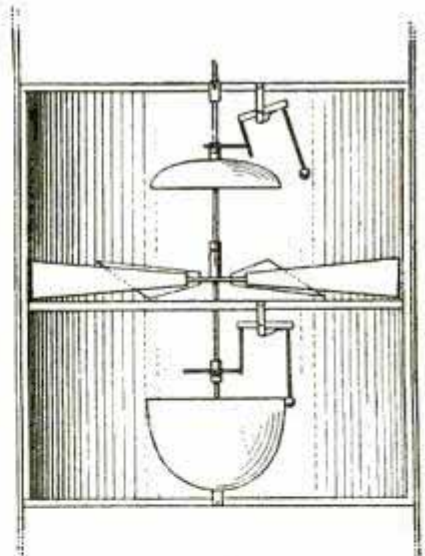

ing, so that the aeronaut can tell by the tone of the bell which way the vertical movement is. Furthermore, the interval between the hammer strokes diminishes when the descent or ascent is rapid, and vice versa, which enables

the aeronaut, after he has accustomed himself to the use of the apparatus, to estimate fairly accurately the rapidity of the rise or fall. When sailing on the same level, the alarm will of course remain silent.

## THE MAKING OF ARTS-CRAFTS LAMPS

By JOHN D. ADAMS

### PART XII—PIANO LAMP

**T**HE piano lamp is by no means limited in its usefulness to the reading of music. Placed alongside of the morris chair it furnishes an excellent light for reading, and also may be used to advantage in connection with a card table or sewing stand, both of which are usually too small to conveniently hold a lamp.

The woodwork is a trifle more elaborate than in any of the lamps thus far described, but this need not deter the reader from undertaking its construction, as the carpentry involved is of the very simplest nature—in fact, not a single mortise or tenon is employed. Commence the construction with the two crosspieces for the base, which, after having been trimmed off squarely and to length, should be halved out to one-half their thickness where they cross one another, so that when fitted

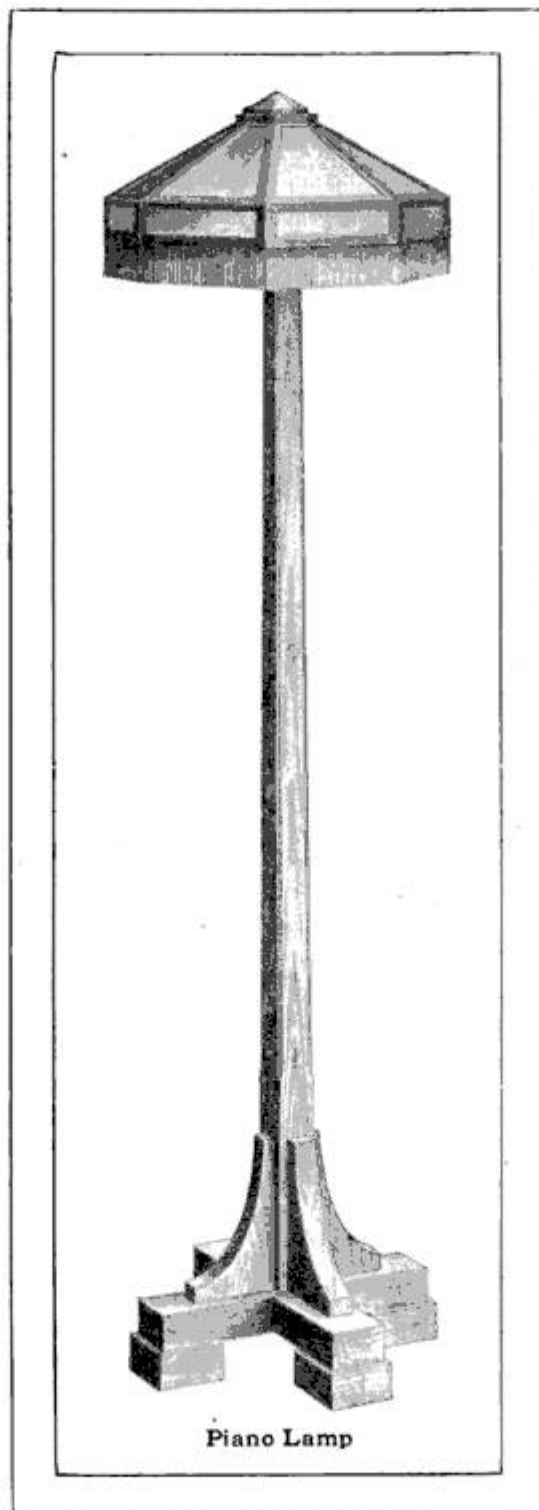

Piano Lamp

together the thickness of the connection will be but 2 in. The four blocks for the feet should now be trimmed up perfectly square and smooth on their ends, after which all the pieces thus far made should be put together. Use glue at all joints, supplementing it with a few long slender screws set in from underneath. The center post should now be taken up and planed to a uniform taper from a point about 10 in. from the lower end clear to the top, after which the corners are to be beveled off in the manner shown. The four angle brackets are now to be sawn out and trimmed up to a perfect right angle, after which the center post should be placed in position and the brackets attached by means of glue and screws. In the matter of staining, the other furnishings in the room should be considered.

The shade is of octagonal form and will necessitate a sheet of cardboard about 28 by 29 in. While possibly not the quickest, the most accurate way to lay out the pattern is to draw it directly on the cardboard. Draw a circle of  $11\frac{1}{2}$ -in. radius, and space off

eight chords,  $7\frac{5}{8}$  in. long, around the circumference, and from each of the nine points (indicated by small circles on the drawing), draw radial lines to the center. On the outer side of each chord lay out the lines for the small side panels, and on the inner side and also along the radial lines mark off the  $\frac{3}{4}$ -in. strips that form the borders of the triangular spaces that form the sloping portion of the shade. Having drawn the completed pattern as shown, score with the knife along the dotted lines so that a good

sharp bend may be made, and then cut the remaining lines clear through. The bending should be done over the sharp edge of a table or board. First bend the strips along the lower edges of the side panels to a right angle, and then bend the panels downward to almost a right angle. The frame should next

be given a slight bend along each of the radial lines, after which the first and last sections may be connected by means of the extra strip, to which a good coat of glue is to be applied. The pointed ends shown at each outer corner of the side panels will now be

found to lie in a horizontal position and to overlap. Set in a paper fastener at each of these points, and then apply passe-partout tape to the eight vertical and radial bends. A small octagonal block should now be prepared, and after bending in the eight tabs at the top of the shade, this block should be secured in place by means of glue and tacks set in from the inside. Give the entire framework a coat of dull black and when dry proceed with the colored paper lining. Before attaching the shade in

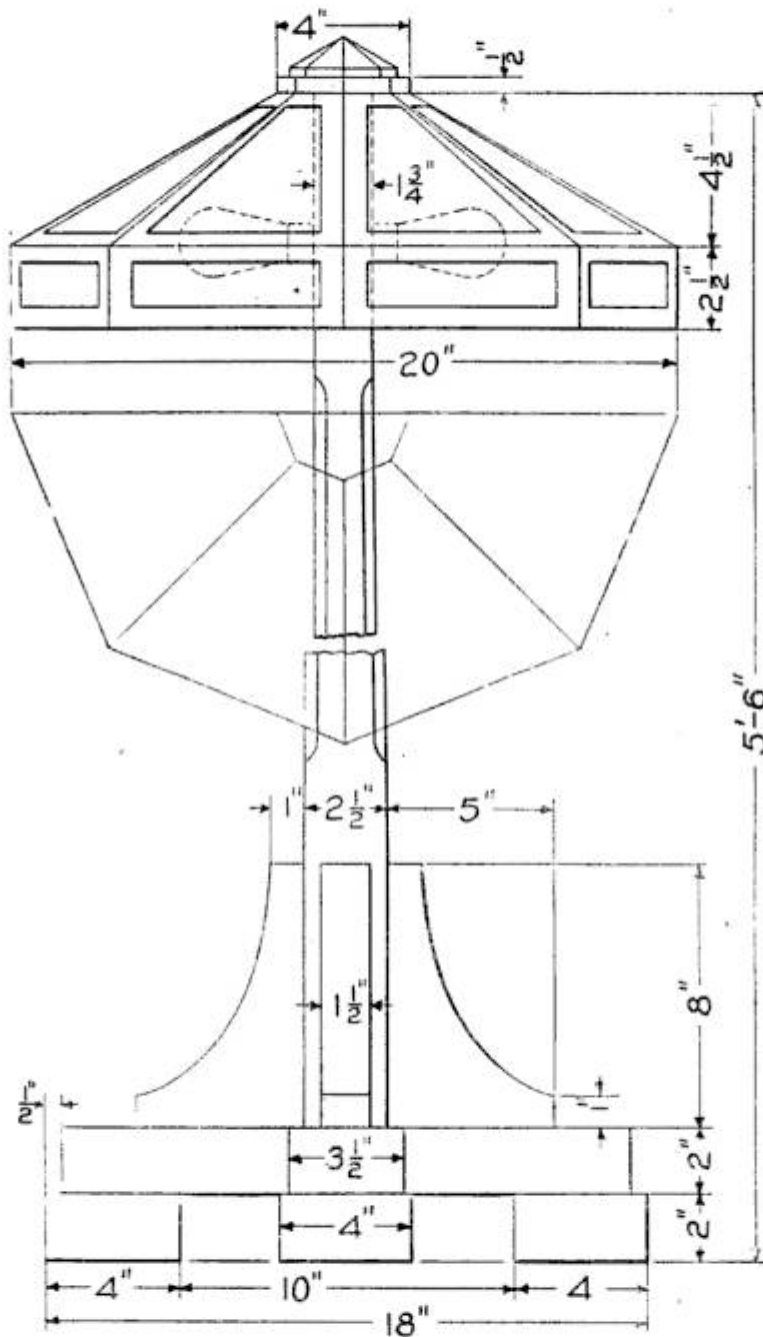

The Standard and Base Details of the Arts-Crafts Piano Lamp, Showing the Finished Shade in Place

position, the porcelain receptacles for the lights should be attached to the center post. Two or four lights, as desired, may be used. The cord should be amply long and connect with an outlet in the side wall, where the controlling switch may be placed. A switch can be attached to the center



post near the top and close to the lights, if no controlling device is in the line back of the attachment plug. The cord can be carried to the base, in case the plug attachment is in the baseboard.

### LARGE ELECTRIC BAKERY

Bakeries in which nothing but electricity is used for heating purposes are becoming increasingly common in parts of Europe where abundant water power enables the current to be sold at a price at which it competes successfully with other heating agents. At Brengenz, near the Swiss border in Austria, there is a bakery which has an oven baking surface of 14 sq. yd., in two stories. In the ovens there are 20 heating elements, arranged in such a manner that when they are all working, the heat is evenly distributed. These elements are connected by separate electric circuits to switches correspondingly located on a convenient switchboard. Thus, as any combination of the heating elements may be used, the amount of heat in the ovens, as well as its manner of distribution, may be regulated to a nicety. It is said that this electric oven requires only 47 per cent of the time to handle

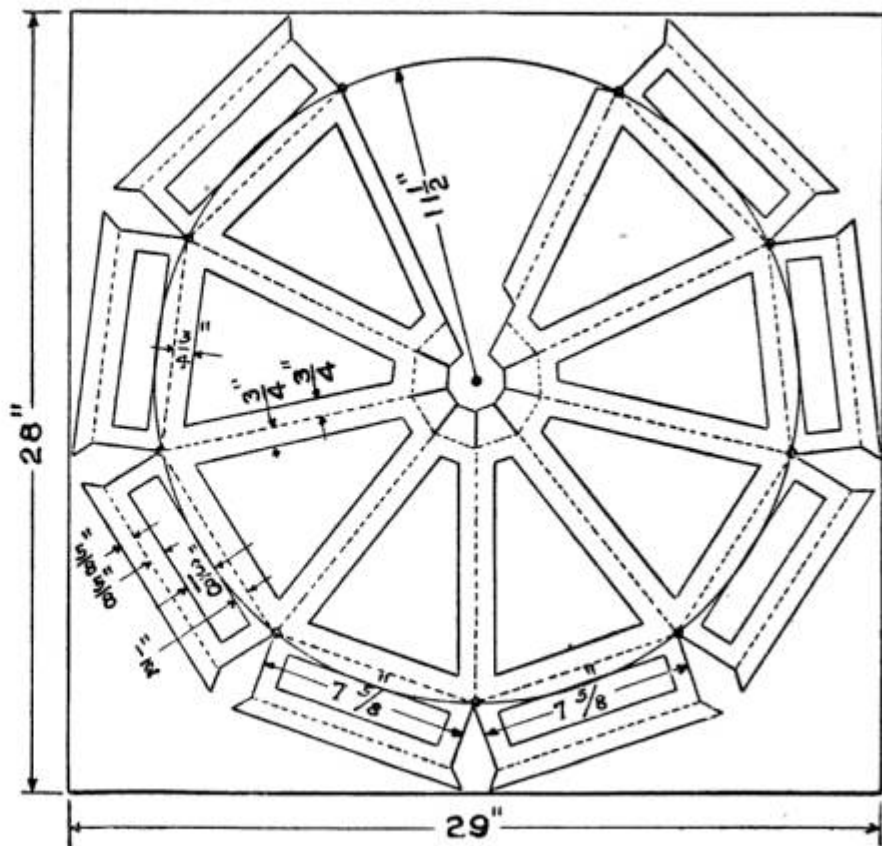

Plan of the Shade for Piano Lamp

a given output as does the ordinary type of baker's oven.

### TANDEM MOTORCYCLE

An ordinary motorcycle converted into a tandem machine by a frame of the owner's own design and construction is shown in this illustration. Bucket seats are provided for both the driver and the passenger, the latter being slightly higher than the former. Both, however, are considerably lower than in the usual motorcycle construction.

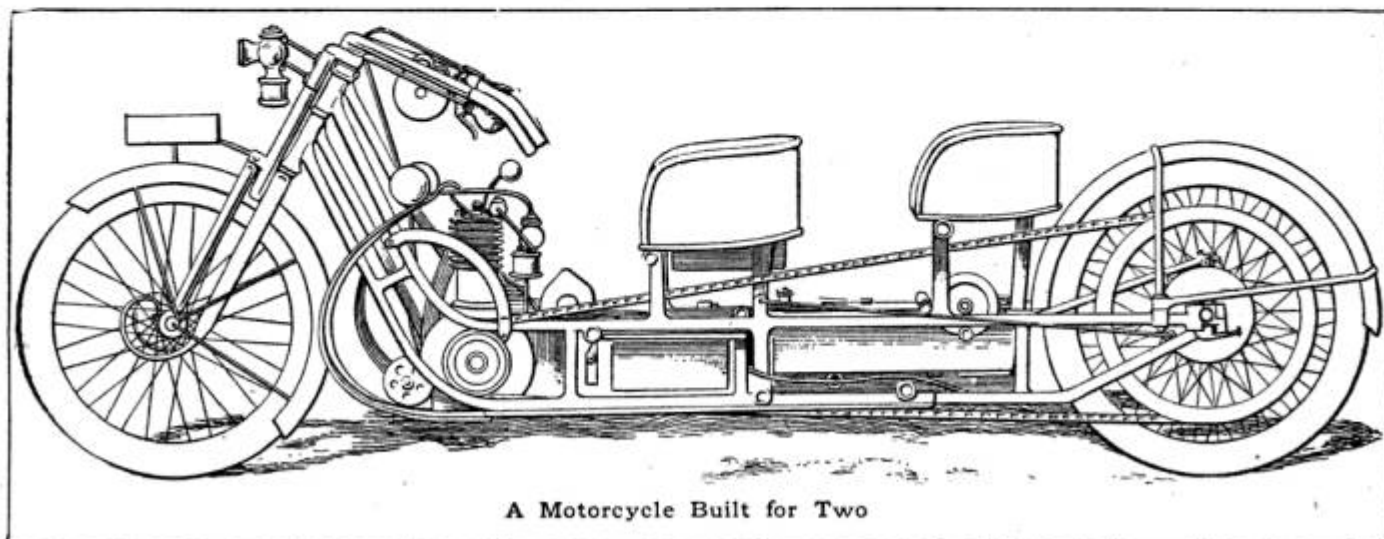

A Motorcycle Built for Two

## ELECTRIC FAN WITH BED BRACKET

An attachment for fastening an electric fan to the corner post of the foot-board of any brass or iron bed is

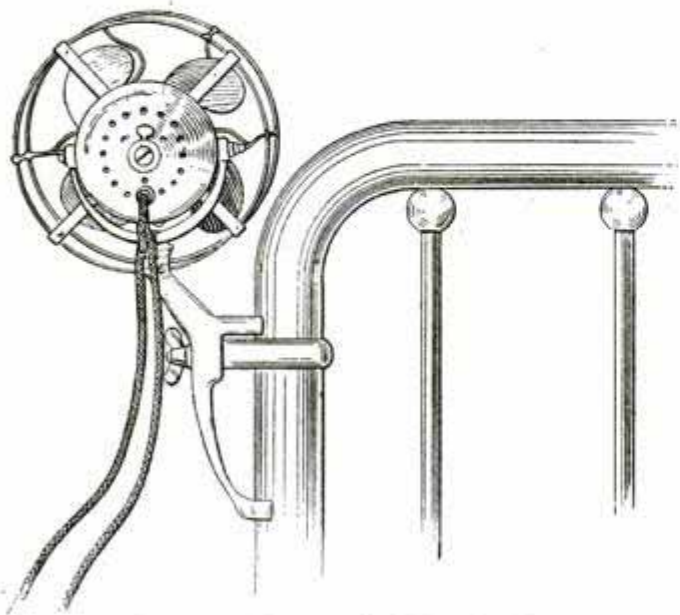

Bedstead Bracket for Electric Fan

shown in this illustration. The four prongs of the bracket are covered with felt, and, as the bracket is held securely by a piece of cotton webbing, no metal comes in contact with the post of the bed to mar its finish. The adjustment may be changed at a moment's notice by loosening the thumb screw, and the fan may be directed to blow on the bed, over it, or to create a general circulation of air about the room.

## PAPER CONSUMPTION IN 1910

The paper consumption for the year 1910 in the United States, Great Britain, Germany, France, Austria, and Italy, amounted to 5,270,000 tons, of which the United States consumed more than half, or 2,730,000 tons. Germany came next with 937,000 tons, which is within 13,000 tons of the whole world's paper consumption 20 years ago. Great Britain used 573,000 tons; France, 419,000 tons; Austria, 346,000 tons, and Italy, 265,000 tons.

The per-capita consumption in the United States has increased about six-fold since 1890.

## BRAZIL'S RUBBER FORESTS ARE VAST

The vast rubber forests of the Amazon Valley, a zone of 1,000,000 square miles, have been explored and exploited in only a small way, the great drawback being that the better the conditions are for wild rubber the worse they are for human habitation. Each year some new stream or tributary whose banks are heavily wooded with rubber trees is discovered, but away from the streams are vast forests of which no clear estimate can be made. The reason for this is the density and the dampness of these great stretches, and the difficulty of reaching them. In fact, the difficulties are apparently so unsurmountable that great plantations of rubber trees are being grown in Brazil in regions easier of access.

## GIANT KEY IS WEATHER VANE

The weather vane of St. Peter's church, Cornhill, is one of the most unique in the British Isles. It is a giant key, 9 ft. high, and its allusion to St. Peter's position as keeper of the gate of heaven is obvious.



According to *La Nature* (France) the number of organic chemical compounds—that is, in which carbon enters as a constituent—definitely known to science at present amounts to 150,000, to which chemists each year add from five to eight thousand.

## SOLIDIFIED GASOLINE

The nature of the solidified gasoline which is being experimented with in Europe as a substitute for liquid gasoline has already been described in this magazine, but the accompanying illustration shows one of the jelly-like blocks suspended on a fork. It is claimed that the solidified gasoline is more convenient for automobiles than liquid gasoline.

A writer in the Automobile Owner explains that "the petrol is mixed with a small amount of stearin which has first been treated with hydrochloric acid. To this mixture is added a mixture of methylated alcohol which has first been treated with sodium hydrate. The two liquids are stated to unite with considerable energy and, after the addition of water, the gelatinous mass results.

"It is claimed that the petrol so treated is far safer to handle than in the liquid condition, and no doubt this is so, for as jelly, the activities of the petrol seem to a certain extent to be suspended. Thrown into the fire, the jelly burns little more fiercely than candle grease. I am told that, after exposure for  $3\frac{1}{4}$  hours in a laboratory, the loss by evaporation was about 44 per cent., but one would think that this



A Block of Solidified Gasoline on a Fork

rate is more than sufficient to be dangerous."

Probably the longest direct telegraphic circuit yet established in practice was put in use for one hour or more when a war correspondent at Douglas, Ariz., recently wired to New York by way of Los Angeles, El Paso, Dallas, Kansas City and Chicago, a total distance of over 4,000 miles.

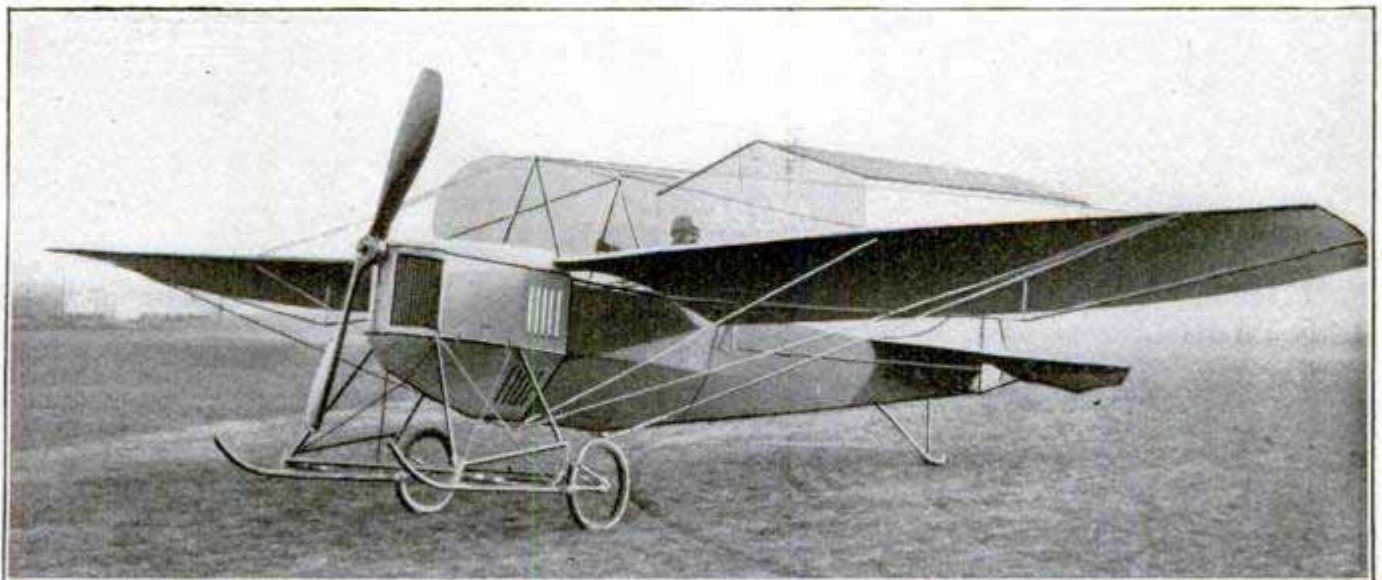

CLEMENT-BAYARD'S NEW MONOPLANE

The 45-hp., 4-cylinder motor is inclosed behind the radiator in front. The machine made its first flight recently at Issy-les-Moulineaux, France

## THE OLDEST AMERICAN COOKING STOVE

This stove, believed to be the oldest cooking stove in America, was made in 1767 at the Hereford furnace, near

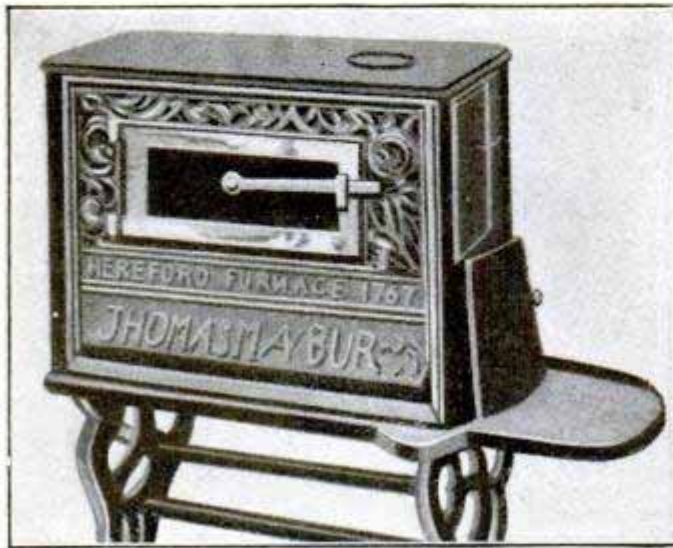

Cooking Stove Cast in Pennsylvania in 1767

Huff's Church, Berks County, Penn., one of the first charcoal furnaces established in that state. The stove is of the box form, standing upon legs similar to those of a sewing machine, weighs 500 lb. complete, and is 36 in. long, 34 in. high, and 12 in. wide. The top is lidless, the only opening being a small hole for the pipe. The oven is small, being only 14½ in. long, 12 in. wide, and 6 in. high. The floor of the oven

is removable, and there is no grate in the bottom of the stove, the fire being built directly on the bottom, and the heat passing below the oven, back of it, and over the top to the pipe.

## "DELAWARE" EXCEEDS TRIAL SPEED IN NEW TEST

The huge battleship "Delaware," after a cruise to South America of about 26,000 miles, successfully completed her four-hour forced-draft run recently, at an average speed of 21.86 knots (25.17 miles per hour). In this test, the ship exceeded her trial speed, which was 21.56 knots (24.83 miles).

This remarkable efficiency which the "Delaware" has shown, together with her great fighting power, leads the naval authorities to believe that, alone, she would have been able to destroy the entire fleets of both American and Spanish navies that were assembled at Santiago.

## STRETCH OF RAILROAD BUILT ON SALT

What in this illustration appears to be a train standing in a field of snow is in reality a train on the surface of a vast field of salt near the Great Salt Lake in Utah. The stretch of railroad

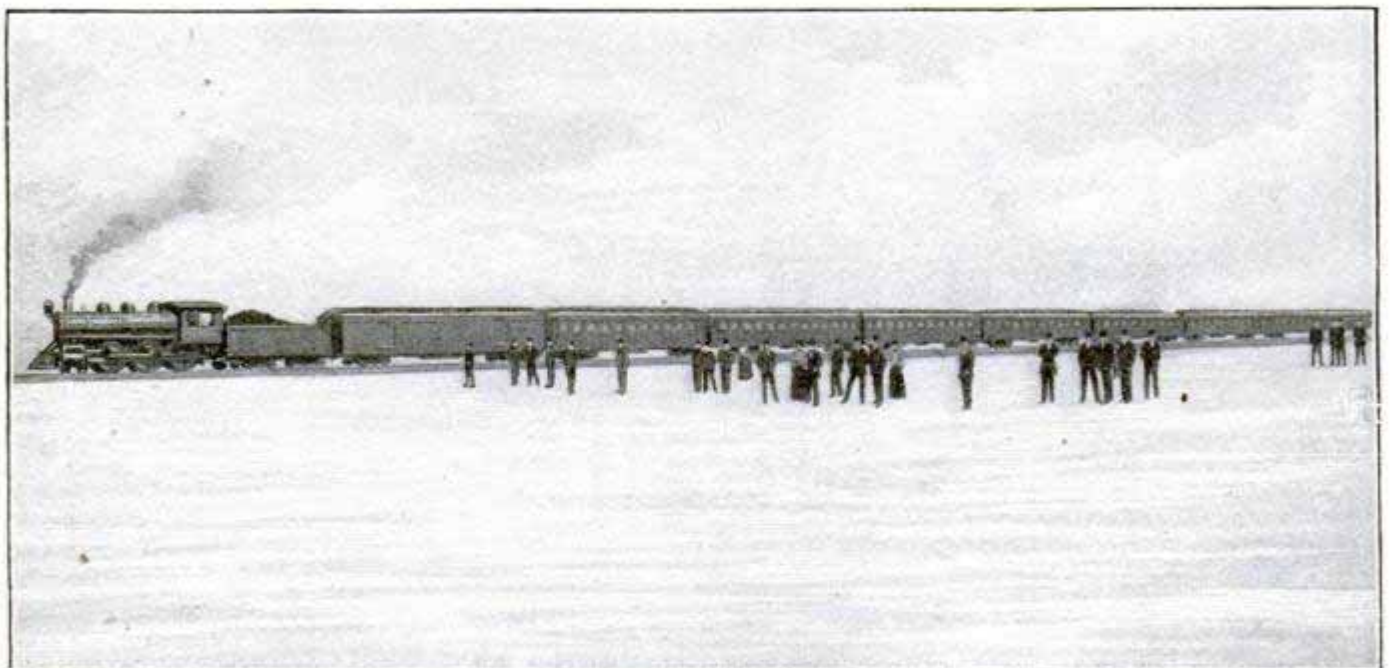

The Vast Salt Beds near the Great Salt Lake of Utah are Now Traversed by a Railroad Line



Baling Hay by Camel Power on the Steppes of Siberia

over this deposit of salt is part of the new line of the Western Pacific system extending from Salt Lake to San Francisco.

In constructing the line around the lake the engineers found it expedient to build a stretch across the vast salt beds, the average depth of which is about 8 ft. The salt is so hard and solid that most of the line traversing it was built directly upon the deposit; all of it, in fact, except where the grade necessitated cutting through the salt incrustations to the earth.

When the air is moist and the sun shining, the expanse of salt may readily be mistaken for a field of dazzling white snow.

### BALING HAY IN SIBERIA

American agricultural machinery has made excellent advance into Siberia. Nevertheless, methods of tilling the soil are rather primitive in that part of the world, and in the accompanying photograph one sees the kind of hay-baler sometimes employed on the steppes. It is run, as will be observed, by camel power. As that animal is walked around in a circle, the hay, thrown into the machine from a stack

is compressed into solid bales. Undoubtedly, the contrivance does the work very satisfactorily, though less rapidly than might be desired.

### ARMOR FOR X-RAY OPERATORS

This improved armor or garment for the protection of physicians and surgeons from the influence of the X-rays, comprises a rubber mask with spectacles of lead glaze, a long blouse made of lead, rubber, and bismuth, and thick gauntlets of the same material. The head covering, with its broad nose-piece and spectacles gives the wearer a strange appearance, indeed.



Protected from X-Rays

## SCIENCE AND MECHANICS IN THE MIDDLE AGES

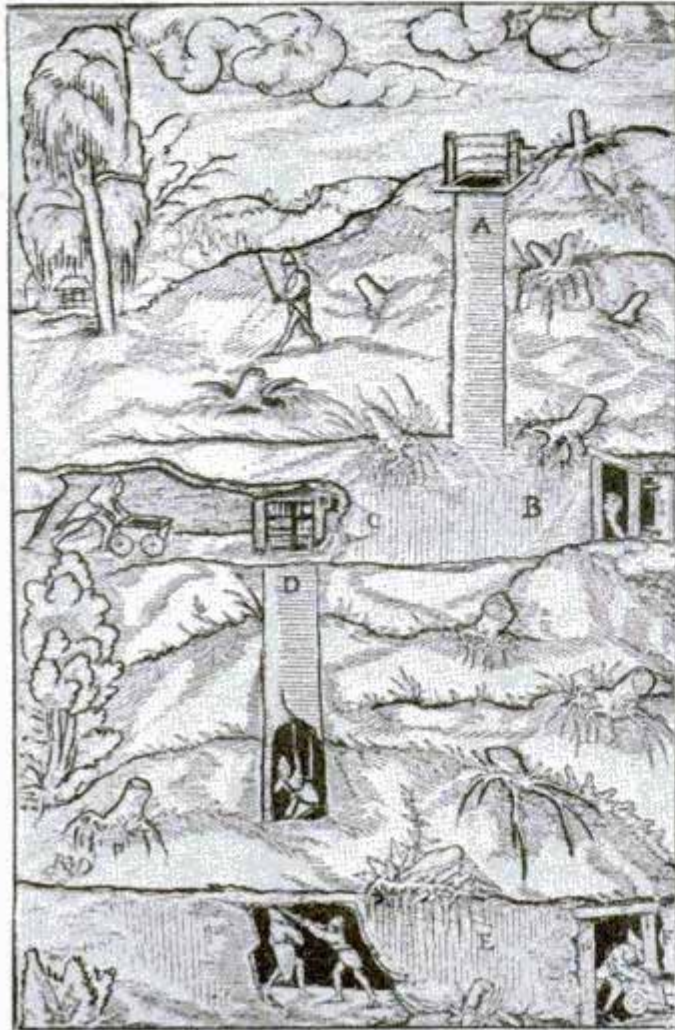

No. 7—EARLY MINING.—In 1557, John Agricola, a famous divine of Saxony, published a book on mining from which the accompanying illustrations were taken. The first shows the workings of two levels of a mine, with methods of timbering and hoisting, and the other a chain-pump worked by men treading inside a wheel. A pump of this type was found 50 or 60 years ago in a mine that had been abandoned in the fifteenth century.

## ADVERSE REPORT ON GREAT LAKES REGULATION

The International Waterways Commission, appointed to consider the proposition for regulating the level of Lake Erie made by the board of engineers on deep waterways in 1900, has at last turned in a report that is adverse to the proposition.

The plan proposed by the board of engineers consists of a submerged weir or dam in connection with a set of sluice gates located across the outlet of Lake Erie. With the sluice gates all closed, the low water flow would be discharged over the fixed submerged weir, and, at times when the lake was receiving its maximum supply, the surplus would likewise be allowed to escape by opening the sluice gates, thus keeping the lake at practically the same level at all times. Such a dam would hold the level of the lake at or near 574.7 ft. above mean tide at New York, which is higher than any monthly mean stage reached since authentic records were commenced in 1860. The scheme would lessen the low water stage of Lake Erie about 1 ft., that of Lake St. Clair 0.61 ft., and of Lakes Huron and Michigan 0.27 ft.

The adverse report, however, is based on the fact that the advantages for Lakes St. Clair and Erie are not sufficient to offset the disadvantages for Lake Ontario and the St. Lawrence River. The oscillation in Lake Ontario would be increased about 5½ in., and low water would be made lower by about 4½ in. The depth of the St. Lawrence canals would be diminished by about 7.66 in., and the city of Buffalo and its southerly suburbs would suffer by increased damage of floods, and from the postponement of the date of opening of navigation in the spring.

¶The latest material for the wing surfaces of aeroplanes is fine wire gauze, the meshes of which may be filled with lacquer, varnish, boiled oil, particles of cotton, wool, etc.



Water-Soaked Materials, Rescued from Fires, being Dried in the Drying Loft of the Underwriters' Salvage Company of New York

## DRYING MATERIALS SAVED FROM FIRES

The Underwriters Salvage Company of New York has an ingenious electric plant, utilizing the entire loft of one of its warehouses, in which all the water-soaked material rescued from fires is dried. Almost everything from harness and hardware to silk dresses and lingerie is dried there. As soon as the materials arrive they are hung in rows from front to rear on specially constructed hangers, garments made of the most delicate fabrics being subjected to the process without the slightest damage resulting from the drying.

A 30-hp. electric motor supplies the power for two monster fans, one of which drives the air through a maze of vertical steam pipes, where it becomes heated, and then forces it into a gallery which runs the entire length of the loft. From this gallery the air is distributed into the room with sufficient force to send it to the remotest corner, and the second fan creates a suction which draws off the damp air through a gallery at the bottom of the room. The temperature of the room

begins to rise a few minutes after the motor is set in motion, and continues to rise until the loft becomes uncomfortably warm.

The floor of the drying room is covered with galvanized iron, which renders it fireproof and also makes a perfect drainage system.

## THE DESTRUCTIVE FORCE OF A TORNADO

When it is taken into account that a tornado needs for its existence a whirling velocity of between 200 and 400 miles an hour, and that the atmospheric pressure in its vicinity is reduced from 2,000 to 1,000 lb. per square foot, its destructive force may well be appreciated. These facts were brought out by George S. Bliss, of the United States Weather Bureau, during a recent lecture in Philadelphia. He stated that it would be impossible, under any circumstances, to construct buildings, pole lines, etc., that would withstand even the mildest of tornados.

## SCHOOL BOYS COMPETE IN KITE FLYING

An adaptation of the Chinese pastime of kite flying for the instruction of school boys has become one of the



Measuring the Altitude at a New York High School Kite-Flying Contest

features of the year in a New York school. The director of science of the institution has devised a series of kite-flying contests that have a more or less educational value and at the same time contain all the elements of play that attract the boy. One of the features of the affair is the altitude contest which instructs the youthful competitors in the art of measuring the altitude of their kites. At the last of the competitions held this year the altitude prize went to a boy whose kite registered 3,500 ft., this being the altitude reached by the kite and not the length of the cord that held it. The longest flight, or length of cord, was 8,000 ft. The competition closed with a battle in the clouds that was unique. A dozen or more kites armed with sharp knives were sent up and the boys handling the reels manipulated them so that their kites would cut the strings or structures of the others.

## TELEPHONES TO AID FIRE FIGHTERS IN FORESTS

Rangers in the national forests will be supplied with portable telephone sets with a special flexible wire which can be easily and quickly run along the ground to isolated places in the forests. The telephones will be of use in summoning help to prevent a repetition of the disastrous conflagrations in the Northwest last August. The adoption of these telephones is due to experiments conducted since last summer with sets similar to those used by the signal corps of the army.

Prevention of large fires has been furthered since last year through lengthening trails and extending permanent lines. When the fire season arrives, an extra force of rangers will penetrate the isolated parts of the forests, laying their telephone lines along the ground as they go. Metal boxes containing fire-fighting implements, together with a supply of food, have also been distributed along the many trails where they will be easy of access.

## CAMEL WATER CART

The water carts of Aden, Arabia, are drawn through the streets by camels. These carts deliver daily from house to house a free ration of 10 gal. of condensed water, the only kind procurable in that community of about 45,000 population.

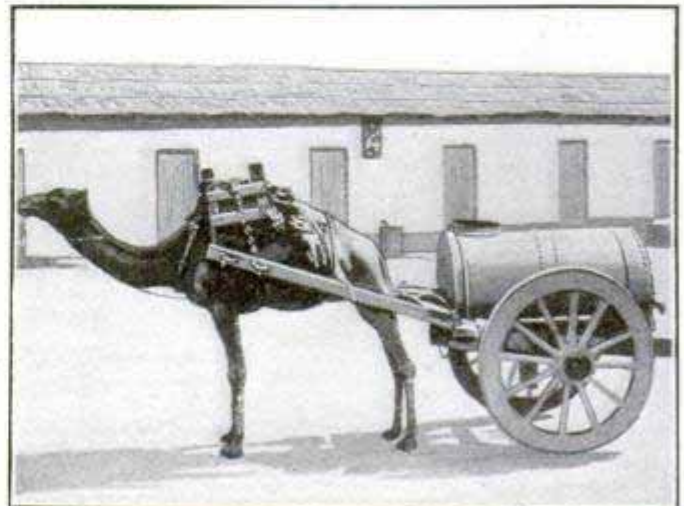

Delivering Free Water in Aden, Arabia



# The Kingdom of Dust

By J. Gordon Ogden, Ph. D.

THIS is the fifth of a series of articles by Dr. Ogden, who is professor of physics at the Fifth Avenue High School, Pittsburg, Pa. In every home, in every office, in every shop or factory, the fight against Dust is never-ending. Dr. Ogden illuminates this subject in a manner which brings a realization of its infinite importance.

## V—The Foe of the Workman

SCIENCE with her wizard appliances has done marvelous things for mankind in the matter of protection against disease. She has searched out the causes of the scourges that formerly played havoc with the human race. Smallpox, diphtheria, cholera and typhoid fever have been hunted down and made to reveal their death-dealing secrets. We have learned to be cautious as regards the character of our drinking water. We know the danger of the malaria-carrying mosquito. We appreciate the insidious menace of the common house-fly. We understand the importance of enforcing pure-food laws. Nevertheless, there is one avenue, broad and wide, along which disease and death march arm in arm, right into the very heart of the citadel of life: It is the highway that leads

from the Kingdom of Dust. The myriads of dust motes are the real executioners of mankind, especially in those occupations where the formation of dust is a necessary concomitant.

An average man breathes about 21 cu. ft. of air per hour. Under the very

best conditions possible, the air he breathes is never entirely free from dust. Under ordinary conditions, the average business man in his comparatively sanitary office breathes in thousands of dust particles every hour. The workman, who earns his livelihood in shop, factory, or mine, has his proportion of motes enormously increased, owing to the nature of his work; unfortunately, also, the character of these particles is too often changed from the innocuous kind to the death-dealing splinters due to certain occupations.

An artisan working with keen-edged tools must exercise extreme care in order to prevent harm to himself. If he is surrounded by circular saws revolving at lightning speed, or with vats of corrosive acids, or furnaces of molten steel, these perils are at least in

open view, and may be guarded against. It is different, however, with the dangers lurking in dust. They are invisible, but none the less deadly. In a steel-grinding factory, the air is charged with flying, jagged splinters of steel, infinitely sharper and more dangerous



The Painter Works with One of the Most Dangerous Poisons Known to the Arts



Many Unsuspecting Women Carry About Furs Laden with Deadly Arsenic



Human Lung in Health



Steel Grinder's Lung



Coal Miner's Lung



Dust from Sandstone

## MICROPHOTOGRAPHS OF HEALTHY AND DUST-FILLED LUNGS

than the razor-edged tools to which he is accustomed. Every breath sends bits of metal, keener than the far-famed Damascus blades, right into the midst of his delicate lung tissue.

It has been said that everyone in the course of life must eat a peck of dirt. But what about the dust we breathe? The peck of dirt is comparatively harmless; the dust is either an irritant, producing inflammation, or else it may be a toxic substance, eventually causing death. The lungs of a gold miner, for example, upon chemical analysis, showed 24.4 per cent of their total weight to be pure silica, inhaled during the work of rock drilling.

It is true, of course, that the "phagocytes" or microbe-eaters in the lungs, act as scavengers and tend to keep the tissues free from organic dust; but they are practically powerless in the matter of inorganic material such as sand and clay. All that the phagocytes can do with such materials is to transport them to the bronchial glands. After death from "dust consumption" the long black lines of pigment may be observed, marking the course of the dust particles through the respiratory apparatus. Hesse, a German scientist, has made a careful study of the amount of dust inhaled by workmen in different trades as is shown by the appended table:

	Per day	300 days per year
Iron foundry	2.16 gr.	648 gr.
Tobacco works	5.6 "	1680 "
Flour mill	1.93 "	579 "
Chemical works	17.3 "	5190 "
Saw mill	13.9 "	4170 "
Horsehair works	7.7 "	2310 "

From this it follows that an ironworker adds over an ounce of iron dust to his lung tissue every year! Of course, all of this dust does not remain permanently in the lungs, but some of it does, especially the jagged splinters of steel, which imbed themselves deeply in the tissue. Is it any wonder that fibroid phthisis results? Is it any wonder that we hear so frequently of "steel-grinder's consumption," of "stonemason's phthisis," and of "potter's rot"?

Not only are the immediate workers in the shops affected by this dust of death, but the ordinary wayfarer on the streets and highways must take his proportion also of this concentrated essence of disease. For example, a careful investigation of the conditions prevailing in the 21 miles of subway in New York City, indicates that in each 1,000 cu. ft. of air, there are 61.6 milligrams (0.00217 oz.) of dust, and that 61.3 per cent of this dust is pure steel in jagged splinters! This high percentage of metal is accounted for by the fact that the brake-shoes alone wear down at the rate of 2,000 lb. per month, without taking into account the loss from the wheels and rails.

The list of trades that pay tribute to the Kingdom of Dust is very large, and few people realize the startling proportions of the part played by dust, or the tremendous havoc wrought by this frightful, insidious agent of death. The following table, compiled from Sommerfield, will give some



The Beautiful Glaze Made by the Potter Often Kills Him

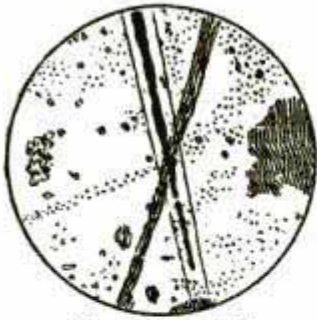

Dust from Felt Manufacturing



Dust from Silk Factory



Dust from a Saw Mill



Dust from Needle Grinding

AND DUST OF SOME OF THE DANGEROUS TRADES

notion of the tremendous toll dust takes from mortals:

	No. Deaths due to phthisis per 1,000 persons.	No. Deaths due to phthisis per 1,000 deaths.
Occupation without production of dust .....	2.39	381
Occupation with production of dust .....	5.42	480
Population of Berlin of same age .....	4.93	332.3
Trades giving rise to—		
A. Metallic dusts.....	5.84	470.6
(a) Copper trades.....	5.31	520.5
(b) Iron trades.....	5.31	520.5
(c) Lead trades.....	7.79	501.7
Trades giving rise to—		
B. Mineral dusts.....	4.42	403.4
(a) Pottery workers.....	14.00	591.0
(b) Stonemasons.....	4.26	382.0
Trades giving rise to—		
C. Organic dusts .....	5.64	537.04
(a) Dust from leather, skins, feathers .....	4.45	565.9
(b) Dust from wool and cotton .....	5.35	554.1
(c) Dust from wood and paper .....	5.96	507.5
(d) Dust from tobacco .....	8.47	598.4

It will be observed from a study of this table that dust, on the average, adds 25 per cent to the death rate! In some cases, as in the trades of pottery making and tobacco handling, this percentage is cruelly increased, being 55 and 57 per cent, respectively!

The painter who deftly adorns and protects the woodwork of our homes with a thin covering of paint derived from lead, is working with one of the most dangerous poisons known in the arts. "Painter's colic" is produced by lead dust. And not only do painters suffer from lead poisoning but likewise a host of other artisans in a variety of trades are afflicted with "plumbism" in one or other of its many forms. The potter secures the beautiful glaze

on his handiwork by means of lead. The enameler, who covers iron plates with the deep blues, rich vermilions, and snow whites so familiar to us in the letters cemented on the glass of shop windows, has much to do with lead, and suffers accordingly. Even the diamond cutter has to be more careful of the dust from the lead and tin "knob" in which the diamond is imbedded, than of the diamond dust itself. The printer who handles lead type, the file cutter who uses lead in a certain stage of his work, the glass-worker, the electrician who builds electrical accumulators, the ship-builder, the lithographer, the dyer, and a score of other artisans pay tribute to the dust from lead. For some curious reason, women are especially liable to lead poisoning, and many attempts have been made to secure legislation that would prevent the employment of women in the manufacture of white enameled beds, in which lead is used so abundantly.



The Cigar-Maker's Trade Pays a Heavy Toll of Human Life to Dust

Before leaving the subject of lead dust, it might be well to reiterate the oft repeated warnings against drinking water that has stood for any considerable time in lead pipes. Water is a powerful solvent. It will dissolve practically every substance under the sun, and gradually takes up, little by little, enough lead to render the water slightly poisonous. Lead is a "cumulative" poison, and, particle by particle, it collects in the body, producing in time the well

known effects of lead poisoning. No doubt many thousands of people in every large community suffer from plumbism in a mild form. They may not suffer from "wrist drop" or develop the characteristic blue line on the gums, but they do develop minor symptoms that are sufficient to make life miserable, and yet not pronounced enough to alarm the sufferer or to cause him to seek the aid of a physician.

Workers in copper and brass suffer from the minute portions of these metals that wear off from the surface of rods and implements and poison the hands. Every street-car passenger has observed the peculiar greenish appearance of the hands of the motormen and conductors who are constantly in touch with either the brass rods on the summer cars, or of the brass handles of the controllers. A "green" motorman or conductor learns to his sorrow that brass, literally, must be handled with gloves.

Mercury, in the form of dust, claims thousands of victims annually. In the extraction of gold from the ore, mercury is, in several processes, quite essential, and the operators suffer from mercury poisoning. Workmen in factories where thermometers are made have constantly to be on their guard against the entrance of mercury dust into the mucous membrane of the body.

Phosphorus is another substance whereby fatal effects are produced by the entrance of a small amount of "dust" into the body. The recent dedication to the public of the patent rights of a harmless process for the manufacture of matches from phosphorus will save thousands of lives.

The beautiful gilding on Christmas cards is obtained by a process known as dry bronzing, in which the deep reds and greens, as well as the silver and gold, are produced by a mixture of copper, zinc, and arsenic. The dust, when breathed, sets up an inflammation of the respiratory tract, which afterward becomes chronic.

Arsenic was formerly much used as a coloring matter in wallpapers. The

wonderful greens, yellows, browns and reds of a score of years ago had for their base an arsenical compound. Many weird tales are told of certain "haunted" chambers where death was certain to overtake the unfortunate traveler who slept a certain number of nights in a certain bedroom. Investigation has shown that the walls of such apartments were frescoed with arsenical colors. These pigments are constantly giving off a very fine dust. This dust, breathed into the lungs for a period of eight or ten hours, causes all the preliminary symptoms of arsenical poisoning, and if kept up night after night would eventually cause death. Fortunately for the public weal, the use of arsenic as a coloring is practically done away with, so far as wallpapers are concerned. Workmen who are employed in the manufacture of the arsenical compound known as Scheele's green suffer from painful ulcers.

The use of arsenic in the curing and preservation of furs is a source of danger, not only to the workman who prepares the fur, but likewise to the unsuspecting wearer of the garment. Arsenic is a powerful insecticide; hence its use as a preservative. About 25 per cent of the furs recently examined by an American chemist proved to be heavily laden with arsenic. The use of more than one grain of arsenic per square yard is forbidden by law, and yet 170 grains have been found.

In the damp, hot atmosphere of churches and theaters in winter, the danger from arsenical poisoning rises to the maximum, and few people suffering therefrom are willing to attribute it to their handsome furs.

---

☞ All ships sailing from United States ports, carrying 50 or more passengers, and plying between ports more than 200 miles apart, must be equipped with wireless apparatus capable of maintaining communication over distances of at least 100 miles. The act, which was passed in June, 1910, has just gone into effect.



View of the Japanese Bungalow Built on a Pier 200 Ft. Out from Staten Island Shore

## JAPANESE BUNGALOW BUILT ON A PIER

A dainty Japanese bungalow that has its foundations sunk to the bottom of New York Harbor, sits on the end of a pier 200 ft. from the shore at Rosebank, Staten Island. The house is a picturesque feature of the Staten Island shore line. The building of this house, which is a work of art in addition to being an engineering feat, made necessary the use of several odd forms of construction. The entire

framework, both walls and cross partitions between the four rooms and pantry, were braced and counterbraced to withstand the terrific pressure of the gales which blow during the fall and winter. The sill was secured to the dock floor with heavy bolts driven into the piling and rods  $\frac{3}{4}$  in. in diameter were carried through the studding from plate to sill and secured to heavy timbers bolted to the dock piles. The

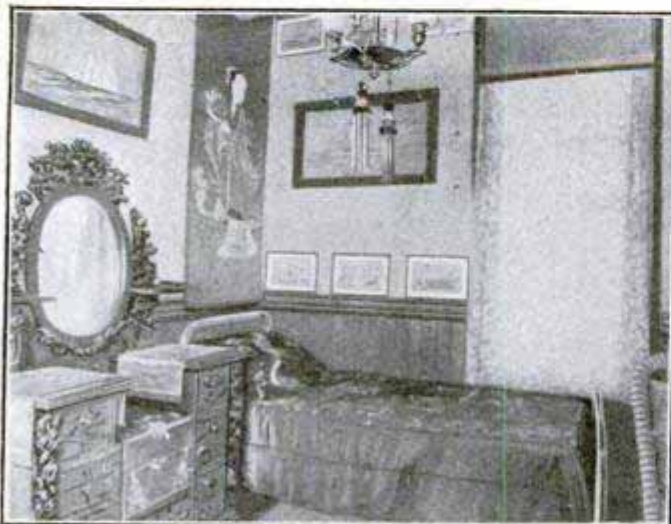

Corner of One of the Bedrooms

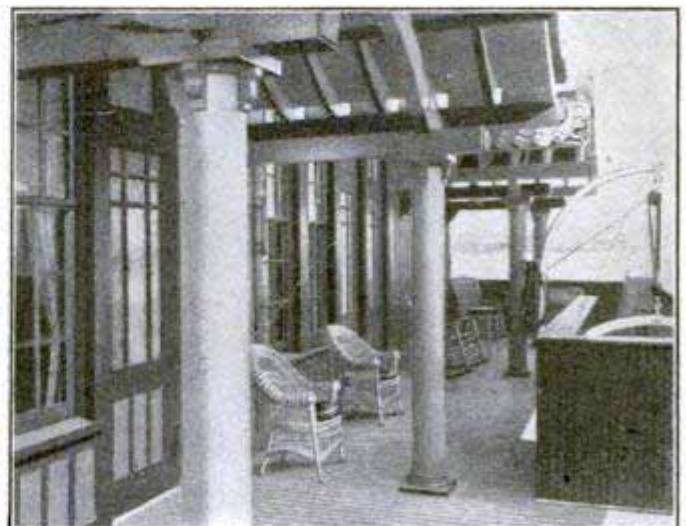

Wide Porch of the Japanese Bungalow

dock itself was originally intended as a motorboat landing and this feature has been preserved, steps leading down from each side to a landing in the center of the front. The architectural design follows Japanese lines. All the furniture, which is elaborately carved, and the handsome embroidered decorations were made in Japan after designs drawn in this country. The house has a wide front porch and has three large rooms, a butlery and a bathroom. There are two bedrooms and a living room, all facing the water.

The coloring of the exterior is subdued, the house being finished in buff with trimmings of light brown. The roof is painted dark green with a lighter tint for the moldings, and the high lights of the ornaments are touched with gold. All exposed beams and ends are painted red. One of the features of the house is the equipment of outside rolling shutters for the windows and doors which can be tightly closed in time of storm. The reels for the shutters are concealed in the attic above the ceiling.

## SPHERICAL WATER TANK

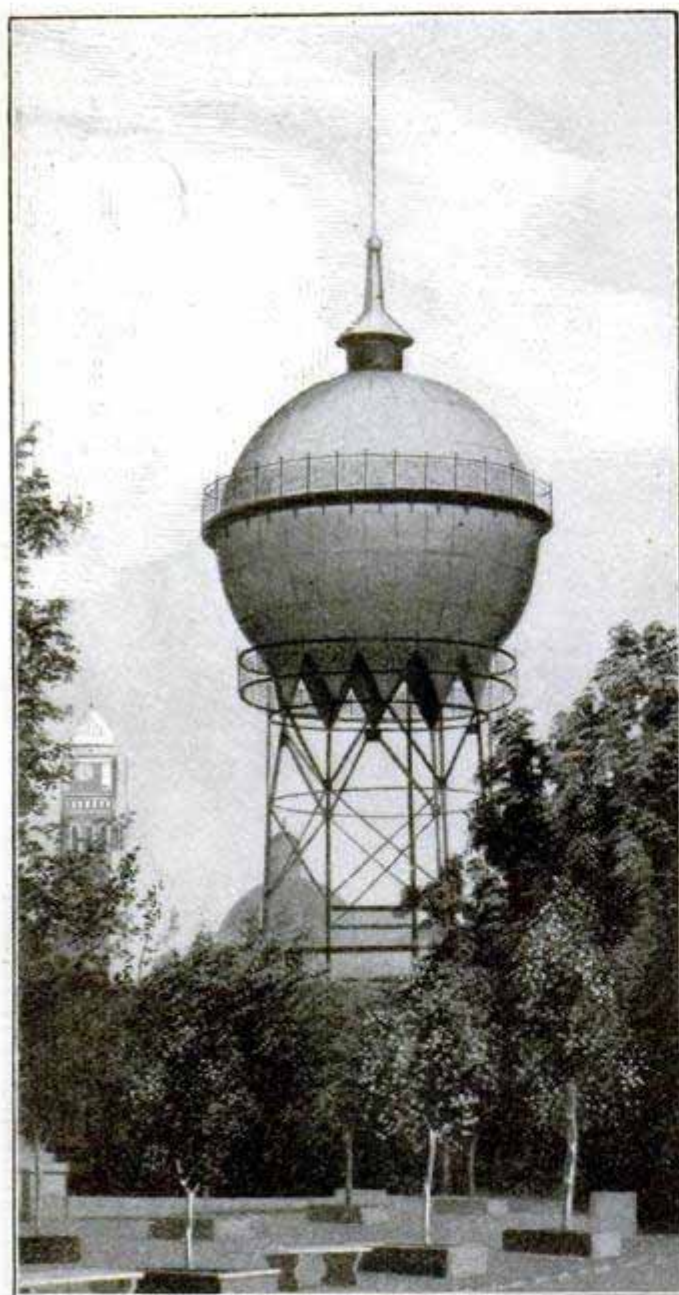

A Spherical Water Tank in Mexico

In the little city of Celaya, Mexico, is a rather novel and artistic water tank in the form of a steel sphere, mounted on a steel standard. Around the equator of this water globe is a narrow observation walk with railing, and rising from the top is the north pole in the guise of a flagpole. An electric pump lifts the water up into the tank from an artesian well at its side.

## NEW EXPLOSIVE PIERCES ANY ARMOR PLATE

The United States government has sole control of Hudson Maxim's new explosive, which is considered the most destructive possessed by any nation. The value of this new explosive lies in the fact that it will send a projectile through any armor now in use. Mr. Maxim says he believes this government is better prepared than any other for the destruction of warships of any enemy with high-explosive projectiles.

## RUBBERIZING AEROPLANE WINGS

Aeroplanes are now being made in such large numbers in France that time-saving methods are being adopted in their production. The way in which the fabric used for the covering of wings and rudders is coated with rubber to make it waterproof and give it

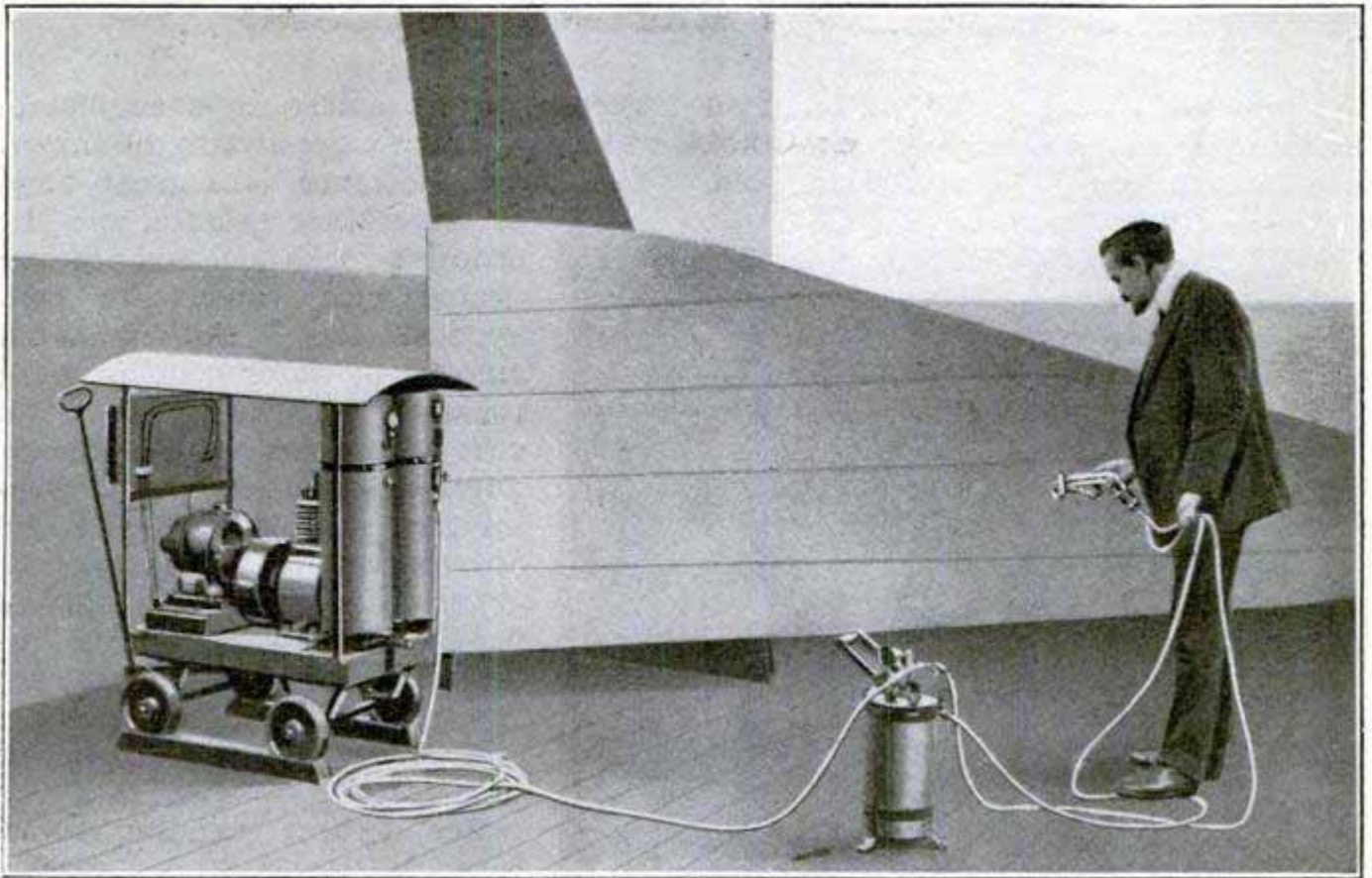

Coating an Aeroplane Wing with Rubber at a French Factory

better sustaining qualities in the air, as employed in the Deperdussin works in Paris, is shown in the illustration. Having been stitched together, the widths of muslin, cut to the desired shape, are stretched on frames and sprayed with a rubber solution. The spraying device or atomizer is held in the hand of the operator and moved about in front of the cloth. One of the rubber tubes leading from it conveys solution from the portable tank on the floor and the other tube leads to the tanks of compressed air on the hand truck at the left. The supply of compressed air in the tanks is maintained by a small air-compressor driven by a small electric motor.

### BOTTLE A FLY COULD NOT CRAWL INTO

Probably no class of artisans enjoys the production of novelties more than glass blowers, who always manage to find time to make unusual articles from the fragile material. In a big glass works at Millville, N. J., there has been rivalry for a long time among the men

to see who could blow the smallest bottle. One of them recently blew a perfect bottle that, stopper and all, can be hidden under a one-cent piece, and which is but a hairsbreadth taller than a dime is wide. The stopper is provided with a ball at the top and is ground so truly that the bottle may be picked up with it. The opening in the bottle is as perfectly shaped as the outside and is so small that it is doubtful whether a common housefly could fold his wings closely enough to crawl into it.

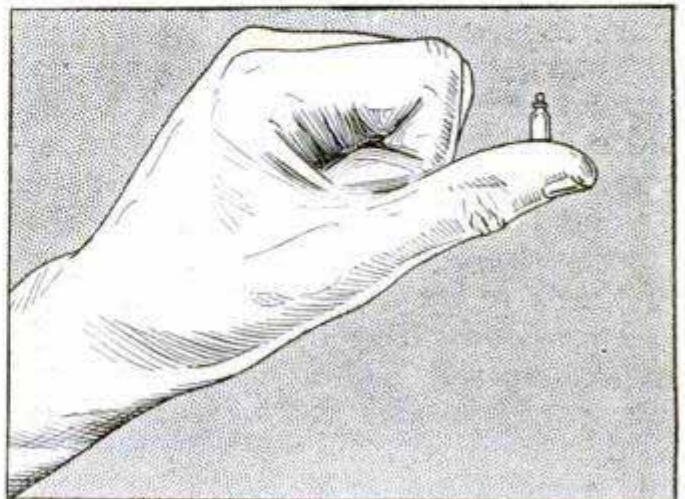

Tiny Glass Bottle Made by New Jersey Glass Blower

## DRAINING AN EXTINCT VOLCANO

From the throat of the crater of an extinct volcano at Cripple Creek, Colo., has been taken \$218,000,000 in gold.

Deeper in the crater, it is estimated, at least as much more awaits the miner. The crater, however, is a great bowl of impervious granite, and the eruptive rocks inclosed are saturated with water. For each vertical foot, the estimated amount of water held by these rocks is 50,000,000 gal. The cost of removing the water by pumping has been found prohibitive, and consequently the alternative of piercing the granite by drainage tunnels has been adopted. The recently completed Roosevelt tunnel is three miles long, and will lower the water level in the crater by 730 ft. The water is now receding about 3 in. daily or 8 ft. per month. At this rate about 100 ft. a year will be added to the depth of the accessible ore bodies, and it will take seven years to complete the work for which the tunnel was constructed. The construction of a still deeper tunnel to continue the drainage of the crater below the level of the Roosevelt tunnel is under consideration.

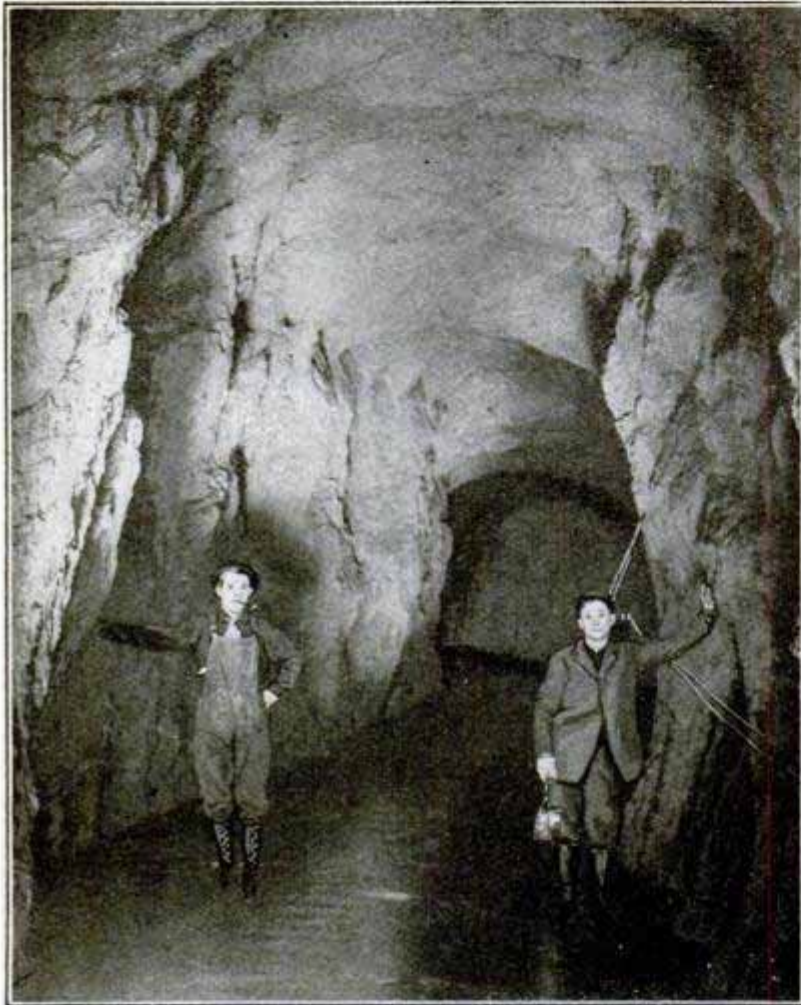

Tunnel Which Drains Cripple Creek Mines

## UNIQUE CEMENT BARN BUILT BY INDIANA FARMER

M. S. Yoder, a farmer living at Shipshewana, Indiana, is the designer and builder of a unique cement barn. Besides drawing up the plans and superintending the construction, Mr. Yoder invented a hay-carrying device that conveys hay from the mow to any part of the barn by gasoline power.

The barn itself is remarkable in shape, as it is a polygon with 12 equal sides and contains in its structure not a stick of wood from ventilator to cellar. One of the unusual features of its construction is that the reinforcement



Unique Barn Built by Indiana Farmer



in the concrete is simply junk iron, mostly from an old bridge, but which served as well as the material made and sold for that purpose. This iron was wound with wire fencing to hold the cement to the beams and girders. Another praiseworthy feature of the barn is the entire absence of wooden door and window frames, for the doors are all hung on the outside and the windows are attached by bolts imbedded in the cement while it was soft.

The roof in this barn is of concrete as well as the walls, and it conforms to the shape of the sides, giving the

structure a pleasing appearance. The ground floor is arranged for cattle and houses 30 horses and cows. The second floor is a threshing-floor and is approached by an old highway bridge used as reinforcement with the cement. The haymow is very roomy, and the ventilator is cast on an iron wheel-rim made by knocking out the spokes of an old spurred harvester wheel. In mixing and conveying the cement the farmer called his gasoline engine into use, with considerable saving of labor. The barn complete cost \$1,700, besides the work of the farmer and his horses and hands.

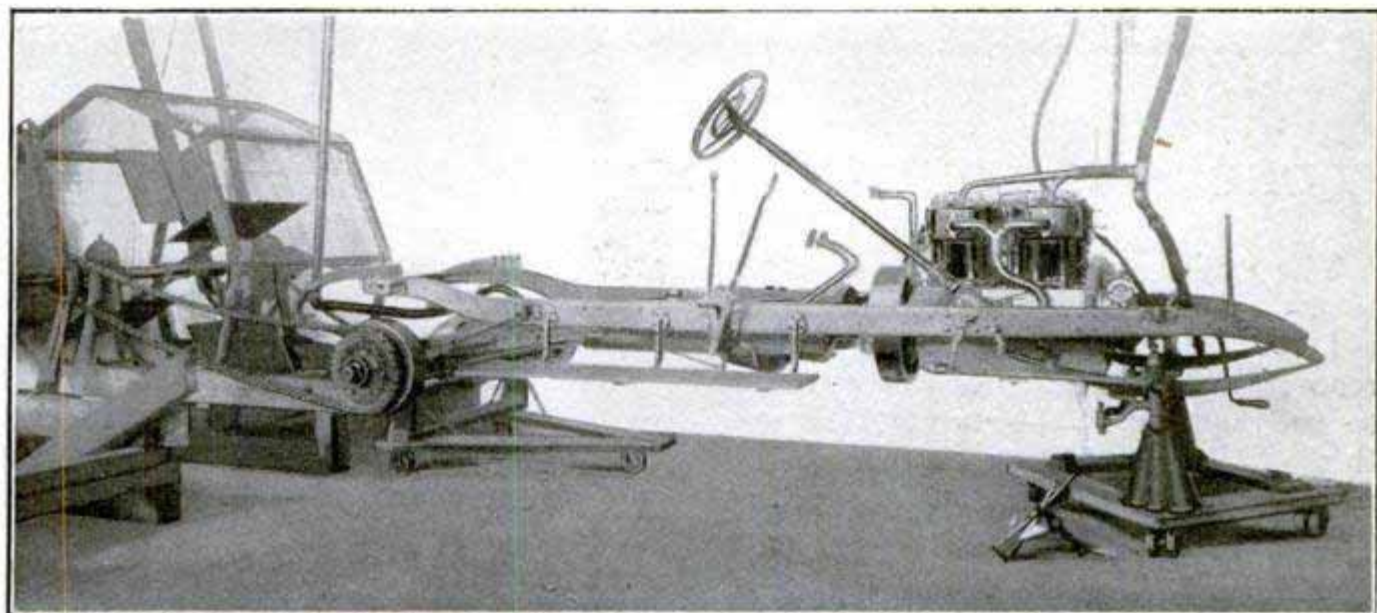

The Resistance of Revolving Fan Takes Place of Road Resistance in Testing Engine

## TESTING AUTO ENGINES WITH FANS

Owing to difficulties encountered in giving road tests to automobiles, a western manufacturer has adopted a new method of testing auto power plants which is said to be far more satisfactory and thorough than any possible combination of shop or road tests. The testing is accomplished by simply attaching the shaft drive to a fan whose blades, four in number, are attached at right angles to their path of rotation. The fan is mounted on substantial bearings and driven by chains, which run over sprockets fitted to the wheel hubs. The blades of the fan are mounted on radial supporting arms in a manner

which allows them to be adjusted to vary the diameter of their circle of travel, thus changing the load on the motor.

The faster the fan is driven the greater the load, and thus the load on the motor may be varied as under actual running conditions. A speedometer is fitted to the shaft of the dynamometer or fan, so that the actual speed of the car, and the distance traveled, were it running upon the road, can be recorded. The running time and exact elapsed time are also noted. In this manner a positive test is assured and under conditions which are more severe than ordinary road tests.

## FOLLOWS DUCKS WITH HIS AUTOMOBILE

Knowing that wild ducks move from lake to lake at certain seasons of the

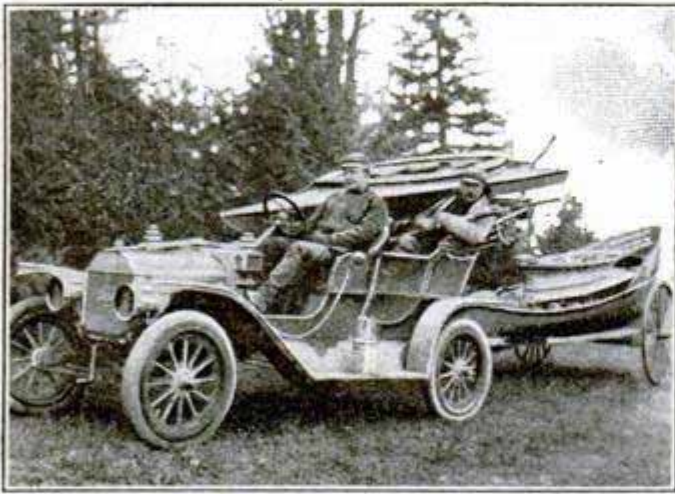

Moving the Hunting Camp to the Next Lake

year, R. G. K. Hepburn, of Picton, Canada, has rigged up his automobile so that he can run from one lake to another, following the birds, and so be able to keep up his "shooting average" from day to day. This enthusiast carries two boats, one an 18-ft. skiff which is pulled behind the automobile on a two-wheeled truck, and the other an inclosed duck boat carried on the tonneau of the car. The miscellaneous equipment includes no less than 250 decoys, two monitors, and 500 rounds of ammunition. Mr. Hepburn's outfit is practically a complete hunting camp on wheels.

## ONE MAN COMPILES AND PRINTS DICTIONARY

The giving of a civil list pension of about \$250 a year to Ewen MacDonald, of Herne Bay, a Kentish coast resort of England, has drawn attention to the fact that this man has secured this official recognition for his work in compiling and printing a Gaelic dictionary.

It is a one-man dictionary. Mr. MacDonald has not only personally compiled and verified every word himself, noting local variations, but has drawn practically every illustration, set the type, cast and made his own plates,

printed, trimmed and bound the pages, and mailed the parts, as they were produced, to the subscribers. Fourteen years have already been spent in the work, and if all goes well, the "Faclair Ghaidlig" will be completed by the end of this year. It will contain more than 1,000,000 words.

A clear idea of the extent of Mr. MacDonald's work is not possible without some idea of the obstacles he had to overcome. Although born of Celtic parents, he heard but little of the language in his youth. He decided to ac-

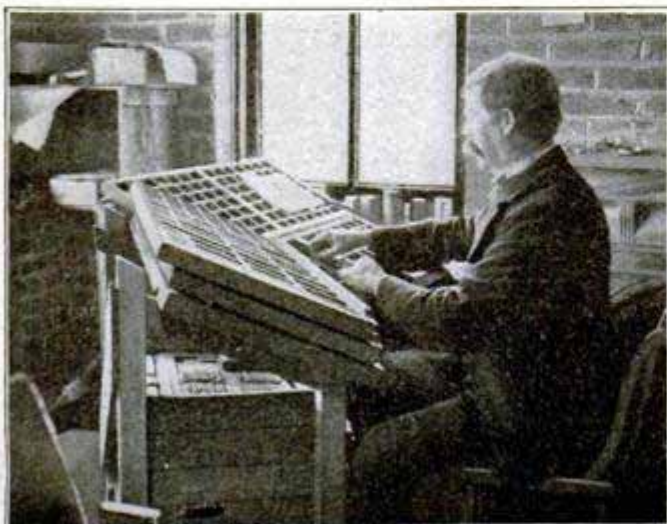

Setting Up the Gaelic Dictionary



Drawing a Proof



Casting the Plates



Trimming the Paper

quire what was really his mother tongue, and to extend his knowledge joined various Scottish regiments. In his studies he felt the want of a good Gaelic dictionary, and a few years later began the task of providing one that would serve as a standard.

Having but little money, he was unable to proceed with the publication in the ordinary way. Instead, he found himself obliged to print the work him-

self, distributing it in monthly instalments when he had progressed sufficiently to start publishing. He had absolutely no knowledge of printing and had to acquire it as he went along. After a study of typesetting he proceeded to buy such machines as his means would allow, and by printing handbooks, circulars and other small matter, earned enough to make a start in issuing the dictionary.

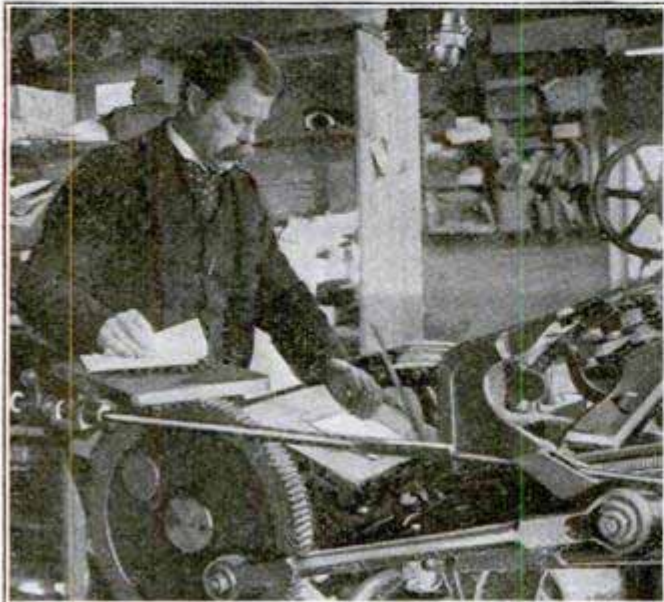

Printing the Pages



Mailing the Monthly Parts

## AMATEUR ARCHITECTURE

What might be considered a warning to amateur architects, who have ambitions to erect "palaces" in their own suburbs, is shown in this photograph of a castle-like structure in a



The Design for This House Has Never Won a Prize

California town, which contains "57 varieties" of architecture. The home builder apparently had a leaning toward the medieval, and machicolated towers in every conceivable point of vantage give it a warlike, not to say theatrical effect.

## ELECTRIC-SUPPLY TROUBLE FROM WIRELESS OUTFITS

Many electric-supply companies have experienced troubles on their lines due to the "kick-back" from wireless-telegraph outfits connected to the mains. This has caused sockets and lamps to be burned out, fuses to be blown, lamps to "wink," and meters to be disabled. According to the experiences of several companies, as expressed in a recent bulletin of the National Electric Light Association, the best way to overcome this difficulty is to furnish an individual service to each wireless outfit from an individual transformer.

## CAMPBOR FROM LEAVES

For past centuries, and at present in Japan, camphor has been obtained from a tree, "Cinnamomum Camphora," by steaming chips of the wood and subliming the product, thereby destroying the tree, but in parts of Malaya and East Africa the industry has been revolutionized. Instead of taking the camphor from the wood, it is extracted from the leaves, the latter being regularly harvested without destroying the trees.

That the wood of the camphor tree contains only an insignificant fraction of the whole of the camphor in the tree, and that a far greater amount of camphor may be extracted from the leaves whether green, dry or dead, is borne out by tests made by Dr. Duncan, of the University of Kansas.

This investigator brought back with him from Jamaica nearly a ton of wood, leaves and twigs, which was worked up to the last ounce in the university laboratory. The result was astonishing, only 0.61 per cent of crude camphor being obtained from the wood, while the green leaves gave 2.37 per cent; dried leaves, 2.52 per cent, and dead leaves, 1.39 per cent. These results are said to be exceptionally high, however, owing partly to the fact that the material had undergone a considerable amount of drying on its long journey from Jamaica to Kansas, and partly because of the ideal conditions in Jamaica for the growth of camphor.

Such facts, according to Dr. Duncan, place the camphor monopoly of Japan in a position that would be laughable were it not rather pitiful. Proceeding on the assumption that the old traditional method of extraction was the only one, and fearing that the trees would not grow fast enough to meet the demands, the Japanese have felled

only trees 50 years old, yet have left the leaves out of consideration.

### TABLE MADE OF 67 KINDS OF WOOD

This remarkable library table, constructed by George Kensing, of El Paso, Ill., has, inlaid on a foundation of solid mahogany, an intricate design formed of 67 different kinds of wood collected from every part of the world. The table was built during the idle moments of three years, and its construction necessitated the use of 2,223 separate pieces of wood, some of which were so small that it seemed almost impossible to fit them in their places.



This Table is Formed of 2,223 Separate Pieces of Wood of 67 Varieties

The table was finished and polished without the aid of paint, varnish or stain.

### PROTECTING RURAL MAIL BOX FROM CATTLE

An Arizona rancher, down in the "cow country," was annoyed by the range cattle that used his rural delivery mail box and the post supporting it as a scratching post, sometimes working the box loose from its position and finally knocking it off entirely with their efforts. So the rancher took two long thoughts, with the following result: He drove a short rod of iron into the center of the post for a pivot and on this he set two 4-ft. lengths of light wood so that they would revolve like a turnstile. These were fixed at right



The Device which Prevents Cattle from Using R. F. D. Box for a Scratching Post

angles to each other by strands of baling wire, and then the letter box was secured on the end of one crosspiece, while a rock was attached to the other end as a balance. When the cow tries to scratch her sides on the turnstile it simply revolves, and the mail box travels around in a circle, but is not dislodged.

### CAT CONDUCTS ORPHANAGE FOR MOTHERLESS RATS

A cat effected a queer compromise with nature in Los Angeles recently when she made orphans of a family of rats and then adopted the youngsters and raised them to healthy adult rathood. The cat, in this instance, had just been deprived of three offspring of her own and it is presumed the instinct to mother the young and helpless was uppermost in her nature after she had satisfied the craving to kill by making away with the mother rat.



Cat which Adopted a Family of Motherless Rats

### THE FIRST COPYING PRESS

The first copying process, including the special ink for writing the original, is accredited to James Watt, who in-

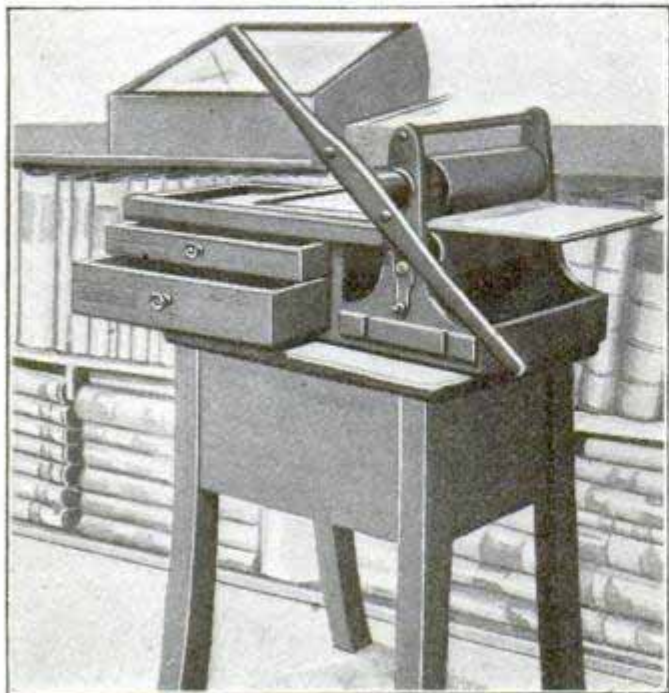

The Roller Copying Press Invented by James Watt

vented his apparatus about 1778. In the illustration is shown his roller copying press, which is now in the Watt Museum in Birmingham, Eng. This press is understood to be the one in use in his counting house.

### TURNS EXPENSE INTO GAIN IN STOCKYARD PROBLEM

Confronted suddenly with the problem of disposing of 200 tons of manure a day, on account of a recent government ruling preventing its being dumped into the river and a city ordinance prohibiting the practice of burning it on account of the objectionable odor, the Kansas City Stockyards Company has found a method of treating the refuse which is not only unobjectionable, but yields a handsome profit besides.

The manure is gathered up and placed in vitrified brick retorts, where, being moist, it soon generates enough heat to take fire and become burnt to ashes. There is a secret connected with the process, which is carried out

so as to remove the objectionable odor from the burning manure. When the fires in the retorts die out, there is left a fine powder which contains a large percentage of phosphoric acid and potash. The ash is readily sold to farmers, who use it for a fertilizer.

The cost of treating a ton of manure in this way is 25 cents, and each ton yields 100 lb. of ashes, worth 75 cents. According to these figures, therefore, the daily profit is \$100, which contrasts very favorably with the estimated cost of \$100 a day for hauling the manure away by railroad.

The Chicago stockyards are now considering another method of manure disposal which is said to be even more profitable than the Kansas City plan. True to Chicago traditions, nothing will be wasted. The fertilizing elements will be removed chemically and the residue used for making strawboard.

### BUCK'S HORN FOUND IN TREE

In one of the maple logs of a consignment received by an Indiana carriage company was found a buck's

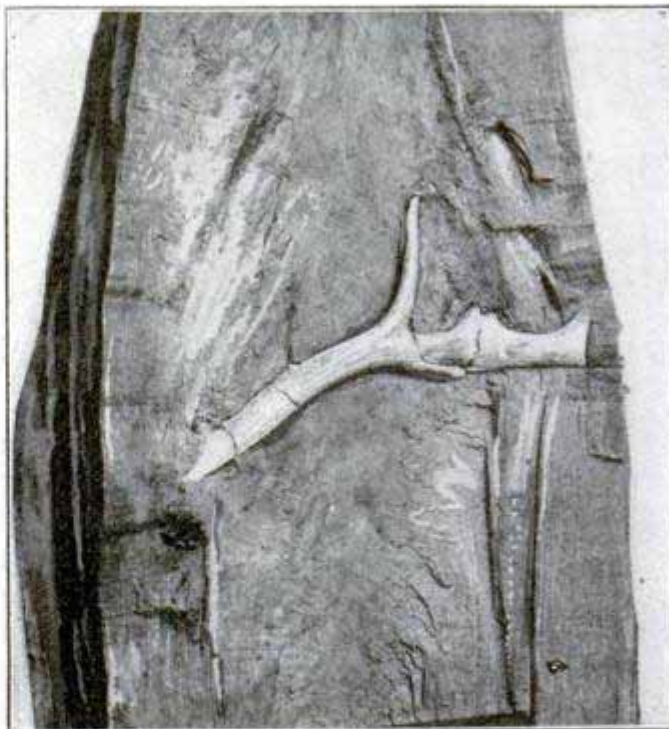

Horn of a Deer Found Solidly Imbedded in Maple Log

horn, solidly imbedded as shown. The log was 3 ft. in diameter, and the horn was about 15 in. long. It is assumed that the horn was broken off in the

tree, and that, through the ensuing years, the trunk grew around it. The section of log shown is only half the diameter of the tree.

varies according to the number of stories he desires. The rooms are caves hollowed out in the sides of the circular covered pit, and the bottom of the pit

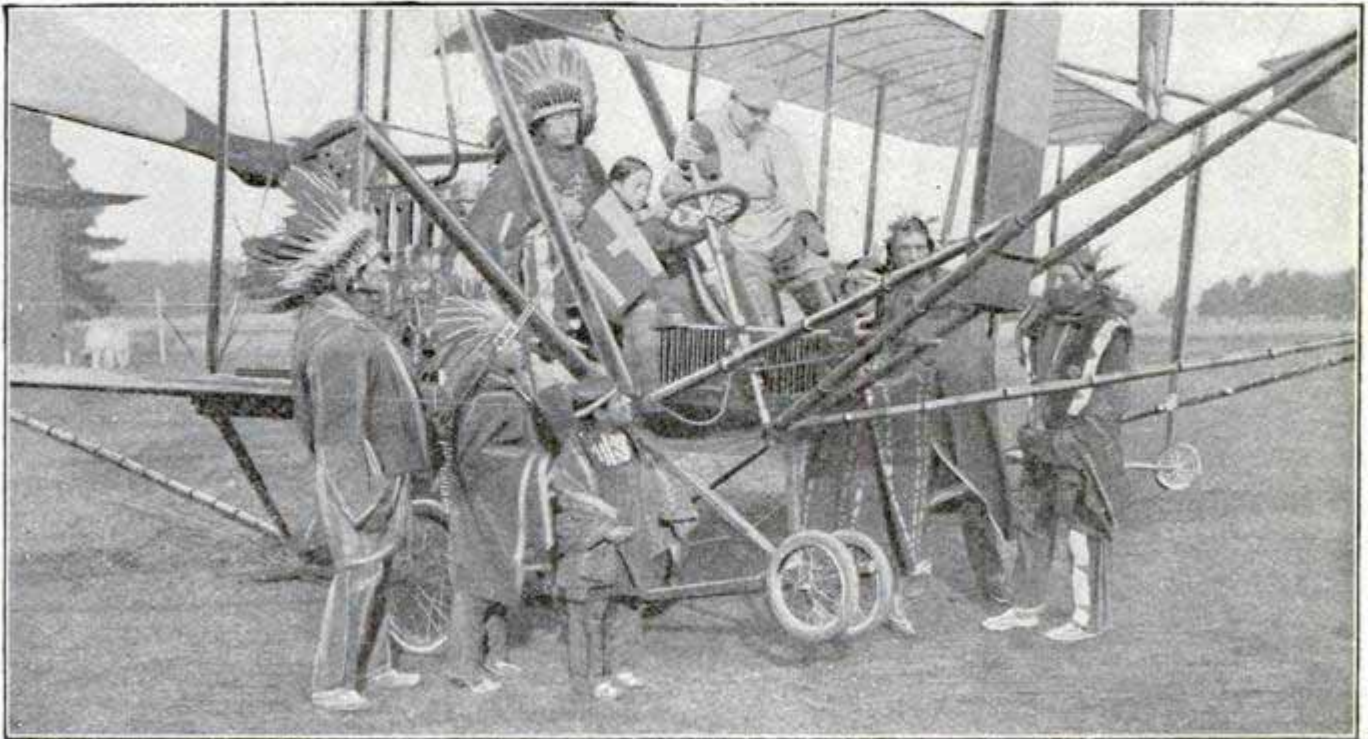

The Points of a British Aeroplane being Explained to Indians

## INDIANS EXAMINE BRITISH AEROPLANE

During recent flights in his British army aeroplane, Captain Cody, the American who built the first successful British war aeroplane, was watched by an interested group of Indians who were being exhibited in England. The illustration shows several of them in the aeroplane, with Captain Cody explaining its points.

## THE CAVE DWELLERS OF TUNIS

The capital city of the "Matmatas," the cave-dwellers of Tunis, containing about 3,000 inhabitants, is one of the strangest in the world. It is not erected upon the ground, but is burrowed in the earth, the country being a high, rocky plateau, barren, sun-baked, and swept by the simoon. When one of these people wishes to build a dwelling, he chooses his spot, traces a circle to show its location, and then digs until he reaches the desired depth, which

forms the courtyard, which is a usual feature of a Moorish house. Besides the rooms, a passage is also dug, communicating with the outside world, and a door is built at the outer end. The soil is a malleable clay, is easily cut, and lends itself well to excavation, the roof of each room requiring no support as long as it is well arched.

The cave-dwellers inhabit the territory between the town of Gabes, on the Tunis coast, and the sand-hills of the Sahara.

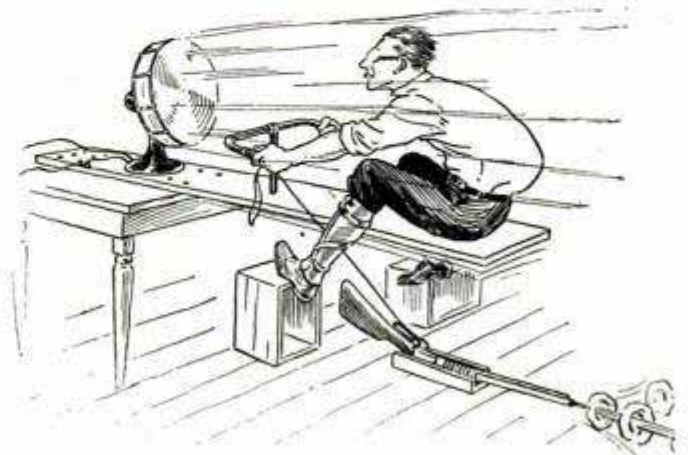

Courtesy the Motorcycle

Practice for Motorcycle Fiend Who "Likes the Noise"

## BULLETS RECEIVE PRINT OF PIERCED MATERIAL

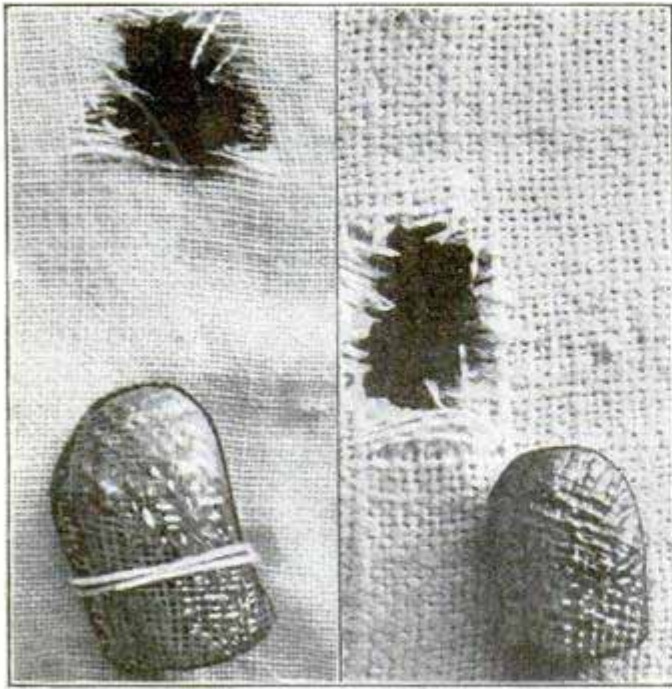

Bullets on Which was Impressed the Weave of the Material They Passed Through

French criminal experts draw attention to the fact that it is sometimes possible to identify a bullet by means of the markings it receives in passing through an obstruction. Demonstration is given of this in the two illustrations. The bullets tore through the garments of a man found murdered, without entering the body, one of them tearing its way through a coarse-weave material and receiving the impression of it, and the other through a lighter material.

Winnipeg's new municipal electric power plant is expected to be opened formally on July 1 by King George of England pressing a button at Buckingham Palace, London, England, about 5,000 miles away.

### "STREET-CAR" BOATS FOR LAGOON SERVICE

One of the curious "street-car" boats built for passenger service on the Cedar Point lagoons near Sandusky, Ohio, is shown in the illustration. It is 38 ft. long and 13 ft. wide, with seats of the

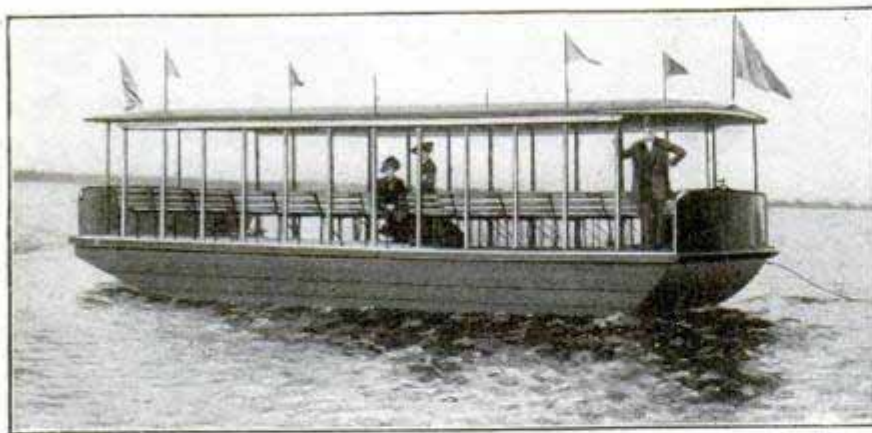

Unique Motor-Scow Provided with Street-Car Seats

open street-car type, running crosswise, and with running boards on the sides. The gasoline engine is located in the center under the floor, and is controlled by the steersman from forward. The boat will carry close to one hundred passengers, and, so loaded, will not draw more than 2 ft. of water.

### REMARKABLE PREDICTION OF NEW MINING METHOD

Mining men in South Africa are still talking about a revolutionary plan predicted (we do not know how seriously) by A. M. Robeson, a well known consulting expert, at a recent dinner given in his honor. Mr. Robeson said the time is coming when the ore will be beaten to powder at the working face in the mine, so as to do away entirely with blasting and shoveling.

This in a way is a reversion to the methods of the ancients, who used to break the rock by first heating it with fire and then dashing cold water upon it. But the modern way would be to use some kind of a mechanical device to effect the same result without any of the attendant dangers of fire, besides being much quicker, more convenient, and cheaper. Electricity would furnish the power. When the new electric power station on the



Rand, the principal gold field in South Africa, is completed, there will be 100,000 hp. available for use in the mines.

With the development of a suitable "beating-to-powder" machine, all sorting, hoisting, breaking and stamp-milling would be eliminated, for the dust would be allayed and continuously removed by water, sluiced to sumps or wells at the stations, and pumped direct to the surface and into tube mills, merely requiring an all-slime cyanide treatment. Levels would have to be run with sufficient rise to allow for this, or perhaps the tube-milling might be done underground, and the slimes pumped up to the surface for a simple, single process of gold extraction.

### BRAZIERS AT A RACE MEET

During the annual race meet of the Household Brigade, which is one of the fashionable sporting events of the early London season, the weather was so cold that it was necessary to scatter braziers about the inclosure, so that the guests could keep themselves warm. The meeting was held at Hawthorne Hill.

The Household Brigade is the designation given the officers of the guards on duty at the royal residence.



Keeping Warm at an English Race Meet

### POLICE STATION AT MONTEREY

In Monterey, California, may be seen one of the oddest police stations in America. It looks somewhat like a

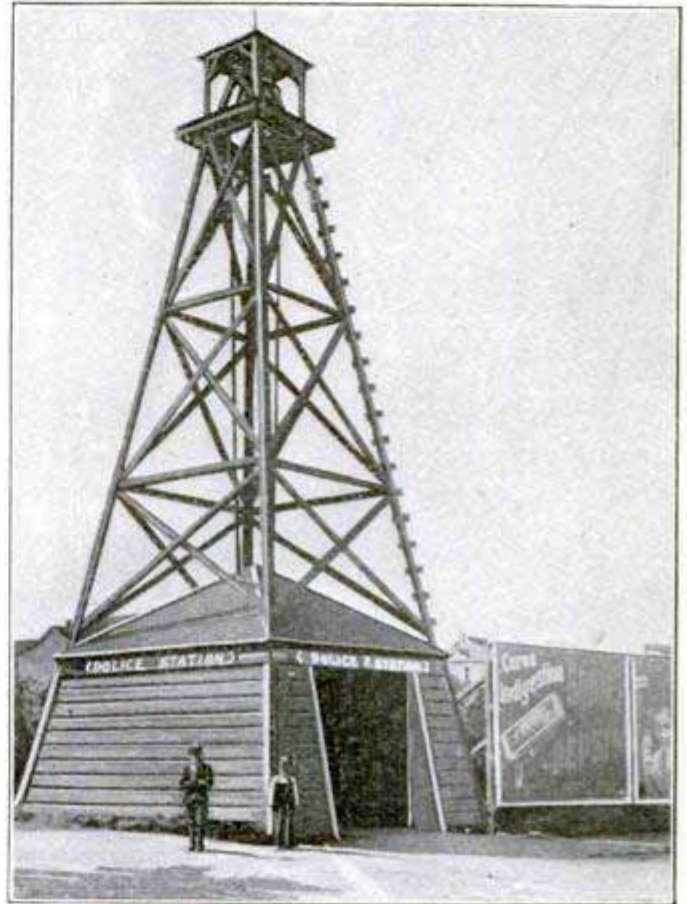

The Monterey Lockup

huge dry-goods box, with a derrick, such as is used for drilling oil wells, superimposed upon it. In the top of the derrick hangs a bell, which is rung in case of fire.

### RAILWAY HAS ILLUMINATED SPEED-WARNING BOARDS

Owing to several serious accidents on British railways, all of which occurred at night and were due to disregard of permanent speed restrictions, the London & Southwestern Railway has installed illuminated speed-restriction indicators on all its sections.

Each set of indicators consists of three boards, the first bearing figures corresponding with the highest permissible speed in miles per hour of the trains, the second bearing a "C," and

the third a "T." The first indicator, giving the speed, is located at some distance from the beginning of the actual

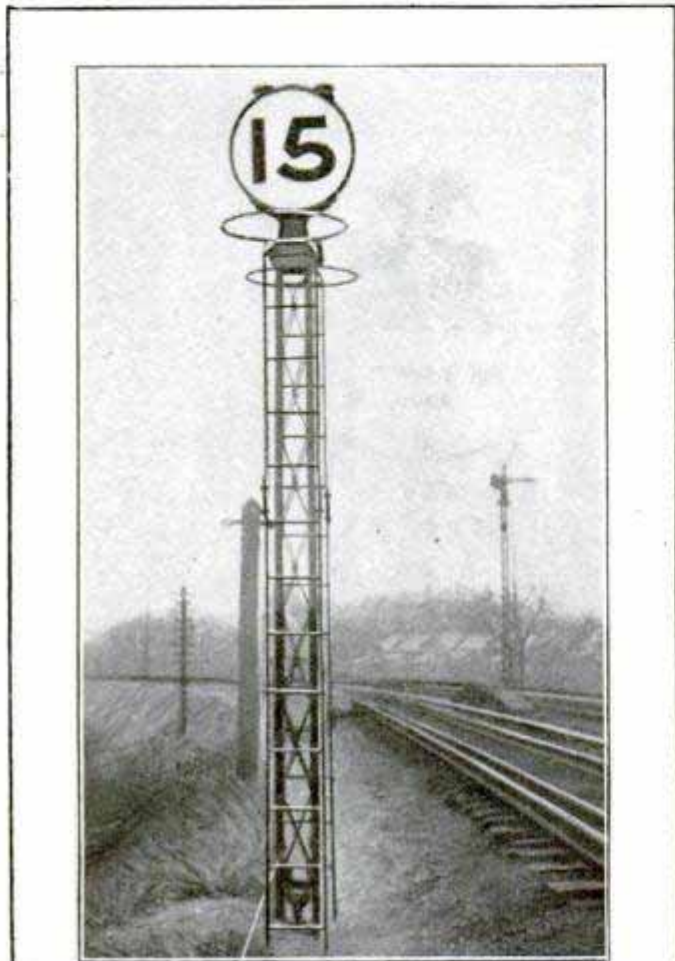

One of the Illuminated Speed-Restriction Boards Installed on a British Railway

restricted section, and serves merely as a distant warning signal. The second indicator, bearing the letter "C," is placed at the exact point where the speed restriction begins, and the "T" indicator is situated at the point where the restriction terminates. These indicators are illuminated by long-burning lamps.

Speed-restriction indicators of the type ordinarily used are not illuminated, consequently are not visible at night. It may, of course, be argued that an experienced engineer knows the whereabouts of every speed restriction in force on the section of line over which he runs, but such an argument would tend to prove that speed-warning boards were therefore unnecessary in the daytime, if unnecessary at night, a conclusion with which railroad operating officials would hardly agree.

## GYROSCOPES TO BALANCE UNIQUE AEROPLANE

Besides the usual hand-operated steering and balancing devices, Captain Lucas-Girardville, a French inventor, has designed special gyroscopic apparatus to operate smaller supplementary balancing rudders to prevent undue pitching or rolling of his unique biplane. He seeks also to eliminate the upsetting gyroscopic action of his motors and propellers by using two separate motors revolving in opposite directions, one operating a pulling propeller and the other a pushing propeller.

The captain has applied that property of the gyroscope which causes the instrument to gyrate at right angles to a disturbing force applied to its axis of rotation. To this end, the inventor has mounted two gyroscopes, each driven by a flexible cable, and arranged so that it may turn with its axis of rotation moving in a plane vertical to the shaft on which it revolves.

Each gyroscope operates its own biplane rudder, through suitable gearing, and the action of the rudder is to restore quickly and effectively the state of equilibrium which preceded the action of a disturbing force. One gyroscope is arranged to correct pitching, and the other rolling. The gyroscope rudders are much smaller than the main rudders and so do not interfere unduly with the maneuvering of the aeroplane by the pilot.

The biplane itself is novel in its construction details. Rigidity of the machine as a whole is guaranteed by a circular, latticed, steel framework, 23 ft. in diameter, through which passes

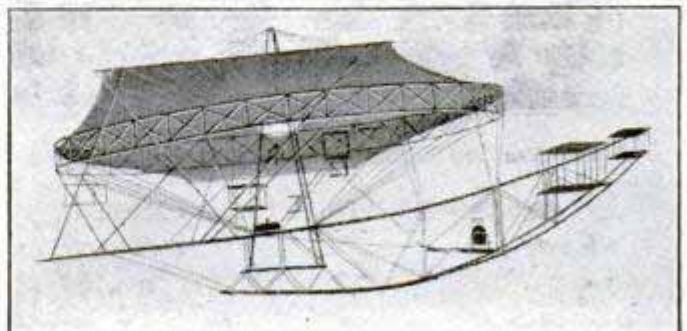

Unique Type of Aeroplane Which is Automatically Balanced by Gyroscopes

an open pyramidal structure supporting the main parts of the machine and based on the runners below. The upper, larger plane rests directly on the circular framework, and the latter is connected by stays to the pyramidal structure similar to the wire spokes of a bicycle wheel.

### CONCRETE PEDESTAL PILES

The plasticity of concrete before it is set has made possible the bulbous or pedestal piling shown in these illustrations. All that is necessary is to bulge the concrete out into the earth by simply displacing it with a suitable rammer.

The apparatus necessary consists of a casing and a rammer or core, the former being about 16 in. in diameter. The rammer is a smaller and longer pipe, with a cast-steel point and an enlarged cast-steel head. Rammer and casing are driven into the ground to the desired depth, then the rammer is pulled out, a charge of concrete dropped to the bottom of the casing, the rammer again placed in the casing, and driven down through the concrete.

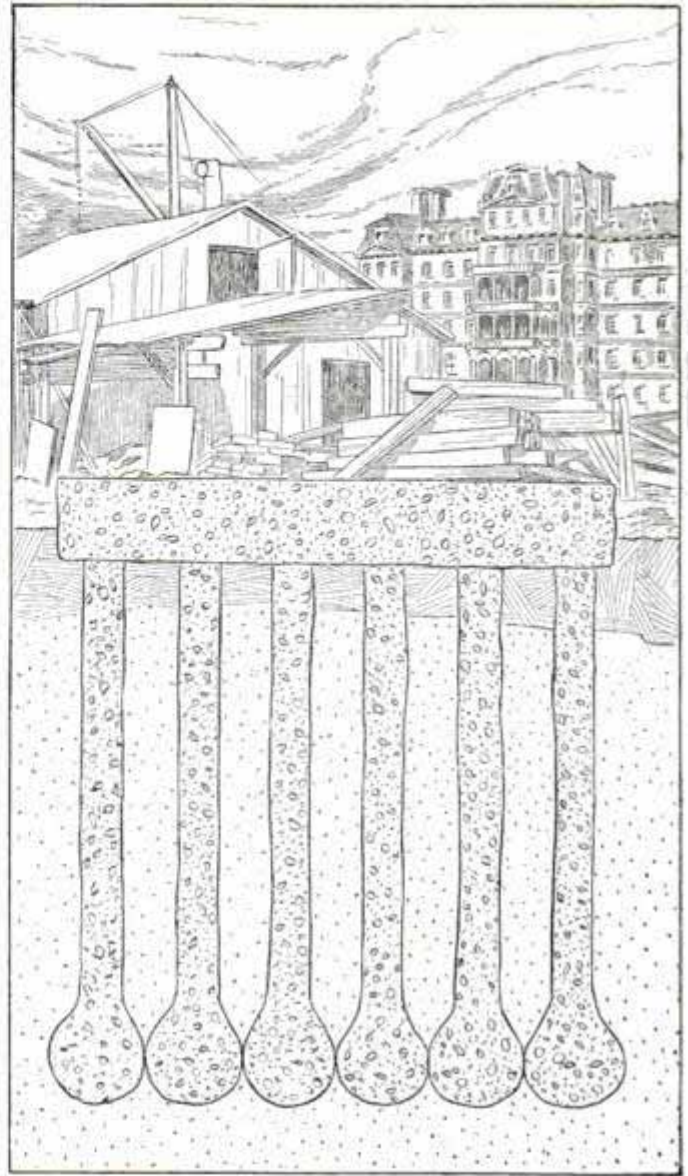

A Series of Pedestal Foundation Piles with Bulbs Touching

Thus the concrete is forced out against the soil, pushing back and compacting the surrounding earth. The rammer being withdrawn, another charge of concrete is dropped into the casing, and the process repeated until enough concrete has been mushroomed out to provide a footing of the desired size, after which the rammer is removed for good and the casing filled to the top with concrete.

One of the illustrations shows a series of such foundation piles with the bulbs sufficiently expanded to touch each other, forming a solid continuous base.

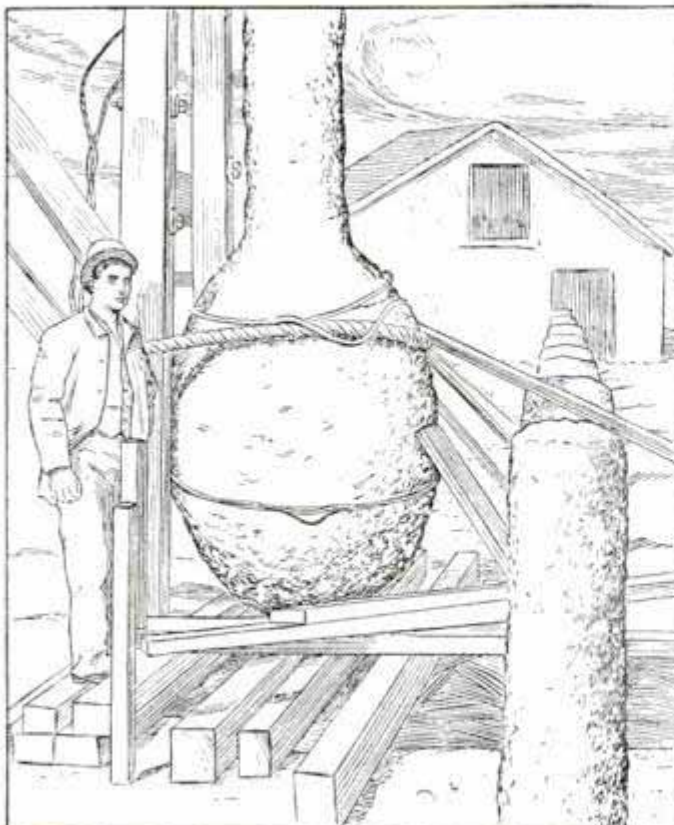

A Pedestal Concrete Pile, the Bulb of Which is Formed by Ramming

☐The first aviators' strike occurred in London when 16 airmen struck for 25 per cent of the gate money at Brooklands.

## SEATTLE MAN MAKES HOME IN HOLLOW TREE

Declining the comfortable home offered him by his son, Patrick Sloan of



Giant Fir Tree Which Serves as a Home for Seattle Man

Seattle has established a residence in a hollow tree in the city of Seattle and proposes to pass the evening of his life in this old giant of the forest. The tree, a monster of the fir family which towers 200 ft. in the air, has been hollowed by dry rot to such an extent that Mr. Sloan has a room 6 ft. in diameter. He has built a stockade about the place and declares he lives in comfort and quiet, a thing not possible at the home of his son where visitors disturbed the father's peace.

Mr. Sloan is a native of Ireland and spent many years in the logging camps. His son owns property about Seattle and it is on one of his lots that the old man has established his queer home. For an occupation he is clearing his son's lots of the heavy growth of timber which covers them.

☞The street-railway motorman who sounds his gong the fewest number of times is the one who has the least accidents,—at least that is what a traction expert of San Antonio, Texas, claims to have found.

## LONDON ACQUIRES A BABY SEA ELEPHANT

London has a sea elephant on its hands which is an object of interest to zoologists throughout the world be-

cause this is one of the few members of this branch of the elephant family in captivity. The sea elephant is not

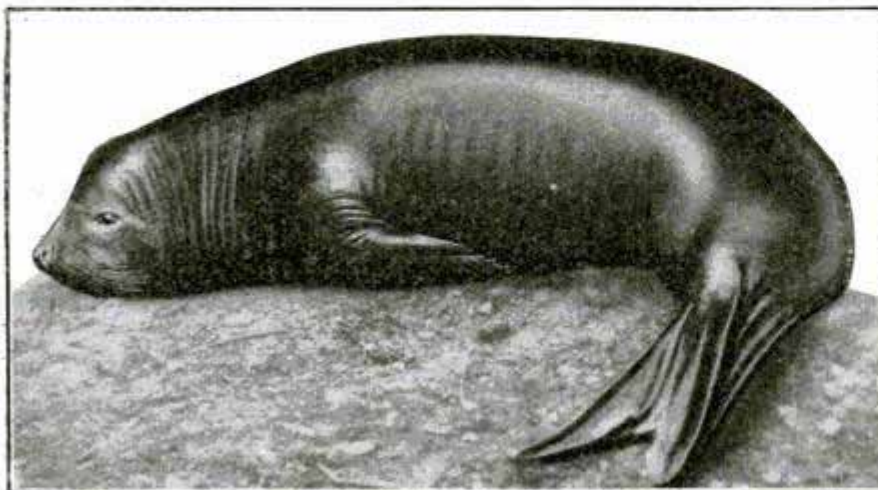

The Sea Elephant Which King George Has Presented to the London Zoological Gardens

really a member of the elephant fraternity, being a seal and called after the big land pachyderm because of its tremendous size. The London acquisition is only a babe, but it appears to be in the best of health and will doubtless grow to the average size of its kind, some of which have been known to reach a total length of 20 ft. with proportionate girth. King George was donor of the animal to the

Zoological Park, His Majesty having received it from the director of the South African Museum at Capetown.

The sea elephant is an inhabitant of the seas of the southern hemisphere and this particular specimen came from the Crozet Islands in the Antarctic. It produces a quantity of oil, a fact that has almost led to its extermination.

## AUTO ACCIDENTS PREVENTED BY LARGE MIRROR

The scheme of placing a looking glass where it will show the stretch of road around an abrupt corner is not new, but the majority are usually small, and mounted on a post, while the one here shown is exceptionally

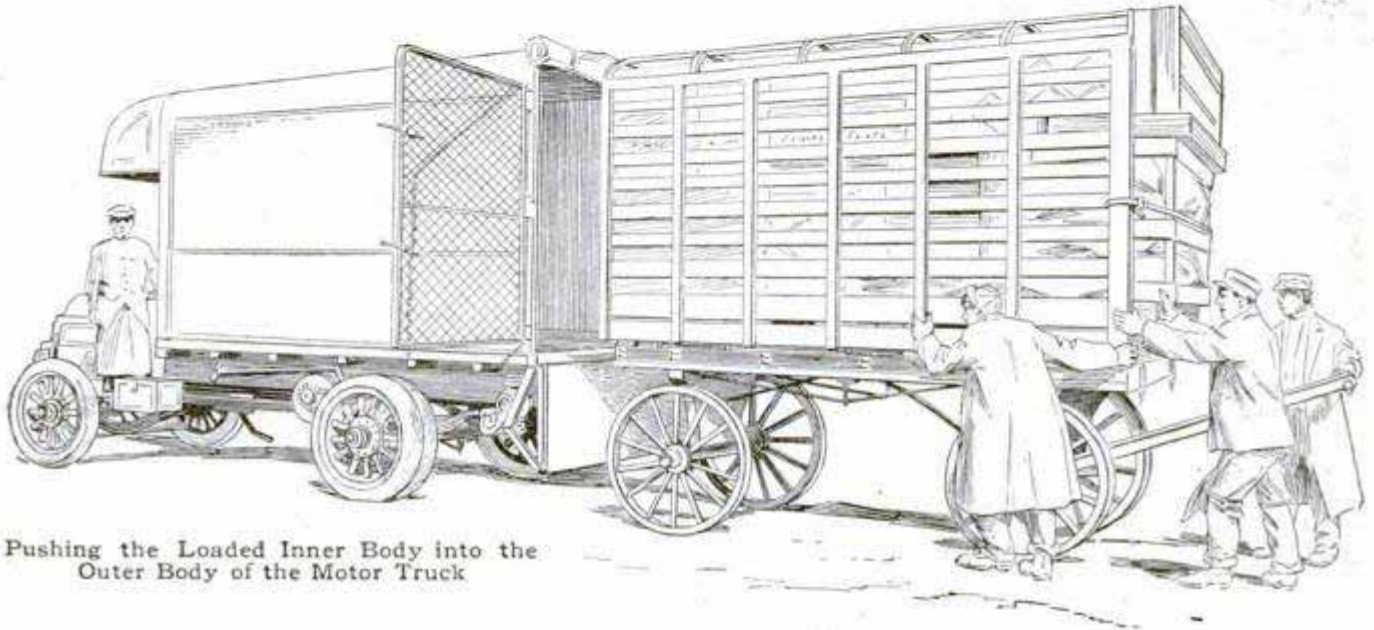

Pushing the Loaded Inner Body into the Outer Body of the Motor Truck

## MOTOR TRUCK WITH REMOVABLE LOADING RACKS

The manner of loading motor delivery trucks adopted by one of the great retail stores of New York is simple and ingenious. Each truck is provided with a set of inner bodies, one of which is being loaded with goods while the other is out with the truck. On the return of the motor truck from a trip, the empty inner body is rolled out onto a hand truck, and the other inner body, which has been loading, takes its place, the exchange being made in a few moments. By this system, no time is wasted in loading, the motor trucks being rushed right out again only a few minutes after they arrive. The inner bodies are of light rack construction.

⌈The Society of Automobile Engineers is trying to induce its members to adopt standard dimensions for the small parts of cars, as washers, pins, I-beams, etc., which would result in a material reduction in the cost of manufacturing.

large, showing the entire stretch of street. It is at an abrupt turn at Malmesbury, in England, where several accidents have recently occurred.



Exceptionally Large Looking Glass Mounted at Abrupt Turn in England

## SURFACE IRON-ORE MINES NORTH OF ARCTIC CIRCLE

Extending from about 25 to 90 miles north of the Arctic Circle, in Swedish Lapland, is one of the richest iron-ore districts in the world, the mining of which is being carried on largely by means of electric power.

The iron-ore mountains lie on an elevated plateau consisting of vast moorlands and moraines, the highest mountains reaching an altitude of

The two great mining fields are known as the "Kiruna" and the "Gellivare," the former being 90 miles north of the Arctic Circle and the latter about 35 miles north. The output from these mines in 1909 was 2,540,846 tons, the total number of employes, exclusive of engineering and office forces, being 2,000.

The Kiruna mine is situated in a des-

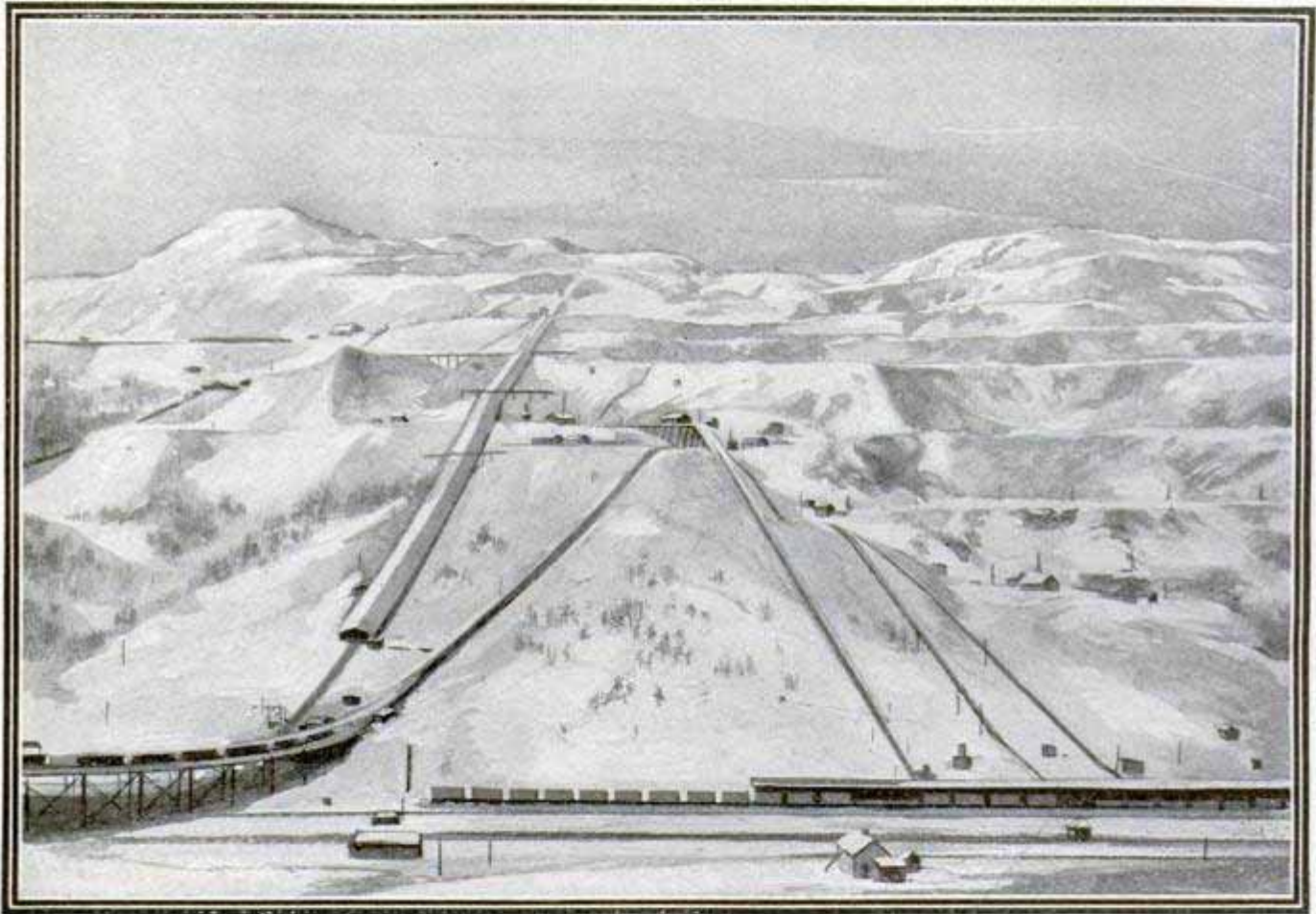

Face of the Kiruna Mine, Showing Chutes by Which the Ore is Shot Down the Incline

about 2,500 ft. above sea level, and rising about 1,000 ft. above the plateau. The ore lies exposed, and the mining is open, as in stone quarries, the ore being torn off from the mining face by blasting.

The total estimate of the available ore which can be mined by open-face methods, is 1,010,000,000 tons. About 24,000,000 tons have already been taken out. The percentage of iron in the ore varies from 58 to a little over 70 per cent.

olate country. Formerly, the district was only periodically visited by nomadic tribes of Laps, who for many hundred years were the only inhabitants. The mining town of Kiruna now contains more than 8,000 inhabitants, and an electric railway runs from the central part of the town to the center of mining activities at the foot of Kiirunavaara Mountain. The climate is rather severe, the winter lasting from the beginning of October to the end of May. During a period of 30

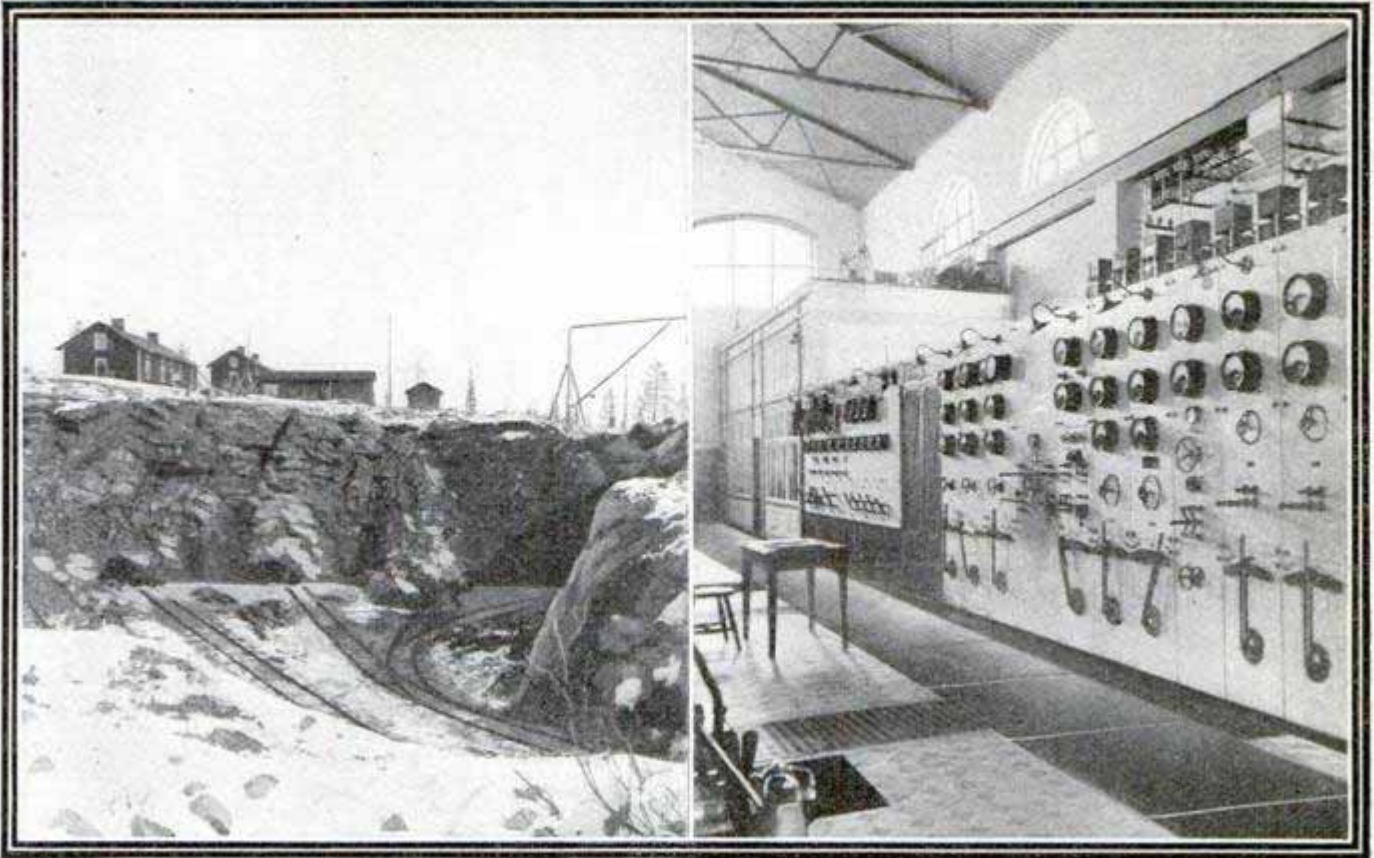

One of the Iron-Ore Quarries of the Gellivare Field

One Corner of the Electric Power Plant, 90 Miles North of Arctic Circle

days, about Christmas time, the sun is below the horizon, but in the summer the midnight sun gives a bright illumination, day and night.

The ore is shipped partly by way of Luleå, about 186 miles from the

Kiruna mine, on the Baltic Sea, and partly by way of Narvik, Norway, both ports being equipped with modern ore-loading machinery. The latter port is open all the year around, due to the vicinity of the Gulf Stream.

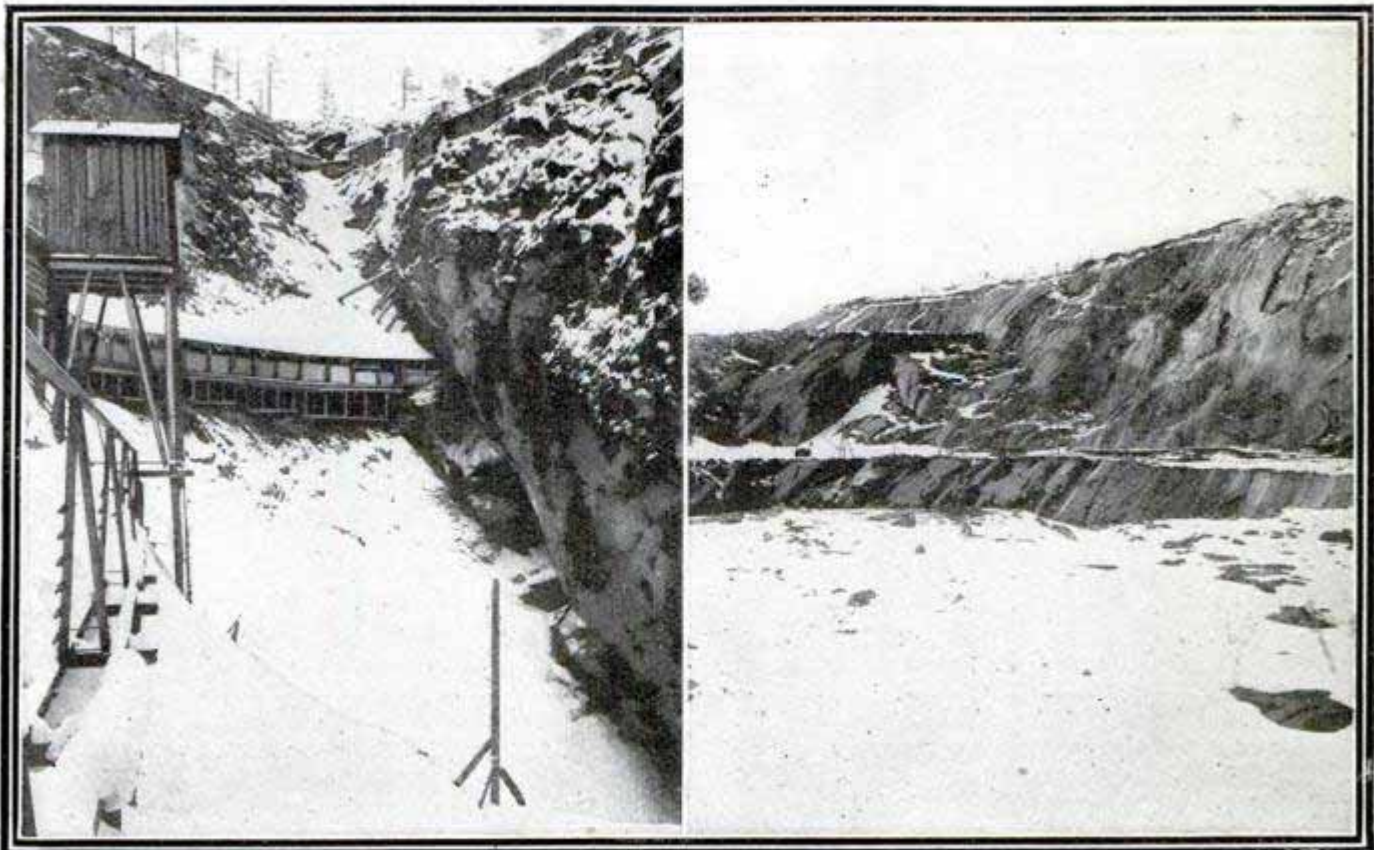

Another Mine-Facing at Gellivare

Rich Iron-Ore Formation and Snow

## GYROCOMPASS UNDER TEST SHOWS NO DEVIATION

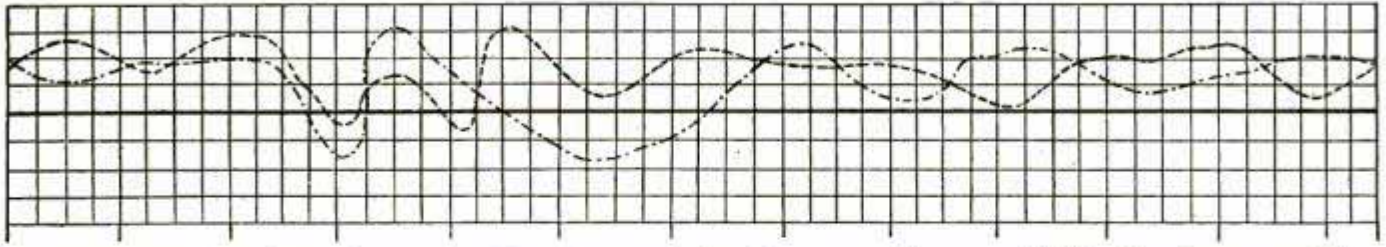

The Straight Black Line Shows the Steadiness of the Gyroscope Compass While Big Guns are Being Fired, as Compared with the Unsteadiness of the Ordinary and Azimuth Compasses, Indicated by the Wavy Lines

The gyroscope compass is said to be far in advance of any other type of compass, in that it does not deviate

from its initial direction under any conditions. The record reproduced in one of the illustrations shows the steadiness of the gyroscope compass while big guns were being fired. The straight black line is the record of the gyroscope compass, and the zigzag lines indicate the oscillations of an ordinary compass and of an azimuth compass, respectively.

In the experimental apparatus shown in one of the illustrations, the large ring, which rotates in its socket, represents the earth, and the gyroscope upon it is free to rotate in two directions. The pivot upon which the gyroscope turns keeps strictly parallel to the axis of rotation of the earth, and consequently is independent of magnetic variations. An elaboration of the same principle, for use on shipboard, is used to control, by means of an electric circuit, the compasses in other parts of the ship. One of these gyroscope compasses is also shown.

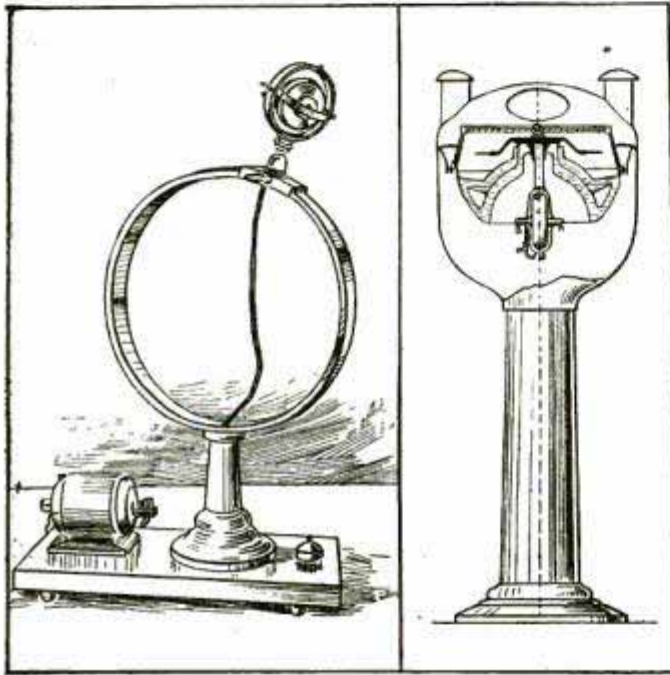

The Axis of the Gyroscope Keeps Parallel to the Axis of Rotation of the Ring (Representing the Earth) as the Apparatus Moves Around

One of the Gyroscope Compasses Controlled by a Special Gyroscopic Apparatus

## MAUD AND THE AEROPLANE

Maud Muller on a summer's day,  
Was in the meadow raking hay.  
She always had enjoyed good health,  
But had a hankering for wealth.  
Her cheeks were red, her eyes were brown;  
She longed to live in the far-off town.  
She wished she might be richly dressed,  
And circulate among the best.  
The judge came sailing up the lane,  
Upon his nice, new aeroplane.  
Below him he beheld the maid,  
And tried to stop, and swooped and swayed.  
He ripped a top rail from the fence,  
And talked as if he had no sense.  
The engine got beyond control,  
The judge lost his immortal soul.  
Maud stood there with a sickly grin,  
Until he hit her with a fin.  
"My Lord!" she yelled, and ducked away;  
The judge lit on a pile of hay.

She hurried where the spring gushed up  
And filled her little old tin cup.  
At first she thought the judge was dead,  
But she splashed the water on his head.  
He looked upon his aeroplane  
And said some things that gave Maud pain.  
At last he rose, and with a frown  
He started for the distant town.  
Then, bringing himself to halt,  
He said, "This, girl, is all your fault.  
If you had not been raking here,  
I'd have stayed in the atmosphere.  
You've cost me dear and spoiled my sport;  
I'll fine you for contempt of court!"  
He then went onward up the lane,  
And Maud returned to work again.  
She gazed upon his wrecked machine  
And said, "Alas! what might have been!  
Ah, well, in heaven we'll all have wings!  
And not depend on such fool things!"

—Chicago Record-Herald.





## Folding Target

The construction of a target for field practice that can be rolled up and carried is shown in the illustration. The

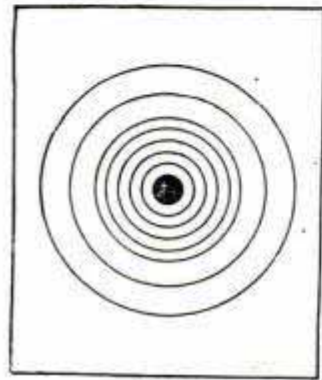

FIG. 1



FIG. 2

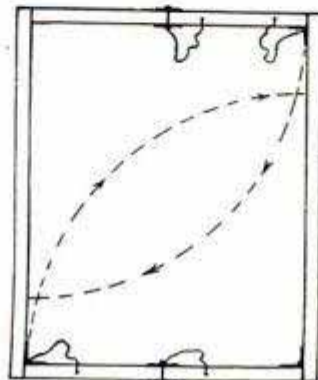

FIG. 3

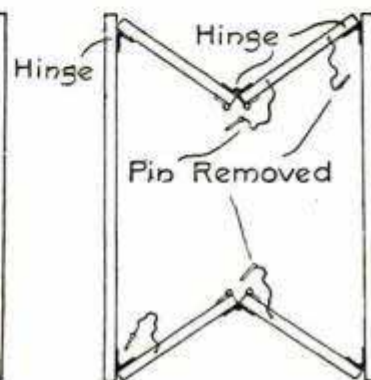

FIG. 4



FIG. 5

Construction of the Target Frame

target ready for use, shown in Fig. 1, is made of cloth stretched on a frame which is hinged together at the corners and in the center of two sides, as shown in Figs. 2 and 3. Where the two sides are hinged in the center, two hinges are provided, one on each side of the wood, the inside one having a loose pin which is kept from being lost by tying it to the frame. When the pins are removed, as shown in Fig. 4, the frame separates and closes, then it can be rolled into a small bundle, as shown in Fig. 5.—Contributed by Walter W. White, Denver, Colo.

## Engraving on Glass

A simple way to mark glassware, such as tumblers, fruit dishes, etc., and also glass of small sizes for doors, is shown in the sketch. Procure or make a small oblong box large enough for the pieces to be marked. For ordinary purposes the box should be made of  $\frac{3}{4}$ -in. material about 7 by 12 by 18 in.

with one end left open. Make several ends of the same material to fit the open end of the box. Bore a small hole in each corner of the end pieces to admit screws for fastening them on the box.

A hole, shaped so that the article to be marked will fit in the center of an end piece should also be provided. The one shown is for a tumbler.

Procure some shot (about No. 8 will do) and some medium fine emery, place them in the box and fasten the end in place. Paste a stencil having the desired design on the article to be engraved, and fasten it in place with straps, as shown in the sketch. Shake the box so that the shot falls from one end to the other. The emery soon be-

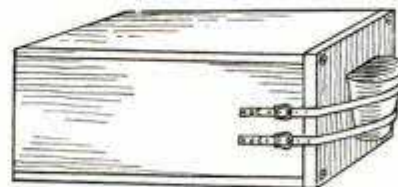

Box with Tumbler Strapped in Place

comes imbedded in the shot, thus forming sharp cutting surfaces.

The shot falling on the glass will cut it through the open places in the pattern. Letters or designs used should have no fine lines.—Contributed by R. B. Cachamed, Ohio, Ill.

### Iceless Refrigerator

A good cooling box or refrigerator suitable for camp use can be made as follows: The inside measurements of the base are 18 by 48 in. The posts

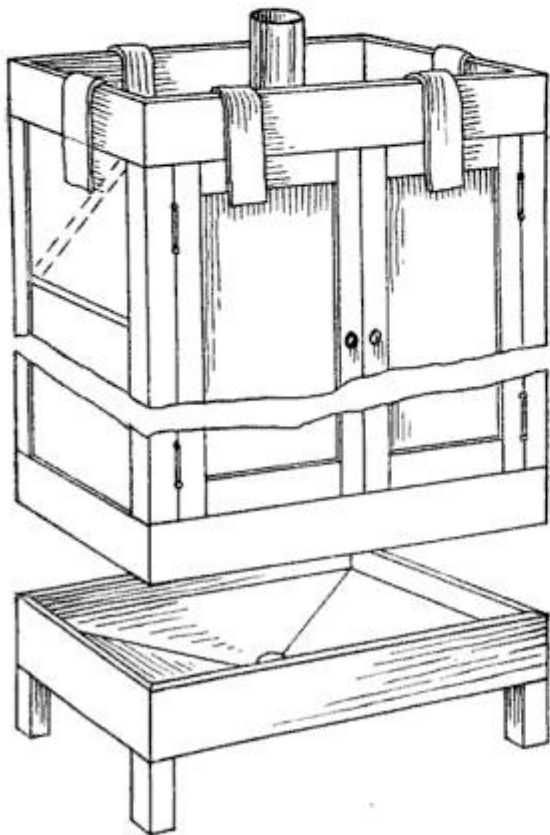

Frame of the Refrigerator

are of 2 by 4-in. material 15 in. long, and 1 by 6-in. stuff is used for the frame. Let the frame extend above the top of the posts  $1\frac{1}{2}$  in., to allow the drip pan to set on top of the posts. The drip pan is made of galvanized iron, 18 by 42 in., with a turned-up edge,  $1\frac{1}{2}$  in. high. The pan is made sloping toward the center, where a drain pipe is soldered to the metal.

The outside dimensions of the top part at the base are 15 by 39 in., and at the top, 13 by 39 in. The corner posts are 2 by 2 in. and the rails around the bottom are 1 by 4 in., and at the top, 1 by 10 in. The height of the top may be from 48 to 60 in. Brace the ends and back in the form of a cross between each shelf. The braces are made of 1 by 2-in. material. The top rails are extended 3 or 6 in. above the tops of the posts, to provide a place to set the water tank. The tank is made of galvanized iron, 5 or 6 in.

deep, with a round ventilator, 4 in. in diameter, soldered in the center. The ventilator should be long enough to create a good draft.

The bottom and top rails of the doors are of 1 by 4-in., and the side rails, 1 by 3-in. material. The number of shelves is determined by the height of the top. They are made of 1 by 12-in. boards, which are held in place with long screws turned into the corner posts.

Cover the entire top and all sides, including the doors, with burlap, allowing it to reach to the top of the tank on all sides. Keep the shelves away from the wet burlap. The cooling agent is the water in the tank, which keeps the burlap constantly damp by the aid of six siphons from 4 to 6 in. in width, made of lamp wick, old blanket or felt. If they siphon too fast, make them narrower.

Paint all the woodwork. The strip of burlap across the 1 by 10-in. rail at the top must be raised when the doors are opened. An outside case, well perforated, can be made to fit over the entire box to make it more presentable. Fill the tank with water and set the top on the base. If the box is made right and a good draft obtained, the inside temperature will be lowered to a surprising degree. The siphons must rest over the burlap and extend well into the water.—Contributed by F. W. Preston, Paterson, N. J.

### Receptacle for Soldering Acid

A glass insulator used on telephone or telegraph wires makes a good receptacle for soldering acid, if it is fitted with wire legs, as shown in the sketch. When the lengths of wire are carefully measured and twisted, the legs will project at equal distances apart. Two legs are first twisted on the wire then it is placed in the groove on the



insulator and the ends twisted together to form the remaining leg.—Contributed by Claude M. Sessions, Waynesville, Ill.

### Measuring Cuts of Cheese

Not having a regular cheese cutter which automatically registers half pounds, etc., I devised a plan of measuring the cheese into parts equal to  $\frac{1}{4}$  lb. The circumference of the standard round cheese was measured with a tape measure and found to be 42 in. The weight of the cheese was exactly 21 lb. Each 2 in. on the circumference cut to the center, wedge-shaped, represented 1 lb. in weight. The circumfer-

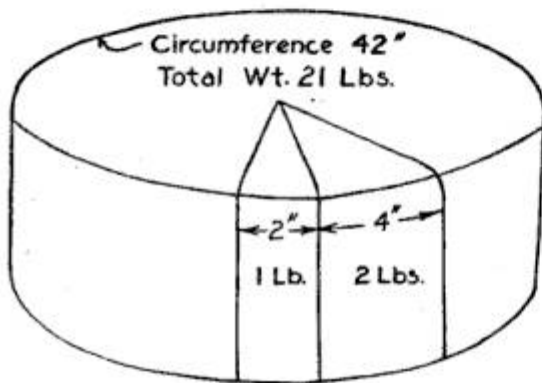

Each 2-In. Slice Weighs 1 Lb.

ence was divided into  $\frac{1}{2}$ -in. parts and marked with a pencil. Costly guess work was avoided by this method.—Contributed by John Shahan, Attalla, Alabama.

### Cutting Worm Gears on a Lathe

While working in a small repair shop I had occasion to cut several worm gears, and not having a milling machine, the work was held back until a jig could be made for the lathe. I turned up a post to fit in the T-slot or tool-post holder. The post had a shoulder which extended far enough above the T-slot to allow a nut to be screwed on to act as a locknut. The post extended  $1\frac{1}{2}$  in. above the lathe centers and two collars were turned to fit the post, and each was provided with a setscrew. The complete post is shown in the sketch.

The hob was placed on a mandrel and put in the lathe centers. The post was placed in position and locked, and

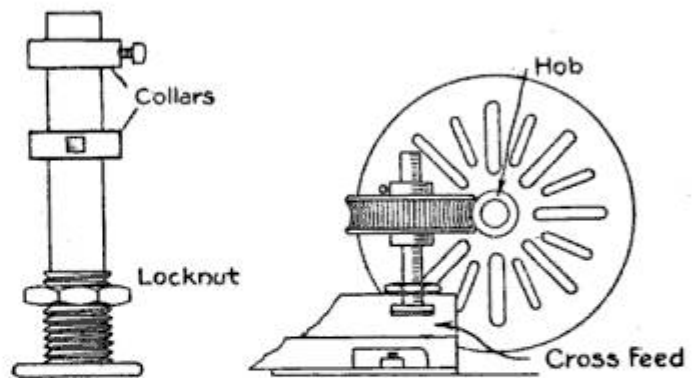

Wheel on Special Post

a blank gear put on between the collars. The feed was screwed up so as to hold the blank against the hob while the setscrews were tightened to hold the collars in place. Then the machine was started and the gear fed slowly against the hob.—Contributed by W. R. Ayers, Pittsburg, Pa.

### Home-Made Torch

A torch that will produce a strong light can be made of pipe and pipe fittings as shown in the sketch.

The top part of the body A is a reducing coupling,  $\frac{3}{8}$  by  $1\frac{1}{2}$  in., screwed on to a  $1\frac{1}{2}$ -in. nipple, B, 6 in. long, which has a cap, C, for the bottom. The wick pipe is fitted with a tee, D, to which the pieces of pipe, F and G, are attached for a handle in carrying,

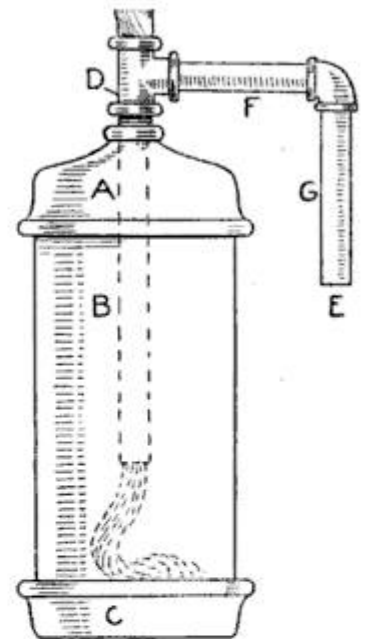

or to hang the torch on a pipe or other projection. A certain amount of the air entering at E goes through the wick and helps to produce a brighter light than the ordinary torch will make.—Contributed by J. E. Noble, Toronto, Canada.

### Boring Holes in Balls

A carpenter having a contract to build a pavilion for a fair, the plans of which called for 16 flag poles on the roof without mentioning any ornaments for their tops, put up the building and started to raise the poles. The poles without ornaments appeared unfinished and it was decided to place a ball on the end of each pole. As it was impossible to turn

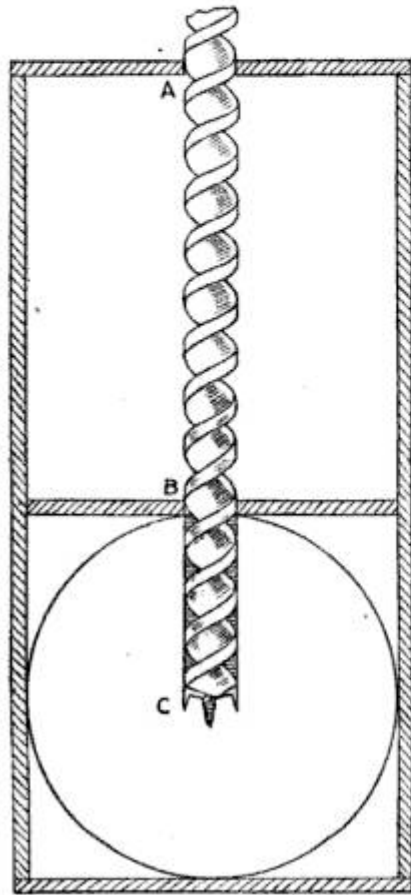

up balls on short notice, common croquet balls were used. These were taken from sets purchased at a local hardware store. A box was used as shown in the illustration to guide the bit for boring a hole part way in each ball. In this case the box was made the right size for a croquet ball. The ball was held so it could not turn while the hole was being bored.—Contributed by Edward Hild, Lake Forest, Ill.

### Keeping a T-Square from Slipping

Place two rubber bands on the blade of the T-square, one near the head and one at the other end, and it will remain in place when the board is at any ordinary angle. The wider the bands the better.—Contributed by Henry R. Bowman, Baltimore, Md.

☞Keep the spoons bright for spoon-hook fishing.

### Fumigating Rooms

Formaldehyde and sulphur dioxide are the two agents generally used in fumigating after contagious diseases. The vapor from formaldehyde is caused by heat which is produced by igniting the chemical, placed in an old tin pan within the room. The same vapor will exterminate moths. As it is inconvenient to vaporize a closet or a small room I devised a simple and effective method whereby a closet or room may be fumigated without a person entering it.

The apparatus described in the following can be used in small places. The exact amount of formaldehyde to be used can be easily determined. It requires no experience to adjust the flame which is used to produce the vaporization. It is not necessary to remove any of the clothing from the room, but be sure they are far enough apart so that the vapor can easily get between them.

The amount of 40-percent formaldehyde solution to be used for each 1000 cu. ft. of air is about 3 pt. Commercial formaldehyde contains approximately this percentage of the active constituent.

Take a piece of board, 1 by 5 by 14 in., and nail a piece of 5 by 6-in. material to the bottom of it, letting the end project beyond the upright piece so that when it is tied to the door knob, the back will hang straight. Set a small alcohol lamp on the 5 by 6-in. piece and drive two long nails or spikes just above the lamp flame and allow enough of the end to protrude to support the oil can that is used to hold the formaldehyde.

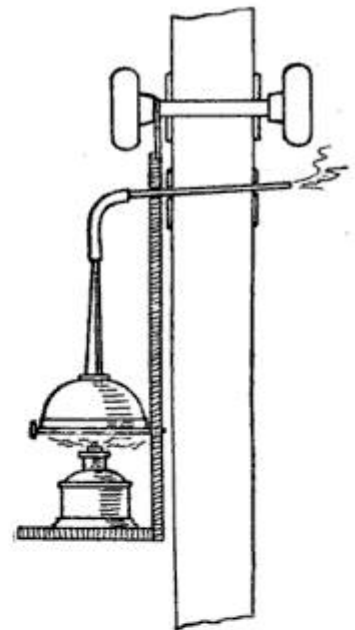

A small alcohol lamp can be made from a discarded ink bottle. A hole is punched in the cork and a piece of tin is rolled and placed in it; then a wick is inserted in the tube. The spout of the oil can is extended with a piece of hollow wire such as used for installation of gasoline lighting systems, or with a small rubber hose. Run this tube through the board and keyhole and allow it to extend into the room to be fumigated about 5 or 6 in., or enough to clear the knob on the inside.

After giving the room a good fumigating, leave the door closed for 24 hours before airing. It takes only a short time to get rid of the odor.

The same results can be accomplished by the use of sulphur dioxide. Sulphur either in the "flowers" or rolls, is placed in an iron water bath which is set over a large pan of water. Each 1000 cu. ft. of air space will require 3 lb. of sulphur to which is added about 1 pt. of alcohol. Set fire to the alcohol and the heat will form the vapor. These same methods and amounts are used in fumigating after contagious diseases.—Contributed by Dr. D. D. Smith, Sandusky, Ohio.

#### Four Ways of Locking Nuts

A great many methods are used to fasten piston-head and other bolt nuts to keep them from working loose under heavy strain. The sketch shows four of the best and simplest ways to lock these nuts. In the first sketch is shown a wire pin through the bolt end; a clamp made of the nut, in the sec-

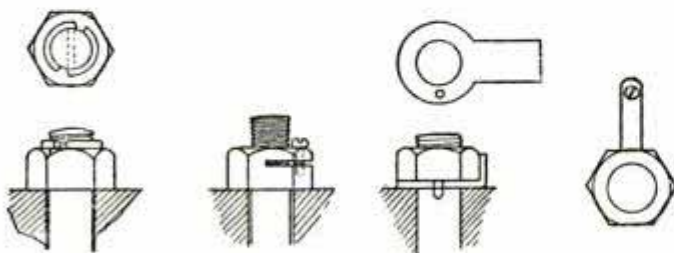

Locking Nuts

ond, while the third is held with a pin and clip. The fourth is locked by a clip held against the facet with a screw.

#### Hedge-Trimming Machine

The revolving cutter and blade from a small, discarded lawn mower can be made into a hedge-trimming machine

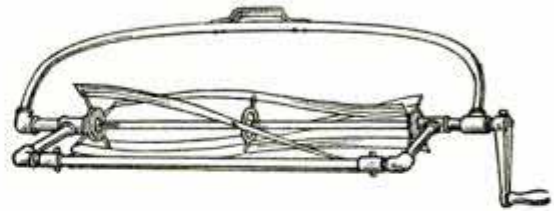

Cutter in Frame

by constructing a frame for the shaft to turn in and a holder for the cutting blade. The sketch clearly illustrates the way to make the frame. Such a machine will quickly trim the tip ends of a hedge smooth and leave no unevenness.—Contributed by H. Krauskoff, New Rochelle, N. Y.

#### Idler for a Belt

An inexpensive belt idler may be made by removing the straps of metal from an old bicycle pedal and allowing the belt to ride over the center of the

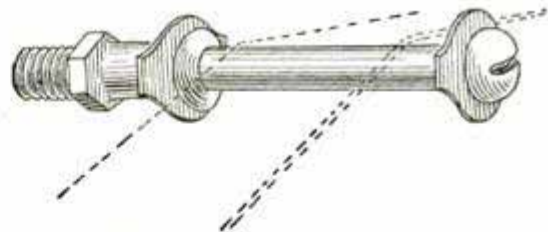

Idler Made of Bicycle Pedal

revolving part. Such an idler can be used only on narrow belts.—Contributed by C. Darling, Worcester, Mass.

#### Replacing Automobile Cylinders

An easy way to replace automobile cylinders without help or without danger of breaking the piston rings is to disconnect the connecting rods and pistons, taking care to keep account of the shims required for each one, and insert the pistons in the cylinders, and the whole can be easily set in place and the connecting rods fastened from underneath the crankcase.—Contributed by William J. Weber, New York City.

## Repairing a Broken Connecting Rod

One of the connecting rods on an automobile engine broke, as shown in Fig. 1, and I made the repair in the

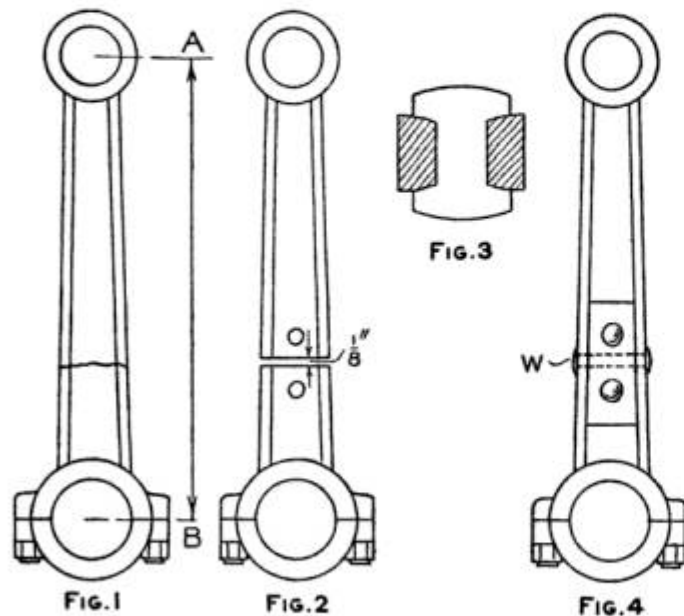

Connecting Broken Parts with Steel Plates

following manner, which has stood the test of daily use for a year. The broken parts were placed together and the distance from A to B accurately measured. Both ends of the parts were filed off flat and smooth. This made a space of  $\frac{1}{8}$  in. (Fig. 2) to be filled with a wedge.

A hole for a rivet was drilled in the channel about  $\frac{1}{2}$  in. from each end and  $\frac{1}{2}$ -in. machine steel side plates fitted as shown in Fig. 3. Holes were drilled in the side plates so that when they were riveted in place, the connecting rod was about  $\frac{1}{32}$  in. short. The wedge W, Fig. 4, was driven into the space between the ends and riveted to keep it in place.—Contributed by Emil M. Buerger, Cincinnati, O.

## Blueprint Washing Tank

There are many small manufacturing concerns that have occasion to make blueprints in moderate quantities, and the best method of handling this work is always a problem, especially if room is scarce, and initial expense a consideration.

A tank designed by a correspondent of the American Machinist should ap-

peal to anyone having little space to spare and but few prints to make. The tank is made to hang on the wall in any convenient location, suspended by two straps as shown, and is made of heavy galvanized iron with a  $\frac{1}{4}$ -in. stiffening wire rolled around the front.

The water supply enters from above through a  $\frac{3}{4}$ -in. globe valve, and the stream is distributed over the back of the tank by means of a T-shaped sprinkler, the construction of which is readily seen by inspection of the detail view of same.

When assembling the piping, the horizontal pieces and the  $\frac{3}{4}$ -in. T are located so that the streams of water play against the back of the tank, and the flange of the globe valve and the flange of the T serve to hold the sprinkler in position in the tank. A short drain pipe or a brass union may be soldered into the lower portion of the trough, and the outlet piped to any convenient point.

The width and height of the tank will, of course, depend on the size of the largest blueprint that it will be necessary to wash. To wash the prints, the water is first turned on and after the back of the tank is wet all

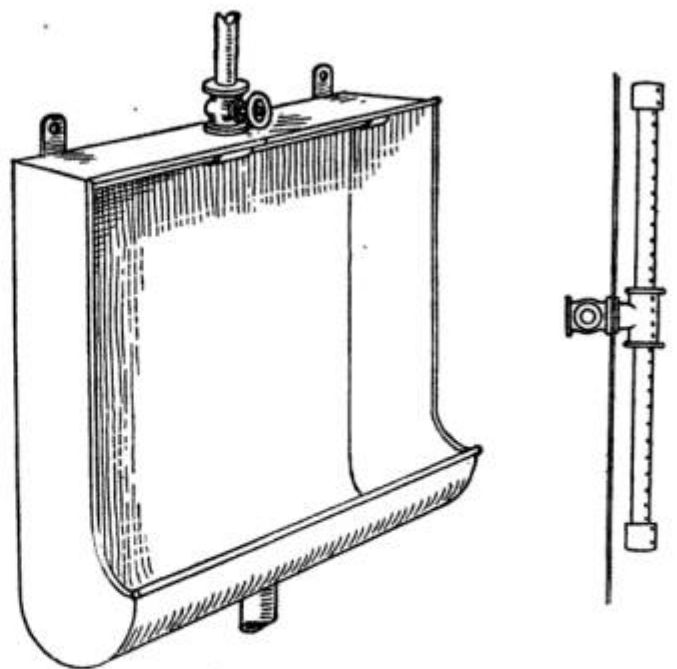

Tank for Small Space

over, the print is placed against it with the sensitive side of the paper outward, and so that the upper edge of the paper will come above the point

where the small streams of water hit the back of the tank. The water will then flow down over the print, which will adhere to the back at once and remain there until removed, to be hung up and dried.

### A Small Screw Jack

The tool shown in the illustration proved to be quite handy for use in riveting a liner on a locomotive cross-

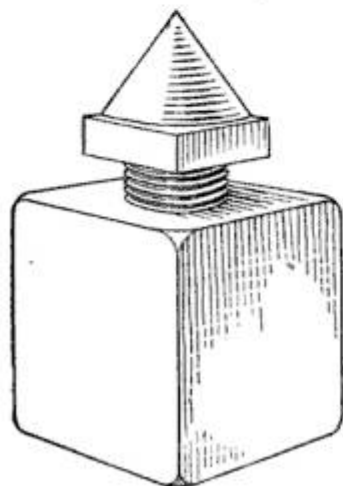

head. It was impossible to hold a solid surface on the rivet heads while riveting, and the little jack was placed in the intervening space with its bottom against the rivet head and then screwed up tight. The

work was accomplished without wasting time.

The jack can be easily made on a lathe. The base dimensions are 2 in. square and 3 in. high. The screw is  $\frac{3}{4}$  in. in diameter.—Contributed by Harry J. Ruark, Interbay, Wash.

### Universal Chuck Used as a Centering Tool

Any universal chuck may be used to spot round stock for centering by simply making a plug with a center to fit the hole in the chuck. This plug should be made a snug fit and a small hole drilled through its center. One end of the small hole is made larger and a plug with a 60-deg. point turned up to fit it. The plug should be as long as the chuck is wide so that when the chuck is laid on a block the point will just project above the face of the chuck.

When a round piece of stock is put into the chuck and the jaws turned up snugly on its circumference, it is

struck with a babbitt hammer, which spots the lower end. This method is

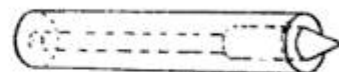
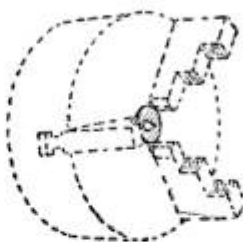

Center in Chuck

many times quicker than using a bell center or calipers.

The large plug is fitted snugly in the chuck and the small plug is hardened and fitted into the hole of the large plug. The small hole is for use in removing the small plug if the point breaks.—Contributed by Andrew Smith, New Haven, Conn.

### Placing Coil Springs in Hose

When putting in a new water-supply connection between the engine and the tank on a locomotive, it is necessary to run a coil of spring wire through the hose to keep it from kinking. The hose that is furnished for this purpose is generally flattened out through shipment or in packing. An easy way to insert the coil is as follows:

Procure a gas pipe about  $\frac{1}{4}$  or  $\frac{3}{8}$  in. smaller in diameter than the inside diameter of the coil, and cut a small slot in one end of it. Slip the coil over the pipe and fasten one end of it to the pipe by means of the slot. Place the pipe in a vise and twist the coil until it is drawn closely on the pipe. The hose can then be easily slipped over it, and when the coil is released, it will spring right back into position and



Coil Spring on Pipe

the hose and coil can be easily removed from the pipe. In using this method the coil is evenly distributed throughout the whole length of the hose.—Contributed by Harry L. Ruark, Interbay, Wash.

### Sign in the Blast of an Electric Fan

One sign maker constructs for his customers signs for window attractions which have words spelled with

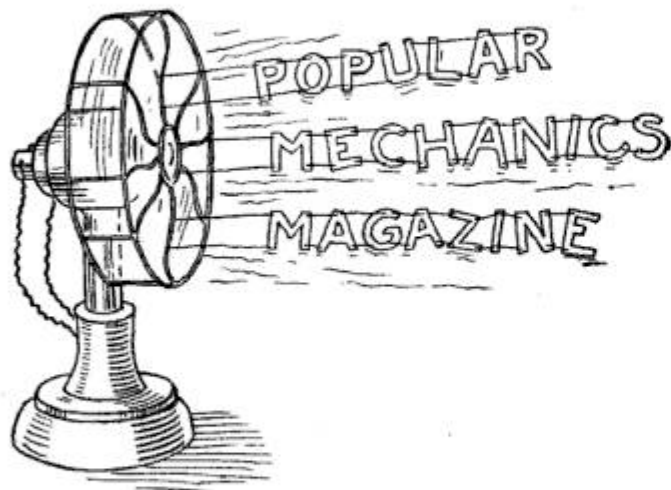

Letters Tied to Strings

letters tied to strings and attached to the guard on an ordinary electric fan. The current of air will keep the letters out in a readable shape, yet they will swing like a waving flag. The letters are made of light material and coated with tinsel. The tinsel gives a beautiful effect at night.—Contributed by A. Jungman, Bronx, N. Y.

### Locks for Camp and Shed Doors

Doors on empty buildings and places that do not require expensive locks, yet should be kept closed from pilfering marauders, can be fastened with home-made latches that will serve the purpose as well as any lock. An ordi-

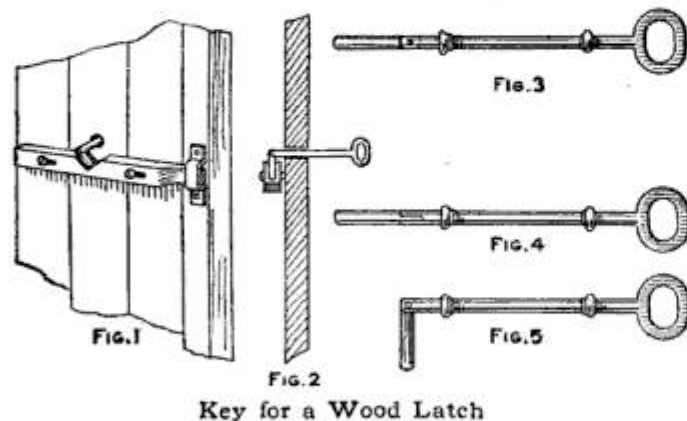

Key for a Wood Latch

nary sliding latch, operated with a key, is shown in Figs. 1 and 2. The latch is made from a stout piece of hard

wood and has two slots which slide on two screws turned into the door. The key is made to hinge, as shown in Fig. 3. The keeper is a piece of strap iron bent into shape and fastened with screws. The key is inserted through a round hole in the door while it is held in the position shown in Fig. 4. Turning the key causes the end to drop down (Fig. 5) and enter the notch cut in the top of the latch.

In Fig. 6 is shown a back sneck. In this device, the sneck is lifted from the outside by passing a small wire through a hole in the door (Fig. 7) thus pressing out the hinge strap and raising the sneck from the keeper. The hanging straps are made of two small pieces of leather, 1 in. wide and 7 in. long, the lower one having two holes cut in it, the lower hole for the

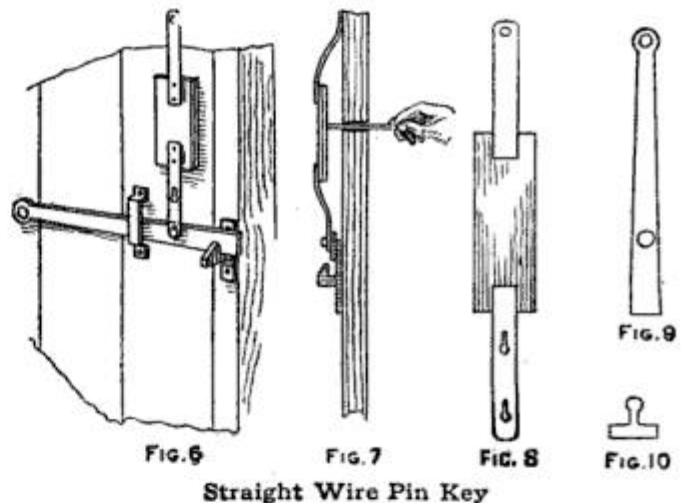

Straight Wire Pin Key

sneck when in use and the top one made so the sneck can be hooked up when not required as a lock. The other strap has one hole in the upper end for fastening it to the door. A small piece of wood joins the two straps in the center as shown in Fig. 8.

The sneck is shown in Fig. 9, and the cross section through the button in Fig. 10.—Contributed by John T. Dunlop, Craighead, Tollcross, Scotland.

☞ When painting stairs, apply the paint to every other step, and when dry, paint the remaining steps, placing small blocks on the dry ones to attract attention. Stairs may be used all the time by painting in this manner.



## Bracket for Roof Scaffolds

Almost 40 per cent of the accidents in building operations are due to inadequate construction of false work and scaffolding. In building frame structures accidents of this nature show even a larger percentage. The fault is not always laid at the door of the contractor, for workmen will often take risks that endanger their lives, without any good reason other than to save time and labor. A carpenter who builds his own scaffolds is often as careless as any one in this respect. Lack of proper time or material for building strong scaffolds will often induce him to put up flimsy affairs that may any day fall and kill or wound several men.

Shingling roofs is even more risky than framing the house. Where the pitch is sharp, the risk is greatly enhanced. In repairing roofs, a good many carpenters do not even go to the bother of building scaffolds, but depend upon their ability to hold themselves on the slope. If one had folding brackets which would make roof shingling simple and safe, fewer accidents of this nature would be recorded. A carpenter with a pair of folding brackets as a part of his equipment would never be in danger of slipping or sliding from the roof while shingling. His equipment would consist simply of a pair of brackets and a board.

The brackets, as illustrated, are made to fold up and are self-sustaining. That is, the board which fits flat against the slant of the roof is spiked to cling to the surface and it would take a good deal to break it loose from its moorings. The spikes are made of ordinary screws with the ends protruding  $\frac{1}{4}$  in. beyond the flat board and filed to a sharp point. Three of these at the lower end of the bracket and two at the upper end serve to hold the brackets firmly in position. A slight tap of a hammer will drive the brads in sufficiently and when the scaffolding board is placed across the brackets, the thrust, being downwards, tends to push the

points of the spikes deeper into the wood surface. A pair of brackets of this nature will sustain the weight of

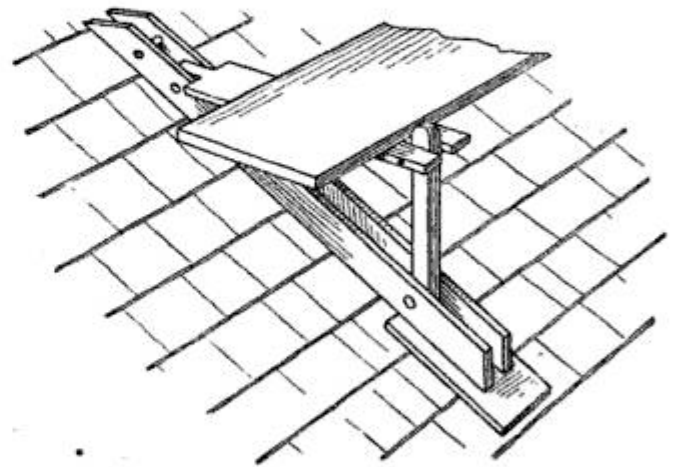

Folding and Adjustable Bracket

several men working on the same board. The illustration shows clearly the construction of each bracket.—Contributed by Geo. E. Walsh, New York, N. Y.

## Keyseat Gauge

The illustration shows an internal and external keyseat gauge made of sheet metal. The outside arc has the same radius as the inside arc, thus forming a combination gauge for a certain size shaft and bore of a pulley having the same diameter. Such a gauge can be used for laying out the keyseat, and as a depth gauge. A set of such gauges with the size, width and depth on each made to standard will enable the workman to cut all keyseats and make all keys uniform.—Contributed by E. D. Reynolds, Los Angeles, Cal.

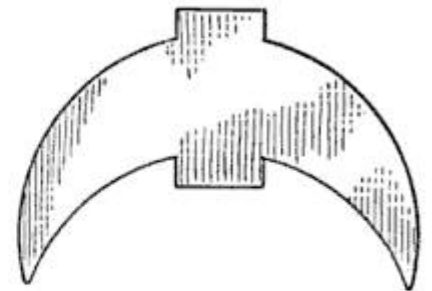

CA tent may be warmed up for the night by an inverted metal bucket filled with red-hot stones. A discarded bucket will do.

### Sight Gauge for an Icebox

Where no drain pipe is provided beneath an icebox, a drip pan takes its place. This is usually forgotten and

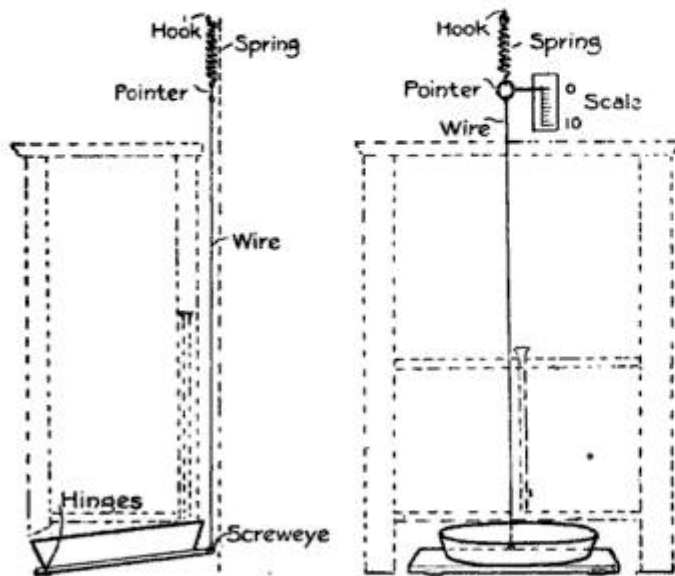

Gauge above Refrigerator

runs over before it is emptied. As the pan cannot be seen beneath the box, a simple gauge can be worked by the weight of the water so a pointer will designate the depth of the water in the pan. The arrangement is shown in the sketch.

The drip pan is set on a board that is hinged on the front side and attached to a wire on the back side with a screweye, the wire having a spiral spring on the upper end above the top of the icebox. The upper end of the spring is placed over a hook turned into the wall. A pointer and scale is provided, all in plain sight above the top of the box. Anyone taking food from the icebox cannot do so without seeing the scale, which will designate at all times the depth of the water in the drip pan, and the running-over point.—Contributed by K. Kuga, Hoquiam, Wash.

### A Disinfectant

A very simple and inexpensive article to use as a good disinfectant is potassium chlorate with an equal amount of sulphur. These are mixed together, placed in a small tin pan and

lighted. The result is a sulphur trioxide which, uniting with the moisture in the air, forms a weak acid that purifies the room and all the articles in it at the same time.

During the summer this compound can be used in ice boxes, and once this is done, milk will not sour, even if the ice should run low for a few hours. It is also very useful in cisterns and cellars. Both chemicals, which are harmless and very cheap, can be purchased at any drug store, and a teaspoonful of each will purify a large room or cellar.—Contributed by Loren Ward, Des Moines, Iowa.

### Keyseating a Large Pulley by Hand

Occasionally a large pulley comes to a shop to be keyseated, and, if the shop is a small one, no appliances are at hand large enough to do the work. A tool that will do the job satisfactorily may be made in the following way: In the first place, a piece of shaft which just fits into the hole in the hub must be obtained. Drill into the shaft and tap the hole to receive a threaded bolt, as shown at A. The point of the threaded bolt should be tapered. A cutter, B, should be made and the back end ground to fit the taper on the bolt.

Allow the shaft to project above the wheel 12 or 14 in. and attach a lever D as shown. Drill a hole in the opposite end of the lever and fasten a short piece of chain, E, which in turn is fas-

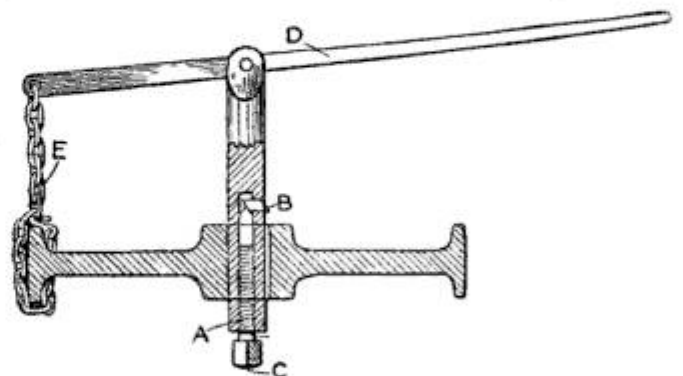

Lever Operates Cutter

tened to the rim of the wheel. Screw the bolt C up until the cutter is forced out far enough to make a cut. Apply pressure to the end of the lever and

force the cutter through. Draw the cutter back and turn the bolt up a little to force the cutter out for a second cut and again apply pressure to the lever. In this way a keyseat can be cut as perfect as if done on a keyseating machine.—Contributed by J. N. Bagley, Webber, Kansas.

### Remedy for Roaring Gas Burners

Gas stoves in which the gas, just before combustion, enters through a row of openings, perhaps  $\frac{3}{8}$  in. in diameter, will make a roaring noise when the gas is turned on full force. This may be remedied by bending a piece of wire in the shape shown in the sketch so that each bend or projection shall enter one of the openings. This checks the pressure of the gas so that it begins to

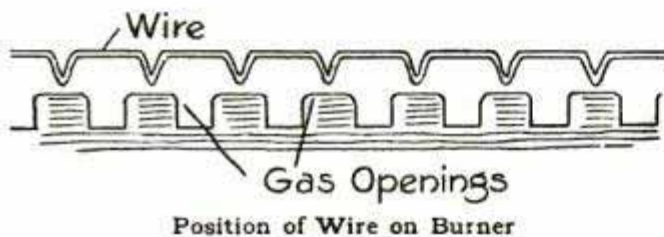

be consumed as soon as it enters the stove and not 2 or 3 in. above the opening.—Contributed by Walter E. Wright, Delaware, Ohio.

### Sharpening Oilstones

Fine oilstones, emery wheels, or other grinding stones sometimes become covered with a coating of hardened grease and dirt which forms a smooth and useless surface. This may be removed quickly and easily without harming or wasting the stone, by boiling it for a few minutes in water containing about one teaspoonful of lye to a quart of water. Care must be taken not to let the stone rest on the bottom of the pan, as the heat may crack it. The lye unites with the grease, forming soap, which comes to the surface, thus freeing the dirt from the pores of the stone. Stones treated in this manner have the appearance of new stones.—Contributed by R. H. Galbreath, Denver, Colo.

### Miter Box Made of Box Corners

A durable miter box which is simple as well as cheap may be quickly

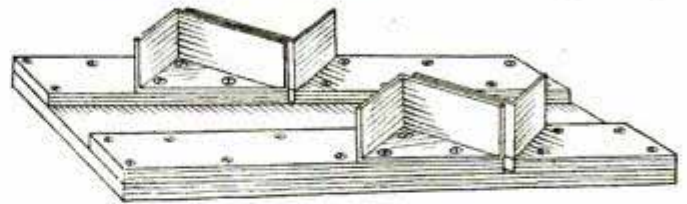

Box Corners on the Base

made by screwing four box corners to a board, as shown in the illustration. The corners are raised from the baseboard by strips of wood fastened to the edges. The box corners are set just far enough apart to allow the saw to pass freely between them.—Contributed by Edwin C. Wright, Newport, Kentucky.

### A Ventilator and Draft Deflector

An excellent way to ventilate an office is to use an arrangement as shown in the sketch. It permits a constant flow of fresh air which is deflected upward, and letters, papers, etc., will not be blown from desks. The device is constructed of two wood brackets secured to the window casing and two glass panels inserted in a frame supported by the brackets, the top being left open for the free passage of air. The glass frame may be constructed detachably, sliding in a groove on each

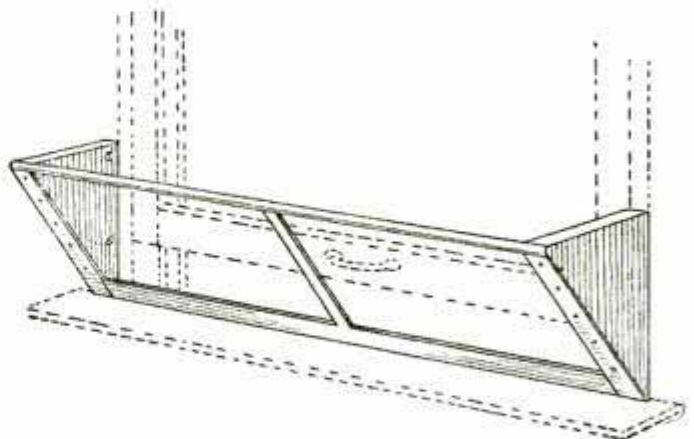

Ventilator on Window

bracket formed by two pieces of quarter round. The glass panels can be removed if one wishes to lean out of the window.—Contributed by Victor Labadie, Dallas, Texas.

### Hand Drill for Fine Work

A very handy little tool for drilling small holes is the so-called fiddle drill, says the American Blacksmith. The tool is very easily made, and costs nothing

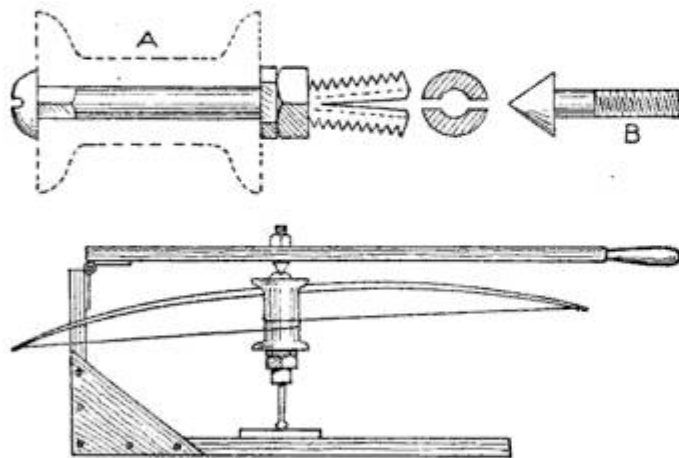

Fiddle Drill

but a small amount of time to put it together. All the material required is a spool, a  $\frac{3}{8}$ -in. bolt long enough to go through the spool and allow about 1 in. to extend at the end, one small hinge, one short  $\frac{1}{4}$  or  $\frac{3}{16}$ -in. bolt, and one narrow piece of leather or belt lacing. A piece of stout cord will answer for the latter.

Use a springy piece of wood about 25 in. long for the bow. The cord is tied on the ends of the bow, leaving it so that when the cord is wound once around the spool there will be sufficient tension to turn the spool. The  $\frac{3}{8}$ -in. bolt has a hole drilled about  $\frac{3}{16}$ -in. deep in the end. The bolt is then taken to the vise and a slot sawed down with a hacksaw, about  $\frac{3}{4}$  in. deep. This part of the bolt serves as a chuck to hold the drill.

The shank of the drill should be made a little larger than the hole in the bolt, so that when it is put in, the end of the bolt will spring apart, and when the nut is screwed down tight, it will squeeze in on the drill and hold it securely. There should be two nuts on this bolt, one to jam up and hold the spool tight and the other to clamp the drill as shown at A. A deep hole is then made with a center punch in the center of the bolt head.

Procure a  $\frac{1}{4}$ -in. bolt and shape the

head as shown in B by filing to fit the center-punch hole on the head. Build a small frame of wood and assemble the parts as shown. When the bow is drawn back and forth, the spool with the drill will revolve rapidly. The drill can be ground so that it will cut both ways by leaving a very thin edge.

The top piece of the frame with handle and hinge are used to feed the drill. Small holes can be drilled with this better than by the hand drill press. It is very handy for anyone having light, delicate work to perform at home.

### Circumference of a Circle Obtained with a Square

The circumference of any circle may be secured with an ordinary 2-ft. carpenter's square, when the diameter is given, in the following manner: Draw a straight line; then lay the square on the line with the 16-in. mark of the long side and the 5-in. mark of the short side, both intersecting the straight line as shown in the upper sketch. Draw a line on the long side of the square AC and measure off three divisions, each the length of the diameter of the circle. Draw a line at right angles from the third division mark on AC, until it intersects the

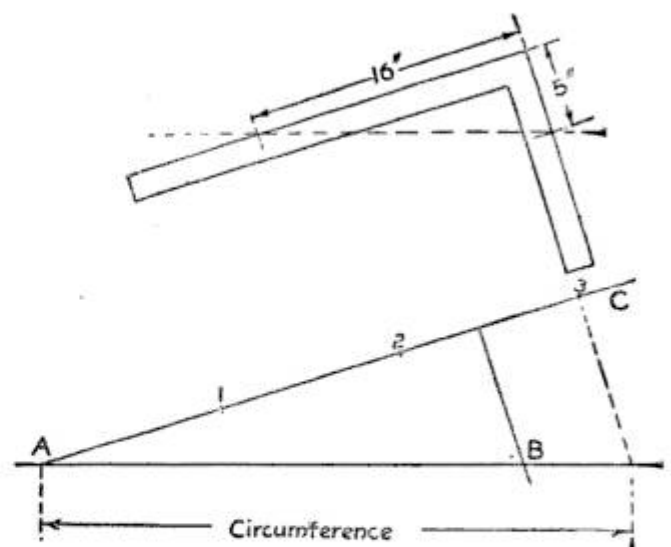

Square Used to Find Circumference

line AB. The distance from A to where the line crosses the line AB will be the circumference of the circle.—Contributed by S. J. Heath, Lestershire, N. Y.

### Boilermaker's Center Punch

A time and labor-saving tool that takes the place of a scratch awl and dividers for marking location of holes on a plate through holes of another, is shown in the sketch. The required center is located and at the same time a test circle is marked as a guide in drilling and punching. The center point A of the tool should extend  $\frac{1}{32}$  in. beyond the cup rim B, and the diameter C

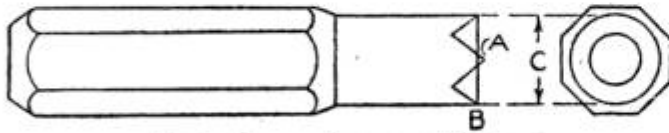

Marks Circumference of Holes

should be the same as that of the holes to be marked. Such a tool should be used only for marking, as the center can be enlarged with an ordinary center punch.—Contributed by Claud H. Sanford, Fayetteville, Ark.

### Pliers for Twisting Wire on Hose Connections

An ordinary pair of pliers with holes drilled in the tip ends of the jaws, as shown, makes a good tool for fastening wire rings around rubber hose. The ends of the wire are stuck into the

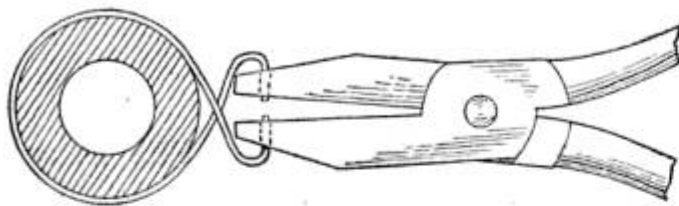

Wire in the Holes

holes, then the handles of the pliers are spread to draw the wire closely on the hose, after which the ends are twisted together by turning the pliers.—Contributed by S. N. Crane, Anderson, Cal.

### Spline for Laying Out Boat Curves

A spline for use in taking off and laying out curves in building small boats can be made of four or five pine strips about  $\frac{1}{2}$  in. thick and  $\frac{3}{4}$  or 1 in. wide with any length suitable to the

work. Lay the strips together and bore oblong holes through them every 14 in. Countersink the holes and use

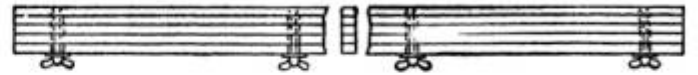

Bolts in the Strips

thumbnuts on the threaded end of the bolts. The spline is set for a curve, then the nuts are turned up to hold the shape.

The holes must be bored and cut long enough to give the strips end play as they bend around a curve.—Contributed by Joseph F. Bolton, Jr., South Duxbury, Mass.

### Home-Made Staple Puller

A very handy staple puller can be made from an old pair of pinchers by

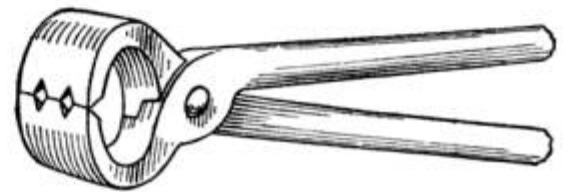

Notches Filed in the Jaws

simply filing notches in the jaws, as shown. The manner of removing the staple is obvious.—Contributed by Will Parker, Olaf, Ia.

### Improved Hardy for an Anvil

While trying to draw out a split weld to the proper shape as most smiths do, I thought of a way to make a hardy that would be of assistance after the iron was split. The tool is shown in Fig. 1. The shank of the

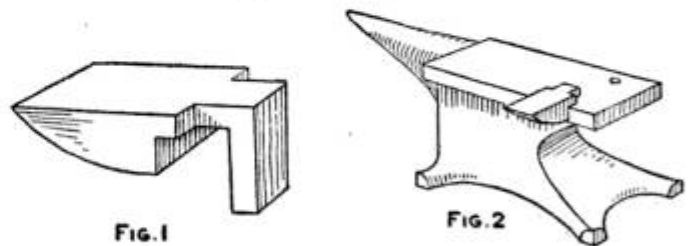

FIG. 1

FIG. 2

Tool on the Anvil

tool fits the square hole in the anvil and the heel lies closely against the side as in Fig. 2.—Raymond E. Chase, Melville, R. I.

### Removing Screw-Top Can Covers

Considerable trouble is experienced many times in removing the metal caps screwed on cans and canisters of different kinds.

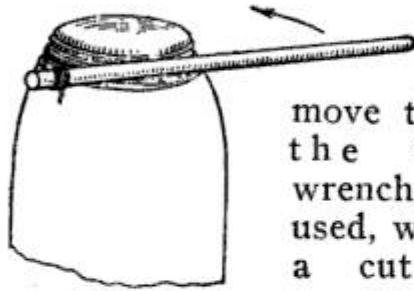

Where one cannot remove the cover with the fingers, then wrenches or pliers are used, which results in a cut or mashed cover. One of the

easiest ways is to take a strong cord or string and wrap it around the cap from right to left several turns, making each turn cover the end of the string. Then take a few turns around the end of a strong stick and twist so that the string will pull the stick up snug against the cap. The stick will come in contact with the string and press it against the cap so it cannot slip, and the cap can be turned easily.—Contributed by L. A. Gardner, Oakland, Cal.

### Removing Sand from Water in a Pump

A great deal of inconvenience is generally experienced with newly driven wells using common pitcher pumps, as small gravel stones are apt to be drawn up and lodged under the lower valve, scoring the cylinder walls and causing damage to the valve seats.

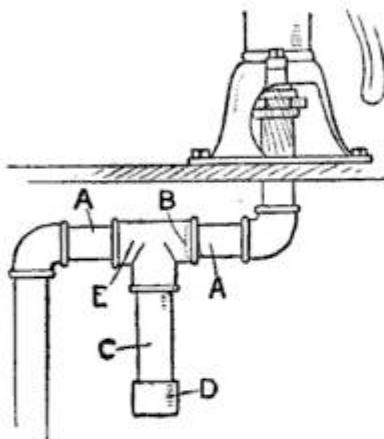

When the lower valve is held open by a small stone, the pump will not work and it becomes necessary to take it apart and remove the obstruction.

Nearly all of this trouble may be eliminated by placing in the pipe line A, preferably near the pump, a pipe C

capped on the end D and screwed into the tee E. A piece of about No. 20 gauge mesh screen wire is put over the end of the pipe A at B. This same trap can be put into any pipe line to arrest particles which would otherwise pass and cause obstructions in pumps.—Contributed by Clare L. Parshall, Wayland, N. Y.

### Making an Eye in a Rod End

The average mechanic will find it no small task to put an eye in the end of a rifle-cleaning rod, after it has been



broken, or when making a new one. An easy method is to heat the end of the rod red hot, flatten it for a length of about 1½ in., double the end back at the center of

the flat surface, place it in a vise and saw a slot for the length wanted. Heat it again, straighten it, and smooth with a file.—Contributed by Geo. A. Hinkle, Halstead, Kansas.

### Cutting Threads with a File Tang

The lubricator on my engine froze and broke the thread off from one of the fittings, and as I had no screw plate small enough to rethread it, I succeeded in cut-

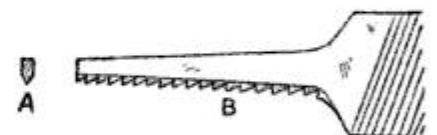

ting the threads with the shank of an old file shaped as shown at A in the sketch, with teeth B, and tempering it. Starting on the old thread and sawing around I succeeded in making a fairly good thread and the lubricator worked as good as new.—Contributed by L. A. Knutsen, Tacoma, Wash.

### Leveling Table Legs

The sketch herewith shows how an object—in this instance a heavy bench—can be made perfectly level on an uneven base. The number of supports the object has does not render the leveling process any more difficult.

Bore the holes deep enough in the supports to permit the bolts being placed as shown. Holes must be just large enough to allow the bolts to fit in without any play sidewise. Round-headed bolts are used with threads running to the heads if possible. The size of the bolt will depend upon the thickness of the support. For instance, a large bolt would be strong enough in itself but would not be advisable in a slender support, as there would be but a shell of wood surrounding it. Use a

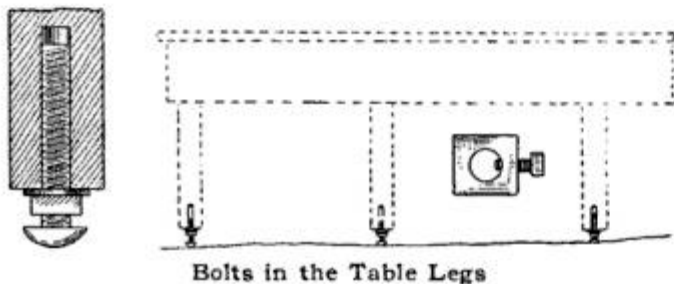

Bolts in the Table Legs

round washer between the nut and the bottom of the support so as to prevent wear.

When the bolts are in place, set the object on the base and turn the nuts so as to raise or lower the object to the proper level. If desired, the nuts may be locked by tapping them and inserting setscrews as shown. In leveling a heavy object, it may be necessary to grip the bolt with a wrench to prevent it from turning while the nut is being screwed up or down.—Contributed by James M. Kane, Doylestown, Pa.

### Double-Acting Pliers

The tool illustrated will be found very useful about the shop and especially so for removing screw calks from horses' shoes and for turning any metal rod or bolt. It should be made of good tool steel and well tempered.

The handles are forged into the shape shown and teeth filed in them.

They are made to hinge at the end with a strong pin. The side plates are cut out and teeth filed in them, and a slot cut diagonally to slide on a pin in

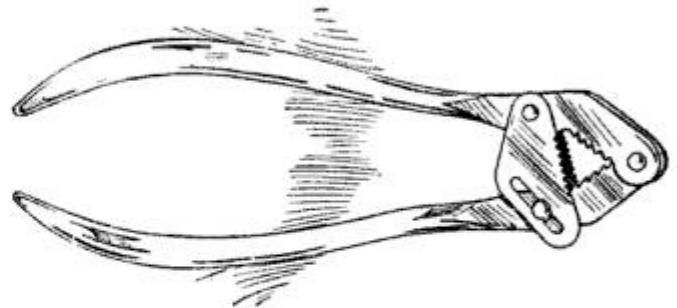

Pliers for Removing Screw Calks

one of the handles, the other end being pivoted on the other handle. As the handles are spread or brought together the pin sliding in the slot forces the side plates in or out with great leverage, as the jaws coming together form a triple grip much stronger than afforded by the ordinary pliers.—Contributed by Thos. L. Parker, Olaf, Iowa.

### Squaring a Timber on a Band Saw

When a post or board of some thickness and width is to be cut on a band saw, and a square end is desired, instead of using a square, run the board against the saw and then draw it back. A saw mark is cut on the board. Turn

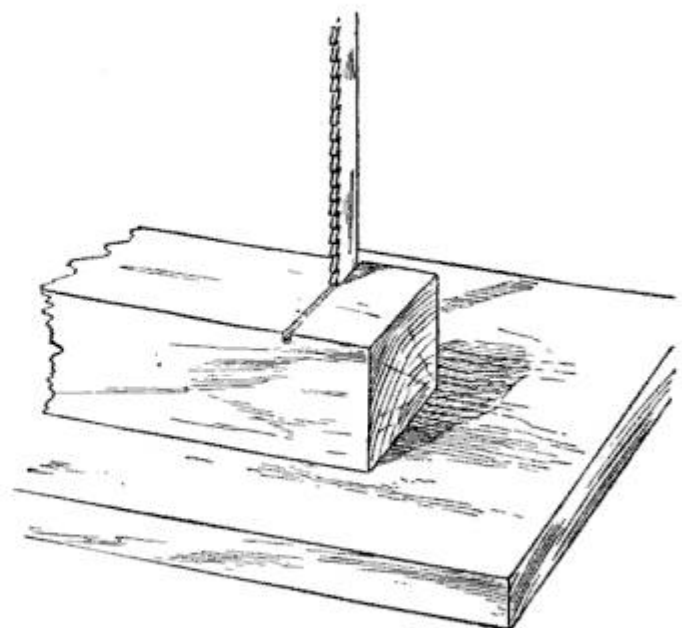

Saw Mark on Post

the post over and use the saw mark for a guide line.—Contributed by R. M. Barth, Chicago, Ill.

### Caliper Large Threads

The ordinary caliper cannot be used to obtain the outside diameter over large threads, owing to the space on

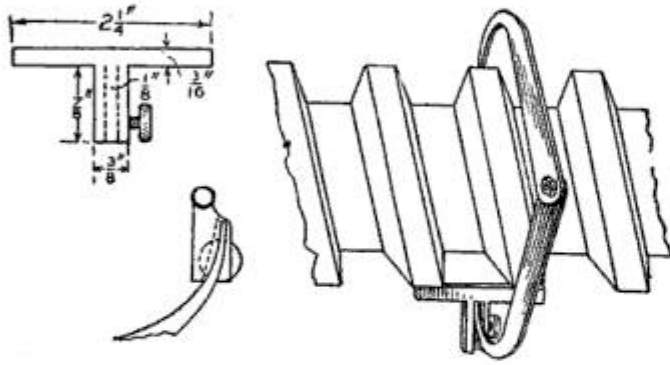

Bridging Device on Caliper End

one side being directly opposite a thread on the other. If the space is bridged, the diameter can be readily obtained and this may be accomplished with the little device illustrated which fits on the leg of any caliper. The shape of the piece and the manner of securing the diameter is clearly shown. —Contributed by Adolph Schiver, Buffalo, N. Y.

### Hinge Spring for a Door

The sketch shows pretty plainly how I fixed a door that was hard to keep

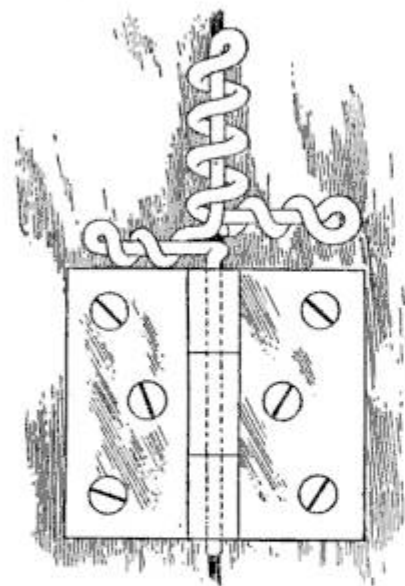

closed. I bought a piece of copper-plated spring wire and first bent it out  $\frac{3}{4}$  in. and over to the left 2 in., then round, and gave it a couple of twists on its way back to the starting point. From there I bent

it up and let it run straight for 3 in.; then bent it down and round and round in a coil till within  $\frac{1}{2}$  in. of the first bend; then 3 in. in the opposite direction from the left arm, thereby making

an arm to rest on the door. Then I turned it round and twisted it as shown on its way back to the coil. Removing the pin from the hinge of the door, I gave the spring one turn and inserted the stem into the hinge. Where one coil is not strong enough to swing a door, another may be affixed to the other hinge.—Contributed by George Madsen, Chicago.

### Polishing Wheel for the Lathe

A polishing wheel for the lathe can be quickly made by turning up a board 2 in. thick and about 7 in. in diameter, then boring a hole in the center of any desired diameter to fit a mandrel and attaching emery cloth to its face. The

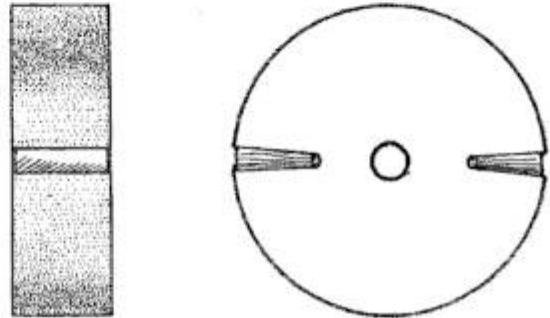

Emery Cloth on Wood Wheel

emery cloth may be fastened by wedges as shown in the sketch.

Two notches are sawed in the wood, one opposite the other across the diameter, and wood wedges fitted in them. Take two strips of emery cloth as wide as the wheel and place them on the circumference, tuck the ends into the notches and drive the wood wedges in place. The wedges will draw the emery cloth close on the face of the wheel.—Contributed by Chas. Homewood, Waterloo, Iowa.

### Imitating Hard Wood on an Old Floor

A floor that is old and rough with yawning cracks can be converted into a floor equal to a new one, in fact a carpet will not be necessary. Any person can do the work at a nominal expense.

The first and most tedious part of the process is to clean out the cracks.



This is done by brushing with a whisk broom. Where the dirt is solidly packed some edged tool like a screw driver or the claw end of a hammer may be used. When cracks are free from dirt, cleanse the floor by thoroughly scrubbing it with hot soap-suds.

Allow the boards to dry. After a day's time apply a good coat of cream-colored paint to them, using a large brush, and work lengthwise of only one board at a time. A freshly opened can of ready-mixed paint sold in the shops is of proper consistency and needs no thinning. If the can should stand open for some time, a little turpentine may be added to the paint.

Allow the paint to become thoroughly dry, then fill all the cracks and other holes with putty or with one of the patent crack and crevice fillers sold at paint stores. The best tools for this job are the fingers and the thumbs assisted by a broad, flexible case knife, if a putty knife is not available. Wipe off all the loose crumbs of putty with a dry cloth and immediately apply a second coat of the same cream-colored paint. Let this dry for a day or more and then stain the floor with the lightest shade of oak that can be had in an oil stain, and after it is dry, complete with a coat of varnish. A second coat of varnish can be added for effect but it is not necessary. If the foregoing directions are followed, the floor will shine like a mirror and will be smooth enough for a ballroom.—Contributed by Katherine D. Morse, Syracuse, New York.

### Bench Screw Made of Pipe Fittings

Having need for a bench screw and it not being possible to purchase one in our small town, I set about to make one from pipe fittings, says a correspondent of the Automobile Dealer and Repairer. In the first place, a piece of 1-in. pipe, A, is threaded for about 14 in. On one end of this, screw a 1-in. tee, C, and drill a small hole, F, and drive a pin in to prevent the tee from unscrewing. Next in order is a 3-in. washer reamed

out to slip freely over the pipe. Four holes are drilled and countersunk in this washer for screws. Slip it up against the tee C, after which take the

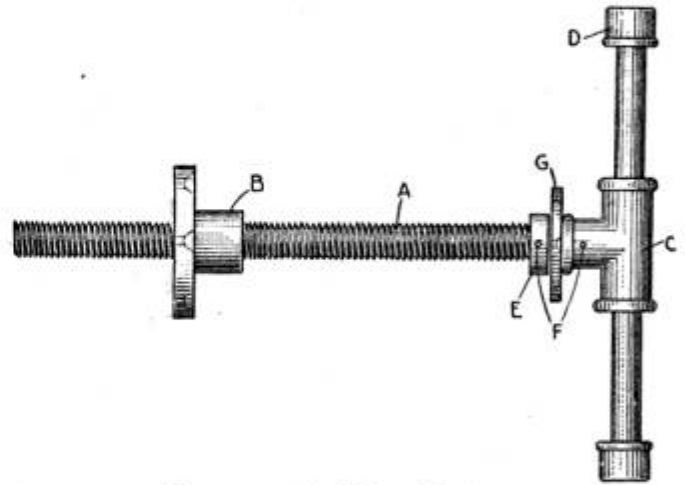

Constructed of Pipe Fittings

hacksaw and saw a coupling in the middle and screw one half with the square shoulder E up close to the washer, allowing just room for the washer to turn freely. Cut a piece of  $\frac{3}{4}$ -in. pipe, 12 in. long, and thread both ends to receive a cap as shown at D. Use a floor plate for the stationary nut B. Place the screw in the wood jaws in the same way one would fit an ordinary screw, and it will work in the most satisfactory manner.

### Fastening Screws in Brick

In hanging fixtures, brackets, etc., on brick or marble, I have found the following device very effective, where expansion sleeves are not at hand. Make a wood plug a little larger than the hole drilled and as long as it is deep, and open the small end with a knife or chisel. Make a wedge as shown, and insert it in the opening in the plug and drive in place. When the wedge strikes the bottom of the hole, it will spread the plug and act just as an expansive sleeve, making a very tight wedge.—Contributed by G. T. Nelson, St. Paul, Minn.

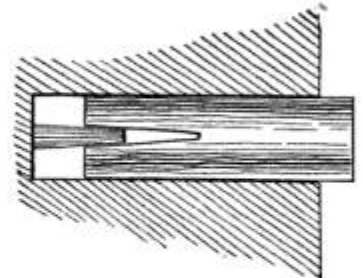

### Forcing Bushings in Place

In many cases bushings are pressed into large parts of machinery that are too heavy to readily take apart, or because the places are not easily accessible. Driving them in with a hammer and a block of wood or brass is bad, and poor practice. The sketch shows a simple method of quickly and safely drawing them in with nothing but a bolt and two washers. The bushing is bound to go straight and is in no danger of being bent, as when driven with a hammer.

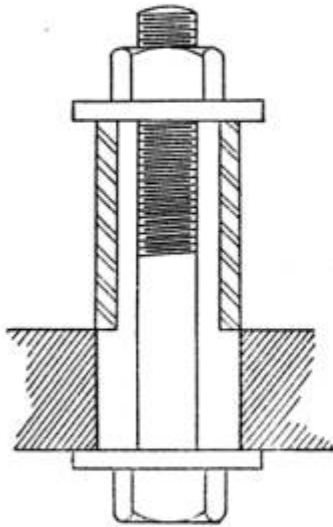

### Beam Calipers

A caliper head for a trammel makes it possible to measure diameters of large wheels. Such a caliper head can be made of a block of hard wood, preferably maple, which is used on  $\frac{1}{4}$ -in. pipe as a beam. The wood is shaped as shown and the caliper points made of  $\frac{1}{4}$ -in. round steel.

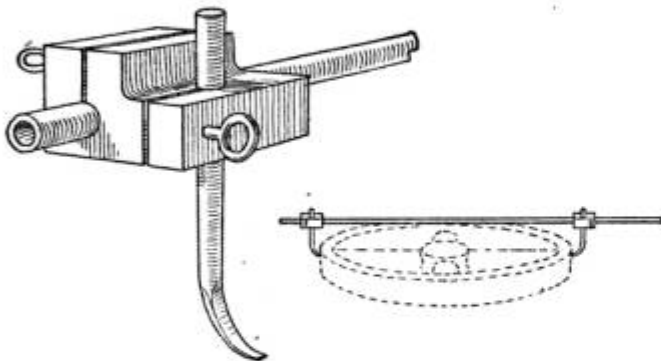

Wood Block Holding Caliper Point

To grip the head on the beam and the points in the head make saw cuts from the edge of the block to the holes as shown and insert screweyes for clamping. A mechanic can usually find the materials to construct this instrument on the job. The pipe beam

is especially advantageous as it may be enlarged to any size by screwing together several lengths of pipe.—Contributed by J. J. O'Brien, Buffalo, New York.

### Self-Centering Saw Arbor

All circular saws bored for a certain sized mandrel do not always fit snugly. In changing one saw for another, it may not fit close enough to make the teeth cut true all the way around. To obviate the trouble, some kind of a self-centering device must be employed. The illustration shows a device, designed by a correspondent of Wood-Worker, to center a saw per-

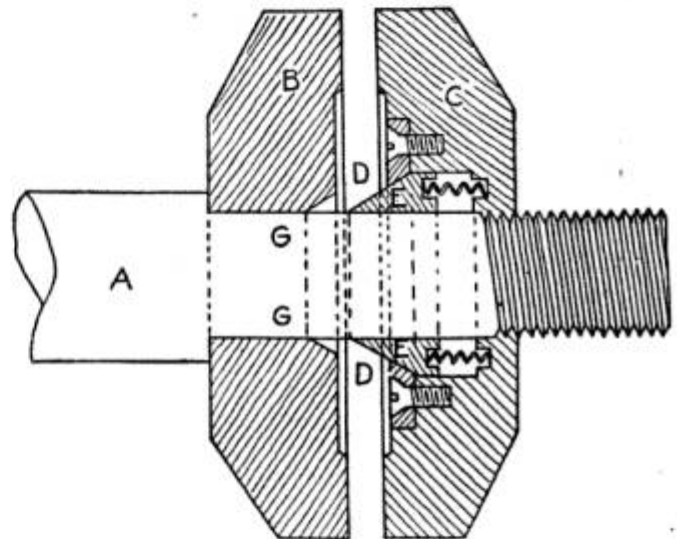

Cone in Collar Centers Saw

fectly, if the hole is quite large. It consists of an ordinary collar, being fitted to allow the free action of the centering piece, which is a steel ring or band, about  $\frac{5}{16}$  in. thick and  $\frac{3}{4}$  to  $\frac{7}{8}$  in. wide, with  $\frac{3}{8}$  in. of the width beveled to the inside diameter, as shown by EE. This adjustable ring rests on spiral springs which are held in place by seats drilled in the back edge of the ring and the bottom of the cored-out part of the main collar, as shown. The ring E is held in place by another ring D, having its inside beveled to fit the bevel on E. This ring is sunk flush with the face of the collar and held in place by screws, as shown. If a saw fits the arbor, the centering ring E will be pressed back in the

collar. If a saw having a larger hole is used, though the variation may be but little, the ring E will be forced into it by the springs and hold the saw on an absolute center.

### A Detachable Auger Crank

Carpenters using large augers have a crank handle welded to the shank of each auger so that it can be turned easily. If only one auger is used, this plan is a good one, but if several sizes are carried in a tool box, the crank handles are rather bulky. The sketch shows a crank handle that may be attached to any large-sized bit or auger. The dimensions given will make a well

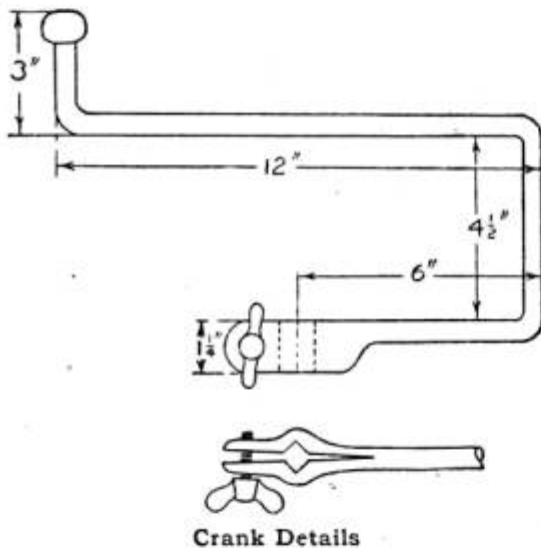

Crank Details

proportioned handle, using 1/2-in. round machine steel as material.—Contributed by Wm. Skoglund, Brooklyn, New York.

### Testing Wrought-Iron Pipe

The device shown in the sketch was designed for testing small sizes of wrought-iron pipe under steam pressure. The operation is as follows:

The three-way valve A is operated by the lever handle B. The steam entering the valve through the pipe C, is used and exhausted through the pipe D. The reducer E can be changed to suit any size of pipe, F, which is being tested. The outer or coupling end of the pipe is closed with a plug which, for convenience in handling, can be a

capped nipple, about 6 or 8 in. long. The steam can be successively ad-

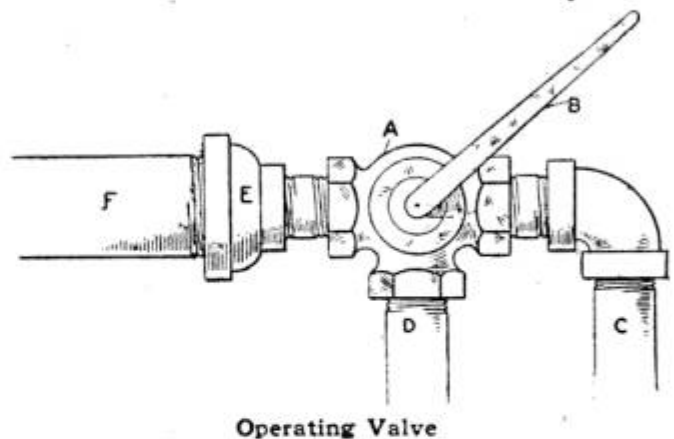

Operating Valve

mitted and exhausted from the pipe F. The pipe should be struck several sharp blows with a hammer while under pressure to expose any split or rust hole.—Contributed by Jas. N. Kilgore, Hollidaysburg, Pa.

### Marking Threads on a Bolt

Some bolts had to be shortened about 3 in. in repairing a steam pump located a long distance from a machine shop. The threads varied in size, owing to the bolt sizes, and the length cut off from each bolt would remove the threaded portion, thus making it necessary to cut new threads on the shank of the bolts.

The only tools at hand were a vise and some small files and the threads were cut in the following manner: The nut was placed on the end of the bolt and given a turn on one thread. A piece of board was notched out to fit on the nut and a hole made through the other end by driving in a nail and drawing it out. A pencil was put in

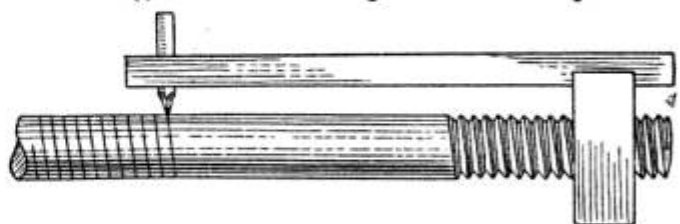

Marker Fastened to Nut

the hole and the bolt was rubbed with chalk and then, by turning the nut and wood strip, it marked the thread wanted. The old thread was cut off and a new one filed in with a three-cornered file.—Contributed by Arthur L. Kerbaugh, Allentown, Pa.

### Double Glass Windows

In many localities the frosting of glass windows is some little source of annoyance aside from the obstruction of light. The sketch shows how by the use of two glass plates a dead air space can be formed. The two plates of glass are set in the frame in the same manner as a single plate with a thin sheet of rubber, A, placed between their outer edges. This will prevent the accumulation of frozen moisture on the inside glass.—Contributed by F. W. Bentley, Jr., Huron, South Dakota.

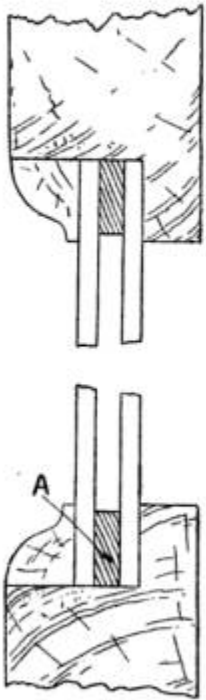

### Bushing a Pulley with Babbitt

I had a 24-in. pulley with a  $2\frac{3}{8}$ -in. hole, that I wanted in a hurry to use on a  $1\frac{3}{16}$ -in. shaft. To make an ordinary cast-iron bushing would take too long; so I laid the pulley, rim down, on the planer table. Then a short piece of  $1\frac{3}{16}$ -in. shaft was faced off square on both ends and stood up inside the hole, and a clamp put on top to keep it in place. The shaft was squared up with a try-square and a bar of straight steel laid across the upper rim face of the pulley. Then the pulley was shifted until it was concentric with the shaft, as near as could be measured with a scale, and clamped too. The setscrews were brought down until just in contact with the shaft, and the hole was filled with babbitt.

Thus in a half hour's time I had a pulley bushed to run true within less than  $\frac{1}{32}$  in., and with setscrew holes all tapped. This was not, of course, a very durable job, but it was a quick one, and subsequently, though not at first intended to, it ran over a year in steady service.

### Drilling Holes in Lead

At one time I had to drill  $\frac{1}{8}$ -in. holes in a large number of lead pieces. At first glance this appeared to be a snap—nice, soft metal, etc., but that very softness proved the undoing of the snap. The holes were  $\frac{1}{2}$  in. deep and before half that depth was reached, a ragged burr of considerable size was thrown up around the top, the hole would be worn out of shape by the "crawling" of the chips, and the drill clogged and stuck repeatedly. I tried water drilling compounds, kerosene, drilling without lubricant, but to no avail.

A good grade of lard oil, and plenty of it, was used as a last resort, and the holes were drilled through straight and smooth, without any burr except the usual small one on the under side. With the oil, it was necessary to lift the drill out at least once to clean up the chip. A drill speed of 800 to 900 r. p. m. was found to give good results.—Contributed by Donald A. Hampson, Middletown, N. Y.

### Punching Attachment for a Vise

Light punching can be accomplished on an ordinary vise with the attachment shown in the sketch. Two clamps of flat bar are tapped to receive screws for fastening them on the punch and die. Setscrews hold the clamps to the vise jaws, which also provides a way for considerable adjust-

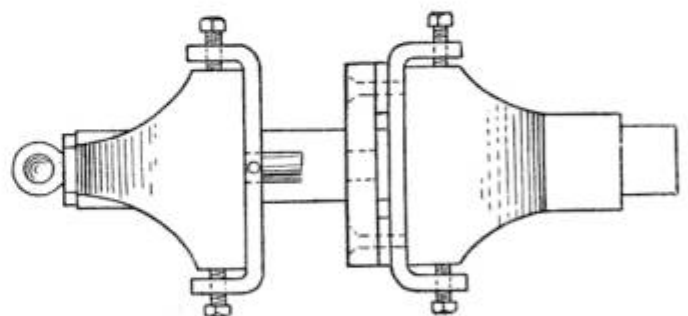

Punch and Die on Vise Jaws

ment. Irregular-shaped holes can be punched with dies fixed to this attachment.—Contributed by Norman Best, Monmouth, Ill.

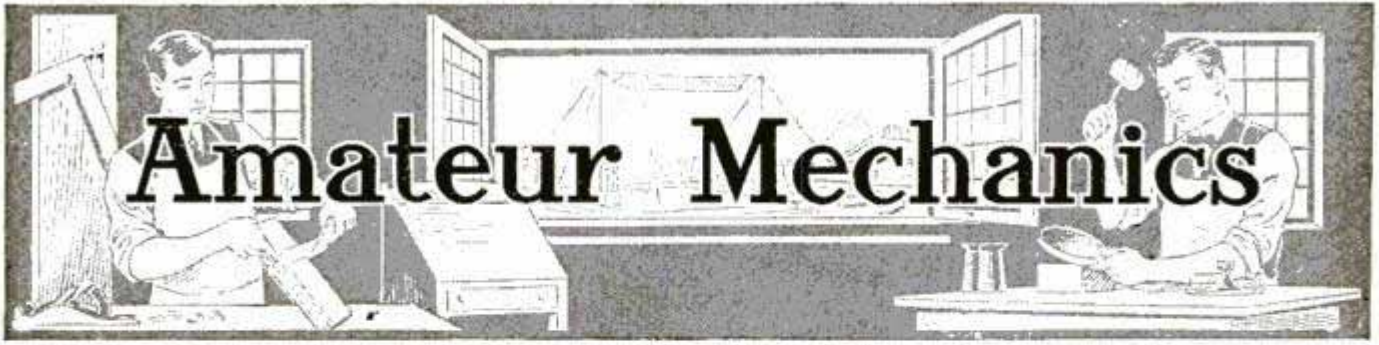

# Amateur Mechanics

## Home-Made Shower Bath

While in the country, during vacation time, I missed my daily bath and devised a shower bath that gave complete satisfaction. The back porch was enclosed with sheeting for the

The water will run from 10 to 15 minutes. The addition of some hot water will make a splendid shower bath.—Contributed by Dr. C. H. Rosenthal, Cincinnati, O.

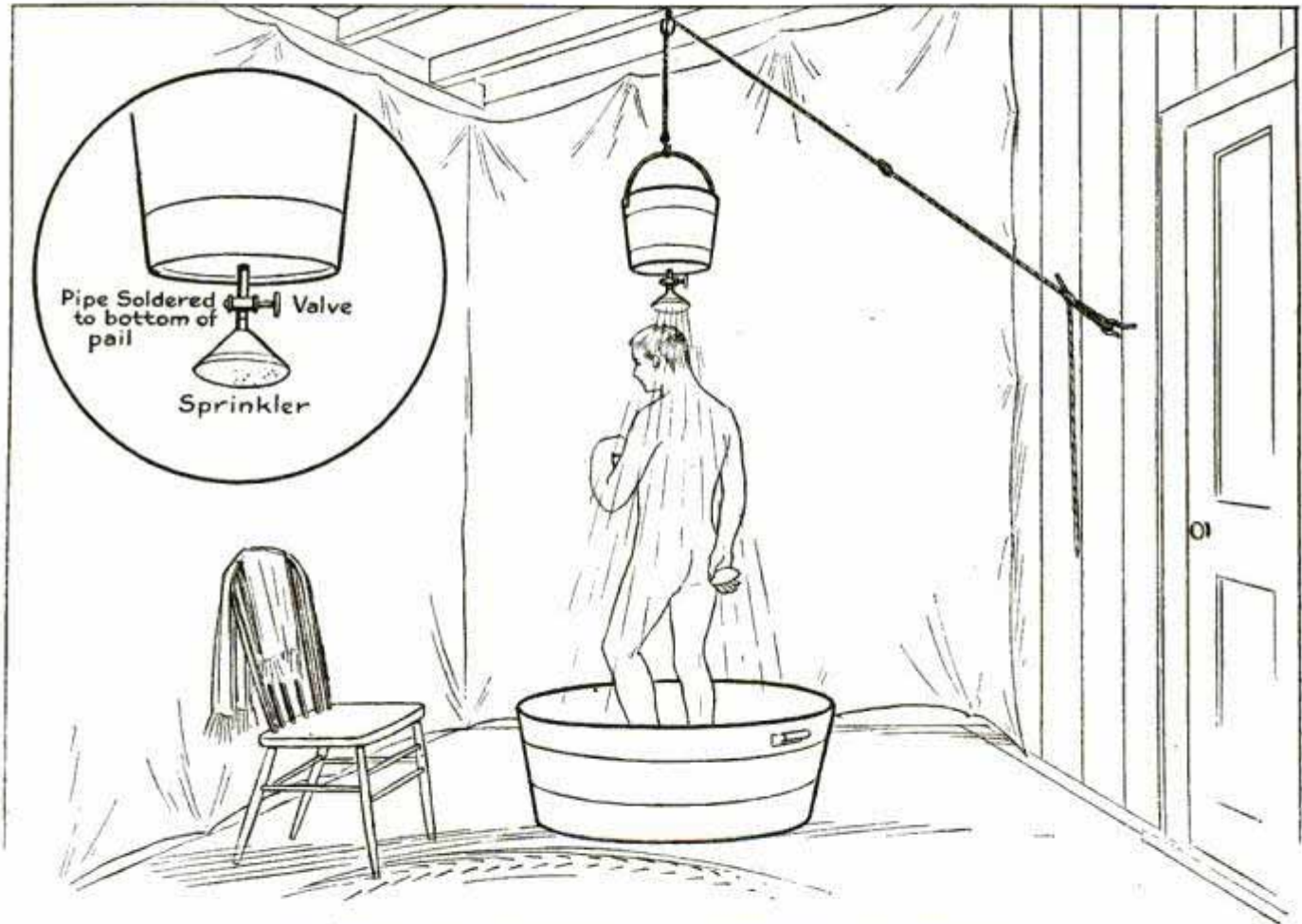

A Shower Bath That Costs Less Than One Dollar to Make

room, and the apparatus consisted of a galvanized iron pail with a short nipple soldered in the center of the bottom and fitted with a valve and sprinkler. The whole, after filling the pail with water, was raised above one's head with a rope run over a pulley fastened to the roof of the porch, and a tub was used on the floor to catch the water.

ⒸThe gas meter should not be located in a warm place or the gas will expand before the meter measures it and the gas bill will be proportionately increased. Gas expands about 1-491 times its volume for each degree Fahr. that it is heated. If the meter is warmed 10 deg. Fahr., it will make the gas cost over 2 per cent more, and with no corresponding benefit.

## Home-Made Motion-Picture Camera and Projector

## IN THREE PARTS—PART II

## Developing

After having exposed the film in the camera, the next steps are to develop and make a positive film from the negative. The developing and exposing of

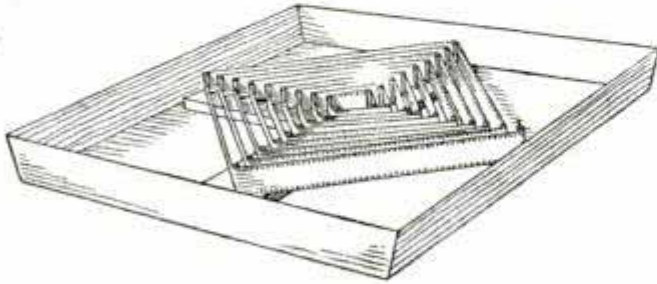

Fig. 4—Cross Arms with Pins

the film for the positive are the same as in ordinary photography for making negatives and lantern slides, the only difference being in the apparatus for handling the long films. One of the simplest ways of developing a long film is to use a large tray in connection with a cross arm having upright pins around which the film is wrapped in a continuous spiral. A film 100 ft. long would require a tray 18 by 22 in., with pins set in the cross arm about  $\frac{3}{8}$  in. apart. This method of developing is shown in Fig. 4.

A long film can be developed in a small tray by using two flanged wheels or spools mounted on a frame (Fig. 5) that holds them directly above the liquid in the tray. The spools have a wood core or center with metal sides of sufficient diameter to take in the length of film to be developed. One end of the undeveloped film is attached to one spool and then wound upon it, then the other end is passed through the guides, gelatine side down, and fastened to the other spool. The film is first run slowly through a water bath until it is thoroughly saturated, then it is passed through the developing solution again and again until the proper density is secured. The trays can be easily removed and others substituted for fixing, washing, hardening and soaking, the film being passed through each solution in the same manner. Before develop-

ing either negative or positive film, small test strips should be run through the solution so that the proper timing and treating of the full-length strip will correspond to the test strip.

A reel should be prepared for drying the film. This can be made of small slats placed around two disks to form a drum (Fig. 6) about 1½ ft. in diameter and 2½ ft. long. After the film has been passed through the various solutions and is ready for drying, it is wound spirally around on the slats with the gelatine side out, and the whole hung up to dry.

## Printing

The printing to make the transparency is accomplished by a very simple arrangement. The negative and positive films must be drawn through a space admitting light while their gelatine surfaces are in close contact. A box may be constructed in several ways, but the one shown in Fig. 7 illustrates the necessary parts and their relative positions.

The sprocket A is placed directly back of the opening B which may be regulated to admit the proper light. The sprocket can be purchased from a

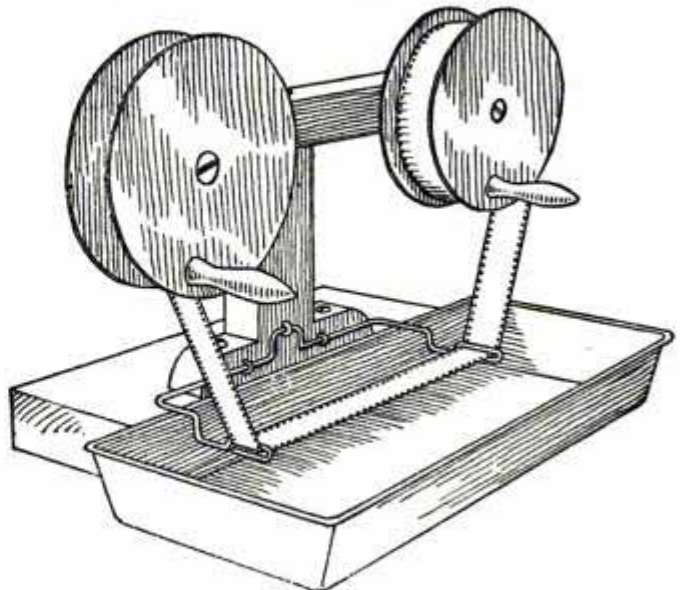

Fig. 5—Developing Long Films

moving-picture stock house cheaply, but if the builder so desires, one can be made from wood turned up about 1 in.

in diameter, or so that the circumference will receive sprockets at points  $\frac{3}{16}$  in. apart. The sprockets are made of metal pins driven into the wood. Two rows of them are placed around the wood cylinder about  $1\frac{1}{8}$  in. apart.

The cylinder is provided with a small metal shaft at each end which turns in round holes or bearings in the sides of the box. One of the shafts should project through the side of the box and have a grooved wheel, C, attached. The sprocket cylinder is driven by a smaller grooved wheel or pulley, D, to which a crank is attached for turning. The relative sizes of these wheels are determined by the speed of the exposure and the kind of light used. A 3-in. or 4-in. wheel on the cylinder sprocket shaft, driven by a pulley about 1 in. in

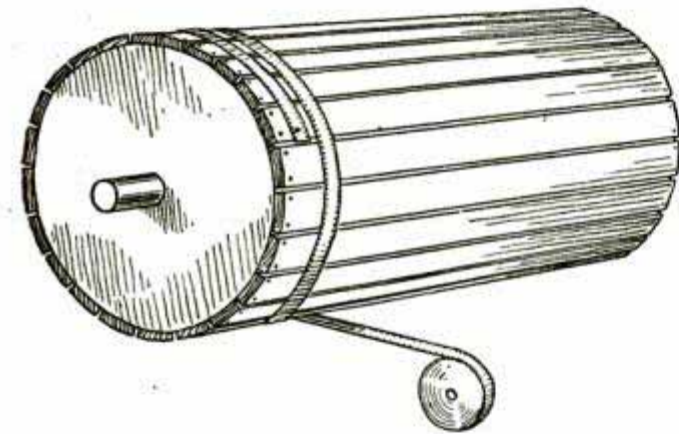

Fig. 6—Drying Reel

diameter, will be suitable under ordinary circumstances. The opening B may be adjusted by two metal slides which fit tightly in metal grooves fastened to the wood front. The metal grooves and slides can be made of tin and painted a dead black. The films after passing over the sprocket, fall into the bottom of the box, or, if very long films are to be made, the instrument can be used in the dark room and the light admitted only to the opening B, then the ends can be dropped into a basket or other receptacle at the bottom and the unprinted portions carried on reels above the box.

The speed of the exposure and the width of the opening B can be determined by making test strips. This can be done by setting the opening B to a certain width and turning the crank for

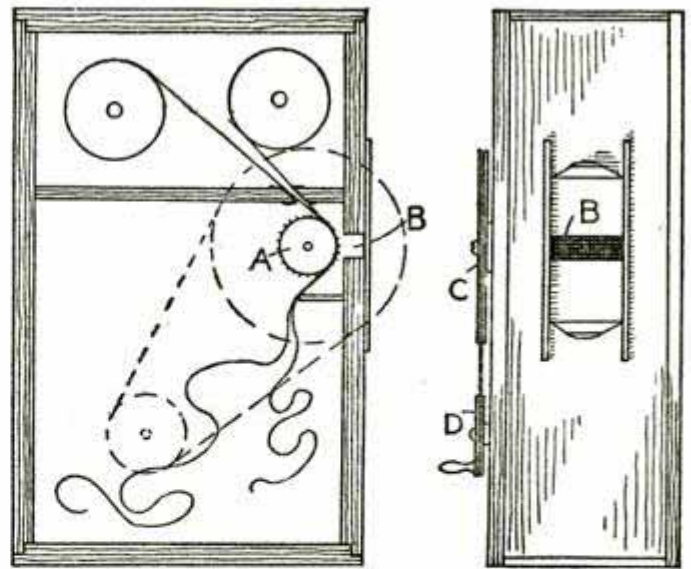

Fig. 7—Printing Machine

10 or 15 seconds and counting the number of revolutions. The proper exposure can be easily attained by this method.

(To be continued)

### An Emergency Clamp

While making an extra large guitar I did not have clamps large enough to hold the top and bottom onto the sides while gluing, so I fastened three pieces of wood together, each piece being about 1 by 2 in., as shown in the sketch. Then I bored holes in both top and bottom pieces and inserted a piece of soft wire in the form of a loop, which, when twisted, drew the ends of the clamp together.—Contributed by Geo. E. Walsh, Buffalo, N. Y.

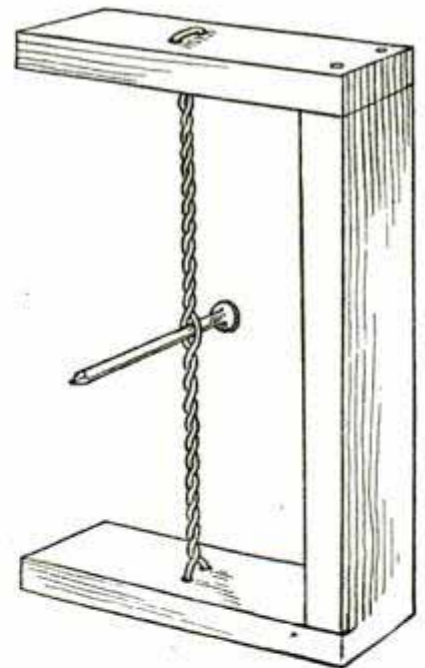

☞ While camping, remember a hot stone wrapped up makes an excellent substitute for a hot-water bag.

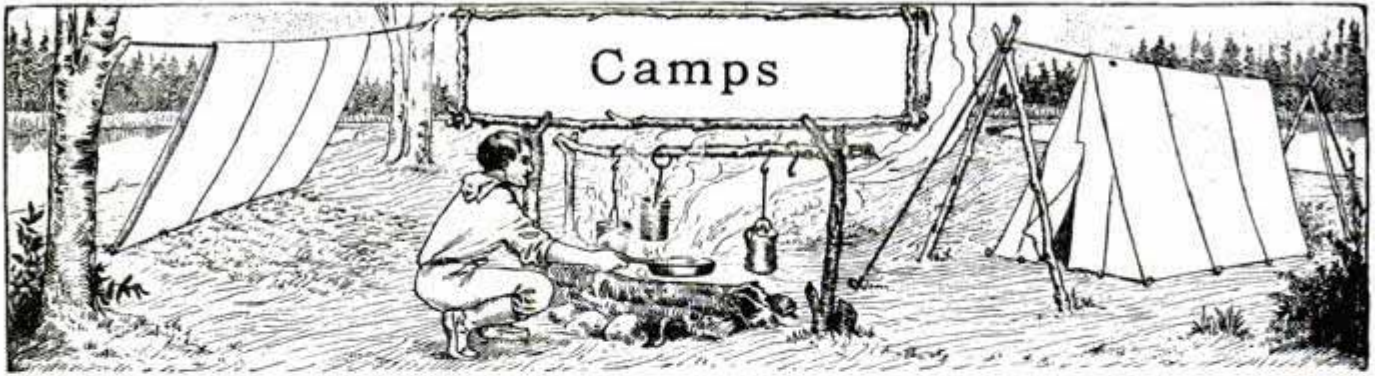

By F. S. CHARLES

A good site, pure water in abundance, and a convenient fuel supply, are the features of a temporary camp that should be given first consideration when starting out to enjoy a vacation in the woods. The site should be high and dry, level enough for the tent and camp fire, and with surrounding ground sloping enough to insure proper drainage. A sufficient fuel supply is an important factor, and a spot should be chosen where great effort is not required to collect it and get it into proper shape for the fire.

When locating near streams of water be careful to select a spot above

If the camping party consists of more than two persons, each one should do the part allotted to him, and the work will be speedily accomplished. Remember that discipline brings efficiency, and do not be slack about a camp just because it is pleasure. One of the party should attend to the camp fire and prepare the meals while another secures the fuel and water. The tent can be unpacked and the ground cleared by the other members of the party, and when ready, all should assist in raising the tent, especially if it is a large one.

#### Tents

An ordinary A or wedge tent is sufficient for one or two campers. Where you do not wish to locate permanently, this tent can be set up and taken down quickly. It should have a ring fastened to the cloth in each peak through which to pass a rope or line to take the place of a ridge pole. Such a tent can be pitched be-



Wall Tent

high water mark so the ground will not be overflowed by a sudden rise of the stream. Do not select the site of an old camp, as the surroundings are usually stripped of all fuel, and the grounds are unclean.

#### Division of Work

Clear the selected spot and lay out the lines for the tent, camp fire, etc.



Lean-To of Boughs



Log Cabin





Fire between Two Logs



Fire Built against a Log

tween two trees or saplings, and, after tying the rope to the trees, it can be tightened with a long forked stick, placed under one end of the rope. If two trees are not conveniently located, then two poles crossed and tied together will make supports for one or both ends, the ridge line running over them and staked to the ground.

On a chilly night, the A tent is quite advantageous. The stakes can be pulled on one side and the cloth doubled to make a lean-to, open on the side away from the wind. A fire can be built in front and the deflected heat on the sleeper will keep him comfortable and warm.

For larger parties, the wall tent with a fly is recommended. These tents can be purchased in various sizes. The fly is an extra covering stretched over the top to make an open air space between the two roofs. It keeps the interior of the tent delightfully cool in hot summer weather and provides a better protection from rain. The fly can be made extra long, to extend over the end of the tent, making a shady retreat which can be used for lounging or a dining place.

#### Protection from Insects

Where mosquitoes and other insects are numerous, it is well to make a second tent of cheesecloth with binding tape along the top to tie it to the ridge pole of the regular tent. The sides should be made somewhat longer than the regular tent so that there will be plenty of cloth to weight it down

at the bottom. This second tent should be made without any opening whatever. The occupant must crawl under the edge to enter. The cheesecloth tent is used inside of the ordinary tent, and when not in use it is pushed aside.

Two camps are illustrated showing the construction of a lean-to for a temporary one-season camp, and a log cabin which makes a permanent place from year to year. (A more elaborate and more expensive camp was described in the May issue of this magazine.) The construction of these camps are very simple. The first is made of poles cut in the woods. A ridge pole is placed between two trees or held in place with poles of sufficient



Forked Sticks Supporting Cooking Utensils

length, set in the ground. Poles are placed on this at an angle of about 45 deg., forming a lean-to that will be en-

tirely open in front when finished. The poles are covered, beginning at the bottom, with pine boughs, laid in layers so as to make a roof that will shed water. A large fire, built a short distance from the open front will make a warm place to sleep, the heat being reflected down the same as described for the A tent.

#### A Permanent Camp

A good permanent camp is a log cabin. This can be constructed of materials found in the woods. Trees may be felled, cut to length, and notched to join the ends together at each corner so as to leave little or no space between the logs. The roof is constructed of long clapboards, split from blocks of wood. The builder can finish such a camp as elaborately as he chooses, and for this reason the site should be selected with great care.

#### Camp Fires

There is no better way to make a camp fire than to have a large log or two against which to start a fire with small boughs. Larger sticks can be placed over the logs in such a way as to hold a pot of water or to set a frying pan. Forked sticks can be laid on the log and weighted on the lower end with a stone, using the upper end to hang a cooking vessel over the flames. Two logs placed parallel, with space enough between for the smaller sticks, make one of the best camp cooking ar-

rangements. Two forked sticks, one at each end of the logs, may be set in the ground and a pole placed in the forks lengthwise of the fire. This makes a convenient place for hanging the cooking utensils with bent wires.

#### Food Supplies

The conditions in various localities make a difference in the camper's appetite and in consequence no special list of food can be recommended, but the amount needed by the average person in a vacation camp for two weeks, is about as follows:

Bacon.....	15 lb.	Baking Powder.....	½ lb.
Ham.....	5 "	Sugar.....	5 "
Flour.....	20 "	Beans.....	4 "
Corn Meal.....	5 "	Salt.....	2 "
Rice .....	5 "	Lard.....	3 "
		Coffee.....	3 lb.

A number of small things must be added to this list, such as pepper, olive oil, sage, nutmeg and vinegar. If the weight is not to be considered, canned goods, preserves, jam and marmalade, also vegetables and dried fruits may be added. Do not forget soap and matches.

Food can be kept cool in a box or a box-like arrangement made of straight sticks over which burlap is hung and kept wet. This is accomplished by setting a pan on top of the box and fixing wicks of cloth over the edges. The wicks will siphon the water out evenly and keep the burlap wet.

#### A Drinking Tube

When on a walking tour through the woods or country, it might be well to provide a way to procure water for drinking purposes. Take with you several feet of small rubber tubing and a few inches of hollow cane of the size to fit the tube.

In one end insert the cane for a mouthpiece, and allow the other end to reach into the water. Exhaust the air from the tube and the water will rush up to your lips.—Contributed by L. Alberta Norrell, Augusta, Ga.

#### Washing Photographic Prints

The usual way of washing photographic prints is to place them in a shallow tray in which they will become stuck together in bunches, if they are not often separated. A French magazine suggests that a deep tank be used instead, and that each print be attached to a cork by means of a pin stuck through one corner, the cork thus becoming a float which keeps the print suspended vertically, and at the same time prevents contact with its nearest neighbor.

**A Rotary Tuning Coil**

The rotary tuner shown in the sketch was designed by a correspondent of Modern Electrics. The circle is cut

shown by the dotted lines in the sketch. This will enable the player to quickly turn the pages one at a time.—Contributed by Chas. Homewood, Waterloo, Ia.

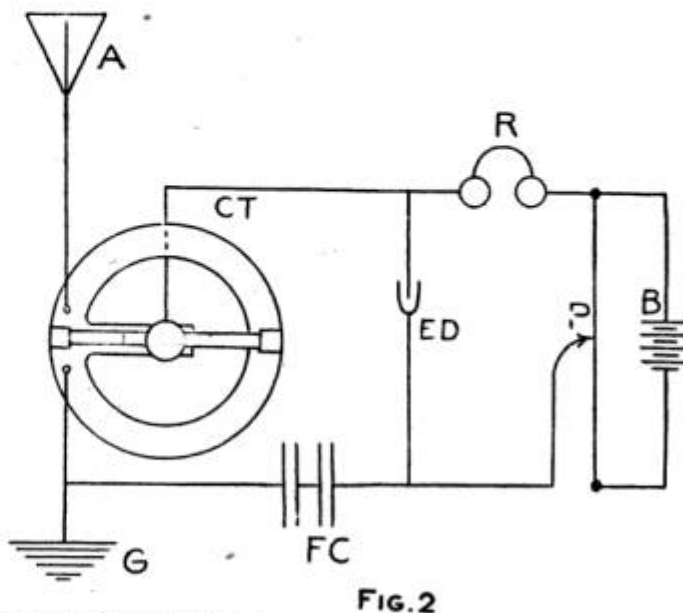
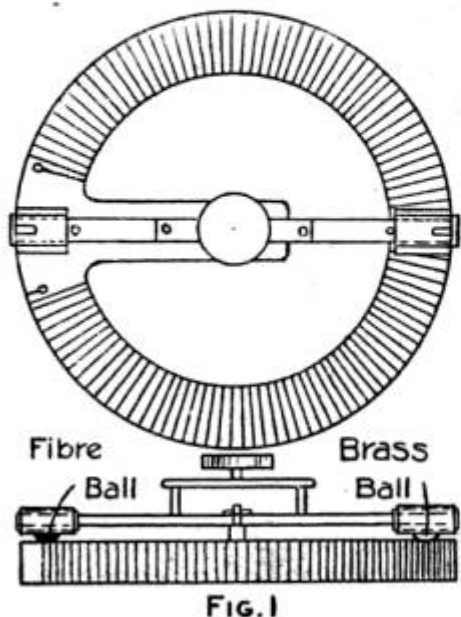

Tuning Coil and Wiring Diagram

from 3/4-in. stock, 1 in. wide and well covered with insulating material. It is then wound with No. 24 single cotton-covered copper wire so that the coils will lie flat. All the arms are of 1/4-in. square brass. The supports are smaller in section. Sliders are mounted on the ends of the long arms and are kept in place by setscrews.

The insulation on the wire is removed with a small piece of sandpaper pasted on a block of wood. This should be temporarily fastened to the revolving lever at the point where the contact is wanted, then the lever is turned until the insulation is removed. The wiring diagram shows the location of the tuning coil in the line.

**Preparing Sheet Music for Turning**

Each page on sheet music having three or more pages should be cut 1/4 in. shorter than the preceding page, as

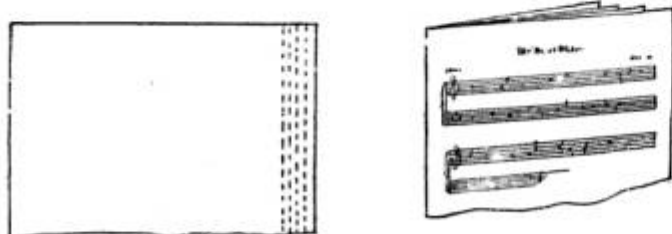

Leaves Cut for Turning

**Toy Parachute Cut-Away for Kite Liner**

An interesting pastime while flying kites is to attach large toy parachutes to the lines and have some device to drop them when they are at a great

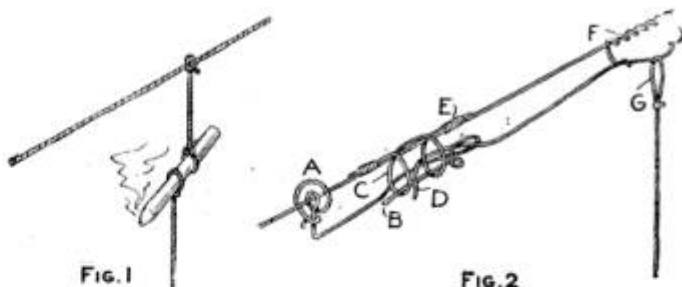

Two Parachute Drops

height. In Fig. 1 is shown how the parachute is dropped by the burning of a piece of punk.

Another method is shown in Fig. 2. It is only necessary to send a piece of paper or cardboard along the line and when it strikes the wire coil A (Fig. 2) the part B slides out of the loops C, the end D will then fall and disengage the loop G on the end of the parachute string. The wires E and F are twisted around the kite string.—Contributed by Thos. De Loof, Grand Rapids, Michigan.

## Wood-Working for Beginners

Making a Cabinet — Typical Form for Elementary Cabinet Construction —  
Door and Drawer Construction

By IRA S. GRIFFITH

## CHAPTER XVI

In Fig. 111 is shown the perspective drawing of a cabinet that embodies in its construction the elementary principles of cabinet construction. This

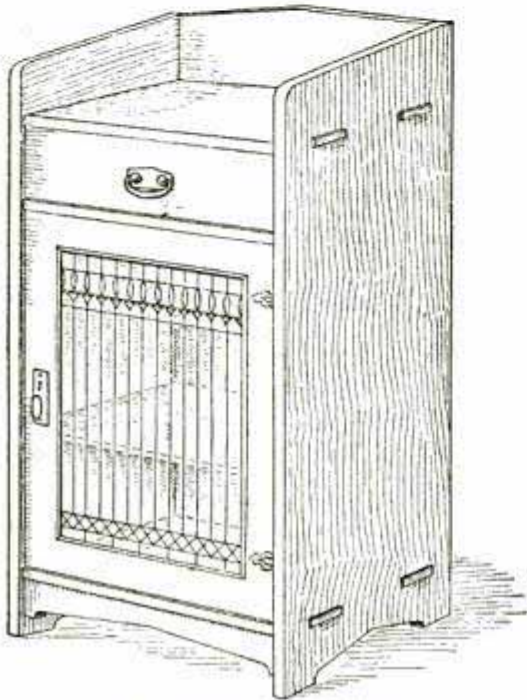

Fig. 111 — The Cabinet

cabinet is intended primarily for holding music, either sheet or roll, but it will serve as a curio case equally well. Figure 112 gives the necessary dimensions for the case.

Square up the two sides and shape the ends. Square up the three shelves and work the tenons. The mortises in the sides may then be laid out and worked. These joints, including the dadoes of the stationary shelf next the top shelf, are laid out and worked in a manner similar to those joints in the magazine stand of Chapter XIV, the key and its mortise omitted of course. The two shelves of  $\frac{1}{2}$ -in. stock shown in Fig. 112 are to be movable and to be worked later.

The back of the cabinet is to be a paneled frame and is to be set into the sides of the cabinet one-half their thickness. The sides of the cabinet will, therefore, have to be rabbeted ac-

cordingly. A rabbet or rebate is a rectangular recess cut along the edge of a board. Figure 113 shows the rabbeted side of the cabinet. Rabbeting may be done with a chisel, the sides of the rabbet being first gauged deeply with the marking gauge. The manner of loosening up or scoring the waste of the rabbet preparatory to paring the sides with the chisel is shown. If the rabbet does not run full length as in Fig. 113, the chisel and gauge must be used. The rest of the rabbet can be worked more advantageously, however, by means of a combination plane, shown in Fig. 22, Chapter V. This plane has a guide or fence which can be adjusted so as to hold the cutter on the board at the proper distance from the edge. It also has a stop which can be set and thus cause the cutter to cease cutting when the desired depth has been reached. With these guides, no gauge line is necessary. In a rabbet like this one, the practical cabinet-maker would hardly take time to make a stopped rabbet, but would rabbet the full length of the side with the plane. Of course the

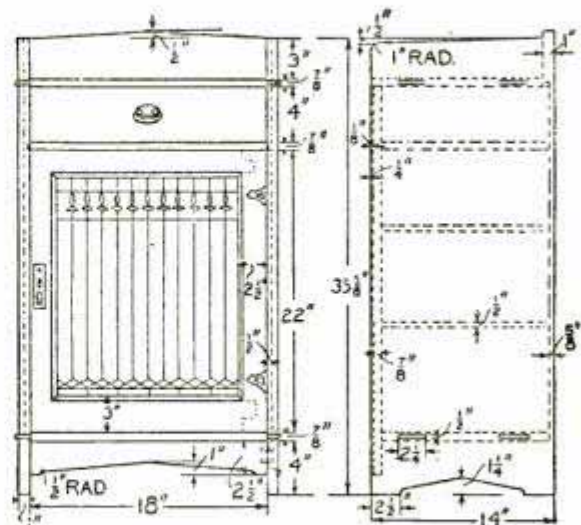

Fig. 112 — Cabinet Details

lower part of the rabbet will not be filled by the panel, but it will not be visible from the front.

## Directions for Making Panel

The top backing of 1-in. stock may next be shaped after which the back paneling is to be made. The stiles and rails of this paneling are to be made of  $\frac{5}{8}$ -in. stock. The panel proper is to be of  $\frac{7}{16}$ -in. stock. Figure 114 shows the detail. This is what is known as a flush panel, the panel being rabbeted on one side so that that side shall be flush or even with the frame. In making this panel, get out the stock for the rails and stiles about  $\frac{1}{4}$  in. wider than the drawing calls for and somewhat longer. This is to make it possible to plane and fit the frame in place. In ripping their width, take pains to get them all to a uniform excess over the width called for. Work a face edge on each piece and plow a groove the full length of each as indicated in the cross-section of Fig. 114. Use the combination plane, ad-

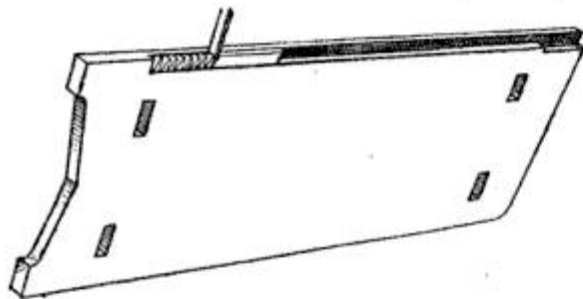

Fig. 113—Cutting a Rabbet

justing it suitably. Lay off on the two rails the proper distance between the shoulders, and, using these as shoulder lines, lay out tenons that shall fit the grooves just made as mortises. Cut these tenons. Work the panel to size and rabbet the edges as called for by the drawing. If the lumber is well seasoned, it will be necessary to make the panel slightly smaller in width than the dimensions given to allow for swelling. Nothing need be allowed in length, for wood does not shrink appreciably along the grain. Get the bar clamps ready, mark the proposed location of the rails on the stiles, so that no time need be lost after the glue is applied, then glue the tenons and assemble the panel with its frame. Do not place any glue on the panel edge, unless it be a slight touch at either end in the middle. The panel

must be free to move in the groove with the swelling or shrinkage, or it will split. The touch of glue at the

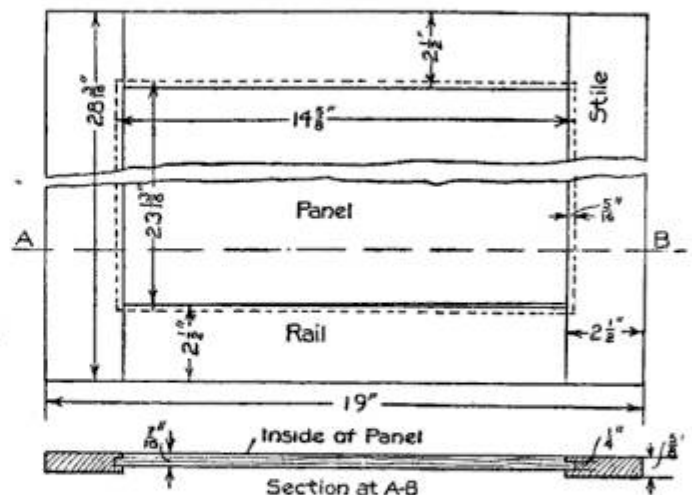

Fig. 114—Detail of Door

center of the ends is to hold the panel centering as it swells or shrinks. Place the clamps over the rails and adjust the blocks so that the pressure leaves the surface of the panel and frame level and out of wind. Test the panel with a straightedge crosswise and diagonally, or sight across it with the eye.

This is a common way of making the frame for a panel and answers very well where the four sides of the frame are to be supported as in this case. On a door, however, stub tenons using the grooves as mortises would not be strong enough. In this case, a deeper mortise and a longer tenon would be necessary. To make it possible to plow the full length of the rails and stiles, the tenon is shouldered as in

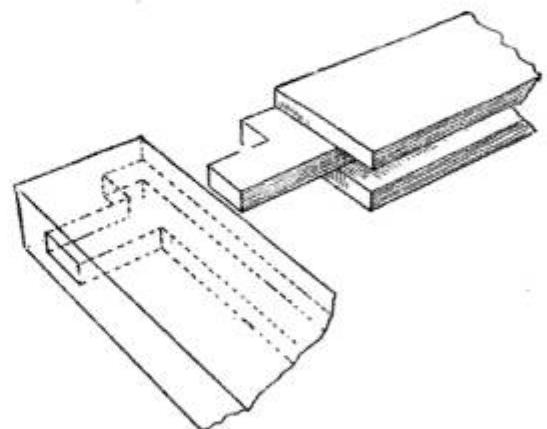

Fig. 115—Shouldered Tenon Joint

Fig. 115. This is what is known as a haunched tenon-and-mortise. Mortise and tenon are made first and the

grooves plowed afterward, the tenon and mortise being given the same thickness and location as the groove.

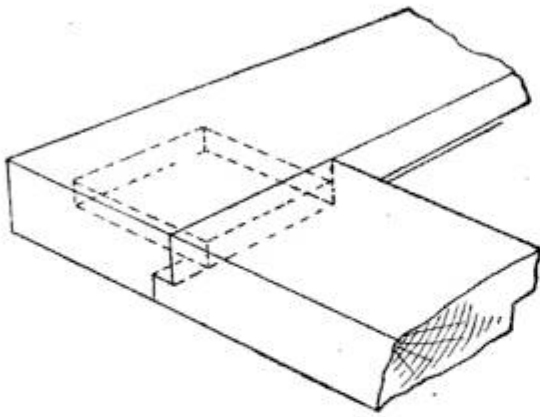

Fig. 116—Shouldered Tenon Joint for Glass Panel

#### Doweling Front Brace

Shape the lower edge of the front brace, square the ends, then dowel them. After this, the surfaces of the parts already worked may be smoothed and these parts put together. The tenons of the horizontals and the doweled ends of the front brace are to be glued with good hot glue, but the entire backing should be fastened with screws.

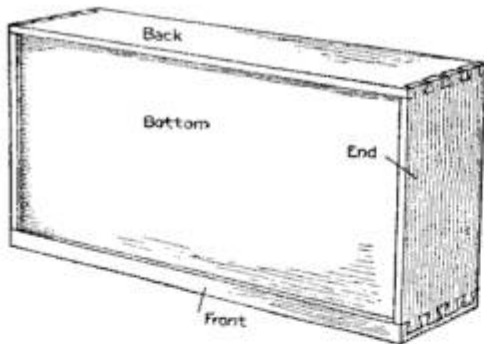

Fig. 117—Two Styles of Drawers

#### Directions for Making Door

There remains to be made the drawer, door and shelving. The door

may be made with a wood panel, in which case it will be worked by methods similar to those used on the back panel. It will not be necessary to use a flush panel. Use one with a thickness equal to the width of the grooves. The haunched tenon-and-mortise should be used. If an art-glass panel is to be used, as shown in the perspective drawing, it will be necessary to work the joints at the corners of the frame a little differently. Saw out the stiles and rails, as in the back panel, making them somewhat wider and longer than the dimensions of the drawing, but of uniform excesses. Plane face edges and lay out mortises and tenons on them as in Fig. 116—tenons on the rails and mortises on the stiles. The size and location of these will depend upon the rabbet or recess that is to be made to receive the glass.

It will be noticed that one shoulder of the tenon is worked enough longer than the other that it may extend to the bottom of the rabbet. This makes it possible to rabbet the full length of both stile and rail with the plane. Work the joints and then rabbet the edges. Glue the tenons and mortises and clamp the frame, sighting for wind and adjusting the clamping blocks so as to leave the door square and true.

#### Directions for Making Drawer

While the glue on the door is hardening, the drawer may be made. Figure 117 shows two styles of drawers. The first is easier to make but the second, the one with dovetail joints, is better and is the style used on fine cabinet work. Drawer fronts are usually thicker than the rest of the drawer stock. While the front is always of the same kind of material as the rest of the cabinet, the sides, back and bottom are usually of some close-grained wood such as yellow poplar. To make either style of drawer, get out the requisite number of pieces of the thicknesses necessary. Square them to size. The length of the drawer should be  $\frac{3}{16}$  in. less than the place in which it is to slide. This is

to allow for swelling. The drawer front, however, may be squared up to a length equal to that of the opening, allowing its ends to project beyond the sides of the drawer. This will allow fitting the front without having to plane the sides of the drawer. Plow the grooves in which the bottom is to rest in the front and sides, also in the back of the dovetailed type. Lay out and cut the dados in the sides, into which the back is to be placed in the ordinary type, then the rabbeted corners on the drawer front. In this type the back of the drawer rests upon

the drawer bottom. In the dovetail type, the back of the drawer is the same width as the front. The dovetails are to be laid out and worked. The dovetail at the front is known as a half-blind dovetail and that at the back as a multiple plain dovetail. Of course the half-blind dovetail might be used at the front with the dado construction at the back as in the first type of drawer. It is very important to follow the rule about placing the faces, face sides being turned in so as to make the members of the joints fit face to face.

(To be continued)

### Back Rest for Use on Beaches

The rest consists of two sets of sticks fastened together with a small bolt shown at A in Fig. 1. Two heavy cords are run through the holes B B and knots tied in their ends to keep them from slipping through. A piece of canvas is sewn on the cords to form a back. In use the pointed ends of the sticks are pushed into the sand.

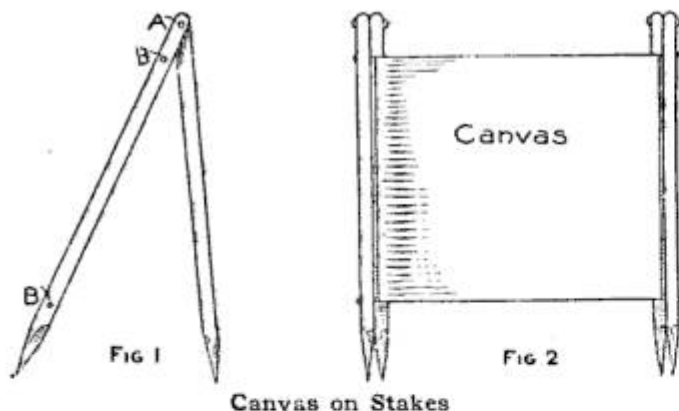

Canvas on Stakes

When not in use, it is rolled up into a small bundle.—Contributed by James E. Noble, Toronto, Can.

### How to Tighten a Curtain Roller Spring

A common table fork can be used to hold the little projection on the end of a curtain roller for tightening the spring. Hold the fork firmly with one hand while turning the roller with the other. Do not let go of the fork until

the little catches are set in position to prevent the spring from turning, or else



Holding Spring with Fork

the fork may be thrown off with dangerous force.

### An Egg-Shell Funnel

Bottles having small necks are hard to fill without spilling the liquid. A funnel cannot be used in a small opening, and pouring with a graduate glass requires a steady hand. When you do not have a graduate at hand, a half egg-shell with a small hole pricked in the end will serve better than a funnel.



Place the shell in an oven to brown the surface slightly and it will be less brittle and last much longer.—Contributed by Maurice Baudier, New Orleans, La.

## INTERESTING PATENTS

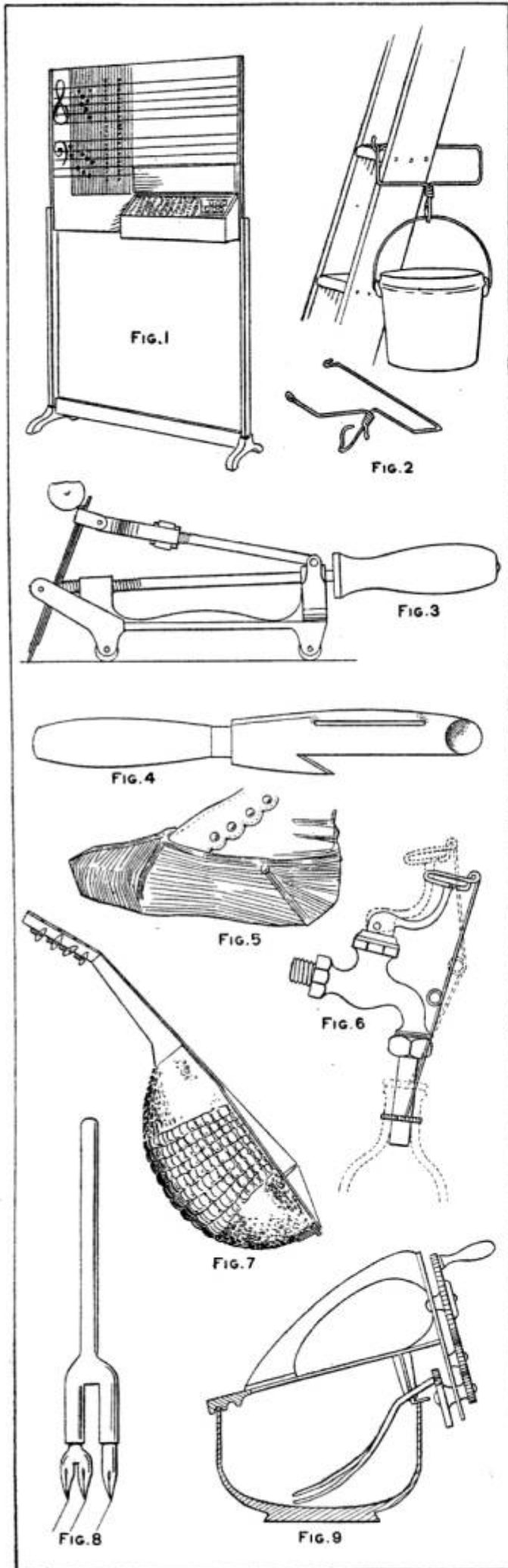

**KEY-CONTROLLED MUSIC INSTRUCTION BOARD**—This board (Fig. 1) is a simple and efficient accessory in the teaching of sight-singing and ear-training in schools, enabling the teacher to simultaneously present to view all the notes and signs of any chord, in any key, with the same facility with which he would strike them on the piano. It consists of a rectangular wooden black-board, about 3 ft. by 4 ft., bearing treble and bass staves. This board may be attached to a wall, or be supported by a stand. On the face of the board near the left side is a plate-glass panel, 15 in. wide. This is painted black on the inside and has several series of light openings, in which the various signs are made to appear white on movable black cardboard strips. To the right on the board, at the bottom, is a projecting case containing the keyboard, and rotary pegs suggestive of the stops on an organ. The keys, resembling those of a typewriter, stand in sets of six, each set corresponding to a degree on the staff. The six keys of each set operate differentially on a common lever; thus the nearest key will press the lever far enough to bring only the proper note into view on the panel, the second key presses it farther and produces the note with a sharp in the light opening before it; the third key presses it still farther, showing the note with a flat, and so on through the set.

**PAINTER'S AUTOMATIC LOCKING POT-HOOK**—Figure 2 is an automatic, adjustable, safety-locking pot hook, from which the pot cannot be detached without the hook being detached from the ladder, thus assuring that the pot will not be shaken off accidentally. With this device, the pot hangs at the side of the ladder where it may be easily reached, instead of hanging between the uprights.

**FLOOR-SCRAPER**—A small and simple one-hand-operated floor-scraper is shown in Fig. 3. The scraper blade is mounted on the front of a little truck about the size of a roller skate, at the back of which is a handle, for use in pushing the device back and forth over the floor.

**COMBINATION KNIFE**—Figure 4 is a knife designed for several uses. The outer end of the blade terminates in a rounded cup-like arrangement. The intermediate portion of the blade near one edge is slotted, one of the edges thus provided being used for paring and the other as a guard. The opposite side of the blade has a pointed lug with sharp inner edge for use as a can-opener.

**DUST MOCCASIN**—The moccasin shown in Fig. 5 is designed to protect the lower portion of the shoes from dust when riding. It is formed of a thin material, drawn over the shoe and fastened by means of hooks and eyes.

**BOTTLE-FILLING ATTACHMENT FOR BIB-FAUCETS**—Figure 6 shows a device for automatically starting and shutting off the water flow of a bib-faucet in filling milk bottles. The parts consist of a short nipple fitted to the end of the faucet, a clamp for the faucet handle, and a rod connecting the clamp with a ring that fits over the nipple. The connecting rod has a coil in the center so as to enable it to adapt itself to the changing angles. In filling a bottle, the neck is slipped over the nipple, and, coming in contact with the ring, pushes it up, thus lifting the faucet handle and allowing the water to flow. When the bottle is removed, the faucet closes by pressure from its own spring.

**ARMADILLO MANDOLIN**—An inventor in San Antonio, Tex., has just received a patent on a mandolin (Fig. 7) having the bowl formed of the armor-like carapace of the armadillo, with a sounding-board united to the edges of the carapace.

**DOUBLE PENHOLDER**—A double penholder, designed for ledger work, is shown in Fig. 8. The holder has a U-shaped ending, in which may be inserted a double and a single pen when three lines are to be drawn, or two single pens.

**EGG-BEATER**—Figure 9 is a crank-turned egg-beater which has practically the same movement as a fork in hand-beating.



## PRACTICAL OR UNIQUE

**IMPROVED RAIL JOINT FOR TRACK SCALES AND TURNABLES**—An improved rail joint for use in connection with draw and lift bridges, turntables, and track scales especially, is shown in Fig. 10. When an open joint is used in connection with the latter, a severe pound on the scale is caused by the cars as they pass over, and it is to ease this pounding that the new joint was designed. The ball of the approach and scale rails are planed off on the outside, even with the web, after which the "easer" is bolted firmly to the approach rail, allowing a  $\frac{3}{8}$ -in. space between the side of the scale rail and the "easer joint," which is said to give ample room for movement of the scale. The "easer" being about  $\frac{1}{8}$  in. higher where the approach and scale rails meet, the car wheels are practically lifted over the open space and allowed to land on the scale without perceptible jar or pound.

**BILL-DELIVERY MECHANISM FOR GAS METERS**—A meter designed to present you with the bill for the amount consumed during the month is shown in Fig. 11. It is a combination, with meter gearing, of a recording wheel, a gear wheel for intermittently advancing the recording wheel, and means for moving the recording wheel bodily to take a record therefrom.

**SURGICAL NEEDLE**—Figure 12 is a surgical needle provided with a cylindrical, tubular handle, in which is held a fluid receptacle containing the thread to be used in the operation. The thread passes out of the receptacle by means of a passage in the cap.

**REVERSIBLE TROLLING BAIT**—In trolling, the revolutions of the artificial minnow used as bait will, despite the fact that it is attached to the line by means of a swivel, twist the line more or less, and sometimes to such an extent that it becomes useless. The artificial minnow shown in Fig. 13 is designed to overcome this trouble. Instead of being made in one piece with the fin-like propeller blades solidly attached to the body, it is made in three parts, and two sets of fins, designed to revolve in opposite directions, are furnished with it. When, after trolling for some time, the line becomes too twisted, the set of fins in use is removed, and the other set takes its place, the exchange being easily made. Thus, provided with fins whirling in the opposite direction, the line is gradually untwisted, then retwisted again, necessitating another change of fins later.

**WEIGHING WAGON**—A wagon which weighs as well as carries its load, thus saving the user the necessity of driving to a public scale, is shown in Fig. 14. The scale is instantly thrown into or out of action by turning the wheel under the driver's foot-board.

**TEAKETTLE**—A teakettle provided with a spout on one side and a filling extension at the opposite is illustrated by Fig. 15. A rod, mounted in a tube on the top of the kettle, and provided with a knob, opens and closes the cover of the filling extension by being slid back and forth.

**BLINDER TO STOP RUNAWAY HORSES**—The instruction accompanying this unique device (Fig. 16) is, "Pull up the curtain when the horse is running away." The device is a safety bridle comprising a doubled leather noseband formed with a receiving pocket, loops and a strap, and connected cheek pieces provided with side rods. Normally accommodated within the pocket is a semi-transparent, light-impeding curtain, which, sliding on the side rods, is drawn up over the horse's eyes by means of the safety reins when the animal attempts to run away.

**COMBINED FISHING FLOAT AND FLASH SIGNAL**—Figure 17 is a fishing float provided with a battery and an electric lamp which flashes when a fish is caught. The pull of the fish on the line brings the rod into action and makes the contact required to flash the lamp.

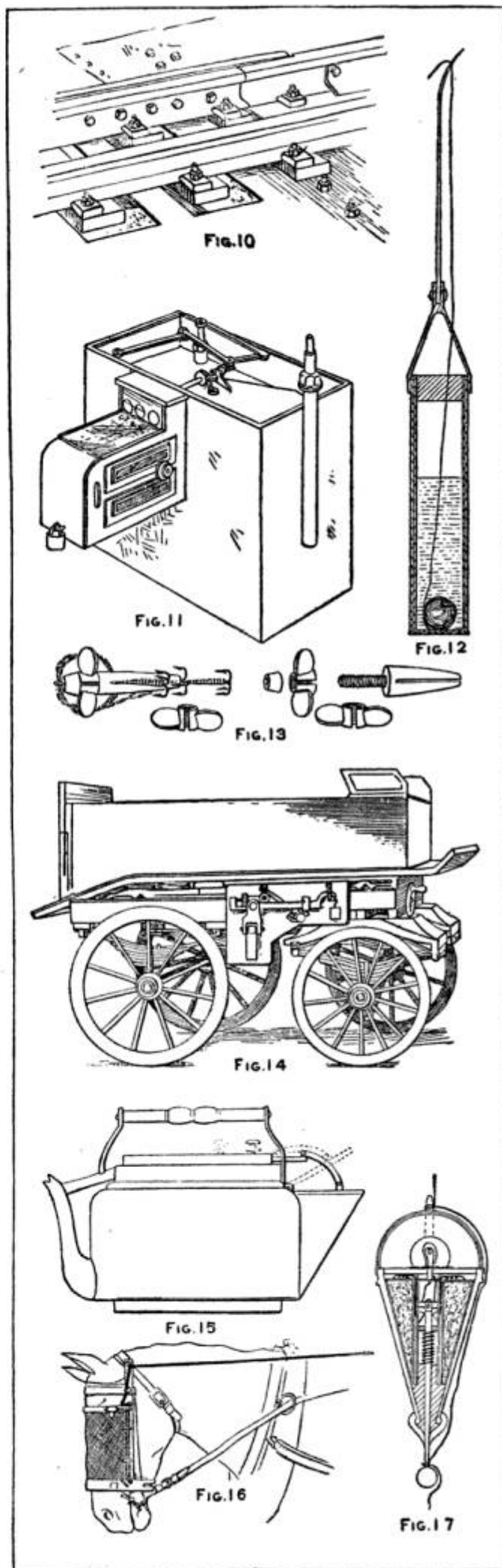

A stuttering man was arraigned before a magistrate.

"What is your name?" asked the magistrate.

"S-s-s-s-siss-s-s-s-s," began the prisoner, and then stopped.

"What's that?" demanded the magistrate.

"S-s-s-s-sis-s-s-s-s" hissed the stutterer.

"His name's Sisson," interrupted the policeman who had made the arrest. "He stutters."

"So it seems," said the magistrate. "What's he charged with?"

"I don't know, your Honor," said the policeman, "it seems to be soda water."—*Railway Age Gazette.*

We observe that the man's fingers are all twisted and bent into the most uncouth shapes.

"Poor fellow!" we say to our friend. "Evidently he is a victim of rheumatism."

"No," our friend explains. "He is deaf and dumb and has been trying to talk Scotch dialect on his fingers."

Mary had an aeroplane,

With wings as white as snow;

They're picking up the pieces now,

Because it wouldn't go.

A man entered a drug store in a hurry and asked for a dozen two-grain quinine pills.

"Shall I put 'em in a box, sir?" the clerk asked as he counted them out.

"Oh, no," replied the customer, "I want to roll them home."

"Why, I declare!" exclaims the trusting wife, "I won't have to buy any new dresses or hats all this spring!"

"You won't?" asks the crafty husband. "Surely you will need something."

"Not a thing. I've been looking through this month's fashion magazine that you brought home for me, and I find that there isn't the slightest change in style from last spring."

And the crafty husband, gloating over the success of his scheme to paste a this year's cover on a last year's magazine, leans back in his chair and smokes.—*Atlantic City Gazette.*

"Why, Willie, what are you drawing?" asked a teacher of one of his scholars.

"I'm drawing a picture of God."

"But, Willie," said the teacher, "you musn't do that; nobody knows how God looks."

"Well, they will when I get this done," said Willie.—*Marine Journal.*

It was a hot evening following a regular scorcher of a day, and Casey and the family were sitting out on the front porch trying to keep cool.

"Sure, t'was an awful day in the kitchen," said Mrs. Casey.

"I have t' smile when I hear ye complainin' about the heat, for, as a matter iv fact, ye don't know what heat is," said Casey.

"Oh, I don't know," said Mrs. Casey. "Sure I'd change places with you any day, for while I'm workin' over a hot cook-stove all day I'm thinkin' iv th' fine picnic you're havin' workin' down there in that nice cool sewer."

Innocent Bystander—I thought you fellows were striking for higher pay.

Workman—We are, but the strikebreakers they hired to break the strike are striking for higher pay, so they've hired us strikers to break the strike of the strikebreakers. See?—Puck.

"How large is the apartment house you live in?"

"Well, I don't remember the exact dimensions," replied Mr. Flatson, "but it's so big that when we asked the janitor for heat on Sunday morning steam didn't get around to the radiator till the next Thursday."—*Domestic Engineering.*

A sea captain and his mate went ashore on getting into port and made for the nearest restaurant.

They ordered soup; when it arrived, the captain examined the curious-looking fluid and shouted: "Here, waiter, what d'ye call this?"

"Soup, sir," said the waiter.

"Soup," said the captain, turning to the mate; "blame me, Bill, if you and me ain't been sailin' on soup all our lives and never knowed it."

## NEW BOOKS

**PRINCIPLES AND DESIGN OF AEROPLANES**—By Prof. Herbert Chatley, B. Sc. A simple little treatise which explains by the aid of some elementary mathematics the fundamentals underlying the problems of mechanical flight, and including descriptions of the successful devices adopted up to date in their solution. There is much that may be read with profit by the nontechnical reader. 100 pages, 3¼x6, cloth, illustrated, \$0.50. D. Van Nostrand Company, New York.

**QUESTIONS & ANSWERS for Automobile Students and Mechanics**—By Thomas H. Russell, A.M., M.E. A compendium of practical information on the automobile arranged in catechism form to impress the memory. 140 pages, 5½x7¾, flexible binding, \$1.00. Charles G. Thompson Company, Chicago.

**STORAGE BATTERIES**—By Prof. A. E. Watson, E.E., Ph.D. The second edition of this standard little treatise includes a description of the latest applications of the storage battery, besides a full exposition of the battery and its evolution. 166 pages, 4¾x7, cloth, illustrated, \$1.50. Bubier Publishing Company, Lynn, Mass.

**THE SUGAR BEET AND BEET SUGAR**—By Samuel Jodidi, Ph.D. A practical book for farmers who grow beets for sugar making. 76 pages, 4¾x7½, cloth, \$1.00. Beet Sugar Gazette Company, Chicago.

**HOW TO READ PLANS**—By Charles G. Peker. This book is intended as a guide to the ambitious workman who seeks to be competent to work direct from plans without waiting for detailed instructions. 104 pages, 4¾x7¼, cloth, illustrated, \$0.50. Industrial Book Company, New York.

**HOW IT FLIES**, or, the Conquest of the Air—By Richard Ferris, B.S., C.E. An easily read treatise which brings the subject down to the end of 1910. 475 pages, 5x7¼, cloth, illustrated, \$1.20 net. Thomas Nelson & Sons, New York.

**WEBSTER'S NEW INTERNATIONAL DICTIONARY**—The price of this work is from \$12.00 up (not \$10.00 as has been erroneously stated), according to binding. G. & C. Merriam Company, Springfield, Mass.

**MACHINE SHOP MECHANICS: The Why of Things in the Shop**—By Fred H. Colvin, A.S.M.E. A book that teaches the principles of mechanics and illustrates the same by showing typical applications in practice. Unlike most treatises on applied mechanics, it is not written "above the head" of the average workman. 177 pages, 4½x7, cloth, illustrated, \$1.00. McGraw-Hill Book Company, New York.

**ENGINEERING OF TODAY**—By Thomas W. Corbin. Tells in everyday English and in a most readable way the wonderful things that the engineer has done and is doing for the benefit of mankind. Many unique achievements are described, and not a little real information is imparted in sugar-coated form so as to command the interest of the most nontechnical reader. Cloth, illus., 367 pp. Price, \$1.50, net. J. B. Lippincott Co., Philadelphia, Pa.

**CONCRETE WALL FORMS**—By A. A. Houghton. No. 1 of Concrete Worker's Reference Books. 62 pages, paper, illustrated, 50 cents. Norman W. Henley Publishing Company, New York.

# SOME INVENTIONS WHICH WERE NEVER PATENTED

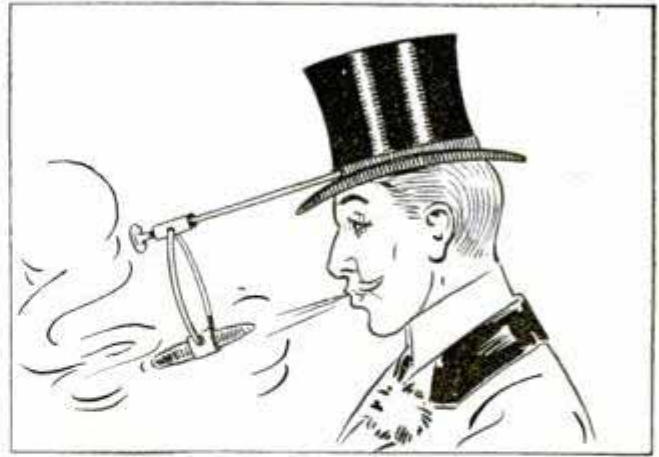
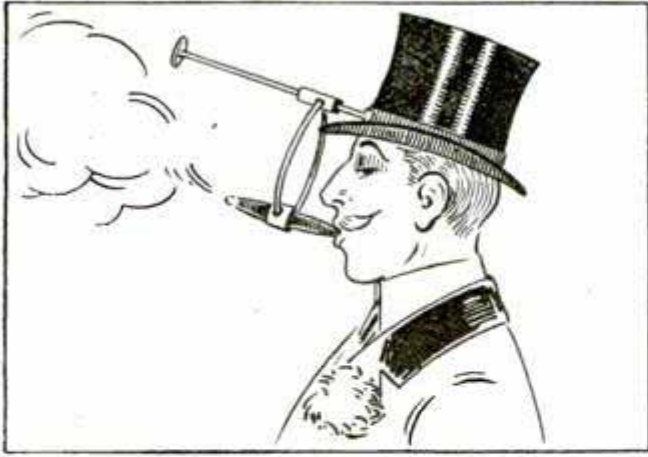

A suggested device, making it possible, by a slight motion of the head, to convey a cigar to the mouth and remove it therefrom, without taking the hands out of the pockets

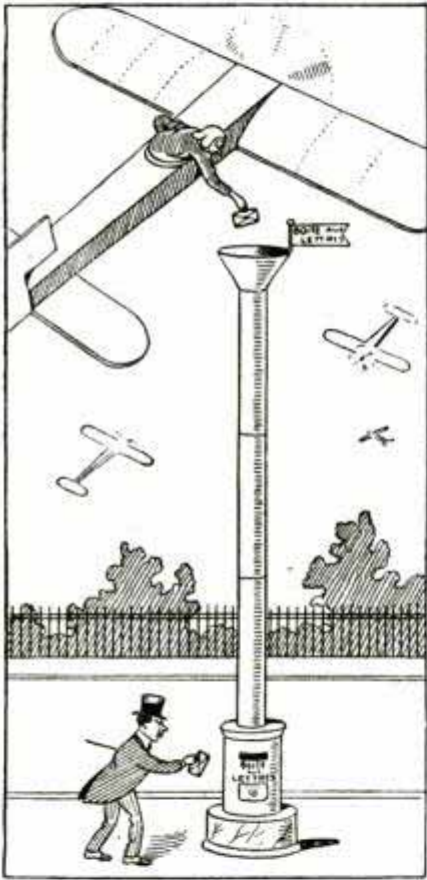

Design for a letter box of the future, dedicated to Postoffice Department



A scheme for artists overwhelmed with work — two pictures at the same time

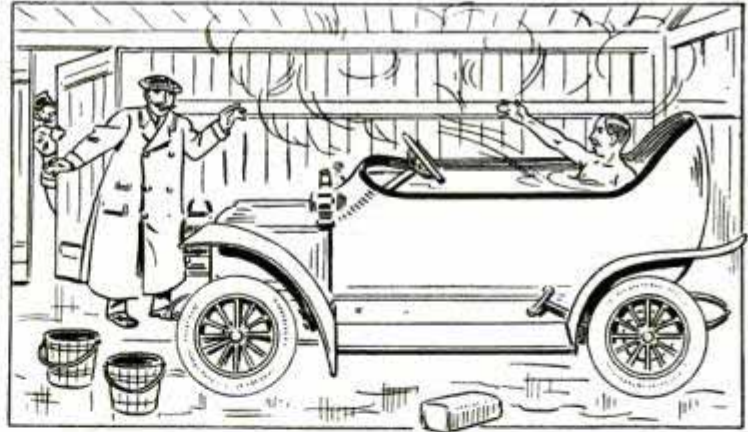

What's the use of buying an up-to-date auto if it cannot be turned to such healthful uses as this



A costume for aviators



Insuring a safe descent

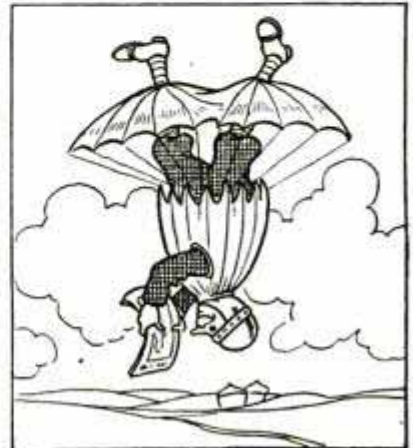

Even in case of turning over  
From Pêlè Mèlè, Paris



# About Remembering

by Elbert Hubbard



Without his notes he is helpless



The lessons you learn are rot unless you retain them by memory



He never misses a fact



FOR some long time I have been promising myself to write up my good friend, Mr. Henry Dickson of Chicago, and I have not forgotten.

Mr. Dickson is teaching a Science or System, whichever you choose to call it, which I believe is of more importance than the entire curriculum of your modern college.

MR. DICKSON teaches Memory.

Good Memory is necessary to all achievement.

I know a man who is fifty-five years old. He is a student. He is a graduate of three colleges, and he carries more letters after his name than I care to mention. But this man is neither bright, witty, clever, interesting, learned nor profound.

He's a dunce.

And the reason is that he **CAN NOT REMEMBER**. Without his notes and his reference literature, he is helpless.

This man openly confesses that he can not memorize a date or a line of poetry, and retain it for twenty-four hours. His mind is a sieve through which sinks to nowhere the stuff that he pours in at the top.



**EDUCATION** is only what you remember. The lessons that you study into the night and babble about the next day in class are rot, unless you retain them and assimilate them by the slower process of memory. You can not gulp and discharge your facts and hope that they will do you good. Memory only makes them valuable.

**EVERY** little while in business I come across a man who has a memory, a **TRAINED MEMORY**, and he is a joy to my soul.

He can tell you when, where, why, how much, what for, in what year, and what the paper said the next morning.

Like this man is another, the general manager of a great corporation in a Western City. He never misses a face. If he sees you once that's enough. The next time he'll call you by name, inquire about the folks at home, and ask if you have recovered from that touch of rheumatism.

He told me how he did it. He told me that he studied memory-training with Professor Dickson of Chicago. Also, he said a lot of nice things about Professor Dickson, that I hesitate to write down here lest my good friend Dickson object.



**THIS** Dickson System of Memory-Training, as I understand it, and I do understand it, is very simple. If you want to enlarge your arm to increase the power and strength of your muscle, you exercise it. The same with your mind.

You must put your brain through a few easy exercises regularly to discover its capacity. You will be surprised, when you go about it the right way, to know how quickly it responds to you.

To the man or woman whose memory plays you tricks, I especially recommend that you write to Professor Dickson to send you his literature. It will cost you nothing, and if his credentials and recommendations and the facts he sets forth, do not convince you, you are not to be convinced—that's all.

You do not know when you will be called to stand on your feet and tell what you know; then and there a trained memory would help you.



**YOU'VE** sympathized with the little girl who stuttered her "piece." But you've wept for the strong man who stammered and sucked air and gurgled ice-water and forgot, and sat down in the kindly silence. In the child it was embarrassment, but in the adult it was a bad memory.

Professor Dickson's System can give you a **BETTER MEMORY** because it is based upon right principles.

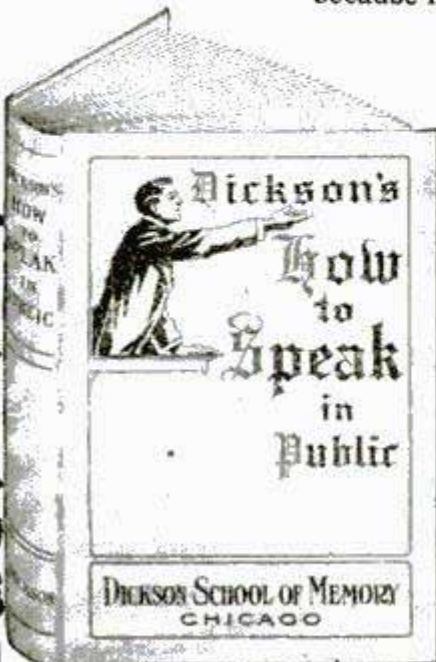

Write and ask Professor Dickson to tell you how he trains the memory. Fill out the Coupon or Postal and mail **TODAY**. It means success.

**How to Get a FREE Copy of This Book**

full of carefully selected material exactly suited to meet the needs of the man or woman who desires to be a successful public speaker. **SUCCESS** in Life depends on what you say and how you say it. This book of mine on Public Speaking and Self Expression is based on my 30 years of success as an instructor in Public Speaking in Chicago University, University of Notre Dame, and other well known schools. Taken in connection with my memory training, you can obtain a far better and more needful education than is afforded by many of the best universities. The price of this 1911 de luxe edition is \$2.00. I will, however, present a copy absolutely free to every student who enrolls for my course of memory training within ten days after reading this offer.

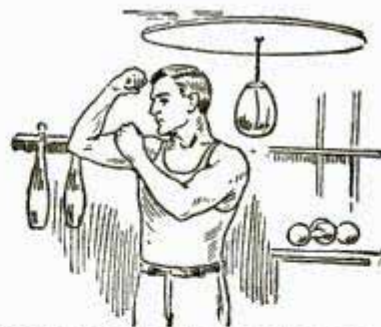

If you want to enlarge your arm, you exercise it. The same with your mind



The man whose memory plays tricks



The little girl who stuttered her piece



The strong man who stammered and sucked air and gurgled ice water and forgot.

De luxe edition, handsomely illustrated, richly bound. Is

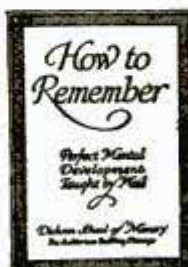

**PROF. HENRY DICKSON**  
Principal, Dickson School of Memory,  
705 Auditorium Bldg., CHICAGO, ILL.

Send me free Booklet "How to Remember," also full particulars how to obtain a free copy of "Dickson's How to Speak in Public."

NAME .....

STREET .....

CITY..... STATE.....

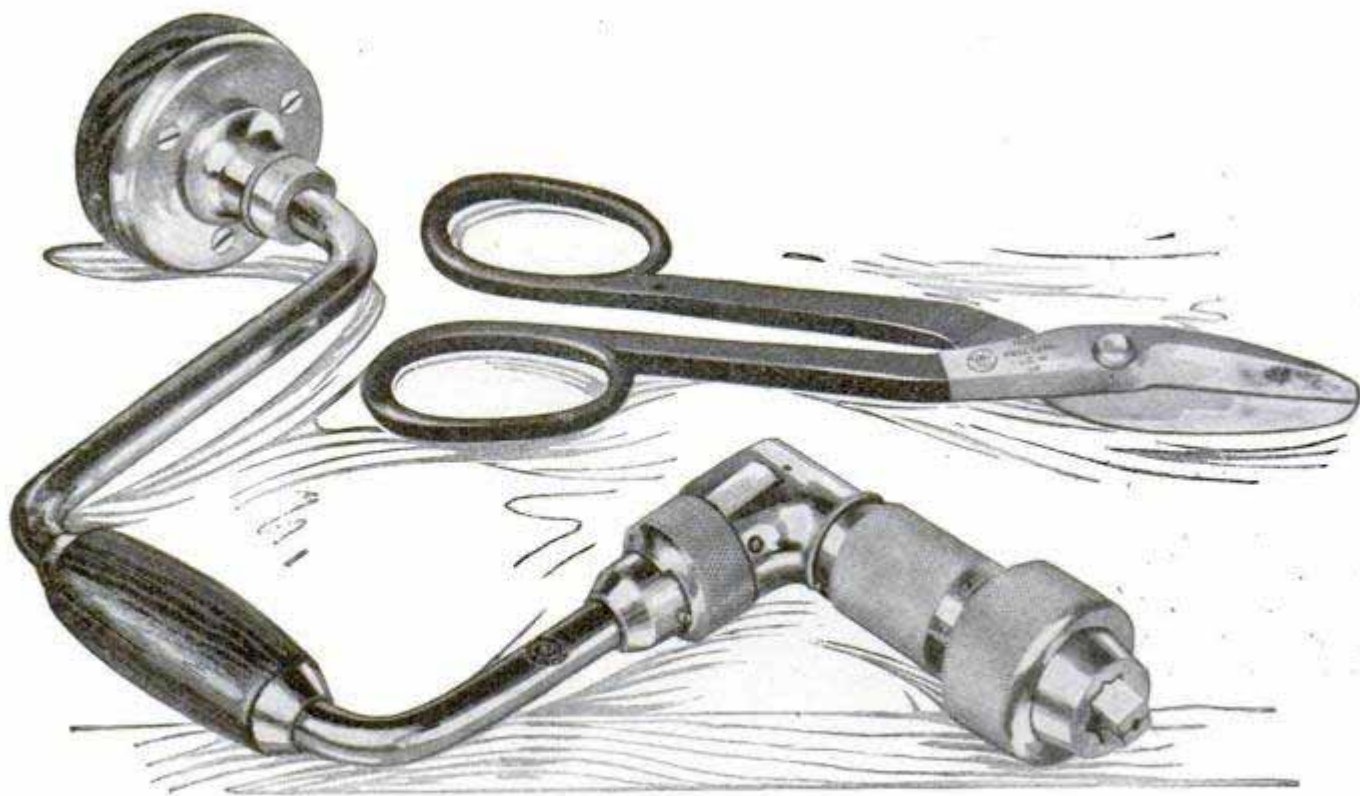

## Four Top-Notchers

Each of these four tools is the top-notch in a large line of guaranteed hand tools, made by us and stamped with our factory brand

### The MARK of the MAKER.

That mark is our Guarantee of Excellence to you and is put only on tools that are perfect in quality and workmanship and up to the high standard of over 90 years of manufacturing experience, ability and progress.

**THE SAMSON BRACE.** known to mechanics everywhere as the "Big Chuck Brace." It has the steel-clad head, alligator-jaw, and the Ball-bearing Chuck—the greatest of all improvements in brace-construction.

**THE No. 30 STAR RIVET, BOX-JOINT PLIER**—preferred by electricians everywhere because the joint works smoothly and easily, the cutting edges meet accurately and cut clean.

**THE SOLID-HANDLE WRENCH**—Head, bar, shoulder and handle-frame made of one piece of solid steel, case-hardened. The only other pieces are the sliding-jaw, screw and wood-facing of handle.

**THE 1819 ORIGINAL SNIP**—The first high-grade tinner's snip on the American market, and the best snip sold today. Made of the best Norway Iron, with special high-grade tool steel laid deep into the blade, increasing cutting power and long life.

Write today for your copy of the "Mechanics' Handy List," a 165-page book containing many pages of valuable shop-information and a catalog of over 200 Hand Tools for Carpenters, Machinists, Electricians, Tinsmiths, etc.

## The Peck, Stow & Wilcox Co.

MFRS. of the Largest Line of Mechanics' Hand-Tools Offered by any Maker

Address Correspondence to 20 Murray St., New York City

Established 1819

Five Large Factories

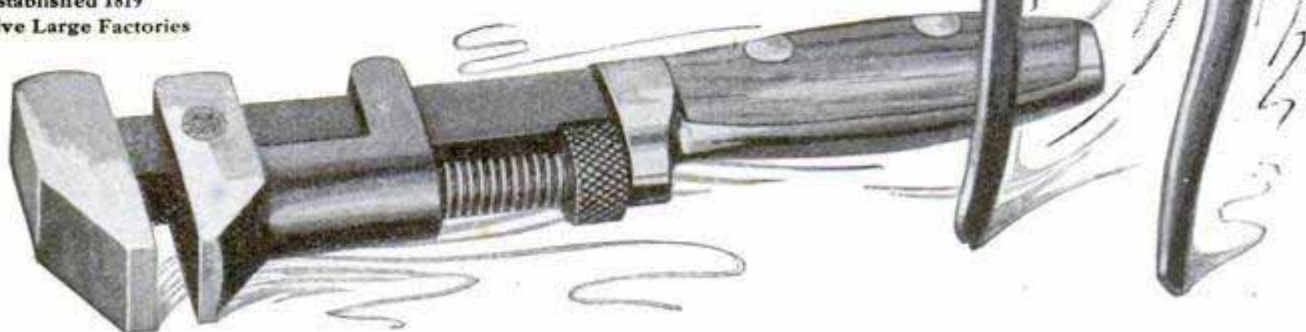



# The Business of This Place is to Raise Salaries

From every section, and from all sorts and conditions of men, messages come to tell of earnings increased and futures brightened through study of I. C. S. Courses.

One letter gives the romance of a young man in California that began with little or no education; another tells the story of a high-school graduate in Maine that found himself educated for everything but to make a living. Here are the heart throbs of a fellow that toiled twelve hours a day and studied his Course as best he could; there is the experience of a clerk or office hand with plenty of spare time and the will to use it. Now we read of some one whose pay was a mere pittance; now of a foreman or superintendent that enrolled because his ambition aimed at bigger things.

All sought betterment through knowledge and found it. All are enthusiastic. All remember with pleasure the day they marked and mailed an I. C. S. Coupon.

I. C. S. Courses have made draftsmen, foremen, and superintendents of shop hands; building contractors, architects, structural and concrete engineers of carpenters and masons; advertising men, window trimmers, show-card writers, chemists, illustrators, and designers of clerks; electrical, mechanical, and steam engineers of laborers; mine inspectors, foremen, and mining engineers of mine workers; bridge engineers, surveyors and mappers, civil engineers, gas engineers, automobile runners, and civil service employes of young men willing to use their spare time to mold a career.

Mark and mail the coupon and learn how the I. C. S. can raise *your* salary.

## International Correspondence Schools

Box 872, Scranton, Pa.

Please explain, without further obligation on my part, how I can qualify for a larger salary and advancement to the position, trade, or profession before which I have marked X.

Electrical Engineering  
 Electric Lighting  
 Electric Railways  
 Electrician  
 Electric Car Running  
 Dynamo Foreman  
 Dynamo Tender  
 Wireman  
 Mining Engineer  
 Telephone Expert  
 Civil Engineer  
 Automobile Running

Mechanical Engineer  
 Mechanical Draftsman  
 R. R. Constructing  
 Concrete Construction  
 Architect  
 Contracting & Building  
 Architectural Draftsman  
 Plumbing & Heating  
 Chemist  
 Bookkeeper  
 Advertising Man  
 Civil Service Exams.

Name \_\_\_\_\_

St. and No. \_\_\_\_\_

City \_\_\_\_\_ State \_\_\_\_\_

Present Occupation \_\_\_\_\_

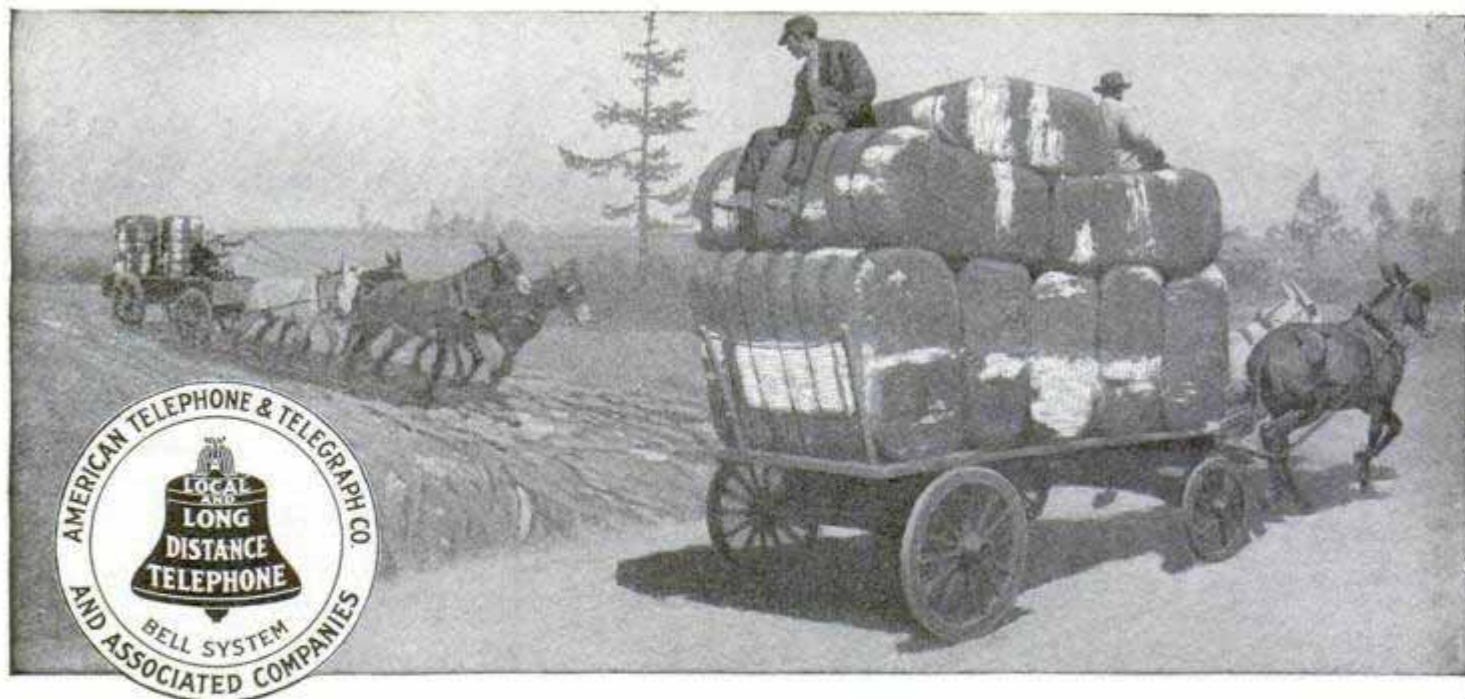

# The Good Road For Universal Service!

Every man's home faces on a road which connects with every other road and leads to every other home throughout the whole land.

Main highways connect with cross-roads so that a man can go where he chooses, easily and comfortably if conditions are favorable. But the going is not always the same; some roads are good—some are bad.

The experts in the South illustrate the difference by showing four mules drawing two bales of cotton slowly over a poor, muddy cross-road, and two mules drawing eight bales of cotton rapidly over a first-class macadam highway.

The Bell Telephone lines are the roads over which the speech of the nation passes.

The highways and byways of personal communication are the 12,000,000 miles of wire connecting 6,000,000 telephones in homes on these highways. Steadily the lines are being extended to every man's home.

The public demands that all the roads of talk shall be good roads. It is not enough to have a system that is universal; there must be macadamized highways for talk all the way to every man's home. A single section of bad telephone line is enough to block communication or confine it to the immediate locality.

Good going on the telephone lines is only possible with one policy and one system. Good going everywhere, at all times, is the aim of the Bell system.

**AMERICAN TELEPHONE AND TELEGRAPH COMPANY  
AND ASSOCIATED COMPANIES**

***One Policy***

***One System***

***Universal Service***

*Please Mention Popular Mechanics*



# FREE TRIAL for 6 Months

We want you to grind your tools on this perfected carborundum grinder for six months so you can find out its great value in your work. If after six months' trial you decide not to keep it, return it to us — no hard feelings, just send it back. The six months' use will have cost you nothing.

Foot Power Mechanic's Special with Twist Drill Grinding Attachment

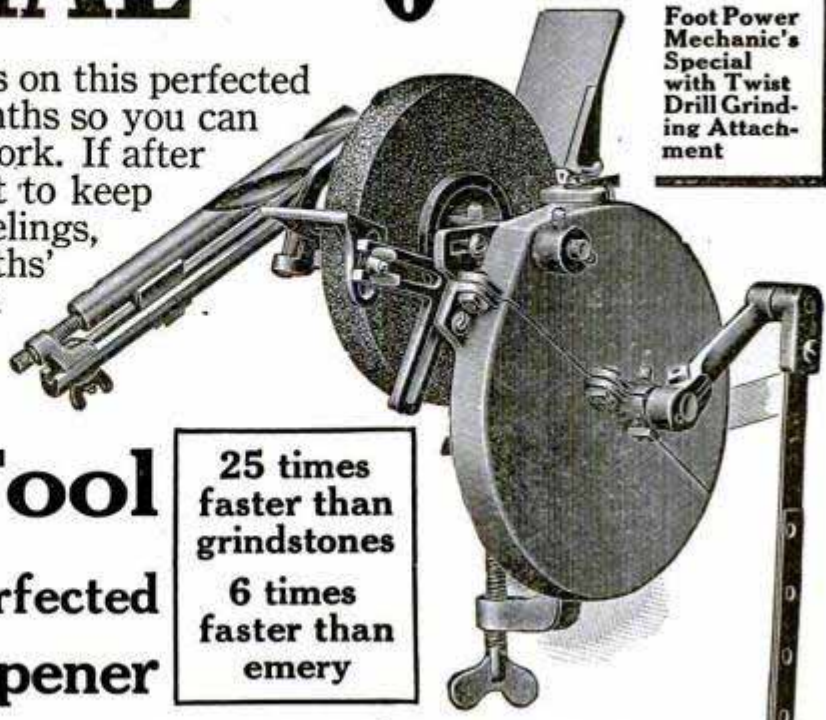

## Luther Diamond Tool Grinder The Perfected Carborundum Sharpener

25 times faster than grindstones  
6 times faster than emery

### WILL NOT DRAW TEMPER

#### 25 Times Faster Than Grindstones

This Luther Grinder — the standard of the world — with its wheels of the wonderful abrasive carborundum, is 25 times faster than grindstones. It cuts the hardest steel as emery does copper. One man with the Luther does the work of 20 men with any other sharpening device. *Does not draw temper.* No need of hard pressing — just a light touch — the hard, sharp carborundum crystals of the wheels peel off steel in tiny shavings. No water needed.

#### Hand and Foot Power Equipped with Sharpening Attachments

The special sharpening attachments enable anyone to do the most difficult sharpening, such as sharpening twist drills, chisels, plane bits, etc. Luther Diamond Tool Grinders are the standard grinders of the world. In addition to their wonderful carborundum wheels, that never need dressing, they

are mechanically perfect machines — machine cut spur gears — dust proof and bronze bearings — machined parts run in bath of oil. In short, a Luther Diamond Tool Grinder will please you by its solid construction, and because it makes it easy to have keen edged tools without drudgery.

**11 Machines in One** The outfit consists of one Mechanic's Special Luther Diamond Tool Grinder, with the following attachments, which supply every grinding, buffing and polishing need:

1. One rough, genuine Carborundum wheel.
2. One fine, genuine Carborundum wheel.
3. One chisel grinding attachment.
4. One twist drill attachment.
5. One polishing spindle.
6. One buffer.
7. One polisher
8. One oil stone
9. One Carborundum hone in leather case.
10. One Carborundum scythe stone.
11. One foot power attachment.

Hand Power Mechanic's Special with Attachment



#### Return This Coupon for Our 6 Months' FREE TRIAL OFFER

Send for our 6 months' free trial offer — we will also send you free a booklet telling the interesting story of the discovery of carborundum — the wonderful abrasive that will scratch the diamond itself and cut steel as emery does copper.

**LUTHER GRINDER MFG. CO.**  
1009 Madison Street  
MILWAUKEE, WIS.

**LUTHER GRINDER MFG. CO.**  
1009 Madison St., MILWAUKEE, WIS.

Please send me free and prepaid your free carborundum booklets and your six months free trial offer on the Luther Diamond Tool Grinder Mechanics' Special.

Name..... Address.....  
Dealer's Name..... Dealer's Address.....

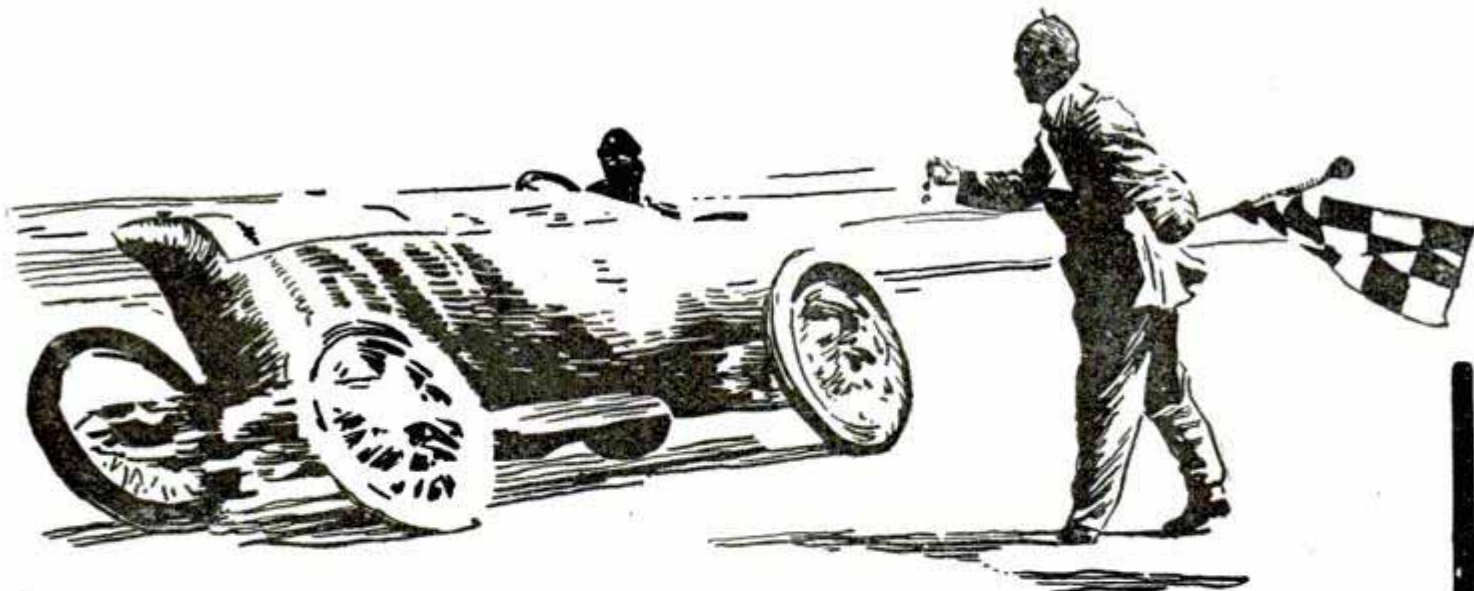

# POLARINE

"The Winning Oil for Winning Cars"

Daytona, Fla., April 23, 1911.

STANDARD OIL COMPANY,

"To-day I lowered my world's record for the kilometre and mile; also established world's record for two miles. Used Standard Oil Gasoline and Polarine in practice and in final trials, and it helped me break records. Nothing but Polarine for me from now on."

(Signed) BOB BURMAN.

## What POLARINE did:

Former World's Records (Benz Car, without POLARINE)		Burman's World's Records (Benz Car, using POLARINE)	
Kilometre,	17.04 seconds 211.27 kilometres per hour	Kilometre,	15.88 seconds 226.7 kilometres per hour
Mile,	27.33 seconds 131.72 miles per hour	Mile,	25.40 seconds 141.73 miles per hour
Two Miles,	55.87 seconds 128.89 miles per hour	Two Miles,	51.28 seconds 140.4 miles per hour

**POLARINE was worth more than 10 miles an hour to the Blitzen Benz.**

These performances again prove **POLARINE** the best automobile oil yet produced.

You will get more power, longer wear out of your car by using it.

Get Polarine direct from your dealer, or write our nearest agency.

**Standard Oil Company**  
(Incorporated)

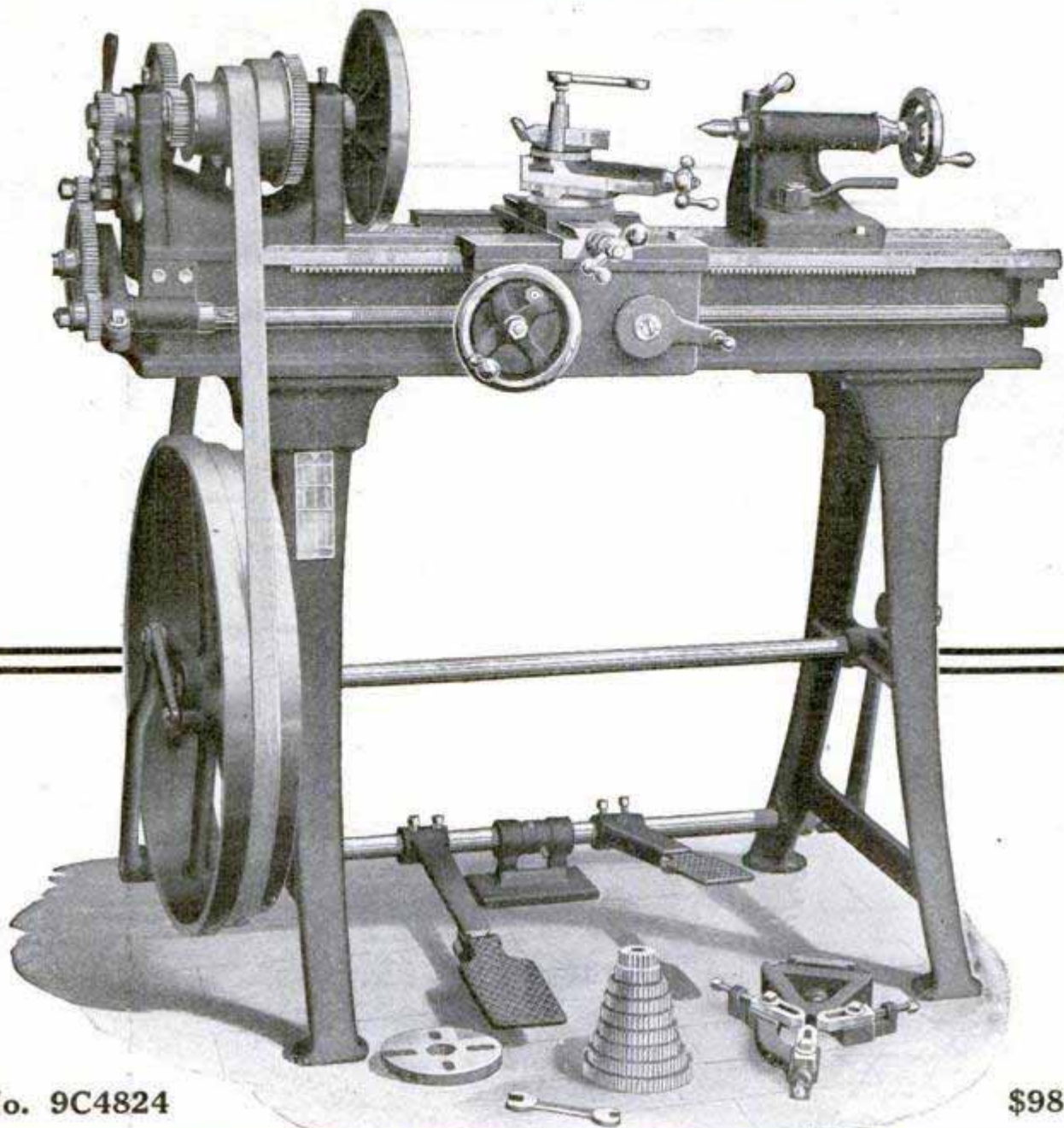

No. 9C4824

\$98.00

**\$98<sup>00</sup>** BUYS THIS 11-INCH FOOT POWER SCREW CUTTING ENGINE LATHE, complete, as illustrated, including compound rest. Bed, 4 feet long; 26 inches in the clear between centers; swings 11 $\frac{1}{4}$  inches over the bed, 7 $\frac{3}{4}$  inches over the carriage.

Our lathes are practical in design, well made and accurate. All the material that enters into their construction is the best that money can buy or experience can select. Perfect satisfaction in use guaranteed or your money back.

**WE CARRY FINISHED LATHES IN STOCK AT FACTORY AND SHIP PROMPTLY AFTER RECEIPT OF ORDER.**

Write for our complete Machinery Catalog C, which gives a full description of the lathe illustrated and also shows a complete line of lathes in all sizes, ranging from 9 to 13-inch swing and from 3 $\frac{1}{2}$  to 8 feet in length of bed. This same catalog also quotes money saving prices on pulleys, belting, shafting, files, hack saws, and a full line of regular shop equipment. Catalog mailed free on request.

As examples of the big money saving bargains we offer you in this catalog, we can sell you a complete screw cutting engine lathe as low in price as \$63.00, while for \$147.00 we can furnish a 13-inch swing, 6-foot bed lathe that you would expect to pay \$200.00 for elsewhere. Ask for the catalog, which shows the complete line.

**WRITE FOR MACHINERY CATALOG C. IT IS FREE.**

**Address SEARS, ROEBUCK AND CO., CHICAGO, ILL.**

# ELGIN WATCHES ON CREDIT



**Special This Month—\$16<sup>50</sup>**  
**17-Jewel Genuine ELGIN** IN 20-YEAR GOLD FILLED CASE **only \$16<sup>50</sup>**  
 Sent PREPAID On *Free Trial* at Our Special ROCK BOTTOM WHOLESALE PRICE.

**Let me send you this Beautiful Genuine 17-Jewel Elgin Watch Complete in 20-Year Gold Filled Case—the BIGGEST BARGAIN Ever Offered!**  
**NO MONEY DOWN \$2 A Month**  
 \$2.50 After Examination.



**You Assume No Risk Whatever in Dealing With Us** **Guaranteed for 20 Years.**  
 because before you buy or pay one cent, we place the watch right in your own hands and let it do its own talking. We ask **NO SECURITY and NO INTEREST**—just plain honesty among men. Our Elgin Watches are so well known and our CREDIT PLAN so easy, that no matter where you live or how small your wages, **WE WILL TRUST YOU**, so that you and every honest man and woman can own a **DIAMOND** or High-Grade Elgin Watch in a beautiful Guaranteed 25 year Gold Filled Case and wear it while paying for it in such small payments that you never miss the money. *Write today for our Big Free Watch and Jewelry Catalog.* It tells all about our easy credit plan and how we send Elgin 19-Jewel B. W. Raymond and 21 and 23-Jewel Elgin Veritas everywhere on Free Trial, without security or one cent deposit, positively Guaranteed to Pass Any Railroad Inspection. **HARRIS-GOAR CO.** Dept. 154 **KANSAS CITY, MO.**  
 The House that Sells More Elgin Watches than Any Other Firm in the World.

**WATCH AND DIAMOND Book FREE**  
 Write For It.

## EXCEPTIONAL BUSINESS OPPORTUNITY

**\$5 to \$15 per Day** has been made printing business, calling cards, posters, tickets, etc., in department stores, parks, fairs and store windows.



**900% Profit**  
 Blank cards cost 5c per hundred; sell for 50c printed.

**Only \$175.00** on easy payments **PAYS FOR ITSELF**

Automatic Card Printing Presses—practical, easily operated, self-feeding and inking; uses standard type; prints 120 cards per minute. Free catalog and sales plan.

**AUTOMATIC PRINTING PRESS COMPANY**  
 218 So. Jefferson St. **CHICAGO**

## Brain Power and Health Through Correct Combinations of Daily Foods

—You should eat for Energy, Brain Power, Good Looks and Success. I can tell you, without technical terms, the best combinations and proportions of the different foods for your condition. **I HAVE NO FOODS TO SELL.** No Fasting, Privation, Exercises or Drugs. **A BRAINY DIET SYSTEM.** My 4 Books Prove it.

- (1) Tests of Brainy Diet
- (2) Diet Versus Drugs
- (3) Effects of Foods
- (4) Key to Longevity

Send 10 Cents for Postage, etc.  
 Send the address of your sick friends to

**G. H. BRINKLER**  
**Food Expert Dept. 16 Washington, D. C.**

**Rowboat \$20<sup>00</sup>**  
**MONEY IN BOAT LIVERY!**  
 Can ship in any quantity. Need No Boat House. Never Leak, Rust, Check, Crack or Rot. **Absolutely safe.** Every boat has water-tight compartments, so cannot sink. 20 different designs. **Demonstrator Agents Wanted in Every Community.** Write TODAY for FREE Illustrated Catalog and Special Factory Prices.  
**Michigan Steel Boat Co., 156 Bellevue Ave., Detroit, Mich.**

**TAILOR'S HAND TRAVELS 4,000 MILES.**—There are many people who, without walking, are constantly moving some portion of their bodies, and these moving portions cover, in the aggregate, an amount of space which is absolutely astounding. Take the case of a man who scarcely moves at all—a tailor. Seated Turkish fashion, he plies his needle from morning to night in order to have an overcoat or a pair of trousers ready for an impatient customer at the appointed time. His needle flies to and fro at the rate of about

# Try a Detroit Fireless Stove at Our Risk



**RADIANT STYLE**  
 Heat the metal radiators a few minutes—then the imprisoned heat cooks the food.

Cooking in a Detroit Fireless (electric or with radiators) is the most delicious way—all flavor and nutriment retained; the most **economical** way—saves 80% of your fuel bill; the most **comfortable and convenient** way—saves work over a hot stove—saves constant watching—saves worry.

**Built Like a Range—Does All a Range Does**

“Detroit Fireless Stoves” (both Electric and Radiant) are made from planished steel and aluminum—no wood to warp or split—no stones to break. No felt or pad to absorb steam and odors. They **roast and bake** perfectly—rich brown; they **fry or boil** perfectly; they steam and stew perfectly. Our famous **Water Seal** keeps all steam and odors out of the house.

**Get Our Free Trial Offer.** A “Detroit Fireless” will be sent you on 30 days’ trial. Write today—get our handsome catalog and this new offer.

**Detroit Fireless Stove Co.**  
 103 Jefferson Avenue, Detroit, Mich.



**ELECTRIC STYLE**—A few minutes’ current from any electric light socket **STARTS IT**—the imprisoned heat then cooks the food.

# Over 1,000 Gallons

Per hour against 140 ft. head.

## Fairbanks-Morse Eclipse Pumper

Engine and Pump Jack complete ready to attach to any windmill pump and will pump as much water as a 10 or 12 ft. windmill in a 20-mile wind.

# \$5000

F.O.B. Factory Beloit, Wis.

This engine has two belt pulleys to be used for driving cream separator, churn, washing machine, grind stone, sprayer, etc. It can be lifted from pump jack and moved about if desired.



All of this is described in our free Catalog No. MX449

**Fairbanks, Morse & Co.**  
Wabash Avenue and Eldredge Court, Chicago, Ill.

once a second. If we reckon a space of 20 in. as that covered by the course of the needle, what should you imagine this distance amounts to in a year? The figure is, to say the least of it, surprising—about 12 miles for a day's work of 10 hours, or nearly 4,000 miles for a year of 300 working days. In a little over six years the tailor's needle, and consequently his hand, will have covered a distance equal to the circumference of the globe!—The Strand.

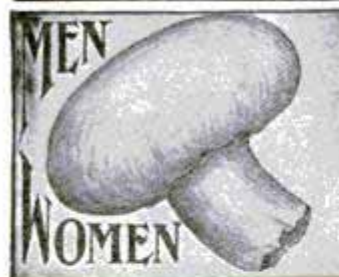

### Amazing Profits In Mushrooms

Anybody can add \$8 to \$40 per week to their income, entire year growing mushrooms in cellars, sheds, barns, boxes, etc. Markets waiting for all you grow.

Free Illustrated Instruction Booklet

**HIRAM BARTON**

Desk 2, 329 W. 48th St., New York

## Your Time Should Pay Big Dividends

It is just plain folly to work long hours for a meager salary. Any man or woman, who is willing to work a specified number of hours per day, and who is gifted with only ordinary intelligence, can make a good income obtaining subscribers for **Technical World Magazine**. Technical World is just as different from any other magazine as is the proposition it makes to capable workers. Payment runs as high as 66⅔% of the gross amount of business done. There are many special propositions that are very attractive and enormously helpful in obtaining business.

Write for particulars to Circulation Manager,  
**TECHNICAL WORLD MAGAZINE**

58th St. and Drexel Ave.

CHICAGO, U. S. A.

# Over 1/2 Million

**T**HE TRAVELERS INSURANCE COMPANY paid in 1910 over half a million dollars to its policy holders for accidents peculiar to the vacation season.

These enormous benefits, paid by this largest of all accident companies for vacation injuries, should impress you with the necessity of accident insurance.

Now is the time when many people are injured in hunting, boating, fishing, bicycling, baseball, golf, riding and driving, automobilizing and travel. Every year one in eight of the population is injured, and one death in every ten is from accident. There are more people disabled every year in this country by accident than were killed and wounded in any year of the Civil War.

Such is the life we must live. Its density of population—its feverish activity—its desire for rapid transportation—its diversity and mechanical complexity—its increasing desire for hazardous sports, make protection by insurance an absolute necessity.

The benefits are so broad and the cost so small, that if a man does not carry accident insurance it is generally because he does not know the facts. Let us tell you how much insurance \$25 a year will buy.

USE THIS COUPON.

## THE TRAVELERS INSURANCE COMPANY

HARTFORD, CONNECTICUT

How much accident insurance will \$25 buy?

Name \_\_\_\_\_

Pop. Mechanics Address \_\_\_\_\_

Please Mention Popular Mechanics

# FINISHES for CONCRETE SURFACES



Ordinary paints when used on concrete peel and crack off. **Trus-Con Finishes** become part of the concrete and resist wear.

## For Damp and Stained Walls

**Trus-Con Exterior Wall Finish**, applied with a brush, prevents and overcomes dampness, stains and efflorescence—protects walls with a uniform, decorative, flat finish without gloss—conceals hair cracks—enters into the surface pores, hardening and fusing with the concrete.



## For Dusty Concrete Floors

**Trus-Con Floor Enamel** is washable and stain-proof—prevents the formation of concrete dust—produces a tile-like surface which resists wear and is easily cleaned by mopping.

Trus-Con Wall Finishes and Floor Enamel are Furnished in a Variety of Colors

Write for Free Booklet and Color Card. Tell us about your work and we will send free suggestions.

**TRUSSED CONCRETE STEEL COMPANY**

462 Trussed Concrete Bldg.

DETROIT, MICHIGAN

## Clean by Water Power

"THE WATER DOES THE WORK—THE AIR DOES THE CLEANING"

Investigate this wonderful **PRESTO VACUUM CLEANER**. Look into the matter thoroughly so you will not confuse it with so-called cleaners on the market that are three and four times as costly. Consider this really **SANITARY** system and you will equip your home with no other kind.

THE PRESTO takes the dust, dirt and disease germs AWAY from the home and puts them into the sewer

where they belong. A mighty important feature. No emptying bags or boxes of bacteria-laden dirt. No dusting necessary. Cost of operating

THE PRESTO is less than one cent per hour. Cleaners guaranteed for 10 years. PRESTO Stationary Cleaners installed in your home AT \$50 AND UPWARDS, according to piping required. We also manufacture PORTABLE cleaners that can be attached to any kitchen bib, at \$30.00 complete with fifty feet of one-inch vacuum hose, and five cleaning tools. Write to-day for full information.

**PRESTO CLEANER CO., Office 114-116 Colonnade Bldg., TOLEDO, OHIO**

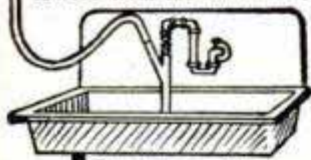

**WIND IN THE MOVING PICTURES.**—"What makes the wind blow so much in the moving-pictures?" The question is asked by almost every one who has been bitten by the bug of the moving-picture show. It is a fact that in every scene where there's half a chance of getting up a breeze it blows a tornado, or at least a brisk gale disports itself in the trees in the background and the skirts of the harassed heroine in the front.

A moving-picture man solved the problem. "That's easy," he replied in answer to a query. "If the pictures were taken when the air was perfectly still, then if the living characters happen to be still also, the picture would be as dead-looking as a 35-cent chromo of 'Twilight.' So a time is selected for photographing the scenes outside when the wind is playing old hob with things generally, trees swaying and skirts fluttering and hair flying—haven't you ever noticed how much more effective a woman is when her hair is streaming behind her like the burgee on a racing yacht? Then, too, when everything's busy moving, it looks like there's something doing all around."—Philadelphia Ledger.

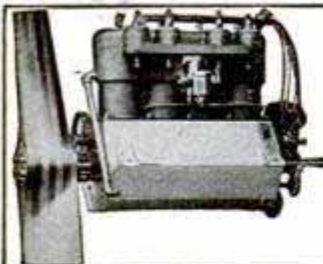

## The AEROMOTOR

The most compact, powerful and light aeronautic power plant built; 4 and 6 cylinders—4-cycle—30 to 75 H. P.

Detroit Aeronautic Construction Co.  
76 Crane Ave., DETROIT, MICH., U. S. A.



## GOFF'S Prize Winning Model Aeroplanes

Best and Go Furthest

Our **RED WING** model is the speediest Flyer made. One customer writes: "Your **RED WING** model 'B' is a remarkable Flyer, its maneuvering in a wind being wonderful." Our machines are not mere toys, but are built on scientific lines of the finest material and workmanship. Large, powerful motor and propeller, made to stand rough usage. Size of machine 15 in. wide by 18 in. long, no parts to put together, every machine guaranteed to fly 125 feet. (Simple directions sent with each outfit as well as a blue print 18 1/2" x 26 1/2" of Bleriot Monoplane FREE.) Sent by prepaid express on receipt of \$1.00.

WRITE FOR CATALOG

Goff Aeroplane Co., 219 S. Dearborn St., Chicago

# DIAMONDS

ON CREDIT

**\$37 50**

With confidence we offer these perfect blue-white Diamonds at a price that cannot be duplicated—our guarantee goes with each sale—all goods sent prepaid for inspection—10% discount for cash. Send for catalogue just issued No. 3 (Established 1843)

\$7.50  
CASH  
\$3.75  
PER MONTH

\$7.50  
CASH  
\$3.75  
PER MONTH

**J. M. LYON & CO.** 71-73 NASSAU ST. NEW YORK

# Working Drawings of the "Demoiselle"

Price \$2<sup>00</sup>  
Postpaid

SANTOS-DUMONT'S  
Remarkable Aeroplane

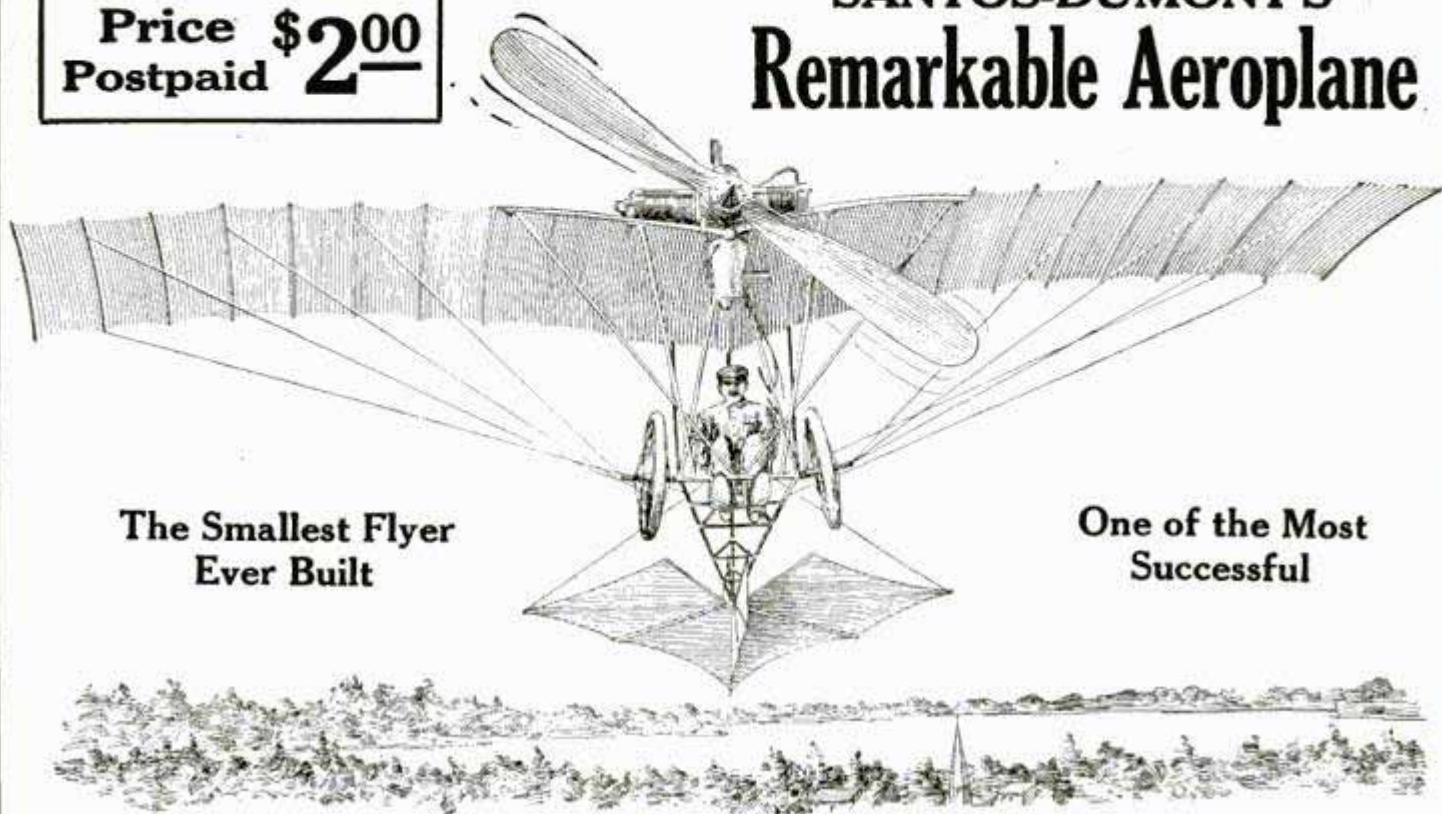

The Smallest Flyer  
Ever Built

One of the Most  
Successful

Complete plans for the construction of the wonderful monoplane offered to the public for the first time.

The machine is unencumbered by patent rights, the famous aviator preferring to place his invention at the disposal of the world in the interest of the art to which he has devoted his life. These plans were secured by representatives of Popular Mechanics from Santos-Dumont, and are the result of consultations with his engineers and observations made at his workshops.

## How the "DEMOISELLE" Ranks With Other Machines

*From New York Times, October 9, 1910.*

"M. Garros, famous French aviator, uses a Demoiselle aeroplane, the invention of Santos-Dumont, which has proved to be one of the most interesting types of flying machines in Europe. It has been called the humming bird of the heavier-than-air brood. It is the smallest flying machine in existence, weighing less than 250 pounds. It is capable of enormous speed, and darts about through the air in a way that has provoked both laughter and wonderment from the crowds at the European meetings. Garros is by far the most expert driver of these little machines in Europe. During the past season he has made remarkable flights in various places, but his flights from Pinard to St. Malo, over the water, have been regarded as most remarkable. While these baby monoplanes in the hands of ordinary pilots keep very close to the ground, Garros has driven his machine to great altitudes, and has taken his place in many of the important contests of France with the larger monoplanes."

*The set comprises seven large blue prints, showing every detail of construction, accompanied by a description of how to build.*

---

---

## POPULAR MECHANICS COMPANY

318 W. Washington Street, CHICAGO, ILLINOIS

**192 PAGES****A NEW BOOK THAT IS NEEDED****Price, \$1.00**

# Power Gas and the Gas Producer

By **J. C. MILLER, M. E.**

**An Authentic Text Book and a Complete Reference Manual  
Covering Every Detail of Installation and Operation**

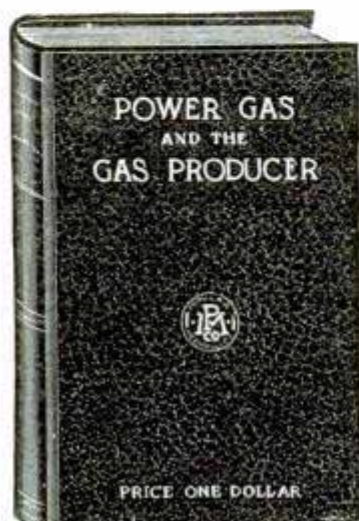

**S**CARCELY twenty years have gone by since the Gas Producer was first proposed for power purposes, and in this short time its growth in use and in potentiality has proceeded by leaps and bounds. The new method of adapting the latent power in coal to man's best use is still a mystery even to the well informed, because nearly all the literature on the subject has been written under the assumption that the reader knows as much about the subject as the writer. A comprehensive treatise, clear of abstruse technicalities, in every way authentic, yet

**“Written So You Can Understand It”**

has therefore been needed for some time. Such is the book just published. The *author* is an *authority* on this subject, and he has covered it thoroughly, as may be seen from the following condensed summary of contents:

Producer Gas—The Gas Producer—Chemistry of Producer Gas—Classes of Gas Producers—The Anthracite Producer—The Suction Producer—The Down-Blast Producer—Industrial Gases—Nitrogen—Natural Gas—Blast-Furnace Gas—Water Gas—Heat Values—Government Experiments—The Siemens Producer—The Wile Producer—The Smith Producer—The Taylor Gas Producer—The Loomis-Pettibone Producer—The Morgan Gas Producer—Gas Producer Fuels—Use of Peat for Gas Producer Fuel—Lignite—Heat Loss in Steam Plant Compared with a Gas Producer Plant—Water Required in Gas Producer Plant—Cost of Repairs—Present Standing of Producer Gas—Producer Gas for Furnace Work—Stand-by Losses—Heat in the Engine—Cooling Water—Gas Holder—Noise Produced by Gas Engines—The Gas Producer and the Smoke Problem—Producer Troubles—The Operator for the Gas Power Plant—Objections Urged Against the Gas Producer—Reliability of Gas Power—Compressed Air for Starting—The Gas Producer from the Insurance Standpoint—Capacity of the Gas Producer—Time Required to Start a Gas Producer Plant—Adaptation to Specific Use—Engines Should be Adapted to Fuel Used—The Erection of the Producer Plant—Building for a Gas Producer—Producer Casing—The Testing of Producer Gas—Starting a Gas Producer in Operation—Efficiency of a 500-Hp. Plant—Comparative Cost of Steam and Producer Gas Installation—Tables, Diagrams, etc., etc.

**For the Steam User**—This book will enable the Steam User to judge intelligently as to the economy and advisability of changing from Steam to Producer operation.

**For the Steam Engineer**—It will enable the Steam Engineer to understand thoroughly the working of the new system if the change is made, and to handle a plant competently and with confidence.

“**POWER GAS AND THE GAS PRODUCER**” is published in one handsome volume of 192 pages, printed on the best quality of book paper, profusely illustrated with half-tones from photographs, diagrams, etc., and durably bound in extra cloth.

**Price, \$1.00****Sent postpaid to any address****192 PAGES**

**POPULAR MECHANICS BOOK DEPARTMENT, CHICAGO**



THE  
MECHANICS  
HANDBOOK

ELECTRICAL  
ENGINEERS'  
HANDBOOK

BUILDING  
TRADES  
HANDBOOK

ADVERTISERS'  
HANDBOOK

BUSINESS  
MAN'S  
HANDBOOK

BOOKKEEPERS'  
HANDBOOK

STENOGRAPHER  
AND  
CORRESPONDENTS'  
HANDBOOK

PLUMBERS  
AND  
FITTERS'  
HANDBOOK

TELEPHONE  
AND  
TELEGRAPH  
ENGINEERS'  
HANDBOOK

MARINERS'  
HANDBOOK

# \$1.25 Handbooks for 50c.

No books in existence contain in so small space as much information about the trades and professions of which they treat as do these Handbooks. They are little giant encyclopedias of practical knowledge giving data and information that is hard to find in ordinary books. These Handbooks have been prepared by the well-known textbook writers of the International Correspondence Schools whose textbooks are recognized the world over as the most practical treatises on applied sciences ever published. These Handbooks are consulting experts of the highest rank, and are the most powerful force in the world for the promotion of ambitious men. They are an indispensable help to quicker and better work that will command advancement. They are printed on a high-grade book paper in clear type, and durably and handsomely bound in cloth with gilt titles; contain on an average of 364 pages and 175 illustrations and are regularly sold for \$1.25 each.

**SPECIAL OFFER.**—We are selling these Handbooks, durably bound in cloth with gilt titles, at a special price for each Handbook of 50 cents.

**Mechanics'**—Tables; formulas; measurements; belting; mechanical powers; hydro-mechanics; strength of materials; shafting; boiler design; care of boilers; power of boilers; chimneys; exhaust heating; machine design; machine tools; slide valve; pulleys; cylinders and steam chests; pistons; gearing; transit surveying; triangulation; curves; radii and deflections; earth work; track work; electricity; etc.

**Advertiser's**—How to plan and write an advertisement; type and type measurements; points on printing style; display; preparation of manuscript; proof reading; engraving and printing methods; electrotypes; matrices; advertisement illustrations; magazines; newspapers; retail, department-store, general, trade-paper, and mail-order advertising; trade marks; circulars; advertising agencies; etc.

**Stenographer's & Correspondent's**—Advice to beginners; shorthand speed; letters of application; punctuation; correct and faulty diction; business correspondence; type-writing; abbreviations; addressing; mailing; rates of postage; duplicating work; etc.

**Telephone and Telegraph**—Useful tables; mechanics; electricity; magnetism; primary batteries; storage batteries; electrical measurements; telephony; tests with magnetogenerator and bell; telegraphy; Morse telegraph systems; multiplex telegraphy; etc.

**Electrical Engineer's**—Mechanics; electricity; electrical units; symbols and quantities; physical and electrical properties of metals and alloys; wire gauges; magnetism; dynamos and motors; electric batteries; alternating current apparatus; alternators; transformers; wattmeters; electric transmission; electric lamps; wiring; electric heating and welding; electromagnets; controllers; car wiring; etc.

**Business Man's**—Arithmetic; tables; business forms; card systems; measures of extension; weight and capacity; time; value of foreign coins; duties on imports; bookkeeping; stenography; correspondence; postal information; financial terms; money and the money market; brokers and brokerage; patents; copyright and trade marks; corporations; business law; publicity; etc.

**Plumbers and Fitters'**—Arithmetic; involution and evolution; powers, roots, and reciprocals; circles; decimals; geometrical drawing; weights and measures; formulas; mensuration; mechanics; hydro-mechanics; building construction; heating and ventilation; gas-fitting; plumbing; etc.

**Mariners'**—Logarithms; trigonometry; navigation; terrestrial navigation; celestial navigation; organization of a man of war; naval ordnance; explosives; torpedoes; ship building; speed, tonnage, and fuel consumption; ropes; wind and weather; signals, nautical memoranda; etc.

**Building Trades**—Loads and structures; strength of materials; properties of sections; strength of rivets and pins; materials of construction; footings and foundations; masonry construction; woods used in building; qualities of timbers; joinery; framing; estimating; elements of architectural design; drainage systems; plumbing fixtures; plumbers' tables; heating and ventilation; gas and gas-fitting; etc.

**Bookkeeper's**—Arithmetic; formulas; tables; money; percentage; interest; equation of accounts; money and the money market; business law; financial terms; banks and banking; postal information; distances and time between various places; bookkeeping; business forms; card systems; modern office methods; cost accounting; bank bookkeeping; clearing house methods; etc.

## International Textbook Co.

Box 872, SCRANTON, PA.

I enclose \$\_\_\_\_\_ for which please send me the books BEFORE which I have marked X.

- —Mechanics' Handbook
- —Elect. Eng. Handbook
- —Bldg. Trades Handbook
- —Plum. & Fit. Handbook
- —Tel. & Tel. Handbook
- —Advertiser's Handbook
- —Business Handbook
- —Bookkeeper's Handbook
- —Sten. & Corr. Handbook
- —Mariners' Handbook

Name \_\_\_\_\_

St and No. \_\_\_\_\_

City \_\_\_\_\_ State \_\_\_\_\_

→ **Protect Your Idea!** ←

# PATENTS THAT PAY

“My Trade-Mark”

## Special Offer:

Mr. Inventor: I invite you to come to see me, and bring, (or send by registered mail), sketches or photograph or model and description of your idea or invention for **FREE** examination of U. S. PATENT OFFICE Records and report as to patentability of the same;—to find out as to whether you are entitled to a patent will not cost anything;—then, if your invention is new, upon receiving instructions, I will prepare **ALL** necessary (application) papers.

**DO THIS AND SAVE TIME AND MONEY!**

**WRITE NOW!**

### Highest References:

Lincoln National Bank,  
Washington, D. C.

NOTE: When writing these clients send two-cent stamp for reply.

Little Giant Hay Press Co.,  
Alma, Mich., and  
Dallas, Texas.

American Railway  
Appliance Co.,  
Oil City, Pa.

Farmers' Mfg. Co.,  
Norfolk, Va.

Anderson Mfg. Co.,  
Tulsa, Okla.

Griffin Mfg. Co.,  
New York, N. Y.

Warsaw Paper Box Co.,  
Warsaw, N. Y.

Sanford Mfg. Co.,  
Sanford, N. C.

Butler Engineering Co.,  
Akron, Ohio

Thompson Drug Co.,  
Sioux City, Iowa

Garl Electric Co.,  
Akron, Ohio

Gray Lithograph Co.,  
New York, N. Y.

Iowa Mfg. Co.,  
Oskaloosa, Iowa

New Era Mfg. Co.,  
Fairfield, Iowa.

Bernhard Furst,  
Vienna I,  
Austria-Hungary

A. J. Corai,  
Irish Town,  
Gibraltar

Otto von Rottenburg,  
Schwindstrasse 20,  
Frankfort A/M,  
Germany

H. A. Fonseca,  
Rica Dos Ourives 20,  
Sobrado, Rio de Janiero,  
Brazil

Electro Importing Co.,  
New York, N. Y.

Rex Electric Co.,  
St. Louis, Mo.

Sam'l Allen & Son Mfg. Co.,  
Dansville, N. Y.

Smith-Evenson  
Electrical Co.,  
Seattle, Wash.

Camp Conduit Company,  
Cleveland, Ohio

## INFRINGEMENT, VALIDITY AND INTERFERENCE WORK SOLICITED

I am admitted to practice before the United States Supreme Court and others

“I want to thank you for the most excellent services you have rendered me in this suit [B. Williams vs. Central Drug Co., U. S. C. C., Northern District of Illinois—E. Div.], and assure you that I appreciate it very much, and if at any time I can secure some business for you, I will be only too glad to do so.”  
(Signed) J. THOMPSON, Mgr. Central Drug Co., Sioux City, Iowa.

### Other Important Suits Successfully Settled

**FREE: Two Books—61-page “Inventor’s Guide” and 64-page “Proof of Fortunes in Patents—What and How to Invent”**

### Foreign Patents a Specialty

If you have a U. S. application write me for excellent literature and terms for promoting your Foreign Patents. Liberal discounts.

### I Advertise My Clients’ Patents Free

in a publication having over 2,000,000 circulation. Write for Special Offer. Successful clients in every section of the U. S.



My Office and the Patent Office  
(I give you proof of my location)

Across the street from the U. S. Patent Office

Expert—Prompt Services

**E. E. VROOMAN, Patent Lawyer Wash., D. C.**

Registered Patent Attorney. Patent Litigation

871 F Street, N. W.

High-Class Work—Excellent Testimonials

**\$217,440.00 \$**  
MADE BY MY CLIENTS

**YOU Should Have My FREE BOOK**

Telling HOW OTHERS will do the same IN THE FUTURE. “WHAT and HOW to INVENT” BOOK FREE!

“I received ONE HUNDRED DOLLARS (\$100.00) down (in re my Can Righting Machine inventions) and in thirty days NINE HUNDRED DOLLARS (\$900.00), and when my patents are issued ONE THOUSAND DOLLARS (\$1000.00) more. I can conscientiously state to my fellow inventor that he will do the right thing by placing his patent business in Mr. Vrooman’s hands for the best iron-clad patents.”  
(Signed) WILLIAM C. BRIDGES, Wapello, Iowa.

# PATENTS TRADEMARKS AND COPYRIGHTS SECURED OR FEE RETURNED

## SPECIAL OFFER — FREE SEARCH OF PATENT OFFICE RECORDS

Send us a model, photograph or sketch and description of your invention, and we will make a *Free Search* of the *Patent Office Records* to ascertain if it is patentable. If we report the invention patentable, we will guarantee to obtain a patent or return our fee, and furnish a certificate of patentability backed by a bonded contract to that effect.

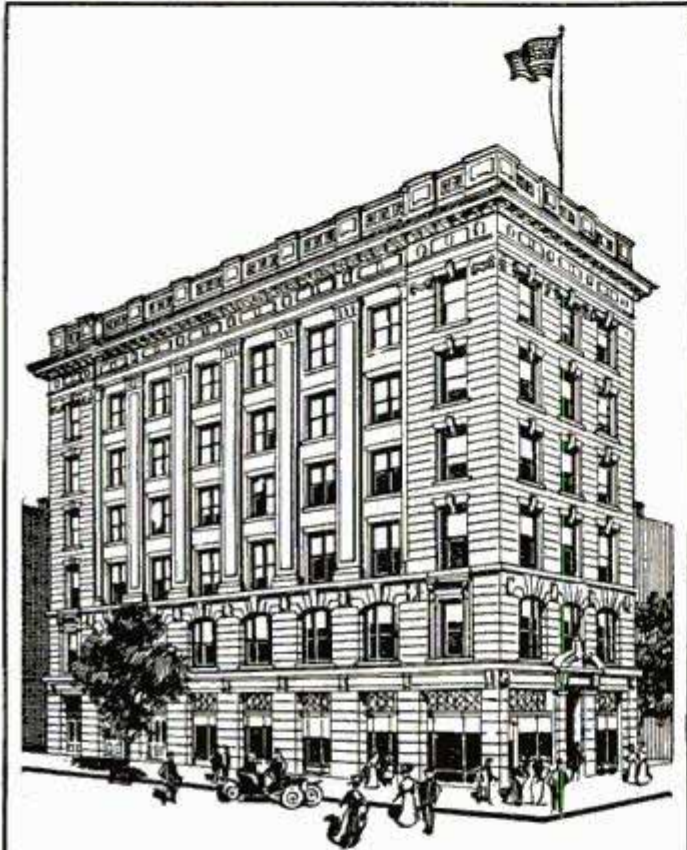

VICTOR BUILDING

Our new \$150,000 building, opposite the U. S. Patent Office, specially erected by us for our own use, designed and equipped with all modern appliances for our patent business.

This Certificate of Patentability will protect the inventor and serve as proof of the invention until the case can be filed in the U. S. Patent Office.

### OBTAINING ASSISTANCE FOR INVENTORS

Our certificate is of great assistance to inventors who require financial aid to obtain patents. It is useless to attempt to interest capital unless evidence is furnished that the invention is patentable. Our certificate gives this necessary assurance.

### OUR FOUR BOOKS MAILED FREE

to any address. Send for these books—the finest publications ever issued for free distribution.

### HOW TO OBTAIN A PATENT

Our illustrated eighty-page Guide Book is an invaluable book of reference for inventors, and contains 100 mechanical movements illustrated and described.

### FORTUNES IN PATENTS

Tells how to invent for profit, and gives history of successful inventions.

### WHAT TO INVENT

Contains a valuable LIST OF INVENTIONS WANTED and suggestions concerning profitable fields of invention; also information regarding prizes offered for inventions, among which is

### PRIZE OF ONE MILLION DOLLARS

offered for one invention, and \$10,000 for others.

### PATENTS THAT PAY

Contains fac-similes of unsolicited letters from our clients who have built up profitable enterprises founded upon patents procured by us; also indorsements from prominent inventors, manufacturers, Senators, Congressmen, Governors, etc.

### WE ADVERTISE OUR CLIENTS' INVENTIONS FREE

in a list of Sunday newspapers with two million circulation, in manufacturers' journals and in the *World's Progress*. Sample Copy Free. We also send a LIST OF PATENT BUYERS. We not only save you time and money in securing patents, but obtain patents which PROTECT the invention and PAY. After the patent is granted we assist you TO SELL YOUR PATENT.

### FOREIGN PATENTS

WE HAVE DIRECT AGENCIES IN ALL THE PRINCIPAL FOREIGN COUNTRIES and can secure FOREIGN PATENTS in the shortest possible TIME and at the LOWEST COST. We GUARANTEE TO SECURE THE FOREIGN PATENTS OR RETURN OUR FEES. Write for our Illustrated Guide Book on Foreign Patents, sent free to any address.

### REFERENCES:

Second National Bank, Washington, D. C.  
R. G. Dun & Co., Washington, D. C.  
National Savings and Trust Co., Washington, D. C.  
Smethport Glass Co., Smethport, Pa.  
Schrade Cutlery Co., Walden, N. Y.  
Clum & Atkinson, Brass Founders, Rochester, N. Y.  
Rochester Rotary Pump Co., Rochester, N. Y.  
Lawrence Mills, Mfrs. Bed Spreads, 51 Brooke Ave., Englewood, N. J.  
The Melvin Gauge and Signal Inst. Co., Scranton, Pa.  
Damon Mfg. Co., Mfrs. "Missing Link" Flour Mill Disintegrators, Bowling Green, Ky.  
Modern Canner Co., Mfrs. Canning Machinery and Canners' Supplies, Bridgeport, Ala.  
M. Winter Lumber Co., Sheboygan, Wis.

C. K. Lassiter, Mechanical Engineer, Schenectady, N. Y.  
Pitner Gasoline Lighting Co., Chicago, Ill.  
Sprout, Wardon & Co., Mfrs. of the Monarch Feed Governor, Muncy, Pa.  
The L. B. Dozier Co., Mfrs. of Plumbing, Heating and Machinery Supplies, Columbia, S. C.  
B. B. Earnshaw & Bro., Mfrs. "Cream Blend" Flour, Washington, D. C.  
A. L. Schultz, Consulting Engineer, Pittsburgh, Pa.  
Arthur H. Swan & Co., Mfrs. of Peel-Blade Tips, 279 Warren St. Roxbury, Pa.  
The H. V. Moore Piano Truck Co., Anderson, Ind.  
The Culver Novelty Co., Mfrs. of Carbureters and Mixers, Culver, Ind.

**VICTOR J. EVANS & CO.,** VICTOR BUILDING  
724-726 9th St., N. W.  
(Formerly EVANS, WILKENS & CO.)  
Opposite United States Patent Office WASHINGTON, D. C.



MR. H. ELLIS CHANDLEE

## PATENT WHAT YOU INVENT!

**YOUR IDEAS MAY BRING YOU A FORTUNE**

**There is A Constant Demand For Good Inventions.**

One of our clients recently made \$85,000; another \$7,000; another \$5,000; another \$3,400; two others \$1,000 each, and two others \$500.

WRITE FOR  
**"OPPORTUNITY"**

A List of Needed Inventions

Also, "U. S. LETTERS PATENT," telling how to obtain a patent.  
"THOUGHTS THAT HAVE PAID," a history of successful inventions.  
"TESTIMONY," giving our testimonial letters from manufacturers and inventors.

Mailed free to any interested person

**IF YOU HAVE AN INVENTION** send us a rough sketch and description, model or photograph of it, and we will give you our opinion as to its patentability **WITHOUT CHARGE**. If our opinion is favorable, we will issue a contract binding us to **refund every cent of our fee if we fail to obtain a patent.**

This assures you that we will not make application unless the chances of success are good, and that **every effort** will be made to obtain an allowance. We advertise the patents of Our Clients for sale in prominent dailies free of charge.

**"Prompt and Proper Service"**

**H. Ellis Chandlee & Co.**

Suite 55, Bornot Building, WASHINGTON, D. C.

# PATENTS THAT PROTECT and PAY

Send for FREE 96-page book. Advice free. Terms reasonable. Highest references. Best results.

Send sketch or model for FREE examination and opinion.

Recommended Patent Lawyer in the Bankers' Register and special list of selected lawyers. Also in Martindale's Law Directory, Sharp and Alleman's Directory of Lawyers, The Gast-Paul Directory of Lawyers, and Kime's International Law Directory.

**ALL BUSINESS GIVEN PROMPT AND PROPER ATTENTION**

A large list of strong recommendations furnished free

**WATSON E. COLEMAN, Patent Lawyer, 622 F St., N.W., Washington, D.C.**



**Patent Your Ideas—It Pays**  
"WE GUIDE YOU TO SUCCESS"

25 years' experience as Attorney and U.S. Patent Examiner. Send sketch of invention for Free report and Illustrated Guide Book. No Patent—No Charge. We succeed where others fail.

**BUNYEA PATENTS CO.**  
Room 27 WASHINGTON, D. C.

## LANGDON MOORE

Counselor-at-Law and Patent Attorney  
**Patents, Trade-Marks  
Designs and Copyrights**

9th and F Streets, WASHINGTON, D. C.

Formerly Examiner U. S. Patent Office

SEND FOR BOOKLET

**ARTIFICIAL FUR PRODUCED**—A curious new process for producing artificial furs is mentioned in the Paris Nature. It is the invention of a Frenchman.

Briefly put, the process makes it possible to use skin and fur as separate commodities. The raw pieces of pelt are placed together flat in a chemical refrigeration apparatus. When frozen the skin is carefully sawed off, thawed and sent to the tanneries to be made in the usual way into leather.

There remains the frozen fur. This is allowed to thaw

**INVENTORS** Our Brain Belongs to You. Our Ideas Are Free of Charge.

All we want in return is to build your model, special machinery, dies, tools and jigs to manufacture sheet metal goods, etc. We are expert mechanics, over thirty years experience and have one of the best equipped shops in the country. Ask for Booklet No. 17. Consultation free. Experimental work strictly confidential.

**A. NACKE & SON**  
236-242 S. 9th St., Philadelphia, Pa.

## WANTED-IDEAS

The demand for good, patentable ideas is greater than ever before. Am constantly in receipt of letters from parties desiring to buy patents procured through me. Electrical devices, tools of all kinds, advertising novelties, agents' supplies, mail order articles, and many other inventions are sought after. Protect your idea! Write for "Stepping Stones" (containing over 200 new inventions wanted) and new guide book "Successful Patents."

Clients' patents sold free. My personal services. Highest references.

**RICHARD B. OWEN**

9 Owen Bldg.

WASHINGTON, D. C.

## CAPITALIZE YOUR BRAINS

### PATENT YOUR INVENTION

The only way to protect it. Let us send you our free search and contingent fee proposition. FREE BOOKLET.

**MILO B. STEVENS & CO., Attys.**

ESTABLISHED 1864

685 F St., Washington; 353 Monadnock Blk., Chicago

Guaranteed by Bankers' Register and highest rating by Martindale's Law Directory.

## A Patent of Quality

is the only kind that will protect your invention and make it salable. You need my free advisory information. Send for it.

**GEO. R. HAMLIN, Patent Lawyer**

801-8th Street, N. W.

WASHINGTON, D. C.

## BARODA DIAMONDS

Flash Like Genuine  
ANY STYLE at 1/40 the cost—IN SOLID GOLD RINGS  
Stand acid test and expert examination. We guarantee them. See them first—then pay. Special Offer—14k Tiffany ring 1 ct. \$5.98. Gents ring 1 ct. \$8.98. 14k Stud 1 ct. \$4.88. Sent C.O.D. for inspection. Catalog FREE, shows full line. Patent ring gauge included, 10c. The Baroda Co., Dept. A5, Leland & Dover Sts., Chicago

## PATENTS

**C. L. PARKER**  
Ex-Examiner U. S. Patent Office  
**PATENT LAWYER**  
210 MCGILL BLDG.  
WASHINGTON, D. C.

Patents, Trade Marks, Copyrights, Patent Litigation

Handbook for Inventors, "Protecting, Exploiting and Selling Inventions" sent free upon request.

# A Talk to the Inventor



If there is any basis for an application in your idea, I can find it. But I will explain it to you before filing your application.

Copies of Nearest Patents, and Report, in Every Case I have patented inventions reported unpatentable elsewhere

Send for  
FREE  
BOOK

What You Should Know  
What to Invent  
What NOT to Invent  
How to Sell Your Patent

H. L. WOODWARD, 8th and G Sts., Opposite Patent Office

WASHINGTON, D. C.

# Water Works

## For Country Homes

By our Pneumatic Water System, water is forced anywhere in house, stable or yard, for all domestic purposes and for fire protection. Cool water in summer and ice water need not be supplied to stock in winter. Tank underground—no freezing or bursting of pipes. Entirely automatic in action. Air pressure generated by hand pump, windmill or engine. Sold on

### 30 DAYS' TRIAL

Awarded two medals and two diplomas at St. Louis World's Fair. Hundreds of our individual water works plants are in use. We have many letters from these satisfied users, and have published about fifty of them in book form. It makes a book of strong personal opinions—a copy free. Costs \$50.00 and up, according to your requirements. Write for full particulars.

**C. A. BURTON  
WATER SUPPLY  
COMPANY**

26 W. 7th St.  
KANSAS CITY  
MO.

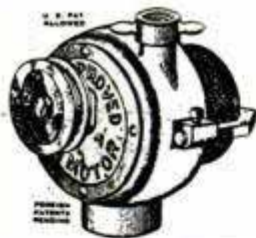
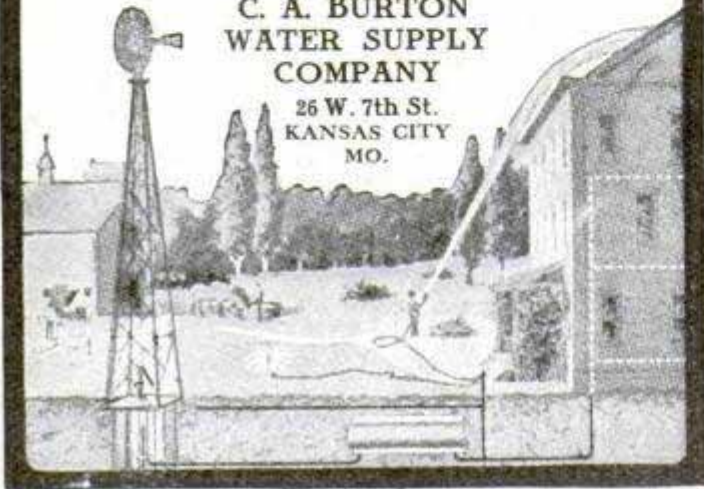

### Norton Improved Water Motor

Has the high speed required for grinding, polishing, etc. It also has a power side where the speed is reduced to 1000 Revolutions, thus making it an ideal motor for WASHING MACHINES with WRINGER ATTACHMENT. NO OPEN GEARS TO CATCH. Made of solid brass. Sent on receipt of **\$6.50**, express to be paid by receiver. Shipping weight 6 pounds.

Norton Water Motor Co., Inc., Roslindale, Mass.



## "JARVIS"

New Model Pump has them all stopped. No more "Waterlogged" Pressure Tanks. Pumps both air and water.

Send for List No. 6. We also make Tanks.

JARVIS ENGINE AND MACHINE WORKS LANSING, MICH.

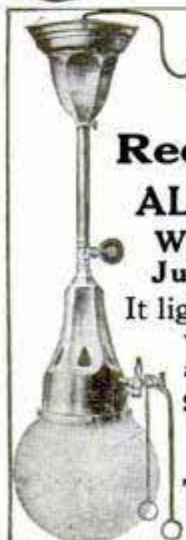

**THE**  
*Wizard*  
**Lighting  
Systems**

**Require No Generation  
ALWAYS READY**

**When You Want Light  
Just Pull the Chain**

It lights instantly. As convenient as electricity at one-tenth the cost. So simple anyone can operate.

For further particulars and Agency, address  
**The Nagel-Chase Mfg. Co.**  
143 West Ohio St., CHICAGO



## LET THE RED DEVIL WATER MOTOR DO YOUR WORK

### 6-inch Motor

Improved construction, absolutely perfect, runs your washing machine and a hundred other things. Power for small tools.  $\frac{1}{4}$  horse power on  $\frac{1}{2}$ -inch pipe, 80 pounds pressure; 1 horse power on 2-inch pipe, 60 pounds pressure. New net price, \$5.00 cash with order.

No. 1492 4-inch Motors for grinding, polishing and buffing. Runs sewing machines, fans, bottle washers, etc. Price with emery, buffing wheel, silver polish and pulley, \$3.00. No. 1493 Motor and pulley only, \$2.50.  $\frac{1}{8}$  horse power on 80 pounds pressure. Improved construction. Speeds, 3,000 to 5,000 revolutions per minute. Only scientifically and mechanically perfect small water motor manufactured. Patented construction makes it possible. Tremendous output warrants the price. Money back for any reason.

**CATALOGUE AND  
LARGE SHEET FREE**

## DIVINE WATER MOTOR CO.

Dept. T UTICA, NEW YORK, U.S.A.

For the name of your local hardware or tool dealer, we will send you free booklet on "Theory and Design of Water Motors."

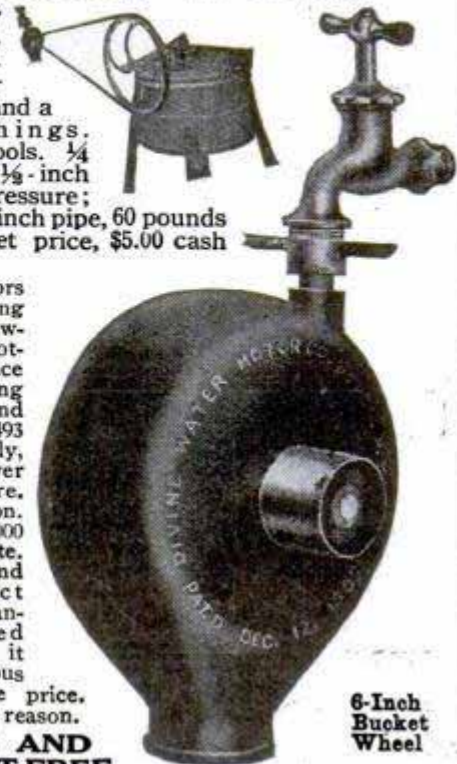

6-Inch  
Bucket  
Wheel

slightly at the bottom so that a small part of the hair is freed from ice. This part is then covered with a rubber solution, which is left to dry. The result after the final thawing is that large seamless pieces of fur are obtained which are much cheaper than those with the natural skin, seeing that the skin itself has already been utilized separately. These semi-artificial furs, it is declared, are more lasting than the natural ones, since they are immune from the attacks of moths and other destructive insects.

## Let Us Do Your Manufacturing

Buying material in large quantities and having a modern factory equipped with the latest machinery enable us to make almost anything in metal or wood at a very low price. Estimates free. We have a complete model and pattern department.

TINLEY PARK MFG. CO., 222 N. State Street, CHICAGO



## DON'T DISCARD BROKEN PARTS

Have them welded together by the Oxy-Acetylene Process. Steel, Cast Iron, Bronze, Copper, Aluminum and all other metals can be welded. Manufacturing quoted on. Welding equipments for repair shops or large plants supplied.

**DAVIS BOURNONVILLE CO.**  
105 West Street NEW YORK, N. Y.

## Do You Need A Gear



of any description for any purpose? We carry practically all the standard sizes in stock ready for immediate shipment.

We make gears of any style, size or material to order—promptly.

Our new free catalogue contains tables and rules for figuring both spur and bevel gears.

Grant's "Treatise on GEARS"—Price \$1.00 is a valuable reference book for the student and designer.

**Philadelphia GEAR Works, Inc.**  
1120 Vine Street GEO. B. GRANT, PRES. Philadelphia, Pa.

# Pipe Machines AND Die Stocks

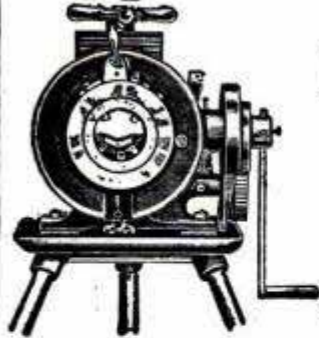

You can find what you want in the latest Oster catalog.

A postal will do.

WRITE TO

**THE OSTER MFG. CO.**  
2100 East 61st St., CLEVELAND, OHIO

## CRESCENT

Jointers are Equipped With Safety Heads to prevent accident to operators. As additional precaution against injury



you can have your jointer equipped with round safety head at a slight additional charge. Send today for catalog giving complete description and telling about our line of Band Saws, Saw Tables, Jointer, Borers, Swing Saws, Shapers, Planers, Planers and Matchers, Disk Grinders Variety Wood Workers.

THE  
**CRESCENT MACHINE CO.**  
93 Columbia St., Leontia, O.

**INSURANCE AGAINST BANDITS**—The bandits of Manchuria and Mongolia have adopted a new way of acquiring at least a portion of the goods of the traveler. These mounted highwaymen in bands not only constantly attack the peaceful native population but even rob travelers in broad daylight.

As a provision against this danger, says the Oriental Economic Review, an insurance bureau where one buys a banner, at a cost of about 1-500 of the value of the property to be insured, is established there.

This banner carried by a traveler will save him from

**Rife Automatic Hydraulic Ram** Pumps water by water power. No attention; no expense; 2 feet fall elevates water 50 feet, etc. Guaranteed. Catalogue free.  
**RIFE RAM COMPANY** 2131 Trinity Building, NEW YORK CITY

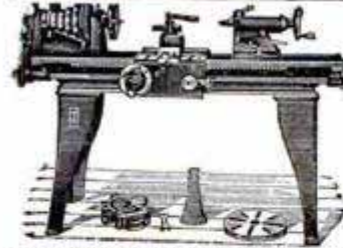

## LATHES

**\$75** Screw Cutting Foot or Power 9 to 13 inch

CATALOG FREE

**SOUTH BEND MACHINE TOOL CO.,** 423 Madison St., South Bend, Ind.

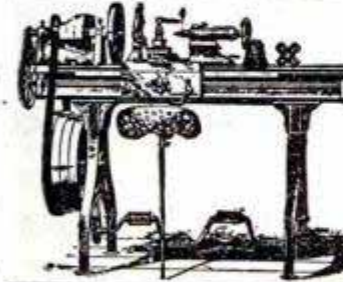

## LATHES

9 to 13-inch Swing List price \$75 and up according to size. When ready to buy send for Lathe Catalog and prices.

**W. F. & John Barnes Co.**  
100 Ruby Street, ROCKFORD, ILL.



## BLOWERS

for oil and gas forges, melting, brazing blowpipes, gas producers

## VACUUM PUMPS

for vacuum cleaners

Take up their own wear. No springs. Noiseless. Can't get out of order. Send for catalog No. 22 for blowers and No. 23 for vacuum pumps.

**LEIMAN BROS. NEW YORK** 62 P-JOHN ST.

# Put It at Work in YOUR Shop

THE "MULTIMOTOR" SHOP ENGINE increases your profits but not your payroll. Does the work of three men at an expense of less than a cent an hour.

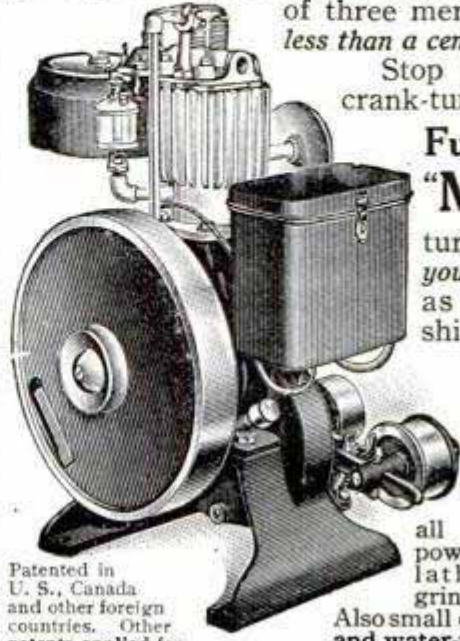

Stop pedal-pushing and crank-turning! Let the

## Fuller & Johnson "Multimotor"

turn the wheels in your shop. "Handy as a pocket in a shirt."

## Boy-Size—Man-Power!

This big little engine is small in size but a giant in power. Runs all hand-power or foot-power machines—jig saws, lathes, emery wheels, grindstones, drills, etc., etc. Also small electric lighting plants and water-pressure system. Just the thing for a boy's workshop!

Patented in U. S., Canada and other foreign countries. Other patents applied for.

## Simple, Safe and Portable

Simplest, neatest, strongest, most reliable little engine ever built. Comes to you complete—nothing to add but gasoline. For indoor use has outdoor fuel tank, insuring perfect safety.

Important working parts protected by dust-proof case. Needs no attention while running. Works steadily, all day, on a few cents' worth of grocery-store gasoline. Is air-cooled, fool-proof, cannot freeze or overheat.

### CONTRACTORS

can take the engine to various jobs on an ordinary hand truck.

### Guaranteed!

In design, material and construction equals the best automobile engines. Every engine guaranteed.

### Fuller & Johnson

### Farm Pump Engine

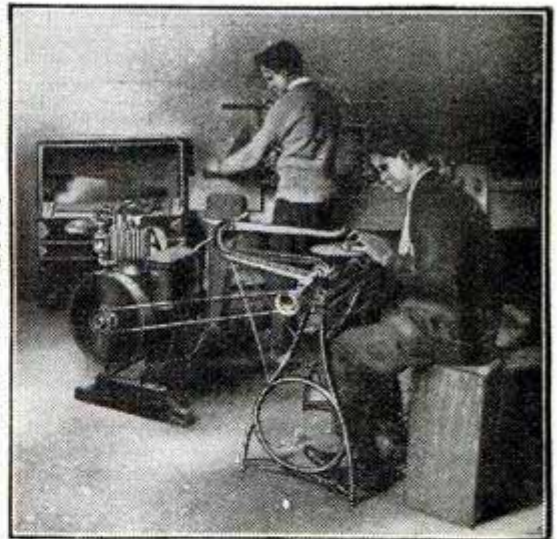

The Engine in Boys' Workshop

Practically the same as "Multimotor," with pumping gears added. Can be hooked up to any pump in 15 minutes. Needs no belts, arms, jack or special platform. Pumps 400 to 1,500 gallons per hour. Perfectly adapted to farm and suburban use.

## Engine Book Sent FREE!

Book giving full information about "Multimotor" and Farm Pump Engines sent FREE on request. Let us tell you more about these amazing little power-producers. We will direct you to nearest dealer who will show you the engine and explain what it can do. If interested in larger engines, ask for Catalog of Fuller & Johnson famous Double-Efficiency Engines. (301)

**FULLER & JOHNSON MFG. CO.**  
7 Partridge St. (Estab. 1840) Madison, Wis.

Please Mention Popular Mechanics

# Does Your Hardware Dealer Sell Carborundum Sharpening Stones

Ask him—If he doesn't; send direct—you can't afford to wait. If you use edged tools of any kind *you need* these most remarkable of all sharpening tools.

- |           |  |        |           |   |       |
|-----------|--|--------|-----------|---|-------|
| No. 107 H | Round Combination stone for Carpenters   | \$1.00 | No. 114 H | Sportsman's pocket stone in soft leather case | \$.75 |
| No. 108 H | Oblong Combination stone                 | 1.25   | No. 149 H | Pocket stone in cardboard case                | .15   |
|           | Oblong Combination stone in aluminum box | 2.75   | No. 191 H | Scythe and grass hook stone                   | .25   |

**THE CARBORUNDUM COMPANY, Niagara Falls, N. Y.**

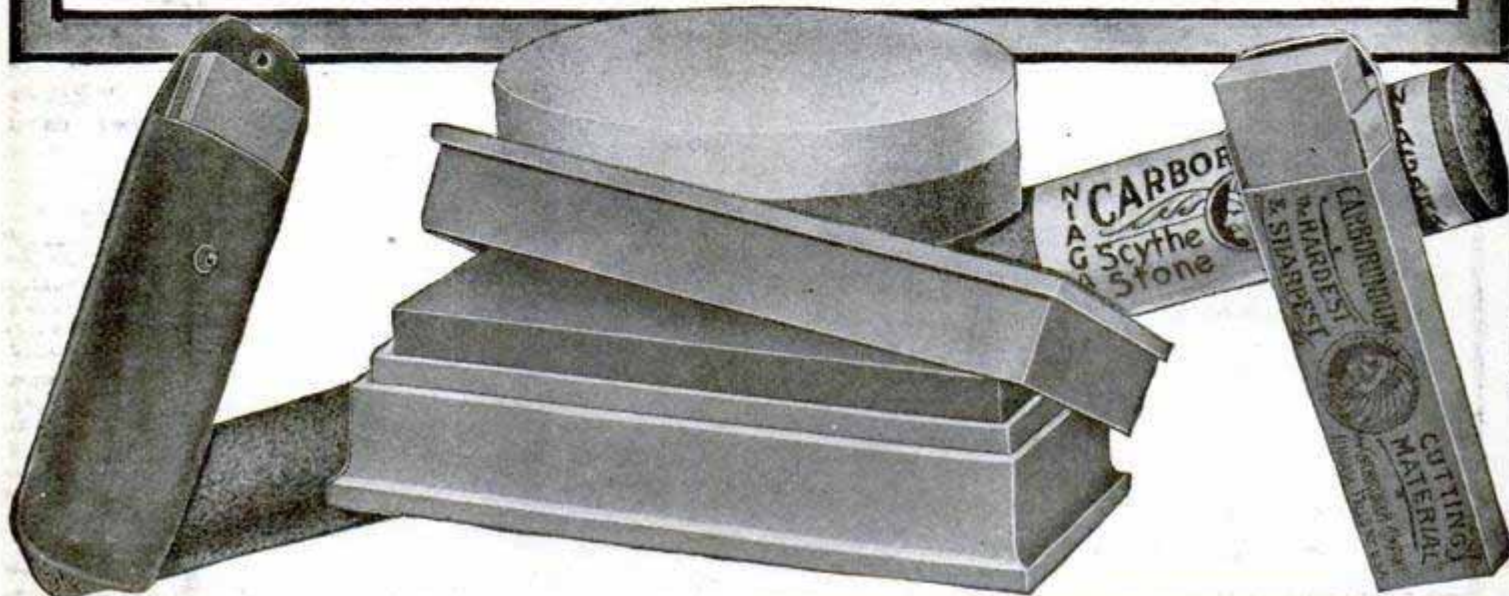

## GASOLINE SOLDERING IRON BLOW TORCH

Puts the heat right to the spot. Get Booklet today.  
**EMMELMANN BROS. MFG. CO., INDIANAPOLIS, IND., U.S.A.**



## BAR BENDERS

For Concrete Reinforcements

WRITE FOR OUR BENDING TOOL CATALOGUE.



Wallace Supply Co. 124 No. Jefferson St., Chicago  
26 Cortlandt St., New York City

the bandit's attack; for curiously enough they themselves conduct this insurance business. But it has its limitations.

"We paid our premium at the insurance bureau," says a Japanese traveler, "secured a red banner, and our party then started from Harbin, using several sturdy ponies for ourselves and the carrying of our luggage. After traveling about ten miles, we reached a small town called Takiu, where we put up at an inn for the night in order to do business with our customers there. Several of these customers came to see us in the

### Make Your Own Repairs!

Mends Harness, Shoes, Canvas; Myers' Sewing Awl makes lock-stitch like sewing machine. \$1 postpaid. BIG MONEY FOR AGENTS. C. A. MYERS CO.



The Awl for All.

6339 Lexington Ave., Chicago, Ill.

## "Ohio" Tools

Insist on them — it will pay you Carefully made from specially selected steel — fully warranted.

Write for complete catalog of

"Ohio" Planes, Chisels, Drawing Knives, Auger Bits, Screw Drivers, etc.



**OHIO TOOL CO., DEPARTMENT 3 COLUMBUS, O.**



## LUFKIN

### Measuring Tapes

Now made with Instantaneous Readings, the big improvement in markings. Saves time and eliminates errors. Send for sample piece of tape and our complete catalog.

**THE LUFKIN RULE CO.**

SAGINAW, MICH.

New York

London, Eng.

Windsor, Can.

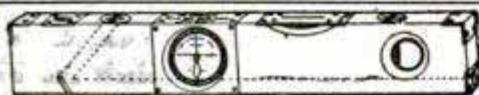

## The American Combined Level and Grade Finder

Most Practical, Durable and Convenient Instrument Made At one glance you can get the true slant on any line or grade either in degrees, inches or percentage, or all at the same time, and will at once give the exact distance needed to plumb up to a true level. The longitudinal recess shown in cut is well worth the low price of the instrument. Write AT ONCE for circular and

EDWARD HEIR Mfg. Box 75 RAILROAD PENNA.



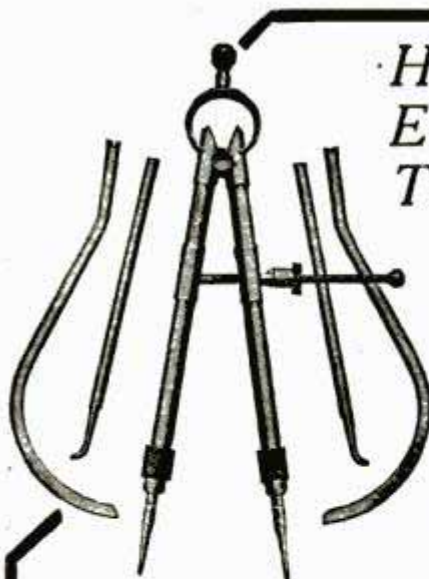

*Handy and  
Economical  
Tools to Use*

**B. & S.  
Combination  
Calipers  
and  
Dividers**

**Handy** — because you can quickly shift from one kind of measurement to another by substituting a different style of leg.

**Economical** — because it saves the cost of different tools for the different kinds of work.

*Our General Catalogue shows these  
Calipers and others. Sent on request*

**BROWN & SHARPE MFG. CO.**  
PROVIDENCE, R. I., U. S. A.



**For fastening fixtures in walls  
of brick, stone and concrete**

ANYBODY interested in building will benefit by the knowledge gained from a demonstration of the use of the Star Expansion Bolts or Sebco Screw Anchors.

Tell us the kind of work you are doing, we will send samples and catalog that will help you and show you a way to save money.

**STAR EXPANSION BOLT CO.**  
CATALOG DEPT. 34  
147-149 CEDAR ST., NEW YORK

evening and warned us that there were many mounted bandits in the neighborhood. When we told them there was no cause for anxiety on their account because of the insurance, they informed us that by it our safety was guaranteed only on the highways, but that the bandit bureau was not responsible for what might happen inside of any building."

**This \$18 Table (36x22") \$7.25**



This splendid piece of the famous Come-Pack Furniture (Quarter Sawn White Oak) shipped in sections, any finish, for \$7.25. Money back any time you say so.

**SECTIONAL  
"COME-PACK"  
FURNITURE**

Order today for prompt shipment or write for free catalog of 200 other bargains in Mission and Bungalow Furniture, direct from our factory to you.

COME-PACK FURNITURE CO., 701 Edwin St., ANN ARBOR, MICH.

**\$5.00 to \$10.00 A Day Made Easy**

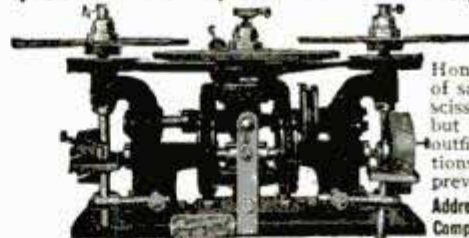

**The "American"  
No. 3 Patented**

Hones razors, sharpens all kinds of safety razor blades, clippers, scissors, etc. No make-believe, but the real thing. Complete outfits furnished with instructions how to do the work. No previous experience required.

Address, Mgr. Dept. 708, Illinois Cutlery Company, 184 Washington St., Chicago



**Mr. Mechanic!**

Don't throw your tools one on top of the other. Keep them in good condition, orderly arranged and easily accessible in a "Gerstner" Case. Why not be up-to-date and show your fellow workmen that you are a "man who cares." Ask for our catalogue showing the best built, the neatest and most practical Tool Cases ever offered to the up-to-date mechanic. You'll find one to suit your requirements and purse—we'll please you or refund your money.

**A. Gerstner & Sons.**

Mfrs. of Mechanics' High Grade Tool Cases  
818 Germantown Street, DAYTON, OHIO

**Here's Another New "YANKEE" Quick Return No. 130**



Same as the No. 30, but with a Spring in the handle that drives the spindle back, ready for the next push. A great advantage for overhead work or where only one hand can be used. Takes all the Attachments used in the No. 30.

*Send for Tool Book Free. Tells you about 35 Styles and 75 Sizes.*

*A postal brings it to you FREE. Your dealer sells "YANKEE" Tools.*

**NORTH BROS. MFG. CO. Sta. O. PHILADELPHIA, PA.**



# Shop Notes for 1911

Vol. VII of the Series—Just Published—Price 50c Postpaid

**T**HE Series of Shop Notes Year Books now comprises seven volumes and constitutes a *Mechanics Encyclopedia* of unequalled value. The low price of 50 cents a volume or \$3.50 for the complete set places them within the reach of all and no one who uses tools should do without them. The investment of but \$3.50 places at the disposal of every tradesman over

## 4000 Easy Ways To Do Hard Things

some of which daily confront him. These books are "*Written So You Can Understand Them*," and cover every department of mechanics. They represent the "boiled down" experience of expert engineers, firemen, carpenters, machinists, plumbers, painters, iron and wood workers, electricians, masons and other tradesmen.

☐ The addition of a new volume each year affords the purchaser of a set an opportunity of keeping abreast with the newest and best developments, as each volume contains matter entirely different from the others and of a strictly up-to-date nature.

200 Pages	Vol. I,	"Shop Notes for 1905"	385 Illustrations
228 Pages	Vol. II,	"Shop Notes for 1906"	555 Illustrations
228 Pages	Vol. III,	"Shop Notes for 1907"	580 Illustrations
212 Pages	Vol. IV,	"Shop Notes for 1908"	536 Illustrations
224 Pages	Vol. V,	"Shop Notes for 1909"	461 Illustrations
224 Pages	Vol. VI,	"Shop Notes for 1910"	451 Illustrations
224 Pages	Vol. VII,	"Shop Notes for 1911"	468 Illustrations

Sold singly at 50 cents a volume postpaid, or the complete set of seven volumes may be had in a handsome case at \$3.50 prepaid.

**Popular Mechanics Co., Publishers**

318 W. Washington Street

CHICAGO, ILLINOIS

## A GOOD, USEFUL BOOK

# Wood-Working for Amateur Craftsmen

"Written So You Can Understand It"

By IRA S. GRIFFITH, A. B.

125 Illustrations  
128 Pages Cloth Cover  
Size 5 x 7 inches

Price 50 Cents  
Postpaid



One of the latest of  
Popular Mechanics  
series of Industrial  
Handbooks

This book was especially designed to cover every essential step from the A B C to the X Y Z of woodworking. The chapters dealing with making special articles bring out every cut, joint and process used in this important trade, and the proper use and care of tools, working up of materials, etc., are treated thoroughly and plainly.

### CONTENTS:

Making Out a Stock Bill—Laying Out Rough Stock—Hand Saws—Sawing with Hand Saws—Planes: How to Set and Adjust the Irons—Squaring Up Mill Planed Stock—Squaring Up Rough Stock—Whetting Plane Irons and Chisels—Grinding Plane Irons and Chisels—Making a Bird Box—Making a Tabouret—How to Make an Umbrella Stand—Making a Magazine Stand—Making a Table—Making a Cabinet.

**A valuable book for either self instruction or use in manual training courses**

ORDER OF YOUR NEWSDEALER, BOOKSELLER OR DIRECT FROM

**POPULAR MECHANICS BOOK DEPARTMENT, Publishers, CHICAGO**

# GET THE BEST LAMP FOR YOUR BICYCLE

Look at this illustration.

Isn't this lamp a beauty?

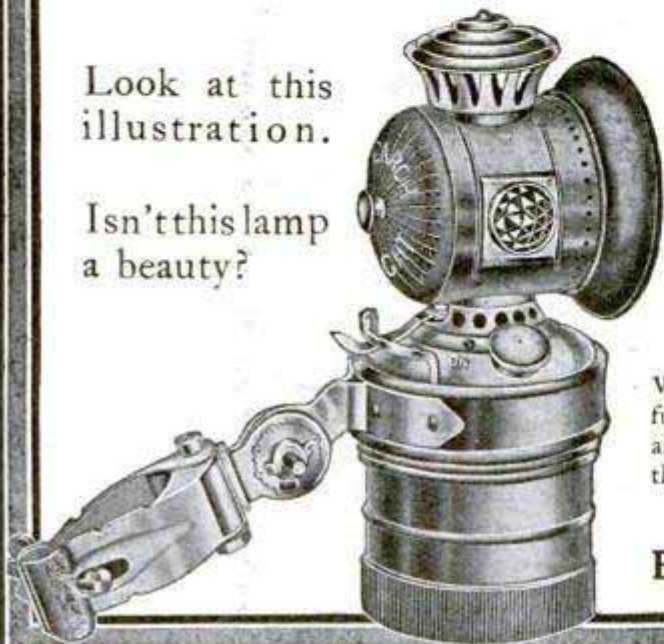

## "Search-Light"

**Burns Gas—Makes Own Gas**

Get a new lamp for your wheel, but get the BEST lamp—the "Search-Light." It gives a powerful, brilliant light that makes night riding a pleasure.

The "Search-Light" will not jar out, even over the roughest roads. You can attach it to the head or fork of your wheel and the adjustable bracket enables you to direct the rays any way you want.

Will not get out of order. Handsomely nickel-plated, beautifully finished. The finest material is used. Go to your dealer and get this lamp. If he is sold out write us and we will see that you are supplied.

Write Today for Interesting Booklet

**Bridgeport Brass Company, 132 Crescent Ave. Bridgeport, Conn.**

**EVOLUTION OF HUMAN PHYSIQUE**—The physical decay of men over 40 must be more frequently mentioned lest we forget the fact that our physique was evolved for only 35 or 40 years of strenuous use, says American Medicine.

It was not so long ago that 45 was extreme old age, counting time in the large way of evolution. Lengthening of life has been possible only because civilization has let up the physical strains, so that if we continue them we must expect to break as of old.

Athletes stop their efforts merely because they are

### MAKE A MOTORCYCLE OF YOUR BIKE



at small cost, by using our attachable outfit. It fits any bicycle. Motorcycles, all makes, new and second hand \$35.00 up. Send stamp for catalogue and bargain list. Keller's new 104-page booklet, "Construction, Management and Care of Motorcycles" is now ready. Price, postpaid, 25c.

**SHAW MFG. CO., Dept. B, Galesburg, Kansas**

## Is Your Motor Ball Bearing?



If you bought a specially built racing motorcycle your motor is probably ball bearing. If it is just a roadster it probably isn't—unless you bought an **R. S. Motorcycle**.

All **R. S.** Motors have the finest imported ball bearings. All **R. S.** Motors have mechanically operated valves. All **R. S.** Motorcycles have numerous other features found only in special machines of other makes. Write for 1911 **R. S.** catalog. *Established dealers*, we have open territory and a fine agency proposition.



**READING STANDARD CO.**

405 Water St., Reading, Pa.

*Makers Renowned Reading Standard Bicycles*

## We Sell You At Wholesale Agents' Price, One



### American Motorcycle or Bicycle

As an introductory offer we give **30 Days' Free Trial** and prepay the freight. Hundreds of people will snap up this introducing proposition. The number of machines we sell on this liberal basis is limited—first come, first served. **Here is our plan:**—You ride the motorcycle or bicycle for 30 days. If it is not satisfactory, you may return it. If you like it, it's yours at the wholesale agents' price. **The American Motorcycles** are highest grade made, easy to start, simple to handle and powerful. You do not have to be a mechanic to run one. The American won the 1910 F. A. M. Western Endurance Contest, scoring 1000 per cent perfect. **The American Bicycles** are the best on the market. We give a **Life Guarantee**.

We have a money making proposition for live agents. Our enormous advertising campaign makes it easy to sell American machines. Don't delay a moment. Our catalog and introducing offer will interest you; it's **free**. Write us which you want, motorcycle or bicycle. **Do it now.**

**AMERICAN MOTOR CYCLE CO., 107 American Bldg., CHICAGO, ILL.**





**UNITED STATES TIRES**

**The Nobby Tread**  
(MORGAN & WRIGHT BRAND)

Is the most remarkable non-skid tire ever invented

The knobs grip the slipperiest road or pavement with bull-dog tenacity. They burrow into the mud or sand and keep the wheel straight to its course. The extra rubber on the tread to form the knobs makes a tire of double value—a non-skid for hundreds and hundreds of miles, with the mileage of the plain tread still to come.

Considering the service you get, they are **BY ALL ODDS** the cheapest tire the Motorcyclist can use.

**UNITED STATES TIRE COMPANY**  
Broadway at 58th St., NEW YORK

## "Couldn't Help Talking About Them"

One dealer said he just couldn't help telling people about the wonderful power developed by Curtiss Motors.

**HE HANDLES FOUR OTHER MACHINES** but the Curtiss motors seemed so superior to him he unconsciously found himself telling customers about them. He made comparative tests, which resulted so unanimously in favor of the Curtiss, that he couldn't keep it to himself, although he had a number of other machines due on contract.

The power development of Curtiss Motors is not wonderful, it's the simple, expected result of a design that is mechanically perfect.

Off-set cylinder. Valves in the head. Perfect lubrication.

Catalog "B" gives you full details of these machines. Have you a copy?

**IMMEDIATE DELIVERIES ON ALL MODELS**

**CURTISS MOTORCYCLE CO.**  
HAMMONDSPOET, N. Y.



**HAVOLINE MOTOR OILS**

**FOR AUTOMOBILES**

Lubricates: Burns Cleanly.  
Write for Booklet. "The Common Sense of Automobile Lubrication"

**HAVOLINE OIL CO.**  
Main Office, 129 William Street,  
New York City.  
Western Office  
Cincinnati, Ohio

**All Garages**  
W. P. Fuller & Co.

**All Dealers**  
San Francisco, Cal.  
Agents

beaten by younger men, but the non-athletic seem to think that it is necessary to keep up excessive exercises though the tissues simply cannot stand it.

There is no mystery in the large number of damaged hearts now being found and they will continue to increase in number and severity until the medical profession succeeds in impressing the lesson. Let us repeat it over and over again until every man over 40 or 45 realizes that he has lived his allotted time of physical vigor and must ease up the strains to retain his health.



## Solar Motorcycle Lamps

are the neatest looking, strongest and most efficient lamps made. The product of light specialists, makers of 90% of the automobile lamps used on the high grade cars of America. Catalog shows many styles—gas, oil and electric. Write for it today.

**BADGER BRASS MFG. CO.**

Kenosha, Wis. New York City, N. Y.



## WANTED—RIDER AGENTS IN EACH TOWN

and district to ride and exhibit a sample 1911 Model "Ranger" bicycle furnished by us. Our agents everywhere are making money fast. Write at once for full particulars and special offer. **NO MONEY REQUIRED** until you receive and approve of your bicycle. We ship to anyone, anywhere in the U. S. without a cent deposit in advance, *prepay freight*, and allow **TEN DAYS' FREE TRIAL** during which time you may ride the bicycle and put it to any test you wish. If you are then not perfectly satisfied or do not wish to keep the bicycle you may ship it back to us at our expense and you will not be out one cent.

**LOW FACTORY PRICES** We furnish the highest grade bicycles it is possible to make at one small profit above the actual factory cost. You save \$10 to \$25 middlemen's profits by buying direct of us and have the manufacturer's guarantee behind your bicycle. **DO NOT BUY a bicycle or a pair of tires from anyone at any price** until you receive our catalogues and learn our unheard of factory prices and remarkable special offer.

**YOU WILL BE ASTONISHED** when you receive our beautiful catalogue and study our superb models at the wonderful low prices we can make you. We sell the highest grade bicycles at lower prices than any other factory. We are satisfied with \$1.00 profit above factory cost. **BICYCLE DEALERS**, you can sell our bicycles under your own name plate at double our prices. Orders filled the day received. **SECOND HAND BICYCLES**—a limited number taken in trade by our Chicago retail stores will be closed out at once, at \$3 to \$8 each. Descriptive bargain list mailed free.

**TIRES, COASTER BRAKE** rear wheels, inner tubes, lamps, cyclometers, parts, repairs and everything in the bicycle line at half usual prices. **DO NOT WAIT**—but write today for our Large Catalogue beautifully illustrated and containing a great fund of interesting matter and useful information. It only costs a postal to get everything. Write it now.

**MEAD CYCLE CO. Dept. S108. CHICAGO, ILL.**



**Overland Tires Overcome All Road Conditions**

Through Illinois sand, Kansas mud, Ohio dirt-ruts, or Canadian corduroy—the Overland tire gets over. A tire possessing real reserve strength, that is built for wear and tear, with the heaviest tread of any tire on the American market—reinforced where needed to overcome side friction when running in dried mud-ruts. The Overland is full size and made for either Dunlop or Clincher rims.

Our list of inside prices is an invitation to you to save from 20 to 40 per cent on your next tire purchase.

**Cut Down Expenses With Overland Tires**  
**OVERLAND TIRE COMPANY**  
 Dept. L 1409 Michigan Ave., CHICAGO, ILL.

**Every Good Motorcycle Part**

is listed in our big catalog at lowest prices. We save you \$ \$ \$. Over half the riders

in America buy of us because we ship same day as the order is received and guarantee everything we sell.

Send for free catalog today and see what is new for 1911

**MOTORCYCLE EQUIPMENT CO.**  
 HAMMONDSPORT, N. Y.

**THE CZAR'S LUXURIOUS TRAIN**—The new Russian imperial railway train in which the Czar and Czarina travel is said to be the most luxurious in the world, eclipsing even the Kaiser's elaborate train de luxe.

The Czar's train consists of eleven carriages. It is entirely on the corridor system, is fitted with electric bells and lighted by electricity. The carriages of the Emperor and Empress are in the middle of the train.

The Empress's drawing-room has the walls covered with pale rose silk and her bedchamber is hung with light blue satin, the furniture being covered with English cretonne of the same color. Each sleeping saloon has a bathroom and dressing-room attached. The Emperor's simple tastes are shown by the fact that he uses the dining saloon as a study, and it is there he transacts all his business with the help of his two secretaries.—New York Sun.



**Convert Your Bicycle into a Motor-Cycle** using our Attachable Outfit. Fits any wheel. Also Marine and Stationary Motors and Finished Castings. Stamp for catalog. **STEFFEY MFG. CO.**, Girard Ave. and 30th St., PHILADELPHIA, PA.

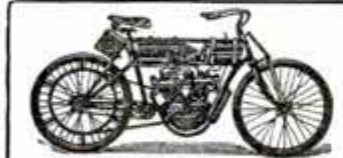

**\$40 Motorcycle**

We have the largest line of new and used Motorcycles in the country at the lowest prices. We also have a thoroughly equipped repair department and are in position to furnish repairs for any machine. Send us your machine to be overhauled.

Send for Catalog.

**HARRY R. GEER CO., 888 McLaran Ave., ST. LOUIS, MO.**



**A MONEY MAKER**

We want an agent in every town and city to sell the only TWO-SPEED SPRING FRAME

**MOTORCYCLES**

The N. S. U. holds the Trans-Atlantic Record, the Economy Record and is the fastest Belt Drive Machine in this country.

WRITE TODAY--DEPT. D

**N. S. U. MOTOR CO.**  
 206 W. 76th St., New York City

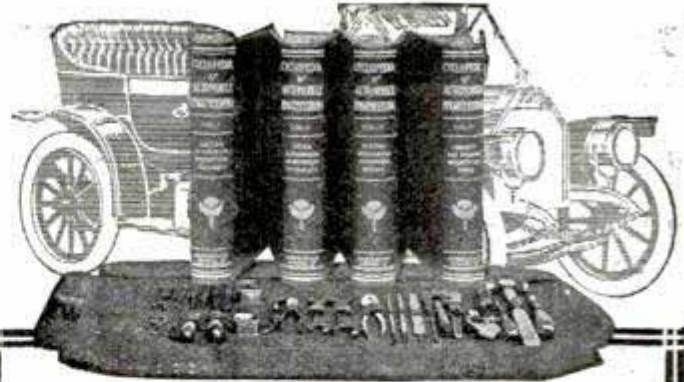

**Know All About Your Auto**

No matter how fine the car you own, or drive, or manufacture; no matter how thoroughly it is equipped, your outfit is not complete unless you own the new

**Cyclopedia of Automobile Engineering**

Four large, handsome volumes bound in half morocco, 1200 illustrations, full-page plates, diagrams, etc., 1500 pages, 7x10 inches, crammed with interesting and very necessary information concerning automobiles, aeroplanes, and motor boats; knowledge that you've got to get some way or other before you can thoroughly understand or enjoy the automobile "game."

**CONDENSED TABLE OF CONTENTS**

**VOL. I—GASOLINE AUTOMOBILES:** Running Gear, Power, Operation, Repair. **AUTOMOBILE MECHANISMS:** Carbureters, Starting Devices, Clutches, Gears, Brakes.

**VOL. II—STEAM AUTOMOBILES:** Flash Boiler, Engines, Operation and Repair. **COMMERCIAL VEHICLES:** Selection, Delivery Trucks, Upkeep, Mileage, Capacity. **TYPES:** Selection, Price, Demonstration, Speed.

**VOL. III—ELECTRIC AUTOMOBILES:** Battery, Motor, Transmission, Control, Tires, Capacity, Driving. Elements of Electricity. Electric Current. **AUTOMOBILE DRIVING:** Starting and Stopping, Gear Changing, Use of Spark and Throttle, Care of Car, Road Repairs.

**VOL. IV—AERIAL NAVIGATION:** Dirigible Balloons, Aeroplanes, Airship Motors. **GAS AND OIL ENGINES:** Ignition, Testing. **MOTOR CYCLES:** Construction, Operation. **MOTOR BOATS:** Types, Engines, Installation.

**Read This Free Examination Offer**

You can examine these books for five days in your own home or office, free of all cost. Don't risk missing this offer by stopping to think it over now. Order now and do your careful thinking with the books before you. That costs nothing. Mail the coupon.

**Here's Our Liberal Selling Plan**

If you like the books after examination, send us \$2.00; then \$2.00 a month until the special price of \$12.80 is paid. If they are not satisfactory, advise us and we will have the books returned at our expense. Order promptly, and we will include for one year, as a monthly supplement, the **TECHNICAL WORLD MAGAZINE**, a regular \$1.50 monthly, full of interesting scientific topics written in popular form.

**AMERICAN SCHOOL OF CORRESPONDENCE**  
 CHICAGO, U. S. A.

**FREE EXAMINATION COUPON**

**American School of Correspondence:**

Please send set Cyclopedia of Automobile Engineering for 5 days' free examination; also Technical World for 1 year. I will send \$2.00 within 5 days and \$2.00 a month until I have paid \$12.80 for books and magazine; or notify you and hold the books subject to your order. Title not to pass until fully paid. Pop. Mech. 7-11

NAME .....

ADDRESS .....

OCCUPATION .....

EMPLOYER .....

# PIERCE

Mechanical Simplicity, Originality of Design, Reliability, Speed, Power and Durability are the Qualities of **PIERCE PRODUCTS.**

Catalog (U)  
free upon  
request.

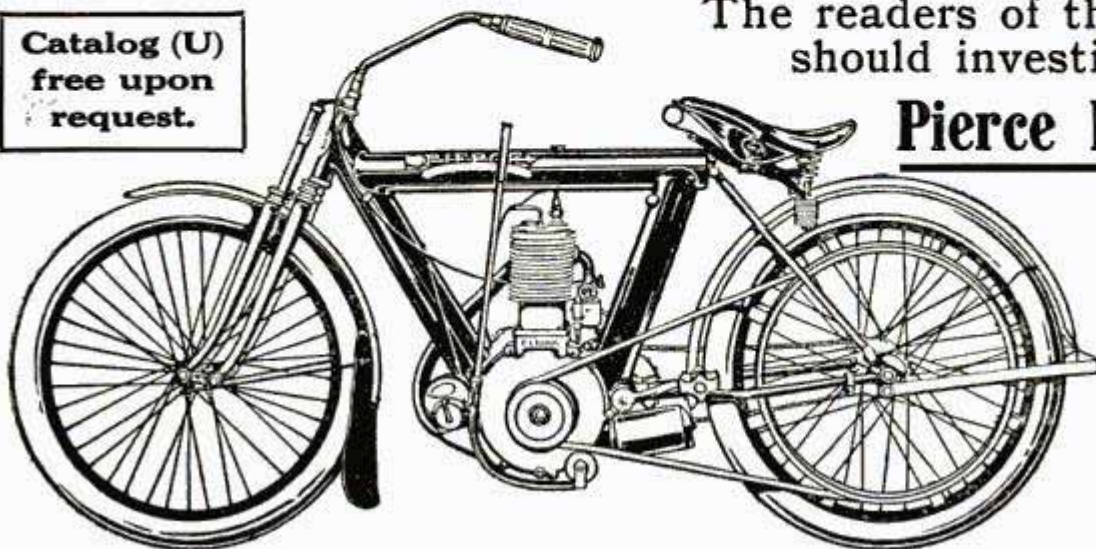

The readers of this Magazine should investigate the

**Pierce Motorcycles**

FOR

**Mechanical  
Excellence**

before making a purchase.

**PIERCE CYCLE CO. BUFFALO, N. Y.**  
Branch: OAKLAND, CAL.

**VACATIONS FOR CATTLE**—In Western Australia one farmer may be heard to inquire of another whether he has yet sent his cattle on their vacation, and what is meant is just what is asked. Those farmers who live anywhere near the coast—and in Australia "near" might mean a distance that would startle dwellers in other lands—send their cattle for a month or six weeks' holiday at the seashore each summer. The change of air and food is said to be extremely beneficial. The grass on the coast is impregnated with salt and has the effect of a tonic on the animals.—Harper's Weekly.

**FREE Murray Style Book**

Save \$30  
Before you buy, it will pay you to get this money-saving book; 178 pages and 251 illustrations of genuine Vehicle and Harness bargains of every kind and for every purpose. Vehicles built to order, direct from our factory; 4 weeks' road trial, 2 years' guarantee. Send for Big Free Book, best ever published.



THE W. H. MURRAY MFG. CO., 366 E. 5th Street, CINCINNATI, O.

**From Factory To Horse**



**Best grade cedar canoe for \$20**

We sell direct, saving you \$20 on a canoe. All canoes cedar and copper fastened. We make all sizes and styles also power canoes. Write for free catalog giving prices with retailer's profit cut out. We are the largest manufacturers of canoes in the world  
**DETROIT BOAT CO., 156 Bellevue Ave., Detroit, Mich.**

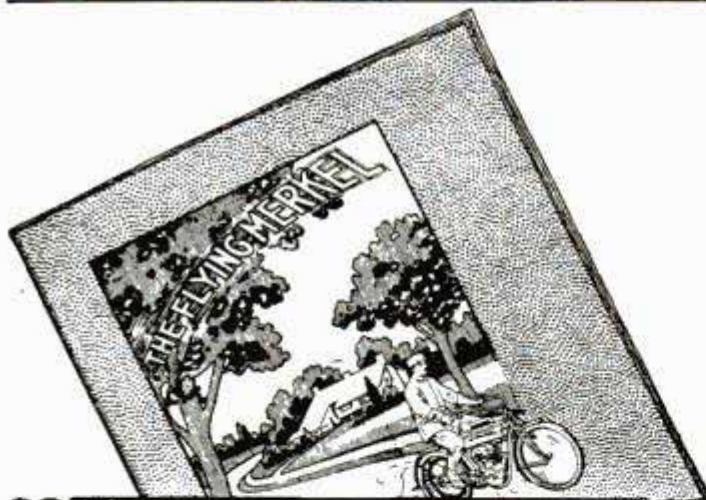

**Send for This Free Book**

It describes and pictures in detail the various models and distinctive features of

**THE FLYING MERKEL**

"The World's Most Comfortable Motorcycle"

You should certainly look it over carefully before you make your choice of a machine.

"The Flying Merkel" is the most comfortable, because it is the only motorcycle with a Spring Frame and Spring Fork. Plenty of speed, too.

Send for this catalog now. It will open your eyes as to what real motorcycle comfort, speed, endurance and economy actually are.

**THE MIAMI CYCLE & MFG. CO.**

Merkel Motorcycle Division

350-370 Hanover St.

POTTSTOWN PA.



## SCHACHT

**3 Cars in 1—\$850.00**

The Schacht is the greatest under \$1000 car ever put on the market for it not only is a remarkably staunch and speedy roadster, but the addition of a rear seat makes of it a big, roomy family car; or the addition of a box, an up-to-date delivery car.

SEND FOR CATALOG

**THE SCHACHT MOTOR CAR CO.**  
2802 Spring Grove Ave., CINCINNATI, OHIO

**A CORNER IN CANDLES.**—As an example of trusts and monopolies prevalent even in that early day, it may be mentioned that in 1750 one Benjamin Crabb obtained the exclusive right to make sperm candles in Massachusetts for 14 years.

A year later, however, a factory was started in Providence, R. I., and within the decade there were eight factories in New England and one in Philadelphia. Their output greatly reduced the price of candles, which not long before sold for five shillings a pound. In those days \$1.25 was worth fully three times as much as it is now.—Designer.

# Prest-O-Lite Gas Tank



## The Best and Cheapest Light for Motorcycles

The Prest-O-Lite Gas Tank (used on 75% of the automobiles of America) floods the road far ahead with strong, steady, dependable light, turned on and off like a gas jet. Prevents costly, dangerous accidents. Motorcycle size gives 40 hours of light (using 1/4 ft. burner). Easily attached—our booklet shows how. Full tank in exchange for empty, at small fee. This clean, convenient service usually costs less than the carbide consumed in a generator. Genuine Prest-O-Lite Tanks, when empty, can be promptly exchanged, anywhere and always, at all automobile and motorcycle dealers. Imitations cannot.

**FREE** Our flexible folding rule. Measures depth of gasoline in tank. Measures tires, etc. Very handy. Sent free to anyone giving name and address, and make of motorcycle.

**The Prest-O-Lite Co.,** 265 East South St., Indianapolis, Ind.

Branches and charging stations in the principal cities from coast to coast

EXCHANGE AGENCIES EVERYWHERE

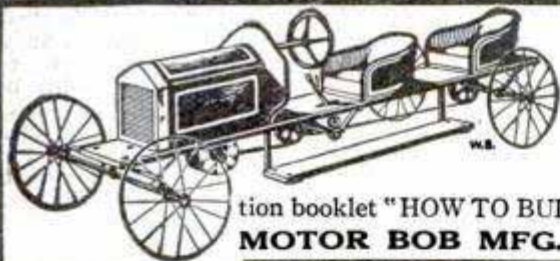

# THE MOTOR BOB

A PRACTICAL MINIATURE AUTO propelled by a small air cooled gasoline motor. Any boy of 12 years and up can (at little cost) build and operate the MOTOR BOB, thereby learning standard automobile construction and operation. Lots of fun without danger. Will carry two boys anywhere. Send 25cts. (coin preferred) for a complete instruction booklet "HOW TO BUILD A MOTOR BOB" with pictures, plain, simple drawings and list of parts.

**MOTOR BOB MFG. CO., Dept. H., Main and Amherst Sts., Buffalo, N. Y.**

## THE WHITE AEROPLANE CO.

337 ADAMS ST., BROOKLYN, N. Y.

We are building our Miniature pneumatic tired wheels, much lighter for racing Models, also reducing the weight in our famous Ball Bearing Shafts and have made up a new lot of very light turnbuckles and eyebolts for racing machines. Our plant has been enlarged and we invite all inquiries large or small. Finest Model making wood, straight selected grain strong and light, all sizes. AAI English Para Rubber. A postal will bring our Second Edition 1911 Catalogue S.



## ELECTRIC WHISTLES

and horns for motor boat, automobile, factory and fire alarm use. Searchlights, dynamo and other accessories at low prices.

SEND FOR CATALOGUE

**THE EDGAR MFG. CO.**

104-5 Hanover St., Boston, Mass., U. S. A. \$8.75



OUR O'BRIEN No. 1

# This Magnificent Steel Launch

Non-Sinkable

Non-Leakable  
Non-Rustable



**Stylish 16-Footer Fully Equipped  
with Engine Ready to Run!**

# \$96

1911 models of the Michigan Steel Launch are now ready for delivery at the lowest prices quoted on boats anywhere. Our special low price schedule for immediate orders covers every launch we make—16, 18, 20, 23 and 27-footers. All sizes in stock for immediate shipment. We are the sole owners of patents covering rolled-seam constructed boats. This construction lasts practically a lifetime. We have the only construction

that has successfully made the terrific trip through Grand Canyons of Colorado and Arizona. Write for booklet describing trip. Gold medals awarded our Boats and Engines by Royal Imperial Tech. Society, St. Petersburg; Internat'l Exposition, Milan; Nat'l Motor Boat Show, Paris.

**Equipped Bow and Stern with Air-Tight Compartments. The Non-Sinkable Boat—Absolutely Safe! Needs No Boathouse**  
Leave your Michigan Launch in the water or out on the beach in all kinds of weather for months. It is puncture-proof. Equipped with the wonderful Detroit Engine, guaranteed for five years, any horse-power from 2 to 50. Fewest moving parts of any engine made. Anyone can run it. Free fully illustrated catalog shows all 1911 models. Don't buy a launch until you see this book. Write for special proposition and prices to Demonstrator Agents. STEEL ROWBOATS, \$20. Need no boathouse. Big money in boat livery.

**MICHIGAN STEEL BOAT COMPANY, 1271 Jefferson Avenue, Detroit, Michigan, U. S. A.**

(77)



Residence Dr. L. A. Neill, New Decatur, Ala.

## UNION METAL COLUMNS (PATENTED)

The age of Classic Art and the age of Steel attain their highest expression and their utmost usefulness in Union Metal Columns for Porch or Pergola.

The ancient forms of Greece and Rome are retained in all their exquisite simplicity in these beautiful columns.

The shafts are of solid steel—with seams securely locked and turned inside so as to leave a surface of perfect smoothness.

Impervious to the action of the elements, Union Metal Columns are as indestructible as the Pyramids—and inexpensive withal.

Send today for the artistic catalogue illustrating beautiful homes, gardens and buildings in which they are being used throughout the country.

Made in all sizes up to 40 inches in diameter and a maximum length of 35 feet

THE UNION METAL MFG. CO., 471 Maple Ave., Canton, O.

## Solid Oak Extension Diner and Chairs

**\$20<sup>50</sup>**



48-inch, round top, pedestal dining table, extends to 72 in.....\$13.50  
4 Dining chairs..... 7.00

This sensational price is made possible by our original exclusive method of manufacturing in sections and shipping in a compact package which may be unpacked and the furniture made ready for use in thirty minutes.

You do not risk one cent. Use the furniture for thirty days in your home. Prove our claim that you cannot duplicate it for double our price — then if you are not satisfied notify us and we will return all the money you have paid.

Don't confuse this furniture with cheap furniture. We manufacture quality furniture only. Free catalog full of similar bargains, giving full details, and a postal will bring it to you. Send for it today.

**BROOKS MFG. CO., 707 Rust Ave., SAGINAW, MICH.**

The oldest and largest firm of its kind in the world.

## THE "BEST" LIGHT



More brilliant than electricity or acetylene and cheaper than kerosene. Costs 2 cents per week. Casts no shadow. Most perfect light for stores, churches, factories, public halls or the home. Makes and burns its own gas. Simple, durable and handsome. In use in every civilized country in the world. No dirt. No grease. No odor. Over 200 different styles. Agents wanted everywhere. Write for catalog and prices.

**THE BEST LIGHT CO.**  
324 E. 5th St., Canton, O.

**GOLD WORKERS' CLOTHES**—Light suits of clothes are not favored in factories where work is done on gold. In fact, in many factories a dark suit of clothes is absolutely required and even a light waistcoat may lose a man a job. The reason for this is that any stray grains of gold that may get on the clothing can easily be caught on a dark suit, while they might get away from the establishment if light clothes were worn.

That such a rule was enforced among gold workers one man learned recently when a Bohemian gold beater applied to him for a helping hand. The Bohemian said



## Home Ironing Machine

On Easy Payments. 30 Days' Free Trial.

A heated mangle that irons all flat pieces better, easier, and in one-quarter the time. Costs 1c an hour for heat—gas or gasolene. Turned by hand, by power or by motor. "Clean Linen" booklet Free. Ask for it.

Home Ironing Machine,  
311-F, Western Ave.  
CHICAGO

## Buy Direct—Save Money—We Pay Freight

Our monthly installment plan of selling direct saves you the dealer's profit and his excessive charges for installation and repairs. You can save at least 1/3 the cost of your furnace. We have been building Jahant Furnaces for over 30 years and guarantee satisfaction

## JAHANT DOWN DRAFT FURNACE

THE BEST HEATING SYSTEM MADE for residences, schools, hotels, churches, etc. It is the most economical furnace too and saves 1/3 to 1/2 the cost of fuel because the patented "Down-Draft System" burns wood, hard or soft coal, and burns it ALL without clinders, clinkers or any waste. Needs less attention, yet heats much better than any other furnace, not air, steam or hot water heating system. Our plan of monthly payments

**ONLY \$10 DOWN and \$10 A MONTH**

makes it easy for any one to have the best heating system made. Every Jahant Furnace is sold with a strong "Guaranty Bond" that allows you 365 DAYS TRIAL. You don't run any risk buying from us.

We send complete outfit, furnace, pipes, registers, etc., together with special plans, full directions and all tools for installing. If you can drive a nail you can install a Jahant Furnace without the aid of a tinner.

**Write To-Day for Catalog**

which explains the Jahant Down-Draft System and tells why it gives more heat at less cost.

**THE JAHANT HEATING CO.,**

**3 Mill Street, Akron, O.**

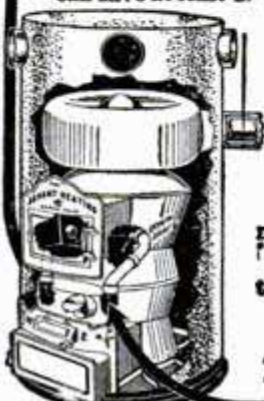



# Wizard Table Lamp

Operated by merely pulling the chain. As convenient as electricity at one-tenth cost. Always ready for instant use. Requires no generation. Can be regulated to any candle power from 1 to 700.

For further particulars, agency and illustrated catalog, address

**THE NAGEL-CHASE MFG. CO.**  
144 West Ohio Street, CHICAGO, ILL.



FOREMAN \$1900 A YEAR

SUPERINTENDENT \$2500 A YEAR

CONTRACTOR \$3000 A YEAR



## Learn to Fill BIGGER SHOES!

Don't be satisfied with merely pushing a saw and driving nails. Be a master of your craft. Learn to plan as well as to work—to use your brain with the same skill that you use your hands.

### How You Can Do It

You can master every branch of building construction, architecture and carpentry—at almost no expense at all. You can have the knowledge and experience of over four score experts at your command, for use whenever you want it—by allowing us to place in your hands this great ten volume set, without you sending us one cent in advance.

## THIS CYCLOPEDIA OF Architecture, Carpentry and Building

is the most practical work on the building trades that has ever been published. It covers every detail of building construction from common carpenter work to reinforced concrete and steel. Contains over 3,000 drawings, full page plates, diagrams, etc., 4,670 pages, bound in half morocco, printed on special paper—large clear type—10 massive volumes, titles engraved in 23 karat gold.

### Partial Table of Contents

- Carpentry — Building Materials — Building Superintendence — Reinforced Concrete — Contracts and Specifications — Estimating — Stair Building — Masonry — Heating — Hardware — Ventilation — Steel Construction — Elevators — Architectural Drawing — Freehand Drawing — Making Blue Prints — Wiring Door Bells — Burglar Alarms — Sheet Metal Pattern Drafting — Mechanical Drawing — Lettering.

## Get These Books and See for Yourself

Look them over at your leisure. Keep them for five days before you decide whether you want them or not, and then if you don't believe that each volume is actually worth more to you than the price of the entire set, send them back, at our expense and the transaction won't cost you one penny. If you keep them, our charge will be \$24.00, in easy payments of only \$2.00 a month. We don't ask you to buy these books on our description of them. We don't ask you to trust our judgment. We simply ask you to get the books and see for yourself. Sign the coupon now. It will bring the books, not an agent.

**SPECIAL**—For a short time we will include with each order a year's subscription to the Technical World Magazine—a regular \$1.50 popular illustrated magazine.

**AMERICAN SCHOOL OF CORRESPONDENCE**  
CHICAGO, U. S. A.

### FREE EXAMINATION COUPON



American School of Correspondence, Chicago:  
Please send set Cyclopaedia of Architecture, Carpentry and Building for five days' free examination, also T. W. for one year. I will send \$2.00 within five days and \$2.00 a month until I have paid \$24.00 for the books and magazine, or notify you and hold the books subject to your order. Title not to pass until fully paid. Pop. Mech. 7-11

NAME .....

ADDRESS .....

OCCUPATION .....

EMPLOYER .....

## NULITE Gasoline Table Lamp

A beautiful lamp for homes, hotels, offices, stores, banks, cafes. Portable, safe; can be turned upside down or rolled on the floor without danger or affecting the light. 300 c.p. of soft, brilliant light, 1/2c per hour. Also 200 different styles of lamps and systems.

**AGENTS**—We want town, county and traveling salesmen. Best proposition ever offered. Sells everywhere. WRITE FOR SPECIAL OFFER.

**NATIONAL STAMPING & ELECTRIC WORKS**  
422 So. Clinton St. CHICAGO



## This Morris Chair \$1.25

65c monthly—total price \$5.45. CASH  
Latest design. Kiln dried heavy stock. Genuine Fabricord Leather. We have 3000 such bargains for you. And all

### SOLD ON CREDIT

You use and enjoy the goods now—pay as you can. 30 DAYS' GUARANTEED FREE TRIAL. Send at once for our big illustrated catalogue. It's FREE to you.

**Spiegel, May, Stern Co.**  
1542 35th St., Chicago, Ill.



that he had only recently come to this country, that he had had a chance to obtain a good job at his trade but that the place had been refused him because he turned up with a light coat and waistcoat on, and they were the only clothes he had.

The man whom he approached was struck by the story and offered to help him out if it proved true. He went to a downtown factory with him and found out that the man could have the job if he presented himself within an hour with the proper clothes on. Two dollars enabled the man to rig himself out in the dark coat and waistcoat to go with his dark trousers, and sure enough

**BUY PLUMBING SUPPLIES** Will Save You 30%  
**AT WHOLESALE**  
Don't pay retail prices. Full stock on hand for prompt shipment. Send for free catalog.  
B. F. KAROL, 768 to 772 West Harrison St., Chicago

## Only \$9750 Per Carat for Perfect Cut, Genuine Diamonds

We save you 40%. Learn all about the BASCH plan. Write for catalogue "A," guarantee, money-back contract and prices FREE. Diamonds sent C. O. D. with privilege of examination.

**L. BASCH & CO., 272 State St., CHICAGO, ILL.**

**BYSTROM LIGHT** GOOD AGENTS WANTED  
Great Money-Making Opportunity. Bystrom lights most up-to-date on market. Convenient as gas or electricity, brighter, safer, cheaper. Endorsed by insurance companies. Burn 96% air, 4% gasoline 500 C. P. light costs 1/2 cent an hour. Write today for free booklet. **THE BYSTROM GAS LAMP CO., Dept. Q., Defiance, Ohio.**

# BISHOPRIC WALL BOARD AND SHEATHING

SAVE MONEY, TIME, AND LABOR IN BUILDING

**BISHOPRIC WALL BOARD** is cheaper and better than lath and plaster. Easily nailed to studs. Applied dry, it is ready at once for paint, paper or burlap—inexpensive or artistic decoration. Made of kiln-dried, dressed laths, imbedded in Asphalt Mastic, insuring a solid, substantial covering for



## Walls and Ceilings

Will not shrink, warp or crack. Clean, odorless and sanitary. Guaranteed proof against dampness, heat, cold, sound and vermin. Used for finishing new buildings of every description; also for partitions, attics, cellars, porches, laundries, garages. It is the original Wall Board, construction patented.

**BISHOPRIC SHEATHING** is made of same materials as Wall Board, but is nailed smooth side to studs with laths and asphalt exposed.

**SAVES 75 PER CENT**

in material and labor. Does away with building paper. Makes smooth, solid job. Proof against heat, cold, dampness and vermin. Used under weather boards, flooring and ready roofing or cement; also as lining for barns, poultry houses and other out-door buildings. Houses finished with Bishopric Wall Board and Sheathing are ready for immediate occupancy. Write today for prices and

**FREE** Booklet and SAMPLE of *Bishopric Wall Board*  
*Bishopric Sheathing*  
*Bishopric Ready Roofing*

Dealers write for attractive proposition

The Mastic Wall Board & Roofing Mfg. Co., 60 East Third St., Cincinnati, O.

## You Can Read or Work All Night

without tiring your eyes by the light of one of these wonderful

### INVERTED TRIUMPH LAMPS

as the pure white and soft steady light is restful and pleasing to the eyes and pronounced by *oculists* to be the nearest approach to daylight of any artificial light, and almost as cheap, as one quart of gasoline lasts 15 to 20 hours, giving light equal to 100 burning candles. Five times as cheap as kerosene. Our **HANDY** or **BONANZA** gasoline lighting systems will light your store or home from cellar to garret with pure white gas light at less than 15c per 1000 feet. Better than gas companies charge \$1.00 to \$2.50 a 1000 feet for.

Send now for P.O.P. catalog—it's free and tells why.

**BRILLIANT GAS LAMP CO.,** New No. 182 N. State St.  
CHICAGO, ILL., U. S. A.

Department 1



## HESS FURNACE

Sent on Approval



We will deliver a complete heating equipment at your station at factory prices and wait for our pay while you test it during 60 days of winter weather.

The entire outfit must satisfy you or you pay nothing. Isn't this worth looking into? Could we offer such liberal terms if we didn't know that the Hess Furnace excels in service, simplicity, efficiency, economy?

We are makers—not dealers—and will save you all middlemen's profits. No room for more details here. Write today for free 48-page booklet which tells all about it.

Your name and address on a post card is sufficient.

**HESS, 910 Tacoma Bldg., Chicago**

No. 48  
"Leader" Hess  
Steel Furnace  
Price \$49

Delivered East of Omaha and  
North of Ohio River  
Pipe and Registers Extra

he got the job.

"You may think this strange," said the man at the factory, "but it means quite a little to us. Every man's clothing is carefully examined when he leaves here at night and the gold brushed off whenever we see any on his clothing.

"It is impossible to hide even tiny grains on a dark background, but take a mixed or a light suit and we might easily lose quite an amount of gold, and gold isn't anything you want to lose even in small quantities."

—New Haven Register.



## PRINT FOR YOURSELF

Cards, circulars, book, newspaper. Press \$5, Larger \$18, Rotary \$60. Save money Print for others, big profit. All easy, rules sent. Write factory for press catalog, TYPE, cards, paper.

**THE PRESS CO., Meriden, Connecticut**

## Grab's Wonder Lighter!



Everybody's buying it. The safest, most efficient and economical substitute for dangerous and costly matches. Flashes instantly, igniting any gas or alcohol. Good for 5,000 lights. A household necessity. Simple, durable. Price prepaid only 10c. Think of it. Hurry order. Agents wanted.

**VICTOR M. GRAB & CO., 17 Ashland Blk., Chicago, Ill.**

## AERIO VACUUM CLEANER

The one staple vacuum cleaner for general popular use. Easily operated by one person. Sheepskin diaphragm, enclosed dust cylinder, double action and constant suction. Throw away the woman killer broom.

### TEN DAY FREE TRIAL

If you are not entirely satisfied with the Aerio within ten days after you receive it, your money will be returned to you without word or question. Sold with factory guarantee for five years.

Price  
\$10.00  
Prepaid

Agents Wanted for exclusive territory

**BRAHAM MANUFACTURING CO.**

150 CINCINNATI, OHIO

## \$38.95 BUYS THIS COMPLETE BATHROOM OUTFIT



MODERN  
BATHROOM  
FOR EVERY  
HOME

THE LUXURIES OF MODERN PLUMBING AT HALF THE ORDINARY COST

Complete Pneumatic Water Supply Systems from \$42 upwards

SAVE \$100 to \$250 on your steam or hot water heating plants.

Gasoline engines for farm and shop. Electric Lighting Plants for your home - \$300

Hydraulic Rams, Pumps, Pipe, Valves, Fittings at lowest prices. Farmers' Tanks for every purpose.

Acetylene Lighting Plants, Gas and Electric Fixtures. All high grade, strictly guaranteed goods. Get our prices and we will save you money.

**BIG CATALOGUE FREE!**

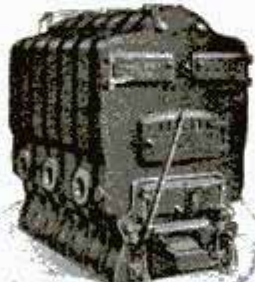

**M. J. GIBBONS** DEPT. A  
DAYTON, O.



## Thor Free Engine Clutch and the Motor Goes on Just the Same

No need to stop the motor, even though you do stop the machine. The Thor Free Engine Multiple Disc Clutch running in oil is now equipped on all Thor Chain Drive models at no extra charge. It is perfect in action and principle of construction. It enables you to bring your machine to a standstill while the motor runs smoothly and silently on.

### Thor Motorcycles — Champions of all Endurance Contests

Won every important endurance contest last season as well as this season. Endurance is the real test of a motorcycle—because you do want absolute dependability. For 1911 we submit five very handsome models—Four (4) horse power single cylinder and one (1) seven horse power double cylinder, all described in our big booklet sent anywhere on request. "A Guide to Motorcycles."

**Agents**—there are a few more openings in good territory; this is a big business opportunity. Act quickly if you want to get in on the ground floor.

**AURORA AUTOMATIC MACHINERY COMPANY, Dept. 4, 1307 Michigan Ave., Chicago, Ill.**

## AGENTS—MEN—WOMEN BOYS—GIRLS MAKE \$15 to \$35 EVERY WEEK

**NEW SELLING PLAN**  
WE GIVE THIS \$2.50 KITCHEN SET TO  
YOUR CUSTOMERS TO ADVERTISE  
OUR GOODS



Big snap for agents. Over 2,000 guaranteed fast-selling articles. Work pleasant and easy. No experience needed. We teach you Free. Earle White (age 21) made \$32.96 first week. Never sold goods before. Make big profits in your spare time. Samples furnished workers. Liberal credit terms.

THE MOST STARTLING OFFER EVER MADE

## THIS \$1,000 MAXWELL AUTOMOBILE GIVEN

This handsome, new 1911 five passenger automobile given to agent selling most goods. 2nd prize \$400 piano. 300 prizes in all. In case of a tie, equal prizes given. Write at once.



Make big money and win this auto

McLEAN, BLACK & CO., 700 Doty Bldg., Boston, Mass.

## Is Your Water Supply Satisfactory?

Let us send you our descriptive booklet—tells how and at what cost your home, summer cottage, farm, hotel or camp can be supplied with

### Water Under Pressure

If you will tell us briefly your water needs, we will send our recommendations free of cost or obligation on your part. Running water in the home is not a LUXURY—it is a NECESSITY.

WRITE TODAY FOR OUR NEW CATALOG

**The Dayton Pump & Mfg. Co.**  
No. 7 Norwood Ave. DAYTON, OHIO

## AGENTS \$45. TO \$90. A WEEK

I want a good man in every territory in the United States—as local agent for one county, or as General Agent for a number of counties. This is a new proposition and offers you an opportunity to make from \$45.00 to \$90.00 a week, and on up to \$8,000 or \$10,000 a year. No experience is necessary; but I want men—young or old—who will treat me square, who will follow instructions, and who will do their level best.

THE NEVER FAIL CO., 1048 Colton Building, TOLEDO, O.

## BOOK OF PIANO TESTS

Read this book and you will know how to tell a good piano every time. This book explains the INSIDE facts about soundboard, action, cost of woods, nickel used in strings, how to detect FRAUDS in piano making, etc., etc. The New York World says: "A book of educational interest everyone should own." With this book we send free latest circular illustrating the high grade Wing Pianos (the only pianos sold direct from our exclusive piano factory, and saving ALL middlemen's profits. Send for this FREE great Piano Book today—free prepaid

WING & SON  
9th Ave., and 13th St.  
Dept. 119Y, New York



## Let the Slide Rule Do Your Work—Do Your Work

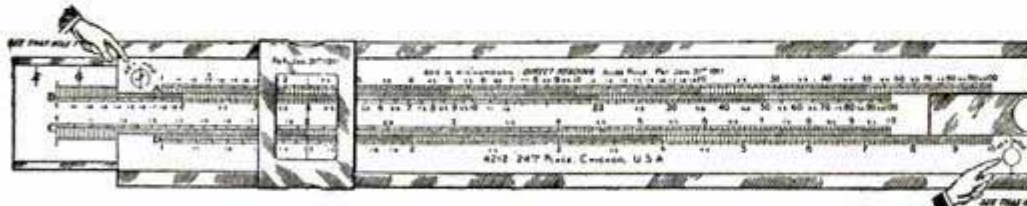

Engineers, Electricians, Draftsmen, Superintendents, Managers, Master Mechanics, Estimators and Business Men:

Your Time is too valuable to waste in solving problems or checking over the work of others. The Richardson Slide Rule will do it mechanically.

One of the most valuable instruments ever offered to mankind is the Slide Rule. Not until the above rule was designed did it become possible for a person of a limited education to learn to operate it. Besides, the usual price has been reduced one-half, and the free instruction book is "written so you can understand it."

This Slide Rule will multiply, divide, solve proportion, extract the square and cube roots, find the decimal equivalent of vulgar fractions or "vice versa," calculate interest, percentage. In addition to above the rule is direct reading for forty-four other problems, such as the Horse Power of Engines, Pumps, Boilers, Belts, Water Falls; size of motor to run a pump; size of duct for ventilating; percentage a recording wattmeter is "Slow" or "Fast"; radiation and size grate, and steam main required; change gear and pulley problems; areas, circumference and diameter of circles. You simply place the key to the problem in the key hole (the key is printed in red) and answer is given direct. This rule is my latest improved type now being placed upon the market for the first time. "See sectional cut" curved slide bound with aluminum. No other like it: Good value. Price \$2.50 with substantial pocket case and instruction book. Stock aluminum 1 1/8 inches with runner. Scales celluloid printed and polished in two colors and washable.

**GEO. W. RICHARDSON,** Mechanical and Electrical Engineer

4218-24th Place, CHICAGO, ILL.

# Are You Building?

Then let us send you copy of our new booklet PA-7 — which tells all about the proper method of finishing floors and interior woodwork.

## Johnson's Wood Dye

makes inexpensive soft woods just as artistic and beautiful as hard woods. Tell us the kind of woods you will use and we will mail you panels of those woods artistically finished— together with our 25 cent booklet— all free and postpaid.

S. C. Johnson & Son, Racine, Wis.  
The Wood Finishing Authorities

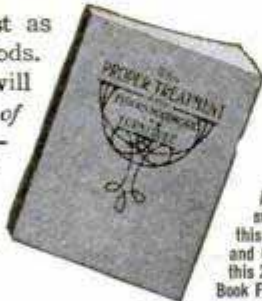

Answer this Ad and Get this 25c Book Free

## "Avoid Blade Trouble"

Ask for and insist upon getting

## STAR HACK SAW BLADES

For Machine Use 12x5/8

There are none better—none better can be made STAR HACK SAW BLADES, the recognized "STANDARD" by which Hack Saw Blades have been judged FOR OVER A QUARTER OF A CENTURY.

All Dealers Keep Them. Send for Particulars

28 Warren St. Millers Falls Co. New York



## UNIVERSAL CABINET For Everybody For Everything

50 Drawers 8x3x2 1/2 inches inside; 2 Removable partitions, making 150 compartments. Perfect imitation Antique Oak finish. Polished Brass Pulls and Card Holders. \$11. Sample Drawer. 15c. A. F. & MFG. CO., Troy, Ohio

## Be Sure of Your Boat by Building It Yourself

Build your own boat from PIONEER PERFECT FRAMES and PIONEER PLANS and Save One-Half. Just as simple as 1-2-3. Every rib bent and fitted in our factory, then frame knocked down and shipped to you for re-assembling. Write for the whole story in Book Form. Sent FREE for the asking, showing how easy it is.

Materials and satisfaction guaranteed.

PIONEER BOAT & PATTERN CO., Wharf 33, BAY CITY, MICH.



## Elbridge Aeronautic Motors

Positively automatic in operation. Guaranteed to run ten hours at 1200 or more r. p. m. without adjustment or attention. The result of years of careful experiment under all conditions of flight. The lightest and most compact reliable motor ever built.

"American Amateur Aviation," a history of 1910 amateur achievements and our 1911 catalog for six cents.

Elbridge Engine Co., 62 CULVER ROAD, ROCHESTER, N. Y.

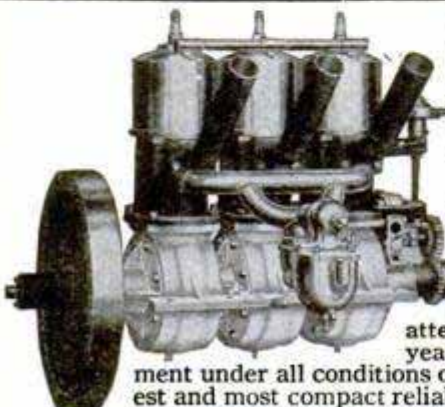

## The Best Motor Boat

Is the one that has a reliable motor exactly adapted to the hull. Elbridge Marine Engines have made good in every type of hull. They have proven reliable, strong, economical. Our range of sizes and styles is so varied that we can furnish you the motor exactly suited to your needs.



Our 1911 Catalogue gives detailed information. It's Free.

ELBRIDGE ENGINE CO.  
62 Culver Road, Rochester, N. Y.

## I Earn \$35.00 A Week as a "BUFFALO" GRADUATE



"They made me an expert chauffeur in a few weeks' time (right in my own home). The model they give free to every student and their easy

lessons made it a cinch for me to learn." We'll do the same for you. We give our graduates addresses to parties requiring chauffeurs and wait till they're located for one-third the cost of the course. Small down payment starts you. Free sample of lessons, letters complimenting our method, etc. Road lessons. Let us prepare you for the jobs that get the money.

BUFFALO AUTOMOBILE SCHOOL  
351 Edward Bldg. BUFFALO, N. Y.

**Does Your Razor Pull?** We will grind out the nicks, hone and polish up as good as new. We also sharpen all makes flat safety blades, 2 1/2c each including premium. Write at once for special offer. GUARANTEE SHARPENING CO., Box F. 518, CHICAGO

## VELVET—The Smoothest Tobacco—10c

**CIGARS** from maker to smoker, by mail, at wholesale price. Send for catalog. La Reclama Cuban Factory, 414A, E. 32d St., N. Y. C.

## Fairbank's Pummo Soap

A Glycerine Pumice Soap

"CLEANS LIKE A FLASH"



## Send for Our Free Vibrator Book

describing the White Cross Electric Vibrator. This Vibrator is a rubbing machine which draws the blood to any aching part of the body to do its work. This machine rubs much better and much faster than the hands. While the hands are giving a few dozen rubs, the White Cross Vibrator gives several thousand. Send today for the Free Vibrator Book. It may mean health to you. Lindstrom-Smith Co., 253 La Salle St., Dept. 119Y Chicago

(ESTABLISHED 1842)

## Reed & Sons Pianos

Highest Award World's Columbian Exposition

Now Sold Direct to You from Factory

30 DAYS' FREE TRIAL IN YOUR HOME. Take your own time to pay. No payment in advance required. For free book address

REED & SONS PIANO MFG. CO.

Dept. 17 Cor. Jackson Blvd and Wabash Ave. CHICAGO

# L. C. Smith & Bros. Typewriter

(BALL-BEARING, LONG-WEARING)

Ball-bearing carriage, quickest in operation with much less tension.

Ball-bearing typebars, in full action from the very beginning of the key-stroke — top speed at a touch, without a push to start it.

Ball-bearing shift, one-third ordinary shift-key pressure — carriage not lifted to write capitals.

With a printing process that is ball-bearing from start to finish, the user of an L. C. Smith & Bros. Typewriter is positively assured of the quickest, easiest operation and the most perfect rapid work it is possible for a typewriter to produce.

Ask for free "Book of the Typewriter."

Branches in all large cities.

L. C. SMITH & BROS. TYPEWRITER CO.

Head Office for Domestic and Foreign Business, Syracuse, N. Y., U. S. A.

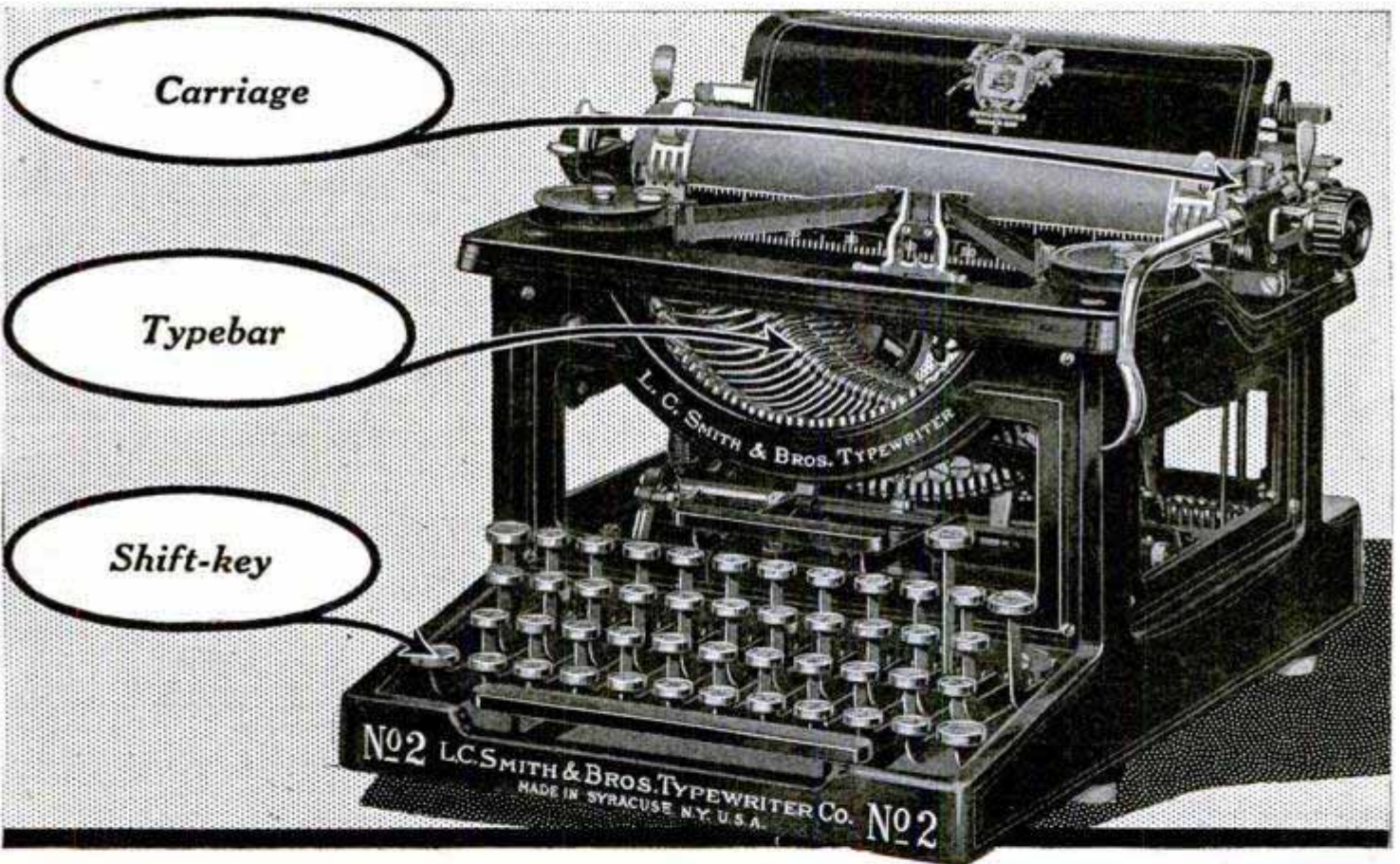

It cost \$40,000,000 to run the whole Federal Government for the year 1800. Now "travel expenses" of officials total \$12,000,000 for a year. The nation's growth is thus strikingly illustrated.—Brooklyn Eagle.

**\$4000 A YEAR TO AGENTS**

100 agents — salesmen — managers wanted. From \$50 a week to \$4,000 a year. McGough, O., made \$160 in one week. E. J. Dirr, Mich., cleared \$22.50 in one day. Needed in every home, office, factory, public buildings and by auto and motor boat owners. A Wonderful New Fire Extinguisher. Used by U. S. Government. Write quick. Try for this big money.

**UNITED MFG. CO., 1577 Mill St., LEIPSI, O.**  
Reference Bank of Leipzig, Capital \$1,000,000.00

## Wireless

We publish the best 25c wireless books in the country. Your money refunded if these books are not the greatest value for the money you run across. "How to Make Wireless Instruments" by 20 wireless experts, 96 pages, 75 illustrations. "Wireless Telephone," by H. Gernsback, 80 pages, 57 illustrations. "Construction of Induction Coils and Transformers" by H. W. Secor, 100 pages, 72 illustrations. "Wireless Hoo-kupa" 100 pages, 161 illustrations. Each book mailed for 25c, or the four for \$1. MODERN ELECTRICS PUBLICATION, 231 Fulton St., N. Y. CITY.

**Folding BATH TUB**

Costs but little and will last for years. Weight only 15 pounds. Requires but little water, and no plumbing necessary. Folds into small roll and no more trouble to carry than a valise. Enjoy the delights of a full length bath in your private room. Far superior to a tin tub. Write for description and special offer to agents. **ROBINSON MFG. CO., 654 Jefferson Ave., Toledo, Ohio, Mfrs Turkish Bath Cabinets.**

## Geissler Tubes

We carry the most complete assortment of Geissler Tubes and other Electrical Tubes in the U. S. Our prices are lower than any one else. Prompt shipments guaranteed. If you have a spark coil, you cannot afford to be without one of these tubes as the wonderful colors and beautiful effects of same will give you more pleasure of your coil than anything else. 3" tube plain 20c; with fluorescent liquid 30c. 6" tube plain 35c; with fluorescent liquid 50c. Mail extra 10c each tube. Send today 4c for our great 196 page Electrical Encyclopedia containing 400 illustrations. No postals answered. **THE ELECTRO IMPORTING CO., 233a Fulton St., New York**



Information on Wireless, Experiments, etc. "Everything for the Experimenter"

## GET THE NEW 1911 BOOK OF SCRIPPS MOTORS

You should have this new 1911 catalog of Scripps Motors. It tells how these famous marine engines are made, and why they are preferred by experienced motor boat owners in every part of the world.

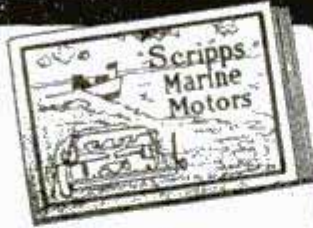

Scripps Motors are not the cheapest in first cost, but their owners are constantly writing us of their freedom from repair bills and the troubles that usually go with the cheap motor. There is no real economy in a motor that is continually causing expense and vexatious delay.

There is the same satisfaction in owning a Scripps Motor that there is in owning a thoroughbred horse or dog. You know it comes from a good family that has never failed to show its true worth when put to the test.

All Scripps Motors are of the four cycle type, and range in power from 4 to 100 H. P., one to six cylinders. Be sure to get our catalog before you select your engine for the season.

### SCRIPPS MOTOR COMPANY

650 Lincoln  
Avenue

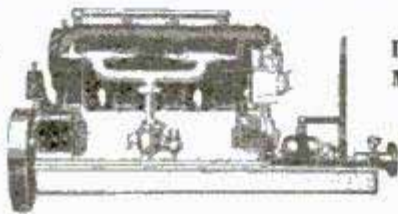

DETROIT,  
MICHIGAN

## ELLIS USE KEROSENE ENGINES

Cheapest, safest, simplest power for barn work, house work, mill work, dairy work, electric light plants, etc. Guaranteed for 10 years. Free trial. Write for catalog. ELLIS ENGINE CO., 39 Mullett Street, Detroit, Mich.

## Mullins Steel Motor Boats



Have no equal. Can't sink or warp. Puncture-proof, noiseless. Lowest in price, too. Complete line of Row Boats, Hunting and Fishing Boats and Marine Engines. Write for finest Boat Book ever printed. Free, postpaid.

The W. H. Mullins Co., 151 Franklin St., Salem, Ohio

We have for sale a limited number of complete files of

## Popular Mechanics for 1909

These consist of the 12 issues of the magazine and a complete index suitable for binding.

Price \$1.25 postpaid.

POPULAR MECHANICS, 318 W. Washington St., Chicago

Two Excellent Books for Those Who Like to Make Things

## Amateur Mechanics Nos. 1 and 2

PRICE 25 CENTS EACH POSTPAID

Popular Mechanics Book Department 318 W. Washington St. CHICAGO

## READ THIS WONDERFUL STORY

128 Pages.  
Bound in Cloth.  
Illustrated.

# HEAT

Price  
Post-  
paid, 50c

By J. GORDON OGDEN, Ph. D., Professor of Physics, Fifth Ave. High School, Pittsburg

*Thoroughly Understandable—Instructive—Immensely Interesting*

This book consists of a series of articles, each complete in itself, yet all pertaining to heat and its relation to modern mechanics.

**F**EW people realize that fire is the most remarkable and valuable discovery ever made by man. Prior to this, man was brother to the brute, but with the coming of fire, came all the wonderful development that has enabled man to assert and defend his claim as lord of creation. We are only in the infancy of high temperature development, yet read of the harnessing of intense heat to the wheels of progress; the contrivances whereby we are able to emulate the volcano in our laboratories so far as heat is concerned and weld steel rails in the street where they lie; the discovery of uses of rare metals in industrial lines by aid of heat. Investigation of the realm of low temperatures also discloses some wonderful facts. All these, and many other phases of this interesting subject are treated as shown by the following list of chapters:

1—Nature of Heat and How It Is Measured. 2—How Low Temperatures Are Produced. 3—Some Effects of Low Temperature Upon Matter. 4—The Production and Uses of High Temperature. 5—High Temperatures and the Rare Metals. 6—How Heat Travels. 7—How Heat is Measured. 8—Expansion and Contraction. 9—Energy and Fuels. 10—The Manufacture of Artificial Ice. 11—Steam Boilers and Engines.

Popular Mechanics Book Dept., 318 W. Washington Street, Chicago

# Self-Registering Wire Gauge

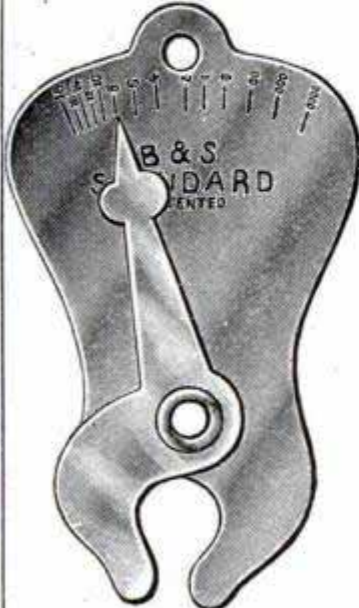

An accurate, quick reading wire gauge. Will register instantly the B. & S. standard size of any wire from Nos. 0000 to 18 inclusive. Made of hardened finished steel. Can be carried on the key ring or small safety chain or in the vest pocket.

**PRICE**  
**25 Cents**

Send for Catalog 24P

**Manhattan Electrical Supply Co.**  
NEW YORK 17 Park Place CHICAGO 112-114 South Fifth Ave.

**WATCH THE REFRIGERATOR**—Watch the refrigerator. Not for thieves, but for something worse than thieves—germs. It is stated by eminent authority that probably more disease is traceable to the family refrigerator than to any other source. This same authority says: "Scald your refrigerator every day and keep old food out of it. Don't let anything of this sort accumulate with the idea of having it by making members of the family eat it when their appetites for the thing returns. Old food, if eaten is worse than wasted." Then the same authority points out the necessity for

**ELECTRIC** GOODS FOR EVERYBODY. World's headquarters for Dynamos, Motors, Fans, Toys, Railways, Batteries, Belts, Bells, Pocket Lamps, Telephones, House Lighting Plants, Books. If it's electric we have it. Undersell all. Fortune for agents. Big Catalogue 4 cents.  
**OHIO ELECTRIC WORKS, CLEVELAND, OHIO**

**BRANDES** WIRELESS RECEIVERS  
Don't fail to send stamp to Dept. M for our new pamphlet, giving full description of our Wireless Receivers from \$1.50 each to \$13.00 a set.  
**U. BRANDES No. 111 Broadway, NEW YORK**

**BIG 200-p ELECTRICAL and WIRELESS CATALOG** Mailed for 6c Stamps  
which may be deducted from first order. Largest and most artistic Electrical Catalog Published. 60 pages WIRELESS Instruments for commercial and experimental use. 15 pages Motors and Dynamos of all sizes. 35 pages Miniature Trains and Imported Electrical TOYS. 20 pages Telegraph Instruments. 40 pages Electrical Novelties, etc. 30 pages general Electrical Supplies.  
**J. J. DUCK, 424-6 St. Clair Street, TOLEDO, OHIO**

**EVERY BOY HIS OWN TOYMAKER**  
GREATEST BOYS BOOK EVER WRITTEN. Tells how to make a STEAM ENGINE, CAMERA, WINDMILL, MICROSCOPE, ELECTRIC TELEGRAPH, TELEPHONE, MAGIC LANTERN, BOATS of every kind, KITES, BALLOONS, TOYS, WAGGONS, BOWS and ARROWS, STILTS, ANIMAL TRAPS, etc.  
OVER 200 PICTURES. THIS BOOK and CATALOGUE ONLY 10 cents. POSTPAID  
**ELECTRIC FUN MAKERS**  
Dept. 1 KEWANEE, ILL.

# Bargain Prices on New and Used Electrical Machinery



We Buy, Sell, Rent, Trade and Repair Electrical Machinery. Our Stocks are Large, Prices Low and our Used Machinery is as Good as New. Write for Bargain Booklet Number Twenty. Tell us what you have and what you need. We can interest you.

**SWITCHBOARDS**  
For POWER or LIGHTING  
Whether large or small, Alternating or Direct Current, we do or will build the Switchboard that meets your requirements.



Ask for Switchboard Bulletin Number Twenty-two. It gives prices.

We do not handle novelties or toys.  
**The F. BISSELL COMPANY**  
226-230 Huron St. TOLEDO, OHIO

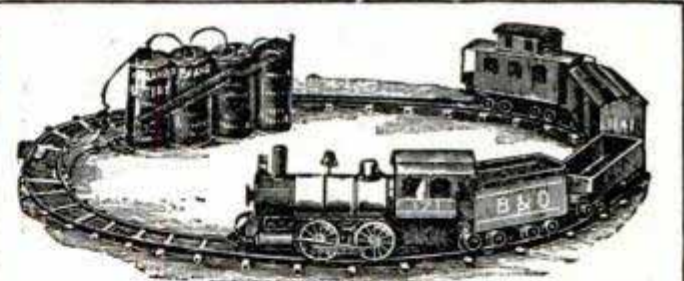

Electrical railways, tracks, switches, trolley cars, dynamos, motors, dynamo castings, gas engine castings, everything for the young electrician. Send for our complete catalog "B."  
**The Carlisle & Finch Co.**  
262 E. Clifton Ave. Cincinnati, Ohio

**SECONDARY "UNITS" FOR WIRELESS**  
INDUCTION COILS AND TRANSFORMERS: THESE UNITS COST BUT LITTLE MORE THAN WIRE ALONE. SEND 2 CENT STAMP FOR WIRELESS CATALOGUE.  
**Dawson & Winger Electric Co., 429 Dearborn Street, Chicago**

**ELECTRICITY**  
The most wonderful and fascinating scientific study of the age. Every Boy, Girl and Grown-up should know about it. The new "VOLTAMP ELECTRICAL PRODUCTS"—our 112 Page Catalog now ready, the most complete and interesting book ever issued—is full of illustrations and descriptions of the latest Voltamp. Electrical Novelties—Motors, Dynamos, Toys, Machine Models, Telegraph and "Wireless" Instruments, Ruhmkorff Coils, Spark Coils, Geissler Tubes, Switches, Meters, Lamps, Flashlights, Transformers, Tools, etc. The greatest line of Miniature Electric Railways ever shown. Ideal Christmas Gifts. Prices consistently low.  
Send for this Catalog—6 cents in stamps or coin, which will be refunded on first order of 50 cents or over. No postals answered.  
**VOLTAMP ELECTRIC MFG. CO., Voltamp Bldg., Baltimore, Md.**

# Rémoh Gems

## Not Imitations

A marvelously reconstructed gem—the greatest triumph of the electric furnace. Looks like a diamond—wears like a diamond—will cut glass—stands filing, fire and acid tests like a diamond—guaranteed to contain no glass. Rémoh Gems have no paste, foil or artificial backing—their brilliancy is guaranteed forever. One-thirtieth the cost of a diamond. These remarkable gems are set only in 14 Karat Solid Gold Mountings. Sent on approval—your money cheerfully refunded if not perfectly satisfactory. It will be well worth your while to get our De-Luxe Jewel Book—yours for the asking. Cut out and mail the coupon below—or write a postal. Address

**Rémoh Jewelry Co.**  
429 N. Broadway, St. Louis, Mo.

**Rémoh Jewelry Co.,**  
429 N. Broadway, St. Louis, Mo.  
Send your De-Luxe Jewel Book.

Name.....

Address.....

City.....

State.....

**Sign  
And  
Mail This  
Coupon Today**

## LET US GIVE YOU THIS TRANSPARENT CELLULOID TRIANGLE

It is 4 inch size, 30°+60° angles. Lowest retail price, 25 cents. Absolutely essential to everyone who draws. We make this offer to introduce our new catalogue showing

### SPAULDING'S NEW CARRYING CASES AND COMPLETE OUTFITS

for designers, architects, engineers and students—compact, durable and convenient. Spaulding's Carrying Cases are made light and strong. They provide well arranged compartments, including space for drawing board and T square. Handled like a suit case; unique, practical, inexpensive. Outfits include all necessary equipment. If you draw, send us five 2-cent stamps to-day to pay postage and get the free triangle and the catalogue.

**SPAULDING PRINT PAPER CO.**  
44 Federal St. BOSTON



## KNIPE BALL-BEARING DRAWER ROLL

Send 10c for Sample

**KNIPE MFG. CO.,** 522 South Delaware Ave. Philadelphia, Pa.

# Want This Typewriter?

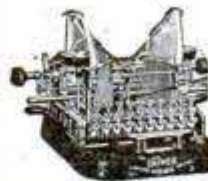

## No Deposit! Send No Money! 5 Days' Free Trial! Our Risk!

You can have the famous No. 3 Oliver in your own home or office, on approval.

You can write on it in 10 minutes. It writes in sight. You see every letter

and word as you write it.

"The simple typewriter that never wears out!"

You can use it 5 days! Without paying us a cent!

Then—if you want to keep it—send us \$5.00—and \$5.00 a month until you have paid \$50.00—which is one-half the catalog price (\$100.00).

You save the other \$50.00!

No need—now—to spend money renting!

Our wonderful plan has created a vast army of new typewriter users.

The universal use of typewriters is at hand!

Our booklet will be a revelation to you!

Write—"Send it!"—on a postal card—lead pencil will do. It's FREE. (37)

Typewriters Distributing Syndicate, 159 A UN. State Street, Chicago

## RED or BLACK VULCAN STYLOS

Moderate priced, easy writing pens that give satisfaction; unequaled for rapid writing and ruling.



\$1.00 Postpaid. Two Sizes, 4¼ and 5¼ Inches  
AGENTS WANTED. Extra size, 8 inches (BLACK ONLY) \$1.25  
**J. C. ULLRICH & CO., 27 Thames St., NEW YORK**  
Manufacturers of Stylo and Fountain Pens

## Get an Oliver Typewriter for 17c a Day!

Write at once for the most liberal offer ever made on a high grade, brand new typewriter. Let your pennies pay for the splendid New Model Oliver No. 5. Thousands are buying on this convenient plan. See the nearest Oliver agent or address

THE OLIVER TYPEWRITER CO., 107 Typewriter Building, CHICAGO

sunning the bread box every day. These are things which the unthinking may believe to be of minor importance, but it is just these little things that exact their toll in sickness and death from the family every year. Many a case of poisoning, or ill-health and slow death can be traced to a neglected refrigerator or bread box.—Hartford Post.



## TYPEWRITERS ALL MAKES

All the Standard Machines SOLD or RENTED ANYWHERE at ¼ to ½ MFR'S PRICES, allowing RENTAL TO APPLY ON PRICE. Shipped with privilege of examination. Write for Illustrated Catalog L.

TYPEWRITER EMPORIUM, 92-94 Lake St., CHICAGO

## LEARN ISOMETRIC DRAWING

Easy to produce quickly read working plans. The Isograph makes an expert of a novice. Invaluable to inventors and designers. Handy for any draftsman. Celluloid 6x6 inches. Postpaid 50c with simply illustrated instructions, 2c stamps accepted. Send today.

**THE ISOGRAPH CO.**  
145 E. 23d St. NEW YORK CITY

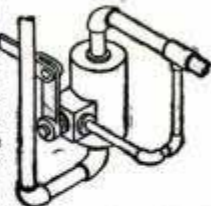

## Geisha Diamonds

THE LATEST SCIENTIFIC DISCOVERY

Bright, sparkling, beautiful. For brilliancy they equal the genuine, standing all test and puzzle experts. One twentieth the expense. Sent free with privilege of examination. For particulars, prices, etc., address

**THE R. GREGG MFG. & IMPT. CO.**  
Dept. II, 517 Jackson Blvd., Chicago, Ill.



## ASTRONOMICAL TELESCOPES

Complete with Case, Sun Shade, Sun Glass and Extra Eye Piece for Night Observation **\$18.00**

One of these superb instruments will give material enjoyment. It will enable you to pick out the smallest Boats on the Horizon, tell the time by a clock at many miles distant, and view the country for fifty miles around. This telescope for Astronomical Work is simply unequaled, with its aid the Mountains in the Moon, Jupiter's Moons and Saturn's Rings are clearly discernible.

A. S. ALOE COMPANY, 515 Olive S. St. Louis, Mo.

# ALOE'S

## Our Renowned Double Combination TELESCOPE

Size 2 in. Object Glass, Length 63 in. Prof. Hicks, of Word and Works Almanac, says they are far superior to others he has examined at twice the price.





# Our Big Special Band Catalog

It is the greatest band catalog in the world. Everybody interested in bands or in brass band music should have a copy of this great catalog. It is the most complete encyclopedia of brass band information ever published. We will send it to you, postpaid, free, just as soon as you send us your name and address. At the same time we will send you that extremely popular little book entitled—"The Tale of Two Towns" free.

## Lyon & Healy

Here is the Greatest Band Catalog in the World

Learn to play a band instrument. Join a brass band. Organize a brass band yourself. We give all inside pointers and more assistance than you ever expected. Our expert information on organizing and equipping bands, and making them earn money, is free to you.

**SPECIAL OFFERS** For a limited time we are making very special offers on all band instruments listed in our great catalog. Full band equipment or single instruments—on easy payments. Terms as low as **15 cents per day**. Select the highest quality instrument if you prefer on these very liberal easy payment terms.

When you send your name and address we send you our great band catalog and the very interesting book, "The Tale of Two Towns" and valuable little booklet—"How an Amateur Band Can Make Money." We will send you a copy of Lyon & Healy *Band Herald*, also free, and a copy of drum major's tactics, constitution and by-laws, etc. All of these valuable books sent you, postpaid, free just as soon as you send us your name and address.

Write today to get full benefit of special offers

**LYON & HEALY, 19-88 E. Adams Street, CHICAGO, ILL.**



**WHY ORANGE BLOSSOMS?**—Why does the bride wear orange blossoms, rather than any other flower?

In the language of flowers, the significance of the orange blossom is "Your purity is equal to your loveliness." The orange stands for abundance; it figures in the old mythologies where Gaea, goddess of earth, is represented as bringing boughs bearing golden apples as her gift at the wedding of Juno and Jupiter.

The most commonly accepted legend as to the associa-

### Send To-day for the Free Meister Piano

catalog. We will send any piano contained in the book direct to your home without charge on thirty days' free trial. If it pleases you, you may pay for it on terms as low as \$1.00 a week.

**No Cash Payments Down** No Extras We Pay the Freight  
No Interest

Rothschild's ten-year guaranty with each instrument  
**THE MEISTER PIANO CO., Dept. X**  
ROTHSCHILD & COMPANY, Sole Owners. CHICAGO, ILL.

## NO MORE BALD HEADS



When our VACUUM CAP is used a few minutes daily. We accept no pay until you have tried the Cap 60 days and are satisfied. The Vacuum Cap is an appliance that draws the blood to the Hair Roots and starts a new healthy crop of hair. It stops Dandruff, stops the hair from falling out. Bought by Doctors and men who

know that it is the only reasonable HAIR GROWER known to science. No Drugs Used. Write for application blank, testimonials, and booklet on "HAIR," sent sealed in plain envelope, FREE.

**THE MODERN VACUUM CAP CO.**

S. 559 BARCLAY, DENVER, COLO.

## Machinists, Ironworkers, Molders, Painters, Printers, Shoemakers, Miners and All Mechanics

If you come in contact with mechanics, we want you for our agent to earn extra money while at work. To live, energetic, conscientious workers we offer a proposition that simply coins money and establishes a permanent, ever-growing business. If you are awake to your opportunities, Address

**HASTINGS & MILLER** 118 NASSAU ST., NEW YORK CITY

OVER \$400 Made in One Day Operating the

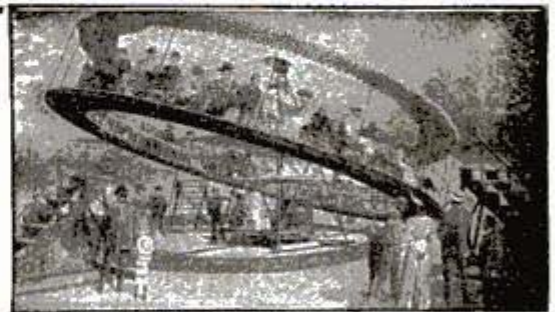

### CIRCLING-WAVE AMUSEMENT DEVICE *Read this*

Armitage & Guinn; At Egerton, Ind., away back from no place we got in \$350.00 in six hours' run. At Crawfordsville, Ind., we had a \$402 day.

BOOHER BROS.

**IF BOOHER BROS. DID THIS, WHY CAN'T YOU?**

Let us tell you all about this marvelous CIRCLING WAVE, and its wonderful money-making power. Address,

ARMITAGE & GUINN, 34 Mill St., Springville, Erie Co., N.Y., U.S.A.

# The Clock That Runs Itself

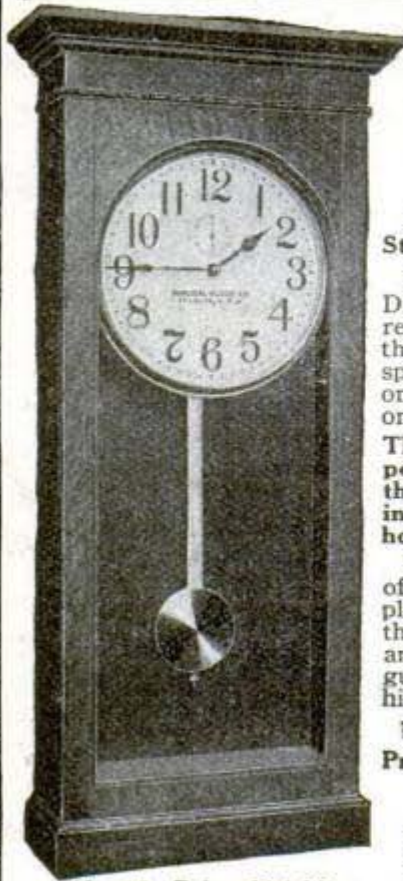

## IMPERIAL CLOCKS Of Quality

For the Home, Office, Store, Factory, or School

Our clocks are run by Dry Cell Batteries. They require no winding but run themselves. They have no springs, complicated parts or mechanism to get out of order.

They are thoroughly dependable time keepers that keep constantly ticking off the minutes and hours with accuracy.

The Design and Finish of the Cases make them pleasant to look upon, while the high grade of Material and Workmanship is a guarantee of service of the highest quality.

We guarantee satisfaction  
Prices range from \$10.00 to \$60.00

Shipped Complete and Ready to Run. Synchronized Systems for Schools, Factories, etc., a Specialty. Write us for further information.

**IMPERIAL CLOCK CO.**  
114 N. Fourth St., Saint Louis, U.S.A.

No. 18—Price \$24.00  
Length 43 inches, width 17 inches  
Dial 12 inches  
Golden Oak or Birch-Mahogany Finish  
An ornament for any wall

# LITHOLIN

THE broiling, sizzling sun of summer's hottest day cannot wilt a

## Litholin Waterproofed Linen Collar

As fresh looking when you quit work at night, as when you start in the morning. Cool and flexible. Launder with a damp cloth.

The same collar will serve for work or play, day after day. Litholin is the same collar you have always worn—only waterproofed.

At your dealer's, or by mail on receipt of price. Write for booklet.

Collars  
25c each

Cuffs  
50c a pair

**The Fiberloid Co.**  
7 & 9 Waverly Place, N.Y.



## Your Picture in a Postal Card IN ONE MINUTE



The pictures are developed, toned and finished in a single developing solution. No experience is necessary. Price of machines \$7.50 and \$15.00—circulars describing our machines sent free. We are also headquarters for supplies for all minute picture machines.

**AMERICAN MINUTE PHOTO COMPANY**  
Dept. U, 726-728 W. 12th St., Chicago, Illinois  
The largest manufacturers and distributors of minute picture machines and supplies in the world.

## BENJAMIN AIR RIFLE FOR MEN AND OLDER BOYS

An air gun that will shoot through half inch pine easily. Many times more powerful than spring guns. Uses compressed air, same as air brakes, rock drills, etc. 15c pays for 1,000 shots (delivered 30c). Practical for small game. 37 inches long. Walnut stock. Nickel barrel. Take down. Sold by dealers everywhere. If your dealer does not carry it, write us. Sent prepaid east of Rocky Mountains on receipt of \$2.50. Pacific Coast and Parcel Post Countries \$3. Circular free.

**Benjamin Air Rifle & Mfg. Co.,** 2002 Frisco Bldg., St. Louis, Mo.

tion of the orange blossom and the bride is that an African king gave to a King of Spain an orange tree which was so highly prized by the king that the gardener in charge of the royal gardens was forbidden to permit seed or scion to be taken therefrom under pain of death. Once, however, he listened to the pleadings of his youngest daughter for a spray of the exquisite flowers, which she placed in her hair. An ambassador of another nation who had coveted the beautiful tree, offered her a generous sum for it. She was betrothed to a young man

## \$15. to \$35. PER DAY IN MINUTE PHOTOGRAPHY

**WE CAN PROVE IT.** Our No. 4 Ferrottype machine takes three sizes of pictures, on plates 2 1/4 x 3 1/2—1 3/4 x 2 1/4 and buttons. It is also reversible. Send for Our Descriptive Catalog. It tells all about it. Don't delay. It means your future.

**NEW YORK FERROTYPE CO., Dept. 72**  
168 1/2 Delancey St., NEW YORK, U.S.A.



## WHITE VALLEY GEMS IMPORTED from FRANCE

**SEE THEM BEFORE PAYING!** These gems are chemical white sapphires—LOOK like Diamonds. Stand acid and fire diamond tests. So hard they easily scratch a file and will cut glass. Brilliance guaranteed 25 years. All mounted in 14K solid gold diamond mountings. Will send you any style ring, pin or stud for examination—all charges prepaid—no money in advance. Write today for free illustrated booklet, special prices and ring measure.

**WHITE VALLEY GEM CO.,** 901 G Saks Bldg., Indianapolis, Ind.

## \$5.50 THIS OUTFIT

Make \$15.00 a day with our TAKE QUICK Machine which takes and finishes in one minute a square or button picture in a POSTAL CARD or BROOCH which costs you less than one cent and sells from 10 to 15 cents each. No Dark Room. No Experience Necessary. The best money getter wherever crowds assemble. Fairs, Carnivals, Conventions, etc. Be your own boss, a small investment starts you in business.

Write for FREE catalog describing our machines.  
**INTERNATIONAL METAL & FERROTYPE CO.**  
INCORPORATED ESTABLISHED 1891  
Dept. B, 1262-64 Blue Island Ave., CHICAGO, ILL.



# 500% PROFIT

Operating a Daydark Photo Post Card Machine. Three photo postal cards of any object made and delivered on the spot in ten minutes. No experience required—no dark room necessary. All work done in the machine in open day. Establish a profitable business at home by opening a Daydark Postal Parlor. Big money maker on the street, at fairs, etc. Send at once for free catalog and sample post card showing the fine work the machine does.

**DAYDARK SPECIALTY CO.** 2121 Cass Ave., St. Louis, Mo.



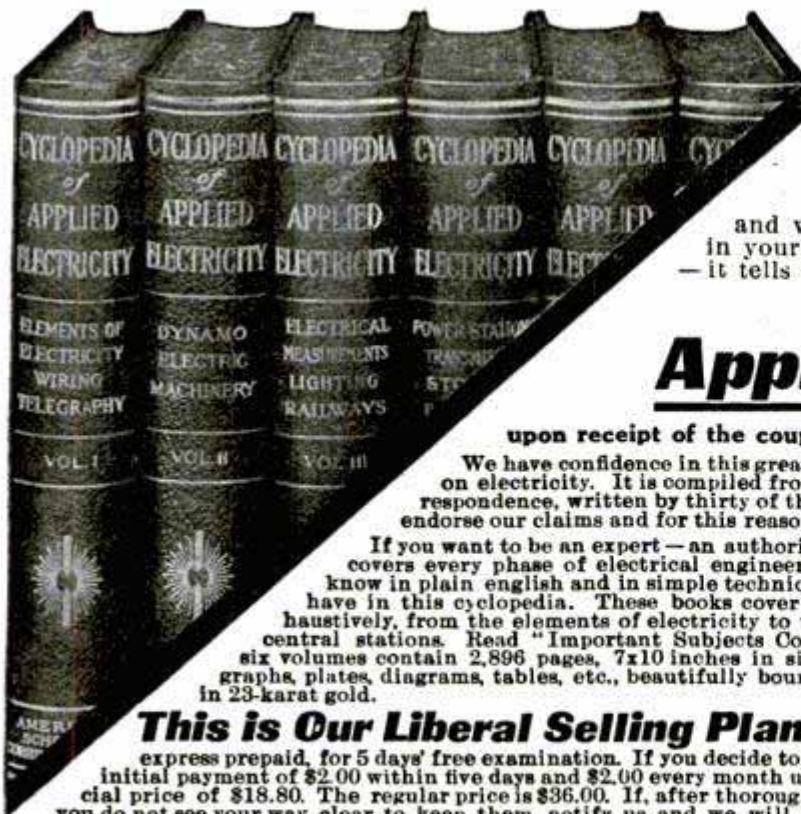

# Here is the Standard Reference Work on Electricity

and we want you to examine it absolutely free of charge in your own home or office. Read our Liberal Selling Plan—it tells how we will send you the great six-volume

## CYCLOPEDIA OF Applied Electricity

upon receipt of the coupon and allow you to examine it free of charge.

We have confidence in this great cyclopedia; we know that it is the reliable authority on electricity. It is compiled from the instruction papers of the American School of Correspondence, written by thirty of the world's greatest electrical experts. We want you to endorse our claims and for this reason we make you this free offer.

If you want to be an expert—an authority on everything electrical, you need a work that covers every phase of electrical engineering—a work that will tell you what you want to know in plain English and in simple technical terms and formulas. That is just what you have in this cyclopedia. These books cover every branch of electricity thoroughly, exhaustively, from the elements of electricity to the design and construction of power and central stations. Read "Important Subjects Covered," and then mail the coupon. The six volumes contain 2,896 pages, 7x10 inches in size; 2,000 special illustrations, photographs, plates, diagrams, tables, etc., beautifully bound in half morocco; titles stamped in 23-karat gold.

### This is Our Liberal Selling Plan.

Upon receipt of the coupon the books will be sent you, express prepaid, for 5 days' free examination. If you decide to keep the books, send us your initial payment of \$2.00 within five days and \$2.00 every month until you have paid the special price of \$18.80. The regular price is \$36.00. If, after thoroughly examining the books, you do not see your way clear to keep them, notify us and we will send for them at our expense. Send the coupon today.

#### IMPORTANT SUBJECTS COVERED

Types of Dynamos and Motors; Elevators; Direct-Current Motors; Electrical Measurements; Electric Lighting; Electric Railways; Alternating Current Machinery, etc.; Electric Welding; Mercury-Vapor Converter; Management of Dynamos and Motors; Power Stations; Central-Station Engineering; Central-Station Design; Storage Batteries; Power Transmission; Electric Wiring; Electric Telegraphy; Wireless Telegraphy; Telephony; Automatic Telephone; Wireless Telephony, etc.

For a short time we will include as a monthly supplement, for one year, the TECHNICAL WORLD MAGAZINE. This is a regular \$1.50 monthly, full of Twentieth Century scientific facts, written in popular form. Also contains the latest discussions on timely topics in invention, discovery, industry, etc.

American School of Correspondence, Chicago, U. S. A.

Pop. Mech. 7-11  
A. S. of C.  
Please send set Cyclopedia of Applied Electricity for five days' free examination, also Technical World for one year. I will send \$2.00 within 5 days and \$2.00 a month until I have paid \$18.80

for books and magazine, or notify you and hold the books subject to your order. Title not to pass until fully paid.

NAME .....

ADDRESS .....

OCCUPATION .....

REFERENCES .....

whose family objected to the smallness of her dowry; she therefore accepted the bribe. When she married, in token of her debt to the tree, she wore its blossoms in her hair and thus set the fashion for other brides, who have for centuries thus adorned themselves for the altar.—Detroit Free Press.

Hungarians in this country sent \$37,000,000 to their relatives in Hungary last year, and no doubt they are still referring to them as their poor relations.—Detroit Free Press.

**Every Boy His Own Toymaker**  
Greatest boys' book ever written. Tells how to make a Steam Engine, Microscope, an Electric Telegraph, Telephone, Magic Lantern, Boats, kites, balloons, electrical and mechanical toys, traps, fishing tackle. 200 illustrations. Price only 10c postpaid, 3 for 25c. Western Puzzle Co., St. Paul, Minn.

**A Postal Brings Grand Free Millwork Catalog** 5,000 Bargains in Building Material!  
Send at once for the great Catalog of 5,000 Bargains in the highest grade Guaranteed Millwork and Lumber. Issued by the Largest Building Material Plant in America. Buy Doors, Windows, Mouldings, Stair and Porch Work—everything you need to build, remodel or repair—at 50 per cent saving! Quality, Safe Delivery and Satisfaction Guaranteed. (38)  
GORDON-VAN TINE CO., 2588 Case Street, DAVENPORT, IOWA

**BOX BALL NOW GUARANTEED! PROFITS**  
Practically all Box Ball operators are eminently successful—so we now GUARANTEE profits! Our Profit-Guarantee-Bond positively insures you against loss of a dollar! Vast amounts are made yearly by Box Ball operators—get into the business quick! Ask us for the valuable Box Ball monopoly for YOUR community. Some other "live wire" may write tomorrow—You write today to  
THE AMERICAN BOX BALL COMPANY, 363 Van Buren St., INDIANAPOLIS, IND.

**Over 2000 Per Cent Profits**  
That sounds almost unbelievable—yet it's true—a proved fact. A pound of ordinary sugar and the wonderful **EMPIRE CANDY FLOSS MACHINE** will make 30 packages of filmy, quick selling candy floss every eight minutes. A fair, race track, circus or anywhere a crowd collects is the place to turn the trick.  
The daily profit is astonishing—figure it for yourself. Eight years of big money-making experience, with no repair expense, have proved this your opportunity. Today is the day to get the facts on this machine. Also ask for catalog of Popcorn and Peanut Roasters and Ice Cream Cone Machines.  
Write to STEVENS MFG. & SUPPLY CO., Dept. C, 1225 Wabash Avenue, Chicago, Ill.

### GO INTO THE Moving Picture Business

FROM \$45 to \$60 STARTS YOU AND YOU WILL EARN AS MUCH IN 1 OR 2 NIGHTS  
The small payment required to get our machine will make more money than thousands of dollars invested in any other enterprise.  
**\$25** and more per night can be made exhibiting with our machine in halls, schools, churches, theaters, etc., in your own and surrounding towns. We furnish everything—rent films, too.  
Write for particulars about our Moving Picture Machines and our 6-months-to-pay plan.  
P. & W. SALES CO., 839 Temple Court Bldg., CHICAGO

**3 BEAUTY POSES 25c.**  
Decorate your "Den" with "Art Gems"  
Exquisite portrayals of female loveliness. 3 bewitching poses 25c; 6 for 50c. One 6½x8½ photograph free with every order for six.  
Our Dollar Special: Two 6½x8½ photographs, 6 cabinet size and 32 small photos, all for \$1.  
Our pictures are all real photographs. No reproductions of paintings or other cheap trash. Money back if not pleased.  
ART PHOTO CO., 2007 P. M., Grand Rapids, Mich.

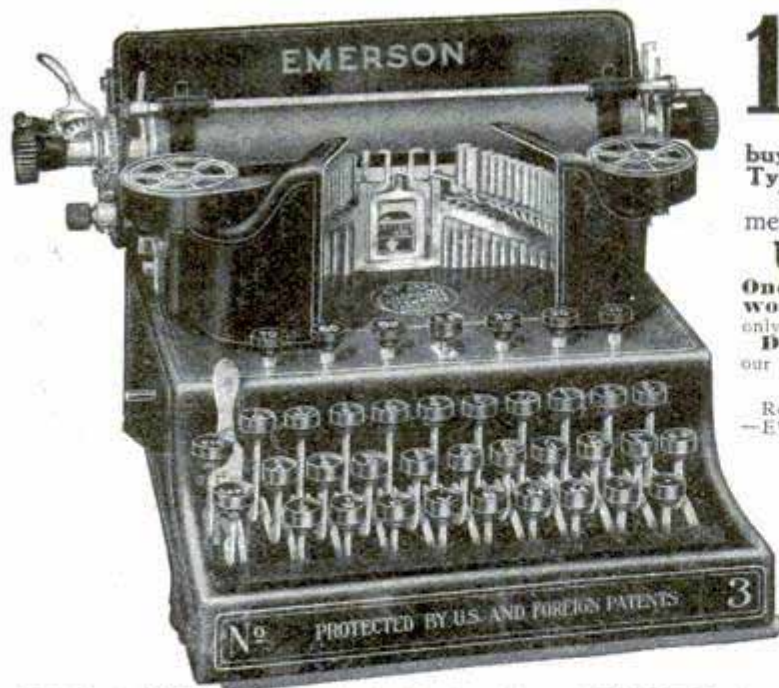

# 10 CENTS A DAY

buys the New Improved Wholly Visible Wonderful Emerson Typewriter.

Two-Color Ribbon, Tabulator, Back Spacer, Every improvement. One of the best typewriters made.

## UNHEARD-OF LOW PRICE

One Emerson Typewriter FREE to any person, man or woman, boy or girl who will do us a slight service, no selling, no canvassing, only a few moments of your spare time required.

Don't pay even \$20 for any typewriter made until you first write for our FREE Offer.

### Our Customers Write Like This:

Received a piano and typewriter free for not more than five hours of my time.—EVERETT WALKER, Tunnelton, W. Va.

Earned an Upright Grand Piano and EMERSON Typewriter in five hours. Since getting the "EMERSON" I have set my \$100 machine aside.—R. W. SUTTON, Hillsdale, Ind.

Received a piano and typewriter free. It comes nearer to getting something for nothing than I ever thought possible. There is no \$100 typewriter that excels the "EMERSON."—W. C. BENTLEY, Las Animas, Colo.

The EMERSON Typewriter excels all others. I wasn't six hours earning an Upright Grand Piano and Typewriter. People writing for your Free Offer will be greatly surprised and delighted, for they will find they can earn a piano and typewriter free in a very few hours easily.—B. J. MILLER, Benson, Ill.

Consider the "EMERSON" the best machine made. I earned mine in just a few hours.—I. N. CLACK, Lampasas, Texas.

The "EMERSON" is beyond anything on the market in the shape of a typewriter. I earned a typewriter and piano in one day.—K. S. VAN ZANDT, Whitt, Texas.

### We Could Fill This Paper With Similar Letters

Earned an EMERSON Typewriter in just a few minutes.—F. W. HORN, Burlington, Iowa.  
 Earned an EMERSON Typewriter for less than two hours work. The EMERSON is better than any \$100 typewriter on the market.—JOS. M. FOX, Centralia, Mo.

**FOR OUR GREAT FREE OFFER** and to learn of our easy terms, and full particulars regarding this **Great Offer**, for copies of letters from the many who are using Emerson Typewriters which they received **FREE** for only a few hours of their time. For everything we and others can tell you about the Emerson Typewriter **on a Postal Card or in a letter** to us, simply say **"Mail Me Your FREE Offers."**

**THE EMERSON TYPEWRITER COMPANY, Box 169, WOODSTOCK, ILL.**

### THE HAT WITH THE MOST FRIENDS!



**3 Felt Hats IN ONE**

Sent Postpaid To You For Only

The noblest and most comfortable hat you can buy at any price for business, knock-about, traveling, motoring, golf and all outdoor sports. It is made of genuine English felt, has flexible sweat band, and will wear like iron. Can be rolled up and into several shapes without damaging. All sizes in black, blue, brown, white and gray. If not exactly as represented—drop us a line and we will refund your dollar by return mail—AND YOU MAY KEEP THE HAT. You can't lose—send us a dollar TODAY. Write for Booklet of "Working Clothes for Workingmen."  
**GEO. F. BUNGAY, 28 S. William St., N. Y.**

**HIS OFFICE PORTABLE**—A man who actually carries his office in his hand is the railroad conductor. Usually it is a box specially made and ornamented with bright brass trimmings and brass handles and with the conductor's name neatly engraved on a brass plate.

When his trip is finished you will see him leave the train carrying his office with him. The railroad has no rent to pay for him and yet he is one of the busiest of employes, with many accounts to keep.

In this hand office of the conductor's are all the records of his trip, and it is a model of neatness and compactness. There is a place in his office for all the

## Grow Mushrooms

Big and Quick Profits

Costs Little to Start a Safe Business



Increase your income \$5 to \$70 a week by learning mushroom culture from biggest mushroom man in the world. Fourteen years' experience enables me to give any man or woman practical instructions worth many dollars. Only spare time required. Can be grown in

sheds, old barns, or basements. I have started thousands and will show you how Free. This is your opportunity; send for Free Book giving particulars, how to start, etc. Address

**JACKSON MUSHROOM FARM 6194 E. Western Avenue CHICAGO, ILLINOIS**

## AMATITE ROOFING

Mineral surfaced. Needs no painting. Send for free sample. **BARRETT MANUFACTURING CO., New York, Chicago**

## WORK FOR US

ALL-OR-SPARE TIME



GET YOUR SHARE of this **EASY MONEY**



Selling **EASY WRINGER Mops**  
**150 % PROFIT—**

**START—NOW**

Two turns of crank wrings out every drop of water. Simple, practical, reliable, durable, never wears out. Every home buys. No talking necessary. Show it, take the order. Get started now, don't wait. We will help you. We want Agents, Salesmen, Managers in every county to fill orders, appoint, supply, control sub-agents. 150 per cent. profit. No investment required. Sample free with first order. New catalog, Instructions, sworn to evidence, all Free. **U. S. MOP CO., 1380 Main St., Leipsic, Ohio**

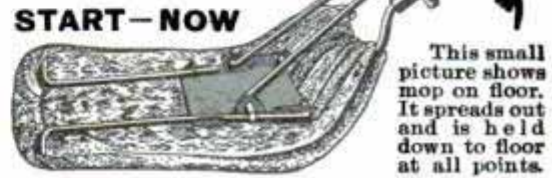

This small picture shows mop on floor. It spreads out and is held down to floor at all points.

# DIAMONDS-WATCHES ON CREDIT

**THIS ELGIN WATCH, 17 JEWELS, ADJUSTED,**

Men's 16 Size, (also Ladies' O Size) Thin Model, New Marginal Minute Dial, in Gold Filled Case, Guaranteed for 25 Years, plain polished or handsomely engraved, sent prepaid on

**30 DAYS FREE TRIAL**

**Then \$2.50 a Month**

Our cut price of \$25.50 for this magnificent Elgin Watch, that will pass Railroad Inspection, is the greatest bargain ever heard of. **NO MONEY DOWN**--\$2.50 a Month after examination by you. Whether you are a railroad man or not, this is the Watch you want. No matter where you live, we will trust you. Send us your order today. Write for our free Catalog, containing over 2,000 illustrations of Diamonds, Watches, Jewelry, Silverware, etc. It tells all about our easy credit plan. Write today, before you forget it.

**LOFTIS BROS. & CO.**

THE OLD RELIABLE, ORIGINAL DIAMOND AND WATCH CREDIT HOUSE  
DEPT G173, 92 to 98 STATE ST., CHICAGO, ILL.  
Branch Stores: Pittsburg, Pa., and St. Louis, Mo.



GUARANTEED 25 YEARS

No. 364

**Our Great Special**  
**LOFTIS "PERFECTION" RING**  
Finest pure white diamond

**\$48 TERMS**  
**\$4.80 A MONTH**

Other sizes and styles at \$25, \$75, \$100, \$125. See our Catalog. Sent Free.

No. 363

## Let Me Send you *The Rapid*



**FIRELESS COOKER**  
At Factory Price. Satisfaction guaranteed or no charge. Saves 80 per cent on fuel, time and work.

**On 30 Days' Trial**  
Pays for itself in a month or two. No experience needed. Boils, Steams, Stews, Roasts, Bakes, Fries. Genuine Aluminum Cooking Utensils Free. Also metal composition Heat Radiators, can't break or crack. Send for free book and 125 splendid recipes today.  
WM. CAMPBELL CO., Dept. 64, Detroit, Mich.

tickets collected, an envelope for his cash fare receipts and many blank forms which he is required to fill out with particulars of the run.

Usually the conductor opens up his office in the baggage car or in an empty seat after his train has left the last station of the run. For some time thereafter he is a busy man.

His portable office when opened is transformed into a little desk having pigeonholes and writing materials, and with it open in front of him the conductor counts his tickets, sorts them among the proper pigeonholes and makes up his accounts. It is all done generally before the train gets in, and upon arrival at the terminal he takes his office with him and departs with the rest of the passengers.—New York Sun.

## AGENTS WANTED



Mechanics and Shopmen make over \$100 a month in spare time selling Transparent Handled Novelty

Knives and Razors. Big Profits. Quick Sales. Write for terms.  
**NOVELTY CUTLERY CO., 67 Bar St., Canton, Ohio**

## 10 Days' Free Trial

Send Us Your Name and Address We Will Send You

AT OUR EXPENSE, ON APPROVAL

This Hand-Engraved



**WATCH**  
**50<sup>c</sup> A WEEK**

Exactly like this illustration

Sold by all retail stores for \$38.50

**Hunting Case Model \$24<sup>50</sup>**

If perfectly satisfied after Ten Days' Free Trial, we give you the wholesale factory price . . . . .

To be paid on the very easy terms of

**50c A WEEK or \$2.00 A MONTH**

Remember, we take the risk, not you. A high-class Elgin, Illinois or Waltham 15-jeweled movement, in a heavy gold-filled case, guaranteed for 20 years. Stem wind and stem set, fancy gold hands. Mail your order now to

**STERLING MANUFACTURING CO., Dept. 39**  
NEW YORK PHILADELPHIA CHICAGO  
Drawer 180 (Home Office) Drawer 765

**WHEN YOU WANT ANYTHING AND DON'T KNOW WHERE TO FIND IT WRITE BUREAU OF INFORMATION, POPULAR MECHANICS CHICAGO**

# \$1500<sup>00</sup> MADE IN ONE MONTH WITH A 'LONG' POPCORN CRISPETTE MACHINE

You might just as well make as much

J. A. M., Maryland, took in \$250.00 in one day. Every nickel brought almost 4 cents profit. Best season just at hand. You can make lots of money this Summer and Fall at Fairs, Parks, Summer Resorts, Amusement Halls, Circuses, etc. Or, stay in your own town—rent a small store—a window—where the people will pass—set up your machine—sell Crispettes—make big money. Crispettes are fine—different in shape, taste and quality. Everybody—young and old—craves them. Sell for 5c a package—popular price—easy to get money. Think of fortunes made in 5c propositions—5c and 10c stores—moving pictures—street cars—Easy money to spend—mounts into the dollars—then figure what you can do. Write me today. Get full particulars—reports from others. Act upon the prompting you have—now—address



**W. Z. LONG, 334 HIGH ST., SPRINGFIELD, OHIO**

# The Young Electrician

By **HAMMOND HALL**

**289 PAGES—12MO—CLOTH—ILLUSTRATED**

A book intended to afford instructive amusement to intelligent youths. Strictly a beginners' book, but no better introduction to this important subject was ever offered.

**Price \$1.50 Postpaid**

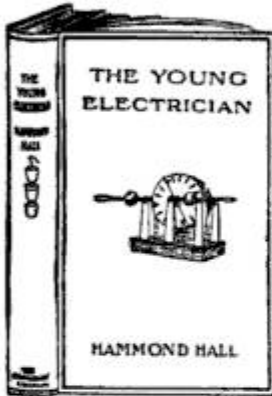

## CONTENTS

The Romance of Electrical Science—Experiments in Attraction and Repulsion—The Goldleaf Electroscope—Electro Static Induction and Distribution—The Leyden Jar—The Wimshurst Machine—Atmospheric Electricity—Galvanic or Voltaic Electricity—The Charging and Care of Batteries—Electrotyping and Electroplating—Magnetism—Electro Magnetism—The Electric Telegraph—The Telephone—The Induction Coil—The Dynamo—Motors—Switch Boards and Transformers—Electric Lighting—Public Electric Supply Stations—Wireless Telegraphy—Index.

**Presents the subject in the right sort of way to arouse a boy's interest**

**SUPPLIED BY**

**POPULAR MECHANICS BOOK DEPT., CHICAGO**

**JUST READY**

**HOW TO MAKE A**

# WIRELESS SET

By **ARTHUR MOORE**

A book of 96 pages, bound in cloth, explaining in an understandable manner the construction of an outfit suitable for transmitting four or five miles. This set can be easily constructed at a small cost by any boy of ordinary ability.

*Complete details with illustrations*

**PRICE 50 CENTS POSTPAID**

*ORDER OF YOUR NEWSDEALER OR SEND DIRECT TO THE PUBLISHER*

**Popular Mechanics Book Dept.** 318 W. Washington Street  
CHICAGO, ILL.

# Ann Arbor

## "INSTANTO"



### GASOLINE LIGHTING SYSTEMS

Change from a 150 candlepower light to 2 candle power in a jiffy. This latest and most perfect development of the gasoline lamp found only in Ann Arbor Lighting Systems. It gives the country home a lighting system as perfect, handsome and modern as city gas. Ann Arbor Lighting Systems are brighter than gas, steadier and clearer than electric light, and cost about one-tenth as much to operate. Each lamp gives 150 to 500 candlepower for less than 1-3 cent per hour. Fuel is gasoline; perfectly safe.

**We Make Complete Lighting Systems for Homes, Churches, Stores, etc.**

Prices \$10 up, according to number of lamps desired.

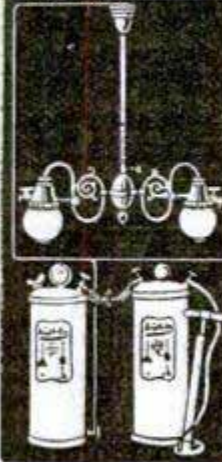

**We Want Agents** who will push our line. A splendid opportunity right now for hustling agents in large cities to sell to owners of summer cottages, country homes and resorts. No other light can equal it in brilliancy, beauty of fixtures and economy.

CATALOG AND PRICES ON REQUEST

**Superior Manufacturing Company**  
294 Second St. Ann Arbor, Mich.

**WHERE THE FISHERMAN'S "CATGUT" IS MADE**—Probably but a small percentage of the fishermen who use flies strung with fine translucent "catgut" are aware that the almost unbreakable substance that holds the hooks against the fiercest struggles of the struck fish comes from silkworms.

The principal center of the manufacture of this kind of catgut is the island of Procida, in the Bay of Naples, but most of the silkworms employed are raised near Torre Annunziata, at the foot of Vesuvius. The caterpillars are killed just as they are about to begin the spinning of cocoons, the silk glands are removed and subjected to a process of pickling, which is a secret of the trade, and afterward the threads are carefully drawn out by skilled workers, mostly women. The length of the thread varies from a foot to nearly twenty inches.—Los Angeles Times.

We have for sale a limited number of complete files of

**Popular Mechanics for 1909**

These consist of the 12 issues of the magazine and a complete index suitable for binding.

Price \$1.25 postpaid

POPULAR MECHANICS, 225 Washington St., CHICAGO

# Something New

The Biggest Surprise of the Age

**Post Card Photos on Paper — Direct No Negatives**

Here's your chance to start your own big money-making business. No experience needed. Everybody buys post card photos. The

**MANDEL COMBINATION No. 1 CAMERA**

Is the biggest money getter today on street corners, at fairs and at all outdoor



attractions. Mr. N. M. Green of Maywood, Ill., writes, "I cleaned up \$32.80 on Sunday." You can do the same. The camera makes three styles of photos. Post cards (3x4 1/4), miniature post cards (2x3), on paper direct. No negatives. Also 1-inch photo buttons.

**Price of Camera, \$40** Post cards (3x4 1/4), \$2.00 per 100; miniature post cards (2x3), \$1.00 per 100. Button photos, 50c per package of 50.

Write Today for Booklet and Circular FREE

**CHICAGO FERROTYPE CO., Dept. 102**  
Congress and Laflin Sts., CHICAGO, ILL.



**MODEL AEROPLANES** Drawing and directions for building perfect three-foot

model Bleriot Monoplane. Clear and simple. Only 15 cents. Complete supplies for model aero builders. Send stamp for Catalog.

**IDEAL AEROPLANE & SUPPLY CO.** 1203 Bedford Ave. BROOKLYN, N. Y.

**FREE UPON REQUEST**

OUR

**Valuable 96-Page Catalogue**

OF THE

**Best Mechanical Books**

It is well worth having and keeping for reference.

**Popular Mechanics Book Dept.**

318 W. Washington Street, Chicago

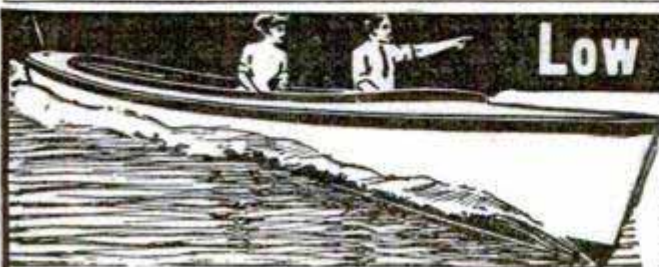

**Low Prices to Kill the Boat Trust!**

**This Handsome, Graceful, Seaworthy, Speedy Runabout Complete, Only \$94.50**

16, 18, 20, 21, 23, 25, 27, 28, 30 and 35 Footers at Proportionate Prices

We have the largest power-boat factory in the world. We build and sell more pleasure crafts than all the concerns in the Authorized Thirteen-Million-Dollar Boat Trust combined. No one has such facilities. That's why we build Detroit Boats and Engines so good that no one in the Trust can ever imitate them. Our great business enables us to sell at the smallest profits. That's why we are able to sell Detroit Boats and Engines at the smallest profits, so the Boat Trust has declared war on us—

but our low prices will kill the Trust. We ship you a Detroit Boat immediately on order. All sizes in stock. Send today for our large, handsome, illustrated Catalog, mailed free, which describes 64 different models in all sizes, ready to ship, equipped with the most reliable and efficient marine motor ever produced, guaranteed for five years. Get our new confidential proposition and special prices to demonstrating agents. (114) **DETROIT BOAT COMPANY, 1100 Jefferson Avenue, Detroit, Michigan**

## LOOKING STRAIGHT AHEAD INTO YOUR FUTURE

CAN YOU SEE WHERE YOUR  
PRESENT OCCUPATION  
IS GOING TO LAND YOU?

Can you continue in your present line of business long enough to lay aside sufficient money to live comfortably in later years, or will your strength and earning power give out while you are dependent upon your salary?

You must support yourself *now* and provide means for those rainy days that *are* coming.

You live in deeds, not years—in thought, not breath. You should count time by profits, not earnings. He most lives who thinks most, feels the noblest, acts the best, and makes provisions for the future.

The earnings of a Chiropractor range from \$250.00 to \$1,500.00 per month. The work consists of saving lives and removing the cause of sickness and affliction of suffering humanity.

One of our middle aged graduates made more money in his first 20 months of practice than he had earned in his *whole* previous life. Why this success? He learned a new profession at the best institution.

You can learn Chiropractic. You can accomplish the same results. Our home study course is within your reach. Payments on monthly installment plan.

Write for our Free Book "The P. S. C. Way to Health for Wealth," and catalog FREE. Write Now!

And learn how to become a "Doctor of Chiropractic."

**PALMER SCHOOL OF  
CORRESPONDENCE**

Department P. M.  
DAVENPORT, IOWA



Only \$14.50

For this Home Bench

Besides its convenience and usefulness, you will save its price in a year by doing repair work and "fixing things" that you now pay a carpenter or repair man to do. Thousands of homes have home benches we have furnished—why not you?

Top is 50 in. long, 20 in. wide, with a 13-inch glued-up portion of thick maple.

**Grand Rapids Hand Screw Co.**  
620 N. Front St. GRAND RAPIDS, MICH.

## All the Secrets of Watch Markings Explained!



Write for the new Burlington Watch Book—sent free—with an explanation of the inner secrets of the watch business. This book explains to the public for the first time how to judge a good watch by the factory markings—the real meaning of the trade signs and symbols on the case and works. Everybody thereby will be able to tell the grade of the watch he carries—judging it just like an expert. While a manufacturer may say great things for his watch, the law forces him to mark his watch correctly. The Burlington Watch Company is circulating this book free in order to scatter correct information on watches. Even though you may not intend to buy a watch just now, you are sure to do so some time and you should have this information for your own protection. Just your name and address on a postal card or letter brings you this valuable book free and prepaid.

**BURLINGTON WATCH COMPANY**  
Millard Station Dept. 119Y Chicago, Illinois

## THE EXCELSIOR BRAD SET. PRICE 25 CENTS

Takes No. 18  
and No. 20  
Brads from 3/4  
to 1 in. long



THIS END IS  
MAGNETIZED

The tool illustrated above will be indispensable to the Pattern Maker, Cabinet Maker, or Picture Framer who purchases it. It will set brads in places that would be inaccessible without it, and dispenses with the bradawl and nail set. If, after a fair trial, you are not satisfied that you have received your quarter's worth, your money will be promptly returned to you on receipt of tool.

STANDARD TOOL AND SUPPLY CO., TORRINGTON, CONN.

## Best Turkish Bath At Home 2c



Just flush out the three million pores in your body with the "Robinson" Thermal Bath. It takes only 15 minutes. Costs only two cents. Relieves La Grippe, Bad Colds, Rheumatism, Dyspepsia, Skin Diseases. Our Big #2 Hook Free for a few days only.

Robinson Mfg. Co., 172 Snowflake Bldg., Toledo, O.

## Model Aeroplanes and Accessories

We manufacture the highest grade of aeroplane models on the market. Every part is well made from the best of materials and in exact accordance with the designs submitted to us. We have on hand at all times stock models of all well-known machines. We carry a complete stock of accessories of all descriptions—miniature pneumatic wheels, ball-bearing shafts, turnbuckles, eyebolts, light model wood, Para rubber, wire, etc. Our simple and compound elastic motors are the most durable sold. Our prices are very reasonable. Send at once for our catalogue C, and see particularly our labor saving elastic motor winder.

**Aero Mfg. & Accessories Co.**

18 Dunham Pl.

BROOKLYN, N. Y.

\$18 to \$30 a Week Sure

Farmers "Ever Ready"  
Tool Kit does it

10 TOOLS

IN ONE

Agents going wild over results M. Snyder made \$46 in 2 hours Joseph Pine took 65 orders in 2 days. M. D. Finch sold 42 in 9 hours. Had no experience. You can do it. To show it means a sale. FREE SAMPLE to workers.

FOOTE MANUFACTURING CO., Dept. 260, Dayton, O.

## (English Sword Hunting Knife, 50c)

Worth \$4.00 Sheffield steel, 12 in. blade, the finest tempered, best edge-holding steel on earth; 5 in. hardwood handle, brass riveted. Bought a big lot from British government. Can be ground down to razor edge. Finest kind of hunting, butcher or hedge knife, or any purpose where a long-bladed knife is needed. Sent anywhere on receipt of 50c, a mere fraction of manufacturing cost.

Catalog Free Illustrating thousands of equally great government goods and other bargains.

CAL HIRSCH & SONS, U. S. Dept. 131 St. Louis, Mo.

## Magic Lanterns with the Alco-Radiant Light



The Alco-Radiant is the only practical, intense light for Lanterns if electric is not to be had. It burns alcohol, costs little to use and a trifle to buy; weighs 3 lbs.; adaptable to any Lantern. New Lantern slides for Lenten season, plain or colored, for sale or rent. Lecture sets of slides with readings, such as Judas, Herod, The Multitude, Way of Grief, Seven Words from the Cross, Passion Play of 1910, etc. Ask About Post Card Projectors. They show on a screen the image reflected from a post card or any other picture or flat object. Prices, \$4.50, \$13.50, \$25.00, \$60.00.

WILLIAMS, BROWN & EARLE, Dept. 20, 918 Chestnut Street, Philadelphia, Pa.



A NEW BOOK FOR WHICH THERE IS A REAL NEED

# A PRACTICAL COURSE IN MECHANICAL DRAWING

"Written So You Can Understand It"

By WM. F. WILLARD

(For several years instructor in Mechanical Drawing at Armour Institute of Technology, Chicago.)

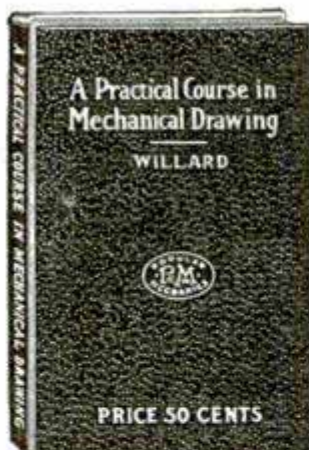

134 Pages  
131 Illustrations

Price 50 Cents  
POSTPAID

Cloth Cover  
Size, 5x7 Inches

A book for individual study, shop classes, trade or high schools, and those who would like to know something of the DRAFTING PROFESSION.

## WHAT OTHERS SAY ABOUT IT.

"It is one of the best books on Practical Mechanical Drawing I have ever seen and I can recommend it to any one who desires to make an individual study of drawing."

E. S. LIBBY, B.S., M.E., Prof. in Experimental Engineering, Armour Institute.

"This is a very useful little book, and every young fellow who is desirous of making himself more valuable to both himself and his employer will find it a great help in 'boosting' himself to a higher plane and 'bigger pay.'"

—THE NATIONAL BUILDER.

# POWER GAS AND THE GAS PRODUCER

"Written So You Can Understand It"

By J. C. MILLER, M. E.

The only authentic reference manual covering every detail of installation and operation which has been written in a non-technical manner. This book was prepared especially for the inquirer in this field who would like to be able to judge intelligently as to the economy and advisability of changing from other forms to Producer operation. It will also appeal to the engineer who wishes to understand thoroughly the working of the new system and thus be prepared to handle a plant competently.

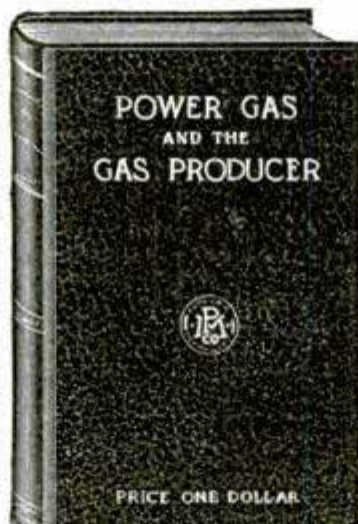

One handsome, cloth bound volume of 192 pages, printed on the best quality of book paper and profusely illustrated.

Price Post-Paid \$1

The following list of chapter headings shows how thoroughly the author has covered his subject: Producer Gas and the Gas Producer—Classes of Gas Producers—Industrial Gases—Comparison of Heat Values—Types of Producers—Gas Producer Fuels—Gas Producer Operation—Gas Power and Steam Compared—Reliability of Gas Power—Gas and Steam Power Costs—Gas Producer Installation—Alphabetical Index.

# PATTERN-MAKING

Price \$1 Postpaid

By G. H. WILLARD

WITH ADDITIONAL CHAPTERS ON

# CORE-MAKING AND MOLDING

"Written So You Can Understand It"

A book for the man who has to do the work. Written by a practical pattern-maker of many years' experience. Gets right down to business in the first chapter and keeps it up throughout the book. Full of kinks and actual working information. Profusely illustrated. Every one following this trade, or intending to learn it, should have a copy of this valuable book.

"Ten chapters are devoted to careful instruction for the making of specific patterns. The patterns chosen are of gradually increasing difficulty and cover practically all the points that come up in ordinary practice. Considering especially the low price of \$1.00, this book is remarkably practical and comprehensive. It is written in a style much more readable and effective than is usual with books on this subject."

—Engineering News.

224 Pages, 312 Illustrations, Cloth Cover

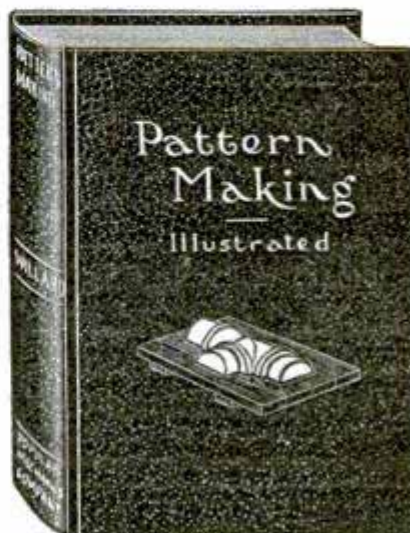

POPULAR MECHANICS BOOK DEPT., PUBLISHERS, CHICAGO

# POWER USERS

Buy your equipment from the manufacturer and save money.



**Machine Moulded Pulleys, Gears, Shafting, Hangers, Belt-ing, Friction Clutches, Sprocket Wheels, and Chain Belt Or anything in the line of appliances for transmitting power**

We are the largest Manufacturers of Machine Moulded Pulleys in the United States. No order too small for attention. No order too large to execute.

Our Catalog A-18 Shows Our Complete Line

**W. A. Jones Foundry & Machine Co.** Mail Order Department  
1400 North Ave., CHICAGO, U. S. A.

## Use KEROSENE Engine FREE!

Amazing "DETROIT" Kerosene Engine shipped on 15 days' FREE Trial, proves kerosene cheapest, safest, most powerful fuel. If satisfied, pay lowest price ever given on reliable farm engine; if not, pay nothing.

### Gasoline Going Up!

Automobile owners are burning up so much gasoline that the world's supply is running short. Gasoline is 8c to 15c higher than coal oil. Still going up. Two pints of coal oil do work of three pints gasoline. No waste, no evaporation, no explosion from coal oil.

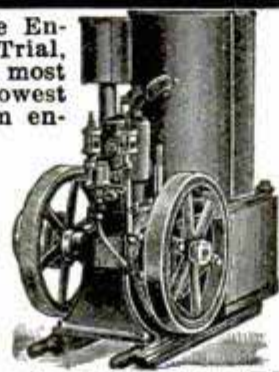

## Amazing "DETROIT"

The "DETROIT" is the only engine that handles coal oil successfully; uses alcohol, gasoline and benzine, too. Starts without cranking. Basic patent—only three moving parts—no cams—no sprockets—no gears—no valves—the utmost in simplicity, power and strength. Mounted on skids. All sizes, 2 to 20 h.p., in stock ready to ship. Complete engine tested just before crating. Comes all ready to run. Pumps, saws, threshes, churns, separates milk, grinds feed, shells corn, runs home electric-lighting plant. Prices (stripped), \$29.50 up.

Sent any place on 15 days' Free Trial. Don't buy an engine till you investigate amazing, money-saving, power-saving "DETROIT." Thousands in use. Costs only postal to find out. If you are first in your neighborhood to write, we will allow you Special Extra-Low Introductory price. Write!

DETROIT ENGINE WORKS, 213 Bellevue Ave., DETROIT, MICH.

## "Caldwell Special"

60 Days Trial FREE

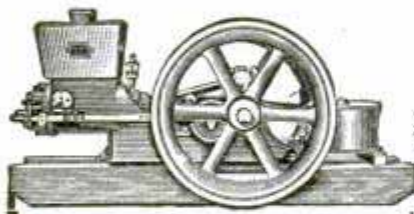

Prove it on your own premises that it saves time, saves labor and makes money.

The "Caldwell Special" is as clean cut as a race horse. Built right—works right. Simply built—always gives full H. P. Costs little to run—big profit producer to pump water, run cream separator, shred or grind corn and a dozen other things.

Write any or all the 8 Banks of Waterloo as to our responsibility. Sixty day Trial Free. We prove it to you on your own premises at our expense that you cannot afford to do without a "Caldwell Special."

**CALDWELL - HOLLOWELL MFG. Co.**  
514 Commerce Street, WATERLOO, IOWA.

## WITTE ENGINES

**GAS - GASOLINE - DISTILLATE**  
Cheapest of all powers. One cent average cost per horse power per hour. Nothing can equal.

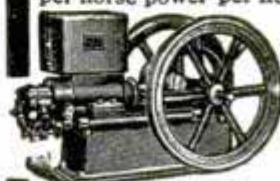

**FIVE YEAR GUARANTEE**  
We build all sizes. Hopper jacket or water tank cooling. Inducements to introduce in new localities. Write stating size and style wanted.

**WITTE IRON WORKS CO.**  
1654 Oakland Ave., Kansas City, Mo.

## You Need an Engine

You can save money by telling me just what you wish to run, in the Shop or on the Farm. Plain or hopper cooled. Free trial.

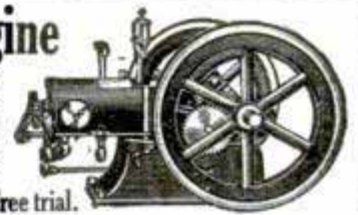

**H. L. CHAPMAN, Box 595, Marcellus, Mich.**

**CINEMATOGRAPH PARTIES**—Cinematograph parties are the latest amusement in Berlin society. Guests are shown on the screen secretly taking cinematograph records of themselves riding and walking or standing about, laughing and chatting in places where smart people congregate.

The victim's gaiety is often somewhat forced when an awkward gesture or an idiotic grin is all too faithfully reproduced on the screen, but he consoles himself with

## \$50 to \$300 SAVED

We are manufacturers, not merchants. Save dealers', jobbers' and catalog house profit. I'll save you from \$50 to \$300 on my High Grade Standard Gasoline Engines from 2 to 22 h.p. — Price direct to you lower than dealers or jobbers have to pay for similar engines in carload lots for spot cash.

## GALLOWAY

Price and quality speak for themselves and you are to be the sole judge. Sell your poorest horse and buy a **5-H.-P. only \$119.50**



**Direct From My Factory on 30 Days' Free Trial.**

Satisfaction or money back. Write for special proposition. All you pay me is for raw material, labor and one small profit. Send for my big **BOOK FREE.**

**WM. GALLOWAY, Pres.**  
**WM. GALLOWAY CO.**  
1965 Galloway Station  
WATERLOO, IOWA

## DON'T BUY A GASOLINE ENGINE

until you investigate "The Master Workman," a two-cylinder gasoline, kerosene or alcohol engine, superior to any one-cylinder engine; revolutionizing power. Its weight and bulk are half that of single cylinder engines, with greater durability. Costs Less to Buy—Less to Run. Quickly, easily started. Vibration practically overcome. Cheaply mounted on any wagon. It is a combination portable, stationary or traction engine. SEND FOR CATALOGUE THIS IS OUR FIFTY-NINTH YEAR.

**THE TEMPLE PUMP CO., Mfrs., 431 West 15th St., CHICAGO**

**5 YEAR GUARANTEE**

**Price WATERLOO BOY THE PRICE MAKER** No other gasoline engine reduced the price of gasoline engines like the **WATERLOO BOY**

Has fewer parts than any other engine. It costs less to make few parts than many parts. *Waterloo Boy* is made in large quantities. It costs less per engine to make 100 engines a day than 10. That's why we make the under-selling price

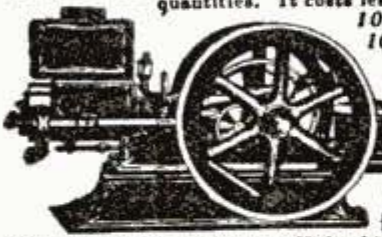

**Service**  
**Waterloo Boy is Dependable**

Always ready to go. No fuss. No bucking. Starts easy in winter. Igniter simple as a pair of scissors. Automatic feed regulation. No bother or expense of a pump. Speed lever works like a throttle on a locomotive. Nearly all parts are interchangeable. If you want satisfaction all the year round buy the Waterloo Boy. Waterloo Boy Lasts. Built of best material by men that know how

**Waterloo Gasoline Engine Co.**  
1621 W. 3rd Ave.,  
Waterloo, Iowa.

**Durability**

**WE DO AS WE ADVERTISE**

**I H C Gasoline Engines Make and Save Most Money**

They are most dependable, simplest, most economical, most efficient, most durable and strongest, and they are adaptable to most kinds of work. I H C Gasoline Engines are made in all styles, 1 to 45-horse power. Write today for the I H C catalogue, and read about the I H C engine that meets your needs best.

Address, INTERNATIONAL HARVESTER COMPANY of AMERICA (Incorporated)  
16 Harvester Building Chicago U S A

the hope that the next film may give him a chance of poking fun at his neighbor.

Another development of the idea is to have one's domestic joys, such as marriages and christenings, cinematographed and the films presented to friends. A wedding that took place last week was cinematographed from beginning to end, including the drive to the church and back to the bride's house. Copies of the films were sent to relatives of the family in Australia, China and India.—New York Tribune.

**FERRO MARINE ENGINES \$60 AND UP The Engine that Mastered Niagara**



**THE World's Standard Two-cycle Marine Motor.**  
Ten sizes; one, two or three cylinders; 3 to 25 horse power. High-tension magneto; new idea in carburetor; many other advantages.

1911 Catalog **The Ferro Machine & Foundry Co.**  
all models, 18 Hubbard Ave., Cleveland  
sent free Agents in Principal Cities and Ports.

**Get This Power Boat at Maker's Prices**  
BUY DIRECT FROM MANUFACTURER AND SAVE DEALERS' PROFITS



This Toppan Power Dory as illustrated above is made of best guaranteed materials and is the standard rough water boat of the world. Safe and reliable—used by U. S. Government in all departments. Send 4c in stamps for catalogue. Ask for prices and facts about Toppan Reversible Motors, built with 2, 3, 5, 8 and 12 Horse Power—and if you want to build your own dory, having exactly HALF ask for **TOPPAN BOAT MFG. CO.** FREE KNOCK-DOWN BOAT QUOTATIONS. 3 Haverhill St. BOSTON, MASS.

**BAY STATE MOTORS**

"Perfect Simplicity" and "Simple Perfection" are the results, embodied in these Motors, of 15 years devoted to the developing of these essential characteristics, which enable us to put on the market a reliable and economical motor at a reasonable price. Write for catalog, stating size and type (2 or 4 cycle) of motor wanted. We also furnish casings for these motors.



**BAY STATE MOTOR WORKS**  
Successor to  
**A. J. HOULE MOTOR WORKS**  
580 South East Street, HOLYOKE, MASS.

**This Kerosene Engine Cuts Your Expenses 75%**

**YOU** should not even consider engines that operate on gasoline only. The rapidly rising price of gasoline, now 6 to 16 cents higher than kerosene, absolutely makes operation on this fuel too expensive. The Perfection Kerosene Engine operates on any engine fuel. When you purchase it you are on the safe side—proof against all fluctuations of the market. You can always run this engine at a great fuel saving and get the greatest amount of work done. The Perfection vaporizes its own kerosene and so makes it as efficient as gasoline—something other engines cannot do.

The Perfection is very light, portable, has only three moving parts, runs everything about the place, is lower in price than any other engine of its capacity on the market.

**PERFECTION Kerosene Engine Sent You on 15 Days Free Trial**

See your dealer at once and ask him to let you have a copy of our **Free ENGINE BOOK** which shows the sizes and styles of the "Perfection" and explains this very attractive offer. Your dealer will send any "Perfection" engine to your farm for 15 days and let you return it if you are not satisfied. Ask him about it. If he does not carry the "Perfection" write to us and we will send you our **Free Engine Book** direct.

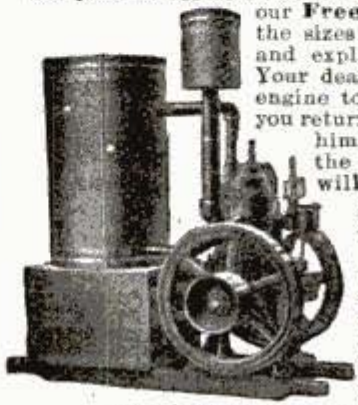

**QUICK SHIPMENT GUARANTEED**  
The day we get your order we will ship your engine. No delays at this time of the year—a man wants his engine and wants it quick. We have ready right now the very engine you require. Get your order in quick.

**CALLE PERFECTION MOTOR CO.**

205 Second Ave. DETROIT, MICH.

**THE STRELINGER**

Means first quality in **MARINE GASOLINE ENGINES**. They are **RELIABLE, DURABLE** and consume **LESS FUEL** than any other Marine Motor made. Prices and terms will please you. No matter what size engine you wish, it will pay you to read our catalog before placing your order elsewhere.



Write today. Agents Wanted  
**THE STRELINGER MARINE ENGINE CO.**  
Mfrs. of Marine and Stationary Motors  
45 E. Congress Street, DETROIT, MICH., U. S. A.

**TOLEDO MOTORS HIGH QUALITY, LOW PRICE!**

- 3 H. P., complete . . . \$ 65.00
- 6 H. P., 2 cyl., complete . . . 125.00
- 6 H. P., 1 cyl., complete . . . 84.00
- 12 H. P., 2 cyl., complete . . . 155.00
- 18 H. P., 3 cyl., complete . . . 250.00

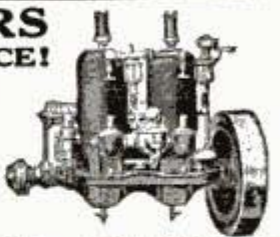

**FULLY GUARANTEED, ORDER NOW.**  
3½ x 3½ and 4½ x 4½—2 cycle 2 port  
Send for Cat. "C" Schebler Carburetors

**UNIVERSAL MACHINE CO., Palmwood Ave., TOLEDO, OHIO**

**FOOS Gas, Oil and Gasoline ENGINES**

embody an ignition system more positive than any other engine on the market. Electrode points cleaned by the wiping action of the revolving igniter, throw a spark many times hotter and stronger than is possible to obtain from an ordinary make and break contact.

Full description of this igniter in addition to many other exclusive Foos features given in catalog 50.

**The Foos Gas Engine Co.**  
SPRINGFIELD, OHIO  
Largest Exclusive Factory in America



# 5 Years' Absolute Guaranty

## On this Wonderful Detroit Marine Engine

**You Are the Only Judge** of the engine and its merits. 25,000 satisfied users. Material and workmanship guaranteed for five years.

### Greatest Engine Bargain Ever Offered!

Fewest moving parts of any practical engine on the market. Nothing complicated or liable to get out of order. Only three moving parts. Extra long plastic white bronze bearings. Vanadium steel crankshaft. Adjustable steel connecting rod. All bearing surfaces ground. French gray iron castings. Water-proof ignition system. Runs at any speed from trolling to racing.



Starts without cranking. Reversible while in motion. Perfectly counter-balanced. No vibration.

**30 Days' Trial** Try the engine for 30 days. If you are not fully satisfied, return it and we will promptly refund all money paid us.

Demonstrator Agents wanted in every boating community. Special wholesale price on first outfit sold. Single cylinder, 2-8 h. p. Double cylinder, 8-20 h. p. 4-cylinder, 20-50 h. p. Thoroughly tested before shipment. Comes to you complete with boat fittings and ready to run. Write for free catalog, testimonials and details of the greatest protective guaranty ever offered. Suitable for any boat from canoe to cruiser. Also railroad track car. All sizes in stock ready to ship. Write today for our wonderful demonstrator offer. (74)

**DETROIT ENGINE WORKS**  
1271 Jefferson Avenue, DETROIT, MICH.

## \$25.00 Buys the Frame of This Boat

Including illustrated instructions to finish

Length 23 feet, beam 56 inches, speed with 6 h. p. motor 10 miles; 12 h. p. motor, 15 miles.

### The Best Boat Bargain of the Year

You save better than two-thirds the regular price. Build it by the Brooks System which means you can purchase all or part of the material in



the knock down, every piece cut to shape, machined and accurately fitted so that it will go together the right way only. Build your boat now, use it this season and you can then sell it for double your investment. For years we have been establishing amateurs in the boat building business.

Free catalog of similar bargains, giving full details. A postal brings it. **BROOKS MANUFACTURING CO., 707 Rust Ave., Saginaw, Mich.**  
The oldest and largest firm of its kind in the world.

## \$40 2 H.P. COMPLETE

With fittings, including propeller and shafting, stuffing box, wiring, etc

Ready to install in your boat

This is a powerful engine for High Speed Boats, complete with all fittings. Absolutely Reliable. Extra Power and Extra Wear. Compact, Silent, Low running cost, Perfect two-cycle, reversing engine. 2 Year Guaranty. So simple a woman or child can run it. Used in Government Harbor Service and Chicago Police Boats.

**3, 4, 5, 6, and 10 H.P.**  
Prices Are In Proportion  
Special Prices to Boat Builders and Agents

Our Engine Book No. 12 E. contains valuable facts about Marine Engines and describes complete line.

FREE ON REQUEST

**NORTHWESTERN STEEL & IRON WORKS, 707 Spring St., Eau Claire, Wis.**



### WATKINS' SPECIAL MOTORS

3 H. P. Single Cylinder . . . 30 lbs.  
6 H. P. Double Cylinder . . . 60 lbs.  
12 H. P. Four Cylinder . . . 100 lbs.

A strictly HIGH GRADE Motor that will give CONSTANT and EFFICIENT service. Especially adapted for CANOES and LIGHT BOATS. Aluminum base, copper water jacket, steel shaft, bronze bearings.

**THE WATKINS MOTOR CO.**

837-839 West Sixth Street CINCINNATI, OHIO

## Make a Motor Boat of Any Boat in Five Minutes



You can do it with the Waterman Out Board Motor, which you can quickly attach (and detach) to the stern of any skiff, rowboat, dinghy, punt, sail boat, and have a good motor boat. It is not a toy, but a reliable 2 H. P. Marine Motor that will drive an 18-ft. rowboat 7 miles an hour, 4 hours on one gallon of gasoline. Simplest motor made. Weight 40 lbs. Six years successful results behind it. Canoe and larger motors—light weight models K and B

—LIFE GUARANTEE.

**WATERMAN MARINE MOTOR CO.**  
1507 Fort St., West, DETROIT, MICH., U. S. A.

**BANK OF ENGLAND NOTES**—Every one may not know that the Bank of England notes are made from new white linen cuttings—never from anything that has been worn. So carefully is the paper prepared that even the number of dips into the pulp made by each workman is registered on a dial by machinery, and the sheets are counted and booked to each person through whose hands they pass. They are made at Laverstroke, on the River Whit, in Hampshire, by a family named Portal, descending from a French Huguenot refugee, and have been made by the same family for more than one hundred and fifty years. They are printed within the building, there being an elaborate arrangement for making them so that each note of the same denomination shall differ in some particular from the other.

**FAMOUS MICHIGAN SPEED WHEELS**  
**REVERSE GEARS & MARINE HARDWARE**



## MOTOR BOAT MEN

Send for our large catalog of valuable information on speed wheels, reverse gears and marine hardware. Everything new and up-to-date.

Prices Right. Satisfaction Guaranteed

We carry an immense stock and can make you prompt shipments and save you money. Send for our free catalog today

**MICHIGAN WHEEL COMPANY**  
565 Canal Street, GRAND RAPIDS, MICHIGAN



# Gile Launches

"Made in the Heart of Motor Boat Country"

THE finest type of small boat architecture. Classy design; great speed; ample power, assured safety; low cost; expert build; dependable, reversible engines; greatest possible roominess, buoyancy and seaworthiness. Dry in roughest weather. 16, 18, 20, 26-foot models.

Hulls of seasoned timber, stoutly built and sheathed inside. Clean-cut from stem to stern. Brass deck hardware. Driven at high speed by the famous 2-cycle, non-cranking Gile Engine—positively reversible—controlled by one lever. 3, 5, 6, 10, 15 horsepower. Engines and boat equipment sold separately. Drop us a postal TO-DAY for the handsome, money-saving free catalogue. **Special 16-ft. Launch, \$87.**  
**GILE BOAT & ENGINE CO., 301 Main St., Ludington, Mich.**

(This is the 16-foot Ideal)

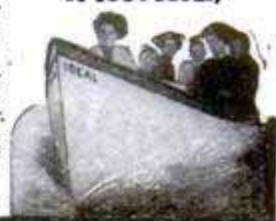

# ROBERTS MOTORS THE MOTORS THAT NEVER BACKFIRE

## AEROPLANE MOTORS THAT MAKE FLIGHT CERTAIN

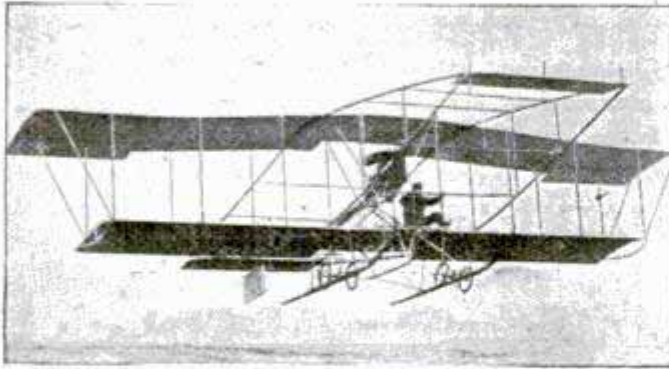

C. O. HADLEY AT MINEOLA, N. Y.

Flies at first trial on half throttle and carried one passenger. Powered with a Model 4 X Roberts 50 H. P. Motor.

Order Promptly to Insure Delivery

Complete Aero Catalog on Request

## MARINE MOTORS THAT GIVE PERFECT SATISFACTION

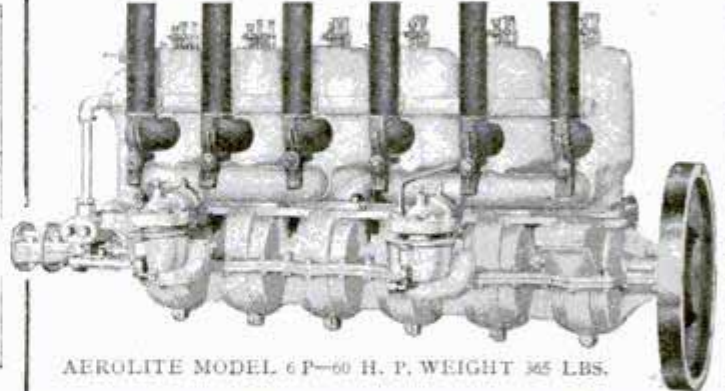

AEROLITE MODEL 6 P-60 H. P. WEIGHT 365 LBS.

Special light weight models for speed boats, canoes, and all installations requiring extreme light weight. All models furnished in nine sizes, 3 to 60 H. P., 1 to 6 cylinders.

Standard Models in Stock for Prompt Delivery

Complete Catalog will be Mailed Upon Request

THE ROBERTS MOTOR CO., 1419 Columbus Ave., Sandusky, Ohio

**CHURCH TAXES INCOMES**—The Westminster Presbyterian church in Milwaukee has solved the riddle of how to keep out of debt by imposing a tax on the incomes of its members. Incomes of \$1,000 or less are assessed 2 per cent, those from \$1,000 up to \$3,000, 5 per cent. Pew rents as well as collections have been abolished. The church made its budget in advance, was enabled to compute the expenditures and to make them fit the revenue, and after trying the novel experiment for a year is not only without a deficit, but has a surplus which is to be invested.—Washington Herald.

## Baldrige Reverse Gear Controls Your Motor Boat Like an Automobile

By moving a single lever this gear makes your boat stop, go forward or backward, as you please. Engine doesn't stop. Nearly 6000 in use. Write for interesting booklet.

SMITH & BALDRIDGE MACHINE CO.  
62 AMSTERDAM AVE., DETROIT, MICHIGAN

## GRAY JUNIOR

Complete All Ready to Run

\$58

MADE TO LAST A LIFE TIME

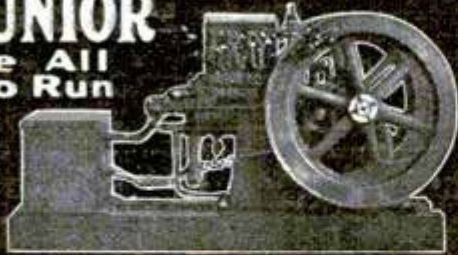

Most remarkable stationary work engine ever offered for the money. Operates on gasoline, kerosene, alcohol, naphtha or distillate. Runs any kind of small machinery—lathes, presses, saws, separator, feed grinder, water system, electric light outfit, etc. Not at all complicated—

This Engine will do **15 Cents** your work for only **15 Per day**

a woman or boy can run it. Best material and workmanship and guaranteed by a big responsible concern the same as if it cost \$500. **BIG MONEY** for agents and dealers. Write **TODAY** for big catalog.

GRAY MOTOR COMPANY, 732 Charlotte Avenue, Detroit, Mich.

## T & M MARINE ENGINES

Reliable in every emergency. Speedy and economical. Easy to install—real pleasure to operate. Correctly designed and constructed. Best engine

## For Rough Weather

Will stand up under strongest seas. Right size and type for all craft up to 65 ft. 1-2-3 and 4 cyl. 2 h. p. and up.

TERMAAT & MONAHAN CO.  
Department A OSHKOSH, WIS.



Agencies in all principal cities

## "Runs Like A Scared Rabbit"

Writes Cleburne Grady, Montgomery, Ala. who, while yet a green hand at motors, averaged 12.92 miles per hour on a 8.62 mile river trip.

## Perfection Marine Motor

The "Perfection" is so worthy of the name it needs little attention. Just a regular flow of gasoline and a good spark will keep it working on hard towing, ferrying or pleasure jaunts—and it will last as long as

Write for catalog. **CAILLE PERFECTION MOTOR CO., 105 Caille St., Detroit, Mich.**

Prompt Shipment Guaranteed.

Send for our Stationary Kerosene Engine Catalog if Interested.





# CHIEF DRAFTSMAN

Will INSTRUCT PERSONALLY a limited number selected, ambitious men in

## Practical Drafting, Detailing, Designing

### Draftsmen Drawing \$125-\$150 Monthly

Are NOT MADE in Schoolrooms,  
 Are NOT MADE by reading books,  
 Are NOT MADE by making Copies,  
 Are NOT MADE at home drawing pictures  
 from printed book lesson.

### LET ME TELL YOU:

It requires actual, practical, up-to-date  
 DRAFTING-ROOM WORK to train YOU  
 to gain the PRACTICAL EXPERIENCE  
 that your employer will demand of you.



# FREE

This \$13.85  
**DRAWING  
 OUTFIT**

and **Free Position.**

As Chief Draftsman of Engineering firm I know exactly the Quality and Quantity of PRACTICAL training, knowledge and actual up-to-date experience (not school knowledge) you must have, in order to obtain a good position and advance to highest salary.

I give **INSTRUCTION UNTIL COMPETENT** and  
**PLACED in POSITION** at above Salary.

DON'T waste TIME and MONEY trying to learn from books or printed "STUFF" you can only learn on PRACTICAL WORK which I furnish you.

Address **CHIEF DRAFTSMAN**  
**Div. 19, Eng's Equip't Co. (Inc.), Chicago**

Dealer's price to you now  
and easy monthly pay-  
ments on this marvel-  
lous new type engine.

# Best Shop Engine

3 horsepower.

Air Cooled.

Has a Spark  
Retarder.

Send free  
coupon.

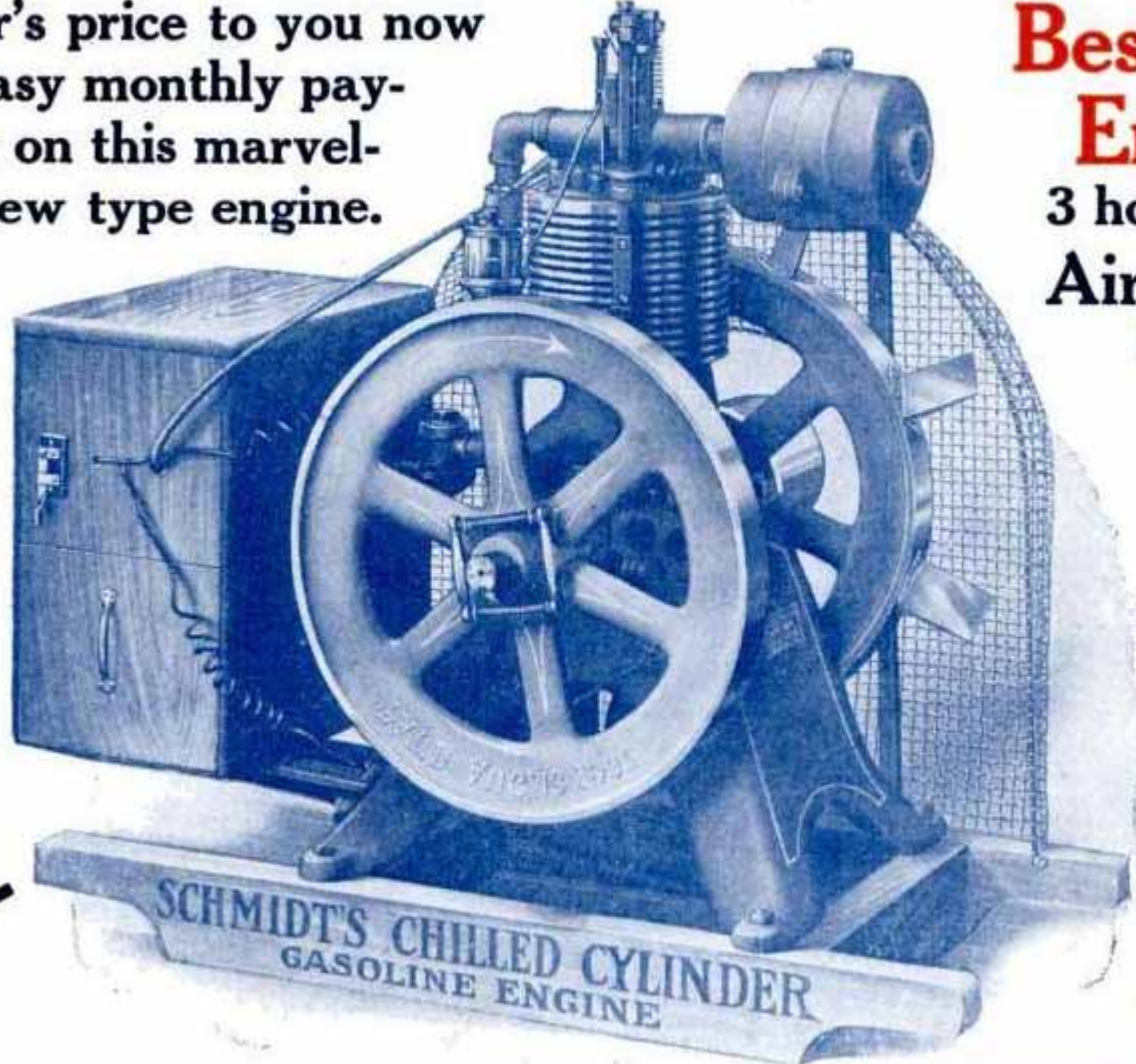

TAKES UP  
LESS FLOOR  
SPACE.

## FREE This Marvel- lous Chilled Cylinder Gasoline Engine sent Free

Yes, absolutely free on the most liberal offer ever made. Use this engine ten days on your own place then send it back at our expense or keep it on easy monthly payments at dealer's price just as you choose. Send direct to the engine works and save dealer's profits.

## Send No Money Easy Payments 5 Years' Guarantee

SCHMIDT'S Chilled Cylinder Gasoline Engine is absolutely guaranteed in every part for five full years. You take no risk of any kind. You get the best and most economical engine on earth. The only engine with a chilled cylinder for all kinds of power work at the engine works' price. Send the free coupon now for catalogs and all particulars free.

Schmidt Bros. Co. Engine Works  
Dept. 119 Y Davenport, Iowa

## Power Equipment for FARM OR SHOP.

Have your own power plant. With Schmidt's easy new type hangers, pulleys, shafting, bearing, etc., at small cost. On this special introductory offer you can get engine and power equipment at dealer's price. SEND FREE COUPON NOW



We send the engine to you on your request without a cent down in any way. Get all particulars of this amazing free offer.

Take long time to pay on your own security. No notes or mortgages. Same price as for all cash. Most liberal terms ever made to you.

## FREE COUPON

Schmidt Bros. Co. Engine Works  
Dept. 119 Y, Davenport, Iowa

Gentlemen: Without any obligations on me you may send me free and prepaid catalog explaining your new free offer and easy payment terms on Schmidt's Chilled Cylinder Gasoline Engine.

Name .....

Address .....



**Here's**  
to Your Good Health  
and Pleasure

Come---follow the arrow 'til you  
join the merry throng of palate  
pleased men and women who have quit  
seeking for the one best beverage because  
they've found it---

**Coca-Cola**

Real satisfaction in every glass---snap and  
sparkle---vim and go. Quenches the thirst---  
cools like a breeze.

**Delicious---Refreshing---Wholesome**

**5c Everywhere**

Send for  
our interest-  
ing booklet,  
"The Truth  
About Coca-Cola"

THE COCA-COLA CO.  
Atlanta, Ga.

Whenever  
you see an  
Arrow think  
of Coca-Cola