

# POPULAR MECHANICS

WRITTEN SO YOU CAN UNDERSTAND IT.



FROM BUD TO BLOSSOM  
IN COLORED MOTION PICTURES—TIME THREE DAYS

# \$665 BUYS THE MATERIAL NEEDED TO BUILD THIS HOME!

**Price includes Blue Prints; Architect's Specifications; Full Details; Working Plans and Typewritten Material List**

## OUR HOUSE DESIGN NO. 84

A cozy, attractive cottage that cannot but win the admiration of all those who appreciate a comfortable home. Including the bay, its size is 24 ft. wide x 27 ft. deep. Contains six rooms and bath—Parlor, Dining Room, Kitchen, Reception Hall, and Pantry downstairs, three Chambers and Bath upstairs.

The general construction and design of this house represent the greatest possible economy combined with convenience of arrangement, dependability, and harmony and beauty of appearance.

The material we furnish for construction has been selected with extreme care and is of most excellent quality throughout. Our Guaranteed Building Proposition insures you of ample quantity of the quality specified, prompt shipment, safe arrival and absolute satisfaction on the entire deal. Every home builder should take advantage of this extraordinary money-saving opportunity. Write today for more complete information and description.



## We Save You Big Money on Lumber and Building Material!

The Chicago House Wrecking Co. is the largest concern in the world devoted to the sale of Lumber, Plumbing, Heating Apparatus and Building Material direct to the consumer. No one else can make you an offer like the one shown above. We propose to furnish you everything needed for the construction of this building except Plumbing, Heating and Masonry material. Write for exact details of what we furnish. It will be in accordance with our specifications, which are so clear that there will be no possible misunderstanding.

### How We Operate

We purchase at Sheriffs' Sales, Receivers' Sales and Manufacturers' Sales, besides owning outright sawmills and lumber yards. Usually when you purchase your building material for the complete home shown above, elsewhere, it will cost you from 50 to 60 per cent more than we ask for it. By our "direct to you" methods we eliminate several middlemen's profits. We can prove this to you.

### What Our Stock Consists of

We have everything needed in Building Material for a building of any sort. Lumber, Sash, Doors, Millwork, Structural Iron, Pipes, Valves and Fittings, Steel and Prepared Roofing. Our stock includes Dry Goods, Clothing, Furniture, Rugs, Groceries, etc., Machinery, Hardware, Wire Fencing—in fact, anything required to build or equip. Everything for the Home, the Office, the Factory or the Field, besides everything to wear or to eat. Send us your carpenter's or contractor's bill for our low estimate. We will prove our ability to save you money. WRITE US TODAY, giving a complete list of everything you need.

### Free Book of Plans

We publish a handsome, illustrated book, containing designs of Houses, Cottages, Bungalows, Barns, etc. We can furnish the material complete for any of these designs. This book is mailed free to those who correctly fill in the coupon below. Even if you have no immediate intention of building, we advise that you obtain a copy of our FREE BOOK OF PLANS. It's a valuable book.

### Our Guarantee

This company has a capital stock and surplus of over \$1,000,000.00. Absolute satisfaction guaranteed in every detail. If you buy any material from us not as represented, we will take it back at our freight expense and return your money. We recognize the virtue of a satisfied customer. We will in every instance "Make Good." Thousands of satisfied customers prove this. We refer you to any bank or banker anywhere. Look us up in the Mercantile Agencies. Ask any Express Company. Write to the publisher of this publication. Our responsibility is unquestioned.

**\$2.00 Buys a Complete Set of Blue Prints** We send you a set of plans for the house described above, including the necessary specifications and complete list of material, transportation charges prepaid, for the low cost of \$2.00. This is only a deposit, a guarantee of good faith, and the proposition to you is that after receiving these blue prints, specifications and list of material, if you can place an order with us for complete bill of material, we will credit your account in full for the \$2.00 received, or we will allow you to return these plans, specifications, and list of materials to us and we will refund \$1.50, thereby making the total cost to you 50 cents.

### High Grade Bathroom Outfits!



The price of this Bathroom Outfit **\$37.50.**

Plumbing material direct to you at Bargain prices.

We have everything needed in Plumbing Material. Our prices mean a saving to you of 30 to 60 per cent.

Here is an illustration of a bathroom outfit we are selling at \$37.50. Your plumber would ask you about \$60.00 for this same outfit. It is only one of many other complete outfits that we are offering at prices ranging from \$25.00 to \$50.00. Our catalog describes them in detail. Get our prices on Pipe and Fittings. Write us today.

### Hot Air Furnaces!

Don't let the contract for your hot air furnace until you get our figures.

We will cut your local dealer's price in half. We can furnish you a complete equipment, including pipes, registers, furnace; everything required at a price not much more than what an ordinary heating stove would cost you. Complete hot air heating plants **\$48.00 up.**

Get our heating catalog at once. Tells you all about it. Write us today. We guarantee to save you money. We loan you tools. We make you plans. Every heating plant we sell is backed by our guarantee bond.



### Hot Water Heating Plants!

We guarantee to save you 50 to 75 per cent on a modern hot water heating plant for your home.

We make you complete plans and instructions and help you out every way we possibly can. We loan you tools. Every plant backed by our guarantee bond. We furnish the material; you get the plant installed. Cut out the local dealer's profit and cut the cost in half. Thousands of our plants installed and working perfectly in every part of the country. Write today for our Special Heating Catalog. Tells all about our heating proposition. We can furnish Heating Apparatus for any building, no matter how large. Tell us your needs.



**Water Supply Outfits** Modern Air Pressure Water Supply Systems at prices ranging from \$48 to \$225. They are strictly new, first-class and complete in every detail. It makes no difference whether you live in the country, you can enjoy every city comfort at little expense. Why not investigate this? We are ready to furnish you with all facts free of charge. All material fully guaranteed. We also have a complete stock of Pipe, Valves and Fittings at 40 to 60 per cent saving. Gasoline engines at low prices.

**Free Publications** Besides a Free Book of Plans described above, we send free to anyone answering this advertisement in the United States the following additional booklets: **Our Plumbing Material Catalog**—A book covering every phase of the Plumbing subject, shows the latest and most modern ideas in Bathroom equipment, as well as sanitary appliances of every kind. **Cold Weather Comfort** is the title of our Heating Catalog; describes in full hot water, hot air and steam heating. The subject is treated in language so plain that no one can misunderstand it.

**CHICAGO HOUSE WRECKING CO., 35th and Iron Sts., CHICAGO**

### Send Us This Coupon

Chicago House Wrecking Co. (539)

I saw this ad in June Popular Mechanics.

I am interested in.....

NAME.....

TOWN.....

CO.....STATE.....

# Navy's Fine Young Men

---

---

**T**ODAY it is not a matter of finding men who are willing to enlist in the U. S. Navy. It is a matter of selecting from among the applicants only those who will match up in every way with the high class men now in the service.

The United States Navy's standard of requirements has been raised only gradually, but the increase in the number of applicants during the last few years has enabled the Department to set this standard now at the highest point in the history of the navy.

This increase is due to the fact that young men are now understanding better what the Navy does for a man—the remarkable training it gives, its unusual opportunities for a successful career with financial reward, its congenial work and surroundings.

Only men of sound physique, men of clean habits morally and physically, and men between the ages of 17 and 35 are desired or admitted. The Navy Department urges no one to enlist. Young men who are ambitious will be interested in knowing what the Navy does offer.

---

---

Call at any Navy Recruiting Station or Address

**BUREAU OF NAVIGATION**

DESK 69

NAVY DEPARTMENT

WASHINGTON, D. C.

# KEEN KUTTER

## Quality Tools



This name and mark on tools and cutlery is your protection in buying, for it guarantees perfection of quality, temper, adjustment and satisfactory service.

Keen Kutter is the only complete line of *identified* and guaranteed tools and cutlery under one name and trademark.

Order by the name Keen Kutter and you remove all uncertainty in tool buying. If they prove at all disappointing for any reason, the dealer will refund your money.

Send for free Home Design Booklet No. 976, showing working drawings of simple craftsman furniture designs

**"The Recollection of Quality Remains Long After the Price is Forgotten."**

Trade Mark registered.—E. C. Simmons

**Simmons Hardware Company**  
Inc.

**If not at your Dealer's, write us.**

**St. Louis and New York, U. S. A.**

# Popular Mechanics Magazine

318 W. Washington Street, Chicago, U. S. A.

EDITED BY H. H. WINDSOR

ISSUED MONTHLY

SUBSCRIPTION:

SINGLE COPY, 15 CENTS

In United States, and its possessions, Cuba and Mexico, per year, postpaid - - - - \$1.50

To Canada - - - - - 1.75

To all other countries in the Postal Union - - - - - 2.00

All subscriptions are discontinued at expiration. Please examine the date printed on your wrapper.

Entered as Second Class Matter Sept. 15, 1903, at the Postoffice at Chicago, Illinois, under Act of March 3rd, 1879.

Published monthly by POPULAR MECHANICS CO.

Copyrighted 1911, by H. H. WINDSOR.

The attention of prospective advertisers is called to the policy of this magazine in accordance with which the publisher waives all claim for payment of any advertisement appearing in any issue where the number of copies actually printed and circulated is less than the number printed on the front cover page.

## Contents for June, 1911

Ten Tons of Bread for Twenty Thousand Men...771	Remarkable Resuscitation from Electric Shock...816
By Florence Fuller	English Lamp Reduces Blinding Glare.....816
Puts an Air Cushion on Short-Arm Jabs.....773	Largest Grain Elevator Built of Concrete.....817
Ingenious Safety Device for Machines.....773	Electricity Heats Rugs with Woven Wires.....818
Shadow Dance is Latest Theater Novelty.....774	Finger Weapons of the Parisian Apaches.....819
Lehigh Valley Railroad Dates Its Cross Ties...774	Using Picture Tiles to Educate the Young.....819
A Cabinet Kitchen That Looks Like a Desk...774	Asiatics Large and Small.....820
Fog Bell Rung by Water Meter.....775	Lizard Theory Sets Oil Operators Agog.....820
Concert in a Lion's Den.....776	Wireless Interrupts Lighting Circuit.....820
Motorboat Racing at Monaco.....777	The Work of the "Heart Stations".....821
A Wonder Bungalow.....778	Sawing a House in Two to Move It.....822
By Frank Maynard	Automobiles Especially for Roadless Country...823
European Nations Buying Many War Aero-planes.....782	Machine Plugs the Knot Holes of Box Boards...824
Hollow Concrete Poles.....784	Vacuum Cleaner with a Utility Motor.....825
Large Electric Storage Battery.....784	An Electric Shop Truck.....825
A Hotel for Immigrants.....785	Ring the "Bad News" Bell at Lloyds.....825
Auto to Chase Balloons and Aeroplanes.....785	Tilting Platform Motor Truck.....826
Aerial Propeller-Driven Trolley Line.....786	Oriental Rug Truly a Giant Carpet.....826
Automatic Stokers for Locomotives.....786	Armor Plate for Turrets.....828
Electric Transformer Crucible Furnace.....787	Improved Ship-Coaling Machine.....828
A Submarine Dreadnought.....787	Copying the Kaiser.....829
By L. William Thavis	X-Ray Works Overtime on Pugilist's Skull.....829
The Southern Pacific's \$10,000,000 Tunnel.....788	Calculating Machine Made in 1642.....829
Great Britain to Blaze on Coronation Night.....788	Explosions and Explosives.....830
Sails as Railway Motive Power.....789	By Hudson Maxim
A Projectile as a Satellite.....790	Modern Loading Device Works for Charity.....834
Steel Sheathed Cars for Mexico.....790	Print Four Million Post Cards a Day.....835
Electric Illumination Spoils Observatory.....791	An Electric Kitchen Maid.....836
Transporting Machinery in West No Easy Task...791	Haste to Fly for Money May Balk Progress.....836
A Municipal Elopement.....792	Two Ears of Corn on One Stem.....837
A Vision of the Future.....793	Tame Eagles as Decoys for Wild Eagles.....837
To Defend German Army Against Air Craft.....793	The Newer Stage Scenery.....838
Planning a Philadelphia Beautiful.....794	Sleeve Mirror for Motorcyclists.....839
Comment and Review.....795	A Bird Cart for the Dutch Princess.....839
By H. H. Windsor	Botanical Curiosities.....839
Science Has New Weapon to Fight Impure Milk...797	Through the Rockies on a Prairie Grade.....840
Motorboat Makes Nearly a Mile a Minute...797	The First Aerial Postal Service.....841
A Dog That Really Speaks Words.....798	Truck to Tow Aeroplanes.....841
Concrete Stand Built in Record Time.....798	Milk Bottle Opener and Stopper.....841
Headless Butterflies.....799	Digging in River Bed to Disprove Shakespeare...842
Places Burden of Handbag on Shoulder.....799	Potatoes Raise Brood in Dark Cellar.....842
Coronets the Peers and Peersesses Wear.....800	A Lighthouse on a Light Ship.....843
French Aero-Hydroplane.....800	Electric Compressor for Sawdust Briquettes...844
Finding Place for Aero in World's Affairs.....802	The Compass Needle as a Heat Indicator.....844
Scouting in an Aeroplane.....803	Apparatus for Testing Railroad Lamps.....844
Fighting Fires on Ships with Carbon Dioxide Gas.804	Small House with Two Alcove Bedrooms.....845
Suffragette Sleeps in a Bath tub.....805	Girl Blown into the Air by Wind and Killed...846
World's Largest Ship in Biggest Drydock.....805	Farmer's Motor Was Too Isolated.....846
The Colors of Nature in Moving Pictures.....806	Counting Three Hundred Million People.....846
A Whistling Well.....808	The Making of Arts-Crafts Lamps.....847
The Other Side of the Fly Question.....809	By John D. Adams
Deciphering Writing on Burned Manuscripts...811	Automobile Hood and Tent.....849
Children as Aeroplane Passengers.....811	Silhouettes the Newest Moving-Picture Fad...849
Atlantic Liner, "Prinzess Irene".....812	Combined Bath and Wash Basin.....849
Largest Freight-Sorting Yard in the World...813	Locomotive Transported Oversea Intact.....850
Wonderful Resuscitation Apparatus.....814	World's Gold Production in 10 Years.....850
Remarkable New Filter.....814	Machine Makes Square Deal Certain.....851
Camera Shot into Air Makes Photograph.....815	Electrical Apparatus for Photography.....851
Girl Organizes Fire Department.....815	Combination Pneumatic and Solid Tire.....852
Newest Outdoor Sport Costume for Women...816	A Wireless System with No Sparks or Arcs...852
	Hardened Copper.....852

[Continued on Page 6]

## Contents—Continued

Testing Engines with a Fan Dynamometer.....	852	Pipe Guides for a Bench Vice.....	899
Automobile Mail Van on Indian Railway.....	853	Baseboard Marking Hook.....	899
Rotoplane Aeroplane.....	853	Portable Lamp for the Garage.....	900
Elastic Suspension for Tungsten Lamps.....	853	A Flaring Pattern Rule.....	900
De Luxe Sleeping Cars for New York Road.....	854	Bakery and Milk Check Holder.....	900
Silences the Exhaust of Motorboats.....	854	An Inexpensive Flower Pot.....	901
Gasoline Engine with Stationary Pistons.....	854	Heating a Funnel for Thick Oil.....	901
Unique Test of Steel Vehicle Body.....	855	Setting a Diamond for Dressing Emery Wheels.....	901
Subterranean Wireless.....	855	Soap and Brush Holder for a Shaving Mug.....	901
German Monocar.....	855	Tool for Holding Piston Rings While Replacing Piston.....	902
Stencil Decorations for Awnings.....	856	Small Spanner Wrench and a Nut-Threading Tool.....	902
Portable Swing-Frame Emery Wheel.....	856	A Truss for Aeroplane Construction.....	903
New Instruments for the Practice of Medicine.....	856	An Emergency Snap.....	903
Brush Cleans Path of the Automobile.....	857	Adjustable Curtain Stretcher.....	903
The Metallic Luster of Insects.....	857	Locking a Wood Screw.....	903
How to Make an Umbrella Stand.....	857	A Simple Pipe Wrench.....	903
High-Tension Outlets.....	858	Boring Oval Holes.....	904
Nitrogen and Carbonic Acid Preserve Eggs.....	858	Preparing Logs for Sawing.....	904
Mechanical Terms.....	859	Eccentric Clamp for Wood Lathe Rest.....	904
Revolver, Knuckles, and Stiletto Combined.....	860	Lug on a Pipe to Hold a Locknut.....	905
Experiments Determine Shapes of Fish.....	860	Shear-Holder for Paperhangers.....	905
"Duck Boat" Body for Automobiles.....	860	Extension Spout for an Oil Can.....	905
Two New French Aeroplanes.....	861	Bottle Cleaner.....	905
Athletics Makes Women's Feet Larger.....	861	Preventing the Lower End of a Ladder from Slip- ping.....	906
A High Wireless Tower on the Pacific.....	862	A Lapping Tool.....	906
Varying the Alcohol Content of Beer.....	862	A Pruning Hook.....	906
The Kingdom of Dust.....	863	Fitting Glass in Picture Frames.....	906
By J. Gordon Ogden, Ph.D.			
Clearing the Sleeping Sickness Areas.....	868	Pencil Holder for Beam Compasses.....	907
The Harem Skirt Obligatory for Airwomen.....	869	A Panel Spacer.....	907
Woodpecker Chips.....	869	Gauge and Protector for a Hatchet.....	907
Russian Balalaika Has Tone Like Violin.....	869	Repairing a Cracked Spoke in a Wheel.....	908
Adam Type of Interior Decoration.....	870	An Improved Thread-Cutting Tool.....	908
Alarm Clock That Acted as an Engineer.....	870	How to Make Tweezers.....	908
Electric Trouble-Hunter for Motorists.....	871	How to Use an Expansive Bit.....	908
The Santa Fe's New Supply Train.....	871	Tin Tongs for the Kitchen.....	909
Dirigible "Suchard" Built to Cross the Atlantic.....	872	Coat Hanger for the Shop.....	909
A Skyscraper Disaster.....	872	Home-Made Tire-Upsetting Machine.....	909
The Trial of the Camorrista.....	874	Oiling a Screw Jack.....	909
Electricity in Wool Spinning.....	874	Mixing Valve for Gasoline Engine.....	910
Morning Glory Climbs a Telegraph Pole.....	875	A Home-Made Marking Pen.....	910
Mexico Building an All-Concrete Harbor.....	875	Applying Pressure on Patched Inner Tubes.....	910
Insignia for the Office of President.....	876	<b>AMATEUR MECHANICS</b>	
First Railroad to Densest Timber Belt.....	877	A Guitar That is Easy to Make.....	911
By H. M. Wright			
Irrigate 1,000,000 Acres in Washington.....	880	Home-Made Motion-Picture Camera and Pro- jector.....	912
Gas Engine Blows Itself through Building.....	880	A Swimming Raft.....	914
Salving the Steamer "Richardson".....	881	Removing Finger Marks on Books.....	914
Giant Auto Trucks to Haul 35 Tons.....	881	Tightening a Tennis Net.....	914
To Predict Earthquakes.....	882	Holding Fishing-Rod Joints Together.....	915
Science and Mechanics in the Middle Ages.....	883	Roller Skates on a Bicycle Wheel.....	915
Old Ferry Boat Used as a Clubhouse.....	883	Rope Oarlocks.....	915
Count Zeppelin Renews Dirigible Flights.....	884	Umbrella Used as a Flower Trellis.....	916
Naval Crane Lifts Its Own 216-Ton Truss.....	885	Combined Shade and Awning.....	916
One-Cylinder Engine for Aeroplanes.....	885	Vauling-Pole Attachments.....	916
Machine Replaces Hands for Stripping Hemp.....	886	Separating Drinking Glasses.....	916
By Monroe Woolley			
Metallized Paper.....	887	Wood-Working for Beginners.....	917
Scarecrow Protects Sunshine Recorder.....	887	How to Mix Plaster of Paris.....	920
Wheel for Motor Trucks.....	887	Floor Push Button.....	921
Clearance Car of the Pennsylvania System.....	888	A Wrist Brace.....	921
Reinforced Macadam Pavements.....	888	Protecting a Kettle Handle from Heat.....	921
Magnetic Ship on Wheels.....	889	Tin Can Used for Watering Chickens.....	921
Disease Mixes Sounds and Colors.....	889	<b>INTERESTING PATENTS, PRACTICAL OR UNIQUE</b>	
Motor Street Cleaner Absorbs the Debris.....	890	Sanitary Drinking Fountain.....	922
<b>SHOP NOTES</b>			
How to Kill Dandelions.....	891	Poison-Bottle Cork.....	922
A Sanitary Drinking Fountain.....	891	Flagpole Attachment.....	922
Felling Trees by Fire.....	891	Revolving Kettle Lid.....	922
Repairing a Lawn-Mower Ratchet.....	891	Perfect Tie-Slip Collar.....	922
Cutting Arcs on a Metal Planer.....	892	Combined Tying Device and Label Holder.....	922
Cleaning Gas Mantles.....	892	Waist-Retaining Device.....	922
Holding a Door Open.....	892	Machine for Capping Milk Bottles.....	922
Renewing an Old Brush.....	892	Disk Counter for Baseball Games.....	922
Space Economy in a Lumber Yard.....	893	Sanitary Drinking Fountain.....	923
Hardening Hammers.....	893	Street Fixture for Electric Lamps.....	923
Gauge for an Anvil.....	893	A Whirling Sparkler.....	923
Repairing a Broken Jaw on a Chuck.....	894	Moving-Picture Advertising Chair.....	923
Distinguishing Wrought Iron from Steel.....	894	Fire-Shutter Controller.....	923
Truck for a Refrigerator Drip Pan.....	894	Stopper Extractor.....	923
Gauge for Marking Tapering Octagon Poles.....	895	Convertible Garden Tool.....	923
Repairing a Broken Locomotive Wheel.....	895	Animal Trap.....	923
Plant Protector.....	895	Shampoo Cap.....	923
An Inexpensive Drilled Well.....	896	Jokes.....	924
Pipe Tool Attachments for Monkey Wrenches.....	898		
Form for Molding Concrete Slabs.....	899		

# There's Money for You in Selling

## Everyman's \$485 *The Brush Runabout* Car

**I**T is easy to sell people something they need and can afford. The Brush Runabout at \$485 is just such a proposition. People need it—all kinds of people, in every line of business. And the price is such that they can afford to buy it.

There is good profit for you in selling the Brush because you can make many sales and because your selling expenses are low. Your customers are all around you—no need for you to spend money travelling.

### Field Is Unlimited

**Every man** (or employer of men) whose value depends on quick and economical transportation can use the Brush to advantage. For it is quicker, more reliable and cheaper to use than horse and buggy—costing a cent a mile or less to operate.

**Salesmen, physicians, storekeepers, real estate men, insurance agents, contractors, plumbers, tax collectors, gas, electric and telephone companies**—all need the Brush and are quick to realize it, when the proposition is put up to them.

These different businesses are just a suggestion of the big market for Brush Runabouts that exists already right in your own town. And just outside are the farmers—every farmer needs a Brush; they realize it, too.

### Price Within Reach of All

There are few men engaged in business of any kind who cannot pay \$485 for something that will make or save money for them.

That's what makes it easy to sell the Brush. You can easily prove to your customer that the Brush will save him money. And when you've done that he isn't frightened by a big initial outlay.

Write for our proposition to dealers. Sending a postal may be the means of doubling your income.

### Demand Is Increasing

The Brush is already successfully employed in 84 different kinds of businesses—we want to send you a folder, "The Brush as a Commercial Asset," which gives names and photographs.

The demand is growing steadily every day as more and more people realize the adaptability of the Brush to their own business.

### Easy for You to Sell

All that is necessary to sell the Brush is to tell its true story and show the car. We are telling the story for you all over the United States in our advertising. All **you** need to do is to call on the individual prospects in your own town and show them what the Brush will do.

You don't need to know a lot about automobiles and machinery to sell the Brush. It is the simplest car built.

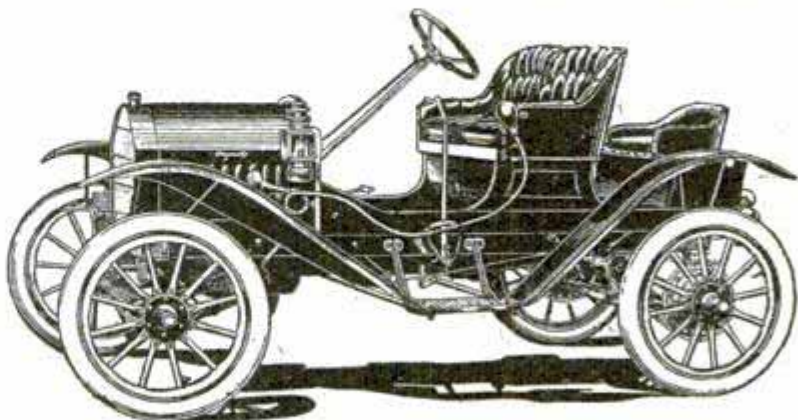

**BRUSH RUNABOUT COMPANY,**

(Division of United States Motor Company)

686 Rhode Island Ave.  
DETROIT, MICH.

Licensed under Selden Patent

This One



# LEARN TO RUN AND REPAIR AUTOMOBILES FOR

# \$10

**BARNEY  
OLDFIELD  
SAYS:  
IT IS THE BEST  
SYSTEM FOR TEACHING  
BY MAIL.  
IF OTHERS CAN  
LEARN AND EARN  
\$20 TO \$50 WEEK  
YOU CAN**



Why don't you learn this profession and double your salary? If you master this profession you are independent. Repairmen and Chauffeurs are needed in every town and city of the country.

My system is positively the only system in the world that can be successfully taught by mail.

My system of teaching by mail is a New Idea—it's different from others. I will so thoroughly train you that you will not only be able to drive a car, but you can repair motors, overhaul cars, repair tires, repair launch engines, repair stationary gasoline engines—you could go into the repair business—and also sell cars and engines.



## Read These Testimonials —You Can Do as Well

"I have been driving a car now for a month, and I owe it all to your Course."  
—Ramsey Stewart, Jansen, Utah.

"I am working in a repair shop. Have increased my income \$20 more per month so far and expect to get as high as \$50 more per month."  
—Jno. C. DeKoster, Lynden, Wash.

"I am now working in the American Auto Co., was formerly in the jewelry business."  
—James Tronto, Providence, R. I.

"I am now driving a Packard 30. Your Course helped me wonderfully."  
—Edw. Hauler, New Orleans, La.

"I am driving a 'Winton Six.' I do

all my own repair work."  
—Edw. Sawyer, Montclair, N. J.

"Your Course enabled me to get a good position which has increased my income."  
—Geo. E. Davelarr, Prosser, Wash.

"I was formerly farming, but am now in the auto repair business."  
—Geo. Millholke, Rheinbeck, Iowa.

## SEE THESE WORKING MODELS

There are other models: one of a Magneto, Engine and Carbureter; also a Manikin of an automobile. The Manikin can be taken apart and the models actually work. All moving parts on the models made of real metal.

The Course consists of 29 Instructions, 3 Models, and a Manikin, and examinations, diplomas, etc. Special price right now is but \$10.00. If you paid \$1,000.00 you couldn't get a better course—nor as good a course—because it is the only one of its kind.

## Send To-day for My Free 24-Page Book

Will tell you how to get into the Auto business—we will also show you testimonial letters from students everywhere who are now driving cars, working in Auto Repair Shops, who have gone into the Auto Repair Business, and who are making money.

## WE WILL DO MORE

We will show you actual reproduced letters from Barney Oldfield, Chas. Duryea, (the man who built the first Auto in America) and other leading Motor authorities—who endorse this system.

Surely this system must be something wonderful—and it is—let me tell you all about it.

Why Don't You Make Your Start—N-O-W?

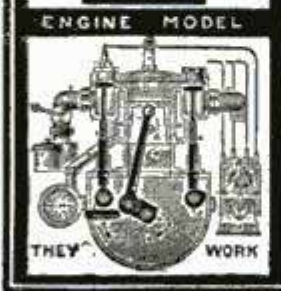

With this engine model you learn the principle of a gasoline engine and you can actually set the valves, time the ignition, etc.

**DYKE'S CORRESPONDENCE SCHOOL OF MOTORING**

Box 88, Roe Building, ST. LOUIS, MO.

(A. L. Dyke is the originator of the first Auto Supply Co. in America)

# The Sebastian

15-Inch Standard High Grade  
Low Price ENGINE LATHE

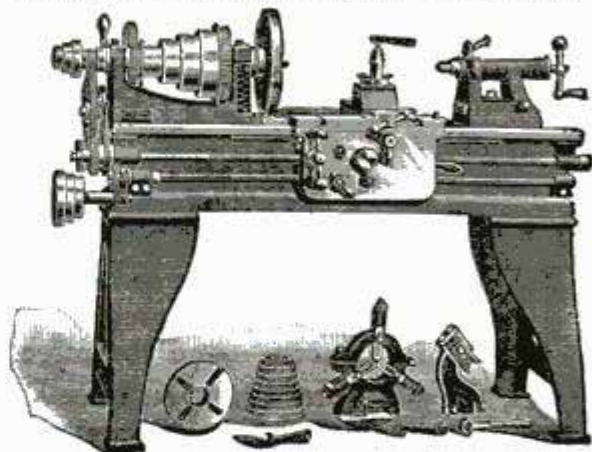

Automobile Builders, Garages, Repair Shops and General Jobbing Shops find this the Ideal Lathe for their work. Our Catalogue of Lathes and Tools Mailed FREE on request.

**THE SEBASTIAN LATHE CO.,** 107 Culvert Street, CINCINNATI, O.

## ENGINEERS, DRAFTSMEN

and all others who have lettering to do need a good system of easy lettering.

HERE IT IS

### CONTENTS:

**BLOCK LETTERS:**  
Heavy, Outline, Condensed, Expanded, Fancy, Shaded and Italics.

**GOTHIC:**  
Condensed, Expanded, Italics.

**ROMAN:**  
Fancy, Italics.

**SCRIPT: MODERN ARCHITECTURAL**

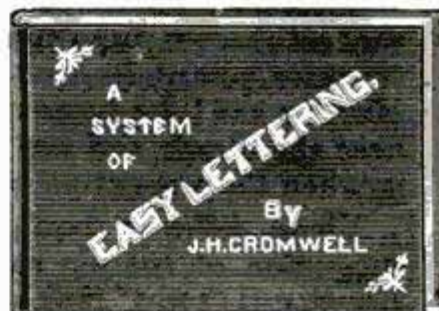

A new edition has just been issued with a supplement containing 8 new alphabets

*Well printed on good paper and handsomely bound in cloth,  
Sent postpaid on receipt of 55 cents.*

**Spon & Chamberlain,** 123 P. M. Liberty St  
NEW YORK, U.S.A.

WHEN YOU WANT ANYTHING AND DON'T  
KNOW WHERE TO FIND IT  
WRITE BUREAU OF INFORMATION,  
POPULAR MECHANICS CHICAGO

# A CHANGE

Under a new plan effective April 1,  
1911, our street number is changed to

**318 West Washington St.**

The change in address is caused by a re-numbering of the streets and is not a change of location. Please address our mail to the new number.

**Popular Mechanics Magazine**



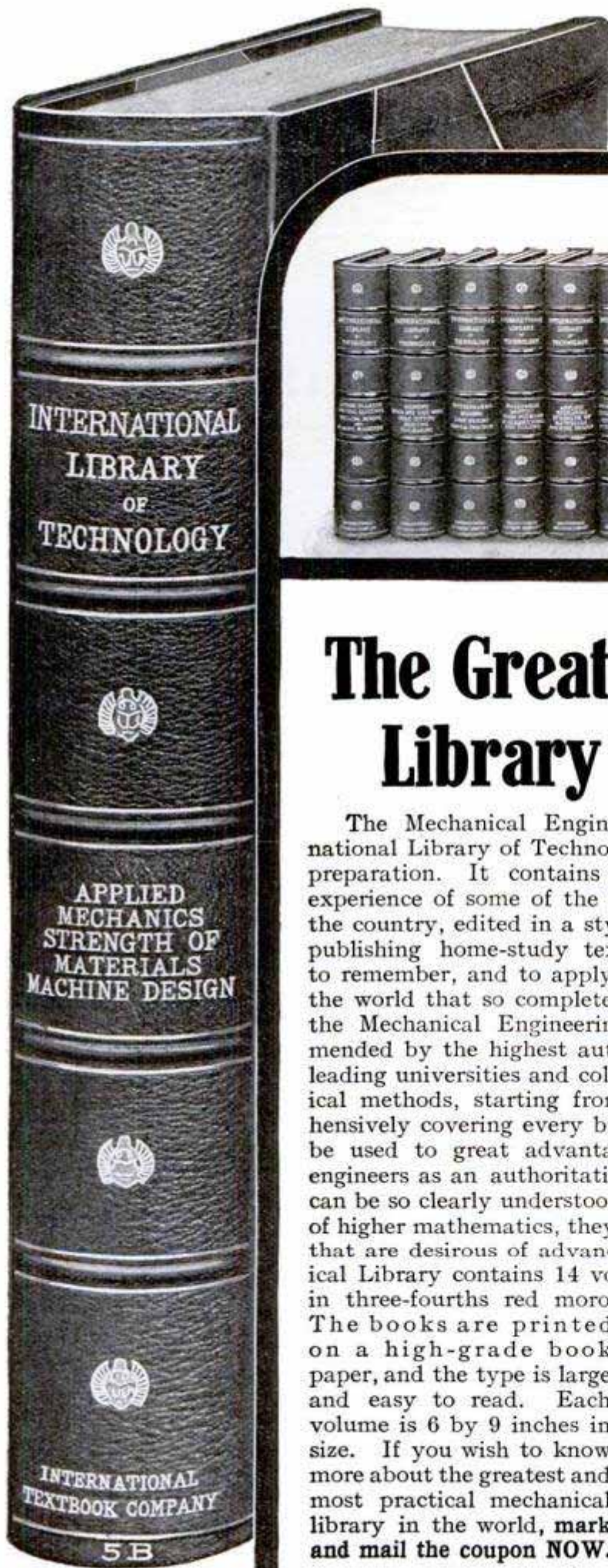

## The Greatest Mechanical Library in the World

The Mechanical Engineering Library is part of the International Library of Technology that cost \$1,500,000 in its original preparation. It contains the knowledge given from the life experience of some of the best mechanical engineering experts in the country, edited in a style that nineteen years of experience in publishing home-study textbooks has proved easiest to learn, to remember, and to apply. There is no other reference work in the world that so completely meets the needs of the mechanic as the Mechanical Engineering Library. The volumes are recommended by the highest authorities and are used in nearly all the leading universities and colleges. They treat of practical mechanical methods, starting from the simplest problems and comprehensively covering every branch of the work. Not only can they be used to great advantage by superintendents, foremen, and engineers as an authoritative guide in their work, but since they can be so clearly understood even by persons having no knowledge of higher mathematics, they can be used by all classes of mechanics that are desirous of advancing to higher positions. The Mechanical Library contains 14 volumes durably and handsomely bound in three-fourths red morocco, stamped and numbered in gold. The books are printed on a high-grade book paper, and the type is large and easy to read. Each volume is 6 by 9 inches in size. If you wish to know more about the greatest and most practical mechanical library in the world, mark and mail the coupon NOW.

### INTERNATIONAL TEXTBOOK COMPANY

Box 872, Scranton, Pa.

Please send, without further obligation to me, full particulars in regard to the International Library of Technology, with special reference to the Library of Mechanical Engineering.

Name \_\_\_\_\_

St. & No. \_\_\_\_\_

City \_\_\_\_\_ State \_\_\_\_\_



# About Remembering

by Elbert Hubbard



Without his notes he is helpless



The lessons you learn are rot unless you retain them by memory



He never misses a face



FOR some long time I have been promising myself to write up my good friend, Mr. Henry Dickson of Chicago, and I have not forgotten.

Mr. Dickson is teaching a Science or System, whichever you choose to call it, which I believe is of more importance than the entire curriculum of your modern college.

MR. DICKSON teaches Memory.

Good Memory is necessary to all achievement.

I know a man who is fifty-five years old. He is a student. He is a graduate of three colleges, and he carries more letters after his name than I care to mention. But this man is neither bright, witty, clever, interesting, learned nor profound.

He's a dunce.

And the reason is that he **CAN NOT REMEMBER**. Without his notes and his reference literature, he is helpless.

This man openly confesses that he can not memorize a date or a line of poetry, and retain it for twenty-four hours. His mind is a sieve through which sinks to nowhere the stuff that he pours in at the top.

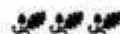

**EDUCATION** is only what you remember. The lessons that you study into the night and babble about the next day in class are rot, unless you retain them and assimilate them by the slower process of memory. You can not gulp and discharge your facts and hope that they will do you good. Memory only makes them valuable.

EVERY little while in business I come across a man who has a memory, a **TRAINED MEMORY**, and he is a joy to my soul.

He can tell you when, where, why, how much, what for, in what year, and what the paper said the next morning.

Like this man is another, the general manager of a great corporation in a Western City. He never misses a face. If he sees you once that's enough. The next time he'll call you by name, inquire about the folks at home, and ask if you have recovered from that touch of rheumatism.

He told me how he did it. He told me that he studied memory-training with Professor Dickson of Chicago. Also, he said a lot of nice things about Professor Dickson, that I hesitate to write down here lest my good friend Dickson object.

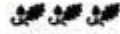

**THIS** Dickson System of Memory-Training, as I understand it, and I do understand it, is very simple. If you want to enlarge your arm to increase the power and strength of your muscle, you exercise it. The same with your mind.

You must put your brain through a few easy exercises regularly to discover its capacity. You will be surprised, when you go about it the right way, to know how quickly it responds to you.

To the man or woman whose memory plays you tricks, I especially recommend that you write to Professor Dickson to send you his literature. It will cost you nothing, and if his credentials and recommendations and the facts he sets forth, do not convince you, you are not to be convinced—that's all.

You do not know when you will be called to stand on your feet and tell what you know; then and there a trained memory would help you.

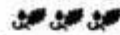

**YOU'VE** sympathized with the little girl who stuttered her "piece." But you've wept for the strong man who stammered and sucked air and gurgled ice-water and forgot, and sat down in the kindly silence. In the child it was embarrassment, but in the adult it was a bad memory.

¶ Professor Dickson's System can give you a **BETTER MEMORY** because it is based upon right principles.

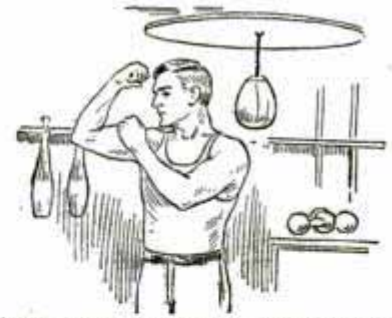

If you want to enlarge your arm, you exercise it. The same with your mind



The man whose memory plays tricks



The little girl who stuttered her piece



The strong man who stammered and sucked air and gurgled ice water and forgot.

Write and ask Professor Dickson to tell you how he trains the memory. Fill out the Coupon or Postal and mail **TODAY**. It means success.

**How to Get a FREE Copy of This Book** De luxe edition, handsomely illustrated, richly bound. Is full of carefully selected material exactly suited to meet the needs of the man or woman who desires to be a successful public speaker.

**SUCCESS** in Life depends on what you say and how you say it. This book of mine on Public Speaking and Self Expression is based on my 30 years of success as an instructor in Public Speaking in Chicago University, University of Notre Dame, and other well known schools. Taken in connection with my memory training, you can obtain a far better and more needful education than is afforded by many of the best universities. The price of this 1911 de luxe edition is \$2.00. I will, however, present a copy absolutely free to every student who enrolls for my course of memory training within ten days after reading this offer.

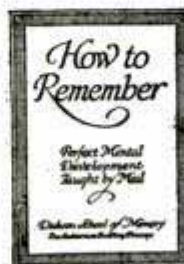

**PROF. HENRY DICKSON**  
Principal, Dickson School of Memory,  
705 Auditorium Bldg., CHICAGO, ILL.

Send me free Booklet "How to Remember," also full particulars how to obtain a free copy of "Dickson's How to Speak in Public."

NAME .....

STREET .....

CITY..... STATE.....

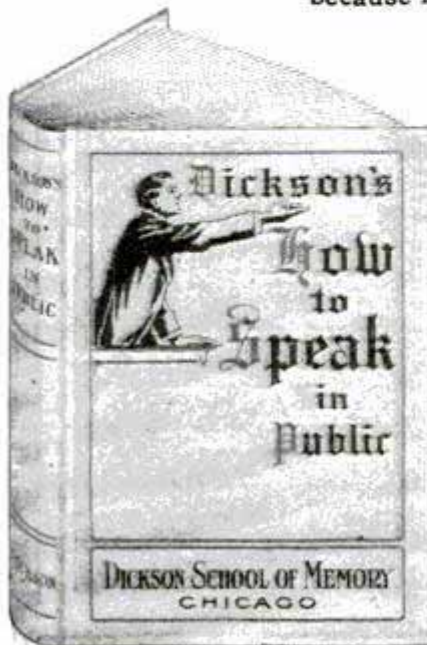

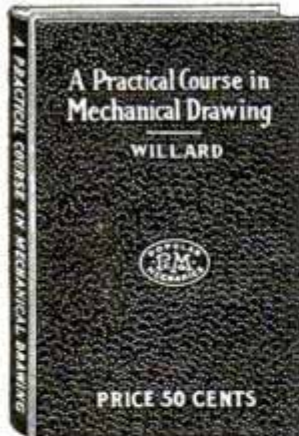

A NEW BOOK FOR WHICH THERE IS A REAL NEED

# A PRACTICAL COURSE IN MECHANICAL DRAWING

"Written So You Can Understand It"

By WM. F. WILLARD

(For several years instructor in Mechanical Drawing at Armour Institute of Technology, Chicago.)

134 Pages  
131 Illustrations

Price 50 Cents  
POSTPAID

Cloth Cover  
Size, 5x7 Inches

A book for individual study, shop classes, trade or high schools, and those who would like to know something of the DRAFTING PROFESSION.

## WHAT OTHERS SAY ABOUT IT:

"It is one of the best books on Practical Mechanical Drawing I have ever seen and I can recommend it to any one who desires to make an individual study of drawing."

E. S. LIBBY, B.S., M.E., Prof. in Experimental Engineering, Armour Institute.

"This is a very useful little book, and every young fellow who is desirous of making himself more valuable to both himself and his employer will find it a great help in 'boosting' himself to a higher plane and 'bigger pay.'"

—THE NATIONAL BUILDER.

# POWER GAS AND THE GAS PRODUCER

"Written So You Can Understand It"

The only authentic reference manual covering every detail of installation and operation which has been written in a non-technical manner. This book was prepared especially for the inquirer in this field who would like to be able to judge intelligently as to the economy and advisability of changing from other forms to Producer operation. It will also appeal to the engineer who wishes to understand thoroughly the working of the new system and thus be prepared to handle a plant competently.

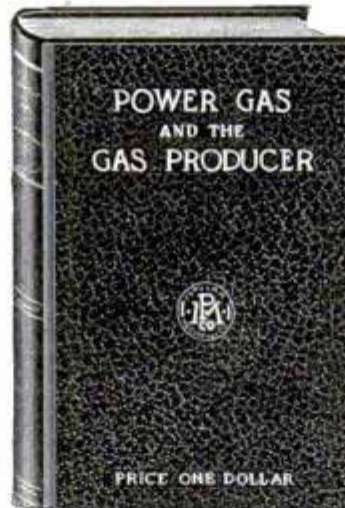

By J. C. MILLER, M. E.

One handsome, cloth bound volume of 192 pages, printed on the best quality of book paper and profusely illustrated.

Price Post-Paid \$1

The following list of chapter headings shows how thoroughly the author has covered his subject: Producer Gas and the Gas Producer—Classes of Gas Producers—Industrial Gases—Comparison of Heat Values—Types of Producers—Gas Producer Fuels—Gas Producer Operation—Gas Power and Steam Compared—Reliability of Gas Power—Gas and Steam Power Costs—Gas Producer Installation—Alphabetical Index.

# PATTERN-MAKING

Price \$1 Postpaid

By G. H. WILLARD

WITH ADDITIONAL CHAPTERS ON

# CORE-MAKING AND MOLDING

"Written So You Can Understand It"

A book for the man who has to do the work. Written by a practical pattern-maker of many years' experience. Gets right down to business in the first chapter and keeps it up throughout the book. Full of kinks and actual working information. Profusely illustrated. Every one following this trade, or intending to learn it, should have a copy of this valuable book.

224 Pages, 312 Illustrations, Cloth Cover

"Ten chapters are devoted to careful instruction for the making of specific patterns. The patterns chosen are of gradually increasing difficulty and cover practically all the points that come up in ordinary practice. Considering especially the low price of \$1.00, this book is remarkably practical and comprehensive. It is written in a style much more readable and effective than is usual with books on this subject."

—Engineering News.

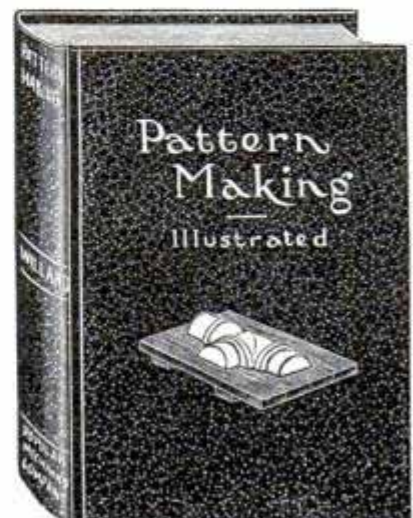

POPULAR MECHANICS BOOK DEPT., PUBLISHERS, CHICAGO



# FREE

for SIX MONTHS

# INVESTING

for PROFIT

I am making this great offer to introduce my new magazine—INVESTING FOR PROFIT, which tells of the enormous profits made from judicious investments—profits the magnitude of which bankers and large corporations strive to hide from the masses. It explains the rules by which small investors have made stupendous fortunes—how \$100 grows into \$2200—how you can determine the *Real Earning Power* of your money.

One good investment is worth a lifetime of labor. Don't invest a dollar in anything until you have read at least the first issue of this wonderful magazine.

If you can save only \$5 or \$10 a month, INVESTING FOR PROFIT is *absolutely indispensable* to you, as the less you have to invest the more certain you should be that your investments are not only highly profitable, but reliable in every particular.

Send a postal today for your first copy.

H. L. BARBER, Publisher

R. 418, 26 Jackson Blvd.

CHICAGO, ILL.

*New, Revised, Enlarged Edition  
of our popular book for boys*

# Mechanics for Young America

gives plain directions for making scores of articles which delight the heart of the average youth. This volume has been thoroughly revised from cover to cover and improved where possible. Much entirely new matter has been added, making it **unusually instructive and interesting.**

150 Articles	<b>Price</b> <b>25 cents</b> Postpaid	221 Illustrations
128 Pages		Size 6½ x 9½ in.

**Some of the things it tells how to make are:**

- Boats—Searchlight—Electric Engine—Sailing Cycle—
- Ice Boat—Camps—Steam Turbine—Camera—Kites—
- Trolley Coaster—Trailer for a Bicycle.

Order of your newsdealer or send direct to the publisher

**POPULAR MECHANICS CO.**  
CHICAGO



THE NEW  
CYCLOPEDIA OF  
**ENGINEERING**

At Half Price

Every Engineer must read if he would progress—the biggest men in the field can't go around telling what they know—but they can write it. And you can read it—in our New Cyclopedia of Engineering—the most valuable set of books on this subject ever offered to Engineers. This Cyclopedia has just been revised—it's right up to the minute.

These books cover every subject you are likely to meet in practical engineering. They are interestingly written by well-known authorities and are not only valuable for studying, but also as permanent reference books.

The seven books contain 3,200 pages, size 7x10 inches, and over 2,500 illustrations, full page plates, diagrams, etc. The regular price of these books is \$36.00, but as a special introductory offer we have put the price at \$18.80.

**\$2.00 Down \$2.00 a Month**

Shipped express prepaid so you can examine them before paying a cent

This price and these terms make it easy for any engineer to secure the valuable set of books. Read the brief description below and see what you will get when you mail the coupon.

### Our Protective Guarantee

Send for the Cyclopedia of Engineering, examine it carefully and if, at the end of five days, you see that you need it, send us your first \$2.00 and \$2.00 each month thereafter until the total, \$18.80, has been paid. If the books are not satisfactory—don't send us a cent—we will pay all charges. Use this coupon. We absolutely protect you against loss. Signing the coupon does not obligate you in any way.

#### READ THIS SYNOPSIS

Construction of Boilers—Boiler Accessories—Fuel Economizers—Mechanical Stokers—Steam Pumps—Steam Engines—Indicators—Valve Gears—Steam Turbines—Gas and Oil Engines—Fuels—Automobiles—Carbureters—Locomotive Boilers and Engines—The Air Brake—Single-Phase Electric Railway—Elevators—Marine Boilers—Marine Engines—Heating and Ventilating—Compressed Air—Transmission—Absorption and Compression Refrigeration—Ammonia Machines—Direct Current Dynamos and Motors—Management of Dynamos and Motors—Electric Wiring—Electric Lighting, etc.

For a short time we will include, as a monthly supplement, for one year, the TECHNICAL WORLD MAGAZINE. This is a regular \$1.50 monthly, full of Twentieth Century Scientific facts, written in popular form.

#### FREE EXAMINATION COUPON

**American School of Correspondence**  
CHICAGO, U. S. A.

Please send set Cyclopedia of Engineering for 5 days' free examination. Also Technical World for 1 year. I will send \$2.00 within 5 days and \$2.00 a month until I have paid \$18.80 for books and magazine; or notify you to send for the books. Title not to pass until fully paid. POP. MECH. 6-'11

NAME .....

ADDRESS .....

OCCUPATION .....

EMPLOYER .....

Please Mention Popular Mechanics

" NOW READY "

# ELECTROPLATING

"Written So You Can Understand It." By HENRY C. REETZ

112 Pages  
Fully Illustrated  
Cloth Cover  
Size 5 x 7 in.

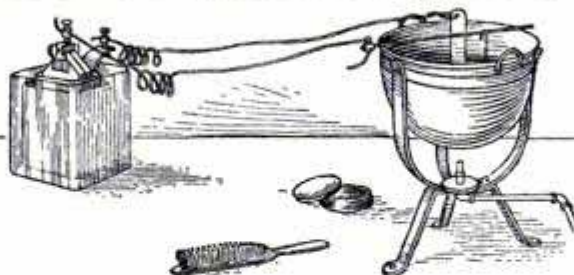

Price  
25 Cents  
Postpaid

**One of the Latest of Popular Mechanics 25-Cent Series of Industrial Handbooks**

**T**HIS handbook gives brief and practical directions calculated to be of benefit to those already engaged, as well as to those about to engage, in the electroplating business, with no more technical detail than is necessary for practical work, and yet with such explicit directions concerning the actual operations as an old hand at the business thinks may be useful to the beginner.

**CONTENTS:**

Introduction—Electrical Equipment—Shop Equipment—Cleaning Goods before Plating—Copperplating—Nickelplating—Silverplating—Goldplating—Miscellaneous—First Aid to the Injured—Business Suggestions.

Order of your News-dealer, Bookseller, or **POPULAR MECHANICS BOOK DEPT., Publishers, CHICAGO**

**A GOOD, USEFUL BOOK**

## *Wood-Working for Amateur Craftsmen*

"Written So You Can Understand It"

By IRA S. GRIFFITH, A.B.

125 Illustrations  
128 Pages Cloth Cover  
Size 5 x 7 inches

Price 25 Cents  
Postpaid

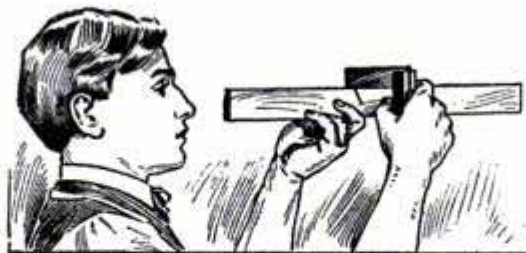

One of the latest of  
Popular Mechanics  
25-cent series of In-  
dustrial Handbooks

This book was especially designed to cover every essential step from the A B C to the X Y Z of woodworking. The chapters dealing with making special articles bring out every cut, joint and process used in this important trade, and the proper use and care of tools, working up of materials, etc., are treated thoroughly and plainly.

**CONTENTS:**

Making Out a Stock Bill—Laying Out Rough Stock—Hand Saws—Sawing with Hand Saws—Planes: How to Set and Adjust the Irons—Squaring Up Mill Planed Stock—Squaring Up Rough Stock—Whetting Plane Irons and Chisels—Grinding Plane Irons and Chisels—Making a Bird Box—Making a Tabouret—How to Make an Umbrella Stand—Making a Magazine Stand—Making a Table—Making a Cabinet.

**A valuable book for either self instruction or use in manual training courses**

ORDER OF YOUR NEWSDEALER, BOOKSELLER OR DIRECT FROM

**POPULAR MECHANICS BOOK DEPARTMENT, Publishers, CHICAGO**

# Practical Instruction In the Fascinating Art of METAL SPINNING

By PROF. F. D. CRAWSHAW  
College of Engineering, University of Illinois



This book, the **only one** published on this interesting art, is one of the series of 25-Cent Industrial Handbooks being published by Popular Mechanics Co. It is written by a man who has made a thorough study of all obtainable information on the subject, making the work absolutely authentic and adapted to use as a working manual both

for those who desire to spin metal as an art recreation and to follow this work as a trade.

80 Pages. 33 illustrations. Cloth cover.

**Price 25 Cents, Postpaid**

Can be ordered through your newsdealer or direct from the publisher

**Popular Mechanics Book Dept., Chicago**

**WHEN YOU WANT ANYTHING AND DON'T  
KNOW WHERE TO FIND IT  
WRITE BUREAU OF INFORMATION,  
POPULAR MECHANICS CHICAGO**

## MONTHLY CASH PRIZES

Until further notice in this magazine the Editor of Popular Mechanics will pay two cash prizes each month for the best original contributions to its

### SHOP NOTES DEPARTMENT

**\$10 for the Best Contribution  
\$5 for the Second Best**

THIS IS IN ADDITION to our usual rates for such contributed articles. Quality, not length counts.

Checks will be sent on the last day of each month for the prize articles received during that month. Publication in the magazine will follow in about two months.

### PRIZES AWARDED FOR APRIL, 1911

- First Prize—J. F. THALL, Ypsilanti, Mich. .... \$10  
"Cutting Keyways on a Lathe"
- Second Prize—MISS MARGARET S. HUMPHREYVILLE,  
Mount Pleasant, O. .... \$5  
"An Easy Way to Remove Corks"

### EXTRA AWARD

On account of there being four contributions this month, each of which deserved second prize, we have made an EXTRA AWARD of four additional second prizes, as follows:

- W. W. McLEAN, St. Louis, Mo. .... \$5  
"Anchoring a Motor Boat"
- HARRY E. WELLS, Scottsburg, Ind. .... \$5  
"Pulling Posts"
- IRL R. HICKS, Hallsville, Mo. .... \$5  
"Nut Holder for Monkey Wrenches"
- H. L. DAVIS, Duluth, Minn. .... \$5  
"Weighing Without Scales"

All accepted contributions to our departments, "SHOP NOTES" and "AMATEUR MECHANICS," are paid for immediately; checks for prize awards are sent at the end of each month.

**Address, EDITOR POPULAR MECHANICS  
318 W. Washington St., Chicago**

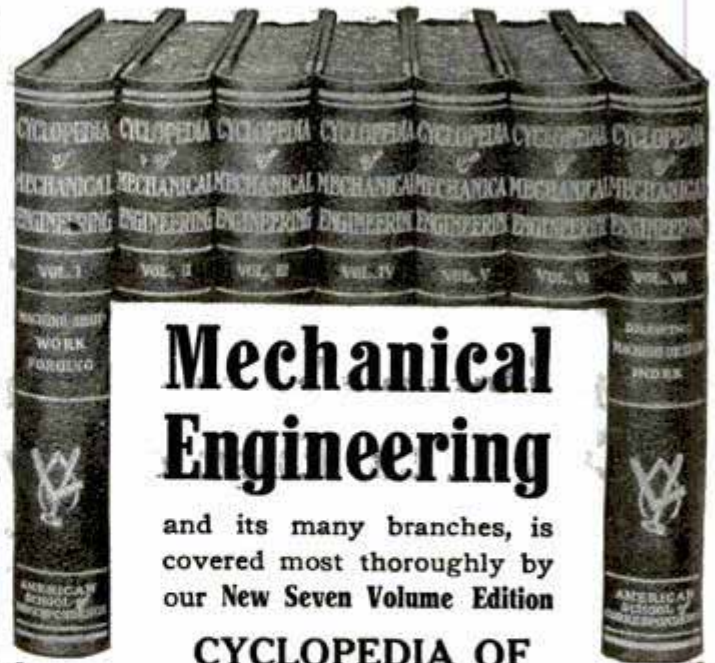

# Mechanical Engineering

and its many branches, is covered most thoroughly by our New Seven Volume Edition

CYCLOPEDIA OF

# Mechanical Engineering and Modern Shop Practice

These seven great volumes contain 2,992 seven by ten inch pages of information which is of vital interest to every progressive mechanic.

In this wonderful work will be found instruction in Machine Shop Work; Assembling of Machinery; Tool Making and Shop Management in such simple and comprehensive form that the student cannot fail to benefit by it. Every detail of mechanical engineering is thoroughly analyzed and treated, rendering the books of unusual value to the experienced mechanic and shop manager, as you will note by reading "Subjects Thoroughly Covered."

The Cyclopedic is supplemented with a series of practical test questions and includes over 2,000 full-page plates, illustrations, tables, formulas and "shop kinks."

### TO PROVE THEIR VALUE TO YOU

we will send you the complete Cyclopedic absolutely free for examination—just mail the coupon. Keep the books five days—apply the principles to your work—test every formula. You will agree that they are all we state, and more. Send \$2.00 after examination and \$2.00 a month until you have paid the special price of \$18.80. The regular list price is \$36.00. If the books do not meet with your requirements, advise us and we will remove them at our expense.

### Subjects Thoroughly Covered

- Machine Shop Work—Vertical Milling Machine—Motor-driven Shops—Shop Lighting—Forging—Electric Welding—Tool Making—Metallurgy—Manufacture of Iron and Steel—High-Speed Steel—Flaws in Castings—Electric Lifting Magnets—Magnetic Clutches—Making a Machinist—The Ideal Foreman—Pattern Making—Foundry Work—Automatic Coal and Ore Handling Appliances—Machine Parts—Construction of Boilers—Types of Boilers—Boiler Accessories—Steam Pumps—Air Compressors—The Steam Engine—The Steam Turbine—Indicators—Valve Gears—Refrigeration—Gas Producers—Gas Engines—Automobiles—Elevators—Sheet Metal Work—Practical Problems in Mensuration—Mechanical Drawing—Drafting Room Organization—Machine Design.

**SPECIAL OFFER IF YOU MAIL COUPON PROMPTLY** For a short time we will include, as a monthly supplement, for one year, the TECHNICAL WORLD MAGAZINE. This is a regular \$1.50 monthly, full of Twentieth Century Scientific Facts, written in popular form. Also contains the latest discussions on timely topics in invention, discovery, industry, etc.

### Free Examination Coupon

**American School of Correspondence,  
CHICAGO, U. S. A.**

Please send set Cyclopedic of Mechanical Engineering for 5 days' free examination. Also Technical World for 1 year. I will send \$2 within 5 days and \$2 a month until I have paid \$18.80, for books and magazine; or notify you and hold the books subject to your order. Title not to pass until fully paid.

NAME.....  
 ADDRESS.....  
 OCCUPATION.....  
 EMPLOYER.....

**50c**  
Each

**ENTIRELY NEW**  
**IN THIS COUNTRY**

**50c**  
Each

# Separable-Parts Models

## of Steam Engine, Wireless Telegraph, Motor Car, Gas Engine, Dynamo, Steam Turbine

Size 8x14 inches

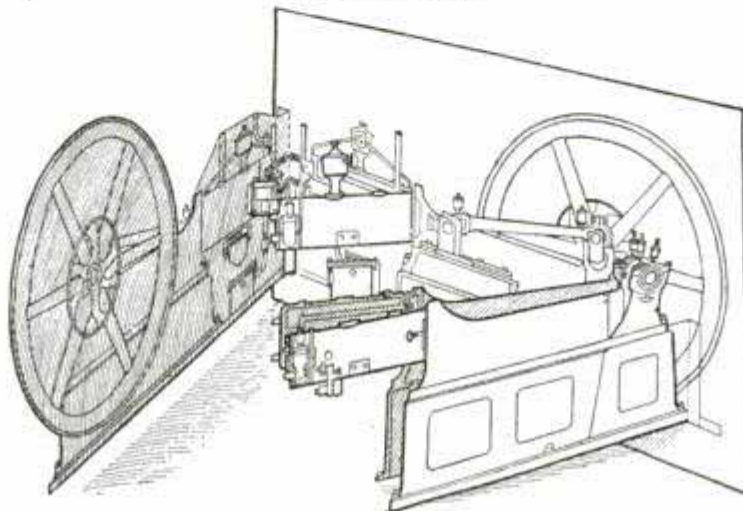

*Price*  
**50c**  
*Each*  
*Postpaid*

*Complete Set*  
*of*  
*6 Models*  
**\$2.50**  
*Postpaid*

Illustration shows how parts separate

**T**HESE models are of great value as a means of graphically showing *all* the interrelated parts of the above named mechanisms by virtue of their construction, which is similar to that of educational manikins of the human body and organs, with which nearly everyone is familiar. Beginning with the outermost or surface parts of the gas engine, for example, these are all differently colored and numbered to correspond to a printed key of names which comes with each model. By means of their hinge-like attachment, they may then be lifted, thereby disclosing to view the layer of parts next underneath, exactly as they would be in the engine itself, and so on until the innermost construction is shown.

The models are carefully made by hand in Bavaria, and this is the first time they have been offered in this country. We are the sole representatives in the United States.

As their value to engineers, students and, in fact, everyone having occasion to refer to the construction and working of the different mechanisms mentioned, was at once apparent to us, we felt that they would be highly appreciated here. They are substantially made of heavy paper, and with ordinary care will last indefinitely.

**Supply Limited — Order Now**

ADDRESS

**Popular Mechanics Book Dept.,** 318 W. WASHINGTON STREET  
**CHICAGO**



# Shop Notes Quarterly

for the second quarter of 1911 is an unusually interesting number.

**214 Compact Pages — 300 Illustrations**

**Among the special features are:** "The Liquid Fuel of the Future," by J. C. Miller, M. E.; "The Steam-Engine Indicator," a plain, practical treatise by L. Stinson, M. E.; "Files and Filing," the first of a series of practical articles on the making and use of tools, by Henry Farrington, M.Sc.; "Art in American Architecture," by F. J. Schulte; "The Lost-Wax Process of Ornamental Molding," by Cliff M. Bleyer; "Electricity on the Farm," by M. A. Johnston; "Recent Progress in Electric Lighting," by E. W. Marchant, D. Sc.; "Wood and Timber," by W. L. Hammons; "Designing from Plant Forms," with twelve examples by John W. Wadsworth. **The regular departments devoted to shop kinks, drafting notes, etc., are unusually replete.**

Each number contains more than three times as much reading-matter as the ordinary 15-cent magazine. An alphabetical index makes all the contents available for ready reference. **Shop Notes Quarterly** is the largest publication in the world devoted exclusively to Mechanics, Science, and Practical Knowledge.

**\$1.00 a Year—Ask the Newsdealer—25c a Copy**

*One Dollar for One Year's Subscription is a Wise Investment for Those Who Want Up-to-Date Information on Modern Methods in All the Mechanic Arts.*

---

**Popular Mechanics Co., 318 W. Washington St., Chicago**

# Classified Advertisements

Advertisements in this section, 10 cents per word, each insertion payable in advance. To insure ads being inserted under proper classified head in the July issue, copy must reach this office not later than June 1st.

Chicago, April 5, 1911.

Popular Mechanics Magazine, Chicago Ill.

Gentlemen: As continuous and satisfied advertisers in your classified columns, we congratulate you upon the success of your magazine as an advertising medium. What pleases us best of all is the class of people your magazine reaches, our experience having shown us that the readers of Popular Mechanics Magazine are without exception educated people of the better class: students, mechanics and young men of the "ambitious to get ahead" kind, thinking and serious minded persons who do not answer advertisements or ask for information out of mere curiosity. You may rest assured that when we get our new catalogue and correspondence course out, we will increase our advertising in your columns substantially.

Wishing you all the success a really good and reliable advertising medium deserves, we are,

Sincerely yours,  
**GREER COLLEGE OF MOTORING**  
Erwin Greer, Manager.  
1456 Wabash Ave.

## AUTOMOBILES

**STEVENS-DURYEA.** Model "U" six cylinder, newly painted and completely overhauled. Magneto, speedometer, clock, shield, etc. Price, \$1,300. Cheap for value offered. Model "X" four cylinder used six months. Factory guarantee runs six months yet. Good as new with coat varnish. Cost with equipment \$3,100. Price \$2,100 for quick sale. Selling out account wife's health. J. W. Burroughs, 211 Union St., Nashville, Tenn.

**AUTOMOBILE CYLINDERS REBORED** and accurately ground, including new piston and rings, fifteen dollars. Cast Iron Brazing Co., Manchester, N. H.

**FORD MODEL N Roadster,** 3 passenger. Wind shield, gas lights, generator and speedometer. Tires nearly new. This machine is in good running order. First \$300.00 takes it. S. W. Soule, Applegate, Mich.

**FOR SALE—4-cylinder Pope Toledo,** 5-passenger touring car, thoroughly overhauled, ignitor, extra tire and tube, full lamp equipment, \$450. Herbert A. Ireland, 263 North Broad, Norwich, N. Y.

**ADD POWER TO YOUR AUTOMOBILE,** eliminates carbon. Accelerator attaches to any carburetor. Scientifically correct. Circulairs free. Baum's Brass & Model Works, Minneapolis, Minnesota.

**WHITE'S RADIATOR ANTI-LEAK** for leaky radiators (guaranteed), 50c box, mailed. Agents wanted. Ellis S. White, 1939 W. North Ave., Baltimore, Md.

**FOR SALE—Four passenger Rambler '08 model,** first-class running order. Address J. O. Leinart, Clinton, Tenn.

**FOR SALE—MODEL N Ford,** top and wind shield, \$250. 22 Winchester repeating rifle, \$8. 20 hp. steam engine, \$100. 1½, 2, 3 and 4 hp. gasoline engine, \$25 to \$85. Automobile express, \$150. Olds delivery auto, \$250. F. J. Rettig, Wabash, Ind.

**LOGAN—5 pass. Tour. Car,** 24 hp., good tires, fine condition, \$250.00. Winton 1 cyl., \$125.00. A. H. Naish, 723 Hopkins St., Cincinnati, Ohio.

**OLD SPARK PLUGS,** we buy them. Send list. Potts Mfg. Co., Camden, N. J.

**PARTS TO BUILD Metz Automobile,** \$375. Norman Eddington, Brighton, Ill.

**AUTOMOBILE TURNTABLES,** write for particulars. Sterling Elliott Co., Newton, Mass.

**SANDUSKY AUTOMOBILE** in running order, \$50. Bair Bros., Tiffin, Ohio.

**USED AUTOMOBILES,** almost given away, get bargain sheet. T. S. Culp, Canton, Ohio.

**MAGNETOS-BOSCH, D6, D4 and DR4,** dual and independent; Simms, S4 and SD4. MEA, BK4 and BH4. We always carry a large stock of first class magnetos, new and second hand, at reasonable price. Geo. Dubucs, 1777 Broadway, second floor, rooms 229-231 Thoroughfare Building, New York.

**22 HORSE POWER HOFFMAN RUNABOUT** with detachable tonneau, new motor, good tires. First check \$100.00 takes it. List of other bargains for stamp. Rubel Co., Louisville, Ky.

**TRADE REO TOURING CAR** for 1911 Brush or Metz. H. Burlingame, Box 1435, Providence, R. I.

**FORD, 4 CYLINDER, RUNABOUT,** runs and looks like new, \$225.00. Shonnard, 114 Fifth Ave., New York City.

**AUTOMOBILE DRIVING** is great sport. Figure it out yourself from Pratt's Special Automobile Treatise. The best and latest books. Booklet C explains it. The C. H. Pratt Co., Cleveland, Ohio.

**REO, 5 PASSENGER TOURING CAR,** good as new, \$300.00. Apartment No. 18, 115 West 129th St., New York City.

**FOR SALE—Locomobile Steam Runabout,** good condition, no tires, \$60. C. Calloway, Box 135, Saugerties, N. Y.

**CADILLAC, 5 PASSENGER** touring, excellent running order, first \$175.00. Room No. 73, 217 West 125th St., New York City.

**BARGAINS IN MITCHELL USED CARS.** Taken in exchange for 1911 models. Rebuilt—Repainted—Guaranteed. Prices from \$450 up. Send for list. Mitchell Automobile Co., 2334-36-38 Michigan Ave., Chicago.

**STEAM CAR OWNERS.** Myers Kerosene Burner, something new; write for circular. 729 West Colfax Ave., Denver, Colo.

**AUTOMOBILE INSTRUCTION,** four weeks' course covering shop and road work—provision for out-of-town men. Send for booklet P. M. West Side Y. M. C. A. Automobile School, 318 West 57th St., New York City, N. Y.

**FORD OWNERS.** Drop us a postal for our catalogue. It will save you money. Auto Paris Co., Providence, R. I.

"THE HOW AND WHY of the Automobile."—A 200 page book of practical information for seekers after the fundamental facts regarding the gasoline engine and its application to the motor car. Interesting and instructive to both the beginner and the expert. Bound in full cloth—250 illustrations. Price \$1.00 postpaid. Popular Mechanics Book Dept., Chicago.

**AUTOMOBILES—Over Four Hundred Bargains** \$95.00 upward. All guaranteed. Freight prepaid. Write now for Latest Illustrated Bulletin. Motor Car Exchange, Dept. C-215, West 125th St., New York City.

**STEAM CAR Correspondence School.** Particulars, 520 Fourteenth St., Denver, Colo.

**NEED SOME REPAIR.** Make offer. Send for list of bargains. 275, Burlington, Wis.

**AUTOMOBILE MODEL.** Every part shown and named. You can to all intents and purposes take off the wheels, raise the hood and remove the body; exposing to view the vital parts. The only practical method of studying the automobile. Price 50 cents postpaid. Popular Mechanics Book Dept., Chicago.

## AUTO SUPPLIES

**ONE PACKAGE OF SCHROEDER'S Auto Radiator Compound** may save a broken crank-shaft as it holds all mud and foreign matter in suspension in the water. It don't let the mud bake on the hot surfaces causing high cylinder temperature, which carbonizes the oil. The carbon is what makes the engine back fire. Friction and back firing breaks more crank-shafts than anything. One package will last a season. Shipped C. O. D. Price, \$5. Schroeder Chemical & Specialty Co., Successor to W. J. McKnight, 45-47 Cayuga St., Buffalo, N. Y.

**EVERY REPAIR SHOP AND GARAGE** should be fitted up for brazing. We supply the whole outfit. If you already have suitable apparatus, buy our Braziron, best compound in the market for brazing cast iron. Write us for Special Offer. The A. & J. Manufacturing Co., 557 W. Lake St., Chicago, Ill.

**SAVE REPAIR BILLS.** Motor trouble detector and instructions using experts' methods, \$1.50. Roller bearing valve grinder, any valve very fast, \$2. Straight lift valve spring lifter, no bent stems, \$2. Agents wanted. Geo. H. Taber Mfg. Co., 14th St., Elmira, N. Y.

**FOUR CYLINDER MOTORS—28, 25, 19 hp.,** \$135.00, \$100.00, \$75.00. 50 horse transmission, \$75.00. 34 horse friction transmission complete, \$50.00. Radiator, fan, hood, \$30.00. Steering gear, \$15.00. 1½ solid axles, four 32x4 wheels, two tires, \$50.00. Butts, Oxford, N. Y.

**FOR SALE OR EXCHANGE—Nearly new 4 cylinder,** two cycle air cooled motor, 22 horsepower. Just what you want and the price is right. Parrett Machine Co., Wenona, Ill.

**BARGAIN IN SECONDARY** and primary windings for experimental work. Timers, carburetors, switches, coils and 2 cylinder seven hp. Ferro marine engine, etc. The R. E. Hardy Co., 1134 Austin Ave., Chicago.

**GOING TO BUILD AN AUTO?** Steam or gasoline? If so, send for list telling us what you need. J. L. Lucas & Son, 3 Fox St., Bridgeport, Conn.

**AIR-COOLED CARS—Does your fan** thoroughly cool your engines? Consult experts upon fan construction addressing Spear, the D. A. N. Co., Colonial Building, Boston, Mass.

**NEW 4 CYL, 20 hp. Auto Motor,** Remy Magneto and Clutch for \$145. F. E. Alford, Goshen, Ind.

**BRASS POLISH,** effective but harmless; two formulas for 25c. M. S. Ryan, Laredo, Texas.

**STEAM AUTO BOILERS** Bought, Sold and Repaired. J. L. Lucas, No. 2 Fox St., Bridgeport, Conn.

**AUTO CASINGS, FIRST QUALITY,** fresh stock, 28x3, \$10.30; tube, \$2.40. 30x3, \$11.30; tube, \$2.65. 30x3½, \$15.45; tube, \$3.25. 32x3½, \$16.70; tube, \$3.50. 32x4, \$21.45; tube, \$4.60. 34x4, \$23.10; tube, \$4.80. Price list sent on all size cases, tubes and reliners. I ship on receipt of 10% of order, allow examination. Try them. Many others have reordered. Largest mail order Tire Dealer in the Central States. Wm. Vanderpool, Springfield, Ohio.

**WE ARE OFFERING** our 20 hp. Four Cylinder Motor, guaranteed for one year, with unit power plant, with multiple disc clutch, selective type transmission for \$190.00. The Nichols Co., Detroit, Mich.

**FOR SALE—A few good second-hand motors** and transmissions, axles, bodies, radiators and parts. Send for list. Sallberville Model & Machine Works, Route 1, Salineville, Ohio.

**CHAUFFEUR'S BLUE BOOK,** 40 illustrations; shows how to drive, adjust and maintain automobiles and pass examinations; send 50c. Charles Milwerd, 1546 North 60th, Philadelphia, Pa.

**WE ARE OFFERING** our Four Cylinder 20 hp. motor, guaranteed for one year, with Bosch magneto, high tension, oiler and carburetor for \$165.00. The Nichols Co., Detroit, Mich.

## MOTORCYCLES

'07 THOR \$45, '09 Thor \$85, '09 Magneto 7 hp, M. M. \$115, '07 Indian \$60, '08 Indian \$70, '08 Twin Indian \$95, '09 Indian Loop \$95, '09 Indian Magneto Twin \$125. Postal brings bargain sheet and catalogue. Howard A. French, Baltimore, Md.

**MOTORCYCLES, \$50 UP.** Indians, Royals, Thors, Harley Davidsons, Excelsiors, Wagners, etc.; every one guaranteed; send for bargain list and large motorcycle supply catalogue, repairs, etc. F. B. Widmayer Co., 2312 Broadway, New York City.

**MOTORCYCLISTS**, see our adv. April issue. "Comet" tool set. Don't fail to order one. \$1.00 postpaid. Send for circular. J. C. Barrett Co., Hartford, Conn.

**SUPPLIES**—The largest stock in America. Immediate shipment. Lowest prices. A hundred new ideas shown in our big free catalogue P. Motorcycle Equipment Co., Hammondsport, N. Y.

**THOR MOTORCYCLE**, good condition, \$60; light automobile running gear, complete with tires, \$15. Box 96, Kendall, N. Y.

**MUST SELL 1910 4 hp. Indian**, magneto ignition, free engine clutch; horn; run only 1,000 miles. Guaranteed good condition. \$200 cash. D. L. Sandretto, Ladd, Ill.

**ARMAC MOTORCYCLE '09**, 3½ hp., good condition, newly enameled, has speedometer, horn, gas lamp, \$80. H. Carruthers, 229 Columbus, Elyria, Ohio.

**FOR SALE**—Royal Pioneer Motorcycle, magneto ignition; used 500 miles; cost \$265; sell \$165; guaranteed. H. A. Wilkinson, Ames, Iowa.

**1911 DETROIT \$160.00**, 1910 Emblem \$150.00, Indian \$75.00, etc. Every motorcycle guaranteed. Send stamp for catalogue. Rullman Bros., Louisville, Ky.

**RARE BARGAINS**. New Reliance 4 hp. and 7 hp. Twins. Address Dept. A. W. H. Ives Mfg. Co., Owego, N. Y.

**YALE MOTORCYCLES WIN**. Your old machine, etc., taken for part pay. English Motor Company, New Castle, Pa.

**ROTARY BICYCLE SIRENS**, \$2; motorcycle sizes \$5 and \$6; chain repair tools, \$1. Battery or magneto cut-out switches, 75c. Magneto covers, 75c. Coaster brake bicycles, \$25 up. Send for samples. F. Widmayer, 231 Broadway, New York City.

**\$55.00 BUYS 1908 Indian**, in A1 running condition. Indian Agency, 325 N. Delaware St., Indianapolis, Ind.

**FOR SALE**—MOTORCYCLE, 4 hp., bargain. Correspondence solicited. L. D. Dickinson, Owego, N. Y.

**WANTED**—Motorcycle. Howard J. Brooks, Rushford, N. Y.

**M. M. MOTORCYCLE**, \$80.00. 3 hp. Motorcycle Engine, \$12.50. George French, Melrose Highlands, Mass.

**MOTORCYCLE CASES AND TUBES**, fresh stock, 28x2, corrugated \$5.00, Bailey \$3.50, tube \$2.40; 28x2½, corrugated \$5.25, Bailey \$6.25, tube \$2.65; 28x2¾, corrugated \$5.50, Bailey \$7.00, Nobby \$7.75, tube \$2.66. Price on tubes is by mail including postage. Send post office order for tubes and 25% on cases and 1 ship, allow examination. Wm. Vanderpool, Springfield, Ohio.

**KELLER'S LATEST BOOKLET**, "Construction, Management and Care of Motorcycles," most complete instruction book on motorcycles ever published. Sent postpaid for 25c stamps or silver. Keller & Risque Motor Co., St. Paul, Minn.

**INDIAN 4 hp. magneto model 1910**. Good as new. Price, \$200. T. Hotchkiss, Waterbury, Conn., R. F. D. No. 3.

**WAGNER MOTORCYCLE**, \$80. 584 Fuller Flat 2, St. Paul, Minnesota.

**90 USED motorcycles** for your selection. Illustrated catalogue for 2c in stamps. Rubel Co., Louisville, Ky.

**MOTORCYCLE**; will ship C. O. D. John H. Hull, Mt. Hope, Pa.

**MOTOR CYCLES**—Enormous variety of American and Imported makes—Indians, Marsh's, \$35.00. Hundreds of other bargains. Shipped freight prepaid. Write now. Large illustrated bulletin free. Motorcycle Exchange, 215 West 125th St., New York City.

**ACCOUNT OVER STOCK**, we now offer until sold new Dow Coils for single cylinder, \$3.50; double, \$4.00. Hundreds of other bargains in our catalogue. Write to-day. Motorcycle Equipment Co., Hammondsport, N. Y.

**WANTED**—Motorcycles of any make. Several Wagners wanted. Give description and lowest price for yours. Shaw Mfg. Co., Dept. 28, Galesburg, Kans.

**DON'T BUY A BICYCLE Motor Attachment** until you get our catalog and prices. Shaw Mfg. Co., Dept. 27, Galesburg, Kans.

**PIERCE FOUR CYLINDER MOTORCYCLES** scarcely used and in first class condition; for sale at very low prices. Wm. B. Colburn, 18 Hanover St., Buffalo, N. Y.

**MOTORCYCLES \$35 UP**. All makes. Send today for bargain list. Shaw Mfg. Co., Dept. 30, Galesburg, Kansas.

**60 SECOND HAND MOTORCYCLES**, 3 tricars, all bargains. Model Motorcycle Garage, 318-20 W. 48th St., New York.

## AERONAUTICS

**LATEST MODEL PLANS**. Send us \$1.00 and we will mail you blueprints and full directions for building a 3-ft. model new Headless Wright biplane, or 3-ft. Antoinette, or 2-ft. Bleriot monoplane, or 2-ft. Santos Dumont. Or blueprints and directions for a 20-ft. Glider. Chicago Aeronautic Supply Co., 6030 South Park Ave., Chicago, Ill.

**4 HP. AIR-COOLED MOTOR**, new, \$40.00. New Curtiss carburetor, for above, \$5.00. New 1 cyl. coil with batteries, \$3.75. 40 watt dynamo, \$5.00. The MacClean Machine Works, Norristown, Pa.

**COMPLETE SET** of wood and metal parts, turnbuckles, etc., for improved Curtiss, \$90.00. Can be disassembled and assembled in one hour. Wolverine Aeronautic Co., Albion, Mich.

**LEARN AVIATION** by taking up a Correspondence Course in The American School of Aviation. A thorough grounding in the principles of Aeronautics without troublesome formulae and calculations. Especially suited for the mechanic. Send for particulars to M. K. Kasmar, Secretary, 1952 North Ave., Chicago.

**AERO SUPPLIES**; plain and formed wood; aeroplane and balloon cloth; propellers, motors, books and drawings. Machine built to specifications. First aero supply house in America. Largest stock, lowest prices. Large catalogue 10c. Aeronautic Supply Co., 6663 Delmar Blvd., St. Louis.

**PROPELLERS FOR MODELS**. Aluminum blades, steel shafts; 6 in. 25c, 8 in. 35c, 10 in. 50c, 12 in. 75c. Postpaid. Low quantity prices. Danielson, 1931 Broadway, New York.

**BLERIOT FLYING MODELS**, rattan construction, aluminum joints, steel wire wing braces. Guaranteed flyers. Price, 25c prepaid. Balritt Importing Company, 158 Lawrence St., Brooklyn, New York.

**1/3 HP. GASOLINE ENGINES**, \$20. Weight with flywheel, 4 lbs. Air cooled and guaranteed. Castings, \$6. Prizewinning racing models, 1 oz., record over 900 feet, \$1.10 postpaid. Large catalogue, 5 stamps. A. Melcombe, Castle Rd., Bedford, Eng.

**FOR SALE**—Farman type that flies; cheap. Box 790, Pasadena, Cal.

**RENTON'S CHICAGO AERO WORKS**, 164 North Wabash Ave. Aeroplanes, accessories, wheels, motors, also models, wood, rubber, propellers. Stamp for catalogue.

**DETROIT AERO**, 1911, including propeller, carburetor, ignition; 200 lbs. minimum thrust, 150 lbs. maximum weight. Detroit Aeroplane Co., Detroit, Mich.

**PERFECT MODEL WOODEN PROPELLERS**, 8 in. 50c, additional inches, 10c. Send for list of supplies. Shortt-Canniff Co., Marlboro, N. Y.

**EVERYTHING FOR AIRCRAFT**. Heath Aerial Vehicle Co., 3403 Southport, Chicago. Send 6 stamps for catalogue.

**SCIENTIFIC TAILLESS KITE OUTFIT**, 20c postpaid. Percy Ewing Deatur, Ill.

**FOR SALE**—4 cylinder air-cooled motor; cheap. Box 790, Pasadena, Cal.

**GOOD CHANCE** for partner with capital to patent and build new aeroplane. My address is Postmaster, Coningsby, Ontario, Canada.

**CLOTH MADE AIRTIGHT** and waterproof, formula \$1. Box 790, Pasadena, Cal.

**PATENTS SECURED** on Aeronautical Inventions. C. L. Parker, ex-examiner Patent Office, 910 G. St., Washington, D. C.

**30-40 HORSE POWER**, 4 cylinder "Gray Eagle" aero motor, \$485.00, complete with magneto, carburetor and oiler, fully guaranteed. Immediate deliveries. Circular for stamp. Rubel Co., Louisville, Ky.

**16 SQUARE FEET AEROPLANE**; correct in every detail. Perfect flying machine; ready to set up. \$2.00 prepaid. Aeroplane Manufacturing Company, 309 Fifteenth St., Brooklyn, N. Y.

**AERO, AMERICA'S AVIATION WEEKLY**, two dollars a year. Ten weeks' trial, fifty cents. Sample, four cents. Aero, 21 South Broadway, St. Louis.

**CURTISS AEROPLANE** for sale, \$250. Drew, Technology Chambers, Boston, Mass.

**LARGE ILLUSTRATED CATALOGUE OF AEROPLANES** and supplies just published, mailed on receipt of 10c in stamps. We offer \$1,500.00 in prizes to aviators purchasing motors of us. Rubel Co., Louisville, Ky.

**BLUE PRINTS AND WORKING DRAWINGS** of Curtiss and Bleriot type aeroplanes. Also of Curtiss, Wright, Bleriot and Antoinette model aeroplanes. Price \$1.00 each. Dept. G, Chicago Aeroplane Mfg. Co., Chicago.

**SPECIAL OFFER TO AMATEURS**. Man-carrying glider, can be equipped with power. To any amateur club or person interested, \$50.00. Send for particulars. Amateur Aero Promoters, 253 Benjamin T. Grand Rapids, Mich.

**DO YOUR CALCULATING MECHANICALLY** by use of Slide Rule. Circular sent. Geo. W. Richardson, Mechanical Engineer, Dept. S, 4218 24th Place, Chicago.

**INVENTORS, DON'T GET** an inefficient, poorly designed propeller for your model that took you hours to make. Get a propeller that you know is worthy of your model. Guaranteed satisfactory in every respect or money cheerfully refunded. Send for price list. Pollock Propeller Co., 9333 Howard Ct., Chicago.

**AVIATION DIRECTORY, LAWRENCE, KANSAS**, 50c. Aviatie Concerns' addresses; (Motors, Aeroplanes, Supplies, Schools); "Motor Knowledge," "Aviators' Earnings," "Aviation Records," and other information.

**FLYING MACHINES**; successful model air travelers, of international reputation. Catalogue explains fully. American Flying Machine Company, Racine, Wis.

**AEROPLANE MODEL**, won first prize St. Louis Aero Show; record flight 175 feet. 50c. Globe Sales Co., Box 542, Pontiac, Michigan.

**MEN WITH COURAGE AND NERVE** to learn to fly. We have our own factory and assembling rooms and aviation field. Positions for competent aviators. Write for particulars. Dept. G., Chicago School of Aviation, Chicago.

**COMPLETE PLAN**, drawn to scale, for building a Three Foot Flying Bleriot Monoplane Model with full instructions. 15c postpaid. Stamp brings list of materials. Ideal Aeroplane & Supply Co., 1200 Bedford Ave., Brooklyn, N. Y.

**MODEL AEROPLANE SUPPLIES**. Send stamp for catalogue. McCutchen Aero Company, 2043 W. Tioga St., Philadelphia, Pa.

**MODEL AEROPLANES HOW TO MAKE AND FLY THEM**. By W. Twining. Consisting of 5 sheets of scaled drawings, showing three different models, with descriptive booklet. By mail 5c. Popular Mechanics Book Dept., Chicago.

**"VEHICLES OF THE AIR"**, the newest and only up-to-date contribution to the literature of aeronautics, contains large working plans of all successful modern flying machines. This book of 500 pages, 140 half-tone photographs and 130 drawings is the only book published containing every known fact of this interesting subject. Size, 9x5½ inches. Price \$2.50 net, postage 25 cents extra. Popular Mechanics Book Dept., Chicago.

**WORKING DRAWINGS OF THE "DEMOISELLE"**. Santos-Dumont's remarkable monoplane, offered to the public for the first time. The set comprises seven large blue prints, showing every detail of construction, accompanied by a description of how to build. The machine is unencumbered by patent rights, the famous aviator placing his invention at the disposal of the world. Price \$2.00 postpaid. Popular Mechanics Book Dept., Chicago.

## BOOKS AND PERIODICALS

**375 MONEY MAKING SECRETS**, 5c. Boy's own toy maker book, 5c. Big prize combination package, 5c. All three above offers and our catalog, 10c. P. M. Greenhalgh, Sta. C., Brooklyn, New York.

**BOOKS**; any kind you want; catalogue free. Reese Publishing House, Mt. Pleasant, Pa.

**CERTAINTY OF IMMORTALITY**. Four hundred page book on the Future Life. Greatest work on subject. Only fifteen cents. Bookman Landenberger, Wisconsin Place, St. Louis, Mo.

**YOUR LATENT FORCES**: How to use them, 120 pages 25c. Personal Magnetism, 146 pages of valuable advice, insuring success in life, 30c. Catalogues free. August Martens, Popular Publisher 61, Burlington, Iowa.

**3,000 FORMULAS, RECIPES** and money-making secrets, 368 page cloth bound volume, 25c prepaid. Books on Modern Subjects, Trades, etc. Catalogue free. Clarence Hardage, Syracuse, N. Y.

"**METAL SPINNING**" is the name of the only book published on this interesting art. A concise working manual both for those who desire to spin metal as an art recreation and to follow this work as a trade. 80 pages, 33 illustrations. Price, 25 cents postpaid. Popular Mechanics Book Dept., Chicago.

**YACHT AND BOAT BUILDING BOOKS**, ship pictures, etc. Send for 80-page illustrated catalogue. The Rudder Publishing Co., 3 Hudson St., New York City.

**WONDERFUL BOOK ON HYPNOTISM**, Personal Magnetism, and other Occult sciences sent free to anyone. Send your address today. M. D. Betts, Sta. 65, Jackson, Mich.

**ENGINEERS'** questions and answers for license, by Hobson, for twenty-five cents, postpaid. Send stamps. Reilly's Book Store, Philadelphia, Pa.

**GAS FOR POWER** is taking the place of steam for reasons of economy. Learn all about this great change by reading our new non-technical book on this subject, written by a first class authority for the practical man. 192 pages, profusely illustrated, cloth binding. Price \$1.00 postpaid. Popular Mechanics Book Dept., Chicago.

## EDUCATIONAL AND INSTRUCTION

**LEARN BOOKKEEPING AT HOME** for 50c. Its simplicity shown by practical set of books and business forms. For every entry full and clear explanation. No long study, no high tuition. Price 50c, postpaid, by G. Melville, P. O. Box 531, Syracuse, New York.

**FREE TUITION BY MAIL**—Civil Service, Mechanical Drawing, Stationary Engineering, Electrical Engineering, Electric Wiring, Agriculture, Poultry, Normal, Bookkeeping, Shorthand, and Typewriting Courses. For Free Tuition apply Carnegie College, Rogers, Ohio.

**SHORTHAND**. New 1911 self-teaching method. Most rapid readable system. Text book, 50c. Money returned if not satisfied. Agents wanted. Unigraph Co., Omaha, Neb.

**TOUCH TYPEWRITING**—New, quick and sure method, 144 pages. Price 50c, 10 for \$3.50. Mayer & Miller Co., 525 S. Dearborn St., Chicago.

**MOTION PICTURE PLAYS WANTED**. You can write them. We teach you by mail. No experience needed. Big demand and good pay. Book free. Ass'd. M. P. Schools, Desk 5, 32 N. Clark St., Chicago.

**FISH NETS**, and How to Make Them—Used for den decorating, hanging photos, hammocks, fishing. Shuttle, material complete instructions by mail, 50c. "Old Salt," Box 198, Leonia, New Jersey.

**NEW BOOK**—"How Stenographers Make Big Incomes." Postal brings descriptive circular. Twin City Supply Co., Minneapolis, Minnesota.

**LEARN THE ART GLASS TRADE** in all its branches. Full course \$10. St. George, 13 Woodward, Detroit, Mich. Learn Chemical Oil Painting, a money maker.

**LEARN SOMETHING WORTH WHILE**. We teach photo retouching and mechanical wash drawing by a system of individual instruction. This course covers every department of mechanical illustration and is so simple, the lessons being so gradual, that any intelligent person cannot fail to make a success of it. We furnish a full equipment to each scholar including the latest type of airbrush and compressor. This is the best paid branch of art and is strictly commercial, not being "Art for Art's Sake," but "Art for Money." Special talent or originality not necessary. Send for full particulars and proofs. Mechanical Art Studio, 112 Wisconsin St., Milwaukee, Wis.

**BRIEF-HAND. WHY SPEND MONTHS LEARNING** shorthand, when you can quickly acquire at home a speed of 100 words a minute with the wonderful new system, Brief-Hand, using longhand characters. Practical, simple, rapid, accurate. Author was for fifteen years an expert court, commercial, railroad and government stenographer. Sample lesson ten cents. Premier Briefhand School, Box 97-A, Washington, D. C.

**BOOKS**—I. C. S. SETS, A. S. C. cyclopedias, works on machine shop practice, electricity, mechanical, medical, law, chemistry, wireless, aeronautics and every branch of science. Get my prices. Geo. F. Williams, Box 408, New Orleans, La.

**LEARN BOOKKEEPING: FIRST LESSON FREE**. Course of 26 lessons \$6.50, you pay 25c for each, you're not compelled to take entire course. Work corrected free. Send 2 cent stamp for first lesson and particulars. Cox & Beck, Accountants, Office 43, Warburton Bldg., Yonkers, N. Y.

**STUDY MATHEMATICS AND MECHANICS** by private correspondence. Obtain a college education in these subjects at home, at small expense. A rare opportunity. Write for booklet. The Jeffery School of Mathematics, Huron, Ohio.

**DRAFTSMEN**—Get "Structural Drafting," \$1.00. National Book Co., Collinwood, Ohio.

**LEARN BOOKKEEPING**—A complete, practical system—in your spare time—direct from a thoroughly experienced accountant, at one-tenth the cost of a "course." Write for first lesson, free. John Harmon, Box 88, Chicago.

**WITHOUT KNOWING SHORTHAND** you can write 100 words a minute and increase your income—treble your dispatch of business—save your time. Let me explain to you fully how with my new method, Abbreviated Longhand, any longhand writer can easily become the equal of the average professional stenographer—in a few short evenings—at merely nominal cost. Sample Lesson 20c, and full particulars free. Write to-day. A. B. Weaver, Court Reporter, Dept. C, Buffalo, N. Y.

**\$200 TO \$600 MONTHLY** easily made fitting eyeglasses. Short, easy mail course. Diploma. Special reduced tuition fee. Big demand for opticians. Best and easiest money-making business. Quick sales. Tremendous profits. We assist you to start. Write today for free "Booklet 4." Tells how. National Optical College, St. Louis, Mo.

**BEST SHORTHAND BOOK** for home study. Thousands of successful stenographers learned from it; so can you! Pitman system complete, cloth bound, handy size, finest engraving; specially arranged for self-instruction. Price \$1. Every book contains coupon entitling the purchaser to receive one month's practical instructions by mail. Lessons given by the author, Eldon Moran, our best known American Shorthand Instructor. Students are introduced and correspond with each other. The time to begin is now. Young pupils succeed well. Book well worth \$1; besides, mail lessons worth \$2 will be received without extra cost. Book and lessons sent immediately upon receipt of order. Address Popular Mechanics Book Dept., Chicago.

**ELECTROPLATING**. Learn this useful occupation from our 112-page treatise. It is "written so you can understand it" and will enable the humblest beginner to make a start. Price, 25c postpaid. Popular Mechanics Book Dept., Chicago.

**EDUCATION?** Learn typewriting. See what I say under "Typewriters." Atchison.

**THE COLLETTE SCHOOL**, teaches jeweler's engraving by mail. Pleasant—refined—Independent profession easily learned at home. Pays \$50.00 weekly. Our students earn money while learning and are in great demand. Write for particulars. The Collette School of Engraving, 37-39 Maiden Lane, New York.

## PICTURES AND POSTCARDS

**ART PICTURES AT BARGAIN PRICES**. Reproductions of celebrated pen and ink sketches, produced in colors. Suitable for framing. These pictures are worth 25c; 11x17 inches in size; ready for framing. In order to get your name we will send you three different pictures for 10c. Allen & Co., 818 E. 47th Place, Chicago, Ill.

**FIFTEEN BEAUTIFUL POSTCARDS** of New York City for 12 cents. Ben Levy, 47-49 Maiden Lane, New York City.

**DECORATE YOUR "DEN"** with "Art Gems." Three bewitching poses 25c, 6 for 50c. One 6½x8½ photograph free with every order for six. All real photographs. Money back if not pleased. Art Photo Co., 1406 P. M., Grand Rapids, Mich.

**100 CARDS FOR 10 CENTS**. Western Scenery, pretty girls, animals, flowers, birthday, seashore, etc., gold, silver, blue, embossed, etc., no trash. Star Card Co., Dept. 21, Chicago, Ill.

**100 HIGH GRADE POSTCARDS** Free. Send 10c today for postage, etc., on our special samples and big bargain offer. Home Supply Co., Dept. B, 2511 E. Broad, Richmond, Va.

**100 POSTCARDS FREE!** Samples, catalog, plan, 4c. Alvin Card Co., Mount Pleasant, Pa.

**MAPLE VALLEY CARD EXCHANGE**. To introduce our membership, 4 nice birthday cards free, enclose 2c stamp. Box 1183, Pittsfield, Mass.

**POSTCARDS**—15c—100, send 4c for samples. Seacoast Card Co., Box 865-P, Asbury Park, N. J.

**1 SAMPLE PACKAGE**, 10 assorted high grade postcards, birthday, best wishes, etc., 10c, no trash. F. W. Ackerman, Quincy, Ill.

**10 ELEGANT** Rare Virginia Views, all different, 10c; 30, 25c. Good's Printery, Harrisonburg, Va.

**YOU'LL GET CARDS** from everywhere. Membership, 10c. Idaho Card Exchange, Dept. K, Box 906, Boise, Idaho.

**"FRENCH BEAUTIES"**. Send 25c coin for 3 genuine photos. A. C. Warren, Box 291, Detroit, Mich.

**3 DIFFERENT VIEWS** of Porto Rico, 25c. L. Smith, 31 Calle Villa Ponce, Porto Rico.

**WONDERFUL, NEW!** Rare pretty girls paintings, artistic, latest hits of Coney Island, 6 for 25c. Pioneer Novelty, 214 Prospect Park, Brooklyn, N. Y.

**FREE! FREE!** To advertise our Celebrated Photographic Goods, will give one Gem Camera and Complete Outfit to any one sending 35c to cover packing, mailing, etc. Wayside Supply Co., Everett, Mass., Dept. 10.

**IF YOU REALLY WANT** to exchange postcards, try our splendid club. Lists circulate in many countries. Membership, 10c. Haleyon Club, Box 133, Erie, Pa.

**PICTURE-POSTAL** from Guam, Uncle Sam's beautiful coconut isle. Send 10c coin. S. E. Braggins, Guam, Marianas.

**FREE!** 50 names of people all over U. S. who will exchange Postcards, to anyone sending dime for 6 Art Cards. W. Hale, Everett, Mass.

**MODEL OF PANAMA CANAL** in relief, \$1. Greenback or M. O., payable Cristobal, Canal Zone. Panama Souvenir Co., box 165, Colon, R. P.

**100 BEAUTIFUL NOVELTY POST CARD** Views. Your name in big mail and post card club and a bundle of mail postpaid for 10c. Coeur d'Alene Supply Co., Box 1641, Spokane, Wash.

## CAMERAS, PHOTO SUPPLIES, ETC.

**DEVELOPING AND PRINTING**—Good work and no delays. No tank or machine-work done. Fifteen years' experience. John R. Smith, P. O. Box 343, Provincetown, Mass.

**MAKE PHOTOS CHEAP!** Get our catalog—Cameras, Supplies, Developing, Enlarging. Valuable exposure meter included, 10c. Rex Bromide Co., A. Lincoln Park Station, Chicago.

**AMATEUR PHOTOGRAPHERS** send us a film, we develop your first one free. Barbeau's Art School, D 182, E. 2nd St., Oswego, New York.

**EVERY WORKER IN PHOTOGRAPHY** should read *The Camera*, \$1.00 a year. Send 25 cents for three months' trial subscription. *The Camera*, Philadelphia, Pa.

**ENLARGEMENTS FREE.** Films developed, 10c; prints, 3c. Photoelectric Shop, Rock Island, Ill.

**6½x8½ CAMERA**, \$6.00. 4x5, 5x7 cameras and outfits, \$10.00, \$12.00. Butts, Oxford, N. Y.

**WRITE US BEFORE YOU BUY.** Bargains or exchange in everything Optical and Photographic. Send for free catalogue and bargain list No. 15. Special: Achromatic Telescope, 3 draw, 10 power, post free, \$2.00. Kahn & Co., Established 1850, 26 John St., N. Y.

**PHOTOISMS**—A magazine that will appeal. Send 25c for 3 mos. subscription or \$1 for a year and a Wager Exposure Scale free. Photoisms, Advertising Dept., 196 Broadway, N. Y.

**FILMS DEVELOPED**, 10c per roll. All sizes. Prints: 2¼x3¼, 3c; 2½x4¼, 3½x3½, 3¼x4¼, 4c; 3¼x5½ and 4x5, 5c. Prompt returns. Highest grade work. Send 2 negatives and will print free as sample. G. R. Hoke, 6206 Jefferson Ave., Chicago.

**FILMS DEVELOPED FREE;** printing, 50c dozen, all sizes. Don't write. Send 25c stamps with films. Kime the Kodak Finisher, 622½ Main St., Little Rock, Ark.

**"CAMERA WORK for Profit,"** 25c. "Photography Self Taught," 25c. National Book Co., Collinwood, Ohio.

**66 2-3% DISCOUNT.** The \$1 popular book entitled, "The Selection of a Photographic Outfit," sacrificed at 33c; 10c extra for mailing. Order now before supply is exhausted. Willoughby, 814 Broadway, New York City.

**KODAK FILMS DEVELOPED**, 10c per roll, any size. Prompt attention given mail orders. Prints 2¼ x 3¼ to 3¼ x 4¼, 3c; 4 x 5 to 3¼ x 5½, 4c. J. M. Manning, 1062 Third Ave., New York City.

## TRADE SCHOOLS

**AUTO TIRE REPAIRING.** Learned in three to six weeks. A situation assured. An opportunity to get into a business of your own. Instruction in our factory shop. Very low tuition. Haywood Tire & Equipment Co., 530 N. Capitol Ave., Indianapolis, Indiana.

**LEARN PLUMBING, EARN \$5.00 A DAY.** We qualify you in four to six months by actual experience on new buildings, which feature of instruction cannot be obtained in other schools in the country. Tools furnished Free. Tuition reduced. For particulars address Master Plumbers Trade School, 3657 Finney Ave., St. Louis, Mo.

**A COMPLETE COURSE** in Practical Automobile Engineering, under experienced instructors, with all modern equipment and appliances. Our four-story building offers special accommodation to out-of-town students. Call or write for our liberal proposition on Resident or Home Courses. Automobile School of Chicago, 1339 Michigan Ave., Dept. P. M.

**WANTED**—Men by large Contracting Co. \$20,000.00 contract work going. Can learn automobiles, electricity, plumbing, brick-laying trade in few months. No apprentices or helpers work and no expense. Catalogue free. United Trade School Contracting Co., Los Angeles.

**AUTOMOBILE SCHOOL.** You learn with your hands under the superintendence of the best instructors obtainable at the Chicago School of Motoring. Write for particulars. F. E. Edwards, Inst., Dept. "B," 1619 Michigan Ave., Chicago, Ill.

**PLUMBING, ELECTRICITY, BRICKLAYING** or Mechanical Draughting, taught by expert workmen. Short time and small cost. Positions always open. Catalogue free. Write today. Coyne National Trade Schools, 80 E. Illinois St., Chicago.

**SLIDE RULE**, will help you solve problems. Circular sent. Geo. W. Richardson, 4218 24th Place, Chicago, Dept. S.

## BUSINESS OPPORTUNITIES

**SMALL CAPITAL** will start new, independent business. Make \$5 to \$10 a day. The American razor honing and safety blade sharpening machines are money makers; they hone razors, sharpen all kinds of safety razor blades, clippers, scissors, etc. No previous experience required. For particulars address, Manager, Illinois Cutlery Co., Dept. 608, 184 Washington St., Chicago.

**CASH YOUR IDEAS!** If patentable and practical you can sell them or start a business on them; my clients make money on their patents, send sketch for free opinion of merit and patentability; reliable dependable service. Book free. H. Sanders, Crilly Bldg., Chicago.

**START A MAIL ORDER BUSINESS** of your own. Be your own boss. I made \$25,000 in two years with small capital to start. My booklet "Money Making Opportunities in the Mail Order Business," sent free. Address, McKean, Dept. 375, No. 2232 Eighth Ave., New York.

**MAKE MORE MONEY!** Start a mail business; operate a "Silent Salesman" system; evenings; possibilities unlimited. The best money making plans are in "Booster." Get away from wage slavery! "Booster" starts you in business for yourself with small investment. Send 10c for two months' trial. *Booster Magazine*, Dept. W, 208 N. Fifth, Chicago.

**PATENTS SECURED**—C. L. Parker, ex-examiner Patent Office, 910 G St., Washington, D. C.

**WOULD YOU CARE** to make a moderate investment in a non-competitive business of a more far-reaching and wealth-creating nature than even Thomas Edison's inventions, although in an entirely different industry? If interested write for full information and references to F. B. Hart, care *Popular Mechanics*, 225 Washington St., Chicago, Ill.

**EARN \$10 TO \$15 A WEEK** and hold your position besides. No canvassing. We, as manufacturers of patented specialties, have New Easy Mail Order Plans to keep our factories busy. Large profits. Small capital. If you are one of the want-to-go ahead kind write for plans, sworn statement. J. M. Pease Mfg. Co., 5000 Pease Bldg., Buffalo, N. Y.

**MAKE "ONCE-A-WEEK" STOVE POLISH.** Applied to hot stove without burning. Gives lasting shine, cheapest to make, easiest to sell. Formula and directions, one dollar. Canadian Formula Bureau, Toronto.

**FREE—"INVESTING FOR PROFIT"** Magazine. Send me your name and I will mail you this magazine absolutely free. Before you invest a dollar anywhere, get this magazine—it is worth \$10 a copy to any man who intends to invest \$5 or more per month. Tells you how \$1,000 can grow to \$22,000. How to judge different classes of investments, the real power of your money. This magazine six months free, if you write today. H. L. Barber, Publisher, R 410, 20 Jackson Boulevard, Chicago.

**MAKE \$50.00 WEEKLY** in Mercantile Collection Business; capital and experience unnecessary; start during spare time and become independent; particulars free. E. W. Briggs Co., Washington, D. C.

**BIG MONEY AT AMUSEMENT PLACES** with device for testing batting strength; weight indicates home run, one, two or three base hit. Send for catalogue. Wm. Sullivan, Richmond Hill, N. Y.

**WANTED—RAILWAY MAIL CLERKS, City Carriers, Post-office Clerks, Government Stenographers and Bookkeepers.** Thousands of appointments coming. Average salary about \$1100. No "Layoffs." Short hours. Annual vacations. Common education sufficient. Political influence not needed. Send postal immediately for schedule showing places of coming examinations. Free coaching. Franklin Institute, Dept. J 83, Rochester, N. Y.

**CHICAGO FIRM WANTS RELIABLE MAN** as State Representative. Responsible man with few hundred dollars can positively clear \$150.00 monthly. We manufacture 350 varieties Highgrade Air Brush Design Show Cards. Peoples Show Card Concern, 752 W. Madison St., Chicago.

**A FEW GOOD STATES** left for first class sales agencies. Exclusive contract for distribution of the Victor Furnace Tender. Write now. V. E. Cozine, Gloversville, N. Y.

**I MADE \$50,000** in five years with a small mail order business; began with \$5. Send for free booklet. Tells how. Heacock, Lockport, N. Y.

**I WILL HANDLE GENERAL AGENCY** for any good electrical or mechanical novelty, office supplies, etc. E. E. Clayton, Caixa Postal, 718, Rio de Janeiro, Brazil.

**MAIL ORDER ADS THAT PAY.** 20 different propositions fully explained. All bona-fide, sure-fire Money-getters. Each one the foundation of a successful Mail Order business. Send 10c for full particulars and regular bulletin of new propositions. Mail Dealers Wholesale House, 450 Franklin Bldg., Chicago, Ill.

**WANTED BY PITTSBURG MANUFACTURER,** few energetic salesmen to sell the leading high-grade specialty of U. S. Applicants must be high-grade salesmen. Hutchison Mfg. Co., 321 Wood St., Wilkensburg, Pa.

**BIG PROFITS**—Open a dyeing and cleaning establishment, splendid field, very little capital needed. We teach a successful method by mail. Write for free booklet. Ben-Vonde System, Dept. C, Staunton, Va.

**1,000,000 CIRCULATION** for advertisers, rates 25c line. (3,000 redbordered gummed stickers, 95c.) Circulars mailed 20c, 100; \$1.50, 1,000. Commission mailers wanted. Agents; electric lighters, 90c dozen. Kellner Advertising Agency, Louisville, Ky.

**FREE YOURSELF** from wage drudgery! 12 ways 10 cents. Be. Money Back Store, Baltimore.

**WE START YOU** manufacturing article which brings 100% Profit. No competition. Sample and particulars, 25c. Tallala Mfg. Co., Talladega, Ala.

**ABSOLUTELY ONLY CORRECT MAILING LIST** every American Fruit Grower's address ever compiled; limited number, type-written, offered (restricted) June 1. Invaluable. Never yet circularized. Apply. The American Fruit Union, Cincinnati, Ohio.

**BE YOUR OWN BOSS.** Start mail order business at home. Devote whole or spare time. We can tell you how; very good profits. Everything furnished. No catalog outfit proposition. For "starter" and free particulars address P. M. Krueger Co., 155 Washington St., Chicago, Ill.

**INCORPORATE** your patents and business under Arizona Laws. Cost very small. No annual or franchise tax. Members exempt from corporate debts. No public statements required. No restrictions. Hold meetings and do business anywhere. Charters cannot be repealed by subsequent laws. Particulars, laws and forms free. Southwestern Securities & Investment Co., Box L488, Phoenix, Arizona.

**FORTUNES MADE MAILING CIRCULARS.** Plan and 25c sample, 10c. Other circulars mailed with ours reasonable. Results guaranteed. Mutual Benefit Club, 7114 Eggleston Ave., Chicago.

**TURN YOUR SPARE TIME** into money with our live, up-to-the-minute mail order plan; \$5 capital will start. Circulars with your imprint furnished. Profitable for man or woman. Particulars free. Stark Co., Whiting, Ind.

**LEARN THE SILVER PLATING BUSINESS** and be assured of a good living for life. Simple instructions. Write for free descriptive pamphlet. Humboldt Publishing Co., 4743 State St., Chicago, Ill.

**CASH FOR FORMULAS,** processes, ideas, trade secrets. Steady, profitable home business. Instructive booklet free. Information System, 246, Marietta, Ohio.

**MR. MANUFACTURER OR MECHANIC**, here's your opportunity to possess reprints of valuable collection of trade secrets, shop formulas of old Southern Chemist; embracing several hundred useful subjects as Gas Mantles, "Swiss" Maple Flavor, "Solar" Liquid Metal Polish, "Solve" Paint Remover, Artificial Rubber, Liquid "Ham Smoke," Yale's Toilet Specialties. Some new, others in use for years safely guarded, making owners independent. Introductory offer \$1.00. Don't judge this proposition by the low price. I can furnish strictly reliable formulas for anything. Write me your wishes. Liscomb Miller, Evak Chemical Co., Marietta, Ga.

**FOR SALE**—American Brass & Aluminum Works, Indianapolis, Indiana. Thoroughly modern in equipment. Last year's business nearly \$200,000.00. Second largest Automobile center in United States. Nearly thirty Auto factories in city and vicinity. Other industries here and within radius of one hundred miles require large quantities of Brass castings. Have parties who will take half interest in a reorganization who are the best qualified and who have had the longest practical experience in the manufacture of Aluminum castings in the United States. Present owner engaged in other business requiring his time. Address F. E. Janes, Pres., care F. E. Janes Coal & Grain Company, Indianapolis, Indiana.

**CONCERN DOING A LARGE BUSINESS** in bronze marine goods desires to acquire patents or manufacturing rights to a suitable article which can be marketed during the fall and winter. Equipment comprises well equipped brass foundry, machine shop and polishing room. Location near New York. Address, L. J. Hall, Freeport, Nassau County, New York.

**MUSHROOMS**—NEW PURE TISSUE culture summer spawn. Now is the time, plant this new spawn; produces big crop white mushrooms all summer. Four other varieties winter planting; modern plan forcing plants, mushrooms, early quick crop. Book free. Fresh sample brick, 35c postpaid. We are originators and manufacturers of pure tissue culture mushroom spawn. Order direct from laboratory. Challenge Farm, 6961 Gravois Ave., St. Louis, Mo.

**MAKE MIRRORS AT HOME**. Big profits with little outlay. One 18x36-in. mirror costs \$2 to \$5. You can silver a glass this size for 20c. Send \$1 in stamps or money order and we will send you explicit directions how to do it; also how to emboss, grind, foil, gold leaf, frost, chip and make imitation stained glass. How to transfer photos on glass, bore holes in glass and cut skylights. George L. Patterson & Co., Dept. 3, Brookville, Ky.

**BUILD A BUSINESS** of your own and escape salaried drudgery for life. Learn the Collection Business. Limitless field; little competition. Few opportunities so profitable. Send for "Pointers" today. American Collection Service, 101 State St., Detroit, Mich.

**I WILL START YOU** earning \$4 daily at home in spare time, silvering mirrors; no capital; send for free instructive booklet, giving plans of operation. G. F. Redmond, Dept. 306, Boston, Mass.

**LEARN THE TRUTH** about Mail Order Business before buying "outfits." Important information and particulars for starting free. Mail Order Library, P. M. Tompkinsville, New York City.

**HAVE YOU ANYTHING TO ADVERTISE?** Our Rate Book tells you all about advertising mediums, rates, circulation, closing dates, etc. Sent for 10c. Worth dollars. Folder free. Correspondence invited. Dearborn Advertising Agency, 455 Franklin Bldg., Chicago.

**FORM A CORPORATION**—Congress Law for D. C. and all States; cheap. Raise money easily; advice free. U. S. Legal Corporation, Washington, D. C. Representing \$1,225,000.00.

**POSITIVELY BEST RIBBONS**, three, \$1.10. See what I say under "Typewriters." Atchison.

### AGENTS WANTED

**WEAR A STYLISH SUIT!** Clothes make the man. The man who is admired is the well-dressed man whose clothes are fashionable, and are 1911 styles. You will be that man in your neighborhood! 1911 styles are just in. Get this suit—the swellest, classiest, snappiest style we ever created, and better your appearance! This is our idea: We want one man as our representative in your neighborhood. You've got a lot of friends. They wear clothes. It is the easiest thing in the world to get them to order their clothes from you. Prices, \$7.50 and up. These orders mean a big business that more than doubles your salary, and the work is the easiest, cleanest, nicest occupation in the world. New representatives make \$5 to \$10 a day. You simply take the order and measurements and mail them to us. We make the clothes, ship them on approval to your friend and hand you the profit money. A Regular Cinch! That's the beauty of being in business for yourself. Sit right down now; write us a postal or a letter for the free outfit to representatives. And you get the swellest suit of fashionable, tailor-made, all-wool, 1911 clothes ever worn in your neighborhood. If your personal appearance and a big business is worth a postal or a 2-cent stamp to you, then act now—write us today. Address, American Woolen Mills Co., Dept. 468, Chicago.

**A LARGE MANUFACTURER** of Vacuum Cleaners wants exclusive representative in each County. Only men of ability considered. Men now selling Vacuum Cleaners preferred. Our proposition should give the right man an income of \$300.00 per month the year around. This machine is operated with ease by one person and sells for \$10.00 under factory guarantee. Sample machine shipped you for inspection without remittance. The Braham Manufacturing Co., X 10, Cincinnati, Ohio.

**AGENTS**—Secure the Hill Lock Valve Agency in your community. A patented lock valve which effectually prevents, when locked and key removed, gasoline flowing to carburetor, consequently engine cannot be started. A sale can be made to almost every automobile or motor boat user. Tremendous profits. Hill Lock Valve, Room 329 Newfield Building, Bridgeport, Conn.

**AMAZING INVENTION**—Entirely new lamp burner. Changes ordinary kerosene illumination into beautiful large white gas light. Guaranteed smokeless, odorless. Not a mantle. Can't break. Unlike others. Brings you quick sales, large profits. Show ten, sell nine. Only 35c retail. This territory just opened. Act now. "Radiolite," 364 Colonnade, Toledo, Ohio.

**LIVE AGENTS WANTED**. High class proposition. "Koeth Kombination Kit," 15 tools in one. High grade tool steel. Fully guaranteed. Exclusive territory. Wonderful seller. Every Auto owner buys on sight. One agent made \$10.00 in two hours. Currier-Koeth Mfg. Co., 37 West St., Coudersport, Pa.

**BE YOUR OWN BOSS**. Sell "Modern" Self-heating Irons, Iron Stands and "Modern-Make-Milwaukee" household specialties. 100% profit. 10c brings Burglar Lock. We manufacture, advertise; you sell. Our agents become independent and own their business. Write at once for New Spring Catalogue "P." Exclusive proposition. Modern Specialties Mfg. Co., Milwaukee, Wisconsin.

**AGENTS**. \$100 weekly, selling ready made air brush show cards to merchants. 339 varieties 11x14, two colors. Can start mail order business. Write for catalog, sample and circular Art of Sign Painting. Popular Show Card Co., Desk AM, 1235 Michigan Ave., Chicago.

**WANTED AGENTS EVERYWHERE** for Duplexo Vacuum Cleaner. Only perfect hand machine. Double Suction, weighs 6 lbs., cleans carpets, floors, curtains, furniture. A wonder. Can't get out of order. A child can use it. Demonstration means a sale. Big profits. High class permanent business. Write for particulars to the Duplexo Co., Dept. F, 95 So. 5th St., Brooklyn, New York.

**AGENTS WANTED IN EVERY TOWN** and county to handle the most practical vacuum sweeper ever put on the market, sells for \$5. Weighs 6 lbs. Hustlers make big money; demonstration means sale. Operated by one person. If interested send for sample. Get the town or county you want and get busy. Don't wait till the other fellow gets ahead of you. W. H. Heddings Co., York, Pa.

**AGENTS**—To sell the newest electric appliance on the market; sold everywhere there is electricity, in the home and office; liberal profit; sales driving sample, weighs a pound, no experience or knowledge of electricity required; it shows how to use one light instead of two and get the same results; sells for \$3.50 and saves the purchaser an investment of \$25. Write for particulars. The Handy Light Co., 211 Opera Place, Cincinnati, Ohio.

**REPRESENT US EXCLUSIVELY** in your territory. Build up permanent business by repeat orders. We, as manufacturers of patented household necessities want "I will" men on our co-operative plan. If your letter indicates that you mean business we will outline our plan. J. M. Pease Mfg. Co., Co-Operative Dept. 4004, Buffalo, N. Y.

**AGENTS**—BIG MONEY selling gold and silver glass window novelty and changeable signs; illustrated catalogue. Climax Novelty Co., Gay Bldg., St. Louis.

**AGENTS**: Send for free booklet, inside information on the agency business. Filled with money making plans. Pointers and experience of thousands of successful agents. Address, J. M. Finch, 1162 3rd St., Dayton, Ohio.

**AGENTS**—Biggest money-maker known. The new Canchester Incandescent Kerosene Lamp revolutionizes old lighting methods. Burns air, not money. Six times brighter than electricity, gas or acetylene at 1-10th cost. Burns with or without mantle. Burner fits any lamp. Saves 75% oil. No trimming wicks. Showing means selling. Territory going fast. Write today. Handsome outfit furnished. Canchester Light Co., Dept. P. M. 6, 204 No. State St., Chicago.

**LIVE AGENTS WANTED**—HUSTLERS to handle our attractive 1911 combination packages of soap and toilet articles with valuable premiums. One Michigan agent made \$65 in 47 hrs.; another \$21 in 8 hrs.; another \$22.50 in 10 hrs. Write today. Davis Soap Works, 264 Davis Building, 1429 Carroll Ave., Chicago.

**SCRIBNER'S MAGAZINE SUBSCRIPTION SOLICITORS** easily earn liberal commissions and also can pick up extra prize money by persistent work. For full particulars regarding commissions, prizes, free advertising matter, sample copies, etc., address Desk 81, 155 Fifth Ave., New York City.

**AGENTS**—Quit peddling! Do it by mail! Your spare time worth \$25 weekly. Investigate our unique mail business. Amazing profits for shrewd people. Write for details. Fredericks & Co., 776 Unity Bldg., Chicago.

**MATCHLESS CIGAR LIGHTER**. Agents: live wire proposition. Just out; pocket cigar lighter shaped like fountain pen. Sells at sight. Sample 15c. Schiller Mfg. Co., Inventors, Dept. B, Schiller Bldg., Chicago.

**AGENTS**—Sell aluminum egg separators, 100% profit, sample 10c, round aluminum roaster, 10 inches diameter, 5 inches deep, sample 98c. Texas Aluminum Co., Desk E, Box 532, Chicago.

**AGENTS WANTED**—Our new spark gas lighter dispenses with matches. Sample, postpaid, 12 cents. Simmond Mfg. Co., 514 W. 154th St., New York.

**BOYS AND GIRLS WANTED** to sell Jewelry, Mending Tissue, Thimbles or Postcards. When you sell 24 packages at 10c each you get Camera or Watch free. Send now. Roxbury Card Co., Dept. 5, Roxbury, Mass.

**AGENT OR MACHINIST**—Send postal with your address for most important information that concerns your interest. Albert Alba, 302 West 54th St., New York City.

**AGENTS FOR PROFITABLE OFFICE ARTICLE**. Good side income for bookkeepers. F. A. Marble, Rockville, Conn.

**AGENTS**—Portraits, 35c; frames, 15c; sheet pictures, 1c; stereoscopes, 25c; views, 1c. 30 da's credit. Samples and catalog free. Consolidated Portrait, Dept. 119X, 1027 W. Adams St., Chicago.

**EARN A SUIT IN ONE HOUR!** Your profit for an hour or two as the representative of our great tailoring house pays for a special made-to-measure suit for you—the handsomest, the most stylish and the most durable ever made. Just show two or three of your friends the samples of our fine wool suitings, take two or three orders and you have earned the suit. You can't fail to get orders. Our 60 beautiful samples create a sensation wherever shown. No one ever saw such materials at the price before. You take no risk. Everything is shipped on approval, subject to 24 hours' examination. Customers try goods on and must be satisfied with style, fit and quality before paying. We pay express on everything. You can undersell everybody. Get clothes for your friends at less cost than they pay anywhere else and make wholesaler's, jobber's and retail dealer's profits. That means the swiftest, cleanest and nicest business in America! A Big Business that more than doubles your earnings. We want you to represent us now. Don't wait until somebody else takes this great business. No experience necessary. We furnish you our portfolio with 60 samples of the latest weaves, fabrics and colors, absolutely free. Do you want this swell made-to-order suit and this remarkably easy money-making business that will make you rich? A postal or letter mailed to us at once gives you swell clothes and a big business. Write us now. A postal card will do. Or tell your friends about it. Paragon Tailoring Company, Dept. 11, Chicago, Ill.

**AGENTS—WE MANUFACTURE GLASS PAPER.** Plain glass windows made to look like real stain glass; something new; easily applied; big money maker; two sample sheets of paper, with catalogue in colors and discount sheet, for 10c. S. H. Parrish & Co., 202 S. Clark St., Chicago.

**\$90 MONTHLY** to trustworthy people to distribute samples and catalogues at home. Steady work. \$45 expense allowance. S. Scheffer, Treas., M. Q. Chicago.

**AGENTS—Send for free sample** Surridge's Holdite Patches for repairing Inner Tubes. 55 East Walnut, Pasadena, Cal.

**EXCLUSIVE TERRITORY GIVEN** to agents who demonstrate they can sell the best gasoline sad iron manufactured. Sample at reduced rates. Herz Mfg. Co., Jackson St., St. Paul, Minn.

**RAINCOATS—"FROM MAKER TO WEARER,"** at manufa. prices. Write for particulars and samples. Agents wanted. Regal Raincoat Co., Dept. 69, 1367 Broadway, New York.

**COUNTY AGENTS** for the only five year guaranteed Vacuum Cleaner made; sells \$14; business pays for itself out of profits; no canvassing; free trial; write today. Hercules Cleaner Co., Rochester, N. Y.

**PERFECTION POCKET ADDING MACHINE.** Lightning seller. Agents wanted. Cincinnati Specialty Mfg. Co., Dept. R., Cincinnati, Ohio.

**AGENTS WANTED** to sell our beautiful scripture wall mottoes. Frank Shilling Co., Navarre, Ohio.

**FAIRY-DELL PERFUMES** blended from California's sweetest flowers; a bottle by mail 10c silver. Agents wanted. Tropical Perfume Co., 322 S. Spring St., Los Angeles, Cal.

**ANY LIVE AGENT CAN** make 100% profit working for us. New article, sells for 25c, universal demand, exclusive territory, quick sales. Send now for free sample and terms. The G. V. Sales Co., 150 Nassau St., New York, Room 1325.

**AGENTS—Either sex** to represent us in every town in Wisconsin and Northern Michigan. Permanent business assured. Becher Specialty Co., 856 Becher St., Milwaukee, Wis.

**WE WANT AN AGENT** in every factory for our goods. Fast selling article, good profit, used daily. Worcester Chemical Co., 642 Pleasant St., Worcester, Mass.

**LATEST NOVELTY.** All merchants interested. Two dollars commission on twelve dollars sale. Send 50c to cover cost of sample. Western Sales Agency, 205 Byers Ave., Joplin, Mo.

**THE LEWDALE COMPANY,** West Somerville, Mass., manufacture a most wonderful Scalp Food and Skin Beautifier. They offer reliable agents, either sex, a splendid opportunity. Co-operative plan and continued premiums.

**AUTO SALESMEN, CHAUFFEURS—**Make big money. Sell our loud, simple, reliable "Samson" Electric Horn. Special offer to agents. Write quick to A. R. Cook, Agency Supt., American Electric Company, State and 58th Sts., Chicago, Ill.

**CLARK'S FLY EXIT** at top of screen lets flies out. They can't return. Postpaid, 25c. Agents wanted. Dr. L. W. Clark, Carterville, Mo.

**SMALLEST ALARM CLOCK,** bible and telescope, 10c each prepaid. W. H. Garner, A-119 South Lafayette St., Evansville, Indiana.

**SELF-THREADING NEEDLES,** 10c a paper. Agents wanted, samples and terms free. Ladies' Art Co., Dept. 41, St. Louis, Missouri.

**AGENTS—Iceless Refrigerator,** tremendous seller; everybody buys; retails at \$4.50; territory given. Write today. Iceless Refrigerator Co., 120 Main St., Prairie Depot, Ohio.

**AGENTS, WOODWORKERS OR HANDY MEN** why not start a business of your own, easily manufactured—biggest seller out. Every family a customer. The "Folding Climax iron stand," best ever invented. Full instructions and patterns only one dollar; wake up and get busy; send for circular. N. Scholl, Chillicothe, Ohio.

**AGENTS—Write for free samples and catalog** of fastest selling household specialties; quick sales; big profits; don't delay, write now. E. Gruber & Co., Stanwood, Iowa.

**\$1000 FOR THREE MONTHS'** work. We pay this if you are a salesman well and favorably known in your community and can devote part of your time. Address Kinsey & Rideout, 262 Wilcox Building, Los Angeles, Cal.

**AGENTS WANTED—**Thirty-eight best selling household articles. Big profits. Write for catalog. Davenport Merchandise Company, Davenport, Iowa.

**WE ARE MANUFACTURERS** of New Highgrade Original Air Brush Design Show Cards. Every storekeeper buys. 400% profit. Catalog containing 350 varieties free. Samples 10c. Peoples Show Card Concern, 750 W. Madison St., Chicago, Ill.

**\$50.00 A WEEK** is better than your present income. It is no harder to earn. We want men and women, aggressive, hard workers, as sales agents for the best selling specialty on market; nationally advertised, perpetual seller, fully guaranteed. Household necessity for town and country. New invention, large profits and special prizes. Write for territory. The Progress Company, 101 Progress Bldg., Chicago, Ill.

**AGENTS EARN BIG MONEY** selling latest styles beautiful braided and embroidered waist patterns, dresses, Mexican drawn work linens, renaissance, petticoats, etc. Catalogue free. National Importing Co., Desk 27, 699 Broadway, New York.

**WE START YOU** in mail order business selling shirtwaist and suit patterns, silks, foulards, lawns, etc., small capital, big profits; send for catalogue and samples. F. B. Smith Co., 1353 Exchange Bldg., Paterson, N. J.

**AGENTS WANTED—SELL RICH LOOKING** imported 36x68 rugs, \$1 each. R. H. Carter, Milan, Tenn., sold 115 in four days; his profits \$51. You can do as well. Write for sample offer and unique selling plan; exclusive territory. A. Condon, Rug Importer, Stonington, Maine.

**CASH FOR NAMES,** ideas, information. Steady, profitable home business. Instructive booklet free. Information System, 247, Marietta, Ohio.

**WANTED—AGENTS—7 CENTS PROFIT EACH** 10c sale; best little article ever offered; sample for 3c in stamps. Rawlings, Box 945, St. Louis.

**PERFECTION CIGAR BOX COVER** and Price Card Holders. Big profits. Wonderful seller. Sample dozen, 20c. Michigan Novelty Co., Detroit.

**AGENTS—Smallest Bible** in the world. Greatest novelty of the age. Send 10c for sample and terms. Q. B. Scott, Box 682, Oklahoma, Okla.

**SPECIAL KNIFE OFFER.** High-grade 2-blade knife with your name and address on transparent handle. Sent postpaid for 75c. Agents wanted. Driscoll, Brennan & Cooke, Waterbury, Conn.

**LIVE WIRE SALESMEN,** sell our own make brushes for every household use. Write for particulars, territory and the eight advantages of our propositions. 125% profit. Capitol Brush Co., Hartford, Conn.

**AGENTS—Union Brand Hand Soap** for mechanics, in attractive cans, retails 10c. Profit 100%. 1146 Harrison Ave., Boston, Massachusetts.

**AGENTS—Make big money** selling our Silk Hosiery direct from the mill to the consumer. Address Dept. X, The Perfection Silk Hosiery Mfg. Co., 1218 Allegheny Ave., Philadelphia, Pa.

**STERLING IGNITERS—**Sample 25 cents. Sterling A. Co., Box 766, Trenton, N. J.

**BOKARA DIAMONDS—**Agents, everyone to wear and sell our famous Bokara diamonds. Write for sample offer and catalogue free. Northwestern Jewelry Co., 52 Northwestern Bldg., Chicago.

**GERMAN SILVER KEY CHECKS—**Steel letters for marking same, key rings, etc.; over 30 styles. Agents wanted. Sample marked with your name and address, and key ring, 15c. Pease, Die Maker, Winchester, N. H.

**ONE MILLION AGENTS** wanted to sell needles. Send 10c for sample and particulars. J. V. Curin, 1807 Fisk St., Chicago.

**AGENTS, EITHER SEX,** to sell Oscillating, Self-cleaning all metal washing machines. Nothing else like it. Good profit to agents. Domestic Equipment Co., 32 Lake St., Chicago.

**EARN \$25 TO \$50 WEEKLY,** spare time; no canvassing; repeat orders; sample 10c; write now. Berner, 333 Washington St., Boston, Mass.

**AGENTS—Over 500% profit.** Gold sign letters; sell everywhere; sample free. Johnston Co., Quincy, Ill.

**WANTED—GENERAL DISTRIBUTING AGENT** in each state to control a new specialty; every man needs one, new selling plan, permanent business. Particulars free, sample 10c. The Kelsh-Bennage Co., Denckla Building, Philadelphia, Pa.

**HOUSEHOLD NECESSITIES.** Big money. Dime brings samples. Cowles, Canton, Conn.

**AGENTS—To sell new automatic device;** big profits; unworked field. Write today for our profitable offer. Superior Wrench Co., Box 427, Marshalltown, Iowa.

**SEVEN-IN-ONE** New Novelty in jewelry. Scarf pin each day of week. Seven superb imported stones, match any color tie. Agents wanted. Exclusive territory. Investigate. Weeks, 3344, Boston, Mass.

**PORTRAIT AGENTS—**Get your work done direct from the artist, lowest prices. Write for particulars. J. Hausknecht, 1730 W. 18th St., Chicago, Ill.

**AGENTS WANTED—\$25 to \$100** per week easily made selling high-grade Automobile Specialty. Agents Supply Co., Box 98, Muscatine, Iowa.

**MEN AND WOMEN AGENTS** wanted to handle proposition which sells at sight. Two to six in almost every home. Particulars free. C. M. Cunningham, Dept. 9, Sims, N. Dak.

**\$25 WEEKLY DISTRIBUTING GOLD Medal Baking Powder.** Send 10c for samples, particulars. Home Company, Boston.

**\$90 PER MONTH** and expenses to men to travel, advertise and put out catalogues. Big mail order house. Silverton Company, M. L. Chicago, Ill.

**WE HAVE** an ideal side line. Nets big returns, \$6.00 to \$10.00 a day easily made. Getting orders for our Safety Matches bearing Dealer's special advertisement. Something new. Sells itself. If you have a few spare moments on your route, this is your opportunity. Pocket sample case. For particulars, address Dept. P, Importers, 2282 East 55th St., Cleveland, Ohio.

## HELP WANTED

**SELL SOMETHING ALREADY IN DEMAND.** Energetic specialty salesmen make \$2,000 up on our remarkable, original advertising proposition. Unlimited earning opportunity. Reliable advertising specialty salesmen wanted—state selling experience. Agency Dept. Taylor Brothers Company, Rochester, N. Y. Established 58 years.

**AGENTS—\$50 weekly;** we manufacture the best needle case made; a wonderful seller; 200 to 500 per cent profit; talking unnecessary; our copyrighted "Trust Scheme" Envelopes do the work; general agents can make over \$100 weekly; send 10c for a 25c sample containing 115 needles; particulars free; buy direct from the factory at wholesale. Paty Needle Co., 102 Union Sq., Somerville, Mass.

**BECOME A MANUFACTURER'S AGENT.** We manufacture hosiery which outwears 3 of the ordinary kind, replaced free when hole appears. Easy sales; large profits. First reply obtains agency your city. Triplewear Mills, Dept. D, 724 Girard Ave., Philadelphia, Pa.

**MEDALLIONS SELL AT SIGHT.** 300 per cent to 500 per cent profit. Make up your own goods and be independent. "It's easy." Catalog free. Fred Resag Co., 1205 W. Randolph St., Chicago.

**AGENTS—\$5 daily selling our Handy Tool,** 12 articles in one. Lightning seller. Sample free. Thomas Mfg. Company, 462 Third St., Dayton, Ohio.

**THE NOEL KEROSENE MANTLE LAMP** beats electricity, gas or gasoline. The most economical light to burn. A whirlwind seller. Customers delighted. Agents write for territory. John S. Noel Co., 10th St., Grand Rapids, Mich.

**AGENTS: \$30.00 WEEKLY** easily made selling our Yankee Self-Wringing Mop and Duster; 500 other fast sellers; samples free. Scheff Co., 1637 Wells Street, Chicago.

**AGENTS—HANDKERCHIEFS, DRESS GOODS,** Carleton made \$8 one afternoon; Mrs. Bosworth made \$25 in 2 days. No experience needed. Free samples. Credit. Freeport Manufacturing Company, 59 Main St., Brooklyn, N. Y.

**WIDOWS, Ladies, Men, New, Interesting.** Profitable, easy work. Spare time or permanent. Sell our useful specialties. Our original selling plan will double your sales. Particulars and \$2.00 premium offer free. Fair Mfg. Co., HF51, Racine, Wis.

**YOU CAN MAKE \$\$\$\$** as our general or local agent. Household necessity; saves 80 per cent; permanent business; exclusive territory; salary or commission; free sample; credit. J. Pitkin, Newark, N. Y.

**OUR STARTLING NEW INVENTIONS.** Saxonia Spark Gas Lighter; cheaper than matches; Vacuum Cleaner, cheaper than brooms; incandescent kerosene mantle lamps, cheapest and best light known. Quik sales and large profits. U. S. A. Lighting Co., Box G, Springfield, Mass.

**I WILL START YOU** earning \$4 daily at home in spare time, silvering mirrors; no capital; send for free instructive booklet, giving plans of operation. G. F. Redmond, Dept. 306, Boston, Mass.

**AGENTS—\$75 monthly.** Combination Rolling Pin. Nine articles combined. Lightning seller. Sample free. Forshee Mfg. Co., Box 535, Dayton, Ohio.

**AGENTS make big money** selling our new gold letters for office windows, store fronts and glass signs. Any one can put them on. Write today for free sample and full particulars. Metallic Sign Letter Co., 406 N. Clark St., Chicago.

**ONE MILLION AGENTS WANTED;** fast seller costing 5c, selling 50c. Every firm needs. Orders to \$50. Postal brings samples. Embossed Co., 2497 Milwaukee Ave., Chicago.

**AGENTS—100% profit.** Combination monkey-wrench, plumber's pliers. 15 tools combined. Lightning seller. Sample free. Forshee Company, Box 1335, Dayton, Ohio.

**FREE GOLD SAMPLE** goes with first letter. Something entirely new. Every firm wants it. Orders \$1.00 to \$100.00. Nice pleasant business. Write today. Metallic Mfg. Co., 406 N. Clark, Chicago.

**AGENTS—Sell the Pinless Clothes Line.** A labor-saving invention; sells on sight; write quick; exclusive territory; \$25 to \$75 weekly; freight prepaid; sample 25c. Pinless Clothes Line Co., 558 Lumber Exchange, Portland, Oregon.

**AGENTS—\$1.00 hourly.** One handed flour sifter. Just patented. Only one in the world. Sample free. Forshee Mfg. Co., B. 1535, Dayton, Ohio.

**SALESMEN WANTED—to sell trees and plants.** Free outfit. Commission paid weekly. Write for terms. Perry Nurseries, Rochester, New York.

**AGENTS WANTED—Rubber stamps and novelties.** Send 4c for full particulars. A. S. Mankin & Co., Alexandria, Va.

**AGENTS WANTED—25c novelty,** housekeepers buy at sight; tea kettle attachment prevents scalding. William Cram, Box 8794, Haverhill, Mass.

**WANTED LIVE AGENT** in each locality for high class guaranteed line of paints. Commission basis. The Colorcraft Co., Cleveland, Ohio.

## MECHANICAL ENGINEERS

**HAVE YOU** any intricate mechanical problems to solve? If you have, let me solve them for you at a saving of money, time and trouble. Developing inventions to a practical and commercial basis my specialty. Benjamin Brownstein, Mechanical Engineer and Expert Designer. Ellwood City, Pa.

## DIAMONDS, WATCHES AND JEWELRY

**THE "LUCKY" CLUTCH,** for scarf pins. Safeguard against loss of scarf pin. P. O. Box 57, Sandusky, Ohio.

**AGENTS—We will train absolutely free** of cost energetic, ambitious men who are willing to sell. A splendid line of home, office and farm specialties from which to select. Magnificent 20 book, \$75.00 correspondence course in Practical Salesmanship that insures your success, free to you while selling for us. Good money from start and a splendid income after graduation. Write today for "The Plan that Makes You Win." Stace, Burroughs & Co. (Manufacturers' Representatives), Offices 760, 1008 S. Michigan Ave., Chicago.

**\$3,000 TO \$10,000 YEARLY** in the real estate business, without capital; we will teach you the business by mail, appoint you special representative in your locality, of leading real estate company, list with you readily salable properties, co-operate with and assist you to permanent success; a thorough commercial law course free to representatives. If you are honest and ambitious, our free 62-page book will surely interest you. Address International Realty Corp., Dept. 1634, Chicago, Ill.

**WANTED—RAILWAY MAIL CLERKS,** City Carriers, Post-office Clerks, Government Stenographers and Bookkeepers. Thousands of appointments coming. Average salary about \$1100. No "Layoffs." Short hours. Annual vacations. Common education sufficient. Political influence not needed. Send postal immediately for schedule showing places of coming examinations. Free coaching. Franklin Institute, Dept. J-21, Rochester, N. Y.

**WE START YOU** in a permanent business with us and furnish everything. We have new easy selling plans and seasoned leaders in the Mail Order line to keep our factories busy. No canvassing. Small capital. You pay us out of the business. Large profits. Spare time only required. Personal assistance. Write today for plans, positive proof and sworn statements. J. M. Pease Mfg. Co., 6000 Pease Bldg., Buffalo, N. Y.

**YOU ARE WANTED FOR GOVERNMENT POSITIONS.** \$80.00 month. Annual vacations. Short hours. No "layoffs." Common education sufficient. Over 12,000 appointments coming this year. Influence unnecessary. Send postal immediately for list of positions open. Franklin Institute, Dept. J-21, Rochester, New York.

**WHY BE A FAILURE?** Why stay behind when you can get the very idea you need for health, self-help, success in business or domestic life, occultism, etc., in the books we loan you by mail free or at a small rental charge. For lists, Weekly Bulletin, impartial advice, address H. N. Stokes, Librarian 119, Washington, D. C.

**BECOME A SALES-REPORTER—Great side line.** For men or women. Nothing to sell. Write for particulars. The Sales-Reporter Co., Box 73, Caywood, N. Y.

**MEN WANTED** for Government Positions. Average salary \$1100. Annual vacations. Short hours. Send postal immediately for list of positions open. Franklin Institute, Dept. J-21, Rochester, N. Y.

**WANTED—FOREMAN PATTERN MAKER** and machinery designer. Address, Sprout, Waldron & Co., Muncy, Pa.

**WE TRAIN DETECTIVES.** You can be one. Splendid opportunities. Travel. Earn \$100 to \$300 monthly. This fascinating profession taught practically and scientifically by mail at a nominal cost. American School of Criminology, Dept. F, Detroit, Mich.

**GOVERNMENT EMPLOYES WANTED.** Send postal for list of positions open. Franklin Institute, Dept. J-21, Rochester, New York.

**GOVERNMENT WANTS HELP—Write immediately** for list of coming examinations in your vicinity. Franklin Institute, Dept. J-21, Rochester, N. Y.

**CIRCULAR MAILERS WANTED EVERYWHERE.** Mail Dealer's and Agent's Specialties; sells like wildfire; big profits; write for circulars. Rheu, Electric Supply Co., Box 391, M. Detroit, Mich.

**MEN WANTED** for Government positions. Average salary \$1100. Send postal for list of positions open. Franklin Institute, Dept. J-21, Rochester, N. Y.

**CIRCULAR MAILERS WANTED Everywhere.** Write Walter's Printery, Brooklyn, N. Y.

**MEN WANTED** for Government Positions. Influence unnecessary. Average salary \$1100. Annual vacations. Short hours. Send postal immediately for list of positions open. Common education sufficient. Franklin Institute, Dept. J-21, Rochester, New York.

**WANTED! ENERGETIC MAN OR WOMAN,** in every city, to advertise, deliver and collect. \$4.00 daily easily made. Experience not necessary. Steady employment to right party. Write us at once for particulars. Dexter Supply Co., 508 S. Dearborn St., Chicago.

**BIG MONEY WRITING SONGS.** Thousands of dollars for anyone who can write successful words or music. Past experience unnecessary. Send us your song poems, with or without music, or write for free particulars. Acceptance guaranteed if available. Washington only place to secure copyright. H. Kirkus Dugdale Co., Dept. 265, Washington, D. C.

**WANTED—25 men** to learn to buy and sell, drive and repair automobiles. Pleasant, healthy and interesting out-of-doors employment. Our 32 page booklet "How to Drive" tells you all about it. Sent free for the asking. Greer College of Motoring, 1457 Wabash Ave., Chicago.

**CASH FOR NAMES,** ideas, formulas, information. Steady, profitable home business. Instructive booklet free. Information System, 248, Marietta, Ohio.

**WANTED—DISTRIBUTORS** of advertising matter everywhere. Oliver D. Barkley, Mount Pleasant, Pa.



**WANTED ONE THOUSAND CHAUFFEURS** and repair men. Our demand for automobile engineers exceeds the supply. Calls for men of intelligence and mechanical bent capable of commanding \$100.00 to \$150.00 per month upon graduation. Resident course \$20.00 to \$60.00. Home Correspondence course completed by practical road and shop work at this school, highly successful. Look this up. Auto Schools of America, Dept. T. 1600 Michigan Ave., Chicago.

**WE HAVE A STUNNING PROPOSITION** for an Engineer and traveling salesman in every Village, Town and City in U. S. Little time required. Will not interfere with your work. Particulars, Address, P. O. Box 24, South Stillwater, Minn.

**WANTED, AGENTS, MACHINISTS, ATTENTION!** Increase salary, new revised Saunders' Hand Book of Practical Mechanics. Best ever ready reference. Thousands in use. Postpaid \$1.00 cloth; \$1.25, \$1.50 leather flap. Big profits. E. H. Saunders, 216 Purchase St., Boston, Mass.

**PLUMBING, ELECTRICITY, BRICKLAYING** or Mechanical Draughting, taught by expert workmen. Short time and small cost. Positions always open. Catalogue free. Write today. Coyne National Trade Schools, 80 E. Illinois St., Chicago.

**EXPERIENCED OR SUCCESSFUL SALESMEN** to sell gasoline lighting system suitable for any place or purpose; attractive proposition. Write for catalogue. Doud Lighting Co., 174 N. Sangamon St., Chicago, Ill.

**WANTED—A man or woman** to act as our information reporter. All or spare time. No experience necessary. \$50 to \$300 per month. Nothing to sell. Send stamp for particulars. Sales Association, 601 Association Bldg., Indianapolis, Ind.

**\$100 TO \$150 A MONTH** paid to chauffeurs, demonstrators and truck drivers; no experience necessary. Write for free tuition certificate. Sweeney's Automobile School, 1436 Woodland Ave., Kansas City, Mo.

**I WILL START YOU** earning \$4 daily at home in spare time, silvering mirrors; no capital; send for free instructive booklet, giving plans of operation. G. F. Redmond, Dept. 306, Boston, Mass.

**PINLESS CLOTHESLINE AGENTS** coin money. Sample prepaid. 25c. 503 Lumber Exchange, Portland, Oregon.

#### MACHINERY AND TOOLS FOR SALE

**\$1.50 WILL BUY** complete set of castings and all material for an automatic steam engine of 1/16 hp. Blue prints and instruction sheets, 25c. Complete engine ready to run, \$6.00. Elgin Wheel & Engine Co., Elgin, Ill.

**ONE 2 HP. MARINE ENGINE**, slightly used; first \$22.00 takes it. Send C. O. D. if wanted. H. Specht, West, Iowa.

**FOR SALE—One Bolter** for bolting flour, etc., 16 feet in length, Hexagon shape with removable iron screens in sections, conveyor at the bottom for removing tailings, used only two weeks. Cost \$550.00, will sell for \$250.00. Fenimore & Co., Trenton, N. J.

**2½ HP. SHOP OR MARINE gasoline engine**, complete, good order, \$25.00. H. Caruthers, 229 Columbus St., Elyria, Ohio.

**FOR SALE—Entire equipment** of ten track steam tunnel dryer, or cars separately, gage 25 inches, roller bearings. Condition excellent. Smith Bros. Brick Co., 407 Park Bldg., Pittsburgh, Pa.

**TAPPING AND THREADING ATTACHMENT.** Use it in any lathe. Greatest time and money saver on the market, \$24.00. Circular sent. J. C. Barrett Co., Hartford, Conn.

**ELECTRIC MOTOR; DIRECT CURRENT;** one-half horse; rheostat; good condition; \$25.00. Fort Worth Printing Co., Fort Worth, Texas.

**TWO-CYCLE, TWO-CYLINDER 4 in.** by 3½ in. marine and automobile gasoline engines 16 hp., at \$94 complete. Castings and drawings of same for sale. Richards Iron Works, Manitowoc, Wis.

**STEAM SHOVEL 1½ yard capacity**, standard gauge, used but in good order, also 24 by 46 Corliss engine. Clifford Chase, Russell, Lake Co., Ill.

**INTERESTED IN GASOLINE ENGINES?** Send 50c for booklet, "How to Run and Install Gasoline Engines," and a year's subscription to Gas Energy, 28 Murray St., New York.

**16x24 INCH STEAM ENGINE**, \$450.00. 6 hp. with boiler, \$65.00. 8 hp. with boiler, portable, \$80.00. Box 242, Jannette, Pa.

**TWO CYCLE 3¼x3¼ inch Marine Engine**, \$30; complete casting for same for sale, \$9.00. Box 83, Harrison, Ark.

**FOR SALE—Engine and boiler**, 3 hp., bargain, correspondence solicited. L. D. Dickinson, Owego, N. Y.

**STEAM MANGLE**, \$50. Easily fitted for gas. Pierce, Shelburne Falls, Mass.

**FOR SALE—Shepherd lathe**, 10 inch, 36 between centers. All gears, \$45. M. Kakara, Streator, Ill.

**\$500 WORTH OF ELECTRICAL EXPERIENCE.** We will send complete material and drawings for a dynamo that will light twenty sixteen-candlepower Tungsten lamps for \$12.00, or drawings only \$2.00. Austin Bros., Muncie, Ind.

**CASTINGS, one horse power marine**, \$8. Box 36, Newport, Kentucky.

**ONE 11"x6' STAR LATHE**, fine condition, with two chucks and tools. One 16"x7' lathe, bad order; two 12" sensitive drills, good. One power hack saw, good. One 5 light dynamo D. C. with rheostat. One grinder with column, countershaft and wheels, light. 400 five gallon barrels with tops, ash; well hooped. Harry Kerslake, Paris, Ky.

**PULLEYS, GEARS, SPROCKETS, Shafting Hangers;** see page 144. W. A. Jones Foundry & Machine Co., Chicago.

**NEW 3 HP. STATIONARY**, also Marine gasoline engines, cheap. Leo. Gillon, Chicago, Ill.

**ENGINE CASTINGS, 1½ horse vertical gasoline, air-cooled.** \$7. Three horse marine water-cooled. \$9 cash; drawings included; catalogue for stamp. Novelty Manufacturing Co., 853 West Sixth St., Cincinnati, Ohio.

**GAS ENGINES, 3-6-10 & 20 H. P.** Also large stock Lathes, Planers, Drill Presses and other metal working machinery. Western Machinery Co., Cincinnati, Ohio.

**STEAM BOILER OUTFITS Complete;** 1½ Horse Power 20" diam., 51" high, \$40.00. Page Boiler Company, 815 Larrabee St., Chicago.

**ENTIRE EQUIPMENT** of Statuary Bronze foundry. Also gas engine milling machine. 3 ton Harrington hoist, flexible shaft. M. H. Mosman, 43 Chapin St., Chicopee, Mass.

**FOR SALE—Rebuilt; Throttling, Automatic and Corliss Engines, Boilers, Pumps, Heaters, Machine Tools, Tanks, Saw Mills, and general machinery,** at bargain prices. Let us know your wants. The Randle Machinery Co., 1761 Powers St., Cincinnati, Ohio.

**FOR SALE—Gasoline Engines, automobiles, marine and stationary,** also castings. Second hand ones taken in exchange and for sale. Apply with stamps. B. W. Richardson, R. No. 36, Peoria, Ill.

**FOR SALE—Engine lathe, swings 9½ in., takes 25 in. between centers.** Complete with full set change gears to cut all size threads, 3 to 40 in.; price only \$43.50. Address L. F. Grammes & Sons, Allentown, Pa.

**LATHES—Send for free circular** showing bargains on small Screw Cutting Engine Lathes. S. B. Machine Tool Co., Dept. L, South Bend, Ind.

**JOINTER HEADS 6 to 16 in.** with cast iron frame that head runs in ready to bolt to wood table. Write for circular and prices. W. L. Sherwood, Kirksville, Mo.

**FOR SALE: Triple expansion marine engine, 11¼" x 16" x 22½" x 18" Twenty H. P. Nash gas engine.** Geo. J. Adams, 39 South St., New York.

**LITHOGRAPHIC MODELS—Series of 6 subjects—Wireless Telegraph—Motor Car—Dynamo—Steam Engine—Steam Turbine—Gas Engine—Size 8x14 inches—All the parts of those mechanisms are shown and numbered to correspond to printed keys of names.** Price per set of 6—\$2.50 or 50c each postpaid. Popular Mechanics Book Dept., Chicago.

**TO RENT—Electric Motors, all sizes.** Send for list and rates. Gregory Electric Co., Chicago, Ill.

**PATTERN-MAKERS! A book devoted to the principles of pattern and core making and molding.** Written by G. H. Willard, a practical pattern maker of years experience. This book, just published, treats the subject in a much more simple, direct and effective manner than most books along this line. 224 pages, 312 illustrations. Price \$1.00 postpaid. Popular Mechanics Book Dept., Chicago.

#### MANUFACTURING MACHINERY

**IRON, BRASS AND ALUMINUM CASTINGS.** Metal Specialties. Patterns, Models, Polishing, Plating and Japanning. North Chicago Tool Works, North Chicago, Ill.

**DIES, MODELS, Special Machinery.** Ask for estimates. Box 316, Fulton, Ill.

**THE NEW ERA MFG. CO., Fairfield, Iowa.** Wood and metal patterns, models made.

**THE PIERCE MODEL WORKS.** We make Models of any description. Experience and our modern equipped shop enables us to give you the best results at the lowest cost. We will improve your invention, make samples for exhibition, and sales agents. We also make the necessary tools and dies to manufacture same on contract. Write for catalogue of model supplies. The Pierce Model Works, 117 N. 5th Ave., Chicago, Ill.

**YOUR INVENTION MANUFACTURED** at lowest cost. We are equipped for all kinds of metal specialty work. Designs perfected, etc. C. Spiro Mfg. Co., New York.

**PATTERNS AND CASTINGS MADE.** Send sketch for estimates. "Mail Order" Garage, No. 3 Fox Street, Bridgeport, Conn.

#### BOATS, LAUNCHES AND STEAMBOAT MACHINERY

**ENGINES—100 new and used, all sizes—open and cabin launches, sailboats, etc.** 3 to 10 hp. stationary engine. R. M. Delagrang, Boat-Broker, Stonington, Conn.

**MODELS—CASTINGS, FITTINGS, DRAWINGS** and instructions. Build a model steam or gasoline engine, dynamo, motor, motor boat, etc., outfit, in your spare moments. We furnish the material and instructions, you contribute a few hours pleasantly spent. Finished models carried in stock. Enclose two cents for illustrated booklet. The B. A. B. Model & Mfg. Co., Room 536B, Singer Bldg., 149 Broadway, N. Y.

#### WANTED

**WANTED—BOOKS, Cylinder Records, Typewriter, Camera,** for cash or hatching eggs. Edw. Lafot, Lakefield, Minn.

**WANTED SMALL SPECIALTIES** and novelties, also children's wearing apparel and household utilities for exclusive mail order house just organized. Reynaud & Co., Whitehall Building, New York.

**WANT MERITORIOUS ARTICLE** that could be sold entirely by mail? Like to hear from manufacturers or patent holders. Address D. B. O., 3402 Lexington St., Chicago, Ill.

## FOR SALE

**ALUMINUM EYEGLASS CASES.** Polished, look like silver. Velvet lined. Light as paper. 3 sizes. Mailed free on receipt of 50c. Enhaus & Son, 31 John St., New York City.

**DESKS**—Direct from factory to user. Write for our new catalogue. Monarch Desk Co., Columbus, Ohio.

**TATTOOING MACHINE** and outfit cheap. D. W. Knight, Fairfield, Maine.

**GARAGE BUSINESS** for sale. Done \$40,000 business last season. Write C. L. Olmstead, Big Timber, Mont.

**LONG'S POP-CORN CRISPETTE** Outfit and supplies. Cost \$242.00. Price \$125.00. Wm. Grow, Wilsonburg, W. Va.

**\$10 DRAUGHTING SET** (new) \$6.50. Write. C. P. Kopperman, 288 Triangle St., Buffalo, N. Y.

**FOR SALE**—Moving picture film 1c foot. H. Davis, Watertown, Wis.

**FOR SALE OR LEASE**—Machine shop and garage; plenty business; investigate. P. O. Box 154, Bedford, Ind.

**AUTOMOBILE.** Camera, Bicycles, Electrical Engineering Course, sell cheap for cash. Ralph L. Cowles, Canton, Conn.

**NEARLY NEW** coin operated pianos and harps, one-third cost. Box 985, Ashtabula, Ohio.

**"TEXTIGUM" TYPEWRITER COVERS,** fine, 50c. See what I say under "Typewriters." Atchison.

**REAL BARGAINS, MOTOR CYCLES, BICYCLES,** marine and stationary engines, furniture, musical instruments, pianos, typewriters, sewing machines, etc. Agents wanted. Make a whole lot of money getting orders for us. Write for booklet. Atlantic Supply Co., Long Branch, N. J.

## SALE OR EXCHANGE

**SEVENTEEN EDISON** cylinder concert records, class M, for ten dollars value. Address A. A. Moore, Box 350, Shasta Co., Redding, Cal.

**PHOTOGRAPHER'S OUTFIT,** \$100 value, trade for small lathe. Vanpelt, 1822 S. Gr. Ave., Springfield, Ill.

**GOLD WATCH,** gentleman's size, for motorcycle without engine. C. Jackson, Trumansburg, N. Y.

## CEMENT

**IF YOU WANT** the best information on cement and concrete construction, subscribe for Concrete, leading cement and concrete monthly. Sample copy, 10 cents. Yearly subscription, \$1.00. Concrete, 135 Newberry Bldg., Detroit, Mich.

## STEEL STAMPS, STENCILS, DIES, ETC.

**STAMPS, STENCILS, SEALS, CHECKS, Punches and Dies.** Presswork. Dickey-Grabler Co., Cleveland, Ohio.

## BLACKSMITHS

**BLACKSMITHS.** There is a great demand for good steel workers and at big salaries. Buy Toy's Modern Methods, welding new steels solid and doing all hard jobs easy; forging and tempering all tools to a standard by colored charts. All for \$1. Send for samples free. W. M. Toy, Sidney, Ohio.

## DUPLICATORS AND DUPLICATING DEVICES

**How to get a Hektograph** that will make 150 copies in 10 minutes; letter size, \$2.00. Write for circular. Heyer Duplicator Co., 118 No. La Salle St., Chicago.

## COLLECTIONS

**OUR PRINTED DUES** will bring the money on your old or slow accounts. Ten forms. Sample set, ten cents. United Mercantile Agencies, St. Louis, Mo.

**LEGAL OPINIONS, REPORTS and Collections** in all states. Reasonable fee. Charles Fitzgerald, Attorney at Law, Roanoke Bldg., Chicago.

**ACCOUNTS COLLECTED ANYWHERE.** Fidelity Credit Co., Richmond, Va. Collections. Law.

## PATENTS

**MECHANICAL DRAFTING SOLICITED;** Including Working drawings of every description, Dies, Jigs, Special Machinery, Patent Office Drawings, Tracing and Blueprinting. E. O. Klann, 1113 Hadley St., Milwaukee, Wis.

**PATENTS SECURED**—Reports on patentability, validity and infringement. Patent suits conducted. C. L. Parker, ex-examiner Patent Office, 910 G St., Washington, D. C.

**MODELS MADE FOR INVENTORS.** Inventions and ideas developed and patented, draughting, blue printing, etc., at startlingly low rates. It pays to investigate. The B. A. B. Model & Mfg. Co., Room 536B Singer Bldg., New York.

**WE SELL PATENTS.** Established ten years. To buy or having one to sell write Charles A. Scott Co., 1096 Granite Bldg., Rochester, N. Y.

**PATENTS**—Our advanced methods save you 80% of your money. "How to succeed as an Inventor" sent free. Inventors and Investors Corporation, Philadelphia, Pa.

**INVENTORS**—Let us sell your patent. We are manufacturers' agents. Write for plan. Atlantic Supply Co., Long Branch, N. J.

## PATENTS FOR SALE

**FOR LEASE OR SALE**—Fluid-Motor Patent, U. S. No. 971,517; recently granted. Very valuable device, comprising valve-gear to be used all kind motives-fluids. "Dead Center" absolutely avoided by same valve-device. No more "Fly-Wheel." Greatest simplicity of construction, and several other advantages. For particulars address Carlos F. Benitez, Guadalajara (Mexico), 141 Ocampo Street.

**GAS FIXTURE CHANDELIER ATTACHMENT.** Supports shades. Protects ceilings from heat, smoke. Also adjustable girder clamps and expansion pipe hanger. Patent. MacTaggart, 1233 Arch, Philadelphia, Pa.

**VALUABLE PATENT** on quick, positive repair of all Pneumatic Tires and Tubes. American or European interests for sale. Whole or part. Gustav Kaul, Hackensack, N. J.

**FOR SALE**—Patent No. 877,966, improved hand-seeder, necessity on every farm. For blueprints address G. E. Swanson, R. 5, LaPorte, Ind.

**FORTUNE MAKING PATENT HOUSEHOLD NECESSITY.** Cash, royalty, or incorporation. Most liberal terms. Corporation Company, Boston.

**FOR SALE OR EXCHANGE** for land. Patent on improved fruit jar and opener. F. W. Bettis, Fayette, Ala.

**FOR SALE**—PATENT No. 977,479, issued Dec. 6th, 1910, on nut lock, must be sold. Address J. A. Schmutz, Wells Creek, Pennsylvania.

**PATENT NO. 899,260,** Parkinson's Evercool Cover Lifter. No more burnt fingers. H. C. Parkinson, Berkeley, Cal.

**WEIGHING MACHINE,** U. S. No. 976,228, Nov. 22, 1910. For manufacturing business men. Address Stockman, 3644 Meramec, St. Louis.

**AEROPLANE PATENTS,** \$59,274, 926,159 and 976,765. Will sell outright or 1/2 interest. Valuable. J. Holmes Wilson, Carlisle, Pa.

## PATENT ATTORNEYS

**PATENTS**—Books, 100 mechanical movements, perpetual motions, 50 illustrations. Mailed free. F. Dietrich & Co., Patent Lawyers, Washington, D. C.

**IMPORTANT NOTICE**—Read my page ad on page 120 Advertising Section, of this magazine, relative to patents, trademarks, etc. Special offers contained in the ad. E. E. Vrooman, Patent Lawyer, Washington, D. C.

**PATENTS PROCURED** and positively sold if the idea has merit; all countries; satisfied clients my best references; send sketch; book free. H. Sanders, Crilly Bldg., Chicago.

**PATENTS WITHOUT ADVANCE ATTORNEYS' FEES,** payable when patent allowed. Send sketch for free report. Books free. Fuller & Fuller, Washington, D. C.

**PROMPT, RELIABLE AND SKILLFUL** Patent Attorney. Edward W. Byrn, 627 F St., N. W., Washington, D. C.

**PATENTS SECURED**—Located opposite the Patent Office; prompt and personal attention assured. Trade-Marks registered. Parker Cook, Victor Bldg., Washington, D. C.

**"PATENTS AND PATENT POSSIBILITIES,"** a 72-page treatise sent free upon request; tells what to invent and where to sell it. Write today. H. S. Hill, 905 McGill Building, Washington, D. C.

**PATENTS PROMPTLY OBTAINED.** Our free booklet will help you to fortune. Read pages 11 and 12 before applying for patent. Free searches. Write today. D. Swift & Co., 317 7th St., Washington, D. C.

**PATENTS**—HERBERT JENNER, patent attorney and mechanical expert, 608 F. St., Washington, D. C., established 1883. I make a free examination and report if a patent can be had and exactly what it will cost. Send for circular.

**SEND FOR FREE BOOKLET.** All about Patents and their Cost. Shepherd & Campbell, 500A Victor Bldg., Washington, D. C.

**PATENTS THAT PROTECT** and pay. Advice and books free. Rates reasonable—Highest references; Best results. Watson E. Coleman, Patent Lawyer, 622 F. St., N. W., Washington, D. C.

**C. L. PARKER,** Patent Attorney, Ex-examiner U. S. Patent Office, 910 G. St., Washington, D. C. Inventor's handbook "Protecting, Exploiting and Selling Inventions" sent free upon request.

## REAL ESTATE AND FARM LANDS

**MONEY-MAKING FARMS** throughout 15 states; improved, one to 1,000 acres \$10 to \$100 per acre. Stock and tools included with many to settle estates quickly. Mammoth illustrated catalogue "No. 34" free. E. A. Strout, Station 3043, Old Colony Bldg., Chicago, Ill.

**FOR SALE OR EXCHANGE**—Lands of all kinds. Timber, cut-over, farm and plantation in the famed "Delta" of Mississippi, Arkansas and Louisiana. The most fertile, healthful and productive as well as the cheapest land in the United States. Can sell on easy terms. Write me. J. B. Hamner, 89 Madison St., Memphis, Tenn.

**TEXAS PAN HANDLE BARGAINS**—640 acres, good improvement, fine climate and water, near school. Also 320 or 640 acres unimproved. J. J. Comstock, LaGrange, Ill.

**SPECIAL FLORIDA LAND OFFER.** "Far Famed Indian River Section." Given for little spare time one 5 acre prairie farm and railroad fare. For particulars, Box 120, Titusville, Florida.

**NEW JERSEY**—For poultry, fruit, truck, etc., healthy climate, good markets, few five and ten acre plots left. \$40.00 acre up, easy payments, near depots. W. Risch, 2600 Arctic, Atlantic City, N. J.

**563.331 ACRES EXCLUDED** from Ozark National Forest, Arkansas. The "Vacant Land Subject to Homestead, How, When and the Law," sent for 25c. Robt. Workman, Everton, Arkansas.

**SEATTLE, WASH.**—Real estate, city and country, investments, loans, residences and lots State University district. Bank references. C. F. Reeves, 406 Arcade, Seattle, Wash.

**RICH ARKANSAS LANDS** on railroad, cheap; no rocks. Robert Sessions, Winthrop, Ark.

**FREE MAP OF JEFFERSON CO., TEX.**, and full information concerning Gulf Coast Country. Junker & Edwards, Beaumont, Texas.

**12,000 ACRES FLORIDA** cutover pine land, \$3.50 acre, worth \$6 quick sale. B. I. Hazard, Georgetown, S. C.

**CANADA**—For sale, magnificent islands—200 acres. Ashuapmouchou River, Lake St. John, P. Q. Ideal fishing, bathing. Rich farming land. Write M. P. Hudon, Murray-Bay, P. Q. Canada.

**BITTER ROOT VALLEY**, irrigated, 20 acres orchard land, \$5,000; or 30 acres, 6 orchard, 24 rich "bottom," \$3,500, near Hamilton, easy terms. D. O. Welty, 206 Heyworth Bldg., Chicago.

**7,680 ACRES**—Solid body, good improvements, joining city of Midland, over \$100,000.00 profit in the purchase. Biggest bargain on Southern Plains of West Texas. Will send full particulars. Write me. W. J. Moran, Midland, Texas.

**FLORIDA FARM-HOMES** at fraction usual cost through cooperative land clubs. Large colony successfully located. New club forming. Desirable members invited. Edward Miller, 1016 Franklin St., Tampa, Fla.

**SACRAMENTO, CALIFORNIA, SUBURBAN** small farms; about 20 minutes' ride on electric cars to center of Sacramento; city conveniences combined with country life, good income, low cost of living and small investment; climate, delightfully mild; twelve months' growing season and outdoor life; land very fertile; raise nuts, oranges, olives, great variety of other fruits, vegetables, poultry, etc.; Panama canal, Panama Pacific International Exposition, deep waterway and suburban feature will all boost values; absolutely high class; closest investigation courted; prices very low, easy payments; supply limited; excursion rates. Write today to A. C. Roebuck, Investments, Farm Land Dept., 35, 1024 N. American Trust Bldg., Chicago.

**CALIFORNIA OIL LAND**—But 3¼¢ per acre per day. Here opportunity knocks. Ten acre tracts. No interest, no taxes. Easy monthly payments. Write now. Frank Thorne, P. O. Box 1168, Los Angeles, Calif.

### DOGS, POULTRY AND LIVE STOCK

**KEEP YOUR HENS** and houses free from lice and mites. Pleasant dreams. Half gallons one dollar. Dept. A, Webb, 2137 Madison Ave., New York City. Agents wanted.

**FOR SALE**—Two broke spotted Arab stallions 3 year old and sound. Hampshire hogs all ages, prize blood. C. W. Welsenbaum, Altamont, Labette Co., Kan.

### GAMES AND ENTERTAINMENTS

**TRICKS, MAGICAL APPARATUS AND SUPPLIES**—Amateurs supplied as well as the great professionals. Easy, interesting and entertaining, amuse and astonish your friends, 4c stamps brings our four catalogues: Magical Apparatus, Latest Supplement. Marvelous Card Effects and Trick Novelties and Jokers. Send now. Read & Covert, 817C East 43d St., Chicago, Ill.

**GO ON THE STAGE!** Will tell you how! Write for descriptive circular. It is free! Percy Ewing, Decatur, Ill.

**PUZZLE-GAME** that puzzles. Sample 10 cts. R. K. Eldridge, Syracuse, Ind.

**MAGIC**, magazine of wonder. World's most fascinating periodical. Forty pages filled with sparkling pictures, conjuring tricks and magical entertaining news. \$1 a year; sample copy, 10c. F. T. Singleton, 3625 Thompson Ave., Kansas City, Mo.

**145 PARLOR GAMES**, 10c. Ventriloquism, 10c. Free catalogue. Barstow, Box 18, Oakland, Cal.

**LEARN VENTRILISQUISM QUICK!** I want representatives everywhere. Big money! Great fun! Success assured. Free interesting booklet tells how. Send stamp. Instructor Bailey, 771 Iglehart, St. Paul, Minn.

**100 TRICKS**, with directions, fifteen cents. Bamberg, 1193 Broadway, New York.

**MAGIC-SKULL**, shines in dark, 10 cents. Klein, 1193 Broadway, New York.

### RARE COINS AND STAMPS

**COINS**—10c liberty head, 5c silver, 3c nickel, 2c piece, large cent, U. S. ½ cent, Connecticut cent, war cent, 10c U. S. note, Confederate note, Georgia war note, one copper and nickel foreign coin, lot for \$1.00 delivered. Good beginner's set. Other coins on application. William Hesslein, 674 Elm St., New Haven, Connecticut.

**CONFEDERATE MONEY**, as used before the war. Sets \$1.00. L. Nichols, 269 Royal St., Mobile, Ala.

**TEN DIFFERENT OLD COINS**, 25c; five different old bills, 25c; premium coin book, 10c. C. Burgess, 1018 Huron, Toledo, Ohio.

**POSTSCRIPT STAMPS**—Phenomenal success. Engraved 5 colors. Sheet 25 different 10c; 3, 25c. J. Helwig, 49 Clinton St., Albany, N. Y.

**WANTED—OLD COINS, STAMPS** and mutilated money. Latest buying catalog, 10c. Michigan Coin Co., Detroit.

**STAMPS**—105 China, etc., stamp dictionary and list, 2c. Bullard, Sta. A, Boston.

**\$7.75 PAID FOR RARE DATE 1853 Quarters**, \$20.00 for a Half-Dollar. We pay a cash premium on hundreds of coins. Keep all money coined before 1880, and send 10 cents at once for our New Illustrated Coin Value Book; size 4x7. It may mean your fortune. C. F. Clarke Co., Coin Dealers, Dept. 14, Le Roy, N. Y.

**STAMPS**—40 U. S., 6 CENTS, 10 different coins and coin book, 15c. 10 large U. S. cents, 40c. 10 broken bank and state notes, 30c. F. L. Toupal Co., Chicago Heights, Ill.

**STAMPS 100 ALL DIFFERENT, FREE**. Postage 2c. Mention paper. Quaker Stamp Co., Toledo, Ohio.

### FOR THE HOME

**PLASTIC STOVE LINING** easily fitted to any cook stove. Made of best fire clay—fits close and last longer—keeps moist till exposed to the air. Hardens quickly in the fire. Refine your own stoves early and get best results. Directions on packages. Four slabs \$1.35, or three slabs \$1.15. Express paid to any place within five hundred miles of Chicago or New York. Satisfaction and fit guaranteed or money refunded. Send mail orders to Magic Stove Lining Co., 1301 W. 35th St., Chicago.

**"NEVER RUBBED A BIT!"** Convincing thousands! ¼ time saved. Marvelous washday help. Agents, big profits! "Cameo," Detroit, Mich.

**BUY PLUMBING GOODS**, heating plants and water supply systems at wholesale. Catalogue free. Monarch Sales Co., 204 W. 3rd, Cincinnati.

**MAKE YOUR OWN MISSION FURNITURE** at the minimum of expense. Our 2 books "Mission Furniture, How to Make It." Parts 1 and 2, tell in plain, simple language just how to make 50 different pieces. Full dimensioned working drawings and half tones of finished articles. Price 25 cents each or 50 cents for the two volumes, postpaid. Popular Mechanics Book Dept., Chicago.

**BEAUTIFUL ARTS-CRAFTS LAMPS**—Anyone can make them out of paper, cardboard and wood. 16 designs. Inexpensive yet artistic. Complete book of instructions. Price 25c postpaid. Popular Mechanics Book Dept., Chicago.

**METAL WORK AND ETCHING**—A 96-page handbook for art metal workers telling how to make a great variety of useful and ornamental objects such as desk sets, arts-crafts jewelry, etc. Price, 25c postpaid. Popular Mechanics Book Dept., Chicago.

### FOR MEN

**GILLETTE AND OTHER SAFETY RAZOR** blades resharpened. Our new patented power machine grinds off nicks, hones and strops. Perfect work guaranteed. Safety blades 2¼ cents, we pay return postage, ordinary razors honed 15 cents. Detroit Cutlery Co., 29-31 Monroe Ave., Detroit, Mich.

**FOR MEN**—If you want to discard your suspenders and wear a belt this summer, there is only one practical natural fitting non slipping belt.—The L. & N. guaranteed for one year. Price \$1.00, postpaid. Send waist measure with order. Send for circular. Agents wanted. L. & N. Belt Co., 1257 N. Clark St., Chicago, Ill.

**\$1.50 BUYS A RODGERS' English Razor**, set ready for use, with the most lasting Sheffield edge. Catalog free. Keene Bros., 32 N. Clark St., Dept. 30, Chicago.

**SAFETY RAZOR BLADES SHARPENED**, Gillette, Gerns and all thin models. 2c each. Star blades 10c. Old style razors honed 25c. Keen Edge Co., Oshkosh, Wis.

**FOR SALE**—30,000 pounds best leaf tobacco, mail stamps for samples. Anton Wavrin, Franklin, Ky.

**"THE LITTLE WONDER,"** safety razor blade holder for sharpening single or double edge blades. Agents wanted. Prepaid, 50c. John Earl, No. 311 Orange St., Newark, N. J.

**GUARANTEED RAZOR** and strop, only \$1.25. Hill Co., Ulmer, Iowa.

**SAFETY RAZOR BLADES** sterilized and sharpened better than new; 2 cents each. Five years' success. Send for blade box and circular. Electro Stropping Co., 134 Shelby St., Detroit, Mich.

### MUSIC

**ANY SHEET MUSIC** you want, no matter where published, we will supply at 15c per copy postpaid. Willis Woodward & Co., 1193 Broadway, New York.

**"ONE KIND WORD," "If I Knew," "One of the Herd,"** and "Mars." Piano copy, 10c; 4 for 35c. Burdick, Box 300, Lockport, N. Y.

**COMPOSERS**—Get your song, march, waltz or two-step published. Send for particulars. George F. Briegel and Co., 1367 Broadway, New York.

**MUSICIANS SHOULD POSSESS** our publication "Scales, Key Signatures, Related Keys." 35 cents. No stamps. Testimonials. Musical Press, 422, Philadelphia Post Office.

**IF YOU WANT** the latest music and a better assortment for less money than elsewhere, write today for catalog. Semple's Music House, 204 West Ave., Norwalk, Conn.

**EDISON OR VICTOR RECORDS**—15 and 25 cents, or will exchange 2 for 3. Kirkbride, 4537 No. 16th St., Philadelphia, Pa.

## PRINTING

1,000 IMITATION TYPEWRITER CIRCULAR LETTERS, bond paper, heading black, body purple, \$2.75. 6x9 circulars, \$1.35. Elegant line samples free. Good's Printery, Harrisonburg, Va.

1,000 BOND LETTER HEADS, 8½x11, \$2.00; 1,000 Envelopes, 6½ \$2.00; 1,000 Statements, \$2.00; 1,000 Bill Heads, \$2.00; 1,000 Business Cards, \$2.00. Particular Printing Co., Bellevue, O.

GUMMED LABELS, 3,000, \$1.00. Catalogue free. Advertising specialties. MacTaggart, 1233 Arch, Philadelphia, Pa.

100 ENGRAVED style visiting cards, 25c, postpaid. Samples. Jones Bros., West Lafayette, Ind.

WANTED—Automatic card printing press. Potts Mfg. Co., Camden, N. J.

YOUR NAME, ON 100 visiting cards, 25c; card case free. 100 envelopes, 32c. F. Johnson, 625 E. 40th St., Chicago.

FOR SALE—5x8 inch Printing Press and Outfit, \$25. H. E. White, Coudersport, Pa.

SEND FOR FREE PRINTING PRESS catalog and instruction book; good presses, low prices. L. M. Carroll & Co., 167 W. Washington St., Chicago.

## TYPEWRITERS

TYPEWRITERS—Every kind on the market, write today for best bargain you ever secured. Shipped anywhere on approval. \$10.00 up. Fletcher Typewriter Co., 207 N. 7th St., St. Louis, Mo.

STENOGRAPHER WILL SELL her brand new Remington typewriter, does splendid work. \$30.00. Miss King, 2228 7th Ave., New York City.

GOOD REMINGTON TYPEWRITER for \$15.00. A bargain. R. K. Eldridge, Syracuse, Ind.

GOOD TYPEWRITER CHEAP; on trial; easy terms. Meier, Russell, Kan.

BEST TYPEWRITER BARGAINS and easiest terms for any make of machine. For illustrated catalogue and list of our prices, write L. J. Peabody, 264 Minot Bldg., Boston, Mass.

BUY REBUILT TYPEWRITERS with guarantee. Oliviers \$20 to \$35, Smiths \$12 to \$18, Remingtons \$10 to \$35. Write for catalogue. Cash or time. Knight's, 257 12th, St. Louis, Mo.

CARBON PAPER AND TYPEWRITER RIBBONS. Buy from factory; half usual price. Samples free. Manufacturer, Binghamton, N. Y.

TYPEWRITER RIBBONS? "We sell 'em fast and furious" for 35c, 3 for dollar; carbon paper 1½c sheet. Wallace Company, 1219 Arch St., Philadelphia.

TYPEWRITER CARBON PAPER, \$1.25 per 100 sheets; typewriter ribbons, 3 for \$1.05. Geo. Birt, Russell Ave., Indianapolis.

I WANT TO CORRESPOND with persons who are about to buy a high-grade typewriter, and object to paying the high prices generally asked by manufacturers and dealers. Any make on approval. Catalogue, bargain list and valuable information sent free. A. E. Atchison, 4127 West 21st St., Chicago.

CASH SAVES: Why pay installment houses 40% more? We sell high-grade rebuilt Remingtons, Smiths, \$17; Underwoods, Oliviers, \$33—others cheap; sent on approval; sold under guarantee. Old Reliable, Consolidated Typewriter Exchange, 245 B'way, N. Y.

REMINGTON TYPEWRITERS \$12.00, Calligraphs \$6.00, Hammonds, Yost, Densmores, \$10.00, Smith Premiers and Jewetts \$15.00, Oliviers, Underwoods, L. C. Smiths and Royals \$25.00. Fifteen days free trial, and one year's guarantee, don't purchase until you get our prices. Harlem Typewriter Exchange, Dept. P.M., No. 217 West 125th St., New York City.

## TELEGRAPHY

TELEGRAPHY, both Morse and Wireless, taught quickly. Also Station Agency Work, R. R. Dispatcher's and Western Union wires, and complete wireless station and school. Big demand for operators. Living expenses earned. Correspondence courses if desired. Catalogues free. Dodge's Institute, 15th St., Vaiparalso, Ind. Est. 1874.

TELEGRAPHY TAUGHT in the shortest possible time. The Omnigraph Automatic Transmitter combined with standard key and sounder. Sends you telegraph messages at any speed just as an expert operator would. Five styles. \$2 up; circular free. Omnigraph Mfg. Co., 41 G. Cortlandt St., New York.

## WIRELESS

WHY NOT BUILD A REAL WIRELESS telephone set that will work from one to twenty-five miles? You can do this yourself with our "Vec" parts. We supply drawings free. Send stamp for our latest bulletins. Victor H. Laughter, Mgr., Volta Electric Co., Chicago.

WE ARE OFFERING some unusual values in absolutely reliable wireless apparatus. Send stamp for catalogue. Alden Wireless Co., Dept. T. Campello, Mass.

WIRELESS SET, How to Make—96 page book telling how to construct at small cost an outfit suitable for transmitting four or five miles. Price 25 cents, postpaid. Popular Mechanics Book Dept., Chicago.

## MISCELLANEOUS

WHY LOOK THROUGH dimmed eye glasses when the "Magic Cleaner" will instantly give you perfect vision? Send self-addressed stamped envelope for free sample to F. H. Smith, Dept. O, Akron, Ohio.

"THE AD WRITERS' ASSISTANT"—Book containing 350 phrases, headlines, suggestions, interesting opening chapters, each illustrated with appropriate cut, mailed, 25 cents. Cuts supplied. F. S. Alles, Drexel Building, Philadelphia, Pa.

TEN DOLLAR formula 25 cents. Dry color, renews hats, flowers, etc., sample, quick, harmless. Higbee, 614 E. Main, Casey, Ill.

3,000 TRADE SECRETS and formulas, cloth bound book, 50c postpaid. W. H. Luecent, 2035 Wilmot Ave., Chicago.

FREE. TO INTRODUCE OUR SPLENDID line of goods, will give away free to those who are interested, the following articles: Fountain Pen, Pocket Knife, Needle Threader, Polishing Cloth, Sheet Music, Safety Razor, Mysterious Plate Lifter. Write, inclosing four U. S. one-cent stamps for full particulars. No postal cards answered. A. Lagerstrom Supply Co., Dept. 1, Cannon Falls, Minn.

PERSONAL—TATTOO MARKS REMOVED—Proven formula, \$2.00. 6 valuable household formulas, 50c. 6 perfumes, 50c. 6 formulas for toilet preparations, 50c. Formulas for anything. Satisfaction guaranteed. Western Formula Bureau, Box 907, Porterville, Cal.

\$ DOLLAR \$ ADDER: A practical adding and subtracting machine; capacity \$999,999.99. Sent prepaid for \$1.00. Money back if not satisfied. Circular free. Eiler Sales Co., 1711 Leavenworth, Omaha, Neb.

"WINNER" FOUNTAIN PENS are plain, no ornamentation. The cost is in the material and workmanship. Fitted with solid gold pens, med. or pointed, \$1.00 postpaid. Use it ten days. Return to us and get your money if not satisfied. A. C. Warren, Box 291, Detroit, Mich.

"THE HOME COURSE of Physical Culture." Get health and strength in your own home. Drop a postal and let one who has had fourteen years' experience in Y. M. C. A.'s and private clubs, tell you how. Jamieson E. Provan, Eddystone, Pa.

GINSENG—Roots and seed for sale. Send for price list. Plymouth Ginseng Gardens, Plymouth, Wis.

LATEST NOVELTY and catalogue 10c. B. Goral Novelty Co., 99 Logan Ave., Milwaukee, Wis.

CANDY MAKING—\$15 course 50c; circular free. Eagle Co., "L," Quincy, Mass.

COLORED FIRE FOR JULY 4th cheaply made at home. Instructions 25c. W. Lovell, Wilmette, Ill.

SEND TWO CENTS for Digest, containing 100 formulas, etc 6 months for 10c. Worth dollars. Digest, Grand Rapids, Mich.

FORMULAS—500 SELECT FORMULAS for everything. Book form, 25c. Globe N. Co., 1745 Leavenworth, Omaha, Neb.

SKIM-MILK PAINT can be made for 15 cents a gallon, durable, cheap. Formula, 25 cents coin. Davis, Lock Box 735, Kansas City, Mo.

RECIPES—9 INKS, LIQUID GLUE, water proof blacking, rubber stamp ink, all 6c. Ladies' Art Co., Dept. 41, St. Louis, Mo.

HANDCUFFS, LEGIRONS, NIPPERS, etc., repairs, keys, handcuffs, \$2.50 pair up. Frank Widmayer, 2312 Broadway, New York City.

50c BRINGS 5 FORMULAS and full instructions for metalizing, mounting and coloring flowers, insects, etc., for jewelry. Easy home work. Big profits. P. Benson, Stewartville, Minn.

TEN DANDY FORMULAS for 5 names and addresses and 4c. P. Benson, Stewartville, Minn.

FIREPROOFING FORMULA; easily and cheaply prepared. Fireproofs all inflammable goods; can be used without danger; known to be effective. Formula 50 cents. Ezra Stiedinger Fairbury, Ill.

FORMULAS for anything, 25 cents. D. B. Croy, 228 Nye St., Lima, Ohio.

CORRECT FORMULAS, 20c each. Malalane Company, 1411 Longfellow Ave., New York.

TRANSFER PHOTOS TO WATCH CASES, chinaware, sofa pillows, etc. New process. Very profitable. 25c brings full instructions. P. Benson, Stewartville, Minn.

SHOE LACES, 6 pairs 20c. Big value. Ladies or gents. P. O. Box 57, Sandusky, Ohio.

MERRY-GO-ROUND for children. Anyone can build for \$5. Complete plans, two dimes. Inventor, 1331 Millard Ave., Chicago.

WATCH FOR ONE hour's work, we want to give one to every boy and girl; send red stamp, no money. St. Louis Specialty Co., 2628 Jefferson, St. Louis.

"CACHOO," the genuine sneeze producing powder. Sample with catalogue, 12c. Percy Ewing, Decatur, Ill.

SELF-FILLING Fountain Pen. Worth \$2.00, now 50c. P. O. Box 57, Sandusky, Ohio.

PATENTS SECURED—C. L. Parker, ex-examiner Patent Office, 910 G St., Washington, D. C.

12 PIECE SECRETARY'S OUTFIT—Finest writing material. Just what you are looking for. Just what you must have. Contents: 6 goldline pens; 1 reversible penholder; 1 fountain pen; 1 auto pencil; 1 tube leads; 1 package ink powder; 1 glass pen for linen marking. All in neat labeled box. Good honest goods. Only \$1.00. Don't miss this bargain. R. Williams Supply, Box 282, Perry County, Newport, Pa.

YOUR MONOGRAM OR INITIAL on your stationery embossed with my new steel-die nickel plated embosser is as "swell" as the highest grade work. Single initial, 25c. Monogram, 50c. Send stamp for specimen sheets. See the work you'll want one. H. L. Miller, Distributor, Marietta, Ga.

MODEL—STEAM AND GASOLINE ENGINES, Dynamos, Motors, Motor Boats, etc. We have them or you can build them with our castings and instructions. Send two cents for illustrated booklet. The B. A. B. Model & Mfg. Co., Room 536B, Singer Bldg., 149 Broadway, N. Y.

WORTH DOLLARS TO YOU! Either sex. Dime brings guaranteed high class money-making proposition. Samples, directions, etc., ready for immediate operation. Brown's Delicacy Supply, 722 W. 3rd St., Los Angeles, Cal.

WONDERFUL INSTANTANEOUS CALCULATOR. Multiplies, divides, handles fractions, decimals, percentages, discounts, etc., almost instantly. Cloth, \$1.00. Unbound, 50c. Michigan Novelty Co., Detroit.

CATALOGUE OF RUBBER STAMPS and sample of Stuart's printer pencils free. W. M. Stuart, Marshall, Mich.

**CORRUGATED PAPER BOXES.** Bottle wrappers and Mailing Tubes, etc. Best Box Builders, 4337 North 16th St., Philadelphia, Pa.

**KNOUSE'S WONDERFUL LOCK SECRET** exposed. A marvelous mechanical mystery that has defied expert locksmiths. Complete explanation, 25 cents, no stamps. J. McDonough, No. 908 17th St., Altoona, Pa.

**MANUFACTURE** remedies and toilet articles. One hundred formulas, 25c. P. C. Bruckner, 1218½ Elm St., Dallas, Texas.

SEE OUR AD page 39. Western Puzzle Works.

**RENEW DRY BATTERIES,** Metalize Flowers, Transfer Photos to Watch Dials. Formulas 10 cents each, 3 for 25 cents. Mail Order Bureau, Box 283, Scranton, Pa.

**HANDSOME OPAL RING** absolutely free. No money required. Write today. Mail Order Co., Manchester, Md.

**DRY BATTERIES** renewed by anyone for 10c to 25c per doz. Saves half your battery expense. Particulars free. Fairmount Co., Leightons Corners, N. H.

**ANYBODY CAN MAKE GOOD CUTS** with my simple zinc etching process; price, \$1; write for specimens and particulars. T. M. Day, Box M, Windfall, Ind.

**CITY GONE "DRY"**—Must sell coin operated pianos and harps. Box 965, Ashtabula, Ohio.

**WRITE TODAY,** for free booklet explaining our plan of furnishing legal advice, medical advice, mechanical advice and the best advice and information on any subject in which you may be interested. National Bureau of Advice, 41 Jackson Blvd., Chicago.

**PERSONAL MAGNETISM WINS.** 120 page book 25c. Larger one, 148 pages, 30c. "How to Win Success in All Things," 352 pages, \$2.00. Everything mentioned for \$2.35. "Hypnotic Wonders" and Catalogue free. Popular Institute, Normal "El" Building, Chicago.

**WRITE US FOR OUR BOOK,** how to make money at home, only 10c. T. A. Walker Supply Co., Yonkers, N. Y.

**I WILL START YOU** earning \$4 daily at home in spare time, silvering mirrors; no capital; send for free instruction booklet, giving plans of operation. G. F. Redmond, Dept. 306, Boston, Mass.

**MOTION PICTURE MACHINES.** Film Views, Magic Lanterns, Slides, and similar Wonders For Sale. Catalogue Free. We also Buy Magic Machines, Films, Slides, etc. Harbach & Co., 809 Filbert St., Philadelphia, Pa.

**TRICKS, JOKERS, PUZZLES, ILLUSIONS,** Novelties—Magic Pocket Trick Free. Illustrated Catalog included. Send 6c stamps. Magic Dept., 10-270 West 39th St., New York.

**TOBACCO CAUSES CHRONIC IRRITATION** of brain and nerve cells. Ni-Ko heals this irritation. You don't want tobacco any more. You will feel so good. Write today. King Ni-Ko, 7, Wichita, Kans.

**BROTHER**—Accidentally discovered root will cure tobacco habit. Gladly send particulars. F. Stokes, Moltaw, Florida.

**"TEXTIGUM" TYPEWRITER COVERS,** fine, 50c. See what I say under "Typewriters." Atchison.

**YOUR AD** in over fifty magazines 3 months, 5 cents per word. A. S. Mankin & Co., Alexandria, Va.

#### TOO LATE TO CLASSIFY

**POSITIVELY BEST RIBBONS,** three, \$1.10. See what I say under "Typewriters." Atchison.

**BE A TRUE AMERICAN.** Decorate your room, den or office with a beautifully colored picture of the Capitol, White House, Mt. Vernon and Congressional Library. Size 5"x10½" all for 25 cents, or any two for 15 cents, postage paid. Address E. J. Hutter, Collins, Guerry Bld'g., Washington, D. C.

**AGENTS**—We manufacture specialty never placed on market before. Not for sale in stores. Household necessity. Sample and particulars 10c. LeRoy Speciality Co., 76 Park Place, Room 52, New York.

**RAINCOATS**—"FROM MAKER TO WEARER" at Manufacturers' prices. Write for particulars and samples. Agents Wanted. Regal Raincoat Co., Dept. 69, 1367 Broadway, New York

**TEN ORE SPECIMENS**—Gold, silver, copper, iron, lead, zinc, tin, nickel, graphite, sulphur. Also mineral booklet, 25c. McLaughlin, Sharpsville, Pa.

**3,000 STICKERS** 96c—Twenty styles. Trial order convinces. Samples Free. M. Terrace Mfg. Co., Pittsburg, Pa.

**MODEL PLANS, DESCRIPTIONS,** Bieriot type, 10c, easily made. Complete knock down bi-plane, ready to assemble 50c. Modelaero Company, 714 Grosse Building, Los Angeles, Cal.

**BLERIOT MONOPLANE,** Aluminum, bamboo construction. 30' flier. Roberts, 344 Cumberland, Brooklyn, N. Y.

**WHITE STEAMER,** five passenger, good tires, top, gas generator and lamps. Guaranteed in first class condition. Photo if wanted. \$500 cash. C. B. Pennock, Franklin, Tenn.

**FOR SALE**—One new 4 cylinder automobile engine with magneto and clutch. Bert Monn, Goshen, Ind.

**FOR SALE**—R. S. TWIN magneto Motorcycle, excellent condition \$125.00. Glen Smith, St. Joseph, Mo. Care Brown Transfer.

**WROUGHT IRON** house heating boiler; 23 inch firepot; new; half wholesale price. F. Booth, Stanley, N. Y.

**YOUR HANDWRITING IMPROVED** by my new, easy method in a short time at a small cost. Write for circulars. Francis B. Courtney, Cedar Rapids, Iowa.

**FOR SALE** 2 H. P. 4 cycle boat engine, carburetor, \$18.50. F. W. Steffen, 635 W. 4th St., Spencer, Iowa.

**LIVE AGENTS WANTED,** fast sellers, big profit. Dennis and Co., East Las Vegas, N. M.



## Strikes Fire Without Matches!!

### McLaughlin's "Imperator" Pocket Lighter

makes an instantaneous flame of fire every time you press the button. It operates with one hand and takes the place of matches in the vest pocket. It is smaller than a match safe and makes 1000 lights with 60 drops of benzine. Lasts for years and operates without winding or scratching—just push the button. Take this adv. to your Druggist or Cigar Dealer and get one if stamped "McLaughlin's Imperator." If not stamped "McLaughlin's" we will send you one by insured mail upon receipt of \$1 to

**McLAUGHLIN SALES COMPANY**  
Office 622—705 Olive Street ST. LOUIS, MO.

Exclusive Licensed Manufacturers for America



## SLIDING FURNITURE SHOES

replacing castors. Save Carpets, Polished Floors, Slide like a flat-iron. Sell quickly on Demonstration.

**AGENTS WRITE QUICK**

**FAIR MFG. CO., FM73, 5th St., RACINE, WIS.**

## Want This Suit?

Show our samples to three of your friends, take two orders easy and make profit enough to get this swell tailored suit free. No trouble, simply show our new up-to-date samples. Everybody surprised, prices so low, styles so beautiful, orders come easy. We pay the express and guarantee perfect fit or no sale. You can make \$5.00 a Day Easy. Write quick and get samples and agents' outfit free, everything explained, and special inside price on a suit for yourself. It's a wonderful chance.

**BANNER TAILORING CO., Dept. 18, CHICAGO**



## "BRIGHTENSALL"

(POLISHING CLOTH)

**MAKES ALL METALS LOOK LIKE NEW**

"Brightensall" the newly discovered **MOIST POLISHING CLOTH.** Always ready. DOES NOT DRY UP—instantly polishes all metals, silverware and jewelry. WILL NOT scratch. Leaves no "white dust" around edges; superior to pastes, powders or liquid polishes. For household use, and for polishing automobiles, motor boats, bicycles, brass signs cannot be equalled. Package (two pieces.) sent postpaid for 25c. 3 packages for 50c. Use "Brightensall" to save time, temper, and extra work. Agents (either sex) and dealers wanted.

**LITHOLIA PM. MFG. CO., West 125th Street, NEW YORK**

We have for sale a limited number of complete files of

## Popular Mechanics for 1909

These consist of the 12 issues of the magazine and a complete index suitable for binding.

**Price \$1.25 postpaid**

**POPULAR MECHANICS, 225 Washington St., CHICAGO**

**WHEN YOU WANT ANYTHING AND DON'T KNOW WHERE TO FIND IT**

**WRITE BUREAU OF INFORMATION,**

**POPULAR MECHANICS**

**CHICAGO**

## FREE UPON REQUEST

OUR

**Valuable 96-Page Catalogue**

OF THE

## Best Mechanical Books

It is well worth having and keeping for reference.

**Popular Mechanics Book Dept.**

318 W. Washington Street, Chicago

# Working Drawings of the "Demoiselle"

Price \$2<sup>00</sup>  
Postpaid

SANTOS-DUMONT'S  
Remarkable Aeroplane

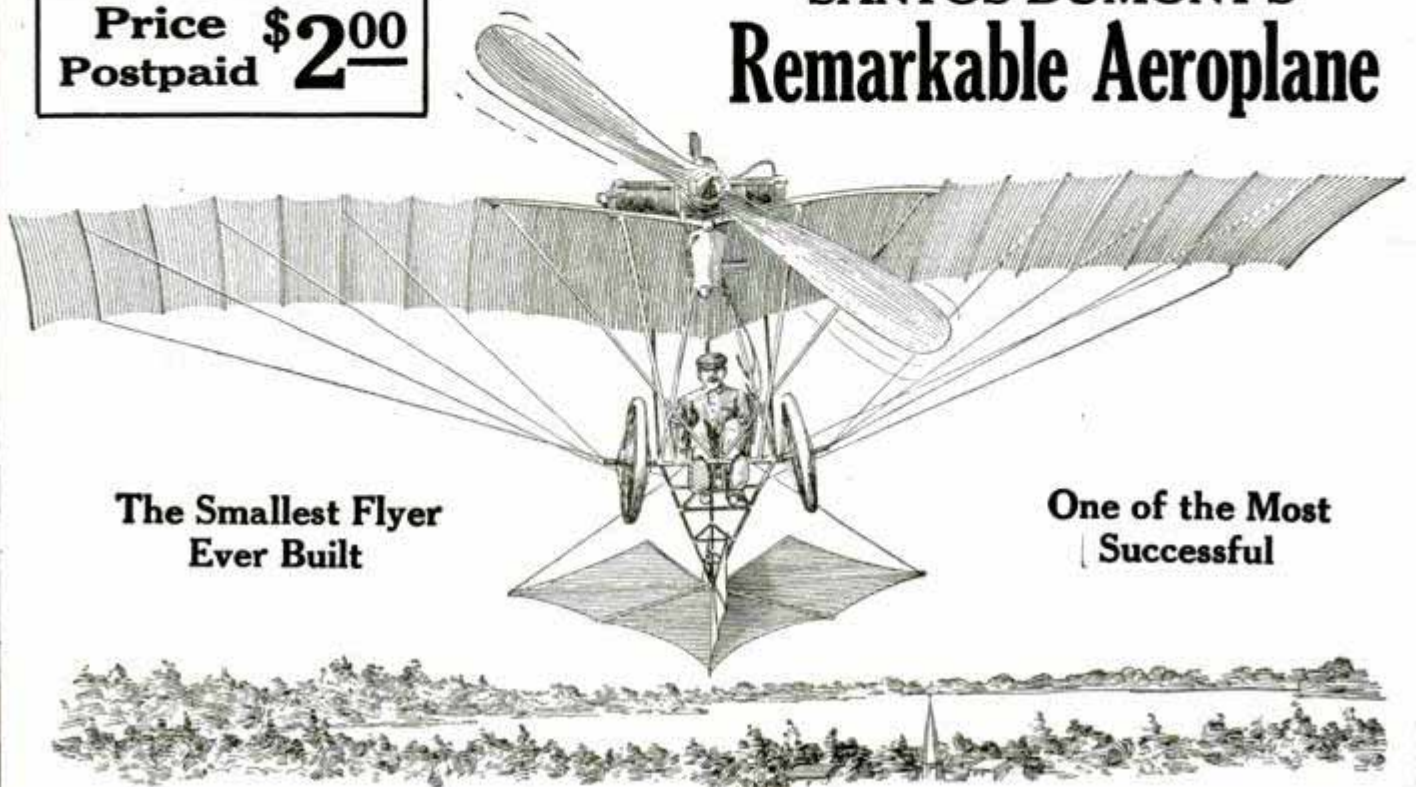

The Smallest Flyer  
Ever Built

One of the Most  
Successful

Complete plans for the construction of the wonderful monoplane offered to the public for the first time.

The machine is unencumbered by patent rights, the famous aviator preferring to place his invention at the disposal of the world in the interest of the art to which he has devoted his life. These plans were secured by representatives of Popular Mechanics from Santos-Dumont, and are the result of consultations with his engineers and observations made at his workshops.

## How the "DEMOISELLE" Ranks With Other Machines

*From New York Times, October 9, 1910.*

"M. Garros, famous French aviator, uses a Demoiselle aeroplane, the invention of Santos-Dumont, which has proved to be one of the most interesting types of flying machines in Europe. It has been called the humming bird of the heavier-than-air brood. It is the smallest flying machine in existence, weighing less than 250 pounds. It is capable of enormous speed, and darts about through the air in a way that has provoked both laughter and wonderment from the crowds at the European meetings. Garros is by far the most expert driver of these little machines in Europe. During the past season he has made remarkable flights in various places, but his flights from Pinard to St. Malo, over the water, have been regarded as most remarkable. While these baby monoplanes in the hands of ordinary pilots keep very close to the ground, Garros has driven his machine to great altitudes, and has taken his place in many of the important contests of France with the larger monoplanes."

*The set comprises seven large blue prints, showing every detail of construction, accompanied by a description of how to build.*

## POPULAR MECHANICS COMPANY

318 W. Washington Street, CHICAGO, ILLINOIS

# Mission Furniture

## HOW TO MAKE IT

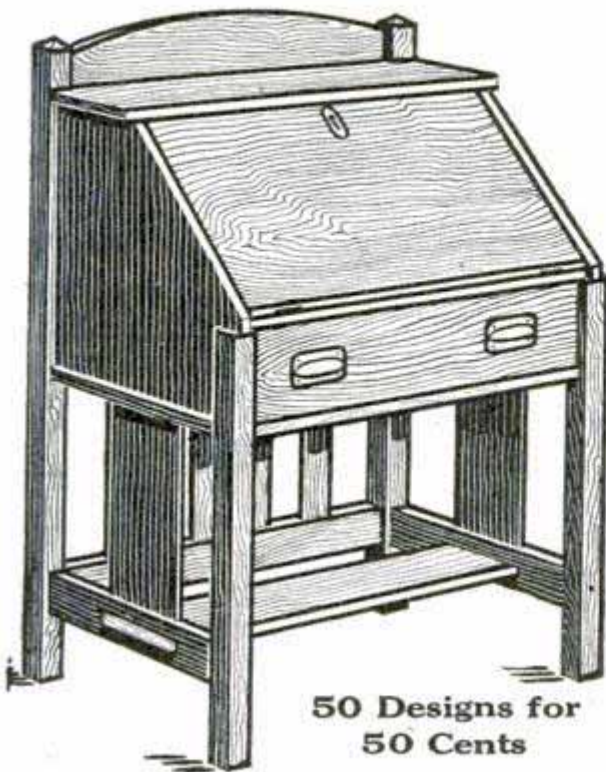

50 Designs for  
50 Cents

### Read What One Man Did

Hattiesburg Miss  
Aug 19, 1910  
Popular Mechanics Co.,  
225 Washington St Chicago.  
Sirs -  
Please find enclosed  
25¢ for which send me  
Part Two Mission Furniture  
How to make it, by mail post  
paid I have part 1, and have  
made one pe. of ~~the~~ furniture  
and sold \$400.00 Four hundred  
dollars worth of it, and I am  
not a carpenter either but with  
the instructions written so I  
can understand it I have a business  
of my own. Yours truly  
John D. Pleman

### TWO VOLUMES

PART ONE

PART TWO

21 Designs. 96 Pages. | 32 Designs. 128 Pages.

Cloth Cover. 25 Cents Each, Postpaid

POPULAR MECHANICS BOOK DEPT.

318 W. Washington Street, CHICAGO

Please Mention Popular Mechanics

# S'pose We Gave YOU

**\$35.00**

Weekly!

Would  
You  
Accept?

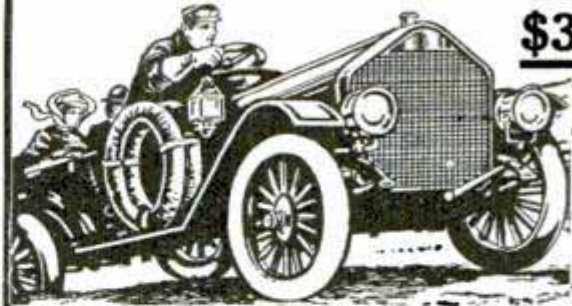

**OF COURSE YOU WOULD! THEN,**

help us do so by sending for our prospectus with Free Samples of Lessons, etc. You will see then how Easy it is! Become an expert Automobilst, Wireless Telegrapher or Aviator by means of our Home Study Course. Such experts

**Earn \$35 to \$60 A Week**

You can learn in few weeks' time, and Small Payment Starts You. We assist to better your position. Post-graduate Course in Automobile operation, etc., to those who desire it. Valuable models Free to every student. This is YOUR opportunity.

**TEAR OFF, FILL IN AND MAIL COUPON**  
BUFFALO  
AUTOMOBILE SCHOOL  
300 Edward Building, Buffalo, N. Y.

Automobile  
 Wireless Telegraphy  
 Aviation

Send me free books  
and literature on  
subject marked X.

Name.....

P. O. Address.....

City..... State.....



TOP-28x42

**STOCK & WORKING DETAILS FOR THIS TABLE \$75**  
ALL THE DIFFERENCE BETWEEN THIS ANY K.D. FURNITURE IS THE BORING OF DOWEL HOLES, SANDPAPERING THE WOOD SMOOTH. ALL THE STOCK IS OF THE BEST GRADE OF OAK, KILNDRIED & DRESSED SMOOTH. THE TOP IS IN ONE PIECE. THE END PIECES ARE BANDSAWED TO SHAPE. WE WILL FURNISH MATERIAL & WORKING DETAILS FOR ANY PIECE OF MISSION OR FLANDERS FURNITURE AT PROPORTIONATE PRICES  
**FURNITURE-STOCK-CO.**  
217-CHAMBER-COMMERCE-BLDG, CHICAGO.



**I TEACH BY MAIL**

WRITE FOR MY FREE BOOK

"How to Become a Good Penman"

and beautiful specimens. Your name elegantly

written on a card if you enclose stamp. Write

today. Address F. W. TAMBLYN, 418 Meyer Bldg., Kansas City, Mo.

**WHEN YOU WANT ANYTHING AND DON'T KNOW  
WHERE TO FIND IT—WRITE BUREAU OF  
INFORMATION, POPULAR MECHANICS, CHICAGO**

### Increase Your Earnings!



Train yourself for a responsible position, educate yourself to increase your earning capacity and fit yourself for a professional life by studying

## DRAFTING

Our courses are the most practical ever planned and cover all branches. Hundreds of plans of buildings and machinery in course of construction are at the disposal of students, who can also inspect actual work of construction. Short, practical courses, full or sectional courses, as needed; day and evening classes. Students assisted to obtain positions while attending school. Entrance can be made at any time—no examinations required. Start at once your step towards a lucrative career—call, or write for catalogue. Do it today.

Correspondence Courses in Architectural, Mechanical and Structural Drafting and Design, Plan Reading, Estimating, etc. If interested in correspondence courses, write for Folder No 2.

CHICAGO TECHNICAL COLLEGE, 603 Athenaeum Bldg., CHICAGO

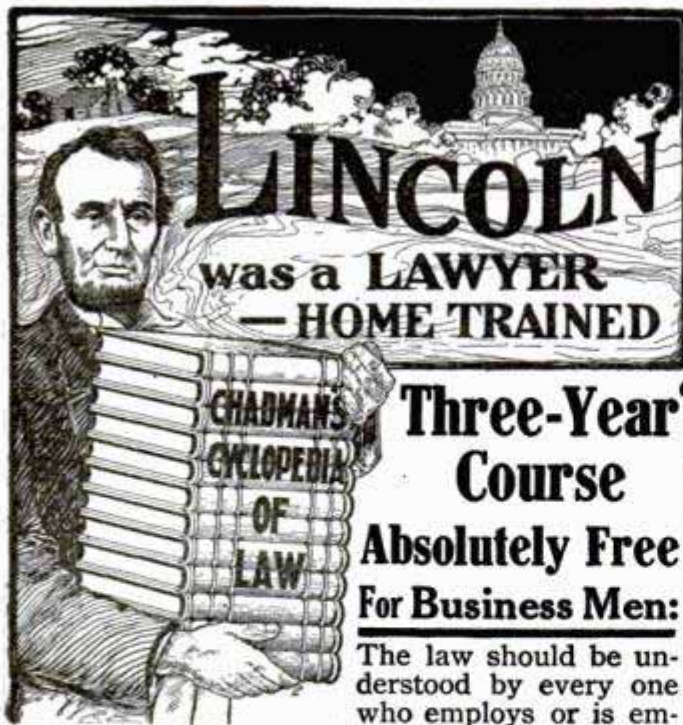

# LINCOLN

was a **LAWYER**  
— HOME TRAINED

## Three-Year Course Absolutely Free For Business Men:

The law should be understood by every one who employs or is employed, especially that branch which pertains to a particular trade or profession. A correct understanding of the law will prove to be worth thousands of dollars to every business man during the course of his career. Can't you, as a business man, see where you have lost opportunities to protect yourself, or to make money, had you possessed a knowledge of law at the time? By our method of instruction, you can acquire a knowledge of the law without interfering with your business in any way.

**To the Law Student:** Law offers greater opportunities to the young man than any other profession. Nineteen of the twenty-six presidents of the United States were lawyers, and a large number of the members of the Senate and House of Representatives, at Washington, are lawyers. There is no profession so profitable, none so honorable. We assist the law student; we direct his study; we tell him what to read, how to read, how to absorb the contents of the different books, and pave the way and make the road to a legal education easy to travel.

Don't you want a knowledge of the law? Our course is absolutely free to a few. Don't you want to be one of the few? Judge Chadman, a graduate of the University of Michigan, after years of study, has just completed and perfected a plan whereby every business man or law student can obtain a legal education at home without interrupting his regular work. To introduce this plan, Judge Chadman has authorized us to give away, absolutely free, a limited number of complete three-year scholarships in this school. The course suggests text-books, supplies examination questions, lectures on law subjects written by eminent jurists, and a three-year Consulting Certificate. Upon satisfactorily completing course, the school issues a final credit Diploma.

If you are interested in securing one of these free scholarships, sign the attached coupon and mail it to us at once.

### AMERICAN CORRESPONDENCE SCHOOL OF LAW 1325 Michigan Boulevard, CHICAGO, ILLINOIS

GENTLEMEN:

Without obligation to me, please send at once full information regarding free scholarship in your School of Law.

NAME.....

STREET.....

OCCUPATION.....

CITY.....STATE.....

Please Mention Popular Mechanics



## WANTED CHAUFFEURS

Big demands from manufacturers, dealers and owners. Good wages—steady, pleasant employment. We teach how to run and repair any automobile by mail. Most complete Auto School in the world. Satisfaction guaranteed or money refunded. Complete course only \$15.00. Enroll now—small payment down—balance weekly payments. No extra charge for practical instruction, under personal supervision of C. A. Coey, America's premier autoist. **FIRST LESSON FREE.** Write for it today.

**C. A. COEY'S SCHOOL OF MOTORING**  
DEPT. H, 1426 MICHIGAN AVENUE, CHICAGO, ILL.

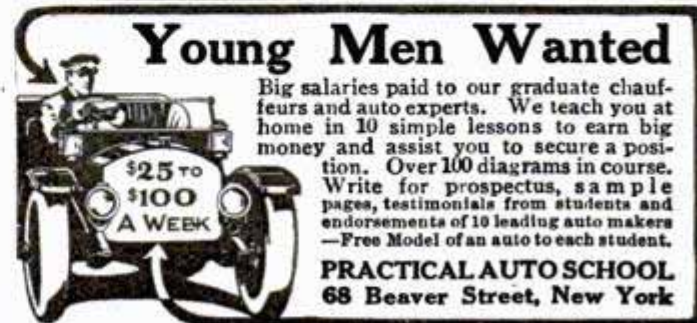

## Young Men Wanted

Big salaries paid to our graduate chauffeurs and auto experts. We teach you at home in 10 simple lessons to earn big money and assist you to secure a position. Over 100 diagrams in course. Write for prospectus, sample pages, testimonials from students and endorsements of 10 leading auto makers —Free Model of an auto to each student.

**PRACTICAL AUTO SCHOOL**  
68 Beaver Street, New York

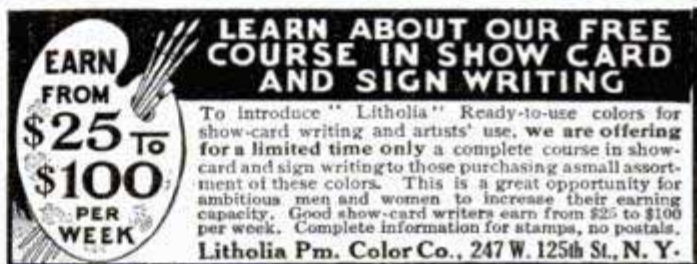

## LEARN ABOUT OUR FREE COURSE IN SHOW CARD AND SIGN WRITING

EARN FROM  
**\$25 TO \$100**  
PER WEEK

To introduce "Litholia" Ready-to-use colors for show-card writing and artists' use, we are offering for a limited time only a complete course in show-card and sign writing to those purchasing a small assortment of these colors. This is a great opportunity for ambitious men and women to increase their earning capacity. Good show-card writers earn from \$25 to \$100 per week. Complete information for stamps, no postals. Litholia Pm. Color Co., 247 W. 125th St., N. Y.



## LEARN AUTOMOBILE BUSINESS IN THE FACTORY.

After 4 years of successful operation we have consolidated our school with an automobile factory. We teach the theory by mail and finish each student right in the factory. This is the best way to learn the automobile business. We employ all students. For photos of our factory and full information, write for Plan F.

**Automobile College of Washington, Washington, D. C.**



## LEARN TO WRITE IF YOU ARE EARNING ADVERTISEMENTS LESS THAN \$25 A WEEK

we can positively show you by mail how to increase your salary. Send for beautiful prospectus, mailed FREE.

**PAGE-DAVIS SCHOOL, Dept. 112, CHICAGO, ILL.**



## BE A SALESMAN

### Earn While You Learn!

Trained Salesmen make from \$1,200.00 to \$10,000.00 a year and expenses. Hundreds of good positions now open. No former experience needed to get one of them. We will teach you to be a Salesman by mail in eight weeks and assist you to secure a position where you can earn a good salary while you are learning. Write today for our free book, "A Knight of the Grip" which contains full particulars about how to get one of the hundreds of good positions we now have open, also testimonial letters from hundreds of men we have recently placed in good positions. Address nearest office, Dept. 124.

**National Salesmen's Training Ass'n.**  
Chicago New York Kansas City  
New Orleans Seattle, U. S. A.



# LOOKING STRAIGHT AHEAD INTO YOUR FUTURE

**CAN YOU SEE WHERE YOUR PRESENT OCCUPATION IS GOING TO LAND YOU?**

Can you continue in your present line of business long enough to lay aside sufficient money to live comfortably in later years, or will your strength and earning power give out while you are dependent upon your salary?

You must support yourself *now* and provide means for those rainy days that are coming.

You live in deeds, not years—in thought, not breath. You should count time by profits, not earnings. He most lives who thinks most, feels the noblest, acts the best, and makes provisions for the future.

The earnings of a Chiropractor range from \$250.00 to \$1,500.00 per month. The work consists of saving lives and removing the cause of sickness and affliction of suffering humanity.

One of our middle aged graduates made more money in his first 20 months of practice than he had earned in his *whole previous life*. Why this success? He learned a *new profession at the best institution*.

You can learn Chiropractic. You can accomplish the same results. Our *home study course* is within your reach. Payments on monthly installment plan.

Write for our Free Book "The P. S. C. Way to Health for Wealth," and catalog FREE.

**Write Now!**

And learn how to become a "Doctor of Chiropractic."

**PALMER SCHOOL OF CORRESPONDENCE**

Department P. M  
DAVENPORT, IOWA



# "HELP WANTED"

-Uncle Sam.

**Railway Mail Clerks**  
Clerks in the Departments at Washington, D. C.  
City Carriers — Postoffice Clerks

Over 15,000 positions will be filled during 1911.

**\$800.00 to \$1800.00 a Year for LIFE**

No "layoffs" without pay, because of strikes, financial furies or the whims of some petty boss. Excellent opportunities for quick advancement to Higher Government Positions. If you want immediate appointment, send **TODAY** for our schedule showing locations of the coming examinations. Any delay means the loss of just so much time in preparing yourself for examination.

**We Prepare Candidates Free**

SEND COUPON BELOW

**FRANKLIN INSTITUTE**

Dept. K 109, ROCHESTER, N. Y.

The coupon, filled out as directed, entitles the sender to a free copy of our book, "Government Positions and How to Obtain Them," and to consideration for Free Coaching for the examination here checked.

**COUPON**

- |                         |                   |   |                   |
|-------------------------|-------------------|---|-------------------|
| .... Railway Mail Clerk | [\$800 to \$1400] | .... Customs Positions                      | [\$600 to \$1500] |
| .... Postoffice Clerk   | [\$800 to \$1200] | .... Internal Revenue                       | [\$700 to \$1800] |
| .... Postoffice Carrier | [\$800 to \$1200] | .... Stenographer                           | [\$800 to \$1500] |
| .... Rural Mail Carrier | [\$500 to \$ 900] | .... Clerk in the Departments at Washington | [\$500 to \$1500] |
| .... Bookkeeper         | [\$900 to \$1800] |   |                   |

Name .....

Address ..... K 109

*Use this before you lose it. Write plainly.*

# LEARN THE AUTO BUSINESS

## EARN A SPLENDID SALARY

Chauffeurs, Auto Salesmen, Repairmen, Testers, Assemblers and Inspectors are in demand at big salaries. We have trained hundreds for good positions. Our home study course covers mechanism, operation and repairing and prepares for the best positions. Let us train you in your spare time and put you in line for a good auto job. Results guaranteed or no pay. Send today for free catalogue and names of successful graduates.

**CLEVELAND AUTOMOBILE SCHOOL, 2167 East 9th St., Cleveland, Ohio**  
"THE SCHOOL THAT MAKES GOOD."

## Learn Telegraphy

**MORSE and WIRELESS**

At My Practical School. Demand for operators greater than supply. We also teach Station Agency Work. Graduates assisted. We occupy our own 2 large modern buildings equipped with R. R. Dispatchers and Western Union Wires and Wireless Station. Endorsed by Railroad, Wireless and Western Union Officials. Exclusive Methods. Teachers are practical experts. Living expenses earned. Easy payments. Catalogs Free. Correspondence course if desired. **GEORGE M. DODGE, Pres., Dodge's Institute, 8th St., Estab. 1874, Valparaiso, Ind.**

# LEARN TO REPAIR AND RUN AUTOMOBILES

## EARN BIG MONEY IN AUTOMOBILE BUSINESS

as a chauffeur, repairman, salesman. Work pleasant. Big demand for trained men. Fine chances for starting automobile livery, agencies, taxicab and repair companies. Learn the automobile—every part, and its mechanical operation thoroughly and practically in a few weeks. **Write today for our interesting free book** and learn about the tremendous opportunities everywhere in

this new business and our excellent course of training.  
**KANSAS CITY AUTOMOBILE SCHOOL**  
(Conducted by CLIFF HOGAN)  
(Largest and Best Equipped Automobile School in America)  
2139 E. 15th Street, Kansas City, Mo.



## I Can Increase Your Earnings

If you want an independent business of your own requiring no capital, mail your name and address and let me send you our **Big Free 62-Page Book** showing how you may earn \$3,000 to \$10,000 a year in the

**Real Estate, Brokerage and Insurance Business**

Our system is a positive success. It equips you to conduct these money making branches and gives you a valuable Commercial Law Course Free. Clerks, Book Keepers, Salesmen, Agents, Solicitors and others should investigate this. Send no money, simply your name and address and I will mail you our **Big 62-Page Book, absolutely free**. Write today.

**International Realty Corp., 1636 Manhattan Bldg., Chicago**  
Successors to The Cross Co. and H. W. Cross & Co.



**\$45 to \$300 a Month  
Through I. C. S. Training**

Mr. O. J. Gibboney, Erecting Engineer, No. 300 Eagle St., Mount Pleasant, Pa., who is now engaged in a responsible position as erecting engineer, writes to the I. C. S. as follows:

"In 1906 I was working in a large steel plant for the small sum of \$45 a month. Knowing of the I. C. S., I decided to take up a Course and push to a better position. July 9, 1906, I began a Course of Complete Steam Engineering, and two months later I was rewarded with an increase in wages of \$5 a month. November 1, 1906, I was offered a position in the same plant at a salary of \$90 a month. January 30, 1907, I accepted a position at \$115 a month, and in July of the same year my salary was increased to \$150 a month. In October, 1909, I again accepted a position netting me \$175 a month, and on June 1, 1910, my salary was increased to \$300 a month—about 550 per cent. more than the salary I received when first taking up my Course."

Would you be willing to make a small investment that would increase your salary 50, 100, 200, or 500 per cent.?

If you are not satisfied with your present position mark and mail the attached coupon. Doing so will cost you only postage and will place you under absolutely no obligation.

**Send this Coupon NOW.**

**INTERNATIONAL CORRESPONDENCE SCHOOLS**  
Box 872, SCRANTON, PA.

Please explain, without further obligation on my part, how I can qualify for the position, trade, or profession before which I have marked X.

Stationary Engineer	Civil Service	} Spanish } French } German } Italian
Telephone Expert	Architect	
Mechanical Engineer	Chemist	} Banking } Building Contractor
Mechanical Draftsman	Languages	
Electrical Engineer	Architectural Draftsman	} Industrial Designing } Commercial Illustrating
Electric Lighting Supt.	Window Trimming	
Electric Wireman	Show-Card Writing	} Advertising Man } Stenographer
Automobile Running	Concrete Construction	
Mine Superintendent	Civil Engineer	} Bookkeeper
Mine Foreman	Textile Manufacturing	

Name \_\_\_\_\_  
St. & No. \_\_\_\_\_  
City \_\_\_\_\_ State \_\_\_\_\_

Please Mention Popular Mechanics



Working on Dynamo



Home of the Schools

**FREE**—Large Illustrated Book of the School. Write Today.

**COYNE NATIONAL TRADE SCHOOLS**  
57 East Illinois Street, CHICAGO, ILL.

**STOP!!  
Looking for  
WORK**

Come to the COYNE NATIONAL TRADE SCHOOLS, quickly learn to be an  
**Electrician, Plumber  
Bricklayer  
Painter and Decorator**  
or start a Business of your own and you will always have  
**WORK LOOKING FOR YOU**

Trades that pay \$5 to \$8 a day the year 'round. Anybody can learn in the right school. Come here. Most thorough, practical trade school in the world. No books, but tools instead. Individual teaching. Low expense. Success assured. Graduates never out of work.

**PRACTICAL  
ELECTRICAL  
EDUCATION**

We teach by practical work and scientific methods under practical working conditions. All branches of Electrical Science and Engineering.

Students can enter at any time for the full or special courses.

No matter what your education, we start you at the very point you are competent to begin. By our system of individual instruction you can complete our course as quick as your ability warrants. We guarantee positions. Many of our students have started to earning from \$1500 a year and up immediately upon completion of course.

Handsome Illustrated Catalog 6, giving full particulars FREE, upon request. FREE SUMMER SCHOOL BEGINS JUNE 19th, 1911

**School of Engineering** 1021-27 Winnebago St. MILWAUKEE, WIS.

**Government Positions**

45,837 Appointments were made to Civil Service places during the past year. Excellent opportunities for young people. Each year we instruct by mail thousands of persons who pass these examinations, and a large share of them receive appointments to life positions at \$840 to \$1,500 a year. If you desire a position of this kind, write for our Civil Service Announcement, containing full information about all government examinations and questions recently used by the Civil Service Commission.

**COLUMBIAN CORRESPONDENCE COLLEGE, WASHINGTON, D. C.**

**LEARN WATCHMAKING**

refined, profitable labor—Competent men always in demand. We teach it thoroughly in as many months as it formerly took years. Does away with tedious apprenticeship. Money earned while studying. Positions secured. Send for catalog  
**St. Louis Watchmaking School, St. Louis, Mo.**

**BE AN  
AUCTIONEER**

Send self-addressed stamped envelope for particulars. I teach it by mail.  
**O. A. Smith, Room H 30, 823 Bigelow St., Peoria, Ill.**

**LEARN WATCHMAKING  
AT HOME**



You can learn by our modern and original system of instruction every part of the Watchmaker's Trade at home as good or better than at a shop. You can earn money while learning and secure a well paying position or start in business after completing our course of instruction. Good watchmakers are always in demand and earn from \$20 to \$35 per week. For particulars apply to the WISCONSIN SCHOOL OF WATCHMAKING, Enterprise Bldg., MILWAUKEE, WIS.

# Make \$25 to \$75 Weekly Be a Watchmaker!

## Let us Start You in Business for Yourself

You can learn this high class, gentlemanly and extremely profitable trade in a few weeks without leaving home or quitting your present occupation.

Best of all, we will teach it to you without any cost whatever.

**We furnish you absolutely free**—text books, necessary lessons, illustrated chart and photo prints, showing exactly how to repair each job, no matter how complicated. You won't have to spend a penny except to buy a few tools as you need them while you are learning.

## LIVE PARTNERS WANTED—Capital Furnished

In order to quickly open up new fields for our unequalled line of goods, our directors have decided to establish a number of men in this **best of all businesses**; take them into partnership with us so that they, with us, may reap the benefits of our capital and long experience and profit from their own integrity, brains, business ability and character.

**We Will Stand Back of Hustlers** to the limit and will leave them a big success. With our backing and instruction you should soon become one of the **moneyed men in your community**. The profits in the jewelry business are immense; the field has not even been scratched; the opportunity to become prosperous is now open. **These letters prove** that success is within your grasp—almost as surely as day follows night. I personally want to clearly lay our plans before you. Won't you write me today.

**CHAS. F. ELMORE, Principal of Watchmaking College**

Royers, Thurman & Co.,

101-103 N. Wabash Avenue, Chicago



Thank you for starting me in this business. Monday and Tuesday I made \$19.85 at my work bench, and sold four watches, netting me \$27 for two days. I get at least half the work of this place and have been open but 10 days.—D. C. Files.

I can do any kind of repairing. Thank you for your assistance in starting me. Business growing all the time.—Henry Baker.

Your instructions are very easy to follow. I have just commenced, and have cleaned and repaired 8 watches and 2 clocks. Repair work is coming as fast as I can take care of it.—W. W. Hass.

I made \$3 the first day after I got my tools in operation, and average one to three repair jobs a day.—A. A. Hilley.

Your instruction books and charts are simply fine. I am doing a good business. All my customers pleased.—J. O. Curry.

## Mackay School of Mines

University of Nevada

Best equipped mining school in the country—all buildings of special construction. Faculty composed of prominent engineers and every department is in charge of experienced instructors. Located close to great mining district—students can make money and gain practical experience during vacations. Splendid climate—every opportunity for outdoor life amidst beautiful surroundings. Summer school of Mine Survey and Geology begins May 18th. (Eight weeks' course.) Regular term opens Aug. 14th. Endowed by Clarence H. Mackay, 253 Broadway, New York. For detailed information address

JOSEPH E. STUBBS, President, Dept. 14, Reno, Nevada

### COPY THIS SKETCH

and let me see what you can do with it. You can earn \$20.00 to \$125.00 or more per week, as illustrator or cartoonist. My practical system of personal individual lessons by mail will develop your talent. Fifteen years successful work for newspapers and magazines qualifies me to teach you. Send me your sketch of President Taft with 6c. in stamps and I will send you a test lesson plate, also collection of drawings showing possibilities for YOU.

**THE LANDON SCHOOL** OF ILLUSTRATING and CARTOONING  
1438 Schofield Building, Cleveland, Ohio.



**PLUMBING,** Electricity, Bricklaying, Painting taught in a few months. No age limit. Positions secured. Free Catalogue. **GREAT EASTERN TRADE SCHOOL, 49 E. 32d St., New York City, and 121 South 23d St., Philadelphia.**

### LEARN CHIROPRACTIC

The new method of drugless healing  
**EARN \$50 TO \$100 PER WEEK**

Our free book tells how you can learn to detect disease and remove the cause by Howard's method of Spinal Adjustment. Positively the most simple, direct, advanced and scientific method of drugless healing. Based on unerring natural laws anyone can understand it; learned in spare time. Improve your social prominence and financial standing. Start now on the road to honor and success. Write for free book and special scholarship offer.  
**NATIONAL SCHOOL OF CHIROPRACTIC**  
806 Wendell Building CHICAGO, ILL.



## How to Run an Auto



"Homans' Self Propelled Vehicles" gives full details on successful care, handling and how to locate trouble.

Beginning at the first principles necessary to be known, and then forward to the principles used in every part of a Motor Car.

It is a thorough 1910 course in the science of Automobiles, highly approved by manufacturers, owners, operators and repairmen. Contains over 400 illustrations and diagrams, making every detail clear, written in plain language. Handsomely bound.

Price \$2.00 postpaid, or sent **Free on Approval**

The only way the practical merit of this MANUAL can be given is by an examination of the book itself, which we will submit for examination, to be paid for or returned after looking it over.

Upon receipt of the following agreement, the book will be forwarded:

No money in advance required, sign and return

**THEO. AUDEL & CO., 63 Fifth Ave., NEW YORK, N. Y.**

Kindly mail me copy of Homans' Automobiles, and, if found satisfactory, I will immediately remit you \$2, or return the book to you

NAME.....

OCCUPATION.....

ADDRESS..... June Pop. Mech.

## Highland Park College

DES MOINES, IOWA



**2000 Students Annually**

**Enter Any Time**

One of the most completely equipped **ENGINEERING SCHOOLS** in the country

Students may enter any time, and their term is 12 weeks from the day they enter.

Mention course in which you are interested. Address,  
**O. H. LONGWELL, President, Des Moines, Ia.**

### COURSES OFFERED

**1. CIVIL, ELECTRICAL AND MECHANICAL ENGINEERING COURSES.** Standard courses are offered in Civil, Electrical and Mechanical Engineering. Special opportunity is offered for making up work or for taking a complete course preparatory to the standard Engineering Courses. Shop work from the beginning comes in preparatory courses. See our new Engineering Catalogue.

**2. SHORT COURSES**

1. **One Year Electrical Engineering Course**
2. **One Year Telephone Engineering Course**
3. **One Year Steam Engineering Course**
4. **One Year Machinists' and Automobile Course**
5. **One Year Course in Mechanical Drawing**

Just a fair common school education is all that is required for entrance to these courses. These courses are very practical and are intended for those who have but limited education and do not see their way clear to take a complete Engineering Course. The Machinists' Course is especially practical. The machine shop is the most complete to be found in connection with any Engineering School in the United States.

### SPECIAL COURSES

1. **TRACTION ENGINEERING.** This is the most complete course in Traction Engineering offered by any Engineering School in the country. It may be completed in three months. Students are taught how to make all repairs on engines as well as to handle them. Four traction engines used for experimental purposes.
2. **GASOLINE AND AUTOMOBILE COURSES.** These courses may be completed in three months. They are exceedingly practical. Complete Chauffeur practice. Just a fair common school education is all that is necessary to enter.
3. **FARM BLACKSMITHING, FARM CARPENTRY.**



## Learn Photography, Photo-Engraving or 3-Color Work

Photographers and Engravers Earn \$20 to \$50 Per Week

Only College in the world where these paying professions are taught successfully. Established 17 years. Endorsed by International Association of Photo-Engravers and Photographers' Association of Illinois. Terms easy; living inexpensive. Graduates assisted in securing good positions. Write for catalog, and specify course in which you are interested.

Illinois College of Photography or } 999 Wabash Av.,  
Bissell College of Photo-Engraving } Effingham, Ill.  
L. H. BISSELL, Pres.



**LEARN PIANO TUNING AT HOME** by the aid of the TUNE-A-PHONE. A Profession that can be converted into money at any time or place in the civilized world at an hour's notice. Earn \$5.00 to \$15.00 per day. Valuable illustrated book FREE. Write NILES BRYANT SCHOOL OF PIANO TUNING, 31 Music Hall, Battle Creek, Mich.



## STAMMER

My book "How to Stop Stammering"—a treatise on "Scientific Talking"—direct to the point.

Write M. L. HATFIELD, 1462 Grove St., OAKLAND, CALIF.

## SHORTHAND IN 30 DAYS

Boyd Syllabic System—written with only nine characters. No "positions"—no "ruled line"—no "shading"—no "word-signs"—no "cold notes." Speedy, practical system that can be learned in 30 days of home study, utilizing spare time. For full descriptive matter, free, address

**CHICAGO CORRESPONDENCE SCHOOLS**

969 Chicago Opera House Block CHICAGO, ILL.



## DO YOU LIKE TO DRAW?

That's all we want to know

Now we will not give you any grand prize—or a lot of free stuff if you answer this ad. Nor do we claim to make you rich in a week. But if you are anxious to develop your talent with a successful cartoonist, so you can make money, send a copy of this picture with 6c. in stamps for portfolio of cartoons and sample lesson plate, and let us explain.

The W. L. Evans School of Cartooning  
321 Kingmoore Bldg., Cleveland, O.

# ELECTRICITY

## Complete in One Year

**SCIENTIFIC ELECTRICITY IN ALL ITS BRANCHES**

### Bliss Electrical School



Studies restricted to theoretical and practical electricity, mechanical drawing and necessary engineering work. Teaches simplicity, concentration, hard work. For young men of energy and character. 18 years of greatest success. Graduates hold first-class positions. **Opens Sept. 20.** Write for new catalog.

15 Takoma Ave., WASHINGTON, D. C.

## ARITHMETIC

**SELF-TAUGHT**

A plain, easily-understood volume for all who have not had the opportunity of learning this subject thoroughly, or who have forgotten what they once learned. 257 Pages. Requires no teacher. This great little book sent postpaid for 60 CENTS. Stamps accepted, leather binding \$1.

**GEO. A. ZELLAR BOOK CO.**  
Est. 1870, 442 W. Belle Place, ST. LOUIS, MO.

SPANGENBERG'S  
PRACTICAL  
ARITHMETIC  
Self-Taught

## Learn Watch Repairing

Be a watchmaker—you can learn this profitable trade by correspondence in a few weeks in your own home by the DeSelms Chart System. After you complete the course you will know a watch from A to Z. You will know just what the matter is and how to repair one. When you graduate you will be a practical watchmaker and repairer and competent to fill any position. Positions for our graduates.

Ask for our Free Book. It explains our system and terms.

**THE DeSELMS WATCH SCHOOL**  
23 Perry St. ATTICA, INDIANA

## LEARN WATCHMAKING

Watchmaking pays and you can earn while you learn. Write for FREE BOOK, "How to be a Watchmaker." Postal brings it.

Stone's School of Watchmaking  
912 Globe Bldg. St. Paul, Minn.

## LEARN JEWELERS' ENGRAVING

A high-salaried and easily learned trade, taught thoroughly by mail. We will teach the beginner better engraving than he can gain in years of rigid apprenticeship. We will also improve the skill of any engraver. Send for our catalog.

**The Engraving School, Dept. 112, Pace Building, Chicago Ill.**

## LEARN PLUMBING

A trade that will make you independent for life. Hours Shorter—Pay Bigger—Demand Greater than most any trade. You need no previous experience. Our practical methods enable you in a few months to hold position as skilled plumber or conduct your own business. Catalog sent free.

**St. Louis Trades School**  
4430 Olive St. ST. LOUIS, MO.

BIG  
PAY  
SHORT  
HOURS

# New York Electrical School

Offers to men and boys a theoretical and practical course in applied electricity without limit as to time.

Instruction individual, day and night school, equipment complete and up-to-date. Student learns by doing, and by practical application is fitted to enter all fields of electrical industry fully qualified. School open all year. Write for free prospectus.

44 West Seventeenth St., NEW YORK



## QUICK, THOROUGH ELECTRICAL INSTRUCTION

A complete college course in two years. Time and money saved. Taught by graduate engineers. Practice on apparatus and machines—construction, operation and repair. Every branch of generation, transmission and application. Graduates in leading electric companies. New classes July and September.

—WRITE FOR DETAILS—

**BRYANT & STRATTON COLLEGE**  
No. 111, College Bldg., Buffalo, N. Y.



# “You Are Making Good”

Don't you want your employer to say this to you? Don't you want him to say: "I've been watching you, young man, and I'm going to give you a raise and a better position"?

That is the kind of *recognition* training wins.

YOU can gain just such advancement with the help of I. C. S., as thousands of others have done. Your employer will be glad to advance you as fast as you show *progress in training*—other employers will want you—there are always big opportunities for the man who is "making good."

Mark the coupon now to show what line you prefer—the one you want as *your* pathway to Success—mail it to-day—costs only postage—and let I. C. S. explain how it comes to you in your own home, *in spare time*, without your giving up your present place or all your recreation, and helps you to become an EXPERT in your chosen line.

Don't delay—don't waste any time—don't neglect—for your own sake, **mark the coupon NOW.**

# LEARN WATCHMAKING

Engraving and Jewelry Repairing. Practical specialists in charge of all instruction. Students trained for the best paying positions. Earn while learning. Our school is endorsed and recommended by leading jewelers. A few months will make you an expert. Positions secured for graduates. Demand for watchmakers greater than the supply. Write for free catalog.

**CHICAGO SCHOOL OF WATCHMAKING**  
Dept. 20, Bush Temple, CHICAGO



# IF YOU STAMMER

attend no school till you hear from me. Largest school in the world, employing the advanced natural method for the cure of stammering, stuttering, etc. No sing-singing or time-beating. If let run, stammering will wreck your life's happiness and handicap your endeavors. I cured myself and thousands of others by my method and can cure you. Beautiful 188 page book and Special Rate sent FREE.

Leo Wolfe Millard, Pres., North-Western School for Stammerers, Inc., 917 First St., Milwaukee, Wis.

## MUSIC LESSONS FREE AT YOUR HOME

Write Today for our Booklet. It tells how to learn to play Piano, Organ, Violin, Mandolin, etc. Beginners or advanced pupils. American School of Music, 50 Lakeside Bldg., Chicago, Ill.

# STAMMER NO MORE

I can cure you. Reputation world-wide. Established 16 years. Trial lesson explaining Home Instruction, with 200-page book, FREE. Answer at once. George Andrew Lewis, 178 Adelaide Street, Detroit, Mich.



LEARNED BY ANY MAN OR BOY AT HOME SMALL COST

# VENTRILOQUISM

Send today 2c stamp for particulars and proof.

O. A. SMITH, Room D 6, 823 Bigelow St., PEORIA, ILL.



## I TEACH SIGN PAINTING

SHOW CARD WRITING or LETTERING by mail and guarantee success. Only field not overcrowded. My instruction is unequalled because practical, personal and thorough. Easy terms. Write for large catalogue.

CHAS. J. STRONG, Founder

**DETROIT SCHOOL OF LETTERING**  
DEPARTMENT PM. DETROIT, MICH.

"Oldest and Largest School of its Kind"

## INTERNATIONAL CORRESPONDENCE SCHOOLS, Box 872 SCRANTON, PA.

Please explain, without further obligation on my part, how I can qualify for the position, trade or profession before which I have marked X.

Automobile Running Mine Superintendent Mine Foreman Plumbing, Steam Fitting Concrete Construction Civil Engineer Textile Manufacturing Stationary Engineer Telephone Expert Mechanical Engineer Mechanical Draftsman Electrical Engineer Electric Lighting Supt. Electric Wireman	Civil Service Architect Chemist Languages— Banking Building Contractor Architectural Draftsman Industrial Designing Commercial Illustrating Window Trimming Show Card Writing Advertising Man Stenographer Bookkeeper	Spanish French German Italian
--	--	--

Name \_\_\_\_\_  
 Present Occupation \_\_\_\_\_  
 Street and No. \_\_\_\_\_  
 City \_\_\_\_\_ State \_\_\_\_\_

Please Mention Popular Mechanics

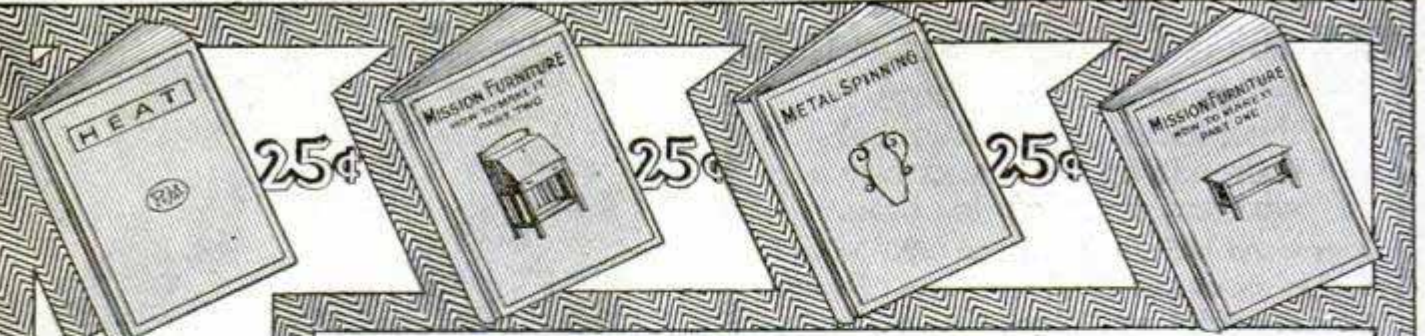

25¢



25¢



25¢

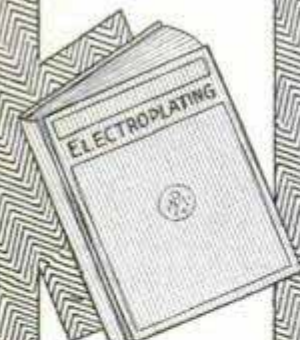

25¢

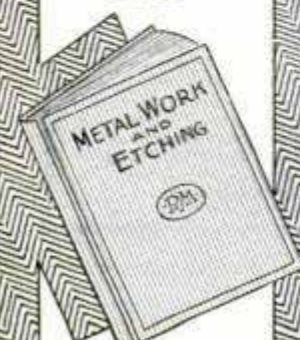

## Popular Mechanics 25 Cent Series of Industrial Handbooks

"WRITTEN SO YOU CAN UNDERSTAND IT"

THESE books furnish reliable information on mechanical subjects at a price within the reach of all. They are convenient and uniform in size (5 by 7 in.) and neat and attractive in appearance; being bound in a good grade of durable cloth with artistic cover designs, printed in clear readable type on good book paper and fully illustrated.

A useful, compact library of mechanical books unequaled anywhere at the price **Each 25c Postpaid**

THESE ARE READY

### Mission Furniture, How to Make It, Part I.

96 Pages.

A handy little manual containing plain directions for making 21 designs, with working drawings and illustrations.

### Mission Furniture, How to Make It, Part II.

128 Pages.

A companion volume to Part I containing 32 additional designs.

### Arts-Crafts Lamps, How to Make Them.

96 Pages. By J. D. ADAMS.

Plain instructions for making 16 beautiful designs from paper, cardboard and wood. Good results can be obtained by anyone possessed of a fair amount of patience.

### How to Make a Wireless Set.

96 Pages. By ARTHUR MOORE.

Explains in an understandable manner the construction of an outfit for transmitting 4 or 5 miles. This set can be easily constructed at a small cost by any boy of ordinary ability.

### Metal Spinning. 80 Pages. By PROF. F. D. CRAWSHAW, University of Wisconsin.

The only book published on this interesting art. A practical working manual for those who desire to spin metal as an art recreation or to follow this work as a trade.

### Heat.

128 Pages. By PROF. J. GORDON OGDEN, Ph. D., Prof. of Physics,

Fifth Avenue H. S. Pittsburg.

An immensely interesting and instructive story pertaining to heat and its relation to modern mechanics.

### Electroplating.

112 Pages.

A treatise which will not only enable the humblest beginner to make a start, but which gives pointers of value to even the most experienced electroplater.

### Metal Work and Etching.

96 Pages.

A complete handbook for art metal workers giving every detail for making a great variety of useful and ornamental objects such as book ends, desk sets, arts and crafts jewelry, hinges, drawer pulls, paper knives, letter openers, match boxes, tie and pipe racks, pad corners, etc. Fully illustrated.

### OTHER EQUALLY GOOD OR BETTER TITLES TO FOLLOW

A few convincing statements regarding this series

#### 1. Regarding the Price:

"The wonder is that a cloth-bound book profusely illustrated with working drawings can be produced and sold at such a very moderate price. The descriptions and illustrations are excellent."—From review of Mission Furniture, Part II, in *Scientific American*.

#### 2. As to Practicability:

Hattiesburg, Miss., Aug. 19, 1910  
Popular Mechanics Co., 225 Washington St., Chicago  
Sirs: Please find enclosed 25c for which send me Part Two Mission Furniture How to Make It, by mail, post paid. I have part I, and have made one piece of furniture and sold (\$400.00) four hundred dollars worth of it, and I am not a carpenter either, but with the instructions "Written so I can understand it," I have a business of my own. Yours truly,  
JOHN S. COLEMAN.

#### 3. The High Character of Contents:

"This is the first book published in the English language on metal spinning. In spite of its price, 25 cents, it is an excellent little treatise on the subject. The book is well written and contains much information for those interested in the subject. It is well worth the price."—Review of Metal Spinning—*Brass World*.

Obtainable at News stands, bookstores or direct from the publishers.

**Popular Mechanics Book Dept., CHICAGO**

**THE ONLY WAY**



Between  
**CHICAGO**  
**ST. LOUIS**  
PEORIA SPRINGFIELD AND  
**KANSAS CITY**

**"Alton" Trains**  
**RIDE EASY**

No Noise No Dust

Rock Ballast Roadbed

Perfect Passenger Service

**Chicago & Alton R.R.**

R. J. McKAY, General Passenger Agent, Chicago

## 50 SMOKES FOR 99 CENTS



Send me 99 cents by mail Now and I will send you this box of 50 Menges Havana Seed Stogies post prepaid. You'll find them stogies only in shape; in quality superior to many 10-cent cigars. My tobacco is grown in this country from pure Havana seed and is rich, aromatic, flavory. Get this box, try one—if not satisfactory send the rest back and get all your money back.

**H. MENGES, Smoker's Friend**  
504 Menges Bldg. ST. LOUIS, MO.

We have for sale a limited number of complete files of

## Popular Mechanics for 1909

These consist of the 12 issues of the magazine and a complete index suitable for binding.

Price \$1.25 postpaid.

POPULAR MECHANICS, 318 W. Washington St., Chicago



**Wear One Side Today—  
The Other Side Tomorrow**

Linene collars are reversible; both sides are alike. It costs but 1¼c for each wearing.

A box of 10 for 25 cents at the stores, or by mail for 30 cents in U. S. stamps. Sample for 6 cents.

*Give Size and Style*

**REVERSIBLE COLLAR COMPANY**  
Department U, BOSTON, MASS.



## MECHANICAL PUZZLES

127 varieties of Iron, Wood and Wire Puzzles. Sample leader with Catalog 10 cents.

**WESTERN PUZZLE WORKS**  
ST. PAUL, MINN.

## 9,059-Word Business Book Free

Simply send us a postal and ask for our free illustrated 9,059-word Business Booklet, which tells how priceless Business Experience, squeezed from the lives of 112 big, broad, brainy business men, may be made yours—yours to boost your salary, to increase your profits. This free booklet deals with

- How to manage a business
- How to sell goods
- How to get money by mail
- How to buy at rock-bottom
- How to collect money
- How to stop cost leaks
- How to train and handle men
- How to get and hold a position
- How to advertise a business
- How to devise office methods

Sending for this free book binds you to nothing, involves you in no obligation; yet it may be the means of starting you on a broader career. Surely you will not deny yourself this privilege, when it involves only the risk of a postal—a penny! Simply say, "Send on your 9,059-word Booklet." Send to **SYSTEM, Dept. 81-6, 151-153 Wabash Avenue, Chicago**

## A SCHOOL WITHIN ITSELF

There are XX chapters in all, XIX carrying you from the fundamental principles of electricity on through the various branches to a point where the careful student comprehends the complete designing, care and operation of a dynamo or motor, and one chapter on electric automobiles, outlining their construction, care and operation, and all about storage batteries and how to handle them. Each subject is carefully written and to the point. After a student studies a subject, he is questioned on that subject in such a manner as to bring clearly to his mind the points he needs to know regarding same. The book contains a dictionary defining 1500 Electrical Words, enabling the reader to ascertain the meaning of any electrical word, term or phrase used in this book, as well as hundreds of others in common use. All required tables necessary in the study are in it.

**\$2.00 PER COPY—SIXTH EDITION—30,000 COPIES SOLD.**

The offer we make of refunding money if book is not satisfactory upon examination is AN UNUSUAL ONE in connection with the sale of a book. But we have no fear of its return. Your decision will be what thousands of others have been. Money would not buy it if it could not be duplicated. We could print testimonials by the hundreds. It is best to order and be your own judge of its merits.

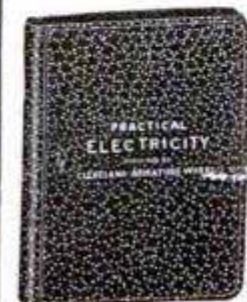

**CLEVELAND ARMATURE WORKS, Cleveland, Ohio**

Armatures and Fields Wound—Commutators Filled  
AMERICA'S GREATST REPAIR WORKS

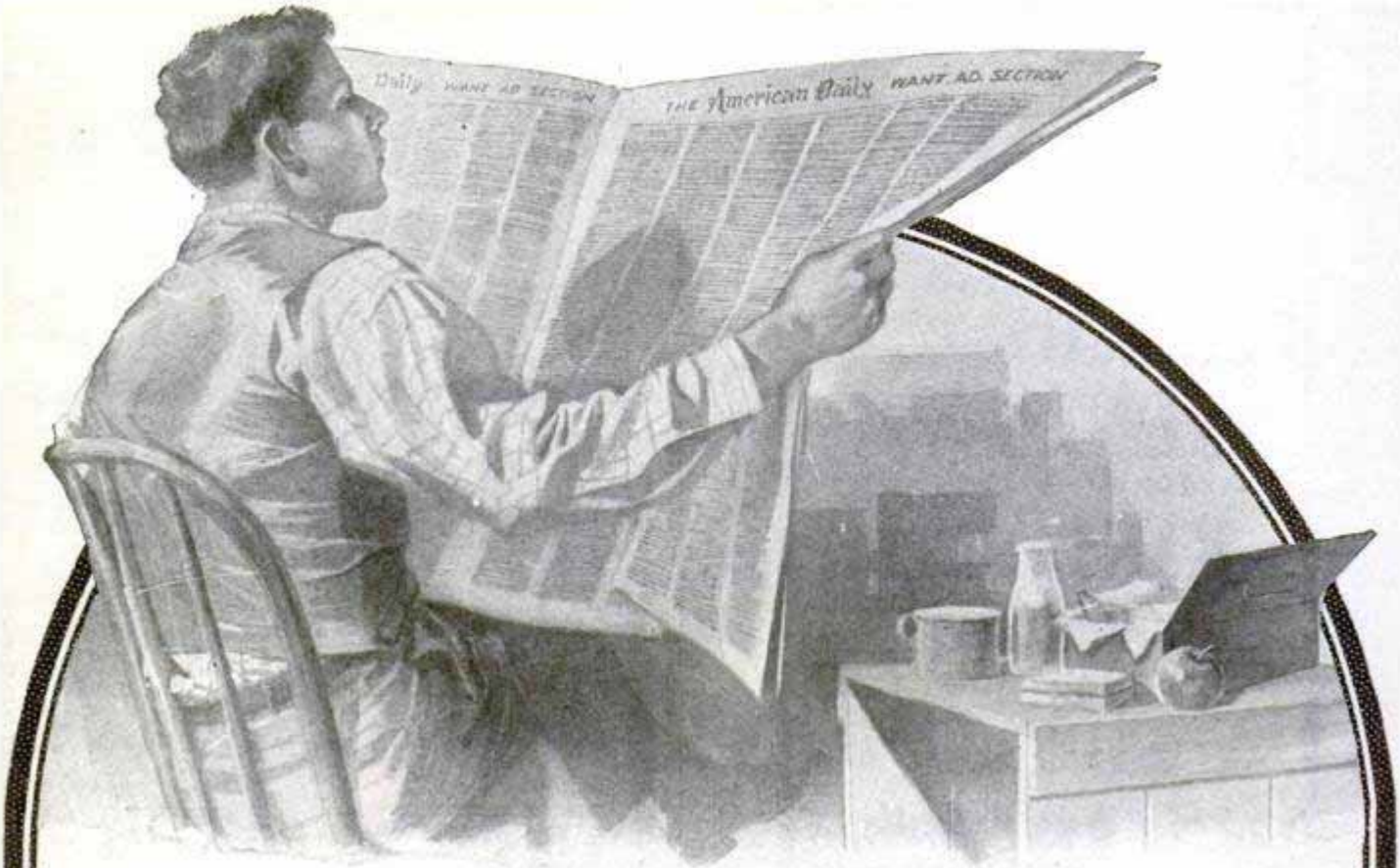

# Thousands of Trained Men Wanted

Every year thousands of *good jobs* are seeking *trained men* through the daily press. You won't have to look for a good job if you have the necessary training to fill one—*the job will look for you*—the "Help Wanted" columns in every daily paper prove this.

Read this special proposition which the American School of Correspondence has decided to offer every ambitious man:

If you lack the time and money to stop work and take a course in training, the American School will *lend you the cost of the training you need* and let you make your own terms about repaying us.

This is the greatest offer that has ever been made to men who have "got it in them to make good." We have studied this matter carefully and know that there are thousands of men who are capable and ambitious, but simply lack the money necessary to pay for their training.

These are the men we want to help.

Check the coupon and send it to us today so we can explain fully our "*Deferred Tuition Plan*"—how we will lend you the cost of tuition and not ask you to pay us back until the increase in your pay equals the amount of the loan.

The American School is an educational institution. It does not employ agents, representatives or collectors. Signing the coupon will not place you under any obligations whatever or bring an agent to your door. All business will be carried on privately—by correspondence.

**American School of Correspondence**  
CHICAGO, U. S. A.

## Opportunity Coupon

American School of Correspondence, Chicago, U. S. A.

Please send me your Bulletin and advise me how I can qualify for the position marked "X." Pop. Mech. 6-'11

- |                            |                                 |
|----------------------------|---------------------------------|
| ..... Draftsman            | ..... Book-keeper               |
| ..... Architect            | ..... Stenographer              |
| ..... Civil Engineer       | ..... Accountant                |
| ..... Automobile Operator  | ..... Cost Accountant           |
| ..... Electrical Engineer  | ..... Systematizer              |
| ..... Mechanical Engineer  | ..... Certified Public Acc'tant |
| ..... Moving Picture Op'r  | ..... Auditor                   |
| ..... Steam Engineer       | ..... Business Manager          |
| ..... Fire Insurance Eng'r | ..... Commercial Law            |
| ..... College Preparatory  | ..... Reclamation Engineer      |

NAME .....

ADDRESS .....



# Popular Mechanics Magazine

WRITTEN SO YOU CAN UNDERSTAND IT

Vol. 15

JUNE, 1911

No. 6

## TEN TONS OF BREAD FOR TWENTY THOUSAND MEN

By FLORENCE FULLER

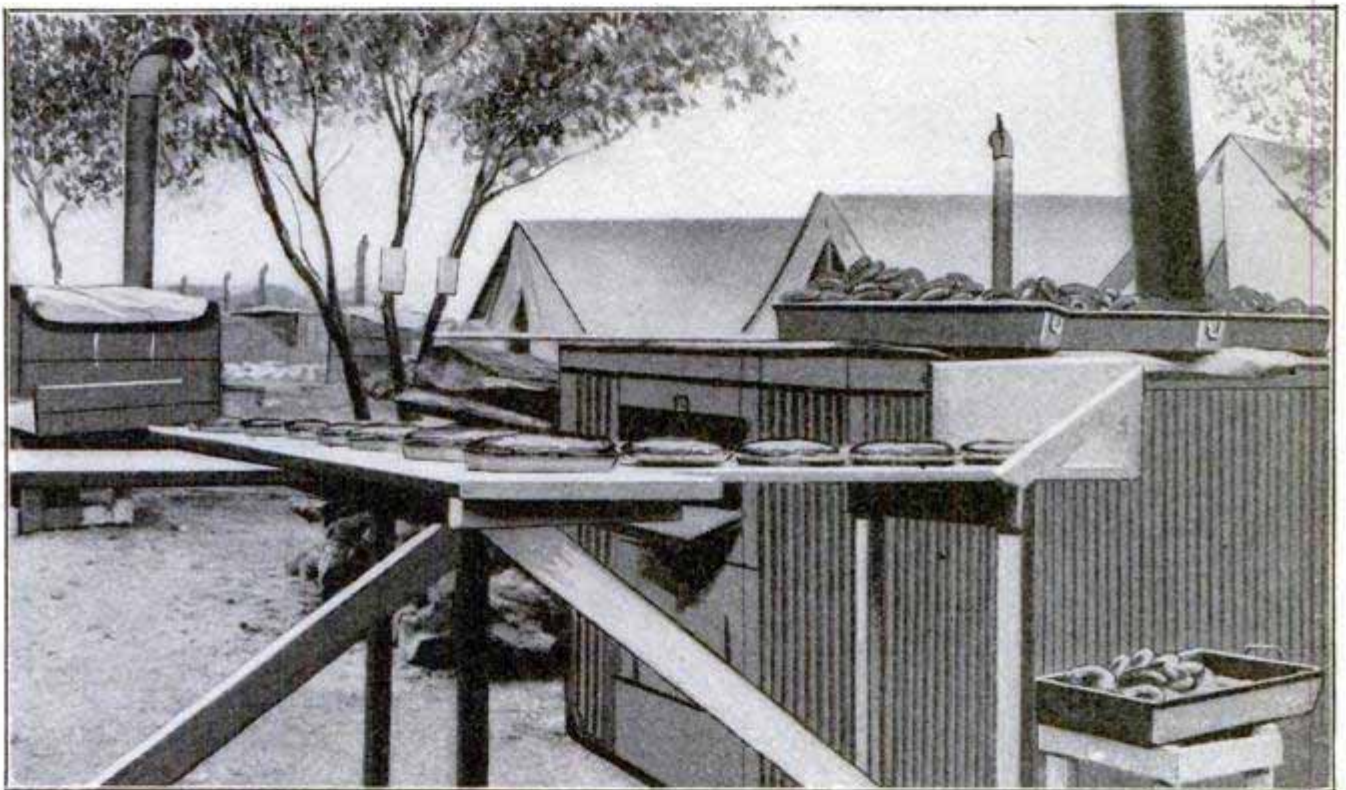

Pies, Doughnuts and Pastry Cooked in the New Army Oven

**Y**EARS of study and experiment have enabled the experts of the War Department to perfect a field bakery equipment for the army that is claimed to be the best of its kind in the world. At San Antonio, Texas, in the big military camp, the 12 huge ovens that stand out in the open



Pans of Bread Baked in the New Army Oven

produce 20,000 lb. of the finest bread daily, baked in 10,000 creamy loaves. Pies, cakes, and pastry of all kinds are baked when the ovens are not filled with "the staff of life."

The bakery at the big camp has been one of the marvels for the foreign military attachés on duty there and they

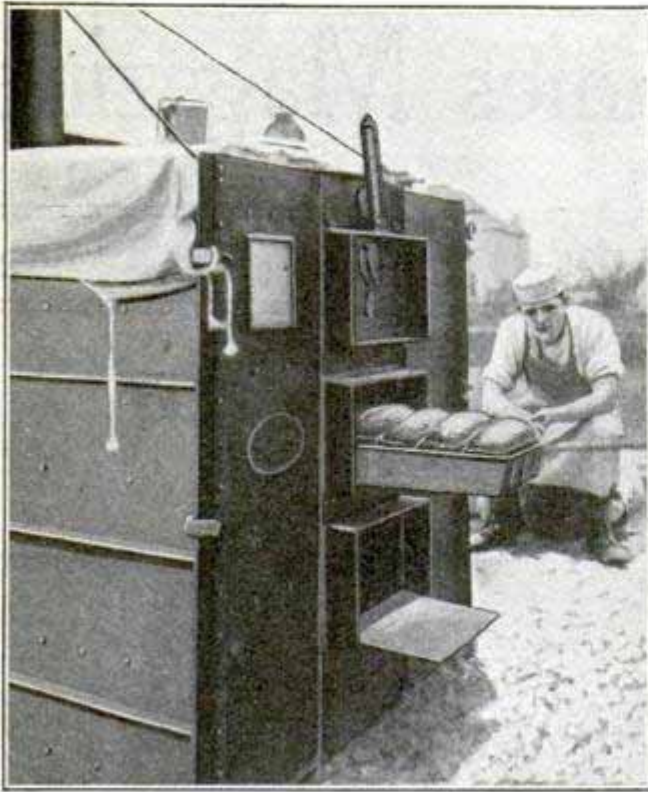

Front View of the Army Field Bakery Oven



Rear View of Army Oven Showing the Fire Box

never fail to remark its wonderful work in discussing the camp and its features. The big ovens stand 12 in a row and on either side of them is a line of tents in some of which the materials are kept, in others the sponges are set, the dough "proved," or let rise, kneaded, and made into loaves, and in still others the bread is cooled and kept on racks of wire netting.

All this equipment, including the oven, is collapsible, and each unit, consisting of the two tents, one oven, the necessary sponge cans, dough troughs, kneading tables, bread racks, etc., may be folded or telescoped and packed on one wagon, the total weight falling under 3,000 lb.

The Army Field Bake Oven No. 1 is constructed entirely of sheet iron and asbestos, measuring 4 ft. 8 in. high, 4 ft. wide and 5 ft. long at the outside of the base, being 3 in. smaller at the top. The top is covered with sand or gravel and a canvas cover. It is fitted with a pyrometer and a clock. The fire is built in a brick-lined pit, over which the oven stands, and it is attended to from the rear. Any fuel may be used.

A curved trench cover of sheet-iron and asbestos radiates the heat, which

is conducted by drafts upward and around the three baking chambers, which are separated by 4-in. flues. The baking chambers, built somewhat narrower in the center than at the ends, are made of an inner sheet of heavy iron, and an outer of lighter iron. At the corners, where the heat is most intense, these are packed with 14 sheets of  $\frac{1}{16}$ -in. asbestos, so graduated in length that toward the center they taper down to nothing, and there are a few inches where there is no packing. Thus an even heat is secured throughout. It requires only 20 minutes to heat each oven ready to bake. The baking capacity is 216 lb. per oven.

The field bakery is conducted on strictly scientific principles. The sponges are set in the big sponge-cans every 20 minutes, and an average temperature of 80 deg. Fahrenheit is maintained. To every 100 lb. of flour there is added 20 oz. each of salt, sugar, and lard, and 4 oz. of compressed yeast. If compressed yeast is not at hand, dry yeast is used, and if that is unavailable, the army bakers make their own yeast. Baking has been carried on successfully with these ovens during long heavy rains, and when the temperature was 20° below zero.



Side View of Pneumatic Boxing Glove, Showing Finger Closing

Inflating the Glove before a Bout  
Appearance of the Glove Deflated

The Glove as It Appears When  
It is Inflated

## PUTS AN AIR CUSHION ON SHORT-ARM JABS

A Philadelphian has invented a pneumatic boxing glove that some experts believe will cause the old "pillow" type to be discarded. The inventor, a trainer of pugilists and fight referee, evolved the new glove from his many years' experience in the prize ring. He was spurred to the realization of his idea of a perfect glove by reason of the fact that in training it was desirable to avoid injuries, and the old padded

glove, no matter how carefully it was used, was never a sure protection. With the pneumatic glove, with its cushion of air it is impossible to cut or bruise an opponent in boxing practice. For this reason the glove would seem to be a good thing for gymnasiums and for all friendly bouts where it is the object of the opponents to score points without hurting each other.

## INGENIOUS SAFETY DEVICE FOR MACHINES

Guards for running parts of machines are common enough, but a safety device that automatically drops into place to prevent possible accidents to machine operators while the piece of work is being shaped is an innovation. Such is the character of the safety appliance shown herewith. It consists of an extensible or folding gate on the "lazy-tongs" principle, which drops down in front of the work when the foot treadle is depressed to start the machine. When the machine stops, the gate folds up again, leaving the

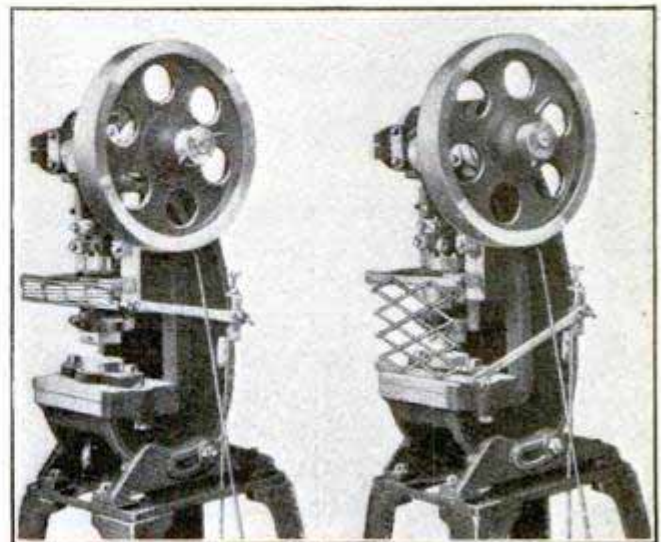

Guard Folded Up Out of  
the Way When Ma-  
chine is Stopped

The Safety Guard in Place  
with the Machine in  
Operation

work accessible for removal or adjustment. The work is plainly visible at all times, and the gate does not interfere with the rapidity of the operator.

### SHADOW DANCE IS LATEST THEATER NOVELTY

A London theatrical manager has achieved more than a day's fame by the presentation of a series of dances, old



Shadow Dancer Who Performs behind a Screen, Only the Outline of Her Figure Being Visible to the Audience

in their form, but entirely new in their method of production. The entertainment is called "shadow dancing" and consists of a very graceful young woman, draped only in diaphanous fabric, performing a dance of classic movements behind a white curtain, a strong light being thrown on the curtain and only the shadow of the dancer's figure being seen by the audience. Shadow pictures originated back in the stone age when the first

loving father doubled up his fists and showed his joyous offspring the picture of the rabbit formed by the shadow his hands cast when held between the side of his cave and the pine torch that gave him light. Persons with nimble fingers have introduced the same form of amusement in vaudeville, performing behind small screens. But the London instance is the first time that the entire figure has been used in a production and it is stated that the results obtained were exceedingly pleasing. The dancer became famous throughout London and all Europe for her graceful postures and novel way of presenting them.

### LEHIGH VALLEY RAILROAD DATES ITS CROSS TIES

The Lehigh Valley Railroad has adopted a plan by which it will be able to determine, with mathematical accuracy, the relative efficiency of the different woods of which its new cross ties are composed, and the value of the creosote preservation treatment. In each new tie put down will be driven a nail, on the head of which will be stamped a numeral indicating the year. The numeral "11," for example, will indicate that the tie was laid in 1911. In the future when a tie has to be replaced, the date stamp will show just how long it lasted.

### A CABINET KITCHEN THAT LOOKS LIKE A DESK

In these days of labor-saving machinery there has been developed, with disappearing furniture and small apartments, what might be termed a system of "intensive" living, bearing the same relation to the old-fashioned home life in a two-story, eight-room house that the old system of cultivating 100 acres of land bears to the work of the intensive farmer on his two acres. Intensive living has begotten many labor-saving devices, one of the newest of which is a cabinet kitchen which might make an ornament for a living

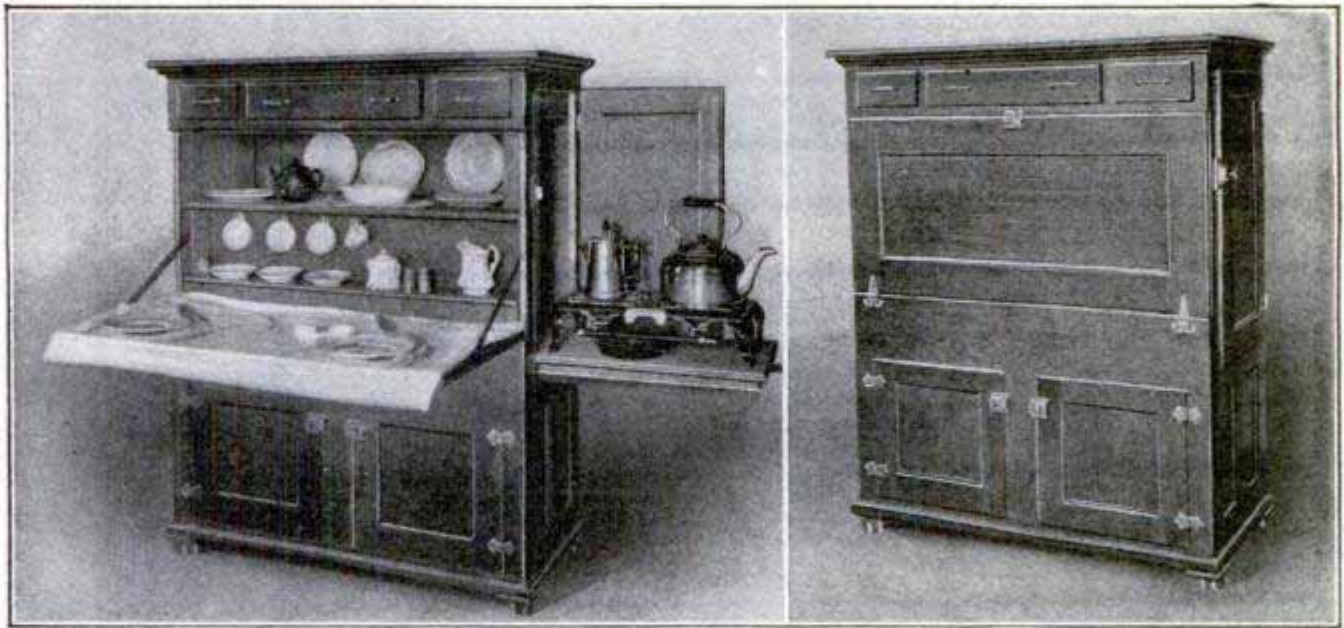

Not a Desk nor a Folding Bed, but a Cabinet Kitchen Designed for Use in Small Apartments

room when not on duty preparing the meals of the family. The cabinet, closed, resembles a desk and may be constructed with a mission finish that will add to this feature. Open, it provides the housewife with a kitchen and dining table, a china closet and space for storage of small groceries in the upper portion, while below are cupboards for pots and pans and the storage of more bulky articles of food. The side of the cabinet is opened, and on a slide that pulls out is found a two-burner oil or gas stove with an oven, if desired, and space on the stove to keep the larger pots and pans when not in use. The cabinet is mounted on casters and may be placed anywhere in the house.

### FOG BELL RUNG BY WATER METER

A fog bell rung by a water meter is the interesting method adopted in connection with the ferry system at San Diego, Cal., to do away with the expense of keeping a man on the wharf to ring the bell in times of fog. The apparatus consists simply of an old water meter with a piston attached to its plunger so as to strike against the bell at regular intervals of about six seconds. When a fog comes on—an infrequent happening in the locality—all that is necessary is that a deck hand

go ashore and turn the valve on the water pipe, and the water does the rest. The amount of water wasted is nominal, and the device is considered both

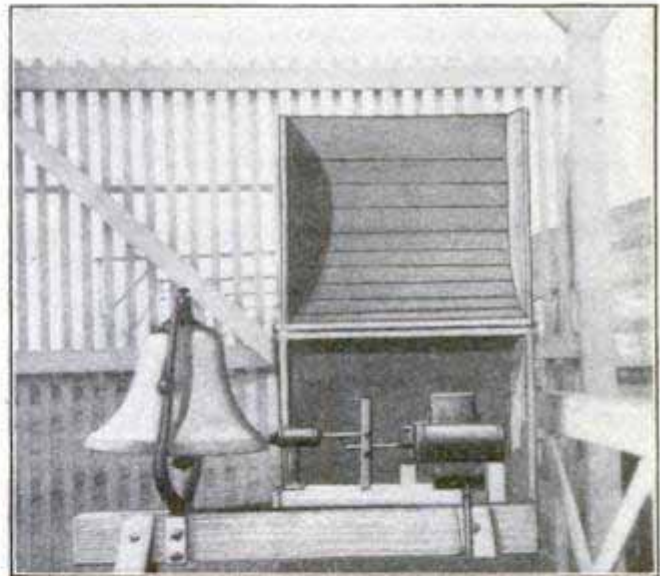

Water Meter Operating Fog Bell

practical and useful by the company operating the ferry.

Baron d'Estournelles de Constant, the French advocate of international peace, has estimated that the wars during the revolution and the first empire have reduced the population of that nation by 20,000,000. He figures that the wars cost the lives of between 2,000,000 and 5,000,000 men, and multiplying the minimum by several generations, he reached his conclusion.

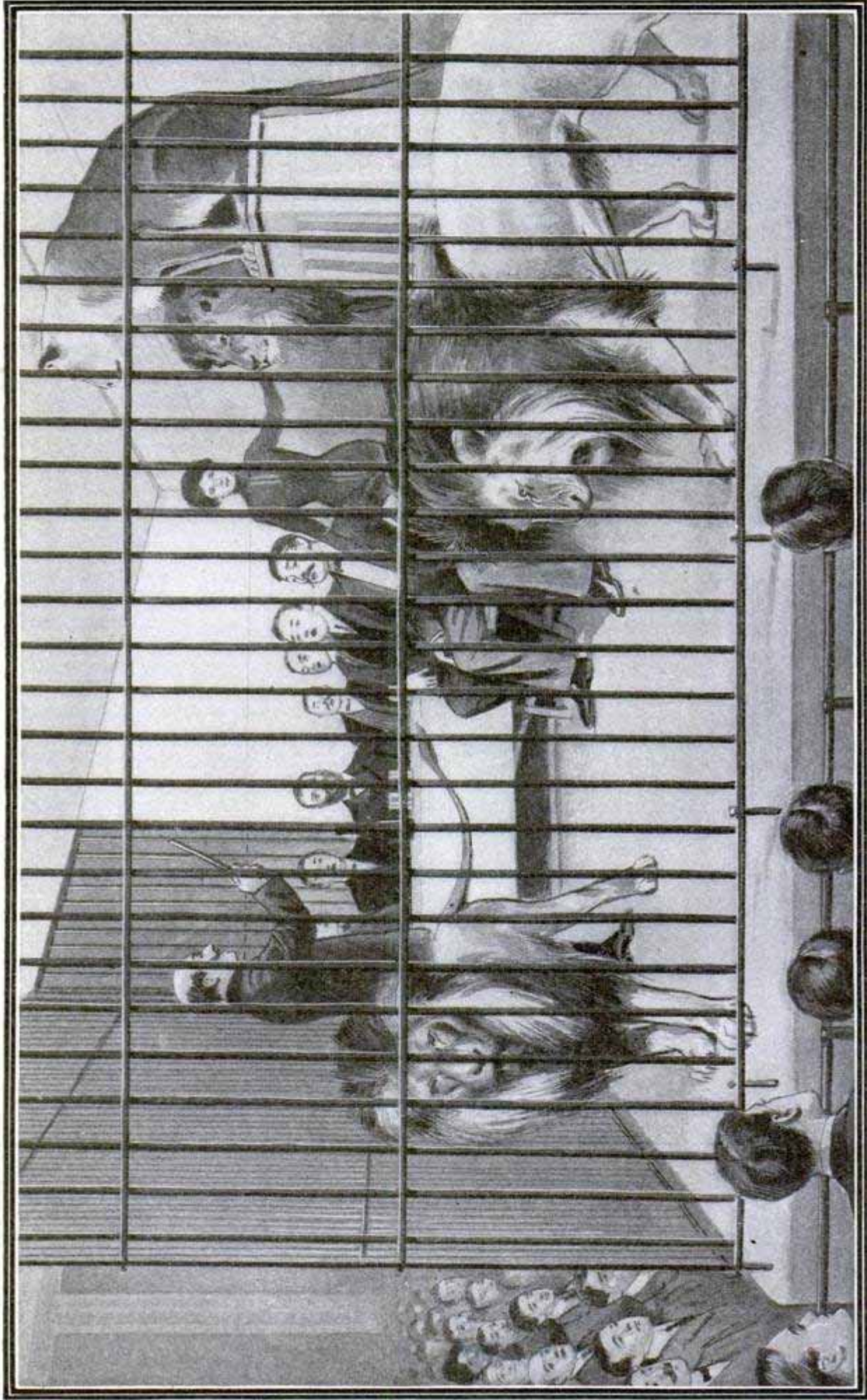

### CONCERT IN A LION'S DEN

The choral society of Durlach, Germany, recently gave a concert in the lion's cage of a menagerie. Several songs were given, but the lions were perfectly quiet, apparently absorbed in the music.

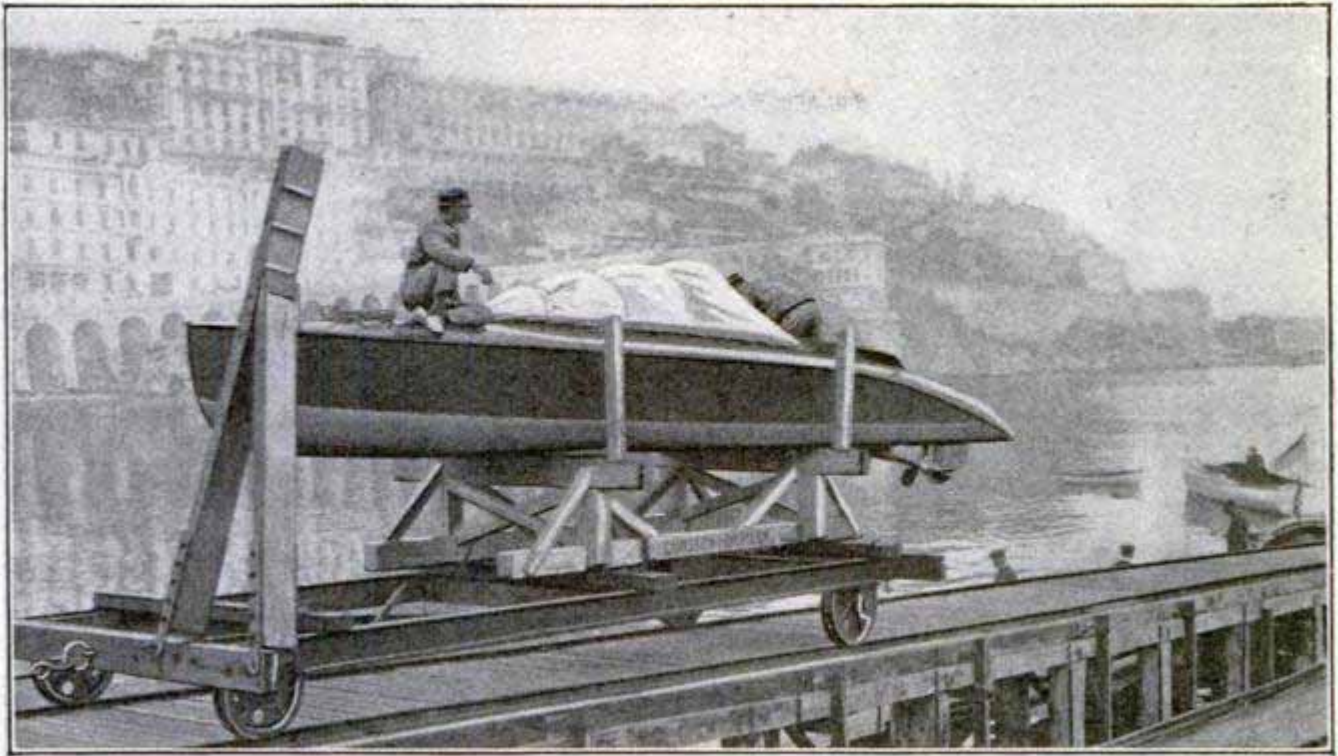

Launching One of the French Contestants

## MOTORBOAT RACING AT MONACO

The motorboat races held every year at Monaco, in the very shadow of the great gambling casino of Monte Carlo, are probably the most exciting and extensive held anywhere in the world. Races are arranged for boats of nearly every type, size, and horsepower, from little 12-ft. dingies to powerful racers of 800 hp. Scenes in connection with the overhauling of boats before a race are shown in the accompanying illustrations.

It was at Monaco last year that the Duke of Westminster broke the world's speed record for any kind of water craft with the "Ursula," a

500-hp. motorboat. This year he has entered a hydroplane driven by two motors, the combined horsepower of which is 800 hp.

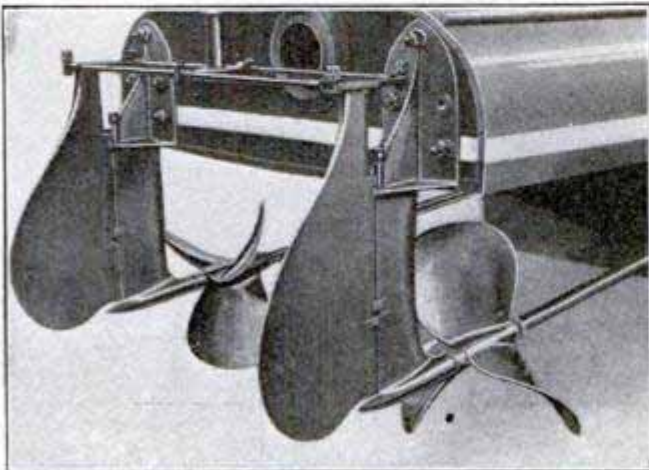

Stern of the "Maple Leaf III," Showing the Mounting of the Rudders on the Ends of Propeller Shafts

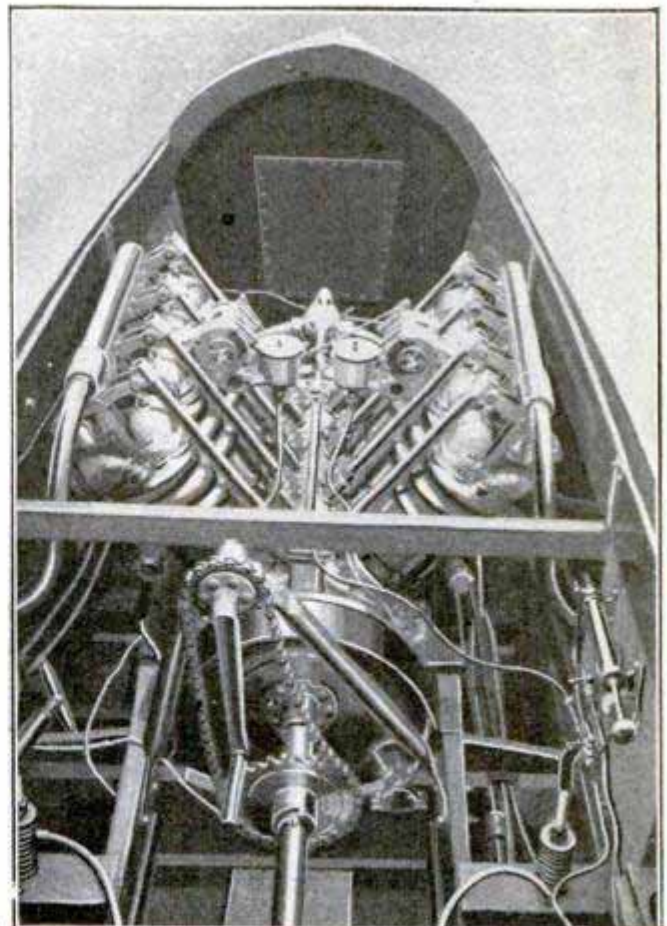

The 200-Hp. Motor of the Motorboat "La Fleche" (The Arrow)

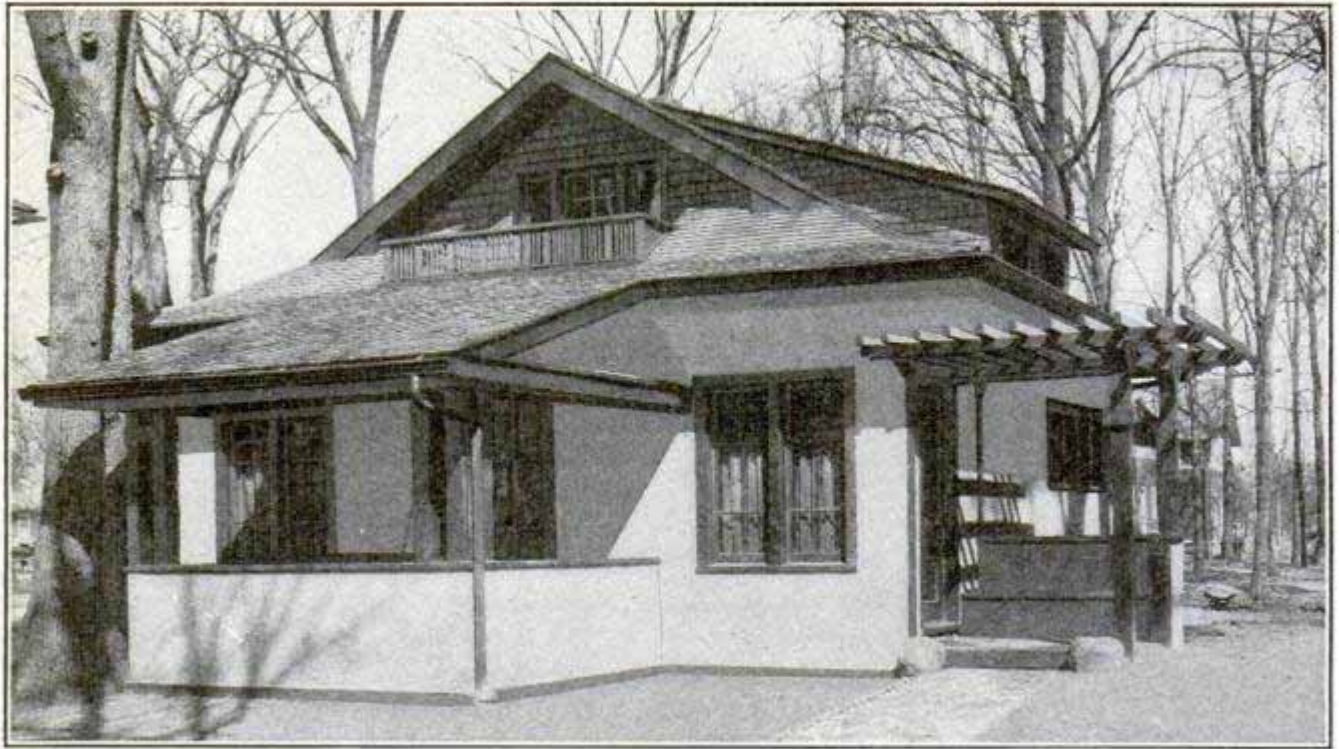

Exterior View of a Remarkably Artistic Bungalow in Which Every Inch of Space is Used to Advantage

## A WONDER BUNGALOW

By FRANK MAYNARD

**T**HIS magazine published last year an article entitled "A House of Many Wonders," in which was described a remarkably unique and artistic bungalow home, costing only \$1,600, and but 25 ft. square. Yet it

had, on the ground floor, a large living room, one end of which could, in a twinkling, be converted into a dining room, and the other end into a spare bedroom; a kitchen, bedroom, bathroom, china cabinet, chests of

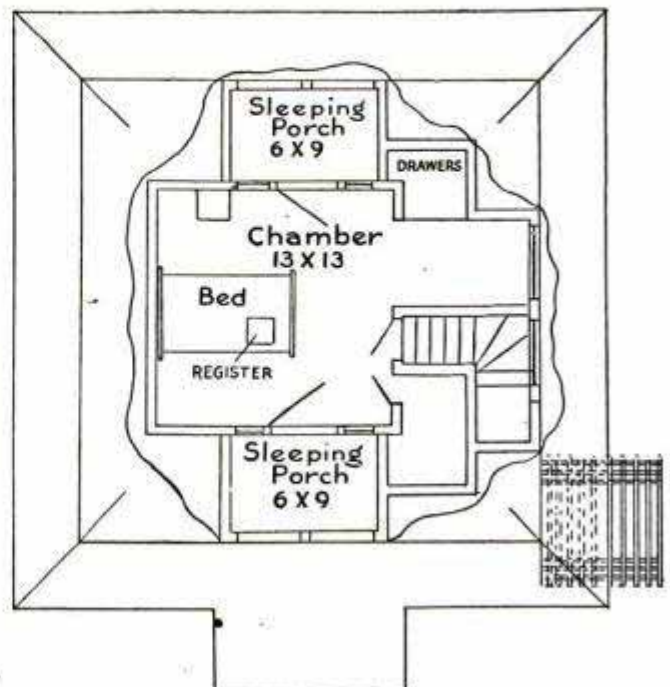
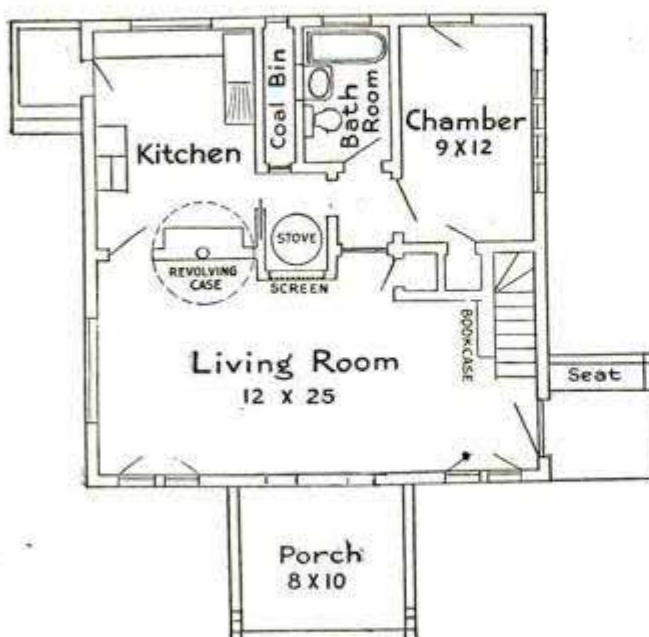

Ground and Second-Story Floor Plans, Showing Dimensions of the Rooms



drawers, many closets, and also a folding stairway and a small loft bedroom.

The ingenious ideas incorporated in the little house were those of its owner, Adam Int-Hout, a young chemist of Chicago, who had but recently married and desired as artistic and complete a home as was within his means. Among the other requirements were, a home which Mrs. Int-Hout could easily take care of without a servant, and one that could be completely heated by one stove.

The result proved perfectly satisfactory, but soon after the article describing the unique house had been published, the troubles of the couple commenced. An almost continual stream of people journeyed to Evanston, the Chicago suburb in which the house was located, to see it. They came one at a time, in couples, and in parties. The record was reached on a pleasant Sunday afternoon, during which 50 people viewed the house both inside and out. Then the Int-Houts, too courteous to close the doors from the inside, resorted to strategy. Early the next Sunday morning they locked up the house and departed for parts unknown. For two months they did this, not returning until after dark. Tiring at last of these flittings, they decided to spend a few Sundays at home, but the people still continued to come. Then, in despair, they sold the house, slipped away to the adjoining suburb, Wilmette, and started the building of another wonder house, of which the remainder of this article will deal.

Naturally, Mr. Int-Hout profited by his first experience in house designing, and his present wonder house is a great improvement on the first. Then too, it cost about \$1,000 more, and the ingenious features are not quite so much in evidence. The folding stairway of the first house has given way to a solid staircase in the second; the sliding wall panel which admitted the dining table from the kitchen to one end of the living room when the meal was to be served, is absent, and the transition is accomplished by means

of a wall which revolves on a pivot. Likewise, the furnace-stove, which adequately heats the entire house in the coldest weather, is hidden by a grill, instead of standing out in the room, and the second floor is finished off into a large airy bedroom, with sleeping porches both front and back, and a little niche having a window seat and sufficient space for a sewing machine and other sewing accessories.

At the first view of the house one is struck with its artistic quaintness. But 26 ft. square, with a living porch 8 ft. by 10 ft. extending out from its front, and a little entrance porch provided with a porch seat at its side, it is built on a lot of 50-ft. frontage, between two great elm trees, whose foliage form a complete arch about 40 ft. above. All outside walls are cement stucco.

From the entrance porch, one steps into a beam-ceiled living room, 25 ft. long, by 12 ft. wide, extending unbroken clear across the front, with casement windows on all three sides. Directly to the right is the staircase, the balustrade side of which is a bookcase. In the center of the front wall are French windows leading to the living porch. Next to the staircase is a little closet for outdoor wraps. In the back wall of the living room is the opening of a small hall leading to the ground-floor bedroom, the bathroom, and the stove space. Next is the grill which hides the stove, and beyond this, the revolving wall and swinging door which close off the kitchen.

When not in use, the dining-room table is placed in a corner of the kitchen. It is set for breakfast, lunch, or dinner, as the case may be, in the kitchen, then the meal is placed upon it, the swinging door is hooked back, the revolving wall swung around, the table being pushed along at the same time, and in a moment one end of the living room has assumed the characteristics of a dining room. On one side of the revolving wall is a china cabinet, which is in the living room when the latter is converted into a dining room, and in the kitchen when the

## VIEWS WHICH SHOW SOME OF THE UNIQUE AND



Living room, 25 ft. long, as viewed from entrance, showing general arrangement, beamed ceiling and grill hiding the stove. The revolving wall may be seen just beyond the stove grill with its living-room side out. The electric light fixtures were designed especially for this room by the owner.

The swinging door between the kitchen and living room has been hooked back, the revolving wall half swung around, and the table, set for the meal, pushed partially into the living room, thus half completing the conversion of one end of living room into dining room. The window shown is of the casement type.

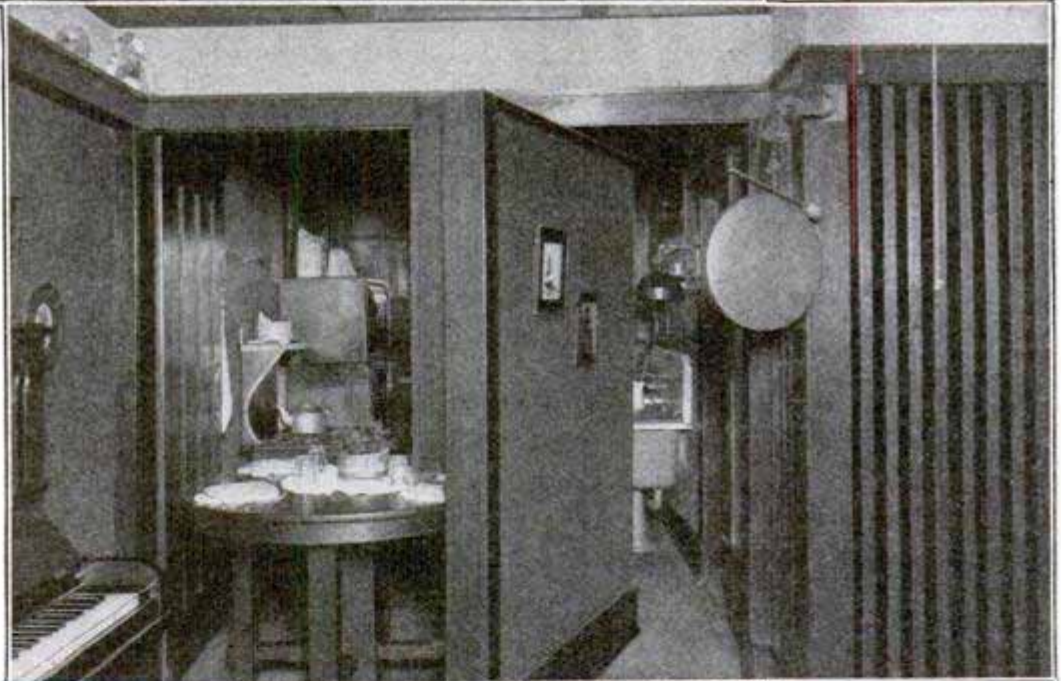

The end of the living room after it has been converted into a dining room. The side of the revolving wall, which ordinarily faces in the kitchen, now faces the living room. On it is the china cabinet in which are kept the dishes required from time to time through the meal. The cabinet is about a foot deep.



# ARTISTIC FEATURES OF THE WONDER BUNGALOW

View of one corner of the kitchen, with the dining room table in the position it occupies when a meal is not being served. After the meal, the soiled dishes are easily transferred to the dripboard of the sink, which likewise forms a top for the laundry tub. The furnace-stove may also be seen behind its grill.

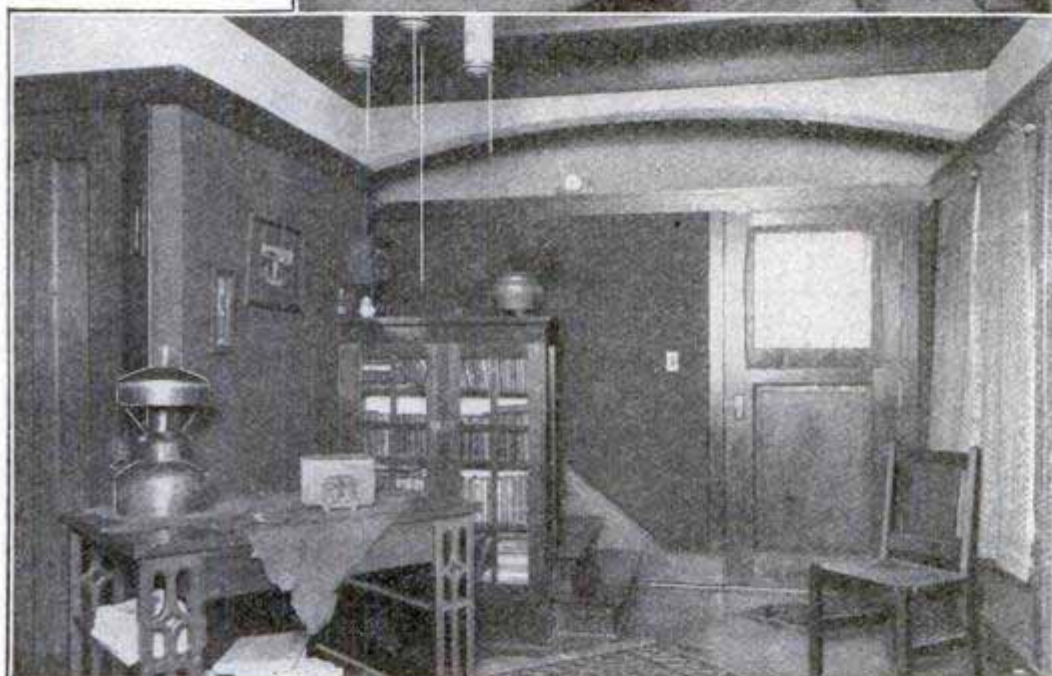
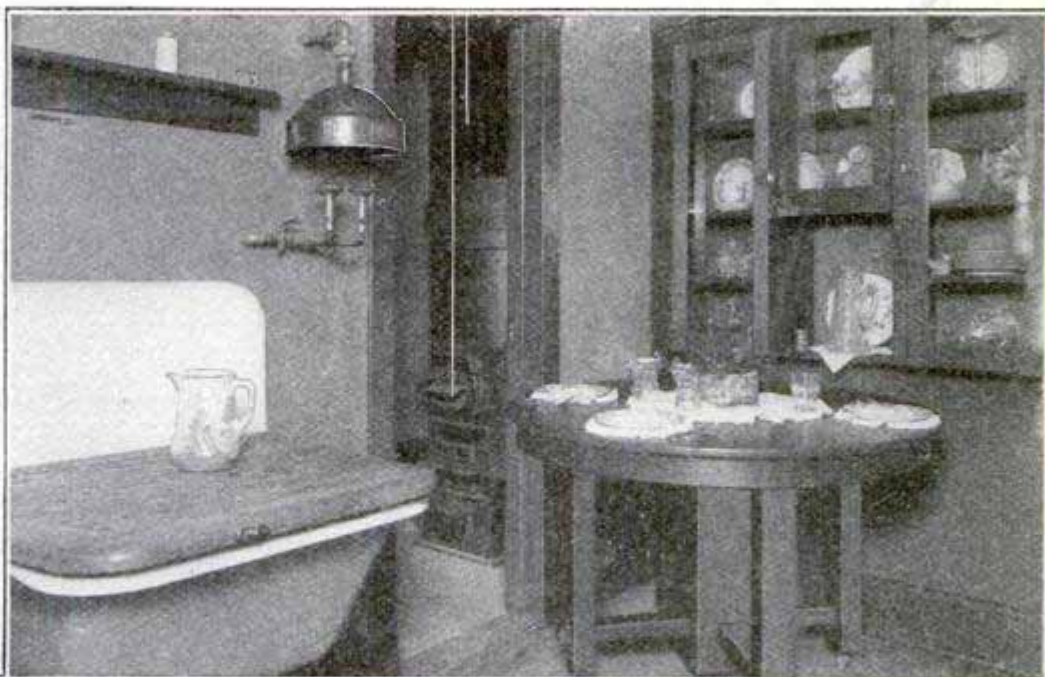

Entrance end of the 25-ft. living room, showing the staircase with its bookcase balustrade. The stretch of beamed ceiling is artistically terminated just inside the staircase line by means of the shallow plaster arch. At the left is a coat closet. The drawers mentioned in the description of the ground-floor bedroom extend under the stairs.

The second-floor chamber, which is 13 ft. square, and has two sleeping porches and a deep window niche, the latter serving as a sewing room. The glassed-in sleeping porch at the back of the house is shown in the illustration, the photograph having been taken from the front sleeping porch.



living room again assumes its natural role.

Other features of the kitchen are the stationary porcelain laundry tub, the wooden top of which forms the drip-board of the sink, and the kitchen cabinet, located in the back wall. The lower part consists of drawers and swinging-door receptacles, and the upper of shelves, the unique feature of which is the glassing-in of both front and back. Were the kitchen cabinet of the customary type, and built into the back wall, the kitchen would only receive natural light from one side, but the glass at the back of the upper part of the cabinet is really a set of windows. The articles placed upon the shelves do not shut off the light to any serious extent, and the inner glass, in the form of swinging doors, not only lets the light through and keeps out the dust, but also keeps out most of the heat from the kitchen, thus providing a place not too cold or too warm for the keeping of milk and other perishable foods during the winter months.

In the illustration which shows the dining table in the kitchen may also be seen the heating apparatus behind its grill. It is a hot-air furnace of the type used for heating houses of medium size, but it is used as a stove, there being no piping of any kind. Its cost was slightly less than for an ordinary coal stove covered with nickel.

The kitchen is 8 ft. by 11 ft., the bathroom  $7\frac{3}{4}$  ft. by 5 ft., and the ground-floor bedroom 9 ft. by 12 ft. Between the bathroom and the kitchen

is a 2-ft. space, provided with a slanting floor, for the storage of coal. Between the bathroom and the space containing the stove is a passage by means of which it is possible to pass from kitchen to bedroom, and to the bathroom without entering the living room. The bedroom has a clothes closet and a set of drawers, the longest of which is over 6 ft. These drawers slide under the stairs, thus completely utilizing this space, the longest drawer being the bottom one. It would, of course, be unsatisfactory to pull these drawers all the way out every day or so, but the back part of each provides space for the storing of summer garments during the winter, and winter garments in the summer.

The floor of the living room is of oak, highly waxed, and the wall covering is of a warm yellow-brown burlap. Both the ground floor and upstairs bedrooms are of rough plaster, tinted with burnt-orange. The upstairs bedroom is  $13\frac{1}{2}$  ft. square with a glassed-in sleeping porch at the back, and an open sleeping porch at the front. The sleeping porches, both 9 ft. by 6 ft., are entered by means of French windows. The upstairs bedrooms also have a spacious clothes closet and set of drawers, as well as the niche for sewing machine and window seat. The house rests upon a concrete foundation and there is no basement. The electric light fixtures in the living room were designed especially by Mr. Int-Hout to fit the house. The amount of coal required to heat the house during the past winter was a little less than five tons.

## EUROPEAN NATIONS BUYING MANY WAR AEROPLANES

Some significant facts concerning the activities of European nations in the acquisition of war aeroplanes were disclosed at the recent aero exhibition at London. The presence of two Russian airmen, sent by their government to examine the various machines, revealed the information that Russia has

decided to buy a fleet of 300 aeroplanes, all to be delivered before the end of the summer. It already possesses eight British-built Bristol biplanes, five Farman biplanes, and 40 Bleriot monoplanes.

The representatives of M. Bleriot at the show declared that his firm is build-

ing 80 war aeroplanes for the French government. Thirty of these machines, both single and double-seated monoplanes, have already been supplied to the government and are in use. French officers have begun to learn to fly so rapidly that there are now not far short of 100 military airmen in France. So great is the demand now for war aeroplanes for various countries that M. Bleriot cannot deliver any more two-seated military machines for reconnoitering work for the next five months.

An extensive order for Breguet biplanes has been given by the French government. These machines, constructed almost entirely of steel, can be taken to pieces in half an hour for expeditious military transport. A number of Farman military-type biplanes—in which the two occupants of the machine sit in a neat enclosed body like that of a racing motor-car—have also been bought by the French, Italian, and Spanish governments.

With the recent orders for Bleriot and Farman aeroplanes, added to the number of machines of other makes already bought by the French government—such as Sommer, Maurice Farman, Antoinette, Goupy, Nieuport, and Hanriot machines—the French War Office will shortly possess an air fleet of at least 150 war aeroplanes.

The fast-flying war monoplane, as designed by M. Bleriot, was the striking feature of the exhibition. Sitting side by side, protected from the wind by a dome-shaped metal screen, and with maps and compass fixed in frames before them, the driver of the machine



Pilot's Seat in New Bleriot Monoplane, Showing Maps, Compass, Watch, Barometer, and Revolution Indicator.

and the observer will rush through the air at a speed of 60 miles an hour, inspecting a wide panorama of country over the sustaining wings, which have been set farther back to facilitate reconnoitering.

A notable fact concerning the activity in France was cited by an international expert at the London exhibition. If France were involved in war tomorrow she could, by calling up her civilian airmen as well as her military pilots, put a fleet of more than 300 aeroplanes into the field.

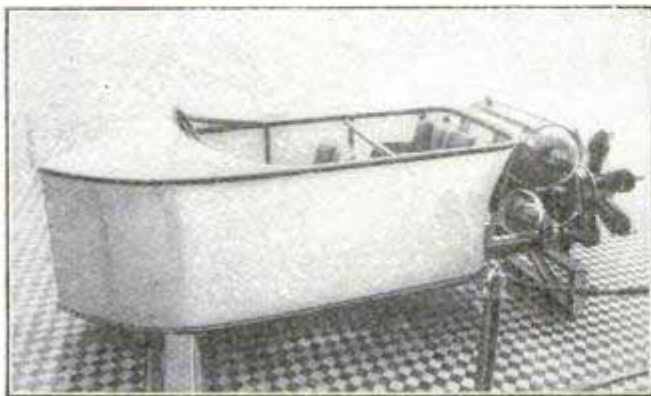

A Three-Seated Biplane Body

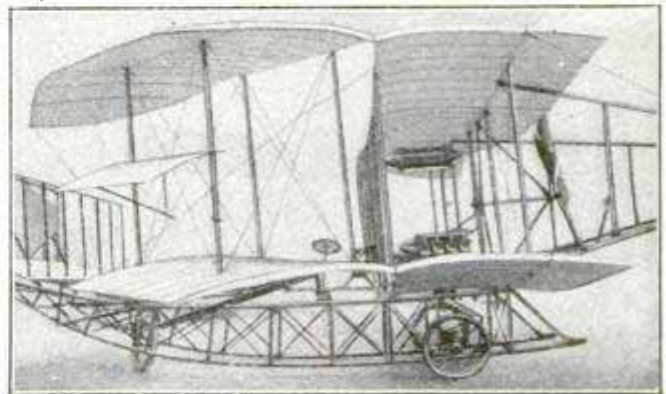

Folding Wings on Sanders Biplane

## HOLLOW CONCRETE POLES

Various methods have been evolved for the construction of hollow concrete poles, but nearly all of them utilize a core or mandrel of some kind, around which to build the concrete shell. The one instance in which a core is not used is in a German centrifugal process of casting.

The tubular mold or shell consists of long wooden strips lined with sheet metal and linked together. In this is placed the steel frame for reinforcing the concrete. Then it is filled with a sufficient quantity of wet concrete, and the whole is placed in a lathe and rapidly whirled. The centrifugal force packs the concrete in a uniform manner against the walls of the mold, and, after hardening, the mold is removed and the finished product taken out.

Emery cord is a new product recently placed on the market for polishing out needle holes or small parts that cannot be readily reached. It consists of a strong cord coated with fine emery.



Hollow Concrete Pole  
Which Was Cast by  
the New Centrifugal  
Process

## LARGE ELECTRIC STOR- AGE BATTERY

An electric storage battery, weighing complete over 1,000,000 lb. and capable of supplying 4,000 hp. at a moment's notice, has recently been ordered by a Baltimore electric company. It is claimed to be the largest and most powerful electric battery in the world. Such batteries are now being largely used by electric power companies for use as a standby when a part of the electric generating apparatus is out of commission or when an unusually heavy overload is suddenly put on the system. For instance, during a heavy snowstorm in New York city last winter, the demand for current increased in ten minutes from 100,000 to 166,000 hp. Many a time a city has been left for hours without electric light on account of a disastrous short-circuit which disabled the dynamos. A storage battery in such cases will supply power to any desired amount within its capacity with little or no interruption to the service.

The Baltimore battery will consist of 152 cells of 133

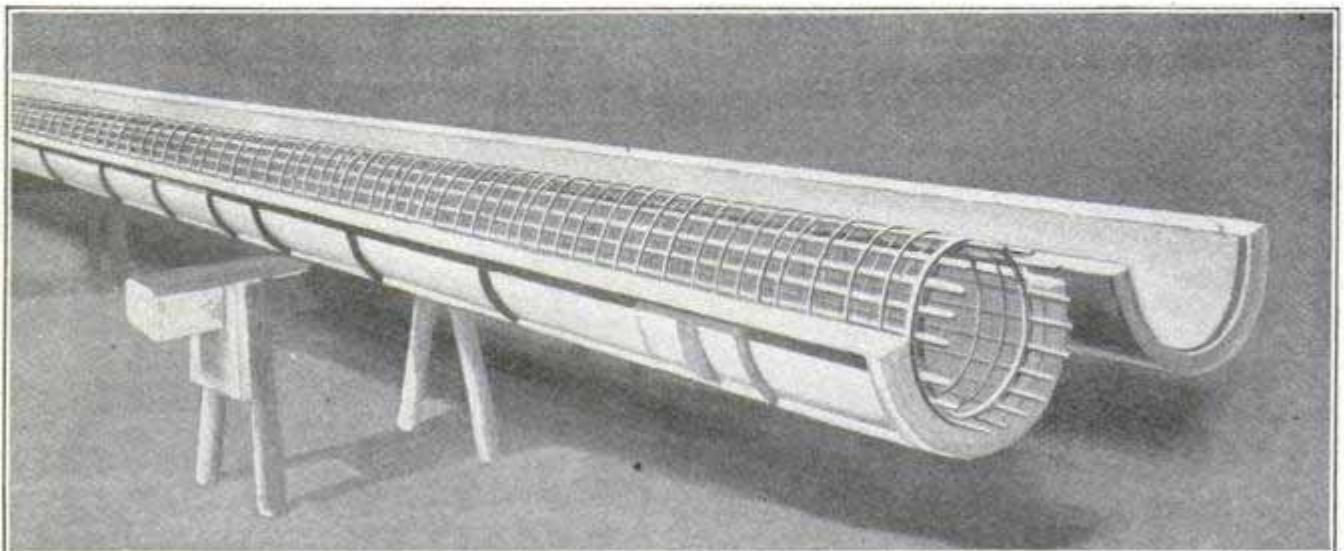

One of the Molds Open, Showing the Steel Reinforcing Frame in Place

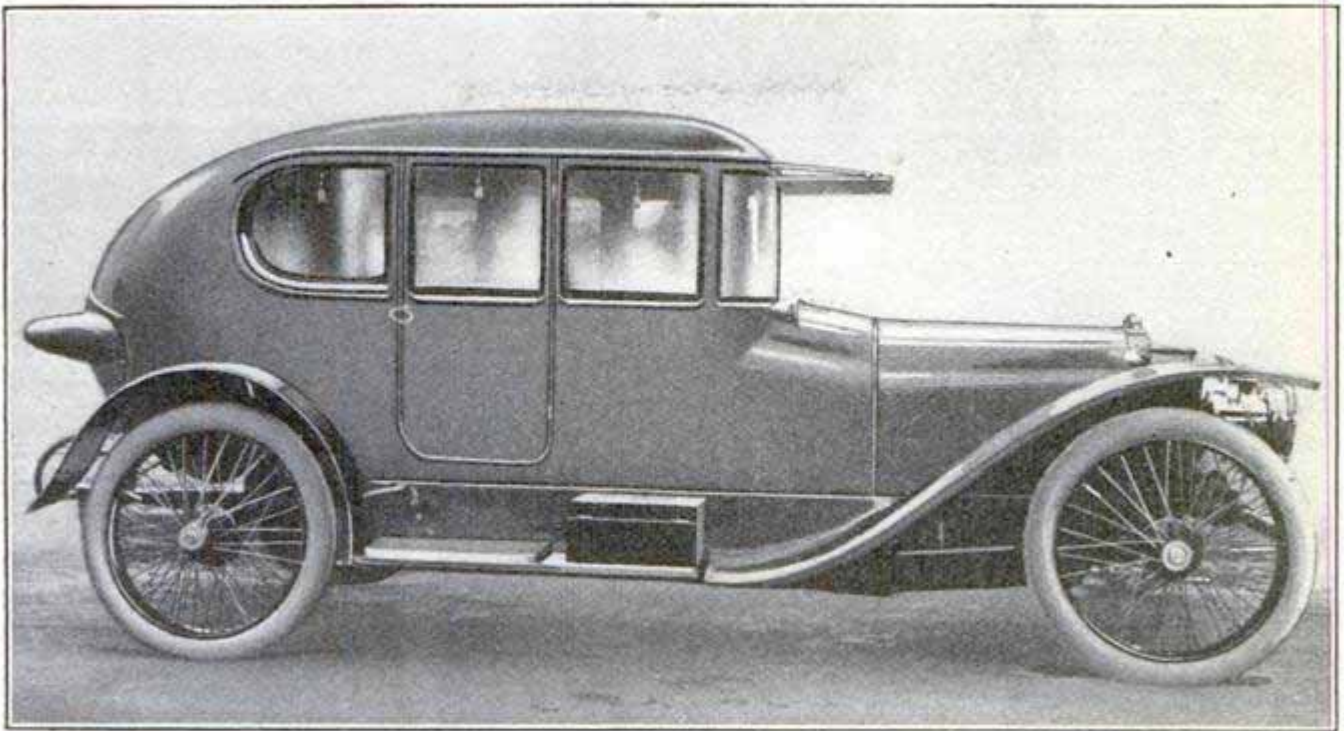

Aeroplane-Chasing Automobile Designed Both for Speed and Observation.

plates each. The lead-lined wooden tank for each cell will measure 4 ft. 2 in. high, 21 $\frac{3}{4}$  in. wide and 6 ft. 6 $\frac{7}{8}$  in. long, and will weigh 940 lb., without plates or liquid. The battery, fully charged, will supply enough current to light 120,000 tungsten lamps of 20 cp. each for one hour, or a corresponding amount of electric energy for a less or greater time as may be required.

### A HOTEL FOR IMMIGRANTS

A magnificent hotel for the use of immigrants has recently been opened in Buenos Ayres. Although but two stories high, it has sleeping accommodations for 3,200 persons, and railroad ticket offices are maintained on the premises so that those destined for the interior can purchase transportation without going outside of the hotel.

### AUTO TO CHASE BALLOONS AND AEROPLANES

An automobile that caters to the wants of the tourist who would watch aeroplane and balloon flights without discomfort, as well as being constructed for high speed in all kinds of weather, has recently made its appear-

ance in France, and because of its extreme shape has attracted considerable attention. Entirely aside from the fact that it has what is called the submarine shape, and that the whole car is tightly inclosed from the driver's seat to the tool box and extra tire case in the rear, the top and back are fitted with glass so that the passengers and driver can see above and to the rear as well as on all sides. The peculiar shape of the car is designed to lessen resistance to the wind and permit of extreme speed. The driver's seat is inclosed. The tire case is incorporated in the body of the car and, with the tool box,

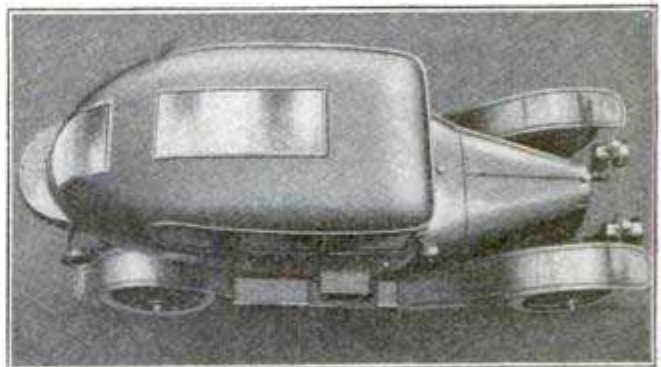

Windows in the Roof and Rear of the Aeroplane-Chasing Automobile

is reached by opening a door in the bulging, arc-shaped section in the rear.

## AERIAL PROPELLER-DRIVEN TROLLEY LINE

An aerial trolley line, the cars of which are patterned after the modern airship and driven by aerial propellers, is proposed between Burbank and

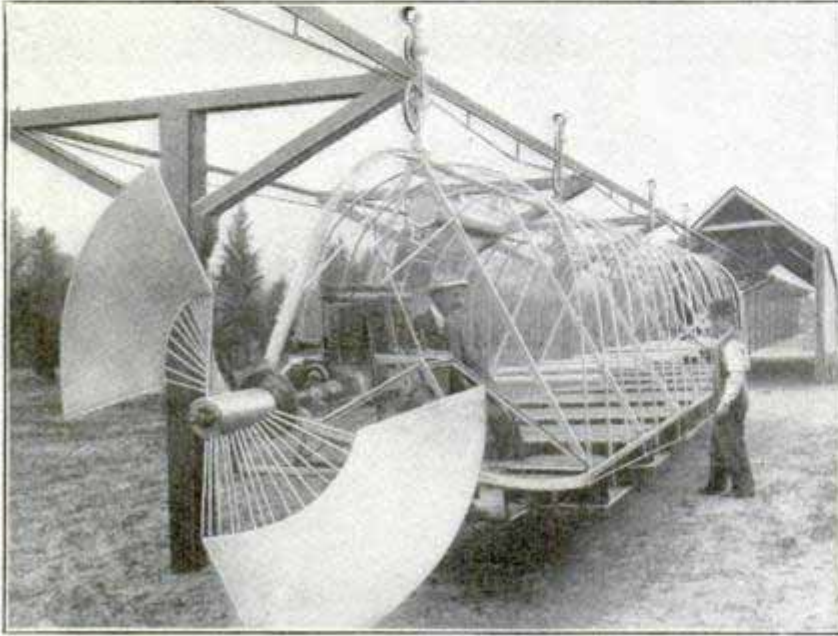

Aerial Propeller-Driven Trolley Car

Glendale, a suburb of Los Angeles, with the understanding that eventually the line will run directly into the heart of the city.

The unique nature of the aerial line and the type of car which will be operated upon it, is shown in the illustration of a section of the experimental line. The car, which is cigar-shaped, is built of aluminum, with the exception of the parts requiring steel. It will seat 50 persons, and is driven by an aerial propeller operated by a 20-hp. gasoline engine. For actual service the car will be inclosed in an aluminum shell provided with the necessary windows.

CA London scientist has suggested that the custom of keeping house snakes, so prevalent in the tropics now, and in all sections of the world in ancient days, be revived as a precaution against rats that are now proven to be the vehicles of plague germs. The snake is regarded as a much surer exterminator of rats than either terriers or cats.

## AUTOMATIC STOKERS FOR LOCOMOTIVES

It has been reported a number of times in the past that a successful locomotive stoker had finally been designed, but a year or so later it has been found that it is still in the experimental stage, and finally it has practically disappeared from view, says the American Engineer and Railroad Journal. This is not meant to reflect in any way on the reporters, since there is no doubt that there have been several automatic stoker designs which would successfully maintain the steam pressure of the locomotive under very severe conditions, and from this standpoint they have been successful, but experience has clearly

shown that the mere ability to distribute large amounts of coal in proper form to be burned and thus maintain steam pressure, does not constitute a success, although, of course, it is an essential feature of a successful machine of this kind.

A really successful stoker, however, must, in addition to this, be reliable to the last degree. If it is not capable of operating continuously with a reliability at least equal to that of the air pump it cannot be considered an entire success. Further, it must be rugged enough to do this without any unusual attention in the roundhouse. No doubt, when stokers come into more general use, it will be found advisable to organize a small force in the roundhouse for their inspection and repair, practically the same as is now maintained for air brakes. While it can hardly be expected at the start, the successful stoker must finally prove itself to be in the same class with the air brakes and injectors and should be treated in the same manner at terminals.

The ability to handle quantities of



coal beyond the limits of hand firing will, of course, be demanded of the automatic stoker, and while it is desirable to burn this as economically as possible, the first essential is to burn it and maintain the steam pressure. An increase in the "horse power of the fireman" is the constantly increasing demand of present conditions.

### ELECTRIC TRANSFORMER CRUCIBLE FURNACE

The largest of a new and unique line of German electric furnaces for crucible melting is shown in the accompanying illustration. These furnaces are intended for the melting of brass, copper, silver, gold, platinum, tin, zinc, iron or steel, and also for glass, enamel, etc., and range in capacity from 1 lb. to 250 lb. The method of tilting the larger sizes is clearly shown in the illustration.

The ordinary graphite crucible is used, but must be first treated with a special preparation supplied by the maker of the furnaces. The principle

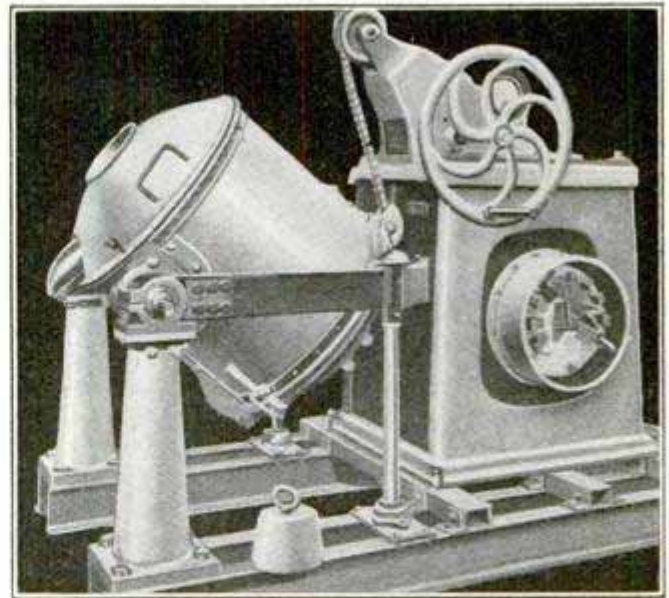

Largest of a Unique German Line of Electric Transformer Crucible Furnaces

of these furnaces is not new, being that of electrical resistance, but it is claimed that the firm construction, the rapid and certain manner of working, the lack of annoyance from heat, smoke or soot, and the possibility of continually watching the melting process, make this furnace the most perfect evolved up to the present time.

## A SUBMARINE DREADNOUGHT

By L. WILLIAM THAVIS

The United States government has under construction 13 submarines, three of which are the largest and most

formidable in the world. If the first of the largest type proves a success, this improved engine of warfare will



The "Seal," Just Completed for the Government, Which Embodies Some Advanced Ideas in Submarines

have a large bearing on the future of the navy. It will tend to increase the importance of subsurface war vessels, and at the same time lessen the importance of the greater battleships which this and other countries are striving to build.

Three of the 13 submarines are being constructed by the Lake Torpedo Boat Company, while the others will be of the Holland-Electric type. The first of the submarine Dreadnoughts to be constructed was the "Seal." The government will give the strange and uncertain craft a trial trip across the Atlantic.

If the "Seal" type comes up to the specifications and promises, it will be capable of going long distances. Its length is 161 ft. and its displacement about 535 tons. The government contract calls for a speed of 14 knots (16.12 miles an hour), but it is expected to make more. This is when the submarine is traveling on the surface. The submerged speed by the contract is  $9\frac{1}{2}$  knots (10.9 miles an hour). The cruising radius on surface and at an economic speed is expected to be over 2,800 miles.

The "Seal" is called a submarine dreadnought, and is designed especially for long ocean cruises in rough weather. It is designed to travel alone, without being accompanied by a tender. The armament consists of six torpedo tubes and room is provided for

10 torpedoes. The crew will consist of about 22 members.

As with other submarines, the "Seal" can travel on the surface, or partially submerged, or completely submerged. If the "Seal" can travel as its inventor expects it to, there is nothing to prevent its going along as an auxiliary with a fleet of battleships and in an engagement sneaking quietly under the surface into the very midst of the fleet of the enemy.

Among the new features of the submarine are hydroplanes. These correspond to the planes of an aeroplane. They are designed for the purpose of steadying the boat and holding it even when under the water. Another feature is the drop keel, which weighs several tons, and can be released in case of an accident, thus adding to the buoyancy of the vessel. On the bottom of the boat are wheels, calculated to protect the bottom when the vessel drops down to the bed of the ocean. Various other features are important in the construction of this type of submarine.

The provisions for the safety of the crew are as complete, seemingly, as they can be made. Enough storage air is provided for 48 hours under water. The vessel is provided with powerful gasoline engines, which propel her when running at the surface. But under the water the power is furnished by storage batteries.

### THE SOUTHERN PACIFIC'S \$10,000,000 TUNNEL

It is said that the Southern Pacific Railroad Company will soon commence its long projected tunnel under a portion of the Sierra Nevada mountains. The total length of this immense tunnel, which has been held in contemplation for almost 10 years, will be six miles, and the cost will approximate \$10,000,000. Its completion will materially shorten the line, do away with many grades, and make the line practically free from snow troubles.

### GREAT BRITAIN TO BLAZE ON CORONATION NIGHT

If the proposals are carried out, great bonfires will blaze from nearly all the headlands and heights of Great Britain on the night of the coronation of King George, June 22. The committee having the plans in charge recommended that a detonating rocket be sent from every principal height of England, Ireland, and Wales at 9.55 to call attention, and that at 10 o'clock a magnesium star rocket should be fired, to be followed by other rockets and the lighting of the



Courtesy the Sphere, London

The Heights and Headlands of Great Britain are Expected to Blaze with Bonfires Such as These on Coronation Night

bonfires. The program for Scotland is the same, but the time is set half an hour later, owing to the long daylight in the north.

### SAILS AS RAILWAY MOTIVE POWER

In the vicinity of Antofagasta and Orouro, Chile, are several remarkable short railways, which utilize the trade winds as motive power, the cars being equipped with sails. The idea of the sailing cars is credited to an engineer in charge of important government coast improvement. Impressed by the

fact that a stiff breeze could be depended upon for several hours every morning and evening, he built several cars and provided each of them with a sail. The idea proved so practical, according to the Railway and Engineering Review, that a number of such railways soon followed, the cheapness and practical worth making a strong appeal.

The speed attainable by the sailing cars is said to be as high as 35 miles an hour, but this may be checked to any extent desired by the manipulation of the brakes. The trade winds blow with clock-like regularity.

## A PROJECTILE AS A SATELLITE

Flammarion, the French astronomer and scientist, commenting on the increasing size of big guns, says that a

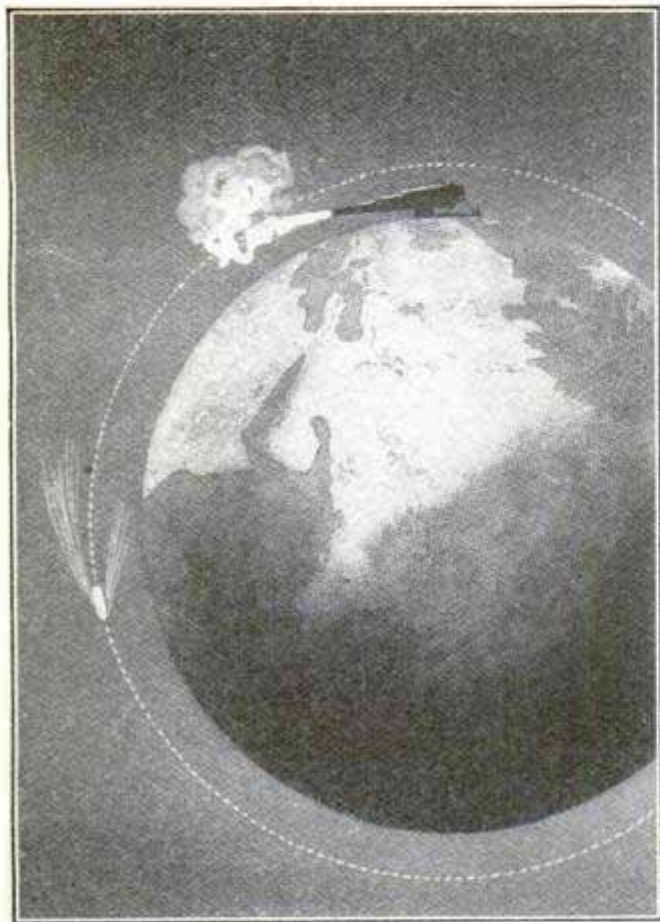

Flammarion Says a Muzzle Velocity of 26,000 Ft. per Second Would be Sufficient to Enable a Projectile to Overcome the Earth's Gravity Enough to Become a Satellite

muzzle velocity of 26,000 ft., or 5 miles, per second would be sufficient to enable a projectile to overcome the earth's gravity enough to send it re-

volving around the world forever as a satellite having a 1-hr. 20-min. orbit.

It is suggested that such a projectile-satellite, making a complete revolution around the world once every 80 minutes, would provide a useful world's timekeeper, or a monument to the world's peace.

The muzzle velocity of the 12-in. guns of the United States navy is about 2,400 ft. per second.

## STEEL SHEATHED CARS FOR MEXICO

In its effort to put down the revolution in the northern part of the republic, the Mexican government has constructed three armored cars, and an armored engine to draw them over the lines of railroad which pass from the capital northward to the United States boundary. The cars are ordinary freight cars, lined inside with  $\frac{1}{4}$ -in. steel, with a space of 2 in. between the wooden sides and ends and the steel lining in which sand has been poured, making an armor practically impenetrable to the ordinary rifle ball.

In each end of each car have been placed three rapid-fire guns, while there are portholes on each side for 20 rifles. Benches beneath these portholes furnish standing space for the men while firing out of the portholes. The doors of the cars interlock with the walls, and the whole outside of the

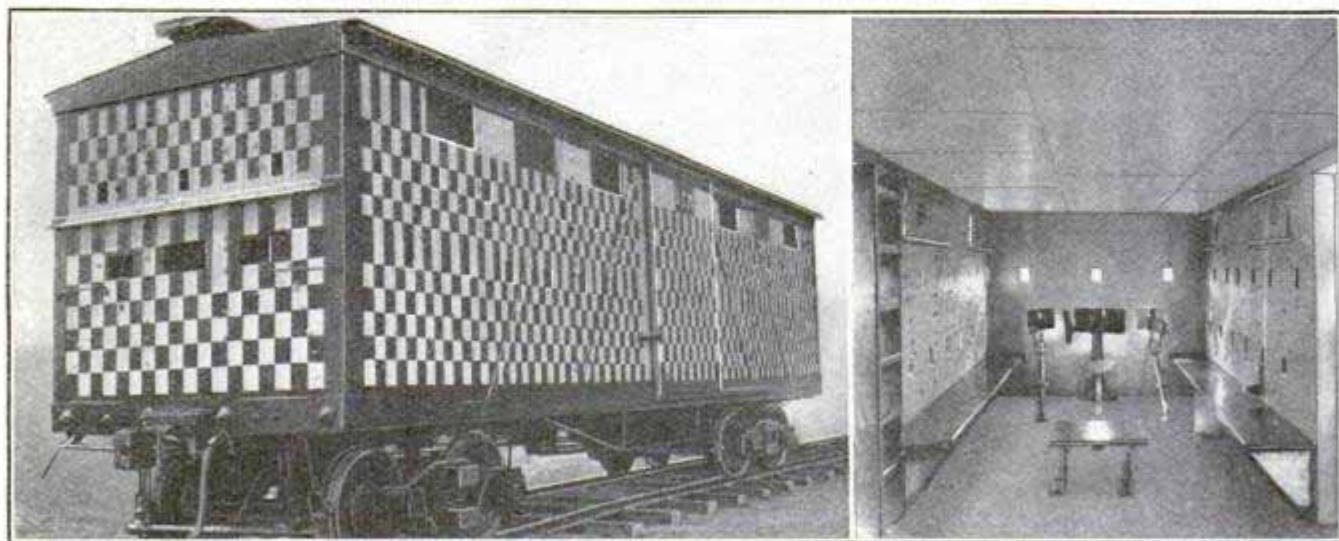

Exterior and Interior Views of Railroad Car Transformed into Moving Fort by Mexicans. Checkerboard Appearance Makes it Difficult for Enemy to Locate Portholes



48-Horse Team Hauling Machinery for a California Electric-Generating Station

cars is painted black and white, checkerboard pattern, with the portholes in black squares, so as not to be visible to the enemy. The engine to draw these cars is an ordinary small passenger locomotive, completely sheathed, from top of smokestack to bottom of drivers, and from rear end of tender to pilot, in  $\frac{1}{4}$ -in. steel.

### ELECTRIC ILLUMINATION SPOILS OBSERVATORY

Owing to the steadily increasing brilliance of the electric illumination in the vicinity, the astronomical department of the Brooklyn Institute of Arts and Sciences has started an active campaign for a new observatory, to be located near the institute building on Mount Prospect. Not only does the direct light of the great electric signs affect the observations, but the sum total of the downtown lighting is said to be so great that it sets the entire heavens aglow.

### TRANSPORTING MACHINERY IN WEST NO EASY TASK

Most people are familiar, from reading accounts in the public press, with the great engineering projects that are going on in our great West. But few realize the enormous difficulties in transporting heavy masses of machinery over rough trails and paths in the mountainous districts, far from the railroads or the navigable streams and canals that help to simplify such tasks in the more thickly settled communities. The illustration shows a 48-horse team struggling along with a heavy casting destined for the Kern River hydroelectric plant of the Southern California Edison Company.

CA parlor trolley car is to make its appearance on an Illinois interurban road, the first of its kind for the use of the general public. This same company operates a regular line of sleeping cars for night passengers.

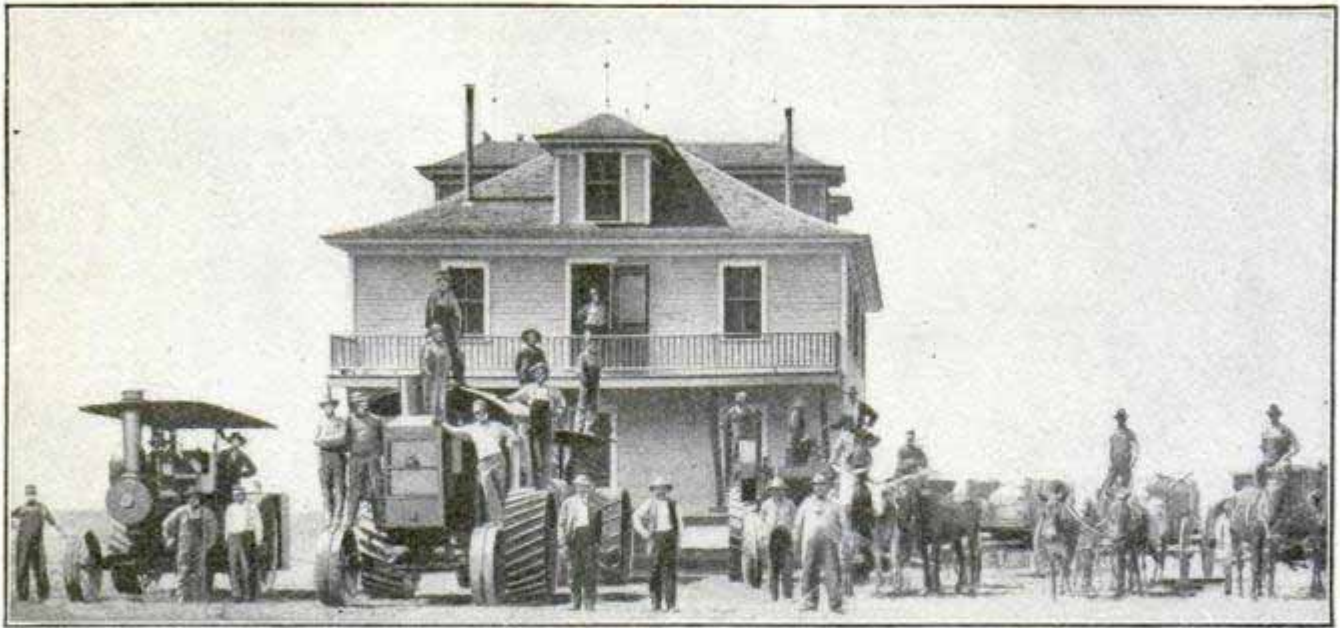

A Picturesque Elopement—Emma's Hotel Going to Its Successful "Suitor"

## A MUNICIPAL ELOPEMENT

When a town in the panhandle of Texas finally yielded to the seductive offers of a suitor and eloped, she—the town's name was Emma—adopted the appropriately unique method of eloping by traction engines. This sets a new record in elopements and in municipal deeds. The story is of one of the most picturesque of county-seat scraps, which grew out of the fact that Emma, the county seat, was not located at the geographical center of the county, nor in fact within the five-mile radius of the geographical center, which the Texas law requires.

When records from the surveyor general's office showing the county center were received, two rivals sprang into the field, desperately wooing and hoping to win Emma by offers of trades of lots for lots in Emma. The result was that Emma's old home on the prairie is now deserted and from each yawning cellar-hole there are deep grooves in the sod across the fields to Crosbyton. Hereafter, where Crosbyton lodges there will Emma lodge, and the name of Emma has been obliterated from the map in favor of Crosbyton.

It was a picturesque passing, the drygoods and grocery emporiums, the churches, the school and the flock of

houses which had constituted the town of Emma: To-day they are all scattered through the town which was the successful rival in the race for the county seat. The last of the buildings was moved during the winter. The first started across the prairie on August 17, last year, and by the 19th the elopement was on, 11 houses were under contract to be moved, two churches and a parsonage were on the way. When the day for the county seat election arrived, the town of Emma was already standing up with Crosbyton, ready for the knot to be tied. An injunction against the formal nuptial knot was secured, but the county judge, after turning the ballot boxes over to the county clerk, calmly drove out of the county and left the rival claimants to settle their own disputes.

---

☐The asphalt resources of Cuba, are expected to prove superior to any other in the world, not excepting the famous deposits in the island of Trinidad.

---

☐A Boston electric company has equipped one of its electric automobiles with a motor-driven outfit for pumping out manholes.

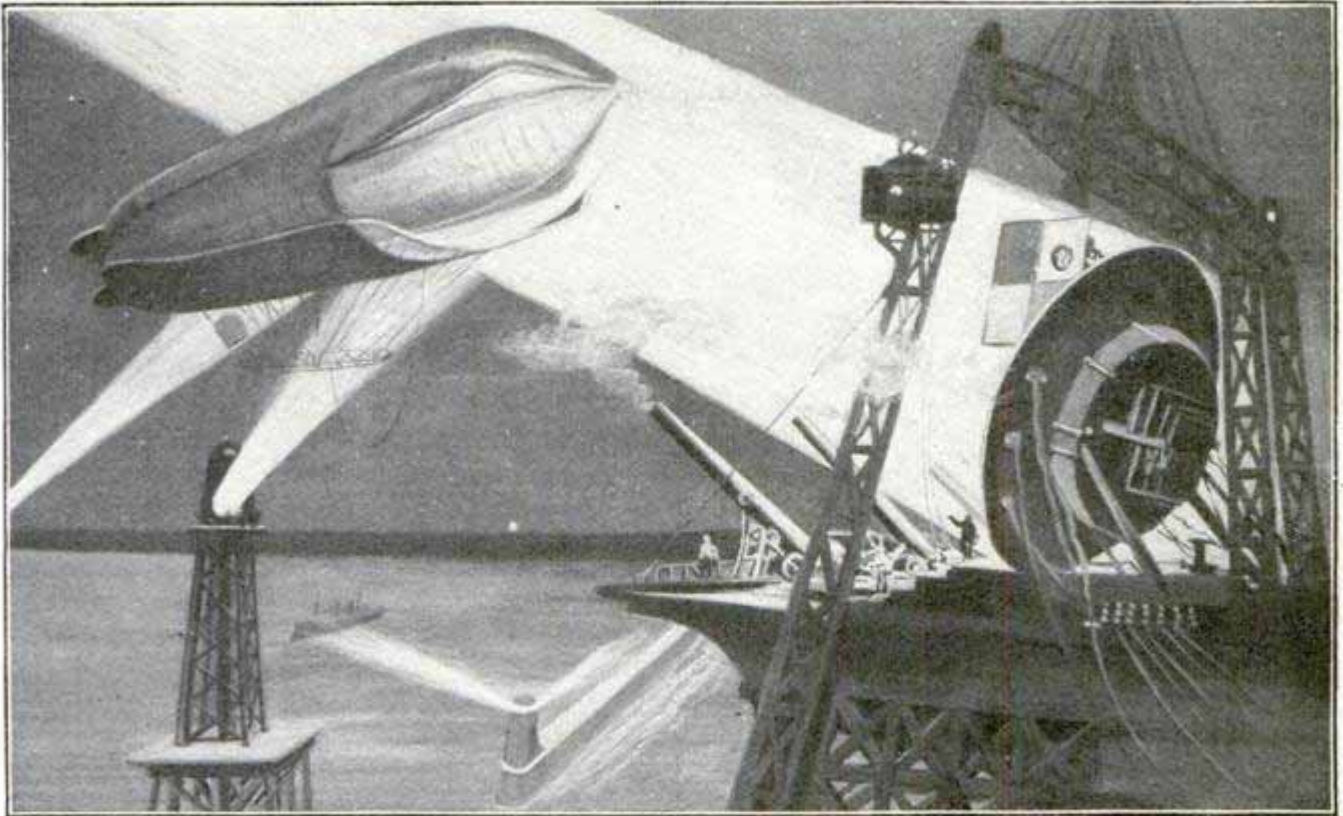

### A VISION OF THE FUTURE

A French artist's idea of how coast defenses will appear in the future, fitted with powerful searchlights and huge guns to repel attacks by aerial craft

## TO DEFEND GERMAN ARMY AGAINST AIR CRAFT

German ordnance experts claim to have developed a gun that will furnish protection against balloons and aeroplanes under all ordinary conditions.

This gun and its limber are incorporated in an automobile carriage, the gun being loaded and fired on the platform formed by the bed and sides of the car.

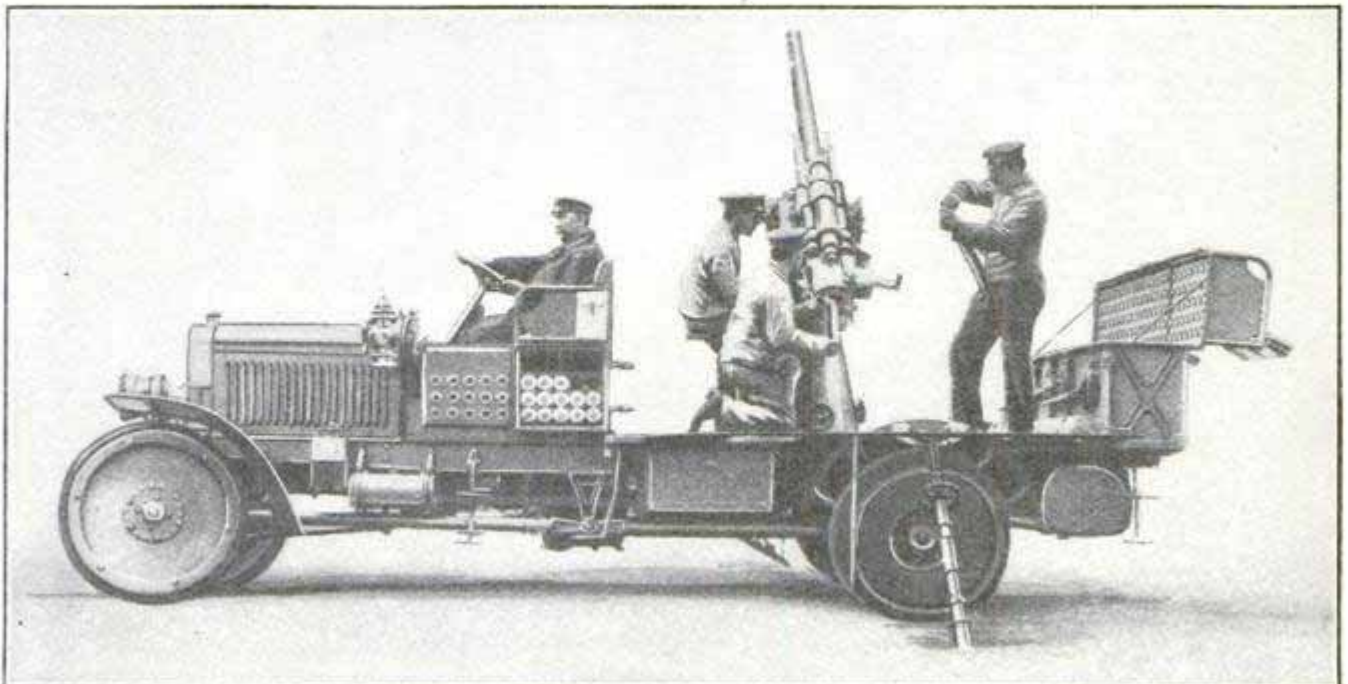

New Gun Designed for the German Army as Protection Against Air Craft

The ammunition is carried in chests under the driver's and cannoners' seats in the front and rear. The gun is mounted just behind the center of the truck and when in action the platform on which it is mounted is furnished with extra bracing by a long arm which is let down from the frame of the car and rests on the ground, thus permitting the absorption of at least a part of the shock of the explosion and recoil, and relieving the strain on the running gear.

One feature of the car that appeals to artillerymen is that the bed of the

contact shells, and time fuses did not always explode near the object of attack. The new fuse was developed by the Krupp experts.

### PLANNING A PHILADELPHIA BEAUTIFUL

Included in Philadelphia's \$200,000,000-plan to make the city both attractive and practical, is included an amusement center with a great convention hall as one of its chief features. The city government has under consideration an immediate appropriation

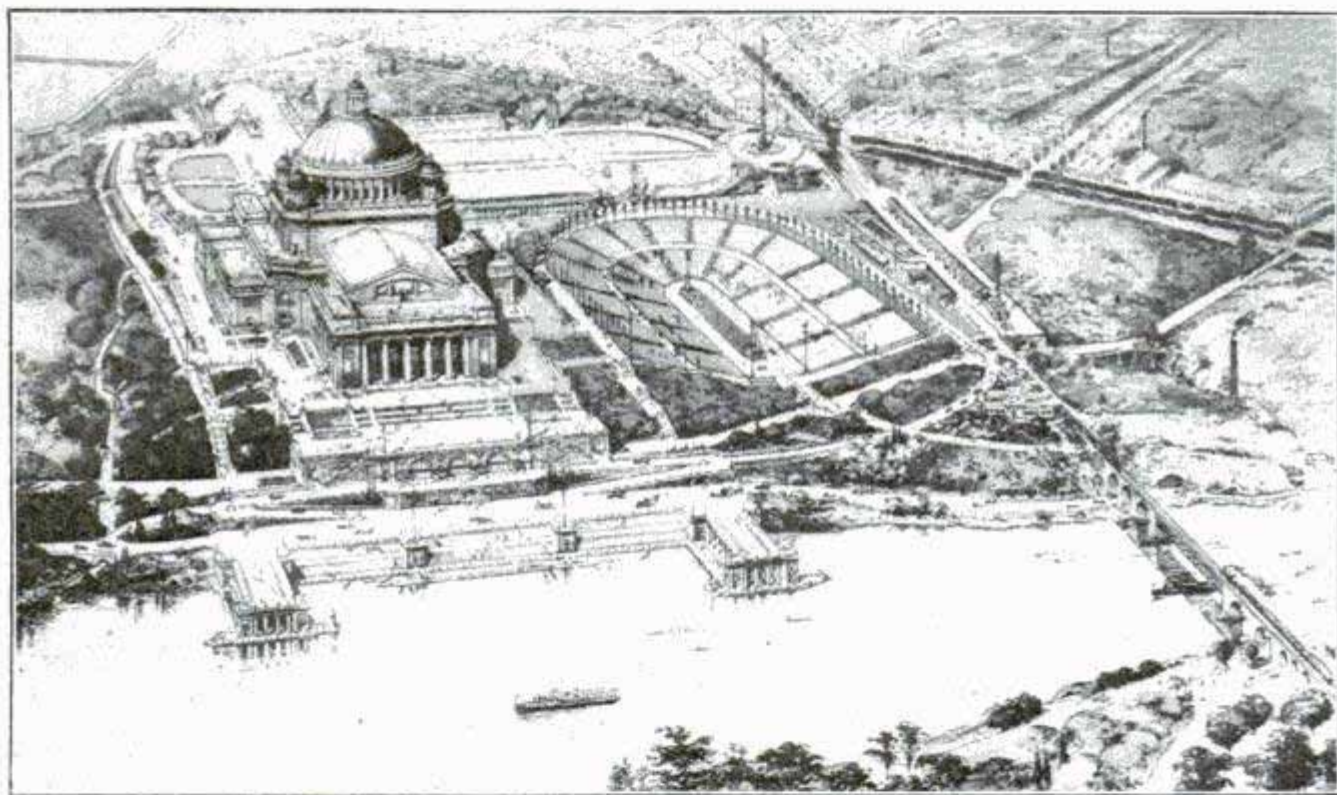

Sketch of Philadelphia's Proposed Amusement Center, with Great Convention Hall as a Chief Feature

body need not be any wider than is necessary to mount the gun, as the wide sides of the car are hinged and can be let down to form a platform on which the gunner stands. The mounting of the gun provides, of course, for the direction of the fire toward the sky.

With this gun, it is understood, there will be used the new German shells that explode on contact with the lightest fabric. These shells have been recently perfected and are regarded as a great advance over the ordinary ammunition. Heretofore more positive resistance than the delicate fabric of a balloon envelope was necessary for

of \$500,000 to start the work, and a total appropriation, before June of next year, of \$1,500,000 for the amusement center. The plans submitted by the citizens' committee include improvements that will cost over \$200,000,000. Some of the most important features, the mayor believes, can be taken up within a reasonable time. Legislation now pending will enable the city to borrow virtually an unlimited amount for subway and dock improvements, provided such improvements yield sufficient revenue to meet the interest charges, and create a sinking fund to retire the bonds.



# COMMENT AND REVIEW

**Prominent Chinese Cut Queues**

TO the average man, a hair cut is simply a necessary and unpleasant evil, and the thought of making the event a great social function, to be performed as a solemn ceremony, would seem ridiculous. There was, however, a case of barbering recently, which not only became the talk of a whole nation, but the event was cabled around the globe, and to diplomats, scientists and students of world progress it was full of significance. For centuries his queue was dearer to the Chinaman than even the head which it adorned; in fact, if he went abroad and lost his locks, he had much better never return. But even time, which moves slowly in the land of Confucius, perhaps because it has been moving so many thousand years, at last brings a social revolution, and the queue is about to lose its hold. The average American is so absorbed in doing things he is quite indifferent as to whether he is bald or not, and is therefore unable to realize the portentous seriousness of a Chinese hair cut. A guillotine execution in France would cause far less excitement.

The leader in this reform is no other than Wu Ting-Fang, at one time Minister to the United States. One hundred and fifty leading officials, business men and prominent citizens joined him in the ceremony, which was performed in public after due announcement. With such a notable example, the effect upon their four hundred million of fellow-citizens can be imagined. Seriously, the event means vastly more than the loss of a few handfuls of long hair; it reflects the growing spirit of an age of progress in the largest and most exclusive nation in the world, and is significant of a development which, a generation or less hence, will give the other nations of the world abundant food for thought—if not action.



**Parade of World's Navies**

THE greatest naval pageant in the history of the world will be the most spectacular feature of the ceremonies incident to the opening of the Panama Canal. The President has been authorized by Congress to invite

all foreign powers to participate in a great naval parade, which will insure not only representation of every navy in large numbers, but each country will send its largest and best ships. The spectacle will be the sight of a lifetime.

The fleets will assemble in Hampton Roads and proceed up the Chesapeake Bay and Potomac River to Washington, where a formal call will be made upon the President of the United States. On their return the President will review the fleets from his yacht, which will be stationed at the Virginia capes; then this vast armada will sail southward and pass through the Panama Canal as part of the official opening program. By no means the least interesting part of the announcement is the continued cruise of the

combined fleets to San Francisco, during the Panama Canal Opening Exposition. This will furnish an attraction which no international exposition has ever had, and will enable thousands of people who cannot get to the Atlantic coast, to enjoy the inspiring sight of the greatest assemblage of fighting ships ever brought together in the history of the world.



**T**O discontinue the time-honored custom of delivering mail to callers at the postoffice on Sundays, seems at first thought like a step backward. The tendency of the age would more naturally suggest one delivery at the home or office. Conditions have changed, however, to so large an extent during the past few years as to make Sunday closing of the postoffice, at least in the large cities, a not impractical thing. In the smaller country towns, where carrier service is not maintained, the labor involved to distribute the letter mail would impose no very serious hardship on the postmaster, or his clerk, for the amount to be handled is comparatively small. In the large cities, however, conditions are reversed: Not only must an enormous quantity be sorted, but it must necessarily be done by the same carriers who have worked hard all the week; and after sorting they must remain to hand it out, because they alone are able to recognize the proper parties to whom it should be delivered.

*Sunday  
Delivery of  
Mail*

While an occasional hardship must result to travelers who wish to leave the city Sunday night, yet the number of such compared to the public served is really infinitesimally small. It is said a larger number of business concerns in Chicago than any other city call for their office mail on Sunday, and yet a recent count developed the fact that less than one-fifth of one per cent of the population used the postoffice on Sunday, and not to exceed 20 per cent of those who did call received anything. On a recent Sunday in Jersey City, with a population of over 300,000, only 36 persons called for mail, but to accommodate this handful 121 men were compelled to report for work.

The recent facilities of the telegraph companies in providing night lettergrams at prices practically within the reach of everybody, would seem to greatly simplify the Sunday-closing question, as the rates to points within 500 miles would debar few from their use in case of emergency, and letters coming from any greater distance would usually be 24 hours old, too long a time in case of illness or death. Business men would generally use the wires for telegraph or telephone, regardless of Sunday closing.

The work of the letter carrier, both city and rural, is hard enough at best, and the public should willingly make some sacrifice to give this great army of faithful, conscientious workers a day of rest. There are many services, especially in cities, which cannot be entirely abandoned even on Sunday, but the closing of the postoffice on that day would seem not to be one of them.

H. H. WINDSOR



The Parts of the New Milk Container Disassembled Showing the Three Essential Features

Manner in Which the New Milk Container for Grocers is Used in Retailing Any Quantity

## SCIENCE HAS NEW WEAPON TO FIGHT IMPURE MILK

Some modern philosopher has said that assurance of pure milk is the best insurance of life to the infant of the tenement. Scientists in all countries have worked for years to evolve systems of insuring the purity of milk, some of which are successful while others have left the life-maintaining fluid open to all sorts of germs. The latest device that has been presented for this purpose appears to have many advantages in that it furnishes practically a sealed receptacle for the use of the milk dealer, permitting the sale of any quantity, absolutely preserving the milk from contamination, and providing cold storage.

This promising device consists of two vessels, one of metal and the other of wood. The metal vessel, which is the milk container, fits inside the other, leaving plenty of room for ice between them. The covers of both vessels are screwed and clamped on tightly. A pipe, led through the outer wooden vessel, connects a sanitary measuring device and faucet combined with the milk container, into the lid of which it is tightly screwed. A stand which permits the tilting of the entire apparatus is furnished so that it may be emptied to the last drop. The faucet and measuring device consist of a large glass cylinder into which the

milk is drawn in the quantity desired. For this purpose the cylinder is graduated and provided with a piston, which can be set at any point of the cylinder by means of a threaded regulator. When the amount of milk wanted has been drawn into the cylinder, a spring cock is pressed and it flows out into the pitcher or glass of the purchaser. The whole is so made that all the parts can be easily cleaned.

### MOTORBOAT MAKES NEARLY MILE A MINUTE

Previous to being sent to the Monaco races, the British international racer, "Maple Leaf III," is said to have attained the marvelous speed of  $49\frac{1}{2}$  knots (about  $56\frac{1}{2}$  miles per hour) which is by far the fastest time ever made by any water craft. This record was not officially timed, however, and consequently cannot be considered as a standing record.

The "Maple Leaf III" is a twin-screw boat, 40 ft. long, with a beam of 9 ft., driven by two engines developing about 650 hp.

Driving the famous 200-hp. Benz car, "Bob" Burman attained a speed of 141.7 miles an hour at Daytona, Fla., on April 23.

## A DOG THAT REALLY SPEAKS WORDS

There have been many so-called speaking dogs, that is, dogs who have this remarkable dog can really speak, although its vocabulary is limited as yet to about ten words.



The Dog That Actually Articulates and the Daughter of His Master, Who is a German Royal Gamekeeper

been trained to give a certain number of barks to indicate certain wants, but fact that he does speak the words, but also by examination by scientists.

The wonderful gift that enables the dog to articulate was discovered quite accidentally by its owner, Herr Hermann Ebers, a German royal gamekeeper. One day the dog was begging at the table and his master asked him (in German, of course) "What will you have?" The dog answered, "haben" (have), and since then has been taught eight or nine other words. His name is Don, and this word he can say very distinctly, also "Ruhe" (quiet) and "Hunger" (hunger). That he can really articulate has been proven not only by the

## CONCRETE STAND BUILT IN RECORD TIME

One of the most remarkable achievements to date in the field of rapid concrete construction was recently concluded in the city of Washington, D. C. It involved the construction within a period of 22 days of a concrete grandstand 500 ft. in length and 69 ft. in width. On March 17 of this year the grandstand at the major league baseball grounds at the national capital was totally destroyed by fire. As the regular baseball season was scheduled to begin on April 12, the resulting situation was a serious one. However, plans were quickly drawn, and on the morning of March 20 a large force of men set to work in a race against time.

Work was carried on day and night by a force of more than 800 men work-

ing in three shifts. The concrete work was all in the shape of steps, forming a vast semicircular structure, and there were employed wooden molds or "falsework" of the regulation type, most of this frame support being allowed to remain in place after the stand was ready for occupancy. For one interval of three days the operating force maintained a record of 1 sq. yd. of concrete per minute,—mixed and poured into place. The contract involved the laying of 600,000 sq. yd. of concrete reinforced by steel rods, ranging in dimension from  $\frac{3}{16}$ -in. round rods to square rods  $1\frac{1}{4}$  in. square. About 6,000 sq. yd. of concrete was used in the foundation for the stand. On this contract there was no time to install the ordinary style of

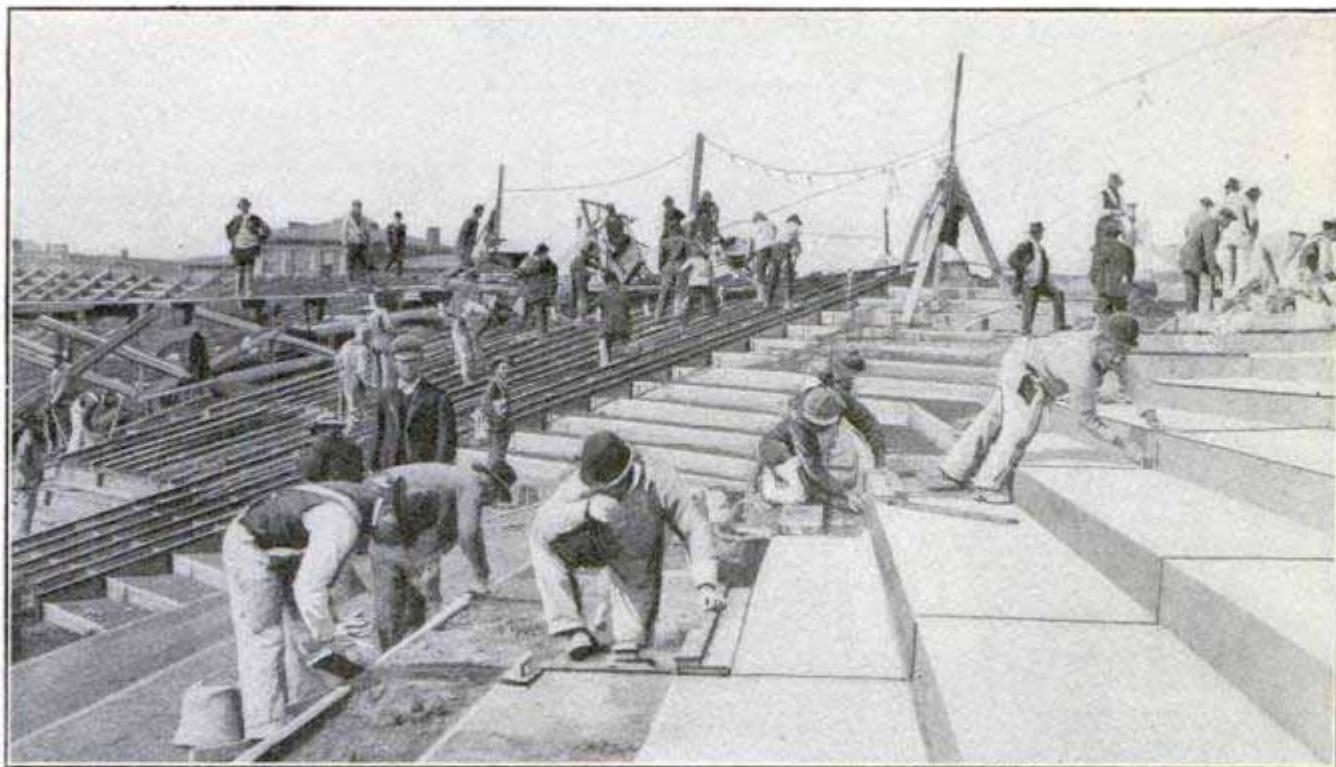

Rushing the Work on the Washington Baseball Grandstand

plant for handling concrete, and accordingly the great buckets of concrete were hoisted by derrick from the mixer to a hopper at the top of a wooden tower, centrally located.

### HEADLESS BUTTERFLIES

According to the French scientific review, *Cosmos*, two French biologists have produced butterflies without heads.

They carefully removed the heads of a number of larvæ and most of them survived the operation, continuing to develop into the pupa stage; but only some few underwent the last change and emerged as normal butterflies—minus the head.

### PLACES BURDEN OF HAND BAG ON SHOULDER

Creators of fashions for women in Paris have devised a new adjunct to feminine furnishings which is nothing less than a handbag of large size. The bags are mostly made of gobelin tapestry, are frequently embellished with large tassels and fringes and bear some

faint resemblance to the old-fashioned carpet sack. They are so large and top heavy that it is almost out of the question to carry them in the hand, so they are provided with a long, heavy cord of tapestry which is placed around the neck or thrown over the shoulder.



Tapestry Bag of Modest Proportions Worn in Accordance with the Latest Fashion

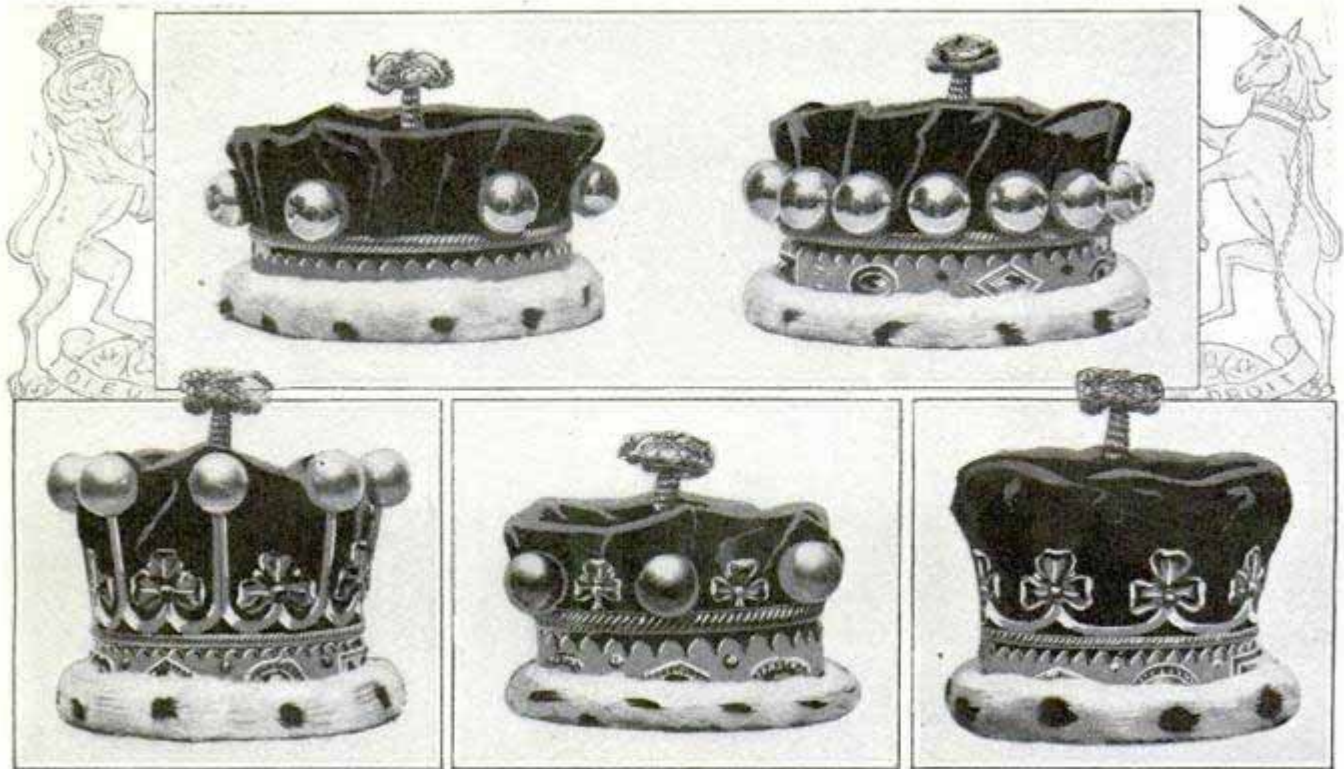

Earl

Baron

Marquis

Viscount

Duke

## CORONETS THE PEERS AND PEERESSES WEAR

The king and queen of England are not the only people who will have crowns placed upon their heads at the coronation ceremonies in London. Every one of the peers and peeresses of the realm will also be crowned, the difference in the coronations being that at the time the king and queen are invested with their royal diadems by high officials of state, the dukes, marquises, earls, viscounts and barons will each place upon their own heads the "circlet of gold" ornamented according to their ranks. Their ladies will crown themselves with similar circlets, of a smaller size, and equipped with hatpins to hold them in place. The highest order of the English peerage is held by the duke who wears a "circlet of gold surrounded by eight low points, each surmounted by a strawberry leaf." The marquis is similarly provided with "eight low points," but only four of these are surmounted by strawberry leaves, the other four being provided with pearls. The earl, on the other hand, has the "eight low points surmounted by strawberry leaves" but they must be small enough to permit

of being placed between them "eight lofty points or spines topped by pearls." The viscount is next in order and the relative subordination of his degree is shown in the fact that he is not permitted to have any "points" but is restricted to the use of 16 pearls "in apposition and close to the rim." The baron, the junior rank of peers, is permitted to use but six large pearls, "set directly on the rim but not touching one another."

## FRENCH AERO-HYDROPLANE

One of the several combination water and aerial craft entered for the motorboat exhibition races at Monaco this year was this curious French aero-hydroplane designed by M. Fabre. The wing surface was 258 sq. ft., the weight of the floats, on which the machine glides over the surface of the water, was 176 lb., and the total weight is 990 lb. It made some successful flights, arising from the water, but met with disaster one day when it alighted on the water too suddenly. The pilot was not injured.

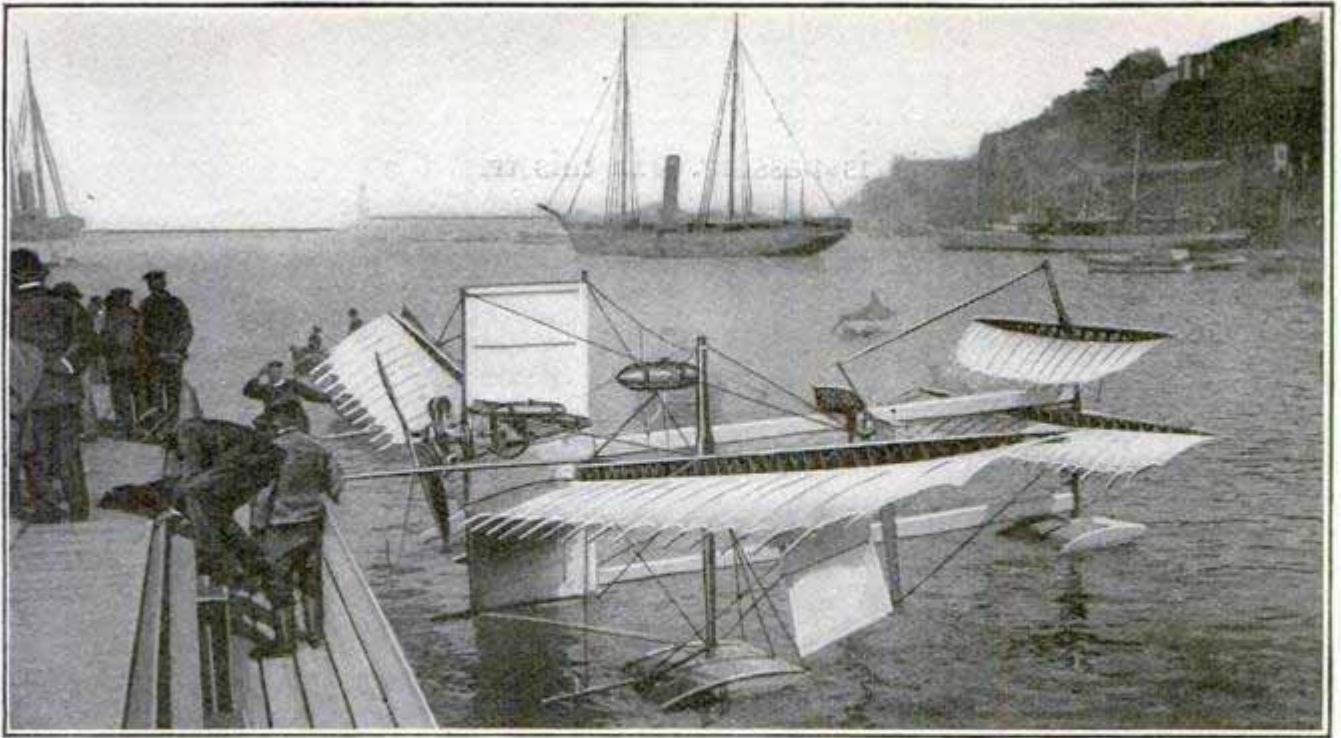

**The French Half-Water, Half-Air Craft, Which Attracted Attention at Monaco**

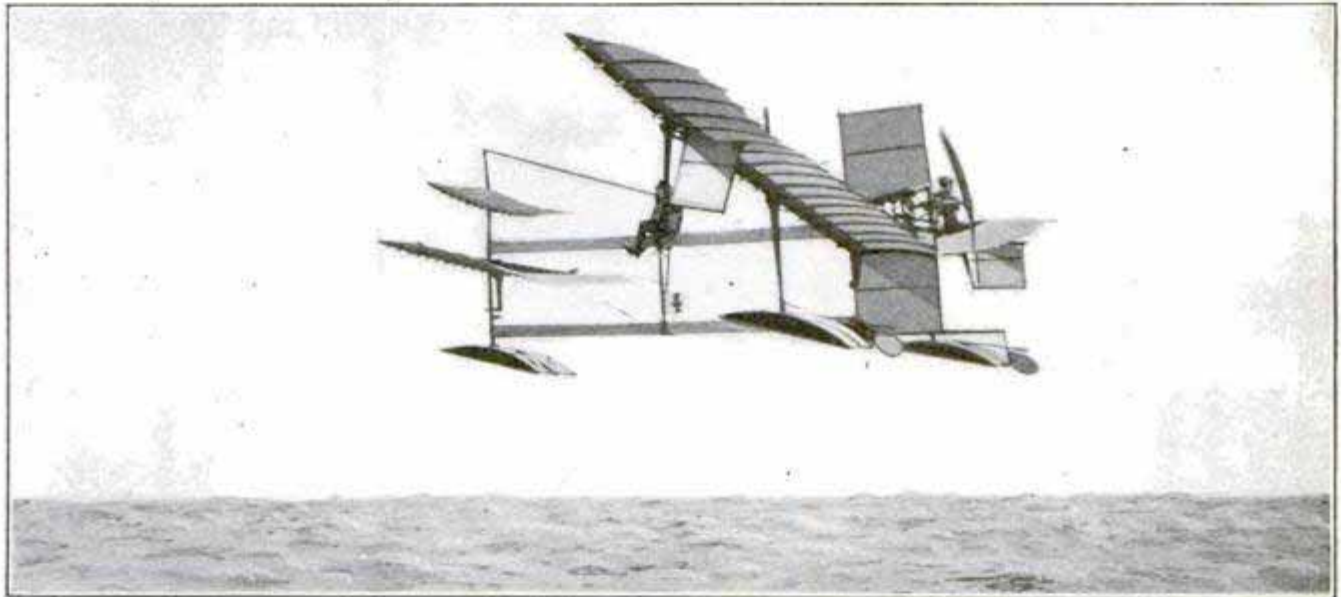

**Making a Successful Flight after Arising from the Water**



**The Result of Alighting Too Suddenly on the Water**

## FINDING PLACE FOR AERO IN WORLD'S AFFAIRS

The freak age of flying is passing. Reckless airmen will continue to defy death for the plaudits of the crowd for years; the people will flock to such exhibitions as long as they are held; but the time has passed when the aeroplane created awe in the soul of the average citizen and the records that are yet to be made—that are now in the making—are those which have to do with the practical use of the machine, its application to commerce or as an aid to scientific progress. The men who have engaged in the exploitation of aircraft are redoubling their efforts to perfect a machine which will be something more than an adjunct to a circus or a county fair. They are realizing the possibilities the new science opens to them as rapidly as the progress of invention makes possible. From now on, it is safe to predict, the development of aeroplanes will be along lines calculated to secure them a permanent place in the work of civilization. At present the development tends to the adaptation of the machine to uses of war—the most primitive of the civilized arts.

The most startling exploit in the air during the past few weeks has been the accomplishment of a London-to-Paris flight of 250 miles without a stop. M. Pierre Prier, a French airman, performed this feat in a Bleriot monoplane which he drove at the rate of 63 miles per hour, making his journey from Hendon, a suburb of London, to Issy-les-Moulineaux, just outside of Paris, in 3 hr. 58 min. This is the seventh journey to be made by air route across the English channel, but it is the first trip between Paris and London without a stop. The journey made by M. Prier is covered by railroad and steamship a distance of 270 miles in about 6 hr.

Aside from the remarkable sustained flight of M. Prier, possibly the most important feat of recent months was the two days' flights of Captain Belanger and of Lieutenant de Rose of the French army, from Pau to Paris.

In this trip, the officers covered a distance of 500 miles and during the entire time battled with head winds that tended to force them back. Some idea of how this handicapped them can be obtained from the fact that the last 155 miles were made by Captain Belanger in 319 min. and by Lieutenant de Rose in 397 min. That this was remarkably slow time for the modern aeroplane can be understood when it is remembered that the same day the officers started on their journey, March 31, M. Pierre Vedrines flew from Poitiers to Paris at the rate of 94.54 miles per hour, the entire distance of 208 miles being covered in 2 hr. 12 min. This record was made by an airman alone in his machine. An interesting comparison with it is found in the flight of Lanser from Kiewit to Brussels, Belgium, with three passengers, a distance of 54 miles. The three passengers were sisters of the airman.

That the practical use of the aeroplane has not been overlooked by persons with evil designs is recorded in a newspaper dispatch from Geneva, Switzerland, which tells of the arrest of an Italian airman named Smeroglio who attempted to fly into Switzerland carrying dutiable articles. His machine fell on Mount Cenis, where the smuggled goods and the smuggler were taken into custody by the customs officers.

Captain Carron, of the French army aviation corps, died as the result of injuries received in an aeroplane accident near Versailles, France, April 18. He was making a cross-country flight from Villacoublay to Versailles. Flying at a height of 250 ft. something went wrong, causing his machine to fall. It turned over as it fell and the airman was pinned beneath the wreckage. Lieutenant Byasson of the French naval aviation corps, was another victim of the aeroplane. Lieutenant Byasson was in the air in his monoplane at Coignieres, France, when the machine turned a somersault and crashed to the earth on top of him.



## SCOUTING IN AN AEROPLANE

While the enthusiasts are declaring the day is not far away when the aeroplane will be a practical engine of destruction in warfare, there is no unanimity of opinion on the subject among scientists. There are many problems to be solved before the nations of the world will cease building battleships and turn all their navy yards into immense aeroplane factories.

As an aid to reconnoissance, however, it has proved its usefulness. The French army authorities have been training officers as aerial scouts for the past year, and a number of special devices have been evolved for this special work, such as means of communication between the pilot and the scout for giving directions, and utilizing the pilot's back as a rest for a small sketching board.

C. F. Williams, an artist of the London Illustrated News, recently made several experimental flights to prepare sketches and notes such as might be useful for military purposes, and he

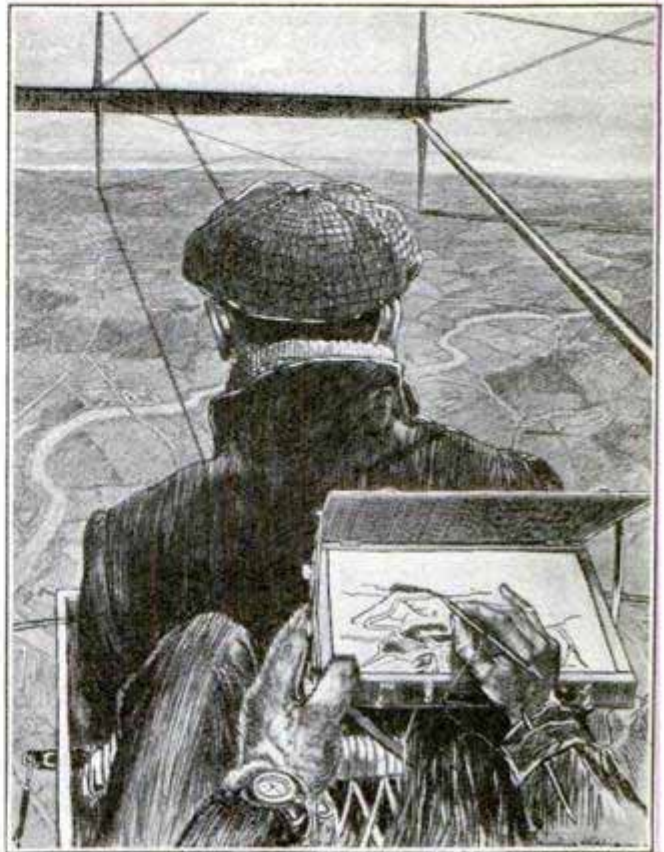

Making "Military" Drawings while Flying in Aeroplane—Note Compass Attached to Wrist, Pencils Sharpened at Both Ends and Attached by Strings, and Novel Drawing Board and Wind Shield for Hand

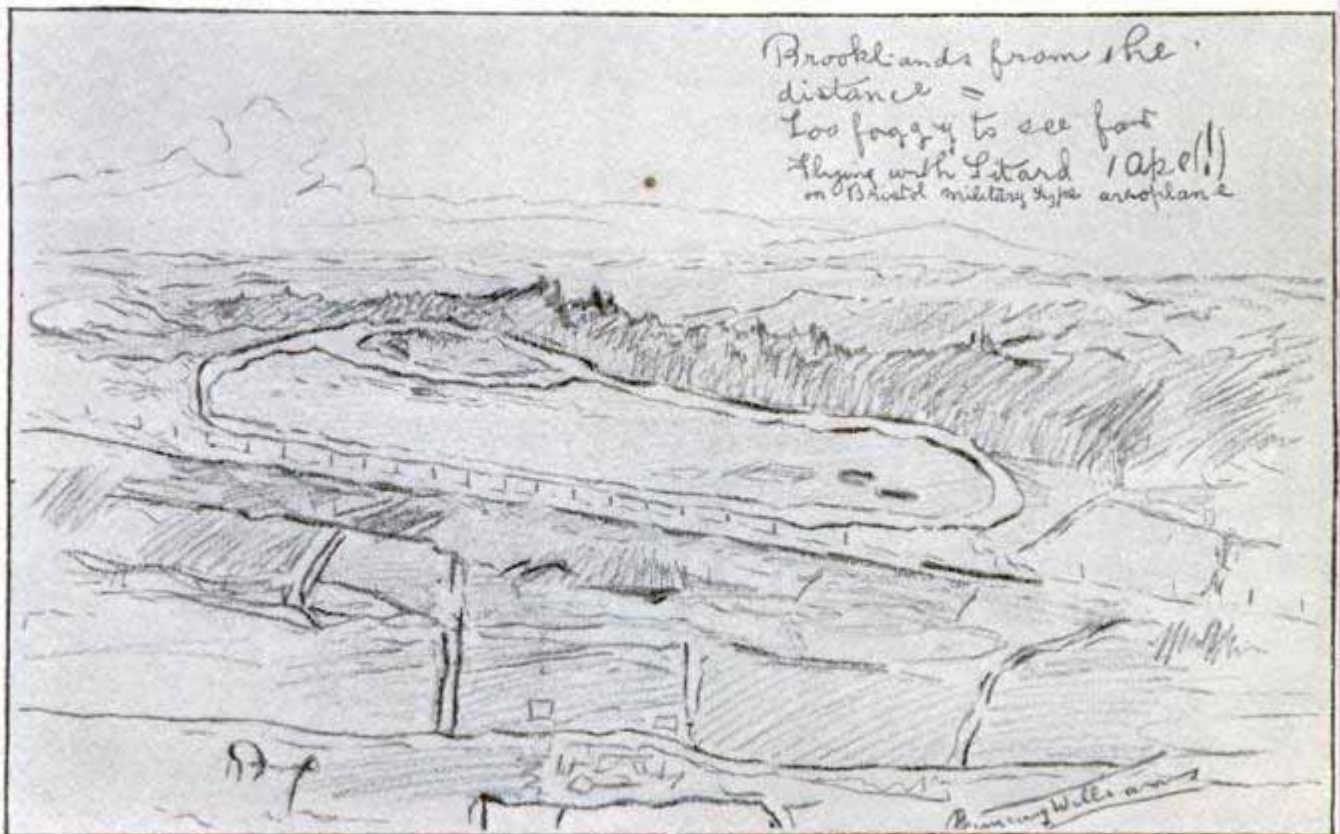

"BROOKLANDS FROM THE DISTANCE"

Facsimile of a Drawing Made by Artist C. F. Williams while Flying in a Biplane

brings out some very interesting and enlightening facts.

"My first flight was a short one," he writes, "and I made no attempt to sketch. When I was pulling my sketchbook and pencil out before starting for the second, Captain Wood (the aviator) viewed them with suspicion. 'For God's sake don't let that pencil go while we are in the air,' he said; 'if you do, we come down.' He explained that if it struck the propeller, the tips of which are running at 300 miles an hour, it would shatter the propeller to pieces. My sketchbook, too, needed a lot of clinging on to.

"From my preliminary flights, I saw that to sketch successfully on an aeroplane one must have: (1) A book or board firmly strapped to one knee; (2) several pencils, sharpened at both ends and securely fastened on strings—in the one case to avoid the necessity of using a knife for sharpening, and in the other to avoid all risk of dropping a pencil; (3) a wind shield to protect the hand; (4) a means of securing new paper without having to turn a leaf. I went back home and made a board, having the paper wound on two ratcheted drums, and passing over a hard surface for drawing on. It is somewhat similar to the principle of a kodak. It has a lid which can be fastened up with brass legs to act as a wind screen, and can be strapped onto the knee. Armed with this instru-

ment, I was enabled to work with something approximating comfort.

"I found considerable difficulty in being able to sketch fast enough to get even a hint of the country over which we passed, owing chiefly to the fact that we did not ascend high enough. From my experience, I should say that, for purposes of military route-sketching, a height of at least 2,000 ft. is necessary. However, from a height of about 500 ft., I was able to make more or less intelligible notes. For purely military purposes, the less there is in the sketch the better; but I endeavored to fill in my outlines as much as possible, simply to see how much I could do in the time. In a case where it might be desirable to make a sketch of a military encampment, the roughest sketch could be afterwards redrawn and perfected from memory.

"One difficulty I found was that, as the aeroplane circled round, my drawing would be in a different direction from that in which we were flying, and it is very confusing to have to reconstruct each line before you put it down. I should recommend that each aeroplane sketching-board should be held in such a way that it could be swiveled round at the direction of a small compass fixed to it. In that way it would be possible to circle round and round any spot, and make a drawing that would be integrally accurate in every direction."

### SHIP FIRES FOUGHT WITH CARBON DIOXIDE GAS

If the recommendations of the San Francisco fire chief are carried out, all fires in the holds of shipping in the harbor of that city will be extinguished with carbon dioxide gas instead of with water. The plan is to provide each fire-boat with a steel lighter equipped with large gas tanks and generators.

For the past year Fire Chief Murphy has been working with Professor O'Neil, of the University of California, on the idea. They have succeeded in

generating a carbon dioxide gas at little cost, which can be pumped into the hold of a vessel and will effectually extinguish the blaze with no damage to the balance of the cargo. The gas, being twice as heavy as air, forces the latter from the hold, thus smothering the fire.

Cargoes valued as high as \$2,000,000 enter the port of San Francisco, and in handling a fire that would actually do no more than \$10,000 of damage, goods are often destroyed to the value of ten times this amount through the necessity of flooding.

### SUFFRAGETTE SLEEPS IN A BATHTUB

A large number of the suffragettes in London refused to be counted in the census because, not having votes, they did not consider the country had any right to include them in its population. Many schemes for avoiding the census takers were resorted to, and a number of the well known suffragettes slept, on census night, in the homes of sympathizers who refused to fill up the forms. One of these houses was so crowded that one of the suffragettes had to utilize the bathtub as a bed.



Suffragette Sleeping in a Bathtub So as Not to Be Counted in the Census Returns

### WORLD'S LARGEST SHIP IN BIGGEST DRYDOCK

The accompanying illustration is remarkable because it shows not only the "Olympic," which is the largest vessel ever built, but also shows her entering the largest drydock in the world, and the only one large enough for such a monster ship. The dry-

dock, which was built by the Belfast Harbor Commissioners at a cost of about \$1,600,000, is 887½ ft. long, with a breadth of floor of 100 ft. The "Olympic" with a length of 882½ ft. just slips into it. The construction of the dock is such that it may be lengthened 200 ft. at any time, should the dimensions of new ships launched require it.

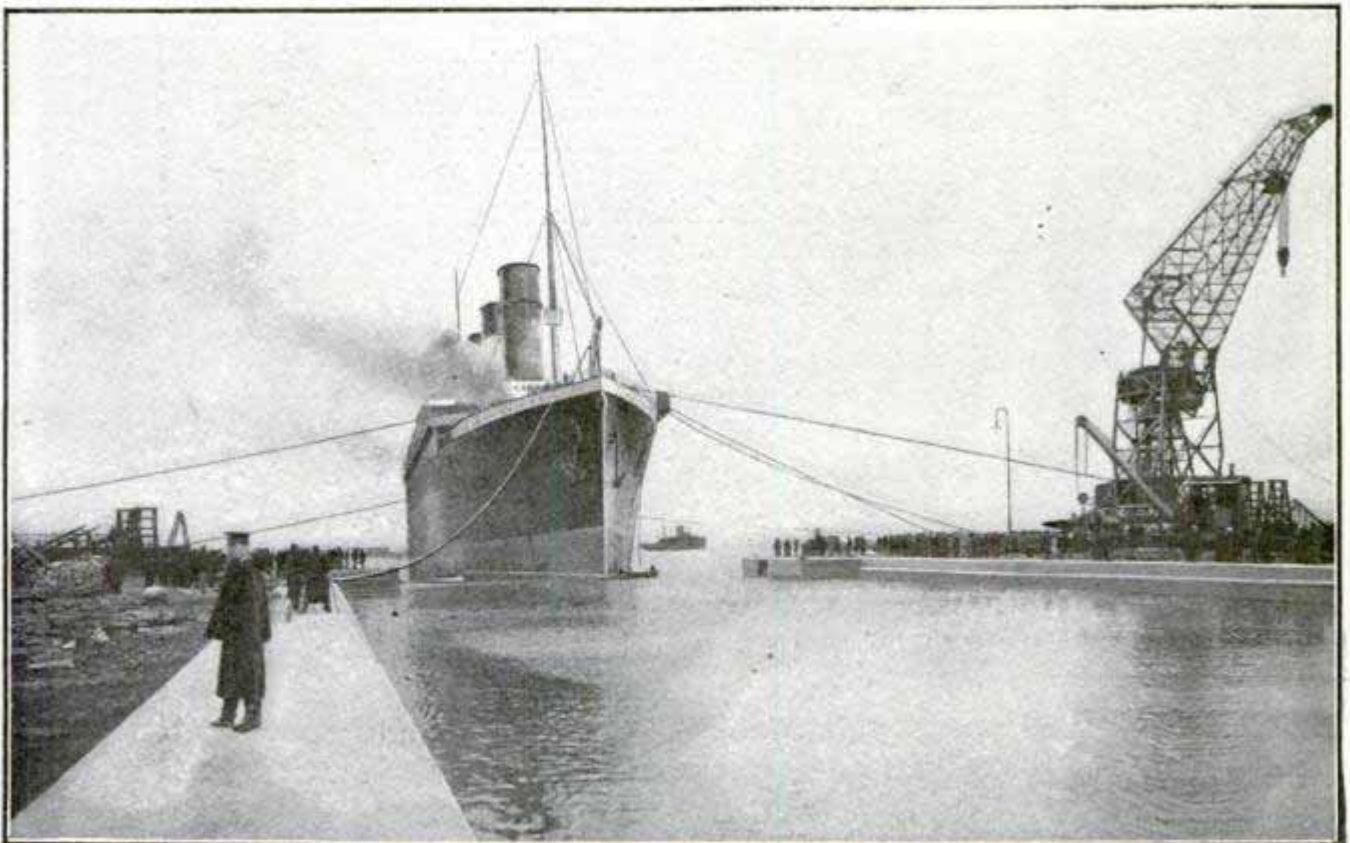

The "Olympic" Entering the New 887½-Ft. Drydock at Belfast

# How the Colors of Nature Are Reproduced in Moving Pictures

By J. Q. ROBERTS

FROM the old familiar yet ever wonderful rainbow to the latest and most remarkable application of color photography in motion pictures seems a far cry. Yet there is a close connection. It has long been known that the rainbow is caused by the shining of the sun on a mist or shower of rain, but it remained for Sir Isaac Newton, who discovered the theory of gravity, and who was a pioneer in many other branches of science, to show how it was formed. That was in 1675.

He passed a beam of sunlight through a glass prism, and the light came out in a band of various colors—violet, indigo, blue, green, yellow, orange, and red. These are the colors of the spectrum. When Newton placed a second prism behind the first in a reversed position, the various colors were brought back to a white spot on a screen instead of the gaily colored band. From that he concluded that white light was a mixture of lights of all the rainbow colors.

When the process of making black and white pictures by photography was invented men immediately turned their attention to the task of securing photographs in the natural colors of the objects depicted. Color photography may be said to date back to 1810. In that year it was discovered that if the "spectrum" or band of colors produced by the prism were thrown on moist chloride-of-silver paper and allowed to remain or "print" for 15 minutes, color changes could be recorded. Since then research in this branch of photography has led to



Sections of Films Showing the Development of Roses from Buds to Blossoms

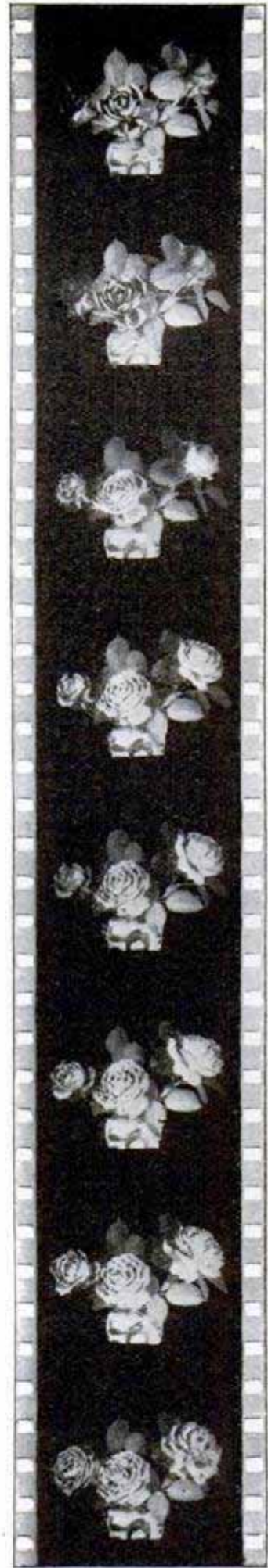

These are Not Shown in Pairs as Used, But Merely Show Different Stages

many interesting disclosures. The discovery of the power of certain dyes to render the photographic plate sensitive to all visible colors was the one step needed to make color photography and color printing possible.

It is known, therefore, that ordinary white light consists of a large number of colored lights, which, meeting the eye together, produce the sensation of white light. The colors of the spectrum, as given above, are seven, although in reality there is an enormous if not an infinite number of distinct colors in it. These colors are frequently called the primary colors, and other tints and shades are producible by mixing them; but in a stricter sense the primary colors are three in number, namely, red, green, and violet (or blue). These three colors or kinds of light cannot be resolved into any others, while a yellow ray, for instance, can be resolved into a red and green, or can be produced by the mingling of red and green light, consequently yellow is not now regarded by scientific men as a primary color. Inasmuch, however, as a yellow and a blue pigment will always produce a green when mixed, red, yellow and blue are still, in a sense, regarded as primary.

Just as the invention of photography in black and white spurred scientists on to find a means of taking colored photographs, so the extraordinary popularity of motion pictures led to innumerable attempts to still further strengthen the illusion by representing

moving scenes in colors on the screens. Single colored photographs are now secured by means of plates covered with pigment dyes, but this method is impossible under the conditions involved in the taking of motion pictures. Many films have been stained by hand, but the work is so tedious and the result so unsatisfactory and unreal that this method has never become popular. When it is considered that many films are 1,000 ft. long and contain over 16,000 separate pictures, it can be seen that the time and expense required to color them by hand make this process impracticable.

Charles Urban and G. Albert

Smith, two Englishmen engaged in research along this line, recently brought out a method of projecting motion pictures on a screen in colors which resemble natural colors to a remarkable degree of perfection. It was first done by the use of "color filters," red, blue, and green glasses which absorb all the red, blue, or green light passing through them. This same method has been used for some years in taking colored photographs and is the basis of the three-color printing process.

Later improvements reduced the number of color filters to two, red and green, the green filter used being one which transmits a considerable amount of blue light. With the two filters reds and greens and their orange and yellow combinations as well as browns, grays, and even blues and indigos, are brought out. This process has

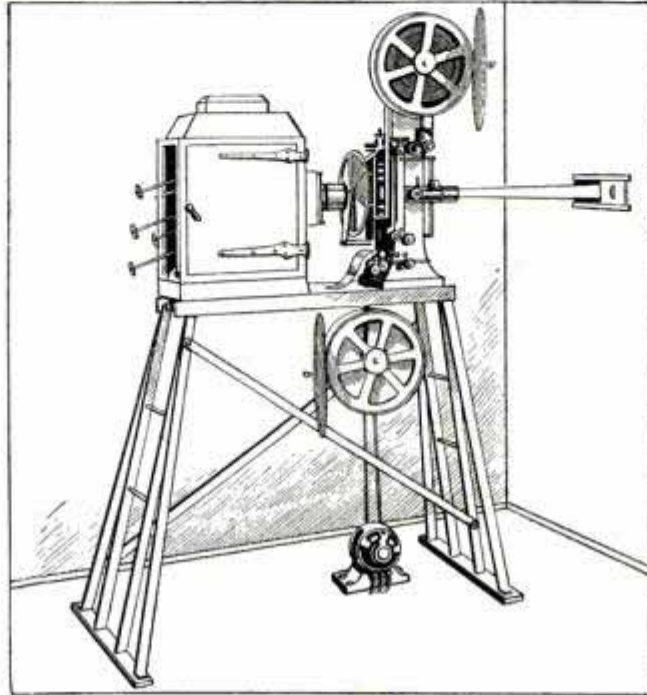

Special Apparatus Arranged for Projection of Pictures in Colors, Showing How Red and Green Filter is Placed in Center



The Rotary Color Filter

been called the "kinemacolor" process. It depends upon what is known as the "persistence of vision." When a lighted stick is whirled around, it forms to the eye an unbroken circle of fire. The first impression of the moving object melts into the next impression. Probably the application of this principle to the moving picture is better illustrated by the familiar colored top which carries a card divided into sections painted blue, green and red. If the top be spun rapidly, each color fuses into the next and a combined sensation of white appears to the eye.

The camera used in this process is somewhat similar to the ordinary moving picture camera. It moves twice as fast, however. While the ordinary camera takes 16 pictures a second, the "kinemacolor" camera takes 32. The essential difference between the cameras is that the latter has a rotating color filter which is placed between the lens and the shutter. This filter consists of a skeleton wheel having one segment filled in with red-dyed gelatine and a similar one filled with green-dyed gelatine, and is so geared that the exposures are made through the filters alternately. The film, when exposed, is developed, and a positive film made from it. If the negative film be examined, it will be found to con-

sist of images in pairs which differ from each other inasmuch as they are records of the red and the green, respectively, in the object photographed.

In the projection of the pictures also the rotary color filter is used and is made to synchronize with the film. When the two pictures are rapidly projected one after the other onto the screen the combined effect gives rise to red flowers and green leaves. If the positive film is placed in the wrong order, i. e., the "green" picture opposite the red light, the colors would be complementary ones all through. In order to prevent mistakes the edges of the films are marked.

The cover design on this issue of Popular Mechanics Magazine is not, therefore, a true representation of the "kinemacolor" film, but has been colored as it would appear on the screen at certain parts of a film which shows the development of a rose from the bud stage to the blossom. This film was taken by a series of exposures, made about every four minutes and a half, extending over a period of three days. There were about 1,000 pictures on the film, which is run off at the rate of 32 a second. When viewed as it is thrown on the screen by the projector the result is astonishing, for the three days of growth are visualized in fewer minutes.

### A WHISTLING WELL

A resident of West Seattle, a suburb of Seattle, Wash., has in his back yard a whistling well which predicts changes of weather instead of gushing water. With the intention of boring for water this man drove a drill 153 ft. below the surface. The well was abandoned at this depth because no water was in sight. Later the owner noticed that the pipe which capped the bore was spouting wind with considerable force, making a peculiar whistling sound. At other times the pipe seems to suck in wind. By observation it has been found that the expul-

sion of air precedes a storm of some sort and the influx of air a change for the better. This natural barometer is explained on the theory that the bore has penetrated a cavern of some size and that the air beneath the earth is driven out when the atmospheric pressure lessens and flows back when the pressure becomes heavier.

CA committee has been formed in Chicago charged with the duty of collecting a fund of \$100,000, and completing arrangements to hold a big aviation meeting at Grant Park, on the Chicago lake front, some time during the summer.



# The Other Side of the Fly Question

**Fly is of Extreme Value as a "Danger Signal" to Indicate the Presence of Unsanitary Conditions, and It is These Conditions and Not Primarily the Fly Itself Against Which We Must Wage War**

**J**UST about this time of the year there are many injunctions in the public press to "swat the fly," with a promise of the most direful results if this warning be not followed. But few people know much about the real truth of the fly question, beyond the fact that the house-fly is a carrier of the germs of certain diseases, such as typhoid fever, intestinal disorders and tuberculosis, and it is with a view to presenting the why and wherefore of the fly that the following remarks, compiled from opinions specially written by some of the greatest entomologists on the North American continent, are set forth.

One question that will naturally occur to the thinking person is: "If the fly be exterminated, supposing that were possible, would it tend to upset the 'balance of nature' and result in some other plague that might be even worse than the flies themselves?"

Similar things have happened before. The decimation of the coyotes resulted in a plague of gophers. The mongoose was practically exterminated

and the rats multiplied so as to become a menace. The weasels were killed off and the rabbits overran the countryside and ate up every green thing in sight. The English sparrow was imported to destroy the measuring worm and now people are wondering how to kill off the sparrow which has increased so alarmingly as to become a pest. In northern China the wolves kept down the marmot or land otter, but when the natives waged war on the wolf the marmot increased and spread the plague.

These are but a few instances out of many that could be quoted. Is a similar parallel possible in the case of the fly? Most of the experts say no, but Dr. E. Porter Felt, State Entomologist of New York, at least admits that there may be. Says Dr. Felt: "There is a possibility that a biting, dung-breeding form, such as the stable-fly, might, in the event of the disappearance of the house-fly, become dominant, and, with a following modification in habit, inflict more serious annoyance upon mankind and possibly

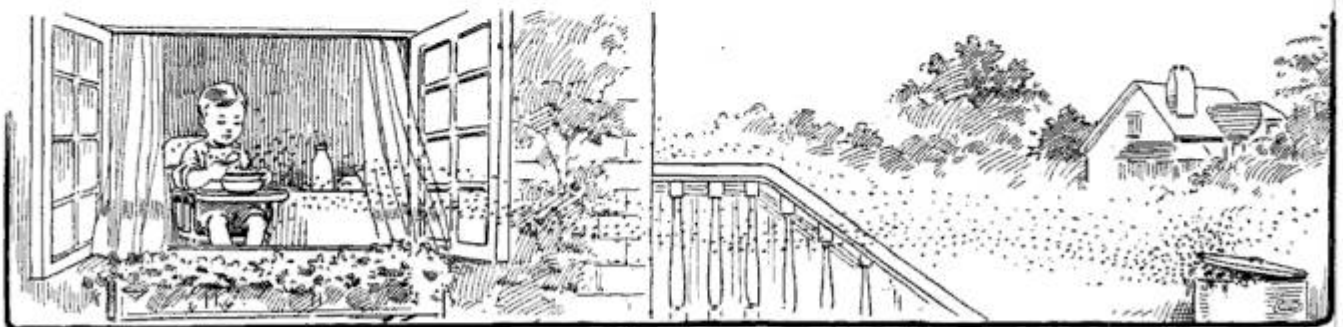

be equally as efficient as a carrier of disease. Potentially speaking, a number of species might take the place of the house-fly (some perhaps unknown at present) and we have no assurance that any one of these would be less objectionable to mankind."

And it may be said that there are other people who see the matter in this light, and they are not without plausible arguments to back up their contentions. For new species of animals, plants and insects are continually being evolved, and existing species are changing their habits to suit altered environments, as the sheep breeders of Australia know to their cost. In Australia there is a certain bird that kills sheep to eat a certain part of the back of the animal, which, from a height, resembles a vegetable growth that formerly comprised the bird's natural food. And Civil War veterans will remember with a shudder a certain fly which laid its eggs in the wounds of any unfortunate who happened to be overlooked for a few hours on the field of battle, and caused most horrible torment until the developing insects were painfully extracted by the surgeon's knife.

To return to the house-fly, it may be asked: "Has this insect any real function in the scheme of nature?" And all the experts answer in the affirmative. Quoting Dr. L. O. Howard, Chief of the Bureau of Entomology, U. S. Department of Agriculture: "The house-fly breeds only in fermenting organic matter. Its larvæ, therefore, act to a certain extent as scavengers. . . . The larvæ, moving in an excrementitious mass, accelerate putrefaction and help the spread of the putrefactive germs throughout the substance."

Dr. John B. Smith, Entomologist, New Jersey Agricultural Experiment Stations, puts the same thing in a somewhat different way. "The campaign," says Dr. Smith, "is not so much against the fly as it is against the conditions which require the presence of the fly as a natural scavenger. . . . The fly is man's good friend and a nec-

essity so long as man is a filthy animal. When he becomes a clean pig the flies will naturally disappear."

Perhaps, however, the value of the fly in destroying dung and similar matter is somewhat overrated, for, as is stated in a bulletin issued by the New York State Museum, it has been estimated that 1,200 house-flies might be bred from 1 lb. of manure, and at this rate a good load would produce two and a half million!

From all of which it would seem that merely killing off the flies by "swatting," by fly-papers, fly-traps and the like, is of no avail in the aggregate. To destroy the insect effectually requires the abolition of its breeding places. The filth in which the fly deposits its eggs is the dangerous thing, probably more so than the flies themselves. As Dr. C. Gordon Hewitt, Dominion Entomologist, Canada, puts it: "House-flies indicate the presence of refuse, garbage, and other unsanitary conditions. The house-fly is useful therefore; it is of the greatest use as a danger signal, as a 'red flag.'" And then he pertinently adds: "But we should not require danger signals in such enormous quantities!"

Prof. S. W. Williston, of the University of Chicago, points out that the fly is purely a domestic product, like the dog, the sheep and the ox, and that it would become extinct should man cease to exist. It is never found far from man's habitation, and there are many places, as in the Rocky Mountains, where a house-fly would not be found in hours of search. Thirty years or so ago, says the professor, the fly was unknown even on the plains, where now it exists in unnumbered millions.

Thus it is not the fly which is primarily to blame for epidemics of typhoid fever and the like. It is man's segregation into cities and towns where he has not provided himself with the requisite sanitation. If the *cause* of the fly be removed, the fly will disappear, largely if not entirely, and the probability is that if in some miraculous way we could exterminate



the fly without removing the cause, there would be something worse speedily develop to take its place.

It might not be amiss to add that on one occasion, the fly—probably the stable-fly—besides fulfilling his mission as a “danger signal,” performed a real and valuable service to the people of this country. It happened in the stirring times of '76, when the patriots were assembled in Philadelphia to debate whether or not this country

should declare its independence. Several delegates, more cautious or fearsome than the rest, were holding out against the Declaration. It was then that a swarm of biting flies, settling on the unprotected stockings of the colonial fathers, speedily forced the delinquents to make up their minds and even to risk their precious necks (should they be beaten in the struggle that followed) rather than be slowly eaten alive by the insect pests.

### DECIPHERING WRITING ON BURNED MANUSCRIPTS

The processes of color photography have recently been applied to obtain a legible photograph of the writing on burned manuscripts which were unreadable by any other known means. As long as the sheet has not been entirely disintegrated, positive results can be obtained every time.

The charred manuscript is carefully arranged, in as near its original shape as possible, on a sheet of glass, and covered with a drying varnish, after which it is backed by another sheet of glass. By using carefully selected color screens, and orthochromatic plates (which can be obtained from any good photographic supply house), a perfectly legible photograph of the writing may be taken, although there may be no marks on the charred remains that are visible to the eye.

This is the only known method that will give results when the writing has been made with vegetable inks. Ordinary photography, however, can be used successfully when the ink contains aniline or iron in its composition. Pencil writings should be photographed with the objective inclined on its axis so as to produce the proper reflection of light from the graphite marks.

### CHILDREN AS AEROPLANE PASSENGERS

Considerable protest is being made in Europe against the growing practice of loading an aeroplane with children instead of adults when an attempt to



M. Breguet and His Passengers, Most of Whom are Children

establish a new passenger record is being made. Children do not weigh as much or take up as much room as adults, and, naturally, more can therefore be carried, but should an accident occur, the offending airman would very justly be accused of sacrificing children to his desire for a record.

Two recent records were made by M. Breguet and M. Sommer, the former flying six miles with 10 passengers, and the latter taking up 12 on his machine. All but three of M. Breguet's passengers were children.

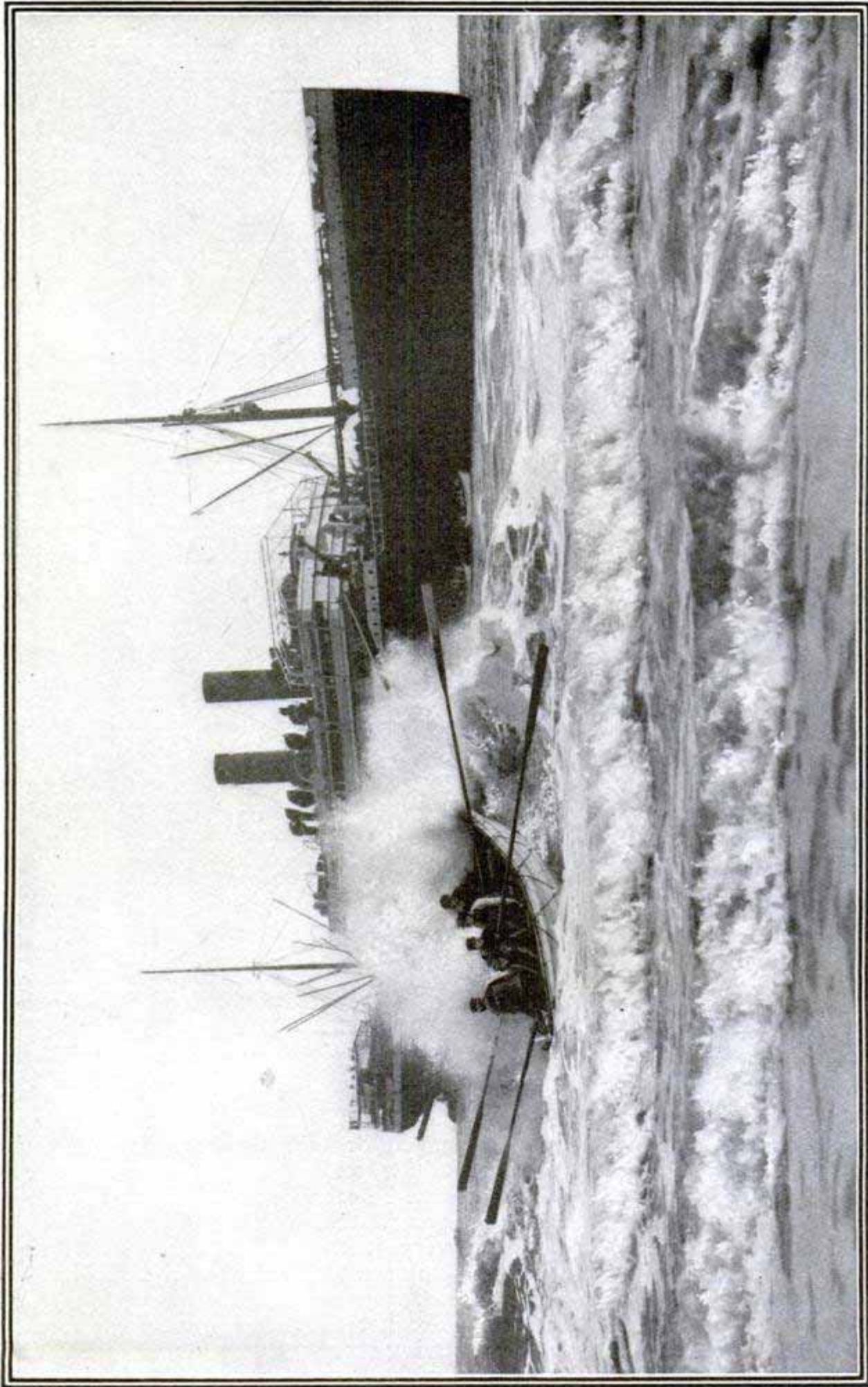

Remarkable photograph of the Atlantic liner, "Prinzess Irene" as she lay on a sand bar off Long Island, April 6. The ship, with 1,700 passengers and a large cargo, ran aground in a fog at 4 o'clock in the morning. All her passengers were taken off and part of the cargo removed before the vessel was released. She was practically undamaged.

## LARGEST FREIGHT-SORTING YARD IN THE WORLD

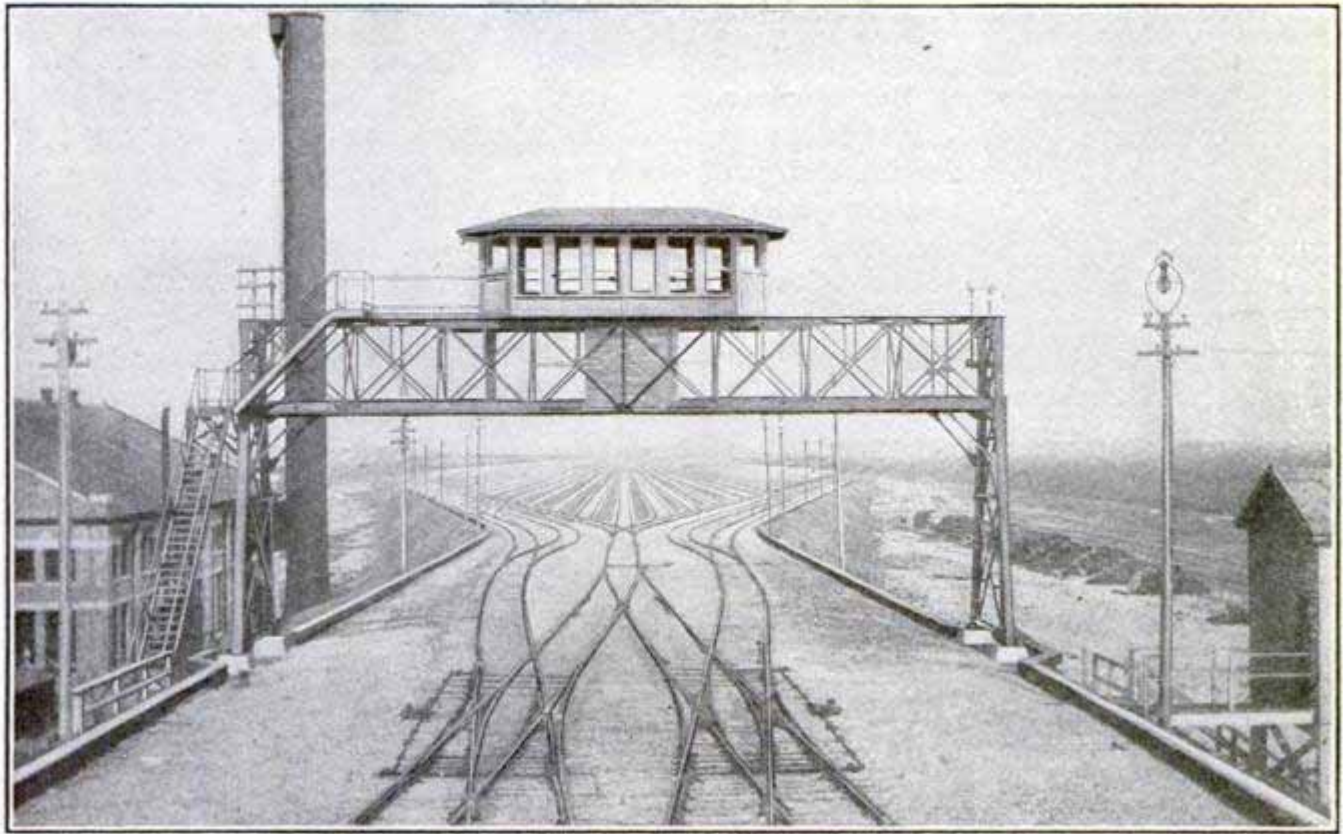

Chicago's Great Freight-Distributing Yard. The "Hump" is Shown in the Middle Foreground, and the Man in the Switch Tower Electrically Controls the Switching of the Cars to Their Proper Tracks

Chicago's phenomenal growth and its undisputed position as the greatest railroad center in the world have long called for a freight-handling yard outside of the congested part of the city in order to release valuable land for other uses and to expedite and lessen the expense of the handling of the four to five million railroad cars that are distributed yearly by the 23 trunk lines entering the city.

This is the way the interchanging problem has been worked out: At a point midway between the ganglia of east and west trunk lines, and between the two main belt lines, the Chicago Union Transfer company laid out a set of tracks which are designed to serve the same purpose as the shelves of a ware-



The Cars on the Tracks, Sorted without a Switch Engine and without Risk to Life or Limb, Ready to Go Direct to the Railroads Which Are to Take Them from Chicago

room, upon which are sorted out the various kinds of merchandise in stock. The tracks are in two sets connected by main tracks on an elevation. From the main tracks run main sidings like the veins of a leaf, and branching from these lateral veins are other

parallel tracks into which, in the sorting process, the cars belonging to each road are sent, ready for delivery.

The sorting process is accomplished by the uncoupling of a car from a train standing on the elevation between the two fanlike sets of tracks. The car is uncoupled, given a push, and rolls down the decline, destined for a certain one of the branch tracks off from the main laterals. A brakeman on the car and the operator in the tower over

the elevation—"hump," it is called—do it all. As if by magic one switch after another opens as a car approaches, and closes when it has passed. These switches are operated by electricity from the tower, and all the operator has to do is to press the button, properly labeled, and the switches silently guide the car into its destined stall.

It is all very expeditiously done. A train from east or west rolls up on the main tracks of the "hump" and stops. The cars of the train from the east are sorted into the storage tracks at the west, and the cars of the train from the west are sorted into the tracks at the east. Without a switch engine, without the bumping and puffing, and without the risks to life and limb that

attend switching in the downtown yards, the cars are assorted and made ready to go direct to the railroads which are to take them outbound from Chicago.

In constructing this switch yard, the "center of gravity" of the transportation of Chicago was first estimated, and about this the clearing yards were built. Prairie to the extent of 5,000 acres was purchased, and the foresight of the designers was evidenced by the fact that provision was made for towns and industries that were expected to follow the improved railroad facilities. The towns of Argo and Clearing, unknown a few months ago, are evidence of the fact that this prejudgment was not misplaced.

## WONDERFUL RESUSCITATION APPARATUS

To bring back life when all other methods have failed is the claim made by the Bureau of Mines for a wonderful resuscitation apparatus recently added



The Pulmotor at Work near One of the Rescue Cars

to its equipment. It is called the "pulmotor," is of German origin, and was but little known in this country until taken up by the bureau. Today it is installed in all the rescue cars and at all the rescue stations, and the records of the bureau give evidence of instances where men, pronounced dead after exhaustive resuscitation efforts, have been literally snatched back to life.

The parts of the apparatus consist

of a cylinder for the storage of oxygen up to a pressure of 125 atmospheres, a blowing and suction valve, actuated by two accordion bellows, a face mask which encloses the mouth and nose, and two flexible tubes leading from the mask to the two bellows. After the mask is placed on the face and made air-tight, and the air turned on, the apparatus works automatically. Oxygen is forced into the lungs until a certain pressure is reached, then the elongation of the accordion ceases and it collapses, a valve starts the other accordion and the lungs are emptied. A lever permits the oxygen to flow in and out.

There are on record two instances of the remarkable efficiency of the apparatus. In one, the rescue car arrived 26 hours after the accident at a mine where an explosion had killed 150 workers. The rescue corps found the body of a miner near the entrance of the mine ready to be moved away with the dead, and, although physicians insisted no spark of life remained, the pulmotor was set to work. Resuscitation followed and the man is alive today. In the other instance, three men were laid aside as dead following

an explosion of dust in an Ohio mine. Again physicians, judging from the ordinary tests, declared the cases hopeless, but after three hours' treatment by the pulmotor the men recovered.

### REMARKABLE NEW FILTER

Perfect sterilization of liquids by means of filtration only seems to be made possible on a large scale, through a process, originated by two French scientists and reported to the Academy of Sciences at a recent meeting. It is known that membranes of collodion have the property of retaining all the microbes in a liquid filtered through them. But they are very fragile and therefore impractical outside of the laboratory. By reinforcing the collodion membrane with a fine wire screen imbedded in it, just as a pane of glass is thus reinforced, the two scientists constructed a filter, not only strong enough for practical purposes, but so effective as to exclude even molecules of salts dissolved in the liquid.

### CAMERA SHOT INTO AIR MAKES PHOTOGRAPH

A remarkable method of making bird's-eye photographs and one of the photographs so taken are shown in the accompanying illustrations. The camera, which is called a "gun camera," is shot several feet into the air



Photograph Taken by Gun Camera of a Group Watching Its Flight; Note the Fore-Shortening of the Bodies



Shooting the Gun Camera into the Air

from the top of a standard in the head of which is an explosion chamber. The camera is set to expose from 1 to 10 seconds after the explosion, when it reaches its full height. It must be caught in a net when it comes down, to prevent it from being smashed.

### GIRL ORGANIZES FIRE DEPARTMENT

Port Tampa, Florida, is to be protected from fire by a brigade organized and trained by the daughter of the late chief of the Tampa fire department. This girl, Maggie Harris, is said to be the first girl in the United States and probably in the world to organize a fire department. About 40 men have agreed to serve under her direction. She is drilling them according to the rules and methods of her late father.

Of the 7,500,000 telephones installed in the United States, 500,000 are located in hotel bedrooms.

### NEWEST OUTDOOR SPORT COSTUME FOR WOMEN

The costume shown in this illustration is announced as the ideal for the modern athletic woman, whether her



Ready for Aerial Trip, Cross-Country Tramp, Motorcycle Trip or a Brisk Canter

stead be an aerial one, a horse or a motorcycle. It is also suitable for cross-country tramps, especially if the ground be rough or hilly. The costume is made of strong mohair, and the cap is attached.

### REMARKABLE RESUSCITATION FROM ELECTRIC SHOCK

A remarkable case of resuscitation from apparent death caused by an electric shock is reported from Europe. A linesman accidentally took hold of one of the high-tension wires of a 7,500-volt 55-cycle circuit; several minutes elapsed before the line was disconnected; about 15 minutes before the linesman was found, and at least half an hour before he was brought to the

ground. In all about 50 minutes elapsed from the time of the shock until the first efforts at resuscitation were made. When brought to the ground the victim showed absolutely no signs of life, and the attempts to produce artificial respiration by movement of the arms, etc., were without effect. Then it was recalled that instructions relating to the tongue had been neglected, whereupon the mouth was forced open and the tongue pulled out and allowed to recede rhythmically. The patient responded almost at once, began to breathe, and after two hours had not only gained consciousness, but, with the exception of a few burns, was in a normal condition.

### ENGLISH LAMP REDUCES BLINDING GLARE

Relief from the dangerous and dazzling glare of the automobile headlight, now under the ban in many American cities, is promised by the invention of the new lamp shown herewith. The metal globe containing the lamp is furnished with four lenses, through which the light is thrown upon four reflectors at the angles of the surrounding frame. By this indirect distribution of the light, the requisite illumination is given without the glare.

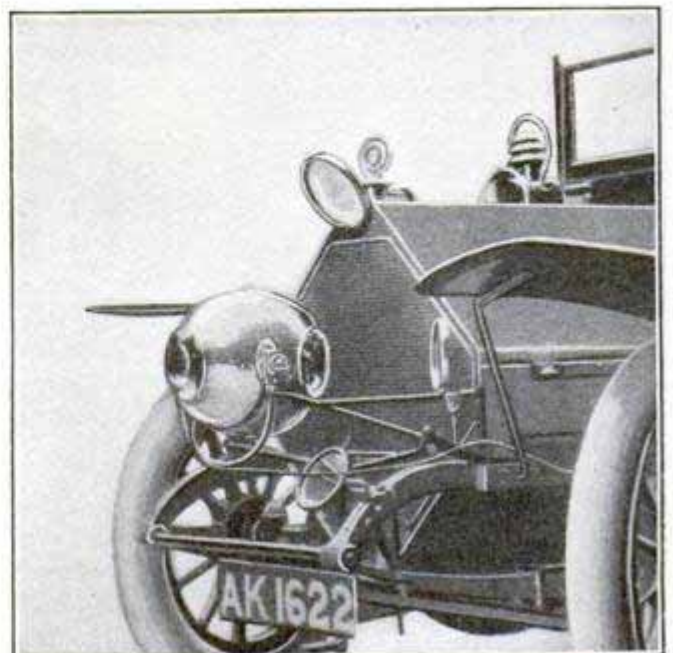

New Automobile Lamp That Prevents Glare by Deflecting Dazzling Rays to Four Reflectors

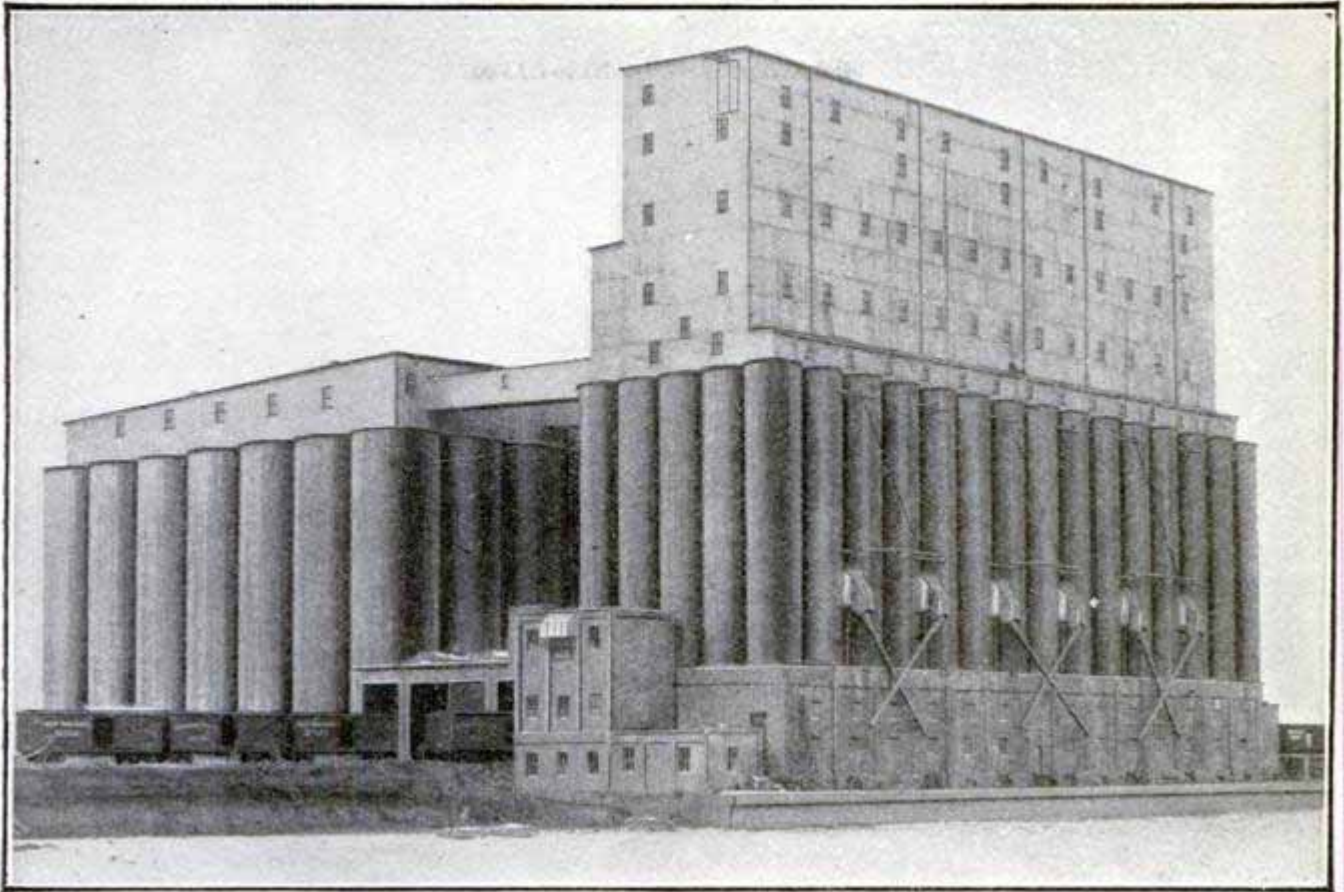

Fort William Reinforced Concrete Grain Elevator. Working House on Right, Storage Bins in Rear

## LARGEST GRAIN ELEVATOR BUILT OF CONCRETE

Almost half of the crop of Minnesota, the country's greatest wheat producing state for 1910, could be stored in the big elevator that has recently been constructed at Fort William, (Ont.) Canada, entirely of reinforced concrete. With its total capacity of 40,000,000 bu. and the scheme of building left so open that bins for storage might be added to care for an indefinite quantity of the great staple, the Fort William structure is what engineers believe to be one of the most important examples of reinforced concrete work of the present day.

It would require the cultivation of nearly 3,000,000 acres of land with an average yield of 13.8 bu. per acre (the average yield in the United States for 1910) to fill this monster storehouse. The Minnesota 1910 crop of 94,080,000 bu. would fill the bins twice and leave a bit for other elevators. The second largest crop, that of Kansas, with 61,660,000 bu. would only fill it about one and a half times, while the Illinois

crop of 31,500,000 bu. would leave plenty of room for a few of the smaller states.

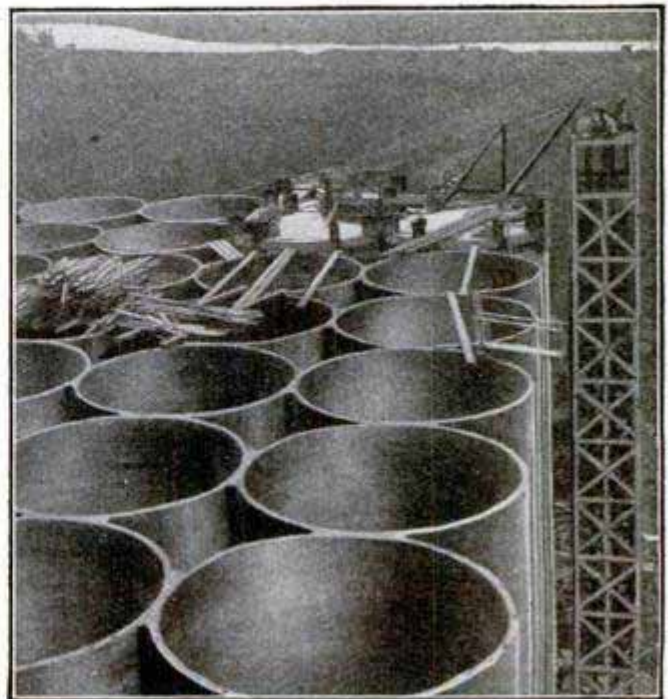

Grain Bins in Fort William Elevator before Cupola Was Put On, Showing Interstices Between Bins Where Grain Is Also Stored—From Photograph Taken before Superstructure Was Built.

Work on the big elevator was commenced late last fall with the sinking of 12,000 piles upon which the concrete base that forms the foundation was laid. The weather was extremely cold during the time the foundations were being prepared, the thermometer registering as low as 55 deg. below zero on one day. One of the workmen was frozen in going from one section of the site to another. The elevator is built on the delta formed by the Kaministiquia and Mission Rivers, near Lake Superior. A concrete wharf, 337 ft. long and 12 ft. wide, forms the water front and there is sufficient depth of water for the largest of the lake freighters to lie alongside.

All of the storage bins planned have not yet been completed. The principal section of the building is the working house which adjoins the wharf and

which includes the 75 circular concrete bins arranged in five rows of 15 bins each. These bins have a diameter of 12 ft. and are 79 ft. high. There are five rows of these giant cylinders and in order that no space may be lost the interstices between the cylinders are used for storage purposes also. Above the bins is a steel cupola, 85 ft. high. The storage section of the plant consists of 70 circular concrete tanks arranged in ten rows. They have an inside diameter of 23 ft. 3 in. and rise to a height of 95 ft. The interstices between these tanks are also used for storage. Between the storage section and the working house is a track shed, a steel frame structure, 68 ft. wide by 240 ft. long, where, under normal conditions, 200 freight cars may be received and unloaded in 10 hours or 500 freight cars in 24 hours.

## ELECTRICITY HEATS RUGS WITH WOVEN WIRES

A gentle warmth may be secured from rugs by a new invention for weaving fine, insulated wire into the fabric of the material. By means of a suitable electric connection, every particle of the rug is electrically heated to a desired temperature with no danger of burning or shock.

The ordinary electric heating pad has a few wires heated to a comparatively high temperature. The new electric heating fabric has a fine wire in every

thread, and the temperature is not excessive. Each thread has a core of wool around which is wound spirally a thin flat braid consisting of several fine wires of pure nickel. Over this is braided an insulating covering of wool, silk or cotton. The thread thus produced is flexible enough to be woven into textile material. The electric resisting properties of the nickel wire make the temperature practically self-regulating.

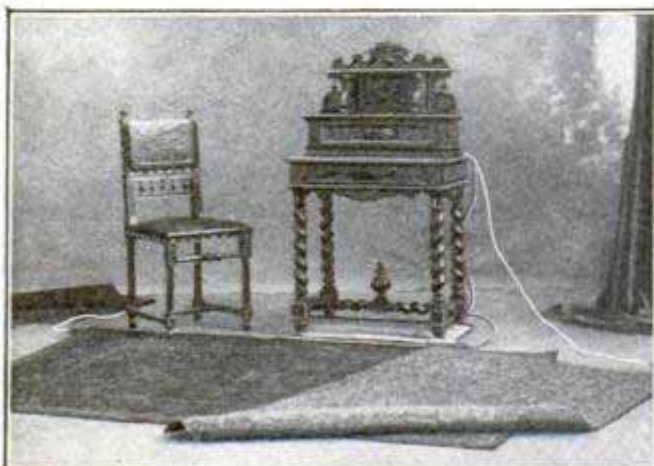

Rugs Woven from the New Electric Heating Fabric



Bed Comforter and Other Conveniences Made from the Fabric



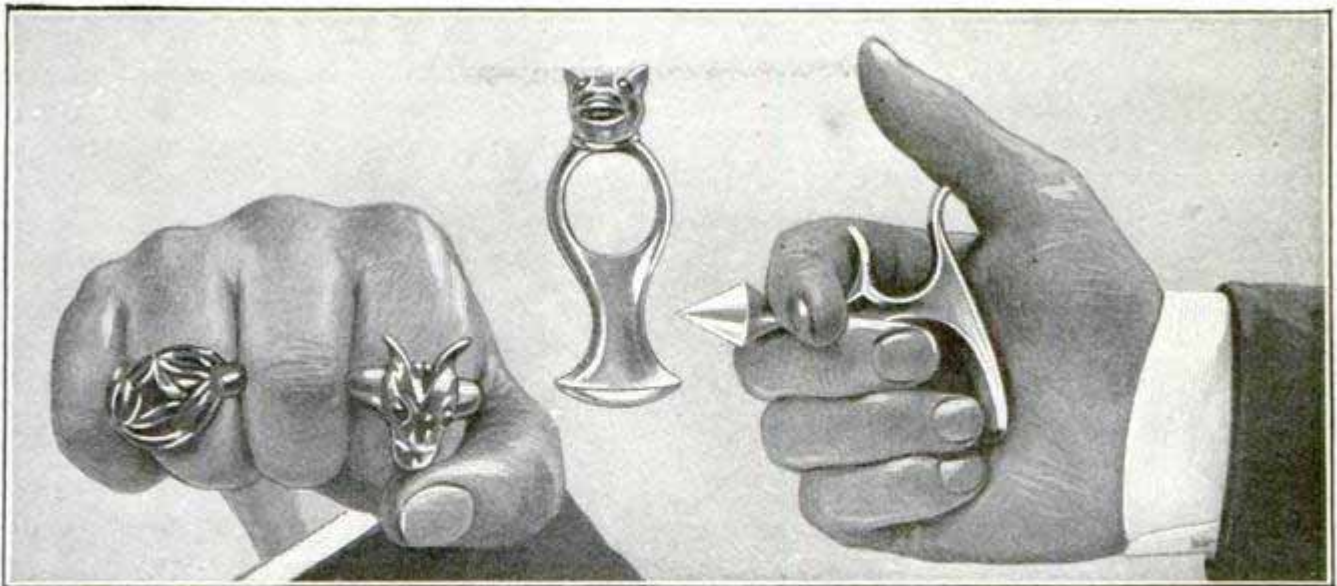

A Fist Studded with Apache Rings

Vicious Ring Used by Apaches

How the "Thorn Punch" Is Used

### FINGER WEAPONS OF THE PARISIAN APACHES

All the weapons used by the Apaches in Paris are unique, but none are more ingenious than these curious rings and the device known as the "thorn punch." The latter, held as shown in the illustration and delivered with a hard, straight blow, would drop a man as if hit by a sledge. The rings, however, are more subtle, as they appear to be nothing more than ordinary finger adornments provided with the exaggerated settings or heads often worn by fad extremists, but hidden within the hand is an extension. This rests against the palm when the fist is doubled and adds much to the force of the blow.

### USING PICTURE TILES TO EDUCATE THE YOUNG

The instruction of children finds one of its most modern expressions in the fittings of the Carnegie library in Cleveland, Ohio, where mantel tiles to represent stories told the children have been introduced in the room devoted to the younger readers. A photograph was recently made of one of these mantel picture-stories representing a series of La Fontaine's Fables. There are seven distinct stories in the mantel tiles shown in the photograph and these

stories are told to the children as they view the illustrations. The tiles are so placed that they may be taken out and sent to the branch libraries to be put to the same use. There are numbers of sets of them, all illustrating



Mantel Tiles That Illustrate Stories Told to Children

well known stories. The tiles are in bright colors and are usually the work of some distinguished artist.

ⒸA wireless apparatus, consisting of a special head telephone receiver and a detector coil, has been devised to locate the exact position of iron pipes without unnecessary digging. An electric current is passed through the pipe, and the electric wave thus produced is picked up by the apparatus.

### ASIATICS LARGE AND SMALL

The man at the left of this illustration is one of the largest in India and

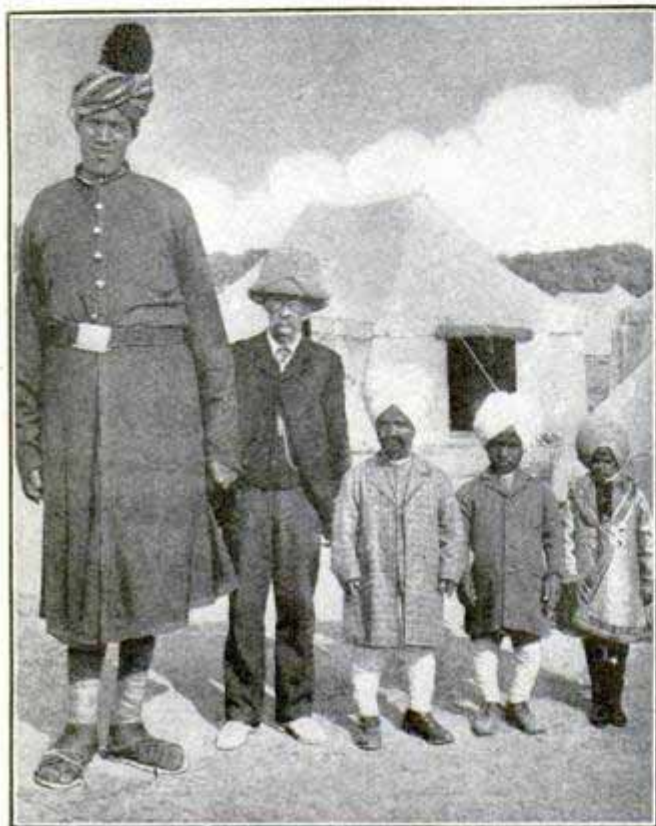

Courtesy The Sphere, London

A Giant 7 Ft. 9 In. in Height and a Midget 2 Ft. 4 In. High

the one at the right is one of the smallest. The huge human being, who is known as the Kashmir Giant is 7 ft. 9 in. in height, and the smallest figure, known as the Patiala Midget is but 2 ft. 4 in. high. The Englishman is of the average height and the other two men belong to a diminutive race. Both the Giant and the Patiala Midget are 23 years of age.

### LIZARD THEORY SETS OIL OPERATORS AGOG

Oil operators are enjoying what they believe to be a joke perpetrated by one of their own kind who has solemnly asserted that the deposits of oil found in various parts of the United States are the direct result of the decomposition of some form of lizard which inhabited the earth at a prehistoric period. According to this investigator, who sets forth his findings in the most serious fashion, the lizards inhabited a vast

inland sea that extended from the Alleghenies to the Rockies. He believes these reptiles were from 40 to 80 ft. long and weighed many tons each and were largely composed of fat. When the upheaval took place which threw the plains above the water, all the creatures that were its inhabitants took refuge in pools and the water in these was gradually evaporated. As this water was being evaporated the lives of these amphibious animals were sacrificed and the fat was literally boiled out of them. The oil rose to the surface and was covered with a layer of dust and sand that became so heavy it sank. In the meantime other lizards were being boiled out and a new layer of oil formed on the top of the water, which collected its stratum of dust and sand and sank on top of the first, thus forming the successive layers of oil-bearing sands and oil pools. The operator who set forth this theory declared he believes some of the lizards were big enough to produce from 300 to 1,000 bbl. of oil.

### WIRELESS INTERRUPTS LIGHTING CIRCUIT

The wireless-telegraph installation of two Denver boys is held responsible for queer interruptions of the electric lighting circuits in the neighborhood in which they live. At a certain hour on several evenings the fixtures in nearby houses began to sizzle and pop, and the lights to go out. Subsequent investigation proved that these occurrences took place when the wireless apparatus was started working. The apparatus derived its power from one of the electric company's feed wires, and the "kick back" current was the cause of the trouble.

According to the Electrical World, an electrician successfully relieves the croupy coughs of his young son by placing an electric water heater inside the crib and then inclosing the crib. The steam rising from the heater moistens the air.

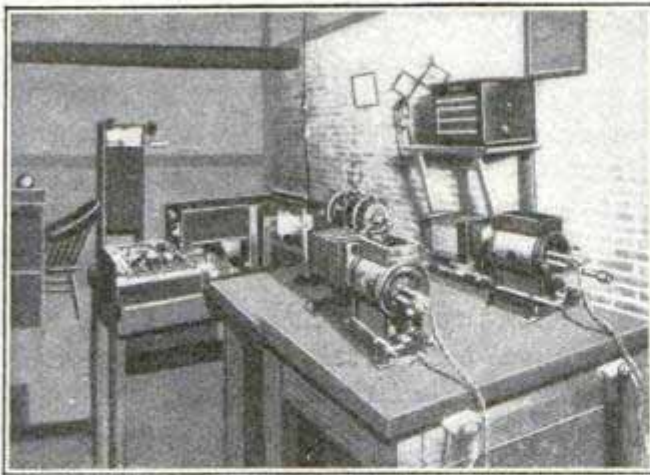

View of "Heart Station"—The Light from the Two Arc Lights in the Foreground Passes Through the Galvanometers on the Second Table, Projecting the Shadows of the Fibers onto the Photographic Apparatus in the Background. The Switchboard on the Shelf Serves to Connect and Control the Current Coming from the Patient

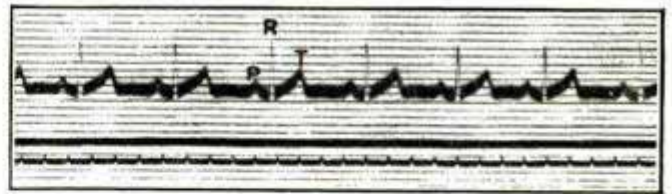

Curve of Normal Heart Action Showing P, R and T Waves. Lower Line Marks Every Fifth of a Second

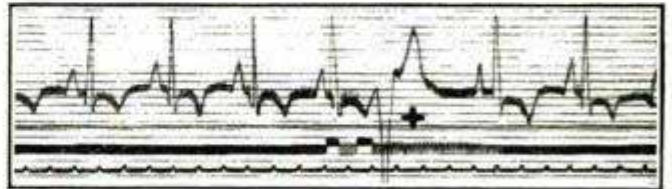

Cross Shows Abnormal Heart Beat, Causing Irregularity. The Other Beats are Also Abnormal

## THE WORK OF THE "HEART STATIONS"

In past generations members of the medical profession depended entirely upon their own senses to detect the symptoms of disease, but the present age of machinery has had its effect even in this branch of science. This is shown by the gradual development of instruments of precision for noting the minute changes which take place in the human body. In the study of the heart, more than any other organ, these means are now utilized to a very great extent. We have instruments for accurately determining the blood-pressure that the heart is maintaining, others which record on paper, in the form of curves, the feeble pulsations of the arteries and veins of the neck and wrist, and by the use of the X-ray, the size, shape, and contraction of the heart itself can be observed and recorded.

For more than half a century it has been known that every muscular movement, including the rhythmic muscular action of the heart, liberated small electrical currents. The problem has been to obtain some means to record these currents, as they would give a very valuable clue to the many changes which might take place in the contraction of the heart. Therefore men of science have for many years been trying to devise some instrument which would serve this purpose. It remained

for W. Einthoven, a Dutch physiologist at Leyden, to supply this need, when he devised, in 1903, what is termed the "string galvanometer." This forms the essential part of the "electrocardiograph" as the apparatus for recording the heart currents is called. In the past two years so-called "heart stations" where this work is done have been established in four places in this country: One in Baltimore at the Johns Hopkins hospital and three in New York at the Presbyterian, Mt. Sinai, and Rockefeller hospitals.

The string galvanometer is very simple in principle, though complex in con-

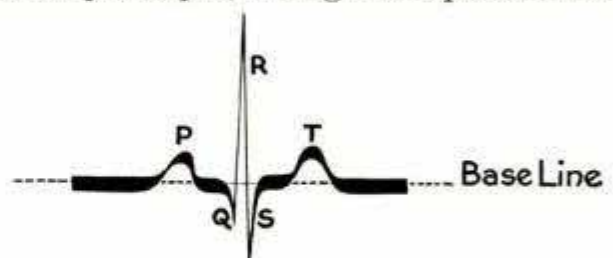

Schematic Drawing Showing the Waves Which Occur during One Contraction of the Heart, and Their Lettering. Ordinarily Q and S are not Present in the Curves Obtained from Normal Individuals

struction, and is based on the physical law that whenever a current passes through a magnetic field, it is deflected to one side or the other, depending on its direction. If some medium which has little weight can be used as the conductor, it would consequently be de-

flected along with the current. For this purpose a very delicate fiber of platinum or quartz (silvered so as to conduct) is hung in the magnetic field of two powerful electromagnets and is attached at its two ends so that it vibrates like the string of a musical instrument. From this the instrument derived its name. The fiber is about 3.5 in. long and varies in diameter from 1-2500 to 3-2500 of an inch, while its estimated weight (it cannot be weighed even with the most delicate of balances) is about .000004 of a gram. It is finer than the most delicate cobweb and can only be seen with the naked eye when a strong light is thrown upon it so as to catch the reflection.

In order to see and record the minute vibrations of this fiber to the currents which are passing through it, it must be magnified about a thousand times. To do this, the light of a very powerful arc lamp is focused down on the fiber by means of a microscope. This produces a shadow of the fiber on the opposite side and this is enlarged and projected by another microscope to a screen about two yards away. Here the fiber appears as a black line about  $\frac{1}{8}$  in. wide, and its vibrations are from  $\frac{1}{2}$  to 1 in. in either direction. If one wishes to make a permanent record of the vibrations, a special type of photographic apparatus is placed in the position of the screen. This consists of a slit behind which a film is moved at a regular rate, and the oscillations of the shadow form a series of waves in the picture.

The patient may be at any distance from the heart station, provided the

proper wiring has been done, and Einthoven himself has his laboratory a mile and a half away from the hospital. The only difficulty in transmitting it from almost any distance is the great danger of induction from larger currents in the vicinity. In actual practice this permits leaving the patients in their beds in the wards while the records are being taken some distance away. As the tissues around the heart are conductors, it is only necessary to connect the arms or an arm and leg with electrodes and the currents can be led off from the body to the apparatus. These electrodes consist of large plates of German silver, covered with felt, and saturated with salt solution, and are simply bound on to the extremities. Wires connect to these which lead to the galvanometer.

Every normal individual gives an electrocardiogram which follows a certain type. There are five waves to each heart beat, lettered P, Q, R, S, T, two below and three above the base line. These have all been determined experimentally to represent a contraction of certain portions of the heart. Any change in the height, width or time of any one of them shows that there is some defect in the contraction of that part of the heart and thus we can determine the seat of disease.

This subject is as yet almost in its infancy and there is a great deal yet to be done before it can be placed upon the plane of the absolute. As it appears at present, it promises to be one of the most valuable aids to diagnosis in heart work, that is in possession of the medical profession.

---

## SAWING A HOUSE IN TWO TO MOVE IT

Few feats of house moving have presented the difficulties that met the contractor charged with the transfer of a three-story frame dwelling from College and Francesca Aves., Somerville, Mass., to a site more than a mile away.

The method employed was equal to

the emergency, however, and to get the building off of its 10-ft. elevation above the street and move it, it became necessary for the movers to saw it completely in two. Each section was then braced and moved by the "roller process" to its destination, and the two sections again brought firmly together



Moving a House by Cutting It in Halves and Taking It to New Location in Two Loads

and fastened. The sections were almost 40 ft. in height and measured 20 by 35 ft. at the base. Thus it may be easily seen that it was no small job to move such a topheavy piece of house. It was feared that the slightest puff of wind might turn over the sections while in transit, but by loading the lower floor with bricks the sections were made quite stable.

After joining the two sections together the mark of division was invisible to the casual observer, and only on close examination was it possible to see the saw cut.

### AUTOMOBILES ESPECIALLY FOR ROADLESS COUNTRY

The owner of some thousands of square miles of land in Australia, nearly all of which is devoid of anything in the nature of roads, has been shipped ten specially constructed automobiles. He required a machine capable of a fair speed, provided with gears for stationary work, a winch for hoisting or

pulling it out of soft ground, and with sufficient clearance to negotiate several feet of water.

Although the specifications were difficult and many parts had to be specially made, the result is a car that in general appearance looks quite a smart touring vehicle of the ordinary

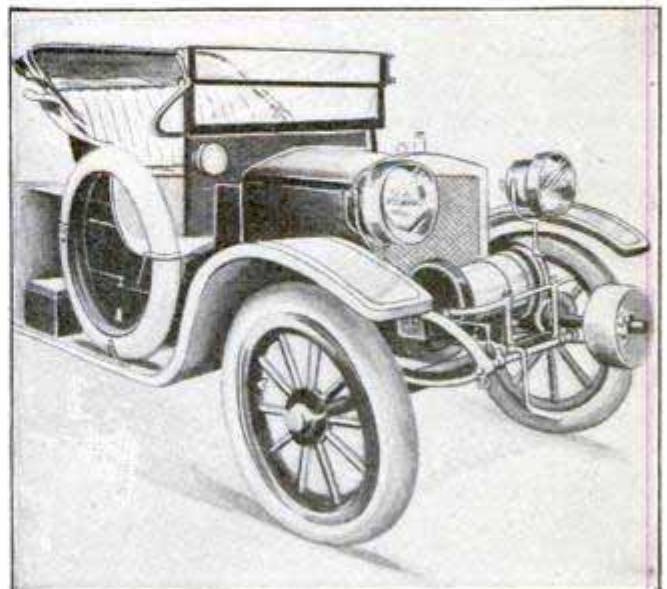

Type of Specially Equipped Automobiles Which Have Been Constructed for Use over Roadless Australian Country

kind. It is high-set, giving 15 in. absolute clearance, and carries a winding drum and gear forward of the radiator for stationary work.

The engine develops 24 hp., and has an overhead drive to a magneto situated in a casing on the driver's side of the dash. The carburetor is placed even higher, so that 3 ft. of water cannot interfere with it. The shaft for station-

ary work projects forward beyond the frame, so that a pulley can be clamped on as shown in the illustration. This shaft also carries a worm, which engages a worm wheel, to which the transverse winding drum is attached. The drum carries 100 yd. of  $\frac{3}{8}$ -in. wire rope, made specially to insure sufficient flexibility for winding on such a small drum.

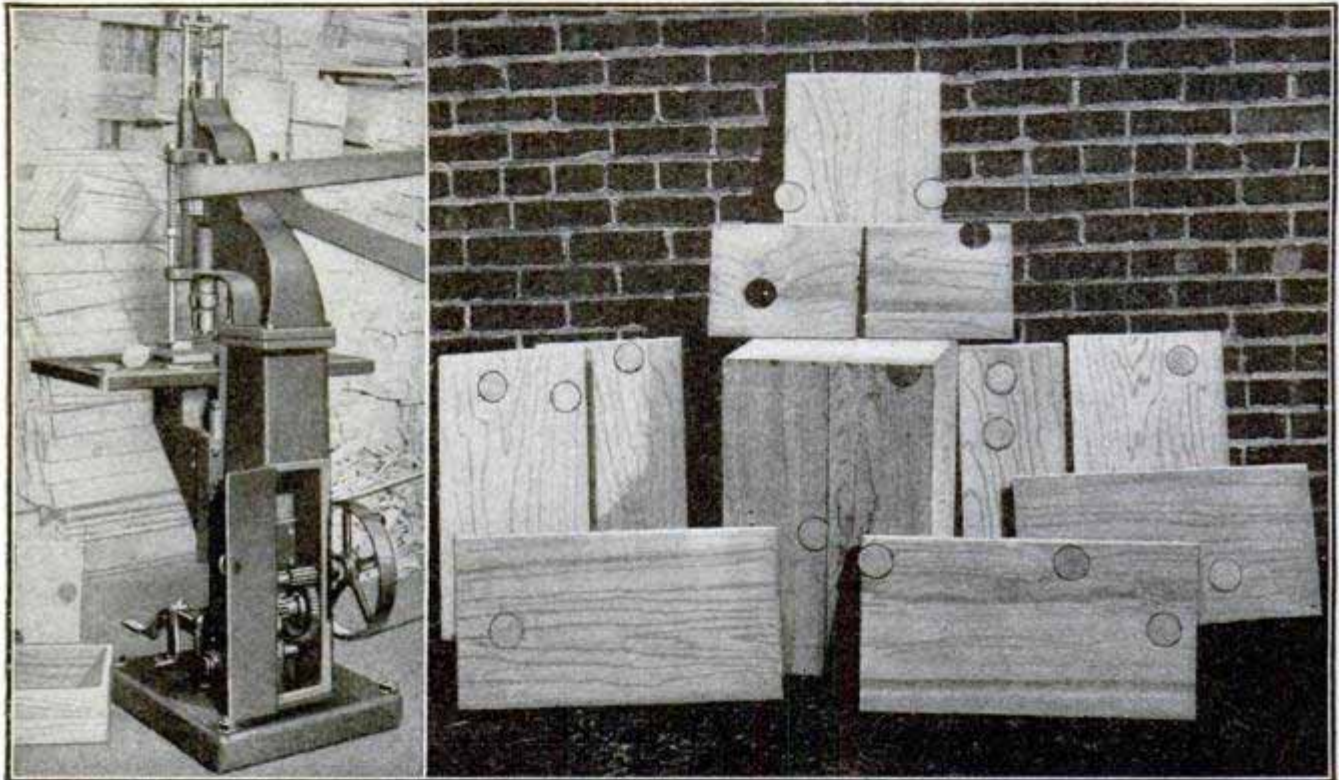

Machine That Plugs the Knot Holes

Removal of Knots Gives Packing-Case Boards Greater Strength

## MACHINE PLUGS THE KNOT HOLES OF BOX BOARDS

Boxes containing knot holes are not salable, and in some localities the lumber used for the box shooks is full of such blemishes, with the result that 20 per cent of the total board footage has to be discarded. Much attention, however, is now being directed in all industries toward the utilization of material until recently considered as worthless, and one of the developments of this activity in the box-making industry is a machine that plugs knot holes.

This machine, invented by a Californian, saws out the knot or the section containing the knot hole, produc-

ing holes of uniform size. The same machine also saws the plugs for the holes, the work being done by two small band saws. The plugs are cut from waste blocks of a thickness that corresponds with that of the boards to be plugged. The plugs, being cut slightly larger than the holes made for them, fit snugly, and are held firmly in place by small crimper nails, which leave both the inner and outer surfaces perfectly flush and smooth.

It is estimated that one man operating this machine three or four hours a day can save at least 1,000 ft. of lumber that would otherwise be wasted.

## VACUUM CLEANER WITH A UTILITY MOTOR

A recent novelty in vacuum cleaners is a machine of this class having a motor that can be used for a variety of purposes. By making minor adjustments, the motor can be adapted to run a sewing machine, a polisher for brass or silver ware, a grinder for cutlery, and so forth. The vacuum cleaner itself can also be used for drying the hair after a shampoo or for currying horses.

## AN ELECTRIC SHOP TRUCK

This diminutive truck is one of four being successfully used by a well known manufacturing concern to carry machinery, etc., in and about the factory, on to elevators, and the like. It is similar to the larger commercial electric trucks now so common on city streets. The operator sits on the front edge of the truck and operates the steering wheel and electric control mechanism just like a regular chauffeur.

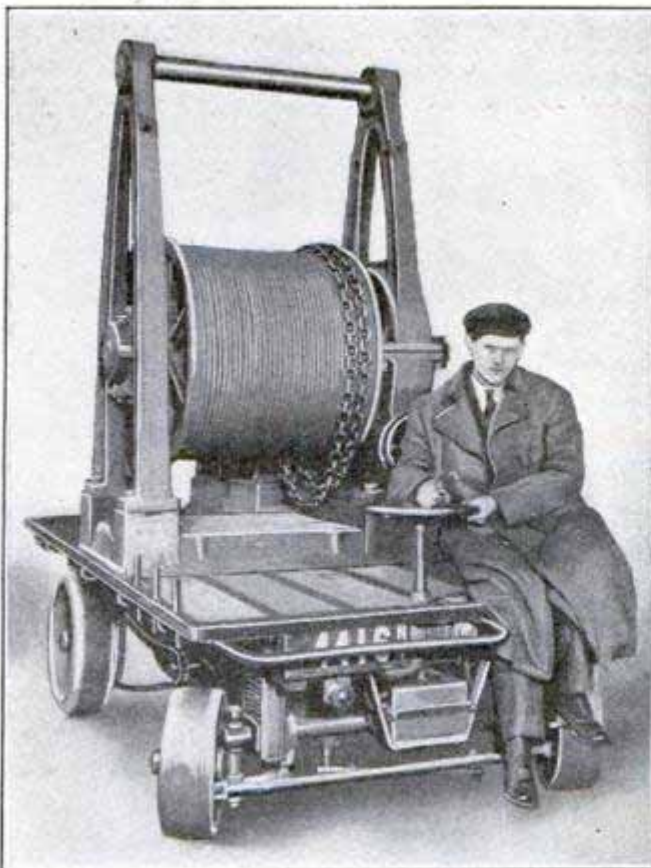

Electric Truck for Shop Service

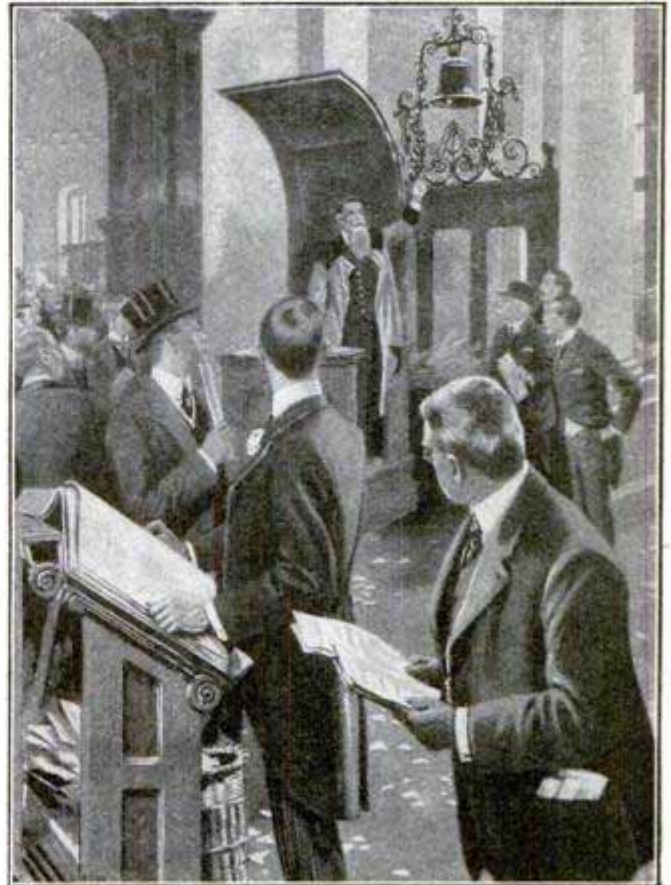

Courtesy Illus. London News

Bell of an Ill-Fated Treasure Ship is Rung at Lloyd's When a Ship is Reported Missing

## RINGING THE "BAD NEWS" BELL AT LLOYD'S

The bell of the British frigate "Lutine," which sank off the Dutch coast in 1799, with a cargo of coin and specie valued at \$6,000,000, is the "bad news" bell at Lloyd's. Whenever news is received that a ship is overdue, or when definite news comes of the loss of a ship, the bell is rung by the "caller." At its tolling, all transactions are suspended until the news it heralds is read.

Many attempts, some partially successful, have been made to recover the golden cargo of the "Lutine." About \$500,000 of the sum has been found, the bulk of it in 1800. It was in one of these attempts that the bell was found. Only a short time ago the wreck was again located, and search for the treasure is now being made.

CA national aviation school, under the patronage of the federal government of the country, has been opened at Lima, Peru.

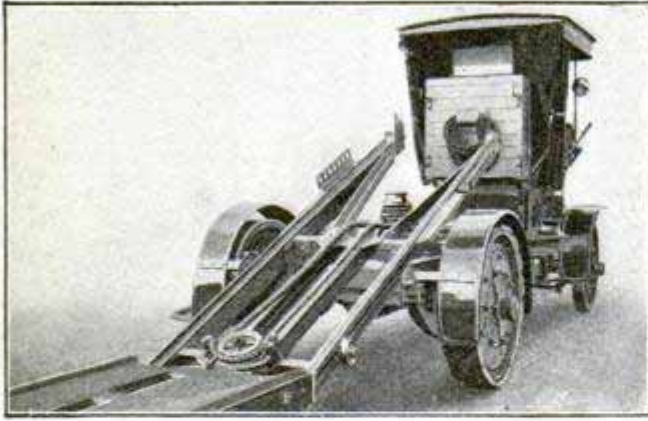

Tilting Frame Motor Truck Ready to Receive a Load

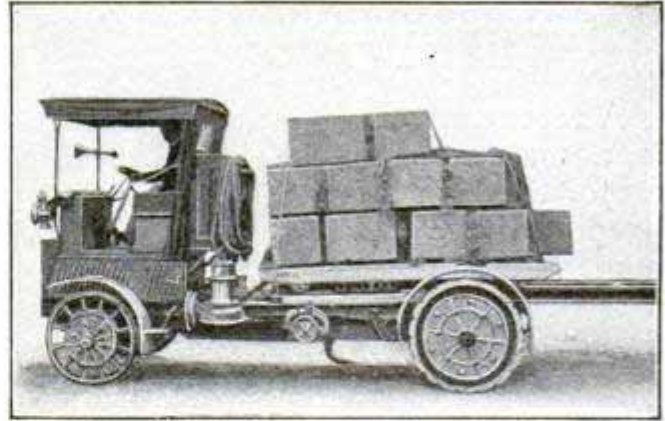

Truck Loaded and Ready to Start on a Trip

## TILTING PLATFORM MOTOR TRUCK

A French motor truck equipped with a capstan, tilting platform, and a load-carrying truck operating on the platform, is shown in the accompanying illustrations. This type of truck is being utilized in France for military service as well as in industrial work where heavy weights are handled, and saves much hand labor.

The tilting platform, which is about 13 ft. long, is tilted over the rear axle and the loading truck run out on the ground. When the articles to be transported are placed on the truck, the latter is drawn back upon the tilting

frame by means of a capstan, and the frame is tilted back and locked in place, thus completing the operation.

☐ One of the state supreme courts has recently decided that the operator of an unlicensed or unregistered motor vehicle cannot recover damages for injuries received in collision with a railroad train even on a wholly unprotected crossing, on the ground that the operation of an unregistered automobile is unlawful and that the law will not exert its powers to protect one who is himself a violator of the law.

## ORIENTAL RUG TRULY A GIANT CARPET

How many housekeepers would care to shoulder the responsibility of cleaning and safeguarding an Oriental rug of the finest texture that is 67 ft. 5 in. long and 38 ft. wide? This burden has been placed upon the shoulders of the steward of the Pacific Union Club at San Francisco by the receipt in this country of a magnificent rug, one of the largest in the world, which was especially made for the club lounging room in a famous rug establishment just outside of Vienna, Austria.

The design of the rug is a reproduction of the ceiling of the lounging room except that a number of cupids that gambol about the ceiling were not given place in the floor covering. It is made entirely of hand tied knots,

as the trade phrase goes, which means that it was made by hand, there being some 9,518,800 knots of the very best sheep's wool used in the weaving. The work was done by 14 of the most skillful women weavers and they spent 70 working days on the rug. So big was the rug to be that a loom was built especially for it. The shearing and finishing required a full week and 24 men were necessary to handle the rug in these operations, as it weighed exactly a ton. The rolling for shipment was done out of doors, there being no room at the factory large enough. The roll was double-burlaped and packed in a case 3 ft. high, 3 ft. wide and 40 ft. long, in a bed of straw. So long was the case that in shipping to Hamburg



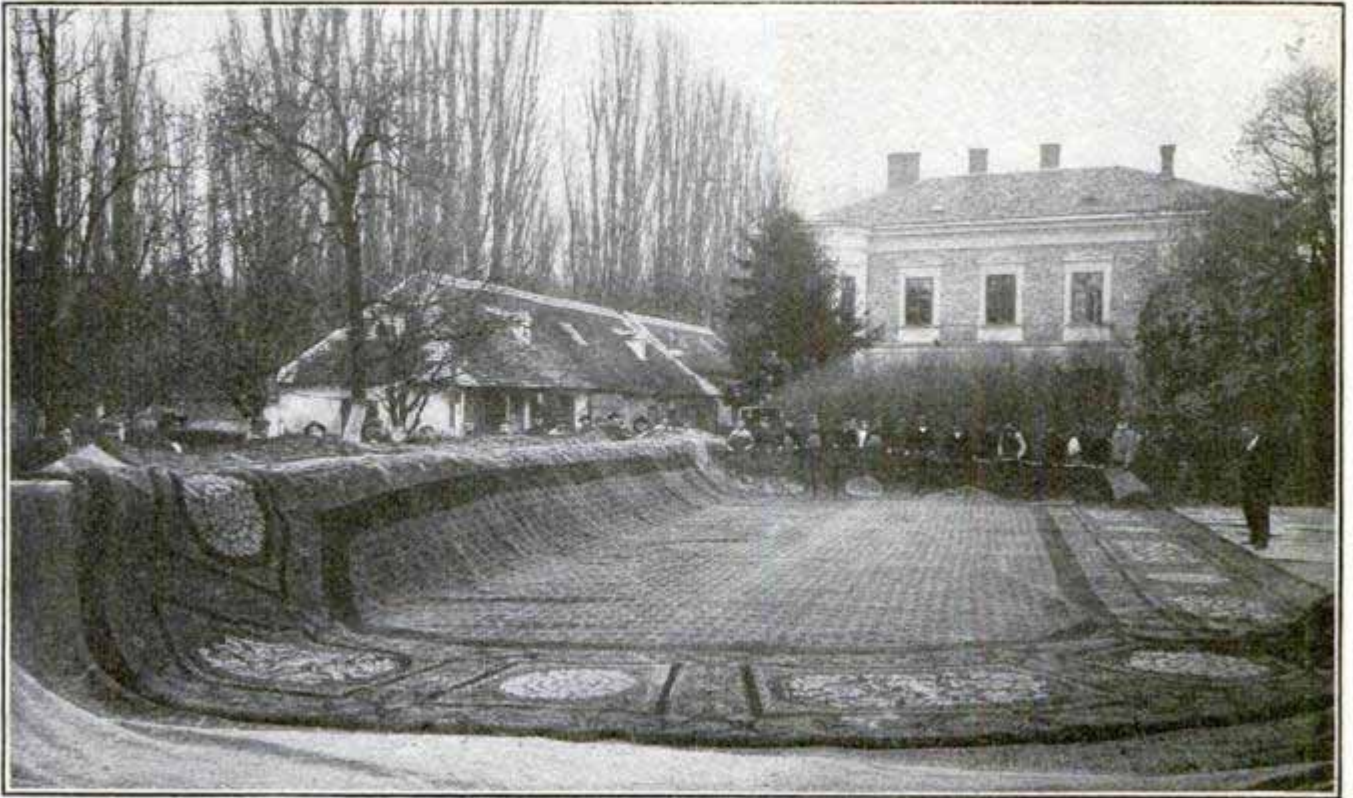

**Oriental Rug Especially Made for a San Francisco Club**

where it was placed aboard a steamer, two flat cars were necessary. The case was too large to be placed in the hold of one of the big Atlantic liners selected to carry it and it was necessary to wait for one of the largest ships of the line before it could be shipped. In New

York 14 men were required to unroll and roll the rug for customs inspection and it was necessary to use a special truck, such as is employed in hauling steel girders, to carry it across the city to the dock of the steamship line which is to carry it to San Francisco.

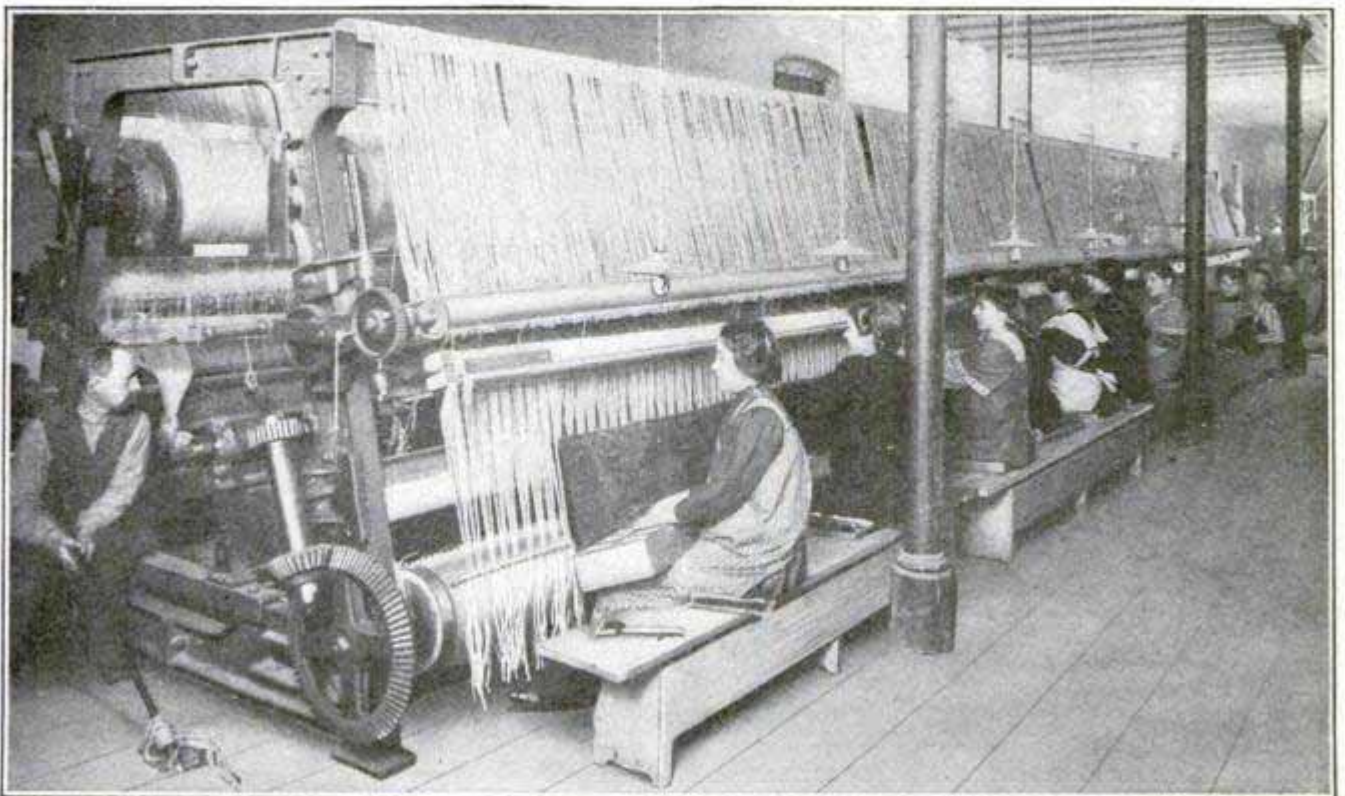

**Big Loom at Which 14 Women Worked 70 Days Weaving the Rug**

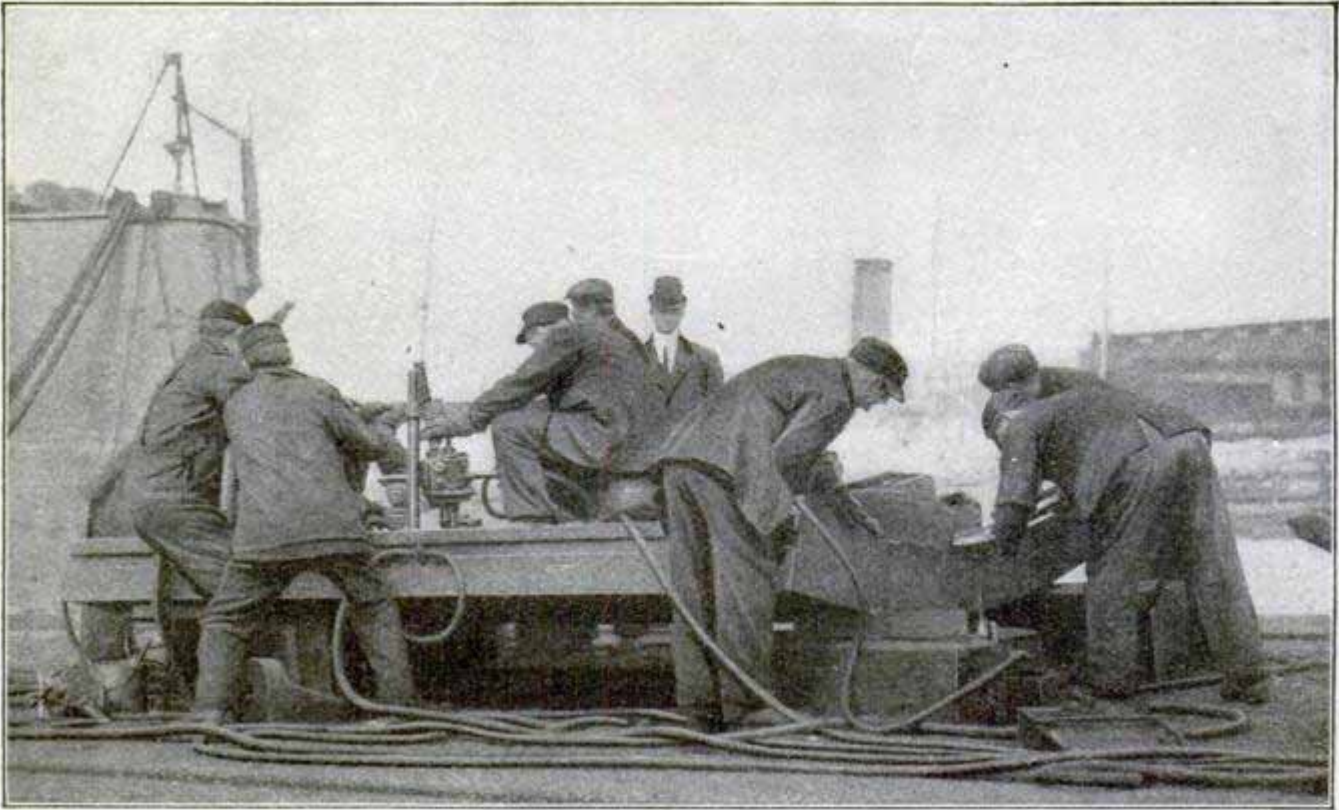

ARMOR PLATE FOR TURRETS

Among the finishing touches in the construction of a great battleship is the work upon the turrets. The illustration shows activity upon a heavy piece of armor for one of the turrets of the U. S. S. "Florida."

## IMPROVED SHIP-COALING MACHINE



New Type of Ship-Coaling Tower Constructed at Southampton, Eng.

A ship-coaling apparatus having a capacity of from 100 to 150 tons per hour without dust has been constructed at Southampton, Eng. It consists of an 80-ft. tower mounted on two pontoons, 28 ft. apart. The pontoons are 80 ft. long and support a frame 12 ft. high, on which the tower rests.

When the apparatus is brought alongside the vessel to be coaled, a barge laden with coal is towed into place between the pontoons, and the coal is picked up by an endless chain of buckets, raised to the inclosed hopper at the top of the tower, and discharged through the chutes directly into the bunkers.

¶Gustav Lilienthal, son of Germany's pioneer in aviation, has organized a society in Germany which seeks to realize man flight without the aid of a motor, and to this end is promoting the study of the flight of birds.

## COPYING THE KAISER

The upturned mustache of the Kaiser, which sets the style for most of the mustaches of Germany, is not easy to acquire in the first place and is always difficult to maintain in spick and span uprightness. A forcible means of shaping the ends is required, and such means is usually found in the form of a shield which fits over the upper lip and cheeks and is fastened around the head. The ends of the mustache are turned straight up against the cheeks and moulded in this form by means of the shield.

The device is usually worn on retiring at night, but that it may also be worn in the daytime is shown by the



How German Sports Keep Their Mustaches Like the Kaiser's

photograph. The wearer is asleep on the sand, presumably after a dip in the sea, which probably destroyed the uprightness of the mustache ends.

## X-RAY WORKS OVERTIME ON PUGILIST'S SKULL

This is an X-ray portrait—profile—of Jack Johnson, the enthusiastic colored motorist who became the world's champion heavyweight pugilist a year or so ago. The average mortal's cranium is a rather dainty affair, rather less than a quarter of an inch in thickness; but a solid half inch of good, honest bone shields Johnson's brain from the unkind world. The common

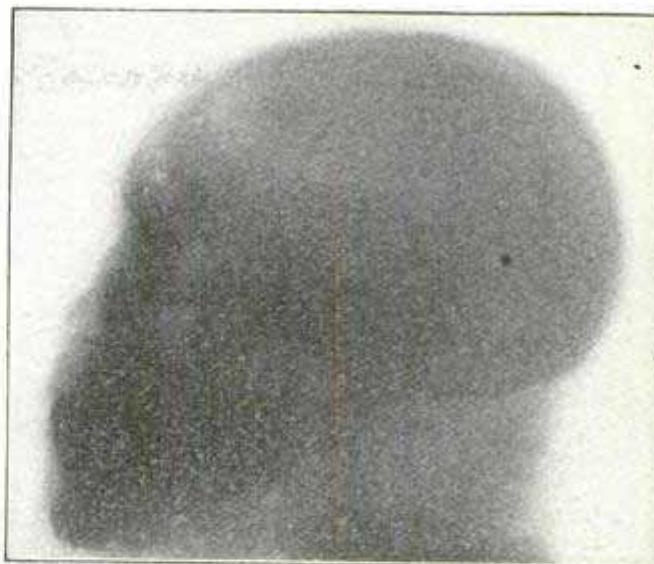

A Five-Minute Exposure Was Necessary to Obtain an X-Ray Picture of Jack Johnson's Head—From 10 to 15 Seconds Suffices for Ordinary Mortals

or garden variety of X-rays can penetrate the average mortal's skull in 10 or 15 seconds; but the same rays had about five minutes of hard work doing the same thing for Mr. Johnson's.

## CALCULATING MACHINE MADE IN 1642

This calculating machine, the first of its kind, was invented and constructed by Blaise Pascal, a Frenchman, in 1642, in which year he was but 19 years of age. It was made by him with the aid of one workman, and was presented to the chancellor of France. During the revolution it was found in a junk shop at Bordeaux, and at present is the property of M. Bougouin of that city. All of the four simple mathematical operations can be made with it.

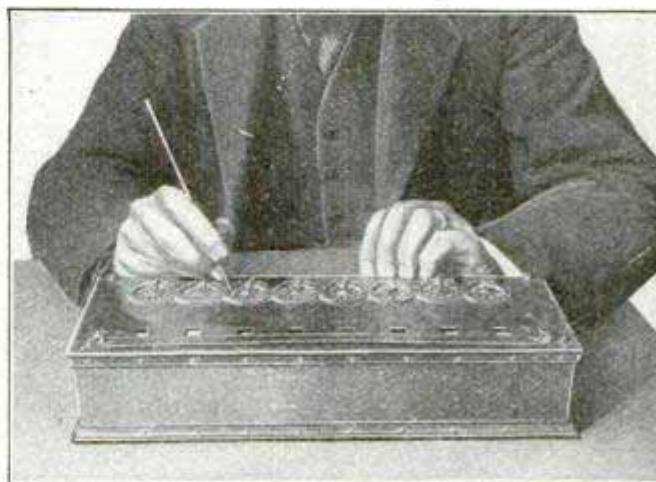

Calculating Machine Invented in 1642



# Explosions and Explosives

By HUDSON MAXIM

THE destruction of the powder factory at Pleasant Prairie, Wis., on March 9 last, and the previous explosion of dynamite near Jersey City, have given rise to no little concern in the public mind regarding the manufacture and handling of high explosives. As is usual in such cases, the facts have been largely distorted in current accounts of these disasters, although, in the Wisconsin explosion, only one man was killed and serious damage to property was entirely local, notwithstanding that between 500 and 1,000 tons of black blasting powder were consumed in several distinct explosions, and the earth and air shocks distinctly felt 100 miles away.

In order to present to the readers of Popular Mechanics Magazine an expert account of the nature of such explosions, Mr. Hudson Maxim, the greatest living authority on this subject, was requested to explain the apparent vagaries of accidental and violent explosions. — THE EDITOR.

WHENEVER an explosion occurs in an inhabited portion of country, whether it be of 100 lb. or 500 tons, of black gunpowder or dynamite, the air wave and the earth wave set up by the blast always produce within the radius traversed by them a highly exaggerated impression in the minds of the inhabitants concerning the actual destructive force of these waves, with the result that the damage done, if any, within the radius of the effects of the blast is correspondingly overestimated.

This was especially exemplified on the occasion of the recent explosion of 10,000 lb. of dynamite at Communipaw, N. J. The fact that considerable window glass was broken throughout Jersey City, Hoboken and the Borough of Manhattan, and that the shock was felt all over Greater New York and its immediate suburbs, gave the impression that a vast amount of damage had been done.

As one result of the mental perturbations, a bill was actually introduced at Albany, N. Y., to limit the amount of explosive in transit through the larger cities and towns to 28 lb., and the amount that might be stored in any one place to 1,000 lb. If such a

bill should become a law, and the law enforced, the cost of constructive work involving the use of explosives in Greater New York alone would be so increased as, in many cases, to be quite prohibitive, and in most cases impracticable. It is a moderate statement that the effects of such a burdensome law would cost the city every day more than the entire damage done by the explosion.

A wider public knowledge, therefore, is much needed concerning the nature and effects of explosions, and the limitations and extent of actual serious damage they are capable of producing.

The fact that the atmospheric disturbance and the earth tremor produced by the explosion of a few tons of dynamite may be felt at a distance of 50 miles is not remarkable; but that any serious damage should be done at a distance of 8 miles by the explosion of even 100 tons of explosive would be remarkable. There is a vast difference between an apparently serious and destructive disturbance of earth and atmosphere produced by an explosion, and a really destructive disturbance.

On a quiet evening certain small



This Hole, All that Marks the Spot where One of the Powder Magazines Stood at Pleasant Prairie, Wis., is about 150 Feet Long, and 50 Feet Deep at One End. Great Lumps of Hard Clay Cling to the Sides of the Hole



Exact Spot where the Pleasant Prairie Explosion Started; All that Remained of the Glazing Mill, where 1,000 Pounds of Powder was Ignited by Some Agency, Probably Friction

insects may be heard at a distance of half a mile. When we take into consideration that a grasshopper-like insect, the katydid, may, by rubbing his thighs against his wings, set in audible agitation half a cubic mile of air, weighing many thousands of tons, it is not surprising that the voice of a ton of exploding dynamite should be heard and felt at a distance of a few miles. Obviously, the amount of energy actually developed by a katydid is exceedingly small, and still it is able to shake half a cubic mile of air weighing thousands of tons, which, in turn, makes all the forest trees and houses tremble, and even the earth to vibrate under the agitated air, although the agitation of the trees, houses and earth is not sufficiently powerful to be perceptible to us.

In 1883, in the Straits of Sunda, the whole top of an old extinct volcano, known as Krakatoa, was blown into the sky by the most stupendous blast within historic time. This explosion actually shook the whole earth sufficiently to affect a seismograph on the opposite side of the globe. A tidal wave was set up that encircled the earth; and an atmospheric wave, so great that it actually encircled the earth three times, was set in motion. But the actual destructive effects of the volcano were limited to the immediate volcanic zone where the explosion occurred.

Evidently then, the actual distances at which an explosion may be felt and its effects made visible are no indication that the effects are actually destructive to any such distance.

Let us examine into what really happens when a mass of explosive, such as dynamite, is set off upon the earth's surface. At the instant of detonation, the explosive body is converted into a ball of incandescent gases under an initial pressure or tension of, perhaps, 300,000 to 500,000 lb. to the square inch. This ball of hot gases under the enormous pressure expands rapidly in all directions. Its expansion downward is arrested by the earth, which offers far greater re-

sistance than does the atmosphere, with the result that the blast forms a crater in the earth under it, while the mass of expanding gases rebounds upward from the crater into the air in the form of an inverted cone, carrying the air before it. The amount of explosive energy directed upward, displacing the atmosphere, is as much greater than the energy directed downward, as the resistance of the atmosphere is less than the resistance of the earth.

Therefore, when a large mass of explosive, like that at Pleasant Prairie, explodes, the expanding gases lift an enormous quantity of air in their upward rush, greatly compressing it, with the result that this great lifted body of air moves outward in all directions upon the surrounding air, both by virtue of its gravity and by its powers of expansion. Therefore, a great wave of compression is sent upward and outward in all directions.

The stratum of air composing the wave of compression actually moves through but a small distance. It merely transmits its energy to a succeeding stratum of air outside of it, and then returns to its original position, and so on. In other words, the wave of compression is one of atmospheric vibration. Actually, it is a large sound wave, and travels at the speed of sound, namely, about 1,100 ft. per second. The earth wave travels more rapidly than the atmospheric wave, because the vibrations are transmitted through earth more rapidly than through air. Thus it is that two shocks follow each other in quick succession after an explosion—the first is the earth shock and the second is the air shock.

The amplitude or length of the vibration which travels through the earth is much less, that is to say, the wave length of the earth vibration is much less than the atmospheric vibration. While a distinct jar of the earth may be felt at a long distance, little destructive effects are ever produced by the earth vibration, even at comparatively short distances.

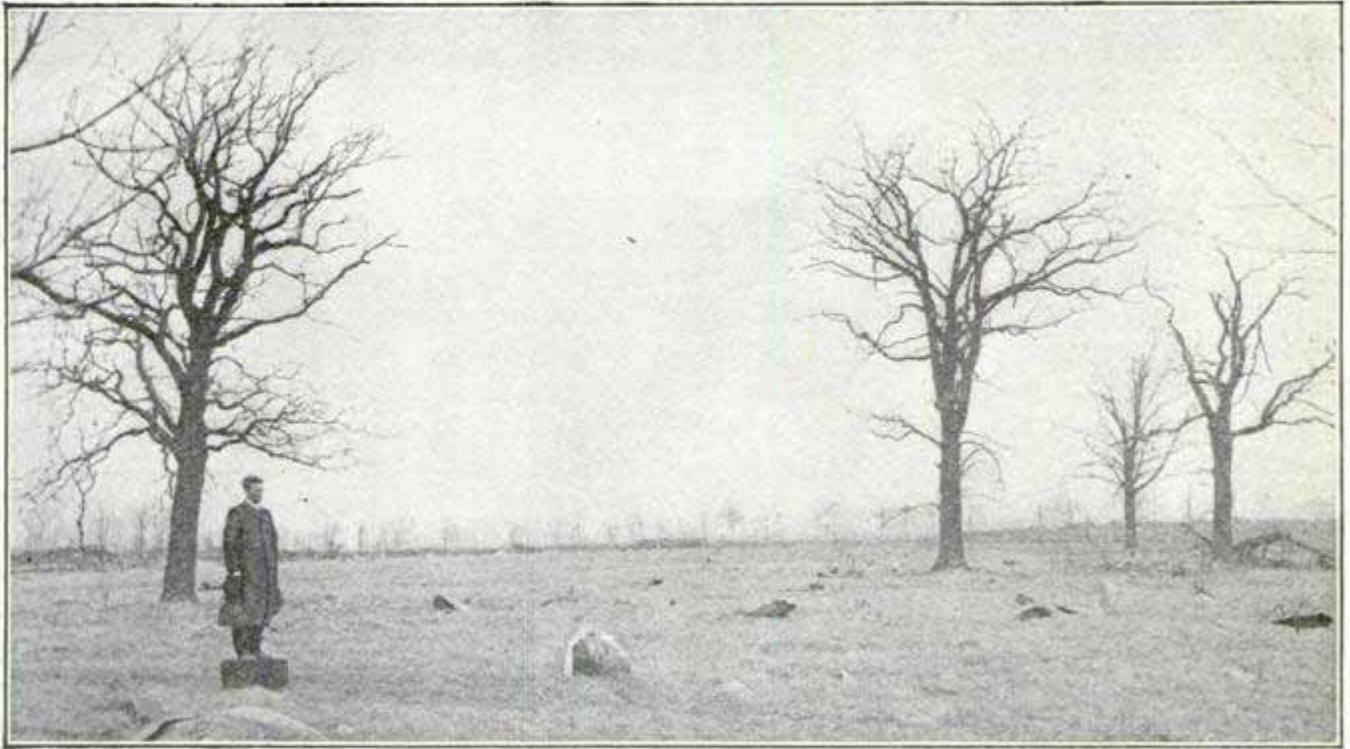

One of the Vagaries of the Pleasant Prairie Explosion—A Person Standing where the Man is Shown Would Probably Have Escaped Injury, as the Tree Near Him Was Not Damaged, Yet Trees Not More than 150 Feet to the Right Were Shattered

It is the atmospheric vibration or atmospheric wave that breaks the window glass. The reason why much glass is frequently broken, even at great distances from an explosion, is interesting, as is also the reason why the broken glass falls outward into the street.

Let us, for example, take a ball of dynamite a foot in diameter, and suspend it high in the air, so that when exploded, the gases may expand freely in all directions, and let us assume that, at the instant of detonation, the pressure be 400,000 lb. to the square inch. When the ball has expanded to twice its original diameter, it will occupy 8 times the space, and when it has again doubled its diameter, it will occupy a space 64 times as great as it originally did, and so on, so that by the time it has expanded to 100 ft. in diameter, or 50 ft. radius, it will occupy a space one million times as great and will exert only one-millionth of the pressure which it originally did—that is to say, two-fifths of a pound.

But the work done in displacing the surrounding atmosphere would consume a good deal of energy, with corresponding reduction of heat and expansive power, so that by the time a

foot of dynamite had expanded in all directions to a distance of 50 ft., its expansive power, at least, would become zero, followed by a reaction of the surrounding atmosphere to fill the void formed by the cooling gases.

There are two ways in which the atmosphere yields to the force of an exploding body. The air in the immediate vicinity of the explosion is driven forward like a projectile, and with a velocity which may be at a rate of several thousand feet per second, until the expansive force of the gases is expended. The distance through which this occurs is very short.

When the expansive power of the gases is exhausted, the great wave of compression which is produced, is, in effect, a great sound wave and obeys the same laws that govern sound. It travels at the same speed as sound as it moves outward in all directions. It thins out just as a soap bubble thins out when it is blown bigger. Also its degree of compression decreases as the square of the distance, so that when it has traveled to a distance of two miles, it exerts only one-quarter of the pressure that it exerted when it had traveled to a distance of one

mile, and the duration of the pressure will be only one-quarter as long, etc.

As the wave of atmospheric compression is in the form of a hollow sphere, it would take 8 times the quantity of explosive to produce a given effect at 2 miles that it would take to produce the same effect at a distance of one mile. Actually, then, in order to produce a very destructive effect at any great distance, an enormous quantity of explosive is required.

The effects of explosions of all magnitudes upon buildings and other structures at all distances where effects are perceptible, have been carefully tabulated, and curves of their average effects drawn, and it has been shown beyond question that at distances of a few miles, the effects are not at all in proportion to the quantity of explosive consumed. At a distance of 10 miles, it would not matter much whether 200 tons or 2,000 tons of dynamite exploded, the damage would still be confined mostly to broken glass, and other frail and non-massive objects and structures.

How then is so much glass broken? Two things are necessary to produce destructive effects upon massive structures—time and pressure. As much as 500 lb. of dynamite may be hung upon the face of 12-in. armor plate and exploded, without injury to

the plate, because the time is too short. Although the pressure for an instant is enormous, still its duration is not long enough to cause the strong and massive plate to yield. In consequence, the gases rebound from the plate, themselves becoming a projectile. Thus it is, that the duration of the atmospheric wave is not long enough materially to affect the massive walls of buildings beyond the immediate zone of the explosion, where the air is driven as a projectile.

The fact, however, is otherwise with window glass, owing to its lack of mass. Let us suppose that the atmospheric wave exerts a pressure of one-tenth of an ounce to the square inch. This would be about 1 lb. pressure per square foot, and on a pane of glass 10 ft. square, it would represent a total pressure of 100 lb., which would be sufficient to spring the glass inward. But the wave of compression is relieved so quickly that before the glass has time to break under the pressure, the external pressure has gone, and is succeeded by a corresponding node of minus pressure, so that we then have the energy stored in the glass and a minus pressure outside. Consequently, the two acting together force the glass outward with such force as to break it. This is why window glass blown out by an explosion falls into the street.

## MODERN LOADING DEVICE WORKS FOR CHARITY



Photograph by Underwood & Underwood

Flour for Relief of Starving Chinese Being Loaded on Board the Army Transport "Buford" by the Most Improved Loading Machinery

Much of the success of the quick dispatch of the U. S. Army Transport "Buford" to China with a hold full of flour for the relief of the starving in the plague and famine stricken districts, was due to the use of modern machinery for loading the vessel at the Seattle docks. The "Buford" carried thousands of sacks of flour purchased with the proceeds of a popular subscription collected by The Christian Herald. In Seattle, where the vessel was loaded, the entire community aided in the work. A ball was



given for the benefit of the fund and society girls sold tickets for this affair on the streets. The longshoremen who work on the docks volunteered their services free and the United States government provided the vessel, without cost.

Under the old conditions, all post cards were printed on flatbed presses and afterward the sheets were cut up into individual cards on a separate machine. With the new cylinder presses, the cards are printed at the rate of 96 to each revolution of the press and

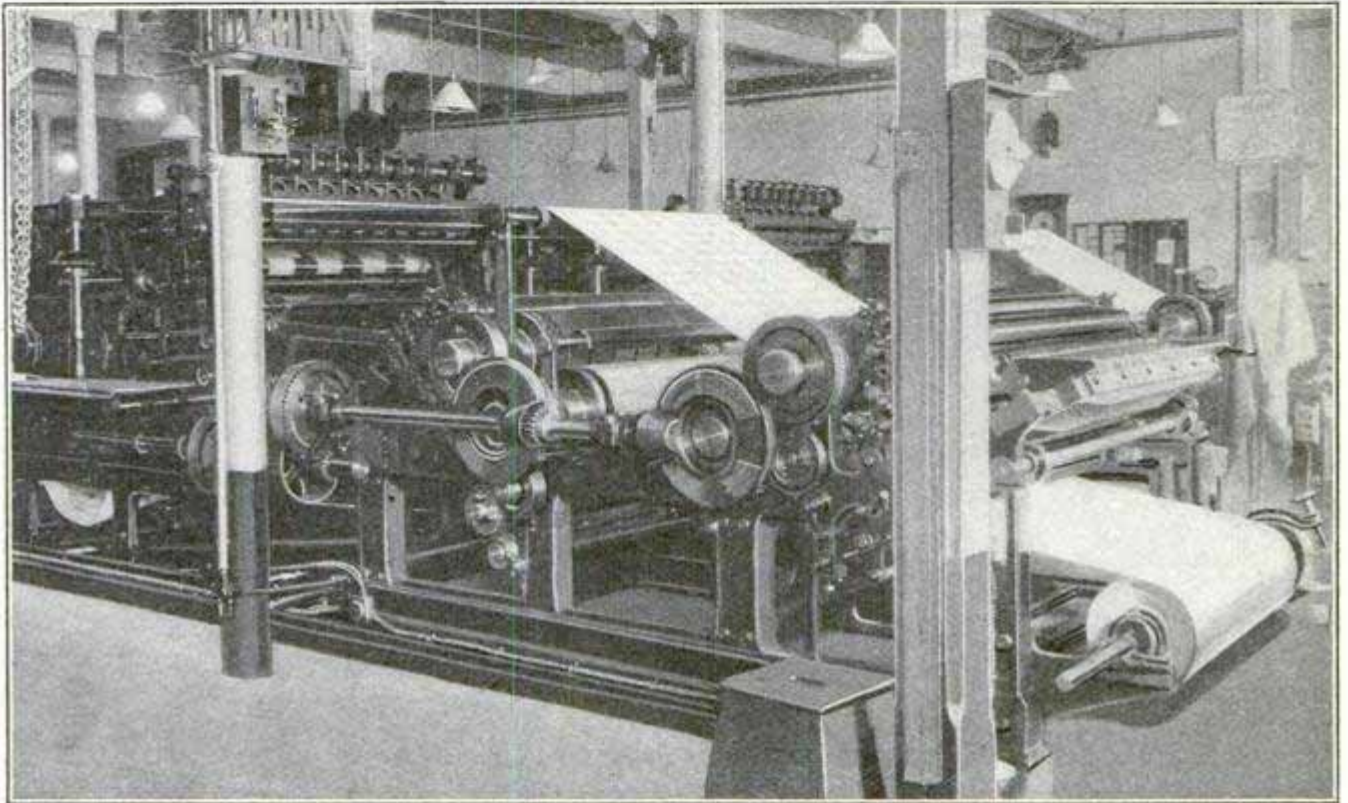

New Government Press Which Turns Out Postal Cards by the Million

### PRINT FOUR MILLION POST CARDS A DAY

The latest and certainly one of the most interesting additions to Uncle Sam's category of automatic marvels is found in two monster presses costing \$36,000, recently installed at the Government Printing Office at Washington, for printing postal cards. These presses were designed and constructed for this work, and rank as the fastest presses of the kind in the world. Each is capable of turning out 2,200,000 complete post cards in an 8-hour working day, and under ordinary operating conditions they average 1,800,000 cards per day,—the two presses now turning out between 3,500,000 and 4,000,000 cards per day,—six days per week, this output being required to keep pace with the correspondence of the American people.

the cutting, trimming, and counting of the cards is included in the work performed, thus reducing the labor cost about 50 per cent. Within six months the government expects to have in operation a supplementary machine which will apportion the post cards in packages, a work which now requires the services of a dozen young women.

The special paper for the cards is fed to the presses in the form of rolls each weighing 1,200 lb. and containing material for 225,000 cards. Post cards turned out by the new presses are put up in packages containing 10,000 cards each. A surplus stock of 70,000,000 post cards is kept on hand at all times in a reserve vault.

CA national school of telegraphy has been established in Panama, the capital of the Central American republic of the same name.

## AN ELECTRIC KITCHENMAID

With the exception of scrubbing the floor, this electric cabinet is designed to do practically every kitchen chore requiring that commodity commonly known as "elbow grease." It is simply

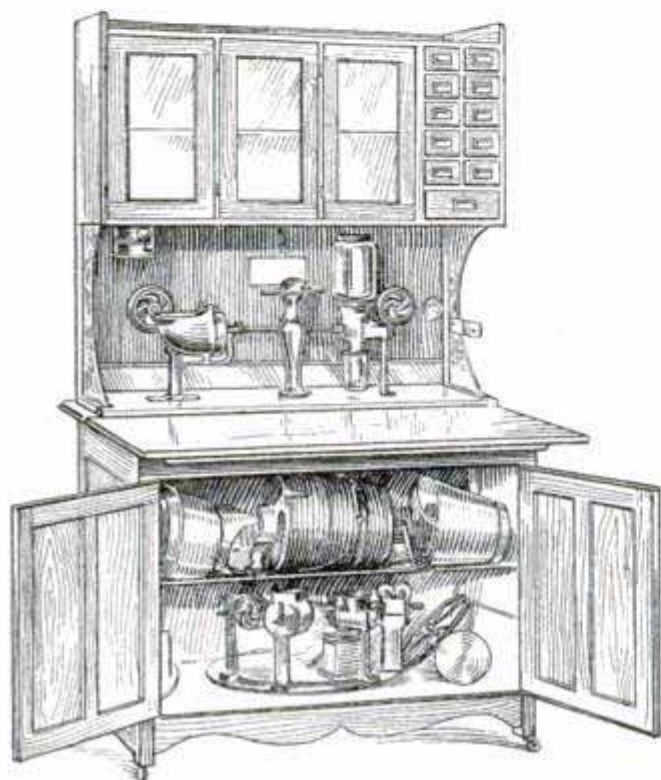

Kitchen Cabinet Provided with 11 Electrically Operated Culinary Devices

a case of "turn on the current and the motor does the rest."

In a special compartment, out of harm's way and protected from dust and damp, is a little electric motor somewhat more powerful than an average man and so economical that if it were run two hours a day, the cost for electric current would be only about 13 cents a week, at the average city rate for electric power.

On the table top of the cabinet there projects a standard on either side of which is a revolving power arm. At the end of each arm there is a simple clutch that gears with the spindle of the kitchen utensils. These devices are fitted with a standard base for sliding in a grooved channel under either power arm and can be connected up or detached while the motor is running. In the illustration there is shown a vegetable slicer connected to the power arm on the left, and a coffee grinder

on the right. Besides these, there are, compactly arranged in the base of the cabinet, a bread mixer, cake mixer, egg beater, meat chopper, potato and lemon grater, cherry pitter, knife sharpener, knife polisher, and ice-cream freezer. A special extension shaft can be fitted to operate a pulley at the right side of the cabinet for running the ice-cream freezer or any household device, such as a dish washer, clothes washer or sewing machine. The upper part of the cabinet contains a flour bin and sifter, besides compartments for spices, tea, coffee, sugar, and the like.

## HASTE TO FLY FOR MONEY MAY BALK PROGRESS

In the early days of the automobile, the noisy, unreliable engine of only 4 hp. was sufficient, and people enjoyed automobiling then, many thinking the desired had been accomplished and that the clumsy little rattle-traps were a great invention, says a writer in *Aeronautics*. The design of those early automobiles was very blind to good engineering. Most of them were poor jobs of carriage building, with a very crude motor attached. The condition of the carriage building trade at that time was very little behind what it is today and there was no excuse for such atrocious body designs as were perpetrated in the name of the automobile. How different the present 30 to 60-hp. car, with its refinements and conveniences and excess power enough to negotiate any hill or road with ease? This refinement has not come from learning how to build better carriages or do better upholstery, but from the increased life and service of the motor—the improvement that has changed the auto from an occasional plaything to a daily necessity.

Aeroplane building is following in the wake of the automobile, and already is more attractive as a sport. Unless the public is more discerning in its demands, the progress in the development of the aeroplane will be as slow as with the automobile. To be sure, the automobile grew at a tremendous

rate, but the aeroplane should profit by the lessons taught. There is no good reason for building aeroplanes with wood work on them that would make any conscientious carpenter blush with shame, with metal work that any good ornamental iron worker could improve by 50 per cent, and with covering of which no upholsterer or sail maker would be guilty. The haste to get to flying and win the large prizes offered for various flights has been provocative of these things, and as a result, most of the prizes have been premiums on daring, rather than substantial recognitions of scientific or engineering ability applied to aeroplanes.

The money prize as a premium on daring is a detriment to the growth of a substantial industry. The public wants aeroplanes built with the same engineering intelligence that is applied to roads, ships, bridges and present-day automobiles. The sooner the crude little aeroplanes, built by adventurers, are replaced by the production of skilful and thorough designers, the better chance this country will have to lead the world in aeronautics. It should be possible for us to profit by the experience of the past and avoid great waste of money and effort on worthless productions.

### TWO EARS OF CORN ON ONE STEM

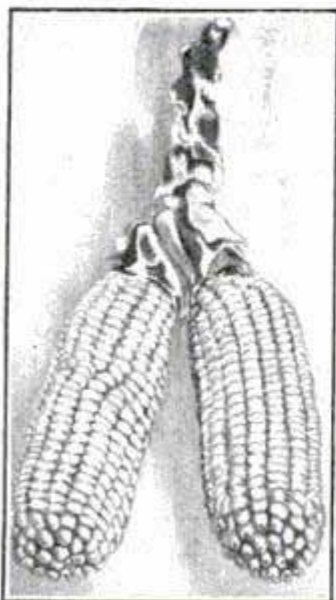

and each having 14 rows of grain.

In the last crop of corn grown on the Crunk & Thomas farm, near New Haven, Ill., was found a genuine "nature freak" in the form of two ears of corn growing on one stem. The ears are the same size, both being  $8\frac{1}{2}$  in. long,

### TAME EAGLES AS DECOYS FOR WILD EAGLES

Thousands of Chinese hunters trap wild eagles in Mongolia every year by the employment of tame eagles as

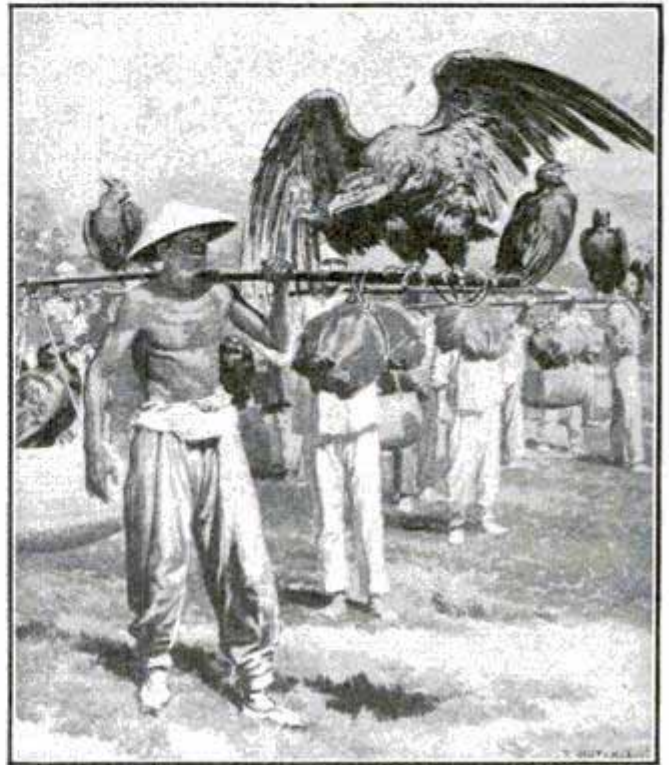

Courtesy The Sphere, London

Chinese Trapper, Armed with Tame Eagles, Starting Out on an Eagle Hunt

decoys. They carry the tame eagles on their shoulders in the manner shown by the illustration, and when a likely locality is reached, they arrange nets within which are placed large quantities of bait, usually small fish. Operating lines are stretched to a distance of about 500 yd. from the nets and, when the wild birds have joined the tame ones at the feast, these nets are brought into action.

The value of the capture depends upon the condition of the feathers, which are used for fans. Only the largest feathers are of use, and a fan of black feathers, white near the middle, brings as high as \$25.

Probably the only person exempted specifically by law from paying tariffs is the president of the republic of Panama, who, by a recent law, may import any article duty free for his own personal use.



Soft, Mellow Background Secured in "Chantecler"  
Staging by Novel Scenic Arrangement

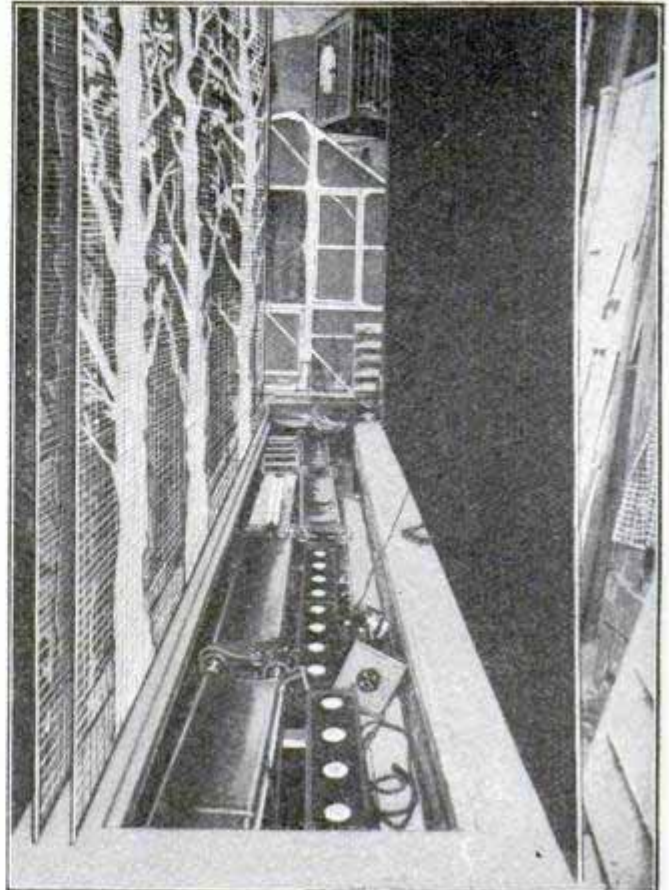

Copyright by Charles Frohman  
Gauze Screens, Lighting Trap, and Black Velvet  
Curtain at Rear of Stage

## THE NEWER STAGE SCENERY

Hurrying the boy to the station with a tightly-rolled mountain-range in one hand, a neatly wrapped forest in the other and the village green snugly tucked under one arm will lack novelty to the actor of next year. Stagecraft has taken a huge forward stride in the novel scenery used in the New York production of "Chantecler."

The innovation, which eliminates cumbersome wooden stage settings altogether, is the product of the artistic genius of Mr. John W. Alexander, president of the National Academy, although in its practical development, Miss Maude Adams has had no small share. Briefly, plain blue gauze of varying shades and thickness forms the basis of the new scenery, the variations making for different effects of light and distance. The sky is painted on in solid blue color; the scene, trees, etc., are laid on in hardly more than outline, so that they are very nearly transparent. An invisible framework of light chain around the edges holds

the gauze solidly in position during the play; and when the time comes to clear the stage, it is necessary only to release the tension, drop the whole to the stage and roll it up.

A little distance to the rear, a solid black velvet curtain is hung across the entire stage, and between gauze and curtain lies the lighting trap, sunk below the level of the flooring. The whole trick, of course, lies in the skillful manipulation of the lights which, thrown upon the gauze, cause the objects to melt softly into the black background, while the sky remains blue.

On the artistic side, the gauze scenery does away completely with the harshness of the conventional stage setting, which, however faithfully it may reproduce detail, generally fails utterly to give the eye an impression of things as they appear in everyday life. Instead, it keeps its place in the scheme of the picture and furnishes a mellow and harmonious background for the movements of the actors.

From a commercial standpoint, the story seems briefly and fully told in the recent statement of Mr. Charles Frohman, pioneer of the new scenery, to the effect that in transportation it will occupy not more than one-quarter the space of wooden scenery, and that he alone expects to save by its use something like \$100,000 annually in the shipping cost of his productions.

### SLEEVE MIRROR FOR MOTORCYCLISTS

A small convex mirror, fastened to

one of the sleeves at the wrist by means of a rubber band, is a handy little device for motorcyclists. By lifting upright the arm to which it is attached, the road behind may be seen

without the necessity of twisting around in the saddle.

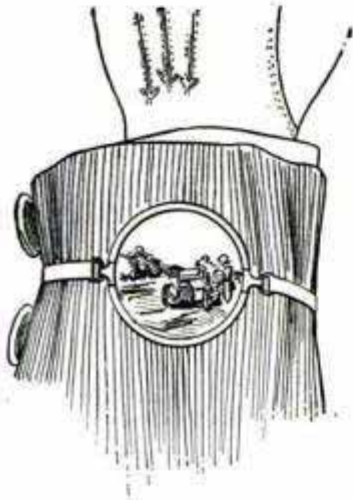

### A BIRD CART FOR THE DUTCH PRINCESS

The curious little cart presented to the Queen of Holland for the use of the little Princess Juliana by Prince Pokoe Alam VII., sovereign of one of the

states of the East Indies, is probably the most costly child's cart in the world. The body takes the shape of a

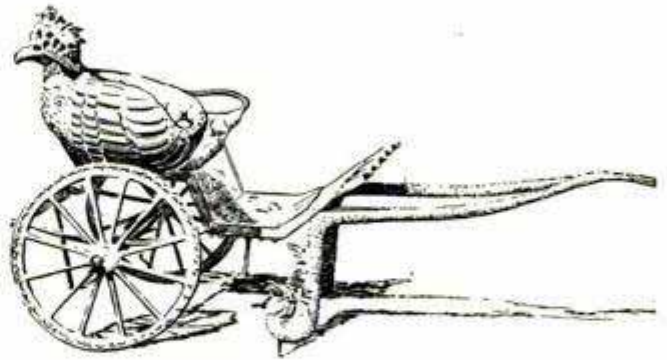

The Gift of Prince Pokoe Alam VII. to the Little Princess Juliana of the Netherlands

“garoedo,” a mystic bird sacred to the Hindu religion, and the entire cart is ornamented with artistic carved work.

### BOTANICAL CURIOSITIES

Tropical plants, of course, must be kept in hot houses during the winter months in cold countries, but in India there are houses for protection of flowers which are just the reverse. Plants from the colder countries, unused to the heat of India, are kept in cold-houses, the curious construction of which is shown in the illustration of one in the botanical garden in Calcutta.

The other illustration is of a lily pond in Zurich, Switzerland, which is heated so that tropical lilies will thrive in it. The heating pipes are on the bottom of the pond. The arrangement is for the summer months only, and the plants have to be transferred to a hot-house in the winter.

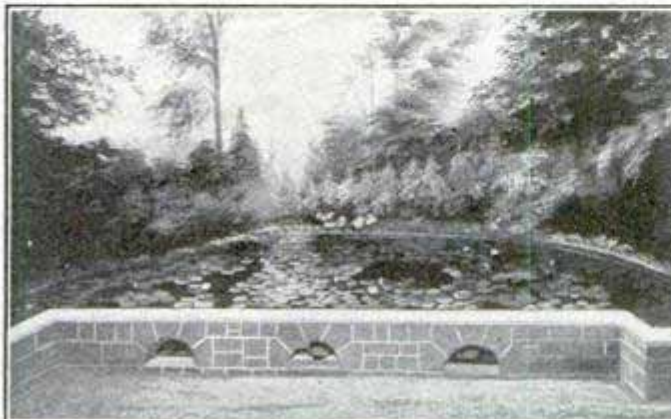

Lily Pond in Switzerland Heated so That Tropical Lilies Will Thrive in It

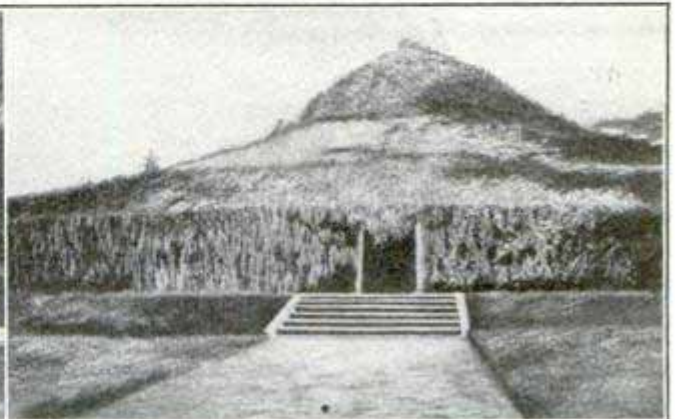

Cold-House of Calcutta Botanical Gardens for Plants Unused to the Heat of India

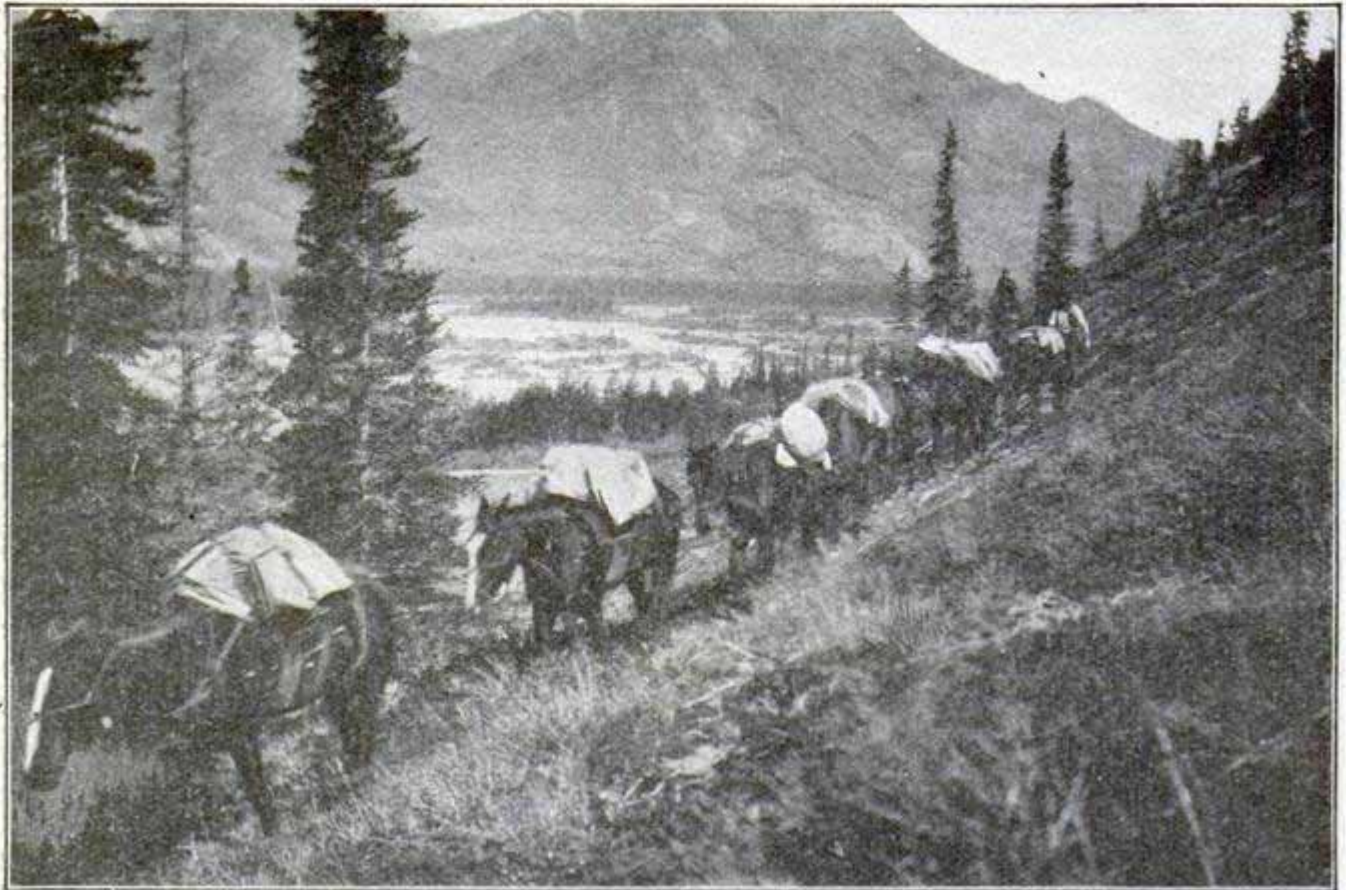

The Gap in the Backbone of the American Continent, Showing Discoverers' Pack Train

## THROUGH THE ROCKIES ON A PRAIRIE GRADE

Construction crews this spring reached Tête Jaune Pass, the one gap through the continental fence of the Rockies through which a railroad can build on a prairie grade. The Grand Trunk Pacific had reconnoitering parties in the field for three years before the pass was found, for such a gap in the great mountain barriers has been the prize sought by high-priced engineers for years, from Mexico north. Through this hole, which the giants of the mountains failed to stuff up, this third Canadian transcontinental line will reach the Pacific on a grade no greater than that of nearly all western roads over which hogs are hauled to the Chicago market across the prairie states.

The highest mountain summit is 3,712 ft., so that the heaviest grade against trains west-bound will be 26 ft. to the mile. The grade against east-bound trains will be only 21 ft. to the mile. It was considered a great achievement when the Canadian Pa-

cific blasted, dug and tore its way through the Rockies with an extreme elevation of 5,299 ft. at one point and 4,308 at another, which made a grade of 237 ft. to the mile against east-bound traffic.

In the United States, the Santa Fe rails go over the Rockies at an elevation of 7,000 ft., one summit being 6,987 and another 7,132 ft. The Western Pacific negotiated the mountain barriers at 5,712 ft., and the Union Pacific crosses five summits, one of which is 8,247 ft., and another is 7,107.

The task of groping through the wilderness, winter and summer, in the search for this pass, was accomplished without the loss of a man, notwithstanding that all the provisions had to be packed in from the Pacific on one side and from Edmonton on the other, a distance of more than 1,000 miles, on the backs of horses and mules. The commissary department, during this reconnoitering feat, was quite as important as the engineering of it, for

without the assurance of abundant "grub" in the "caches" in the mountains and forests, the achievement never would have been accomplished.

### THE FIRST AERIAL POSTAL SERVICE

The first aerial post established under government postoffice regulations and having its own distinctive postmark was inaugurated at the Exposition of the United Provinces of Allahabad, India. Captain Wyndham, one of the well known English airmen, obtained permission from the British government to establish the postal substation at the exposition grounds, from which he carried letters to the central postoffice at Allahabad, which lies across the Jumna River.



Letters Stamped with the First Aerial Postmark and Carried by First Aerial Post Under Government Regulations

The aeroplane mail service was besieged with "His Majesty's Mails," as many as 6,000 letters being carried on one trip. The postmark with which the letters were stamped consisted of an aeroplane and the inscription "First Aerial Post. Exposition of the United Provinces of Allahabad, 1911."

### TRUCK TO TOW AEROPLANES

As a means of rapid transportation over roads and through the city, the Wright brothers have developed a very interesting truck fitted with pneumatic tires, placed underneath

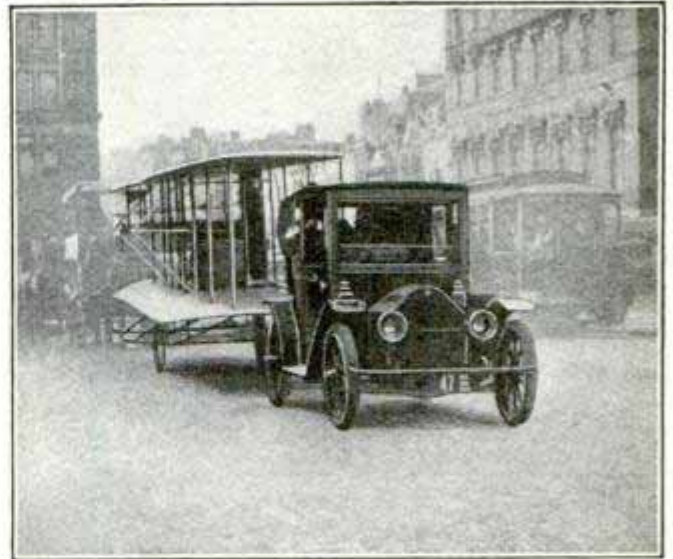

Aeroplane Truck Being Towed through City Streets by Auto

the aeroplane so that one end of the plane can be attached to an automobile and in this way be towed with ease.

To make the plane ready for transportation, it is only necessary to remove the tail and fold the front skids up against the machine, in which way the plane has no greater breadth than that of the ordinary automobile, and can be towed up any street through which an automobile can pass.

### MILK BOTTLE OPENER AND STOPPER

The problem of keeping milk free from dust after the cardboard cap has been removed from the bottle is solved by the use of a unique stopper now being distributed by a Waltham, Mass., firm. In the bottom of the stopper is a hook by means of which the ordinary



Used as an Opener and Stopper

cardboard cap may be removed from the bottle without danger of spilling or squirting the milk or cream in every direction.

## DIGGING IN RIVER BED TO DISPROVE SHAKESPEARE

Dr. Orville Owen, a physician of Detroit, Mich., and one of the best known Baconians in this country, is

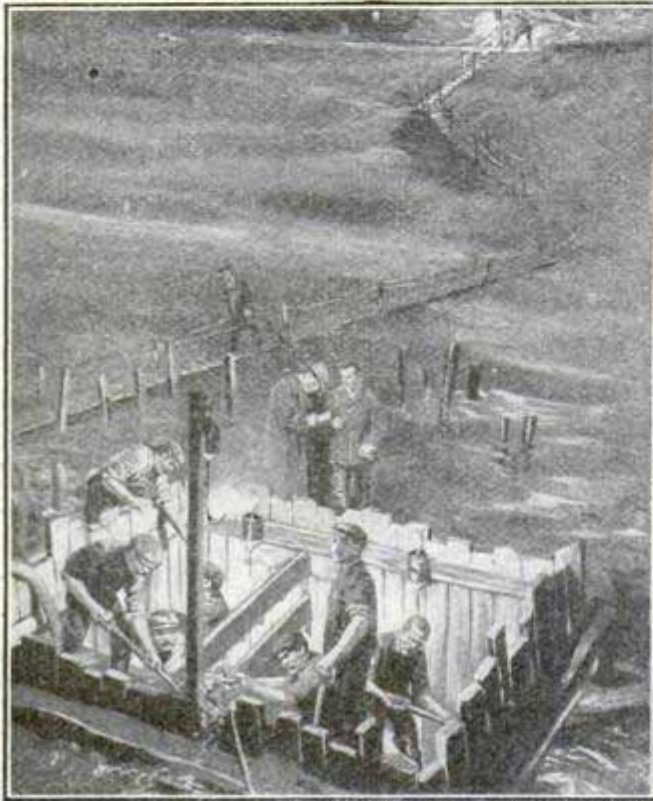

Courtesy Illustrated London News

Digging in the River Wye, England, for Proofs That Bacon Wrote Shakespeare

holding public attention by his mining operations in the River Wye, England, through which he hopes to conclusively prove that Francis Bacon wrote not only the works of Shakespeare but also the works of Greene, Marlowe, Spencer, Peele, and Sir Philip Sidney, and was the son of Queen Elizabeth. Proofs of these statements were hidden in the River Wye at Chepstow by Bacon himself, according to Dr. Owen, who believes these proofs will be found to include the original manuscripts of the plays in question.

Dr. Owen bases his beliefs on a cipher which he is said to have discovered in an edition of Sir Philip Sidney's "Arcadia." The cipher is said to contain such sentences as ". . . boxes like eels in the mud, boxes swathed in camlet and covered with tar"; "make a triangle of 123 feet due

north and thirty-three paces;" "I filled up the shallow water with mud and beams;" "I cut down all the trees and turned the course of the river."

## POTATOES RAISE BROOD IN DARK CELLAR

A unique potato development or cultivation, possible in a dark cellar, at any season of the year, has resulted from an accidental discovery by an English farmer, and the experiments he subsequently undertook to satisfy his curiosity. He had left a quantity of potatoes in a dark cellar and forgotten them. Upon remembering the fact some time later, he expected to find them decayed, but instead discovered that each potato was surrounded by perfectly white and sound little potatoes. He took the best of these, had them cooked, and found the flavor fully as good, if not better, than "new" potatoes. They were also much firmer, and the skin so soft and thin that scraping or peeling was unnecessary.

After several experiments he found that large, perfectly sound potatoes, preferably of the last season's crop, made the best brood potatoes. In the cultivation, it is first necessary to prune off the roots, which are likely to sprout. The pruning should be done under feeble artificial light, and care should

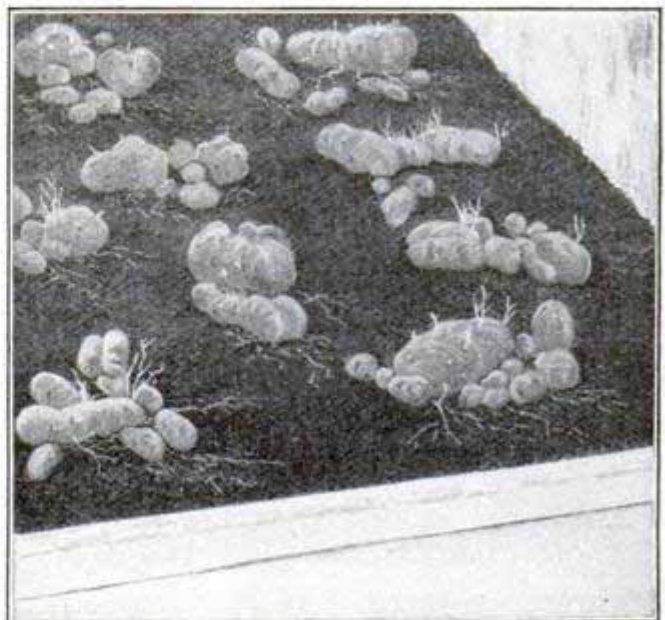

The Old Potatoes and the Broods that Result from Unique Method of Cultivation in a Dark Cellar



be taken to remove any possibly decaying matter from the potato. Then the potatoes are spaced about 4 in. apart on a layer of dry and finely sifted loam, spread to a depth of an inch or two over boards. In a short time they become covered with what might be called "potato buds," and within two or three weeks these develop into edible potatoes. After a similar period, a second crop will be developed, and

even a third, until nothing remains of the old brood potatoes but the skins. It is an interesting fact that the combined weight of the crops from each brood potato will be greater than its own original weight.

The originator of this potato culture says that if the potatoes are put in cold water, boiled for 10 minutes, then fried in butter, the resultant dish is very delicious.



Equipped with a Revolving Light on a Hollow Mast Containing a Ladder, This is the Most Up-to-Date Light Ship in the Country

## A LIGHTHOUSE ON A LIGHT SHIP

The first of its type built in America, this light ship is just as safe in a storm as in a calm, so long as the vessel keeps afloat, inasmuch as the light is set on top of a hollow spar, 75 ft. high, constituting in effect a lighthouse on a light ship. There is a ladder within this spar, so that the crew may climb up to the revolving light without being exposed to the stress of weather.

The vessel, which is 135 ft. long, 29 ft. beam and 12 ft. 6 in. draft, is sta-

tioned on Frying Pan Shoal, on the coast of North Carolina. Her steaming equipment includes two Scotch marine boilers and a fore-and-aft compound engine, and in addition there is a steam-operated fog signal giving an automatic whistle blast of three seconds' duration twice a minute. There is a wireless station in the after deck house, and the vessel is built so that she may be equipped with auxiliary sails, in case of expediency. Altogether, she is the most up-to-date light ship in the country, and is the prototype of others that are being built on similar lines.

## ELECTRIC COMPRESSOR FOR SAWDUST BRIQUETTES

An invention which the makers believe will eliminate the waste in planing mills, sawmills and other plants

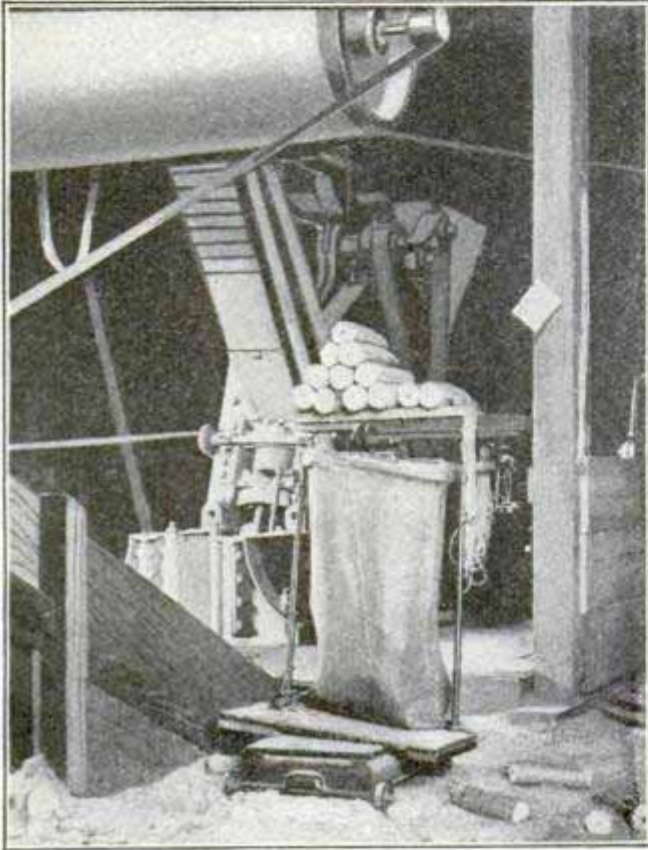

Electrically Driven Machine that Compresses Five Tons of Sawdust Briquettes per Day

that produce sawdust and shavings has been devised by a Los Angeles inventor, and the product of the machine is now on the market in the shape of cylinders of pressed sawdust about the size and shape of stove wood. No sticky substance is required to hold the particles together, as the material is compressed with a pressure of 30 tons. The mass of waste matter is said to come out as a clean, dry and convenient fuel, which burns with no soot and very little smoke.

The machine is driven by electric power, and the sawdust, shavings, etc., are automatically fed into steel dies, through which they are forced by the enormous pressure of a pair of plungers. In order to keep the briquettes or cylinders from flaking, a rough hemp cord is fed through the dies along with the sawdust, and forms a core which might be com-

pared to the wick of a candle. As the sawdust cylinder emerges from the machine, it is cut into the desired lengths by a knife operating with a trigger.

The machine shown in the illustrations has a capacity of five tons per day.

## THE COMPASS NEEDLE AS HEAT INDICATOR

In order to determine the most favorable degree of heat for hardening steel tools, an ordinary compass can be used, according to the French magazine "Cosmos."

As steel is heated, it gradually loses its magnetic properties and in different proportions for different qualities of steel, so that this phenomenon might easily be utilized to measure the temperature. It has been found that the degree of heat at which all magnetic reaction disappears, coincides exactly with the temperature most suitable for hardening of drills, chisels, planer-irons, etc. The tool is heated in the forge and held at a certain distance from a compass. If the needle deviates, it is again heated until no deviation is observed, when it is immersed in the bath as usual.

## APPARATUS FOR TESTING RAILROAD LAMPS

In order to devise a tungsten lamp that will be rugged enough to withstand the jolting and jarring of a railroad train, a French inventor has made a testing machine to imitate the rough usage of actual railroad travel so that he may readily ascertain in his laboratory the shock-resisting properties of the various improvements he tries out from time to time. The holder in which the test lamp is placed is automatically given a continuous succession of shocks which are registered by a counter. The breaking of a lamp filament causes the electric current which drives the "shocking" device to be cut off automatically, so that no further attendance is required until the test is completed.

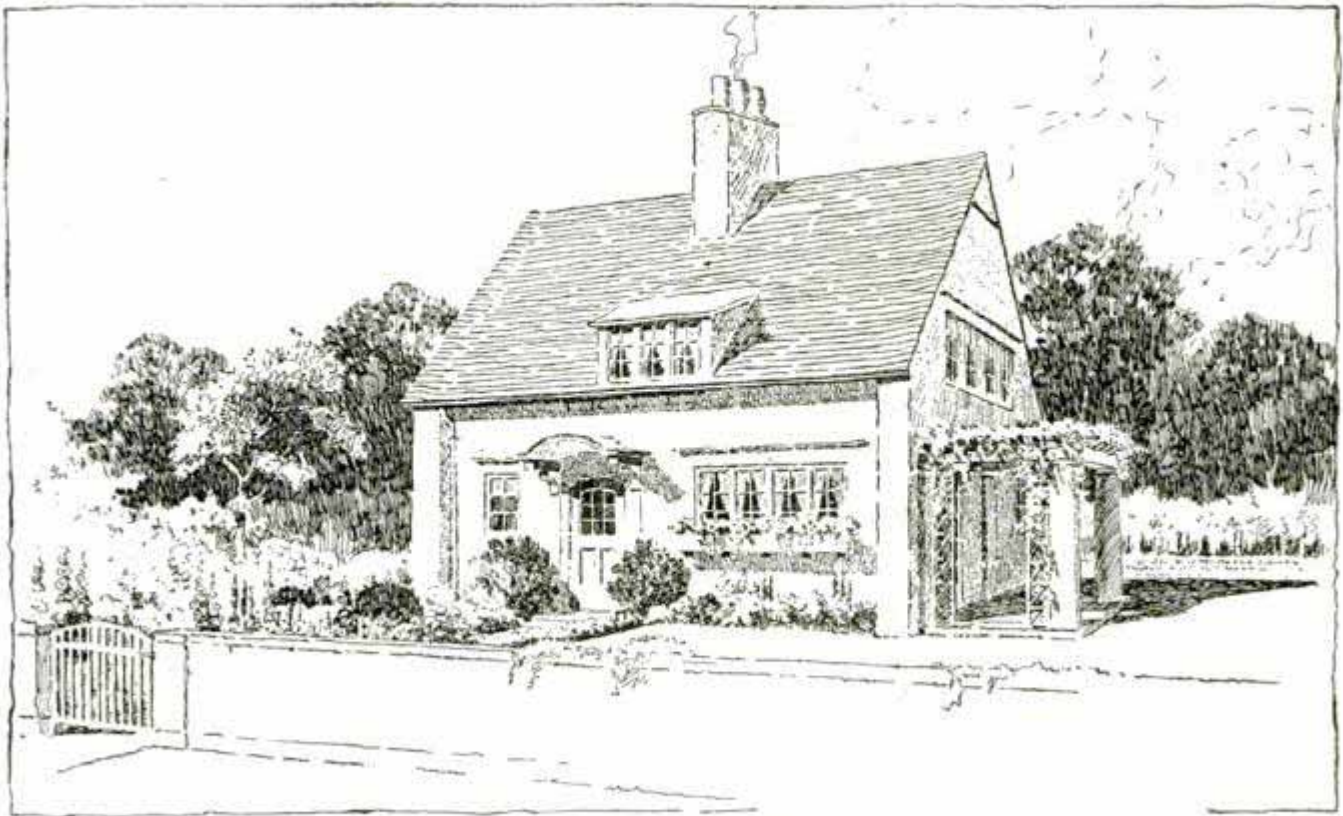

Front Elevation, Showing Side Porch or Loggia

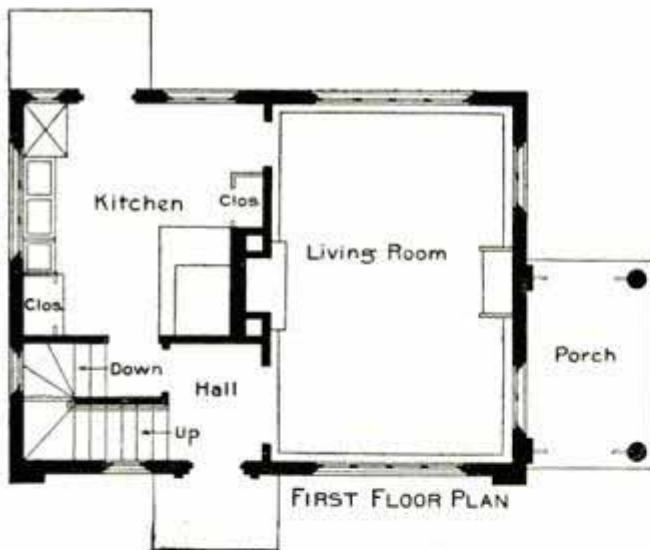

FIRST FLOOR PLAN



SECOND FLOOR PLAN

Designed by Mink &amp; Carson, Architects

## SMALL HOUSE WITH TWO ALCOVE BEDROOMS

A large living room and dining room, combined, and two bedrooms with alcoves are the distinctive features of this \$2,500 small house plan, which won one of the New York Building Trades Employers' Association prizes. Alcove bedrooms are not common in houses of such a character and the architects in this instance have provided a most attractive plan.

The house is to be constructed of concrete and the specifications provide

for mill work of moderate price. A side porch or loggia with pergola-like extensions over either side and the end, add to the outward beauty of the design, while the canopy over the entrance softens the severe straight lines of the front. Four rooms and bath are provided for in the plans, which also make ample provision for closet space. A big fireplace is designed for the living room which is allotted a space 13 ft. by 19 ft. 9 in.

## GIRL BLOWN INTO THE AIR BY WIND AND KILLED

The illustration shows the scene of one of the most curious fatal accidents occurring in England in recent years.



Courtesy Illustrated London News

How a Girl Was Blown into the Air by the Wind and Killed by the Fall

A 16-year-old girl, while in the yard of a school at Bradford, was lifted into the air by a gale of wind, and, after rising to a height estimated as 30 ft., fell to the ground and was killed. Witnesses stated that the girl was carried into the air because her skirt was blown out like a balloon.

## FARMER'S MOTOR WAS TOO ISOLATED

That something more than the money for first cost and the will to experiment is needed before electric power can be installed on the farm was learned by a Kansas farmer recently. Attracted by an advertisement that painted the ease of farming with the

aid of electrically driven machinery, the Kansan ordered a complete outfit from a big manufacturing concern. The order was promptly filled and instructions sent as to the wiring and setting up of the machinery. The manufacturer was much surprised to receive a letter from his customer about two weeks later complaining that the motor would not "run" despite the fact that the directions accompanying it had been faithfully complied with. A "trouble" man was hastened to the spot and found that every detail of the setting up and wiring had been properly attended to and there was nothing wrong with the outfit with the single exception that the nearest electric current was some 20 miles away. That was all.

## COUNTING THREE HUNDRED MILLION PEOPLE

The fourth general census of India, taken on March 10, a date specially selected as being an unauspicious one for marriages, festivals, fairs, and other events likely to take people from their homes, was the largest aggregate and uniform enumeration in the world. It covered more than 1,750,000 square miles, or more than the whole of Europe excluding Russia, and took stock of nearly one-fifth the total estimated population of the whole world.

The taking of a census in India is extremely difficult owing to the great diversification of physical features and climate, from malarial swamps and arid deserts to lonely mountain tracts, and from the jungle homes of wild nomadic tribes to the crowded towns. Little more than five per cent of the population, which it is believed will slightly exceed 300,000,000, can read and write. The caste system differentiates the people into 2,000 species of mankind, which are said by one writer to have as little in common in the physical relations of life as the inmates of a zoological garden. The services of over 1,250,000 persons were required for the taking of the census.

# THE MAKING OF ARTS-CRAFTS LAMPS

By JOHN D. ADAMS

## PART XI—ONE-LIGHT BRACKET

WHILE the method of constructing this bracket lamp is along the same lines as those previously described, its successful completion will largely depend on the care and accuracy with which the various pieces are laid out. There are quite a number of small pieces to be fitted and some rather sharp angles, all of which necessitate considerable care. When completed, the lamp is very attractive and will well repay the labor expended. Aside from the electric light and socket, the cost is practically nothing.

The first thing to do is to cut out the pattern for the lower portion of the shade on a piece of heavy paper, which should then be marked off four times on a large piece of cardboard so as to obtain the four sides complete in one piece. In the pattern drawings the dot-

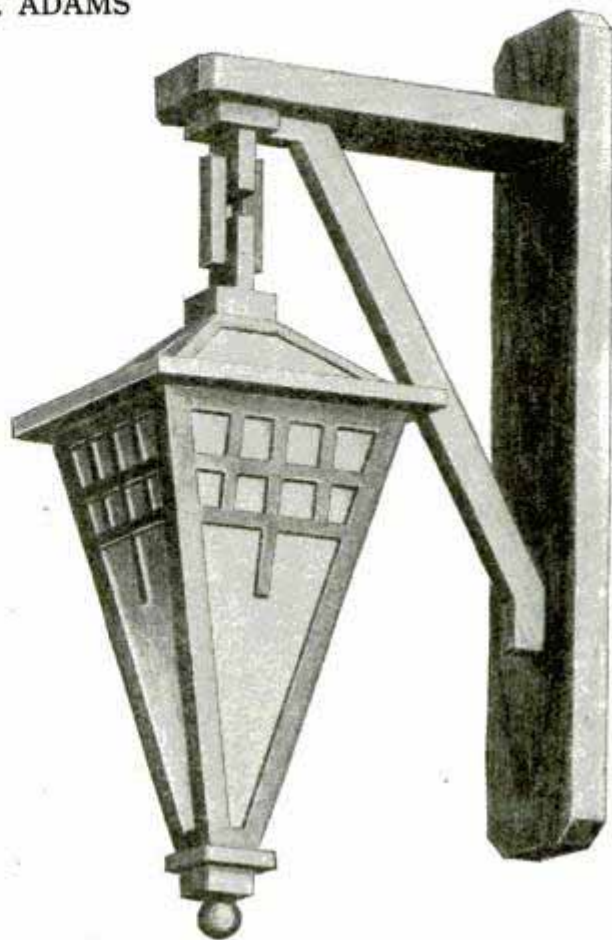

An Artistic, Easily Made, Bracket Lamp

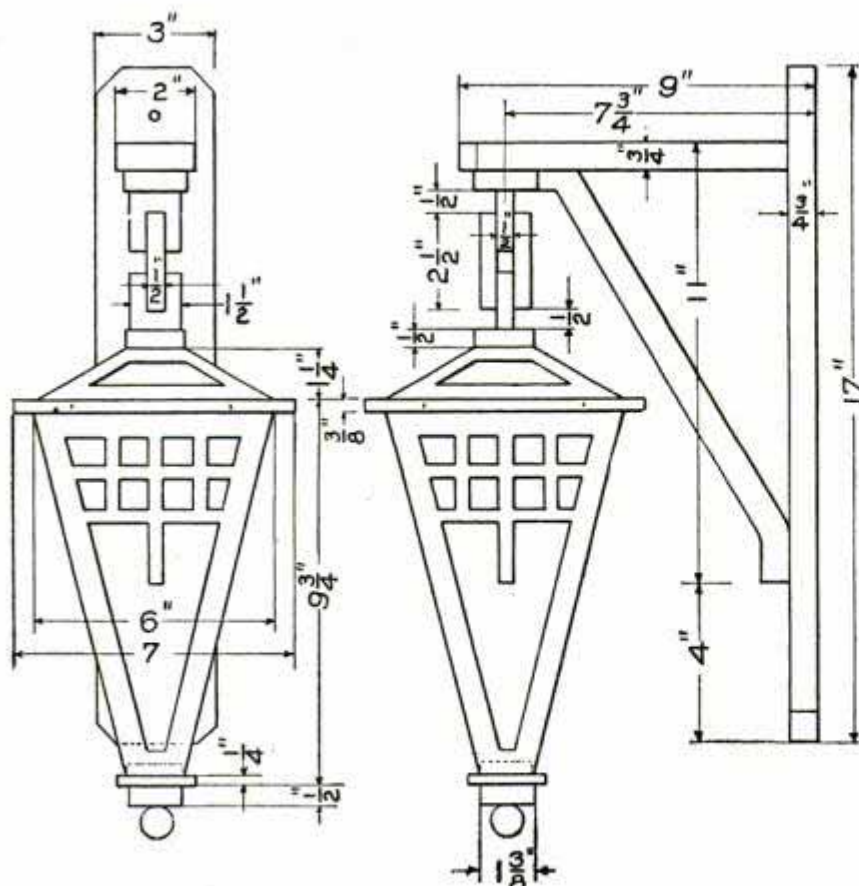

General Dimensions of Bracket Lamp

ted lines indicate those that are to be merely scored with the knife for bending, and the full lines those that are to be cut clear through. After all the cutting has been done, paste on the colored paper, which, if desired, may be of one color for the eight small openings and another for the lower triangular portion. The cardboard should now be bent into shape and the first and last sections connected by means of the extra strip provided for that purpose. The bending can be best done over the sharp edge of a table or board by holding the cardboard down tightly with a straightedge while the projecting portion is gradually bent along the

entire length. Passe-partout tape should be applied to the connecting edge and also to the three remaining edges.

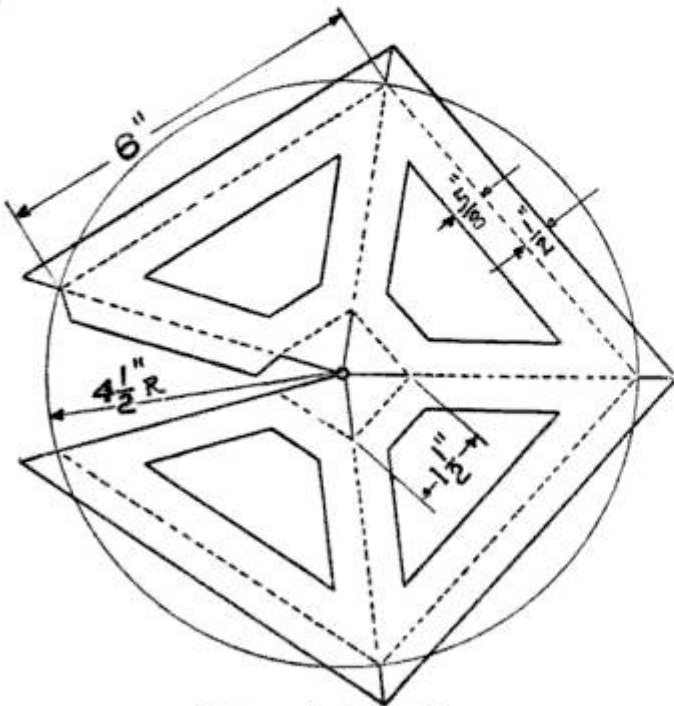

Pattern for Lamp Top

Procure a piece of light board, 7 in. square, and cut a 4-in. square hole in the center. Now bend the extra strips at the top inward and glue them to the under side of the board. To hold this connection firmly while the glue is

setting, push in a few thumb tacks from the inside through the cardboard into the wood. The lower end is closed with a couple of little blocks and ornamented with a wooden ball such as children play with on the end of a rubber band. This completes the lower portion of the shade, which should now be painted a dull black and set aside. In laying out the pattern for the upper portion of the shade, draw a circle of  $4\frac{1}{2}$ -in. radius, and then space off four 6-in. chords, after which the remaining lines can be drawn in in a few minutes. Bend this into shape and bind the four corner edges with passe-partout tape. Bend the points at the top inward and fasten them to the under side of the small block. The extra strips along the lower edges should now be bent outward, so that they will lie flat on the upper side of the 7-in. board, to which they are to be later attached with thumb tacks. The wooden bracket and the small connecting blocks (supposed to represent a link of a wooden chain) are all so clearly shown in the drawings that the reader will have no difficulty in working them out. After the bracket is complete with the upper portion of the

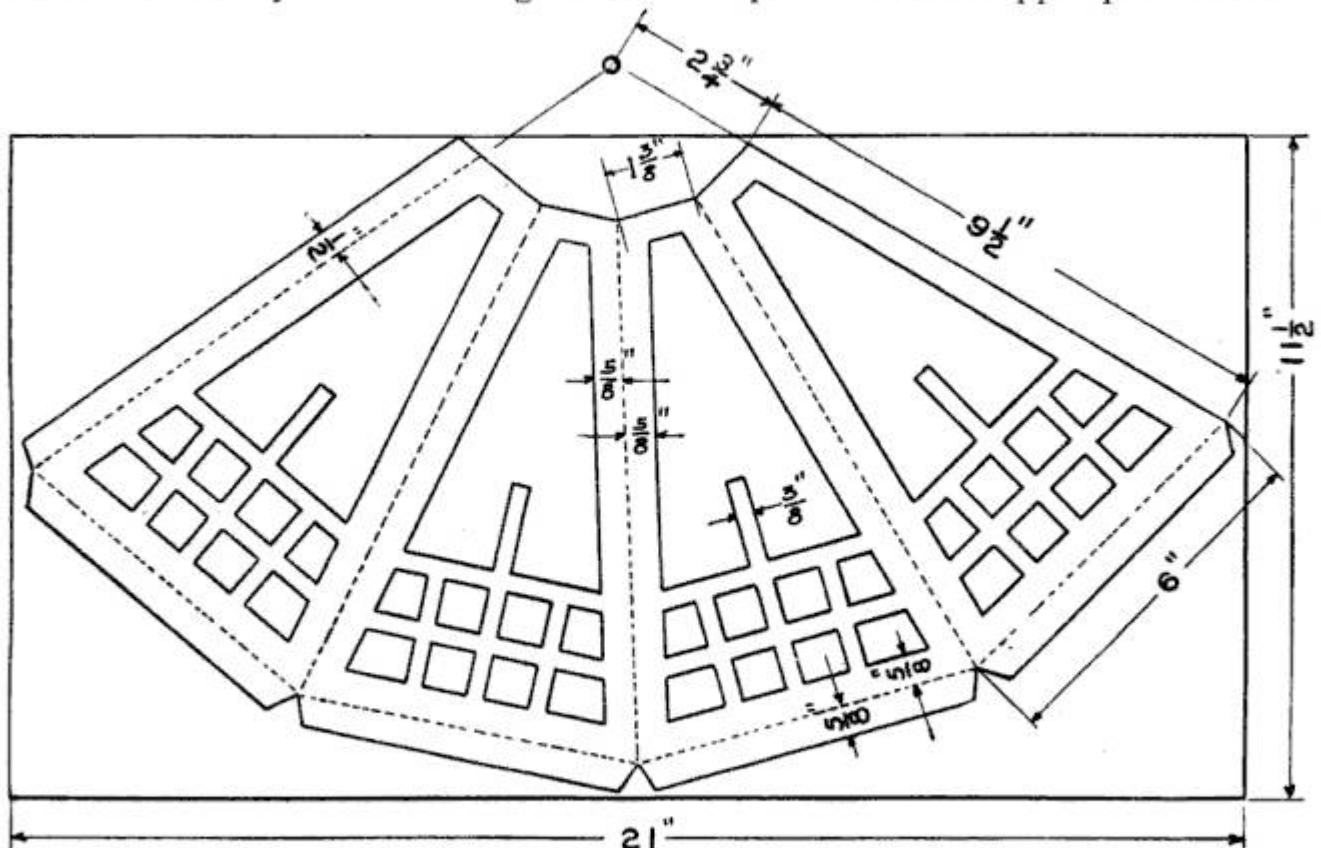

Pattern for the Shade of Bracket Lamp

shade fastened in place, the cord should be run up through the center and along the top of the bracket arm. Screw the globe into the socket and adjust the lower portion of the shade, and our lamp is complete.

are now being made as to how to obtain the best results. Silhouette moving pictures may in time come to bear the same relation to the regular films as the pantomime does to legitimate drama.

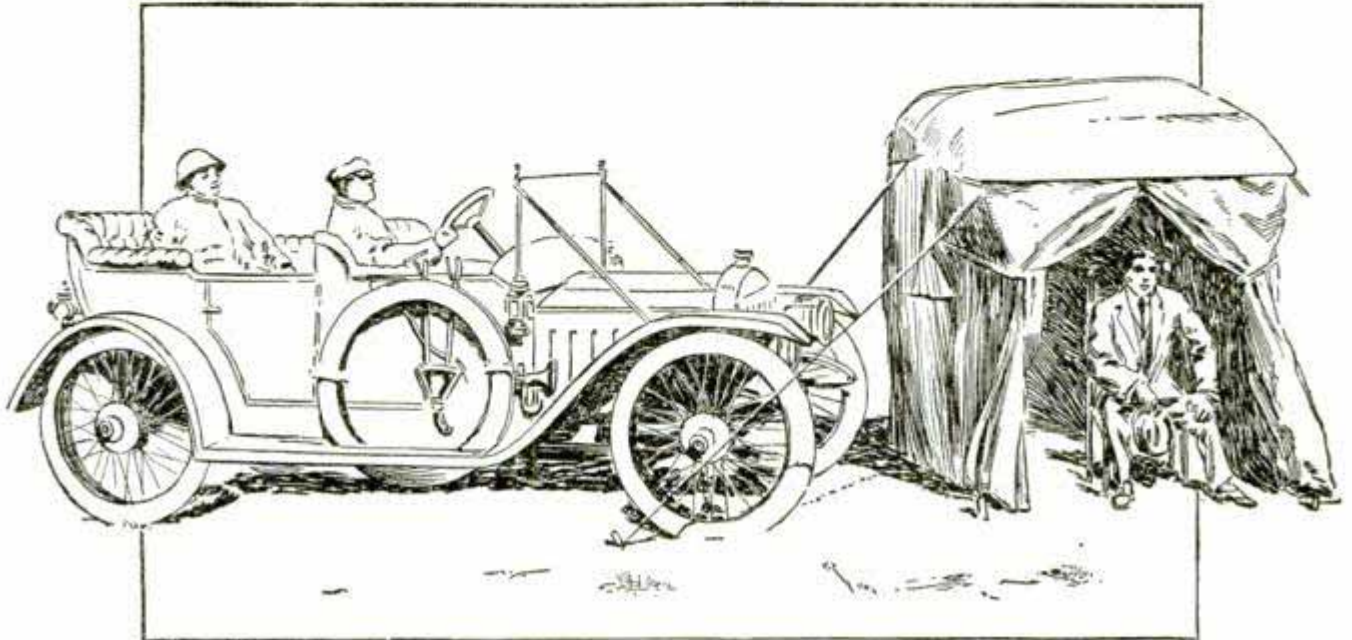

Automobile Hood Set Up as a Tent

### AUTOMOBILE HOOD AND TENT

An automobile hood which can be used as a protection for motorists when disembarked for the night, as well as when riding in the car, was especially constructed for C. J. Peerbhoy, of Bombay, India. When used on the car, it has the appearance of an ordinary hood, but its special features make possible a quick conversion into a portable tent.

### SILHOUETTES THE NEWEST MOVING-PICTURE FAD

Silhouetted moving pictures are the newest things in the film world and the men who are interested in such things commercially are watching closely the results obtained from the first films, on which depends their future attitude toward this peculiar form of picture. The many figures that appear in the pictures are simply shadows with sharp outlines. The manner of making is simple and experiments

### COMBINED BATH AND WASH BASIN

Restricted bathroom space is responsible for this type of combined bathtub and wash basin. It was de-

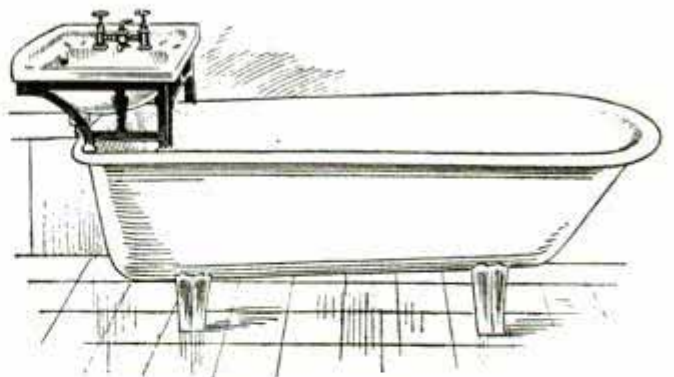

Lavatory Mounted on End of Bathtub

signed for small cottages, especially those built before the bathroom idea spread to England.

CA telephone equipment and a collapsible pole for tapping the wires, will be furnished shortly to trains running between Toronto and London, Ont., on the Canadian Pacific Railway.

## LOCOMOTIVE TRANSPORTED OVERSEA INTACT

For the first time in maritime history a railroad locomotive has been picked up by a loading crane, lowered intact to

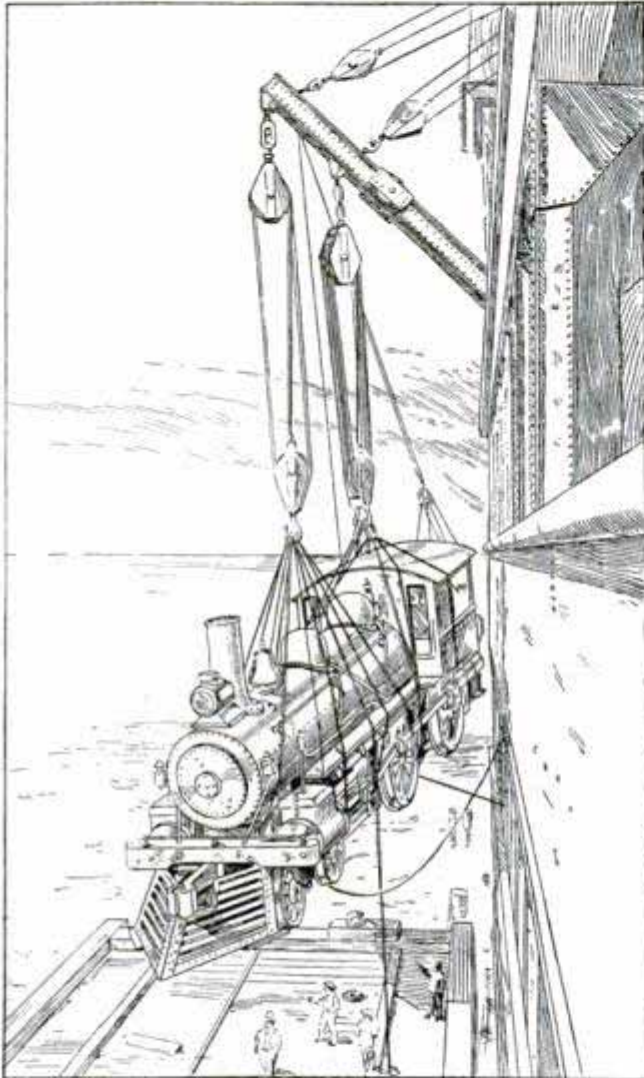

Hoisting the 65-Ton Locomotive Aboard Ship

the hold of the steamer and transported several thousand miles, where it was unloaded in the same manner and run ashore from a railroad barge under its own steam. The feat was accomplished on the Pacific and the locomotive was a 65-ton giant that had been purchased for use on a railroad at Hilo in the Hawaiian Islands. The engine was run to the side of the steamer "Wilhelmina" under its own steam and the fires were drawn. With heavy slings the big piece of machinery and its tender were hoisted on board the steamer and stowed away. On arriving at Hilo, despite the heavy swell running at the time, the locomotive was swung over

the ship's side and placed squarely on the rails of a waiting railroad barge. The barge was run to its slip ashore, the engine driver and his fireman getting up steam on the way. By the time the barge was securely moored, steam was up and the engine was run off to the shore tracks. While locomotives have been transported to all parts of the world, disassembled, and with the separate parts securely packed, this is the first time one of them was ever transported intact.

## WORLD'S GOLD PRODUCTION IN 10 YEARS

The world's production of gold in 1910 is estimated to have been \$455,832,000, or sufficient to cover an area of about 8.1 acres, if made into a single coin the thickness of a \$5 gold piece. The total gold produced in the last ten years is nearly eight times this amount, and would cover an area of 64.4 acres, if made into a single coin of the thickness of the American eagle. All of this gold, however, if beaten out into gold leaf, would gild a globe only 22 miles in diameter, although such a sphere would tower nearly five times as high as the Himalayas, the greatest mountains in the world.

Incidentally, it would require about 1,548,000,000,000 lb. of gold to gild the entire surface of the earth with the thinnest of gold leaf, although this leaf is so thin that it would take 360,000 leaves of gold laid flat on each other to make a thickness of one inch. This amount of gold would cost more than \$450,000,000,000,000. That is to say, it would take about a million years, at the rate at which gold was produced in 1910, to obtain enough of the precious metal to gild the earth.

Two Chinese airmen, Li Pao-Chun and Lim Tso-Chen, have erected a temporary building on one of the parade grounds in Peking for the purpose of conducting experiments in aviation.



## MACHINE MAKES SQUARE DEAL CERTAIN

There is no chance for a misdeal if card players use the machine exhibited at the recent Paris automobile show, designed to give every person in a card game a square deal. The machine consists of a heavy base which supports on its center a toothed disk and a pivot around which the remainder of the apparatus may be turned. The dealing part of the device consists of a rectangular frame in front of which is a small platform on which the cards

are placed. The cards are brought in firm contact with a rubber cylinder. The rubber cylinder will grip and carry off one card from the package and will deposit it in front of the first player to be dealt a hand, when a button is pressed. Releasing the button, the cylinder picks up another card and swings to the second player and so on throughout the deal, depositing a card at a time in front of each person to be dealt a hand with mathematical precision and accuracy. The machine is so adjusted that only one card can be dealt at a time.

## ELECTRICAL APPARATUS FOR PHOTOGRAPHY

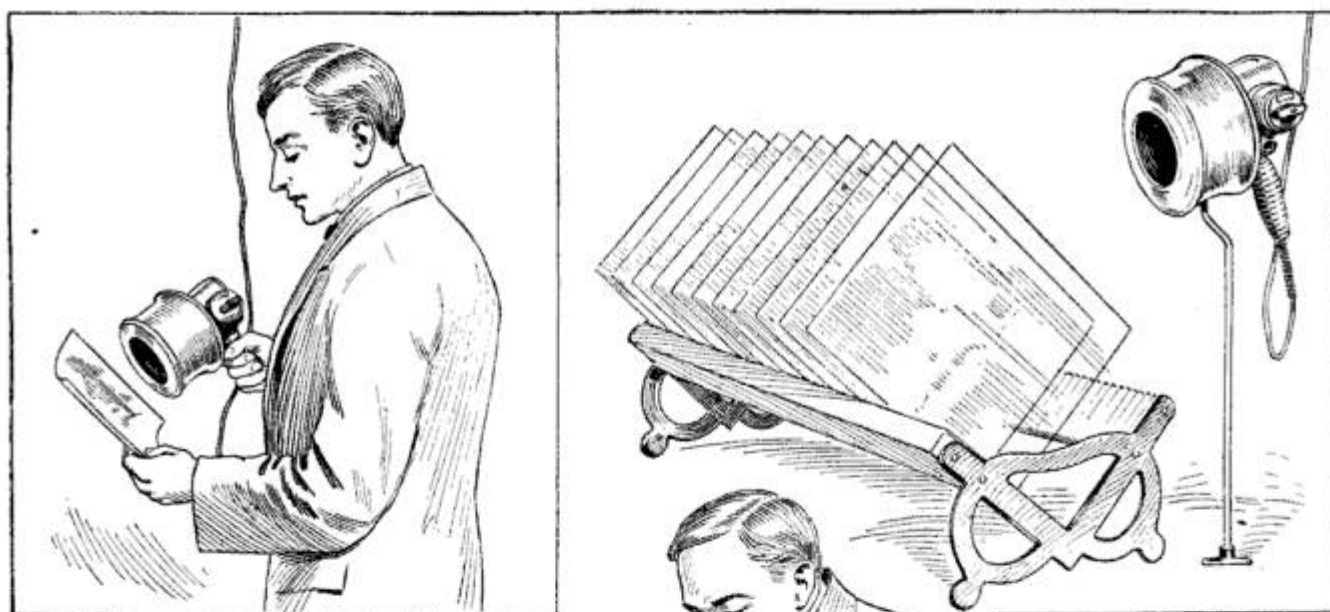

Using an Electric Hair-Dryer to Dry Prints

Many electrical devices, designed for altogether different purposes, are finding a field of usefulness in the developing branch of photography. An electric hair-dryer and flatiron are shown as examples. The former, which is one of the many electrical devices of hair-dressing parlors, can be used for drying both negatives and prints. The current of warm air

Drying Negatives with the Hair-Dryer

from the dryer can only be directed on one negative at a time, but the drying is accomplished in 15 min. When prints are being so dried,



Mounting Prints by the Aid of an Electric Flatiron

they should be fastened to a board to prevent curling. The electric flatiron is said to give excellent results in mounting prints. Gum tissue is placed between the print and the cardboard, and the electric iron is then applied.

### COMBINATION PNEUMATIC AND SOLID TIRE

This combination solid and pneumatic tire for a u t o m o b i l e s possesses several good features. The metal side rims, one of which is detachable, completely inclose the inner air tube and also that part of the

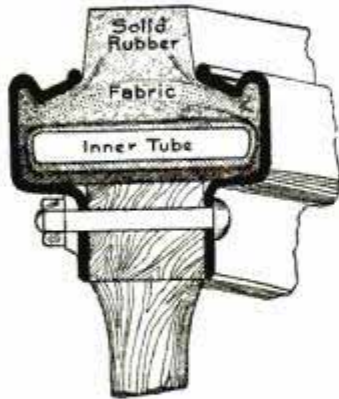

tire which has to withstand the pressure of the air in the tube. The outer tire of solid rubber is practically puncture-proof. The combination tire appears to be able to absorb most ordinary shocks, but does not seem to have the same easy-riding properties as the ordinary pneumatic when passing over small obstacles.

### A WIRELESS SYSTEM WITH NO SPARKS OR ARCS

By using a machine which generates an electric current that reverses in direction over 100,000 times a second, a German scientist has produced a system of wireless telegraphy that

needs no spark gaps, "singing" arcs, or such like devices to set up the etheric electric waves from the wire network or antenna (as it is called) of the transmitting station. It is claimed that the time of the day and the atmospheric conditions do not affect the working of the apparatus, which, if true, will prove a great advantage over other wireless systems. It is further said that there is no limit as to the distance over which messages may be sent, although it must be that the radius of the apparatus depends on its power. A machine that has been tested since April of last year gives an electrical output of 17 hp. at an efficiency of 80 per cent. The inventor claims that machines of 80 or 100 hp., or even more, may readily be constructed.

### HARDENED COPPER

Hardened "copper," which is really a hard bronze, is now being made on a commercial scale in this country. It is said to be capable of taking a keen edge, and is especially useful for making fish knives, as it is not affected by the action of sea water.

The tempering of copper is one of the so-called "lost arts" of the ancients. It would seem that this particular lost art has been re-discovered.

### TESTING ENGINES WITH A FAN DYNAMOMETER

A simple form of dynamometer designed by a New York inventor utilizes

the power of the engine under test. As this dynamometer operates best at a high speed, the engine is geared up by means of a belt and pulley so that the fan runs at a speed of several times that of the engine. A tachometer, or speed indicator, is connected to the dynamometer and the speed of the engine is obtained by dividing the reading on the dial by the number representing the ratio of the diameter of the engine fly-

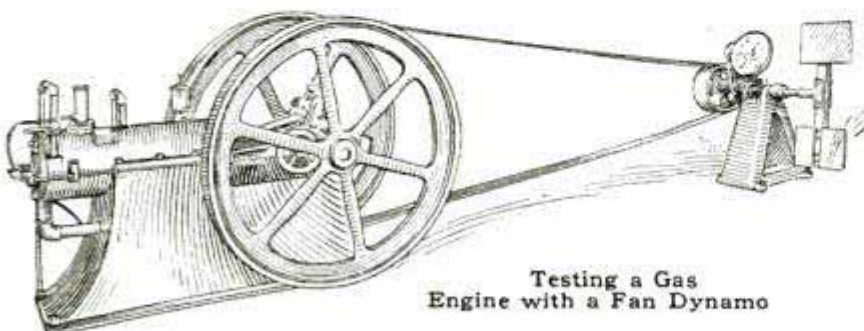

the resistance of the air against the paddles of a two-bladed fan to absorb

wheel (plus the thickness of the belt) to the diameter of the dynamometer pulley (also plus the belt thickness). The dynamometer is simpler than a hydraulic or electric brake and is useful for absorbing the power of the engine while testing for horsepower, for "running in" an engine, or for working down the piston rings, bearings, etc.

### AUTOMOBILE MAIL VAN ON INDIAN RAILWAY

A novel automobile mail van has been placed in service on the Kalka-Simla Railway in India. The car has a length of 14 ft. and a breadth of 5½ ft., the rear section of the body consisting of a receptacle for the mail bags. Mail may also be carried on the roof, which is railed. The car is driven by an engine of about 25 hp., and the speed gears

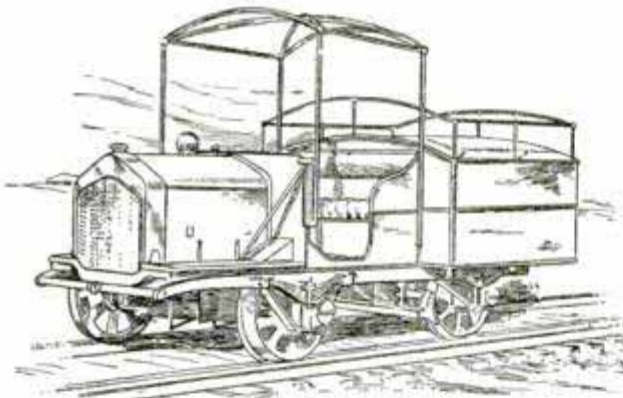

Rail Motor Van Which Carries Mail into Mountains of India

are especially heavy. Considerable power is required both in driving and control, as the car has to climb grades of 1 in 30 up to Simla, which is 7,000 ft. above sea level.

### ROTOPLANE AEROPLANE

Instead of the rigid main planes used on the standard types of monoplane and biplane, this curious aeroplane, the invention of two Australians, utilizes, as its main supporting surface, two circular planes designed to rotate in opposite directions, at a speed of about 300 revolutions per minute. The circular planes are built like bicycle wheels, and the inventors assume that the rotation in opposite

directions will have a sufficient gyroscopic effect to assure perfect equilib-

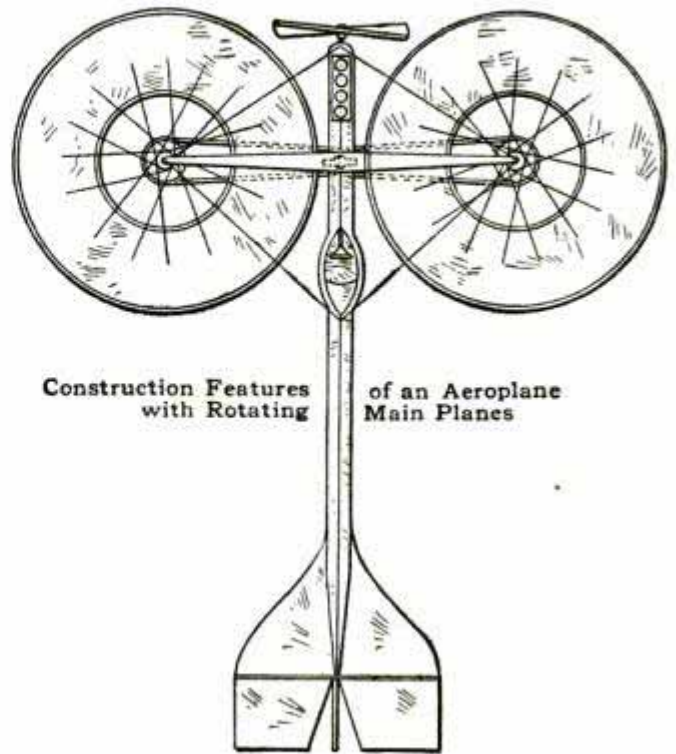

rium regardless of sudden squalls or strong adverse winds.

### ELASTIC SUSPENSION FOR TUNGSTEN LAMPS

The fact that the filaments of tungsten lamps are very brittle, and therefore liable to breakage from the slightest shock, has led a French concern to devise the shock-absorbing suspension shown in the accompanying illustration. Both vertical and lateral shocks are absorbed.

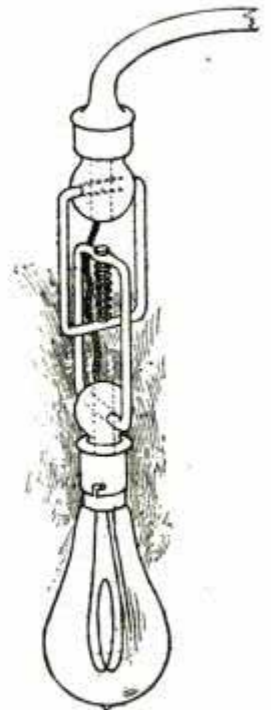

Quinine stands first on the list of drugs used in the tropics, with Epsom salts next and then comes calomel, castor oil, tincture of iron, opium and brandy. A large majority of the drugs used being those that have been known to the medical world for two generations or more.

## DE LUXE SLEEPING CARS FOR NEW YORK ROAD

The corridor compartment cars attached to the night expresses leaving

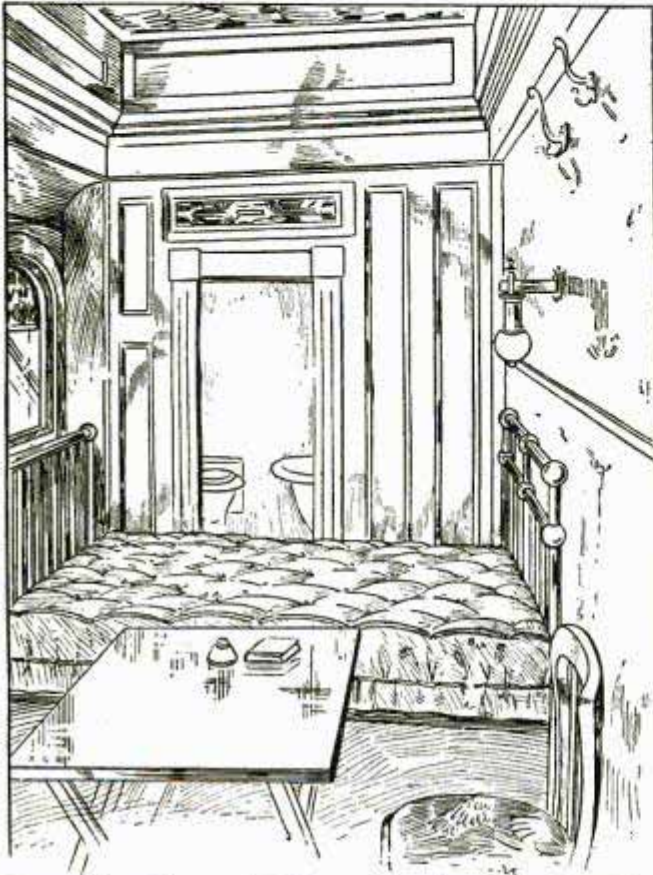

One of the Compartments on Sleeping Cars Running Between New York and Boston

New York for Boston, and Boston for New York simultaneously at 1 a.m. on the New York, New Haven & Hartford Railroad, are the most luxurious cars to be found on any road in this country, exclusive of private cars.

These cars contain seven compartments, each having an independent toilet and dressing room. In each compartment is a full-length brass bed, 4 ft. wide, two chairs, a folding table, and an electric fan. By means of a thermostatic control apparatus, each passenger is enabled to regulate the heat in his compartment in accordance with his own desires.

A plan to increase the egg-laying proclivities of his hens by the use of tungsten electric lamps in the hen house during the winter months, has been proved successful by an electrician of Battleford, Saskatchewan, Can.

## SILENCES THE EXHAUST OF MOTORBOATS

The campaign against noise in New York has resulted in the elimination of much of the whistling by boats in the North and East Rivers, and now there has been introduced a muffler for motorboats that does away with the noise of the exhaust almost entirely, without depriving the boat of power. The gases are led gradually with increasing expansion from the engine cylinders and are gradually relieved of their heat by an even admixture of cold water vapor until the gases are cooled and they are then exhausted through an opening in the boat's side above the water. The noise made cannot be heard a cable's length away.

## GASOLINE ENGINE WITH STATIONARY PISTONS

Completely reversing the general practice, the pistons of this curious French gasoline engine are firmly attached to the base and it is the cylinders that move up and down. The spark plugs are inserted in the tops of the cylinders. The pistons carry the valves, which are regulated by a cam shaft located underneath. As shown in the illustration, the outside cylinders are just completing the up-stroke and the inner cylinders are down.

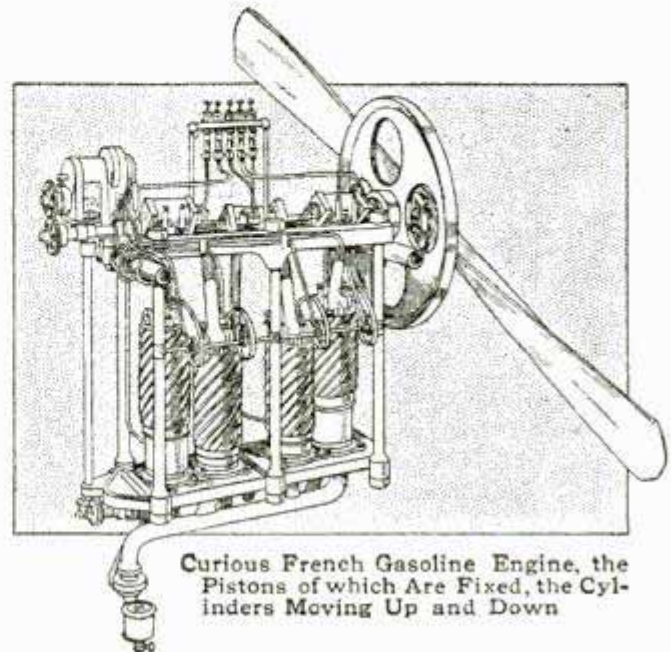

Curious French Gasoline Engine, the Pistons of which Are Fixed, the Cylinders Moving Up and Down

## UNIQUE TEST OF STEEL VEHICLE BODY

A carriage manufacturer who is now making buggy seats and bodies of pressed steel instead of wood, demon-

strates the strength of these bodies in the manner shown in the illustration. The body is supporting 10 men, the combined weight of whom is 2,067 lb. The whole weight is resting entirely on the seat risers instead of being distributed around over the whole body to minimize the strain.

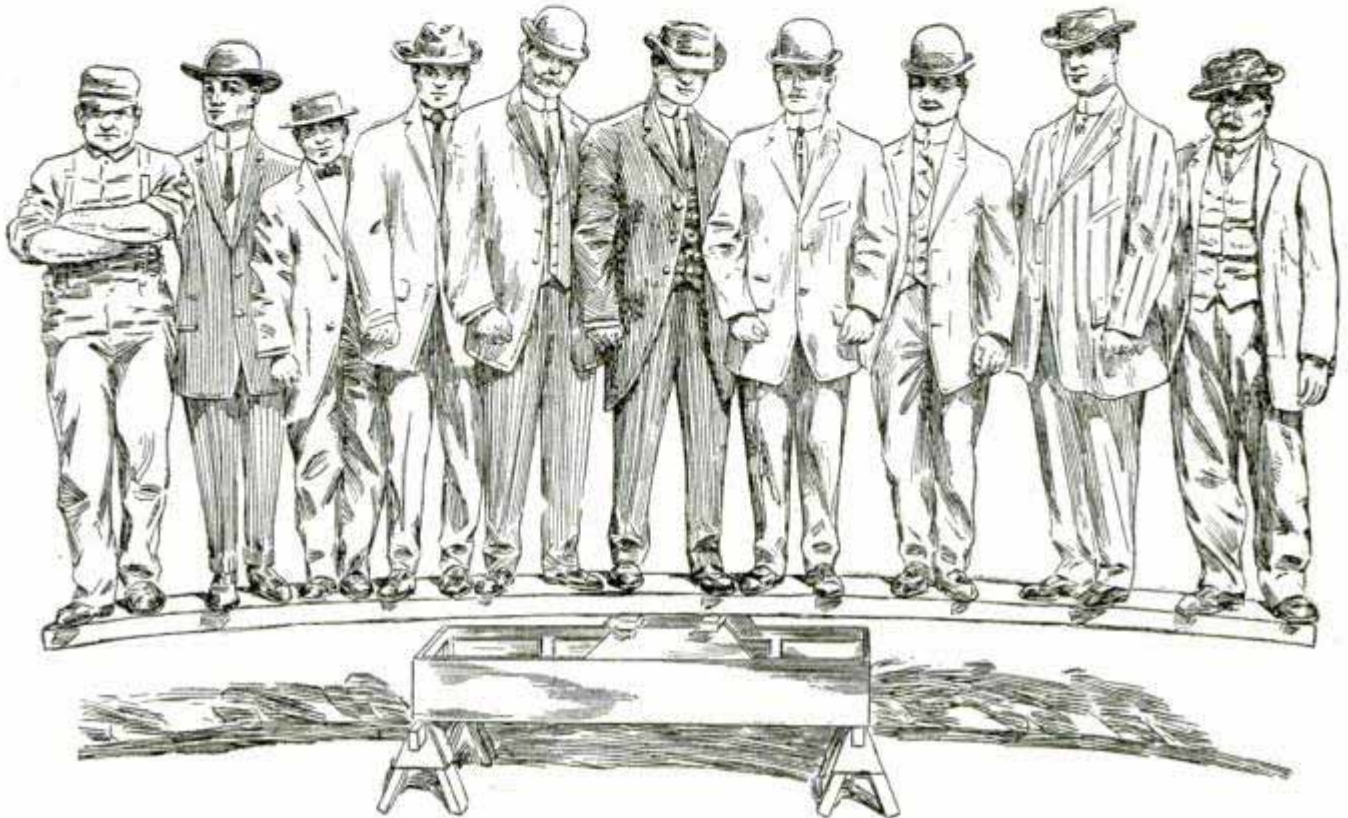

Steel Vehicle Body, Supporting Combined Weight of 10 Men

strates the strength of these bodies in the manner shown in the illustration. The body is supporting 10 men, the combined weight of whom is 2,067 lb. The whole weight is resting entirely on the seat risers instead of being distributed around over the whole body to minimize the strain.

## SUBTERRANEAN WIRELESS

An important aid to the safeguarding of lives and property in subterranean mines is the discovery of a successful system for wireless telegraphic communication under the earth. The experiments were made by two German scientists, Drs. Leimbach and Loewy, in the potash mines in the North Harz mountains in Germany. Wireless messages were very clearly received through a distance of nearly a mile and a half, at a depth below the surface of 1,600 ft.

## GERMAN MONOCAR

This new German monocar is a cross between a motorcycle and an automobile. The body is of the torpedo type with expanded scuttle dash. The seat is luxuriously upholstered, and the steering is by wheel. Double forks are utilized for the mounting of the front wheel.

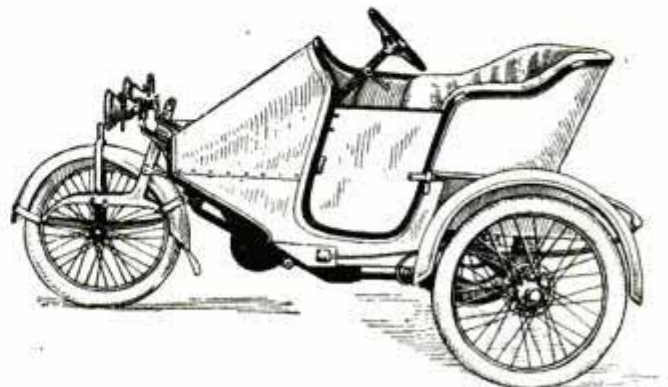

One of the Latest Productions of the German Motor Manufacturers

## STENCIL DECORATIONS FOR AWNINGS

There is a growing demand this year, especially for country and suburban homes, for awnings having an appliqué or stencil form of decoration,

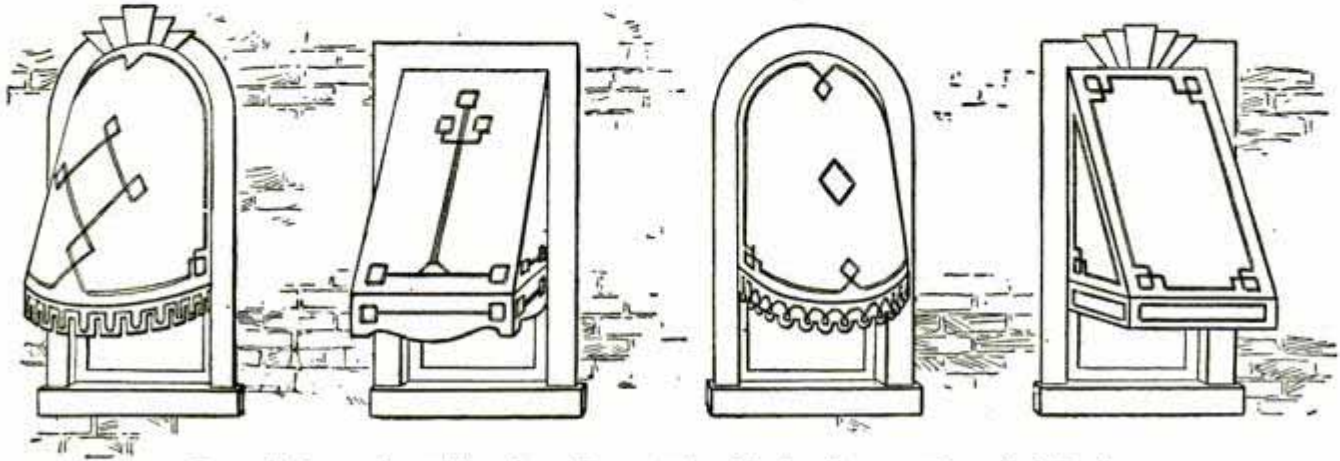

Several Examples of Awnings Decorated with Applique or Stenciled Designs

the colors most in demand for the design being green, blue, red, brown and maroon, on white. The under side of these awnings are being painted to render them opaque, but considerable difficulty is being encountered in coloring the under side with a fast color, and at the same time preserving the outside whiteness and the pliability of the duck.

## PORTABLE SWING-FRAME EMERY WHEEL

A remarkably effective mounting for awkward grinding work has been developed by a manufacturer of

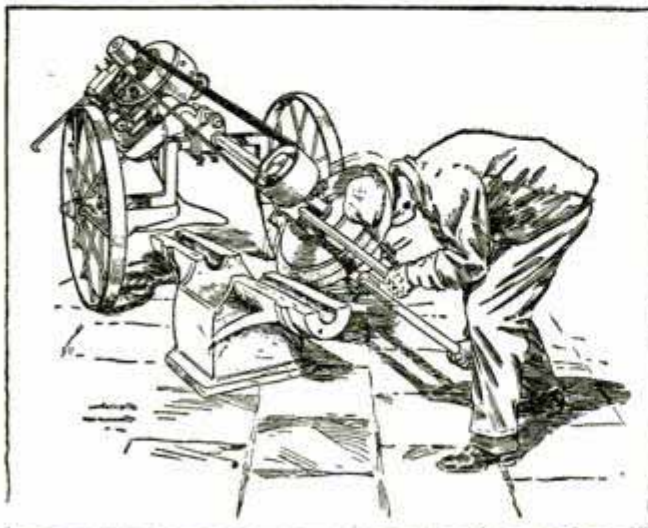

Electrically Driven Grinder Mounted on Portable Swing Frame. The Motor Develops 5 Hp.

emery wheels. The motor is supported on one end of the shaft and the wheel head on the other. The shaft is free to swing in the bearing on the axle, but is retained in balance by an adjusting screw which takes care of any variation in balance due to the

wearing of the wheel. The whole is mounted on a pair of 42-in. wheels.

## NEW INSTRUMENTS FOR THE PRACTICE OF MEDICINE

A German physician has devised a sprayer for iodine that permits the free use of this chemical in the dressing of wounds and eliminates all danger of discomfort and bad results through the violent caustic properties it possesses in its soluble form. Surgeons have been forced to use the utmost care with iodine in the past because the alcohol with which the solution is made tends to contract the tissues and the liquid sometimes decomposes, forming a caustic that is extremely painful. This is eliminated by applying the iodine in a gaseous form at a high temperature. Air is heated by being forced through a platinum coil heated with an electric current. Passing through the iodine container directly in front of the coil, the air evaporates the chemical and the whole is forced through a platinum screen and out the nozzle of the instrument in the form of a spray. The instrument is small and is easily handled.

Another new instrument for surgeons is an electric pharyngoscope

which consists of two tubes which can be rotated, one containing the optical arrangement and the other a small electric lamp. An indicator in the eyepiece end of the instrument gives the position of the prism so that the operator may know just which region of the throat he is viewing at all times.

### BRUSH CLEANS PATH OF THE AUTOMOBILE

The brush shown in the illustrations is one of a pair set before the front wheels of the automobile to clear from the path of the tires such articles as pieces of glass, nails, sharp stones, etc. The brushes are set to just clear the ground, so as to avoid continually

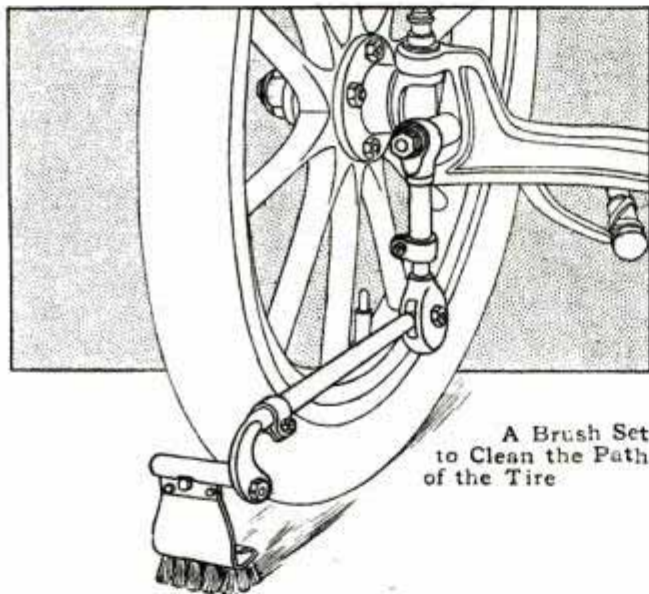

A Brush Set to Clean the Path of the Tire

brushing and the consequent raising of dust, but are sufficiently low to brush aside small objects lying on the road surface.

### THE METALLIC LUSTER OF INSECTS

The coppery luster of a certain beetle, explained Prof. A. A. Michelson, at a recent scientific meeting in Chicago, is produced by a thin surface film, the thickness of which he estimated as  $1/254,000$  in. One beetle sent to him for examination looked so much like a bit of brass that he thought, until he had made tests, that some one had had it electroplated by way of a joke.

### HOW TO MAKE AN UMBRELLA STAND

The umbrella stand shown in the accompanying illustration will be found quite appropriate for the hall or reception room that is furnished in mission style. It can be made of any of the furniture woods, but quarter-sawed oak gives the best results. The stock necessary to make this stand can be secured from the mill ready cut to length, squared and sanded, and is given in the following list:

- 4 posts,  $1\frac{1}{2}$  by  $1\frac{1}{2}$  by 28 in., S-4-S.
- 4 top rails,  $\frac{7}{8}$  by 2 by 10 in., S-2-S.
- 4 lower rails,  $\frac{7}{8}$  by 3 by 10 in., S-2-S.
- 4 slats,  $\frac{3}{8}$  by 3 by 20 in., S-2-S.
- 1 bottom,  $\frac{7}{8}$  by 10 by 10 in.

First square up the posts and bevel the tops as shown in the detail sketch.

Place them side by side, on a flat surface with the ends square and lay out the mortises with a try-square on all four pieces at the same time. This will insure your getting them all straight and of the same height. Now lay out the tenons on the rails in the same manner and cut them to fit the mortises in the posts. Mortises should also be cut in the rails for the ends of

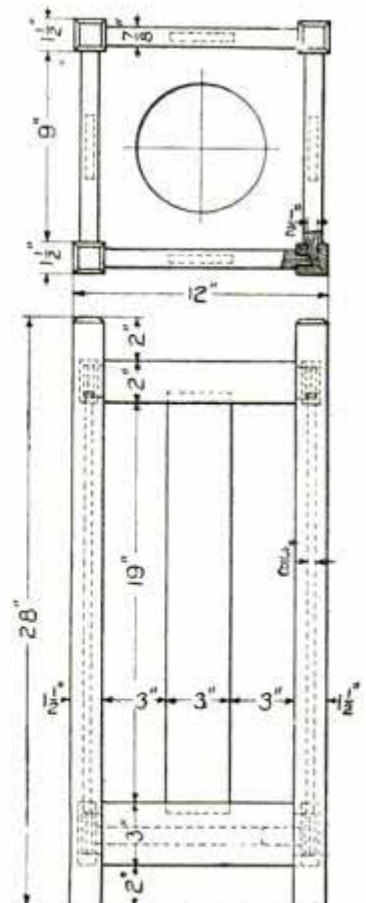
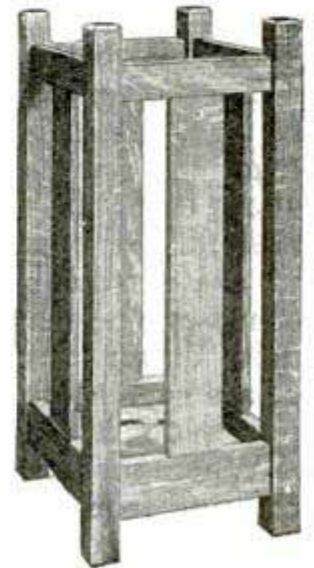

the side slats as shown. Try all the joints and see that they fit tight and square. Glue two sides of the stand together and let them dry for at least 24 hours, then glue the remaining parts, being careful to get everything together perfectly square.

The bottom board can now be fitted in place. It should have a hole cut in it for the drip pan. The pan should be about 6 or 7 in. in diameter. One suitable for the purpose can be purchased in any hardware store. The bottom board can be fastened to the rails with nails driven from the under side, or cleats can be nailed to the rails for it to rest upon.

When the stand is complete scrape all glue from about the joints and go over the whole with fine sandpaper, removing all rough spots. Apply the finish you like best, or the one that will match your other furniture.

### HIGH-TENSION OUTLETS

The type of high-tension entrance and outlet conductors used at Niagara

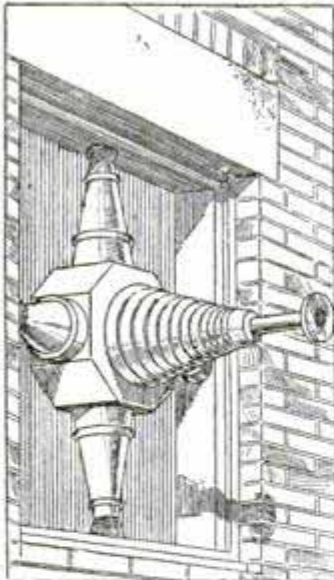

by the Ontario Hydro-Electric Power Co. in its 110,000-volt transmission system is shown in the accompanying illustration. The conductor is a copper tube set in a porcelain tube about 6 ft. long, surrounded by a porcelain bushing 40 in. long. The supports by

which each outlet is fixed in the center of its 5-foot-square opening in the wall are four in number, placed at right angles. The openings are fitted with plate glass.

Under wet test these insulators withstood a pressure of 220,000 volts without leakage.

### NITROGEN AND CARBONIC ACID PRESERVE EGGS

Eggs as fresh in flavor after 10 months' storage as when newly laid, are claimed by means of a treatment and method of cold storage recently adopted in France. The eggs are placed in galvanized iron cases, so constructed as to allow a free circulation of air around each egg. A small quantity of anhydrous (that is, perfectly dry) chloride of lime, serving to absorb the moisture from the surrounding atmosphere, is placed in each case, and the covers are soldered on. A hole,  $\frac{3}{16}$ -in. in diameter in the top of each case is left open for the withdrawal of the air in the cases and the admittance of the gases utilized in the subsequent treatment.

These cases are then placed in a cylinder from which the air is exhausted, and perfectly dry carbonic-acid gas, slightly heated, is substituted for the withdrawn air. When the pressure becomes slightly in excess of that of the outside air, the injection of carbonic-acid gas ceases, and the pressure gradually becomes lower as the gas is absorbed by the whites of the eggs. When the pressure indicator becomes stationary, which shows that the whites have ceased to absorb the carbonic-acid gas, a certain amount of the gas is pumped out of the cylinder, nitrogen is admitted under pressure, and is in turn absorbed by the whites of the eggs. Finally the supply of nitrogen is shut off, the cylinder opened, and the small holes in the tops of the cases closed with solder.

The treatment thus incloses the eggs in an atmosphere of dry carbonic-acid gas and nitrogen, but no oxygen, the proportions of the gases being the same as found in the whites of new-laid eggs. The cases are then stored as usual in a temperature of from 32 to 35 deg. F., but no attention need be paid to the humidity of the storage rooms.

The cost of the treatment, including cases, but not the expense of installing the plant, is 80 cents per 1,000 eggs.



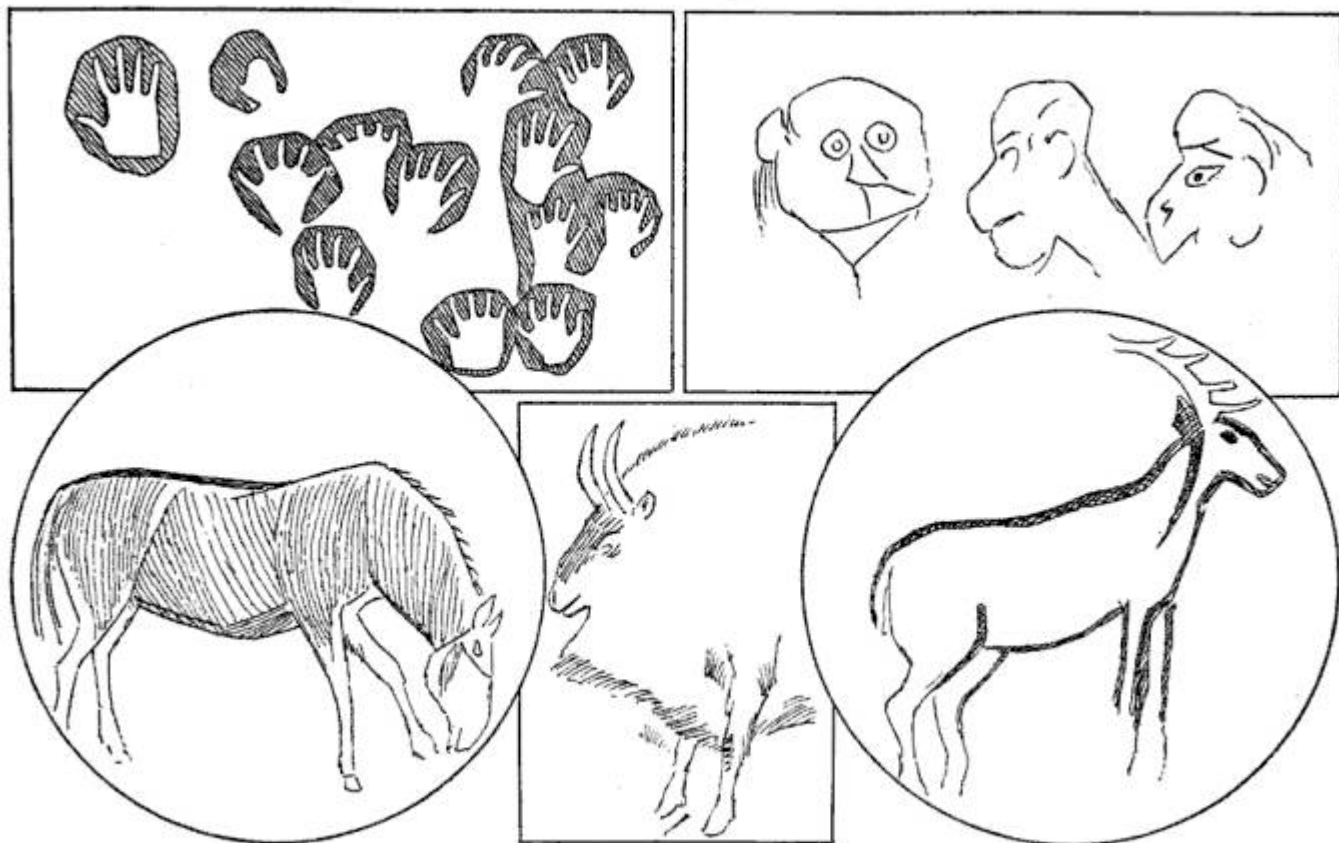

Drawings by Artists of the Stone Age—Human Hands Drawn by Placing Hand Against Wall and Following the Outlines, and Drawings of Human Heads and of Animals Found on Walls of Caves in the Pyrenees

### PAINTINGS AND DRAWINGS OF THE STONE AGE

On the northern slope of the Pyrenees, France, are three caves which were used by prehistoric man in the stone age as dwellings. They have a special interest over several like caves recently discovered, because of the paintings and drawings that cover the walls, ranging in size from 6 or 7 in. to as many feet. The variety of subjects is rather limited, and among them the bison and horse predominate. A scarcity of human likenesses would suggest a superstitious fear of self-portraiture, and those that have been found are real caricatures, childish in conception and execution. In this respect they contrast strongly with the, in many instances, excellent pictures of animals, of which the horse and bison are excellent examples.

One of the caves is rich in human hands, made by holding the hand outspread against the wall and painting around it. Out of 144 hands, only eight represent the right hand, which is conclusive proof that man was right handed as far back as the stone age.

### UNLOADING PIG IRON WITH ELECTRIC MAGNETS

Two 62-in. electric lifting magnets recently unloaded 4,000,000 lb. of pig iron from the hold of the Great Lakes steamer "Erwin L. Fisher" in 10½ hours. The vessel docked at 7.15 in the morning, and the work commenced 20 min. later, continuing with an interruption of half an hour at noon for oiling and inspection, until the task was finished. In all 1,281 lifts were made by the two magnets, the average lift per magnet being 3,122 lb.

### EXTENSIBLE MAST THAT WINDS UP

One of the latest types of extensible mast, which among other uses is adapted for portable wireless outfits, winds up like a steel tape measure. The mast is square in section and consists of four interlocking steel strips that are fed from four reels through a square hole in a guide plate. Steel brace plates, encircling the mast, are automatically placed at intervals as the mast is extended.

## REVOLVER, KNUCKLES AND STILETTO COMBINED

The arrest of a 16-year-old school boy in New York recently divulged a combination weapon of a type unfamiliar

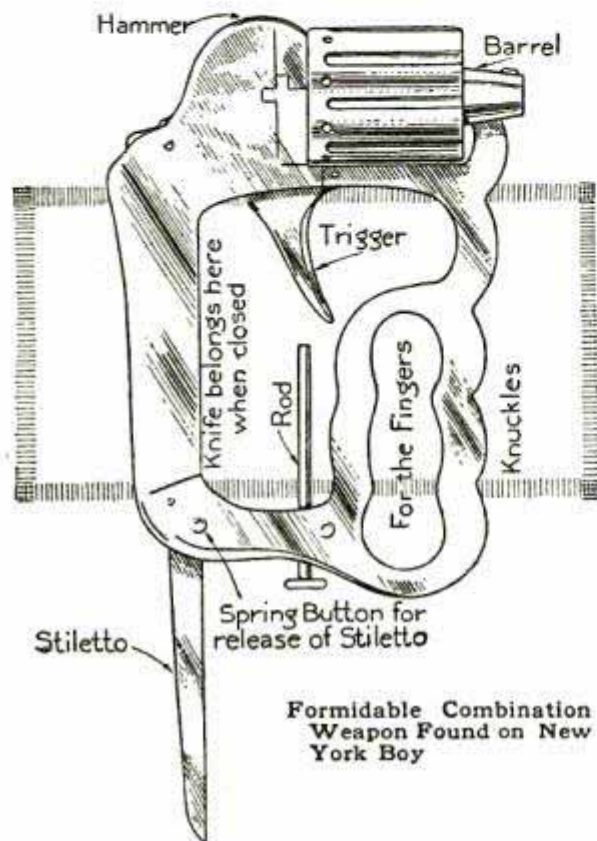

even to the police of that city. It comprises a revolver, stiletto and knuckles, in the form shown in the accompanying illustration. The stiletto extends downward from the rear base of the revolver grip, when required for use. When not in use, it is hidden in the revolver grip, from which it is released by means of a spring button.

## EXPERIMENTS DETERMINE SHAPES OF FISH

Additional evidence of the influence of environment on living things is found in the experiments recently conducted by a French scientist with fish models. These experiments were conducted with a bag made of flexible material filled with a plastic substance and tightly sealed, the bag being without shape of any particular kind. The experimenter placed his apparatus in a tank and drew it through the water at

varying speeds, noting the effect of the passage each time. He found that when the bag was pulled through the water rapidly, it soon assumed the most common shape of a fish, the upper and lower portions of the front and the lateral portions of the rear end flattening, leaving the greatest bulk of the body nearer to the front end. The varying speeds produced variations of this shape and indications were found as to the arrangement of fins suitable for the various forms of fish from the bull-nosed to the flat and cylindrical. From these experiments, fish models were constructed and many interesting scientific theories were tested.

## "DUCK BOAT" BODY FOR AUTOMOBILES

The new automobile body turned out by a motor car company of Dayton, Ohio, is called the "duck boat" because of its peculiar shape. It is a radical departure in body design, there being but one door, on the left side at the front. The occupant of the single rear seat enters through this door and passes between the two front seats. Mud aprons, attached to the fenders,

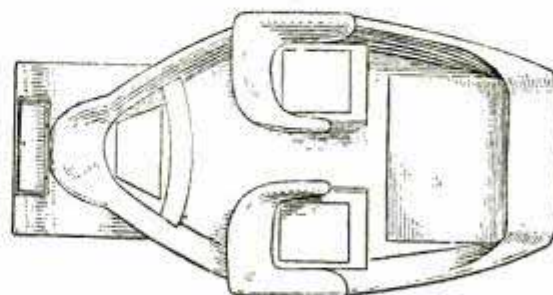
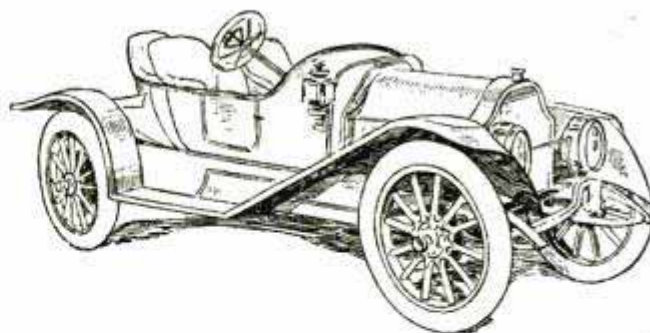

Two Views of the "Duck Boat" Automobile Body

protect the lamps and radiator from being splashed by the mud thrown up by the front wheels.

## TWO NEW FRENCH AEROPLANES

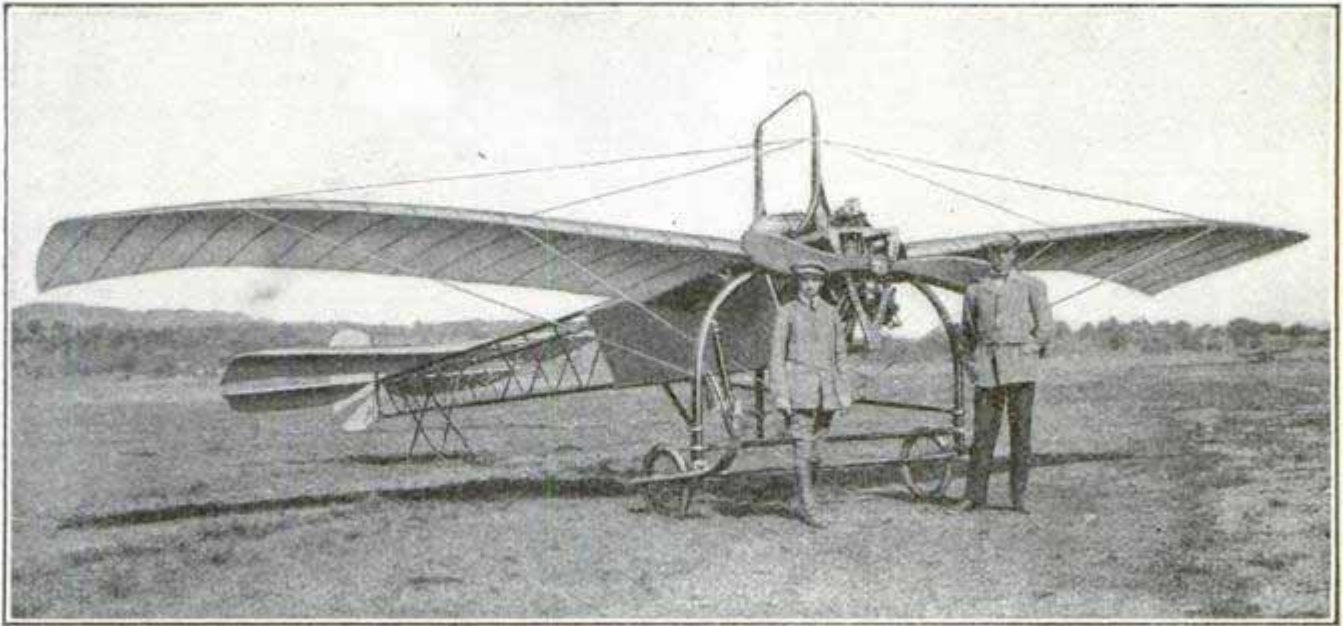

New Monoplane "Erg," with 50-Hp. Viale Motor

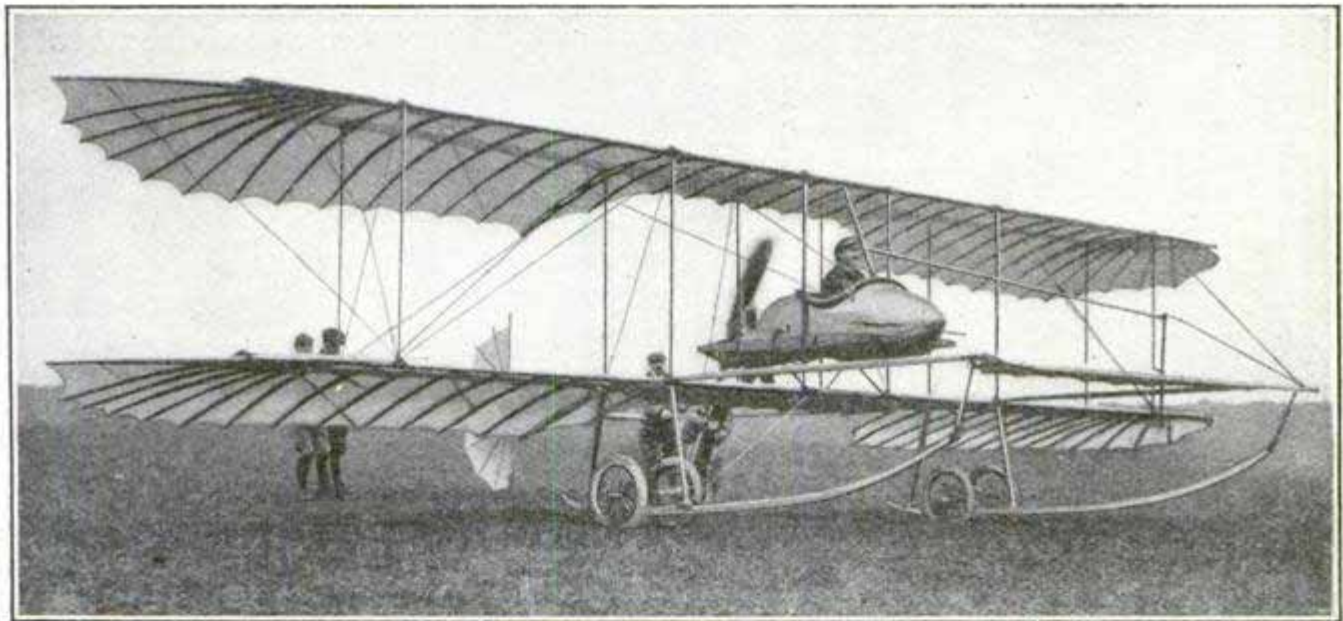

M. Paulhan, not satisfied with his previous flying machines, has just constructed a biplane with flexible and warping extremities. It has a 50-hp. Gnome motor, weighs 880 lb. and has a wing surface of 474 sq. ft.

### ATHLETICS MAKES WOMEN'S FEET LARGER

If woman insists upon being a golfer, an equestrian, a walker or an out-of-door person generally, she must content herself to have large feet. One of the largest shoe manufacturers in the country has just discovered that the feet of the women of today require a shoe  $5\frac{1}{2}$  C in size in place of the  $4\frac{1}{2}$  B size worn ten years ago. The calcu-

lations were based upon the orders received for shoes for women during the last year and for a like period ten years ago. Thousands of orders were examined and an average struck. An investigation was made as to the cause, and from the results of this, it has been determined that the prevalence of the athletic spirit among women is responsible. It was also found that the height and weight of the average woman have increased considerably in ten years.

## A HIGH WIRELESS TOWER ON THE PACIFIC

One of the highest wireless telegraph towers in the United States has been completed recently in Seattle.

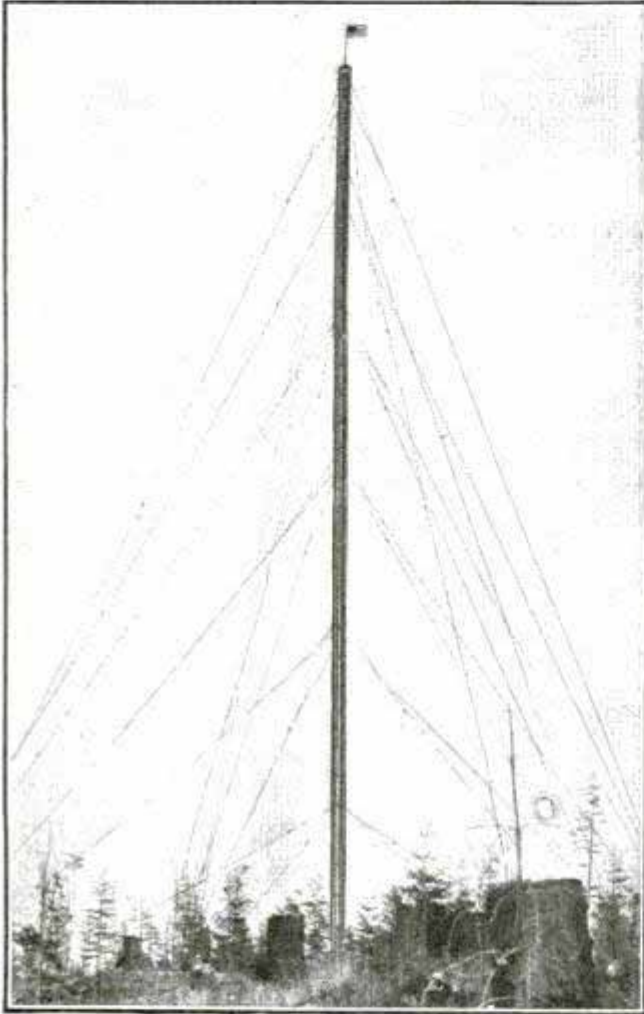

Wireless Tower 320 Feet High on Pacific Coast

Rearing 320 ft. above the ground, it stands on a hill 500 ft. above the level of the sea.

When the entire system of antenna wires is completed, 40,000 ft. of wire will have been used. These wires will stretch from the top of the tower like the ribs of a gigantic umbrella to eight masts each 100 ft. high and 500 ft. from the base of the tower.

According to William Dubelier, the Seattle man who has invented a successful wireless telephone, this tower will give his telegraph plant a working radius in the daytime of 2,500 miles, and at night probably 3,500 miles. If this proves to be the case, then messages can be sent from Seattle to Alaska or Honolulu direct or even

to Chicago and Atlantic coast points. The great antenna system will cover more than 30 acres.

The tower is constructed of steel and wood and in its center it has an elevator operated by a gas engine. It is the intention of the wireless men to flash signals at noon each day giving the time to boats plying the Pacific Ocean. An arc light of high power will be operated at night on the top of the tower and it is expected it will be visible 40 miles on clear nights.

A 20-kilowatt generator will give the station one of the most powerful outfits in the world.

## VARYING THE ALCOHOLIC CONTENT OF BEER

Prohibitionists and personal-liberty advocates have all the elements of a nice little controversy on the merits and demerits of the true foaming lager and the various "near-beers," in the recent announcement that a brewing chemist has found a simple method of materially reducing the amount of alcohol in beer. This consists in passing carbonic-acid gas, made chemically from soda and sulphuric acid, through the beer at a temperature of about 70 deg. F. Beer having 4 per cent of alcohol, treated in this manner, lost about 95 per cent of its intoxicating principle, but became flat in the process, without, however, losing any of its nutritive qualities or palatability. Another peculiar thing was that the beer was restored to its original condition by passing the same kind of gas through it at a much lower temperature.

Whether this research will lead to anything in the nature of a commercial dealcoholized beer remains to be seen.

CA new form of arc lamp, claimed to be of extraordinary efficiency, has its arc between a piece of metallic tungsten and a pool of mercury, placed a short distance apart in a vacuum or an atmosphere of inert gas.

# The Kingdom of Dust

By J. Gordon Ogden, Ph. D.

THIS is the fourth of a series of articles by Dr. Ogden, who is professor of physics at the Fifth Avenue High School, Pittsburg, Pa. In every home, in every office, in every shop or factory, the fight against Dust is never-ending. Dr. Ogden illuminates this subject in a manner which brings a realization of its infinite importance.

## IV—Earth's Winding Sheet

AH, make the most of what we yet may spend  
Before we, too, into the dust descend.  
Dust into dust, and under dust to lie,  
Sans wine, sans song, sans singer, and sans end.

For I remember stopping by the way  
To watch a potter thumping his wet clay,  
And with its all-obliterated tongue  
It murmured, "Gently, brother, gently, pray."  
*Omar Khayyam*

AS dust was the beginning, so shall it be the end of all things earthly. It is the cosmic undertaker of the ages, and silently, resistlessly, and eternally it has performed its function. The proudest monuments built by man, the Sphinx, the Pyramids, the Colossus of

Rhodes, the Gardens of Babylon and the glories of Grecian art, have either crumbled to the dust whence they sprang or have been buried deep in its winding sheet. So far as human grandeur is concerned, even "imperial Caesar, dead and turned to clay, might



THE ROMAN FORUM AS IT LOOKS TO-DAY

Every Wind Carries Away Dust Particles of this Once Proud Monument of a Mighty City

stop a hole to keep the wind away!" No one knows how many Londons or Jerusalems there have been. Excavations into the dust on which these cities are built reveal the relics and remains of former cities which once flourished and were mighty, but were finally entombed in the course of untold centuries by the gradual but immense deposits of dust and debris. When Macaulay's New Zealander shall muse in profound melancholy upon the shattered remains of London Bridge, he will behold a vast battlefield, where half-buried columns and desert sands shall proclaim the final sovereignty of dust.

How many cities, like Nineveh and Babylon, and numberless cities of the plains, are known to us only by a few shards and other fragments of pottery, drifting about in deserts of shifting sand?

The mighty Himalayas, whose snowy summits have as yet defied the foot of man, are slowly crumbling into dust, and the lofty peaks of the Andes are splintering, fragment by fragment, until they, too, shall become clods of the valley. Every wind that blows "soft o'er Ceylon's Isle" carries away in tiny dust particles some of its beautiful hills and vales. Every brooklet trickling down the rugged mountain side bears part of a continent to the sea. Every

year the Mississippi River carries down to the gulf little motes of matter, river-worn dust, amounting to over  $7\frac{1}{2}$  billion cubic feet. In 3,500 years, the

Mississippi cuts down its entire basin one foot, and as the mean height of the continent is only 2,000 ft., were the process to go on uninterrupted, North America would be reduced to the sea level in about 7,000,000 years. When we stop to consider what the other great rivers of the globe are doing, such as the Nile, the Yang-tse-kiang, the Yukon,

and the Danube, we can appreciate in some measure the everlasting waste that is eating away great continents, and foresee the inevitable supremacy of the Kingdom of Dust.

Volcanoes are active agents in the formation and distribution of dust. On August 27, 1883, a violent explosion took place on the island of Krakatao, in the Sunda Strait. Half of the island was destroyed. According to official evidence, the explosion was heard at a distance of 1,800 miles, and the air wave that accompanied it, injured buildings hundreds of miles distant. Immense quantities of dust, some coarse, some fine, were projected

into the atmosphere. This dust, the fragments of a volcanic island, was carried into the upper atmosphere and some of it circled the entire globe twice



Dust from the Eruption at St. Pierre, Magnified 500 Times, Showing Angular Fragments of Dust



Sand Dune Destroying Forest at Cape Charles, Va. These Dunes Overwhelm and Destroy Every Living Thing in Their Path

or thrice before it finally disappeared. The brilliant sunsets, glorious in their chromatic splendor, that characterized the years of 1883, 1884, 1885, and 1886, were due to the minute dust particles from this volcano. And even to this day, after almost three decades have elapsed, it is quite probable that dust from Krakatao is still flitting aimlessly in space, silently moving throughout the profound wastes of the aerial sea. Possibly some of the finer dust, attaining the higher reaches of the atmosphere and impelled by the pressure of light, has left the confines of earth forever and has begun an age-long wandering into the awful abysses of interstellar space.

The volcanic outburst of St. Pierre with its tremendous outpouring of dust, in May, 1902, is still fresh in the minds of all. Professor Jagger, of Harvard University, who visited Martinique the day following the greater outburst, wrote: "I looked toward the gray old volcano, whose summit was shrouded, but the lower slopes were sunlit, silent, and powdery; the whole landscape is powdery, like old statuary with a dust coating, that makes stronger the modeling of the city."

The most dramatic description of a volcanic eruption, ever penned by man, was written by Pliny the Younger, in a letter to Tacitus. After a preliminary account of the eruption of Vesuvius, he said: "At length, preceded by a strong sulphurous stench, a black and dreadful cloud, skirted on every side by forked lightning, burst into a train of fire and igneous vapor, descended over the surface of the ocean, and covered the whole bay of the crater, from the island of Capreae to the promontory of Misenum with its noxious exhalations; while the thick smoke, accompanied by a slighter shower of ashes, rolled like a torrent among the miserable and affrighted fugitives, who, in the utmost consternation, increased their danger by pressing forward in crowds, without an object, amidst darkness and desolation; now were heard the shrieks of women, screams of children, clamors of men, all accus-

ing their fate, and imploring death, the deliverance they feared, with outstretched hands to the gods, whom many thought about to be involved, together with themselves, in the last eternal night. Three days and nights were thus endured in all the anguish of suspense and uncertainty; many were doubtless stifled by the mephitic vapor; others, spent with the toil of forcing their way through deep and almost impassable roads, sank down to rise no more; while those who escaped spread the alarm, with all the circumstances of aggravation and horror, which their imaginations, under the influence of fear, suggested. At length a gleam of light appeared, not of day, but fire; which, passing, was succeeded by an intense darkness, with so heavy a shower of ashes, that it became necessary to keep the feet in motion to avoid being fixed and buried by the accumulation. On the fourth day the darkness by degrees began to clear away, the real day appeared, the sun shining forth sickly as in an eclipse; but all nature, to the weakened eyes, seemed changed; for towns and fields had disappeared under one expanse of white ashes, or were doubtfully marked, like the more prominent objects, after an Alpine fall of snow."

If such be the description of this most tremendous visitation, as it affected Stabiae and Misenum, comparatively distant from the source of the calamity, what must have been the situation of the unfortunate inhabitants of Pompeii, so near, of Herculaneum, within its focus? Must we not conclude that, at the latter place at least, most of those not overwhelmed by the torrents of stony mud which preceded others of flaming lava, burying their city 60 ft. under the new surface, were overtaken by the showers of volcanic matter in the field, or drowned in attempting to escape by sea, their last, but hopeless resource, since it appears to have received them to scarcely less certain destruction?

The recent disaster at Martinique recalls to mind the eruption of St. Vincent in the year 1812. A sea

captain, Basil Hall, wrote a very graphic and striking account of this modern Pompeii, and his own words are best in describing it: "On the first of May, 1812, after some violent detonations that terrified the inhabitants of the Barbadoes, a black cloud was descried, seaward, upon the northern horizon. Ere long, it covered the whole sky, which had just been emerging from the shadows of morning twilight. At length, the darkness became such that it was impossible, indoors, to tell where the windows were, while, in the open air, many persons could not see the trees near which they were passing, the outlines of the neighboring houses, or even white handkerchiefs placed a few inches from their eyes. This phenomenon was occasioned by the fall of an enormous quantity of volcanic dust issuing from a crater on the Isle of St. Vincent, and containing, according to the analysis made by Dr. Thompson, 91 parts of silex and aluminum, 8 parts of calcareous matter, and 1 part of oxide of iron. This new kind of rain and the profound darkness it occasioned, did not cease entirely until between noon and one o'clock; but several times during the morning there were noticed by the aid of a lantern, showers, so to speak, in which the dust fell in greater abundance. Trees whose wood was flexible, bent beneath the burden and the noise that other trees made in breaking contrasted in a very striking manner with the calmness of the atmosphere. The sugar canes were completely broken down, and the whole island was covered with a bed of greenish ashes an inch in depth."

In many parts of the world there are dust storms so dense and so frequent that travelers when caught in them are in imminent danger of their lives. These storms are known under various names, such as the harmattan, the khamsin, the sirocco and the simoon. They transport from place to place immense quantities of dust.

That these great dust storms have always been in evidence since the world began is shown by certain geological

formations. Along the valleys of the Rhine and the Mississippi, in Central China, North Germany, Poland, and in the Carpathians, are immense deposits of a peculiar dust known as "loess," a fine powder produced by the grinding of prehistoric glaciers and consequent flood streams. The loess is generally of a brownish or yellowish color, and sometimes has a depth of over 2,000 ft. Pumpelly, in describing the loess of China says: "In Asia, thousands of villages are excavated in the most systematic manner at the base of cliffs of loess. Doors and windows pierced through the natural front give light and air to suites of rooms which are separated by natural walls and plastered with cement made from the loess concretions. These are the comfortable dwellings of many millions of Chinese farmers and correspond to the rude 'dugouts' of Nebraska." This loess is never stratified, and hence was not water-deposited. It is simply dust that has overwhelmed cities and villages and even mountains with a fine powdery deposit. In Central Asia the air is sometimes so thick with sand and dust that it is impossible to read a book at noonday. Along the Caspian steppes, fine clay and sand are constantly drifting, and no plant life can exist where these storms are common. Even in our own country, especially along the seashores, we have many examples of the wastes produced by sand dunes. These dunes, like those on Cape Charles, overwhelm and destroy every living thing in their pathway.

The terrible desolation produced by shifting sands, however, may best be seen in northern Africa. The desert of Sahara is a typical example. Wind-driven, the white, powdery sand sifts ceaselessly over the ancient domain of the Pharaohs. Almost all of northern Africa is now naught but a desert and in a few hundreds of years, the sand will have reached the mountains near the Red Sea; inevitably it will overtop these natural barriers, and march onward into Arabia, carrying ruin and destruction in its train.





Hanging Gardens of Babylon



Tomb of Mausolos



Colossus of Rhodes



Statue of Zeus



Pharos of Alexandria

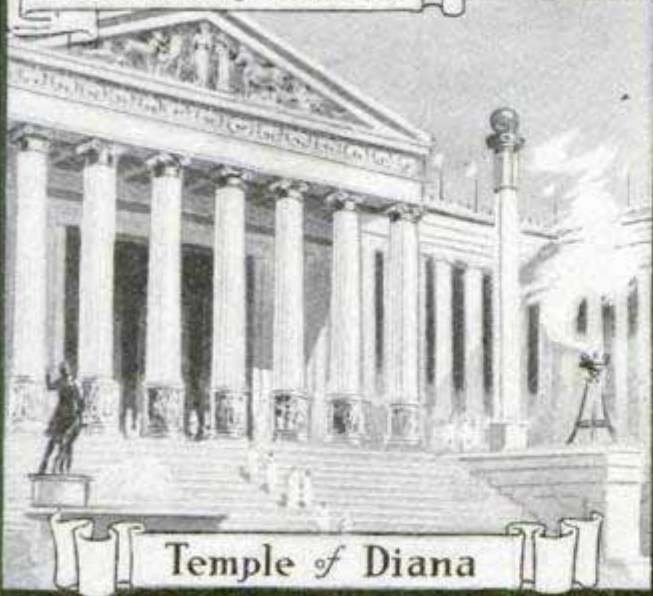

Temple of Diana



Great Pyramids

THE "SEVEN WONDERS" OF THE WORLD

"The proudest monuments built by man . . . have either crumbled to the dust whence they sprang, or have been buried deep in its winding sheet. So far as human grandeur is concerned, even imperial Caesar, dead and turned to clay, might stop a hole to keep the wind away."

Mysterious, dreamy Egypt, whence has come so much that has made the world wiser, is being slowly entombed by the relentless, shifting sands. The grim and silent Sphinx, wistfully looking afar with its dust-bleared eyes, beholds only wastes of shining sands, where once fair rising uplands, graced with beautiful temples and stately façades, marked the garden-spot of the world. Even the Sphinx itself is

slowly sinking into the dust with its riddle unanswered, its mystery unrevealed to wondering mortals.

Perhaps in some future age, the sands will roll away, Earth's winding sheet will unfold, and again will the Sphinx, the strangest of all the handiwork of man, ask in vain, with lips of stone, its world-old riddle, before it disappears, for all eternity, into the wonderful Kingdom of Dust.

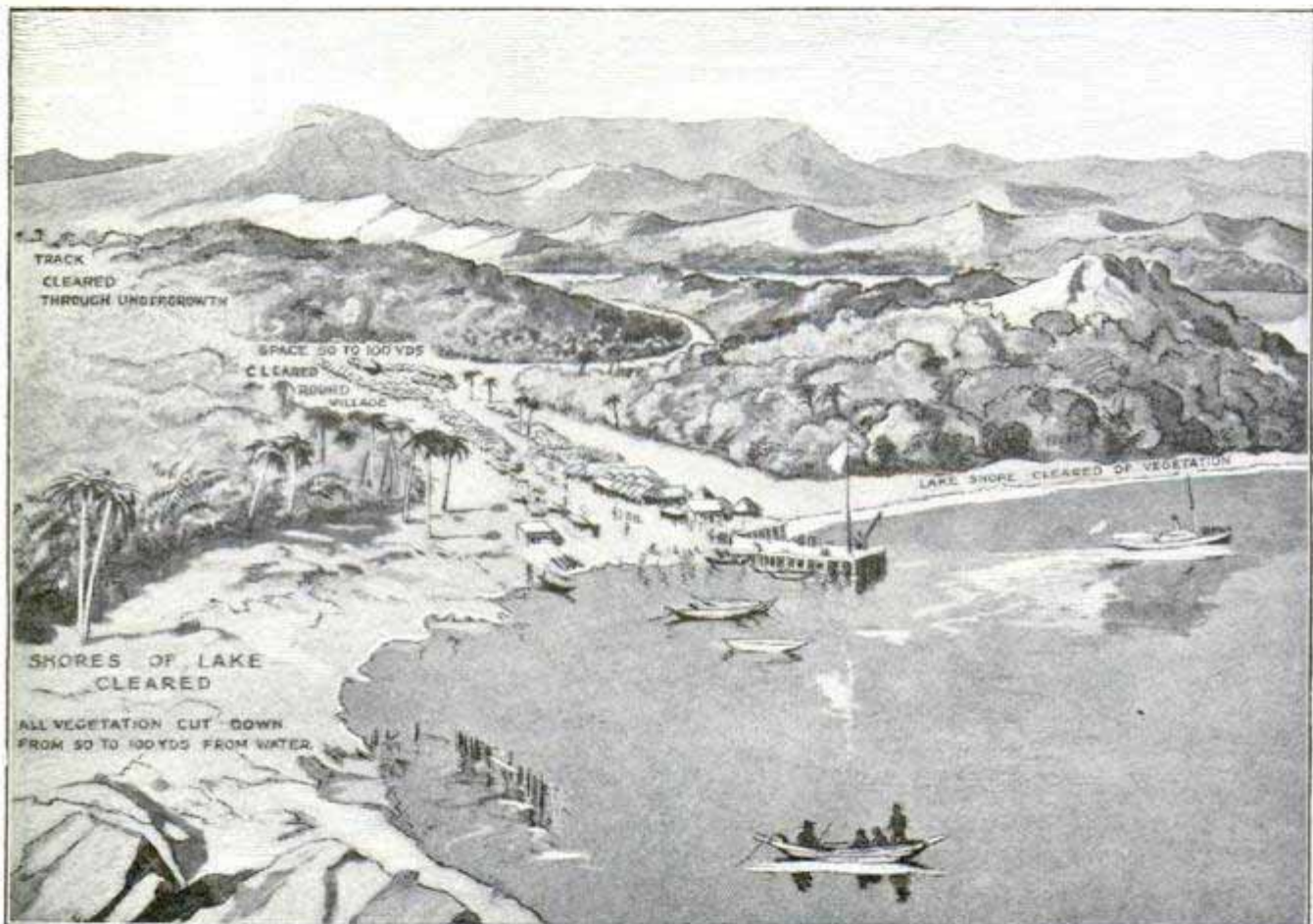

Courtesy the Sphere, London

Northern Shores of Lake Victoria Nyanza Cleared of Growth in Sleeping-Sickness Campaign

### CLEARING THE SLEEPING SICKNESS AREAS

The fact that the tsetse fly, which spreads the sleeping sickness, inhabits the low-lying growth around the lakes and rivers in Africa, and only travels a short distance from such areas, has caused an organization fighting the disease to clear the northern shores of Lake Victoria Nyanza, where one of the most terrible outbreaks occurred. All vegetation has been cut down from 50 to 100 yd. from the water, a space of 100 yd. cleared around the villages, and

tracks 50 yd. wide cleared through the undergrowth to the higher levels.

Two aspects of the disease must be combated in the fight of extermination: first, the infection of human beings by the fly, and secondly, the infection of the fly from infected human beings. All along the northern shores of the lake, the sick have been removed from the infected belt and segregated in camps, where various remedies sent out from Europe have been tried, but with little success. When definite evidence of sleeping sickness appears, the sufferer seems to be doomed.

### THE HAREM SKIRT OBLIGATION FOR AIRWOMEN

Airmen and conductors of aviation schools in France advocate the wearing of the harem skirt by airwomen, and that their advice has not fallen on deaf ears is demonstrated daily at Maurice Farman's aviation field at Buc. The rule is intended to apply to women passengers as well as aviators. Mme. Maurice Farman, who often makes aerial trips, has ordered one of these skirts.

### WOODPECKER CHIPS

A friend of birds, and one who had always supposed that the bits of wood removed by woodpeckers in building nests were like sawdust, discovered, to his great surprise, that the pieces of wood taken out by one member of the woodpecker family were about as large as his little finger. He consequently photographed a few of the chips, including a thimble in the photograph for comparison of size.

The chips shown are considered remarkably large, and were taken out by the flicker or yellow-hammer branch of the woodpecker family. In preparing its home, the woodpecker chisels

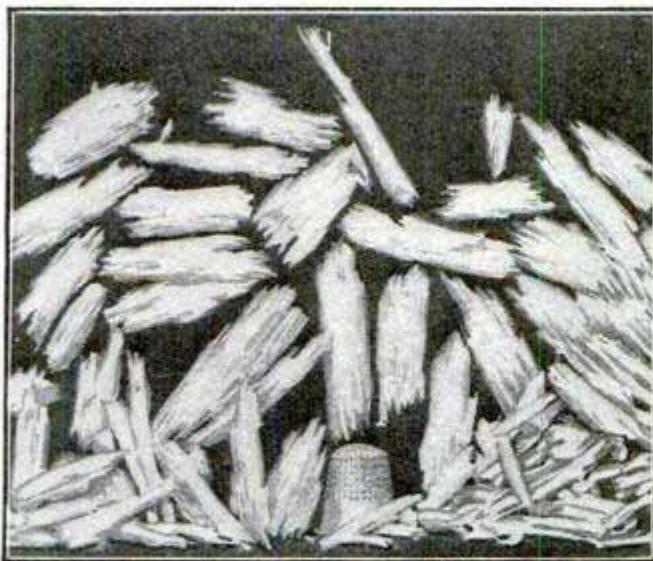

Chips of Wood Chiseled out by the Flicker Branch of the Woodpecker Family While Making a Hole for a Nest

out a hole in a tree, then curves the hole downward and builds the nest at the bottom.

### RUSSIAN BALALAIKA HAS TONE LIKE VIOLIN

Many Russian folk songs are arranged for an orchestra of balalaika, the Russian instrument which has been



A Member of the Imperial Russian Court Orchestra Playing the Balalaika

compared in tone with the violin. One of the most important features of the season at St. Petersburg is the series of concerts by the Imperial Court Balalaika Orchestra. The instrument is of many sizes and shapes and the difference in tone procured by the various arrangements of the strings and the sizes of the instruments give the writers and adapters of folk songs a wide range for orchestration. The instrument is said to be the only one that can be compared with a violin, although music lovers who have heard both still give preference to the violin.

ⒸAn Indiana court has decided that a blind person can collect damages for injuries received while walking along a public road from collision with an automobile, on the ground that the operator of such a machine going at a high rate of speed should make every effort to avoid collision with a pedestrian, and especially with a child or an infirm person, whose legal right to the use of the public highway is unquestioned, so long as they observe due care.



Drawing Room in a Priory Reconstructed and Decorated by the Brothers Adam

This Dining Room in the Home of the Earl of Morley, in Devon, England, Was Designed by R. and J. Adam

### ADAM TYPE OF INTERIOR DECORATION

Fine examples of interior decoration and furniture designed by R. and J. Adam, whose influence in architecture, interior decoration and furniture design was greatly felt in England from 1765 to 1790, are shown in these illustrations.

The two brothers not only designed walls, ceilings, mantel-pieces, even door knobs and locks—everything, in fact, that went into rooms; but built palaces for the nobility, houses, terraces, bridges, and even streets and squares. The furniture made by them was designed to fit their rooms.

### ALARM CLOCK THAT ACTED AS AN ENGINEER

The automatic stopping of the pumping machinery in five oil wells simultaneously by means of an alarm clock is the simple expedient used by an operator in an Ohio oil field to save himself a midnight trip to his pumping station. This operator was interested in another field and could not work the pumps on the five wells except at night. As is well known, oil wells in some sections of the country cannot be pumped continuously without injuring the properties, and these wells were of that class. They could only be pumped five hours at a time. Such a limit

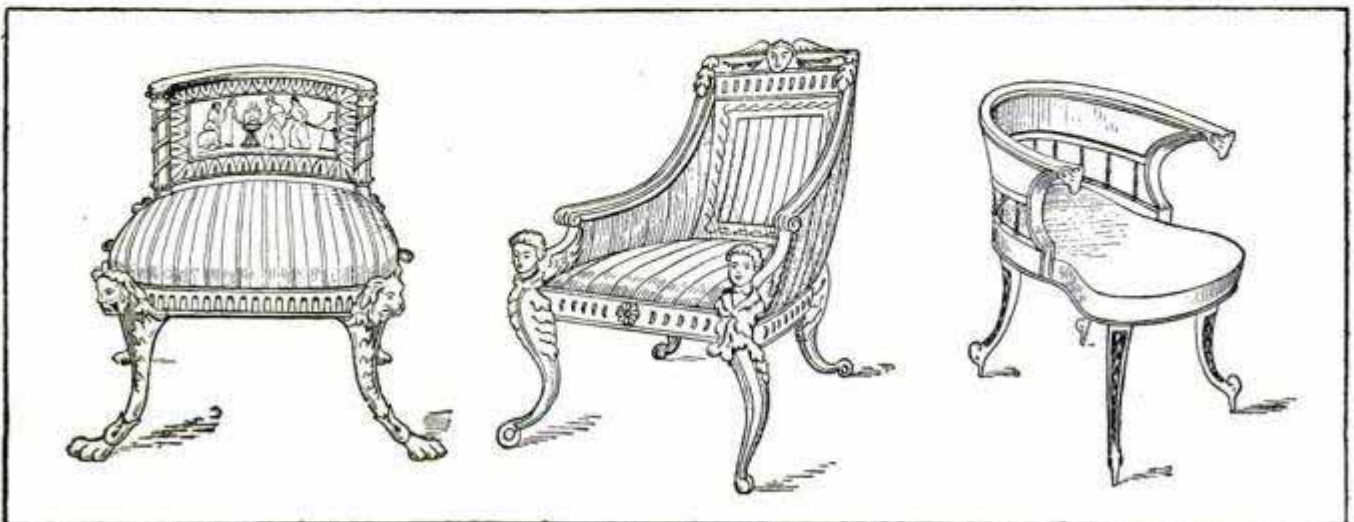

Chairs Designed to Fit Certain Adam Rooms

Courtesy Upholsterer

would have made it necessary for the operator to make a trip to his pumping station at the end of that time and stop the machinery. But he did not care to do this, and let the alarm clock do it for him.

The plan he adopted was very simple. He removed the bell and striker from the clock and when he started his pumps would set the alarm at a time five hours in advance. To the key with which the alarm was wound he attached a light cord, the other end of which was fastened to a weight that was just balanced on a bench in the engine room. From the weight a stouter cord was run to the gas valve and oil cup of the engine. When the time came for the alarm to sound, the key would turn, pulling the weight from the bench, and in dropping to the floor the weight would pull the heavy cord attached to the gas valve and oil cup, effectually stopping the engine by shutting off the supply of fuel and lubricant.

### ELECTRIC TROUBLE-HUNTER FOR MOTORISTS

A handy little device for locating breakdowns in inaccessible parts of an automobile is shown in the cut. It is a



Portable Electric Lamp with Adjustable Mirror

combination of the portable electric lamp with a mirror that can be tilted at any angle by a simple movement of the forefinger.

### THE SANTA FE'S NEW SUPPLY TRAIN

The new method of handling and transporting supplies adopted on the Albuquerque, Arizona and Los Angeles divisions of the Santa Fe lines is said to make possible the saving of two or three thousand dollars each month.

Small materials of all kinds, such as office supplies, are carried on a special car recently constructed for the purpose, the interior of which is provided

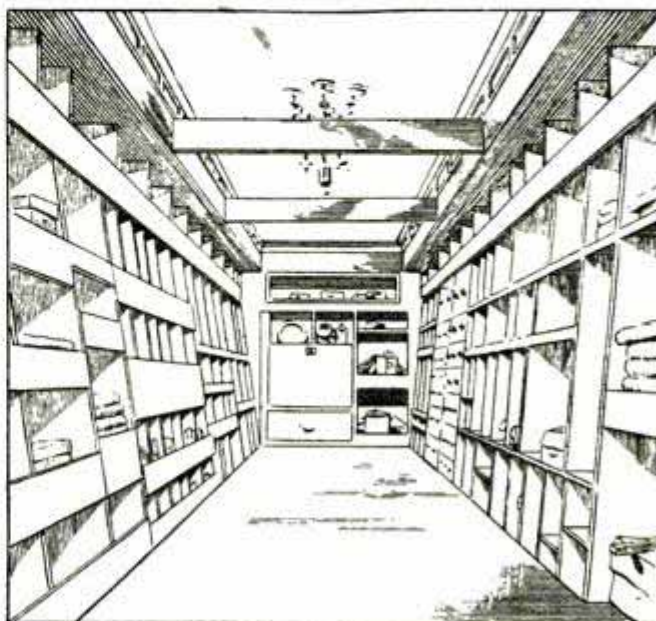

Interior View of the New Supply Car for the Santa Fe Lines

with shelves, pigeonholes, and other receptacles so arranged as to greatly facilitate the work of distribution. For conveying larger and heavier material, flat cars are attached to the main supply car.

The train starts out from a given point on the first day of each month, loaded with all the supplies for renewals and repairs requisitioned from different points. In the main supply car are office supplies of various forms sufficient to last every station agent on the three divisions for 30 days. The flat cars, which vary from five to seven, are loaded with track tools, frogs, switches, cattleguards, farm gates, fence wire, staples, spikes, bolts and practically all articles for renewals smaller than the complete reconstruction of bridges and the erection of buildings.

A Minneapolis man has arranged an indestructible phonograph record in combination with a loud-speaking telephone instrument on his automobile. A touch of the chauffeur's button causes this noise-making mechanism to hurl the name of the car or any other desired phrase.

## DIRIGIBLE "SUCHARD" BUILT TO CROSS THE ATLANTIC

No contingency that can be foreseen has been overlooked by Joseph Brucker, the German-American jour-

with a car or motorboat built like a canoe, to which the propellers are attached. Equilibrium is to be maintained by means of water pumped from the sea. The "Suchard" was built at Kiel, Germany, and was christened by Princess Henry of Prussia. The starting point selected by Mr. Brucker was the Canary Islands and he hoped to land in the West Indies.



The "Suchard's" Car, a Canoe-Shaped Motorboat Equipped with All the Necessities for a Record-Breaking Trip

nalist, who has planned the transatlantic voyage of the dirigible balloon "Suchard." The airship is equipped

with a crew as announced by Mr. Brucker, including Captain Joerdens of the German army, pilot; Captain Friedlaender, of the German navy; Mr. Mueller-Peissenberg, chief engineer; Dr. E. Alt, meteorological expert; and Mr. Brucker. The "Suchard" is equipped with two 200-hp. gasoline engines.

## A SKYSCRAPER DISASTER

While the fatality among workmen engaged in the erection of the modern skyscrapers is surprisingly small when the hazardous nature of their occupation is considered, few big buildings are completed without claiming at least one human life. The men are, from the very nature of the business, inclined to grow careless and to take chances that those in other walks in life would not dream of and they are always expecting accidents. When they do happen, there is little fuss and feathers about them and the dead or injured man is gotten out of the way as soon as possible.

The other day, in Washington, an ironworker on a 13-story steel skeleton that was fast assuming the shape of a building was perched upon an upright column swinging a crosspiece into place. He had done the same thing hundreds of times before and to

him it was mere routine of a day's work. But this time there was a slip somewhere—just a little miscalculation perhaps—and down he went two stories, crushing his skull against the metal which stopped his body in its fall.

In a moment the men around him had secured a ladder and the unconscious man was tied, back down, along the rungs while the word passed down story by story to the street for the foreman to send in a call for an ambulance. Then the great crane, in obedience to a signal, swung over the ladder, the hook was made fast to the ropes attached to the ends of the improvised litter and all was ready for the downward shoot.

And just here came in that wonderful touch of nature which manifests itself so often in unexpected places. Two men stepped forward and took

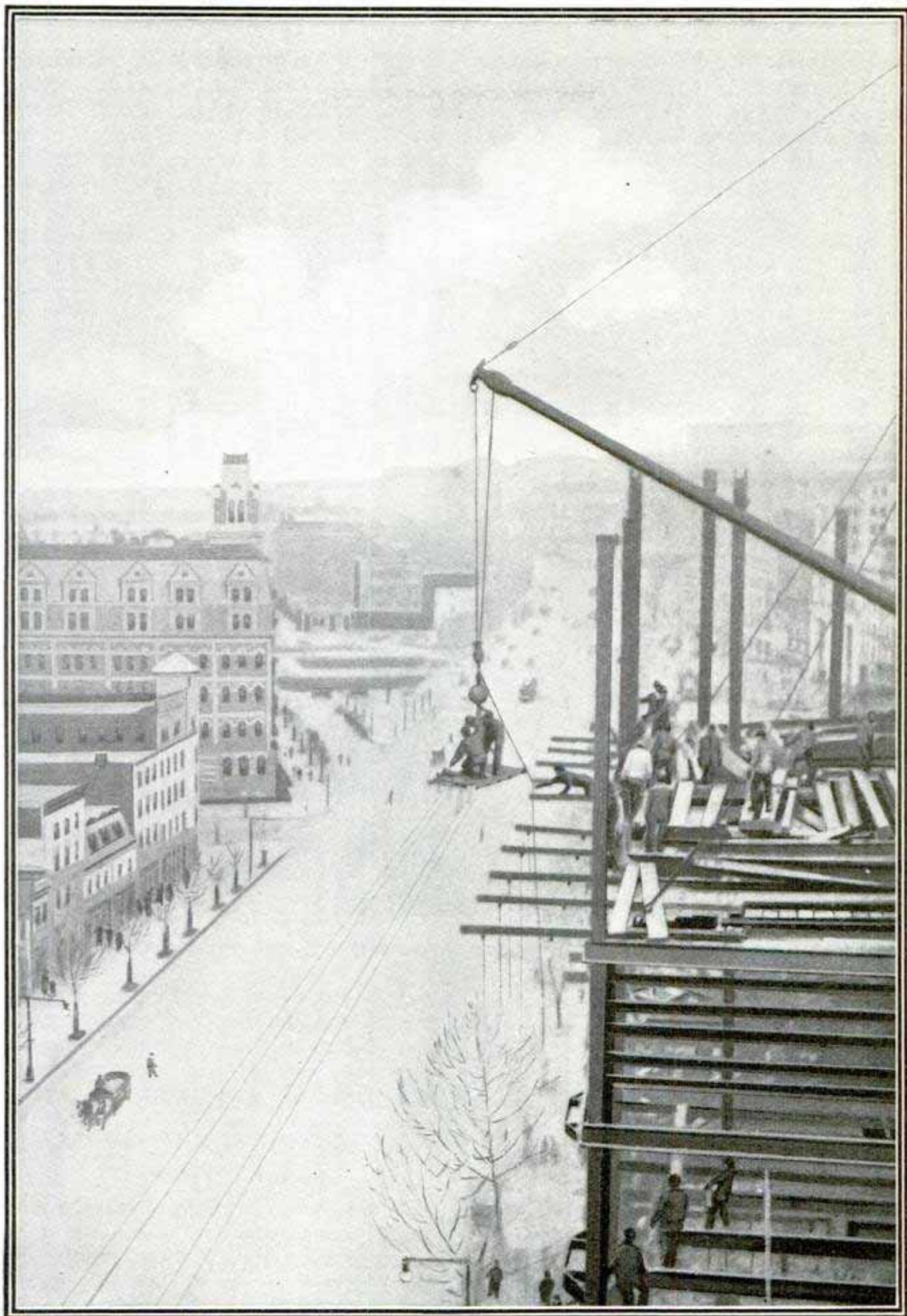

Structural Steel Workers Risking Death Lowering an Injured Fellow Workman to the Ground Quickly on  
• a Perilous Aerial Litter

their places on the ladder standing bolt upright, one at the fallen workman's head and one at his feet, and grasped the ropes. Not a word was spoken but everybody understood.

Two whistles, and the crane raised its load, swung slowly to the left, clear of the steel framework, and then the ladder and its burden started downward. Three stories down something caught; the ladder tipped perilously; the standing figures swayed and

sought to balance the load. Suddenly a man crawled out on a projecting beam, reached far over, shook free a rope that had caught and the ladder righted itself and continued on its downward course. The picture shows it all; the upturned feet of the wounded man and the figure on the cross beam reaching for the rope. It is a reproduction from a remarkable photograph taken by a man who happened to be on the roof of an adjoining building.



The Prisoners' Large Cage during the Trial of the Camorristi in Italy. Informer Occupies Smaller Cage

### THE TRIAL OF THE CAMORRISTS

The trial of the Camorristi, claimed by the Italian police to be the most powerful "black hand" society of modern times in Italy, has aroused extraordinary interest through all Europe and the United States. It is being held in the Church of the Scalzi, at Viterbo, which dates from 1675, and is now a court of assize. The accused, of whom there are 36, are placed in a great cage in the courtroom. The alleged member of the society, who, because the society had sentenced him to death, turned informer, occupies a smaller cage. It is interesting to note

that the cage in which the prisoners are confined while the trial progresses is over the tomb of Lorenzo da Viterbo, who was one of the great painting masters of the pre-Raphaelite period.

### ELECTRICITY IN WOOL SPINNING

In the spinning of wool, unless adequate precautions are taken, the yarn becomes electrified. As a result, the fibers diverge from it, part is torn off and goes to waste, the yarn becomes of uneven thickness, and frequent breakage and a general deterioration occur.

This electrification is prevented in



one of the great wool-spinneries of Fourmies, France, by means of high-frequency electrical currents, the system utilizing the Oudin resonator, aerial conductors and a series of pointed metal wires. The old method of prevention was to maintain a high degree of humidity in the workrooms, but, although this remedied the ill, the result was a high temperature and a lack of ventilation disastrous to the health of workers.

Since the installation of the new electrical system in the spinnery at Fourmies the windows are kept wide open, thorough ventilation is provided, the yarn made is more solid and elastic, and the waste and breakage are minimized.

### MORNING GLORY CLIMBS A TELEGRAPH POLE

Some years ago an expert of the department of Agriculture in Washington referred to a certain variety of morning glory seeds as a kind that the planter must drop into a deep hole quickly and then run away to avoid being tripped up by the vine in its growth. The perfection of a plant of this nature is reached in California and other places of equable climate, where

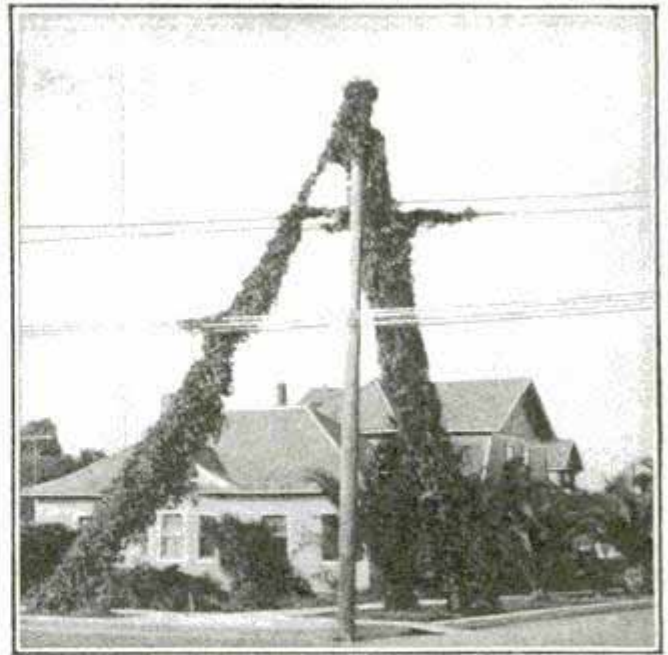

California Morning-Glory Vine That Grew on an Unusual Trellis

it grows in the utmost profusion, sometimes becoming a menace by the manner in which it entangles wires or shuts out light from a house, but more often adding beauty to the landscape and completing the ideal of the "vine covered cottage" of song and story. In Long Beach, California, there is one specimen of this vine that has grown along the guy wires of a telegraph pole in a mass several feet thick, making a very attractive festoon for a prosaic and otherwise undecorated pole.

### MEXICO BUILDING AN ALL-CONCRETE HARBOR

One of the most complete concrete harbors in the world is being constructed for the city of Manzanillo, on the west coast of Mexico. When finished, the harbor works will represent an expenditure of \$14,000,000 Mexican, or about \$7,000,000 in United States currency. About half of the work has been done. The improvements in progress consist of a long breakwater and a heavy sea wall. The breakwater section already built is 1,446 ft. long, 315 ft. wide at the base, 27 ft. wide at the crown, and 87 ft. high. Construction is now in progress on another section. A harbor of 165 acres will be inclosed, with an average depth, at mean tide, of 50 ft. Stone and con-

crete to the amount of 775,000 tons have already been used in the construction up to date. The foundations of the breakwater consist of blocks of stone weighing from 30 to 60 tons each. The sea face of the breakwater is capped with blocks of concrete, each weighing 30 tons, and the crown is a solid cap of concrete, 13 ft. high and 27 ft. wide, weighing about 60,000 tons.

Inside, the harbor is walled in along the shore with a facing of concrete 6,135 ft. long and 10 ft. high above mean tide. The outer slope is protected with a buttress of 15-ton granite blocks, the remainder of the construction being concrete. With the construction of this sea wall an area of

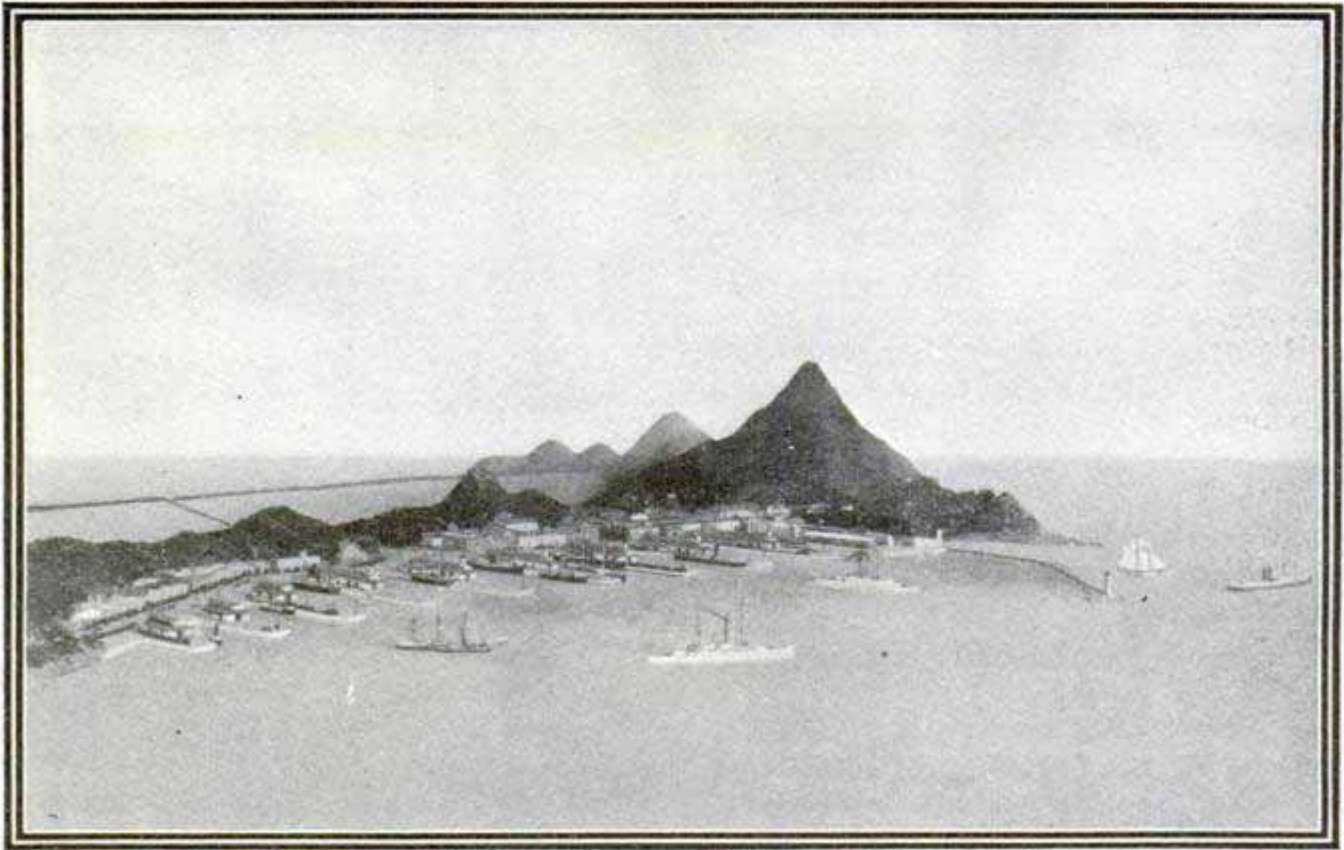

Model of the Harbor at Manzanillo, as It Will Appear When Completed

322,928 sq. ft., or nearly eight acres, has been reclaimed from the seashore, which will be utilized for the construction of warehouses, etc. In connection with the work there has been 640,920 cu. yd. of sand and soft material dredged from the harbor together with 71,490 cu. yd. of stone and hard material. In the construction of the workshops, etc., 5,000,000 ft. of lumber was used, and 37,000 bbl. of cement were necessary for the con-

struction of that section of the work that has been completed. The wharves and docks, it is proposed to build, will be 15,466 ft. long and will accommodate 50 vessels at one time. The imports of Manzanillo, according to the latest figures obtainable, amount to \$582,573.47, leading all the other Pacific coast ports in Mexico by many thousands of dollars. Six steamship lines make the town a regular port of call.

### INSIGNIA FOR THE OFFICE OF PRESIDENT

The Israelites of old cried for a king, American heiresses continue to seek foreign titles, and now the president of our sister republic of Brazil has been endowed with a special badge of office—all of which goes to show that human nature still has a leaning toward the "boast of heraldry, the pomp of power." The Brazilian president will in future wear a band of ribbon, 6 in. wide, terminating at its ends in gold fringe. On it will be embroidered in gold the heraldic arms of Brazil, over a ground

of the national colors. Suspended from the ribbon will be a gold medal showing on one side the Brazilian coat of arms, and on the obverse side the inscription "Presidencia da Republica do Brazil."

According to advices from Nottingham, England, the reduction of \$1,629,696 in the business of the lace factories of that section is directly attributed to the discarding of the petticoat by women who now wear hobble skirts or styles of garments designed to cling close to the figure.

# FIRST RAILROAD TO WORLD'S DENSEST TIMBER BELT

By H. M. WRIGHT

**B**Y the latter part of 1912 a new railroad line, owned jointly by the Southern Pacific and Santa Fe railroads, will have been completed between San Francisco Bay and Eureka, Cal., and will tap the giant redwood belt on the north coast of California, which contains some of the densest stands, acre for acre, of commercial timber in the world.

The redwood forests, which comprise the only extensive stretches of redwood in the world outside of 2,000 acres in Southern Oregon, extend from Northern Sonoma County, Cal., to the Oregon line,—a distance of about 230 miles. The belt varies in width from 10 to 45 miles, and lies in the foggy

region between the Pacific Ocean and the Coast Range.

Much of the country wherein the redwoods grow is peculiarly rugged and precipitous, and the new line, known as the Northwestern Pacific, will throw open to exploitation forests which, according to estimates of government officials, will yield at least 45,000,000,000 ft. of sawn redwood. This estimate does not include millions and millions of feet hidden away in remote cañons, which will not be cut for generations to come.

The redwood, which is a huge cypress-like tree, is one of the largest, tallest, and oldest trees in the world. The product of a single giant redwood

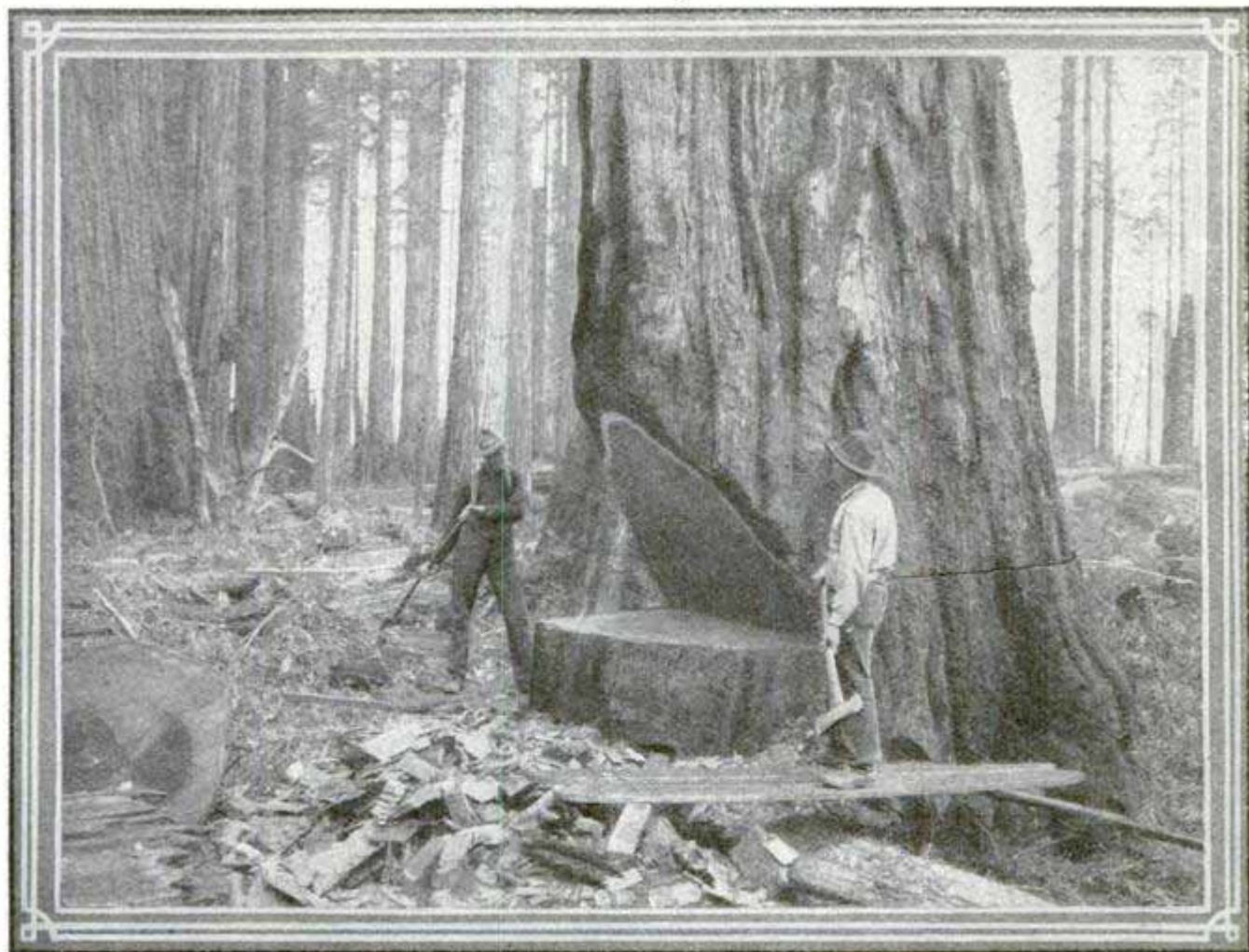

Felling a Redwood. The Tree is Cut Until the V-Shaped Niche Almost Reaches the Line That Has Been Sawed Through; Then a Wedge is Placed in the Sawed Part; It is Driven in and the Tree Topples Over

has been as much as 166,000 ft. board measure,—enough lumber to build ten ordinary-sized eight-room houses. When it is considered that 20,000 ft. of lumber is a good yield per acre for pine forests, some of the unusual features of redwood lumbering may be inferred.

The new line will give the first railroad connection between the timber belt and the outside world. Trains are already operating on a part of the system. What remains to be completed is a 105-mile gap between Shively, a lumbering camp 15 miles south of Eureka, and Willits, 137 miles north of San Francisco.

Orders have been given the contractors to rush the construction; within a year the line will have penetrated the heart of the vast redwood belt, and the whistles and bells of the locomotives will echo for miles in the redwood forests, where every sound seems magnified a thousand times. Six thousand men will be employed on the construction during the summer of 1911. The engineering task is a difficult one, but the world needs lumber.

Although the annual cut of redwood is about 350,000,000 ft., the demand for the wood is gradually spreading from the Pacific coast to foreign countries, and it is only a matter of time when the present facilities for marketing the redwood forests would have proved inadequate. In Humboldt County, the center of the redwood industry, about 5,000 men are employed in various phases of redwood logging and manufacture. In Mendocino, Del Norte and Sonoma Counties, the number is probably less, for there are vast stretches of redwood forests which have seldom been penetrated by any white man, except government experts and timber cruisers in the employ of big lumber firms. In Humboldt County there are 11 great sawmills, some of them among the largest in the world. And there are more than 40 shingle mills that turn out over 700,000,000 shingles annually. Redwood shingles are made from the branches of the trees which are larger than ordinary pines.

Redwood itself is a most valuable commercial wood. It is almost unburnable. It comes in great sizes. It is easily sawed and worked, and when polished and made up into furniture, takes on a luster like mahogany.

So far as the present generations are concerned, the redwood forests are practically inexhaustible. Originally, it is estimated, they covered 538,000 acres. At least 62,000 acres have been cut within the past 60 years, thus leaving 476,000 acres still standing. Based on an estimate of 100,000 ft. of merchantable lumber per acre, there is an uncut reserve of 47,600,000,000 ft. of redwood. But this is probably an underestimate because in the first-growth forests many single trees will run 100,000 ft.

Visitors to California usually confuse the redwoods with the "Big Trees." The trees are cousins, being the only two known species of the genus *Sequoia*, but they inhabit different localities.

Logging the redwoods is more than a one-man job. It takes at least three expert cutters to fell a big tree. Because of the vast weight of the forest giants a bed of underbrush must be prepared before the tree is felled. This prevents the breaking of any branches. When the bed is made, the cutters build a platform around the trunk and several feet above the ground. On the opposite side from which the tree is to fall the trunk is sawed through almost to the center. This is the cross cut. A wedge is then cut in with axes on the side on which the tree will fall; this is the undercut. When the wedge passes the center of gravity the tree topples over with a noise that can be heard for miles.

After the tree has fallen, the branches are sawed off and then "ringers" and "peelers," with axes and crowbars, tackle the trunk. The bark is first ringed or sawed off, every 12 or 14 ft., and is then pried from the wood with crowbars. All this work leaves an immense amount of debris in a redwood timber cutting. With all this rubbish surrounding the trunk the loggers are

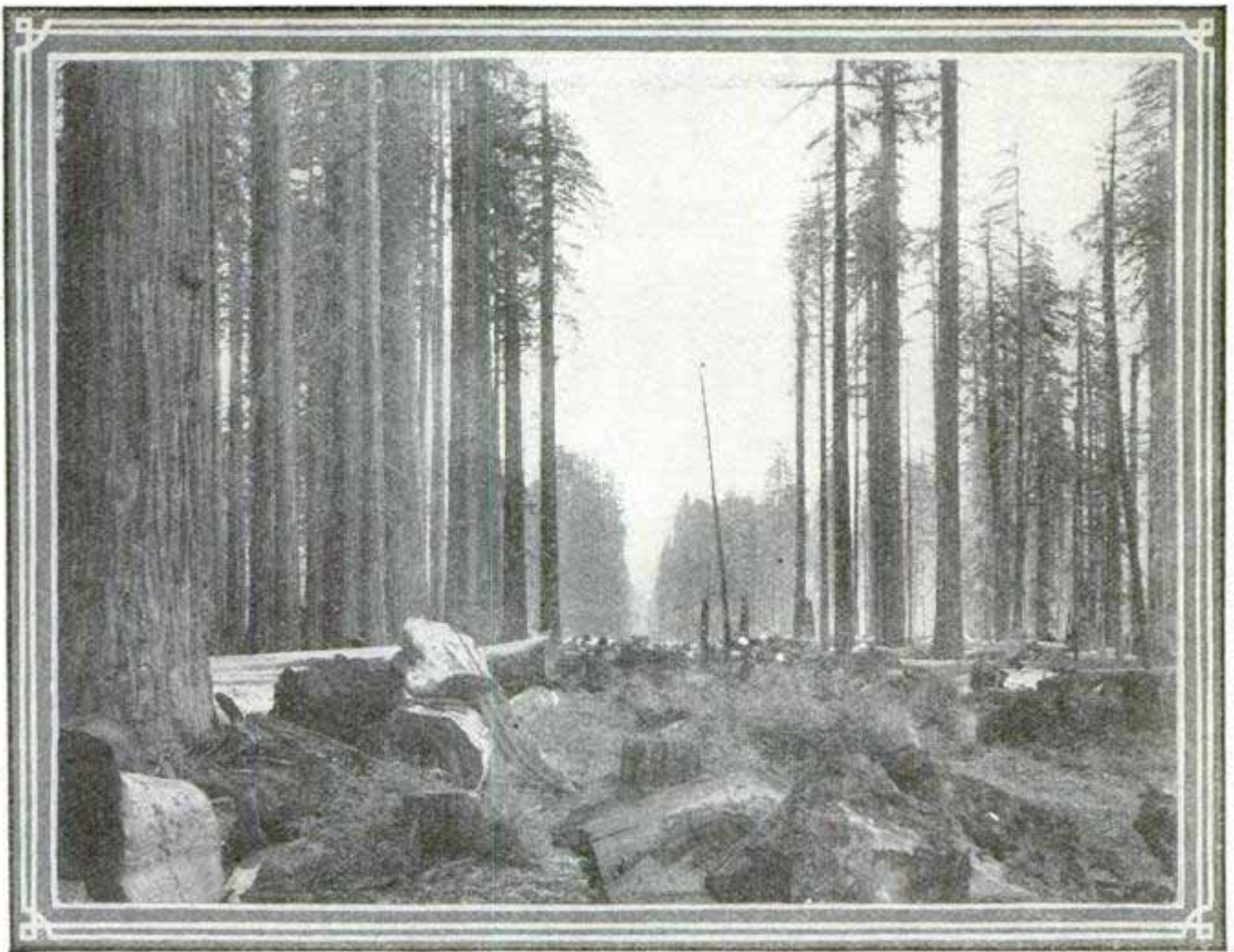

Hewing the Right of Way for the New Line through the Vast California Redwood Belt

unable to handle the tree at all so they choose a quiet day in which there is no wind and set fire to the mass. Owing to the fact that redwood does not burn readily, the wooden sections of the trunk are hardly more than scarred.

When the ground has been cleared by fire, donkey engines operating through blocks and tackle furnish the power to drag these huge logs over skidways to the railroad track. Special apparatus has been devised to handle redwood timber and the work of the loggers in the most precipitous country is really wonderful. Many of the logs are twice or even three times the height of an ordinary man as they lie upon the ground.

☪The available supply of the nitrate fields of northern Chile has been recently computed to be 245,827,000 tons, or sufficient to supply the world's needs for 50 years.



A Typical Big Tree, the Grizzly Giant, at Maricopa, Cal. The Big Tree, *Sequoia Gigantea*, is the First Cousin of the Redwood, *Sequoia Sempervirens*



L'Aero, Paris

"WHAT KIND OF A PLAGUE OF GRASS-HOPPERS IS THIS?"

A Paris paper proposes a race from Marseilles to Algeria as the great all-French aviation event of the year. The above is a French artist's idea of the reception the aeroplanes would receive in Africa after their flight across the Mediterranean.

### IRRIGATE 1,000,000 ACRES IN WASHINGTON

Work will begin this spring on irrigation projects covering more than 1,000,000 acres of land in eastern and central Washington. The total cost is estimated at \$55,000,000, provided by private capital. This is exclusive of the federal government's projects in central Washington.

Most of the irrigation plants to be installed will be in the Quincy Valley project, 100 miles west of Spokane, where 500,000 acres of land will be reclaimed. The cost of watering the tract, which is owned by ranchers, is estimated at \$25,000,000.

No less than 300,000 acres in south central Washington are included in the Horse Heaven project. This work alone will cost in the neighborhood of

\$12,000,000. Water rights are being sold to farmers, who own the land, at a rate of \$60 an acre, payable in 15 annual installments. A reservoir will be built to store the water, which will be delivered to the land in cement-lined canals. The plan also contemplates the development of 40,000 horsepower in electrical energy, to be used in pumping additional water from the Columbia River.

### GAS ENGINE BLOWS ITSELF THROUGH BUILDING

After this engine had been running about 10 years, its bedplate cracked at the top where the cylinder was bolted on. A strap of iron was put on, but the bolts holding the cylinder continually worked loose, and could not be made permanently tight. As a result, the cylinder, which weighed about 800 lb. and was fastened to the bedplate by ten 1-in. cap screws, at last broke loose with explosive violence, tore its way through the door of the engine room, and landed 20 ft. away.

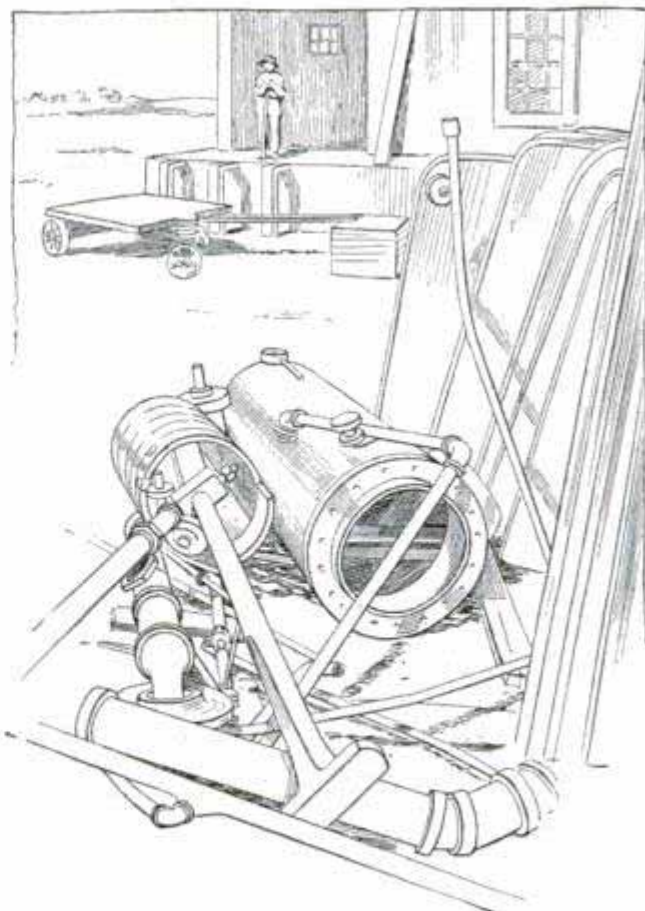

Cylinder and Piston of Gas Engine Blown Out of Engine Room



At Work in the Unsuccessful Attempt to Raise the Str. "W. C. Richardson," the Twin Pumps Emptying the Hull on the Left

## SALVING THE STEAMER "RICHARDSON"

The foundering of the steamer "W. C. Richardson" just outside the breakwater of the Buffalo Harbor during one of the terrific gales that swept the Great Lakes in December, 1909, was more or less of a mystery to marine men, and it has been a mystery ever since. The first attempt to raise her proved futile, a second also failed. In the spring of 1910 a third attempt was made, and this likewise failed, the

steel covers made for the hatches being swept overboard by the seas. A fourth attempt has met with but little more reward. When success seemed about to crown this effort, the decks fell in under the weight of the ice and the seas, and holes, somewhat difficult to explain, were found in the hull. Again the work started, then a hurricane swept the ice onto the hulk again and carried everything before it.

## GIANT AUTO TRUCKS TO HAUL 35 TONS

Arizona is about to be the scene of operations of two of the largest motor vehicles in the country which the owners term "auto freight wagons." The distinctive feature of the wagons, in addition to their tremendous size, lies in the fact that they are driven by electric current generated on the machine itself by a 90-hp. gasoline en-

gine. The trucks are 25 ft. long and 10 ft. wide and are capable of transporting a load of 20 tons at the rate of six miles per hour over almost any kind of country. The wheels have steel tires, 12 in. broad. The outer edges of the tires are smooth, but the central portion, extending about two-thirds the width of the tire, consists of

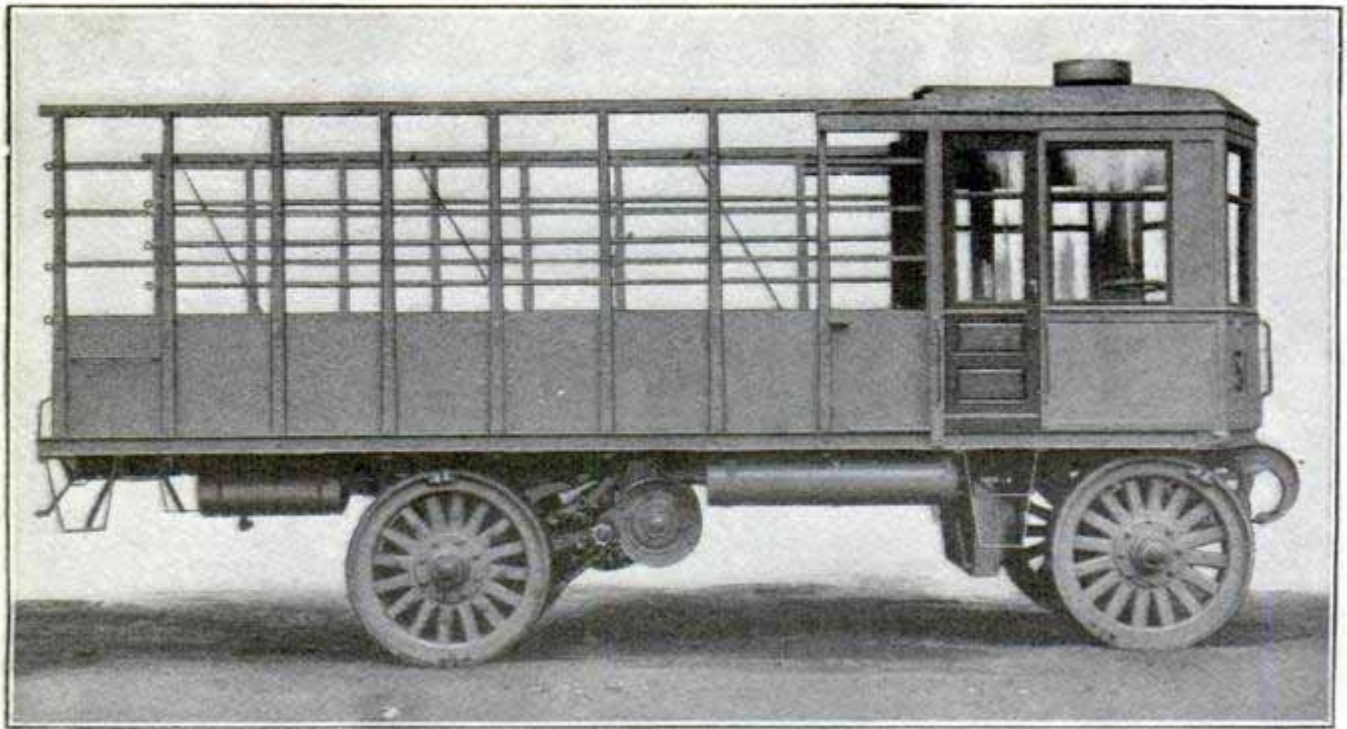

Twenty-Ton Gasoline Truck for Hauling Ore and Mining Supplies over Desert and Mountain Trails

corrugations which the builders claim make it possible to secure traction on any kind of road or even in places where there are no roads.

The gasoline engine is placed forward in a species of cab, walled off from the remainder of the truck. The engine is connected by a shaft to a 125-volt electric generator, from which the power is supplied to the rear wheel. There is a  $7\frac{1}{2}$ -hp. motor for each of the rear wheels, either of which is capable of driving the car when fully loaded. The use of electric current in place of gasoline is to obtain greater flexibility of power. The motors are connected with the wheels by chain drive. The motor-man-engineer is provided with a controller similar to that on a trolley car, in front of which is placed the steering apparatus consisting of a tiller wheel of the same style as that used on an automobile. Practically all of the machinery is in the cab, which is about 4 ft. deep and extends the width of the car.

The trucks are built of steel throughout, except the floor and the cab. The frame was especially made for the purpose and is very heavy. The trucks are to be put into service at Kingsman, Arizona, over a road 85

miles long, to carry supplies from the railroad to a mining camp and haul ore from the camp to the railroad. The capacity of the trucks is 20 tons and in addition to this they are each equipped with coupling devices that will enable them to haul trailers carrying 15 tons more.

### TO PREDICT EARTHQUAKES

With a view to obtaining data from which impending earthquakes of volcanic character may reasonably be predicted, and to make observations on ore formation within spheres of volcanic influence, several Italian scientists, under the leadership of Signor Immanuel Friedlaender, of Naples, are endeavoring to establish an international volcanological institute at Mount Vesuvius. Although an observatory has existed for some time past on Vesuvius, it is said that systematic investigation such as planned for the new institute has never yet been attempted, in any place in the world. A building and equipment fund of \$300,000, and a yearly income of at least \$10,000, are requisite for the foundation. It is aimed to secure these by the first of January, 1912.



## SCIENCE AND MECHANICS IN THE MIDDLE AGES



No. 6—AN OLIVE-OIL MILL.—The olive has been cultivated in Syria, Palestine, and other parts of the East since the earliest times. Its cultivation extends as far south as Cairo, and north to the middle of France. In the illustration is shown a sixteenth-century olive mill of southern Europe in activity. The grinding mill is worked by an ox and the press by men.

## OLD FERRY BOAT USED AS A CLUBHOUSE

An ingenious use has been made of an abandoned ferry boat in San Diego Bay. It was bought for a song, hauled up in shallow water and securely an-

chored by piles driven all around it. A trestle was built connecting the boat with the shore, and the whole interior, after being stripped of its machinery,

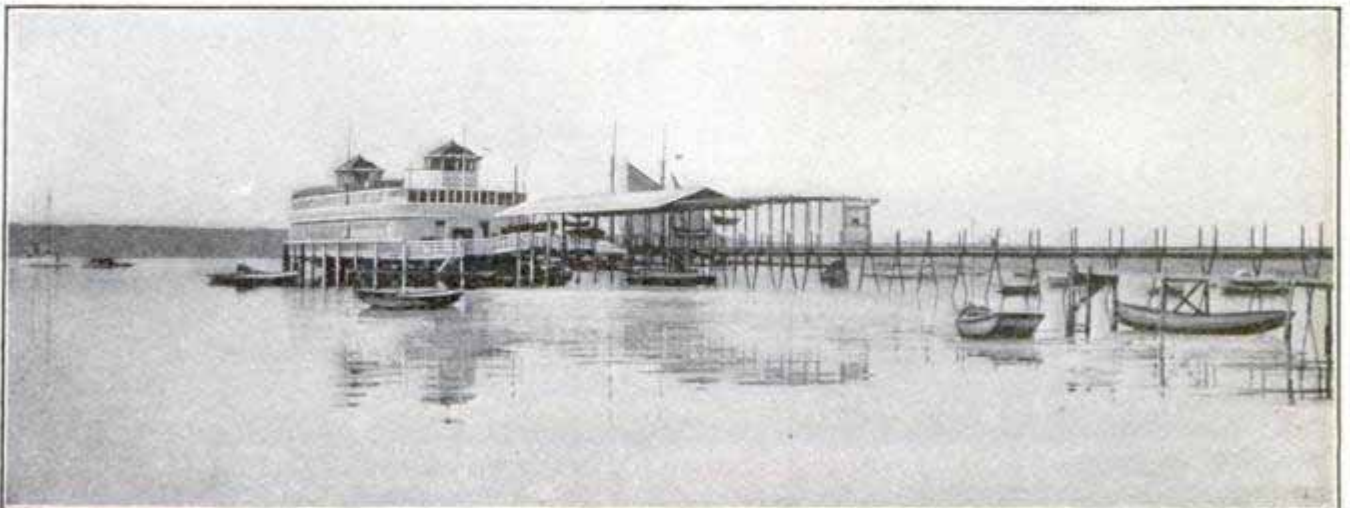

Old Ferry Boat Now Used as a Pleasure Pier at San Diego, Cal.

was rebuilt as a dancing pavilion, promenade, kitchen, dining room and in fact all that goes to make up a pleasure resort. It is the property of a yacht club in San Diego and forms one of the interesting landmarks of that beautiful harbor.

The two pilot houses form observation towers, and the old ferry boat, in its coat of glistening white paint, makes very appropriate quarters for the club.

The old "Benicia" which formerly

## COUNT ZEPPELIN RENEWS DIRIGIBLE FLIGHTS

Undaunted by the disasters that have overtaken his previous ventures in the field of aerial navigation, Count Zeppelin has begun a season's work with dirigible balloons, the first of his new fleet having made an eight-hour journey between Friederichshafen and Baden-Baden by way of Stuttgart. The new "Deutschland" is a powerful airship and on the first trip Count Zep-

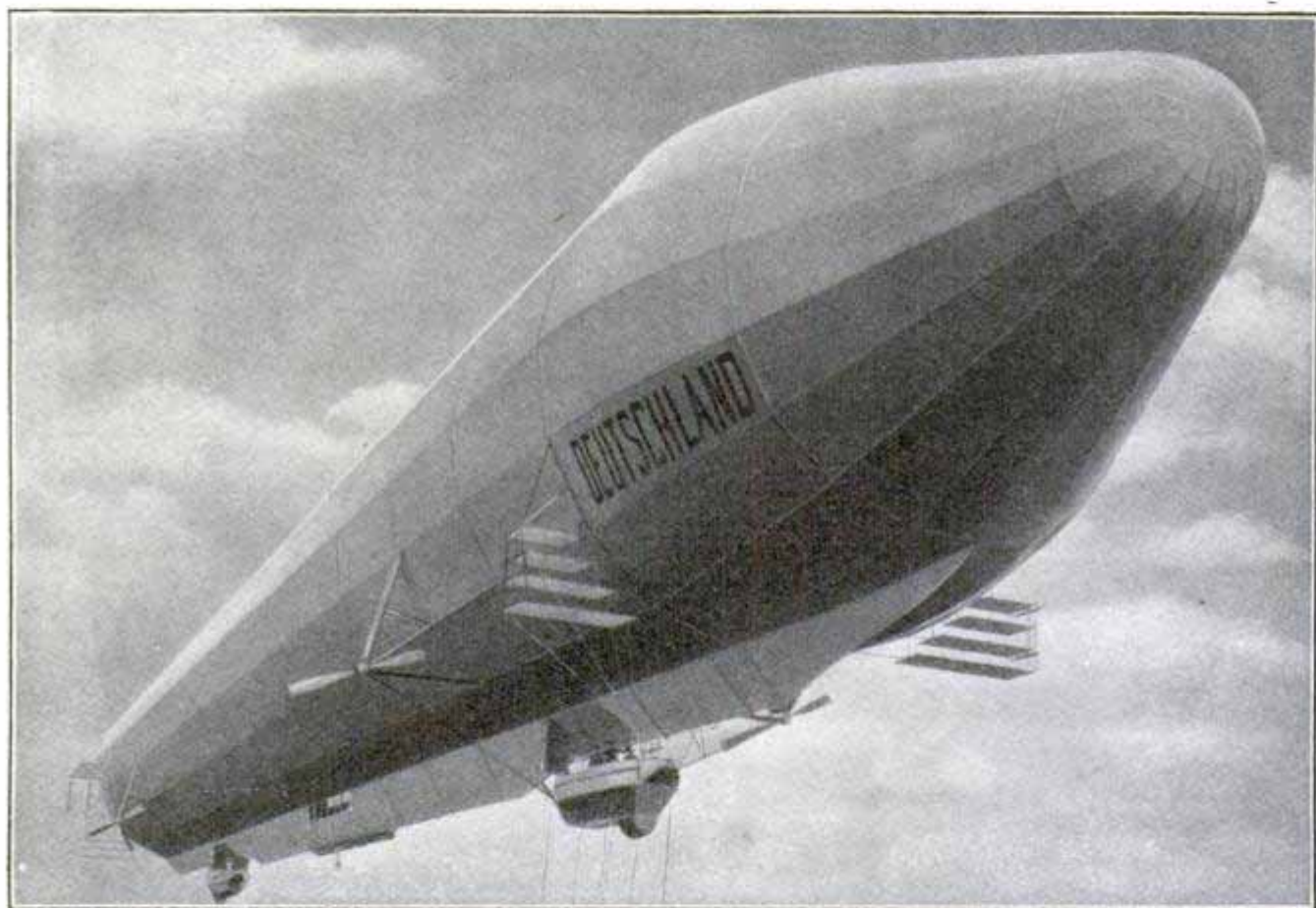

Type of the New Zeppelin Dirigible "Deutschland" Which Made Its Initial Voyage in Germany Recently

traveled back and forth in San Francisco Bay was brought down to San Diego to serve as a ferry boat between that city and Coronado, but the distance is so short between these points that the powerful machinery would hardly get started before it was necessary to stop it and the huge boat was as unwieldy as a whale in an aquarium. For that reason it was abandoned for a long time and would have rotted away if some enterprising club members had not hit upon the idea of utilizing it as described.

pelin carried 10 passengers. The German scientist has not yet made public all his plans for the summer season, but the presumption is that he will continue his efforts to establish a regular passenger-carrying dirigible service in Germany.

☐ Experts in shop efficiency and scientific management regard the distribution of labor in the big-gun practice of the United States navy to be one of the finest exemplifications of their creed to be found in the world today.

## NAVAL CRANE LIFTS ITS OWN 216-TON TRUSS

The great floating crane "Hercules" of the New York Navy Yard in Brooklyn, now reconstructed and more powerful than before, broke all lifting records recently by lifting her own steel trolley truss into position at the top of the uprights or legs. The trolley truss is 200 ft. long and weighs 216 tons.

Two weeks of preparation were required before the lifting feat was attempted. A test lift of a few feet was made with 70 tons of steel piled upon the truss, as a means of making certain that the capacity of the apparatus was sufficient. The lifting was accomplished by means of steel hoisting cables, working over eight steel pulley blocks, each of which weighed a ton and was especially constructed for the purpose. The power was supplied by the Hercules' own engines. The huge steel truss was held suspended about 45 minutes, rising smoothly and steadily. Steel pins, 8 in. in diameter, were used to fasten the truss in place.

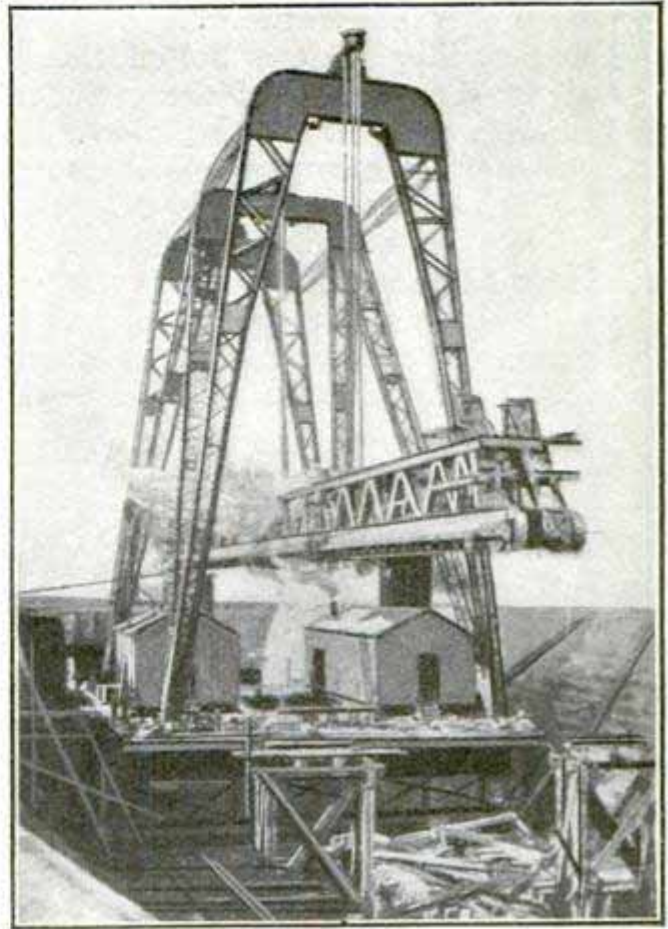

The "Hercules" Raising Her Own 216-Ton Truss into Place

## ONE-CYLINDER ENGINE FOR AEROPLANES

An interesting type of "rotary" aeroplane engine, invented by two French engineers, develops 75 hp. and weighs

only 165 lb. (1 hp. for 2 1/5 lb. of weight), although it has only one cylinder. Its special feature is the method

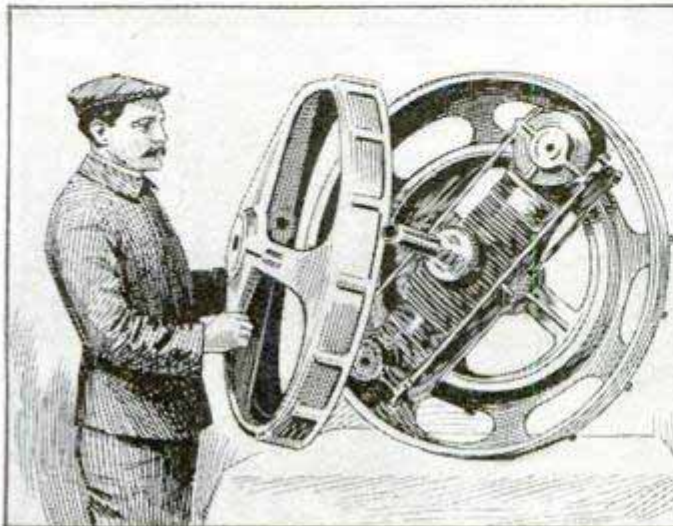

Engine with Part of Housing Removed

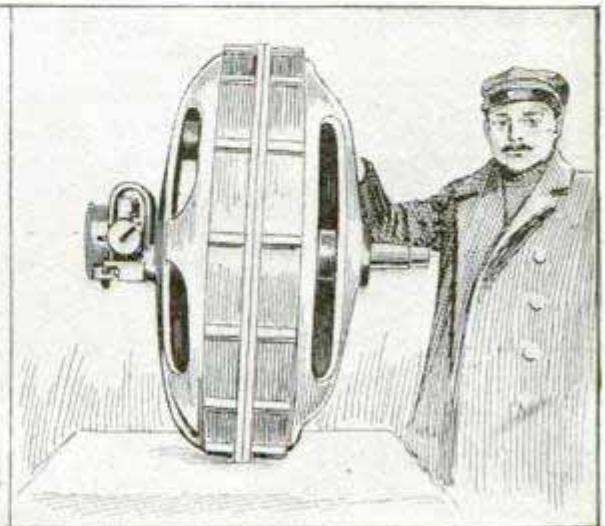

Single-Cylinder "Rotary" Engine

of gearing down an engine speed of 4,000 revolutions a minute to a propeller speed of 500 revolutions.

The propeller shaft is bolted transversely to the middle of the cylinder and rotates with it. In the middle of this cylinder is the combustion chamber from which two pistons work in opposite directions to rotate, by their connecting rods and cranks, a pair of small gears or pinions, there being one pinion outside of each crankcase at either end of the cylinder. These pinions run

around on a large stationary gear wheel, concentrically arranged with regard to the cylinder, thus forming a "sun and planet" gear. The proportions of the pinions and large gear wheel determine the speed reduction, which is chosen in this case as 8 to 1. The pinions carry around the cylinder, and therefore the propeller shaft, at the reduced speed made possible by the gearing arrangement. The whole is enclosed in a stationary aluminum housing.

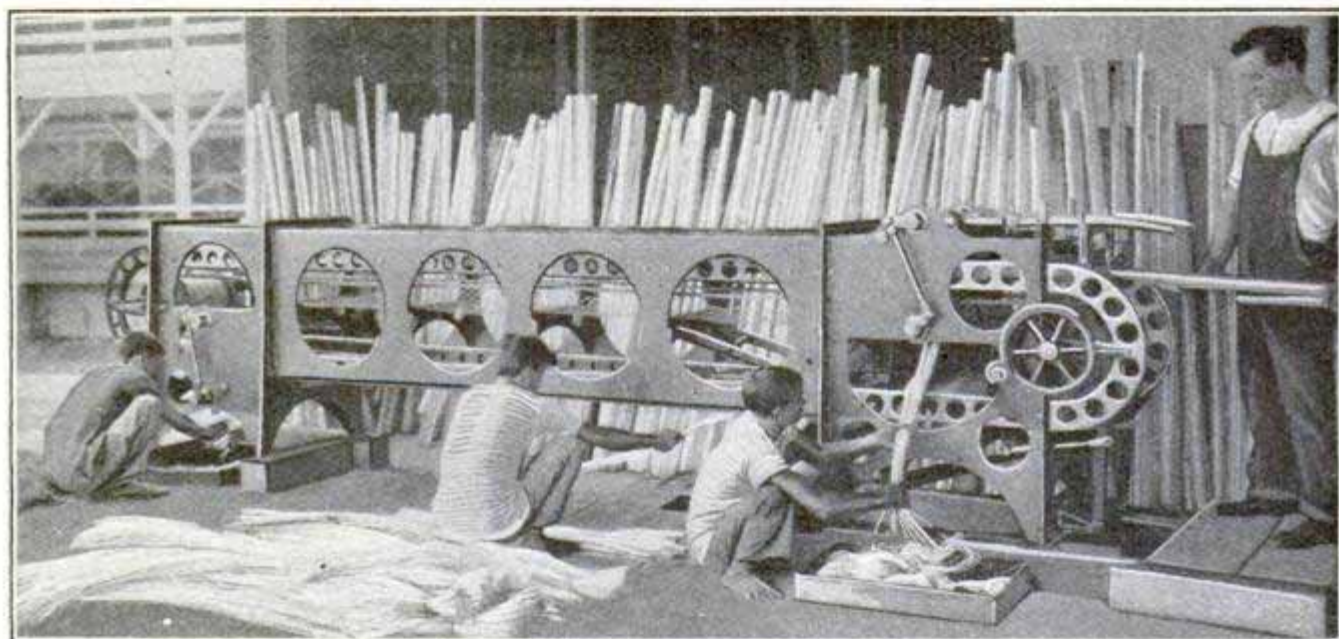

Machine that is Relieving the Filipinos of the Laborious Work of Stripping Hemp Fiber

## MACHINE REPLACES HANDS FOR STRIPPING HEMP

By MONROE WOOLLEY

The world's hemp supply, unlike Manila paper, comes from the Philippines. Until a few years ago all hemp produced in the islands was stripped from the stocks of the plant from which it is taken by hand, a slow, tedious, and wasteful process. When Americans first landed, one of the first things to attract the attention of the commercially inclined was the need of a machine to harvest hemp. Soldiers, government officials, merchants, and school teachers set themselves to the task of inventing one, dreams of wealth and fame urging them on. For ten years they struggled with their schemes but

it was not until as late as 1907 that a machine of real worth was given a trial in Manila. Shortly after, two or three others of value appeared, and were given public tests in town and in the field, all coming off with more or less honors.

The most successful of these, which is driven by steam or electricity, does the work of a small army of native Filipino strippers, does it quicker, and turns out a much superior grade of hemp than that obtained by the hand method.

Hemp is produced from a fibrous plant much resembling the banana

plant. The long strands of fiber which look like golden threads, and which we see every day worked up into rope, are stripped from the trunk of the plant. These trunks, when the outer leaves are trimmed away, greatly resemble over-grown stocks of celery, as will be noted from the stack of the raw product standing just back of the stripping machine in the illustration. Formerly the natives stripped the strands from it by means of a toothed knife, similar to a saw or comb, which they raked over the pithy substance.

The hemp-stripping machines do away with all the faults and flaws. Most of the machines have a set of teeth which revolves and starts the strands from the stock. Later, a system of cylindrical brushes made of wire, complete the operation of separating all the pulp from the strands, leaving the latter clean, even, and of a uniform length. The pulp and waste is carried by belt conveyors to refuse piles, from which it is hauled away to be worked up into merchantable by-products. Hemp-stripping machines as perfected by most of the American inventors are made in two or three sizes. One size is adapted to hand operation, another is a portable power plant.

### METALLIZED PAPER

Metallized paper is being manufactured by a German process as a substitute for tinfoil. Ordinary paper is treated with a mixture of finely powdered metal and resin and then subjected to friction, with the result that it becomes as flexible, brilliant and impermeable as sheets of tinfoil. Wax or an alcohol solution of gum lac may be used instead of the resin.

In making the tinfoil paper, either pure tin in a powdered state may be used, or a mixture of aluminum powder and tin. The final polishing is done by calendering, which, hitherto always done with heated rollers, is accomplished in this process by means of refrigerated rollers.

### SCARECROW PROTECTS SUNSHINE RECORDER

The erection of scarecrows as a means of protecting fruit or grain from birds is very common, but this is one



Scarecrow Protects Sunshine-Recording Apparatus from the Curiosity of Seagulls

of the first instances recorded in which such a means has been adopted to protect an object not edible. The scarecrow in question is placed beside the sunshine-recording apparatus at Ventnor, Isle of Wight, the working of which had been interfered with by curious seagulls.

### WHEEL FOR MOTOR TRUCKS

In this wheel for heavy motor trucks, the spokes at the hub end are grooved and mortised so as to interlock, forming what is claimed to be an absolutely

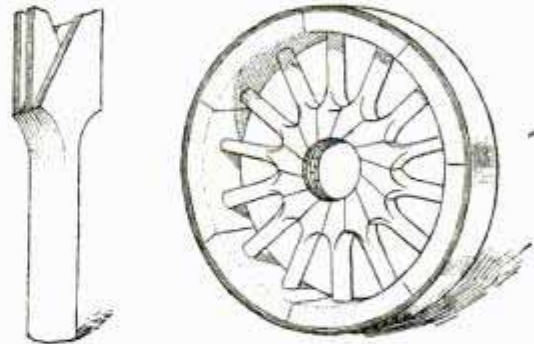

Interlocking Spoke, and Truck Wheel Made of Such Spokes

compact, immovable assemblage that cannot loosen under the most severe strain. This design is intended to give a positive and evenly distributed spoke support, thus reducing to a minimum the chances of breakage.

## CLEARANCE CAR OF THE PENNSYLVANIA SYSTEM

The new clearance car of the Pennsylvania Railroad lines, now being run as rapidly as possible over every division east of Pittsburg and Erie, in order

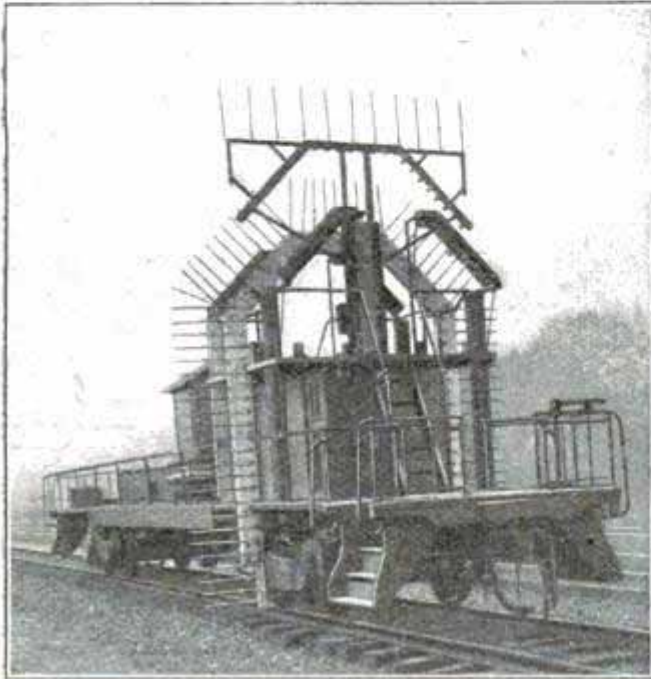

Clearance Car of Pennsylvania Railroad, Showing Stationary and Auxiliary Templets

to secure measurements of the distances from the tracks to projecting portions of station buildings, tunnels, bridges and other objects, is equipped with ingenious automatic mechanisms. The clearance measurements are made by means of templets, one of which is an auxiliary templet for overhead measurements. The car is also designed to indicate automatically the elevation and degree of curvature of the rails while running over curves.

All measurements are taken at the center of the wheel truck, from which clearances are computed. The main templet, which is erected directly over the center of the truck, has a width of 10 ft., and rises to a height of about 12 ft. above the top of the rail. In front of the main templet is an auxiliary templet, designed to measure overhead bridges, tunnels and other objects whose elevation is from 17 to 20 ft. above the top of rail. Attached to the sides and tops of the templets are fingers or feelers, 2 ft. long, spaced 6

in. apart. They are hinged to the templets and held in the different positions by friction. Attached to the feelers and the side of the templet are graduated scales which automatically indicate the distance from the rim of the templet to the side or overhead object touched by the feelers.

The attachments for measuring the track elevation and degree of curvature of curves consist of a device on the rear truck, the recorder of which is in a cabinet erected in the middle of the car, and a vertically suspended pendulum, likewise within the cabinet.

As all the attachments work automatically, it is possible to take all the measurements while running at a speed of four miles per hour.

## REINFORCED MACADAM PAVEMENTS

Many experiments are being made in Europe in the hope of finding a comparatively inexpensive type of paving that will withstand the destructive action of automobile traffic. Trials have lately been made in France with a so-called reinforced macadam, the idea of a road superintendent in the department of Vendee. The bottom layer of this pavement is concrete, the middle layer is of cement mortar reinforced with iron rods, and the top layer is crushed stone and mortar.

This road surface is said to be much more elastic and durable than ordinary macadam, and in cost does not exceed that of brick paving in France.

☞The withdrawal of France from the international distance aeroplane flights planned in Continental Europe is believed to have been caused partly by a feeling of resentment over the statement made in the Reichstag at Berlin that implied Germany was in the lead in aeronautics and aviation. The flights in question were to take place between German, French, and Belgian cities but will now be held wholly within the boundaries of Germany.

## MAGNETIC SHIP ON WHEELS

The Naval Observatory at Washington has recently installed a machine by which the magnetic effect of the steel and iron parts of a ship upon the ship's compass can be measured. The same force that turns the compass needle north and south also magnetizes the iron and steel of the ship. This magnetism naturally influences the compass needle, and must be compensated for if the ship is to be steered correctly.

The machine at Washington represents the bow of the vessel and has a full-sized compass on board of it. The whole can be placed in one room. It is set up on a circular track so that the bow may be directed to all points of the compass. A horizontal steel plate on top represents the soft steel of the ship, the magnetism of which changes with the direction of the vessel. The hard steel of the ship, which is permanently magnetized by the earth's influence when

the vessel is building, is represented by bars laid across the plate at right angles. Small bar magnets can be inserted beneath the compass to correct deviations, and this correction is further aided by two big balls of iron placed one on each side of the compass. Various adjustments are made

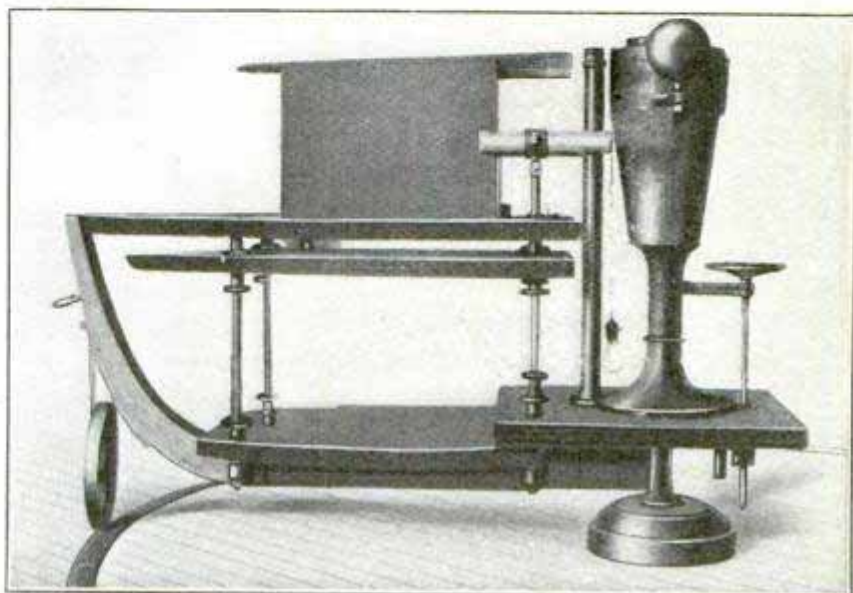

The Magnetic "Ship"

as the machine is rotated, so that finally the compass registers correctly in any position, just as if it were placed on an actual vessel afloat on the ocean.

## DISEASE MIXES SOUNDS AND COLORS

Physicians now recognize a condition which probably accounts for the hallucinations and delusions of the insane. It is called synesthesia, and those afflicted with it are known as synesthetics. It is that peculiar condition in which sounds create the idea of colors, and vice versa, or in which colors, tastes, sounds, and odors are confused.

"Synesthesia is not a matter of much practical importance," says American Medicine, "but it is highly interesting, to say the least. It is that curious phenomenon of the overflow of sensations so that air waves for instance, give a sensation of color as well as sound. It

seems that through some defect of development the cortical centers (of the brain) are not insulated from each other completely, so that a stimulus received from the retina, say, is not confined to the visual centers, but affects adjoining ganglia.

"The commonest form is colored hearing, and most of the cases of synesthesia investigated up to a few years ago were of this type. No two were alike, that is, the same sound would cause different colors or shadings in the different cases; a locomotive whistle would be yellow to one, or white to another, and so on.

"Moreover, in some cases only a few sounds are colored, such as the

tones of a piano from black in the bass to white in the upper keys, with a spectrum in between. In other cases every sound has a light sensation added to it. Then there are cases in which colors or odors give sound sensations—glaring colors being loud, literally as well as figuratively, and, of course, there must be an infinite variety of mixtures of the other sensations.

“The most distressing cases are those in which there is an actual confusion of sensations, so that odors and tastes and sounds are not differentiated. No doubt these abnormalities are at the basis of many delusions and hallucinations of the insane.

“The nervous instability of synesthesics is the practical side of this subject. Without an exception, the cases present evidences indicating considerable nervous involvement, in the way

of abnormal development. Some, if not most of them are highly intelligent, though incapable of that hard work necessary for success, and all are very sensitive to irritations which the average man ignores.

“Perhaps the condition is far more common than we imagine, and it would be well to keep it in mind in the treatment of neurasthenics. We might find that they are great sufferers from jarring sensations, not in the way usually thought of, but in these overflows to other centers.

“A normal woman may be made actually ill by garish colors or coarsely arranged music, and we all know the bad effects of certain tastes and odors; how much more suffering there must be in synesthesics where the irritant affects more than one center.”

## MOTOR STREET CLEANER ABSORBS THE DEBRIS

Instead of sweeping the debris to the curbing, where it would later have to be shoveled into piles and carted away, this motor-driven street-cleaning machine collects and carries it to the dump, where it is disposed of.

Its essential parts are a motor-driven truck, a rotary broom, a belt-conveying device, and a large dust and dirt compartment mounted on the rear end of the truck. A 40-hp. engine supplies the power for propelling the machine and operating the broom and conveyor. Two men are required to operate it, a driver on the front end, and an attendant to control the sweeping operations.

It is claimed that with this machine, streets can be thoroughly and rapidly cleaned without water and without causing dust, permitting cleaning during the

winter months when water cannot be used. The suction or vacuum principle is not involved, the debris simply being swept up on the conveyor by the rotary broom, and carried into the dust compartment of the machine.



This Street-Cleaning Machine Sweeps Up the Debris, Conveys It into a Dust Compartment and Carries It to the Dump

This machine is being thoroughly tested out by the New York street-cleaning department.





# Shop Notes

## How to Kill Dandelions

An easy way to kill dandelions in lawns is to apply kerosene to the roots of the plant. Cut the root about 1 in. below the surface and apply a few drops of the oil before the earth is pressed in place. The plant will not grow from a root treated in this manner.—Contributed by Charles W. Cooper, Oakland, Cal.

## A Sanitary Drinking Fountain

The illustration shows a simple method which I have used for some time as a sanitary drinking fountain.

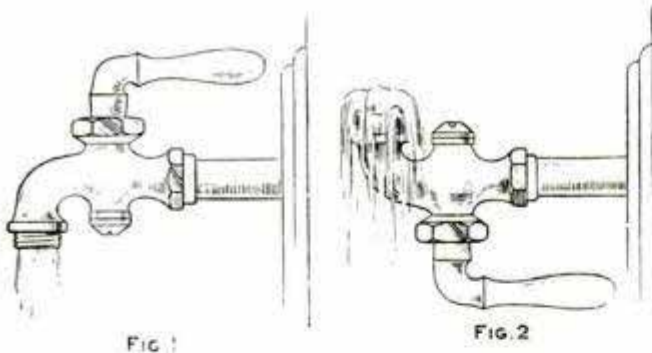

FIG. 1

FIG. 2

Faucet Turned Over

In most shops no cup or glass is kept for drinking purposes. If the ordinary faucet (Fig. 1) is turned half way round, as in Fig. 2, it makes a sanitary fountain such as found in parks. When through drinking, the faucet can be turned to its original position.—Contributed by Walter C. Heidt, Chicago.

## Felling Trees by Fire

A method of felling spruce trees by fire is shown in the sketch. A hole is bored horizontally into the trunk of the tree for about 1 ft. and another hole bored at an angle to meet the first one

(Fig. 1). Hot coals are placed at the intersection of the holes so as to ignite

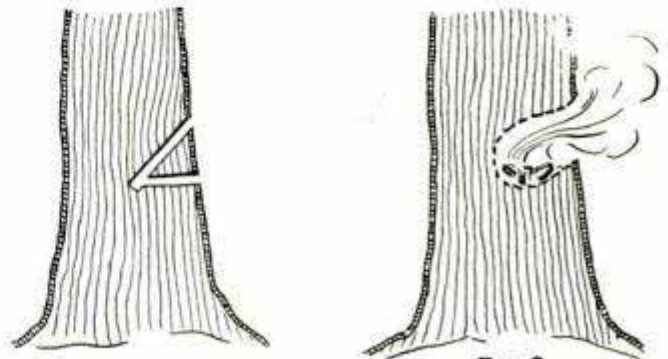

FIG. 1

FIG. 2

Firing a Tree

the pitch running from the pores. The draft will cause a rapid combustion and in a short time the tree will be burned through, causing it to fall toward the burning side.—Contributed by A. J. Staver, Portland, Oregon.

## Repairing a Lawn-Mower Ratchet

A worn driving-pin or shoulder of the ratchet on a lawn-mower will

cause the wheel to slip at times instead of driving. A longer pin will rectify one defect, but if the shoulder is rounded, it can be rem-

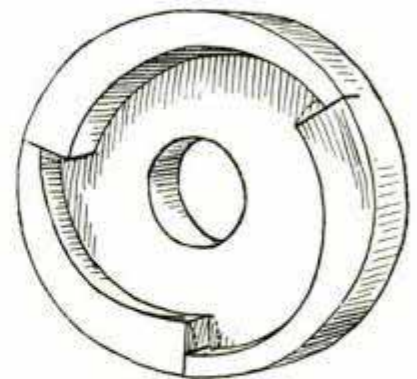

edied by cutting through the casting with a hacksaw so as to make a new straight shoulder. The heavy line shows the saw cut and the dotted line the part removed.—Contributed by Frank S. Henry, Haddon Heights, New Jersey.

### Cutting Arcs on a Metal Planer

Quadrants may be machined to any arc of a circle on an ordinary metal planer by using the attachment shown

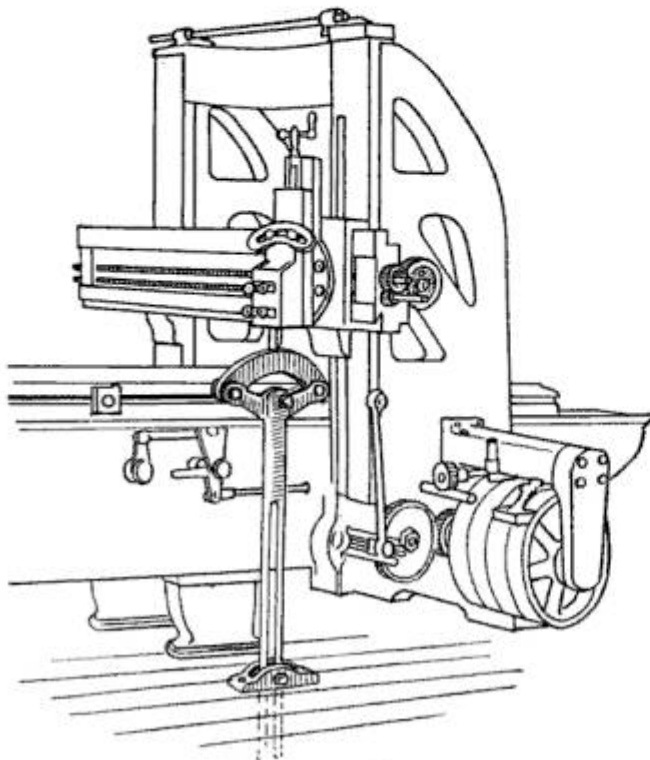

Rocker on Planer

in the illustration. The device rocks on a bolt for an axis. This is set in the tee slot on the side of the planer bed. The rocking motion is caused by a slotted arm that passes through a metal block on the floor. This block is fitted with a pin to slide in the slot of the arm.

If the arm is slotted at both ends, it will provide an adjustment for cutting various sized quadrants.—Contributed by Carmi L. King, Concord, New Hampshire.

### Cleaning Gas Mantles

Because of the imperfect combustion of the carbon in the modern gas lighting jet, when a mantle is used, the part enclosed usually collects a deposit of carbon which shortens the life of the fixture and gives to the mantle a smoky appearance.

The carbon can be removed and the mantle cleaned by sodium chloride, better known in household circles as salt. It may be gently sprinkled on

the burner or in it, if possible, while the gas is burning. The salt unites with the carbon, leaving the gas burner and mantle clear of it, and coated with a substance that will not allow carbon to deposit on the burner or mantle for some time. The application of the salt is perfectly harmless and no injury can result to the fixture.

A large quantity of salt is not needed. The same material can be used in cleaning gas stove burners and gas irons which collect carbon deposit inside while being used.—Contributed by Loren Ward, Des Moines, Iowa.

### Holding a Door Open

A clip that will hold a door open and work almost automatically is shown in Fig. 1. It is made of a piece of strap

iron 1 in. wide and about 6 in. long. Both ends are turned up as shown and a hole drilled in the center for a screw.

When set in the position shown in Fig. 1, the movement of the door will cause the clip to turn over the end as in Fig. 2. In closing the door the clip is turned with the foot.—Contributed by J. C. Judkins, W. Medford, Mass.

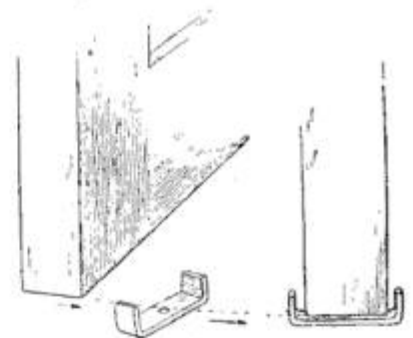

FIG. 1

FIG. 2

### Renewing an Old Brush

Anyone who has used a common brush for any length of time finds that the point end will wear faster than the



Reversing Brush Handle

heel and the brush becomes tapering as shown. If one is inclined to economize in such matters, it is possible to

get nearly double the wear out of a brush by squaring the worn end, sawing off the handle and fastening to the opposite end as shown by the dotted lines in the sketch. The wear will then come on the unused part.—Contributed by C. S. Bourne, Lowell, Mass.

### Space Economy in a Lumber Yard

A western lumber man, who has a limited space in the city for piling his stock, has hit upon an ingenious way of stacking lumber so that it can be within reach and take up very little room. A strong rack of 6 by 6-in. material was built and the lumber was up-ended against this, care being taken to balance the stacks on each side so that the support will not be forced out of plumb. In this way the owner was able to carry a great variety of lengths and sizes which would otherwise require many times the ground space, and in addition to that, he could pick out any particular piece he required with less trouble than it could be sorted from an ordinary flat pile.—Contributed by C. L. Edholm, Los Angeles, California.

### Hardening Hammers

Hammers for working iron and steel are hardened with good results in the following manner: Heat the hammer to a cherry red, using a blast to produce a quick heat, then hold it so that a stream of water will strike the face and flash away from the eye. This will temper the face only, with the hardest part in the center. This will prevent water cracks and the cracking of the metal through the eye. A bucket with a hole in the center of the bottom (Fig. 1) or a siphon placed in a tub of water (Fig. 2) will do equally as well as the faucet shown in Fig. 3.

Do not take the hammer away from the water until it is perfectly cold, as it is not necessary to draw the temper. Ball-peen hammers are tempered in the same way, only less heat is used. If the steel be of a poor grade or a

harder temper is wanted, then hold the hammer lower down in the stream of water.

Hammers tempered by this method

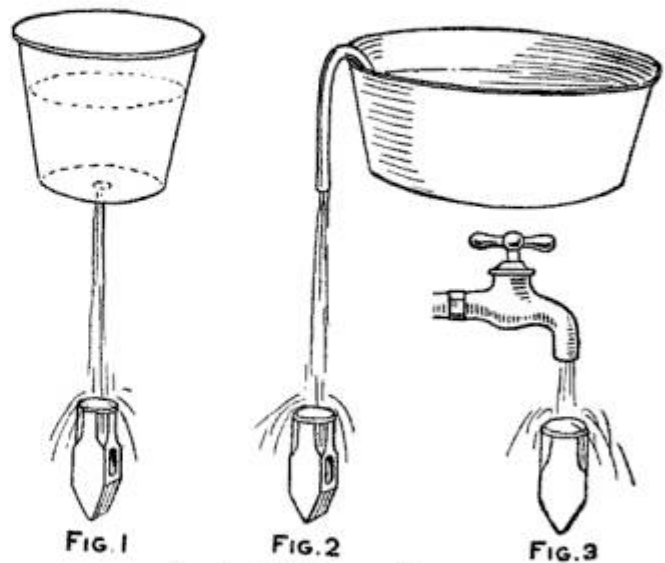

Pouring Water on Hammer

are good for working iron or steel, but it is not the right temper for stone and brick work.—Contributed by James E. Roy, Philadelphia, Pa.

### Gauge for an Anvil

A length gauge that can be easily placed in the round hole of an anvil and used for measuring while cutting red-hot metals is shown in the illustration. The gauge consists of a T-shaped rod with an adjustable attach-

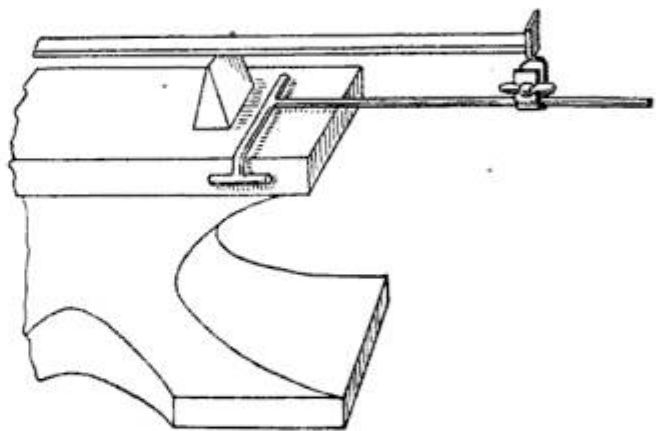

Gauge on Anvil

ment to set for the lengths to be cut. The method of construction is obvious and further explanation is unnecessary.—Contributed by Raymond E. Chase, Mellville, R. I.

## Repairing a Broken Jaw on a Chuck

The lower lug on the jaw of a chuck used on our 18-in. lathe broke at a time when the shop was rushed with

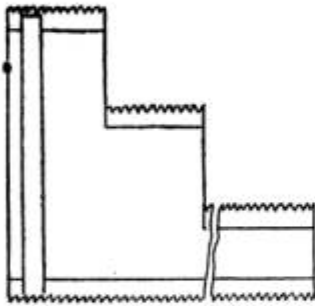

FIG. 1

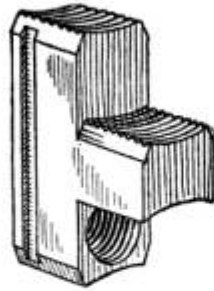

FIG. 2

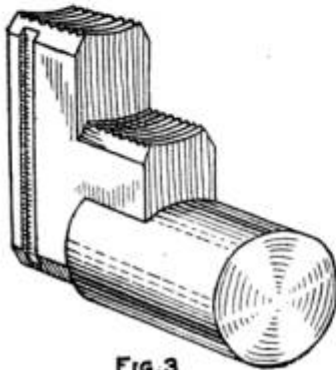

FIG. 3

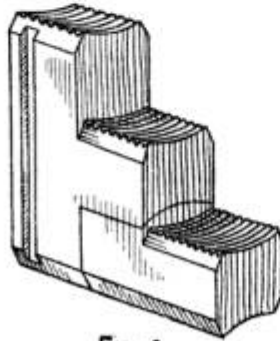

FIG. 4

Broken and Repaired Jaw

work, and a repair was made as shown in the sketch.

The broken jaw (Fig. 1) was placed in another chuck and the broken part centered. The piece was turned out so that a part of a circle remained on the lower part of the second lug. A hole was drilled in the center and tapped (Fig. 2). A piece of metal was then turned up round and one end threaded to fit in the hole. The round piece was plenty large (Fig. 3) to square up on a shaper and finish as shown in Fig. 4. The repaired part proved to be as strong as the other jaws and it saved considerable time that would be required to receive a new one from the factory.—Contributed by W. R. Ayers, Pittsburg, Pa.

## Distinguishing Wrought Iron from Steel

For many purposes wrought iron is superior to steel, although large quantities of soft steel are now used where wrought iron was previously employed. Wrought iron resists corro-

sion better than steel, as the slag in the fibers acts as a protective coating when corrosion sets in. For skimmers and stirrers used in brass melting, wrought iron lasts much longer than steel and should be used for this purpose. The Brass World gives a test that will serve to indicate the difference between wrought iron and steel. The sample to be tested is cleansed of grease and scale by scouring and is then immersed in a solution composed as follows:

Water .....	9 parts
Sulphuric acid .....	3 parts
Muriatic acid .....	1 part

The acids are poured into the water and allowed to cool. A glass or porcelain vessel is used. The specimen is allowed to remain in the solution for 15 or 20 minutes, when it is removed, rinsed in water and dried with a cloth. The fibers should now show plainly; but if not, the specimen is returned and allowed to remain longer. As iron is made up of a series of fibers, with slag between, it is a simple matter to distinguish it. Soft steel dissolves uniformly and without the fibrous structure found in wrought iron.

## Truck for a Refrigerator Drip Pan

Having been troubled with spilling water when drawing the drip pan from under the refrigerator, I devised the simple pan truck shown in the sketch. The wheels are  $2\frac{1}{4}$  in. in diameter with  $\frac{1}{2}$ -in. face. The size of the refrigerator will determine the dimen-

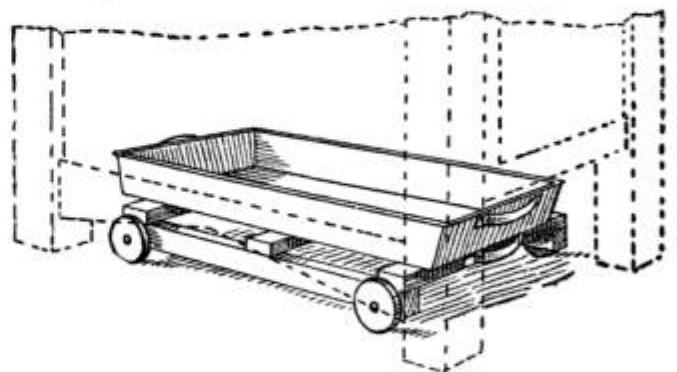

Pan on Truck

sions for the truck frame which can be made of spruce. The handle is made of a strip of tin.—Contributed by J. E. Cooley, Hartford, Conn.

**Gauge for Marking Tapering Octagon Poles**

In making a flagpole or a mast, it is essential first to taper and square the stock and then cut it to an octagon before rounding. A gauge is shown in Fig. 1 for making the lines necessary to reduce the wood to an octagon. The gauge is made of a piece of pine, 1 in. thick, 2 in. wide, and about 4 in. longer than the widest dimension on the end of the pole. Cut the wood as shown in Fig. 2, so that it will fit neatly over the large end of the pole.

Lay out the octagon on the end of the pole and the distance AA will be the depth of the cut from the corner. Drive a nail through the gauge at each

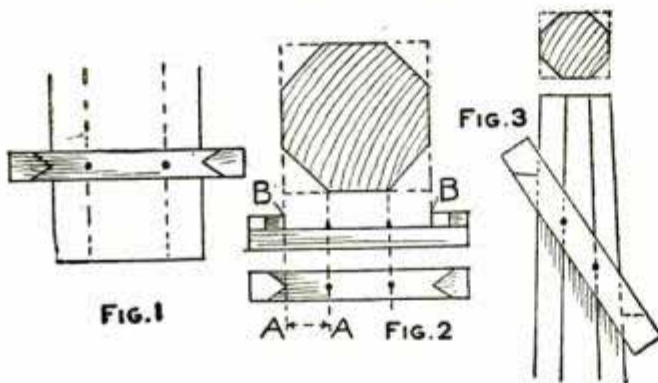

Positions of Gauge on Pole

inside point, A, and sharpen the ends for markers. Start the gauge at the large end of the pole and pull it toward the smaller end, at the same time twisting it so that the points BB will be close against the wood. The gauge in position at the small end of the pole is shown in Fig. 3. The points BB are shaped so the gauge can be turned as it slides toward the small end of the pole.—Contributed by F. O. Andersen, San Francisco, Cal.

**Repairing a Broken Locomotive Wheel**

The crank part on a locomotive drive wheel was cracked in two places, as shown in the illustration, and an inexpensive repair was made by shrinking a 1½-in. square band of metal around the contour of the

crank. To keep the band from slipping off, the metal on the hub was

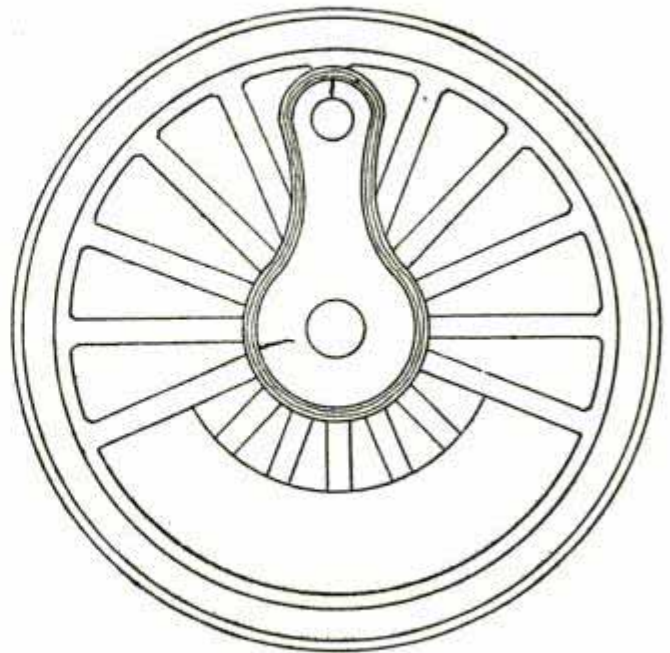

Band Shrunk on Cracked Crank

chipped off on an angle toward the center.—Contributed by Benjamin H. Baird, Kingsland, N. J.

**Plant Protector**

A device for protecting plants from wind and rain can be made from stakes and a piece of canvas. The stakes may be of any desired length and if more than two are used, the plant can be protected from all sides. Three

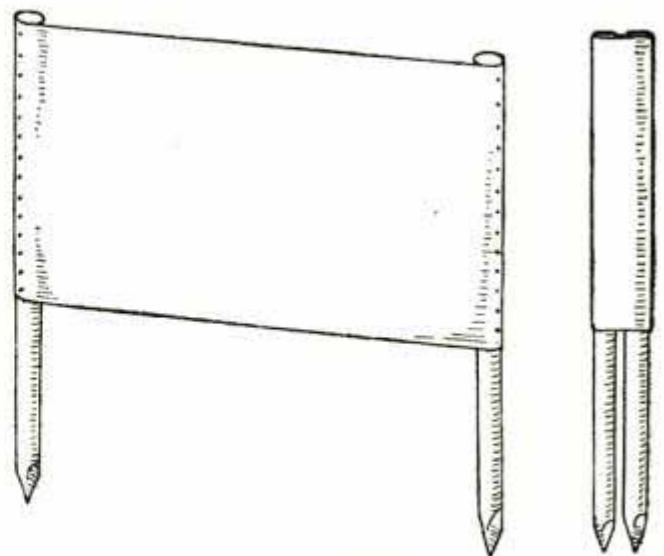

Canvas on Stakes

stakes will form a triangle and four a square. When not in use, it can be rolled up and put away.

## An Inexpensive Drilled Well

By J. G. ALLSHOUSE

The unhealthful well sunk by old-fashioned methods, is practically a thing of the past in all localities where drilling machines are to be found. The only safe and successful way of get-

In Fig. 1 is shown some tools the writer used successfully to drill a well 34 ft. in depth. Any blacksmith can make them. To a bar of iron about 1 in. in diameter and 5 ft. long weld enough steel to form a bit. This bit (A) should be fashioned as nearly as possible like the regular bits used on heavy drilling tools. The face of the bit, or the gauge, can be about  $2\frac{1}{2}$  in. for starting the well, then reduced in gauge after the well is cased. A sand pump or bailer shown at B is necessary. It is made of a piece of  $1\frac{1}{2}$ -in. tin pipe about 3 ft. long with a heavy wire bent in the form of a bail and fastened in one end. A dart valve is placed in the other end. It is made by driving a wooden ring or core into the pipe so it will act as a valve seat for a piece of leather, through which a large nail or spike about 3 in. long has been driven. The valve seat is held in place by several small nails or tacks driven through the tin. In case the tin pipe cannot be procured, 1-in. iron pipe may be used. Manila rope,  $\frac{1}{4}$  to  $\frac{3}{8}$  in., is heavy enough to use with the bailer. For the drilling tools use  $\frac{3}{8}$ -in. or  $\frac{1}{2}$ -in. rope.

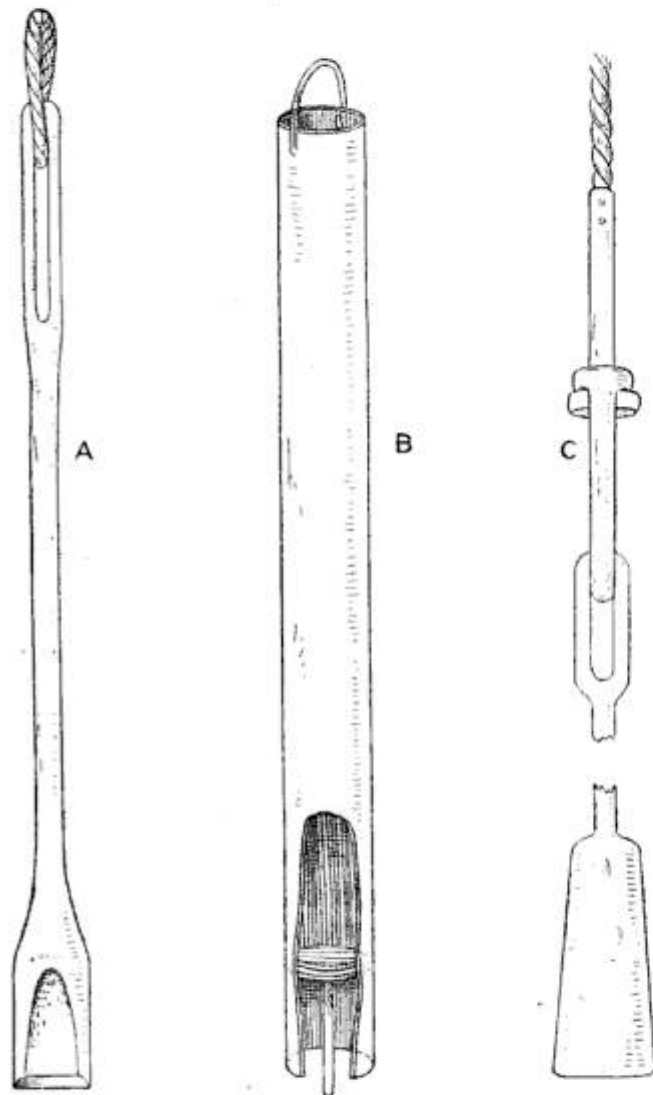

Fig. 1—Drilling Tools

ting a supply of well water is by casing to the rock, thus cutting off the impure surface water, and drilling into the rock until an artesian stratum is struck which furnishes water made pure by filtering through the rocks and sands of the earth. Where it is not possible to drill a well because of the expense or the lack of suitable machines, the dweller in the rural districts or suburbs, who has average mechanical ability, can accomplish the purpose by his own work and the use of easily constructed tools at an insignificant cost.

The tool shown in C is to be used when drilling a deep well. Two pieces of  $1\frac{1}{4}$ -in. pipe, one 5 ft. and the other 10 ft. long, are required to make this tool. Make from suitable material a pair of jars, which loop together like links in a chain with a play or stroke of about 18 in. These links each have a shank 1 ft. long, welded into each piece of the pipes mentioned. The one link is left open until they are welded to the pipes and then the link is closed by welding. The links must be made small enough to work freely inside of a 2-in. pipe. Make a steel bit like the one for the tool first described with a shank 1 ft. long, which is welded into the remaining end of the 10-ft. piece of pipe. Drill several small holes in the end of the 5-ft. piece of pipe to attach

the rope. Take a piece of 1-in. rope as long as will be required and fasten one end in the pipe with rivets. After riveting, drive some soft-wood wedges round between the rope and metal of the pipe.

The rig or derrick is made as shown in Fig. 2. It is about 15 ft. high, simply constructed of poles or scantling with pulleys, and any suitable windlass. A ratchet device can be attached to the windlass to regulate the rope, and a brake to save time when lowering tools in the well. The illustration shows the manner of drilling. A jerk line tied to the main rope is used to raise the tools and let them drop. The main rope is kept taut to get all the drop possible, and as the drill cuts deeper, it is let out gradually. If too much rope is let out at a time, it will be impossible to keep the hole round and smooth. Allow the tools to drop without aid in turning and they will make a nice round hole in rock. When drilling keep 2 or 3 ft. of water in the hole and after sinking

if it becomes wedged in the hole. A few upward strokes of the jars after

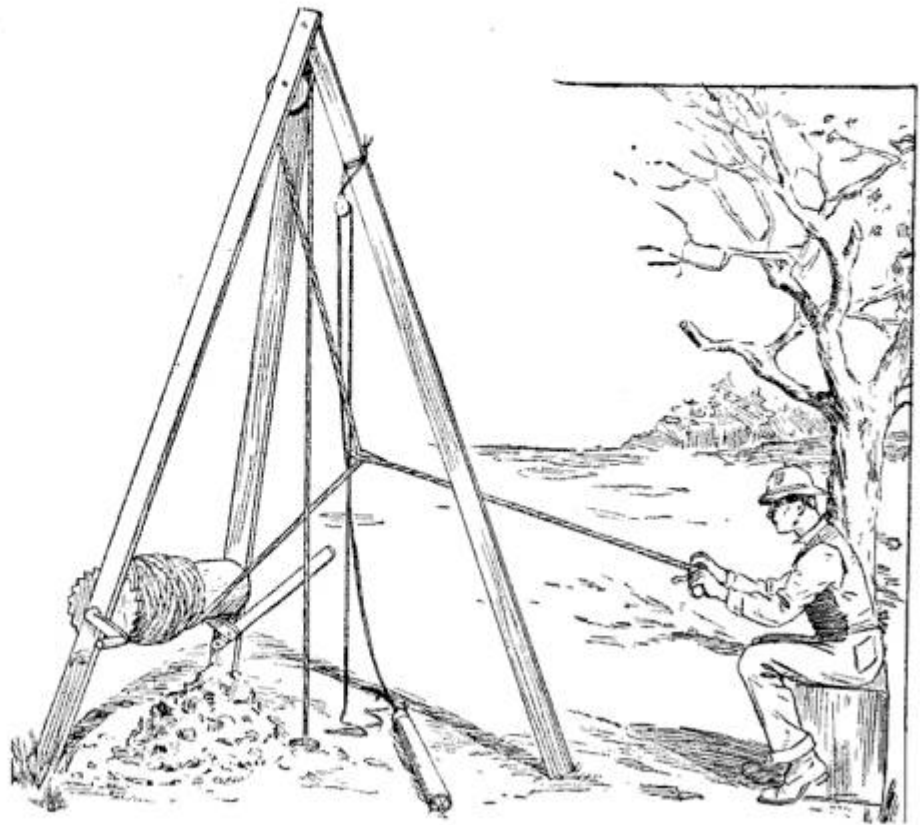

Fig. 2—The Derrick

loosening the ropes will be sufficient to remove a wedged drill. It is best to start a hole with a 2½-in. bit and after it is down below the soft clay, which is liable to cave in, drive a joint of 3-in. casing. Continue drilling inside of the pipe until the hole is below the strata of surface water and impure drainage and case the well with 2-in. pipe. Reduce the size of the bit to 1¾ in. and continue drilling inside of this casing until pure water is found. Drill deep enough below the point where this water is found to insure a basin to hold water enough for immediate demands, if the flow does not come fast enough.

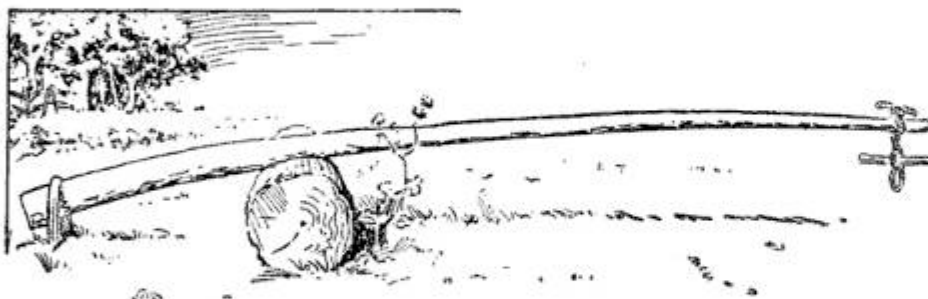

Fig. 3—The Spring Pole

from a few inches to 1 ft., as the case may be, pull the tool out and use the bailer to remove the sediment from the bottom of the well. The sediment mixes with the water and enters the bailer through the dart valve. The jars enable the driller to loosen a tool

When drilling a deep well, use a spring pole as shown in Fig. 3 in connection with the derrick. This pole should be from 20 to 25 ft. long with a block placed under it, 8 ft. from the end fastened to the ground and in such a manner as to raise the end of the pole

over and about 4 ft. up from the hole. The rope holding the tool in the well is fastened to the pole with clamps which are arranged to turn on a swivel or by a link large enough to receive a loop of the rope. There should be a handle above the clamps or the link for use in turning the swivel. The first 15 ft. will be the hardest to drill with this rig and tools. If the formation is clay, a  $2\frac{1}{2}$ -in. well auger may be used to drill the first 15 ft., but if it is gravel or the like, the tools must be spudded in the same as with the derrick, until the hole is deep enough to use the spring pole.

The bits used with either of these methods determine to a great extent the ease and speed of drilling. For soft material they may be made rather sharp and shaped as in C, Fig. 1, but

for rock, the bit needs to be fashioned more like the ones used on heavy water-well, oil or gas-well machinery, that is, a rather short bevel for the cutting edge—in fact almost blunt. As it wears out of gauge, even if not too dull to drill well, it must be dressed frequently to preserve the gauge. It is almost impossible to give instructions as to the proper shape of a bit. This must be learned by experience of the driller. If possible, examine a large bit used on the regular drilling machines and note the shape. The speed of drilling by hand is greater than would be expected after a slight experience in drilling at the top of the hole. With the tool as shown in C, Fig. 1, operated with the spring pole, 30 or 40 ft. can be drilled in clay or 10 to 15 ft. in rock, in a day.

### Pipe Tool Attachments for Monkey Wrenches

Two useful attachments that can be easily fitted to the ordinary types of monkey wrench to make them suitable for working on pipe are described by the Motor Magazine of Canada. The

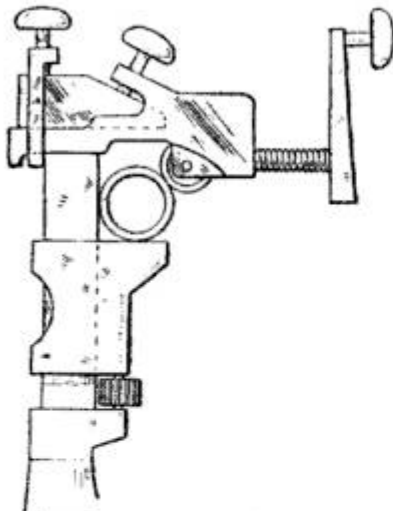

Fig. 1

Pipe-Cutting and Wrench Attachment

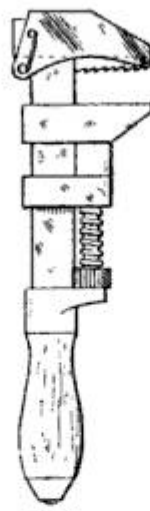

Fig. 2

one outlined in Fig. 1 is a simple pipe cutter comprising a jaw member having a recess to receive the jaw of the wrench, this being provided with parallel arms adapted to straddle the shank of the wrench. A cutting wheel or roller is mounted in a block sliding in

and guided by a suitable yoke piece. This can be moved as desired by turning the crank on the feeding screw. Simple clamp screws make it possible to easily and quickly attach it securely to the wrench. The pipe is placed between the movable jaw of the wrench and the cutter, and is backed by the shank of the tool. The device is used in the same manner as a pipe cutter, the wrench being revolved around the pipe and the pressure on the cutter block being increased gradually to cut deeper into the pipe each revolution.

The device shown in Fig. 2 is a simple member having a series of serrations or teeth to permit it to grip a round surface. This is made of hardened steel and has a simple clip member by which it may be easily attached to the fixed jaw of the wrench. The U-shaped plate is adapted to closely engage the top and sides of the wrench jaw. The serrated plate is pivoted to the plate to lie beneath the face of the fixed member. A locking member, composed of a pin having a grooved end and retention spring, is passed through



the U-member back of the wrench shank to hold the attachment in place. The spring catch engages the groove in the pin when the latter is in the position indicated.

### Form for Molding Concrete Slabs

A form for making concrete slabs that is easily made, convenient to handle, and constructed similar to a snap flask used by foundrymen, is shown in the accompanying sketch.

The form may be made in any size from  $\frac{3}{4}$  or 1-in. lumber. Two of the sides are nailed or screwed securely together at right angles. The other two sides are hinged on the ends of these two joined sides as shown. When in position, the two hinged sides are

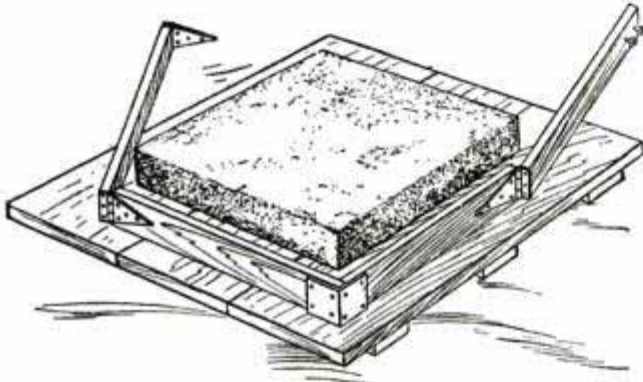

Removing Form from Block

locked by means of a hinge and two screw eyes or a large hasp. The screws are put into the wood through the screw holes in the long wing of the hinge.

Paper may be placed between the concrete and the inner faces of the frame, or the frame may be greased instead. When the concrete is set, the screw eyes are withdrawn, the frame opened, the two sides swung clear of the slab, and the frame pulled away from the other two sides of the slab.—Contributed by James M. Kane, Doylestown, Pa.

### Pipe Guides for a Bench Vise

In fitting up a home-made bench with a vise, I found it rather difficult to mortise in the two guide pieces, so I decided to make it an easier way. I

had an iron bench screw, and my vise block being  $1\frac{3}{4}$ -in. maple, I procured two pieces of  $\frac{1}{2}$ -in. pipe, each 15 in.

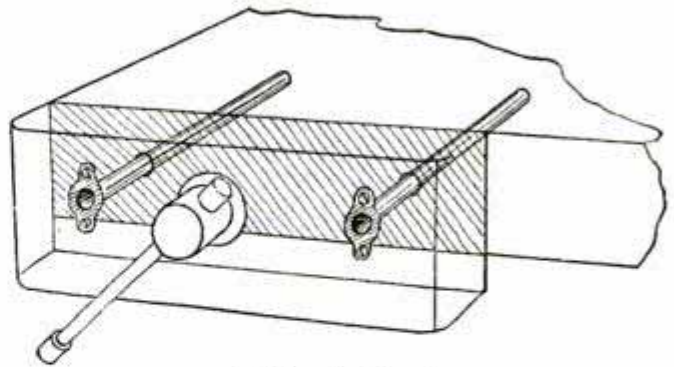

Guides in Bench

long with threads on one end, and each was fitted with a  $\frac{1}{2}$ -in. waste nut. The block was then screwed up tight against the bench by means of the screw and two 1-in. holes bored through for the guides, which were easily slipped through, and the waste nuts screwed to the outside.—Contributed by Edwin Otto, Chicago, Ill.

### Baseboard Marking Hook

The device shown in Fig. 1 is for marking a line on the baseboard for sawing closely against a door facing. It consists of a piece of wood, A, Fig. 1,  $2\frac{1}{2}$  in. wide and 12 in. long, squared up true on all sides. A 1-in. opening, B, is sawn out 10 in. long. The hook is placed on the baseboard D, Fig. 2,

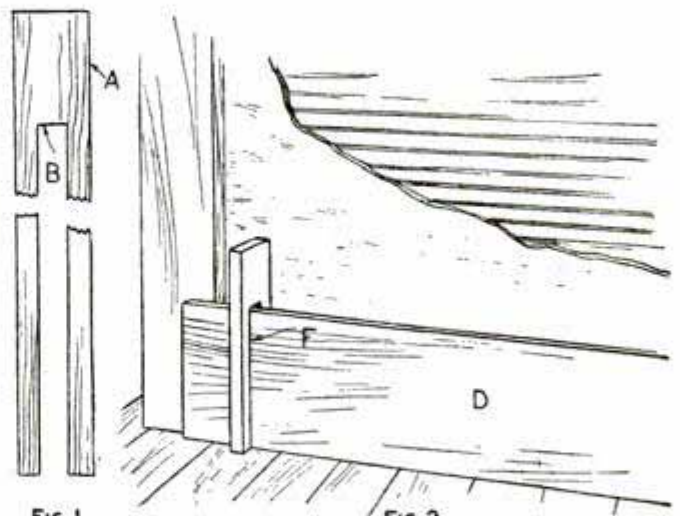

FIG. 1

FIG. 2

Hook on Baseboard

and the line made along the opposite edge from F when the hook is against the facing.

### Portable Lamp for the Garage

In garages and repair shops, extension cords for electric lamps are practically indispensable, and strange though it may seem, there are few, if any shops, that have practical supports for these portable lamps, says Motor Age. The illustration shows a home-made portable lamp of gas pipe and fittings. The

base A is a 2-in. pipe flange, 8 or 10 in. in diameter. A reducer is used in the 2-in. hole to make the size  $\frac{3}{4}$  in. A  $\frac{3}{4}$ -in. nipple and a plain coupling is turned into the base and fastened to a piece of flexible conduit, C, which connects the base with the electric lamp D.

All the fittings included in the make-up of this lamp are standard and may be assembled without the use of tools. This lamp can be placed anywhere about or under the automobile. The lamp may be raised, lowered, or twisted into almost any desired position by means of the flexible conduit, which is stiff enough to hold it in the position set.

### A Flaring Pattern Rule

Draw the lines AB and AC with an ordinary square and mark a point B from A on the line equal to one-half the large diameter of the finished object. The slant height is from A to F. Draw a line parallel to AB on the slant height, or FG. One-half the small diameter of the finished object is marked on the line at G from F. A line drawn

intersecting B and G and extending to D, establishes a center from which an arc of a circle is drawn with a radius from A to D.

The arc is shown from H to H with the center K. The small arc having a radius from D to F is shown from J to J. The length of the arc is determined by spacing the line AB into seven equal parts and using the dividers set for one space to step off the arc HH 22 times for one piece, 11 times for two pieces,  $7\frac{1}{3}$  times for three pieces and  $5\frac{1}{2}$  times for four pieces. The pattern is then given sufficient edge, as shown by the dotted line, for seams or other

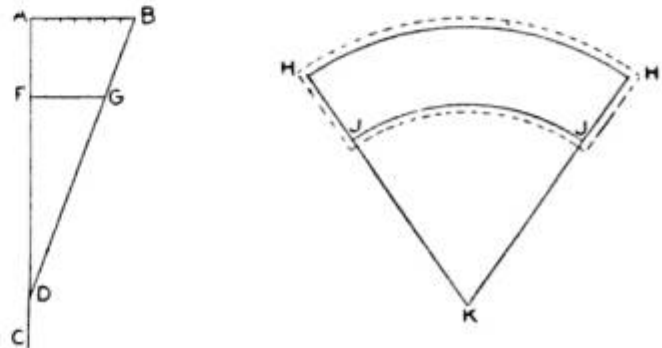

Laying Out the Pattern

purposes.—Contributed by S. C. Shipman, Steubenville, Ohio.

### Bakery and Milk Check Holder

The accompanying illustration shows how common paper clips can be used to hold milk and bread checks. The paper clip, Fig. 1, is fastened with two

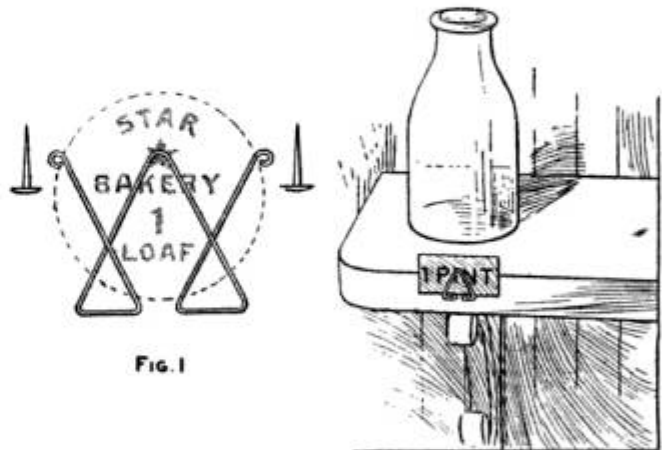

FIG. 1

FIG. 2

Method of Using a Paper Clip

small nails or brads to the edge of the shelf, as shown in Fig. 2.—Contributed by Victor Labadie, Dallas, Texas.

**An Inexpensive Flower Pot**

An artistic flower pot can be made from an old paint keg—one made of oak preferred. Saw off one of the ends, leaving two-thirds of the keg, remove the hoop and scrape the paint or varnish from the wood. Sand the hoops and paint them with bronze and stain the wood a dark color, allowing the grain to show; then replace the hoops and drive them tightly in place. Fasten them to the keg by boring holes through both hoop and stave and driving pins in the holes. Bore several holes in the bottom of the keg for drainage. Attach drop handles on opposite sides of the keg.

**Heating a Funnel for Thick Oil**

It is difficult to empty a keg of oil into the engine-room tank or can in cold weather, as the oil will not run through the funnel fast enough to take the flow from the bung hole. The remedy is a simple one and can be adapted to any sized funnel. If a coil of small copper pipe is wound spirally round the mouth of the funnel and a small amount of steam applied to the pipe, the oil will flow steadily. The heavy oils that need warming up do not generate explosive gases, so the method is quite safe.—Contributed by Hy. W. Hankin, Troy, New York.

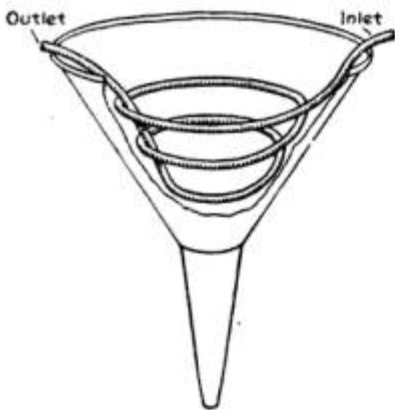

**Setting a Diamond for Dressing Emery Wheels**

The holder is made of a piece of machine steel with the end prepared in a lathe, as shown in Fig. 1. The hole in the center must be large enough

to easily take the base or largest part of the diamond and about  $\frac{1}{16}$  in. deeper than the depth wanted when finished.

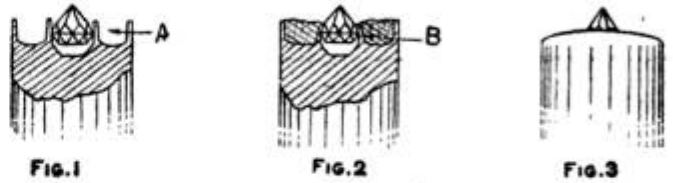

Setting Diamond in a Steel Rod

Make a groove around the hole, as shown at A, so that the metal between will be very thin.

Place enough clean iron filings and flux in the hole to keep the diamond at the proper height. The filings are important to make a perfect seat for the base of the diamond. Select the largest part of the diamond and set it firmly on the filings and close the thin metal in snugly all around with a small punch. Provide a small hole at B, Fig. 2, to admit spelter to the filings. Fill the groove heaping full of spelter and flux. Heat slowly and evenly to the melting point and then remove the holder from the fire and let it cool slowly. Finish the end as shown in Fig. 3.—Contributed by Rudolph Miller, Shippersburg, Pa.

**Soap and Brush Holder for a Shaving Mug**

An attachment for a shaving mug for holding the soap and brush can be made of a piece of sheet metal. The illustration plainly shows the construc-

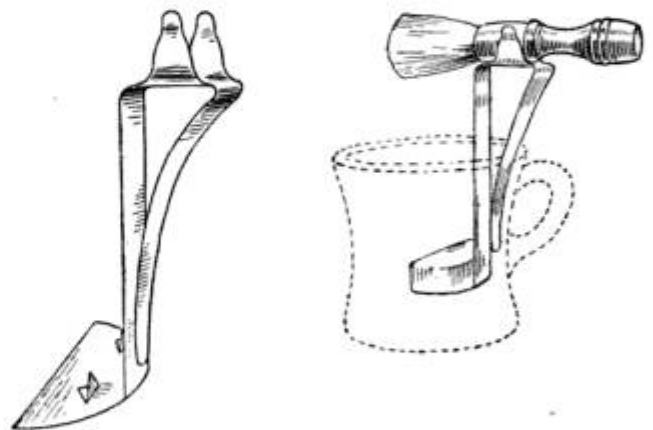

Holder and Position on Cup

tion. The piece is cut and shaped to slip over the edge of a cup. It can be easily attached and removed.

### Tool for Holding Piston Rings While Replacing Piston

When replacing pistons in cylinders of gasoline engines, some device must be provided for holding each ring in its groove so it will easily enter the bore.

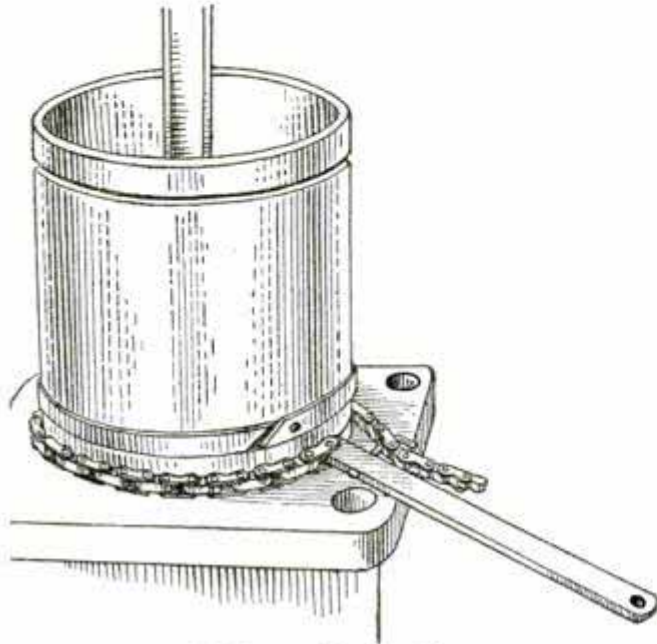

Holding a Ring in Place

Copper wire may be used to advantage where one or two pistons of the same size are to be replaced. In repairing engines of various sizes and replacing their pistons, the tool shown in the sketch can be quickly applied to each ring just before it enters the bore.

The tool is made from a length of bicycle chain with a lever attached to one end on which a hook is fastened in such a manner as to take up the chain and close it in on the ring. The sketch shows its construction.—Contributed by Orlia A. Young, Loudonville, Ohio.

### Small Spanner Wrench and a Nut-Threading Tool

In motor car repairing, one is often forced to drive a particularly stubborn bolt or bearing pin, having a threaded end, out of place because it has become firmly fixed by rust. The thread is bruised to some extent, even if care is taken in driving the bolt out, by some projecting piece of metal in the bearing in which it sits.

When the bolt is replaced, it is often difficult or even impossible to get the

nut to run on the damaged thread, says the Motor Magazine of Canada.

A simple screw thread corrector may be made of a steel nut of the right size to fit the thread. This is softened, and a V-shaped slot cut on the inside, running across the threads and a little deeper than the bottom, as shown at A in the sketch. This must be cut very carefully with a fine three-cornered file, so that no burrs adhere to the edges. The nut is then tempered to a light straw color, and when cooled it is ready for use. Screw this nut on and off the threads several times and they will be toned up and straightened, and the original nut can be replaced without difficulty. A set of these handy tools can be made from a number of standard sized nuts commonly used and they will do the work as well as the more expensive stocks and dies.

In removing inaccessibly placed nuts and bolts it is often necessary to screw these out by driving a chisel or punch held against the corners of the facets, which damages them and makes it difficult to apply a wrench to the nut or bolt head with success when this is necessary. The small spanner shown in B is intended to be placed over the nut or bolt head and the projection struck with a hammer directly, or

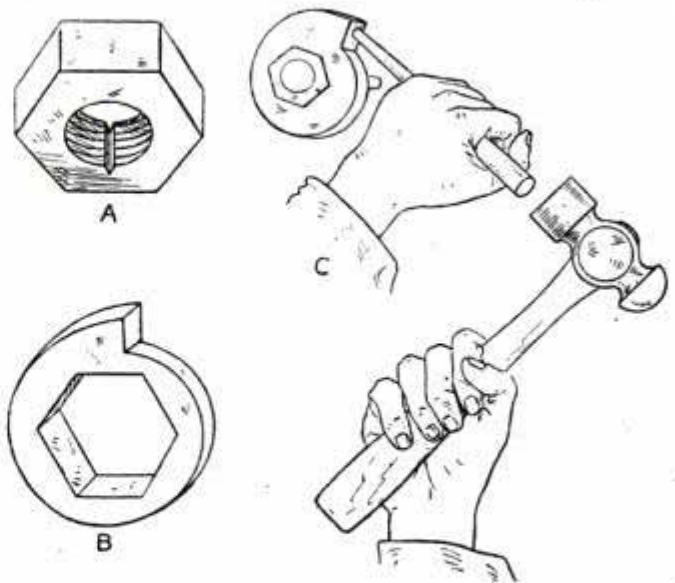

Threading Die and Spanner

turned by a chisel struck with a hammer, as shown by C. These can be made in different sizes to fit standard nuts and bolt heads.

### A Truss for Aeroplane Construction

A truss for strengthening the weak places in aeroplane construction is shown in the sketch. It is made of a  $\frac{3}{16}$ -in. bolt having the head cut off and a hole drilled through for a No. 18-gauge wire. The body is made of ash with a hole bored into the top end the length of the bolt and the side cut out to form a slot. The other end may be formed to suit the frame where it

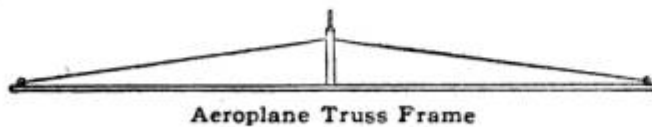
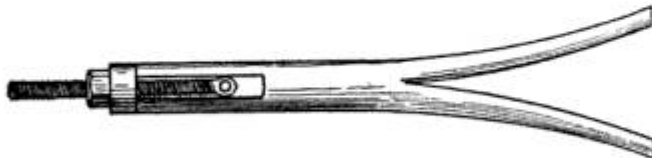

Aeroplane Truss Frame

is to be placed. A brass ferrule is placed under the nut of the bolt and over the end of the slotted part. The tightening of the truss is plainly shown.—Contributed by F. W. Stromer, Gig Harbor, Wash.

### An Emergency Snap

A snap can be made from an ordinary split cotter pin for temporary use. To make the snap, spread the parts, cut off one end and bend the



Snap Made of a Cotter Pin

other as shown in the sketch.—Contributed by Lester L. Kell, St. Louis, Missouri.

### Adjustable Curtain Stretcher

There is hardly a household in which a curtain stretcher does not, at some period of the year, play an important part, says the American Carpenter and Builder. A prominent woodworking concern makes what is known as the

adjustable pin stretcher, the brass nickel-plated pins which hold the curtain being set in adjustable sliding

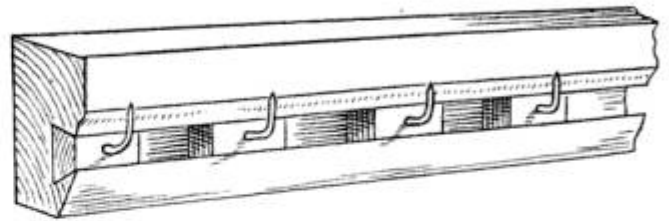

Adjustable Hooks

blocks. The sketch shows how the groove is cut for the sliding blocks to adjust themselves to any position endways.

### Locking a Wood Screw

Many times advertisements or framed notices fastened with screws on the outside walls are stolen for their wood frames. By using the ordinary wood screws with the heads filed on two sides, against which the screwdriver blade bears when unscrewing, it makes the screw easy to turn in but impossible to turn out.—Contributed by Percy d'Romtra, Cape May Point, N. J.



### A Simple Pipe Wrench

The illustration shows a very serviceable wrench which may be made in a short time. The wrench is, in every way, as efficient as the best factory product. It is forged from steel and the teeth filed in the jaws before tempering. This wrench may be made in all sizes and will be found very

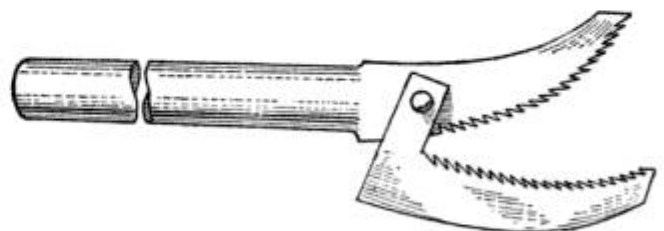

Home-Made Pipe Wrench

handy for any branch of the mechanical trades.—Contributed by A. J. McKelvie, Ladysmith, B. C.

### Boring Oval Holes

Lay out and cut to shape a form or guide, A, Fig. 1, of machine steel, as required, and fasten it to the work to

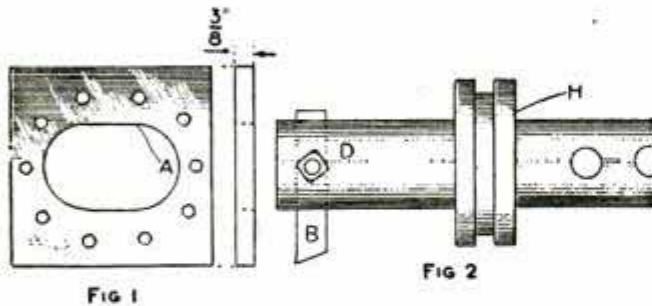

FIG 1

FIG 2

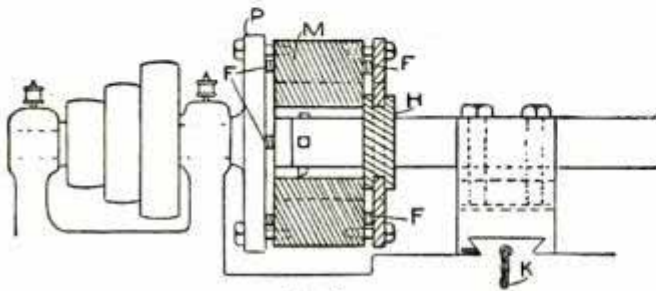

FIG 3

Shape and Position of the Guide Form

be bored or turned. The boring bar (Fig. 2) has the usual cutter, B, fastened with the setscrew D. A collar, H, is made a sliding fit for the bar. Drill the guide and work for cap screws and place parallels, FFF, Fig. 3, between the guide, work M, and faceplate P, for clearance. The boring bar collar H is held against the guide plate by attaching a weight to a chain, K, which is fastened to the tool-post feed after removing the screw.

The guide plates can be made in various shapes for making cams, cylinder, jig, and experimental work.—Contributed by J. B. Roberts, Everett, Massachusetts.

### Preparing Logs for Sawing

All the logs for a hardwood mill were shipped by rail and a large amount of mud and gravel was found sticking to the surfaces. A derrick was used to load the logs on a car in the yard and at the foot of the incline the car was stopped for a short time, and a stream of hot water from an injector cleaned off nearly all the mud, and softened what it did not remove.

The mill turns out a large amount of quarter-sawed material, and saws are changed three times a day. The forced stream of water from an injector is better than cold water, and the saws are saved at a trifling expense.

### Eccentric Clamp for Wood Lathe Rest

A quick acting eccentric clamp for a rest on a wood lathe can be made of parts as shown in Fig. 1. The eccentric lever A takes the place of the regular hand wheel on the bolt. The lever turns in a half circle bearing, cut in the cross block B. The piece C is fastened on top of the block B to keep it straight across the bed of the lathe. Both pieces have a slot cut in them for the lateral movement of the bolt. The lever A is fastened to the end of the bolt, a little off center, with a pin. A spring, D, is placed above the clamp to release it from the bed when adjusting the rest.

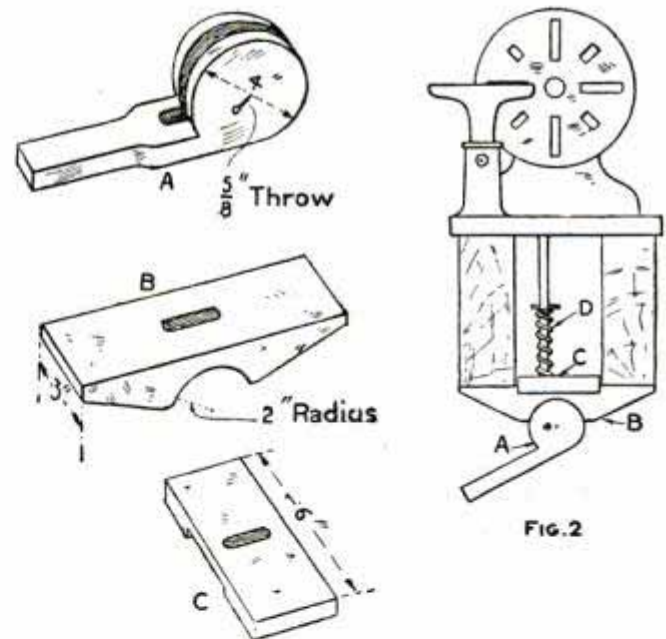

FIG. 1

Clamping a Wood Lathe Rest

FIG. 2

The lever may be tightened and released with the foot, thus leaving both hands free to move the rest.—Contributed by C. M. Graham, Oskaloosa, Iowa.

□ A kitchen-sink putty is made of litharge, 20 oz.; dry slaked lime, powdered, 1 oz., and linseed oil.

### Lug on a Pipe to Hold a Locknut

Sometimes a lubricator or steam gauge has, of necessity, exceedingly long connecting pipes of copper for pressure or oil feed, and a great deal of annoyance is caused by the connecting nuts slipping down on the pipe to a turn or other fittings. Where they are located over a hot boiler or leading through a maze of other hot pipes, it is dangerous to reach for the nut and slip it back to place. A good way to keep the nuts up near their place is to braze a small brass lug to the copper pipe, a little below the joint. It will save a great many burned wrists and, if placed on the back side of the pipe, it will never be seen. The nut cannot slip past the lug.

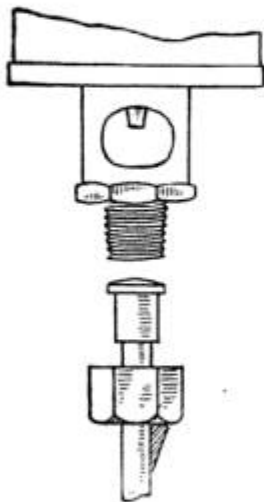

### Shear-Holder for Paperhangers

An ordinary wire opener such as is used for opening bottles having a crown top makes a good shear-holder for paperhangers. The opener is sewed to the outside of the overalls as shown in the sketch. The angle with the opening is suitable for the shears or a painter's duster.—Contributed by Hazel Duncan, Denver, Colo.



⌈The ornamental raised ledge around the keyhole of a lock often keeps the latch key from readily entering. Unless the key happens to be put directly in the hole, the ledge will prevent it from slipping in. The ledge can be removed in a few minutes by cutting it off with a sharp cold chisel.

### Extension Spout for an Oil Can

The straight spout on an ordinary oil can is not long enough or shaped right to oil bearings located in complicated machinery. The straight spout can be extended and a bend made in it by attaching a piece of wire of the desired length and shape, then drawing a piece of small rubber tubing over it.—Contributed by Harry S. Moody, Newburyport, Mass.

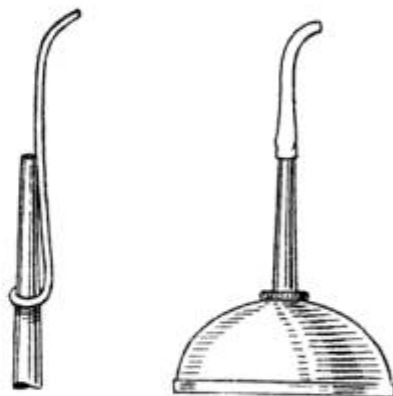

### Bottle Cleaner

The usual method of cleaning the inside of a bottle is to put into it some nails or sand, partly fill with water, and shake well. While this will clean the bottle, there is a possibility of leaving a nail or some sand within. This trouble may be overcome and the bottle thoroughly cleansed by using a chain cleaner attached to the cork of the bottle as shown.



The cleaner can be made of an old key chain attached to the cork with a small brass screw-eye. The chain should have a few knots of cord tied at intervals in the links. Pour some warm water in the bottle, place the chain and cork in and shake well. This is especially useful for cleaning tea, nursing and all kinds of small medicine bottles.—Contributed by David Major, Providence, R. I.

### Preventing the Lower End of a Ladder from Slipping

The lower end of a ladder may be kept from slipping by using a device made from heavy sheet metal, as

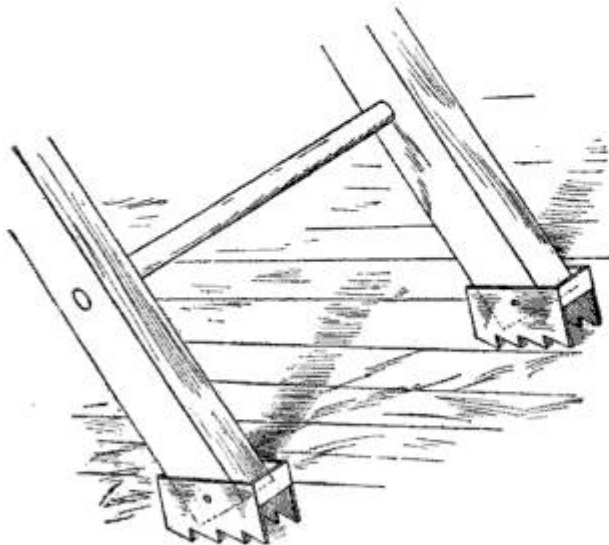

Nonslipping Ladder Ends

shown in the sketch. The attachments are made to fit the wood loosely, and the edge intended for the lower part is notched like a saw. A hole is drilled through the metal and a corresponding hole is bored in the wood for a draw-pin or bolt. This makes them fit the base, no matter at what angle the ladder slants, and also provides a way to quickly remove them.—Contributed by W. A. Jaquythe, Richmond, Cal.

### A Lapping Tool

An adjustable tool used for lapping out hardened bushings such as wrist pin bushings for automobile engines, can be made of babbitt metal. The babbitt is placed on a taper arbor turned from cold rolled steel. A  $\frac{1}{4}$ -

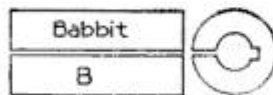
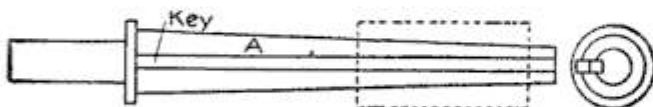

Detail of Lapping Tool

in. keyway is cut and a key inserted the full length of the taper. Use a piece of tubing larger than the hole

and as long as the lap to be made and place it on end on a smooth surface for a mold. Hold the taper arbor in the center with the small end down and fill the space with melted babbitt. When cold, remove the tube from the babbitt and turn it to the right size. Remove the babbitt from the arbor and split it opposite the keyway.

If there is a great deal of lapping of one size, it is best to use copper instead of the babbitt. When using copper, there is no need of a keyway as this metal will grip the taper. The tool can be used in a drill press or a lathe. As the lap wears, it is driven up on the taper arbor to increase the size.—Contributed by V. E. Swanson, Chicago.

### A Pruning Hook

The pruning hook shown in the illustration is for cleaning the dead wood from raspberries, currants and other small fruit, as the handle per-

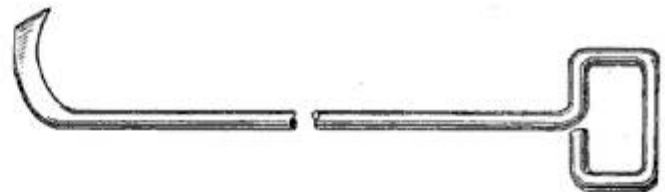

Made of a Steel Rod

mits it to be drawn towards the worker, thus making the task much easier.

It is made from a length of steel rod,  $3\frac{1}{2}$  ft. long, one end of which is bent into a hook and flattened. The flattened part is tempered and ground to a knife edge. The opposite end is bent into a handle as shown, making it easier to grasp than the ordinary straight handle.

### Fitting Glass in Picture Frames

When cutting glass for picture frames do not fit it to the rabbet tightly, says the Master Painter. Allowance should be made for expansion and contraction. For the same reason, springs should not be forced hard on the packing at the back of the glass.



### Pencil Holder for Beam Compasses

An easily made, yet very efficient pencil holder for use with beam compasses is shown in the sketch. Care should be taken that the wedge-shaped piece have the same taper as the groove in the sliding block. One side of the wedge should be beveled and made to dovetail into the block. This will give a better grip on the pencil.

This pencil holder has an advantage over the ordinary type of holder in that it can be easily slipped along the trammel rod and any number of lines made without the usual tedious and very trying method of screwing and unscrewing the head as in the case of the ordinary beam compass. Of

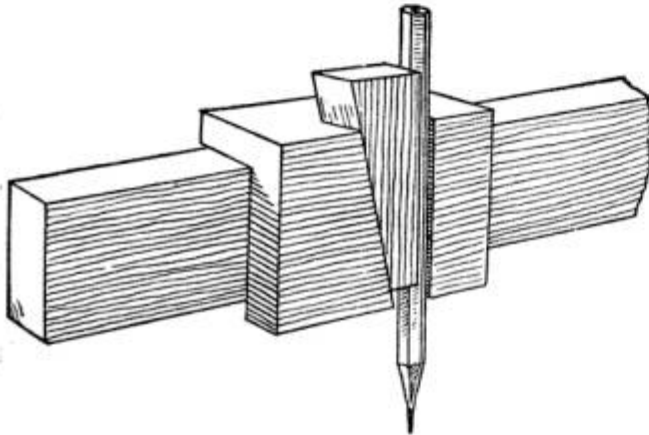

Holder on the Beam

course, it has to be grasped in the hand while the line is being made, but if both are grasped in the hand at the same time, no trouble will be experienced.—Contributed by Wilfred Butler, Perth Amboy, N. J.

### A Panel Spacer

The device shown in the sketch is for use in spacing panels in painting, paper hanging and decorating. In use, the bottom of the spacer is placed on the baseboard and the crossarms are set to suit the width of the stiles for the panel. When it is once set, no change will need to be made for the entire room. When not in use, the spacer can be folded up for carrying or storing. The crossarms can be made of wood or metal. If made of wood, they should be lined on both sides with channel brass and counter-

sunk screws, so that they can be used as a straightedge for trimming paper

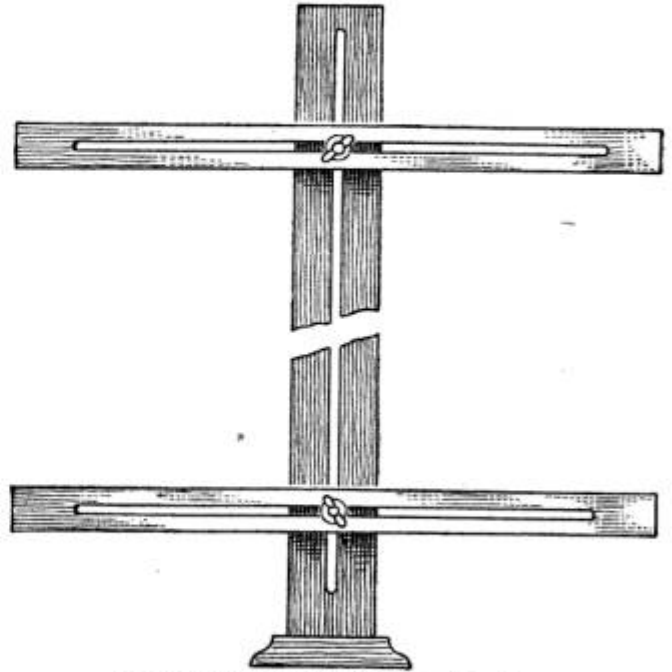

Marking Boards in Position for Use

with a butting knife.—Contributed by A. E. Johnson, Frankfort, Ind.

### Gauge and Protector for a Hatchet

The attachment for a shingler's hatchet, as shown in the sketch, can be used as a gauge (Fig. 1) in shingling, and a protection for the edge (Fig. 2) when the hatchet is being carried to and from work or placed in a tool box.

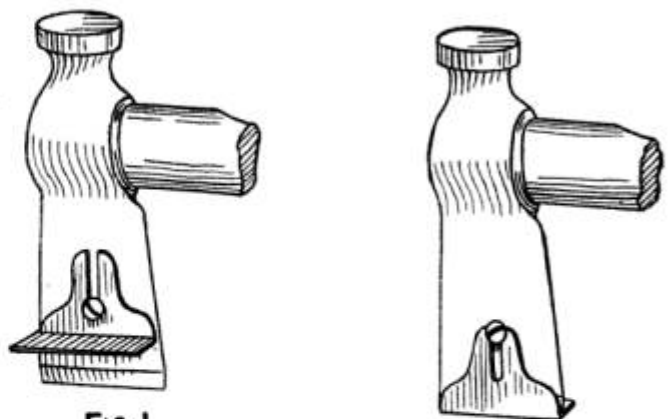

FIG 1

FIG 2

Attachment as Gauge and as Protector

The illustration shows its construction and how it is attached to the blade of the hatchet.—Contributed by M. M. Burnett, Richmond, Cal.

☞ A strong solution of oxalic acid will usually remove stains from lumber.

### Repairing a Cracked Spoke in a Wheel

A cracked spoke may be permanently repaired by drilling a hole through the crack and putting in a rivet. The rivet heads prevent side play in one direc-

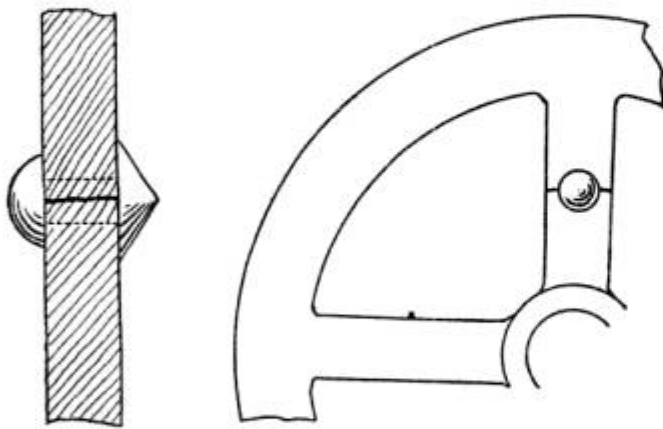

Repaired Spoke

tion and the shank prevents motion in a direction at right angles to this.—Contributed by Will Parker, Olaf, Iowa.

### An Improved Thread-Cutting Tool

A common thread-cutting tool is not free cutting as it has no top rake. The strain being so great on such a tool, it is hard to keep it sharp and in good condition.

If a lathe has a compound rest, the tool shown in Fig. 1 may be used for cutting V-threads. The compound rest is set at 60 deg. with the axis of the work as in Fig. 2 and the tool is set with the thread gauge in the usual manner. This tool is given a top rake

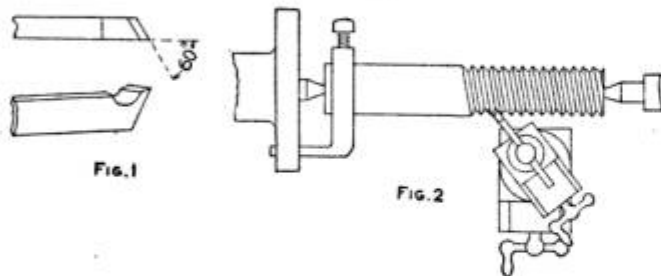

Tool in Position

and cuts a clean chip from the edge, the feed being set to the work by the compound slide.—Contributed by E. R. George, Baltimore, Md.

☞The lead screws of a lathe should be adjusted from time to time.

### How to Make Tweezers

Every workman in a factory, garage or home workshop should be provided with at least one pair of "sliver pullers" or tweezers. A sliver in the hand is a very painful thing, especially if it is run under a nail, and should be removed as soon as possible. If you do not care to buy the tweezers, but have a little spare time, you can make them from a broken hacksaw blade, the teeth of which have been ground off. Heat the blade in a fire and bend it to the shape shown in Fig. 1. Do not try to make the bend after one heating, as the metal is so thin that it cools before the bend can be completed. The sides can be ground out in curves and the surface highly polished. After polishing, lay the tweezers on a heated stove and allow the metal to take on a blue finish.

The tweezers shown in Fig. 2 are made with flattened instead of sharp points. The latter are made of the per-

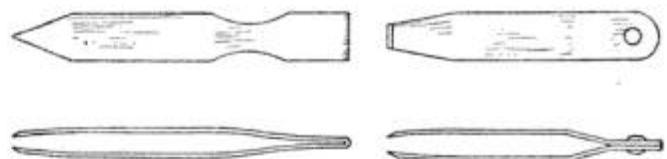

FIG. 1  
Tweezers Made of Broken Hacksaw Blades

forated ends of the saw blades and riveted together.—Contributed by Donald A. Hampson, Middletown, New York.

### How to Use an Expansive Bit

I was boring a 1½-in. hole with an expansive bit in a dry, hard maple timber, and it took a good deal of muscle to keep the bit turning, says a correspondent of the Wood-Worker. A carpenter passed and advised me to turn the cutter of the bit in the same direction as the handle of the brace, and stand with the grain or length of the stick. The result was it lightened the strain of the cutting a good deal and taught me something new. The hardest part of the cut, across the grain, is made while you have the greatest leverage on the brace.

### Tin Tongs for the Kitchen

A device which will often be found useful in the kitchen is a pair of tongs cut out of heavy tin and shaped as shown in the sketch. The length is 20 in., with the width of each member  $\frac{1}{2}$  in. at the points and  $\frac{3}{4}$  in. in the middle where it is bent. Corrugating the points will cause them to hold more satisfactorily. Any tinsmith will cut out these tongs for a small price, and they will last for years. They can be used for taking out boiled eggs, extracting pickles from a deep jar, removing soap from hot water, and also for washing the inside of lamp chimneys. The corrugated points will also hold a dust



A Useful Kitchen Utensil

cloth firmly, and there are scores of other uses which will occur to the intelligent housekeeper.—Contributed by Katharine D. Morse, Syracuse, N. Y.

### Coat Hanger for the Shop

The device shown in the accompanying illustration is used for hanging up coats in the workshop on a nail well above the heads of persons passing by. The coat is hung on the peg and the stick is suspended on the nail by means of the hole shown near the end of the stick.

The stick may be 5 to 6 ft. long and the peg or dowel about 5 in. long. The



A Coat Hanger for Use in Shops

hole for the peg is about 6 in. from one end of the stick and the other hole about 3 in. The diameter of the holes and of the peg may be about  $\frac{5}{8}$  in. The stick may be made of  $\frac{7}{8}$ -in. stuff, and taper in width from 4 in. at the top to 2 in. at the bottom.—Contributed by William M. Kishpaugh, Harrisburg, Pennsylvania.

### Home-Made Tire-Upsetting Machine

The work of upsetting tires can be done so well with home-made devices

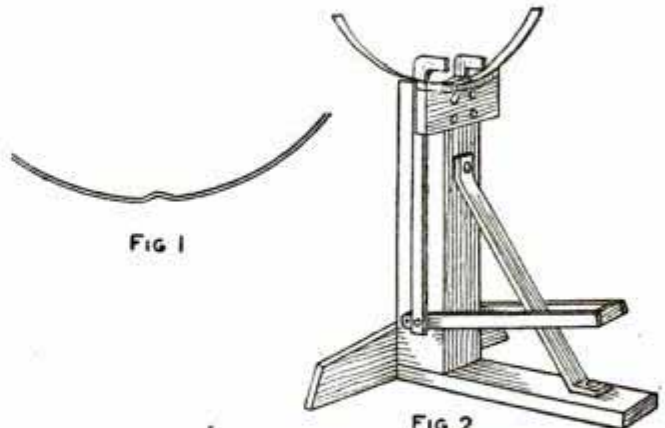

Easy to Place Tire in Clamp

that it does not require the expensive upsetting machine in a small shop. While the small clamps do good work, they are not easily handled by one person. The illustration shows a device which, although more elaborate, can easily be constructed by any smith. With all of the devices a bend must be made in the tire as shown in Fig. 1, then after taking a good heat, the tire is set on the anvil of the upsetter (Fig. 2) and clamped in place by a pressure of the foot on the treadle. The large parts are made of wood and fitted with a metal anvil and clamps.—Contributed by John C. Ham, Pine City, N. Y.

### Oiling a Screw Jack

It is very aggravating to be compelled to relieve a screw jack when it is under a load for oiling, and then to oil it good the screw must be removed. This difficulty may be overcome by cutting a few nicks with a chisel in the body to keep the drill from working over, and drill into the threads as shown in the sketch. Holes  $\frac{1}{8}$  or  $\frac{3}{16}$  in. in diameter are large enough. The jack can be oiled under load and without removing the screw.

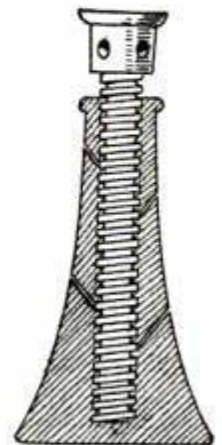

### Mixing Valve for Gasoline Engine

The gas-engine mixing valve described herewith was made at short

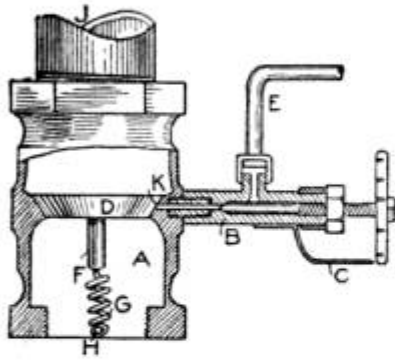

notice from a vertical check valve and a part of an old gasoline stove, when a new valve could not otherwise have been ob-

tained in less than a week.

At a point opposite the seat of a 1-in. vertical check valve was drilled a  $\frac{1}{8}$ -in. hole about half way through the thickness of the material. A similar hole was then drilled in the end of the valve part of the gasoline stove, both holes tapped, and a small brass plug screwed in to connect these parts and sweated in with solder, as shown in the sketch. The needle valve B having been removed, a small hole about the diameter of a large pin was drilled clear through to pierce the check-valve seat at K.

The spindle of the check valve was then drilled to hold the end of a small spring G, at F, the spring being secured in position with a drop of solder. The other end of the spring was bent around a pin, H, which was fastened in the walls at the bottom of the check valve. An indicator C was made of wire and soldered in position to register against the file marks on the small hand wheel, shown to the extreme right, to indicate the position of the needle valve B, and thus show the amount of gas passing to the engine. At the upper end of the check valve was attached the admission pipe J. The gasoline pipe is shown at E, this being in the same position as when used on the stove.

The mixing valve, as described, has been operating perfectly ever since it was made and installed. The suction of the engine causes the valve D to lift, and induces a flow of air through A and a spray of gasoline through K. If thought advisable, however, an air-

regulating device could be attached at the bottom of the check-valve part.—Contributed by J. N. Bagley, Webber, Kansas.

### A Home-Made Marking Pen

A marking pen can be made of a piece of wood and two pieces of clock spring. The wood, which is to be used for the handle should be  $\frac{1}{4}$  in. thick, as wide as desired, and 6 in. long. Procure two pieces of old clock spring and attach them to the wood with linen thread, allowing 1 in. of each spring to project, as shown in the sketch. The springs should be placed on the wood with the curve inside so as to bring the extending ends closely together. The contact of the two springs should be even to make the ink flow the full



Springs Tied to the Handle

width in a smooth broad line.—Contributed by Henry C. Wood, Toronto, Canada.

### Applying Pressure on Patched Inner Tubes

The motorist when making a tire repair on the road can apply sufficient pressure on a patch by using two blocks of wood as shown in the sketch. The blocks can be carried in the tool box.

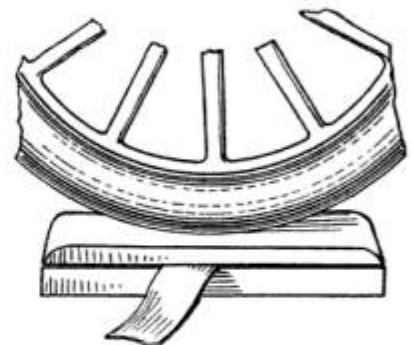

They should be shaped for the tires, about 5 in. wide and 9 in. long, with a curve cut in the one used on top. The inner tube with the patch in place is put between the blocks and one of the inflated wheels on the car rolled on to it.—Contributed by Edwin Marshall, Oak Park, Ill.

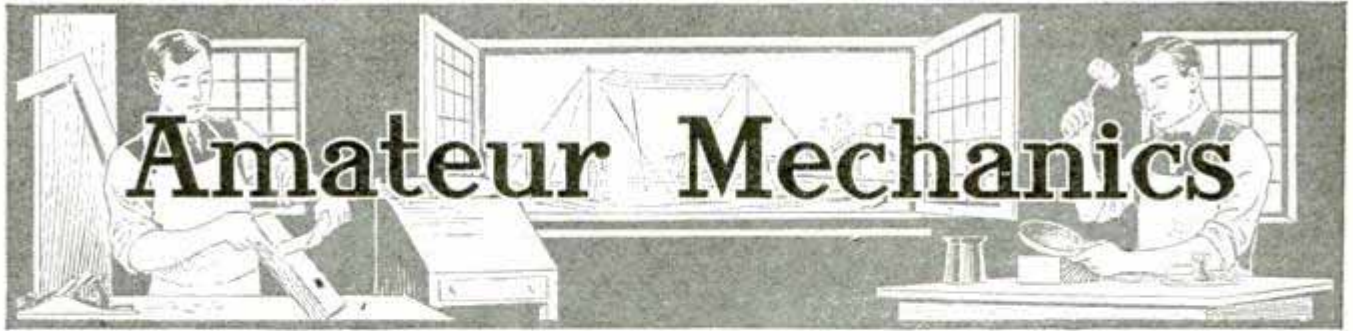

## A Guitar That Is Easy to Make

A guitar having straight lines, giving it an old-fashioned appearance, can be made by the home mechanic, and if care is taken in selecting the material, and having it thoroughly seasoned, the finished instrument will have a fine tone. The sides, ends and bottom are made of hard wood, preferably hard maple, and the top should be made of a thoroughly seasoned piece of soft pine. The dimensioned pieces required are as follows:

- 1 Top,  $\frac{3}{8}$  by 14 by 17 in.
- 1 Bottom,  $\frac{3}{8}$  by 14 by 17 in.
- 2 Sides,  $\frac{3}{8}$  by  $3\frac{3}{8}$  by  $16\frac{1}{4}$  in.
- 1 End,  $\frac{3}{8}$  by  $3\frac{3}{8}$  by  $13\frac{1}{8}$  in.
- 1 End,  $\frac{3}{8}$  by  $3\frac{3}{8}$  by  $9\frac{1}{8}$  in.
- 1 Neck, 1 by  $2\frac{3}{8}$  by  $18\frac{1}{2}$  in.
- 1 Fingerboard,  $\frac{1}{8}$  by  $2\frac{5}{8}$  by 16 in.

Cut the fingerboard tapering and fasten pieces cut from hatpins with small wire staples for frets. All dimensions for cutting and setting are shown in the sketch. The neck is cut tapering from G to F and from J to F, with the back side rounding. A draw-knife is the proper tool for shaping the neck. Cut a piece of hard wood,  $\frac{1}{4}$  in. square and  $1\frac{7}{8}$  in. long, and glue it to the neck at F. Glue the fingerboard to the neck and hold it secure with clamps while the glue sets.

The brace at D is 1 in. thick, cut to any shape desired. The sides are glued together and then the front is glued on them. Place some heavy weights on top and give the glue time to dry. Fasten pieces of soft wood in the corners for braces. Glue the neck to the box, making it secure by the addition of a carriage bolt at A. A small block C is glued to the end to reinforce it for the bolt. Glue strips

of soft wood, as shown by K, across the front and back to strengthen them. The back is then glued on and the outside smoothed with sandpaper.

Make the bottom bridge by using an old hatpin or wire of the same size

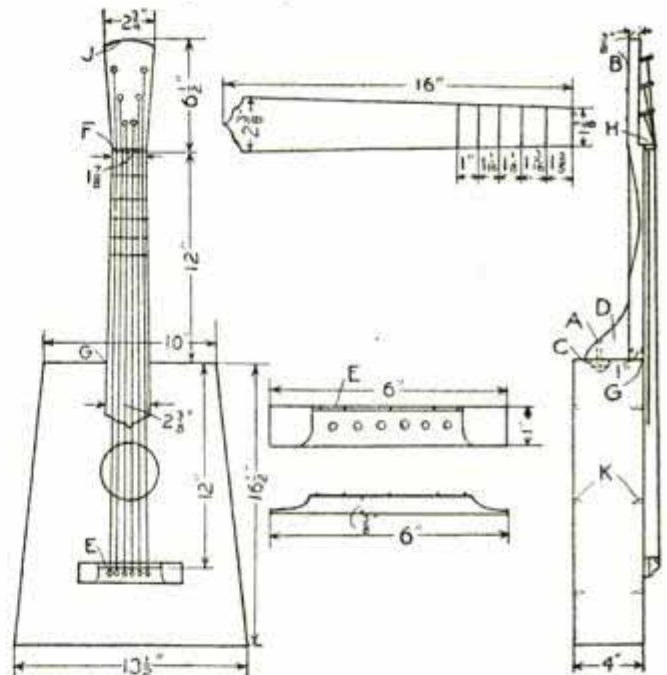

Details of Guitar

for E secured with pin staples. Glue the bridge on the top at a place that will make the distance from the bridge F to the bottom bridge E just 24 in. This dimension and those for the frets should be made accurately. Six holes,  $\frac{3}{16}$  in. in diameter, are drilled in the bottom bridge for pins. The turning plugs B and strings can be purchased at any music store.—Contributed by J. H. Stoddard, Carbondale, Pa.

◀Mold on wallpaper can be removed at once by applying a solution of 1 part salicylic acid in 4 parts of 95-per cent alcohol.

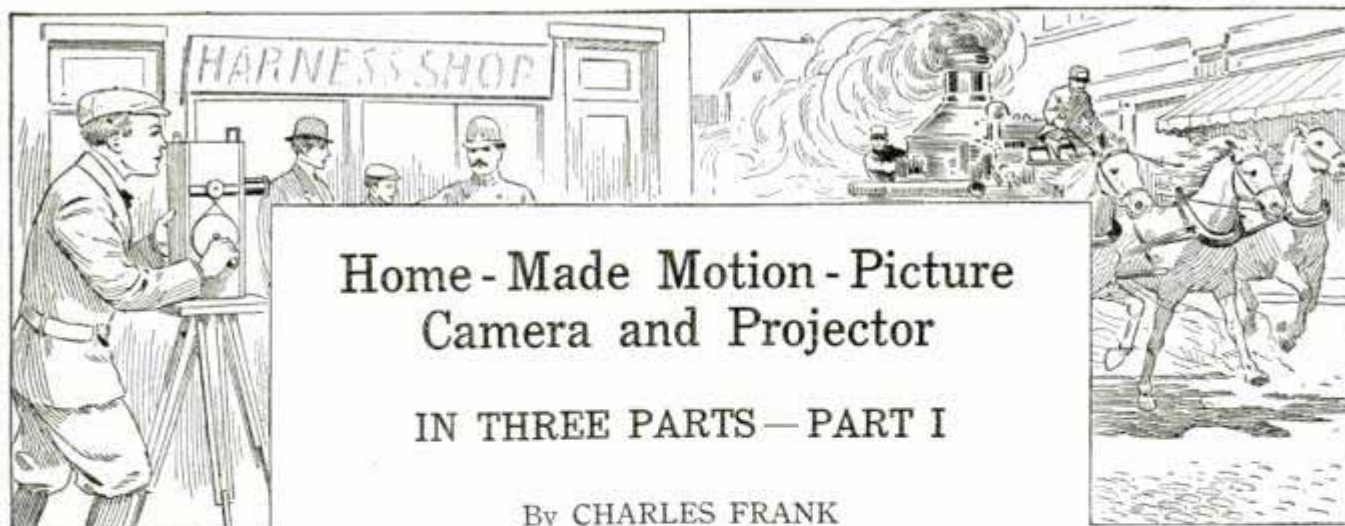

## Home-Made Motion-Picture Camera and Projector

### IN THREE PARTS—PART I

By CHARLES FRANK

Motion pictures are made and reproduced by means of a camera and projector, each having a similar mechanism that would seem entirely too complicated for the average person to construct at home, yet a correspondent of the *Nickelodeon* has devised a simple rotary cylinder shutter that can be substituted for the complicated parts.

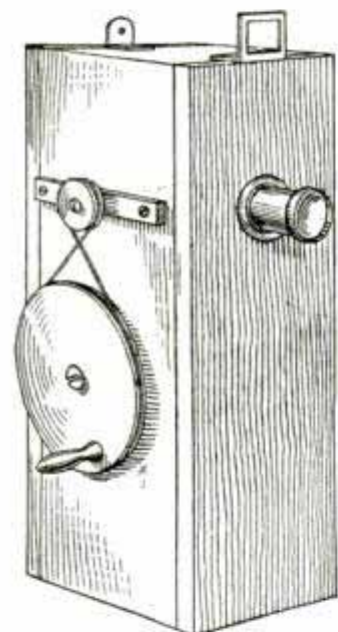

Fig. 1

While this simple cylinder shutter is not claimed to be non-infringing on existing patents, yet, as it has no commercial value, there would be no objection on this score. The instruments described are nothing more than toys, and if the amateur photographer can secure a few dozen feet of animated photographs about the home that are dear to his heart, and reproduce them on a screen, it will have served its purpose. The camera and projector described uses standard film,  $1\frac{3}{8}$  in. wide, with perforations every  $\frac{3}{16}$  in.

#### The Camera

The ordinary hand camera for making still pictures consists of a light-

tight box with a lens at one end and a sensitized plate or film at the other. The motion-picture camera (Fig. 1) is nothing more than a hand camera with a mechanical device for stepping a long roll of film through a space in the focal plane of the lens at a speed of about 16 pictures a second, and stopping the film long enough to make the requisite exposure on each division. The first thing to consider is the lens. A lens having ordinary speed for a hand camera, and one with about 3-in. focal length will give satisfactory results. If one does not care to purchase a lens, a small  $1\frac{1}{2}$ -in. or 2-in. reading glass can be used, if it is stopped down, or a lens may be taken from a hand camera. The width of the camera from front to back (W, Fig. 2) must be determined by the focal length of the lens. The dimensions given in the drawing are only approximate, and they can be changed if the camera is to be used in making an extra long film negative.

The roll of unexposed film (A, Fig. 2) is placed on a small shaft between U-shaped bearings, made of sheet metal and screwed to the top board of the camera. The lens B is set in the front board at a point 4 in. below the top. If a large roll of film is to be used, this distance must be greater to allow room for the film roll in the top of the camera. The cylinder C, which acts as a shutter and intermittent movement, revolves directly behind and in the path of the light passing through the lens. Partitions, DD, are set in grooves cut

in the boards, forming the sides of the camera. These partitions are to keep the light, which may be diffused from the lens, from striking the film at either side of the shutter, and at the same time acting as guides for the film at the rear end of the camera. Their edges at the back are covered with black velvet. The back of the box is a hinged door, rabbeted on all edges, and opening at the side to allow the insertion and removal of the film, and also acting as a guide for the film when closed. A strip of black velvet, E, a little wider than the film, is pasted to the inside surface of the door, so that it bears lightly against the back edges of the partitions DD. The film passes between the edges of the partitions and the velvet on the door with some friction, which keeps it from moving except when pulled through with the roller shutter. A wire-staple guide, F, is fastened in the lower partition, through which the end of the film is passed before closing the door. The film as it is run through drops in folds in the bottom of the box.

The rotary cylinder shutter is the heart of the machine and should be made well and strictly according to the dimensions. The detail of this part is shown in Fig. 3. A rectangular opening is mortised through one of its diameters to admit light on the film when in certain positions. The cylinder is of wood with a  $\frac{1}{4}$ -in. steel rod inserted in the center of each end for axles. A small grooved pulley (G, Fig. 2), about 1 in. in diameter, is fastened to the outer end of one of these rods. The cylinder is revolved by a round belt from a drive wheel, H, 3 or  $3\frac{1}{2}$  in. in diameter and turned by the aid of a crankpin. Owing to the backward rotation of the cylinder, the belt must be crossed between the drive wheel H, and the pulley G. The projections or sprockets, Fig. 3, must be accurately set at a distance of  $\frac{3}{8}$  in. from the 90-deg. point, using the center of the mortised hole as a base. These projections can be pins or small staples, but they must not be over  $\frac{1}{16}$  in. in size. The base of the sprockets must fit the

hole in the film snugly, but the points should be slightly rounding, so that they will easily enter the perforations. When the upper sprocket, which is approaching the film, engages a perfora-

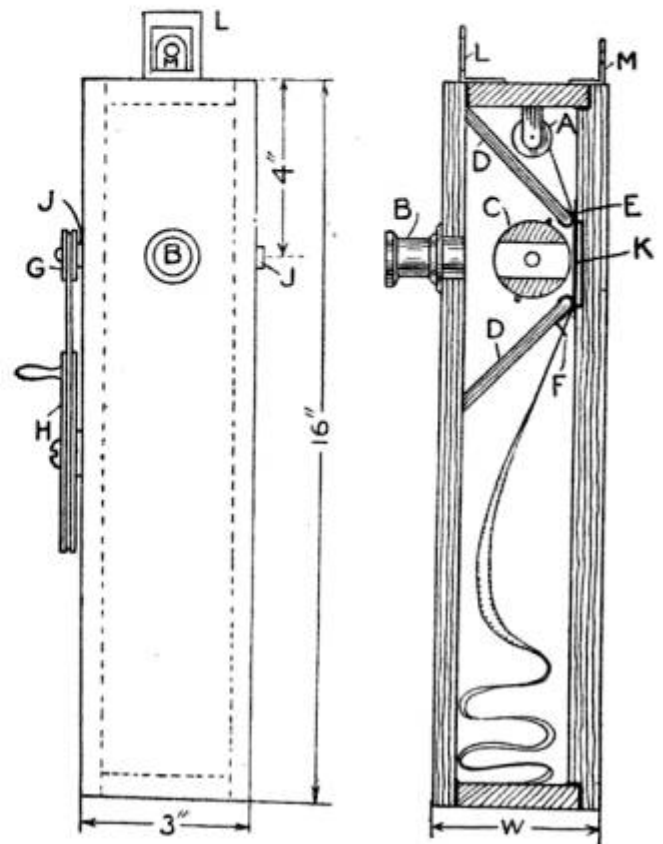

Fig. 2—Details of Camera

tion, just below the upper partition, it will carry the film downward until the sprocket disengages from the perforation at the lower partition. The distance of travel must be exactly  $\frac{3}{4}$  in., as that is the height of each picture. The cylinder requires some adjustment to meet this condition; therefore the axles are made to revolve in holes bored in two strips of wood, JJ, which can be moved forward or backward to obtain the proper distance from the film. To allow for this movement, the axles pass through slots cut in the sides of the camera box instead of round holes. The strips JJ are fastened temporarily and when the correct position for the cylinder is found, they are permanently fastened to the box. Grooves, K, are cut through the black velvet and into the back of the door to allow a space for the sprockets to pass through freely. The inside of the box should be painted a dead black, and black paper pasted on all corners and joints. Black velvet

is pasted in the rabbet of the door to insure a light-tight joint when the door is closed. The cylinder shutter is also painted a dead black inside and out.

The cylinder in revolving exposes the

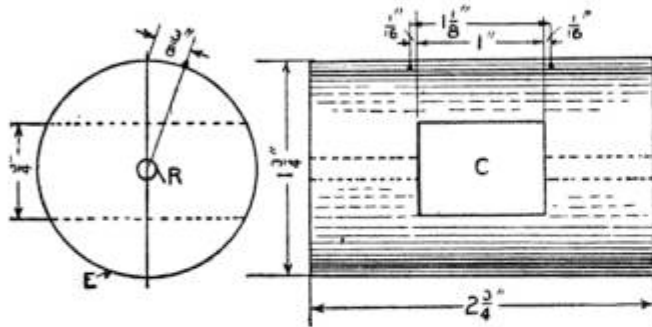

Fig. 3—Details of Shutter

film immediately behind it through the mortised hole. The sprockets or cylinder does not touch the film while the exposure is being made, but as the hole turns toward a perpendicular position, the sprockets catch the perforations of the film and it moves down  $\frac{3}{4}$  in. Just as soon as the sprockets disengage the film, the shutter exposes the next sec-

tion of film, and so on as rapidly as the cylinder is turned, but the average should be about 16 pictures per second.

A view finder must be supplied so the field covered by the lens can be determined. Such a finder is made of two pieces of metal, L and M, bent L-shaped and fastened to the top of the camera box. One of the pieces (L) has a rectangular opening 1 in. wide and  $\frac{3}{4}$  in. high, and the other (M) is drilled with a  $\frac{1}{8}$ -in. drill, the distance between the two pieces being the focal length of the lens. One eye applied to the  $\frac{1}{8}$ -in. hole in the piece M will see through the rectangular hole in the piece L about the same field as covered by the lens. The pieces should be accurately placed and fastened on the box when the camera is set, so that the lens will throw the same portion of the picture on the space where the film passes as will be seen through the finder.

(To be continued)

### A Swimming Raft

Swimming is learned only by experience and to get this experience one must not be afraid to trust himself in the water. This is sometimes accomplished by the use of a swimming raft or water wings. As the water wings need to be inflated frequently, I made a swimming raft instead, in the fol-

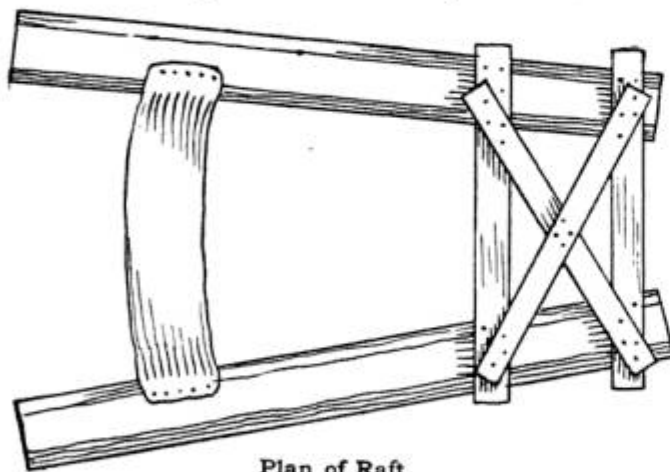

Plan of Raft

lowing manner: Two logs, about 6 or 7 ft. long and about 8 in. in diameter, were fastened together with large nails, as shown in the illustration, and

a piece of burlap or other strong material was nailed across the center with slack enough for it to be partially submerged.

The middle of the band, its depth, etc., can be adjusted to suit the user. Be sure to remove all the roughness of the logs and boards with a rasp and sandpaper.—Contributed by W. P. Johnston, Sumner, Ill.

### Removing Finger Marks on Books

Dampen a piece of wash leather and use it to rub pumice on the spot to be cleaned. Brush off the pumice and rub again with a piece of dry wash leather.

### Tightening a Tennis Net

Anyone who has ever played tennis will readily see the advantage of the net-tightening device shown, in preference to the old method of pulling the net tight by hand. All that is necessary to make the device is 1 ft. of or-



dinary gas or water pipe, 8 or 10 in. of  $\frac{1}{2}$ -in. iron bar, and two twenty-penny nails. The posts generally used are 6 by 6 in. About 4 in. from the top of the post bore a 1-in. hole, parallel with the direction the rope is to run. On the inside surface of the post bore four  $\frac{1}{4}$ -in. holes.

Drill a  $\frac{1}{2}$ -in. hole 1 in. from one end of the pipe, and a  $\frac{1}{4}$ -in. hole 1 in. from the other end. Put the iron bar in the  $\frac{1}{2}$ -in. hole, tie the rope around the pipe and bar at A and wind. With the leverage of the iron bar one can readily pull the net to any desired tightness. After the net is drawn in position, put one of the nails through the  $\frac{1}{4}$ -in. hole

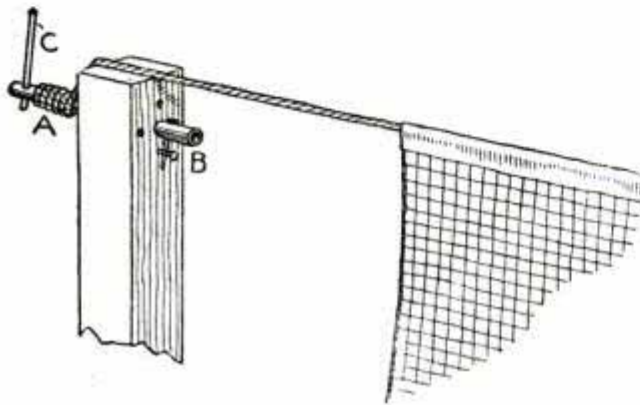

Tightener on Post

in the pipe and the other in one of the  $\frac{1}{4}$ -in. holes in the post.—Contributed by Wm. S. Looper, Gainesville, Ga.

### Holding Fishing-Rod Joints Together

The addition of two or three screw-eyes properly placed in a jointed fishing rod of the ordinary type will prove decidedly worth while, as the joints will often pull out easily when they should not and stick tightly when they should pull apart.

Assemble the rod and bore small holes through the brass sockets into the joints as shown in Fig. 1 and place some screweyes into the holes. Mark the joints so that the holes in the joints and holes in the brass sockets will always be in the same position.

The screweyes prevent the joints from pulling out when an effort is made to free the line from some object in which it has become entangled. They

also act as guides for the line. Should the joints fit too tightly, scrape the ends until they slip easily into the sock-

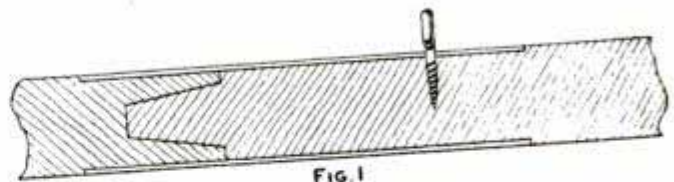

FIG. 1



FIG. 2

Screweye in Joint

ets, as the screweyes will hold them properly, even if they fit a little loose after the scraping.

### Roller Skate on a Bicycle Wheel

When the front tire on a bicycle will not hold and needs to be taken to a repair

shop, strap or tie a roller skate to the rim of the wheel, as shown, and no trouble

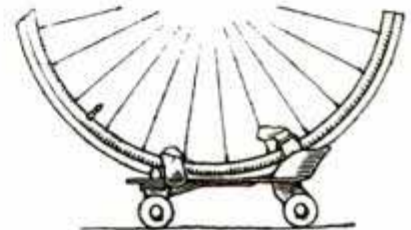

will be experienced in wheeling or riding the bicycle to the shop.—Contributed by K. Chase Winslow, Elizabeth, N. J.

### Rope Oarlocks

Having considerable trouble because of breaking of oarlocks, I devised a successful way by which the difficulty was

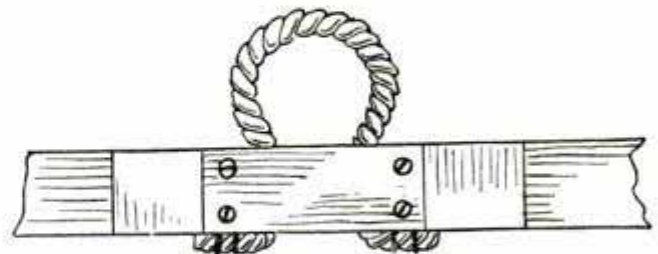

Piece of Rope in Place

overcome. The device is extremely simple and is nothing more than a piece of rope fastened to the gunwale as shown in the sketch.—Contributed by Arthur L. Chetlain, Rogers Park, Illinois.

### Umbrella Used as a Flower Trellis

Procure a discarded umbrella and remove the cloth, leaving only the steel frame. Join the ends of the ribs by



Frame Supporting a Vine

running a fine wire through the tip of each rib and giving it one turn around to hold them at equal distances apart. The handle is then inserted in the ground and some climbing vine planted beneath it. The plant will climb all over the steel frame and make a very attractive lawn piece.—Contributed by John F. Campbell, N. Somerville, Massachusetts.

### Combined Shade and Awning

An ordinary window shade makes a good awning as well as a shade, if it is attached to the outside of the window with the device shown in the illustration. The shade and spring roller are put into a box for protection from the weather and the box is fastened in the window casing at the top.

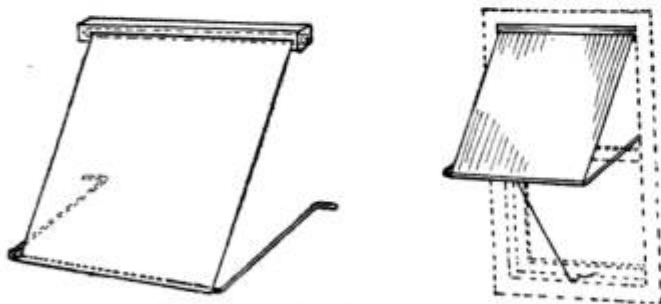

Shade Attachments

A narrow slit on the under side of the box permits the shade to be drawn out. The stick at the end is removed and a

U-shaped wire inserted in the hem in its stead. The wire is bent so the ends may be inserted in holes in the window casing. As the shade is drawn out, it is extended outward by the wire in the position of an awning.—Contributed by Arthur Kesl, Chicago, Ill.

### Vaulting-Pole Attachments

Some means must be provided on vaulting-pole standards to allow for the free release of the pole should the vaulter strike it in going over. One of the simplest of the many devices that can be used for this purpose is shown in Fig. 1. It is made of heavy wire, bent and slipped over the standard as shown in Fig. 2. The projection on the inside of the link is used similar to the tongue of a buckle in adjusting the height of the pole on the standards.

Each standard has a series of holes on its front side. These holes may be numbered for convenience. The pole

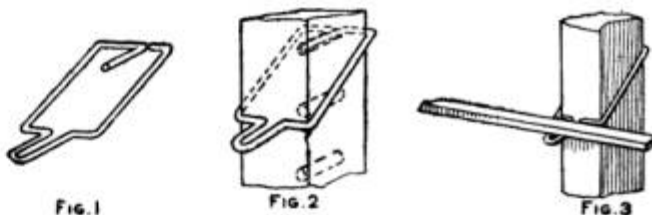

Fig. 1

Fig. 2

Fig. 3

Pole Adjuster on Standard

in place is shown in Fig. 3.—Contributed by John Dunlap, Craghead, Tollcross, England.

### Separating Drinking Glasses

When two thin glasses are put one into the other they often become stuck and cannot be removed. To separate them with ease, set the lower glass in warm (not hot) water and pour cold water in the upper one. The expansion of the lower and the contraction of the upper will make release an easy matter.—Contributed by Maurice Baudier, New Orleans, La.

☞ Bronze striping, when thoroughly dry, should be covered with a thin coat of white shellac to keep it from tarnishing.

## Wood-Working for Beginners

Making a Table — Typical Form for the Method of Laying Out and Making a Glue Joint — Pinned and Closed Mortise-and-Tenon

By IRA S. GRIFFITH

## CHAPTER XV

In Fig. 101 is shown the perspective of a table which contains a glue joint, closed mortise-and-tenon, and a pinned mortise-and-tenon joint. By means of the working drawing, Fig. 102, make out a stock bill and order the necessary lumber. The lumber for the top is to be cut in several pieces.

The top may be built up first and the glue allowed to dry while the other parts are being made. If the boards are rough, one side should be planed up for a face side. Before jointing the edges, take a look at the ends of the pieces as well as the surfaces. Lay out the pieces the way they are to be fitted to one another and mark them so that this order can be maintained hereafter. The annual rings should be fitted as in Fig. 103. If this is done, any warpage in one piece will tend to equalize that of its neighbor so that the general surface of the top will be level. Again, so plan the fitted parts that the surface grain



Fig. 101 — The Table

may all run in the same direction. If this is not done, it will not be possible to plane the surfaces over the joints without roughing up the wood from one direction or the other.

Place two pieces in the vise, Fig. 104, face sides together, and plane the edges

until you think they are straight and level, no try-square test is necessary. Use a jointer and make sure the plane iron is ground straight across.

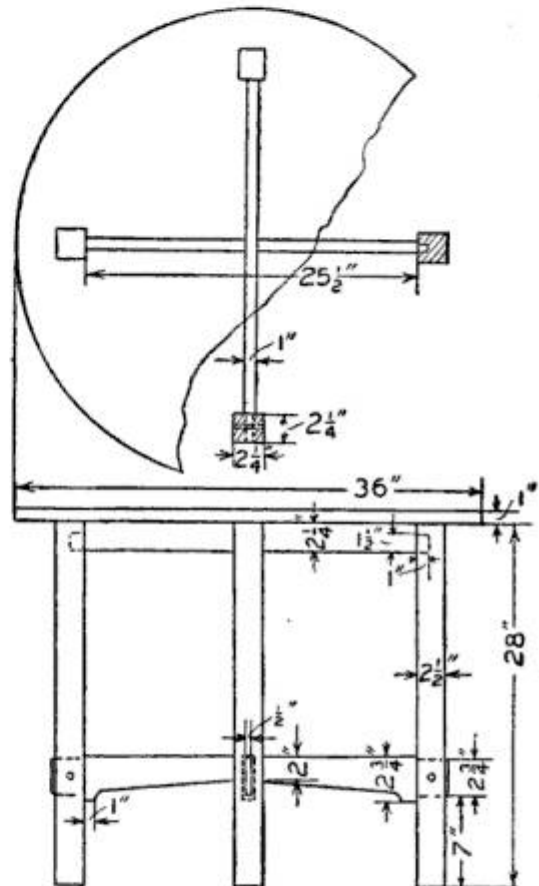

Fig. 102 — Table Details

Separate the pieces and, keeping one in the vise, set the other on this, both face sides on the same side of the work. Look at the joint to see whether any light can be seen through it. Also slide the top board endwise to feel for suction. Tap the lower board lightly to see if the upper will rock. Finally test as shown in Fig. 105 to see whether the face sides lie in the same plane or not. Plane until you get a good joint, for a poor glue joint is no joint at all.

When a surface of contact has been obtained that extends the whole length of the edges, and the face sides lie in the same plane, the clamps are to be gotten ready and the glue heated preparatory to gluing the joints. Fig-

ure 106 shows the manner of applying the glue to the edges. Figure 107 shows the boards in the clamps. Before applying the glue, have everything in readiness, the wood warmed, if possible, so that it will not chill the glue, in order that no time may be lost be-



Fig. 103

tween applying the glue and the clamping.

When the glue has hardened, which usually takes 24 hours, the clamps are to be removed and the pieces surfaced and treated as one. Sometimes dowels are used between glue joints. Many mill-men, however, do not consider them necessary.

The mortises and their tenons may be made next. The tenons on the upper stretchers are to be 1 in. long so that the full length of each piece will

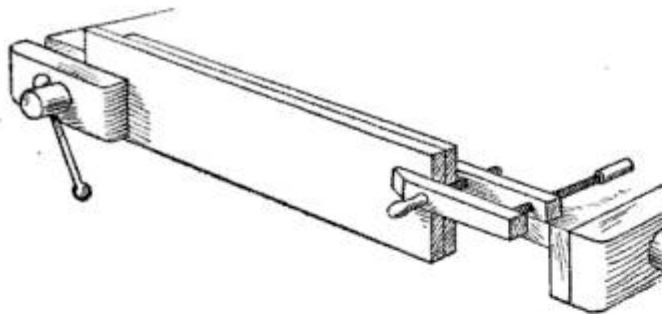

Fig. 104—Clamping Face Sides of Boards Together

be  $27\frac{1}{2}$  in. They are to be shouldered on three sides. Tenons may be shouldered on one, two, three or four sides. The reason for shouldering these on three sides and making one of these shoulders so large is to prevent any danger of splitting out the ends of the legs.

The important thing in laying out mortises and tenons is to keep the head of the gauge always against the face side or the face edge and to make as much use of the tool you hold in your hand as is possible before laying it down to take up another. As an illustration, the tenons of the upper stretchers are  $\frac{1}{2}$  in. thick. This leaves  $\frac{1}{4}$  in. on either side. The amateur always

wants to gauge both of these sides with the same setting of the gauge,  $\frac{1}{4}$  in. This is contrary to trade practice, for, while it saves resetting the gauge, it makes the thickness of the tenons dependent upon the thickness of the stock. The correct way is to set the gauge to  $\frac{1}{4}$  in. and gauge all the tenons for this setting, holding the head of the gauge against the face side, then reset to  $\frac{1}{4}$  in., plus the thickness of the tenon,  $\frac{1}{2}$  in., which makes  $\frac{3}{4}$  in. Again hold the head of the gauge

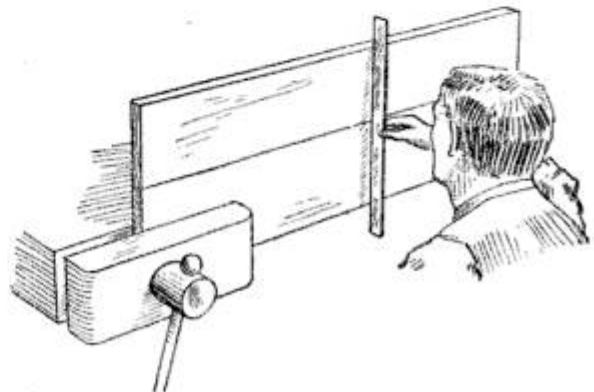

Fig. 105—Testing for Flat Surface

against the face side. In this way all the tenons will be  $\frac{1}{2}$  in. thick, no matter how much the pieces may vary in thickness. This same principle applies to gauging the mortises.

In laying off the shoulders and tenon lengths, place the pieces in the vise or clamp them together on the bench with the face edges up. The face edge of the upper stretchers is to be the lower edge of the piece and on the lower stretchers the upper edge.

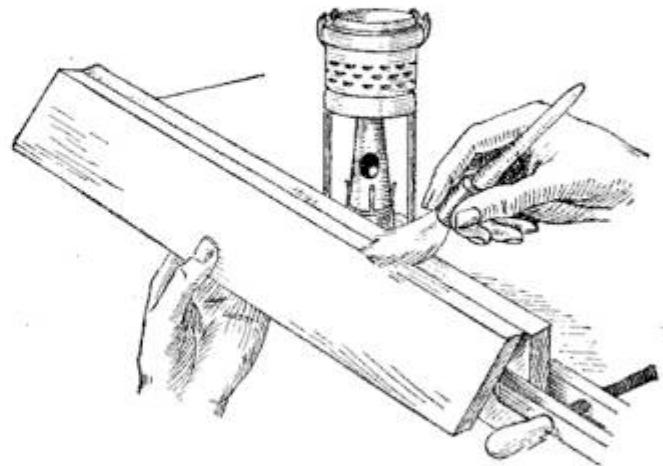

Fig. 106—Applying Glue to the Edges

Measure from the centers of the stretchers toward the ends one-half

the distance called for. Measure on out toward the ends from these lines the length of the tenon. Mark these places with a knife, and with try-square place knife lines across the edges of all the pieces. Separate the pieces and with knife and try-square carry these lines entirely around the pieces, observing the rule about keeping the beam of the try-square against only the face side or face edge.

Observing the cautions given above, gauge the pieces on the surfaces and edges as far back as the shoulder lines just made and across the ends.

Using the tenon saw or back-saw first, rip carefully to the gauge lines, keeping the kerf on the waste, but leaving no wood between it and the

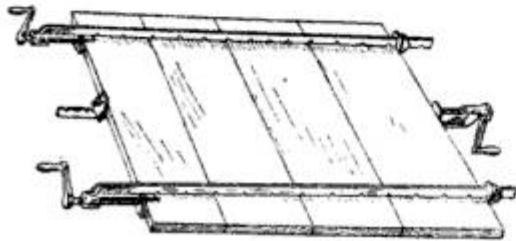

Fig. 107—Boards in Clamps

line. Second, crosscut to the knife lines that indicate the shoulders, Fig. 108.

The mortises are to be made next. Place the legs on the bench, face sides up, and measure off the locations of the ends of the mortises. The face sides are to be turned in and the mortises are to be worked in them because they are more likely to be accurate than are the other sides, the shoulders are more likely to fit up snugly against them. Separate the legs and carry the lower lines entirely around. It will be well to use a sharp-pointed lead pencil in marking around the legs for the lower mortises. These mortises extend entirely through the legs so that the lines have to be carried all around the legs and were knife lines used, they would show badly on the finished piece. Keeping the gauge head against the faces, gauge the sides of the mortises. Gauge all the mortises first at  $\frac{7}{8}$  in., then at  $1\frac{3}{8}$  in. The ends of the mortises which were penciled may

now be knifed between the gauge lines to facilitate setting the chisel. Use the try-square with the knife.

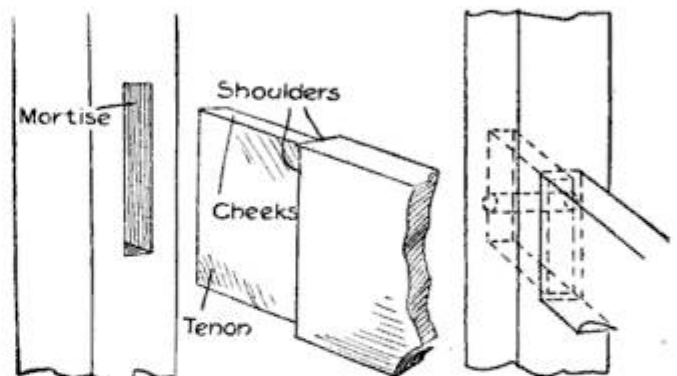

Fig. 108—A Tenon-and-Mortise Joint

In laying off for gauge settings, instead of measuring directly for them, the rule is placed as in Fig. 97 of Chapter XIV. The measuring is done from the center of the piece each way. Afterward, the spur is set in these knife point marks and the head pushed up against the face and the screw set.

There are two ways of cutting a mortise that are common. One way, which is especially advantageous in large mortises, is to bore a series of connected holes very nearly the entire length of the mortise. If the mortise is closed, as are the upper mortises in the legs of this table, the holes must be of uniform depth and correct. Figure 109 shows a simple device for obtaining uniform and correct depth. The block is to be sawed off to the length required by the depth of the mortise and the length of the bit. This can be determined by turning in the

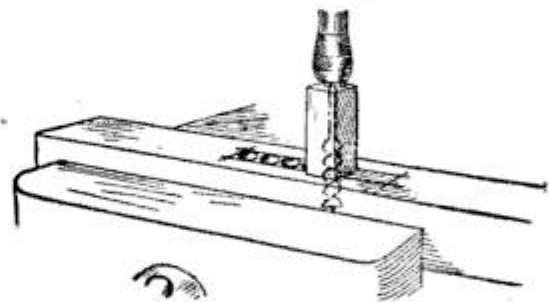

Fig. 109—Depth Gauge

spur until the lips are ready to cut, then measuring the length of the bit up to the jaw. Subtract from this the depth of the hole and the length of the block is known. Beginning at the center, pare off thin slices of wood un-

til the gauge and knife lines are reached. The sides of the mortise must be cut down plumb or the tenon cannot fit. In the through tenon and mortise the holes must be bored from

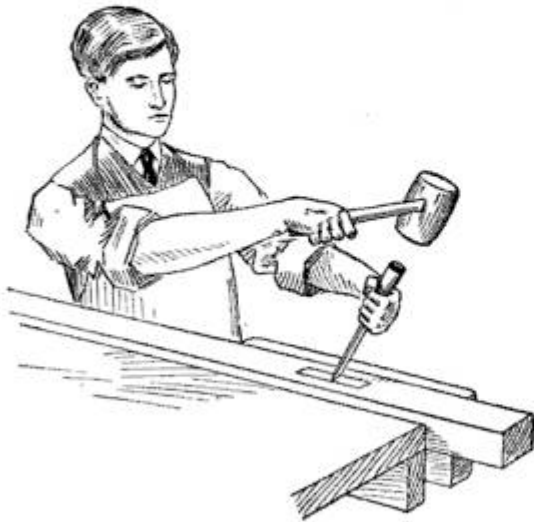

Fig. 110—Cutting a Mortise

each side of the leg and likewise chiseled.

The second method consists in only chiseling the mortise. Use a chisel that is the same width as that of the mortise. Stand so as to be able to look along the length of the mortise and cut out a V-shaped opening the depth of the mortise, Fig. 110. If the mortise is to extend through, cut a little over half way. Next, begin in the center and, with the bevel side of the chisel toward you, take vertical cuts and work gradually toward the other or far end. Cut the full depth of the mortise each time and pull the chisel toward you after each cut before removing it to break the waste from the sides of the mortise.

Cut to within  $\frac{1}{8}$  in. of the end and then reverse the piece and cut out toward the second end. Pry out the chips occasionally. Finally finish the two ends out to the knife line but do not pry on them after these cuts. If the mortise is a through one, cut one side of the leg, then reverse and cut from the second side, being careful that the cutting from the second side shall be plumb. Otherwise there will be danger of the chisel splintering the arrises of the first side. Never allow the chisel edge to be forced beyond two-thirds of the way through.

There remains the boring of the holes for the pins. Lay these out very carefully on the legs with rule, try-square and gauge. Instead of inserting the tenons and boring both mortise sides and tenon at once, lay out the holes on the tenons separately, very carefully. Use the same measurements as for the mortises, except that the center is to be drawn toward the shoulders about  $\frac{1}{32}$  in., strong. This is to insure the pins' pulling the shoulders up snugly to the leg and is called draw-boring. Too much draw-bore would split the tenon, therefore care must be taken to have everything just right.

Use  $\frac{3}{8}$ -in. doweling for pins. Cut them off longer than the leg is wide and point the end so that it can find the way through without splitting off the arrises of the hole at the far side. Use glue and clamps on the upper joints.

The top is to be fastened from the under side of the top stretchers by means of screws.

(To be continued)

### How to Mix Plaster of Paris

For the mixing of plaster of Paris for any purpose, add the plaster gradually to the water, instead of the contrary, says the Master Painter. Do not stir it, just sprinkle it in until you have a creamy mass without lumps. Equal parts of plaster and water is approximately the correct proportion.

The addition of a little vinegar or glue water will retard the setting of the plaster, but will not preserve its hardening. Marshmallow powder also retards the setting. In this way the plaster may be handled a long time without getting hard. If you wish the plaster to set extra hard, then add a little sulphate of potash, or powdered alum.

### Floor Push Button

An ordinary electric push button can be used for a floor push button by placing it on a bracket or shelf attached to a joist, as shown, and using a nail for the extension push. A  $\frac{1}{4}$ -in. hole is bored through the floor, also through a small piece of wood fastened beneath the floor, at the right place to direct the nail so that it will strike directly upon the small black knob of the push button. The nail

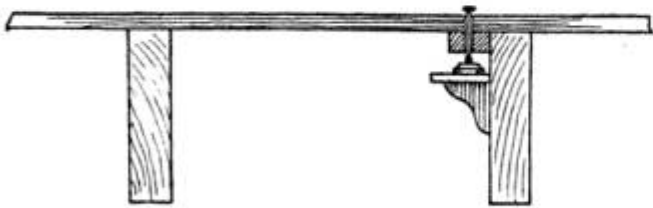

Push Button on Joist

should be just long enough to rest lightly on the knob.—Contributed by Reginald R. Insole, Hamilton, Can.

### A Wrist Brace

To strengthen a weak wrist, take a piece of leather, preferably white oak tanned, 2 in. wide and 14 in. long, and carefully shave it down with a sharp knife, until it is  $\frac{1}{16}$  in. thick. Then cut it as shown in Fig. 1, the wide part or body being 7 in. long, and the narrow part or neck, 6 in. long and 1 in. wide. Cut a semicircular hole, 1 in. from the extreme end of the body,  $\frac{1}{2}$  in. wide and  $1\frac{1}{4}$  in. long, to allow the neck to slip through, then punch three holes in each end and lace with rawhide or shoestring, or, better still, if you happen to have a small buckle, sew it neatly to the body. It looks better



FIG. 1

Brace Made of Leather

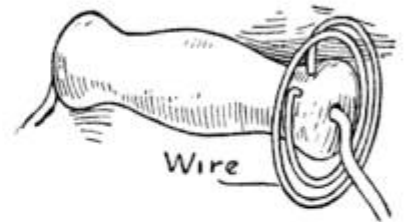

FIG. 2

and saves time in adjusting. When complete and on the wrist, it will appear as in Fig. 2.—Contributed by J. H. Harris, Berkeley, Cal.

### Protecting a Kettle Handle from Heat

The wood handle of a kettle or cooking utensil when not in use usually comes in contact with the side of the vessel and it will absorb enough heat each time to finally char and crack the wood.



The heat of the handle at times is so intense that it often results in a burned hand. The spiral metal handle provides a way for cooling by exposing a considerable surface to the air, yet the metal retains the heat so that many times it is too hot to handle. If a wood handle is provided with a coil of wire as shown in the accompanying sketch, the wood cannot come in contact with the side of the heated vessel and the air encircling the wood prevents it from getting too hot to handle. The spiral can be attached to a metal handle with solder.

### Tin Can Used for Watering Chickens

An ordinary discarded tomato can makes a good watering vessel for young chickens. Care must be taken in opening the can to cut the tin so the cover will hinge. Cut the tin about  $1\frac{1}{2}$  in. from the bottom so that it will form a U-shaped piece as shown in the sketch and push the hanging portion in the can. Fill the can up to the opening with water, close the cover and set it in the coop.—Contributed by L. Alberta Norrell, Augusta, Ga.

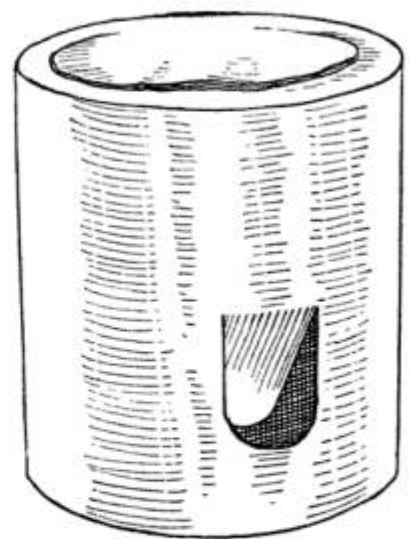

## INTERESTING PATENTS

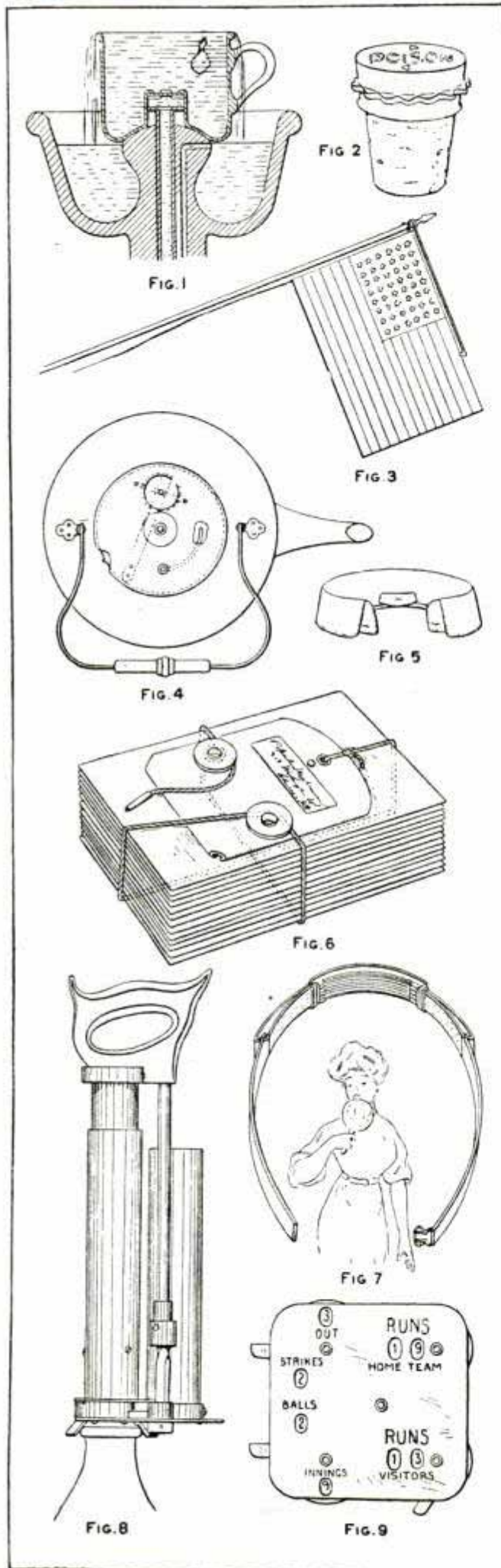

**SANITARY DRINKING FOUNTAIN**—A drinking fountain, the cup of which may be lifted to the lips but when not in actual use has water continually flowing over its rim, is shown in Fig. 1. The fountain has a convex head with a supply pipe projecting from it, and upon this the cup is seated. The cup has a concave bottom provided with a central tubular upwardly projecting valve casing adapted to receive the supply pipe. In the casing is a check valve. When the cup is on the fountain head, the water enters and overflows, and when the cup is removed by the drinker, it retains the water in it.



**POISON-BOTTLE CORK**—The danger of mistaking a bottle of poison for some harmless drug when groping in the dark is made practically impossible by a poison top of the type shown in Fig. 2. It is a metal cap provided with a stopper-engaging flange, which is outwardly flared and crimped to provide regularly spaced flat projections. In drawing the cork, the fingers cannot help but come in contact with the projections, and this draws attention to the nature of the contents.



**FLAGPOLE ATTACHMENT**—To persons who object to flags drooping when the air is still, this little device (Fig. 3) may be found useful when flags are flown on a pole set at an angle. It comprises a rod having its inner end formed into a coil to encircle the flagpole and its outer end adapted to secure the flag. The coil or collar is sufficiently loose to allow the rod to rotate about the pole.



**REVOLVING KETTLE-LID**—Figure 4 shows a kettle provided with a nonremovable lid. The lid is in two parts, one being stationary and the other revoluble. The revoluble lid-member is provided with an inlet opening which registers with the valve opening in the stationary member when the former is turned to its open position.



**PERFECT TIE-SLIP COLLAR**—Instead of the hole for the back collar button being in the neckband of this turn-down collar (Fig. 5), it is in a tab attached as shown. This leaves an unobstructed tie-space in which the tie can easily be slid back and forth in the process of tying, and gives a lateral movement that allows the collar to adjust itself to the neck and shirtband.



**COMBINED TYING DEVICE AND LABEL HOLDER**—Figure 6 is a handy combined label holder and package tie, the method of application of which is clearly shown in the drawing.



**WAIST-RETAINING DEVICE**—The perverse inclination of a waist to creep up in the back and bulge out when held only by an ordinary belt may be prevented by using a belt of the kind shown in Fig. 7. The friction member designed to hold the waist in place is provided with a number of inwardly facing projections, which the inventor believes will restrain the climbing movement without harming the fabric.



**MACHINE FOR CAPPING MILK BOTTLES**—It is claimed that milk bottles may be capped by this machine (Fig. 8) at a speed several times greater than by the ordinary process. The caps are contained in the shorter cylinder, and are fed, one at a time, under the plunger in the capping cylinder.



**DISK COUNTER FOR BASEBALL GAMES**—An ingenious score keeper or counter for baseball games is shown in Fig. 9. Provision is made for the innings, strikes, balls, number of men out, and the runs made by both sides.



## PRACTICAL OR UNIQUE

**SANITARY DRINKING FOUNTAIN**—The agitation against the public drinking cup has resulted in many schemes for the elimination of the danger of infection from such a source, but none of them is more curious than the idea shown in Fig. 10. Beneath the water faucet is a rotary drum having radially disposed runway channels, above each of which is a cup chained to a ball that rolls back and forth in each channel. Underneath the drum is a receptacle divided into two basins, in one of which is an antiseptic solution and in the other a rinsing solution. The drum is revolved by means of the balls at the end of the chains, and, as the cups are used, they drop first into the antiseptic bath and then are dragged over the separating wall into the rinsing basin.



**STREET FIXTURE FOR ELECTRIC LAMPS**—The operation of the curved street-lamp support is clearly shown in Fig. 11. The electric circuit is automatically cut out when the arm has been moved to a predetermined position.



**A WHIRLING SPARKLER**—The Fourth-of-July pyrotechnic toys known as sparklers have become exceedingly popular because, while harmless, they provide the child with something which produces a shower of sparks. In Fig. 12 is shown a new form. It is loop-shaped, and provided with a handle by which it may be whirled while burning.



**MOVING-PICTURE ADVERTISING CHAIR**—On each arm of this advertising chair (Fig. 13) is a glass-covered space, 4 in. square, under which passes a roll which is covered with advertisements, the reading matter being changed with every rock. The shaft operating the rolls is turned by means of a ratchet, cog, and lever mechanism which engages with the floor during the rocking action of the chair.



**FIRE-SHUTTER CONTROLLER**—A fire-shutter controller by which it is claimed that common swing-shutters may be opened and closed quickly and safely from the outside of a building without impairing their usefulness, is shown in Fig. 14. The mechanism was invented by a lieutenant of the Boston fire department, and is designed simultaneously to close or open from the ground all the shutters that are hung in vertical alignment, as well as to allow any single shutter to be operated from windows on the inside.



**STOPPER EXTRACTOR**—Figure 15 is a cork extractor comprising an impaling screw and a supporting member shaped to rest on the top of the neck of a bottle. The supporting member acts as a fulcrum for the drawing of the cork.



**CONVERTIBLE GARDEN TOOL**—A combination of hoe and spade is shown in Fig. 16. A ratchet between the shank of the blade and the handle permits adjustment in any desired position.



**ANIMAL TRAP**—This method of trapping animals, presumably mice and rats, was patented by an Iowa inventor. Attached to the end of a table top is a wire for the bait and a runway so mounted that it will tip under weight and drop the animal into a tub partially filled with water.



**SHAMPOO CAP**—A protecting cap or shield for use when shampooing the hair is shown in Fig. 18. It passes around the head and forms a protection for the face and neck. In the front is a transparent section through which the user may see.

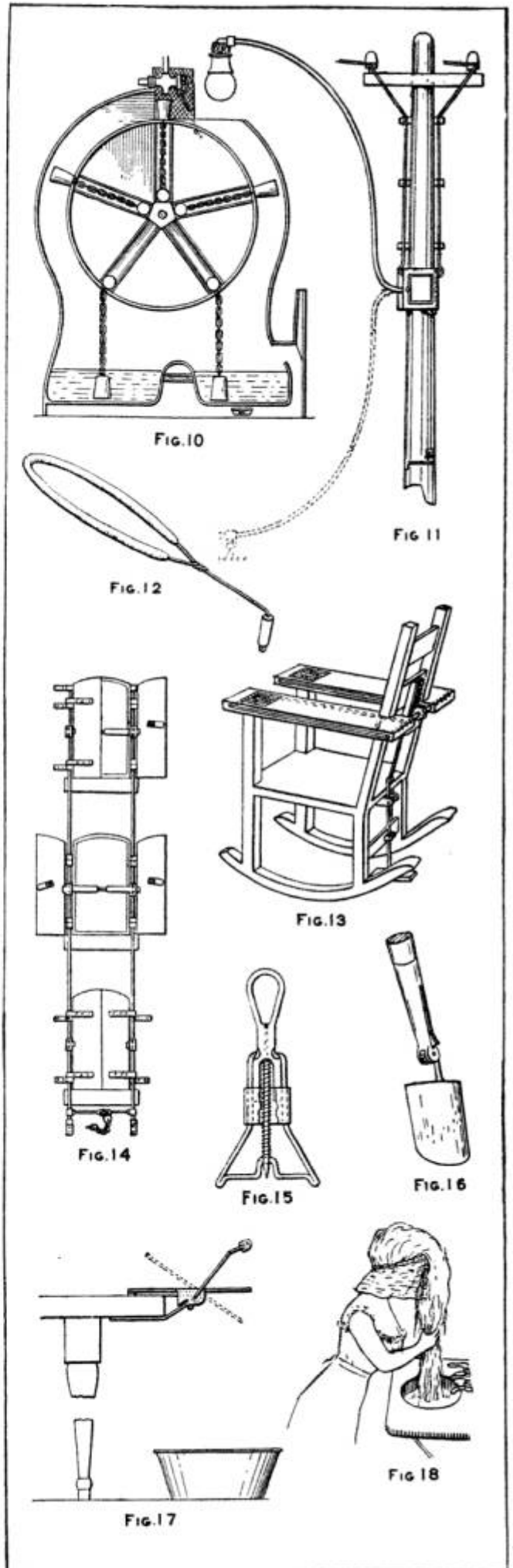

TWO contractors were discussing the methods of building work in New York and Chicago. The contractor from the latter city claimed that they put up buildings much faster there than in New York. "Sure," said the Chicagoan, "they will be digging for the foundation of a 52-story building today and in two weeks it will be finished." "Well, that's nothing to the way they do things here," the New Yorker retorted. "To give you an idea how fast we are let me tell you that the day before yesterday they began building a 20-story apartment on our block and this morning they were dispossessing some of the tenants for being behind with their rent."—Engineering-Contracting.

◆◆◆

Little Willie—Say, pa, doesn't it get colder when the thermometer falls?

Pa—Yes, my son.

Little Willie—Well, ours has fallen.

Pa—How far?

Little Willie—About five feet, and when it struck the porch floor it broke.

◆◆◆

A French woman, proud of her limited knowledge of English, and an American woman proud of her limited knowledge of French, were introduced at an evening company. The French woman insisted on expressing herself in bad English and the American woman would talk nothing but bad French.

When the guests began to depart they were still at it. At last they arose to go. Here is their watery farewell:

"Reservoir," said the fair American.

"Tanks," responded her new friend.

◆◆◆

"Waiter!" called a diner, at a local club, "come here at once! Here's a hook-and-eye in this salad!" "Yessch, yessch," said the waiter, grinning broadly. "Dat's a paht of de dressing, seh!"—

◆◆◆

The principal of one of the East Side night schools was enrolling a new pupil, who was togged out in a suit of clothes so new that it hurt him. Just before the boy came in the principal heard the sound of the fire engines in the street.

"What is your name?" the principal asked the lad.

"Tom Dugan," was the reply.

"Where was the fire, Tommy?" asked the principal as he wrote down the name. There was no reply; only a scowl.

"I say, where was the fire?" repeated the principal.

"Don't git gay wit me," was the somewhat astonishing answer. "Dere wasn't no fire, see? I bought dis here suit and I paid seventy-five cents fer it."—New York Press.

◆◆◆

"It's a hard world," said the aviator who felt that he was not appreciated.

"Yes," replied the colleague. "The world would be much easier for our business if it could have been made of rubber and inflated."—Washington Star.

◆◆◆

A motorist who had been scorching on a country road was brought before a justice of the peace, who had fined him before.

"You have been out with that machine again, have you?" demanded the justice. "Frightening horses again, eh? Why don't you get a flying machine if you want to beat time and be eccentric?"

"It would be no good," wearily replied the prisoner. "You would arrest me for frightening the birds."—Royal Magazine.

◆◆◆

An Iowa woman who looked into the barn and saw her husband hanging to a cross beam is reported to have exclaimed:

"Land sakes! So that's where my clothesline went to!"—Cleveland Plain Dealer.

◆◆◆

"How did Clarence come to get into a disgraceful fight with that camera fiend?"

"Well, you see, Clarence was walking in the park

last Sunday with his fiancee, Miss Fryte. And whenever the lady got in range of the camera, the man would snap it."

"And so Clarence objected?"

"Well, he spoke to the man about it. And the fellow answered that he wasn't taking her picture, but only closing the shutter when she passed, because the lens was too valuable to risk."—Toledo Blade.

◆◆◆

"Have you a spare room in your flat?"

"No; but I stand in with the janitor, and when I have a guest overnight he lets me use the telephone booth."

◆◆◆

O'Hare was a section foreman. He was showing a friend, who had just arrived from the old country, his section. They finally reached a tunnel, and, as they were walking along, a train came rushing by at high speed, passed them and dashed into the tunnel with a great roar.

O'Hare's friend gazed after the train with open mouth and staring eyes.

"Well," said O'Hare, "what do you think of this road? Don't you think I have a well-kept section of track?"

"Yis, indade," said his friend, "but, holy snakes! Just think what an awful calamity it would be if the train should miss the hole!"—Railroad Man's Magazine.

◆◆◆

The motorist emerged from beneath the car and struggled for breath. His helpful friend, holding the oil can, beamed upon him.

"I've just given the cylinder a thorough oiling, Dick, old man," said the helpful friend.

"Cylinder," said the motorist, heatedly, "that wasn't the cylinder; it was my ear!"

◆◆◆

With much trouble the burglar had effected an entrance into the trust company's office. As he approached the big steel safe he was confronted by this sign:

SAVE YOUR DYNAMITE.  
THIS SAFE IS NOT LOCKED.  
TURN KNOB AND OPEN.

"I don't know what their little game is," he said, "but I'll just see if it really is unlocked."

He grasped the knob and gave it a turn.

Whereupon he received an electric shock that nearly floored him, an alarm bell rang loudly, the office became flooded with light, a door in the wall flew open, and a big dog sprang at him.

"Darn my fool hide!" he exclaimed an hour later, as the door of a cell in the police station closed on him; "I know what's the matter with me! I'm too trusting!"—Chicago Tribune.

◆◆◆

"Can you give my constituent here a job on your railroad?" asked the State Senator.

"But he can't talk English."

"Well, give him a job calling trains."

◆◆◆

"You know that fellow, Jim McGoarty, the lad that's always comin' up an' thumpin' ye on th' chist an' yellin' 'How are ye?'"

"I know him."

"I'll bet he's smashed twenty cigars for me—some o' thim clear Havannays—but I'll get even with him now."

"How will ye do it?"

"I'll tell ye. Jim always hit me over the vest pocket when I carry my cigars. He'll hit me there just once more. There's no cigars in me vest pocket this mornin'. Instead of it there's a stick of dynamite, d'ye moind?"

◆◆◆

Old man from Missouri (viewing aeroplane for the first time)—"Holy Smokes! if that ain't the queerest-lookin' balloon I ever seen."

Young man (also from Missouri, scornfully)—"Balloon? That ain't no balloon; that's parcels goin' by this noo wireless telegraph."—Judge.



Phantom view showing the simple construction of the G - E Flatiron.

The well-known "Calorite" heating unit with and without mica insulation.

The shell and base before being clamped together.

## Transparent Simplicity

### The General Electric Company's Electric Flatiron Lasts a Lifetime

Careful attention to the smallest detail in design and production has resulted in an iron that remains in perfect working order for a generation.

The part that transforms electricity into heat cannot burn out. This unit, insulated by mica and tightly clamped between the two halves of the base, is thus protected from possible injury by two layers of cast iron, each of which is three-eighths of an inch thick. The base is clamped into the shell of the iron so firmly that years of hard service cannot loosen it.

Half a million women use this flatiron that makes ironing a pleasure instead of drudgery. The iron gets "just hot enough" so that it "floats" over the work, leaving the smoothest, glossiest finish imaginable. Every woman realizes how infinitely superior to the old way *electric* ironing is. Every household can have this electric iron that costs only about five cents an hour to operate.

Most electric lighting companies and dealers sell this iron but, if you cannot get one locally, send \$5.75 and we will deliver one promptly through our nearest representative. A three-deck stand, attaching plug and six feet of silk-covered cable are sent free with every iron.

**Be sure to state the voltage of your lighting circuit**

# General Electric Company

Schenectady, N. Y.

Largest Electrical Manufacturer in the World



## The MARK of the MAKER is the Mark of Excellence

IT makes you sure of getting GOOD TOOLS because it *makes us responsible* for the quality.

Any item in our four large lines of Guaranteed Hand Tools has to be up to the standard of over 90 years of supremacy in tool-making before we are willing to stamp that mark on it with a steel die.

That means the greatest care in selection of materials, the most skillful workmanship and the most rigid testing. We couldn't afford to risk our reputation by the slightest defect.

Look for The MARK of the MAKER on P. S. & W. Guaranteed Hand Tools for Carpenters, Machinists, Electricians, Tinsmiths, etc.

## The Peck, Stow & Wilcox Co.

MANUFACTURERS of the Largest Line of Mechanics' Hand-tools Offered by Any Maker

Established  
1819

Address correspondence to 20 Murray St.  
NEW YORK CITY

Five Large  
Factories

## You Need This Book

It's just the right size to slip into your pocket or to keep in your kit or tool-chest.

It contains a handy reference catalog of over 200 of the best hand-tools made, with full descriptions, prices, etc.

Besides that, it has 35 pages of valuable shop-information—statistics, reference tables, etc.

We've had such a demand for it that the book is already in its third edition.

Write today and we'll send you a copy free.

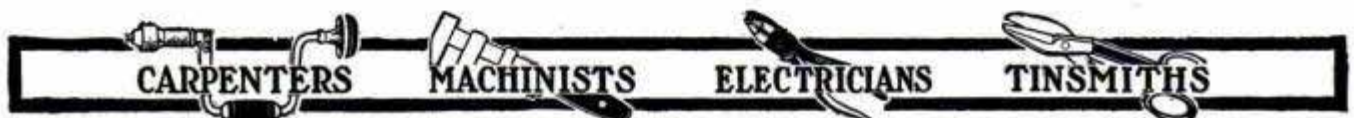

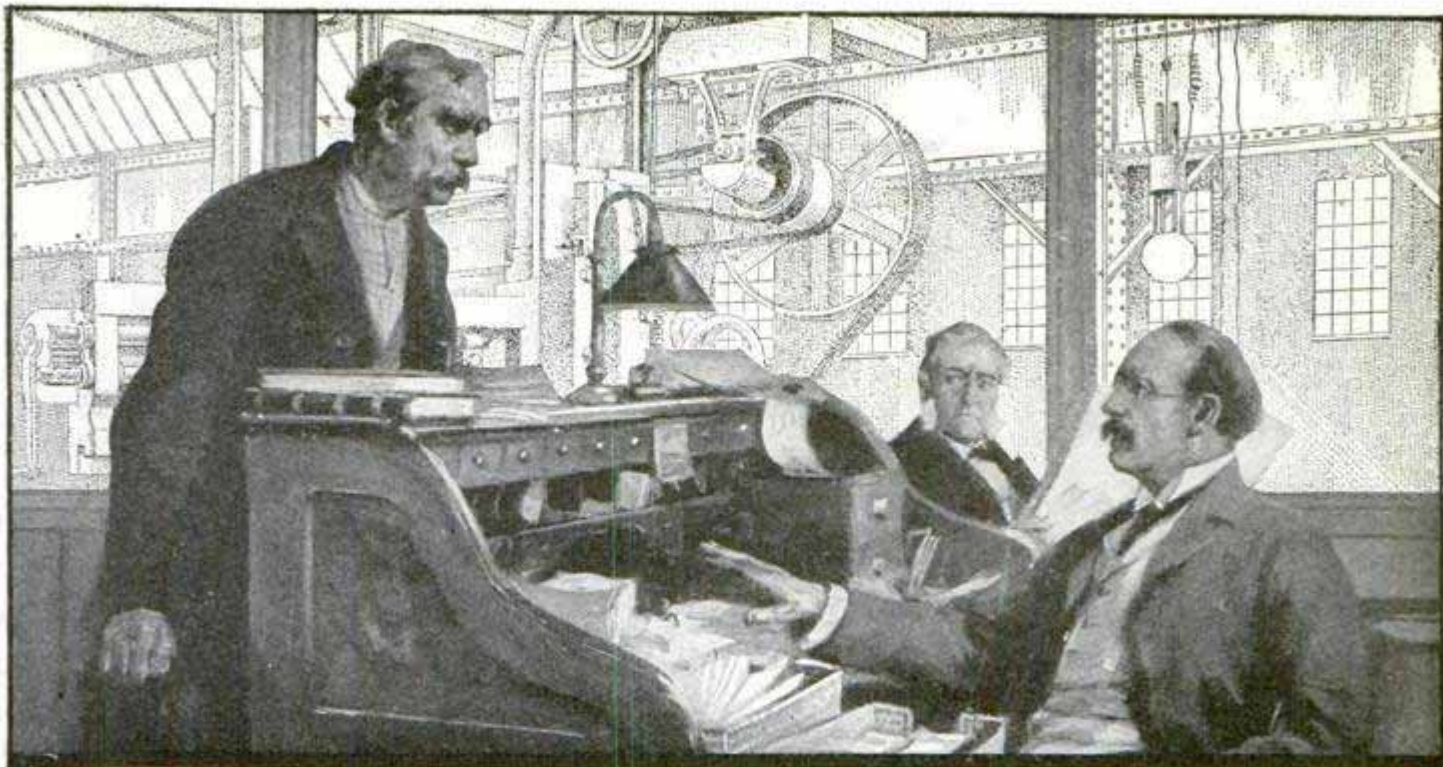

# On Which Side of the Desk Are YOU?

In every business there is a desk with two sides. The man on the one side thinks and makes money—the man on the other side works and draws “wages.” On which side of the desk are YOU?

The man before the desk works with his *hands* and is paid for his *labor*. The man behind the desk works with his *head* and is paid for his *knowledge*. It is merely a question of “knowing how.”

For 19 years the International Correspondence Schools, of Scranton, Pa., have been enabling people to advance in position and earn more money. Every month there are received at the I. C. S. over 400 voluntary letters telling of positions bettered and salaries increased through study of I. C. S. Courses. The writers of these letters are not men of genius—not the sort known as “gifted,” “naturally bright,” etc. They are plain men that have studied diligently the work of their choice. Spare-time study won their advancement.

Thousands that have doubled, tripled, or quadrupled their salaries made their start by marking and mailing an I. C. S. coupon.

If you want to raise *your* salary, mark and mail the attached coupon. Mailing the coupon will bring to you a full explanation of the I. C. S. salary-raising plan.

**Mark and mail the coupon NOW.**

## International Correspondence Schools

Box 872, Scranton, Pa.

Please explain, without further obligation on my part, how I can qualify for a larger salary and advancement to the position, trade, or profession before which I have marked X.

Electrical Engineering  
Electric Lighting  
Electric Railways  
Electrician  
Electric Car Running  
Dynamo Foreman  
Dynamo Tender  
Wireman  
Mining Engineer  
Telephone Expert  
Civil Engineer  
Automobile Running

Mechanical Engineer  
Mechanical Draftsman  
R.R. Constructing  
Concrete Construction  
Architect  
Contracting & Building  
Architectural Draftsman  
Plumbing & Heating  
Chemist  
Bookkeeper  
Advertising Man  
Civil Service Exams.

Name \_\_\_\_\_

St. & No. \_\_\_\_\_

City \_\_\_\_\_ State \_\_\_\_\_

Present Occupation \_\_\_\_\_

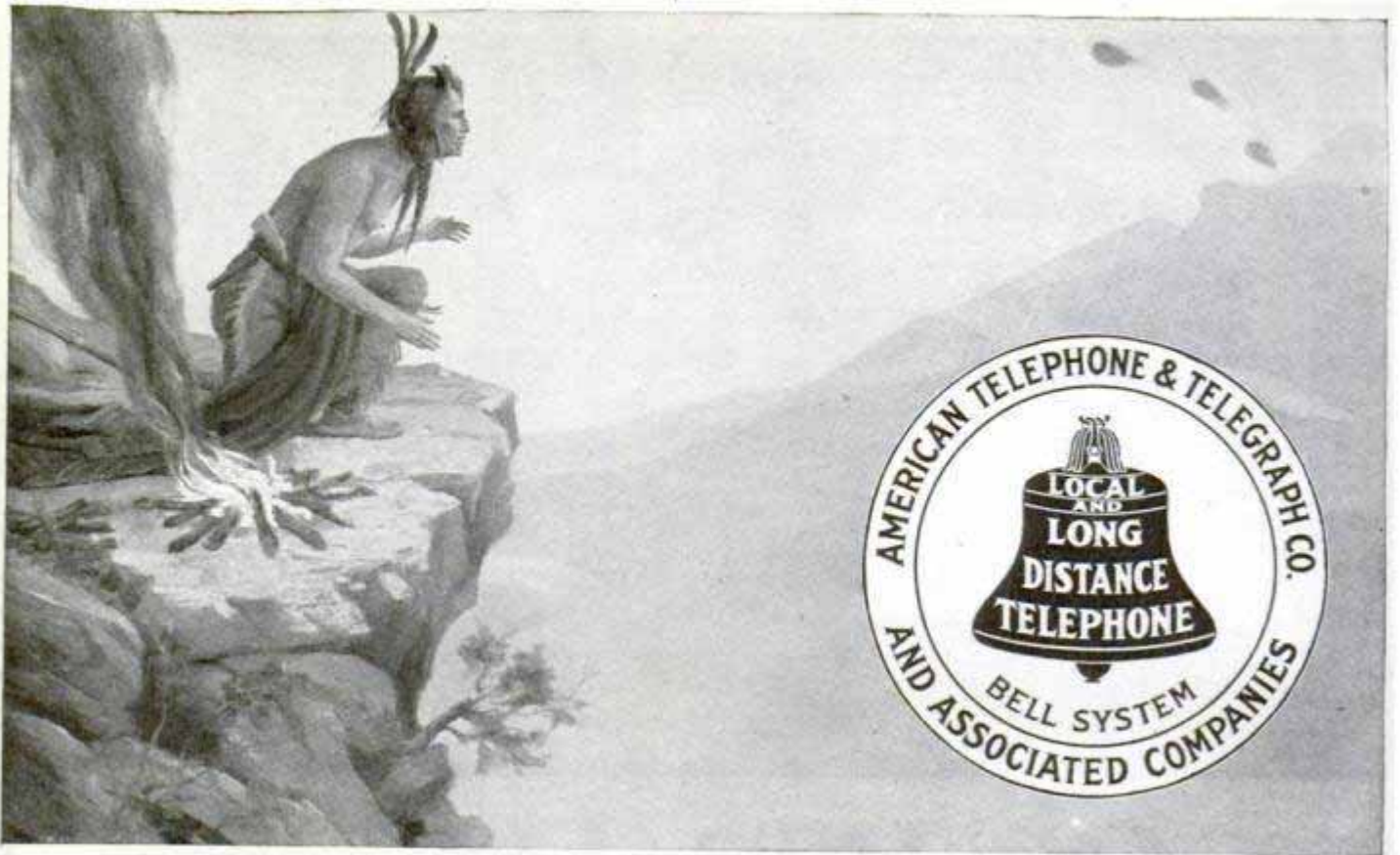

# Civilization—from Signal Fire to Telephone

**T**HE telephone gives the widest range to personal communication. Civilization has been extended by means of communication.

The measure of the progress of mankind is the difference between the signal fire of the Indian and the telephone service of to-day.

Each telephone user has a personal interest in the growth of the whole telephone system.

He is directly benefited by every extension of his own possibilities. He is indirectly benefited by the extension of the same possibilities to others, just as he is benefited by the extension of the use of his own language.

Any increase in the number of telephones increases the usefulness of each telephone connected with this system.

The Bell System is designed to provide Universal service.

**AMERICAN TELEPHONE AND TELEGRAPH COMPANY  
AND ASSOCIATED COMPANIES**

***One Policy***

***One System***

***Universal Service***

*Please Mention Popular Mechanics*



The Keenest Edge  
in Shortest Time, on  
Any Tool, With No  
Danger of Draw-  
ing Temper.

**6 MONTHS**

With  
Twist Drill  
and  
10 other  
Attach-  
ments

**FREE TRIAL**



**11 Tools  
in One**

We want every tool-user to prove by 6 months' Free Trial, on your own tools, how this grinder saves time and money, makes work easier, saves and makes money. We will send this Mechanics Special on 6 months' Free Trial, and then, if you wish, send it back at our expense.

# Luther Diamond Tool Grinder

**Genuine Carborundum Wheels  
Will Not Draw Temper**

The genuine Carborundum Wheels on this grinder cut hardest steel, as emery does soft copper, and do not draw temper—no water cooling necessary. You can do work in two minutes on this grinder that would take a half hour on the grindstone. With this grinder it is quick and easy work to keep tools bright and keen-edged, which means faster, easier general work.

**25 Times  
Faster Than  
Grindstones  
6 Times  
Faster Than  
Emery  
Hand and  
Foot Power**

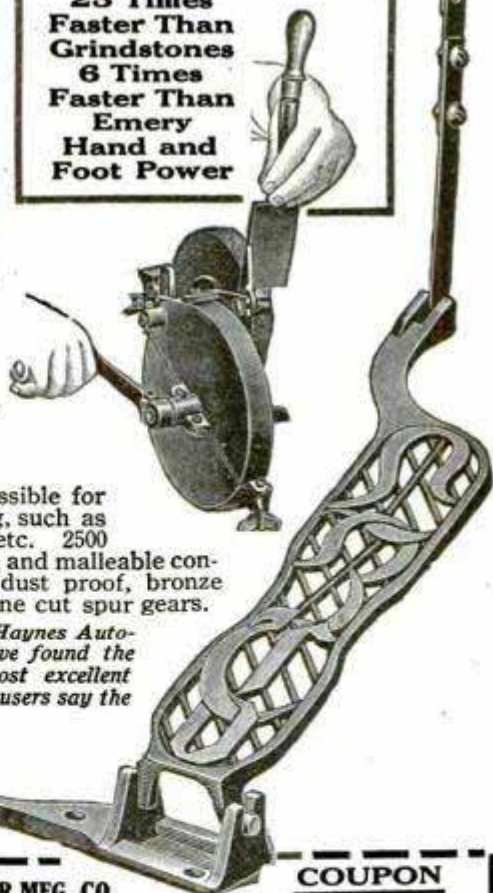

Return This  
Coupon For  
Six Months' **FREE**  
**TRIAL OFFER**

**Built Like a High  
Grade Lathe**

Special tool holders make it possible for anyone to do difficult grinding, such as twist drills, saws, chisels, etc. 2500 revolutions per minute—steel and malleable construction, enclosed gears, dust proof, bronze bearings in oil bath, machine cut spur gears.

*Elmwood Haynes, Pres. of Haynes Automobile Co., says: "I have found the Mechanics Special a most excellent device." Thousands of users say the same.*

Return this coupon for 6 months' Free Trial Offer—a whole half year of free test. Let us give you full description of the Mechanics Special—full particulars of our liberal offer, and also the wonderful story of the discovery of Carborundum, as it appeared in McClure's Magazine. Returning the coupon puts you under no obligations. It is well worth your while to find out all about the grinder guaranteed for 5 years—that will outlast any number of emery wheels—save tools and make work easier. Return the coupon today.

**Luther Grinder Mfg. Co.**  
2000 Madison St., MILWAUKEE, WIS.

**LUTHER GRINDER MFG. CO.**

2000 Madison Street, Milwaukee, Wis.

**COUPON**

Please send me free and prepaid your free Carborundum booklet and Six Months' Free Trial Offer on Mechanics Special Luther Diamond Tool Grinder. This obligates me in no way whatsoever.

NAME.....  
ADDRESS.....  
DEALER'S NAME.....  
DEALER'S ADDRESS.....

# Gray Junior

*All Ready to Run*

**\$58** All around Stationary  
Work Engine  
Complete

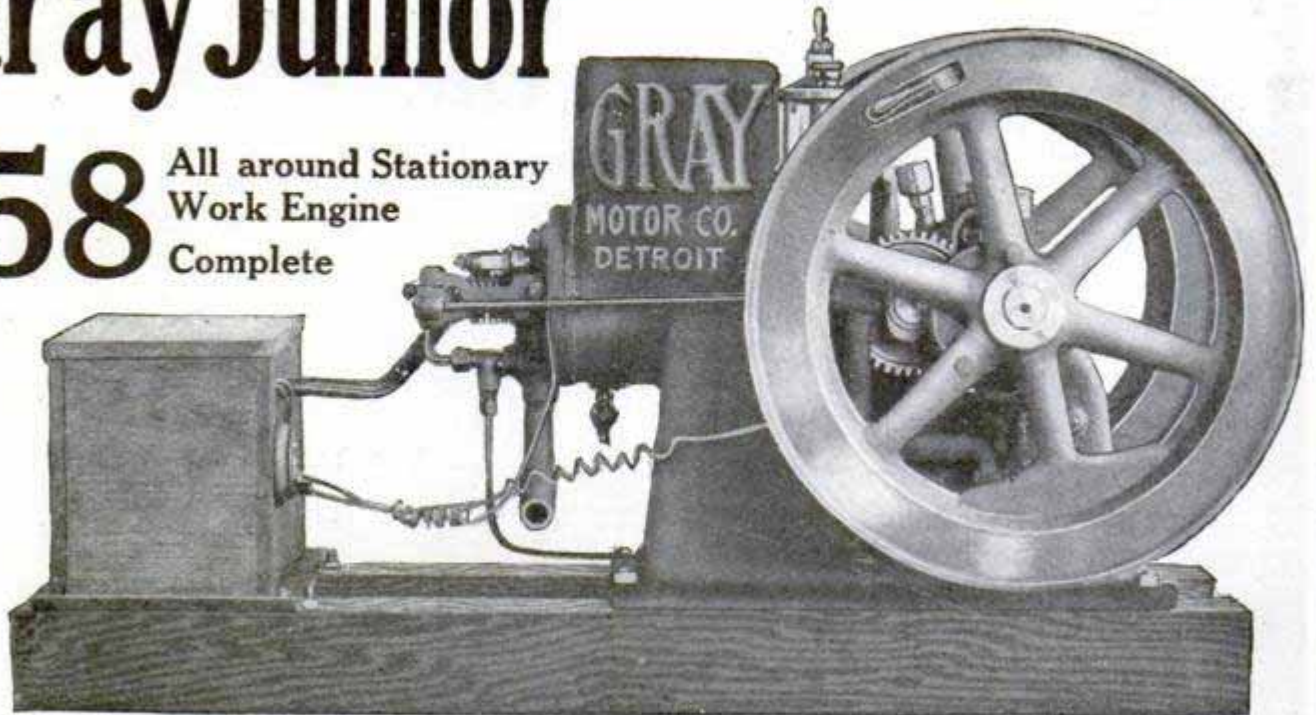

**Built Right** A good small motor. Guaranteed the same as if it cost \$500, by a big responsible concern. Made to last a life time. A woman can run it. Hopper cooled. Powerful—good material, workmanship and finish. Comes mounted, already to run as you see it. Put in your gasoline and start it up.

Agents make big money selling it because it sells itself and makes no trouble after it is sold.

It looks good, runs good and is good. Occupies a field distinctly its own because of its high quality.

Write for agent's proposition today.

## Gray Farm - Pumping and General Power Motors

Gasoline or kerosene, 3 to 36 horsepower.

6 h.p. Farm Engine, \$94 to \$124 complete.

3 h.p. Farm and Stationary Engine \$65, guaranteed to develop 4 h.p.

24 h.p. Irrigation Pumping Engine, \$346—36 h.p. for \$560.

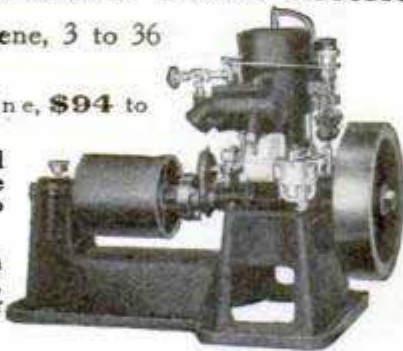

## Gray Marine Motors

For Cruisers, Work Boats  
Speed Boats and Canoes

"The engine that requires no attention"

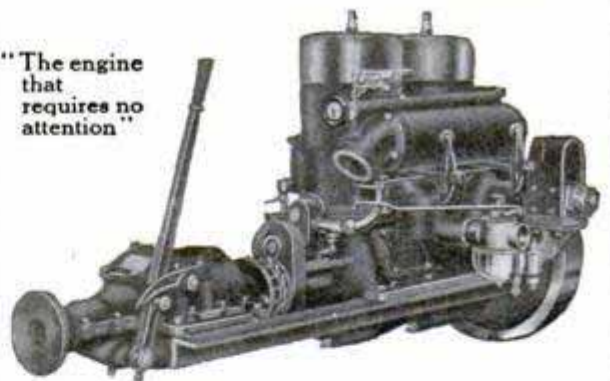

3 h.p. \$65—6 h.p. \$89.50—12 h.p. \$188.00  
24 h.p. \$330.00—36 h.p. \$528.00—Complete ready to install in your boat.

Absolutely guaranteed in every detail.

7 to 36 h.p.—1, 2 and 3 cylinders—combination 2 and 3 port.

Bosch High Tension Magneto—the most up-to-date marine engine built.

**Write today for Big New Catalog**

[ *Be sure to specify whether you want Marine or Stationary Catalog, and what you want to use the engine for* ]

**GRAY MOTOR COMPANY, 632 Woodward Ave., Detroit, Mich.**

Canadian Gray Motors, Ltd., 632 River Front St., Walkerville, On



Let Us Put This Piano in Your Parlor  
Not a Dollar To Pay Us!

# SEND NO MONEY

Enjoy This Piano—Take Your  
Own Time—Sent to You  
on 30 Days' Free Trial

Write right now and let us put this piano  
in your parlor — not a dollar to pay us.

Let us send you our big, free, actual photograph, color-illustrated, handsome book, and offers to trust you absolutely with any celebrated and artistic Reed & Sons Piano on as long time as you want, even three years or more, if you are satisfied after 30 Days' Free Trial. Not a cent to pay down— not a dollar for any of our beautiful styles you select from the book we send you on



## REED & SONS PIANOS

Established 1842. Given Highest Award  
at World's Columbian Exposition, 1893

We've sold through dealers, jobbers and agents—for over 68 years—but now we have cut out their big profits and are giving the savings to our customers. We have made our direct-to-you wholesale factory prices so low that you can have a celebrated Reed & Sons Piano, for lifelong service, at a price as low as the price of many "cheap" made pianos—and get the highest artistic quality. Our 25-year guarantee bond goes with every Reed & Sons instrument. Hundreds have had generations of enjoyment from our pianos. So can you on our plan and prove it positively at our risk.

Now Sold Direct to  
You From Factory

Saves you from \$128.00 to \$222.00 on  
price. No Security  
— No Interest to  
Pay—No Col-  
lectors.



### Also Self-Playing Pianos

Reed & Sons Self-Playing Pianos now sold on the most liberal plan. Thousands who "never knew a note" are now enjoying our Self-Players. See our offers and prices all explained in handsomest color-illustrated catalog sent Free.

Take Your Own Time  
—On Trying and Pay-  
ing — We Pay Freight  
Both Ways.

Take 30 Days' Free Trial in your home with your family and friends to judge the beautiful tone quality—handsome exclusive design and finish—easy action and splendid satisfaction. After a full year's enjoyment send our Reed & Sons Piano or Self-Playing Piano back and we'll pay the freight if not exactly as represented. That's the fairest offer ever made. It means 365 Days' Approval Test, besides 30 Days' Free Trial and 3 years' time to pay if satisfied. When absolutely satisfied you can pay \$1.00 a week, or by the month, or 3 months, or twice a year. We don't care how. Suit your own time. We want you to be happy with one of our pianos or self-playing pianos—prove it at our risk—right now. Write right now—a Postal Today—or the Coupon—For Our Big Book.

REED & SONS PIANO MFG. CO., 253 Wabash Ave.  
CHICAGO, ILL.  
Capital and Resources, \$1,750,000.00—Largest Factory-to-Home  
Piano Manufacturers in the World.



## Big Book Free

Reed & Sons Piano Mfg. Co.,  
253 Wabash Ave., Chicago, Ill.

Please send me your Big Color Illustrated Piano Book and offer  
FREE. Everything at your risk.

Name \_\_\_\_\_

Address \_\_\_\_\_

Town \_\_\_\_\_ State \_\_\_\_\_

365 Days Approval Test

# Try a Detroit Fireless Stove at Our Risk

SIX SIZES



**RADIANT STYLE**  
Heat the metal radiators a few minutes—then the imprisoned heat cooks the food.

Cooking in a Detroit Fireless (electric or with radiators) is the most delicious way—all flavor and nutriment retained; the most economical way—saves 80% of your fuel bill; the most comfortable and convenient way—saves work over a hot stove—saves constant watching—saves worry.

## Built Like a Range—Does All a Range Does

“Detroit Fireless Stoves” (both Electric and Radiant) are made from planished steel and aluminum—no wood to warp or split—no stones to break. No felt or pad to absorb steam and odors. They roast and bake perfectly—rich brown; they fry or boil perfectly; they steam and stew perfectly. Our famous Water Seal keeps all steam and odors out of the house.

**Get Our Free Trial Offer.** A “Detroit Fireless” will be sent you on 30 days’ trial. Write today—get our handsome catalog and this new offer.

**Detroit Fireless Stove Co.**  
103 Jefferson Avenue, Detroit, Mich.



SIX SIZES

**ELECTRIC STYLE**—A few minutes’ current from any electric light socket STARTS it—the imprisoned heat then cooks the food.

## MAKES A PHONOGRAPH SOUND LIFE-LIKE

### The Morse Clarifier

THIS remarkable little device is made to fit in tube between reproducer and horn of phonographs, renders the sound loud, clear

and life-like and eliminates that unpleasant metallic effect which is more or less common to all phonographs regardless of price. Can be attached in a minute—lasts as long as the machine. Thoroughly tested and proven successful.

**Mailed Prepaid upon Receipt of Price, \$1.00. Guaranteed Absolutely Satisfactory or Money Refunded.**

In ordering please state whether for Victor, Victor Victrola, Edison with metal or rubber connection, Columbia Disc with new or old style tone arm or Columbia Cylinder. Information and circular matter free.  
**MORSE BROTHERS, Manufacturers and Distributors,**  
450 Lumber Exchange, Minneapolis, Minn.



PAT. APPLD. FOR  
“THE SOUL OF A PHONOGRAPH”

## Machinists, Ironworkers, Molders, Painters, Printers, Shoemakers, Miners and All Mechanics

If you come in contact with mechanics, we want you for our agent to earn extra money while at work. To live, energetic, conscientious workers we offer a proposition that simply coins money and establishes a permanent, ever-growing business. If you are awake to your opportunities, Address

**HASTINGS & MILLER** 118 NASSAU ST., NEW YORK CITY

# Over 1,000 Gallons

Per Hour

## Fairbanks-Morse Eclipse Pumper

**\$5000**

**F. O. B. Factory**



**Engine and Pump Jack Complete**

Free Catalog No. MH 449

**Fairbanks, Morse & Co.**  
900 So. Wabash Ave., Chicago, Ill.

A patent movable foundation for a house adapting the roller-skate principle is the thing that will save money in powder-mill towns. Parachute overalls for the workers ought also to be required by Dr. Talman’s industrial safety propaganda.—Brooklyn Eagle.

## BE YOUR OWN BOSS



### Make Money Easy

AGENTS wanted in every county to sell the popular Golden Rule Knives with name, address, photo, lodge emblems, etc., on handle. Agents earn \$75 to \$200 a month selling our shears, transparent handled pocket knives and razors. Big profits, quick sales. Exclusive territory. Experience unnecessary. **WE TEACH YOU HOW.** Write today for terms and become one of our successful salesmen.



**GOLDEN RULE CUTLERY CO., 125 Wendell St., Dept. 118, CHICAGO**

## “Avoid Blade Trouble”

Ask for and insist upon getting

## STAR HACK SAW BLADES

For Machine Use 12 x 5/8

There are none better—none better can be made STAR HACK SAW BLADES, the recognized “STANDARD” by which Hack Saw Blades have been judged FOR OVER A QUARTER OF A CENTURY.

All Dealers Keep Them. Send for Particulars

28 Warren St. **Millers Falls Co.** New York



# That Clean Feeling

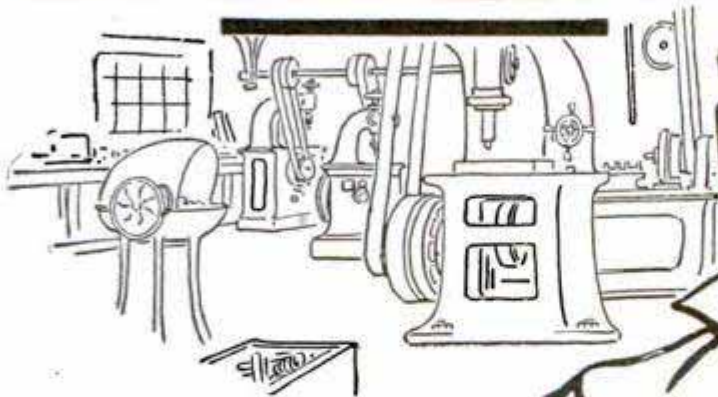

is not possible for the mechanic, who daily comes in contact with grease and grime, with the use of ordinary toilet soap.

**Pummo** is a hand soap composed of vegetable oils, the finest Italian pumice and glycerine. It takes out grease, grime and stains like magic.

The old fashioned way to rub a bit of ordinary pumice over the hands after soap had been used, in order to remove stains and spots which soap alone would not efface. In **Pummo**, the soap and pumice are combined so that only one operation is necessary, instead of two as formerly.

The glycerine in **Pummo** is also a valuable feature. It soothes and heals and keeps the skin soft and white.

**5c** is all it will cost you to try **Pummo Soap**, and one trial will prove its excellence and efficacy.

If your dealer does not have **Pummo** in stock, write us, giving his name, and we will send you a free sample by return mail.

Made by  
**The N. K. Fairbank Company**  
CHICAGO



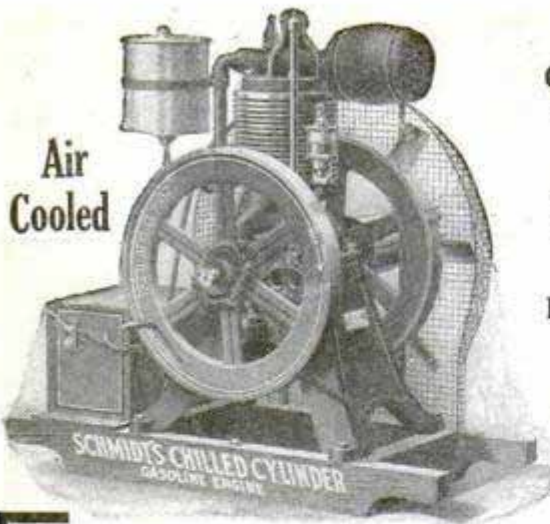

Air Cooled

Send the FREE COUPON and get Dealer's Price and Easy Payment Terms on the Most Stupendous Gasoline Engine Offer Ever Made

5 Years Guarantee

## This Engine FREE Sent to You

Here is the first real free trial offer ever made on a gasoline engine. We will actually send you our marvelous new model 3 h. p. gasoline engine for your free use for 10 days. Ten full days after you get the engine to your own place to set it working. A wonderful new type gasoline engine—the engine that has revolutionized the gasoline industry. Schmidt's Chilled Cylinder Gasoline Engine, the engine that does more kinds of work on the farm than any other engine ever made. So easy to handle we can trust it to any farmer or shop owner on absolute free trial. Lightest 3 h. p. Takes up less room.

### Easy Payments

Take long time to pay for this engine if you keep it. If you don't like it send it back at our expense. Try it first free. Then decide for yourself. Make small monthly payments if your prefer.

### Send No Money

Just a request for a free trial brings this engine to you. No advance payments to us, no deposit, no C. O. D. to us, no notes, no mortgages, no security but your own word. 5 years guarantee on this engine. You can save all dealers' and agents' profits on this engine if you write to the engine works direct.

### SHOP ENGINE

This engine is suited to all the needs of a farm or shop. It can't "kick back" because it has our Spark Retarder—the only farm-engine with a Spark Retarder. A woman or a boy can handle this engine.

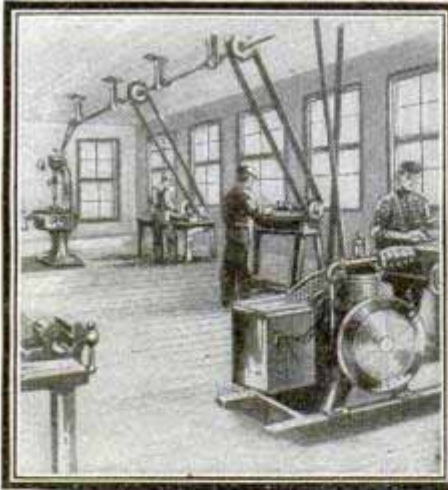

**HOW TO USE POWER** To all who send the free coupon promptly, we will send a very valuable booklet on how to use power on a farm or in a shop. It will tell you the newest things about saving time and labor on a farm that you certainly ought to know.

**FREE COUPON**

Schmidt Bros. Co. Eng. Works, Dept. 119X Davenport, Iowa

### Send Free Coupon

Schmidt Bros. Co. Engine Works Dept. 119X Davenport, Iowa.

Gentlemen: Without any obligation on me you may send me catalogs and full particulars of your free trial offer, your wholesale price and easy payment terms on Schmidt's Chilled Cylinder Gasoline Engine, also free book "How to Use Power" all free and postpaid.

NAME.....

ADDRESS.....

Please Mention Popular Mechanics



**SCHACHT**

## 3 Cars in 1—\$850.00

The Schacht is the greatest under \$1000 car ever put on the market for it not only is a remarkably staunch and speedy roadster, but the addition of a rear seat makes of it a big, roomy family car; or the addition of a box, an up-to-date delivery car.

SEND FOR CATALOG

**THE SCHACHT MOTOR CAR CO.**  
2802 Spring Grove Ave., CINCINNATI, OHIO



### Send for Our Free Vibrator Book

describing the White Cross Electric Vibrator. This Vibrator is a rubbing machine which draws the blood to any aching part of the body to do its work. This machine rubs much better and much faster than the hands. While the hands are giving a few dozen rubs, the White Cross Vibrator gives several thousand. Send today for the Free Vibrator Book. It may mean health to you. Lindstrom-Smith Co., 253 La Salle St., Dept. 119X Chicago

**GULL FORETELLS COMING OF THE HERRING**  
—The herring gull is the advance agent of prosperity in some sections of the New England coast. This peculiar species of bird invariably appears just previous to the beginning of a "herring run" as the appearance of large schools of this kind of fish is called. When the people of Taunton, the "herring city" of Massachusetts, see a herring gull, the joyful news is sped through the town and the fishermen get away as soon as possible, that they may be first on the fishing grounds and get the best of the "run."—Exchange.

**Own a Model AEROPLANE**  
Be up-to-date. Learn how to fly with our Flying Bat 12 in. model. It flies 200 feet by its own power. Very instructive and amusing. Sent complete, postpaid, on receipt of 30c in stamps. Satisfaction guaranteed. Send for catalogue. **GOFF AEROPLANE CO., Dept. P.M., CHICAGO**

## INSTRUCTION BOOK

and Wood Finishing Samples **FREE**

Here's the best book ever published on artistic wood finishing, the work of famous experts, illustrated in 5 colors. For a limited time only we will mail it free and pay postage to anyone interested in the latest and most artistic way of finishing furniture, woodwork and floors. Ask your leading dealer in paint for free samples of



In answering this ad, ask for Book PA 6

### Johnson's Wood Dye



(made in 15 popular shades) and Under-Lac (better than shellac or varnish). If your dealer hasn't samples send us his name and we will mail them to you free.

**S. C. Johnson & Son Racine, Wis.**

"The Wood Finishing Authorities"

# It's Printype!



"What a beautiful typewritten letter—as plain as print—as easy to read as a primer! It must be the new Oliver PRINTYPE! I wish all our correspondents used The Printype Oliver Typewriter!"

—A composite quotation from ten thousand business and professional men on being introduced to Printype

ALL eyes are watching Printype. Its attraction is irresistible. Its beauty and grace, in a typewritten letter, are alluring, attention-compelling. Although absolutely new to *typewriting*, its counterpart—Book Type—has been used on all the world's presses since the printing art had its inception. It is the Oliver ideal of perfect typography applied to typewriter uses.

We had brought the machine to its maximum of efficiency. We had added, one by one, a score of great innovations. There remained but one point—that was *the type itself*.

Then came the inspiration which meant a *revolution in typewriter type*. We would design and produce a new typewriter type face, conforming to the type used in newspapers, magazines and books.

We did! It's here! It's PRINTYPE!

Printype is not an experiment. It is, in all essentials, the type that meets your eye when you read your morning paper, your magazine or your favorite novel. Now that Printype is an accomplished fact, the thought occurs to thousands, why didn't typewriter manufacturers think of it years ago? The same question was asked when, over ten years ago, we introduced *visible writing*.

## A Long Step in Advance

The change from the old-style thin outline letters known as Pica Type, universally used up to now on all standard typewriters, to the new, beautiful, readable Printype, is one of vast significance. It means relief from the harmful effect on eyesight of the "outline" typewriter type. For Printype is as easy to read as a child's primer.

It means less liability of mis-reading, due to blurring of outline letters, whose sameness frequently makes the words run together. Printype letters are *shaded*, just as Book Type is shaded.

It means less danger of costly errors, due to confusing the numerals. No possible chance of mistaking 3 for 8 or 5 for 3—each figure is distinct. It means a degree of typographic beauty never before known in typewriting.

And now, because of its *newness*, it has the enhanced charm of *novelty*.

## Printype Now Famous

The reception of Printype by the business public has been most enthusiastic. We withheld any formal announcement until the machine had been on the market for one year. Personal demonstrations were its only advertising. The resulting sales were stupendous. Printype letters soon began to appear among commonplace old-style correspondence. Wherever received, these mysterious, distinctive, beautiful letters awakened immediate interest. Business men began asking each other, "What's that new kind of typewriter that writes like real print?" Thus the fame of Printype grows as its beauty and utility dawn on the business world.

## Ask for Book, Specimen Letter and Demonstration

We will gladly send you a Printype Book, together with a letter written on The Printype Oliver Typewriter. This letter will be a revelation.

Our great sales organization enables us to make an improvement of this character immediately and simultaneously available to the public. Press the button and see how quickly an Oliver Agent will appear with a "Printyper," ready to tell you all about it and write several Printype letters for you. Address Sales Department

# Printype — OLIVER Typewriter

The Standard Visible Writer

## Printype Aids Eyes

The manifold merits of Printype are a constant source of surprise. Printype is restful to eyesight. It delivers its message in the most easily readable form.

The constant reading of thin outline letter typewriting plays havoc with the eyes. It sends thousands to oculists and opticians.

A comparative test of Printype and ordinary typewriting will win you to *the type that reads like print*.

## We Have Not Raised Our Price

We do not ask a premium for The Printype Oliver Typewriter. We have declared a big dividend in favor of typewriter users by supplying this wonderful type, when desired, on the new model Oliver Typewriter.

Our price is \$100, the same as our regular model with Pica Typewriter Type.

## "17-Cents-a-Day" Offer

You can buy the new Printype Oliver Typewriter on the famous "17-Cents-a-Day" Purchase Plan. A small first payment brings the machine. Then save 17 cents a day and pay monthly. You can turn in any make of typewriter on your first payment.

If the Penny Plan interests you, ask for details.

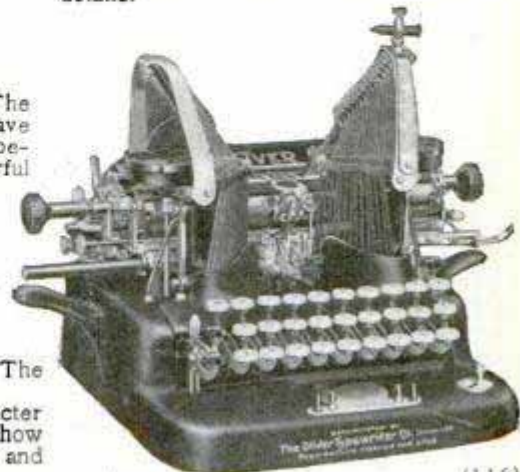

(116)

THE OLIVER TYPEWRITER COMPANY, 763 Oliver Typewriter Bldg., CHICAGO

Please Mention Popular Mechanics

# CYCLOPEDIA of TELEPHONY & TELEGRAPHY



Every reader of Popular Mechanics can examine this great work — FREE

This cyclopedia is brand new, up-to-date, just off the press. The theory and practice of every phase of electrical communication is thoroughly covered, also recent developments in Automatic Telephone Systems, Wireless Telegraphy and Telephony.

Written by National Experts

The writers are men whose reputation in their respective fields is international.

- Kempster B. Miller, M. E.**—Consulting Engineer and Telephone Expert.
- George W. Patterson, S. B., Ph. D.**—Head Department of Electrical Engineering, University of Michigan.
- Charles Thom**—Chief of Quadruplex Department, Western Union Main Office, New York City.
- Robert Andrews Millikan, Ph. D.**—Associate Professor of Physics, University of Chicago.
- Samuel G. McMeen**—Consulting Engineer and Telephone Expert.
- Charles G. Ashley**—Electrical Engineer and Expert on Wireless.
- Francis B. Crocker, E. M., Ph. D.**—Head of Department of Electrical Engineering, Columbia University.
- Morton Arendt, E. E.**—Instructor in Electrical Engineering, Columbia University, New York.
- David P. Moreton, B. S., E. E.**—Associate Professor of Electrical Engineering, Armour Institute of Technology.
- Leigh S. Keith, B. S.**—Managing Engineer with McMeen and Miller.

### What These Books Contain

- VOL. I.—Fundamental Principles. Substation Equipment: Transmitters — Receivers — Signaling Apparatus — Repeating Coils. Party Line Systems: Non-Selective — Series and Bridging — Selective — Lock-Out. Protection: Electrical Hazards. Manual Switchboards: Exchanges — Trunk and Toll Lines — Operation.**
- VOL. II.—Manual Switchboards: Common-Battery Switchboards — Magneto-Multiple Switchboards. Automatic Systems: Operation — Auto-Manual System. Power Plants and Buildings: Apparatus — Power Switchboards. Special Service Features: Private-Branch Exchanges — Intercommunicating Systems — Traffic — Measured Service. Telegraph and Railway Work: Phantom, Simplex and Composite Circuits.**
- VOL. III.—Line Construction: Open Wires — Cables — Underground Construction — Distribution. Engineering and Maintenance: Development Studies — Toll Lines — Maintenance and Depreciation — Testing. Electrical Measurement. Storage Batteries.**
- VOL. IV.—The Telegraphs: Messages — Railway Telegraphy — Switchboards — Repeaters — Multiplex Telegraphy — Duplex — Quadruplex. Wireless Telegraphy: Development — Selective Signaling — Apparatus — Singing Arc — Aerials — Systems. Wireless Telephony: Development — Apparatus — Systems.**

### Examine These Books at Our Expense

Fill in the coupon and we'll send you the books by prepaid express. Keep them in your office for five days, examine them carefully. If they contain information of value to you and you want to keep them, send us \$2.00, then \$2.00 each month until you have paid the special introductory price of \$12.80. If you don't want the books, notify us and we will have them returned at our expense.

**AMERICAN SCHOOL OF CORRESPONDENCE CHICAGO, U. S. A.**

### FREE EXAMINATION COUPON

AMERICAN SCHOOL OF CORRESPONDENCE:  
Please send set Cyclopaedia of Telephony and Telegraphy for 5 days' free examination. Also Technical World for 1 year. I will send \$2.00 within 5 days and \$2.00 a month until I have paid \$12.80 for books and magazine, or notify you to send for the books. Title not to pass until fully paid. Pop. Mech. 6-11

NAME .....

ADDRESS .....

OCCUPATION .....

EMPLOYER .....

Please Mention Popular Mechanics

# \$38.95 BUYS THIS COMPLETE BATHROOM OUTFIT



**MODERN BATHROOM FOR EVERY HOME**

**THE LUXURIES OF MODERN PLUMBING AT HALF THE ORDINARY COST**

**Complete Pneumatic Water Supply Systems from \$42 upwards**

**SAVE \$100 to \$250 on your steam or hot water heating plants.**

Gasoline engines for farm and shop. Electric Lighting Plants for your home - \$300

Hydraulic Rams, Pumps, Pipe, Valves, Fittings at lowest prices. Farmers' Tanks for every purpose.

Acetylene Lighting Plants, Gas and Electric Fixtures. All high grade, strictly guaranteed goods. Get our prices and we will save you money.

**BIG CATALOGUE FREE!**



**M. J. GIBBONS DEPT. A DAYTON, O.**

**HOW TO TELL GOOD MEAT.**—Good beef has a reddish-brown color and contains no clots of blood. Well-nourished beeves furnish a flesh which, while raw, is marked with spots of fat; it is firm and compact. Old, lean animals furnish a flesh which is tough, dry and dark; the fat is yellow. Veal is but slightly reddish and has tender white fibers. The fat is not distributed through the lean, as in beef. The same is true of mutton. In well-nourished animals white fat accumulates along the borders of the muscles. Pork is rose red and has fat distributed through the muscle. The lard is white and lies in heavy deposits under the skin.—New York Herald.

**CACHOO!** Make the whole family and all your friends "just sneeze their heads off" without knowing why, with CACHOO, the new long distance harmless snuff. Sent anywhere for 10c. 3 for 25c. 90c a dozen. Catalog included FREE. P. T. & N. CO., Department B, Chicago, Ill.



### Every Boy His Own Toymaker

Greatest boys' book ever written. Tells how to make a Steam Engine, Microscope, an Electric Telegraph, Telephone, Magic Lantern, Boats, kites, balloons, electrical and mechanical toys, traps, fishing tackle. 200 illustrations. Price only 10c postpaid, 3 for 25c. Western Puzzle Co., St. Paul, Minn.

**Brass Band Instruments, Drums, Uniforms, Supplies**

Write for catalog. Hundreds of illustrations, FREE; it gives information for musicians and new bands.

**LYON & HEALY 30-89 Adams St. Chicago**

**BARODA DIAMONDS** Flash Like Genuine

ANY STYLE at 1/40 the cost—IN SOLID GOLD RINGS

Stand acid test and expert examination. We guarantee them. See them first—then pay. Special Offer — 14k Tiffany ring 1 ct. \$5.98. Gents ring 1 ct. \$6.98. 14k Stud 1 ct. \$4.86. Sent C. O. D. for inspection. Catalog FREE, shows full line. Patent ring gauge included, 10c. The Baroda Co., Dept. A5, Leland & Dover Sts., Chicago

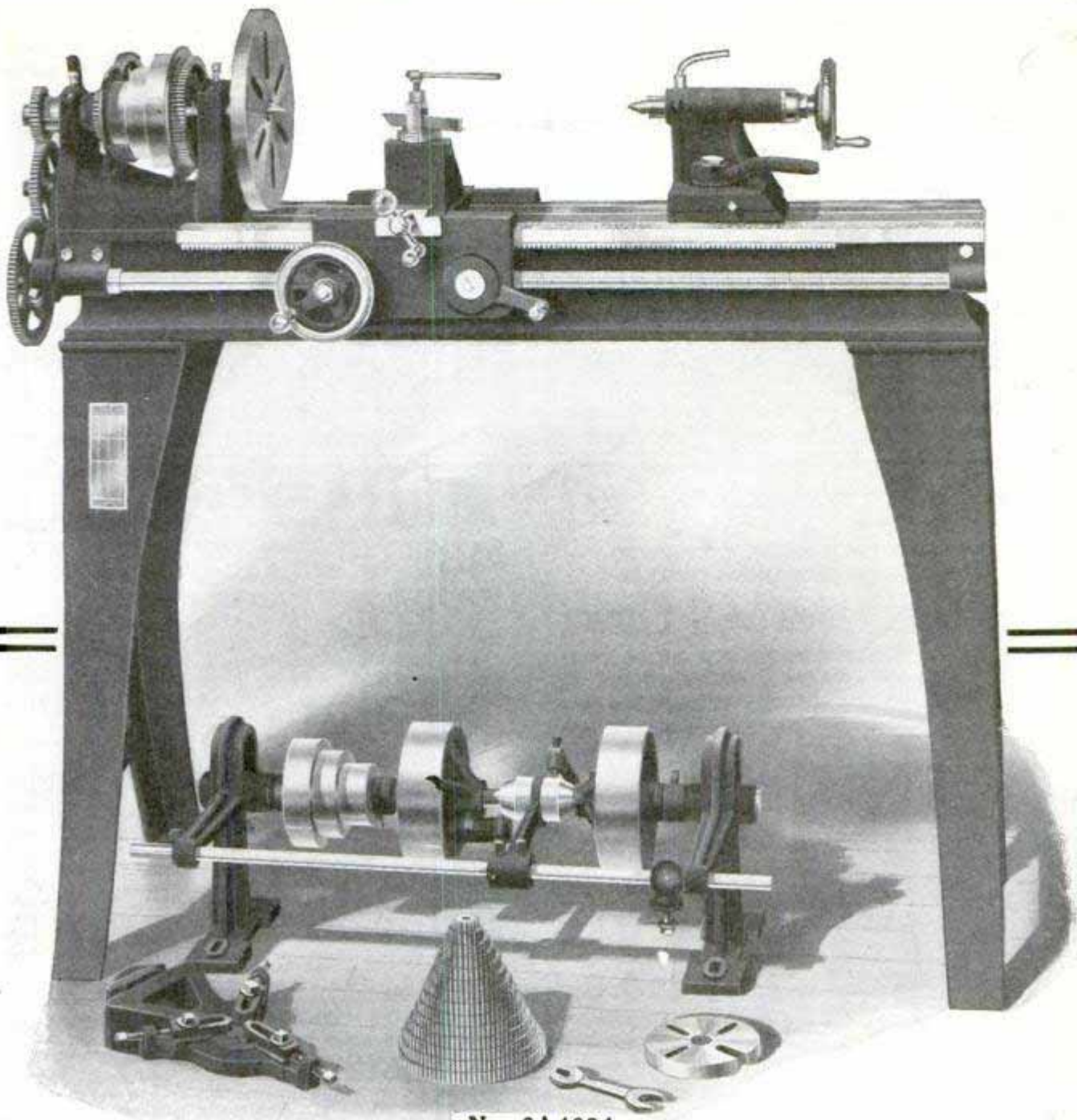

No. 9A4834

**\$68<sup>00</sup>** Buys this 10-Inch Screw Cutting Engine Lathe, complete as illustrated, including countershaft. Bed, 42 inches long; 24 inches in the clear between centers; swings  $10\frac{1}{4}$  inches over the ways, 7 inches over the carriage.

If you pay \$90.00 to \$100.00 elsewhere you will not get any more for your money than we offer for \$68.00 in this complete well made machine.

### You Can Save Money

If you buy of us, not only on lathes, but on pulleys, belting, shafting, files, saws and all kinds of regular shop equipment.

Ask for our complete Machinery Catalog A. It tells the whole story.

***We carry finished lathes in stock at factory and ship promptly after receipt of order.***

The above illustration is of only one of the many money saving big bargains to be found in our complete Catalog of Machinery. We carry lathes in all sizes from 9 to 13-inch swing and from  $3\frac{1}{2}$  to 8 feet in length of bed.

We sell a 13-Inch Swing, 6-Foot Bed Lathe for \$147.00 that you would expect to pay not less than \$200.00 for elsewhere.

**WRITE FOR MACHINERY CATALOG A "THE GUIDE TO ECONOMY" IT IS FREE**

**Address SEARS, ROEBUCK AND CO., Chicago**

# BISHOPRIC WALL BOARD AND SHEATHING

SAVE MONEY, TIME, AND LABOR IN BUILDING

**BISHOPRIC WALL BOARD** is cheaper and better than lath and plaster. Easily nailed to studs. Applied dry, it is ready at once for paint, paper or burlap—inexpensive or artistic decoration. Made of kiln-dried, dressed laths, imbedded in Asphalt Mastic, insuring a solid, substantial covering for



## Walls and Ceilings

Will not shrink, warp or crack. Clean, odorless and sanitary. Guaranteed proof against dampness, heat, cold, sound and vermin. Used for finishing new buildings of every description; also for partitions, attics, cellars, porches, laundries, garages. It is the original Wall Board, construction patented.

**BISHOPRIC SHEATHING** is made of same materials as Wall Board, but is nailed smooth side to studs with laths and asphalt exposed.

**SAVES 75 PER CENT**

in material and labor. Does away with building paper. Makes smooth, solid job. Proof against heat, cold, dampness and vermin. Used under weather boards, flooring and ready roofing or cement; also as lining for barns, poultry houses and other out-door buildings. Houses finished with Bishopric Wall Board and Sheathing are ready for immediate occupancy. Write today for prices and

**FREE** Booklet and **SAMPLE** of { Bishopric Wall Board  
Bishopric Sheathing  
Bishopric Ready Roofing

Dealers write for attractive proposition

The Mastic Wall Board & Roofing Mfg. Co., 60 East Third St., Cincinnati, O.

## Earn Big Money—Why Not?

There was never a better opportunity—never a bigger proposition than the

### Mandel Combination No. 1 Camera

Postcard and photo button camera—makes 3 styles photos on paper—direct—without the use of negatives.

Large postcards, size 3x4½; miniature postcards, size 2x3 and 1-inch photo buttons.

### The Chance of a Life Time

to go into a big money making business of your own. No experience needed—our instructions teach you the business in 30 minutes.

Price of Camera \$40.00

400% Profit on Supplies

### Wonder Cannon Camera

Photo button outfit, \$25.00. This pays for a Wonder Cannon, tripod and enough supplies to make 400 finished photo buttons. We

manufacture and sell supplies for all photo button and sleeve machines. All our gilt frames, button plates, developing powders, etc., are guaranteed to be perfect.

Write for Descriptive Matter—FREE

CHICAGO FERROTYPE CO., Dept. 102  
Congress and Laflin Sts., CHICAGO, ILL.

## "MILL TO MAN"

**\$13.50 TAILOR MADE SUITS**

WE DYE THE YARNS, WEAVE THE CLOTH AND TAILOR TO YOUR MEASURE.

You save 4 middlemen's profits and get a suit at from \$13.50 to \$23.75 for \$20 to \$40 values.

**THIS MEANS TAILOR-MADE SUITS AT PRICES OF "READY MADES."**

Our patterns embrace the latest weaves in gray, brown and blue; also the new beautiful pencil stripe effects. Best trimmings, linings and workmanship.

We guarantee garments to hold their shape. New York styles without extremes or freaks. Complete satisfaction or money back. Express prepaid. Write for samples & self-measurement instructions.

**Colonial Woolen Mills,**  
DEPT. 203 LAWRENCE, MASS.



A UNIQUE COLLECTION—Nearly every one has the collecting habit at some time in his life, and some people never get over it. Recently there died, in Edinburgh, Edward Young, who had long been in the iron business. He began to collect horseshoes of all countries and of all ages. Before he died he had a complete series of the various types of horseshoes, from Roman times to the present, representing the work of smiths for 1700 years.—Christian Herald.

For the real truth about  
**PATENTS**  
Write, Mason, Fenwick & Lawrence  
613 F. Street Washington, D. C.

Established 50 years—Booklet and advice FREE

## UNION METAL COLUMNS

(PATENTED)

The age of Classic Art and the age of Steel attain their highest expression and their utmost usefulness in Union Metal Columns for Porch or Pergola.

The ancient forms of Greece and Rome are retained in all their exquisite simplicity in these beautiful columns.

The shafts are of solid steel—with seams securely locked and turned inside so as to leave a surface of perfect smoothness.

Impervious to the action of the elements, Union Metal Columns are as indestructible as the Pyramids—and inexpensive withal.

Send today for the artistic catalogue illustrating beautiful homes, gardens and buildings in which they are being used throughout the country.

Made in all sizes up to 40 inches in diameter and a maximum length of 35 feet

THE UNION METAL MFG. CO., 470 Maple Ave., Canton, O.



Residence Dr. L.A. Neill, New Decatur, Ala.



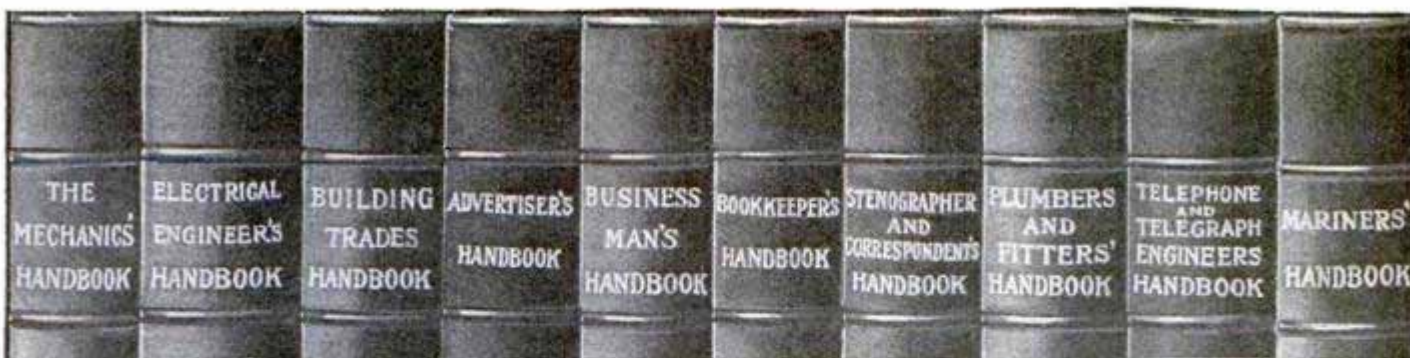

## \$1.25 Handbooks for 50c.

No books in existence contain in so small space as much information about the trades and professions of which they treat as do these Handbooks. They are little giant encyclopedias of practical knowledge giving data and information that is hard to find in ordinary books. These Handbooks have been prepared by the well-known textbook writers of the International Correspondence Schools whose textbooks are recognized the world over as the most practical treatises on applied sciences ever published. These Handbooks are consulting experts of the highest rank, and are the most powerful force in the world for the promotion of ambitious men. They are an indispensable help to quicker and better work that will command advancement. They are printed on a high-grade book paper in clear type, and durably and handsomely bound in cloth with gilt titles; contain on an average of 364 pages and 175 illustrations and are regularly sold for \$1.25 each.

**SPECIAL OFFER.**—We are selling these Handbooks, durably bound in cloth with gilt titles, at a special price for each Handbook of 50 cents.

**Mechanics'**—Tables; formulas; measurements; belting; mechanical powers; hydro-mechanics; strength of materials; shafting; boiler design; care of boilers; power of boilers; chimneys; exhaust heating; machine design; machine tools; slide valve; pulleys; cylinders and steam chests; pistons; gearing; transit surveying; triangulation; curves; radii and deflections; earth work; track work; electricity; etc.

**Advertiser's**—How to plan and write an advertisement; type and type measurements; points on printing style; display; preparation of manuscript; proof reading; engraving and printing methods; electrotypes; matrices; advertisement illustrations; magazines; newspapers; retail, department-store, general, trade-paper, and mail-order advertising; trade marks; circulars; advertising agencies; etc.

**Stenographer's & Correspondent's**—Advice to beginners; shorthand speed; letters of application; punctuation; correct and faulty diction; business correspondence; type-writing; abbreviations; addressing; mailing; rates of postage; duplicating work; etc.

**Telephone and Telegraph**—Useful tables; mechanics; electricity; magnetism; primary batteries; storage batteries; electrical measurements; telephony; tests with magneto-generator and bell; telegraphy; Morse telegraph systems; multiplex telegraphy; etc.

**Electrical Engineer's**—Mechanics; electricity; electrical units; symbols and quantities; physical and electrical properties of metals and alloys; wire gauges; magnetism; dynamos and motors; electric batteries; alternating current apparatus; alternators; transformers; wattmeters; electric transmission; electric lamps; wiring; electric heating and welding; electromagnets; controllers; car wiring; etc.

**Business Man's**—Arithmetic; tables; business forms; card systems; measures of extension; weight and capacity; time; value of foreign coins; duties on imports; bookkeeping; stenography; correspondence; postal information; financial terms; money and the money market; brokers and brokerage; patents; copyright and trade marks; corporations; business law; publicity; etc.

**Plumbers and Fitters'**—Arithmetic; involution and evolution; powers, roots, and reciprocals; circles; decimals; geometrical drawing; weights and measures; formulas; mensuration; mechanics; hydro-mechanics; building construction; heating and ventilation; gas-fitting; plumbing; etc.

**Mariners'**—Logarithms; trigonometry; navigation; terrestrial navigation; celestial navigation; organization of a man of war; naval ordnance; explosives; torpedoes; ship building; speed, tonnage, and fuel consumption; ropes; wind and weather; signals; nautical memoranda; etc.

**Building Trades**—Loads and structures; strength of materials; properties of sections; strength of rivets and pins; materials of construction; footings and foundations; masonry construction; woods used in building; qualities of timbers; joinery; framing; estimating; elements of architectural design; drainage systems; plumbing fixtures; plumbers' tables; heating and ventilation; gas and gas-fitting; etc.

**Bookkeeper's**—Arithmetic; formulas; tables; money; percentage; interest; equation of accounts; money and the money market; business law; financial terms; banks and banking; postal information; distances and time between various places; bookkeeping; business forms; card systems; modern office methods; cost accounting; bank bookkeeping; clearing house methods; etc.

### International Textbook Co.

Box 872, SCRANTON, PA.

I enclose \$\_\_\_\_\_ for which please send me the books BEFORE which I have marked X.

- **Mechanics' Handbook**      **Advertiser's Handbook**
- **Elect. Eng. Handbook**      **Business Handbook**
- **Bldg. Trades Handbook**      **Bookkeeper's Handbook**
- **Plum. & Fit. Handbook**      **Sten. & Corr. Handbook**
- **Tel. & Tel. Handbook**      **Mariners' Handbook**

Name \_\_\_\_\_

St. and No. \_\_\_\_\_

City \_\_\_\_\_ State \_\_\_\_\_

FREIGHT PREPAID **30 DAYS** FREE TRIAL

**\$1 a Week** For the Artistic

# MEISTER PIANO

SOLD DIRECT FROM FACTORY TO YOU



No Cash Down. No Interest.  
No Extras.

Price **\$175.00**

**STOOL and SCARF FREE**

*A guaranteed saving of \$100 at least, on each instrument*

**WE** believe the correct way to buy a piano is to try it in your own home first. We don't want the trial to cause you any expense, hence we pay the freight—also the return freight if the piano is not entirely satisfactory.

Notwithstanding our easy terms of payments *and our extremely low prices*, the Meister is a high-class instrument of standard construction and quality fully guaranteed for 10 years. Ask your local banker to investigate our standing. Rothschild & Co's resources exceed \$3,000,000.00.

*We sell more pianos direct from factory to home than any other concern in the world*

Send A Postal for the Piano Book

*It is free, and illustrates in the colors of the wood eight styles of the Meister*

**The Meister Piano Co.**

Rothschild & Company, Sole Owners  
State, Van Buren and Wabash Ave.

Department 16 G CHICAGO, ILL.

*Please Mention Popular Mechanics*

## The Card That Wins

is not merely the one that is played right. It must be of the right calibre. Your business card will win you the chance to present your proposition, if that card is of the right calibre. It makes a vast difference in the business game.

### Peerless Patent Book Form Cards

are the highest value cards manufactured. They are card economy too, because they save fifty per cent of card cost, every card being kept in a perfect state so that every one will be used. They are carried in a seal leather case and detached one by one as they are handed out. There are no perforated edges. Not the slightest indication is evident on the most critical examination that the card has been detached. Send for a sample tab and detach them yourself. Prove it to your own satisfaction. These cards are always clean; they are always together; they are always fresh, flat and perfect. Lay down the right card of the right calibre in the business game. It wins. Write today

OUR SMART  
CARD CASE

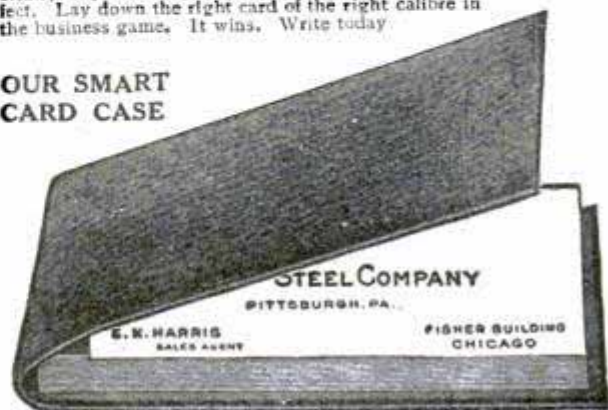

**The John B. Wiggins Company**

*Established 1857*

Engravers Die Embossers Plate Printers  
62-64 East Adams St., Chicago

**NAMES IN SAMOA**—Travelers visiting Samoa are puzzled at first by the fact that many boys bear feminine names, while girls as frequently have masculine names. The visitor learns after a while, however, that this confusing use of names instead of being due to ignorance is in reality the result of a native custom which is highly poetic.

Thus if a girl is born soon after the death of a brother the latter's name is given to her in the belief that his spirit and all his good qualities have been transferred to her. On the other hand, if a boy is born after the death of a sister, he takes the latter's name, and, as the Samoans believe, all her lovable traits become his.—London Globe.

Uncle Sam has not beaten his swords into plowshares or his spears into pruning hooks, but now and then he converts a battleship into a target.—Chicago Tribune.

## AMATITE ROOFING

Mineral surfaced. Needs no painting. Send for free sample.  
BARRETT MANUFACTURING CO., New York, Chicago



## TENT CATALOG Free!

If you expect to go camping do not fail to get this valuable book, and get it now.

**A Camp Guide given away!**

The most complete catalog of Tents and Camp Supplies ever issued. Enables you to buy direct from the largest manufacturer in the country. Protects you against frauds. Everything we make is the best. Our prices are absolutely the lowest. This catalog contains a valuable collection of hints on camping, fishing, hunting, etc., an authority on buying and a mine of information—and we send this catalog and camp guide free. Stop reading now and write for catalog.  
H. Channon Company, 32 Market St., Dept. 119X Chicago.

# Young Men Wanted

to earn \$25 to \$50 weekly in the **AUTOMOBILE BUSINESS**

**C**HAUFFEURS, automobile salesmen and repairmen get big pay for pleasant, congenial work, *because the demand for trained men exceeds the supply.* We have taught hundreds of young men without previous mechanical experience, and we can teach you in ten weeks if you study a few hours a week. The work is interesting. You see everything worth seeing on tours—you go everywhere. Our simple course by mail guarantees efficiency because all our instruction is personal. Free model of automobile with all parts to every student. Our graduates are everywhere, earning \$25.00 a week and up. Ask *them* about us and about the positions we obtained for them.

## To Automobile Owners and Garages

When you want competent chauffeurs or men for any class of automobile work write to us. We can put you in touch with the man you want.

## Answer This Ad Today

Ask us for the first lesson. We will send it without any charge, and from it you will get an idea of how we train you in every phase of automobile knowledge. You will be impressed at once with the remarkable thoroughness of the instruction outlined even in this preliminary lesson.

## EMPIRE AUTO. INSTITUTE

590 Empire Building  
ROCHESTER, N. Y.

*The Original Automobile School*

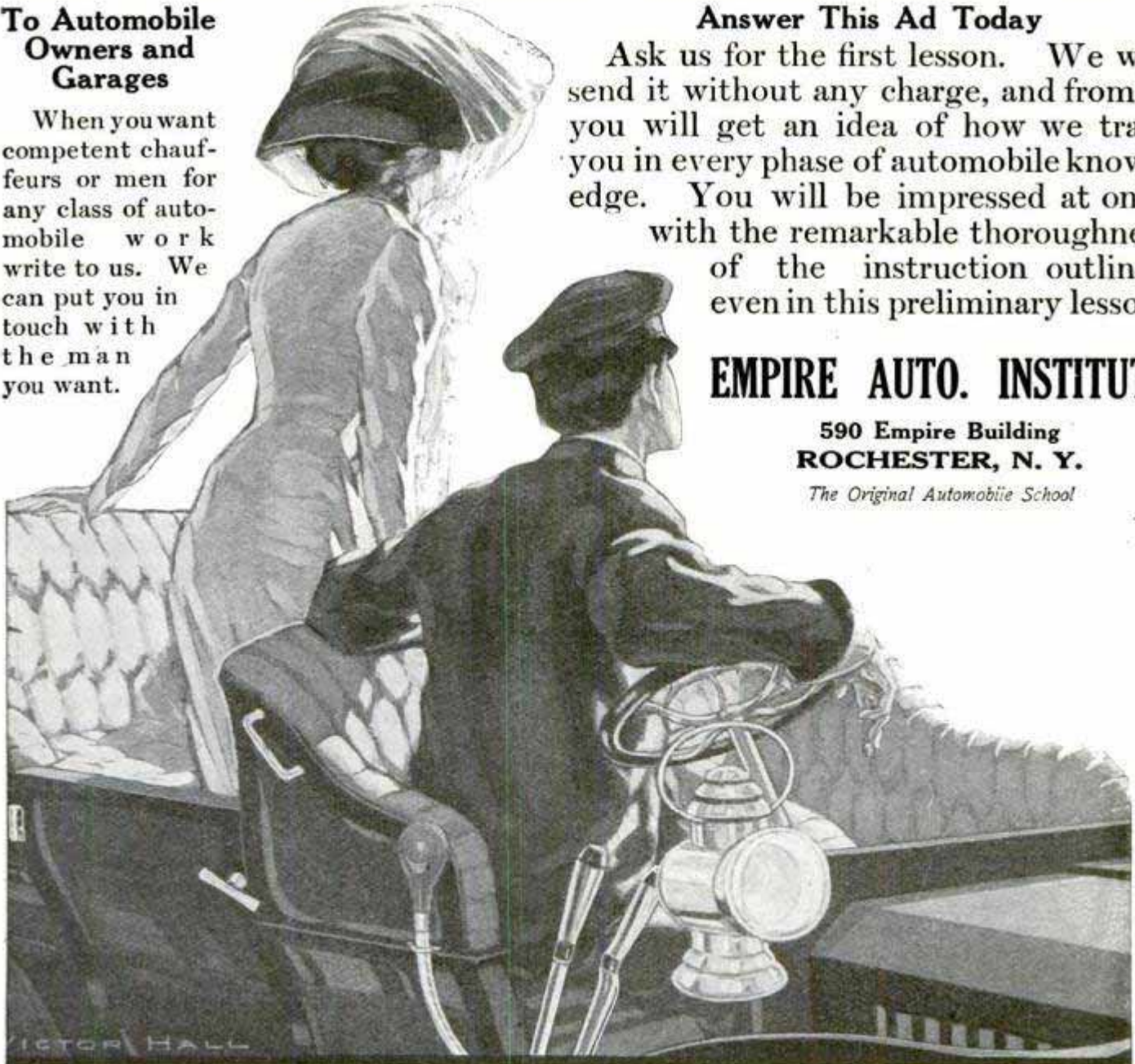



MR. H. ELLIS CHANDLEE

# PATENT WHAT YOU INVENT! PATENT

**YOUR IDEAS MAY BRING YOU A FORTUNE**

**There is A Constant Demand For Good Inventions.**

One of our clients recently made \$85,000; another \$7,000; another \$5,000; another \$3,400; two others \$1,000 each, and two others \$500.

WRITE FOR  
**"OPPORTUNITY"**

A List of Needed Inventions

Also, "U. S. LETTERS PATENT," telling how to obtain a patent.  
"THOUGHTS THAT HAVE PAID," a history of successful inventions.  
"TESTIMONY," giving our testimonial letters from manufacturers and inventors.

Mailed free to any interested person

IF YOU HAVE AN INVENTION send us a rough sketch and description, model or photograph of it, and we will give you our opinion as to its patentability **WITHOUT CHARGE**. If our opinion is favorable, we will issue a contract binding us to **refund every cent of our fee if we fail to obtain a patent.**

This assures you that we will not make application unless the chances of success are good, and that **every effort** will be made to obtain an allowance. We advertise the patents of Our Clients for sale in prominent dailies free of charge.

**"Prompt and Proper Service"**

**H. Ellis Chandlee & Co.**

Suite 55, Bornot Building, WASHINGTON, D. C.

# PATENTS TRADEMARKS AND COPYRIGHTS SECURED OR FEE RETURNED

## SPECIAL OFFER — FREE SEARCH OF PATENT OFFICE RECORDS

Send us a model, photograph or sketch and description of your invention, and we will make a *Free Search of the Patent Office Records* to ascertain if it is patentable. If we report the invention patentable, we will guarantee to obtain a patent or return our fee, and furnish a certificate of patentability backed by a bonded contract to that effect.



**VICTOR BUILDING**

Our new \$150,000 building, opposite the U. S. Patent Office, specially erected by us for our own use, designed and equipped with all modern appliances for our patent business.

This Certificate of Patentability will protect the inventor and serve as proof of the invention until the case can be filed in the U. S. Patent Office.

### OBTAINING ASSISTANCE FOR INVENTORS

Our certificate is of great assistance to inventors who require financial aid to obtain patents. It is useless to attempt to interest capital unless evidence is furnished that the invention is patentable. Our certificate gives this necessary assurance.

### OUR FOUR BOOKS MAILED FREE

to any address. Send for these books—the finest publications ever issued for free distribution.

### HOW TO OBTAIN A PATENT

Our illustrated eighty-page Guide Book is an invaluable book of reference for inventors, and contains 100 mechanical movements illustrated and described.

### FORTUNES IN PATENTS

Tells how to invent for profit, and gives history of successful inventions.

### WHAT TO INVENT

Contains a valuable LIST OF INVENTIONS WANTED and suggestions concerning profitable fields of invention; also information regarding prizes offered for inventions, among which is

### PRIZE OF ONE MILLION DOLLARS

offered for one invention, and \$10,000 for others.

### PATENTS THAT PAY

Contains fac-similes of unsolicited letters from our clients who have built up profitable enterprises founded upon patents procured by us; also indorsements from prominent inventors, manufacturers, Senators, Congressmen, Governors, etc.

### WE ADVERTISE OUR CLIENTS' INVENTIONS FREE

in a list of Sunday newspapers with two million circulation, in manufacturers' journals and in the *World's Progress*. Sample Copy Free. We also send a LIST OF PATENT BUYERS. We not only save you time and money in securing patents, but obtain patents which PROTECT the invention and PAY. After the patent is granted we assist you TO SELL YOUR PATENT.

### FOREIGN PATENTS

WE HAVE DIRECT AGENCIES IN ALL THE PRINCIPAL FOREIGN COUNTRIES and can secure FOREIGN PATENTS in the shortest possible TIME and at the LOWEST COST. We GUARANTEE TO SECURE THE FOREIGN PATENTS OR RETURN OUR FEES. Write for our Illustrated Guide Book on Foreign Patents, sent free to any address.

### REFERENCES:

Second National Bank, Washington, D. C.  
R. G. Dun & Co., Washington, D. C.  
National Savings and Trust Co., Washington, D. C.  
Smethport Glass Co., Smethport, Pa.  
Schrade Cutlery Co., Walden, N. Y.  
Clum & Atkinson, Brass Founders, Rochester, N. Y.  
Rochester Rotary Pump Co., Rochester, N. Y.  
Lawrence Mills, Mfrs. Bed Spreads, 51 Brooke Ave., Englewood, N. J.  
The Melvin Gauge and Signal Inst. Co., Scranton, Pa.  
Damon Mfg. Co., Mfrs. "Missing Link" Flour Mill Disintegrators, Bowling Green, Ky.  
Modern Canner Co., Mfrs. Canning Machinery and Canners' Supplies, Bridgeport, Ala.  
M. Winter Lumber Co., Sheboygan, Wis.

C. K. Lassiter, Mechanical Engineer, Schenectady, N. Y.  
Pitner Gasoline Lighting Co., Chicago, Ill.  
Sprout, Wardon & Co., Mfrs. of the Monarch Feed Governor, Muncy, Pa.  
The L. B. Dozier Co., Mfrs. of Plumbing, Heating and Machinery Supplies, Columbia, S. C.  
B. B. Earnshaw & Bro., Mfrs. "Cream Blend" Flour, Washington, D. C.  
A. L. Schultz, Consulting Engineer, Pittsburgh, Pa.  
Arthur H. Swan & Co., Mfrs. of Peel-Blade Tips, 279 Warren St., Roxbury, Pa.  
The H. W. Moore Piano Truck Co., Anderson, Ind.  
The Culver Novelty Co., Mfrs. of Carbureters and Mixers, Culver, Ind.

**VICTOR J. EVANS & CO.,** VICTOR BUILDING  
(Formerly EVANS, WILKENS & CO.) 724-726 9th St., N. W.

Opposite United States Patent Office

WASHINGTON, D. C.

→ **Protect Your Idea!** ←

# PATENTS THAT PAY

"My Trade-Mark"

## Special Offer:

Mr. Inventor: I invite you to come to see me, and bring, (or send by registered mail), sketches or photograph or model and description of your idea or invention for FREE examination of U. S. PATENT OFFICE Records and report as to patentability of the same;—to find out as to whether you are entitled to a patent will not cost anything;—then, if your invention is new, upon receiving instructions, I will prepare ALL necessary (application) papers.

DO THIS AND SAVE TIME AND MONEY

**WRITE NOW!**

### Highest References:

Lincoln National Bank,  
Washington, D. C.

NOTE: When writing these clients send two-cent stamp for reply.

Little Giant Hay Press Co.,  
Alma, Mich. and  
Dallas, Texas.

Gray Lithograph Co.,  
New York City, N. Y.

Farmers Mfg. Co.,  
Norfolk, Va.

New Era Mfg. Co.,  
Fairfield, Iowa.

Bernhard Furst,  
Vienna,  
I. Austria-Hungary.  
Otto von Rottenburg,  
Schwindstrasse 20,  
Frankfort a/M,  
Germany.

H. A. Fonseca,  
Rua Dos Ourives 20,  
Sobrado, Rio de Janeiro,  
Brazil, S. A.

A. J. Corsi,  
Irish Town,  
Gibraltar.

Bell Show Print Co.,  
Sigourney, Ia.

The Camp Conduit Co.,  
Cleveland, O.

The Iowa Mfg. Co.,  
Oskaloosa, Ia.

Sam'l Allen & Son Mfg. Co.,  
Dansville, N. Y.

The Garl Electric Co.,  
Akron, O.

Superior Mfg. Co.,  
Sidney, O.

Tidnam Tel. Pole Co.,  
Oklahoma City, Okla.

Edw. H. Smith,  
Aberdeen, Wash.

C. O. Cracroft,  
Cordova, Alaska.

V. C. de Ybarrondo,  
Los Angeles, Cal.

Wm. H. Garlock,  
Leland Hotel,  
Seattle, Wash.

F. Rutherford,  
Copper Queen Con. Min. Co.  
Douglas, Arizona.

Gas Range & Heater Co.,  
S. Pasadena, Cal.

Newberg Brick & Tile Co.,  
Portland, Ore.

## INFRINGEMENT, VALIDITY AND INTERFERENCE WORK SOLICITED

I am admitted to practice before the United States Supreme Court and others

"I want to thank you for the most excellent services you have rendered me in this suit [B. Williams vs. Central Drug Co., U. S. C. C., Northern District of Illinois—E. Div.], and assure you that I appreciate it very much, and if at any time I can secure some business for you, I will be only too glad to do so."

(Signed) J. THOMPSON, Mgr. Central Drug Co., Sioux City, Iowa.

### Other Important Suits Successfully Settled

**FREE: Two Books—61-page "Inventor's Guide" and 64-page "Proof of Fortunes in Patents—What and How to Invent"**

### Foreign Patents a Specialty

If you have a U. S. application write me for excellent literature and terms for promoting your Foreign Patents. Liberal discounts.

### I Advertise My Clients' Patents Free

in a publication having over 2,000,000 circulation. Write for Special Offer. Successful clients in every section of the U. S.



My Office and the Patent Office  
(I give you proof of my location)

Across the street from the U. S. Patent Office

Expert—Prompt Services

High-Class Work—Excellent Testimonials

871 F Street, N. W.

**E. E. VROOMAN, Patent Lawyer Wash., D.C.**

Registered Patent Attorney. Patent Litigation

**\$217,440.00 \$**  
**MADE BY MY CLIENTS \$**

**YOU Should Have My FREE BOOK**

Telling HOW OTHERS will do the same IN THE FUTURE. "WHAT and HOW to INVENT" BOOK FREE!

"I received ONE HUNDRED DOLLARS (\$100.00) down (in re my Can Righting Machine inventions) and in thirty days NINE HUNDRED DOLLARS (\$900.00), and when my patents are issued ONE THOUSAND DOLLARS (\$1000.00) more. I can conscientiously state to my fellow inventor that he will do the right thing by placing his patent business in Mr. Vrooman's hands for the best iron-clad patents."

(Signed) WILLIAM C. BRIDGES, Wapello, Iowa.

# WANTED-IDEAS

The largest  
and best known manufacturers and  
buyers of patents in the world want ideas protected  
through me. Send for my literature and read their letters.

## Free

New 72-page guide book "Successful Patents" (tells how to proceed in order to be successful); book "Stepping Stones" (contains list of over 200 inventions wanted); "How and Why I Will Make You Succeed" (with list of recent successes) sent free on request. Highest references. Free manufacturing facilities. Clients' patents sold free. **FEE'S RETURNED IF NOT SUCCESSFUL.**

**SPECIAL:** Send sketch or model of invention for free report. No obligation incurred by writing me.  
**RICHARD B. OWEN, Dept. 9, WASHINGTON, D. C.**

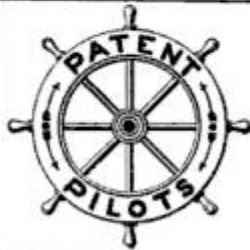

## Patent Your Ideas—It Pays

"WE GUIDE YOU TO SUCCESS"

25 years' experience as Attorney and U. S. Patent Examiner. Send sketch of invention for **Free** report and Illustrated Guide Book. **No Patent—No Charge.** We succeed where others fail.

**BUNYEA PATENTS CO.**  
Room 27 WASHINGTON, D. C.

## PATENT

## SECURED OR FEE RETURNED

Free expert search of official records. Send for free handbook.

**MILO B. STEVENS & CO., Attorneys**

ESTABLISHED 1864

685 F. St., WASHINGTON D. C.

370 Monadnock Bldg., CHICAGO

Guaranteed and recommended by the Bankers' Register. Highest rating by Martindale's American Law Directory.

# PATENTS

NEW AND EASY PLAN OF MAKING PAYMENTS

**Valuable Book Free** Illustrates and describes 100 Mechanical Movements, and contains useful information for inventors. **MAILED FREE.**

**CHAS. E. BROCK, Patent Attorney**

(Twenty-five years' experience)

918 F. STREET

WASHINGTON, D. C.

**MINING FOR COFFIN PLANKS.**—One of the most curious industries in the world is the business of mining for coffin planks, which is carried on in Upper Tonquin, a portion of the French possessions in south-eastern Asia. In a certain district in this province there exists a great underground deposit of logs, which were probably the trunks of trees engulfed by an earthquake or some other convulsion of nature at a comparatively recent period.

The trees are a species of pine known to the natives,

## PATENTS:

For facts about Prize and Reward offers and Inventions that will bring from \$5000 to 10 Million Dollars; and for books of Intense Interest to Inventors, send 8c postage to **R. S. & A. B. LACEY, Div. 45 Washington, D. C. Estab. 1889**

# PATENTS

**C. L. PARKER**

Ex-Examiner U. S. Patent Office

**PATENT LAWYER**

210 MCGILL BLDG.

WASHINGTON, D. C.

Patents, Trade Marks, Copyrights, Patent Litigation

Handbook for Inventors, "Protecting, Exploiting and Selling Inventions" sent free upon request.

## A Patent of Quality

is the only kind that will protect your invention and make it salable. You need my free advisory information. Send for it.

**GEO. R. HAMLIN, Patent Lawyer**

801-8th Street, N. W.

WASHINGTON, D. C.

## LANGDON MOORE

Counselor-at-Law and Patent Attorney

**Patents, Trade-Marks**

**Designs and Copyrights**

**9th and F Streets, WASHINGTON, D. C.**

Formerly Examiner U. S. Patent Office

SEND FOR BOOKLET

# PATENTS THAT PROTECT and PAY

Send for **FREE** 96-page book. Advice free. Terms reasonable. Highest references. Best results.

Send sketch or model for **FREE** examination and opinion.

**Recommended Patent Lawyer in the Bankers' Register and special list of selected lawyers.**

Also in Martindale's Law Directory, Sharp and Alleman's Directory of Lawyers, The

Gast-Paul Directory of Lawyers, and Kime's International Law Directory.

**ALL BUSINESS GIVEN PROMPT AND PROPER ATTENTION**

**A large list of strong recommendations furnished free**

**WATSON E. COLEMAN, Patent Lawyer, 622 F St., N. W., Washington, D. C.**



## "OHIO" TOOLS

have distinctive features that interest the experienced mechanic and therefore make them desirable for shop and home use.

"Ohio" Edge Tools are made from specially selected steel, carefully manufactured and tempered by the most improved process.

"Ohio" Planes have our special thick cutter that will not chatter and tremble.

"Ohio" Chisels are made of one solid piece of tool steel—socket and blade.

We cannot mention all of the points here that will interest you, but will be glad to send our complete catalog on request.



Every "Ohio"  
Tool Warranted

**OHIO TOOL CO.**

(Dept. No. 3)

Columbus, Ohio Auburn, N. Y.



**Mr. Mechanic!**

Don't throw your tools one on top of the other. Keep them in good condition, orderly arranged and easily accessible in a "Gerstner" Case. Why not be up-to-date and show your fellow workmen that you are a "man who cares." Ask for our catalogue showing the best built, the neatest and most practical Tool Cases ever offered to the up-to-date mechanic. You'll find one to suit your requirements and purse—we'll please you or refund your money.

*J. Gerstner & Sons*

Mfrs. of Mechanics' High Grade Tool Cases  
818 Germantown Street, DAYTON, OHIO

## FOR MENDING HARNESS

shoes, tents, awnings, pulley belts, carpets, saddles, suit cases, buggy tops, dash boards, or any heavy material. Stewart's Automatic Awl is the only perfect Sewing Awl.



It takes a wax thread, feeds from spool and does the work of any harness maker machine. It is indispensable for farmers. Agents wanted. Sent prepaid for \$1.25. Send at once for catalog.

**STEWART-SKINNER CO.**

26 Hermon Street  
Worcester, Mass.

## THE EXCELSIOR BRAD SET. PRICE 25 CENTS

Takes No. 18 and No. 20 Brads from 1/4 to 3/4 in. long

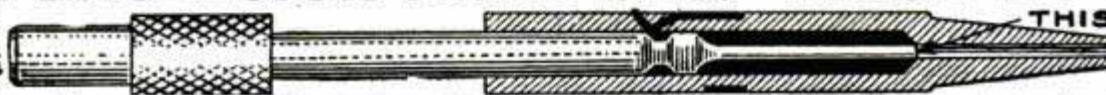

THIS END IS  
MAGNETIZED

The tool illustrated above will be indispensable to the Pattern Maker, Cabinet Maker, or Picture Framer who purchases it. It will set brads in places that would be inaccessible without it, and dispenses with the bradawl and nail set. If, after a fair trial, you are not satisfied that you have received your quarter's worth, your money will be promptly returned to you on receipt of tool.

## Let Us Do Your Manufacturing

TINLEY PARK MFG. CO., 14 State Street, CHICAGO

Buying material in large quantities and having a modern factory equipped with the latest machinery enable us to make almost anything in metal or wood at a very low price. Estimates free. We have a complete model and pattern department.

## Do You Need A Gear



of any description for any purpose? We carry practically all the standard sizes in stock ready for immediate shipment.

We make gears of any style, size or material to order—promptly.

Our new free catalogue contains tables and rules for figuring both spur and bevel gears.

Grant's "Treatise on GEARS"—Price \$1.00 is a valuable reference book for the student and designer.

**Philadelphia GEAR Works, Inc.**  
1120 Vine Street GEO. B. GRANT, PRES. Philadelphia, Pa.

and also to some extent to European commerce, as "nam-hou." The wood is almost imperishable, and has the quality, either through its nature or as the result of its sojourn under ground, of resisting decay from damp. This quality makes it particularly valuable for the manufacture of coffins, and for this purpose it is largely exported to Europe.

The trees are often a yard in diameter. They are buried in sandy earth, at a depth of from two to eight yards, and are dug up by native labor as demand is made for them.—New York Times.

Active Powers of Inventive Genius

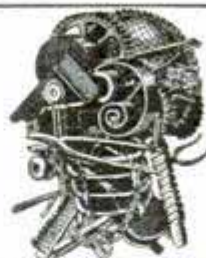

**INVENTORS** Our Brain Belongs to You. Our Ideas Are Free of Charge.

All we want in return is to build your model, special machinery, dies, tools and jigs to manufacture sheet metal goods, etc. We are expert mechanics, over thirty years experience and have one of the best equipped shops in the country. Ask for Booklet No. 17. Consultation free. Experimental work strictly confidential.

**A. NACKE & SON**  
236-242 S. 9th St., Philadelphia, Pa.

# PATENTS \$55 EIGHT MONTHS TO PAY First Payment Only \$5

Send me a rough sketch, small model or other description of your invention by return mail and I will send you a free report as to its patentable nature.

## REJECTED CASES MY SPECIALTY

I am the only attorney making a specialty of procuring patents in cases rejected by the Patent Office. If I report such a case patentable, I will procure the allowance of patent, or make no charge for my service. Send for my references and testimonials; they cannot be equaled.

\$3.00 in cash for inventors names. Book on Patents and full particulars free.

**ALEXANDER J. WEDDERBURN, JR.** Registered Patent Attorney  
WASHINGTON, D. C.

Branch Offices—New York, Chicago, Boston, Philadelphia, Pittsburg and Cincinnati



## "IDEAL" LAWMOWER GRINDER

"You Grind It As You Find It."

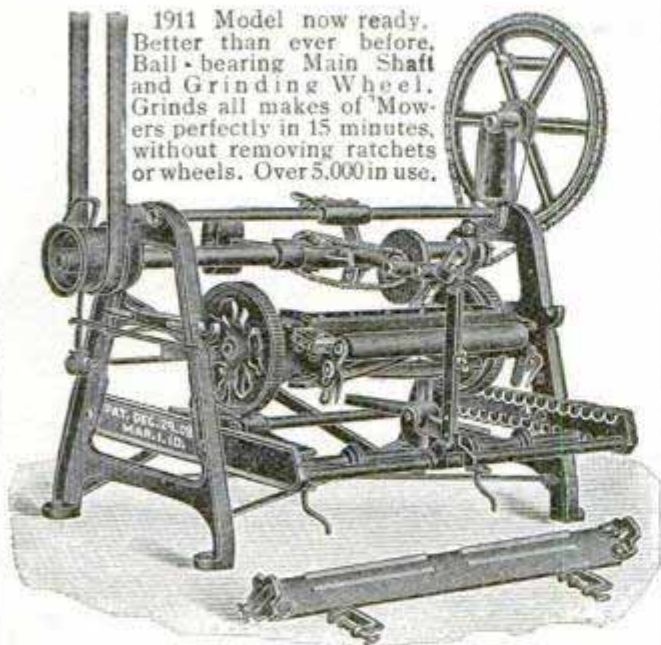

1911 Model now ready. Better than ever before. Ball-bearing Main Shaft and Grinding Wheel. Grinds all makes of Mowers perfectly in 15 minutes, without removing ratchets or wheels. Over 5,000 in use.

Write Today for full information of this wonderful labor-saver and money-maker. No up-to-date shop complete without it. Will more than pay for itself the first season because it does the work so much quicker and better. Used by U. S. Government and N. Y. City Parks. New Skate Sharpener Attachment for grinding skates. Fully warranted. Write now—TODAY.

HEATH FDY. & MFG. CO., PLYMOUTH, O.

**KEEPING THE TELEPHONE BUSY.**—Every death and every birth in a small city means about 300 extra telephone calls, according to figures issued to-day by the Columbia Telephone Company. After the necessary calls for the doctor, undertaker, relatives and others the news spreads among friends over the wires.

Then the acquaintances take it up, the telephone officials say, until persons in the rural exchanges out in the country are hearing of the deaths of persons whom they never knew or heard of. A birth will cause not so many telephone calls, but each conversation is longer because more women will use the telephone.—Kansas City Star.

**Rife Automatic Hydraulic Ram** Pumps water by water power. No attention; no expense; 2 feet fall elevates water 50 feet, etc. Guaranteed. Catalogue free. RIFE RAM COMPANY 2131 Trinity Building, NEW YORK CITY

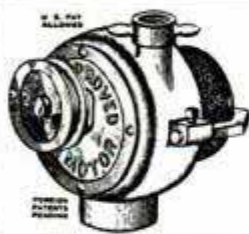

### Norton Improved Water Motor

Has the high speed required for grinding, polishing, etc. It also has a power side where the speed is reduced to 1000 Revolutions, thus making it an ideal motor for WASHING MACHINES with WRINGER ATTACHMENT. NO OPEN GEARS TO CATCH. Made of solid brass. Sent on receipt of \$6.50, express to be paid by receiver. Shipping weight 6 pounds.

Norton Water Motor Co., Inc., Roslindale, Mass.

## YOU WILL BUY CRESCENT MACHINES

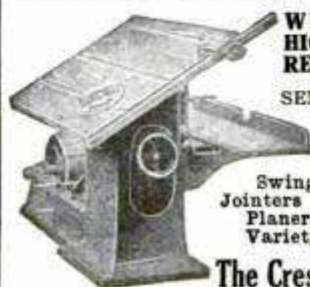

WHEN YOU WANT HIGH QUALITY AT A REASONABLE PRICE

SEND FOR CATALOG

Band Saws  
Saw Tables  
Disk Grinders  
Swing Saws Boreers  
Jointers Planers Shapers  
Planers and Matchers  
Variety Wood-Workers

The Crescent Machine Co.

No. 93 Columbia St.

LEETONIA, OHIO



## LET THE RED DEVIL WATER MOTOR DO YOUR WORK

### 6-inch Motor

Improved construction, absolutely perfect, runs your washing machine and a hundred other things. Power for small tools.  $\frac{1}{4}$  horse power on  $\frac{1}{2}$ -inch pipe, 80 pounds pressure; 1 horse power on 2-inch pipe, 60 pounds pressure. New net price, \$5.00 cash with order.

No. 1492 4-inch Motors for grinding, polishing and buffing. Runs sewing machines, fans, bottle washers, etc. Price with emery, buffing wheel, silver polish and pulley, \$3.00. No. 1493 Motor and pulley only, \$2.50.  $\frac{1}{8}$  horse power on 80 pounds pressure.

Improved construction. Speeds, 3,000 to 5,000 revolutions per minute. Only scientifically and mechanically perfect small water motor manufactured. Patented construction makes it possible. Tremendous output warrants the price. Money back for any reason.

CATALOGUE AND LARGE SHEET FREE

**DIVINE WATER MOTOR CO.**

Dept. T UTICA, NEW YORK, U.S.A.

For the name of your local hardware or tool dealer, we will send you free booklet on "Theory and Design of Water Motors."



6-Inch Bucket Wheel

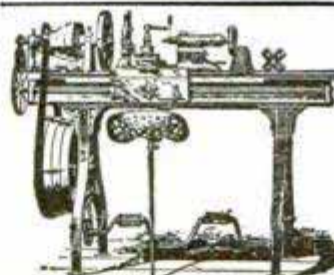

## LATHES

9 to 13-inch Swing

List price \$75 and up according to size. When ready to buy send for Lathe Catalog and prices.

W. F. & John Barnes Co.  
100 Ruby Street, ROCKFORD, ILL.

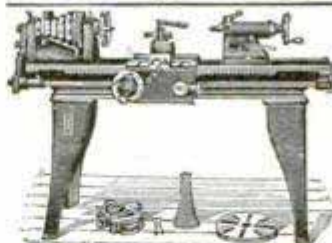

## LATHES

\$75 Screw Cutting Foot or Power

9 to 13 inch

CATALOG FREE

SOUTH BEND MACHINE TOOL CO., 423 Madison St., South Bend, Ind.

## LEIMAN BROS. POSITIVE HIGH PRESSURE BLOWERS AND VACUUM PUMPS

Used wherever a blast of air is required; for furnaces, forges, sand blasts, blow pipes; all gas and oil appliances; boat whistles.

### VACUUM CLEANING

Where to Get Them: Colorado: Denver, Scott Supply & Tool Co. Illinois: Chicago, Chas. F. L. Hommedieu & Sons Co. Indiana: Indianapolis, Vonnegut Hardware Co. Massachusetts: Boston, D. T. Cortis; Taylor Machinery Co.; Holt, Shattuck Co. Michigan: Detroit, Chas. A. Strelinger Co. Minnesota: Minneapolis, Harris Machinery Co.; St. Paul, Chas. A. Stickney Co. Missouri: St. Louis, J. W. Wright & Co. New York: Buffalo, Root, Neal & Co.; Syracuse, Wayne-Berry Co. Oregon: Portland, Portland Machinery Co.; Zimmerman, Wells, Brown Co. Pennsylvania: Pittsburgh, Baird Machinery Co. Rhode Island: Providence, Brownell Machinery Co.; Thos. McWilliams.

FOREIGN DEALERS—Austria-Hungary: Vienna, White, Child & Boney. Canada: Brantford, Kerr & Goodwin; Montreal, Williams & Wilson, Ltd.; England: Sheffield, Thos. Ashton, Ltd.

Toronto, A. R. Williams Machinery Co. Or get Catalog No. 22 for blowers or No. 23 for vacuum from LEIMAN BROS., 62 P John St., New York



## A Million People Bought Carborundum Sharpening Stones Last Year

More people than ever before bought any single brand of sharpening stones in a single year.

Proof positive that Carborundum Sharpening Stones are better than any other sharpening stones that were ever made.

### There is a Carborundum Stone for Every Sharpening Need

- No. 107-H—Round Combination Stone for carpenters' use \$1.00
- No. 108-H—Oblong Combination Stone for general use.. 1.25
- No. 103-H—Razor Hone, in neat box..... 1.00
- No. 146-H—Pocket Stone, for Every Man's use; in leather case..... .35
- No. 191-H—Scythe and Grass Hook Stone..... .25

*Ask your dealer for Carborundum Sharpening Stones  
If he hasn't them, send direct—Write for the booklet*

**THE CARBORUNDUM COMPANY, Niagara Falls, N. Y.**



**Make Your Own Repairs!**  
Mends Harness, Shoes, Canvas, Myers' Sewing Awl makes lock-stitch like sewing machine. \$1 postpaid. **BIG MONEY FOR AGENTS.**  
**C. A. MYERS CO.**  
6339 Lexington Ave., Chicago, Ill.

**The Awl for All.**

**WHEN JAPANESE ADVERTISE**—The Japanese have an original way of advertising, and they apply to the art all the poetry that their Oriental imagination is capable of. They have recourse to the most varied and improvised methods, and their combinations are some-

**The American Combined Level and Grade Finder**  
**Most Practical, Durable and Convenient Instrument Made**  
At one glance you can get the true slant on any line or grade either in degrees, inches or percentage, or all at the same time, and will at once give the exact distance needed to plumb up to a true level. The longitudinal recess shown in cut is well worth the low price of the instrument. Write **AT ONCE** for circular and Testimonials. Special Introductory Price given to First Applicants with privilege of taking Agency. Address **EDWARD HELB, Mfr., Box 75, RAILROAD, PENNA.**

**ENORMOUS SAVINGS AND BETTER WORK BY USING**  
**Eclipse Air Brush**  
A Scientific machine for high class work in applying—Paint, Varnish, Japan, Bronze, Lacquer.  
**ONE MAN CAN DO THE WORK OF FOUR**  
Write for Booklet and tell us what finishing you do.  
**ECLIPSE AIR BRUSH & COMPRESSOR COMPANY**  
BLOOMFIELD, N. J.

**WE SHIP ON APPROVAL**  
Our Hand Power Angle Benders are so indispensable for bending rods, squares, and flat pieces into all sorts of angles that we do not hesitate to ship tools for 10 days free trial. Made in 3 sizes to cover a wide range of work. We also make hand power tools for bending eyes, hooks, "U" shapes, hinges, rings, etc. Write for complete descriptive catalogue

**WALLACE SUPPLY CO., 124 No. Jefferson St., Chicago; 26 Cortlandt St., New York City**

**Here's Another New "YANKEE" Quick Return No. 130**

Same as the No. 30, but with a Spring in the handle that drives the spindle back, ready for the next push. A great advantage for overhead work or where only one hand can be used. Takes all the Attachments used in the No. 30.

*Send for Tool Book Free. Tells you about 35 Styles and 75 Sizes.  
A postal brings it to you FREE. Your dealer sells "YANKEE" Tools.*

**NORTH BROS. MFG. CO., Sta. Q, PHILADELPHIA, PA.**

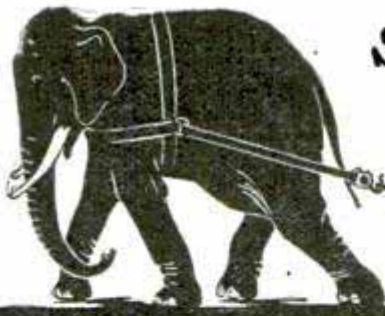

*Star Expansion Bolts  
Hold Anything*



## If You Have Work to Do

that entails the fastening of fixtures to walls where ordinary screws will not hold, use the **Star Expansion Bolts** for heavy work and the **Sebco Screw Anchors** for lighter work.

You should let us send you some working samples and our catalog—we illustrate and describe many uses for our **Expansion Shields** and other products that will interest you and show you a way to do better work at no additional cost for labor or material. Tell us the work you are doing; we will offer suggestions and send working samples.

**STAR EXPANSION BOLT CO.**

147-149 Cedar Street

CATALOG DEPT. 34

NEW YORK CITY

times as picturesque as they are original. A Japanese merchant informs his customers that his goods are sent off with the rapidity of a shot. A stationer calls his knowledge of natural history to his aid thus, "Our wonderful paper is as durable as the hide of an elephant." A Tokio grocer borrows some psychology, and, in mordant language, announces that "Our vinegar of extra quality is sharper than the bitterness of the most diabolical of mothers-in-law."—Detroit Free Press.

## AGENTS Here It Is

POCKET SEWING MACHINE



That's what Ed Hopper calls it. Sold 97 in few days.

He's pleased. Retail at **100% PROFIT** If you want a ridiculously low price, quick seller, one that gets the money easy, send now for confidential terms and FREE BOOKLET, "Inside information on the agency business." A few hours a day means many a dollar in your pocket. Send a postal. **A. MATHEWS, 6248 Wayne Street, DAYTON, OHIO**

# LUFKIN

## Measuring Tapes



Now made with **Instantaneous Readings**, the big improvement in markings. Saves time and eliminates errors. Send for sample piece of tape and our complete catalog.

**THE LUFKIN RULE CO.**

SAGINAW, MICH.

New York

London, Eng.

Windsor, Can.

# B & S

## IMPROVED

### TOOLMAKERS

## CLAMPS



The spring holds the "loose" jaw firmly in place. It prevents the jaw falling when many pieces of the same size must be clamped for drilling.

Catalogue mailed on request

**BROWN & SHARPE MFG. CO.**  
PROVIDENCE, R. I., U. S. A.

Please Mention Popular Mechanics

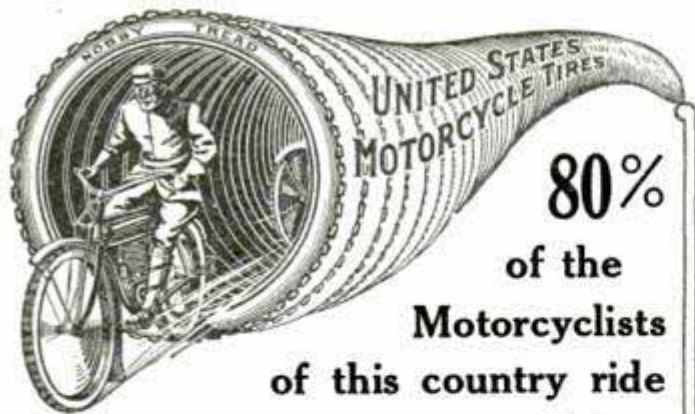

**80%**  
of the  
**Motorcyclists**  
of this country ride

## United States Motorcycle Tires

G. & J. or  
**MORGAN & WRIGHT BRAND**

No other brand of motorcycle tires are built under as favorable conditions, which may account for the universal use of the G. & J. and Morgan & Wright Tires.

**UNITED STATES TIRES** are  
the **STRONGEST** tires made

Get in line  
with the **80%** **THEY KNOW**

**UNITED STATES TIRE COMPANY**  
Broadway at 58th St. NEW YORK, N. Y.

## Bicycle Tires FREE

KEPT IN REPAIR

Only bicycle tire you can absolutely depend on is one that will stand this guaranty. We absolutely guarantee Cloverleaf (Fixitfree) Brand Tires to keep in perfect repair for a whole season, will make all repairs due to puncture or any other cause or give you another tire, absolutely Free. Valves and "rim cuts" excepted. This insures perfect tire service for a whole season. **Cloverleaf Tires \$5.85 Pair. We Pay Express and Fixit-Free.** Special low price to introduce. Cloverleaf Tires have stood every test. Don't judge tire by valueless fancy tread designs. Wear resisting and trouble saving qualities alone count. Order while special price lasts—\$5.85 pair. Give size wanted. Catalog free.

**The Vim** Chicago, Ill., Des Moines, Ia., or Minneapolis, Minn.

**\$5.85 PAIR**

AGENTS WANTED

## MOTORCYCLE CHEAP

We have several new Erie **\$40 2 h.p. motors** that we will sell for **\$15** each while they last. This is way below cost.

You can make you a good motorcycle cheaply with bicycle or other frame.

Write today for circular No. P. M. describing engine and fittings. If you own a motorcycle, ask for our big new catalog P of supplies.

**MOTORCYCLE EQUIPMENT CO., Hammondsport, N. Y.**

**WHEN YOU WANT ANYTHING AND DON'T KNOW WHERE TO FIND IT—WRITE BUREAU OF INFORMATION, POPULAR MECHANICS, CHICAGO**

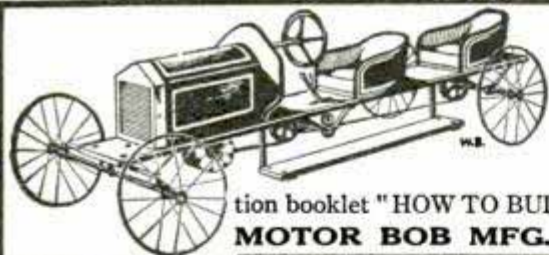

## THE MOTOR BOB

**A PRACTICAL MINIATURE AUTO** propelled by a small air cooled gasoline motor. Any boy of 12 years and up can (at little cost) build and operate the **MOTOR BOB**, thereby learning standard automobile construction and operation. Lots of fun without danger. Will carry two boys anywhere. Send 25cts. (coin preferred) for a complete instruction booklet "HOW TO BUILD A MOTOR BOB" with pictures, plain, simple drawings and list of parts.

**MOTOR BOB MFG. CO., Dept. H., Main and Amherst Sts., Buffalo, N. Y.**

## MAKE A MOTORCYCLE OF YOUR BIKE



at small cost, by using our attachable outfit. It fits any bicycle. Motorcycles, all makes, new and second hand **\$35.00 up**. Send stamp for catalogue and bargain list. "Keller's new 104-page booklet, "Construction, Management and Care of Motorcycles" is now ready. Price, postpaid, 25c.

**SHAW MFG. CO., Dept. B, Galesburg, Kansas**

**WORLD'S BIGGEST BAKERY.**—The largest bakery in the world is located in Essen, Prussia, the home of the great Krupp gun factory. It is a vast building in which 70 workmen, divided into two shifts, work night and day.

Everything is done by machinery. A screw turns unceasingly a kneading trough, into which are poured some water and 10 sacks of flour of 200 lb. each.

This machine makes about 40,000 lb. of bread each day in the shape of 25,000 small loaves and 25,000 large

## We Sell You At Wholesale Agents' Price, One



### American Motorcycle or Bicycle

As an introductory offer we give **30 Days' Free Trial** and prepay the freight. Hundreds of people will snap up this introducing proposition. The number of machines we sell on this liberal basis is limited—first come, first served. **Here is our plan:**—You ride the motorcycle or bicycle for 30 days. If it is not satisfactory, you may return it. If you like it, it's yours at the wholesale agents' price. **The American Motorcycles** are highest grade made, easy to start, simple to handle and powerful. You do not have to be a mechanic to run one. The American won the 1910 F. A. M. Western Endurance Contest, scoring 1000 per cent perfect. **The American Bicycles** are the best on the market. We give a **Life Guarantee**.

We have a money making proposition for five agents. Our enormous advertising campaign makes it easy to sell American machines. Don't delay a moment. Our catalog and introducing offer will interest you; it's **free**. Write us which you want, motorcycle or bicycle. **Do it now.**

**AMERICAN MOTOR CYCLE CO., 106 American Bldg., CHICAGO, ILL.**



# PIERCE

Mechanical Simplicity, Originality of Design, Reliability, Speed, Power and Durability are the Qualities of **PIERCE PRODUCTS.**

Catalog (U)  
free upon  
request.

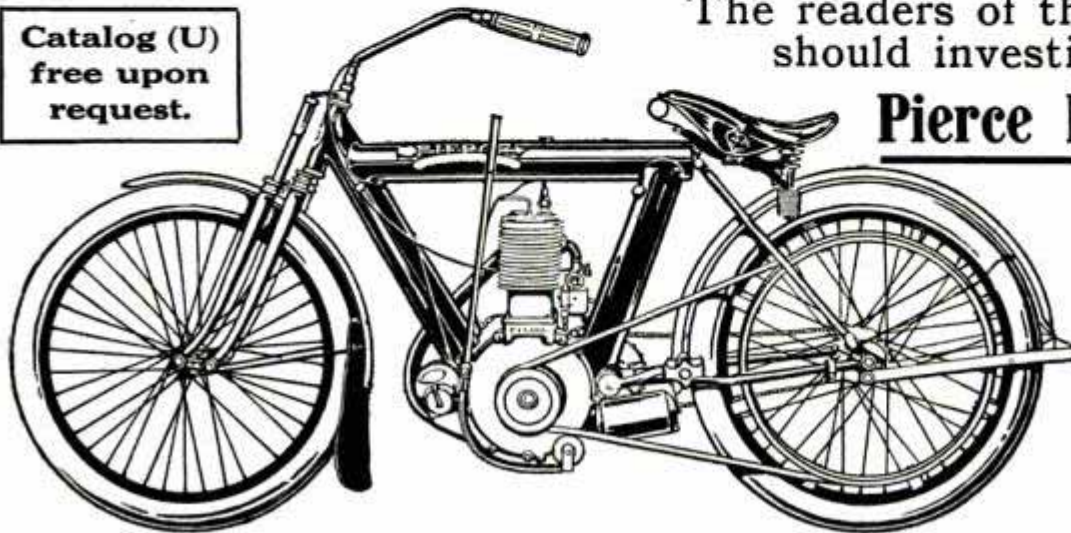

The readers of this Magazine should investigate the

**Pierce Motorcycles**

FOR

**Mechanical  
Excellence**

before making a purchase.

**PIERCE CYCLE CO. BUFFALO, N. Y.**  
Branch: OAKLAND, CAL.

loaves, produced by 230 sacks of flour of 200 lb. each. All the operations of breadmaking are performed in this colossal bakery. The wheat arrives there, is cleaned, ground, and brought automatically to the kneading trough by a series of rising and descending pipes.

There are 36 double ovens, and the workmen who watch over the baking of the bread earn from 8 to 10 cents an hour, making an average of 90 cents a day for 11 hours on duty. They have coffee and bread free; also the use of a bathroom, for they are required to keep themselves spotlessly clean, and must wash their hands eight times a day.—London Post.

The British mint recently turned out its first square coins, 5-cent nickel-bronze pieces, for use in Ceylon.—Detroit Free Press.



**Convert Your Bicycle into a Motor-Cycle** using our Attachable Outfit. Fits any wheel. Also Marine and Stationary Motors and Finished Castings. Stamp for catalog. **STEFFEY MFG. CO.**, Girard Ave. and 30th St., PHILADELPHIA, PA.



Lubricate—Burn cleanly  
Leave no carbon deposit

**ALL GARAGES—ALL DEALERS**

*Write for Booklet*

"The Common Sense of Automobile Lubrication"

**INDIAN REFINING COMPANY**  
INCORPORATED

First National Bank Building, Cincinnati, Ohio  
123 William Street, New York City  
W. P. Fuller & Co., San Francisco, Cal., Agents



**10 DAYS FREE TRIAL** We will ship you a "RANGER" BICYCLE on approval, freight

prepaid, to any place in the United States without a cent deposit in advance, and allow ten days free trial from the day you receive it. If it does not suit you in every way and is not all or more than we claim for it and a better bicycle than you can get anywhere else regardless of price, or if for any reason whatever you do not wish to keep it, ship it back to us at our expense for freight and you will not be out one cent.

**LOW FACTORY PRICES** We sell the highest grade bicycles direct from factory to rider at lower prices than any other house. We save you \$10 to \$25 middlemen's profit on every bicycle. Highest grade models with Puncture-Proof tires, Imported Roller chains, pedals, etc., at prices no higher than cheap mail order bicycles; also reliable medium grade models at unheard of low prices.

**RIDER AGENTS WANTED** in each town and district to ride and exhibit a sample 1911 "Ranger" Bicycle furnished by us. You will be astonished at the wonderfully low Prices and the liberal propositions and special offer we will give on the first 1911 sample going to your town. Write at once for our special offer. **DO NOT BUY a bicycle or a pair of tires from anyone at any price until you receive our catalogue and learn our low prices and liberal terms.** BICYCLE DEALERS, you can sell our bicycles under your own name plate at double our prices. Orders filled the day received. **SECOND HAND BICYCLES**—a limited number taken in trade by our Chicago retail stores will be closed out at once, at \$3 to \$8 each. Descriptive bargain list mailed free.

**TIRES, COASTER-BRAKE** rear wheels, inner tubes, lamps, cyclometers, parts, repairs and everything in the bicycle line at half usual prices. **DO NOT WAIT**, but write today for our Large Catalogue beautifully illustrated and containing a great fund of interesting matter and useful information. It only costs a postal to get everything.

Write  
it Now.

**MEAD CYCLE CO. Dept. S108, CHICAGO, ILL.**



THE OLD WAY

## No Hard Pedalling on a *Racycle* Motorcycle

THIS 4 H. P. beauty has abolished hard pedalling starts. Equipped with V Belt and Free Engine, engaged, the engine runs free, you mount and get away smoothly and easily—just like an automobile is started.

Controlled from the handle bar grip, you can start and stop anywhere—uphill or level ground—without taking hands from bars. Equipped with Muselman Armless air-cooled brake—surest, strongest and simplest motor brake made. Anti-vibratory spring seat post makes riding over rough roads pleasurable. A Flat Belt 1911 Model, with Idler, enables rider to have tightener for belt constantly at command. Both Battery and Magneto models can be furnished. Materials and workmanship are fully guaranteed.

Write for our 1911 FREE Illustrated Catalog. It explains the simplicity and perfection of the Racycle clutch, and other safety and comfort features which make the Racycle Motorcycle the one really desirable machine.

THE MIAMI CYCLE & MFG. CO.

53 Grand Avenue,  
Middletown, Ohio  
U. S. A.



STARTS  
IN THE STAND



### Solar Motorcycle Lamps

are the neatest looking, strongest and most efficient lamps made. The product of light specialists, makers of 90% of the automobile lamps used on the high grade cars of America. Catalog shows many styles—gas, oil and electric. Write for it today.

**BADGER BRASS MFG. CO.**

Kenosha, Wis. New York City, N. Y.



### NEW BIG MOTORCYCLE SUPPLY CATALOG

Write today for one FREE. It lists over 100 1912 articles that you should know about.

**Motorcycle Equipment Co.**  
Hammondsport, N. Y.

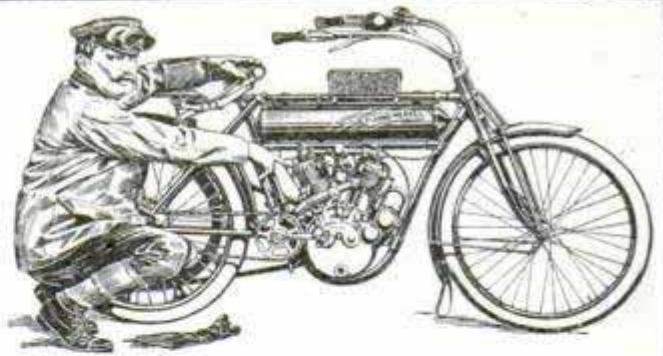

The ball-bearing motor of

**THE FLYING MERKEL**

MOTORCYCLE

*Is the Most Powerful of Any Its Size in the World*

This is one reason for "The Flying Merkel's" great speed, wonderful reliability, simplicity and ease of operation. It is the only motorcycle with a Spring Frame and Spring Fork, a device that eliminates all jolting and vibration, making motorcycling, even over rough roads, a genuine pleasure.

Send for our FREE Motorcycle Book

**MERKEL-LIGHT MOTOR CO.**  
350-370 Hanover St., POTTSTOWN, PA.

**HAWAIIAN MUSICAL INSTRUMENT**—The ukelele is the pet musical instrument in Hawaii. It has



### \$40 Motorcycle

We have the largest line of new and used Motorcycles in the country at the lowest prices. We also have a thoroughly equipped repair department and are in position to furnish repairs for any machine. Send us your machine to be overhauled.

Send for Catalog.

**HARRY R. GEER CO., 888 McLaran Ave., ST. LOUIS, MO.**

### FREE Murray Style Book

Save \$30  
Before you buy, it will pay you to get this money-saving book: 178 pages of genuine Buggy, Harness and Saddle bargains; 251 illustrations; 133 styles Vehicles, 74 designs in Harness. Biggest and best book ever printed. Murray "Highest Award" Buggies Direct from his Factory; 4 weeks' road trial; 2 years' guarantee. Send for this Big Free Book today.

The W. H. Murray Mfg. Co., 366 E. 5th St., Cincinnati, O.

**From Factory To Horse**

## FOR YOUR WHEEL

### "SEARCH-LIGHT" LAMP

BURNS GAS—MAKES ITS OWN GAS

Here's a powerful, reliable lamp for your wheel. Will not jar out—absolutely gas-tight. Can be attached to head or fork. Has universal bracket. Adjusted to any angle. WRITE TODAY FOR BOOKLET.

BRIDGEPORT BRASS COMPANY, 132 Crescent Ave., BRIDGEPORT, CONN.



# Thor

## MOTORCYCLES The Ideal Mount

You may want a motorcycle just for

the fun of an occasional cross country spin and a fast trip over the boulevards. Or you may want it to double your business capacity by double-quick "get-there-and-back" action about town. You may want high speed or the slowest possible drive. You *do want absolute dependability*. You may want everything of which the best motorcycle is capable. And you'll find them all in THOR Motorcycles.

They won every important endurance contest last season. They made 15,000 miles with a perfect score. The THOR is as fast as they make them. It will stand up under the hardest service. It has been refined and improved up to the highest notch. And for 1911 we submit five very handsome Models.—Four (4) H. P. single cylinder and one (1) 7 H. P. double cylinder. All described and illustrated in the **FREE BOOK** Sent Anywhere upon Request. A Guide to Motorcycles. Write for Your Copy TODAY!

**AURORA AUTOMATIC MACHINERY COMPANY, Dept. 1, 1307 Michigan Ave., Chicago**



**Agents**

Write for Liberal 1911  
Proposition. Territory  
being closed up rapidly. Get  
in on the ground floor now.

the shape of the guitar, but is only about one-fourth the size of that instrument and can be held in one hand while it is thrummed with the other. No serenade party is complete without the ukulele. The natives are very skillful in their use of the device and keep up a humming threnody much less metallic than the American banjo, and employed to accompany their fine, full voices it becomes truly agreeable. The native bass and baritone singers in some respects improve on the African voices so popular in the states. They sing with great feeling, but their voices are so thunderous as to need outdoors to be heard to complete advantage.—Chicago News.

## Motorcyclists!

Here are the newest motor cycle improvements. Your machine may have one or two of them, but you can not ride in such safety, comfort or satisfaction unless you have them all. Every one of them is found in the **R. S. MOTORCYCLE**. Ball Bearing Motor, Mechanically Operated Valves, Shock Absorbing Seat Post, Auxiliary Brake on Belt Rim, Foot Controlled Belt Tension Device, Adjustable Foot Rest. These and other features are the regular standard of the R. S. On other motorcycles they are furnished only as extras at extra prices. Write for 1911 catalog. Established dealers—write today for open territory and agency proposition.



**READING STANDARD COMPANY**  
Makers Renowned Reading Standard Bicycles  
406 Water St., Reading, Pa.



## Immediate Deliveries

on all models of the

Famous "World's Record"

## Curtiss Motorcycles

¶ This simple statement is an important one to you, Mr. Motorcycle Buyer.

¶ You know the machines—big, powerful, speedy ones. We've told you about delivery, and we'll further add that the price is right.

¶ This is your chance—just the one you've been waiting for.

¶ Catalog "B" mailed for the asking. Fresh, too. Just off the press.

**THE CURTISS MOTORCYCLE CO.**

**HAMMONDSPOUT, N. Y.**

Please Mention Popular Mechanics

# NSU

## A MONEY MAKER

We want an agent in every town and city to sell the only TWO-SPEED SPRING FRAME

## MOTORCYCLES

The N. S. U. holds the Trans-Atlantic Record, the Economy Record and is the fastest Belt Drive Machine in this country.

WRITE TODAY--DEPT. D

**N. S. U. MOTOR CO.**  
206 W. 76th St., New York City

# 1911 Model Hawthorne \$17<sup>75</sup>

**Coaster Brake**  
**Extra \$3.25**

The quality others  
ask \$25.00 for

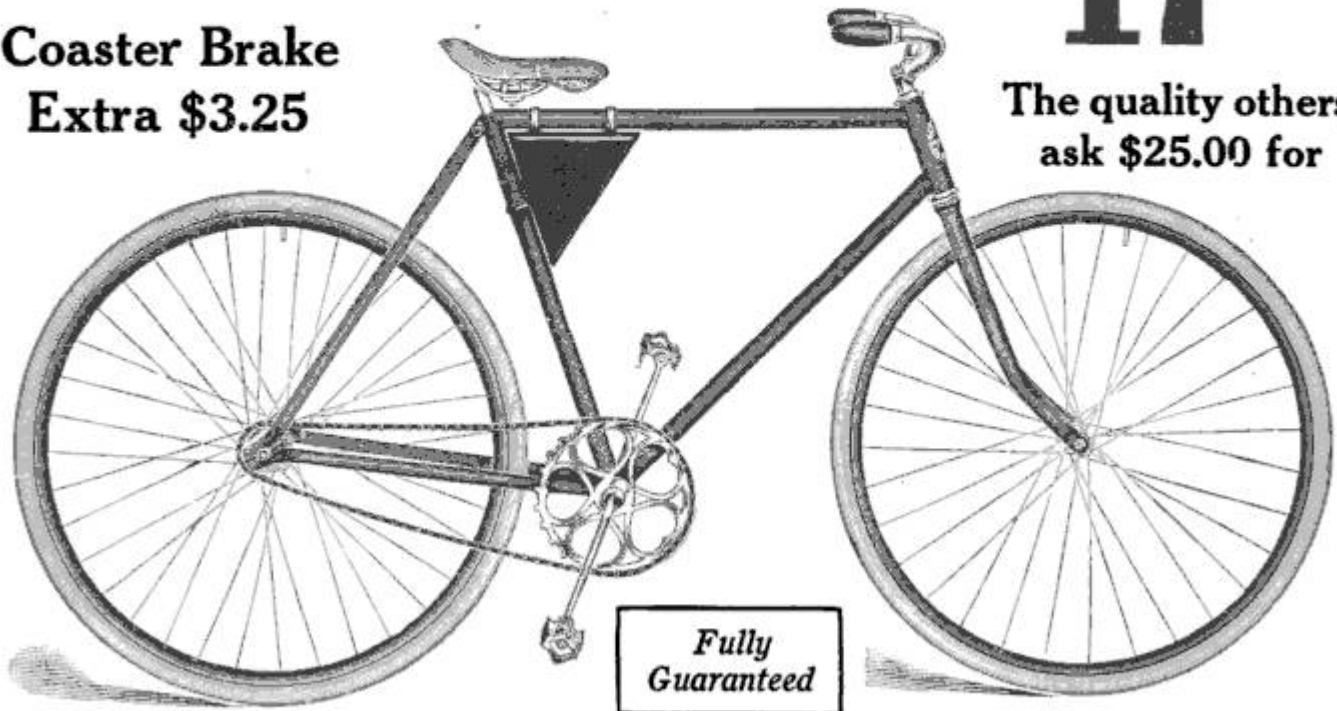

**Fully  
Guaranteed**

**Nowadays one buys a bicycle on its merits. You want a high-grade wheel that looks well, runs easy and will "stand up" under usage.**

We have been selling bicycles 25 years, and sell to thousands of riders each season. We are among the largest bicycle dealers in the world. **Our Hawthorne is known and used in every civilized land, and has every qualification any rider can possibly require in a wheel.** It is as good, in speed, construction, looks, and every way, as those that brought \$100 a few years ago, during the "craze." You cannot get a better bicycle, no matter how much more you pay. We ask you to read the specifications through carefully and notice its splendid equipment. Then bear in mind that if we sold our wheels through agents we would have to ask you at least \$25.00, as others do, but that by our plan of selling direct to you the usual agent's profit is left in your pocket.

## Specifications of the Hawthorne Bicycle

**FRAME.** Regular 24, 22 or 20 inch. 1 inch seamless tubing in main frame,  $\frac{3}{8}$  inch tapered to  $\frac{1}{2}$  inch in rear stays, with cross braces brazed in to make the rear stays rigid. Seat post clusters, hanger clusters and head clusters are reinforced on the inside with steel.

**FRONT FORK.** Fitted with drop forged steel crown, slightly arched over center, with lugs that run into the fork sides. The stem is reinforced on the inside with steel.

**HUBS.** The celebrated New Departure best turned hubs.

**WHEELS.** Made with swaged spokes, best quality, 32 front, 36 rear. Best quality wood rims, enamelled in blue with hair line stripes to match frame.

**HANGER.** First quality turned steel one piece oval cranks, with 26 tooth sprockets for 3-16 inch chain, polished and nickel plated; Cups and cones are made from best tool steel, oil tempered, with 5-16 inch balls and ball retainers.

**SADDLE.** Genuine Troxel Star, best grain leather finely padded, with loop spring.

**HANDLE BAR.** Adjustable. May be put in any position desired and fastened perfectly rigid. Fitted with turned leather grips and nickel plated ferrules.

**PEDALS.** Genesee guaranteed pedal, polished and nickel plated.

**FINISH.** The frames are dipped in anti-rust solution after which they are given three coats of

rich royal blue enamel with fine hair line striping, thoroughly baked on. The cups, cones and fork crown are nickel plated on copper.

**CHAIN.** "B" block pattern, 3-16 inch with blued side plates, polished rivets and center blocks.

**GEARS.** We use 26 tooth front sprockets, and either 9 or 10 tooth rear, making 80 or 72 gear, as you wish.

**TOOL BAG.** Pebbled grain leather, with wrench, oil can, pump and repair outfit.

**TIRES.** Thornproof. Thick tread, single tube, guaranteed, with corrugated non-slip tread.

**B 22050—Hawthorne Bicycle, price each \$17.75**

**B 22060—Hawthorne Bicycle, with New Departure improved coaster brake, price each \$21.00**

Now that you know the high quality in the Hawthorne and the reason for its low price, we ask you to send us your order, being sure, when you do so, to state height of frame and gear wanted. One dollar will pay the express about 500 miles from Chicago; \$1.25 will take a wheel from Chicago to Boston. You pay the charges when the bicycle arrives. We guarantee safe delivery and satisfaction. We can send you our bicycle catalog if you want it, but why delay? This is the bicycle you want and you can have it sent you at once, have it to ride as quickly as you could get the catalog. Then when you receive it and try it you will understand why we claim for the Hawthorne that it is **The Best Bicycle Made.**

ADDRESS ORDERS TO THE HOUSE NEAREST YOU

## MONTGOMERY WARD & CO.

19th and Campbell Sts.  
KANSAS CITY

Chicago Avenue Bridge  
CHICAGO



# POPE BICYCLES

COLUMBIA

CLEVELAND

RAMBLER

TRIBUNE

The proved perfection of these famous bicycles is due to many distinctive features of great merit not found in other makes. They are safe to buy and safe to ride. **Cycling is a Returning Fashion**

The bicycle is the most widely used vehicle, because it serves for utility, pleasure, exercise, health, economy and business. Over 300,000 new bicycles were made and sold last year.

*CAUTION! Thousands of very low-grade wheels, with fancy paint and deceptive names, are being sold at high-grade prices. If you see a name-plate that you do not know, beware! Everyone knows Pope Quality. Fully Guaranteed, \$25 to \$100.*

**The Pope Daily Service Bicycle**—A new proposition. Send for full particulars about this magnificent wheel and our convenient method of selling it.

**THE POPE MFG. CO., 479 Capitol Ave., Hartford, Conn.**  
*There is a catalogue for each make Dealers wanted everywhere*



**DWARF ELEPHANTS TO UGANDA**—Capt. C. Graham of the Fourth King's African Rifles, reports from Uganda a herd of dwarf elephants which to him seem to differ remarkably from the ordinary elephants of Africa.

They are notable for their small tusks, those of an old, well-grown bull weighing only sixteen pounds apiece. The animals are notable for their small size, and especially for their small feet and very tiny head. Unfortunately no measurements are given, but now that the existence of these animals has been reported, specimens will undoubtedly be measured and brought in.—Forest and Stream.

**L. C. SMITH & BROS. TYPEWRITERS** writing in sight.



## Amazing Profits In Mushrooms

Anybody can add \$8 to \$40 per week to their income, entire year growing mushrooms in cellars, sheds, barns, boxes, etc. Markets waiting for all you grow.

Free Illustrated Instruction Booklet  
**HIRAM BARTON**  
 Desk 2, 329 W. 48th St., New York

## DETROIT REVERSE GEAR

Starts—Reverses—Stops INSTANTANEOUSLY

**The Simplest, Most Reliable, Most Compact** and the Smallest Perfect Marine Reverse Gear ever offered. No outside moving parts to throw the oil or grease, tear the skirts, bruise the hands or catch waste. No noise. Manufactured in sizes for from 2 to 80 H. P. We carry all sizes in stock for immediate shipment. Guaranteed for one year. Write for special prices and free catalog. Valuable information from our Consultation Department FREE to motor boat men.



(40)

Detroit Engine Works, 24 Beaufait Ave., Detroit, Mich.

**Ann Arbor "INSTANTO" GASOLINE LIGHTING SYSTEMS**

Change from a 150 candlepower light to 2 candle power in a jiffy. This latest and most perfect development of the gasoline lamp found only in Ann Arbor Lighting Systems. It gives the country home a lighting system as perfect, handsome and modern as city gas. Ann Arbor Lighting Systems are brighter than gas, steadier and clearer than electric light, and cost about one-tenth as much to operate. Each lamp gives 150 to 500 candlepower for less than 1-3 cent per hour. Fuel is gasoline; perfectly safe.

**We Make Complete Lighting Systems for Homes, Churches, Stores, etc.**

Prices \$10 up, according to number of lamps desired.

**We Want Agents** who will push our line. A splendid opportunity right now for hustling agents in large cities to sell to owners of summer cottages, country homes and resorts. No other light can equal it in brilliancy, beauty of fixtures and economy.

CATALOG AND PRICES ON REQUEST

**Superior Manufacturing Company**  
 294 Second St. Ann Arbor, Mich.

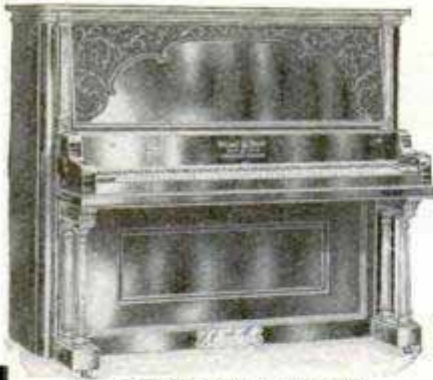

ONE OF OUR 40 DESIGNS

## A GENUINE Shipped to You—Prepaid WING PIANO Absolutely FREE!

Yes, absolutely free. An astounding liberal offer direct to you and from one of the largest manufacturers of high-grade pianos in the world. We will ship you a genuine, tested and guaranteed Wing Piano without asking you for a cent. We will even pay all the freight in advance, so that you are not out a single penny on this ultra generous offer. **FOUR WEEKS' FREE TRIAL.** We will allow you to keep this superb Wing which we send you, for four full weeks, without paying anybody a cent. Use this grand instrument for four weeks, just as though it were your own, then, if for any reason, you are not more than satisfied with the Wing in every single respect, send it right back to us, and we pay all the freight charges.

But if you decide to keep the Wing after the four weeks' free trial, we will allow you the privilege of either cash or time payments and at the factory price. And besides we give you an absolute guarantee, backed by the factory which has been manufacturing pianos for 42 years and which has sent out almost 50,000 pianos. One of the oldest piano factories in America.

### Valuable PianoBook FREE

The biggest and most valuable piano book ever published sent absolutely free on your simple request. If you own a piano now, or if you ever expect to own a piano, you should send for this splendid book right away. Tells how you can judge a piano as well as any expert and gives a series of tests by which you can confirm your judgment. Besides this "Book of Complete Information about Pianos," we send you our splendid art catalogue, showing all the latest style Wing Pianos. Just your name and address on postal or letter brings you this valuable book and the art catalogue free. Now, don't wait—write now. WING & SON (Est. 1868), Wing Bldg., 13th St. and 9th Ave., Dept. 119X, NEW YORK, N.Y.

### \$1.00 DOES THE WORK OF \$2.00

HOW? By having high grade furniture shipped direct to you from the factory in the natural wood, together with all the materials necessary to give it the proper finish (or stained prior to shipment if preferred) and in assembled, easy-to-put-together sections.



Take for example the chair shown in the illustration. You simply put the four assembled sections together (two sides, front and back), slip the cushion in place, and by this act you have reduced the cost of that piece of furniture exactly, yes, more than half.

**FIRST**--You pay but one profit only--the manufacturer's profit. All retailers' profits and expenses are done away with.

**SECOND**--The freight rate on furniture shipped in this manner is very low, about one-quarter of that charged on completed furniture, which charges are always included in the dealer's price to you.

**THIRD**--The finishing and packing charges are reduced to a minimum.

**FOURTH**--The size of the factory, and therefore the expense of maintenance, is reduced, no enormous storage space being necessary. This naturally reduces the manufacturing cost. Send today for our new catalog No. 12, which shows an extensive line of furniture for every room in the house, club or office, each piece backed by our Guarantee of Satisfaction or your money refunded.

**BROOKS MFG. CO., 706 Rust Ave., Saginaw, Mich.**

### BUY PLUMBING SUPPLIES AT WHOLESALE Will Save You 30%



Don't pay retail prices. Full stock on hand for prompt shipment. Send for free catalog. R. P. KAROL, 768 to 772 West Harrison St., Chicago



### This Morris Chair \$1.25 CASH

65c monthly--total price \$5.45. Latest design. Kiln dried heavy stock. Genuine Fabricord Leather. We have 3000 such bargains for you. And all

#### SOLD ON CREDIT

You use and enjoy the goods now--pay as you can. 30 DAYS' GUARANTEED FREE TRIAL. Send at once for our big illustrated catalogue. It's FREE to you.

**Spiegel, May, Stern Co.**  
1541 35th St., Chicago, Ill.

**2¢ A WEEK**

A safe, very brilliant, powerful, steady, white light. Is better than electricity or acetylene and cheaper than kerosene.

Every lamp is a complete self-contained miniature light works. Clean--bright--odorless--portable. Made in over 200 styles for every purpose. Fully guaranteed. Catalog free. Agents wanted.

**THE BEST LIGHT CO.**  
324 E. 5th Street  
Canton, O.

**THE "BEST" LIGHT.**

**THE CZAR'S WATCH**--There is in the possession of the czar a very remarkable watch. It was made by a Polish mechanic named Jules Curron. The czar had heard some wonderful tales about the inventive ability of this man, and, wishing personally to test his skill, he sent him a parcel containing a few copper nails, some wood chippings, a piece of broken glass, an old cracked china cup, some wire and a few cribbage board pegs. Accompanying this was a command to make them into a timepiece. Within a remarkably short time the czar

**Home Ironing Machine**

On Easy Payments, 30 Days' Free Trial.

A heated mangle that irons all flat pieces better, easier, and in one-quarter the time. Costs 1c an hour for heat--gas or gasoline. Turned by hand, by power or by motor. "Clean Linen" booklet Free. Ask for it.

**Home Ironing Machine,**  
311-F Western Ave.  
CHICAGO

### Buy Direct--Save Money--We Pay Freight

Our monthly installment plan of selling direct saves you the dealer's profit and his excessive charges for installation and repairs. You can save at least 1/3 the cost of your furnace. We have been building Jahant Furnaces for over 30 years and guarantee satisfaction

## JAHANT DOWN DRAFT FURNACE

THE BEST HEATING SYSTEM MADE for residences, schools, hotels, churches, etc. It is the most economical furnace too and saves 3/4 to 1/2 the cost of fuel because the patented "Down-Draft System" burns wood, hard or soft coal, and burns it ALL without cinders, clinkers or any waste. Needs less attention, yet heats much better than any other furnace, not air, steam or hot water heating system. Our plan of monthly payments

### ONLY \$10 DOWN and \$10 A MONTH

makes it easy for any one to have the best heating system made. Every Jahant Furnace is sold with a strong "Guaranty Bond" that allows you 365 DAYS TRIAL. You don't run any risk buying from us. We send complete outfit, furnace, pipes, registers, etc., together with special plans, full directions and all tools for installing. If you can drive a nail you can install a Jahant Furnace without the aid of a tinner.

**Write To-Day for Catalog**

which explains the Jahant Down-Draft System and tells why it gives more heat at less cost.

**THE JAHANT HEATING CO.,**

**3 Mill Street, Akron, O.**



# POTENTIOMETER

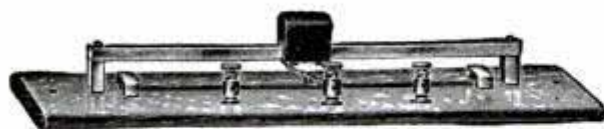

Our Potentiometer regulates current and voltage very gradually. The slider maintains perfect contact with the resistance rod which is practically indestructible.

This instrument and a complete line of high grade wireless instruments are described in our 80 page Manual of Wireless Telegraphy and Catalog No. 1P which will be mailed upon request.

## MANHATTAN ELECTRICAL SUPPLY CO.

17 Park Place, NEW YORK 112-114 So. Fifth Ave., CHICAGO

received them back in the shape of a watch. The case was made of china, and the works of the other odds and ends. So pleased and astonished was the czar that he sent for the man and conferred several distinctions upon him.—Detroit Journal.

Corn cobs, compressed into blocks and treated with a waterproofing liquid, are used as building material in some sections of Germany and Russia.—Houston Post.

## BRANDES WIRELESS RECEIVERS

We have high class wireless receivers for professionals and amateurs costing from \$1.50 each to \$13.00 a pair. Send stamp for new catalog. C. BRANDES No. 113 Broadway, NEW YORK

**ELECTRIC** GOODS FOR EVERYBODY. World's headquarters for Dynamos, Motors, Fans, Toys, Railways, Batteries, Belts, Bells, Pocket Lamps, Telephones, House Lighting Plants, Books. If it's electric we have it. Undersell all. Fortune for agents. Big Catalogue 4 cents. OHIO ELECTRIC WORKS, CLEVELAND, OHIO

## BIG 200-p ELECTRICAL and WIRELESS CATALOG Mailed for 6c Stamps

which may be deducted from first order. Largest and most artistic Electrical Catalog Published. 60 pages

WIRELESS Instruments for commercial and experimental use. 15 pages Motors and Dynamos of all sizes. 35 pages Miniature Trains and Imported Electrical TOYS. 20 pages Telegraph Instruments. 40 pages Electrical Novelties, etc. 30 pages general Electrical Supplies.

J. J. DUCK, 424-6 St. Clair Street, TOLEDO, OHIO

## SPARK COILS

We build more Spark Coils for experimental work than any other concern in the U. S. Coils are built for Experimental and WIRELESS work. 3/4 inch spark \$2.20 1 inch spark \$4.50 1 1/2 inch spark 3.10 2 inch spark 9.00 ALL COILS GUARANTEED FOR ONE YEAR Sell also all kinds of Spark Coil Parts. Send today 4 cents postage for our famous 196 page Electrical Encyclopedia containing 400 illustrations. Information on Wireless, Experiments, etc. "Everything for the Experimenter"

THE ELECTRO IMPORTING CO., 233a Fulton St., New York, N. Y.

## Bargain Prices on New and Used Electrical Machinery



We Buy, Sell, Rent, Trade and Repair Electrical Machinery. Our Stocks are Large, Prices Low and our Used Machinery is as Good as New. Write for Bargain Booklet Number Twenty. Tell us what you have and what you need. We can interest you.

## SWITCHBOARDS

For POWER or LIGHTING

Whether large or small, Alternating or Direct Current, we do or will build the Switchboard that meets your requirements.



Ask for Switchboard Bulletin Number Twenty-two. It gives prices.

We do not handle novelties or toys.

**The F. BISSELL COMPANY**  
226-230 Huron St. TOLEDO, OHIO

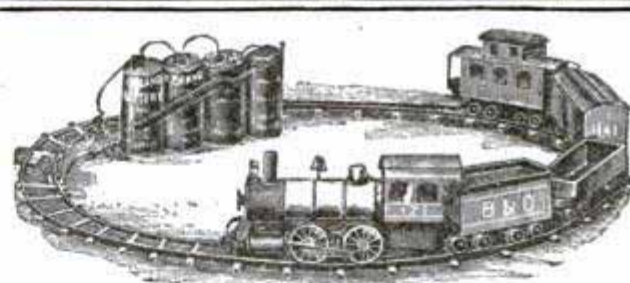

Electrical railways, tracks, switches, trolley cars, dynamos, motors, dynamo castings, gas engine castings, everything for the young electrician. Send for our complete catalog "B."

**The Carlisle & Finch Co.**  
262 E. Clifton Ave. Cincinnati, Ohio

**SECONDARY "UNITS" FOR WIRELESS**  
INDUCTION COILS AND TRANSFORMERS; THESE UNITS COST BUT LITTLE MORE THAN WIRE ALONE. SEND 2 CENT STAMP FOR WIRELESS CATALOGUE.

Dawson & Winger Electric Co., 429 Dearborn Street, Chicago

## ELECTRICITY

VOLTAMP

The most wonderful and fascinating scientific study of the age. Every Boy, Girl and Grown-up should know about it. The new "VOLTAMP ELECTRICAL PRODUCTS"—our 112 Page Catalog now ready, the most complete and interesting book ever issued—is full of illustrations and descriptions of the latest Voltamp. Electrical Novelties—Motors, Dynamos, Toys, Machine Models, Telegraph and "Wireless" Instruments, Ruhmkorff Coils, Spark Coils, Geissler Tubes, Switches, Meters, Lamps, Flashlights, Transformers, Tools, etc. The greatest line of Miniature Electric Railways ever shown. Ideal Christmas Gifts. Prices consistently low.

Send for this Catalog—6 cents in stamps or coin, which will be refunded on first order of 50 cents or over. No postals answered.

VOLTAMP ELECTRIC MFG. CO., Voltamp Bldg., Baltimore, Md.



# "I Made \$20 Today"

Sold 48 This Week, profit (\$84.00.)

Writes M. G. Clark, Mont.

## "WOMEN BUY AT SIGHT"

**SCRUBS  
DRIES FLOORS  
CLEANS  
AND  
BRIGHTENS**



"Started yesterday: sold 10, and today 12 more. It's a gold mine. Rush 50 more," writes J. H. Hodson, N. Y. Hundreds of men and women making **\$50 to \$100 a Week**

actually making a week's wages every day. They're banking money, buying homes, automobiles. **New discovery** makes it easy for them—should do the same for you. Tremendous sale of the

### "Home Comfort" Scrubbing and Floor Drying Machine

breaks all records. New, popular, irresistible—double your money every sale. Every housewife a customer. World's greatest labor saving invention. **No more back breaking scrubbing, and floor cleaning days.** New marvelous machine replaces hands, old style brushes, unsanitary rags, and hand disfiguring mops. **Vibration does the work.** Scrubs, dries floors, cleans, brightens—removes dirt, grease, stains, germs—works like magic. A God-send to women. **Self feeding, self emptying, self sudsing.**

Turns scrubbing and floor cleaning drudgery into neat, easy, quick, pleasant task. Child can do it the Home Comfort way.

Weights 7 pounds. Sells

for \$3.50—lasts for years.

Not sold in stores. Home

Comfort is truly a never-end-

ing household boon. Pleases,

astonishes all. Customers wonder how

they ever got along without it. Mrs.

Harris, Ill., writes:

"Home Comfort has

been a God-send. It's

so easy to scrub and

clean. Really wonder-

ful how quick it works." Mrs. H. Cole, N. Y., writes: "I am simply delighted.

**\$3.50**

Robs scrubbing and floor cleaning of all its hard work and takes so little time. Can clean dirtiest floors with scarcely any effort." C. Barnes, S. C., writes: "No other invention means so much to the home. I am booking orders like lightning. It takes every woman by storm." What woman hasn't been eagerly waiting for the Scrubbing and Floor Cleaning Machine? It's here—perfected—selling like wildfire. Sells for \$3.50—banishes forever woman's worst torture. Could anything be more appreciated, popular, irresistible? **Don't delay**—seize this live opportunity. Be first—get exclusive territory—make a fortune. Send today for agency, free sample and credit terms.

**SANITARY SUPPLY CO., Box 308, Sta. F, TOLEDO, OHIO**



## KNIFE BALL-BEARING DRAWER ROLL

Send 10c for Sample

**KNIFE MFG. CO., Drexel Bldg., Philadelphia, Pa.**

## THE O. K. ELECTRIC THOUGHT REGISTER

Every professional and business man or woman should have an O. K. ELECTRIC THOUGHT REGISTER. It relieves your mind and saves you time, money and worry. Nearly every person has some very important thought flash through his mind before going to sleep at night and matters which should have been taken care of have been forgotten. Send \$2 in Stamps, Draft, M. O. or Cash for an O. K. Electric Thought Register, on 30 days' trial. **WEIS MANUFACTURING & SUPPLY CO., Hammond, Ind.**

## LET US GIVE YOU THIS TRANSPARENT CELLULOID TRIANGLE

It is 4 inch size, 30°+60° angles. Lowest retail price, 25 cents. Absolutely essential to everyone who draws. We make this offer to introduce our new catalogue showing

### SPAULDING'S NEW CARRYING CASES AND COMPLETE OUTFITS

for designers, architects, engineers and students—compact, durable and convenient. Spaulding's Carrying Cases are made light and strong. They provide well arranged compartments, including space for drawing board and T square. Handled like a suit case; unique, practical, inexpensive. Outfits include all necessary equipment. If you draw, send us five 2-cent stamps to-day to pay postage and get the free triangle and the catalogue.

**SPAULDING PRINT PAPER CO.**  
44 Federal St. BOSTON

## Independent Safety Fountain Pen



Can be safely carried in any position. New idea cap locks pen when not in use. All pure rubber and 14 kt. pens. Made in two sizes, 3¼" and 5¼", \$1.50 and \$2.00 postpaid.

**J. C. ULLRICH & CO., Fountain and Stylo Pens**  
27 Thames St., N. Y. C.



## ADD or SUBTRACT—QUICK!!

The Bassett \$1.00 adder insures rapid and accurate calculations in addition and subtraction. An invaluable aid to every business man. Simple to operate. Capacity 999,999.99. Durably made. Quickly reset to zero. Sent prepaid for \$1.00. Money returned if not as represented. Brand new offer to agents.

**J. H. BASSETT & CO., Dept. 81, 5921 Indiana Ave., CHICAGO, ILL.**

**LEGIBILITY OF LETTERS**—Roman letters of various sizes are commonly employed by oculists in testing acuteness of vision. Recent experiments show great differences in the ease with which the different



## TYPEWRITERS ALL MAKES

All the Standard Machines **SOLD or RENTED ANYWHERE** at 1/4 to 1/2 MFR'S PRICES, allowing RENTAL TO APPLY ON PRICE. Shipped with privilege of examination. Write for Illustrated-Catalogue L. TYPEWRITER EMPORIUM, 92-94 Lake St., CHICAGO



**This Cabinet** made of Oak, finished golden, 44" long, 24" wide, has drawers, extension slide, roll front, paper cabinet, etc., as shown. We sell it at low price to introduce our **OFFICE FURNITURE**—Desks, Chairs, Tables, Files, Book Cases, etc. **ASK FOR PRICES AND CATALOG No. 211.**

We make **UPHOLSTERED FURNITURE**—Turkish and Odd Rockers, Parlor and Library Suites, Davenport and Couches in Oak and Mahogany, Flanders, mission and regular. Covered in best leather money will buy—every piece guaranteed. Ask for prices and Catalog No. 411. **E. H. STAFFORD MFG. CO., 242 Adams St. Chicago, Ill.**

## BE ACCURATE



Enlarged  
Section  
of Ruler

Here is a new scale—on a New Principle. A Sharp Notch every 32d of an inch guides your pencil instantly to the right spot. Quick. Convenient. Absolutely Accurate. 12 inches long; extra heavy celluloid. Throw away your old rulers and send for the **Saw 50c post paid** Tooth Ruler today. *Money back if desired.*

**THE ISOGRAPH CO., 145 E. 23d Street, NEW YORK CITY**

*ALOE—For Fifty Years the Standard of the World for Quality. Established 1860—ALOE*

## Civil Engineering and Surveying Instruments

**DRAWING MATERIALS AND SUPPLIES  
BLUE PRINT PAPER, TRACING CLOTH, ETC.**

"FREE." Write for Catalogue. Sent "FREE."

**A. S. ALOE COMPANY, 514 Olive Street, ST. LOUIS, MO.**





# 6c Invested Makes \$150

That sounds almost unbelievable. But it's true—a proved fact. A 6 cent pound of ordinary sugar and the wonderful

## EMPIRE CANDY FLOSS MACHINE

will turn the trick and do it every eight minutes, at a fair, a race track, a circus or anywhere a crowd collects.

**\$100.00 a Day** is an easy profit with this wonder money-maker. And it keeps on making this enormous profit year after year with no expense for repairs. Eight years of big money-making experience have proved this your opportunity. Today is the day to get the facts. Also ask for Catalog of Popcorn and Peanut Roasters and Ice Cream Cone Machines. Write to Dept. C, STEVENS MFG. & SUPPLY CO., 1223 Wabash Avenue, Chicago, Ill.

OVER  
**\$400**  
Made  
in One  
Day

Operating  
the

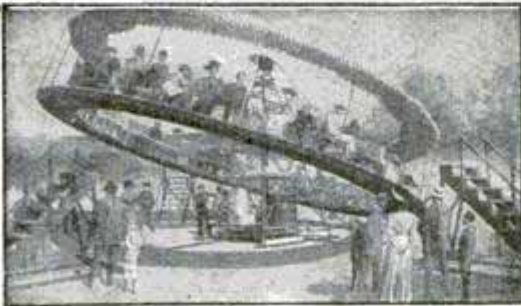

### CIRCLING-WAVE AMUSEMENT DEVICE *Read this*

Armitage & Guinn; At Eagerton, Ind., away back from no place we got in \$350.90 in six hours' run. At Crawfordsville, Ind., we had a \$402 day.

BOOHER BROS.

**IF BOOHER BROS. DID THIS, WHY CAN'T YOU?**  
Let us tell you all about this marvelous CIRCLING WAVE, and its wonderful money-making power. Address, ARMITAGE & GUINN, 34 Mill St., Springville, Erie Co., N.Y., U.S.A.

letters are recognized by the same person. T is especially difficult of recognition, and is apt to be mistaken for Y. By a similar optical illusion the angle of L is rounded off, making the letter resemble a reversed J. V is the easiest of all letters to recognize, and O presents little difficulty. K is more easily recognized than H, which resembles it closely, and both N and Z are easily recognized. A is easily guessed from its general form, but is difficult of positive recognition, including distinct perception of the horizontal line. E and F are among the most difficult of all the letters.—Philadelphia Enquirer.



## Wheel Chairs

A Wheel Chair is often an invalid's greatest comfort. We offer over 75 styles of these easy, self-propelling and invalid's Rolling Chairs, with latest improvements. Ship direct from factory to you, freight prepaid, and sell on

**THIRTY DAYS' TRIAL**

Liberal Discounts to all sending for free Catalogue NOW.

**GORDON MFG. CO.**

472 Madison Ave. TOLEDO, OHIO

# NO MORE BALD HEADS



When our VACUUM CAP is used a few minutes daily. We accept no pay until you have tried the Cap 60 days and are satisfied. The Vacuum Cap is an appliance that draws the blood to the Hair Roots and starts a new healthy crop of hair. It stops Dandruff, stops the hair from falling out. Bought by Doctors and men who

know that it is the only reasonable HAIR GROWER known to science. No Drugs Used. Write for application blank, testimonials, and booklet on "HAIR," sent sealed in plain envelope, FREE.

**THE MODERN VACUUM CAP CO.**

R. 559 BARCLAY, DENVER, COLO.

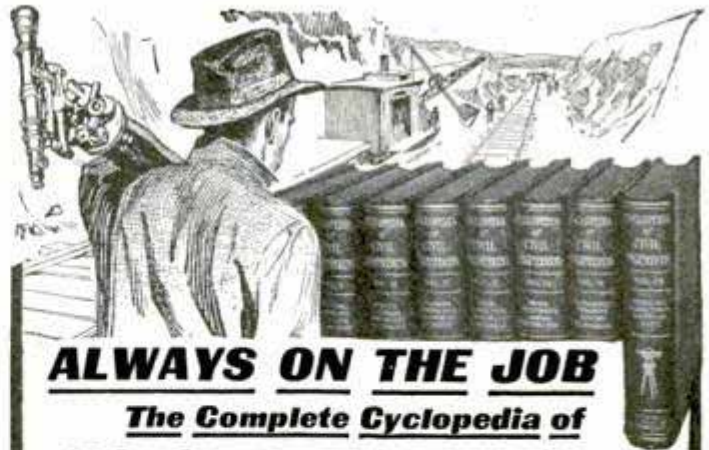

## ALWAYS ON THE JOB

*The Complete Cyclopaedia of*

# Civil Engineering

is always on the job. It contains more up-to-date, accurate, money saving information on reinforced concrete, irrigation, water supply and water power development than you can get in any other book or set of books. It is especially adapted

## For Home Study and Self Improvement

It goes straight to the point, uses plain English. From it you can learn the first principles of plane surveying or solution of the most abstruse problems in strains and stresses. Bound in half morocco, 3,908 pages, 7 x 10 inches. 3,000 full page plates, folding maps, diagrams, etc., carefully indexed so you can turn at once to the topic you want.

### IMPORTANT SUBJECTS COVERED

Plane Surveying—Mechanical Drawing—Plotting and Topography—Steel Construction—Railroad Engineering—Statics—Strength of Materials—Roof Trusses and Mill Building Construction—Cost Analysis in Relation to Engineering—Masonry—Bridge Engineering—Practical Problems in Construction—Hydraulics—House Drainage and Sanitation—River and Harbor Improvements—Irrigation Engineering.

## Examine These Books Free of Charge

If you will send us your name and address on coupon below, we will send you a complete set of these books by prepaid express. You can keep them in your home five days. Examine them carefully, apply the information they will give you, to your daily needs. If you think they will help you in your work, send us \$2.00, then \$2.00 every thirty days until the special price of \$24.00 has been paid. The regular price is \$48.00. If the books are not what you want, advise us. We will have them returned at our expense.

### Special Offer if You Mail Coupon Promptly

For a short time we will include, as a monthly supplement, free of charge for one year, the TECHNICAL WORLD MAGAZINE. This is a regular \$1.50 monthly, full of Twentieth Century Scientific facts, written in popular form. Also contains the latest discussion on timely topics in invention, discovery, industry, etc. The magazine will be mailed immediately upon receipt of coupon.

### SPECIAL PREPAID OFFER COUPON

AMERICAN SCHOOL OF CORRESPONDENCE, Chicago, U. S. A.

Please send set Cyclopaedia of Civil Engineering for 5 days' free examination. Also Technical World for 1 year. I will send \$2 within 5 days and \$2 a month until I have paid \$24.00 for books and magazine; otherwise I will notify you and hold the books subject to your order. Title not to pass until fully paid.

NAME .....

ADDRESS .....

OCCUPATION .....

EMPLOYER .....

POP. MECH. 6-11

# Let the "Multimotor" Run Your Shop!

A Powerful Engine of Midget Size with Over 100 Uses

Let the little "Multimotor" drive the machines in your workshop. It makes machinery hum. Saves time, money and muscle. "Handy as a Pocket in a Shirt." Most compact and complete unit for light power purposes ever designed.

**Big Power for Less Than 1c an Hour**

Write for Free Book

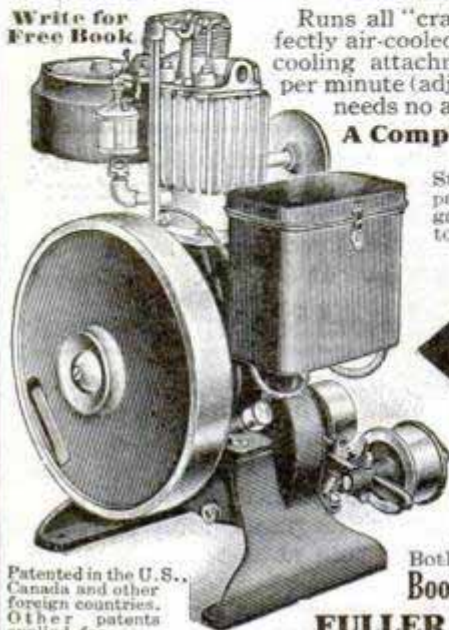

Patented in the U.S., Canada and other foreign countries. Other patents applied for.

Runs all "crank" or "treadle" machines. A perfectly air-cooled, vertical type engine without fans or cooling attachments. Speed, 500 to 600 revolutions per minute (adjustable). Self-governing, self-oiling; needs no attention while running.

**A Complete Portable Power Plant. No "Extras" to Buy**

Needs no concrete foundation. Runs anywhere—indoors or out. Starts instantly. Cannot freeze or overheat. Important working parts inclosed in dust-proof crank case. "Everything but the gasoline" comes in the packing case. Engine complete and ready to run, weighs only 250 pounds.



**Runs All Hand-Power or Foot-Power Machines.** Every Mechanic, Carpenter, Cabinet Maker, Contractor, Blacksmith, Repair Man, Home Owner—all who use light machinery—need this wonderful engine. **THE FULLER & JOHNSON FARM PUMP ENGINE.** Practically the same as the "Multimotor." Pumps 400 to 1,500 gallons per hour and runs light machines. Both engines are as **High Grade as Automobile Engines and Fully Guaranteed.** Write for Catalog and name of nearest dealer who has these Engines on exhibition. **Book Free** If interested in large engines, ask for Double-Efficiency Engine Catalog. (294)

**FULLER & JOHNSON MFG. CO., (Estab. 1840) 6 Partridge St., Madison, Wis.**



The "Multimotor" in Carpenter's Shop

**Some of the 100 Uses**

- Running Lathes
- Saw Outfits
- Emery Wheels
- Drills, Punch Presses
- Small Printing Press
- Spray Pumps
- Ditch Pumps
- Domestic Water Supply Systems
- Cream Separators
- Washing Machines
- Mangles
- Fanning Mills
- Feed Cutters
- Etc., Etc., Etc.

## BOX BALL NOW GUARANTEED! PROFITS

Practically all Box Ball operators are eminently successful—so we now GUARANTEE profits! Our Profit-Guarantee-Bond positively insures you against loss of a dollar! Vast amounts are made yearly by Box Ball operators—get into the business quick! Ask us for the valuable Box Ball monopoly for YOUR community. Some other "live wire" may write tomorrow—You write today to

THE AMERICAN BOX BALL COMPANY, 363 Van Buren St., INDIANAPOLIS, IND.

**THUNDERSTORM OBSERVATORY**—It is announced that a thunderstorm observatory has been established in Spain, in which atmospheric discharges, both local and distant, are detected graphically and acoustically. A wireless telegraph instrument is used for this purpose, because each lightning discharge is accompanied by electro-magnetic waves similar to those used in wireless telegraphy.—Kansas City Journal.



## JUMP

**Graflex Cameras, Kodaks, Lenses**  
Bought—Sold—Exchanged  
Our Bargain List is a Money Saver. Send stamp. We consider a sale is made only when the customer is satisfied.  
**WILLOUGHBY & A SQUARE DEAL**  
814 Broadway, New York

## \$18 to \$30 a Week Sure

Farmers "Ever Ready" Tool Kit does it  
**10 TOOLS IN ONE**  
Agents going wild over results M. Snyder made \$46 in 2 hours Joseph Pine took 65 orders in 2 days. M. D. Finch sold 42 in 9 hours. Had no experience. You can do it. To show it means a sale. **FREE SAMPLE** to workers.  
**FOOTE MANUFACTURING CO., Dept. 260, Dayton, O.**

# DIAMONDS

## ON CREDIT

# \$37.50

With confidence we offer these perfect blue-white Diamonds at a price that cannot be duplicated—our guarantee goes with each sale—all goods sent prepaid for inspection—10% discount for cash. Send for catalogue just issued No. 3 (Established 1843)

# J. M. LYON & CO.

71-73 NASSAU ST. NEW YORK



\$7.50 CASH  
\$3.75 PER MONTH



\$7.50 CASH  
\$3.75 PER MONTH

# 6 Important Books For Electrical Men



Bound in Half Morocco,  
3,500 Pages,  
1900 Illustrations,  
Page Plates,  
Etc.

We Want You to Examine These Books  
**FREE OF CHARGE**

These books are just what you want if interested in any branch of electrical engineering.

***This Great Cyclopedia of***  
***Applied Electricity***

is written by thirty expert electrical engineers—the biggest men in the profession. It is especially designed as a working guide for the expert. *Their reference value is guaranteed* because they are compiled from the regular text books used in the correspondence courses of the American School of Correspondence.

**You Take No Risk.** Examine the books five days at our expense. So confident are we that the books are just what you want, that we will send them to you by prepaid express. Keep them five days, test them—apply them to your every-day work. If satisfied that they are the most complete and comprehensive work ever published on Electricity, keep them and send us \$2.00, then pay \$2.00 a month until you have paid our special introductory price of \$18.80. The regular price is \$36.00. If the books do not satisfy you and are not just what we claim them to be, notify us and we will have them returned at our expense. Just fill in and send the coupon. *The books will be sent to you free.*

**IMPORTANT SUBJECTS TREATED IN DETAIL**

Electric Wiring—Electric Telegraph—Wireless Telegraphy—Telautograph—Theory, Calculation, Design and Construction of Generators and Motors—Types of Dynamos and Motors—Elevators—Direct Current Motors—Direct-Driven Machine Shop Tools—Electric Lighting—Electric Railways—Alternating Current Motors—Single Phase Electric Railway—Management of Dynamos and Motors—Power Stations—Central Station Engineering—Storage Batteries—Power Transmission—Alternating Current Machinery—Telephony—Automatic Telephone—Wireless Telephony—Telegraphone, etc.

For a short time we will include, as a monthly supplement, for one year, the TECHNICAL WORLD MAGAZINE. This is a regular \$1.50 monthly, full of Twentieth Century Scientific facts, written in popular form. Also contains the latest discussions on timely topics in invention, discovery, industry, etc.

**AMERICAN SCHOOL OF CORRESPONDENCE**  
CHICAGO, U. S. A.

Pop. Mech. 6-11  
A. S. of C.

Please send me Cyclopedia of Applied Electricity for five days' free examination. Also T. W. for one year. I will send \$2 within five days and \$2 a month until I have paid \$18.80 for books and magazine; otherwise I will notify you and hold the books subject to your order. Title not to pass until fully paid.

**FREE EXAMINATION COUPON**

NAME .....

ADDRESS .....

OCCUPATION .....

EMPLOYER .....



Portable Reading Lamp

¶ This book contains plain explicit instructions with detail drawings and illustrations for making 16 designs of extensive variety as follows:

Two Light Portable—Portable Reading—Four Light Chandelier—Reading Lamp—Dining Room Dome—Porch or Den Lantern—Four Light Chain Hung Chandelier—One Light Portable—Lantern—Drop Light—One Light Bracket—Piano Lamp—Wall Lamp—Electric Candle Sconce—Newel Post Lamp—Chain Hung One Light Bracket.

## ARTISTIC—INEXPENSIVE

# Arts-Crafts Lamps

## How To Make Them

“Written So You Can Understand It”

By JOHN D. ADAMS

Beautiful lamps that are usually made from expensive leaded glass can be made at home out of paper, cardboard and wood at an almost negligible expenditure by anyone possessed of a fair amount of patience. A great variety of lamps may thus be produced which will, nine times out of ten, be mistaken for the product of a professional rather than of an amateur.

## Price 25 Cents Postpaid

A handy little working manual of 96 pages, printed on the best quality of book paper and handsomely bound in cloth. Supplied by your newsdealer or may be ordered direct from the publisher

**POPULAR MECHANICS BOOK DEPARTMENT, CHICAGO**



## Shop Notes for 1911

Vol. VII of the Series—Just Published—Price 50c Postpaid

THE Series of Shop Notes Year Books now comprises seven volumes and constitutes a *Mechanics Encyclopedia* of unequalled value. The low price of 50 cents a volume or \$3.50 for the complete set places them within the reach of all and no one who uses tools should do without them. The investment of but \$3.50 places at the disposal of every tradesman over

### 4000 Easy Ways To Do Hard Things

some of which daily confront him. These books are “Written So You Can Understand Them,” and cover every department of mechanics. They represent the “boiled down” experience of expert engineers, firemen, carpenters, machinists, plumbers, painters, iron and wood workers, electricians, masons and other tradesmen.

¶ The addition of a new volume each year affords the purchaser of a set an opportunity of keeping abreast with the newest and best developments, as each volume contains matter entirely different from the others and of a strictly up-to-date nature.

200 Pages	Vol. I,	“Shop Notes for 1905”	385 Illustrations
228 Pages	Vol. II,	“Shop Notes for 1906”	555 Illustrations
228 Pages	Vol. III,	“Shop Notes for 1907”	580 Illustrations
212 Pages	Vol. IV,	“Shop Notes for 1908”	536 Illustrations
224 Pages	Vol. V,	“Shop Notes for 1909”	461 Illustrations
224 Pages	Vol. VI,	“Shop Notes for 1910”	451 Illustrations
224 Pages	Vol. VII,	“Shop Notes for 1911”	468 Illustrations

Sold singly at 50 cents a volume postpaid, or the complete set of seven volumes may be had in a handsome case at \$3.50 prepaid.

**Popular Mechanics Co., Publishers**  
318 W. Washington Street  
CHICAGO, ILLINOIS



# ELGIN WATCHES ON CREDIT

**OUR BIG CATALOG FREE**

201 D - \$1.50  
202 D - \$1.75  
203 - GOLD BRACELET GTD. 25 YRS \$3.50  
204 - \$3.50  
205 D - \$15  
206 D - \$20  
207 D - \$17.50  
208 D - \$50  
209 D - \$12.50  
210 - \$4.00  
211 - \$3.00  
212 - SOLID GOLD BRACELET \$15.00  
213 - \$7.50  
214 - \$4.00  
100 - \$16.50

GUARANTEED TO PASS R.R. INSPECTION  
16 SIZE 25 YEAR WATCH  
ADJ. TO 5 POSITIONS  
SOLID GOLD  
GUARANTEED 25 YEARS  
17 JEWEL



## WEAR THESE GOODS WHILE PAYING FOR THEM!

Our Rock-Bottom Prices and Easy Terms must appeal to you. The large volume of our business enables us to make Credit Prices lower than most cash houses. We have thousands of customers in all parts of the world and wish to add you to our list.

**Special This Month** *Let Us Send You a Beautiful*  
**Genuine 17-Jewel**  
**Elgin, Complete in a 25-year Gold-Filled** **\$16.50**  
**Case—Biggest Bargain Ever Offered, only**

**No Money Down — \$2.00 A MONTH**

**\$2.50 AFTER EXAMINATION,**  
**You Assume No Risk Whatever in Dealing With Us**

**P. STEPHEN HARRIS, Pres.**  
I want to send you a free copy of my latest book, "Facts vs. Fanc," or all about the Watch Business both at home and abroad.

where you live or how small your wages, **WE WILL TRUST YOU**, so that you and every honest man and woman can own a DIAMOND or High-Grade Elgin Watch in a beautiful Guaranteed 25 year Gold Filled Case and wear it while paying for it in such small payments that you never miss the money. **Write Today for Our Big Free Watch and Jewelry Catalog.** It tells all about our easy credit plan and how we send Elgin 19-Jewel B. W. Raymond and 21 and 23-Jewel Elgin Veritas everywhere on Free Trial, without security or one cent deposit, positively Guaranteed to Pass Any Railroad Inspection.

**HARRIS-GOAR CO. DEPT. 113, KANSAS CITY, MO.**

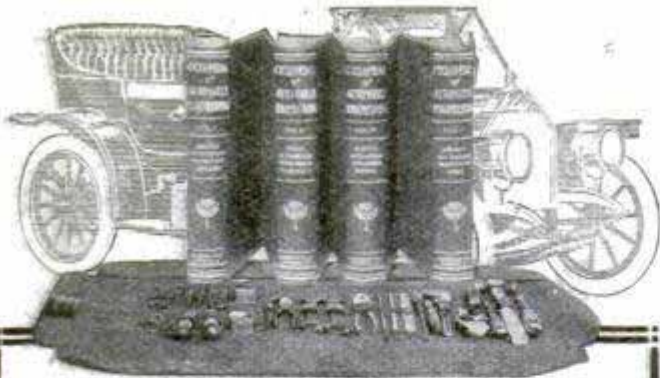

## Know All About Your Auto

No matter how fine the car you own, or drive, or manufacture; no matter how thoroughly it is equipped, your outfit is not *complete* unless you own the new

### Cyclopedia of Automobile Engineering

Four large, handsome volumes bound in half morocco, 1200 illustrations, full-page plates, diagrams, etc., 1500 pages, 7x10 inches, crammed with interesting and very necessary information concerning automobiles, aeroplanes, and motor boats; knowledge that you've got to get some way or other before you can thoroughly understand or enjoy the automobile "game."

#### CONDENSED TABLE OF CONTENTS

**VOL. I—GASOLINE AUTOMOBILES:** Running Gear, Power, Operation, Repair. **AUTOMOBILE MECHANISMS:** Carburetors, Starting Devices, Clutches, Gears, Brakes.

**VOL. II—STEAM AUTOMOBILES:** Flash Boiler, Engines, Operation and Repair. **COMMERCIAL VEHICLES:** Selection, Delivery Trucks, Upkeep, Mileage, Capacity. **TYPES:** Selection, Price, Demonstration, Speed.

**VOL. III—ELECTRIC AUTOMOBILES:** Battery, Motor, Transmission, Control, Tires, Capacity, Driving. Elements of Electricity, Electric Current. **AUTOMOBILE DRIVING:** Starting and Stopping, Gear Changing, Use of Spark and Throttle, Care of Car, Road Repairs.

**VOL. IV—AERIAL NAVIGATION:** Dirigible Balloons, Aeroplanes, Airship Motors. **GAS AND OIL ENGINES:** Ignition, Testing. **MOTOR CYCLES:** Construction, Operation. **MOTOR BOATS:** Types, Engines, Installation.

### Read This Free Examination Offer

You can examine these books for five days in your own home or office, free of all cost. Don't risk missing this offer by stopping to think it over now. Order now and do your careful thinking with the books before you. That costs nothing. Mail the coupon.

#### Here's Our Liberal Selling Plan

If you like the books after examination, send us \$2.00; then \$2.00 a month until the special price of \$12.80 is paid. If they are not satisfactory, advise us and we will have the books returned at our expense. Order promptly, and we will include for one year, as a monthly supplement, the **TECHNICAL WORLD MAGAZINE**, a regular \$1.50 monthly, full of interesting scientific topics written in popular form.

### AMERICAN SCHOOL OF CORRESPONDENCE

CHICAGO, U. S. A.

#### FREE EXAMINATION COUPON

#### American School of Correspondence:

Please send set Cyclopedia of Automobile Engineering for 5 days' free examination; also Technical World for 1 year. I will send \$2.00 within 5 days and \$2.00 a month until I have paid \$12.80 for books and magazine; or notify you and hold the books subject to your order. Title not to pass until fully paid.

NAME.....  
 ADDRESS.....  
 OCCUPATION.....  
 EMPLOYER.....  
 Pop. Mech. 6-11

Please Mention Popular Mechanics



## Wizard Table Lamp

Operated by merely pulling the chain. As convenient as electricity at one-tenth cost. Always ready for instant use. Requires no generation. Can be regulated to any candle power from 1 to 700.

For further particulars, agency and illustrated catalog, address

**THE NAGEL-CHASE MFG. CO.**  
 144 West Ohio Street, CHICAGO, ILL.

## HANDY LAMP

### Gasoline Lighting System

Gives a 300 Candle Power Shadowless Light the instant you move the lever. Turns up or down, like gas, burns dim when not in use, or can be turned up instantly when more light is needed. It floods a 30-ft. space with a brilliancy like daylight. Far cheaper than gas, kerosene or electricity and so simple that anyone can use it.



You can depend on it for years for any purpose demanding a big, strong light. Catalog POP tells why. Send for it Now.



**BRILLIANT GAS LAMP CO.**  
 Dept. 1, New No. 182 N. State St., Chicago, Ill.

**COLLECTION OF CIGAR BANDS**—A French banker who died recently left a collection of 63,000 cigar bands each differing in some particular from the others. These had cost him 50 years of smoking and had been arranged systematically in a number of specially constructed cabinets. When put up to auction the collection which had entailed the expenditure of so much time and money realized \$4.00.—London Chronicle.



## Geisha Diamonds

THE LATEST SCIENTIFIC DISCOVERY

Bright, sparkling, beautiful. For brilliancy they equal the genuine, standing all test and puzzle experts. One twentieth the expense. Sent free with privilege of examination. For particulars, prices, etc., address

**THE R. GREGG MFG. & IMPT. CO.**  
 Dept. H, 517 Jackson Blvd., Chicago, Ill.



## NULITE Gasoline Table Lamp

A beautiful lamp for homes, hotels, offices, stores, banks, cafes. Portable, safe; can be turned upside down or rolled on the floor without danger or affecting the light. 300 c.p. of soft, brilliant light, 1/2¢ per hour. Also 200 different styles of lamps and systems.

**AGENTS**—We want town, county and traveling salesmen. Best proposition ever offered. Sells everywhere. WRITE FOR SPECIAL OFFER.

**NATIONAL STAMPING & ELECTRIC WORKS**  
 422 So. Clinton St. CHICAGO

**GAS READING LAMP**

**TWO MODERN APPLIANCES FOR THE HOME**

The convenience of city gas at a fraction of its cost. No installation, no wires, no pipes. Each a complete in itself.

**AGENTS**—This is the greatest outfit ever offered. Big profits. Quick Sales to Resorts, Villagers and Farmers. Get Particulars, Quick.

**Consumers Lighting Co.**  
 125. Iowa St. Grand Rapids, Mich.

**SELF HEATING GAS LAMP**

# DIAMONDS-WATCHES ON CREDIT

**THIS ELGIN WATCH, 17 JEWELS, ADJUSTED,**  
Men's 16 Size, (also Ladies' O Size) Thin Model, New Marginal Minute Dial, in Gold Filled Case, Guaranteed for 25 Years, plain polished or handsomely engraved, sent prepaid on

**Our Great Special**  
LOFTIS "PERFECTION" RING  
Finest pure white diamond

**\$48 TERMS**  
**\$4.80 A MONTH**

Other sizes and styles at \$25, \$75, \$100, \$125. See our Catalog. Sent Free.

**30 DAYS FREE TRIAL**  
**Then \$2.50 a Month**

Our cut price of \$25.50 for this magnificent Elgin Watch, that will pass Railroad Inspection, is the greatest bargain ever heard of. **NO MONEY DOWN**—\$2.50 a Month after examination by you. Whether you are a railroad man or not, this is the Watch you want. No matter where you live, we will trust you. **Send us your order today.** Write for our free Catalog, containing over 2,000 illustrations of Diamonds, Watches, Jewelry, Silverware, etc. It tells all about our easy credit plan. Write today, before you forget it.

**LOFTIS BROS. & CO.**  
THE OLD RELIABLE, ORIGINAL DIAMOND AND WATCH CREDIT HOUSE  
DEPT F173, 92 to 98 STATE ST., CHICAGO, ILL.  
Branch Stores: Pittsburg, Pa., and St. Louis, Mo.



**No. 364**  
GUARANTEED 25 YEARS

## Learn to Dance

# WALTZ FREE LESSON

We will send you complete lesson teaching the waltz step absolutely free. Get this lesson today—no cost to you—you can then decide whether or not you want entire course, which teaches you, in three weeks' time, to dance perfectly, smoothly and gracefully. Young and old learn very quickly—right at home.

**YOU CAN MAKE MONEY**  
Our wonderful new system also teaches how to make good money giving dancing lessons and organizing dancing clubs. Send postal or letter today for free waltz lesson and full particulars about the remarkable low cost on special offer.

**UNIVERSAL DANCING ACADEMY** Dept. 119X, Bush Temple of Music, CHICAGO



## Have Running Water On Your Place

Whenever and wherever you like—Bath, Laundry, Toilet, Kitchen, Upstairs and down, Barns, Lawn. Force enough for fire protection. Air pressure guaranteed at all times by our patent pump. So simple anyone can install. Every detail worked out for your individual needs by expert engineers without charge. Complete specifications furnished.

**Burton Water Works**  
received only medal ever awarded a water supply system—proof of its superiority. Best constructed tank on market. Sold on 30 Days' Free Trial. Correspondence with Villages, Towns, Public Institutions as well as farms, ranches, country houses solicited. Write for testimony of satisfied users near you and booklet, "An Interesting Tale Simply Told."

**C. A. Burton Water Supply Co., 26 West 7th St., Kansas City, Mo.**

**30 Days FREE**

Write for Book



\$50.00 Up. Lasts a Lifetime.

**USE SHORT WORDS.**—Literary aspirants should religiously eschew polysyllabic orthography. The philosophical and philological substructure of this principle is ineluctable. Excessively attenuated verbal symbols inevitably induce unnecessary complexity and consequently exaggerate the obfuscation of the mentality of the peruser. Conversely, expressions which are reduced to the furthestmost minimum of simplification and compactness, besides contributing realistic verisimilitude, constitute a much less onerous handicap to the reader's perspicacity.

Observe, for instance, the unmistakable and inescapa-

## KEITH'S

The Authoritative Magazine for Home Builders. Each 80-page issue shows 8 to 10 Plans of Artistic Homes. 20c copy. \$2 a year. Send \$1. for 6 mos. sub. and book of Cottages and Bungalows.

**100 PLANS**

**M. L. KEITH, 675 Lumber Exchange, Minneapolis, Minn.**



No. 37. Cost \$2200. One of the 100

## Only \$9750 Per Carat for Perfect Cut, Genuine Diamonds



We save you 40%. Learn all about the BASCH plan. Write for catalogue "A," guarantee, money-back contract and prices FREE. Diamonds sent C. O. D. with privilege of examination.

**L. BASCH & CO., 272 State St., CHICAGO, ILL.**

## Fish Bite

like hungry wolves and keep you busy pulling them out whenever you use our Wonderful Fish-Luring Bait.

25c. a box. Write for free booklet and our special offer of one box to help introduce it. Walton Supply Co., Dept 20, St. Louis, Mo

## HESS MEDICINE LOCKER

The Only Modern, Sanitary STEEL Medicine Cabinet



The Recessed Steel Medicine Cabinet

or locker finished in snow-white, baked everlasting enamel, inside and out. Beautiful beveled mirror door. Nickel plate brass trimmings. Steel or glass shelves.

**Costs Less Than Wood**  
Never warps, shrinks, nor swells. Dust and vermin proof, easily cleaned.

**Should Be In Every Bath Room**  
Four styles—four sizes. To recess in wall or to hang outside. Send for illustrated circular.

**HESS, 910 L. Tacoma Bldg., Chicago**  
Makers of Steel Furnaces. Free Booklet.

# PATENTS

OVER 65 YEARS' EXPERIENCE

TRADE MARKS  
DESIGNS  
COPYRIGHTS, &c.

Anyone sending a sketch and description may quickly ascertain our opinion free whether an invention is probably patentable. Communications strictly confidential. HANDBOOK on Patents sent free. Oldest agency for securing patents. Patents taken through Munn & Co. receive special notice, without charge, in the

## Scientific American.

A handsomely illustrated weekly. Largest circulation of any scientific journal. Terms, \$3 a year; four months, \$1. Sold by all newsdealers.

# MUNN & CO. 359 Broadway NEW YORK

Branch Office, 625 F St., Washington, D. C.

# Remoh Gems

## Not Imitations

A marvelously reconstructed gem—the greatest triumph of the electric furnace. Looks like a diamond—wears like a diamond—will cut glass—stands filing, fire and acid tests like a diamond—guaranteed to contain no glass. Remoh Gems have no paste, foil or artificial backing—their brilliancy is guaranteed forever. One-thirtieth the cost of a diamond. These remarkable gems are set only in 14 Karat Solid Gold Mountings. Sent on approval—your money cheerfully refunded if not perfectly satisfactory. It will be well worth your while to get our De-Luxe Jewel Book—yours for the asking. Cut out and mail the coupon below—or write a postal. Address

**Remoh Jewelry Co.**  
429 N. Broadway, St. Louis, Mo.

**Remoh Jewelry Co.,**  
429 N. Broadway, St. Louis, Mo.  
Send your De-Luxe Jewel Book.

Name.....  
Address.....  
City.....  
State.....

**Sign  
And  
Mail This  
Coupon Today**

## \$5.50 THIS OUTFIT

Make \$15.00 a day with our TAKE QUICK Machine which takes and finishes in one minute a square or button picture in a POSTAL CARD or BROOCH which costs you less than one cent and sells from 10 to 15 cents each. No Dark Room. No Experience Necessary. The best money getter wherever crowds assemble. Fairs, Carnivals, Conventions, etc. Be your own boss, a small investment starts you in business.

Write for FREE catalog describing our machines.  
**INTERNATIONAL METAL & FERROTYPE CO.**  
INCORPORATED ESTABLISHED 1891  
Dept. B, 1262-64 Blue Island Ave., CHICAGO, ILL.



## Your Picture in a Postal Card IN ONE MINUTE

The pictures are developed, toned and finished in a single developing solution. No experience is necessary. Price of machines \$7.50 and \$15.00—circulars describing our machines sent free. We are also headquarters for supplies for all minute picture machines.

**AMERICAN MINUTE PHOTO COMPANY**  
Dept. U, 720-728 W. 12th St., Chicago, Illinois  
The largest manufacturers and distributors of minute picture machines and supplies in the world.

## BENJAMIN AIR RIFLE FOR MEN AND OLDER BOYS

An air gun that will shoot through half inch pine easily. Many times more powerful than spring guns. Uses compressed air, same as air brakes, rock drills, etc. 15c pays for 1,000 shots (delivered 30c). Practical for small game. 37 inches long. Walnut stock. Nickel barrel. Take down. Sold by dealers everywhere. If your dealer does not carry it, write us. Sent prepaid east of Rocky Mountains on receipt of \$2.50. Pacific Coast and Parcel Post Countries \$3. Circular free.  
**Benjamin Air Rifle & Mfg. Co.,** 2002 Frisco Bldg., St. Louis, Mo.

ble expressiveness of onomatopoeic, interjectional monosyllabic utterances, especially when motivated under strenuous emotional circumstances. How much more appealing is their euphonious pulchritude than the preposterous and pretentious pomposity of elongated verbiage.—Life.

# 500% PROFIT

Operating a Daydark Photo Post Card Machine. Three photo postal cards of any object made and delivered on the spot in ten minutes. No experience required—no dark room necessary. All work done in the machine in open day. Establish a profitable business at home by opening a Daydark Postal Parlor. Big money maker on the street, at fairs, etc. Send at once for free catalog and sample post card showing the fine work the machine does.

**DAYDARK SPECIALTY CO.**

**2120 Cass Ave., St. Louis, Mo.**



## PRINT FOR YOURSELF

Cards, circulars, book, newspaper. Press \$5, Larger \$18, Rotary \$60. Save money. Print for others big profit. All easy, rules sent. Write factory for press catalog, TYPE, cards, paper.  
**THE PRESS CO., Meriden, Connecticut**



I will send as long as they last my 25 Cent Book  
**STRONG ARMS**  
For 10c in stamps or coin

Illustrated with 20 full page halftone cuts, showing exercises that will quickly develop, beautify, and gain great strength in your shoulders, arms, and hands, without any apparatus.

**PROF. ANTHONY BARKER**  
642 Barker Bldg., 110 W. 42d Street, New York

## GO INTO THE Moving Picture Business

**FROM \$45 to \$60 STARTS YOU AND YOU WILL EARN AS MUCH IN 1 OR 2 NIGHTS**

The small payment required to get our machine will make more money than thousands of dollars invested in any other enterprise.

**\$25** and more per night can be made exhibiting with our machine in halls, schools, churches, theaters, etc., in your own and surrounding towns. We furnish everything—rent films, too.

Write for particulars about our Moving Picture Machines and our 6-months-to-pay plan.  
**P. & W. SALES CO., 839 Temple Court Bldg., CHICAGO**

When you want anything and don't know where to find it—write Bureau of Information, Popular Mechanics, Chicago

## Low Prices to Kill the Boat Trust!



This Handsome, Graceful, Seaworthy, Speedy Runabout Complete, Only \$94.50 16, 18, 20, 21, 23, 25, 27, 28, 30 and 35 Footers at Proportionate Prices We have the largest power-boat factory in the world. We build and sell more pleasure crafts than all the concerns in the Authorized Thirteen-Million-Dollar Boat Trust combined. No one has such facilities. That's why we build Detroit Boats and Engines so good that no one in the Trust can ever imitate them. Our great business enables us to sell at the smallest profits. That's why we are able to sell Detroit Boats and Engines at the smallest profits, so the Boat Trust has declared war on us—

but our low prices will kill the Trust. We ship you a Detroit Boat immediately on order. All sizes in stock. Send today for our large, handsome, illustrated Catalog, mailed free, which describes 64 different models in all sizes, ready to ship, equipped with the most reliable and efficient marine motor ever produced, guaranteed for five years. Get our new confidential proposition and special prices to demonstrating agents. (114) **DETROIT BOAT COMPANY, 1100 Jefferson Avenue, Detroit, Michigan**

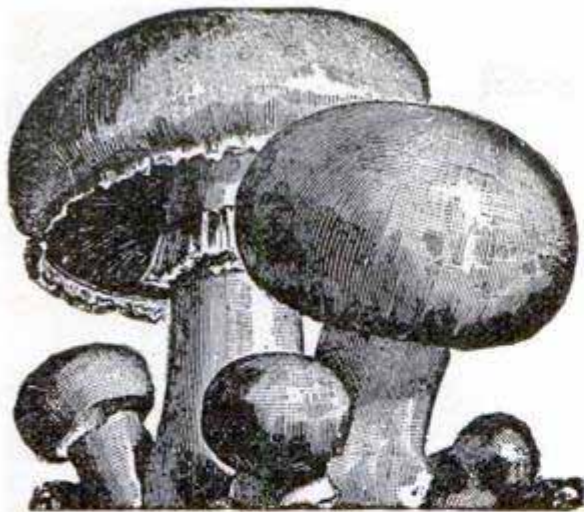

# Grow Mushrooms

**For Big and Quick Profits**

**Small Capital to Start      A Safe Business**

I am the largest grower in America. Ten years experience enables me to give practical instruction in the business worth many dollars to you.

No matter what your occupation is or where you are located, here is an opportunity to acquire a thorough knowledge of this paying business.

Send for Free Book giving particulars and information, how to start, cost, etc. Address

**JACKSON MUSHROOM FARM**

**6182 N. Western Ave., Chicago, Illinois**

**UP-TO-DATE FLOOR-LAYING**—There is a new idea in oak flooring. In narrow strips this flooring has made great progress for several years now. The latest idea is to take these small units and fasten them together at the flooring plant, making them into broad boards, to facilitate laying. It is thought that this new idea will make oak flooring appeal more forcibly to the carpenters and builders, as the one objection they have urged against it has been the tediousness of laying and nailing it in small units.—Wood-Worker.

## THE WHITE AEROPLANE CO.

**337 ADAMS ST., BROOKLYN, N. Y.**

We are building our Miniature pneumatic tread wheels much lighter for racing Models, also reducing the weight in our famous Ball Bearing Shafts and have made up a new lot of very light turnbuckles and eyebolts for racing machines. Our plant has been enlarged and we invite all inquiries large or small. Finest Model making wood, straight selected grain strong and light, all sizes. A.A.1 English Para Rubber. A postal will bring our Second Edition 1911 Catalogue S.



## The AEROMOTOR

The most compact, powerful and light aeronautic power plant built; 4 and 6 cylinders —4-cycle—30 to 75 H. P.

Detroit Aeronautic Construction Co. 76 Crane Ave., DETROIT, MICH., U. S. A.



## WHITE VALLEY GEMS IMPORTED from FRANCE

**SEE THEM BEFORE PAYING!**

These gems are chemical white sapphires —LOOK like Diamonds. Stand acid and fire diamond tests. So hard they easily scratch a file and will cut glass. Brilliance guaranteed 25 years. All mounted in 14K solid gold diamond mountings. Will send you any style ring, pin or stud for examination—all charges prepaid—no money in advance. Write today for free illustrated booklet, special prices and ring measure. **WHITE VALLEY GEM CO., 901 F Saks Bldg., Indianapolis, Ind.**

# \$1.00

Brings You this Splendid  
**19 Jewel**  
Watch

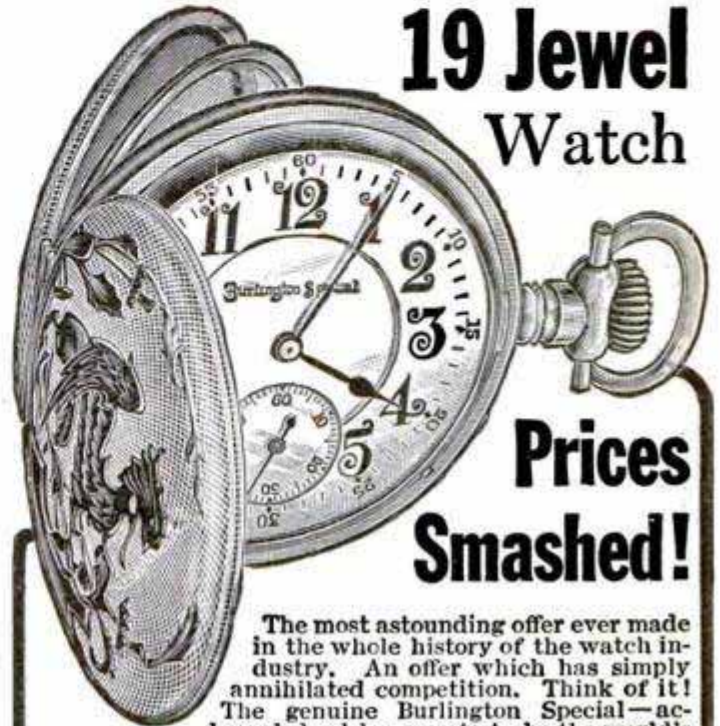

**Prices Smashed!**

The most astounding offer ever made in the whole history of the watch industry. An offer which has simply annihilated competition. Think of it! The genuine Burlington Special—acknowledged by experts to be the world's masterpiece of watch manufacture—now shipped direct to you for an absolutely free examination. Only \$1.00 down—yes, only **one dollar**—brings this superb 19 jewel Burlington. Then, if watch is satisfactory, you pay balance at \$2.50 a month. We want you to compare them with any watch that you ever saw, no matter what the price. If you decide not to keep the watch after you have had the free examination, simply ship it right back to us at our expense. But you will find the Burlington Special a quality superior to that of the highest priced competitive product on the market. And at a price within the reach of all.

## The Splendid Burlington Special—Now Shipped DIRECT

We are determined to introduce our unparalleled line of watches throughout the country and in the shortest possible time. We are determined that every man, every lady, who wants a **really high grade watch**, may now have an opportunity to secure the world's best time-piece and on terms which they simply cannot afford to refuse.

## Watch Book FREE

If you want to get posted on the real inside facts about the watch business, then send the coupon for the free Burlington Watch Book today. Read about our \$1,000 challenge to the giant watch factories of the world. A challenge backing the Burlington Special on quality—a challenge which has never been accepted. Besides, this book will post you on watch values and explain full particulars of our amazing offer telling you how you can get a Burlington Special sent to you on free examination for only \$1.00, then \$2.50 a month. No obligations at all in sending for the free book—your name and address on the coupon or a postal or letter will bring it free. **Send NOW.**



**Burlington Watch Co., Dept. 119X, Millard Sta., Chicago, Ill.**

**BURLINGTON WATCH CO., Dept. 119X Millard Station, CHICAGO, ILL.**

Please send me, without obligations and prepaid, the Free Burlington Watch Book, copy of your \$1,000 Challenge, and full particulars of your offer to ship me a Burlington Watch on receipt of \$1.00.

Name .....

Address .....



# POWER USERS

Buy your equipment from the manufacturer and save money

**Machine Moulded Pulleys, Gears, Shafting, Hangers, Belting, Friction Clutches, Sprocket Wheels and Chain Belt**

**Or anything in the line of appliances for transmitting power**

We are the largest Manufacturers of Machine Moulded Pulleys in the United States. No order too small for attention. No order too large to execute.

Our Catalog A-18 Shows Our Complete Line  
**W. A. JONES FOUNDRY & MACHINE CO.**

MAIL ORDER DEPARTMENT

1400 North Avenue CHICAGO, U. S. A.

## WITTE ENGINES

**GAS - GASOLINE - DISTILLATE**  
Cheapest of all powers. One cent average cost per horse power per hour. Nothing can equal.

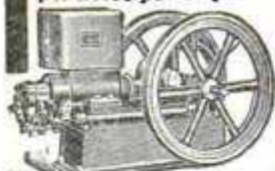

**FIVE YEAR GUARANTEE**

We build all sizes. Hop-per jacket or water tank cooling. Inducements to introduce in new localities. Write stating size and style wanted.

**WITTE IRON WORKS CO.**  
1654 Oakland Ave., Kansas City, Mo.

## \$50 to \$300 SAVED

We are manufacturers, not merchants. Save dealers', jobbers' and catalog house profit. I'll save you from \$50 to \$300 on my High Grade Standard Gasoline Engines from 2 to 22 h.p.  
— Price direct to you lower than dealers or jobbers have to pay for similar engines in carload lots for spot cash.

### GALLOWAY

Price and quality speak for themselves and you are to be the sole judge. Sell your poorest horse and buy a

**5-H.-P. only \$119.50**

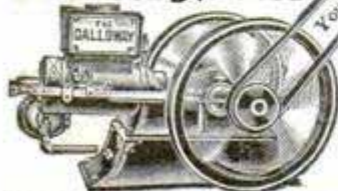

*You Can Make From \$5 to \$10 a Day*

Direct From My Factory on **30 Days' Free Trial.**

Satisfaction or money back. Write for special proposition. All you pay me is for raw material, labor and one small profit. Send for my big **BOOK FREE.**

WM. GALLOWAY, Pres.  
**WM. GALLOWAY CO.**  
1965 Galloway Station  
WATERLOO, IOWA

## This Kerosene Engine Cuts Your Expenses 75%

**Y**OU should not even consider engines that operate on gasoline only. The rapidly rising price of gasoline, now 6 to 16 cents higher than kerosene, absolutely makes operation on this fuel too expensive. The Perfection Kerosene Engine operates on **any** engine fuel. When you purchase it you are on the safe side—proof against all fluctuations of the market. You can always run this engine at a great fuel saving and get the greatest amount of work done. The Perfection **vaporizes its own kerosene** and so makes it as efficient as gasoline—something other engines **cannot** do.

The Perfection is very light, portable, has only three moving parts, runs everything about the place, is lower in price than any other engine of its capacity on the market.

### PERFECTION Kerosene Engine



Sent You on 15 Days Free Trial

See your dealer at once and ask him to let you have a copy of our **Free ENGINE BOOK** which shows the sizes and styles of the "Perfection" and explains this very attractive offer. Your dealer will send any "Perfection" engine to your farm for 15 days and let you return it if you are not satisfied. Ask him about it. If he does not carry the "Perfection" write to us and we will send you our **Free Engine Book** direct.

**CAILLE PERFECTION MOTOR CO.**

205 Second Ave. DETROIT, MICH.

**CLOTHES FROM SEAWEED**—A marine textile has been discovered in Australia. It is a sea plant of the genus *Posidonia*, which is abundant in Spencer Gulf. This plant contains fibers fit for conversion into threads like cotton. Mixed with woolen threads, it

## I H C Gasoline Engines Make and Save Most Money

They are most dependable, simplest, most economical, most efficient, most durable and strongest, and they are adaptable to most kinds of work. I H C Gasoline Engines are made in all styles, 1 to 45-horse power. Write today for the I H C catalogue, and read about the I H C engine that meets your needs best.

Address, **INTERNATIONAL HARVESTER COMPANY OF AMERICA (Incorporated)**  
16 Harvester Building Chicago U S A

## "Caldwell Special"

**60 Days Trial FREE**

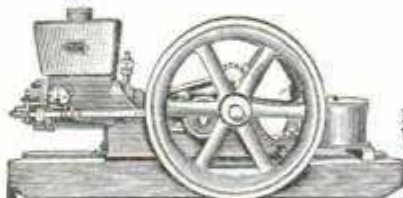

Prove it on your own premises that it saves time, saves labor and makes money.

The "Caldwell Special" is as clean cut as a race horse. Built right—works right. Simply built—always gives full H. P. Costs little to run—big profit producer to pump water, run cream separator, shred or grind corn and a dozen other things.

Write any or all the 8 Banks of Waterloo as to our responsibility. Sixty day Trial Free. We prove it to you on your own premises at our expense that you cannot afford to do without a "Caldwell Special."

**CALDWELL - HOLLOWELL MFG. Co.**  
514 Commerce Street, WATERLOO, IOWA.

## DON'T BUY A GASOLINE ENGINE

until you investigate "The Master Workman," a two-cylinder gasoline, kerosene or alcohol engine, superior to any one-cylinder engine; revolutionizing power. Its weight and bulk are half that of single cylinder engines, with greater durability. Costs Less to Buy—Less to Run. Quickly, easily started. Vibration practically overcome. Cheaply mounted on any wagon. It is a combination portable, stationary or traction engine. SEND FOR CATALOGUE THIS IS OUR FIFTY-NINTH YEAR.

**THE TEMPLE PUMP CO., Mfrs., 431 West 15th St., CHICAGO**

FOR FARM SHOP HOME

# ELLIS ENGINE

USE

WE PAY THE FREIGHT

## KEROSENE

gasoline, distillate, any fuel oil, perfectly—without change.

**Cheapest, Safest, Simplest POWER**

for barn work, house work, mill work, dairy work, well work, grinding grain, spraying, sawing, irrigation, electric lights, pumping, cutting fodder

Astonishing success. More power, gallon for gallon. Hundred less parts. Patent throttle gives three engines for price of one. *Catalog free—tells how.* Double-duty tank revolutionizes cooling systems. Force feed lubricator—perfect oiling. Automobile muffler. Ball bearing governor. Starts instantly. No pre-heating, no crank. Experience unnecessary. Women can operate. Vibration eliminated. Quality high—price low. Comes complete. Always hungry for work—and thrives on it.



**FREE TRIAL**  
No obligation till you are satisfied. **10-year Guarantee.** "Engine Facts," our new catalog, free; write postal for it **NOW.**

**ELLIS ENGINE CO.**  
89 Mullett Street,  
(V2) DETROIT, MICH.

**3 to 12 Horse Power**

takes the dye like pure wool.

The fiber woven from this plant is excellent, among other purposes, for coffee sacks. Attempts have been made to use the weed instead of hemp and wood pulp in paper-making; and, though unsuccessful so far, they are still in progress.

The weed from which this textile is made is not of present-day growth, but consists of fossilized vegetation, the softer parts of which have decomposed, leaving only the hard and fibrous portions. The supply is considered almost inexhaustible.—Harper's Weekly.

**5 YEAR GUARANTEE**

**Price WATERLOO BOY THE PRICE MAKER** No other gasoline engine reduced the price of gasoline engines like the **WATERLOO BOY**

Has fewer parts than any other engine. It costs less to make few parts than many parts. *Waterloo Boy* is made in large quantities. It costs less per engine to make 100 engines a day than 10. That's why we make the under-selling price



**Service**  
*Waterloo Boy is Dependable*

Always ready to go. No fuss. No bucking. Starts easy in winter. Igniter simple as a pair of scissors. Automatic feed regulation. No bother or expense of a pump. Speed lever works like a throttle on a locomotive. Nearly all parts are interchangeable. If you want satisfaction all the year round buy the *Waterloo Boy*. *Waterloo Boy Lasts.*

Built of best material by men that know how

**Waterloo Gasoline Engine Co.**  
1021 W. 3. d Ave.,  
Waterloo, Iowa.

**Durability**

**WE DO AS WE ADVERTISE**

FOREMAN \$1900 A YEAR

SUPERINTENDENT \$2500 A YEAR

CONTRACTOR \$3000 A YEAR



**Learn to Fill BIGGER SHOES!**

Don't be satisfied with merely pushing a saw and driving nails. Be a master of your craft. Learn to plan as well as to work—to use your brain with the same skill that you use your hands.

**How You Can Do It**

You can master every branch of building construction, architecture and carpentry—at almost no expense at all. You can have the knowledge and experience of over four score experts at your command, for use whenever you want it—by allowing us to place in your hands this great ten volume set, without you sending us one cent in advance.

**THIS CYCLOPEDIA OF Architecture, Carpentry and Building**

is the most practical work on the building trades that has ever been published. It covers every detail of building construction from common carpenter work to reinforced concrete and steel. Contains over 3,000 drawings, full page plates, diagrams, etc., 4,670 pages, bound in half morocco, printed on special paper—large clear type—10 massive volumes, titles engraved in 23 karat gold.

**Partial Table of Contents**

- Carpentry — Building Materials — Building Superintendence — Reinforced Concrete — Contracts and Specifications — Estimating — Stair Building — Masonry — Heating — Hardware — Ventilation — Steel Construction — Elevators — Architectural Drawing — Freehand Drawing — Making Blue Prints — Wiring Door Bells — Burglar Alarms — Sheet Metal Pattern Drafting — Mechanical Drawing — Lettering.

**Get These Books and See for Yourself**

Look them over at your leisure. Keep them for five days before you decide whether you want them or not, and then if you don't believe that each volume is actually worth more to you than the price of the entire set, send them back, at our expense and the transaction won't cost you one penny. If you keep them, our charge will be \$24.00, in easy payments of only \$2.00 a month. We don't ask you to buy these books on our description of them. We don't ask you to trust our judgment. We simply ask you to get the books and see for yourself. Sign the coupon now. It will bring the books, not an agent.

**SPECIAL**—For a short time we will include with each order a year's subscription to the Technical World Magazine—a regular \$1.50 popular illustrated magazine.

**AMERICAN SCHOOL OF CORRESPONDENCE**  
CHICAGO, U. S. A.

**FREE EXAMINATION COUPON**

**American School of Correspondence, Chicago:**

Please send set Cyclopaedia of Architecture, Carpentry and Building for five days' free examination, also T. W. for one year. I will send \$2.00 within five days and \$2.00 a month until I have paid \$24.00 for the books and magazine, or notify you and hold the books subject to your order. Title not to pass until fully paid. Pop. Mech. 6-11

NAME .....

ADDRESS .....

OCCUPATION .....

EMPLOYER .....

# Prest-O-Carbon Remover



**Cleans  
Out Any  
Gas Engine**

**Automobile, Motor Boat, Motorcycle,  
or Stationary**

Tearing an engine to pieces and scraping out the carbon is slow, hard work, and likely to do more harm than good.

Prest-O-Carbon Remover, injected in the cylinder, loosens and removes all carbon from cylinder walls, piston, piston rings and valves. Cleans a cylinder perfectly in an hour for 25 cents or less. Increases compression, power and durability. Has no effect whatever on metal—cannot injure the engine in any way. We guarantee this. Easy to use—directions on can.

**Try It Under This Guaranty:—**

There are many imitations of our preparation, so, to make sure you get the genuine article, send us your order and we will ship you, express prepaid in the U. S. (Quart, \$1; Half Gallon, \$2; Gallon, \$3.75.) If you are not fully satisfied with the results, simply tell us and we will promptly refund your money.

**The Prest-O-Lite Co.** 265 E. South St.  
Indianapolis, Ind.  
(Makers of Prest-O-Lite Gas Tanks.)

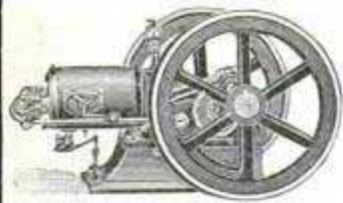

**WHICH WOULD YOU  
RATHER DO**

Buy a cheap engine and save \$10 to \$50 in first cost, or buy an **ECONOMIZER** and save \$50 to \$500 in running expenses? **Free Trial.**

**H. L. CHAPMAN, Box 595, MARCELLUS, MICHIGAN**

## This Engine FREE for 30 DAYS

Test it out and prove to yourself it's the best little all-around gasoline engine ever produced. Adapted for all uses in Shop, Farm and Home. We ship complete ready for use. Simply fill in the gasoline—give it a turn and away it goes. **THOMPSON GASOLINE ENGINES** are built on correct lines. Let us send you free book and tell you all about our wonderful 30-Day Free Trial Offer. Write today.

**J. THOMPSON & SONS MANUFACTURING CO., 22 Oak St., Beloit, Wis.**



## You Will Have a Boat This Summer

So should every healthy, red-blooded man or boy. Then build it yourself by the Brooks system.

Add a little of your money to a little of your spare time and profitably enjoy many a dull hour. You can own just the boat you are looking for at a ridiculously low cost.

**MAKE \$1.00 DO THE WORK OF \$3.00**

How? By purchasing the full sized paper patterns and instructions for a boat, or by purchasing all or part of the material in the knock-down—that is, every piece cut to shape, machined

and accurately fitted, so that it will go together but one way—the right way.

Send to-day for catalog No. 25. It tells the whole story and shows an extensive line of boats from canoes to cabin cruisers.

**BROOKS MANUFACTURING COMPANY, 706 Rust Ave., Saginaw, Mich.**

# FOOS Gas, Oil and Gasoline ENGINES

embody an ignition system more positive than any other engine on the market. Electrode points cleaned by the wiping action of the revolving igniter, throw a spark many times hotter and stronger than is possible to obtain from an ordinary make and break contact.

Full description of this igniter in addition to many other exclusive Foos features given in catalog 50.

**The Foos Gas Engine Co.**  
SPRINGFIELD, OHIO  
Largest Exclusive Factory in America

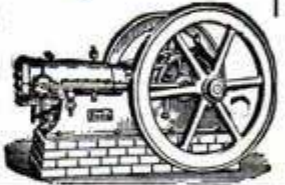

## FERRO MARINE ENGINES

**\$60 AND UP** The Engine that Mastered Niagara



THE World's Standard Two-cycle Marine Motor. Ten sizes; one, two or three cylinders; 3 to 25 horse power. High-tension magneto; new idea in carburetor; many other advantages.

1911 Catalog all models, sent free **The Ferro Machine & F'dry Co.**  
18 Hubbard Ave., Cleveland  
Agents in Principal Cities and Ports.



## WATKINS' SPECIAL MOTORS

3 H. P. Single Cylinder . . . 30 lbs.  
6 H. P. Double Cylinder . . . 60 lbs.  
12 H. P. Four Cylinder . . . 100 lbs.

A strictly **HIGH GRADE** Motor that will give **CONSTANT** and **EFFICIENT** service. Especially adapted for **CANOES** and **LIGHT BOATS**. Aluminum base, copper water jacket, steel shaft, bronze bearings.

**THE WATKINS MOTOR CO.**  
837-839 West Sixth Street CINCINNATI, OHIO

**PLATINUM IN JEWELRY.**—For the richer jewelry, platinum is the pre-eminent metal of the hour. The price to-day is twice that of 18-carat gold, according to its bulk, and, what is more, the scrap or waste

## FAMOUS MICHIGAN SPEED WHEELS · REVERSE GEARS & MARINE HARDWARE



## MOTOR BOAT MEN



Send for our large catalog of valuable information on speed wheels, reverse gears and marine hardware. Everything new and up-to-date.

**Prices Right. Satisfaction Guaranteed**  
We carry an immense stock and can make you prompt shipments and save you money. Send for our free catalog today  
**MICHIGAN WHEEL COMPANY**  
565 Canal Street, GRAND RAPIDS, MICHIGAN



# ROBERTS MOTORS

THE MOTORS THAT NEVER BACKFIRE

## AEROPLANE

MOTORS THAT SHOW THE POWER

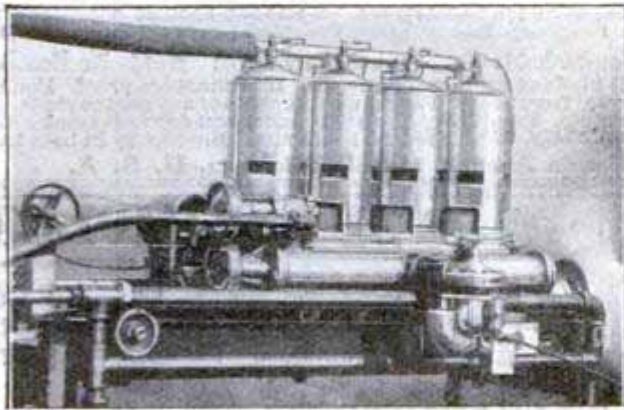

### 400 POUNDS THRUST

with a motor weighing only 170 pounds complete. More than  $2\frac{1}{3}$  lbs. thrust per lb. of motor, and at a reasonable price.

Complete Aero-Motor Catalog Mailed Upon Request

THE ROBERTS MOTOR CO., 1419 Columbus Ave., SANDUSKY, OHIO

## MARINE

MOTORS THAT GIVE SATISFACTION

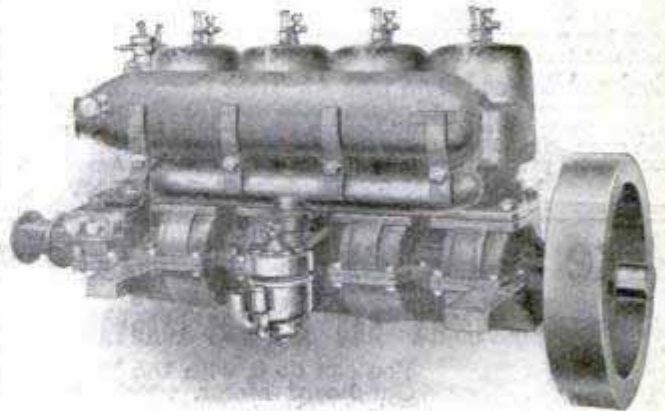

MODEL 4M—20 H. P.

Do not be misled by saving at first cost—consider your repair bills.

**ROBERTS MOTORS** are strictly high grade. **GUARANTEED FOR FIVE YEARS.** Could we offer such a guarantee on anything but the best grade of material and workmanship? We acknowledge no superior in economy of fuel, ease of starting, flexibility of control, and sustenance of torque at all speeds.

Made in nine sizes—one to six cylinders—three to sixty H. P. **IMMEDIATE DELIVERY** of all models.

Write for our Marine Motor catalog. It will interest you.

is many times greater than gold; its expense in the jewel is hence two to two and one-half times that of the precious metal.

It is so ductile that 1 oz. of platinum wire can be spun so thin that it will reach from New York to New Orleans. In jewelry to-day, platinum is not worked so thin, but some of the plaques which measure 2 in. across represent a single piece of metal saw-pierced, with the delicacy of a spider's web, just as they are decorated with the patterns of the web, of the honey-comb, or straight bars that have the delicacy of a hair.



### 3 h.p. Gile Boat Engine \$42

Bronze Propeller and Stuffing Box included  
30-day Trial

Famous on the Great Lakes and Both Coasts. Guaranteed as specified, or money refunded. Catalogue gives every detail of materials and build, and tells why we sell so low. Write for it and testimonials. Equally low prices on 5, 6, 10, 15 h.p.

SPECIAL OFFER TO DEMONSTRATORS  
GILE BOAT & ENGINE CO., 301 Filer St., LUDINGTON, MICH.

## STRELINGER MARINE ENGINES

BUILT EXPRESSLY FOR HARD SERVICE

For more than twelve years "The Strelinger," the old reliable 4-Cycle Marine Motor, has stood for the best in Marine Gasoline Engines. A distinct success.

The most Durable, Reliable and Economical Marine Motor made. The Engine that always makes good, because it is built right. Famous for endurance. Customers who bought the first Engines write: "It is as good today as the day it was purchased. It always goes and never gives any trouble; have not spent a dollar for repairs." That is the Engine you want. We also manufacture the "Little Giant" 2-Cycle Marine Motors. Customers who have used these Motors for the past seven years say, "They are the best 2-Cycle Gas Engine made." We can furnish you anything you want from  $1\frac{1}{2}$  H.P. upward, 2 or 4-Cycle, Marine or Stationary. Send for our 1911 catalog, which tells you all that is new about Marine Motors; also how to avoid trouble and save money on your Marine Engine outfit.

**THE STRELINGER MARINE ENGINE CO.**  
Manufacturers of Marine and Stationary Gas Engines

171-173-175 Woodbridge St. West, DETROIT, MICHIGAN, U.S.A.



# 5 Years' Absolute Guaranty

## On this Wonderful Detroit Marine Engine

You Are the Only Judge of the engine and its merits. 25,000 satisfied users. Material and workmanship guaranteed for five years.

### Greatest Engine Bargain Ever Offered!

Fewest moving parts of any practical engine on the market. Nothing complicated or liable to get out of order. Only three moving parts. Extra long plastic white bronze bearings. Vanadium steel crankshaft. Adjustable steel connecting rod. All bearing surfaces ground. French gray iron castings. Water-proof ignition system. Runs at any speed from trolling to racing.

Starts without cranking. Reversible while in motion.

Perfectly counter-balanced. No vibration.



**30 Days' Trial** Try the engine for 30 days. If you are not fully satisfied, return it and we will promptly refund all money paid us.

Demonstrator Agents wanted in every boating community. Special wholesale price on first outfit sold. Single cylinder, 2-8 h. p. Double cylinder, 8-20 h. p. 4-cylinder, 20-50 h. p. Thoroughly tested before shipment. Comes to you complete with boat fittings and ready to run. Write for free catalog, testimonials and details of the greatest protective guaranty ever offered. Suitable for any boat from canoe to cruiser. Also railroad truck car. All sizes in stock ready to ship. Write today for our wonderful demonstrator offer. [74]

**DETROIT ENGINE WORKS**  
1271 Jefferson Avenue, DETROIT, MICH.

# This Magnificent Steel Launch



**Stylish 16-Footer Fully Equipped with Engine Ready to Run!**

**\$96**

1911 models of the Michigan Steel Launch are now ready for delivery at the lowest prices quoted on boats anywhere. Our special low price schedule for immediate orders covers every launch we make—16, 18, 20, 23 and 27-footers. All sizes in stock for immediate shipment. We are the sole owners of patents covering rolled-seam constructed boats. This construction lasts practically a lifetime. We have the only construction that has successfully made the terrific trip through Grand Canyons of Colorado and Arizona. Write for booklet describing trip. Gold medals awarded our Boats and Engines by Royal Imperial Tech. Society, St. Petersburg; Internat'l Exposition, Milan; Nat'l Motor Boat Show, Paris.

**Equipped Bow and Stern with Air-Tight Compartments. The Non-Sinkable Boat—Absolutely Safe! Needs No Boathouse**

Leave your Michigan Launch in the water or out on the beach in all kinds of weather for months. It is puncture-proof. Equipped with the wonderful Detroit Engine, guaranteed for five years, any horse-power from 2 to 50. Fewest moving parts of any engine made. Anyone can run it. Free fully illustrated catalog shows all 1911 models. Don't buy a launch until you see this book. Write for special proposition and prices to Demonstrator Agents. STEEL ROWBOATS, \$20. Need no boathouse. Big money in boat livery.

MICHIGAN STEEL BOAT COMPANY, 1271 Jefferson Avenue, Detroit, Michigan, U. S. A. (77)

## Make a Motor Boat of Any Boat in Five Minutes



You can do it with the Waterman Out Board Motor, which you can quickly attach (and detach) to the stern of any skiff, rowboat, dinghy, punt, sail boat, and have a good motor boat. It is not a toy, but a reliable 2 H. P. Marine Motor that will drive an 18-ft. rowboat 7 miles an hour, 4 hours on one gallon of gasoline. Simplest motor made. Weight 40 lbs. Six years successful results behind it. Canoe and larger motors—light weight models K and B

—LIFE GUARANTEE.

**WATERMAN MARINE MOTOR CO.**  
1507 Fort St., West, DETROIT, MICH., U. S. A.

## BAY STATE MOTORS



"Perfect Simplicity" and "Simple Perfection" are the results, embodied in these Motors, of 15 years devoted to the developing of these essential characteristics, which enable us to put on the market a reliable and economical motor at a reasonable price. Write for catalog, stating size and type (2 or 4 cycle) of motor wanted. We also furnish casings for these motors.

**BAY STATE MOTOR WORKS**  
Successor to  
**A. J. HOULE MOTOR WORKS**  
580 South East Street, HOLYOKE, MASS.

## \$40 2 H.P. COMPLETE

With fittings, including propeller and shafting, stuffing box, wiring, etc.

Ready to install in your boat

This is a powerful engine for High Speed Boats, complete with all fittings. Absolutely Reliable. Extra Power and Extra Wear. Compact, Silent, Low running cost, Perfect two-cycle, reversing engine. 2 Year Guarantee. So simple a woman or child can run it. Used in Government Harbor Service and Chicago Police Boats.

**3, 4, 5, 6, and 10 H.P.**  
**Prices Are in Proportion**  
**Special Prices to Boat Builders and Agents**

Our Engine Book No. 12 E. contains valuable facts about Marine Engines and describes complete line.

FREE ON REQUEST

**NORTHWESTERN STEEL & IRON WORKS, 707 Spring St., Eau Claire, Wis.**



It is especially used in the reproductions of studies of Louis Seize jewelry.

While in the time of Louis XVI, rose diamonds were used, now brilliants, of which one hundred to three hundred weigh but one carat, are employed. Unknown at that time, platinum is virtually white gold, and it possesses the quality of not detracting from the beauty of any known jewel; in other words, the setting appears invisible, whereas gold is apparent and obtrudes itself in the finer settings.—Handicraft.

## Gile Launches

"Made in the Heart of Motor Boat Country"

**T**he finest type of small boat architecture. Classy design; great speed; ample power; assured safety; low cost; expert build; dependable, reversible engines; greatest possible roominess, buoyancy and seaworthiness. Dry in roughest weather. 16, 18, 20, 26-foot models.

Hulls of seasoned timber, stoutly built and sheathed inside. Clean-cut from stem to stern. Brass deck hardware. Driven at high speed by the famous 2-cycle, non-cranking Gile Engine—positively reversible—controlled by one lever. 3, 5, 6, 10, 15 horsepower. Engines and boat equipment sold separately. Drop us a postal TO-DAY for the handsome, money-saving free catalogue. **Special 16-ft. Launch, \$87.**  
**GILE BOAT & ENGINE CO., 301 Main St., Ludington, Mich.**

(This is the 16-foot Ideal)



## Get This Power Boat at Maker's Prices

BUY DIRECT FROM MANUFACTURER AND SAVE DEALERS' PROFITS



This Toppan Power Dory as illustrated above is made of best guaranteed materials and is the standard rough water boat of the world. Safe and reliable—used by U. S. Government in all departments. Send for stamps for catalogue. Ask for prices and facts about Toppan Reversible Motors, built with 2, 3, 5, 8 and 12 Horse Power—and if you want to build your own dory, saving exactly HALF, ask for **TOPPAN BOAT MFG. CO. FREE KNOCK-DOWN BOAT QUOTATIONS.** 3 Haverhill St. BOSTON, MASS.

## Baldrige Reverse Gear

Your Motor Boat Is Not Safe Without This Device

Don't stop your engine. Just move a single lever and boat stops, goes forward or backward as you please. Nearly 6000 in use. Write for Booklet.

**SMITH & BALDRIDGE MACHINE CO.**  
62 AMSTERDAM AVE., DETROIT, MICHIGAN

## "Runs Like A Scared Rabbit"

Writes Cleburne Grady, Montgomery, Ala., who while yet a green hand at motors averaged 12.92 miles per hour on a 8.62 mile river trip.

## Perfection Marine Motor



The "Perfection" is so worthy of the name it needs little attention. Just a regular flow of gasoline and a good spark will keep it working on hard towing, ferrying or pleasure jaunts—and it will last as long as Write for catalog. **GAILLE PERFECTION MOTOR CO., 105 Caille St., Detroit, Mich.**

the boat. We build 2, 2½, 3½, 4, 6 and 8 H. P. in the single cylinder and 8 to 30 H. P. in the two, three and four-cylinder engines. Prices range from \$40 to \$450 according to type and horse power.

Send for our Stationary Kerosene Engine Catalog if interested

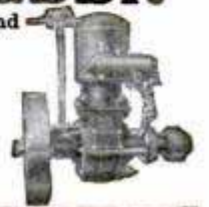

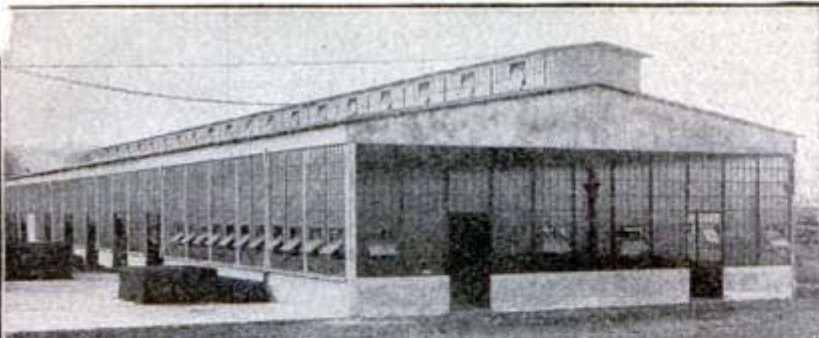

Building No. 40, General Electric Co., Schenectady, N. Y.

## Maximum Strength and Daylight



Windows equipped with United Steel Sash are fireproof, permanent and flood the interior with daylight.

# United Steel SASH

Are made of deep rolled steel sections of exceptional strength and rigidity. The joints are not weakened by cutting or punching. Ventilators are large and wide with double circular contact joints to shut out drafts and weather. Special spring clips provide improved method of glazing.



FREE.—1911 United Steel Sash Catalog (8x11 ins., 32 pages) full of details, illustrations, tables, etc.

TRUSSED CONCRETE STEEL COMPANY, 762 Trussed Concrete Bldg., Detroit, Mich.

**MUST EDUCATE THE MULES**—Mules, we have no hesitation in saying, are more useful to an army than aeroplanes, and we do not underrate the value of these machines for reconnoitering. Quite recently a drove of the plodding ration carriers bolted at the sight of a biplane. Not the least of the "maneuvers" devolving upon Major General Carter will be the education of pack mules to attend to business when an aeroplane goes by.—New York Sun.



## TOLEDO MOTORS HIGH QUALITY, LOW PRICE!

- 3 H. P., complete - - - \$ 65.00
- 6 H. P., 2 cyl., complete - 125.00
- 6 H. P., 1 cyl., complete - 84.00
- 12 H. P., 2 cyl., complete - 155.00
- 18 H. P., 3 cyl., complete - 250.00

3½ x 3½ and 4½ x 4½—2 cycle 2 port  
Send for Cat. "C" Schebler Carburetors  
Universal Machine Co. Palmwood Ave. TOLEDO, OHIO

## BOOK OF PLANS FREE

Over 50 Free Designs of Houses, Bungalows, Cottages; Farm, Dairy and Cattle Barns, Corn Houses, Garages, Implement Houses, etc., etc. An unexcelled collection of Practical, Economical Plans, embodying best architectural ideas developed by over 40 years of experience in the building trade. A limited edition for free distribution to advertise our Millwork Plant, the largest in the world. Enclose 10 cents for postage and mailing. (39)

GORDON-VAN TINE CO., 2587 Case St., Davenport, Iowa

## Best Turkish Bath 2c At Home



Just flush out the three million pores in your body with the "Robinson" Thermal Bath. It takes only 15 minutes. Costs only two cents. Relieves La Grippe, Bad Colds, Rheumatism, Dyspepsia, Skin Diseases. Our Big #2 Book Free for a few days only.

Robinson Mfg. Co., 172 Snowflake Bldg., Toledo, O.



## MULLINS Steel Motor Boats

Though so far superior to ordinary boats, still can be obtained very reasonably. You'll be surprised by low prices. They have hulls of steel plates—puncture-proof. Can't sink—can't leak or warp, waterlog, crack, split, dry out or open at seams. Motors simple, powerful, won't stall—start like auto—ONE MAN CONTROL—famous Mullins Silent Under Water Exhaust. 12 Models, 16 to 26 feet, 3 to 30 horse power.

### Handsome Boat Book—Free

Send to-day for handsomest boat book ever printed. Illustrated in colors. Details of famous Mullins line. Amazing prices this year. Investigate. Get free book.

THE W. H. MULLINS CO., 151 Franklin St., Salem, Ohio

Complete Line of Row Boats and Duck Boats \$22 to \$39



AN UNUSUAL BOOK

# Time and Its Measurement

"WRITTEN SO YOU CAN UNDERSTAND IT"

By **JAMES ARTHUR**

*Large 8vo. Richly illustrated with half tones. Printed on enamel paper. Handsome cloth cover.*

Mr. James Arthur who, besides being president of an important manufacturing business in New York City, is an enthusiastic scientist, a successful inventor and extensive traveler, has for years made an exhaustive study of clocks, watches and time-measuring devices. His collection of over 1500 timepieces gathered from all parts of the world has been pronounced the finest in existence and his research has made him a great authority on this subject.

This story is a readable and instructive history of time measurement from the sun dial of remote ages, through the clepsydra in its various forms down to the clock period and the present day. The book is illustrated with half tone cuts of various time-measuring devices and notable clocks and will prove of interest not only to watch and clock makers and repairers but to those who take even a casual interest in horology. Much of the information in this book is not available elsewhere.

Supplied by the Publishers

**Popular Mechanics Book Dept., Chicago**

**Price \$1.50 Postpaid**

EDITION LIMITED

**CHAPTERS :**

- 1—Historic Outline.
- 2—Japanese Clocks.
- 3—Modern Clocks
- 4—Astronomical Foundation of Time.

## Books for Young and Old Who Like to Make Things

**Amateur Mechanics No. 1—** 174 Articles  
165 Illustrations

**Amateur Mechanics No. 2—** 193 Articles  
196 Illustrations

**Mechanics for Young America—** 150 Articles  
196 Illustrations

These books tell how to make hundreds of different articles of daily use and the directions are "Written So You Can Understand It."

Instructions are given for making such things as Workbench—Wireless Telegraph Outfit—Boats of Various Kinds—Induction Motor—Lantern Slides—Arc Lamp—Motorcycle—Devices for Winter Sports—Electric Locomotive—Aerial Glider—Flash Lamp—Static Electric Machine—Ice Boat—Steam Engine—Bobsled—Induction Coils—Lathe, etc.

**Price 25 cents each, postpaid**

For sale by all newsdealers or can be ordered direct from the publishers

**Popular Mechanics Book Dept.** 318 W. WASHINGTON ST.  
CHICAGO

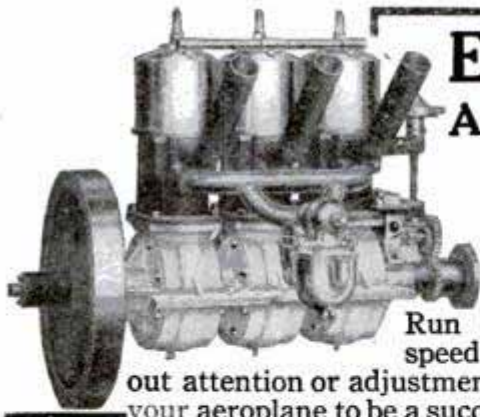

## Elbridge Aeronautic Engines

Have made good in all standard types of aeroplanes. Run at maximum speed for hours without attention or adjustment. If you want your aeroplane to be a success, investigate.

"American Amateur Aviation" a history of 1910 amateur achievements and our new catalog for six cents postage.

Elbridge Engine Co., 62 CULVER ROAD, ROCHESTER, N. Y.



## ELECTRIC WHISTLES

and horns for motor boat, automobile, factory and fire alarm use. Searchlights, dynamo and other accessories at low prices.

SEND FOR CATALOGUE

THE EDGAR MFG. CO. 104-5 Hanover St., Boston, Mass., U. S. A. \$8.75



OUR PATENT NO. 1

## Be Sure of Your Boat by Building It Yourself



Build your own boat from PIONEER PERFECT FRAMES and PIONEER PLANS and Save One-Half. Just as simple as 1-2-3. Every rib bent and fitted in our factory, then frame knocked down and shipped to you for re-assembly. Write for the whole story in Book Form, Sent FREE for the asking, showing how easy it is.

Materials and satisfaction guaranteed.

PIONEER BOAT & PATTERN CO., Wharf 33, BAY CITY, MICH.

**RADIUM FROM PORTUGAL**—Particulars of the discovery in Portugal a short time ago of mineral deposits which proved rich in radium show that the deposits are situated near Guarda, adjacent to the main line of the Paris-Lisbon Railway. A British mining engineer of the name of Bower, learning that the Portuguese in the vicinity attributed remarkable health-giving properties to a certain stream, visited the locality and found that in one place the stream flowed over a yellow quartz encrusted with crystals of uranite phosphate containing more than fifty per cent of uranium oxide. Investigations revealed the existence of one main lode extending for a mile and a half, with a width of five feet at the surface to twelve feet at a depth of fifty feet.—Philadelphia Inquirer.

## DON'T DISCARD BROKEN PARTS

Have them welded together by the **Oxy-Acetylene Process**. Steel, Cast Iron, Bronze, Copper, Aluminum and all other metals can be welded. Manufacturing quoted on. Welding equipments for repair shops or large plants supplied.

DAVIS BOURNONVILLE CO.  
105 West Street NEW YORK, N. Y.



1911 Speed Motor Canoe \$110 Complete

## Charm of Canoeing—Speed of Motoring —Safety of a Cruiser

A high speed, perfectly safe boat of a wonderful model. Stiff—steady—safe—graceful in design—dry. Comfortable arrangement. Fully guaranteed—strongest motor canoe made. Twenty feet long—made of cedar—copper fastened—equipped with the simplest, most reliable, smoothest running 2 H. P. engine. A child can run it. Demonstrating Agents wanted everywhere. Send today for Power Canoe Bulletin 31. (82)

DETROIT BOAT CO., 46 Canton Ave., Detroit, Mich.

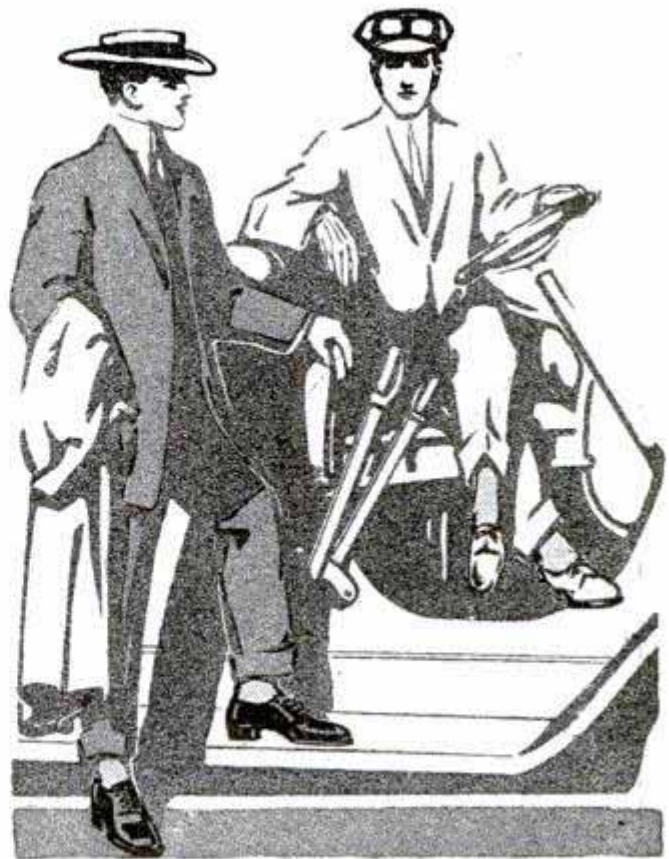

## How to Get Stylish Socks

IN style, color, fit and finish, Shawknit Socks excel. We secure our style information through the most reliable authorities. In Shawknit Socks, your feet will always be stylishly "well-dressed."

We insure comfort by the use of fine, soft, flexible, long-fibre yarns knit by the "Seamless Process." This shapes Shawknit Socks to the natural lines of your feet. The "Seamless Process" was invented in our factory. We have developed it. We have improved it. It means comfort for tenderest feet.

Wearing quality is made certain in Shawknit Socks by the use of yarns of unusual tensile strength—knit by special processes—died with "fast colors." Shawknit Socks are thoroughly hygienic. They are sterilized in the making, inspected and re-inspected before shipment. The matter of service which you should get from Shawknit Socks is left entirely to you.

## Guaranteed Without Limit

Wear your Shawknit Socks as long—as many times—as often as your good judgment dictates. If they do not give all the wear you think they should—merely send them back to us with the Guarantee ticket which is attached to every pair. We will replace them direct from the factory, without question or cost to you. We know Shawknit Socks, from fibre to finished product. We have been knitting them for 35 years. During that time we have supplied millions of satisfied customers. Please ask your dealer for Shawknit Socks De Luxe. If he does not have them—or if it is more convenient for you to buy them by mail—write us. We will supply you direct from the factory.

Shawknit Socks De Luxe are packed three pairs of a size and color in a box—extra light weight—sizes 9 to 11½. Colors—Black, Navy Blue, Cadet Blue, Marine Blue, Tan, Royal Purple, Hunter Green, Heliotrope, Gun Metal Grey, Ox Blood Red. In ordering state size and color desired. Remit \$1.00 for each three pairs. But please ask your dealer first. For your further information write us for our little book "Stylish Socks." We send it FREE and postpaid.

Address

Shaw Stocking Co., 1206 Shaw St., Lowell, Mass.

## Look for Stores That Sell

*Shawknit*  
TRADE MARK.

JUST PUBLISHED

# Metal Work and Etching

*"Written So You Can Understand It"*

By JOHN D. ADAMS

96 pages  
Richly illustrated  
Cloth  
Size 5x7 inches

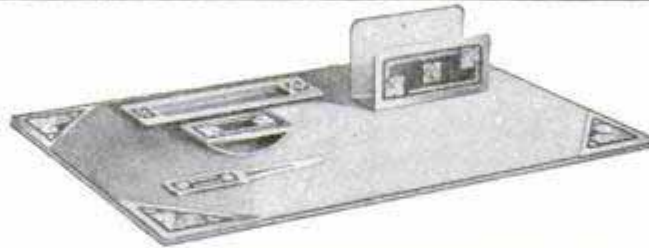

Price  
**25 Cents**  
Postpaid

*One of the Latest of the Popular Mechanics 25-Cent Series of Industrial Handbooks*

A complete manual for art metal workers giving every detail for making a great variety of useful and ornamental objects such as book ends, desk sets, pad corners, paper knives and letter openers, stationery racks, rocking blotter, desk calendars, match boxes, tie and pipe racks, whisk broom holders, candle sconce, arts and crafts jewelry, hinges, drawer pulls, etc.

ORDER OF YOUR NEWSDEALER, BOOKSELLER, OR

POPULAR MECHANICS BOOK DEPT., *Publishers*, CHICAGO

# The Young Electrician

By HAMMOND HALL

**289 PAGES—12MO—CLOTH—ILLUSTRATED**

A book intended to afford instructive amusement to intelligent youths. Strictly a beginners' book, but no better introduction to this important subject was ever offered.

**Price \$1.50 Postpaid**

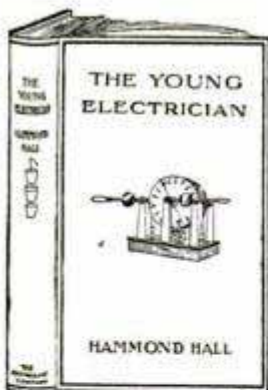

## CONTENTS

The Romance of Electrical Science—Experiments in Attraction and Repulsion—The Goldleaf Electroscope—Electro Static Induction and Distribution—The Leyden Jar—The Wimshurst Machine—Atmospheric Electricity—Galvanic or Voltaic Electricity—The Charging and Care of Batteries—Electrotyping and Electroplating—Magnetism—Electro Magnetism—The Electric Telegraph—The Telephone—The Induction Coil—The Dynamo—Motors—Switch Boards and Transformers—Electric Lighting—Public Electric Supply Stations—Wireless Telegraphy—Index.

Presents the subject in the right sort of way to arouse a boy's interest

SUPPLIED BY

POPULAR MECHANICS BOOK DEPT., CHICAGO

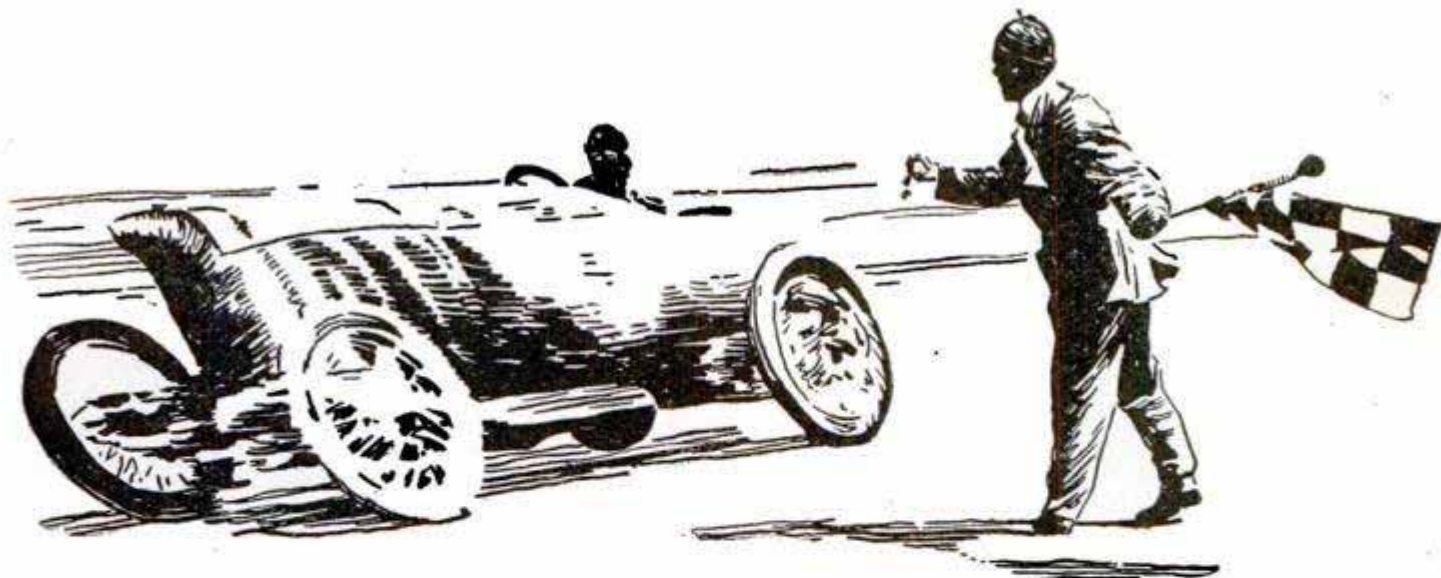

# POLARINE

*"The Winning Oil for Winning Cars"*



Daytona, Fla., April 23, 1911.

The Standard Oil Company,  
New York, N. Y.

Gentlemen:-

"To-day I lowered my world's records for the mile and kilometre; also established a world's record for two miles. Time for kilometre 15.88 seconds; for mile 25.40 seconds; for two miles 51.28 seconds. Used Standard Oil Gasolene and POLARINE in practice and in final trials and it helped me break records. Nothing but POLARINE for me from now on."

Very truly,

"When examined carefully after the trials, the Blitzen Benz was found to be in as perfect condition as ever."—*New York Times*.

This accomplishment again proves that POLARINE is the best  
Automobile Oil yet produced

## Are You Using Polarine on Your Car?

If you cannot obtain it from your dealer, write our nearest Agency

**Standard Oil Company**  
(Incorporated)

*Please Mention Popular Mechanics*

# Vehicles of the Air

By VICTOR LOUGHEED

Member of the Aeronautic Society

Founder Member Society of Automobile Engineers

## A Popular Exposition of Modern Aeronautics with Working Drawings

550 pages. Bound in cloth,  
handsomely stamped in  
gold. Size 9x5 $\frac{3}{4}$  in. Sent  
on receipt of price, \$2.50  
net. Postage 25c extra.

This book positively presents every known fact concerning  
aerial navigation and air vehicles—with working drawings.

Authentic—complete—up-to-the-minute—500 subject headings—200 aeronautical terms defined—270 illustrations, including working drawings of machines and parts—140 halftone views—history of 1000 flights, with tabular comparisons of successful flying machines.

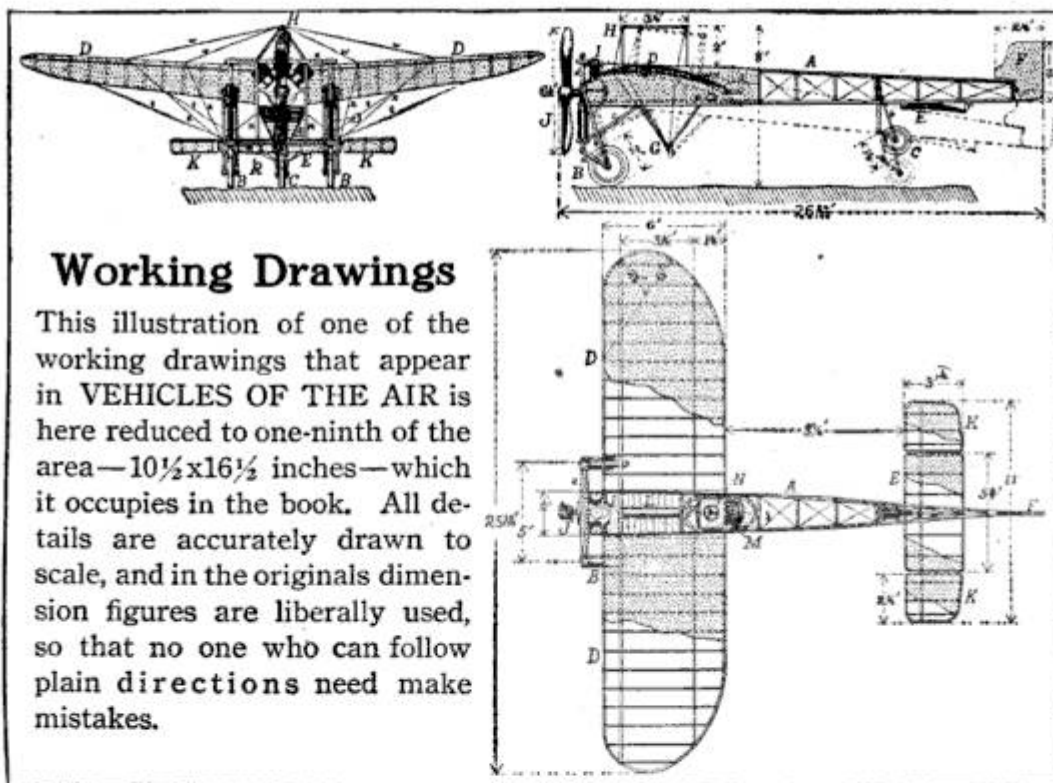

### Working Drawings

This illustration of one of the working drawings that appear in VEHICLES OF THE AIR is here reduced to one-ninth of the area—10 $\frac{1}{2}$ x16 $\frac{1}{2}$  inches—which it occupies in the book. All details are accurately drawn to scale, and in the originals dimension figures are liberally used, so that no one who can follow plain directions need make mistakes.

Figure 197—Scale Drawings of Bleriot Monoplane Number XI

### Make Your Own Flying Machine

The author fully treats all phases of aerial navigation—with particular attention to modern types of successful aeroplanes. With the information afforded by this book any one of ordinary mechanical abilities, and with very little money, can build and operate machines of known flying capabilities.

FOR SALE BY

POPULAR MECHANICS BOOK DEPT., 225 Washington St., Chicago



# Let the Slide Rule Do Your Work—Do Your Work



**Engineers, Electricians, Draftsmen, Superintendents, Managers, Master Mechanics, Estimators and Business Men:**  
Your Time is too valuable to waste in solving problems or checking over the work of others. The Richardson Slide Rule will do it mechanically.

One of the most valuable instruments ever offered to mankind is the Slide Rule. Not until the above rule was designed did it become possible for a person of a limited education to learn to operate it. Besides, the usual price has been reduced one-half, and the free instruction book is "written so you can understand it."

This Slide Rule will multiply, divide, solve proportion, extract the square and cube roots, find the decimal equivalent of vulgar fractions or "vice versa," calculate interest, percentage. In addition to above the rule is direct reading for forty-four other problems, such as the Horse Power of Engines, Pumps, Boilers, Belts, Water Falls; size of motor to run a pump; size of duct for ventilating; percentage a recording wattmeter is "Slow" or "Fast"; radiation and size grate, and steam main required; change gear and pulley problems; areas, circumference and diameter of circles. You simply place the key to the problem in the key hole (the key is printed in red) and answer is given direct. This rule is my latest improved type now being placed upon the market for the first time. "See sectional cut" curved slide bound with aluminum. No other like it. Good value. **Price \$2.50** with substantial pocket case and instruction book. Stock aluminum 11x1 1/2 inches with runner. Scales celluloid printed and polished in two colors and washable.

**GEO. W. RICHARDSON,** Mechanical and Electrical Engineer **4218-24th Place, CHICAGO, ILL.**



## 12 Art Panels 50c

Beautiful Duo Tint Reproductions of Famous Paintings—Panel Size 7x10

These pictures are real gems—the most exquisite portrayals of

### "WOMAN BEAUTIFUL"

ever shown in one collection. We send a full set of 12 in handsome Art Portfolio, packed flat and safe delivery guaranteed, together with lifelike miniatures of 70 other beautiful and catchy den pictures, for only 50c. coin, money order or U. S. stamps. **Send at once. Money back if not satisfied.** Or send \$1.25 for same set hand-colored.

**Florentine Art Company**  
DEPT. U6, 2009 PRAIRIE AVE., CHICAGO, ILL.  
**FREE** Order panels at once and we will include "Free" a beautiful den picture in colors.

**ORIGIN OF THE MARINES**—Marines are really soldiers serving on shipboard, and not sailors. They are a part of the armament of the ship, not a part of its crew. The marine system began in the British navy about the year 1665, when an order in Council authorized the raising of 1,200 soldiers for sea-service. The system, however, of having soldiers exclusively for service at sea was not carried into effect until 1698, when two marine regiments were formed.—Shipping World.

## POP-CORN FRITTERS MAKE BIG MONEY



Perrine, Cal., says: "One day's sales \$380.00." Start in safe, easy, profitable, fascinating business. Everybody likes fritters—everybody buys. Think of fortunes made in 5c pieces. Get full particulars—reports from others. Hurry. Write a card now.

330 High St. **W. Z. LONG CO., SPRINGFIELD, OHIO**



## BIG MAIL FREE

Put your name in the **U. S. Agents' Directory** and get hundreds of **FREE SAMPLES** of Agents' Goods, Books, Cards, Music, Medicines, Household Articles, Agents' Outfits, Magazines, Catalogs, etc., from firms all over the U. S. Get more mail than anyone in your town. Send in your name today.  
**U. S. AGENTS' DIRECTORY CO.,**  
Room 215, 417 Dearborn St. Chicago

## Osteopathy FREE

Our Valuable 100 Page Book on Drugless Healing

### FREE

This free book explains the **Theory and Practice** of the latest and best method of **Drugless Healing** and shows a correct way to master disease without the use of injurious or habit-forming drugs.

We give you this interesting book **absolutely free** in order to tell you all about **Mechano-Therapy**—the Recognized System of Drugless Healing which pays

## \$3,000 to \$5,000 Yearly

In a few months by our system you can begin practicing **Mechano-Therapy**—an elevating and highly paid profession for men and women. Simpler and more comprehensive than Osteopathy. Endorsed by physicians. A fascinating study, easy to learn. We teach you in your own home by mail or in class and guarantee success—an ordinary education and our course of instruction fits you for a professional life. Authorized diplomas to graduates. Work absorbingly interesting. Vast opportunities for social and financial betterment. Special terms now. Write today for our 100-page book on Osteopathy, 84-page ill. prospectus sent free.  
American College of Mechano-Therapy, Dept. 466, 120-122 Randolph St., Chicago.

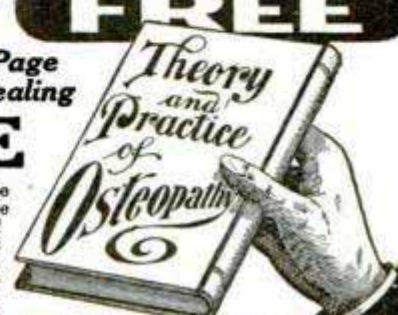

## GASOLINE SOLDERING IRON BLOW TORCH

Puts the heat right to the spot. Get Booklet today.



**EMMELMANN BROS. MFG. CO., INDIANAPOLIS, IND., U.S.A.**

## Elbridge MARINE ENGINES

Develop most power for weight and bulk.

Run equally well at all speeds.

So accurately made that they utilize every possible ounce of power.

Covered by an **Unlimited** guarantee.

Our 1911 Catalog will interest you. **IT'S FREE**

### ELBRIDGE ENGINE CO.

62 Culver Road

ROCHESTER, N. Y.



## Rowboat \$20.00

### MONEY IN BOAT LIVERY!

Can ship in any quantity. Need No Boat House. Never Leak, Rust, Check, Crack or Rot. **Absolutely safe.** Every boat has water-tight compartments, so cannot sink. 20 different designs. **Demonstrator Agents Wanted in Every Community.**

Write TODAY for FREE Illustrated Catalog and Special Factory Price.  
**Michigan Steel Boat Co., 156 Bellevue Ave., Detroit, Mich.**



## FREE BOOK ON BYSTROM LIGHT

### Great for Agents

Brightest, safest, cheapest light for home or store. Burns 96% air to 4% gasoline; 400 candle-power per mantel. Runs 44 hours from 1 gallon. Costs 1/3 cent an hour. Leaks impossible. Endorsed by insurance companies. No noise. No smell. Least heat. Write **BYSTROM GAS LAMP CO., Dept. Q, DEFIANCE, O.**

# "The How and Why of the Automobile"

By **FAY L. FAUROTE**

**200 Pages. Bound in full cloth. 250 illustrations. Price \$1.00 Prepaid.**

**D**ID you ever read a book which gave you just the information you wanted without being compelled to go through page after page of introduction and history?

Did you ever talk to a man who came over on your side of the fence and talked WITH you and not AT you—who explained things in such a way that you laughed at yourself afterwards for not understanding the subject before—it was really so simple?

Do you remember when you used to study by outlines—how difficult problems unfolded themselves—how the logical sequence of facts seemed to make what you expected to find hard, readily understandable?

Do you remember the innumerable times you have said to yourself, "If I only had somebody here to explain things—someone who would go through this proposition with me until I understood it—someone who would use homely and familiar examples to explain things, instead of talking over my head by using technical terms?"

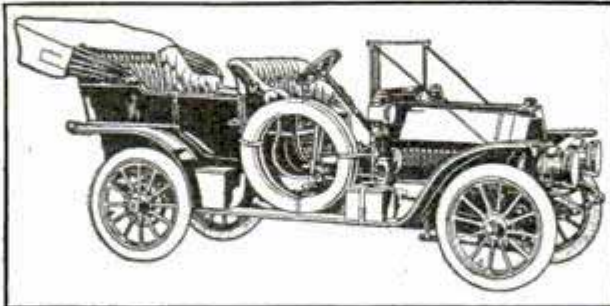

The author realized all these difficulties himself, because he has been through it all. Not only that, but his experience as an instructor of a large motor school taught him the way to explain the various parts of a motor vehicle in simple language, so that even the boy of

fifteen could understand and appreciate them.

For instance, did you ever think that the physician uses a form of carburetor whenever he gives chloroform or ether—do you realize that a shotgun is a form of gas engine whose action is almost identical with that of an automobile motor?

Do you want to know what a sliding gear transmission is—explained in such simple language that anyone can understand it?

Would you like to see what's inside of an automobile engine—would you like to know the name of every part—be able to talk intelligently about it and be your own mechanic—tell your chauffeur what to do—know when he is bluffing you?

In a word, would you like to know all about a motor car—how it works—how to drive it and how to take care of it? Then subscribe for a copy of

## "The How and Why of the Automobile"

A book of practical information for seekers after the fundamental facts regarding the gasoline engine and its application to the motor car. Interesting and instructive to both the beginner and the expert—the former for information, the latter for reference. Written by Fay L. Faurote, B.S., (M.E.), for five years closely associated with the Experimental Department of a pioneer automobile factory, for two years instructor in the Detroit Motor School. The book, which is handsomely bound in full cloth, printed on high-grade enameled paper, contains over 200 pages and 250 illustrations and covers the following subjects:

### CONTENTS:

**GENERAL THEORY OF GAS ENGINES.** Simple explanation of cycle—The four-stroke cycle—The two-stroke cycle—Advantages and disadvantages of each.

**MOTOR DESIGN.** Cylinder, what it is and its use. Valves, mechanical and automatic—Forms of valves—Valve timing and its influence on the motor—Valve grinding, how to do it—Valve nomenclature. Crank Case—The construction. Bearings—Accessibility—Working parts—Uses. A crank case oiling system. Crank Shafts—What they are—One, two, four and six-cylinder crank shafts—Crank case diagram, showing instantly conditions in all cylinders—Diagram showing firing points and sequence of same. Connecting Rods, construction and material—Bearings and lubrication. Pistons—Piston rings—Piston Pins.

**THE TRANSMISSION.** Reason for and use of transmission. Simple Explanation of Action—Individual clutch type—The sliding gear—The three speed progressive—The three speed selective—The four speed selective—Planetary gear—Friction drive.

**METHODS OF DRIVING.** Single chain drive—Double chain drive—Bevel gear drive.

**THE CARBURETOR.** A very simple explanation of carburetion—The mixing valve—A few of the first types—Some of the modern carburetors—Foreign carburetors.

**IGNITION.** The make and break system—A simple explanation of the apparatus used. The Jump Spark System—Electrical units. Sources of Electricity—The dry cell—The storage cell—Dynamos and magnetos—The spark-coil—Commutators and timing devices—Spark plugs—Wiring diagrams.

**COOLING SYSTEM.** Air Cooling. Water Cooling—Direction of circulation—Radiators—Water pumps—Fans—Anti-freezing solutions.

**RUNNING GEAR.** Front Axle—Construction of—Steering Gear. Rear Axle—Differential gear—The live axle—The dead axle—Wheel construction—Bearings.

**HORSE POWER DETERMINATIONS.** Engine testing—Indicated horse power—Brake horse power—Mechanical and heat efficiency—Road testing.

Send in your order at once—don't delay. The price is \$1.00 postage prepaid, and the address is

**POPULAR MECHANICS BOOK DEPARTMENT**

**225 Washington Street, CHICAGO**

**This \$18 Table (36x22") \$7.25**

This splendid piece of the famous **Come-Pack Furniture** (Quarter Sawn White Oak) shipped in sections, any finish, for \$7.25. Money back any time you say so.



Order today for prompt shipment or write for free catalogue of 200 other bargains in Mission and Bungalow Furniture, direct from our factory to you.

COME-PACK FURNITURE CO., 601 Edwin St., ANN ARBOR, MICH.



**No Deposit**  
**Nothing Down** **\$50**  
**—1/2 Regular Price**

We put the best typewriter in the world right in your home or office. Shipped on approval. Use it five days. If you want to keep it send us \$5 a month. You get the same value as tho' you paid \$100 for this standard No. 3 Oliver (Visible) machine. Buying from us saves the 100 per cent. agency profits other people pay. Our booklet is worth \$50 to you, because it saves you that much. It's FREE. Tell us where to send YOUR copy. (34)

Typewriters Distributing Syndicate, 159W N. State Street, Chicago

**"Jarvis" Pumps**

For domestic water supply are in use everywhere. We furnish complete systems. Any kind of power.

Send for Catalogue No. 5

JARVIS ENGINE AND MACHINE WORKS LANSING, MICH.

It is reported that 50,000,000 lb. of butter made in 1910 have been left over in cold storage warehouses. Had the Egyptians possessed these wonderful cold storage secrets, our Thothmes III, Seti I and Ramoses II would be pink and fresh after 4,000 years.—Brooklyn Eagle.

Seven hundred and fifty miles of telephone wire are used in a single New York office building.—Louisville Courier Journal.

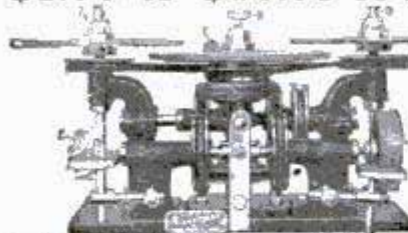
**\$5.00 to \$10.00 A Day Made Easy**

The "American"  
No. 3 Patented

Hones razors, sharpens all kinds of safety razor blades, clippers, scissors, etc. No make-believe, but the real thing. Complete outfits furnished with instructions how to do the work. No previous experience required.

Address, Mgr. Dept. 806, Illinois Cutlery Company, 184 Washington St., Chicago

**Best grade cedar canoe for \$20**

We sell direct, saving you \$20 on a canoe. All canoes cedar and copper fastened. We make all sizes and styles, also power canoes. Write for free catalog giving prices with retailer's profit cut out. We are the largest manufacturers of canoes in the world.

DETROIT BOAT CO., 156 Bellevue Ave., Detroit, Mich.

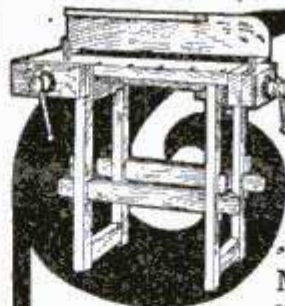
**HOME BENCH**  
**No. 97 Price \$7.40**

One of our most popular sellers. Has two vises, is built sturdy and solid from best kiln dried Michigan Maple. Guaranteed not to warp or split. Just such a bench as you need in your home. You should have a copy of our free catalog showing our many styles. One of them is sure to please you. Just a postal will bring it. Write today.

GRAND RAPIDS HAND SCREW CO.  
620 N. Front Street, Grand Rapids, Mich.

**EXCEPTIONAL BUSINESS OPPORTUNITY**

**\$5 to \$15 per Day**

has been made printing business, calling cards, posters, tickets, etc., in department stores, parks, fairs and store windows.

**900% Profit**

Blank cards cost 5c per hundred; sell for 50c printed.



**Only \$175.00** on easy payments  
**PAYS FOR ITSELF**

Automatic Card Printing Presses — practical, easily operated, self-feeding and inking; uses standard type; prints 120 cards per minute. Free catalog and sales plan.

AUTOMATIC PRINTING PRESS COMPANY  
218 So. Jefferson St. CHICAGO

**A Refreshing Tub Bath**

It is now made possible for everyone—whether you reside in the city or village or on a farm. No Plumbing Necessary. The Robinson Portable Water Bath is a godsend to humanity. It is within the reach of every family, and permits of all the luxury of full-length tub baths. Far preferable to tin tubs, and will last for years. Shipped on approval subject to inspection. Two grades, No. 1, \$1.40; No. 2, \$0.95. Money back if wanted. Don't deprive yourself and family of this luxury another day. Send for descriptive literature. Robinson Mfg. Co., 654 Jefferson Av., Toledo, O.

**EVERY BOY HIS OWN TOYMAKER**

GREATEST BOYS BOOK EVER WRITTEN. Tells how to make a STEAM ENGINE, CAMERA, WINDMILL, MICROSCOPE, ELECTRIC TELEGRAPH, TELEPHONE, MAGIC LANTERN, BOATS of every kind, KITES, BALLOONS, TOYS, WAGONS, BOWS and ARROWS, STILTS, ANIMAL TRAPS, etc. OVER 200 PICTURES. THIS BOOK and CATALOGUE ONLY 10 cents. POSTPAID. ELECTRIC FUN MAKERS Dept. 1 KEWANEE, ILL.

**\$15. to \$35. PER DAY IN MINUTE PHOTOGRAPHY**

WE CAN PROVE IT. Our No. 4 Ferrotypes machine takes three sizes of pictures, on plates 2 1/2 x 3 1/4 — 1 1/2 x 2 1/4 and buttons. It is also reversible. Send for Our Descriptive Catalog. It tells all about it. Don't delay. It means your future. NEW YORK FERROTYPE CO., Dept. 72 168 1/2 Delancey St., NEW YORK, U S A.

**Magic Lanterns with the Alco-Radiant Light**

The Alco-Radiant is the only practical, intense light for Lanterns if electric is not to be had. It burns alcohol, costs little to use and a trifle to buy; weighs 3 lbs.; adaptable to any Lantern. New Lantern slides for Lenten season, plain or colored, for sale or rent. Lecture sets of slides with readings, such as Judas, Herod, The Multitude, Way of Grief, Seven Words from the Cross, Passion Play of 1910, etc. Ask About Post Card Projectors. They show on a screen the image reflected from a post card or any other picture or flat object. Prices, \$4.50, \$13.50, \$25.00, \$60.00.

WILLIAMS, BROWN & EARLE, Dept. 20, 918 Chestnut Street, Philadelphia, Pa.

# READ THIS WONDERFUL STORY

128 Pages.  
Bound in Cloth.  
Illustrated.

# HEAT

Price  
Post-  
paid, **25c**

By **J. GORDON OGDEN, Ph.D., Professor of Physics, Fifth Ave. High School, Pittsburg**

*Thoroughly Understandable — Instructive — Immensely Interesting*

This book consists of a series of articles, each complete in itself, yet all pertaining to heat and its relation to modern mechanics.

**F**EW people realize that fire is the most remarkable and valuable discovery ever made by man. Prior to this, man was brother to the brute, but with the coming of fire, came all the wonderful development that has enabled man to assert and defend his claim as lord of creation. We are only in the infancy of high temperature development, yet read of the harnessing of intense heat to the wheels of progress; the contrivances whereby we are able to emulate the volcano in our laboratories so far as heat is concerned and weld steel rails in the street where they lie; the discovery of uses of rare metals in industrial lines by aid of heat. Investigation of the realm of low temperatures also discloses some wonderful facts. All these, and many other phases of this interesting subject are treated as shown by the following list of chapters:

1—Nature of Heat and How It Is Measured. 2—How Low Temperatures Are Produced. 3—Some Effects of Low Temperature Upon Matter. 4—The Production and Uses of High Temperature. 5—High Temperatures and the Rare Metals. 6—How Heat Travels. 7—How Heat is Measured. 8—Expansion and Contraction. 9—Energy and Fuels. 10—The Manufacture of Artificial Ice. 11—Steam Boilers and Engines.

**POPULAR MECHANICS BOOK DEPARTMENT, 225 Washington St., CHICAGO**

## JUST READY

### HOW TO MAKE A

# WIRELESS SET

By **ARTHUR MOORE**

A book of 96 pages, bound in cloth, explaining in an understandable manner the construction of an outfit suitable for transmitting four or five miles. This set can be easily constructed at a small cost by any boy of ordinary ability.

*Complete details with illustrations*

**PRICE 25 CENTS POSTPAID**

ORDER OF YOUR NEWSDEALER OR SEND DIRECT TO THE PUBLISHER

**Popular Mechanics Book Dept.** 318 W. Washington Street  
CHICAGO, ILL.



The clay pipe - the French briar - the corn cob - the meerschaum - What's the odds so long as you smoke "Velvet."



"Velvet" is the finest example of Burley that ever went to a pipe. Two years of aging—think of the rare old mellowness it got. The leaf hung until the bite was out of it—and the smoothness developed. Velvet has had most careful handling and curing—packed in airtight tins—price 10c. A marvelous smoke of "Burley the Great." Don't fail to try it. It's splendid! 10c at all dealers.

*Velvet should be on every dealer's shelf - IF OUT, send us 10c. for the regular tin - sent only in United States.*

**SPAULDING & MERRICK**  
Chicago, Ill.

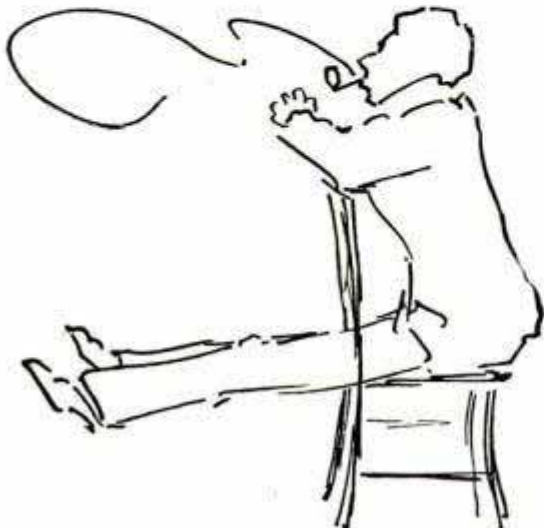

**FREE SAMPLE BOX**



Value  
**50c**  
Retail

WE WANT TO PROVE TO YOU—AT OUR OWN EXPENSE, OUR OWN RISK—THAT LA RECLAMA CIGARS, SOLD FROM FACTORY-TO-SMOKERS AT WHOLESALE PRICE, ARE DOUBLE THE VALUE OF ANY CIGARS YOU CAN BUY IN THE REGULAR RETAIL WAY.

*These samples will tell their own story and you alone will be their judge*

This confidence in our ability to please the most exacting, is the result of our 30 years' experience as manufacturers of cigars, together with the intimate knowledge of smokers' requirements gained through always having sold our entire product directly to the actual user.

**Our customers save 50%, pay no money in advance and are always guaranteed complete satisfaction or no sale.**

We make the same fair margin of profit which is added to their product by manufacturers who sell to jobbers. In each case the cost of distribution is the same, consequently our thousands of customers save for themselves the profits and expenses of jobbers, salesmen and retailers. Furthermore, they receive each shipment on Ten Days Free Trial with the privilege of testing the cigars before deciding to buy; therefore, we must always keep up the quality because every box is virtually a sample box.

**TO SHOW THE ADVANTAGE OF ORDERING CIGARS DIRECTLY FROM OUR FACTORY, COMPARE THOSE IN THIS SAMPLE BOX WITH THE BEST CIGAR SOLD BY YOUR DEALER FOR 10c.**

Our factory-to-smoker price for the Panolas is \$4.50 per 100, delivery prepaid. These cigars, here shown in exact size and shape, are hand made, with a rich, fragrant, LONG Havana filler and silky Sumatra wrapper. They will burn evenly with a firm, white ash and at retail would cost 10c each or \$9.50 per 100 by the box—more than twice our factory-to-smoker price.

**How to Get this Sample Box.** Simply write on your business letterhead, or on your employer's, and say—"Send me the Sample Box of Panolas offered Free of Charge." Enclose 10c to cover postage and packing; also mention strength desired.

**Send for these rich Havanas to-day. You risk nothing: promise nothing.**

EXACT SIZE

**La Reclama Cuban Factory**  
F. BRIDGEMAN President  
CIGARS from MAKER to SMOKER by MAIL

414 East 32nd St.

NEW YORK

## GET THE NEW 1911 BOOK OF SCRIPPS MOTORS

You should have this new 1911 catalog of Scripps Motors. It tells how these famous marine engines are made, and why they are preferred by experienced motor boat owners in every part of the world.

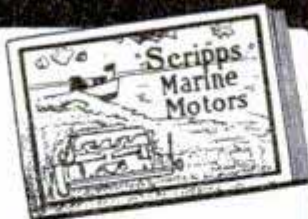

Scripps Motors are not the cheapest in first cost, but their owners are constantly writing us of their freedom from repair bills and the troubles that usually go with the cheap motor. There is no real economy in a motor that is continually causing expense and vexatious delay.

There is the same satisfaction in owning a Scripps Motor that there is in owning a thoroughbred horse or dog. You know it comes from a good family that has never failed to show its true worth when put to the test.

All Scripps Motors are of the four cycle type, and range in power from 4 to 100 H. P., one to six cylinders. Be sure to get our catalog before you select your engine for the season.

### SCRIPPS MOTOR COMPANY

650 Lincoln  
Avenue

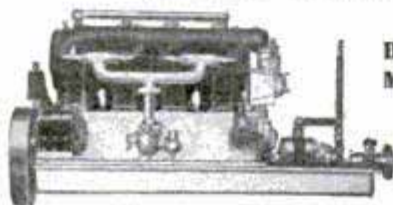

DETROIT,  
MICHIGAN

## CHALK-TALK & LECTURE ILLUSTRATING COURSE



Would you like to make money in Vaudeville or give illustrated lectures for churches, lodges, or amuse your friends? Our Chalk-Talk course will teach you how. No great amount of art ability is necessary. Ten lessons and two bound vols. for \$15. Let us tell you about it. Address

The Lockwood Art School, Dept. 127, Kalamazoo, Mich.

## AGENTS \$45. TO \$90. A WEEK

I want a good man in every territory in the United States—as local agent for one county, or as General Agent for a number of counties. This is a new proposition and offers you an opportunity to make from \$45.00 to \$90.00 a week, and on up to \$8,000 or \$10,000 a year. No experience is necessary; but I want men—young or old—who will treat me square, who will follow instructions, and who will do their level best.

THE NEVER FAIL CO., 1048 Colton Building, TOLEDO, O.

## 3 BEAUTY POSES 25c.

Decorate your "Den" with "Art Gems"

Exquisite portrayals of female loveliness. 3 bewitching poses 25c; 6 for 50c. One 6½x8½ photograph free with every order for six.

Our Dollar Special: Two 6½x8½ photographs, 6 cabinet size and 32 small photos, all for \$1.

Our pictures are all real photographs. No reproductions of paintings or other cheap trash. Money back if not pleased.  
ART PHOTO CO., 2006 P. M., Grand Rapids, Mich.



The Best Book For Beginners

## A Practical Course in Mechanical Drawing

By  
Wm. F. Willard

Price 50c  
Postpaid

POPULAR MECHANICS BOOK DEPT.  
318 W. Washington Street, Chicago

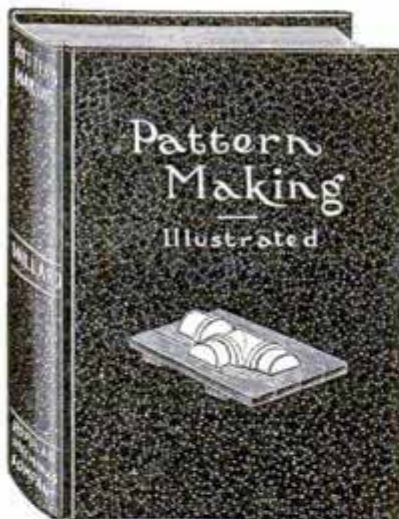

## A HELPFUL BOOK

# PATTERN-MAKING

WITH ADDITIONAL CHAPTERS ON

## CORE-MAKING and MOLDING

By G. H. WILLARD

### READ THESE OPINIONS:

"I find that the book contains a great many suggestions which will be of substantial benefit to me."

THEO. JOHNSON, Supt. of Pattern Shop,  
Chicago Flexible Shaft Co.

"We are much pleased with the simple style of the book and the amount of information it conveys."

THE OSBORN MFG. CO., Cleveland, O.  
R. H. Griswold.

"I think the book is the best I ever saw for the price."

EDWIN SLUYTER, Construction Engineer,  
Burroughs Adding Machine Co., Detroit.

"I consider this is a valuable book and should be in the hands of all men engaged in this line of business."

E. W. CLARKE,  
Wilmington Malleable Iron Co., Wilmington, Delaware.

"Written So You Can  
Understand It"

224 Pages  
312 Illustrations  
Cloth Cover

Price \$1 Postpaid

PUBLISHED BY

POPULAR MECHANICS BOOK DEPARTMENT, Chicago

## Prest-O-Lite Gas Tank



### The Best and Cheapest Light for Motorcycles

The Prest-O-Lite Gas Tank (used on 75% of the automobiles of America) floods the road far ahead with strong, steady, dependable light, turned on and off like a gas jet. Prevents costly, dangerous accidents. Motorcycle size gives 40 hours of light (using  $\frac{1}{4}$  ft. burner). Easily attached—our booklet shows how. Full tank in exchange for empty, at small fee. This clean, convenient service usually costs less than the carbide consumed in a generator. Genuine Prest-O-Lite Tanks, when empty, can be promptly exchanged, anywhere and always, at all automobile and motorcycle dealers. Imitations cannot.

**FREE** Our flexible folding rule. Measures depth of gasoline in tank. Measures tires, etc. Very handy. Sent free to anyone giving name and address, and make of motorcycle.

**The Prest-O-Lite Co.,** 265 East South St., Indianapolis, Ind.

Branches and charging stations in the principal cities from coast to coast

EXCHANGE AGENCIES EVERYWHERE

An Omaha surgeon says he is certain he can cure kleptomania by the use of the knife. His suggestion is that the "patient's" hands be amputated.—Cleveland Plain Dealer.

The bicycle was invented 20 years too soon to do the harem skirt any good.—Washington Post.



**LOTS OF FUN!!** DOUBLE THROAT. Fits roof of mouth. Invisible when in use. Astonish and mystify your friends. Whine like a puppy, sing like a canary, and imitate other birds and beasts of field and forest. **LOTS OF FUN.** Thousands sold. Price, 10c each; 4 for 25c or 12 for 59c. **ELECTRIC FUN MAKERS,** Dept. C, Kewanee, Ill.

## AERONAUTICS

We build scale Models to your own design or supply all necessary materials. Drawing and directions for three-foot model Bleriot Monoplane, 15 cents. Stamp brings Catalog.

**IDEAL AEROPLANE & SUPPLY CO.**  
1203 Bedford Ave. BROOKLYN, N. Y.

**4000**  
**A YEAR**  
**TO**  
**AGENTS**

100 agents — salesmen — managers wanted. From \$50 a week to \$4,000 a year. McGough, O., made \$160 in one week. E. J. Durr, Mich., cleared \$22.50 in one day. Needed in every home, office, factory, public buildings and by auto and motor boat owners. **A Wonderful New Fire Extinguisher.** Used by U. S. Government. Write quick. Try for this big money.

**UNITED MFG. CO.,** 1577 Mill St., LEIPSI, O.  
Reference Bank of Leipsic, Capital \$1,000,000.00

WANTED

**THE LIGHT THAT NEVER FAILS**

Has been imitated but never equaled. Burns its own gas and makes more money for agents than any other artificial lighting device on earth. We give exclusive territory and large discounts to good men. For further information and full particulars address Light Dept.

**NATIONAL STAMPING & ELECTRIC WORKS**  
418 So. Clinton Street, Chicago

AGENTS

## HERE IS THE CAR Write for Special Price

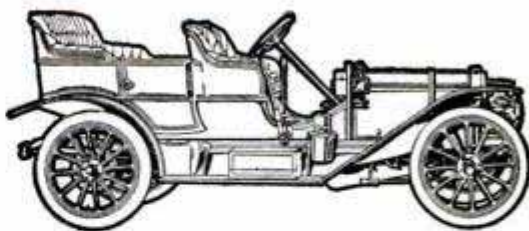

Rambler Thirty-four  
Original Price \$2250. Special price upon request.

### SPECIAL FOR THIS MONTH

Here is a car which originally sold for \$2250. It was taken in exchange from a satisfied Rambler owner who has purchased one of the 1911 models.

Many Rambler owners buy a new car each year in order to enjoy the very latest improvements. This car must be sold immediately and a special price will be made to you if you will write at once, giving full name and address.

Remember, you get the same guarantee of service and satisfaction that goes with the new Rambler. The car is in first class shape, having been taken apart, worn parts replaced and the entire car rebuilt, readjusted and repainted.

You take no chance when you buy a Rambler. Look up the rating of this company in Dun and Bradstreet's. Send today for our special price.

### THE THOMAS B. JEFFERY COMPANY

Main Office and Factory, KENOSHA, WISCONSIN

## Clean by Water Power

"THE WATER DOES THE WORK—THE AIR DOES THE CLEANING"

Investigate this wonderful **PRESTO VACUUM CLEANER**. Look into the matter thoroughly so you will not confuse it with so-called cleaners on the market that are three and four times as costly. Consider this really **SANITARY** system and you will equip your home with no other kind.

THE PRESTO takes the dust, dirt and disease germs AWAY from the home and puts them into the sewer

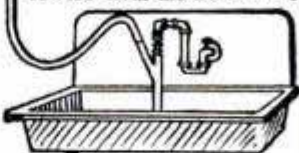

where they belong. A mighty important feature. No emptying bags or boxes of bacteria-laden dirt. No dusting necessary.

Cost of operating THE PRESTO is less than one cent

per hour. Cleaners guaranteed for 10 years. PRESTO Stationary Cleaners installed in your home AT \$50 AND UPWARDS, according to piping required. We also manufacture PORTABLE cleaners that can be attached to any kitchen bib, at \$30.00 complete with fifty feet of one-inch vacuum hose, and five cleaning tools. Write to-day for full information.

**PRESTO CLEANER CO.,** Office 114-116 Colonnade Bldg., TOLEDO, OHIO

## T & M MARINE ENGINES

Powerful, speedy, smooth running, silent. Correctly designed and constructed to the slightest detail.

### Instantly Responsive

and easy to operate. Right type and size for craft up to 65 ft.—light, medium and heavy duty—2 H. P. and up. Write for catalog and name of nearest dealer.

**TERMAAT & MONAHAN CO.**  
Department "A" OSHKOSH, WIS.

Agencies in all principal cities



# 501 Persons Have Purchased American Automobile Mfg. Co. Stock to the Amount of \$271,635.00 up to April 1st, 1911. :: :: Selling Price Per Share will be Advanced from \$5.00 to \$7.50 June 15th, 1911.

**T**HE first published announcement of the sale of our stock was made February 10th, 1911.

Up to April 1st, 501 people from all sections of the United States and Canada (many who visited our plant at their own expense and investigated our proposition very carefully) have bought stock aggregating \$271,635.

We are going to sell \$500,000 worth of our stock.

Its present selling price is at the par value of \$5 per share.

We believe from the present interest shown in our proposition—from the way in which the stock in our company is being purchased—that by June 15th sufficient stock will be sold to take care of our needs for additional machinery and working capital.

And on June 15th the selling price of our stock will be advanced 50%.

From that date the selling price will be \$7.50 per share.

An audit of our books has been completed, showing our condition April 1, 1911.

Herewith is our financial statement.

Please read this statement through very carefully, keeping the following points in mind:

First: The company owns a splendid manufacturing plant and has large resources with but a small current indebtedness.

Second: Detailed written valuation of the company's real estate and buildings were made by independent and impartial appraisers.

Third: The patents covering the Jonz motor and other patents belonging to this company have been valued at the exact cost to the company.

Fourth: From our surplus of \$28,970.68

the company could declare a 10 per cent. dividend right now.

It is amply justified.

The thought must come to you now that while the possibilities for money making in the automobile business are great—

So great that many automobile manufacturers have declared dividends of from 60 to 1300%—

Nevertheless that there must be some element in our proposition that makes it exceedingly strong—

So strong that 501 persons have bought \$271,635.00 worth of our stock.

Well there *is* such an element—one that we believe will make our company forge ahead of every other automobile company in this country—

An element that absolutely *assures* our success, and makes positive the dividends that are bound to accrue to our stockholders—

And that element is the motor used in our automobiles—the celebrated Jonz motor.

Now, whether you know anything about automobiles or not—whether you're an expert or absolutely ignorant of automobile construction,

Know this—the Jonz motor is the only vapor-cooled, two-cycle automobile motor on the market.

Our four-cylinder motor has only nine moving parts—the average motor has ten times as many.

Our 40 horsepower motor weighs only 175 pounds—the average 40 horsepower motor of other types, including the radiator and water, weighs from three to five times as much. This means an immense saving in tire upkeep.

It presents extraordinary points of advantage.

Financial Statement	
AMERICAN AUTOMOBILE MANUFACTURING COMPANY	
March 31st, 1911	
<b>RESOURCES</b>	
Real Estate.....	\$ 11,000.00
Buildings.....	122,374.44
Sprinkler System (Fire Protection).....	23,000.00
Power Plant.....	4,700.00
Machinery and Fixtures.....	12,126.69
Patents.....	107,019.17
Materials.....	11,703.11
Tools, Jigs and Patterns.....	4,042.21
Finished Cars on Hand.....	3,500.00
Mill Supplies.....	480.00
Office Furniture.....	825.00
Office Supplies.....	320.00
Bills Receivable.....	31,437.50
Accounts Receivable.....	2,818.40
Cash on hand and in bank.....	9,146.62
	<u>\$344,493.14</u>
<b>LIABILITIES</b>	
Bonds (balance purchase price of plant).....	\$ 24,500.00
Bills Payable.....	2,132.35
Accounts Payable.....	17,255.11
	<u>\$ 43,887.46</u>
Assets Exceed Liabilities.....	300,605.68
	<u>\$344,493.14</u>
Capital Stock.....	\$271,635.00
Surplus.....	28,970.68
	<u>\$300,605.68</u>



It's the simplest motor made "fool-proof"—a child can run it.

And it can be manufactured at a very low cost.

The Jonz motor has been thoroughly tested and has demonstrated its efficiency beyond any question—it's no experiment.

We'll give you the names of people who own Jonz motors, to whom you can write for first-hand information as to their simplicity and reliability.

You must do it—stock advances from \$5 to \$7.50 per share June 15th, and that's not far off.

After you've read our literature, should you want further information come to the factory.

Meet our officers—see our factory—ride in one of the Jonz cars.

If you buy \$1000 worth of stock or more we'll pay your transportation from any point in the United States.

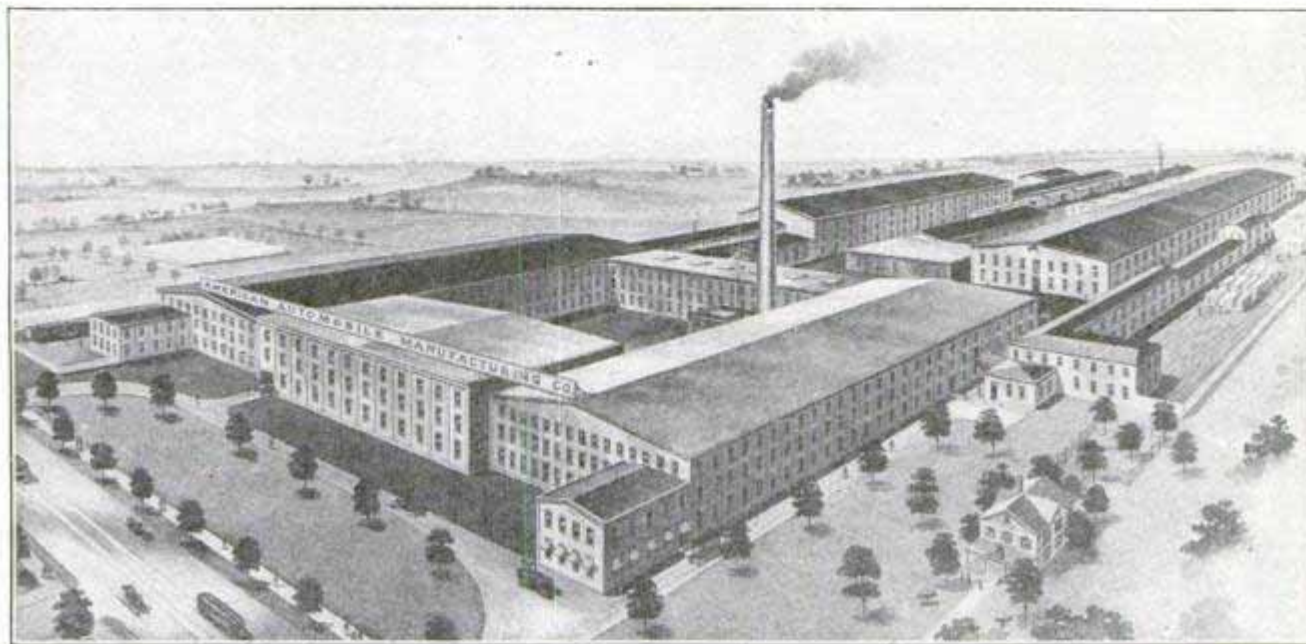

Plant of the American Automobile Mfg. Co. at New Albany, Ind., opposite Louisville, Ky.—  
Over 5 Acres Floor Space

Those who buy American Automobile Mfg. Co. stock we believe will find it the most profitable investment they have ever made.

Every man connected with the management of the company has years of successful business experience behind him.

They are devoting their entire time to the interests of the company.

All the stock is common stock—fully paid and non-assessable; *every share* issued has been paid for—there is no promotion stock.

All stockholders share alike in the profits of the company—in proportion to the amount of stock held.

Now, we would advise you to send for our literature at once.

It pays us to do this, since everyone who has been here has purchased stock and has told his friends, who have in turn purchased stock.

If you find our proposition not as herein represented we will pay your transportation anyway.

Fill in the coupon for prospectus and literature—and send to us to-day. Do it now.

## American Automobile Manufacturing Company

105 Vincennes St., New Albany, Ind.

**From 60% to 1300% Dividends Coupons for Popular Mechanics Readers**

American Automobile Manufacturing Company, 105 Vincennes St., New Albany, Indiana.

GENTLEMEN:—Kindly send me your book—"From 60% to 1300% Dividends" relating to stock in American Automobile Manufacturing Company.

Name.....Address.....

Town.....State.....

# CHIEF DRAFTSMAN

Will INSTRUCT PERSONALLY a limited number selected, ambitious men in

## Practical Drafting, Detailing, Designing

### Draftsmen Drawing \$125-\$150 Monthly

Are NOT MADE in Schoolrooms,  
 Are NOT MADE by reading books,  
 Are NOT MADE by making Copies,  
 Are NOT MADE at home drawing pictures  
 from printed book lesson.

### LET ME TELL YOU:

It requires actual, practical, up-to-date  
 DRAFTING-ROOM WORK to train YOU  
 to gain the PRACTICAL EXPERIENCE  
 that your employer will demand of you.



# FREE

This \$13.85  
**DRAWING  
 OUTFIT**

and **Free Position.**

As Chief Draftsman of Engineering firm I know exactly the Quality and Quantity of PRACTICAL training, knowledge and actual up-to-date experience (not school knowledge) you must have, in order to obtain a good position and advance to highest salary.

I give **INSTRUCTION UNTIL COMPETENT** and  
**PLACED in POSITION** at above Salary.

DON'T waste TIME and MONEY trying to learn from books or printed "STUFF" you can only learn on PRACTICAL WORK which I furnish you.

Address **CHIEF DRAFTSMAN**  
**Div. 19, Eng's Equip't Co. (Inc.), Chicago**

# Can You Invest ?

\$100. to \$5000.

to realize a large annual income for at least 56 years in an exclusive instructive-publication project of a value recognized by the **Carnegie Institute**, **heartily endorsed by the Public Press** and leading Educational, Commercial and Agricultural Authorities everywhere as of the weightiest importance to people of all Nations, certain to multiply the Agricultural wealth of the world, which in turn will favorably affect every branch of Industry and Commerce, and combining the following features:

**Competition Impossible**  
**Remarkable Dividend Earning Power**  
**Benefit to Humanity**  
**Universal Necessity**  
**Ready Market**  
**Ability and Integrity of Management**

The Principal owns absolute sole rights for the United States and all foreign countries—protected against competition under the positive copyright laws, is widely known in the trade and can present abundant Banking, Commercial and Personal References extending through 30 years of business life.

There is no project of more world-wide importance from the standpoint of public utility or philanthropic worth, at the same time it would be hard to find an investment as certain of developing an equally as great dividend-paying capacity.

Immediate answers are invited from substantial readers of the Popular Mechanics Magazine capable of making the investment if completely satisfied with details. 1500 shares at \$100. is the total available for subscription. Information with proper credentials will be submitted promptly on request.

---

Write your name and address on this coupon

**H. R. Brown, care Popular Mechanics Magazine**  
**225 Washington St., Chicago, Ill.**

Please submit the information upon the investment referred to in your advertisement to me as follows:

Name \_\_\_\_\_

Address \_\_\_\_\_

Tear it off and mail before other matters crowd the memory



## Wherever You Go

North, East, South or West, you will find **Coca-Cola**. And find it the beverage that everybody (all classes, ages and sexes) drinks and likes.

So don't forget---while you're waiting for your vacation time to come around, make the best of heat and weariness and impatience by treating yourself to

# Coca-Cola

When you're on your vacation, put an edge to your enjoyment---with **Coca-Cola**.

When you get back and the return to a burdened desk or an upset house irks you mentally and physically, remember that **Coca-Cola** is

**Delicious--Refreshing--Thirst-Quenching**

**5c Everywhere**

THE COCA-COLA CO.  
Atlanta, Ga.

Send for our interesting booklet, "The Truth About Coca-Cola"

Whenever you see an Arrow think of Coca-Cola