

May

This Issue 258,000

15 Cents

POPULAR MECHANICS

WRITTEN SO YOU CAN UNDERSTAND IT.

The Winged Hydroplane



Popular Mechanics offers no premiums; does not join in "clubbing offers," and employs no solicitors to secure subscriptions. It is for sale by nearly every newsdealer in the United States and Canada.



\$960

BUYS THE MATERIAL NEEDED TO BUILD THIS HOUSE

Price includes Blue Prints; Architect's Specifications; Full Details; Working Plans and Typewritten Material List

OUR HOUSE DESIGN NO. 53

This is a strictly modern, thoroughly practical and beautiful home. In size it is 27 ft. by 36 ft. The lower floor has a Reception Hall, large Dining Room, Kitchen, Pantry and Closets. The second floor, three large Bedrooms, Alcove, Bath and roomy Closets. Note the Colonial Windows, the large Porch, the general beauty and harmony of the entire design. The interior represents convenience of arrangement, good taste and a most homelike and artistic appearance. The material we furnish for construction is positively guaranteed in every respect. We invite you to come to Chicago and personally inspect this material. It is of exceptionally good quality and *brand new*. Figured to such a nicety that there is not one penny's waste, which means an enormous saving of time, labor and money. This is a most extraordinary bargain for home builders, and worthy of your prompt acceptance. Write us today.

We Save You Big Money on Lumber and Building Material!

The Chicago House Wrecking Co. is the largest concern in the world devoted to the sale of Lumber, Plumbing, Heating Apparatus and Building Material direct to the consumer. No one else can make you an offer like the one shown above. We propose to furnish you everything needed for the construction of this building except Plumbing, Heating and Masonry material. Write for exact details of what we furnish. It will be in accordance with our specifications, which are so clear that there will be no possible misunderstanding.

How We Operate

We purchase at Sheriffs' Sales, Receivers' Sales and Manufacturers' Sales, besides owning outright sawmills and lumber yards. Usually when you purchase your building material for the complete home shown above, elsewhere, it will cost you from 50 to 60 per cent more than we ask for it. By our "direct to you" methods we eliminate several middlemen's profits. We can prove this to you.

What Our Stock Consists of

We have everything needed in Building Material for a building of any sort. Lumber, Sash, Doors, Millwork, Structural Iron, Pipes, Valves and Fittings, Steel and Prepared Roofing. Our stock includes Dry Goods, Clothing, Furniture, Rugs, Groceries, etc., Machinery, Hardware, Wire Fencing—in fact, anything required to build or equip. Everything for the Home, the Office, the Factory or the Field, besides everything to wear or to eat. Send us your carpenter's or contractor's bill for our low estimate. We will prove our ability to save you money. WRITE US TODAY, giving a complete list of everything you need.

Free Book of Plans

We publish a handsome, illustrated book, containing designs of Houses, Cottages, Bungalows, Barns, etc. We can furnish the material complete for any of these designs. This book is mailed free to those who correctly fill in the coupon below. Even if you have no immediate intention of building, we advise that you obtain a copy of our FREE BOOK OF PLANS. It's a valuable book.

Our Guarantee

This company has a capital stock and surplus of over \$1,000,000.00. Absolute satisfaction guaranteed in every detail. If you buy any material from us not as represented, we will take it back at our freight expense and return your money. We recognize the virtue of a satisfied customer. We will in every instance "Make Good." Thousands of satisfied customers prove this. We refer you to any bank or banker anywhere. Look us up in the Mercantile Agencies. Ask any Express Company. Write to the publisher of this publication. Our responsibility is unquestioned.

\$2.00 Buys a Complete Set of Blue Prints We send you a set of plans for the house described above, including the necessary specifications and complete list of material, transportation charges prepaid, for the low cost of \$2.00. This is only a deposit, a guarantee of good faith, and the proposition to you is that after receiving these blue prints, specifications and list of material, if you can place an order with us for complete bill of material, we will credit your account in full for the \$2.00 received, or we will allow you to return these plans, specifications, and list of materials to us and we will refund \$1.50, thereby making the total cost to you 50 cents.

High Grade Bathroom Outfits!



The price of this Bathroom Outfit **\$37.50.**

Plumbing material direct to you at Bargain prices.

We have everything needed in Plumbing Material. Our prices mean a saving to you of 30 to 60 per cent.

Here is an illustration of a bathroom outfit we are selling at \$37.50. Your plumber would ask you about \$60.00 for this same outfit. It is only one of many other complete outfits that we are offering at prices ranging from \$25.00 to \$50.00. Our catalog describes them in detail. Get our prices on Pipe and Fittings. Write us today.

Hot Air Furnaces!

Don't let the contract for your hot air furnace until you get our figures.

We will cut your local dealer's price in half. We can furnish you a complete equipment, including pipes, registers, furnace;

everything required at a price not much more than what an ordinary heating stove would cost you. Complete hot air heating plants **\$48.00 up.**

Get our heating catalog at once. Tells you all about it. Write us today. We guarantee to save you money. We loan you tools. We make you plans. Every heating plant we sell is backed by our guarantee bond.



Hot Water Heating Plants!

We guarantee to save you 50 to 75 per cent on a modern hot water heating plant for your home.

We make you complete plans and instructions and help you out every way we possibly can. We loan you tools. Every plant backed by our guarantee bond. We furnish the material; you get the plant installed. Cut out the local dealer's profit and cut the cost in half. Thousands of our plants installed and working perfectly in every part of the country. Write today for our Special Heating Catalog. Tells all about our heating proposition. We can furnish Heating Apparatus for any building, no matter how large. Tell us your needs.



Water Supply Outfits Modern Air Pressure Water Supply Systems at prices ranging from \$48 to \$200. They are strictly new, first-class and complete in every detail. It makes no difference whether you live in the country, you can enjoy every city comfort at little expense. Why not investigate this? We are ready to furnish you with all facts free of charge. All material fully guaranteed. We also have a complete stock of Pipe, Valves and Fittings at 40 to 60 per cent saving. Gasoline engines at low prices.

Free Publications Besides a Free Book of Plans described above, we send free to anyone answering this advertisement in the United States the following additional booklets: **Our Plumbing Material Catalog**—A book covering every phase of the Plumbing subject, shows the latest and most modern ideas in Bathroom equipment, as well as sanitary appliances of every kind. **Cold Weather Comfort** is the title of our Heating Catalog; describes in full hot water, hot air and steam heating. The subject is treated in language so plain that no one can misunderstand it.

CHICAGO HOUSE WRECKING CO., 35th and Iron Sts., CHICAGO

Send Us This Coupon

Chicago House Wrecking Co. (539)

I saw this ad in May Popular Mechanics.

I am interested in.....

NAME.....

TOWN.....

CO.....STATE.....

OUR NAVY REQUIRES PICKED MEN



FOR a number of years THE NAVY has endeavored to fix a high standard for recruits. Owing to the steadily increasing demand for Navy positions, and the limited number of vacancies, the Navy Department has determined to raise still higher the requirements for enlistment, and to accept only picked men—morally, mentally and physically.

The Navy has much to offer the serious minded young man (or boy over 17) who is ambitious to make his life a success; who is eager to win advancement by his own efforts; and who wants to be assured of retirement with a competency in his declining years.

Ne'er-do-wells and adventurers need not try to join the Navy. Even should they pass the recruiting officer, they would not find the service to their liking, and their discharges would probably follow; but any honest, industrious young man, of sound physique and clean habits, can meet the requirements, and such young men are welcomed.

No man is urged to join the Navy. They are only asked to investigate Navy life; to talk it over with their parents. The best way to obtain a correct idea of Navy life is to read "The Making of a Man-O'-Warsman." It will be sent *free* on application.

Call at any Navy Recruiting Office, where all questions will be answered willingly by men who have had years of experience;—or address

BUREAU OF NAVIGATION

DESK 69

NAVY DEPARTMENT

WASHINGTON, D. C.



Work Anyone Can Do With a Few Good Tools

Anyone can make a screen door—just nail the frame together and tack on the wire, yet it takes good tools even to do a simple job well.

With a few good tools you can do lots of odd jobs about the house that are so trifling you would not send for a carpenter, and, consequently, they would never be done.

KEEN KUTTER

is a name identifying the only complete line of guaranteed Tools and Cutlery made.

All you need remember is this name when buying tools, and you will be sure of getting the best—sure because you know if anything is wrong, you can have your money back.

This name and guarantee covers tools for workbench, home, garden and farm, pocket knives, scissors and shears, table and kitchen cutlery, safety razors.

Sold for over 40 years under this motto:

"The Recollection of Quality Remains Long After the Price is Forgotten."

Trademark Registered.

—E. C. SIMMONS.

If not at your dealer's, write us.

Simmons Hardware Company (Inc.), St. Louis and New York, U.S.A.

POPULAR MECHANICS MAGAZINE

H. H. WINDSOR, EDITOR, 318 W. Washington St., CHICAGO, U. S. A.

Copyrighted, 1911, by H. H. Windsor.

Exchange Editors are at liberty to quote from these pages by giving the usual credit.

Contents for May, 1911

Height Line Supplants the Age Limit in Street Cars	617	Navy Practice Includes Aeroplane Defense.....	658
Firefighters Idealized by Sculptor.....	618	Wooden Ball Removes Sewer Obstructions.....	659
Obsolete Warship Adrift.....	618	Italian Soldiers as Trick Cyclists.....	659
Long Skirts Prohibited in Nuremberg Streets.....	619	Parading for Quinine.....	659
Wrecking Engine Wrecks Telephone System.....	619	Uncle Sam's Automatic Dampening Machine.....	660
The Battle in the Clouds.....	620	Gasoline Traction Cultivator.....	661
San Francisco's Safety and Loading Islands.....	621	Aluminum Electromagnet Coils.....	661
Jail on Wheels.....	621	Some Historical Absurdities Which May Be Committed by Future Writers.....	662
Both Gravestone and Sundial.....	621	"Loop" Jewelry Latest Fad.....	664
Two Locomotives Made into One.....	622	Two New Processes for Making Balloon Gas.....	664
Five Million Dollars for an Idea.....	622	Experimental Tanks for Ship Models.....	665
Circling the Leaning Tower of Pisa.....	623	Colony of Inoculated Monkeys.....	665
A Somersaulting Bicycle.....	624	Philippine Moros Build Concrete Capitol.....	666
Chemically Produced Lace.....	624	Distinctive Plan for Small Concrete House.....	667
Exports Electricity to Mexico.....	624	Aeroplane Designed for Soaring Flight.....	668
Brace-Operated Jack.....	624	Curious Tracer Information.....	668
Carting a 62-Ton Girder Across New York.....	625	Electroplating Porcelain with Silver.....	668
The Markings of Old English Silver.....	625	Kansas Farmer Has Hog for a Mount.....	668
A Musical Canary.....	626	Three Volumes Valued at \$40,000.....	669
Liquid Concave Mirror for Telescopes.....	626	Cleaning Steel Cars with Sandblast.....	669
The Latest French Army Dirigible.....	627	Feeding Gulls on Lake Michigan.....	669
Scenes in a Woman's Medical College.....	629	Youngest Airman is But Three Years Old.....	670
Motorboat Built to Cross Atlantic.....	629	Motion Pictures with Lights Turned Up.....	670
Muscles Forced Out of Place by Ornaments.....	630	Training Police Dogs to Jump Fences.....	670
New Largest Vaults in the World.....	630	From Torch to Tungsten in Light's History.....	671
French Monoplane of Unique Shape.....	631	Remarkably Slender Concrete Bridge.....	672
Bullfighting in Mexico.....	631	Traveling Sewage-Cinder Washing Machine.....	672
Berlin's Telephone Building.....	632	Japanese Girls in an Adding Race.....	673
Expected to be Fastest Boat in the World.....	632	Food-Preserving Power of Substances.....	673
Photo Gallery of Army Horses.....	632	Testing Sail Cloth.....	674
Aerial Experiment Car.....	633	Marking Criminals with Wax.....	674
Bad Church Lighting Causes Sleepiness.....	633	Past and Present in New Mexico.....	674
Silken Note of Thanks from Japan.....	634	Science and Plain English.....	675
Novel French Aeroplane Prize.....	634	Electric Pump in Quick Emergency Service.....	680
De Lesseps is Awarded \$10,000 Prize.....	634	Church Converted into Electric Laundry.....	681
Acid Not Essential in Rusting of Iron.....	634	Model Barracks in France.....	681
The Modern Blacksmith (Verse).....	635	Porch Fireplace.....	682
Britain's Naval Airship.....	636	Combined Track Gauge and Level.....	682
Boy and Goat Cultivate Cornfield.....	636	Intense Cold at High Altitudes.....	683
Parachute Experiments from Eiffel Tower.....	637	Lessens Fire Risk and Prevents Lamps Falling.....	683
French Traveling Theater.....	637	Fish Yawn Like Human Beings.....	683
Train Wrecked by Wild Elephant.....	638	Enough Oil to Float the United States Navy.....	683
Aero-Hydroplanes Built in United States and England Simultaneously.....	638	The Plague in Manchuria.....	685
Razing Concrete Structure a Difficult Task.....	640	Bird Breaks Clean Hole Through Window.....	685
Mountain Climber Needs Agility of a Goat.....	641	Oldest Lighthouse in America.....	686
Lizards Photographed While Fighting.....	642	The Hermit and the Oil Cans.....	686
Railway Bridge Over Panama Canal.....	642	Arc-Lamp Carrier for Street Lamp-Posts.....	687
Special Automobile for Lamp Trimmers.....	642	Mexican Capital Is a City of Concrete.....	687
Assembling an Army in Ten Days.....	643	Tickets Made While You Wait.....	689
Hotel Burned While Crossing Ice.....	646	Test Gyroscope as War Vessel Stabilizer.....	690
Target Battleship Riddled by Naval Gunners.....	647	First Painting of World's Largest Waterfall.....	690
A Hot-Air Engine That Needs no Water Cooling.....	648	Effect of Water in Waterproofing Concrete.....	691
Stopping a River to Sink a Tunnel.....	649	Hamburg's Traffic and Pedestrian Tunnel.....	691
Rigid Inspection Result of New York Fire.....	650	The "Olympic's" Whistles Largest Ever Made.....	691
Comment and Review, by H. H. Windsor.....	651	Trackless Trolley for Leeds, England.....	691
Over Thousand Tons of Explosive "Lets Go".....	653	Coaling Gear of U. S. Collier.....	692
Airmen Make Records with Passengers.....	654	An Advertising Clock That Talks.....	692
Nongyroscopic Aeroplane Motor to Increase Stability.....	655	Discovery of America Caused by a Bug.....	692
The Harem Skirt Obligatory for Airwomen.....	658	The Making of Arts-Crafts Lamps.....	693
Remarkable New Filter.....	658	Automatic Extinguisher Suffocates Fire.....	694
		Remarkable Gas Engine Uses Coal as Fuel.....	695
		A Novel Screwdriver.....	695

[Continued on Page 6]

ISSUED MONTHLY

SUBSCRIPTION:

SINGLE COPY, 15 CENTS

In United States, and its possessions, and Mexico, per year, postpaid	\$1.50
To Canada	1.75
To all other countries in the Postal Union	2.00

All subscriptions are discontinued at expiration. Please examine the date printed on your wrapper.

Entered as Second Class Matter Sept. 15, 1903, at the Postoffice at Chicago, Illinois, under Act of March 3rd, 1879.

Published monthly by POPULAR MECHANICS CO.

The attention of prospective advertisers is called to the policy of this magazine in accordance with which the publisher waives all claim for payment of any advertisement appearing in any issue where the number of copies actually printed and circulated is less than the number printed on the front cover page.

This One



VTIC-TQI-AEVO

Contents—Continued

"Freak" Locomotive Built in Egypt.....	696
The Foundation of the Great Pyramid.....	696
Safety Loop for Automobile Shafting.....	696
The Grooming of Flowers.....	697
Electrically Operated Rock Drill.....	697
Substitute for Radium.....	697
A Mission Screen.....	698
Soft Soap Waterproofs Concrete.....	698
Boiler Repair Bolt.....	699
Motor-Driven Lawn Mower.....	699
Corrugated Propellers.....	700
Motor-Driven Blueprint Trimmer.....	700
Vote Canvassing in Boats.....	700
To Exploit the Minerals of the Dead Sea.....	700
Portable Squares for Carpenters.....	701
Police Automobile as Bomb Carrier.....	701
Drip Cups for Bottles.....	702
A Handy Pulley Remover.....	702
Rolling Dams in Mexico.....	702
A Novel Water Motor.....	703
Extension Rim for Auto Wheel.....	703
Wooden Steam Boilers.....	704
Old Wallpaper a Menace to Health.....	704
Long-Distance Flight in France.....	704
New Umbrella Shape.....	704
Great Irrigation Project in New South Wales.....	705
Anti-Splash Faucet.....	705
Bag-Tying Tool.....	705
Twelve Miles of Concrete Pipe.....	705
New Tooth Brush Cleans Inner Surface.....	706
The Dwarf Gardens of Japan.....	706
Belt-Driven Automobiles.....	706
The Kingdom of Dust.....	707
Successful Grafting of Cold-Storage Skin.....	711
Prehistoric Animals in Cement.....	711
Insuring the Safety of a 40-Story Skyscraper.....	712
New Monoplane Has No Horizontal Rudder.....	713
Fulfilling Condition of Ancient Bequest.....	713
Hopping for Husbands.....	714
A Gigantic Light Buoy.....	714
Alligator Furniture.....	714
A Terrific Locomotive Explosion.....	715
Big Iron Ore Beds Hold a Billion Tons.....	716
Waste Would Light House with Electricity.....	716
Radish Peel a Sensitive Detector for Acids.....	716
The Great Bronze Doors of a Church in Fairhaven, Mass.....	717
Machine Makes Model for Every Shoe.....	718
Telephone Poles Made of Old Steel Rails.....	718
Automobile Maintenance for Fixed Sum.....	718
World's Largest Fan Ventilates Mine.....	718
Making Moving Pictures within the Arctic Circle.....	719
Acetylene Flares for Airmen.....	722
Ancients Knew Microbes as Contagion Bearers.....	722
Government Guarantee of Antique Furniture.....	722
New "Engineering" Professions.....	722
Some Strange Flower Creations.....	723
Aeroplane "Merry-Go-Round".....	724
Catching Whales in Nets in New Zealand.....	724
Telescope Spectacles for Extreme Nearsightedness.....	724
Unique Landing Devices at Lighthouse.....	725
The Dutch Game of "Kolf".....	726
Gold-Coated Containers for Food.....	726
Sings at His Own Funeral.....	726
Guarding Prisoners from Public Gaze.....	726
Sawdust Concrete Used in Library.....	727
New Swimming Apparatus.....	727
Improved Type of Self-Discharging Car.....	727
Electrolytic Corrosion of Metal in Concrete.....	728
A Million Tons of Sand to Dress Marble.....	728
Influence of Speed on Compass Needles.....	729
"Pure Milk Squeezed Out".....	729
Swimming Machine.....	729
Ammonia Tank Explosion Lesson in Boiler Design.....	730
Railways Need Standard of Equipment.....	730
"Doctoring" Circassian Walnut.....	730
X-Ray Admits Chinaman to Country.....	730
Bed Canopy as Picture Background.....	732
Science and Mechanics in the Middle Ages.....	733
New York Dock Problem Temporarily Solved.....	733
Fleas from Madagascar Trained to Act.....	734
Removing a Mountain Top.....	734
New Postal Vending Machine.....	736
Warship a Boer Boy's Mind's Eye Saw.....	736

SHOP NOTES

Flower Pot Drain.....	737
A Foot-Power Hammer.....	737
Raising a Countershaft.....	738
Reclaiming Scrap Solder and Lead.....	738
How to Clean a Straw Hat.....	738
Emergency Repair on an Automobile Spring.....	738
A Partnership Desk.....	739
Joint for Aeroplane Construction.....	739
A Small Plow Plane.....	739
An Air Hoist.....	740
Clamp Coupling for a Water Pipe.....	740
How to Make Stamp-Pad Ink.....	741
Noise Caused by Service Wires.....	741
Cranking an Automobile by Foot Power.....	741
How to Cut Brass Tubes with a Hacksaw.....	741
Weight and Indicator for Tanks.....	742
Counterbalance for a Trapdoor.....	742
Cutter for Inlaying Wood.....	742
An Inexpensive Summer Bungalow.....	743
Attaching Rubbers to Shoes.....	746
A Washtub for Use in a Sink.....	746
Soldering a Hole on an Overhead Surface.....	746
Brazing Broken Band Saws.....	747
Filling Container from Gasoline Storage Tank by Air Pressure.....	747
How to Fit Door Locks.....	748
Welding Steel without Compounds.....	749
Making Clearance on a Twist Drill.....	749
Closing a Split Cotter Pin.....	750
Weight on a Belt Shifter.....	750
Cutting a Gear on a Milling Machine.....	750
A Stop for a Drawer.....	751
Preventing a Saw from Sliding on Sloped Surfaces.....	751
Repairing Umbrellas.....	751
Electric Connection for a Door Latch.....	752
Balance for Measuring Liquids Automatically.....	752
Cutting Steam-Gauge Glasses.....	752
A Vacuum Sticker.....	752
Blacksmith's Parallel Tongs.....	753
Repairing a Broken Valve Stem.....	753
Setting a Lathe Tool.....	753
Ladder Fastener.....	754
Plowshare Tongs.....	754
Holding Food for Stock.....	754
Home-Made Moisture Gauge for Incubators.....	755
An Emergency Marking Gauge.....	756
Home-Made Window Lock.....	756
Abrasive for Grinding Valve Seats.....	756
Handle for Carrying Tools.....	756
Tempering a Chisel.....	756

AMATEUR MECHANICS

Wood-Block Printing on Fabrics.....	757
Removing a Snagged Fishhook.....	757
Locking Several Drawers with One Lock.....	758
Testing Small Electric Lamps.....	758
How to Make a Pin Ball.....	758
Cleaning Woodwork.....	759
Bill File Made of Corkscrews.....	759
Ornamental Metal Inkstand.....	759
Holding Eyeglasses Firm.....	759
Substitute for Gummed Paper.....	759
Repairing a Broken Phonograph Spring.....	760
A Small Bench Lathe Made of Pipe Fittings.....	760
Holder for Flexible Lamp-Cord.....	761
Support for Double Clotheslines.....	762
Hot Pan or Plate Lifter.....	762
Weighting Indian Clubs.....	762
Venting a Funnel.....	762
Wood-Working for Beginners.....	763
A Stringless Package.....	766
Making a Clock Run by Changing Its Position.....	766
To Make "Centering" Unnecessary.....	767
Fountain Pen Cap Used as a Ruler.....	767
Vanishing Handkerchief Trick.....	767
Removing Glass Letters from Windows.....	767

Interesting Patents, Practical or Unique.....	768
Jokes.....	770
New Books.....	770
A Definite Date, Please (Verse).....	770

There's Money for You in Selling

Everyman's \$485 *The Brush Runabout* Car

IT is easy to sell people something they need and can afford. The Brush Runabout at \$485 is just such a proposition. People need it—all kinds of people, in every line of business. And the price is such that they can afford to buy it.

There is good profit for you in selling the Brush because you can make many sales and because your selling expenses are low. Your customers are all around you—no need for you to spend money travelling.

Field Is Unlimited

Every man (or employer of men) whose value depends on quick and economical transportation can use the Brush to advantage. For it is quicker, more reliable and cheaper to use than horse and buggy—costing a cent a mile or less to operate.

Salesmen, physicians, storekeepers, real estate men, insurance agents, contractors, plumbers, tax collectors, gas, electric and telephone companies—all need the Brush and are quick to realize it, when the proposition is put up to them.

These different businesses are just a suggestion of the big market for Brush Runabouts that exists already right in your own town. And just outside are the farmers—every farmer needs a Brush; they realize it, too.

Price Within Reach of All

There are few men engaged in business of any kind who cannot pay \$485 for something that will make or save money for them.

That's what makes it easy to sell the Brush. You can easily prove to your customer that the Brush will save him money. And when you've done that he isn't frightened by a big initial outlay.

Write for our proposition to dealers. Sending a postal may be the means of doubling your income.

Demand Is Increasing

The Brush is already successfully employed in 84 different kinds of businesses—we want to send you a folder, "The Brush as a Commercial Asset," which gives names and photographs.

The demand is growing steadily every day as more and more people realize the adaptability of the Brush to their own business.

Easy for You to Sell

All that is necessary to sell the Brush is to tell its true story and show the car. We are telling the story for you all over the United States in our advertising. All **you** need to do is to call on the individual prospects in your own town and show them what the Brush will do.

You don't need to know a lot about automobiles and machinery to sell the Brush. It is the simplest car built.

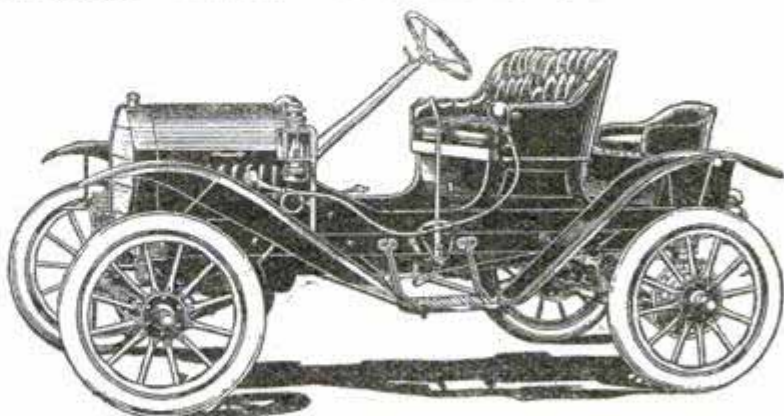

BRUSH RUNABOUT COMPANY,

(Division of United States Motor Company)

586 Rhode Island Ave.
DETROIT, MICH.

Licensed under Selden Patent

We will show you hundreds of testimonials.

"I am now driving a 'Winton Six'—and do all my repair work."—EDW. DWYER, Montclair, N. J.
 "Am opening a Garage and Repair Shop."—F. J. HARRY, Lewisburg, Ohio.
 "I am now doing Auto Repair Work—increased my income 50%."—L. P. SAYERS, Bogue, Kans.

Dyke's system is **POSITIVELY** the only system which can successfully be taught by mail.

LEARN TO RUN & REPAIR AUTOMOBILES. YOU CAN

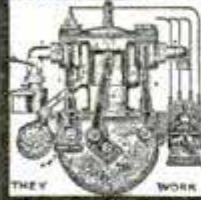

ENGINE MODEL



MAGNETO MODEL



CARBURETTOR MODEL

With This NEW IDEA System

Anyone who can read, can learn. Positively the only plan for successfully teaching by mail. Mr. Dyke published the first book on autos printed in the U. S.; but reading was not practical enough, so two years ago he originated the idea of teaching Automobile Engineering and Repairing by mail with clever and wonderful

Real Working Models

of all important moving parts of the automobile (only two models here illustrated). They show the parts in operation while you study.

Dyke's Course is Complete and Costs but \$10.00

It is easier to understand and far more complete than courses costing \$20.00 to \$80.00. In addition to 12 books there are 120 charts and **Working Models** with real metal moving parts. All sent you at one time. Diploma on examinations.

We Helped Hundreds Many are now driving cars, others are repairmen, some have opened their own repair shops. Let us prove our claims and show you letters wherein our system is

Endorsed by Barney Oldfield, Chas. Duryea and other leading authorities

SEND TODAY FOR MY FREE BOOK: How to Get into the Auto Business and Its Opportunities
DYKE'S CORRESPONDENCE SCHOOL OF MOTORING
 Box 1— 3947 Washington St., ST. LOUIS, MO



FREE

for SIX MONTHS

INVESTING for PROFIT

I am making this great offer to introduce my new magazine—**INVESTING FOR PROFIT**, which tells of the enormous profits made from judicious investments—profits the magnitude of which bankers and large corporations strive to hide from the masses. It explains the rules by which small investors have made stupendous fortunes—how \$100 grows into \$2200—how you can determine the *Real Earning Power* of your money.

One good investment is worth a lifetime of labor. Don't invest a dollar in anything until you have read at least the first issue of this wonderful magazine.

If you can save only \$5 or \$10 a month, **INVESTING FOR PROFIT** is *absolutely indispensable* to you, as the less you have to invest the more certain you should be that your investments are not only highly profitable, but reliable in every particular.

Send a postal today for your first copy.

H. L. BARBER, Publisher
 R. 418, 26 Jackson Blvd. CHICAGO, ILL.



MECHANICAL PUZZLES

127 varieties of Iron, Wood and Wire Puzzles. Sample leader with Catalog 10 cents.
WESTERN PUZZLE WORKS
 ST. PAUL, MINN.

WHEN YOU WANT ANYTHING AND DON'T KNOW
 WHERE TO FIND IT—WRITE BUREAU OF
 INFORMATION, POPULAR MECHANICS, CHICAGO

The Sebastian

15-Inch Standard High Grade
 Low Price ENGINE LATHE

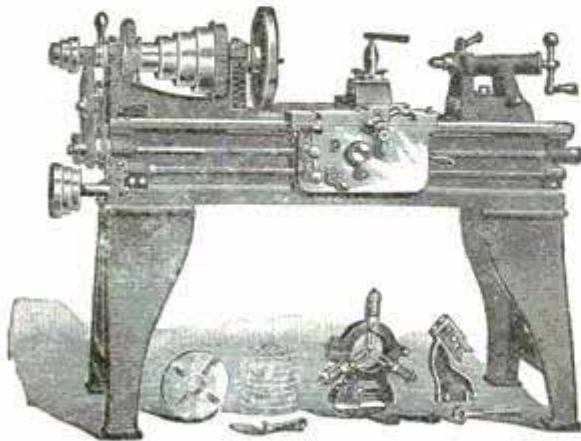

Automobile Builders, Garages, Repair Shops and General Jobbing Shops find this the Ideal Lathe for their work. Our Catalogue of Lathes and Tools Mailed FREE on request.

THE SEBASTIAN LATHE CO., 107 Culvert Street, CINCINNATI, O.

A CHANGE

Under a new plan effective April 1, 1911, our street number is changed to

318 West Washington St.

The change in address is caused by a re-numbering of the streets and is not a change of location. Please address our mail to the new number.

Popular Mechanics Magazine

FREE UPON REQUEST

OUR

Valuable 96-Page Catalogue

OF THE

Best Mechanical Books

It is well worth having and keeping for reference.

Popular Mechanics Book Dept.

318 W. Washington Street, Chicago

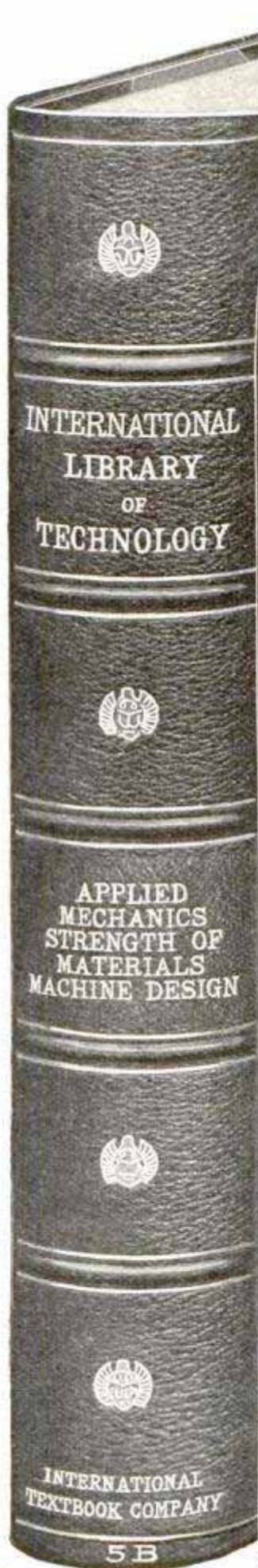

The Greatest Mechanical Library in the World

The Mechanical Engineering Library is part of the International Library of Technology that cost \$1,500,000 in its original preparation. It contains the knowledge given from the life experience of some of the best mechanical engineering experts in the country, edited in a style that nineteen years of experience in publishing home-study textbooks has proved easiest to learn, to remember, and to apply. There is no other reference work in the world that so completely meets the needs of the mechanic as the Mechanical Engineering Library. The volumes are recommended by the highest authorities and are used in nearly all the leading universities and colleges. They treat of practical mechanical methods, starting from the simplest problems and comprehensively covering every branch of the work. Not only can they be used to great advantage by superintendents, foremen, and engineers as an authoritative guide in their work, but since they can be so clearly understood even by persons having no knowledge of higher mathematics, they can be used by all classes of mechanics that are desirous of advancing to higher positions. The Mechanical Library contains 14 volumes durably and handsomely bound in three-fourths red morocco, stamped and numbered in gold. The books are printed on a high-grade book paper, and the type is large and easy to read. Each volume is 6 by 9 inches in size. If you wish to know more about the greatest and most practical mechanical library in the world, mark and mail the coupon NOW.

INTERNATIONAL TEXTBOOK COMPANY

Box 872, Scranton, Pa.

Please send, without further obligation to me, full particulars in regard to the International Library of Technology, with special reference to the Library of Mechanical Engineering.

Name _____

St. & No. _____

City _____ State _____

Shop Notes Quarterly

for the second quarter of 1911
is an unusually interesting number.

NOW READY

Among the special features are: "The Liquid Fuel of the Future," by J. C. Miller, M. E.; "The Steam-Engine Indicator," a plain, practical treatise by L. Stinson, M. E.; "Files and Filing," the first of a series of practical articles on the making and use of tools, by Henry Farrington, M. Sc.; "Art in American Architecture," by F. J. Schulte; "The Lost-Wax Process of Ornamental Molding," by Cliff M. Bleyer; "Electricity on the Farm," by M. A. Johnston; "Recent Progress in Electric Lighting," by E. W. Marchant, D. Sc.; "Wood and Timber," by W. L. Hammons; "Designing from Plant Forms," with twelve examples by John W. Wadsworth. The regular departments devoted to shop kinks, data sheets, drafting-room notes, etc., are unusually replete.

214 Compact Pages — 300 Illustrations

Each number contains more than three times as much reading-matter as the ordinary 15-cent magazine. An alphabetical index makes all the contents available for ready reference. **Shop Notes Quarterly** is the largest publication in the world devoted exclusively to Mechanics, Science, and Practical Knowledge.

\$1.00 a Year—Ask the Newsdealer—25c a Copy

Popular Mechanics Co., 318 W. Washington St., Chicago

"How to Remember"

A Valuable Book on Memory Training Absolutely Free to Readers of Popular Mechanics

If you want a perfect memory, you can have it; for a perfect memory, like perfect health, can be acquired. Here is a book that tells you exactly how to get it.

The author, Prof. Dickson, is America's foremost authority on mental training. His book is clear, specific and intensely interesting. He explains how you can easily and quickly acquire those retentive and analytical faculties, which contribute so much to all social, political and business success. He offers you a valuable opportunity to investigate the benefit of memory training for yourself—without assuming any risk, obligation or expense.

Simply sign and mail the coupon below—or send a letter or postal—and this book will come forward to you at once, absolutely free and postage prepaid.



PROF. HENRY DICKSON

Principal Dickson School of Memory. The Largest and Most Successful School of Mental Training in the World

Who is Prof. Dickson?

Prof. Dickson is backed by reputation and experience as a teacher, extending over twenty years in the leading Universities and Schools of the day.

Personal contact with thousands of pupils impressed him with the fact that each one was hampered by the same deficiency—a marked absence of proper powers of Attention, Concentration, Retention, Self-Control, Memory, etc. **He was one of the first educators** to discover the universal and primary need of the cultivation of these faculties, preliminary to the attempted acquisition of knowledge. **He was the pioneer** in the application of this newly discovered principle that no matter what course of training the student intended to take up later, these drills of the faculties of memory were absolutely necessary as preliminary training. His students learned so much more easily and so thoroughly retained their acquired knowledge, that his method attracted world-wide attention. The result was the foundation of the Dickson School of Memory.

What Prof. Dickson Has Done

The fame of this school and its unique methods has spread over the country. To date over 40,000 enrollments have been recorded and successful graduates fill every walk of business and professional activity. While the weakest minds can be strengthened, it must not be imagined that this method is applicable only to this class. Many of the most intellectual men of the day have availed themselves of Memory Training. W. T. Harris, former U. S. Commissioner of Education—the late Col. Robert Ingersoll, Mark Twain, and thousands of like minds have testified to the great benefit to be derived from Memory Training.

How He Can Help You

Thousands of successful men in all walks of life gratefully testify that they owe the consummation of their highest ambitions to his teachings, and he surely can help you—no matter who or what or where you are.

- He teaches you
- How to remember names and faces of people you meet.
- How to focus your mind instantly, to use effectively the points of a business proposition.
- How to recall small but vital points of business without burdening the memory.
- How to commit a speech or toast to memory quickly, and deliver it unhesitatingly in public or private.
- How to think on your feet and make an extemporaneous speech.
- How to converse at social gatherings in a natural, interesting way that wins friends.
- How to overcome self-consciousness, bashfulness, etc.
- How to control your thinking faculties.
- How to apply concentration to the subject at hand.
- How to acquire the habit of easy, logical thinking.
- How to memorize for studies, examinations, etc.

Highly recommended by Elbert Hubbard, Prof. David Swing, Dr. Latson, and thousands of others

Fill out coupon, tear out, mail TODAY, or send postal

DICKSON MEMORY SCHOOL
705 Auditorium Building, Chicago, Ill.
Send me free "How to Remember."

NAME _____

STREET _____

CITY _____

STATE _____

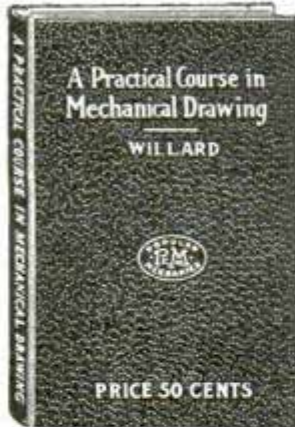

A NEW BOOK FOR WHICH THERE IS A REAL NEED

A PRACTICAL COURSE IN MECHANICAL DRAWING

"Written So You Can Understand It"

By WM. F. WILLARD

(For several years instructor in Mechanical Drawing at Armour Institute of Technology, Chicago.)

134 Pages
131 Illustrations

Price 50 Cents
POSTPAID

Cloth Cover
Size, 5x7 Inches

A book for individual study, shop classes, trade or high schools, and those who would like to know something of the DRAFTING PROFESSION.

WHAT OTHERS SAY ABOUT IT:

"It is one of the best books on Practical Mechanical Drawing I have ever seen and I can recommend it to any one who desires to make an individual study of drawing."

E. S. LIBBY, B.S., M.E., Prof. in Experimental Engineering, Armour Institute.

"This is a very useful little book, and every young fellow who is desirous of making himself more valuable to both himself and his employer will find it a great help in 'boosting' himself to a higher plane and 'bigger pay.'"

—THE NATIONAL BUILDER.

POWER GAS AND THE GAS PRODUCER

"Written So You Can Understand It"

The only authentic reference manual covering every detail of installation and operation which has been written in a non-technical manner. This book was prepared especially for the inquirer in this field who would like to be able to judge intelligently as to the economy and advisability of changing from other forms to Producer operation. It will also appeal to the engineer who wishes to understand thoroughly the working of the new system and thus be prepared to handle a plant competently.

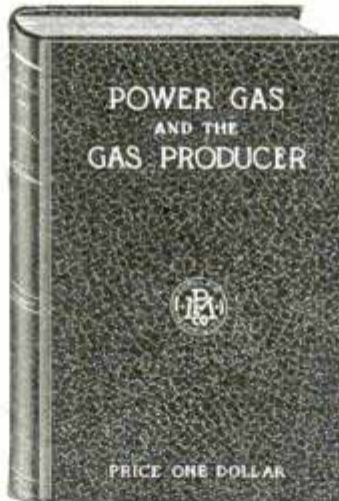

By J. C. MILLER, M. E.

One handsome, cloth bound volume of 192 pages, printed on the best quality of book paper and profusely illustrated.

Price Post-Paid \$1

The following list of chapter headings shows how thoroughly the author has covered his subject: Producer Gas and the Gas Producer—Classes of Gas Producers—Industrial Gases—Comparison of Heat Values—Types of Producers—Gas Producer Fuels—Gas Producer Operation—Gas Power and Steam Compared—Reliability of Gas Power—Gas and Steam Power Costs—Gas Producer Installation—Alphabetical Index.

PATTERN-MAKING

Price \$1 Postpaid

By G. H. WILLARD

WITH ADDITIONAL CHAPTERS ON

CORE-MAKING AND MOLDING

"Written So You Can Understand It"

A book for the man who has to do the work. Written by a practical pattern-maker of many years' experience. Gets right down to business in the first chapter and keeps it up throughout the book. Full of kinks and actual working information. Profusely illustrated. Every one following this trade, or intending to learn it, should have a copy of this valuable book.

224 Pages, 312 Illustrations, Cloth Cover

"Ten chapters are devoted to careful instruction for the making of specific patterns. The patterns chosen are of gradually increasing difficulty and cover practically all the points that come up in ordinary practice. Considering especially the low price of \$1.00, this book is remarkably practical and comprehensive. It is written in a style much more readable and effective than is usual with books on this subject."

—Engineering News.

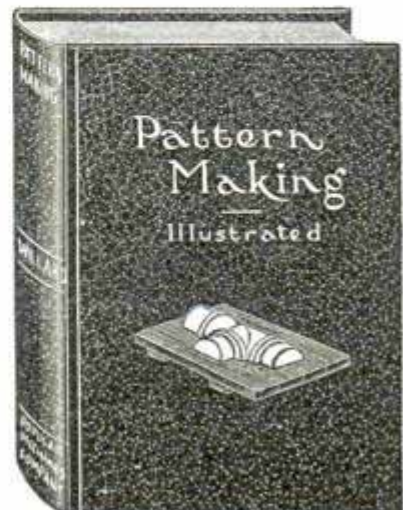

POPULAR MECHANICS BOOK DEPT., PUBLISHERS, CHICAGO

Cucumbers vs. Corporations

By

FRANKLIN O. KING

The Tendency of the Times is More and More toward Centralization. Vast aggregations of Great Wealth have fastened their Tentacles on most of the Natural Resources of our Country, and the chances of the Wage-Earner seem to grow Less each Year. By the "Wage-Earner" I mean the Man who Toils by Hand or Brain at a Daily Wage or on a Monthly salary for some great Corporation, and by the same Token, my Friend, I mean YOU.

You Can not "Make a Silk Purse out of a Sow's Ear," nor "Gather Figs from Thistles." Mincing Matters will not Mend Them, and the Sooner You Open Your Eyes to Existing Conditions, the Quicker You Will Take Steps to Get Out of the Rut into which You have Fallen.

When You get Your Pay Envelope Saturday Night You Know Full well where almost Every Dollar of It is Bound to Go. After the Butcher and Baker and Candlestick-Maker and the Landlord Get Theirs, there isn't Much Left for Anybody Else. You have to Work Harder to Get a Dollar Today than ever Before and the same Dollar will Buy

Less than at any Time in our History.

Having refreshed your Memory, let me suggest a Remedy. Why Don't You Have the Courage to Pull Up Stakes and Start for a New Country? Other Men have done it, Why Not You? You Know Full Well that the Farmer is the most Independent Man in this Broad Land of Ours to-day. He is Working for Himself—Getting 100 Cents of Every Dollar he Earns. His Children are Better Clothed and Better Fed, and the State Universities and Other Educational Institutions have More Students Enrolled from Farming Communities than any other Sections of this Country. The Farmer Feeds Us All, but He Gets Well Paid for it, and Nowhere else are his Returns so Large, or his

Please Send Me Your Book, "Independence on Ten Acres."

Profits so Certain as in the Rain Belt of the Texas Gulf Coast.

These Gulf Coast Lands are Producing up to \$1,000 an Acre for Oranges, and the Growers of Strawberries and Early Vegetables Net \$300 to \$500 an Acre each Crop—and Grow Three Crops a Year in some instances. Just think of Raising Strawberries, Potatoes, Cabbage, Cucumbers, Spinach and other Vegetables in December, January, February, and March. You who have bought Them in these Months know what they Cost. Many Instances can be shown where Colonists have Paid for their Land with their First Year's Crop—and even from One Crop.

Owners of Orange and Fig Orchards in the Texas Gulf Country are becoming Wealthy on a Small Acreage. Mr. N. E. Stout sold \$6,363 worth of Satsuma Oranges from 6½ Acres last Year. His 1,500 Fig Trees brought him \$1,893.86, or more than \$1.25 per Tree. Mr. P. I. Gill made \$800 per Acre from Oranges in 1908 and \$1,000

per Acre in 1909. With both Oranges and Figs a Man can Plant Vegetables between the Rows and have a Sure Source of Income while his Trees are coming into Bearing.

We don't have to irrigate in this, the "Rain Belt" Region of Texas, and the Soil is so Rich and Deep as to Require Absolutely no Fertilizer.

Our Company is To-day offering Ten, Twenty and Forty Acre Farms, allowing You Five Years and Six Months to Pay for Your Land. It simply Means a Saving of TWENTY-FIVE CENTS A DAY to Secure Ten Acres of this Productive Land.

Should You Die, or become Totally Disabled, while Paying for Your Land, Your Family will get the Farm, without the Payment of another Penny. We will absolutely Refund Your Money, with 6% Interest, should you become Dissatisfied, according to the terms of our Guarantee.

The Transportation is Perfect, and the Climate is Healthful and Superior to that of California or Florida—Winter and Summer—owing to the Constant Gulf Breeze. Write for our FREE BOOK. Fill out the Blank Space in the First Column with your Name and Address and Mail it to the Texas Gulf Fruit Land Co., 1303 People's Gas Bldg., Chicago, Ill. Read the Book Carefully and then Use Your Own Good Judgment.

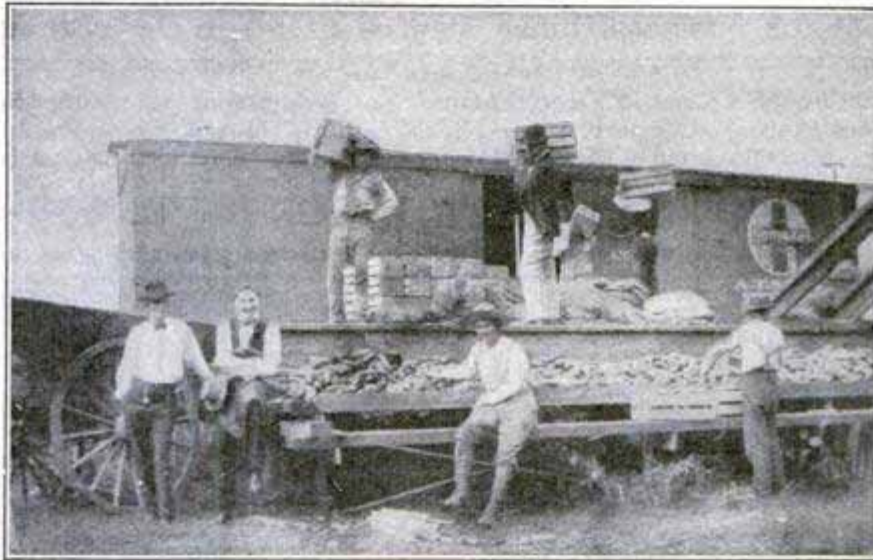

Cucumbers in Carload Lots

— NOW READY —

ELECTROPLATING

"Written So You Can Understand It." By HENRY C. REETZ

112 Pages
Fully Illustrated
Cloth Cover
Size 5 x 7 in.

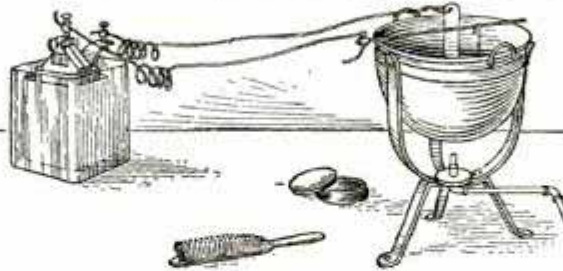

Price
25 Cents
Postpaid

One of the Latest of Popular Mechanics 25-Cent Series of Industrial Handbooks

THIS handbook gives brief and practical directions calculated to be of benefit to those already engaged, as well as to those about to engage, in the electroplating business, with no more technical detail than is necessary for practical work, and yet with such explicit directions concerning the actual operations as an old hand at the business thinks may be useful to the beginner.

CONTENTS:

Introduction—Electrical Equipment—Shop Equipment—Cleaning Goods before Plating—Copperplating—Nickelplating—Silverplating—Goldplating—Miscellaneous—First Aid to the Injured—Business Suggestions.

Order of your News-dealer, Bookseller, or

POPULAR MECHANICS BOOK DEPT., Publishers, CHICAGO

JUST PUBLISHED

Metal Work and Etching

"Written So You Can Understand It"

By JOHN D. ADAMS

96 pages
Richly illustrated
Cloth
Size 5x7 inches

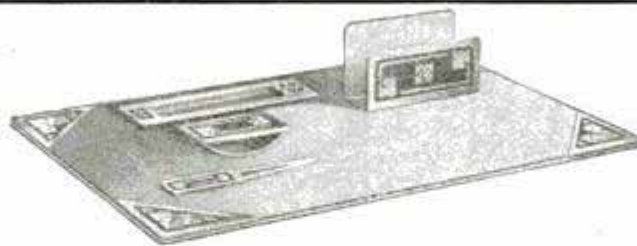

Price
25 Cents
Postpaid

One of the Latest of the Popular Mechanics 25-Cent Series of Industrial Handbooks

A complete manual for art metal workers giving every detail for making a great variety of useful and ornamental objects such as book ends, desk sets, pad corners, paper knives and letter openers, stationery racks, rocking blotter, desk calendars, match boxes, tie and pipe racks, whisk broom holders, candle sconce, arts and crafts jewelry, hinges, drawer pulls, etc.

ORDER OF YOUR NEWSDEALER, BOOKSELLER, OR

POPULAR MECHANICS BOOK DEPT., Publishers, CHICAGO



6c Invested Makes \$150

That sounds almost unbelievable. But it's *true*—a proved fact. A 6 cent pound of ordinary sugar and the wonderful

EMPIRE CANDY FLOSS MACHINE

will turn the trick and do it every eight minutes, at a fair, a race track, a circus or anywhere a crowd collects.

\$100.00 a Day is an easy profit with this wonder money-maker. And it keeps on making this enormous profit year after year with no expense for repairs. Eight years of big money-making experience have proved this your opportunity. Today is the day to get the facts. Write to Dept. C. Stevens Mfg. & Supply Co., 1223 Wabash Ave., Chicago, Ill.

Elbridge MARINE ENGINES

Most power for weight and bulk.
Greatest flexibility.
Most economical in fuel consumption.
Covered by an Unlimited guarantee.

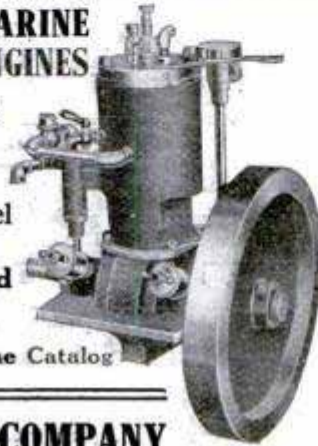

Send for Our 1911 Marine Catalog

ELBRIDGE ENGINE COMPANY

62 Culver Road ROCHESTER, N. Y.



Your Picture in a Postal Card IN ONE MINUTE

The pictures are developed, toned and finished in a single developing solution. No experience is necessary. Price of machines \$7.50 and \$15.00—circulars describing our machines sent free. We are also headquarters for supplies for all minute picture machines.

AMERICAN MINUTE PHOTO COMPANY
Dept. U, 720-728 W. 12th St., Chicago, Illinois
The largest manufacturers and distributors of minute picture machines and supplies in the world.

BOX BALL NOW GUARANTEED! PROFITS

Practically all Box Ball operators are eminently successful—so we now GUARANTEE profits! Our Profit-Guarantee-Bond positively insures you against loss of a dollar! Vast amounts are made yearly by Box Ball operators—get into the business quick! Ask us for the valuable Box Ball monopoly for YOUR community. Some other "live wire" may write tomorrow—You write today to

THE AMERICAN BOX BALL COMPANY, 363 Van Buren St., INDIANAPOLIS, IND.



Every Boy His Own Toymaker

Greatest boys' book ever written. Tells how to make a Steam Engine, Microscope, an Electric Telegraph, Telephone, Magic Lantern, Boats, kites, balloons, electrical and mechanical toys, traps, fishing tackle. 200 illustrations. Price only 10c postpaid, 3 for 25c. Western Puzzle Co., St. Paul, Minn.



1911 Speed Motor Canoe \$110 Complete

Charm of Canoeing—Speed of Motoring

—Safety of a Cruiser A high speed, perfectly safe boat of a wonderful model. Stiff—steady—safe—graceful in design—dry. Comfortable arrangement. Fully guaranteed—strongest motor canoe made. Twenty feet long—made of cedar—copper fastened—equipped with the simplest, most reliable, smoothest running 2 H. P. engine. A child can run it. Demonstrating Agents wanted everywhere. Send today for Power Canoe Bulletin 31. (82)
DETROIT BOAT CO., 46 Canton Ave., Detroit, Mich.

FOREMAN
\$1900 A YEAR

SUPERINTENDENT
\$2500 A YEAR

CONTRACTOR
\$3000 A YEAR



Learn to Fill BIGGER SHOES!

Don't be satisfied with merely pushing a saw and driving nails. Be a master of your craft. Learn to plan as well as to work—to use your brain with the same skill that you use your hands.

How You Can Do It

You can master every branch of building construction, architecture and carpentry—at almost no expense at all. You can have the knowledge and experience of over four score experts at your command, for use whenever you want it—by allowing us to place in your hands this great ten volume set, without you sending us one cent in advance.

THIS CYCLOPEDIA OF Architecture, Carpentry and Building

is the most practical work on the building trades that has ever been published. It covers every detail of building construction from common carpenter work to reinforced concrete and steel. Contains over 3,000 drawings, full page plates, diagrams, etc., 4,670 pages, bound in half morocco, printed on special paper—large clear type—10 massive volumes, titles engraved in 23 karat gold.

Partial Table of Contents

Carpentry—Building Materials—Building Superintendence—Reinforced Concrete—Contracts and Specifications—Estimating—Stair Building—Masonry—Heating—Hardware—Ventilation—Steel Construction—Elevators—Architectural Drawing—Freehand Drawing—Making Blue Prints—Wiring Door Bells—Burglar Alarms—Sheet Metal Pattern Drafting—Mechanical Drawing—Lettering.

Get These Books and See for Yourself

Look them over at your leisure. Keep them for five days before you decide whether you want them or not, and then if you don't believe that each volume is actually worth more to you than the price of the entire set, send them back, at our expense and the transaction won't cost you one penny. If you keep them, our charge will be \$24.00, in easy payments of only \$2.00 a month. We don't ask you to buy these books on our description of them. We don't ask you to trust our judgment. We simply ask you to get the books and see for yourself. Sign the coupon now. It will bring the books, not an agent.

SPECIAL—For a short time we will include with each order a year's subscription to the Technical World Magazine—a regular \$1.50 popular illustrated magazine.

AMERICAN SCHOOL OF CORRESPONDENCE CHICAGO, U. S. A.

FREE EXAMINATION COUPON



American School of Correspondence, Chicago:

Please send set Cyclopedic of Architecture, Carpentry and Building for five days' free examination, also T. W. for one year. I will send \$2.00 within five days and \$2.00 a month until I have paid \$24.00 for the books and magazine, or notify you and hold the books subject to your order. Title not to pass until fully paid. Pop. Mech. 5-11

NAME

ADDRESS

OCCUPATION

EMPLOYER

Classified Advertisements

Advertisements in this section, 10 cents per word, each insertion payable in advance. To insure ads being inserted under proper classified head in the June issue, copy must reach this office not later than May 1st.

March 18, 1911.

Popular Mechanics Magazine, Chicago, Ill.

Gentlemen: We are amazed at the pulling power of your publication. The accumulative results have exceeded any classified medium ever used by us. For over two years we have advertised in your classified columns without ceasing.

We enclose check to cover the publication of enclosed advertisement under the classification "Aeronautics" in the May issue.

Very truly yours,

THE AEROFLYER COMPANY,
Medford, Mass.

AUTOMOBILES

BARGAINS IN MITCHELL USED CARS. Taken in exchange for 1911 models. Rebuilt—Repainted—Guaranteed. Prices from \$450 up. Send for list. Mitchell Automobile Co., 2334-36-38 Michigan Ave., Chicago.

PREMIER F TOURING CAR. 4 cyl. 3 $\frac{1}{2}$ x4 $\frac{1}{4}$, has complete equipment including top, windshield, exhaust whistle, 8 day clock, etc. Brand new tires, also extra tires and Woodworth threads. Fine condition. Cost \$1,600; will sell for \$500. Oldsmobile runabout, first class condition, has leather top, good tires, etc. Will take \$125. Above machines must be sold at once. E. J. Gustafson, 1402 N. Hickory St., Joliet, Ill.

27 AUTOMOBILES to be sold at low prices. Quitting the automobile business; list for stamp. Rubel Co., Louisville, Ky.

MICHIGAN RUNABOUT, GOOD ORDER, \$75.00; Edison Phonograph, 50 records, \$25.00; \$25.00 Miami Bicycle \$10.00. Two 9 in. lamps and generator, 8.00. Formula for repairing aluminum 25c. A. R. Sisson, Marshall, Ill.

WILL TRADE—18-H. P. Robinson traction engine in A1 shape, for five-passenger automobile, model T Ford preferred. Alfred Metzger, Newport, Minn.

AUTOMOBILE INSTRUCTION. Four weeks' course covering shop and road work—provision for out-of-town men. Send for booklet P. M. West Side Y. M. C. A. Automobile School, 318 West 57th St., New York City, N. Y.

STEAM CAR OWNERS should subscribe for the Automobile Dealer & Repairer; an 80-page illustrated monthly with special "steam" department devoted exclusively to the interests of the steam propelled automobile. \$1 per year; 15 cents per copy. Charles D. Sherman, 212 Orchard Road, New Haven, Conn.

AUTOMOBILE with solid tires, less power \$75.00. Box No. 275, Burlington, Wis.

FOR SALE—METZ RUNABOUT. \$350; RUN 200 miles; Schebler carburetor. Bosch magneto, Goodrich tires. Box 136, Astoria, Ill.

FORD OWNERS. Drop us a postal for our catalogue. It will save you money. Auto Parts Co., Providence, R. I.

WAYNE, H. runabout, 20-hp., unite power plant, gas generator, 5 lamps, tires, and all A1 condition, \$1,400.00. Car for \$250.00. Geo. R. Gustafson, 627 $\frac{1}{2}$ Cass St., Joliet, Ill.

OLDSMOBILE RUNABOUT, excellent condition, leather top, good tires, \$85. Also 10-hp. air-cooled automobile or marine engine complete, \$70. W. Robb, Canal Dover, Ohio.

AUTOCAR, 4-passenger running order. Bargain, \$300. 3519 N. Grand, St. Louis.

FORD "1910" TOURING CAR, five-passenger full equipment, as good as new, first \$450 takes it. Write for full particulars. King, 2230 7th Ave., N. Y. C.

"THE HOW AND WHY of the Automobile."—A 200 page book of practical information for seekers after the fundamental facts regarding the gasoline engine and its application to the motor car. Interesting and instructive to both the beginner and the expert. Bound in full cloth—250 illustrations. Price \$1.00 postpaid. Popular Mechanics Book Dept., Chicago.

1908 MODEL Mora Roadster in good condition, has detachable tonneau, must sell, will accept best offer. O. Bannan, Flemingsburg, Ky.

KIBLINGER RUNABOUT, with top; almost new. Must be sold at once. No reasonable offer refused. F. Booth, Stanley, N. Y.

REO TOURING CAR. Fine condition. Cheap for immediate sale. H. Burlingame, Box 1435, Providence, R. I.

KNOX 5-PASSENGER TOURING CAR, top, windshield, lamps, 2 extra tires, everything O. K., \$425. Geo. Gauer, Ellis St., New Britain, Conn.

FOR SALE CHEAP. 16-inch Ofeldt Boiler, used, five-pint Ofeldt fuel Automatic. 729 West Colfax, Denver, Colo.

AUTOMOBILES—Over Four Hundred Bargains \$95.00 upward. All guaranteed. Freight prepaid. Write now for Latest Illustrated Bulletin. Motor Car Exchange, Dept. C-215, West 125th St., New York City.

GOING TO BUILD AN AUTO? Steam or gasoline? If so, send for list telling us what you need. J. L. Lucas & Son, 3 Fox St., Bridgeport, Conn.

RAMBLER—FIVE-PASSENGER touring car, excellent condition. G. Wills, Canal Dover, Ohio.

STEAM CAR Correspondence School. Particulars, 520 Fourteenth St., Denver, Colo.

STEAM AUTO BOILERS Bought, Sold and Repaired. J. L. Lucas, No. 2 Fox St., Bridgeport, Conn.

NEED SOME REPAIR. Make offer. Send for list of bargains. 275, Burlington, Wis.

AUTOMOBILE MODEL. Every part shown and named. You can to all intents and purposes take off the wheels, raise the hood and remove the body; exposing to view the vital parts. The only practical method of studying the automobile. Price 50 cents postpaid. Popular Mechanics Book Dept., Chicago.

FOR SALE—STANLEY STEAMER 1909 runabout, 10 horsepower, with removable flat rear seat; top, wind-shield, etc.; complete; guaranteed in good condition; first certified check for \$600 takes it; reason, buying touring car. Add. Box 44, Mifflinburg, Pa.

AUTOMOBILE DRIVING is great sport. Figure it out yourself from Pratt's Special Automobile Treatise. The best and latest books. Booklet C explains it. The C. H. Pratt Co., Cleveland, O.

HOLSMAN CHEAP; or trade for motorcycle. Pierce runabout, \$150. 1710 Jenny Lind St., McKeesport, Pa.

BARGAIN, \$275—2-cyl. 16-hp. shaft-drive runabout. R. J. Edwards, Shullsburg, Wis.

METZ 1910 RUNABOUT in good condition. Cheap. King, 872 No. Prairie St., Jacksonville, Ill.

40-HP. shaf drive, \$350.00. Must sell immediately. W. F. Cooper, Norwalk, Ohio.

AUTOMOBILE SUPPLIES

AUTO CASES, new fresh stock, first quality 28x3, \$10.30; tube, \$2.40. 30x3, \$11.30; tube, \$2.65. 30x3 $\frac{1}{2}$, \$15.45; tube, \$3.25. 32x3 $\frac{1}{2}$, \$16.70; tube, \$3.50. 32x4, \$21.45; tube, \$4.60. 34x4, \$23.10; tube, \$4.80. Clincher or Dundap. For other sizes, send for price list. Send 10% with order; examination allowed. W. Vanderpool, Springfield, O. Largest tire dealer in the Central States.

QUICK SALE—4-hp. motorcycle engine and all accessories, \$35. Set automobile axles, wheels, sliding gear transmission and steering gear, \$40. C. W. Morrison, 87 Seward Ave., Bradford, Pa.

BOILERS, engines and other steam car parts. Send for bargain sheet. E. C. Walker Mfg. Co., Louisville, Ky.

ELIMINATE YOUR TIRE EXPENSE 100%. Kit will permanently repair inner tire any place in minute. Any body can operate it. Send for Booklet today. Oblinger, Dept. M, Albia, Nebr.

AUTOMOBILE OWNERS, Chauffeurs, get our book on tires. Information worth Dollars. Send 25c for copy. American Advertising Syndicate, St. James, Minn.

A SUPERIOR POLISH can be made at home, polishes all metal, absolutely harmless, sample 10c, formula 50c silver. Johnson, 720 Filbert St., Pittsburgh, Pa.

FOR SALE CHEAP—Brand new 4-cyl. 20-hp. auto engine; 2-cyl. 8-hp. marine engine. F. E. Alford, Goshen, Ind.

FOR SALE—Fourteen horsepower double opposed water cooled automobile motor, fine condition., \$35. F. M. McGrew, 509 So. Van Buren St., Auburn, Ind.

FOR SALE—20-hp. Compound White Steam Auto Engine with flash generator and all fittings. W. W. Macfarren, 341 Sixth Ave., Pittsburg, Pa.

FOR SALE—12-hp. ENGINE (Auto) high wheeled running gear with body. Schaefer, 922 24th Street, Milwaukee, Wis.

FORD ENGINE and radiator repairing by experts. Angler's, Streator, Ill.

\$15 RUNNING gear for light machine—cheap. A. L. Kolpien, 763 Park Ave., Dunkirk, N. Y.

FOR SALE—Parts for Stanley and Loco. steamers. A. V. Monroe, Taunton, Mass.

FOR SALE—Running gear complete, 6 horse auto engine. Set Midgley wheels 28x3. Wire wheels 28. Circulating pumps, sprockets, auto car steering gear. Auto car body with top. Also other parts. Anvil 150. State your wants. Chamberlain, Bartley, N. J.

STEAM AUTOMOBILE ENGINES, BOILERS; parts of Prescotts, Locomobiles, Mobiles, Stantons, or other steamers; for sale at reasonable prices. Send for list. State wants. E. L. Marshall, 34 Vernon Ave., Lake View, N. J.

3 $\frac{1}{2}$ x4 FOUR CYLINDER air cooled motor \$80.00. New 4-cylinder coil \$15.00. Butts, Oxford, New York.

POPE, 10-H. P. auto engine, Schebler carburetor, coil, etc., \$40.00. Zoller Bros., Muncie, Ind.

TWO SEATED upholstered auto body, \$21.00. Four-cyl. radiator, \$14.00. New planetary transmission, \$18.00; acetylene lamps and generator, \$11.00. Camp, 791 Superior St., Milwaukee, Wis.

MOTORCYCLES

LARGE ILLUSTRATED CATALOGUE of ninety motorcycles and supplies for three cent stamps. You will save money and get a good motorcycle when you buy one of our guaranteed machines. Rubel Co., Louisville, Ky.

TANDEM ATTACHMENTS for loop frame Indians, cheap. Write for particulars. Also discount sheet of Motorcycle sundries. Mitchell Plumbing Co., Springfield, Ohio.

WANTED—SECONDHAND MOTORCYCLES and bicycles in exchange for 1911 Harley-Davidson, Excelsior, Emblem, Servens, Ashtabula, Ohio.

KELLER'S LATEST BOOKLET. "Construction, Management & Care of Motorcycles," most complete instruction book on motorcycles ever published. Sent postpaid for 25 stamps or silver. Keller & Risque Motor Co., St. Paul, Minn.

MOTOR CYCLES—Enormous variety of American and Imported makes—Indians, Marsh's, \$35.00. Hundreds of other bargains. Shipped freight prepaid. Write now. Large illustrated bulletin free. Motorcycle Exchange, 215 West 125th St., New York City.

ACCOUNT OVER STOCK, we now offer until sold new Dow Coils for single cylinder, \$3.50; double, \$4.00. Hundreds of other bargains in our catalogue. Write to-day. Motorcycle Equipment Co., Hammondsport, N. Y.

WANTED—Motorcycles of any make. Several Wagners wanted. Give description and lowest price for yours. Shaw Mfg. Co., Dept. 28, Galesburg, Kans.

3½ CURTISS MOTORCYCLE (demonstrator) in excellent condition, \$150. Ernst Swensen, Valders, Wis.

NEW 1910 CURTISS Motorcycle engine, 4-hp., \$30. Carl Truckenbrod, West Brooklyn, Ill.

DON'T BUY A BICYCLE Motor Attachment until you get our catalog and prices. Shaw Mfg. Co., Dept. 27, Galesburg, Kans.

INDIAN OR YALE ENGINE. 2½-hp. Complete. Perfect condition, \$35. A bargain. All motorcycle parts at price cutting rates. Kolbe, Moran & Co., Ann Arbor, Mich.

PIERCE FOUR CYLINDER MOTORCYCLES scarcely used and in first class condition; for sale at very low prices. Wm. B. Colburn, 18 Hanover St., Buffalo, N. Y.

FOR SALE—R. S. twin, excellent condition, \$135.00; B. & C. two speed, \$15.00; new side car, \$48.00; cost \$100.00. Glen D. Smith, St. Joseph, Mo., care Brown Transfer.

NEW 4½-hp. Motorcycle Bosch Magneto, \$210. Walter Cahill, Akron, Ohio.

CASH for used motorcycles. Rubel Co., Louisville, Ky.

2½ MINNEAPOLIS, direct drive, run 1,600 miles, \$100. E. Thompson, Casselton, N. D.

INDIAN MOTORCYCLE cheap for cash. Borden, Campbell, N. Y.

INDIAN TWIN MOTORCYCLE, cheap. Jonathan Laubach, Fairmount Springs, Pa.

1910 INDIAN, 2½-hp. motorcycle, \$130. George Buss, New Philadelphia, Ohio.

1910 R. S. BELT DRIVE, in fine condition, \$165.00. A bargain. G. Stangel, Peru, Ill.

MOTORCYCLES \$35 UP. All makes. Send today for bargain list. Shaw Mfg. Co., Dept. 30, Galesburg, Kansas.

60 SECOND HAND MOTORCYCLES, 3 tricycles, all bargains. Model Motorcycle Garage, 318-20 W. 48th St., New York.

PIERCE four, two speed, same as new, owner sick, first order \$240. C. M. Goetzman, 198 Vermont St., Buffalo, N. Y.

INDIAN—1907 model 3-hp. chain drive. New tires. \$65.00. N. R. Long, Harrisburg, Pa.

FOR SALE, Curtiss Motorcycle, 3½-hp. \$80. Karl Kolbe, 1245 Market St., McKeesport, Pa.

AERONAUTICS

EVERY BUILDER OF ANY TYPE flying machine should have our catalogue showing everything needed to build aeroplanes, including complete machines, motors, propellers, etc. We also manufacture the Gray Eagle Biplanes that you can use for exhibition without infringement. Send 10 cents in stamps for new large illustrated catalogue. Rubel Co., Louisville, Ky.

TWO FT. AEROPLANE MODELS—Send us \$1 and you will receive postpaid model of any of the following aeroplanes, Bleriot, Curtiss, Wright, Antoinette, Santos-Dumont, Farman. All parts furnished. Plans and instructions with each model. Blueprints for building all of above aeroplanes, \$2 postpaid. National Aero Co., Dept. B, 385 East 4th St., New York City.

MONOPLANE; plans and description, 25c; large model, anyone can make it; or complete knock down biplane, including propeller, parts all cut to size, \$1.00; Model Aeroplane Company, 714 Grasse Bldg., Los Angeles, Cal.

LEARN AVIATION by taking up a Correspondence Course in The American School of Aviation. A thorough grounding in the principles of Aeronautics without troublesome formulae and calculations. Especially suited for the mechanic. Send for particulars to M. K. Kasnar, Secretary, 1932 North Ave., Chicago.

AERO TOY MFG. CO., P. O. Box 290, Washington, D. C. Airship samples complete, prepaid, 50c and \$1. This is for boys and girls who have "High aspirations." Agents wanted everywhere. Sends on demonstration. Full instructions on each carton.

CURTISS, WRIGHT, BLERIOT, OR SANTOS-DUMONT Blueprint drawings with complete directions for building any one of the above Aeroplane Models, 25 cents postpaid, or a complete model of any mentioned type ready for assembling, sent postpaid for \$2.00. International Aeroplane Co., B 628 World Building, N. Y.

SPECIAL OFFER TO AMATEURS. Man-carrying glider, can be equipped with power. To any amateur club or person interested, \$50.00. Send for particulars. Amateur Aero Promoters, 253 Benjamin T. Grand Rapids, Mich.

GRAY EAGLE 4 CYLINDER AERONAUTICAL MOTOR, will fly Curtiss biplane, Bleriot or Demoiselle Monoplane and cost but \$485.00. It develops thirty-five horse power, is equipped with Bosch Magneto, carburetor, oiler and plugs, fully guaranteed for one year. Gives 210 to 250 pounds thrust. Circular for stamp. Rubel Co., Louisville, Ky.

DETROIT-AERO 1911 Complete power plant, 7-ft. propeller, carburetor, battery ignition. Price, \$350; catalogue free. Guarantee; 200 lbs. minimum standing thrust, 149 lbs. maximum weight; 36 hours delivery. Detroit Aeroplane Co., Detroit, Mich.

AERO SUPPLIES; plain and formed wood; aeroplane and balloon cloth; propellers, motors, books and drawings. Machine built to specifications. First aero supply house in America. Largest stock, lowest prices. Large catalogue 10c. Aeronautic Supply Co., 3932 Olive St., St. Louis.

AEROPLANE MODELS, guaranteed to fly, 25 improved styles, 50c to \$7.50. Antoinette model, flying 150 feet, only \$1 prepaid. Send 2c stamps for new and complete catalogue just out. Aeroflyer Co., Medford, Mass.

WOODEN, MODEL, AEROPLANE PROPELLERS, perfect and light, 8 in. 35c. Each additional inch 8c. Postage, 5c. O. W. Schmidt, 915 Kent Ave., Brooklyn, N. Y.

PERFECT MODEL WOODEN Propellers, 8 in., 50c, additional inches, 10c. Postpaid. Shortt-Canniff Co., Marlboro, N. Y.

BLERIOT MONOPLANE. Aluminum Bambo construction. Guaranteed 30' fier, 25c. Roberts, 344 Cumberland, Brooklyn, N. Y.

MODEL AEROPLANE SUPPLIES. Send stamp for catalogue. McCutchen Aero Company, 2043 W. Tioga St., Philadelphia, Pa.

MODEL AEROPLANES HOW TO MAKE AND FLY THEM. By W. Twining. Consisting of 5 sheets of scaled drawings, showing three different models, with descriptive booklet. By mail 55c. Popular Mechanics Book Dept., Chicago.

EVERYTHING FOR AIRCRAFT. Heath Aerial Vehicle Co., 3403 Southport, Chicago. Send 6 stamps for catalogue.

"VEHICLES OF THE AIR," the newest and only up-to-date contribution to the literature of aeronautics, contains large working plans of all successful modern flying machines. This book of 500 pages, 140 half-tone photographs and 130 drawings is the only book published containing every known fact of this interesting subject. Size, 9x5½ inches. Price \$2.50 net, postage 25 cents extra. Popular Mechanics Book Dept., Chicago.

WORKING DRAWINGS OF THE "DEMOISELLE," Santos-Dumont's remarkable monoplane, offered to the public for the first time. The set comprises seven large blue prints, showing every detail of construction, accompanied by a description of how to build. The machine is unencumbered by patent rights, the famous aviator placing his invention at the disposal of the world. Price \$2.00 postpaid. Popular Mechanics Book Dept., Chicago.

BALL-BEARING PROPELLER SHAFTS 50c. Complete material with drawings and instructions for 3-foot improved Flying Bleriot Monoplane \$3.00. Prepaid. Everything for model making. Stamp brings list. Ideal Aeroplane & Supply Co., 1200 Bedford Ave., Brooklyn, N. Y.

AVIATORS, AEROPLANE BUILDERS! The Directory tells where to obtain aeroplanes, motors, supplies. Aviatric concerns listed free. Sample copy, 50c. Aviation Directory, Lawrence, Kansas.

WORKING DRAWINGS AND DESCRIPTION of Santos-Dumont's monoplane or Wright's biplane. Fifteen cents each, both for twenty-five. Hibline, 708 W. Lafayette, Baltimore, Maryland.

FULL SET CURTISS RIBS, spars and struts, \$60.00. Ten days delivery. E. M. Mincet Aero Co., 1122 West Locust St., Davenport, Iowa.

30-H. P. OPPOSED AERO POWER plant with carburetor, magneto and propeller; cost \$400. Goes for half. Has flown. Photo for 2 stamps. 3403 Southport, Chicago.

PROPELLER, 6, 7 and 8 foot, high class laminated, new, used experiment only. High thrust. Reasonable. Rehbein, 281 Avenue E., Bayonne, N. J.

MAKE A REAL FLYING MACHINE of your bicycle for \$10.00. Great sport. Blueprints sent for 25c. Leitner Co., 832 N. Paulina St., Chicago.

SCIENTIFIC TAILLESS KITE OUTFIT 20c postpaid. Percy Ewing, Decatur, Ill.

CAMERAS, PHOTO SUPPLIES, ETC.

KODAK FILMS DEVELOPED, 10c per roll, any size. Prompt attention given mail orders. Prints 2¼ x 3¼ to 3¼ x 4¼, 3c; 4 x 5 to 3¼ x 5½, 4c. J. M. Manning, 1062 Third Ave., New York City.

PHOTOGRAPHERS: For 50 cents we will send you in powder form, chemicals, to make 32 ounces of developer, for plates, films and gaslight papers, also 32 ounces of acid hypo fixing bath. Miller and Howard, 16 South Main, Adrian, Mich.

FILMS DEVELOPED, 10c per roll. All sizes. Prints: 2¼ x 3¼, 3c; 2½ x 4¼, 3½ x 3½, 3¼ x 4¼, 4c; 3¼ x 5½ and 4x5, 5c. On postcards, 5c. Prompt returns. Highest grade work. Send 2 negatives and will print free as sample. G. R. Hoke, 6205 Jefferson Ave., Chicago.

SEND US YOUR Kodak work, 1st class material, expert work, right prices. Price list and sample for stamp. Tutthill Studio, Middletown, N. Y.

EXPOSE CORRECTLY—The Columbia Exposure Meter shows correct time, for any plate or film under all conditions, 15c. C. Dum, 74 Guilford Ave., Columbus, O.

ENLARGEMENTS, EXPERT WORK! From any good film neg. 6, 5x7, 3, 8x10, 4, 6½x8½, 2, 10x12, 1, 11x14. Prepaid for one dollar. Sent anywhere. J. Griffiths, 926 Main St., Brockton, Mass.

BETTER GET OUR CATALOG—FREE—Cameras, Supplies, Enlarging, Developing. Valuable Exposure Meter included, 10c. Rex Bromide Co., A. Lincoln Park Station, Chicago.

66 2-3% DISCOUNT. The \$1 popular book entitled, "The Selection of a Photographic Outfit," sacrificed at 33c; 10c extra for mailing. Order now before supply is exhausted. Willoughby, 814 Broadway, New York City.

FOR SALE CHEAP, 6 in. lenses. Ed. Flamme, St. Hilaire, Minn.

\$100 CAMERA, \$30.00. 3519 N. Grand, St. Louis.

BOOKS AND PERIODICALS

CHAUFFEURS BLUE BOOK (\$1.00 value) questions and answers for license. How to run an automobile. Over 40 illustrations, timing and wiring diagrams, etc. Carburetor and engine trouble fully explained, postpaid 50c. License guaranteed. Agents wanted. Chas. Milwerd, 1546 N. 60th St., Phila., Pa.

BOOKS LOANED FREE—BY MAIL—on many subjects; others rented and sold. Occultism, success, business, health, new thought, etc. For conditions, lists, Weekly Bulletin, full information and impartial advice, address Librarian Oriental Esoteric Society, 119, Washington, D. C.

3,000 FORMULAS, RECIPES and money-making secrets, 368 page cloth bound volume, 25c prepaid. Books on Modern Subjects, Trades, etc. Catalogue free. Clarence Hardage, Syracuse, N. Y.

THE PICTURE AND ART TRADE is a magazine devoted to the picture business. Subscription \$1.00 a year. Send 15 cents for sample copy. 528 Monadnock Block, Chicago.

"METAL SPINNING" is the name of the only book published on this interesting art. A concise working manual both for those who desire to spin metal as an art recreation and to follow this work as a trade. 80 pages, 33 illustrations. Price, 25 cents postpaid. Popular Mechanics Book Dept., Chicago.

THE THEORETICAL AND PRACTICAL Boiler Maker, 310 pages; 65 illustrations. By Samuel Nichols. Price \$2.50. Special offer \$1.50 postpaid. Circular free. J. S. Ogilvie Publishing Co., 577 Rose St., New York. Agents wanted.

YACHT AND BOAT BUILDING BOOKS, ship pictures, etc. Send for 80-page illustrated catalogue. The Rudder Publishing Co., 3 Hudson St., New York City.

WONDERFUL BOOK ON HYPNOTISM, Personal Magnetism, and other Occult sciences sent free to anyone. Send your address today. M. D. Betts, Sta. 65, Jackson, Mich.

BOOKS: any kind you want; catalogue free. Reese Publishing House, Mt. Pleasant, Pa.

BEFORE BUYING BOOKS ELSEWHERE get our list. Any book in print. State subject wanted. Antlers, 322 Royal St., New Orleans, La.

ENGINEERS' questions and answers for license, by Hobson, for twenty-five cents, postpaid. Send stamps. Reilly's Book Store, Philadelphia, Pa.

GAS FOR POWER is taking the place of steam for reasons of economy. Learn all about this great change by reading our new non-technical book on this subject, written by a first class authority for the practical man. 192 pages, profusely illustrated, cloth binding. Price \$1.00 postpaid. Popular Mechanics Book Dept., Chicago.

"CAN THE SCIENTISTS BE MISTAKEN?" Astounding theories: The only ultimate energy is motion (momentum); mv, the only true measure; inertia, only ultimate force. Matter does not "hold" together, or act outward through space, per se. Phenomena due to balanced, or counterbalanced aether atom motion. Only one element, aether. Earth carried by vortex motion of aether. Gravity, a "push" down. Pamphlet, ten cents. C. C. Gates, Tuscola, Ill.

BRIGHT BOOKS. Catalogue for stamp. Paul Duff, P-2713 Mozart St., Chicago.

"KEEN KNOWLEDGE," Annual subscription 25c. Palmland, Floral Park, N. Y.

BACK NUMBERS ALL MAGAZINES sold at publication prices. Some bought. Drawer Ninety, Lebanon, N. Y.

YOUR LATENT FORCES: How to use them, 120 pages 25c. Personal Magnetism, 146 pages of valuable advice, insuring success in life, 30c. Catalogues free. August Martens, Popular Publisher 51, Burlington, Iowa.

I. C. S. textbooks bought. Geo. F. Williams, Box 498, New Orleans, La.

PERSONAL MAGNETISM WINS. 120 page book 25c. Larger one, 148 pages, 30c. "How to Win Success in All Things," 352 pages, \$2.00. Everything mentioned for \$2.35. "Hypnotic Wonders" and Catalogue free. Popular Institute, 55 Randolph, Chicago.

WANTED

WANTED—New high grade useful specialties to put out through agents, or the trade. R. P. Chinn & Co., Manufacturers Agents, 1206-15th St., Denver, Colorado.

WANT TO BUY good second hand Encyclopedia. Theo. P. Bonner, Jr., General Delivery, Roanoke, Va.

WANTED—Second hand Fortuna Skiving Machine—two-inch skive. Frigid Fluid Company, Chicago, Ill.

WANTED—Set tinner's tools. H. Rohweder, 1553 Fifteenth Ave., Moline, Ill.

MOVING PICTURE MACHINES wanted. Fred L. Smith, Amsterdam, New York.

WANTED—A four cylinder auto engine, 30 or 40-hp, friction drive, and double chain transmission. Will exchange a 4-hp, horizontal gasoline engine in good order for it. M. J. Kelley, Olanta, Pa.

SALE OR EXCHANGE

WILL SELL OR EXCHANGE. Empire candy floss machine for motorcycle, gasoline engine or what? Cost \$165. Used one day. Arthur Dunn, Vanderbilt, Pa.

A VALUABLE MOUNTED GAME HEAD and horn collection for late model auto, any standard make. R. H. Chaney, Willow City, Texas.

FOR SALE OR TRADE, railway mail clerk course, complete, 10th Dist. Robt. Jensen, Howard, S. D.

CAMERA—EIGHT BY TEN—View-Portrait outfit. Bargain for cash. Might take No. 10 Remington Typewriter. Meacham, Acton, Ind.

EDUCATIONAL AND INSTRUCTION

WITHOUT KNOWING SHORTHAND you can write 100 words a minute and increase your income—treble your dispatch of business—save your time. Let me explain to you fully how with my new method, Abbreviated Longhand, any longhand writer can easily become the equal of the average professional stenographer—in a few short evenings—at merely nominal cost. Sample Lesson 20c, and full particulars free. Write to-day. A. B. Weaver, Court Reporter, Dept. C, Buffalo, N. Y.

LEARN AT HOME, in a few evenings, how to construct, operate and repair automobiles, commercial trucks, flying machines, motorcycles, motor boats, gasoline engines, electric motors. Big demand, with good pay for competent men. Thousands of positions open. Let us help you in place and pay. A postal card will do. Address, Extension Department, The Charles C. Thompson Co., 549 Wabash Avenue, Chicago.

\$200 TO \$600 MONTHLY easily made fitting eyeglasses. Short, easy mail course. Diploma. Special reduced tuition fee. Big demand for opticians. Best and easiest money-making business. Quick sales. Tremendous profits. We assist you to start. Write today for free "Booklet 4." Tells how. National Optical College, St. Louis, Mo.

STUDY MATHEMATICS AND MECHANICS by private correspondence. Obtain a college education in these subjects at home, at small expense. A rare opportunity. Write for booklet. The Jeffery School of Mathematics, Huron, Ohio.

INTERESTED IN AN ELECTRICAL COURSE? Save \$25.00, by buying my International Corr. Schools electrical engineering scholarship. Harry Wechsler, 2556 E. 37th St., Cleveland, Ohio.

LEARN PIANO OR ORGAN PLAYING by the "Simplex Easy Method." Write for Free Book and testimonials. Simplex School, 704 Curtiss Bldg., Kansas City, Mo.

MAKE YOURSELF WORTH MORE MONEY. Complete course in Touch Typewriting; 33 lessons, \$15, \$5 a month. Bound lessons free at finish. Piscataqua School of Touch Typewriting, 29 Tanner St., Portsmouth, N. H.

SHORTHAND TYPEWRITER saves learning stenography; high speed quickly acquired. Boxmakers' National Convention reported on Anderson Shorthand Typewriter, 5714 Cedar Ave., Philadelphia, Pa.

COURSE IN LOGARITHMS and Trigonometry. I teach what you need, no more no less. Capt. C. Nielsen, Willits, Cal., E. Box 448.

BEST SHORTHAND BOOK for home study. Thousands of successful stenographers learned from it; so can you! Pitman system complete, cloth bound, handy size, finest engraving; specially arranged for self-instruction. Price \$1. Every book contains coupon entitling the purchaser to receive one month's practical instructions by mail. Lessons given by the author, Eldon Moran, our best known American Shorthand Instructor. Students are introduced and correspond with each other. The time to begin is now. Young pupils succeed well. Book well worth \$1; besides, mail lessons worth \$2 will be received without extra cost. Book and lessons sent immediately upon receipt of order. Address Popular Mechanics Book Dept., Chicago.

ELECTROPLATING. Learn this useful occupation from our 112-page treatise. It is "written so you can understand it" and will enable the humblest beginner to make a start. Price, 25c postpaid. Popular Mechanics Book Dept., Chicago.

EDUCATION? Learn typewriting. See what I say under "Typewriters." Atchison.

THE COLLETTE SCHOOL, teaches jeweler's engraving by mail. Pleasant—refined—Independent profession easily learned at home. Pays \$50.00 weekly. Our students earn money while learning and are in great demand. Write for particulars. The Collette School of Engraving, 37-39 Maiden Lane, New York.

LEARN MECHANICAL DRAFTING in your spare time. Constant demand; big pay; short hours for competent men. Individual instructions by mail. Draftsman, Box 122, Allentown, Pa.

AMERICA'S FINEST PENMAN can make you a good writer at home. Circular free. Elaborately written card for stamp. Francis B. Courtney, Cedar Rapids, Iowa.

TEN ORE SPECIMENS—Gold, silver, copper, iron, lead, zinc, tin, nickel, graphite, sulphur. Also mineral booklet, 25c. McLaughlin, Sharpsville, Pa.

LEARN TO CARVE beautiful flowers, etc., on cardboard. A money-making home employment. Information free. A. W. Dakin, Syracuse, N. Y.

BOOKS—TECHNICAL, CORRESPONDENCE SETS, encyclopedias, agricultural, mechanical, general. Get my prices. Geo. F. Williams, Box 498, New Orleans, La.

DUPLICATORS AND DUPLICATING DEVICES

How to get a Hektograph that will make 150 copies in 10 minutes; letter size, \$2.00. Write for circular. Heyer Duplicate Co., 118 No. La Salle St., Chicago.

COLLECTIONS

ACCOUNTS COLLECTED ANYWHERE. Fidelity Credit Co., Richmond, Va. Collections. Law.

DIAMONDS, WATCHES AND JEWELRY

AGENTS WANTED to wear and sell our watches. Gold-filled Walthams as low as \$3.50. Don't buy until you have seen ours. Free lapel chain to agents. The Heeley Company, Wholesalers, North Attleboro, Mass.

"THE POPULAR" DOLLAR WATCH—The good kind. Send for descriptive circular. Popular Jewelry Co., 1235 Michigan Ave., Chicago.

SPORTING GOODS

FISHERMAN'S GAFF HOOK; closes and opens like telescope. $8\frac{1}{2}$ inches long, closed. $3\frac{1}{2}$ feet, open. Hook when closed folds up and point sets in handle. Price, \$1.75. Wulff Mfg. Co., Minneapolis, Minn.

PICTURES AND POSTCARDS

MODEL OF PANAMA CANAL in relief, \$1. Greenback or M. O., payable Cristobal, Canal Zone. Panama Souvenir Co., box 165, Colon, R. P.

DECORATE YOUR "DEN" with "Art Gems." Three bewitching poses 25c. 6 for 50c. One $6\frac{1}{2} \times 8\frac{1}{2}$ photograph free with every order for six. All real photographs. Money back if not pleased. Art Photo Co., 1495 P. M., Grand Rapids, Mich.

JOIN THE CURTIS CORRESPONDENCE CLUB and receive postcards from members everywhere. Largest in existence. Membership 10c. C. C. Club, 47, Kansas City, Mo.

100 BEAUTIFUL NOVELTY POST CARD Views. Your name in big mail and post card club and a bundle of mail postpaid for 10c. Coeur d'Alene Supply Co., Box 1641, Spokane, Wash.

GENUINE PHOTOGRAPHS TAKEN IN FRANCE, Italy and Germany. \$1.00 per set of ten. Ten cents will bring you two sample copies and list of subjects. S. Diamond, 416 6th Ave., N. Y.

PICTURE STORE AND FRAME SHOP. A book full of hints, suggestions, and recipes relating to pictures and framing. Paper cover, \$1.25. J. S. Ford, 528 Monadnock Block, Chicago.

JOIN OUR POSTAL CORRESPONDENCE CLUB. Send 10c silver for list of members. Some foreign names. B. Barret, Box 266, Kansas City, Mo.

100 POST CARDS FREE. Highest quality Decoration Day, Nursery Rhymes series, Birthdays, etc. New designs only. Sample package and plan, 6c. Gallatins, York, Pa.

YOU'LL GET CARDS from everywhere. Membership 10c. Idaho Card Exchange, Dept. K, Box 906, Boise, Idaho.

"FRENCH BEAUTIES." Send 25c coin for 3 genuine photos. A. C. Warren, Box 291, Detroit, Mich.

EXCHANGE POSTCARDS through the "Berkshire Hills." Membership 10c. Berkshire Hills Postcard Exchange, P. O. Box 1494, Pittsfield, Mass.

JUMPING RING CARDS. Amuse everybody. 5 for 10c. F. Rempe, 1917 Myrtle St., Oakland, Calif.

POSTCARDS, wholesale, 90c—1,000 up. Catalog and 20 assorted, 10c postpaid. Vern Co., 66 Decatur St., Brooklyn, New York.

50 SAMPLES HIGH GRADE Post Cards, assorted, good subjects. All pretty. No comics, 25c. Hanna Mfg. Co., Campbell Hill, Ill.

"STAGE BEAUTY" POSES. Send 2c stamp for complete illustrations and free offer. Gordon Art Co., Dept. P, New York City.

100 POSTCARDS FREE! Samples, catalog, plan, 4c. Alvin Card Co., Mount Pleasant, Pa.

IF YOU REALLY WANT to exchange post cards, try our splendid club. Lists circulate in many countries. Membership, 10c. Halcyn Club, Box 133, Erie, Pa.

10 ELEGANT Rare Virginia Views, all different, 10c; 30, 25c. Good's Printery, Harrisonburg, Pa.

TWENTY POST CARDS, any photo, \$1. H. Jones, Marathon, Ia.

PORCELAIN MINIATURES copied from any picture Sepia Tone for \$1. Tinted in water color, \$2. High grade copying and engraving. Jeffres, 6 Lafayette Ave., Baltimore, Md.

REAL PHOTOS pretty girls, latest hits; art gems, 6 for 25c; larger and better ones, 15c each, 5 for 50c. "Personal Magnetism," 25c; "How to Hypnotize," over 200 pages, \$2. Curtis Co., 148 West 73rd St., Chicago.

TRADE SCHOOLS

AUTO TIRE REPAIRING. Learned in three to six weeks. A situation assured. An opportunity to get into a business of your own. Instruction in our factory shop. Very low tuition. Haywood Tire & Equipment Co., 530 N. Capitol Ave., Indianapolis, Indiana.

LEARN PLUMBING, EARN \$5.00 A DAY. We qualify you in four to six months by actual experience on new buildings, which feature of instruction cannot be obtained in other schools in the country. Tools furnished free. Tuition reduced. For particulars address Master Plumbers Trade School, 3657 Finney Ave., St. Louis, Mo.

A COMPLETE COURSE in Practical Automobile Engineering, under experienced instructors, with all modern equipment and appliances. Our four-story building offers special accommodation to out-of-town students. Call or write for our liberal proposition on Resident or Home Courses. Automobile School of Chicago, 1339 Michigan Ave., Dept. P, M.

WANTED—Men by large Contracting Co. \$20,000.00 contract work going. Can learn automobiles, electricity, plumbing, brick-laying trade in few months. No apprentices or helpers work and no expense. Catalogue free. United Trade School Contracting Co., Los Angeles.

AUTOMOBILE SCHOOL. You learn with your hands under the superintendence of the best instructors obtainable at the Chicago School of Motoring. Write for particulars. F. E. Edwards, Inst., Dept. "B," 1619 Michigan Ave., Chicago, Ill.

PLUMBING, ELECTRICITY, BRICKLAYING or Mechanical Drafting, taught by expert workmen. Short time and small cost. Positions always open. Catalogue free. Write today. Coyne National Trade Schools, 80 E. Illinois St., Chicago.

GREER COLLEGE OF MOTORING, Aeronautics, and Motor Boat Operation. 15,000 feet of floor space devoted to the Practical Teaching of Automobile Driving and Repairing. Home study courses on the above subjects. Send for our free book—"Motoring." 1457 Wabash Ave., Chicago, Ill.

GAMES AND ENTERTAINMENTS

TRICKS, MAGICAL APPARATUS AND SUPPLIES—Amateurs supplied as well as the great professionals. Easy, interesting and entertaining, amuse and astonish your friends, 4c stamps brings our four catalogues; Magical Apparatus, Latest Supplement, Marvelous Card Effects and Trick Novelties and Jokers. Send now. Read & Covert, 817C East 43d St., Chicago, Ill.

153 TRICKS, ALL KINDS joke books, how to box, recitations, puzzles, card and coin tricks, 10 and 25c. Cat. free. Stoddard Co., Box 373, Pittsburg, Pa.

LATEST JOKERS' NOVELTIES, right off the griddle; a red hot one postpaid 12 cents, with illustrations; fifty others. Genesee Specialty Co., Dept. PM, Retsof, N. Y.

PLAYS, VAUDEVILLE Sketches, Monologues, Dialogues, Speakers, Minstrel Material, Jokes, Recitations, Tableaux, Drills, Musical Pieces, Entertainments for all occasions, Make up Goods, Large Catalog free. T. S. Denison & Co., Dept. 11, Chicago.

LEARN VENTRILQUISM QUICK! I want representatives everywhere. Big money! Great fun! Success assured. Free interesting booklet tells how. Send stamp. Instructor Bailey, 771 Iglehart, St. Paul, Minn.

THE MAGIC COINER, a mystifying trick, complete for 10c. R. Armstrong, Meyran Ave., Pittsburg, Pa.

FOUR GOOD TRICKS and big catalog, 15c. Rodger Kauffman, Medicine Lodge, Kansas.

100 TRICKS, with directions, fifteen cents. Bamberg, 1193 Broadway, New York.

MAGIC-SKULL, shines in dark, 10 cents. Klein, 1193 Broadway, New York.

153 NEW TRICKS, 10c. Solaway, 584 Henry St., Brooklyn, N. Y.

150 MAGIC TRICKS, 12c. "Lycke," Omaha, Nebraska.

MAGIC, magazine of wonder, World's most fascinating periodical. Forty pages filled with sparkling pictures, conjuring tricks and magical entertaining news. \$1 a year; sample copy, 10c. F. T. Singleton, 3625 Thompson Ave., Kansas City, Mo.

LADIES' JUTE WIG, 75c; men's dress or bald wigs \$1.00, and \$2.25 grades; beard, 60c; mustache, 30c; mask, any character 25c. Genuine Linen Skull Head, \$1.00. Negro wig, 50c. All postpaid. Percy Ewing, Decatur, Illinois.

FOR SALE

KEEP COOL! for sale, 200 new 8" A. C. & D. C. bracket fans, complete with cord and attachment plug, \$6.50 each. Noiseless, for telephone booths, residences, hospitals or sick rooms. Order at once as they are going fast. Money refunded if not satisfactory. Electrical Supply & Salvage Co., 529 W. Van Buren St., Chicago.

FORTY PER CENT DISCOUNT on new disc and cylinder talking machines and records to close out stock. Make money selling your friends. Particulars free. Box 965, Ashtabula, Ohio.

FOR SALE 33 x 56 Reeves separator with parson feeder, weigher and blower. D. E. Young, Crown Point, Ind.

GARAGE BUSINESS for sale. Done \$40 business last season. Write. C. L. Olmstead, Big Timber, Mont.

FOR SALE—6 Direct Current, 110 volt ceiling fans, \$60.00. Never used. W. R. McCormick, 198 East Third St., Pittsburg, Kan.

FOR SALE a quantity of light sleigh runner steel, also some high grade bodies. For particulars write to John G. Rathel, Little Falls, N. Y.

FOR SALE: Motor cycle engine, Wireless instruments. Lewis Barrell, 38 Pear St., Zanesville, Ohio.

FOR SALE—Indian Motor cycle, 11 x 17 printing press. Twelve inch screw cutting lathe. Geo. Wills, Canal Dover, Ohio.

CORRUGATED PAPER BOXES. Bottle wrappers and Mailing Tubes. Best Box Builders, 4537 North 16th St., Philadelphia, Pa.

FOR SALE. Wheatstone Bridge, reflecting galvanometer, pocket telegraph instrument. C. J. Conner, Coatesville, Pa.

FOR SALE—Moving picture film 1c foot. H. Davis, Watertown, Wis.

"TEXTIGUM" TYPEWRITER COVERS, fine, 50c. See what I say under "Typewriters." Atchison.

REAL BARGAINS, MOTOR CYCLES, BICYCLES, marine and stationary engines, furniture, musical instruments, pianos, typewriters, sewing machines, etc. Agents wanted. Make a whole lot of money getting orders for us. Write for booklet. Atlantic Supply Co., Long Branch, N. J.

SANDWICH JUNIOR HAY PRESS, complete with gas engine or without. Nearly new. Terms. Nell, Lebanon, N. Y.

BUSINESS and property for sale at a sacrifice. Robt. Y. Mangum, P. M., Alamo, Texas.

ENGINEERS TRANSITS—levels and compasses, John Burnett, Ludlow, Ky.

BLUEPRINT, SHOWING HOW TO MAKE $1\frac{1}{4} \times 1\frac{1}{2}$ cylinder, steam engine, 25 cents. Drawings actual size. L. A. Knutsen, Box 481, Tacoma, Wash.

NEW NAMES—Prosperous farmers in east, 1,000 only \$1.00, 3,000 for \$2.25. Typewritten. Montgomery, Lebanon, N. Y.

BLACKSMITHS

BLACKSMITHS. There is a great demand for good steel workers and at big salaries. Buy Toy's Modern Methods, welding new steels solid and doing all hard jobs easy; forging and tempering all tools to a standard by colored charts. All for \$1. Send for samples free. W. M. Toy, Sidney, Ohio.

BUSINESS OPPORTUNITIES

MUSHROOMS—NEW PURE TISSUE culture summer spawn. Now is the time, plant this new spawn; produces big crop white mushrooms all summer. Four other varieties winter planting; modern plan forcing plants, mushrooms, early quick crop. Book free. Fresh sample brick, 35c postpaid. We are originators and manufacturers of pure tissue culture mushroom spawn. Order direct from laboratory. Challenge Farm, 6961 Gravois Ave., St. Louis, Mo.

BUSINESS OPPORTUNITY—\$200.00 to \$400.00 a month profit can be made by you with our machines. You are your own boss and get the monopoly. Only one in each locality. You must invest from \$100.00 to \$300.00. If you are not satisfied after month's trial, just return outfit and we send your money back. We are responsible and furnish Dun, Bradstreet and bank reference. Full plans free. Address Fred Hoke, 1644 Van Buren Street, Indianapolis, Ind.

BIG MONEY in automatic musical instruments. To close out we offer electric player pianos, pianinos, harps, less than half price. Pay for themselves in few months in public places. Box 965, Ashtabula, Ohio.

WANTED—SCHOOL BOARDS, SUPERINTENDENTS and dealers in school apparatus, to take interest in patented novelty; practical help for schools, homes, libraries. For descriptive circulars, address: C. A. Iffert, Monroe, Wis.

MAKE MIRRORS AT HOME. Big profits with little outlay. One 18x36-in. mirror costs \$2 to \$5. You can silver a glass this size for 20c. Send \$1 in stamps or money order and we will send you explicit directions how to do it; also how to emboss, grind, foil, gold leaf, frost, chip and make imitation stained glass. How to transfer photos on glass, bore holes in glass and cut skylights. George L. Patterson & Co., Dept. 3, Brooksville, Ky.

BUILD A BUSINESS of your own and escape salaried drudgery for life. Learn the Collection Business. Limitless field; little competition. Few opportunities so profitable. Send for "Pointers" today. American Collection Service, 101 State St., Detroit, Mich.

I WILL START YOU earning \$4 daily at home in spare time, silvering mirrors; no capital; send for free instructive booklet, giving plans of operation. G. F. Redmond, Dept. 306, Boston, Mass.

LEARN THE TRUTH about Mail Order Business before buying "outfits." Important information and particulars for starting free. Mail Order Library, P. M. Tompkinsville, New York City.

FREE YOURSELF FROM WAGE DRUDGERY Send 10 cents at once for 12 Valuable Ways to Start a Profitable Business of Your Own; be independent and make more money. Satisfaction guaranteed or dime refunded. "Bc. Money Back Store," Baltimore.

LIVE MEN IN EACH COMMUNITY to own and operate combined local and mail-order business; new, permanent demands, no canvassing. Profits are \$50 each week. Address: L. J. Mortenson, 1417 Chatham St., Racine, Wis.

WANTED—One man or woman in every locality to start a "candy kitchen." Best paying small business on earth! Few dollars starts you. Get away from wage slavery! Write for particulars. E. E. Nichols, 407 W. Hume, Aberdeen, Wash.

BIG MONEY—How to make paint for one cent a pound. Sell formula to painter for \$1. Formula, 25c. Howard Lindsey, Dept. P-M, Northville, N. Y.

QUIT HARD WORK and impossible propositions! Operate a "Silent Salesman" system; possibilities up to \$100 weekly. Also Mail Business, evenings, \$28 weekly. Get away from wage slavery. "Booster" starts you in business for yourself with small investment. Send 10c for two months trial. Booster Magazine, 208 N. Fifth, Chicago.

MAKE MONEY WRITING SHORT STORIES. Big pay. Free booklet. Tells how. United Press Syndicate, San Francisco.

FREE—"INVESTING FOR PROFIT" Magazine. Send me your name and I will mail you this magazine absolutely free. Before you invest a dollar anywhere, get this magazine—it is worth \$10 a copy to any man who intends to invest \$5 or more per month. Tells you how \$1,000 can grow to \$22,000. How to judge different classes of investments, the real power of your money. This magazine six months free, if you write to-day. H. L. Barber, Publisher, R 419, 20 Jackson Boulevard, Chicago.

BIG PROFITS: Open a dyeing and cleaning establishment, splendid field, excellent profits, very little capital needed. We teach a successful method by mail. Write for booklet. Ben-Vonde System, Dept. C, Staunton, Va.

MAKE MONEY, RE-INKING TYPEWRITER RIBBONS. Complete instructions and working plans, 50c. Mail Order Bureau, Box 283, Scranton, Pa.

"IT'S FREE"—Brochure of business opportunities. Start business for yourself. Be independent. Write today. Western Mfg. Co., Sterling, Ill.

MAKE \$50.00 WEEKLY in Mercantile Collection Business; capital and experience unnecessary; start during spare time and become independent; particulars free. E. W. Briggs Co., Washington, D. C.

LOOK! LOOK! You can make over 150% profit manufacturing furniture and floor polish. Send 35c to-day for formula and instructions. Percival Boosa, 312 Hearne Ave, Avondale, Cincinnati, Ohio.

EARN MORE \$\$\$; SCHEMER MAGAZINE. Alliance, O., shows how; 48 pages newest and best \$-getters every month; copy and catalogue, 800 big winners, only 10c.

TO CATHOLICS ONLY: If you have \$20 or more to invest in a safe and profitable enterprise which has banking endorsements, send for my free book. Philip Harding, Dept. C509, Box 96, Spokane, Wash.

CASH YOUR IDEAS! If patentable and practical you can sell them or start a business on them; my clients make money on their patents; send sketch for free opinion of merit and patentability; reliable dependable service. Book free. H. Sanders, 25 No. Dearborn St., Chicago.

INDEPENDENCE and fortune quickly attained in the Manufacturing Mail Order Business. I furnish formulas, manufacturing processes and trade secrets in all lines. Sold under a positive guarantee; 18 years' practical experience. Revision and improvement of formulas and processes; reduction of manufacturing cost; utilization of waste materials, etc., a specialty. Booklet, formula list and valuable information free. W. L. Cummings, Ph. D., 127 Standart St., Syracuse, N. Y.

BOYS, REAL MONEY can be made by our plan. You get the money, we do the work. Nothing to sell. Automatic Co., Box 616, Omaha, Nebr.

TERRITORIAL MANAGERS WANTED—EXTRAORDINARY OPPORTUNITY—Able business men with clean records are invited to investigate proposition whereby an investment of \$500 to \$5,000 will yield annual income of \$1,500 to \$15,000. Correspondence invited from high-grade men whose services are immediately available as investment without services will not be considered. Address: John Budge, Sales Manager, Hartford Building, Chicago.

START A NEW BUSINESS. The "American" Razor Honing and Safety Blade Sharpening Machine earns \$5 to \$10 a day. We teach you how. No previous experience required. R. Green, 171 Washington St., Chicago.

BE A HANDCUFF KING; make big money on the stage; all vaudeville circuits pay from \$50 per week up. I teach everything in this line. For particulars address, Box 992, Springfield, Mass.

MONEY MAKER—See my ad under machinery—Neil.

FORTUNES MADE MAILING CIRCULARS. Plan and 25c, sample 12c. Popular Institute, 56 Randolph, Chicago.

SELL ANYTHING. Quick results, all classes, read The Buyers' Guide. Send 5c for copy and rates. 50c a year. 219 So. Dearborn St., Chicago.

"VALUABLE TRADE SECRETS"—See Miscellaneous column. Gold mine of information.

MAILING LISTS, entirely new, residents of small towns, 50c per 100 names, \$3.00 per 1,000. F. Coughlin, Riverdale, Ave., Yonkers, N. Y.

INCREASE YOUR INCOME. Be independent. Our book contains a valuable collection of formulas, plans, schemes; how to make good money during your sparetime. Send 15—2c stamps now and turn your sparetime into cash. Albany Supply House, 4322 N. Albany Ave., Chicago.

WANTED—Up-to-date wallpaper and painting business man as partner in old established firm; some capital required. Address "Decorator," P. O. Box 176, Vancouver, B. C.

87% PARTICIPATING STOCK IN NOISELESS TYPEWRITER. Big firms using it. Anderson Shorthand Typewriter, 5714 Cedar Avenue, Philadelphia, Pa.

CASH FOR FORMULAS. Ideas, processes, information. Steady, profitable home business. Instructive booklet free. Information System, 243, Marietta, Ohio.

BAKERY, including building, nice store, fixtures, electric mixer, good oven, good retail and wholesale trade, in growing manufacturing town of 6,000; only bakery in town; best proposition between St. Louis and Memphis; good reason for selling; bargain. J. H. Fisher, 305 Main St., Blytheville, Ark.

RAISE GINSENG—\$1 per square foot of ground. \$25,000 on 1/2 A. Grows anywhere; 1/2 city lot a bonanza. 10c brings booklet. Sheboygan Ginseng Gardens, Sheboygan, Wis.

COMPLETE INSTRUCTIONS FOR RESILVERING TABLEWARE. Simple, sure, lasting method; for home or commercial use. Only fifty cents. F. P. Daniels, Minneapolis, Minn.

ONE BLACKSMITH OR MACHINIST in each town can double his income by welding cast iron, aluminum and other metals. Our system is the best and prices right, and we school you in the work. J. R. Luckey, Norwood, Cincinnati, Ohio.

INTERESTED IN OIL? The Oil Mirror—new and better oil paper than you have seen—costs nothing now for three months subscription. Please send your address immediately. Ward-McIntyre Company, 732 Higgins Building, Los Angeles, California.

HAVE YOU ANYTHING TO ADVERTISE? Our Rate Book tells you all about advertising mediums, rates, circulation, closing dates, etc. Sent for 10c. Worth dollars. Folder free. Correspondence invited. Dearborn Advertising Agency, 455 Franklin Bldg., Chicago.

FORM A CORPORATION—Congress Law for D. C. and all States; cheap. Raise money easily; advice free. U. S. Legal Corporation, Washington, D. C. Representing \$1,225,000,000.

3c A WORD places "ads" in over 100 reputed magazines. Zenith Agency, Station N, Cincinnati, Ohio.

CONDUCT A "CANDY KITCHEN." Clear \$20 daily. Small capital required. Send for particulars. Kennon & Co., 148 West Ontario St., Dept. A, Chicago.

I MADE \$50,000 in five years with a small mail order business; began with \$5. Send for free booklet. Tells how. Heacock, Lockport, N. Y.

1911 MAILING LISTS—Any trade or profession in Philadelphia. During April, \$2.00. P. S. Co., 1108 Arch St., Phila., Pa.

FOR RENT—BRICK FACTORY building in Sterling, Ill., fine location. Joseph Wright, Sterling, Ill. Room 5 H. & W. Bldg.

I HAVE AN ARTICLE to manufacture at home that beats them all. Particulars free. P. Benson, Stewartville, Minn.

YOU CAN MAKE PRINTING CUTS—Any size, for 2c each! Explicit, complete instructions, 25c, prepaid. "Gearhart," Box 12, Fresno, California.

TURN YOUR SPARE TIME into money with our live, up-to-the-minute mail order plan; \$5 capital will start. Circulars with your imprint furnished. Profitable for man or woman. Particulars free. Stark Co., Whiting, Ind.

POSITIVELY BEST RIBBONS, three, \$1.10. See what I say under "Typewriters." Atchison.

AGENTS WANTED

WEAR A STYLISH SUIT! Clothes Make the Man! The man who is admired is the well dressed man whose clothes are fashionable and are 1911 styles. You will be that man in your neighborhood! 1911 styles are just in. Get this suit—the swellest, classiest, snappiest style we ever created—and better your appearance! This is our idea: We want one man as our representative in your neighborhood. You've got a lot of friends. They wear clothes. It is the easiest thing in the world to get them to order their clothes from you. Prices, \$7.50 and up. Those orders mean a big business that more than doubles your salary, and the work is the easiest, cleanest, nicest occupation in the world. New representatives make \$5 to \$10 a day. You simply take the order and measurements and mail them to us. We make the clothes, ship them on approval to your friend and hand you the profit money. A regular cinch! That's the beauty of being in business for yourself. Sit right down now; write us a postal or a letter for the free outfit to representatives. And you get the swellest suit of fashionable, tailor-made, all-wool, 1911 clothes ever worn in your neighborhood. If your personal appearance and a big business is worth a postal or a 2-cent stamp to you, then act now—write us today. Address, American Woolen Mills Co., Dept. 468, Chicago.

WANTED BRANCH MANAGERS for mail order business at your own home. Male or female. No canvassing. Mail the ten catalogues and make from \$1 to \$20. One young married couple made over \$100 in two months. You can do the same. We furnish everything. Outfit, ten catalogues, full particulars, etc., for 10 cents in stamps to pay postage, etc. Address: Ybrad Co., 434 Cortlandt Bldg., New York City.

AGENTS. WHY DON'T YOU WRITE? Send a postal. Doesn't cost much, does it? Agents making \$75 weekly. Why not you? Storekeepers all crazy to buy. 350 varieties Ready Made Show Cards 11x14, printed in colors. Beautiful air brush designs, changeable signs and price tickets, too. Also postcards. You can start mail order business, we furnish everything. Send no money. Write a letter or postal for new catalog, printed in colors and sample. These cards will get you going. They spell success, and will make you all kinds of money. Break away and get out into the sunshine and be your own master. Popular Show Card Co., Desk M, 1235 Michigan Ave., Chicago, Ill.

LAMP—200 HOURS OF LIGHT for 1 cent. Makes and burns its own gas from kerosene oil, which is vaporized by a glass bulb burner. Scientific wonder of the world. Lamps used where people have electric lights. Makes it possible to sell to every household. Lamp made entirely of brass. Riches awaiting you. Rush \$1.50. Complete lamp will be sent, charges paid. We guarantee lamp as above stated, or your money returned. Town, county and township agents wanted. Lamp a whirlwind seller. Pat. U. S. A. and foreign countries. New Process Mfg. Co., Dept. 99, Salina, Kans.

AGENTS—To sell the newest electric appliance on the market; sold everywhere there is electricity, in the home and office; liberal profit; sales-driving sample, weighs a pound, no experience or knowledge of electricity required; it shows how to use one light instead of two and get the same results; sells for \$3.50 and saves the purchaser an investment of \$25; write for particulars. The Handy Light Co., 211 Opera Place, Cincinnati, Ohio.

AGENTS. WRITE QUICK for our liberal terms and special offer. Many agents making \$15 a day. Big profits—easy work—satisfied customers. Victor Suction Cleaner is the best and fastest dirt getter. Works by hand—one person operates it—easily moved from room to room—runs on roller casters—has greatest suction—lasts for many years. Every machine guaranteed. Don't delay. Write now. Victor Suction Cleaner Company, 226 High Ave., Cleveland, Ohio.

WE HAVE AN IDEAL SIDE LINE. Nets big returns, \$6.00 to \$10.00 a day easily made. Getting orders for our Safety Matches bearing Dealer's special advertisement. Something new. Sells itself. If you have a few spare moments on your route, this is your opportunity. Pocket sample case. For particulars, address Dept. P, Importers, 2282 East 55th St., Cleveland, Ohio.

BE YOUR OWN BOSS—Sell "Modern-Make-Milwaukee" Specialties, 100% profit. We manufacture and advertise, you sell them. Our agents become independent and own their business. 10c brings sample Burglar Lock. Represent us exclusively. Outfit furnished. Spring catalogue "P" free, write at once. Modern Specialties Mfg. Co., Milwaukee, Wis., U. S. A.

AGENTS. "KALUX" STEEL HARDENING and tempering solution for all tools made from water hardening steels increasing their efficiency by 50 to 300%. Repeat orders from firms using for the past five years vouch for its merits. 25c sample sufficient for two months. Liberal commissions. Metal Hardening Solution Co., Granite Bldg., Rochester, N. Y.

DO BIG SPRING and summer business selling new and winning invention. Over 250,000 sold during 1910; 50,000 first two months 1911. Nationally advertised—a necessity in every home. Preston Hurmon writes: "Secured 110 orders first week." Quick sales, large profits, exclusive territory; attractive samples furnished; credit given. The Progress Company, 911, 210 Monroe St., Chicago.

BIG MONEY. PUT MENDETS TOGETHER at home in 10 and 25c boxes. Easy work for all. They mend all leaks instantly in graniteware, hot water bags, cooking utensils, etc. No solder, cement or rivet. Millions sold. Special offer to live agents. Own and operate new business. Profits enormous. Write today. Collette Mfg. Co., Box 1116, Amsterdam, N. Y.

SELL SOMETHING ALREADY IN DEMAND. Energetic specialty salesmen make \$2,000 up on our remarkable, original advertising proposition. Unlimited earning opportunity. Reliable advertising specialty salesmen wanted—state selling experience. Agency Dept. Taylor Brothers Company, Rochester, N. Y. Established 58 years.

AGENTS EASILY MAKE \$25 to \$100 per week with greatest labor saving invention. If out for the money, send dime for three samples, wholesale prices, and unique selling plan which is a winner and money getter. Particulars free. Eagle Rubber Company, 213 East Tenth Street, New York.

EARN THIS SUIT in One Hour! Your profit for an hour or two as the representative of our great tailoring house pays for a special made-to-measure suit for you—the handsomest, the most stylish and the most durable ever made. Just show two or three of your friends the samples of our fine wool suitings, take two or three orders and you have earned the suit. You can't fail to get orders. Our 60 beautiful samples create a sensation wherever shown. No one ever saw such materials at the price before. You take no risk. Everything is shipped on approval, subject to 24 hours' examination. Customers try goods on and must be satisfied with style, fit and quality before paying. We pay express on everything! You can undersell everybody. Get clothes for your friends at less cost than they pay anywhere else and make wholesaler's, jobber's and retail dealer's profits. That means the swellest, cleanest and nicest business in America! A Big Business that more than doubles your earnings. We want you to represent us now. Don't wait until somebody else takes this great business. No experience necessary. We furnish you our portfolio with 60 samples of the latest weaves, fabrics and colors, absolutely free. Do you want this swell made-to-order suit and this remarkably easy money-making business that will make you rich? A postal or letter mailed to us at once gives you swell clothes and a big business. Write us now. A postal card will do. Or tell your friends about it. Paragon Tailoring Company, Dept. 11, Chicago, Ill.

LARUE'S PINE TAR PASTE, and Velvety Paste are fast selling hand cleaning specialties which competition has not touched. Not common scap. Something out of the ordinary. Liberal terms to reliable agents. Samples 10c prepaid. F. C. LaRue Soap Co., 584 Niagara St., Buffalo, N. Y.

ONE ALADDIN MANTLE LAMP AGENT made \$700 in 60 days. Another sold \$50 on money back guarantee and not one was returned. Burns kerosene (coal oil). Brighter than electricity. Sell themselves on over-night trial. Improved 1911 line is finest in world for homes, offices, public places. Guaranteed. Ask nearest office for agency proposition. Mantle Lamp Co., Desk 567, Chicago, Portland, Ore., Waterbury, Conn., Montreal, Winnipeg, Can.

AGENTS—Biggest money-maker known. The new Canchester Incandescent Kerosene Lamp revolutionizes old lighting methods. Burns air, not money. Six times brighter than electricity, gas or acetylene at 1-10th cost. Burns with or without mantle. Burner fits any lamp. Saves 75% oil. No trimming wicks. Showing means selling. Territory going fast. Write today. Handsome outfit furnished. Canchester Light Co., Dept. P. M. 5, 204 No. State St., Chicago.

AGENTS—\$50 weekly; we manufacture the best needle case made; a wonderful seller; 200 to 500 per cent profit; talking unnecessary; our copyrighted "Trust Scheme" Envelopes do the work; general agents can make over \$100 weekly; send 10c for a 25c sample containing 115 needles; particulars free; buy direct from the factory at wholesale. Paty Needle Co., 102 Union Sq., Somerville, Mass.

WANTED—A GOOD LIVE AGENT in every shop in the U. S. to handle on the side an article that is used by every mechanic, automobilist, plumber, and also by the housewife. Nice profits for the hustler. Can make from \$5.00 to \$25.00 extra every month. Free samples. Goods guaranteed or money refunded. No fake. Write: The Klenzola Co., Erie, Penna.

ANY LIVE AGENT CAN make 100% profit working for us. New article, sells for 25c, universal demand, exclusive territory, quick sales. Send now for free sample and terms. The G. V. Sales Co., 150 Nassau St., New York, Room 1325.

AGENTS—Big money for you, introducing our new specialty that sells on sight. Manufactured and distributed by us only. Free sample. Columbine Co., Dept. 9, Boulder, Colo.

BECOME A MANUFACTURER'S AGENT. We manufacture hosiery which outwears 3 of the ordinary kind, replaced free when hole appears. Easy sales; large profits. First reply obtains agency your city. Triplewear Mills, Dept. D, 724 Girard Ave., Philadelphia, Pa.

AGENTS—Positively perfect incandescent lamps. As represented or money refunded. Burns common kerosene oil 16 hours on 1 quart, with or without a mantle. 100 candlepower. Fine proposition. Write at once. American Light Co., Birmingham, Ala.

MEDALLIONS SELL AT SIGHT, 300 per cent to 500 per cent profit. Make up your own goods and be independent. "It's easy." Catalog free. Fred Resag Co., 1205 W. Randolph St., Chicago.

AGENTS—\$5 daily selling our Handy Tool, 12 articles in one. Lightning seller. Sample free. Thomas Mfg. Company, 462 Third St., Dayton, Ohio.

AGENTS: \$30.00 WEEKLY easily made selling our Yankee Self-Wringing Mop and Duster; 500 other fast sellers; samples free. Scheff Co., 1637 Wells Street, Chicago.

AGENTS—HANDKERCHIEFS, DRESS GOODS, Carleton made \$8 one afternoon; Mrs. Bosworth made \$25 in 2 days. No experience needed. Free samples. Credit. Freeport Manufacturing Company, 59 Main St., Brooklyn, N. Y.

WIDOWS, Ladies, Men, New, Interesting. Profitable, easy work. Spare time or permanent. Sell our useful specialties. Our original selling plan will double your sales. Particulars and \$2.00 premium offer free. Fair Mfg. Co., HF51, Racine, Wis.

AGENTS: 100% profit. New patented awl. Sews harness, shoes, grain bags, anything. Sample free to workers. A. Mathews, 1262 Third St., Dayton, Ohio.

THE NOEL KEROSENE MANTLE LAMP beats electricity, gas or gasoline. The most economical light to burn. A whirlwind seller. Customers delighted. Agents write for territory. John S. Noel Co., 10th St., Grand Rapids, Mich.

AGENTS: Send for free booklet, inside information on the agency business. Filled with money making plans. Pointers and experience of thousands of successful agents. Address: J. M. Finch, 1162 3rd St., Dayton, Ohio.

YOU CAN MAKE \$\$\$\$ as our general or local agent. Household necessity; saves 80 per cent; permanent business; exclusive territory; salary or commission; free sample; credit. J. Pitkin, Newark, N. Y.

OUR STARTLING NEW INVENTIONS. Saxonia Spark Gas Lighter; cheaper than matches; Vacuum Cleaner, cheaper than brooms; incandescent kerosene mantle lamps, cheapest and best light known. Quick sales and large profits. U. S. A. Lighting Co., Box G, Springfield, Mass.

AGENTS earn \$25 to \$50 weekly selling our latest styles beautiful braided waists, and dresses, Mexican drawn work, petticoats, various embroideries. Catalogue free. National Imp. Co., Desk 27, 699 Bway, N. Y.

I WILL START YOU earning \$4 daily at home in spare time, silvering mirrors; no capital; send for free instructive booklet, giving plans of operation. G. F. Redmond, Dept. 306, Boston, Mass.

AGENTS—\$75 monthly. Combination Rolling Pin. Nine articles combined. Lightning seller. Sample free. Forshee Mfg. Co., Box 535, Dayton, Ohio.

AGENTS make big money selling our new gold letters for office windows, store fronts and glass signs. Any one can put them on. Write today for free sample and full particulars. Metallic Sign Letter Co., 406 N. Clark St., Chicago.

\$25 WEEKLY and expenses to men and women to collect names, distribute samples and advertise. Steady work. C. H. Emery, M. K., Chicago, Ill.

SELF-THREADING NEEDLES. 10c a paper. Agents wanted, samples and terms free. Ladies' Art Co., Dept. 41, St. Louis, Mo.

ONE MILLION AGENTS WANTED; fast seller costing 5c, selling 50c. Every firm needs. Orders to \$50. Postal brings samples. Embossed Co., 2497 Milwaukee Ave., Chicago.

AGENTS—PORTRAITS 35c, FRAMES 15c. Sheet Pictures 1c, Stereoscopes 25c, Views 1. 30 days' credit. Samples and catalog free. Consolidated Portrait, Dept. 1195, 1027 W. Adams St., Chicago.

\$100 MONTHLY and expenses to trustworthy men and women to travel and distribute samples; big manufacturer. Steady work. S. Scheffer, Treas., M. P., 125, Chicago.

AGENTS—100% profit. Combination monkey-wrench, plumber's pliers. 15 tools combined. Lightning seller. Sample free. Forshee Company, Box 1335, Dayton, Ohio.

FREE GOLD SAMPLE goes with first letter. Something entirely new. Every firm wants it. Orders \$1.00 to \$100.00. Nice pleasant business. Write today. Metallic Mfg. Co., 406 N. Clark, Chicago.

ACTIVE MEN OR WOMEN to work individually or organize and direct selling crews on patented gas cooking appliance. Saves fifty per cent. Exclusive territory and 100% profit. A. F. Decker, Sales Manager, 37 E. 28th St., N. Y.

AGENTS—Sell the Pinless Clothes Line. A labor-saving invention; sells on sight; write quick; exclusive territory; \$25 to \$75 weekly; freight prepaid; sample 25c. Pinless Clothes Line Co., 558 Lumber Exchange, Portland, Oregon.

BE YOUR OWN BOSS; Start Mail Order Business at home; devote whole or spare time. We tell you how; very good profits. Everything furnished. No catalog outfit proposition. For "Starter" and free particulars address P. M. Krueger Co., 155 Washington St., Chicago, Ill.

AGENTS: Quit peddling! Do it by mail! Your spare time worth \$25 weekly. Investigate our unique mail business. Amazing profits for shrewd people. Write for details. Fredericks & Co., 776 Unity Bldg., Chicago.

KEROSENE MANTLE LAMPS—One agent writes: "Just sold the fourth burner to one customer—left one on trial—bought three then sold him the fourth today. If you want repeat orders, sell 'Guilford Guaranteed goods.'" Guilford Co., Seville, Ohio.

BOY AND GIRL AGENTS—Sell 24 packages postcards at 10c each and receive camera, aeroplane or rifle free. Address Shurwin Supply Co., 208 West St., Wilkesburg, Pa.

AGENTS—\$1.00 hourly. One handed flour sifter. Just patented. Only one in the world. Sample free. Forshee Mfg. Co., B. 1535, Dayton, Ohio.

SEND YOUR ADDRESS, and we will mail you our catalogue of 750 quick sellers. Over 3,500 guaranteed articles beautifully illustrated in our 4 free catalogues. \$500 prize contest this month. A. W. Holmes & Company, 151 Broad Street, Providence, Rhode Island.

AGENTS—Mail Order Dealers, write us for circulars and prices on two new household articles. Thompson Mfg. House, 187 Schaeffer St., Brooklyn, N. Y., Dept. P.

THE greatest agents' seller ever produced; every automobile owner buys it on sight; big profits. Write to-day. Illustrated booklets. Bayer Specialty Co., Clayton, Mo.

WANTED—RAILWAY MAIL CLERKS; city carriers; post-office clerks; government stenographers and bookkeepers. Thousands of appointments coming. Average salary about \$1,100. No "Layoffs." Short hours. Annual vacations. Common education sufficient. Political influence not needed. Send your name immediately for schedule showing places of spring examinations. Free coaching. Franklin Institute, Dept. H 85, Rochester, N. Y.

REPRESENT US EXCLUSIVELY in your territory. Build up permanent business by repeat orders. We, as manufacturers of patented household necessities want "I Will" men on our co-operative plan. If your letter indicates that you mean business, we will outline our plan. J. M. Pease Mfg. Co., Co-Operative Dept. 4000, Buffalo, N. Y.

Agents—Our new line automobile specialties are big winners; large demand; quick sales; big profits; success assured; don't wait; particulars free. Mitchell Specialty Co., Houston, Texas.

SALESMEN WANTED—to sell trees and plants. Free outfit. Commission paid weekly. Write for terms. Perry Nurseries, Rochester, New York.

CASH FOR NAMES, ideas, formulas, information. Steady, profitable home business. Instructive Booklet free. Information system, 244, Marietta, Ohio.

SPECIALTY SALESMEN the quickest seller on earth make \$50 a week easy, sample one dollar, money back if unsatisfactory. Write quick for particulars. St. Louis Burglar Protection Co., St. Louis.

BULLY! GREAT! IMMENSE! That's what all our agents say after selling our attractive 1911 combination packages of soap and toilet articles with valuable premiums. 100% to 300% profit. One Michigan agent made \$65 in 47 hours; another \$21 in 8 hours; another \$22.50 in 10 hours. Act now—not tomorrow. Davis Soap Works, 264 Davis Bldg., 1429 Carroll Ave., Chicago.

IF TIRED OF WORKING for others send for our big money making propositions. \$1.00 sample and full particulars for 10c. Dietz & Co., 3420 Lincoln Ave., Chicago.

AS YOU CAN CLEAR \$1,500 annually mailing music evenings, why look further? Send only 10c for facts, proof and elegant new sheet music. Weber Music Co., 3527, Boston, Mass.

KEEP YOUR HENS and houses free from lice and mites. Pleasant dreams. Half gallons one dollar. Dept. A, Webb, 2137 Madison Ave., New York City. Agents wanted.

AGENTS in every city and town; best selling automobile specialty; large demand for goods; success assured; start at once. Leo Critz Co., 34, Riverside, Ia.

GOOD HUSTLERS, men and women, can make for themselves elegant future, selling "Raincoats." We are manufacturers. New proposition. Write for interesting particulars. Regal Raincoat Co., Dept. 69, 1367 Broadway, New York.

SALESMAN; TAKES ONE MINUTE to sell. Pays you a dollar. Sell ten, twenty a day. Side line. Every salesman or clerk buys because it puts money in his pocket as well as yours. Sales Managers Publishing Co., 125 Sycamore St., Milwaukee, Wis.

GOVERNMENT WANTS RAILWAY MAIL CLERKS, city carriers, postoffice clerks. Write for dates of examinations everywhere. Franklin Institute, Dept. H, Rochester, N. Y.

DO YOU WANT a soliciting or manufacturing county agency of our new advertising plates for business men? Big commission. Mail postal to Roof, Abilene, Indiana.

LIVE MEN WANTED to sell a new and attractive safety razor combination. John Williams & Co., 46 West Broadway, New York.

AGENTS—To sell automobile owners necessary article; make \$5 to \$25 per day; sells on sight. Desk C, Emaus Supply Co., Muskegon, Mich.

GET WISE—Every lady buys latest Dutchess hat pins. Sample 50c, forth \$1. Dozen, \$5. F. J. Seck Co., 192-4 Woodlawn Ave., Jersey City, N. Y.

EXCLUSIVE TERRITORY GIVEN to agents who demonstrate they can sell the best gasoline sad iron manufactured. Sample at reduced rates. Herz Mfg. Co., Jackson St., St. Paul, Minn.

AGENTS! You can make \$10.00 a day selling our new high-grade original design show cards to storekeepers. 350 varieties. Catalog free. Samples 10c. Peoples Show Card Concern, 711 W. Madison St., Chicago, Ill.

LIVE AGENTS to sell the only perfect door lock made. Enormous profits. Sells on sight. Safety Link Lock Co., 3734 Cottage Grove Ave., Chicago, Ill.

AGENTS WANTED—Rubber stamps and novelties. Send 4c for full particulars. A. S. Mankin & Co., Alexandria, Va.

AGENTS WANTED to sell our improved patented Match Machine; good side line; for particulars address Lion Machine Co., 64 Second St., Detroit, Mich.

AGENTS—WE MANUFACTURE GLASS PAPER. Plain glass windows made to look like real stain glass; something new; easily applied; big money maker; two sample sheets of paper, with catalogue in colors and discount sheet, for 10c. S. H. Parris & Co., 202 S. Clark St., Chicago.

WANTED—AGENTS—7 CENTS PROFIT EACH 10c sale; best little article ever offered; sample for 3c in stamps. Rawlings, Box 545, St. Louis.

AGENTS WANTED to sell our beautiful scripture wall mottoes. Frank Shilling Co., Navarre, Ohio.

AGENTS WANTED—25c novelty, housekeepers buy at sight; tea kettle attachment prevents scalding. William Cram, Box 8704, Haverhill, Mass.

AGENTS; SEND FOR PARTICULARS of automobile specialty; fast seller; big profits; free illustrated booklets. Sutton Specialty Co., Saugerties, N. Y.

\$35 WEEKLY SELLING MUSIC. Send 25c for samples (worth \$2.50) and particulars. Home Co., Boston, Mass.

AGENTS wanted selling Masonic, I. O. O. F., Grange, K. of P. charts; write quick for particulars; sample \$1.35, size 22x28. Empire, Stonington, Me.

AGENTS: Do you want an agency that will pay you \$60.00 a month for life, besides, handsome premiums free. Box 52F, American Pharmacal Co., Evansville, Ind.

SMALLEST ALARM CLOCK, bible and telescope, 10c each prepaid. W. H. Garner, A-119 South Lafayette St., Evansville, Ind.

AGENTS—BEST SELLER, portable Nail and Screw Holding Cabinets for shop, house, etc. Clean proposition. Billstone & Co., Findlay, Ohio.

AGENTS WANTED—New system bookkeeping. Sample, 40c postpaid. Order today. G. S. Taylor, Jamestown, N. Y.

GAS LIGHTERS; Automatic and Mechanical. Gas Ranges are in use now. L. Sterling Co., Box 766, Trenton, N. J.

LATEST RAT and mouse trap (combined). Gets them all. Sample, 25c. Zerby, Sacramento, Penna.

AGENTS—BOTH SEXES—We control a specialty never placed on market before. Not for sale in stores. Particulars free, sample 10c. LeRoy Specialty Co., 76 Park Place, Room 52, New York.

SEVEN-IN-ONE New Novelty in jewelry. Scarf pin each day of week. Seven superb imported stones, match any color tie. Agents wanted. Exclusive territory. Investigate. Weeks, 3344 Boston, Mass.

AGENTS WANTED—To sell rich looking imported 36x68 rugs at \$1 each. R. H. Carter, Milan, Tenn., sold 115 in 4 days; his profit, \$51. You can do as well. Write for sample offer and unique selling plan; exclusive territory. A. Condon, Rug Importer, Stonington, Maine.

MORE MONEY! Lots of money! Agents! And general Agents! Quickest selling 25c article with beautiful premium. Unique selling plan which pulls orders. Send 10c for sample; handsome premium, circulars, prices, etc. Litholia Pm. Co., 247 W 125th St., N. Y.

400% PROFIT SELLING GORDON Photo Pillow Tops. High grade work. Samples and catalogue free. Luther Gordon Co., 164 Washington St., Chicago.

AGENTS MAKE 100% PROFIT selling our product. Write today for particulars. Taylor & Dize Co., 44 High St., Mansfield, Ohio.

PLEASANT DREAMS KILLS ALL VERMIN. Invaluable to hotels, hens, houses, boats. Exclusive territory. Liberal discount. Dept. A, Webb, 2137 Madison Ave., New York City.

WANTED LIVE AGENT in each locality for high class guaranteed line of paints. Commission basis. The Colorcraft Co., Cleveland, Ohio.

AGENTS, MANAGERS; No-Poison Rat Annihilator. Box 249 Cincinnati, Ohio.

THE STOTZ STUTZ BOOKLET "Successful Sellers. How to Buy, Cash or Credit, How to Sell," was written for the man or woman agent; for the teacher wishing to make money during vacation; for the student working his way through school. Stotz Stutz lists successful sellers only, saving you the time and expense of answering advertisements for agents. Join the Stotz Stutz Sellers by sending 25 cents, coin, to P. O. Box 838, Pittsburgh, Pa., and get absolutely disinterested advice, with brains and ideas to draw upon for future help. Do it now.

YOU CAN EARN from \$40.00 to \$60.00 extra every month by selling "Peerless" Belt Dressings to your friends. Write now. Peerless Belt Dressing Co., Cleveland, Ohio.

LIVE WIRE SALESMEN, sell our own make brushes for every household use. Write for particulars, territory and the eight advantages of our proposition. 125% profit. Capitol Brush Co., Hartford, Conn.

EXCLUSIVE HOUSEHOLD SPECIALTIES: actual necessities; samples and catalogue free. Write today. Phillip O'Donnell Co., Stoughton, Mass., Dept. B.

LIVE AGENTS to introduce article needed in every home. Fast seller, large profits. Customers waiting for it. For particulars, write The LaPlace Specialty Co., Box 27, LaPlace, Ill.

VACUUM CLEANERS ARE SELLING fast now. Get our special agency offer on a guaranteed high grade Hand Power Machine with blower attachment, 9 ft. hose and fifteen extra attachments for cleaning everything. Victor Cleaner Company, McClurg Bldg., Chicago.

AGENTS MAKE MONEY, selling the Dollar Adding and Subtracting Machine. Particulars free. B. Bassett, 5921 Indiana Ave., Chicago.

BOKARA DIAMONDS—Agents, everyone to wear and sell our famous Bokar diamonds. Write for sample offer and catalogue free. Northwestern Jewelry Co., 52 Northwestern Bldg., Chicago.

MANUFACTURE AND MARKET your own goods. Practically all profit. Information free. Barstow Company, Box 18, Oakland, Calif.

GERMAN SILVER KEY CHECKS—Steel letters for marking same, key rings, etc.; over 30 styles. Agents wanted. Sample marked with your name and address, and key ring, 15c. Pease, Die Maker, Winchester, N. H.

AGENTS—FOR HOUSEHOLD NECESSITY; enormous profits; sells like wildfire; send for sample and terms. Rose City Novelty Company, Dept. A., Box 2110, Portland, Ore.

MONEY MAKER—Only half the work pumping water when using spring attachment. Equalizer Spring Works, 549 Quincy St., Chicago.

INVISIBLE POCKET PEN and Pencil Holder. Beats them all. Get busy you agents. Sample 10 cents. Nouveau Sales Co., Box 92, Raleigh, N. C.

GOLD SIGN LETTERS—Sell everywhere; agent's profit over 500%; sample free. Johnston Co., Quincy, Ill.

KEY CHECK MEN, ATTENTION. If you are paying over \$12 per thousand for German silver emblem checks, join our club. Pease, Die Maker, Winchester, N. H.

BOATS, LAUNCHES AND STEAMBOAT MACHINERY

MODELS—CASTINGS, FITTINGS, DRAWINGS and instructions. Build a model steam or gasoline engine, dynamo, motor, motor boat, etc. outfit, in your spare moments. We furnish the material and instructions, you contribute a few hours pleasantly spent. Finished models carried in stock. Send plans of your ideas; we furnish estimates on models of all descriptions. Enclose two cents for illustrated booklet. The B. A. B. Model & Mfg. Co., Room 536 B, Singer Bldg., 149 Broadway, N. Y.

MAGNIFICENT RIVER CRUISER MARJORIE; forty footer; perfect condition. Price \$2,200.00. Worth Seven Thousand. L. S. Bernheim, Louisville, Ky.

HELP WANTED

WANTED ONE THOUSAND CHAUFFEURS and repair men. Our demand for automobile engineers exceeds the supply. Calls for men of intelligence and mechanical bent capable of commanding \$100.00 to \$150.00 per month upon graduation. Resident course \$20.00 to \$60.00. Home Correspondence course completed by practical road and shop work at this school, highly successful. Look this up. Auto Schools of America, Dept. T, 1600 Michigan Ave., Chicago.

\$3,000 to \$10,000 YEARLY in the Real Estate business, without capital; we will teach you the business by mail, appoint you special representative in your locality, of leading real estate company, list with you readily salable properties, co-operate with and assist you to permanent success; a thorough commercial law course free to representatives. If you are honest and ambitious, our free 62-page book will surely interest you. Address, International Realty Corp., Dept. 1534, Chicago, Ill.

WANTED—RAILWAY MAIL CLERKS; City Carriers; Post-office Clerks; Government Stenographers and Bookkeepers. Thousands of appointments coming. Average salary about \$1,100. No "Layoffs." Short hours. Rapid promotion. (Postmaster General Hitchcock, commenced as clerk.) Annual vacations. Common education sufficient. City and country residents stand same chance for immediate appointment. Political influence not needed. Send your name immediately for schedule showing places of Spring Examinations. Free coaching. Franklin Institute, Dept. H21, Rochester, N. Y.

FREE! FREE!—A complete course in Show Card and Sign Writing to those purchasing small assortment of "Litholia," ready to use colors for show card writing and artists' use. Great opportunity to earn big salary, or establish money-making business. Information free. Litholia Pm. Color Co., 247 W. 125th St., New York City.

WE HAVE A STUNNING PROPOSITION for an Engineer and traveling salesman in every Village, Town and City in U. S. Little time required. Will not interfere with your work. Particulars, Address, P. O. Box 24, South Stillwater, Minn.

RAILWAY MAIL CLERKS WANTED—Average salary \$1,100. Alternate weeks off with full pay. No "Layoffs." Common education sufficient. Preparation free for coming examinations in your section. Franklin Institute, Dept. H21, Rochester, N. Y.

WANTED, AGENTS, MACHINISTS, ATTENTION! Increase salary, new revised Saunders' Hand Book of Practical Mechanics. Best ever ready reference. Thousands in use. Postpaid \$1.00 cloth; \$1.25, \$1.50 leather flap. Big profits. E. H. Saunders, 216 Purchase St., Boston, Mass.

CASH FOR NAMES, ideas, information, formulas. Steady, profitable home business. Instructive booklet free. Information System, 245, Marietta, Ohio.

500 MEN 20 TO 40 years old wanted at once for Electric Railway Motormen and Conductors; \$60 to \$100 a month; no experience necessary; fine opportunity; no strike; write immediately for application blank. Address Railway, X510, 203 Dwight Bldg., Kansas City, Mo.

WANTED, RELIABLE GENTLEMAN OR LADY in every city, something new; waterproof sanitary rug; both sides are alike; sells in every home; \$40.00 weekly easily made; every rug guaranteed. Start now; full size rug sent prepaid upon receipt of \$1.00. For particulars address Dexter Supply Co., 508 S. Dearborn St., Chicago.

BIG MONEY WRITING SONGS. Thousands of dollars for anyone who can write successful words or music. Past experience unnecessary. Send us your song poems, with or without music, or write for free particulars. Publication guaranteed if acceptable. Washington only place to secure copyright. H. Kirkus Dugdale Co., Dept. 265, Washington, D. C.

YOU ARE WANTED for government positions, \$80.00 month. Annual vacations. Short hours. No "layoffs." Common education sufficient. Over 12,000 appointments coming this year. Influence unnecessary. Send postal immediately for list of positions open. Franklin Institute, Dept. H21, Rochester, N. Y.

DON'T YOU WANT TO MAKE YOURSELF a Real Estate Broker? We will make it easy for you without capital. You can be independent of bosses and have your own office instead of a job—swing big deals and make big commission instead of working at details on a salary. Write today for booklet "P." No financial backing needed. U. S. Real Estate Institute, 500 Fifth Ave., New York.

PLUMBING, ELECTRICITY, BRICKLAYING or Mechanical Drafting, taught by expert workmen. Short time and small cost. Positions always open. Catalogue free. Write today. Coyne National Trade Schools, 80 E. Illinois St., Chicago.

EXPERIENCED OR SUCCESSFUL SALESMEN to sell gasoline lighting system suitable for any place or purpose; attractive proposition. Write for catalogue. Doud Lighting Co., 174 N. Sangamon St., Chicago, Ill.

WANTED—A man or woman to act as our information reporter. All or spare time. No experience necessary. \$50 to \$300 per month. Nothing to sell. Send stamp for particulars. Sales Association, 601 Association Bldg., Indianapolis, Ind.

WANTED—GOOD ABLE-BODIED MEN as Interurban Motormen, Conductors. \$65 to \$90 per month. New lines under construction. New positions opening up. Experience unnecessary. Enclose stamp for map new traction lines. I. Railway Co., L, No. 16, Indianapolis, Ind.

\$100 to \$150 A MONTH paid to chauffeurs, demonstrators and truck drivers; no experience necessary. Write for free tuition certificate. Sweeney's Automobile School, 1436 Woodland Ave., Kansas City, Mo.

I WILL START YOU earning \$4 daily at home in spare time, silvering mirrors; no capital; send for free instructive booklet, giving plans of operation. G. F. Redmond, Dept. 306, Boston, Mass.

MANY GOVERNMENT POSITIONS ARE OPEN. Spring Examinations everywhere. Large salaries; short hours; annual vacations. Write for list of positions. Franklin Institute, Dept. H21, Rochester, N. Y.

"PATENTS AND PATENT POSSIBILITIES," a 72-page treatise sent free upon request; tells what to invent and where to sell it. Write today. H. S. Hill, 905 McGill Building, Washington, D. C.

TRAVELING SALESMEN WANTED—Our machine pays for itself each month; salesmen sell 40 per cent firms visited; commission \$46. Damon Co., Bowling Green, Ky.

PINLESS CLOTHESLINE AGENTS coin money. Sample prepaid. 25c. 503 Lumber Exchange, Portland, Oregon.

WANTED DISTRIBUTERS of advertising matter everywhere. Oliver P. Barkley, Mount Pleasant, Pennsylvania.

ORGANIZERS AND INDIVIDUAL WORKERS, \$50.00 to \$150.00 month. Whole or spare time. Box B-293, Covington, Ky.

GOVERNMENT WANTS RAILWAY MAIL CLERKS—City Carriers, Postoffice Clerks. Write for dates of Examinations everywhere. Franklin Institute, Dept. H21, Rochester, N. Y.

SHORT METHODS—Mechanical Draftsmen are paid \$150 monthly. Complete course at your home 4 months. P. O. Box 433, Newark, N. J.

IF YOU can read and write and are willing to try, we will teach, train and equip you to be a top-notch, scientific salesman, a splendid position with us is then yours; no previous experience necessary. We want "I Can" and "I Will" men for our permanent sales force. This is an opening for the man who wants to be a real salesman, with exceptional money-making opportunities. If you believe in doing business on a "100 per cent honesty basis," if you want "success," if your wishbone is not where your backbone ought to be, write us today for particulars. Stace, Burroughs & Co., (manufacturers representatives), 310 Michigan Ave., Offices 750, Chicago.

MEN WANTED, age 18-35, for firemen, \$100 monthly, and brakemen \$80 on all railroads. Experience unnecessary; no strike. Positions guaranteed competent men. Promotion. Railroad Employing Headquarters—over 400 men sent to positions monthly. State age; send stamp. Railway Association, Dept. 89, 227 Monroe Street, Brooklyn, N. Y.

SALES LADIES WANTED to sell Black Silk Petticoats, direct from Silk Mills, can earn \$10 to \$50 weekly. Particulars free. Address P. & B. Skirt Co., Lynn, Mass. Advt. Dept.

WANTED—A first-class foreman for a plant that manufactures hardware specialties, stove trimmings, stove bolts, rivets, etc. Address F. W., 318 W. Washington St., 6th Floor, Chicago.

"VALUABLE TRADE SECRETS," see Miscellaneous column. Gold mine of information.

MANUFACTURING MACHINERY

THE PIERCE MODEL WORKS, 85 5TH AV., CHICAGO. Models, dies, tools and manufacturing of patent articles; catalogue of model supplies.

WANTED: To get in correspondence with some party who has a good marketable machine to manufacture. We have the machine shop and capital if you have a good article. Lexington Machine Works, Lexington, Ky.

YOUR INVENTION MANUFACTURED at lowest cost. We are equipped for all kinds of metal specialty work. Designs perfected, etc. C. Spiro Mfg. Co., New York.

PATTERNS AND CASTINGS MADE. Send sketch for estimates. "Mail Order" Garage, No. 3 Fox Street, Bridgeport, Conn.

WANTED—1,000 spring motors, about 15 pound capacity; what have you? Merchants Supply Co., Kansas City, Mo.

CEMENT

IF YOU WANT the best information on cement and concrete construction, subscribe for Concrete, leading cement and concrete monthly. Sample copy, 10 cents. Yearly subscription, \$1.00. Concrete, 135 Newberry Bldg., Detroit, Mich.

DOGS, POULTRY AND LIVESTOCK

WORLD'S BEST STRAINS of Lordly Black Langshans, Rhode Island Reds and Bantams. Eggs, \$2.00 per 15; \$6.00 per 100. Ohio Improved Chester White Hogs; weaned pigs, \$10.00; 125 lb. shoats, \$15.00. Bred Gills, \$25.00. Fashionable Collie Pups, our specialty, \$10.00 to \$25.00. White Neck Collie Kennels, Box 187, Brownsburg, Ind.

GOLDEN BUFF LEGHORNS—None better. Splendid layers. Silver cup winners. 30 fresh eggs, \$3.00 and \$5.00. Agnes Smiley, Braddyville, Iowa. Page Co.

INDIAN RUNNER DUCKS, white egg strain, healthy, farm raised. Eggs, \$1 for 13, \$3 for 50, \$5 for 100. Leslie Bullion, Route 1, Rockville, Ind.

STEEL STAMPS, STENCILS, DIES, ETC.

STAMPS, STENCILS, SEALS, CHECKS, Punches and Dies. Presswork. Dickey-Grabler Co., Cleveland, Ohio.

PIANOS AND MUSICAL INSTRUMENTS

CONN-QUEROR CORNETS, \$30.00. Holton Cornet, \$35.00. York Professional Cornet, \$35.00. All silverplated. J. Placht & Bro., St. Louis, Mo.

VIOLIN FOR SALE—Sweet-toned Stradivarius. Write Miss Bertha Mardes, Route 5, Rosedale, Kansas.

MACHINERY AND TOOLS FOR SALE

HARRISON KEY FILING JIG (Improved). No Locksmith or Superintendent of large buildings can afford to be without one, makes accurate duplicate pin tumbler lock keys at once, never touching original key with file. Send for new price list just out; within reach of everybody. Harrison & Co., 81 New St., New York, N. Y.

FOR SALE: 50 slightly used Radio Storage Batteries, 6 V. No. 860, \$5.50 each. One Viascope picture machine, complete, good as new, \$40.00, 100 new 8", 110 V. A. C. fans, \$7.50 each. We guarantee all our goods or money refunded. Electrical Supply & Salvage Co., 529 W. Van Buren St., Chicago, Ill.

4 H. P. MARINE ENGINE all equipped, \$35.00; 12 H. P. two cylinder, two cycle water cooled auto engine, \$85.00; three cylinder 20 H. P. water cooled two cycle auto motor all equipped, \$125.00. We can save you money on your engines, any size, trial allowed; get our free catalogue. Climax Electric Works, New Salem, Mass.

GAS ENGINES, 3-6-10 & 20 H. P. Also large stock Lathes, Planers, Drill Presses and other metal working machinery. Western Machinery Co., Cincinnati, Ohio.

MOTORS: For sale, cheap, 100 1/12 H. P. brand new, Western Electric \$15.00 motors, D. C., 110 V. and 220 V., for \$5.75 each. If motors are not satisfactory we will cheerfully refund money. Electrical Supply & Salvage Co., 520 W. Van Buren St., Chicago.

ENGINE CASTINGS, 1 1/2 horse vertical gasoline, air-cooled, \$7. Three horse marine water-cooled, \$9 cash; drawings included; catalogue for stamp. Novelty Manufacturing Co., 853 West Sixth St., Cincinnati, O.

STEAM BOILER OUTFITS Complete: 1 1/2 Horse Power 20" diam., 51" high, \$40.00. Page Boiler Company, 815 Larrabee St., Chicago.

ENTIRE EQUIPMENT of Statuary Bronze foundry. Also gas engine milling machine, 3 ton Harrington hoist, flexible shaft. M. H. Mosman, 43 Chapin St., Chicopee, Mass.

FOR SALE—Rebuilt; Throttling, Automatic and Corliss Engines, Boilers, Pumps, Heaters, Machine Tools, Tanks, Saw Mills, and general machinery, at bargain prices. Let us know your wants. The Randle Machinery Co., 1761 Powers St., Cincinnati, Ohio.

FOR SALE—Gasoline Engines, automobiles, marine and stationary, also castings. Second hand ones taken in exchange and for sale. Apply with stamps. B. W. Richardson, R. No. 36, Peoria, Ill.

FOR SALE—Engine lathe, swings 9 1/2 in., takes 25 in. between centers. Complete with full set change gears to cut all size threads, 3 to 49 in.; price only \$43.50. Address L. F. Grammes & Sons, Allentown, Pa.

TWO-CYCLE, TWO-CYLINDER 4 in. by 3 1/2 in. marine and automobile gasoline engines 10 hp., at \$94 complete. Castings and drawings of same for sale. Richards Iron Works, Manitowoc, Wis.

LATHES—Send for free circular showing bargains on small Screw Cutting Engine Lathes. S. B. Machine Tool Co., Dept. L, South Bend, Ind.

JOINTER HEADS 6 to 16 in. with cast iron frame that head runs in ready to bolt to wood table. Write for circular and prices. W. L. Sherwood, Kirksville, Mo.

FOR SALE CHEAP. Two second-hand gasoline engines. One marine 6 H. P. One Upright 3 H. P. C. E. Doty, 1003 East 7th St., Muscatine, Iowa.

FOR SALE: Triple expansion marine engine, 11 1/4" x 16" x 22 1/2" x 18" Twenty H. P. Nash gas engine. Geo. J. Adams, 39 South St., New York.

EMERY GRINDERS—all sizes for the shop or factory; write for folder. C. King Bros. Machine Works, Spring City, Tenn.

MUST SELL AT ONCE!! Two brand new W. E. direct connected exhaust fans, equipped with Blackman and Fuller blades. 60" at \$225.00, cost \$450.00; 1 7/2" at \$275.00, cost \$600.00, 110 V. D. C. Bargains in all kinds of fans and motors. Electrical Supply & Salvage Co., 529 W. Van Buren St., Chicago.

DYNAMO OR MOTOR CASTINGS, wire, etc., complete, \$2.00. Working specifications, 10c. Hugh Dyar, Keilworth, Ill.

FINISHED CASTINGS COMPLETE for 500 watt enclosed dynamo, \$20. Art. P. Fletcher, Lowell, Mich.

WANTED—all kinds of machinery for manufacturing machine shop. Fred. Dickw., 33 So. Desplains St., Chicago.

ONE 4 x 6 Triplex power pump. McKeesport Brick Company, McKeesport, Pa.

LITHOGRAPHIC MODELS—Series of 6 subjects—Wireless Telegraph—Motor Car—Dynamo—Steam Engine—Steam Turbine—Gas Engine—Size 8x14 inches—All the parts of those mechanisms are shown and numbered to correspond to printed keys of names. Price per set of 6—\$2.50 or 50c each postpaid. Popular Mechanics Book Dept., Chicago.

PULLEYS, GEARS, SPROCKETS, Shafting Hangers; see page 146. W. A. Jones Foundry & Machine Co., Chicago.

ELECTRIC MOTOR—3 hp., 2 phase, 550 colts, 133 cycles. Stanley make. W. G. Snyder, 37 State St., North Adams, Mass.

TO RENT—Electric Motors, all sizes. Send for list and rates. Gregory Electric Co., Chicago, Ill.

ENGINE AND BOILER, 4-hp. steam. John Paque, 3517 Warsaw Ave., Cincinnati.

INTERESTED IN GASOLINE ENGINES? Send 50c for booklet, "How to Run and Install Gasoline Engines," and a year's subscription to Gas Energy, 28 Murray St., New York.

PATTERN-MAKERS! A book devoted to the principles of pattern and core making and molding. Written by G. H. Willard, a practical pattern maker of years experience. This book, just published, treats the subject in a much more simple, direct and effective manner than most books along this line. 224 pages, 312 illustrations. Price \$1.00 postpaid. Popular Mechanics Book Dept., Chicago.

WOOD WORKING MACHINES of every description. R. Pinner, 122 Water St., New York, N. Y.

FOR SALE at a great bargain, several 6x6 four cylinder, four cycle, 80-hp. gas engines suitable for speed launch, heavy motor truck or traction engine work. For particulars address Motor Truck Company, St. Paul, Minn.

FOR SALE—Power hay press, with or without engine. Neil, Lebanon, New York.

STONE CRUSHERS, contractors' machinery, pumps, air compressors. R. Pinner, 122 Water St., New York, N. Y.

FOR SALE CHEAP—1 brand new Elbridge type A, 2-cylinder 2-cycle Marine Engine. A. W. Goding, Durand, Va.

GASOLINE, GAS, OIL and steam engines, 5, 7, 10, 15, 25-hp. R. Pinner, 122 Water St., New York, N. Y.

NEW 3/4 HORSE Fox Marine Motor cheap. L. Gillou, Milwaukee, Wis.

LATHE, SHAPER, DRILL PRESS, Punch Press, Planer and Milling Machine. R. Pinner, 122 Water St., New York, N. Y.

A NEW 16 INCH by 6 foot lathe, never unrated, cost \$450.00, will sell for \$300.00. R. Pinner, 122 Water St., New York, N. Y.

PATENTS FOR SALE

TRANSMISSION GEARED WINDMILL delivering 50 per cent more pumping power than any modern Windmill. Frank Strickland, North McAlester, Okla.

FOR SALE OR ROYALTY, patented music leaf turner, piano attachment, reads eight sides, works back and forth with treadles. M. & J. Schweibold, 2726 Master St., Philadelphia, Pa.

PATENT FOR SALE—Fan for any Rocking chair. Rocking causes cool breeze, also drives away flies, mosquitoes; useful novelty; can be manufactured cheap. Sweetser, 123 Main Plaza, San Antonio, Tex.

WILL SELL TWO VALUABLE PATENTS for Amplifying Horn. Positively unequalled for its clear, sweet tone. F. Murphy, 239 Third St., Jersey City, N. J.

FOR SALE—Patent No. 600,381. An improvement in electric railway of the underground trolley type. For further information address 4264 Sheandoah Ave., St. Louis, Mo.

FOR SALE PATENT recently granted, wire holder for any style fruit jar. Inexpensive household necessity. Makes canning easy. Schaumburg, Olalia, Wash.

WAGON TONGUE YOKE ATTACHING DEVICE. Prevents accidents either up hill or down. If Yoke, Yoke straps, Traces, Single or Double Tree breaks horses cannot get away from Tongue. Particulars, Fred'k G. Mitchell, Glencoe, Md.

FOR SALE—U. S. Patent No. 972,733, Fence Fastener for Concrete Fence Posts. E. H. E. Thieroff, Redoe, Cal.

FOR SALE OR ROYALTY Patent 965,078, Roof Scaffold Bracket. Demonstrated success, engine. B. F. Carr, Jacksonville, Tex.

FOR SALE—Collapsible Geographical Globe. Inflates with air. Patent No. 952,119. Herbert H. Van Keuren, Baldwin, Kans.

SEWING MACHINE sharpening attachment. Apply Laurence Roberts, 907 Gilpin Ave, Wilmington, Del.

"SANITARY PATENT APPLIED Book Service for schools; a seller." Maude Yaggar, Panama, N. Y.

INVENTOR will sell half interest in profitable invention relating to lavatories and bathtubs. Cheap for cash. Model sent to responsible parties. Louis R. Porter, Box 14, Dana, Ind.

FOR SALE—PATENT 34,928. An article for tailors and dressmakers, highest offer accepted. L. Limandy, 4394 Topaz St., Los Angeles, Cal.

PATENTS

HAVE YOU A GOOD patented specialty? We can manufacture and sell it for you. Send us full details at once. The Olson Company, Kewanee Illinois, U. S. A.

PATENTS—Our advanced methods save you 80% of your money. "How to succeed as an inventor" sent free. Inventors and Investors Corporation, Philadelphia, Pa.

MECHANICAL DRAFTING SOLICITED; Including Working drawings of every description, Dies, Jigs, Special Machinery, Patent Office Drawings, Tracing and Blueprinting. E. O. Klamm, 1113 Hadley St., Milwaukee, Wis.

INVENTORS—Let us sell your patent. We are manufacturers' agents. Write for plan. Atlantic Supply Co., Long Branch, N. J.

MODELS made for inventors. Low prices. Howard Merryman, Towson, Md.

DRAWINGS: for manufacturing. Inventions developed. E. J. Paque, 503 Johnston Bldg., Cincinnati.

PATENTS THAT PROTECT are secured through Pacific Coast Patent Agency, Inc., Dept. D, Stockton, California.

INVENTORS, WE MAKE MODELS and metal specialties. Ludlow Model Works, Ludlow, Ky.

INVENTORS WISHING to sell outright or royalty communicate Engineer, Boulevard & 26th Street, Bayonne, N. J.

TELEGRAPHY

TELEGRAPHY TAUGHT in the shortest possible time. The Omnigraph Automatic Transmitter combined with standard key and sounder. Sends you telegraph messages at any speed just as an expert operator would. Five styles, \$2 up; circular free. Omnigraph Mfg. Co., 41 G. Cortlandt St., New York.

TELEGRAPHY, both Morse an' Wireless, taught quickly. Also Station Agency Work. R. R. Dispatcher's and Western Union wires, and complete wireless station and school. Big demand for operators. Living expenses earned. Correspondence courses if desired. Catalogues free. Dodge's Institute, 15th St., Vauvaraiso, Ind. Est. 1874.

PATENT ATTORNEYS

PATENTS PROMPTLY OBTAINED. Our free booklet will help you to fortune. Read pages 11 and 12 before applying for patent. Free searches. Write today. D. Swift & Co., 317 7th St., Washington, D. C.

"POINTERS FOR INVENTORS", telling inventors how to succeed in raising money to develop and patent inventions. "Pointers for Patentees," telling patentees how to succeed in working patents. Copyrighted, 25 cents each. Egerton R. Case, Temple Bldg., Toronto, Canada.

PATENTS PROCURED and positively sold if the idea has merit; all countries; satisfied clients my best references; send sketch; book free. H. Sanders, 25 N. Dearborn St., Chicago.

PATENTS SECURED.—Located opposite the Patent Office; prompt and personal attention assured. Trade-Marks registered. Parker Cook, Victor Bldg., Washington, D. C.

PATENTS—HERBERT JENNER, patent attorney and mechanical expert, 608 F. St., Washington, D. C., established 1883. I make a free examination and report if a patent can be had and exactly what it will cost. Send for circular.

PATENTS SECURED and sold. No attorneys' fee until patent allowed. Free books. Fuller & Fuller, Washington, D. C.

IMPORTANT NOTICE—Read my page ad on page 124 Advertising Section, of this magazine, relative to patents, trademarks, etc. Special offers contained in the ad. E. E. Vrooman, Patent Lawyer, Washington, D. C.

PATENTS—Books, 100 mechanical movements, perpetual motions, 50 illustrations. Mailed free. F. Dietrich & Co., Patent Lawyers, Washington, D. C.

SEND FOR FREE BOOKLET. All about Patents and their Cost. Shepherd & Campbell, 500A Victor Bldg., Washington, D. C.

PATENTS THAT PROTECT and pay. Advice and books free. Rates reasonable—Highest references; Best results. Watson E. Coleman, Patent Lawyer, 622 F. St., N. W., Washington, D. C.

C. L. PAIKER, Patent Attorney, Ex-examiner U. S. Patent Office, 910 G. St., Washington, D. C. Inventor's handbook "Protecting, Exploiting and Selling Inventions" sent free upon request.

PROMPT, RELIABLE AND SKILLFUL Patent Attorney. Edward W. Bryn, 627 F St., N. W., Washington, D. C.

FOR THE HOME

MECHANICS SHOULD KNOW all about the devices in taking away the odors of cooking, etc. Send 10 cents for red book, Homes Pub. Co., 730 South St., Elizabeth, N. J.

BUY PLUMBING GOODS, heating plants and water supply systems at wholesale. Catalogue free. Monarch Sales Co., 204 W. 3rd, Cincinnati.

FRESH EGGS, KEEP 8 MONTHS. 10 years experience dipping in hot solution. Costs cent a day. Prepaid package, 50c. Directions easy. Galvomed Dip, Clarinda, Iowa.

500 DRESS CUTTING CHART; sample 10c. Ladies' Art Co., Dept. 41, St. Louis.

MAKE YOUR OWN MISSION FURNITURE at the minimum of expense. Our 2 books "Mission Furniture, How to Make It," Parts 1 and 2, tell in plain, simple language just how to make 50 different pieces. Full dimensioned working drawings and half tones of finished articles. Price 25 cents each or 50 cents for the two volumes, postpaid. Popular Mechanics Book Dept., Chicago.

BEAUTIFUL ARTS-CRAFTS LAMPS—Anyone can make them out of paper, cardboard and wood. 16 designs. Inexpensive yet artistic. Complete book of instructions. Price 25c postpaid. Popular Mechanics Book Dept., Chicago.

METAL WORK AND ETCHING—A 96-page handbook for art metal workers telling how to make a great variety of useful and ornamental objects such as desk sets, arts-crafts jewelry, etc. Price, 25c postpaid. Popular Mechanics Book Dept., Chicago.

FOR MEN

FOR MEN—If you want to discard your suspenders and wear a belt this summer, there is only one practical natural fitting non slipping belt.—The L. & N. guaranteed for one year. Price \$1.00, postpaid. Send waist measure with order. Agents wanted. L. & N. Belt Co., 1257 N. Clark St., Chicago, Ill.

SAFETY RAZOR BLADES (all makes) resharpened "good as new, many say better." 30c per dozen. Send address for mailing Jacket. Keenedge Co., 611 Keenedge Bldg., Chicago, or 169 Congress St., Boston.

SAFETY RAZOR BLADES sterilized and sharpened better than new; 2 cents each. Five years' success. Send for blade box and circular. Electro Stropping Co., 134 Shelby St., Detroit, Mich.

SAFETY RAZOR BLADES RESHARPENED by "Keenedge Process." 2c each postpaid. Send address for convenient mailer. Keenedge Co., 827 No. Tacoma, Indianapolis, Indiana.

MENS LISLE THREAD HOSE, spliced linen, double heel and toe, 3 pair 60c, postpaid; state color and size wanted. A. Tibbets, Box 1203, Springfield, Mass.

MUSIC

IF YOU WANT the latest music and a better assortment for less money than elsewhere, write today for catalog. Semple's Music House, 204 West Ave., Norwalk, Conn.

"SOMEHOW OR OTHER." A beautiful song, 10 cents. Great music bargains. Sample pages free. E. E. Guilford Music Pub., North Adams, Mass.

ANY SHEET MUSIC you want, no matter where published, we will supply at 15c per copy postpaid. Willis Woodward & Co., 1193 Broadway, New York.

SHEET MUSIC—Latest popular songs 15c each. Write for circular. Jersey Music Company, 2903 Westfield Ave., Camden, N. J.

POEMS WANTED—Cash paid for songs. Needham Music House, St. Louis, Mo.

REAL ESTATE AND FARM LANDS

SACRAMENTO, CALIFORNIA, SUBURBAN small farms; about 20 minutes' ride on electric cars to center of Sacramento; city conveniences combined with country life, good income, low cost of living and small investment; climate, delightfully mild; twelve months' growing season and outdoor life; land very fertile; raise nuts, oranges, olives, great variety of other fruits, vegetables, poultry, etc.; Panama canal, Panama Pacific International Exposition, deep waterway and suburban feature will all boost values; absolutely high class; closest investigation courted; prices very low, easy payments; supply limited; excursion rates. Write today to A. C. Roebuck, Investments, Farm Land Dept., 35, 1024N American Trust Bldg., Chicago.

ADVANTAGES OF OREGON—100-page book gives amount of government land open to homestead in each county in the states of Oregon and Washington, and description of same; gives homestead, desert, timber, stone, coal and mineral laws; two maps of Oregon in colors, 21x28, showing railroad in operation, one showing all proposed railroad and electric lines, including eastern and central Oregon. 20c each, or the three 50c. Map of Washington in colors, 21x28, 20c. Nimmo, Runey & Co., Hamilton Bldg., Portland, Ore.

FREE. A CALIFORNIA HOME SITE in Los Angeles vicinity. To advertise and develop our holdings, we will, as special offer, give to any responsible applicant replying to this from your locality, and properly qualifying with us, a full sized lot in new townsite tract, being settled on our properties. This is your opportunity to secure what is rapidly becoming beyond the means of most: A Homesite in the famous Los Angeles section; the most attractive and rapidly increasing community in the world. Write and be convinced to your profit. Syndicate Sales and Development Co., Lock Box 1302, Los Angeles, Cal.

RICH GEORGIA FARM LANDS for actual settlers. In no other state are greater opportunities offered the man of purpose and energy, the actual farmer, than in Georgia, the garden spot of the South. If you are not satisfied with your present location and the return on your money and energy, come to Georgia, the land of "all-the-year-round" crops. We have some rich farms for sale at very reasonable prices and terms. If interested write to-day for our farm list, and booklet full of valuable information. Isbell Realty Co., Calhoun, Georgia.

FOR SALE—TOWNSITE and 112½ acres farming land at junction of two trunk line railroads in Michigan at half its value for cash. Big opportunity for farmer, manufacturer, or speculator. J. E. Merritt, Manistee, Mich.

MONEY-MAKING FARMS throughout 15 states; great variety, size and price, stock and tools included with many to settle estate quickly. Mammoth Illustrated catalogue No. 34 free. E. A. Strout, Station 3043, 47 W. 34th St., New York City.

WRITE C. W. WAUGHTEL, Homeland, Georgia, a northern town in a southern state. Splendid opportunities for those tired of the rigid climate.

FLORIDA FARM-HOMES at fraction usual cost through co-operative land clubs. Large colony successfully located. New club forming. Desirable members invited. Edward Miller, 1016 Franklin St., Tampa, Fla.

880 ACRES, well improved, near Midland, on the Southern Plains of West Texas, special bargain; write me, will send full particulars. W. J. Moran, Midland, Tex.

GROW ORANGES, GROW FIGS, grow rich and grow happy at Alcoa Orchards. Profits \$500 to \$1,000, yearly per acre. Best location, best people (all American) largest orange groves in Texas. We will plant your orchard for you. Free booklet "I." Gulf Coast Dev. Co., Alcoa, Texas.

GOVERNMENT FARMS FREE—Official 112-page book "Vacant Government Lands" describes every acre in every county in U. S. How secured free. 1911 diagrams and tables. All about irrigated farms. Price 25c postpaid. Webb Pub. Co., (Dept. 385), St. Paul, Minn.

GROW FRUIT IN CALIFORNIA; live at home; escape detail; insure efficiency; all by investing in our treasury stock. Safe. Based on income bearing realty. Packers of Geraldsons Figs. Write. Foothill Orchard Co., Newcastle, Cal.

\$2,500 FOR MY 120 acre farm. A. Gill, Mauston, Wis.

CALIFORNIA OIL LAND—But 3¼c per acre per day. Here opportunity knocks. Ten acre tracts. No interest, no taxes. Easy monthly payments. Write now. Frank Thorne, P. O. Box 1968, Los Angeles, Calif.

LAND for sale, any amount, improved and unimproved, in Washington and Fort Bend Counties. Tefs Land Company, Brenham, Tex.

FOR SALE—320 acres Michigan land; extra fine. Price \$4,000; easy terms. Circular free. J. E. Merritt, Manistee, Mich.

RICHEST CORN FARM—150 bus. per a. Guaranteed. Write owner, Box 7C, Sullivan, Ind.

STEPHENS COUNTY, TEXAS. Farms and ranches. As good as Texas affords, \$10.00 to \$35.00 per acre. W. A. Cox, Breckinridge, Texas.

WHY BE A SHOP DRUDGE? An improved place near Tampa will give you health, wealth and happiness. Fastest growing city in Florida. Ideal climate, winter or summer. Reliable information. Write today. Thos. Beasley, Tampa, Fla.

WIRELESS

FULL LINE OF QUALITY INSTRUMENTS for amateur and professional use, shown in Catalog 8. Beginner's receiving set, complete with receivers, \$15.00. Wm. J. Murdock Co., 10 Carter St., Chelsea, Mass.

POCKET WIRELESS TELEGRAPH Receiver, \$2. Instructions for making same 25 cents, or included with book "Electricity Explained", (nine chapters), \$1. Calvin Tompkins, 452 West 164th St., New York.

COMPLETE LONG DISTANCE WIRELESS Receiving Set, with 1000 ohm receiver \$5.95. 1000 ohm double-pole receivers \$1.75. All kinds and parts of wireless apparatus. Send stamp for Catalogue. Dept. T, Alden Wireless Co., Campello, Mass.

FOR SALE: One complete wireless receiving and sending station. Walter Dziadik, 130 Main St., Derby, Conn.

WIRELESS SET, How to Make—96 page book telling how to construct at small cost an outfit suitable for transmitting four or five miles. Price 25 cents, postpaid. Popular Mechanics Book Dept., Chicago.

ENAMELED WIRE at 33 1-3% to 40% off list. Stranded Antennae Wire at equal discount. Samples free. Send for circular. Other wireless goods also listed. B. Kendig, 7th Ave., Mt. Vernon, N. Y.

TYPEWRITERS

ENTERPRISE EXCHANGE INC., 609 E. Baltimore St., Baltimore, Md. Remanufactured typewriters, all makes, three days' examination allowed. Catalogue upon request. Write to us and we will save you \$5.

GENUINE TYPEWRITER BARGAINS, no matter what make, will quote you lower prices and easiest terms. Write for big bargain list and illustrated catalogue. L. J. Peabody, 264 Minot Building, opposite Postoffice, Boston, Mass.

I WANT TO CORRESPOND with persons who are about to buy a high-grade typewriter, and object to paying the high prices generally asked by manufacturers and dealers. Any make on approval. Catalogue, bargain list and valuable information sent free. A. E. Atchison, 4127 West 21st St., Chicago.

REMINGTON \$18.75. This is your opportunity. Write at once for the most interesting proposition ever made. We are the final word. Standard Typewriter Exchange, 23 Park Row, New York.

CASH SAVES: Why pay installment houses 40% more? We sell highgrade rebuilt Remingtons, Smiths, \$17; Underwoods, Oliviers, \$33—others cheap; sent on approval; sold under guarantee. Old Reliable, Consolidated Typewriter Exchange, 245 B'way, N. Y.

REMINGTON TYPEWRITERS \$12.00. Caligraphs \$6.00. Hammonds, Yost, Densmores, \$10.00, Smith Premiers and Jewetts \$15.00, Oliviers, Underwoods, L. C. Smiths and Royals \$25.00. Fifteen days free trial, and one year's guarantee, don't purchase until you get our prices. Harlem Typewriter Exchange, Dept. P.M., No. 217 West 125th St., New York City.

TYPEWRITERS—Every kind on the market, write today for best bargain you ever secured. Shipped anywhere on approval. \$6.00 up. Fletcher Typewriter Co., 207 N. 7th St., St. Louis, Mo.

FOR SALE OR EXCHANGE—Fox No. 3 Typewriter, absolutely good as new. Write for specimen work, terms. W. B. Pope, Athens, Georgia.

SHORTHAND TYPEWRITER: One stroke prints a word; hundred words a minute in six weeks; stenography unnecessary. Anderson, 5714 Cedar Ave., Philadelphia, Pa.

PRINTING

SPECIAL OFFER—100 Bond Letterheads and 100 Envelopes, \$1.00 postpaid. Patterson Press, Beaver Falls, Pa.

1,000 Envelopes, Letter Heads, Business Cards, or Bill Heads, \$1.50. Humboldt Pub. Co., 4743 State St., Chicago, Ill.

1,000 **IMITATION TYPEWRITER CIRCULAR LETTERS**, printed on good bond paper, heading black, body purple, \$2.75. 6x9 circulars, \$1.35. Elegant set samples free. Good's Printery, Harrisonburg, Va.

100 **FINE EMBOSSED EMBLEM CARDS**, any order. Name and address, name and number of order, in Old English. \$1.25 postpaid. Feltt Bros., New Castle, Ind.

GUMMED LABELS, \$3,000 \$1; two colors. Catalogue free. 1233 Arch, Philadelphia, Penn.

100 **ENVELOPES OR CARDS**, etc., 50c. Start mail order business. Money in every mail. Send 10c for samples. (M) Kirtledge Printery, So. Framingham, Mass.

SEND FOR FREE PRINTING PRESS catalog and instruction book; good presses, low prices. L. M. Carroll & Co., 167 W. Washington St., Chicago.

250 **ENVELOPES** and 250 Letterheads, printed from artistic trade cuts, or 4 lines composition, both \$1.00. Churchside Press, Binghamton, N. Y.

RARE COINS AND STAMPS

FOREIGN STAMPS, 250 MIXED 10c. 50 all different, 5c. 250 old United States, 10c. 35 different, 5 cents. Stamps bought, list 4 cents. Kleinman, 3643 Marshall, Philadelphia, Penna.

\$7.75 PAID FOR RARE DATE 1853 Quarters, \$20.00 for a Half-Dollar. We pay a cash premium on hundreds of coins. Keep all money coined before 1880, and send 10 cents at once for our New Illustrated Coin Value Book; size 4x7. It may mean your fortune. C. F. Clarke Co., Coin Dealers, Dept. 14, Le Roy, N. Y.

STAMPS—40 U. S., 6 CENTS, 10 different coins and coin book, 15c. 10 large U. S. cents, 40c. 10 broken bank and state notes, 30c. F. L. Toupal Co., Chicago Heights, Ill.

STAMPS FREE. 3 different Soudan (camel), or 5 different Tunis, free with stamp lists, 50c coupon; details of \$1,000 stamp contest for 2c postage. W. C. Phillips & Co., Glastonbury, Conn.

WANTED—Old Coins and Stamps. Highest prices paid. Two books giving prices we pay, 12c. A. C. Roessler, 10 Clay St., Newark, N. J.

RARE OLD PAPER MONEY, 5 different bills 25c. 10 different rare coins 25c. 20 for 50c. Burgess Coin & Stamp Co., 1018 Huron, Toledo, Ohio.

STAMPS 100 ALL DIFFERENT, FREE. Postage 2c. Mention paper. Quaker Stamp Co., Toledo, Ohio.

STAMPS—195 China, etc., stamp dictionary and list, 2c. Bullard, Sta. A, Boston.

MISCELLANEOUS

LET ME SEND YOU my steel die embosser with your initials for embossing your stationery, etc. Saves printer's bills. Single initial, 25 cents. Monogram, two and 3 letters, 50 and 75c; nothing like it; just patented; satisfaction guaranteed. H. L. Miller, Engraver, Marietta, Ga.

WE MAKE A SPECIALTY of mailing lists and can furnish you with just the list of buyers to suit your business. Ask us for information stating line desired. Our imitation typewritten letters are business getters. Commercial Sales & Mfg. Co., Oberlin, Ohio.

CUT YOUR NAME ON YOUR TOOLS, knives or other belongings in one minute. Will not come off. Fluid will not hurt your hands. Enough for 100 names sent postpaid with instructions for using, 25c. Geo. W. Prather, 7350 St. Fresno, Cal.

CARMEN ADJUSTABLE BRACELET FREE—A gold finished bracelet, guaranteed to wear, given for selling 18 ten-cent Mexican Drawn Work Handkerchiefs. Fits any wrist and looks neat. Send ten cents for samples and premium list. Avon Handkerchief Co., Somerville, Mass.

MAKE MORE MONEY. Our book filled with money making formulas, plans, schemes, etc., will enable you to increase your income. Send 15-2c stamps today and start making money. Albany Supply House, 4322 N. Albany Ave., Chicago.

I WILL START YOU earning \$4 daily at home in spare time, silvering mirrors; no capital; send for free instruction booklet, giving plans of operation. G. F. Redmond, Dept. 306, Boston, Mass.

MOTION PICTURE MACHINES, Film Views, Magic Lanterns, Slides, and similar Wonders for Sale. Catalogue Free. We also Buy Magic Machines, Films, Slides, etc. Harbach & Co., 809 Filbert St., Philadelphia, Pa.

MAKE MONEY. LEARN HOW to metalize flowers, leaves, etc.; renew dry batteries; transfer photos to watch dials. Formulas 10c, 3 for 25c. Mail Order Bureau, Box 283, Scranton, Pa.

300 MONEY MAKING FORMULAS and six \$ getting secrets all for only 20c. H. Thurston, 2205-5th Ave., Terre Haute, Ind.

RUBBER STAMPS—Cushioned, mounted with handle, 10c a line; daters, numberers or pads, 10c each, wholesale catalogue with an order (only). Douglas & Son, 751-6th Ave., N. Y.

TRICKS, JOKERS, PUZZLES, ILLUSIONS, Novelties—Magic Pocket Trick Free. Illustrated Catalog included. Send 6c stamps. Magic Dept., 10-270 West 39th St., New York.

ANYBODY CAN MAKE GOOD CUTS with my simple zinc etching process; price, \$1; specimens and particulars for stamp. T. M. Day, Box M, Windfall, Ind.

TOBACCO CAUSES CHRONIC IRRITATION of brain and nerve cells. Ni-Ko heals this irritation. You don't want tobacco any more. You will feel so good. Write today. King Ni-Ko, 7, Wichita, Kans.

500 MONEY MAKING FORMULAS and Digest, publishing monthly 100 Money Makers, one year for 25c. Trial 6 months, 10c. Digest, Grand Rapids, Mich.

BROTHER—Accidentally discovered root will cure tobacco habit. Gladly send particulars. F. Stokes, Mohawk, Florida.

FORMULA METAL POLISH, Gallon costs, 50c. Sells for \$12.00. Sent postpaid, 50c. Co-operative Sales Co., Marion, Ind.

MAKE CUTS—Multiplate halftones made easily, quickly, cheaply by anybody. Multiplate and process, \$1.00. Guaranteed. Particulars free. M. McKinley, Winona, Minn.

INVISIBLE INK—After secret treatment plain and permanent. Powder for several bottles, 75c silver. R. DeLano, Port Washington, N. Y.

MANUFACTURE TOILET ARTICLES, formulas 6 cents. Trebla Co., Navarre Bldg., St. Louis.

DRAWING PAPERS, tracing papers, blue printing. H. Knight, Racine, Wisconsin.

MAKE Invisible Ink, formula 10c. Frederic Chase, New Britain, Conn.

CORRECT FORMULAS, 20c each. Malalane Company, 1411 Longfellow Avenue, New York.

FORMULAS—Anything, 25 cents. D. B. Croy, 224 Nye, St. Lima, Ohio.

50c BRINGS 5 FORMULAS and full instructions for metalizing, mounting and coloring flowers, insects, etc., for jewelry. Easy home work. Big profits. P. Benson, Stewartville, Minn.

NEW BAIT for bass and pickerel. Sample 30c. Tecumseh Tackle Co., Tecumseh, Mich.

DRAWINGS, TRACINGS AND BLUEPRINTS MADE to order. Send sketch for estimate. Satisfaction guaranteed. Danner Draft Shop, P. O. Box 83, Dayton, Ohio.

TRANSFER PHOTOS TO WATCH CASES, chinaware, sofa pillows, etc. New process. Very profitable. 25c brings full instructions. P. Benson, Stewartville, Minn.

LET US MAIL YOUR CIRCULARS, 50c per 100 and we pay the postage. Only legitimate propositions solicited. Commercial Sales & Mfg. Co., Oberlin, Ohio.

METALIZE FLOWERS, TRANSFER PICTURES to glass, gold plate without battery. Each 50c, three \$1. W. T. O'Hara, Talladega, Ala.

ONE DIP PEN. Will write six hundred words. Send ten cents in coin. T. E. Brooks, Birmingham, Alabama.

MECHANIC'S HAND SOAP. Make yourself. Sell others. Formula, 25c. "Lycke," Omaha, Nebraska.

FORMULAS FOR ANYTHING, 20c. Satisfaction guaranteed. Lee Mountain, Chavies, Ala.

TRIED FORMULA for casehardening soft steel and iron, 50c. D. D. Hagen, R. D. 6, Lancaster, Pa.

"TEXTIGUM" TYPEWRITER COVERS, fine, 50c. See what I say under "Typewriters." Atchison.

YOUR NAME ON 12 rubber tip pencils 50c, also a good pocket knife free. W. M. Stuart, Marshall, Mich.

YOUR AD in over fifty magazines 3 months, 5 cents per word. A. S. Mankin & Co., Alexandria, Va.

300 MONEY MAKING FORMULAS, 25c. Sorenson Bros., Perth Amboy, N. J.

VALUABLE TRADE SECRETS, offered by experienced Chemist for the first time to the public. "Liquid Glass" Egg Preservative, Peroxide Bleach, Massage Cream, Artificial Rubber, Bismuth harmless hair Dye, Non-inflammable Benzine, Powdered Tasteless Castor Oil. Including formulas for advertised novelties: Butter Merger, Cachoo, Mirror-making, Ink for engraving steel, photographs on watch dials, silk or linen, Disappearing Ink and over 2,500 other valuable recipes, shop secrets, neatly bound in flexible cloth. This collection cannot be had elsewhere—is worth many times the price. \$1.00. Liscombe Miller Evak Chemical Co., Marietta, Georgia.

MODEL—STEAM AND GASOLINE ENGINES, Dynamos, Motors, Motor Boats, etc. We have them or you can build them with our castings and instructions. Send two cents for illustrated booklet. The B. A. B. Model & Mfg. Co., Room 536B, Singer Bldg., 149 Broadway, N. Y.

PLAYED OUT dry cell batteries perfectly renewed; half cent each; directions easily followed; 25c coin. L. M. Burgess, Monda-min, Iowa.

SMALLEST BIBLE AND CLOCK on earth and secret writing cards, 25c. Curtis, 207 Citizens Bank, Los Angeles, California.

CACHOO—Sample, 12c; dozen, 80c. Ewing's, 190 Thatcher Place, Decatur, Illinois.

800 CHOICE FORMULAS and selected trade secrets, 35c. Process Company, 816 Oakwood Blvd., Chicago.

HECTOGRAPHS, make yours, best improved, at wholesale cost; directions easily followed; 10c (coin). L. M. Burgess, Monda-min, Iowa.

ONE THOUSAND NAMES—1911 selected list—R. F. D. and villages, eastern Carolina—printed—\$1.00. Nouveau Sales Co., Box 92, Raleigh, N. C.

RICH LIST—Revised edition all fruitgrowers, 1,500 names \$1.50. Montgomery, Lebanon, New York.

READ MY ADS under "Patents" and "Business Chances." Sanders, Chicago.

TOO LATE TO CLASSIFY

POSITIVELY BEST RIBBONS, three, \$1.10. See what I say under "Typewriters." Atchison.

"VALUABLE TRADE SECRETS." See Miscellaneous column. Gold mine of information.

Want This Suit?



Show our samples to three of your friends, take two orders easy and make profit enough to get this swell tailored suit free. No trouble, simply show our new up-to-date samples. Everybody surprised, prices so low, styles so beautiful, orders come easy. **We pay the express and guarantee perfect fit or no sale. You can make \$5.00 a Day Easy.** Write quick and get samples and agents' outfit free, everything explained, and special inside price on a suit for yourself. It's a wonderful chance.

BANNER TAILORING CO., Dept. 709, CHICAGO

OK We Want Widows, Ladies and Girls
Needing Light, Profitable Employment, spare time or permanent work, to write us. Our offer will interest you. **Something new.** Also one man wanted in every town. Particulars Free.
FAIR MFG. CO., FM 69, RACINE, WIS.

Time and Its Measurement

By JAMES ARTHUR

Reprinted from Popular Mechanics. So far as known is entirely different from anything previously written on the subject. Mr. Arthur is a great authority along this line, having for years made an extensive study of clocks, watches and time-measuring devices.

Contents: Chapter 1—Historic Outline. 2—Japanese Clocks. 3—Modern Clocks. 4—Astronomical Foundation of Time.

"Written So You Can Understand It"

64 pages. Profusely illustrated. Size 7x10 in. Printed on coated paper with handsome blue cloth covers.

Price \$1.50 Postpaid

Popular Mechanics Co., 318 W. Washington St., Chicago

Working Drawings of the "Demoiselle"

Price \$2⁰⁰
Postpaid

SANTOS-DUMONT'S
Remarkable Aeroplane

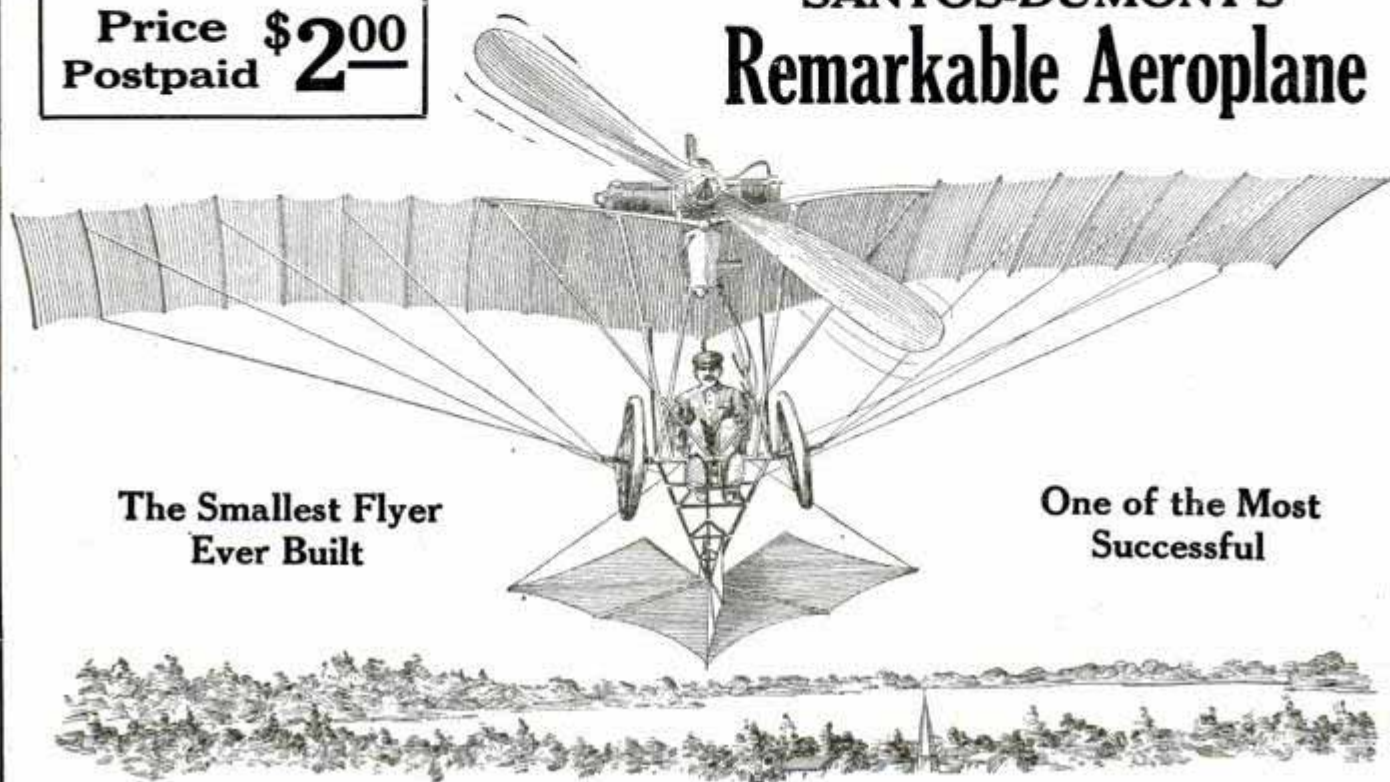

The Smallest Flyer
Ever Built

One of the Most
Successful

Complete plans for the construction of the wonderful monoplane offered to the public for the first time.

The machine is unencumbered by patent rights, the famous aviator preferring to place his invention at the disposal of the world in the interest of the art to which he has devoted his life. These plans were secured by representatives of Popular Mechanics from Santos-Dumont, and are the result of consultations with his engineers and observations made at his workshops.

How the "DEMOISELLE" Ranks With Other Machines

From New York Times, October 9, 1910.

"M. Garros, famous French aviator, uses a Demoiselle aeroplane, the invention of Santos-Dumont, which has proved to be one of the most interesting types of flying machines in Europe. It has been called the humming bird of the heavier-than-air brood. It is the smallest flying machine in existence, weighing less than 250 pounds. It is capable of enormous speed, and darts about through the air in a way that has provoked both laughter and wonderment from the crowds at the European meetings. Garros is by far the most expert driver of these little machines in Europe. During the past season he has made remarkable flights in various places, but his flights from Pinard to St. Malo, over the water, have been regarded as most remarkable. While these baby monoplanes in the hands of ordinary pilots keep very close to the ground, Garros has driven his machine to great altitudes, and has taken his place in many of the important contests of France with the larger monoplanes."

The set comprises seven large blue prints, showing every detail of construction, accompanied by a description of how to build.

POPULAR MECHANICS COMPANY

318 W. Washington Street, CHICAGO, ILLINOIS

Practical Instruction In the Fascinating Art of METAL SPINNING

By PROF. F. D. CRAWSHAW
College of Engineering, University of Illinois

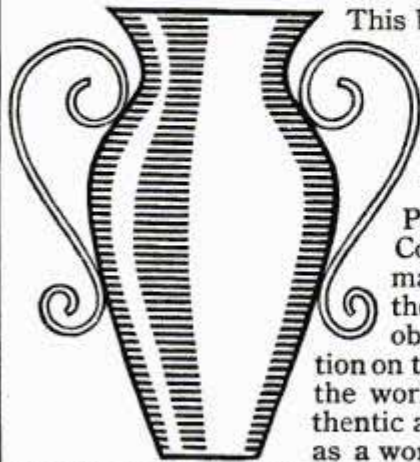

This book, the **only one published** on this interesting art, is one of the series of 25-Cent Industrial Handbooks being published by Popular Mechanics Co. It is written by a man who has made a thorough study of all obtainable information on the subject, making the work absolutely authentic and adapted to use as a working manual both

for those who desire to spin metal as an art recreation and to follow this work as a trade.

80 Pages. 33 illustrations. Cloth cover.

Price 25 Cents, Postpaid

Can be ordered through your newsdealer or direct from the publisher

Popular Mechanics Book Dept., Chicago

WHEN YOU WANT ANYTHING AND DON'T
KNOW WHERE TO FIND IT
WRITE BUREAU OF INFORMATION,
POPULAR MECHANICS CHICAGO

MONTHLY CASH PRIZES

Until further notice in this magazine the Editor of Popular Mechanics will pay two cash prizes each month for the best original contributions to its

SHOP NOTES DEPARTMENT

\$10 for the Best Contribution
\$5 for the Second Best

THIS IS IN ADDITION to our usual rates for such contributed articles.

Quality, not length counts.

Checks will be sent on the last day of each month for the prize articles received during that month. Publication in the magazine will follow in about two months.

PRIZES AWARDED FOR MARCH, 1911

First Prize—R. B. CAEHAMED, Ohio, Ill. \$10
"Etching on Glass"
Second Prize—ANDREW SMITH, New Haven, Conn. \$5
"Universal Chuck Used as a Centering Tool"

EXTRA AWARD

On account of there being four contributions this month each of which deserved second prize, we have made an EXTRA AWARD of four additional second prizes, as follows:

EDWIN C. WRIGHT, Newport, Ky. \$5
"Miter Box Made of Box Corners"
JOSEPH F. BOLTON, JR., S. Duxbury, Mass. \$5
"Spline for Laying out Boat Curves"
CLAUDE H. SANFORD, Fayetteville, Ark. \$5
"Boilermakers' Center Punch"
GEO. E. WALSH, New York City \$5
"Bracket for Roof Scaffolds"

All accepted contributions to our departments, "SHOP NOTES" and "AMATEUR MECHANICS," are paid for immediately; checks for prize awards are sent at the end of each month.

Address, EDITOR POPULAR MECHANICS
318 W. Washington St., Chicago

Mission Furniture

HOW TO MAKE IT

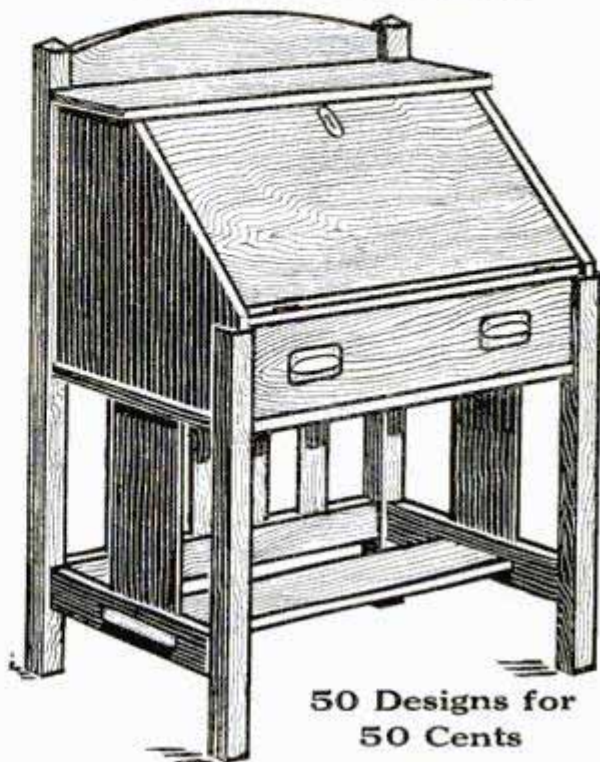

50 Designs for
50 Cents

Read What One Man Did

Hattiesburg Miss
Aug 19, 1910

Popular Mechanics Co.,
225 Washington St Chicago.
Sir

Please find enclosed
25¢ for which send me
Part Two Mission Furniture
How to make it, by mail post
paid I have part 1, and have
made one pe. of ~~the~~ furniture
and sold \$400.00 Four hundred
dollars worth of it, and I am
not a carpenter either but with
the instructions written so I
can understand it I have a business
of my own. Yours truly
John D. Peman

TWO VOLUMES

PART ONE

PART TWO

21 Designs. 96 Pages. | 32 Designs. 128 Pages.
Cloth Cover. **25 Cents Each, Postpaid**

POPULAR MECHANICS BOOK DEPT.

318 W. Washington Street, CHICAGO

A GOOD, USEFUL BOOK

Wood-Working for Amateur Craftsmen

"Written So You Can Understand It"

By IRA S. GRIFFITH, A. B.

125 Illustrations
128 Pages Cloth Cover
Size 5 x 7 inches

Price 25 Cents
Postpaid

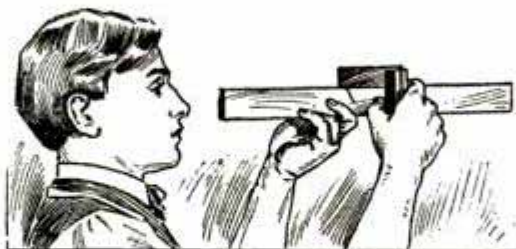

One of the latest of
Popular Mechanics
25-cent series of In-
dustrial Handbooks

This book was especially designed to cover every essential step from the A B C to the X Y Z of woodworking. The chapters dealing with making special articles bring out every cut, joint and process used in this important trade, and the proper use and care of tools, working up of materials, etc., are treated thoroughly and plainly.

CONTENTS:

Making Out a Stock Bill—Laying Out Rough Stock—Hand Saws—Sawing with Hand Saws—Planes: How to Set and Adjust the Irons—Squaring Up Mill Planed Stock—Squaring Up Rough Stock—Whetting Plane Irons and Chisels—Grinding Plane Irons and Chisels—Making a Bird Box—Making a Tabouret—How to Make an Umbrella Stand—Making a Magazine Stand—Making a Table—Making a Cabinet.

A valuable book for either self instruction or use in manual training courses

ORDER OF YOUR NEWSDEALER, BOOKSELLER OR DIRECT FROM

POPULAR MECHANICS BOOK DEPARTMENT, Publishers, CHICAGO

JUST READY

HOW TO MAKE A

WIRELESS SET

By ARTHUR MOORE

A book of 96 pages, bound in cloth, explaining in an understandable manner the construction of an outfit suitable for transmitting four or five miles. This set can be easily constructed at a small cost by any boy of ordinary ability.

Complete details with illustrations

PRICE 25 CENTS POSTPAID

ORDER OF YOUR NEWSDEALER OR SEND DIRECT TO THE PUBLISHER

Popular Mechanics Book Dept. 318 W. Washington Street
CHICAGO, ILL.

ENGINEERS, DRAFTSMEN

and all others who have lettering to do need a good system of easy lettering. HERE IT IS

CONTENTS:

- BLOCK LETTERS:**
Heavy, Outline, Condensed, Expanded, Fancy, Shaded and Italics.
- GOTHIC:**
Condensed, Expanded, Italics.
- ROMAN:**
Fancy, Italics.
- SCRIPT: MODERN ARCHITECTURAL**



A new edition has just been issued with a supplement containing 8 new alphabets

Well printed on good paper and handsomely bound in cloth. Sent postpaid on receipt of 55 cents.

Spon & Chamberlain, 123 P. M. Liberty St. NEW YORK, U.S.A.

LEARN WATCHMAKING

Engraving and Jewelry Repairing. Practical specialists in charge of all instruction. Students trained for the best paying positions. Earn while learning. Our school is endorsed and recommended by leading jewelers. A few months will make you an expert. Positions secured for graduates. Demand for watchmakers greater than the supply. Write for free catalog.

CHICAGO SCHOOL OF WATCHMAKING
Dept. 26, Bush Temple, CHICAGO



FINANCING AN ENTERPRISE

Practical two-vol. work by Francis Cooper telling how to secure capital and successfully promote a business enterprise. Prospectus writing, patents, capitalization, incorporation—clear discussion of entire subject from 15 years' promoting experience. Thousands sold. Third ed. 543 pp. \$4 prepaid. Circular on request. **Ronald Press Co., 198A Broadway New York**

HOME STUDY



Senator Depew

Learn to Talk Well!

To be a successful Banker, Business Man, Real Estate Operator, Salesman, Lawyer or Clerk—you must know how to present your proposition effectively—tersely—quickly. The practical principles of our course in Oratory and Argumentation have helped hundreds of men to increase their incomes. Why not you? Easy payments. Small cost. Officers and teachers, all well known men. Write for catalog 025.

INTERCONTINENTAL UNIVERSITY, WASHINGTON, D. C.

Salesmen Wanted

Trained Salesmen earn from \$1,200.00 to \$10,000.00 a year, and expenses. Hundreds of good positions now open. No experience needed to get one of them. We will assist you to secure a position where you can get Practical Experience as a Salesman and earn \$100 a month or more while you are learning. Write to-day for our free book "A Knight of the Grip," list of good openings, and testimonials from hundreds of men recently placed in good positions.

Address nearest office, Dept. 116

National Salesmen's Training Association

Chicago New York Kansas City Seattle New Orleans

The Best Book For Beginners

A Practical Course in Mechanical Drawing
By **Wm. F. Willard**

Price 50c Postpaid

POPULAR MECHANICS BOOK DEPT.
318 W. Washington Street, Chicago

"HELP WANTED"

-Uncle Sam.

**Railway Mail Clerks
Internal Revenue Employees
Clerks in the Departments at
Washington, D. C.
City Carriers — Postoffice Clerk**

Over 15,000 positions will be filled during 1911.

**\$800.00 to \$1800.00 a Year
for LIFE**

No "layoffs" without pay, because of strikes, financial fluctuations or the whims of some petty boss. Excellent opportunities for quick advancement to Higher Government Positions. If you want immediate appointment, send **TODAY** for our schedule showing locations and dates of the coming examinations. Any delay means the loss of just so much time in preparing yourself for examination.

We Prepare Candidates Free

The coupon, filled out as directed, entitles the sender to a free copy of our book, "Government Positions and How to Obtain Them," and to consideration for Free Coaching for the examination here checked.

SEND COUPON BELOW

FRANKLIN INSTITUTE
Dept. J 109, ROCHESTER, N. Y.

COUPON			
... Railway Mail Clerk	[\$800 to \$1400]	... Customs Positions	[\$600 to \$1500]
... Postoffice Clerk	[\$800 to \$1200]	... Internal Revenue	[\$700 to \$1800]
... Postoffice Carrier	[\$600 to \$1200]	... Stenographer	[\$800 to \$1500]
... Rural Mail Carrier	[\$500 to \$ 900]	... Clerk in the Departments at Washington	[\$500 to \$1500]
... Bookkeeper	[\$900 to \$1800]		

Name

Address J 109

Use this before you lose it. Write plainly.

I WANT MEN

Like YOU, Who Want to Make **\$3,000 A Year or More**



We need a good live man right now in your territory to handle real estate deals for us. No experience or capital necessary. I will teach you the Real Estate Business. Also Commercial, Law and Business Methods, then appoint you representative in your locality. Easy work; large profits. Write for free book.

MORDEN LAND & LOAN COMPANY,
406 Palace Building, Minneapolis, Minnesota.



Learn to Write

I can make a good penman of you at home during spare time. Write for my freebook, "How to Become a Good Penman." It contains specimens and tells how others mastered penmanship by my method. Your name will be elegantly written on a card if you enclose stamp.

F. W. TAMBLYN, 418 Meyer Bldg., KANSAS CITY, MO.



STAMMER

My book "How to Stop Stammering"—a treatise on "Scientific Talking"—direct to the point.

Write **M. L. HATFIELD, 1462 Grove St., OAKLAND, CALIF.**

EARN FROM \$25 TO \$100 PER WEEK

LEARN ABOUT OUR FREE COURSE IN SHOW CARD AND SIGN WRITING

To introduce "Litholia" Ready-to-use colors for show-card writing and artists' use, we are offering for a limited time only a complete course in show-card and sign writing to those purchasing a small assortment of these colors. This is a great opportunity for ambitious men and women to increase their earning capacity. Good show-card writers earn from \$25 to \$100 per week. Booklets and complete information free.

Litholia Pm. Color Co., 247 W. 125th St., N. Y.



**EARN \$25 to \$50 WEEKLY
IN AUTOMOBILE BUSINESS**

Chauffeurs, Automobile Salesmen, Demonstrators and Repairmen are in big demand everywhere. The field is new, work pleasant, and anyone can learn. We teach you in 10 weeks of study during spare time to become thoroughly efficient. Our course of instruction by mail is simple, practical, and very interesting. Besides, we assist you to secure a good position. Free model of automobile to every student.

FIRST LESSON SENT FREE—WRITE NOW

Don't miss this offer. Send us a postal today.

Empire Auto. Institute 537 Empire Bldg.,
ROCHESTER, N. Y.

The Original Automobile School

Chauffeurs and competent men supplied owners and garages.

ELECTRICITY



Complete in One Year

**SCIENTIFIC ELECTRICITY
IN ALL ITS BRANCHES**

Bliss Electrical School

Studies restricted to theoretical and practical electricity, mechanical drawing and necessary engineering work. Teaches simplicity, concentration, hard work. For young men of energy and character. 18 years of greatest success. Graduates hold first-class positions. **Opens Sept. 20.** Write for new catalog.

15 Takoma Ave., WASHINGTON, D. C.

**LEARN WATCHMAKING
AT HOME**



You can learn by our modern and original system of instruction every part of the Watchmaker's Trade at home as good or better than at a shop. You can earn money while learning and secure a well paying position or start in business after completing our course of instruction. Good watchmakers are always in demand and earn from \$20 to \$35 per week. For particulars apply to the **WISCONSIN SCHOOL OF WATCHMAKING** Enterprise Bldg., MILWAUKEE, WIS.



**LEARN
WATCHMAKING**

Watchmaking pays and you can earn while you learn. Write for **FREE BOOK**, "How to be a Watchmaker." Postal brings it.

Stone's School of Watchmaking
912 Globe Bldg. St. Paul, Minn.



COPY THIS SKETCH

and let me see what you can do with it. You can earn \$20.00 to \$125.00 or more per week, as illustrator or cartoonist. My practical system of personal individual lessons by mail will develop your talent. Fifteen years successful work for newspapers and magazines qualifies me to teach you. Send me your sketch of President Taft with 6c. in stamps and I will send you a test lesson plate, also collection of drawings showing possibilities for YOU.

THE LANDON SCHOOL OF ILLUSTRATING
and CARTOONING
1438 Schofield Building, Cleveland, Ohio.

YOU CAN BE A SALESMAN

EARN WHILE YOU LEARN

We have **Salesman's Positions** open in which you can secure **Practical Training** and **earn good money** while studying our course. Men equipped with our system of Practical Training earn from \$1,500 to \$5,000 a year. Positions now open. Address: **C. J. Brown, President,**

THE PRACTICAL SCHOOLS OF SALESMANSHIP
Box 815 Cleveland, O. Box 815 Ft. Worth, Tex. Box 815 N. Y. City



LEARN ENGRAVING

We can teach you by mail. Established 22 years, with hundreds of prosperous graduates. Students in demand at big salaries. Catalogue and first lesson free.

REES SCHOOL 551 Granite Bldg.
ROCHESTER, N. Y.

LEARN TO WRITE ADVERTISEMENTS IF YOU ARE EARNING LESS THAN \$25 a WEEK

We can positively show you by mail how to increase your salary. Send for beautiful prospectus, mailed **FREE.**

PAGE-DAVIS SCHOOL, Dept. 112, CHICAGO, ILL.



LEARN CHIROPRACTIC

**The new method of drugless healing
EARN \$50 TO \$100 PER WEEK**

Our free book tells how you can learn to detect disease and remove the cause by Howard's method of Spinal Adjustment. Positively the most simple, direct, advanced and scientific method of drugless healing. Based on unerring natural laws. Anyone can understand it; learned in spare time. Improve your social prominence and financial standing. Start now on the road to honor and success. Write for free book and special scholarship offer.

NATIONAL SCHOOL OF CHIROPRACTIC
508 Wendell Building CHICAGO, ILL.



**\$3,000 to \$10,000
Per Year For You**

I can make you prosperous. If you want to earn more money—if you want to establish yourself in an independent business requiring no capital—send me your name and address on coupon below, (or a postal will do) and I will mail you, free, our **Big 62-Page Book**, fully explaining just how you can fit yourself to earn big money in the

Real Estate, Brokerage and Insurance Business. Our thoroughly tested successful system not only equips you fully on every point of Real Estate, Brokerage and Insurance, we also give you, free, a valuable course in Commercial Law. Our Free Book is of great interest to anyone, but is of vital importance to Clerks, Book Keepers, Salesmen, Agents, Solicitors and others who are ambitious to be in a good paying business of their own.

International Realty Corp., 1536 Manhattan Bldg., Chicago
Successors to The Cross Co. and H. W. Cross & Co.

This Book Shows You How to Succeed in Real Estate, Brokerage and Insurance

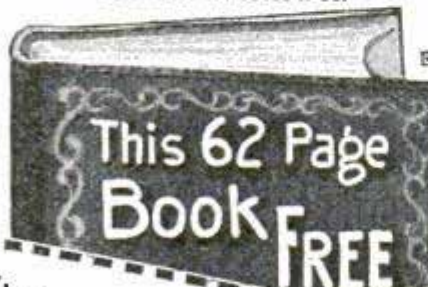

Send no money, but merely your name and address on a postal or on the Coupon below.

NAME

ADDRESS.....

Make \$25 to \$75 Weekly Be a Watchmaker!

Let us Start You in Business for Yourself

You can learn this high class, gentlemanly and extremely profitable trade in a few weeks without leaving home or quitting your present occupation.

Best of all, we will teach it to you without any cost whatever.

We furnish you absolutely free—text books, necessary lessons, illustrated chart and photo prints, showing exactly how to repair each job, no matter how complicated. You won't have to spend a penny except to buy a few tools as you need them while you are learning.

LIVE PARTNERS WANTED—Capital Furnished

In order to quickly open up new fields for our unequalled line of goods, our directors have decided to establish a number of men in this **best of all businesses**; take them into partnership with us so that they, with us, may reap the benefits of our capital and long experience and profit from their own integrity, brains, business ability and character.

We Will Stand Back of Hustlers to the limit and will leave them a big success. With our backing and instruction you should soon become one of the **moneyed men in your community**. The profits in the jewelry business are immense; the field has not even been scratched; the opportunity to become prosperous is now open. **These letters prove** that success is within your grasp—almost as surely as day follows night. I personally want to clearly lay our plans before you. Won't you write me today.

CHAS. F. ELMORE, Principal of Watchmaking College
Rogers, Thurman & Co., 101-103 N. Wabash Avenue, Chicago



Thank you for starting me in this business. Monday and Tuesday I made \$19.85 at my work bench, and sold four watches, netting me \$27 for two days. I get at least half the work of this place and have been open but 10 days.—D. C. Files.

I can do any kind of repairing. Thank you for your assistance in starting me. Business growing all the time.—Henry Baker.

Your instructions are very easy to follow. I have just commenced, and have cleaned and repaired 8 watches and 2 clocks. Repair work is coming as fast as I can take care of it.—W. W. Hass.

I made \$3 the first day after I got my tools in operation, and average one to three repair jobs a day.—A. A. Hulley.

Your instruction books and charts are simply fine. I am doing a good business. All my customers pleased.—J. O. Curry.

Government Positions

45,837 Appointments were made to Civil Service places during the past year. Excellent opportunities for young people. Each year we instruct by mail thousands of persons who pass these examinations, and a large share of them receive appointments to life positions at \$840 to \$1,500 a year. If you desire a position of this kind, write for our Civil Service Announcement, containing full information about all government examinations and questions recently used by the Civil Service Commission.

COLUMBIAN CORRESPONDENCE COLLEGE, WASHINGTON, D. C.

Teach Yourself Arithmetic

with a set of **ARITHMETIC HELP**. Any and all examples and problems in arithmetic, from the easiest to the hardest, are worked out and explained so **anyone** can understand. For the student or business man. Easy and simple; 2 volumes, 630 pages; over 200 illustrations and color plates; bound in red silk cloth. Most complete ever published. A \$2 bill brings a set prepaid anywhere. Send for a set. If not pleased, return at our expense and get your money back. Order today.

STANDARD SALES CO., 23 Fifth Ave., CHICAGO



Learn Telegraphy

MORSE and WIRELESS

At My Practical School. Demand for operators greater than supply. We also teach Station Agency Work. Graduates assisted. We occupy our own 2 large modern buildings equipped with K. R. Dispatchers and Western Union Wires and Wireless Station. Endorsed by Railroad, Wireless and Western Union Officials. Exclusive Methods. Teachers are practical experts. Living expenses earned. Easy payments. Catalogs Free. Correspondence course if desired. GEORGE M. DODGE, Pres., Dodge's Institute, 8th St., Estab. 1874, Valparaiso, Ind.



LEARN PIANO TUNING AT HOME by the aid of the TUNE-A-PHONE. A Profession that can be converted into money at any time or place in the civilized world at an hour's notice. Earn \$5.00 to \$15.00 per day. Valuable illustrated book FREE. Write NILES BRYANT SCHOOL OF PIANO TUNING, 31 Music Hall, Battle Creek, Mich.

LEARN WATCHMAKING

refined, profitable labor—Competent men always in demand. We teach it thoroughly in as many months as it formerly took years. Does away with tedious apprenticeship. Money earned while studying. Positions secured. Send for catalog

St. Louis Watchmaking School, St. Louis, Mo.

PLUMBING, Electricity, Bricklaying, Painting taught in a few months. No age limit. Positions secured. Free Catalogue. GREAT EASTERN TRADE SCHOOL, 49 E. 32d St., New York City, and 121 South 23d St., Philadelphia.

LEARN PLUMBING

A trade that will make you independent for life. Hours Shorter—Pay Bigger—Demand Greater than most any trade. You need no previous experience. Our practical methods enable you in a few months to hold position as skilled plumber or conduct your own business. Catalog sent free.

St. Louis Trades School
4430 Olive St. ST. LOUIS, MO.

**BIG
PAY
SHORT
HOURS**

Send now
One year
\$1.00



Do You Want to Make \$100

or more working at cash art assignments? The STUDENTS ART MAGAZINE every issue publishes from \$5 to \$50 worth of cash art assignments for amateur artists and art students of all schools. Besides this the magazine gives easy lessons and advance lessons in Designing, Illustrating and Cartooning, lessons in Chalk-talking and Lettering and general articles of interest to artists and art students. A year's subscription will help you much more than a cheap correspondence course. This magazine is a live wire; it's cheerful, helpful, truthful and clean. No art student can afford to be without it. Send your subscription today. If you do not find the magazine ENTIRELY satisfactory your money will be refunded. One year, 12 issues, \$1.00. Do it NOW. Address, G. H. Lockwood, Editor, Dept. 88, Kalamazoo, Mich.

Send now
\$1.00 for
One year



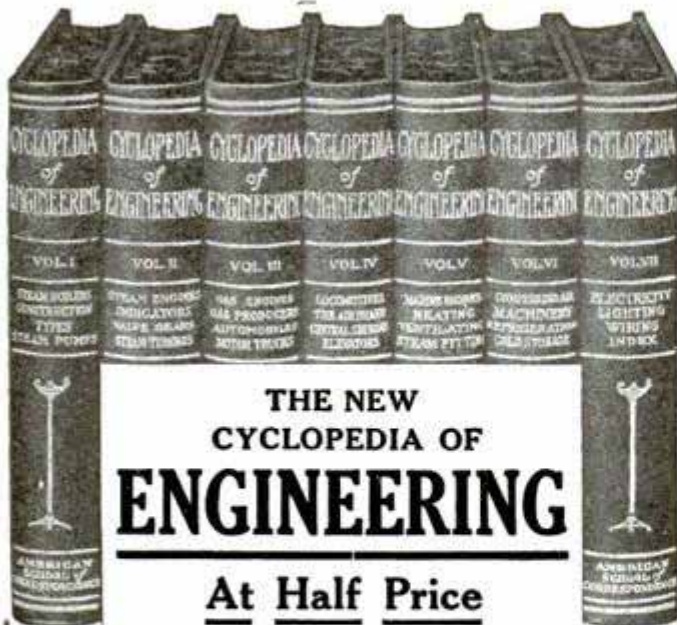

**THE NEW
CYCLOPEDIA OF
ENGINEERING**

At Half Price

Every Engineer must read if he would progress—the biggest men in the field can't go around telling what they know—but they can write it. And you can read it—in our New Cyclopedia of Engineering—the most valuable set of books on this subject ever offered to Engineers. This Cyclopedia has just been revised—it's right up to the minute.

These books cover every subject you are likely to meet in practical engineering. They are interestingly written by well-known authorities and are not only valuable for studying, but also as permanent reference books.

The seven books contain 3,200 pages, size 7x10 inches, and over 2,500 illustrations, full page plates, diagrams, etc. The regular price of these books is \$36.00, but as a special introductory offer we have put the price at \$18.80.

\$2.00 Down \$2.00 a Month

Shipped express prepaid so you can examine them before paying a cent

This price and these terms make it easy for any engineer to secure the valuable set of books. Read the brief description below and see what you will get when you mail the coupon.

Our Protective Guarantee

Send for the Cyclopedia of Engineering, examine it carefully and if, at the end of five days, you see that you need it, send us your first \$2.00 and \$2.00 each month thereafter until the total, \$18.80, has been paid. If the books are not satisfactory—don't send us a cent—we will pay all charges. Use this coupon. We absolutely protect you against loss. Signing the coupon does not obligate you in any way.

READ THIS SYNOPSIS

Construction of Boilers—Boiler Accessories—Fuel Economizers—Mechanical Stokers—Steam Pumps—Steam Engines—Indicators—Valve Gears—Steam Turbines—Gas and Oil Engines—Fuels—Automobiles—Carbureters—Locomotive Boilers and Engines—The Air Brake—Single-Phase Electric Railway—Elevators—Marine Boilers—Marine Engines—Heating and Ventilating—Compressed Air—Transmission—Absorption and Compression Refrigeration—Ammonia Machines—Direct Current Dynamos and Motors—Management of Dynamos and Motors—Electric Wiring—Electric Lighting, etc.

For a short time we will include, as a monthly supplement, for one year, the TECHNICAL WORLD MAGAZINE. This is a regular \$1.50 monthly, full of Twentieth Century Scientific facts, written in popular form.

FREE EXAMINATION COUPON

**American School of Correspondence
CHICAGO, U. S. A.**

Please send set Cyclopedia of Engineering for 5 days' free examination. Also Technical World for 1 year. I will send \$2.00 within 5 days and \$2.00 a month until I have paid \$18.80 for books and magazine; or notify you to send for the books. Title not to pass until fully paid. POP. MECH. 5-'11

NAME

ADDRESS

OCCUPATION

EMPLOYER

Please Mention Popular Mechanics



EARN A SPLENDID SALARY

Chauffeurs, Auto Salesmen, Repairmen, Testers, Assemblers and Inspectors are in demand at big salaries. We have trained hundreds for good positions. Our home study course covers mechanism, operation and repairing and prepares for the best positions. Let us train you in your spare time and put you in line for a good auto job. Results guaranteed or no pay. Send today for free catalogue and names of successful graduates.

CLEVELAND AUTOMOBILE SCHOOL, 2167 East 9th St., Cleveland, Ohio
"THE SCHOOL THAT MAKES GOOD."

New York Electrical School

Offers to men and boys a theoretical and practical course in applied electricity without limit as to time.

Instruction individual, day and night school, equipment complete and up-to-date. Student learns by doing, and by practical application is fitted to enter all fields of electrical industry fully qualified. School open all year. Write for free prospectus.

44 West Seventeenth St., NEW YORK



\$25 to \$100 a Week

Be a live wire. Big salaries paid to our graduate chauffeurs and auto experts. We are an accredited school with competent staff of graduate engineers, and teach you at home in 10 simple lessons to earn big money and assist you to secure a position.

Over 100 diagrams included in course. Write for prospectus, sample pages, testimonials from students and endorsements of 10 leading auto makers—FREE. (Free model to each student.)

**Practical Auto School
68 Beaver Street
New York**

Learn Watch Repairing

Be a watchmaker—you can learn this profitable trade by correspondence in a few weeks in your own home by the DeSelms Chart System. After you complete the course you will know a watch from A to Z. You will know just what the matter is and how to repair one. When you graduate you will be a practical watchmaker and repairer and competent to fill any position. Positions for our graduates.

Ask for our Free Book. It explains our system and terms.

**THE DeSELMS WATCH SCHOOL
23 Perry St. ATTICA, INDIANA**



STAMMER NO MORE

I can cure you. Reputation world-wide. Established 16 years. Trial lesson explaining Home Instruction, with 200-page book, FREE. Answer at once. George Andrew Lewis, 178 Adelaide Street, Detroit, Mich.



**ARITHMETIC
SELF-TAUGHT**

A plain, easily-understood volume for all who have not had the opportunity of learning this subject thoroughly, or who have forgotten what they once learned. 257 Pages. Requires no teacher. This great little book sent postpaid for 60 CENTS. Stamps accepted, leather binding \$1.

**GEO. A. ZELLAR BOOK CO.
Est. 1876, 4462 W. Belle Place, ST. LOUIS, MO.**

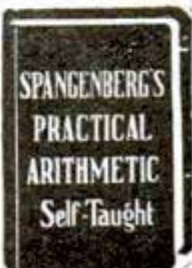



\$1.25 Handbooks for 50c.

No books in existence contain in so small space as much information about the trades and professions of which they treat as do these Handbooks. They are little giant encyclopedias of practical knowledge giving data and information that is hard to find in ordinary books. These Handbooks have been prepared by the well-known textbook writers of the International Correspondence Schools whose textbooks are recognized the world over as the most practical treatises on applied sciences ever published. These Handbooks are consulting experts of the highest rank, and are the most powerful force in the world for the promotion of ambitious men. They are an indispensable help to quicker and better work that will command advancement. They are printed on a high-grade book paper in clear type, and durably and handsomely bound in cloth with gilt titles; contain on an average of 364 pages and 175 illustrations and are regularly sold for \$1.25 each.

SPECIAL OFFER.—We are selling these Handbooks, durably bound in cloth with gilt titles, at a special price for each Handbook of 50 cents.

Mechanics'—Tables; formulas; measurements; belting; mechanical powers; hydro-mechanics; strength of materials; shafting; boiler design; care of boilers; power of boilers; chimneys; exhaust heating; machine design; machine tools; slide valve; pulleys; cylinders and steam chests; pistons; gearing; transit surveying; triangulation; curves; radii and deflections; earth work; track work; electricity; etc.

Advertiser's—How to plan and write an advertisement; type and type measurements; points on printing style; display; preparation of manuscript; proof reading; engraving and printing methods; electrotypes; matrices; advertisement illustrations; magazines; newspapers; retail, department-store, general, trade-paper, and mail-order advertising; trade marks; circulars; advertising agencies; etc.

Stenographer's & Correspondent's—Advice to beginners; shorthand speed; letters of application; punctuation; correct and faulty diction; business correspondence; type-writing; abbreviations; addressing; mailing; rates of postage; duplicating work; etc.

Telephone and Telegraph—Useful tables; mechanics; electricity; magnetism; primary batteries; storage batteries; electrical measurements; telephony; tests with magnetogenerator and bell; telegraphy; Morse telegraph systems; multiplex telegraphy; etc.

Electrical Engineer's—Mechanics; electricity; electrical units; symbols and quantities; physical and electrical properties of metals and alloys; wire gauges; magnetism; dynamos and motors; electric batteries; alternating current apparatus; alternators; transformers; wattmeters; electric transmission; electric lamps; wiring; electric heating and welding; electromagnets; controllers; car wiring; etc.

Business Man's—Arithmetic; tables; business forms; card systems; measures of extension; weight and capacity; time; value of foreign coins; duties on imports; bookkeeping; stenography; correspondence; postal information; financial terms; money and the money market; brokers and brokerage; patents; copyright and trade marks; corporations; business law; publicity; etc.

Plumbers and Fitters'—Arithmetic; involution and evolution; powers, roots, and reciprocals; circles; decimals; geometrical drawing; weights and measures; formulas; mensuration; mechanics; hydro-mechanics; building construction; heating and ventilation; gas-fitting; plumbing; etc.

Mariners'—Logarithms; trigonometry; navigation; terrestrial navigation; celestial navigation; organization of a man of war; naval ordnance; explosives; torpedoes; ship building; speed, tonnage, and fuel consumption; ropes; wind and weather; signals; nautical memoranda; etc.

Building Trades—Loads and structures; strength of materials; properties of sections; strength of rivets and pins; materials of construction; footings and foundations; masonry construction; woods used in building; qualities of timbers; joinery; framing; estimating; elements of architectural design; drainage systems; plumbing fixtures; plumbers' tables; heating and ventilation; gas and gas-fitting; etc.

Bookkeeper's—Arithmetic; formulas; tables; money; percentage; interest; equation of accounts; money and the money market; business law; financial terms; banks and banking; postal information; distances and time between various places; bookkeeping; business forms; card systems; modern office methods; cost accounting; bank bookkeeping; clearing house methods; etc.

International Textbook Co.

Box 872, SCRANTON, PA.

I enclose \$_____ for which please send me the books BEFORE which I have marked X.

- Mechanics' Handbook
- Elect. Eng. Handbook
- Bldg. Trades Handbook
- Plum. & Fit. Handbook
- Tel. & Tel. Handbook
- Advertiser's Handbook
- Business Handbook
- Bookkeeper's Handbook
- Sten. & Corr. Handbook
- Mariners' Handbook

Name _____

St. and No. _____

City _____ State _____



Highland Park College

DES MOINES, IOWA

Enter Any Time

2000 Students Annually

One of the most completely equipped ENGINEERING SCHOOLS in the country

Students may enter any time, and their term is 12 weeks from the day they enter.

Mention course in which you are interested. Address,

O. H. LONGWELL, President, Des Moines, Ia.

COURSES OFFERED

1. CIVIL, ELECTRICAL AND MECHANICAL ENGINEERING COURSES. Standard courses are offered in Civil, Electrical and Mechanical Engineering. Special opportunity is offered for making up work or for taking a complete course preparatory to the standard Engineering Courses. Shop work from the beginning comes in preparatory courses. See our new Engineering Catalogue.

2. SHORT COURSES

1. One Year Electrical Engineering Course
2. One Year Telephone Engineering Course
3. One Year Steam Engineering Course
4. One Year Machinists' and Automobile Course
5. One Year Course in Mechanical Drawing

practical and are intended for those who have but limited education and do not see their way clear to take a complete Engineering Course. The Machinists' Course is especially practical. The machine shop is the most complete to be found in connection with any Engineering School in the United States.

Just a fair common school education is all that is required for entrance to these courses. These courses are very

SPECIAL COURSES

1. TRACTION ENGINEERING. This is the most complete course in Traction Engineering offered by any Engineering School in the country. It may be completed in three months. Students are taught how to make all repairs on engines as well as to handle them. Four traction engines used for experimental purposes.

2. GASOLINE AND AUTOMOBILE COURSES. These courses may be completed in three months. They are exceedingly practical. Complete Chauffeur practice. Just a fair common school education is all that is necessary to enter.

3. FARM BLACKSMITHING, FARM CARPENTRY.

LEARN TO REPAIR AND RUN AUTOMOBILES



EARN BIG MONEY IN AUTOMOBILE BUSINESS

as a chauffeur, repairman, salesman. Work pleasant. Big demand for trained men. Fine chances for starting automobile livery, agencies, taxicab and repair companies. Learn the automobile—every part, and its mechanical operation thoroughly and practically in a few weeks. Write today for our interesting free book and learn about the tremendous opportunities everywhere in

this new business and our excellent course of training.

KANSAS CITY AUTOMOBILE SCHOOL

(Conducted by CLIFF HOGAN)

(Largest and Best Equipped Automobile School in America)

2139 E. 15th Street, Kansas City, Mo.



Learn Photography, Photo-Engraving or 3-Color Work

Photographers and Engravers Earn \$20 to \$50 Per Week Only College in the world where these paying professions are taught successfully. Established 17 years. Endorsed by International Association of Photo-Engravers and Photographers' Association of Illinois. Terms easy; living inexpensive. Graduates assisted in securing good positions. Write for catalog, and specify course in which you are interested.

Illinois College of Photography or 999 Wabash Av., Bissell College of Photo-Engraving Effingham, Ill.

L. H. BISSELL, Pres.

LEARN JEWELERS' ENGRAVING

A high-salaried and easily learned trade, taught thoroughly by mail. We will teach the beginner better engraving than he can gain in years of rigid apprenticeship. We will also improve the skill of any engraver. Send for our catalog. The Engraving School, Dept. 112, Page Building, Chicago Ill.

MUSIC LESSONS FREE AT YOUR HOME

Write Today for our Booklet. It tells how to learn to play Piano, Organ, Violin, Mandolin, etc. Beginners or advanced pupils. American School of Music, 50 Lakeside Bldg., Chicago, Ill.



DO YOU LIKE TO DRAW?

That's all we want to know

Now we will not give you any grand prize—or a lot of free stuff if you answer this ad. Nor do we claim to make you rich in a week. But if you are anxious to develop your talent with a successful cartoonist, so you can make money, send a copy of this picture with 6c. in stamps for portfolio of cartoons and sample lesson plate, and let us explain.

The W. L. Evans School of Cartooning
321 Kingmoore Bldg., Cleveland, O.

HYPNOTISM!

Wonderful science easily mastered by anyone. Send address for free book and other literature.

M. D. BETTS, Dept. 65, JACKSON, MICH.

SHORTHAND IN 30 DAYS

We absolutely guarantee to teach shorthand complete in thirty days. You can learn in spare time in your own home, no matter where you live. No need to spend months as with old systems. Boyd's Syllabic System is different in principle from all other systems. The first radical improvement in shorthand since 1839. It is easy to learn—easy to write—easy to read. Simple. Practical. Speedy. Sure. No ruled lines—no positions—no shading, as in other systems. No long list of word signs to confuse. Only nine characters to learn and you have the entire English language at your absolute command. The best system for stenographers, private secretaries, newspaper reporters. Lawyers, ministers, teachers, physicians, literary folk and business men may now learn shorthand for their own use. Thousands of business and professional men and women find their shorthand a great advantage. The Boyd System is the only system suited to home study. Our graduates hold lucrative, high-grade positions everywhere. Send today for free booklets, testimonials, guarantee offer, and full description of this new Syllabic shorthand system. Address—

CHICAGO CORRESPONDENCE SCHOOLS, 969 Chicago Opera House Block, CHICAGO, ILL.

How's Your Job Alongside of His?



You can take **his** place

Do you want to "get ahead?" If you will let us we can show you how to become an expert auto driver—like the man at the wheel. His job isn't work—it's a cinch. Such experts

Earn \$35. to \$50. a Week

and there is a big demand for them. Our Home Study Course trains you in your own home in a few weeks' time. A Small Down Payment Starts You. Separable Models of working parts showing every detail and movement free to every student. Write today for our Free prospectus, with Samples of lessons. We assist to better positions.

We are in constant touch with owners and garages requiring competent men.

Practical Road lessons given after graduation
BUFFALO AUTOMOBILE SCHOOL

The auto school that comes to you.

44 Centaur Building **BUFFALO, N. Y.**



IF YOU STAMMER

attend no school till you hear from me. Largest school in the world, employing the advanced natural method for the cure of stammering, stuttering, etc. No sing-songing or time-beating. If let run, stammering will wreck your life's happiness and handicap your endeavors. I cured myself and thousands of others by my method and can cure you. Beautiful 188 page book and Special Rate sent FREE.

Leo Wells Millard, Pres., North-Western School for Stammerers, Inc., 917 First St., Milwaukee, Wis.



I TEACH SIGN PAINTING

HOW CARD WRITING or LETTERING by mail and guarantee success. Only field not overcrowded. My instruction is unequalled because practical, personal and thorough. Easy terms. Write for large catalogue.

CHAS. J. STRONG, Founder

DETROIT SCHOOL OF LETTERING
DEPARTMENT PM. **DETROIT, MICH.**

"Oldest and Largest School of its Kind"

BOOKS THAT REALLY TEACH

you the things you want to know, and in a simple, practical way that you can understand.

Our illustrated catalogue, which will be sent you free upon request, tells all about the Practical Mechanical Books for Home Study that we publish. No matter what your ambition or desire for knowledge may be, we publish books written by authorities in their different lines that will give you just the mechanical training and information that you want and need. Write today for this up-to-date and complete illustrated catalogue and popular price list. It is free.

FREDERICK J. DRAKE & CO.

PUBLISHERS OF SELF-EDUCATIONAL BOOKS, 1327 MICHIGAN AVENUE, CHICAGO



Boston Garter

Velvet Grip

Fits smoothly and keeps up the sock with neatness and security. It is comfortable because its wearer doesn't feel it.

The Boston Garter keeps its strength and excels in wear-value Fully guaranteed—a new pair free if you find an imperfection Easy to buy because all dealers have it.

See that Boston Garter is stamped on the clasp.

Boston Garters

Recognized the Standard, and Worn the World over by Well Dressed Men.

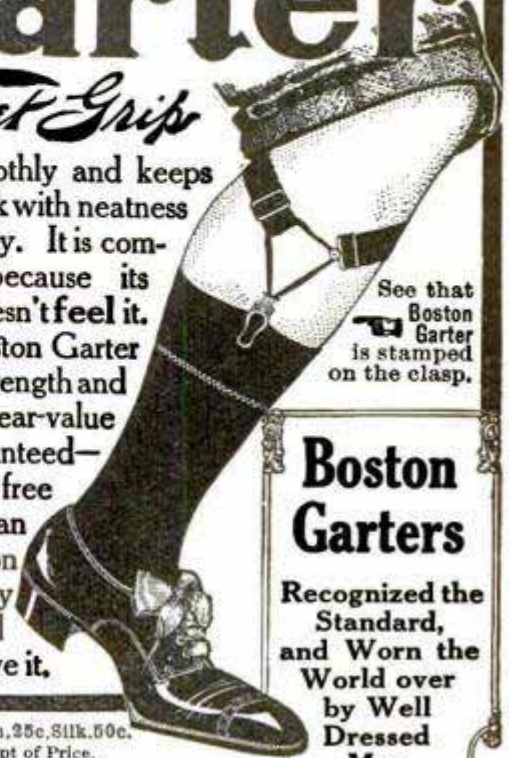

Sample Pair, Cotton, 25c. Silk, 50c. Mailed on Receipt of Price.

GEORGE FROST CO., MAKERS
Boston, U.S.A.

How to Run an Auto



"Homans' Self Propelled Vehicles" gives full details on successful care, handling and how to locate trouble.

Beginning at the first principles necessary to be known, and then forward to the principles used in every part of a Motor Car.

It is a thorough 1910 course in the science of Automobiles, highly approved by manufacturers, owners, operators and repairmen. Contains over 400 illustrations and diagrams, making every detail clear, written in plain language. Handsomely bound.

Price \$2.00 postpaid, or sent **Free on Approval**

The only way the practical merit of this MANUAL can be given is by an examination of the book itself, which we will submit for examination, to be paid for or returned after looking it over.

Upon receipt of the following agreement, the book will be forwarded:

No money in advance required, sign and return

THEO. AUDEL & CO., 63 Fifth Ave., NEW YORK, N. Y.
Kindly mail me copy of Homans' Automobiles, and, if found satisfactory, I will immediately remit you \$2, or return the book to you.

NAME.....

OCCUPATION.....

ADDRESS.....(May Pop. Mech.)



25c



25c



25c



25c



25c



25c



25c



Popular Mechanics 25 Cent Series of Industrial Handbooks

"WRITTEN SO YOU CAN UNDERSTAND IT"

THESE books furnish reliable information on mechanical subjects at a price within the reach of all. They are convenient and uniform in size (5 by 7 in.) and neat and attractive in appearance; being bound in a good grade of durable cloth with artistic cover designs, printed in clear readable type on good book paper and fully illustrated.

A useful, compact library of mechanical books unequaled anywhere at the price **Each 25c Postpaid**

THESE ARE READY

Mission Furniture, How to Make It, Part I. 96 Pages.

A handy little manual containing plain directions for making 21 designs, with working drawings and illustrations.

Mission Furniture, How to Make It, Part II. 128 Pages.

A companion volume to Part I containing 32 additional designs.

Arts-Crafts Lamps, How to Make Them. 96 Pages. By J. D. ADAMS.

Plain instructions for making 16 beautiful designs from paper, cardboard and wood. Good results can be obtained by anyone possessed of a fair amount of patience.

How to Make a Wireless Set. 96 Pages. By ARTHUR MOORE.

Explains in an understandable manner the construction of an outfit for transmitting 4 or 5 miles. This set can be easily constructed at a small cost by any boy of ordinary ability.

Metal Spinning. 80 Pages. By PROF. F. D. CRAWSHAW, University of Wisconsin.

The only book published on this interesting art. A practical working manual for those who desire to spin metal as an art recreation or to follow this work as a trade.

Heat. 128 Pages. By PROF. J. GORDON OGDEN, Ph. D., Prof. of Physics,

Fifth Avenue H. S., Pittsburg.

An immensely interesting and instructive story pertaining to heat and its relation to modern mechanics.

Electroplating. 112 Pages.

A treatise which will not only enable the humblest beginner to make a start, but which gives pointers of value to even the most experienced electroplater.

Metal Work and Etching. 96 Pages.

A complete handbook for art metal workers giving every detail for making a great variety of useful and ornamental objects such as book ends, desk sets, arts and crafts jewelry, hinges, drawer pulls, paper knives, letter openers, match boxes, tie and pipe racks, pad corners, etc. Fully illustrated.

OTHER EQUALLY GOOD OR BETTER TITLES TO FOLLOW

A few convincing statements regarding this series

1. Regarding the Price:

"The wonder is that a cloth-bound book profusely illustrated with working drawings can be produced and sold at such a very moderate price. The descriptions and illustrations are excellent."—From review of Mission Furniture, Part II, in *Scientific American*.

2. As to Practicality:

Hattiesburg, Miss., Aug. 19, 1910
Popular Mechanics Co., 225 Washington St., Chicago
Sirs: Please find enclosed 25c for which send me Part Two Mission Furniture How to Make It, by mail, post paid. I have part I, and have made one piece of furniture and sold (\$400.00) four hundred dollars worth of it, and I am not a carpenter either, but with the instructions "Written so I can understand it," I have a business of my own. Yours truly,
JOHN S. COLEMAN.

3. The High Character of Contents:

"This is the first book published in the English language on metal spinning. In spite of its price, 25 cents, it is an excellent little treatise on the subject. The book is well written and contains much information for those interested in the subject. It is well worth the price."—Review of Metal Spinning—*Brass World*.

Obtainable at News stands, bookstores or direct from the publishers.

Popular Mechanics Book Dept., CHICAGO

THE ONLY WAY



Between
CHICAGO
St. LOUIS
PEORIA SPRINGFIELD AND
KANSAS CITY

"Alton" Trains
No Noise **RIDE EASY** No Dust

Rock Ballast Roadbed

Perfect Passenger Service

Chicago & Alton R.R.

R. J. McKAY, General Passenger Agent, Chicago

REVERSIBLE
"Linene"
TRADE MARK

COLLARS
CUFFS AND BOSOMS

LINENE COLLARS

are accurately moulded to the neck, are cool and perfectly flexible, do not fray or chafe, and are up to date in style.

10 for 25 cents at the stores

By mail 30 cents, or sample 6 cents in U. S. stamps.
Give Size and Style.

REVERSIBLE COLLAR CO.
Department U BOSTON, MASS.



VAN DYCK
Sizes 12 to 18 Inches
Front 1 1/2 Inches-Back 1 1/2 Inches

ANGELO
Sizes 12 to 20 Inches
Front 2 1/2 Inches-Back 1 Inch

RAPHAEL
Sizes 12 to 20 Inches
Front 2 1/2 Inches-Back 1 Inch

RUBENS
Sizes 12 to 20 Inches
Front 2 Inches-Back 1 Inch

ANTI-NICOTINE PIPE

Get the Pleasure
"Without the Poison"
(Trade Mark Reg.)
40c 3 FOR \$1.00



THE PIPE THEY LET YOU SMOKE AT HOME

Looks and colors like meerschchaum. Absorbs the nicotine and keeps on tasting sweet. You never had such an enjoyable smoke. Sent prepaid anywhere. Money back if not satisfactory.

Order 3 or More Today
H. MENGES, The Smokers' Friend
605 N. 7th St. ST. LOUIS, MO.

WHEN YOU WANT ANYTHING AND DON'T KNOW WHERE TO FIND IT
WRITE BUREAU OF INFORMATION,
POPULAR MECHANICS CHICAGO

9,059-Word Business Book Free

Simply send us a postal and ask for our free illustrated 9,059-word Business Booklet, which tells how priceless Business Experience, squeezed from the lives of 112 big, broad, brainy business men, may be made yours — yours to boost your salary, to increase your profits. This free booklet deals with

- How to manage a business
- How to sell goods
- How to get money by mail
- How to buy at rock-bottom
- How to collect money
- How to stop cost leaks
- How to train and handle men
- How to get and hold a position
- How to advertise a business
- How to devise office methods

Sending for this free book binds you to nothing, involves you in no obligation; yet it may be the means of starting you on a broader career. Surely you will not deny yourself this privilege, when it involves only the risk of a postal—a penny! Simply say, "Send on your 9,059-word Booklet." Send to **SYSTEM, Dept. 81-5, 151-153 Wabash Avenue, Chicago**

We have for sale a limited number of complete files of

Popular Mechanics for 1909

These consist of the 12 issues of the magazine and a complete index suitable for binding.

Price \$1.25 postpaid.

POPULAR MECHANICS, 225 Washington St., CHICAGO

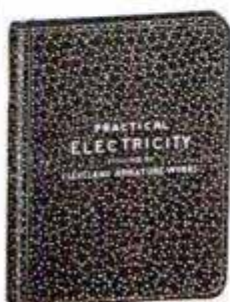

A SCHOOL WITHIN ITSELF

There are XX chapters in all, XIX carrying you from the fundamental principles of electricity on through the various branches to a point where the careful student comprehends the complete designing, care and operation of a dynamo or motor, and one chapter on electric automobiles, outlining their construction, care and operation, and all about storage batteries and how to handle them. Each subject is carefully written and to the point. After a student studies a subject, he is questioned on that subject in such a manner as to bring clearly to his mind the points he needs to know regarding same. The book contains a dictionary defining 1500 Electrical Words, enabling the reader to ascertain the meaning of any electrical word, term or phrase used in this book, as well as hundreds of others in common use. All required tables necessary in the study are in it.

\$2.00 PER COPY—FIFTH EDITION—26,000 COPIES SOLD.

The offer we make of refunding money if book is not satisfactory upon examination is AN UNUSUAL ONE in connection with the sale of a book. But we have no fear of its return. Your decision will be what thousands of others have been. Money would not buy it if it could not be duplicated. We could print testimonials by the hundreds. It is best to order and be your own judge of its merits.

CLEVELAND ARMATURE WORKS, Cleveland, Ohio

Armatures and Fields Wound — Commutators Filled
AMERICA'S GREATEST REPAIR WORKS



The only Solution:

Get a better job

Are you "trying to make both ends meet" on a small, unsatisfactory salary? Are you one of the thousands of energetic, capable men whose days are spent in work not suited to their natural talents?

Then read this wonderful offer. We mean it and there is a fine chance for you if you improve it.

If you lack the time and the means to stop work and take a course of training, the American School will **lend you the cost of the training** you need and let you make your own terms for repaying us.

This is the greatest offer ever made to men who have "got it in them to rise," and we are prepared to help everyone who comes to us in earnest.

Check the coupon, mail it to us, and we will explain fully our "Deferred Tuition" plan, how we will lend you the cost of the tuition, and allow you to pay us back when the increase in your yearly income equals the amount of the loan.

No Promotion—No Pay—that's what our "Deferred Tuition" Scholarship means. Send the coupon today and prepare for a **better job**.

AMERICAN SCHOOL OF CORRESPONDENCE
CHICAGO, U. S. A.

Opportunity Coupon

American School of Correspondence, Chicago, U. S. A.

Please send me your Bulletin and advise me how I can qualify for the position marked "X." Pop. Mech. 5-'11

- | | |
|-----------------------------|---------------------------|
|Book-keeper |Draftsman |
|Stenographer |Architect |
|Accountant |Civil Engineer |
|Cost Accountant |Automobile Operator |
|Systematizer |Electrical Engineer |
|Certified Public Acc't |Mechanical Engineer |
|Auditor |Moving Picture Op'r |
|Business Manager |Steam Engineer |
|Commercial Law |Fire Insurance Eng'r |
|Reclamation Engineer |College Preparatory |

NAME

ADDRESS.....

Popular Mechanics Magazine

WRITTEN SO YOU CAN UNDERSTAND IT

Vol. 15

MAY, 1911

No. 5

HEIGHT LINE SUPPLANTS THE AGE LIMIT IN STREET CARS

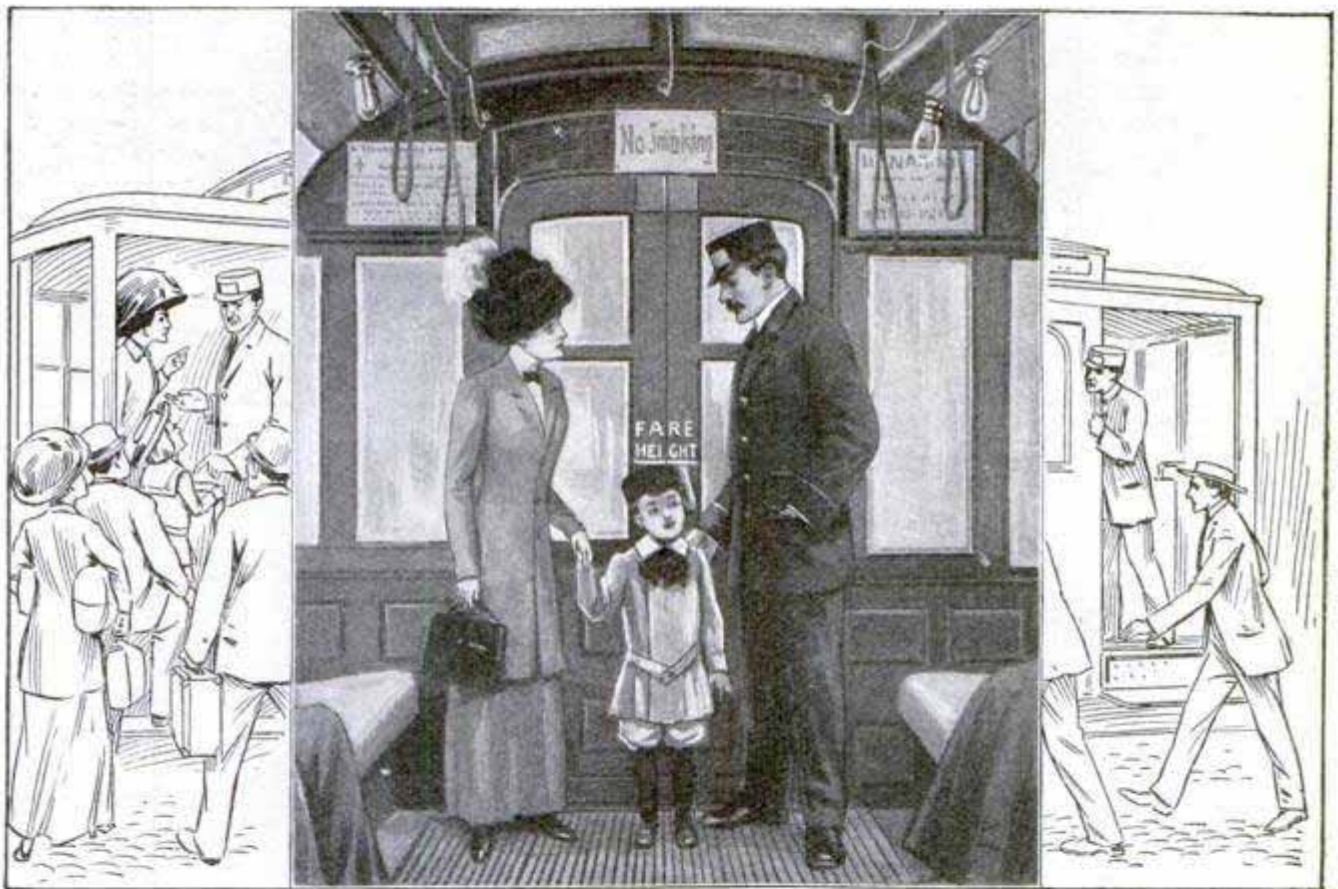

Every Child Who Can Walk Under the Height Line Rides Free

ANY person under 41 in. in height can ride free on the cars of a Pittsburg interurban electric road. That is the average height of the American child of five years, and the question of whether a person is above or below that figure in stature can be accurately determined on every car of this company's line. A white line just 41 in. from the floor of the car has been painted on one of each pair of car doors. The rules of the company require all

children five years old and over to pay fare. As there were constant disputes as to the age of children brought into the cars, a way out of the difficulty was found in the establishment of a "height line." The proper height was determined by obtaining figures from insurance companies as to the average height of a five-year-old American child. The managers of the Pittsburg road declare that the method has eliminated disputes between passengers and conductors.

FIREFIGHTERS IDEALIZED BY SCULPTOR

To show in sculptured bronze or marble an idealization of the common-



"Heroes of Peace"—"Play Away, Thirty-One!"
by John Paulding

place things of life is the ambition of a Chicago artist who attracted some little attention during an exhibition in that city with a group he called "He-

roses of Peace" which showed three firemen holding the nozzle of a hose pipe, braced and waiting for the water to be turned into it. The group represents the usual crew of three pipemen and they are represented as having advanced over a fallen wall with their pipe. Every detail of the costume and apparatus is faithfully reproduced. One of the men is signaling with his hand above his head and the sub-title of the group is "Play Away, Thirty-One!", this being the order the man whose hand is raised is supposed to be giving. This, too, is strictly in accordance with the ways of the firefighters and is the method they use in signaling their readiness to play the hose at any point to which they are directed.

OBSOLETE WARSHIP ADRIFT

The obsolete French warship "Richelieu," broke away from the tugs while being towed from Toulon to Rotterdam and drifted off Brest in the path of the transatlantic liners, striking the Retarrier rocks of the Scilly islands, and floating free again to become a danger to sea traffic. The British warship "Inflexible" was sent out to search for the derelict, and interposed herself to windward as a



Obsolete French Warship Being Towed Out of Track of Transatlantic Liners

floating breakwater, so that the tugs, thus screened, could get hold of the wanderer. She will be broken up for junk.

LONG SKIRTS PROHIBITED ON NUREMBERG STREETS

A French writer who has made a tour of Europe and America to study street hygienic measures found two cities where trailing dresses are absolutely forbidden on the streets. These places are Nuremberg and Nordhau-

ser, Germany, where the violation of the trailing-skirt ordinance is punishable by a fine. At other places of Austria and Germany the authorities are content with posting placards requesting women not to wear trailing skirts or at least to carry the trains in such a manner as not to raise objectionable dust.

The short walking dress of the American women and the anti-spitting ordinances more or less enforced in most of the American cities were praised by the French investigator.



House in Girard, Ohio, Wrecked by Poles and Cables Caught by Speeding Wrecking Engine

WRECKING ENGINE WRECKS TELEPHONE SYSTEM

The telephone service of Girard, Ohio, was wrecked recently by an unusual kind of accident, the agency responsible for the trouble being a railroad wrecking engine, which was rushing through the town in the night to reach the scene of an accident. The engine was equipped with a large derrick, the long boom of which caught up the wires and cables of the telephone company where they crossed the rail-

road's right-of-way. Before the engine could be stopped, nine poles were torn down and bumped against houses, many windows in buildings near the tracks were smashed, and one corner of the house shown in the illustration was wrecked by the cable. Three of the poles were stopped by this house. Farther down the yards, the telephone cable wrapped itself around one of the railroad towers.

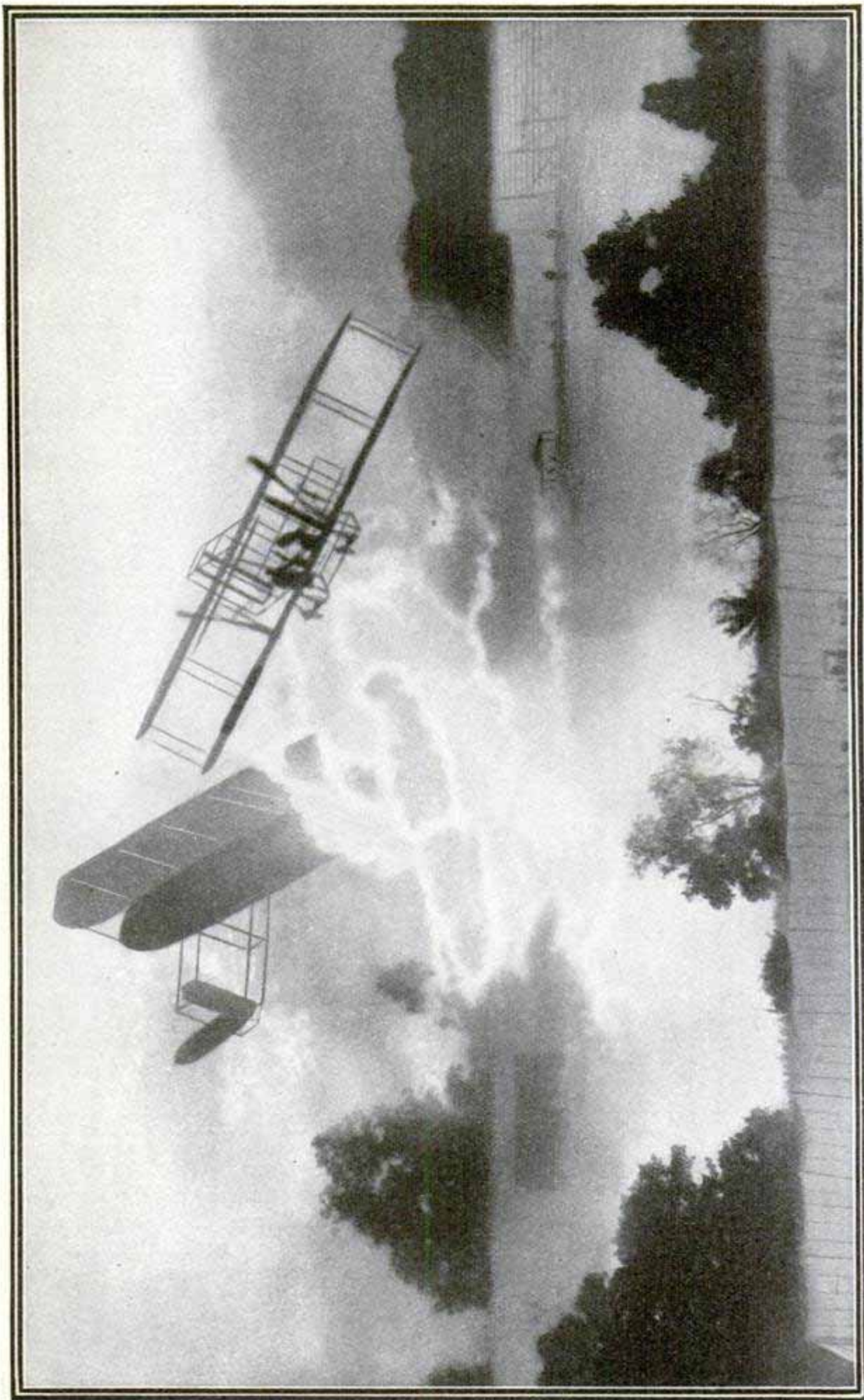

Copyright by the Pictorial News Co.

THE BATTLE IN THE CLOUDS

The effect of a battle between aeroplanes was secured by the photographer by accident. The peculiar picture was obtained through a double exposure, two aeroplane photographs being made on the same negative. Both happened to be made the same day and within a short time of one another from almost the same viewpoint.

SAN FRANCISCO'S SAFETY AND LOADING ISLANDS

The safety and car-loading islands in the center of Market street, San Francisco, are proving so successful that other cities in the country are beginning to take notice. Market street is the main artery of the great reconstructed western metropolis and practically all the car lines entering the downtown district traverse it. Although a wide street, it is congested, and the slightly elevated islands or stations, on which pedestrians can stand while waiting for a car or use as a safety area in crossing the street, were necessary.



A Safety Island and Car-Loading Station in Center of Market Street, San Francisco

The stations, constructed of concrete, are 60 ft. long, and provided with ornamental lamp standards at either end with seats at the bases.

JAIL ON WHEELS

East Point, an incorporated suburb of Atlanta, Ga., has gained the distinction of being the most accommodating little city in the South. Besides having all the conveniences of modern city life, East Point has provided the law-breaking element with a jail on wheels, and, instead of dragging an obstreperous drunk to prison, the town constable hitches a couple of horses to the prison, drives over and loads up. On

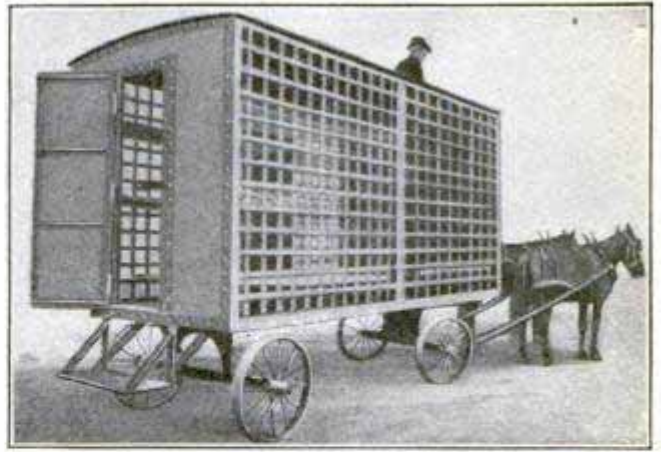

A Portable Lockup

trial day the load of malefactors is towed over to the courtroom in it. This portable prison has accommodation for 12 prisoners. The prisoners are also conveyed from place to place to work on roads, etc., this being the practice in the state of Georgia.

BOTH GRAVESTONE AND SUNDIAL

In an old graveyard near Barmouth, Wales, is a stone cross which is both a gravestone and a sundial. The shadow is cast by the arms and sides of the inclined cross in a very ingenious way, the hours being cut in the sides of the cross shaft. The time indicated by the shadow at the moment the gravestone was photographed is about 10:30.



Both a Gravestone and a Sundial

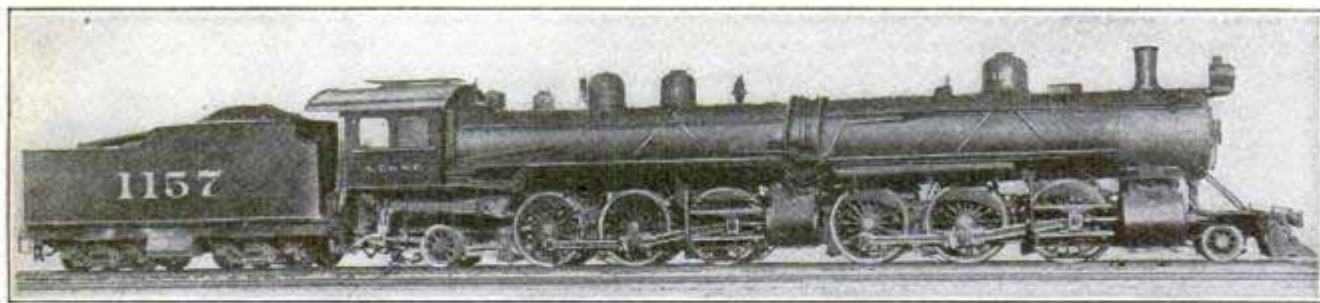

Mallet Locomotive with Articulated Boiler Formed Out of Two Prairie-Type Locomotives by the Atchison, Topeka & Santa Fe Railroad

TWO LOCOMOTIVES MADE INTO ONE

That the Mallet principle of locomotive design is adapted to solve the question of the disposition of the older and smaller locomotives by combining two such locomotives into one, or by adding a new front section to an existing locomotive, is being demonstrated by the Atchison, Topeka and Santa Fe Railroad.

Two Prairie-type freight locomotives have been converted into a single Mallet locomotive in this company's shops at Topeka, Kan., and are now in service in this form. Careful investigation, however, has demonstrated, that adding a new front section to an old locomotive, is more satisfactory and economical than combining two old locomotives, consequently 14 locomotives are being converted in this manner. Combining two locomotives depletes the total of locomotives in service, while the addition of a new front section to one old locomotive increases the capacity to the same extent and at the same time does not affect the number. The cost of a new front section is also considerably less than that of a complete locomotive.

The unique feature of the two Prairie-type locomotives combined

into a single Mallet is the flexible joint permitting the articulation of the boiler. It was designed by a draftsman in the Topeka shops, and permits the forward section of boiler to move contiguously with the forward wheel section.

FIVE MILLION DOLLARS FOR AN IDEA

According to reports from England, James Hodgkinson, of Salford, has sold the American rights to his process of salt making for \$5,000,000, and a royalty. The Canadian rights have been sold to the Canadian Pacific Railway, but the price has not been announced.

It is claimed that the invention is not only an improvement in salt making but is revolutionary. It is said that it will produce salt four or five times as easily as the present process, will save three tons for every four tons of coal now consumed, will make the various qualities of salt and every size of crystal simultaneously by the use of a single regulated fire, will produce by a process of pure crystallization a salt equal to the present finest ground salts, and will secure an automatic discharge of the salt from the pans.

The experimental plant consisted of three covered and four uncovered pans, all heated from one fire instead of from seven, as at present. Uniform temperature is assured by means of a patent stoker, and the intensity of the heat furnished each pan is under the control of a special draught system.

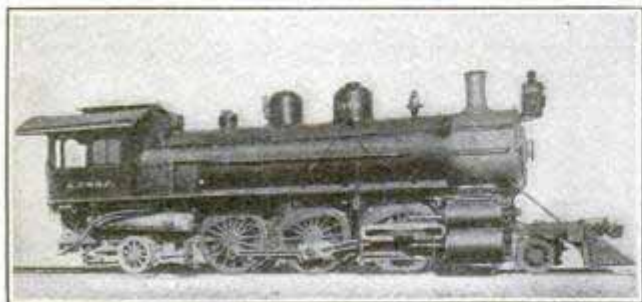

Prairie Type of Locomotive, with Two of Which the Mallet Engine Was Built

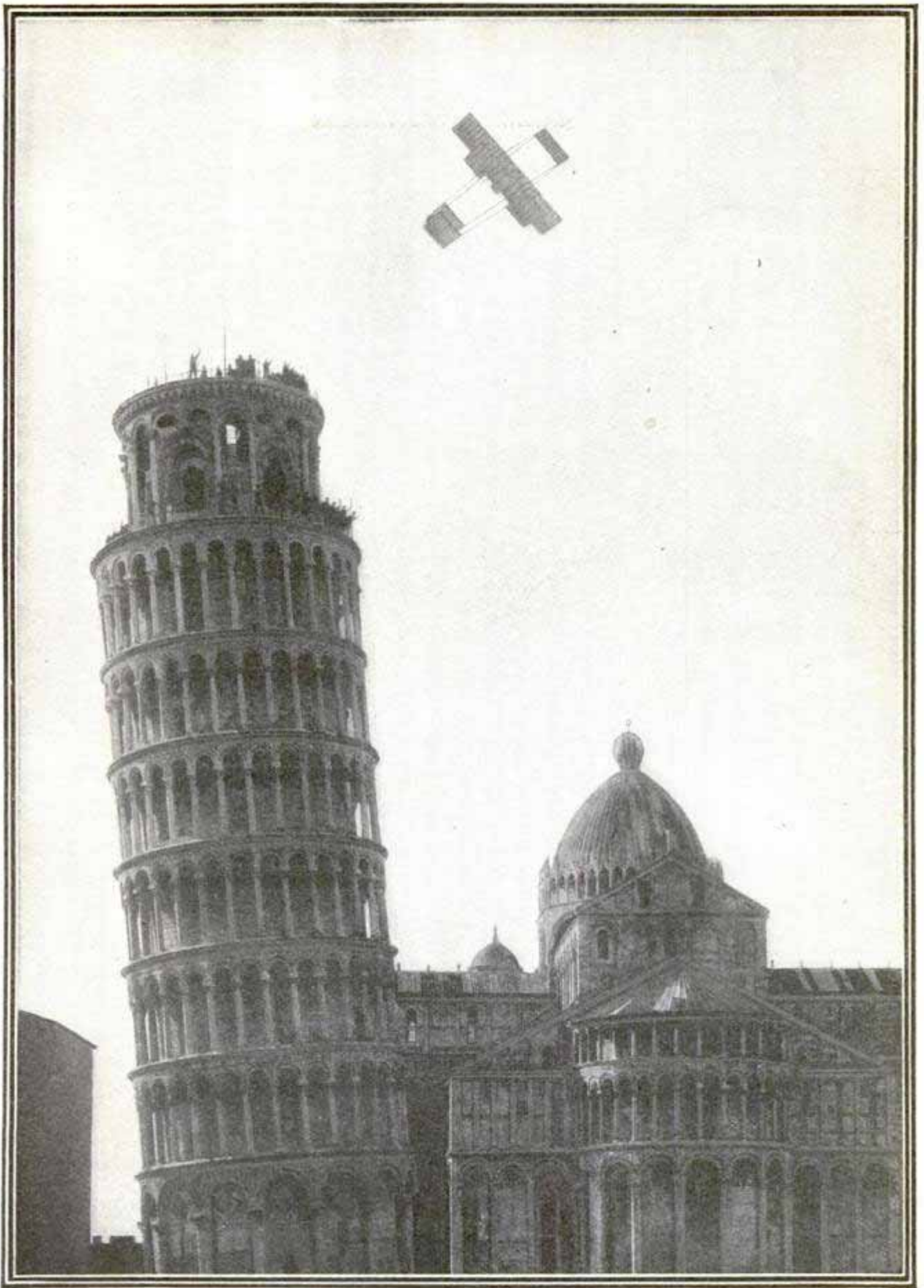

CIRCLING THE LEANING TOWER OF PISA

The famous leaning tower of Pisa, from the upper galleries of which Galileo made the famous tests with falling bodies, proving that globes of different weights, dropped from the same height reached the ground in the same time, was recently circled by an aeroplane operated by Mario Cobianchi, an airman of Bologna.

A "SOMERSAULTING" BICYCLE

A trick cyclist has been entertaining amusement seekers in Berlin by turn-



Trick Cyclist Performing the "Salto Mortale."

ing somersaults on a bicycle, which is especially equipped as shown in the illustration, for such feats. The arch provides a support for the head and back of the cyclist as he makes the turns.

CHEMICALLY PRODUCED LACE

The lace manufacturers of Lyons, Calais, and Caudry have for some time been much perturbed, according to S. M. Taylor, U. S. consul at Nottingham, Eng., over the advent of a so-called artificial lace. The manufacture of this lace is simple, no weaving being required. The machine that produces this lace consists in its essential parts of a receptacle containing a cupro-ammoniacal solution of cellulose, a cylinder on which is engraved the negative of the lace design, and a coagulation vat. A rotary motion is given the cylinder and the solution flows over it, entering the interstices of the engraved pattern and fixing itself in the coagulative liquid. The result is a lace texture ready to be dyed and dressed.

The "artificial" lace, is said by Consul Taylor to be beautiful in appearance, homogeneous and unalterable, more durable and less combustible than ordinary lace, and not affected by water. Any desired pattern may be obtained by engraving cylinders.

EXPORTS ELECTRICITY TO MEXICO

The electric power plant of the Copper Queen Co., Douglas, Arizona, is preparing to export electricity to El Tigre, Mexico, 65 miles distant. Before the 40,000-volt transmission line could be constructed across the border, several novel questions had to be decided, one of which was whether or not electricity came under any of the heads of commodities upon which a duty could be assessed. The decision admits electric energy free of duty.

BRACE-OPERATED JACK

The newest thing in jacks especially designed for automobile purposes is operated by a long brace of the shape used for making deep bores through wood. The new jack does away with the disagreeable crouching down and pumping accompanying the use of the ordinary types of jacks.



Place the Jack, Turn the Brace, and Up She Goes

CARTING A 62-TON GIRDER ACROSS NEW YORK

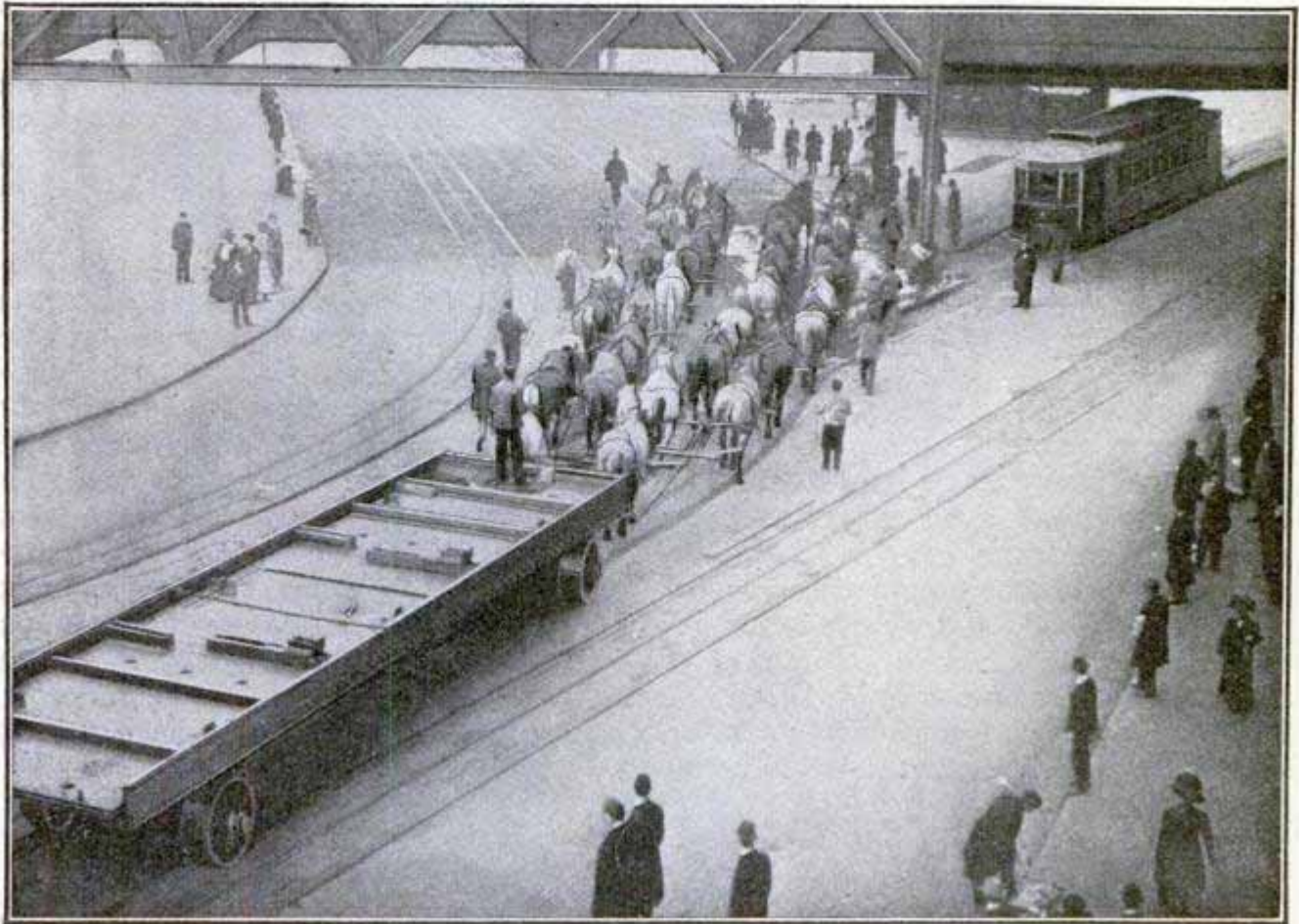

62-Ton Girder Passing Under Brooklyn Bridge Structure

The tremendous weight of the 40-story tower of New York's new municipal building* will rest upon five massive steel girders, the smallest of which weighs 50 tons. They were all

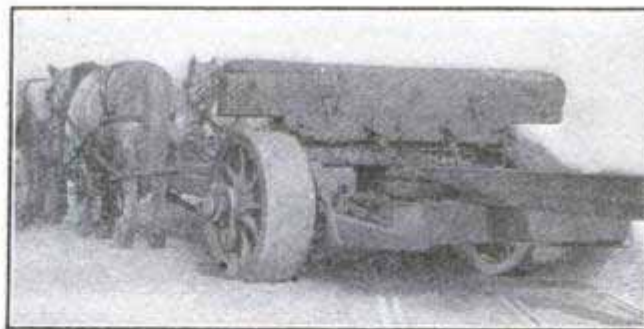

Front of 100-Ton Truck with 14-In. Wheels

New York's streets weighs 62 tons.

The tackle by means of which the girders were lifted from the lighter to the truck and finally deposited in place on the tower foundations

was especially constructed for the purpose, and handled the massive pieces of steel as easily as ordinary tackle handles a single I-beam. The truck's front wheels have a 14-in. tread.

dations was especially constructed for the purpose, and handled the massive pieces of steel as easily as ordinary tackle handles a single I-beam. The truck's front wheels have a 14-in. tread.

THE MARKINGS OF OLD ENGLISH SILVER

The positive knowledge as to the period and date of manufacture of old English silver makes its collection of the greatest interest to connoisseurs.

To one fully posted there is no uncertainty, as every genuine piece must have its hall marks. The Goldsmiths Guild, established in 1180, to guarantee the

work done by the gold and silversmiths of England, received its first charter from the crown in 1327, and since 1300 every authentic piece of silver made in England has been stamped with the hall marks in the guild hall at London, or in the guild halls at Sheffield, Chester, Birmingham, Exeter, and Newcastle-on-Tyne.

The hall mark adopted about the year 1300 was a leopard's head and all silver produced in England was stamped with it by the guild. Until 1776 the head was shown with whiskers, and after that year without. Until 1822 the leopard's head was crowned, but from that time to the present the crown has been absent. About the year 1478, a date letter was adopted in conjunction with the leopard's head, a different letter being used each year. All the letters of the alphabet, excepting J, V, W, X, Y, Z, were used consecutively year by year in several styles, each cycle being

set in different shields so that any piece so stamped could readily be identified as to the year in which it was made.

In 1514 the mark of the lion was first established, and also the mark of the maker, which is an initial or some other emblem indicating the name of the maker as then registered in the guild hall. From this time on the lion became the mark of quality, and the leopard's head used with it attested to the fact that the mark was made at the London guild hall. In the same manner, an anchor instead of a leopard's head in conjunction with the lion shows that the piece of silver was made in Birmingham and registered at its local guild hall, while that made and registered in Sheffield has a crown instead of a leopard's head. The mark of the lion is the "Lion Passant." Previous to 1822, the head was turned outward, but since that date, it has been turned to the left.

A MUSICAL CANARY

A canary, owned by a musical family in London, demonstrates its extraordinary fondness for musical instruments

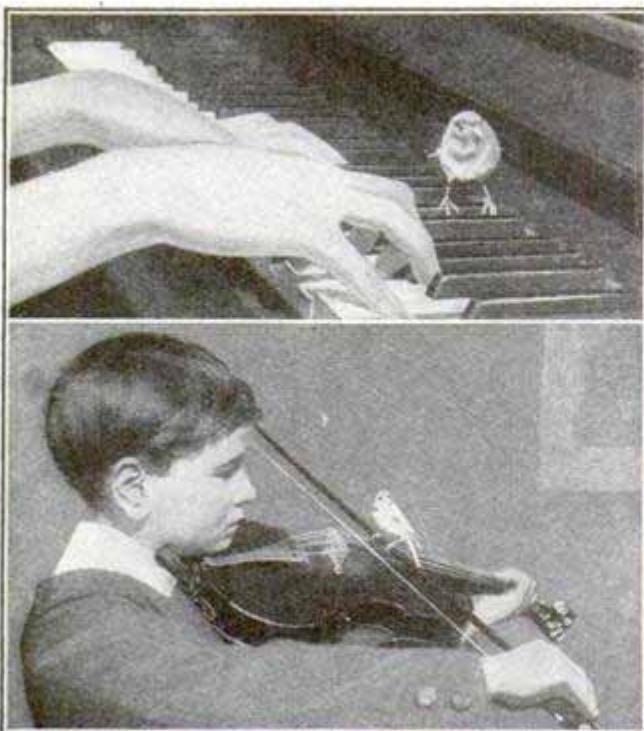

Courtesy Black & White, London

Listening Intently and Dodging the Fingers of the Player—Riding on the Bow of the Violin

whenever the instruments are being played. The bird's behavior is a source of constant amusement and interest. It flies to the keyboard every time the piano is played, where it dodges the player's fingers during the performance. When the violin is being played it clings to the bow, no matter how rapid the player's passages are.

LIQUID CONCAVE MIRROR FOR TELESCOPES

The most important part of a reflecting telescope is the mirror, which is usually a silver-coated reflecting bowl, ground and polished with great precision to an exact shape. This shape is the form assumed by the upper surface of a liquid held in a suitable container and rotated about a vertical axis. This fact has led scientists to propose the substitution of a revolving pool of mercury for the very expensive mirror of silver-coated glass or speculum metal, but, owing to the unsteadiness of the apparatus employed, the surface of the mercury rippled and was

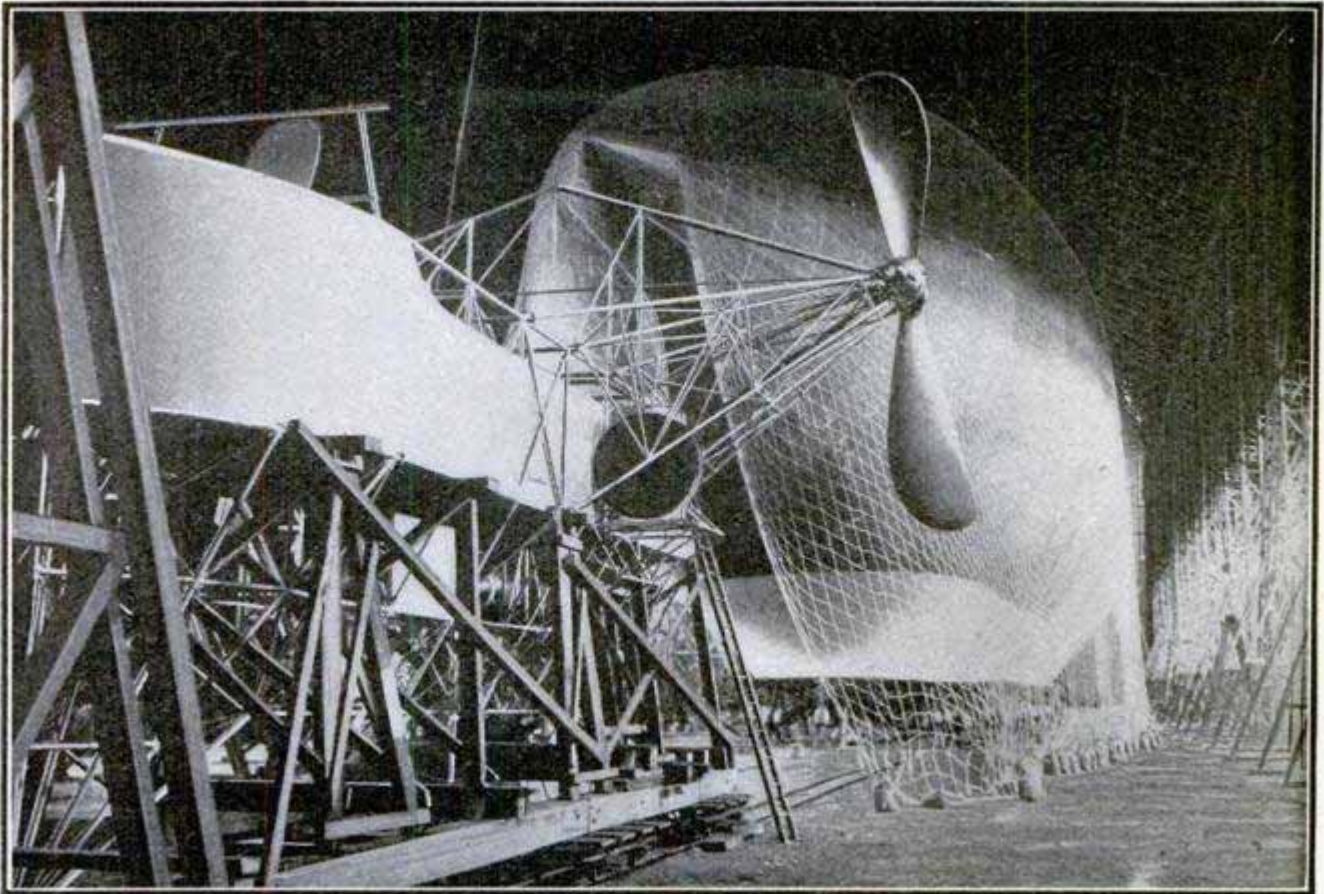

The Gas Bag and Car of the "Captain Marchal," Presented to the French Army by Popular Subscription

unsuitable for the purpose intended. Two physicists of the Philippine Bureau of Science have recently devised an apparatus by which this rippling action is eliminated. Instead of having one revolving vessel, three are employed, and a heavy, black paraffin oil is used instead of mercury. The vessels are of graduated diameters so as to fit one inside another, and are separated at the bottom central points by conical steel pivots. Oil is poured into each vessel to about one quarter of its depth, and the apparatus is rotated by a small electric motor. The innermost of the vessels is thus rotated by what is in effect a double, liquid friction drive, and all unsteadiness is absorbed by the liquid in the outer vessels. The curvature of the oil pool in the inner vessel can be altered at will by varying the speed of the motor, and in this way, a mirror of any desired focal length and magnifying power is obtainable.

This innovation is of the greatest importance to astronomers and scientists in general.

THE LATEST FRENCH ARMY DIRIGIBLE

The dirigible balloon, "Captain Marchal" which has been presented to the French army by popular subscription, and which will be placed in commission soon, will have two 60-hp. motors (Panhard-Levassor type), which can work coupled or separate, each driving both propellers, so that in the event of accident to one motor, the dirigible would be able to travel by the other. The volume of the great gas bag will be about 258,000 cu. ft. The suspended car, shown on a trestle in the illustration, is 29½ ft. long, and has a beam of 5¼ ft.

☐The general superintendent of the U. S. steamboat inspection service estimates that approximately one ten-thousandth of one per cent of the passengers and crews carried by vessels of all classes on all waters of the globe, lost their lives during the past year, the actual figures being 379 lost in a total of 328,666,000 persons.

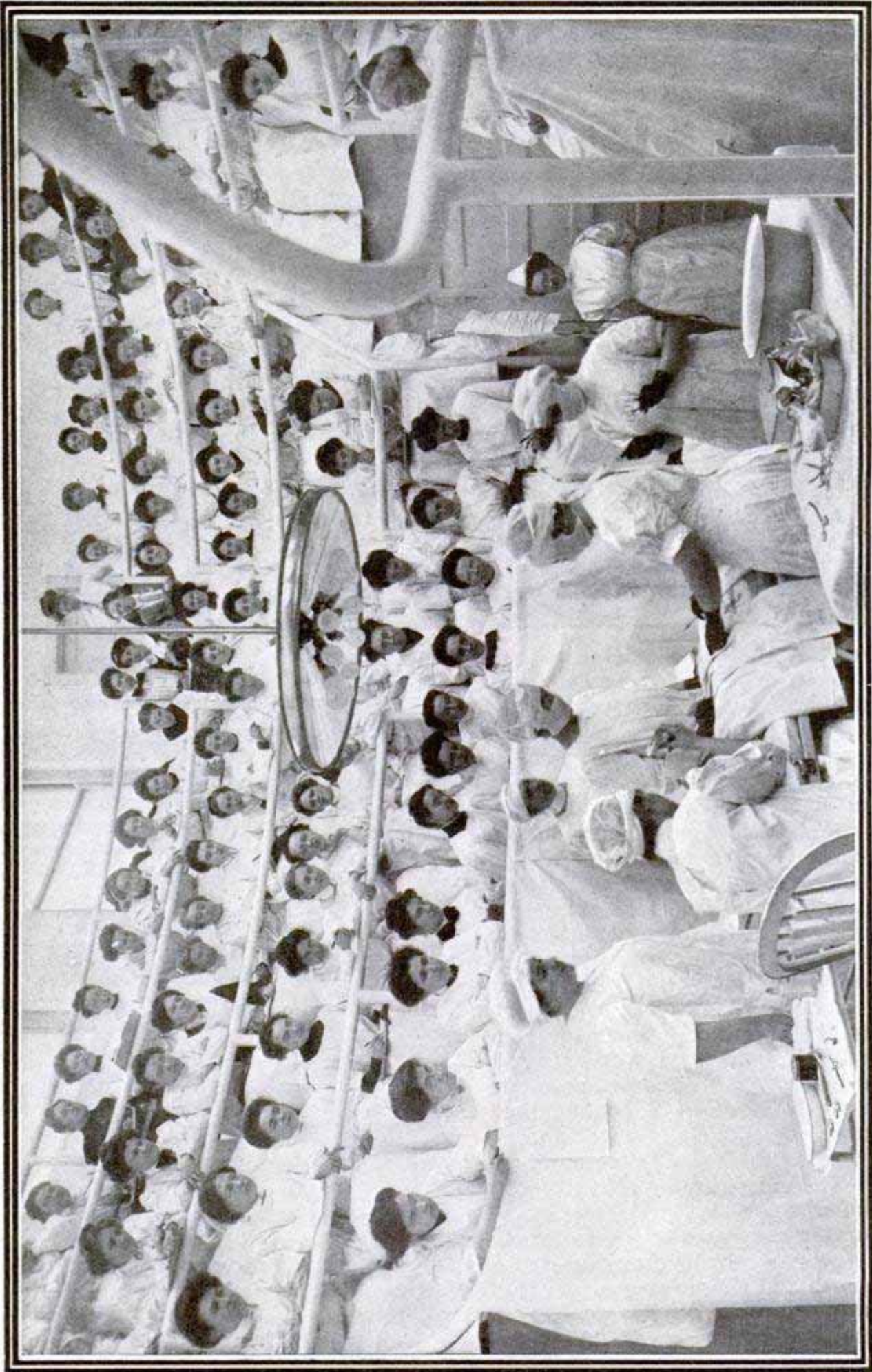

SCENE IN WOMAN'S CLINIC DURING AN OPERATION

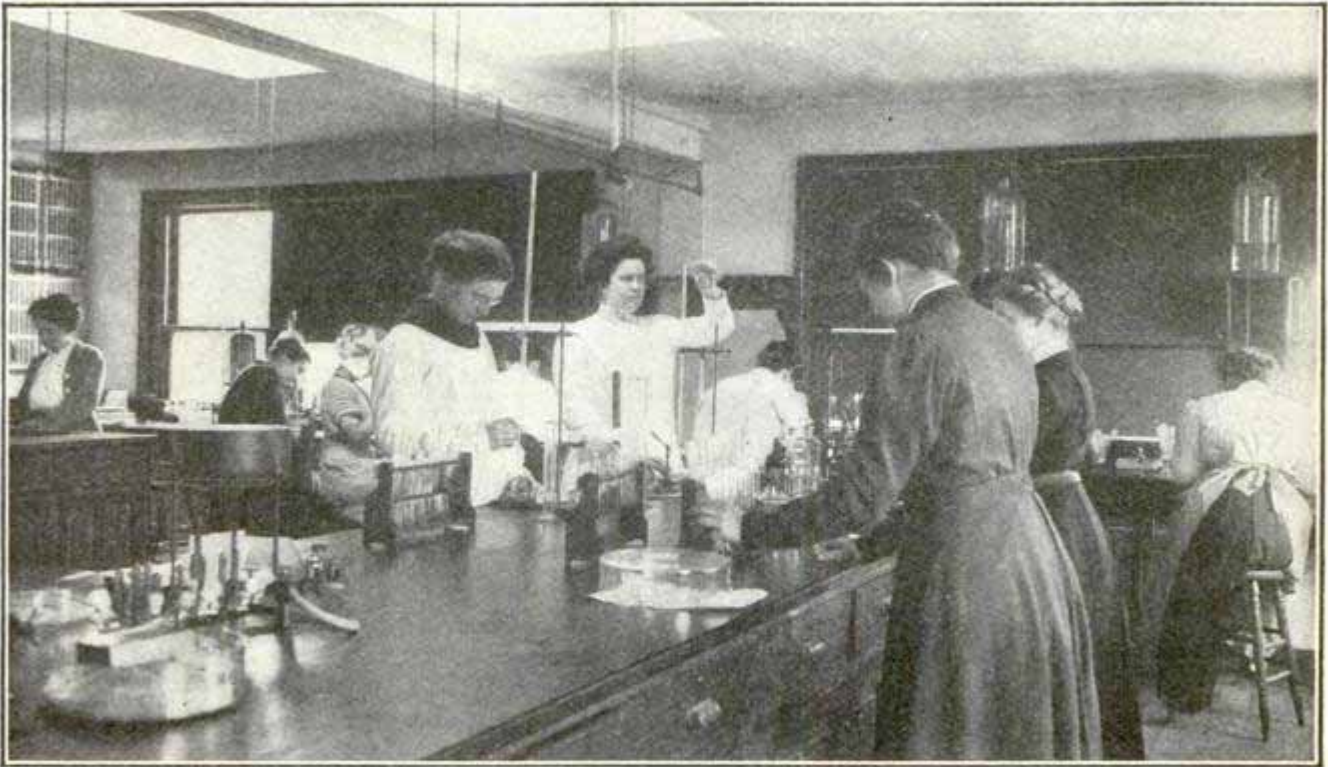

Medical Students in the Bacteriological Laboratory of the Woman's Medical College of Pennsylvania

SCENES IN A WOMAN'S MEDICAL COLLEGE

The new clinic in the hospital of the Woman's Medical College of Pennsylvania, equipped with every appliance and up-to-date accessory of the scientific operating room, is said to be one of the most perfectly appointed places of its kind in any woman's hospital in the world. One of the illustrations shows the appearance of this clinic during an operation. Not a man is present, the operating surgeons, nurses and attendants being women.

Woman students come to this woman's medical college from all over

the world. It is seldom that there is not at least one Chinese and two or three Japanese girls seeking the degree of M. D., and there are also girls from Turkey, Russia, Germany, France and many other countries. They come, graduate, and return to their native land to work among their fellow women. The majority of foreign students come from the Orient, where the woman physician is always popular. Many of the American girl graduates seek diplomas, intending to devote their lives to healing the physically ill in the eastern countries with a view to administering later to spiritual needs.

MOTORBOAT BUILT TO CROSS ATLANTIC

Capt. John Weller, a seaman and boat builder of Carlstadt, New Jersey, is to attempt to cross the Atlantic in a 50-ft. raised-cabin motorboat cruiser, which he has been constructing for the past several months. The little vessel is 50 ft. long, with a beam of 12 ft., and a draft of 3 ft. She is driven by a 37-hp. gasoline engine, which is expected to give a steady speed of a little

over 10 miles an hour. The deck is perfectly clear, except for a 3 by 4-ft. pilot house rising 14 in. above it.

The trip will be started from New York about July 15, and the run will be along the coast to Boston, thence to Halifax, Nova Scotia, and St. Johns, Newfoundland. The actual trip across the Atlantic starts at St. Johns, the course being between the two transat-

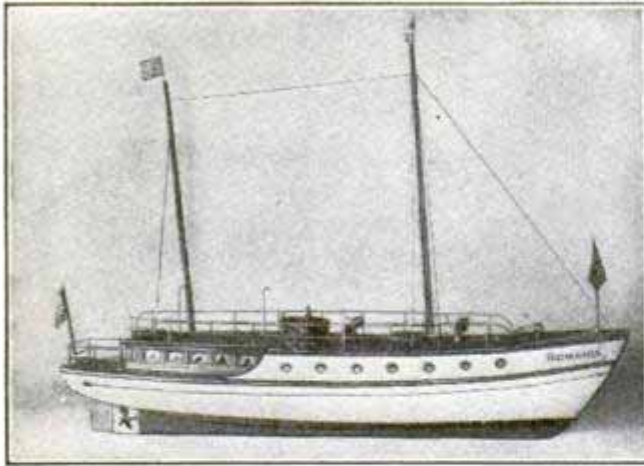

Raised-Cabin Motorboat with Which Captain Weller and a Crew of Seven Expect to Cross the Atlantic

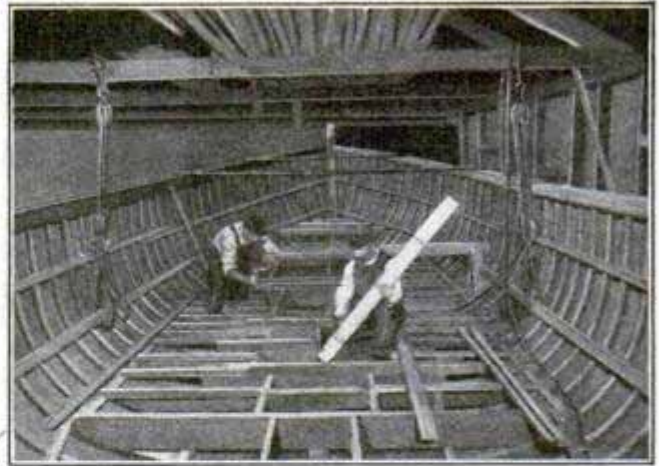

Captain Weller and Assistant at Work on the Interior Construction of His Transatlantic Motorboat

lantic lines from Quebec and New York, the contemplated landing being Galway Bay, Ireland. Captain Weller expects to make the run of 1,677 miles from land to land in eight days. He will take a crew of six or seven

men with him, and sufficient provisions for two months. The fuel tanks, installed in the bow and sides of the boat, will be filled with 1,500 gal. of gasoline, about twice as much as Captain Weller expects to use.

MUSCLES FORCED OUT OF PLACE BY ORNAMENTS

One of the most remarkable and distorting ornaments worn by African tribes is the armband of the Langos, a people who inhabit a country to the east of the Victoria Nile, and about three degrees north of the equator.

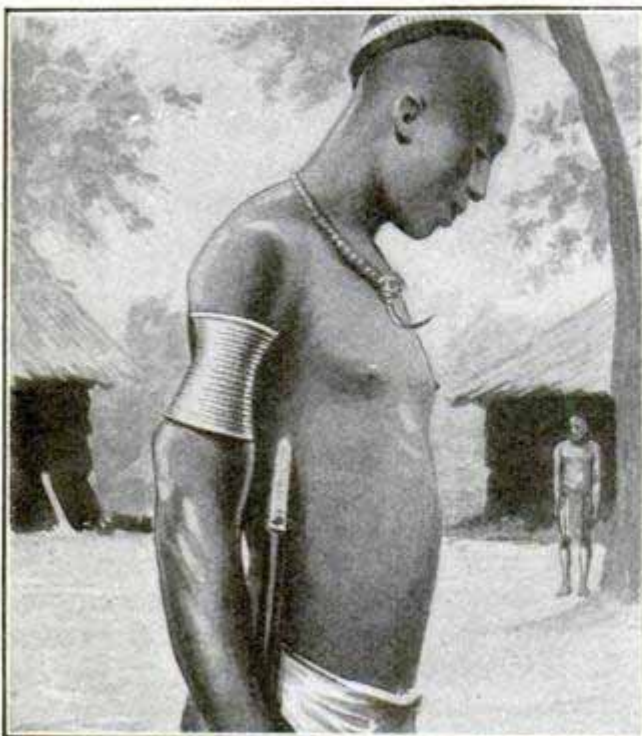

Remarkable Distortion of Muscle Caused by Armband

These armlets are set on the upper part of the arm in youth, and, as the arms grow, force the muscles of the biceps out below them. In the example shown by the illustration, the girth at the point which should have been the broadest part of the biceps is only $8\frac{1}{2}$ in., while just below the elbow, it is 15 in.

NEW LARGEST VAULTS IN THE WORLD

Three vaults will soon be constructed by Uncle Sam in the Bureau of Engraving and Printing, which will be the largest in the world. The vaults are for paper money, printing plates, and postage and revenue stamps. Each will be 30 ft. long, 12 ft. high, and 30 ft. wide. The doors will be 3 ft. through, of alternate layers of chrome and bessemer steel, a combination that is held to be impregnable. To transfer the steel for the new vaults to Washington will require 300 freight cars. To build the three great safes will take nearly three years. The expense of installing them is estimated at about \$600,000.

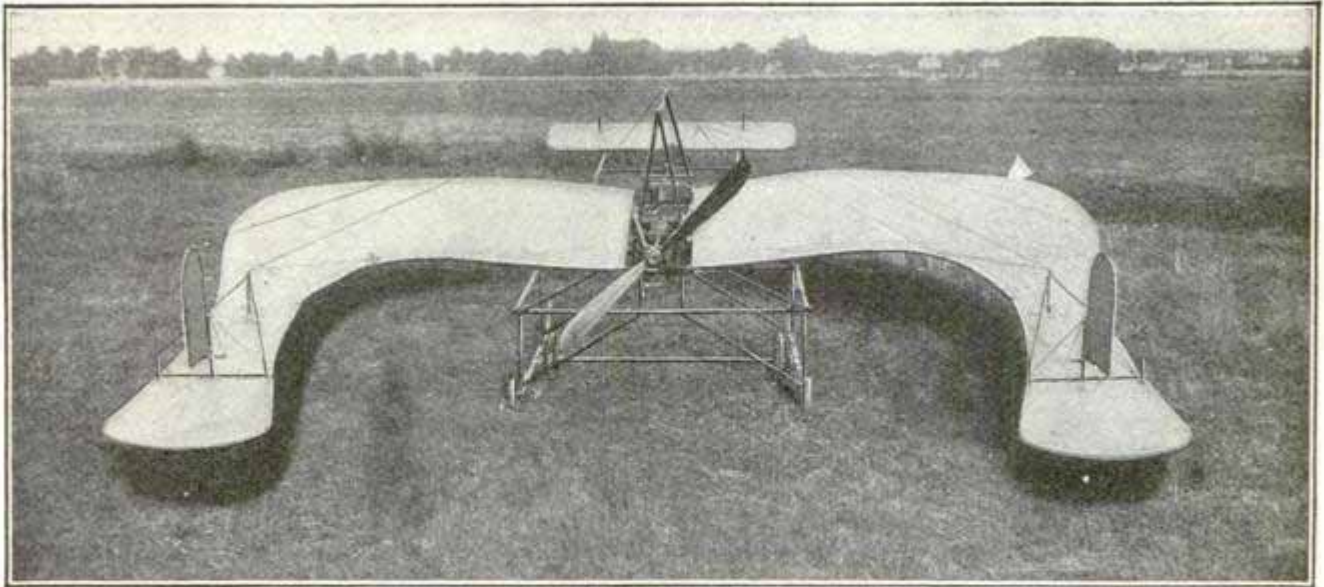

Rear View of Curiously Shaped French Monoplane

FRENCH MONOPLANE OF UNIQUE SHAPE

A curiously-shaped French monoplane has made several successful test flights at Juvisy, France. It weighs 880 lb., is driven by a 50-hp. motor, and has a supporting area of 344 sq. ft. The machine has two vertical rudders, one being located on each side of the backward extending sections of the plane.

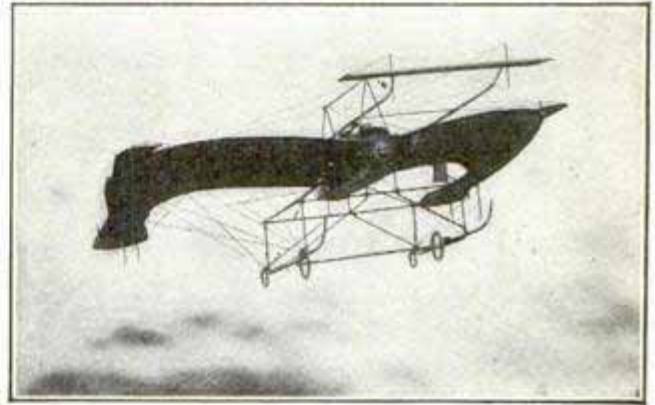

The Machine in Flight at Juvisy, France

BULLFIGHTING IN MEXICO

One of the illustrations shows one half of the Mexico City bull ring on a day when all attendance records were broken by a crowd of more than 40,000 persons. The "corrida," a parade of

the bull fighters is seen just entering the ring. Although 40,000 is the largest crowd ever recorded, crowds of from 25,000 to 35,000 attend every Sunday during the season, which is an



Half of the Mexico City Bull Ring on the Day All Records Were Broken by an Attendance of More Than 40,000 Persons



The Two Famous Bull Fighters Who Drew the Record Crowd

attendance much larger than even Saturday and Sunday baseball crowds in this country.

The two bull fighters who drew the record attendance are shown in the other photograph. The taller of the two is Antonio Fuentes, the most famous of Spanish matadors, and the smaller is Rodolfo Gaona, a popular idol of Mexico. Fuentes received \$8,000 for four fights in Mexico City, and in addition was given a benefit which netted \$12,000.

BERLIN'S TELEPHONE BUILDING

Berlin's new telephone exchange, claimed by Germany to be the largest installed under a single roof anywhere in the world, is housed in a building of unusual architectural beauty, in a prominent location. The



Berlin's Handsome New Telephone Exchange Building

exchange will serve 40,000 subscribers' lines terminating in its local switchboard, and big trunking and toll boards are provided for handling suburban and long-distance calls.

The local exchange equipment is situated in a magnificent hall, the natural lighting of which has been provided for by a long stretch of skylights on both sides of the center of the room, and windows spaced at frequent intervals back of the switchboards.

EXPECTED TO BE FASTEST BOAT IN WORLD

The 50-ft. hydroplane, built for the Duke of Westminster as a defender of the Grand Prix International Cup at Monte Carlo, is expected to prove the



England's Defender of the Grand Prix International Cup

fastest boat in the world. She is named the "Brunehilde," and is designed to attain a speed of 40 knots (46 miles) an hour. The cup was won for the Duke of Westminster by the "Ursula," which at present holds the world's record for speed.

PHOTO GALLERY OF ARMY HORSES

Experiments are being conducted by the United States army with a view to establish a system of photographic identification for service horses. Specially constructed cameras are being used, by which two views of the same horse can be taken on one plate. By this system a colt will be photographed

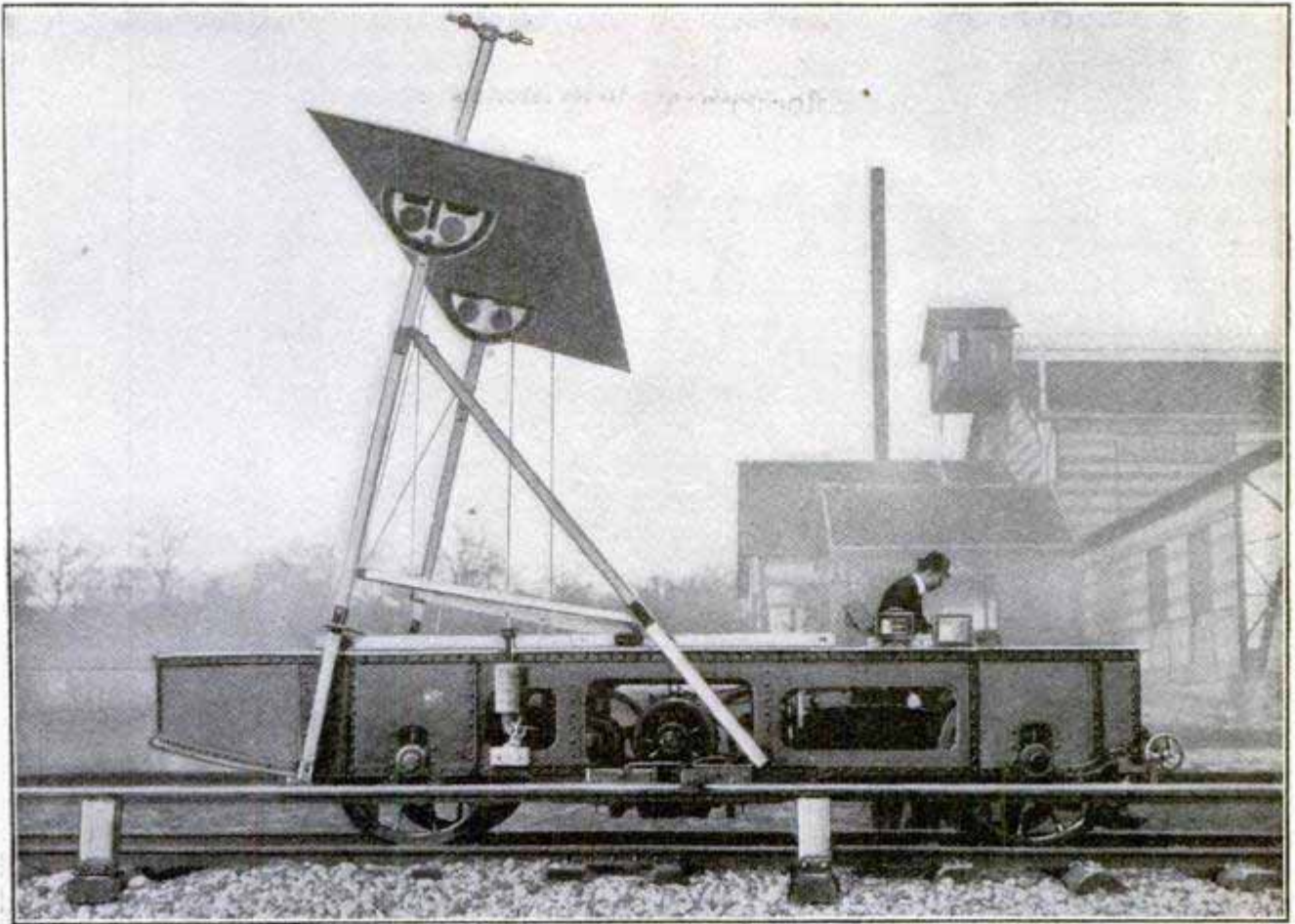

Testing Wind Pressure and the Resistance of a Plane on a French Electric Aerial Experiment Car

when it is purchased by the government. The picture will be attached to the colt's identification papers and will be kept in its record wherever it is sent. The horse will also be photographed at different periods of its development, including the time when it is issued for service and when it is transferred from one organization to another. It is thought that these photographs will not only perfect a system of identification, but also will show the growth and development of the horse under different conditions. The claim is made that by a system of photographs, the merits of different kinds of forage also can be more accurately obtained.

AERIAL EXPERIMENT CAR

One of the most ingenious aerial experiment devices of the Aeronautical Institute at St. Cyr, near Paris, is an electric car designed for use in determining the resistance of any plane of a flying machine. The car runs on a

track 8,000 ft. long, and is provided with means for registering the speed of the wind as well as its own speed. The plane being tested is mounted on the supports as shown. These supports, as well as the plane itself, may be set at any angle.

BAD CHURCH LIGHTING CAUSES SLEEPINESS

Very few churches, according to an illuminating engineer, are lighted in a satisfactory manner, the common mistake being an exposed light source, which becomes an irritant to the optic nerves. This frequently produces sleepiness, a great mental effort is required to remain awake, and the preacher is usually blamed instead of the direct lighting units.

¶The lives of every member of a London family were saved recently by a parrot which awakened everyone by cries of "Father, come quick!" when the building caught fire.

SILKEN NOTE OF THANKS

With a message of thanks and esteem woven in delicate colors on a handsome piece of tapestry the members of the Japanese commission which visited this country recently paid their compliments to the members of the Business Men's Club of Cincinnati and several other commercial bodies who entertained them. The tapestry is silk and the weaving has been done with infinite care. The inscriptions are all in Japanese characters and recite the



Message of Thanks Woven in Silk Sent by Japanese Commissioners to Their American Entertainers

pleasure the Japanese visitors had in this country and their indebtedness to the American business men who entertained them.

NOVEL FRENCH AEROPLANE PRIZE

The French motor manufacturer, Anzani, has instituted a prize for an aeroplane flight from Paris to Orléans and return, which is a novelty of its kind. The prize consists of a gold medal, the award of which entitles the holder to collect daily at the offices of Mr. Anzani the sum of 20 francs (\$4) as long as he retains the prize, and no one may try to beat the holder's record for the purpose of winning the prize from him, unless he give two days' notice of his intention. After one year

has elapsed from the date of the first award, M. Anzani will make it known whether or not the competition shall continue.

DE LESSEPS IS AWARDED \$10,000 PRIZE

Count De Lesseps, who was third in the aeroplane race from Belmont Park to the Statue of Liberty and return in the International Aviation Meet last fall, was declared the winner and awarded the \$10,000 prize, by the executive board of the Aero Club of America, on March 14. Both the late John B. Moisant and Claude Grahame-White were disqualified, the former because he had failed to make a previous flight of one hour, according to the conditions of the contest, and the latter because he fouled a pylon in rounding the course.

This decision settles a controversy which has lasted nearly five months, and gives to France the honor of winning one of the big events of the meet, Grahame-White having won the grand speed prize for England and the late Ralph Johnstone the altitude prize for America.

ACID NOT ESSENTIAL IN RUSTING OF IRON

That acid of any kind is not an essential in causing iron to rust was recently proved by two English scientists. They also showed conclusively that when chemically pure iron was kept in contact with pure water even for many months, the iron did not rust. But when the slightest impurity was present, the iron was attacked very quickly, although not a trace of acid was present. Hitherto it had been supposed that rusting could not occur in the absence of an acid.

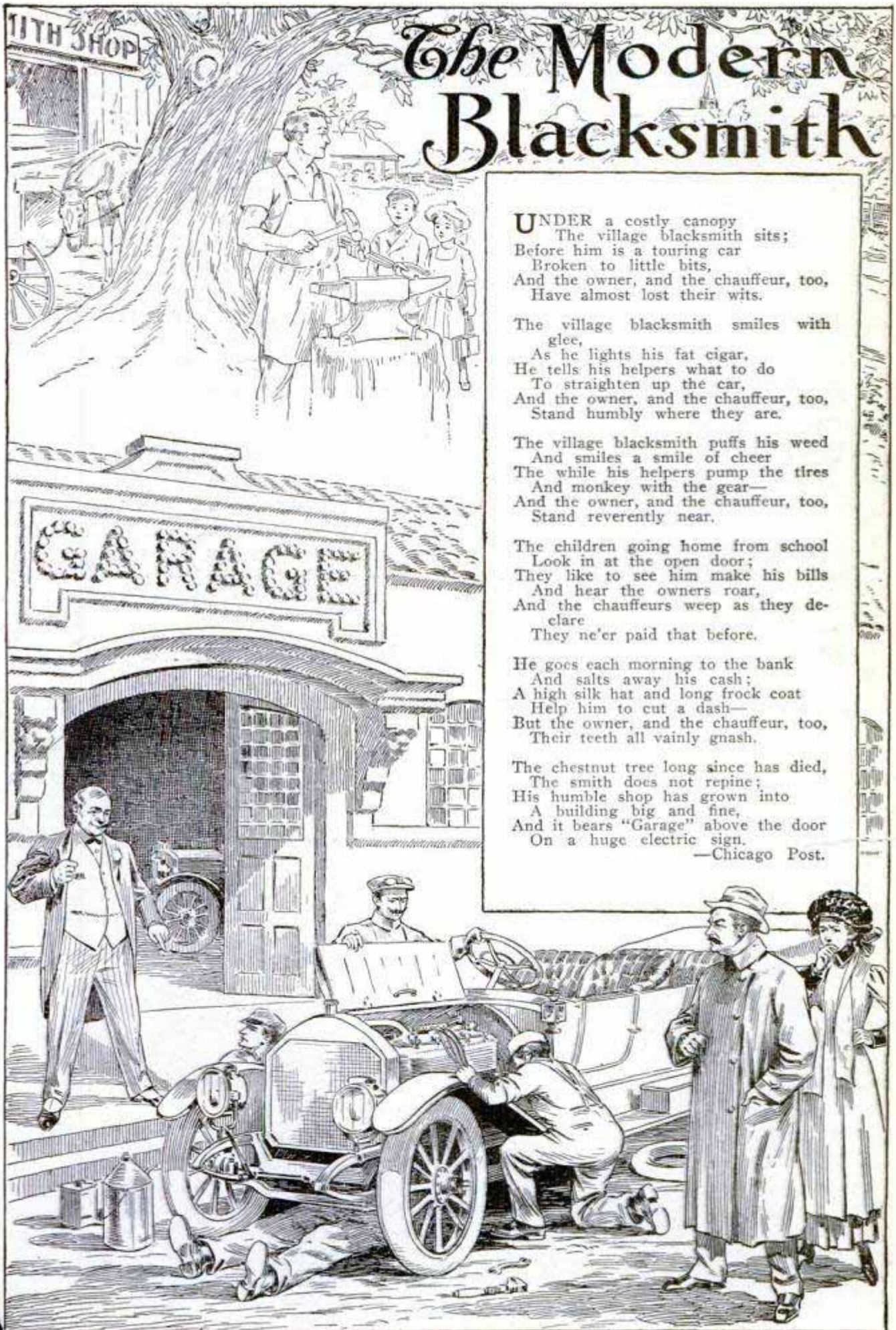

The Modern Blacksmith

UNDER a costly canopy
The village blacksmith sits;
Before him is a touring car
Broken to little bits,
And the owner, and the chauffeur, too,
Have almost lost their wits.

The village blacksmith smiles with
glee,
As he lights his fat cigar,
He tells his helpers what to do
To straighten up the car,
And the owner, and the chauffeur, too,
Stand humbly where they are.

The village blacksmith puffs his weed
And smiles a smile of cheer
The while his helpers pump the tires
And monkey with the gear—
And the owner, and the chauffeur, too,
Stand reverently near.

The children going home from school
Look in at the open door;
They like to see him make his bills
And hear the owners roar,
And the chauffeurs weep as they de-
clare
They ne'er paid that before.

He goes each morning to the bank
And salts away his cash;
A high silk hat and long frock coat
Help him to cut a dash—
But the owner, and the chauffeur, too,
Their teeth all vainly gnash.

The chestnut tree long since has died,
The smith does not repine;
His humble shop has grown into
A building big and fine,
And it bears "Garage" above the door
On a huge electric sign.

—Chicago Post.

BRITAIN'S NAVAL AIRSHIP

The first airship built for the British navy and now in commission is a huge craft with an outer envelope 512 ft.

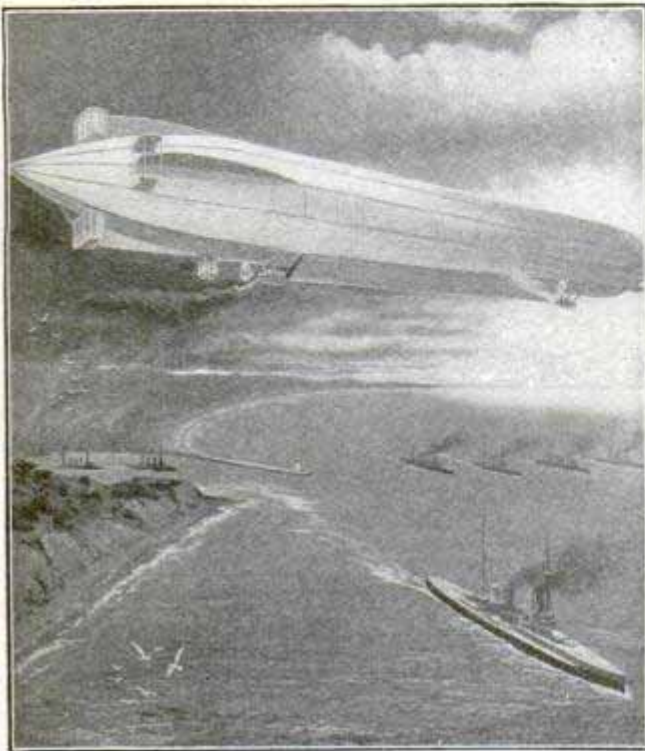

The First Airship Constructed for the British Navy is a Craft 512 Ft. Long

long and 48 ft. in diameter. The framework is of "duralumin," which is one of the magnesium alloys of aluminum and the envelope is constructed of a

fire-resisting silk, the upper half of which is coated with aluminum dust to reflect the sun's rays. The two cars, each of which contains a powerful engine, one driving two propellers and the other one propeller, are boat-shaped and constructed of wood, so that they will float on the water. Three parallel horizontal planes on both sides, forward and aft, are utilized to raise and lower the craft, while lateral movement is obtained by three groups of vertical rudders. Lifting power is obtained by 20 balloons within the outer envelope.

BOY AND GOAT CULTIVATE CORN FIELD

A 50-bushel yield of corn from an exceptionally rocky acre of land cultivated only an inch or two deep has drawn the attention of the U. S. Agricultural Department to the achievements of Earl Hopping, a 15-year-old boy of Rogers, Ark., and his billy goat. With the help of the goat, the boy hauled manure fertilizer to the field in a small packing-box cart, and then plowed the flint-rock-strewn ground with a little iron plow drawn by the goat.

The yield of 50 bushels of corn from



One of the Shocks of Corn, the Boy, Goat, and Plow which Cultivated the Field, and the Cart Used to Draw Fertilizer to It

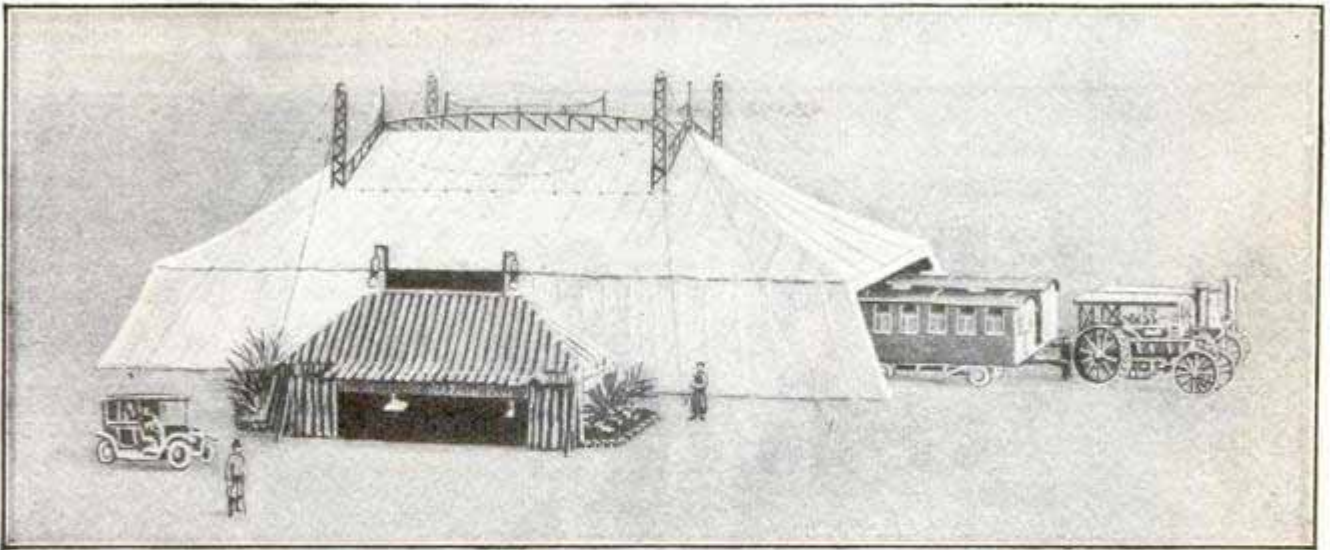

Side Exterior View of Remarkable Traveling Theater Which is Transported from Town to Town in France in Cars Drawn by Traction Engines

this acre of rocky ground is one of the finest instances the Agricultural Department has to demonstrate the possibilities of shallow cultivation after careful preparation.

PARACHUTE EXPERIMENTS FROM EIFFEL TOWER

Successful tests of parachute safety devices for airmen were made recently from the Eiffel tower, Paris, under conditions as near as possible to those attending an actual fall of an aeroplane. A stuffed dummy of the average weight of a man was attached to the parachute and the whole placed in an aeroplane frame in the position the operator would occupy. Then the tackle from which the framework was suspended was cut. In all the tests the parachute and dummy cleared the framework and dropped slowly to the ground, while the framework was completely smashed.

FRENCH TRAVELING THEATER

By a remarkably ingenious assembling, the manager of a Parisian theatrical troupe sends his company and a portable theater to the provincial cities and towns of France each summer in 21 specially constructed cars drawn by eight traction engines.

Besides the theater tent, which is supported by towers and girders after the fashion of airship hangars, the

equipment consists of knock-down structural material for the stage, scenery, theater chairs, dressing rooms and an electric plant. Two cars are provided for the transportation of the performers, one for the women and the other for the men; a car for the costumes, and two large cars, which, placed one on each side of the stage, constitute box seats. The two trains

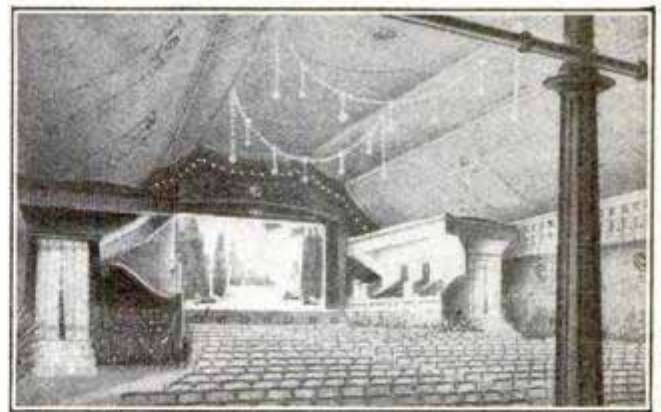

Interior of Theater Showing Arrangement of Stage and Seats, and Two of the Cars Converted into Boxes

drawn up in the rear of the stage, partially under the tent, contain the dressing rooms. The entrance to the theater is on the side.

¶ In spite of the fact that cottonseed meal does not agree with pigs, G. S. Fraps, a government experimenter, does not believe that cottonseed food products would prove harmful to man, provided a sufficient amount of other food containing little or no protein were eaten at the same meal.

TRAIN WRECKED BY WILD ELEPHANT

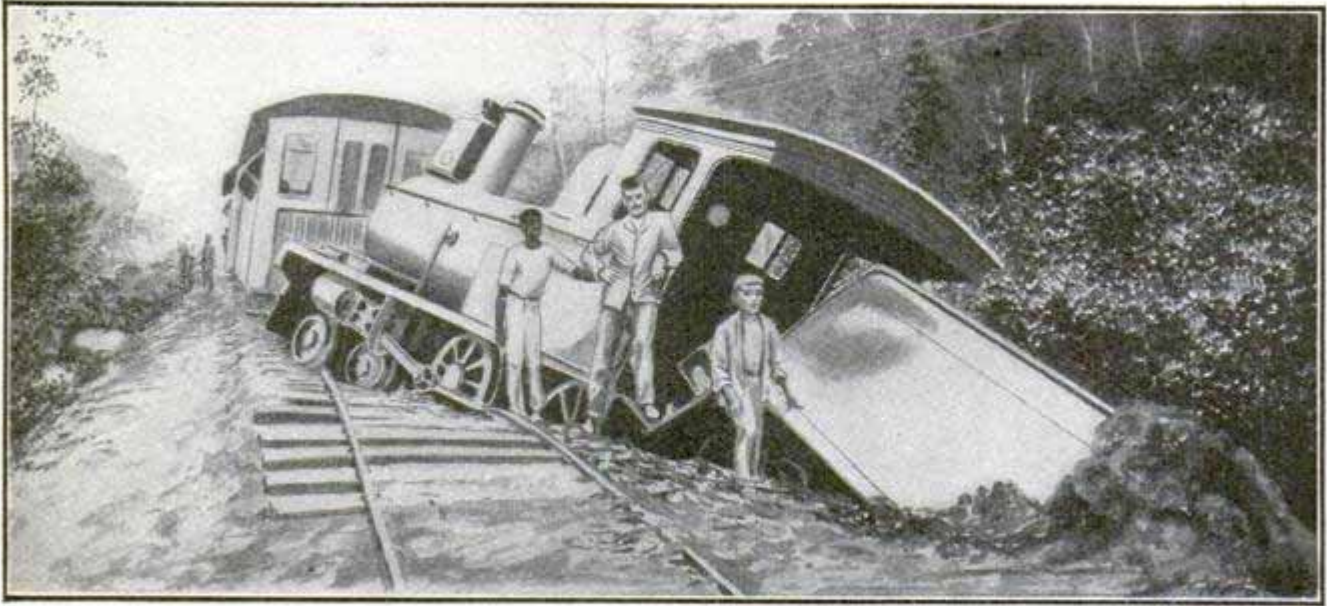

Derailed by Collision with Wild Elephant on the Malay Peninsula

Among the photographs published in the last official report of the Federated Malay States Railways were the two remarkable ones here illustrated, showing the wreck of a passenger train and the wild elephant which caused it.



The Elephant Got the Worst of It

The huge animal, apparently frightened by the noise of the approaching train, started to

blow and thrown into a ditch on one side of the roadbed.

cross the track and was struck by the engine. The force of the impact was sufficient to throw the engine and tender from the tracks in the position shown by one of the illustrations. The elephant was almost instantly killed by the force of the

AERO-HYDROPLANES BUILT IN UNITED STATES AND ENGLAND SIMULTANEOUSLY

Two curious machines, half aeroplane, half water craft, have been built in America and England. The European machine, designed by a French airman, was built by an English firm at East Cowes for the Monaco motorboat races, and consists of two hydroplane floats, each about 20 ft. long, hinged to

supports carrying a boat-shaped body. The aerial propeller is driven direct by a 50-hp. rotary engine, located at the stern of the raised body. The aerial steering rudder is over the bow of the raised body, and is controlled from the driver's seat by a steering wheel. Two planes, designed to provide vertical

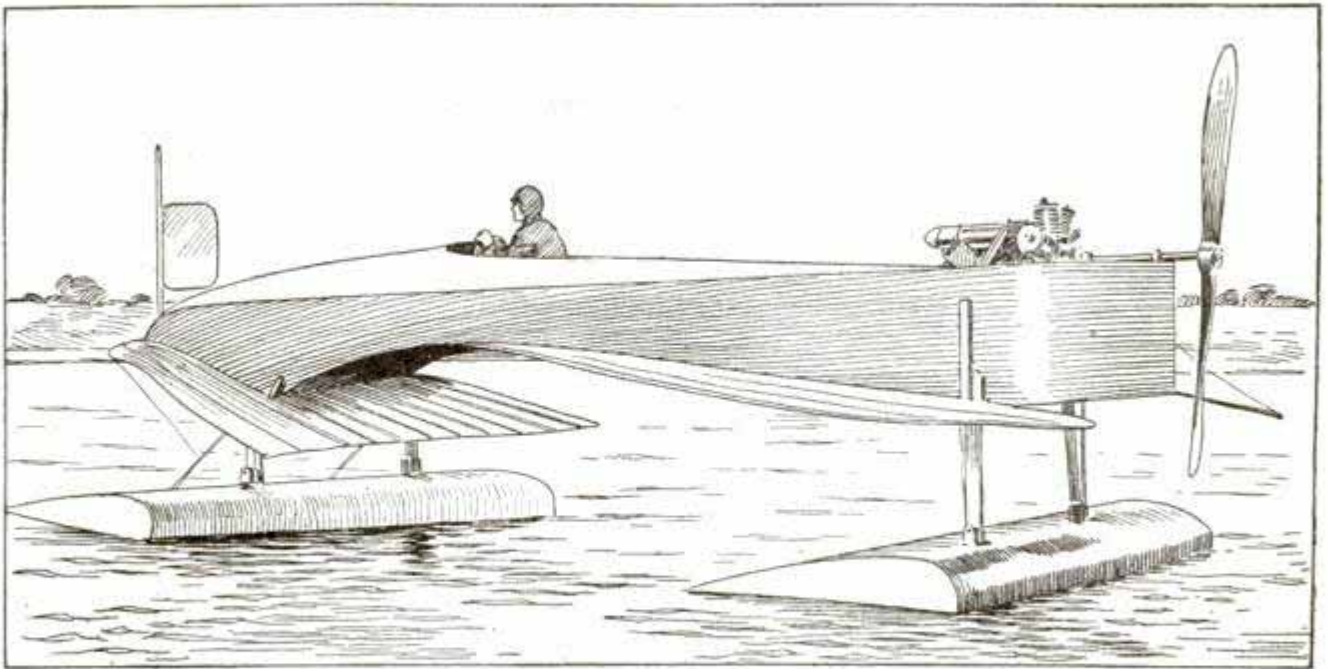

Aero-Hydroplane Built to Compete in the Monaco Motorboat Races

stability, run from amidships to the stern, one on each side of the body, and a third plane, triangular-shaped, is arranged under the bow for the same purpose. The floats skim lightly over the top of the water.

The American machine, carrying out in a different form the same idea as shown in the European aero-hydroplane, has attained a speed of over 60 miles an hour on the Detroit River. This machine, which was built by a Detroit boat concern, is appropriately called the "Flying Fish," as it skims over the water, barely touching it. The hull is a watertight aluminum tank, 5 ft. 7 in. wide, 7 ft. 2 in. long, and 2 ft.

deep. In the front of the hull is an 8-cylinder aeroplane motor, which drives an 8-ft. aerial propeller at high speed. Above the hull is a single plane, 26 ft. by 6½ ft., and on a framework back of this is an aerial rudder.

When sufficient speed is attained to lift the hull completely out of the water, it rides upon its tail, which is a flat board, 5 ft. 7 in. long and 1 ft. wide, fastened to arms extending several feet back of the hull. The rush of air against the plane at times lifts the craft several feet above the surface of the water, but the tail board, however, is always in the water and controls the equilibrium.

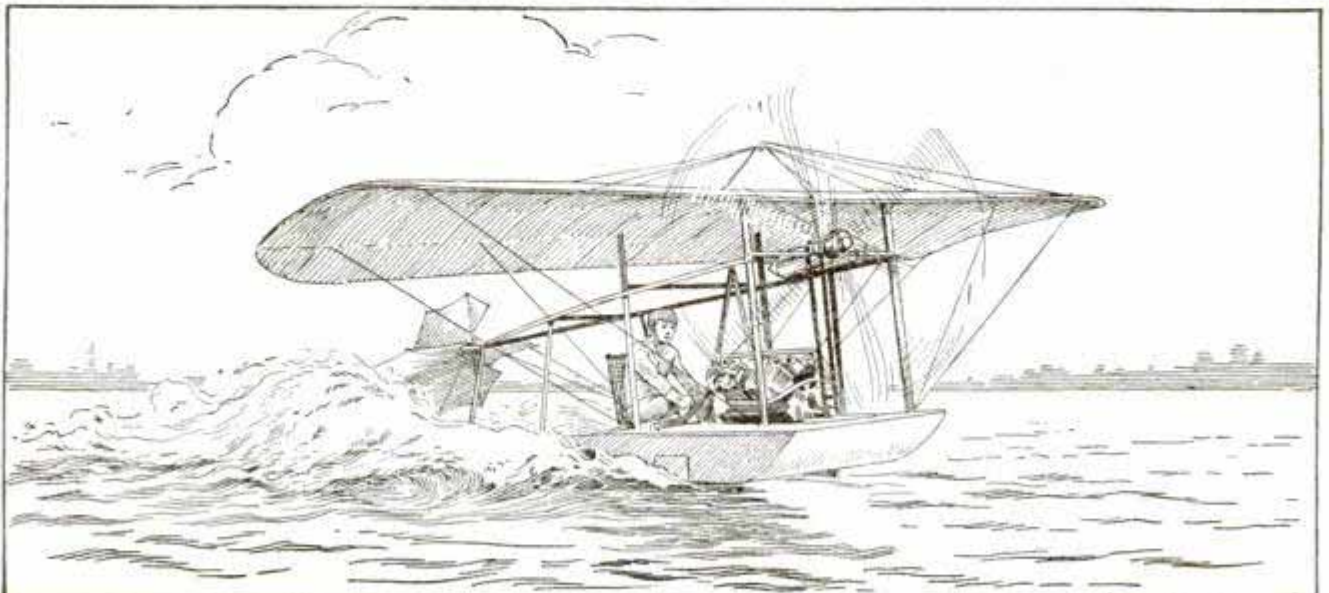

A Craft That Flies Over the Water with Only Its Tail Submerged

RAZING CONCRETE STRUCTURE A DIFFICULT TASK

By STUART S. SCOTT

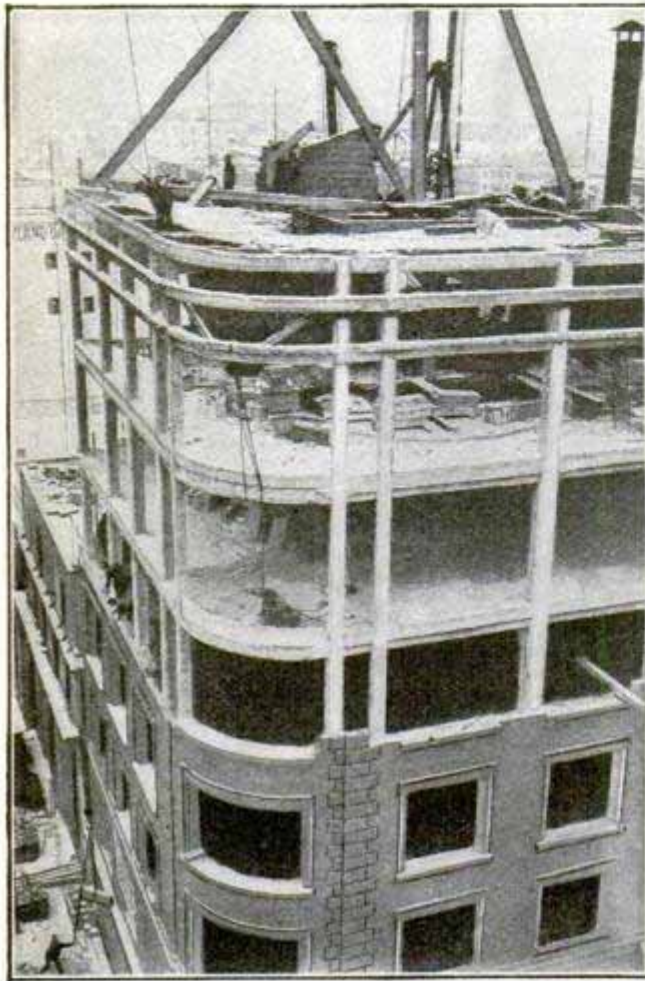

Removing the Facade of Second Largest Concrete Building

With pneumatic drills, oxygen blowpipes, sledge hammers and dynamite, the second largest concrete building in the United States is being torn down in Baltimore to make room for a skyscraper of the steel skeleton type. The building being razed is the Baltimore News Building which was erected in 1905, following the great conflagration, and with its nine stories from foundation to roof and its floor area of 57 ft. by 78 ft., it was at that time the most extensive reinforced concrete structure that had ever been attempted.

Built on a percentage basis and designed to carry the weight of linotypes and a composing room on the sixth floor, great care was exercised in making the framework substantial. To this end all of the outer edge columns were made 14 in. square, while the

inner columns were 18 in. square. The beams varied in size from the main stringers through the center, which were 18 in. by 40 in., to 14 in. square.

Through these beams are interlaced hundreds of tons of steel bars, ranging from slender tie-rods to 2-in. rods, all interlaced to form a solid mass of metal and concrete.

When it was proposed to raze the structure, bids were requested, but, to the surprise of the owner, the contractors not only wanted the entire building but bonuses ranging from \$40,000 to \$90,000. The company which has the contract for the erection of the new building then agreed to wreck the structure at cost and give the salvage to the owner. It is estimated that the wrecking will cost \$30,000 exclusive of what the salvage will bring.

It is expected that the work of razing will require 90 days. With pneumatic drills, the concrete is chipped away from the columns and beams and the steel rods are exposed. The rods are then cut with the blowpipe. The sections thus taken out are being sent to a salvage firm that, with a drop-weight, is crushing the cement from the rods.

Drop-weights were tried upon the floors of the building, but they were ineffective, so gangs of negroes with sledges are employed to knock the concrete out, the blowpipe then cutting out the rods.

In the basement, where are the foundations upon which the press stood, dynamite, in small charges, is being used with success. This explosive, however, can only be used at night. During the day the work is carried on by a gang with sledges and drills, much the same as quarrying is done.

ⒸAn oil having a higher explosive quality than gasoline is being extracted from the waste gases of coke ovens at Dunbar, Pa.



Photograph of a Mountain Climber in Colorado Just as He Leaped from One Rocky Shelf to Another

MOUNTAIN CLIMBER NEEDS AGILITY OF A GOAT

The mountain goat can hardly outdo the students of the University of Colorado, at least so far as pictorial effect is concerned, when a leap from one crag or shelf to another is to be accomplished. It would seem also that the young men are making ready to qualify as human flies, according to photographs recently made of a party of students who were doing a few mountain climbing feats for exercise. Near Boulder, Colorado, there are five or six very precipitous peaks known as "The Flatirons." Some of them have never been scaled and great fame awaits the student of the University of Colorado who will be the first to climb and affix the University "C" to the highest of these. The feat is yet to be accomplished, although it has been attempted time and again. The peaks are about 30 miles from Denver and on a recent trip of a party of the students, in addition to climbing some of the heights that have never before been reached by man, some remarkable photographs were made of the climbers. One of these shows a member of the party in midair just as he was leaping from one

shelving rock platform to another. A second photograph shows a line of climbers going up the side of a rock that seems almost perpendicular.

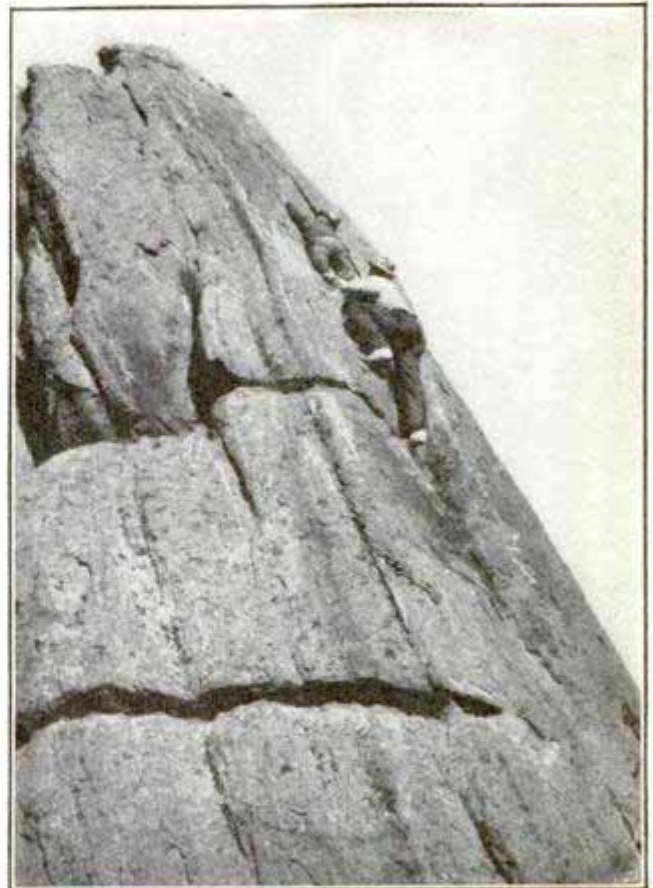

Men Climbing the Rocky Mountains in Colorado Seem to Have the Powers of Flies

LIZARDS PHOTOGRAPHED WHILE FIGHTING

In this part of the world lizards are small, inoffensive reptiles, fond of bask-



A Battle between Giant Lizards in Australia

ing in the sun; but in Australia, the monitors, which are reptiles nearly allied to the true lizards, often reach a length of 6 ft. These lizards, of a greenish-gray color, are very active, and defend themselves vigorously when attacked.

An encounter between two giant monitors in the rocky bottom of a ravine was recently watched by a hunter, who approached within a few feet of the battle and photographed them without being noticed, so absorbed were they in the fight. Sometimes the huge reptiles raised themselves on their tails and grappled like wrestlers, then rolled on the ground and bit ferociously.

RAILWAY BRIDGE OVER PANAMA CANAL

Plans are being prepared for a great steel bridge over the Panama Canal at Empire to accommodate both the Panama Railway and roadway traffic. The bridge, which will probably be of the steel arch type, will require a span of approximately 500 ft., in order to se-

cure the required clearance height of 175 ft. above the entire width of the canal. Difficulties in securing a good foundation for the abutments may necessitate an even longer span.

The new bridge will be located near the present suspension bridge, which is a temporary structure built two years ago. This bridge is ample for light roadway traffic but cannot carry railroad trains. The plans for the new bridge provide for a 16-ft. railway width, a 16-ft. highway width, and footwalks.

SPECIAL AUTOMOBILE FOR LAMP TRIMMERS

Automobiles of novel construction are being used by the "trimmers" of electric street lamps in Philadelphia as a means of increasing the speed of the work. In a test run, one man cleaned and inserted new carbons in 165 lamps in six hours. The unique features of the "trimmers' truck" are the elevated driving seat and the extended steering wheel and controls. A driving seat is also provided in the usual position, as well as a second set of wheels for use



One Man Cleaned and Inserted New Carbons in 165 Lamps in Six Hours with This "Trimmers' Truck"

when steering and controlling the machine from this seat.

Assembling an Army

Of 20,000 Men
on the Rio Grande

in Ten Days

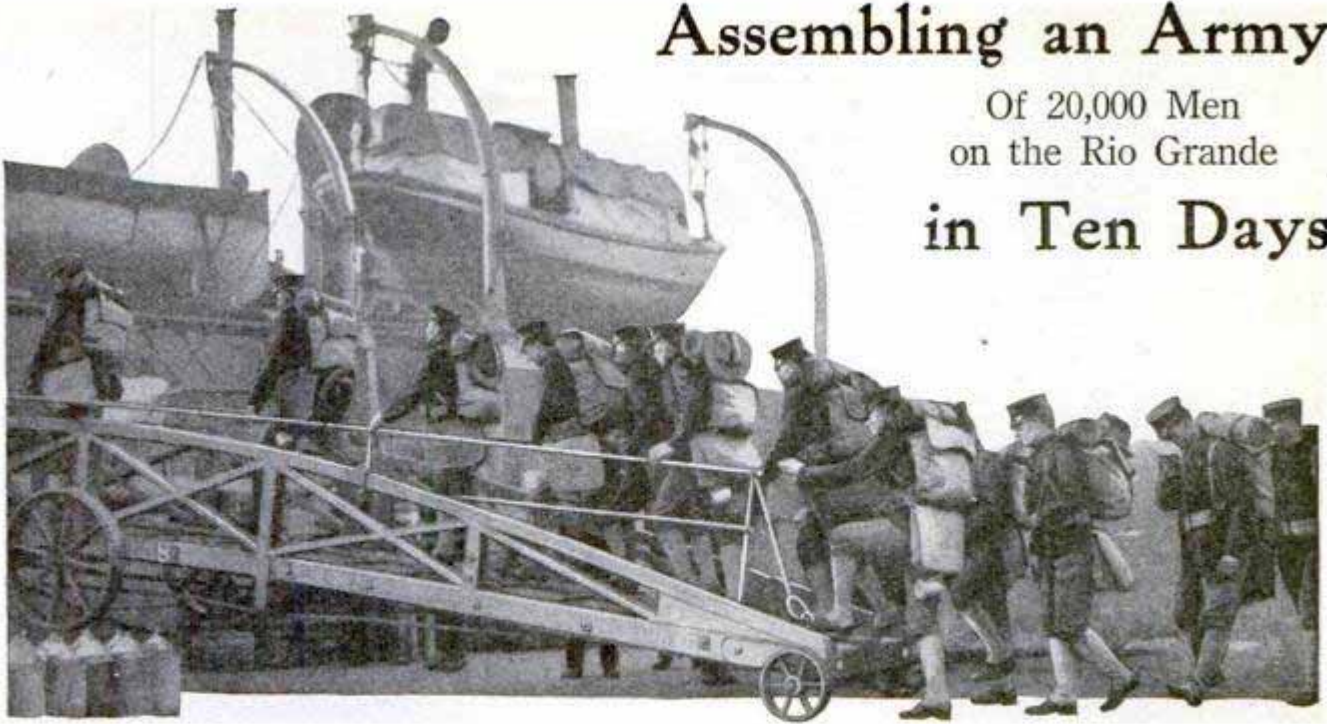

U. S. Marines Boarding a Transport for the South

How Magnificent Organization Made Possible the Gathering of Widely Scattered Units into a Single, Completely Equipped Fighting Force, Ready for Instant Action

By L. WILLIAM THAVIS

NEVER before in the history of this country was so large a body of troops mobilized at one point in so short a time as was taken in establishing the maneuver camp at San Antonio, Texas. Orders for the movement of the troops were issued from the War Department during the afternoon of March 6. The 17th Infantry, stationed at Fort McPherson, Ga., was the first organization to receive its orders at 9:30 that night. By 4 p. m., March 16, just 10 days later, an army numbering practically 20,000 was encamped about the Texas city.

That such a seemingly impossible feat as this could be accomplished in so short a period is due, according to General Leonard Wood, Chief-of-Staff of the army, to the theoretical training which army officers now receive at the War College in Washington and also to the practical training they have

had in the movement of troops to and from the Philippines.

When this country declared war with Spain, practically two months had elapsed before a body of troops of any appreciable size had been mobilized at any one point, and this was only done after the greatest confusion and turmoil. The recent movement of troops was accomplished without the slightest bit of excitement; and 36 hours after the determination was reached to mobilize a whole army division in Texas, the officials of the War Department were sitting tranquilly at their desks watching with quiet interest the workings of the magnificent machinery that had been so carefully built up to respond to just such an emergency as the present.

There was good reason for this, for every detail of the movement had been worked out with the great-



Major General Leonard Wood, Chief of Staff and Ranking Officer of the U. S. Army

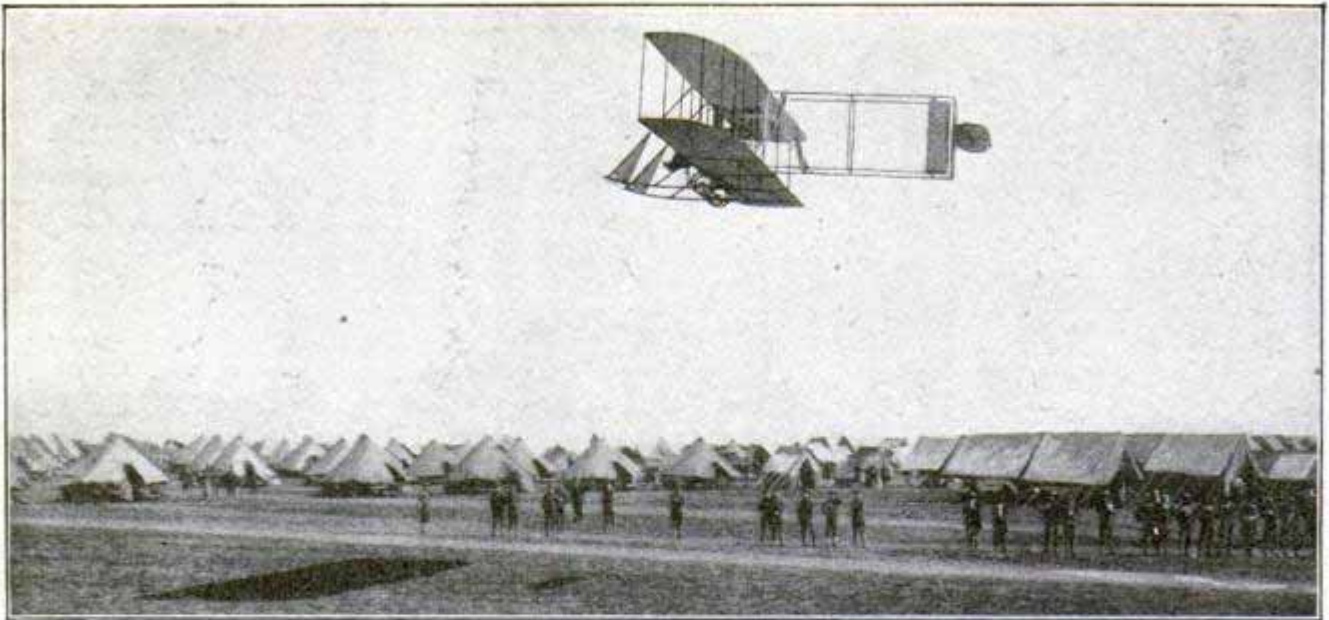

Copyright by the American Press Association
Aeroplane in Flight with Lieut. Foulois over the Camp at San Antonio

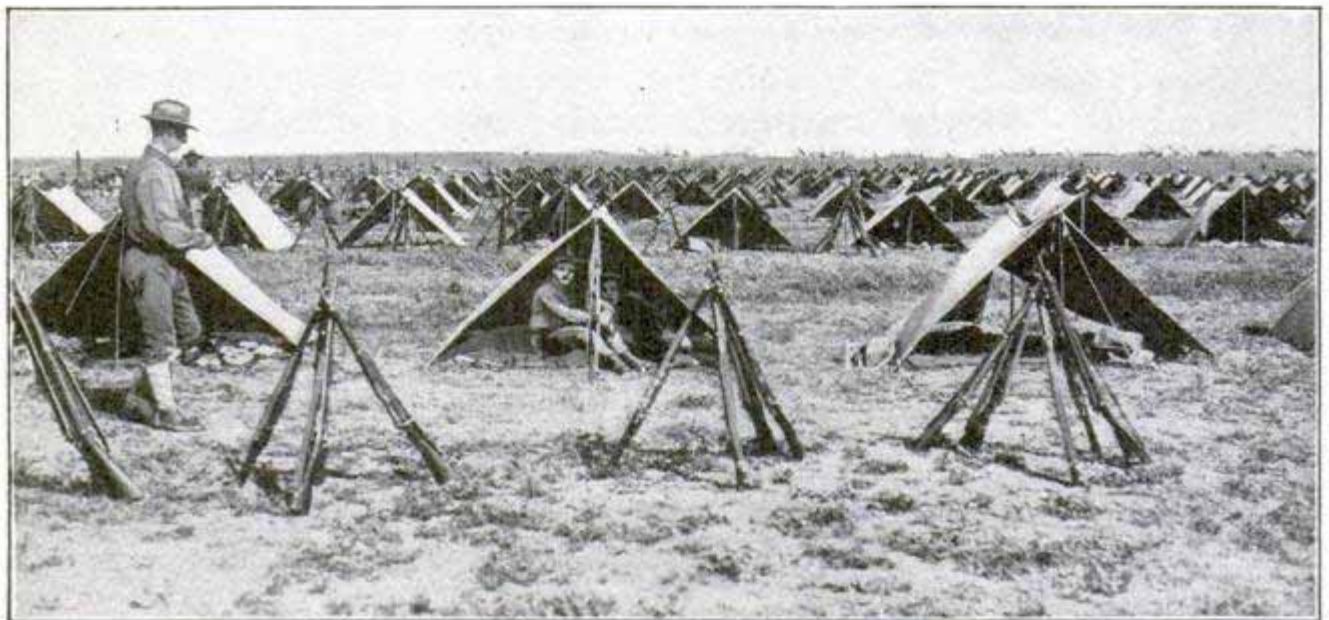

Photograph by Underwood and Underwood
Shelter Tent Camp of the 15th U. S. Infantry. The Tents of the 11th U. S. Cavalry in the Background



Photograph by Underwood and Underwood
Supplies Being Loaded at the League Island Navy Yard, Philadelphia, for Troops and Sailors Engaged in the Maneuvers



Extreme Left of Insurrecto Line, Showing Smelter on American Side of Rio Grande

Copyright American Press Assn.
Types of Insurrecto and Mexican Federal Soldiers Engaged in Conflict

est perfection long in advance, and there was not an officer concerned who had not taken part in other movements of less scale. The management of the United States army is no longer a matter of guesswork, but a highly scientific undertaking.

At the War College in Washington, the mobilization of just such bodies of troops as those now encamped about San Antonio is one of the chief studies of



the course. Even the smallest detail in connection with such an undertaking is not overlooked. Plans are prepared for the mobilization of forces about practically every large city in the country. Every particle of information that might be needed in the preparation of these plans is at hand at the War College, so that nothing need be left to guesswork. When once one of these mobilization plans has been completed



Citizens of El Paso, Tex., Watching Battle Two Miles Above Juarez

by the officers under instruction at the institution and approved by those in authority, it is filed away for future reference. Included in the work of the War College there is the collection, arrangement and publication of historical, statistical and geographical information; war maps, American and foreign; general information regarding foreign armies and fortresses; and collation and discussion of all obtainable data relating to strategical, tactical and logistic features of future military operations and formation of complete working plans for passing from state of peace to state of war. With such an arrangement, every possible bit of assistance is given the army officers when the time comes to order troops into the field.

When once there has been issued such an order as the one that brought 20,000 troops to San Antonio, the greatest amount of work then falls on the commissary and quartermaster departments. At the San Antonio camp, the problem of feeding 20,000 men is no easy task, although carried on in this particular instance under the most favorable conditions. In estimating the amount of food necessary to feed an army, the unit of measure used is known as a ration, or that amount of food required by one man for one day. One army ration costs the government about 23½ cents at the present time. Several years ago it could be purchased at several cents less cost. The 20,000 rations needed to feed the army one day cost the government \$4,704 and require the services of 312 cooks and as many assistants in its preparation.

In a camp of this size, some of the items of food consumed each day are 28,000 lb. of beef, 200 lb. of dried and canned fish, 1,000 lb. of lard and 600 lb. of butter, 1,700 lb. of coffee, 2,000 cans of condensed milk and 6,000 lb. of sugar. Between 30,000 and 40,000 loaves of bread also must be included.

If the regiments camped about San Antonio were to be ordered in the field for a week of active campaigning, it would be necessary to carry along 45,-

000 lb. of canned beef, 78,750 lb. of bacon, and 150,000 lb. of bread. Other items would be 30,000 lb. of desiccated onions and potatoes, 15,000 lb. of canned tomatoes, 12,000 lb. of coffee, 22,250 lb. of beans, 13,125 lb. of jam, 375 lb. of pepper, 6,000 lb. of salt, 13,500 lb. of vinegar, 6,000 lb. of soap and 2,850 lb. of candles.

When such enormous weights as these are considered, it is no wonder that the quartermaster's branch of an army division numbering 20,000 should have to provide 1,400 draft horses and 3,696 draft and pack mules to haul the 1,008 wagons necessary, not to mention 48 ambulances. Besides carrying this great amount of food, these wagons must also haul the 4,500 tents required to provide shelter for the troops. No less than 128,000 lb. of hay and 10,000 lb. of oats are required each day to feed the horses and mules. Among other items picked at random from a long list are 1,078 brooms, 980 buckets, 1,168 garbage cans, 1,530 cases of axle grease. One rather unusual item is 92 pairs of handcuffs.

These figures are but a few of those that have been filed away in the War Department as the result of the investigations made at the War College and in other branches of the service. They represent the outcome of investigation work dating back as far as 15 years. No doubt many of them will be modified and changed somewhat during the next year, for it is the intention of the commanding officers of the army to use the present maneuvers about San Antonio as a test for their calculations.

HOTEL BURNED WHILE CROSSING ICE

Bungalow Inn, a small summer hotel on Lake Cobbosseecontee, Maine, burned recently under unusual circumstances. The proprietor of the hotel decided to move it from its island location to the mainland, and when it had been dragged half way across the lake on the ice, it caught fire in the night and burned with all its furnishings.

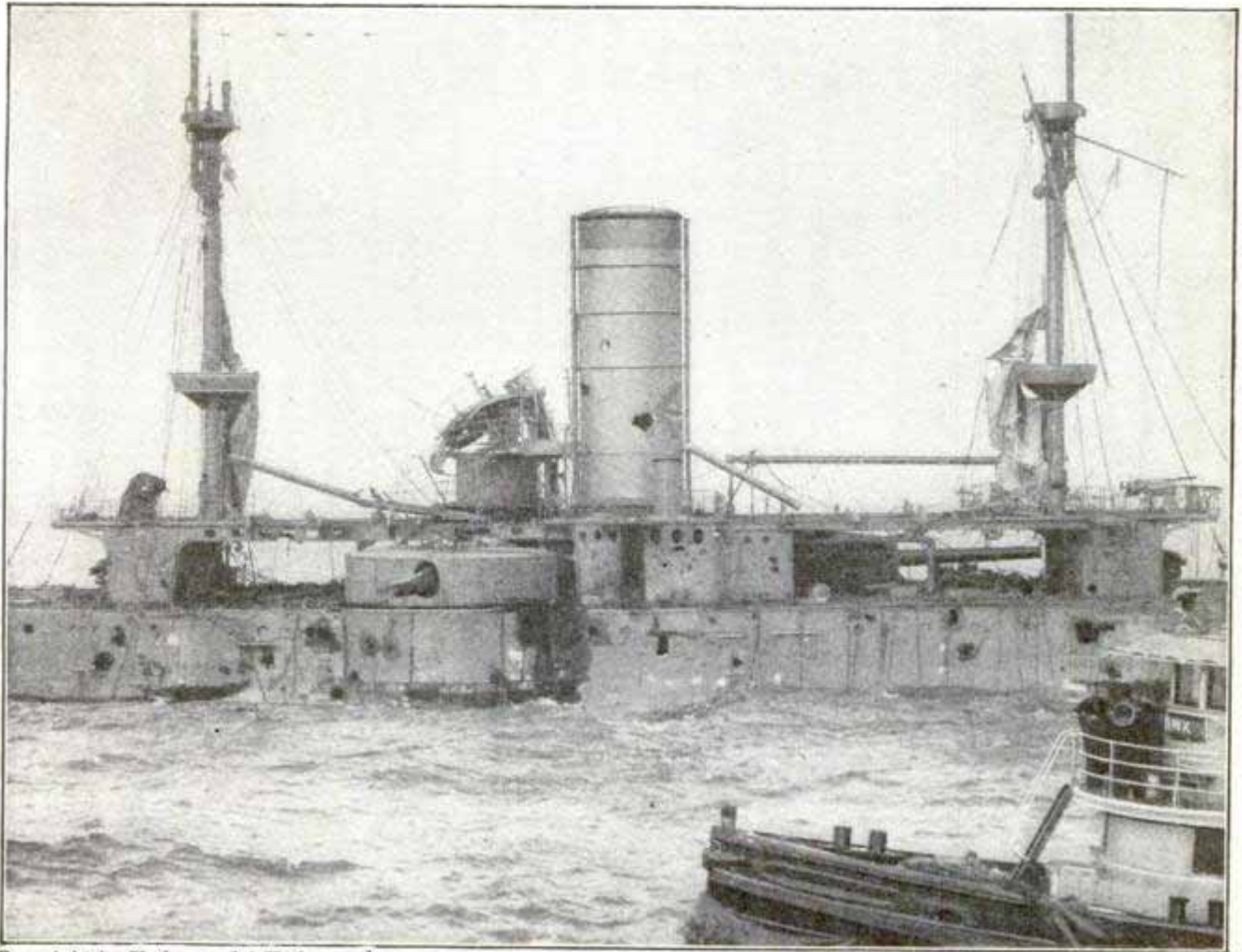

Copyright by Underwood & Underwood

A View of the Port Side of the Target Battleship "San Marcos," after She Had Been Riddled by the Guns of the "New Hampshire"

TARGET BATTLESHIP RIDDLED BY NAVAL GUNNERS

A rooster and a cat have earned places on the honor rolls of the navy as a result of their having lived through a hail of shot and shell from a modern battleship's big guns when the "New Hampshire" of the Atlantic fleet, tested the effect of its batteries against the condemned battleship "San Marcos" in the Chesapeake Bay, March 21, and sank her. The "San Marcos," before becoming a target for naval ordnance, was known as the second-class battleship "Texas" and was for many years the "hoodoo" ship of the navy. The cat and the rooster were placed aboard the ship to discover the effect of the gases and shock on living things. Both came through the ordeal in better shape than the ship, although the rooster will go through life with but one leg, the other having been sacrificed in the performance of his hazardous duty.

The "San Marcos" was literally shot to pieces by the gunners of the "New Hampshire." A number of shots were fired at the target from a distance of seven miles. Most of them went home and great jagged holes were found in the heavy modern armor in vulnerable parts of the ship. These were plugged up to keep the ship from sinking until the test could be completed with the firing of broadsides, at a medium range. The effects of the latter were sufficient to completely wreck the old vessel, and leave her in a sinking condition.

☞The harem skirt is doomed in Atlanta, Ga., if a proposed city ordinance passes the council. In this bill the new garment is stigmatized as "violative of convention" and "provocative of riot."

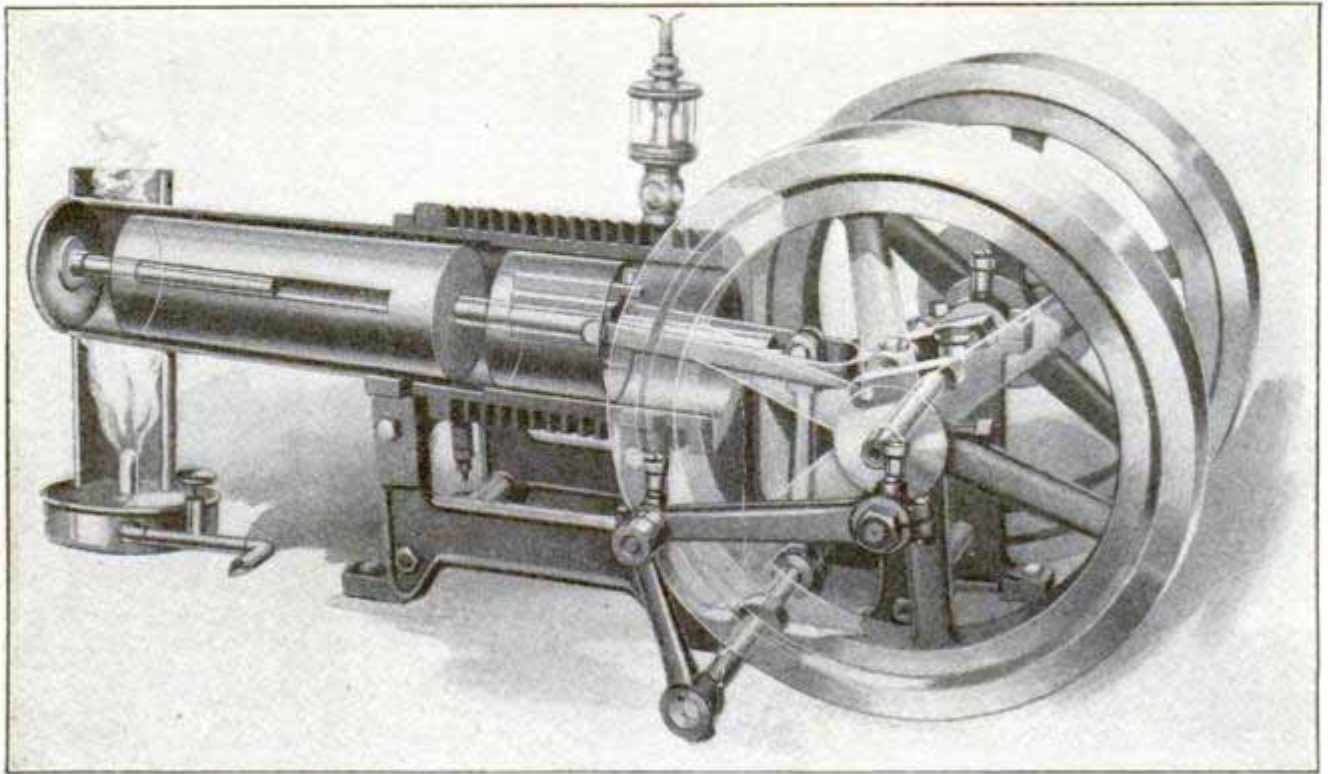

Cross-Section and Phantom View of New Type of Hot-Air Engine That Promises to Rival Other Types of Fractional-Horsepower Motors

A HOT-AIR ENGINE THAT NEEDS NO WATER COOLING

Like many another notable discovery, an accidental circumstance was responsible for the invention of this hot-air engine, the wonderful performance of which, for its type of engine, has converted several well known engineers from skeptics into admirers.

In the accompanying illustration, the cylinder is given in section and some other parts are "phantomed" to show the mechanical connections. There are two pistons. The smaller one fits snugly in the cylinder and is connected direct to the engine crankshaft by a forked pitman or connecting rod. The larger piston, which has a small clearance between it and the cylinder walls, is guided horizontally by the fixed cylindrical rod secured to the cylinder cover at the extreme left, and also by the piston rod which slides through a central bore in the smaller piston. This piston rod is pivoted at its other end to a short link which in turn is jointed to a rocking lever rigidly secured at its lower end to the horizontal rockshaft which runs in transverse bearings formed in the

engine bedplate. The near end (in front of the picture) of this rockshaft is rigidly keyed to another rocking lever which is pivoted to a connecting rod cranked to the flywheel in front. A glance at the cut will show this quite clearly.

The action of the engine is as follows: At the beginning of the working stroke, the pistons are both together at the left end of the cylinder. The expansion of the air forces them forward. A short distance from the starting point, the forward (small) piston pulls quickly away from the other, forming a partial vacuum (between the pistons) into which the heated air can rush (around the loosely fitting large piston) and expand. After this expansion, while both pistons are going forward, the pistons come together again. The expansion of the air cools it quickly and effectively, and a water jacket or cooling system, which is indispensable in other types of hot-air engines, is thus rendered unnecessary.

The engine, being of a nonexplosive

type, needs no spark plugs, batteries, carburetors, etc. Its fuel cost is said to be less than one cent an hour, for gas or kerosene, and it is so simple that a woman or child can run and op-

erate it. It seems to be well adapted for running small lathes, grinders, drills, cream separators, washing machines, pumps, domestic lighting plants, etc.

STOPPING A RIVER TO SINK A TUNNEL

A modern parallel to Joshua's miracle of old was furnished in the stopping of the flow of the Chicago River while the twin tube for the La Salle Street tunnel of the Chicago street railway system was being sunk into place. This precaution was necessary as the enormous tube, which is 278 ft. long and 41 ft. in width, would otherwise have dammed up the river, probably resulting in a displacement of the tunnel and serious damage to the bridges and shipping of Chicago's busy waterway.

Each of the tubes forms three-quarters of a cylinder of circular section, 24 ft. in diameter. Within the tubes there is a reinforced concrete lining varying from 20 to 40 in. thick, while the middle concrete wall is 3 ft. thick. The trench for the tunnel was made by dredging.

The flow of the Chicago River was stopped temporarily by closing the

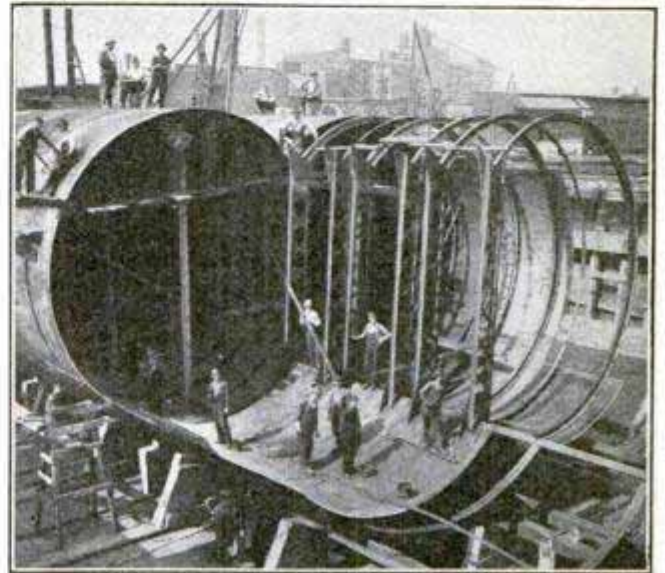

Erecting the Steelwork for the La Salle Street Tunnel, Chicago

locks at Lockport while the tube was being towed to its site and sunk into position.

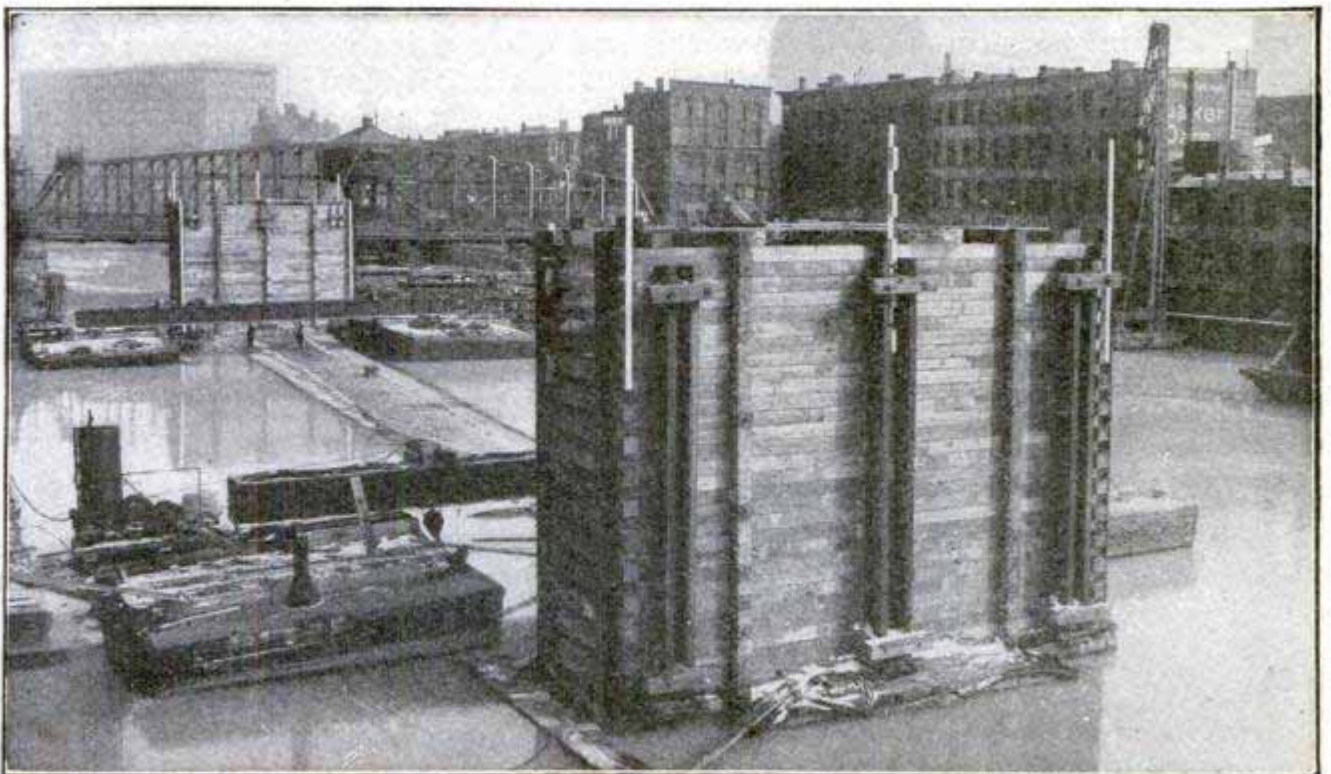

The Tunnel Lying Afloat and Nearly Submerged in the Chicago River, at Right Angles to Its Site. The Upstanding End Portions Are Caissons for Use in Joining Tunnel to Its Approaches



How the Bodies of Victims Were Taken from the Shirtwaist Factory after Tragic Fire



Many of the 141 Persons Killed in the Fire Jumped from the Top Stories of This Building

RIGID INSPECTION RESULT OF NEW YORK FIRE

As has always been the case after a great fire in which many lives were lost, the factory fire in New York, in which 141 workers, all but 16 of whom were girls, suffered a horrible death, resulted in a rigid inspection of buildings in many cities of the country. This inspection found, as did previous inspections, that there were hundreds



Hole Made in Iron and Glass Sidewalk by Bodies Falling from Top Floors of Building

of buildings in New York, Chicago, and other cities where the workers are just as poorly safeguarded as in the fatal shirtwaist factory.

The great majority of the dead ended their lives by jumping or being pushed from the windows of the burning building. Sixty-three bodies were picked up from the sidewalk, 50 were found on the ninth floor of the building behind barriers they could not pass, and 30 bodies were found at the bottom of the elevator shaft.

The fire-escape equipment was totally inadequate, and investigation brought to light the fact that the doors providing exit from the floor from which the death list was greatest were kept locked during working hours so that the hundreds of workers could not indulge in petty thievery. The subsequent inspection has brought to light many buildings where the same conditions exist.

COMMENT AND REVIEW

THE Pan-American Congress recently held in the new building at Washington, dedicated to the promotion of closer relations between the twenty-one western republics represented, was as notable as in many respects it was unusual.

The Pan-American Congress

Ambassadors, ministers, consuls general, business experts, manufacturers, and other interested delegates to the number of over 1,200, were present. The sessions started at 9 A.M., and continued until 10 P.M., with brief recesses at noon and evening, for six consecutive days, and not a minute was wasted. A full month could have been profitably employed, for, as one delegate expressed it, "I have not learned as much in the same length of time since I left college."

THE program arrangement was unique, but distinctly businesslike, as befitted a gathering of business men intent on extending trade relations. Director General John Barrett, who presided, planned the proceedings like a railroad timetable,—and this was rigidly adhered to. Seven minutes, only, were allowed each speaker, or paper to be read, after which the speaker answered questions which any delegate was allowed to ask. The only restriction was to debar all subjects political, diplomatic, or controversial. After answering questions for not to exceed fifteen minutes, the speaker repaired to one of the committee rooms, where any delegates desiring special information met him for further questioning on details not of general interest to the assembly.

AFTER the first session the convention easily fell into a condition of cordiality which made the whole affair take on the nature of a great international family gathering. There was a good deal of eye-opening on both sides. As one South American said: "You have the impression we are volcanoes in continual eruption, while our people think of the United States as a place abounding in murders, divorces and railroad accidents." This opinion of us proved to be founded on the press dispatches sent out from the States, the correspondents here assuming the subjects named to be of chief interest to South American readers. Steps will now be taken to correct this condition.

IT is manifestly impossible to condense into these few lines even a general outline of the proceedings. It is planned, however, to issue in book form a verbatim report that should be in the hands of every business concern in the United States which has the remotest idea of considering export trade. As no appropriation is available, a small nominal charge will be made per copy, and, as the edition will be limited, orders for the book should be sent in at once. No public document of any government in the world on foreign trade affairs has anything like the practical value to our manufacturers that this book will contain.

AMONG the interesting discoveries, and there were many on both sides, was the common mistake of our manufacturers in sending catalogs printed in Spanish into Brazil. Portuguese is the language of Brazil, and not only do few Brazilians read Spanish, but they feel far from complimented on receiving a letter, circular or pamphlet printed in Spanish. Such literature is promptly consigned to the waste basket; and yet, through ignorance, tons of such matter are being sent constantly into Brazil. Spanish printed matter is proper for all the other Central and South American republics. In regard to traveling repre-

sentatives, it was strongly urged to send salesmen, not academic linguists, but if possible to send salesmen who can speak the language of the countries visited. Exporting firms in Great Britain and Germany not only do this, but have their men carefully educated in the social and business customs of the countries visited. While a bright Yankee salesman can accomplish a good deal through an interpreter, the method is not to be recommended. Another instance of business shortsightedness is the custom of many of our manufacturers to quote prices f.o.b. at their factory in some small, or even large town perhaps a thousand miles from nearest seaboard. The South American has no facilities for securing freight rates to port of export, and is thus frequently prevented from purchasing because he has no idea of the total cost.

IN the matter of packing, great improvement was reported, yet many shippers continue to pack in boxes which insure destruction of the contents. Europeans never do this, but pack with care, which insures delivery in a salable condition. While thousands of miles of railroad are already in operation, and thousands more building, the territories to be reached are so vast (Brazil alone being larger than the United States) that much of the shipments to the interior must go via river steamers for hundreds of miles, and then often transfer to pack trains. And yet the natural resources, and soil fertility of Argentine and Brazil especially, are such that with all our own native wastefulness we can scarcely comprehend the unlimited ability of these countries to purchase whatever they want, regardless of price. Productively these two countries are today what the United States was 100 years ago, and it is not hard to imagine what the present up-to-date business man would do if those conditions existed here today. Yet such are precisely the opportunities in South America at the present moment.

THE Episcopal bishop of Rio de Janeiro, a resident there for the past twenty-one years, and a native of Richmond, Va., said to me: "The great obstacle to a vast trade from the United States is our colossal ignorance of South American possibilities, and a lack of ships. We paid Brazil \$101,000,000 more in 1910 alone than she paid us, while the people of that country are earnestly anxious to buy a thousand articles and commodities we can export to advantage, and profitably." The same willingness to trade is true of other Pan-American republics.

AN interesting new sidelight was flashed on the Panama Canal. It was stated by a business expert that, upon the opening of the water connection, a vast clearing house for freight would be established there. Vessels from both the Pacific and Atlantic coasts of North and South America will dock at this central point, and discharge and reload entire cargoes of mixed freight. Thus a few tons of dried fruit, for instance, will find prompt through service from San Francisco to either Lima, Buenos Aires, New Orleans, or New York, without the delay of waiting for some vessel to secure a full cargo of freight to either of the ports named. The illustration will readily suggest the unlimited possibilities of commerce, not only to the large ports, but to a coastwise trade including over 12,000 miles of coast line. In addition, freight will clear promptly at the canal for all parts of the world.

WE are asleep at the switch while Germany and England are active in developing trade in a continent that during the next century will be the world's greatest producer of foodstuffs, and a correspondingly large consumer of everything we manufacture. Already Argentine is shipping more beef to Europe than the United States, and in a very few years we ourselves will be importing wheat. There is no time to lose, and it is to be hoped, as many, including the writer, believe, that the Pan-American Congress has advanced the possibilities of our export trade fully ten years. H. H. WINDSOR.

N. Y. AUTO TEST PRESAGES PASSING OF FIRE HORSE

As a result of the recent successful test of a new type of self-propelled fire engine by the New York City Fire Department, it has been officially predicted that in five or six years there will not be a single horse-drawn fire engine, tender, truck or water tower in that city.

This auto fire engine differs from its predecessors inasmuch as it comprises a 110-hp. gasoline motor, under the hood in front, for propulsion purposes, and a separate steam-engine equipment in the rear, capable of pumping up to 800 gal. of water a minute at a pressure of 125 lb. per square inch, as proved by actual test. The engine attained a speed of 40 miles an hour in a test run under service conditions, which compares most favorably with the 12 miles an hour of the horse-drawn vehicle.

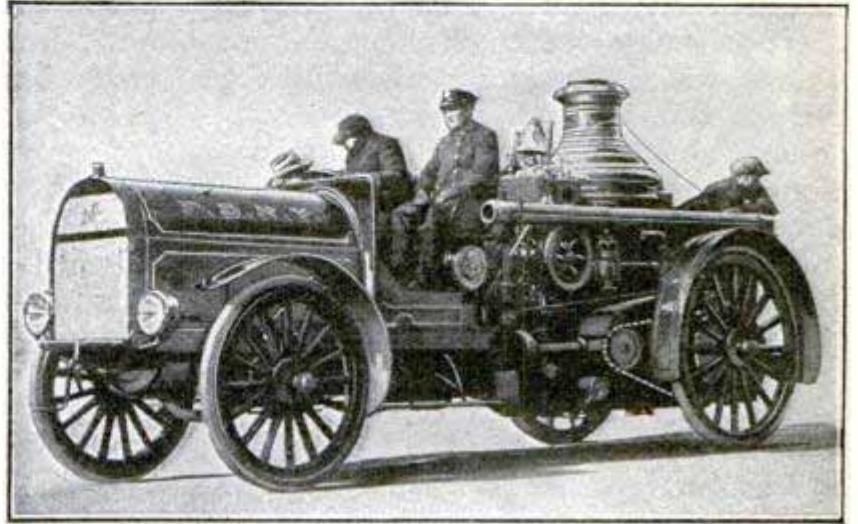

New York's Automobile Fire Engine

The engine weighs 16,000 lb. and cost the city \$9,772, of which \$5,272 represents the value of the steam engine, etc., and \$4,500 the motive machinery. Hereafter, the old horse-drawn vehicles can be converted into a similar type of auto engine at an estimated expense of \$6,000 each. The cost of maintenance of each machine

is stated to be between \$50 and \$100 a year, as against \$700 to \$800, the present yearly charges for a team of horses for one machine.

OVER THOUSAND TONS OF EXPLOSIVE "LETS GO"

One of the greatest explosions the world has ever felt occurred recently at Pleasant Prairie, Wisconsin, completely wiping out the powder plant, doing damage in a radius of 60 miles, and causing a commotion felt in five states. In all, 1,033 tons of explosive let go. Of this amount a little less than 1,000 tons was black (soda) blasting powder, of which 1,125,000 lb. was stored in one magazine and 870,000 lb. in another. In a third magazine was 65,000 lb. of dynamite, which was also detonated.

The trouble started in the glazing mill, where 1,000 lb. of powder was being handled. Fire from some source impossible to determine, but probably due to friction, ignited this powder,

and it is presumed that pieces of metal entered at least one of the magazines, the three of them exploding in rapid succession.

FRANCE STOPS TIME FOR A FEW MINUTES

A measure adopted by the French Senate resulted in the annihilation of time for 9 min. 21 sec. on March 10. At exactly midnight all the republic clocks were stopped for that length of time and then started again, this action making the time all over France exactly the same as that of Greenwich.

Owing to the change in time, a question arose in the French press as to whether or not a child that was born and died within the elapsed time could be said to have legally lived.

AIRMEN MAKE RECORDS WITH PASSENGERS

The past few months have been noteworthy in the history of aviation because of the development of passenger-carrying machines of great capacity. Where a few months ago airmen were contending for altitude, speed and endurance records, their efforts now seem to be centered on carrying aloft as many passengers as their machines will hold, and with additional weight thus gained, attempting endurance and distance flights. Roger Sommer is the record holder, up to date, having soared two-thirds of a mile with 13 persons in his biplane at Mouzon, France, March 24. While this is a greater number by one than was carried by Louis Bréguet at Douai, France, March 23, Bréguet is believed to have made the better flight in that he flew two miles with his passengers in a monoplane.

Perhaps the greatest passenger-carrying feat in the history of the science was that of Renaux who, on March 7, won the special Michelin prize of \$20,000 by flying from Saint Cloud to the summit of Puy de Dôme, a distance of 217 miles, in 5 hr. 8 min., carrying a passenger. Puy de Dôme is a mountain peak 4,800 ft. above sea level and the flight for the prize had been unsuccessfully attempted by several well known French airmen.

Notable also during the last few months has been the infrequency of serious accidents. Three persons are reported to have lost their lives. At Madrid an airman lost control of his machine while descending and one bystander was killed when the plane struck the ground. A dispatch from Krefeld, Prussia, announces the death of Paul Kayser, pilot of the balloon "Düsseldorf IV" as the result of a bad descent, the basket of the balloon having struck the water in the Zuider Zee with such force that Kayser was instantly killed, and his passenger seriously injured. M. Cei, the third victim, fell with his aeroplane from a height of 2,200 ft. at Paris, March 28.

He died a few hours after the accident.

The mobilization of a large body of troops in Texas, and the revolution in Mexico has enabled the army officers to use the machines belonging to the signal corps in some interesting experiments in carrying dispatches. A new Curtiss machine which was especially built for military uses has been purchased by the War Department.

Lieutenant Bague, of the French Algerian Rifles, established a new record for oversea flight, March 5, by going a distance of 125.5 miles over the Mediterranean sea from Antibes, France, to Gorgona, a small island between Corsica and Leghorn, Italy. He intended to land at Ajaccio, Corsica, but steered too far north.

J. A. D. McCurdy set a new record with his Curtiss biplane in Florida, March 6, by receiving the first wireless message in an aeroplane in flight. The operator who accompanied McCurdy picked up signals from several stations while aloft, in addition to taking a regular message addressed to the airman from the Palm Beach station.

One of the fastest short flights on record was made by Airman Say at Issy-les-Moulineaux on a circular course when he flew 63 kilometers (39.15 miles) in 32 min.

At Mourmelon, March 10, Nieuport established a new record for speed by flying 68.5 miles with two passengers at the rate of 64 miles an hour.

Rene Simon opened a new field of usefulness for aviation in Texas by rounding up a herd of a cattle on a big ranch near Houston.

Ice dealers throughout the country are being urged by a manufacturer of advertising novelties to give to each of their customers an ice pick the manufacturer is making, on the ground that "the more they chop the more they buy."

NONGYROSCOPIC AEROPLANE MOTOR TO INCREASE STABILITY

Inventor Pits Gyroscope Against Itself, Advancing Theory That Its Action in Flywheels and Revolving Motors Has Been Cause of Many Aeroplane and Automobile Accidents and Fatalities

By J. Q. ROBERTS

WORKING on a theory that many automobile accidents and most aeroplane disasters are caused by the gyroscopic action of the revolving parts of the motor when making a sudden change in direction of the machine, Thomas Preston Brooke, well known in many parts of the country as the former leader of the Chicago Marine Band, has designed an aeroplane motor in which this action is modified by dividing up the revolving parts into two units and making them turn in opposite directions.

It would seem, therefore, that what has been considered an aid to stability has under certain conditions been a mysterious agent of destruction. Mr. Brooke claims that the conditions under which the gyroscope aids stability are not present in the aeroplane or automobile, and his demonstrations with models seem to carry out his arguments.

The nongyroscopic motor weighs 172 lb., and develops from 75 to 85 hp. when both sections are operating. It has 10 air-cooled cylinders, 5 in each

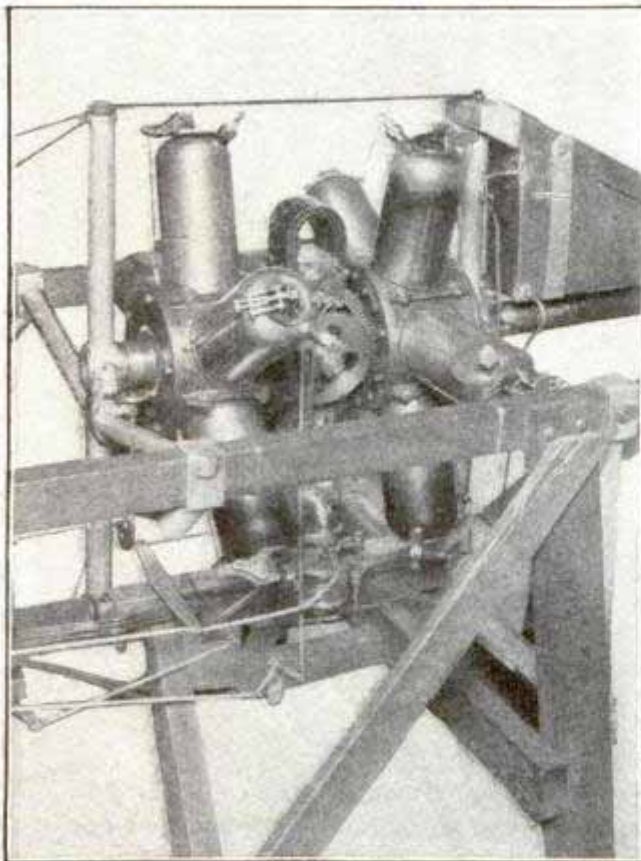

The Nongyroscopic Motor on Temporary Framework, Showing How Units Are Connected

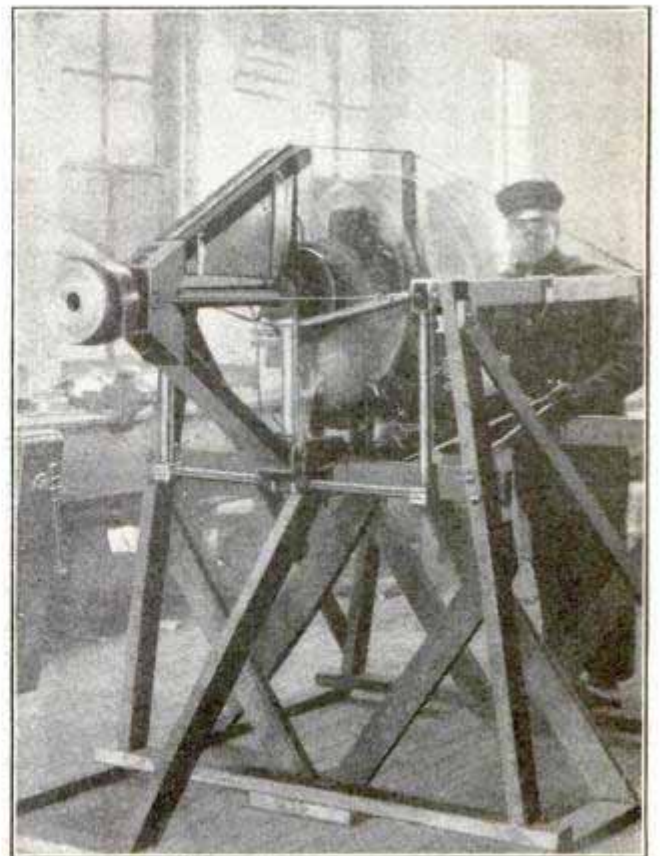

Motor in Operation, Revolving Propeller at the Rate of 1200 R.P.M.



Thomas Preston Brooke,
Inventor of Nongyroscopic Motor

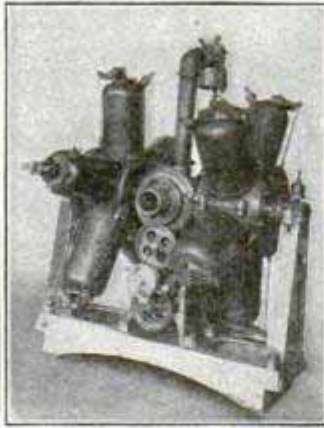

His First Nongyroscopic
Motor—Built Two
Years Ago

unit, and either half may be run independently of the other. This is considered an advantage for long cross-country flights, as one-half of the motor will develop enough power to operate the machine while the other half is resting and cooling off, if necessary.

The inventor has reduced the motor to a remarkable degree of simplicity by the introduction of many excellent mechanical features, some of them unique. All working parts and lubricating devices are inclosed in the crank cases, easily accessible; the ignition system is simple, and only 12 in. of high-tension cable are used in the entire motor; no timer is necessary; carburetor troubles are minimized by mixture of air and gasoline in crank case; the cylinders are offset; and every bolt is pinned. No trouble is experienced in starting the experimental motor, a throw of one-quarter of a turn sufficing.

The discoverer of this means of utilizing the force of the gyroscope has driven an automobile for years, and it was while driving one of the first models that the phenomenon of the "skidding" car came to his notice. The older cars had very large and heavy flywheels, and the gyroscopic action was therefore more noticeable. The large racing cars of today, however, are also provided with heavy flywheels.

Mr. Brooke is the first to bring forward a motor involving this new principle. The Ligez motor, a recent

French invention, turns the crankshaft and propeller in an opposite direction from that of the revolving engine. A few months ago M. Bouchaud-Praceiq, a Frenchman, brought out the same theory before a French society of civil engineers. He mounted two small gyroscopes on a board and demonstrated the results of revolving them in opposite directions. It is a strange coincidence that he points out that the death of Chavez was due to the gyroscopic action of his motor, as does Mr. Brooke in the statement which follows. M. Bouchaud-Praceiq said in his discussion before the French society: "No doubt some day the aeroplane will carry two motors rotating in opposite directions, one driving a tractive propeller; the other a propulsive; the propellers also turning in opposite directions and exactly counterbalancing each other."

The American inventor made his first motor two years ago, and applied for his French patents last fall.

In discussing the theory of his invention, Mr. Brooke says:

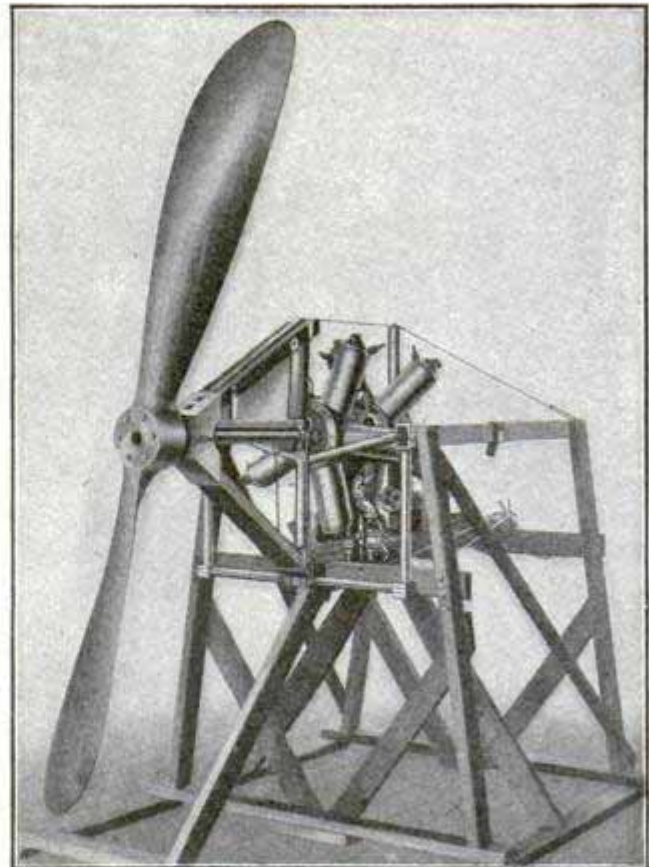

Brooke Motor and Propeller on Framework Used for
Experimental Purposes

"Since Brennan employed the gyroscope to stabilize his monorail car, the idea has steadily grown that it would be a good thing to use this force in connection with flying-machine stabilizing until it has become an almost universally accepted theory. The gyroscope as used by Brennan is a vastly different proposition from that of the revolving parts of our high-speed aeronautic motors.

"In the accident that caused the death of Chavez, and also in those of more recent date that killed Moisant and Hoxsey, the aviators had just finished a long glide, and, while traveling at a terrific speed, suddenly changed their paths from an angle of 30 deg. to a horizontal. In each of the above cases the motors were running at

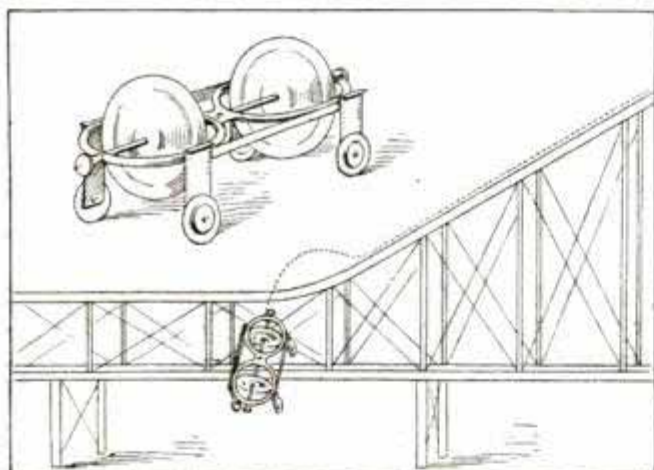

Model with Two Gyroscopes, Which When Revolved in Same Direction, and Run Down Incline, Acted as Aeroplanes Do Under Same Conditions. The Model Turns to the Left and Leaves the Track

highest speed and were all revolving anti-clockwise as viewed from the front. All the published accounts of these accidents agree in that 'at the point where the elevator was raised to alter the gliding angle the machine seemed to shudder for an instant, turn slightly to the left and plunge downward.' This tallies exactly with dozens of my experiments, conducted to demonstrate the cause of these accidents, and in not one instance has my apparatus failed to act just as did these aeroplanes when subjected to the same conditions.

"The presence of this force in the flywheels and clutches of automobile motors has been the direct cause of at

least 75 per cent of all automobile accidents. It is this force that lifts the rear wheels of a two-ton automobile clear of the pavement and causes it to slowly skid or revolve until very often the auto has turned a complete circle. Again it has caused autos to skid around into the path of an oncoming train, causing loss of life and property, or again, has smashed the wheels of the auto against the curbstone.

"The most common accident as the result of this force is that of causing two autos to collide. The cars meet on a curve or short turn in the road; both drivers release their 'clutches'

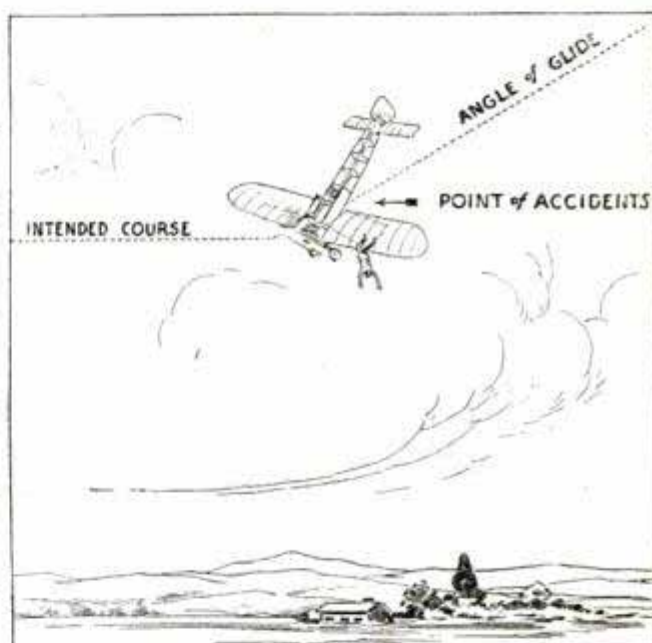

Inventor's Theory of Cause of Accidents—Gyroscopic Force Gets in Deadly Work at Point of Change in Direction

to be ready to apply their brakes and by this action allow their motors to jump to a high speed of revolution. This high speed, coupled with the revolving parts of the motors all turning in the same direction, immediately sets up a terrific centrifugal force, the sudden swerving of the autos awakens the slumbering gyroscopic force, causing the autos at once to begin to skid or float.

"It is this force that causes nearly all the accidents to racing automobiles, either directly or indirectly. One reads in the newspaper accounts of these fatal accidents, that 'just as . . . in his 100-hp. car started to

take the curve the machine seemed to leap into the air, and, with a corkscrew motion, turned completely over, crushing and instantly killing him and his mechanic.' No less than four of these accidents happened during a recent speedway meeting and the description quoted above fits exactly to each case.

"If gyroscopic force is so dangerous and destructive in its action to the automobile motor, what great havoc must it create through the motor of the delicately constructed and poised aeroplane! The flying-machine of all kinds is continually subjected to sud-

den shifts from its direct path of flight by side gusts of wind. What, then, must be the force exerted by the high speeds of aeronautic motors and particularly that of the revolving kind.

"In the accounts of accidents to aeroplanes one almost invariably reads that 'for some unknown reason the aeroplane seemed to swerve suddenly to one side, crumple up and crash to the earth a tangled mass.' When one fully understands the erratic action of gyroscopic force there can remain no cause for wonder at these accidents, and the only marvel is that there are not more of them."



NEW YORK STATE CAPITOL DESTROYED BY FIRE

Fire wrecked the beautiful state capitol building at Albany on March 29, millions of dollars damage being caused by the flames. The greatest damage occurred in the library, which contained thousands of volumes, pamphlets, and historical manuscripts, the loss of which is irreparable. The handsome assembly chamber was wrecked, and the main staircase in the building, which cost \$1,500,000 was ruined.

WOODEN BALL REMOVES SEWER OBSTRUCTIONS

A most effective method is used in Paris to remove obstructions from the sewers. A hollow ball 6 ft. in diameter, made of wood, is lowered into the sewer pipe and the flow of the sewage starts it rolling toward the Seine. The ball is so heavy that only the most extraordinary obstructions can stand before it and its failure to pass certain points along the route gives notice of the presence of such obstructions. The ball is built in sections and these are put together at the place where it is to be lowered in the sewer. When the sections are put together they are covered

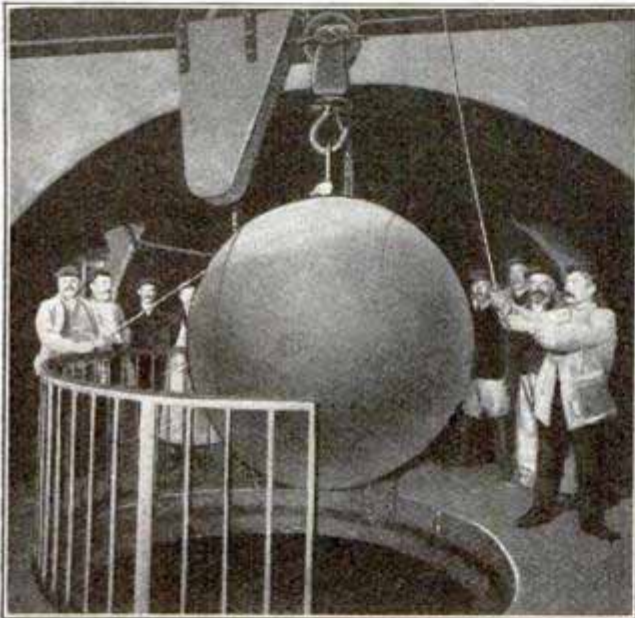

Lowering the Huge Wooden Ball into One of the Sewers of Paris

with a framework of metal and the whole ball is allowed to bound through the sewers. This method of removing obstructions is in continual use in Paris now, the municipal officials feeling that they must leave nothing undone to keep the drains of the city free and eliminate as far as possible further flood danger.

ITALIAN SOLDIERS AS TRICK CYCLISTS

The Bersaglieri cyclists of the Italian army are veritable acrobats, performing as many "stunts" as might be expected of a circus troop. The Bersaglieri, or sharpshooters, are Italy's



Gun Drill on the Shoulders of Companion Cyclists

most popular soldiers. The special duty of the cyclists in time of war is to co-operate with the cavalry, occupy important strategical points on the line of advance, and draw the enemy's fire.

PARADING FOR QUININE

So called "quinine parades" occur in every part of India during the malaria season, the natives marching to the hospital and squatting down in lines to await their turn in being dosed. In order to make sure that each swallows the proper dose, the hospital assistants pour the liquid quinine into the mouths opened to receive it. The illustration shows a sepoy in the act of swallowing a dose dropped into his mouth from a glass measure. From the expression on the face of the native at the right of the illustration it is obvious that the dose he received was not altogether pleasant.



Dosing the Natives of India with Quinine

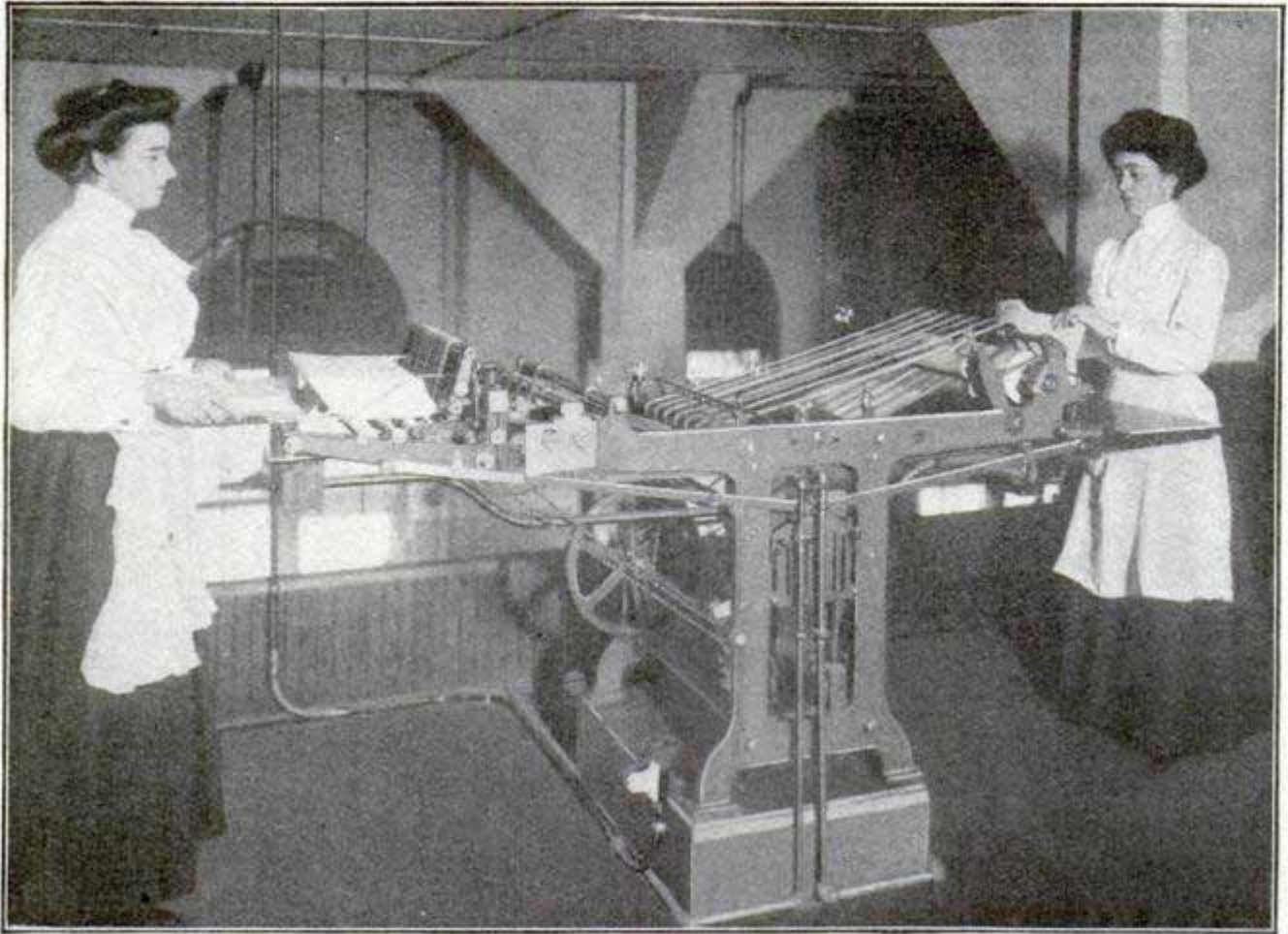

This Machine Saves the Government \$42,000 a Year by Dampening Currency Paper

UNCLE SAM'S AUTOMATIC DAMPENING MACHINE

By THOMAS D. GANNAWAY

The United States government is in possession of the latest improvement in the art of plate printing. There has been invented for the Bureau of Engraving and Printing at Washington, a machine which it seems will greatly advance the art of printing paper money. There has been but little change in the art of plate printing since its invention in Italy nearly 400 years ago.

So difficult is the printing of paper money that it all has to be done on hand presses. And yet it is impossible to get perfect impressions on the paper. In order to make perfect and uniform prints, the paper must be of a uniform condition. Before the printer can use this paper, it must be wet and then allowed to lie awhile and absorb the moisture. The best approved method

of doing that is by hand. A board a little larger than a sheet of paper is used for a starting base. On top of this is put a wet cloth, then 20 sheets of paper, then another wet cloth, and another 20 sheets of paper, and so on until there are 1000 sheets in the stack. This stack is then put under a slight pressure for 24 hours. It is then taken out and, naturally, the sheets which were next to the cloths are wetter than the others. These packs of 20 sheets have to be split in the middle and the wet sides turned together and then repacked as before for another 24 hours. On account of the cloths absorbing the animal matter contained in the sizing which the manufacturer has put on the paper, a new (or different) set must be used each time, as they will sour if left in the package too

long, thus injuring the quality of the paper. Notwithstanding all of this time and trouble, the paper is not uniformly wet.

When a sheet of paper has received the proper amount of moisture, it will have expanded $\frac{1}{2}$ in. If it is too wet, it will expand more than this and if it is not wet enough, it will not expand so much. When these sheets have all been printed and then put through the drying process, they will contract back to their natural dimensions. One can, now, readily see that there will be a variation in the dimensions of these notes, which at one time was considered evidence of counterfeit, but upon a thorough investigation, it was found that it was impossible for the plate printer to print them so that they would all be of a uniform size.

The new automatic dampening machine wets every sheet exactly alike and does 48,000 of them in seven hours. Three girls can operate two machines at once. The feeder, feeding from the bottom of the stack will operate successfully under 3,000 sheets. The sheets are carried through a tank of water in the machine and up through a rubber wringer which has been adjusted so as to leave the proper amount of water in each sheet. It takes 5 lb. of water to 1,000 sheets to properly mellow them. They are taken from this machine to a humidor.

This humidor is an airtight case constructed especially for this work. The paper may lie in it a week without injury, whereas, by the old method of wetting, it has to be used within 24 hours after the second wetting.

Wetting the paper by hand costs the government 52 cents per 1000 sheets, while with the machine it can be done for 14 cents, thus making possible a saving of \$42,000 per year on this one item.

☐ Hereafter all arms, ammunition, uniforms and other equipment for the Chinese army will be manufactured in China.

GASOLINE TRACTION CULTIVATOR

This three-wheeled gasoline traction cultivator and general utility power plant for farm work weighs 4,500 lb. and develops 25 hp. The drivewheels

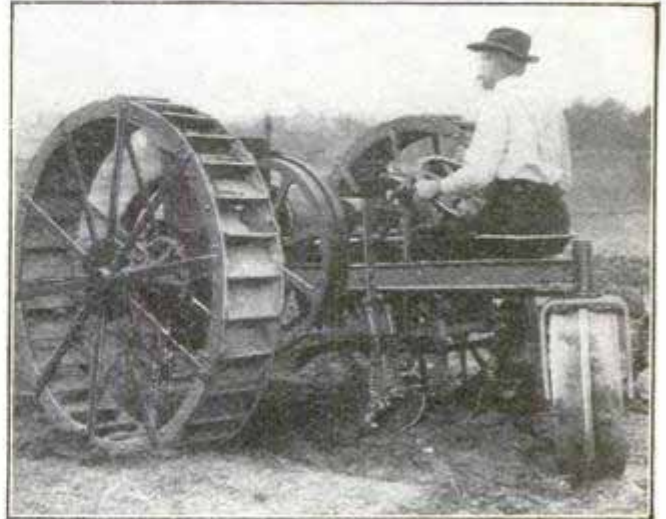

Gasoline Traction Cultivator Making a Turn

are 5 ft. in diameter and adapted to travel over ground of any character. The feature of the machine is its flexibility of movement. By locking one or the other of the drivewheels and turning the steering wheel as far as it will go, the single rear wheel turns at right angles and the machine describes a half circle, coming into position to cultivate the next two rows without the necessity of stopping or backing.

The treads of the drivewheels are 6 in. broad and 10 in. long, set at an angle, with an open space of $2\frac{1}{2}$ in. between each, so that the soil may pass through instead of packing hard.

ALUMINUM ELECTROMAGNET COILS

German electrical engineers have introduced an innovation in electromagnet manufacture, making the coils of bare aluminum wire instead of insulated copper wire. The aluminum immediately becomes covered with a whitish film of aluminum oxide when brought in contact with humid air, and this provides an excellent insulator. It is claimed that a short circuit between the windings is impossible with these coils.

SOME HISTORICAL ABSURDITIES WHICH



A Future Novelist May Easily Get Mixed Up in His Dates and Imagine the "Maine" to Have Been Sunk by a Bomb Dropped from an Aeroplane



It Is Quite Probable That Some Careless Author May Overlook the Fact That the X-Ray Was Not Known Until 30 Years after the Civil War



Joan of Arc, Seated at Her Sewing Machine, Dreams of Driving the English from France, More Than 400 Years before the Machine Was Invented

"In the darkness of the night a tiny monoplane with muffled engine shot out silently from behind the forts of Havana and crossed and recrossed the ill-fated 'Maine' which was lying at anchor in the harbor. The airman began to drop his deadly bombs. Splash! The first one missed and fell into the water. The second aim was deadly and true. Down one of the big smokestacks fell the tiny engine of destruction. A muffled roar, and the doomed ship commenced to sink. What of the airman? History does not relate."—*22nd-century novel.*

Of course such a statement is absurd. Only 13 years ago was the "Maine" sunk in Havana Harbor. But the historical novelist of 200 years hence has no such near view of the facts. He is looking back through a long perspective, and the war with Spain will probably have been overshadowed by the greater significance of later events.

The aeroplane is now a new invention. At the time of the Spanish War it was unknown as a practical piece of apparatus. It therefore could not have been used in connection with the blowing up of the "Maine." The supposed writer in the 22nd century would thus have perpetrated an anachronism, that is, a historical portrait including an idea wrongfully borrowed from a later period in history.

In the suppositional case previously cited, the difference in time is but a few years. Twelve years or so later, the sinking of a ship by means of a bomb dropped from an aeroplane would have been feasible and even probable under the circumstances.

More remarkable anachronisms than this have occurred in the works of some of the best painters and in the writings of the most celebrated authors and novelists. Thus, in his picture of the manna gathering in the desert, Tintoretto has armed the Hebrews with guns. Thackeray, writing of an incident of the year 1712, mentions a novel which was not published until 1750. Schiller records the use of a lightning

MAY BE COMMITTED BY FUTURE WRITERS

conductor more than 100 years before the date of its invention. The Virgin Mary has been represented in paintings as an Italian peasant woman and as a Dutch housewife, and in an altar piece at Capua she is shown seated in a rich arm-chair, with a cup and a silver coffee-pot standing on the table beside her.

Even Shakespeare is not free from historical misstatements, though probably these were made for the sake of effect. Thus, the great dramatist in Julius Caesar makes Cassius say "the clock hath stricken three," although striking clocks were not invented for many hundreds of years later than the time of the Roman emperors.

Goldsmith was nearly hoaxed into putting into his "History of Greece" an account of a battle between Alexander the Great and Montezuma, and John Britton makes Judge Jeffreys preside at the trial of Charles I, although the infamous jurist was only one year old at the time of the execution of that unhappy monarch.

These are but a few of the many anachronisms that are on record. Since the 18th century, writers and painters have usually been careful to ascertain the true circumstances and depict them accordingly, but the fact remains that it is almost impossible for a novelist to project his mind into the atmosphere of a by-gone age and reflect faithfully the life and character of the times of which he writes.

The last century has witnessed some wonderful developments. The first ten years of this present century are crowded with important happenings. The commercially successful automobile, the wireless telegraph and the aeroplane are innovations still fresh in the minds of even the younger generation of today. How easy, then, will it be for a writer centuries ahead to confuse the priorities of these several wonders of an inventive age, especially as the probability is that many more wonderful things will be developed in the years to come.

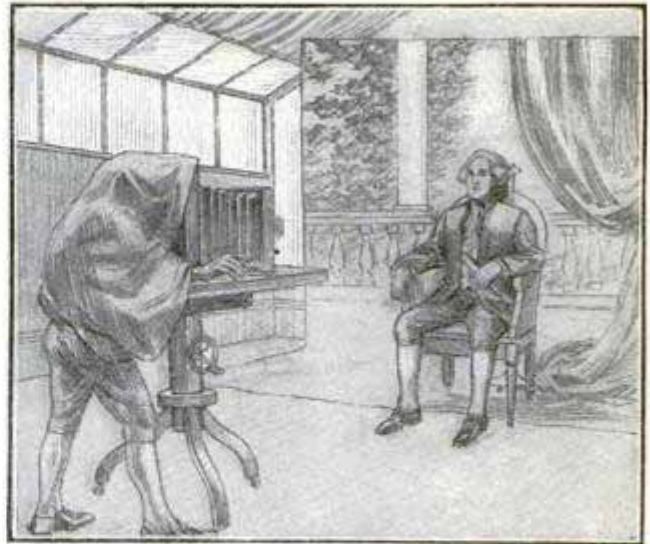

George Washington Posing for His Photograph! The "Father of His Country" Died 40 Years before the First Photographic Portrait Was Taken



Napoleon Antedates the Telephone by 55 Years, the Machine Gun by about 50 Years, and the Modern Revolver by 30 Years



Chinese Gordon Might Have Been Saved at Khartoum If He Had Had the Wireless Telegraph. But the Latter Came 10 Years after His Death

"LOOP" JEWELRY LATEST FAD

The latest fad for the adornment of hands and wrists is called "loop jewelry," and consists of one or more

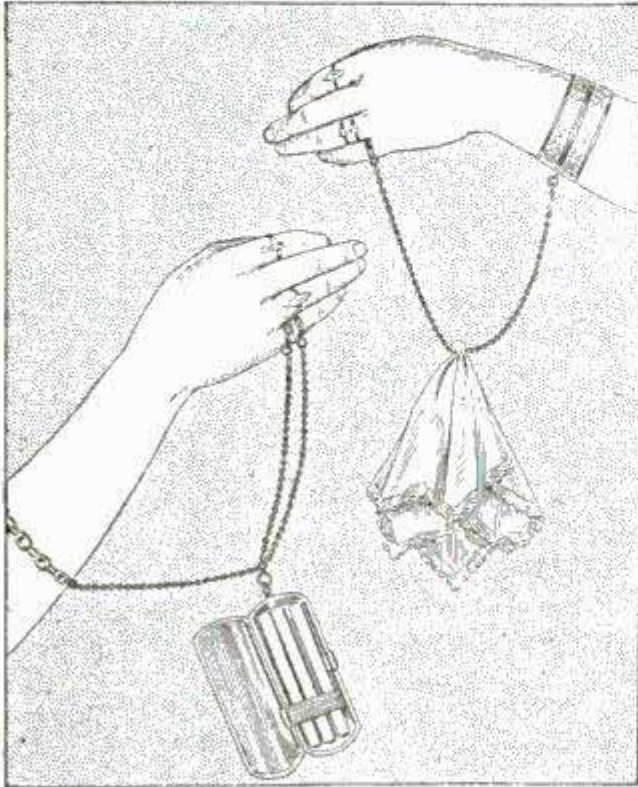

Chains Supporting Cigarette Case and Fastened to Finger Rings and Bracelet and the "Loop" Chain as a Support for the Handkerchief

trinket-supporting gold chains connecting the finger rings and bracelet. Among the articles designed to be carried by the chains are puff boxes, cigarette cases, mirror lockets, watches, etc. The chains are also useful as handkerchief carriers.

Advocates of the chain fad say that such adornment is an effective disguise

for lack of symmetry of arm, wrist, and hand, and that two or three chains, each carrying a trinket, cause angularities and disproportions to disappear.

TWO NEW PROCESSES FOR MAKING BALLOON GAS

Two new methods of making balloon gases are being tried out in Germany.

One method consists in treating water gas with an absorbent to remove the carbon monoxide and the hydrocarbon compounds, or achieving a similar result by passing the gas through coke-filled retorts heated to 2,200 deg. F. The resultant gas contains from 80 to 84 per cent of pure hydrogen, and can be made (in Germany) at an estimated cost of 75 cents per 1,000 cu. ft.

In the other process, a clay-lined iron retort is nearly filled with coke, ignited, and raised to a white heat by an air blast. The retort is then closed, and petroleum or coal tar is introduced from the top for about 20 minutes. The gas thus generated is passed through a sprinkling tower and filtered into the gasometer. The process is then repeated indefinitely, with periodical renewing of the retort charge and removal of the ashes. The gas contains about 94 per cent of pure hydrogen, which may be increased to 98.4 per cent by a further treatment. The cost is but little, if any, greater than in the first process, although the gas produced is much lighter.

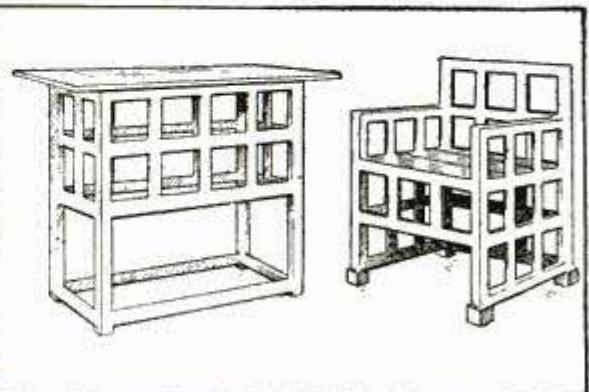
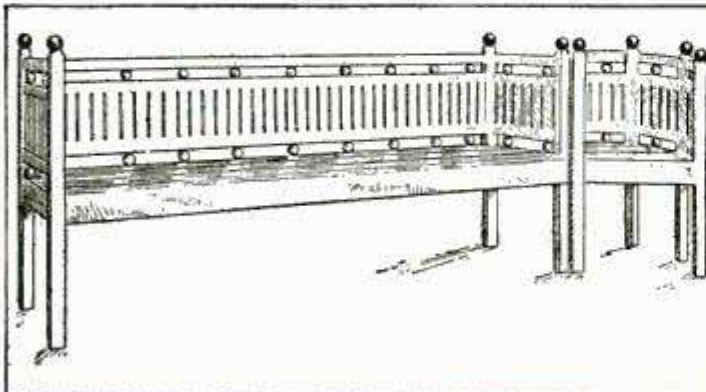

An artistic type of garden furniture for more or less formal small gardens is shown in the accompanying illustrations. It is apposed to the rustic and is suitable where rustic garden furniture would be out of place. Courtesy "The House Beautiful"

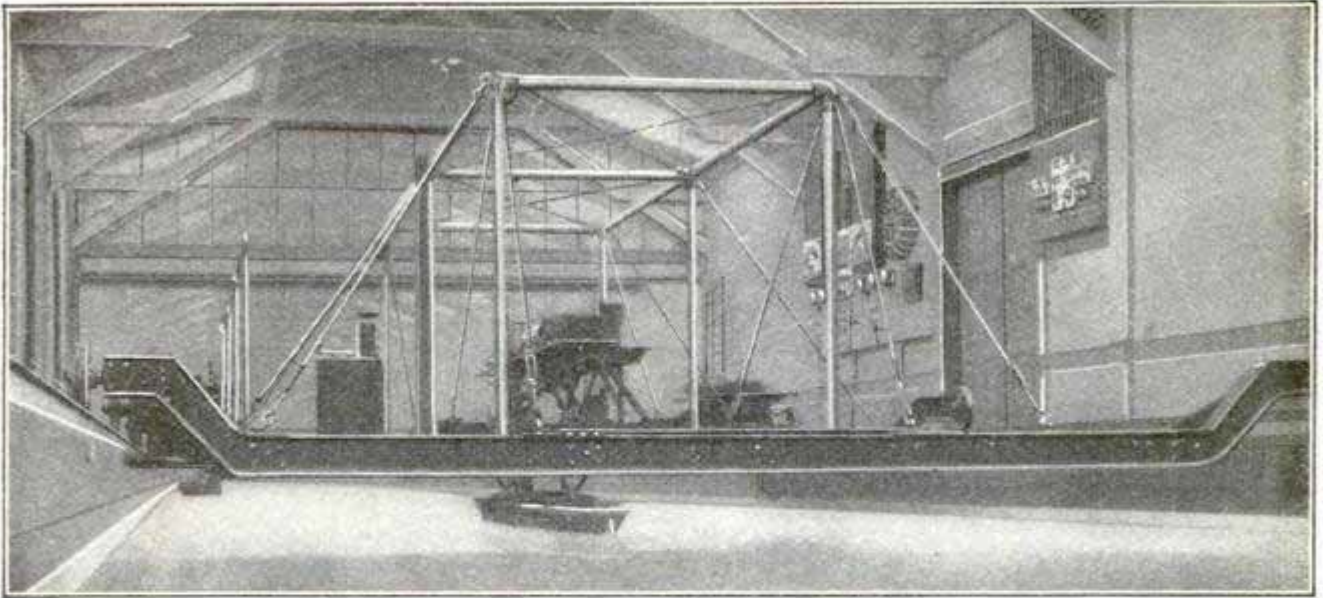

Experimental Tank at Bremerhaven for Testing Ship Models

EXPERIMENTAL TANKS FOR SHIP MODELS

Not a little of the success of the ships of a large German shipowning company is attributed to experimental work with ship models in tanks at Bremerhaven. Every naval country of importance now has its model tanks, and many shipbuilding firms are so equipped.

It took many years of careful research to demonstrate that the resistance of a large ship could be predicted with reasonable accuracy from experiments made with a small model. The total resistance to a ship is divided into frictional resistance, wave-making resistance, eddy-making resistance and air resistance. The total of these components is the aggregate resistance.

The basin of the big German line laboratory is 418 ft. long. The models are made of paraffin wax, and are from 15 to 18 ft. in length, and when finished with are melted again. The models are attached to a moving platform which spans the basin. This platform is virtually a traveling laboratory, with delicate instruments for noting the behavior of the model which is attached to it while resting in the water below. Before the keel of a new liner is laid down in the shipyard, from 20 to 30 models are invariably made and tested.

The National Physical Laboratory at Bushey, Eng., has recently constructed two notable tanks for this purpose. In one, the ship model will be held stationary while the water is circulated past it at a uniform velocity. The other will be used for moving models. Thousands of dollars are often saved as a result of such tests.

COLONY OF INOCULATED MONKEYS

In the war waged against the deadly "sleeping sickness," the germs of which are carried about by the tsetse fly, the British government has established an experimental station at

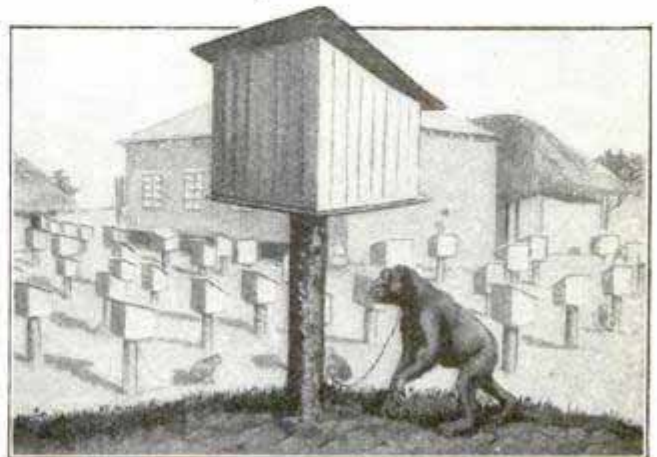

Colony of Monkeys Inoculated with the "Sleeping Sickness" Germ

Uganda, British East Africa. At least one hundred monkeys have been inoculated with the disease, and their symptoms are being constantly studied in the endeavor to find a vaccine or serum to fight it. The monkeys are kept in the open, each having an individual home in the form of a box mounted on a post.

the Moro province of the Philippines, the provincial capitol building was erected of concrete blocks almost entirely with Moro labor. These people are classed as among the civilized tribes of the Philippines. They are Mohammedans of the most extreme type and were never completely under Spanish domination in the days before

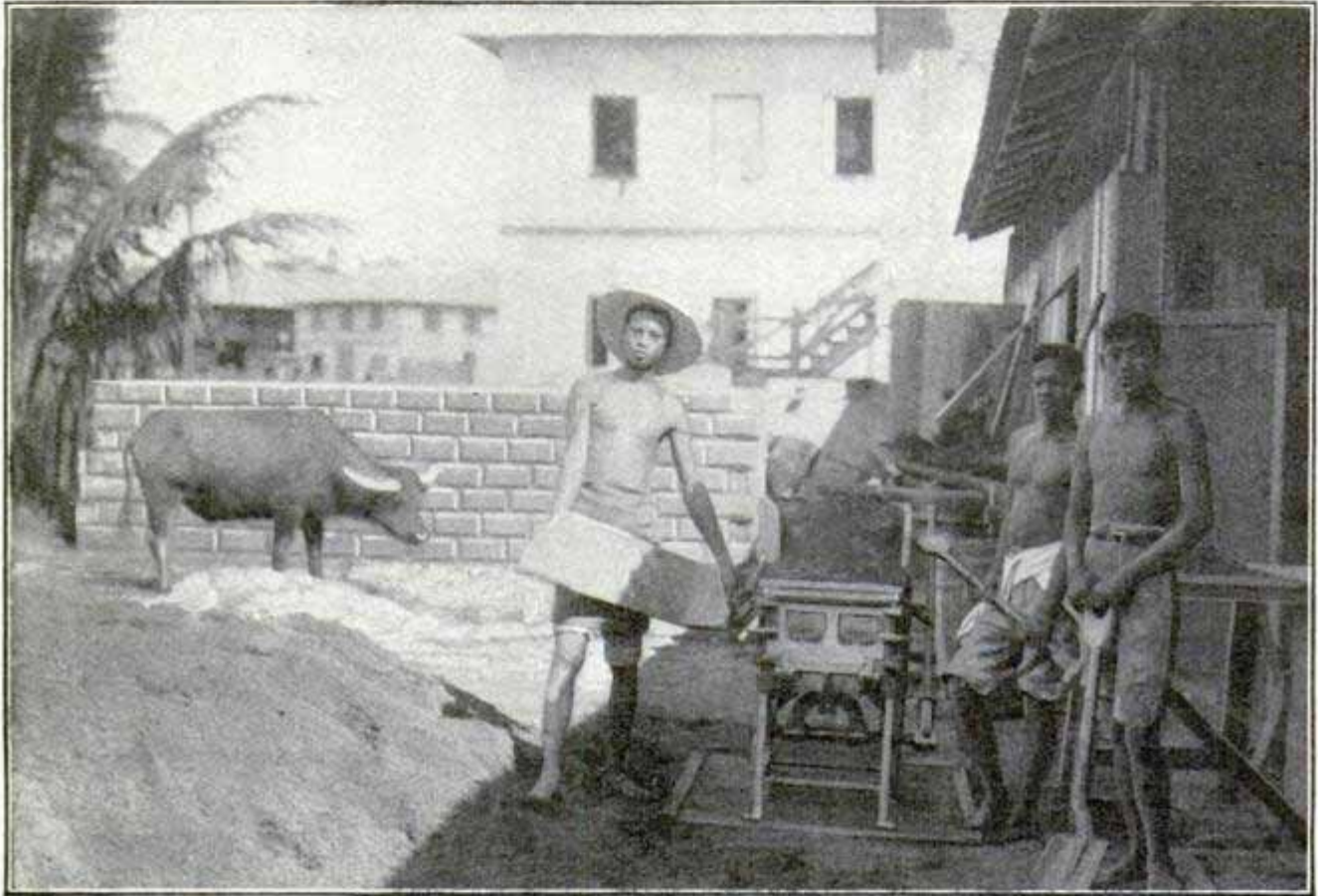

Moro Workmen Making Concrete Blocks for Their Provincial Capitol Building

PHILIPPINE MOROS BUILD CONCRETE CAPITOL

The concrete-block machine bids fair to rival the harvester appliances as a sign post of American enterprise around the world. In all sections of the earth, concrete construction has received a tremendous impetus during the past few years and structures of all sorts made of solid concrete or cement blocks are likely to greet the traveler, no matter what out-of-the-way port he may visit. The facility with which the work is done is the principal appeal it makes to builders in far-away places. Skilled workmen are not necessary. Recently in the city of Zamboanga, the capital of

the American occupation. Since 1898 they have acknowledged the sovereignty of the United States, however, and the people who had been warriors, pirates and bandits became fairly industrious citizens. Photographs of the construction work on the provincial capitol show Moros doing practically all the day-labor jobs. One of these was making concrete blocks, the Moros turning out 100 blocks each day of eight hours with each machine. They were paid at the rate of 50 cents per day.

Recent reports show that the English import from America 808,528 lb. of gumdrops annually.

DISTINCTIVE PLAN FOR SMALL CONCRETE HOUSE

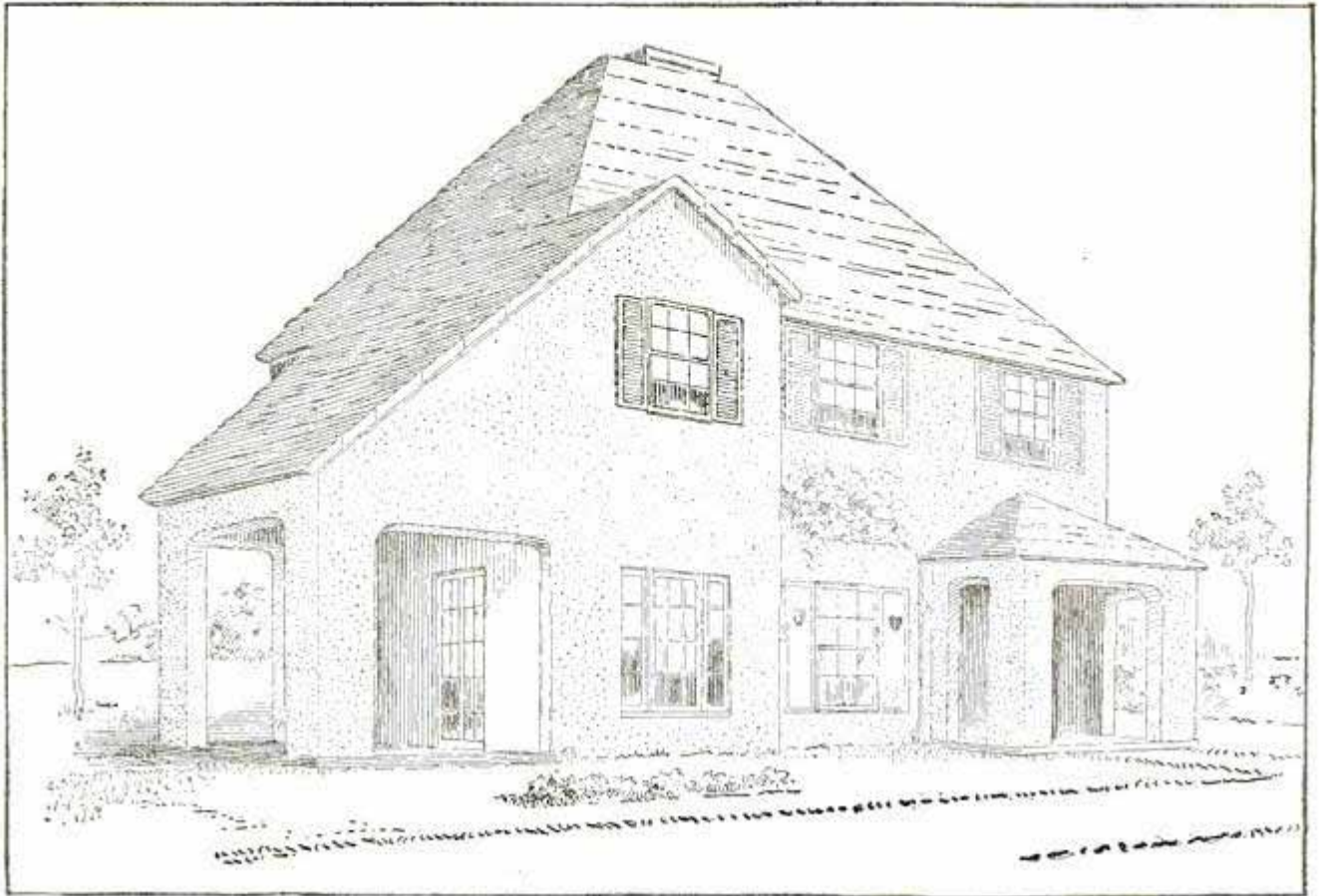

Front Elevation, Showing Entrance and Loggia at the Side



Mink and Carson, Architects

The distinctive feature of this house plan is that it contains but one chimney and its stairway arrangement is out of the ordinary. The estimate of cost by the architects is \$4,800. The building is to be constructed of concrete and finished with moderate price mill work and trimmings. Two stories and an attic are

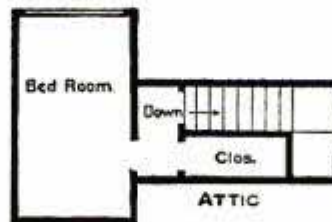

Plan of the Attic

provided for, giving eight rooms and a large, roomy hall. The chimney rises in the center of the building and a large fireplace is provided for the living room. A small entrance porch and an attractive loggia or porch at the side together with a living room of unusual size, are features of the plans.

AEROPLANE DESIGNED FOR SOARING FLIGHT

Mons. M. Gonnels, a French airman, has designed an aeroplane that will be especially adapted for soaring flight by combining a boat-shaped bracing and



Front View of Gonnels' Aeroplane

supporting planes with parachute-like wings. The inventor claims that his machine will execute the dangerous vol-plane with greater safety than any of the present models. While the span of the wings is but 10 ft. 5 in., the planes have great length and 376.75 sq. ft. of surface. With a 50-hp. motor, the inventor has been able to obtain excellent results with this unusual machine.

CURIOUS TRACER INFORMATION

An advertisement recently published in the Optician, London, offering a large reward for a "wanted" man, described his facial characteristics in the following unusual manner:

"Usually wears a pair of rolled gold curl-side spectacles, centers $2\frac{1}{2}$ in. (unsymmetrical face), left eye $\frac{1}{8}$ in. farther from median line than right eye, bridge $\frac{1}{8}$ in. up, and $\frac{1}{4}$ in. out. No. 3 nose, caliber 14, glazed R. — I^D + 2.75 D_c hor. L. — 0.5 D_s + 2.75 D_c 20°. His complexion is freckled, and he has fair hair, ginger-colored, slightly deformed ears, height about 5 ft. 2 in., slight build."

ELECTROPLATING PORCELAIN WITH SILVER

The network of thin silver in a variety of ornamental designs now so popular in this country as a decoration for glassware, is applied to the glass by an electro-deposition process, which has greatly cheapened the cost over that of the original hammered silver plate. The same process is now being used for coating the whole exterior of porcelain ware with a shell of silver, the articles at present offered consisting chiefly of platters, bowls, tureens, teakettles, coffee pots, tea sets and egg bowls. The process of producing a conductive coating on the porcelain is accomplished by dissolving the silicate of an alkali and suspending finely powdered graphite in the solution. This is applied to the surface of the porcelain.

KANSAS FARMER HAS HOG FOR A MOUNT

While Maud S., who is a gentleman hog by the way, tips the scales at 800 lb. and would bring about \$65 on the



Reliable as a Mount, but Not Much on Speed

market, P. I. Nelson, a Kansas farmer, who owns him, has refused \$200 for him. The reason is that Maud S. has been broken to the saddle and the owner frequently rides him around his farm. Maud, however, isn't much on speed, his best record being a half mile in seven minutes.

THREE VOLUMES VALUED AT \$40,000

The three volumes of Fox's "Book of Martyrs," which belonged to John Bunyan during his imprisonment in

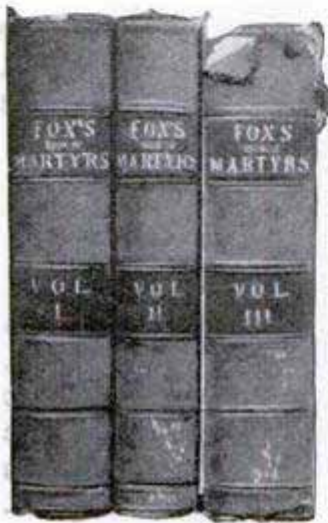

the jail at Bedford, England, and, with the bible, constituted his entire library, are to be sold by the corporation of Bedford to pay off a mortgage on its library building. The volumes have been owned by Bedford since

1841 and are valued at \$40,000.

John Bunyan was sentenced to perpetual banishment under the act against conventicles, passed following the restoration, and was placed in Bedford jail, where he remained 12 years. It was during this imprisonment that he wrote the "Pilgrim's Progress." Sets of Fox's Martyrs of the same edition as the one owned by Bunyan may be bought for \$150, so that the fact that these three volumes belonged to him is accountable for \$39,850 of their value.

CLEANING STEEL CARS WITH SANDBLAST

A sandblast apparatus is used at a western car plant as a simple and economical means of cleaning steel cars before painting. The sand, driven by an air pressure of 90 lb., smoothes off all rusted surface and gets into the corners around the bolt heads and

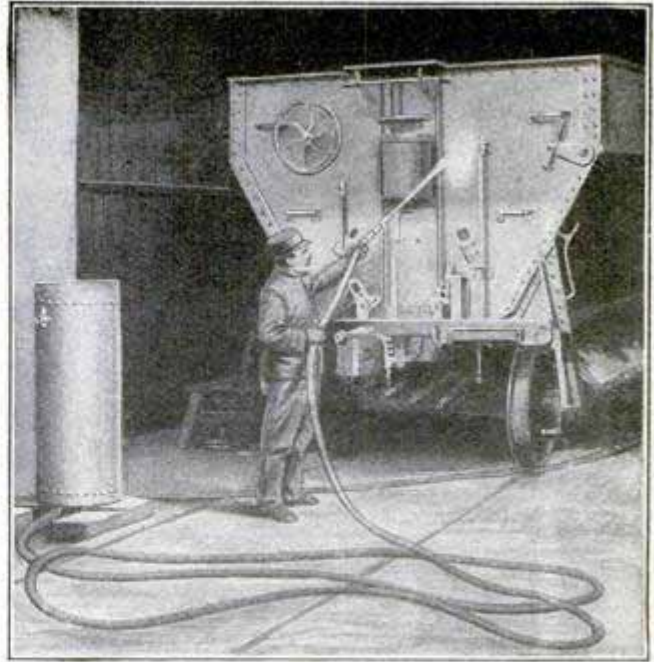

Cleaning Steel Car with Sandblast

rivets, where it is difficult to do effective work with hand tools. One man and apparatus clean three cars a day.

FEEDING GULLS ON LAKE MICHIGAN

While the fishing tugs are running home to Manistique after hauling the nets in Lake Michigan, the crew dress the fish and throw the offal into the lake. Thousands of gulls follow the tugs to partake of the daily feast, swooping into the water and bearing away the offal as fast as it is thrown overboard. The scene is an exciting one, the gulls screaming and crowding in the struggle, which often lasts for hours at a time.



Hundreds of Gulls Feeding on Offal Thrown Overboard from a Fishing Tug

YOUNGEST AIRMAN IS BUT THREE YEARS OLD

No dolls, rattles, toy soldiers, or Noah's ark menageries are to be found



Three-Year-Old Frank Lawson, the Youngest Airman in the World

among the playthings of three-year-old Frank Lawson of Mineola, L. I. He is the youngest airman on record and he made his first flight in the machine owned by William Hilliard, for whom the elder Lawson works. Mr. Hilliard took his mechanic and little Frank for a trial spin in his big machine at Mineola. After three circuits of the aviation field, the machine was brought to the ground very much to the disappointment of the boy, who wanted to remain in the air. The boy was held in his father's arms during the flight.

MOTION PICTURES WITH LIGHTS TURNED UP

A hitherto much criticized feature of moving-picture or magic-lantern entertainments is the fact that the hall has to be darkened while the pictures are being shown. Apart from the moral side of the question, there is the ever-

present danger of stumbling when passing to or from one's seat in the dark.

Two recent inventions, brought out almost simultaneously, enable the pictures to be shown in daylight or with the artificial lights turned on. One of these establishes an artificial contrast on the screen by projecting a very bright light around the edges, the inner portion, on which the picture is projected by the ordinary machine, being shadowed by an opaque slide in the first machine. The other invention consists in treating the screen with a preparation of aluminum so as to give it a fine granular texture. The pictures are projected in the ordinary way. Each of these methods is said to give excellent results.

TRAINING POLICE DOGS TO JUMP FENCES

If a criminal being tracked by a police dog goes over a fence or wall, the dog, naturally, must follow, and to make this possible the Swiss police train the dogs to surmount obstacles that would daunt the average canine. In the illustration a dog is shown making his way over a practice fence.



Training Police Dogs to Jump Over High Fences and Walls

FROM TORCH TO TUNGSTEN IN LIGHT'S HISTORY

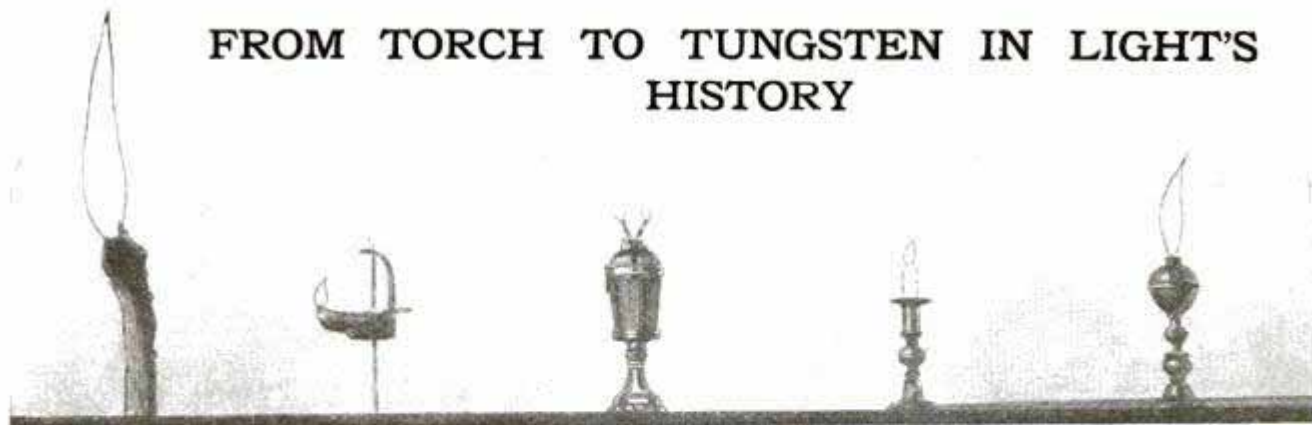

Pine Torch

"Betty" Lamp

Whale-Oil Lamp

Candle

Fluid Lamp

The ten stages of artificial light, as calculated by a Rochester, N. Y., electrical expert, offer an interesting study of history as well as an exposition of the progress of invention. The ten steps toward the electric light of today are given with the pine torch in the first place followed in regular order by the "betty" lamp used by the ancients and the people of the 18th century; the double wick whale-oil lamp; the candle; the fluid lamp, used during the middle of the 19th century; the open-flame gas light, used from 1817 to the present time; the "Rochester" burner, used from 1860 to the present time; the reflectolier or incandescent gas lamp; the carbon incandescent electric lamp, and the Mazda lamp, used since 1909.

The pine torch is the earliest known form of artificial illumination. It may have lighted the Garden of Eden on dark evenings, history relates nothing to the contrary. The "betty" lamp was the old floating wick light that is to be found in all pictures that pretend to show the forms of illumination of an-

cient days. It had many distinct types, always made on the same principle.

The whale-oil double wick and the fluid lamp were improvements on the "betty" lamp in that they gave much more light. Both came into use during the middle ages. The fluid lamp used camphene, an explosive mixture of alcohol and turpentine and had a very brilliant glow. The candle was perfected in 1740.

The earliest of the open-flame gas lamps was very little different from the type used today and the cost has been estimated at 3/100 cents per candlepower per hour. The introduction of the gas lamp was the beginning of the epoch of brilliance in illumination. In 1860 the "Rochester" burner for kerosene oil lamps was introduced and was found to have a smaller candle-hour cost than gas by 1/100 cents. The most important step in the development of illumination as a science was taken when the carbon filament incandescent electric lamp was invented, the cost of which was estimated at 6/100 cents per candle-hour.



Rochester Burner

Open-Flame
Gas LampIncandescent Gas Lamp
or ReflectolierCarbon Incandescent
LampTungsten Lamp
with Reflector

REMARKABLY SLENDER CONCRETE BRIDGE

A remarkable bridge of reinforced concrete has been erected to connect

It is 172 ft. long in one span, and is supported mainly by two parallel arches abutting against the cliffs at the ends. The width between the horizontal beams is but $4\frac{1}{2}$ ft., and the footway is 150 ft. above the surface of the water. Concrete was used in preference to steel because the bridge is in such an exposed position as to be often enveloped in spray, which would make the life of steel short and its maintenance costly.

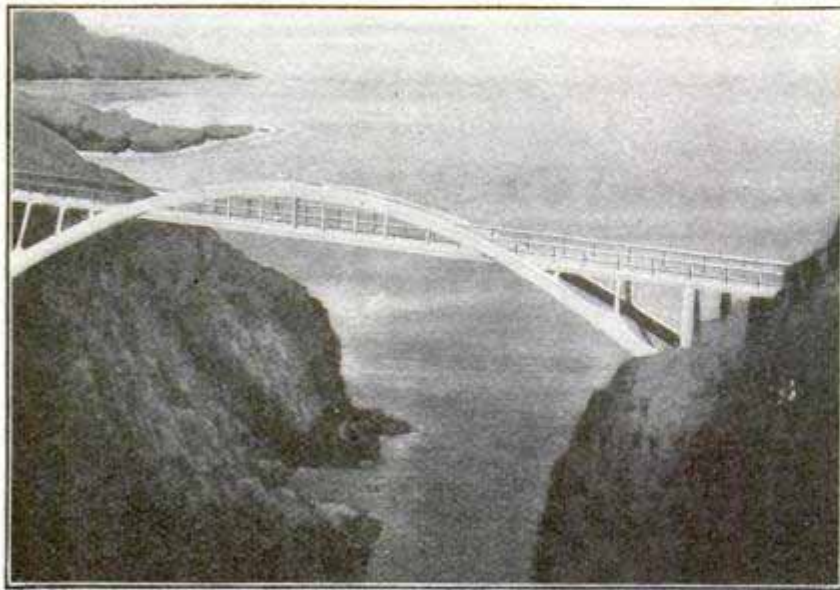

Long, Slender Concrete Span Bridge in Ireland

two cliffs over an arm of the sea at the extreme southwest point of Ireland.

to the fog-signal station on the island cliff.

TRAVELING SEWAGE-CINDER WASHING MACHINE

The unusual type of cinder washing machine built to meet the special requirements of the sewage disposal plant at Salford, England, embodies

the world, as it handles on an area of less than 20 acres the sewage from a population of 250,000 people. On this space are plants for pumping and chemical precipitation, rough filtration beds, and trickling bacteria beds. The sludge is shipped to sea by steamer.

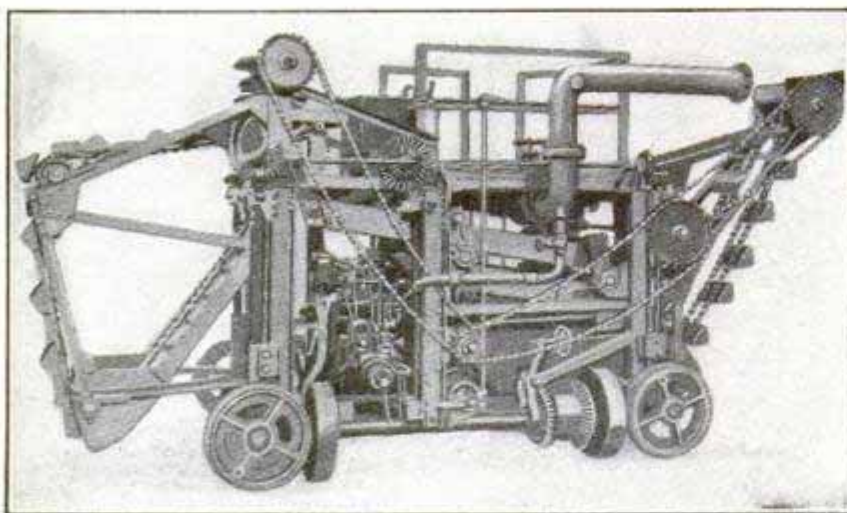

Self-Propelled Machine Used to Wash the Cinders Which Form the Bacteria Beds of an English Sewage-Disposal Plant

several interesting features, one of which is self-propulsion.

The sewage plant in question is claimed to be the most concentrated in

The cinder bacteria beds, covering eight acres, are without division walls, but arranged in a number of bays, or sections, to allow of alternate working and resting. Although frequently raked, and occasionally dug up, these beds have been worked nearly nine years without the thorough cleaning that is now being given them with this machine. It runs on the concrete bottom of the beds, traveling forwards or sideways,



Japanese Girls Participating in an Open-Air Addition Match

excavating the bed in front of it, washing the material, and then depositing it again behind in layers.

At the forward end of the machine is a bucket-digger, carried on a frame pivoted on a vertical axle so that it can be swung to the right or left. The buckets tip the cinders and clinkers onto the uppermost of two shaker screens, carried within the frame. The screens are of strong wire, the upper one having holes 1 in. square, and the lower one but $\frac{1}{4}$ -in. square. The washing water is supplied in the form of a spray above the upper screen. All the material too large to pass through the upper screen is deposited by chutes on the floor of the bacteria bed, forming the lower layer. The material which passes through the upper screen but is too large to shake through the lower, is lifted by a chain bucket-elevator and deposited on the top of the larger material, thus forming the upper layer of the newly formed bed.

CA cheap method of making nitrate for fertilizing purposes consists in passing an electric current through sea water and then passing electrified air through the resulting solution.

JAPANESE GIRLS IN AN ADDING RACE

One of the most curious events, to the tourists at least, of the athletic meeting of the savings bureau of the Japanese department of communications, held recently in Tokio, was the addition match for the female employes. The illustration shows the girls, all in line as if set for a 100-yd. dash, hard at work adding. The Japanese do not add with pencil and pad or slate, but use a frame of wires strung with balls, which are slid back and forth in making the calculations. The Chinese calculating frame is called an abacus, and the Japanese frame a soroban.

FOOD-PRESERVING POWER OF SUBSTANCES

The preservative power of certain substances used in food products at ordinary temperatures is given as follows by F. F. Hasbrouck in a recent issue of Food Products, the food in all cases being assumed to be at least slightly acid: 1 lb. of salt preserves 6 lb. of food material; 1 lb. of benzoate of soda, 500 lb.; 1 lb. alum, 200 lb.; 1 lb. acetic acid, 40 lb.; 1 lb. sugar, 1 lb.; 1 lb. glycerol, 4 lb.; 1 lb. alcohol, 8 lb.

TESTING SAIL CLOTH

In order to make certain that sails, especially those for racing yachts, contain no flaws that will cause them to

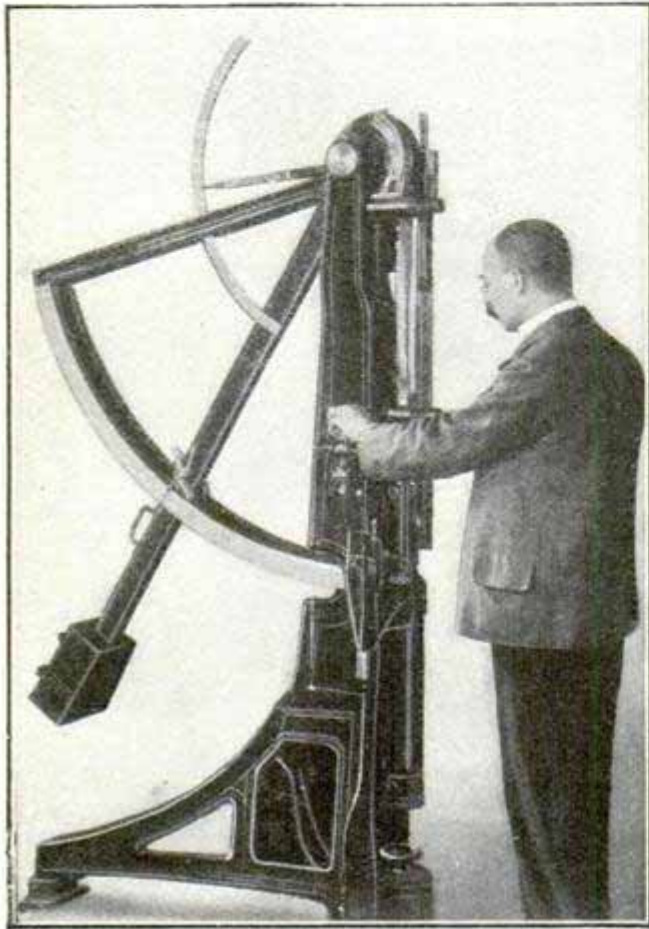

Testing a Strip of Sail Cloth in a Machine Built Especially for the Purpose

tear under severe strain, the sail cloth is tested by means of the machine shown in the illustration. The strain is applied to a strip of the cloth by means of the long weighted arm or lever, the number of weights on the end of which may be increased or decreased as desired. The scale shows the exact degree of strain exerted on the cloth by the pull of the weighted arm.

MARKING CRIMINALS WITH WAX

A French physician proposes a subcutaneous injection of paraffin wax to identify persons who have a criminal record. His method consists of simply injecting the wax, which is absolutely harmless, under the skin, where it will form a permanent mem-

branous cyst, instead of being absorbed and carried away by the blood. It need not be outwardly visible, but, being situated at a precisely defined spot, its presence will denote a criminal record. Its location may also indicate the nature of the offense.

The system, according to the French magazine "Cosmos," is not meant to supplant or supersede the Bertillon recording systems, but to operate in connection with them. Comment is also made upon the possibility of the criminal so marked having the wax removed by an operation without leaving a tell-tale scar.

PAST AND PRESENT IN NEW MEXICO

The accompanying illustration well illustrates the vanishing of the frontier, showing how closely the new order is crowding the remnants of the old. The picture was taken only two or three blocks distant from the business center of Albuquerque, the commercial metropolis of New Mexico. In the foreground is shown a "hogan" of the Navajo Indians, which is occupied by a family of blanket-weavers of that large and powerful tribe. In the background is a modern brick business block, and between the two is a billboard advertising a "Wild West" show—now as much of an attraction in the heart of the erstwhile "wild west" as in any part of the east.



A Navajo "Hogan," a Modern Industrial Plant, and a Wild West Show Poster



Science and Plain English



That Technical Subjects May Be Treated Popularly Without Losing Anything of Value Is the Consensus of Opinion of Many of America's Greatest Scientists and Educators

SCIENCE and mechanics have advanced from the time when they were the hobbies of a few learned philosophers, secluded in home laboratories and workshops, or in the inner retreats of exclusive seats of learning. They have become, in the broadest sense, the principal aids to human progress, and as such they belong to everybody. The labors of the scientist, the inventor and the educator are for the people. Personal gain, in the form of money, advancement or fame, is a secondary matter, although it may, in some instances, form the motive for the work. And after all, it is the productive work of the people that makes it possible for learned men and specialists to discover and invent things that are making this world of ours a better place in which to live.

Unfortunately for the ordinary intelligent person who desires to keep in touch with the world's progress, the various advancements in learning bring along with them a lot of special technical terms to describe new ideas. Some of these terms eventually become almost household words, especially when they are connected with inventions, such as the telephone and the automobile, that are used every day by a large number of people, or the aeroplane, which is so opposed to former knowledge and expectations, that its advent has given rise to a keen popular inter-

est. But, for the most part, this technical language is seldom used outside of the specialized field that called it into being. In many cases, there is a technical term applied to something that already has a popular name, and the mania for specialization has sometimes caused two or more different kinds of terminology, each understood fully only by its own adherents, for the same branch of science. Thus, when there is confusion among even the doctors of learning, it is difficult for the "man in the street" to keep informed.

Nevertheless, it is possible to present scientific and technical material in such a way that it may be understood by the average intelligent person. The difficulty, however, is in finding the people who have the ability or who will take the trouble to do this. Such men as Faraday, Tyndall, Darwin, Huxley and Helmholtz have written fascinating accounts of their great work in plain, unvarnished language. If they used a technicality, a definition was appended or the context explained it. They were scientists of the highest order. They had the style and the simple and easy mode of expression of the finished writer. And, in a great portion of their work at least, they were not above catering directly to the public, both in their writings and their lectures. Are these not examples worth following?

A few weeks ago, a man who has

three university degrees and who was a specialist and a general scientific editor on a great American dictionary everywhere accepted as a standard, attended one of the sessions of The Illinois State Academy of Science, then meeting in Chicago. The subjects discussed were some with which he is not technically familiar, although he is acquainted with them to some extent. With the exception of one lecture, the proceedings were to him absolutely unintelligible. Here was a man whose vocabulary was probably more extensive than that of any scientist present, and yet he was unable to glean anything from all but one of the papers, and this one told him something he had many times observed in walking through the woods near his home. One lecturer even stated that his paper would be technical and uninteresting, which should have been a very excellent reason for not reading it at all.

With the object of obtaining a consensus of opinion on this question of technical English, a number of prominent American scientists and educators were requested to give their views in writing. The letters received, or extracts from them, were as follows:

A. C. True, Director of the Office of Experiment Stations, United States Department of Agriculture:

"The scientific or technical man makes a great mistake when he affects a highly technical terminology in presenting scientific or technical subjects, even before learned societies. Some men have a mania for the invention of technical terms. Such men, as a rule, exhaust their energies in this task and make few real contributions to knowledge.

"The effort to present scientific facts and principles in such language as will be understood by intelligent laymen is in most cases the best means of clarifying the thought of the author on the subject he is treating. While there may be occasions when special themes may be appropriately presented and discussed in highly technical language by

small groups of specialists, the reading of papers of this character before the ordinary scientific society is an absurdity and makes the author a bore. This is a growing abuse and is leading many thoughtful men to doubt the value of scientific societies as at present conducted. It is really the duty of an author to consider the requirements of the audience he is to address and to use his best efforts to make himself intelligible to them. Unless he does this he should not be surprised if he receives a more or less silent verdict that he is an ass. As a rule he is a wise man who makes his oral address a brief summary in as good and simple vernacular as he can command and asks leave to print the details.

"With the abundant opportunity now afforded for the printing of any really valuable scientific or technical material, there is no good excuse for inflicting on scientific or popular audiences masses of details which no human mind can grasp or digest when they are presented in this way.

"Scientific men are often surprised and disappointed because the general public take so little interest in them and their work. If they would take more pains to bring the results of their work to the attention of the public through clear and simple summaries they would do much to remove this popular prejudice."

A. T. Hadley, President of Yale University:

"Looking back as far as I can, it seems to me that the proportion of intelligible and unintelligible matter presented to the learned societies remains about the same; and I am afraid that I cannot attempt to lay down any general laws as to the conditions under which papers should be read by title. It seems to me that this is essentially a matter for each society to decide for itself; and if an inside minority or an outside majority do not like the decision, they have a simple remedy—they can stay away."

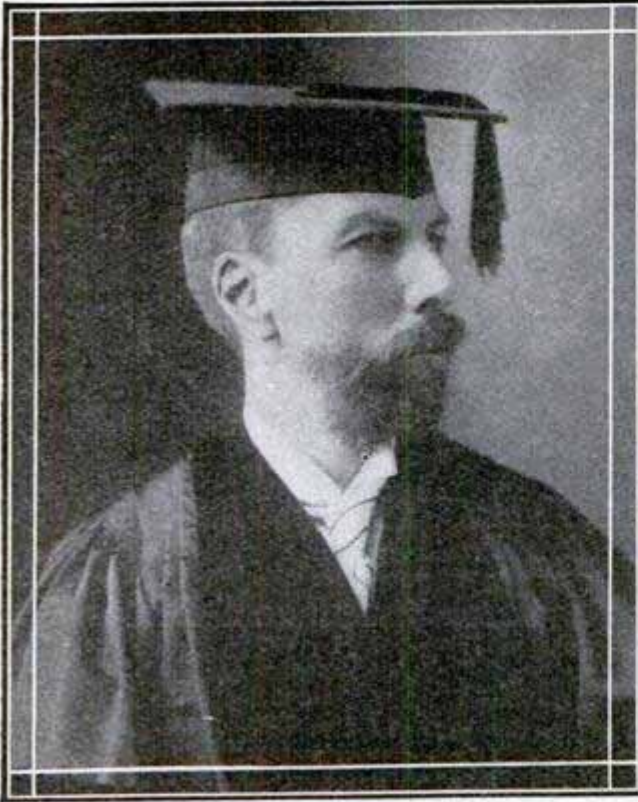

Dr. A. T. Hadley, President, Yale University,
New Haven, Conn.

"It seems to me that the proportion of intelligible and unintelligible matter presented to the learned societies remains about the same . . . This is essentially a matter for each society to decide for itself."

Prof. A. A. Michelson, Chicago University:

"The proceedings of a scientific society are not intended for the layman and should not be criticized from his viewpoint. I, nevertheless, quite agree that scientific subjects can and should be so presented that the layman may get the benefit."

Charles W. Eliot, Former President
Harvard University:

"Most branches of science now possess nomenclatures and technical languages of their own, each of which is intelligible only to those who study that particular branch. Accordingly, in a learned society which gives attention to many sciences, scientific papers on one subject are apt to be unintelligible except to students of that subject. This is one of the gravest difficulties of scientific societies at the present day. It results from the great division of labor and narrow specialization within each

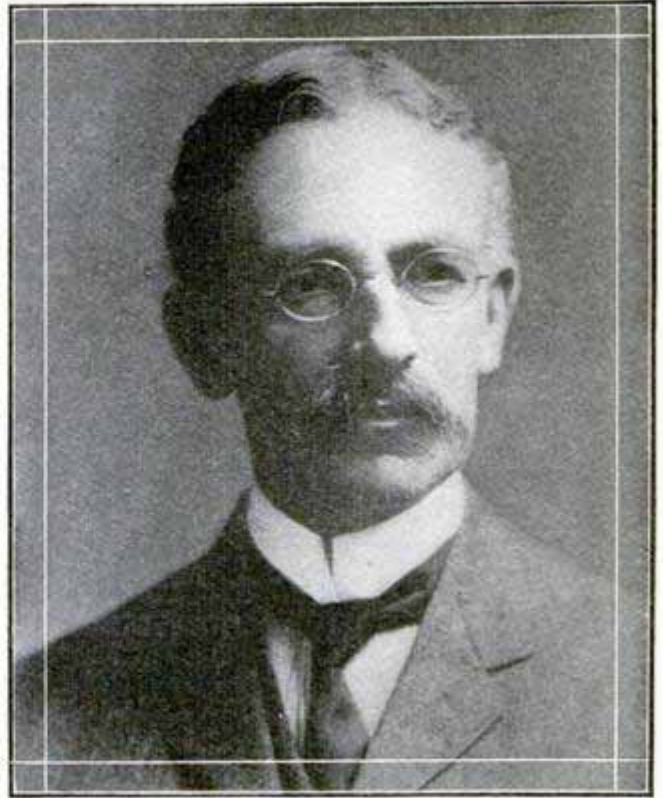

Dr. A. C. True, Director, Office of Experiment Stations,
U. S. Department of Agriculture

"The effort to present scientific facts and principles in such language as will be understood by intelligent laymen is in most cases the best means of clarifying the thought of the author on the subject he is treating."

of the several sciences. It is very difficult at the present day to write clearly and accurately about a scientific subject for popular reading. Michael Faraday, John Tyndall, and Charles Darwin succeeded in doing that; but within twenty years past the task has much increased in difficulty, because the rapid progress of applied science has made necessary a large number of new terms and new conceptions.

"I have never been a popular lecturer on scientific subjects, and have had no occasion to consider in my own practice the means of making difficult scientific conceptions understood by a popular audience; but I have a firm conviction that teaching through the eye by the use of diagrams, lantern slides, models, and so forth, is an invaluable adjunct in popular lecturing. That method of teaching should also be used in schools to a much larger extent than it is now. Great masses of facts can be compactly and intelligibly

presented in a diagram, when tables of numbers representing the same facts would be almost unintelligible."

Prof. David P. Todd, Amherst College:

"I quite agree that it is very little use writing things in words which one's readers can fairly be supposed unable to understand.

"The famous mathematician, Sylvester, used to say that he never felt sure of any mathematical result attained at the end of remote analytical formulæ until he had gone over it so thoroughly in all aspects in his own mind that he would be able to make it absolutely intelligible to the first man he might button-hole in the street.

"Tyndalls and Huxleys, I am inclined to think, are made, not born; I wish we had more of them. Certainly it is a much more difficult thing to write an untechnical article than a research paper, but I often think it is much more worth the doing."

Prof. Henry C. Cowles, Chicago University:

"It seems to me that it is quite proper for scientific organizations to give technical papers . . . but only before those whose technical training fits them to profit from such meetings. I also believe that a distinct mission of these organizations should be to have other meetings at which the results of research should be presented in a non-technical manner, and thus made available for colleagues of sister sciences and the laity in general."

Prof. W. A. Noyes, President, the Illinois State Academy of Science:

"I am heartily in sympathy with the endeavor to make certain phases of scientific work intelligible to the public. There must always be, however, many portions of our work which is a closed book to many persons, who have not the knowledge to understand it."

Prof. J. A. Udden, Vice-President, the Illinois State Academy of Science:

"I am decidedly of the opinion that the principal contents of most scientific papers may be rendered in lan-

guage that is intelligible to people of general culture . . . The best interests of all would be promoted if a synopsis were given by authors of papers, stating in the least technical language possible the main results and the character of the investigations reported."

J. R. Mohler, Chief of the Division of Pathology, Bureau of Animal Industry, United States Department of Agriculture:

"That the most salient features of a scientific work may be presented in every-day language and still retain the original worth of the article has been repeatedly demonstrated in instances in which farmers' bulletins have been prepared from scientific bulletins, and although somewhat shorter than the original work, these farmers' bulletins have been in great demand for distribution among the farmers, and have been gladly and profitably read by those who have obtained them."

Prof. R. T. Salisbury, University of Chicago:

"I know some foreign societies which have open sessions and technical sessions. At the latter, technical papers may be presented technically, but a large attendance is not expected. There is, in some quarters, a curious and pedantic prejudice against the popularizing of scientific matter . . . I think this prejudice is diminishing, and that it is now much less general than it was twenty years ago."

Prof. Henry Crew, Northwestern University:

"It seems to me highly desirable that editors of popular magazines should obtain clear, simple, straightforward, untechnical presentations of the best scientific work of the day."

Prof. G. L. Kittredge, Harvard University:

"It is not merely the use of technical terms that causes the difficulty. It is also the fact that most scientific writers give themselves little concern about style."



Dr. A. A. Michelson, Professor of Physics, Chicago University, Chicago, Ill., Nobel Prize Winner

"I quite agree that scientific subjects can and should be so presented that the layman can get the benefit."

Prof. T. C. Chamberlin, Chicago University:

"Let the press of all kinds and grades write up science for the devotees of science, just as they write up golf for the devotees of golf, sport for the devotees of sport and so on, and for **no others** (the emphasis was made by the writer quoted)—except as kindergarten stuff for learners, proffered with due warning of the fact, and an apology."

Prof. L. V. Pirsson, Yale University:

"There are occasions and audiences where one is justified in the fullest use of technical language—others where it would be obviously improper."

Prof. E. S. Sheldon, Harvard University:

"The writer of an article to be read to an audience ought to consider his audience, and try to make his paper intelligible to the hearers he expects to



Dr. Chas. W. Eliot, Former President, Harvard University, Cambridge, Mass.

"I have a firm conviction that teaching through the eye by the use of diagrams, lantern slides, models, and so forth, is an invaluable adjunct in popular lecturing."

have. If his audience consists of scholars in his own line of work, I think he should present his results clearly and in good English, if he can. If he can likewise make his paper intelligible to possible hearers not at home in the technicalities of the subject, so much the better, and this, at least to a considerable extent, I believe can be done, often with no sacrifice of anything important to scholars."

Prof. E. S. Dana, Yale University:

"There is no question but that scientific investigations must be carried forward on high lines in order to be thoroughly successful. Papers describing the results of work in pure science as originally published are undoubtedly unintelligible to the mass of readers, and indeed would not be worth publishing if this were not the case; at the same time, in a great many instances, it is practically possible for one conversant with the facts to present them

in such a form that the intelligent reader can get the gist of the matter and see what progress is being made. With the common attempt now-a-days to popularize science in this way I am entirely in sympathy."

Prof. W. B. Smith, Tulane University:

"The authors (of highly technical papers) wish to appear, and even actually to be, learned and original, to widen the spirit of light and knowledge, and it is easiest to do this by some form of research into neglected trifles, which indeed sometimes have extreme value, but in general make but small contribution to our intelligence or comprehension of the universe."

Prof. L. R. Jones, University of Wisconsin:

"I do think that it is possible to prepare in all cases a descriptive article upon any technical subject which can be understood by any intelligent person. I do not think, however, that it is practicable in all cases to make such a paper a synopsis of a technical account. Certainly no public audience could properly understand the technical details which are often the things of primary scientific importance."

It will be noted that the distinguished heads of two of the bureaus of the United States Department of Agriculture come out unequivocally for nontechnical English, while some of the college professors are more or less "on the fence" so to speak. The reason is obvious. All of the professors are not yet emancipated from the narrow associations of college life and learning. The government agricultural scientists, on the other hand, are working directly for the people, and the United States Department of Agriculture is doing the most valuable work ever undertaken for the people of America, and this cannot be put too strongly.

Undoubtedly there is much written in the guise of science that were better left undone, but this is no reason why the intelligent and educated layman should be classed as a being apart from our "men of high degree." The world is interested in its scientists. The world supports them. It is vitally concerned in the results of their labors—then has it not a right to know what is going on for its welfare, and how can it comprehend the results if they are hidden in a language that is harder than Greek to understand?

ELECTRIC PUMP IN QUICK EMERGENCY SERVICE

The quickness and determination characteristic of the truly efficient engineer were strikingly exemplified in an emergency pumping service recently installed for the city of Phoenix,

Ala., when the regular pumping plant went out of commission during a spell of dry weather. About 1,000 ft. away from the pumping station there was found a small stream having a flow of

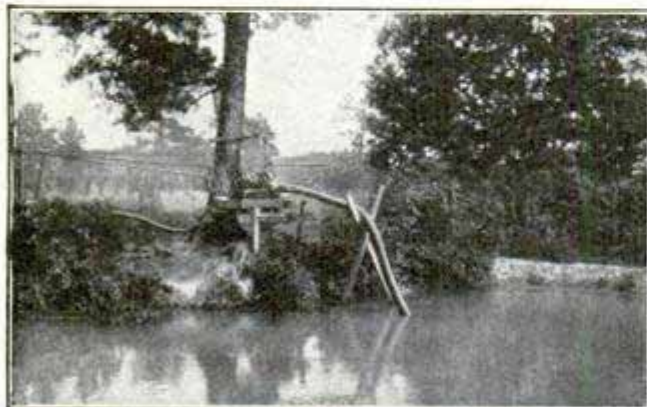

The Intake from the Dammed-Up Stream

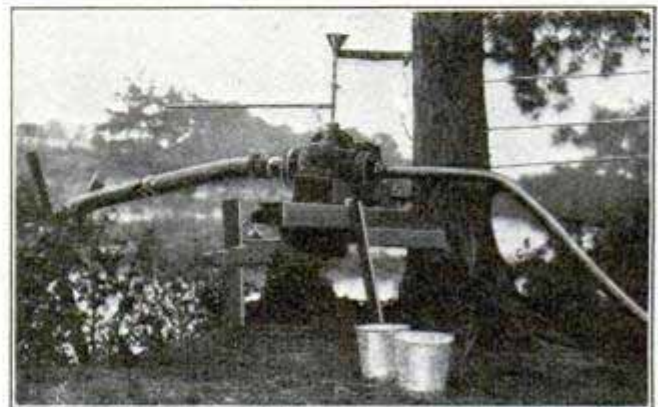

The Motor-Driven Pump, and Intake and Delivery Pipes

250 gal. per minute. In less than 24 hours the stream was dammed up, a motor-driven pump was put in service, and a 2½-in. fire hose was supplying water to the city for drinking and fire purposes. The service wires from the old pumping station were run across a cotton field and hung on fence posts and the limbs of trees, and in spite of the hurry-up nature of the work, the temporary installation proved quite capable of supplying the needs of the occasion.

CHURCH CONVERTED INTO ELECTRIC LAUNDRY

That "cleanliness is akin to godliness" is strikingly illustrated in the conversion of a church in Baltimore into an up-to-date and enterprising laundry.

Not only is electric light used to illuminate the interior of the edifice, but all the flatirons are electrically heated and the machines are driven by electric motors.

The original power equipment consisted of a 75-hp. steam engine driving a 50-kw. dynamo, but increasing business has necessitated the recent addition of a 150-hp. steam engine, a 100-kw. dynamo and a 200-hp. boiler, besides several machines in the laundry department.

MODEL BARRACKS IN FRANCE

The new barracks occupied by an infantry regiment, located near one of the gates of Paris, are far in advance in comfort, sanitation and hygiene of



French Soldier Surveying Himself in a Large Mirror Placed on the Outer Wall of His Quarters

anything of the kind ever before erected in France. Each company has separate wash and toilet facilities and a fully equipped barber shop, and when the soldier emerges from his quarters, he can survey himself in a large mirror set in the outer wall near the door, to see that his uniform is spick and span.

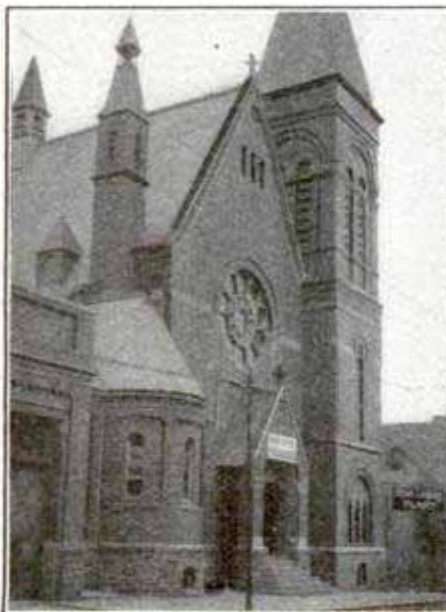

Once a Church, Now an Electric Laundry



View in the Ironing Department

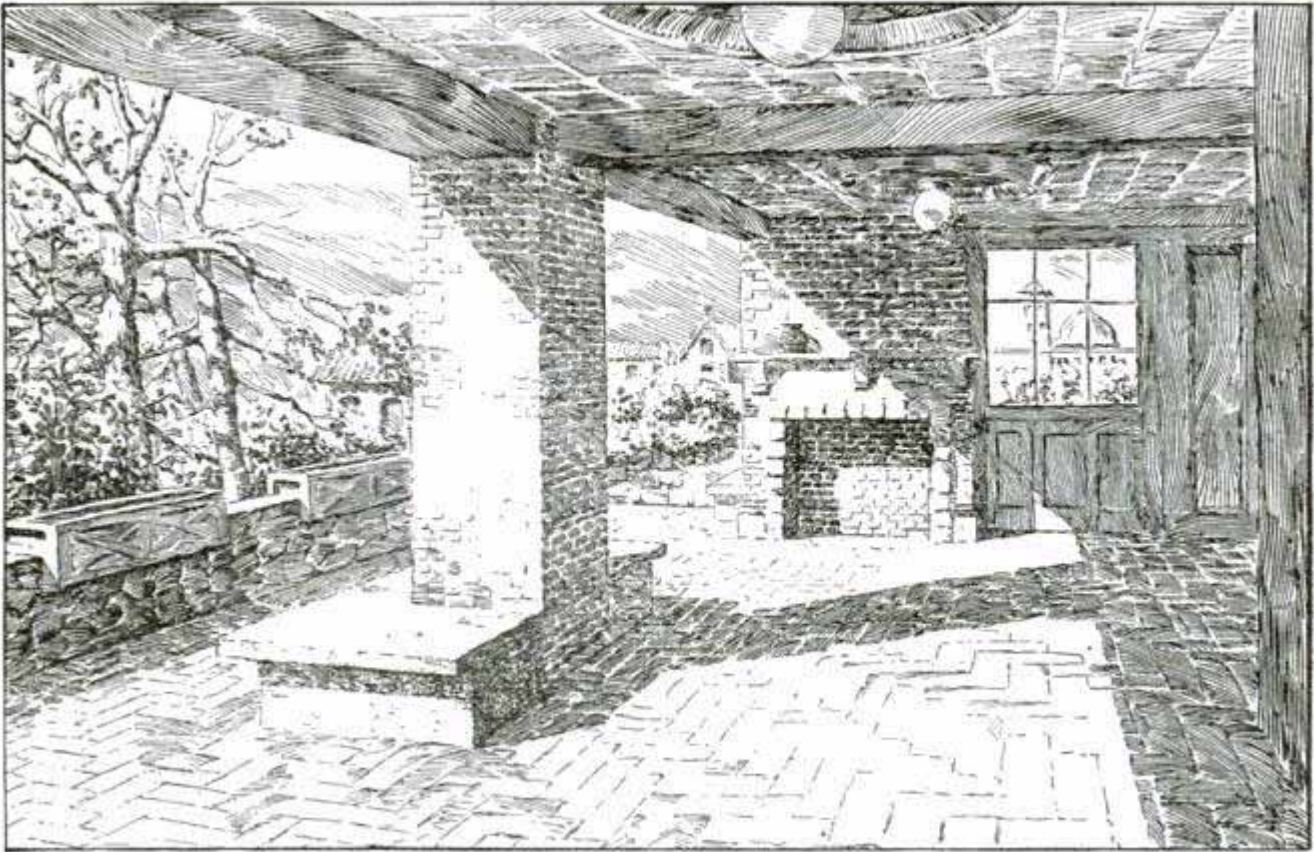

Fine Example of Open-Air Fireplace

PORCH FIREPLACE

A fine example of porch fireplace is shown in this illustration. The exposure of the porch is southern, and the fireplace makes it comfortable at least

a month earlier in the spring and a month later in the fall than would be the case if a fire were not available. It also serves on cool or damp evenings.

COMBINED TRACK GAUGE AND LEVEL

An ingenious combination track gauge and level has been designed by James J. Hill, the great railroad builder. It consists of a rectangular base built

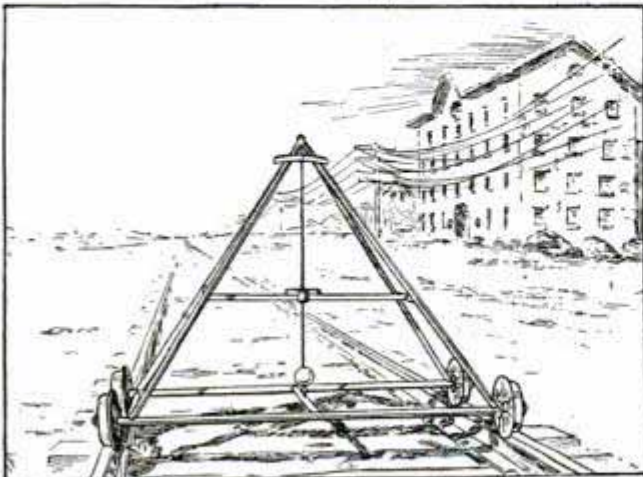

Ingenious Combination Track Gauge and Level,
Designed by James J. Hill

of steel tubing and mounted on four 6-in. wheels. The distance from flange to flange is exactly the track gauge. On this base, a pyramid of steel tubing is built, with a cross bar at about one-half the height, to which a spirit level is attached. A pendulum, with the lower end weighted and the upper end running to a point and moving along the arc of the circle, which is fastened to the frame near its top, is pivoted on the same cross bar to which the spirit level is attached.

When the device is on a level track, the pendulum points to zero, the arc of the circle being so graduated that the difference in elevation of the two rails is correctly indicated on the dial, the smallest reading being 0.2 in. By pushing the apparatus over the track, the operator is able to check the gauge,

while the dial reading indicates high or low spots on a straight section of track, or the elevation on curves. Over 30 of these instruments are being used on the LaCrosse division of the Burlington road.

INTENSE COLD AT HIGH ALTITUDES

Temperature and barometric pressure instruments attached to a parachute and sent up by balloon from the Toronto meteorological observatory, Feb. 3, were recovered in March. The recording instruments showed that the balloon reached a height of $7\frac{1}{2}$ miles before it burst, and that the temperature was 90 below zero.

It is said that $7\frac{1}{2}$ miles is the highest mark at which temperature has ever been recorded in America.

LESSENS FIRE RISK AND PREVENTS LAMPS FALLING

This new electric lamp socket has separate inlets for its leading-in wires, a feature which practically eliminates any danger of short circuits and consequent blowing of the fuse and possible fires.



FISH YAWN LIKE HUMAN BEINGS

An English biologist has observed a certain action in fish, which is, according to him, an exact counterpart of the yawn of a human being, and serves the same physiological purpose.

A person yawns during periods of depression, such as sleepiness, the physiological reason for and purpose of the yawn being to stimulate the brain by carrying to it an abnormally large amount of blood. The yawning of fish is said to occur especially when the water is slightly heated and therefore contains less air in solution.

ENOUGH OIL TO FLOAT THE UNITED STATES NAVY

The oil produced last year in this country would easily float the entire



The United States Army Could Easily Stand on the Head of This Barrel, Which Would Hold the Oil Produced in This Country Last Year. The Eiffel Tower, the Highest Structure in the World, Is Shown for Comparative Size

United States navy and leave considerable room for the vessels to maneuver into position. In actual amount it was estimated at 216,588,308 barrels (42 gal. to barrel). A reservoir 40 ft. deep, big enough to contain this quantity of oil, would have an area of over one square mile. If the oil were put into a barrel of the usual proportions as to height and diameter, such a cask would be about 1,500 ft. high. The head of this barrel would be 975 ft. in diameter, and have an area of about 17 acres, or enough space to accommodate very easily the whole of the standing army of the United States.

The total oil production last year of the entire world was about 340,600,000 barrels. A barrel to hold this oil would have to be about 1,750 ft. high.

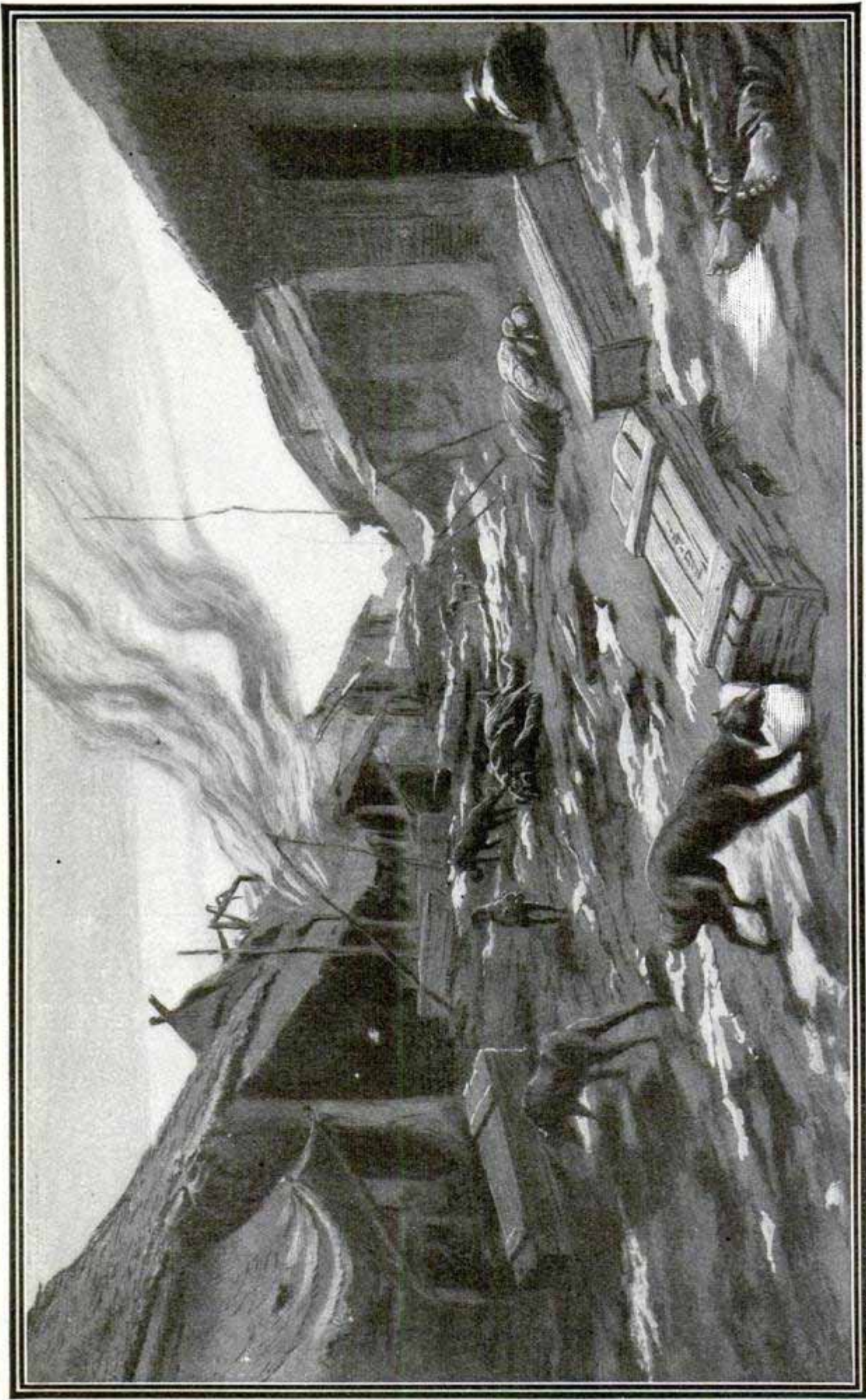

Courtesy L'Illustration

TOWN IN MANCHURIA DESOLATED BY THE PLAGUE; ANIMALS FEEDING UPON THE VICTIMS

THE PLAGUE IN MANCHURIA

The origin of the plague responsible for thousands of deaths in the Chinese cities of Manchuria, desolating whole towns, is attributed to a rodent resembling the kangaroo, with long hind legs and coarse hair. It is said that a hunter was inoculated with the plague bacilli from one of these animals, which are very common in Manchuria, and that the epidemic spread with incredible rapidity from this source.

The plague in its present form is much more virulent than the ordinary bubonic plague, and any one seized with it succumbs in from 30 minutes to three or four days at the longest. The description of the ravages of the plague in Fuchiatien, as reported by a Russian correspondent in Harbin, is applicable to many other small Manchuria towns. This correspondent says that Fuchiatien has become a dead city. Streets are deserted, the houses empty, the bazaars closed. The dogs and rats that devour the corpses of the victims are the only evidences of life. Even the hospitals are empty, both physicians and patients having been stricken.

The character of this plague is pneumonic, consequently it may be communicated by the breath of a victim and acts with crushing speed. One reason for its rapid spread was the failure of the Chinese government to provide adequate means for checking it. Viceroy Hsi, after pressure had been exerted by the diplomatic corps, finally adopted radical measures and cooperated with the Japanese authorities. After considerable hesitation and delay, about 2,000 infected bodies were cremated instead of being buried, this being the first radical step. Then 1,000 soldiers were dispatched to Fuchiatien to enforce strict quarantine, as the plague was spreading more rapidly there than anywhere else. The Chinese coolies were quite indifferent to the dread disease. They objected to their bodies being examined and smuggled themselves away in the

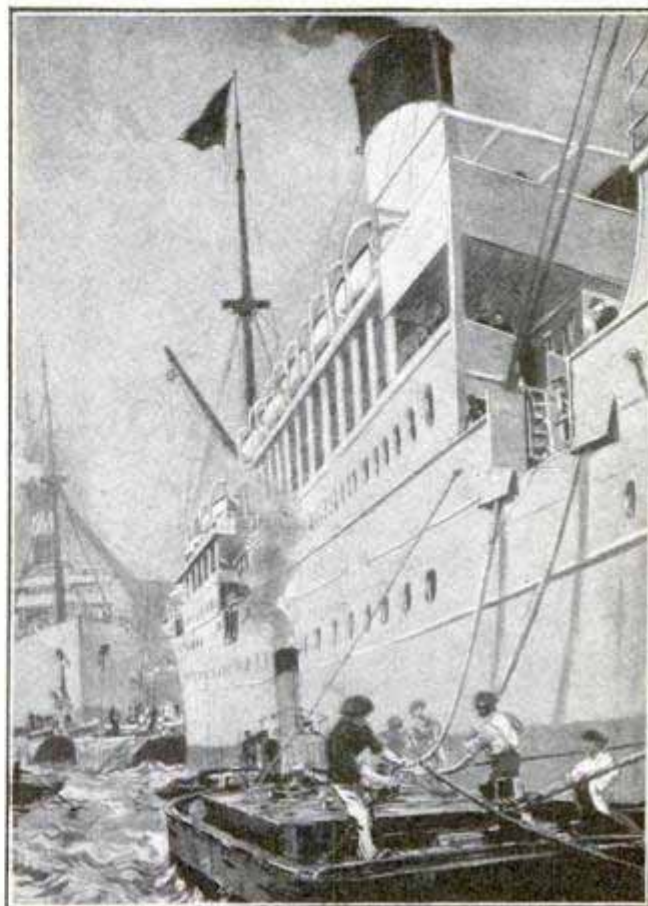

Courtesy Illustrated London News

Fumigating the Hold of a Ship at London, as a Means of Exterminating Rats, Which Might Possibly Spread the Plague

night, thus carrying the plague to the southern provinces.

Fear that the epidemic might find its way to Europe and America has resulted in great precautions being taken at every port. One of the illustrations shows a floating fumigating plant pumping sulphur dioxide into the hold of a vessel as a means of exterminating rats, which might possibly spread the plague.

BIRD BREAKS CLEAN HOLE THROUGH WINDOW

Evidence of the terrific speed of the quail when on the wing is found in a window pane 42 in. square, in West Virginia. The quail was flying from a hawk and mistook the window of a house for an open space that showed a way of escape. The bird smashed through the glass, making a clean hole, such as would be made by a bullet. It

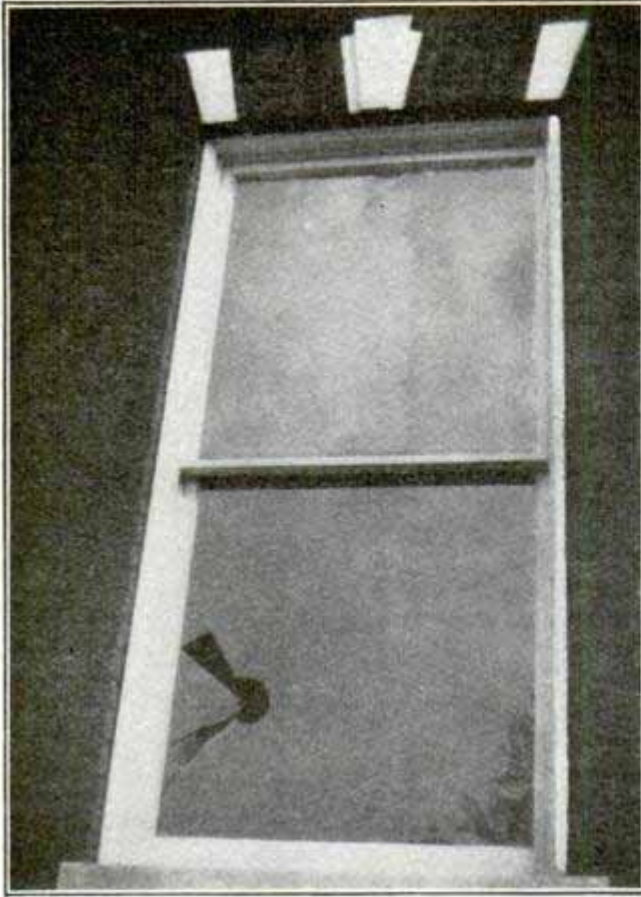

Window Through Which a Bird Flew

was dead when picked up, its head being almost severed from its body. The hole made by the bird is just a little larger than its body.

OLDEST LIGHTHOUSE IN AMERICA

Boston light, which stands on Little Brewster Island, at the outer end of the channel which ocean liners follow, about eight miles below the city, is claimed to be the oldest in America. The lighthouse itself, which is of rough boulder stone hooped with iron bands, was built in 1715 by the government of England. An old cannon, still lying on the ground near its base, was provided by the Cunard company to give signals before the fog horn was installed.

The families of the head keeper and his two assistants, and a school teacher provided by the town of Hull in conjunction with the state, live at the light, numbering 12 inhabitants in all. The school room in which the five children study and recite is on the top floor of the head keeper's house and looks out in all directions upon the sea.

THE HERMIT AND THE OIL CANS

There are a few things to be said in favor of Standard Oil, after all. The modern hermit would find himself



The "Nature Man" Above His Oil-Can-Roofed Abode in the Hills Back of Papeete, Tahiti

badly handicapped, especially in the tropics, were it not for the tin cans which that organization furnishes to the ungrateful world. Ernest Darling, a disciple of the simple life, well known in San Francisco, Los Angeles and the Honolulu islands, lately residing in the South Sea island paradise of Tahiti, in the French colony of Oceania, thought it expedient to cover his Robinson Crusoe shanty with a roof made from straightened Standard Oil cans; and as he dreams of an individualistic and vegetarian colony on the plantation into which he turned a jungle, 1,200 ft. above the wicked town of Papeete, he accumulates a new supply of that roofing material on the resting places along his usual trail, to be brought up to his "mountain home" when he is not overburdened, on his return from the English lessons he gives to a few Chinamen in Papeete.

ARC-LAMP CARRIER FOR STREET LAMP-POSTS

The novel feature of the arc-lamp carrier shown in the sketch is the central harp which permits the lamp to be hung vertically over the standard and to be swung to one side so that it may be lowered to the ground for trimming and cleaning.

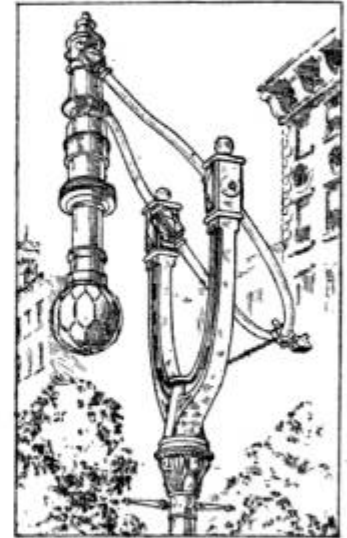

A weather hood protects the lamp to some extent from rain and snow.

MEXICAN CAPITAL IS A CITY OF CONCRETE

The City of Mexico, nestling on the floor of a wind-swept, treeless tableland 7,140 ft. above the level of the sea, might justly be termed the world's first and largest city of concrete. For more than four centuries practically every building in the city has been constructed of concrete or brick. Wooden structures are so rare that they are curiosities, and brick is almost as scarce as wood. The peculiar location of President Diaz's capital, with its population of almost half a million and its acres of homes and business blocks, partly surrounded by mountains rising from 10,000 to 16,000 ft. above sea level, makes wood in all its forms one of the scarcest articles of commerce. Brick clay is not found to any extent in the vicinity of the city, while lime and sand are in abundance. Concrete is cheaper in Mexico City than anywhere else in the world and, as a result, practically all of the building in the city has been done with this material.

Some of the buildings in the city are

magnificent from the point of view of the artist as well as the builder, and further than this, are constructed of material that makes them impervious to the heavy rains, proof against the most severe earthquakes and firm as solid rock against the fierce blasts of the tempests that sweep down from the northwest coast. All the government buildings, the business structure and the private residences of any consequence are built of this native material reinforced with steel. The postoffice is one of the finest buildings of this character in North America and cost the government \$7,000,000 Mexican (about \$3,500,000). It could not be duplicated in the United States for anywhere near that sum. The National Theater, which has been building for the past six years and is not yet completed, is to cost \$25,000,000 Mexican (about \$12,500,000), and is constructed of reinforced concrete and marble. The building is faced on the outside with the finest Italian marble. It rests on a raft of concrete and railroad ties sunk

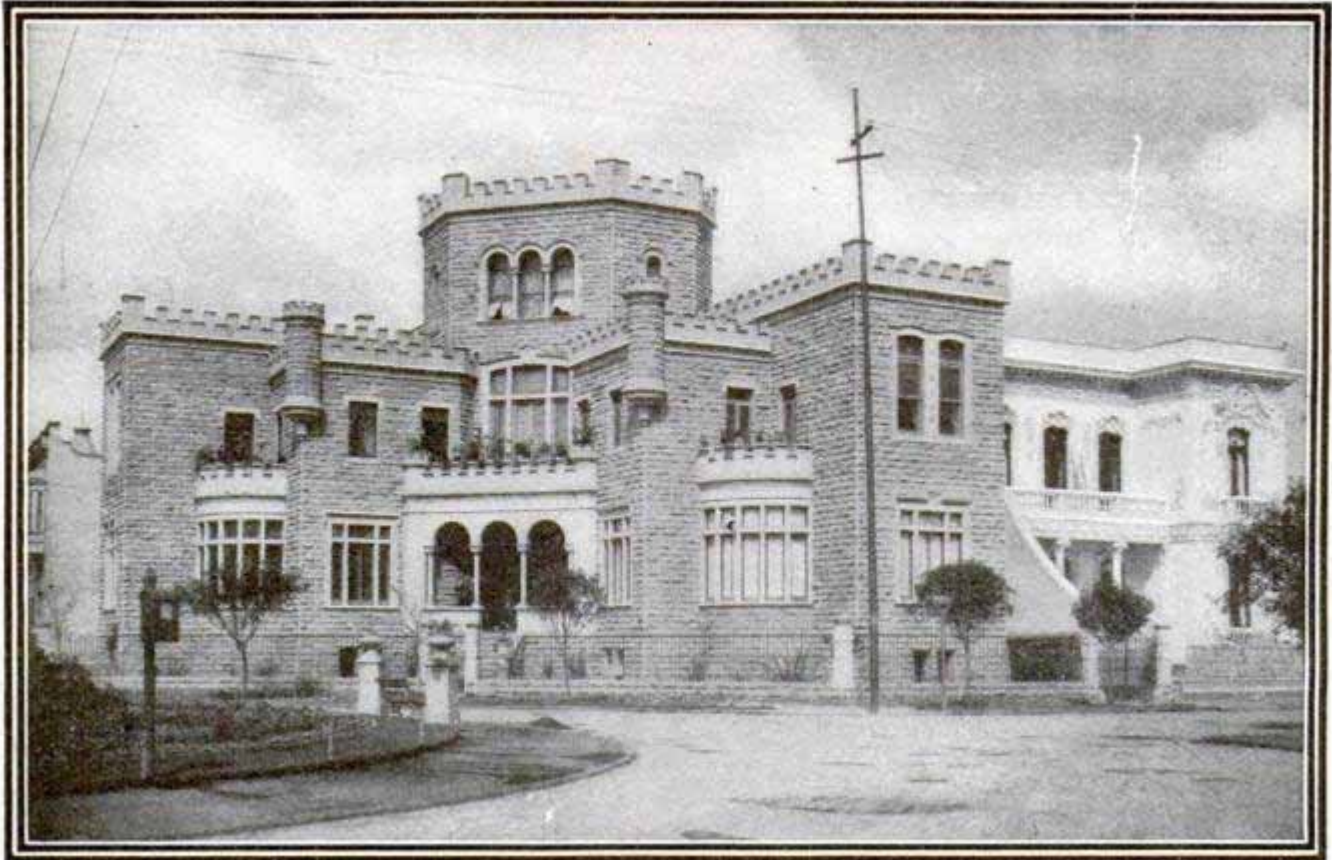

Two Examples of Concrete Construction in the Residence Section of Mexico City—The House in the Fore-ground Is Built of "Imitation Stone" Blocks Made of Concrete—The Building on the Right, Which Shows Almost Pure White, Is of Concrete without Steel Reinforcement.

30 ft. in the ground. The palace of the president is a magnificent structure in which the ornamentation, as

well as the walls and partitions, is of concrete, designed to endure forever. The water supply of the city is

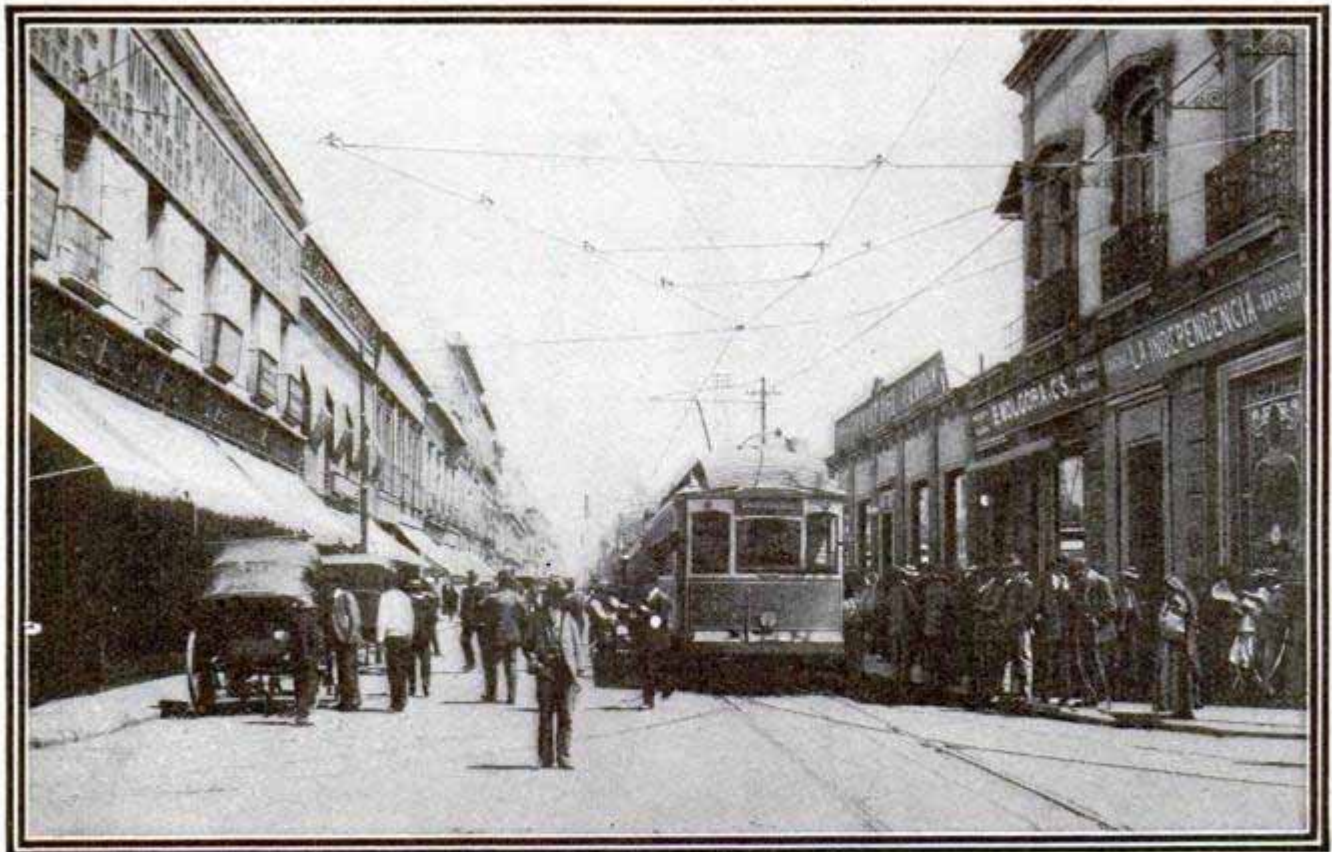

Avenida de Diez y Seis Septiembre, Mexico City, One of the Principal Business Streets of the Capital—Every Building on It Is Concrete, for the Most Part without Reinforcement

through concrete aqueducts. The same system of supply has been in vogue 400 years, but it has been improved in detail from time to time and is quite in keeping with modern re-

quirements. The water is brought from Monterey, on the northern border of the republic. The huge aqueducts are carried over hill and valley on concrete bridges where necessary.

TICKETS MADE WHILE YOU WAIT

The spacious ticket case, as a form of mural decoration in the station agent's office, seems threatened with extinction by the new type of ticket-printing machine recently installed at the Brooklyn terminal of the Long Island Railroad. The machine, which prints the complete ticket on the spot, is of French manufacture and is at present the only one of its kind in this country.

Roughly, the operation may be described as follows: A series of electrotype blocks are arranged upon an endless belt, facing outward. By turning the sidewheel, the belt is moved at will and the required block brought into printing position, this being indicated by a pointer which travels simultaneously along a white face on the upper part of the machine, whereon are printed the names of the stations. The block having been set, an electric switch is thrown in and starts a motor at the base of the machine. The balance of the operation is automatic, for the motor drives a most complicated set of mechanism which feeds down the paper, makes the impression, numbers the ticket, cuts it off and delivers the finished product. Coincidentally with the printing, the machine records on two slips full information of the sale, for the agent's record and the accounting office. Still further, dials upon the face of the machine show the total number of tickets turned out.

In this type, two kinds of thin cardboard stock are used on the rolls of unprinted material at the top—blue for express tickets and yellow for local—and separate records of each are kept automatically. There is a considerable latitude in the possible speed of production, the present speed of 65 tickets

per minute, or a little less than one second for the complete manufacture of each ticket, being far below the capacity of the machinery.

The device saves space by rendering unnecessary the printing of a supply

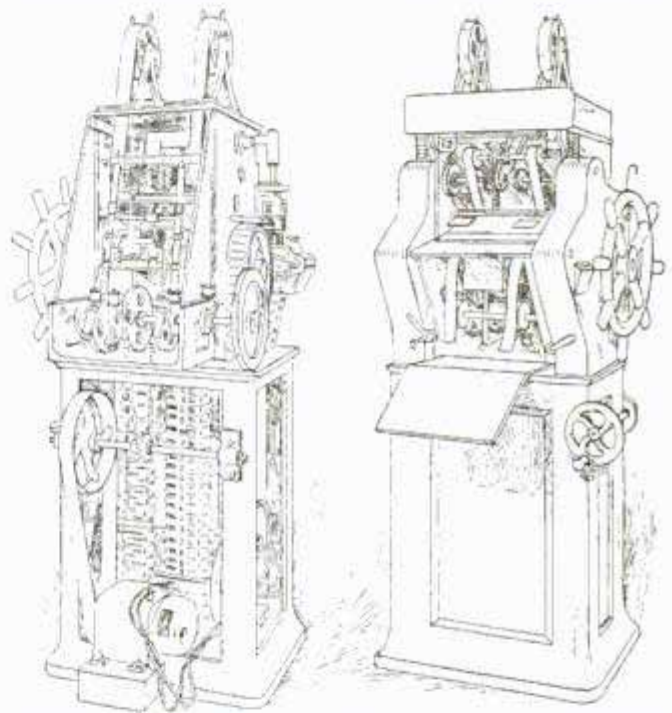

Front and Rear Views of Machine to Make Railroad Tickets While You Wait

of tickets, and time in selecting pasteboards from a rack and dating them. It spares the agent from one to two hours' work in preparing his report after the day's business, for his account is made up with mechanical accuracy and his cash must tally with the totals printed on the slips at the end of his tour. The public is protected by the automatic printing of the price of the ticket upon its face.

☞The Chinese government is considering plans to extend its wireless system to connect the principal ports with the capital of the empire.



Victoria Falls, Zambesi, Africa, the Greatest Waterfall in the World, from the Painting of Edward H. Houlder

TEST GYROSCOPE AS WAR VESSEL STABILIZER

The naval authorities are perfecting plans for extensive tests of the gyroscope as a means of promoting the stability of vessels of war. Much faith is expressed in the mechanism, which has been under examination by high naval officials. It is intended to install the gyroscope on board one of the older torpedo destroyers, and to conduct a series of tests which will show, under conditions of actual service, the demands made on a vessel in the way of weight and space. The experiments will be conducted this summer.

ⒸThe Commonwealth Edison Co. of Chicago was astonished recently at the courtesy and ingenuity of one of its customers. The meter reader was unable to obtain access to the premises, owing to this customer's absence during the greater part of the day, therefore the customer made a photograph of the watt-hour meter and maximum-demand indicator and sent it in.

FIRST PAINTING OF WORLD'S LARGEST WATERFALL

The first painting ever made by a professional artist of the Victoria Falls, on the Zambesi, in South Africa, is that reproduced in the accompanying photograph. To make it, Edward H. Houlder, famed in Europe for his large and beautiful landscape pictures, had to make a journey of 7,700 miles, that being the distance from his home in London to Cape Town and from the latter place to the Falls.

These falls were first discovered by Livingstone in 1855, and named after the late Queen Victoria. They are situated in Southern Rhodesia at a height of no less than 2,300 ft. above the level of the sea. They are over a mile in width, more than double that of Niagara, while there is a sheer drop of over 400 ft. against Niagara's 187 ft. This wide sheet of water descends into a narrow chasm and rushes through a small outlet into a narrow zigzagging gorge for a distance of nearly 40 miles.

EFFECT OF WATER IN WATER-PROOFING CONCRETE

It has long been recognized, according to C. M. Chapman in a paper read before the National Association of Cement Users, that the quantity of water used in mixing concrete has a large influence upon the impermeability of the resulting mass. A concrete may be too wet or too dry to produce the most impermeable product, and one extreme is as bad as the other. The theory is generally held that, other conditions being the same, a wet mix makes a more waterproof concrete than a dry mix, as the latter produces a more porous mass, unless very tightly compacted by much hard tamping or enormous pressure. A slight difference in the percentage of water used will make a large difference in permeability.

HAMBURG'S TRAFFIC AND PEDESTRIAN TUNNEL

The double tunnel which has been in process of construction for the past three years under the River Elbe at Hamburg, Germany, will be opened this year. It is about 1,500 ft. long and the cost of the two bores will be close to \$2,500,000. Each bore has a roadway for automobiles and other wheeled traffic, and two footpaths. One bore is used for the up traffic and the other for down traffic.

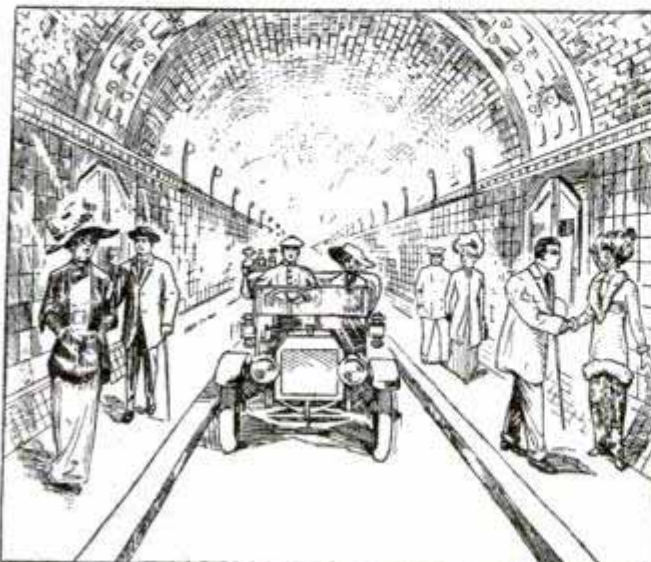

One of the Bores of the New Double Tunnel Under the River Elbe at Hamburg, Germany

THE "OLYMPIC'S" WHISTLES LARGEST EVER MADE

The whistles of the "Olympic" are the largest ever made. Each set, of which there are two, one on each of the forward funnels, consists of three bell domes, 9 in., 15 in. and 12 in. in diameter, grouped together on a branch piece. The height from the base of the branch piece to the top of the center dome is 4 ft. 2½ in., and the combined weight of the three domes and the branch piece is 764½ lb.

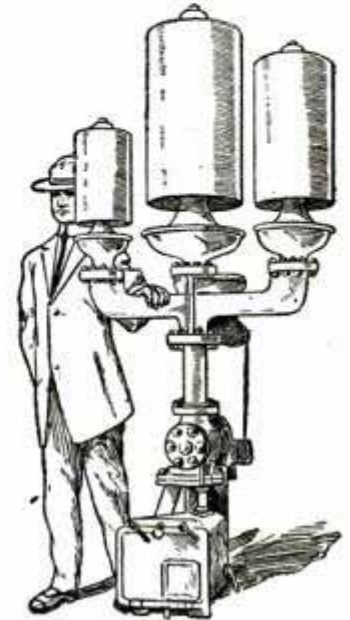

The whistles, which are electrically controlled, are so arranged and tuned as to give the distinctive harmonious blast which is known by the White Star line navigators as their own recognized sound.

TRACKLESS TROLLEY FOR LEEDS, ENGLAND

The corporation of Leeds, Eng., is operating a trackless trolley or trolley omnibus line over a mile of streets and will extend the route to a length of four miles. The omnibuses, which are single-deckers provided with cross seats accommodating 28 passengers, use the ordinary trolley wires for positive current, and additional wires, one on a side, for the negative return. This part of the overhead equipment is supported by side poles and bracket arms.

Both the exit and entrance to the trolley omnibuses are at the front, and the motorman takes the fares. Unless the traffic becomes exceptionally heavy, conductors will not be employed.

COALING GEAR OF U. S. COLLIER

The coaling gear of the U. S. N. collier "Cyclops," as viewed looking for-

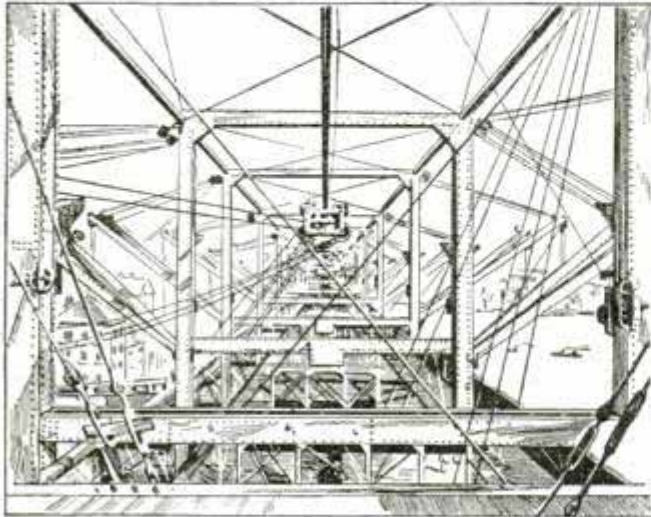

Steel Structural Work Rising Above Deck of the U. S. Collier "Cyclops"

ward from the stern, might be taken for the steel skeleton work of a building. It consists of 14 steel masts or upright supports, arranged in pairs and connected by fore-and-aft and cross ties, giving a clear deck for the operation of the unloading gear. The foremost and aftermost pairs of upright supports are really masts, being carried

up twice the height of the others and rounded off. Each upright, with the exception of the four just mentioned, carries two steel crane booms.

The "Cyclops" has a length of 542 ft. over all, a beam of 65 ft., and a coal-carrying capacity of 12,500 tons. She is capable of handling coal at a rate of 1,440 tons per hour.

AN ADVERTISING CLOCK THAT TALKS

An electric clock that operates display advertisements and attracts attention by shouting to passers-by is one of the latest advertising devices.

This timepiece resembles a mission-style grandfather's clock. In front of the lower part of the case are 30 advertisements which are changed at regular intervals by an electrically operated mechanism. Above this and below the clock proper is a phonograph which can be made to say anything in the manner of the most expert "barker," or to entertain an audience, if desired, with the latest musical selections. The principal advertising value of the device lies in its novelty.

DISCOVERY OF AMERICA CAUSED BY A BUG

A bug, similar in many respects to the cockroach of our day and time, is believed by some historians to be responsible for the discovery of America.

This information is contained in an article, written by the Rev. Alexander Darley, a native of California, who has been engaged in historical research in the Orient. He states that the continent of North America was discovered 17 centuries before Columbus sailed on his memorable voyage by a Chinese mariner named Hee Li who landed on the Pacific coast, June 10, 217 B. C., near where the city of Monterey, California, is now situated. Authentic data has been obtained to prove this assertion, it is claimed, and also to prove the influence of the bug on the opening of transpacific commerce at a

time when Christianity was unheard of. Hee Li was captain of a junk that was caught in a typhoon off the coast of China, according to this version of the discovery of America. A bug took refuge from the storm in the compass of his ship and so disarranged the apparatus that the sturdy seaman, in following its direction in the manner to which he had been accustomed kept his vessel headed east instead of the way he intended to go and after many days landed on a new continent. It was not until after he had made land that he discovered something to be wrong with the compass and then the bug was found.

Traces of Chinese visitations are to be found in California, Peru and Alaska, according to the savants who

have been investigating the subject. The village of Eten, Peru, contains a number of people who speak a language that is not understood by the other peoples living in the vicinity, but is easily translated by Chinese coolies who have visited the place from time to time. Chinese characteristics are found among the Digger Indians of California and there is a strong resemblance between the Alaskan Indians and the Chinese. Captain Hee Li returned to China with the news of

his discovery and for more than 100 years boats plied between the Pacific coast of America and China. No attempt was made, apparently, to colonize the new country and no reason for this failure is brought forth by the records. The commercial intercourse between China and the Americas was simply allowed to die. Buried in the musty recesses of some Chinese library there may exist today a complete story of what the Chinese found on the Pacific shores.

THE MAKING OF ARTS-CRAFTS LAMPS

By JOHN D. ADAMS

PART X—FOUR-LIGHT, CHAIN-HUNG CHANDELIER

At the first glance this mission chandelier will strike the reader as a rather elaborate undertaking. It will, of course, necessitate some little time, but there is really nothing about it that is difficult or that requires the use of special tools. The shades used are of the simple pattern described for the drop light in Part IX, and consist of only cardboard and paper. The chains can be had at any hardware store and may be connected to the wood with screw eyes or staples. The wood work consists of two pieces of dressed 2 by 4-in. pine in the form of a cross, the connection

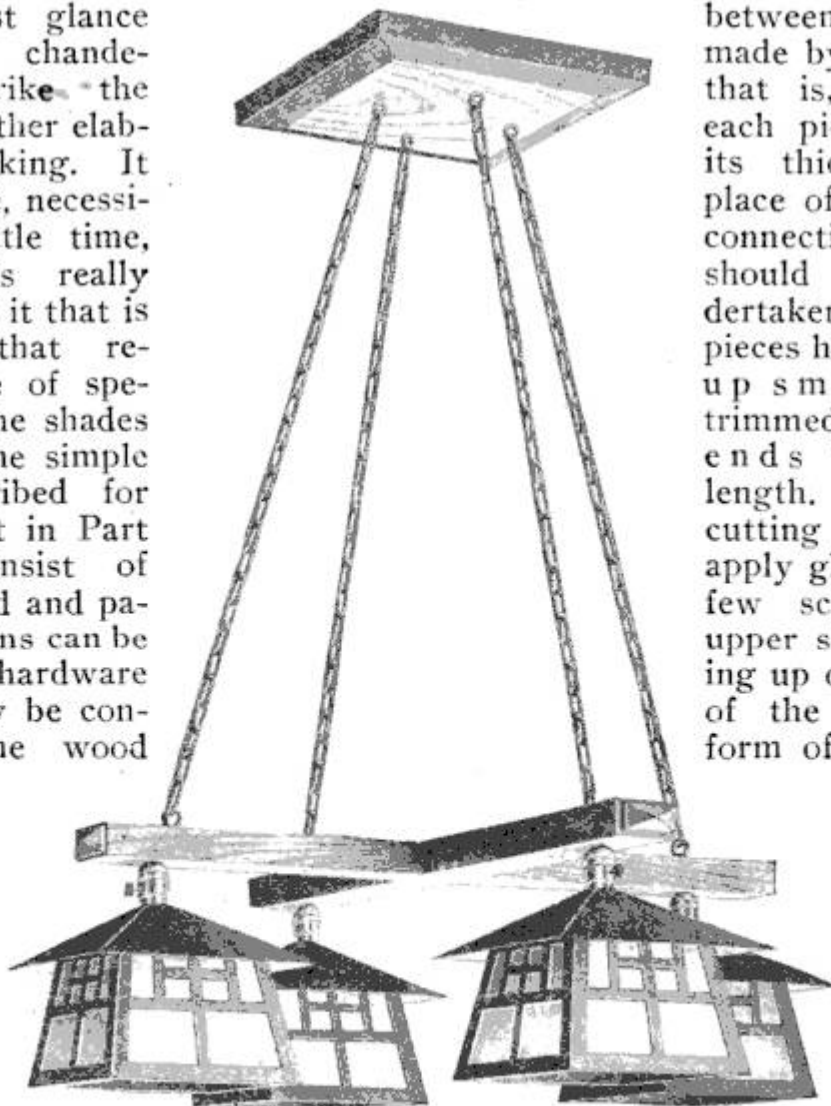

Four-Light Chandelier

between the two being made by cross lapping, that is, notching out each piece to one-half its thickness at the place of crossing. This connection, however, should not be undertaken until the two pieces have been planed up smoothly and trimmed off on their ends to the exact length. When all the cutting has been done, apply glue and set in a few screws from the upper side. The shaping up of the four ends of the cross, to the form of the dull point as shown, means some little labor, which can only be avoided by sawing off each end perfectly square and then tacking

on a small pyramid-shaped block, a procedure which is a rather poor deception at best of the natural end wood.

Before boring the holes through each end for the wires from the sockets, run the $\frac{1}{2}$ -in. bit in for a short distance, so that the $\frac{1}{2}$ -in. projection found on the top of all sockets will set clear into the wood. The hole for the wires should be about $\frac{1}{4}$ in. in diameter, and is to be plugged up tightly from above with a wooden peg after the wires are in place, so that the socket will be held firmly. The ceiling plate consists of but one

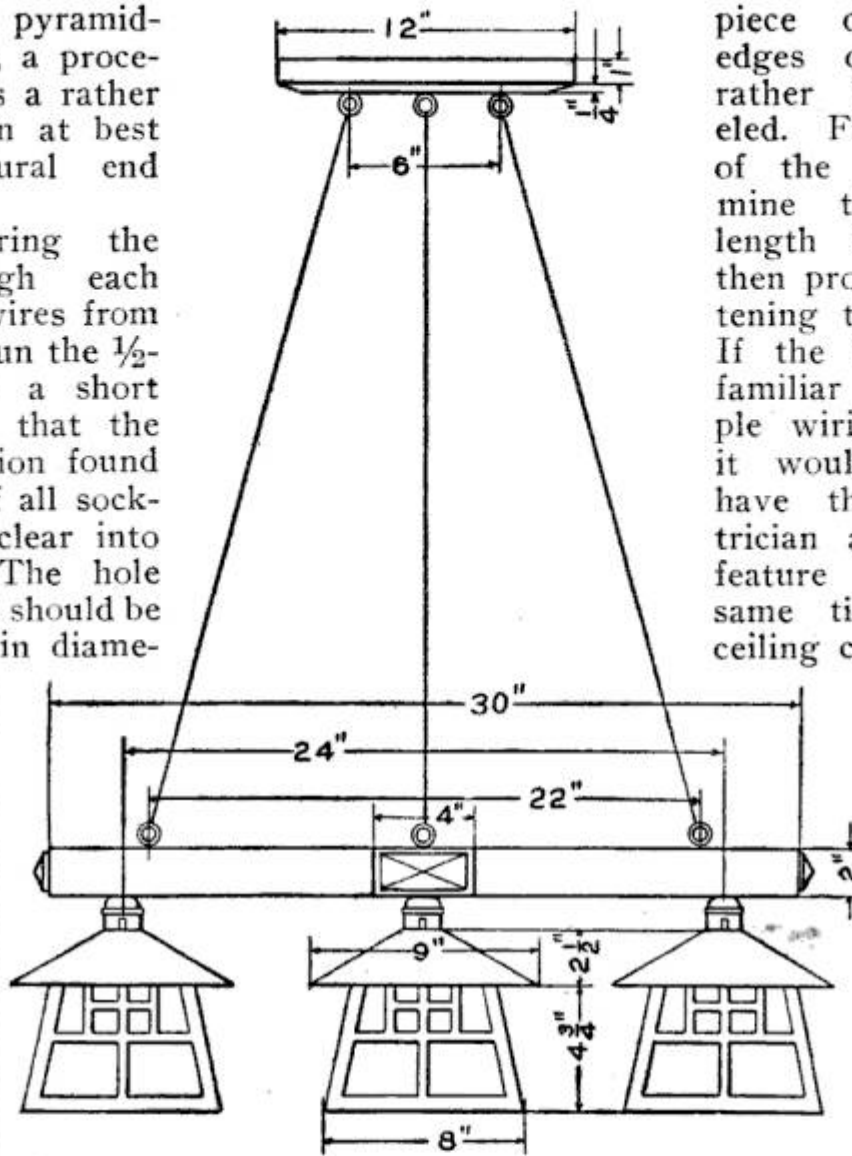

General Dimensions of Chandelier

piece of wood, the edges of which are rather liberally beveled. From the height of the ceiling determine the necessary length of chain, and then proceed with fastening them in place. If the reader is not familiar with the simple wiring necessary, it would be well to have the local electrician attend to this feature and at the same time make the ceiling connection. All

this, however, should be attended to before the shades are attached to the sockets.

The lead wires may be run through the links of one of the chains.

AUTOMATIC EXTINGUISHER SUFFOCATES FIRE

An automatic fire alarm and extinguishing system, which puts out fire by suffocating it with carbonic acid gas, has been tested with excellent results by the fire departments of Kiel and Hanover and on a German warship.

The apparatus consists of two distinct parts, one being the extinguisher, which is a generator of carbonic acid, and the other an electric alarm. The generator is a galvanized-iron tank partially filled with a solution of potash. Its cover has a cap so constructed as to intercept any of the fluid, while the generated gas freely passes out through perforations. In-

side of the tank is a cast-iron reservoir filled with concentrated sulphuric acid, the top being perforated with several small holes. This reservoir rests on a horizontal shaft, having at one end and outside of the tank a lever held in a horizontal position by a catch attached to the armature of an electromagnet. The passing of an electric current energizes the magnet and releases the lever, the reservoir is overbalanced, and the sulphuric acid drips down into the solution of potash, generating about 500 cu. ft. of carbonic acid gas in 25 to 30 seconds. The gas is forced out of the generator under pressure, and smothers the fire.

The automatic operation of the system depends upon the expansion by the heat of the fire of a curved laminated band of two metals of different expansibility, so arranged that when the temperature has reached a certain degree the band bends enough to cause an electric circuit to be closed, the alarm is sounded, and the gas generator started. The accidental starting of the generator through the breakage of a conductor is prevented by means of a special arrangement of electrical connections.

REMARKABLE GAS ENGINE USES COAL AS FUEL

Receiving the claims at first with incredulity, makers of gas engines are now greatly interested in a remarkably ingenious internal-combustion engine which works directly from ordinary coal, and is said to run well, although as yet it is only in an experimental stage.

A large percentage of the heat generated in the ordinary gas engine is wasted, but in this engine, it is used for changing the coal into gas, although there is no separate gas producer. Bituminous coal, broken up into small particles, is placed in the fuel box and fed into four pipes by means of a bevel-driven screw feeder. These pipes pass, first of all, through a box extending from the engine, in which they are heated by the exhaust gas, and then right through the combustion chamber, out again on the other side of the engine, and down into a water chamber. The coal is heated to incandescence inside the pipes, steam from the top of the water jacket is brought in contact with the coal, and air is also introduced into the mixture. The resultant gas is drawn off into the cylinder by the suction of the piston, fired by an electric spark, and exhausted in the ordinary way. The four pipes in which the particles of coal are gasified have their ends dipped in water, so that if any coal dust should pass beyond the point where the pipes bend downward, and

not be converted into gas, it will fall into the water, from which it may be removed when desired. The pipes by

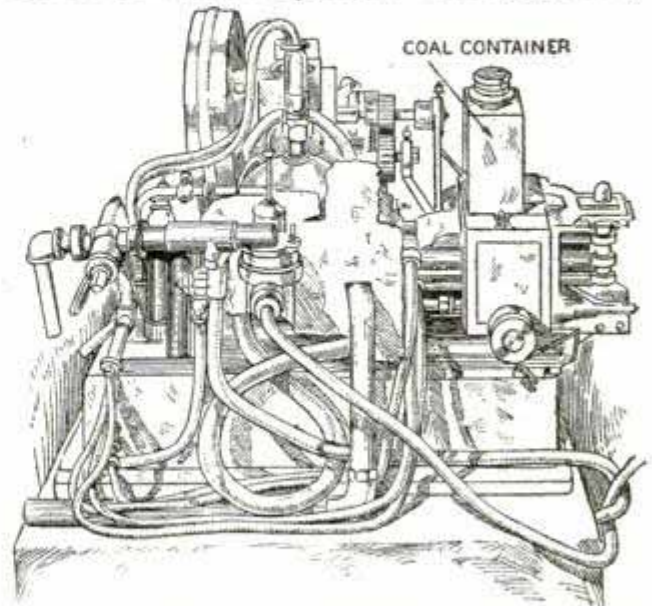

This Remarkable Internal Combustion Engine, Invented by a Londoner, Takes Its Fuel Direct from Coal

which the gas is drawn from the hot coal also lead into this water chamber, but at a point above the water line. The gas then passes direct to the inlet valve of the engine through a pipe leading from the top of the chamber.

The engine has been run several hours at a time on a coal consumption of less than 0.4 lb. per horsepower-hour. In its present state it must be started up and run until warm on gasoline.

A NOVEL SCREWDRIVER

A screwdriver, the handle of which will never come off, except it gets in the way of a sledge hammer or the cutter of a shearing machine, is shown in the accompanying illustration. It is made of a single piece of steel and the handle is fluted so as to afford a natural and positive grip, and also to



An All-Steel Screwdriver

reduce the weight. The design is slightly modified in different sizes of the tool, but all of these are on the general lines of the screwdriver shown herewith.

"FREAK" LOCOMOTIVE BUILT IN EGYPT

This locomotive of remarkable appearance was the object of feed-water heating experiments carried out on the

the pyramid was forced open in 818 A. D., by the Caliph Mamoun.

The joinings of the casing stones, and those of the super-pavement on which they rest, are almost invisible, appearing in places like mere pin

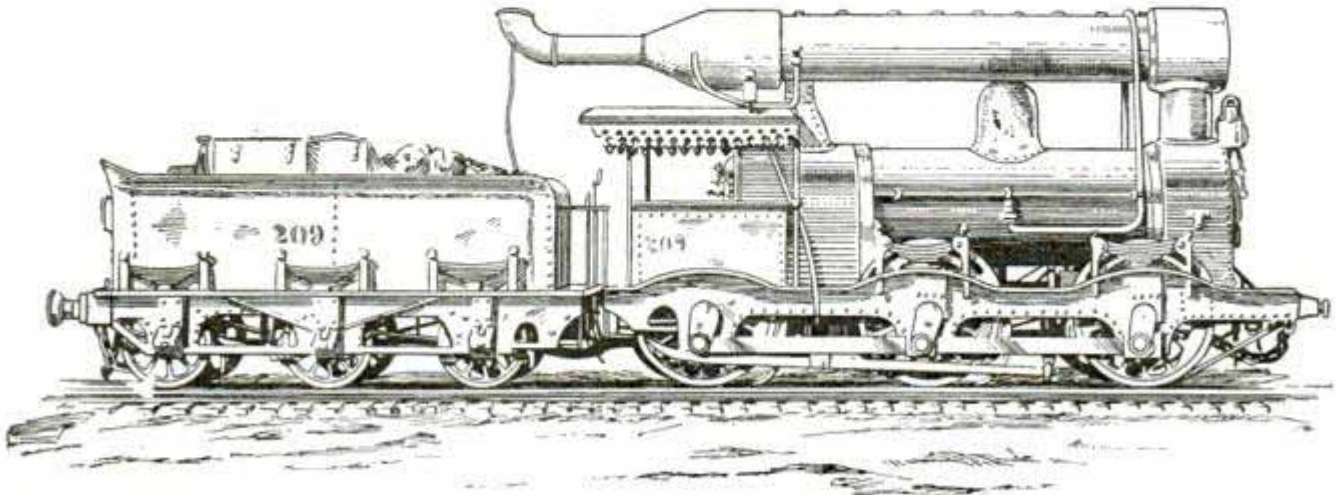

Experimental Egyptian Locomotive Provided with a Long Horizontal Exhaust-Steam and Flue-Gas Heater

Egyptian State Railways. The curious pipe is a long horizontal combined exhaust-steam and flue-gas heater, carried at the smokebox end by a vertical length of cylindrical flue, and near the cab end by a saddle fixed to the boiler shell. A considerable proportion of the exhaust steam was condensed by this arrangement, but at the same time, dirty water was thrown out of the chimney mouth, which did much damage to goods loaded in the cars behind. Minor modifications failed to minimize this nuisance, so the idea in this form was abandoned.

THE FOUNDATION OF THE GREAT PYRAMID

The latest excavation work on the Great Pyramid of Cheops by Dow Covington, the American Egyptologist and explorer, has laid bare a course of casing stones at the base, and now, for the first time, it is possible, at a glance, to see the entire structural details.

Nearly 20 casing stones and the pavement on which they rest have now been cleared. Four of the casing stones are perfectly preserved, owing to the debris which came down when

scratches, but every joint contains a web-like film of almost white cement.

The Great Pyramid of Cheops dates back to about 3700 B. C.

SAFETY LOOP FOR AUTOMOBILE SHAFTING

The possibility of an accident which would cause the propeller shaft and radius rods of an automobile to become detached and fall to the ground while the car is running at a fast rate, has caused one company to provide a preventive.

It is in the form of a light but strong safety loop, so contrived as to pass around the suspended members. Should the propeller shaft or radius rods become detached, this device would keep them from falling.

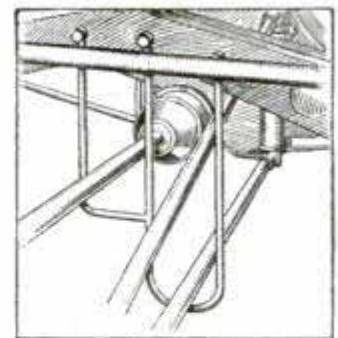

Should the propeller shaft or radius rods become detached, this device would keep them from falling.

⌚The Navy Department plans to use balloons as targets for a part of the battle practice of the Atlantic Fleet during the maneuvers off the Virginia capes this spring.

THE GROOMING OF FLOWERS

The instruments used by the French florists to prolong the life of cut flowers and remove imperfections are as numerous and delicate as those on a well equipped dressing table. They include scissors of all sizes and shapes, small cutting pliers and pincers of many kinds, brushes, atomizers, sprays and bottles containing various gums.

A withered leaf or even one poorly developed ruins the appearance of a rosebud, consequently the one is cut off, and the other, if possible, is re-shaped. The buds are also pierced as near the base of the flower as possible, with minute wires which keep the leaves in place. An instrument very similar to a curling iron is used to dress a faulty leaf.

One of the means employed to prolong the life of the flower is to remove the anthers, so as to prevent the spreading of the pollen, for, if fertilization is allowed to take place, the flower has fulfilled its mission and soon fades. In flowers of the lily order, the anthers are removed for still another reason. They develop such an abundance of yellow pollen that it falls and taints the leaves, thus marring the spotless white beauty of the flower.

The stems of flowers that begin to hang their heads are placed in very hot water for about five minutes, and then are placed in a dark and cool place for about an hour.

ELECTRICALLY OPERATED ROCK DRILL

A new electric rock drill, claimed to combine the ruggedness of the air or steam drill with the efficiency, flexibility and economy of electrical power, utilizes compressed air as the medium transmitting the energy from the motor to the plunger. This air is not exhausted from the drill, but is retained to act continuously as a cushion between the piston of the plunger and the motor-driven reciprocating cylinder in which it operates.

The cylinder is connected to the motor through gearing and makes about 500 strokes per minute. Flexibly

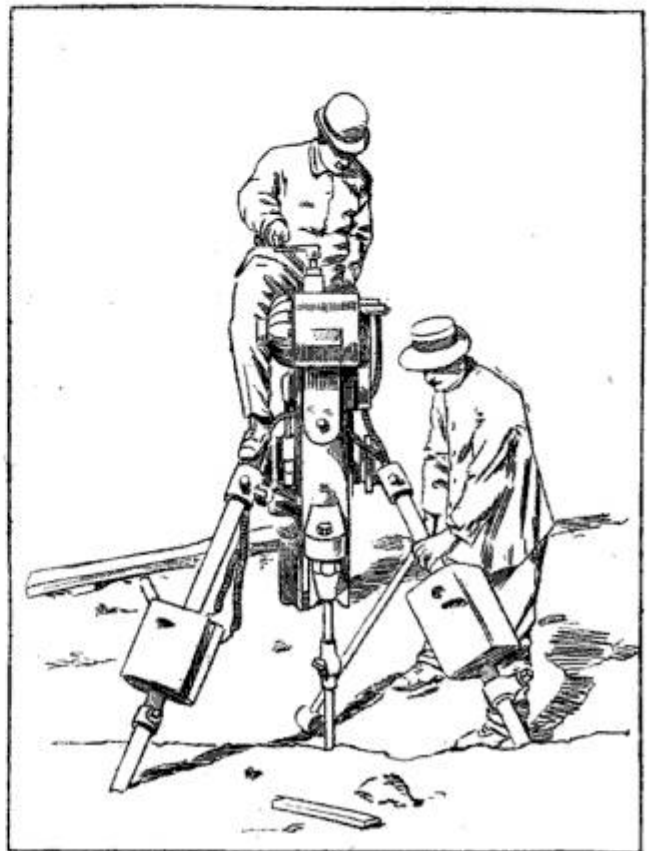

A Compressed-Air Cushion Transmits Energy from Motor to Plunger in this Rock Drill

connected to this cylinder through the compressible air cushion at each end, is the head of the piston, which, of course, makes the same number of strokes per minute. The difference between this drill and the ordinary air drill is that the cylinder in which the air acts upon the piston is movable instead of stationary, and the compressed air is retained to protect the mechanism from shocks from the plunger, instead of being allowed to escape after having performed its work at the end of each stroke.

SUBSTITUTE FOR RADIUM

A cheap substitute for radium, said to be just as good for medical purposes, has been discovered. It is called mesothorium and is made from thorium, a heavy metallic iron-gray powder extracted from thorite, a mineral found principally in Norway.

A MISSION SCREEN

In selecting or making up mission furniture for the home, a screen is nec-

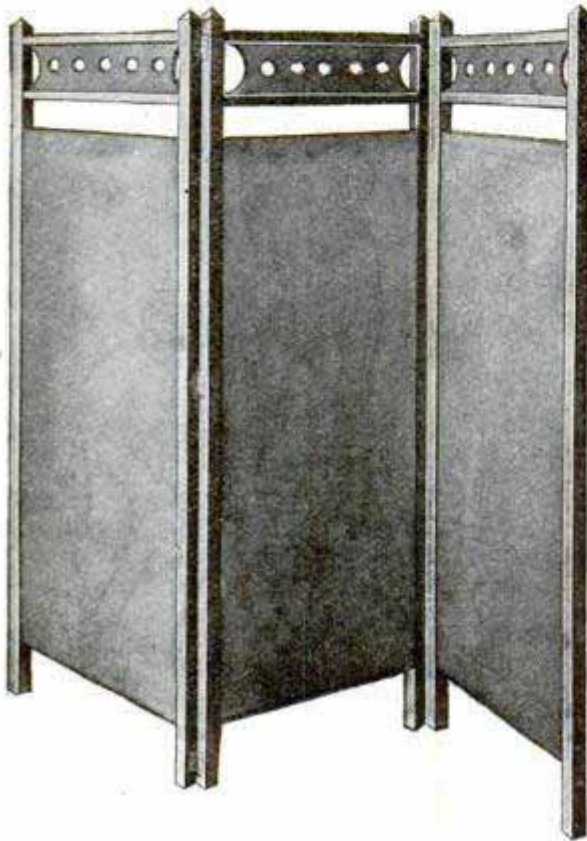

An Easily Made Mission Screen

essary sometimes to add to the appearance of a room. The screen shown in

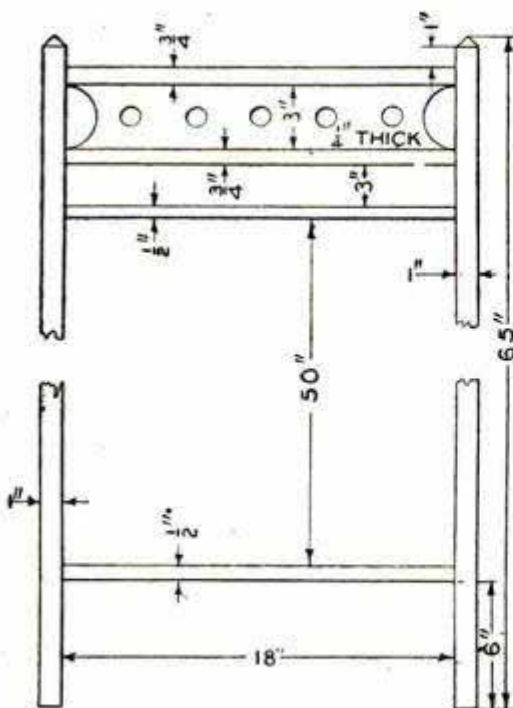

Details of Screen

the accompanying illustration consists of a few parts which are easily put to-

gether. The stock can be bought of any planing mill planed, sanded and cut to the proper lengths. The cloth, which should be of dark color, can be purchased at a dry goods store. The following list of material will be needed:

- 6 posts, 1 in. square by 65 in.
- 6 rails, $\frac{3}{4}$ in. square by 18 in.
- 6 rails, $\frac{1}{2}$ in. square by 18 in.
- 3 panels, $\frac{1}{4}$ by 3 by 18 in.
- 6 yd. of cloth.
- 4 double-acting hinges.
- 2 doz. $2\frac{1}{2}$ -in. slender screws.

Cut or plow a groove $\frac{1}{4}$ in. wide and $\frac{1}{4}$ in. deep in the center of one surface on each of the $\frac{3}{4}$ -in. rails. Cut out the ends with a compass saw. The five holes are bored with a 1-in. bit. The edges of these panels are inserted in the grooves of the $\frac{3}{4}$ -in. rails, using plenty of good glue.

When the glue has dried for at least 24 hours the screen frame can be put together. Holes for the screws should be bored through the posts where the $\frac{3}{4}$ -in. rails are joined and a screw turned into the end grain of each rail.

Scrape off all the surplus glue and sandpaper all the parts well. When this is done the finish can be applied. Any one of the mission stains can be used and finished with wax and polished.

The cloth is cut to length, a hem sewed on each end and one $\frac{1}{2}$ -in. rail put through each hem. Place the top rail in position and screw it fast. Stretch the cloth tight and fasten the lower $\frac{1}{2}$ -in. rail with screws at the bottom. Each section of the screen is finished in the same way.

The hinges are attached about 4 in. from each end of the posts in the same manner as in hanging a door.

SOFT SOAP WATERPROOFS
CONCRETE

The concrete foundation of a large grain elevator and flour warehouse on the bank of the river at Budapest, Hungary, on ground subject to high floods, has been thoroughly waterproofed by the use of soft soap. Instead of using

pure water in mixing the concrete and mortar for the 4-in. outer layer, a solution of soft soap was utilized, the proportion being about 8 lb. of soap per cubic yard of concrete and mortar.

Shortly after the completion of the work, the foundation was subjected to high water pressure and was found to be perfectly watertight, although a similar foundation near by, which had not been so waterproofed, allowed the water to seep through. The waterproofing action of the soft soap is not attributed to any water-repelling quality in soap, as in fat and mineral oils, but through the combining of the free lime of the cement with the potash in the soap, forming an insoluble compound which fills the pores.

BOILER REPAIR BOLT

The domestic boilers used in connection with kitchen ranges or other sources of heat to provide hot water for household use are frequently discarded when a leak develops, because of the difficulty in repairing the weak places caused by interior corrosion. Such leaks cannot be soldered because of the expansion and contraction of the metallic surface when heated and cooled, but the leak may be effectively stopped by means of a special boiler repair bolt, the method of application of which is shown in the illustrations.

The hole through which the water is leaking is first reamed to the proper size and the twin bolts inserted as shown in the first illustration. Then the threaded sections are drawn together and a hard rubber washer placed over the bolt and against the outer shell of the boiler, followed by a steel washer and a cap, the latter being tightly screwed down upon the washers.

MOTOR-DRIVEN LAWN-MOWER

Many lawn-mowers of the large type, have for some time been equipped with gasoline engines as motive power, but

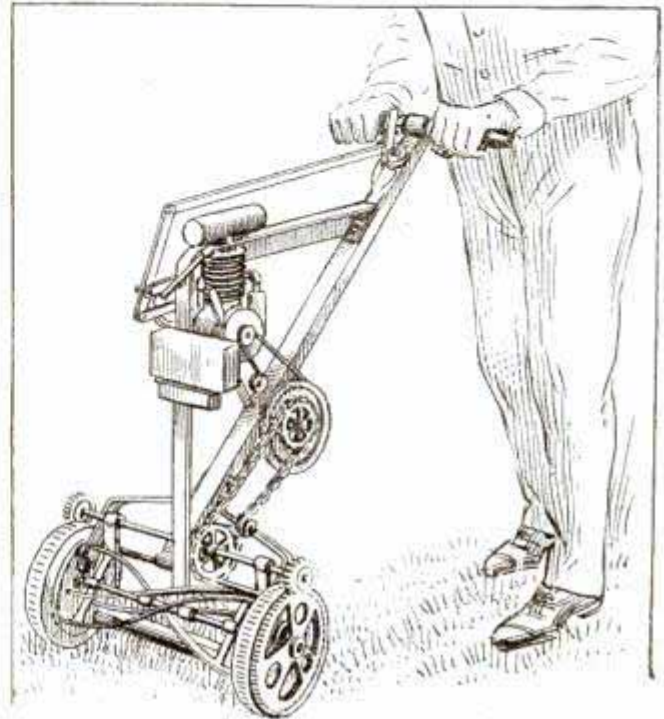

Small Motor-Driven Lawn-Mower

the accompanying illustration shows a gasoline engine-driven lawn-mower of the small type, ordinarily pushed over the lawn by the operator.

The actual mowing machine differs but little from the hand-pushed device, but attached to the handle is a framework bearing a small air-cooled engine, gasoline tank, ignition device, and the gears required for harnessing the power to the mower proper. The weight of the power plant is disposed on the frame in such manner as to be balanced in respect to the center of gravity of the mowing mechanism.

The operator walks behind the machine, grasping the handle in the same manner as if he really had to push it. All that is required of him is to keep it balanced and control the engine.

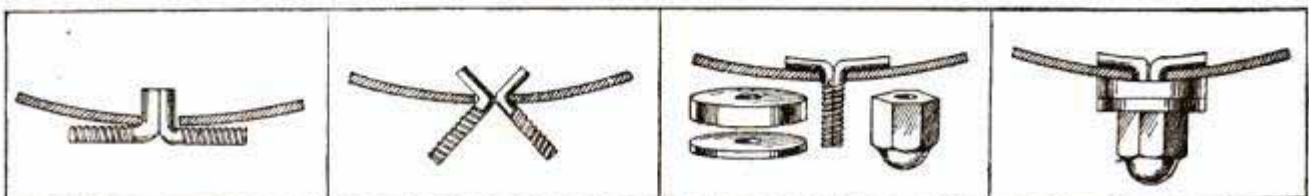

Inserting Twin Bolts in Hole

Turning the Bolts to Position

Ready for the Washers

The Completed Boiler Repair

CORRUGATED PROPELLERS

The corrugations on the driving side of this propeller effectually arrest the

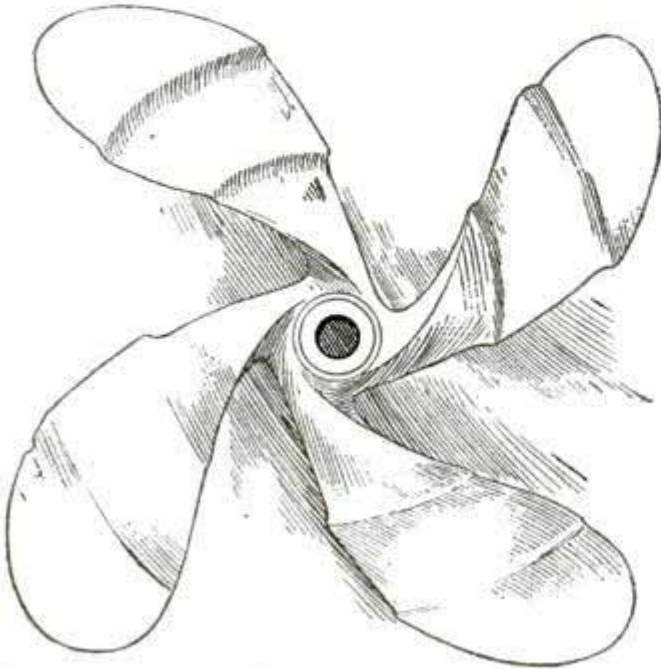

Corrugations Arrest Centrifugal Action of Water Along the Blade

centrifugal action of the water along the blade, thus preventing slip, and increasing the driving power of the machinery without increasing the revolutions or the consumption of coal. The corrugations are part of a true helix which enters the water without the slightest shock.

The corrugated propellers are made in sizes suitable for motorboats as well as for ocean steamships.

MOTOR-DRIVEN BLUEPRINT TRIMMER

A trimming table for blueprints and drawings, equipped with a motor-driven revolving knife which will cut a single

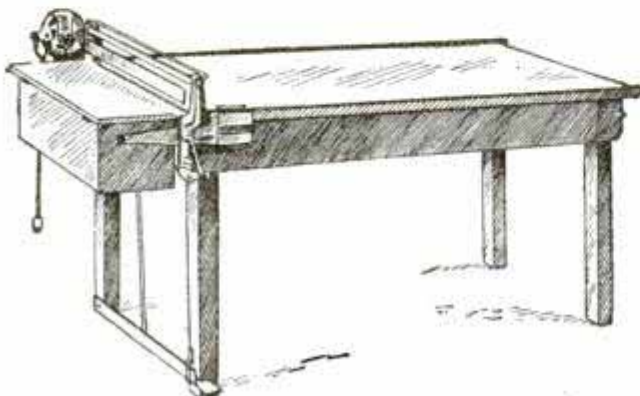

Motor-Driven Paper Cutter

sheet of the thinnest paper or as many as ten sheets at the same time, has been placed on the market by a Chicago firm. The top of the table is laid off in inches, and a sizing diagram gives, at a glance, the size and square foot measurement of any tracing or print.

The paper is held in position for cutting by a clamp operated by a foot treadle. The knife, which works in either direction, is started and stopped at any point by a specially designed wrist-controlled switch. This leaves the hands of the operator free for adjusting the paper.

VOTE CANVASSING IN BOATS

Although several sections of England were very much under water, owing to an unprecedented season of rain, during the weeks when the recent British election campaign was at white

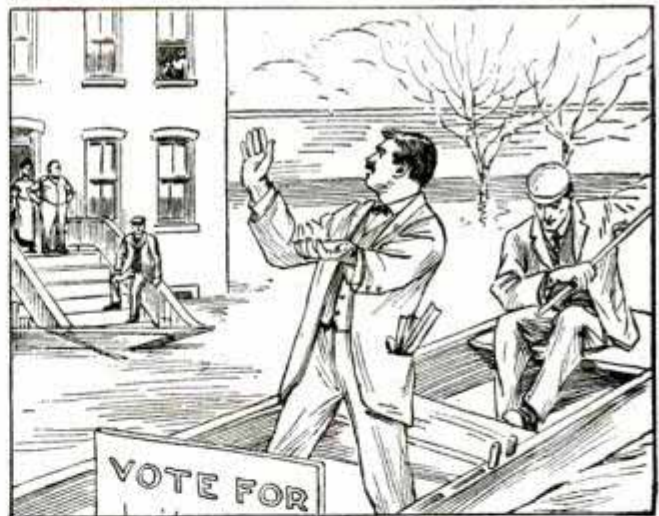

Soliciting Votes in a Flooded District

heat, workers persisted in visiting every voter. In the North Huntingdon division the unionist candidate visited many of the voters' homes in a punt.

TO EXPLOIT THE MINERALS OF THE DEAD SEA

The Dead Sea basin, in Palestine, is likely to become a center of great activity. An important concession has just been granted by the Turkish government to an influential body of

capitalists to exploit the minerals here, a sum of \$350,000 having, it is said, been paid for these rights. It is well known that the fine bitumen and also quantities of sulphur are obtainable here. Then, in Byzantine times, copper mines were worked near the south end of the Dead Sea, both in horizontal galleries and vertical shafts, while the basin is rich in marble, porphyry and other fine classes of stone as well as in phosphates. It often has been stated by American connoisseurs traveling to the Dead Sea that evidences of coal and oil that in America would be unmistakable, are very apparent in this region. Salt is also to be found in great quantities. In many ways this is the strangest body of water on the face of the globe. It is some 47 miles long and 10 miles wide at its greatest breadth, but its surface is no less than 1,300 ft. below sea level. The water contains 23 per cent of solid matter, and is, bulk for bulk, heavier than the human body. Indeed, it is impossible to sink in it, and it is so bitter and salt that fish cannot live in it.

PORTABLE SQUARES FOR CARPENTERS

Any carpenter will appreciate the convenience of folding his square when packing his tool chest to travel from place to place, as the rigid square in common use is an unhandy thing to carry around and is refused by express companies when it protrudes from the box. One of the tools shown was invented by a practical carpenter in California, who solved the problem by cutting a dovetail of 65 deg. and swinging on a solid steel rivet, butting against dovetail shoulders which lock by two hardened, tapered screws. The inventor claims that it serves the purpose of four tools, namely square miter, bevel and try-square, as it sets and locks at any angle. Enough of these folding squares have been in actual use to demonstrate their value to carpenters.

A second form of portable square is also shown. Here the square, instead

of being foldable, is made in two pieces which can be taken apart and packed

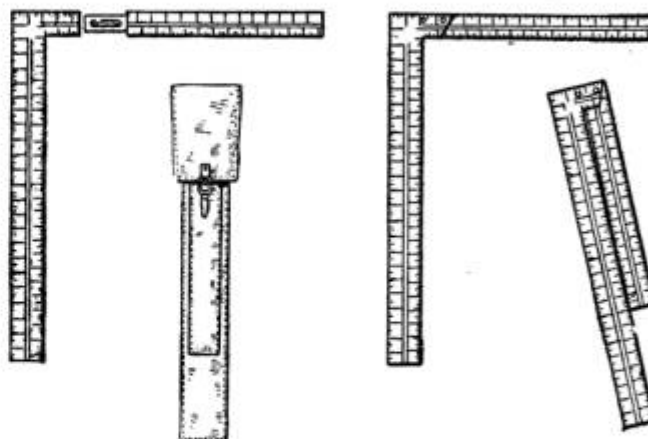

Two Forms of Portable Squares

in a neat little case as shown in the illustration.

POLICE AUTOMOBILE AS BOMB CARRIER

One of the police automobiles of Paris is provided with a specially designed box for the transportation of the bombs often discovered in anarchists' quarters. The box is fixed under the automobile body between the rear

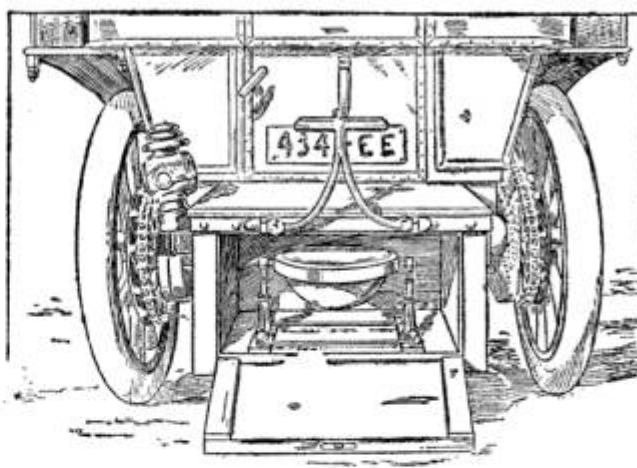

Bomb-Carrying Automobile of the Paris Police

wheels, and contains a bowl, supported by a standard, in which the bombs are placed.

A hydraulic clutch for gasoline automobiles is a device being introduced by an English concern. It is said to enable a gasoline car to start with an ease rivaling that of the steam-driven car.

DRIP CUPS FOR BOTTLES

The soiling of table linen by the drip that runs down the sides of a bottle



Protecting the Table Linen from Drip

after each using can be prevented by means of this drip cup. The cup, which is made of silver plate or nickel, is firmly held to the bottom of the bottle by means of spring clips. The shape of the receptacle is such that a bottle may be completely emptied of its contents without the cup spilling any of the drip it has caught.

A HANDY PULLEY REMOVER

Most motorists and mechanics have experienced, at some time or another, a great difficulty in removing a pulley from its shaft or spindle. The handy device illustrated herewith is designed to fill a long-felt want in this connection.



It can be fitted with different-sized grips for pulleys of various diameters. The same tool may be used for removing cams and other parts, and is usually capable of

handling even the most obdurate of pieces by a few turns of the spanner and the application of a drop or two of oil.

ROLLING DAMS IN MEXICO

Great steel cylinders that are lifted and lowered by means of electric power, are being used to form water-storage reservoirs and to govern the flow for irrigation purposes in the Laguna district of Northern Mexico.

The rolling dams, as these cylindrical structures are called, are attracting much attention among irrigationists of this part of Mexico. They are an interesting and practical novelty, said to be specially valuable in controlling the water supply of the different canal systems. One of the benefits of this type of dam is that of permitting an uninterrupted flow of water through the streams in time of flood. This is done by lifting the cylinders above the flood water, and, when the current has subsided to a point where the danger of overflow is past, lowering them again and conserving the remainder of the flow.

These rolling dams in the Laguna district are of considerable magnitude. The first one to be constructed was on the San Marcos cotton plantation. It comprises two cylinders, each about 60 ft. long and 8 ft. in diameter, strengthened by interior bracing.

The installation of a rolling dam much larger than this is now being made in the great canal upon the plantation of the Sociedad del Tajo de la Trasquila in the Laguna district. This dam will cost approximately \$250,000. It will consist of two cylinders, each 90 ft. long and 12 ft. in diameter. The power equipment will be so arranged as to enable the lifting of these cylinders to a height of 25 ft. to get them out of the high waters when necessary. The electrically operated hoisting equipment is located above the masonry pier in the center of the river or canal, between the two cylinders. Each cylinder is controlled independently of the other.

A NOVEL WATER MOTOR

Floated on Kettle River, Washington, at a point where the stream is but 18 in. deep and flows at a speed of three miles an hour, the ingenious current motor shown herewith continuously pumps an astonishing quantity of water to a height of 20 ft.

The motor is mounted between two floats, forming a catamaran which is anchored at both ends. The mechanism consists of two shafts mounted between the floats forward and aft. At each end and in the middle of the shafts are sprocket wheels over which run endless chains carrying a series

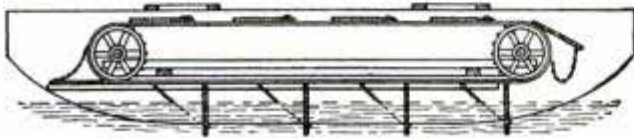

Side Diagram of the Motor

of current boards. These boards are provided with pintles to engage in guides paralleling the floats beneath the horizontal plane of the shafts, thus preventing the sagging of the chains. The boards work free upon their con-

nections with the chains and have their free edges stayed by chains attached

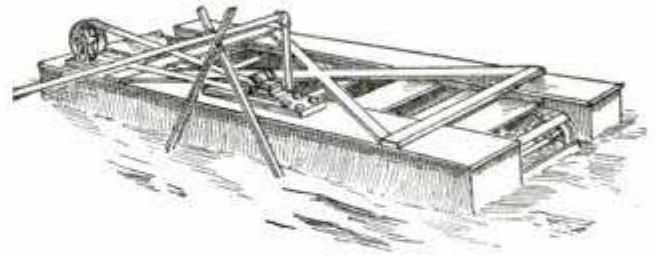

In Operation on Kettle River

to the driving chains. These stay-chains hold the boards in a vertical position when they fall into contact with the current.

The motor is thrown out of operation by feathering the current boards by means of a lever, which throws bolts into the guides. The bolts catch the boards before they fall and hold them in a horizontal position. As the last board engaging the water passes out of the current, the motor stops. Mounted within one of the floats is a pump, belted by means of a pulley to one of the shafts.

EXTENSION RIM FOR AUTO WHEEL

A motor truck, claimed to be perfectly practical as a tractor in plowing and harrowing land as well as for haul-

The wheel rim is cast steel, perforated and filled with 2-in. round hardwood plugs, set diagonally across the face of the rim. The plugs give a good grip for traveling over soft plowed ground or muddy roads. The automatic extension rim is to provide an auxiliary bearing surface for the machine when traveling over very soft ground. Between wrought-iron bars are heavy lugs, 8 in. in width, mounted on pivots. When traveling over soft soil these lugs touch the ground, and the revolution of the wheel causes them

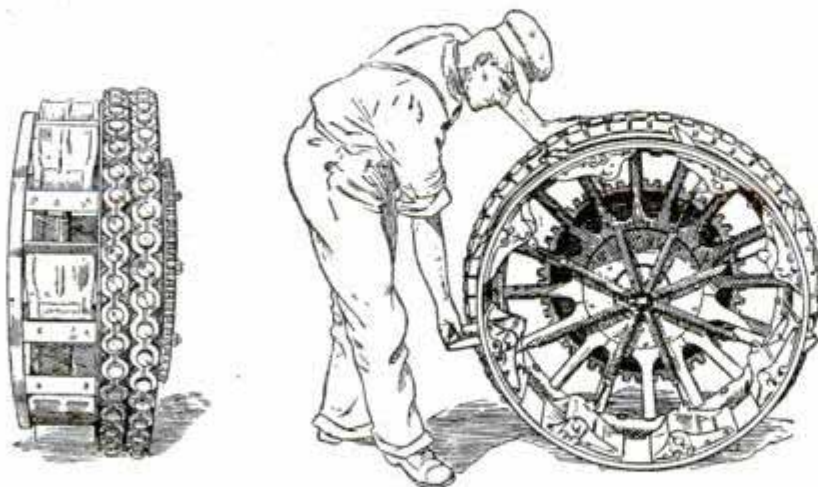

Wood Plug Tires and Expansion Bearing Surface on Wheel of Motor Farm Truck and Extension Rim with One of the Lugs Pulled Out

ing loads over ordinary roads, is equipped with front wheels having wood-plug tires and rear wheels provided with an automatic extension rim.

to be extended vertically, forming a solid bearing surface against which to push. They are drawn back by springs and go out of action when not needed.

WOODEN STEAM BOILERS

Steam boilers made of wood! It sounds incredible, and yet such boilers were formerly made and used. Even as recently as 1817, a steamboat plying between Norwich and New London,

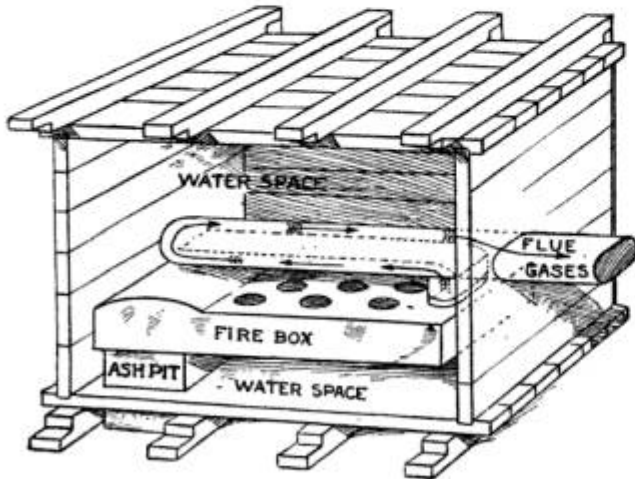

Wooden Boiler Used in Philadelphia 100 Years Ago—Side Open to Show Inside Arrangement

Conn., was equipped with wooden boilers, and the reason that they burst under "extreme" pressure was attributed principally to the fact that they had no "condensers, safety valves, or balance wheels." From 1801 to 1804 there was a wooden boiler in service at the Center Square Water Works, Philadelphia. A partial view of this boiler is shown herewith. The ashpit, fire-box and flues were made of iron, but the inclosing box, in which the water was contained and the steam generated, was of wood. The steam pressure used was very little above that of the atmosphere, but the difficulty of preventing leaks even with this small pressure led to the early abandonment of wood as material for steam boilers.

OLD WALLPAPER A MENACE TO HEALTH

But five of the largest cities in the United States have ordinances preventing the affixing of wallpaper to the walls of any tenement houses unless all the old wallpaper shall have been first removed. Chicago, New York, Philadelphia, Baltimore and Louisville are the cities that boast the existence of such a municipal regulation. In

New York there is a state law to this effect which forms part of the so called "Tenement-House Act." The existence of the law or ordinance is due largely to the efforts of the sanitation experts who believe that disease germs are liable to find refuge behind the old paper. Fire department officials also endorse the ordinance because the removal of old paper will lessen the amount of inflammable material in a building.

LONG-DISTANCE FLIGHT IN FRANCE

The recent flight of Captain Belanger in a Bleriot monoplane from Paris to Pau is accounted a remarkable feat, considering that the temperature was below freezing and that no mishaps of any kind occurred. The flight from Paris to Bordeaux, a distance of 345 miles, was made in 5 hr. 21 min. of actual flight, with two descents, one of an hour and the other of about two hours. The fastest time ever made from Paris to Bordeaux was in an automobile race, the time being 5 hr. 13 min. The flight from Bordeaux to Pau, a distance of 112 miles, was made in 1 hr. 53 min., thus making a flight of 457 miles in 7 hr. 14 min. of actual flying time, which is an average speed of a little over 63 miles an hour.

NEW UMBRELLA SHAPE

Owing to the peculiar construction of this new umbrella, with its flatter



New Umbrella Shape Compared with Old

top and greater circumference, it offers much more protection and comfort

than is usually found in umbrellas of customary shape. It has three more ribs than the umbrella which is shown beside it for comparison.

GREAT IRRIGATION PROJECT IN NEW SOUTH WALES

A great masonry dam for irrigation storage, similar in design and dimensions to the Roosevelt dam in this country, is being constructed on the Murrumbidgee River in New South Wales, Australia. The maximum depth of water behind the dam will be 224 ft. When the dam is full, the main river will be backed up for 40 miles, and two important tributaries to a distance of 24 and 19 miles. The capacity of the reservoir thus formed will be 33,380,000,000 cu. ft.

The estimated cost of the dam is \$3,680,000.

ANTI-SPLASH FAUCET

A faucet that will emit a stream of water which will spread instead of splashing against an object is one that will be appreciated by the careful housewife. The faucet shown here with controls the flow of the water and prevents splattering by means of two small curved ribs cast inside of the spout. This construction has the merit of providing no place for the lodgment of sediment, as is the case with the gauze-wire devices sometimes used in faucets to prevent splash.



BAG-TYING TOOL

The operation of closing bags with a wire tie by means of a specially constructed tool is shown in the accompanying illustrations. The wire tie is looped at both ends, and, when passed around the neck of the bag, these loops are placed over the two hooks at the

end of the tool. The sliding handle is then pulled, this action revolving the

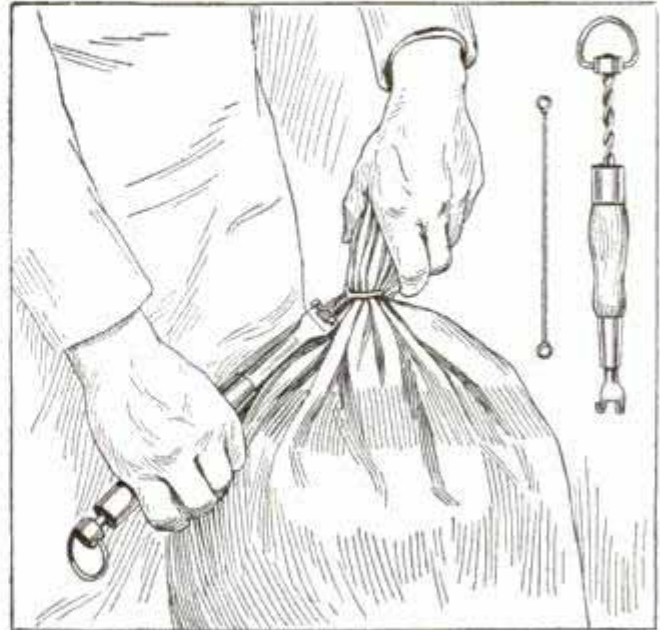

The Wire Tie, After Being Passed Around the Bag and the Loops Placed Over the Hooks, is Twisted by Pulling Out the Sliding Handle

central rod bearing the hooks and twisting the ends of the wire together. Due to the formation of the loops at the end of the wire, which are left separated when the tying is completed, the latter is easily untwisted when the bag is to be opened.

TWELVE MILES OF CONCRETE PIPE

Twelve miles of 36-in. concrete pipe have been constructed down a canyon on the east slope of the Rocky Mountains, in Colorado, to convey water to the hydroelectric power plant of the Eastern Colorado Power Co. The line extends from a concrete masonry dam across a stream 8,000 ft. above sea level to the power house near Boulder, the grade having a fall of approximately 26 ft. to the mile.

The construction of this pipe line was unusually difficult, a large percentage of the excavation being through solid rock. Rocky hills, jutting out here and there into the canyon in such manner as to make the cutting of a trench impracticable, had to be tunneled. Seven tunnels, having a total length of 1,500 ft., had to be pierced through this rock.

NEW TOOTH BRUSH CLEANS INNER SURFACE

A double-ended tooth brush designed especially for cleaning the inner sur-

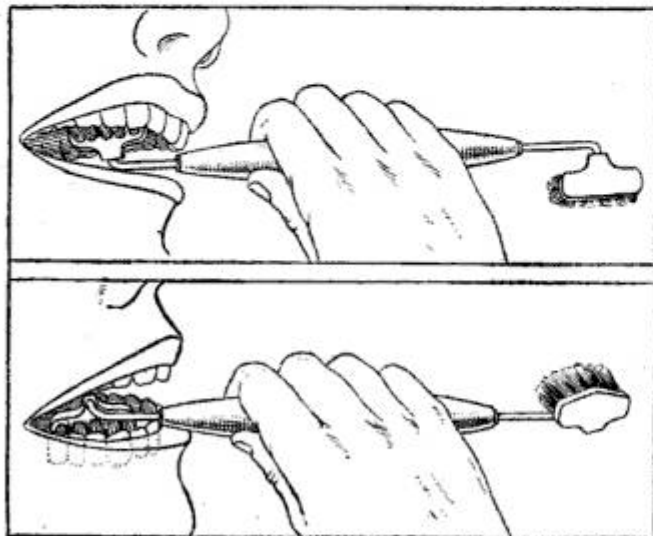

A Brush to Clean Inner Surfaces of the Teeth

face of the teeth is shown in the accompanying illustrations. It was invented by a dentist of Memphis, Tenn., and its shape enables the user to brush the teeth with a rotary motion. The brush on one end is designed to operate on the right side of the lower jaw and on the left side of the upper, the brush on the other end being modeled for the lower left side and the upper right jaw.

THE DWARF GARDENS OF JAPAN

The diminutive size of things Japanese, and especially of the dwarfed trees and gardens, is partly due, according to a Japanese magazine, to the limitations of the land itself. This necessitates the utilization of every foot available for cultivation for the maintenance of the millions of Japanese, and even in towns and villages, the houses are grouped together and seemingly confined to small dimensions for the purpose of yielding to the plow the space they might occupy.

A great affection is therefore felt for the dwarfed tree or plant, the Japanese as a people being lovers, some-

times almost worshipers, of nature. The poorest and meanest habitation in the most densely populated parts of the large cities, without space enough, it would seem, for even the smallest building, will often have a portion of this space, if only 6 ft. square, devoted to a tiny garden, where things are necessarily in miniature.

An available garden space of like size in America would be given over to one lilac bush or a group of sunflowers, and could not be compared in any way with the gardens of more fortunate beings, who have large ground space. Such utilization of a 6-ft. space does not appeal to the Japanese. The garden, though tiny, must have many trees and plants, and usually a lake or brook. Consequently everything must be in miniature. But the dwarfed trees and plants are not confined to such gardens. In the spacious gardens of the Japanese rich they are usually chosen in preference to full-sized trees, as being unique and artistic.

There are two general classes of dwarfed trees and plants, one being the natural, and the other the fantastic. In the former, the exact character of the full-sized tree is preserved, root, trunk and branch, the height not exceeding 2 or 3 ft., and sometimes much under that. The fantastic or conventional class includes umbrella, fan, boat, dragon shapes, etc., and also imitations of the growth of other trees, such as training plum branches to droop like those of the willow, or making a pine grow like a banyan.

BELT-DRIVEN AUTOMOBILES

A belt-driven automobile is being marketed by an English concern of some repute. Changes of speed are effected by pushing the belt from one pair of pulleys to another up or down conical parts which connect the pulleys of different diameters. One merit of this method of speed control is that a change of speed can be made without any sudden jarring.

The Kingdom of Dust

By J. Gordon Ogden, Ph. D.

THIS is the third of a series of articles by Dr. Ogden, who is professor of physics at the Fifth Avenue High School, Pittsburg, Pa. In every home, in every office, in every shop or factory, the fight against Dust is never-ending. Dr. Ogden illuminates this subject in a manner which brings a realization of its infinite importance.

III—Cosmic Dust

FEW of the inhabitants of this old world of ours realize that we are constantly being bombarded from the heavens above and below us. Every 24 hours from ten million to fifteen million shots are fired, each of the projectiles having a velocity far greater than that of a rifle bullet; and this does not include the myriads of projectiles too small to be seen by the naked eye. Luckily for us, we are protected by a sheathing of atmosphere, that is quite effective against these swiftly moving messengers from outer space. Occasionally a mass weighing anywhere from a pound up to a ton or more, slips through, but, for the most part, these projectiles are tiny particles of dust and gas, and their only effect is to produce a brilliant streak of light known to us as a "shooting star." A "shooting star"

is in no sense a star. Were a real star to strike our earth, this planet would vaporize almost instantaneously and all that would be left of us would be an incandescent mass of gas and vapor, just as we once were, billions of years ago.

When a "shooting star" strikes our atmosphere, its energy of motion is transformed into heat, from the friction produced by the air, and the "star" is literally burnt to ashes. These ashes fall upon us in a continual shower, and constitute the greater part of what is commonly known as cosmic dust. Nordenskjold, the Swedish naturalist, by melting several tons of snow in far-off Spitzbergen, found distinct globules of iron in the sediment thus obtained. By the use of a specially constructed dredge, ooze from the bottom of the



Meteorite Pitted by Great Heat Due to Friction with Earth's Atmosphere—Fell from the Sky at Canon Diablo, Colo.

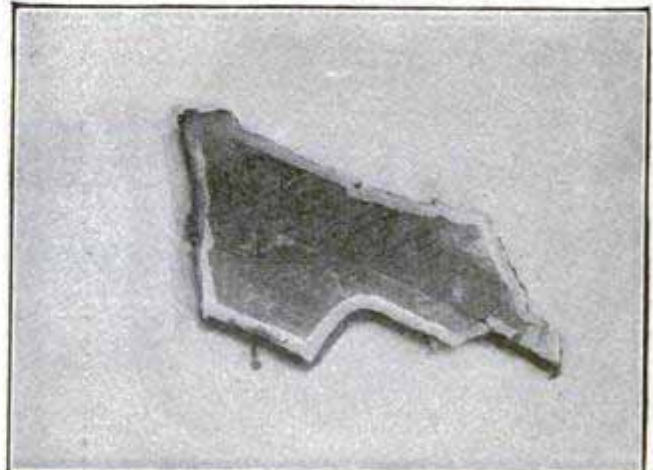

Peculiar Markings on Section of Meteoric Iron, Supposed to Be Messages from Inhabitants of Other Worlds

deepest part of the ocean has been brought up, and part of it is undoubtedly cosmic dust.

It is an extremely difficult matter to determine the chemical composition of these cosmic visitors, but in a few instances, observers have been fortunate enough to analyze their light by means of the spectroscope, and have determined the probable presence of sodium and magnesium. Although the earth is continually receiving additions to its mass in the form of finely divided dust, it would take a long time to gather enough to make any appreciable difference in its weight or its velocity. It has been calculated that it would take at least a thousand million years to accumulate enough dust of this character to make a layer an inch thick all over the surface of the earth. And yet, insignificant as is this small daily accretion of cosmic matter from meteors and shooting stars, it is bound, in time, to bring about important and seemingly wonderful changes in this old globe of ours. For example, this added weight will gradually shorten the year by adding to the mass of the earth, thus increasing the attraction between the earth and the sun; it will diminish the size of the orbit of the earth, adding to its velocity, and will increase the length of the day by increasing the earth's diameter.

However, it is quite unnecessary for us to worry about any possible changes in the calendar, or to take into account the increased length of day, as from all these sources it will take over a million years to make a change of one second in the length of our year.

The meteors which flash through the air and fall upon the earth as meteorites are objects of wonderful interest. How delightfully vague is their origin! What untold billions of miles have they traveled! What wonderful tales could they tell were they able to talk to us about their age-long wanderings! Possibly they were thrown out from our own sun, as no elements have been found in them which are not present in the chief of our solar system. At one time it was suggested that possibly

these strange wanderers from out the infinite night might be messengers projected to us from the inhabitants of other worlds than ours.

A German scientist, Widmanstätten, made a curious discovery relative to meteorites, which at first glance seemed to bear out the dream of those who believed that possibly some meteorites might be messengers from sentient beings somewhere in the vast empyrean. When meteoric irons are etched by a powerful acid, strange figures and designs appear upon the surface. Immediately, the fanciful seized upon these Widmanstätten figures as absolute evidence of an effort on the part of the inhabitants of other worlds to communicate with us.

In 1880, an attempt was made by Dr. Hahn, of Tübingen, to prove the presence of animal life such as crinoids and corals in a certain meteorite, and he also claimed that the Widmanstätten figures are the result of plant life. Scientists generally regard this memoir of Hahn's as an elaborate jest. Widmanstätten figures, as shown in one of the illustrations, are probably due to crystallization resulting from the intense heat to which the meteorite was subjected in its passage through the atmosphere. In other words, the meteorites, siderolites and aerolites that have come to us from afar have not furnished us with a scintilla of evidence of life beyond our earth. It is true that some of the visitors from outer space show the presence of carbon to a marked degree. While carbon is a strong presumptive evidence of life, since it is by plants that carbon is elaborated from gaseous compounds, it has been pointed out that the carbon in meteorites may have been derived from the atmosphere by absorption. Professor Maskelyne has shown in this connection that all carbon compounds in a meteorite may be completely removed without pulverization of the stone, thus bearing out the theory that the carbon was only in the pores of the meteorite, and not an original constituent.

A curious fact concerning the extremes of temperatures to which me-



"Outposts of the Kingdom of Dust"—The Great Nebula in Orion



Spiral Nebula, Billions of Miles in Extent, in the "Great Bear"

eteorites have been subjected may not be uninteresting. A meteorite moving through space beyond the atmosphere receives heat only from the sun and stars, and as the temperature of space is very low, probably near to the absolute zero of temperature, 459 deg. below Fahrenheit zero, these wanderers in space are extremely cold. And yet when they fall upon the earth their outer crust of iron is curiously pitted from the intense heat produced by the friction of the atmosphere. These pittings are undoubtedly due to partial melting. As iron melts at 2800 deg. Fahrenheit, a meteorite passes in a short interval through a range of nearly 3000 deg. Fahrenheit.

The interior of a large meteorite is intensely cold for a considerable time after its fall. One which fell in India in 1860, embedded itself in moist earth, and was found half an hour after its fall coated with solid ice. After a meteor has passed through the atmosphere, very often a train of luminous dust is left which glows sometimes for an hour. Physicists have speculated as to the cause of this luminescence, as it could not possibly be from heat. A similar phenomenon has been observed when certain substances are cooled below the temperature of liquid air. Whatever may be the cause, it is certainly a case of light without heat.

On a clear starlit night, anyone

possessed of good eyesight may see a faint, hazelike cloud of glowing splendor in the girdle of the constellation Andromeda. If Orion is above the horizon, the same phenomenon may be observed in this well-known group of stars. These shining cloudlike forms, far-flung throughout the starry depths, a billion times more delicate than the filmiest lace ever wrought by the hand of woman, are known as nebulae. It was formerly thought that they were stars so remote that no telescope could ever resolve them. It is now known that they are not stars, but are probably made up of extremely rarefied hydrogen, and other gases, containing small particles of solid matter—outposts of the Kingdom of Dust. These nebulae are of different forms, some being lens-shape, others resemble a dumb-bell, while many occupy billions of miles in the form of great winding spirals.

From a study of these nebulae, Laplace, Kant, and Swedenborg evolved the famous nebular hypothesis, a wonderful and stupendous conception, which seeks to account for the origin of such aggregations as our own solar system. Briefly stated, the nebular hypothesis is simply this: that our sun, for example, was once a nebula extending far beyond the present orbit of the uttermost planet Neptune; that a revolving, whirling motion was set up in this nebula, and that the different planet



"Stars Whose Light We Could Not See Through 15 Miles of Ordinary Air at Sea Level, May Readily Be Seen Through Ten Million Miles of a Comet's Tail"
—Daniel's Comet, August, 1907



"A Billion Times More Delicate Than the Finest Lace Ever Wrought by the Hand of Woman"—The Great Nebula in Andromeda, One of the Northern Constellations

masses were set free from the parent mass; that these planet masses in their turn disengaged still smaller masses, which formed the various moons of the solar system; that the sun is all that is left of the original mass of our primal nebula.

There are quite a number of objections to the nebular hypothesis, one being the failure to account for the peculiar distribution of the larger and smaller planets. Professors Moulton and Chamberlain have formulated a very clever and reasonable modification of the nebular theory, known as the planetesimal hypothesis. This hypothesis does away with a number of the inconsistencies of the original theory of Laplace, and is quite favorably regarded by scientists.

Another theory is known as the meteoric hypothesis, or "capture" theory, so strongly advocated by Professor See. This theory claims that the larger masses in the universe attract to themselves the smaller bodies. But, though we know not which theory is nearest to the truth, the fact remains that small particles of matter—world dust in fact—form the primordial stuff of the universe, and that in all probability all the heavenly bodies from the giant suns like Sirius, down to the smallest particle of cosmic dust that constitutes a shooting star, originated in dust—dust so fine, that stars of small magnitude may readily be seen through it.

It is quite probable that cosmic dust,

although it is so fine and so rare, has an important effect in the fact that it obscures to a greater or less extent the light of the more distant stars. We see through a veil of dust, and it is quite likely that the stars whose distance has not been determined are not nearly so far away as they appear.

Arrhenius has estimated that if there are upward of a hundred of particles of cosmic dust to every cubic mile of space, evenly distributed, they would be sufficient to block from our view the most distant stars, and to render the light of those that are nearer much fainter.

Closely allied to meteorites and nebulae are those wonderful and spectacular members of the celestial family known as comets. Sweeping through the heavens with frightful velocity, and occupying such vast areas with their shining tails, it is no wonder that they have been objects of superstitious dread in all ages and climes. There are known to us about 450 of these mysterious cosmic tramps, and all are members of the solar system. Between 35 and 40 of these are termed periodic comets, as their orbits have been calculated and their return may be prophesied with certainty. The others are the waifs and strays of our solar system, and some of them have immensely long periods. The comet of 1811, for example, will not make us a return visit until the year of our Lord 4876.

What is a comet? Simply a mass of

shining dust and gas, with possibly some larger particles of matter as a nucleus or head. As regards a comet's weight, no one has been able to estimate it, for the reason that no comet has as yet been observed to have the slightest pull on any of the planets. Some astronomers claim that an ordinary comet could be crowded into an ordinary hat box, and would weigh only a few pounds, while others claim that millions of tons would be nearer the truth. The matter in a comet is distributed over such tremendous area that its average density is less than the vacuum of an ordinary incandescent electric bulb. That a comet is made up of highly rarefied matter is shown by the fact that

stars, whose light we could not see through 15 miles of ordinary air at sea level, may readily be seen through ten million miles of a comet's tail.

It is quite probable that at certain times our own earth has a cometary tail, extending five or six hundred miles into space. The wonderful Aurora Borealis and the Aurora Australis are supposed to be electrically illuminated particles of gas and dust similar to those observed in the tails of great comets. The earth's comparatively enormous mass prevents the escape of any noteworthy portion of our gaseous envelope, and hence we are unable to rival the smaller bodies in the length of their appendages.

SUCCESSFUL GRAFTING OF COLD-STORAGE SKIN

A piece of skin that had been removed from an injured man in the Samaritan hospital, Philadelphia, and placed in a cold storage room, was taken out of storage five days later and grafted upon the injured arm of a woman patient. The success of this operation shows the possibilities of cold storage in surgery as a preservative of animal matter which is not at the moment required but may prove of value later.

PREHISTORIC ANIMALS IN CEMENT

In striking contrast to the live animals, and furnishing a remarkable object lesson to the student of natural history and evolution, the collection of life-sized cement models of prehistoric reptiles and mammals now nearing completion in the grounds of Carl Hagenbeck's animal park at Hamburg, enable one to review in comprehensive fashion the animal life of millions of years ago. From the best authorities and the finest museums of natural history have been gathered the data to make this seeming fairyland as perfect and trustworthy as possible.

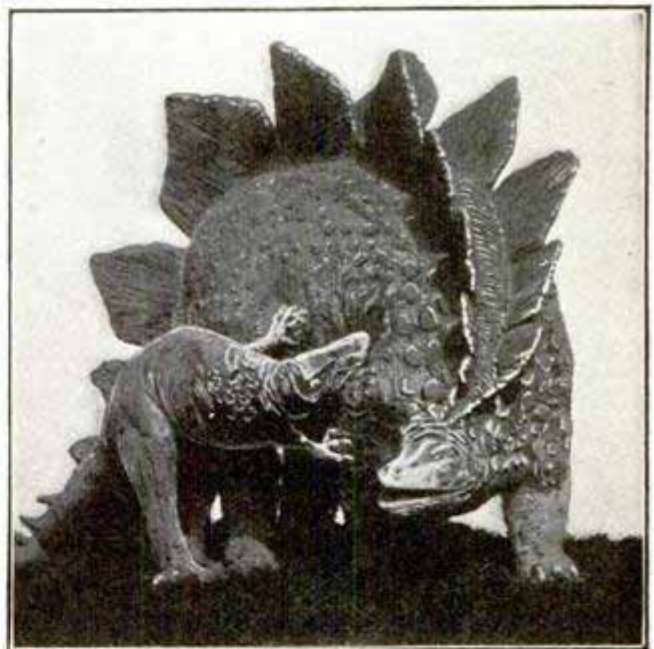

Cement Model of Stegosaurus in Hagenbeck's
Animal Park

Among the specimens represented are the 66½-ft. diplodocus, a herbivorous dinosaur with a long neck and tail and diminutive head; the stegosaurus, another of the dinosaur family, having great bony ridges down its back; the triceratops, a 25-ft. monster with a 7-ft. head having two large horns projecting from above the eyes, a horn on the nose, and a great bony hood over the neck; and the giant sloths, mammoths and flying reptiles with enormous teeth and terrible claws, all now as extinct as the dodo.

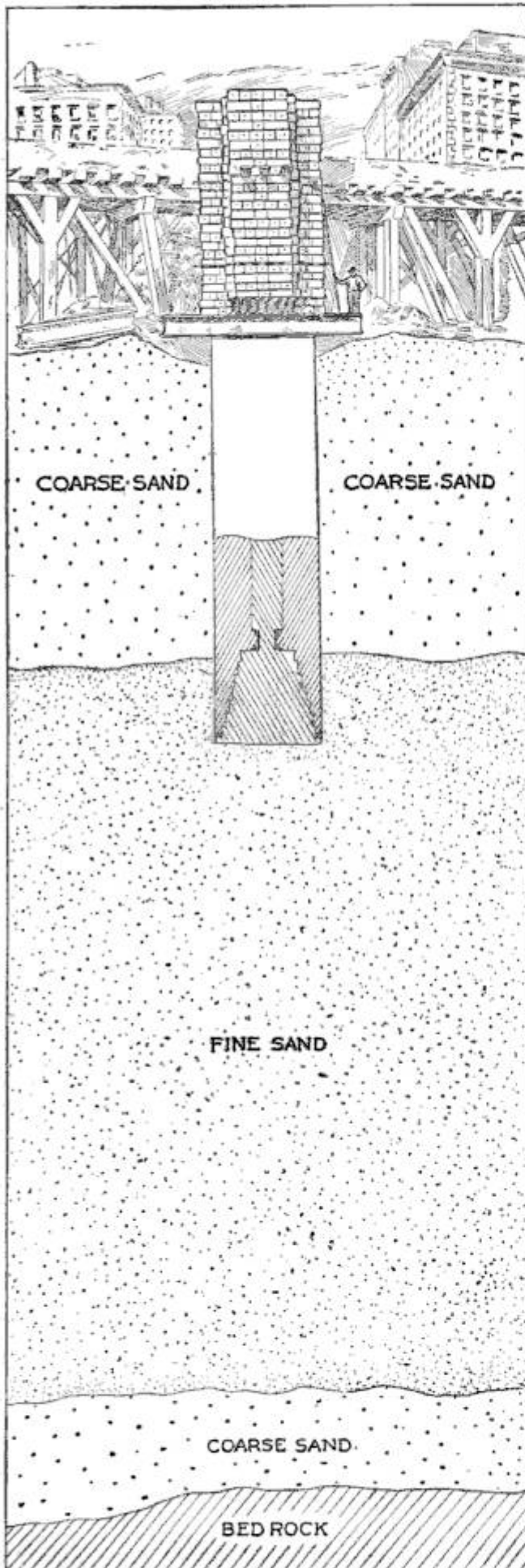

One of the Greatest Tests in the History of Engineering. A Sand-Supported Pier Sinks Less Than One Inch Under Direct Load of 908 Tons

INSURING THE SAFETY OF A 40-STORY SKYSCRAPER

Loaded with a dead weight sufficient to crush a solid cast-iron column $8\frac{3}{4}$ in. in diameter, one of the 106 concrete piers that will support a 40-story skyscraper in New York City settled less than an inch, although resting on a sand foundation. This remarkable test entirely demonstrated the safety of building part of the immense structure on sand, for the test load of 908 tons on the concrete pier exceeded by 66 per cent the maximum load that will ever be put on this particular support, even under the most extreme conditions of wind pressure, and the pier used for the test was purposely chosen as being the weakest link in the chain of piers comprising the foundations of the building.

This 40-story structure, the latest of New York's mammoth skyscrapers, is the municipal building being erected at the Manhattan terminus of the Brooklyn Bridge. The engineers have calculated that a total vertical load of 165,000 tons will have to be supported by the foundations under the most extreme conditions of loading and wind pressure, a force that would absolutely crush a solid cast-iron column of about 10 ft. diameter.

Owing to the fact that a quicksand underlies the site of the building, some extraordinary engineering problems had to be solved in its construction, and these were rendered still more difficult inasmuch as only 68 of the 106 concrete piers could be sunk by the pneumatic caisson process to reach the solid rock. The others had to bear on sand, and this was the reason for making a direct bearing test on the most unfavorably situated of the remaining 38 piers, to make sure that they would support and transmit through the sand to the underlying rock the load of 6 tons per square foot they have to bear. The rock-supported piers carry 15 tons per square foot.

The test was extended over a period of 24 days, the load being added gradually for 17 days and left in position for

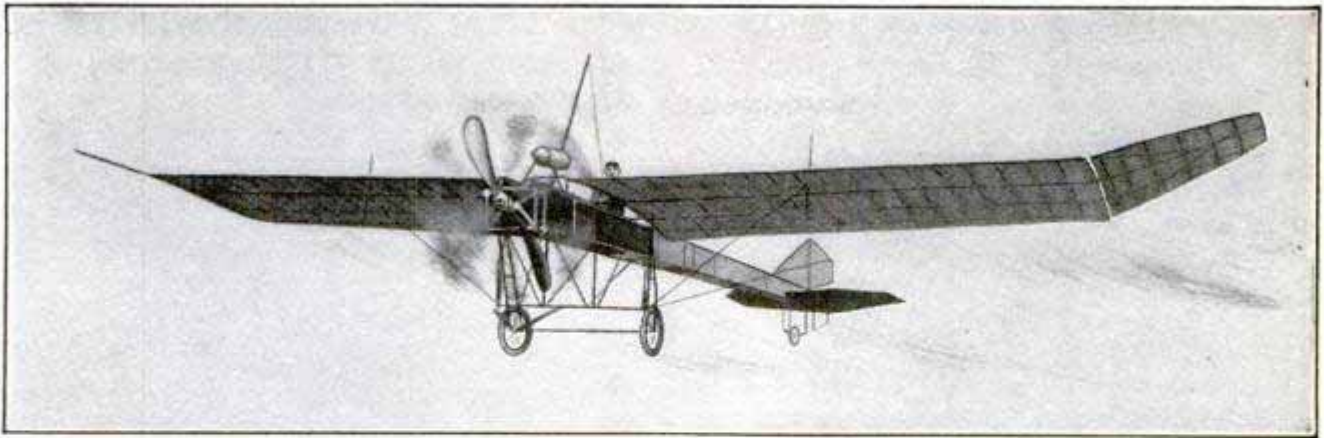

A French Aeroplane without Horizontal Rudder

a week before being removed. The pier tested is 10 ft. 9 in. in diameter and 34 ft. 5 in. deep. A grillage of two tiers of 24-in. I-beams was laid over a bed of 3-in. plank placed on top of the pier, so as to form a cross measuring 15 ft. by 20 ft. in extreme dimensions. On this were placed the loading blocks of cast-iron, weighing about 3,500 lb. each.

NEW MONOPLANE HAS NO HORIZONTAL RUDDER

The new Lefevre monoplane, which has recently undergone its first trials and shown remarkable stability, is a radical departure in aeroplane construction, in that horizontal rudders usually affixed in front of or behind the supporting planes are entirely done away with. The vertical steering is accomplished by changing the angle of incidence of the main planes, the operation being accomplished in a manner similar to that of turning the front wheels of an automobile.

One noteworthy improvement in this machine is that, no matter what inclination it is given by the operator, the angle formed by the tail planes and main wings always has its apex downward, thus maintaining the longitudinal stability at all times. In descending, the curve described by the aeroplane tends to flatten instead of becoming more abrupt, the latter being a frequent cause of fatal accident.

The lateral stability is not obtained by warping the wings, but by means of the "ailerons," which are the hinged

ends of the main supporting wings. The weight of the machine, with the operator, fuel and oil, is 1,100 lb.

FULFILLING CONDITION OF ANCIENT BEQUEST

By an ancient bequest of Thomas Glanville, whose body rests in the graveyard of the quaint old parish church of Wooden Hatch, near Dorking, Eng., seven boys are awarded \$10 each every year, if they can successfully recite the Lord's Prayer, the Ten Commandments and the Apostles' Creed while standing with their hands on the tomb.



Seven Boys Reciting Lord's Prayer, Ten Commandments and the Apostles' Creed to Secure \$10 a Year

HOPPING FOR HUSBANDS

This huge pillar, bearing an iron man on its top, is associated with a curious

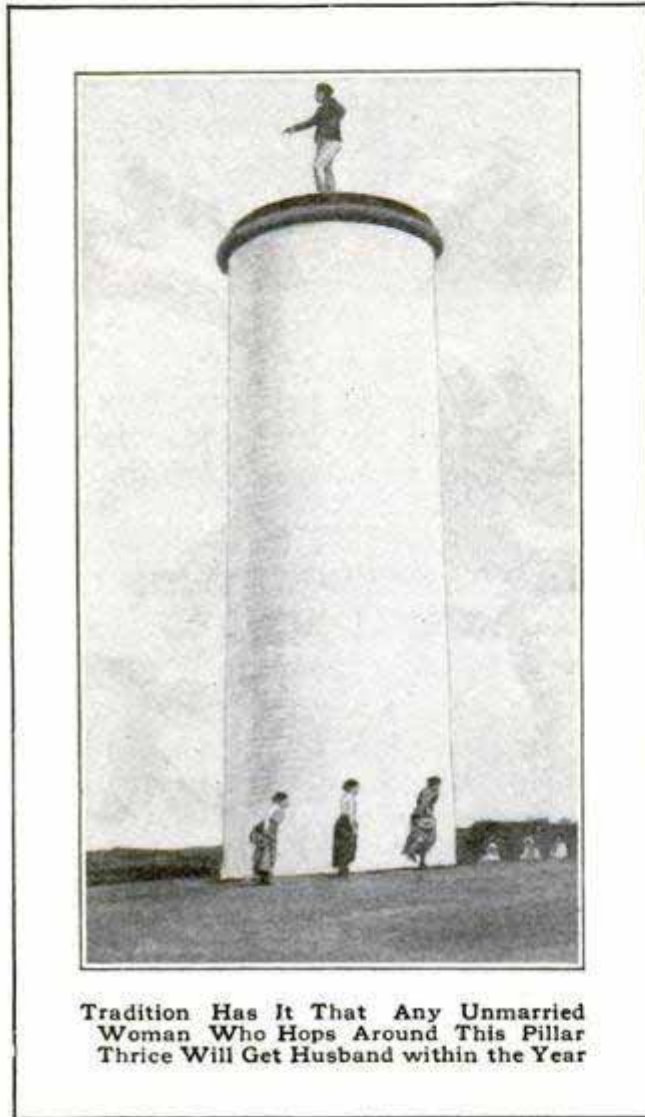

superstition that any unmarried woman succeeding in hopping around it three times will get a husband within the year, and many visitors test the value of the legend. The pillar is a few miles out of Waterford, Ireland, and was erected to enable vessels to distinguish between Tramore Bay and Waterford Harbor.

A GIGANTIC LIGHT BUOY

At the mouth of the river Gironde, about 60 miles from Bordeaux, France, will be placed what is said to be the largest light buoy in the world. Its cylindrical main body has a diameter of 3.1 meters (10.7 ft.) and is 6.5 meters (21.32 ft.) high with a capacity of 45 cubic meters (about 1,600 cu. ft.). Be-

sides being the float, the body also serves as a reservoir for the illuminating gas, which is confined under 85 lb. pressure. The anchoring chains are attached to a bridle, pivoted at the middle of this cylinder, which is weighted with 26 tons of ballast to prevent capsizing. The mast has a diameter of 0.98 meter (3 $\frac{1}{4}$ ft.), is 6 meters (19.7 ft.) high, and supports at its upper end a platform on which the lighting apparatus is installed. This is reached through an outside iron ladder and a trapdoor.

ALLIGATOR FURNITURE

One of the oddest sets of furniture in the world is made from the hides, heads and feet of alligators. The upholstered chair is covered with the beautiful checkered skin and two young alligators apparently climbing up the back of the chair meet face to face at the top. The legs are covered with skin from the tail, which has a ridge of hard protuberances, and these have a decorative effect which is quite unique. The table is even more striking, as it has four natural looking alligator heads, one grinning from each corner. A footstool of the same unusual material completes the set, which is owned by a man in Los Angeles, who raises the big saurians for the market. It is valued at \$500 and is said to have required the hides of 16 of his pets.



Chair and Table Finished with Alligator Hide



The Skeleton of a Locomotive in the Foreground Was Driven from a Position between the Other Locomotives by an Explosion That Killed Nine Men

A TERRIFIC LOCOMOTIVE EXPLOSION

One of the most terrific locomotive explosions ever recorded occurred recently on the turntable in the yards of the Missouri, Kansas & Texas Railroad at Smithville, Texas, instantly killing nine men and injuring 11.

The locomotive had just come from the shop, where it had practically been rebuilt, and was standing on the turntable among other locomotives. It is believed that the explosion was due to the fact that the pipe leading to the steam gauge was corroded and clogged up. The gauge only recorded 145 lb. of steam, while the actual head is believed to have been between 600 and 800 lb. The safety valve, which was being adjusted by a machinist when the explosion occurred, was screwed down as far as it would go.

The force of the explosion was tremendous. The machinist was torn to

pieces, part of the body being blown over the roundhouse and falling 600 ft. distant. Three legs were picked up with this body, while another body, with neither arms nor legs, was blown

700 ft. in another direction, falling in the yard of a residence. The locomotive was skidded over the ground a distance of 75 ft., in the condition shown in one of the illustrations, and the tender was blown back into the pit of the turntable. A piece of the fire-box, weighing not less than 800 lb.,

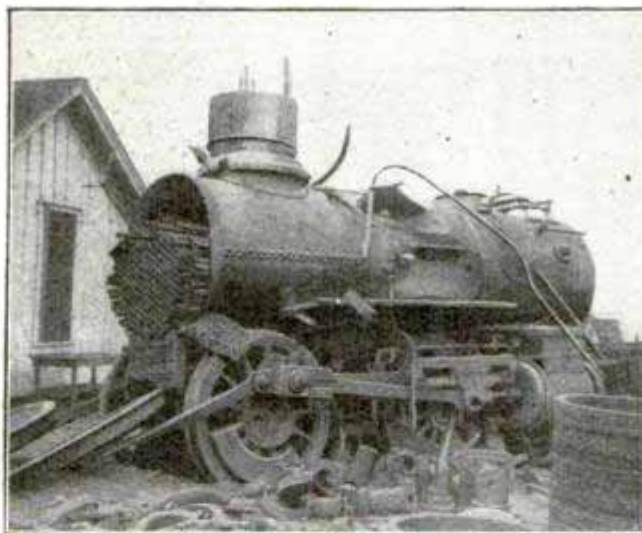

Near View of the Locomotive Which Exploded and Was Blown 75 Ft. The Drivers Were Stripped from the Axles But Held by the Side Rods

was hurled over the house tops and fell in an alley in the business section of the town, about 750 ft. distant. Another piece of about the same size fell in a street 900 ft. distant in the opposite direction. The locomotives standing on either side of the ill-fated engine were badly wrecked, one of them being moved bodily sidewise and dropped into the turntable pit.

BIG IRON ORE BEDS HOLD A BILLION TONS

With the prospect of finding beneath the surface beds of iron ore estimated to contain a billion tons, mining experts are conducting a series of pumping operations in the comparatively new Baraboo district of Wisconsin. Mining has been carried on to a more or less greater extent in this district for some time past, according to *The Iron Age*, but the discovery of the large deposits of ore is of comparatively recent date. The Baraboo district lies in the southern part of Wisconsin and includes parts of Sauk and Columbia counties. It is 25 miles long and has a width of 2 miles at the eastern end which widens to 10 or 12 miles at the western and central portions. The area of the district is approximately 225 square miles and the chief rock exposures are a dense vitreous quartzite. This seems to form a canoe shaped body, the greatest depth of which from

the surface is estimated at 2,000 ft. Iron was discovered in the district 12 years ago after persistent investigations that were undertaken on the abandonment of the region by one company organized to extract the ore. The ore bed was effectually masked by a heavy bed of sandstone which is believed to account for the failure of previous operators to locate the ore. Several companies were formed and began operations. The ore taken out was found to have 55 per cent iron, dried, and about .045 per cent phosphorus. Operations by large corporations were then undertaken, one of them securing control of lands believed to contain more than 400,000,000 tons of ore, 80,000,000 tons of which is believed to be of the 55 per cent grade, and some 200,000,000 tons averaging 40 to 50 per cent, with the remainder better than 30 to 35 per cent. The ore as it stands in the ground is not especially wet, but in taking it out it becomes a pasty mass.

WASTE WOULD LIGHT HOUSE WITH ELECTRICITY

The average householder throws away each day enough garbage to light his house with electricity. From figures given by an English authority, it can be shown that if the garbage were destroyed in a refuse destructor and used to raise steam, there would be enough electricity generated to light six 16-cp. carbon-filament lamps continuously for three hours a day. If the more efficient tungsten lamps were employed, the equivalent of six 40-cp. lamps could be used for three hours a day.

England has seriously taken up this question of generating electricity from household refuse. Already there are in that country about 80 electric plants using this form of fuel, and they are increasing at the rate of 20 a year. The ashes from these plants are being used in the manufacture of concrete, paving bricks, etc., the profits from which go a long way toward paying for the cost of making the electricity.

RADISH PEEL A SENSITIVE DETECTOR FOR ACIDS

Every schoolboy learning chemistry knows that litmus paper turns red when put in an acid, and blue when immersed in an alkaline solution. Litmus, turmeric, methyl orange and other preparations are thus used for detecting the presence of an acid or an alkali. A German chemist has recently discovered that the extract of the peel of red radishes in alcohol is more sensitive than any of these detectors.

☞ Experiments show that butter loses by evaporation about one per cent of its weight, during shipment and storage, in 7 days.

☞ The third international aeronautical exhibition will be held in Paris sometime during the months of November and December this year, in the Grand Palais des Champs-Élysées, where it was also held last year.

THE GREAT BRONZE DOORS OF A CHURCH IN FAIRHAVEN, MASS.

The great bronze doors for the main entrance of the church and associate buildings given to the Unitarian Society of Fairhaven, Mass., by the late Henry H. Rogers, is one of the finest examples of the architectural and sculptural treatment of doors in America. The design is based upon English Gothic of the last or perpendicular phase. The doors measure 14 ft. in height by 8 ft. in width, and each leaf, with the exception of the statuettes, was cast in one piece, the whole weighing 4½ tons.

The central feature on the outside is a figure of Christ in the act of benediction, set in a niche and sheltered by a canopy of intricate design, bearing four angelic heralds proclaiming the gospel message to the four quarters of the world. The central figure is flanked on either side by three of the apostles, six on the outer face, the other six being placed in corresponding positions on the inner face of the doors. Judas is not included, however, St. Paul appearing in his place.

Forming a frame around the doors on both the exterior and interior is a series of canopied niches filled on the exterior with figures representing great characters in the history of Christianity. The period from the beginning of the Christian era to the reformation is represented by great men of the Catholic church, while great reformers, members of the various Protestant bodies, represent the post-reformation period. The figures include Saints Clement of Rome, Mark the Evangelist, Luke,

Ignatius, Justin the Apologist, Athanasius the Great, Cyprian, Cyril of Jerusalem, Ambrose, John Chrysostom, Jerome, Paulinus of Nola, Augustine,

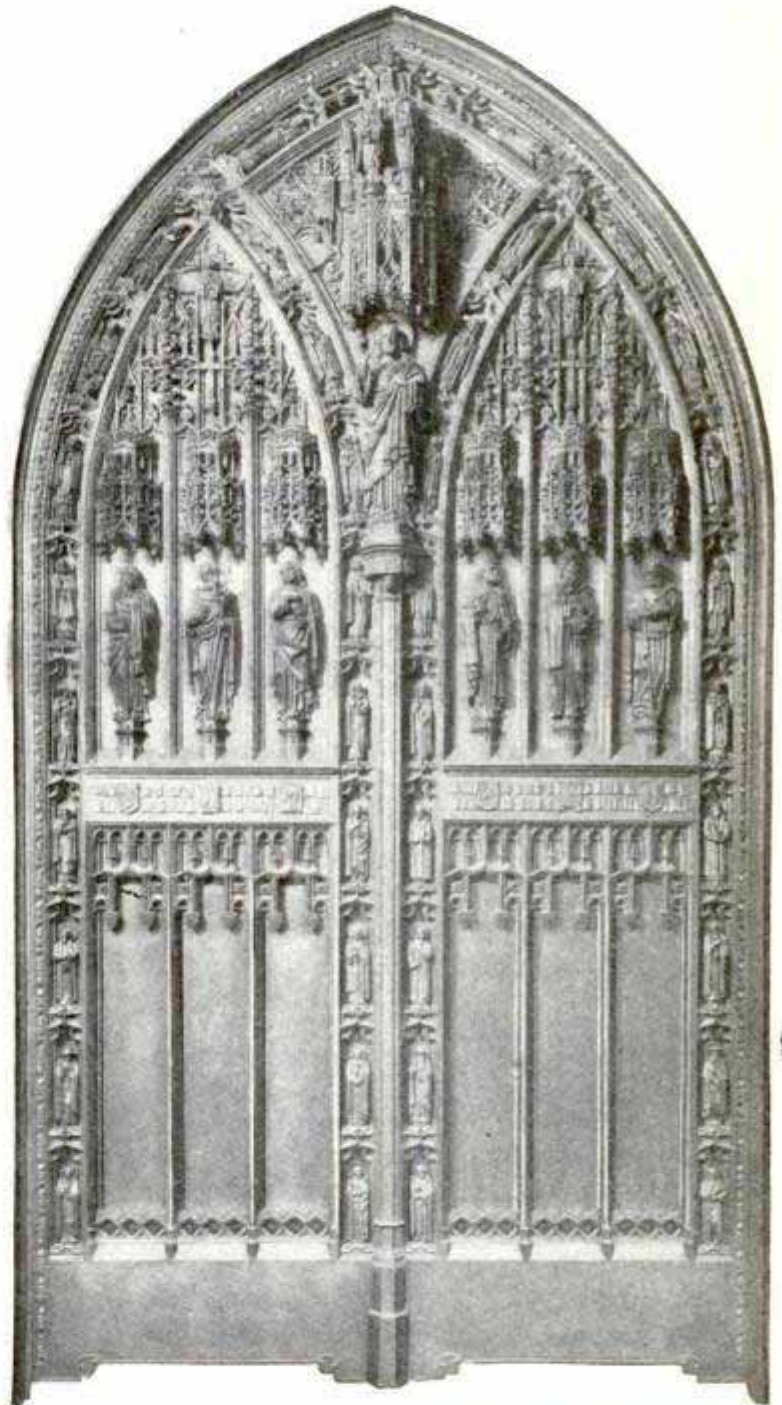

Copyright by Jno. Williams, Inc.

Beautiful Bronze Doors Which Weigh 4½ Tons

Leo the Great, Gregory the Great, Augustine of Canterbury, Bernard of Clairvaux, Bede the Venerable, and

Francis of Assisi; King Alfred, Thomas a Kempis, Savonarola, Wycliffe, Servitus, Melanchthon, Luther,

Calvin, Swedenborg, Latimer, Bunyan, Baxter, Williams, Wesley, Fox, Knox, Priestly, Parker, and Channing.

MACHINE MAKES MODEL FOR EVERY SHOE

This machine is used in France in making shoes to order. A plaster cast is made from a customer's foot or an

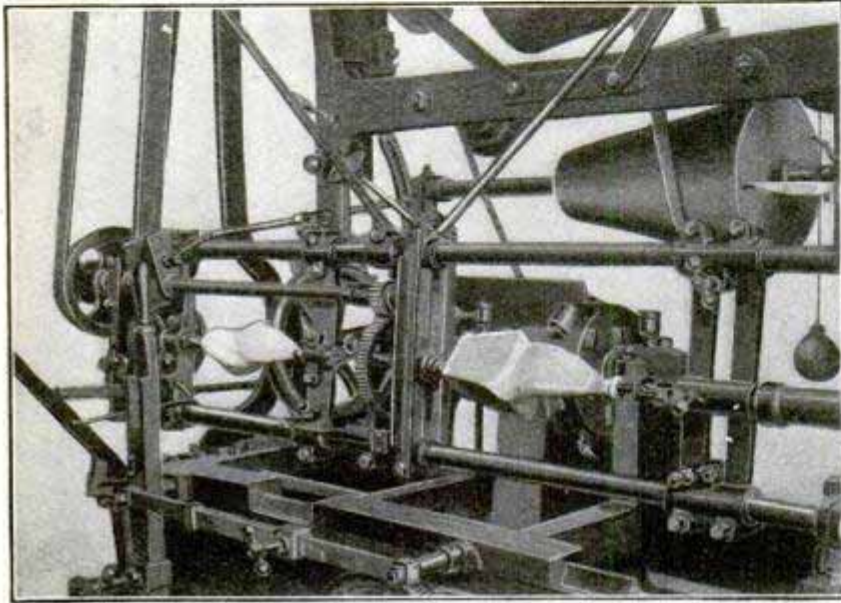

Making Forms for Shoes in Paris Shop

old shoe and placed between centers in the left side of the machine. The right-hand side of the machine then cuts out a wooden form or last according to the plaster model.

TELEPHONE POLES MADE OF OLD STEEL RAILS

A novel use has been found for old steel rails in building the telephone line along the railroad in the Isthmus of Panama. Set upright in concrete bases, these rails have been found excellent for use as telephone poles, and many of them are now doing duty in a climate where the ordinary wooden poles would be impracticable on account of the ravages of tropical insects. The concrete prevents rusting at the base, and provides such a good support as to render unnecessary the use of bracing or guy wires.

AUTOMOBILE MAINTENANCE FOR FIXED SUM

A new departure in the problem of automobile cost and upkeep has been introduced by an automobile manufacturer. This firm guarantees to maintain its cars for one, two or three years for a sum of from \$1,100 a year, this payment to include the services of a chauffeur, tire insurance and all expenses connected with the keeping and running of the car.

The same concern has another scheme for the upkeep of its cars. For a sum which is not to exceed \$25 the first year, \$37.50 the second year, \$50 the third year, and so on, it guarantees to execute all repairs due to

fair wear and tear without any further obligation on the part of the owner.

WORLD'S LARGEST FAN VENTILATES MINE

It has been well said that the "heart" of a modern coal mine is the fan that furnishes pure air to the grimy workers underground, making it possible for them to continue their labors. Without this, the subterranean workings would become chambers of horror and death. Every mine in the United States has its ventilating system, but none has such a huge fan wheel as the great works of a company in Washington county, Pennsylvania. It is 35 ft. in diameter and 6 ft. wide.

It supplies oxygen to 5,000 miners. And it is very necessary that it work continuously; that it lose not a single "beat" of its mighty steel heart, for

just as the man of weak heart cannot do the work of one with a strong, normal heart, so the mine with inadequate ventilation cannot be expected to produce the amount of coal that a properly ventilated mine can.

This fan is made of heavy steel plates, none lighter than $\frac{1}{4}$ in., some being 1 in. in thickness. It is supported by two heavy "spiders" borne by portions of the shaft nearest the bearings. For driving the fan two specially constructed engines were installed, each one capable of operating the fan to its full capacity. An ingenious arrangement of friction clutches makes it possible to keep the wheel running continuously, one engine caring for the load while the other is being repaired. Much valuable time is saved by a mechanism in each engine room which applies and releases these clutches with ease and safety while the fan is revolving. While the fan oper-

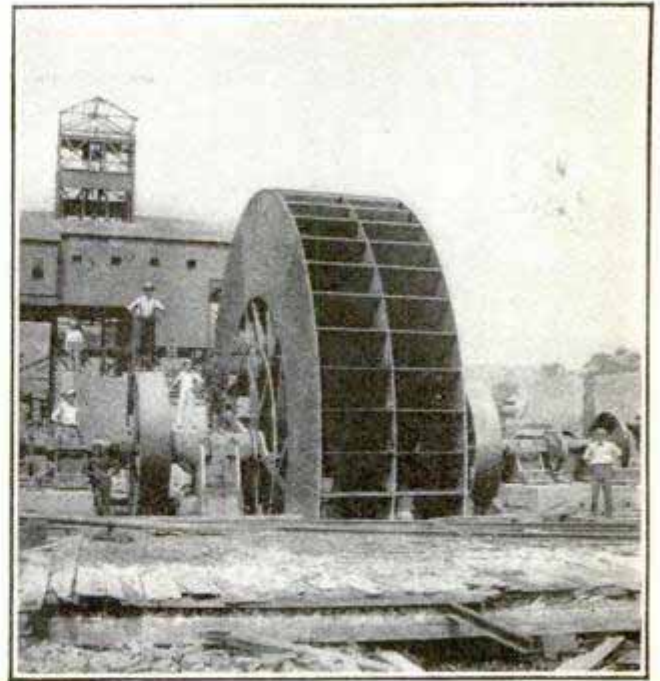

Huge Ventilating Fan for a Coal Mine

ates as a blower, it is also provided with exhaust stack and reversing doors by which the ventilation may be reversed quickly and with ease.

MAKING MOVING PICTURES WITHIN THE ARCTIC CIRCLE

By W. T. PROSSER

Moving pictures have been made of many strange peoples and strange scenes, but only recently has life within the Arctic Circle, with its interesting tribes and animals, been successfully reproduced upon the gelatine films. The moving-picture expeditions sent above the temperate zone have had to face almost unsurmountable difficulties, and in the main the results have been discouraging.

A photographer who had spent many years in the Arctic regions, however, became interested in moving-picture photography, and, aided by his experiences under the difficult Arctic conditions, has met with success where so many before him failed. Two winters and a summer were spent by him in quest of scenes and events that would faithfully portray the northern Alaskan inhabitants. The result is nearly five miles of films, in which the natives may be seen in domestic scenes, hunt-

ing, at their sports, and in their religious observances.

A walrus hunt is one of the most remarkable features of the pictures. Some 900 ft. of film show a walrus herd estimated to number 100,000. They form a great black mass out in Bering Sea when the camera is first turned upon them, then successive pictures show them making their way slowly toward the shore. At the first crackle of the rifle they lift their heads out of the water and cock them to one side in curiosity. They sink beneath the surface when the bullets hit true, then the natives are seen quickly throwing harpoons and hauling them to the shore or attaching them to buoys while the hunt proceeds.

Not the least interesting series are those of the dog teams, indispensable beasts of haulage in the Arctic regions. The finest teams in all the North are gathered every winter at Nome to



Some of the 30,000 Reindeer Posing for the Moving-Picture Machine

start in the 210-mile race to Candle City. The eyes of all the North, from the great Treadwell mine in Southeastern Alaska, to bleak Point Barrow, are upon this event, and thousands of dollars in virgin gold are wagered on the event. The films show how the impatient dogs are harnessed, strain-

ing to be off; how the leader pulls and tugs, the signal and the start, with the snow flying in every direction, and the excited throng cheering.

The reindeer herds, which, imported from Siberia about nine years ago, are said to have increased from 700 to 30,000, are also shown. No one can



Stripping the Walrus Hides after the Hunt



Native Walrus Hunters with Trophies

tell exactly what a reindeer will do, and this relationship to the mule is suggested by their poses in some of the series.

From an ethnological point of view the moving pictures taken in the Arctic are of great value, for they will preserve animated scenes of the na-

tive life, which, before many years have passed, may lose its picturesqueness. Simple-minded as children, the natives bestow a blind faith upon Providence, and frequently fail to provide for the dark season. Hunting often proves poor and the tribes are in destitute circumstances.

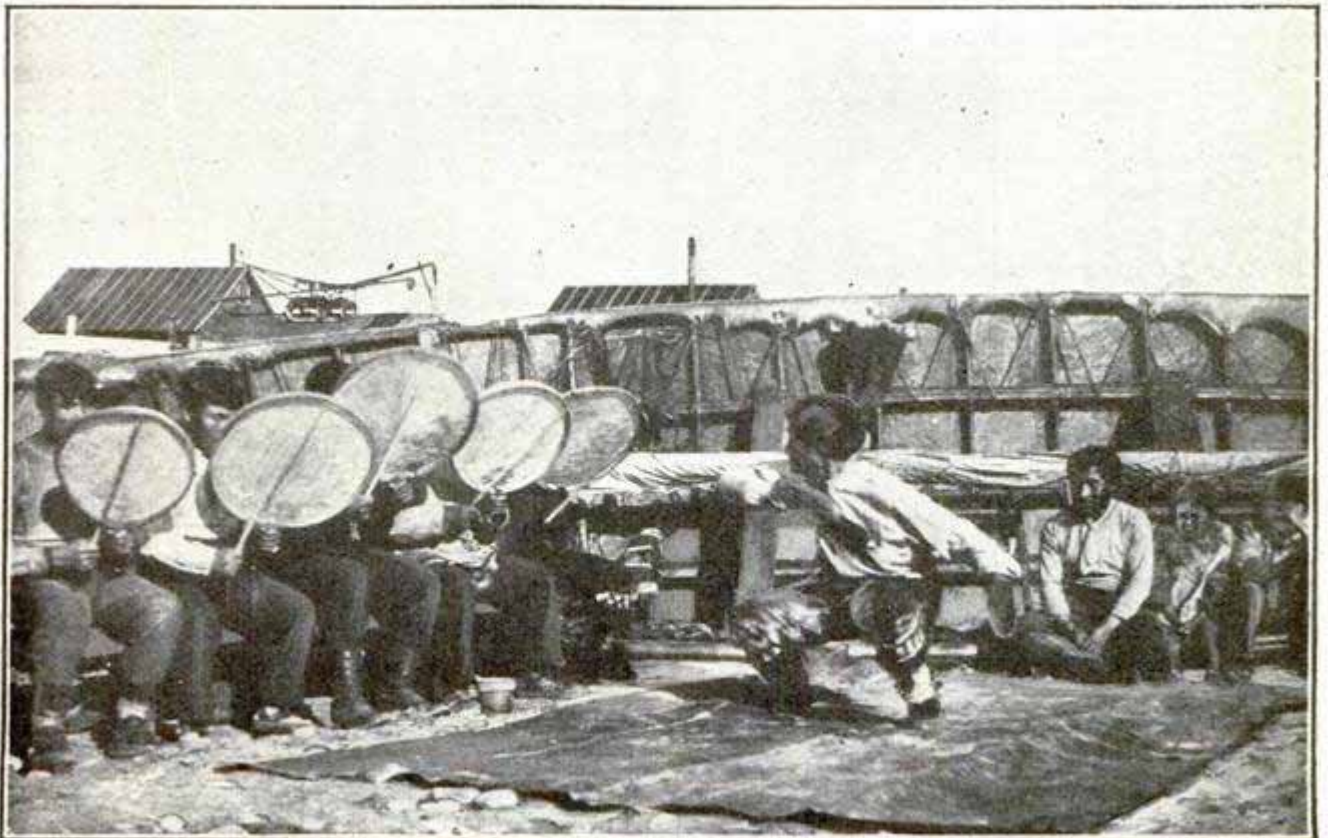

Celebrating a Successful Hunt by the Seal Dance

ACETYLENE FLARES FOR AIRMEN

The drowning of Cecil Grace in crossing from the Continent to England, led Ogilvie, an English airman,

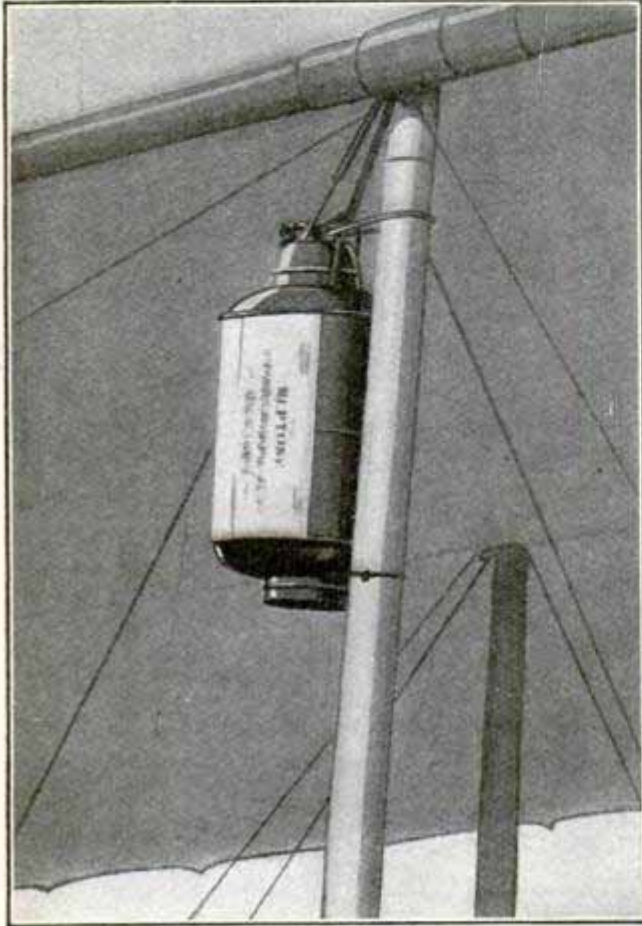

Acetylene Flare Which Bursts into Flame When Aeroplane Drops into Water

to attach to his machine a patent flare, which bursts into a brilliant flame when it comes in contact with water. It was carried by him when competing for the \$20,000 prize offered by Baron de Forest for the longest flight across the English Channel and into the Continent.

The flare is of the type used on life-buoys as an automatic rescue signal.

ANCIENTS KNEW MICROBES AS CONTAGION BEARERS

That knowledge of microbes as carriers of contagious diseases is not entirely modern is borne out by the fact that in 1657, when the plague ravaged Rome, Athanasius Kircher, a Jesuit father, propounded the hypothe-

sis that the plague was caused by infinitely small animated bodies. In 1720, a French physician, embracing this theory, declared that these animated bodies were as small in proportion to a mite as is a mite compared with the size of an elephant.

GOVERNMENT GUARANTEE OF ANTIQUÉ FURNITURE

Under the new tariff, the matter of admitting old furniture free of duty hall-marks it in a manner totally unexpected by sellers and buyers of antiques. The tariff provides that if furniture is found to possess artistic value and be more than 100 years old, it is entitled to free admission, and this provision means that the admission free of duty constitutes a guarantee of genuineness which is of great value to the owner.

According to the government appraiser, the government demands the most positive proof of genuineness, and has experts to pass upon every object that comes in, not being satisfied with just the declarations of the owners. Much antique furniture has undergone repairs, consequently part of a piece may be old and part new. But antique furniture must be altogether old, not a combination of old wood and new wood made to look old, or it will not pass the sharp, expert examination and be admitted free.

NEW "ENGINEERING" PROFESSIONS

A paper recently started in Cleveland, Ohio, under the name of "Human Engineering" draws attention to a new profession called into being by conditions in the industrial world. This profession bears the same name as its publication and seemingly has to do with the human side of industry and the conservation of human energy. In the same way, ethical "uplift" work is often designated as "manhood engineering," and climbing in society as "social engineering."



This Carnation Produces White, Pink, Rose and Deep Crimson Carnations All on the Same Bush

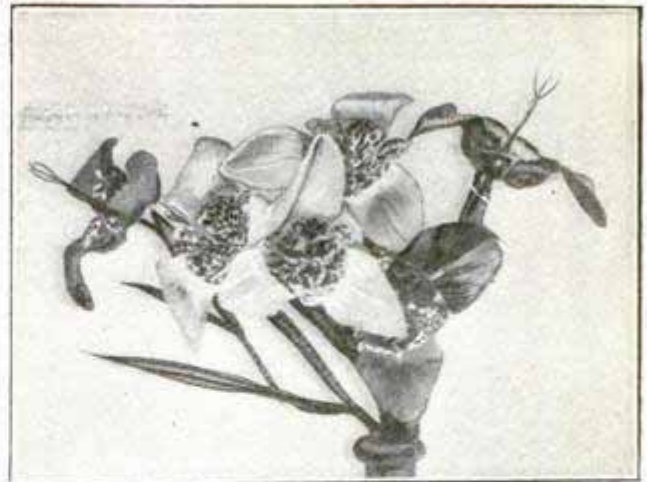

Another Amazing Creation: Hybrid Trigidia, Greatly Improved in Size and Color

SOME STRANGE FLOWER CREATIONS

To produce white, pink, rose and deep crimson carnations all on the same bush at the same time affords perhaps the most unique demonstration yet given of the mutability of plant life when subjected to the process of creating a variation from the normal type through a scientific selection of the preceding generations of plants, and this is the unusual recent accomplishment of Luther Burbank.

At his experiment farms at Sebastopol and Santa Rosa, Cal., Mr. Burbank is constantly working out the evolution of new and commercially valuable fruits, grains and vegetables, and of new varieties of flowers through his selection from thousands of plants of those which depart from the normal type, or which show most strongly the characteristics which he desires to reproduce and make permanent.

One of his most promising developments is the Shasta daisy plant which



New Shasta Daisy Having Wonderful Blooming Qualities, Bearing About 400 Blossoms

bears more than 400 blossoms. The length of bloom has been greatly extended and the plant is probably the most remarkable daisy in the world.

Among other creations of his is a chestnut tree which bears its second crop of nuts at only 18 months from the seed. Mr. Burbank's earlier creations are well known. He is often called a "wizard," but this

term gives a wrong conception as to his methods. His plants are not produced in an instant but through years and generations of plant life.

⌈The members of the Amalgamated Joiners and Carpenters of Great Britain have agreed not to use bicycles during working hours, fearing that their employers will begin to consider the bicycle as a necessary part of the workman's kit which the workman must furnish himself.

"AEROPLANE" MERRY-GO-ROUND

A curious merry-go-round, made to whirl by means of aeroplane wings waved by the riders, was one of the

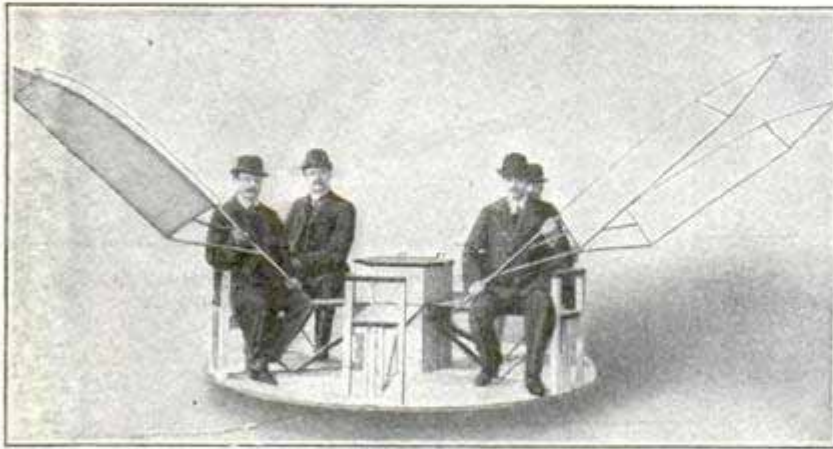

Merry-Go-Round Revolved by Means of Man-Operated Wings

amusement devices at a recent theatrical exhibition in Berlin. The wings are waved slowly in a uniform direction until the merry-go-round starts to turn, after which it is easy to make it revolve at considerable speed by waving the wings rapidly.

CATCHING WHALES IN NETS IN NEW ZEALAND

The idea of catching whales with nets sounds preposterous, yet this is actually done every year by the Maori whalers in New Zealand. Between Solander Rock and the mainland is a channel through which a large number of sperm whales pass at a certain time each year. A special net formed of small cables instead of twine is set across the channel, and the whalers sit down and wait for the inevitable to happen. The whales swim into the net, become entangled in the huge meshes and flounder about until killed with lances.

Experts of the U. S. Geological Survey have calculated that in one year 2,428,313 lb. of arsenic is recovered as a by-product of smelting in the United States.

TELESCOPE SPECTACLES FOR EXTREME NEARSIGHTEDNESS



German Telescope Spectacles in Use, and Different Parts

Unique telescopic spectacles are being made at Jena, Germany, for use in cases of extreme nearsightedness. Each side comprises a large converging lens in front and a smaller diverging lens near the eye, the curvature of the two being such that, when the wearer looks at an object in direct line, the vision will not be marred by distortion or perceptible color effects.

Although the metal mounts are made as light as possible, the spectacles, which have no claim to inconspicuousness, weigh from one-half to three-fourths of an ounce. Tests of the spectacles show that those of small magnifying power are much to be preferred in the majority of cases. The spectacles most recommended increase the size of the retinal image about 30 per cent as compared with the natural image.

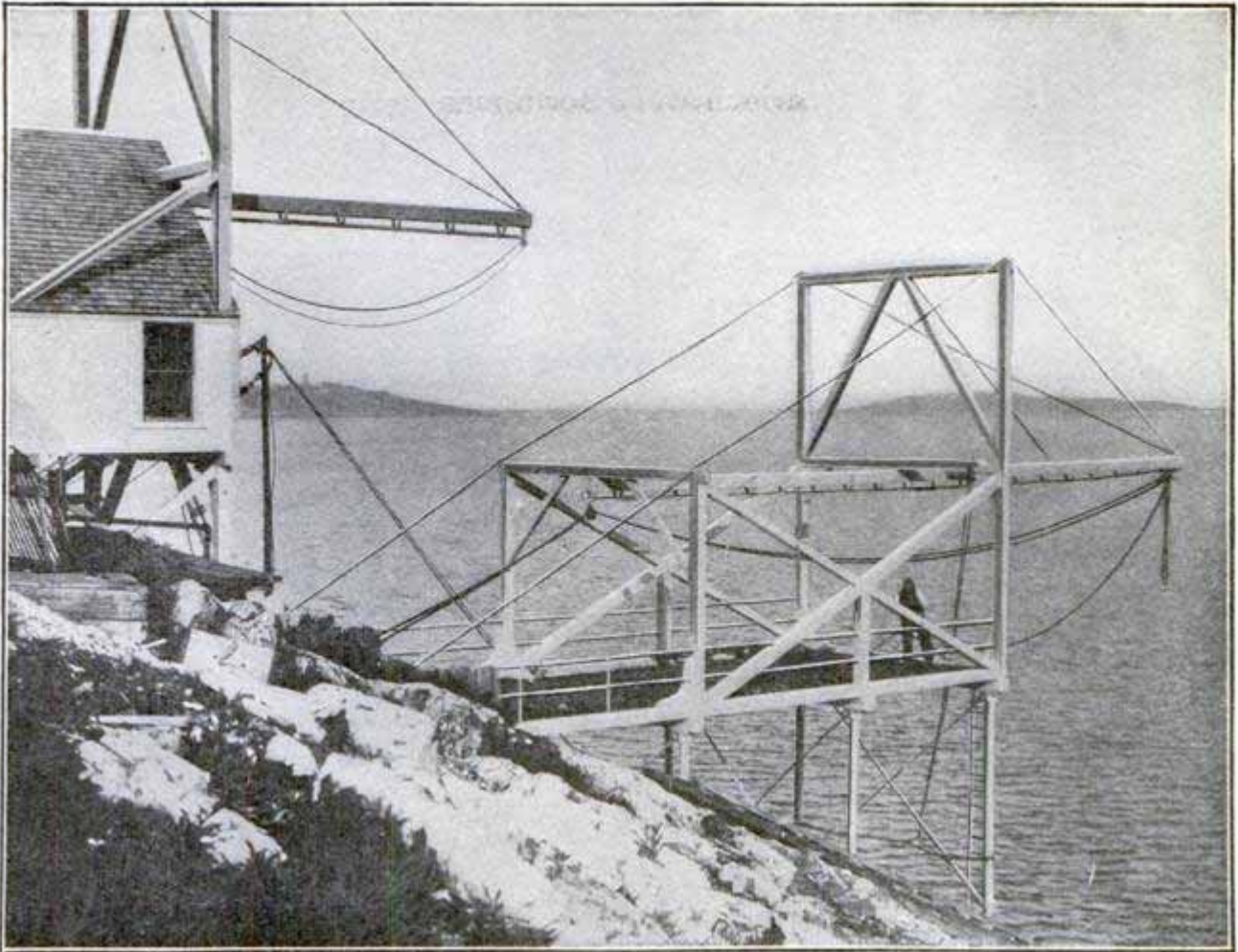

Method Adopted by a Massachusetts Light-Keeper to Land His Boat, Relaying It to House by Two Booms with Tackle

UNIQUE LANDING DEVICES AT LIGHTHOUSE

A curious arrangement is in use at Egg Rock Light, in Lynn Harbor, by the lighthouse keeper to enable boats to land on the island and keep up communication with the mainland. Frequently the water is so rough that boats, whether large or small, would be dashed to pieces on the rocky shores of the island. So the keeper has rigged a landing, built high on steel pipes sunk into the rock below the surface for several feet. This landing is rigged with a tackle and fall, hitched to the end of a frame, extending out over the water beyond the end of the landing platform. A pulley runs along a sort of trolley track and after the boat is hitched to the tackle, it is hauled up out of the water. It is then swung in over the platform and run, by means of the pulley and track, in to dry land. It can then be hooked to another tackle and hoisted still further inshore. If neces-

sary it can be run in to the house near the landing, kept for this purpose as well as for the storage of supplies, or, if the boathouse is already full, it can be stowed beneath the house, on a plank platform built for it. In this way, the light keeper is able to receive visitors and to receive supplies from the mainland. Otherwise he would be cut off from human companionship most of the time.

Recent experiments in Germany proved that drainage waters do not remove any more plant food from fertilized soils than they take away from unfertilized soils.

One of the most up-to-date factories in the world has recently been established in France by a Chinese. The majority of the workmen, also, are Chinese.

THE DUTCH GAME OF "KOLF"

The Dutch game of "Kolf," said to be fully as ancient as golf, which was



"Kolf," a Game of the Netherlands, is a First Cousin to the Familiar Game of Golf

first played in Scotland, is similar to golf in many respects. A quaint book of poems published in Amsterdam in 1719 contains an illustration of the game played in the open, but for at least 100 years it has been played in a court instead of on an open course. Instead of the ball being dropped into holes, the endeavor is to drive it against posts, with the least number of strokes.

GOLD-COATED CONTAINERS FOR FOOD

The cost of gold-plating metallic food containers is ordinarily prohibitive, but a process having the same effect has been discovered which may prove a rival to enameling. An iron vessel is treated with gold amalgam and the mercury is driven off by heat, thus leaving a coating which has the appearance of gold and also its powers of resisting the corrosive action of acids. Two ounces of gold will cover a ton of iron made into utensils.

SINGS AT HIS OWN FUNERAL

Although it is obviously impossible for a man to sing personally at his own funeral, the voice of William Henry Faxon, preserved by phonograph records, sang during the funeral rites over his body in the Methodist church of Ovid, Mich. The records were made two years ago when Mr. Faxon, who had been a church steward about 70 years, was 88 years old. The songs reproduced by the phonograph were: "What is Life," "All the Way," "Rock of Ages," and "I am a Pilgrim."

GUARDING PRISONERS FROM PUBLIC GAZE

When a patrol wagon, called a prison van in England, arrives at a police station in London with a load, screens are stretched across the sidewalk from the entrance to the curbing to protect the prisoners from the gaze of the curious public.

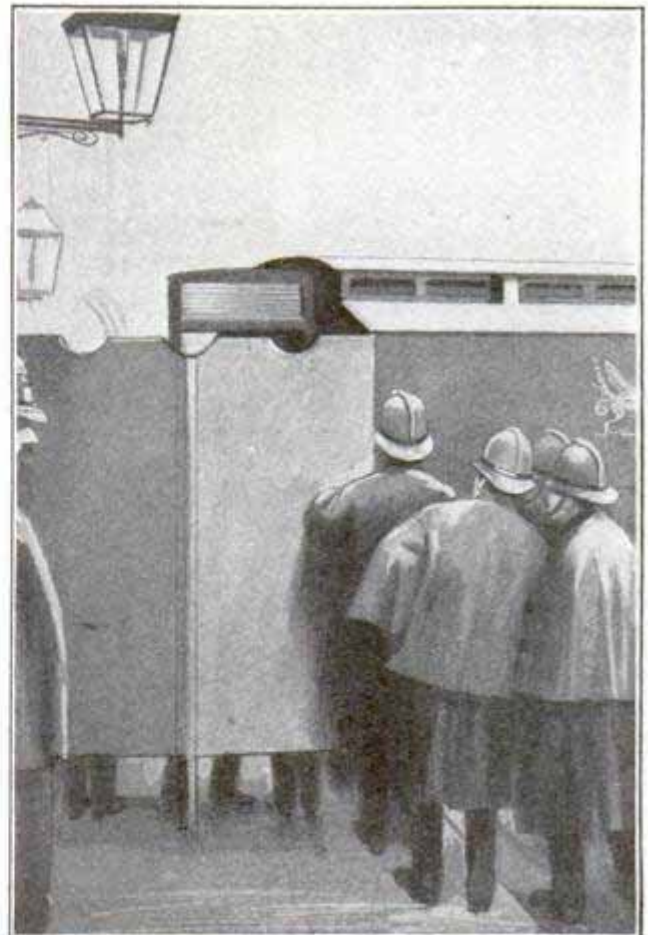

Screens Protect Prisoners from Gaze of Inquisitive Public in England

SAWDUST CONCRETE USED IN LIBRARY

Sawdust concrete was used in the construction of the new library building at Springfield, Massachusetts, as a base on which to lay the cork carpet covering the floors, the object being to obtain a foundation into which nails could be driven and in which the nails would hold. After several experiments, it was found that one part cement, two parts sand, and $\frac{3}{4}$ of a part sawdust would give the desired result. The thickness of the layer was 1 in., and 5,000 sq. ft. were covered.

NEW SWIMMING APPARATUS

The swimming apparatus designed by a German swimming master is both for trained swimmers and those ignorant of the art. When out of use, this apparatus is readily carried in the pocket. It consists of two oblong air cushions, each subdivided into five compartments which are connected together by transversal straps. Before putting on the apparatus, which consists of thin caoutchouc lined with a dense fabric, it is inflated through a valve, within a few seconds, by a few strong breaths.

Being arranged on both sides of the body, the apparatus leaves the head



Novel Swimming Apparatus Which Does Not Interfere with Movements

and neck perfectly free, thus doing away with any pendulating motions characteristic of most salvage apparatus. The person equipped with the apparatus moves about in the water with remarkable safety and stability. A special advantage of the apparatus is its allowing the swimmer at will to take up a vertical or horizontal position, thus enabling him to remain in the water for hours without fatigue.

IMPROVED TYPE OF SELF-DISCHARGING CAR

Fifty self-discharging hopper cars of a new design are now being used on the Buenos Ayres Western Railway

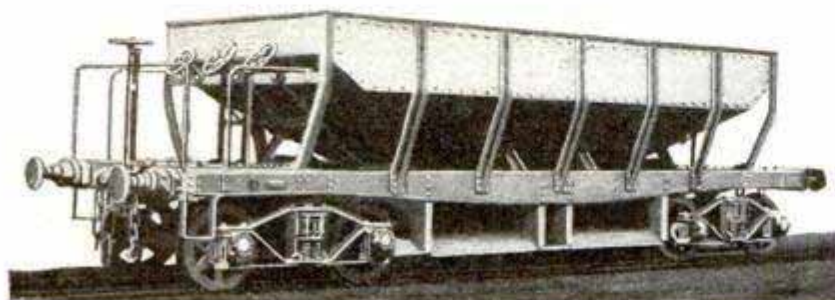

Self-Discharging Ballast Car Especially Designed for Railroad System in the Argentine Republic

for the handling of ballast. The arrangement of the discharging mechanism is such that the distribution of the load may be regulated to a nicety at whatever speed the car is running. Each set of doors can be opened, regulated and closed independently of the others, so that the load can be discharged in the center, at one side or the other, or in the three directions simultaneously. The operating of the doors is entirely under the control of one man, standing on the platform of the car.

ELECTROLYTIC CORROSION OF METAL IN CONCRETE

When concrete has steel imbedded in it under such conditions that stray electric currents pass through the steel and

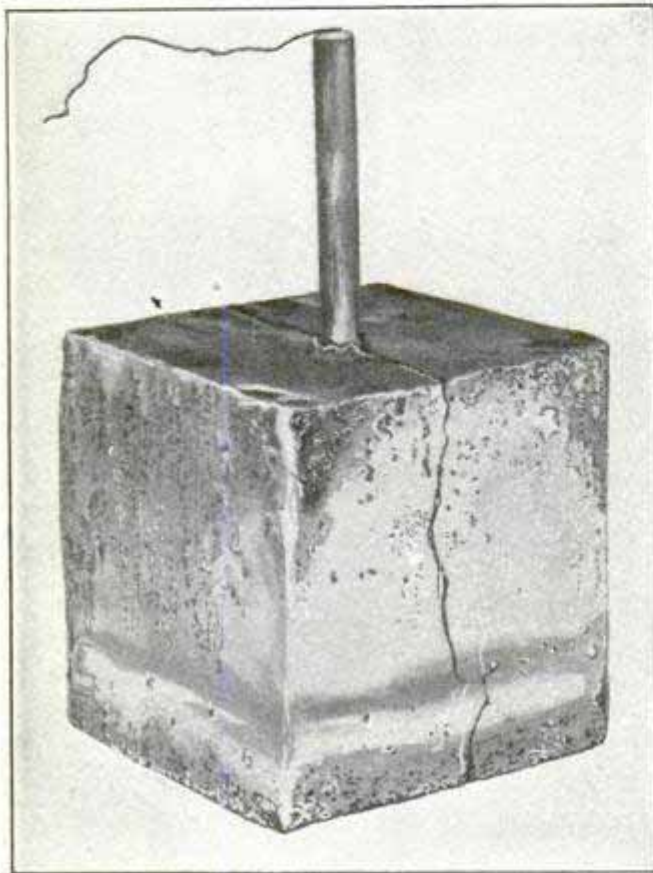

Test Block with Iron Rod Imbedded, Showing Size of Crack after Two Weeks' Exposure to Electric Current

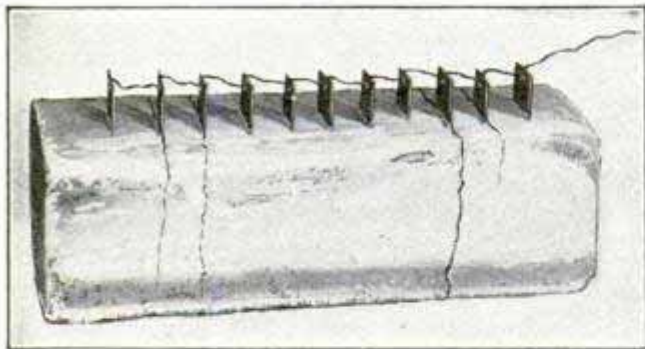

Block Practically Disintegrated after being Submitted to Electrolytic Action for Two Months

from the steel to the concrete, as, for instance, might occur where steel building columns or the bases of elevated electric railway structures are so imbedded, electrolytic corrosion, of a nature which may, in time, crack the surrounding concrete, sets in.

Several experiments made in an endeavor to determine the extent of such

destruction and its action bear out the theory that the cracking and breaking away of the concrete is caused by the expansion of the metal due to electrolytic corrosion. Iron rust occupies more volume than the original metal from which it was formed, and as this rust must find space for itself, an internal pressure is set up as the amount of rust increases, until the confining concrete gives way.

A MILLION TONS OF SAND TO DRESS MARBLE

Sand is a very important factor in the marble industry. Smooth steel bands, moving to and fro, with sand and water pouring down from above, will eat their way through the hardest marble. Moreover, that same sand and water, when used upon swiftly revolving, horizontal steel disks, will take away all the roughness and irregularity from the slabs thus acquired. Of these requisite materials, a supply of water is usually near at hand, and steel may be shipped in from a distance, but the providing of the sand often proves to be a vexing problem.

To meet the demands of the mills at Proctor, Vt., it was necessary to build a tramway over the mountains. In the early days of the business, a few teams could haul all that was needed. Later, when that method became inadequate, a short tramway was constructed, but the limited supply within a half-mile radius was soon exhausted. Then someone discovered what might properly be called a mountain of sand. By extending the tramway $2\frac{1}{4}$ miles to the eastward, it would be possible to feed the mills for an indefinite period.

Accordingly, a pathway was blazed up through the timber land, the standards were raised, and the cables were put in place. Then, one by one, the buckets were attached and sent forth on their endless journey. That was ten years ago. At the present time, the tramway is still in operation and

the buckets never come back empty, although 17 acres have been lowered to a great depth.

Each of the buckets weighs 300 lb. and has a capacity of 500 lb., and so quickly are they filled and emptied that they move along the cable at the rate of one every 50 sec., or 72 an hour. The buckets are operated about 18 hours a day. Thus it will be seen that within the past ten years about one million tons of sand have been moved down into the valley.

INFLUENCE OF SPEED ON COMPASS NEEDLES

It is known that during long voyages in either an easterly or westerly direction, the hulls of steel vessels become magnetized in a manner which will affect the needle of the compass, one side of the hull developing a negative pole, and the other a positive. A French scientist, who has studied this phenomenon in its relation to speed, finds by observations on rapidly moving trains that the same tendency exists in steel cars and that the amount of magnetization varies directly with the speed. Also that the magnetism does not disappear at once when the trains stop.

From these experiments, it would seem that the compass needles on fast ocean liners are more liable to be affected by steel hulls than those on slow steel ships.

"PURE MILK SQUEEZED OUT"

The naive manner in which the Japanese mistreat the English language



"English As She Is Wrote" in Japan

on shop signs is often laughable, as is well demonstrated by this sign over a dairy in Kyoto. The sign reads, "Fresh and Pure Milk Squeezed Out by Veterinarian Okadas Dairy."

SWIMMING MACHINE

A swimming apparatus which may be used on land as well as in the water as a means of teaching beginners how to swim has been designed by a London physician. The person learning to swim is slung on an adjustable support which provides balance and comfort. In front of the sling is an adjustable ladder-like frame, the bars of which are grasped when some additional support is necessary to keep in a horizontal position.

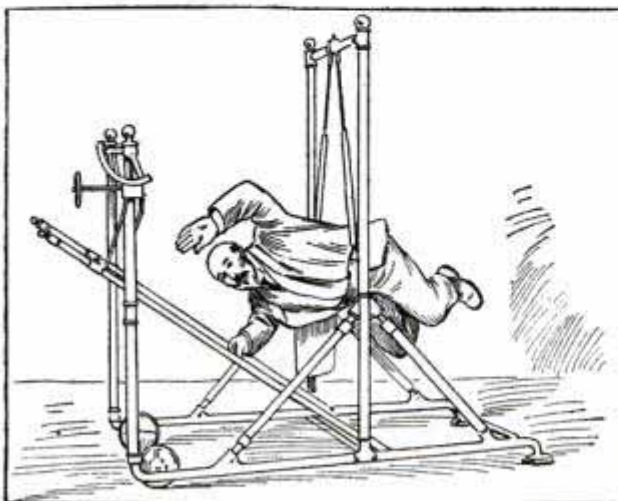

Practicing the Side Stroke on Land

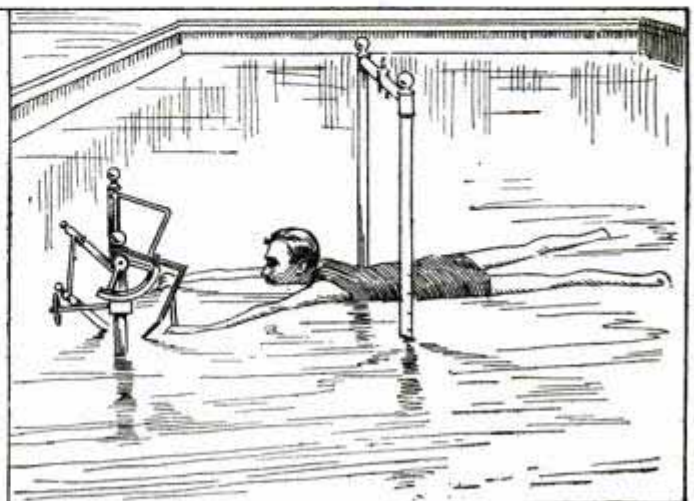

Learning to Swim in the Water

AMMONIA-TANK EXPLOSION LESSON IN BOILER DESIGN

This illustration, showing an ammonia tank which exploded during a recent fire in an ice-manufacturing

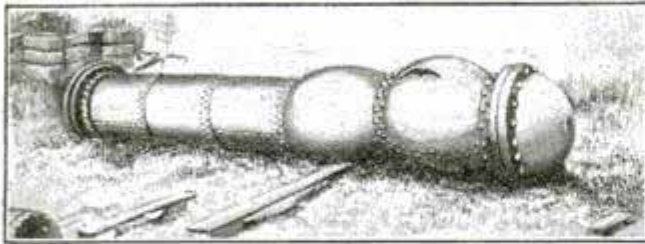

Stiff Girth Joint Prevents Violent Explosion

plant in Coffeyville, Kans., furnishes an important lesson in boiler design. It will be noticed that although the first and second sections of the tank were bulged out from a cylindrical almost to a spherical form by the expansion of the heated ammonia, the girth or circumferential joint between these sections retained practically its original diameter. Thus the stiffening effect of the girth joint proved of the utmost importance, as it prevented a violent explosion instead of the merely local burst seen in the illustration.

RAILWAYS NEED STANDARD OF EQUIPMENT

To the list of the needs of humankind has recently been added the standardization of railway equipment. In all sections of the country, and in all branches of industry, the necessity for a general standard of equipment is keenly felt. The railroads themselves have recognized this in laying their track so that the cars belonging to one company can safely be carried on the rails of another. But the matter of making the cars themselves conform to a uniform system has not made the headway it deserves.

In the passenger department there is so great a demand for high quality of service that the railroad companies advertise widely on the strength of the superior accommodations offered to the traveling public. Any corporation falling below the standard set by keen competition naturally loses business. But the freight equipment is another thing, and it is the freight business that brings in the returns on which depends the livelihood of the great army of railway employes.

There are more types of freight cars in use in the United States than there are railroads doing business.

On some roads there are to be found several styles of cars. Such a conglomeration of equipment makes the average freight train not only a queer-looking procession of car-builder's samples, but in many cases is

actually a menace to the men employed to operate it. A freight train is seldom made up of cars belonging to one company. On the contrary there are many trains that contain but one or two cars owned by one corporation and sometimes all of these are traveling over rails and operated by crews of another company.

In an inspection trip of 1,500 miles undertaken recently by an investigator interested in this subject, photographs were made of some of the most glaring deficiencies resulting from lack of standardization. Sandwiched between cars equipped with air brakes would be found cars having only hand brakes. Frequently the method of attaching the coupler would be such that the space between the cars would be so great as to make it impossible for the brakeman or conductor to reach the hand rail on the other side, and often cars with the box end built flush with the end of the deck would be encountered, leaving no piece on which the brakeman could stand or get footing in passing from car to car. In several instances, cars built as described above came so close together in coupling that it would be a tight squeeze for an ordinary man to get his body between them. The building of the decks of some cars wider than others also holds its menace. A man inspecting a car on the ground is in danger of being "side-

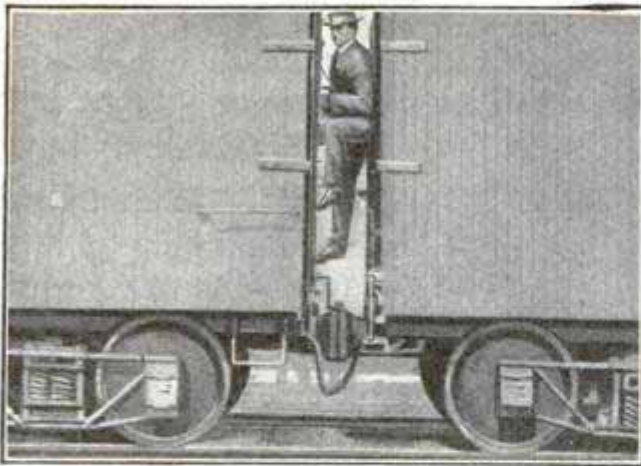

Narrow Space Between Car Ends Caused by Building Box Cars over Entire Deck

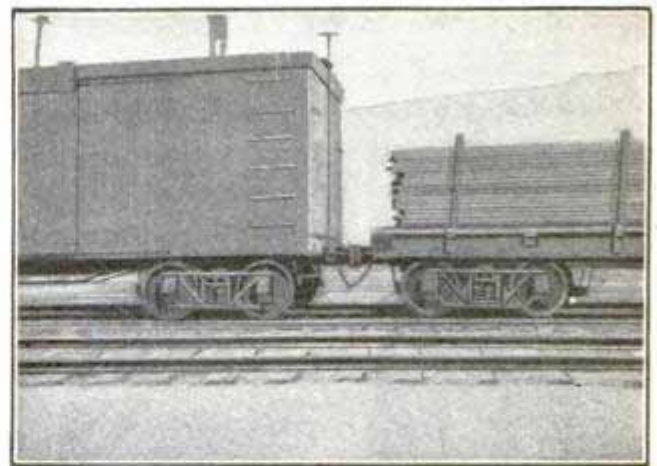

Car Built over Entire Deck Having Side Ladder Coupled with Flat Car

swiped" by a passing train under such conditions.

Possibly the greatest danger and inconvenience are caused by the different designs of tank and gondola cars. In

cars, the man who attempts to go from one to the other while the train is in motion takes his life in his hands.

The same situation presents itself in going from a box car to a tank car,

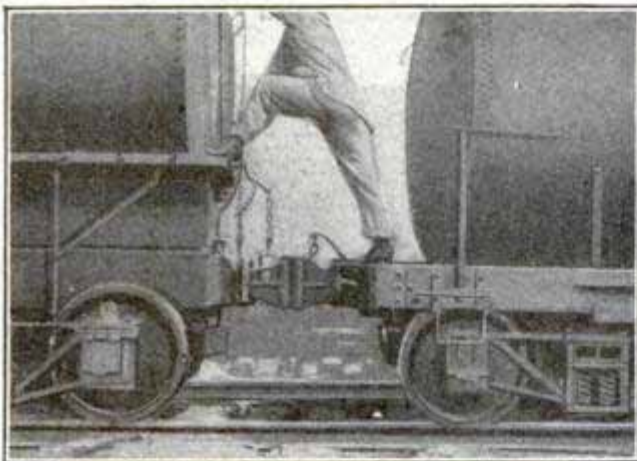

Difference in Height of Deck of Tank Cars

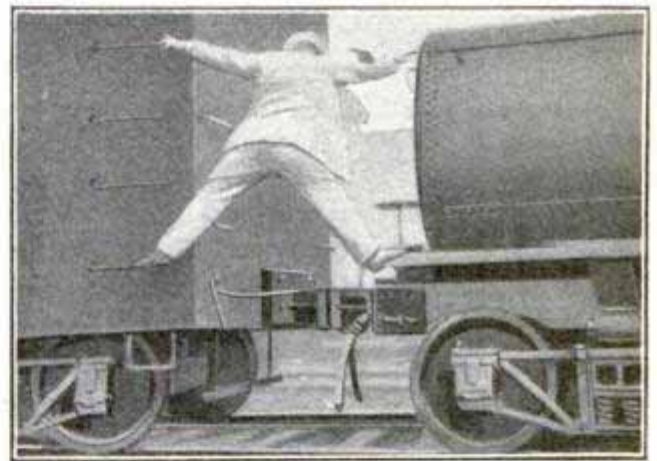

Wide Step from Side Ladder to Tank Car

some instances, it has been found that the deck of a tank car of one type would be from 2 to 3 ft. higher than the deck of another type, and when there is also a wide space between the

when the former is built flush with the deck and has only side ladders instead of end ladders, and the latter has a high deck or a gondola, the end of which is also flush with the end of its deck.

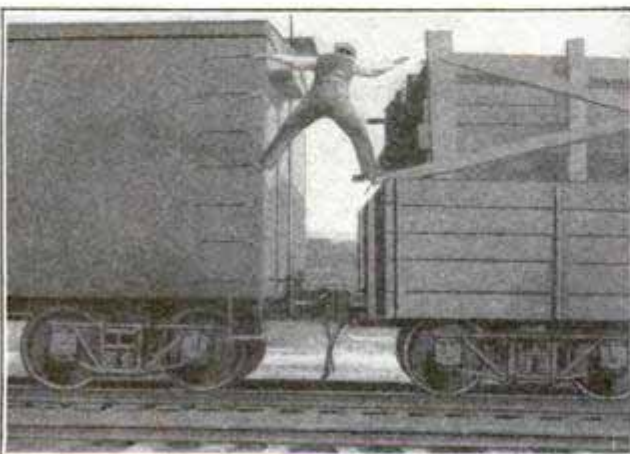

Another Wide Step from Side Ladder Car Which Endangers the Brakeman's Life

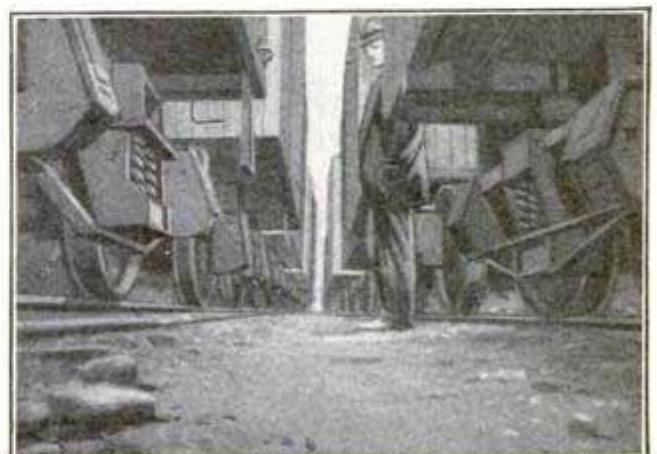

Narrow Space Between Trains Due to Cars of Different Width

"DOCTORING" CIRCASSIAN WALNUT

The beauty of the grain in Circassian walnut is generally enhanced by the presence of sound knots, and, real-

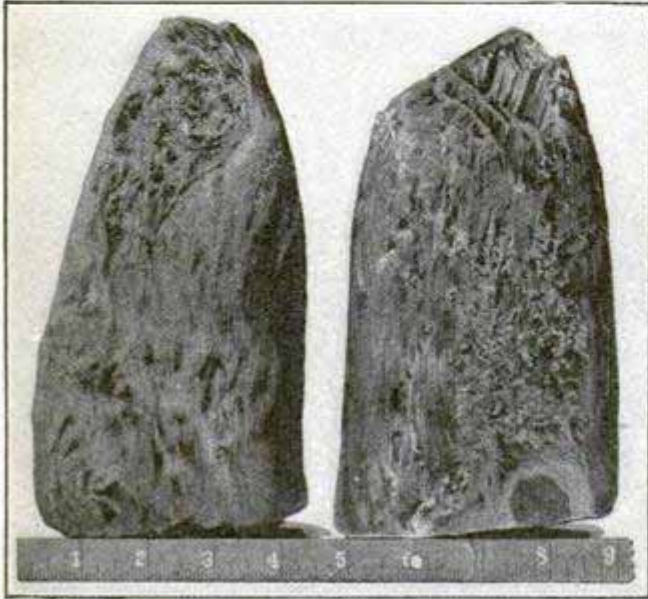

Plugs Taken from Doctored Circassian Walnut

izing this, the Turks often resort to timber doctoring of a kind that fools the buyers, but is almost sure of discovery when the wood is prepared for use.

In the illustration are shown two plugs, or imitation knots, found in a log of Circassian walnut at a plant in Cleveland, Ohio. The log evidently contained hollow knots, which were carefully cleaned out, and then the wooden plugs were hewed out to fit the cavities and driven in tightly. The plugging was done so carefully that the lines about the plug were not considered as more than a small ring shake.

That importers of valuable woods may suffer loss through other reasons than dishonesty, however, is borne out by this rat story: A New York importer recently purchased a Circassian log which weighed 3,000 lb., and to all appearances was solid, although seeming a little light for its size. When opened, preparatory to converting it into veneers, it was found to be a little more than half hollow. A small hole that at first had been taken for a sunken knothole was found to lead into

the cavity, which was filled with pieces of rags, paper, nuts, leaves, etc., and in the midst of this rubbish was an old gray rat.

X-RAY ADMITS CHINAMAN TO COUNTRY

A question of age, having to do with the eligibility of a Chinaman to enter the United States, was determined recently at Boston by means of an X-ray test. Photographs were taken of the wrist and knee bones by the radiographic method at the suggestion of the Chinaman's counsel, who, it is said, thereby proved his client to be only 17 years of age instead of 25, as claimed by the immigration officers.

BED CANOPY AS PICTURE BACKGROUND

Several novel ideas have been incorporated in the arrangement of this Louis XVI bedroom, which is in the home of a famous Parisian prima donna. The coverlet and the hangings and panels at the head and foot of the bed are of fine old laces of great value. The canopy over the head of the bed is utilized as a background for small paintings and photographs.

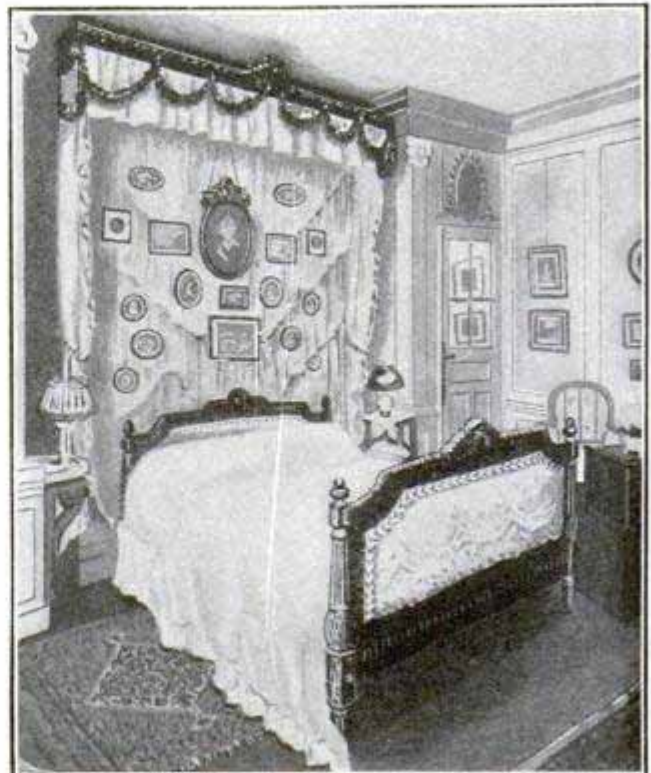

Louis XVI Bedroom in the Home of a Parisian Prima Donna

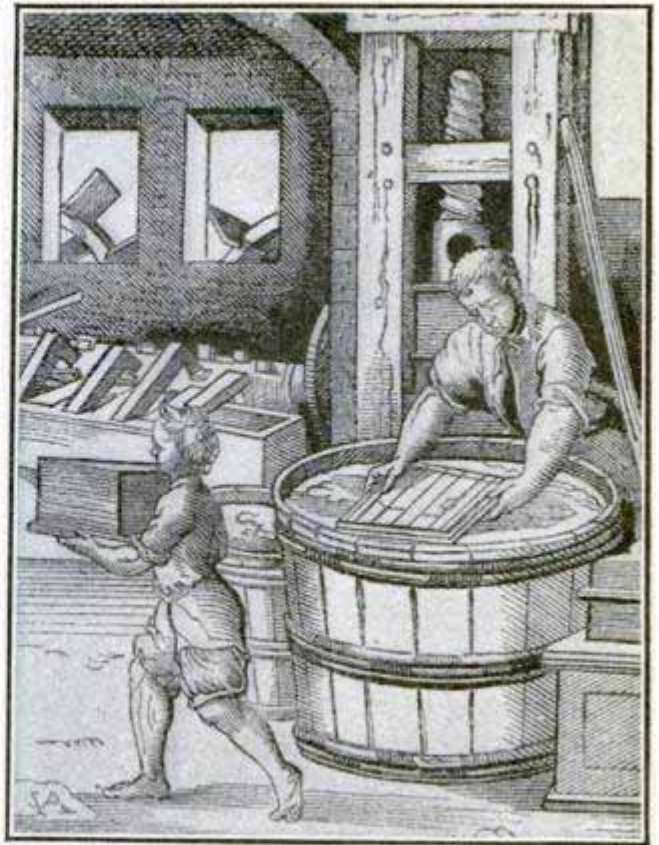

SCIENCE AND MECHANICS IN THE MIDDLE AGES

No. 4—THE PRINTERS.—The printing presses used about 1500 were, of course, very crude, but excellent work was done, considering the difficulties. Presswork and composition as done in 1520 are shown in the illustration, the press being of the screw type, with a contrivance for running the form of type under the point of pressure. Pressure was applied by turning the screw.

No. 5—THE PAPER-MAKERS.—The interior of a paper mill of the sixteenth century is shown in the accompanying illustration. The first maker of paper in England whose name is known, was Tate, who set up a mill in Hertford about 1520. The first paper mill in America was erected in 1690 by William Rittenhouse in Roxborough, which is now within the corporate limits of Philadelphia.

NEW YORK DOCK PROBLEM TEMPORARILY SOLVED

The problem of docking the big Atlantic liners in New York has been temporarily settled by the granting of a permit by the United States Government for the extension of the piers of the International Mercantile Marine Company on each side of one of its slips. This will permit ships like the "Olympic" and "Titanic" to go alongside the dock with none of the stern protruding into the North River channel in an unprotected manner, but the permit does not contemplate permanent extension. It is expressly provided that the additions made to the

piers shall be of a temporary character which will be allowed to remain in place at the discretion of the Secretary of War. On his order it must be removed immediately.

The final solution of the difficulty of docking big ships is still to be found, and while a number of plans have been presented, there has been no definite scheme formed. All of the interests in New York and New Jersey involved in transatlantic commerce realize that the time is coming when permanent docks for the great ocean ships must be provided, and they are bending their efforts toward the formulation of a plan that will meet all needs and be acceptable to all the interests.

FLEAS FROM MADAGASCAR TRAINED TO ACT

Among the interesting immigrants that have settled in the United States during the past few years is a colony

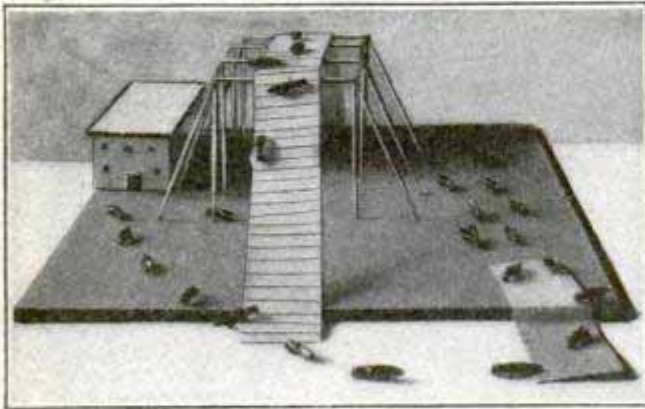

Madagascar Fleas Performing Evolutions at the Word of Command

of fleas from Madagascar that are at present living in a small town in Maine. Whether or not these interest-

ing natives of the big island came in to this country as specimens of natural history or artists is not known, although their accomplishments at present would give them title to entrance under the latter head, as their guiding genius declares they are the best educated community of fleas in the world. He endeavors to prove his point by putting his charges through military evolutions and a series of maneuvers at the word of command that give credence to his claims. The fleas are rather large in size and their performances are said by those who have seen them to be most interesting. Their education and training was accomplished with much skill by their present general manager into whose hands they were placed by a sea captain who had been their guardian on the long voyage from their native haunts to America.

REMOVING A MOUNTAIN TOP

If someone were suddenly to shoot off 16 tons of dynamite and giant powder on the next block, you might reasonably expect to feel some slight surprise, if not actually to see windows break and hear the dishes dance. Yet if the explosion were contrived in the refined and considerate fashion recently used by engineers in removing the top of Roseville Mountain, in Morris County, New Jersey, the chances are that you would know nothing at all about it unless you saw the smoke.

Eastern experts who flocked to the scene to witness the clearing away of the last obstruction to the D. L. & W. railroad's new \$13,000,000 cutoff, counted upon an incredible noise and violent earthquake tremors. They were disappointed in both respects; the explosives were too busy lifting 19,500 cu. yd. of rock to bother about making much noise.

Instead of sinking wells into the mountain top for the reception of the explosives, the contractors had built a horizontal tunnel, 4 by 6 ft., running

73 ft. into the side of the hill, about 30 ft. from the top. This was crossed at the end by another tunnel, 90 ft. in length; and nearer the surface another transverse, 27 ft. long, had been constructed. The 90-ft. tunnel was packed with Judson railroad powder, an explosive slower than dynamite and with greater lifting power. The 73-ft. tunnel was packed with Judson and dynamite, alternating with tampons of sand and stone. The short tunnel was filled with 60-per cent Red Cross dynamite, and the mouth of the main tunnel closed with a cement wall 14 ft. thick.

The blast was, of course, exploded by electricity. There followed a low, ominous rumble. A mighty smoke cloud rose to a height of some 200 ft.; hundreds upon hundreds of tons of rock, of workable size, rolled into the valley—and it was all over. The only building to suffer was the little Roseville schoolhouse, which had stood at the foot of the hill since long before the Revolution, and which was a total wreck after the blast.

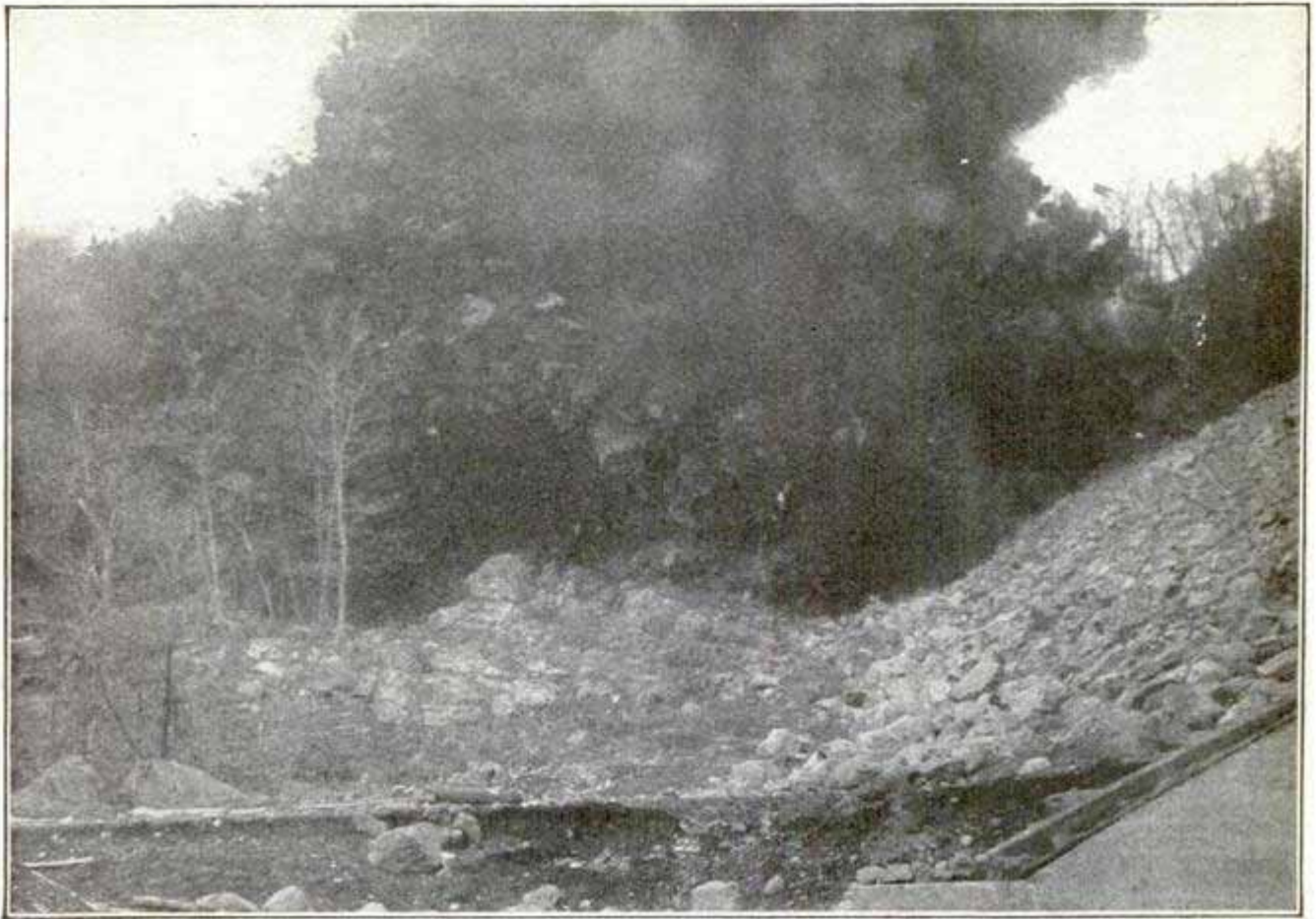

Blowing the Top Off of a Mountain with Dynamite at Roseville, N. J.

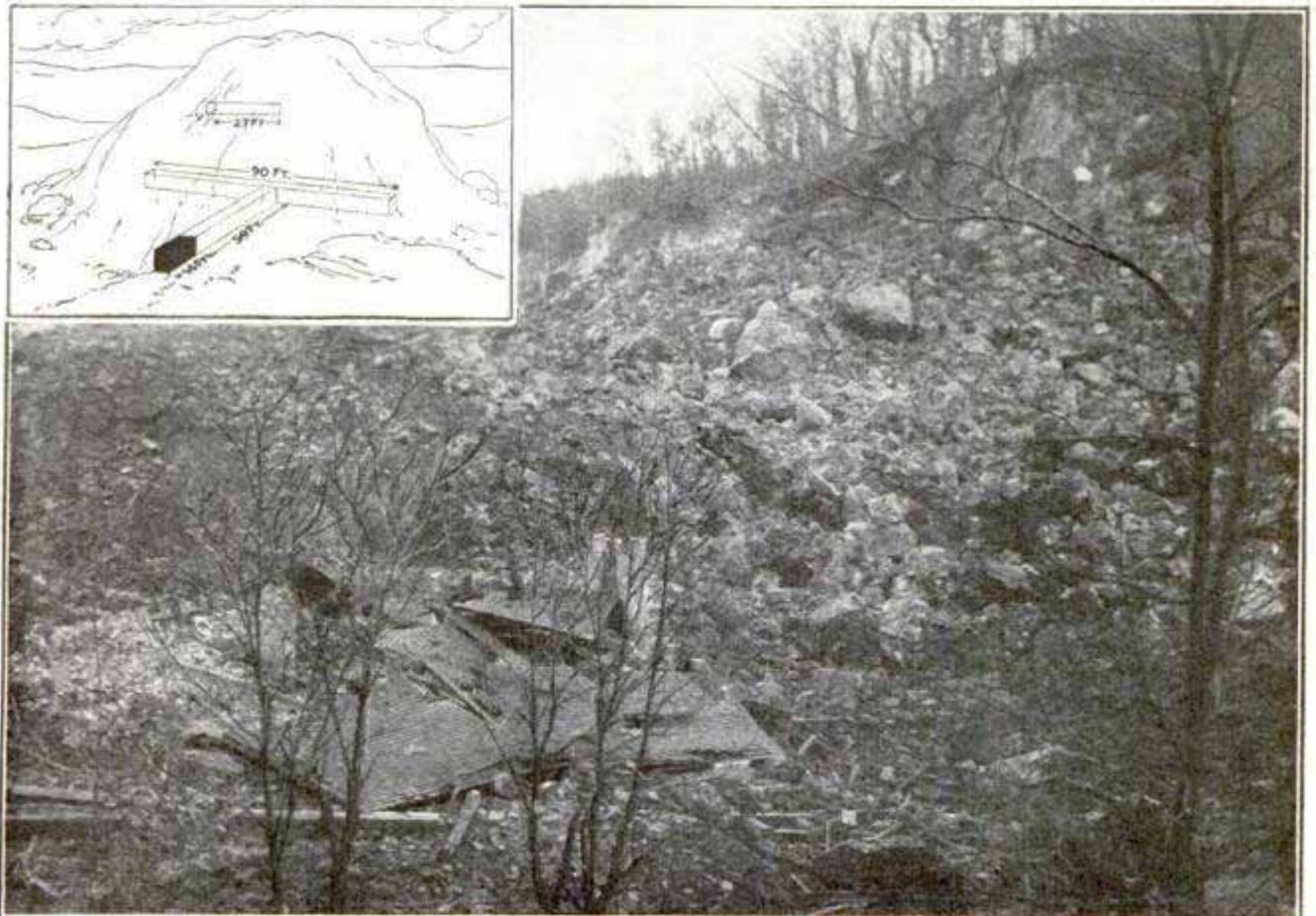
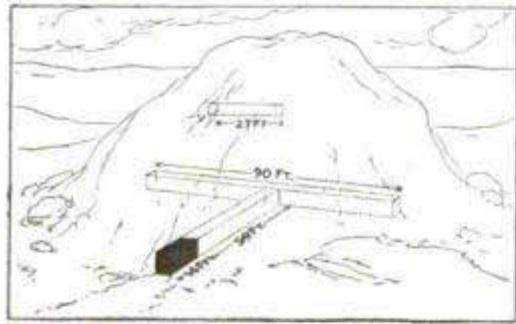

A View of the Erstwhile Mountain Top after the Explosion, the Wrecked Schoolhouse in the Foreground
 —Diagram Shows How Dynamite Tunnels Were Dug and Sealed with 14-Ft. Wall of Concrete

NEW POSTAL VENDING MACHINE

A simple and ingenious picture-postcard vending machine is shown in this illustration.

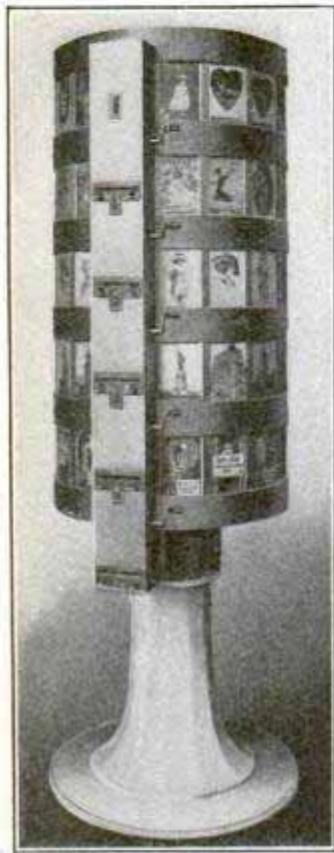

The purchaser of postals turns the drum until the card desired is behind the releasing device, drops in a penny, and turns the crank operating the releasing mechanism of the row containing the card, thus causing it to drop out of the slot.

CM. Henri Deutsch, one of the leading French patrons of aviation, has ordered of Blé-

riot an aeroplane with four seats completely inclosed like the limousine body of an automobile.

WARSHIP A BOER BOY'S MIND'S EYE SAW

How is a battleship pictured in the mind of a person who never saw one?

There are few people who do not form ideas of the appearance of things in common usage long before they see them. Battleships are matters of everyday report, their cruises and maneuvers filling columns of space in the daily press. Millions of Americans have never seen a real battleship in their whole lives, just as millions have never seen the ocean. Photographs of the most intimate character showing the construction of ships of all classes are common property, however, and the mind of almost everyone has pic-

tured a battleship or a cruiser time out of time. It is not everyone, however, who can crystallize this mental picture into a tangible model. This is what a little Boer boy has done in South Africa. He tells how in the following letter to the editor of Popular Mechanics Magazine:

Heidelberg, Transvaal.

Editor, Popular Mechanics,

Dear Sir: The enclosed is a photo of a model Dreadnought made by myself entirely. I am aged thirteen and have never seen a battleship in reality. The hull is of wood covered with paraffin tins cut and riveted together. Size of vessel $4\frac{1}{2}$ feet by 13 inches. The general information I obtained from Popular Mechanics and two patents I made myself, such as a protection for life boats and working of search lights. I have named it H. M. S. "Superb." The vessel is complete with wireless

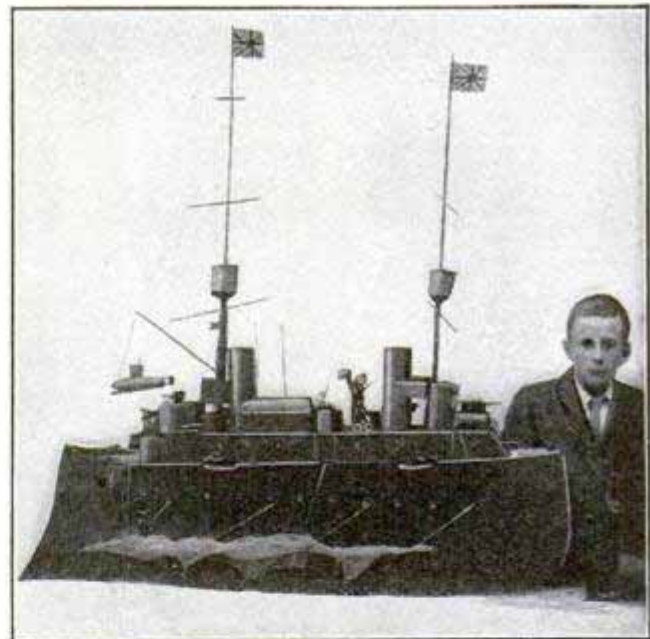

Boer Boy's Battleship Model

telegraphy, guns for firing at aeroplanes and everything required on a ship of its nature as far as my knowledge goes.

Yours sincerely,
Wyville Botha.

¶The first two American airmen to make aeroplane flights in Japan are Captain Baldwin and Airman Mars, who gave their first exhibition at Osaka recently.



Flower Pot Drain

The staining of woodwork on porches and posts caused by the dripping of water from flower pots can be prevented in the following manner:

Make a zinc or galvanized tray of suitable shape in which to set the pots, as shown in the illustration. Solder a tube for the overflow, or dripping, on one side of the tray. Have the tube long enough to clear the post or part of the porch where the flower pot is set. The tube may be placed to the rear so it cannot be seen from the street, if desired. Place some small pieces of wood beneath the tray to allow the passage of air, thus preventing moisture. The tray can be made in any shape to conform to the shape of the pots.—Contributed by Dr. D. D. Smith, Sandusky, O.



A Foot-Power Hammer

The hammer is fitted with a heavy wood handle to which a curved piece of iron is attached with clamps, and

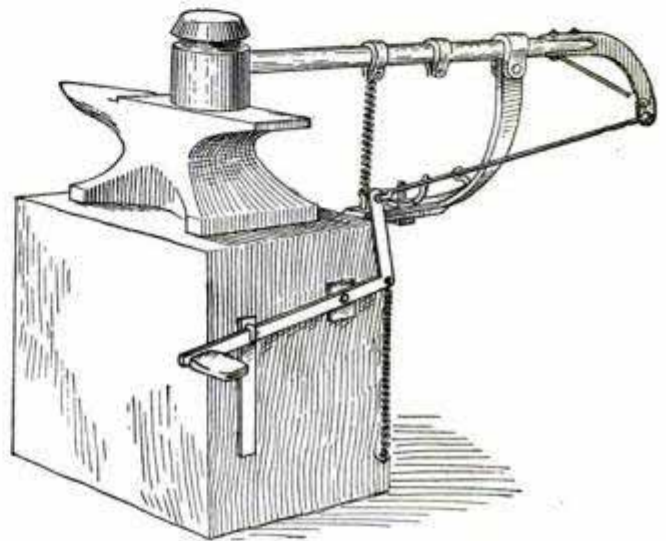

Hammer Attached to Anvil Block

braced with a rod as shown. The yoke at the fulcrum is fastened securely to the handle and also to the bar-iron brace. The brace is attached to an L-shaped bracket on the anvil block, so it can be raised and lowered to permit the hammer to strike with the face parallel to the work. The bell-crank lever is attached to the side of the anvil block with the foot piece near the operator. If several holes are drilled in the top part of the bell-crank lever, the length of the stroke can be adjusted.—Contributed by A. Walle, Ludington, Mich.

CA good way to remove whitewash is to soak it thoroughly with concentrated lye and then use a wire or hard-bristled scrubbing brush. If the lime was put on in a hot condition, it may require more than one such application to remove it entirely.

Raising a Countershaft

The method I used in putting up unassisted a heavy countershaft for a planer is shown in the sketch herewith. I tied a rope to each hanger and fastened their lower ends to the shaft. I turned the shaft by means of the large pulley, thus wrapping the ropes around the shaft and raising it to the bearings.

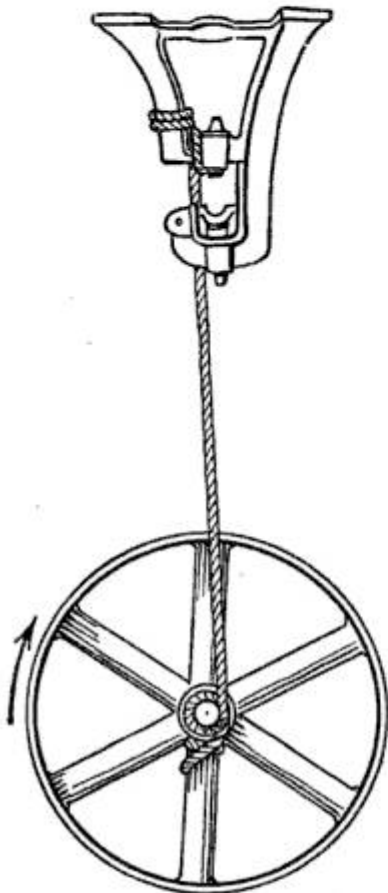

The shaft was lifted into place with surprising ease.—Contributed by Harold M. Ilg, Lowell, Mass.

Reclaiming Scrap Solder and Lead

We had occasion to clean up the season's accumulation of scrap solder and lead, and after separating the two metals we found it necessary to melt them and run into a convenient form for handling.

An old range boiler of 30-gal. capacity was cut in two, and seven or eight holes 2 in. in diameter were punched in the side about midway between the top and bottom of the lower half. The lower end of the tank was then placed in the ground in a hole about 1 ft. deep and tamped carefully to make it solid. The interior of the tank was then filled with dirt up to the holes that were punched in the sides. A coke fire was placed in the tank and a cast-iron soup kettle placed on top of the coke and filled with metal. The dirt was skimmed off from the top of the melted

metal and the clean metal was poured into molds. We found it to be the quickest and best method we had tried.—Contributed by W. W. Hughs, Minneapolis, Minn.

How to Clean a Straw Hat

A simple and inexpensive straw hat cleaner may be made by dissolving 1 oz. of oxalic acid crystals (these can be purchased at any drug store) in 1 pint of boiling water. After the liquid has cooled, it should be shaken thoroughly and then applied to the straw hat with a small nail or tooth brush. Apply copiously and briskly and then rub dry with a clean cloth. The hat should now be pressed with a hot iron over a dry cloth so as to preserve its shape, and when thoroughly dry, it will be as clean as a new hat. This cleansing mixture is the cheapest and most effective known, as the quantity mixed is sufficient for a dozen hats.—Contributed by W. B. Lippard, Buffalo, N. Y.

Emergency Repair on an Automobile Spring

The front spring of an automobile broke while on a trip and it was repaired in the manner shown in the

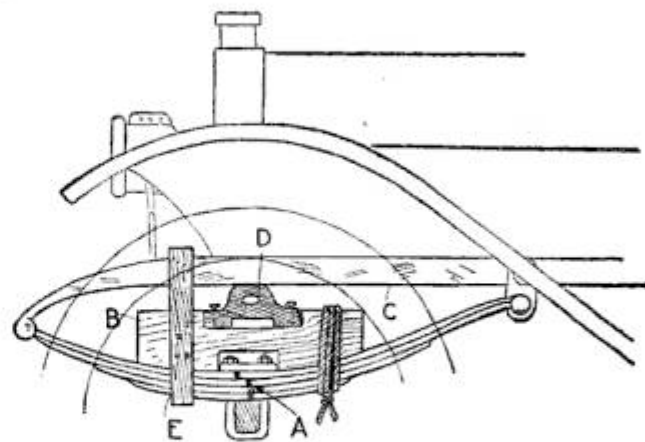

Spring Supported with Wood

sketch. The car was raised with a jack above its normal position and the various leaves of the spring were placed end to end at the fracture A, and the U-bolt clamp drawn tightly down on

them. A piece of 2 by 4-in. pine, B, was procured from a farmer, and, with the aid of a borrowed hatchet and a handsaw, it was cut to fit the curvature of the spring as shown, the top part of the block being left straight. A slot was cut into the block to receive the rubber buffer D, which was held in place by two nails, driven through its flanges and into the wood.

A 1 by 2-in. strip of wood, E, was nailed on each side of the spring near the front end, and a rope wound several turns around the rear part, to hold the piece B in place. When the jack was removed, the frame rested on the rubber buffer. A journey of 50 miles was made over dirt roads without trouble.—Contributed by F. C. Holly, Yazoo City, Miss.

A Partnership Desk

Where office space is limited an arrangement by which two men can work

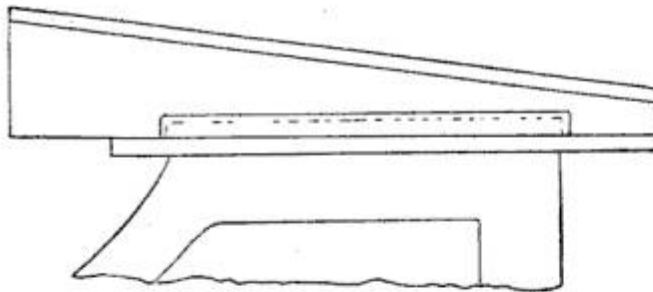

Another Desk on Top

at the same desk will be found of such advantage as to repay the trouble of constructing an extra top, as shown in the illustration. The top board is very convenient for a bookkeeper or draftsman. The construction is self-explanatory. The addition is secured to the top of the desk by two strips which engage with the projecting ends of the desk top. The strips are screwed to the side boards of the addition after the latter is in place. Small strips of blotter should be laid on the desk on the part where the addition rests, to avoid marring the polished surface. Any desired height may be obtained by varying the width of the two side boards which support the false top.—C. W. Nieman, New York City.

Joint for Aeroplane Construction

A very simple, light and inexpensive joint for the framework of aeroplanes

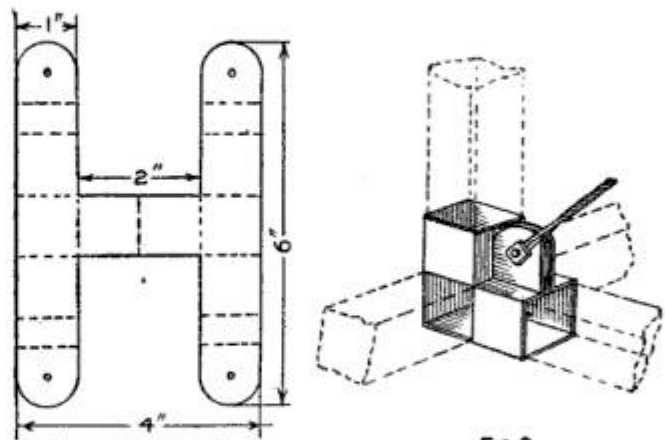

FIG. 1

FIG. 2

Made of Sheet Metal

may be made of sheet brass or aluminum, about 22 or 24 gauge. The sheet metal is cut to produce the shape with the dimensions shown in Fig. 1. After bending the metal on the dotted lines it will take the shape about the joint as shown in Fig. 2. The bolt used for holding the ends of the wire truss clamps the ends of the metal together, thus making a solid joint. This joint is especially adapted for use on aeroplanes built of square material.—Contributed by Henry C. Wood, Toronto, Canada.

A Small Plow Plane

A plane for cutting small grooves in wood may be made in the following way: Saw a slot in a piece of steel, A, Fig. 1, and then turn down the edge E. Drill two holes, B B, for screws to attach the steel to a block of wood.

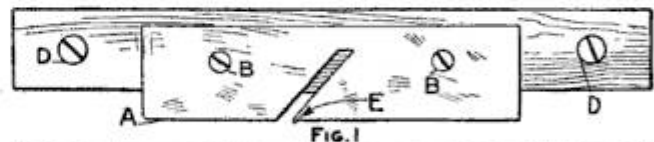

FIG. 1



FIG. 2

Metal on Wood Block

Guides for the plane are made by turning two large screws in part way, as shown by D D, Fig. 2.—Contributed by Geo. Madsen, Chicago.

An Air Hoist

Procure a piece of 1-in. cold-rolled steel, A, and bend a hook, B, on one end. Thread the other end for a standard 1-in. nut.

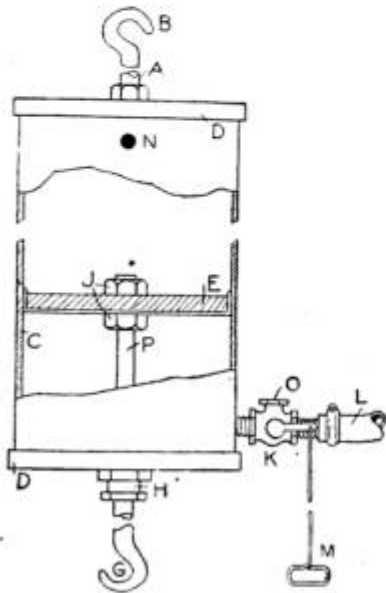

Take a piece of 4-in. steel pipe, C, of the desired length, and thread it on both ends for pipe caps DD. Bore out the pipe C so that the internal walls are straight and smooth. Make a piston, E, $\frac{3}{4}$ in.

thick and $\frac{1}{64}$ in. smaller in diameter than the inside diameter of the pipe C. Turn up a leather disk about $\frac{1}{4}$ in. thick and $\frac{1}{1000}$ in. larger than the inside diameter of C. Drill a $1\frac{1}{4}$ -in. hole in the center of the piston and the leather disk.

Make a piston rod, P, by turning down a piece of $1\frac{3}{8}$ -in. round cold-rolled steel to $1\frac{1}{4}$ in. in diameter and bend a hook, G, on the end. Turn a packing gland, H, into the pipe cap D and push the piston rod through the gland and cap and assemble by means of the lock nuts J. Screw the pipe caps DD in place, making the lower one airtight with a gasket.

Drill and tap the cylinder for a $\frac{3}{4}$ -in. pipe just below the lowest point of the piston travel. Connect a two-way valve, K, by means of a nipple and a hose, L. Make a control rod, M, to operate the valve, and drill a $\frac{1}{2}$ -in. hole, N, in the cylinder. After the hoist is connected and the parts fitted together, take it all apart, clean and oil thoroughly and then reassemble, making all fittings secure and tight.

The hoist is operated by pushing up or pulling down on the rod M. When the rod is up, the air is admitted from the hose L through the valve K, and

into the cylinder. When the control rod is pulled down, the air is allowed to escape through the valve opening O.

This hoist can be made cheaply and used wherever compressed air is obtainable. It will lift 700 lb. with an air pressure of 60 lb.—Contributed by F. B. Hays, St. Louis, Mo.

Clamp Coupling for a Water Pipe

A water pipe coupling had to be disconnected frequently, and, as it took some time with the ordinary screw coupling, I designed the following described joint:

The parts consist of a draw bar, A, made of $\frac{1}{2}$ -in. square bar, a lever, B, also made of $\frac{1}{2}$ -in. stock, and a split collar, C, which was made from sheet metal rolled into shape. The assembled parts are shown by D. An ordinary coupling was cut in half and the pipe E turned into the part F for about one-half its length. The other part, G, was turned on the pipe H, after some of the threads were filed off at the end, so that it would enter the coupling F freely. A small rubber gasket was placed in the coupling F to make a watertight joint.

To connect the pipes, pull the draw-bar back toward the pipe H, lift up and hook it back of the coupling G, at the same time placing the end of the pipe H into the coupling F. Pull the lever

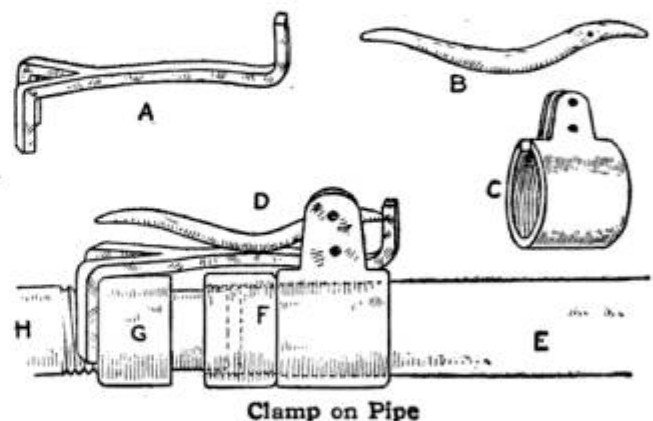

Clamp on Pipe

down and the parts will be drawn tightly together. The degree of pressure may be regulated by turning either half coupling.—Contributed by Thos. L. Parker, Olaf, Iowa.

How to Make Stamp-Pad Ink

Some typewriters and all rubber and metal stamps require the use of a special ink which is sold in small bottles. This ink is sometimes hard to obtain, especially if the address of the dealer is not at hand. It may be made at slight cost by dissolving the point of a common copying or indelible pencil in glycerine. Put a few drops of the glycerine into a bottle and stand the pencil in it after having cut the wood well back from the "lead." It will immediately begin to dissolve, and after a day or two the ink will be ready to use. The pencil will make a convenient tool for applying the ink to the pad or roller.—Contributed by Frank N. Blake, N. Adams, Mass.

Noise Caused by Service Wires

Several complaints came from my customers who claimed they could not sleep on cold nights owing to the noise caused by the service wires, says a correspondent of the Canadian Electrical News. I have tried several times to overcome this trouble and finally with success.

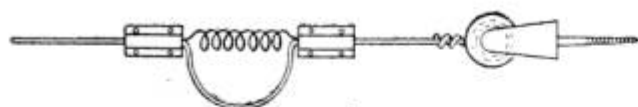

Removing Strain on Wires

A $\frac{1}{4}$ -in. spring wire was coiled $1\frac{1}{2}$ in. in diameter by 10 in. long and placed on the wire with two clamps as shown in the sketch. This takes the direct strain off the side of the house which acts as a sounding board.

Cranking an Automobile by Foot Power

The sketch herewith shows a device for use on an automobile to start the motor by turning the shaft with the pressure of the foot on a lever. While this device may not be efficient on large cars, it will work successfully on small machines. The parts connected to the machine are shown in Fig. 1. The drum C, Fig. 1, which should be

about 6 in. in diameter, is made up of parts as shown in Fig. 2. The casing G encloses a spiral spring, F, and the

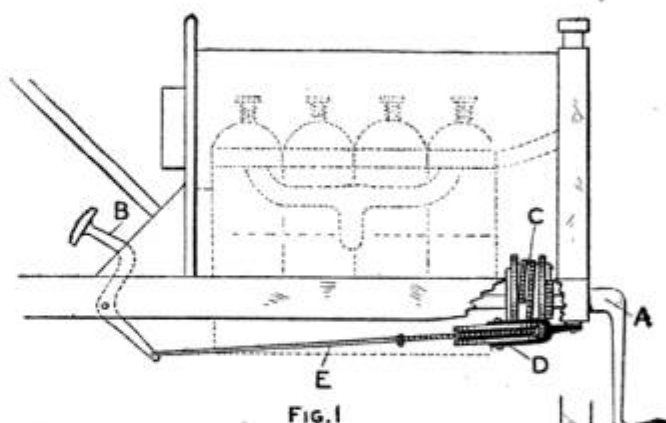

FIG. 1

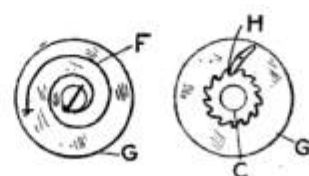

FIG. 2

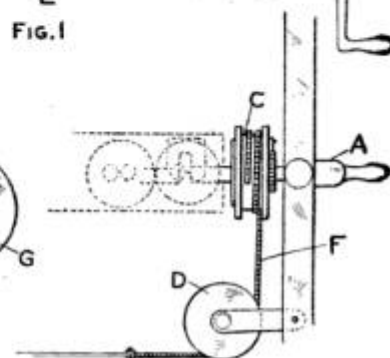

FIG. 3

Foot Starting Attachment

ratchet wheel H is fitted to the motor shaft C so it will disengage the same way as the ordinary crank A, Figs. 1 and 3. The drum C is turned with a bicycle chain, F, Fig. 3, which is connected to the foot lever B by a wire, E, Fig. 1. The idler wheel D, Figs. 1 and 3, can be placed in a suitable position to carry the chain to any desired place for the foot lever B, Fig. 1.—Contributed by D. H. Fairchild, Pana, Illinois.

How to Cut Brass Tubes with a Hacksaw

Place two blades in the saw frame, one in the usual way and the other reversed so that the teeth will point back toward the handle. One blade will cut while the saw is pushed forward, and the other makes its cut when drawing the saw back. While one blade is dragging, it will prevent the other from taking too deep a cut in the metal.—Contributed by H. D. Chapman, Washington, D. C.

Weight and Indicator for Tanks

The weight end of a gauge cock, Fig. 1, makes one of the best weights for a counterpoise or indicator rope,

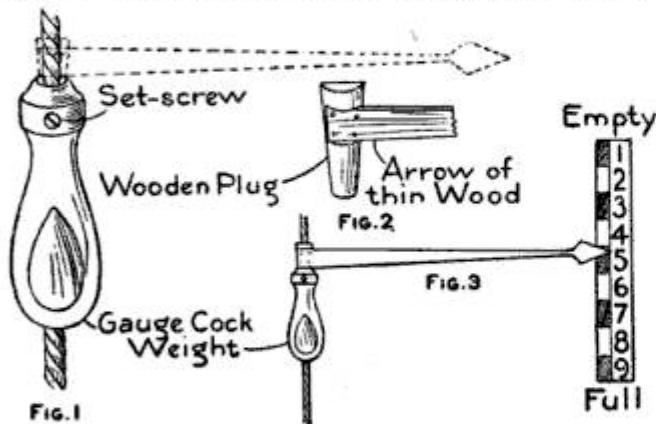

Parts of the Indicator

as it has an opening running through the metal from end to end and a set-screw by means of which it can be easily set at any point without knotting the rope.

In a soft-drink factory, where the indicating weight from the gas tank was in a dark corner, I was obliged to devise some means to show the bottler the condition of the contents. A device of light wood, Figs. 2 and 3, was constructed so that the arrow pointed to a portion of the wall where there was sufficient light to see a scale.—Contributed by James M. Kane, Doylestown, Pa.

Counterbalance for a Trapdoor

A heavy trapdoor opening up from the floor and out from a wall was used as a protection when standing erect in

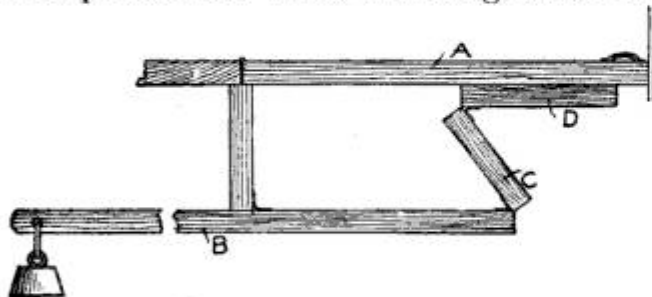

Counterbalance on Door

place of a railing. To keep the door, A, erect when open, an arrangement with a counterbalance had to be connected as shown in the sketch. A plank, B, was fastened with a hinge to the joist. The plank was cut in three

pieces, B, C and D. The piece D was fastened to the door and C, connecting both B and D with hinges. The plank may be any desired length, but the piece C must be as long as the width of the joist plus the thickness of the door. When open, the pieces of plank will form a perpendicular piece parallel with the erect position of the door. The weight must be regulated to counterbalance the door.—Contributed by T. F. Solon, Solon Springs, Wis.

Cutter for Inlaying Wood

An ordinary carpenter's gauge with a V-notch filed in the end of the marker, is useful for cutting small grooves for inlaid work. This device was adopted by the writer in working on drawer fronts of a sewing table. The inlaid strip was $\frac{1}{16}$ in. wide and $\frac{3}{8}$ in. from

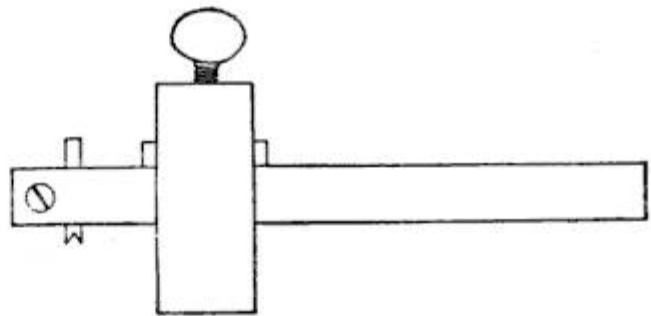

Cutter Made of Gauge

the edge all around. The marking gauge was supplied with a round steel wire having a notch cut in its end as shown. This gauged two lines $\frac{1}{16}$ in. apart and deep enough for the inlay. The stock between the two lines was removed with a narrow chisel made from a flat file.—Contributed by Joseph A. Shelly, Brooklyn, N. Y.

☞ An emergency pair of tweezers can be made by flattening the ends of a common hairpin.

☞ When the revolving work in a lathe chatters so as to destroy the fineness of the cut, the trouble sometimes can be overcome by placing a wad of waste between the arm of the lathe dog and the side of the faceplate slot.

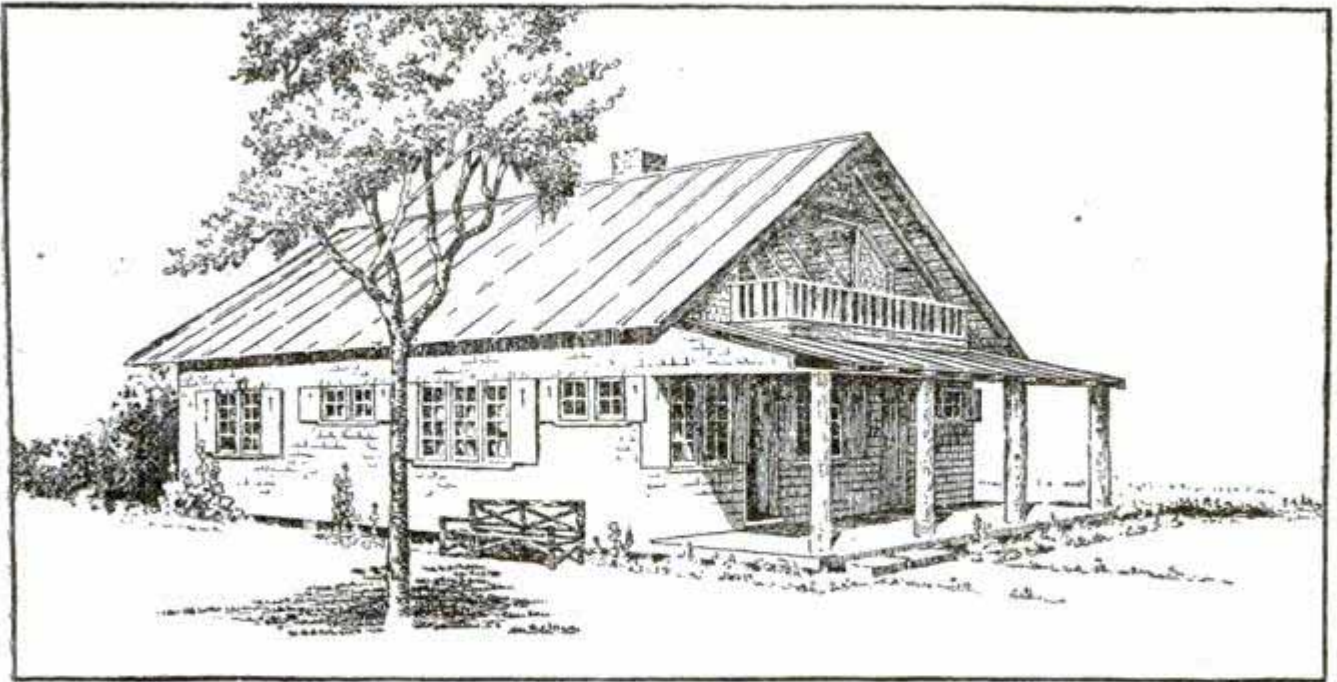

An Ideal Place for Summer Months That can be Built for \$700

An Inexpensive Summer Bungalow *

Summer-vacations have become such a factor in city life among all classes that there is a growing demand for inexpensive cottages, suitable for either seashore or mountains, and planned to meet the needs of a family during the hot days of the summer. The bungalow shown in the sketch is designed to meet this demand.

The problems to be solved in designing houses of this kind are so different from those usually encountered in the planning of city or suburban all-year dwellings that the work at once becomes stimulating, and one wonders why more attention has not been given to these "play houses."

As these dwellings are to be occupied for only a few weeks of the year, the most rigid economies must be observed in their construction, so that the first cost is not prohibitive and that the investment does not become a burden. The bungalow as shown is planned to be built of stock materials, such as can be purchased in any locality, and the simplest methods of construction are recommended. The exterior of the house is of wood, with rubberoid roofs, battened.

The plan for the house is shown without foundation. In selecting a site for this house, care should be taken to

secure a dry, well-drained surface, so that dampness will not rot the floor timbers, as the sills are to rest directly on posts sunk in the ground. A large, flat stone will form a good footing for the posts and will prevent the house from settling. Sawed shingles of either red or white cedar or cypress may be used for the exterior and may be left to weather. But for a few dollars, the owner can add much to the beauty as well as to the life of the cottage by applying creosote stains to the shingles, selecting harmonizing colors in grays, browns or greens to blend with the colors of the roofing and the surrounding landscape.

The walls are constructed of 3 by 4-in. dressed spruce or hemlock studs, placed about 5 ft. apart, and over this is nailed pine sheathing boards, with the dressed sides exposed in the rooms. The overhead beams are left exposed, with the floor above forming the ceiling. This panel construction of the side walls and ceiling becomes at once inexpensive, and yet very interesting. The interior being of wood, it lends itself to decoration in cool tones of gray or green stain.

An abundance of windows have been provided for light and ventilation. Casements are used, being the least

* From an article in *The Craftsman*

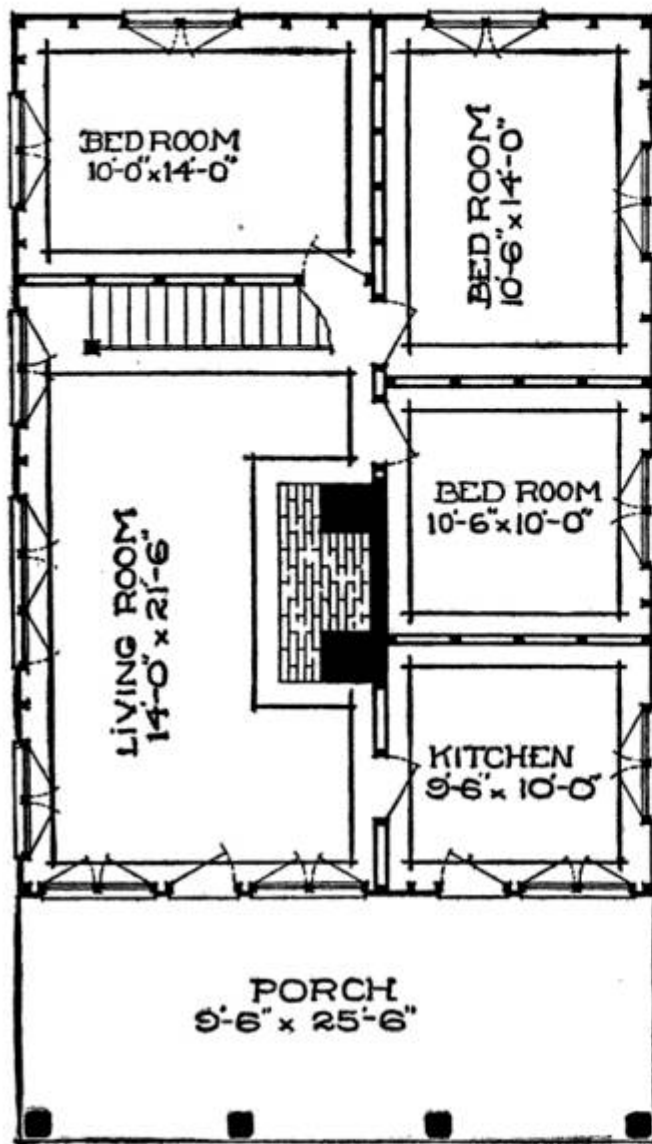

First-Floor Plan for Bungalow

expensive to install, as well as giving the added charm of windows which can

be thrown wide open. The wide entrance porch, with its balcony overhead, supported by hewn trees for posts, is most pleasing in effect. A living room, three bedrooms, and a kitchen are provided on the first floor. No bath is shown, because running water is seldom available, and these houses will generally be built in localities where bathing may be had in a lake or surf. If, however, the owner desires to go to that expense, another partition may be added and a bath placed between two of the bedrooms. The fireplace, built of stone or brick, laid up with wide, raked-out joints, will add to the rustic appearance of the interior and afford much comfort to those who have the leisure to spend a few weeks or months in these delightful places. A door opens directly from the kitchen to the porch, so that meals may be served in the open.

Ample storage room is provided in the attic by partitioning off the spaces under the eaves to a height of about 5 ft. Both ends of the attic are left entirely open, and this place will accommodate a number of cots and form most delightful sleeping quarters. Shutters should be provided for every window, as well as the open ends of the attic, so that the house may be securely closed during the winter months.

List of Materials

4 Spruce sills, 4 by 6 in. by 18 ft.	2 Spruce plates, S-4-S, 4 by 6 in. by 20 ft.	
2 Spruce sills, 4 by 6 in. by 14 ft.	2 Spruce plates, S-4-S, 4 by 6 in. by 14 ft.	
2 Spruce sills, 4 by 6 in. by 12 ft.	2 Spruce plates, S-4-S, 4 by 6 in. by 12 ft.	
All S-4-S (surface 4 sides).	@\$33 per M.	\$ 07
21 Chestnut posts, S-4-S, 6 by 6 in. by 5 ft.	@\$1 each	21.00
1 Spruce girder, 4 by 6 in. by 20 ft.	3 Spruce porch purlins, S-4-S, 4 by 6 in. by 10 ft.	
1 Spruce girder, 4 by 6 in. by 9 ft.	1 Spruce porch purlin, S-4-S, 4 by 6 in. by 18 ft.	
@\$30 per M.	@\$33 per M.	3.16
19 Spruce first-floor beams, 3 by 6 in. by 16 ft.	2 Spruce main-roof purlins, S-4-S, 4 by 6 in. by 10 ft.	
19 Spruce first-floor beams, 3 by 6 in. by 12 ft.	@\$33 per M.	1.32
@\$30 per M.	2 Spruce ridges, S-4-S, 2 by 10 in. by 18 ft.	
19 Spruce second-floor beams, S-4-S, 3 by 6 in. by 16 ft.	@\$35 per M.	2.10
19 Spruce second-floor beams, S-4-S, 3 by 6 in. by 12 ft.	4 Porch columns: hewn chestnut logs, 12 by 12 in. by 8 ft.	
@\$33 per M.	@\$1.50 each	6.00
95 Spruce studs, S-4-S, 3 by 4 in. by 8 ft.	4 Spruce corner posts, S-4-S, 4 by 4 in. by 8 ft.	
30 Spruce studs, S-4-S, 3 by 4 in. by 4 ft.	@\$30 per M.	1.29
12 Spruce studs, S-4-S, 3 by 4 in. by 12 ft.	11,000 White cedar shingles, 18 in. by random widths.	
@\$30 per M.	@\$6.25 per M.	68.75
32 Spruce rafters, S-4-S, 3 by 6 in. by 18 ft.	2,100 Sq. ft. clear pine, T & G flooring, S-2-S, 3/4 by 4 1/2 in.	
@\$33 per M.	@\$32.50 per M.	68.25
10 Spruce porch rafters, S-4-S, 3 by 6 in. by 12 ft.		
@\$33 per M.		
5.94		

3,350 Sq. ft. clear pine, T & G sheathing, S-1-S, for roof and sides, 7/8 by 8 in. @ \$22.50 per M.	\$ 75.37
1,600 Sq. ft. pine partitions, T & G, S-1-S, 7/8 by 8 in. @ \$22.50 per M.	36.00
600 Sq. ft. pine second-floor ceiling, T & G, 7/8 by 4 1/2 in. @ \$32.50 per M.	19.50
19 Rolls of roofing. @ \$3.75	68.55
700 Lin. ft. spruce roof battens, S-4-S, 1 1/2 by 3 in. @ \$30 per M.	7.89
	<hr/>
	\$500.87

PORCH TIMBER

5 Spruce sills, 4 by 6 in. by 10 ft. 1 Spruce sill, 4 by 6 in. by 18 ft. @ \$30 per M.	\$ 4.08
15 Floor beams, 2 by 6 in. by 9 ft. @ \$30 per M.	4.05
300 Sq. ft. pine flooring, T & G. @ \$32.50 per M.	9.75
5 Cypress fascia pieces, 7/8 by 8 in. by 12 ft. @ \$4.80 per M.	1.92
60 Lin. ft. cypress quarter round, 7/8 by 7/8 in. @ 65 cts. per Hun.30

BALCONY RAIL

14 Balusters, 7/8 by 6 in. by 2 1/2 ft. @ 10 cts. each	1.40
16 Balusters, 7/8 by 3 in. by 2 1/2 ft. @ 8 cts. each	1.28
1 Bottom rail, 1 1/4 by 10 in. by 12 ft. 1 Bottom rail, 1 1/4 by 10 in. by 16 ft. @ 6 1/2 cts. per ft.	1.82
1 Top rail, 1 1/4 by 6 in. by 12 ft. 1 Top rail, 1 1/4 by 6 in. by 16 ft. @ 3 1/2 cts. per ft.98
115 Lin. ft. 1/2 in. quarter round. @ 50 cts. per Hun.58

STAIRS—PINE

13 Risers, 7/8 by 7 1/2 in. by 2 1/2 ft. @ 40 cts. per M.88
12 Treads, 1 1/4 by 10 in. by 2 1/2 ft. @ 45 cts. per M.	1.44
2 Strings, 1 1/4 by 12 in. by 16 ft. @ 50 cts. per M.	2.00
3 Newel posts, 5 1/2 by 5 1/2 in. by 4 ft. @ \$1.75 each	5.25
1 Top rail, 16 ft. @ 5 cts. per ft.80
1 Bottom rail. @ 5 cts. per ft.80
24 Balusters, 1 1/4 by 1 1/4 in. by 2 1/2 ft. @ 10 cts. each	2.40
4 Second-floor rails, 7/8 by 6 in. by 14 ft. @ 4 cts. per ft.	2.24

INSIDE BATTEN DOORS

4 Pine, T & G, V-jointed, 2 ft. 6 in. by 7 ft. 4 in., 7/8 in. @ \$2.65 each	10.60
4 Pine, T & G, V-jointed, 2 ft. 6 in. by 4 ft. 4 in., 7/8 in. @ \$1.50 each	6.00

OUTSIDE BATTEN DOORS

4 Pine, T & G, V-jointed, 2 ft. 6 in. by 7 ft., 1 1/4 in. @ \$3.60 each	14.40
---	-------

DOOR STOPS

20 Pieces, 1/2 by 2 in. by 7 ft.	
10 Pieces, 1/2 by 2 in. by 2 ft. 8 in.	

WINDOW STOPS

50 Pieces, 1/2 by 2 in. by 4 ft. 8 in.	
25 Pieces, 1/2 by 2 in. by 2 ft. 1 in. All @ 1 1/4 cts. per ft.	5.87
335 Cu. ft. brick. @ 15 cts. per cu. ft.	50.25
19 Sash, 2 ft. by 4 ft. 6 in. by 1 1/2 in., 8 lights. @ \$1.70 each	32.30

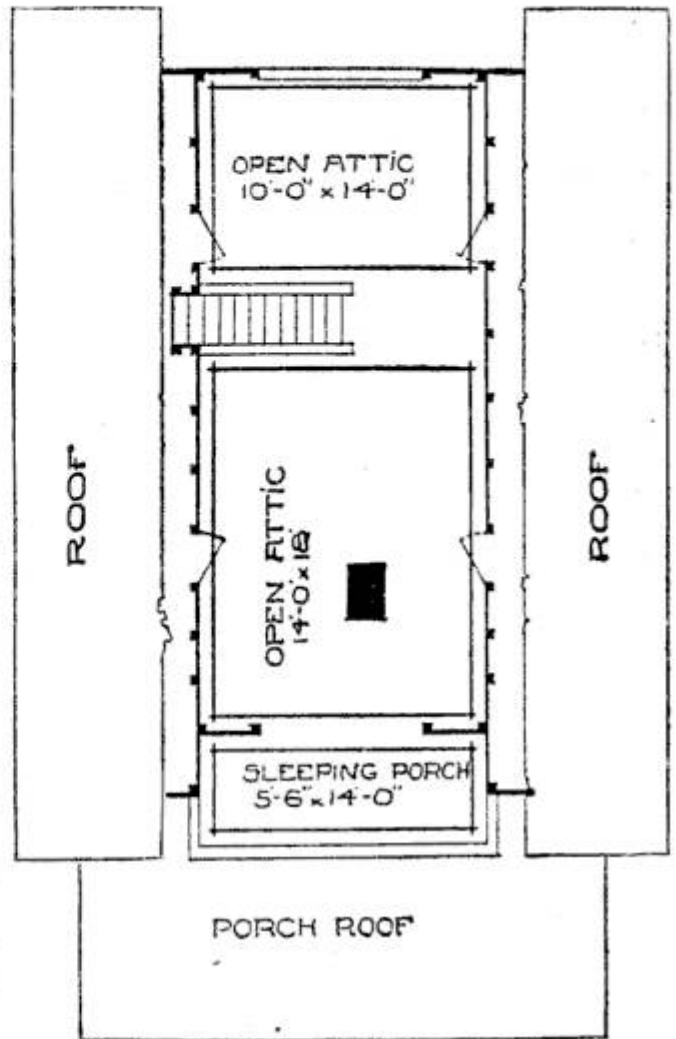

Second-Floor Plan

6 Sash, 2 ft. by 2 ft. 3 in. by 1 1/2 in., 4 lights. @ 90 cts.	\$ 5.40
---	---------

HARDWARE

25 Pairs, 3 by 3-in. sash hinges. @ \$1.20 doz.	2.50
2 Pairs, 4 by 4-in. door hinges. @ \$1.44 doz.24
8 Pairs, 3 1/2 by 3 1/2 door hinges. @ \$1.20 doz.80
8 Pairs thumb latches. @ 60 cts. doz.46
2 Pairs rim locks for outside doors. @ \$2.00 doz.33

\$171.21
509.87

\$681.09

According to the Mechanical World, 4 parts of alabaster plaster and 1 part of finely pulverized gum arabic, mixed with a cold saturated borax solution into a thick paste, make an unequalled all-around cement for stone, glass, bone, horn, porcelain and wood, which becomes hard as marble and possesses the agreeable working quality of not solidifying immediately, but in 24 to 30 hours.

Attaching Rubbers to Shoes

After wearing rubbers a few times, they will become a little larger and fit

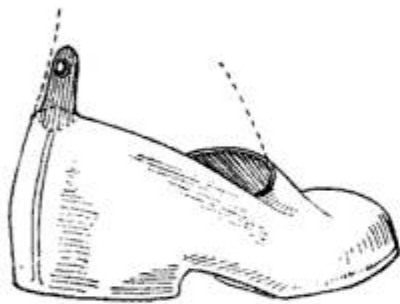

loosely over the shoes. Sometimes the looseness is quite annoying and when walking in

slush and muddy paths it is almost impossible to keep the rubbers on. This trouble I prevented by attaching the tongue and button as shown in the sketch. A tongue is fastened to the upper part of the back on each rubber and a button sewed on the back of each shoe. The tongue has a hole for the button.—Contributed by C. Home-wood, Waterloo, Iowa.

A Washtub for Use in a Sink

The average woman finds the filling and emptying of washtubs quite a task. Even when the washing is sent out, some fine pieces of clothing and flannels are always laundered at home because they are not to be trusted to a laundress or laundry. A tub that can be set in a sink and used in connection with a small washboard, costing 15 cents, and a cheap wringer, will enable any woman to do a small washing

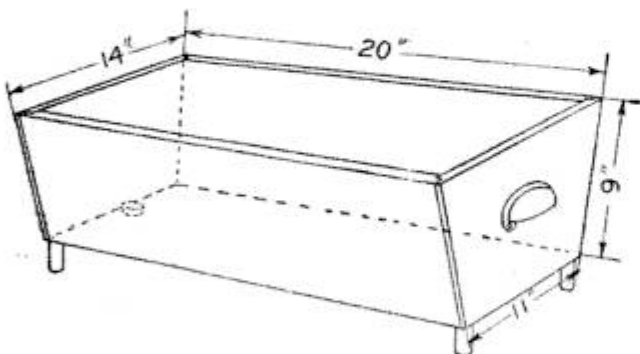

Sink Washtub

without bending, or emptying or lifting the water or tub.

A carpenter can furnish the material and make such a tub for a nominal price. The handles for the ends, and

the feet can be put on at home. A coat of paint may be applied to the outside if one cares for appearance. For the average sized sink the following dimensions will be found correct. It is better to measure the sink before making the tub. Pine wood is used for the material and should be $\frac{3}{4}$ or 1 in. thick. The height of the tub is 9 in. The sides are straight pieces of wood and measure 9 by 20 in. The two ends are 9 by 14 in., and the bottom is 11 by 19 in.

The two ends are rabbeted to receive the sides and bottom. Coat the rabbeted parts with white lead before nailing them together. A drain hole is bored in the bottom of the tub and a cork used instead of a wood plug. The cork swells with the water, but can be renewed when worn out. Feet are attached to keep the tub from resting on the bottom of the sink. This adds to the height of the tub and allows a free passage for the waste water. The feet can be made of pieces $1\frac{1}{2}$ in. in length, cut from a broom handle. The handles for the ends of the tub are the kind that are used on kitchen cupboard drawers.—Contributed by Katharine D. Morse, Sycamore, N. Y.

Soldering a Hole on an Overhead Surface

The mechanic as well as the owner of an automobile does not care to take off the body in order to remove the gasoline tank to solder a leaking rivet in the bottom. During an attempt made by the writer to effect such a repair, it was found that while the metal and rivet became well tinned, the solder would run back on the iron and the leak could not be stopped. The following method eventually proved successful:

A small tin cap of sufficient diameter and depth to cover the rivet head was first filled with solder and then held in place with the hot iron. After the solder was thoroughly melted, the cap was held in place with the point of a file until the solder cooled. A permanent repair was made in this manner.—Contributed by Fred C. Inghram, Tucson, Ariz.

Brazing Broken Band Saws

The factory or mill using band saws in any quantity must be provided with tools for filing and repairing them when they become dull or broken. For those who have only one saw the repair tools cannot be so elaborate. In this case, such a tool as shown in the sketch is not expensive and will be of great assistance in joining the ends of a broken saw blade. It is made of cast iron with the channel planed out perfectly straight. The channel provides a shelf for the saw to lie on and a place on each side of the gap for a setscrew to hold down the saw to the shelf. The saw can be clamped flat with its back against the rear of the casting while brazing, thus keeping the alignment perfect.

The two ends of the saw should be beveled and a piece of silver solder slipped between them. The joint should be made in the middle of the gap. A flame from a blow torch can be turned on the joint, and as soon as the solder has fused thoroughly, a clamp should be applied. On cooling,

this will make a thin, tight joint. If many saws are to be brazed, fit the jaws of a pair of tongs with pieces of

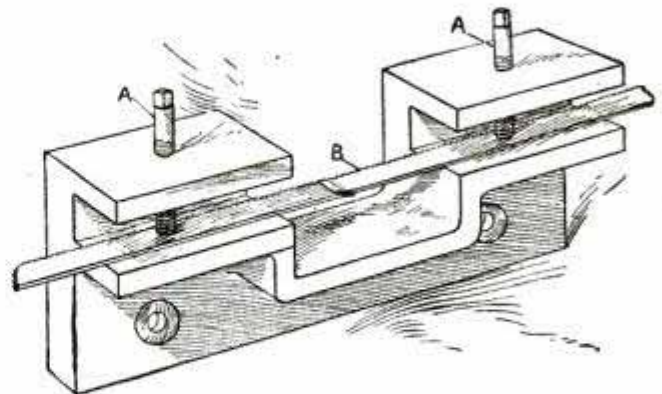

Broken Saw in Holder

steel, each about $\frac{1}{2}$ in. thick by 1 in. square. These false jaws retain the heat well and can be heated in any blacksmith's forge or with a blow torch. The grip of the hands on the tongs will be a sufficient clamp. Ordinary brazing spelter can be used, but it is lumpy for small work and does not flow as readily as the silver solder. Use borax as a flux in either case.—Contributed by Donald A. Hampson, Middletown, New York.

Filling Container from Gasoline Storage Tank by Air Pressure

The light used in my plant consumed gas made in the ordinary way under air pressure from gasoline. The container is a 10-gal. tank with the necessary valves, air gauge and air pump attached. This had to be filled every evening, and it was quite a job to carry gasoline from the large storage tank, besides causing some waste. To do away with this, I changed the arrange-

the container with a $\frac{3}{8}$ -in. pipe, as shown in the illustration. About 40 lb. of air pressure is necessary on the gasoline when the outfit is in operation.

To fill the container, I

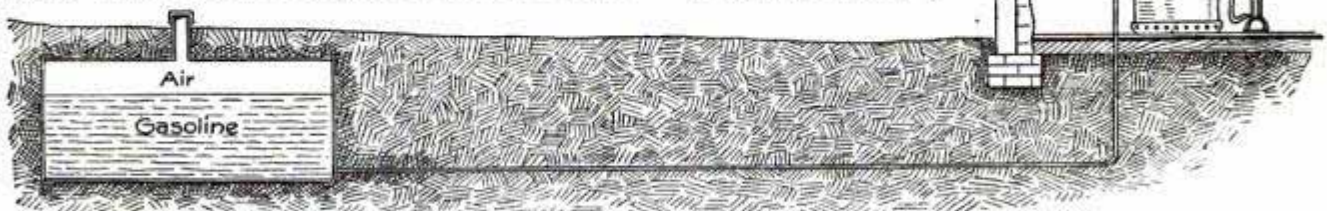

Filling Gasoline Container without Waste

ment of the tanks by burying the 110-gal. storage tank in the ground, 50 ft. from the building and connecting it to

simply open the valve B and let the air pass into the storage tank until the pressure is equalized in both tanks.

The air gauge A will show from 10 to 15 lb., owing to the amount of air space in the storage tank, when the pressure is equal. The plug C is then removed to let the air out of the container. The air pressure in the storage tank will

force the gasoline through the pipe, thus filling the container without waste. The flow of the gasoline can be watched through the hole where the plug C was removed.—Contributed by C. S. Enright, Cle Elum, Wash.

How to Fit Door Locks

Many beginners at carpentry approach the work of putting in a mortise lock with considerable doubt as to their ability of successfully accomplishing the task, and many others who have worked at the trade for years have no regular rule whereby they may do the

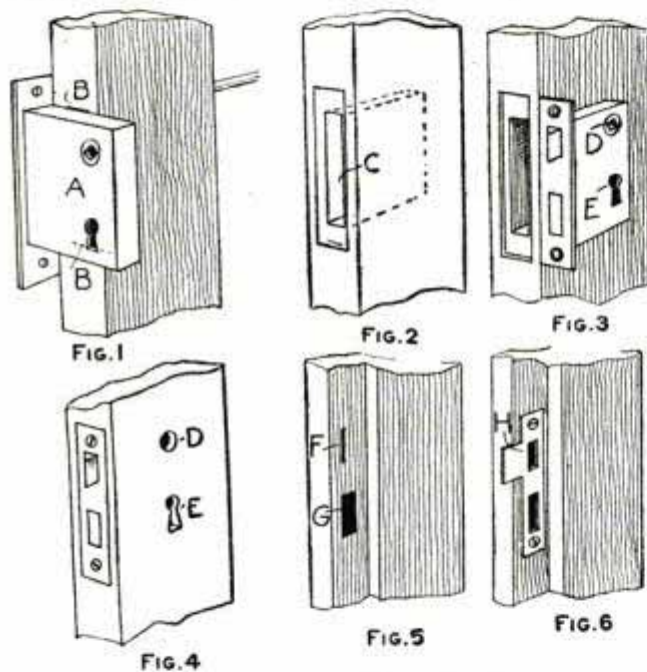

FIG. 4
Different Stages in Lock Fitting

work quickly and accurately. The tools necessary to do the work are, a screwdriver; a brace with two bits, one $\frac{3}{8}$ -in. and one $\frac{3}{4}$ -in.; two chisels, one $\frac{3}{8}$ -in. and one $\frac{3}{4}$ -in.; a scratch awl; a pocket knife; and a marking gauge. A $\frac{1}{2}$ -in. chisel can be used to advantage, but is not necessary.

When putting in mortise locks, two things must be taken into consideration; first, the height from the floor that will make the knob easy to grasp and, second, the place where it may be let into the stile without doing harm to the strength of the door. The distance from the floor to the knob should be from 32 to 36 in., as this is a location easily reached by both children

and adults. Sometimes the tenon on the end of a cross rail will be at this height and the lock, if possible, should be placed either above or below it. If placed in a tenon, it not only weakens the door, but it is difficult to properly clean out the mortise. All doors on the same floor in a house are generally of the same design and the location of the locks will be the same on all doors.

When the location of the lock is found, lay the lock across the edge of the door, as shown in Fig. 1, with the back of the faceplate against the side of the door, and scratch the short lines at the top and bottom with the awl as shown at BB. After setting the gauge to half the thickness of the door, mark a center line from B to B. Bore a hole at B and B with the $\frac{3}{4}$ -in. bit so they will extend a little outside of each mark and to a depth of $\frac{1}{4}$ in. more than the depth of the lock, measuring from the faceplate. Bore as many holes between the two as will be necessary to remove the wood in the mortise. Be careful to bore the holes exactly parallel with the surfaces of the door stile. It is a good plan to file a notch in the bit for a depth gauge to prevent boring too deep.

When the holes are bored, take the large chisel and smooth the sides of the mortise and square the top and bottom with the narrow chisel. Slip the lock into the mortise until the back of the faceplate lies closely against the edge of the door and shows the same margin of wood on each side. Hold it firmly in place and mark along the top, bottom, and both sides of the faceplate with the point of the knife blade, Fig. 2. Remove the lock from the mortise and lay it along the side of the stile as shown in Fig. 3 and mark the location

of the spindle hole D and the inside shape of the keyhole E with the awl. Bore the hole D with the $\frac{3}{4}$ -in. bit and the round hole E with the small bit and cut out the lower part of the keyhole with the knife blade. Should the door be of oak or other hard wood, a keyhole saw should be used instead of the knife. Deepen the cuts made around the faceplate with the knife blade and chisel the wood out around the mortise to a depth equal to the thickness of the faceplate. Insert the lock and fasten it with screws as shown in Fig. 4.

Many mechanics make difficult work of setting the keeper, yet it is the easiest part of lock fitting. When the lock is in place, insert the key and turn out the bolt while the door is open. Take some colored chalk and make it damp, or any other material that will adhere to the metal, and place a little on the face of the bolt and end of the knob latch, after it is turned out the full throw of the knob. Turn them both back and carefully close the door. Release the knob and turn out the key bolt. Turn them back again and open the door and you will find markings on the rabbet of the door frame as shown at F and G, Fig. 5.

Lay the keeper over the impressions on the rabbet and set it so as to have the same margin between the impressions and the holes in the keeper plate top and bottom and allow $\frac{1}{32}$ in. between the upper impression and the front side of the hole in the keeper, as shown at H, Fig. 6. Hold the plate firmly in place and mark all around the outside with the point of the knife blade. Remove the plate and chisel out the wood inside of the knife marks to a depth equal to the thickness of the keeper plate. This is to make it flush with the face of the rabbet. Fasten the plate in place with screws taking care to turn the screws in at right angles with the surface of the work. The screw heads will be level with the surface of the plate, if this caution is observed.

Cut out the mortises in the wood through the holes of the keeper, using the narrow chisel. Make them deep enough to receive the latch and key bolt when they are entirely extended. If these simple instructions are carried out, each lock will work perfectly and the workman need not waste the time measuring for the different parts as in the usual methods.—Contributed by Ed. A. Peacock, Cincinnati, O.

Welding Steel without Compounds

One day I had several auger bits to lengthen and though I was short on welding compound at that time, I completed the work in the following manner:

I used $\frac{1}{2}$ and $\frac{5}{8}$ -in. round iron to weld on the augers to make the length desired. I scarfed them in the ordinary way, then I heated the iron very soft and the steel only a little more than cherry red and used a little sand as a flux. I found that the weld was much better when I put the steel on the iron and hammered it rather light at first, then finishing with harder blows. All of the parts were joined perfectly and I did not miss one heat.—Contributed by Wm. Skoglund, Brooklyn, N. Y.

Making Clearance on a Twist Drill

A twist drill that has the clearance worn off can be repaired as shown in the illustration. Lay the drill flat on



Drive Out the Point

an anvil and strike the cutting edge on the place marked A and grind it in the usual way. An old drill treated this way will work as good as new.—Contributed by Julius Fast, Milwaukee, Wisconsin.

Wet the surface of glass and the diamond or cutter will cut better.

Closing a Split Cotter Pin

A split cotter pin after being opened requires a little "persuasion" to close

it a g a i n. The quick-est and most s a t i s f a c t o r y way to a c c o m p l i s h this is to place one leg of the pin on an i r o n block or the jaw of a vise and gently strike the h e a d with a hammer. This

causes the legs to come together the same as a new pin.—Contributed by A. H. Burton, Chicago.

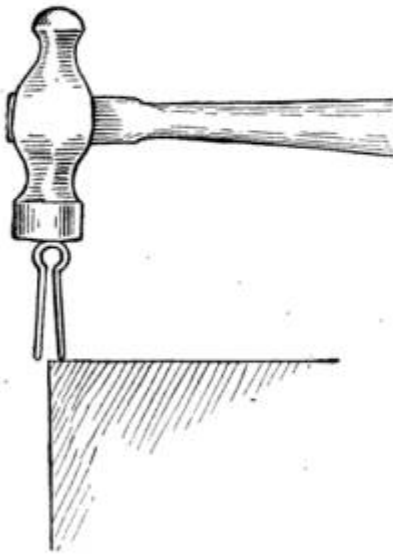

Weight on a Belt Shifter

The constant jar of a countershaft gradually works the shifter handle over until it hangs almost perpendicular, then the belt is half off and half on the driving pulley. The sketch shows an attachment for the shifter handle that will keep the belt on the tight or loose pulley as the occasion demands. When the weight is shifted to either side of the center, it has a tendency to keep the belt over in the op-

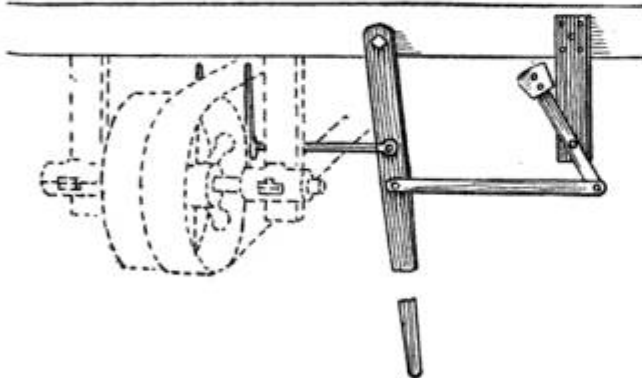

Weight Keeps Belt in Place

posite direction from its position by the jar of the machinery.—Contributed by C. Mike Graham, Oskaloosa, Iowa.

Cutting a Gear on a Milling Machine

The teeth on a gear can be cut with accuracy on the milling machine by using an index head as shown in the sketch. A blank, which has been previously turned up to the proper diameter, is placed on the centers A and B. The machine table is raised so that the cutter just touches the face in the center on the blank gear. Then move the table away from the work, but do not lower it. This will leave the cutter on a level with the face of the blank gear. The depth of the cut is now set by the dial on the milling machine proper. One revolution of this dial will raise the table $\frac{1}{8}$ in. The depth of the cut can be set accurately.

The gear blank being set for the proper depth of cut, the next step to take is to make the proper space from one tooth to another. This is accom-

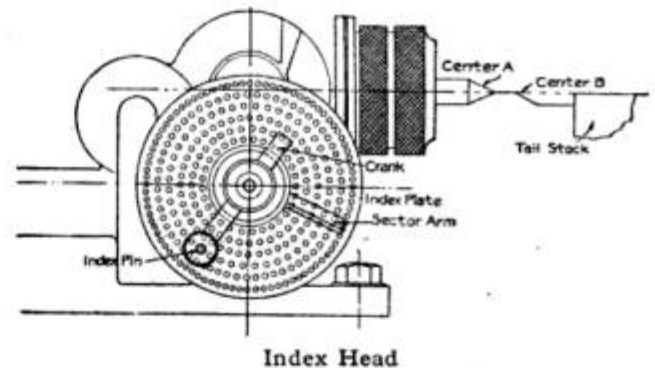

plished by the index head as shown. Take for example, a blank gear that is to have 45 teeth. Almost all index heads have a plate with a circle containing 90 holes. The sketch shows an index plate with 90 holes in the outside circle. To cut 45 teeth on a blank, set the crank so that the index pin will enter a hole in the 90-hole circle.

Assuming that the ratio between the center A and the crank is 40:1 which means that 40 revolutions of the crank revolves center A one turn, then $\frac{1}{45}$ of a revolution of the center A requires $\frac{40}{45}$ of a revolution of the crank. The pin therefore must be moved $\frac{40}{45}$ of 90 or 80 holes for each cut.

Another way which may be a little clearer, is to take the number of teeth on the worm wheel of the head, which is generally 40, for the numerator and

the number of teeth to be cut for the denominator of the fraction. Example: Suppose 30 teeth are to be cut in a blank gear, then the fraction would be $40/30$ or $1\ 10/30$, which would mean that the crank must be set so the index pin would enter holes in the 30-hole circle. The setting for each cut would require one complete revolution of the crank and 10 holes more.

If the index head does not have a circle of 30 holes, then the crank must be set on the 90-hole circle. In this case, the fraction, both numerator and denominator, must be multiplied by 3, which gives $1\ 30/90$. The crank must be turned one complete revolution and 30 holes more, when using the 90-hole circle.

In using the index head on a milling machine, just as good work, and sometimes better work, can be done than on a regular gear cutter.—Contributed by Harold E. Murphy, Pawtucket, R. I.

A Stop for a Drawer

A simple yet practical method to prevent pulling drawers out too far and spilling the contents is shown in the sketch, Fig. 1. A piece of steel about $\frac{1}{16}$ in. thick, $\frac{3}{4}$ in. wide and 3 in. long is drilled and attached by two screws to the back of the drawer (Fig. 2) so as to project about $\frac{1}{2}$ in. above the top edge. The drawer may be removed to screw on the piece and then inserted by slightly tilting the same

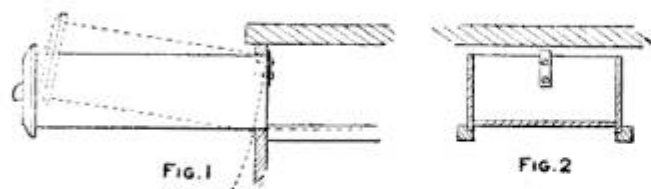

Stop on Drawer Back

upward, as shown in Fig. 1. The drawer is removed for cleaning in the same manner.—Contributed by Otto J. Kling, Youngstown, O.

ⒸAn internal combustion engine run with the water jacket so hot that you cannot hold your hand on it uses less fuel than it would if the jacket were kept cold.

Preventing a Saw from Sliding on Sloped Surfaces

A saw laid on the sloping surface of a roof or on a scaffold is apt to slip and

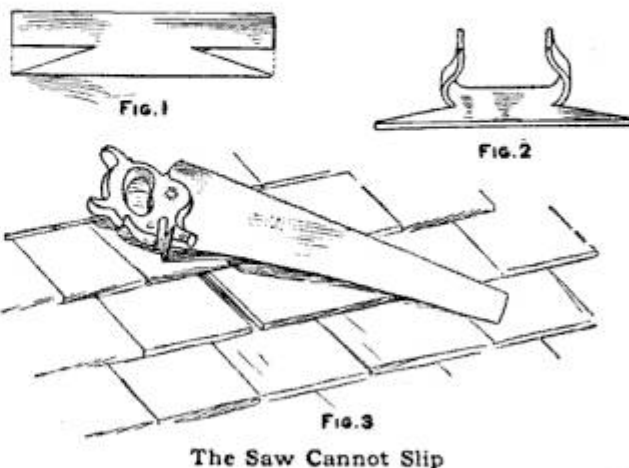

The Saw Cannot Slip

fall if slightly jarred. The sketch shows the construction of a small device I made to fit over the back of a saw handle to hold the saw wherever it is placed. It consists of a piece of sheet metal cut as shown in Fig. 1 and shaped as in Fig. 2. When slipped over the handle a point projects on each side as in Fig. 3. A saw cannot slip with this device attached.—Contributed by C. C. Brabant, Alpena, Mich.

Repairing Umbrellas

Umbrellas may be repaired with no other tools than a pair of pliers, a knife and a needle. No supplies are needed except some thread and a piece of small wire. The operation is too simple to require a description and about the only thing to look out for is to see that a whole rib is put into the place where a broken one was removed. The writer was surprised to find it so easy to make a repair, and, having begun at this work, it was found that there were enough broken umbrellas in the house to supply each member of the family with two good ones after they were mended. If a cover is needed, it may be that one can be taken from an umbrella that is used to supply the ribs for the others.—Contributed by Frank W. Blake, North Adams, Mass.

Electric Connection for a Door Latch

A door latch equipped with an electric connection for "switching on" a light is shown in the sketch herewith. The connection is for use on toilet and bathroom doors. When closing the door after entering the room the latch turns on the light. The socket part is fitted with two contact springs, A, which are the terminals of an electric-light circuit. A small block of wood or insulating material is fastened to the spring as shown, to prevent a shock when turning the handle. The two ends should be well insulated where they enter the lock. The light burns only when the door is secured by the latch.—Contributed by F. G. Christensen, Santa Rosa, Cal.

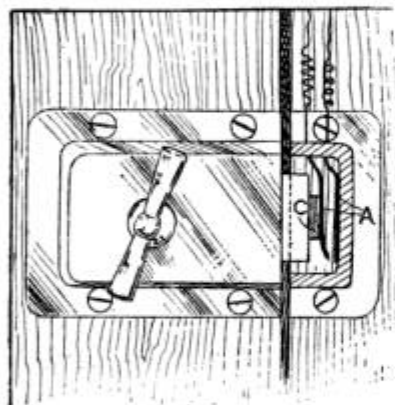

light is shown in the sketch herewith. The connection is for use on toilet and bathroom doors. When closing the door after entering the

room the latch turns on the light. The socket part is fitted with two contact springs, A, which are the terminals of an electric-light circuit. A small block of wood or insulating material is fastened to the spring as shown, to prevent a shock when turning the handle. The two ends should be well insulated where they enter the lock. The light burns only when the door is secured by the latch.—Contributed by F. G. Christensen, Santa Rosa, Cal.

Balance for Measuring Liquids Automatically

When any liquid is poured into an opaque container, it is difficult to determine the depth of the material until it overflows the mouth. To save time and avoid waste, a simple balance will give warning by tilting when the vessel is almost full.

Such a balance can be made of a piece of board, 1 or 2 ft. long, with a triangular strip of hardwood fastened with nails across the under side. Place the can or other vessel on one end and a weight on the other and adjust the balance by moving either fulcrum or weight until the full can just tips it. A strip of wood should be nailed across the end of the board to set the can against so that it will always be placed the same distance from the fulcrum. After adjusting, fasten the weight securely.

This simple apparatus is especially convenient for use in filling gasoline

torches, stove reservoirs, etc. Those having occasion to do this know how slowly the gasoline passes through the strainer unless the funnel is kept well filled, and how carefully the liquid must be poured toward the last, else there is waste. It is particularly applicable to this use because gasoline is generally handled by artificial light, and a fair amount of daylight by which to watch the process of filling is not always available.

Cutting Steam-Gauge Glasses

When cutting a circular piece of glass for a steam gauge, many me-

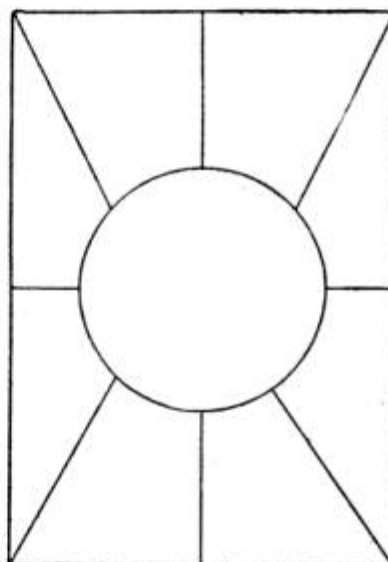

chanics spoil piece after piece in getting the circular section. Radiating cuts to the edge of the stock, as shown in the sketch, will enable one to break away the unnecessary parts without danger of breaking the circular portion.—Contributed by F. W. Bentley, Jr., Huron, S. Dak.

When cutting a circular piece of glass for a steam gauge, many me-

A Vacuum Sticker

A handy vacuum sticker can be easily made from a round, red rubber taken from the porcelain stopper of a beverage bottle, a screw and a short piece of brass wire.

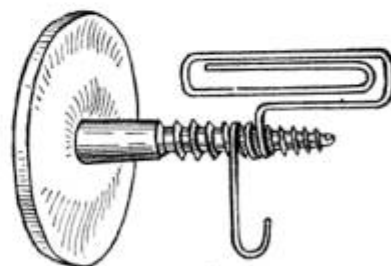

The screw must be of the right size to tightly fit the hole in the rubber. After the screw is pushed through the hole,

the wire is wound on the threads as shown in the sketch. The upper part may be used to hold cards by pushing the edge of the card between the two wire loops. The hook may be used to hold light articles. The sticker is to be used on any non-porous and smooth surface and is applied by first putting some water or glycerine on the rubber, then pressing it against the surface so that the air is expelled. This sticker will hold 3 lb.—Contributed by Abner B. Shaw, N. Dartmouth, Mass.

Blacksmith's Parallel Tongs

The ordinary blacksmith's tongs are not constructed so they will grip pieces of various thicknesses and hold

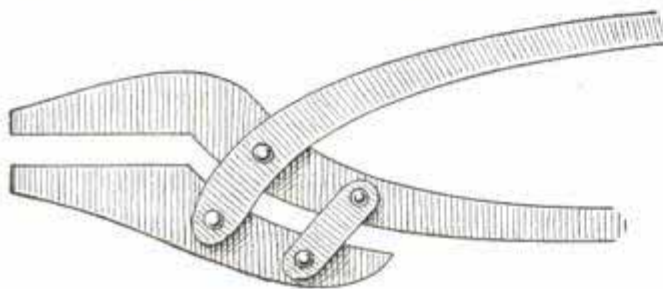

Parallel Jaws

them solidly. The jaws are set so that when opened they will be parallel only at a certain point of separation, thus making it necessary to have a number of tongs about the anvil. The illustration shows a way to make parallel jaws on tongs for holding pieces of various thicknesses. When holding with these tongs, the material held will not turn sideways or slip away from the grip of the jaws.—Contributed by Geo. Newfeld, Philadelphia, Pa.

Repairing a Broken Valve Stem

It is often necessary, because a new valve cannot be obtained immediately, to make a repair on a broken valve stem. The following is a method of repair that will make the old stem as good as a new one. The first operation is to dovetail the end of the broken stem, as shown in Fig. 1. Take a piece of round rod the same size as the stem and cut the end to fit in the

dovetail. Place them together, as shown in Fig. 2, and heat the joint to a bright red, being careful not to burn

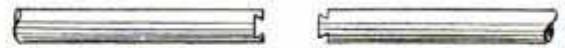

FIG. 1

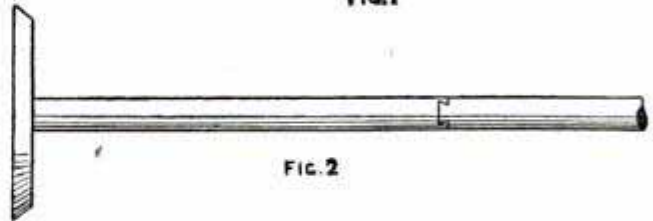

FIG. 2

Joint in Stem

the metal. Cover the parts with borax, and just as soon as it flows, apply spelter. Leave it in the fire until the metal shows a dull red, then remove and allow it to cool. Clean and polish the rod to make it move freely in the guide. Cut to the right length, and the stem will serve as well as a new one.—Contributed by J. N. Bagley, Webber, Kansas.

Setting a Lathe Tool

Much time may be saved in setting the cutting tool in a lathe, by using the simple little device shown in the accompanying illustration. It is made of sheet metal and the holes are drilled in the ends for convenience in hanging it up. The vertical distance between the extreme top and bottom edges is equal to that between the flat surface of the lathe carriage and the point of either of the lathe centers. In use, the device is placed as shown and the lathe

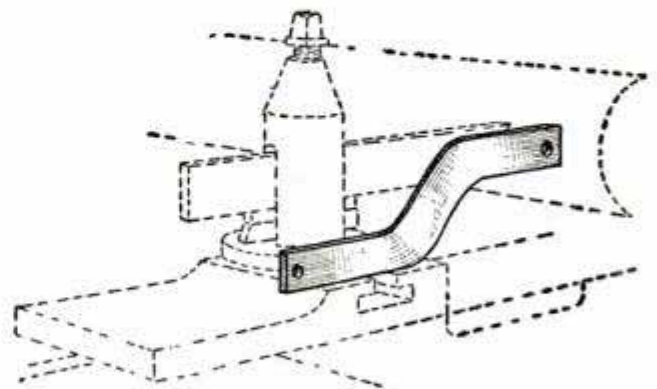

Gauge for Tool Setting

tool is adjusted until its top edge corresponds with that of the device.—Contributed by Joe V. Romig, Allentown, Pennsylvania.

Ladder Fastener

Ladders that are used in a loft, hay mow or similar places where they must be set at such a slant that slipping is liable to occur, should be provided with some kind of a fastener or grip. Such a fastener is shown in the accompanying sketch. It is made of a piece of $\frac{1}{4}$ by $\frac{3}{4}$ -in. iron, bent as shown and attached with two $\frac{1}{4}$ by $1\frac{1}{2}$ -in. wood screws. One of these fasteners on the upper end of each support insures the ladder against slipping.

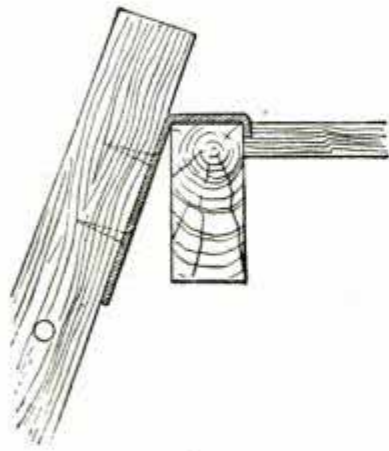

If the lower ends are sharpened a little, they will dig into the floor where there is no recess just back of the beam.—Contributed by Donald A. Hampson, Middletown, N. Y.

Plowshare Tongs

When holding a plowshare for sharpening, some kind of tongs that will stick and at the same time be light and short so that one will have the weight of the share close to the hand are necessary. To get a good grip with ordinary tongs they must have long handles and then the smith must take hold out near the end. This places the weight of the share so far from the hand that it is difficult to manage, and then the share will slip

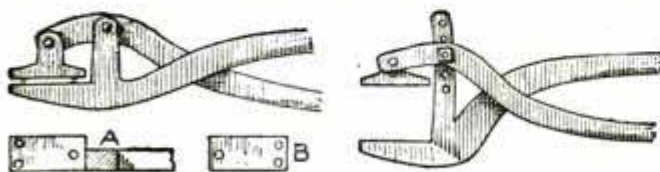

Three-Point Contact on Jaws

and turn where it is not wanted, says a correspondent of the Blacksmith and Wheelwright.

The sketch shows the construction of special plowshare tongs. The entire length from tip to tip is 12 in. The distance between the fulcrum and the load is reduced to the least possible. Each jaw has three raised points, the face of the lower shown in the sketch at A and the upper at B. These points working on the same principle as a stool having three legs, all points will touch the surface with equal weight or pressure. It will be seen that the points are reversed on each jaw; where there is one point on the lower jaw, there are two on the upper, and vice versa. This fulcrum applies great leverage in a short radius and the points give great gripping power.

The tongs shown first in the sketch are for a certain thickness of metal and the last shown are adjustable for various purposes.

Holding Food for Stock

Fodder, such as cornstalks that are not shredded, is frequently tossed out

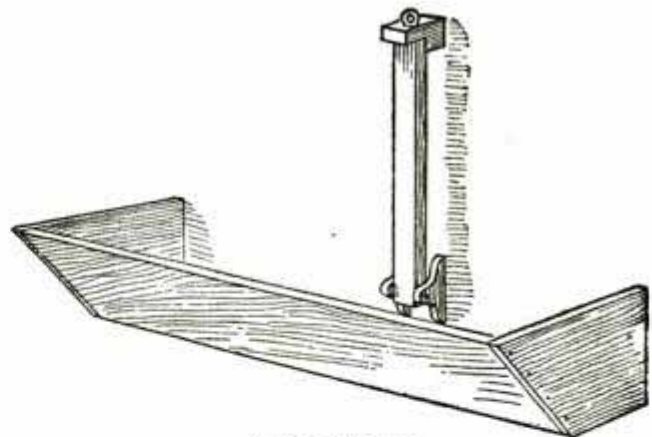

Fodder Clamp

of the manger and wasted. A device for holding this kind of feed against the wall in front of the manger is shown in the sketch. It is made of 2 by 4 in. material, about 3 ft. long, hinged at the lower end and clamped at the top. The stalks are placed behind the upright piece and securely clamped. Several of these devices placed at intervals along the manger will make it hard for the stock to pull the fodder out and waste it.—Contributed by Henry Weber, Sr., Friend, Neb.

Home-Made Moisture Gauge for Incubators

An incubator hygrometer that will give fairly accurate results can be made by fastening two thermometers and a small bottle to a wood back as shown in the sketch. The back should be from $\frac{1}{4}$ to $\frac{1}{2}$ in. thick, as wide as the opening into the egg chamber will allow—usually about $3\frac{3}{4}$ in.—and long enough to hold the articles mentioned. Two holes $\frac{1}{2}$ in. in diameter and $\frac{1}{8}$ in. deep are bored to form bulb sockets. A place is hollowed out for the bottle and grooves cut along the upper edge of the thermometers to accommodate their turned-down edges. The general appearance of the instrument will be greatly enhanced if the back is stained or painted.

The two thermometers should be of the same make or at least should register within $\frac{1}{2}$ deg. of each other. The bulbs should be as close together as possible and the center of each exactly the same height, $1\frac{5}{8}$ in. above the bottom of the tray when the gauge is in position. If the tray is slatted, the thickness of the slats must be taken into consideration. The thermometers are fastened with brass-headed tacks put through small holes drilled in the metal back.

The bottle should be flat and hold from $\frac{1}{2}$ to 1 oz. It must be placed as low as possible. The mouth must be slightly lower than the bulb and about $\frac{3}{8}$ in. from it. The wick can be made of old muslin, wide enough at one end to encircle the bulb. A width of $\frac{3}{4}$ in. is sufficient for the remainder. The muslin is tied above and below the bulb with a thread.

Use distilled water or rain water in the bottle, as ordinary well water will soon clog the wick, thus giving inaccurate readings. In use, the hygrometer stands on edge among the eggs about where the thermometer is usually placed. The temperature is indicated

by the dry bulb, the percentage of moisture by the difference between the two. If the relative humidity runs above 85 or below 25, no chicks need be expected.

To secure the best results, the rela-

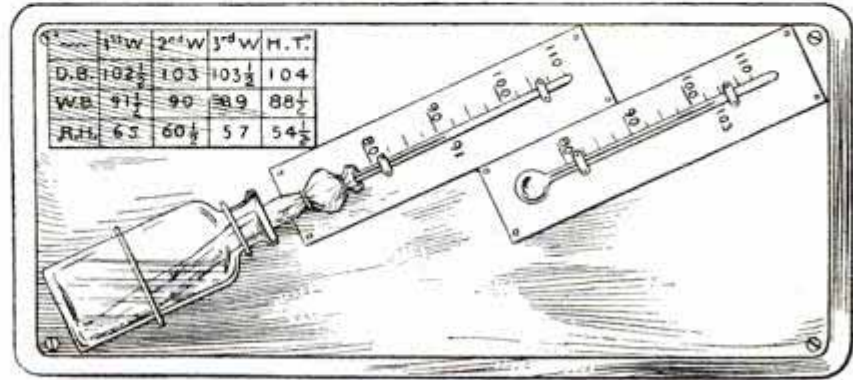

Moisture Gauge and Table

tive humidity should be about 65 when the eggs are put into the machine, and gradually reduced to about 55 by hatching time. To accomplish this, hold the gauge to the table on the base of the gauge shown in the sketch.

A variation of 1 deg. by the wet bulb when the dry bulb remains constant, indicates a difference of about $2\frac{1}{2}$ per cent in amount of moisture. If too wet, give the egg chamber more ventilation. Should the wet bulb range several degrees too high and cannot be lowered sufficiently by the ventilation, then the room where the incubator is placed is probably too damp. The presence of mold will prove this. Air out thoroughly and use some air-slaked lime. In extreme cases, a small chunk of lime may be put in a pan or on a board and set inside the incubator until the humidity falls to the proper degree. If all remedies fail, move the machine to a dryer location. Humidity, like temperature, should be right before eggs are put into the incubator. After that, it is easily controlled.—Contributed by B. Orlando Taylor, Bosworth, Mo.

☞ Mats for flower pots can be cut from the sides of worn-out hot-water bags.

An Emergency Marking Gauge

Having lost or misplaced my marking gauge I used a monkey wrench in its place as shown in the sketch. The jaws were opened to the desired width and the lower jaw placed against the edge of the board, and I ran the wrench along the same as a marking gauge. The corner on the end jaw made the mark.—Contributed by W. D. Castle, Gridley, Ill.



Home-Made Window Lock.

A handy window stop that will permit either sash to be raised or lowered and locked in position can be made with two screw eyes, a large nail and an iron strap.

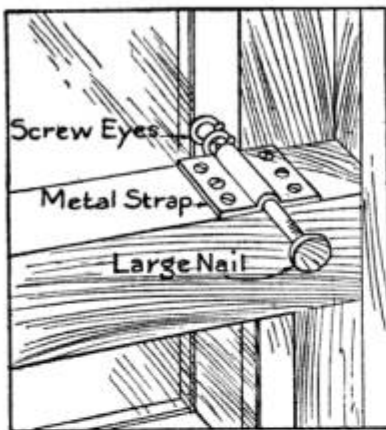

The iron strap is bent to the shape shown in the illustration and drilled for six screws, by which it is fastened to the top of the lower sash. Two screw eyes are screwed into the frame of the upper sash, one in front of the other, with the openings horizontal and in line at right angles to the glass.

The nail is inserted under the strap and pushed in the screw eyes to lock the window. This arrangement allows air to be admitted to the room without fear of intruders climbing through the window.—Contributed by W. A. Jaquythe, Richmond, Cal.

Abrasive for Grinding Valve Seats

If emery cannot be procured for grinding in valve seats, take a piece of glass, any glass will do, and reduce it to a medium powder by pounding with a hammer. Mix the powder with a light oil of any kind and it will grind in a check or air valve quicker and better than the emery used for the same purpose. This is a good thing to remember when sent out from a shop and emery is not always at hand.

Handle for Carrying Tools

Carpenters, electricians, plumbers and others who carry tools, will find

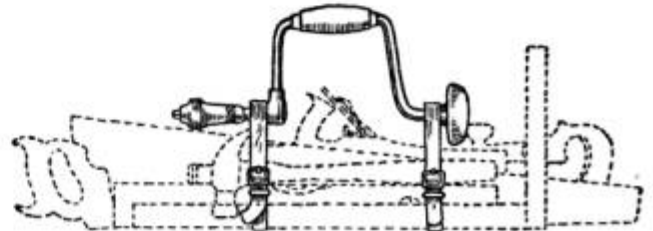

The Brace Makes the Handle

the suggestion given by a correspondent of Wood-Worker of considerable assistance. He suggests to arrange the tools in a compact parcel, leaving the brace out, and placing two straps, one around each end of the bundle. Before buckling the straps, place the brace on top of the pack, then fasten the straps over each end of the brace, and you will have a handle which will greatly reduce the tedium of carrying tools any distance.

Tempering a Chisel

Heat the chisel about 1½ in. up from the cutting edge to a dark cherry red, then cool the edge in water and rub it with an emery stick or a whetstone. Let the heat run down to a dark straw color, then cool the edge again and brighten as before. Let the heat draw to the color of pigeon blue, then cool the entire chisel. Chisels tempered this way will stand much better than those tempered in the ordinary way.

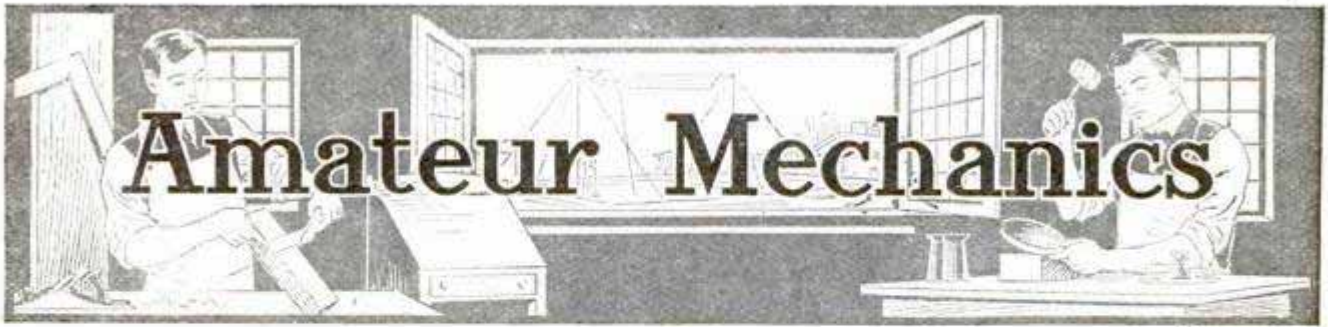

Wood-Block Printing on Fabrics

When one hears of wood-block printing he usually thinks of the crude wood blocks used by printers some 10 or 15 years ago. More recently wood-block printing has been taken up by art craftsmen and we are beginning to revise our ideas about the craft.

Not much is required in the way of equipment for the performance of wood-block printing: A smooth, close-grained wood that will hold color on its surface and a few carver's tools for cutting the outline. Hard maple will answer for the wood. It is so common that there will be no trouble in obtaining it.

The beauty of the effect will depend upon the appropriateness of the design. A beautiful design is not necessarily a complicated one. The accompanying illustration shows some good effects obtained with simple designs on hand-cut blocks. The design must, of course, be traced on the block the reverse of what is wanted on the fabric.

Simple, one-color effects are very satisfactory. Where one knows his materials and is ambitious, he may make use of several blocks successively, getting a combined color effect in a manner quite similar to the way a printer gets pictures of different colors.

On textiles, such as burlap, monks' cloth and curtain and pillow-cover material, use colors ground in oil and thinned with turpentine, only enough to make them of a consistency similar to printers' ink. Apply the color to the block evenly and impress it on the cloth. If the colors are in their origi-

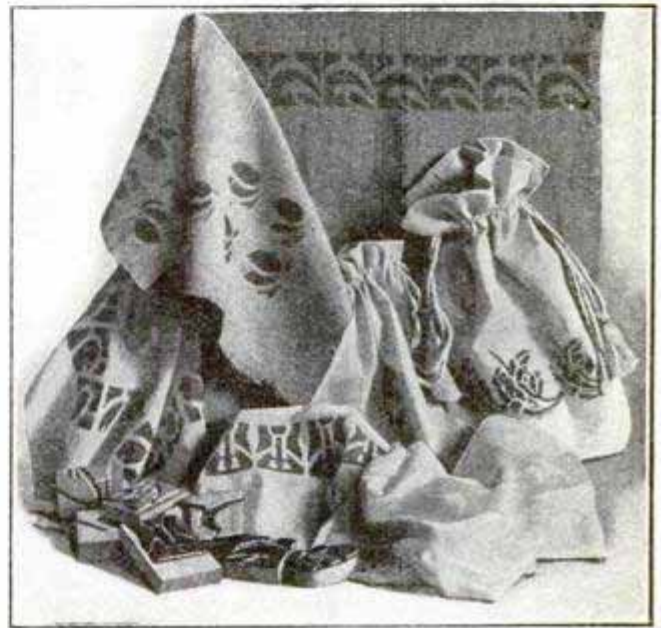

The Blocks and Their Work

nal intensity, they should be "greyed," softened by the addition of black.

Removing a Snagged Fishhook

A device for unhooking a snagged fishhook can be made of the taper end of an old curtain spring and a stick or old fishing pole. A part of the coil is straightened out and a ring bent on the end, large enough to pass over the sinkers. The ring is left open so it can be placed over the line at any point. The remaining coil of the spring is slipped on the end of the stick



Ring on Hook

and fastened with screws or staples. The illustration shows how the device is applied to the fishhook.—Contributed by J. H. Norrell, Augusta, Ga.

Locking Several Drawers with One Lock

A series or row of drawers can be secured with one lock by using the device shown

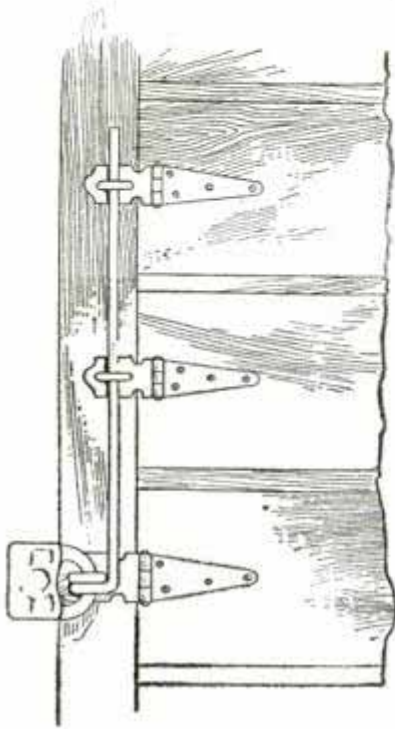

in the sketch. This method takes away several dangling locks and the carrying of many keys. A rod is used through the various staples over the hasps. The rod is upset on one end and flattened

to make sufficient metal for drilling a hole large enough to insert the bar of a padlock. If the bar is made of steel and hardened, it is almost impossible to cut it in two.—Contributed by F. W. Bentley, Huron, S. Dak.

Testing Small Electric Lamps

The accompanying sketch shows the construction of a handy device for testing miniature electric lights. The base is made to take in an electric flash lamp battery. Two strips of brass, C and D, are connected to the battery. The lamp is tested by put-

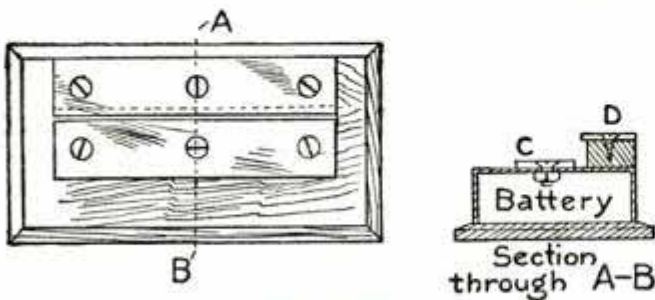

Lamp Tester

ting the metal end on the lower brass strip and the side against the upper one. A great number of lamps can be

tested in a short time by means of this device.—Contributed by Abner B. Shaw, North Dartmouth, Mass.

How to Make a Pin Ball

The pin ball shown in the illustration is made of calfskin modeling leather and saddler's felt. Two pieces of leather are used, and one piece of felt, all three being cut circular to a diameter of about 3 in. The felt may be about $\frac{1}{2}$ in. thick, and leather of a deep brown color is recommended.

Moisten the leather on the back side with as much water as it will take without showing through the face. Lay it on a sheet of heavy glass or copper, or other hard, smooth, nonabsorbent material. Place the design, which has been previously prepared, over the face of the leather. Indent the outline of the design with a nutpick or any other pointed tool that will not cut the leather. Remove the pattern, and go

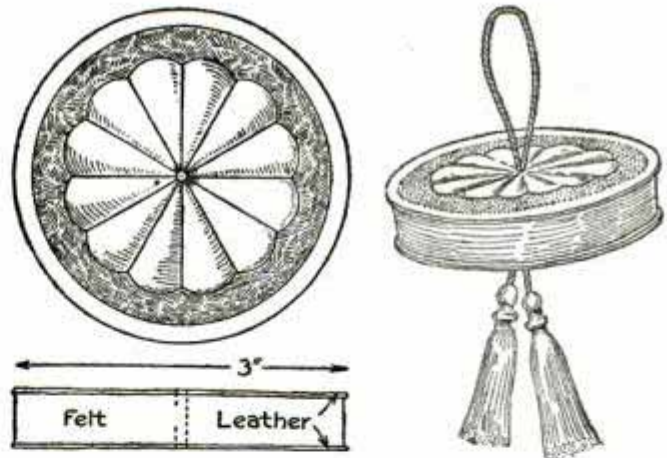

Made of Leather and Felt

over the outline again to deepen the tool marks.

The space between the border and the design is now stamped with a cup-pointed nail set, care being taken not to cut the leather, especially if the tool be new. Rubbing the edges of the nail set over a piece of emery paper will serve to dull them, if they are too sharp.

When the designs have been worked on the leather, paste or glue the leather to the two sides of the belt, and punch a hole in the center through which to place a cord for hanging up the ball.

Cleaning Woodwork

An easy method of removing the dirt and old varnish at the same time around a kitchen sink is told by a correspondent of National Magazine as follows:

Make a soft soap from common yellow laundry soap, and when it is almost cold stir in one tablespoonful of concentrated lye and one-half cupful of kerosene. When the mixture becomes a heavy paste, it is ready to be spread over the woodwork with a paint brush. Allow the soap to remain for a day and a half, then wash it off with plenty of hot water. The woodwork will be clean and ready for varnishing when it dries out.

Bill File Made of Corkscrews

An ordinary corkscrew makes a convenient file for small bills or memoranda. It may be thrown in any position without danger of the papers slipping off. A rack to hold a number of files can be made of a wood strip (Fig. 1) fitted with hooks or screweyes cut in a hook shape, as shown in Fig. 2.

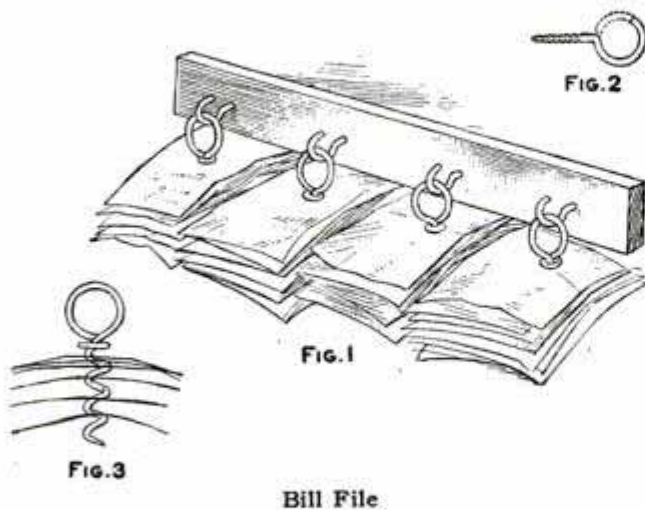

Bill File

Single bills may be separated from the others and will remain separated as in Fig. 3.—Contributed by James M. Kane, Doylestown, Pa.

Ornamental Metal Inkstand

The metal required for making this stand is $\frac{3}{16}$ in. in width and may be

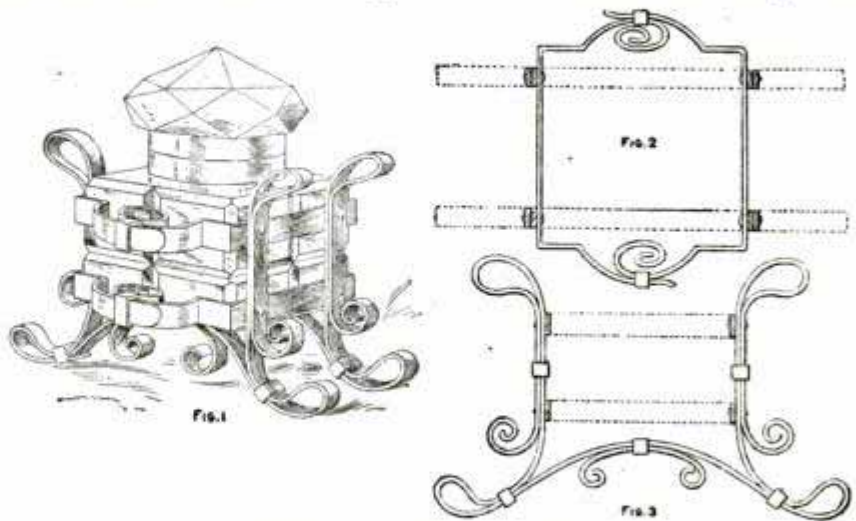

Inkstand and Details of Frame

steel, brass or copper. The shaping is done as shown in Figs. 2 and 3. There are, in all, eight pieces to be bent. The two supports are each formed of one piece of metal with the exception that the end scroll pieces on the under side are made separately. Eight rivets are required to fasten the two horizontal rings to the supports. The glass receptacle can be purchased at a stationery store.

Holding Eyeglasses Firm

Persons who wear nose-glasses and who are troubled with excessive perspiration, should chalk the sides of the bridge of the nose before putting on the glasses. The latter will then never slip, even in the warmest weather. If the chalk shows, use a pink stick, which can be purchased from any art school or supply store.

Substitute for Gummed Paper

Gummed paper is a great convenience in the home especially for labels, but it is not always found among the household supplies. The gummed portions of unsealed envelopes in which circulars are received can be utilized for this purpose. Quite a large label may be made from these envelope flaps.

Repairing a Broken Phonograph Spring

As I live a great distance from a railroad station, I did not care to pay the price, and await the time necessary to deliver a new phonograph spring to replace one that broke in my machine, and I repaired the old one in a creditable manner as follows:

I forced the two ends of the break out where I could get at them, then heated each end separately with a pair of redhot tongs and turned a hook or

A Small Bench Lathe Made of Pipe Fittings

The most important machine in use in the modern machine or wood-working shop is the lathe. The uses to which this wonderful machine can be put would be too numerous to describe, but there is hardly a mechanical operation in which the turning lathe does not figure. For this reason every amateur mechanic and wood-worker who has a workshop, no matter how small, is anxious to possess a lathe of some

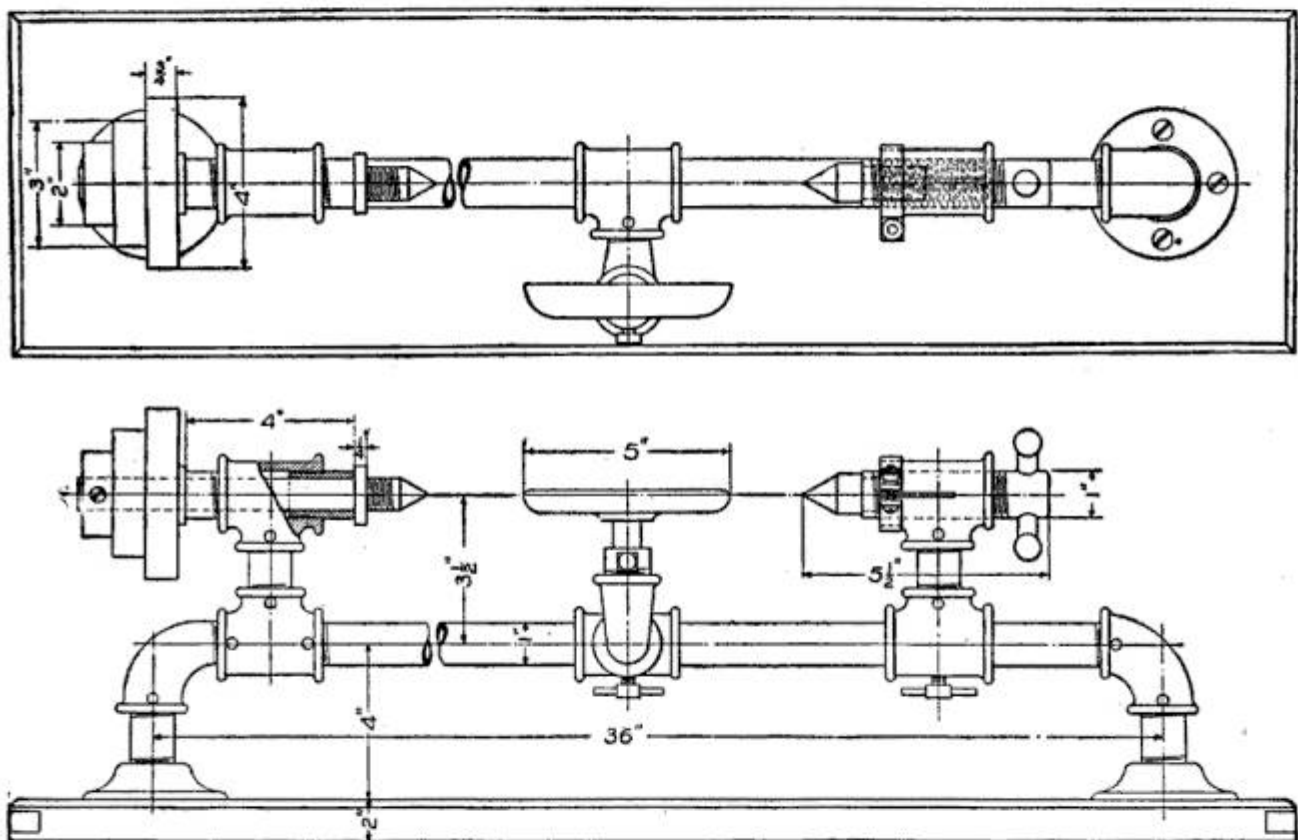

Fig. 1—Details of Lathe

lap on them the same as the joints in knock-down stovepipes. When the ends were hooked together, the spring worked as good as new. The heated portion did not affect the strength of the spring.—Contributed by Marion P. Wheeler, Greenleaf, Oregon.

¶ If you wish to know whether or not the door or telephone bell rings during your absence, place a little rider of paper or cardboard on the clapper in such a way that it will be dislodged if the bell rings.

sort. A good and substantial home-made lathe, which is suitable for wood-turning and light metal work, may be constructed from pipe and pipe fittings as shown in the accompanying sketch.

The bed of this lathe is made of a piece of 1-in. pipe, about 30 in. long. It can be made longer or shorter, but if it is made much longer, a larger size of pipe should be used. The headstock is made of two tees, joined by a standard long nipple as shown in Fig. 1. All the joints should be screwed

up tight and then fastened with $\frac{3}{16}$ -in. pins to keep them from turning. The ends of the bed are fixed to the base-board by means of elbows, nipples and flanges arranged as shown. The two bearings in the headstock are of brass. The spindle hole should be drilled and reamed after they are screwed in place in the tee. The spindle should be of steel and long enough to reach through the bearing and pulley and have enough end left for the center point. The point should extend about $1\frac{1}{2}$ in. out from the collar. The collar can be turned or shrunk on the spindle as desired. The end of the spindle should be threaded to receive a chuck.

The tailstock is also made of two tees joined by a nipple. The lower tee should be bored out for a sliding fit on the bed pipe. The upper one should be tapped with a machine tap for the spindle which is threaded to fit it. The

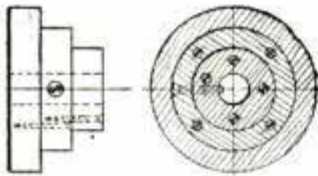

Fig. 2

spindle has a handle fitted at one end and has the other end bored out for the tailstock center.

Both the tailstock and the headstock centerpoints should be hardened. A clamp for holding the tailstock spindle is made of a piece of strap iron, bent and drilled as shown. It is held together by means of a small machine screw and a knurled nut. The tee should have a slot cut in it about one-half its length and it should also have one bead filed away so that the clamp will fit tightly over it.

The hand rest is made from a tapering elbow, a tee and a forging. The forging can be made by a blacksmith at a small expense. Both the lower

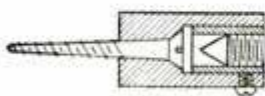

Fig. 3

tees of the hand-rest and the tailstock should be provided with screw clamps to hold them in place.

The pulley is made of hardwood pieces, $\frac{3}{4}$ or 1 in. thick as desired. It is fastened to the spindle by means of a screw, as shown in Fig. 2, or a key can be used as well.

Care must be taken to get the tailstock center vertically over the bed, else taper turning will result. To do this, a straight line should be scratched

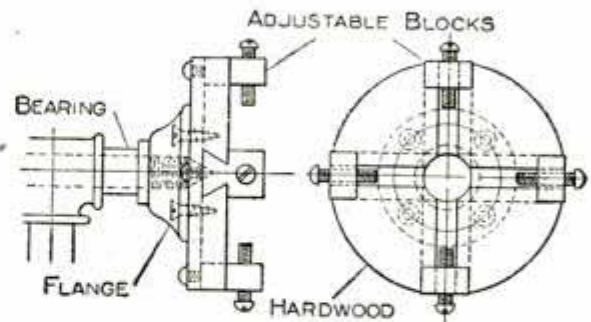

Fig. 4—Chuck

on the top of the bed pipe, and when the tailstock is set exactly vertical, a corresponding line made on this. This will save a great deal of time and trouble and possibly some errors.

The two designs of chucks shown in Figs. 3 and 4 are very easy to make, and will answer for a great variety of work.

As the details are clearly shown and the general dimensions given on the accompanying sketches, it should not be a difficult matter for the young mechanic to construct this machine.—Contributed by W. M. Held, Laporte, Indiana.

Holder for Flexible Lamp-Cord

The holder is made of a round stick—a piece of a broom handle will do—as shown in Fig. 1. It is about 1 in. long with two notches cut out for the strands of the cord. These holders are easily made and will answer the purpose almost as well as the ones made in porcelain. Painting or enameling will improve not only their appearance, but also their insulating properties. Sev-

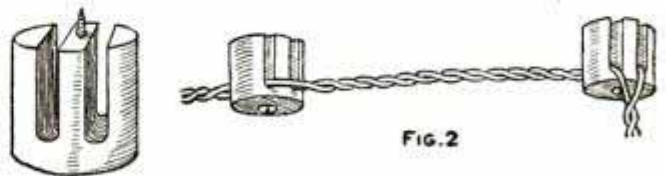

Fig. 1

Fig. 2

Ceiling-Cord Holder

eral of them can be used along a line, as shown in Fig. 2.—Contributed by M. Musgrove, Boissevain, Man.

Support for Double Clotheslines

Anyone using a double clothesline over pulleys will find the arrangement shown in Fig. 1 for supporting the

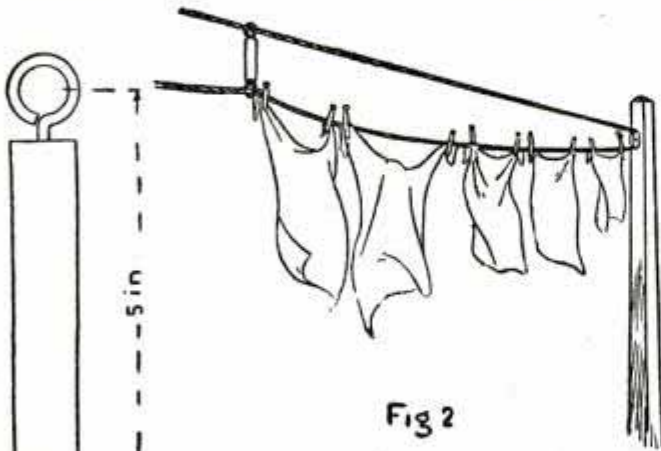

Holder on a Clothesline

lower line quite convenient. The support is made of a piece of $\frac{3}{4}$ -in. square or round wood which has a screw-eye turned into each end. The line is run through these screw-eyes as shown in Fig. 2.—Contributed by W. W. Up-DeGraff, Fruitvale, Cal.

Hot Pan or Plate Lifter

Unless a person uses considerable caution, bad burns may be suffered when taking hot pies from an oven. If one reaches in and takes hold of the pie pan with a cloth, the arm is liable to touch the oven door and receive a



Lifter on Pie Pan

burn. To obviate this, I made the device shown in the sketch for lifting hot pie pans and plates. The handle is of pine about 18 in. long, and the two loops are made of heavy wire. The ends of the first loop of wire are put through the handle from the back, as

shown, and then bent so as to stand out at an angle. The second loop is hinged to swing free on the opposite side of the handle. In use, the hinged side of the loop is dropped under one edge of a plate or pan and the rigid loop is then hooked under the opposite side. The weight of the pan or dish draws the loops together and there is little or no danger of a spill. The same lifter will pick up any size of plate or pan from a saucer to the largest pie plates.—Contributed by E. J. Cline, Ft. Smith, Ark.

Weighting Indian Clubs

An ordinary Indian club can be fixed so that different weights may be had without changing clubs. Each club is bored to receive lead washers which are held in place by a spiral spring. A bolt is run through from the handle end and fastened with a round nut. The lead washers and spring slip over the bolt as shown in the illustration. Changing the number of washers changes the weight of the club.—Contributed by Walter W. White, Denver, Colo.

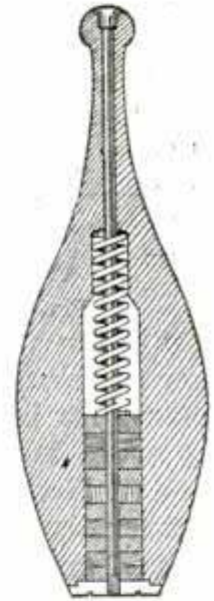

Venting a Funnel

When using a tight-fitting funnel in a small-neck bottle, trouble is usually experienced by the air causing a spill. This can be easily remedied by splitting a match in half and tying the parts on the sides of the stem with thread.—Contributed by Maurice Baudier, New Orleans, La.

A screw may be turned into hardwood easily, by boring a small hole and lubricating the screw threads with soft soap.

Wood-Working for Beginners

By IRA S. GRIFFITH

Making a Magazine Stand—Typical Methods of Making Doweled, Keyed Tenon and Housed Joints

CHAPTER XIV

In Fig. 93 is shown the perspective of a magazine stand which has been chosen to introduce three new kinds of fastenings or joints. Figure 94 gives the dimensions and from them the stock bill is to be made out. In ordering, it may be advantageous to combine the lengths of the shelves and of the sides. It should be noted that the shelves, of $\frac{3}{4}$ -in. stock, are slightly narrower than the sides. They might be made of the same width, but in the first construction any little variation in the location of the joints makes no noticeable difference.

Square up the different pieces as indicated in the drawing, and shape their ends. The making of the joints comes next. Those on the shelf ends may be made first.

Figure 95 shows the joint for the two middle shelves, the housed joint. (1) Place the two shelves on the bench, face edges up, and square two knife

shall be 14 in. If the pieces were cut the correct length, this should leave

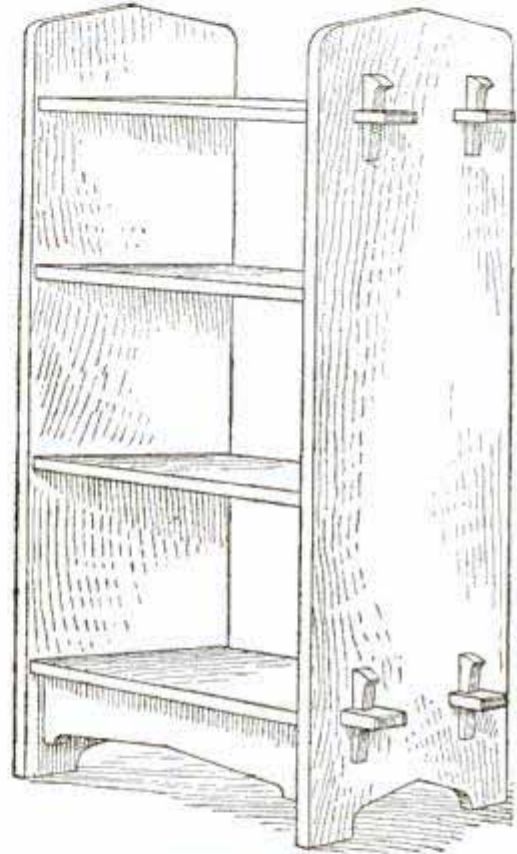

Fig. 93—Magazine Stand

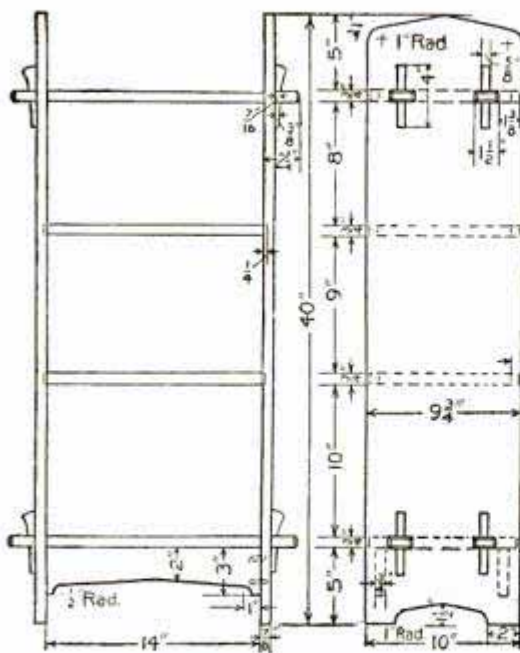

Fig. 94—Magazine Stand Details

lines across them—one at each end—so that the distance between the lines

$\frac{1}{4}$ in. between each line and the end of the piece. (2) Separate the pieces and with the knife and try-square scribe knife lines entirely around each piece at each end. (3) With the gauge set to $\frac{5}{8}$ -in. gauge on the two broad surfaces and on the ends as in Fig. 96. (4) With the backsaw rip to the gauge lines and cross-cut to the knife lines, keeping the kerf on the waste wood. Saw to the lines accurately so that no paring need be done.

Now make the tenons on the upper and lower shelves. (1) Place the shelves on the bench, face edges up and even the ends. (2) Square knife lines across the edges, equidistant from each end, with a distance of 14 in. between. If there was trouble in making the two previous pieces so that their length had to be made shorter than what the draw-

ing called for, of course the distance just specified must be shortened correspondingly. (3) Separate the pieces

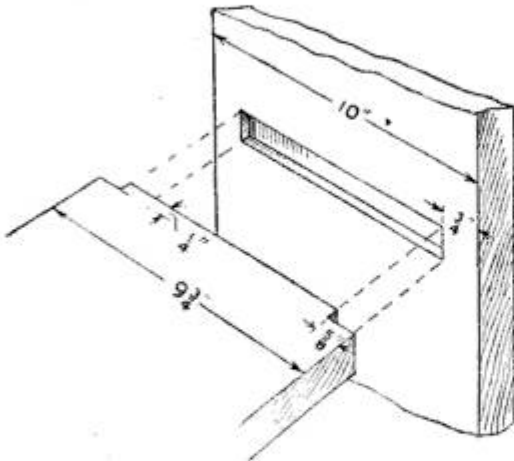

Fig. 95—Shelf Joints

and scribe lines entirely around each end corresponding to the knife lines just made on the face edges. (4) Lay the rule along this line, Fig. 97, and with the knife, point off spaces as indicated. (5) Setting the gauge spur in the mark nearest the edge, gauge all the tenons on the two broad surfaces as far back as the knife lines just made and also across the ends. Reset the gauge to the other mark and repeat until all are marked.

Before these tenons are worked or cut, the mortises for the keys should be laid out. (1) From the knife line that represents the shoulder of the



Fig. 96—Gauging the Ends

tenon, measure toward the end of the tenon $\frac{1}{2}$ in. less than $\frac{7}{8}$ in. The sides of the stand are $\frac{7}{8}$ in. thick and this

$\frac{1}{2}$ in. less is to insure the pins pulling up tight against the sides of the stand. (2) On the upper side of the shelf measure on toward the end from this line $\frac{7}{16}$ in. Square sharp pencil lines across the tenons at these points. (3) Carry the first line entirely around the piece so that it will be across the under side of the board as well. (4) Since the pins or keys have slant to make them wedge, the second line will need to be only $\frac{3}{8}$ in. further out toward the end of the tenon. (5) Lay the ruler along these lines as was done in Fig. 97 and mark off points to indicate the gauge settings for the sides of these mortises. (6) Gauge both sides of the board, and knife the pencil lines be-

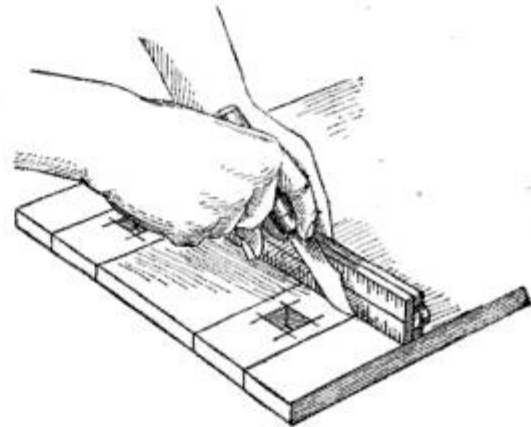

Fig. 97—Marking Spaces

tween these gauge lines. This knifing is to make it easier to chisel the mortise ends accurately. The chisel can be set in knife lines but not in pencil lines. A little thought will make it clear why the knife was not used at the first lining.

Work the tenons and mortises for the keys. (1) Rip with the backsaw to the lines, keeping the kerf in the waste, then cross-cut the exterior shoulders. To cut the inclosed shoulder it will be necessary to bore a hole, and then, using a key-hole saw, cut parallel and very near to the line. The remaining part may be pared away with the chisel, working from both sides. The ends of the tenons are to be chamfered slightly. (2) To work the mortises, bore a hole, and then, working from this hole, pare out to the lines. Bore from the smaller opening, the lower side of the shelf.

Everything is now ready for working the corresponding openings or mortises in the two sides of the stand. (1) Lay the two sides on the bench with the face edges up, and even the ends. (2) Measure off and square knife lines across the edges at the places where the mortises are to be made. If the shelves are of uniform thickness, both sides of the mortises may be laid off by measurement. If not, it will be safer to lay off only the lower lines now and locate the upper lines by superposition. (3) Separate the pieces and square the lines across the face sides, that is, the inner sides. (4) Determine now and mark the way the parts are to rest in the final assembling. (5) By laying the tenons on the corresponding cross lines for the mortises, locate the points from which the gauge settings are to be taken, Fig. 98. (6) For the mortises of the upper and lower shelves, bore in each a series of holes close enough to one another to make one connected opening. Use as large a bit as the mortise will allow safely. With the chisel, work from the hole toward the lines as was done in making the mortises for the keys. (7) In working the mortises into which the ends of the middle shelves are to be housed, it will be necessary to chisel lines parallel to the given lines, about $\frac{1}{8}$ in. in the waste, then work the mortise to depth. After this the sides may be pared to the knife lines without danger of making the mortises too wide. In roughing out the bottoms, the chisel is to be held bevel side down. When nearly to depth a router (Fig. 99) may be used.

The keys or wedges may be made in a variety of shapes. The essential thing is to so design them that they will fit properly and not be likely to break. This matter of proper fitting is the only thing that necessitates definite measurements. (1) Square up the keys to length, having first made a face edge and obtained the proper thickness. (2) Midway between the ends, square two lines across the face side a distance apart equal to the thickness of a shelf or $\frac{3}{4}$ in. Along one of these lines, AB,

Fig. 98, measure from the face edge $\frac{7}{16}$ in. Along the lower, CD, Fig. 98, measure $\frac{3}{8}$ in. The outline of the re-

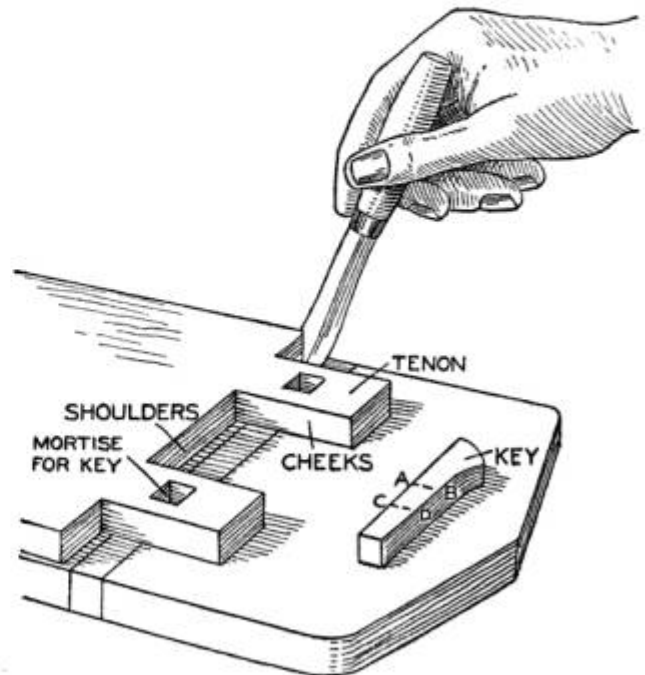

Fig. 98—Marking Mortises

maining unworked edge of the key, whatever its shape, must pass through these two points.

The two braces which are to be placed under the lower shelf are to have their ends doweled into the sides. Use a dowel $\frac{3}{8}$ in. in diameter. Dowels can be purchased put up in bundles, each stick about a yard in length. Cut each pin about $1\frac{1}{2}$ in. long. Slightly round the arrises and with the tenon saw or back saw, saw a shallow slot the full length of the pin. This is to allow any surplus glue in the bottom of

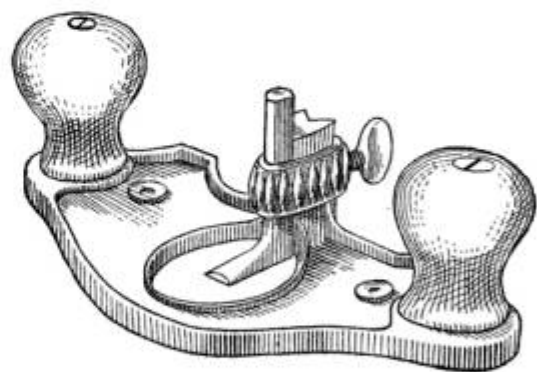

Fig. 99—Router

the hole to escape when pressure is applied to force the dowel in. If the dowel were to fit snugly and the glue not allowed to escape when the pin is

pounded in, the board might be split by the pressure of the glue. The most important thing in making a dowel

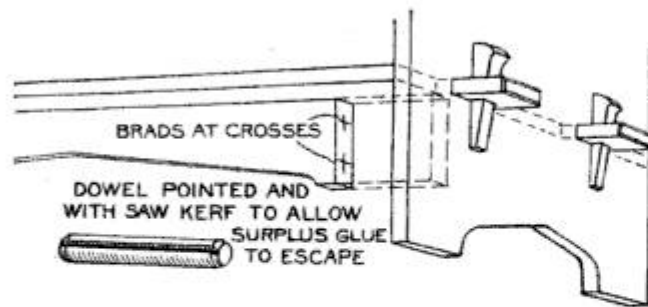

Fig. 100—Marking Holes for Dowels

joint is to get the holes laid out and bored in exactly corresponding positions. The centers for the holes may be

(To be continued.)

A Stringless Package

The usual way to do up a flat package is to turn over the two corners of the wrapping paper at each end and then fold the projecting ends close to the contents, whereupon a piece of string or tape is tied snugly around the package, forming a cross on each side. There is a way to do up such a package firmly and securely without the aid of string, tape or adhesive of any kind, says Photo Era.

The object, which must be flat and

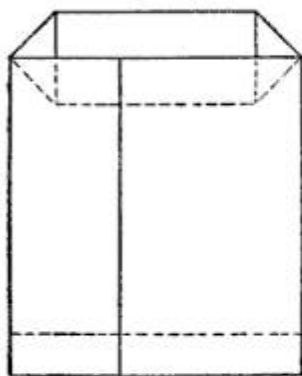

Fig. 1

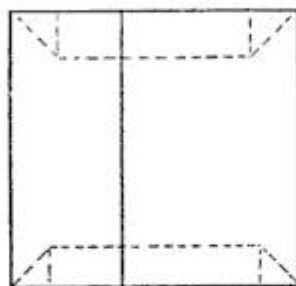

Fig. 2

Folds in the Paper

not over $\frac{1}{4}$ in. thick, is enclosed in a sheet of wrapping paper as usual, but the ends which project say, 1 to 2 in., are not disposed of in the ordinary manner. Instead, they are folded or tucked in. While the package is held firmly between the body and the edge of the counter or table, one side of the

laid out by measurement; but as easy a way, one that insures greater accuracy, is to drive two small brads into one of the members where the centers are to be, and snip off the heads so that the nails project about $\frac{1}{16}$ in. (Fig. 100.) Place the member against the other in its exact position and press these brads into the side of the other member. Remove the piece and the brads, using pincers for the latter, and then carefully bore the holes to depth. With a stick or a small brush, place glue on the sides of the holes that are in the ends of the brace, and insert the dowels. The stand is now ready to be assembled.

uppermost end is evenly tucked inside. The dotted lines in Fig. 1 indicate its position inside the package. Then the other side of the wrapping-paper is folded over toward the body, the edge sharply creased, and this side also tucked in close to its fellow. Finally pass the thumb and forefinger along the outside edge to insure close contact of both edges. After treating the other end of the package in the same way, the contents are held securely therein, but it is virtually open at both ends and permits inspection by the post-office officials in case it is sent by mail. If desired, the outside flap may be pasted closely to the body of the wrapper. The dotted lines in Fig. 2 indicate the appearance of the package with the position of the ends as they are tucked out of sight.

Making a Clock Run by Changing Its Position

Sometimes, especially in cold weather, when an alarm clock stops, it will run if placed on its back, face or side. While a clock in any of these positions is not very useful or attractive, it is much better to have it run in that position than not at all, as it may be the only clock in a house, where the alarm feature is needed.

To Make "Centering" Unnecessary

For drilling a hole in a chucked piece, centering is just one operation too many, if this method is followed:

First, face off the end of the piece, making a true spot at least as big as the diameter of the drill. Put a center punch mark where the tool lines indicate the center of revolution. This serves as a rough guide for placing the drill between the tailstock center and the work as usual. Clamp a tool in the tool-post and, on starting the lathe, bring it in contact with the drill and keep it firmly so until the drill is in fully up to the lips. This prevents the drill from wobbling, and when once in true up to its size, it cannot change any more than under any other starting conditions. After being entered, the drill does not need the tool, which should be backed out of contact.

Fountain Pen Cap Used as a Ruler

When it is necessary to draw a short line and there is no ruler at hand, take

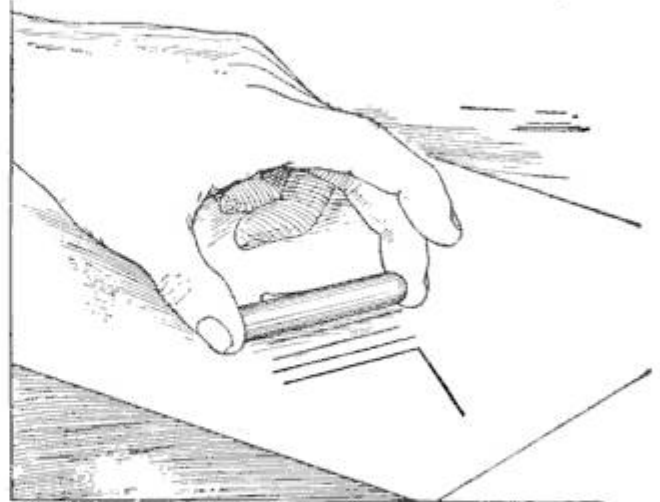

Ruling Lines

off the cap of your fountain pen and use it as a ruler. If the cap is fitted with a retaining clip, all the better, as this will prove a safeguard against slipping.

Vanishing Handkerchief Trick

The necessary articles used in performing this trick are the handkerchief,

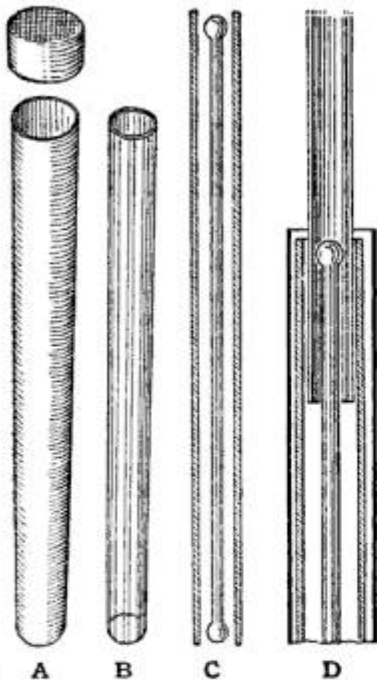

v a n i s h i n g wand, a long piece of glass tubing, about $\frac{1}{2}$ in. shorter than the wand, and a paper tube closed at one end and covered with a cap at the other, says the Sphinx. The handkerchief rod, shown at C,

is concealed in the paper tube A before the performance. The glass tube B, after being shown empty, is put into the paper tube A, so that the handkerchief rod now is within it, unknown to the spectators. The handkerchief is then placed over

the opening of the tube and pushed in by means of the wand. In doing this, the handkerchief and the rod are pushed into the wand, as shown in D. After the wand is removed, the cap is placed over the paper tube, and this given to someone to hold. The command for the handkerchief to vanish is given, and it is found to be gone when the glass tube is taken out of the paper cover. This is a novel way of making a handkerchief vanish. It can be used in a great number of tricks, and can be varied to suit the performer.

Removing Glass Letters from Windows

Glass letters are removed in the same way as metal letters, by applying caustic soda or potash around the edges of the letters. As the cement softens, manipulate the point of a pocket knife under the edges of the letter until the caustic works completely under and makes it easy to lift the letters. With care and patience, every letter may be thus taken off without breakage.

INTERESTING PATENTS

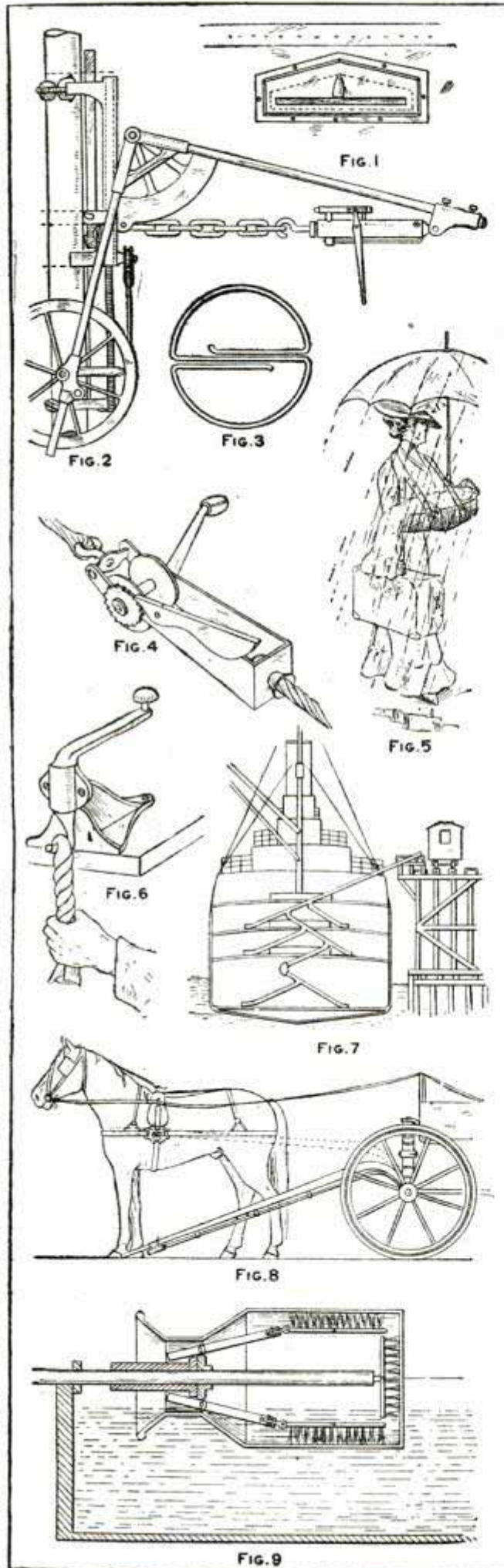

LETTER SLOT FOR TRUNKS—This letter slot attachment (Fig. 1) converts an ordinary trunk into a safe receptacle for the depositing of mail. The slot opening is provided with a spring operated guard, which closes automatically and prevents the intrusion of dust or other matter into the trunk.

POLE-CARRIER AND ERECTOR—A device to take the place of a gin pole in pole erection is shown in Fig. 2. It comprises a tripod with adjustable front legs hinged at the top and united at the bottom by a curved axle carrying a pair of large wheels. The long rear leg has a swivel on its end to which is attached a second pair of wheels, the whole, when the hinged legs are straightened out, forming a truck for the transportation of the pole. The truck carries the pole to the hole in a horizontal position, then, by the force of a pneumatic cylinder, the hinged joint is partially folded, thus raising the pole to an upright position over the hole, into which it is lowered.

DOUBLE KEY RING—Figure 3 is a double key ring, the purpose of which is to separate the keys into two groups, so that they may be more readily accessible when desired. One section, for instance, may be used for office keys and the other for house keys, so that when searching for a certain key it will not be necessary to fumble over the entire set before finding it. The double ring is made of a single length of wire, the ends of which are located within the ring, where they are not liable to catch and tear the pocket.

ROPE-TIGHTENER—A rope tightener comprising an elongated rectangular frame, a winding spool mounted in the frame, and a ratchet rotated by the spool, is shown in Fig. 4.

CHILD-CARRIER—The conditions under which the inventor of this child-carrying basket (Fig. 5) believes it will prove of value are clearly shown in the illustration. When one hand is occupied in holding up an umbrella, and the other is holding a suitcase or some other load, it is quite obvious that some means must be provided for the carrying of a child.

SPONGE-CLOTH WRINGER—Figure 6 is a device for wringing the cloths used for mopping or sponging up water or other liquids. The cloth is doubled over the hook and the turning of the crank arm wrings the liquid from it.

CHUTE CONVEYOR FOR LOADING STEAMSHIPS—A special chute conveyor for steamships, the patents for which have been acquired by an American railroad company, is shown in Fig. 7. It consists of a combination of chutes extending at an angle to each other, one below the other. Hinged gates are provided at the intersections to direct the discharge. In one position the gates shut off the discharge from the upper to the lower chutes, and in the other shut off the delivery chutes on one level so that the material will drop to a lower level.

LIGHTNING HITCHER AND DETACHER—Figure 8 is designated as a lightning hitcher and detacher. The tugs are of special design, carried along the shafts. At the outer ends of the tugs are special attachment means, which are engaged with the harness by a simple movement. The horse may be completely detached from the vehicle by a movement of the driver's foot.

INTERIOR WASHER AND POLISHER FOR MILK CANS—A brush arrangement for cleaning the interior of milk cans is shown in Fig. 9. The device is attached over a water receptacle in such position that a certain amount of water may enter the can after the latter has been pushed into position over the brushes. The milk cans may be whirled by hand around the brushes, or may be held stationary while the brushes are rotated.

PRACTICAL OR UNIQUE

ADJUSTABLE MEASURING DEVICE—This link scale (Fig. 10), formed of alternating single and double links in the same manner as a chain, is designed for measuring the interior circumference of curved surfaces.

IMPLEMENT FOR REMOVING OBSTRUCTIONS IN PIPES—Attached to the end of the brace (Fig. 11) is a flexible shaft consisting of a close coil of spring wire, at the end of which is a corkscrew-shaped member. When inserted in a pipe or drain as shown, the screw, revolved at the end of the flexible shaft by turning the brace, is expected to engage with the cloth or other material forming the obstruction, after which the obstructing article is drawn out in a manner somewhat similar to drawing a cork from a bottle. A wire spiral guide just above the screw acts as a guide.

ROPE-CLIMBING DEVICE—A rope-climber, comprising a pair of lever grips for the hands and a pair of similar grips for the feet is shown in Fig. 12. The foot grips are provided with wire loops for the insertion of the climber's feet. In using the device, the climber first supports himself with the hand levers, his weight causing them to solidly grip the rope. While supporting himself thus, he draws his feet and the foot-grips up the rope. He then allows his weight to rest upon the foot-grips, causing them to engage with the rope, and pushes the hand-grips up.

HAT-FASTENING JAWS—Figure 13 is a hat-fastener invented to take the place of hatpins. In shape and action the device is somewhat similar to a pair of ice tongs, the jaws being engaged with the hair by the operation of a rod concealed in the crown of the hat.

SAFETY CORN-CUTTER—The advent of the safety razor has led to the invention of several devices of like nature for other purposes, such, for instance, as cutting the finger nails. The latest is a safety tool (Fig. 14) for the paring of corns.

SELF-DUMPING HAND-SCOOP—Figure 15 is a self-dumping scoop, the lower part of the inclined wall of which is hinged, so that it will swing out when the latch is released, thus providing a large opening for the escape of its load. The latch is pushed downward out of operation by pressing the thumbpiece located just above the handle.

ELECTRICALLY IGNITED ORCHARD FIRE POTS—In many fruit belts, specially in the West, fire pots are utilized as a means of preventing frost from destroying the fruit crops. In Fig. 16 is shown an electrically ignited fire pot for such purpose, any number of which may be connected up in a circuit. Normally, the fire pots are covered, but the contact points in each are so arranged that a wire will fuse and trip the catch holding the cover down when the current is turned on, and at the same time ignite a wick which sets fire to the fuel. The covers, of course, are weighted so that they will fly open when the catch is tripped. In this manner all the fire pots in the orchard are instantly ignited by turning on the current.

CLOTHESPIN—A clothespin made from a single length of wire is shown in Fig. 17. It is so shaped as to form a ring in the center, through which the clothesline passes.

APPARATUS FOR RELEASING GROUNDED VESSELS—A curious water-jet apparatus, designed for the release of grounded vessels, is illustrated in Fig. 18. Curved pipes are arranged down each side of the bow, 10 on a side, and 26 pipes, grouped to form a triangle, are hung from the bowsprit. Water, forced into the manifolds by a pump, is discharged from the ends of the pipes, it being presumed that these jets will wash away the obstructing bed.

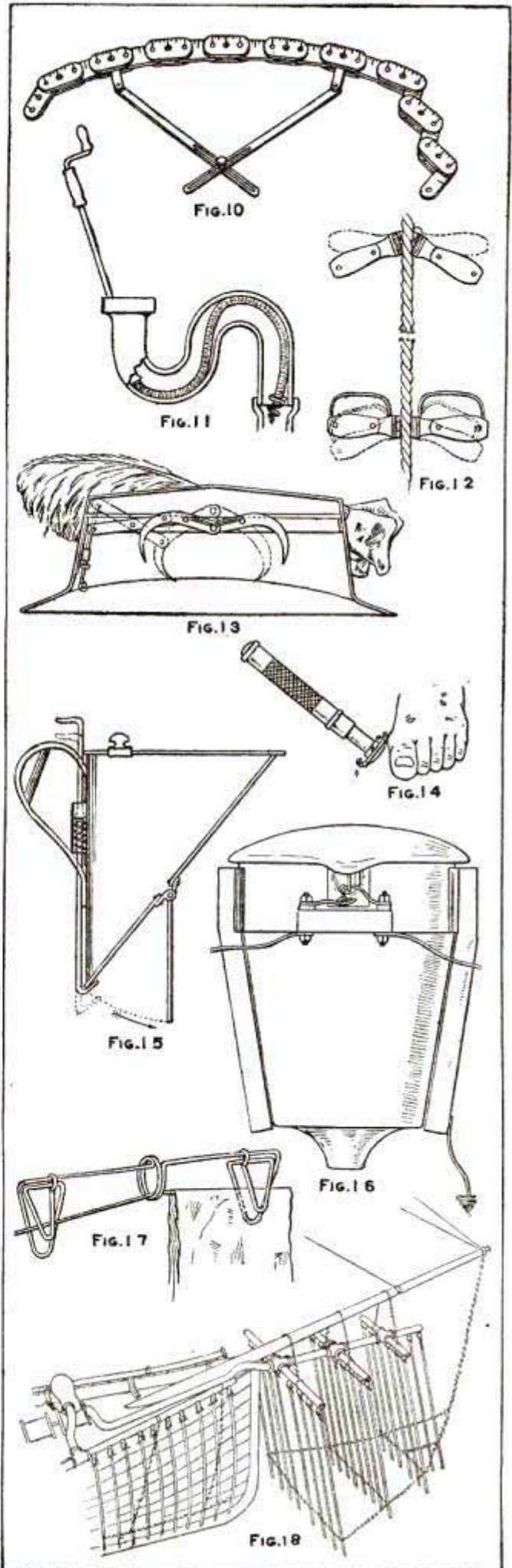

ONE of Michigan's railroad companies established a small flag station, and the grocer, whose knowledge of railroading was very limited, was commissioned agent.

The first morning after he had donned the "regulation suit" he awoke hearing the "limited" whistle in the distance, hurriedly slid into his trousers, and, flag in hand, ran out upon the platform and began wildly waving the flag across the track. The train stopped, and the conductor alighted, with the inquiry:

"Where's your passengers?"

"Haven't any," replied the agent.

"Then why in thunder did you stop us?"

"W-well, I—I—thought perhaps there might be some one who would want to get off here."—Detroit Free Press.

◆ ◆ ◆

A schoolmaster had just finished a lesson on "Food" when a little boy put up his hand. On being asked what he wanted he replied:

"Please, sir, Jones said he knew a baby that was brought up on elephant's milk, and it gained ten pounds in weight every day."

"Jones ought not to tell you such rubbish," said the master. Then, addressing Jones, he added, "Tell me whose baby was brought up on elephant's milk?"

To which Jones hesitatingly replied: "Please, sir, it was the elephant's baby."—Tit-Bits.

◆ ◆ ◆

"He was always a lucky fellow."

"What do you mean?"

"When he fell out of his airship he plumped straight through the skylight of a hospital."

◆ ◆ ◆

The man with the old clock under his arm laid it on the jeweler's showcase. "I wish you'd see what is the matter with this," he said.

The jeweler removed the dial, screwed his eyeglass into place, and inspected the works of the ancient timepiece.

"Nothing is the matter with it—now; its sufferings are over."

"Well, how much do I owe you?" asked the man.

"Nothing," answered the jeweler. "This isn't a professional treatment. This is a coroner's inquest."

NEW BOOKS

Any book mentioned or reviewed here may be ordered direct from the publishers or through Popular Mechanics Book Dept., 225 Washington Street, Chicago.

THE TESLA HIGH-FREQUENCY COIL: Its Construction and Uses—By George F. Haller and Elmer Tiling Cunningham. 119 pages, 12mo, cloth, with 56 illustrations. \$1.25. A working manual for advanced amateurs on the construction of high-frequency coils. D. Van Nostrand Company, New York.

SHOP KINKS—By Robert Grimshaw, M. E. 393 pages, 12mo, illustrated, cloth, \$2.50. This is the fifth edition, revised and illustrated, of this useful book for machinists. The Norman W. Henley Publishing Company, New York.

THE ART OF ROADMAKING—By Harwood Frost, B. A. Sc. 544 pages, 6x9, illustrated, cloth, \$3.00. This comprehensive treatise takes up all the various problems and operations in the construction and maintenance of roads, streets and pavements. The volume also contains an extensive bibliography which will be found a help to any one interested in roadmaking. The Engineering News Publishing Company, New York.

THE TELEGRAPHIC TRANSMISSION OF PHOTOGRAPHS—By Thorne Baker, F. C. S. 146 pages, 12mo, illustrated. Constable & Co., Ltd., London.

ELEMENTARY TELEGRAPHY: A Manual for Students—By H. W. Pendry. 216 pages, 12mo, illustrated, cloth, \$1.00. Whittaker & Co., London. The Macmillan Company, New York.

THE ANNUAL BLUE BOOK OF SOUTHERN PROGRESS, for 1911, is a 64-page pamphlet containing a statistical epitome of the past and present of the South. Price, 25 cents.—The Manufacturers Record, Baltimore, Md.

The elderly matron with the bundles, who was journeying to a point in Wisconsin and occupied a seat near the middle of the car, had fallen asleep. On the seat in front of her sat a little boy. The brakeman opened the door of the car and called out the name of the station the train was approaching. The elderly woman roused herself with a jerk.

"Where are we, Bobby?" she cried.

"I don't know, grandma," answered the little boy.

"Didn't the brakeman say something just now?"

"No. He just stuck his head inside the door and sneezed."

"Help me with these things, Bobby," she exclaimed. "This is Oshkosh. It's where we get off."

◆ ◆ ◆

Captain H. J. Hollinshed, of the navy, recently told this story about a comet:

"We had a good view of the comet off Tarifa in the Mediterranean. The sailors did not like it. They sent a committee to me to get my opinion on it. 'Captain,' said the spokesman, 'we want to ask your opinion.' 'Yes, my lad,' said I. 'What about?' 'About that thing up there,' he replied, pointing at the comet aflame in the western sky. 'Very well,' said I. 'But first tell me what you think it is yourself.' 'Well, sir,' said the spokesman, 'we've talked it over very carefully, and we've about come to the conclusion that it's a star sprung a leak!'"

◆ ◆ ◆

While one thing essential to a cultured lawyer is a thorough knowledge of Latin, it is not necessary that he should parade his classical knowledge, for he might be "taken down a peg," as was the young lawyer who displayed his learning before an Arkansas jury. His opponent replied: "Gentlemen of the jury, the young lawyer who has just addressed you has roamed with Romulus, canted with Cantharides, ripped with Euripides, socked with Socrates, but what does he know about the laws of Arkansas?"

◆ ◆ ◆

"He absolutely lacks the business instinct."

"Does he?"

"Why, he'd have no more idea of business than to open a garage in Venice."—Chicago Record-Herald.

A DEFINITE DATE PLEASE

The recent change of the date of issue of Popular Mechanics Magazine from the 17th of the month to the 20th brought forth the following from a subscriber:

Oh tell me, Mr. Editor:

You of pen and power,

Why do you keep us waiting

So many lonesome hour,

For that good magazine of yours

Which on the seventeenth is due.

The dealer says it's "late" again,

And says it's "up to you."

We take our dime and nickel,

That we've saved for thirty days,

And ask for "Pop" from dealer

And it doesn't "seem to feaze"

Him, just a little bit to say,

We've others "just as good as Pop,"

Let me show you them today.

We know, of course, there's "none so good;"

And are obliged to "call his bluff."

All magazines "look good to him,"

He's out "for business" and "the stuff."

So please, good Mr. Editor,

Get "Macks" out on time;

It's good for circulation

And it gets our five and dime.

So keep us happy—cheer us up

And set a certain date

When we can get our magazine

And never have it "late."

Let that date be what it may

But advertise it well.

Then hustle, bustle, push and pull,

And get it out, in spite of—the dealer.

—By A. C. Pearson, Duluth, Mich.

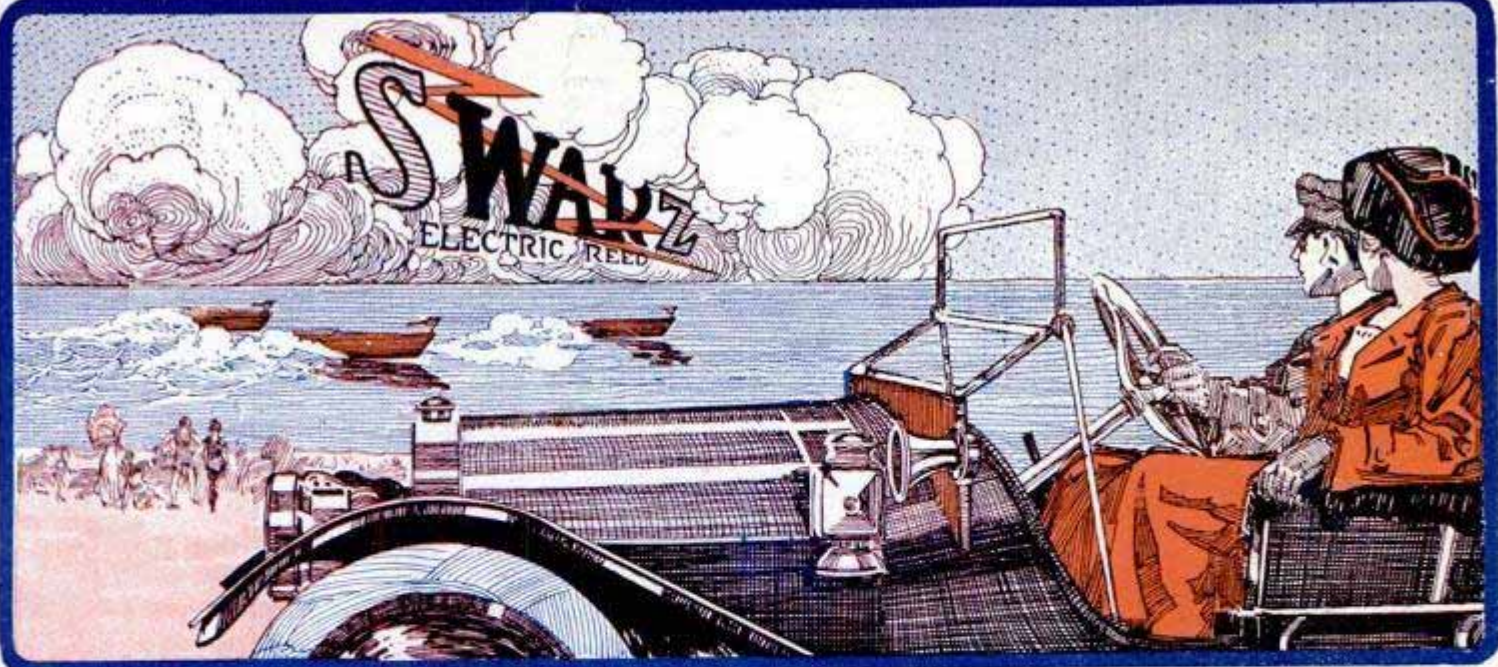

A Practical Electric Signal Device For Automobiles and Motor Boats

Operated by a button convenient to the driver's seat, either foot or hand, responds instantly, giving any desired length of blast.

Insures you against accidents, clears the road, giving you the "Right of Way."

The sound is a deep, rich, mellow, distinctive, warning, neither offensive nor musical, just a business-like warning, "Car Coming," easily heard $\frac{1}{2}$ mile ahead.

Cost of operation is reduced to a minimum; 5 dry cells will last a season with ordinary usage or you can connect it to your storage battery. Consumes less current than any Electric Horn on the market.

Guaranteed to be perfect in material and workmanship.

Prices for Automobiles

SwarZ Electreed Model Z—Complete with highly polished brass horn, hand or foot button (as desired), 10 feet Packard cable, tape, etc., ready to install, . **\$18.00**

SwarZ Electreed Model Y— With heavy metal horn, coated in dark enamel



Model Z



Model Y

Special Offer—Use Coupon

Send Cash or Money Order and we will prepay express charges

Name _____

Street _____

City _____

State _____

Model Desired _____

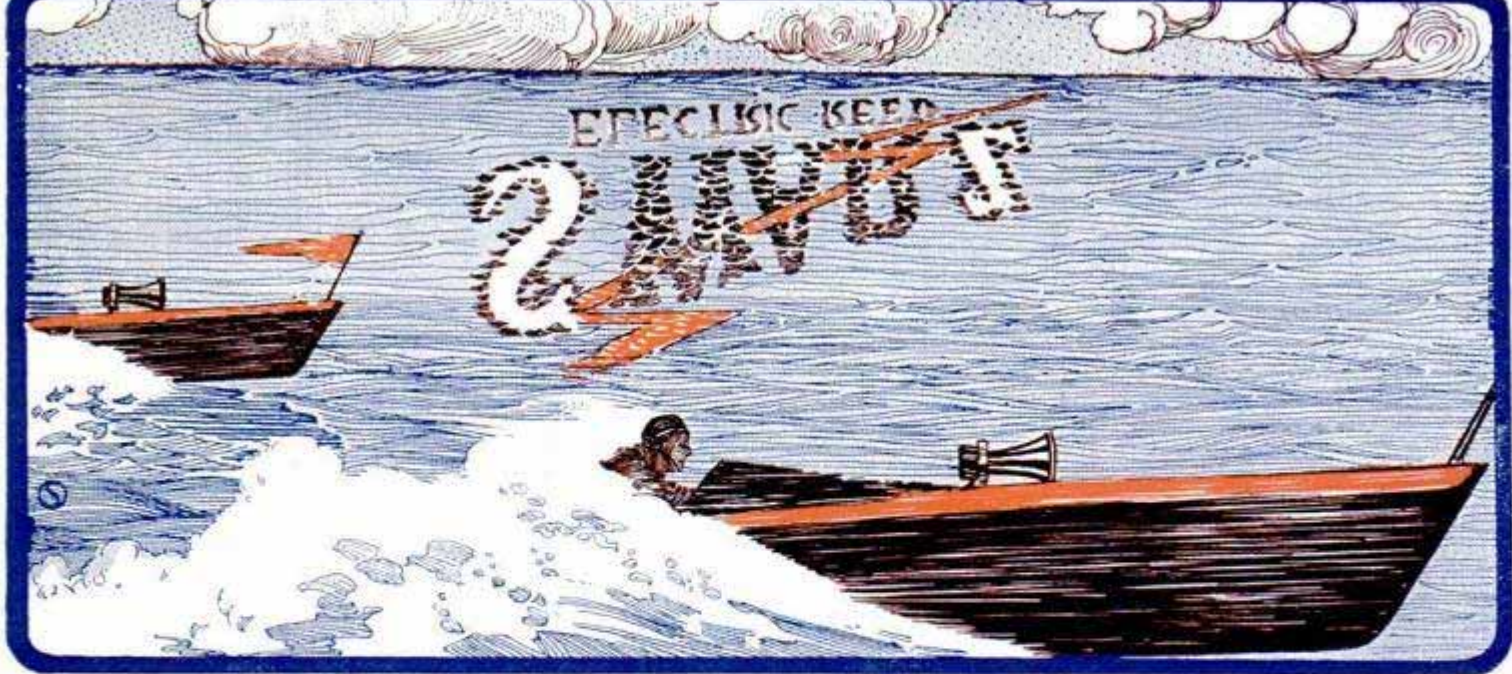

especially treated to withstand weather conditions. Including Packard cable and button, complete, **\$18.00**

Don't throw away your old horn—use

SwarZ Electreed Model X—(without horn) including Packard cable, buttons, tape, etc., and flexible brass tubing ready to apply to any horn, **\$15.00**

Prices for Motor Boats

SwarZ Electreed Model V—Waterproof complete with enameled cast iron horn (requires no polishing, will not tarnish or rust) with swivel deck-stand, Packard cable, foot or hand button, tape, etc. **\$19.00**

SwarZ Electreed Model W—Complete (as in Model V) in highly polished brass, including 10 feet Packard cable, foot or hand button, tape, etc., **\$20.00**

All Prices F. O. B. Detroit.

Dealers the demand for this Horn is unlimited. Write for information.

SwarZ-Detroit Company

Detroit, Michigan U.S.A.

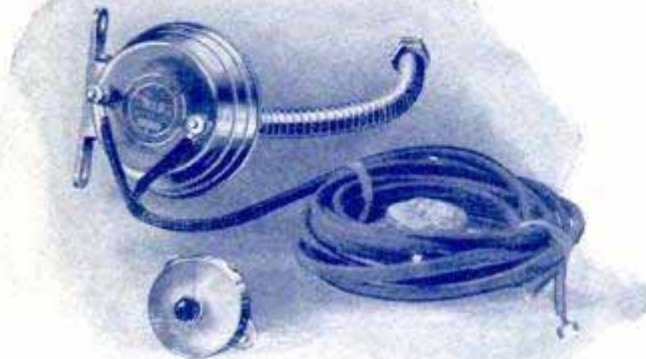

Model X

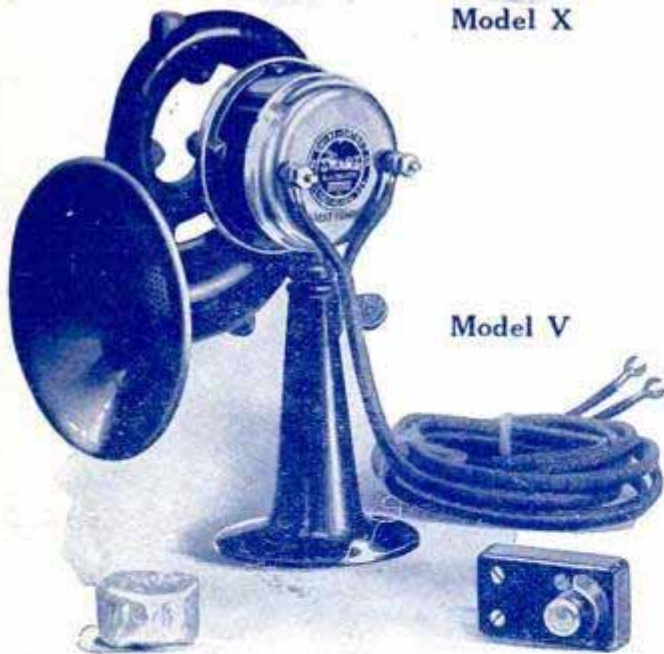

Model V

Special Offer — Use Coupon

Send Cash or Money Order and we will pay the express charges

Name _____

Street _____

City _____

State _____

Model Desired _____

Can You Invest \$100 or more?

to realize a remarkable uninterrupted profit for at least 56 years in a project constituting the only worthy absolute monopoly in existence and presenting the following features :

Universal Necessity
Competition Impossible
World-wide Importance
Immeasurable Benefit to Humanity

Basis known to every intelligent human being throughout the world, heartily endorsed by the Public Press and leading Educational, Commercial, Political and Agricultural Authorities everywhere.

The principal owns absolute sole rights for the U. S. and all foreign countries, is widely known and can present abundant Banking, Mercantile and Personal References extending throughout 30 years of Business life.

There is a limit to the number who can participate. Immediate answers are invited only from substantial men, stating the amount they can invest if completely satisfied with details. Information with proper references will then be promptly submitted.

Address:

H. R. Brown
Care Popular Mechanics Magazine
225 Washington St., Chicago, Ill.

Write now before other matters crowd the memory

Half Price—No Money Down

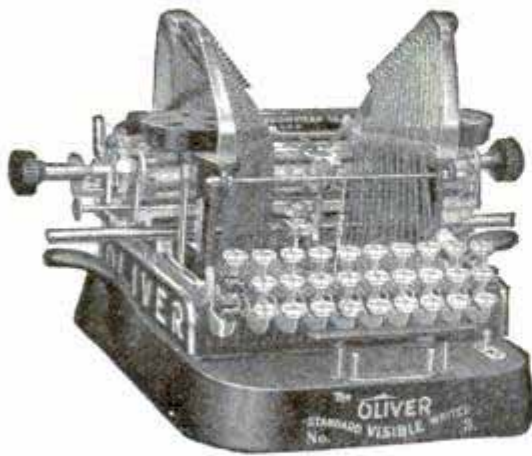

No. 3 Olivers Standard Visible Writers at \$50. On Credit.

We buy and distribute more No. 3 Olivers than any other concern in America. As a result we buy far below the lowest agents' prices.

We send the machines on five days' trial, without any deposit, and let them sell themselves. We have no agents, no salesmen. Our selling cost is only one-seventh the average cost of selling through agents.

Thus we sell these standard machines—listed at \$100—at half that price if sold on credit, or \$47.50 cash.

The machines are complete and in perfect condition. Each is twice inspected. The slightest flaw, or fault, or mark causes us to reject it. Machines sent out to sell themselves must be beyond possible criticism.

Complete equipment goes with each—metal case, baseboard, brush, ribbon, bottle of oil, instruction book, etc. Each is sold under standard warrant.

Mark This Coupon

Typewriters Distributing Syndicate
760 Masonic Temple, Chicago

- Ship me an Oliver No. 3 on 5 days' approval, F. O. B. Chicago.
- Send more information. Hold the machine for me waiting instructions.

Name.....

Address.....

You get every device and feature which has ever been added by the manufacturers, at any price, to the Oliver No. 3.

Oliver Features

Among these features are:

- Visible writing. Lines 9 inches long.
- Writing in colors without changing ribbon.
- The Universal keyboard.
- Choice of three beautiful types.
- The patented U-shaped type bar.
- Absolutely perfect alignment.
- 84 characters written with 28 keys.
- 20 carbons at one writing if desired.
- Utter simplicity. The instruction book enables one to write immediately.
- Light in action—light in weight.
- Lifetime durability.

Over 350,000 Olivers are now in use. They are used by 183 railroads. They are used by the largest mail-order houses, two of whom use over 1,000 each.

The Oliver is so simple, so durable, so trouble-proof that men who know best, select it. It does any practical thing which any typewriter can do.

Pays for Itself

Every person who writes should in these days use a typewriter. Handwriting is now an apology. It cheapens a person—shows him not up-to-date—indicates that his time is not valuable.

When an Oliver No. 3 can be had at half price, simply by selling to yourself, you can afford the best. At \$5 monthly the machine pays for itself. In a single evening one can learn to use it.

Five Days' Trial No Deposit

We will send this machine on 5 days' trial without any deposit. If you don't want it, return it, and we will pay express. If you accept it, send us \$5, then \$5 monthly until \$50 is paid. Or deduct 5 per cent for cash.

If you want the typewriter sent at once on approval, check the first square in the coupon at the left. If you are not in business, and rated, kindly send a couple of references.

If you want more information, check the second square in the coupon, and a machine will be set aside.

Cut out the coupon, mark and sign it, and send it to us at once. Until the machine meets your full approval, you are under no commitment.

Typewriters Distributing Syndicate
760 Masonic Temple, Chicago

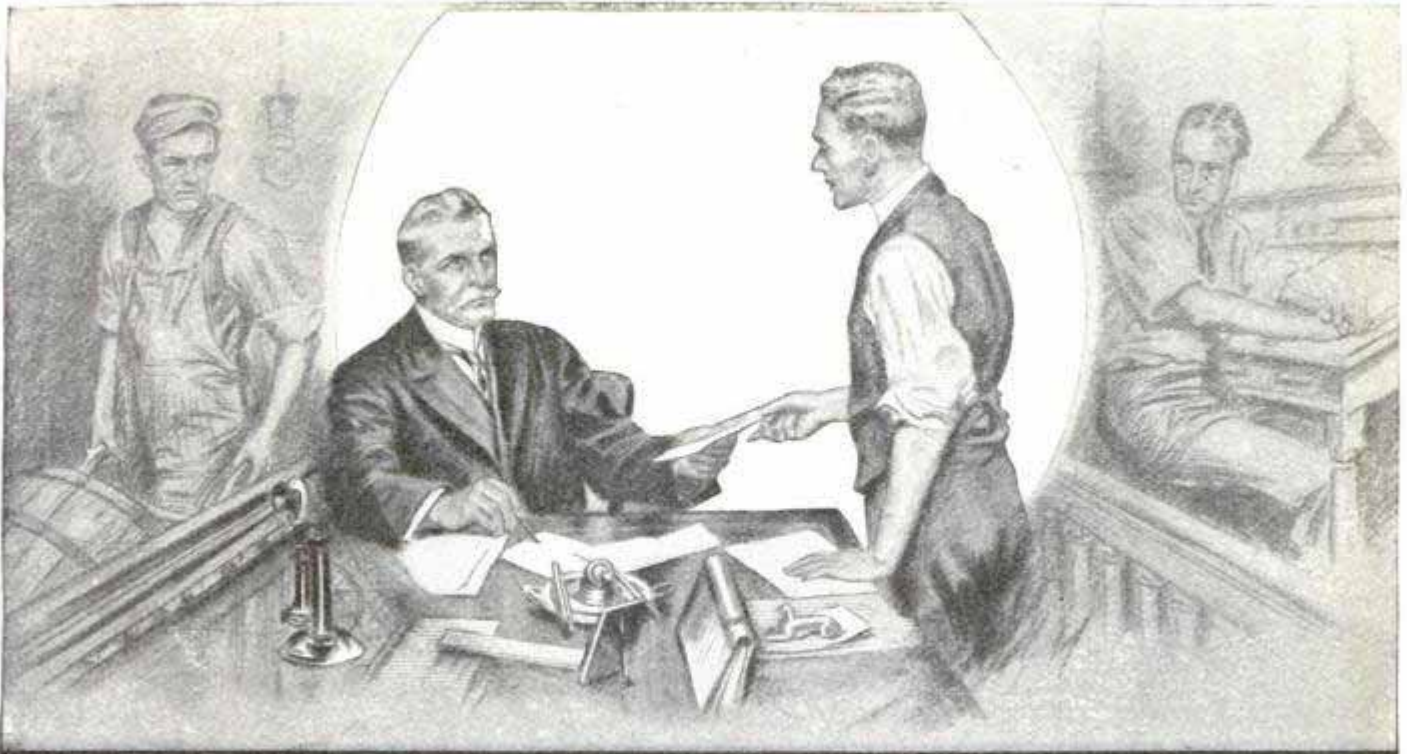

Knowledge Will Put YOU in the Spot Light

The fellow that does only what he has to, and spends his spare time in theaters or pool rooms or on the street corner—that fellow does not expect to go very high.

How did your superintendent, or general manager, or foreman, or department chief land the position he holds? By showing knowledge of his work; by proving that he had ability; by getting ready when he was in the same job you now hold.

How can you get into the spot light? How can you mount over the crowd and attract the attention of the "big man"?

By your own efforts properly directed. By being willing to devote to study a part of your spare time. By giving the International Correspondence Schools a chance to direct your efforts and lead you to the front.

Your spare time, if you would but realize it, could be made more profitable than the time sold to your employer.

Mark and mail the coupon to find out all about the I. C. S. plan to put you into the spot light. Doing so will cost you nothing, and will bring to you a full explanation of just what kind of Course you will get, what you will learn, and what has been done by other students of the same Course.

Three hundred I. C. S. students a month write to tell of progress.

Don't wait.

Mail the coupon NOW.

International Correspondence Schools

Box 872, Scranton, Pa.

Please explain, without further obligation on my part, how I can qualify for a larger salary and advancement to the position, trade, or profession before which I have marked X.

Electrical Engineering
Electric Lighting
Electric Railways
Electrician
Electric Car Running
Dynamo Foreman
Dynamo Tender
Wireman
Mining Engineer
Telephone Expert
Civil Engineer
Automobile Running

Mechanical Engineer
Mechanical Draftsman
R. R. Constructing
Concrete Construction
Architect
Contracting & Building
Architectural Draftsman
Plumbing & Heating
Chemist
Bookkeeper
Advertising Man
Civil Service Exams.

Name _____

St. & No. _____

City _____ State _____

Present Occupation _____

You have a right to know who makes the tools you use

That is the only way you can be sure that good materials and good workmanship went into the making. You can trust P. S. & W. Guaranteed Hand Tools because every one is made by us and branded with

The MARK of the MAKER

Our more than 90 years of able, experienced and progressive tool-making is your protection.

Write today for our free "Mechanics' Handy List," a 165-page book, now in its third edition. Over thirty pages of valuable information and a catalog of over 200 Guaranteed Hand Tools for Machinists, Electricians, Tinsmiths, Carpenters, etc.

The Peck, Stow & Wilcox Co.

MANUFACTURERS of the Largest Line of Mechanics'
Hand-Tools Offered by Any Maker

Address Correspondence to 20 Murray Street, New York City

Established
1819

Five Large
Factories

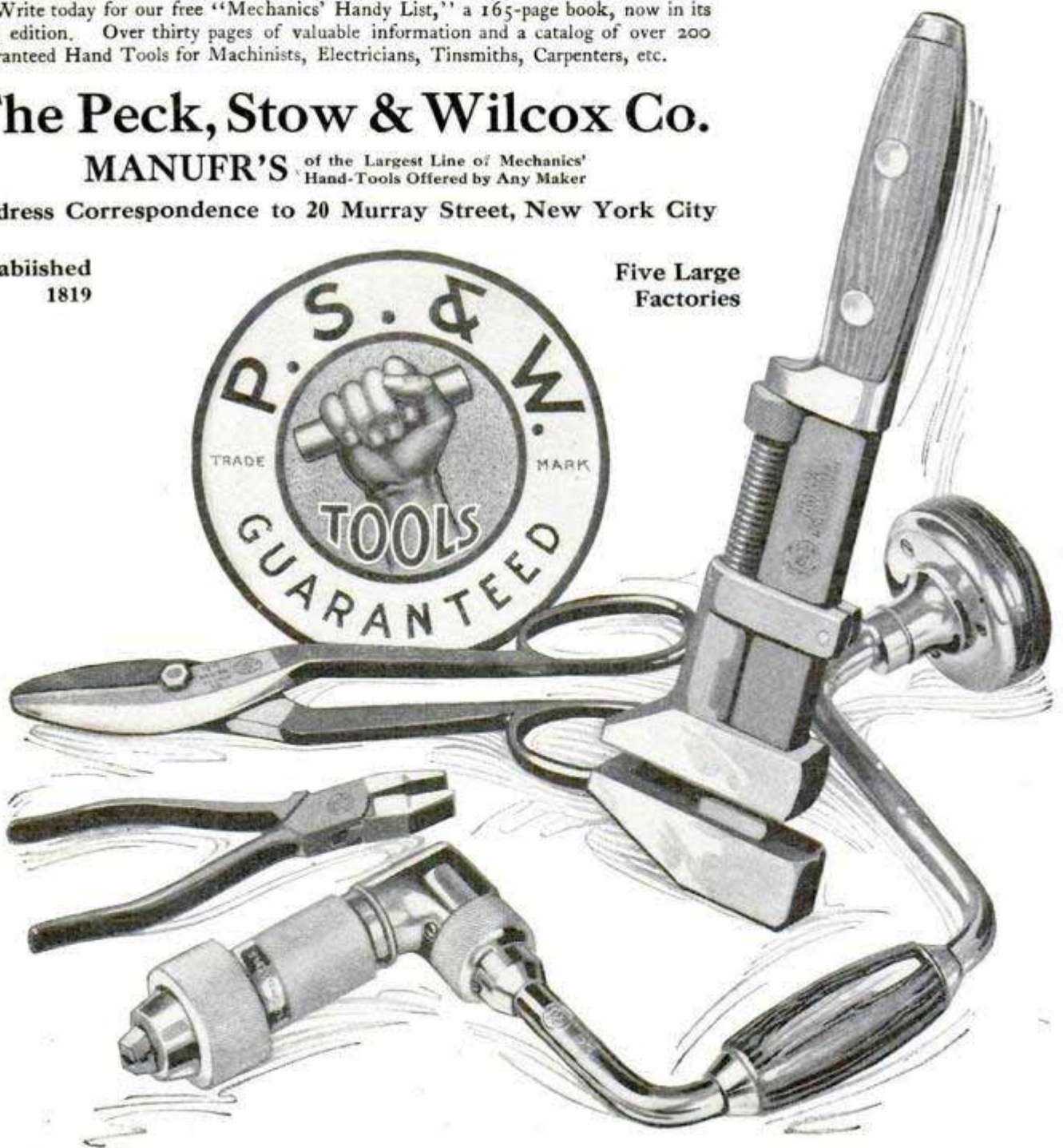

To the Automobiling Public

We are using this page to announce to the automobiling public the success of our latest motor lubricants under the name of

Polarine

Under the Brand POLARINE, Oil, Grease and Transmission Lubricants are supplied. Each product is manufactured for the lubrication of the special parts of the car for which it is recommended.

Our experts have prepared these lubricants and have tested them not only in the laboratory, but also on the road. They have used these lubricants successfully on various makes of automobiles, under favorable and unfavorable temperature and mechanical conditions.

Hundreds of stoppages and breakdowns can be traced directly to the use of unsuitable

lubricants. There is as much difference in lubricants as there is in cars or in roads.

By the use of POLARINE brand of lubricants you will

**Increase Your Speed,
Climb Hills More Easily,
Prevent Many Breakdowns,
Reduce Your Repair Bills,
Make Your Car Run
Smoothly and Greatly
Lengthen its Life.**

All dealers sell POLARINE lubricants or can get them for you.

POLARINE Oil affords perfect lubrication in tropical or zero weather. It is delivered in sealed cans—1 gallon and 5 gallon sizes—or in barrels and half-barrels. Other POLARINE lubricants in cans of convenient size.

During their long experience in making automobile lubricants, our experts discovered so many useful facts about the care of automobiles that they have prepared a booklet entitled "POLARINE POINTERS." This booklet not only gives valuable hints on lubrication, but it also tells the causes of all kinds of engine troubles.

You may have this booklet FREE if you are an automobile owner. Send to our nearest agency.

Standard Oil Company
(Incorporated)

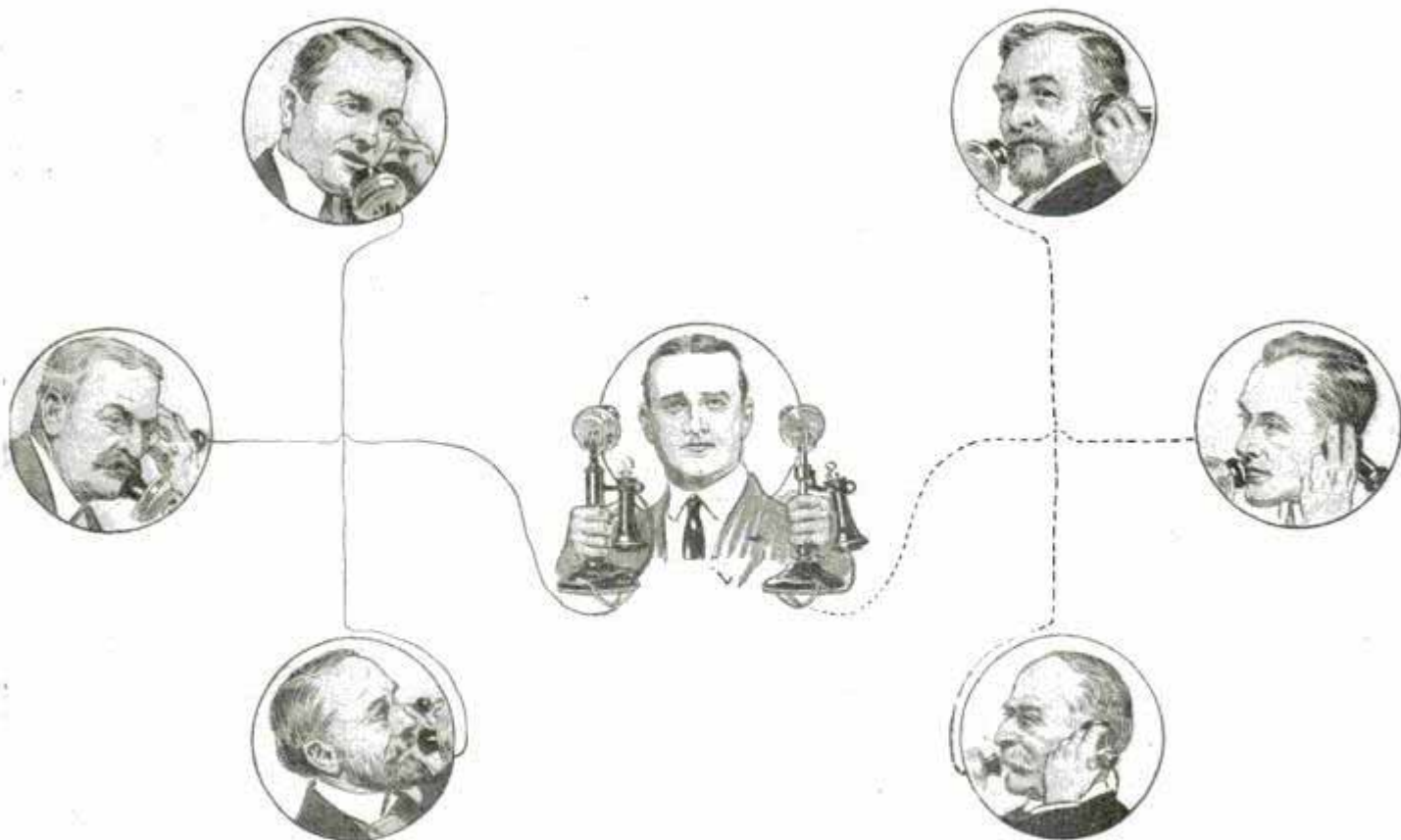

Half Service Or Double Expense

TWO telephone systems in one town mean a divided community or a forced duplication of apparatus and expense.

Some of the people are connected with one system, some are connected with the other system; and each group receives partial service.

Only those receive full service who subscribe for the telephones of both systems.



Neither system can fully meet the needs of the public, any more than a single system could meet the needs of the public if cut in two and half the telephones discontinued.

What is true of a single community is true of the country at large.

The Bell System is established on the principle of one system and one policy, to meet the demands for universal service, a whole service for all the people.

**AMERICAN TELEPHONE AND TELEGRAPH COMPANY
AND ASSOCIATED COMPANIES**

Please Mention Popular Mechanics

Let Us Put This Piano in Your Parlor
Not a Dollar To Pay Us!

SEND NO MONEY

Enjoy This Piano—Take Your
Own Time—Sent to You
on 30 Days' Free Trial

Write right now and let us put this piano
in your parlor — not a dollar to pay us.

Let us send you our big, free, actual photograph,
color-illustrated, handsome book, and offers to trust
you absolutely with any celebrated and artistic
Reed & Sons Piano on as long time as you want,
even three years or more, if you are satisfied after
30 Days' Free Trial. Not a cent to pay down—
not a dollar for any of our beautiful styles you
select from the book we send you on



REED & SONS PIANOS

Established 1842. Given Highest Award
at World's Columbian Exposition, 1893

We've sold through dealers, jobbers and agents—for over
68 years—but now we have cut out their big profits and are
giving the savings to our customers. We have made our
direct-to-you wholesale factory prices so low that you can
have a celebrated Reed & Sons Piano, for lifelong service, at
a price as low as the price of many "cheap" made pianos—
and get the highest artistic quality. Our 25-year guarantee
bond goes with every Reed & Sons instrument. Hundreds
have had generations of enjoyment from our pianos. So can
you on our plan and prove it positively at our risk.

Now Sold Direct to
You From Factory

Saves you from \$128.00 to \$222.00 on
price. No Security
— No Interest to
Pay—No Col-
lectors.



Also Self-Playing Pianos

Reed & Sons Self-
Playing Pianos now
sold on the most
liberal plan. Thou-
sands who "never
knew a note" are now
enjoying our Self-
Players. See our
offers and prices
all explained in
handsome color-
illustrated catalog
sent Free.

Take Your Own Time
—On Trying and Pay-
ing — We Pay Freight
Both Ways.

Take 30 Days' Free Trial in your home with your
family and friends to judge the beautiful tone quality
—handsome exclusive design and finish—easy action
and splendid satisfaction. After a full year's enjoy-
ment send our Reed & Sons Piano or Self-Playing
Piano back and we'll pay the freight if not exactly as
represented. That's the fairest offer ever made. It
means 365 Days' Approval Test, besides 30 Days' Free
Trial and 3 years' time to pay if satisfied. When abso-
lutely satisfied you can pay \$1.00 a week, or by the
month, or 3 months, or twice a year. We don't care
how. Suit your own time. We want you to be happy
with one of our pianos or self-playing pianos—prove it
at our risk—right now. Write right now—a Postal To-
day—or the Coupon—For Our Big Book.

REED & SONS PIANO MFG. CO., 253 Wabash Ave.
CHICAGO, ILL.
Capital and Resources, \$1,750,000.00—Largest Factory-to-Home
Piano Manufacturers in the World.



Big Book Free

Reed & Sons Piano Mfg. Co.,
253 Wabash Ave., Chicago, Ill.

Please send me your Big Color Illustrated Piano Book and offer
FREE. Everything at your risk.

Name _____

Address _____

Town _____ State _____

365 Days Approval Test

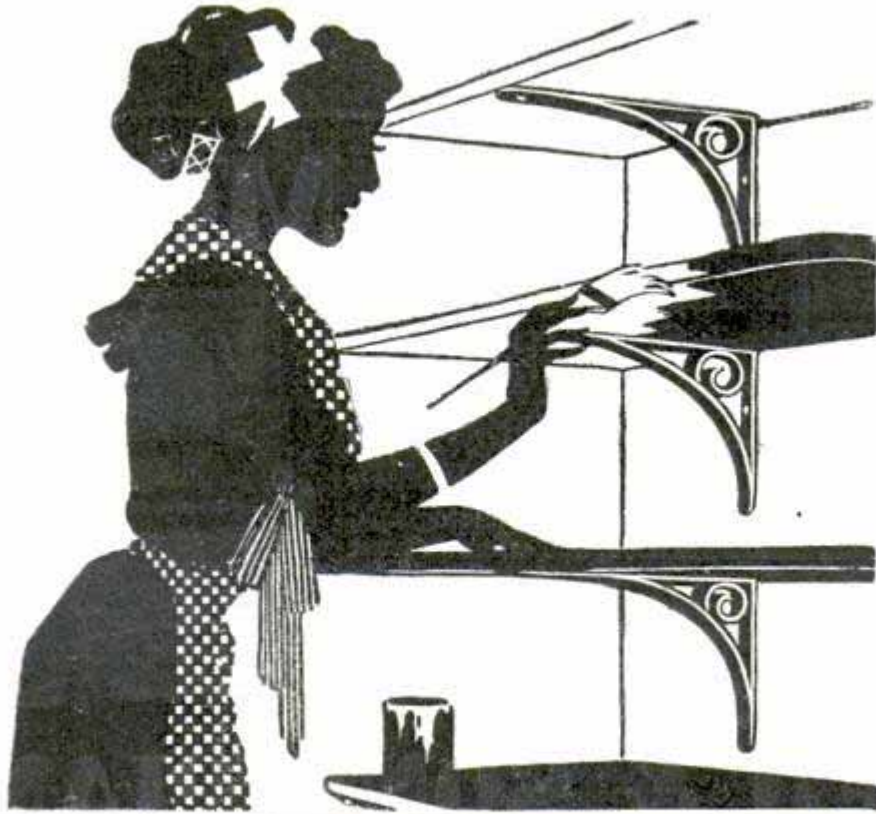

Apply White Jap-a-lac Yourself and Have a Clean, Sweet Pantry Shelf

Oilcloth *costs more* and quickly *wears out*. It *cracks* within a *few weeks* and after that grows *musty* and *smelly*. If you cover your shelves with *paper* you must *take it off* every time you *wash* them, and *then* you have to wait at least *half an hour* until the wood *dries* before you put back your *pots* and *pans*. A little bit of *time* and a little bit of *Jap-a-lac* will give you a sanitary, wholesome kitchen. *Stains* can be removed, *smudges* of all sorts cleaned off of Jap-a-lac as *easily* as from a *china plate*. Jap-a-lac has a *gloss* just like the *glaze* of *porcelain*. It endures *forever*.

JAPALAC

Made in 18
different colors and natural
(clear)—renews everything from cellar to garret

"You can't keep house without it"

For hardwood floors; for restoring linoleum and oilcloth; for wainscoting rooms; for re-coating worn-out zinc or tin bath tubs; for brightening woodwork of all sorts; for coating pantry shelves and kitchen tables; for varnishing pictures (when thinned with turpentine) and gilding picture frames and radiators; for restoring go-carts and wagons; for decorating flower pots and jardiniere stands; for re-painting trunks; for enameling sinks; for restoring chairs, tables, iron beds, book cases and for a thousand and one uses, all of which are described and explained in a little book which you can have for a little request on a post card.

For sale everywhere—it wears forever. Look for the name of Glidden as well as the name Jap-a-lac. There is no substitute.



Cleveland, O.

The Glidden Varnish Co.

Toronto, Ont.

Branches: NEW YORK, CHICAGO

All sizes 20c to \$3.00

YOUR HANDS



YOUR hands will thank you for introducing them to **Pummo Soap**.

Pummo is composed of pure vegetable oils, glycerine and the finest Italian pumice.

Pummo has not only all the cleansing qualities of the best toilet soaps, but it does more—removes grease, grime, paint, oil, ink and other stains from the hands in a way which soap alone will not do.

The soap and pumice remove the dirt and stains like magic; the glycerine softens and soothes the skin.

As an effective and instantaneous cleanser **Pummo** stands in a class by itself.

The price of **Pummo Soap** is **5c**— at druggists and grocers.

If your dealer does not have **Pummo** in stock, write us, giving his name, and we will send you a free sample by return mail.

Made by
The N. K. Fairbank Company
CHICAGO



Double the Purchasing Power of Your Money



YOU know that home surroundings exert a wonderful influence on domestic happiness, but you did not know that every room in your home could be artistically furnished at a price that is ridiculously low, did you? THEN you owe it to yourself—your family, to investigate this proposition. Not knowing means a direct loss to you.

MAKE \$1.00 DO THE WORK OF \$2.00

HOW? By having the furniture shipped to you direct from the factory in the natural wood, together with all the materials necessary to give it the proper finish (or stained prior to shipment if preferred) and in assembled, easy-to-put-together sections. Take for example the chair shown in the illustration. You simply put the four assembled sections together, (two sides, front and back) slip the cushion in place, and by this act you have reduced the cost of that piece of furniture exactly, yes, more than half.

You ask: How does this method reduce the price?

FIRST—You pay but one profit only—the manufacturer's profit. All retailers' profits and expenses are done away with.

SECOND—The freight rate on furniture shipped in this manner is very low—about one-quarter of that charged on completed furniture, which charges are always included in the dealer's price to you.

THIRD—The finishing and packing charges are reduced to a minimum.

FOURTH—The size of the factory and therefore the expense of maintenance is reduced, no enormous storage space being necessary. This naturally reduces the manufacturing cost.

Send to-day for our new catalog No. 12 which shows an extensive line of furniture for every room in the house, club or office, each piece backed by our Guarantee of Satisfaction or your money refunded.

BROOKS MANUFACTURING CO., 705 Rust Ave., Saginaw, Mich.

Printype Wins!

New Oliver Typewriter, Equipped With "Book Type," Makes Tremendous Hit With the Public—"Typewrites PRINT"

Sells for 17 Cents a Day

Another great Oliver innovation—PRINTYPE.

Some months ago, without announcement, we placed The Printype Oliver Typewriter on the market.

Today, *one-third* of our output of Oliver Typewriters are Printypes.

It's more than a success. *It's a revolution in typewriter type!*

Printype is the most beautiful, readable, attractive, attention-compelling type ever evolved for typewriters.

Thousands of dollars have been expended in producing this wonderful typewriter type, yet you pay only the regular price of \$100 for the complete machine, the new Oliver No. 5, equipped to write in Printype. You can buy The Printype Oliver on the famous 17-Cents-a-Day Purchase Plan.

Printype is virtually *book type*—the type which the eye has been *trained* to grasp *quickly*.

The type which the crystallized experience of centuries proves best for the printed page.

Great Beauty and Attention Value

Printype is the very soul of *symmetry*. The shadings give *body*, *refinement* and *life* which are utterly lacking in the old-style thin outline letters and numerals. It's a delight to the eye.

A letter written in Printype attracts the eye—it's *magnetic*. A Printype letter is so strikingly *attractive*, so *forceful*, so *distinctive* that one unconsciously picks it out from a mass of mail, to read *first*.

Its perfection *compels attention*.

A large part of our sales have resulted from letters like this, sent by interested correspondents to users of the new machine: "For goodness sake, what machine did you use to write that letter?"

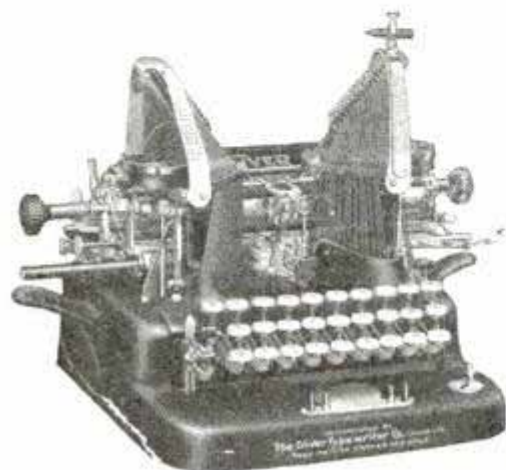

The answer—a *Printype Oliver*—makes the sale.

Aids Eyesight—Prevents Errors

Printype aids and rests the eyes. None of the strain on the optic nerve that sharp, thin, outline type imposes. This elimination of *effort* makes it a positive pleasure to read Printype correspondence. Ask the opinion of your oculist or optician. *He knows the value of Printype!*

Printype —
OLIVER
Typewriter

The Standard Visible Writer

Printype makes every letter, every numeral, every character employed in the whole wide range of commercial transactions *perfectly plain*.

Wherever *accuracy* is demanded, *Printype* is worth a premium.

A Printype Test by Linotype Operators

One of the hundreds of interesting *Printype* tests was made by various newspaper publishers. Linotype operators of equal dexterity were pitted against each other in a speed contest. One set of operators were supplied with copy written with the *regular* typewriter face.

The opposing operators were supplied with copy written in *Printype*.

It was found that the linotype operator could increase his output *ten per cent*, setting from "Printype" copy, over copy written with the ordinary "outline" typewriter type.

Ask Us to Write You a Letter on The Printype Oliver Typewriter

We want to write you a specimen letter on The Printype Oliver Typewriter and forward a copy of the book, "A REVOLUTION IN TYPEWRITER TYPE." Ask us for details of the "17-Cents-a-Day Purchase Plan" which has added so many thousands to the ranks of typewriter users.

We urge upon you the importance of investigating the new face in Typewriterdom—PRINTYPE.

Address Sales Department

(106)

The Oliver Typewriter Company

703 Oliver Typewriter Bldg., Chicago. Agencies Everywhere

Triple the Purchasing Power of Your Money

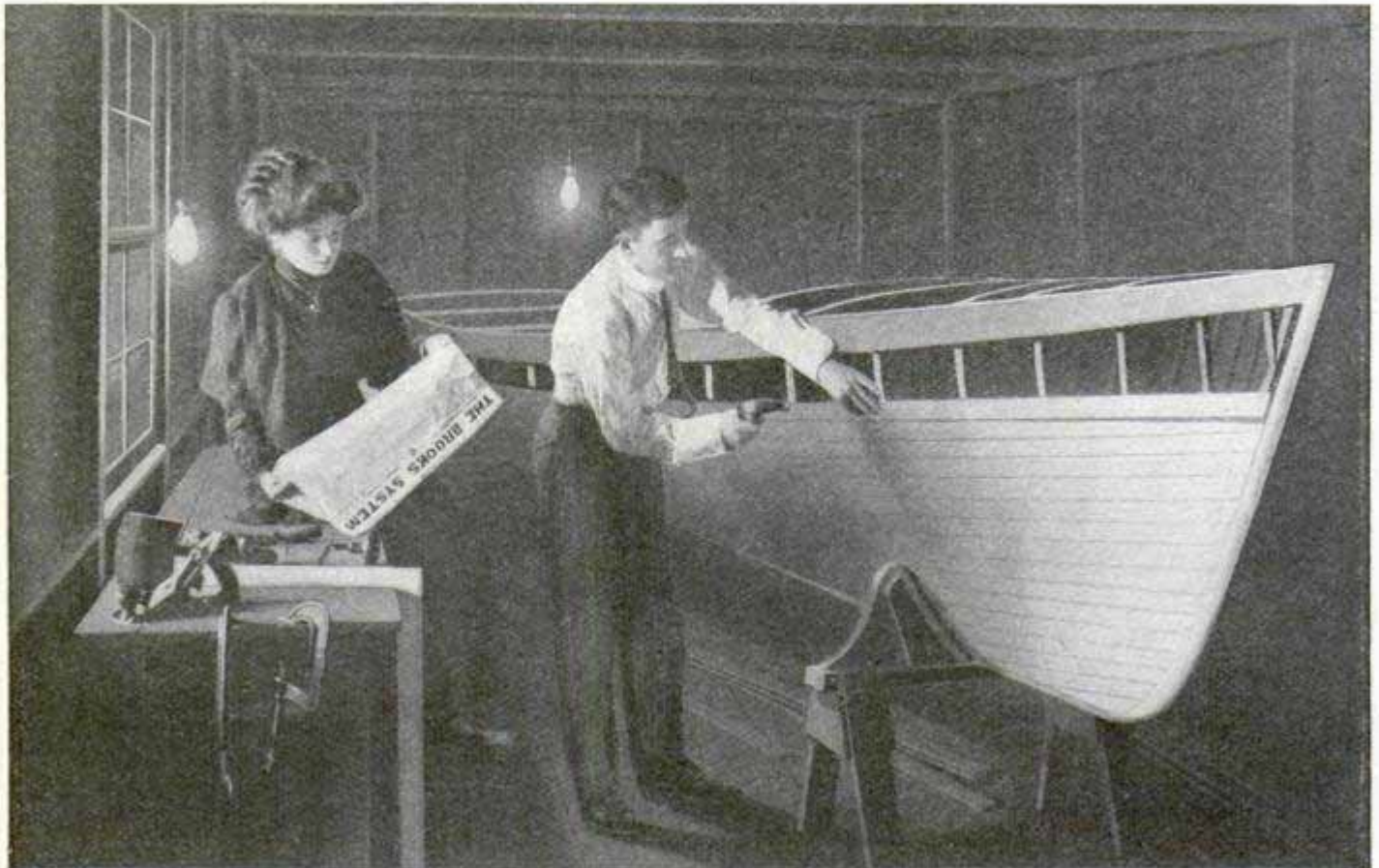

DO you know that it is the health-giving pull of Nature that makes every gingery water breeze, every glance at a beautiful lake or river, attract the red-blooded human being, and make him want a boat? It's your duty to yourself—to your family—to respond to this influence.

AGAIN—Do you know that by adding a little of your money to a little of your spare time, you can profitably enjoy many a dull hour and own a boat at a ridiculously low cost?

Make \$1 Do Exactly the Work of \$3

HOW? By purchasing the full-sized paper patterns and instructions for a boat, or by purchasing all or part of the material in the knock-down—that is—every piece cut to shape, machined and accurately fitted, so that it will go together but one way only—the right way.

You ask: Why does this method reduce the price? There are five reasons:

FIRST: You are spending a few pleasant hours instead of money in assembling the boat, which reduces the cost to you over half.

SECOND: You do not pay—but wait—space in this publication is mighty expensive. Why tell only part of the story? Our new catalog No. 25, goes into detail, and a **postal card** will bring it to you. It shows an extensive line of boats, from canoes to cabin cruisers—every one backed by a **guarantee of satisfaction** or your money refunded. **Send that postal now—right now.**

BROOKS MANUFACTURING CO.

705 RUST AVENUE

SAGINAW, MICH.

Two Million Dollars' Worth

of Housefurnishings—3,021 Lines—Sacrificed by the Makers.
Sold for CASH or CREDIT at an Equal Price.

The year 1910 was a dull year in furniture. Hundreds of makers at the end of the year were loaded with surplus stocks. They welcomed any offer—even much below cost—to turn warehouse stock into money.

We went to those makers with unlimited money. And we bought up bargain stocks from 180 factories. We bought so low that on hundreds of these articles we can quote half usual prices by selling direct.

All these furnishings—over 3,000—are shown in our Bargain Book No. 24. It makes a mammoth book, but we want to mail it—and mail it free—to everyone who has a home. You may never again see an opportunity to get things for the home so cheap.

Pay As Convenient

If you see something you want here there is no need to pay cash. Our cash and credit prices are exactly identical. Open a charge account, if you wish. Over 600,000 people have such accounts here now.

On the average credit account we allow a year to pay. There is no interest, no security, no red tape. Our customers are all buying things for the home, and we gladly give such people credit. You'll find it convenient to buy on open account.

Bargains In

Furniture Silverware
Carpets Chinaware
Rugs Graphophones
Draperies Washing Machines
Stoves Sewing Machines
Ranges Baby Cabs
Pianos Lamps and Clocks

Cash or Credit

30 Days to Decide

Nothing we send you is considered a sale until you have it a month. Everything is sent on approval. If you wish to return it for any reason we will pay freight both ways.

Before you buy anything you see the article right in your home. You compare it with others—compare prices

with others. You take no risk whatever in letting us send you whatever you want to see.

Bargain Book Free

This mammoth book—size 10½ x 17 inches—picturing 3,021 things for the home, is mailed free for the asking. It will show you how low beautiful things can be sold when the makers must have money. You'll find a hundred things you want and at amazing prices.

Cut out this coupon—now, before you forget it. Send it to us and we will mail the book.

Cut Out This Coupon

SPIEGEL, MAY, STERN CO.
1517 35th Street, Chicago

- Mail me the Bargain Book.
 Mail me the Stove Catalog.

Name

Post Office

State

I am particularly interested in



High grade 9x12 rug bargains, bought at auction from largest manufacturer in United States. A saving of 30% is guaranteed on every rug. All patterns and colors. Bargain prices as follows:

Tapestry Brussels Rugs,
9x12 ft. \$11.95 up
Velvet Rugs, 9x12 ft. 13.95 up
Axminster Rugs, 9x12 ft. 17.50 up

Cash or Credit



No. LX485—English Folding Go-Cart Bargain. Newest 1911 design. We take the factory output at a specially low price. Has steel frame, fabricord leather upholstery and large rubber tires. The best collapsible go-cart on the market.

Factory bargain price \$4.85

Cash or Credit



No. 50X435—Tufted Back, Upholstered Rocker Bargain. We bought 9,200 at actual factory cost price for spot cash from a manufacturer who required immediate money. This is a beautiful rocker, upholstered in guaranteed fabricord leather. The American quarter-sawn oak frame is finely finished and handsomely carved.

A great bargain. Factory bargain price . . . \$4.35

Cash or Credit



No. 30X1820—Steel Range Bargain. Made in our famous Empire factory. One of the grandest ranges ever built. We guarantee a saving of at least one-third on all stoves sold by us. This style, bargain price from . . . \$18.20

up, according to size.

Cash or Credit

SPIEGEL, MAY, STERN CO., 1517 35th Street, CHICAGO, ILL.

Gray Junior

All Ready to Run

\$58 All around Stationary
Work Engine
Complete

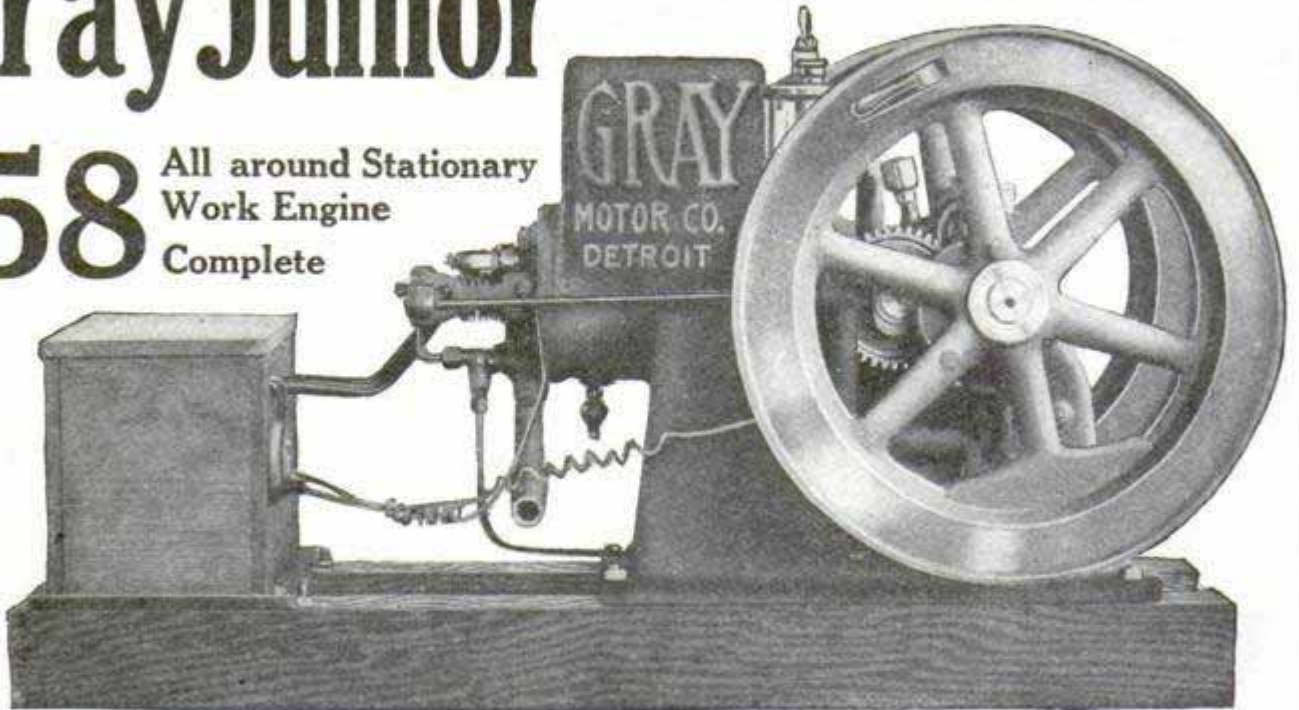

Built Right A good small motor. Guaranteed the same as if it cost \$500, by a big responsible concern. Made to last a life time. A woman can run it. Hopper cooled, Powerful—good material, workmanship and finish. Comes mounted, already to run as you see it. Put in your gasoline and start it up.

Agents make big money selling it because it sells itself and makes no trouble after it is sold.

It looks good, runs good and is good. Occupies a field distinctly its own because of its high quality.

Write for agent's proposition today.

Gray Farm - Pumping and General Power Motors

Gasoline or kerosene, 3 to 36 horsepower.

6 h.p. Farm Engine, \$94 to \$124 complete.

3 h.p. Farm and Stationary Engine \$65, guaranteed to develop 4 h.p.

24 h.p. Irrigation Pumping Engine, \$346—36 h.p. for \$560.

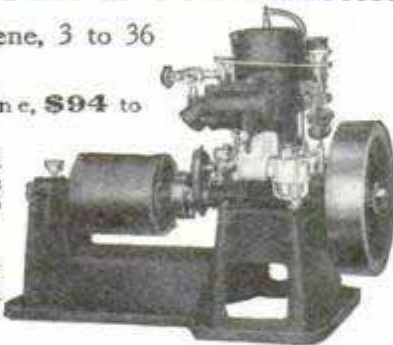

Gray Marine Motors

For Cruisers, Work Boats
Speed Boats and Canoes

"The engine that requires no attention"

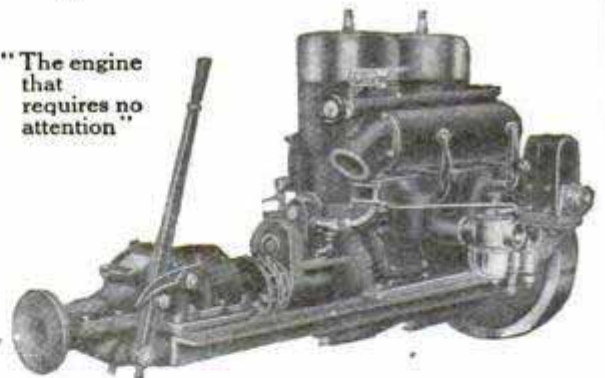

3 h.p. \$65—6 h.p. \$89.50—12 h.p. \$188.00
24 h.p. \$330.00—36 h.p. \$528.00—Complete ready to install in your boat.

Absolutely guaranteed in every detail.

7 to 36 h.p.—1, 2 and 3 cylinders—combination 2 and 3 port.

Bosch High Tension Magneto—the most up-to-date marine engine built.

Write today for Big New Catalog

[Be sure to specify whether you want Marine or Stationary Catalog, and what you want to use the engine for]

GRAY MOTOR COMPANY, 532 CHARLOTTE AVENUE Detroit, Mich.
Canadian Gray Motors, Ltd., 532 River Front St., Walkerville, Ont.

WETMORE Adding Machine

An Opportunity to Share in the Profits of this Company

THE Wetmore Adding Machine Company will manufacture the simplest, most reliable, and durable adding machine ever produced. Those who organize the company are men of long and successful experience in manufacturing, and their interests are permanently bound up with those of the company.

The Wetmore Adding Machine is the only adding and listing machine ever produced whose addition does not depend upon springs, gravity, or friction. Every part in its adding mechanism is driven into position by cam, gear and lever.

A Few Prominent Features

1. Accumulators in direct line of sight.
2. Low key board.
3. Visible works.
4. Keys interlocking or flexible, at choice of the purchaser.
5. Especially convenient angle of keyboard.
6. A new and improved method of inserting paper.
7. Lightest operation of any machine on the market.
8. All keys and levers operated by the right hand, the left being free for turning checks.
9. Two sets of accumulators, one for the debit and one for the credit column, a feature which greatly extends the usefulness of the adding machine.
10. Positive operation; must add right or stop, no other alternative.
11. The design permits of substantial construction.

Eight years ago, the inventor, Mr. Wetmore, was engaged by one of the largest adding machine companies as their General Superintendent. At that time, the company had almost no factory equipment. Mr. Wetmore first undertook the redesigning of their machine and his name appears on the late patents. Next, Mr. Wetmore superintended the designing and building of the special equipment, selecting and installing the standard machinery and superintended for five and one-half years the production of what is known as one of the best adding and listing machines on the market today.

This five and one-half years of building adding machines for the market gave Mr. Wetmore an opportunity to carefully study every other adding machine and this experience convinced him that all adding machines up to this time were designed upon wrong principles.

No one would think of driving a cyclometer on an automobile with a belt. Why? Because belts slip. Why then trust your accounts to a mechanism whose accuracy depends upon its parts being moved by springs? If the spring weakens or the joint in the part becomes corroded or gummed with bad oil or clogged with dirt, you have an incorrect addition.

These troubles led Mr. Wetmore to spend years of time to produce an adding machine whose operation is as positive as a gear drive. If one part in the adding mechanism moves, all the rest must move. If one part is blocked, all parts are blocked. These are features embodied only in the WETMORE ADDING MACHINE.

The Wetmore Adding Machine Co. offers the following very liberal proposition to small investors. We will sell four shares, 7 per cent cumulative preferred stock, par value, \$100.00 per share, for \$400.00. This stock carries a bonus of two shares of common stock. This is the same proposition which is now being made to large investors. This common stock should pay

Not a Spring in Adding Mechanism

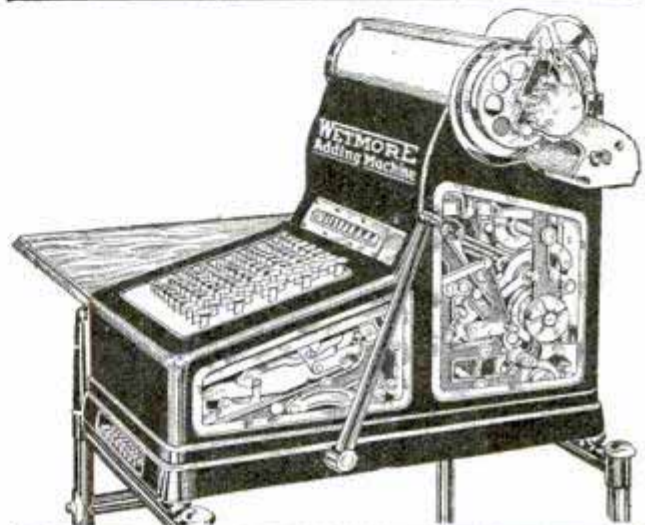

More Work with Half the Mechanism

at least 30 per cent when the factory is selling 3,000 machines per year. In addition to this, for the purpose of introducing our machines into every state in the United States, we will give to a limited number of purchasers of the above amount of stock, in each state in the United States, ONLY, an order on the factory for one of our \$400.00 adding and listing machines upon payment of \$200.00 in cash. If the stockholder wishes he may turn in his two shares of common stock in place of paying the \$200.00 in cash, that is, we will accept this common stock at par for payment on this limited number of machines.

For \$400.00 you get \$400.00 of 7 per cent cumulative preferred stock, \$200.00 common stock, and by paying \$200.00 in cash additional, you get a \$400.00 adding and listing machine. Or for \$400.00 you get \$400.00 7 per cent cumulative preferred stock and one \$400.00 adding and listing machine.

Wetmore Adding Machine Co.
Ford Building, DETROIT, MICH.

COUPON

Wetmore Adding Machine Co.,
Ford Building, Detroit, Mich.

Please send me complete information regarding the proposition you advertise in May POPULAR MECHANICS Magazine and reserve for me one of the machines which is allotted to this State, pending my investigation. It is understood that if I am not satisfied in every respect with your proposition there is no obligation incurred.

NAME

ADDRESS



B

“Why Don't You Use

Amatite

ROOFING.

It Needs No Painting!”

EVERYTHING about Amatite appeals to the man with common sense. He can see its superiority at once—the *real mineral surface* which never needs painting; the *two layers of Pitch* which is the only imperishable waterproofing known; the two layers of *heavy Tarred Felt*—all these contribute to the popularity of Amatite.

We can make Amatite better and cheaper than anyone else on account of our greater facilities, and consequently we sell it at a surprisingly low figure.

Simply the fact that it *needs no painting* is enough to make a man sit up and take notice—especially the man who has spent dollars and days in painting and repainting his smooth surfaced roofings.

Write today for free sample and booklet to nearest office.

Barrett Manufacturing Co.

New York, Chicago, Philadelphia, Boston, Cincinnati, Minneapolis, Cleveland, Pittsburgh, New Orleans, Kansas City, St. Louis, Seattle, London, Eng.

6 Months Free Trial

Try this grinding, buffing and polishing outfit for 6 months Free and prove how it helps tool users, shops, factories and contractors save and earn more money. Keep it a whole half year free, then if you can afford to be without it, send it back.

LUTHER DIAMOND TOOL GRINDERS

Carborundum peels off hardest steel in tiny shavings. No heavy pressing necessary—no need of cooling with water. Wheels do not glaze or get lopsided. Guaranteed five years—Grinder is built like a high grade lathe, steel and malleable construction, dust-proof bronze bearing, machine cut spur gears, machine parts in oil bath—2500 revolutions per minute.

11 Tools in One, consisting of Mechanics' Special Grinder and attachments as follows: Rough Carborundum wheel, fine Carborundum wheel, chisel grinding attachment, twist drill attachment, polishing spindle, buffer, polisher, oil stone, Carborundum hone in leather case, Carborundum scythe stone, foot power attachment.

Write Today for Six Months' Free Trial Offer,

and Free Booklet reprinting from McClure's Magazine the wonderful story of Carborundum.

LUTHER GRINDER MFG. CO.
68 B. MADISON ST., MILWAUKEE, WIS.

Will not draw temper from steel, 25 times faster than grindstones—6 times faster than emery wheels. Hand and foot power.

THE TYPEWRITER ALPHABET.—An ingenious correspondent of the New York Sun suggests that the alphabet be taught to all children in this order:

q w e r t y u i o p
a s d f g h j k l
z x c v b n m

which is the “universal” one, as can be verified by a glance at any typewriter keyboard. He goes on to say: “If the alphabet were so arranged and universally taught, instead of in the arbitrary and useless though historical order, then the literally millions all over the world who are learning to operate, professionally or otherwise, the typewriter, would have their path smoothed for them and be able to get up speed from the start.” In this typewriter age, why wouldn't it be common sense to teach the children their Q W E's, instead of their A B C's?



Fish Bite like hungry wolves and keep you busy pulling them out whenever you use our **Wonderful Fish-Luring Bait.**

25c. a box. Write for free booklet and our special offer of one box to help introduce it. Walton Supply Co., Dept 20, St. Louis, Mo

NO MORE BALD HEADS



When our VACUUM CAP is used a few minutes daily. We accept no pay until you have tried the Cap 60 days and are satisfied. The Vacuum Cap is an appliance that draws the blood to the Hair Roots and starts a new healthy crop of hair. It stops Dandruff, stops the hair from falling out. Bought by Doctors and men who

know that it is the only reasonable HAIR GROWER known to science. No Drugs Used. Write for application blank, testimonials, and booklet on “HAIR,” sent sealed in plain envelope, FREE.

THE MODERN VACUUM CAP CO.

Q. 559 BARCLAY, DENVER, COLO.

6 Important Books For Electrical Men

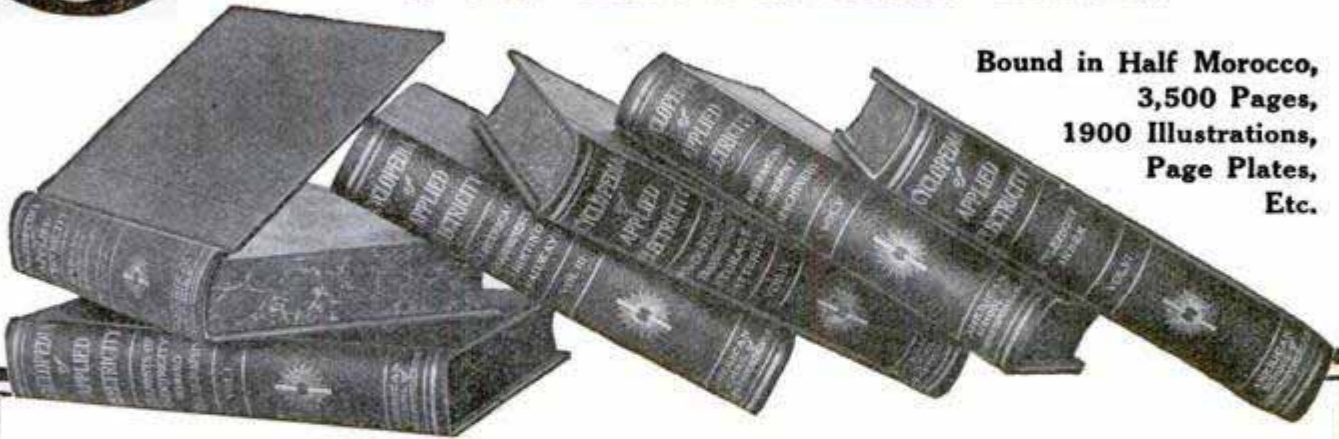

Bound in Half Morocco,
3,500 Pages,
1900 Illustrations,
Page Plates,
Etc.

We Want You to Examine These Books FREE OF CHARGE

They are just what you want if interested in any branch of electrical engineering. We want you to examine the complete set at our expense.

This Great Cyclopedia of **Applied Electricity**

is written by thirty expert electrical engineers—the biggest men in the profession. It is especially designed as a working guide for the student and ready reference for the expert. *Their reference value is guaranteed* because they are compiled from the regular text books used in the correspondence courses of the American School of Correspondence.

You Take No Risk. Examine the books five days at our expense. So confident are we that the books are just what you want, that we will send them to you by prepaid express. Keep them five days, test them—apply them to your every-day work. If satisfied that they are the most complete and comprehensive work ever published on Electricity, keep them and send us \$2.00, then pay \$2.00 a month until you have paid our special introductory price of \$18.80. The regular price is \$36.00. If the books do not satisfy you and are not just what we claim them to be, notify us and we will have them returned at our expense. Just fill in and send the coupon. *The books will be sent to you free.*

IMPORTANT SUBJECTS TREATED IN DETAIL

Electric Wiring—Electric Telegraph—Wireless Telegraphy—Telautograph—Theory, Calculation, Design and Construction of Generators and Motors—Types of Dynamos and Motors—Elevators—Direct Current Motors—Direct-Driven Machine Shop Tools—Electric Lighting—Electric Railways—Alternating Current Motors—Single Phase Electric Railway—Management of Dynamos and Motors—Power Stations—Central Station Engineering—Storage Batteries—Power Transmission—Alternating Current Machinery—Telephony—Automatic Telephone—Wireless Telephony—Telegraphone, etc.

For a short time we will include, as a monthly supplement, for one year, the TECHNICAL WORLD MAGAZINE. This is a regular \$1.50 monthly, full of Twentieth Century Scientific facts, written in popular form. Also contains the latest discussions on timely topics in invention, discovery, industry, etc.

AMERICAN SCHOOL OF CORRESPONDENCE

CHICAGO, U. S. A.

Pop. Mech. 5-11

A. S. of C.

Please send me Cyclopedia of Applied Electricity for five days' free examination. Also T. W. for one year. I will send \$2 within five days and \$2 a month until I have paid \$18.80 for books and magazine; otherwise I will notify you and hold the books subject to your order. Title not to pass until fully paid.

FREE EXAMINATION COUPON

NAME

ADDRESS

OCCUPATION

EMPLOYER

When Your Finger-Tip Taps the Key—What Happens?

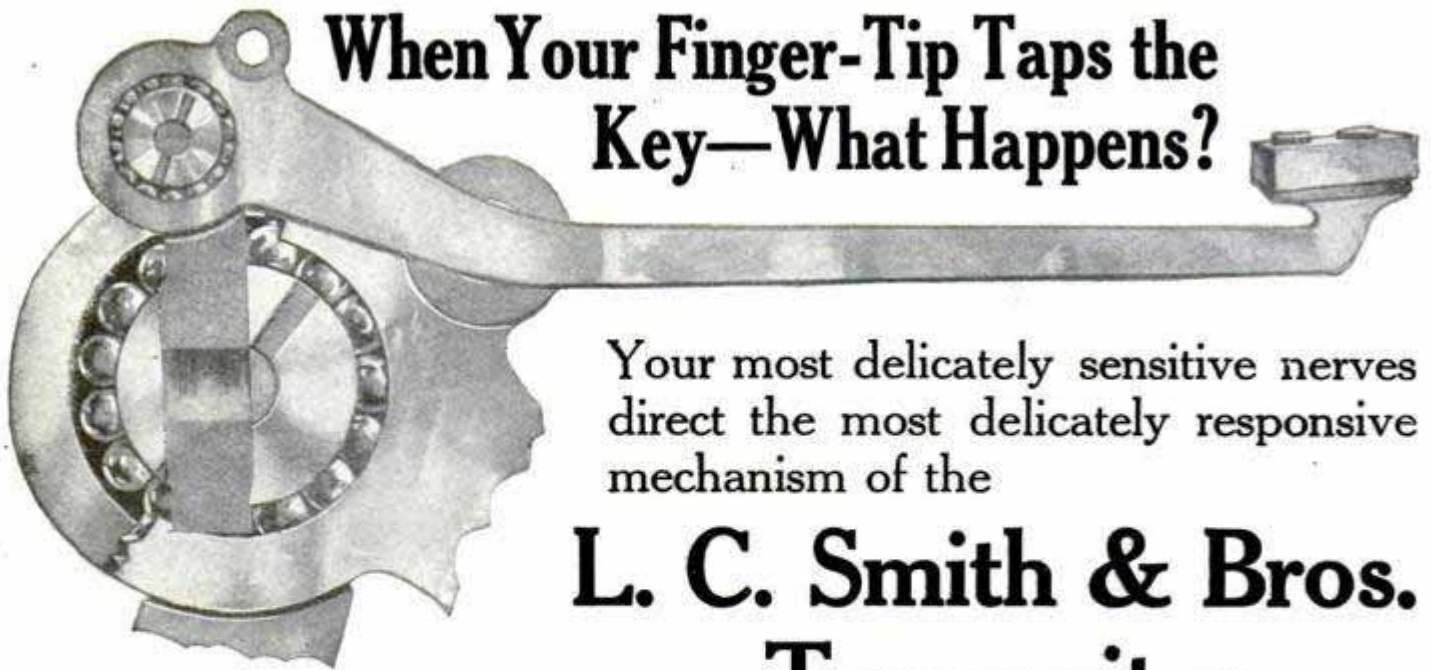

Your most delicately sensitive nerves direct the most delicately responsive mechanism of the

L. C. Smith & Bros. Typewriter.

(BALL-BEARING, LONG WEARING)

Key-lever, typebar, carriage (and shift, if you write capitals)—really all essential operating parts of the typewriter—leap into action and perform their functions with the perfect ease, smoothness and absolute precision of ball-bearings, made and adjusted with scientific exactness.

The nerves of this typewriter are sensitive to the nerves of your finger-tips, and just as instantly responsive as the finger-tips are to the brain.

This immediate, smooth, sympathetic action, duplicated in no other writing machine, is easiest for the operator and most advantageous to the machine. Both wear longer.

Send for Descriptive Literature.

L. C. SMITH & BROS. TYPEWRITER CO.

*Head Office for
Domestic and Foreign Business*

Syracuse, N. Y., U.S.A. Branches in all large cities.

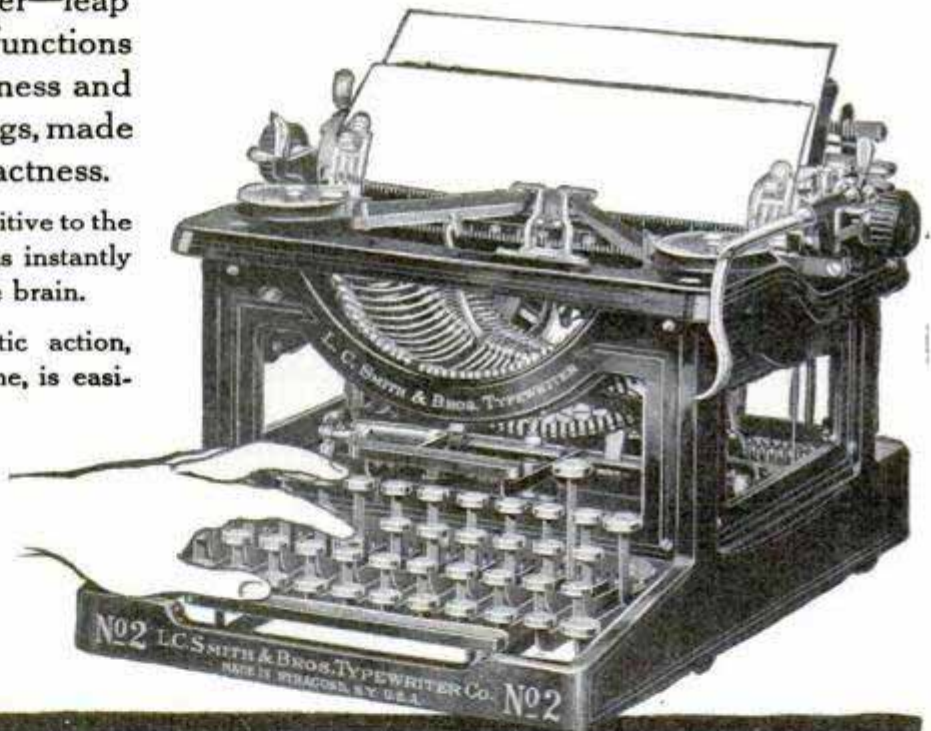

EVERKEEN RAZOR SENT FREE!



Here's the best razor and the best razor offer you ever saw: We will send this high-grade Everkeen Standard Razor prepaid to any man anywhere in the U. S.—free—without a cent in advance. Use it ten days, and if you are sure there is no better razor at any price, send us \$1.00, the wholesale price, and the razor is yours. If not fully satisfied, send the razor back to us by registered mail and you are out nothing.

SEND NO MONEY

We make this wonderful offer because we believe that hundreds who accept it will see what a splendid opportunity it gives them to sell Everkeen Razors to their friends at \$2.25, the regular retail price. If you order one at \$1.00 and are satisfied with it, we will sell you as many as you want at the wholesale price. You can put them out on free trial offer and if any come back on you, we will take them off your hands. Agents lose nothing, risk nothing on our plan. The Everkeen Razor is made of Wardlaw's extra superfine bar razor steel, the finest in the world. Blade is hollow ground by experts, of unusual hardness, and fine temper, and will hold its edge indefinitely. Send no money, just your name and address, and try one of these splendid razors. Address

UNITED FACTORIES, 1200 Wyandotte St., KANSAS CITY, MO.

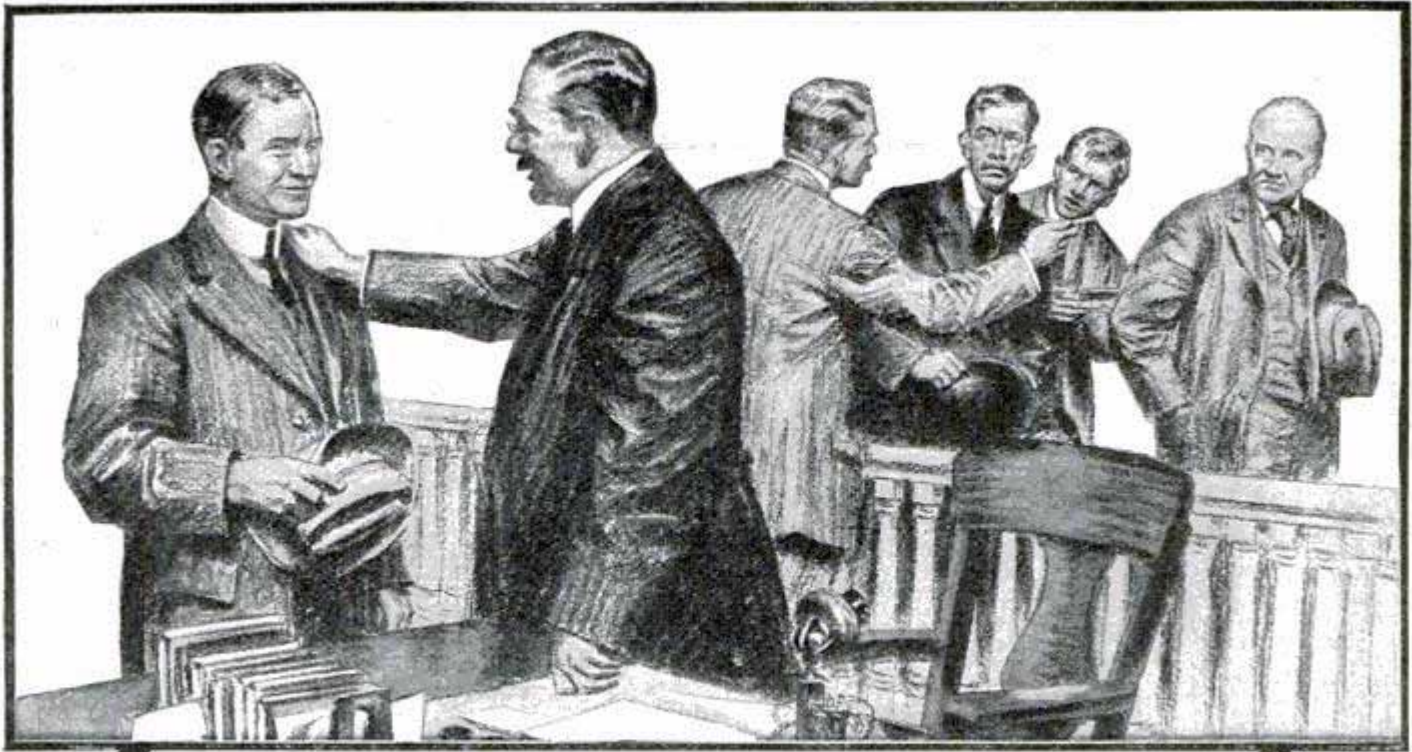

“You Get the Job”

That's what the trained man, the expert in his line, hears today from the man that hires.

Worth-while jobs are not given out haphazard. Training lands the job—training that means high-grade work and a short cut to results. And training wins quick advancement to still better jobs.

The day of the “Jack-of-all-trades” is passed. This is the time of the specialist. No concern can afford to place a high-grade equipment in the hands of low-grade men. Competition forces employers to meet skill with skill.

The business of the International Correspondence Schools is to supply training; to give job-getting and job-bettering ability; to raise salaries.

Every month upward of 300 I. C. S. students write to Scranton to tell of positions secured or bettered—of earnings increased and prospects brightened—through study of I. C. S. Courses. Last month the number was 416. The letters come from every section and from all sorts and conditions of men. Some of the writers live in Pennsylvania—some live in California.

If you wish to make sure of the job you want—there is an I. C. S. way for you. To find out all about it, mark and mail the coupon. Doing so will commit you to nothing, place you under no obligation, and may prove to be the turning point in your career.

Don't wait.

Mail the Coupon NOW!

International Correspondence Schools

Box 872, Scranton, Pa.

Please explain, without further obligation on my part, how I can qualify for a larger salary and advancement to the position, trade, or profession before which I have marked X.

Electrical Engineering
 Electric Lighting
 Electric Railways
 Electrician
 Electric Car Running
 Dynamo Foreman
 Dynamo Tender
 Wireman
 Mining Engineer
 Telephone Expert
 Civil Engineer
 Automobile Running

Mechanical Engineer
 Mechanical Draftsman
 R. R. Constructing
 Concrete Construction
 Architect
 Contracting & Building
 Architectural Draftsman
 Plumbing & Heating
 Chemist
 Bookkeeper
 Advertising Man
 Civil Service Exams.

Name _____

St. & No. _____

City _____

State _____

Present Occupation _____

ELGIN WATCHES ON CREDIT



Special This Month—\$16⁵⁰
17-Jewel Genuine ELGIN IN 20-YEAR GOLD FILLED CASE **only**
 Sent PREPAID On *Free Trial* at Our Special **ROCK BOTTOM WHOLESALE PRICE.**

Let me send you this
Beautiful Genuine 17-Jewel Elgin Watch
Complete in 20-Year Gold Filled Case—
the BIGGEST BARGAIN Ever Offered!

NO MONEY DOWN \$2 A Month
 \$2.50 After Examination.



You Assume No Risk Whatever in Dealing With Us

because before you buy or pay one cent, we place the watch right in your own hands and let it do its own talking. We ask **NO SECURITY** and **NO INTEREST**—just plain honesty among men. Our Elgin Watches are so well known and our **CREDIT PLAN** so easy, that no matter where you live or how small your wages, **WE WILL TRUST YOU**, so that you and every honest man and woman can own a **DIAMOND** or **High-Grade Elgin Watch** in a beautiful Guaranteed 25 year Gold Filled Case and wear it while paying for it in such small payments that you never miss the money. **Write today for our Big Free Watch and Jewelry Catalog.** It tells all about our easy credit plan and how we send Elgin 19-Jewel B. W. Raymond and 21 and 23-Jewel Elgin Veritas everywhere on Free Trial, without security or one cent deposit, positively **Guaranteed to Pass Any Railroad Inspection.**

HARRIS-GOAR CO., Dept. 97 KANSAS CITY, MO.

The House that Sells More Elgin Watches than Any Other Firm in the World.

Guaranteed for 20 Years.

WATCH AND DIAMOND Book FREE
 Write For It.

WHITE VALLEY GEMS IMPORTED from FRANCE
SEE THEM BEFORE PAYING!
 These Gems are chemical white sapphires. Can't be told from diamonds except by an expert. Stand acid and fire diamond tests. So hard they can't be filed and will cut glass. Brilliance guaranteed 25 years. All mounted in 14K solid gold diamond mountings. Will send you any style ring, pin or stud on approval—all charges prepaid—no money in advance. **Write for Free illustrated booklet, special prices and ring measure.** WHITE VALLEY GEM CO., 900 Saks Building, INDIANAPOLIS, IND.

A Genuine Edison Phonograph

On Absolutely **FREE TRIAL**

in your own home. No money down—No C. O. D. No obligations. Sold on easy payments as low as **\$2.00 a month** and at lowest cash prices. Return at our expense if you don't wish to keep it after free trial. Everyone should have our Free Catalog of genuine Edison Phonographs. Write for this great **FREE** catalog today. A postal will do. *But write today.* F. K. BABSON, Edison Phonograph Distr., Suite 1195, Edison Block, Chicago



THE SAUERKRAUT GERM—All Dutchland rejoices that Professor Gruber has discovered the particular, the very best, sauerkraut germ. The cabbage worked up by Gruber's sauerkraut germs hath a far more delicate and aromatic flavor and is simpler of digestion and more easily cooked than common kraut. Gruber's germ is an airless little chap, so the big sinker rock must be well buried in the kraut juices so as to hold the cabbage under the kraut juice and away from the air. If bread and beer and cheese and pearls are made from special germs then why snicker and sneer about the German professor's sauerkraut germs?—New York Press.

WATER WORKS — For Country Homes.
ELECTRIC LIGHTS Simple, satisfactory, cost very little. Write for free information and estimate.
JOHNSTON MFG. CO., No. 3 Eleventh St., KANSAS CITY, MO.

"MILL TO MAN"

\$13⁵⁰ TAILOR MADE SUITS

WE DYE THE YARNS, WEAVE THE CLOTH AND TAILOR TO YOUR MEASURE.

You save 4 middlemen's profits and get a suit at from **\$13.50 to \$23.75** for \$20 to \$40 values.

THIS MEANS TAILOR-MADE SUITS AT PRICES OF "READY MADES."

Our patterns embrace the latest weaves in gray, brown and blue; also the new beautiful pencil stripe effects. Best trimmings, linings and workmanship.

We guarantee garments to hold their shape. New York styles without extremes or freaks. Complete satisfaction or money back. Express prepaid. Write for samples & self-measurement instructions.

Colonial Woolen Mills,
 DEPT. 203 LAWRENCE, MASS.



Grow Mushrooms

For Big and Quick Profits
Small Capital to Start A Safe Business

I am the largest grower in America. Ten years experience enables me to give practical instruction in the business worth many dollars to you.

No matter what your occupation is or where you are located, here is an opportunity to acquire a thorough knowledge of this paying business.

Send for Free Book giving particulars and information, how to start, cost, etc. Address

JACKSON MUSHROOM FARM
 6113 N. Western Ave., Chicago, Illinois

Never Before Such Land at So Low a Price, on Such Easy Payments, With So Broad a Guarantee

One Year to Examine—Two Years to Pay—and Your Money Back With Six Per Cent Interest If Not as Represented

The Land The tract is situated 12 miles from the gulf coast and is in the valley of the Suwanee River. It contains 44,000 acres and is considered as good truck land as there is in the state. It is owned by 37 German farmers who before selecting this special location looked over many other tracts and decided that this was the ideal spot for trucking on a large scale. Their reasons for making this selection were these: First, the soil was exactly what was wanted to take care of the rainfall. The climate was ideal for truck gardening and the general formation of the land here was all that could be asked, good soil, level and near large towns.

Soil Land that will produce \$500 an acre from tomatoes, \$262 from cucumbers and \$100 an acre from Irish potatoes, must be pretty good land, you will admit. That's what the U. S. Census reports credit to Levy County, Florida, land and this report covers the returns from all the crops grown on all the land in the county, not a few acres picked for a showing.

Water Good water can be procured at a depth of 15 to 20 feet, and artesian wells should be had at from 100 to 250 feet.

Climate There are ten growing months when the Florida farmer can produce just the vegetables that the northern markets are clamoring for. The ground can, with intensive cultivation, be made to produce three crops a year. The rainfall is such that there is no danger of a drought and is so distributed that the crops are sure to receive the greatest amount of benefit from it.

Transportation The Seaboard Air Line Railroad runs through the property and there is not any land on the tract over six miles from the railroad. The land that we are allotting now is right on the railroad and within a mile and a half of a town of a thousand people.

Towns There are four towns on the tract already well settled: Otter Creek, Lennon, Elzey, and the new town site of Ariel City, which the company is just surveying. Bronson, the county seat, is only eight miles away. Gainesville, the sight of the experiment farm of the U. S. Department of Agriculture and a town of eight thousand inhabitants, is only eighteen miles away.

Assistance In an earnest endeavor to secure the very best man obtainable to handle the Florida end of this great colonization enterprise, we selected after mature deliberation a man who is known as particularly fitted for

this great work. Mr. John M. Flewollen has had eighteen years' experience in the growing of vegetables in Florida for the winter markets of the North. He is thoroughly acquainted with Florida soils, shipping methods, etc., and knows how to get the best results in the quickest time with the least expenditure of money. Mr. Flewollen is a practical farmer from the ground up and therefore appealed particularly to those farmers who form this syndicate. Mr. Flewollen has established a demonstration farm where all may see just what this section will produce. He will advise and instruct those settlers who are not well versed in agriculture and make the path to success an easy one for everybody.

Neighbors Thousands are writing us, giving the dates on which they will leave for their new home in Florida. You should make preparation to join them.

TERMS The land is offered for sale at the easiest terms. Only \$1.00 an acre down and \$1.00 an acre per month. Twenty-five months to pay for it and immediate possession after the first payment is made. You go on the land at once and with average crops you should be able to pay for the whole of your farm in six months.

GUARANTEE We are the only land company that allows you a whole year to examine your land. Even if you are unable to go down now and see what you are buying we advise you to commence paying for a farm at once, for we assume all the risk. We know that we are selling land that will do all we claim and we show our faith in it by making you the liberal terms and the offer to pay you six per cent interest if you find that we have misrepresented in any single particular.

A home and a business in FLORIDA for \$250.00



Lennon Florida Improvement Company
120 Colonial Building
CHICAGO ILL.

Get This Interesting Book Free

This great book — "A Home and a Business in Florida," will be sent you absolutely free. Fill out the information coupon below and it will be sent to you by return mail without any obligation whatsoever.

Lennon Florida Improvement Company
120 Colonial Bldg.,
Chicago, Ill.

Upon receipt of THIS COUPON you are to send me, without cost or any obligation whatever, your free book and other literature and maps telling about your Lennon Florida Farms.

NAME.....

ADDRESS.....

(No letter necessary with this coupon)

FREIGHT PREPAID 30 DAYS FREE TRIAL
\$1 a Week For the Artistic
MEISTER
PIANO
SOLD DIRECT FROM FACTORY TO YOU



No Cash Down. No Interest.
No Extras.

Price \$175.00

STOOL and SCARF FREE

A guaranteed saving of \$100 at least, on each instrument

WE believe the correct way to buy a piano is to try it in your own home first. We don't want the trial to cause you any expense, hence we pay the freight—also the return freight if the piano is not entirely satisfactory.

Notwithstanding our easy terms of payments *and our extremely low prices*, the Meister is a high-class instrument of standard construction and quality fully guaranteed for 10 years. Ask your local banker to investigate our standing. Rothschild & Co's resources exceed \$3,000,000.00.

We sell more pianos direct from factory to home than any other concern in the world

Send A Postal for the Piano Book

It is free, and illustrates in the colors of the wood eight styles of the Meister

The Meister Piano Co.

Rothschild & Company, Sole Owners
 State, Van Buren and Wabash Ave.

Department 16 F CHICAGO, ILL.

Carpenters, woodworkers, cabinet makers, upholsterers and craftsmen in general recognize in Le PAGE'S LIQUID GLUE the many advantages offered by this ready-to-use adhesive.

The old time glue pot is a thing of the past, for Le PAGE'S GLUE in air tight packages is not only ready for instant use but sets quick and holds fast.

For small work we recommend the handy tube or 10 cent bottle. For larger work we supply this glue in cans containing ½ gills, gills, ½ pints and pints. Sold everywhere.

Library slips with every bottle and tube



LE PAGE'S
LIQUID GLUE

TO THE END
OF TIME

You will be judged by your acts. If you prefer not to be misjudged, send in a

Peerless Patent Book Form Card

its smooth edges; its genuine elegance will tell the character of man you are. Nothing else like it. Used by the men who care for appearances and who command big pay. It ought to be used by you. Send to-day for sample tab of engraved cards, and get right, in the card line.

OUR SMART
CARD CASE

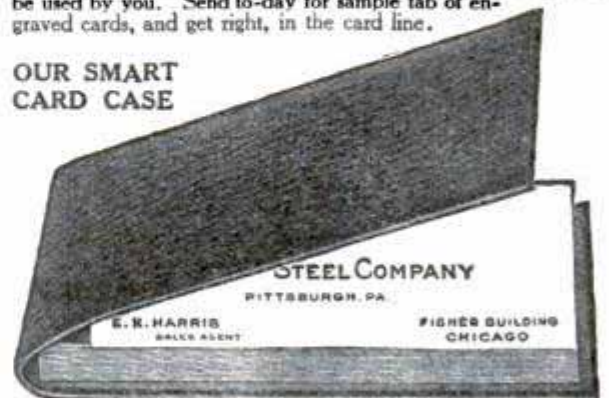

The John B. Wiggins Company

Sole Manufacturers
Engravers Die Embossers Plate Printers
17-19 East Adams St., Chicago
 New York Office, 350 Broadway

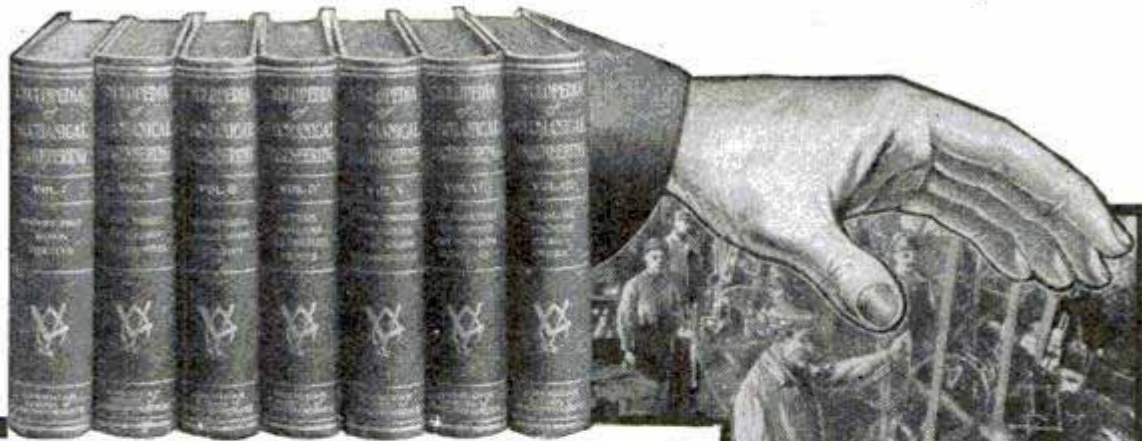

Every Detail Within Your Grasp

How would you like to have the detail of the entire plant at your finger tips—in condensed form, ready for immediate reference? Would you not consider yourself a bigger man mentally than you are now? Would you not be more valuable to your employer?

We are all "up against it" some time or other—it is the wise man who prepares himself for emergencies. You are prepared for any emergency if you have in your library, shop or office, our big, 7 volume edition

Cyclopedia of Mechanical Engineering Including Modern Shop Practice

containing 2,992 pages, size 7 x 10, with over 2,000 illustrations, diagrams, plates, formulas, etc. Substantially Bound in half red morocco; titles stamped on backs in 23 karat gold.

The Cyclopedia is an authoritative reference work, adequate to meet the demands of the most advanced workman and technically trained expert, also adapted to the needs of the beginner and self-taught, practical man. It covers the fundamentals of Mechanical Engineering and Modern Shop Practice thoroughly and gives the fullest instructions on the latest application of new and advanced ideas. The language is clear and simple; the treatment concise yet full; and the arrangement of matter convenient, so as to carry the reader forward by easy stages. Examples for practice and series of test questions are inserted at frequent intervals, combining the advantages of a text-book and a reference work. To acquaint the public with the practical character of the Home Study Courses of the American School of Correspondence, from which the Cyclopedia was compiled, we make this special:

FREE FIVE-DAY OFFER

On receipt of coupon without deposit—we will send these books to you, express prepaid, for five days' FREE examination. If the books are satisfactory and you wish to keep them, send \$2.00 within five days and \$2.00 a month until you have paid the special \$18.60 price; otherwise notify us to send for them at our expense. Regular price, 36.00.

PARTIAL TABLE OF CONTENTS

Machine Shop Work—Vertical Milling Machine—Motor-driven Shops—Shop Lighting—Forging—Electric Welding—Tool Making—Metallurgy—Manufacture of Iron and Steel—High-Speed Steel—Flaws in Castings—Electric Lifting Magnets—Magnetic Clutches—Making a Machinist—The Ideal Foreman—Pattern Making—Foundry Work—Automatic Coal and Ore Handling Appliances—Machine Parts—Construction of Boilers—Types of Boilers—Boiler Accessories—Steam Pumps—Air Compressors—The Steam Engine—The Steam Turbine—Indicators—Valve Gears—Refrigeration—Gas-Producers—Gas Engines—Automobiles—Elevators—Sheet Metal Work—Practical Problems in Mensuration—Mechanical Drawing—Drafting Room Organization—Machine Design.

For a short time we will include as a monthly supplement, for one year, the TECHNICAL WORLD MAGAZINE. This is a regular \$1.50 monthly, full of Twentieth Century scientific facts, written in popular form. Also contains the latest discussions on timely topics in invention, discovery industry etc.

AMERICAN SCHOOL OF CORRESPONDENCE
CHICAGO, U. S. A.

FREE OFFER COUPON

NAME.....

ADDRESS.....

EMPLOYER.....

OCCUPATION.....

Pop. Mech. 5-11

A. S. of C.

Please send set of Cyclopedia of Mechanical Engineering for 5 days' FREE examination, also T. W. for 1 year. I will send \$2 within 5 days and \$2 a month until I have paid \$18.60 for books and magazine, otherwise I will notify you and hold the books subject to your order. Title not to pass until fully paid.

Protect Your Idea!

PATENTS THAT PAY

"My Trade-Mark"

Special Offer:

Mr. Inventor: I invite you to come to see me, and bring, (or send by registered mail), sketches or photograph or model and description of your idea or invention for FREE examination of U. S. PATENT OFFICE Records and report as to patentability of the same;—to find out as to whether you are entitled to a patent will not cost anything;—then, if your invention is new, upon receiving instructions, I will prepare ALL necessary (application) papers.

DO THIS AND SAVE TIME AND MONEY!

WRITE NOW!

Highest References:

Lincoln National Bank,
Washington, D. C.

NOTE: When writing these clients send two-cent stamp for reply.

Little Giant Hay Press Co.,
Alma, Mich. and
Dallas, Texas.

Gray Lithograph Co.,
New York City, N. Y.

Farmers Mfg. Co.,
Norfolk, Va.

New Era Mfg. Co.,
Fairfield, Iowa.

Bernhard Furst,
Vienna,
I. Austria-Hungary.

Otto von Rottenburg,
Schwindstrasse 20,
Frankfort a. M.,
Germany.

H. A. Fonseca,
Rua Dos Ourives 20,
Sobrado, Rio de Janeiro,
Brazil, S. A.

A. J. Corsi,
Irish Town,
Gibraltar.

Bell Show Print Co.,
Sigourney, Ia.

The Camp Conduit Co.,
Cleveland, O.

The Iowa Mfg. Co.,
Oskaloosa, Ia.

Sam'l Allen & Son Mfg. Co.,
Dansville, N. Y.

The Gari Electric Co.,
Akron, O.

Superior Mfg. Co.,
Sidney, O.

Tidnam Tel. Pole Co.,
Oklahoma City, Okla.

Edw. H. Smith,
Aberdeen, Wash.

C. O. Cracroft,
Cordova, Alaska.

V. C. de Ybarrondo,
Los Angeles, Cal.

Wm. H. Garlock,
Leland Hotel,
Seattle, Wash.

F. Rutherford,
Copper Queen Con. Min. Co.,
Douglas, Arizona.

Gas Range & Heater Co.,
S. Pasadena, Cal.

Newberg Brick & Tile Co.,
Portland, Ore.

INFRINGEMENT, VALIDITY AND INTERFERENCE WORK SOLICITED

I am admitted to practice before the United States Supreme Court and others

"I want to thank you for the most excellent services you have rendered me in this suit [B. Williams vs. Central Drug Co., U. S. C. C., Northern District of Illinois—E. Div.], and assure you that I appreciate it very much, and if at any time I can secure some business for you, I will be only too glad to do so."

(Signed) J. THOMPSON, Mgr. Central Drug Co., Sioux City, Iowa.

Other Important Suits Successfully Settled

FREE: Two Books—61-page "Inventor's Guide" and 64-page "Proof of Fortunes in Patents—What and How to Invent"

Foreign Patents a Specialty

If you have a U. S. application write me for excellent literature and terms for promoting your Foreign Patents. Liberal discounts.

I Advertise My Clients' Patents Free

in a publication having over 2,000,000 circulation. Write for Special Offer. Successful clients in every section of the U. S.

COMPARE MY LOCATION WITH OTHERS
MINE IS THE BEST

E. E. VROOMAN



My Office and the Patent Office
(I give you proof of my location)

Across the street from the U. S. Patent Office

Expert—Prompt Services

E. E. VROOMAN, Patent Lawyer Wash., D. C.

Registered Patent Attorney. Patent Litigation

871 F Street, N. W.

\$217,440.00 \$
MADE BY MY CLIENTS

YOU Should Have My FREE BOOK

Telling HOW OTHERS will do the same IN THE FUTURE. "WHAT and HOW to INVENT" BOOK FREE!

"I received ONE HUNDRED DOLLARS (\$100.00) down (in re my Can Righting Machine inventions) and in thirty days NINE HUNDRED DOLLARS (\$900.00), and when my patents are issued ONE THOUSAND DOLLARS (\$1000.00) more. I can conscientiously state to my fellow inventor that he will do the right thing by placing his patent business in Mr. Vrooman's hands for the best iron-clad patents."

(Signed) WILLIAM C. BRIDGES, Wapello, Iowa.

High-Class Work—Excellent Testimonials

PATENTS TRADEMARKS AND COPYRIGHTS SECURED OR FEE RETURNED

SPECIAL OFFER — FREE SEARCH OF PATENT OFFICE RECORDS

Send us a model, photograph or sketch and description of your invention, and we will make a *Free Search of the Patent Office Records* to ascertain if it is patentable. If we report the invention patentable, we will guarantee to obtain a patent or return our fee, and furnish a certificate of patentability backed by a bonded contract to that effect.

This Certificate of Patentability will protect the inventor and serve as proof of the invention until the case can be filed in the U. S. Patent Office.

OBTAINING ASSISTANCE FOR INVENTORS

Our certificate is of great assistance to inventors who require financial aid to obtain patents. It is useless to attempt to interest capital unless evidence is furnished that the invention is patentable. Our certificate gives this necessary assurance.

OUR FOUR BOOKS MAILED FREE

to any address. Send for these books—the finest publications ever issued for free distribution.

HOW TO OBTAIN A PATENT

Our illustrated eighty-page Guide Book is an invaluable book of reference for inventors, and contains 100 mechanical movements illustrated and described.

FORTUNES IN PATENTS

Tells how to invent for profit, and gives history of successful inventions.

WHAT TO INVENT

Contains a valuable LIST OF INVENTIONS WANTED and suggestions concerning profitable fields of invention; also information regarding prizes offered for inventions, among which is

PRIZE OF ONE MILLION DOLLARS

offered for one invention, and \$10,000 for others.

PATENTS THAT PAY

Contains fac-similes of unsolicited letters from our clients who have built up profitable enterprises founded upon patents procured by us; also indorsements from prominent inventors, manufacturers, Senators, Congressmen, Governors, etc.

VICTOR BUILDING

Our new \$150,000 building, opposite the U. S. Patent Office, specially erected by us for our own use, designed and equipped with all modern appliances for our patent business.

WE ADVERTISE OUR CLIENTS' INVENTIONS FREE

in a list of Sunday newspapers with two million circulation, in manufacturers' journals and in the *World's Progress*. Sample Copy Free. We also send a LIST OF PATENT BUYERS. We not only save you time and money in securing patents, but obtain patents which PROTECT the invention and PAY. After the patent is granted we assist you TO SELL YOUR PATENT.

FOREIGN PATENTS

WE HAVE DIRECT AGENCIES IN ALL THE PRINCIPAL FOREIGN COUNTRIES and can secure FOREIGN PATENTS in the shortest possible TIME and at the LOWEST COST. We GUARANTEE TO SECURE THE FOREIGN PATENTS OR RETURN OUR FEES. Write for our Illustrated Guide Book on Foreign Patents, sent free to any address.

REFERENCES:

Second National Bank, Washington, D. C.
R. G. Dun & Co., Washington, D. C.
National Savings and Trust Co., Washington, D. C.
Smethport Glass Co., Smethport, Pa.
Schrade Cutlery Co., Walden, N. Y.
Clum & Atkinson, Brass Founders, Rochester, N. Y.
Rochester Rotary Pump Co., Rochester, N. Y.
Lawrence Mills, Mfrs. Bed Spreads, 51 Brooke Ave., Englewood, N. J.
The Melvin Gauge and Signal Inst. Co., Scranton, Pa.
Damon Mfg. Co., Mfrs. "Missing Link" Flour Mill Disintegrator, Bowling Green, Ky.
Modern Canner Co., Mfrs. Canning Machinery and Cannery Supplies, Bridgeport, Ala.
M. Winter Lumber Co., Sheboygan, Wis.

C. K. Lassiter, Mechanical Engineer, Schenectady, N. Y.
Pitner Gasoline Lighting Co., Chicago, Ill.
Sprout, Wardon & Co., Mfrs. of the Monarch Feed Governor, Muncy, Pa.
The L. B. Dozier Co., Mfrs. of Plumbing, Heating and Machinery Supplies, Columbia, S. C.
B. B. Earnshaw & Bro., Mfrs. "Cream Blend" Flour, Washington, D. C.
A. L. Schultz, Consulting Engineer, Pittsburgh, Pa.
Arthur H. Swan & Co., Mfrs. of Peel-Blade Tips, 279 Warren St., Roxbury, Pa.
The H. W. Moore Piano Truck Co., Anderson, Ind.
The Culver Novelty Co., Mfrs. of Carbureters and Mixers, Culver, Ind.

VICTOR J. EVANS & CO., VICTOR BUILDING
724-726 9th St., N. W.

(Formerly EVANS, WILKENS & CO.)

Opposite United States Patent Office

WASHINGTON, D. C.



MR. H. ELLIS CHANDLEE

PATENT WHAT YOU INVENT!

YOUR IDEAS MAY BRING YOU A FORTUNE

There is A Constant Demand For Good Inventions.

One of our clients recently made \$85,000; another \$7,000; another \$5,000; another \$3,400; two others \$1,000 each, and two others \$500.

WRITE FOR

“OPPORTUNITY”

A List of Needed Inventions

Also, “U. S. LETTERS PATENT,” telling how to obtain a patent.
“THOUGHTS THAT HAVE PAID,” a history of successful inventions.
“TESTIMONY,” giving our testimonial letters from manufacturers and inventors.

Mailed free to any interested person

IF YOU HAVE AN INVENTION send us a rough sketch and description, model or photograph of it, and we will give you our opinion as to its patentability **WITHOUT CHARGE**. If our opinion is favorable, we will issue a contract binding us to **refund every cent of our fee if we fail to obtain a patent**.

This assures you that we will not make application unless the chances of success are good, and that **every effort** will be made to obtain an allowance. We advertise the patents of Our Clients for sale in prominent dailies free of charge.

“Prompt and Proper Service”

H. Ellis Chandlee & Co.

Suite 55, Bornot Building, WASHINGTON, D. C.

WANTED-IDEAS

The largest
and best known manufacturers and
buyers of patents in the world want ideas protected
through me. Send for my literature and read their letters.

Free

New 72-page guide book "Successful Patents" (tells how to proceed in order to be successful); book "Stepping Stones" (contains list of over 200 inventions wanted); "How and Why I Will Make You Succeed" (with list of recent successes) sent free on request. Highest references. Free manufacturing facilities. Clients' patents sold free. **FEES RETURNED IF NOT SUCCESSFUL**

SPECIAL: Send sketch or model of invention for free report. No obligation incurred by writing me.

RICHARD B. OWEN, Dept. 9, WASHINGTON, D. C.



PATENT YOUR IDEAS

\$100,000 for one invention; another, \$8,500. Book "How to Obtain a Patent" and "What to Invent" sent free. Send rough sketch for free report as to patentability. We advertise your patent for sale at our expense. **PATENT OBTAINED OR FEE RETURNED.**

CHANDLEE & CHANDLEE, Patent Atty's

1044 F. Street

WASHINGTON, D. C.

PATENTS

NEW AND EASY PLAN OF MAKING PAYMENTS

Valuable Book Free

Illustrates and describes 100 Mechanical Movements, and contains useful Information for Inventors. MAILED FREE.

CHAS. E. BROCK, Patent Attorney

(Twenty-five years' experience)

918 F. STREET

WASHINGTON, D. C.

AUSTRALIA ON THE PANAMA CANAL.—At the present time food products exported from San Francisco, on the west coast of America, have to travel over 13,300 miles of water to reach the European markets. With the completion of the Panama Canal, the distance will be shortened to 7,660 miles, as against over 12,000 miles from Australia. The shortening of the sea route through Panama from England to the East also threatens the Australian coal trade, and opens

PATENT SECURED OR FEE RETURNED

Free expert search of official records. Send for free handbook.

MILO B. STEVENS & CO., Attorneys

ESTABLISHED 1864

685 F. St., WASHINGTON D. C.

370 Monadnock Bldg., CHICAGO

Guaranteed and recommended by the Bankers' Register. Highest rating by Martindale's American Law Directory.

PATENTS:

For facts about Prize and Reward offers and Inventions that will bring from \$5000 to 10 Million Dollars; and for books of Intense Interest to Inventors, send 8c postage to

R. S. & A. B. LACEY, Div. 45 Washington, D. C. Estab. 1869

PATENTS

OVER 65 YEARS' EXPERIENCE

TRADE MARKS
DESIGNS
COPYRIGHTS, &c.

Anyone sending a sketch and description may quickly ascertain our opinion free whether an invention is probably patentable. Communications strictly confidential. **HANDBOOK** on Patents sent free. Oldest agency for securing patents. Patents taken through Munn & Co. receive *special notice*, without charge, in the

Scientific American.

A handsomely illustrated weekly. Largest circulation of any scientific journal. Terms, \$3 a year; four months, \$1. Sold by all newsdealers.

MUNN & CO. 359 Broadway NEW YORK

Branch Office, 625 F St., Washington, D. C.

PATENTS

Write, Mason, Fenwick & Lawrence
613 F. Street Washington, D. C.

Established 50 years—Booklet and advice FREE

LANGDON MOORE

Counselor-at-Law and Patent Attorney

Patents, Trade-Marks
Designs and Copyrights

9th and F Streets, WASHINGTON, D. C.

Formerly Examiner U. S. Patent Office

SEND FOR BOOKLET

A Patent of Quality

is the only kind that will protect your invention and make it salable. You need my free advisory information. Send for it.

GEO. R. HAMLIN, Patent Lawyer

801-8th Street, N. W.

WASHINGTON, D. C.



A Talk to the Inventor

If there is any basis for an application in your idea, I can find it. But I will explain it to you before filing your application.

Copies of Nearest Patents, and Report, in Every Case I have patented inventions reported unpatentable elsewhere.

Send for
FREE
BOOK

What You Should Know
What to Invent
What NOT to Invent
How to Sell Your Patent
WASHINGTON, D. C.

H. L. WOODWARD, 9th and G Sts., Opposite Patent Office,

PATENTS THAT PROTECT and PAY

Send for FREE 96-page book. Advice free. Terms reasonable. Highest references. Best results.

Send sketch or model for FREE examination and opinion.

Recommended Patent Lawyer in the Bankers' Register and special list of selected lawyers. Also in Martindale's Law Directory, Sharp and Alleman's Directory of Lawyers, The Gast-Paul Directory of Lawyers, and Kime's International Law Directory.

ALL BUSINESS GIVEN PROMPT AND PROPER ATTENTION

A large list of strong recommendations furnished free

WATSON E. COLEMAN, Patent Lawyer, 622 F St., N.W., Washington, D.C.

GREAT FREE BOOK
"How to Learn to Mount Birds and Animals"



Mount Birds and Animals.

SPORTSMEN! Fishermen! Hunters! Naturalists!

The wonderful profession of Taxidermy, so long kept secret, can now be easily learned right in your own home.

We Teach by Mail how to mount

Birds, Animals, Game Heads, tan skins, make rugs, and preserve all trophies. A delightful and fascinating art for men and women. Easily and quickly learned during spare time. Decorate home and den with fine trophies, or command big income selling mounted specimens and mounting for

others. Skilled Taxidermists in great demand. Success guaranteed or no tuition fee. Endorsed by thousands of satisfied graduates. Write today for our Great Free Book "How to Learn to Mount Birds and Animals." Also our beautiful Taxidermy Magazine. **BOTH FREE.** Write today—do it now.

The N. W. SCHOOL OF TAXIDERMY, Inc.
1195 Elwood Bldg., Omaha, Neb.

PATENTS

C. L. PARKER
Ex-Examiner U. S. Patent Office
PATENT LAWYER
210 MCGILL BLDG.
WASHINGTON, D. C.

Patents, Trade Marks, Copyrights, Patent Litigation

Handbook for Inventors, "Protecting, Exploiting and Selling Inventions" sent free upon request.

Active Powers of Inventive Genius



INVENTORS Our Brain Belongs to You. Our Ideas Are Free of Charge.

All we want in return is to build your model, special machinery, dies, tools and jigs to manufacture sheet metal goods, etc. We are expert mechanics, over thirty years experience and have one of the best equipped shops in the country. Ask for Booklet No. 17. Consultation free. Experimental work strictly confidential.

A. NACKE & SON
236-242 S. 9th St., Philadelphia, Pa.

Rémoh Gems

Not Imitations

A marvelously reconstructed gem—the greatest triumph of the electric furnace. Looks like a diamond—wears like a diamond—will cut glass—stands filing, fire and acid tests like a diamond—guaranteed to contain no glass. Rémoh Gems have no paste, foil or artificial backing—their brilliancy is guaranteed forever. One-thirtieth the cost of a diamond. These remarkable gems are set only in 14 Karat Solid Gold Mountings. Sent on approval—your money cheerfully refunded if not perfectly satisfactory. It will be well worth your while to get our De-Luxe Jewel Book—yours for the asking. Cut out and mail the coupon below—or write a postal. Address

Rémoh Jewelry Co.
429 N. Broadway, St. Louis, Mo.

Rémoh Jewelry Co.,
429 N. Broadway, St. Louis, Mo.
Send your De-Luxe Jewel Book.

Name.....
Address.....
City.....
State.....

Sign And Mail This Coupon Today

up a further field for competition. New Zealand likewise stands to benefit, as the short cut through Panama will enable her to get food exports quicker than Australia to Europe. In other respects, so far as Australian trade is concerned, the gentlemen this paper has interviewed think that the position will be in status quo.

The Panama Canal will in no way shorten the trip from London to Australia. The distance via Suez is 11,200 miles, and via the Cape of Good Hope, 12,340

Let Us Do Your Manufacturing

Buying material in large quantities and having a modern factory equipped with the latest machinery enable us to make almost anything in metal or wood at a very low price. Estimates free. We have a complete model and pattern department.

TINLEY PARK MFG. CO., 14 State Street, CHICAGO



DON'T DISCARD BROKEN PARTS

Have them welded together by the **Oxy-Acetylene Process.** Steel, Cast Iron, Bronze, Copper, Aluminum and all other metals can be welded. Manufacturing quoted on. Welding equipments for repair shops or large plants supplied.

DAVIS BOURNVILLE CO.
105 West Street NEW YORK, N. Y.

Do You Need A Gear



of any description for any purpose? We carry practically all the standard sizes in stock ready for immediate shipment.

We make gears of any style, size or material to order—promptly.

Our new free catalogue contains tables and rules for figuring both spur and bevel gears.

Grant's "Treatise on GEARS"—Price \$1.00 is a valuable reference book for the student and designer.

Philadelphia GEAR Works, Inc.
1120 Vine Street GEO. B. GRANT, PRES. Philadelphia, Pa.



A Spotless Collar Will Blaze The Way To A Good Position

CLEANLINESS is an invaluable asset. It is essential that one be both clean and capable. Where there's dirt, there's usually shirk. Wear a clean, white, smartly shaped collar every day.

Litholin Waterproofed Linen Collars

The same collar you have always worn—only waterproofed. Permanently clean. At your dealer's, or by mail on receipt of price. Write for booklet.

Collars **The Fiberloid Co.** Cuffs
25c each 7 & 9 Waverly Pl., N.Y. 50c a pair



miles. By way of the Panama Canal it would be 12,520 miles. The journey from New York to Sydney, however, will be considerably lessened, a 10-knot steamer saving from eight to twelve days. The American manufacturer and the Australian importer are pointed to as chiefly likely to benefit in this respect.—From a Sydney newspaper.

The army of chauffeurs in the United States has between three and four times the numerical strength of the standing army.—Albany Argus.

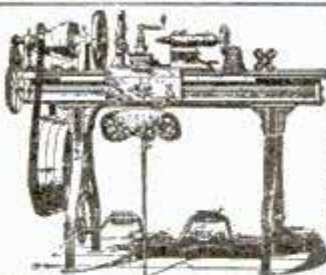

LATHES

9 to 13-inch Swing
List price \$75 and up according to size. When ready to buy send for Lathe Catalog and prices.

W. F. & John Barnes Co.
100 Ruby Street, ROCKFORD, ILL.

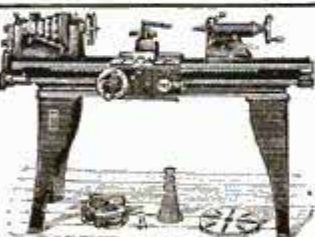

LATHES

\$75 Screw Cutting
Foot or Power
9 to 13 inch

—CATALOG FREE—

SOUTH BEND MACHINE TOOL CO., 423 Madison St., South Bend, Ind.

BARODA DIAMONDS. Flash Like Genuine
ANY STYLE at 1/40 the cost—IN SOLID GOLD RINGS
Stand acid test and expert examination. We guarantee them. See them first—then pay.
Special Offer—14k Tiffany ring 1 ct. \$5.98. Gents ring 1 ct. \$6.98. 14k Stud 1 ct. \$4.88. Sent C. O. D. for inspection. **Catalog FREE**, shows full line. Patent ring gauges included, 10c. The Baroda Co., Dept. A5, Leland & Dover Sts., Chicago



ALWAYS ON THE JOB

The Complete Cyclopedic of

Civil Engineering

is always on the job. It contains more up-to-date, accurate, money saving information on reinforced concrete, irrigation, water supply and water power development than you can get in any other book or set of books. It is especially adapted

For Home Study and Self Improvement

It goes straight to the point, uses plain English. From it you can learn the first principles of plane surveying or solution of the most abstruse problems in strains and stresses. Bound in half morocco, 3,908 pages, 7 x 10 inches. 3,000 full page plates, folding maps, diagrams, etc., carefully indexed so you can turn at once to the topic you want.

IMPORTANT SUBJECTS COVERED

Plane Surveying—Mechanical Drawing—Plotting and Topography—Steel Construction—Railroad Engineering—Statics—Strength of Materials—Roof Trusses and Mill Building Construction—Cost Analysis in Relation to Engineering—Masonry—Bridge Engineering—Practical Problems in Construction—Hydraulics—House Drainage and Sanitation—River and Harbor Improvements—Irrigation Engineering.

Examine These Books Free of Charge

If you will send us your name and address on coupon below, we will send you a complete set of these books by prepaid express. You can keep them in your home five days. Examine them carefully, apply the information they will give you, to your daily needs. If you think they will help you in your work, send us \$2.00, then \$2.00 every thirty days until the special price of \$24.00 has been paid. The regular price is \$48.00. If the books are not what you want, advise us. We will have them returned at our expense.

Special Offer if You Mail Coupon Promptly

For a short time we will include, as a monthly supplement, free of charge for one year the **TECHNICAL WORLD MAGAZINE**. This is a regular \$1.50 monthly, full of Twentieth Century Scientific facts, written in popular form. Also contains the latest discussion on timely topics in invention, discovery, industry, etc. The magazine will be mailed immediately upon receipt of coupon.

SPECIAL PREPAID OFFER COUPON

AMERICAN SCHOOL OF CORRESPONDENCE, Chicago, U. S. A.

Please send set Cyclopedic of Civil Engineering for 5 days' free examination. Also Technical World for 1 year. I will send \$2 within 5 days and \$2 a month until I have paid \$24.00 for books and magazine; otherwise I will notify you and hold the books subject to your order. Title not to pass until fully paid.

NAME.....
ADDRESS.....
OCCUPATION.....
EMPLOYER.....

POP. MECH. 5-11

Please Mention Popular Mechanics

"IDEAL" LAWNMOWER GRINDER

"You Grind It As You Find It."

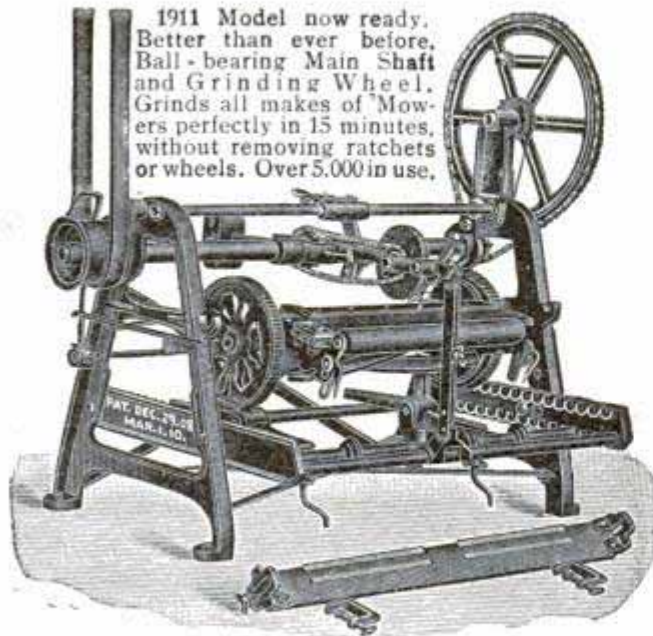

1911 Model now ready. Better than ever before. Ball-bearing Main Shaft and Grinding Wheel. Grinds all makes of Mowers perfectly in 15 minutes, without removing ratchets or wheels. Over 5,000 in use.

Write Today for full information of this wonderful labor-saver and money-maker. No up-to-date shop complete without it. Will more than pay for itself the first season because it does the work so much quicker and better. Used by U. S. Government and N. Y. City Parks. New Skate Sharpener Attachment for grinding skates. Fully warranted. Write now—TODAY.

HEATH FDY. & MFG. CO., PLYMOUTH, O.

LET THE RED DEVIL WATER MOTOR DO YOUR WORK

6-inch Motor

Improved construction, absolutely perfect, runs your washing machine and a hundred other things. Power for small tools, $\frac{1}{4}$ horse power on $\frac{1}{2}$ -inch pipe, 80 pounds pressure; 1 horse power on 2-inch pipe, 60 pounds pressure. New net price, \$5.00 cash with order.

No. 1492 4-inch Motors for grinding, polishing and buffing. Runs sewing machines, fans, bottle washers, etc. Price with emery, buffing wheel, silver polish and pulley, \$3.00. No. 1493 Motor and pulley only \$2.50. $\frac{1}{2}$ horse power on 80 pounds pressure. Improved construction. Speeds, 3,000 to 5,000 revolutions per minute. Only scientifically and mechanically perfect small water motor manufactured. Patented construction makes it possible. Tremendous output warrants the price. Money back for any reason.

CATALOGUE AND LARGE SHEET FREE

DIVINE WATER MOTOR CO.

Dept. T UTICA, NEW YORK, U.S.A.

For the name of your local hardware or tool dealer, we will send you free booklet on "Theory and Design of Water Motors."



6-Inch Bucket Wheel



"Jarvis" Pumps

For domestic water supply are in use everywhere. We furnish complete systems. Any kind of power.

Send for Catalogue No. 5

JARVIS ENGINE AND MACHINE WORKS LANSING, MICH.



BLOWERS

for oil and gas forges, melting, brazing blowpipes, gas producers

VACUUM PUMPS

for vacuum cleaners

Take up their own wear. No springs. Noiseless. Can't get out of order. Send for catalog No. 22 for blowers and No. 23 for vacuum pumps.

LEIMAN BROS. NEW YORK 62 P. JOHN ST.

Have Running Water On Your Place

Whenever and wherever you like—Bath, Laundry, Toilet, Kitchen, Upstairs and down, Barns, Lawn. Force enough for fire protection. Air pressure guaranteed at all times by our patent pump. So simple anyone can install. Every detail worked out for your individual needs by expert engineers without charge. Complete specifications furnished.

Burton Water Works

received only medal ever awarded a water supply system—proof of its superiority. Best constructed tank on market. Sold on 30 Days' Free Trial. Correspondence with Villages, Towns, Public Institutions as well as farms, ranches, country houses solicited. Write for testimony of satisfied users near you and booklet, "An Interesting Tale Simply Told."

C. A. Burton Water Supply Co., 26 West 7th. St., Kansas City, Mo.

30 Days FREE

Write for Book

\$50.00 Up.
Lasts a Lifetime.

THE SURGEON'S THREAD.—When Lister first advocated the employment of catgut as a material for ligatures numerous writers pointed out the objections, both theoretical and practical, to the use of this substance. But time has seen a change, and many surgeons at the present time maintain that the only suitable material for a buried suture is catgut, and that silk should never be employed except for skin sutures.

In this, as in so many other points, the surgeon is greater than the detail. It is certain that millions of silk sutures have been inserted in the deep tissues, and have not cut their way out, for if a suture does make its way to the surface it is probably always because it was septic.

The attempt to find a ligature or suture perfect in every way has caused surgeons to employ many differ-

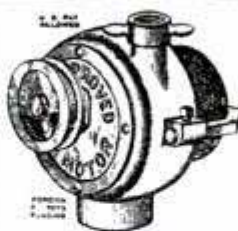

Norton Improved Water Motor

Has the high speed required for grinding, polishing, etc. It also has a power side where the speed is reduced to 1000 Revolutions, thus making it an ideal motor for WASHING MACHINES with WRINGER ATTACHMENT. NO OPEN GEARS TO CATCH. Made of solid brass. Sent on receipt of \$6.50, express to be paid by receiver. Shipping weight 6 pounds.

Norton Water Motor Co., Inc., Roslindale, Mass.

Crescent Saw Tables

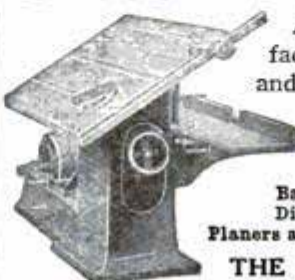

Are the kind that give satisfaction for a long term of years and cost practically nothing for repairs. Built in five sizes. One of them will just suit you.

SEND FOR CATALOG OF
Band Saws Boreers Saw Tables
Disk Grinders Jointers Planers
Planers and Matchers Variety Wood-Workers

THE CRESCENT MACHINE CO.
93 Columbia St. LEETONIA, OHIO.

TAKE THE PLACE OF THE PUNCH AND HAMMER

Automatic Centre Punches

PLAIN OR ADJUSTABLE

All of the marks are of uniform depth, a result impossible to secure with the ordinary punch and hammer.

Thus a line can be followed more accurately.

They are furnished in four plain sizes for various work, and in one adjustable size, the depth of the mark being regulated. *Send for folder.*

BROWN & SHARPE MFG. CO.
PROVIDENCE, R. I., U. S. A.

ent substances. Metallic sutures for a time received much support, though they are rarely seen now.

Animal fibres of various kinds, such as kangaroo tendons and threads of the aorta of the ox, have been praised by some surgeons, and one surgeon claimed that perfection was to be found in fibres obtained from the ligamentum nachae of the narwhal. It is fortunate that the medical world has not fallen in with this latter recommendation, for it is to be feared that the supply would fall far short of the demand.—Philadelphia Inquirer.

SHARPEN YOUR SAW

THE "SPECIAL" SAW SET



CAN BE USED BY ANYONE, AND WILL SET ANY HAND SAW SO THAT IT WILL RUN EASY, TRUE AND CLEAN.

If your dealer don't carry it, order from us.

Price \$1.00, sent Postpaid

Chas. Morrill, 281 Broadway, New York

SEBCO SCREW ANCHORS NEVER PULL OUT

Every Contractor, Builder, Mechanic, Electrician and Plumber has work for which the Sebcos Screw Anchors and Star Expansion Bolts are particularly adapted. There is no better method for fastening all kinds of iron work, brackets, and fixtures to walls of tile, brick, stone, concrete, etc.

Send for free samples and catalog No. 34

Star Expansion Bolt Co.
147-149 Cedar Street, NEW YORK

AGENTS Here It Is

POCKET SEWING MACHINE



That's what Ed Hopper calls it. Sold 97 in few days.

He's pleased. Retailers at 100% PROFIT If you want a quick seller, one that gets the money easy, send now for confidential terms and FREE BOOKLET, "Inside information on the agency business." A few hours a day means many a dollar in your pocket. Send a postal. A. MATHEWS, 6248 Wayne Street, DAYTON, OHIO

LUFKIN

Measuring Tapes

Now made with Instantaneous Readings, the big improvement in markings. Saves time and eliminates errors. Send for sample piece of tape and our complete catalog.

THE LUFKIN RULE CO.

SAGINAW, MICH.

New York

London, Eng.

Windsor, Can.

THE EXCELSIOR BRAD SET. PRICE 25 CENTS

Takes No. 18 and No. 20 Brads from 1/4 to 3/4 in. long



The tool illustrated above will be indispensable to the Pattern Maker, Cabinet Maker, or Picture Framer who purchases it. It will set brads in places that would be inaccessible without it, and dispenses with the bradawl and nail set. If, after a fair trial, you are not satisfied that you have received your quarter's worth, your money will be promptly returned to you on receipt of tool.

STANDARD TOOL AND SUPPLY CO., TORRINGTON, CONN.



A Million People Bought Carborundum Sharpening Stones Last Year
More people than ever before bought any single brand of sharpening stones in a single year.

Proof positive that Carborundum Sharpening Stones are better than any other sharpening stones that were ever made.

There is a Carborundum Stone for Every Sharpening Need

- No. 107-H—Round Combination Stone for carpenters' use \$1.00
 No. 108-H—Oblong Combination Stone for general use.. 1.25
 No. 103-H—Razor Hone, in neat box..... 1.00
 No. 146-H—Pocket Stone, for Every Man's use; in leather case..... .35
 No. 191-H—Scythe and Grass Hook Stone..... .25

*Ask your dealer for Carborundum Sharpening Stones
 If he hasn't them, send direct—Write for the booklet*

THE CARBORUNDUM COMPANY, Niagara Falls, N. Y.



ENORMOUS SAVINGS AND BETTER WORK BY USING



Eclipse Air Brush

A Scientific machine for high class work in applying—Paint, Varnish, Japan, Bronze, Lacquer.

ONE MAN CAN DO THE WORK OF FOUR

Write for Booklet and tell us what finishing you do.

ECLIPSE AIR BRUSH & COMPRESSOR COMPANY

BLOOMFIELD, N. J.



Make Your Own Repairs!

Mends Harness, Shoes, Canvas; Myers' Sewing Awl makes lock-stitch like sewing machine. \$1 postpaid.

BIG MONEY FOR AGENTS.

C. A. MYERS CO.

6330 Lexington Ave., Chicago, Ill.

The Awl for All.

Pipe Threading Tools



with adjustable dies. The simplest kind and the best range of sizes.

Send for catalog.

THE OSTER MFG. CO.

2100 East 61st Street

Cleveland, Ohio

WHITE WAY IN A TOWN OF 1,500—The most remarkable example of street illumination that has yet come to our notice, says the Illuminating Engineer, is that of Winterset, Iowa, a town which boasts of a



BAR BENDERS

For Concrete Reinforcements

WRITE FOR OUR BENDING TOOL CATALOGUE.

Wallace Supply Co. 124 No. Jefferson St., Chicago
 26 Cortlandt St., New York City

"Avoid Blade Trouble"

Ask for and insist upon getting

STAR HACK SAW BLADES

For Machine Use 12 x 5/8

There are none better—none better can be made STAR HACK SAW BLADES, the recognized "STANDARD" by which Hack Saw Blades have been judged FOR OVER A QUARTER OF A CENTURY.

All Dealers Keep Them. Send for Particulars

28 Warren St. **Millers Falls Co.** New York



The American Combined Level and Grade Finder
 Most Practical, Durable and Convenient Instrument Made

At one glance you can get the true slant on any line or grade either in degrees, inches or percentage, or all at the same time, and will at once give the exact distance needed to plumb up to a true level. The longitudinal recess shown in cut is well worth the low price of the instrument. Write AT ONCE for circular and Testimonials. Special Introductory Price given to First Applicants with privilege of taking Agency. Address **EDWARD HELB, Mfr., Box 75, RAILROAD, PENNA.**

"Morse"



TWIST DRILLS

REAMERS, MILLING CUTTERS, ETC.

are good, reliable, accurate, serviceable tools,
made so by experts. Illustrated Catalogue free.

MORSE TWIST DRILL & MACHINE CO.
NEW BEDFORD, MASS., U.S.A.

population of 1,500 and has a real "White Way" illuminated by 39 handsome cluster lampposts. This is at the rate of one lamppost for every 400 citizens. At this rate New York city should contain 120,000 decorative lamp standards. Taking Winterset as a standard of public lighting, the extent of opportunity for the sale of lamps and electric current for this purpose in the other cities and towns in the United States is something whose contemplation will make the central station dizzy.



Mr. Mechanic! Don't throw your tools one on top of the other. Keep them in good condition, orderly arranged and easily accessible in a "Gerstner" Case. Why not be up-to-date and show your fellow workmen that you are a "man who cares." Ask for our catalogue showing the best built, the neatest and most practical Tool Cases ever offered to the up-to-date mechanic. You'll find one to suit your requirements and please—we'll please you or refund your money.

Gerstner & Sons

Mfrs. of Mechanics' High Grade Tool Cases
818 Germantown Street, DAYTON, OHIO



The Ohio Trade Mark is a Guarantee of High Quality
It will pay you to insist on "OHIO" TOOLS
Send for complete catalog of Planes, both Iron and Wood, Chisels, Drawing Knives, Gauges, Auger Bits, Screw Drivers, Cold Chisels, Hand and Bench Screws, Benches, Cement Workers' Tools, etc.



OHIO TOOL COMPANY
(DEPARTMENT No. 3)

COLUMBUS, OHIO

AUBURN, N. Y.



Here's a Beauty
THE NEW
"YANKEE"
HAND DRILL No. 1530

A Tool for Every
Mechanic or Householder

Has the same unique ratchet movement used in our popular Breast Drills, the little slide between the gears changing it instantly from a plain drill to a right and left hand ratchet; or a double ratchet where any movement of the crank forward or backward causes the drill to cut continually. A great convenience when working at close quarters where a full revolution of crank cannot be obtained. Takes round shank drills $\frac{3}{16}$ " and smaller. Drill Points carried in the handle.

Send for Tool Book (Free)
TELLS ABOUT 35 STYLES, 75 SIZES
Your dealer sells the "YANKEE."

NORTH BROS. MFG. CO.
Station Q PHILADELPHIA, PA.

Please Mention Popular Mechanics

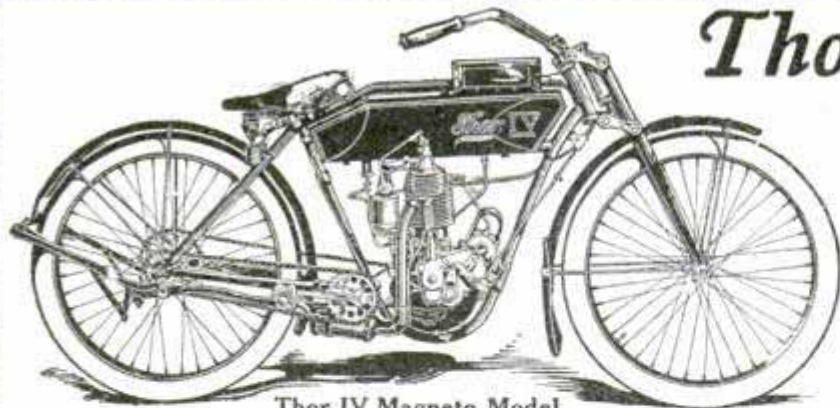

Thor IV Magneto Model

Thor Motorcycles

won every Endurance Contest held last season

THEY ARE BUILT FOR SERVICE

Agents wanted in open territory. Write for our catalog.

AURORA AUTOMATIC MACHINERY CO., Thor Bldg., Chicago

Murray Style Book

FREE

We Want Our Big 1911 Catalog in Every Home

178 pages filled from cover to cover with genuine Buggy, Harness and Saddle bargains; 251 illustrations, many in colors; 138 styles of Vehicles, 74 designs in Harness; the biggest and best book ever printed in this line. Don't miss sending for it!

Murray Highest Award Buggies Direct from his Factory—Four Weeks Road Trial. Insures Safe Delivery—2 Years' Guarantee.

Before buying any kind of vehicle, just get the 1911 Murray Style Book and compare Murray Prices with all others. Costs you nothing. You might as well have this book in your home.

The Wilber H. Murray Mfg. Co.
366 E. 5th St., Cincinnati, Ohio

Our Mechanic's Buggy



Save \$30.00

From Factory To Horse

Make a Motorcycle of Your Bike



at small cost, by using our Attachable Outfit. It fits any bicycle. Send stamp for catalog. Send 15 cents for "The Motorcycle Manual." It treats of motorcycles; how to get more power, etc.

SHAW MFG. CO., Dept. B, Galesburg, Kan.



GEER MOTORCYCLES

We Have the Finest Line in the Country

- 5 H. P. Green Egg.....\$225.00
 - 4 H. P. Bluebird..... 200.00
 - 2 1/2 H. P. Model 4..... 150.00
- Discount to Dealers
Used Motorcycles.....\$40.00

Send for Catalog Immediate Deliveries

HARRY R. GEER CO., 888 McLaren Ave., ST. LOUIS, MO.
Largest Motorcycle Dealers in America

TAXICABS IN SEVENTEENTH CENTURY—

"That the taxicab and the odometer are not new is easily proven by a look into history," says Edwin G. Baldwin, inventor of the auto guide, who, in applying for a patent on his clever device, looked carefully into similar devices for the last 200 years. Two centuries ago the principle of the taxicab and the odometer were known in England, and an advertisement in the London Daily Courant of Jan. 13, 1711, announces

Solar—The Quality Lamp

is used on 80 per cent of the quality cars made in America.

It's used because it's the one reliable, dependable lamp—the only lamp that for service and beauty would not cheapen the car itself.

You can have Solars, too, if you insist on them when you buy your car. "If you don't use a Solar we both lose."

BADGER BRASS MFG. COMPANY

Kenosha, Wis. (38) New York City



WANTED—RIDER AGENTS, IN EACH TOWN

and district to ride and exhibit a sample 1911 Model "Ranger" bicycle furnished by us. Our agents everywhere are making money fast. Write at once for full particulars and special offer. **NO MONEY REQUIRED** until you receive and approve of your bicycle. We ship to anyone, anywhere in the U. S. without a cent deposit in advance, *prepay freight*, and allow **TEN DAYS' FREE TRIAL** during which time you may ride the bicycle and put it to any test you wish. If you are then not perfectly satisfied or do not wish to keep the bicycle you may ship it back to us at our expense and you will not be out one cent.

LOW FACTORY PRICES We furnish the highest grade bicycles it is possible to make at one small profit above the actual factory cost. You save \$10 to \$25 middlemen's profits by buying direct of us and have the manufacturer's guarantee behind your bicycle. **DO NOT BUY** a bicycle or a pair of tires from anyone at any price until you receive our catalogues and learn our unheard of factory prices and remarkable special offer.

YOU WILL BE ASTONISHED when you receive our beautiful catalogue and study our superb models at the wonderful low prices we can make you. We sell the highest grade bicycles at lower prices than any other factory. We are satisfied with \$1.00 profit above factory cost. **BICYCLE DEALERS**, you can sell our bicycles under your own name plate at double our prices. Orders filled the day received.

SECOND HAND BICYCLES—a limited number taken in trade by our Chicago retail stores will be closed out at once, at \$3 to \$8 each. Descriptive bargain list mailed free.

TIRES, COASTER BRAKE rear wheels, inner tubes, lamps, cyclometers, parts, repairs and everything in the bicycle line at half usual prices. **DO NOT WAIT**—but write today for our

Large Catalogue beautifully illustrated and containing a great fund of interesting matter and useful information. It only costs a postal to get everything. Write it now.

MEAD CYCLE CO. Dept. R108, CHICAGO, ILL.



RACYCLE

Round-up of 1911 Models

WHETHER it be Roadster, Yellow Flyer, Rideabout, Pacemaker or Ladies' Pacemaker—the crank hangers on all these 1911 models are *guaranteed three years*. Crank shaft is of solid tool steel and with heavy tool steel cones, giving a perfect bearing surface, is indestructible.

The World's Best Bicycle

The Racycle has 27.9 per cent. less pressure on the bearings than any other bicycle, fully proved in "The Three Reasons" pamphlet. This is the secret of the *easy* riding and unequalled *hill-climbing* qualities.

Pacemaker and Rideabout Models are equipped, without extra charge with our Muselman Armless Coaster Brake—smallest, simplest, lightest and strongest brake made.

1911 Catalog, Pamphlet—"The Three Reasons"—explaining \$10,000 Cash Prize Problem, Racycle Watch, Charm and booklet—"The Major's Story"—all mailed for 2c stamp. Sent FREE if you mention Bicycle Dealer in your town.

THE MIAMI CYCLE & MFG. CO.
32 Grand Ave., Middletown, Ohio, U. S. A.

IT'S ALL IN THE CRANK HANGER

that at the sign of Seven Stars under the piazza of Covent Garden, a chariot was on view that would travel without horses and "measure the mile as it goes." It was capable of reversing and turning and "could go up hill as easily as on ground." Further back than that the Chinese had a vehicle which not only carried its passengers, but dropped a pebble in a receptacle to measure off every mile that was traveled.—Springfield Republican.

SALE! Bicycles Direct From Factory!

Manufacturer's Prices on the Famous "America" Bicycles During Greatest Sale in the History of the Bicycle! Special Sale Prices for Short Time Only in Certain Sections of America!



GUARANTEED TEN YEARS! FREE TRIAL!

This is the most astounding bicycle-buying opportunity that has ever been offered the nation's bicycle riders! In certain sections, to introduce the wonderful "America" Bicycle, we are selling direct to riders at manufacturer's factory-to-rider prices! Thus the world's greatest bicycle value is yours for less money than other wheels. You get middlemen's profits off for introducing the "America."

The double-strength "America Truss Frame Bicycle" and the "America Coaster-Brake Diamond Flyer Bicycle" are guaranteed twice as long as any other wheel. No other wheel can be guaranteed 10 years! Yet during this sale you can get a double value bicycle for less cost than any other

wheel! "America" Bicycles come to you fully equipped—NO EXTRAS TO BUY! "America" Bicycles are fully insured! (See Catalog.) This amazing sale offer can be withdrawn without notice. Writing us at once, today, allows you to grasp this wonderful opportunity. Don't delay—a letter or a postal brings you Sale Prices and complete catalog FREE! That penny saves you dollars on your bicycle. Write today to

AMERICA CYCLE MFG. CO., Dept. 1200

319 Michigan Ave. (The Old-Reliable Bicycle House) Chicago, Ill.



THE FLYING MERKEL

Motorcycle for Reliability, Speed and Comfort

The Merkel's Spring Frame and Spring Fork eliminate all bumping and vibration. All roads are smooth to the "Flying Merkel." Its low cost of maintenance makes it the best connecting link between your home and your business—a big saving in time, rent and carfare if you own a "Flying Merkel."

Unequaled for speed, safety and service. Easy to operate.

Send for free book describing the various models of THE FLYING MERKEL—the world's best motorcycle.

MERKEL-LIGHT MOTOR CO.
350-370 Hanover St. POTTSTOWN, PA.

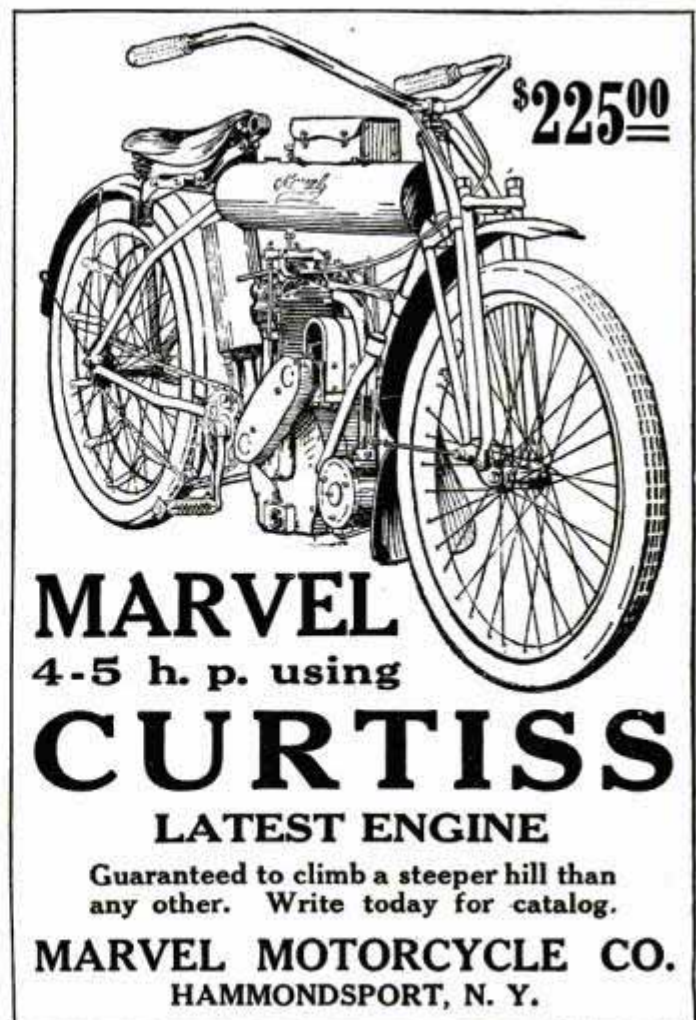

\$225⁰⁰

MARVEL

4-5 h. p. using

CURTISS

LATEST ENGINE

Guaranteed to climb a steeper hill than any other. Write today for catalog.

MARVEL MOTORCYCLE CO.
HAMMONDSPOUT, N. Y.



Buy a Motorcycle You Can Ride Up Hill

The man who owns an **R. S. Motorcycle** owns the finest motorcycle in the world and can ride any place a wheel can travel. Boulevards, country roads, hills, all are smooth sailing. He can go like the hurricane or loaf along like a zephyr.

The R. S. Motorcycle

"Built and Tested in the Mountains"

will develop all the speed your nerve will let you ride, and it will maintain that clip as long as the "juice" holds out. **R. S.** construction invites **R. S.** confidence. The only motorcycle with foot brake and coaster brake. The most effective spring seat post and shock absorber. Let our nearest agent demonstrate the 1911 **R. S.** features. The nearest approach to motorcycle perfection ever recorded. Write for catalog. Agents wanted.

READING STANDARD CO.
Makers Renowned Reading Standard Bicycles
405 Water St., Reading, Pa.



Bicycle Tires FREE

KEPT IN REPAIR

Only bicycle tire you can absolutely depend on is one that will stand this guaranty. We absolutely guarantee **Cloverleaf** (Fixitfree) Brand Tires to keep in perfect repair for a whole season, will make all repairs due to puncture or any other cause or give you another tire, absolutely Free. Valves and "rim cuts" excepted. This insures perfect tire service for a whole season. **Cloverleaf Tires \$5.85 Pair. We Pay Express and Fixit-Free.** Special low price to introduce. **Cloverleaf Tires** have stood every test. Don't judge tire by valueless fancy tread designs. Wear resisting and trouble paying qualities alone count. Order while special price lasts—\$5.85 pair. Give size wanted. Catalog free.

The Vim Chicago, Ill., Des Moines, Ia., or Minneapolis, Minn.



Big New Supply Catalog for 1911

Motorcycle Owners must have this Catalog to become acquainted with the hundreds of new supplies it describes

Ask for Free Supply Catalog P. today

MOTORCYCLE EQUIPMENT CO.

HAMMONDSPORT, N. Y.
The House That Saves You \$\$\$\$

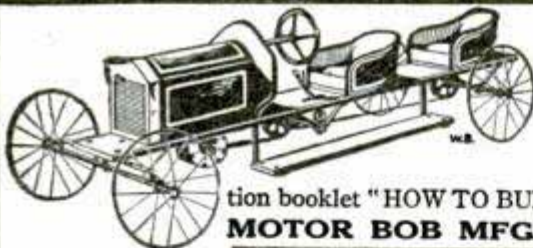

THE MOTOR BOB

A PRACTICAL MINIATURE AUTO propelled by a small air cooled gasoline motor. Any boy of 12 years and up can (at little cost) build and operate the **MOTOR BOB**, thereby learning standard automobile construction and operation. Lots of fun without danger. Will carry two boys anywhere. Send 25cts. (coin preferred) for a complete instruction booklet "HOW TO BUILD A MOTOR BOB" with pictures, plain, simple drawings and list of parts.

MOTOR BOB MFG. CO., Dept. H., Main and Amherst Sts., Buffalo, N. Y.

NSU

A MONEY MAKER

We want an agent in every town and city to sell the only **TWO-SPEED SPRING FRAME**

MOTORCYCLES

The N. S. U. holds the Trans-Atlantic Record, the Economy Record and is the fastest Belt Drive Machine in this country.

WRITE TODAY--DEPT. D

N. S. U. MOTOR CO.
206 W. 76th St., New York City

The woman who bought a book to keep the book agent from knowing she wasn't literary is the wife of the man who ordered an auto to keep people from knowing he couldn't afford to purchase one.—Puck.



Convert Your Bicycle into a **Motor-Cycle** using our Attachable Outfit. Fits any wheel. Also Marine and Stationary Motors and Finished Castings. Stamp for catalog. **STEFFEY MFG. CO.,** Girard Ave. and 20th St., PHILADELPHIA, PA.

30 Days' Free Trial

and if we haven't an agent in your city, we will sell you at
Wholesale Agents' Price one

American Motorcycle or Bicycle

and prepay the freight. Hundreds of people will snap up this introducing proposition. The number of machines we sell on this liberal basis is limited—first come, first served. Here is our plan:—You ride the motorcycle or bicycle for 30 days. If it is not satisfactory, you may return it. If you like it, it's yours at the wholesale agents' price. The **American Motorcycles** are highest grade made, easy to start, simple to handle and powerful. You do not have to be a mechanic to run one. The American won the 1910 F. A. M. Western Endurance Contest, scoring 100 per cent perfect. The **American Bicycles** are the best on the market. We give a **Life Guarantee**.

We have a money making proposition for live agents. Our enormous advertising campaign makes it easy to sell American machines. Don't delay a moment. Our catalog and introducing offer will interest you; it's free. Write us which you want, motorcycle or bicycle. **Do it now.**

AMERICAN MOTOR CYCLE CO., 105 American Bldg., Chicago, Ill.



Cycling—A Returning Fashion

The proved perfection in design of these famous bicycles contains many distinctive features of great merit found only in

POPE

QUALITY Bicycles



This trade mark is on the frame of every genuine Columbia, Rambler, Cleveland and Tribune Bicycle.

THE POPE DAILY SERVICE BICYCLE

A new proposition. Send for full particulars of this magnificent wheel and our convenient method of selling it.

The Pope Manufacturing Co., 468 Capitol Ave., Hartford, Conn.
There is a catalogue for each make. Dealers wanted everywhere.



CAUTION

Thousands of very low grade wheels with fancy paint and deceptive names are being sold at high grade prices.

If you see a name-plate that you do not know, beware.

Everyone knows Pope quality. Pope wheels are safe to buy and ride. \$25 to \$100.

The bicycle is the most widely used vehicle, because it serves for utility, pleasure, exercise, health, economy and business. Over 300,000 new bicycles were made and sold last year.



PRICE OF IVORY INCREASING.—Ivory continues to make rapid gains in cost and may sooner or later be in a class with gold. At the sales in Europe the tremendous demand pushes up the price. The allotment for each sale seems to be the same, and with a gaining consumption, it is logical to expect a price advance.

This will continue until a substitute for ivory is discovered or ivory is secured in greater quantities. Although we buy a great many tusks for piano keys and use the very latest method of cutting and bleaching, the margin of profit in finished key ivory is exceedingly small. With the best of skill in blocking, the waste is enormous, and there are many other details in connection with the key ivory manufacture that require extra time and money.—Music Trade Review.

YOUR NAME PRINTED ON LEAD PENCILS LATEST NEW YORK NOVELTY

We will send you 10 of the very best imported rubber-tipped lead pencils with your name printed on each pencil for 50 cents—regular price 3 for 25 cents. They are all the rage. Send for yours today. P. M. Pencil Supply Co., 41 Fulton St., New York City



Lubricate—Burn cleanly
Leave no carbon deposit

ALL GARAGES—ALL DEALERS

Write for Booklet

"The Common Sense of Automobile Lubrication"

INDIAN REFINING COMPANY
INCORPORATED

First National Bank Building, Cincinnati, Ohio
123 William Street, New York City
W. P. Fuller & Co., San Francisco, Cal., Agents



FOR YOUR WHEEL

SEARCH-LIGHT (Burns Gas) LAMP

Here's a dandy lamp for your wheel. Gives a powerful, brilliant light that illuminates the whole road.

Makes its own gas. Simple to operate—a beauty, handsome nickel finish. Will not jar out over roughest roads.

Can be attached to head or fork. Buy a "Search-Light" today. Write us for booklet.

**BRIDGEPORT
BRASS COMPANY**

132 Crescent Avenue
Bridgeport, Conn.

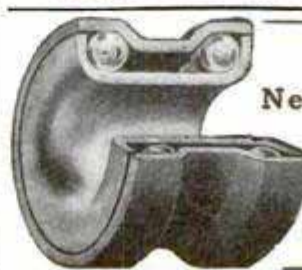

KNIPE

New Two-piece Multiple
Ball Bearing

MADE ONLY BY THE

KNIPE MFG. CO.

Sales Office, Drexel Bldg., Philadelphia
(Send for price list.)



Residence of W.J. Maddox, Jamestown, N.Y.

UNION METAL COLUMNS

(PATENTED)

If you are thinking of building or making over your house don't fail to write for the handsome new catalog of **UNION METAL COLUMNS**

The wonderful strength and durability of these metal columns, together with the beauty of design, make them immeasurably superior and more economical than any other column you can use.

(Made in all sizes up to 40 inches in diameter and a maximum length of 35 feet)

WRITE TODAY

The Union Metal Manufacturing Co.
420 Maple Ave. CANTON, OHIO

THE
Wizard
Lighting Systems

Require No Generation ALWAYS READY

When You Want Light Just Pull the Chain

It lights instantly. As convenient as electricity at one-tenth the cost. So simple anyone can operate.

For further particulars and Agency, address

The Nagel-Chase Mfg. Co.
143 West Ohio St., CHICAGO

HANDY LAMP

Gasoline Lighting System

Gives a 300 Candle Power Shadowless Light the instant you move the lever. Turns up or down, like gas, burns dim when not in use, or can be turned up instantly when more light is needed. It floods a 30-ft. space with a brilliancy like daylight. Far cheaper than gas, kerosene or electricity and so simple that anyone can use it. You can depend on it for years for any purpose demanding a big, strong light. Catalog POP tells why. **Send for it Now.**

BRILLIANT GAS LAMP CO.
Dept. 1, 42 State Street, CHICAGO, ILL.

NULITE Gasoline Table Lamp

A beautiful lamp for homes, hotels, offices, stores, banks, cafes. Portable, safe; can be turned upside down or rolled on the floor without danger or affecting the light. 300 c.p. of soft, brilliant light, 1/2¢ per hour. Also 200 different styles of lamps and systems.

AGENTS — We want town, county and traveling salesmen. Best proposition ever offered. Sells everywhere. **WRITE FOR SPECIAL OFFER.**

CHICAGO SOLAR LIGHT CO.
222 S. Jefferson St. CHICAGO

One of the big ocean liners apologizes for being several hours late in crossing the Atlantic. Eventually the schedule will get down to minutes, and the ocean ferry will be realized, with airships on the side.—St. Louis Globe-Democrat.

BUY PLUMBING SUPPLIES AT WHOLESALE

Will Save You 30%

Don't pay retail prices. Full stock on hand for prompt shipment. Send for free catalog. B. P. KAROL, 768 to 772 West Harrison St., Chicago

WANTED

THE LIGHT THAT NEVER FAILS

Has been imitated but never equaled. Burns its own gas and makes more money for agents than any other artificial lighting device on earth. We give exclusive territory and large discounts to good men. For further information and full particulars address Light Dept.

NATIONAL STAMPING & ELECTRIC WORKS
210 So. Jefferson Street, Chicago

AGENTS

IRON AND WIRE FENCES

CATA-LOG FREE HIGH GRADE FOR ALL PURPOSES

ENTERPRISE FOUNDRY AND FENCE COMPANY
1214 East 24th Street, Indianapolis, Ind.

Buy Direct—Save Money—We Pay Freight

Our monthly installment plan of selling direct saves you the dealer's profit and his excessive charges for installation and repairs. You can save at least 1/3 the cost of your furnace. We have been building Jahant Furnaces for over 30 years and guarantee satisfaction

JAHANT DOWN DRAFT FURNACE

THE BEST HEATING SYSTEM MADE for residences, schools, hotels, churches, etc. It is the most economical furnace too and saves 1/2 to 2/3 the cost of fuel because the patented "Down-Draft System" burns wood, hard or soft coal, and burns, it ALL without cinders, clinkers or any waste. Needs less attention, yet heats much better than any other furnace, hot air, steam or hot water heating system. Our plan of monthly payments

ONLY \$10 DOWN and \$10 A MONTH

makes it easy for any one to have the best heating system made. Every Jahant Furnace is sold with a strong "Guaranty Bond" that allows you 365 DAYS TRIAL. You don't run any risk buying from us.

We send complete outfit, furnace, pipes, registers, etc., together with special plans, full directions and all tools for installing. If you can drive a nail you can install a Jahant Furnace without the aid of a tinner.

Write To-Day for Catalog which explains the Jahant Down-Draft System and tells why it gives more heat at less cost.

THE JAHANT HEATING CO., 3 Mill Street, Akron, O.

This 3-Piece Mission Library Set

— Desk, Book-Rack and Chair, made of selected solid oak—either Early English or Golden finish. Desk has 32x20 inch top, with large drawer for stationery, and back shelves. Book-Rack 44 inches high, with shelves 17x11 inches. Chair extra solid, with 20x20 inch seat.

Sent to your home on receipt of \$1.50. If, after 30 days' trial you find it at least twice the value you could get anywhere else, pay the balance of the special direct-from-factory price of \$9.85 at the rate of 75 cents a month.

And remember, this is not a special value—it is merely a sample of the wonderful bargains we offer in everything for the home—bargains only made possible by our tremendous business.



Set No. L514

Sent to Your Home for \$1.50

This Mission set is made with the same taste and style as distinguish all Hartman furniture. We have furnished thousands of the best city homes through our 22 great retail stores in the large cities—we have 800,000 customers scattered throughout the country. Today, after 56 years of business life, we are selling to people whose grandparents, when first married, started house-keeping with Hartman furniture. You can furnish your home in just the way you want it, at prices you'd hardly think possible for such quality goods, and on terms to suit your convenience. So send today for your copy of our great



FREE BOOK "Everything for the Home"

and why we can furnish homes better and more cheaply on our liberal open-account credit system. The most beautiful and comprehensive book on artistic home-furnishing ever issued. Write today for your free copy.

300 pages of interesting ideas about home-fitting, illustrated with pictures of the articles themselves—many in color. Tells you how

HARTMAN FURNITURE & CARPET CO.

Dept. 14, 223 Wabash Avenue

CHICAGO, U. S. A.

Largest, oldest and best known home-furnishing concern in the world. Established 1855—56 years of success—22 great stores—800,000 customers

HOW CHOPIN COMPOSED THE FUNERAL MARCH.—A picturesque account of the inspiration sought by Chopin for the composition of his famous Funeral March is told by the venerable painter M. Ziem in the Annales.

M. Ziem relates that, when little more than a boy, after a dinner party in a friend's studio he had the idea, in a fit of high spirits, to bring from a cupboard a skeleton. The Prince de Polignac, who was of the



Home Ironing Machine

On Easy Payments, 30 Days' Free Trial.

A heated ironing that irons all flat pieces better, easier, and in one-quarter the time. Costs 1c an hour for heat—gas or gasoline. Turned by hand, by power or by motor. "Clean Linen" booklet Free. Ask for it.

Home Ironing Machine,

311-F, Western Ave.

CHICAGO

HESS FURNACE



We will deliver a complete heating equipment at your station at factory prices and wait for our pay while you test it during 60 days of winter weather.

The entire outfit must satisfy you or you pay nothing. Isn't this worth looking into? Could we offer such liberal terms if we didn't know that the Hess Furnace excels in service, simplicity, efficiency, economy?

We are makers—not dealers—and will save you all middlemen's profits. No room for more details here. Write today for free 48-page booklet which tells all about it.

Your name and address on a post card is sufficient.

HESS, 910 Tacoma Bldg., Chicago

No. 48
"Leader" Hess
Steel Furnace
Price \$49
Delivered East of Omaha and
North of Ohio River
Pipe and Registers Extra

Only \$9750 Per Carat for Perfect Cut, Genuine Diamonds



We save you 40%. Learn all about the BASCH plan. Write for catalogue "A," guarantee, money-back contract and prices FREE. Diamonds sent C. O. D. with privilege of examination.

L. BASCH & CO., 272 State St., CHICAGO, ILL

BENJAMIN AIR RIFLE FOR MEN AND OLDER BOYS

An air gun that will shoot through half inch pine easily. Many times more powerful than spring guns. Uses compressed air, same as air brakes, rock drills, etc. 15c pays for 1,000 shots (delivered 30c). Practical for small game. 37 inches long. Walnut stock. Nickel barrel. Take down. Sold by dealers everywhere. If your dealer does not carry it, write us. Sent prepaid east of Rocky Mountains on receipt of \$2.50. Pacific Coast and Parcels Post Countries \$3. Circular free.

Benjamin Air Rifle & Mfg. Co.,

2002 Frisco Bldg., St. Louis, Mo.

THE "BEST" LIGHT



Makes and burns its own gas. Pure white 500 candle power light, more brilliant than electricity or acetylene, and cheaper than kerosene. Casts no shadow. Costs 2 cents per week per lamp. No dirt, no grease, no odor. Used in every civilized country on earth. Over 200 styles. Every lamp warranted.

Agents wanted. Write for catalog.

THE BEST LIGHT CO.
324 E. 5th St., Canton, O.



THERMOS Pays for Itself in Two Weeks

Think of the change it will make every day of your life in the cold winter months to have four large cups of piping hot home made coffee, tea or soup right in your lunch kit, ready for you, when you are ready for it, or in the hot summer months, ice cold tea, coffee, milk, lemonade, or anything else.

Think of the comfort, convenience and economy this lunch kit will give you wherever you go,—whatever you do. At night it is ideal in the home, for the baby, the wife or the aged mother in serving them hot or cold refreshments as needed, and don't forget it on your hunting, fishing and vacation trips.

Contrast the handsome appearance of this suit case with the old style dinner pail. If you are buying the meals you take away from home, it will save you \$3. every two weeks.

See one at the nearest Thermos dealer and you will buy one on sight. If he will not supply you, write to us direct, and we will see that you get it. Thermos bottles, pints \$2. up, quarts \$3. up. Please be cautious as there are worthless imitations, look for the name Thermos stamped plainly on the bottom, and be sure you see it.

FREE: We will send you our 34 page booklet on request, illustrating and describing all Thermos uses and articles. AMERICAN THERMOS BOTTLE CO., Thermos Bldg., NEW YORK



\$38.95 BUYS THIS COMPLETE BATHROOM OUTFIT



MODERN BATHROOM FOR EVERY HOME

THE LUXURIES OF MODERN PLUMBING AT HALF THE ORDINARY COST

Complete Pneumatic Water Supply Systems from \$42 upwards

SAVE \$100 to \$250 on your steam or hot water heating plants.

Gasoline engines for farm and shop. Electric Lighting Plants for your home - **\$300**

Hydraulic Rams, Pumps, Pipe, Valves, Fittings at lowest prices. Farmers' Tanks for every purpose.

Acetylene Lighting Plants, Gas and Electric Fixtures. All high grade, strictly guaranteed goods. Get our prices and we will save you money.

BIG CATALOGUE FREE!



M.J. GIBBONS DEPT. A DAYTON, O.

FREE BOOK ON BYSTROM LIGHT

Great for Agents

Brightest, safest, cheapest light for home or store. Burns 96% air to 4% gasoline; 400 candle-power per mantel. Runs 44 hours from 1 gallon. Costs 1/2 cent an hour. Leaks impossible. Endorsed by insurance companies. No noise. No smell. Least heat. Write **BYSTROM GAS LAMP CO., Dept. Q DEFIANCE, O.**



Wheel Chairs

A Wheel Chair is often an invalid's greatest comfort. We offer over 75 styles of these easy, self-propelling and Invalid's Rolling Chairs, with latest improvements. Ship direct from factory to you, freight prepaid, and sell on

THIRTY DAYS' TRIAL
Liberal Discounts to all sending for free Catalogue NOW.

GORDON MFG. CO.
472 Madison Ave. TOLEDO, OHIO

party, insisted on placing the skeleton on a music-stool and guiding the bones of the fingers over the keys of the piano.

Not long after Chopin called on M. Ziem, to seek respite after an appalling night passed in a struggle with ghosts that sought to entice him to the underworld. The recital of his nightmares recalled to M. Ziem the piano performance by the skeleton and the Prince de Polignac.

Chopin shuddered; then he asked, "Have you a skel-



Geisha Diamonds

THE LATEST SCIENTIFIC DISCOVERY

Bright, sparkling, beautiful. For brilliancy they equal the genuine, standing all test and puzzle experts. One twentieth the expense. Sent free with privilege of examination. For particulars, prices, etc., address

THE R. GREGG MFG. & IMPT. CO.
Dept. H, 517 Jackson Blvd., Chicago, Ill.

Compare the Prices on COME-PACKT SECTIONAL FURNITURE See the Big Saving!

Put the prices of **Come-Packt Sectional Furniture** side by side with the lowest cash figures of the best stores. You will find you save **over half** buying from our factory. We make and guarantee every piece absolutely. **Quarter Sawn White Oak** used throughout. Shipped completely stained and finished, in sections. Your choice of eight finishes.

\$90.75 Dining Room Suite for \$42.50

No.	Dealers' Price	Come-Packt Price
413, Buffet (Copper Trimmings)	\$40.00	\$17.75
337, Extension Dining Table (3 Leaves)	34.75	14.75
104, Four Dining Chairs	16.00	10.00

Which price do you pay, \$90.75 or \$42.50?

Any of the above sold separately at these figures.

Big Six Catalog Mailed Free. Six money saving departments—Mission and Bungalow furniture (200 pieces) new Willo-Weave Furniture, Mission Lamps, Cluny Lace Curtains, etc. **Write Today.**

COME-PACKT FURNITURE CO., 501 Edwin Street, Ann Arbor, Mich.



This Library Table Sent For \$1.50



The Great Original Credit House-furnish-ers

Here's a Big Opportunity for You

This Massive Colonial Library Table, American quartered-sawed Oak finish, beautiful flaky grain, highly polished, spacious drawer, with wood Knobs, Cabinet work the best, is 40 inches long by 24 inches wide. Order No. 2322.

\$1.50 Cash 75c monthly payments. Total price \$9.25

Our Five Great Credit Catalogs FREE

Our Great Catalog K47—Furniture and Housefurnishings—positively saves you money, shows you exact reproductions of Carpets, Rugs, Oilcloth and Linoleums in their actual colors, also illustrates and describes Furniture, Curtains, Crockery, Silverware, Baby Carriages, Washing Machines, Sewing Machines, Office Desks, Musical Instruments, including Pianos and Organs of famous makes.

Catalog L47—Stoves and Ranges—Gives complete descriptions and illustrations of World's Best Stoves and Ranges.

Catalog M47—Is the great Watch and Jewelry guide; illustrates, describes and tells how to save the most money.

Catalog P47—Clothing for Men—Ask for this Style Book—it tells all about latest makes and styles, the lowest prices, etc.

Catalog S47—Clothing for Women and Children—a complete book, illustrating latest styles, quoting lowest prices.

One or all of these elaborately illustrated money saving books are yours simply for the asking—say which you want, it will be sent FREE.



K1190

This Handsome Rocker, golden oak or mahogany finish, nicely carved, upholstered with Chasleather, spring construction. Order No. K1190.

\$1.00 cash, 50 cents monthly payments. Total price.....\$5.50

Credit Given to Everybody On Everything by this great mail order institution—the house with thousands of satisfied customers and a successful record of over 25 years. Goods shipped any place in the United States. You use them while paying—write at once for any or all of our 5 great money-saving catalogs. Address

Straus & Schram, Inc.
Dept. 47 — 35th Street — CHICAGO, ILL.



150 MAGIC TRICKS
64 page book illustrating these easy sleight of hand passes—only **10c.**
WESTERN PUZZLE WORKS, ST. PAUL, MINN.

CACHOO! Make the whole family and all your friends "just sneeze their heads off" without knowing why, with CACHOO, the new long distance harmless snuff. Sent anywhere for 10c. 3 for 25c. 90c a dozen. Catalog included FREE.
P. T. & N. CO., Department B, Chicago, Ill.



eton?" M. Ziem had not, but promised to obtain one that very evening.

"Then," he goes on, "what had been only a frolic became something grand, agonising, terrible. Pale, his eyes burning with fever, Chopin wrapped himself in a long winding sheet, and as he sat at the piano held against his bosom the skeleton, the spectre of his sleepless nights.

"In the lugubrious silence the notes streamed from the piano, broadly, slowly, overwhelmingly—an unimagined music—the Funeral March! It was created there before our eyes, and it dragged our souls into its unholy rhythm.

"Then the strains died down. We rushed towards Chopin. He had put forth so prodigious an effort that we thought he had fainted in his winding sheet."—London Daily Mail.



\$7.55 Buys Best 140-Egg Incubator

Double cases all over; best copper tank; nursery, self-regulating. Best 140-chick hot-water brooder, \$4.85. Both ordered together, \$11.50. Freight prepaid (E. of Rockies).



No machines at any price are better. Satisfaction guaranteed. Write for book today or send price now and save time.
Belle City Incubator Company, Box 164 Racine, Wisconsin

A Genuine Panama for \$1.00



An Introductory Bargain

This is just as good a Panama Hat as one costing \$10, except it is coarser weave. Warranted genuine, hand-woven, direct importation from South America. Weight 2 oz.; durable, flexible, easily shaped. Worn by everyone, man or woman. Looks like an expensive woman's Panama when trimmed. **Our Bargain Price to introduce only \$1.00.** 2 for \$1.88. We prepay all charges.

\$1.00 Mexican Palm Hat 50c

For Man, Woman or Child

Over 75,000 sold to pleased customers. Warranted genuine hand-woven in Mexico from strong palm fibre; colored design woven in brim. Light, cool, comfortable—not hurt by rain. Retail at \$1.00; our introductory Price only 50c. Three for \$1.25. Both hats here offered sent prepaid for \$1.30. Money back if not pleased. Write today for Free Catalog of Mexican and Panama Hats; it will save you 30 per cent on your summer hat cost.



FRANCIS E. LESTER CO., Dept. EA5H MESILLA PARK, NEW MEX.



PRINT FOR YOURSELF

Cards, circulars, book, newspaper. Press \$5, Larger \$18, Rotary \$60. Save money. Print for others big profit. All easy, rules sent. Write factory for press catalog, TYPE, cards, paper.

THE PRESS CO., Meriden, Connecticut

A BEACON LAMP BURNER FREE WANTED



Incandescent, 100 Candle Power. Burns common coal oil. Gives better light than gas, electricity or six ordinary lamps at one-sixth to one-tenth the cost. Fits your old lamp Unequaled for fine sewing or reading.

COSTS ONLY ONE CENT FOR SIX HOURS

We want one person in each locality to whom we can refer new customers. Take advantage of our special offer to secure a Beacon Burner FREE. Write today. Agents Wanted. **HOME SUPPLY CO.**
248 E. C. Life Bldg., Kansas City, Mo.



Low Prices to Kill the Boat Trust!

This Handsome, Graceful, Seaworthy, Speedy Runabout Complete, Only \$94.50 16, 18, 20, 21, 23, 25, 27, 28, 30 and 35 Footers at Proportionate Prices
We have the largest power-boat factory in the world. We build and sell more pleasure crafts than all the concerns in the Authorized Thirteen-Million-Dollar Boat Trust combined. No one has such facilities. That's why we build Detroit Boats and Engines so good that no one in the Trust can ever imitate them. Our great business enables us to sell at the smallest profits. That's why we are able to sell Detroit Boats and Engines at the smallest profits, so the Boat Trust has declared war on us—

but our low prices will kill the Trust. We ship you a Detroit Boat immediately on order. All sizes in stock. Send today for our large, handsome, illustrated Catalog, mailed free, which describes 64 different models in all sizes, ready to ship, equipped with the most reliable and efficient marine motor ever produced, guaranteed for five years. Get our new confidential proposition and special prices to demonstrating agents. (114) **DETROIT BOAT COMPANY, 1100 Jefferson Avenue, Detroit, Michigan**

All-Wool Clothes Six Months to Pay

**All-Wool
Clothes**
Choice of
34 Fabrics
\$12⁹⁵
to
\$35⁰⁰
Clever
Spring Styles
Made to Fit
Perfectly
Sent on
Approval



Samples Free

We want to send you the new Clement Book, filled with spring styles for young men. Also 34 samples of all-wool fabrics—acid-tested, pre-shrunk—the very cream of all new patterns.

We will send with them a tailor's tape, so you can take your own measures. That saves you one-third under what it would cost if we had a local agent to take the measurements for you.

We will make you a suit in any style or fabric you select, and send it to you on approval. The fit, the fabric, the tailoring, all will be guaranteed. If not satisfactory in every way, send the clothes back and we will pay express both ways.

If all is satisfactory, and you are delighted, pay a little each month for six months. No extra price, no interest, no security, no red tape.

Clement suits and overcoats run from \$12.95 to \$35.00. That means for perfectly tailored clothes, made of all-wool cloth which won't shrink and won't fade. Good enough for a millionaire.

Many thousands of the best dressed men buy Clement clothes every season. Some men whom you know are among them.

Send us your address for the Style Book and samples. A postal will do—write it now. The whole outfit is mailed free.

THE CLEMENT CO.

3585 Morgan St. [12] CHICAGO

When you want anything and don't know where to find it—write Bureau of Information, Popular Mechanics, Chicago

ALOE'S

Our Renowned Double Combination
TELESCOPE

Size 2 in. Object Glass, Length 63 in.
Prof. Hicks, of Word and Works Almanac, says they are far superior to others he has examined at twice the price.
CATALOGUES ON APPLICATION



LET US GIVE YOU THIS TRANSPARENT CELLULOID TRIANGLE

It is 4 inch size, 30°+60° angles. Lowest retail price, 25 cents. Absolutely essential to everyone who draws. We make this offer to introduce our new catalogue showing

SPAULDING'S NEW CARRYING CASES AND COMPLETE OUTFITS

for designers, architects, engineers and students—compact, durable and convenient. Spaulding's Carrying Cases are made light and strong. They provide well arranged compartments, including space for drawing board and T square. Handled like a suit case; unique, practical, inexpensive. Outfits include all necessary equipment. If you draw, send us five 2 cent stamps to-day to pay postage and get the free triangle and the catalogue.

SPAULDING PRINT PAPER CO.
44 Federal St. BOSTON

RED or BLACK VULCAN STYLOS

Moderate priced, easy writing pens that give satisfaction; unequalled for rapid writing and ruling.



\$1.00 Postpaid. Two Sizes, 4½ and 5½ Inches
AGENTS WANTED. Extra size, 8 inches (BLACK ONLY) \$1.25
J. C. ULLRICH & CO., 27 Thames St., NEW YORK
Manufacturers of Stylo and Fountain Pens

LEARN ISOMETRIC DRAWING

Combines clearness of photograph with accuracy of working drawing. The Standard for patent drawings and illustrations for scientific magazines. Makes quickly read working drawings. Invaluable to inventors. THE ISOGRAPH makes isometric projection easy; makes an expert of a novice. Wonderful proficiency obtained with practice. Ample illustrated book of instructions teaches you in a short time. Celluloid 6 x 6 inches, accurately made. Postpaid 50c. Money Order or 2c stamps. SEND TODAY. THE ISOGRAPH CO. 145 E. 23d St. NEW YORK CITY

THE RETURN OF BRASS CANNON—The following item from an English trade publication would seem to indicate that the era of brass cannon has returned:

The largest brass gun ever made in England was cast on July 13 last in a successful manner at the Royal gun factories, Woolwich Arsenal, under the



TYPEWRITERS ALL MAKES

All the Standard Machines SOLD or RENTED ANYWHERE at ¼ to ⅓ MFR'S PRICES, allowing RENTAL TO APPLY ON PRICE. Shipped with privilege of examination. Write for Illustrated Catalog L. TYPEWRITER EMPORIUM, 92-94 Lake St., CHICAGO



This Cabinet made of Oak, finished golden, 44" long, 24" wide, has drawers, extension slide, roll front, paper cabinet, etc., as shown. We sell it at low price to introduce our OFFICE FURNITURE—Desks, Chairs, Tables, Files, Book Cases, etc. ASK FOR PRICES AND CATALOG No. 211.

We make UPHOLSTERED FURNITURE—Turkish and Odd Rockers, Parlor and Library Suites, Davenport and Couches in Oak and Mahogany, Flanders, mission and regular. Covered in best leather money will buy—every piece guaranteed. Ask for prices and Catalog No. 411. E. H. STAFFORD MFG. CO., 242 Adams St. Chicago, Ill.



CLASS PINS AND BADGES

FOR COLLEGE, SCHOOL, SOCIETY OR LODGE

Either style with any three letters and figures, one or two colors of enamel. Sterling Silver, 25c each, \$2.50 doz.; Silver Plated, 10c each, \$1.00 doz. Catalog free. Special designs also made for any School or Society, at attractive prices. Send idea for estimate. BASTIAN BROS. CO., Dept. 487, ROCHESTER, N. Y.



ASTRONOMICAL TELESCOPES

Complete with Case, Sun Shade, Sun Glass and Extra Eye Piece for Night Observation . . . \$18⁰⁰

One of these superb instruments will give material enjoyment. It will enable you to pick out the smallest Boats on the Horizon, tell the time by a clock at many miles distant, and view the country for fifty miles around. "This telescope" for Astronomical Work is simply unequalled, with its aid the Mountains in the Moon, Jupiter's Moons and Saturn's Rings are clearly discernible.

A. S. ALOE COMPANY, 515 Olive S., St. Louis, Mo.

MESCO

MESCO

PEERLESS

The Guaranteed Bell

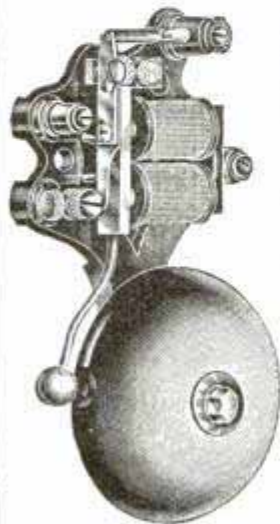

Solid Weatherproof Back. Do you want the BEST? If so specify

PEERLESS

Ask for prices and descriptive matter.

Wireless Manual 1M.
sent on request.

MANHATTAN ELECTRICAL SUPPLY CO.
17 Park Place, NEW YORK 186-188 Fifth Ave., CHICAGO

MESCO

MESCO

direction of Mr. Anderson, assistant superintendent of the department. Upwards of 11 tons of metal were used in the casting, and the gun mould with the dead-head was 20 ft. in depth. This immense piece of ordnance is to be rifled on the muzzle-loading principle, and is intended for experimental trials at the school of gunnery, Shoeburyness, in competition with rifled guns made from steel or cast and wrought iron.

Wonder if the new device for illuminating a man's insides can make some people's heads lighter than they are?—Chicago Tribune.

ELECTRIC GOODS FOR EVERYBODY. World's headquarters for Dynamos, Motors, Fans, Toys, Railways, Batteries, Belts, Bells, Pocket Lamps, Telephones, House Lighting Plants, Books. If it's electric we have it. Undersell all. Fortune for agents. Big Catalogue 4 cents. OHIO ELECTRIC WORKS, CLEVELAND, OHIO

BIG 200-p ELECTRICAL and WIRELESS CATALOG Mailed for 4c Stamp

(to cover postage). 60 pages WIRELESS Instruments for commercial and experimental use. 15 pages Motors and Dynamos of all sizes. 35 pages Miniature Trains and Imported Electrical TOYS. 20 pages Telegraph Instruments. 40 pages Electrical Novelties, etc. 30 pages general Electrical Supplies. Get this catalog today—you need it.

J. J. DUCK, 424-6 St. Clair Street, TOLEDO, OHIO

The Electro Copper Plating Outfit

This little outfit will copper plate not only metal articles, but is also used for metalizing beetles, insects, nuts, fruits, flowers, etc., all of which can be turned out to perfection. There is a large demand for such goods.

THIS OUTFIT NEEDS NO BATTERIES, but supplies its own current, something which no other outfit can do. Size over all 13x5½ inches, weight complete 3½ pounds, comes with copper plating salts ready for use. Price complete \$1.25

Send 4c postage at once for our great 196 page Electrical Cyclopedic containing 400 illustrations

THE ELECTRO IMPORTING CO.
No. 233a Fulton Street NEW YORK
"EVERYTHING FOR THE EXPERIMENTER"

Bargain Prices on New and Used Electrical Machinery

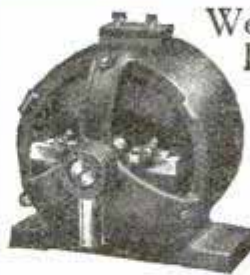

We Buy, Sell, Rent, Trade and Repair Electrical Machinery. Our Stocks are Large, Prices Low and our Used Machinery is as Good as New. Write for Bargain Booklet Number Twenty. Tell us what you have and what you need. We can interest you.

SWITCHBOARDS

For POWER or LIGHTING

Whether large or small, Alternating or Direct Current, we do or will build the Switchboard that meets your requirements.



Ask for Switchboard Bulletin Number Twenty-two. It gives prices.



We do not handle novelties or toys.

The F. BISSELL COMPANY
226-230 Huron St. TOLEDO, OHIO

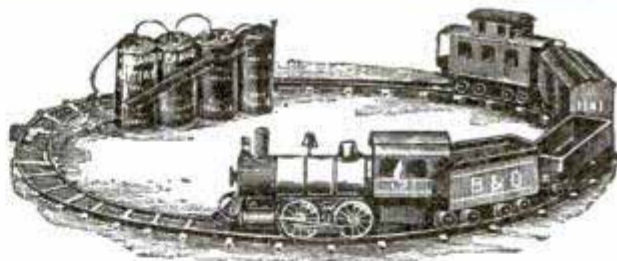

Electrical railways, tracks, switches, trolley cars, dynamos, motors, dynamo castings, gas engine castings, everything for the young electrician. Send for our complete catalog "B."

The Carlisle & Finch Co.

262 E. Clifton Ave. Cincinnati, Ohio

SECONDARY "UNITS" FOR WIRELESS INDUCTION COILS AND TRANSFORMERS. THESE UNITS COST BUT LITTLE MORE THAN WIRE ALONE. SEND 2 CENT STAMP FOR WIRELESS CATALOGUE.

Dawson & Winger Electric Co., 429 Dearborn Street, Chicago

ELECTRICITY

VOLTAMP

The most wonderful and fascinating scientific study of the age. Every Boy, Girl and Grown-up should know about it. The new "VOLTAMP ELECTRICAL PRODUCTS"—our

112 Page Catalog now ready, the most complete and interesting book ever issued—is full of illustrations and descriptions of the latest Voltamp. Electrical Novelties—Motors, Dynamos, Toys, Machine Models, Telegraph and "Wireless" Instruments, Ruhmkorff Coils, Spark Coils, Geissler Tubes, Switches, Meters, Lamps, Flashlights, Transformers, Tools, etc. The greatest line of Miniature Electric Railways ever shown. Ideal Christmas Gifts. Prices consistently low

Send for this Catalog—6 cents in stamps or coin, which will be refunded on first order of 50 cents or over. No postals answered.



VOLTAMP ELECTRIC MFG. CO., Voltamp Bldg., Baltimore, Md.

Prest-O-Carbon Remover



Cleans Out Any Gas Engine

Automobile, Motor Boat, Motorcycle, or Stationary

Tearing an engine to pieces and scraping out the carbon is slow, hard work, and likely to do more harm than good.

Prest-O-Carbon Remover, injected in the cylinder, loosens and removes all carbon from cylinder walls, piston, piston rings and valves. Cleans a cylinder perfectly in an hour for 25 cents or less. Increases compression, power and durability. Has no effect whatever on metal—cannot injure the engine in any way. We guarantee this. Easy to use—directions on can.

Try It Under This Guaranty:—

There are many imitations of our preparation, so, to make sure you get the genuine article, send us your order and we will ship you, express prepaid. (Quart, \$1; Half Gallon, \$2; Gallon, \$3.75.) If you are not fully satisfied with the results, simply tell us and we will promptly refund your money.

The Prest-O-Lite Co. 265 E. South St. Indianapolis, Ind.
(Makers of Prest-O-Lite Gas Tanks.)

FOR FARM SHOP HOME

ELLIS ENGINES
USE

WE PAY THE FREIGHT

KEROSENE

gasoline, distillate, any fuel oil, perfectly—without change.

Cheapest, Safest, Simplest POWER

for barn work, house work, mill work, dairy work, well work, grinding grain, spraying, sawing, irrigation, electric lights, pumping, cutting fodder

Astonishing success. More power, gallon for gallon. Hundred less parts. Patent throttle gives three engines for price of one. *Catalog free—tells how.* Double-duty tank revolutionizes cooling systems. Force feed

lubricator—perfect oiling. Automobile muffler. Ball bearing governor. Starts instantly. No pre-heating, no

crank. Experience unnecessary. Women can operate.

Vibration eliminated.

Quality high—price low. Comes complete. Always hungry for work—and thrives on it.

FREE TRIAL
No obligation till you are satisfied. **10-year Guarantee.** "Engine Facts," our new catalog, free! Write postal for it **NOW.**
ELLIS ENGINE CO.
39 Mullett Street,
(vz) DETROIT, MICH.

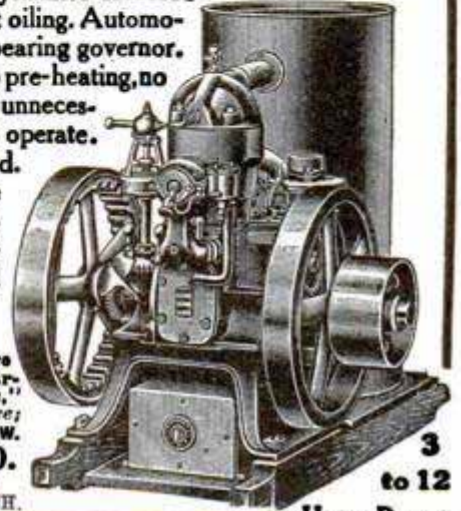

3 to 12 Horse Power

DON'T BUY A GASOLINE ENGINE

until you investigate "The Master Workman," a two-cylinder gasoline, kerosene or alcohol engine, superior to any one-cylinder engine; revolutionizing power. Its weight and bulk are half that of single cylinder engines, with greater durability. Costs Less to Buy—Less to Run. Quickly, easily started. Vibration practically overcome. Cheaply mounted on any wagon. It is a combination portable, stationary or traction engine. **SEND FOR CATALOGUE THIS IS OUR FIFTY-NINTH YEAR.**

THE TEMPLE PUMP CO., Mfrs., 431 West 15th St., CHICAGO

Let SANDOW Run It!

Wonderful Work Engine

Farmers and Shop Owners, Stop Sweating! A few dollars gets this grand little work engine, complete and ready to run Cream Separators, Corn Shredders, Grist Mills, Feed Mills, Dynamos, Printing Presses, etc., etc. Gives a lifetime of steady service! All sizes: 2 to 20 h. p. No cranking! No cams! No gears! Only 3 moving parts. Finest construction. Thousands in use. Guaranteed 5 years. Write for Special Introductory Proposition.

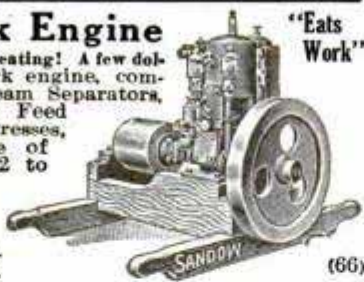

DETROIT MOTOR CAR SUPPLY CO., 2 Canton Ave., Detroit, Mich.

NEW "RITHUMTIC"—In view of the many exposures of short weights and measures, why do we persist in teaching children things in school that they will have to unlearn when they go into business for themselves? Why not revise the tables in the arithmetic to read:

- 14 ounces make a pound.
- 80 pounds make a hundredweight.
- 1500 pounds make a ton.
- 11 inches make a foot.
- 33 inches make a yard.
- 1½ gills make a pint.
- 3 gills make a quart.
- 7 pints make a gallon.
- 7 quarts make a peck.
- 3 pecks make a bushel.—Life.

Fairbanks-Morse Gasoline Tractor

will deliver more than its full rated horse power.

A Satisfactory Engine for Plowing

Seeding

Harvesting

Threshing

Send for Interesting Bulletin No. TR449

Fairbanks, Morse & Co.
900 So. Wabash Ave., Chicago

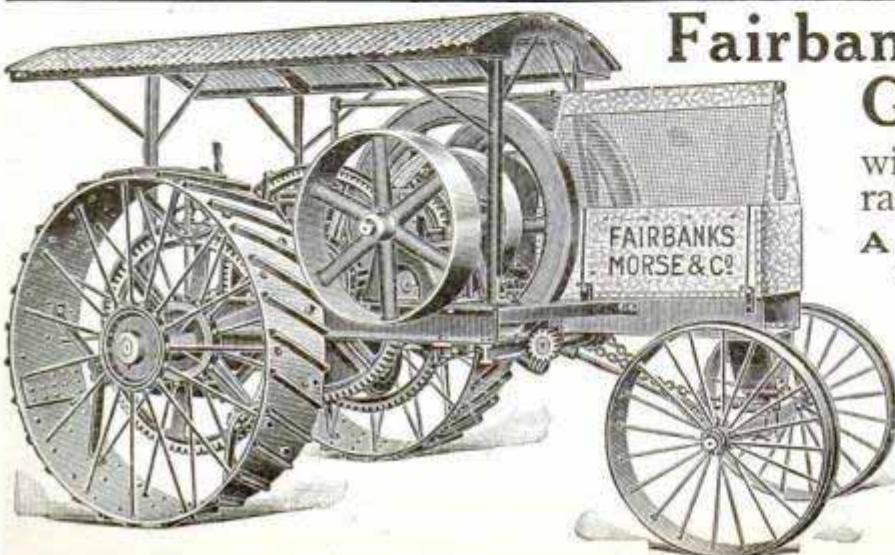

Every Stroke Saves You Money

A good gasoline engine saves time, work, and money. And the engine that saves the most work, the most time, and the most money, every year, for the longest time, is the best paying engine investment for you to make. But in order to save much of your work, time, and money, a gasoline engine must be efficient, simple, economical, strong, and durable. Otherwise, it may cause more annoyance and repair expense than the amount it saves. So you must necessarily be careful of the gasoline engine you decide on. And if you want to be absolutely sure of getting an engine that is a proven money maker, choose one of the

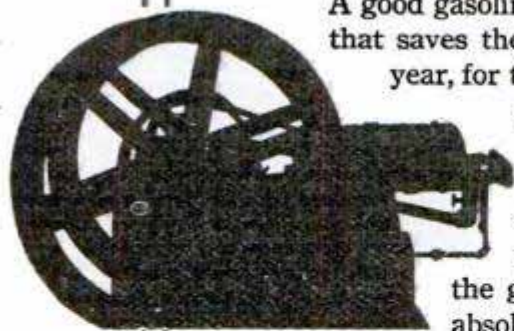

I H C GASOLINE ENGINES

No matter what style or size you want, it is in the I H C line. I H C Horizontal engines are made in 1, 2½, 4, 6, 8, 10, 12, 15, 20, and 25-horse power. I H C Vertical engines are made in 2, 3, 25, and 35-horse power. I H C Air Cooled engines come in 1, 2, and 3-horse power. And I H C Tractors come in 12, 15, 20, 25, and 45-horse power. And you also have choice of stationary or portable style. So whatever kind of an engine you want, you need not sacrifice the many I H C advantages.

The record of I H C engines in the hands of thousands of owners is proof of I H C superiority. But you should get all the facts from the I H C catalogue at once. Simply write a postal request and the catalogue will be sent by return mail. There is no better time than now.

International Harvester Company of America

16 Harvester Building

(INCORPORATED)

CHICAGO U S A



GRANITE AS FERTILIZER.—Farmers, everywhere, but especially in New England, know that granite boulders are not good in tilled land. Yet, according to conclusions that have been drawn by government experts from certain experiments, powdered granite may prove a valuable fertilizer.

Granite contains potash, and potash is so good for land that America imports potash salts from Germany at about a hundred dollars a ton. The imported salts contain only twice as much potash per ton as certain granites which, it is thought, may be ground at a cost of \$3 a ton.—Harper's Weekly.

"Caldwell Special"

60 Days
Trial FREE



Prove it on your own premises that it saves time, saves labor and makes money.

The "Caldwell Special" is as clean cut as a race horse. Built right—works right. Simply built—always gives full H. P. Costs little to run—big profit producer to pump water, run cream separator, shred or grind corn and a dozen other things.

Write any or all the 8 Banks of Waterloo as to our responsibility. Sixty day Trial Free. We prove it to you on your own premises at our expense that you cannot afford to do without a "Caldwell Special."

CALDWELL-HOLLOWELL MFG. CO.
514 Commerce St., WATERLOO, IOWA.

This Engine FREE for 30 DAYS

Test it out and prove to yourself it's the best little all-around gasoline engine ever produced. Adapted for all uses in Shop, Farm and Home. We ship complete ready for use. Simply fill in the gasoline—give it a turn and away it goes.

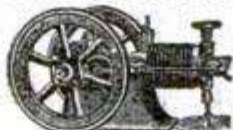

THOMPSON GASOLINE ENGINES

are built on correct lines. Let us send you free book and tell you all about our wonderful 30-Day Free Trial Offer. Write today.

J. THOMPSON & SONS MANUFACTURING CO., 22 Oak St., Beloit, Wis.

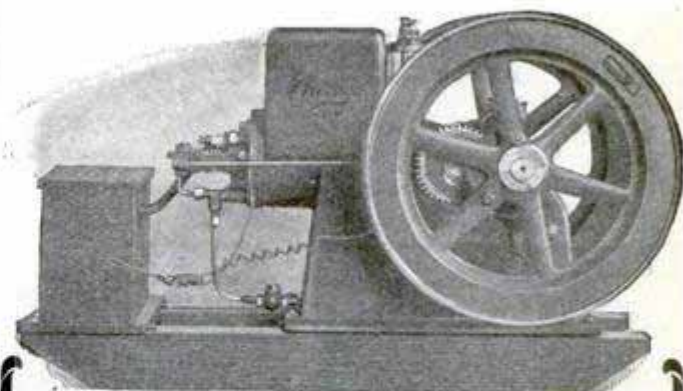

Get Our Price First

Don't buy until you get our Direct from factory prices and catalog describing our line of high grade

CHICAGO GASOLINE ENGINES

You want the best at the lowest cost—investigate the construction simplicity, reliability of the "Chicago"—none better. Save ⅓ usual cost. Sold on Free Trial. Five year guarantee. Sizes 1 to 15 h. p. Write to-day.

COLBORNE MFG. CO., 410 Indiana St., CHICAGO, ILL.

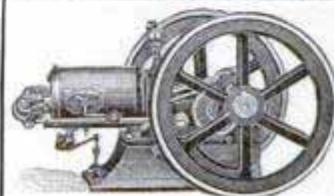

WHICH WOULD YOU RATHER DO

Buy a cheap engine and save \$10 to \$50 in first cost, or buy an ECONOMIZER and save \$50 to \$500 in running expenses? Free Trial.

H. L. CHAPMAN, Box 595, MARCELLUS, MICHIGAN



**MR. GAS ENGINE,
STEAM ENGINE
and MOTOR USER!**

Buy your equipment from the manufacturer and save money

**Pulleys, Shafting, Hangers,
Belting, Gears,
Sprocket Wheels, Chain Belt**

In fact, anything in the line of appliances for transmitting Power, from us

We are the largest Manufacturers of Pulleys in the United States. No order too small for attention. No order too large to execute.

Our Catalog A-18 Shows Our Complete Line

W. A. JONES FOUNDRY & MACHINE CO.

MAIL ORDER DEPARTMENT

1400 North Avenue CHICAGO, U. S. A.



FULLY GUARANTEED Try the engine for 30 days. If you are not satisfied that it is as we represent, return it and we will refund your money. Reversible and entirely controlled by one lever. 3 to 15 H. P. Send postal at once for 1911 Catalogue and Special Offer to Demonstrators.
30 Days' Trial
3 H. P. \$42
Bronze Propeller and Stuffing box included
GILE BOAT & ENGINE CO.
301 Filer Street LUDINGTON, MICH.

5 YEAR GUARANTEE

Price WATERLOO BOY THE PRICE MAKER No other gasoline engine reduced the price of gasoline engines like the **WATERLOO BOY**

Has fewer parts than any other engine. It costs less to make few parts than many parts. Waterloo Boy is made in large quantities. It costs less per engine to make 100 engines a day than 10. That's why we make the under-selling price

Service
Waterloo Boy is Dependable

Always ready to go. No fuss. No bucking. Starts easy in winter. Igniter simple as a pair of scissors. Automatic feed regulation. No bother or expense of a pump. Speed lever works like a throttle on a locomotive. Nearly all parts are interchangeable. If you want satisfaction all the year round buy the Waterloo Boy. Waterloo Boy Lasts. Built of best material by men that know how

Durability **WE DO AS WE ADVERTISE**

Waterloo Gasoline Engine Co.
1021 W. 3. d Ave.,
Waterloo, Iowa.

**This Kerosene Engine
Cuts Your Expenses 75%**

YOU should not even consider engines that operate on gasoline only. The rapidly rising price of gasoline, now 6 to 16 cents higher than kerosene, absolutely makes operation on this fuel too expensive. The Perfection Kerosene Engine operates on any engine fuel. When you purchase it you are on the safe side—proof against all fluctuations of the market. You can always run this engine at a great fuel saving and get the greatest amount of work done. The Perfection vaporizes its own kerosene and so makes it as efficient as gasoline—something other engines cannot do.

The Perfection is very light, portable, has only three moving parts, runs everything about the place, is lower in price than any other engine of its capacity on the market.

PERFECTION Kerosene Engine



Sent You on 15 Days Free Trial

See your dealer at once and ask him to let you have a copy of our **Free ENGINE BOOK** which shows the sizes and styles of the "Perfection" and explains this very attractive offer. Your dealer will send any "Perfection" engine to your farm for 15 days and let you return it if you are not satisfied. Ask him about it. If he does not carry the "Perfection" write to us and we will send you our **Free Engine Book** direct.

CAILLE PERFECTION MOTOR CO.

205 Second Ave.

DETROIT, MICH.

SCENTED TOBACCO.—It would be better, says the London Lancet, in discussing the question of salts in tobacco, if the tobacco manufacturer kept no account with the dry salter and chemist.

"It is pretty certain that if the real demand of the smoker is in favor of a highly-scented tobacco, it matters very little what the quality of the tobacco is. To him tobacco merely serves the role of a smouldering vehicle, his choice of a brand being based upon a scent

**Use KEROSENE
Engine FREE!**

Amazing "DETROIT" Kerosene Engine—shipped on 15 days' FREE Trial, proves kerosene cheapest, safest, most powerful fuel. If satisfied, pay lowest price ever given on reliable farm engine; if not, pay nothing.

Gasoline Going Up!

Automobile owners are burning up so much gasoline that the world's supply is running short. Gasoline is 9c to 15c higher than coal oil. Still going up. Two pints of coal oil do work of three pints gasoline. No waste, no evaporation, no explosion from coal oil.

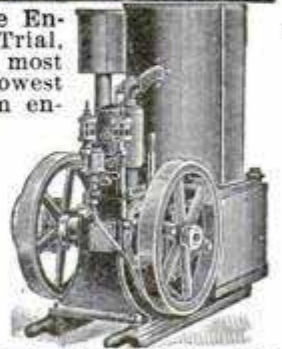

Amazing "DETROIT"

The "DETROIT" is the **only** engine that handles **coal oil** successfully: uses alcohol, gasoline and benzine, too. Starts without cranking. Basic patent—only three moving parts—no cams—no sprockets—no gears—no valves—the utmost in simplicity, power and strength. Mounted on skids. All sizes, 2 to 20 h.p., in stock ready to ship. Complete engine tested just before crating. Comes all ready to run. Pumps, saws, threshes, churns, separates milk, grinds feed, shells corn, runs home electric-lighting plant. Prices (stripped), \$29.50 up.

Send any place on 15 days' Free Trial. Don't buy an engine till you investigate amazing, money-saving, power-saving "DETROIT." Thousands in use. Costs only postal to find out. If you are first in your neighborhood to write, we will allow you **Special Extra-Low Introductory price.** Write!

DETROIT ENGINE WORKS, 213 Bellevue Ave., DETROIT, MICH.

ROBERTS MOTORS THE MOTORS THAT NEVER BACKFIRE

AEROPLANE MOTORS THAT STAND THE TEST

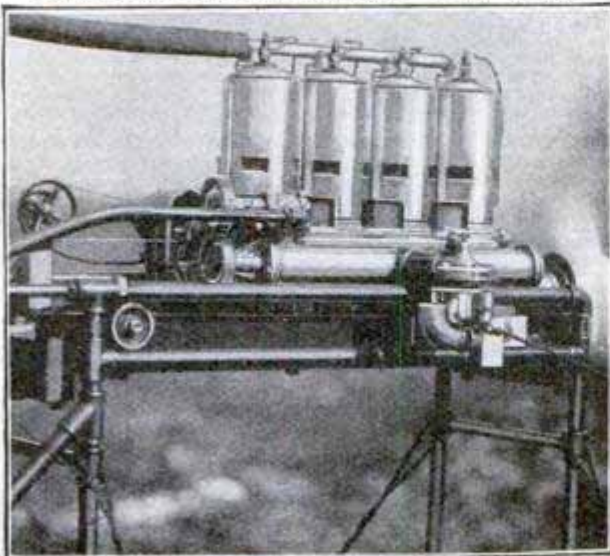

TESTING A 40-50 ROBERTS AERO MOTOR

400 LBS. THRUST AT 900 R. P. M.

Weight complete (NOT STRIPPED) 170 lbs.

Will run indefinitely without heating No vibration whatever
Thrust and weight guaranteed Prompt deliveries
Complete Aero Motor literature mailed on request

MARINE MOTORS THAT SAVE YOU MONEY

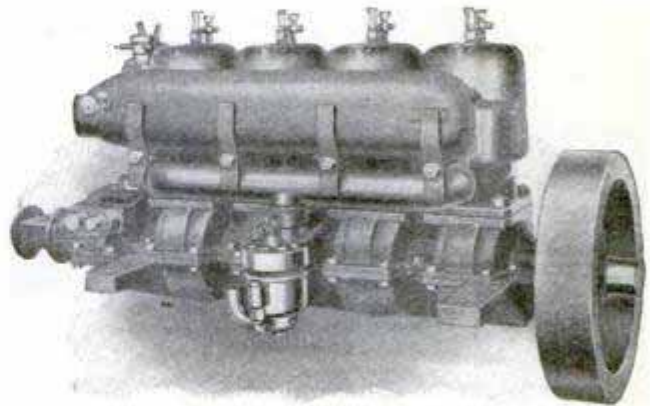

MODEL 4M-20 H. P.

Do not be misled by saving at first cost—consider your repair bills.

ROBERTS MOTORS are strictly high grade. **GUARANTEED FOR FIVE YEARS.** Could we offer such a guarantee on anything but the best grade of material and workmanship?

We acknowledge no superior in economy of fuel, ease of starting, flexibility of control, and sustainment of torque at all speeds.

Made in nine sizes—one to six cylinders—three to sixty H. P.

Write for our Marine Motor catalog. It will interest you.

THE ROBERTS MOTOR CO., 1419 Columbus Ave., SANDUSKY, OHIO.

which is foreign and artificial. Depraved taste may be traced to the action of the trade in the first instance, and to the meek and weak attitude of its patrons.

"The matter is of some importance, because a consideration of it naturally suggests the possibility of foreign materials in tobacco which may give additional

WITTE ENGINES

GAS - GASOLINE - DISTILLATE
Cheapest of all powers. One cent average cost per horse power per hour. Nothing can equal.

FIVE YEAR GUARANTEE

We build all sizes. Hopper jacket or water tank cooling. Inducements to introduce in new localities. Write stating size and style wanted.

WITTE IRON WORKS CO.
1654 Oakland Ave., Kansas City, Mo.

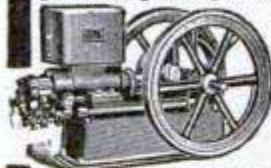

\$50 TO \$300 SAVED

We are manufacturers, not merchants. Save dealers, jobbers and catalog house profit. I'll save you from \$50 to \$300 on my High Grade Standard Gasoline Engines from 2 to 22-H.-P.—Price direct to you lower than dealers or jobbers have to pay for similar engines in carload lots for spot cash.

GALLOWAY

Price and quality speak for themselves and you are to be the sole judge. Sell your poorest horse and buy a **5-H.-P. only \$119.50**

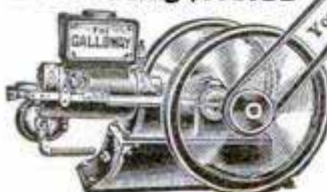

You Can Make From \$5 to \$10 a Day
Direct From My Factory on 30 Days' Free Trial. Satisfaction or money back. Write for special proposition. All you pay me is for raw material, labor and one small profit. Send for my big **BOOK FREE.**

Wm. Galloway, Pres.
Wm. Galloway Co.
1965 Galloway Station,
Waterloo, Iowa.

Boat and Engine Book MAILED FREE

Just like a 30-Footer Do not think of Buying a Launch or Engine until you see our Handsome Book WHICH EXPLAINS FOUR



WONDERFUL LAUNCH BARGAINS

Only \$121 for this complete 16-ft. Launch—3 H. P., guaranteed self-starting Engine, weedless Wheel and Rudder. Result of 30 years' experience. Money back if not as represented. Write for free catalog today. Special Bargains in **Weeco** reversible, self-starting engines to those building or buying their own hulls. Engine controlled by one lever.

C. T. WRIGHT ENGINE CO.
610 Canal Street GREENVILLE, MICH.

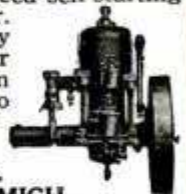

FOOS Gas, Oil and Gasoline ENGINES

embody an ignition system more positive than any other engine on the market. Electrode points cleaned by the wiping action of the revolving igniter, throw a spark many times hotter and stronger than is possible to obtain from an ordinary make and break contact.

Full description of this igniter in addition to many other exclusive Foos features given in catalog 50.

The Foos Gas Engine Co.
SPRINGFIELD, OHIO
Largest Exclusive Factory in America



This Magnificent Steel Launch



Stylish 16-Footer Fully Equipped with Engine Ready to Run!

\$96

1911 models of the Michigan Steel Launch are now ready for delivery at the lowest prices quoted on boats anywhere. Our special low price schedule for immediate orders covers every launch we make—16, 18, 20, 23 and 27-footers. All sizes in stock for immediate shipment. We are the sole owners of patents covering rolled-seam constructed boats. This construction lasts practically a lifetime. We have the only construction trip. Colorado and Arizona. Write for booklet describing trip. Gold medals awarded our Boats and Engines by Royal Imperial Tech. Society, St. Petersburg; Internat'l Exposition, Milan; Nat'l Motor Boat Show, Paris.

that has successfully made the terrific trip through Grand Canyons of Colorado and Arizona. Write for booklet describing trip. Gold medals awarded our Boats and Engines by Royal Imperial Tech. Society, St. Petersburg; Internat'l Exposition, Milan; Nat'l Motor Boat Show, Paris.

Equipped Bow and Stern with Air-Tight Compartments. The Non-Sinkable Boat—Absolutely Safe! Needs No Boathouse

Leave your Michigan Launch in the water or out on the beach in all kinds of weather for months. It is puncture-proof. Equipped with the wonderful Detroit Engine, guaranteed for five years, any horse-power from 2 to 50. Fewest moving parts of any engine made. Anyone can run it. Free fully illustrated catalog shows all 1911 models. Don't buy a launch until you see this book. Write for special proposition and prices to Demonstrator Agents. **STEEL ROWBOATS, \$20.** Need no boathouse. Big money in boat livery.

MICHIGAN STEEL BOAT COMPANY, 1271 Jefferson Avenue, Detroit, Michigan, U. S. A. (77)

\$40 2 H.P. COMPLETE

With fittings, including propeller and shafting, stuffing box, wiring, etc.

Ready to install in your boat



This is a powerful engine for High Speed Boats, complete with all fittings. Absolutely Reliable. Extra Power and Extra Wear. Compact, Silent, Low running cost, Perfect two-cycle, reversing engine. 2 Year Guarantee. So simple a woman or child can run it. Used in Government Harbor Service and Chicago Police Boats.

3, 4, 5, 6, and 10 H.P. Prices Are in Proportion Special Prices to Boat Builders and Agents

Our Engine Book No. 12 E. contains valuable facts about Marine Engines and describes complete line.

FREE ON REQUEST

NORTHWESTERN STEEL & IRON WORKS, 707 Spring St., Eau Claire, Wis.

STRELINGER MARINE ENGINES BUILT EXPRESSLY FOR HARD SERVICE

For more than twelve years "The Strelinger," the old reliable 4-Cycle Marine Motor, has stood for the best in Marine Gasoline Engines. A distinct success. The most Durable, Reliable and Economical Marine Motor made. The Engine that always makes good, because it is built right. Famous for endurance. Customers who bought the first Engines write: "It is as good today as the day it was purchased. It always goes and never gives any trouble; have not spent a dollar for repairs." That is the Engine you want. We also manufacture the "Little Giant" 2-Cycle Marine Motors. Customers who have used these Motors for the past seven years say, "They are the best 2-Cycle Gas Engine made." We can furnish you anything you want from 1 1/2 H.P. upward, 2 or 4-Cycle, Marine or Stationary. Send for our 1911 catalog, which tells you all that is new about Marine Motors; also how to avoid trouble and save money on your Marine Engine outfit.

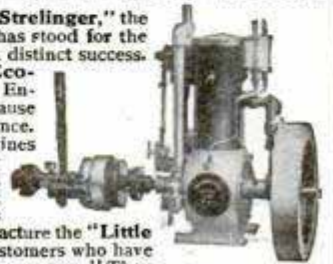

THE STRELINGER MARINE ENGINE CO.
Manufacturers of Marine and Stationary Gas Engines
171-173-175 Woodbridge St. West, DETROIT, MICHIGAN, U.S.A.

risks to the smoking habit. The word adulteration may be objected to, but it is difficult to avoid its use, in view of the fact that large quantities of foreign scents, besides oils, glycerine, formaldehyde, or other preservatives, are added to tobacco."

BAY STATE MOTORS

"Perfect Simplicity" and "Simple Perfection" are the results, embodied in these Motors, of 15 years devoted to the developing of these essential characteristics, which enable us to put on the market a reliable and economical motor at a reasonable price. Write for catalog, stating size and type (2 or 4 cycle) of motor wanted. We also furnish casings for these motors.

BAY STATE MOTOR WORKS
Successor to
A. J. HOULE MOTOR WORKS
580 South East Street, HOLYOKE, MASS.

FERRO MARINE ENGINES \$60 AND UP The Engine that Mastered Niagara

THE World's Standard Two-cycle Marine Motor. Ten sizes; one, two or three cylinders; 3 to 25 horse power. High-tension magnet; new idea in carburetor; many other advantages.

1911 Catalog The Ferro Machine & F'dry Co. all models, 18 Hubbard Ave., Cleveland sent free Agents in Principal Cities and Ports.

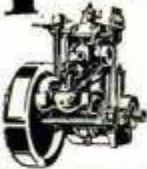

FAMOUS MICHIGAN SPEED WHEELS REVERSE GEARS & MARINE HARDWARE



MOTOR BOAT MEN Send for our large catalog of valuable information on speed wheels, reverse gears and marine hardware. Everything new and up-to-date.

Prices Right. Satisfaction Guaranteed
We carry an immense stock and can make you prompt shipments and save you money. Send for our free catalog today
MICHIGAN WHEEL COMPANY
565 Canal Street, GRAND RAPIDS, MICHIGAN

Get This Power Boat at Maker's Prices
Buy Direct from Manufacturer and Save Dealers' Profits



This Toppan Power Dory as illustrated above is made of best guaranteed materials and is the standard rough water boat of the world. Safe and reliable—used by U. S. Government in all departments. Send stamp for circular. Ask for prices and facts about Toppan Reversible Motors, built with 2, 3, 5, 8 and 12 Horse Power—and if you want to build your own dory saving exactly HALF, ask for FREE KNOCK-DOWN BOAT QUOTATIONS. PRICE \$150 AND UP. SIZES 16 FT. AND UP. PROMPT DELIVERY

TOPPAN BOAT MFG. CO.
3 Haverhill St. BOSTON, MASS.

Baldrige Reverse Gear Doubles the Pleasure of Motor Boating

Move a single lever and your boat goes forward, backward or stops just as you please. Engine keeps running. Makes motor boating safe. Nearly 6,000 in use.

WRITE FOR DESCRIPTIVE BOOKLET
SMITH & BALDRIDGE MACHINE CO., 62 Amsterdam Avenue, DETROIT, MICHIGAN



ELECTRIC WHISTLES

and horns for motor boat, automobile, factory and fire alarm use. Searchlights, dynamo and other accessories at low prices.

SEND FOR CATALOGUE
THE EDGAR MFG. CO.
104-5 Hanover St., Boston, Mass., U.S.A. \$8.75

OUR CATALOG No. 1

SCRIPPS MOTORS

Q We all get it—the “speed bug”—at one time or another; there's a certain fascination in matching boat against boat, engine against engine, and skill against skill.

Q And when you see that you are going ahead inch by inch, and finally show a clean pair of heels to the entire “bunch,” you wouldn't trade places with a king on his throne.

Q An engine that is built right—like the Scripps—needs little handling. It has the smooth, unerring precision of stroke that is characteristic of the highest type of automobile engine. It responds to your slightest wish, and puts forth all its power with apparently no effort, no straining or racking of its parts.

Q The success that so many well-known boats and racing men have had with the Scripps is pretty complete proof that it has not only speed and power, but unusual reliability and efficiency.

Q If you will send for our New 1911 book and read it; if you will go to the nearest Scripps dealer and look at the engine yourself, you will understand why so many experienced motor boat owners “swear by” the Scripps.

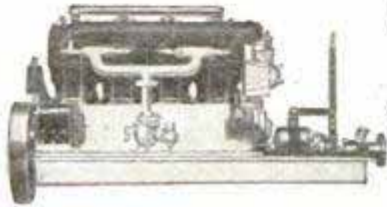

SCRIPPS MOTOR COMPANY

650 Lincoln Ave.
Detroit, Mich.

HOW STAMPS ARE GUMMED.—Officials of the Bureau of Engraving and Printing at Washington aver that one of the most delicate operations connected with the manufacture of our postage stamps is the gumming thereof.

When the sheets have been printed they are passed under a roller, from which they receive a thin coating of gum, and then gradually over coils of steam pipes until they are dried. Much care is exercised to get the layer uniform on every part of the surface.

The gum in the little vats, from which it drops to



TOLEDO MOTORS HIGH QUALITY, LOW PRICE!

6 H. P., complete, \$ 84.00
12 H. P., “ 155.00
18 H. P., “ 250.00

2 cycle, 2 port, 4½" x 4½"

SEND FOR CATALOG “C” AT ONCE

Universal Machine Co. Palmwood Ave. TOLEDO, OHIO

Make a Motor Boat of Any Boat in Five Minutes



You can do it with the Waterman Out Board Motor, which you can quickly attach (and detach) to the stern of any skiff, rowboat, dinghy, punt, sail boat, and have a good motor boat. It is not a toy, but a reliable 2 H. P. Marine Motor that will drive an 18-ft. rowboat 7 miles an hour, 4 hours on one gallon of gasoline. Simplest motor made. Weight 40 lbs. Six years successful results behind it. Canoe and larger motors—light weight models K and B

—LIFE GUARANTEE.

WATERMAN MARINE MOTOR CO.
1507 Fort St., West, DETROIT, MICH., U. S. A.

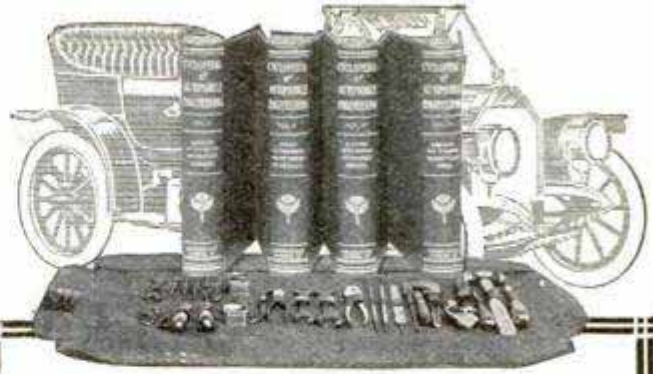

Everything About an Auto

No matter how fine the car you own, or drive, or manufacture; no matter how thoroughly it is equipped, your outfit is not *complete* unless you own the new

Cyclopaedia of Automobile Engineering

Four large, handsome volumes bound in half morocco, 1200 illustrations, full-page plates, diagrams, etc., 1500 pages, 7x10 inches, crammed with interesting and very necessary information concerning automobiles, aeroplanes, and motor boats; knowledge that you've got to get some way or other before you can thoroughly understand or enjoy the automobile “game.”

CONDENSED TABLE OF CONTENTS

VOL. I—GASOLINE AUTOMOBILES: Running Gear, Power, Operation, Repair. **AUTOMOBILE MECHANISMS:** Carbureters, Starting Devices, Clutches, Gears, Brakes.

VOL. II—STEAM AUTOMOBILES: Flash Boiler, Engines, Operation and Repair. **COMMERCIAL VEHICLES:** Selection, Delivery Trucks, Upkeep, Mileage, Capacity. **TYPES:** Selection, Price, Demonstration, Speed.

VOL. III—ELECTRIC AUTOMOBILES: Battery, Motor, Transmission, Control, Tires, Capacity, Driving. Elements of Electricity. Electric Current. **AUTOMOBILE DRIVING:** Starting and Stopping, Gear Changing, Use of Spark and Throttle, Care of Car, Road Repairs.

VOL. IV—AERIAL NAVIGATION: Dirigible Balloons, Aeroplanes, Airship Motors. **GAS AND OIL ENGINES:** Ignition, Testing. **MOTOR CYCLES:** Construction, Operation. **MOTOR BOATS:** Types, Engines, Installation.

Read This Free Examination Offer

You can examine these books for five days in your own home or office, free of all cost. Don't risk missing this offer by stopping to think it over now. Order now and do your careful thinking with the books before you. That costs nothing. Mail the coupon.

Here's Our Liberal Selling Plan

If you like the books after examination, send us \$2.00; then \$2.00 a month until the special price of \$12.80 is paid. If they are not satisfactory, advise us and we will have the books returned at our expense. Order promptly, and we will include for one year, as a monthly supplement, the **TECHNICAL WORLD MAGAZINE**, a regular \$1.50 monthly, full of interesting scientific topics written in popular form.

AMERICAN SCHOOL OF CORRESPONDENCE CHICAGO, U. S. A.

FREE EXAMINATION COUPON

American School of Correspondence:

Please send set Cyclopaedia of Automobile Engineering for 5 days' free examination; also Technical World for 1 year. I will send \$2.00 within 5 days and \$2.00 a month until I have paid \$12.80 for books and magazine; or notify you and hold the books subject to your order. Title not to pass until fully paid. Pop. Mech. 5-'11

NAME

ADDRESS

OCCUPATION

EMPLOYER



MULLINS Steel Motor Boats

are *puncture proof*. Have hulls of steel plates. Find out about these wonderful boats. You'll be surprised at the values for the money. Mullins boats *can't sink*—can't leak, or warp, waterlog, crack, split, dry out or open at seams. Motors *simple, powerful*, won't stall—start like auto—**ONE MAN CONTROL**—famous Mullins Silent Under Water Exhaust—12 models, 16 to 26 ft., 3-30 h.p.

boats *can't sink*—can't leak, or warp, waterlog, crack, split, dry out or open at seams. Motors *simple, powerful*, won't stall—start like auto—**ONE MAN CONTROL**—famous Mullins Silent Under Water Exhaust—12 models, 16 to 26 ft., 3-30 h.p.

THE W. H. MULLINS CO.
151 Franklin Street,
SALEM, OHIO.



Complete line of Row Boats and Duck Boats—\$22 to \$39

Handsome Boat Book—Free

Handsomest, most interesting boat book ever printed, profusely illustrated in colors. All the details and descriptions of noted Mullins line. Low prices this year will astound you. Investigate. Send to-day for *free book*.



WATKINS' SPECIAL MOTORS

3 H. P. Single Cylinder . . . 30 lbs.
6 H. P. Double Cylinder . . . 60 lbs.
12 H. P. Four Cylinder . . . 100 lbs.
A strictly HIGH GRADE Motor that will give **CONSTANT** and **EFFICIENT** service. Especially adapted for **CANOEES** and **LIGHT BOATS**. Aluminum base, copper water jacket, steel shaft, bronze bearings.

THE WATKINS MOTOR CO.
837-839 West Sixth Street CINCINNATI, OHIO

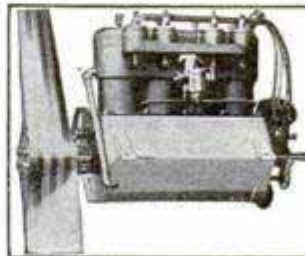

The AEROMOTOR

The most compact, powerful and light aeronautic power plant built; 4 and 6 cylinders—4-cycle—30 to 75 H. P.

Detroit Aeronautic Construction Co.
76 Crane Ave., DETROIT, MICH., U. S. A.

"Runs Like A Scared Rabbit"



Writes Cleburne Grady, Montgomery, Ala., who while yet a green hand at motors averaged 12.52 miles per hour on a 8.63 mile river trip.

Perfection Marine Motor

The "Perfection" is so worthy of the name it needs little attention. Just a regular flow of gasoline and a good spark will keep it working on hard towing, ferrying or pleasure jaunts—and it will last as long as Write for catalog.

GAILE PERFECTION MOTOR CO., 105 Gaile St., Detroit, Mich.

Send for our Stationary Kerosene Engine Catalog if interested

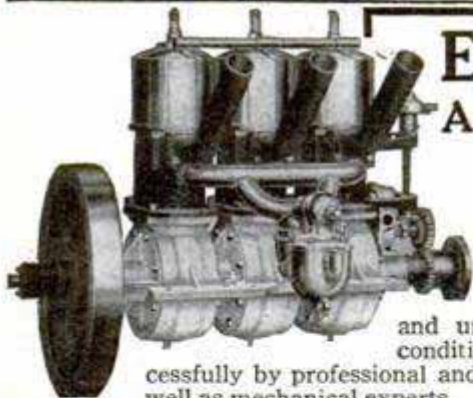

Elbridge Aeronautic Motors

Hold every novice record made in 1910. Have flown every standard type of aeroplane, and under all climatic conditions. Used successfully by professional and business men as well as mechanical experts.

"American Amateur Aviation" is a history of Amateur achievements in 1910. Sent postpaid for six cents.

ELBRIDGE ENGINE COMPANY, 62 CULVER ROAD, ROCHESTER, N. Y.

the roller, is maintained at an even temperature and thickness. Tests are frequently made of the warmth and humidity of the work room.

But even with the perfection of mechanical exactness, some allowance must always be made for the season of the year. For summer sale a slightly harder gum is used, because of the trouble occasioned by the sticking together of stamps. In winter precaution against the cracking of the gummed surface through contraction is necessary. A third grade of the material for other seasons is known as "intermediate."—New York Times.

Make money in spare time

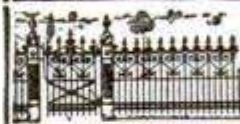

Selling Stewarts Iron Fence, Vases, Settees, etc. Liberal proposition to right persons.

THE STEWART IRON WORKS CO., Cincinnati, Ohio
169 Page Catalog *S FREE*,

5 Years' Absolute Guaranty On this Wonderful Detroit Marine Engine

You Are the Only Judge of the engine and its merits. 25,000 satisfied users. Material and workmanship guaranteed for five years.

Greatest Engine Bargain Ever Offered!

Fewest moving parts of any practical engine on the market. Nothing complicated or liable to get out of order. Only three moving parts. Extra long plastic white bronze bearings. Vanadium steel crankshaft. Adjustable steel connecting rod. All bearing surfaces ground. French gray iron castings. Water-proof ignition system. Runs at any speed from trolling to racing.

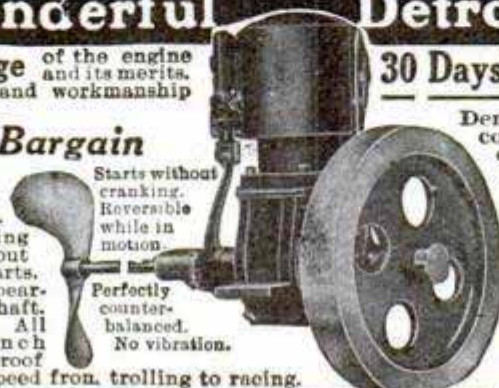

Starts without cranking. Reversible while in motion. Perfectly counter-balanced. No vibration.

30 Days' Trial

Try the engine for 30 days. If you are not fully satisfied, return it and we will promptly refund all money paid us.

Demonstrator Agents wanted in every boating community. Special wholesale price on first outfit sold. Single cylinder, 2-3 h. p. Double cylinder, 8-20 h. p. 4-cylinder, 20-50 h. p. Thoroughly tested before shipment. Comes to you complete with boat fittings and ready to run. Write for free catalog, testimonials and details of the **greatest protective guaranty ever offered**. Suitable for any boat from canoes to cruiser. Also railroad track car. All sizes in stock ready to ship. Write today for our wonderful demonstrator offer. [74]

DETROIT ENGINE WORKS
1271 Jefferson Avenue, DETROIT, MICH.

DIAMONDS WATCHES

ON CREDIT

Big Bargains

\$48



No. 253
Ladies' Diamond Ring,
Loftis "Perfection" mount-
ing. \$4.80 a Month.

Write for our handsome 100-page Catalog containing over 2,000 illustrations of Diamonds (new, exclusive mountings, our own designs) Watches, Artistic Jewelry, Silverware, Novelties. Every article priced 10 to 20 per cent. lower than others charge for equal value. We are direct importers and give our customers every advantage. Let us send you a fine Diamond or Watch on approval, all charges prepaid. If satisfactory, keep it and send us one-fifth of the price, balance in eight equal monthly amounts. Great bargains in ladies' and gentlemen's Watches. We give better values and better terms than any house in America. Send for our booklet, "Historic Diamonds." It is free. Write for Catalog today.

\$72



No. 254—Handsomely carved fine Diamond Ring. \$7.00 a Month.

LOFTIS THE OLD RELIABLE ORIGINAL DIAMOND AND WATCH CREDIT HOUSE
 Dept. E 173, 92 to 98 State St., CHICAGO, ILL.
 BROS & CO. ESTD 1858 Branches: Pittsburg, Pa.; St. Louis, Mo.

"The Water Does the Work— the Air Does the Cleaning"



Investigate this wonderful PRESTO VACUUM CLEANER. Look into the matter thoroughly so you will not confuse it with so-called cleaners on the market that are three and four times as costly. Consider this really SANITARY system and you will equip your home with no other kind.

THE PRESTO takes the dust, dirt and disease germs AWAY from the home and puts them into the sewer where they belong. A mighty important feature. No emptying bags or boxes of bacteria-laden dirt. No dusting necessary. Cost of operating THE PRESTO is less than one cent per hour. Cleaners guaranteed for 10 years.

PRESTO Stationary Cleaners installed in your home (see cut) AT \$50 AND UPWARDS, according to piping required. We also manufacture PORTABLE cleaners that can be attached to any kitchen bib, at \$30.00 complete with fifty feet of one-inch vacuum hose, and five cleaning tools. Write to-day for full information.

PRESTO CLEANER CO.
Office 114-116 Colonnade Bldg., Toledo, Ohio

BUY IN NEW YORK

We Pay the Freight

Buy in New York of the oldest Mail Order House in America and save 25 to 40 per cent. on everything you use, eat or wear. Our Mammoth Catalog containing 75,000 reliable articles for the Home, Farm and Shop, sent free on request. Write to-day.



WHITE, VAN GLAHN & CO.
Oldest Mail Order House in America. Est. 1818
30 Barclay Street, NEW YORK CITY

Auto Craft



18 FT. SPECIAL \$200
A trim, fast, handsomely equipped pleasure launch that is dry, safe and seaworthy. Length 18 ft., beam 4 ft. 6 in. Seats 8 persons comfortably. Speed 8 miles an hour. Equipped with Ferro 3 H. P. engine. Metal air chambers (like a life-boat) insure absolute safety. Auto Craft silencer eliminates all noise. Has outboard gasoline drain.

Write for Free Folder or send 10 cents postage for Big Boat Catalog

of complete line of craft, including 21 1-2 ft. Auto Craft Special (4 H. P. Ferro and Reverse Gear) \$450; 25 ft. Gentlemen's Runabout (11 H. P. Ferro) \$775. Dealers in All Large Cities.

THE CLEVELAND AUTO BOAT MANUFACTURING CO., 1048 River Ave. N. W., Cleveland, Ohio, U. S. A.

FISH THAT SHOOT FLIES.—In Queensland some of the most interesting forms of animal life are to be found. The duck-billed platypus (with the web feet of a duck, which lays eggs and suckles young), the lung fish, the walking perch and many other queer creatures might be mentioned in confirmation of this. A remarkable little fish is the rifle fish, which lives in the far northern rivers of Queensland. A full-grown specimen, writes a correspondent, measures about ten

TYPEWRITERS ALL MAKES



Extra Special No. 3 Olivers, rebuilt, good as new, \$42.50 cash or \$45.00 on installments, easy terms. All other Standard Machines, including Visibles, at equally low prices. Bargains in No. 2 Smith Premiers, Fay Shoes, etc.

PRICES: \$15.00 AND UP
5 days free trial or rented, rental to apply on purchase. Send for Catalogue. Address

ROCKWELL-BARNES COMPANY, 127 Munn Bldg., CHICAGO

Own a Home Bench

Month after month, year after year we have talked home benches to the readers of Popular Mechanics. Hundreds have purchased—dozens more are purchasing each month. Does that suggest anything to you?

Style here shown has three roomy drawers and a cupboard for tools, etc. Two vises. Solidly and sturdily built and smoothly finished. Made of best maple. Will last for years. Send today for catalog of all styles and prices. It's free and interesting.



GRAND RAPIDS HAND SCREW CO.
620 N. Front St., Grand Rapids, Mich.

Gile Launches

"Made in the Heart of Motor Boat Country"

THE finest type of small boat architecture. Classy design; great speed; ample power, assured safety; low cost; expert build; dependable, reversible engines; greatest possible roominess, buoyancy and seaworthiness. Dry in roughest weather. 16, 18, 20, 26-foot models.

Hulls of seasoned timber, stoutly built and sheathed inside. Clean-cut from stem to stern. Brass deck hardware. Driven at high speed by the famous 2-cycle, non-cranking Gile Engine—positively reversible—controlled by one lever. 3, 5, 6, 10, 15 horsepower. Engines and boat equipment sold separately. Drop us a postal TO-DAY for the handsome, money-saving free catalogue. **Special 16-ft. Launch, \$87.**

GILE BOAT & ENGINE CO., 301 Main St., Ludington, Mich.

(This is the 16-foot Ideal)



BISHOPRIC WALL BOARD AND SHEATHING

SAVE MONEY, TIME, AND LABOR IN BUILDING

BISHOPRIC WALL BOARD is cheaper and better than lath and plaster. Easily nailed to studs. Applied dry, it is ready at once for paint, paper or burlap—inexpensive or artistic decoration. Made of kiln-dried, dressed laths, imbedded in Asphalt Mastic, insuring a solid, substantial covering for



Walls and Ceilings

Will not shrink, warp or crack. Clean, odorless and sanitary. Guaranteed proof against dampness, heat, cold, sound and vermin. Used for finishing new buildings of every description; also for partitions, attics, cellars, porches, laundries, garages. It is the original Wall Board, construction patented.

BISHOPRIC SHEATHING is made of same materials as Wall Board, but is nailed smooth side to studs with laths and asphalt exposed.

SAVES 75 PER CENT

in material and labor. Does away with building paper. Makes smooth, solid job. Proof against heat, cold, dampness and vermin. Used under weather boards, flooring and ready roofing or cement; also as lining for barns, poultry houses and other out-door buildings. Houses finished with Bishopric Wall Board and Sheathing are ready for immediate occupancy. Write today for prices and

FREE Booklet and **SAMPLE** of *Bishopric Wall Board*, *Bishopric Sheathing*, *Bishopric Ready Roofing*

Dealers write for attractive proposition

The Mastic Wall Board & Roofing Mfg. Co., 60 East Third St., Cincinnati, O.

MAKES A PHONOGRAPH SOUND LIFE-LIKE

The Morse Clarifier

THIS remarkable little device is made to fit in tube between reproducer and horn of phonographs, renders the sound loud, clear

and life-like and eliminates that unpleasant metallic effect which is more or less common to all phonographs regardless of price. Can be attached in a minute—lasts as long as the machine. Thoroughly tested and proven successful. Mailed Prepaid upon Receipt of Price, \$1.00. Guaranteed Absolutely Satisfactory or Money Refunded.

In ordering please state whether for Victor, Victor Victrola, Edison with metal or rubber connection, Columbia Disc with new or old style tone arm or Columbia Cylinder. Information and circular matter free. MORSE BROTHERS, Manufacturers and Distributors, 450 Lumber Exchange, Minneapolis, Minn.



Best grade cedar canoe for \$20

We sell direct, saving you \$20 on a canoe. All canoes cedar and copper fastened. We make all sizes and styles, also power canoes. Write for free catalog giving prices with retailer's profit cut out. We are the largest manufacturers of canoes in the world. **DETROIT BOAT CO., 156 Bellevue Ave., Detroit, Mich.**

A Postal Brings Grand Free Millwork Catalog 5,000 Bargains in Building Material!

Send at once for the great Catalog of 5,000 Bargains in the highest grade Guaranteed Millwork and Lumber. Issued by the Largest Building Material Plant in America. Buy Doors, Windows, Mouldings, Stair and Porch Work—everything you need to build, remodel or repair—at 50 per cent saving! Quality, Safe Delivery and Satisfaction Guaranteed. (38) **GORDON-VAN TINE CO., 2577 Case Street, DAVENPORT, IOWA**

OVER \$400 Made in One Day Operating the



CIRCLING-WAVE AMUSEMENT DEVICE Read this

Armitage & Guinn; At Esqerton, Ind., away back from no place we got in \$360.00 in six hours' run. At Crawfordsville, Ind., we had a \$402 day. BOOHER BROS.

IF BOOHER BROS. DID THIS, WHY CAN'T YOU?

Let us tell you all about this marvelous CIRCLING WAVE, and its wonderful money-making power. Address.

ARMITAGE & GUINN, 34 Mill St., Springville, Erie Co., N.Y., U.S.A.

inches in length and averages 1 1/2 lb. in weight. The rifle fish derives its name from the fact that it shoots its food. It swims leisurely about the stream a few inches below the surface and is always on the lookout for flies and other insects that settle on the surface of water plants. On getting close enough to its victim it discharges a tiny jet or ball of water, which if shot straight, knocks the fly into the stream, where it is instantly gathered in by the shooter.—London Globe.

Krotanna Kloth THE PERFECT ABRASIVE

Emery Cloth that can be washed and used repeatedly. Nothing like it for scouring and polishing household utensils, farm tools, etc., and for mechanics' use. Not affected by water or oil. **Sample package 4 grades, 10 cents.**

AGENTS WANTED

G. W. HOPPING, 127 Duane St., NEW YORK CITY

DIAMONDS

ON CREDIT

\$37.50



\$7.50 CASH \$3.75 PER MONTH

With confidence we offer these perfect blue-white Diamonds at a price that cannot be duplicated—our guarantee goes with each sale—all goods sent prepaid for inspection—10% discount for cash. Send for catalogue just issued No. 3 (Established 1843)



\$7.50 CASH \$3.75 PER MONTH

J. M. LYON & CO. 71-73 NASSAU ST. NEW YORK

\$50 to \$150 a Week

Now Earned by Operators of Our
Hot Lunch Cars
and Ice Cream Cone Wagons

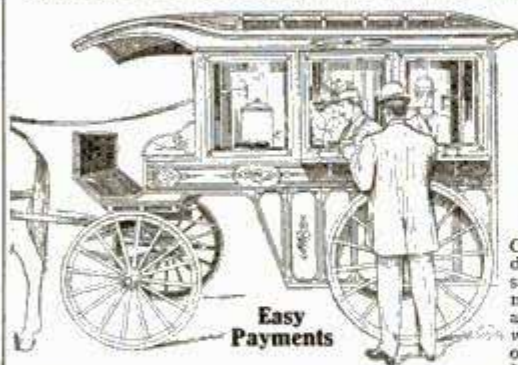

With or Without
Peanut and Pop-
corn Equipment.

\$225
\$300
\$500

Our free catalog describes how to start a big money-making business, and tells of the wonderful success others are having. Explains our easy

payment plan—write for it today. Our Combination Lunch and Ice Cream Cone Wagons offer an exceptional opportunity for men with small capital. They are equipped with air pressure gasoline supply tank, 3-burner stove, light fixtures, coffee urn, hamburger pan, red-hot boiler, waffle and ice cream cone irons. Peanut and Popcorn equipment. A small cash payment with order and balance in monthly installments.

ALLIANCE MFG. CO.

114 Main Street,

STREATOR, ILL.

LYON & HEALY

30-89 ADAMS STREET, CHICAGO

will mail, free, their newly enlarged Catalog of Band Instruments, Uniforms and Equipments. Hundreds of Fine Illustrations describing every article required by Bands or Drum Corps, including Uniforms, Trimmings, etc. Contains instructions for Amateur Bands, Exercises and Scales, Drum Major's Tactics, By-Laws, Selected List of Band Music



KING'S GLOVE HAND.—It is not generally known that King George's custom of appearing with his right hand gloved and the other bare has its origin in something more than a mere whim of fashion. The wearing of a glove on the right hand by a monarch is a distinct survival of the days when the sovereign's touch was held to be a certain cure for all kinds of diseases, especially scrofula.

In the days when at certain dates it was cus-



"C. Q. D." A complete wireless receiving station for \$1.50, sent Postpaid. **Not a toy. We ABSOLUTELY GUARANTEE** that you can catch wireless messages up to 300 miles. Over 500 gov't and com' wireless stations in U. S. One is near no matter where you live. Catch the messages. Outfit comprises: The famous "Electro" Lytic Detector, 75 Ohm tel. receiver, wiring, directions and list. Send 4c stamp for Electric Cyclopedic Cat. containing valuable information. **"EVERYTHING FOR THE AMATEUR."**

French-Amer Wireless & Novelty Co., 31 E. West 125th St., New York

12 Art Panels 50c.

Beautiful Duo Tint Reproductions of Famous Paintings—Panel Size 7x10

These pictures are real gems—the most exquisite portrayals of

"WOMAN BEAUTIFUL"

ever shown in one collection. We send a full set of 12 in handsome Art Portfolio, packed flat and safe delivery guaranteed, together with catalogue of 70 other beautiful and catchy den pictures, for only 50c coin, money order or U. S. Stamps. **SEND AT ONCE. MONEY BACK IF NOT SATISFIED.** Or send \$1.25 for same set hand-colored. (Price of catalogue alone 10c.)

Florentine Art Company
DEPT. U5, 2009 PRAIRIE AVE., CHICAGO, ILL.

FREE Order panels at once and we will include "Free" a beautiful den picture in colors



Camp Guide

Sent

FREE!



Just your name and address on the Coupon below brings

you the new 1911 edition of our famous Camp Guide, absolutely free. The most practical book on camp life ever written. Gives you practical information written by experienced men who have spent years in camps in every part of the country. **This camp guide tells you everything you need to know about camping—** it tells you how to camp successfully and enjoyably—gives you the information that you could not possibly secure otherwise except by actual and often disagreeable experience.

Get Ready NOW for Your VACATION!

The time for planning is growing short. **Go camping.** You cannot find a more healthful or enjoyable way of using the time at your disposal.

But when you do go—go right! Send for our new Camp Guide and Catalog the first thing you do. You will find listed and described the largest line of Tents, Camper's Supplies, Sails and Canvas Specialties carried by any manufacturer in the United States. **We sell direct from our huge factories to you.** You are sure of getting the **very highest qualities** it is possible to obtain at **less** than you would have to pay at retail for decidedly inferior goods.

Look at these Wonderful



Values

This 7x7 ft. Wall Tent, made of the very best quality 8-oz. Single Filling Duck, cut and made with the most extreme care.

A simply astounding bargain at only **\$5.45**



Family Compartment Tent, 9x16½ ft.

Made of the best selected quality of 10-oz. Double Filling Duck. May be divided into rooms for eating and sleeping to suit convenience. Insures

absolute privacy. The ideal tent for family or small party. **Specially priced at only \$22.50**

Now Write for our FREE Camp Guide and Catalog—

don't bother with a letter—just your name and address on the attached coupon will bring you this great book by return mail. Whether you intend going camping this year or not, you should be sure to get this free book at once. You should certainly get our lowest prices, our bed-rock factory prices, on the very finest line of canvas specialties and camper's goods that it is possible to produce.

H.Channon Company,

Department 1195

Market and Randolph Streets

Chicago, Ill.

Don't Bother with a Letter

Send the coupon for this FREE book today

H.Channon Company,

32 Market Street

Dept. 1195

Chicago

Gentlemen.—Kindly forward me free, postpaid, your new 1911 Catalogue and Camp Guide

Name _____

Address _____

No letter necessary; just send the coupon

Please Mention Popular Mechanics

AGENTS A MODERN BATH EQUIPMENT SALESMEN \$6.50

Stoneman received \$1,200 for one month's work, \$15,000 in three years selling—

with hot and cold running water facilities all for

\$6.50



M. Stoneman

Proven by sworn statements—investigation—any proof you want. He writes: "Best thing ever sold. Not one complaint from 2,000 customers." Zimmerman, Indiana Farmer, orders total \$13,245 in 110 days, \$30,000 in 9 months.

NEW INVENTION reduces cost of modern bathing facilities from \$100 to \$6.50—abolishes plumbing, water works, water systems. Installed instantly, without tools, pipes, by anyone. Turns any room into a bathroom with hot or cold running water. Supplies any home with **cleansing, friction, massage, shower baths.** Makes bathing 5 minute operation. So energizes water, very little does wonders. Cleanses almost automatically. No more drudgery, annoyance, muss of lugging water, filling tubs, emptying, cleaning, putting away. **G. Chase, N. Y.,** writes: "Gives advantage of bathroom in any part of the house." **J. Phar, Mont.,** "Makes a modern house on the farm." Thousands tell same story of praise and satisfaction. **Used by U. S. Government.**



R. V. Zimmerman



Allen's Wonderful Bath Apparatus costs but \$6.50, yet does the work of this \$150.00 Bathroom.

AGENTS, SALESMEN, MANAGERS could anything be easier, better to sell than a **modern bath equipment for only \$6.50!** Think of millions who have no bathing conveniences, who would jump at the chance to modernize their homes for \$6.50! No wonder agents without previous experience make small fortunes. **C. A. Korstad, Minn.,** orders total **\$2,212.00 IN TWO WEEKS**

O. Schleicher, Ohio, (Minister) sold 30 Outfits first 12 hours. (Profit \$81.90). **A. Wilson, Ky.,** sold 102 in 14 days. (Profit \$278.40). **J. Hart, Texas, 16 in 3 hours.** Langdon, N. Dak., \$115 worth first day. Reese, Pa. (carpenter) solicited 60 people—sold 55. Spare time gave **Oviatt (Minister) Iowa, \$800 in 11 days, \$4,000 to date.** Reader! These results possible for you at home or traveling. **Make \$8,000 this year.** Don't hesitate—be first—get exclusive rights. **Previous experience unnecessary.** What a winner! A modern bath equipment with running water, hot and cold, for \$6.50, not \$100.

FREE SAMPLE, CREDIT, LIBERAL TERMS

to active agents. Investigate by all means. Address postal today for full details. **ALLEN MFG. CO., 3334 Allen Building, TOLEDO, OHIO**



PRICE \$7.50 UP

Make \$20 a Day

with our wonderful **Champion Picture Machine.** Takes, develops, finishes photo in half minute; 300 an hour. No dark room. *Experience unnecessary.* Photo Post Cards and Buttons all the rage! You coin money anywhere. Small investment; big profits. Be your own boss. Write for Free Book, Testimonials, etc. **AMERICAN MINUTE PHOTO CO., Dept. 34, Chicago, Ill.**



Rowboat \$20.00

MONEY IN BOAT LIVERY!

Can ship in any quantity. Need No Boat House. Never Leak, Rust, Check, Crack or Rot. Absolutely safe. Every boat has water-tight compartments, so cannot sink. 20 different designs. **Demonstrator Agents Wanted in Every Community.** Write TODAY for FREE Illustrated Catalog and Special Factory Prices. **Michigan Steel Boat Co., 156 Bellevue Ave., Detroit, Mich.**

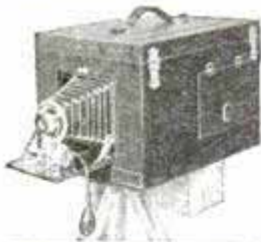

500% PROFIT

Operating a Daydark Photo Post Card Machine. Three photo postal cards of any object made and delivered on the spot in ten minutes. No experience required—no dark room necessary. All work done in the machine in open day. Establish a profitable business at home by opening a Daydark Postal Parlor. Big money maker on the street, at fairs, etc. Send at once for free catalog and sample post card showing the fine work the machine does.



DAYDARK SPECIALTY CO.

2119 Cass Ave., St. Louis, Mo.



\$6.00 Per Day

That's what Mr. W. M. Thomas of Hull, Ga., says he averages; and that isn't the most they make by any means. Isn't that reason enough why you should go into the photo button business? The

Wonder Cannon Camera is the biggest money maker to-day. A sure money getter at all outdoor festivals and wherever the crowds assemble. Anyone can learn the business in 30 minutes.

\$2500 Buys a Complete Outfit—**WONDER CANNON CAMERA**

—tripod and enough supplies to make 400 finished photo buttons.

Extra button plates, \$1.00 per hundred. Gilt frames, \$1.10 to \$1.75 per gross. **500 Percent Profits.**

Write Today for **FREE CATALOGUE**

CHICAGO FERROTYPE CO., Dept. 102, CHICAGO, ILL.

tomary for hundreds of sick men and mendicants of all kinds to be laid out in the courtyard of royal palaces awaiting the healing touch of the "anointed of the Lord" monarchs found it necessary to wear a glove in order to escape infection. Thus arose the habit which during modern times has passed into a mere fad of fashion, the significance of which has long been forgotten by the majority of people.—M. A. P.



BE YOUR OWN BOSS

Make Money Easy

AGENTS wanted in every county to sell the popular **Golden Rule Knives** with name, address, photo, lodge emblems, etc., on handle. Agents earn \$75 to \$200 a month selling our shears, transparent handled pocket knives and razors. Big profits, quick sales. Exclusive territory. Experience unnecessary. **WE TEACH YOU HOW.**

Write today for terms and become one of our successful salesmen.



GOLDEN RULE CUTLERY CO., 362 Wendell St., Dept. 118, CHICAGO

Magic Lanterns with the Alco-Radiant Light



The Alco-Radiant is the only practical, intense light for Lanterns if electric is not to be had. It burns alcohol, costs little to use and a trifle to buy; weighs 3 lbs.; adaptable to any Lantern. New Lantern slides for Lenten season, plain or colored, for sale or rent. Lecture sets of slides with readings, such as Judas, Herod, The Multitude, Way of Grief, Seven Words from the Cross, Passion Play of 1910, etc. Ask About Post Card Projectors. They show on a screen the image reflected from a post card or any other picture or flat object. Prices, \$4.50, \$13.50, \$25.00, \$60.00.

WILLIAMS, BROWN & EARLE, Dept. 20, 918 Chestnut Street, Philadelphia, Pa.

\$17⁵⁰ And You Keep This Great Engine

Yes, sir, that's right—you keep this engine for \$17.50, a wonderful gasoline engine offer, an offer without a parallel. We ship you Schmidt's Chilled Cylinder Gasoline Engine on your simple request without an order or any promise from you. You use the engine 10 entire days, use it all you want to. Then if you don't want it, send it back at our expense. If you do wish to keep it, pay us only \$17.50 and the rest in the easiest monthly payments. We send you the engine free, to prove that it is the greatest air cooled 3 horse power engine on earth. It is the only engine with the marvelous, powerful chilled cylinder. The only engine for farm use with a spark retarder. The new type gasoline engine that has revolutionized the gasoline engine industry. The only engine good enough to send out on actual free trial without a cent down in any way.

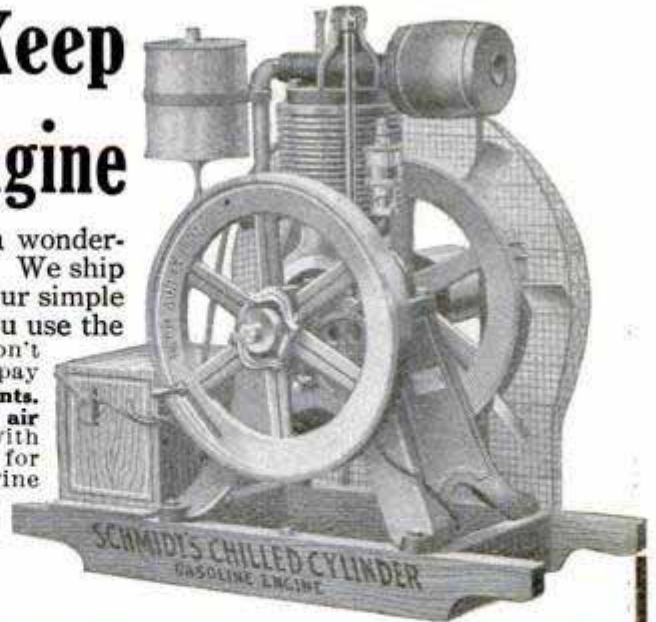

MAKES WOMAN'S WORK LIGHT AND EASY

Ten Days' Trial

FREE This is the first genuine free trial ever offered on gasoline engines for farm and shop use. We want you to see that women and children can run this engine. Use the engine to run any machinery you have—the pump—separator—washing machine—corn sheller—grinder—anything. Engine is ready to run when you get it. We will send you prepaid our sensational offer and our very useful book "How to Use Power" free.

5 Years Guarantee Schmidt's Chilled Cylinder Gasoline Engine is absolutely guaranteed for 5 years in every piece and part. The biggest bank in Iowa backs our \$1,000 challenge offer.

Long Time to Pay If you like this engine after trying it out for ten whole days you can keep it and take long time to pay for it on easy monthly payments, or after using it free for ten days, just send it back at our expense.

How to Use Power To all who will write promptly we will send our useful book "How to Use Power" free. Send us your name and address today.

SCHMIDT BROS. CO. ENGINE WORKS, Dept. 1195, Davenport, Iowa

\$18 to \$30 a Week Sure

Farmers "Ever Ready" Tool Kit does it



Agents going wild over results M. Snyder made \$46 in 2 hours Joseph Pine took 65 orders in 2 days. M. D. Finch sold 42 in 9 hours. Had no experience. You can do it. To show it means a sale. **FREE SAMPLE** to workers.

FOOTE MANUFACTURING CO., Dept. 260, Dayton, O.

Perfex Suction Cleaners



Will clean clean with least labor and expense. Most efficient suction pump yet devised. Also used as blower. Electric, hand and stationary—guaranteed—complete line of tools. Powerful motor can be used for other household machinery. Write postal for free circular.

Agents--Women want the Perfex. For a quick seller with good profits write us.

PERFEX CLEANER CO., Waukegan, Ill.



For Two Cents A Turkish Bath In Your Own Home To Enjoy Regularly



THE delicious sense of refreshment lasts for hours after the bath. When the "Robinson" Thermal Bath becomes a habit, the user is in a constant state of freedom from "off-days" and "staleness." Efficient in cases of La Grippe, Bad Colds, Rheumatism, Dyspepsia, and Skin Diseases. All users enthusiastic.

Great \$2 Book Sent FREE—"The Philosophy of Health and Beauty" represents lifetimes of thought of well-known scientists and is written plainly so that anyone can understand every word. Write in time—today. **ROBINSON MFG. CO., 172 Snowflake Bldg., Toledo Ohio**

"I'm Just a Moderate Drinker"

It's remarkable how many men take refuge in this trite phrase—which means just nothing at all.

Hardly a man will acknowledge that he drinks too much—until a thoroughly debilitated constitution forces the truth upon him.

Few realize that the desire for drink is a well-defined disease, whether in the early "moderate drinking" stage, or in the acute later condition when the whole system craves drink frequently.

In either case it is a serious menace to you and yours and should be determinedly dealt with at once.

It you drink at all you should know the

Oppenheimer Treatment

(No Hypodermic Injection)

This wonderful treatment quickly restores to normal condition the whole devitalized physique.

Those who denied having been even a little under the sway of drink are the first to acclaim the immense benefit derived.

Consult Your Own Doctor

He probably is among the thousands of physicians who know and endorse this treatment.

For the Oppenheimer Treatment is always administered through your own physician.

Not only does this insure absolute professional confidence, but it prevents interference with your business or social duties.

Ask yourself frankly whether you do not need further information about this effective treatment. Then send the coupon to-day.

COUPON

OPPENHEIMER INSTITUTE, 317 W. 57th St., New York

Kindly send me in strictest confidence, and under plain cover, details of the Oppenheimer Treatment.

Name.....

Address.....

Please Mention Popular Mechanics

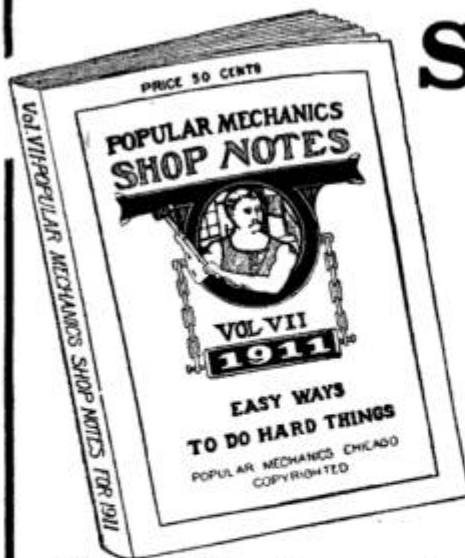

Shop Notes for 1911

Vol. VII of the Series—Just Published—Price 50c Postpaid

THE Series of Shop Notes Year Books now comprises seven volumes and constitutes a *Mechanics Encyclopedia* of unequalled value. The low price of 50 cents a volume or \$3.50 for the complete set places them within the reach of all and no one who uses tools should do without them. The investment of but \$3.50 places at the disposal of every tradesman over

4000 Easy Ways To Do Hard Things

some of which daily confront him. These books are "*Written So You Can Understand Them*," and cover every department of mechanics. They represent the "boiled down" experience of expert engineers, firemen, carpenters, machinists, plumbers, painters, iron and wood workers, electricians, masons and other tradesmen.

☞ The addition of a new volume each year affords the purchaser of a set an opportunity of keeping abreast with the newest and best developments, as each volume contains matter entirely different from the others and of a strictly up-to-date nature.

200 Pages	Vol. I,	"Shop Notes for 1905"	385 Illustrations
228 Pages	Vol. II,	"Shop Notes for 1906"	555 Illustrations
228 Pages	Vol. III,	"Shop Notes for 1907"	580 Illustrations
212 Pages	Vol. IV,	"Shop Notes for 1908"	536 Illustrations
224 Pages	Vol. V,	"Shop Notes for 1909"	461 Illustrations
224 Pages	Vol. VI,	"Shop Notes for 1910"	451 Illustrations
224 Pages	Vol. VII,	"Shop Notes for 1911"	468 Illustrations

Sold singly at 50 cents a volume postpaid, or the complete set of seven volumes may be had in a handsome case at \$3.50 prepaid.

Popular Mechanics Co., Publishers

318 W. Washington Street

CHICAGO, ILLINOIS

Books for Young and Old Who Like to Make Things

Amateur Mechanics No. 1— 174 Articles
165 Illustrations

Amateur Mechanics No. 2— 193 Articles
196 Illustrations

Mechanics for Young America— 150 Articles
196 Illustrations

These books tell how to make hundreds of different articles of daily use and the directions are "*Written So You Can Understand It.*"

Instructions are given for making such things as Workbench—Wireless Telegraph Outfit—Boats of Various Kinds—Induction Motor—Lantern Slides—Arc Lamp—Motorcycle—Devices for Winter Sports—Electric Locomotive—Aerial Glider—Flash Lamp—Static Electric Machine—Ice Boat—Steam Engine—Bobsled—Induction Coils—Lathe, etc.

Price 25 cents each, postpaid

For sale by all newsdealers or can be ordered direct from the publishers

Popular Mechanics Book Dept. 318 W. WASHINGTON ST.
CHICAGO

Have the Earliest
and Finest
**Sweet
Peas**



Also insure
early picking of
better garden beans
and peas than you have ever
grown. These are the results of using—

In Your
Town

FARMOGERM

High-Bred Nitrogen Gathering Bacteria

Just mix with water and moisten seed or sprinkle over rows. The bacteria increase by millions. Quicker, harder, and larger growth follows because the bacteria furnish the nitrates needed. These and some other crops **MUST** be inoculated to thrive best. Ask any expert. See our reports from users. Farmogerm comes in small, specially sealed bottles **READY FOR USE**. Sold by leading seed houses or sent by mail or express paid.

GARDEN SIZE, 50c **ACRE SIZE, \$2.00**

Hardy Lawns are started by mixing in some inoculated white clover seed. Our Free Book No. A gives full particulars and proofs. Write today. It will enable you to break all records this year.

EARP-THOMAS FARMOGERM CO., Bloomfield, N. J.



Amazing Profits In Mushrooms

Anybody can add \$3 to \$40 per week to their income, entire year growing mushrooms in cellars, sheds, barns, boxes, etc. Markets waiting for all you grow.

Free Illustrated Instruction Booklet

HIRAM BARTON

Desk 2, 329 W. 48th St., New York

THE O. K. ELECTRIC THOUGHT REGISTER

Every professional and business man or woman should have an O. K. ELECTRIC THOUGHT REGISTER. It relieves your mind and saves you time, money and worry. Nearly every person has some very important thought flash through his mind before going to sleep at night and matters which should have been taken care of have been forgotten. Send \$2 in Stamps, Draft, M. O. or Cash for an O. K. Electric Thought Register, on 30 days' trial. **WEIS MANUFACTURING & SUPPLY CO., Hammond, Ind.**



SCHACHT

3 Cars in 1—\$850.00

The Schacht is the greatest under \$1000 car ever put on the market for it not only is a remarkably staunch and speedy roadster, but the addition of a rear seat makes of it a big, roomy family car; or the addition of a box, an up-to-date delivery car.

SEND FOR CATALOG

THE SCHACHT MOTOR CAR CO.
2802 Spring Grove Ave., CINCINNATI, OHIO

A Superb Railroad Watch

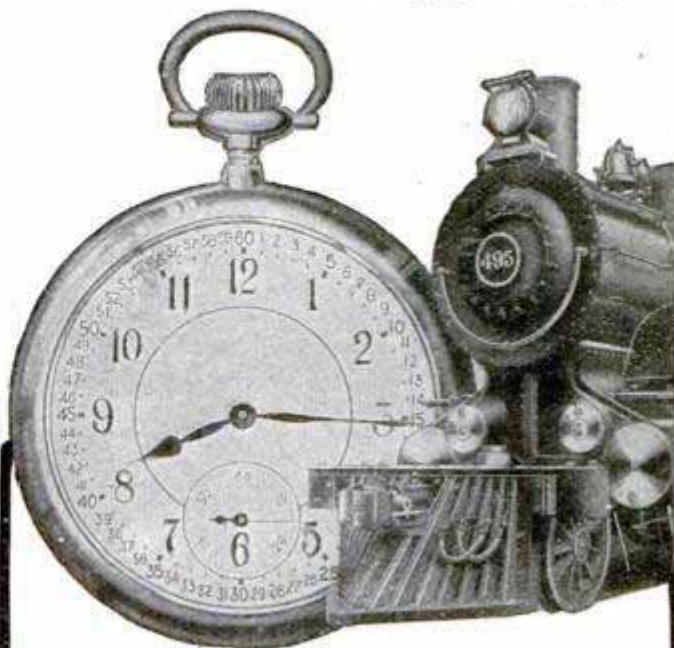

\$3.50

Yes, only \$3.50—Only \$3.50 per month for this magnificent railroad watch. The first time in the history of watch selling that such an astounding offer has been made. A railroad watch that will pass inspection on every railroad in the United States and at only \$3.50 per month.

Positively free examination. Nothing to pay until you have seen the watch and are **satisfied** to take it; you to be the sole judge.

Also at the rock-bottom, the very rock-bottom price—no more than you would pay for ordinary watches. These are the very finest watches which can be made. They are manufactured by the biggest watch factories—all 17 to 23 jewels—positively guaranteed. The most magnificent timepieces it is possible to produce.

Keep Time to the Second!

Every one of these splendid railroad watches keeps time to the second. Wouldn't you like to have such a watch? Wouldn't you like to KNOW that your watch is equal—yes, superior to the best watches carried by many train dispatchers, many engineers, many great steamship captains, a watch that keeps time down to the fraction of a second! Each watch has the famous Montgomery dial, marking the minutes as used on all the very latest railroad watches.

Mail Coupon Today

Free
Coupon

Send this free coupon right away. We can explain this astounding offer only in personal letters. You will be passing up the watch opportunity of your life if you do not send this coupon. So fill in your name and send today.

**Independent
Railway Watch
Distributors**
Dept 1195, 2845 19th St.
CHICAGO, ILL.

**Independent Railway
Watch Distributors**

Dept. 1195
2845 19th St.
Chicago, Ill.

Without obligating me in any way you may send me free your railway watch book and full details of your offer.

Name

Address

Try a Detroit Fireless Stove at Our Risk



RADIANT STYLE—Heat the metal radiators a few minutes—then use imprisoned heat cooks the food.

Cooking in a Detroit Fireless (electric or with radiators) is the most delicious way—all flavor and nutriment retained; the most economical way—saves 80% of your fuel bill; the most comfortable and convenient way—saves work over a hot stove—saves constant watching—saves worry.

Built Like a Range—Does All a Range Does

"Detroit Fireless Stoves" (both Electric and Radiant) are made from planished steel and aluminum—no wood to warp or split—no stones to break. No felt or pad to absorb steam and odors. They roast and bake perfectly—rich brown; they fry or boil perfectly; they steam and stew perfectly. A positive revelation and delight to women. Lids are steam tight.

Get Our Free Trial Offer. A "Detroit Fireless" will be sent you on 10 days' trial; will pay for itself in the first three months. Write today—get our handsome catalog and this new offer.

DETROIT FIRELESS STOVE CO.
103 Jefferson Avenue, Detroit, Mich.



ELECTRIC STYLE—A few minutes' current from any electric light socket STARTS it—the imprisoned heat then does all the rest.



\$1500.00

MADE IN ONE MONTH WITH A "LONG" Popcorn Crispette Machine

You might just as well make as much. Perrine, Cal., took in \$380 in one day. Every nickel brought almost 4 cents profit. Start in this safe, profitable and fascinating business. Best season just at hand. You can make lots of money this Spring and Summer at Fairs, Parks, Summer Resorts, Amusement Halls, Circuses, etc. Crispettes are fine—different in shape, taste and quality. Everybody—young and old craves them. Sell for 5c a package—popular price—easy to get money. Think of fortunes made in five cent propositions—then figure what you can do. Write me today. Get full particulars—reports from others. Act upon the prompting you have—now—address

W. Z. LONG, 253 High Street, Springfield, Ohio

Osteopathy **FREE**

Our Valuable 100 Page Book on Drugless Healing

FREE

This free book explains the Theory and Practice of the latest and best method of Drugless Healing and shows a correct way to master disease without the use of injurious or habit-forming drugs.

We give you this interesting book absolutely free in order to tell you all about Mechano-Therapy—the Recognized System of Drugless Healing which pays

\$3,000 to \$5,000 Yearly

In a few months by our system you can begin practicing Mechano-Therapy—an elevating and highly paid profession for men and women. Simpler and more comprehensive than Osteopathy. Endorsed by physicians. A fascinating study, easy to learn. We teach you in your own home by mail or in class and guarantee success—an ordinary education and our course of instruction fits you for a professional life. Authorized diplomas to graduates. Work absorbingly interesting. Vast opportunities for social and financial betterment. Special terms now. Write today for our 100-page book on Osteopathy, 84-page ill. prospectus sent free.

American College of Mechano-Therapy, Dept. 466, 120-122 Randolph St., Chicago.



Own a Model AEROPLANE



Be up-to-date. Learn how to fly with our Flying Bat 12 in. model. It flies 200 ft. by its own power. Very instructive and amusing. Sent complete, postpaid, on receipt of 30c. Satisfaction guaranteed.

GOFF AEROPLANE CO., Dept. P.M., CHICAGO

TO REGULATE THE TIME OF EUROPE.—The great observatory of Hamburg, in Germany, is so connected with Munich, Copenhagen, Cologne and Paris, together with all intermediate points, by telephone, that at any hour a man within this large European area may set his watch to exact Central European time. The signal is given by a pendulum clock in the observatory. You need only go to the nearest telephone and call up "No. 4000 IV. Hamburg," and as the signals are given automatically it is not necessary to give the number of the caller. No charge is made for the service. The time is indicated by a system of well and easily understood signals, a tone like that of a siren being the decisive one, because it marks the last five seconds of every minute. There is a repeating watch for private use on much the same principle. Awakening in the dark at night and desiring to know the time, by pressing a button the watch will strike the last hour past and add the quarters since that time.—Louisville Courier-Journal.

Let the Slide Rule Do Your Work—Do Your Work



Engineers, Electricians, Draftsmen, Superintendents, Managers, Master Mechanics, Estimators and Business Men:

Your Time is too valuable to waste in solving problems or checking over the work of others. The Richardson Slide

Rule will do it mechanically. One of the most valuable instruments ever offered to mankind is the Slide Rule. Not until the above rule was designed did it become possible for a person of a limited education to learn to operate it. Besides, the usual price has been reduced one-half, and the free instruction book is "written so you can understand it."

This Slide Rule will multiply, divide, solve proportion, extract the square and cube roots, find the decimal equivalent of vulgar fractions or "vice versa," calculate interest, percentage. In addition to above the rule is direct reading for forty-four other problems, such as the Horse Power of Engines, Pumps, Boilers, Belts, Water Falls; size of motor to run a pump; size of duct for ventilating; percentage a recording wattmeter is "Slow" or "Fast"; radiation and size grate, and steam main required; change gear and pulley problems; areas, circumference and diameter of circles. You simply place the key to the problem in the key hole (the key is printed in red) and answer is given direct. This rule is my latest improved type now being placed upon the market for the first time. "See sectional cut" curved slide bound with aluminum. No other like it. Good value. Price \$2.50 with substantial pocket case and instruction book. Stock aluminum 11x1 1/2 inches with runner. Scales celluloid printed and polished in two colors and washable.

GEO. W. RICHARDSON, Mechanical and Electrical Engineer 4218-24th Place, CHICAGO, ILL.

Let me send you a Free Book on Florida



Dan Riley

President Orlando Florida
Farms Company

This Book Tells You of an Opportunity to Secure a Small Farm in the Proven Protected Grapefruit, Orange and Truck Farm Section of Florida.

I want you to send today for "A NEW DOMINION."

This is the name of a book on Florida which I consider the most enlightening of any ever issued from the press.

"A NEW DOMINION" will tell you all about my new Florida project. It tells all about what is probably the **most magnificent tract of Florida land** ever opened up to the public!

This tract starts **within about three miles of Orlando**—the busiest, prettiest and fastest growing city in Florida. It is in the very heart of Florida's greatest producing section.

This land has never before been sold in small tracts! For the first time I am in position to offer this land in 5, 10, 20 and 40 acre allotments. Here is land located in the **proven, protected orange and grapefruit section** of Florida; here is land also that is in the soil belt which produces the greatest returns in the growing of vegetables for the winter markets of the North.

Orlando is a city of over seven thousand people, and is the county seat of Orange County. Orange County may be truthfully called the **real banner county** of the State of Florida.

In the production of citrus fruits, such as oranges, grapefruit, tangerines, etc., this county leads the State; in the production of celery, lettuce, cabbage and other trucking crops it is not approached by any other section of Florida.

The truck growers of Orange County are realizing right now anywhere from \$250.00 to \$1,000.00 per acre clear profit each year. The owners of grapefruit and orange groves are taking off crops that realize from \$600.00 to \$1,200.00 per acre.

The tract of land which I am offering in 5, 10, 20 and 40 acre farms extends from the towns of Gabriella and Golden Rod on the north, to some few miles south of Orlando. Right through the

center of it flows the Econtockhatchee River, a stream that is navigable for quite a distance for boats and launches. To my first buyers I offer a magnificent **free building lot** right on this river!

I am going to sell this land at \$25.00 per acre, and on terms of \$1.00 per acre per month.

**I AM GOING TO GIVE YOU
A FULL HALF YEAR FOR EX-
AMINATION AND INVESTIGA-
TION!**

I have confidence in this land and know that any one who once sees it will be satisfied and delighted. This is the reason that I can offer to give you **plenty of time** to go down there and look over your purchase. All that I want you to do is to send for my new book, "A New Dominion." This book tells you how on five or ten acres men can achieve **independence for life in Florida**.

It is handsomely illustrated from actual photographs showing you orange and grapefruit groves and truck farms right in the heart of this land. This book may be the stepping stone to a glorious future for you and your loved ones. It costs you nothing. I am going to send it to you **free** along with maps and other literature showing the exact location of these magnificent farms.

Fill out the information blank below and it will be sent you by return mail without any cost or obligation whatsoever.

DAN RILEY, President
Orlando Florida Farms Company.



Send for this Great Free Book Today! Fill Out the Information Blank Below and it Will be Sent You Postage Paid Without any Expense or Obligation.

FREE INFORMATION BLANK

Orlando Florida Farms Company,
Fisher Building, Chicago, Ill.

Please send me, postage paid, and without any obligation on my part whatsoever, your free book on Florida entitled "A NEW DOMINION," map showing location of the Orlando Florida Farms, and all information concerning this land.

Name.....

Town.....

State.....

R. F. D.....

(No letter necessary with this blank)

Address your envelope this way:

ORLANDO FLORIDA FARMS COMPANY

307 Fisher Building, Chicago, Ill.

P. M.

50c
Each

ENTIRELY NEW
IN THIS COUNTRY

50c
Each

Separable-Parts Models

of Steam Engine, Wireless Telegraph, Motor Car, Gas Engine, Dynamo, Steam Turbine

Size 8x14 inches

Price
50c
Each
Postpaid

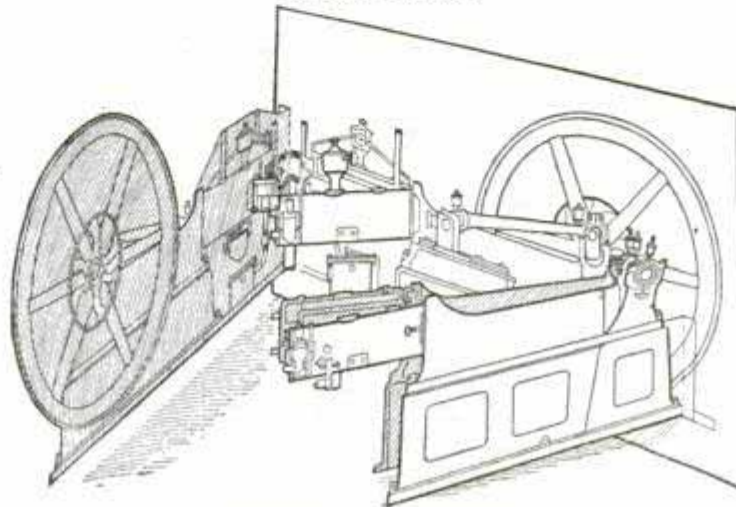

Complete Set
of
6 Models
\$2.50
Postpaid

Illustration shows how parts separate

THESE models are of great value as a means of graphically showing *all* the interrelated parts of the above named mechanisms by virtue of their construction, which is similar to that of educational manikins of the human body and organs, with which nearly everyone is familiar. Beginning with the outermost or surface parts of the gas engine, for example, these are all differently colored and numbered to correspond to a printed key of names which comes with each model. By means of their hinge-like attachment, they may then be lifted, thereby disclosing to view the layer of parts next underneath, exactly as they would be in the engine itself, and so on until the innermost construction is shown.

The models are carefully made by hand in Bavaria, and this is the first time they have been offered in this country. We are the sole representatives in the United States.

As their value to engineers, students and, in fact, everyone having occasion to refer to the construction and working of the different mechanisms mentioned, was at once apparent to us, we felt that they would be highly appreciated here. They are substantially made of heavy paper, and with ordinary care will last indefinitely.

Supply Limited — Order Now

ADDRESS

Popular Mechanics Book Dept., CHICAGO

318 W. WASHINGTON STREET

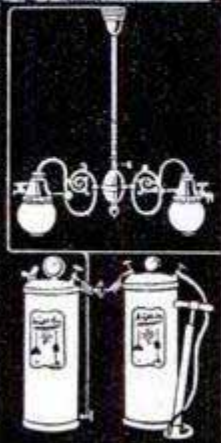

Change from a 150 candlepower light to 2 candle power in a jiffy. This latest and most perfect development of the gasoline lamp found only in Ann Arbor Lighting Systems. It gives the country home a lighting system as perfect, handsome and modern as city gas. Ann Arbor Lighting Systems are brighter than gas, steadier and clearer than electric light, and cost about one-tenth as much to operate. Each lamp gives 150 to 500 candlepower for less than 1-3 cent per hour. Fuel is gasoline; perfectly safe.

We Make Complete Lighting Systems for Homes, Churches, Stores, etc.

Prices \$10 up, according to number of lamps desired.

We Want Agents who will push our line. A splendid opportunity right now for hustling agents in large cities to sell to owners of summer cottages, country homes and resorts. No other light can equal it in brilliancy, beauty of fixtures and economy.

CATALOG AND PRICES ON REQUEST

Superior Manufacturing Company
294 Second St. Ann Arbor, Mich.

IVRY'S NOVEL FIRE ALARM.—M. Jules Contant, the Mayor of Ivry, France, is taking precautions for the safety of his jurisdiction against fire which have not received unanimous support.

He has set up a powerful siren, not at all unlike, as far as sound goes, those in use on the great liners. The alarm can be heard anywhere within a radius of six kilometers, or nearly four miles. The apparatus is not worked by steam, but by electricity. The principal ground of objection to the Mayor's proposals seems to have been based on prejudice—that the siren sounded at night would disturb the slumberers of Ivry. The Mayor, however, requires some stronger reasons before he gives heed to the malcontents.—London Daily Globe.



Send for Our Free Vibrator Book describing the White Cross Electric Vibrator. This Vibrator is a rubbing machine which draws the blood to any aching part of the body to do its work. This machine rubs much better and much faster than the hands. While the hands are giving a few dozen rubs, the White Cross Vibrator gives several thousand. Send today for the Free Vibrator Book. It may mean health to you.

Lindstrom-Smith Co., 253 La Salle St., Dept. 1195 Chicago

Nothing External Revolves

DETROIT REVERSE GEAR
Starts—Reverses—Stops INSTANTANEOUSLY

The Simplest, Most Reliable, Most Compact and the Smallest Perfect Marine Reverse Gear ever offered. No outside moving parts to throw the oil or grease, tear the skirts, bruise the hands or catch waste. No noise. Manufactured in sizes for from 2 to 80 H. P. We carry all sizes in stock for immediate shipment. Guaranteed for one year. Write for special prices and free catalog. Valuable information from our Consultation Department FREE to motor boat men.



(40)

Detroit Engine Works, 24 Beaufait Ave., Detroit, Mich.

Put It at Work in YOUR Shop

THE "MULTIMOTOR" SHOP ENGINE increases your profits but not your payroll. Does the work of three men at an expense of less than a cent an hour.

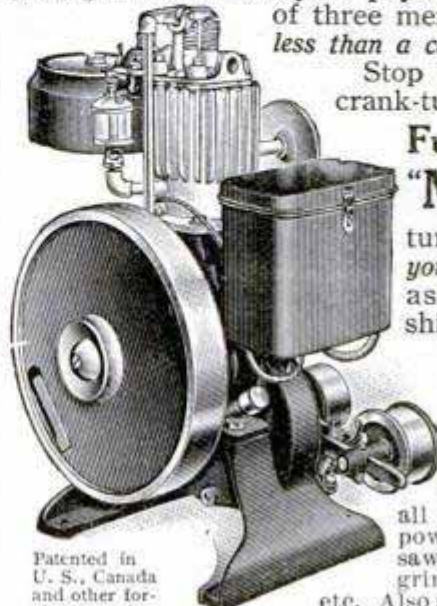

Stop pedal-pushing and crank-turning! Let the

Fuller & Johnson "Multimotor"

turn the wheels in your shop. "Handy as a pocket in a shirt."

Boy-Size—Man-Power!

This big little engine is small in size but a giant in power. Runs all hand-power or foot-power machines—jig saws, lathes, emery wheels, grindstones, drills, etc., etc. Also small electric lighting plants and water-pressure system. Just the thing for a boy's workshop!

Patented in U. S., Canada and other foreign countries. Other patents applied for.

Perfectly Simple, Absolutely Safe

Simplest, neatest, strongest, most reliable little engine ever built. Comes to you *complete*—nothing to add but gasoline. Easily moved anywhere. For indoor use has outdoor fuel tank, insuring perfect safety.

Important working parts protected by dust-proof case. Needs no attention while running. Works steadily, all day, on a few cents' worth of grocery-store gasoline. Is air-cooled, fool-proof, cannot freeze or overheat.

Guaranteed!

The "Multimotor" in design, material and construction equals the best automobile engines. Every engine is thoroughly tested before leaving the factory, and is *guaranteed*.

Fuller & Johnson Farm Pump Engine

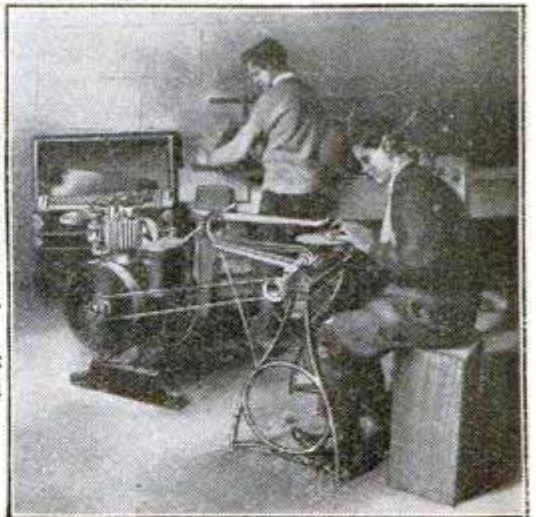

The Engine in Boys' Workshop

Practically the same as "Multimotor," with pumping gears added. Can be hooked up to any pump in 15 minutes. Needs no belts, arms, jack or special platform. Pumps 400 to 1,500 gallons per hour. Perfectly adapted to farm and suburban use.

Engine Book Sent FREE!

Book giving full information about "Multimotor" and Farm Pump Engines sent **FREE** on request. Let us tell you more about these amazing little power-producers. We will direct you to nearest dealer who will show you the engine and explain what it can do.

If interested in larger engines, ask for Catalog of Fuller & Johnson famous Double-Efficiency Engines. (266)

FULLER & JOHNSON MFG. CO.
5 Partridge St. (Estab. 1840) Madison, Wis.

"I Made \$20 Today"

Sold 48 This Week, profit (\$91.20),
Writes M. G. Clark, Mont.

"WOMEN BUY AT SIGHT"

**SCRUBS
DRIES FLOORS
CLEANS
AND
BRIGHTENS**



"Started yesterday; sold 10, and today 12 more. It's a gold mine. Rush 50 more," writes J. H. Hodson, N. Y. Hundreds of men and women making \$50 to \$100 a Week actually making a week's wages every day. They're banking money, buying homes, automobiles. New discovery makes it easy for them—should do the same for you. Tremendous sale of the

"Home Comfort" Scrubbing and Floor Drying Machine

breaks all records. New, popular, irresistible—double your money every sale. Every housewife a customer. World's greatest labor saving invention. No more back breaking scrubbing, and floor cleaning days. New marvelous machine replaces hands, old style brushes, unsanitary rags, and hand disfiguring mops. Vibration does the work. Scrubs, dries floors, cleans, brightens—removes dirt, grease, stains, germs—works like magic. A God-send to women. Self feeding, self emptying, self sudsing.

OLD WAY



Turns scrubbing and floor cleaning drudgery into neat, easy, quick, pleasant task. Child can do it the Home Comfort way. Weighs 7 pounds. Sells for \$3.50—lasts for years. Not sold in stores. Home Comfort is truly a never-ending household boon. Pleases, astonishes all. Customers wonder how they ever got along without it. Mrs. Harris, Ill., writes: "Home Comfort has been a God-send. It's so easy to scrub and clean. Really wonder-

\$3.50

ful how quick it works." Mrs. H. Cole, N. Y., writes: "I am simply delighted. Robs scrubbing and floor cleaning of all its hard work and takes so little time. Can clean dirtiest floors with scarcely any effort." C. Barnes, S. C., writes: "No other invention means so much to the home. I am booking orders like lightning. It takes every woman by storm." What woman hasn't been eagerly waiting for the Scrubbing and Floor Cleaning Machine? It's here—perfected—selling like wildfire. Sells for \$3.50—banishes forever woman's worst torture. Could anything be more appreciated, popular, irresistible? Don't delay—seize this live opportunity. Be first—get exclusive territory—make a fortune. Send today for agency, free sample and credit terms.

SANITARY SUPPLY CO., Box 291, Sta. F, TOLEDO, OHIO

Here is a
Mighty Good
\$18

TYPEWRITER for \$18



in U. S. A.
USE IT
**10 DAYS
FREE**

Learn how well the Bennett Portable \$18 Typewriter does everything you expect of a \$100 machine. Rapid, accurate. Up-to-date conveniences. Standard keyboard of 84 characters. Weighs but 4½ lbs. Slips into pocket or grip like a book, for ready use at home, business, hotels or on trains. Price low, because simply built. Quality guaranteed. You can't afford to be without this handy efficient \$18 typewriter. Representatives wanted. Write for catalog and 10 days free offer. P. E. BENNETT TYPEWRITER CO., 366 Broadway, N.Y.



Working on Dynamo



Home of the Schools

FREE—Large Illustrated Book of the School. Write Today.

COYNE NATIONAL TRADE SCHOOLS
57 East Illinois Street, CHICAGO, ILL.

STOP!! Looking for WORK

Come to the COYNE NATIONAL TRADE SCHOOLS, quickly learn to be an
**Electrician, Plumber
Bricklayer
Painter and Decorator**
or start a Business of your own
and you will always have
WORK LOOKING FOR YOU

Trades that pay \$5 to \$8 a day the year 'round. Anybody can learn in the right school. Come here. Most thorough, practical trade school in the world. No books, but tools instead. Individual teaching. Low expense. Success assured. Graduates never out of work.

WHY NO "SOULS" ON STREET CARS?—A curious survival of an old-world usage is to be found in the term "soul" as applied to a passenger on an ocean-going ship. Of course, one is quite familiar with it in such context as "lost with every soul on board," or "every soul was saved;" but it has a curiously archaic look in cold print with a blank left for the number, "one, two or three (as the case may be) adult souls." It might be originally a west country usage, and so have spread north, for the terms "dear soul" and "poor soul" seem to be frequently used in Devonshire; and, indeed, the paper in which the writer recently met with the word as a shipping description was made out at Bristol, and it may not be in general use elsewhere. But why (asks The Manchester Courier) in the west country, or anywhere else, should a person be specially a "soul" on board a ship? Why should not we be "souls" in trains or trams, instead of being mere wooden automata known as "passengers" or "fares?"—Westminster Gazette.



Patent Your Ideas—it Pays "WE GUIDE YOU TO SUCCESS"

25 years' experience as Attorney and U. S. Patent Examiner. Send sketch of invention for Free report and Illustrated Guide Book. No Patent—No Charge. We succeed where others fail.

BUNYEA PATENTS CO.
Room 27 WASHINGTON, D. C.

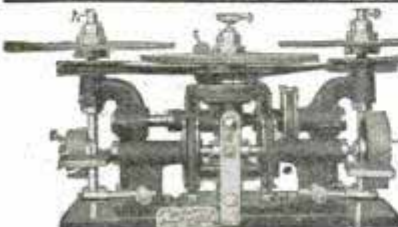

\$5 to \$10 a Day Made Easy

Start in business for yourself
Nothing like being independent

The "American" machines are money makers. The only successful machine ever invented. With these machines anyone without previous experience can hone razors, sharpen all kinds of safety razor blades, clippers, scissors, etc.

NO MAKE BELIEVE, BUT THE REAL THING

FOR PARTICULARS, ADDRESS MANAGER

ILLINOIS CUTLERY CO., Dept. 508, 171 Washington St., CHICAGO

NOTE—We sharpen all kinds of safety razor blades. Razors Honed, 15c.

Please Mention Popular Mechanics

BANKRUPT RAZOR SALE!

Failure of a big hardware jobber has placed in my hands for immediate sale a limited number of the finest and most famous German razors.

Genuine crucible steel; forged, tempered and ground by hand. For a limited time, I will also include free with each razor, the most perfect guard made, enabling you to make a genuine safety razor out of any razor in one second.

While they last, I will send you one of these superb razors, including guard. For only \$2, absolutely satisfactory. If you want this bargain—remember, the guard free—you must act at once. Just mail a \$2 bill today.

A. W. KANE, Receiver, 502 Strauss Bldg., Chicago, Ill.



60 Days' Trial

50 Smokes for 99 Cents

Send me 99 cents by mail now and I will send you this box of 50 Manges Havana Seed Stogies post prepaid. You'll find them stogies only in shape; in quality superior to many 10-cent cigars. My tobacco is grown in this country from pure Havana seed and is rich, aromatic, flavorful. Get this box, try one—if not satisfactory send the rest back and get all your money back. H. Manges, Smoker's Friend, 504 Manges Bldg., St. Louis, Mo.

\$4000
A YEAR
TO
AGENTS

100 agents—salesmen—managers wanted. From \$50 a week to \$4,000 a year. McGough, O. made \$160 in one week. E. J. Durr, Mich., cleared \$22.50 in one day. Needed in every home, office, factory, public buildings and by auto and motor boat owners. A Wonderful New Fire Extinguisher. Used by U. S. Government. Write quick. Try for this big money.

UNITED MFG. CO., 1570 Mill St., LEIPSIK, O.
Reference Bank of Leipsic, Capital \$1,000,000.00

They are flogging children by electricity out in Minnesota. This is up-to-date education, but it is believed the scholars most involved do not appreciate it.—Philadelphia Inquirer.

Though but a small nation, Switzerland makes 10,000,000 pounds of honey a year, so well is its flora adapted to bee culture.—New York Herald.



Send Today for this **69c**
\$1 Flasher. Price

Extension lens, highly polished nickel finish. The greatest bargain in Electrical Pocket Flashers known. Size 2 1/4—2x3 1/4 in. Guaranteed for longer life and greater brilliancy than all others.

FOREIGN ELECTRICAL EXCHANGE
Dept. P. M., 90 Wash Ave.
CHICAGO, ILL.

COMPLETE FILES OF
Popular Mechanics Magazine
FOR 1910

Consisting of the twelve issues of the magazine and a very complete index. Suitable for binding. Supply limited.

May be had while they last at the price of \$1.50 postpaid.

Popular Mechanics Co. 225 Washington St. CHICAGO

Every Reader of Popular Mechanics

who rides a Motorcycle should send at once for a

“Personal Message to Motorcycle Riders”

if he wants to know about the best and most economical tires for his Motorcycle.

United States Tire Company

Broadway, at 58th Street

New York, N. Y.

GO INTO THE Moving Picture Business

FROM \$45 to \$60 STARTS YOU AND YOU WILL EARN

The small payment required to get our machine will make more money than thousands of dollars invested in any other enterprise.

AS MUCH IN 1 OR 2 NIGHTS

\$25 and more per night

can be made exhibiting with our machine in halls, schools, churches, theaters, etc., in your own and surrounding towns. We furnish everything—rent films, too.

Write for particulars about our Moving Picture Machines and our 6-months-to-pay plan.

F. & W. SALES CO., 839 Temple Court Bldg., CHICAGO

WHEN YOU WANT ANYTHING AND DON'T KNOW WHERE TO FIND IT
WRITE BUREAU OF INFORMATION,
POPULAR MECHANICS CHICAGO

PHOTOGRAPHS WANTED

Photographs of new and interesting subjects, suitable for publication in this magazine, may be submitted to its editor and those accepted will be paid for promptly.

Editor Popular Mechanics
225 Washington St. CHICAGO



Portable Reading Lamp

JUST PUBLISHED

Arts-Crafts Lamps

How To Make Them

By JOHN D. ADAMS

16 Beautiful Designs, 25 Cents

AS FOLLOWS:

Two Light Portable—Portable Reading—Four Light Chandelier—Reading Lamp—Dining Room Dome—Porch or Den Lantern—Four Light Chain Hung Chandelier—One Light Portable—Lantern—Drop Light—One Light Bracket—Piano Lamp—Wall Lamp—Electric Candle Sconce—Newel Post Lamp—Chain Hung One Light Bracket.

Plain Instructions—Dimensioned Detail Drawings and Illustrations of Each Finished Design

A handy little working manual of 96 pages, printed on the best quality of book paper and handsomely bound in cloth. Supplied by your newsdealer or may be ordered direct from the publisher

POPULAR MECHANICS BOOK DEPARTMENT, 225 Washington St., CHICAGO

READ THIS WONDERFUL STORY

128 Pages.
Bound in Cloth.
Illustrated.

HEAT

Price
Post-
paid, **25c**

By **J. GORDON OGDEN, Ph.D.,** Professor of Physics, Fifth Ave. High School, Pittsburg

Thoroughly Understandable — Instructive — Immensely Interesting

This book consists of a series of articles, each complete in itself, yet all pertaining to heat and its relation to modern mechanics.

FEW people realize that fire is the most remarkable and valuable discovery ever made by man. Prior to this, man was brother to the brute, but with the coming of fire, came all the wonderful development that has enabled man to assert and defend his claim as lord of creation. We are only in the infancy of high temperature development, yet read of the harnessing of intense heat to the wheels of progress; the contrivances whereby we are able to emulate the volcano in our laboratories so far as heat is concerned and weld steel rails in the street where they lie; the discovery of uses of rare metals in industrial lines by aid of heat. Investigation of the realm of low temperatures also discloses some wonderful facts. All these, and many other phases of this interesting subject are treated as shown by the following list of chapters:

1—Nature of Heat and How It Is Measured. 2—How Low Temperatures Are Produced. 3—Some Effects of Low Temperature Upon Matter. 4—The Production and Uses of High Temperature. 5—High Temperatures and the Rare Metals. 6—How Heat Travels. 7—How Heat is Measured. 8—Expansion and Contraction. 9—Energy and Fuels. 10—The Manufacture of Artificial Ice. 11—Steam Boilers and Engines.

POPULAR MECHANICS BOOK DEPARTMENT, 225 Washington St., CHICAGO

AGENTS

\$45 to \$90 a Week

I want a good man in every territory in the United States—as local agent for one county, or as General Agent for a number of counties. This is a new proposition and offers you an opportunity to make from \$45.00 to \$90.00 a week, and on up to \$8,000 or \$10,000 a year. No experience is necessary but I want men—young or old—who will treat me square, who will follow instructions, and who will do their level best.

One man (Hiram Purdy) took twenty-seven orders the first day out (sworn statement); profit, \$40.50; twenty-six orders next day. J. J. Green started selling in Louisiana and became general agent, controlling extensive territory. At a single time he ordered fifty agents' outfits. Land office business right off the jump. Orders, orders everywhere. L. J. Richardson sold six the first hour he worked. Ordered six dozen by wire. Every customer pleased. Machine absolutely guaranteed in every particular for life.

Brand new business for agents. 100 per cent profit to you. Sales roll up everywhere. 400,000 sold in four months. Field untouched. Agents coining money. Get territory at once. We want 1,000 representatives. Send your name and address on a postal card for complete information free. Territory is going fast. Write to-day. Address

THE NEVER FAIL CO.
1033 Colton Bldg., TOLEDO, OHIO

Make Cement Pipe



Are you looking for a good profitable business that you can carry on as a side line, without a big investment?

Look at This:

24" vitrified clay pipe costs \$1.25 per foot or more. The best 24" cement pipe can be made for 35c—85c profit per foot. Other sizes show equal profits.

You pay back the investment in machinery in one day. Many miles of sewer and irrigation pipe and drain tile laid last season—Double the amount will be used this year.

Start now and be in line for Spring business

Over 2000 started last year making cement pipe, brick, sidewalk tile and Miracle Double Air Space Blocks, the only block with which protection is given to the manufacturer without charge. Small investment only required, and No Previous Experience.

Write now for our big catalog, 128 pages on concrete and concrete machinery, with 500 illustrations. Sent for 24c.

MARSH CO.
957 Old Colony Bldg., CHICAGO



GOOD MORNING



Perpetual daylight is here at last! No more darkness since the invention of this wonderful lamp. Four hundred candle-power—can you imagine it in your home or office? Costs one-third cent an hour. Write for full description and prices.

AGENTS WANTED—Live representatives can make a mint of money handling this lamp. Sells on sight and every lamp sold creates a demand for many others. Investigate.

AMERICAN GAS MACHINE CO.,
147 Clark St., Binghamton, N. Y. Albert Lea, Minn., Fargo, N. D.

Be Sure of Your Boat by Building It Yourself



Build your own boat from PIONEER PERFECT FRAMES and PIONEER PLANS and Save One-Half. Just as simple as 1-2-3. Every rib bent and fitted in our factory, then frame knocked down and shipped to you for re-assembling. Write for the whole story in Book Form, Sent FREE for the asking, showing how easy it is.

Materials and satisfaction guaranteed.

PIONEER BOAT & PATTERN CO., Wharf 33, BAY CITY, MICH.

T & M MARINE ENGINES

Noted for dependable service. Easiest to operate and control. All working parts accessible. T. & M. engines start without cranking and are

Instantly Reversible

All styles and sizes—2—120 H. P. light, medium, and heavy duty. Single and multiple cylinder—2 cycle 2 port type—the right size and type for every craft up to 65 ft. Install a T. & M. in your new power boat—get real engine satisfaction.

Write for catalog and name of nearest dealer.

TERMAAT & MONAHAN CO.
Department "A" OSHKOSH, WIS.



Agencies in all principal cities

PHYSICAL CULTURE



Will You Accept This Complete Course in Physical Culture?

Prepared by Bernarr Macfadden, the Foremost Authority on Health and Body Building

To every person sending us \$1.00 for an eight months' trial subscription to the **Physical Culture Magazine** we're going to give, absolutely without cost, a complete course of illustrated lessons in physical culture. These have been written by Mr. Macfadden personally, and represent the most effective body-building course ever compiled and reflect the knowledge gained in his treatment of patients at his immense Healthatorium, 42nd St. and Grand Boulevard, Chicago.

This Course is Superior to Many Courses Sold at \$50.00 or More

We make this unusual offer as an inducement for you to get acquainted with the **Physical Culture Magazine**—the most needed periodical in the field of literature. It teaches you in a simple, understandable manner how sickness may be avoided and how you may achieve the highest degree of health and strength by just a little physical attention every day. It prescribes a rational and effective treatment of every form of illness. When you are thoroughly acquainted with **Physical Culture** you will become a life subscriber because you won't think that you can get along without it. We will cheerfully return your money if you are not satisfied.

PHYSICAL CULTURE PUBLISHING COMPANY, Room 918 Flatiron Building, New York City

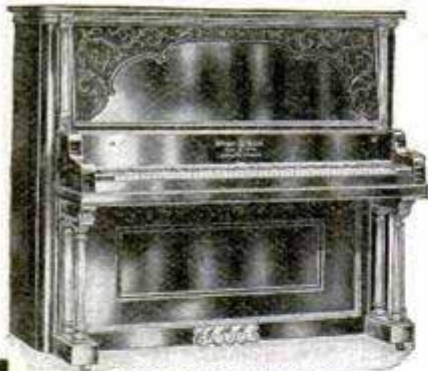

ONE OF OUR 40 DESIGNS

Valuable Piano Book FREE

this splendid book right away. Tells how you can judge a piano as well as any expert and gives a series of tests by which you can confirm your judgment. Besides this "Book of Complete Information about Pianos," we send you our splendid art catalogue, showing all the latest style Wing Pianos. Just your name and address on postal or letter brings you this valuable book and the art catalogue free. Now, don't wait—write now.

A GENUINE Shipped to You—Prepaid WING PIANO Absolutely FREE!

Yes, absolutely free. An astounding liberal offer direct to you and from one of the largest manufacturers of high-grade pianos in the world. We will ship you a genuine, tested and guaranteed Wing Piano without asking you for a cent. We will even pay all the freight in advance, so that you are not out a single penny on this ultra generous offer. **FOUR WEEKS' FREE TRIAL.** We will allow you to keep this superb Wing which we send you, for four full weeks, without paying anybody a cent. Use this grand instrument for four weeks, just as though it were your own, then, if for any reason, you are not more than satisfied with the Wing in every single respect, send it right back to us, and we pay all the freight charges.

But if you decide to keep the Wing after the four weeks' free trial, we will allow you the privilege of either cash or time payments and at the factory price. And besides we give you an absolute guarantee, backed by the factory which has been manufacturing pianos for 42 years and which has sent out almost 50,000 pianos. One of the oldest piano factories in America.

The biggest and most valuable piano book ever published sent absolutely free on your simple request. If you own a piano now, or if you ever expect to own a piano, you should send for how you can judge a piano as well as any expert and gives a series of tests by which you can confirm your judgment. Besides this "Book of Complete Information about Pianos," we send you our splendid art catalogue, showing all the latest style Wing Pianos. Just your name and address on postal or letter brings you this valuable book and the art catalogue free. Now, don't wait—write now. WING & SON (Est. 1868), Wing Bldg., 13th St. and 9th Ave., Dept. 1195, NEW YORK, N.Y.

This Interesting Book Free to You for the Asking

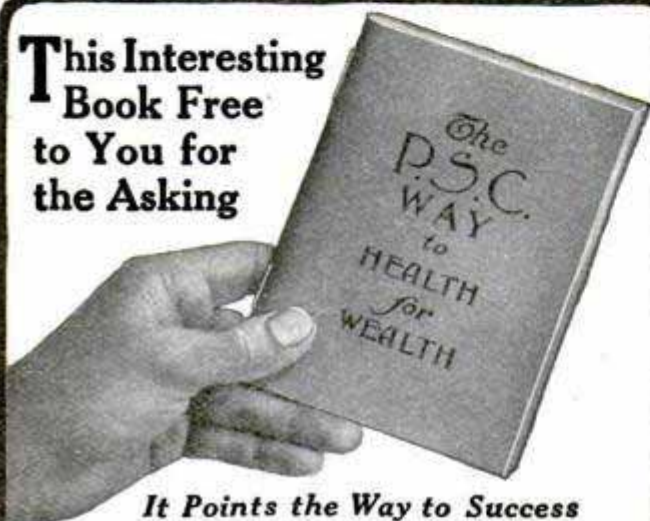

It Points the Way to Success

It will give you an outline of our Correspondence Course in Chiropractic, a modern science

**The Science of Human Service
A Life Work for the Profit of All**

Chiropractic is a profession of the highest class—income from \$2,000 to \$15,000 yearly. Learn to make the sick well, and improve the condition of your fellow men for gratitude, plus profit, without drugs.

Write today for free book and catalog—Write NOW

PALMER SCHOOL of CORRESPONDENCE
DEPARTMENT P. M.
DAVENPORT, IOWA



CAN YOU DRAW?

Our Graduates Are Filling High Salaried Positions

EARN \$25 TO \$100 PER WEEK

In easy, fascinating work. Practical, Individual Home Instruction. Expert Instructors. Superior equipment. Founded 1899. Twelve years' successful teaching. Financial Returns Guaranteed.

Complete Courses in Commercial, Fashion, Magazine, Book and Advt. Illustrating; Newspaper, Cartooning, Lettering, Designing, Show Card, Architectural Perspective, Photo Retouching, Normal, Color, General Drawing, etc.

FREE ARTIST'S OUTFIT of fine instruments and supplies to each student.

Write for particulars and Handsome Art Book. Our Own Fireproof Bldg.

SCHOOL OF APPLIED ART
E 175 FINE ARTS BLDG.
Battle Creek, Mich.



TEN DOLLARS DOWN

and 10 cents a day for a time buys the Wonderful Visible Emerson Typewriter. Two color ribbon, Tabulator, Back Spacer, every improvement. One of the best typewriters made \$60.00 is the price. **BIG OFFERS FOR AGENTS.**

One Emerson Typewriter Free on very easy conditions to anyone who will do us a slight service. Only a few minutes time required.

For Our Great Free Offer—on a postal card or in a letter to us say: "Mail me your Free Offer." Address

The Emerson Typewriter Co., Box 131, Woodstock, Ill.



TOP-28X42

STOCK & WORKING DETAILS FOR THIS TABLE 375
ALL THE DIFFERENCE BETWEEN THIS & ANY K.D. FURNITURE IS THE BORING OF DOWEL HOLES, SANDPAPERING THE WOOD SMOOTH. ALL THE STOCK IS OF THE BEST GRADE OF OAK, KILNDRIED & DRESSED SMOOTH. THE TOP IS IN ONE PIECE. THE END PIECES ARE BANDSAWED TO SHAPE. WE WILL FURNISH MATERIAL & WORKING DETAILS FOR ANY PIECE OF MISSION OR FLANDERS FURNITURE AT PROPORTIONATE PRICES
FURNITURE-STOCK-CO.
217-CHAMBER-COMMERCE-BLDG., CHICAGO.



STUDY ELECTRICITY In This Electrical Center

Complete college training in less time, at less expense. Two year course, covering every phase of generation, transmission and application. Complete equipment—laboratory, machines and apparatus. Graduate engineers for instructors. New classes July and September. Write for details.

BRYANT & STRATTON COLLEGE
No. 111, College Bldg., Buffalo, N. Y.



VENTRILOQUISM

LEARNED BY ANY MAN OR BOY AT HOME SMALL COST

Send today 2c stamp for particulars and proof.

O. A. SMITH, Room D 5, 823 Bigelow St., PEORIA, ILL.

SMITH'S AIRCRAFT (Featherweight) MOTORS

Complete with Propeller, Radiators and Magneto

- 4 cyl. 40 H. P., 160 lbs.
- 8-cyl. 80 H. P., 185 lbs.
- 16-cyl. 160 H. P., 300 lbs.
- 4-cyl. 60 H. P., 150 lbs.
- 8-cyl. 120 H. P., 250 lbs.
- 16-cyl. 240 H. P., 500 lbs.

If you want a motor light yet strong both in power and construction, you will find what you want in SMITH'S AIRCRAFT MOTORS, built for aeroplanes but strong enough for auto and marine purposes. Made in all sizes from 40 to 240 horsepower. All parts made by us from the castings to the finished product. Cylinders, pistons, rings, wrist pins and crank shafts ground to one-thousandth part of an inch. Vanadium used in all mixtures of iron, steel and bronze. To show you our good faith we send one of our expert motor men with each motor, to install and instruct you at our expense. We will furnish you free factory facilities where you can build your own

plane, right in the same factory where our motors are built. We do not manufacture ordinary engines, we manufacture motors—the difference between the two is refinement in the motor.

AIRCRAFT MOTOR COMPANY, 2336 Pope Ave., ST. LOUIS, MO.

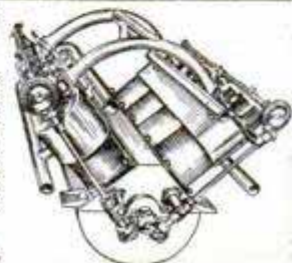

The Standard Automatic Brush

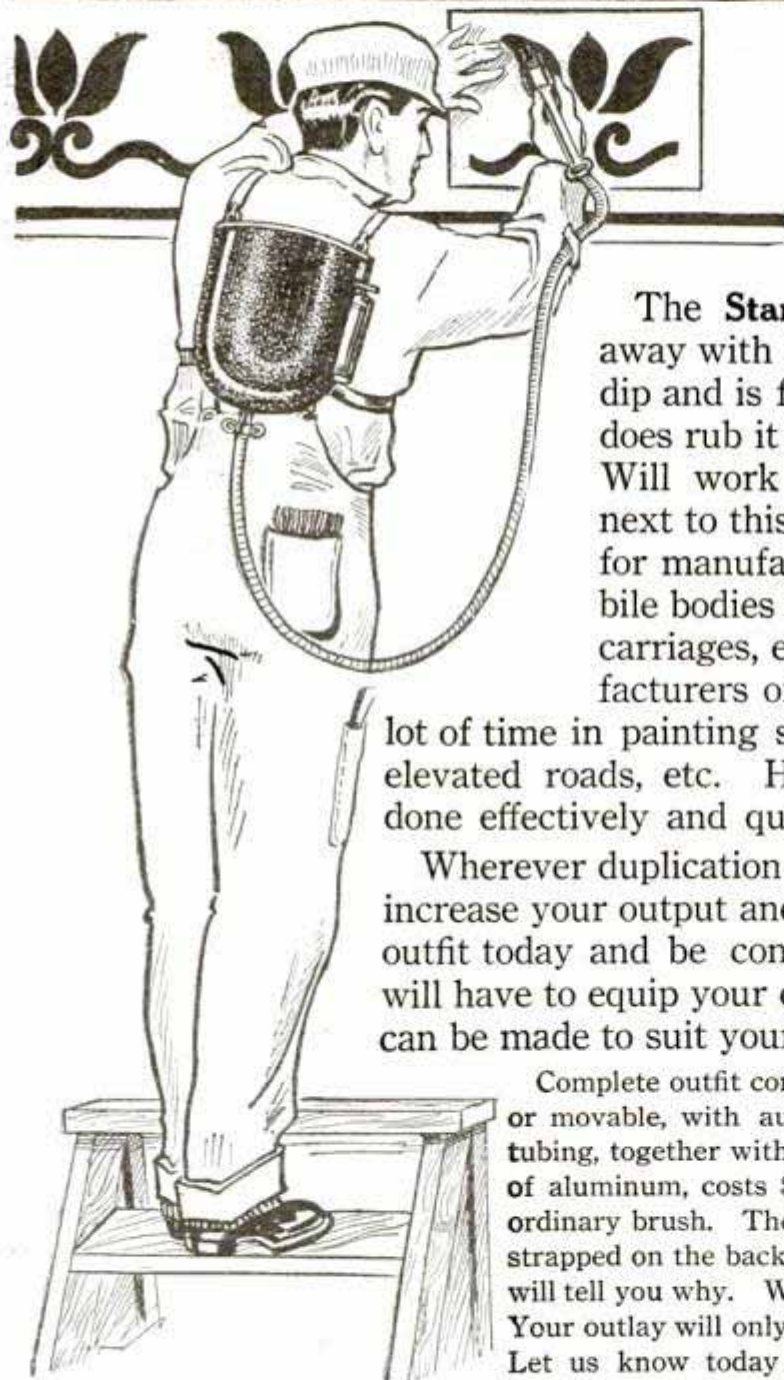

does your painting work in a new way, better, quicker, cheaper, eliminating all waste of paint. An equal flow at all times; thickness of coat can be accurately adjusted; absolutely clean and fireproof.

The **Standard Automatic System** does away with the paint can. It eliminates the dip and is far superior to the spray, but it does rub it in. No air pressure is needed. Will work with any kind of paint. Get next to this new method. Made especially for manufacturers of automobiles, automobile bodies and wheels, all kinds of vehicles, carriages, etc. It is most useful for manufacturers of furniture. It will also save a lot of time in painting structural work, such as bridges, elevated roads, etc. House and sign painting can be done effectively and quick.

Wherever duplication of work exists, this device will increase your output and reduce the cost. Buy just one outfit today and be convinced. We are sure that we will have to equip your entire plant. Special equipments can be made to suit your purpose.

Complete outfit consisting of a large paint tank, stationary or movable, with automatic valve and six feet of flexible tubing, together with the automatic adjustable brush made of aluminum, costs \$7.50 and it is still cheaper than the ordinary brush. The outfit is also made with a tank to be strapped on the back which will cost \$2.50 extra. Our booklet will tell you why. Write for one today. Send in your order. Your outlay will only be once. Apparatus will last a lifetime. Let us know today what you are manufacturing and we will effect a saving for you.

Jobbers and Dealers Wanted Everywhere. Satisfaction Guaranteed or Money Refunded

Standard Automatic Manufacturing Company
50 CHURCH STREET, NEW YORK

"The How and Why of the Automobile"

By **FAY L. FAUROTE**

200 Pages. Bound in full cloth. 250 illustrations. Price \$1.00 Prepaid.

DID you ever read a book which gave you just the information you wanted without being compelled to go through page after page of introduction and history?

Did you ever talk to a man who came over on your side of the fence and talked WITH you and not

AT you—who explained things in such a way that you laughed at yourself afterwards for not understanding the subject before—it was really so simple?

Do you remember when you used to study by outlines—how difficult problems unfolded themselves—how the logical sequence of facts seemed to make what you expected to find hard, readily understandable?

Do you remember the innumerable times you have said to yourself, "If I only had somebody here to explain things—someone who would go through this proposition with me until I understood it—someone who would use homely and familiar examples to explain things, instead of talking over my head by using technical terms?"

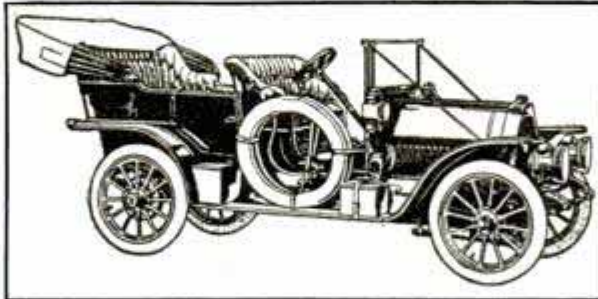

The author realized all these difficulties himself, because he has been through it all. Not only that, but his experience as an instructor of a large motor school taught him the way to explain the various parts of a motor vehicle in simple language, so that even the boy of

fifteen could understand and appreciate them.

For instance, did you ever think that the physician uses a form of carburetor whenever he gives chloroform or ether—do you realize that a shotgun is a form of gas engine whose action is almost identical with that of an automobile motor?

Do you want to know what a sliding gear transmission is—explained in such simple language that anyone can understand it?

Would you like to see what's inside of an automobile engine—would you like to know the name of every part—be able to talk intelligently about it and be your own mechanic—tell your chauffeur what to do—know when he is bluffing you?

In a word, would you like to know all about a motor car—how it works—how to drive it and how to take care of it? Then subscribe for a copy of

"The How and Why of the Automobile"

A book of practical information for seekers after the fundamental facts regarding the gasoline engine and its application to the motor car. Interesting and instructive to both the beginner and the expert—the former for information, the latter for reference. Written by Fay L. Faurote, B.S., (M.E.), for five years closely associated with the Experimental Department of a pioneer automobile factory, for two years instructor in the Detroit Motor School. The book, which is handsomely bound in full cloth, printed on high-grade enameled paper, contains over 200 pages and 250 illustrations and covers the following subjects:

CONTENTS:

GENERAL THEORY OF GAS ENGINES. Simple explanation of cycle—The four-stroke cycle—The two-stroke cycle—Advantages and disadvantages of each.

MOTOR DESIGN. Cylinder, what it is and its use. Valves, mechanical and automatic—Forms of valves—Valve timing and its influence on the motor—Valve grinding, how to do it—Valve nomenclature. Crank Case—The construction. Bearings—Accessibility—Working parts—Uses. A crank case oiling system. Crank Shafts—What they are—One, two, four and six-cylinder crank shafts—Crank case diagram, showing instantly conditions in all cylinders—Diagram showing firing points and sequence of same. Connecting Rods, construction and material—Bearings and lubrication. Pistons—Piston rings—Piston Pins.

THE TRANSMISSION. Reason for and use of transmission. Simple Explanation of Action—Individual clutch type—The sliding gear—The three speed progressive—The three speed selective—The four speed selective—Planetary gear—Friction drive.

METHODS OF DRIVING. Single chain drive—Double chain drive—Bevel gear drive.

THE CARBURETOR. A very simple explanation of carburation—The mixing valve—A few of the first types—Some of the modern carburetors—Foreign carburetors.

IGNITION. The make and break system—A simple explanation of the apparatus used. The Jump Spark System—Electrical units. Sources of Electricity—The dry cell—The storage cell—Dynamos and magnetos—The spark-coil—Commutators and timing devices—Spark plugs—Wiring diagrams.

COOLING SYSTEM. Air Cooling. Water Cooling—Direction of circulation—Radiators—Water pumps—Fans—Anti-freezing solutions.

RUNNING GEAR. Front Axle—Construction of—Steering Gear. Rear Axle—Differential gear—The live axle—The dead axle—Wheel construction—Bearings.

HORSE POWER DETERMINATIONS. Engine testing—Indicated horse power—Brake horse power—Mechanical and heat efficiency—Road testing.

Send in your order at once—don't delay. The price is \$1.00 postage prepaid, and the address is

POPULAR MECHANICS BOOK DEPARTMENT
225 Washington Street, CHICAGO

Dividends From 60% to 1300%

Have Been Paid by Automobile Manufacturers

THIS opportunity we are offering for the Private Investor to purchase Automobile Stock is rapidly being taken advantage of. Act at once.

In the April Popular Mechanics, out March 20th, we made the first announcement of the sale of stock in our company—The American Automobile Manufacturing Company.

On March 21st we began to receive inquiries. These inquiries increased in number each day until they ran into the hundreds every day.

The interest in our proposition has been and is tremendous. Our stock is being rapidly subscribed for—and in this announcement we wish to impress in the strongest possible way the advisability of immediate action on your part, should you wish to own stock in our company.

To recapitulate briefly:

There have been immense dividends paid by the manufacturers of automobiles, ranging from 60 to 1300 per cent. per annum.

The Automobile Industry is in its infancy, all the present existing companies doing only 5 per cent. of possible business at the present time.

We are offering our stock for sale.

We are an established manufacturing concern. We own all the rights, titles and interests in the Jonz Motor.

We own our own plant, comprising five acres of floor space, at New Albany, Indiana, as per the illustration herewith.

Our buildings are valued at \$200,000.

We manufacture the Jonz Car.

We are practical Automobile men.

We already have \$450,000 of these cars on order, which must be built.

Every stockholder becomes a partner in our business, with a voice and a vote in the direction of our affairs.

Our stock is all common stock, fully paid and non-assessable.

No responsibilities are assumed by any shareholder—no promotion stock has been issued.

Dividends should be large and immediate.

Now our capital stock is \$1,000,000, divided into two hundred thousand shares of the par value of \$5 each, fully paid and non-assessable.

If you have \$5, \$10, \$20 or \$100 or \$1,000 that you would invest where it would be absolutely safe and where it would provide a maximum income immediately—with opportunity for still greater profits—fill in and cut

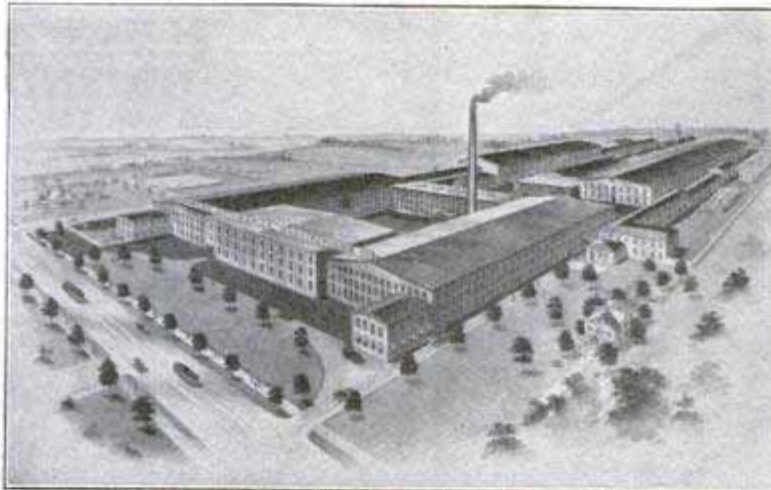

\$200,000 Plant of the American Automobile Co.
at New Albany, Indiana

out the attached coupon and mail it to us today. Be sure you send today. Our stock is being rapidly subscribed for. If you want to secure any you must act promptly.

We tell all about the proposition in our book, "From 60% to 1300% Dividends."

The American Automobile Manufacturing Co.

408-422 Lincoln Bank Bldg., Louisville, Ky.
From 60% to 1300% Dividend Coupon for Popular Mechanics Readers

American Automobile Manufacturing Co.,

408-422 Lincoln Bank Bldg., Louisville, Ky.

Gentlemen:—

Kindly send me your book—"From 60% to 1300% Dividends," relating to stock in the American Automobile Manufacturing Company.

Name

Address

Town State

GIBFORD ZIGZAG AUTOMATIC STROPPER

One Model Sharpens Any Standard Make of Safety Razor Blade

No matter what safety razor you use, you can have a keen, easy-shaving blade for every shave by using the ZigZag Automatic Stropper. You can easily make one blade give perfect service for at least six months.

Make this wonderful little machine a part of your shaving outfit at once. It saves its cost in a short time. It stops the torture of shaving with dull blades. It is easy to use, and makes shaving with a safety razor a pleasure as well as a convenience.



\$1.00
Complete
With Fine
Horsehide
Strop

"The
Curve Cut
Strop Gives the
Barber's Stroke"

Works easier, quicker, and gives better results than heavy, cumbersome machine costing three times as much. Weighs less than 4 oz. Folds compactly into small space. Just the thing for travellers. Sold by the leading druggists, hardware and other dealers everywhere in U. S. for \$1.00; in foreign countries, \$1.50, or sent prepaid from factory on receipt of price. Send for free booklet, "No More Dull Blades For Me."

GIBFORD SPECIALTY CO.

63 East Fort St.

Detroit, Mich.

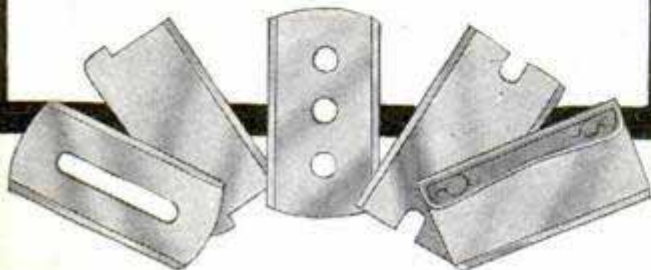

Please Mention Popular Mechanics

POTMEND

The Universal Mender



A Thousand Uses for it
during House Cleaning
HEAT AND MOISTURE PROOF

The Dealer's and Our Guarantee
Goes with POTMEND

We guarantee POTMEND to repair anything from a leaking coffee pot to a leaking roof—and to repair any broken article so it can be used again as if new! If POTMEND is not all we claim for it, we will upon return of package refund the purchase price.

The longer you use POTMEND, the more uses you will find for it

Potmend will stick solidly and permanently any material to any other material, will repair any article in the household.

Potmend will stop leaks in pipes, radiators, refrigerators, bath tubs and cooking utensils. The housewife will find Potmend invaluable for mending any broken articles. The Plumber wants it. The Jeweler wants it. The Manufacturer wants it. For the General Repair Man Potmend is without an equal.

Remember When all others fail Potmend will mend it. —Use Potmend to repair and make things. Order a can now. If your dealer cannot supply you we will. Just send us your name and price for the can.

Sold at 15c, 50c, and \$1.00 per can, Postpaid

POTMEND CO., Inc.

Desk 2, 305 W. 24th St., NEW YORK, N. Y.

Rife Automatic Hydraulic Ram Pumps water by water power. No attention: no expense; 2 feet fall elevates water 50 feet, etc. Guaranteed. Catalogue free. RIFE RAM COMPANY 2131 Trinity Building, NEW YORK CITY

MOTOR CAR CURE FOR WHOOPING COUGH.
—The favorable effects of a change of air in the later stages of whooping cough are well known, and Dr. Manuel Rodriguez Portillo, in Clinica y Laboratorio, states that these results can be even bettered by ordering such patients to indulge in motor drives. He imposes certain conditions, however, namely, that a clear, mild day be chosen for the excursion, a good level road selected, a speed of six and a half miles an hour never exceeded and that the child be placed on the front seat of the car, next to the chauffeur. He attributes the beneficial effects of this treatment to the increased depth of the pulmonary respiration thereby induced acting as a sort of sweeper-out of the respiratory passages as well as to the tonic and stimulating action of the fresh air breathed. The appetite and blood-forming powers of the system are also increased. —The Hospital.

Mechanics For Young America

A book which tells how to make scores of articles which delight the heart of the average boy. Price 25 Cents Postpaid

POPULAR MECHANICS BOOK DEPT.
225 Washington Street, CHICAGO

Two Excellent Books for Those Who
Like to Make Things

Amateur Mechanics Nos. 1 and 2

PRICE 25 CENTS EACH POSTPAID

Popular Mechanics Book Department 225 Washington St. CHICAGO

Fascinating Moving-Pictures in Your Own Home!



By means of the amazing **VICTOR MOTION-PICTURE STEREOPTROPE** this unparalleled entertainment and education is now within reach of every home.

World-famous photographs, astonishing scenes that you have read about—that you have heard described—now belong to the **humblest** and the **grandest** homes. These famous scenes can now be **reproduced, life-size, in your home!**

Thousands of different series of moving-pictures—for **every** age, for **boys, girls, men, women** and all school **children**—furnish remarkable fascinating entertainment.

We furnish a complete library of **moving** and **stationary** pictures, both of which the **Victor Motion-Picture Stereoptrope** reproduces with lifelike accuracy.

In addition to better stereopticon features, it has the additional feature of reproducing pictures in motion—a **combination** obtainable only in this machine.

Word descriptions—**free** with the pictures—can be read by one of the party while the captivating scenes are faithfully reproduced by the wonderful

Get This Machine For Free Examination

The **Victor Motion-Picture Stereoptrope** is nickel-plated on brass and practically indestructible—it will virtually last a lifetime.

It is an amazing revolution of both the moving-picture machine and the stereopticon—it is a remarkable combination of both.

To demonstrate its tremendous entertaining and educational value, order a machine today for **Free Examination**. We will ship it to you, **express prepaid**, cash on delivery, **after examination**, to any point in the United States. We'll send you 6 records **FREE**. Order today—take advantage of our **Special Introductory Offer**.

VICTOR Motion-Picture Stereoptrope

Children's Records consist of fairy tales, comic series, illustrated songs—all brilliantly but naturally colored. Anyone can read the word-descriptions.

Our Educational Stereopticon Records, each containing 15 perfect photographic views, present endless variety of subjects—travel, science in all its branches, art, history, literature, nature studies, industries. Lecture or descriptive reading free with each record.

An Educational Library of **STEREOPTROPE RECORDS** means enlarging your child's knowledge—and your own.

Special STEREOPTROPE RECORDS may be made up from your own camera pictures, family groups, home scenes, at exceedingly low cost.

Our great list of motion records already completed—new subjects **each month**—for every **generation**—all good, clean, hearty, red-blooded entertainment that interests for hours at a time, and interest never lags year in and year out.

The **Victor Motion-Picture Stereoptrope** is **GUARANTEED** absolutely **SAFE!** It is the simplest device of its kind in existence. You fit the films on an axis and simply turn a

crank. Nothing to tip over—any child can operate this machine all day long without any danger whatever. The only motion pictures that **will not burn** and they are not fragile.

Cannot get out of order—electric light or acetylene light can be used. So simple is the machine that a ten-year-old child can easily **get it ready to run—and run it**. No knowledge whatever of mechanics is needed.

The **Victor** has revolutionized moving-picture machines! Its amazing simplicity, the wonderfully clear, beautiful photos and pictures it throws on the screen, its unparalleled simplicity of operation—**simply turning a crank**—makes it the most remarkable invention of its kind in twenty years!

—And its utter simplicity makes its cost **insignificant!** Every intelligent household should have a **Victor**—it is a magnificent **entertainer and educator**.

The **VICTOR MOTION-PICTURE STEREOPTROPE** and six Full Records sent anywhere, express prepaid, for \$10.00. Guaranteed as represented or money refunded at once.

Extra Records at 25c each.

This is the first announcement ever made—so in this **only** we will make you a trial offer of

FREE Examination! We'll Ship You a Machine C. O. D.—Express Prepaid

So please write us at once for catalog of our **motion and stereopticon** picture series. Please write **today**, before we have to withdraw this **introductory offer**.

The **Victor Animato-Graph Company**
10 E. Third Street, Davenport, Iowa

Dealers and Jobbers!

Dealers and Jobbers, write us at once for trade quotations on this fast-selling entertainer—the greatest selling success of a decade. Eastern distributors write to George Borgfeldt & Co., New York City. (1)

Special Offer Coupon

VICTOR ANIMATO-GRAPH CO.,

10 E. Third Street, Davenport, Iowa

Send me by return mail your **Catalog**, and also full particulars of your **Free Examination Offer**.

Name.....

Address.....



CHIEF DRAFTSMAN

Will INSTRUCT PERSONALLY a limited number selected, ambitious men in

Practical Drafting, Detailing, Designing

Draftsmen Drawing \$125-\$150 Monthly

Are NOT MADE in Schoolrooms,
 Are NOT MADE by reading books,
 Are NOT MADE by making Copies,
 Are NOT MADE at home drawing pictures
 from printed book lesson.

LET ME TELL YOU:

It requires actual, practical, up-to-date
 DRAFTING-ROOM WORK to train YOU
 to gain the PRACTICAL EXPERIENCE
 that your employer will demand of you.



FREE

This \$13.85
**DRAWING
 OUTFIT**

and **Free Position.**

As Chief Draftsman of Engineering firm I know exactly the Quality and Quantity of PRACTICAL training, knowledge and actual up-to-date experience (not school knowledge) you must have, in order to obtain a good position and advance to highest salary.

I give **INSTRUCTION UNTIL COMPETENT** and
PLACED in POSITION at above Salary.

DON'T waste TIME and MONEY trying to learn from books or printed "STUFF" you can only learn on PRACTICAL WORK which I furnish you.

Address **CHIEF DRAFTSMAN**
Div. 19, Eng's Equip't Co. (Inc.), Chicago

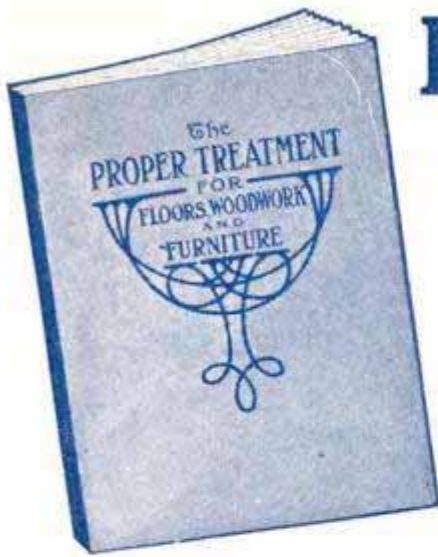

Instruction Book and Wood Finishing Samples **FREE**

HERE'S the best book ever published on artistic wood finishing, the work of famous experts, illustrated in five colors. For a limited time, we will mail it **FREE**, postage paid, together with samples of

Yes! You—yourself—can beautifully finish all furniture, woodwork or floors in the latest and most artistic shades—in little time—at small expense—with

Johnson's Wood Finishes

Johnson's Wood Dye and Prepared Wax

If you are interested in craftsmanship—if you want the correct finish on a new piece of furniture—if you are *building or remodeling*—if you want to brighten up or change the color of any piece of furniture or of woodwork or floors—either hard or soft wood—if interested in basketry—get this expert Instruction Book and **FREE SAMPLES AT YOUR LEADING PAINT DEALERS.**

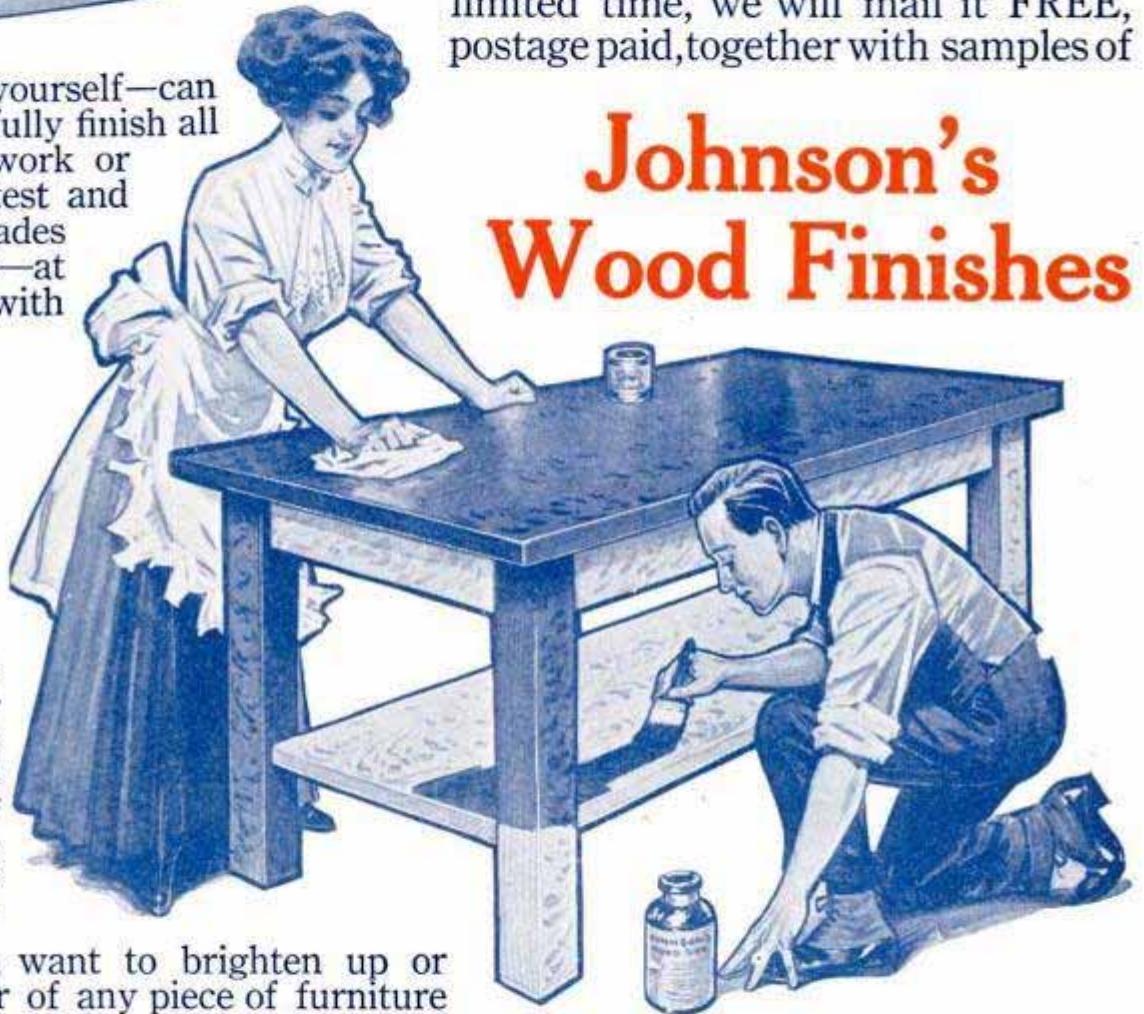

Johnson's Wood Dye is made in many beautiful greens, browns, reds, etc. It is not a mere stain but a penetrating dye which colors the wood so deeply that if it becomes scratched or marred the natural color is not disclosed. It brings out the beauty of the grain without raising it, giving a soft, rich, permanent color. A coat of Johnson's Prepared Wax over the dye gives that beautiful, dull, artistic finish so much admired today. If you prefer a higher gloss than the wax gives apply a coat of **UNDER-LAC** over the dye and then one coat of Prepared Wax.

Under-Lac is a thin, elastic spirit finish very much superior to shellac or varnish. It dries hard in less than an hour. Under-Lac is just what you want for your linoleum and oilcloth; it brings out the pattern making it bright and glossy like new, protects it from wear and makes cleaning easy. It dries so the floors may be walked on in an hour.

Go to your leading paint dealer for Free Instruction Book, Edition No. P. A.-5, and Free Samples of Johnson's Wood Finishes, which we supply to him for his customers' use. If your dealer hasn't samples of our Wood Dye, Under-Lac and Prepared Wax, and the Books, we'll send them to you postpaid for the name of your dealer in paint. In writing mention shade of Dye wanted.

S. C. Johnson & Son, "The Wood Finishing Authorities" **Racine, Wis.**

If
Venus
Had
Arms



NONE GENUINE WITHOUT THIS SIGNATURE

W. K. Kellogg